

PRODUCT CATALOG

30TH
ANNIVERSARY

 **RACEPAK**[®]
AN **MSD** BRAND

DRAG RACING / PRO DRAG RACING / OFF ROAD / CLOSED COURSE / PULLING / STREET / LAND SPEED



CONTENTS

04

HISTORY

08

APPLICATION CHART

10

NEW PRODUCTS

12

DRAG RACING

42

PRO DRAG RACING

58

OFF ROAD /
CLOSED COURSE

82

PULLING

84

STREET

90

LAND SPEED

110

ACCESSORIES /
SOFTWARE

127

RACEPAK APPAREL

130

GLOSSARY

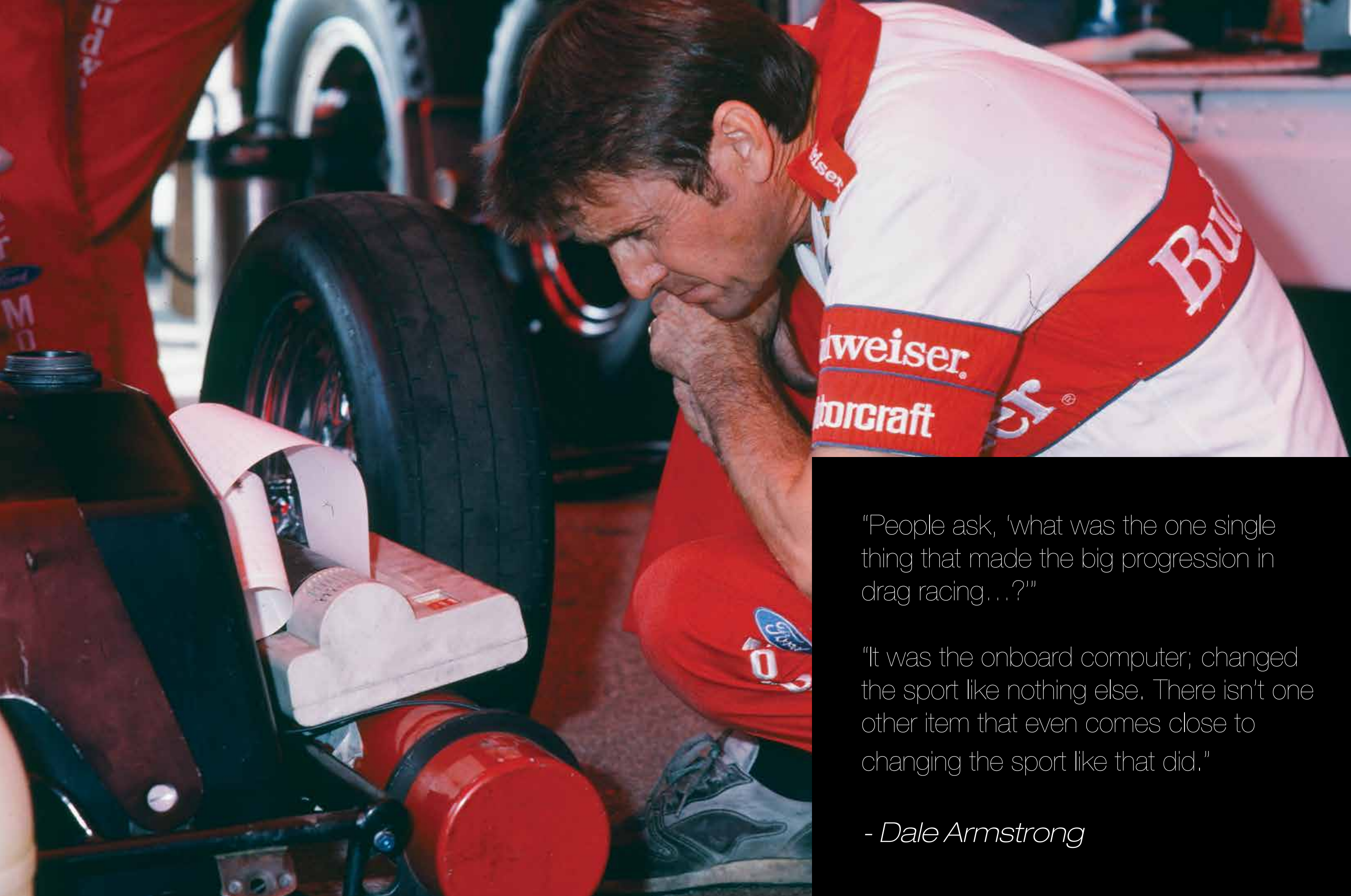

“People ask, ‘what was the one single thing that made the big progression in drag racing...?’”

“It was the onboard computer; changed the sport like nothing else. There isn’t one other item that even comes close to changing the sport like that did.”

- Dale Armstrong

1978

The early years. Before the idea of a personal computer existed. Utilizing an industrial style strip chart recorder, the engine RPM input from a circle track vehicle was recorded and printed onto a paper roll, proving the ability to graphically plot and review data. While a far cry from today's modern PC based data analysis, the ability to print and overlay RPM graph traces from multiple laps signaled the beginning of Racepak.

1982

2K. The first purpose designed Racepak data recorder created specifically for motorsports. With only two RPM inputs and two analog inputs (pressures), the 2K found its way onto and quickly back off a NASCAR vehicle, with officials deeming it not legal for use in their series. Racepak was on to something.

1984

Moving from the excursion into circle track data acquisition, the first drag racing data recorder was installed on Kenny Bernstein's Budweiser sponsored Tempo bodied nitro funny car. This action eventually led to the development of the nitro lock up clutch, larger fuel pumps, higher output magnetos and number of additional speed and ET improving technologies. In addition, this initial relationship led to a 1985 distribution partnership with Kenny Bernstein's King Racing.

1988

The introduction of a portable memory cartridge eliminated the necessity of connecting the users PC to the data recorder, in order to download data. While appearing large compared to modern day SD and MicroSD memory cards, the design behind the portable memory cartridge predated current removable SD memory card technology by ten years.

1992

The release of the Pro series of drag race data recorders signaled the beginning of smaller, more robust designed data loggers, incorporating the latest PC board and sensor input designs.

1995

Expanding outside of drag racing, Racepak became the dominate supplier of data loggers and digital dash products to the snow mobile industry, even becoming OEM equipment on certain snowmobiles.

1998

CANBUS. While seemingly everywhere in modern day vehicles, industrial and other commercial applications, the use of CANBUS in 1998 was unheard in the motorsports industry. Building on the available technology at that time, Racepak develop the very first CANBUS driven, smart sensor based, single cable motorsports data acquisition system. This single technology put Racepak on the worldwide motorsports map, by reducing the wiring, complexity, installation and programming issues plaguing all data systems. This in turn led to the development of an entire Racepak data logger, sensor, instrumentation and power control product line.

2000-05

While GPS was available to government agencies since 1995, the elimination of the Selective Availability aspect of GPS (intentional distortion of signals) in 2000 opened the door for Racepak to develop and release the first motorsports data system specifically designed for us with GPS. This technology enable Racepak to return to the closed course market with a data system providing lap times, lap numbers, speed, track mapping and G forces from nothing more than GPS data, eliminating the need for external speed sensors, trackside beacons and vehicle mounted receivers.

2010

The release of the SmartWire heralded the move of Racepak from a traditional data logger and instrumentation company to a power control company. The SmartWire eliminated the need for fuses and relays, while providing the ability to program, monitor and record all aspects of electronic inputs and outputs used to control vehicle devices.

FUTURE

Racepak will continue to develop motorsports and aftermarket electronic products that exceed customer's expectations, while utilizing the latest in hardware, software, tablet and smartphone technology.

APPLICATION CHART

Application Chart

	SMARTWIRE	SPORTSMAN	LDX	V500SD	V300SD	G2X	G2XPRO	IQ3LD	PROII	PROIIA
Top Fuel, Funny Car, A/Fuel									•	
Nostalgia Top Fuel / Funny Car									•	•
Alcohol Dragster / Funny Car									•	•
Pro Mod, Blown / Nitrous	•			•	•				•	•
Pro Stock Car				•	•				•	
Competition Eliminator	•		•	•	•					
Super Stock, Stock, Brackets	•	•	•	•	•					
8.90, 9.90, 10.90 Index	•	•	•	•	•					
Motorcycle, Blown Fuel			•	•	•					
Motorcycle, Nitrous	•	•	•		•					
Motorcycle, Pro Stock			•		•					
Outlaw Door Car	•	•	•	•	•					
Drag Boat, Blown Fuel									•	
Drag Boat, Blown Gas or Alc.				•	•				•	•
Drag Boat, Unblown Gas or Alc.		•	•		•					
Boat, Unlimited	•		•		•	•	•	•		
Boat, Circle	•		•		•	•	•	•		
Boat, Offshore	•		•		•	•	•	•		
2WD Puller	•					•	•	•		
4WD Puller	•					•	•	•		
Super Stock Puller	•					•	•	•		
Unlimited Modified Puller	•					•	•	•		
Road Racing	•					•	•	•		
Club/Track Days	•					•	•	•		
Oval Track, NASCAR style	•					•	•	•		
Oval Track, Short Track style	•					•	•	•		
Land Speed Racing	•		•	•	•	•	•	•		
Short Course Off Road	•					•	•	•		
Desert Off Road	•					•	•	•		
Dynomometer	•		•	•	•					
Flow Bench, Clutch Dyno	•		•	•						

A. STANDALONE GPS V-VET MODULE

Add GPS speed to any non-gps equipped Racepak V-Net data recorder through the use of Racepak's GPS V-Net module. Utilizing a standard V-Net tee connector, the module is installed and "read" into the DatalinkII software, providing a speed data channel for analytical, display and odometer information. Samples at 10hz

Standalone GPS V-Vet Module **220-VM-GPS**



A. STANDALONE GPS V-VET MODULE

B. TURBO WASTEGATE POSITION V-NET MODULE

Accurately monitor and record the true position of your turbo wastegate valve through the use of this V-Net module. Calibrated in inches of travel, the V-Net module pigtail includes the appropriate mating connector, making installation a snap. Compatible with both Turbosmart and Precision Turbo.

Contact manufacturer for compatible size offering.

Turbo Wastegate Module and Sensor **220-VP-WGATEPOS**

Turbo Wastegate Module **230-VM-TURBOWST**

Turbo Wastegate Sensor **810-SN-TURBOWST**



B. TURBO WASTEGATE MODULE

C. VIRTUAL DASH APP

Stream and view live information from any Racepak Bluetooth enabled data recorder (optional upgrade) on both IOS and Android tablet and smartphones through this use of this app and Racepak Bluetooth module.

Available in both IQ3 or Pro Dash virtualization, each app provides four fully programmable pages and warnings, with intuitive swipe and touch commands.

Use of either app requires Racepak's V-Net Bluetooth module and purchase of app available through the Apple Apps or Google Play.

Virtual Dash App Available at:



C. VIRTUAL DASH APP

D. SMART POWER BACKUP

Designed for use with the Racepak series of V300, V500 or G2X Pro data recorders, the Smart Power Backup is designed to mount underneath it's respective data recorder, without modifications, while insuring an uninterrupted power source in the event of accidental power loss to the recorder.

More than just a reserve power supply, the Power Backup contains a microprocessor capable of determining when the vehicle is running, then supplying up to 20 seconds of reserve voltage, when loss of external voltage is detected.

V300SD Smart Power Backup **800-BT-V300**

V500SD Smart Power Backup **800-BT-V500**



D. V300SD SMART POWER BACKUP



D. V500SD SMART POWER BACKUP

DRAG RACING

DRAG RACING VEHICLE WIRING

DRAG RACING



A. SMARTWIRE POWER CONTROL MODULE



B. SMARTWIRE SWITCH PANEL



B. SMARTWIRE SWITCH MODULE

A. SMARTWIRE POWER CONTROL MODULE

Based on Racepak's exclusive single cable V-Net technology, the Racepak SmartWire module is the electronic "starting point", with a direct main power connection from the vehicle battery to the module. Each input/output is then user defined, both in function, power requirements and current exceeding limits via a USB connection to the user's PC. The design of the module functions to both reduce overall installation weight / clutter, while providing a quicker reacting electronic system, through the solid state switching design.

Manual activation can be achieved through use of either an optional eight switch Racepak Switch Panel or 16-channel Switch Module. From the Racepak SmartWire unit, a single small cable is routed to the Switch Panel, reducing wiring clutter. Users needing additional switch panel capabilities can easily expand through the use of a "jumper" cable to a second Racepak Switch Panel or Switch Module.

FEATURES

CAPACITY:
125 Total Amps

CHANNELS:
30 Total Channel Outputs
8 Channels @ 20 Amp Maximum
22 Channels @ 10 Amp Maximum

12 Hardwired Switch Inputs

DATA OUTPUT:
Volts
Amps
State

RESPONSE:
3.0 Millisecond

PROGRAMMING:
USB Interface

DIMENSIONS:
6" (L) x 5.5" (W) x 1.5" (H)
(25.2 cm x 13.9 cm x 3.8 cm)

INCLUDES:
Racepak SmartWire Module
Connector Kit
USB Cable
Programming Software

SmartWire Module Kit 500-KT-SW30

B. SMARTWIRE ACCESSORIES

SmartWire Switch Panel 500-SW-PNL8

SmartWire Switch Module 500-SW-5MI6

Switch Panel Mount Bracket 500-MB-SP-xxxx
(Available sizes are: 1.50", 1.625" and 1.75")

SmartWire to Switch Panel Cable 500-CA-BN5P-xxx
(Variety of sizes offered)

SmartWire to V-Net Cable 500-CA-BN5P-xxx
(Available sizes are: 9", 18" and 36")

SmartWire Tee Cable 580-CA-BN-TEE
(Available sizes are: 7")

DRAG RACING
DATA RECORDERS

A. V300SD DATA RECORDER

The affordable V300SD data recorder is the most common recorder for Pro Stock, Pro Modified and many of the Sportsman classes. In its base configuration, the V300SD monitors six parameters (Engine RPM, Driveshaft RPM, Accel G, Lateral G, Battery Volts and a 12-volt event), but it can be expanded to monitor up to 67 channels of data to meet the needs of most users. The V300SD can sample data as quickly as 1000 times per second.

Uploading recorded data to your computer is done via a SD memory card, which provides you with hours of recording time and the ability to store many runs prior to uploading the data. The V300SD also has multiple methods of displaying monitored data in real time. When linked by serial cable to your PC you can view all recorded functions in either graph format or on 8 virtual gauges while the vehicle is running. Any monitored function can also be displayed in real time on Racepak's optional Intelli-Gauges or either the IQ3 or Ultra Dash (UDX).

FEATURES

CHANNELS:

67 Total
V-Net: 56
Analog: 4 Hard-Wired
Digital: 4 Hard-Wired
Internal: 3

SAMPLE RATE:

V-Net: Up to 100 per Second
Analog: Up to 1000 per Second
Digital: RPM and Switch Contacts Up to 100 per Second

MEMORY:

SD Memory Card

INTERNAL SENSORS:

Battery Voltage
Longitudinal G-Meter (Acceleration and Deceleration)
Lateral G-Meter (Side-to-Side Motion)

DIMENSIONS:

4.374" (L) x 3.935" (W) x 1.230" (H)
(11.11cm x 9.994cm x 3.12cm)

WEIGHT:

10 Ounces (28kg)

V300SD Data Recorder **500-KT-SW30**

B. V300SD MOUNTING BRACKET

1.250" O.D. Tubing	800-MB-V300-125
1.500" O.D. Tubing	800-MB-V300-150
1.625" O.D. Tubing	800-MB-V300-162
1.750" O.D. Tubing	800-MB-V300-175



A. V300SD DATA RECORDER

V300SD PACKAGE INCLUDES

V300SD Data Recorder
SD Memory Card
Driveshaft or Rear Wheel RPM Sensor with Split Collar and Magnet Kit
Datalink Software Kit with Serial Programming Cable
V-Net Tee Connector with Terminator Caps
Power / Ground / Engine RPM / Driveshaft Harness (Clutch RPM
Optional Upgrade)

TYPICAL USES

Pro Mod
Pro Stock
Top Dragster
Top Sportsman
Comp Eliminator
Super Comp
Motorcycles
Land Speed Cars
Drag Boats

V300SD PACKAGE MONITORS

Engine RPM
Driveline RPM
Engine v. Driveline RPM Differential
Battery Voltage
Acceleration G-Force
Lateral G-Force



B. V300SD MOUNTING BRACKET

DRAG RACING
DATA RECORDERS

C. V500SD DATA RECORDER

If you need to monitor many channels of information while using fast sampling rates for extended recording periods, the V500SD is for you. The V500SD handles more channels of information than the V300SD data recorder, supporting up to 75 total channels of information. With that comes high sampling speed rates (up to 1000/sec.). Information can be displayed in real time on a PC monitor, uploaded to the PC for analysis using the Racepak Datalink Data Analysis software, or displayed on the optional Intelli-Gauges or either the IQ3 or Ultra Dash (UDX). The V500SD can be equipped to monitor overall timing, or individual cylinder timing on those vehicles using the proper programmable ignition system.

FEATURES

CHANNELS:

75 Total
V-Net: 56
Analog: 8 Hard-Wired
Digital: 8 Hard-Wired
Internal: 3

SAMPLE RATE:

V-Net: Up to 100 per Second
Analog: Up to 1000 per Second
Digital: RPM and Switch Contacts Up to 100 per Second

MEMORY:

SD CARD

INTERNAL SENSORS:

Battery Voltage
Longitudinal G-Meter (Acceleration and Deceleration)
Lateral G-Meter (Side-to-Side Motion)

DIMENSIONS:

5.350" (L) x 5.550" (W) x 1.215" (H)
(13.598cm x 14.09cm x 3.08cm)

WEIGHT:

17 Ounces (48kg)

V500SD with Data Cartridge Download **200-KT-V500-4MDC**
(Includes Datalink Standard)



C. V500SD DATA RECORDER

V500SD PACKAGE INCLUDES

V500SD Data Recorder
SD Memory Card
Driveshaft or Rear Wheel RPM Sensor with Split Collar and Magnet Kit
Datalink Software Kit with Serial Programming Cable
V-Net Tee Connector with Terminator Caps
Power / Ground / Engine RPM / Driveshaft Harness (Clutch RPM
Optional Upgrade)

TYPICAL USES

Pro Mod
Pro Stock
Drag Boates
Dynometers
Industrial Equipment

V500SD PACKAGE MONITORS

Engine RPM
Driveline RPM
Engine v. Driveline RPM Differential
Battery Voltage
Acceleration G-Force
Lateral G-Force



E. V500SD MOUNTING BRACKET

D. BLUETOOTH UPGRADE

This feature allows you to communicate wirelessly with your V500SD data logger. Eliminate your programming cable and program your data logger or view real-time data using the wireless telemetry function available with this upgrade.

Bluetooth Upgrade **200-UG-BTV500S**

E. V500SD MOUNTING BRACKET

1.250" O.D. Tubing	800-MB-V500-125
1.500" O.D. Tubing	800-MB-V500-150
1.625" O.D. Tubing	800-MB-V500-162
1.750" O.D. Tubing	800-MB-V500-175

DRAG RACING DATA RECORDERS

A. SPORTSMAN DATA RECORDER

Containing the same hardware and software utilized by our professional series data recorders, the Sportsman Drag Race Data Logger package offers an economical solution for the sportsman drag racer. Utilizing Racepak's exclusive V-Net sensor input compatibility with our full V-Net product line, while the 21 total sensor inputs (internal and external) provide the ideal balance of cost and features, allowing the sportsman racer to monitor information such as EGT, oil pressure, water temperature, transmission pressure, 12 volt event, air fuel etc. The use of a SD memory card ensures hours of recording time and the ability to store multiple run files, before downloading. Installation is simplified by the use of factory terminated wiring harness and pre-programmed software.

FEATURES

CHANNELS:

21 Total
8 EGT
6 V-Net (Add up to 12 additional channels. See details below.)

SAMPLE RATE:

V-Net: Up to 100 per Second

MEMORY:

SD Memory Card
Up to 8MB SD Card

INTERNAL SENSORS:

Engine RPM
Driveshaft RPM
Battery Voltage
Start Record Button
2 Axis G Meter
12 Volt Event

DIMENSIONS:

6" (L) x 4.5" (W) x 1" (H)
(15.2cm x 11.43cm x 2.54cm)

WEIGHT:

.65 lbs

Sportsman	610-KT-SPRTMN
Includes Datalink Lite Software	

B. CHANNEL UPGRADES

Upgrades are available in sets of 2 channels or 4 channels, and can be mixed and matched up to 12 total new channels increasing the total V-Net inputs from 6 to 18, while retaining the 8 pre-programmed EGT channels. (Contact us for upgrade pricing)

2 Channel Upgrade	610-UG-SPRT2
4 Channel Upgrade	610-UG-SPRT4

C. SPORTSMAN MOUNTING BRACKET

1.250" O.D. Tubing	610-MB-125
1.500" O.D. Tubing	610-MB-150
1.625" O.D. Tubing	610-MB-1625
1.750" O.D. Tubing	610-MB-175



A. SPORTSMAN DATA RECORDER

SPORTSMAN PACKAGE INCLUDES

Sportsman Data Logger
User Terminated Harness
Driveshaft Collar, Sensor & Mounting Bracket
Start Record Button
SD to USB Card Reader
USB to Serial Port Adapter
Serial Programming Cable
Datalink Lite Software
Installation / User Manual

TYPICAL USES

Non-Blown Sportsman
Super Comp
Super Gas

SPORTSMAN PACKAGE MONITORS

Engine RPM
Driveline RPM
Battery Voltage
Accel G
Lateral G
12 Volt Event

D. 500HZ VNET SHOCK TRAVEL MODULE

The 500hz V-Net Shock Travel Module for Sportsman Data Logger has the ability to monitor, record and review high resolution shock data and provides:

- Plug and Play connection via Sportsman V-Net port
- Inputs for up to four individual shock sensors
- Sample rate up to 500 times per second, for each channel
- Optional shock velocity channels

When used in conjunction with Racepak's optional shock travel kits, critical shock and chassis adjustments can now be made with confidence through the use of shock travel data.

500hz V-Net Shock Travel Module	230-VM-4ANA7HS
--	-----------------------



C. SPORTSMAN MOUNTING BRACKET



C. LDX LOGGER DASH EXTREME

LDX LOGGER DASH PACKAGE INCLUDES

LDX Logger Dash
Wiring Harness
Driveshaft RPM Sensor Kit
Datalink Download Software Kit with 6 Foot Cable
V-Net Tee Connector with Terminator Caps
Water Temperature Sensor
Oil Pressure Sensor
Instructional Manual

TYPICAL USES

Drag Racing

LDX PACKAGE MONITORS

Engine RPM
Driveshaft RPM
Water Temperature
Battery Voltage

DRAG RACING DATA RECORDERS

C. LDX LOGGER DASH EXTREME

The LDX Logger Dash combines a digital display dash with an internal data recorder, creating a compact, lightweight, all-in-one data acquisition system. The LDX Logger Dash utilizes the benefits of Racepak's single cable V-Net technology by sharing the data from all sensors with the data logger. In addition to the wiring harness, which imports the signals from the engine RPM, driveshaft RPM, water temperature, oil pressure and battery voltage, up to 32 optional sensors may be attached via the single V-Net cable. This yields a total recording capacity of 37 sensor inputs.

The LDX Logger Dash can record and upload data to a PC via a supplied serial cable, while at the same time displaying the input from up to 21 of those sensors on the display screen. With a simple push of a button, users can view the displayed sensor data by scrolling through four screens of information. Each page contains five user programmable sensor inputs, plus the engine RPM bar graph.

Selecting what sensor data will be viewed is accomplished through the DatalinkII software. Also included are output ports to allow connection to an external shift light and warning light. Shift points can be programmed using the left and right buttons located at the bottom of the dash, while reviewing settings on the display. These same buttons are also utilized to program warning limits and review minimum and maximum values for displayed data.

FEATURES

CHANNELS:

37 Total
V-Net: 32 Digital / Analog
Harness: 5 (Engine RPM, Driveshaft RPM, Water Temperature, Oil Pressure, Volts)

SAMPLE RATE:

V-Net: Up to 100 per Second
Digital: RPM and Switch Contacts Up to 100 per Second

MEMORY:

1MB
Recording Time Depends on Number of Channels Monitored and Sample Rates

DIMENSIONS:

10.200" (L) x 4.000" (W) x .750" (H)
(25.908cm x 10.16cm x 1.905cm)
Mounting Surface to Face, 2.000" OAL Depth

SCREEN DIMENSIONS:

7.250" x 2.625"
(18.415cm x 6.6675cm)

WEIGHT:

25 Ounces (71kg)

LDX LOGGER DASH	250-KT-LDX
------------------------	-------------------

01

Tip #1 Did you know you can upgrade the Sportsman data logger to a total of 18 V-Net channels? Both two and four channel upgrades are available. Contact a Racepak technician for complete details.

DRAG RACING INSTRUMENTATION

A. UDX DISPLAY DASH

Capable of being utilized with any of Racepak's V-Net series of data recorders. UDX Utilizes the same V-Net cable the external sensors use. The UDX display is capable of "sharing" sensor data with the data logger, thus providing the ability to display or trigger warnings based on any internal or external sensor in use by the data logger.

FEATURES

SPECIFICATIONS:

Display up to 21 Sensor Inputs via 4 pages.
Adjustable Backlighting
User Defined Warning Lights
Minimum/Maximum Recall

INCLUDES:

UDX Display Dash
V-Net Tee Cable

DISPLAY DASH PROVIDES:

Any 21 Sensor Inputs Shift Light Output Warning Lights

DIMENSIONS:

4" (H) x 10.2" (W) x .75"(deep) * Requires 2" rear clearance
(10.16cm x 25.90cm x 1.90cm)

WEIGHT:

21 ozs. (.58 kg)

UDX DISPLAY

250-DS-UDX



A. UDX DISPLAY DASH

B. IQ3 DASH DISPLAY

The IQ3 can be utilized with any of Racepak's V-Net data loggers, providing a compact LCD digital dash. The IQ3 can be utilized as a standalone display dash, independent of a Racepak V-Net data logger, through the use of optional sensors off of the V-Net port, located on the rear of the dash.

FEATURES

SPECIFICATIONS:

Display up to 28 inputs via 4 pages
Blue backlight
Gear Indicator
Eight user defined alarms
User defined 5 character sensor input names
User defined shift light output
Shielded, low luster display for sunlight viewing
Metric and English capable

DIMENSIONS:

7.25" (L) x 4.000" (W) x 1.125" (deep)
(18.41cm x 10.16cm x 5.39cm)

WEIGHT:

1lb. (453g)

IQ3 DASH DISPLAY

250-DS-IQ3



B. IQ3 DASH DISPLAY

C. IQ3 ACCESSORIES

External Programming Buttons 280-SW-IQ3BTN

Faux Carbon Mounting Panel 800-MB-IQ3-PCF

Black Mounting Panel 800-MB-IQ3-PBLK

Silver Mounting Panel 800-MB-IQ3-PAL



C. EXTERNAL PROGRAMMING
BUTTON

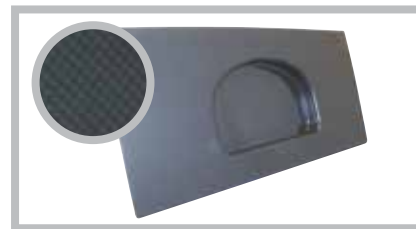

C. MOUNTING PANEL



D. UDX REPLAY DASH



E. UDX MOUNTING PANEL



F. INTELLI-GAUGES

DRAG RACING INSTRUMENTATION

D. UDX REPLAY DASH

Given the popularity of replay and recall gauges, the UDX Replay Dash goes one step further by providing the ability to replay up to 10 minutes of data, while also functioning as full feature LCD display dash.

FEATURES

SPECIFICATIONS:

Display up to 21 sensor inputs via 4 pages.
Adjustable backlighting
User defined warning lights
Minimum/Maximum recall

INCLUDES:

UDX Replay Dash
Water temperature sensor
Oil pressure sensor
Wire loom and connectors for sensor input termination

DISPLAY DASH PROVIDES VIEW OF:

Any 21 sensor inputs connected to the dash
Shift Light Output
Warning Lights

DIMENSIONS:

4" (H) x 10.2" (W) x .75"(deep) * Requires 2" rear clearance
(10.16cm x 25.908cm x 1.905cm)

WEIGHT:

21 ozs. (.58 kg)

UDX Replay Dash

250-DS-UDXRP

E. UDX ACCESSORIES

Faux Carbon Mounting Panel 800-MB-IQ3-PCF

Black Mounting Panel 800-MB-IQ3-PBLK

Silver Mounting Panel 800-MB-IQ3-PAL

F. INTELLI-GAUGES

These are not your average analog or digital gauge. They are both. In addition, they are highly accurate, stylish, dependable, and provide real time display for your monitored functions.

FEATURES

SPECIFICATIONS:

User Programmable warning levels
Download recorded data to PC Plug-and-play installation
Analog and digital display Lightweight, sonic welded
Electro-luminescent radial lighting

DIMENSIONS:

2 5/8" diameter and feature a 270° sweep needle

WEIGHT:

49g

[View Selection Chart on Next Page](#)

INTELLI-GAUGE SELECTION CHART

INTELLI-GAUGE	RANGE	● BLACK FACE	○ WHITE FACE
RPM, TACHOMETER	1,000-10,500 RPM	250-IG-100BB	250-IG-100WB
RPM, TURBINE PERCENTAGE, N1	0-120%	NA	250-IG-218WB
RPM, TURBINE PERCENTAGE, N2	0-120%	NA	250-IG-219WB
TEMPERATURE, WATER (STREET)	100°-280°F	250-IG-110BB	250-IG-110WB
TEMPERATURE, WATER (RACE)	60°-200°F	250-IG-120BB	250-IG-120WB
TEMPERATURE, OIL	140°-280°F	250-IG-130BB	250-IG-130WB
TEMPERATURE, EXHAUST GAS	600°-1,600°F	250-IG-140BB	250-IG-140WB
TEMPERATURE, EXHAUST GAS #2	600°-1,600°F	250-IG-145BB	250-IG-145WB
TEMPERATURE, EXHAUST GAS	0°-1,000°F	NA	250-IG-220WB
TEMPERATURE, CYLINDER HEAD	100°-600°F	250-IG-150BB	250-IG-150WB
TEMPERATURE, TRANSMISSION	50°-350°F	250-IG-135BB	250-IG-135WB
PRESSURE, OIL	0-100 psi	250-IG-160BB	250-IG-160WB
PRESSURE, OIL	0-250 psi	NA	250-IG-162WB
PRESSURE, FUEL	0-15 psi	250-IG-170BB	250-IG-170WB
PRESSURE, FUEL	0-100 psi	250-IG-165BB	250-IG-165WB
PRESSURE, FUEL	0-250 psi	NA	250-IG-167WB
PRESSURE, FUEL	0-500 psi	NA	250-IG-226WB
PRESSURE, BRAKE	0-1,500 psi	250-IG-180BB	250-IG-180WB
PRESSURE, NITROUS	0-1,600 psi	250-IG-175BB	250-IG-175WB
PRESSURE, (GENERIC)	0-200 psi	250-IG-190BB	250-IG-190WB
PRESSURE, (GENERIC)	0-300 psi	250-IG-193BB	250-IG-193WB
PRESSURE, (GENERIC)	0-500 psi	NA	250-IG-223WB
PRESSURE, (GENERIC)	0-1,000 psi	250-IG-197BB	250-IG-197WB
BOOST / VACUUM	30 psi-0-30 in. hg	250-IG-215BB	250-IG-215WB
BOOST	0-60 psi	NA	250-IG-217WB
VACUUM	0-30 in. hg	250-IG-210BB	250-IG-210WB
AIR/FUEL RATIO	10-18	NA	250-IG-224WB
FLOW	3.5-4.5 GPM	NA	250-IG-222WB
FUEL LEVEL	E-F	NA	250-IG-225WB
VOLTS	8-20	250-IG-200BB	250-IG-200WB
VOLTS, (WITH INTERNAL SENSOR)	8-20	250-IG-204BB	250-IG-204WB
VOLTS	20-32	NA	250-IG-221WB



A. GAUGE TO GAUGE JUMPER CABLE

A. GAUGE TO GAUGE JUMPER CABLE

Used to connect each gauge in series after the first gauge. Each end of the cable has the small round connector that plugs directly into the back of the Intelli-Gauges.

8" Cable	280-CA-RGG-008
16" Cable	280-CA-RGG-016
24" Cable	280-CA-RGG-024
48" Cable	280-CA-RGG-048
288" Cable	280-CA-RGG-288

B. GAUGE TEE CABLES

Connects first gauge to V-Net cable or another V-Net module.

8" Cable	280-CA-RGG-T008
16" Cable	280-CA-RGG-T016
24" Cable	280-CA-RGG-T024



B. GAUGE TEE CABLE

V-NET

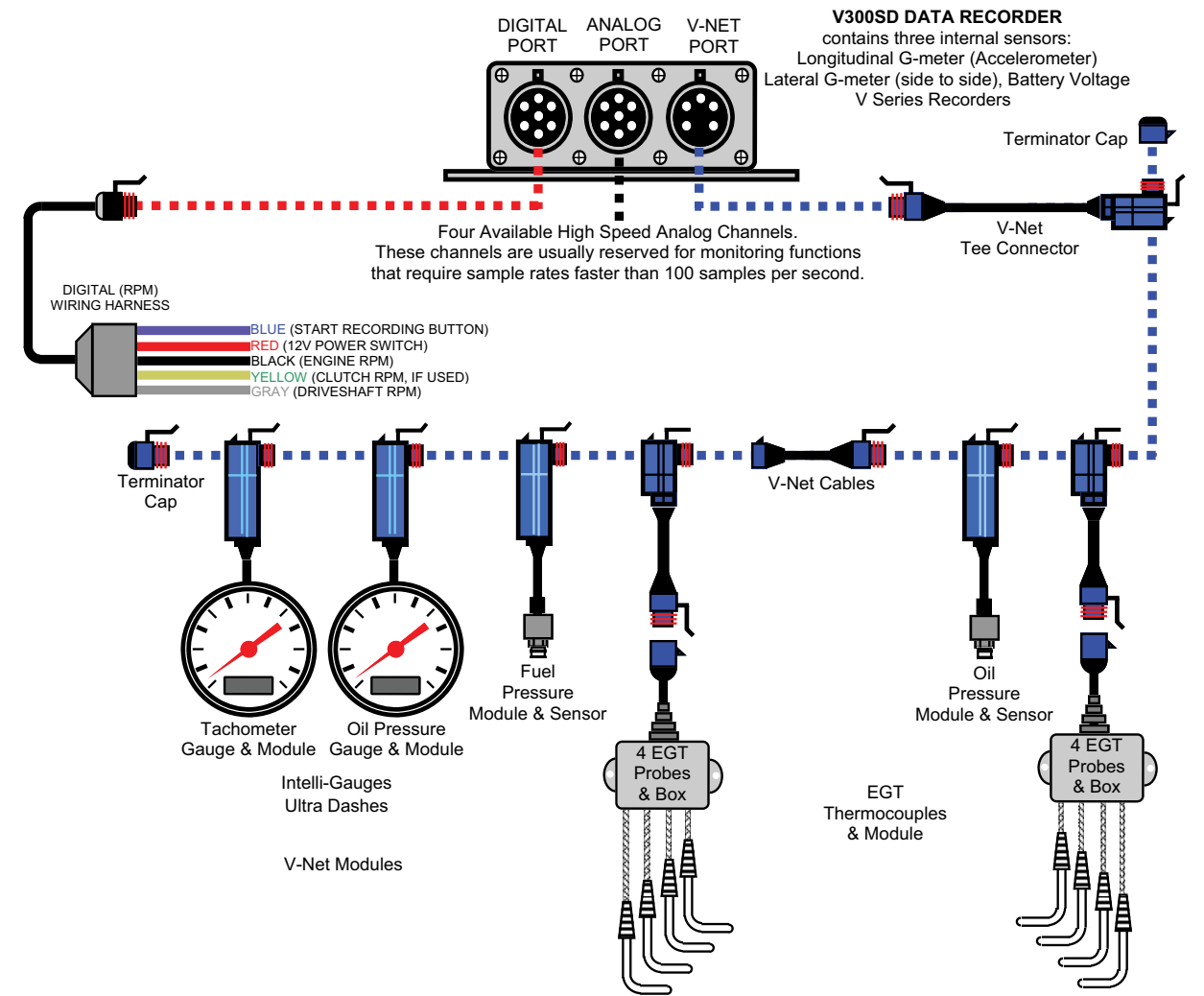

Racepak's Vehicle Network (V-Net) is a "smart data" transfer network providing the ability to transmit multiple signals from each sensor over a single cable. This technology creates a system in which the individual components interact with each other; making a simpler, more compact system which can be expanded with ease.

The key to accomplishing this is in the modular connectors that attach each of the devices to the main V-Net cable. Each module is essentially a miniature computer, which houses circuit boards and a microprocessor that identifies and retrieves only the proper incoming signals and allows other signals to pass through.

Whether you will be installing a single gauge set up, or a full-blown data acquisition system, all components are attached to the system using the modular snap-together connectors. Adding components onto the system is simple. Just find a junction in the main V-Net cable, separate the connectors, and sandwich the new sensor's module between them. Then command your software to read the new configuration. It will automatically recognize any additions or deletions from the system.

Gauge integration is another strength of the V-Net system, but don't mistake the Racepak gauges for garden variety gauges. If your vehicle is equipped with a V-Net recording system, the gauges simply use the sensors and wiring that are already in place to provide full time display of the data being monitored.

The same holds true for Racepak's digital display dashes. Some models of the dash will rely solely upon the data recorder's sensors to provide the information they display, while others are stand-alone requiring no data recorder. When you add Datalink II, the best Windows®-based software in the business, you will see why Racepak continues to be the most popular and widely used data acquisition system in the industry.

In order for a function to be monitored on the V-Net, the signal from that function must pass through two components: a sensor and a module. The sensor is the unit that actually measures the input from the function (i.e. pressure, temperature, etc.), while the module converts the signal so it can be transmitted over the V-Net. In the module sensor section that follows, you will find a complete listing of these components divided into categories.

ANALOG PRE-PROGRAMMED WITH SENSORS

These pre-programmed analog function module and sensor combinations are ready for plug-and-play installation on the V-Net cable.

A. PRESSURE (48" Lead Length)

Boost (Manifold), 0-75 psi	220-VP-PT-BST75
Brakes, 0-1500 psi	220-VP-PT-B1500
Fuel Carburetor, 0-15 psi	220-VP-PT-CP15
Fuel, Nozzle, 0-150 psi	220-VP-PT-NP150
Fuel, Nozzle, 0-300 psi	220-VP-PT-NP300
Fuel, Nozzle, 0-500 psi	220-VP-PT-NP500
Fuel, Pump, 0-75 psi	220-VP-PT-PP075
Fuel, Pump, 0-150 psi	220-VP-PT-PP150
Fuel, Pump, 0-300 psi	220-VP-PT-PP300
Fuel, Pump, 0-500 psi	220-VP-PT-PP500
Nitrous Bottle #1, 0-1500 psi	220-VP-PT-N1
Nitrous Bottle #2, 0-1500 psi	220-VP-PT-N2
Nitrous Fuel #1, 0-15 psi	220-VP-PT-NF115
Nitrous Fuel #2, 0-15 psi	220-VP-PT-NF215
Nitrous Fuel #3, 0-15 psi	220-VP-PT-NF315
Nitrous Fuel #4, 0-15 psi	220-VP-PT-NF415
Oil, 0-150 psi	220-VP-PT-OP150
Oil, 0-300 psi	220-VP-PT-OP300
Pressure Differential, 0-40" H2O to 15 psi	220-VP-PT-PD145
Pressure Differential	220-VP-PT-PD745
Transmission, 0-300 psi	220-VP-PT-TP300
Turbo Back Pressure #1, 0-75 psi	220-VP-PT-EP175
Turbo Back Pressure #2, 0-75 psi	220-VP-PT-EP275
Turbocharger Outlet #1, 0-75 psi	220-VP-PT-TB10
Wheelie Bar, Left, 0-3000 psi	220-VP-PT-WBL3K
Wheelie Bar, Right, 0-3000 psi	220-VP-PT-WBR3K
Wheelie Bar, Left, 0-5000 psi	200-VP-PT-WBL5K
Wheelie Bar, Right, 0-5000 psi	220-VP-PT-WBR5K

B. VACUUM

Manifold, 30 PSI 0-30 In. hg	220-VP-PT-BVAC
Pan (Crankcase), 0-30 In. hg	220-VP-PT-PVAC



A. FUEL PRESSURE



C. FLUID TEMP



D. EXHAUST GAS TEMPERATURE JUNCTION BOX WITH PROBES



E. EXHAUST GAS TEMPERATURE SINGLE CYLINDER

C. TEMPERATURE

Pigtail cable lengths are shown in parenthesis.

Cylinder Head, Left, 0-600°F, (36")	220-VP-TC-HEADL
Cylinder Head, Right, 0-600°F, (36")	220-VP-TC-HEADR
Engine Oil, 0-300°F, (48")	220-VP-TR-OIL
Intake Manifold, Open Tip 0-600°F, (36")	220-VP-TC-MANIF
Intercooler Inlet, 0-300°F, (72")	220-VP-TR-ICTI
Rear End Oil, 0-300°F, (72")	220-VP-TR-RET
Transmission Oil, 0-300°F, (72")	220-VP-TR-TRANS
Water, 0-300°F (72")	220-VP-TR-WATER

D. EXHAUST GAS TEMPERATURES/CYLINDER BANK SETS

EGT junction box sets are ordered by the cylinder bank sequence they serve.

Junction Box & 4 Probes, 1357, Small Block	220-VP-TC-1357S
Junction Box & 4 Probes, 2468, Small Block	220-VP-TC-2468S
Junction Box & 4 Probes, 1357, Big Block	220-VP-TC-1357B
Junction Box & 4 Probes, 2468, Big Block	220-VP-TC-2468B
Junction Box & 4 Probes, 1234	220-VP-TC-1234
Junction Box & 4 Probes, 5678	220-VP-TC-5678
Junction Box & 4 Probes, Motorcycle	220-VP-TC-1234M
Junction Box & 3 Probes, 123	220-VP-TC-123
Junction Box & 3 Probes, 456	220-VP-TC-456
Junction Box & 3 Probes, 135	220-VP-TC-135
Junction Box & 3 Probes, 246	220-VP-TC-246

E. EXHAUST GAS TEMPERATURES/SINGLE CYLINDER

Single cylinder modules include the thermocouple.

Cylinder #1	200-VP-TC-EGT1
Cylinder #2	200-VP-TC-EGT2
Cylinder #3	200-VP-TC-EGT3
Cylinder #4	200-VP-TC-EGT4
Cylinder #5	200-VP-TC-EGT5
Cylinder #6	200-VP-TC-EGT6
Cylinder #7	200-VP-TC-EGT7
Cylinder #8	200-VP-TC-EGT8

A. ANALOG PRE-PROGRAMMED WITHOUT SENSORS

These analog function modules have been programmed for general usage, and have not been assigned to a specific task. Use of these modules on the V-Net cable requires the addition of a sensor and configuration of the module using your DatalinkII software.

Voltage, 0-5 Volt Input, 5 Volt Output	230-VM-AN-5V
Voltage, 0-5 Volt Input, 12 Volt Output	230-VM-AN-12V
Pressure, 5 Volt	230-VM-PT-5V
Position/Movement, Rotary or Linear	230-VM-TPS
Temperature, Fluid-type, 0-300°F <i>For use with sensor #810-TR-300 only</i>	230-VM-TR-300
Temperature, Low, 0-600°F <i>For use with type K thermocouples only</i>	230-VM-TC-600
Temperature, High, 0-1800°F <i>For use with type K thermocouples only</i>	230-VM-TC-1800
Air/Fuel Sensor Input, Single	230-VM-AF
Air/Fuel Sensor Input, 4 Station	230-VM-AF (CYL #s)
Battery Voltage	230-VM-BVOLT
Voltage Differential	230-VM-5VDIFF

ANALOG NOT PRE-PROGRAMMED WITH SENSORS

The module/sensor combinations are the same as the V-Net Modules with Sensors/Analog on pages 19-20 with the exception that they have not been pre-programmed. Each of the pressure or temperature module/sensor combinations below is designed to be attached to the V-Net cable. Once installed, they must be programmed using the Configuration File in the Datalink software.

B. PRESSURE

0-15 psi	220-VS-15GVT
0-75 psi	220-VS-75GVT
0-150 psi	220-VS-150GVT
0-300 psi	220-VS-300GVT
0-500 psi	220-VS-500GVT
0-1500 psi	220-VS-1500SVT
Vacuum/Pressure 30 In. hg-0-30 psi	220-VS-VB

C. TEMPERATURE

Fluid Temperature, 0-300°F, Fluid Type Sensor <i>Uses the #180-TR-300 sensor</i>	220-VS-TR-300
---	---------------



A. VOLTAGE 0-5 INPUT



B. PRESSURE 0-75



C. FLUID TEMPERATURE 0-300°F



F. EXTENSION CABLES



G 2 AND 3 PIN CONNECTOR KITS

D. FLUID TEMPERATURE SENSOR CONNECTOR KIT 810-CN-TR2P

Use with V-Net modules and temperature sensors having prefix number of 220-VP-TR-, 220-VM-TR-, or 230-VM-TR-.

E. PRESSURE SENSOR CONNECTOR KIT 810-CN-TI3P

Use with V-Net module and pressure sensor having prefix number of 220-VP-PT-, 220-VS-, or 230-VM-PT-.

F. EXTENSION CABLES

These custom-built extensions can be used to extend the length of cables that use a 2-Pin or 3-Pin Molex connector to attach the sensor to the power harness or a module's pigtail. Please specify length required when ordering.

2-Pin Molex Cable, Specify Length	800-CA-EXT2P
-----------------------------------	--------------

3-Pin Molex Cable, Specify Length	800-CA-EXT3P
-----------------------------------	--------------

G. MOLEX TERMINAL KITS

These connector kits can be used if the need arises to shorten a cable that is terminate. Available with a two or three pin Molex connector. Kit includes both a male and female connector and pins.

2-Pin Molex Connector Kit	810-CN-MOL2
---------------------------	-------------

3-Pin Molex Connector Kit	810-CN-MOL3
---------------------------	-------------

Crimp Tool for Molex Terminal Pins	800-XP-CRIMP-01F
------------------------------------	------------------

02

Tip #2 Receiving a COM port error message when connecting your PC to a Racepak data logger or digital dash?

Remember, each USB port on a PC is assigned a particular COM port number, which must match the COM number in the Racepak software.

With your config file open, select Settings / Scan Com Ports in the DatalinkII software.

A. DIGITAL PRE-PROGRAMMED MODULES WITH SENSORS

These pre-programmed digital function modules and sensor combinations are ready for plug-and-play installation on the V-Net cable. See sensors only page.

CLUTCH RPM **220-VP-CL-1**
Monitors magnetic pulses using a Zero Crossing sensor.

Drive Shaft RPM, Automotive (Contact Closure Sensor) **220-VP-DS-2**
Contact Closure sensor, includes split collar, magnet, and bracket kit.

Drive Shaft/Rear Wheel RPM, Motorcycle **220-VP-ZXDS-2**
Monitors magnetic pulses using a Zero Crossing sensor.

Front Wheel RPM **220-VP-FWZX**
Monitors magnetic pulses using a Zero Crossing sensor.

Front Wheel RPM **220-VP-FWHE3**
Monitors ferrous metal pulses using a Hall Effect sensor.

Turbo Speed for use with Racepak V-Net Data Loggers **220-VP-TURBORPM**

Turbo Speed V-Net Module only **230-VM-TURBO**

Turbo Speed Sensor only **800-SS-SPEED**

B. DIGITAL PRE-PROGRAMMED MODULES WITHOUT SENSORS

These pre-programmed digital function modules are ready for plug-and-play installation on the V-Net cable. You must add the appropriate sensor to the module.

Zero Crossing Input **230-VM-ZX-1**

Hall Effect Input **230-VM-RPMHE**

Contact Closure Input **230-VM-CC-1**

Event Marker Input, 12 Volt **230-VM-EVENT**

Event Marker Input, Switch Closure **230-VM-EVENTSW**

Flow Meter **230-VM-FLOW**

Four Channel Digital Input **230-VM-4DIGIN**

Four Channel Digital Output **230-VM-4DIGOUT**

C. DIGITAL PRE-PROGRAMMED MODULES NO SENSORS REQUIRED

These modules do not require a sensor. They use the pulse from the component they are monitoring as the signal to the module. Each has been programmed for the specific use noted and is ready for plug-and-play installation on the V-Net cable.

Engine RPM Input Module **220-VP-TACH-4**

Transbrake Event 12 Volt Triggered **220-VP-TBRAKE**

Wide Open Throttle Event **220-VP-WOTEVENT**

Clutch Event 12 Volt Triggered **220-VP-CLTEVENT**



A. DRIVESHAFT RPM



B. ZERO CROSSING INPUT



C. ENGINE RPM INPUT



D. SHIFT LIGHT/EVENT MODULE

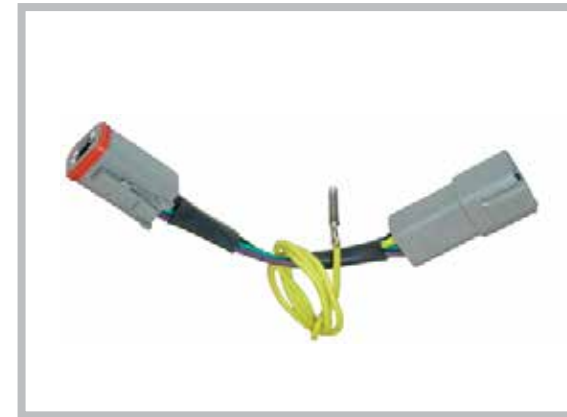

E. MSD PRO MAG TACH CONVERTER



F. IGNITION TIMING KIT OVERALL FOR V500SD

D. SHIFT LIGHT/EVENT MODULE

The Shift Light Module allows you to use any LED-style light (300 milliamp maximum) as a fully-programmable, stand-alone shift light. By accessing the engine RPM off of the V-Net you can program up to six separate shift alarm signals. Each shift point is user-programmable using the DatalinkII software. Shift light module does not include the shift light. This module will also show you when the shift light was triggered to come on.

Shift Light Module (Light Not Included) **230-VM-SHIFTLTE**

E. TACH CONVERTER

The output signal that is used to trigger magnetos is different than a conventional electronic ignition. This compact device converts the Pro Mag's coil signal into a 12 volt square wave signal so common tachometers designed for electronic ignitions can be used with the Pro Mag.

MSD Pro Mag Tach Converter **810-SN-MAG-CONV**

MSD Magneto Pickup Adapter (MSD 12 or 20 amp mag) **800-CA-MAGADPT**
Cable provides easy connection for RPM sensor between magneto and coil.

F. IGNITION TIMING KIT

By equipping the V500 data recorder with this kit it can track the overall timing, or if you are using a battery ignition system that provides adjustable individual cylinder timing, you can monitor the timing on each cylinder as well. These kits provide the components to compare the crankshaft's position to the firing pulse(s) of the ignition. Magneto equipped engines, or battery ignition engines without individual cylinder timing capabilities, would use the overall timing kit.

Ignition Timing Kit, Overall, V500 Only **800-KT-TIMINGOV**

Ignition Timing Kit, Individual, V500 Only **800-KT-TIMING**

V300SD customers can monitor overall ignition timing utilizing Racepak's V300SD Timing Kit. Use of this package requires removal of the start logging button, which is replaced by a crankshaft rpm sensor. Start logging is then initiated by another channel (engine rpm, etc) or by use of a V-Net event module which then allows use of the start logging button.

Note the following requirements:

- Any V300SD not ordered with this option must be returned to Racepak for upgrade:
- Engine must utilize flying magnet crank trigger wheel
- DatalinkII standard software required
- Contact Racepak for complete details

Ignition Timing Kit, Overall, V300SD **200-UG-TIMV300S**

A. EFI DATA INTERFACE

These V-Net modules have been created to interface with many electronic fuel injection systems on the market. Each V-Net EFI Data Interface module is equipped to allow direct connection with EFI. These modules allow your V-series data recorder to share the data collected by these systems rather than having to install duplicate sensors to monitor functions that are already being monitored by the EFI system. The shared data can be recorded or displayed just as you would any function monitored independently by your Racepak V-series recorder. Caution should be exercised to ensure that you do not exceed the maximum number of V-Net channels supported by your particular logger. The individual functions monitored by each EFI system are outlined in the chart below. **For use with Racepak V-Net data loggers.**

Accel DFI Gen VII	230-VM-EFIDFI
AEM	230-VM-EFIAEM
Autronic SMC & SM2	230-VM-EFIAUT
Autronic SM4 V107 & V109	230-VM-EFIAUT4
Big Stuff 3	230-VM-EFIBS3
Corvette C6 OBDII GMX3 (2006 and Later)	230-VM-EFIIC6
EFI Technologies	230-VM-TECH
FAST XFI CAN	230-VM-EFIXFI
FAST Serial	230-VM-EFIFST
Generic J1939 CAN	230-VM-EFICAN
Haltech	230-VM-EFIHAL
Holley EFI	230-VM-EFIHOL
Hondata KPro	230-VM-EFIHOND
Megasquirt I	230-VM-EFIMS1
Megasquirt II	230-VM-EFIMS2
MEFI 4B J1939 (GM PN 12584052, 12575479)	230-VM-EFIIM4
Motec M400, M600, M800, M84	230-VM-EFIMOTEC
Motec M4, M48	230-VM-EFIMOTSR
Omex	230-VM-EFIOMEX
Omniteck EC44	230-VM-EFIEC44
PRO EFI	230-VM-EFIPRO
Vipec	230-VM-EFIVIPEC
WOLF V500	230-VM-EFIWOLF
Atomic LS	230-VM-EFIALS
Atomic TBI	230-VM-EFIATBI
Fuel Tech	230-VM-EFIFUEL

03

Tip #3 Does your Driveshaft RPM appear to be reading too high, or too low? Remember, the Driveshaft RPM sensor channel is only as smart as the programming.

Using a four magnet collar with a 2 magnet channel would fool the software, providing double the magnetic pulses in one revolution and double the RPM reading.

AIR/FUEL SENSORS

Racepak has created a selection of A/F controllers and sensors created specifically for tuning race engines. The 4 channel controller is designed to be connected to the V-Net cable of Racepak V-series recorders. When ordering please be aware that the sensors are calibrated for use on specific ports of the controller and cannot be interchanged from port to port without recalibration. All sensors have a 13" pigtail cable, and the controller has a 37" cable for attachment to the sensor. These lengths cannot be altered. Controllers are ordered by cylinder bank layout.

Racepak A/F sensors are compatible with either gasoline or methanol fueled engines. Gasoline application will display A/F ratios between 9.55:1 and 20:1, while methanol is shown from 4.22:1 to 8.7:1. Please specify the type of fuel you will be using when ordering. Each sensor includes one weldment and plug.



B. 4 CHANNEL AIR/FUEL CONTROLLER

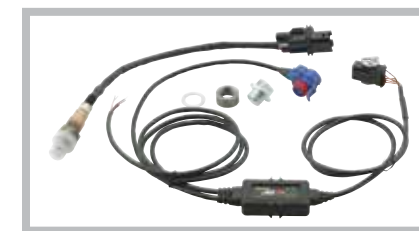

C. SINGLE AIR/FUL CONTROLLER WITH SENSOR

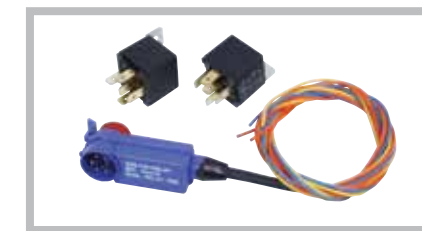

D. RELAY CONTROL



E. STEERING SENSOR PACKAGE

B. AIR/FUEL CONTROLLERS

Sensors must be ordered separately

4 Channel Controller, Cylinders 1, 3, 5, 7, 220-VM-AF4-1357
For use on 1, 3, 5, 7 cylinder bank of V8, i.e. GM & Mopar.

4 Channel Controller, Cylinders 2, 4, 6, 8 220-VM-AF4-2468
For use on 2, 4, 6, 8 cylinder bank of V8, i.e. GM & Mopar.

4 Channel Controller, Cylinders 1, 2, 3, 4 220-VM-AF4-1234
For use on 1, 2, 3, 4 cylinder bank of V8, i.e. Ford.

4 Channel Controller, Cylinders 5, 6, 7, 8 220-VM-AF4-5678
For use on 5, 6, 7, 8 cylinder bank of V8, i.e. Ford.

Air/Fuel Sensor Only 810-SN-AFAMP

Air/Fuel Weldment & Plug 810-TX-AFWLDP
Weldments are included with purchase of controller.

Air/Fuel Harness 'A' Side 280-CA-LSUA-AMP

Air/Fuel Harness 'B' Side 280-CA-LSUBS-AMP

C. SINGLE AIR/FUEL CONTROLLER WITH SENSOR

Single channel air/fuel sensor package. Includes controller, (1) Bosch LSU air/fuel sensor, weld bung, wiring harness, instructions. Includes 0-5V reference output for external devices. For use with Racepak V-Net data loggers.

AF1 Package 220-VM-AF1

D. RELAY CONTROL MODULE

A Relay Control Module is the device which permits the V-Net system to perform a host of automated tasks. It allows any information transmitted over the V-Net to be used to activate external high power devices such as a switch, solenoid, water pump, fan, or lights. Each module has two programmable output relays.

Each relay can have up to two separate (analog and/or digital) control signals that must be met before the relay is engaged. For example, one relay can be programmed to turn on a water pump only when a 'Pump' switch is on and the water temperature is above the programmed value, while the other relay can be used to activate an ignition kill switch only if the engine RPM is above a programmed value and the oil pressure is lower than a predetermined pressure. Relays are included.

AF1 Package 230-VM-RELAY

E. STEERING SENSOR

Column mounting steering sensor package includes rotary sensor, column mount, billet contact wheel and V-Net module. For use with Racepak V-Net data loggers.

Steering Sensor 220-VP-SK-1

A. ANALOG INTERFACE MODULES WITHOUT SENSORS

Shock Travel, Right Front, 28" Pigtail (Std.)	240-IM-TRAV28RF
Shock Travel, Right Front, 38" Pigtail	240-IM-TRAV38RF
Shock Travel, Left Front, 65" Pigtail (Std.)	240-IM-TRAV65LF
Shock Travel, Right Rear, 48" Pigtail (Std.)	240-IM-TRAV48RR
Shock Travel, Right Rear, 72" Pigtail	240-IM-TRAV72RR
Shock Travel, Left Rear, 48" Pigtail	240-IM-TRAV48LR
Shock Travel, Left Rear, 84" Pigtail (Std.)	240-IM-TRAV84LR

B. DIGITAL INTERFACE MODULES WITHOUT SENSORS

Tach Input	240-IM-TACH
Zero Crossing Sensor Input	240-IM-ZX
Contact Closure Sensor Input	240-IM-CC
Contact Closure Sensor, 12v Output	240-IM-CC-12V

C. DOOR CAR DRAG SHOCK KIT FRONT

Includes two 0-4" travel linear sensors, two IM modules, 108" IM cable and installation instructions.

Front Kit	280-KT-DSHKTRVF
-----------	-----------------

D. DOOR CAR DRAG SHOCK KIT REAR

Includes two 0-8" travel linear sensors, two IM modules, 6" IM cable and installation instructions.

Rear Kit	280-KT-DSHKTRVR
----------	-----------------

INTERFACE MODULES

Interface modules are another unique component of the V-series recorders. These black 7-pin modules differ from the blue 5-pin V-Net modules in both the application and the manner in which they perform. They are designed to provide a modular method of assembly for the sensors that connect to either the hardwired RPM or Analog input ports of V300SD, V500SD or G2X Pro data recorders. Each Interface module provides the necessary signal conditioning for its attached sensor thereby allowing the sensors to communicate with the Logger via a single cable.

Interface modules do not require any programming, however you may only attach up to four Interface module together in series. The four modules may be connected directly to each other (Daisy-chained) or they may be linked with an Interface cable as illustrated below.

The list below shows a selection of Interface modules that will help you in the task of connecting almost any type of digital or analog sensor to a V300SD, V500SD or G2X Pro recorder.

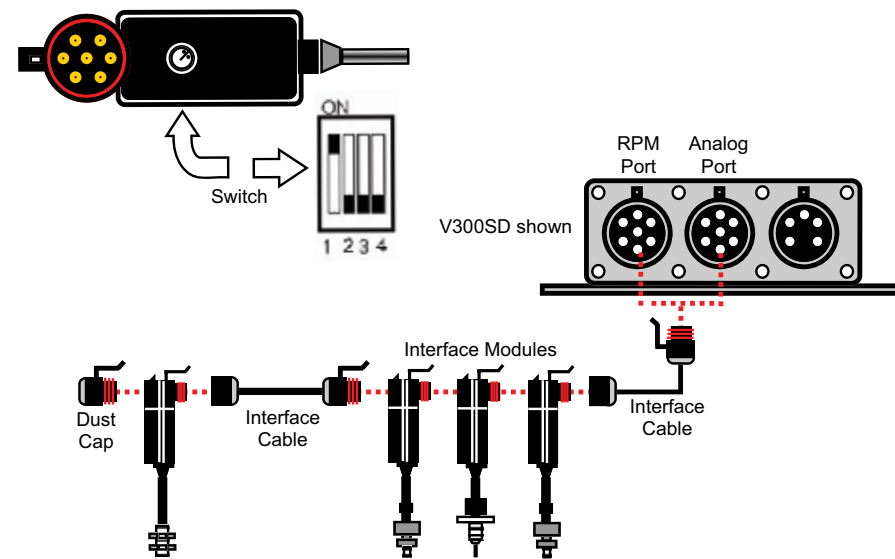

A. SHOCK TRAVEL INTERFACE MODULE

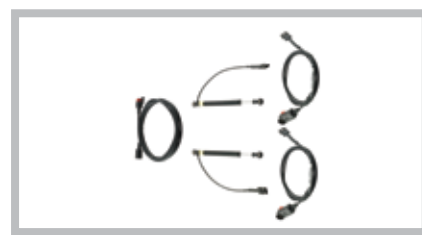

C. FRONT SHOCK KIT



D. REAR SHOCK KIT

CABLES

V-Net modules and Interface modules, although similar in construction and appearance, are very different in the functions they perform. It is important that components designed for one system not be interchanged with the other. V-Net cables use a 5-pin connector, while Interface cables use a 7-pin connector. So that cables can be identified at a glance Racepak has color-coded the connectors on the end of the cables. V-Net cable connectors are blue, just like the modules to which they attach, while Interface cable connectors and modules are black.

The cables listed may be used to link the components to other listed components of the same system, or to their proper port on the recorder. The Interface cables with black connectors will only be used with modules connecting to the RPM or Analog input ports, while the V-Net cables with blue connectors will be used exclusively on items connected to the V-Net port.

CABLE LENGTH	5-PIN BLUE V-NET	7-PIN BLACK INTERFACE
6"	280-CA-VM-006	280-CA-IM-006
12"	280-CA-VM-012	280-CA-IM-012
18"	280-CA-VM-018	280-CA-IM-018
24"	280-CA-VM-024	280-CA-IM-024
36"	280-CA-VM-036	280-CA-IM-036
48"	280-CA-VM-048	280-CA-IM-048
60"	280-CA-VM-060	280-CA-IM-060
72"	280-CA-VM-072	280-CA-IM-072
84"	280-CA-VM-084	280-CA-IM-084
96"	280-CA-VM-096	280-CA-IM-096
108"	280-CA-VM-108	280-CA-IM-108
120"	280-CA-VM-120	280-CA-IM-120
144"	280-CA-VM-144	280-CA-IM-144
168"	280-CA-VM-168	280-CA-IM-168
192"	280-CA-VM-192	280-CA-IM-192
216"	280-CA-VM-216	280-CA-IM-216

TEE CABLES

All V-Net systems must be equipped with a Tee cable. The Tee cable permits the installation of the two terminator caps (one male and one female) which are necessary to the operation of the V-Net system. Just like the ends on the V-Net cables, all V-Net Tee cables and Terminator Caps are blue.

Interface modules can also use a Tee cable, but only for the purpose of providing a branch in the system. It is not a mandatory component as it is on the V-Net system. The black Interface Tee cables and dust caps are used just for the purpose their names imply. They are not required for the system to operate properly.

Bulkhead connectors are used when a V-Net or Interface cable must pass through a firewall, body panel, or motor plate. They provide a male/female connector on each side of the panel. These are specific to the type of cable that is being used and are color coded for easy identification.

COMPONENT	5-PIN BLUE V-NET	7-PIN BLACK INTERFACE
TEE CABLE, 9"	280-CA-VM-T009	280-CA-IM-T009
TEE CABLE, 18"	280-CA-VM-T018	
TEE CABLE, 36"	280-CA-VM-T036	
TERMINATOR CAP, MALE	280-CA-VM-TCAPM	
TERMINATOR CAP, FEMALE	280-CA-VM-TCAPF	
DUST CAP, MALE		280-CA-IM-DCAPM
DUST CAP, FEMALE		280-CA-IM-DCAPF
BULKHEAD CONNECTOR	280-CA-VM-BHEAD	280-CA-IM-BHEAD

A. PRESSURE TRANSDUCERS

The small size and ruggedness of these 'PT-type' pressure transducers make them ideal for the measurement of pressure directly at the source. The transducer requires 5 volt DC power and provides a .5 to 4.5 volt output signal. Each transducer mounts using a 1/8" NPT male pipe fitting.

0-15 psi	810-PT-0015GVT
0-75 psi	810-PT-0075GVT
0-150 psi	810-PT-0150GVT
0-300 psi	810-PT-0300GVT
0-500 psi	810-PT-0500GVT
0-1500 psi	810-PT-1500HP
0-3000 psi	810-PT-3000HP



A. PRESSURE TRANSDUCER

VACUUM/PRESSURE SENSOR

30 In. hg-0-30 psi, Vacuum/Boost	810-PT-VB
----------------------------------	-----------

ADAPTER MODULES

The pressure sensors listed on page 19 can be adapted to the V-Net cable or analog port of the recorders by using the appropriate signal condition module.

V-Net Module	230-VM-PT-5V
For connection to the V-Net cable on the V-series recorders.	

B. FUEL FLOW METER SENSORS

These general purpose turbine-type flow meters require an available digital channel. Gasoline and Nitro-methane flow meters are constructed of aluminum. Methanol fuel requires the use of a stainless steel flow meter. A tee fitting must be used so all fuel can be routed through the flow meter before it is divided between the hat nozzles and the port nozzles on fuel injection applications.

Flow Meter, Gas or Nitro, 8AN (1-10 GPM)	800-FM-AN8-AL
Flow Meter, Gas or Nitro, 10AN (2-25 GPM)	800-FM-AN10-AL
Flow Meter, Gas or Nitro, 12AN (2-70 GPM)	800-FM-AN12-AL
Flow Meter, Methanol, 8AN (1-10 GPM)	800-FM-AN8-SS
Flow Meter, Methanol, 10AN (2-25 GPM)	800-FM-AN10-SS
Flow Meter, Custom Order	Call for information
Tee Fitting 10AN inlet two 8AN outlets	Call for information



B. FUEL FLOW METER SENSORS

ADAPTER MODULES

V-Net Module	230-VM-FLOW
Use to connect flow meter to V-Net Cable.	

C. REED SWITCH RPM SENSOR

These contact closure-type sensors use an internal, fast acting reed switch to indicate the passing of a rotating magnet.

RPM Sensor, 2-Pin 5/16" 24 dia.	800-SS-PRO-5
Commonly used as a driveshaft RPM sensor on pre-2001 clutch RPM sensor with Pro Series recorders.	

RPM Sensor, 2 Spade Connectors, 5/16" 24 dia.	800-SS-RB-5
Commonly used for clutch, driveshaft and front wheel RPM with SC1000 recorders.	



C. RPM 2-PIN CONNECTOR



C. RPM 2-SPADE SENSOR

ZERO CROSSING RPM SENSORS

Zero Crossing RPM Sensor, 3-Pin 3/8" dia. 800-SS-ZX-3
This non-powered sensor is designed for monitoring magnetic pulses. It must be used with an RPM input designed for a zero crossing sensor. Used as the clutch RPM or Front Wheel RPM sensor on V-series and 2001 and newer Pro Series recorders.

Zero Crossing TDC Sensor, 3-Pin 3/8" dia. 800-SS-TDC-3
This sensor is designed specifically for use with MSD-style crank trigger wheel and magnets. It must be used with a RPM input designed for a zero crossing sensor. Commonly used for the TDC indicator on ignition timing monitor with V500 recorders.



C. ZERO CROSSING RPM SENSOR



C. ZERO CROSSING TDC SENSOR

HALL EFFECT SENSOR

Ferrous Material sensor, 3-Pin, 3/8" dia. 800-SS-MSC-3
Commonly used to sense a ferrous bolt or metal tooth, such as used when monitoring the ring gear RPM. These powered sensors require 12v power.

Magnetic Pulse Sensor, 3-Pin, 5/16" dia. 800-SS-MSC-5
Same as above, but triggered by a magnet rather than a ferrous metal.



C. FERROUS MATERIAL SENSOR



C. MAGNETIC PULSE SENSOR

D. ENGINE RPM WITH MAGNETO IGNITION

Occasionally, a V-series data recorder will be used to monitor the RPM of an engine that is equipped with a magneto ignition system. In this situation the engine RPM signal is acquired using the inductive pickup shown below. This sensor sources the ignition pulses between the magneto and the control box, and then transfers the signals to the onboard recorder through the wire harness or a V-Net module.

Inductive Magneto RPM Sensor 280-SN-MAGPU
With connector to plug into the V300 wiring harness.

Inductive Magneto RPM Sensor 280-SN-MAGPU3
With connector to plug into the V300SD wiring harness.



D. INDUCTIVE MAGNETO RPM SENSOR



D. MSD MAGNETO PICKUP ADAPTER

ADAPTER MODULE

V-Net 220-VP-TACH-(NUMBER OF PULSES)
Adapts the Inductive Engine RPM sensor to the V-Net Cable

MSD Magneto Pickup Adapter 800-CA-MAGADPT
(MSD 12 or 20 amp mag)
Adapts the Inductive Engine RPM sensor to the V-Net Cable

A. EXHAUST GAS TEMPERATURE THERMOCOUPLES

V-Net systems and V-series recorders use two types of thermocouple setups to monitor the exhaust gas temperatures, one for an individual cylinder application and another for 3 or 4 cylinder groups. Measuring the EGTs on a single cylinder application is accomplished using a thermocouple that features an inline, two-prong mini-connector. This connector provides the union between the thermocouple and the V-Net module. A selection of single cylinder thermocouples is shown below.

The most frequently used setup is the four thermocouples with junction box combination. This setup simplifies the installation on V8 engines by grouping the four thermocouples on each cylinder bank into a common junction box. The junction box then provides a single wire connection to the V-Net module to facilitate service work. A similar setup is available for V6 engines.

V-Net applications also use two styles of thermocouples. Four cylinder motorcycles make use of the .187-inch diameter tip bullet-style thermocouples, while Harley-Davidsons and the automotive applications employ the .250-inch diameter Stinger-style thermocouples. When replacing a thermocouple probe, use the illustration alongside the chart to determine the length you will need. The thermocouples used with the junction boxes, and some individual thermocouple components that are often requested, are shown in the chart. See page 20 for single or four station EGT modules that include the thermocouples

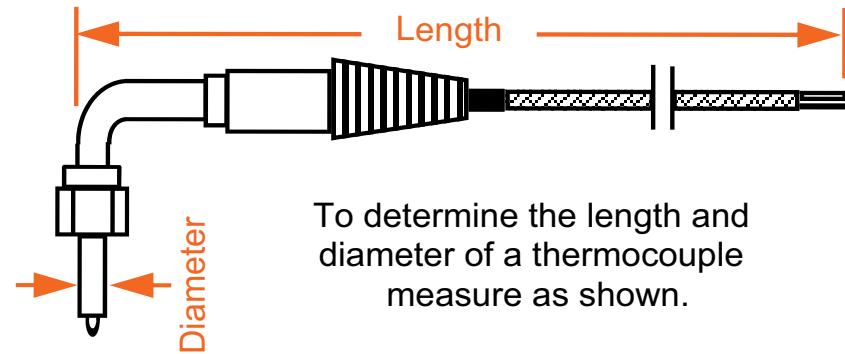

B. SPECIAL PURPOSE THERMOCOUPLES

These Type-K thermocouple assemblies (Nickel-Chromium/Nickel-Aluminum) are specifically designed for the applications listed below. Each must be used with the appropriate thermocouple amplifier module. All probes are 12" in length and are terminated with a male two pin mini-connector. The liquid and manifold assemblies are provided with a 1/8" male NPT compression style fitting.

Cylinder Head Temp. Thermocouple Assem. 800-TC-MT-ASM
Ring type sensor is used to monitor temperature of the metal, not the coolant.

Fluid Temp. Thermocouple Assem. 800-TC-FT-ASM
Used where the probe can be immersed in liquid, such as in a dry sump tank.

Manifold Temp. Thermocouple Assem. 800-TC-MT-ASM
Open end probe reacts quickly to changing temperatures in manifold plenum.



B. THERMOCOUPLE ASSEMBLY

.187" DIA. BULLETS (MOTORCYCLES, 4 CYL)

12"	800-TC-B3-12
16"	800-TC-B3-16
19"	800-TC-B3-19
22"	800-TC-B3-22
Set of 4 - One of each length	800-TC-B3-SET

.250" DIA. STINGERS (AUTO, H-D BIKES)

9"	800-TC-S4-09
13"	800-TC-S4-13
18"	800-TC-S4-18
21"	800-TC-S4-21
23"	800-TC-S4-23
28"	800-TC-S4-28
32"	800-TC-S4-32
Set of 8	800-TC-S4-SET1
2 each: (9", 13", 18", 23")	
Set of 8 Big Block Heads	800-TC-S4-SET2
1 each: (18", 23", 28", 32")	
Set of 8 Small Block Heads	800-TC-S4-SET3
1 each: (13", 18", 21", 28")	
Set of 8 Big Block Turbo Probes	800-TC-S4-SET2
1 each: (18", 23", 28", 32")	

THERMOCOUPLE ADAPTERS MODULES

V-Net Cable Module Adapter	800-TC-S4-32
Analog Port Interface Module Adapter	800-TC-S4-32
Pro Analog Box Module Adapter	800-TC-S4-32

MISCELLANEOUS EGT COMPONENTS

Weldment, Nut & Ferrule Assembly	3/16"	800-TX-WASM3
	1/4"	800-TX-WASM4
Weldment Only, Single		800-TX-WELD4
Weldment Only, Single, Stainless		800-TX-WELD4SS
Weldment Only, Set of 4		800-TX-WELD404
Weldment Only, Set of 8		800-TX-WELD408
Ferrule Only		800-TX-F4
Nut Only		800-TX-WNUT4
Cap Only		800-TX-CAP4
Nut & Ferrule Only		800-TX-NF4

C. FLUID TEMPERATURE SENSOR

This sensor is commonly used in conjunction with the modules shown below to measure the temperature of fluids such as water or engine and transmission oil where the temperature does not exceed 300°F.

Fluid Temperature, Sensor Only 0-300°F 810-TR-300
For use with V-Net modules.

Fluid Temperature, Sensor Only 0-250°F 810-TR-250
For use on Ultra Dash only.

ADAPTER MODULES

V-Net Module 230-VM-TR-300
Used to connect the 810-TR-300 sensor to the V-Net cable.

Interface Module 240-IM-FT-350
Used to connect the 810-TR-300 sensor to the Analog Port.

D. INFRARED TEMPERATURE SENSORS

These infrared sensors are used to monitor temperatures where contact cannot be made with the item being monitored. In racing, they are commonly used to monitor temperatures across the face of a tire, but they can be used for any non-contact measurement. The sensor will measure temperatures from 0-400°F. The IR Temperature sensor has a 4:1 ratio focal point. That means that when the item being monitored is four inches away from the sensor, the focal point will be one inch in diameter. If the sensor is twelve inches away, the focal point will be three inches in diameter.

IR Sensor and V-Net Module 220-VP-IR-T-200

IR V-Net Module Only 230-VM-IR

IR Temp Sensor Only 810-SN-IRT-200

E. ADHESIVE 0-600F THERMOCOUPLE SENSOR

Racepak's adhesive 0-600F thermocouple sensor eliminates the need for bung and other sensor mounting methods, making ideal for a number of surface temperature reading such as Shock Housing Temp, Engine Block Temp, Fuel Tank Temp, Fuel Pump Temp, Electric Motor Temp, Batteries, and many more. For use with V-Net module or Transducer box.

Adhesive 0-600F Thermocoupler Sensor 800-TC-PD-600

F. WIDE OPEN THROTTLE SENSORS

Wide open throttle event switches are used to verify when the carburetor is at full throttle and the throttle blades are wide open.

Switch Only, WOT 800-MB-WOT-SW

Cable Only, Pigtail for WOT Switch 280-CA-HARNWOT

Switch & Pigtail Only 800-MB-WOT-SWC

ADAPTER MODULES

V-Net Module 220-VP-WOTEVENT



C. FLUID TEMPERATURE SENSOR



D. INFRARED TEMPERATURE SENSOR

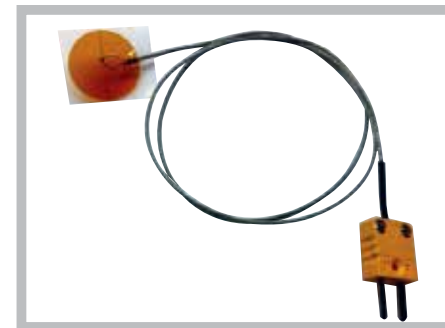

E. ADHESIVE 0-600F THERMOCOUPLER SENSOR

A. SHOCK TRAVEL SENSORS

Monitoring suspension travel aids greatly in gaining an understanding of what the chassis is doing. The information obtained from these sensors is often the key element separating the winners from the losers, regardless of the type of racing. Racepak users can employ these linear potentiometers to record the slightest amount of suspension movement, even at high rates of speed. Shock travel sensors are usually connected through the analog port of V-series recorder and monitored at a high sample rate. Each kit contains a linear travel sensor with attached cable and an Interface module. An available analog channel is required for each sensor. A separate kit is required for each wheel monitored.

Kit Front Shock Travel, V-Series Data Recorders 0-4" **280-KT-SHKTRVF**

Kit Rear Shock Travel, V-Series Data Recorders 0-8" **280-KT-SHKTRVR**
Uses interface module for connection to hardwired analog port of V300SD or V500SD.

Shock Travel Sensor, 0-2", (7.4" to 9.4") **800-LN-TRV2**

Shock Travel Sensor, 0-3", (8.4" to 11.4") **800-LN-TRV3**

Shock Travel Sensor, 0-4", FNT (9.7" to 13.7") **800-LN-TRV4**

Shock Travel Sensor, 0-3", R (12.6" to 20.6") **800-LN-TRV8**

B. LINEAR TRAVEL SENSORS

These linear potentiometers are used to monitor movement or position. They are commonly used on applications such as magneto retard devices, fuel slide valves, and linear clutch bearing position. Their use requires an appropriate signal conditioning module.

Linear Travel Sensor, 0-1.0" **800-LN-FUEL**
Used to monitor pneumatic magneto retard or slide valve fuel system controller.

Linear Travel Sensor, 0-3.0" **800-LN-CLV3**
Used to monitor clutch throw out bearing.

ADAPTER MODULES

V-Net Module **230-VM-TPS**
For connection to V-Net cable on V-series recorders.

Interface Module **240-IM-TRAV**
For connection to Analog port of V300SD or V500SD recorders

C. STRING POTENTIOMETER

This sensor is typically used for linear measurements, such as throttle position, when the mounting angle is not critical. The sensor is calibrated to the travel of the throttle (i.e. 0% when closed and 100% at WOT). By using a string potentiometer, the possibility of interference with the throttle operation is eliminated. Operating range 0-4.750".

String Potentiometer Sensor **800-LN-STRINGP**
Can use the V-Net and Interface Adapter Modules above.



A. FRONT SHOCK TRAVEL



B. LINEAR TRAVEL SENSOR



C. STRING POTENTIOMETER



D. WHEELIE BAR LOAD CELL



E. WHEELIE BAR PRESSURE SENSOR



F. RIDE HEIGHT SENSOR



G. G-FORCE SENSOR

04

Tip #4 What makes Racepak unique among data acquisition companies? Our exclusive V-Net technology.

All Racepak V-Net data loggers, sensors, digital dashes, Intelli-Gauges and the SmartWire connect and share data on single 5 pin cable, as opposed to routing individual wires to each device.

Think of it much the same as cable tv, internet and telephone all arriving in your home on a single cable.

D. WHEELIE BAR LOAD CELL

By incorporating these load cells into each of the wheelie bars, a record of how long and how hard the car was on the wheelie bars, and whether both sides register equal loading pressure, gives a visual record of how the car is reacting to the set-up. Monitoring and graphing the pressures generated in these load cells is accomplished by attaching a V-Net module and pressure sensor to each load cell. Pre-programmed modules and sensors are shown below.

Wheelie Bar Load Cell, Single **800-SN-WBLOAD**

E. WHEELIE BAR PRESSURE SENSOR

V-Net Module & Sensor, Wheelie Bar Pressure (Load cell not included)

Left, 0-3000 psi **220-VP-PT-WBL3K**

Right, 0-3000 psi **220-VP-PT-WBL3K**

Left, 0-5000 psi **220-VP-PT-WBL5K**

Right, 0-5000 psi **220-VP-PT-WBL5K**

F. RIDE HEIGHT SENSOR

Infrared sensors are used to monitor the distance to an object, relative to the sensor, when contact cannot be made with the object. This makes them ideal for use in setting up the suspension by monitoring chassis ride height in relation to the moving ground plane. Infrared Ride Height sensors and modules are commonly attached to the V-Net cable of any V-series recorder. If desired, they can also be attached to the analog port by using an Interface module rather than a V-Net module. These sensors are designed for use in measuring distances ranging from 3.93 to 15.75 inches. Each sensor must be used with the appropriate V-Net module.

Ride Height Sensor Kit, V-Net; Left Front **220-VP-RIDEHTLF**

Ride Height Sensor Kit, V-Net; Right Front **220-VP-RIDEHTRF**

Ride Height Sensor Kit, V-Net; Left Rear **220-VP-RIDEHTLR**

Ride Height Sensor Kit, V-Net; Right Rear **220-VP-RIDEHTRR**

Module Only, Ride Height, V-Net, Left Front **220-VM-RHBLF**

Module Only, Ride Height, V-Net, Left Rear **220-VM-RHBLR**

Module Only, Ride Height, V-Net, Right Front **220-VM-RHBRF**

Module Only, Ride Height, V-Net, Right Rear **220-VM-RHBRR**

Sensor Only, Ride Height **810-SN-RHB**

G. G-FORCE SENSORS (ACCELEROMETER)

These G-force sensors can be adapted to any V-Net system (Note: V300 & V500 data recorders all contain internally mounted G-meters) to measure longitudinal and lateral forces. The externally-mounted G-meter measures 2.0" x 2.0" x 1.250".

G-Meter, 0-6 G **220-VP-GM**

ADAPTER MODULES

V-Net Module Only **230-VM-AN-12V**
Adapts external G-meter to V-Net cable.

A. PRO ANALOG TRANSDUCER BOX II

This is the next generation Pro Analog Transducer Box which is a smaller and lighter version than the previous analog transducer box. Just like the past analog transducer box, this is an additional method of connecting analog sensors into the V-Net recorders. Each Pro Analog Box will house up to four of the Plug-In style transducer modules. The box is then connected to a single V-Net cable. Plug-In style transducers and adapter modules must be purchased separately.

Pro Analog Transducer Box II 230-VM-4TD

Frame Rail Bracket 800-MB-TB2
Adapts Pro Analog Box II to round tube

B. TRANSDUCER MODULES, PLUG-IN STYLE II

When using the Pro Analog Transducer Box these plug-in style transducers and signal conditioning modules are used to convert the input from various analog functions into signals that can be recognized by the recorder. Where required, a special cable is needed for connecting the sensor to the module.

Pressure Transducer, PSI 810-M5-PT2-(SPECIFY PSI)
Available in ratings of: 0 to 15/60/100/150/300/500/750/1500.
Used to measure pressure from parameters such as fuel, oil, boost, nitrous. Route your pressure line directly to the transducer. Transducer has 1/8" NPT female thread.

Vacuum Transducer, 0-30 In. hg 810-MD-PT2-VAC
Typically used to monitor manifold or pan vacuum.
A vacuum line is routed directly to transducer.

Thermocouple Amplifier Module, 0-500°F 810-M-TC2-500

Cable Only, Thermocouple Sensor to Module, over 3'. (specify length) 800-CA-TCEXT-XL

Cable Only, Thermocouple Sensor to Module, under 3'. (specify length) 800-CA-TCEXT-XL
Used on low temp applications such as water, oil, cylinder head. Not for use with EGTs. Module, cable and sensor kit available as PN# 810-KT-TC-500. Specify use and cable length.

0-5 Volt Input Module, can output either 5 or 12 volts to powered sensor 810-MD-0-5V2
Cable Only, Sensor to module 800-CA-3PM (specify length).
Receives 0-5 volt input from powered sensor while providing 5 or 12v to power the sensor.



A. PRO ANALOG TRANSDUCER BOX II

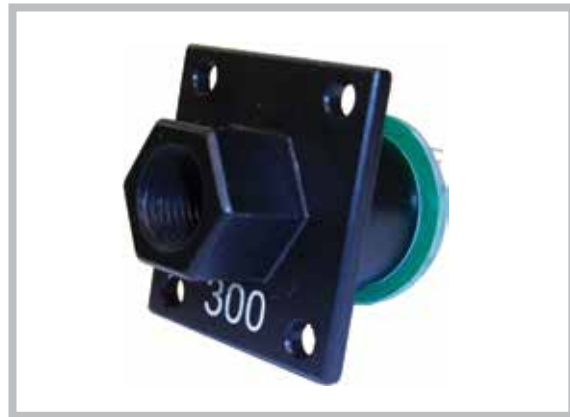

B. PRESSURE TRANSDUCER



D. PRO ANALOG TRANSDUCER BOX OLD STYLE



E. PRESSURE TRANSDUCERS OLD STYLE

A. PRO ANALOG TRANSDUCER BOX OLD STYLE

The Pro Analog Transducer Box offers an additional method of connecting analog sensors into the V-Net recorders. Each Pro Analog Box will house up to four of the plug-In style transducer modules. The box is then connected to either the V-Net cable or the analog port, via a single cable, by using one of the appropriate adapter modules shown below. Plug-in style transducers and adapter modules must be purchased separately.

Pro Analog Transducer Box 810-MB-8P

Frame Rail Bracket 800-MB-ANA
Adapts Pro Analog Box II to round tube

ADAPTER MODULES

V-Net 230-VM-4ANA8
Adapts 8-Pin Pro Analog Box to V-Net cable.

Interface 230-CA-1M-8P
Adapts 8-Pin Analog Box to Analog port V-series recorders.

B. TRANSDUCER MODULES, PLUG-IN OLD STYLE

When using the Pro Analog Transducer Box these plug-in style transducers and signal conditioning modules are used to convert the input from various analog functions into signals that can be recognized by the recorder. Where required, a special cable is needed for connecting the sensor to the module.

Pressure Transducer, PSI 810-MD-PT-(SPECIFY PSI)
Available in ratings of: 0 to 15/60/100/150/300/500/750/1500.
Used to measure pressure from parameters such as fuel, oil, boost, nitrous. Route your pressure line directly to the transducer. Transducer has 1/8" NPT female thread.

Vacuum Transducer, 0-30 In. hg 810-MD-PT-VAC
Typically used to monitor manifold or pan vacuum.
A vacuum line is routed directly to transducer.

Thermocouple Amplifier Module, 0-500°F 810-M-TC-500

Cable Only, Thermocouple Sensor to Module, over 3'. (specify length) 800-CA-TCEXT-XL

Cable Only, Thermocouple Sensor to Module, under 3'. (specify length) 800-CA-TCEXT-XX
Used on low temp applications such as water, oil, cylinder head. Not for use with EGTs. Module, cable and sensor kit available as PN# 810-KT-TC-500. Specify use and cable length.

0-5 Volt Input Module, outputs 5 volts to powered sensor 810-MD-0-5VOUT

0-5 Volt Input Module, outputs 12 volts to powered sensor 810-MD-0-5
Cable Only, Sensor to module 800-CA-3PM (specify length).
Receives 0-5 volt input from powered sensor while providing 5 or 12v to power the sensor.

A. SPLIT COLLARS

These aluminum split collars provide a mounting platform for the magnets that are used to trigger the sensor when monitoring the revolutions of a shaft. They are typically used on rear end yokes or couplers to provide driveshaft RPM. Each collar is approximately .375" wide and houses two magnets which are located 180° apart. Custom size and dual magnet collars are available by special order.

SPLIT COLLAR ONLY WITH TWO MAGNETS

1.050 (27mm)	800-CL-2M-105
1.375	800-CL-2M-137
1.500	800-CL-2M-150
1.625	800-CL-2M-162
1.812	800-CL-2M-181
1.875	800-CL-2M-187
2.125	800-CL-2M-212
2.187	800-CL-2M-218
2.375	800-CL-2M-2375
2.400	800-CL-2M-240
2.500	800-CL-2M-250
3.000	800-CL-2M-300
3.187	800-CL-2M-318
3.250	800-CL-2M-325
3.500	800-CL-2M-350

SPLIT COLLAR ONLY WITH EIGHT MAGNETS

For use with V300SD, V500SD, Sportsman data recorders. If using a recorder other than listed, contact Racepak.

1.875	800-CL-8M-187
2.125	800-CL-8M-2125
2.187	800-CL-8M-2187

B. MAGNETS

These are the rare earth magnets that are currently used in the clutch input shaft, the split collars shown above or with some front wheel RPM applications. Each magnet measures .250" OD x .200" in length. North end of magnet is painted yellow for easy identification.

Magnet Only, Rare Earth, Single	800-MG-SM-.25
---------------------------------	---------------



A. TWO MAGNET SPLIT COLLAR

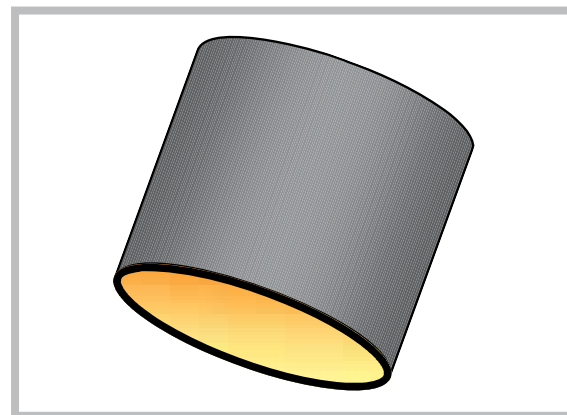
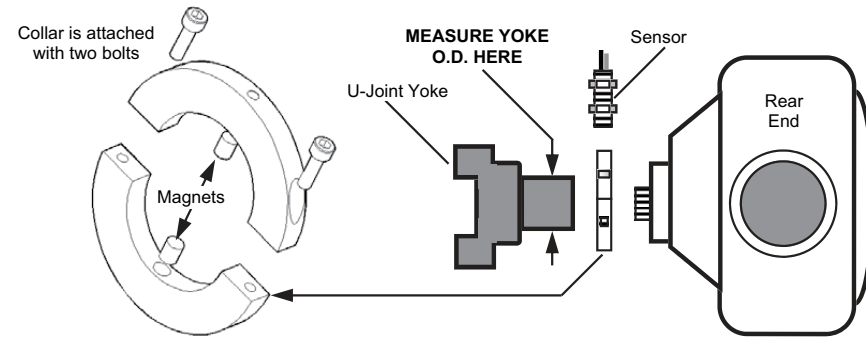

B. RARE EARTH MAGNET

C. SHIFT LIGHT

As a companion component to our programmable V-Net Shift Light Modules, Racepak has made available this high intensity LED shift light. The light features a powerful light emitting diode for luminosity that can't be missed even on the brightest of race days.

Shift Light, Black Housing

800-XP-SLMSD



C. SHIFT LIGHT

PRO DRAG RACING



A. PRO III DATA RECORDER

PRO III PACKAGE INCLUDES

Pro III Data Recorder
 Drive Shaft or Ring Gear Sensor Kit
 2 RPM Modules
 Internal 3-Axis G-Meter
 Main Wiring Harness
 Battery Charger



B. MAGNETO CURRENT KIT

PRO DRAG RACING DATA RECORDERS

A. PRO III DATA RECORDER

The Pro III Data Recorder is designed for use in applications with ultra high cylinder pressures, high amperage magnetos and solid core secondary ignition wires. In other words, worst case scenarios. They are traditionally found on the supercharged nitro-burning engine applications such as Top Fuel Dragsters and Nitro Funny Cars. The expanded RPM and digital input capabilities of the Pro III provide the optional ability to monitor ignition timing for a complete dual-magneto system.

FEATURES

PRO III Base Unit:

2 Engine RPM Channels
 1 Drive Shaft RPM Channel
 Ignition timing, mag phase and timing profiles for 2 magnetos
 Internal 3 Axis G-Meter

Expandable:

Up to 56 Channels
 Up to 16 total RPM/Digital Channels
 8 Exhaust Gas Channels
 Add a Pro Dash to display monitored functions in real time
 Add integrated and synchronized video display to recorded data

Sample Rates:

Up to 200 samples per second

Recording Time :

Up to 200 seconds

Dimensions:

8.780" (L) X 5.110" (W) X 1.790" (H)

Weight:

2 pounds, 8 ounces

PRO III Data Recorder Kit	130-KT-PR03
----------------------------------	--------------------

B. BLUETOOTH UPGRADE

This feature allows you to communicate wirelessly with your Pro III data logger. Eliminate your programming cable and program your data logger or view real-time data using the wireless telemetry function available with this upgrade.

Bluetooth Upgrade	130-UG-BTPR03
--------------------------	----------------------

C. OPTIONAL ACCESSORY KITS

Exhaust Gas Temperature Kit Add capability to monitor EGT's.	130-KT-EGT
--	-------------------

Bluetooth Upgrade Communicate wirelessly with your Pro III data logger.	130-UG-BTPR03
---	----------------------

Magneto Current Kit Add capability to monitor ignition coil output on two coils at 20,000 samples per second.	130-KT-MAGC
---	--------------------

PRO DRAG RACING DATA RECORDERS

A. PRO IIIA DATA RECORDER

The PRO IIIA Data Recorder is a downsized version of the PRO III. It is designed for use in a variety of categories from Alcohol Dragsters and Funny Cars, Nostalgia Top Fuel Dragsters and Funny Cars, and other supercharged applications that use high amperage magnetos with extreme cylinder pressure. Its rugged construction makes it ideally suited for vehicles that encounter severe tire shake.

The PRO IIIA provides the basic functions required by all applications (engine RPM, drive shaft RPM, 8 exhaust gas temperatures) and also includes the ability to monitor ignition timing while having the capability of being expanded to suit each user's individual needs. It can handle other digital channels such as clutch RPM and flow meters, plus up to 16 analog channels. The PRO IIIA also supports the popular Pro Dash, a programmable onboard real time display dash.

FEATURES

PRO IIIA Base Unit:

1 Engine RPM Channel
1 Drive Shaft RPM Channel
Ignition timing, mag phase and timing profiles for 1 magneto
Internal 3 Axis G-Meter

Expandable:

Up to 16 Channels
Up to 8 total RPM/Digital Channels
8 Exhaust Gas Channels
Add a Pro Dash to display monitored functions in real time
Add integrated and synchronized video display to recorded data

Sample Rates:

Up to 200 samples per second

Recording Time:

Up to 200 seconds

Dimensions:

8.780" (L) X 5.110" (W) X 1.790" (H)

Weight:

2 pounds, 6 ounce

PRO IIIA Data Recorder Kit **130-KT-PRO3A**

PRO IIIA Nostalgia Kit **130-KT-PRO3A**

B. OPTIONAL ACCESSORY KITS

Exhaust Gas Temperature Kit **130-KT-EGTA**
Add capability to monitor EGT's.

Bluetooth Upgrade **130-UG-BTPRO3**
Communicate wirelessly with your Pro IIIA data logger.



A. PRO IIIA DATA RECORDER

PRO IIIA BASE PACKAGE INCLUDES

Pro IIIA Data Recorder
Drive Shaft or Ring Gear Sensor Kit
1 RPM Module
Internal 3-Axis G-Meter
Main Wiring Harness
Battery Charger

PRO DRAG RACING INSTRUMENTATION

D. RACEPAK PRO DASH

The Pro Dash is one of the more exciting and useful products to be introduced into data acquisition. It is both a driving instrument and a tuning tool. Although it is more frequently seen in the cockpit of many high profile dragsters it can be mounted anywhere, and it is used more by the crew chiefs than the drivers. The Pro Dash is designed for use with the Pro series data recorders. The Pro Dash will display any function that is being monitored by a Pro III or Pro IIIA data recorder. Up to 36 different functions, in addition to the ever-present RPM bar, can be displayed on its three screens. Four sets of programmable displays allow the user to scroll between displays and view only those functions he needs. Commonly monitored items for display include engine RPM, EGT's, fuel flow, pressures, ignition timing, boost, and temperatures.

FEATURES

Dimensions for the Pro Dash are 3.800" tall x 9.385" wide x .625" deep. Total weight is a mere 17 ounces including its carbon fiber mount. It is backlit for nighttime use.

Racepak Pro III/IIIA Dash **820-DS-DASHPRO3**

Racepak Pro II/IB Dash **820-DS-DASHPRO**

E. RACEPAK WARNING LIGHT MODULE

Both the Pro III and Pro IIIA support Racepak's new warning light modules. Used in conjunction with a warning light transducer box [shown left], these modules monitor information from the data logger and can trigger a warning LED based on pre-programmed conditions to alert a driver of imminent danger, potentially preventing damage to the engine, the vehicle and above all, the driver.

Racepak Warning Light Module **130-VM-WARN**



D. RACEPAK PRO DASH



E. RACEPAK WARNING LIGHT MODULE

A. PRO ANALOG TRANSDUCER BOX II

This is the next generation Pro Analog Transducer Box which is a smaller and lighter version than the previous analog transducer box. Just like the past analog transducer box, this is an additional method of connecting analog sensors into the Pro recorders. Each box features a 5-pin Autosport connector at either end, allowing users the option of connecting several transducer boxes to one another to expand their system. Plug-In style transducers and adapter modules must be purchased separately.

Pro Analog Transducer Box II 130-VM-TB2

Frame Rail Bracket 800-MB-TB2
Adapts Pro Analog Box II to round tube.

B. TRANSDUCER MODULES, PLUG-IN STYLE II

When using the Pro Analog Transducer Box these plug-in style transducers and signal conditioning modules are used to convert the input from various analog functions into signals that can be recognized by the recorder. Where required, a special cable is needed for connecting the sensor to the module.

Pressure Transducer, PSI 810-MD-PT2- (SPECIFY PSI)
Available in ratings of: 0 to 15/60/100/150/300/500/750/1500.
Used to measure pressure from parameters such as fuel, oil, boost, and a variety of gases. Route your pressure line directly to the transducer. Transducer has 1/8" NPT female thread.

Vacuum Transducer, 0-30 In. hg 810-MD-PT2-VAC
Typically used to monitor manifold or pan vacuum.
A vacuum line is routed directly to transducer.

Thermocouple Amplifier Module, 0-500°F 810-MD-TC2-500

0-5 Volt Input Module, can output either 5 or 12 volts to powered sensor 810-MD-0-5V2
Receives 0-5 volt input from powered sensor while providing 5 or 12v to power the sensor.

Battery Voltage Module 810-MD-BATV2
Monitor 0-25 volt input.

Shift Light Module 810-MD-SHIFT2
Program and activate a shift light.

RPM Module 810-MDRPM2
Add additional square wave RPM inputs.

ZX RPM Module 810-MD-ZXRPM2
Add additional zero crossing RPM inputs.

CAN Module 810-MD-CAN2
Integrate with MSD Power Grid.



A. PRO ANALOG TRANSDUCER BOX II

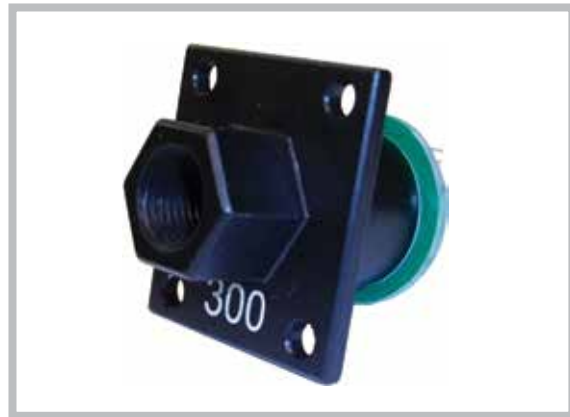

B. PRESSURE TRANSDUCER

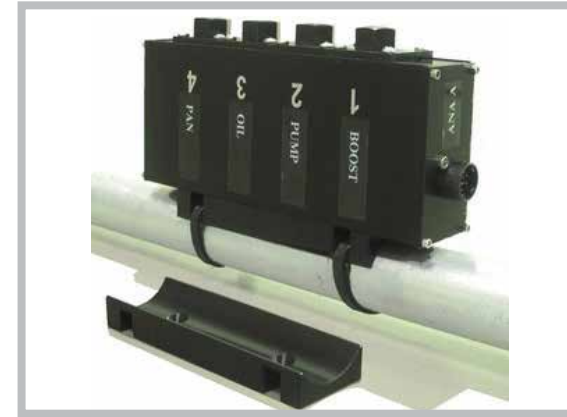

C. PRO ANALOG TRANSDUCER BOX OLD STYLE
(Shown with optional frame rail bracket)



D. PRESSURE TRANSDUCERS

C. PRO ANALOG TRANSDUCER BOX OLD STYLE

The Pro Analog Transducer Box allows the monitoring of analog inputs into the Pro 1, Pro 1B and the Pro II data recorders. Each Pro Analog Box will house up to four of the plug-In-style transducer modules. The box is connected to either the Analog A or B port. Each System can support up to four boxes (two pass-thru and two end boxes) for a total of 16 analog inputs. Plug-in style transducers and adapter modules must be purchased separately.

Pro Analog Transducer Box II 810-MB-4A

Pass-Thru Box 810-MB-4APT

Frame Rail Bracket 800-MB-ANA
Adapts Pro Analog Box II to round tube.

Cable (Specify Length) 800-MB-ANA
Connects Analog Box to another box or data recorder.

D. TRANSDUCER MODULES, PLUG-IN OLD STYLE

When using the Pro Analog Transducer Box these plug-in style transducers and signal conditioning modules are used to convert the input from various analog functions into signals that can be recognized by the recorder. Where required, a special cable is needed for connecting the sensor to the module.

Pressure Transducer, PSI 810-MD-PT-(SPECIFY PSI)
Available in ratings of: 0 to 15/60/100/150/300/500/750/1500.
Used to measure pressure from parameters such as fuel, oil, boost, nitrous. Route your pressure line directly to the transducer. Transducer has 1/8" NPT female thread.

Vacuum Transducer, 0-30 In. hg 810-MD-PT-VAC
Typically used to monitor manifold or pan vacuum.
A vacuum line is routed directly to transducer.

Thermocouple Amplifier Module, 0-500°F 810-M-TC-500

0-5 Volt Input Module, outputs 5 volts to powered sensor 810-MD-0-5V0UT

0-5 Volt Input Module, outputs 12 volts to powered sensor 810-MD-0-5

Battery Voltage Module 810-MD-PT-(SPECIFY PSI)
Monitor 0-20 volt input.

PRO DRAG RACING
CABLES

A. PRO III/IIIA CABLES

Dash cable - Pro III	130-CA-DASH
2-Pin cable, Module to Sensor	800-CA-2PM
3-Pin cable, Module to Sensor	800-CA-3PM
5-Pin Autosport Cable	800-CA-AS05-XX
13-Pin Autosport Cable	800-CA-AS13-XX
Voltage Cable	800-CA-BVOLT
Delay Box Pigtail Pro III - MSD 8971	800-CA-DBX-P3
Flow Cable	800-CA-FM-XX
Pro III EGT Cable	800-CA-HIR12-XX
Mag Phase Cable Amp	800-CA-PHASE-A
Mag Phase Cable Deutsch	800-CA-PHASE-D
Pro III On/Off Cable with Switch Pigtail	800-CA-PWR3
Pro IIIA – MSD PowerGrid Adapter Cable	800-CA-PGRID-XX
Pro III – MSD Top Fuel PowerGrid Adapter Cable	800-CA-PGDTF-XX
Temp cable, Module to Thermocouple over 3'	800-CA-TCEXT-XL
Temp cable, Module to Thermocouple under 3'	800-CA-TCEXT-XX
TDC Cable	800-CA-TDC-XX
Low Temp Cable, Module to Thermocouple over 3'	800-CA-TREXT

B. PRO 1, 1B & PRO II CABLES

Dash cable - Pro II	110-CA-DASH
2-Pin cable, Module to Sensor	800-CA-2PM
3-Pin cable, Module to Sensor	800-CA-3PM
Delay Box Cable MSD	800-CA-DBXM
Delay Box Pigtail - MSD 8971	800-CA-DBX-MSD
EGT Cable - Any Length	800-CA-EGT-XX
Flow Cable	800-CA-FM-XX
Mag Phase Cable Deutsch	800-CA-MAGD-XX
Mag Phase Cable	800-CA-MAG-XX
Pro II On/Off Cable with Switch Pigtail	800-CA-PWR
Temp cable, Module to Thermocouple Over 3'	800-CA-TCEXT-XL
Temp cable, Module to Thermocouple Under 3'	800-CA-TCEXT-XX
TDC Cable	800-CA-TDC-XX
Low Temp Cable, Module to Thermocouple Over 3'	800-CA-TREXT
13-Pin Cable (SPECIFY LENGTH)	800-CA-13H-XX



A. 5-PIN AUTOSPORT CABLE



B. 13-PIN AUTOSPORT CABLE

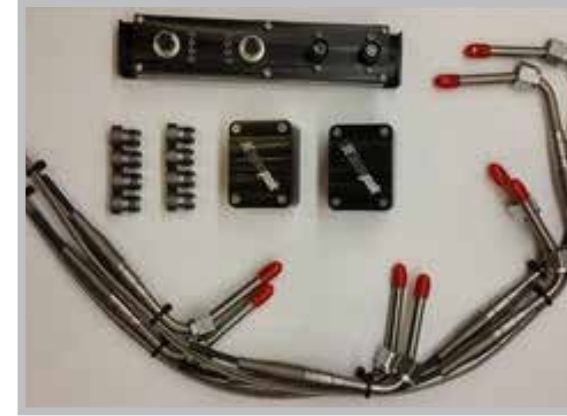

C. EGT KIT
(CABLES NOT SHOWN)



D. PRO EGT BOX

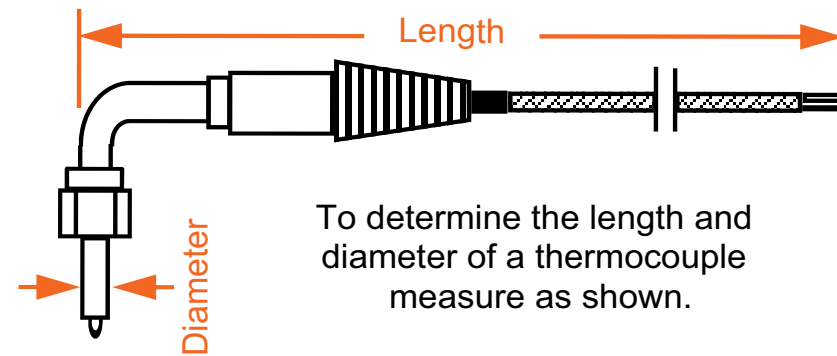

To determine the length and diameter of a thermocouple measure as shown.

E. MEASURING THERMOCOUPLES

PRO DRAG RACING
EGT SENSORS & KITS

C. EXHAUST GAS TEMPERATURE KITS

Monitoring and relaying the EGT signals from each of the cylinders are done using components from three groups: the thermocouple which actually measures the exhaust temperature, the junction box which gathers the four thermocouple cables on each cylinder bank into a group, and an EGT module that connects the two junction boxes to the recorder's network of sensors

PRO III EGT Kit 130-KT-EGT
Includes 8 Bullet EGT probes, 2 EGT boxes and cables, EGT module, 8 nuts, ferrules and weldments.

PRO IIIA EGT Kit 130-KT-EGTA
Same as above kit with Stinger EGT probes.

D. EGT COMPONENTS

Junction Box, 1357	130-JB2-1357
Junction Box & 4 Probes, 2468, Small Block	130-JB2-2468
EGT Module	130-MD-EGT

E. REPLACEMENT EGT COMPONENTS

.250" DIA. BULLETS (NITROMETHANE)

09"	800-TC-B4-09
13"	800-TC-B4-13
18"	800-TC-B4-18
23"	800-TC-B4-23
Set of 8 2 each: (9", 13", 18", 23")	800-TC-B4-SET

.250" DIA. STINGERS (GAS & ALCOHOL)

9"	800-TC-S4-09
13"	800-TC-S4-13
18"	800-TC-S4-18
23"	800-TC-S4-23
Set of 8 2 each: (9", 13", 18", 23")	800-TC-S4-SET1

Weldment, Nut & Ferrule Assembly	800-TX-WASM4
Weldment Only, Single	800-TX-WELD4
Weldment Only, Set of 8	800-TX-WELD408
Ferrule Only	800-TX-F4
Nut Only	800-TX-WNUT4
Cap Only	800-TX-CAP4
Nut & Ferrule Only	800-TX-NF4

A. PRO III INPUT MODULES

In order to reduce the number of wires that would be required to connect all of the digital / RPM sensors directly to the recorder (clutch, drive shaft, front wheel, or ring gear sensors, flow meter, etc.), Racepak has developed RPM Modules to simplify and sanitize the job. The RPM Modules collect the inputs from the various sensors and then transfers the signals to the recorder via a single cable. RPM Modules are designed to mount on a tubular frame member.

PRO III INPUT A MODULE 130-MD-INPA

PRO III INPUT B MODULE 130-MD-INPB

PRO IIIA INPUT MODULE

To reduce the number of modules that would be required to connect all of the digital / RPM sensors directly to the recorder (clutch, drive shaft, front wheel, or ring gear sensors, flow meter, TDC, etc.), the Pro IIIA uses a single RPM Module to collect the inputs from the various sensors and then transfers the signals to the recorder via a single cable. The RPM Module is designed to mount on a tubular frame member.

PRO IIIA INPUT A MODULE 130-MD-INPAA

PRO 1, 1B & PRO II INPUT MODULES

RPM Module (Input A) 110-MD-INPA

Ignition Timing Module (Input B) 110-MD-INPB

B. HIGH-SPEED ANALOG MODULES

The Pro III data logger features high speed monitoring of up to 8 analog channels in its traditional configuration. With the optional Mag Current Kit (130-KT-MAGC), two channels in the box are dedicated to sampling ignition coil output at 20,000 samples per second, leaving the remaining two which are capable of sampling at 1000 samples per second.

4 STATION 1-4 ANALOG BOX 130-MD-4ANA-1-4

4 STATION 5-8 ANALOG BOX 130-MD-4ANA-5-8



A. PRO III INPUT MODULES



B. HIGH-SPEED ANALOG MODULE



C. MANIFOLD/CLUTCH TEMP THERMOCOUPLE



D. FLUID TEMPERATURE SENSOR



E. INFRARED TEMPERATURE SENSOR

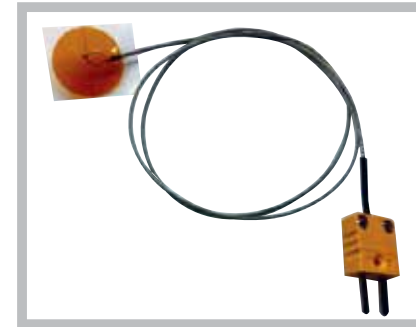

F. ADHESIVE 0-600F THERMOCOUPLE SENSOR

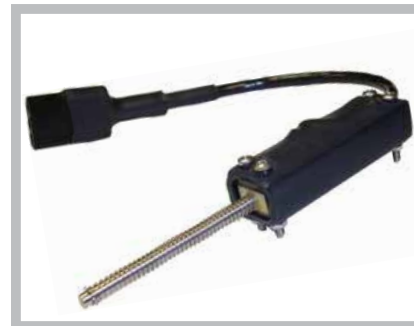

G. THROTTLE LINEAR

C. SPECIAL PURPOSE THERMOCOUPLES

These Type-K thermocouple assemblies (Nickel-Chromium/Nickel-Aluminum) are specifically designed for the applications listed below. Each must be used with the appropriate thermocouple amplifier module. All probes are 12" in length and are terminated with a male two pin mini-connector. The liquid and manifold assemblies are provided with a 1/8" male NPT compression style fitting.

Cylinder Head Temp. Thermocouple Assem. 800-TC-MT-ASM
Ring type sensor is used to monitor temperature of the metal, not the coolant.

Fluid Temp. Thermocouple Assem. 800-TC-FT-ASM
Used where the probe can be immersed in liquid, such as in a dry sump tank.

Manifold Temp. Thermocouple Assem. 800-TC-MT-ASM
Open end probe reacts quickly to changing temperatures in manifold plenum or in bellhousing.

D. FLUID TEMPERATURE SENSOR

This sensor is commonly used in conjunction with the modules shown below to measure the temperature of fluids such as water or engine and transmission oil where the temperature does not exceed 300°F.

Fluid Temperature, Sensor Only 0-300°F 810-TR-300
For use with low fuel temperatures.

E. INFRARED TEMPERATURE SENSORS

These infrared sensors are used to monitor temperatures where contact cannot be made with the item being monitored. In racing, they are commonly used to monitor temperatures across the face of a tire, but they can be used for any non-contact measurement. The sensor will measure temperatures from 0-400°F. The IR Temperature sensor has a 4:1 ratio focal point. That means that when the item being monitored is four inches away from the sensor, the focal point will be one inch in diameter. If the sensor is twelve inches away, the focal point will be three inches in diameter.

IR Temp Sensor Only 810-SN-IR-T-200

F. ADHESIVE 0-600F THERMOCOUPLE SENSOR

Racepak's adhesive 0-600F thermocouple sensor eliminates the need for bung and other sensor mounting methods, making ideal for a number of surface temperature reading such as Shock Housing Temp, Engine Block Temp, Fuel Tank Temp, Fuel Pump Temp, Electric Motor Temp, Batteries, and many more. For use with V-Net module or Transducer box.

Adhesive 0-600F Thermocouple Sensor 800-TC-PD-600

G. THROTTLE SENSORS

Linear Travel Sensor, 0-1.0" 800-LN-FUEL
Used to monitor throttle pedal.

A. TRAVEL SENSORS

Racepak users can employ these linear potentiometers to record the slightest amount of clutch travel, suspension or linkage movement, even at high rates of speed. Travel sensors are usually connected through the high-speed analog box or transducer box on a Pro series recorder and monitored at a high sample rate. A 0-5v module and 3-pin cable is required for each travel or linear sensor.

Travel Sensor, 0-2", (7.4" to 9.4") **800-LN-TRV2**

Travel Sensor, 0-3", (8.4" to 11.4") **800-LN-TRV3**

Travel Sensor, 0-4", FNT (9.7" to 13.7") **800-LN-TRV4**

Travel Sensor, 0-3", R (12.6" to 20.6") **800-LN-TRV8**

B. LINEAR SENSORS

These linear potentiometers are used to monitor movement or position. They are commonly used on applications such as magneto retard devices, fuel slide valves, and linear clutch bearing position. Their use requires an appropriate signal conditioning module.

Linear Travel Sensor, 0-1.0" **800-LN-FUEL**

Used to monitor slide valve fuel system controller.

Linear Travel Sensor, 0-3.0" **800-LN-CLV3**

Used to monitor clutch throw out bearing.

Linear Travel Sensor, 0-4.0" **800-LN-CLV4**

Used to monitor clutch throw out bearing.

C. STRING POTENTIOMETER

This sensor is typically used for linear measurements, such as throttle position, when the mounting angle is not critical. The sensor is calibrated to the travel of the throttle (i.e. 0% when closed and 100% at WOT). By using a string potentiometer, the possibility of interference with the throttle operation is eliminated. Operating range 0-4.750".

String Potentiometer Sensor **800-LN-STRINGP**

Can use the V-Net and Interface Adapter Modules above.



A. TRAVEL SENSOR



B. LINEAR SENSOR



C. STRING POTENTIOMETER



D. WHEELIE BAR LOAD CELL



E. WHEELIE BAR PRESSURE SENSOR



F. RIDE HEIGHT SENSOR



G. G-FORCE SENSOR

D. WHEELIE BAR LOAD CELL

By incorporating these load cells into each of the wheelie bars, a record of how long and how hard the car was on the wheelie bars, and whether both sides register equal loading pressure, gives a visual record of how the car is reacting to the set-up. Monitoring and graphing the pressures generated in these load cells is accomplished by attaching a V-Net module and pressure sensor to each load cell. Pre-programmed modules and sensors are shown below.

Wheelie Bar Load Cell, Single **800-SN-WBLOAD**

E. WHEELIE BAR PRESSURE SENSOR

Remote pressure sensor for use with wheelie bar load cell.

0-3000 psi **810-MD-RM3000**

0-5000 psi **810-MD-RM5000**

F. RIDE HEIGHT SENSOR

Infrared sensors are used to monitor the distance to an object, relative to the sensor, when contact cannot be made with the object. This makes them ideal for use in setting up the suspension by monitoring chassis ride height in relation to the moving ground plane. Infrared Ride Height sensors and modules are commonly attached to the V-Net cable of any V-series recorder. If desired, they can also be attached to the analog port by using an Interface module rather than a V-Net module. These sensors are designed for use in measuring distances ranging from 3.93 to 15.75 inches. Each sensor must be used with the appropriate V-Net module.

Sensor Only, Ride Height **810-SN-RHB-M3**

G. G-FORCE SENSORS (ACCELEROMETER)

These G-force sensors can be adapted to any V-Net system (Note: V300 & V500 data recorders all contain internally mounted G-meters) to measure longitudinal and lateral forces. The externally-mounted G-meter measures 2.0" x 2.0" x 1.250".

G-Meter, 0-10 G **810-SN-GM**

G-Meter Kit **800-SN-ACCEL6**

Includes G-meter, cable and module.

A. PRESSURE TRANSDUCERS

The small size and ruggedness of these 'PT-type' pressure transducers make them ideal for the measurement of pressure directly at the source. The transducer requires 0-5 volt module and 3-pin cable and provides a .5 to 4.5 volt output signal. Each transducer mounts using a 1/8" NPT male pipe fitting.

0-15 psi	810-MD-RM015
0-75 psi	810-MD-RM075
0-150 psi	810-MD-RM150
0-300 psi	810-MD-RM300
0-500 psi	810-MD-RM500
0-1500 psi	810-MD-RM1500
0-3000 psi	810-MD-RM3000
0-5000 psi	810-MD-RM5000

VACUUM/PRESSURE SENSOR

30 In. hg-0-30 psi, Vacuum/Boost	810-MD-RMVAC
----------------------------------	--------------

B. FUEL FLOW METER SENSORS

These general purpose turbine-type flow meters require an available digital channel. Gasoline and Nitro-methane flow meters are constructed of aluminum. Methanol fuel requires the use of a stainless steel flow meter. A tee fitting must be used so all fuel can be routed through the flow meter before it is divided between the hat nozzles and the port nozzles on fuel injection applications.

Flow Meter, Gas or Nitro, 8AN (1-10 GPM)	800-FM-AN8-AL
Flow Meter, Gas or Nitro, 10AN (2-25 GPM)	800-FM-AN10-AL
Flow Meter, Gas or Nitro, 12AN (2-70 GPM)	800-FM-AN12-AL
Flow Meter, Methanol, 8AN (1-10 GPM)	800-FM-AN8-SS
Flow Meter, Methanol, 10AN (2-25 GPM)	800-FM-AN10-SS
Tee Fitting 10AN inlet two 8AN outlets	800-FM-TEE



A. PRESSURE TRANSDUCER



B. FUEL FLOW METER SENSORS



C. RPM 2-PIN CONNECTOR



C. RPM 2-SPADE SENSOR



C. ZERO CROSSING RPM SENSOR



C. ZERO CROSSING TDC SENSOR



C. FERROUS MATERIAL SENSOR



C. MAGNETIC PULSE SENSOR



D. INDUCTIVE MAGNETO RPM SENSOR



D. MSD MAGNETO PICKUP ADAPTER

C. REED SWITCH RPM SENSOR

These contact closure-type sensors use an internal, fast acting reed switch to indicate the passing of a rotating magnet.

RPM Sensor, 2-Pin 5/16" 24 dia. 800-SS-PRO-5
Commonly used as a driveshaft RPM sensor on pre-2001 clutch RPM sensor with Pro Series recorders.

RPM Sensor, 2 Spade Connectors, 5/16" 24 dia. 800-SS-RB-5
Commonly used for clutch, driveshaft and front wheel RPM with SC1000 recorders.

ZERO CROSSING RPM SENSORS

Zero Crossing RPM Sensor, 3-Pin 3/8" dia. 800-SS-ZX-3
This non-powered sensor is designed for monitoring magnetic pulses. It must be used with an RPM input designed for a zero crossing sensor. Used as the clutch RPM or Front Wheel RPM sensor on V-series and 2001 and newer Pro Series recorders.

Zero Crossing TDC Sensor, 3-Pin 3/8 dia. 800-SS-TDC-3
This sensor is designed specifically for use with MSD-style crank trigger wheel and magnets. It must be used with a RPM input designed for a zero crossing sensor. Commonly used for the TDC indicator on ignition timing monitor with V500 recorders.

HALL EFFECT SENSOR

Ferrous Material sensor, 3-Pin, 3/8" dia. 800-SS-MSC-3
Commonly used to sense a ferrous bolt or metal tooth, such as used when monitoring the ring gear RPM. These powered sensors require 12v power.

Magnetic Pulse Sensor, 3-Pin, 5/16" dia. 800-SS-MSC-5
Same as above, but triggered by a magnet rather than a ferrous metal.

D. ENGINE RPM WITH MAGNETO IGNITION

Occasionally, a V-series data recorder will be used to monitor the RPM of an engine that is equipped with a magneto ignition system. In this situation the engine RPM signal is acquired using the inductive pickup shown below. This sensor sources the ignition pulses between the magneto and the control box, and then transfers the signals to the onboard recorder through the RPM module.

Inductive Magneto RPM Sensor 280-SN-MAGPU
With connector to plug into 2-pin cable.

Inductive Magneto RPM Sensor 280-SN-MAGPU3
With connector to plug into 3-pin cable.

ADAPTER MODULE

MSD Magneto Pickup Adapter (MSD 12 or 20 amp mag) 800-CA-MAGADPT
Adapts the Inductive Engine RPM sensor to the V-Net Cable

A. SPLIT COLLARS

These aluminum split collars provide a mounting platform for the magnets that are used to trigger the sensor when monitoring the revolutions of a shaft. They are typically used on rear end yokes or couplers to provide driveshaft RPM. Each collar is approximately .375" wide and houses two magnets which are located 180° apart. Custom size and dual magnet collars are available by special order.

SPLIT COLLAR ONLY WITH TWO MAGNETS

1.050 (27mm)	800-CL-2M-105
1.375	800-CL-2M-137
1.500	800-CL-2M-150
1.625	800-CL-2M-162
1.812	800-CL-2M-181
1.875	800-CL-2M-187
2.125	800-CL-2M-212
2.187	800-CL-2M-218
2.375	800-CL-2M-2375
2.400	800-CL-2M-240
2.500	800-CL-2M-250
3.000	800-CL-2M-300
3.187	800-CL-2M-318
3.250	800-CL-2M-325
3.500	800-CL-2M-350

SPLIT COLLAR ONLY WITH EIGHT MAGNETS

For use with V300SD, V500SD, Sportsman data recorders. If using a recorder other than listed, contact Racepak.

1.875	800-CL-8M-1875
2.125	800-CL-8M-2125
2.187	800-CL-8M-2187

B. MAGNETS

These are the rare earth magnets that are currently used in the clutch input shaft, the split collars shown above or with some front wheel RPM applications. Each magnet measures .250" OD x .200" in length. North end of magnet is painted yellow for easy identification.

Magnet Only, Rare Earth, Single	800-MG-SM-.25
---------------------------------	---------------



A. TWO MAGNET SPLIT COLLAR

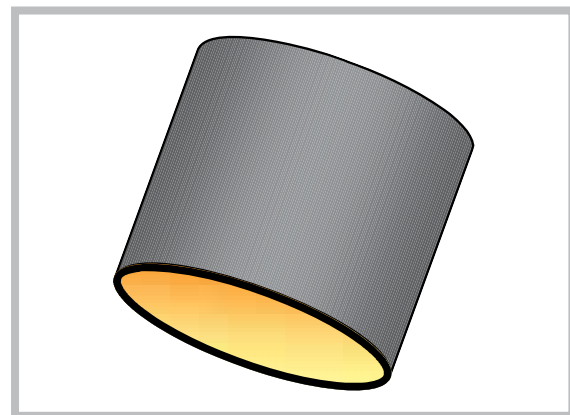
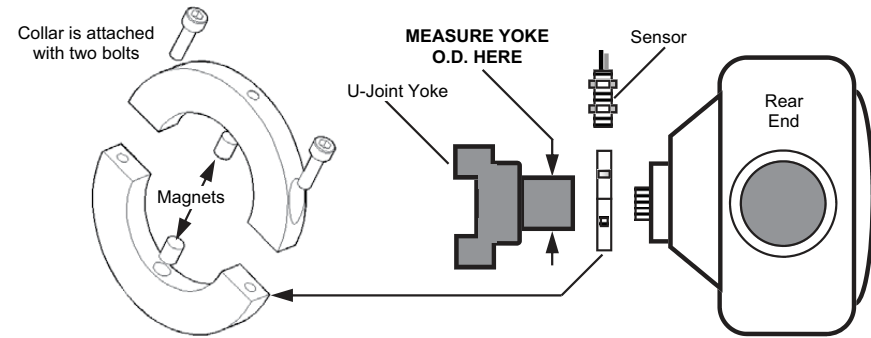

B. RARE EARTH MAGNET



C. SHIFT LIGHT

C. SHIFT LIGHT

As a companion component to our programmable V-Net Shift Light Modules, Racepak has made available this high intensity LED shift light. The light features a powerful light emitting diode for luminosity that can't be missed even on the brightest of race days.

Shift Light, Black Housing	800-XP-SLMSD
----------------------------	--------------

D. BATTERY CHARGERS

For charging the internal lithium-polymer battery inside the Pro III/IIIA data logger. It connects through the logger's USB charging/programming port and has a detachable lead to prevent damage from occurring to the unit. It features a smart charging circuit and LED indicator to ensure the battery gets a proper charge.

Pro III/Pro IIIA Battery Charger	800-BC-LI11
----------------------------------	-------------

Pro 1, 1B & Pro II Battery Charger	800-BC-N12
------------------------------------	------------

05

Tip #5 What can a Racepak digital dash display? Both the UDX and IQ3 can display any valid sensor data connected to the dash, but the flexibility of each dash allows the user to decide which data channel and where it will be displayed on the dash.

OFF ROAD CLOSED COURSE



A. SMARTWIRE POWER CONTROL MODULE



B. SMARTWIRE SWITCH PANEL



B. SMARTWIRE SWITCH MODULE

OFF ROAD / CLOSED COURSE VEHICLE WIRING

A. SMARTWIRE POWER CONTROL MODULE

Based on Racepak's exclusive single cable V-Net technology, the Racepak SmartWire module is the electronic "starting point", with a direct main power connection from the vehicle battery to the module. Each input/output is then user defined, both in function, power requirements and current exceeding limits via a USB connection to the user's PC. The design of the module functions to both reduce overall installation weight / clutter, while providing a quicker reacting electronic system, through the solid state switching design.

Manual activation can be achieved through use of either an optional eight switch Racepak Switch Panel or 16-channel Switch Module. From the Racepak SmartWire unit, a single small cable is routed to the Switch Panel, reducing wiring clutter. Users needing additional switch panel capabilities can easily expand through the use of a "jumper" cable to a second Racepak Switch Panel or Switch Module.

FEATURES

CAPACITY:
125 Total Amps

CHANNELS:
30 Total Channel Outputs
8 Channels @ 20 Amp Maximum
22 Channels @ 10 Amp Maximum

12 Hardwired Switch Inputs

DATA OUTPUT:
Volts
Amps
State

RESPONSE:
3.0 Millisecond

PROGRAMMING:
USB Interface

DIMENSIONS:
6" (L) x 5.5" (W) x 1.5" (H)
(25.2 cm x 13.9 cm x 3.8 cm)

INCLUDES:
Racepak SmartWire Module
Connector Kit
USB Cable
Programming Software

SmartWire Module Kit	500-KT-SW30
----------------------	-------------

B. SMARTWIRE ACCESSORIES

SmartWire Switch Panel	500-SW-PNL8
------------------------	-------------

SmartWire Switch Module	500-SW-5M16
-------------------------	-------------

Switch Panel Mount Bracket	500-MB-SP-xxxx
<i>(Available sizes are: 1.50", 1.625" and 1.75")</i>	

SmartWire to Switch Panel Cable	500-CA-BN5P-xxx
<i>(Variety of sizes offered)</i>	

SmartWire to V-Net Cable	500-CA-BN5P-xxx
<i>(Available sizes are: 9", 18" and 36")</i>	

SmartWire Tee Cable	580-CA-BN-TEE
<i>(Available sizes are: 7")</i>	

OFF ROAD & CLOSED COURSE

OFF ROAD / CLOSED COURSE
DATA RECORDERS

A. IQ3 DATA LOGGER DASH

The IQ3 merges Racepak's V-Net single cable sensor technology and proven GPS based data logging with a fully programmable display, creating a complete data center. The full feature dash includes an internal 42 sensor channel data logger, while track mapping and speed is obtained by the internal GPS board and 3 axis G meter thus eliminating the need for an external data logger, beacon receiver and wheel speed sensor. No sensor wiring harness is required, as all external sensor data is routed to the rear of the dash by a single V-Net cable. The DatalinkII software included with the IQ3 dash provides professional level data analysis capabilities, but in an easy to learn format.

FEATURES

CHANNELS:

47 total
V-Net: 42 digital/analog
Internal: 5

SAMPLE RATE:

V-Net: up to 100 per second

MEMORY:

Up to 16GB microSD Memory Card
Recording time depends on number of channels monitored and sample rates

DIMENSIONS:

7.25" (L) X 4.000" (W) X 1.125" (deep)
(18.41cm X 10.16cm X 5.39cm)

WEIGHT:

1 lb. (453g)

SPECIFICATIONS

42 external sensor input with optional high speed logging modules.
Internal GPS board
Display up to 28 inputs via 4 pages microSD Memory Card
Blue backlight
3 Axis G meter (Accel, lateral, vertical)
Gear Indicator
Eight user defined alarms with on screen warning text and lights
User defined 5 character sensor input names
User defined shift lights
GPS Track Mapping
GPS Speed and Lap Time
Power/Ground/Engine RPM /Remote Programming harness
Shielded, low luster display for sunlight viewing
Metric and English capable

IQ3 Logger Dash **250-DS-IQ3LD**

B. IQ3 ACCESSORIES

External Programming Buttons **280-SW-IQ3BTN**

Faux Carbon Mounting Panel **800-MB-IQ3-PCF**

Black Mounting Panel **800-MB-IQ3-PBLK**

Silver Mounting Panel **800-MB-IQ3-PAL**

CNC-Machined Mounting Bracket **800-MB-IQ3**



A. IQ3 LOGGER DASH

IQ3 PACKAGE INCLUDES

IQ3 Data Logger Dash
Power/Ground/Engine RPM/Remote Programming harness
Rear V-Net connector/GPS antenna connector
512mb microSD memory card
GPS antenna and cable
Programming cable
DatalinkII software and installation manual

TYPICAL USES

Road Racing
Circle Track
Marine
Pulling

IQ3 PACKAGE MONITORS

GPS Lap Time and Lap Number
GPS Speed
Battery Voltage
Accel G/Lateral G/Vertical G
Engine RPM (with appropriate tach signal)
Shift Lights
Warning Lights
Gear Indicator (with appropriate tach signal)
Data logging of included internal sensors and optional external sensors
28 total programmable inputs on four display pages

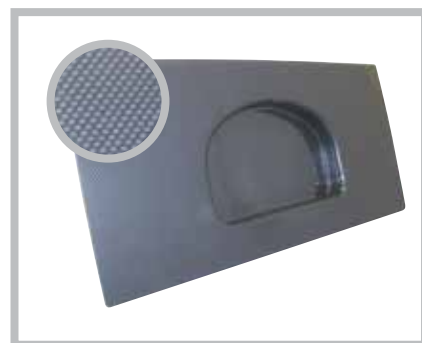

B. MOUNTING PANEL



B. CNC-MACHINED MOUNTING BRACKET

OFF ROAD / CLOSED COURSE
DATA RECORDERS

C. G2X-PRO DATA RECORDER

The G2X-Pro builds on the G2X's already impressive capabilities by allowing the user to monitor up to 71 channels, while providing lap and segment timing along with speed and track mapping functions through the use of GPS information. The G2X-Pro utilizes our exclusive V-Net plug and play technology which allows the data from up to 56 sensors to be transmitted via a single cable to the data recorder. The G2X-Pro brings with it more hardware in the form of our steering position, throttle position, and brake pressure package. This package provides easy installation through the use of a module that permits the user to terminate these sensor cables to the desired length. A single cable then links the module to the G2X-Pro recorder. Suspension and ride height data may also be obtained by purchasing the appropriate shock and ride height sensor package, which installs and transmits data in the same method as the steering/throttle/brake package. In addition, any V-Net sensor may be used with the G2X-Pro.

The G2X-Pro can utilize any of our three available display dashes, depending upon the user's requirements. The UDX provides 21 programmable inputs, but does not allow the ability to set start/finish from the dash. The G2X mini dash (standard G2X dash) allows the user to set start/finish, while programming any two sensor inputs along with shift lights, for display. The IQ3 display dash provides the 24 programmable inputs, shift lights, warning lights and the ability to set start/finish from the dash.

FEATURES

CHANNELS:

72 Total
V-Net: 56
Analog: 8 hard-wired
Digital: 4 hard-wired Internal: 4

SAMPLE RATE:

V-Net: up to 100 per second
Analog: up to 1000 per second
Digital: RPM and switch contacts up to 100 per second

MEMORY:

Up to 16GB SD Memory Card
Recording time depends on number of channels monitored and sample rates

INTERNAL SENSORS:

Battery Voltage
Longitudinal g-meter (acceleration and deceleration)
Lateral g-meter (side-to-side motion)
GPS

DIMENSIONS:

5.350" (L) X 5.5550" (W) X 1.215" (H)
(13.589cm X 14.1097cm X 3.0861cm)

WEIGHT:

17 ozs. (.48 kg)

G2X-Pro Data Recorder **600-KT-G2X-PRO**



C. G2X-PRO DATA RECORDER

G2X-PRO PACKAGE INCLUDES

G2X-Pro Recorder
GPS Antenna
Up to 16GB SD Memory Card
Datalink II Software Communication Cable
Power/Ground/Engine RPM Harness

TYPICAL USES

Road racing
Oval track racing
Boats
Motorcycles
Pulling

G2X-PRO PACKAGE MONITORS

Accel G
Lateral G
Battery Volt
Track Mapping
GPS Speed
Lap Time
Lap Number
Segment Time
Engine RPM



D. G2X-PRO MOUNTING BRACKET

D. G2X-PRO MOUNTING BRACKET

1.250" O.D. Tubing **800-MB-V500-125**

1.500" O.D. Tubing **800-MB-V500-150**

1.625" O.D. Tubing **800-MB-V500-162**

1.750" O.D. Tubing **800-MB-V500-175**

OFF ROAD / CLOSED COURSE DATA RECORDERS

A. G2X DATA RECORDER

The key to the G2X is its ability to interpret signals from GPS satellites to quickly establish the position and movement of the vehicle. From this monitored data other performance parameters can then be calculated. The G2X has the ability to provide track mapping, lap times/number/distance, segment times, speed, lateral G-force, and acceleration G-force.

Enhancing the features of the G2X is its versatile digital display dash that will provide the driver with a display of lap times, lap number, per lap gain/loss, gear indicator, progressive shift light, battery voltage, and G-forces. Engine RPM is available to those with an ignition system that provides a tach signal output, and three additional inputs from external sensors can be displayed on the dash. When the vehicle is stationary the gear indicator becomes a display of the number of satellite currently being monitored. The dash is also used to provide a means of defining the start/finish line while on the track, thus providing immediate access to displayed data. The dash can be attached to a steering wheel or mounted on the dash panel. A single cable provides the connection between the G2X and the dash for programming purposes.



A. G2X DATA RECORDER

G2X GPS PACKAGE INCLUDES

G2X Recorder
GPS Antenna
LED Dash Display
SD Memory Card
Datalink II
Software
Communication Cable
Cigarette Lighter Adapter
Power/Ground/ Engine RPM Harness

TYPICAL USES

Road racing
Oval Track racing
Club racing
Driving schools
Karting
Pulling
Motorcycles
Test Facilities

G2X GPS PACKAGE MONITORS

Lap Times
Lap Number
Per Lap Gain/Loss
Gear Indicator
Progressive Shift Lights
Accel G/Lateral G
Battery Voltage
GPS Speed



D. G2X MOUNTING BRACKET

D. G2X MOUNTING BRACKET

1.250" O.D. Tubing	610-MB-125
1.500" O.D. Tubing	610-MB-150
1.625" O.D. Tubing	610-MB-1625
1.750" O.D. Tubing	610-MB-175

FEATURES

CHANNELS:

V-Net: 18
Internal: 4
16 Total Channels

SAMPLE RATE:

V-Net: up to 100 per second

MEMORY:

Up to 16GB SD Memory Caard
Recording time depends on number of channels monitored and sample rates
Record multiple runs
Cableless download

DIMENSIONS:

5.6" (L) X 4.00" (W) X 1.5" (H)
(14.2cm X 10.16cm X 3.81cm)

WEIGHT:

Logger: 13 oz. (.37 kg)
Kit: 1 lb. 13 oz. (.81 kg)

INTERNAL SENSORS:

Battery Voltage
Longitudinal g-meter (acceleration and deceleration)
Lateral g-meter (side-to-side motion)
GPS

G2X Data Recorder Kit	600-KT-G2XR
Kit without Dash	600-KT-G2XRND

OFF ROAD / CLOSED COURSE INSTRUMENTATION

B. UDX DISPLAY DASH

Capable of being utilized with any of Racepak's V-Net series of data recorders. UDX Utilizes the same V-Net cable the external sensors use. The UDX display is capable of "sharing" sensor data with the data logger, thus providing the ability to display or trigger warnings based on any internal or external sensor in use by the data logger.

FEATURES

SPECIFICATIONS:

Display up to 21 Sensor Inputs via 4 pages.
Adjustable Backlighting
User Defined Warning Lights
Minimum/Maximum Recall

INCLUDES:

UDX Display Dash

DISPLAY DASH PROVIDES:

Any 21 Sensor Inputs Shift Light Output Warning Lights

DIMENSIONS:

4" (H) x 10.2" (W) x .75"(deep*) * Requires 2" rear clearance
(10.16cm x 25.90cm x 1.90cm)

WEIGHT:

21 ozs. (.58 kg)

UDX DISPLAY	250-DS-UDX
-------------	------------

E. UDX ACCESSORIES

2. Faux Carbon Mounting Panel	800-MB-UDX-PAL
3. Black Mounting Panel	800-MB-UDX-PBLK
4. Silver Mounting Panel	800-MB-UDX-PAL



B. UDX DISPLAY DASH



E. UDX MOUNTING PANEL

06

Tip #6 Own a 2008 or later vehicle and looking for the coolest instrumentation panel around? Racepak's OBD2 module is just the answer.

Combined with a Racepak IQ3 digital dash, the OBD2 module can provide complete instrumentation, with setup and programming taking just a few minutes, instead of the typical hours of mounting and wiring gauges.

OFF ROAD / CLOSED COURSE
INSTRUMENTATION

A. IQ3 DASH DISPLAY

The IQ3 can be utilized with any of Racepak's V-Net data loggers, providing a compact LCD digital dash. The IQ3 can be utilized as a standalone display dash, independent of a Racepak V-Net data logger, through the use of optional sensors off of the V-Net port, located on the rear of the dash.

FEATURES

SPECIFICATIONS:
Display up to 28 inputs via 4 pages
Blue backlight
Gear Indicator
Eight user defined alarms
User defined 5 character sensor input names
User defined shift light output
Shielded, low luster display for sunlight viewing
Metric and English capable

DIMENSIONS:
7.25" (L) x 4.000" (W) x 1.125" (deep)
(18.41cm x 10.16cm x 5.39cm)

WEIGHT:
1lb. (453g)

IQ3 DASH DISPLAY	250-DS-IQ3
-------------------------	-------------------

B. IQ3 ACCESSORIES

External Programming Buttons	280-SW-IQ3BTN
Faux Carbon Mounting Panel	800-MB-IQ3-PCF
Black Mounting Panel	800-MB-IQ3-PBLK
Silver Mounting Panel	800-MB-IQ3-PAL

C. INTELLI-GAUGES

These are not your average analog or digital gauge. They are both. In addition, they are highly accurate, stylish, dependable, and provide real time display for your monitored functions.

FEATURES

SPECIFICATIONS:
User Programmable warning levels
Download recorded data to PC Plug-and-play installation
Analog and digital display Lightweight, sonic welded
Electro-luminescent radial lighting

DIMENSIONS:
2 5/8" diameter and feature a 270° sweep needle

WEIGHT:
49g

[View Selection Chart on Next Page](#)



A. IQ3 DASH DISPLAY



B. EXTERNAL PROGRAMMING BUTTON

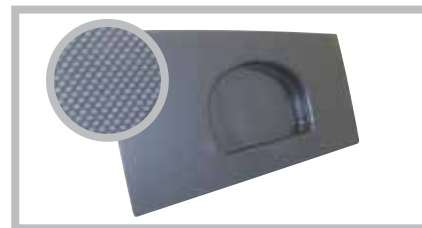

B. MOUNTING PANEL



C. INTELLI-GAUGES

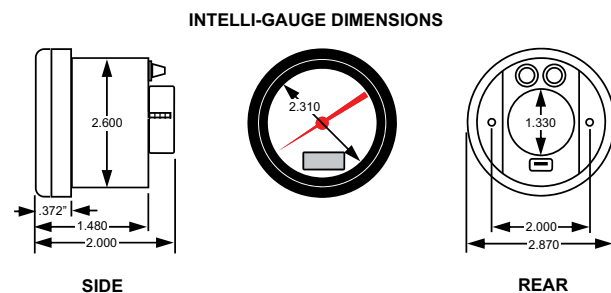

OFF ROAD / CLOSED COURSE
INSTRUMENTATION

INTELLI-GAUGE SELECTION CHART

INTELLI-GAUGE	RANGE	● BLACK FACE	○ WHITE FACE
RPM, TACHOMETER	1,000-10,500 RPM	250-IG-100BB	250-IG-100WB
RPM, TURBINE PERCENTAGE, N1	0-120%	NA	250-IG-218WB
RPM, TURBINE PERCENTAGE, N2	0-120%	NA	250-IG-219WB
TEMPERATURE, WATER (STREET)	100°-280°F	250-IG-110BB	250-IG-110WB
TEMPERATURE, WATER (RACE)	60°-200°F	250-IG-120BB	250-IG-120WB
TEMPERATURE, OIL	140°-280°F	250-IG-130BB	250-IG-130WB
TEMPERATURE, EXHAUST GAS	600°-1,600°F	250-IG-140BB	250-IG-140WB
TEMPERATURE, EXHAUST GAS #2	600°-1,600°F	250-IG-145BB	250-IG-145WB
TEMPERATURE, EXHAUST GAS	0°-1,000°F	NA	250-IG-220WB
TEMPERATURE, CYLINDER HEAD	100°-600°F	250-IG-150BB	250-IG-150WB
TEMPERATURE, TRANSMISSION	50°-350°F	250-IG-135BB	250-IG-135WB
PRESSURE, OIL	0-100 psi	250-IG-160BB	250-IG-160WB
PRESSURE, OIL	0-250 psi	NA	250-IG-162WB
PRESSURE, FUEL	0-15 psi	250-IG-170BB	250-IG-170WB
PRESSURE, FUEL	0-100 psi	250-IG-165BB	250-IG-165WB
PRESSURE, FUEL	0-250 psi	NA	250-IG-167WB
PRESSURE, FUEL	0-500 psi	NA	250-IG-226WB
PRESSURE, BRAKE	0-1,500 psi	250-IG-180BB	250-IG-180WB
PRESSURE, NITROUS	0-1,600 psi	250-IG-175BB	250-IG-175WB
PRESSURE, (GENERIC)	0-200 psi	250-IG-190BB	250-IG-190WB
PRESSURE, (GENERIC)	0-300 psi	250-IG-193BB	250-IG-193WB
PRESSURE, (GENERIC)	0-500 psi	NA	250-IG-223WB
PRESSURE, (GENERIC)	0-1,000 psi	250-IG-197BB	250-IG-197WB
BOOST / VACUUM	30 psi-0-30 in. hg	250-IG-215BB	250-IG-215WB
BOOST	0-60 psi	NA	250-IG-217WB
VACUUM	0-30 in. hg	250-IG-210BB	250-IG-210WB
AIR/FUEL RATIO	10-18	NA	250-IG-224WB
FLOW	3.5-4.5 GPM	NA	250-IG-222WB
FUEL LEVEL	E-F	NA	250-IG-225WB
VOLTS	8-20	250-IG-200BB	250-IG-200WB
VOLTS, (WITH INTERNAL SENSOR)	8-20	250-IG-204BB	250-IG-204WB
VOLTS	20-32	NA	250-IG-221WB



A. GAUGE TO GAUGE JUMPER CABLE

A. GAUGE TO GAUGE JUMPER CABLE

Used to connect each gauge in series after the first gauge. Each end of the cable has the small round connector that plugs directly into the back of the Intelli-Gauges.

8" Cable	280-CA-RGG-008
16" Cable	280-CA-RGG-016
24" Cable	280-CA-RGG-024
48" Cable	280-CA-RGG-048
288" Cable	280-CA-RGG-288

B. GAUGE TEE CABLES

Connects first gauge to V-Net cable or another V-Net module.

8" Cable	280-CA-RGG-T008
16" Cable	280-CA-RGG-T016
24" Cable	280-CA-RGG-T024



B. GAUGE TEE CABLE

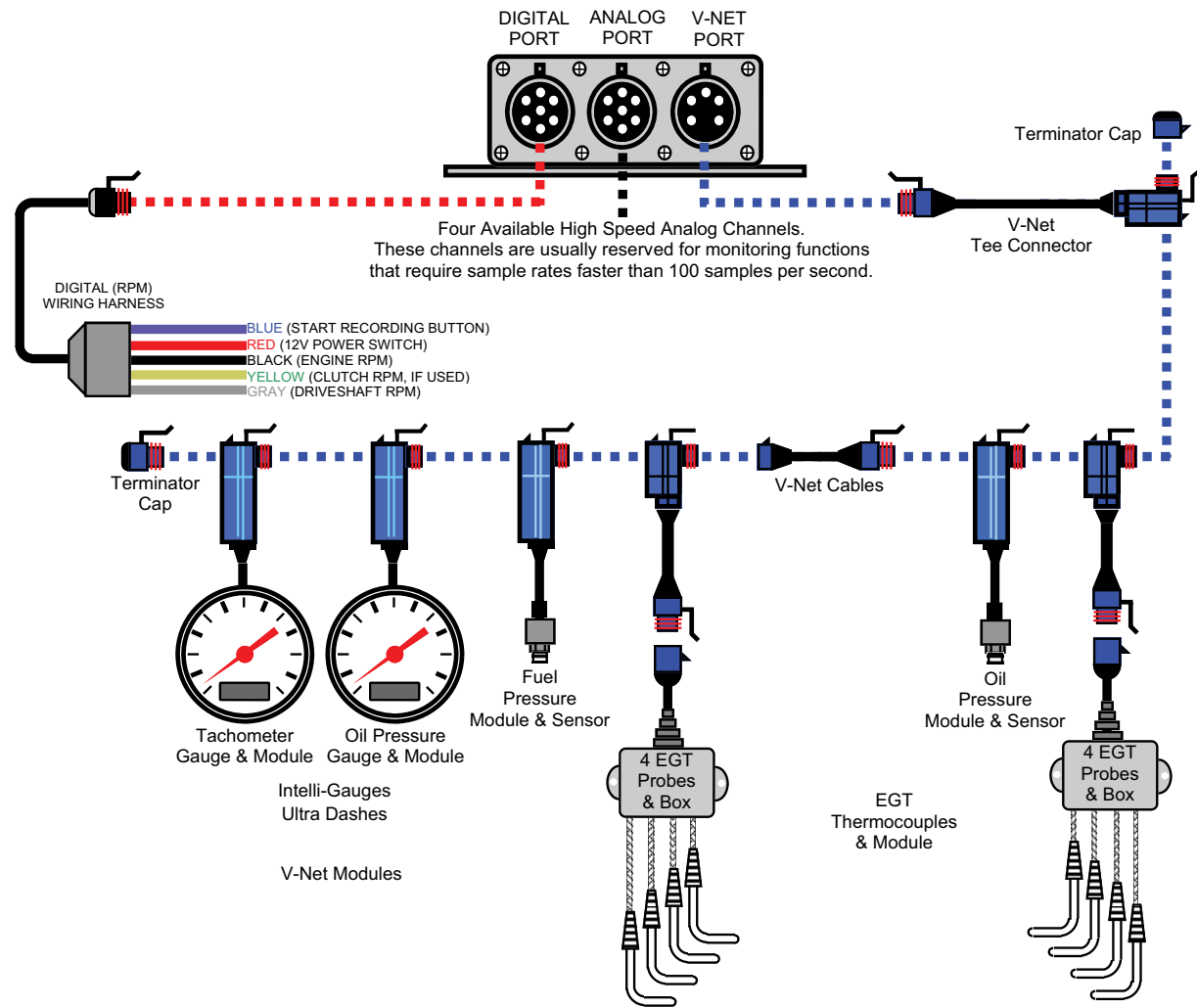

Racepak's Vehicle Network (V-Net) is a "smart data" transfer network providing the ability to transmit multiple signals from each sensor over a single cable. This technology creates a system in which the individual components interact with each other; making a simpler, more compact system which can be expanded with ease.

The key to accomplishing this is in the modular connectors that attach each of the devices to the main V-Net cable. Each module is essentially a miniature computer, which houses circuit boards and a microprocessor that identifies and retrieves only the proper incoming signals and allows other signals to pass through.

Whether you will be installing a single gauge set up, or a full-blown data acquisition system, all components are attached to the system using the modular snap-together connectors. Adding components onto the system is simple. Just find a junction in the main V-Net cable, separate the connectors, and sandwich the new sensor's module between them. Then command your software to read the new configuration. It will automatically recognize any additions or deletions from the system.

Gauge integration is another strength of the V-Net system, but don't mistake the Racepak gauges for garden variety gauges. If your vehicle is equipped with a V-Net recording system, the gauges simply use the sensors and wiring that are already in place to provide full time display of the data being monitored.

The same holds true for Racepak's digital display dashes. Some models of the dash will rely solely upon the data recorder's sensors to provide the information they display, while others are stand-alone requiring no data recorder. When you add Datalink II, the best Windows®-based software in the business, you will see why Racepak continues to be the most popular and widely used data acquisition system in the industry.

In order for a function to be monitored on the V-Net, the signal from that function must pass through two components: a sensor and a module. The sensor is the unit that actually measures the input from the function (i.e. pressure, temperature, etc.), while the module converts the signal so it can be transmitted over the V-Net. In the module sensor section that follows, you will find a complete listing of these components divided into categories.



A. FUEL PRESSURE



B. VACUUM

ANALOG PRE-PROGRAMMED WITH SENSORS

These pre-programmed analog function module and sensor combinations are ready for plug-and-play installation on the V-Net cable.

A. PRESSURE (48" Lead Length)

Boost (Manifold), 0-75 psi	220-VP-PT-BST75
Brakes, 0-1500 psi	220-VP-PT-B1500
Fuel Carburetor, 0-15 psi	220-VP-PT-CP15
Fuel, Nozzle, 0-150 psi	220-VP-PT-NP150
Fuel, Nozzle, 0-300 psi	220-VP-PT-NP300
Fuel, Nozzle, 0-500 psi	220-VP-PT-NP500
Fuel, Pump, 0-75 psi	220-VP-PT-PP075
Fuel, Pump, 0-150 psi	220-VP-PT-PP150
Fuel, Pump, 0-300 psi	220-VP-PT-PP300
Fuel, Pump, 0-500 psi	220-VP-PT-PP500
Nitrous Bottle #1, 0-1500 psi	220-VP-PT-N1
Nitrous Bottle #2, 0-1500 psi	220-VP-PT-N2
Nitrous Fuel #1, 0-15 psi	220-VP-PT-NF115
Nitrous Fuel #2, 0-15 psi	220-VP-PT-NF215
Nitrous Fuel #3, 0-15 psi	220-VP-PT-NF315
Nitrous Fuel #4, 0-15 psi	220-VP-PT-NF415
Oil, 0-150 psi	220-VP-PT-OP150
Oil, 0-300 psi	220-VP-PT-OP300
Pressure Differential, 0-40" H2O to 15 psi	220-VP-PT-PD145
Pressure Differential	220-VP-PT-PD745
Transmission, 0-300 psi	220-VP-PT-TP300
Turbo Back Pressure #1, 0-75 psi	220-VP-PT-EP175
Turbo Back Pressure #2, 0-75 psi	220-VP-PT-EP275
Turbocharger Outlet #1, 0-75 psi	220-VP-PT-TB10
Wheelie Bar, Left, 0-3000 psi	220-VP-PT-WBL3K
Wheelie Bar, Right, 0-3000 psi	220-VP-PT-WBR3K
Wheelie Bar, Left, 0-5000 psi	200-VP-PT-WBL5K
Wheelie Bar, Right, 0-5000 psi	220-VP-PT-WBR5K

B. VACUUM

MANIFOLD, 30 PSI 0-30 In. hg	220-VP-PT-BVAC
Pan (Crankcase), 0-30 In. hg	220-VP-PT-PVAC

OFF ROAD / CLOSED COURSE
V-NET SENSORS AND MODULES

A. TEMPERATURE

Pigtail cable lengths are shown in parenthesis.

Cylinder Head, Left, 0-600°F, (36")	220-VP-TC-HEADL
Cylinder Head, Right, 0-600°F, (36")	220-VP-TC-HEADR
Engine Oil, 0-300°F, (48")	220-VP-TR-OIL
Intake Manifold, Open Tip 0-600°F, (36")	220-VP-TC-MANIF
Intercooler Inlet, 0-300°F, (72")	220-VP-TR-ICTI
Rear End Oil, 0-300°F, (72")	220-VP-TR-RET
Transmission Oil, 0-300°F, (72")	220-VP-TR-TRANS
Water, 0-300°F (72")	220-VP-TR-WATER

B. EXHAUST GAS TEMPERATURES/CYLINDER BANK SETS

EGT junction box sets are ordered by the cylinder bank sequence they serve.

Junction Box & 4 Probes, 1357, Small Block	220-VP-TC-1357S
Junction Box & 4 Probes, 2468, Small Block	220-VP-TC-2468S
Junction Box & 4 Probes, 1357, Big Block	220-VP-TC-1357B
Junction Box & 4 Probes, 2468, Big Block	220-VP-TC-2468B
Junction Box & 4 Probes, 1234	220-VP-TC-1234
Junction Box & 4 Probes, 5678	220-VP-TC-5678
Junction Box & 4 Probes, Motorcycle	220-VP-TC-1234M
Junction Box & 3 Probes, 123	220-VP-TC-123
Junction Box & 3 Probes, 456	220-VP-TC-456
Junction Box & 3 Probes, 135	220-VP-TC-135
Junction Box & 3 Probes, 246	220-VP-TC-246

C. EXHAUST GAS TEMPERATURES/SINGLE CYLINDER

Single cylinder modules include the thermocouple.

Cylinder #1	200-VP-TC-EGT1
Cylinder #2	200-VP-TC-EGT2
Cylinder #3	200-VP-TC-EGT3
Cylinder #4	200-VP-TC-EGT4
Cylinder #5	200-VP-TC-EGT5
Cylinder #6	200-VP-TC-EGT6
Cylinder #7	200-VP-TC-EGT7
Cylinder #8	200-VP-TC-EGT8



A. FLUID TEMP

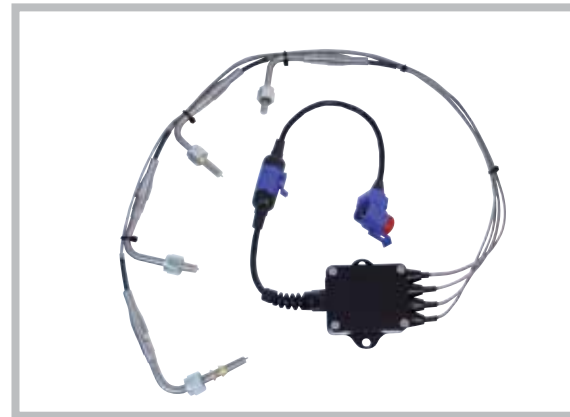

B. EXHAUST GAS TEMPERATURE JUNCTION BOX WITH PROBES



C. EXHAUST GAS TEMPERATURE SINGLE CYLINDER



D. VOLTAGE 0-5 INPUT



E. PRESSURE 0-75



F. FLUID TEMPERATURE 0-300°F

OFF ROAD / CLOSED COURSE
V-NET SENSORS AND MODULES

D. ANALOG PRE-PROGRAMMED WITHOUT SENSORS

These analog function modules have been programmed for general usage, and have not been assigned to a specific task. Use of these modules on the V-Net cable requires the addition of a sensor and configuration of the module using your DatalinkII software.

Voltage, 0-5 Volt Input, 5 Volt Output	230-VM-AN-5V
Voltage, 0-5 Volt Input, 12 Volt Output	230-VM-AN-12V
Pressure, 5 Volt	230-VM-PT-5V
Position/Movement, Rotary or Linear	230-VM-TPS
Temperature, Fluid-type, 0-300°F <i>For use with sensor #810-TR-300 only</i>	230-VM-TR-300
Temperature, Low, 0-600°F <i>For use with type K thermocouples only</i>	230-VM-TC-600
Temperature, High, 0-1800°F <i>For use with type K thermocouples only</i>	230-VM-TC-1800
Air/Fuel Sensor Input, Single	230-VM-AF
Air/Fuel Sensor Input, 4 Station	230-VM-AF (CYL #s)
Battery Voltage	230-VM-BVOLT
Voltage Differential	230-VM-5VDIFF
Universal Sensor Module	230-VM-USM

ANALOG NOT PRE-PROGRAMMED WITH SENSORS

The module/sensor combinations are the same as the V-Net Modules with Sensors/Analog on pages 19-20 with the exception that they have not been pre-programmed. Each of the pressure or temperature module/sensor combinations below is designed to be attached to the V-Net cable. Once installed, they must be programmed using the Configuration File in the Datalink software.

E. PRESSURE

0-15 psi	220-VS-15GVT
0-75 psi	220-VS-75GVT
0-150 psi	220-VS-150GVT
0-300 psi	220-VS-300GVT
0-500 psi	220-VS-500GVT
0-1500 psi	220-VS-1500GVT
Vacuum/Pressure 30 In. hg-0-30 psi	220-VS-VB

F. TEMPERATURE

Fluid Temperature, 0-300°F, Fluid Type Sensor <i>Uses the #180-TR-300 sensor</i>	220-VS-TR-300
---	---------------

OFF ROAD & CLOSED COURSE

OFF ROAD / CLOSED COURSE
V-NET SENSORS AND MODULES

A. FLUID TEMPERATURE SENSOR 810-CN-TR2P

Use with V-Net modules and temperature sensors having prefix number of 220-VP-TR-, 220-VM-TR-, or 230-VM-TR-.

B. PRESSURE SENSOR 810-CN-TI3P

Use with V-Net module and pressure sensor having prefix number of 220-VP-PT-, 220-VS-, or 230-VM-PT-.

C. EXTENSION CABLES

These custom-built extensions can be used to extend the length of cables that use a 2-Pin or 3-Pin Molex connector to attach the sensor to the power harness or a module's pigtail. Please specify length required when ordering.

2-Pin Molex Cable, Specify Length 800-CA-EXT2P

3-Pin Molex Cable, Specify Length 800-CA-EXT3P

D. MOLEX TERMINAL KITS

These connector kits can be used if the need arises to shorten a cable that is terminate. Available with a two or three pin Molex connector. Kit includes both a male and female connector and pins.

2-Pin Molex Connector Kit 810-CN-MOL2

Pin Molex Connector Kit 810-CN-MOL3

Crimp Tool for Molex Terminal Pins 800-XP-CRIMP-01F



C. EXTENSION CABLES



D. 2 AND 3 PIN CONNECTOR KITS



E. DRIVESHAFT RPM



F. ZERO CROSSING INPUT



G. ENGINE RPM INPUT

OFF ROAD / CLOSED COURSE
V-NET SENSORS AND MODULES

E. DIGITAL PRE-PROGRAMMED MODULES WITH SENSORS

These pre-programmed digital function modules and sensor combinations are ready for plug-and-play installation on the V-Net cable. See sensors only page.

CLUTCH RPM 220-VP-CL-1
Monitors magnetic pulses using a Zero Crossing sensor.

Drive Shaft RPM, Automotive (Contact Closure Sensor) 220-VP-DS-2
Contact Closure sensor, includes split collar, magnet, and bracket kit.

Drive Shaft/Rear Wheel RPM, Motorcycle 220-VP-ZXDS-2
Monitors magnetic pulses using a Zero Crossing sensor.

Front Wheel RPM 220-VP-FWZX
Monitors magnetic pulses using a Zero Crossing sensor.

Front Wheel RPM 220-VP-FWHE3
Monitors ferrous metal pulses using a Hall Effect sensor.

Turbo Speed for use with Racepak V-Net Data Loggers 220-VP-TURBORPM

Turbo Speed V-Net Module only 230-VM-TURBO

Turbo Speed Sensor only 800-SS-SPEED

F. DIGITAL PRE-PROGRAMMED MODULES WITHOUT SENSORS

These pre-programmed digital function modules are ready for plug-and-play installation on the V-Net cable. You must add the appropriate sensor to the module.

Zero Crossing Input 230-VM-ZX-1

Hall Effect Input 230-VM-RPMHE

Contact Closure Input 230-VM-CC-1

Event Marker Input, 12 Volt 230-VM-EVENT

Event Marker Input, Switch Closure 230-VM-EVENTSW

Flow Meter 230-VM-FLOW

Four Channel Digital Input 230-VM-4DIGIN

Four Channel Digital Output 230-VM-4DIGOUT

G. DIGITAL PRE-PROGRAMMED MODULES NO SENSORS REQUIRED

These modules do not require a sensor. They use the pulse from the component they are monitoring as the signal to the module. Each has been programmed for the specific use noted and is ready for plug-and-play installation on the V-Net cable.

Engine RPM Input Module 220-VP-TACH-4

Transbrake Event 12 Volt Triggered 220-VP-TBRAKE

Wide Open Throttle Event 220-VP-WOTEVENT

Clutch Event 12 Volt Triggered 220-VP-CLTEVENT

A. EFI DATA INTERFACE

These V-Net modules have been created to interface with many electronic fuel injection systems on the market. Each V-Net EFI Data Interface module is equipped to allow direct connection with EFI. These modules allow your V-series data recorder to share the data collected by these systems rather than having to install duplicate sensors to monitor functions that are already being monitored by the EFI system. The shared data can be recorded or displayed just as you would any function monitored independently by your Racepak V-series recorder. Caution should be exercised to ensure that you do not exceed the maximum number of V-Net channels supported by your particular logger. The individual functions monitored by each EFI system are outlined in the chart below. **For use with Racepak V-Net data loggers.**

Accel DFI Gen VII	230-VM-EFIDFI
AEM	230-VM-EFIAEM
Autronic SMC & SM2	230-VM-EFIAUT
Autronic SM4 V107 & V109	230-VM-EFIAUT4
Big Stuff 3	230-VM-EFIBS3
Corvette C6 OBDII GMX3 (2006 and Later)	230-VM-EFIIC6
EFI Technologies	230-VM-TECH
FAST XFI CAN	230-VM-EFIXFI
FAST Serial	230-VM-EFIFST
Generic J1939 CAN	230-VM-EFICAN
Haltech	230-VM-EFIIHAL
Holley EFI	230-VM-EFIHOL
Hondata KPro	230-VM-EFIHOND
Megasquirt I	230-VM-EFIMS1
Megasquirt II	230-VM-EFIIMS2
MEFI 4B J1939 (GM PN 12584052, 12575479)	230-VM-EFIIM4
Motec M400, M600, M800, M84	230-VM-EFIMOTEC
Motec M4, M48	230-VM-EFIMOTSR
Omex	230-VM-EFIOMEX
Omniteck EC44	230-VM-EFIEC44
PRO EFI	230-VM-EFIPRO
Vipec	230-VM-EFIVIPEC
WOLF V500	230-VM-EFIWOLF
Atomic LS	230-VM-EFIALS
Atomic TBI	230-VM-EFIATBI
Fuel Tech	230-VM-EFIFUEL

B. SHIFT LIGHT/EVENT MODULE

The Shift Light Module allows you to use any LED-style light (300 milliamp maximum) as a fully-programmable, stand-alone shift light. By accessing the engine RPM off of the V-Net you can program up to six separate shift alarm signals. Each shift point is user-programmable using the DatalinkII software. Shift light module does not include the shift light. See Shift Light on page 36. This module will also show you when the shift light was triggered to come on

Shift Light/Event Module	230-VM-SHIFLTE
--------------------------	----------------

C. GMR SENSOR

The GMR (Giant Magneto Resistive) sensor acquires a tach signal inductively from a current carrying wire, and provides an RPM sign of 30% duration when the ignition coil fires. It can be used on the following types of ignition/coil systems: Capacitive Discharge Ignition, Inductive Coil per Cylinder Ignition, Distributorless Coil Pack Ignition, or Diesel Injector. Complete instructions for installation on each type of ignition system are provided with the sensor. No cutting or splicing required.

GMR Sensor	810-SN-GMR
------------	------------



B. SHIFT LIGHT/EVENT MODULE



C. GMR SENSOR

AIR/FUEL SENSORS

Racepak has created a selection of A/F controllers and sensors created specifically for tuning race engines. Each of these 2 and 4 channel controllers are designed to be connected to the V-Net cable of Racepak V-series recorders. When ordering please be aware that the sensors are calibrated for use on specific ports of the controller and cannot be interchanged from port to port without recalibration. All sensors have a 13" pigtail cable, and the controller has a 37" cable for attachment to the sensor. These lengths cannot be altered. Controllers are ordered by cylinder bank layout.

Racepak A/F sensors are compatible with either gasoline or methanol fueled engines. Gasoline application will display A/F ratios between 9.55:1 and 20:1, while methanol is shown from 4.22:1 to 8.7:1. Please specify the type of fuel you will be using when ordering. Each sensor includes one weldment and plug.



D. 4 CHANNEL AIR/FUEL CONTROLLER



E. SINGLE AIR/FUL CONTROLLER WITH SENSOR



F. RELAY CONTROL

D. AIR/FUEL CONTROLLERS

Sensors must be ordered separately

4 Channel Controller, Cylinders 1, 3, 5, 7 220-VM-AF4-1357
For use on 1, 3, 5, 7 cylinder bank of V8, i.e. GM & Mopar.

4 Channel Controller, Cylinders 2, 4, 6, 8 220-VM-AF4-2468
For use on 2, 4, 6, 8 cylinder bank of V8, i.e. GM & Mopar.

4 Channel Controller, Cylinders 1, 2, 3, 4 220-VM-AF4-1234
For use on 1, 2, 3, 4 cylinder bank of V8, i.e. Ford.

4 Channel Controller, Cylinders 5, 6, 7, 8 220-VM-AF4-5678
For use on 5, 6, 7, 8 cylinder bank of V8, i.e. Ford.

Air/Fuel Sensor Only 810-SN-AFAMP

Air/Fuel Weldment & Plug 810-TX-AFWLDP
Weldments are included with purchase of controller.

Air/Fuel Harness 'A' Side 280-CA-LSUA-AMP

Air/Fuel Harness 'B' Side 280-CA-LSUB-AMP

E. SINGLE AIR/FUEL CONTROLLER WITH SENSOR

Single channel air/fuel sensor package. Includes controller, (1) Bosch LSU air/fuel sensor, weld bung, wiring harness, instructions. Includes 0-5V reference output for external devices. For use with Racepak V-Net data loggers.

AF1 Package 220-VM-AF1

F. RELAY CONTROL MODULE

A Relay Control Module is the device which permits the V-Net system to perform a host of automated tasks. It allows any information transmitted over the V-Net to be used to activate external high power devices such as a switch, solenoid, water pump, fan, or lights. Each module has two programmable output relays.

Each relay can have up to two separate (analog and/or digital) control signals that must be met before the relay is engaged. For example, one relay can be programmed to turn on a water pump only when a 'Pump' switch is on and the water temperature is above the programmed value, while the other relay can be used to activate an ignition kill switch only if the engine RPM is above a programmed value and the oil pressure is lower than a predetermined pressure. Relays are included.

Relay Control Module 230-VM-RELAY

A. STEERING/THROTTLE/BRAKE KIT

GPS-based systems like the G2X and G2X-Pro are commonly used for the purpose of assessing a vehicle's handling characteristics in response to the driver's input. Popular functions that are monitored in this evaluation are the driver's steering input, throttle position, and front and rear brake pressures. Racepak has made it easy to add this commonly used selection of sensors to either the G2X or G2X-Pro by packaging all sensors and cables in a kit.

Steering/Throttle/Brake Kit **620-KT-STBB**

B. SHOCK TRAVEL KIT (G2X PRO ONLY)

Monitoring the extension and compression travel of the shock absorbers is one of the prime methods of evaluating the suspension movement and chassis setup. This Shock Travel Kit provides the necessary components to provide that information. The kit includes four 0-8 inch travel sensors and cables. Also included are four Turck connectors which simplify the job of custom tailoring the length of the cables for your application, as well as two Turck bulkhead connectors. Center-to-center distances on the shock travel sensor mounting points are 12.6 inches collapsed and 20.6 inches extended.

Shock Travel Kit **620-KT-4SHOCK**

C. RIDE HEIGHT KIT (G2X PRO ONLY)

The Ride Height Kit has been packaged to provide the components used to monitor the distance between the ground and the sensor at the four corners of the car. The kit consists of four infrared sensors, cables and the connectors that allow you to custom tailor the length of the cables to a Turck bulkhead connector. NOTE: Prior installation of our Shock Travel Kit (PN 620-KT-4SHOCK, shown above) is required as the ride height sensors share the bulkhead connectors used in the shock kit. If the Shock Travel Kit is not used you must add two 280-BH-4ANA-512 bulkhead connectors to this kit.

Ride Height Kit **620-KT-RIDEHT**



A. STEERING/THROTTLE/BRAKE KIT



B. SHOCK TRAVEL KIT



C. RIDE HEIGHT KIT

D. G2X AND G2X-PRO

Both the G2X and the G2X-Pro recorders are somewhat unique within the Racepak line of data acquisition systems. Although they share many components that are also used with other V-Net recorders, the optional and replacement components shown below can only be used with these GPS-based systems.

Also, there are two versions of the G2X. The original G2X (600-KT-G2X) was in a black housing and a new version was introduced in mid 2007 in a red housing. There are different harnesses available for the two models. The components listed here are for the original black housing design.



G2X CABLES

V-Net Adapter, 7' (Auxiliary port to V-Net modules)

BLACK HOUSING **RED HOUSING**

680-CA-AUX-084

NONE

GPS Antenna, 5'

ANTG-ANN-05

ANTG-ANN-05

Power/RPM, 6' (Hard wire into vehicle)

680-CA-PWR-4P

680-CA-PWR-R4P

Power/RPM (Cigarette lighter adapter)

680-CA-PWR-CLA

680-CA-PWR-R4P

Power/RPM, Pigtail Extension Only

680-CA-PWR-WPT

680-CA-PWR-R4P

Serial Cable, 6'

680-CA-SR-G2X

280-CA-ST140SR

Dash Extension, 6'

680-CA-EXT-5P72

NONE

Second RPM, 15' (Used with 800-SS-MS-3 sensor or with 800-SS-MS-5)

680-CA-RPM-4P15

680-CA-RPM-R2

Memory Card

CARD-MEM-CF128M

890-SDWC-2GB



E. V-NET MODULE



E. SERIAL CABLE



E. CABLE, TURCK MOLEX, 192"



E. CABLE, TURCK PACKARD, 192"



E. TURCK CABLE CONNECTOR



E. BULKHEAD CONNECTOR, 5VOLT OUT



E. BULKHEAD CONNECTOR, 12VOLT OUT



E. MEMORY CARD, 128MB



E. COVER PLUG, MEMORY CARD

E. G2X PRO CABLES AND COMPONENTS

V-Net Module	230-VM-4ANA7HR
Serial Cable	680-CA-SR-G2XP
Cable, Turck Molex, 192"	680-CA-TKM-192
Cable, Turck Packard, 192"	680-CA-TKP-192
Turck Cable Connector	800-CN-5143F
Bulkhead Connector, 5 volt out	280-BH-4ANA-5
Bulkhead Connector, 12 volt out	280-BH-4ANA-512
Memory Card, 128MB	CARD-MEM-SD128
Cover Plug, Memory Card	800-SD-COVER

CABLES

V-Net modules and Interface modules, although similar in construction and appearance, are very different in the functions they perform. It is important that components designed for one system not be interchanged with the other. V-Net cables use a 5-pin connector, while Interface cables use a 7-pin connector. So that cables can be identified at a glance Racepak has color-coded the connectors on the end of the cables. V-Net cable connectors are blue, just like the modules to which they attach, while Interface cable connectors and modules are black.

The cables listed may be used to link the components to other listed components of the same system, or to their proper port on the recorder. The Interface cables with black connectors will only be used with modules connecting to the RPM or Analog input ports, while the V-Net cables with blue connectors will be used exclusively on items connected to the V-Net port.

CABLE LENGTH	5-PIN BLUE V-NET	7-PIN BLACK INTERFACE
6"	280-CA-VM-006	280-CA-IM-006
12"	280-CA-VM-012	280-CA-IM-012
18"	280-CA-VM-018	280-CA-IM-018
24"	280-CA-VM-024	280-CA-IM-024
36"	280-CA-VM-036	280-CA-IM-036
48"	280-CA-VM-048	280-CA-IM-048
60"	280-CA-VM-060	280-CA-IM-060
72"	280-CA-VM-072	280-CA-IM-072
84"	280-CA-VM-084	280-CA-IM-084
96"	280-CA-VM-096	280-CA-IM-096
108"	280-CA-VM-108	280-CA-IM-108
120"	280-CA-VM-120	280-CA-IM-120
144"	280-CA-VM-144	280-CA-IM-144
168"	280-CA-VM-168	280-CA-IM-168
192"	280-CA-VM-192	280-CA-IM-192
216"	280-CA-VM-216	280-CA-IM-216

TEE CABLES

All V-Net systems must be equipped with a Tee cable. The Tee cable permits the installation of the two terminator caps (one male and one female) which are necessary to the operation of the V-Net system. Just like the ends on the V-Net cables, all V-Net Tee cables and Terminator Caps are blue.

Interface modules can also use a Tee cable, but only for the purpose of providing a branch in the system. It is not a mandatory component as it is on the V-Net system. The black Interface Tee cables and dust caps are used just for the purpose their names imply. They are not required for the system to operate properly.

Bulkhead connectors are used when a V-Net or Interface cable must pass through a firewall, body panel, or motor plate. They provide a male/female connector on each side of the panel. These are specific to the type of cable that is being used and are color coded for easy identification.

COMPONENT	5-PIN BLUE V-NET	7-PIN BLACK INTERFACE
TEE CABLE, 9"	280-CA-VM-T009	280-CA-IM-T009
TEE CABLE, 18"	280-CA-VM-T018	
TEE CABLE, 36"	280-CA-VM-T036	
TERMINATOR CAP, MALE	280-CA-VM-TCAPM	
TERMINATOR CAP, FEMALE	280-CA-VM-TCAPF	
DUST CAP, MALE		280-CA-IM-DCAPM
DUST CAP, FEMALE		280-CA-IM-DCAPF
BULKHEAD CONNECTOR	280-CA-VM-BHEAD	280-CA-IM-BHEAD

A. PRESSURE TRANSDUCERS

The small size and ruggedness of these 'PT-type' pressure transducers make them ideal for the measurement of pressure directly at the source. The transducer requires 5 volt DC power and provides a .5 to 4.5 volt output signal. Each transducer mounts using a 1/8" NPT male pipe fitting.



A. PRESSURE TRANSDUCER

0-15 psi	810-PT-0015GVT
0-75 psi	810-PT-0075GVT
0-150 psi	810-PT-0150GVT
0-300 psi	810-PT-0300GVT
0-500 psi	810-PT-0500GVT
0-1500 psi	810-PT-1500HP
0-3000 psi	810-PT-3000HP

VACUUM/PRESSURE SENSOR

30 In. hg-0-30 psi, Vacuum/Boost	810-PT-VB
----------------------------------	-----------

ADAPTER MODULES

The pressure sensors listed on page 19 can be adapted to the V-Net cable or analog port of the recorders by using the appropriate signal condition module.

V-Net Module	230-VM-PT-5V
For connection to the V-Net cable on the V-series recorders.	
Interface Module	240-VM-PT-5V
For connection on the analog port on V-series recorders.	

B. FUEL FLOW METER SENSORS

These general purpose turbine-type flow meters require an available digital channel. Gasoline and Nitro-methane flow meters are constructed of aluminum. Methanol fuel requires the use of a stainless steel flow meter. A tee fitting must be used so all fuel can be routed through the flow meter before it is divided between the hat nozzles and the port nozzles on fuel injection applications.



B. FUEL FLOW METER SENSOR

Flow Meter, Gas or Nitro, 8AN (1-10 GPM)	800-FM-AN8-AL
Flow Meter, Gas or Nitro, 10AN (2-25 GPM)	800-FM-AN10-AL
Flow Meter, Gas or Nitro, 12AN (2-70 GPM)	800-FM-AN12-AL
Flow Meter, Methanol, 8AN (1-10 GPM)	800-FM-AN8-SS
Flow Meter, Methanol, 10AN (2-25 GPM)	800-FM-AN10-SS
Flow Meter, Custom Order	Call for information
Tee Fitting 10AN inlet two 8AN outlets	Call for information

ADAPTER MODULES

V-Net Module	230-VM-FLOW
Use to connect flow meter to V-Net Cable.	

A. REED SWITCH RPM SENSOR

These contact closure-type sensors use an internal, fast acting reed switch to indicate the passing of a rotating magnet.

RPM Sensor, 2-Pin 5/16" 24 dia. 800-SS-PRO-5
Commonly used as a driveshaft RPM sensor on pre-2001 clutch RPM sensor with Pro Series recorders.

RPM Sensor, 2 Spade Connectors, 5/16" 24 dia. 800-SS-RB-5
Commonly used for clutch, driveshaft and front wheel RPM with SC1000 recorders.



A. RPM 2-PIN CONNECTOR



A. RPM 2-SPADE SENSOR

ZERO CROSSING RPM SENSORS

Zero Crossing RPM Sensor, 3-Pin 3/8" dia. 800-SS-ZX-3
This non-powered sensor is designed for monitoring magnetic pulses. It must be used with an RPM input designed for a zero crossing sensor. Used as the clutch RPM or Front Wheel RPM sensor on V-series and 2001 and newer Pro Series recorders.



A. ZERO CROSSING RPM SENSOR

Zero Crossing TDC Sensor, 3-Pin 3/8 dia. 800-SS-TDC-3
This sensor is designed specifically for use with MSD-style crank trigger wheel and magnets. It must be used with a RPM input designed for a zero crossing sensor. Commonly used for the TDC indicator on ignition timing monitor with V500 recorders.



A. ZERO CROSSING TDC SENSOR

HALL EFFECT SENSOR

Ferrous Material sensor, 3-Pin, 3/8" dia. 800-SS-MSC-3
Commonly used to sense a ferrous bolt or metal tooth, such as used when monitoring the ring gear RPM. These powered sensors require 12v power.

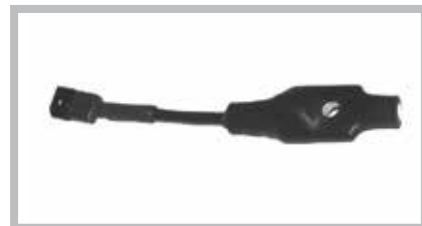

B. INDUCTIVE MAGNETO RPM SENSOR

Magnetic Pulse Sensor, 3-Pin, 5/16" dia. 800-SS-MSC-5
Same as above, but triggered by a magnet rather than a ferrous metal.

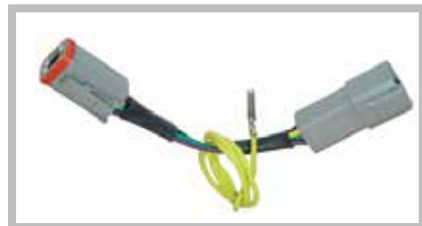

B. MSD MAGNETO PICKUP ADAPTER

B. ENGINE RPM WITH MAGNETO IGNITION

Occasionally, a V-series data recorder will be used to monitor the RPM of an engine that is equipped with a magneto ignition system. In this situation the engine RPM signal is acquired using the inductive pickup shown below. This sensor sources the ignition pulses between the magneto and the control box, and then transfers the signals to the onboard recorder through the wire harness or a V-Net module.

Inductive Magneto RPM Sensor 280-SN-MAGPU
With connector to plug into the V300 wiring harness.

Inductive Magneto RPM Sensor 280-SN-MAGPU3
With connector to plug into the V300SD wiring harness.

ADAPTER MODULE

V-Net 220-VP-TACH-(NUMBER OF PULSES)
Adapts the Inductive Engine RPM sensor to the V-Net Cable

MSD Magneto Pickup Adapter 800-CA-MAGADPT
(MSD 12 or 20 amp mag)
Adapts the Inductive Engine RPM sensor to the V-Net Cable

C. EXHAUST GAS TEMPERATURE THERMOCOUPLES

V-Net systems and V-series recorders use two types of thermocouple setups to monitor the exhaust gas temperatures, one for an individual cylinder application and another for 3 or 4 cylinder groups. Measuring the EGTs on a single cylinder application is accomplished using a thermocouple that features an inline, two-prong mini-connector. This connector provides the union between the thermocouple and the V-Net module. A selection of single cylinder thermocouples is shown below.

The most frequently used setup is the four thermocouples with junction box combination shown below. This setup simplifies the installation on V8 engines by grouping the four thermocouples on each cylinder bank into a common junction box. The junction box then provides a single wire connection to the V-Net module to facilitate service work. A similar setup is available for V6 engines.

V-Net applications also use two styles of thermocouples. Four cylinder motorcycles make use of the .187-inch diameter tip bullet-style thermocouples, while Harley-Davidsons and the automotive applications employ the .250-inch diameter Stinger-style thermocouples. When replacing a thermocouple probe, use the illustration alongside the chart to determine the length you will need. The thermocouples used with the junction boxes, and some individual thermocouple components that are often requested, are shown in the chart. See page 20 for single or four station EGT modules that include the thermocouples

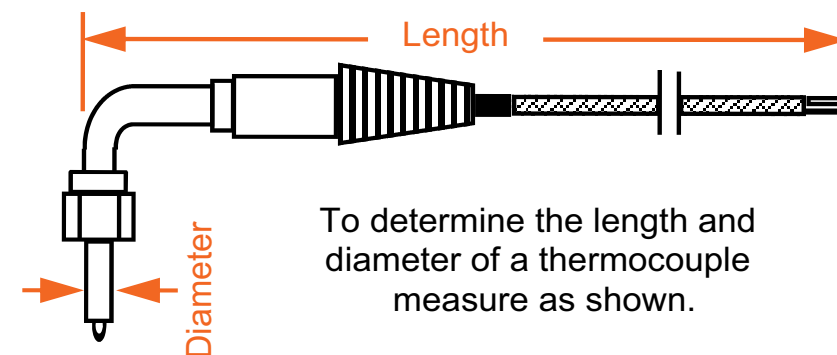

D. SPECIAL PURPOSE THERMOCOUPLES

These Type-K thermocouple assemblies (Nickel-Chromium/Nickel-Aluminum) are specifically designed for the applications listed below. Each must be used with the appropriate thermocouple amplifier module. All probes are 12" in length and are terminated with a male two pin mini-connector. The liquid and manifold assemblies are provided with a 1/8" male NPT compression style fitting.

Cylinder Head Temp. Thermocouple Assem. 800-TC-MT-ASM
Ring type sensor is used to monitor temperature of the metal, not the coolant.

Fluid Temp. Thermocouple Assem. 800-TC-FT-ASM
Used where the probe can be immersed in liquid, such as in a dry sump tank.

Manifold Temp. Thermocouple Assem. 800-TC-MT-ASM
Open end probe reacts quickly to changing temperatures in manifold plenum.



D. THERMOCOUPLE ASSEMBLY

.187" DIA. BULLETS (MOTORCYCLES, 4 CYL)

12"	800-TC-B3-12
16"	800-TC-B3-16
19"	800-TC-B3-19
22"	800-TC-B3-22
Set of 4 - One of each length	800-TC-B3-SET

.250" DIA. STINGERS (AUTO, H-D BIKES)

9"	800-TC-S4-09
13"	800-TC-S4-13
18"	800-TC-S4-18
21"	800-TC-S4-21
23"	800-TC-S4-23
28"	800-TC-S4-28
32"	800-TC-S4-32
Set of 8 2 each: (9", 13", 18", 23")	800-TC-S4-SET1
Set of 8 Big Block Heads 1 each: (18", 23", 28", 32")	800-TC-S4-SET2
Set of 8 Small Block Heads 1 each: (13", 18", 21", 28")	800-TC-S4-SET3

THERMOCOUPLE ADAPTERS MODULES

V-Net Cable Module Adapter	800-TC-S4-32
Analog Port Interface Module Adapter	800-TC-S4-32
Pro Analog Box Module Adapter	800-TC-S4-32

MISCELLANEOUS EGT COMPONENTS

Weldment, Nut & Ferrule Assembly	3/16"	800-TX-WASM3
	1/4"	800-TX-WASM4
Weldment Only, Single		800-TX-WELD4
Weldment Only, Single, Stainless		800-TX-WELD4SS
Weldment Only, Set of 4		800-TX-WELD404
Weldment Only, Set of 8		800-TX-WELD408
Ferrule Only		800-TX-F4
Nut Only		800-TX-WNUT4
Cap Only		800-TX-CAP4
Nut & Ferrule Only		800-TX-NF4

A. FLUID TEMPERATURE SENSOR

This sensor is commonly used in conjunction with the modules shown below to measure the temperature of fluids such as water or engine and transmission oil where the temperature does not exceed 300°F.

Fluid Temperature, Sensor Only 0-300°F 810-TR-300
For use with V-Net modules.

Fluid Temperature, Sensor Only 0-250°F 810-TR-250
For use on Ultra Dash only.

ADAPTER MODULES

V-Net Module 230-VM-TR-300
Used to connect the 810-TR-300 sensor to the V-Net cable.

Interface Module 240-IM-FT350
Used to connect the 810-TR-300 sensor to the Analog Port.



A. FLUID TEMPERATURE SENSOR

B. INFRARED TEMPERATURE SENSORS

These infrared sensors are used to monitor temperatures where contact cannot be made with the item being monitored. In racing, they are commonly used to monitor temperatures across the face of a tire, but they can be used for any non-contact measurement. The sensor will measure temperatures from 0-400°F. The IR Temperature sensor has a 4:1 ratio focal point. That means that when the item being monitored is four inches away from the sensor, the focal point will be one inch in diameter. If the sensor is twelve inches away, the focal point will be three inches in diameter.

IR Sensor and V-Net Module 220-VP-IR-T-200

IR V-Net Module Only 230-VM-IR

IR Temp Sensor Only 810-SN-IRT-200



B. INFRARED TEMPERATURE SENSOR

C. STRING POTENTIOMETER

This sensor is typically used for linear measurements, such as throttle position, when the mounting angle is not critical. The sensor is calibrated to the travel of the throttle (i.e. 0% when closed and 100% at WOT). By using a string potentiometer, the possibility of interference with the throttle operation is eliminated. Operating range 0-4.750".

String Potentiometer Sensor 800-LN-STRINGP

ADAPTER MODULES

V-Net Module 220-VP-WOTEVENT
Use to adapt string potentiometers to V-series recorders.

Interface Module 220-VP-WOTEVENT
Use For connection to Analog port of V300 or V500 recorders.



C. STRING POTENTIOMETER SENSOR

D. RIDE HEIGHT SENSOR

Infrared sensors are used to monitor the distance to an object, relative to the sensor, when contact cannot be made with the object. This makes them ideal for use in setting up the suspension by monitoring chassis ride height in relation to the moving ground plane. Infrared Ride Height sensors and modules are commonly attached to the V-Net cable of any V-series recorder. If desired, they can also be attached to the analog port by using an Interface module rather than a V-Net module. These sensors are designed for use in measuring distances ranging from 3.93 to 15.75 inches. Each sensor must be used with the appropriate V-Net module.

Ride Height Sensor Kit, V-Net; Left Front 220-VP-RIDEHTLF

Ride Height Sensor Kit, V-Net; Right Front 220-VP-RIDEHTRF

Ride Height Sensor Kit, V-Net; Left Rear 220-VP-RIDEHTLR

Ride Height Sensor Kit, V-Net; Right Rear 220-VP-RIDEHTRR

Module Only, Ride Height, V-Net, Left Front 220-VM-RHBLF

Module Only, Ride Height, V-Net, Left Rear 220-VM-RHBLR

Module Only, Ride Height, V-Net, Right Front 220-VM-RHBRF

Module Only, Ride Height, V-Net, Right Rear 220-VM-RHBRR

Sensor Only, Ride Height 810-SN-RHB



D. RIDE HEIGHT SENSOR

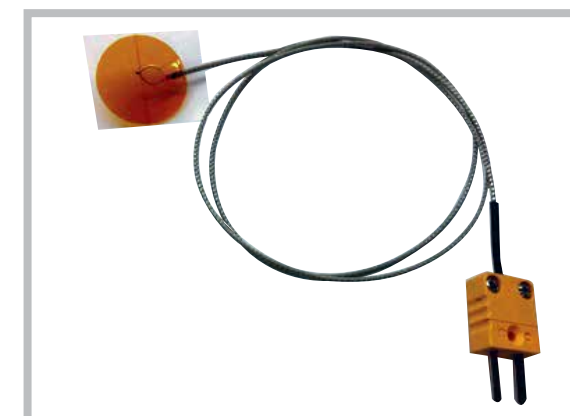

E. ADHESIVE 0-600F THERMOCOUPLER SENSOR

E. ADHESIVE 0-600F THERMOCOUPLER SENSOR

Racepak's adhesive 0-600F thermocouple sensor eliminates the need for bung and other sensor mounting methods, making ideal for a number of surface temperature reading such as Shock Housing Temp, Engine Block Temp, Fuel Tank Temp, Fuel Pump Temp, Electric Motor Temp, Batteries, and many more. For use with V-Net module or Transducer box.

Adhesive 0-600F Thermocoupler Sensor 800-TC-PD-600

F. G-FORCE SENSORS (ACCELEROMETER)

These G-force sensors can be adapted to any V-Net system (Note: V300 & V500 data recorders all contain internally mounted G-meters) to measure longitudinal and lateral forces. The externally-mounted G-meter measures 2.0" x 2.0" x 1.250".

G-Meter, 0-6 G 220-VP-GM

ADAPTER MODULES

V-Net Module Only 230-VM-AN-12V
Adapts external G-meter to V-Net cable.



F. G-FORCE SENSOR

PULLING



A. G2X PRO



B. IQ3 LOGGER DASH



D. G2X DATA RECORDER

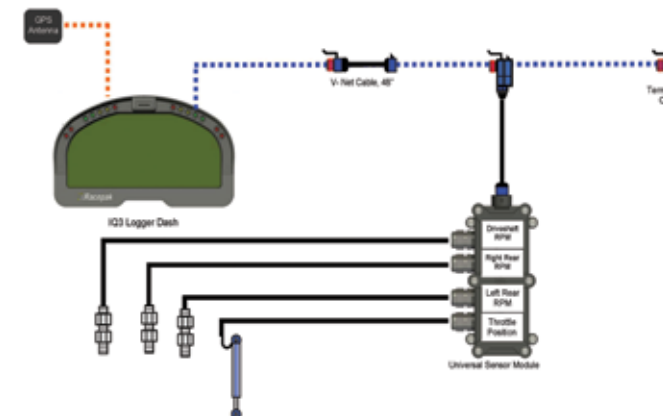

RACEPAK OFFERS A NUMBER OF DATA LOGGERS AND SENSORS, TO FIT YOUR PULLING NEEDS. REFER TO THE DRAG SECTION OF THIS CATALOG, FOR ADDITIONAL SENSOR AND DATA LOGGER PRODUCTS.

BELOW ARE RECOMMENDED DATA SYSTEM KITS FOR THE PULLING COMPETITOR.

A. G2X PRO

Recommended for multi-engine or vehicles requiring a large number of sensor inputs. Includes 71 channel G2X Pro data logger, power/rpm harness, 3 RPM sensors, 10 magnets, throttle position sensor, cables and connectors.

G2X Pro Puller Kit 620-KT-G2XPROPL

B. IQ3

Recommended for 4WD, 2WD, Super style classes or vehicles requiring an all-in-one instrumentation/data logger design with 32 sensor inputs. Includes 32 channel IQ3 Data Logger Dash, four sensor input module, 3 RPM sensors, 10 magnets, throttle position sensor, cables and connectors

IQ3 Puller Kit 620-KT-IQ3LDPL

IQ3 Puller Kit/4WD 620-KT-IQ3LDPL4

C. IQ3 STOCK/SUPER STOCK FARM TRACTOR APPLICATIONS

The IQ3 Stock/Super Stock Farm Puller system will monitor Engine RPM, Battery Volts, 2-G-Meters (Lat & Long), GPS Speed, Driveshaft RPM (could be used for Engine RPM on Diesels), 2 Rear Wheel RPM, Turbo Speed, and Boost Pressure 0-150psi. Default Engine RPM input designed for battery ignition, special adapters/sensors may be required for Diesel or Magneto applications, sold separately.

G2X Pro Puller Kit 620-KT-G2XPROPL

D. G2X

Above are recommended data system kits for the pulling competitor. Racepak offers a number of data loggers and sensors, to fit your pulling needs. Refer to the Drag section of this catalog, for additional sensor and data logger products.

G2X Pro Puller Kit 620-KT-G2XPROPL

STREET



A. SMARTWIRE POWER CONTROL MODULE



B. SMARTWIRE SWITCH PANEL



B. SMARTWIRE SWITCH MODULE

A. SMARTWIRE POWER CONTROL MODULE

Based on Racepak's exclusive single cable V-Net technology, the Racepak SmartWire module is the electronic "starting point", with a direct main power connection from the vehicle battery to the module. Each input/output is then user defined, both in function, power requirements and current exceeding limits via a USB connection to the user's PC. The design of the module functions to both reduce overall installation weight / clutter, while providing a quicker reacting electronic system, through the solid state switching design.

Manual activation can be achieved through use of either an optional eight switch Racepak Switch Panel or 16-channel Switch Module. From the Racepak SmartWire unit, a single small cable is routed to the Switch Panel, reducing wiring clutter. Users needing additional switch panel capabilities can easily expand through the use of a "jumper" cable to a second Racepak Switch Panel or Switch Module.

FEATURES

CAPACITY:
125 Total Amps

CHANNELS:
30 Total Channel Outputs
8 Channels @ 20 Amp Maximum
22 Channels @ 10 Amp Maximum

12 Hardwired Switch Inputs

DATA OUTPUT:
Volts
Amps
State

RESPONSE:
3.0 Millisecond

PROGRAMMING:
USB Interface

DIMENSIONS:
6" (L) x 5.5" (W) x 1.5" (H)
(25.2 cm x 13.9 cm x 3.8 cm)

INCLUDES:
Racepak SmartWire Module
Connector Kit
USB Cable
Programming Software

SmartWire Module Kit 500-KT-SW30

B. SMARTWIRE ACCESSORIES

SmartWire Switch Panel 500-SW-PNL8

SmartWire Switch Module 500-SW-5M16

Switch Panel Mount Bracket 500-MB-SP-xxxx
(Available sizes are: 1.50", 1.625" and 1.75")

SmartWire to Switch Panel Cable 500-CA-BN5P-xxx
(Variety of sizes offered)

SmartWire to V-Net Cable 500-CA-BN5P-xxx
(Available sizes are: 9", 18" and 36")

SmartWire Tee Cable 580-CA-BN-TEE
(Available sizes are: 7")

A. UDX STREET ROD DASH

Taking the technology from our race proven LCD dashes and applying it to the street vehicle market, the UDX Street Rod Dash is a complete dash panel replacement. Containing all the amenities required on a street driven vehicle, this product provides all the information necessary for highway use.

Through a combination of your existing sensors and those included with this kit, the dash will provide the ability to display engine RPM, speedometer, odometer, water and oil temperature, oil pressure, battery voltage and fuel level. Indicator lights are included for items such as low oil pressure, high water temperature, turn signals, high beam and parking brake. Additional features can be displayed with the purchase of the appropriate V-Net sensor and module combination. A relay for an electric fan controller along with a minimum/maximum recall function is included.

FEATURES

SPECIFICATIONS:
Display up to 21 sensor inputs via 4 pages.
Adjustable backlighting
User defined warning lights
Minimum/Maximum recall
Turn signal, high beam, engine warning lights

INCLUDES:
UDX Street Rod Display Dash
Water/Oil temperature sensor
Oil pressure sensor
Wire loom and connectors for sensor input termination

DISPLAY DASH PROVIDES VIEW OF:
Any 21 sensor inputs recorded by the data logger
Shift Lights
Warning Lights

DIMENSIONS:
4" (H) x 10.2" (W) x .75" (deep) Requires 2" rear clearance (10.16cm X 25.908cm X 1.905cm)

WEIGHT:
21 ozs. (.58 kg)

Street Model	250-KT-UDXSXR
--------------	---------------

B. UDX ACCESSORIES

Faux Carbon Mounting Panel	800-MB-UDX-PCF
Black Mounting Panel	800-MB-UDX-PBLK
Silver Mounting Panel	800-MB-UDX-PAL



A. UDX STREET ROD DASH



B. UDX MOUNTING PANEL

C. UDX DISPLAY DASH

Capable of being utilized with any of Racepak's V-Net series of data recorders. UDX Utilizes the same V-Net cable the external sensors use. The UDX display is capable of "sharing" sensor data with the data logger, thus providing the ability to display or trigger warnings based on any internal or external sensor in use by the data logger.

FEATURES

SPECIFICATIONS:
Display up to 21 Sensor Inputs via 4 pages.
Adjustable Backlighting
User Defined Warning Lights
Minimum/Maximum Recall

INCLUDES:
UDX Display Dash
V-Net Tee Cable

DISPLAY DASH PROVIDES:
Any 21 Sensor Inputs Shift Light Output Warning Lights

DIMENSIONS:
4" (H) x 10.2" (W) x .75" (deep) * Requires 2" rear clearance (10.16cm x 25.90cm x 1.90cm)

WEIGHT:
21 ozs. (.58 kg)

UDX Display Dash	250-DS-UDX
------------------	------------

D. IQ3 DASH DISPLAY

The IQ3 can be utilized with any of Racepak's V-Net data loggers, providing a compact LCD digital dash. The IQ3 can be utilized as a standalone display dash, independent of a Racepak V-Net data logger, through the use of optional sensors off of the V-Net port, located on the rear of the dash.

FEATURES

SPECIFICATIONS:
Display up to 28 inputs via 4 pages
Blue backlight
Gear Indicator
Eight user defined alarms
User defined 5 character sensor input names
User defined shift light output
Shielded, low luster display for sunlight viewing
Metric and English capable

DIMENSIONS:
7.25" (L) x 4.000" (W) x 1.125" (deep) (18.41cm x 10.16cm x 5.39cm)

WEIGHT:
1lb. (453g)

IQ3 Display Dash	250-DS-IQ3
------------------	------------

E. IQ3 ACCESSORIES

External Programming Buttons	280-SW-IQ3BTN
Faux Carbon Mounting Panel	800-MB-IQ3-PCF
Black Mounting Panel	800-MB-IQ3-PBLK
Silver Mounting Panel	800-MB-IQ3-PAL



C. UDX DISPLAY DASH



D. IQ3 DASH DISPLAY



E. EXTERNAL PROGRAMMING BUTTON

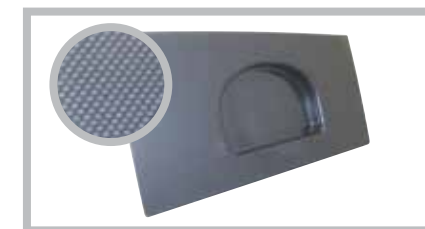

E. MOUNTING PANEL

A. EFI DATA INTERFACE

These V-Net modules have been created to interface with many electronic fuel injection systems on the market. Each V-Net EFI Data Interface module is equipped to allow direct connection with EFI. These modules allow your V-series data recorder to share the data collected by these systems rather than having to install duplicate sensors to monitor functions that are already being monitored by the EFI system. The shared data can be recorded or displayed just as you would any function monitored independently by your Racepak V-series recorder. Caution should be exercised to ensure that you do not exceed the maximum number of V-Net channels supported by your particular logger. The individual functions monitored by each EFI system are outlined in the chart below. **For use with Racepak V-Net data loggers.**

Accel DFI Gen VII	230-VM-EFIDFI
AEM	230-VM-EFIAEM
Autronic SMC & SM2	230-VM-EFIAUT
Autronic SM4 V107 & V109	230-VM-EFIAUT4
Big Stuff 3	230-VM-EFIBS3
Corvette C6 OBDII GMX3 (2006 and Later)	230-VM-EFIIC6
EFI Technologies	230-VM-TECH
FAST XFI CAN	230-VM-EFIXFI
FAST Serial	230-VM-EFIFST
Generic J1939 CAN	230-VM-EFICAN
Haltech	230-VM-EFIHAL
Holley EFI	230-VM-EFIHOL
Hondata KPro	230-VM-EFIHOND
Megasquirt I	230-VM-EFIMS1
Megasquirt II	230-VM-EFIIMS2
MEFI 4B J1939 (GM PN 12584052, 12575479)	230-VM-EFIIM4
Motec M400, M600, M800, M84	230-VM-EFIMOTEC
Motec M4, M48	230-VM-EFIMOTSR
Omex	230-VM-EFIOMEX
Omniteck EC44	230-VM-EFIEC44
PRO EFI	230-VM-EFIPRO
Vipec	230-VM-EFIVIPEC
WOLF V500	230-VM-EFIWOLF
Atomic LS	230-VM-EFIALS
Atomic TBI	230-VM-EFIATBI
Fuel Tech	230-VM-EFIFUEL



B. OBDII DATA INTERFACE

Provides the ability to gather OBDII data, for data logging or display via Racepaks line of digital dash/Intelli-Gauge products. For use with Racepak V-Net data loggers.

OBDII Module	230-VM-OBDDII
--------------	---------------



C. USM FOUR SENSOR INPUT MODULE

Provides the ability to input and program up to 4 individual sensors. Each input has multi-function programming capabilities. RPM, analog, temperature or event. Internal terminal strip provides sensor power (12V or 5V) ground, shield and signal for each input. For use with Racepak V-Net data loggers.

USM Module	230-VM-USM
Racepak temperature sensor cable (144" long) and mating connector	680-CA-A144
Racepak pressure sensor cable (144" long) and mating connector	680-CA-A144
Racepak travel sensor cable (144" long) and mating connector	680-CA-M144

Racepak continues to follow the same guidelines and desires that have placed us atop the data acquisition industry. Our unwavering goal to produce reliable, efficient, state of the art data recorders, at a price accessible to professionals and sportsmen alike, and back them with whatever service our customers may need, is as strong today as it was in 1984. The dedicated team at Racepak is proud of our accomplishments and the accolades that have come our way, but at the same time we believe that our future is directly linked to our reputation. Consequently, quality equipment and customer service continue to be more than just an advertising slogan at Racepak. Our push toward constant improvement, a lack of satisfaction with the status quo, and the burning desire to achieve the impossible, have made us a perfect match for the customers we serve.

LAND SPEED

LAND SPEED DATA RECORDERS



A. V300SD DATA RECORDER

V300SD PACKAGE INCLUDES

- V300SD Data Recorder
- SD Memory Card
- Driveshaft and Wheel RPM Sensor with Split Collar and Magnet Kit
- Datalink Software Kit with Serial Programming Cable
- V-Net Tee Connector with Terminator Caps
- Power / Ground / Engine RPM / Driveshaft / Wheel Speed Harness

V300SD PACKAGE MONITORS

- Engine RPM
- Driveline RPM
- Engine v. Driveline RPM Differential
- Battery Voltage
- Acceleration G-Force
- Lateral G-Force
- Wheel MPH / RPM
- Distance



B. V300SD/V300 MOUNTING BRACKET

A. V300SD DATA RECORDER

The affordable V300SD data recorder is the most common recorder for Land Speed. In its base configuration, the V300SD monitors six parameters (Engine RPM, Wheel Speed, Driveshaft RPM, Accel G, Lateral G, Battery Volts), but it can be expanded to monitor up to 67 channels of data to meet the needs of most users. The V300SD can sample data as quickly as 1000 times per second.

Uploading recorded data to your computer is done via a SD memory card, which provides you with hours of recording time and the ability to store many runs prior to uploading the data. The V300SD also has multiple methods of displaying monitored data in real time. When linked by serial cable to your PC you can view all recorded functions in either graph format or on 8 virtual gauges while the vehicle is running. Any monitored function can also be displayed in real time on Racepak's optional Intelli-Gauges or either the IQ3 or Ultra Dash (UDX).

FEATURES

CHANNELS:

- 67 Total
- V-Net: 56
- Analog: 4 Hard-Wired
- Digital: 4 Hard-Wired
- Internal: 3

SAMPLE RATE:

- V-Net: Up to 100 per Second
- Analog: Up to 1000 per Second
- Digital: RPM and Switch Contacts Up to 100 per Second

MEMORY:

- SD Memory Card
- Recording Time Depends on Number of Channels Monitored and Sample Rates
- Record Multiple Runs
- Cableless

INTERNAL SENSORS:

- Battery Voltage
- Longitudinal G-Meter (Acceleration and Deceleration)
- Lateral G-Meter (Side-to-Side Motion)

DIMENSIONS:

- 4.374" (L) x 3.935" (W) x 1.230" (H)
- (11.11cm x 9.994cm x 3.12cm)

WEIGHT:

- 10 Ounces (28kg)

V300SD Data Recorder	200-KT-V300LSR
----------------------	----------------

B. V300SD MOUNTING BRACKET

1.250" O.D. Tubing	800-MB-V300-125
1.500" O.D. Tubing	800-MB-V300-150
1.625" O.D. Tubing	800-MB-V300-162
1.750" O.D. Tubing	800-MB-V300-175

LAND SPEED DATA RECORDERS

A. IQ3 DATA LOGGER DASH

The IQ3 merges Racepak's V-Net single cable sensor technology and proven GPS based data logging with a fully programmable display, creating a complete data center. The full feature dash includes an internal 47 sensor channel data logger, while track mapping and speed is obtained by the internal GPS board and 3 axis G meter thus eliminating the need for an external data logger, and wheel speed sensor. No sensor wiring harness is required, as all external sensor data is routed to the rear of the dash by a single V-Net cable. The DatalinkII software included with the IQ3 dash provides professional level data analysis capabilities, but in an easy to learn format.

FEATURES

CHANNELS:

47 total
V-Net: 42 digital/analog
Internal: 5

SAMPLE RATE:

V-Net: up to 100 per second

MEMORY:

Up to 16GB microSD Memory Card
Recording time depends on number of channels monitored and sample rates

DIMENSIONS:

7.25" (L) X 4.000" (W) X 1.125" (deep)
(18.41cm X 10.16cm X 5.39cm)

WEIGHT:

1 lb. (453g)

SPECIFICATIONS

42 external sensor input with optional high speed logging modules.
Internal GPS board
Display up to 28 inputs via 4 pages microSD Memory Card
Blue backlight
3 Axis G meter (Accel, lateral, vertical)
Gear Indicator
Eight user defined alarms with on screen warning text and lights
User defined 5 character sensor input names
User defined shift lights
GPS Track Mapping
GPS Speed
Power/Ground/Engine RPM /Remote Programming harness
Shielded, low luster display for sunlight viewing
Metric and English capable

IQ3 Logger Dash	250-DS-IQ3LDLSR
------------------------	------------------------

B. IQ3 ACCESSORIES

External Programming Buttons	280-SW-IQ3BTN
-------------------------------------	----------------------

Faux Carbon Mounting Panel	800-MB-IQ3-PCF
-----------------------------------	-----------------------

Black Mounting Panel	800-MB-IQ3-PBLK
-----------------------------	------------------------

Silver Mounting Pane	800-MB-IQ3-PAL
-----------------------------	-----------------------

CNC-Machined Mounting Bracket	800-MB-IQ3
--------------------------------------	-------------------



A. IQ3 LOGGER DASH

IQ3 PACKAGE INCLUDES

IQ3 Data Logger Dash
Power/Ground/Engine RPM/Remote Programming harness
Rear V-Net connector/GPS antenna connector
Micro SD Memory Card
GPS Antenna and Cable
Programming Cable
Driveshaft Speed Sensor
DatalinkII Software and Installation Manual

IQ3 PACKAGE MONITORS

GPS Speed
Distance
Engine RPM
Driveshaft RPM
Battery Volts
Accel G-Meter
Lateral G-Meter/Vertical G-Meter

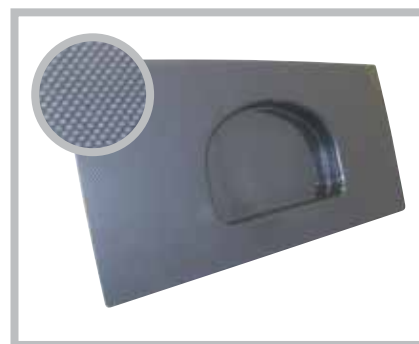

B. MOUNTING PANEL



B. CNC-MACHINED MOUNTING BRACKET



C. G2X-PRO DATA RECORDER

G2X-PRO PACKAGE INCLUDES

G2X-Pro Recorder
GPS Antenna
Up to 16GB SD Memory Card
Datalink II Software Communication Cable
Power/Ground/Engine RPM/Driveshaft Harness
Driveshaft Sensor

G2X-PRO PACKAGE MONITORS

GPS Speed
Distance
Engine RPM
Driveshaft RPM
Battery Voltage
Accel G-Meter
Lateral G-Meter



D. G2X-PRO MOUNTING BRACKET

D. G2X-PRO MOUNTING BRACKET

1.250" O.D. Tubing	800-MB-V500-125
---------------------------	------------------------

1.500" O.D. Tubing	800-MB-V500-150
---------------------------	------------------------

1.625" O.D. Tubing	800-MB-V500-162
---------------------------	------------------------

1.750" O.D. Tubing	800-MB-V500-175
---------------------------	------------------------

LAND SPEED DATA RECORDERS

C. G2X-PRO DATA RECORDER

The G2X-Pro builds on the G2X's already impressive capabilities by allowing the user to monitor up to 72 channels. The G2X-Pro utilizes our exclusive V-Net plug and play technology which allows the data from up to 56 sensors to be transmitted via a single cable to the data recorder. A single cable links the module to the G2X-Pro recorder. Suspension and ride height data may also be obtained by purchasing the appropriate shock and ride height sensor package. In addition, any V-Net sensor may be used with the G2X-Pro.

The G2X-Pro can utilize any of our three available display dashes, depending upon the user's requirements. The UDX provides 21 programmable inputs, but does not allow the ability to set start/finish from the dash. The G2X mini dash (standard G2X dash) allows the user to set start/finish, while programming any two sensor inputs along with shift lights, for display. The IQ3 display dash provides the 24 programmable inputs, shift lights, warning lights and the ability to set start/finish from the dash.

FEATURES

CHANNELS:

72 Total
V-Net: 56
Analog: 8 hard-wired
Digital: 4 hard-wired Internal: 4

SAMPLE RATE:

V-Net: up to 100 per second
Analog: up to 1000 per second
Digital: RPM and switch contacts up to 100 per second

MEMORY:

Up to 16GB SD Memory Card
Recording time depends on number of channels monitored and sample rates

INTERNAL SENSORS:

Battery Voltage
Longitudinal g-meter (acceleration and deceleration)
Lateral g-meter (side-to-side motion)
GPS

DIMENSIONS:

5.350" (L) X 5.5550" (W) X 1.215" (H)
(13.589cm X 14.1097cm X 3.0861cm)

WEIGHT:

17 ozs. (.48 kg)

G2X-Pro Data Recorder	600-KT-G2XPLSR
------------------------------	-----------------------

A. G2X DATA RECORDER

The key to the G2X is its ability to interpret signals from GPS satellites to quickly establish the position and movement of the vehicle. From this monitored data other performance parameters can then be calculated.

Enhancing the features of the G2X is its versatile digital display dash that will provide the driver with a display of gear indicator, progressive shift light, battery voltage, and G-forces. Engine RPM is available to those with an ignition system that provides a tach signal output, and three additional inputs from external sensors can be displayed on the dash. When the vehicle is stationary the gear indicator becomes a display of the number of satellite currently being monitored. The dash can be attached to a steering wheel or mounted on the dash panel. A single cable provides the connection between the G2X and the dash for programming purposes.

FEATURES

CHANNELS:

V-Net: 18
Internal: 4
16 Total Channels

SAMPLE RATE:

V-Net: up to 100 per second

MEMORY:

Up to 16GB SD Memory Caard
Recording time depends on number of channels monitored and sample rates
Record multiple runs
Cableless download

DIMENSIONS:

5.6" (L) X 4.00" (W) X 1.5" (H)
(14.2cm X 10.16cm X 3.81cm)

WEIGHT:

Logger: 13 oz. (.37 kg)
Kit: 1 lb. 13 oz. (.81 kg)

INTERNAL SENSORS:

Battery Voltage
Longitudinal g-meter (acceleration and deceleration)
Lateral g-meter (side-to-side motion)
GPS

G2X Data Recorder Kit

600-KT-G2XLSR



A. G2X DATA RECORDER

G2X GPS PACKAGE INCLUDES

- G2X Recorder
- GPS Antenna
- LED Dash Display
- SD Memory Card
- Datalink II
- Software
- Communication Cable
- Cigarette Lighter Adapter
- Power/Ground/ Engine RPM Harness
- Driveshaft Speed Sensor and Cable

G2X GPS PACKAGE MONITORS

- GPS Speed
- Distance
- Engine RPM
- Driveshaft RPM
- Battery Voltage
- Accel G-Meter
- Lateral G-Meter



B. G2X MOUNTING BRACKET

B. G2X MOUNTING BRACKET

1.250" O.D. Tubing	610-MB-125
1.500" O.D. Tubing	610-MB-150
1.625" O.D. Tubing	610-MB-1625
1.750" O.D. Tubing	610-MB-175

A. UDX DISPLAY DASH

Capable of being utilized with any of Racepak's V-Net series of data recorders. UDX Utilizes the same V-Net cable the external sensors use. The UDX display is capable of "sharing" sensor data with the data logger, thus providing the ability to display or trigger warnings based on any internal or external sensor in use by the data logger.

FEATURES

SPECIFICATIONS:

Display up to 21 Sensor Inputs via 4 pages.
Adjustable Backlighting
User Defined Warning Lights
Minimum/Maximum Recall

INCLUDES:

UDX Display Dash

DISPLAY DASH PROVIDES:

Any 21 Sensor Inputs Shift Light Output Warning Lights

DIMENSIONS:

4" (H) x 10.2" (W) x .75"(deep) * Requires 2" rear clearance
(10.16cm x 25.90cm x 1.90cm)

WEIGHT:

21 ozs. (.58 kg)

UDX DISPLAY

250-DS-UDX



A. UDX DISPLAY DASH

07

Tip #7 Adding a V-Net module and sensor to your V-Net data recorder or digital dash?

Before the data recorder or dash "knows" the sensor is there, you will need to add the sensor to the software, using the Read function in the DatalinkII software.

Connect your PC to the data logger or dash with the Racepak programming cable, power up and unit and select Edit and Read in the main menu of the DatalinkII software.

A. IQ3 DASH DISPLAY

The IQ3 can be utilized with any of Racepak's V-Net data loggers, providing a compact LCD digital dash. The IQ3 can be utilized as a standalone display dash, independent of a Racepak V-Net data logger, through the use of optional sensors off of the V-Net port, located on the rear of the dash.

FEATURES

SPECIFICATIONS:
 Display up to 28 inputs via 4 pages
 Blue backlight
 Gear Indicator
 Eight user defined alarms
 User defined 5 character sensor input names
 User defined shift light output
 Shielded, low luster display for sunlight viewing
 Metric and English capable

DIMENSIONS:
 7.25" (L) x 4.000" (W) x 1.125" (deep)
 (18.41cm x 10.16cm x 5.39cm)

WEIGHT:
 1lb. (453g)



A. IQ3 DASH DISPLAY

B. IQ3 ACCESSORIES

External Programming Buttons	280-SW-IQ3BTN
Faux Carbon Mounting Panel	800-MB-IQ3-PCF
Black Mounting Panel	800-MB-IQ3-PBLK
Silver Mounting Panel	800-MB-IQ3-PAL

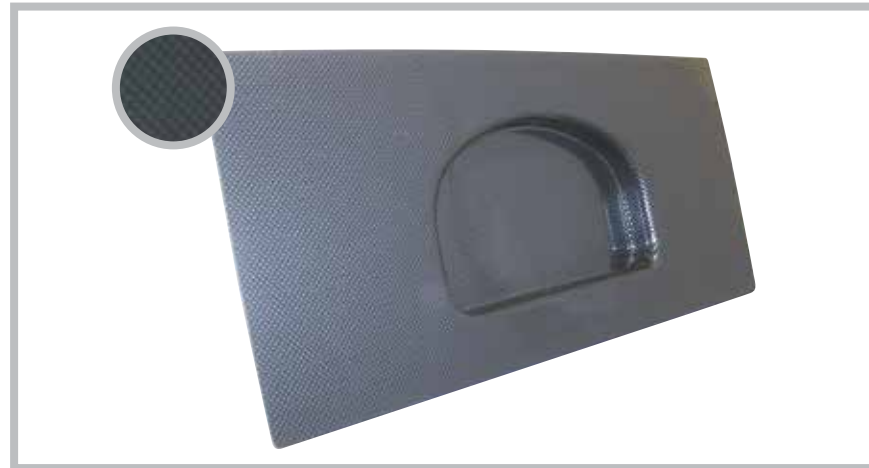

B. MOUNTING PANEL



B. EXTERNAL PROGRAMMING BUTTON

F. INTELLI-GAUGES

These are not your average analog or digital gauge. They are both. In addition, they are highly accurate, stylish, dependable, and provide real time display for your monitored functions.

FEATURES

SPECIFICATIONS:
 User Programmable warning levels
 Download recorded data to PC Plug-and-play installation
 Analog and digital display Lightweight, sonic welded
 Electro-luminescent radial lighting

DIMENSIONS:
 2 5/8" diameter and feature a 270° sweep needle

WEIGHT:
 49g

[View Selection Chart on Next Page](#)



F. INTELLI-GAUGES

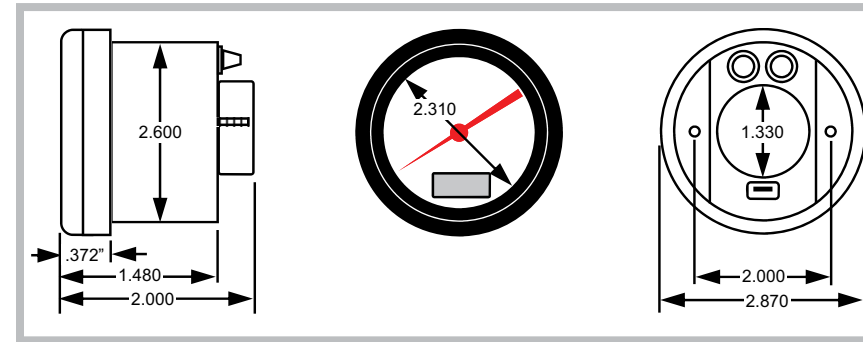

INTELLI-GAUGE DIMENSIONS

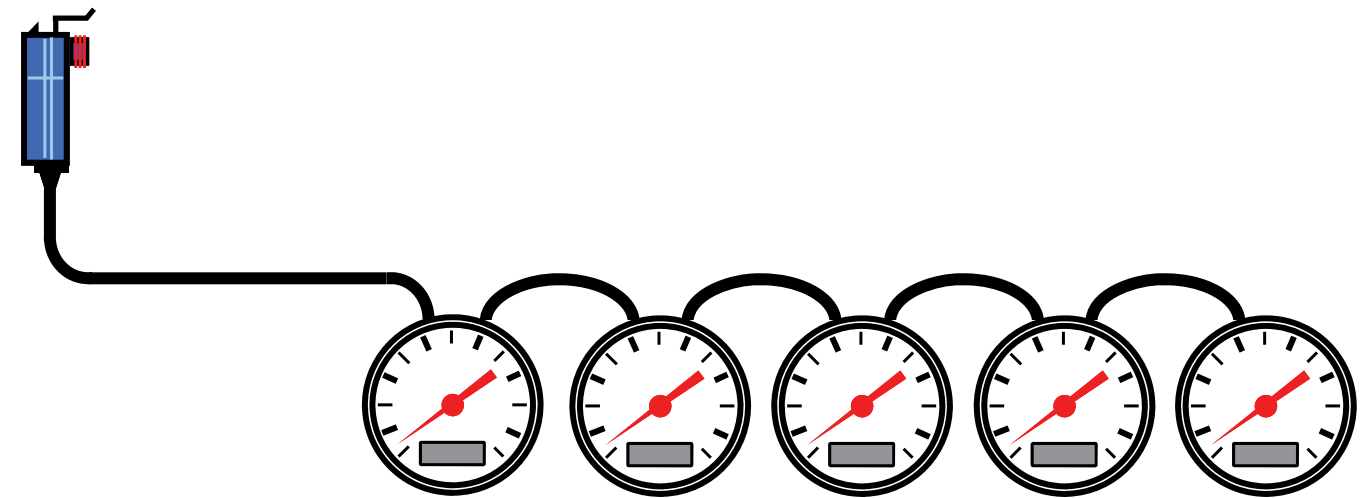

The first Intelli-Gauge connects to the V-Net cable using a Gauge Tee Cable. After the first gauge each subsequent gauge is connected with a gauge to gauge jumper cable

INTELLI-GAUGE SELECTION CHART

INTELLI-GAUGE	RANGE	● BLACK FACE	○ WHITE FACE
RPM, TACHOMETER	1,000-10,500 RPM	250-IG-100BB	250-IG-100WB
RPM, TURBINE PERCENTAGE, N1	0-120%	NA	250-IG-218WB
RPM, TURBINE PERCENTAGE, N2	0-120%	NA	250-IG-219WB
TEMPERATURE, WATER (STREET)	100°-280°F	250-IG-110BB	250-IG-110WB
TEMPERATURE, WATER (RACE)	60°-200°F	250-IG-120BB	250-IG-120WB
TEMPERATURE, OIL	140°-280°F	250-IG-130BB	250-IG-130WB
TEMPERATURE, EXHAUST GAS	600°-1,600°F	250-IG-140BB	250-IG-140WB
TEMPERATURE, EXHAUST GAS #2	600°-1,600°F	250-IG-145BB	250-IG-145WB
TEMPERATURE, EXHAUST GAS	0°-1,000°F	NA	250-IG-220WB
TEMPERATURE, CYLINDER HEAD	100°-600°F	250-IG-150BB	250-IG-150WB
TEMPERATURE, TRANSMISSION	50°-350°F	250-IG-135BB	250-IG-135WB
PRESSURE, OIL	0-100 psi	250-IG-160BB	250-IG-160WB
PRESSURE, OIL	0-250 psi	NA	250-IG-162WB
PRESSURE, FUEL	0-15 psi	250-IG-170BB	250-IG-170WB
PRESSURE, FUEL	0-100 psi	250-IG-165BB	250-IG-165WB
PRESSURE, FUEL	0-250 psi	NA	250-IG-167WB
PRESSURE, FUEL	0-500 psi	NA	250-IG-226WB
PRESSURE, BRAKE	0-1,500 psi	250-IG-180BB	250-IG-180WB
PRESSURE, NITROUS	0-1,600 psi	250-IG-175BB	250-IG-175WB
PRESSURE, (GENERIC)	0-200 psi	250-IG-190BB	250-IG-190WB
PRESSURE, (GENERIC)	0-300 psi	250-IG-193BB	250-IG-193WB
PRESSURE, (GENERIC)	0-500 psi	NA	250-IG-223WB
PRESSURE, (GENERIC)	0-1,000 psi	250-IG-197BB	250-IG-197WB
BOOST / VACUUM	30 psi-0-30 in. hg	250-IG-215BB	250-IG-215WB
BOOST	0-60 psi	NA	250-IG-217WB
VACUUM	0-30 in. hg	250-IG-210BB	250-IG-210WB
AIR/FUEL RATIO	10-18	NA	250-IG-224WB
FLOW	3.5-4.5 GPM	NA	250-IG-222WB
FUEL LEVEL	E-F	NA	250-IG-225WB
VOLTS	8-20	250-IG-200BB	250-IG-200WB
VOLTS, (WITH INTERNAL SENSOR)	8-20	250-IG-204BB	250-IG-204WB
VOLTS	20-32	NA	250-IG-221WB



A. GAUGE TO GAUGE JUMPER CABLE

A. GAUGE TO GAUGE JUMPER CABLE

Used to connect each gauge in series after the first gauge. Each end of the cable has the small round connector that plugs directly into the back of the Intelli-Gauges.

8" Cable	280-CA-RGG-008
16" Cable	280-CA-RGG-016
24" Cable	280-CA-RGG-024
48" Cable	280-CA-RGG-048
288" Cable	280-CA-RGG-288

B. GAUGE TEE CABLES

Connects first gauge to V-Net cable or another V-Net module.

8" Cable	280-CA-RGG-T008
16" Cable	280-CA-RGG-T016
24" Cable	280-CA-RGG-T024



B. GAUGE TEE CABLE

V-NET

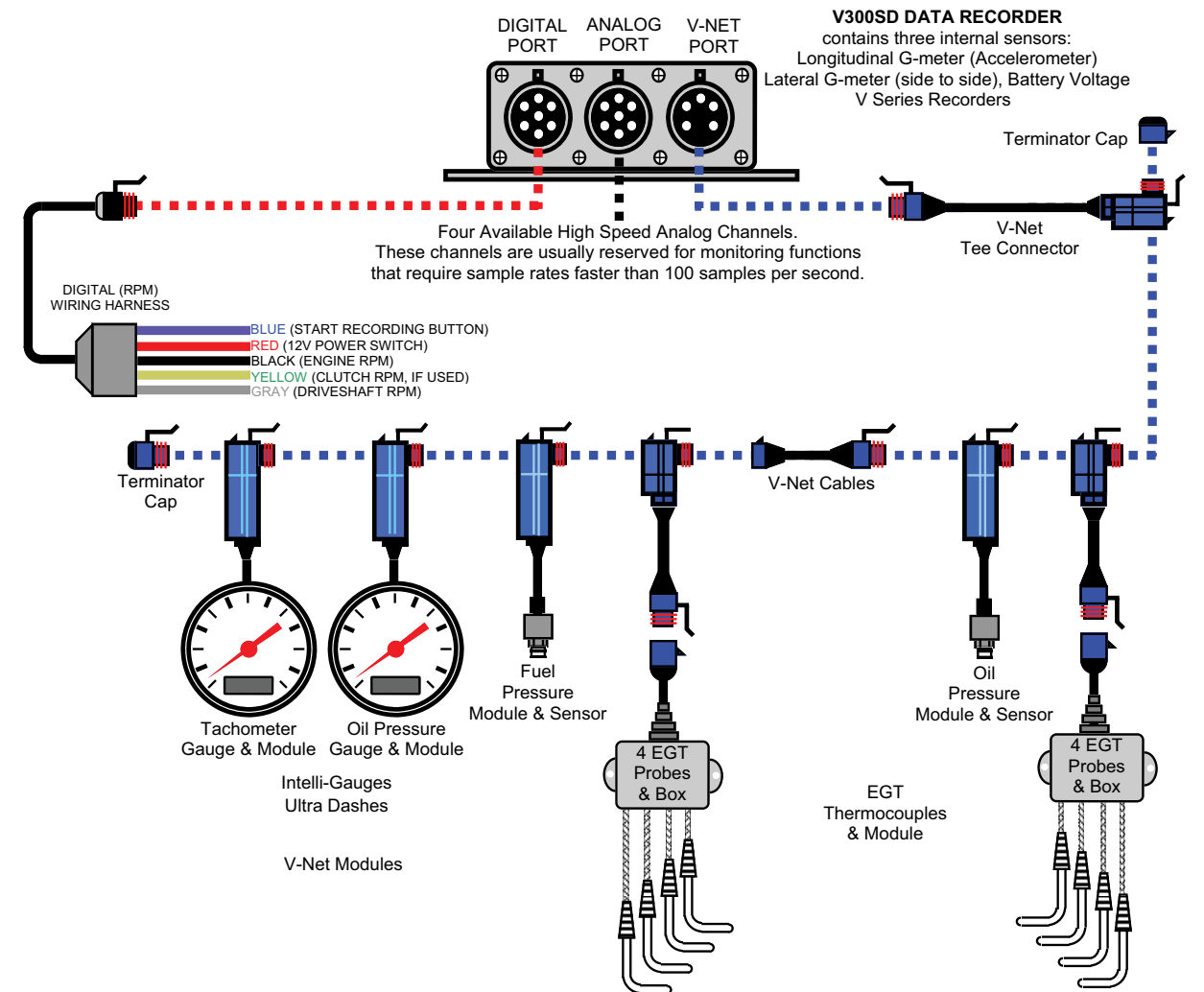

Racepak's Vehicle Network (V-Net) is a "smart data" transfer network providing the ability to transmit multiple signals from each sensor over a single cable. This technology creates a system in which the individual components interact with each other; making a simpler, more compact system which can be expanded with ease.

The key to accomplishing this is in the modular connectors that attach each of the devices to the main V-Net cable. Each module is essentially a miniature computer, which houses circuit boards and a microprocessor that identifies and retrieves only the proper incoming signals and allows other signals to pass through.

Whether you will be installing a single gauge set up, or a full-blown data acquisition system, all components are attached to the system using the modular snap-together connectors. Adding components onto the system is simple. Just find a junction in the main V-Net cable, separate the connectors, and sandwich the new sensor's module between them. Then command your software to read the new configuration. It will automatically recognize any additions or deletions from the system.

Gauge integration is another strength of the V-Net system, but don't mistake the Racepak gauges for garden variety gauges. If your vehicle is equipped with a V-Net recording system, the gauges simply use the sensors and wiring that are already in place to provide full time display of the data being monitored.

The same holds true for Racepak's digital display dashes. Some models of the dash will rely solely upon the data recorder's sensors to provide the information they display, while others are stand-alone requiring no data recorder. When you add Datalink II, the best Windows®-based software in the business, you will see why Racepak continues to be the most popular and widely used data acquisition system in the industry.

In order for a function to be monitored on the V-Net, the signal from that function must pass through two components: a sensor and a module. The sensor is the unit that actually measures the input from the function (i.e. pressure, temperature, etc.), while the module converts the signal so it can be transmitted over the V-Net. In the module sensor section that follows, you will find a complete listing of these components divided into categories.

ANALOG PRE-PROGRAMMED WITH SENSORS

These pre-programmed analog function module and sensor combinations are ready for plug-and-play installation on the V-Net cable.

A. PRESSURE (48" Lead Length)

Boost (Manifold), 0-75 psi	220-VP-PT-BST75
Brakes, 0-1500 psi	220-VP-PT-B1500
Fuel Carburetor, 0-15 psi	220-VP-PT-CP15
Fuel, Nozzle, 0-150 psi	220-VP-PT-NP150
Fuel, Nozzle, 0-300 psi	220-VP-PT-NP300
Fuel, Nozzle, 0-500 psi	220-VP-PT-NP500
Fuel, Pump, 0-75 psi	220-VP-PT-PP075
Fuel, Pump, 0-150 psi	220-VP-PT-PP150
Fuel, Pump, 0-300 psi	220-VP-PT-PP300
Fuel, Pump, 0-500 psi	220-VP-PT-PP500
Nitrous Bottle #1, 0-1500 psi	220-VP-PT-N1
Nitrous Bottle #2, 0-1500 psi	220-VP-PT-N2
Nitrous Fuel #1, 0-15 psi	220-VP-PT-NF115
Nitrous Fuel #2, 0-15 psi	220-VP-PT-NF215
Nitrous Fuel #3, 0-15 psi	220-VP-PT-NF315
Nitrous Fuel #4, 0-15 psi	220-VP-PT-NF415
Oil, 0-150 psi	220-VP-PT-OP150
Oil, 0-300 psi	220-VP-PT-OP300
Pressure Differential, 0-40" H2O	220-VP-PT-PD145
Pressure Differential 0-5psi	220-VP-PT-PD745
Transmission, 0-300 psi	220-VP-PT-TP300
Transmission, 0-500 psi	220-VP-PT-TP500
Turbo Back Pressure #1, 0-75 psi	220-VP-PT-EP175
Turbo Back Pressure #2, 0-75 psi	220-VP-PT-EP275
Turbocharger Outlet #1, 0-75 psi	220-VP-PT-TB10
Wheelie Bar, Left, 0-3000 psi	220-VP-PT-WBL3K
Wheelie Bar, Right, 0-3000 psi	220-VP-PT-WBR3K
Wheelie Bar, Left, 0-5000 psi	200-VP-PT-WBL5K
Wheelie Bar, Right, 0-5000 psi	220-VP-PT-WBR5K

B. VACUUM

MANIFOLD, 30 PSI 0-30 In. hg	220-VP-PT-BVAC
Pan (Crankcase), 0-30 In. hg	220-VP-PT-PVAC



A. FUEL PRESSURE



B. VACUUM



C. FLUID TEMP

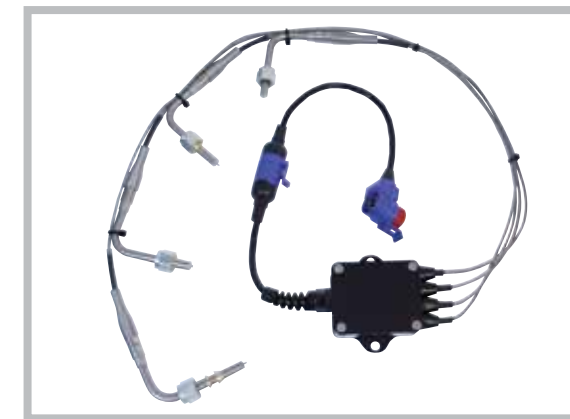

D. EXHAUST GAS TEMPERATURE JUNCTION



E. EXHAUST GAS TEMPERATURE SINGLE CYLINDER

C. TEMPERATURE

Pigtail cable lengths are shown in parenthesis.

Cylinder Head, Left, 0-600°F, (36")	220-VP-TC-HEADL
Cylinder Head, Right, 0-600°F, (36")	220-VP-TC-HEADR
Engine Oil, 0-300°F, (48")	220-VP-TR-OIL
Intake Manifold, Open Tip 0-600°F, (36")	220-VP-TC-MANIF
Intercooler Inlet, 0-300°F, (72")	220-VP-TR-ICTI
Rear End Oil, 0-300°F, (72")	220-VP-TR-RET
Transmission Oil, 0-300°F, (72")	220-VP-TR-TRANS
Transmission Oil, 0-600°F, (72")	220-VP-TC-TRANS
Water, 0-300°F (72")	220-VP-TR-WATER

D. EXHAUST GAS TEMPERATURES/CYLINDER BANK SETS

EGT junction box sets are ordered by the cylinder bank sequence they serve.

Junction Box & 4 Probes, 1357, Small Block	220-VP-TC-1357S
Junction Box & 4 Probes, 2468, Small Block	220-VP-TC-2468S
Junction Box & 4 Probes, 1357, Big Block	220-VP-TC-1357B
Junction Box & 4 Probes, 2468, Big Block	220-VP-TC-2468B
Junction Box & 4 Probes, 1234	220-VP-TC-1234
Junction Box & 4 Probes, 5678	220-VP-TC-5678
Junction Box & 4 Probes, Motorcycle	220-VP-TC-1234M
Junction Box & 3 Probes, 123	220-VP-TC-123
Junction Box & 3 Probes, 456	220-VP-TC-456
Junction Box & 3 Probes, 135	220-VP-TC-135
Junction Box & 3 Probes, 246	220-VP-TC-246

E. EXHAUST GAS TEMPERATURES/SINGLE CYLINDER

Single cylinder modules include the thermocouple.

Cylinder #1	200-VP-TC-EGT1
Cylinder #2	200-VP-TC-EGT2
Cylinder #3	200-VP-TC-EGT3
Cylinder #4	200-VP-TC-EGT4
Cylinder #5	200-VP-TC-EGT5
Cylinder #6	200-VP-TC-EGT6
Cylinder #7	200-VP-TC-EGT7
Cylinder #8	200-VP-TC-EGT8

A. ANALOG PRE-PROGRAMMED WITHOUT SENSORS

These analog function modules have been programmed for general usage, and have not been assigned to a specific task. Use of these modules on the V-Net cable requires the addition of a sensor and configuration of the module using your Datalink software.

Voltage, 0-5 Volt Input, 5 Volt Output	230-VM-AN-5V
Voltage, 0-5 Volt Input, 12 Volt Output	230-VM-AN-12V
Pressure, 5 Volt	230-VM-PT-5V
Position/Movement, Rotary or Linear	230-VM-TPS
Temperature, Fluid-type, 0-300°F <i>For use with sensor #810-TR-300 only</i>	230-VM-TR-300
Temperature, Low, 0-600°F <i>For use with type K thermocouples only</i>	230-VM-TC-600
Temperature, High, 0-1800°F <i>For use with type K thermocouples only</i>	230-VM-TC-1800
Air/Fuel Sensor Input, Single	230-VM-AF
Battery Voltage	230-VM-BVOLT
Voltage Differential	230-VM-5VDIFF

ANALOG NOT PRE-PROGRAMMED WITH SENSORS

The module/sensor combinations are the same as the V-Net Modules with Sensors/Analog on pages 19-20 with the exception that they have not been pre-programmed. Each of the pressure or temperature module/sensor combinations below is designed to be attached to the V-Net cable. Once installed, they must be programmed using the Configuration File in the Datalink software.

B. PRESSURE

0-15 psi	220-VS-15GVT
0-75 psi	220-VS-75GVT
0-150 psi	220-VS-150GVT
0-300 psi	220-VS-300GVT
0-500 psi	220-VS-500GVT
0-1500 psi	220-VS-1500SVT
Vacuum/Pressure 30 In. hg-0-30 psi	220-VS-VB

C. TEMPERATURE

Fluid Temperature, 0-300°F, Fluid Type Sensor <i>Uses the #180-TR-300 sensor</i>	220-VS-TR-300
---	---------------



A. VOLTAGE 0-5 INPUT



B. PRESSURE 0-75



C. FLUID TEMPERATURE 0-300°F



F. EXTENSION CABLES



G. 2 AND 3 PIN CONNECTOR KITS

D. FLUID TEMPERATURE SENSOR 810-CN-TR2P
Use with V-Net modules and temperature sensors having prefix number of 220-VP-TR-, 220-VM-TR-, or 230-VM-TR-.

E. PRESSURE SENSOR 810-CN-TI3P
Use with V-Net module and pressure sensor having prefix number of 220-VP-PT-, 220-VS-, or 230-VM-PT-.

F. EXTENSION CABLES

These custom-built extensions can be used to extend the length of cables that use a 2-Pin or 3-Pin Molex connector to attach the sensor to the power harness or a module's pigtail. Please specify length required when ordering.

2-Pin Molex Cable, Specify Length	800-CA-EXT2P
3-Pin Molex Cable, Specify Length	800-CA-EXT3P

G. MOLEX TERMINAL KITS

These connector kits can be used if the need arises to shorten a cable that is terminate. Available with a two or three pin Molex connector. Kit includes both a male and female connector and pins.

2-Pin Molex Connector Kit	810-CN-MOL2
Pin Molex Connector Kit	810-CN-MOL3
Crimp Tool for Molex Terminal Pins	800-XP-CRIMP-01F

A. DIGITAL PRE-PROGRAMMED MODULES WITH SENSORS

These pre-programmed digital function modules and sensor combinations are ready for plug-and-play installation on the V-Net cable. See sensors only page.

CLUTCH RPM Monitors magnetic pulses using a Zero Crossing sensor.	220-VP-CL-1
Drive Shaft RPM, Automotive (Contact Closure Sensor) Contact Closure sensor, includes split collar, magnet, and bracket kit.	220-VP-DS-2
Drive Shaft/Rear Wheel RPM, Motorcycle Monitors magnetic pulses using a Zero Crossing sensor.	220-VP-ZXDS-2
Front Wheel RPM Monitors magnetic pulses using a Zero Crossing sensor.	220-VP-FWZX
Front Wheel RPM Monitors ferrous metal pulses using a Hall Effect sensor.	220-VP-FWHE3
Turbo Speed for use with Racepak V-Net Data Loggers	220-VP-TURBORPM
Turbo Speed V-Net Module only	230-VM-TURBO
Turbo Speed Sensor only	800-SS-SPEED

B. DIGITAL PRE-PROGRAMMED MODULES WITHOUT SENSORS

These pre-programmed digital function modules are ready for plug-and-play installation on the V-Net cable. You must add the appropriate sensor to the module.

Zero Crossing Input	230-VM-ZX-1
Hall Effect Input	230-VM-RPMHE
Contact Closure Input	230-VM-CC-1
Event Marker Input, 12 Volt	230-VM-EVENT
Event Marker Input, Switch Closure	230-VM-EVENTSW
Flow Meter	230-VM-FLOW
Four Channel Digital Input	230-VM-4DIGIN
Four Channel Digital Output	230-VM-4DIGOUT

C. DIGITAL PRE-PROGRAMMED MODULES NO SENSORS REQUIRED

These modules do not require a sensor. They use the pulse from the component they are monitoring as the signal to the module. Each has been programmed for the specific use noted and is ready for plug-and-play installation on the V-Net cable.

Engine RPM Input Module	220-VP-TACH-4
Transbrake Event 12 Volt Triggered	220-VP-TBRAKE
Wide Open Throttle Event	220-VP-WOTEVENT
Clutch Event 12 Volt Triggered	220-VP-CLTEVENT



A. DRIVESHAFT RPM



B. ZERO CROSSING INPUT



C. ENGINE RPM INPUT



D. SHIFT LIGHT/EVENT MODULE

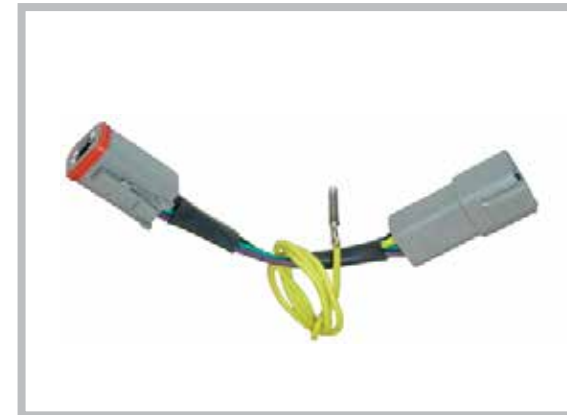

E. MSD PRO MAG TACH CONVERTER



F. IGNITION TIMING KIT OVERALL FOR V500

D. SHIFT LIGHT/EVENT MODULE

The Shift Light Module allows you to use any LED-style light (300 milliamp maximum) as a fully-programmable, stand-alone shift light. By accessing the engine RPM off of the V-Net you can program up to six separate shift alarm signals. Each shift point is user-programmable using the DatalinkII software. Shift light module does not include the shift light. This module will also show you when the shift light was triggered to come on.

Shift Light Module (Light Not Included)	230-VM-SHIFLITE
--	------------------------

E. TACH CONVERTER

The output signal that is used to trigger magnetos is different than a conventional electronic ignition. This compact device converts the Pro Mag's coil signal into a 12 volt square wave signal so common tachometers designed for electronic ignitions can be used with the Pro Mag.

MSD Pro Mag Tach Converter	810-SN-MAG-CONV
-----------------------------------	------------------------

MSD Magneto Pickup Adapter (MSD 12 or 20 amp mag) Cable provides easy connection for RPM sensor between magneto and coil.	800-CA-MAGADPT
---	-----------------------

F. IGNITION TIMING KIT

By equipping the V500 data recorder with this kit it can track the overall timing, or if you are using a battery ignition system that provides adjustable individual cylinder timing, you can monitor the timing on each cylinder as well. These kits provide the components to compare the crankshaft's position to the firing pulse(s) of the ignition. Magneto equipped engines, or battery ignition engines without individual cylinder timing capabilities, would use the overall timing kit.

Ignition Timing Kit, Overall, V500 Only	800-KT-TIMINGOV
--	------------------------

Ignition Timing Kit, Individual, V500 Only	800-KT-TIMING
---	----------------------

V300SD customers can monitor overall ignition timing utilizing Racepak's V300SD Timing Kit. Use of this package requires removal of the start logging button, which is replaced by a crankshaft rpm sensor. Start logging is then initiated by another channel (engine rpm, etc) or by use of a V-Net event module which then allows use of the start logging button.

Note the following requirements:

- Any V300SD not ordered with this option must be returned to Racepak for upgrade:
- Engine must utilize flying magnet crank trigger wheel
- DatalinkII standard software required
- Contact Racepak for complete details

Ignition Timing Kit, Overall, V300SD	200-UG-TIMV300S
---	------------------------

08

Tip #8 Need to email a Racepak runfile?

It is no more complicated than emailing a photo to a friend. Simply create your email, then select the appropriate attach command or icon in your email program.

Runfiles are saved inside your particular data logger folder found in the RacepakData folder, on your C drive.

A. EFI DATA INTERFACE

These V-Net modules have been created to interface with many electronic fuel injection systems on the market. Each V-Net EFI Data Interface module is equipped to allow direct connection with EFI. These modules allow your V-series data recorder to share the data collected by these systems rather than having to install duplicate sensors to monitor functions that are already being monitored by the EFI system. The shared data can be recorded or displayed just as you would any function monitored independently by your Racepak V-series recorder. Caution should be exercised to ensure that you do not exceed the maximum number of V-Net channels supported by your particular logger. The individual functions monitored by each EFI system are outlined in the chart below. **For use with Racepak V-Net data loggers.**

Accel DFI Gen VII	230-VM-EFIDFI
AEM	230-VM-EFIAEM
Autronic SMC & SM2	230-VM-EFIAUT
Autronic SM4 V107 & V109	230-VM-EFIAUT4
Big Stuff 3	230-VM-EFIBS3
Corvette C6 OBDII GMX3 (2006 and Later)	230-VM-EFIIC6
EFI Technologies	230-VM-TECH
FAST XFI CAN	230-VM-EFIXFI
FAST Serial	230-VM-EFIFST
Generic J1939 CAN	230-VM-EFICAN
Haltech	230-VM-EFIHAL
Holley EFI	230-VM-EFIHOL
Hondata KPro	230-VM-EFIHOND
Megasquirt I	230-VM-EFIMS1
Megasquirt II	230-VM-EFIIMS2
MEFI 4B J1939 (GM PN 12584052, 12575479)	230-VM-EFIIM4
Motec M400, M600, M800, M84	230-VM-EFIMOTEC
Motec M4, M48	230-VM-EFIMOTSR
Omex	230-VM-EFIOMEX
Omniteck EC44	230-VM-EFIEC44
PRO EFI	230-VM-EFIPRO
Vipec	230-VM-EFIVIPEC
WOLF V500	230-VM-EFIWOLF
Atomic LS	230-VM-EFIALS
Atomic TBI	230-VM-EFIATBI
Fuel Tech	230-VM-EFIFUEL

AIR/FUEL SENSORS

Racepak has created a selection of A/F controllers and sensors created specifically for tuning race engines. The 4 channel controller is designed to be connected to the V-Net cable of Racepak V-series recorders. When ordering please be aware that the sensors are calibrated for use on specific ports of the controller and cannot be interchanged from port to port without recalibration. All sensors have a 13" pigtail cable, and the controller has a 37" cable for attachment to the sensor. These lengths cannot be altered. Controllers are ordered by cylinder bank layout.

Racepak A/F sensors are compatible with either gasoline or methanol fueled engines. Gasoline application will display A/F ratios between 9.55:1 and 20:1, while methanol is shown from 4.22:1 to 8.7:1. Please specify the type of fuel you will be using when ordering. Each sensor includes one weldment and plug.



B. 4 CHANNEL AIR/FUEL CONTROLLER

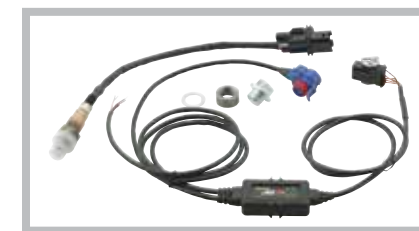

C. SINGLE AIR/FUL CONTROLLER WITH SENSOR

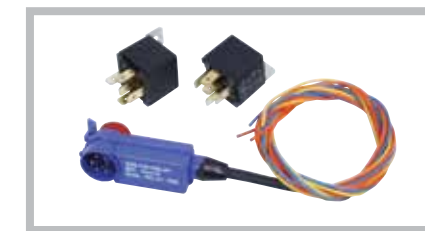

D. RELAY CONTROL



E. STEERING SENSOR PACKAGE

B. AIR/FUEL CONTROLLERS

Sensors must be ordered separately

4 Channel Controller, Cylinders 1, 3, 5, 7, 220-VM-AF4-1357
For use on 1, 3, 5, 7 cylinder bank of V8, i.e. GM & Mopar.

4 Channel Controller, Cylinders 2, 4, 6, 8 220-VM-AF4-2468
For use on 2, 4, 6, 8 cylinder bank of V8, i.e. GM & Mopar.

4 Channel Controller, Cylinders 1, 2, 3, 4 220-VM-AF4-1234
For use on 1, 2, 3, 4 cylinder bank of V8, i.e. Ford.

4 Channel Controller, Cylinders 5, 6, 7, 8 220-VM-AF4-5678
For use on 5, 6, 7, 8 cylinder bank of V8, i.e. Ford.

Air/Fuel Sensor Only 810-SN-AFAMP

Air/Fuel Weldment & Plug 810-TX-AFWLDP
Weldments are included with purchase of controller.

Air/Fuel Harness 'A' Side 280-CA-LSUA-AMP

Air/Fuel Harness 'B' Side 280-CA-LSUBS-AMP

C. SINGLE AIR/FUEL CONTROLLER WITH SENSOR

Single channel air/fuel sensor package. Includes controller, (1) Bosch LSU air/fuel sensor, weld bung, wiring harness, instructions. Includes 0-5V reference output for external devices. For use with Racepak V-Net data loggers.

AF1 Package 220-VM-AF1

D. RELAY CONTROL MODULE

A Relay Control Module is the device which permits the V-Net system to perform a host of automated tasks. It allows any information transmitted over the V-Net to be used to activate external high power devices such as a switch, solenoid, water pump, fan, or lights. Each module has two programmable output relays.

Each relay can have up to two separate (analog and/or digital) control signals that must be met before the relay is engaged. For example, one relay can be programmed to turn on a water pump only when a 'Pump' switch is on and the water temperature is above the programmed value, while the other relay can be used to activate an ignition kill switch only if the engine RPM is above a programmed value and the oil pressure is lower than a predetermined pressure. Relays are included.

AF1 Package 230-VM-RELAY

E. STEERING SENSOR

Column mounting steering sensor package includes rotary sensor, column mount, billet contact wheel and V-Net module. For use with Racepak V-Net data loggers.

Steering Sensor 220-VP-SK-1

A. ANALOG INTERFACE MODULES WITHOUT SENSORS

Shock Travel, Right Front, 28" Pigtail (Std.)	240-IM-TRAV28RF
Shock Travel, Right Front, 38" Pigtail	240-IM-TRAV38RF
Shock Travel, Left Front, 65" Pigtail (Std.)	240-IM-TRAV65LF
Shock Travel, Right Rear, 48" Pigtail (Std.)	240-IM-TRAV48RR
Shock Travel, Right Rear, 72" Pigtail	240-IM-TRAV72RR
Shock Travel, Left Rear, 48" Pigtail	240-IM-TRAV48LR
Shock Travel, Left Rear, 84" Pigtail (Std.)	240-IM-TRAV84LR

C. DOOR CAR DRAG SHOCK KIT FRONT

Includes two 0-4" travel linear sensors, two IM modules, 108" IM cable and installation instructions.

Front Kit	280-KT-DSHKTRVF
-----------	-----------------

D. DOOR CAR DRAG SHOCK KIT REAR

Includes two 0-8" travel linear sensors, two IM modules, 6" IM cable and installation instructions.

Rear Kit	280-KT-DSHKTRVR
----------	-----------------

INTERFACE MODULES

Interface modules are another unique component of the V-series recorders. These black 7-pin modules differ from the blue 5-pin V-Net modules in both the application and the manner in which they perform. They are designed to provide a modular method of assembly for the sensors that connect to either the hardwired RPM or Analog input ports of V300SD, V500 or G2X Pro data recorders. Each Interface module provides the necessary signal conditioning for its attached sensor thereby allowing the sensors to communicate with the Logger via a single cable.

Interface modules do not require any programming, however you may only attach up to four Interface module together in series. The four modules may be connected directly to each other (Daisy-chained) or they may be linked with an Interface cable as illustrated below.

The list below shows a selection of Interface modules that will help you in the task of connecting almost any type of digital or analog sensor to a V300SD, V500 or G2X Pro recorder.

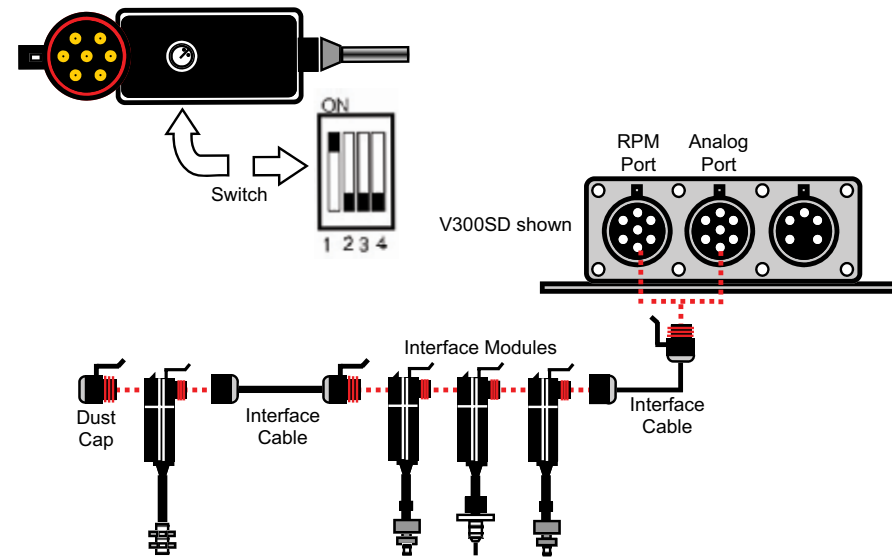

A. SHOCK TRAVEL INTERFACE MODULE

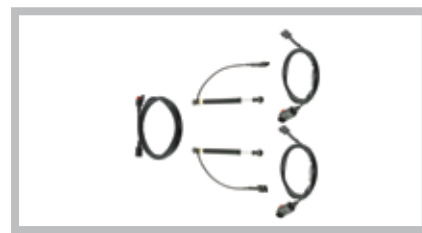

C. FRONT SHOCK KIT



D. REAR SHOCK KIT

CABLES

V-Net modules and Interface modules, although similar in construction and appearance, are very different in the functions they perform. It is important that components designed for one system not be interchanged with the other. V-Net cables use a 5-pin connector, while Interface cables use a 7-pin connector. So that cables can be identified at a glance Racepak has color-coded the connectors on the end of the cables. V-Net cable connectors are blue, just like the modules to which they attach, while Interface cable connectors and modules are black.

The cables listed may be used to link the components to other listed components of the same system, or to their proper port on the recorder. The Interface cables with black connectors will only be used with modules connecting to the RPM or Analog input ports, while the V-Net cables with blue connectors will be used exclusively on items connected to the V-Net port.

CABLE LENGTH	5-PIN BLUE V-NET	7-PIN BLACK INTERFACE
6"	280-CA-VM-006	280-CA-IM-006
12"	280-CA-VM-012	280-CA-IM-012
18"	280-CA-VM-018	280-CA-IM-018
24"	280-CA-VM-024	280-CA-IM-024
36"	280-CA-VM-036	280-CA-IM-036
48"	280-CA-VM-048	280-CA-IM-048
60"	280-CA-VM-060	280-CA-IM-060
72"	280-CA-VM-072	280-CA-IM-072
84"	280-CA-VM-084	280-CA-IM-084
96"	280-CA-VM-096	280-CA-IM-096
108"	280-CA-VM-108	280-CA-IM-108
120"	280-CA-VM-120	280-CA-IM-120
144"	280-CA-VM-144	280-CA-IM-144
168"	280-CA-VM-168	280-CA-IM-168
192"	280-CA-VM-192	280-CA-IM-192
216"	280-CA-VM-216	280-CA-IM-216

TEE CABLES

All V-Net systems must be equipped with a Tee cable. The Tee cable permits the installation of the two terminator caps (one male and one female) which are necessary to the operation of the V-Net system. Just like the ends on the V-Net cables, all V-Net Tee cables and Terminator Caps are blue.

Interface modules can also use a Tee cable, but only for the purpose of providing a branch in the system. It is not a mandatory component as it is on the V-Net system. The black Interface Tee cables and dust caps are used just for the purpose their names imply. They are not required for the system to operate properly.

Bulkhead connectors are used when a V-Net or Interface cable must pass through a firewall, body panel, or motor plate. They provide a male/female connector on each side of the panel. These are specific to the type of cable that is being used and are color coded for easy identification.

COMPONENT	5-PIN BLUE V-NET	7-PIN BLACK INTERFACE
TEE CABLE, 9"	280-CA-VM-T009	280-CA-IM-T009
TEE CABLE, 18"	280-CA-VM-T018	
TEE CABLE, 36"	280-CA-VM-T036	
TERMINATOR CAP, MALE	280-CA-VM-TCAPM	
TERMINATOR CAP, FEMALE	280-CA-VM-TCAPF	
DUST CAP, MALE		280-CA-IM-DCAPM
DUST CAP, FEMALE		280-CA-IM-DCAPF
BULKHEAD CONNECTOR	280-CA-VM-BHEAD	280-CA-IM-BHEAD

A. PRESSURE TRANSDUCERS

The small size and ruggedness of these 'PT-type' pressure transducers make them ideal for the measurement of pressure directly at the source. The transducer requires 5 volt DC power and provides a .5 to 4.5 volt output signal. Each transducer mounts using a 1/8" NPT male pipe fitting.

0-15 psi	810-PT-0015GVT
0-75 psi	810-PT-0075GVT
0-150 psi	810-PT-0150GVT
0-300 psi	810-PT-0300GVT
0-500 psi	810-PT-0500GVT
0-1500 psi	810-PT-1500HP
0-3000 psi	810-PT-3000HP
0-5000 psi	810-PT-5000HP



A. PRESSURE TRANSDUCER

VACUUM/PRESSURE SENSOR

30 in. hg-0-30 psi, Vacuum/Boost	810-PT-VB
----------------------------------	-----------

ADAPTER MODULES

The pressure sensors listed on page 19 can be adapted to the V-Net cable or analog port of the recorders by using the appropriate signal condition module.

V-Net Module	230-VM-PT-5V
For connection to the V-Net cable on the V-series recorders.	

B. FUEL FLOW METER SENSORS

These general purpose turbine-type flow meters require an available digital channel. Gasoline and Nitro-methane flow meters are constructed of aluminum. Methanol fuel requires the use of a stainless steel flow meter. A tee fitting must be used so all fuel can be routed through the flow meter before it is divided between the hat nozzles and the port nozzles on fuel injection applications.

Flow Meter, Gas or Nitro, 8AN (1-10 GPM)	800-FM-AN8-AL
Flow Meter, Gas or Nitro, 10AN (2-25 GPM)	800-FM-AN10-AL
Flow Meter, Gas or Nitro, 12AN (2-70 GPM)	800-FM-AN12-AL
Flow Meter, Methanol, 8AN (1-10 GPM)	800-FM-AN8-SS
Flow Meter, Methanol, 10AN (2-25 GPM)	800-FM-AN10-SS
Flow Meter, Custom Order	Call for information
Tee Fitting 10AN inlet two 8AN outlets	Call for information

ADAPTER MODULES

V-Net Module	230-VM-FLOW
Use to connect flow meter to V-Net Cable.	



B. FUEL FLOW METER SENSORS

C. REED SWITCH RPM SENSOR

These contact closure-type sensors use an internal, fast acting reed switch to indicate the passing of a rotating magnet.

RPM Sensor, 2-Pin 5/16" 24 dia.	800-SS-PRO-5
Commonly used as a driveshaft RPM sensor V300	

RPM Sensor, 2 Spade Connectors, 5/16" 24 dia.	800-SS-RB-5
Commonly used for clutch, driveshaft and front wheel RPM with SC1000 recorders.	

ZERO CROSSING RPM SENSORS

Zero Crossing RPM Sensor, 3-Pin 3/8" dia.	800-SS-ZX-3
---	-------------

This non-powered sensor is designed for monitoring magnetic pulses. It must be used with an RPM input designed for a zero crossing sensor. Used as the clutch RPM or Front Wheel RPM sensor on V-series and 2001 and newer Pro Series recorders.

Zero Crossing TDC Sensor, 3-Pin 3/8" dia.	800-SS-TDC-3
---	--------------

This sensor is designed specifically for use with MSD-style crank trigger wheel and magnets. It must be used with a RPM input designed for a zero crossing sensor. Commonly used for the TDC indicator on ignition timing monitor with V500 recorders.

HALL EFFECT SENSOR

Ferrous Material sensor, 3-Pin, 3/8" dia.	800-SS-MSC-3
---	--------------

Commonly used to sense a ferrous bolt or metal tooth, such as used when monitoring the ring gear RPM. These powered sensors require 12v power.

Magnetic Pulse Sensor, 3-Pin, 5/16" dia.	800-SS-MSC-5
--	--------------

Same as above, but triggered by a magnet rather than a ferrous metal.

D. ENGINE RPM WITH MAGNETO IGNITION

Occasionally, a V-series data recorder will be used to monitor the RPM of an engine that is equipped with a magneto ignition system. In this situation the engine RPM signal is acquired using the inductive pickup shown below. This sensor sources the ignition pulses between the magneto and the control box, and then transfers the signals to the onboard recorder through the wire harness or a V-Net module.

Inductive Magneto RPM Sensor	280-SN-MAGPU
------------------------------	--------------

With connector to plug into the V300 wiring harness.

Inductive Magneto RPM Sensor	280-SN-MAGPU3
------------------------------	---------------

With connector to plug into the V300SD wiring harness.

ADAPTER MODULE

V-Net	220-VP-TACH-(NUMBER OF PULSES)
-------	--------------------------------

Adapts the Inductive Engine RPM sensor to the V-Net Cable

MSD Magneto Pickup Adapter (MSD 12 or 20 amp mag)	800-CA-MAGADPT
---	----------------

Adapts the Inductive Engine RPM sensor to the V-Net Cable



C. RPM 2-PIN CONNECTOR



C. RPM 2-SPADE SENSOR



C. ZERO CROSSING RPM SENSOR



C. ZERO CROSSING TDC SENSOR



C. FERROUS MATERIAL SENSOR



C. MAGNETIC PULSE SENSOR



D. INDUCTIVE MAGNETO RPM SENSOR



D. MSD MAGNETO PICKUP ADAPTER

A. EXHAUST GAS TEMPERATURE THERMOCOUPLES

V-Net systems and V-series recorders use two types of thermocouple setups to monitor the exhaust gas temperatures, one for an individual cylinder application and another for 3 or 4 cylinder groups. Measuring the EGTs on a single cylinder application is accomplished using a thermocouple that features an inline, two-prong mini-connector. This connector provides the union between the thermocouple and the V-Net module. A selection of single cylinder thermocouples is shown below.

The most frequently used setup is the four thermocouples with junction box combination shown below. This setup simplifies the installation on V8 engines by grouping the four thermocouples on each cylinder bank into a common junction box. The junction box then provides a single wire connection to the V-Net module to facilitate service work. A similar setup is available for V6 engines.

V-Net applications also use two styles of thermocouples. Four cylinder motorcycles make use of the .187-inch diameter tip bullet-style thermocouples, while Harley-Davidsons and the automotive applications employ the .250-inch diameter Stinger-style thermocouples. When replacing a thermocouple probe, use the illustration alongside the chart to determine the length you will need. The thermocouples used with the junction boxes, and some individual thermocouple components that are often requested, are shown in the chart. See page 20 for single or four station EGT modules that include the thermocouples.

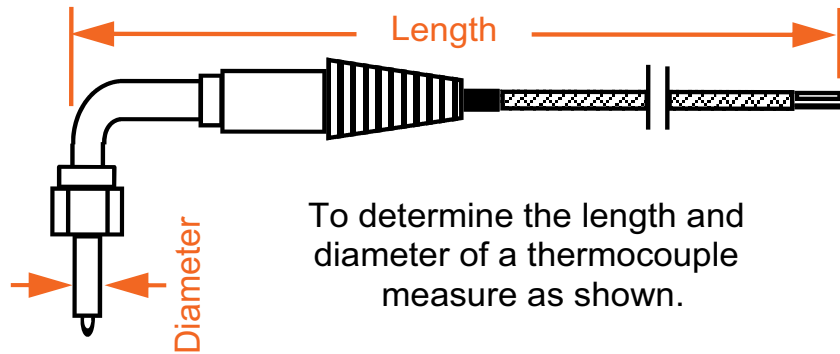

B. SPECIAL PURPOSE THERMOCOUPLES

These Type-K thermocouple assemblies (Nickel-Chromium/Nickel-Aluminum) are specifically designed for the applications listed below. Each must be used with the appropriate thermocouple amplifier module. All probes are 12" in length and are terminated with a male two pin mini-connector. The liquid and manifold assemblies are provided with a 1/8" male NPT compression style fitting.

Cylinder Head Temp. Thermocouple Assem. 800-TC-HT-ASM
Ring type sensor is used to monitor temperature of the metal, not the coolant.

Fluid Temp. Thermocouple Assem. 800-TC-FT-ASM
Used where the probe can be immersed in liquid, such as in a dry sump tank.

Manifold Temp. Thermocouple Assem. 800-TC-MT-ASM
Open end probe reacts quickly to changing temperatures in manifold plenum.



B. THERMOCOUPLE ASSEMBLY

.187" DIA. BULLETS (MOTORCYCLES, 4 CYL)

12"	800-TC-B3-12
16"	800-TC-B3-16
19"	800-TC-B3-19
22"	800-TC-B3-22
Set of 4 - One of each length	800-TC-B3-SET

.250" DIA. STINGERS (AUTO, H-D BIKES)

9"	800-TC-S4-09
13"	800-TC-S4-13
18"	800-TC-S4-18
21"	800-TC-S4-21
23"	800-TC-S4-23
28"	800-TC-S4-28
32"	800-TC-S4-32
Set of 8	800-TC-S4-SET1
1 each: (9", 13", 18", 23")	
Set of 8 Big Block Heads	800-TC-S4-SET2
2 each: (18", 23", 28", 32")	
Set of 8 Small Block Heads	800-TC-S4-SET3
2 each: (13", 18", 21", 28")	

THERMOCOUPLE ADAPTERS MODULES

V-Net Cable Module Adapter	230-VM-TC-1800
----------------------------	----------------

MISCELLANEOUS EGT COMPONENTS

Weldment, Nut & Ferrule Assembly	800-TX-WASM3 800-TX-WASM4
Weldment Only, Single	800-TX-WELD4
Weldment Only, Single, Stainless	800-TX-WELD4SS
Weldment Only, Set of 4	800-TX-WELD404
Weldment Only, Set of 8	800-TX-WELD408
Ferrule Only	800-TX-F4
Nut Only	800-TX-WNUT4
Cap Only	800-TX-CAP4
Nut & Ferrule Only	800-TX-NF4



C. FLUID TEMPERATURE SENSOR



D. INFRARED TEMPERATURE SENSOR

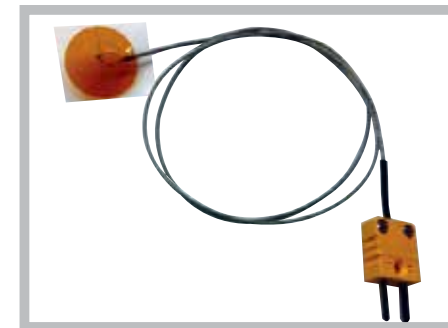

E. ADVESIVE 0-600F THERMOCOUPLER SENSOR

C. FLUID TEMPERATURE SENSOR

This sensor is commonly used in conjunction with the modules shown below to measure the temperature of fluids such as water or engine and transmission oil where the temperature does not exceed 300°F.

Fluid Temperature, Sensor Only 0-300°F 810-TR-300
For use with V-Net modules.

ADAPTER MODULES

V-Net Module 230-VM-TR-300
Used to connect the 810-TR-300 sensor to the V-Net cable.

Interface Module 240-IM-FT350
Used to connect the 810-TR-300 sensor to the Analog Port.

D. INFRARED TEMPERATURE SENSORS

These infrared sensors are used to monitor temperatures where contact cannot be made with the item being monitored. In racing, they are commonly used to monitor temperatures across the face of a tire, but they can be used for any non-contact measurement. The sensor will measure temperatures from 0-400°F. The IR Temperature sensor has a 4:1 ratio focal point. That means that when the item being monitored is four inches away from the sensor, the focal point will be one inch in diameter. If the sensor is twelve inches away, the focal point will be three inches in diameter.

IR Sensor and V-Net Module 220-VP-IR-T-200

IR Temp Sensor Only 810-SN-IRT-200

E. ADHESIVE 0-600F THERMOCOUPLE SENSOR

Racepak's adhesive 0-600F thermocouple sensor eliminates the need for bung and other sensor mounting methods, making ideal for a number of surface temperature reading such as Shock Housing Temp, Engine Block Temp, Fuel Tank Temp, Fuel Pump Temp, Electric Motor Temp, Batteries, and many more. For use with V-Net module or Transducer box.

Adhesive 0-600F Thermocoupler Sensor 800-TC-PD-600

F. WIDE OPEN THROTTLE SENSORS

Wide open throttle event switches are used on Holley® carburetors to verify when the carburetor is at full throttle and the throttle blades are wide open. Two styles of mounting brackets are available. Both bolt directly to the side of the carburetor main body. Monitoring WOT requires an available V-Net channel.

Switch Only, WOT 800-MB-WOT-SW

Cable Only, Pigtail for WOT Switch 280-CA-HARNWOT

Switch & Pigtail Only 800-MB-WOT-SWC

ADAPTER MODULES

V-Net Module 220-VP-WOTEVENT

A. SHOCK TRAVEL SENSORS

Monitoring suspension travel aids greatly in gaining an understanding of what the chassis is doing. The information obtained from these sensors is often the key element separating the winners from the losers, regardless of the type of racing. Racepak users can employ these linear potentiometers to record the slightest amount of suspension movement, even at high rates of speed. Shock travel sensors are usually connected through the analog port of V-series recorder and monitored at a high sample rate. Each kit contains a linear travel sensor with attached cable and an Interface module. An available analog channel is required for each sensor. A separate kit is required for each wheel monitored.

Kit Front Shock Travel, V-Series Data Recorders 0-4" **280-KT-SHKTRVF**

Kit Rear Shock Travel, V-Series Data Recorders 0-8" **280-KT-SHKTRVR**

Uses interface module for connection to hardwired analog port of V300 or V500.

Shock Travel Sensor, 0-2", (7.4" to 9.4") **800-LN-TRV2**

Shock Travel Sensor, 0-3", (8.4" to 11.4") **800-LN-TRV3**

Shock Travel Sensor, 0-4", FNT (9.7" to 13.7") **800-LN-TRV4**

Shock Travel Sensor, 0-3", R (12.6" to 20.6") **800-LN-TRV8**

B. LINEAR TRAVEL SENSORS

These linear potentiometers are used to monitor movement or position. They are commonly used on applications such as magneto retard devices, fuel slide valves, and linear clutch bearing position. Their use requires an appropriate signal conditioning module.

Linear Travel Sensor, 0-1.0" **800-LN-FUEL**

Used to monitor pneumatic magneto retard or slide valve fuel system controller.

Linear Travel Sensor, 0-3.0" **800-LN-CLV3**

Used to monitor clutch throw out bearing.

ADAPTER MODULES

V-Net Module **230-VM-TPS**

For connection to V-Net cable on V-series recorders.

Interface Module **240-IM-TRAV**

For connection to Analog port of V300 or V500 recorders

C. STRING POTENTIOMETER

This sensor is typically used for linear measurements, such as throttle position, when the mounting angle is not critical. The sensor is calibrated to the travel of the throttle (i.e. 0% when closed and 100% at WOT). By using a string potentiometer, the possibility of interference with the throttle operation is eliminated. Operating range 0-4.750".

String Potentiometer Sensor **800-LN-STRINGP**

Can use the V-Net and Interface Adapter Modules above.



A. FRONT SHOCK TRAVEL



B. LINEAR TRAVEL SENSOR



C. STRING POTENTIOMETER



D RIDE HEIGHT SENSOR



E. G-FORCE SENSOR

D RIDE HEIGHT SENSOR (Asphalt Only)

Infrared sensors are used to monitor the distance to an object, relative to the sensor, when contact cannot be made with the object. This makes them ideal for use in setting up the suspension by monitoring chassis ride height in relation to the moving ground plane. Infrared Ride Height sensors and modules are commonly attached to the V-Net cable of any V-series recorder. If desired, they can also be attached to the analog port by using an Interface module rather than a V-Net module. These sensors are designed for use in measuring distances ranging from 3.93 to 15.75 inches. Each sensor must be used with the appropriate V-Net module.

Ride Height Sensor Kit, V-Net; Left Front **220-VP-RIDEHTLF**

Ride Height Sensor Kit, V-Net; Right Front **220-VP-RIDEHTRF**

Ride Height Sensor Kit, V-Net; Left Rear **220-VP-RIDEHTLR**

Ride Height Sensor Kit, V-Net; Right Rear **220-VP-RIDEHTRR**

Module Only, Ride Height, V-Net, Left Front **220-VM-RHBLF**

Module Only, Ride Height, V-Net, Left Rear **220-VM-RHBLR**

Module Only, Ride Height, V-Net, Right Front **220-VM-RHBRF**

Module Only, Ride Height, V-Net, Right Rear **220-VM-RHBRR**

Sensor Only, Ride Height **810-SN-RHB**

E. G-FORCE SENSORS (ACCELEROMETER)

These G-force sensors can be adapted to any V-Net system (Note: V300 & V500 data recorders all contain internally mounted G-meters) to measure longitudinal and lateral forces. The externally-mounted G-meter measures 2.0" x 2.0" x 1.250".

G-Meter, 0-6 G **220-VP-GM**

ADAPTER MODULES

V-Net Module Only **230-VM-AN-12V**

Adapts external G-meter to V-Net cable.

A. PRO ANALOG TRANSDUCER BOX II

This is the next generation Pro Analog Transducer Box which is a smaller and lighter version than the previous analog transducer box. Just like the past analog transducer box, this is an additional method of connecting analog sensors into the V-Net recorders. Each Pro Analog Box will house up to four of the Plug-In style transducer modules. The box is then connected to a single V-Net cable. Plug-In style transducers and adapter modules must be purchased separately.

Pro Analog Transducer Box II 230-VM-4TD

Frame Rail Bracket 800-MB-TB2
Adapts Pro Analog Box II to round tube

B. TRANSDUCER MODULES, PLUG-IN STYLE II

When using the Pro Analog Transducer Box these plug-in style transducers and signal conditioning modules are used to convert the input from various analog functions into signals that can be recognized by the recorder. Where required, a special cable is needed for connecting the sensor to the module.

Pressure Transducer, PSI 810-M5-PT2-(SPECIFY PSI)
Available in ratings of: 0 to 15/60/100/150/300/500/750/1500.
Used to measure pressure from parameters such as fuel, oil, boost, nitrous. Route your pressure line directly to the transducer. Transducer has 1/8" NPT female thread.

Vacuum Transducer, 0-30 In. hg 810-MD-PT2-VAC
Typically used to monitor manifold or pan vacuum.
A vacuum line is routed directly to transducer.

Thermocouple Amplifier Module, 0-500°F 810-M-TC2-500

Cable Only, Thermocouple Sensor to Module, over 3'. (specify length) 800-CA-TCEXT-XL

Cable Only, Thermocouple Sensor to Module, under 3'. (specify length) 800-CA-TCEXT-XL
Used on low temp applications such as water, oil, cylinder head. Not for use with EGTs. Module, cable and sensor kit available as PN# 810-KT-TC-500. Specify use and cable length.

0-5 Volt Input Module, can output either 5 or 12 volts to powered sensor 810-MD-0-5V2
Cable Only, Sensor to module 800-CA-3PM (specify length).
Receives 0-5 volt input from powered sensor while providing 5 or 12v to power the sensor.



A. PRO ANALOG TRANSDUCER BOX II

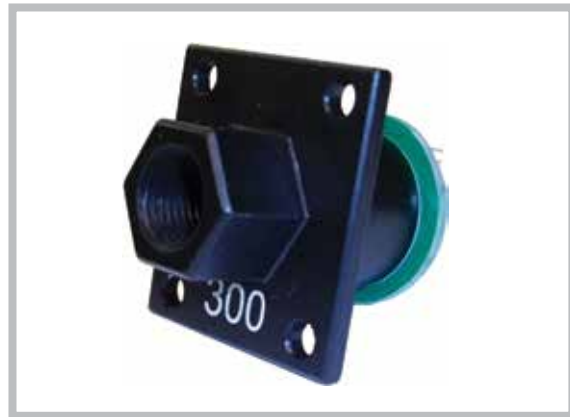

B. PRESSURE TRANSDUCER

09

Tip #9 Trying to decide between a V300SD or Sportsman data logger, for your drag race vehicle?

The first question to be answered is, how many external sensors will you be adding?

The Sportsman is limited to 18 total V-Net sensors (with optional upgrades), for use with unblown or vehicles that do not utilize magneto ignitions, while the V300SD provides for 56 V-Net channels out of the box.

Looking for overall cylinder timing or shock sensors? The V300SD will be your choice.



C. PRO ANALOG TRANSDUCER BOX OLD STYLE



D. PRESSURE TRANSDUCERS

C. PRO ANALOG TRANSDUCER BOX OLD STYLE

The Pro Analog Transducer Box offers an additional method of connecting analog sensors into the V-Net recorders. Each Pro Analog Box will house up to four of the plug-In style transducer modules. The box is then connected to either the V-Net cable or the analog port, via a single cable, by using one of the appropriate adapter modules shown below. Plug-in style transducers and adapter modules must be purchased separately.

Pro Analog Transducer Box II 810-MB-8P

Frame Rail Bracket 800-MB-ANA
Adapts Pro Analog Box II to round tube

ADAPTER MODULES

V-Net 230-VM-4ANA8
Adapts 8-Pin Pro Analog Box to V-Net cable.

Interface 230-CA-1M-8P
Adapts 8-Pin Analog Box to Analog port V-series recorders.

D. TRANSDUCER MODULES, PLUG-IN OLD STYLE

When using the Pro Analog Transducer Box these plug-in style transducers and signal conditioning modules are used to convert the input from various analog functions into signals that can be recognized by the recorder. Where required, a special cable is needed for connecting the sensor to the module.

Pressure Transducer, PSI 810-MD-PT-(SPECIFY PSI)
Available in ratings of: 0 to 15/60/100/150/300/500/750/1500.
Used to measure pressure from parameters such as fuel, oil, boost, nitrous. Route your pressure line directly to the transducer. Transducer has 1/8" NPT female thread.

Vacuum Transducer, 0-30 In. hg 810-MD-PT-VAC
Typically used to monitor manifold or pan vacuum.
A vacuum line is routed directly to transducer.

Thermocouple Amplifier Module, 0-500°F 810-M-TC-500

Cable Only, Thermocouple Sensor to Module, over 3'. (specify length) 800-CA-TCEXT-XL

Cable Only, Thermocouple Sensor to Module, under 3'. (specify length) 800-CA-TCEXT-XX
Used on low temp applications such as water, oil, cylinder head. Not for use with EGTs. Module, cable and sensor kit available as PN# 810-KT-TC-500. Specify use and cable length.

0-5 Volt Input Module, outputs 5 volts to powered sensor 810-MD-0-5VOUT

0-5 Volt Input Module, outputs 12 volts to powered sensor 810-MD-0-5
Cable Only, Sensor to module 800-CA-3PM (specify length).
Receives 0-5 volt input from powered sensor while providing 5 or 12v to power the sensor.

A. SPLIT COLLARS

These aluminum split collars provide a mounting platform for the magnets that are used to trigger the sensor when monitoring the revolutions of a shaft. They are typically used on rear end yokes or couplers to provide driveshaft RPM. Each collar is approximately .375" wide and houses two magnets which are located 180° apart. Custom size and dual magnet collars are available by special order.

SPLIT COLLAR ONLY WITH TWO MAGNETS

1.050 (27mm)	800-CL-2M-105
1.375	800-CL-2M-137
1.500	800-CL-2M-150
1.625	800-CL-2M-162
1.812	800-CL-2M-181
1.875	800-CL-2M-187
2.125	800-CL-2M-212
2.187	800-CL-2M-218
2.375	800-CL-2M-2375
2.400	800-CL-2M-240
2.500	800-CL-2M-250
3.000	800-CL-2M-300
3.187	800-CL-2M-318
3.250	800-CL-2M-325
3.500	800-CL-2M-350

SPLIT COLLAR ONLY WITH EIGHT MAGNETS

For use with V300SD, V500SD, Sportsman data recorders. If using a recorder other than listed, contact Racepak.

1.875	800-CL-8M-187
2.125	800-CL-8M-2125
2.187	800-CL-8M-2187

B. MAGNETS

These are the rare earth magnets that are currently used in the clutch input shaft, the split collars shown above or with some front wheel RPM applications. Each magnet measures .250" OD x .200" in length. North end of magnet is painted yellow for easy identification.

Magnet Only, Rare Earth, Single	800-MG-SM-.25
---------------------------------	---------------

C. SHIFT LIGHT

As a companion component to our programmable V-Net Shift Light Modules, Racepak has made available this high intensity LED shift light. The light features a powerful light emitting diode for luminosity that can't be missed even on the brightest of race days.

Shift Light, Black Housing	800-XP-SLMSD
----------------------------	--------------

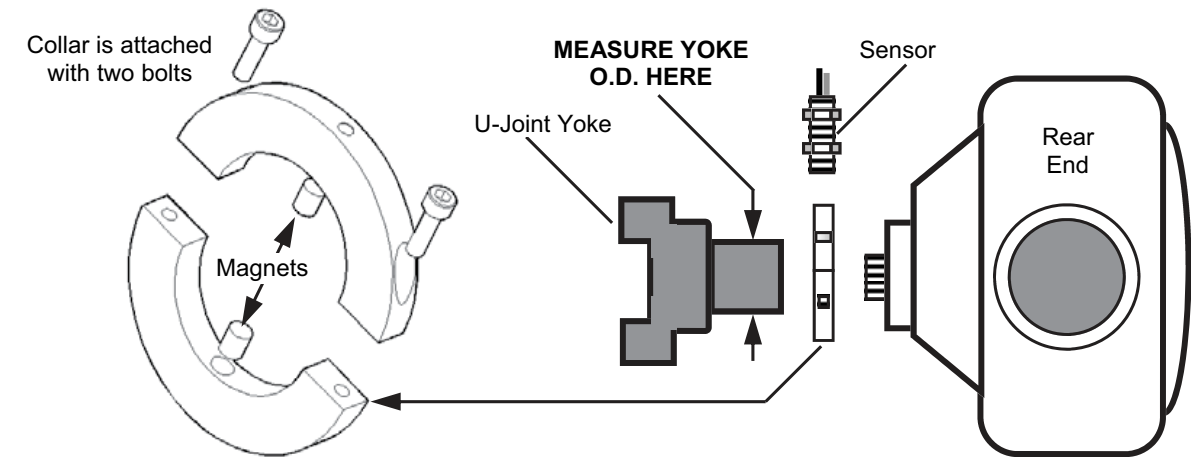

A. TWO MAGNET SPLIT COLLAR



C. SHIFT LIGHT

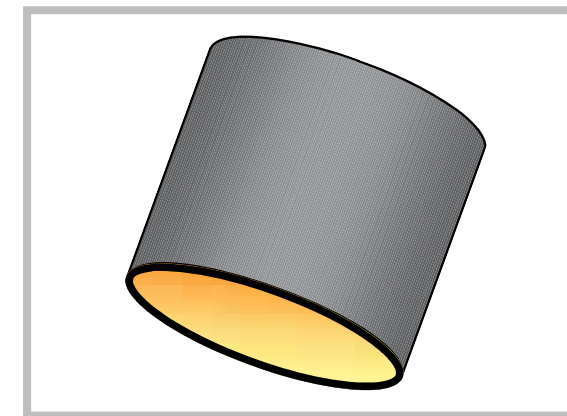

B. RARE EARTH MAGNET

10

Tip #10 Lost your configuration file, or maybe data run files, on your PC?

The search function in your Windows PC will quickly locate those files.

Locate and select the Start icon in the lower left corner of your PC screen.

In the search box, type .rcg. This will locate any configuration file on your PC.

ACCESSORIES & SOFTWARE

A. G2X MOUNTING PLATE

Includes logger mounting plate, black anodized billet aluminum clamp bracket.

G2X 1.250" dia tube	610-MB-125
G2X 1.500" dia tube	610-MB-150
G2X 1.625" dia tube	610-MB-1625
G2X 1.750" dia tube	610-MB-175

B. G2X MOUNTING PANELS

Trim to fit, vacuum formed plastic mounting panel.

Faux Carbon	600-MB-G2XDPCF
Black	600-MB-G2X-DBLK
Silver	600-MB-G2X-DPAL

C. UDX MOUNTING PANELS

Trim to fit, vacuum formed plastic mounting panel.

Faux Carbon	800-MB-UDX-PCF
Black	800-MB-UDX-PBLK
Silver	800-MB-UDX-PAL



A. G2X MOUNTING PLATE



B. G2X MOUNTING PANELS



C. UDX MOUNTING PANELS

D. MOUNTING BRACKETS

V300/V300SD for 1.250" O.D. tubing	800-MB-V300-125
V300/V300SD for 1.500" O.D. tubing	800-MB-V300-150
V300/V300SD for 1.625" O.D. tubing	800-MB-V300-162
V300/V300SD for 1.750" O.D. tubing	800-MB-V300-175
G2X Pro/V500 for 1.250" O.D. tubing	800-MB-V500-125
G2X Pro/V500 for 1.500" O.D. tubing	800-MB-V500-150
G2X Pro/V500 for 1.625" O.D. tubing	800-MB-V500-162
G2X Pro/V500 for 1.750" O.D. tubing	800-MB-V500-175

E. IQ3 MOUNTING PANELS

Trim to fit, vacuum formed plastic mounting panel.

Faux Carbon	800-MB-IQ3-PCF
Black	800-MB-IQ3-PBLK
Silver	800-MB-IQ3-PAL

F. IQ3 PROTECTIVE COVER

Vacuum formed, crystal clear protective cover for IQ3 dash.

Cover with flange	250-DS-IQ3-CVRWF
Cover without flange	250-DS-IQ3-CVR

G. IQ3 MOUNT

CNC-machined, black anodized mounting bracket. Pre-drilled for corresponding IQ3 mounting stud and pattern.

IQ3 Mount Bracket	800-MB-IQ3
-------------------	------------



D. MOUNTING BRACKETS



E. IQ3 MOUNTING PANELS



F. IQ3 PROTECTIVE COVER



G. IQ3 MOUNT

A. SERIAL COMMUNICATION CABLES

The serial cables that are used to communicate or download data from the V300/V300SD/V500 recorders are unlike those found in computer stores. If you need a replacement for your serial cable choose the proper cable from the selection below.

Serial Communication Cable, V300, 25'	280-CA-SR-V300
Serial Communication Cable, Stereo Jack-style, V300SD, Sportsman, G2X red, 6'	280-CA-ST140SR
Serial Cable, V500, V600, 35'	280-CA-SR-V500
Serial Cable, G2X Pro, 35'	680-CA-SR-G2XP
Serial Cable, G2X Black, 6'	680-CA-SR-G2X
Serial Cable, UDX Dashes, 6'	280-CA-SR-UDX
Serial Cable Extension, (Used to extend length of above cables), 25'	890-CA-DB9X-025
USB Adapter, Serial to USB Port (For PC's that do not have a Serial Port)	890-CA-USB2SER
USB Cable Extension, (For PC's that do not have a Serial Port), 6'	890-CA-USBAA-6

B. SD & MICRO SD COMPONENTS

SD / Micro SD USB Card reader	890-SD-RDR-5
SD Memory Card (V300SD, Sportsman, G2X, G2X Pro)	890-SDWC-4GB
Micro SD Memory Card (IQ3)	890-SD-M4GB
Cover Plug, for SD Memory Card	800-SD-COVER

C. MEMORY CARD KIT

Eliminate the memory cartridge and USB to cartridge reader with this kit. Data is downloaded/transferred to users PC via a commonly available SD memory card. For use with Racepak V-Net data loggers utilizing memory cartridge download.

Memory Cartridge to SD Card Adapter	890-KT-CARTSD
-------------------------------------	---------------

D. CHASECAM START RECORD MODULE

Sync Racepak data loggers and Chasecam PDR100 camera recording with this programmable V-Net module.

Chasecam Module	230-VM-CHASECAM
-----------------	-----------------



C. MEMORY CARD KIT

11

Tip #11 Is your graphed RPM data erratic?

Often times, it can be traced to one of two issues. If the graphed data appears to randomly spike downward then instantly back up, the RPM data is, for a brief moment, lost.

If the RPM data spikes upward, that is a sign of too many data points, and can be attributed to noise or an RPM sensor too close to the trigger point.

E. INTEGRATED VIDEO CAPTURE FOR DATALINK

Merge your onboard video with Racepak Data. Contact Racepak for details.

Call Racepak's Technical Department for details.

F. TRACKVISION SOFTWARE

Overlay Racepak data over video. Create customized dash panels, save/export for online video replay.

Trackvision System Package	890-UG-VIDEOAO
----------------------------	----------------

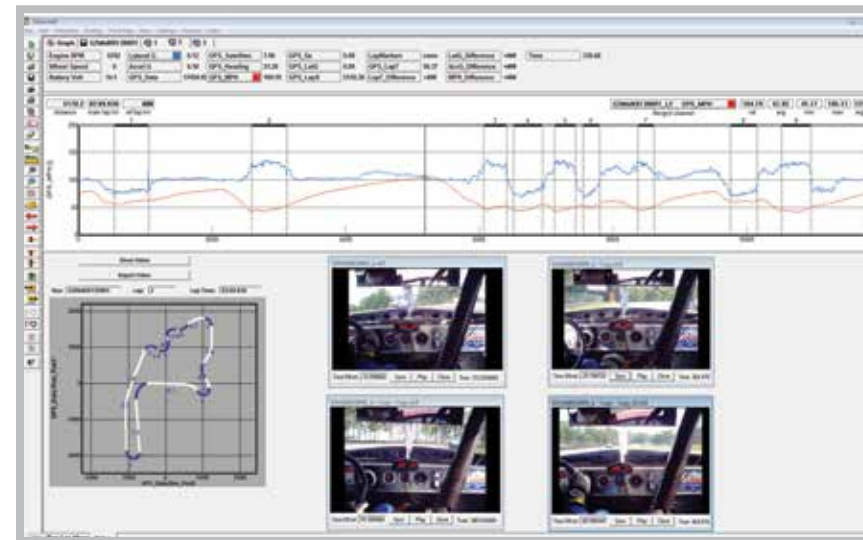
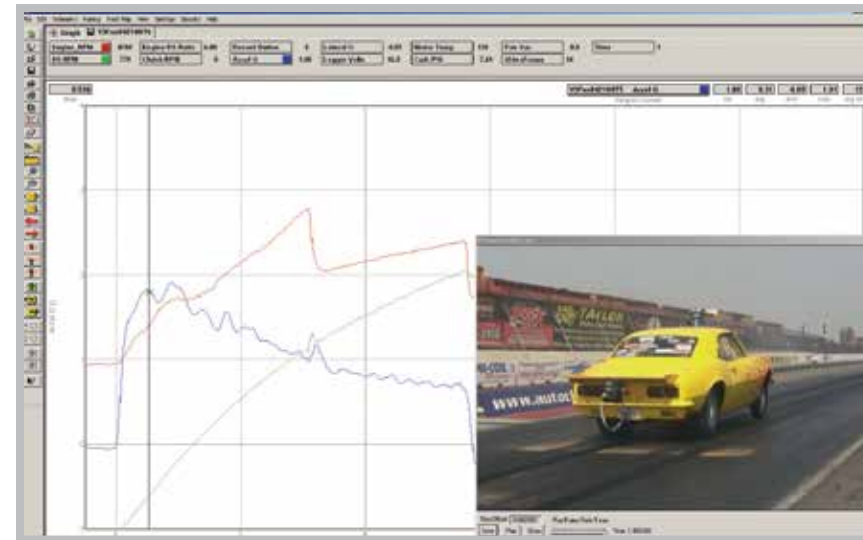

E. INTEGRATED VIDEO CAPTURE FOR DATALINK



F. TRACKVISION

Racepak's DatalinkII family of software programs are the finest available to motorsports. DatalinkII is easy to learn, user-friendly in terms of working within the programs, and above all, capable of quickly and clearly providing the information you need to achieve success. An enormous amount of thought and work has gone into designing this software. Writing software programs that are useful to racers, whether they are a drag, oval track, or road racer, as well as those gathering data not associated with a vehicle, require years of development. Through this process we arrived at three levels of DatalinkII.

DATALINKII LITE: is the base version software used with all Racepak V-series data recorders. It provides the ability to upload recorded information to your PC allowing you to view the data, in both a numeric and graphic format. Each monitored function will have a channel button displaying the numeric value of that channel (at the cursor's location), while also permitting you the option of displaying the channel's data on the scaled graph. Special channels are included to provide clutch and transmission slip curves when the appropriate sensors are installed in your onboard system. A log book section is included to keep records of each run file. This program also allows data transmitted from all V-Net systems and recorders to be displayed on the computer screen in real-time. A typical downloaded DatalinkII Lite screen view contains three panels. The top panel contains the run file tabs and channels buttons for selecting the run file or graph lines you wish to display. Displayed alongside each channel button is that channel's numeric value coinciding with the location of the graph's vertical cursor. In the center is the graph panel. The graphs are displayed with a timeline across the bottom and the scale value along the left edge. The bottom panel contains the tabs to access the log pages related to the file being displayed.

DATALINKII STANDARD: adds full math channels support. The math channels provide you with the ability to create your own channels to display information that is derived from a combination of other collected or known data. For instance, you can create channels that display total wheel or driveshaft turns, shock rates data in inches per second. If you have a G-meter, you can integrate speed and distance traveled. The combinations are endless.

DATALINKII PRO: is a favorite with professional racers or those who spend a lot of time 'crunching' the numbers. It adds full access to the Racer's Logbook. The user can create their own custom log pages which can include calculation spreadsheets, x-y plots, histograms, gauges, and more.

MINIMUM SOFTWARE REQUIREMENTS

- 200 MHZ (Pentium II) CPU.
- Large screen monitor with 1024 x 768 pixel minimum resolution.
- 200 MB of available hard drive space
- Windows® XP, Vista and Windows 7 operating system.
- 16 MB of RAM.
- One available RS-232 serial port (or USB to serial cable adapter).
- CD-ROM drive.
- If you will be using the data cartridge download system your computer must have a USB port and be equipped with Windows® 98, ME, 2000, XP, Vista, or Windows 7 (32 bit operating system).

REPLACEMENT SOFTWARE

Purchase of a V-series recorder includes the data analysis software. However, should a replacement become necessary use the part numbers shown below. It will be necessary for you to provide Racepak with a copy of an existing file so we may configure your software to match your existing setup. DatalinkII Software Kits (includes CD disc, licensing disc, manual).

DatalinkII File Viewer	890-DL-FV
DatalinkII Lite	890-DL-LITE
DatalinkII Standard	890-DL-STD
DatalinkII Pro	890-DL-PRO

UPGRADE SOFTWARE

Use these programs to upgrade from an existing Racepak Windows®-based software program to the latest version of a higher level of DatalinkII.

Upgrade DatalinkII Lite to DatalinkII Standard	890-UG-LITESTD
Upgrade DatalinkII Lite to DatalinkII Pro	890-UG-LITEPRO
Upgrade DatalinkII Standard to DatalinkII Pro	890-UG-STDPRO

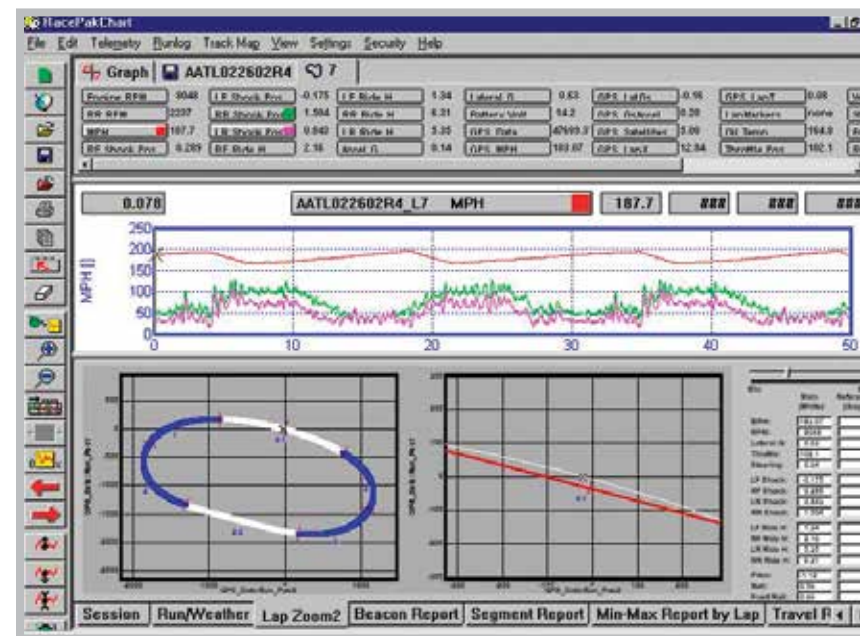
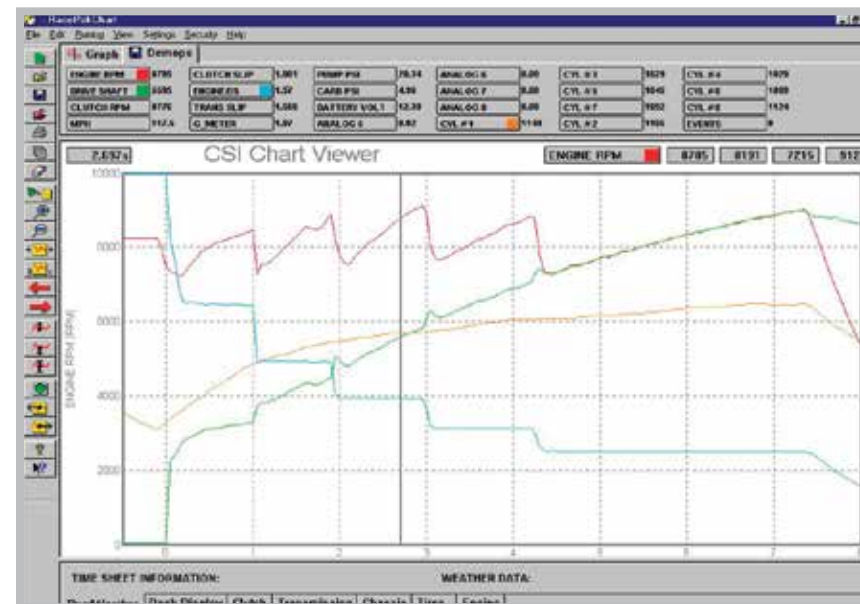

GRAPHS

Clicking the channel buttons allow you to display a single function, or as many functions at once as you desire. Graphs can be expanded or compressed, or you can zoom in on any area of interest. The zero point of the graph's timeline can be set by the user. This allows the occurrence of any event to be measured from a standard reference point.

NUMERIC VALUES

All DatalinkII programs have the ability to overlay the graphs from multiple files. This gives you the ability to visually compare any recording against another. Evaluating the results of tuning changes or driving techniques becomes instantly obvious.

CIRCLE TRACK AND ROAD RACING

With the Pro software you can create a detailed track map of every circuit you run from the information you generate. GPS will allow you to plot the exact position of the car as it travels around the track. You will then be able to compare individual lap times within a recording session, or against laps from previously recorded sessions. You can further divide the track to user-defined segments, such as turns and straights, for comparisons. Each report will contain lap or segment elapsed time, split times, entry speed, exit speed, minimum and maximum speed, acceleration and braking G-force, lateral G-force, altitude, GPS heading, velocity and more.

LOG BOOK

You can keep track of run times, weather data, track information or whatever information you care to note in the comments section. The higher level programs contain detailed logging of engine, tune up, and conditions data. With DatalinkII Pro you can create your own customized log book pages and use the math functions to perform those tedious fuel system, clutch management, chassis set up, or segmented lap time calculations.

REAL TIME

By connecting the onboard recorder to your computer with the serial cable you have the ability to view your recorded functions while they are being monitored. A dynamometer-style screen allows you to display all functions on a graph, or up to eight user-defined virtual gauges. Think of how useful this can be during warm ups in the pits.

The purchase of a Datalink data analysis program includes a licensing agreement. All Datalink programs are licensed to the recorder on which they are to be used. They are not licensed to an individual, nor are they transferable between systems. Due to the customized nature of the software program for the recorder on which it is used it is highly suggested that when purchasing or selling a data recorder that the software be regarded as a component of that particular recorder. Keep the two together as a unit.

MONITORING WEATHER STATIONS

A. ALTA LAB INSTRUMENTS

In every form of motorsports, where engine performance is critical, weather becomes an important factor. Knowing the amount of oxygen that is available for making horsepower, or knowing how much a change in the weather will affect a car's ability to run on a dial-in, has become an integral part of tuning a car. In order to make proper decisions related to the weather you need a quality weather station. As a service to our customers Racepak is pleased to be able to offer one of the best, the AltaCom II weather station by AltaLab Instruments. This weather station is used by profession and sportsman racers in NHRA, IHRA, NASCAR, SCCA, Formula I, and offshore boat racing.

The AltaCom II is designed for superior infield operation. From sensor specification and board design to the remote sensing, paging functions, and software, the AltaCom II is manufactured to provide you with stable, accurate data. Of particular importance to those who use a Racepak data recorder is the ability of the AltaCom II to import its weather data right into the Racepak run files.

The trailer based AltaCom II monitors the four prime weather parameters using a mast mounted, fan aspirated remote sensor station. From the four prime parameters it then calculates seven other weather values. Each value is updated every 20 seconds. The optional pager allows you to stay current with changing conditions even when you are away from the console's LCD display.

AltaCom II Kit Monitors:

- Temperature
- Absolute Barometric Pressure
- Relative Humidity
- Ambient Light

AltaCom II Kit Calculates:

- Density Altitude
- Adjusted Altitude
- Grains of Water
- Absolute Humidity
- Vapor Pressure
- Dew Point
- Air Density Ratio

The base AltaCom II kit includes the display console, remote sensor housing, mounting mast, pager, antenna, serial cable, power cable, Merlin Windows software. Additional pager and anemometer can be added as options.

AltaCom II Weather Station Kit

830-WS-ALTAII



A. ALTACOM II DISPLAY CONSOLE, PAGER,
AND REMOTE SENSOR STATION.



A. THE REMOTE SENSOR HOUSING IS MOUNTED ON THE PVC MAST UNDER
THE ALUMINUM SOLAR ROOF. ALSO SHOWN IS THE OPTIONAL ANEMOMETER
WHICH PROVIDES WIND SPEED AND WIND DIRECTION.



A. LOGO CAP

Caps Sports Racepak	880-PM-CAP2
Caps Sports Racepak S-M	880-PM-SSBK-XL
Caps Sports Racepak L-XL	880-PM-SSBK-XXL
Caps Sports Racepak XXL	880-PM-CAP2XL

B. MOUSE PAD

Racepak Logo Mouse Pad	880-PM-MPAD
------------------------	-------------

C. LAPTOP PAD

Racepak Logo Laptop Pad	880-PM-MPADXL
-------------------------	---------------

D. CAR LOGO T-SHIRT

Racepak T-Shirt Black MD-Small	880-PM-MTBKM-S
Racepak T-Shirt Black MD-Medium	880-PM-MTBKM-M
Racepak T-Shirt Black MD-Large	880-PM-MTBKM-LRG
Racepak T-Shirt Black MD-1X Large	880-PM-MTBKM-XL
Racepak T-Shirt Black MD-2X Large	880-PM-MTBKM-XXL

E. PALM TREE LOGO T-SHIRT

Racepak T-Shirt Black PT-Small	880-PM-MTBKP-S
Racepak T-Shirt Black PT-Medium	880-PM-MTBKP-M
Racepak T-Shirt Black PT-Large	880-PM-MTBKP-LRG
Racepak T-Shirt Black PT-X Large	880-PM-MTBKP-XL
Racepak T-Shirt Black PT-2X Large	880-PM-MTBKP-XXL
Racepak T-Shirt Black PT-3X Large	880-PM-MTBKP-3XL



A. LOGO CAP



B. MOUSE PAD



D. CAR LOGO T-SHIRT



C. LAPTOP PAD



E. PALM TREE LOGO T-SHIRT



F. BLACK RACEPAK LOGO SWEATSHIRT



G. GREY HOODIE WITH PALM TREE LOGO

F. BLACK RACEPAK LOGO SWEATSHIRT

Racepak Sweatshirt Blk MD Medium	880-PM-SSBKM-M
Racepak Sweatshirt Blk MD Large	880-PM-SSBKM-L
Racepak Sweatshirt Blk MD X Large	880-PM-SSBKM-XL
Racepak Sweatshirt Blk MD 2X Large	880-PM-SSBKM_2X

G. GREY HOODIE WITH PALM TREES LOGO

Racepak Sweatshirt Hood PT Small	880-PM-SSBKP-S
Racepak Sweatshirt Hood PT Medium	880-PM-SSBKP-M
Racepak Sweatshirt Hood PT Large	880-PM-SSBKP-L
Racepak Sweatshirt Hood PT X Large	880-PM-SSBKP-XL
Racepak Sweatshirt Hood PT 2X Large	880-PM-SSBKP-2X

H. BLACK HOODIE WITH LOGO

Racepak Sweatshirt Hood PT Small	880-PM-SSBKP-S
Racepak Sweatshirt Hood PT Medium	880-PM-SSBKP-M
Racepak Sweatshirt Hood PT Large	880-PM-SSBKP-L
Racepak Sweatshirt Hood PT X Large	880-PM-SSBKP-XL
Racepak Sweatshirt Hood PT 2X Large	880-PM-SSBKP-2X
Racepak Sweatshirt Hood PT 3X Large	880-PM-SSBKP-3X



H. BLACK HOODIE WITH LOGO

Analog: This term simply refers to a sensor or signal having a large number of potential values. For instance, a water temperature sensor is an analog sensor as the output of the sensor varies continuously with the temperature. This type of sensor is also called a voltage output sensor. Pressure, temperature, vacuum, linear and rotary travel, would all be examples of analog channels.

Data Cartridge: A small rectangular device used to transfer data from the onboard data recorder to a PC without connecting a serial cable between the two. It is used just like you might use a floppy disc to transfer files from one PC to another.

Data Recorder: The onboard hardware device that collects and stores the information transmitted from the sensors. Sometimes referred to as a Data Logger or 'Computer'.

Digital: This term refers to a sensor or signal having only two values. For example, a wide open throttle switch is either on or off. Digital channels, by counting or timing the transitions from off to on, can also be used to measure RPM. For instance by monitoring the number of pulses from the ignition tach output, a data recorder can determine and monitor the engine RPM.

Download: The common term for the process of transferring the information stored in the data recorder to a device, such as a data cartridge, for the purpose of loading it into another piece of hardware, such as a desktop computer for analysis. Also see Upload.

EGT: Abbreviation for Exhaust Gas Temperature. EGT's are commonly used as an indicator of whether a cylinder is running rich (cool) or lean (hot). Thermocouple probes in the exhaust headers are used to monitor the EGT's.

K or KB: Abbreviation for Kilobyte. Each sample of recorded data represents approximately two bytes. A kilobyte is 1024 bytes. It takes about 1 KB to display one page of double spaced text on your computer screen. See MB or megabyte.

MB: Abbreviation for Megabyte. A megabyte is one million bytes (technically correct 1,048,576), or one thousand (1,024) kilobytes. Most large novels could fit into a MB with room to spare. Your auto insurance policy disclaimer would not.

Memory: The capacity of a data recorder or PC to store information, usually expressed in Kilobytes or Megabytes. The length of available recording time is dependant upon how much memory is available. As the number of channels and/or sampling rates per second increase, the recording time is decreased. Purchase a data recorder with lots of memory.

Sampling Rate: The number of times per second the data recorder logs a sample of the incoming information on each channel. Many times the number of samples per second can be changed to suit your needs. A common myth is that faster sampling rates are better. This isn't always true.

Software: The program, usually installed on your PC's hard drive from a CD and/or floppy disc, that provides the instructions enabling your PC to display and process the information uploaded from your data recorder.

Telemetry: The ability to view your monitored functions in real time. V-series recorders using the Datalink Lite or higher version software can display the monitored functions on the computer screen while the vehicle is running by connecting the onboard recorder to the PC. Recorders equipped with radio transmitters can display their recorded data in real time without requiring a serial cable connection.

Thermocouple: A probe inserted into the header, usually near the exit of the exhaust port. This is the 'sensor' for the exhaust gas temperatures. Thermocouples differ from other temperature probes due to the higher range of temperatures in which they must operate.

Transducer: A device that converts a physical property, such as pressure or position, into a voltage signal that the data recorder can understand. Used on temperature, pressure, vacuum, or movement signals.

Transducer Box: A rectangular box that houses up to four hard wired, strain-type pressure transducers or signal conditioning modules. Commonly used as a junction box for pressure lines which are then connected to the V-Net cable with a single module.

Upload: The process of transferring information from a data recorder or data cartridge directly to a laptop or desktop computer.

USB Port: The type of communication port used on newer model computers to connect peripheral equipment such as a mouse or printer. The Racepak data cartridge uploads recorded information into the newer computers through the USB port.

V-Net: An exclusive Racepak system that allows the input or output of information from many sources over a single cable. V-Net greatly reduces the need for wiring, while increasing the capabilities of the system. V-Net allows multiple components (gauges, data recorder, controller motors, etc.) to share the signals being transmitted over the V-Net cable.

Windows®: Is a registered trademark name of the Microsoft Corporation. The term has become generic when referring to the most common method of navigating your way around a computer program. It uses point-and-click on icons, rather than the need for written commands as used with the older DOS programs. Racepak's Datalink software is a Windows-based program.

