



# **Ibex<sup>®</sup> EVO<sup>®</sup> Portable Ultrasound User Guide**

Published 9/17/2018

E.I. Medical Imaging Proprietary and Confidential – Do Not Copy or Distribute. For Internal Use Only.

Copyright© 2018 E.I. Medical Imaging®. All rights reserved.

The information presented in this manual is subject to change without notice and does not represent a commitment on the part of E.I. Medical Imaging. The hardware and software described herein are furnished under a license or nondisclosure agreement. The hardware, software, and manual may be used or copied only in accordance with the terms of this agreement. It is against the law to reproduce, transmit, transcribe, store in a retrieval system, or translate into any medium - electronic, mechanical, magnetic, optical, chemical, manual, or otherwise - any part of this manual or software supplied with the Ibex EVO for any purpose other than the purchaser's personal use without the express written permission of E.I. Medical Imaging.

E.I. Medical Imaging, the E.I. Medical Imaging Logo, Ibex, EVO, Insite, and Durascan are registered trademarks of E.I. Medical Imaging. EVOSTream is a trademark of E.I. Medical Imaging. All other brand or product names are trademarks or registration trademarks of their respective companies or organizations.

Contact Information:

E.I. Medical Imaging  
110 12TH ST SW UNIT 102  
LOVELAND CO 80537-6396  
toll-free/1.866.365.6596  
phone/970.669.1793  
fax/970.669.1902  
<http://www.eimedical.com/>  
E-mail: [info@eimedical.com](mailto:info@eimedical.com)

Supporting Software Version:

1.5.0.3

# FCC Regulatory Information



Contains FCC ID: Z64-WL18SBMOD

Contains IC: 4511-WL18SBMOD

This device complies with Part 15 of the FCC Rules subject to the following two conditions

- 1) This device must not cause interference, and;
- 2) This device must accept all interference, including

interference that may cause undesirable operation.

**WARNING:**

**Modification of this device without consent of the responsible party may void the users right to operate this device.**

EU Compliance



Usage restrictions apply.

See documentation

AT	BE	CY	CZ	DK	EE	FI	FR
DE	GR	HU	IE	IT	IV	LT	LU
MT	NL	PL	PT	SK	SI	ES	SE
GB	IS	LI	NO	CH	BG	RO	TR

EU - Restrictions for Use in the 2.4 GHz Band

This device may be operated indoors or outdoors in all countries of the European Community using the 2.4 GHz Band: Channels 1-13 except where noted.

NOTE:

a) USA-Federal Communications Commission (FCC)

This equipment has been tested and found to comply with the limits for a Class B digital device, pursuant to Part 15 of FCC Rules. These limits are designed to provide reasonable protection against harmful interference in a residential installation. This equipment generates, uses, and can radiate radio frequency energy. If not installed and used in accordance with the instructions, it may cause harmful interference to radio communications. However, there is no guarantee that interference will not occur in a particular installation. If this equipment does cause harmful interference to radio or television reception, which can be determined by turning the equipment off and on, the user is encouraged to try and correct the interference by one or more of the following measures:

- Reorient or relocate the receiving antenna.
- Increase the distance between the equipment and the receiver.
- Connect the equipment to outlet on a circuit different from that to which the receiver is connected.
- Consult the dealer or an experienced radio/TV technician for help.

Caution: Exposure to Radio Frequency Radiation.

This device must not be co-located or operating in conjunction with any other antenna or transmitter.

b) Canada - Industry Canada (IC)

This device complies with RSS 210 of Industry Canada. Operation is subject to the following two conditions:

(1) This device may not cause interference, and

(2) This device must accept any interference, including interference that may cause undesired operation of this device.

L' utilisation de ce dispositif est autorisée seulement aux conditions suivantes: (1) Il ne doit pas produire d'interférence et

(2) l' utilisateur du dispositif doit être prêt? Accepter toute interférence radioélectrique reçue, même si celle-ci est susceptible de compromettre le fonctionnement du dispositif.

Caution: Exposure to Radio Frequency Radiation.

The installer of this radio equipment must ensure that the antenna is located or pointed such that it does not emit RF field in excess of Health Canada limits for the general population; consult Safety Code 6, obtainable from Health Canada's website <http://www.hc-sc.gc.ca/rpb>.

# EU Declaration of Conformity



## **EU Declaration of Conformity No. 060116**

(Manufacturer): E.I. Medical Imaging  
110 12<sup>th</sup> St SW, Unit 102  
(Address): Loveland, Colorado 80537, USA

### **Declares that the product:**

Portable Ultrasound Device for Veterinary Use: **Ibex EVO**

### **Conforms to the following Directives:**

1. Low Voltage Directive 2006/95/EC, Test Report No. EIMI-Ibex-EVO-60601-1
2. Electromagnetic Compatibility Directive 2014/30/EU Test Report No. EI19032016IEC 04/06
3. R&TTE Directive 1999/5/EC Test Report No. ER3N2752 TI Module WL1835MODCOM8B
4. EMF Directive 1999/519/EC Test Report No. TBD
5. RoHS 2 Directive 2011/65/EU

### **Using the following primary standards:**

### **Safety Standards (used as a guide)**

EN 60601-1: 2012- Medical Electrical Equipment - Part 1: General Requirements For Basic Safety & Essential Performance

### **EMC Standards:**

EN 60601-1-2: 2007 : Electromagnetic Compatibility (EMC)

EN 55011: 2009 + A1:2010 : Radiated Emissions- Class B, Group 1

EN 61000-4-2 : Electrostatic Discharge

EN 61000-4-3 : Radiated RF Immunity

EN 61000-4-4 : Electrical Fast Transients/Burst

EN 61000-4-5 : Surge Immunity

EN 61000-4-6 : Conducted RF Immunity

EN 61000-4-8 : Power Frequency H-Field Immunity

EN 61000-4-11 : Voltage Dips, Interruptions

EN 61000-3-2 : Power Line Harmonics and Interharmonics

EN 61000-3-3 : Flicker

EN 300 328 v1.8.1, TI Module Cert WL1835MODCOM8B : ERM Data Transmission in 2.4 GHz Band

EN310 489-1 v1.9.2, TI Module Cert WL1835MODCOM8B : Common Technical Requirements (Radio)

EN310 489-17 v2.2.1, TI Module Cert WL1835MODCOM8B : Specific conditions Broadband Data Transmission

### **And complies with the relevant Essential Health and Safety Requirement**

I, undersigned, hereby declare that the equipment specified above conforms to the above Directives and Standards and is therefore eligible to carry the CE Marking.

Charles Maloy  
(Name)

President, E.I. Medical Imaging  
(Position)

Loveland, CO  
(Signed at place)

June 1, 2016  
(Date)

# Table of Contents

---

<b>Ibex® EVO® Portable Ultrasound User Guide</b> .....	<b>1</b>
<b>FCC Regulatory Information</b> .....	<b>3</b>
<b>EU Declaration of Conformity</b> .....	<b>5</b>
<b>Table of Contents</b> .....	<b>6</b>
<b>1: Introduction</b> .....	<b>10</b>
Product Symbols .....	11
Key Features .....	13
Key Features .....	13
Intended Uses .....	14
Essential Performance .....	14
Intended Use .....	14
<b>2: Getting Started</b> .....	<b>15</b>
System Specifications .....	16
Supported Transducers and Available Accessories .....	18
About the EVO System .....	19
Physical Interfaces .....	19
Battery Compartment .....	20
Powering on the System .....	21
Transducers .....	22
Interacting with the EVO .....	23
Keyboard .....	23
Side Keyboard .....	26
Screen Layout .....	27
On-Screen Keyboard .....	29
Physical Operations .....	30
About the Battery .....	31
Charging the Battery .....	31
Replacing the Battery .....	32
Attaching Transducers .....	32
Wearing the Scanner .....	33
About the Video Headset .....	33
Remote - Optional Accessory .....	33
Pairing the Remote with your EVO .....	33
Remote Buttons .....	34

---

Remote Battery .....	34
Menus .....	35
The On-screen Menus .....	35
Home Menu .....	35
Super Menu .....	35
Moving around the screens .....	36
Using the On-Board Help .....	37
Examples .....	37
Training .....	37
<b>3: Configuration .....</b>	<b>39</b>
Welcome Screen .....	40
Setting Day and Time .....	40
Setting User Presets .....	41
Renaming User Presets .....	42
Changing the Default User Preset .....	42
Changing the Current Preset/User .....	42
Resetting Users .....	42
Adjusting Audio Settings .....	43
Adjusting Video Settings .....	44
Adjusting Misc Options .....	45
Setting Annotations .....	47
B-Mode Scan Options .....	48
Enabling WiFi .....	50
WiFi Indicators .....	51
To connect to a network: .....	51
To Enable the EVO as a Wireless HUB .....	52
Enabling Bluetooth .....	53
RFID Support .....	54
<b>4: Patient Management .....</b>	<b>55</b>
Entering Patient Identification Information .....	55
Searching for a Patient .....	56
<b>5: Managing Images .....</b>	<b>57</b>
Freezing Images .....	58
Saving Images and Cineloops .....	58
Saving Images .....	59
Use Annotation Labels as File Names .....	59

---

Saving Cine-loops .....	60
Recalling Images and Cine-loops .....	61
Recalling Saved Images and Cine-loops .....	61
Renaming Images .....	62
Deleting Images .....	62
Annotating and Measuring Images .....	63
Adding Text Labels to Images .....	63
Adding Text to Saved Images .....	63
Working with Dual Images .....	64
Carcass Merit .....	65
Setting up Carcass Merit .....	65
Animal Entry .....	65
N- New Animal Setup .....	66
Repro Workflow .....	67
<b>6: Manipulating Images .....</b>	<b>69</b>
About Gain Controls .....	69
Using Auto GAIN .....	71
B+M Mode Scanning .....	71
Adjusting Focal Zones .....	72
Doppler Mode .....	73
Color Mode .....	73
Color Doppler Scan Options .....	74
Power Mode .....	76
Power Doppler Scan Options .....	77
Scan Settings for Power Doppler .....	77
Pulse Wave (PW) .....	79
Pulse Wave Scan Settings .....	80
<b>7: Measuring Images .....</b>	<b>83</b>
Taking Distance Measurements .....	83
To associate a distance table to the measurement: .....	83
Taking Area Measurements .....	83
PW doppler: PI / RI calculation .....	84
<b>8: Exporting Files .....</b>	<b>87</b>
Saving Files to a USB Memory Stick .....	87
File Sharing .....	89
Setting up the EVO .....	89



---

From your PC .....	89
<b>9: EVOStream - Sharing live Images .....</b>	<b>92</b>
Connecting over WiFi Direct .....	93
Configuring iPhone® or iPad® .....	94
Configuring an Android™ Device .....	94
<b>10: Advanced System Operations .....</b>	<b>95</b>
Updating System Firmware .....	95
Identifying System Firmware Version .....	95
Downloading New System Firmware .....	96
Installing EVO System Firmware .....	97
Resetting your EVO .....	98
Resetting the System .....	98
Restoring a Backup .....	98
<b>11: Cleaning and Maintaining the EVO .....</b>	<b>100</b>
Disinfectant List .....	101
EVO System   Probes/Transducers   Goggles: .....	101
ICE Extension Handle: .....	101
InSite2 / InSite 3 Headset Care and Maintenance .....	102
Linear Transducer Care and Maintenance .....	102
<b>Warranty .....</b>	<b>103</b>
<b>Appendix - Fetal Tables .....</b>	<b>105</b>

# 1: Introduction

Please read all the instructions and warnings before using the EVO® Portable Ultrasound system.



The Ibex EVO Portable Ultrasound User Guide provides an overview of the features and functionality of the EVO ultrasound system. This guide provides you with the information you need to quickly set up, operate, and maintain the EVO.





The E.I. Medical Imaging Ibex family of ultrasound scanners are internally battery powered veterinary use ultrasound devices. An external AC adapter is provided for charging the internal battery and powering the Ibex scanners.

This guide does not cover the theory or science of diagnostic sonography or clinical veterinary practices. It is intended for users already familiar with ultrasound techniques.

# Product Symbols

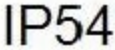
This table describes the symbols marked on the device.

Symbol	Name	Description
	Caution	<p>You must read, understand, and follow all instructions in this manual including all warnings, cautions, and precautions before using the medical device in veterinary practice.</p> <p>Scanner:</p> <p>Is for veterinary use only.</p> <p>Is not user serviceable. Contact E.I. Medical Imaging if defective or damaged.</p> <p>Use only specified AC adapter/charger.</p>
	Type BF Equipment	<p>The Probe (Patient Applied Part) is Type BF (floating from electrical ground) per the Standard EN 60601-1, which offers a specific level of safety.</p>
	RoHS Compliant	<p>The system is compliant with the RoHS guideline 2002/95/EC</p>
	CE	<p>Device complies with the European Union Low Voltage Directive (LVD) and EMC directive.</p>
	Standby	<p>Alternately switch the device between the power-on and standby states.</p>
 <span data-bbox="415 1692 464 1717">USB</span>		<p>USB 2.0 Host I/O Port current limited (100ma per port) for connection to USB FLASH DRIVE file storage and supported peripherals.</p>

Symbol	Name	Description
	Lead Free	All components (e.g. PCBs) are lead free and can be used in lead free solder processes.
	Ingress Protection	Protection from dust and splashing from any direction. Protection from dust and low pressure jets of water from any direction.
 	Do not dispose	This device is not allowed to be disposed in domestic waste.
	Read Manual	Before attempting to use this device, consult the manual and/or the quick start guide.

## Key Features

The Ibx EVO is designed to be flexible and easy to use.



## Key Features

- Ibx EVO advanced imaging software
- Full range of imaging modes: B, B+M, PW, Color, Power Doppler
- Ruggedized DuraScan® transducers 2-14 MHz
- Fast boot time for more uptime
- Customized, veterinary-specific exam presets
- EVOstream™ WiFi Remote Scanning App

- 8.4 inch sealed, sunlight-readable LCD Display
- Sealed, LED backlit keyboard
- 2+ hour battery run time (field swappable)
- Lightweight 6.1 lbs (2.8 kg)
- Engineered with DuraScan® technology
- Continuous record, color doppler, pulse wave doppler, multibeam, harmonic imaging, preset exam types. Speckle reduction.
- Help system

## Intended Uses

The IbeX EVO is intended for veterinary use; Bovine, Equine, Companion Animal, Swine, Exotic, Marine and Small Ruminants

### Essential Performance

The system can provide 2D ultrasound echo and flow imaging as an aid in diagnosis, data processing and guidance of ovum pickup (OPU).

The system uses an OPU guide and collection needles.

The system can perform simple geometric measurements and calculations.

The system is free from artifacts or distortion in the image or error of a displayed value, which can be attributed to a physiological effect and which may alter the diagnosis.

The system displays correct numerical values associated with the diagnosis to be performed.

The system does not generate unintended or excessive ultrasound output or transducer surface temperature.

### Intended Use

The system is intended for diagnostic ultrasound imaging or fluid flow analysis of animals, data processing and guidance of OPU and collection needles. The system is for Veterinary Use Only.

The system performs simple geometric measurements and calculations in Veterinary Diagnostic Imaging

#### Modes of Operation

- B-Mode
- M-Mode
- PW Doppler Mode
- CF Doppler Mode
- Power Doppler

## 2: Getting Started

---

System Specifications .....	16
About the EVO System .....	19
Interacting with the EVO .....	23
Physical Operations .....	30
Menus .....	35
The On-screen Menus .....	35
Moving around the screens .....	36
Using the On-Board Help .....	37
Training .....	37

## System Specifications

The following table lists the system specifications for the EVO scanner.

Applications	Bovine, Equine, Companion Animal, Swine, Exotic, Marine and Small Ruminants
Imaging Modes	B, B+M, M, PW, Color, Power Doppler
System Dimensions	9 x 8.5 x 3 inches
	22.9 x 21.5 x 7.6 cm
Transducer	Lightweight 6.1 lbs (2.8 kg)
	Ruggedized DuraScan® transducers 2.0MHz – 14.0MHz
Connectivity	Support for 2.0 MHz to 14 MHz 128 Element Linear/Curved Linear probes
	Support for user selectable scan directions
Display	USB 2.0 image storage and recall;
	Wireless (802.11) connectivity and Bluetooth connectivity
Power	8.4" diagonal LCD SVGA resolution.
	21.34 cm
Scan Measurements	720P HDMI, NTSC/PAL analog video, EVOStream
	Li-ion battery 2+ hours
Image Storage	Stand alone external battery charger available; AC Power Adapter for charging or operating; Output: 15V DC 4A
	Unlimited caliper sets for distance measurements
Additional Features	Continuous area of circumference
	Grid option for quick measurements
Additional Features	Touch pad for navigation
	Calculation tables
Additional Features	On-screen text annotations and arrows
	Dual image feature for side-by-side comparisons
Additional Features	Tendon calculations: % Lesion   % change   % difference.
	Cardiac calculations: FS   LA/AO
Additional Features	480 frame cineloop memory (60 frames/second frame rate recording)
	Audio Tags can be stored with image
Additional Features	Static images can be saved from cine-loops
	Measure and recalculate from saved images
Additional Features	System Dynamic Range 156 db
	Auto-Optimize image (Auto Gain and TGC)
Additional Features	Software field upgradable
	LED backlit keyboard
Additional Features	DuraScan® technology for system durability



## 2: Getting Started

Streaming Video via 802.11x using H.264 codec to iOS and Android devices.

EVOStream™ WiFi Remote Scanning App

Customized, veterinary-specific exam presets

---

Operating Environment	EVO: 0° to 40° C
Storage and Transportation Environment	InSite2 / InSite 3Headset: 0° to 40° C

---

## Supported Transducers and Available Accessories

AC power supply for EVO ultrasound	391950
EVO ultrasound scanner	390200
Bluetooth Remote for EVO	390001
Lithium Ion rechargeable smart battery pack for EVO	391901
Insite2 headset for ultrasound	290701
i3 headset for ultrasound	390700
L6E transducer for EVO, 2m cable	390400
L6E transducer for EVO, 3m cable	390405
MC8E transducer for EVO, 2m cable	390410
MC8E transducer for EVO, 3m cable	390412
L14x transducer for EVO, 3m cable	390417
MC8OPU transducer for EVO, 2m cable	390420
CL3E transducer for EVO, 3m cable	390430
L3ASE transducer for EVO, 3m cable	390450
CLI3E transducer for EVO, 3m cable	390470
C6E transducer for EVO	390440
C9E transducer for EVO, 2m cable	390445
C90PU-HD, transducer for EVO, 2m cable	390485
L7HD transducer for EVO, 2m cable	390420
L7HD transducer for EVO, 3m cable	390425

## About the EVO System

The EVO system components provide protection against dust and water entering the enclosures as defined in the IEC (International Electromechanical Commission) standards. The EVO has earned a rating of IP54 and is protected against dust and against low-pressure jets of water sprayed from all direction

The IEC standard defines degrees of protection expressed as “IP” followed by two numbers, e.g. IP54. These numbers represent the degree of protection. The first digit shows the degree to which the equipment is protected against human contact and solid particles. The second digit indicates its degree of water protection.

**NOTE:** Refer to the section, [Cleaning and Maintaining the EVO on page 100](#), for proper cleaning instructions.

## Physical Interfaces

The EVO has four inputs:

- Use the 84-pin custom interface to connect the transducers.
- Use the 8-pin male interface to connect either the headset or the DC power input.
- Two USB ports. USB supports storage and peripherals. There is no charging capability.
- One HDMI 720 p

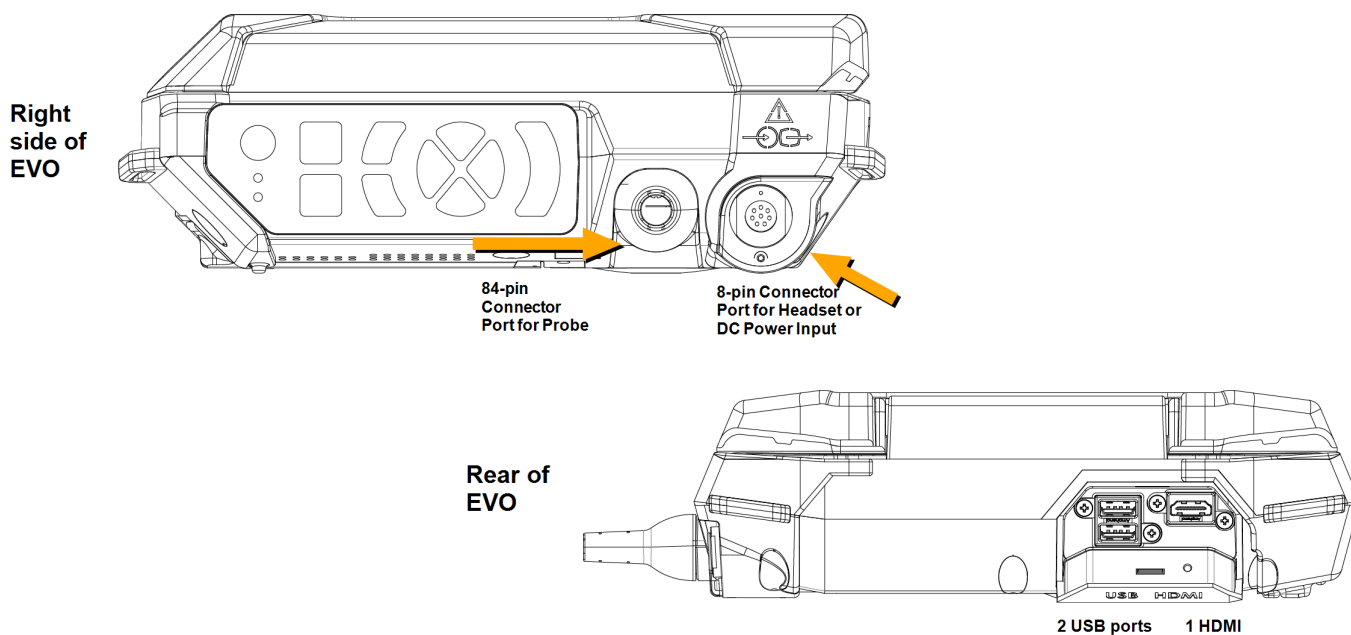

## Battery Compartment

The EVO system houses the battery in a water-resistant system access compartment.

To seal the compartment:

1. Angle to panel inside the metal strip.

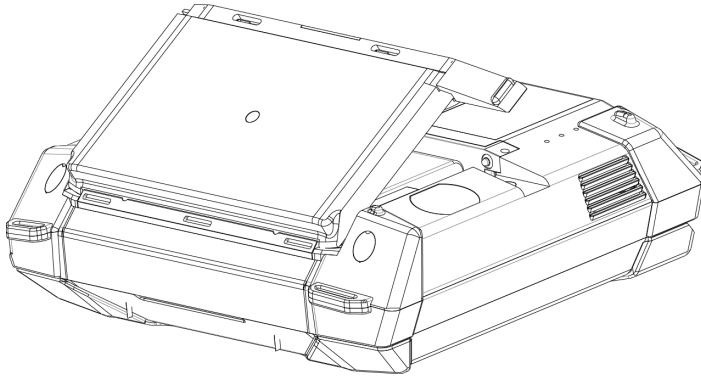

2. Slide the metal latch towards the left until it clicks into the locked position.

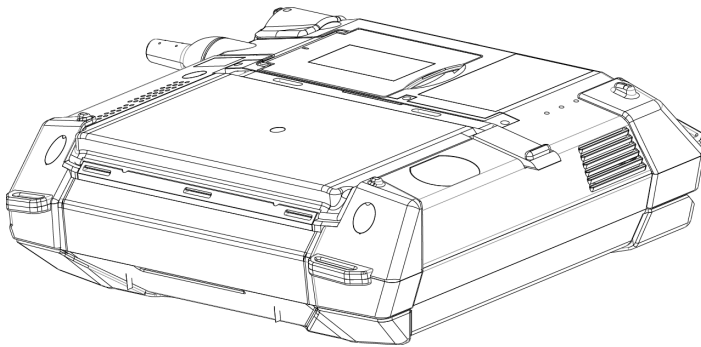

## Powering on the System

The power button  is located on the side keyboard, so it is conveniently accessed when the monitor is open or closed.

Press the green power button to power on the EVO.

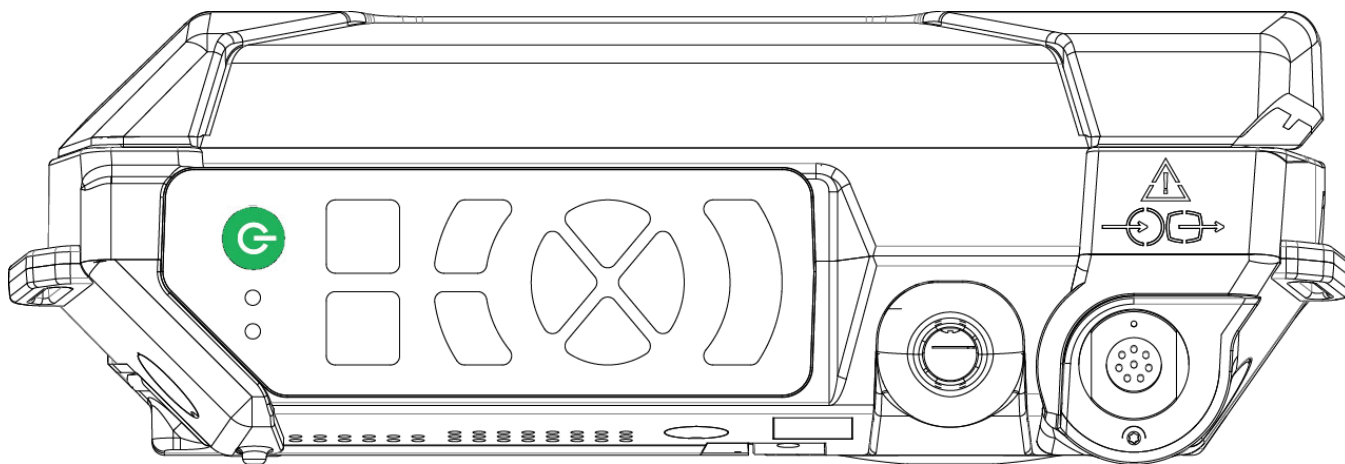

When used near an outlet, the EVO system may be powered directly (with or without the internal Li-Ion Battery Pack installed) by the external Power Supply/Battery Charger or it may be used outdoors (unsheltered locations) as an internally powered system with a charged internal Li-Ion Battery Pack.

## Transducers

The EVO ultrasound supports transducers. A transducer connects to the scanner with its 84-pin male connector. For more information about attaching transducers, see [Attaching Transducers on page 32](#)

**Caution:** It is critical to power-off or freeze the scanner before changing the transducer types. Failure to do so may cause unexpected behavior.

For more information about transducers, contact an E.I. Medical Representative.

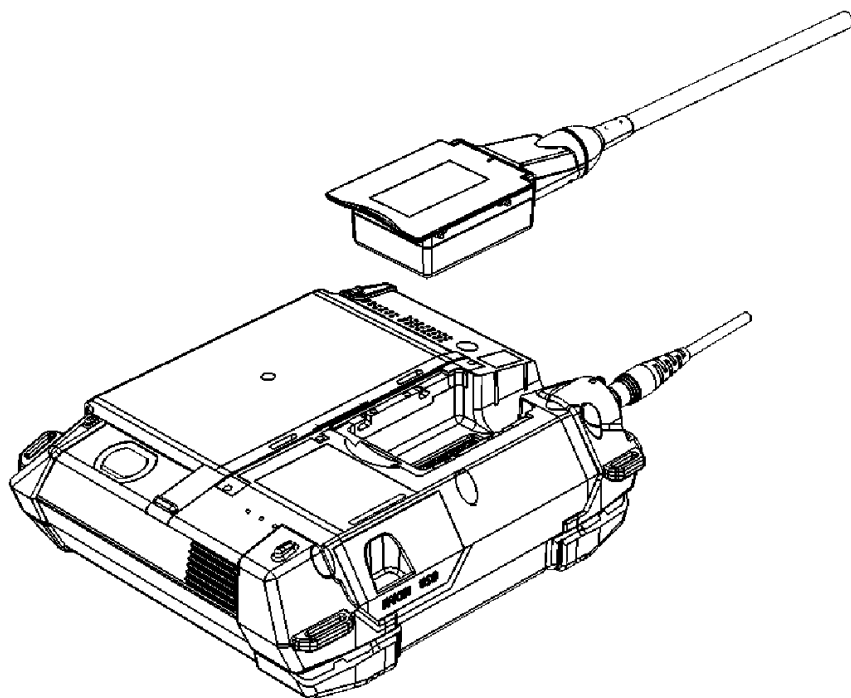



# Interacting with the EVO

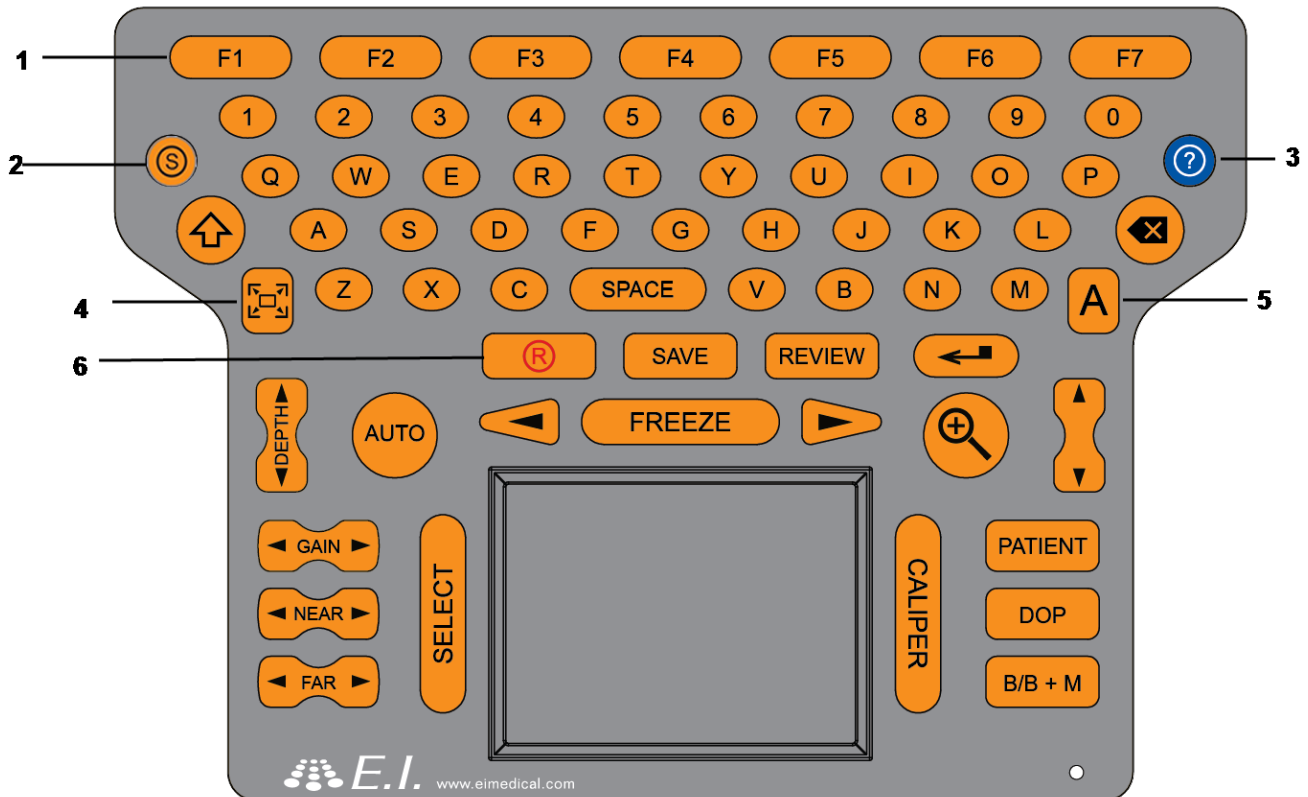





## Keyboard















1	Function Keys	The Function keys coordinate with the on screen menu keys. For example, on the home screen, F1 goes with Exam Type
	Super Key	Press the super key to return the system to active scan mode.
2		Press the super key to return to the Home Menu. Pressing the super key from B mode enters the super menu.
	Help	Use the Help Key to get help on keys and dialogs on the EVO.
3		To view the help for a key, press the Help key, then press the key you want to know about. To view the help for a dialog, first view the dialog, then press Help.
	Full Screen	Press the full screen key to enlarge the image to the edges of the screen. The status indicators and labels you see in the normal view do not appear in Full Screen.
4		Press the full screen key again to return to normal view.

5	Annotate Key	Use the Annotate key to: Add labels to an image, access special characters, and use annotation labels as file names. For more information about adding labels. see <a href="#">Annotating and Measuring Images on page 63</a> . For more about accessing special characters, see <a href="#">Passphrase on page 51</a>
		
6	Record Key	Press the record key to begin recording what you see on the screen. By default, the recording is saved with an automatic name in a directory for the patient. For more about Recording see <a href="#">Saving Cine-loops on page 60</a>
		

The remaining buttons are listed alphabetically.

	Auto	The auto gain feature allows the system to automatically adjust Gain settings for optimal image quality. Auto Gain calculates the optimal Gain values based on tissue composition. Before pressing the Auto key, make sure the probe is on the target anatomy.
	B+M Key	B+M-MODE (Motion Mode) imaging is a scan that displays motion in a wave-like manner. This mode is especially useful in depicting motion in cardiac applications. By incorporating B Mode functionality with M-Mode strips, you can control the exact position of the desired scan location. For more information about this mode, see <a href="#">B+M Mode Scanning on page 71</a>
	Backspace	Use the backspace key to clear text, one character at a time.
	Caliper	Press the Caliper key to automatically enter the measurement area menu during an active scan. In an active scan, pressing the caliper key freezes the image automatically.
	Caps Lock	The Caps Lock key is a toggle. Press it and CAPS are in effect (letters will be entered as capital letters). Press it again to turn off caps.
	Depth	Press the Depth key up or down to adjust the depth of the scan. Note: the current depth is indicated in the upper right corner of the screen
	Doppler	The DOP key enters Doppler functionality. Different Doppler modes (Color, Power, PW) can be entered using the function keys. For more information about Doppler Mode, see <a href="#">Doppler Mode on page 73</a>



	Down/Up	Use the down arrow to move the cursor on the screen. This is particularly useful when entering text into dialogs.
	Enter	Press the Enter key to commit information entered into a field. For example, as you fill in the name, ID and other information for a patient, you can press ENTER to commit the information and move to the next field.
	Far	The far GAIN control is used to make adjustments to the electronic amplification of the echoes in the image area that are farthest away (far field) from the transducer.
	Freeze	Press the Freeze key to freeze and unfreeze the active image on the screen. Freeze keys are also located on select probes.
	Gain	Press the Gain key to adjust the overall gain up or down.
	Left	The arrow keys are located on either side of the freeze key. Use the arrow keys to move the cursor horizontally. This is useful when navigating through dialogs.
	Near	Press near key to adjust near gain.
	Patient	Press the patient key to search for patients and create new patient records. To learn more about Patient Management, see <a href="#">Patient Management on page 55</a>
	Review	Use the review key to view saved images/loops.
	Save	Images are saved to the EVO's local storage. By default, images are saved with automatic names in a directory for the current patient. For more options, see <a href="#">Quick Store on page 46</a> .
	Select	Use the Select key when in caliper mode to set the measurements.
	Space	Use the space key to enter a space between words when entering text into dialog fields.
	Zoom	Press the zoom key to enlarge the image. To exit zoom, press the Zoom key again, or press the Super Key.

## Side Keyboard

When operating the EVO with the LCD monitor closed, use the side keyboard buttons to access and navigate the scanner's menus.

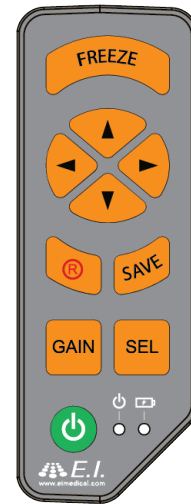

Button	Description
FREEZE	Press the FREEZE key to freeze and unfreeze the active image on the screen. There are freeze keys located on selected probes.
RECORD	Press the record key to begin recording what you see on the screen. By default, the recording is saved with an automatic name in a directory for the patient. For more Recording Options, see <a href="#">Quick Store on page 46</a> .
SAVE	Images are saved to the EVO's local storage. By default, images are saved with automatic names in a directory for the current patient. For more options, see <a href="#">Quick Store on page 46</a> .
GAIN	Press the Gain key from an active scan to open the gain settings slider controls. In any text entry fields, pressing GAIN displays the on-screen keyboard. This allows access to both upper and lower case characters, along with numerals and special characters.
SEL	Pressing the SEL button activates the on-screen menus.

## Screen Layout

The following is the home screen of the EVO.



Parts of the screen

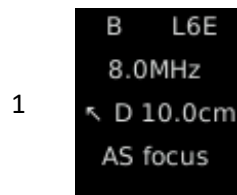

These denote the transducer type attached (L/S - Linear / Sector); the frequency of the transducer; the scanning mode (B or B+M); scanning direction (←/→)

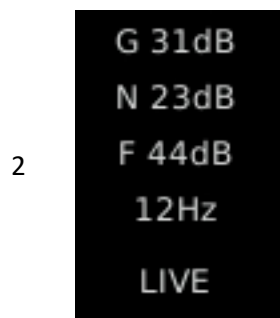

G Gain  
N Near  
F Far  
Current ultrasound frame rate in Hz  
Current mode: LIVE, FROZEN or REVIEW

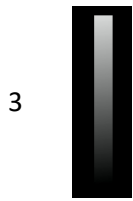

3

The gray-scale bar is for tonal reference.

---

This area indicates:

User1 (or a custom name) - The preset currently in use

4



USB Status



Black means there is no memory stick.



Green means at least one USB port has a memory stick

Bluetooth



Bluetooth is disabled



Bluetooth is enabled



Bluetooth is connected

WiFi



By default WiFi is off.



WiFi enabled (gray )



WiFi connected (white)

Battery



The battery icon with four green bars indicates a full charge; with one yellow bar, the icon indicates 1/4 charge or less.

AC Power



When the unit is plugged in, the AC power icon appears.

5

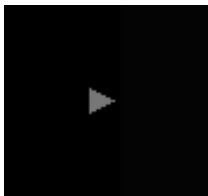

Transmit Focus

This appears on the side of the scan area to indicate the focal region.

Adjust the focus position with the up/down button .

6.



EVO logo used to indicate scan direction.

Menu navigation functions differently when using the video headset, since the monitor is off. Use the side keyboard buttons to perform scanning operations.

## On-Screen Keyboard

To access the on-screen keyboard, press the Annotate key  from any text field menu.

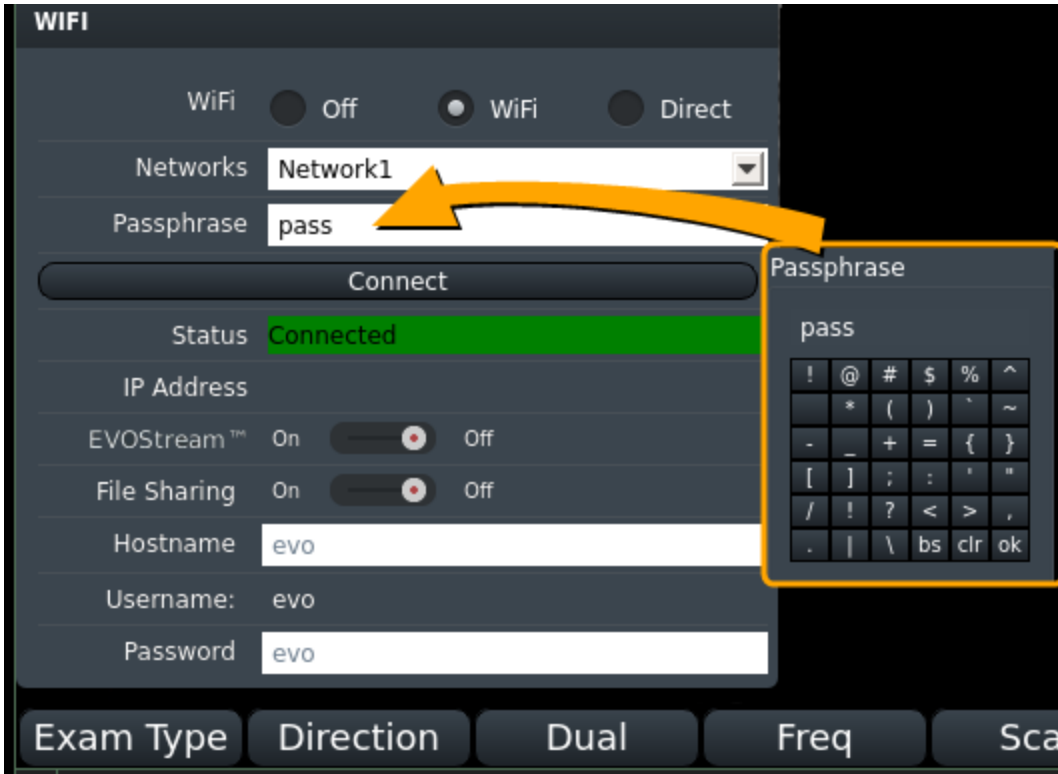

# Physical Operations

This section covers the following topics

---

About the Battery .....	31
Charging the Battery .....	31
Replacing the Battery .....	32
Attaching Transducers .....	32
Wearing the Scanner .....	33
About the Video Headset .....	33
Remote - Optional Accessory .....	33

## About the Battery

The Ibex family of ultrasound scanners can only be charged using the AC adapter supplied by E.I. Medical Imaging. The system has been shipped to you with a partially charged battery. Once you have received and opened the equipment, it is recommended you completely charge the battery prior to use. Follow the procedure below for charging the battery.

**Note** – Battery runtime varies depending on your system configuration and headset.

## Charging the Battery

To charge the battery:

1. Ensure that the battery is installed in the system. (If it is not already installed, see the instructions for installing the battery). Slide the latch to the lock position to ensure the system access door is properly sealed.
2. Connect the AC adapter to the EVO system by aligning the red dot on the connector.
3. Plug the adapter into a 100-240 VAC Outlet.

During the charge cycle the yellow light illuminates indicating the charging process is underway. As the battery reaches its full charge, the light switches off which indicates the battery is at full charge.

The total charge time will range between 120 and 180 minutes from a totally drained battery to a fully charged battery.

**Note:** The AC adapter should not be used during outdoor operation.

## Replacing the Battery

To replace the battery:

1. Power off the system.
2. Slide the silver latch to the right and lift the handle which extends over the edge of the EVO.
3. Remove the cover.
4. Lift the battery by its cloth tab.
5. Insert the new battery pack by angling it into the compartment, ensuring connection.
6. Lock and seal the door.
7. Power on the system.

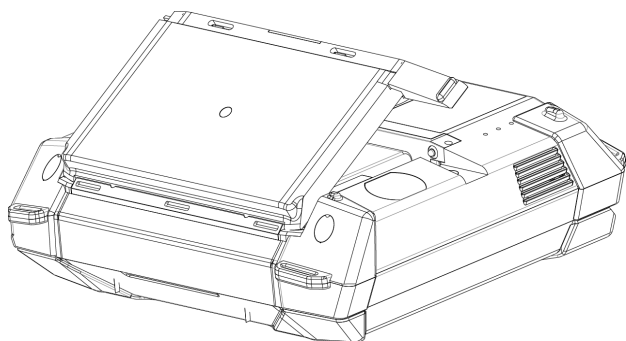

## Attaching Transducers

To attach a transducer:

1. Lift the probe cover latch to open position.
2. Align the metal engagement rods with the metal slots on the system side of the female connector.
3. Press the connector in place to seat.  
**CAUTION: Do not toe in connector. Attach straight down.**
4. Close the connector cover latch to engage rods in connector.

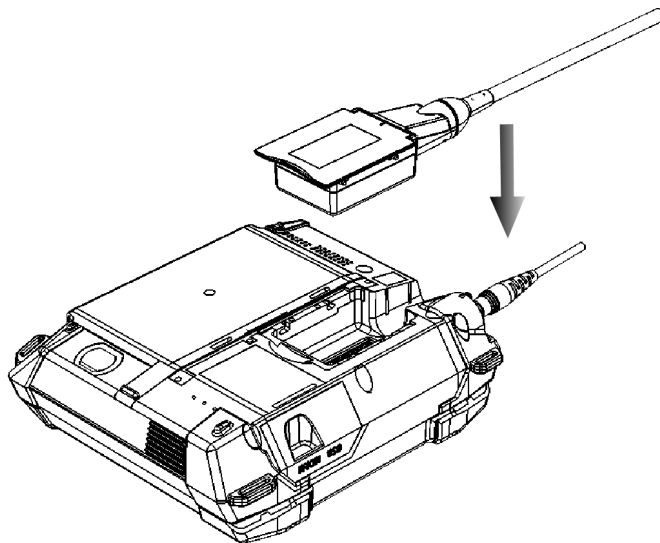



## Wearing the Scanner

The Ibex ultrasound systems can be worn using a shoulder strap or a backpack. Consult with your E.I. Medical representative to find out about these options.

## About the Video Headset

Consult with your E.I. Medical representative to find out about Video Headsets.

## Remote - Optional Accessory

While using a headset or an HDMI connection, you may want to use an optional remote.

The remote is paired to the EVO over Bluetooth; for more information about Bluetooth see [Enabling Bluetooth on page 53](#)

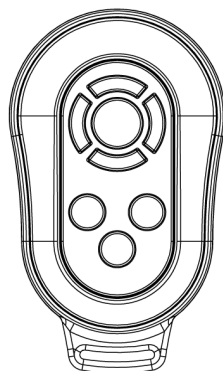

## Pairing the Remote with your EVO

To pair the remote with your EVO

1. Enable Bluetooth (for more information about Bluetooth see [Enabling Bluetooth on page 53](#))
2. From the Bluetooth dialog, click Scan for Remotes.
3. Select your remote from the drop down.

## 2: Getting Started

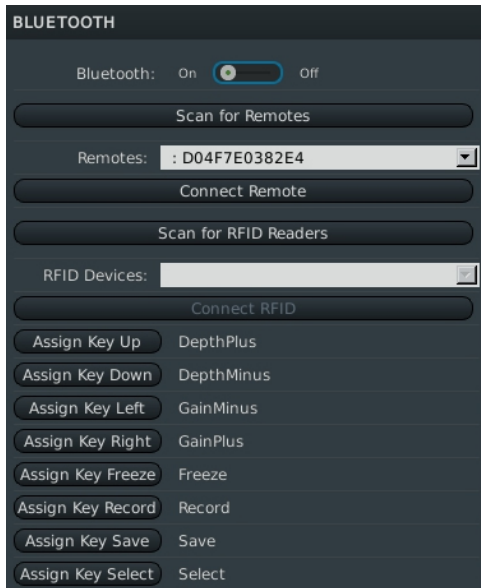

### Remote Buttons

The buttons are configured as shown in the Bluetooth dialog but you can configure them for other functions. For example, to change the FRZ Button, click the Assign Key Freeze in the Bluetooth dialog. When "Press a Key" appears, press the key you want to assign.

### Remote Battery

To replace the battery, remove the screws as shown. Use one CR2032 battery.

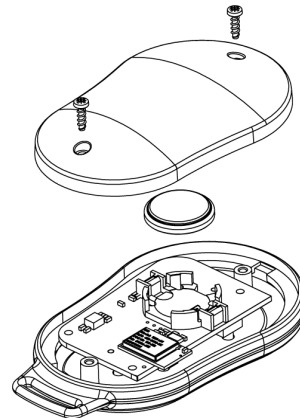

## Menus

### The On-screen Menus

Use the on-screen menus to navigate and execute scanning operations and system functions. Menus can be accessed using the F keys or the touchpad.

#### Home Menu

This is the default menu that appears on the screen.



- Exam type - Various system presets with optimal settings for a specific exam type; for example Equine Repro. Some exam types incorporate Extended View for best performance.
- Direction - Use this to set the scan direction. Arrow points to the direction of the leading edge of the probe. Rotates in 90 degrees. Default is top left.
- Dual - Use this to compare a live view to a frozen or recalled image
- Freq - Frequency cycles through the available frequencies for a specific transducer
- Scan - This displays the scan options. For more information, see [B-Mode Scan Options on page 48](#)
- Gain - This displays the gain options. For more information, see [Managing Images on page 57](#)
- User - Select the user you'd like to work as. For more information, see [Setting User Presets on page 41](#)

#### Super Menu

Press the  to display the Super Menu



##### Option



- Video - [Adjusting Video Settings on page 44](#)
- Audio - see [Adjusting Audio Settings on page 43](#)
- Misc - [Adjusting Misc Options on page 45](#)
- Back - press F6 to go back to the Home menu.

## Setup

USB - see [Saving Files to a USB Memory Stick on page 87](#)

Bluetooth - see [Enabling Bluetooth on page 53](#)

WiFi - [Enabling WiFi on page 50](#)

System-

Clock - see [Setting Day and Time on page 40](#)

Reset- this will return the selected user to defaults.

Info - this is information about the software. For details, see [Identifying System Firmware Version on page 95](#)

Setup - here you can change the clinic name and the host name.

Unlock- this is where you can enable features that are ordered separately.

Export Logs

User - here you can rename the users. For more information, see [Renaming User Presets on page 42](#)

Annotations - set labels here. For more information, see [Setting Annotations on page 47](#)

Back

## Moving around the screens

The touchpad acts like a mouse to move the cursor on the screen. To select, press the Select key or the Enter key. You can also tap the touchpad.

The Function keys coordinate with menu items on the screen.

The Super key calls up other menu options.

## Using the On-Board Help

Use the Help Key to get help on keys and dialogs on the EVO.



To view the help for a key, press the Help key, then press the key you want to know about.

To view the help for a dialog, first view the dialog, then press Help.

### Examples

#### Help for a key

To view the help for the **Fullscreen Key**,

press  then press 

#### Help for a dialog

To learn about the **WiFi Dialog**

Open the WiFi dialog (super key, F2, F3)

When the dialog appears, press 

## Training

Training videos may be available on your EVO depending on the device and configuration.

To access Training, press , **F6** (Super key, Training).

## 2: Getting Started

# 3: Configuration

This section covers:

---

Welcome Screen .....	40
Setting Day and Time .....	40
Setting User Presets .....	41
Adjusting Audio Settings .....	43
Adjusting Video Settings .....	44
Adjusting Misc Options .....	45
Setting Annotations .....	47
B-Mode Scan Options .....	48
Enabling WiFi .....	50
Enabling Bluetooth .....	53
RFID Support .....	54

## Welcome Screen

The first time you power on and log in to the EVO, you will see the following screen. Adjust any values as needed.

WELCOME TO EVO

Welcome to Evo Please take a moment to initialize some unit-specific settings.

Hostname: evo

Clinic Name: E.I. Medical Imaging

Year 2017

Month January

Day 26

Hour 11

Min 22

Format  12  24

Done

## Setting Day and Time

If for any reason your system loses its day and time information, reset it by completing the following:

1. From the home screen, press the , F2, F4, F1 (Super key, Setup, System, Clock).

CLOCK

Year 2017

Month January

Day 24

Hour 1

Min 52

Format  12  24

Update



### 3: Configuration

2. Use the touch pad or the up/down key to move from field to field.  
Select the format you would like the time to appear in.  
**NOTE:** If you are entering a time after 12 noon, even if you choose the 12 hour display format, make sure to enter the time as a 24 time so that it is understood as pm.
3. Click the Update button. Press the Super key to save and return to active scanning.

## Setting User Presets

There are six user presets. This feature allows operators to set the scanner with individual preferences. You can also set suitable presets for different applications.

To access the Presets Dialog, press: , **F2**, **F5** (**Super key, Setup, User**)

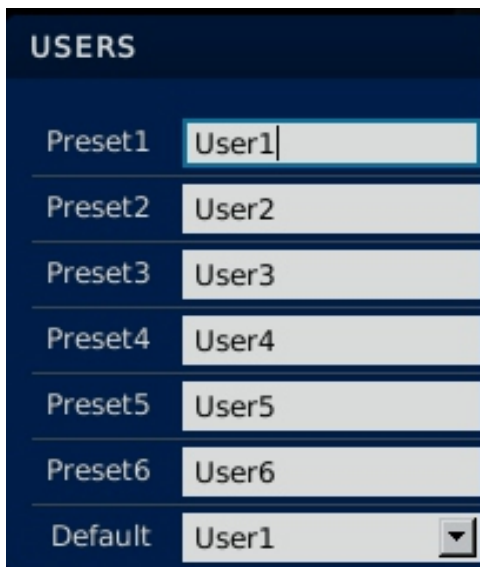



User presets allow you to globally predefine the system settings listed here .

- GAIN and TGCs
- Video settings
- Audio settings
- Scan settings
- Misc settings
- RFID settings
- Quick Store settings



## Renaming User Presets

Once you have established the desired settings, you may want to rename user presets. To rename user presets, complete the following:

1. Access the preset dialog: , **F2**, **F5 (Super key, Setup, User)**.
2. Select the preset you want to rename and key in a new name.
3. Press the Super key  to save and return to active scanning.

## Changing the Default User Preset

To change the default user preset, complete the following:

1. Access the preset dialog: , **F2**, **F5 (Super key, Setup, User)**.
2. Select the default field using the up/down arrow keys or the touchpad.
3. Select a new default preset.
4. Press the Super key  to save and return to active scanning.

## Changing the Current Preset/User

From the home menu, press **User (F7)**. Then select the user you'd like to use.

## Resetting Users

To reset users to factory default settings, see [Advanced System Operations on page 95](#)

## Adjusting Audio Settings

Use the audio options dialog to configure sound settings.

To access the Audio Dialog, press:  , F1 , F2 (Super key, Option, Audio)

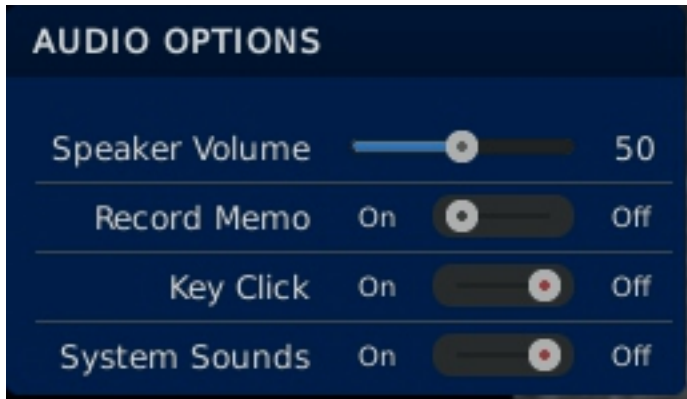

Speaker Volume	This controls the volume for all system sounds. By default, this is set to Off.
Record memo	When this is on, a prompt will appear while saving an image to indicate that recording is taking place. Speak into the EVO to record a voice memo without having to press any additional keys. The voice memo is saved as part of the image file and will play back on the EVO. Can record until internal memory is full; total memory capacity is about 30 minutes.
Key Click	Enables sounds while typing.
System Sounds	When this is on, the system will provide system sounds such as audible battery warnings.

## Adjusting Video Settings

To access the Video settings, press:

 **F1 , F1 (Super key, Options, Video)**



**LCD Brightness** The default brightness setting is 75. Adjust as needed; a lower number may be good in a dark office while a higher number may be optimal when viewing outside.

**Glasses Format** Set this depending on your device.

**Style** Select from one of four styles to change the color themes used in EVO menus. The default color theme is EVO.

**Chroma Red** This adjusts the hue of the image.

**Chroma Blue** This adjusts the hue of the image.

To save the selections and return to active scanning, press .

## Adjusting Misc Options

Use the Miscellaneous Options dialog to set system preferences.

To access Misc Options, press: , **F1**, **F3** (Super key, Options, Misc)



**Grid** Adjust this setting to add rules to the background. These scale appropriately as you adjust the depth.

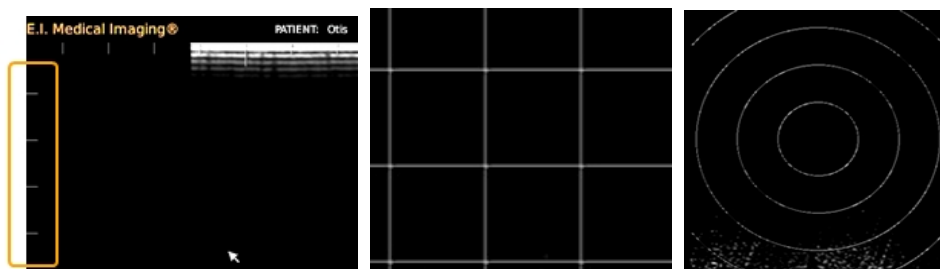

**Clinic Name** Set the name of your clinic here. This will appear at the bottom of jpegs and avi's saved on your system.

**Saved Loop Length** Recording length when you press the record button   
For 2, 4 or 8 seconds, it will automatically stop recording.

For Start/Stop, press  to start and stop the recording.

**Keyboard** This sets the keyboard backlight timeout. The default is 5 seconds. You may want

### 3: Configuration

Backlight	to adjust this to save power.
Quick Measure	When enabled, the caliper key will begin a distance or area measurement when pressed, when disabled the user must select dist. or area before beginning a measurement.
Temperature Units	Some RFID sensor tags report temperature. This is displayed on the right margin. Select Centigrade or Fahrenheit
Distance Units	Millimeters or centimeters; this is used for caliper measurements
Weight Units	Kilograms or pounds; seen in patient screen.
Quick Store	When Quick Store is set to On, images and recordings are saved and named automatically. If a patient has been selected, images are saved to a directory for the patient. If no patient name has been entered, the image is saved in the Unassigned directory  By default, Quick Store is On.
Probe Freeze Disable	For probes which support image freezing. On means the button is disabled. You may want to disable this if the button is frequently bumped.
Calipers Stay Visible	By default this is off.
Repro Workflow	Turns this workflow on or off.
Image Format	JPEG or Bitmap. The default is JPEG.
Export Format	Standard or DICOM. The default is Standard.

## Setting Annotations

The annotations dialog is prepopulated with commonly used labels, but you can change the entries as needed. The same values are available in all exam types.

To access the Annotations Dialog, press:

 , F2 , F6 (Super key, Setup, Annotations)

ANNOTATIONS				
<input checked="" type="checkbox"/>	<input checked="" type="checkbox"/>	<input checked="" type="checkbox"/>	<input checked="" type="checkbox"/>	<input checked="" type="checkbox"/>
Left	Spleen	DH	SDFT	Follicle
Right	Liver	SR	DDFT	CL
Medial	Kidney	CC	uspensory	Male
Lateral	Bladder	HR	Branch	Female
Proximal	Sm Intest	CTS	Front	Fetus
Distal	allbladder	PCS	Hind	GT

These labels appear when you press the  key. Press the annotation key again to cycle through the selections. Unchecking a box to remove the vertical group of annotation options from the button list when selecting an annotation.

## B-Mode Scan Options

B-Mode Scan Options control image adjustment.

To access the Scan Options Dialog, press: **F5 from the main menu (Home, Scan)**

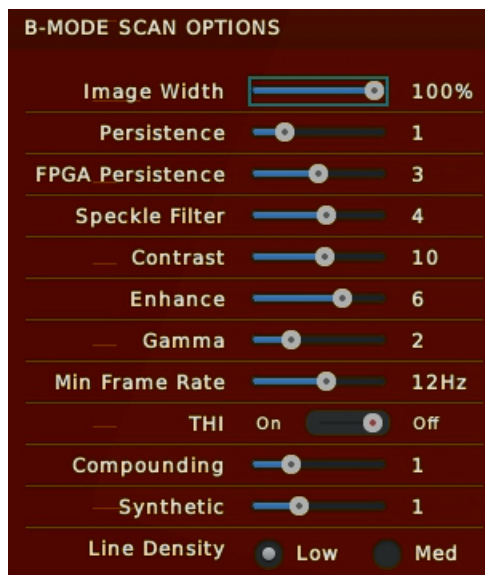

The settings vary depending on which probe you are using; you may not see all of these options.

**Note:** Not all settings are available on all transducers.

Image Width	Adjusts the width of the transducer used. This can improve the frame rate.
Persistence	Persistence is a frame averaging feature which allows you to manipulate images based on application requirements. As a rule of thumb, when persistence is low, the image is faster and grainier. When persistence is high, the image is smoother and slower; smearing is possible.
FPGA Persistence	Provides temporal averaging before speckle filter (contrast with persistence which is applied after).
Speckle Filter	Applies a smart filter to the image to reduce the speckle artifact.
Contrast	Higher number, greater contrast, fewer grays Only affects ultrasound image; not screen
Enhance	This setting can help sharpen edge detection of the active image by enhancing strong echoes.
Gamma	Used in conjunction with Contrast, Gamma helps adjust the grayscale intensities of the active image.
Min Frame rate	Set the minimum frame rate. The range varies depending on the connected transducer. To achieve the minimum frame rate the EVO reduces the image width.
Extended View	Extended View, also known as Trapezoidal Imaging is available on Linear Probes where the



### 3: Configuration

outer edges are not perpendicular to the transducer face but instead open up to allow more image area at bottom of the field of view.

Note: only available for straight, linear (non-curved) transducers.

---



THI	Tissue harmonic imaging adjusts the transmit and receive filters in the ultrasound. This filters out reverberation echoes allowing for a cleaner image with better contrast and less artifact. THI doubles the image acquisition time, reducing the frame rate.
Compounding	For flat linear probes this introduces levels of angle compounding, steering the probe beams for multiple vantage points (multibeam) as well as frequency compounding, using multiple transmit and receive frequencies for a single image. A higher compounding setting will provide a finer image with reduced speckle artifact. Each higher level will increase the image acquisition time, reducing the frame rate. For curved linear probes this introduces only frequency compounding
Synthetic	Adjusts beam sharpening to provide a sharper image with better resolution.
Line Density	Adjusts the number of vertical scan lines that make up the image. A higher setting provides a finer image but increases the image acquisition time, reducing the frame rate.

## Enabling WiFi

The EVO uses WiFi technology to communicate with wireless networks. When enabled, you can transfer saved images and loops to and from any computer on the same network.

**NOTE:** Leaving WiFi enabled uses more battery power and shortens battery run times.



To access the WiFi settings: press: , **F2, F3** ( , **Setup, WiFi**)  
The WiFi dialog will appear as shown above.

You can also click on the WiFi Icon in the status panel; just tap on the touch pad to launch the WiFi dialog

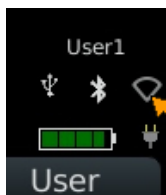

By default, WiFi is disabled; click ON to enable.

## WiFi Indicators

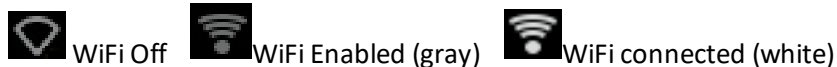

### To connect to a network:

1. Select WiFi to enable wireless connectivity.
2. Enter the appropriate information for your private WiFi network, including:

Off | WiFi | Direct

By default, WiFi is off.

#### WiFi

Select WiFi to join a wireless network.

Select Direct to set the EVO as the wireless hub.

#### Networks

When you turn on WiFi, the EVO searches for available networks. Select the network you want.

Enter the passphrase for the wireless network. To type a special character, such as a dash (-) or ampersand (&), press the annotate key

1. Press the  (annotate) key.
2. The special characters will appear in an on screen keypad.

#### Passphrase



3. Select characters using the arrow keys or the touchpad
4. To exit the keypad, tap OK on the keypad or press the Annotate key again.

#### Status

Indicates: Connected, Disconnected for WiFi.  
Disabled, Connected for Direct WiFi.

#### IP Address

This is the IP address that your EVO has been automatically assigned on the local wireless network.

#### EVOStream

By default this is off. Turn on to use with the EVOstream App.  
For more information about EVOstream, see [EVOstream - Sharing live Images on page 92](#)

#### File Sharing

By default, file sharing is disabled. For more information about File Sharing, see [File Sharing on page 89](#)

#### Hostname

This is autopopulated. Use this value for locating the EVO on your local network for file

sharing.

---

<b>Workgroup</b>	This is autopopulated. Use this value for locating the EVO on your local network for file sharing.
------------------	--

---

<b>Password</b>	This is autopopulated. Use this value for locating the EVO on your local network for connecting to a network.
-----------------	---

---

## To Enable the EVO as a Wireless HUB

1. Select Direct
2. Click Activate Network



3. At this time, you can enable Streaming or File Sharing.

## Enabling Bluetooth

The EVO uses Bluetooth

- to work with Bluetooth RFID readers
- for remote control

To access the Bluetooth settings, press: , **F2**, **F2 (Super key, Setup, Bluetooth)**

You can also click on the Bluetooth Icon in the status panel; just tap on the touch pad to launch the Bluetooth dialog.

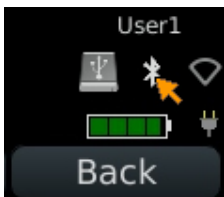

The parts of the dialog are described below.

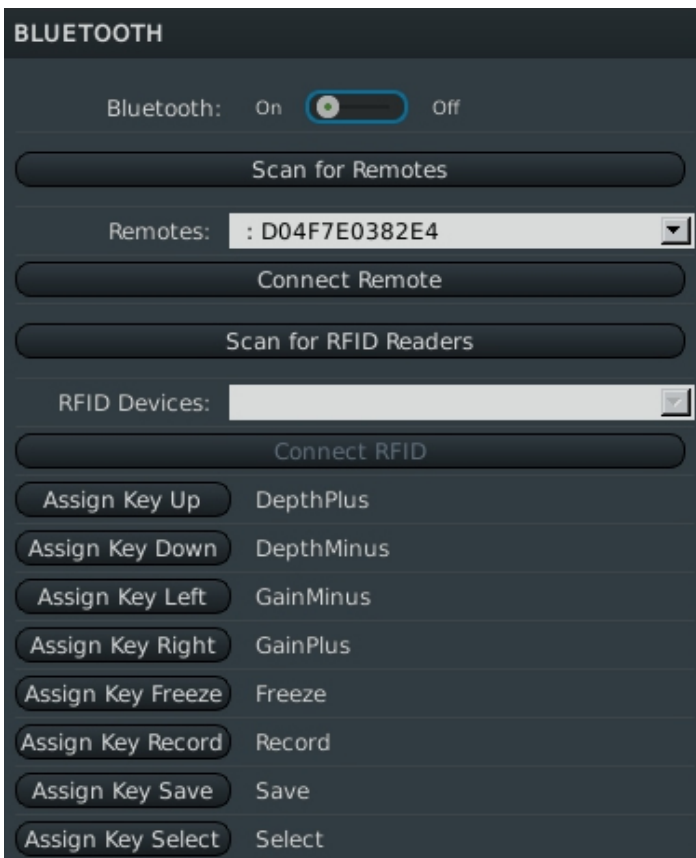

### 3: Configuration

Bluetooth	By default, Bluetooth is disabled. Turn it on here. Bluetooth will continue to be enabled after a system reboot.
Scan for Remotes	Click this to initiate a search for remote devices.
Remotes	Available remote devices are listed here. Select the one you want to use.
Connect Remote	Click this to establish a connection between the EVO and the selected device.
Scan for RFID Readers	Click this to initiate a search for RFID Readers.
RFID Devices	Available RFID Readers are listed here. Select the one you want to use.
Connect RFID	Click this to establish a connection between the EVO and the selected RFID reader.
Assign Key	All remote keys can be reassigned to work as any key on the EVO. Select the key you want to reassign from the list, then physically press the new key.

## RFID Support

The EVO supports the following RFID string formats: ISO, Hex and Decimal 2

# 4: Patient Management



## Entering Patient Identification Information

To maintain a correlation between stored images and the patient, fill in Patient information.

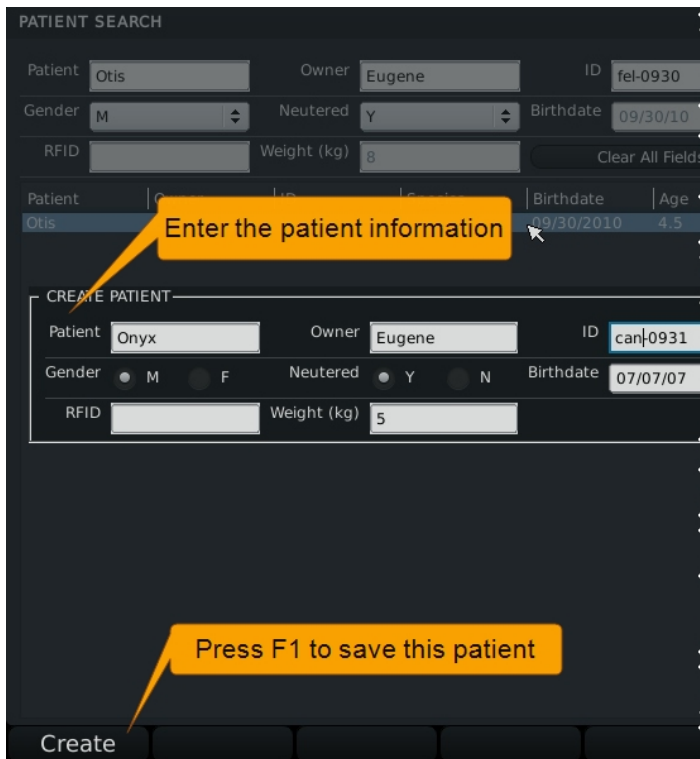
1. Press the patient button  on the keyboard to display the Patient Search Screen.



2. Press F3 to display the Create Patient Dialog. Enter the desired information.

- Use the up/down to key to move from field to field. 
- To enter special characters, press the annotation key . The on screen keyboard will appear. To exit this keyboard and continue editing, use the OK button displayed on the keyboard.

#### 4: Patient Management

3. Press F1 (Create) to save the new patient record.

When you leave the patient creation screen, an exam will start for the newly-created patient. The PID and TAG information displays at the top of the screen.

## Searching for a Patient

1. Press the PATIENT button on the keyboard to display the Patient Search Screen.
2. Move from field to field using the up/down key. Fill in the fields with criteria to search.
3. Select the correct patient from the search results. You can select by double-tapping on the touch pad. You'll be returned to exam mode for the patient selected.



# 5: Managing Images

This section covers:

---

Freezing Images .....	58
Saving Images and Cineloops .....	58
Recalling Images and Cineloops .....	61
Annotating and Measuring Images .....	63
Working with Dual Images .....	64
Carcass Merit .....	65
Repro Workflow .....	67

## Freezing Images

The EVO allows you to freeze any active image for further analysis. Press the Freeze key on either keyboard to:

- Take measurements of images and loops.
- Review images frame by frame using the left and right arrow keys or the touch pad.
- Use the right and left arrows (on either side of the Freeze Key) to step through a cineloop when frozen.
- Press Start and Set End to trim a video.

Probes with a freeze button give the added ability to:

- Freeze images without going to the scanner by pressing and releasing the button once.
- Store images without going to the scanner by holding the freeze button for two seconds from a frozen image.

## Saving Images and Cineloops

When you save an image/cineloop, the system captures and stores the following information in the file:

- The patient name and ID
- The timestamp
- The voice memo
- Probe
- Everything displayed

The system saves images as jpegs (.jpg) and cineloops as AVIs (.avi) file format.

The system assigns a default file name based on the following convention:

Year	Month	Day	Hour	Minutes	Seconds
4-digit	alpha abbreviation	2-digit	2-digit	2-digit	2-digit

Example: 2015Oct16-15.43.47.JPG

## Saving Images

Images are saved to the EVO's local storage. By default, images are saved with automatic names in a directory for the current patient.

- If you have added annotations, they will be saved with the image.
- By default, the image is saved with an automatic name in a directory for the patient.
- If no patient name has been entered, the image is saved in the Unassigned directory.

To save images with user-defined names, disable Quick Store. To disable quick store:

1. Press Super, Options (F1), Misc (F3)
2. Turn Quick Store Off.

Now, when you press SAVE, you'll be prompted to enter a file name for the image.

When Quick Store is disabled, the Save Dialog will look something like this:

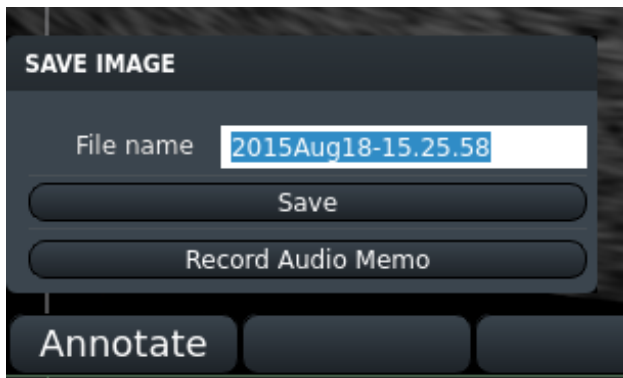

## Use Annotation Labels as File Names

Save images quickly, using annotation labels in the file names.

1. Make sure Quick Store is turned off (described above).
2. Press Save to save an image. When the Save Dialog prompts you for a name, press the Annotation key . Select the label you want pressing the appropriate function key.
3. The image will be saved with the annotation label name.

If you attempt to save images to the same directory with the same label name, a prompt will appear asking if you want to overwrite or rename the previous image. Choose rename and you'll be able to save a series, example: Uterus1, Uterus2, Uterus3 and so on.

## Saving Cineloops

Press the record key to begin recording what you see on the screen; you should see a blinking red circle on the right side of the screen indicating that a recording is in progress. This is a decrementing counter; it indicates the time left until the recording is complete.

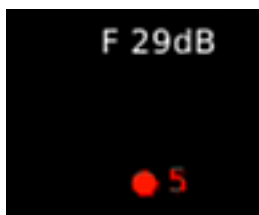

By default, the recording is saved with an automatic name in a directory for the patient.

To save avi files with user-defined names, disable Quick Store. To disable quick store:

1. Press Super, Options (F1), Misc (F3)
2. Turn Quick Store Off.

Now, when you press RECORD, you'll be prompted to enter a file name for the image.

The length of the recording is also set under Misc Options

1. Press Super, Options (F1), Misc (F3)
2. Set Saved Loop Length. You can choose 2 seconds, 4 seconds or 8 seconds.

To record longer Loops, choose Start/Stop. When this is selected, press Record to start and stop the recording for whatever length you like.

## Recalling Images and Cineloops

You can recall stored images and cineloops for comparison studies. Press the Review key to bring up the Review screen.

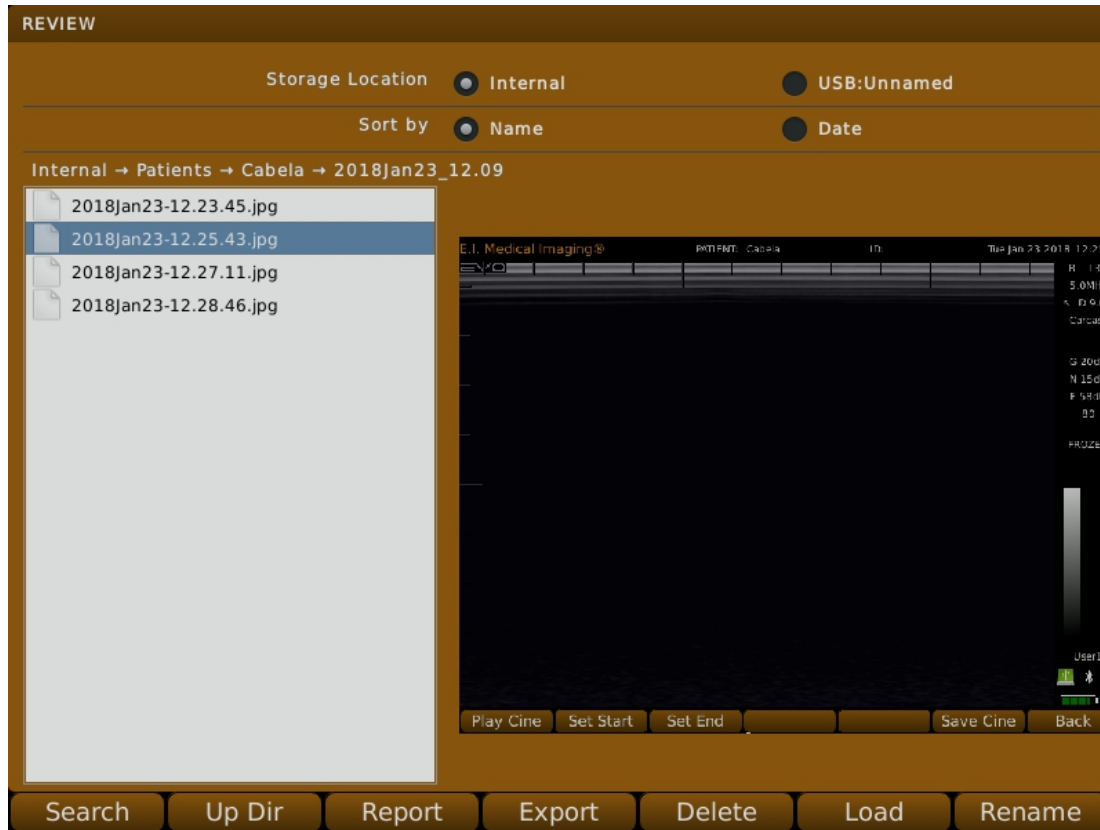

## Recalling Saved Images and Cineloops

1. To recall saved images, press the Review key
2. Select the image or cineloop you'd like to view from the list on the left; to change directories press Up Dir
3. Press Load to View.

When you view a cineloop, a blue bar on the right indicates progress.

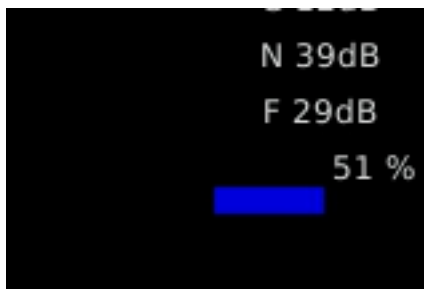

## Renaming Images

1. To recall saved images, press the Review key
2. Select the image or cineloop you'd like to rename from the list on the left.
3. Press Rename (F1).
4. Rename the file and press ENTER.

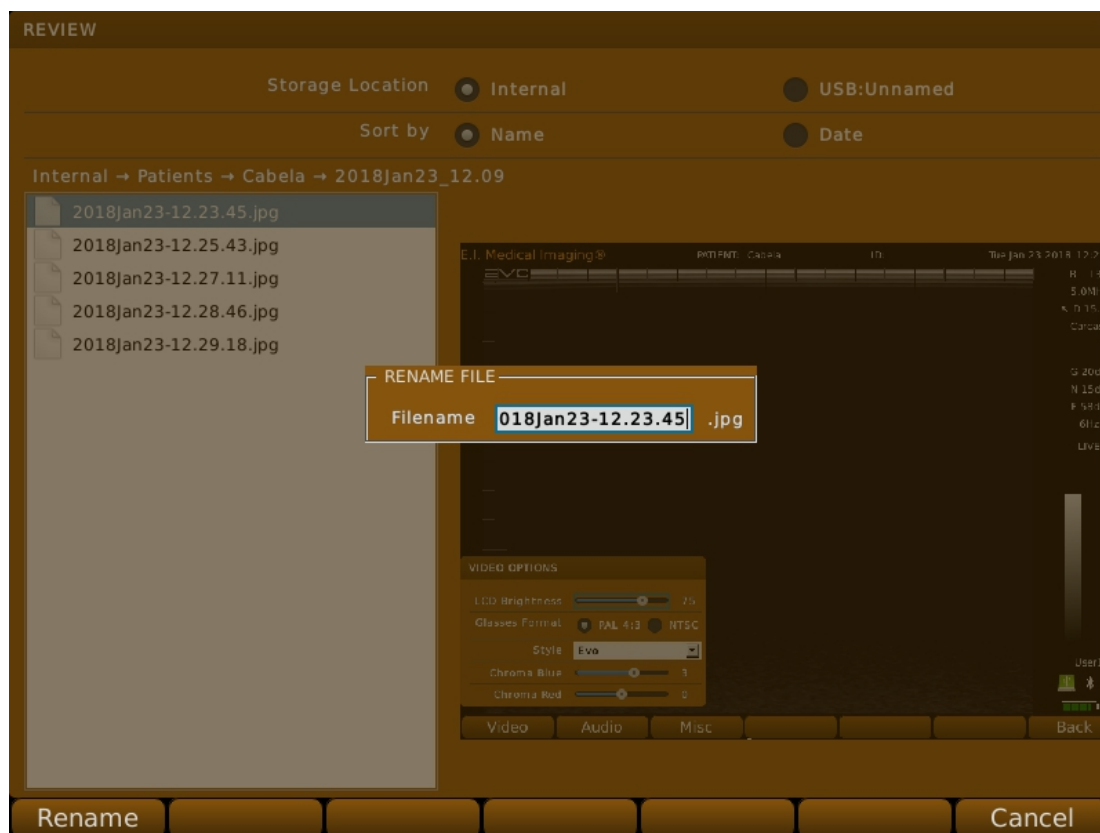

## Deleting Images

To delete images and cine loops for the system, complete the following:

**Caution:** The system will not ask if you are sure you want to delete.

1. Press the Review key to
2. Select the image or cineloop you'd like to delete from the list on the left; to change directories press Up Dir
3. Press Delete (F5)

## Annotating and Measuring Images

This section covers how to:

- Add text to images
- Measure structures

### Adding Text Labels to Images

Follow the instructions below to add text labels to images.

1. Press the **A** (annotate) key
2. When the cursor appears on the screen, you can move it with the touchpad
3. Enter text, or press one of the function keys to use a common label. Press the Select key or the Enter key to anchor the label. Press Annotate to cycle through the lists.
4. Press SAVE to save an image with the labels

The labels stay on the screen until you return to live scanning; to return to scanning, press the Super Key.

**To adjust font size:** Press the **A** (annotate) key to cycle through the options. On the final screen, press Edit . Use F1 and F2 to increase or decrease the font.

**Adding Arrows:** After pressing the annotate key, press F1 to activate the arrow. Use the touchpad to position it as desired. Key in some text as well, to label the arrow and press enter to save the text and arrow. .

This turns the surrounding box from blue to black.

### Adding Text to Saved Images

You can annotate and label saved images (.JPGs) with alphanumeric text.

To add text to saved image files, complete the following:

1. Recall the saved image file ; press the Review Key and load the image you want to add text to.
2. Press the **A** (annotate) key to allow manual text entry or use list of available text labels.
3. Continue to press the **A** (annotate) key to press through list of preset annotations.
4. Press SAVE to save image.

## Working with Dual Images

The dual image feature of the EVO allows you to examine two side-by-side images at the same time. This feature is useful when:

- Comparing past scans with current scans
- Freezing an active scan and repositioning the probe to image the anatomy from a different angle.
- Imaging bilateral structures.

To view dual images:

1. From the Home menu, press Dual (F3). This puts the current view on the left of the screen.
2. Press Review (F3) to select and load an image. This will appear on the left side.
3. To load an image on the right, press Side (F1) and the orange bar moves to the right side of the screen. At this point, you can press Review again to load a saved image, or Live (F2) to view the current live image.

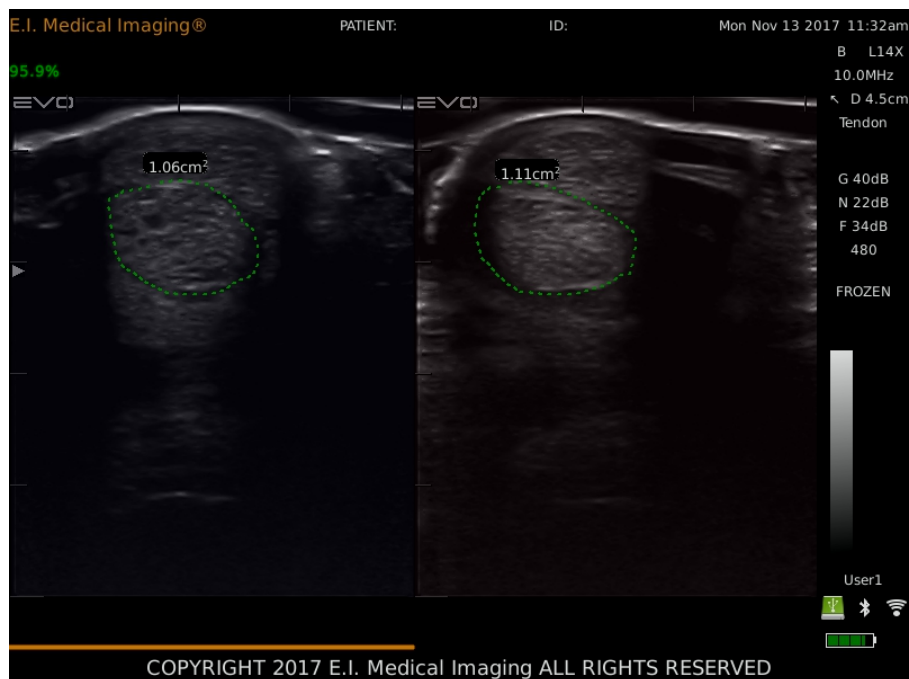



## Carcass Merit

Carcass Merit functionality is only available with the L3ASE transducer. The purpose of this workflow is to quickly enter animal information pertinent to carcass merit.

### Setting up Carcass Merit

To access Carcass merit, first install the L3ASE transducer Press N. The Carcass Merit dialog appears.

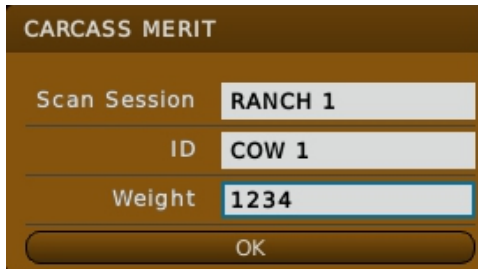

The first time it appears, the fields are blank. To access the setup, press F6 Here is the setup. The fields are described below.

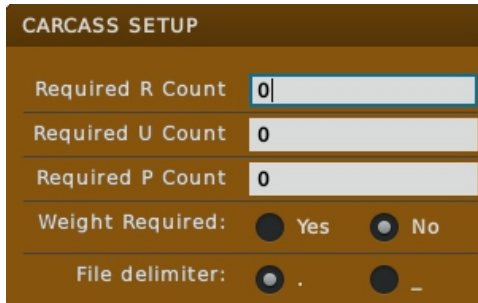

Required R Count	The count required for Rump entry
Required U Count	The count required for Loin entry
Required P Count	The count required for Fat entry
Weight Required	Select yes or no.
File delimiter	The file delimiter is used to separate parts of the image name. Example: COW NUMBER1.R1.jpg or COW NUMBER1_R1.jpg

### Animal Entry

The screens have been designed to accommodate quick entry. Press the associated letter key on the keyboard to bring up the screen. The keys are: N, R, U and P. N - new, R - rump, U - Loin, P - fat.

## **N- New Animal Setup**

Press N to bring up the Carcass Merit entry area.

**Scan Session** - Identifier for group of animals: Ranch name or site name.

**ID** - the specific animal's ID. Automatically populated via RFID scan.

Weight

Fill in the entry fields as needed.

**R- Rump**

**U- Loin Size**

**P- P Fat**

If the required number of images for any particular scan is not saved, the system will alert the you to capture additional images.

## Repro Workflow

To turn on Repro Workflow:

Access Misc Options, press: , **F1**, **F3** (Super key, Options, Misc) and set Repro Workflow to On



When Repro Workflow is on, the regular patient area is not available..



Press the Patient Key  to open the Repro Workflow dialog.

While Repro Workflow is enabled and you save images, they are saved to folders with names using the values set in the Repro Workflow Setup.

- The scan session becomes the folder name in the patient folder.
- The animal ID becomes part of the label.
- The dialog does not let you reuse an animal ID.

To access the Repro Workflow Setup, while the workflow dialog is open, press F6. In the Repro Workflow Setup you can rename the hotkey definitions. The default settings are shown below.

## 5: Managing Images

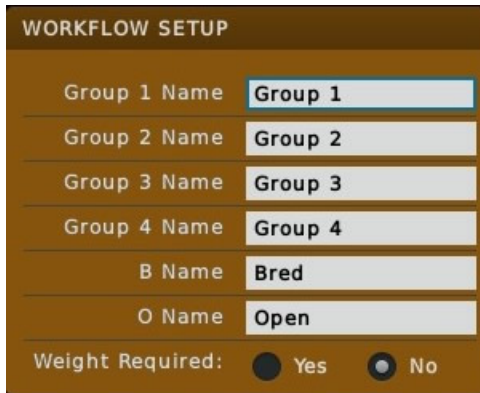

The screenshot shows a dialog box titled "WORKFLOW SETUP" with a dark brown header. Below the header are several rows of text labels and input fields. The first four rows are "Group 1 Name", "Group 2 Name", "Group 3 Name", and "Group 4 Name", each followed by a text box containing "Group 1", "Group 2", "Group 3", and "Group 4" respectively. The fifth row is "B Name" with a text box containing "Bred". The sixth row is "O Name" with a text box containing "Open". The seventh row is "Weight Required:" followed by two radio buttons; the "Yes" radio button is selected.

WORKFLOW SETUP	
Group 1 Name	Group 1
Group 2 Name	Group 2
Group 3 Name	Group 3
Group 4 Name	Group 4
B Name	Bred
O Name	Open
Weight Required:	<input checked="" type="radio"/> Yes <input type="radio"/> No

Once the Animal ID is entered and you are scanning, the 1,2,3,4, B, and O keys will save an image with the name: AnimalID\_hotkey definition\_image number.jpg



The screenshot shows a dialog box titled "REPRO WORKFLOW" with a dark brown header. Below the header are two rows of text labels and input fields. The first row is "Scan Session" with a text box containing "1". The second row is "Animal ID" with a text box containing "flossie". At the bottom of the dialog is a large, rounded "OK" button.

REPRO WORKFLOW	
Scan Session	1
Animal ID	flossie
OK	

### RFID

RFID, if used, opens the workflow dialog and populates the label the animal ID with the RFID tag#.

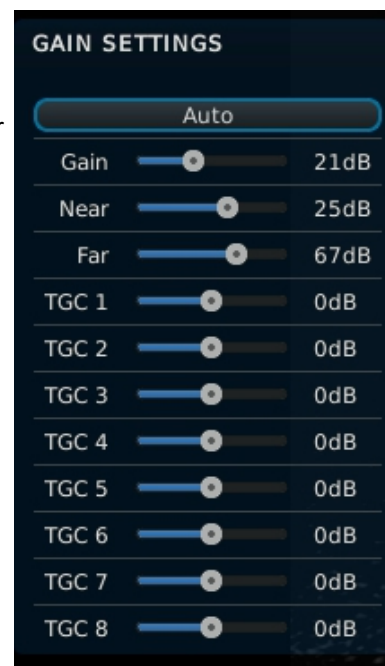

## 6: Manipulating Images

Manipulate images by adjusting the Gain settings. The Gain controls compensate for the reduction in sound amplitude as it travels into tissue. The Gain controls can intensify the returning signals and display images brighter and more visible on the screen. You can adjust the Gain for the near field (higher), far field (lower), or the entire field (overall gain). Excessive increase in Gain will add noise to the image. For optimal diagnostic images, adjust the Gain to produce uniform gray scale responses.



### About Gain Controls

To view all of the Gain settings on one screen, press Gain (F6) from the home menu.

<p>Overall GAIN</p> 	<p>To adjust the overall gain, use the GAIN key. You can increase/decrease the brightness of the entire field.</p>
<p>Near Gain</p> 	<p>The NEAR Gain control is used to lighten or darken the intensity of the echoes in the near field of the image (the area closet to the transducer).</p>
<p>Far Gain</p> 	<p>The FAR gain control is used to make adjustments to the electronic amplification of the echoes in the image area that are farthest away (far field) from the transducer.</p>
<p>Time Gain Compensation (TGC)</p>	<p>TGC refers to the time taken for an echo to travel from the transducer to the target area. As the ultrasound signal travels further into the tissue, more and more of its energy is absorbed causing the echoes to decrease in strength. Therefore, at greater depths, the TGC needs to be set at a higher setting. Conversely, at a short distance, for example near the skin line, there is more energy level available and therefore the TGC can be run at nearly a minimum setting.</p> <p>The EVO offers 8 TGC settings. Adjust these using the touchpad.</p>

6: Manipulating Images

The following images are examples of scans created using high, low, and optimal Gain settings:

High Gain Setting – Images will appear bright with detail lost.

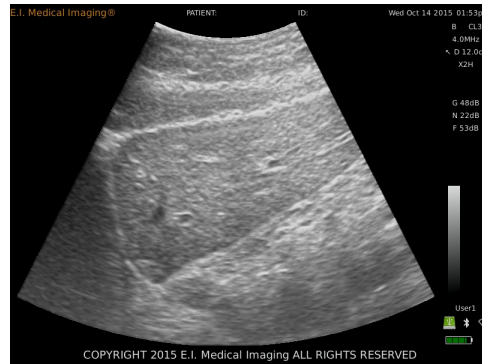

Low Gain Setting – Images will appear dark with no detail.

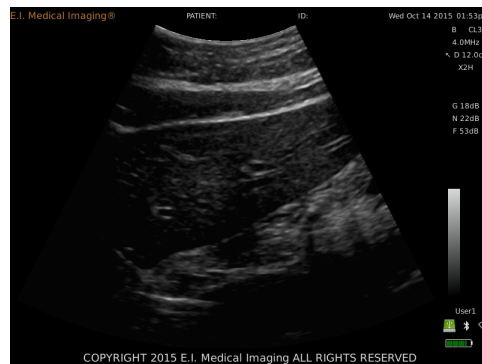

Optimal Gain Setting – Images appear with uniform gray-scale and with optimal detail.

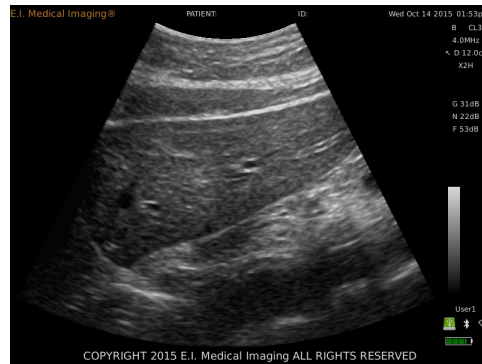

## Using Auto GAIN

The auto gain feature allows the system to automatically adjust Gain settings for optimal image quality. Auto Gain calculates the optimal Gain values based on tissue composition.

To use the Auto Gain feature, select the Auto button in the Gain Settings dialog, and then press SELECT to apply.

## B+M Mode Scanning

M-MODE (Motion Mode) imaging is a scan that displays motion in a wave-like manner. This mode is especially useful in depicting motion in cardiac applications. By incorporating B Mode functionality with M-Mode strips, you can control the exact position of the desired scan location. The following is an example of B+M mode image.

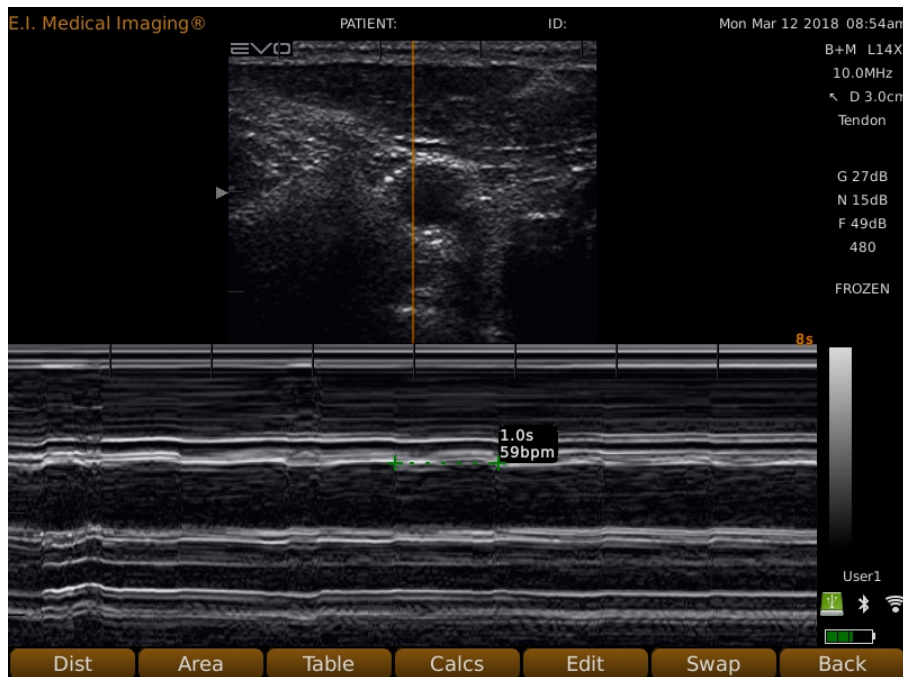

Your B Mode image appears in the top center of the screen. The M-Mode strip appears in the lower half of the screen. You can position the M-Mode scan line using the vertical gold line displayed in the B-Mode image. Use the right/left arrows to set your line in the B-Mode image. Adjust the speed of the positioned line using the slower and faster function keys.

## Adjusting Focal Zones

You can control areas of focus within an image by adjusting the focal zone. By default, the area of focus is the

center section of the image. However, by pressing the Up/Down key , specific focal zone control is enabled. A white arrow will appear on the left side of the image indicating the area of the image with highlighted focus. Use the up/down keys to change the targeted focal area.





## Doppler Mode

To enable Doppler functionality, press the DOP key. By default, this enters you into Color mode. Other Doppler modes can be accessed through the function keys.

- Adjust Control Doppler Gain using the function keys.
- Overall gain is controlled by the gain keys.
- Not all doppler modes are available on all transducers.

## Color Mode

Utilizing the "Doppler effect".

Color Doppler is used to visualize blood flow in a particular region to or away from the transducer face utilizing color spectrum (colors Red and Blue).

- When Color mode is activated, the Region of Interest (ROI) box is displayed with a blue dashed line. After the desired ROI box size and shape is created, click the touchpad to set the location.
- The Color gradient bar on right side changes based on scale. Color dictates flow and direction.

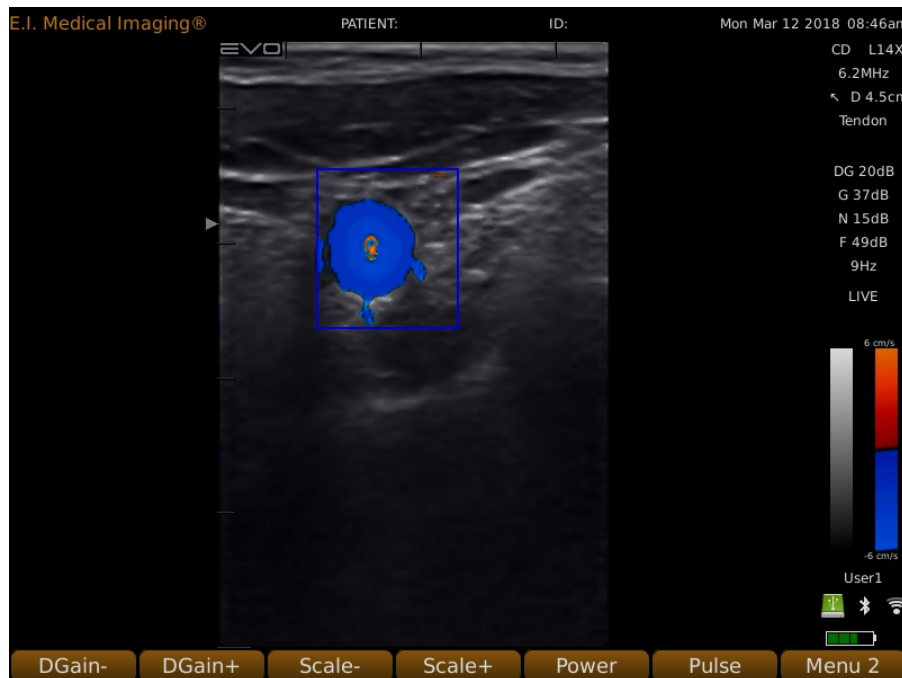

## Color Doppler Scan Options

Color Doppler Scan Options control image adjustment.

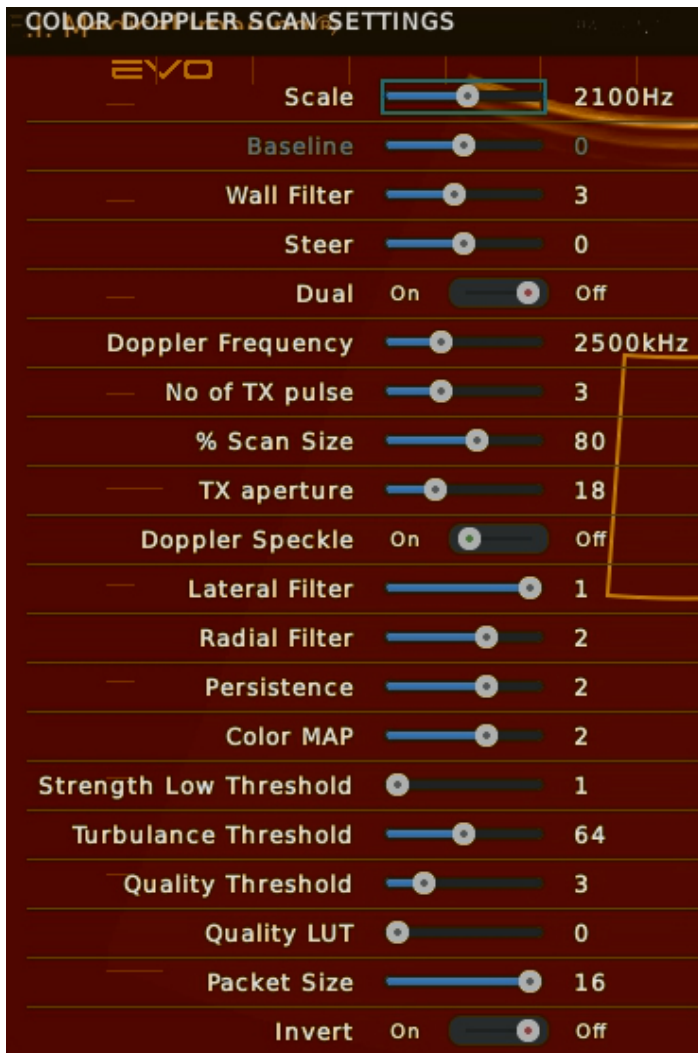

The settings vary depending on which probe you are using.

Scale	The range is probe specific AKA: Pulse repetition frequency low pulse repetition frequency to look at low velocities, high pulse repetition frequency reduces aliasing.
Baseline	Ranges from -75 to 75. No unit of measure. This is an offset of the scale from the middle region. For CFM, this option is only enable for Color Map = 0.
Wall Filter	0 - 7 Used to remove the low frequency reverberation of an arterial wall motion.

Steer	Supported on Linear probes only - steers the doppler beam, changes the ROI.
Dual	Displays a B-Mode image on the left with no doppler color, and an image on the right that is composed of the B-Mode image and the color content.
Doppler Frequency	Probe specific range - depends on the connected transducer.
No of TX Pulse	1 to 7 Selects the number of transmit pulses per Doppler beam. More pulses provides a wider beam, more acoustic power, increases the sensitivity but decreases the resolution
% Scan Size	50 to 100% Image width. Reducing the image width to gain frame rate.
TX Aperture	0 - 64. Increments by 2.
Doppler Speckle	On or Off. Reduces speckle.
Lateral Filter	0 to 1 Selects the bandwidth of the lateral filter. 0 = weak filter; 1 = strong
Radial Filter	0 to 3 The bandwidth of the lateral filter (0 weak and 3 strong)
Persistence	0 to 3 Selects the strength of the color persistence filter (0 = off, 3 strongest)
Color MAP	0 to 3 Selects one of four different color maps.
Strength High Threshold	0 to 255 The strength of the Doppler signal has to be below this threshold. otherwise no color is shown.
Strength Low Threshold	0 to 255 The strength of the Doppler signal has to be above this threshold, otherwise no color is shown. Use for noise suppression.
Turbulence Threshold	0 to 127 The turbulence level of the Doppler signal has to be below this threshold, otherwise no color is shown.
Quality Threshold	0 to 15 The quality measure of the Doppler signal has to be above this threshold, otherwise no color is shown.
Quality LUT	0 and 1 Selects the lookup table which defines a minimum quality for a certain B-Mode brightness.
Packet Size	8, 12, 16 The packet size is the number of sound bursts transmitted at the same location to acquire one color scanline
Invert	On / Off Virtually inversion of the flow direction PWD: flips the spectrum. CFM: inverts the color (red becomes blue and vice versa).

## Power Mode

Used in conjunction with Color, Power Doppler is used to determine the strength of the Doppler signal as compared to the direction or flow of blood. Power Doppler is non-directional.

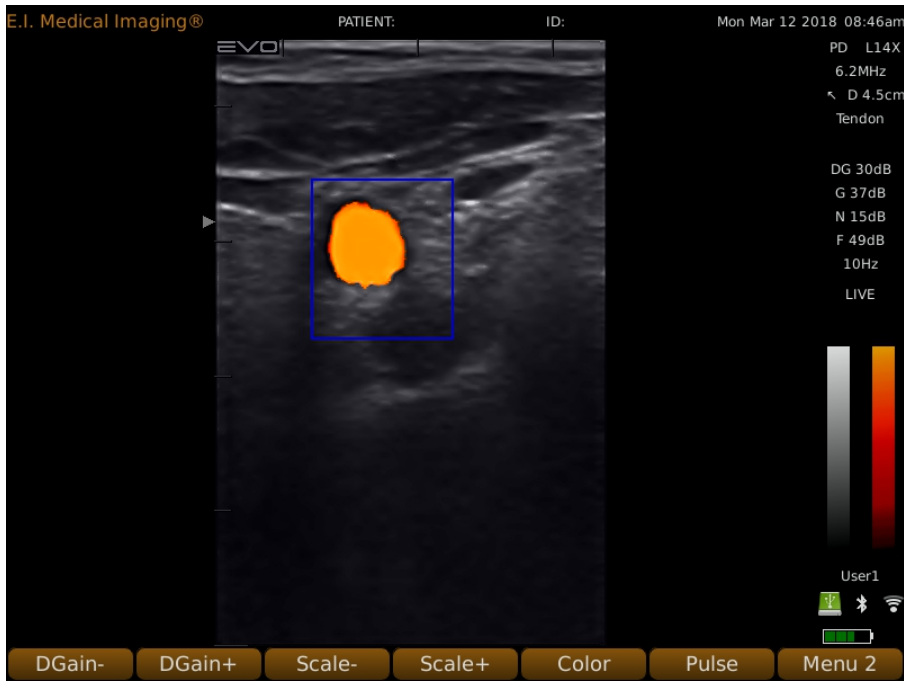

## Power Doppler Scan Options

Power Doppler Scan Options control image adjustment.

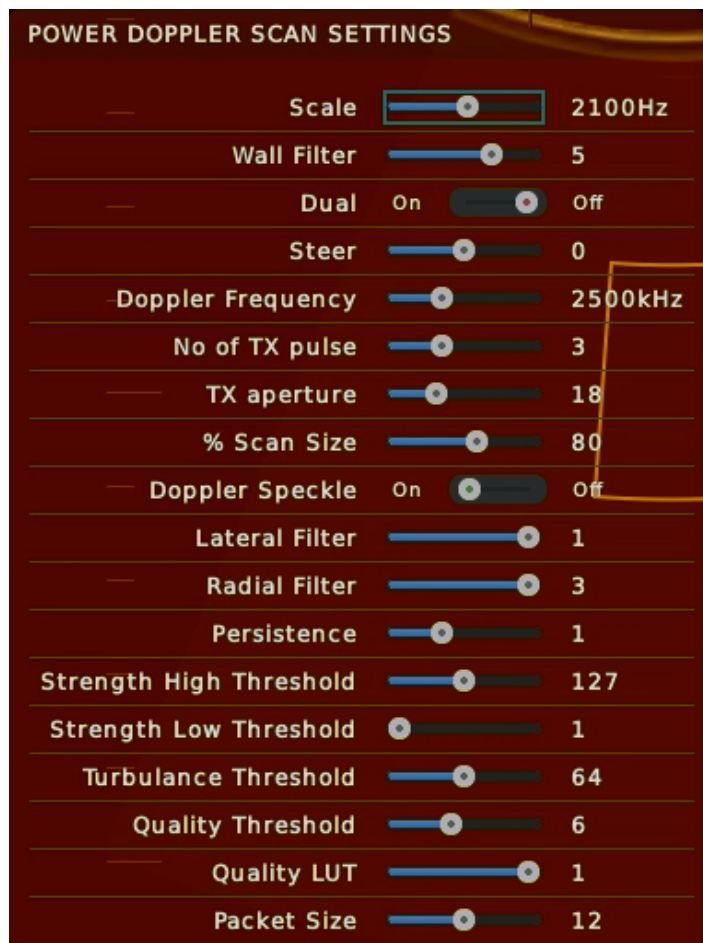

The settings vary depending on which probe you are using.

### Scan Settings for Power Doppler

Scale	The range is probe specific AKA: Pulse repetition frequency low pulse repetition frequency to look at low velocities, high pulse repetition frequency reduces aliasing.
Wall Filter	0 - 7 Used to remove the low frequency reverberation of an arterial wall motion.
Dual	Displays a B-Mode image on the left with no power doppler , and an image on the right that is composed of the B-Mode image and the power doppler content.
Steer	Supported on Linear probes only - steers the doppler beam, changes the ROI.
Doppler Frequency	Probe specific range - depends on the connected transducer.
No of TX pulse	1 to 7 Selects the number of transmit pulses per Doppler beam. More pulses provides a wider

	beam, more acoustic power, increases the sensitivity but decreases the resolution
TX Aperture	0 - 64. Increments by 2.
% Scan Size	50 to 100% Image width. Reducing the image width to gain frame rate.
Doppler Speckle	On or Off. Reduces speckle.
Lateral Filter	0 to 1 Selects the bandwidth of the lateral filter. 0 = weak filter; 1 = strong
Radial Filter	0 to 3 The bandwidth of the lateral filter (0 weak and 3 strong)
Persistence	0 to 3 Selects the strength of the color persistence filter (0 = off, 3 strongest)
Strength High Threshold	0 to 255 The strength of the Doppler signal has to be below this threshold. otherwise no color is shown.
Strength Low Threshold	0 to 255 The strength of the Doppler signal has to be above this threshold, otherwise no color is shown. Use for noise suppression.
Turbulence Threshold	0 to 127 The turbulence level of the Doppler signal has to be below this threshold, otherwise no color is shown.
Quality Threshold	0 to 15 The quality measure of the Doppler signal has to be above this threshold, otherwise no color is shown.
Quality LUT	0 and 1 Selects the lookup table which defines a minimum quality for a certain B-Mode brightness.
Packet Size	8, 12, 16 The packet size is the number of sound bursts transmitted at the same location to acquire one color scanline

## Pulse Wave (PW)

Using a "gate" of determined size, Pulse Wave Doppler determines blood velocities versus time.

When PW mode is activated, the target line and gate is activated and displayed in orange. The line and gate position can be changed and manipulated by clicking on the line using the touchpad. To change the gate angle, click on the line again which allows for control of gate angle. The gate angle can be adjusted to +45°, 0°, -90° relative to the position line. Once the correct position and gate angle have been set, click again to lock the position for scanning.

- When the gate is solid, you can adjust the gate position
- When the gate is dashed, you can adjust the gate size.

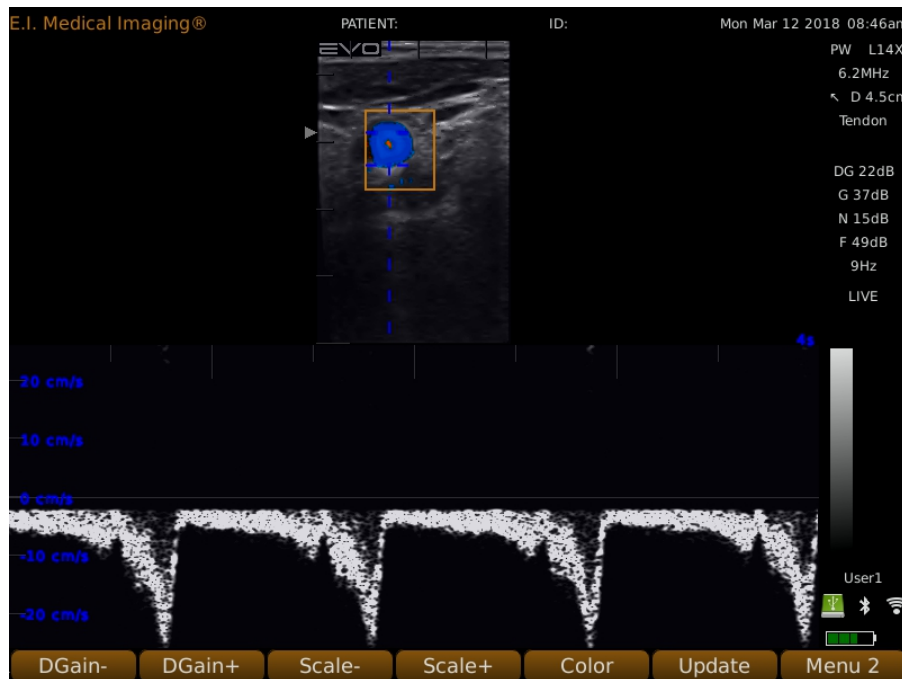

## Pulse Wave Scan Settings

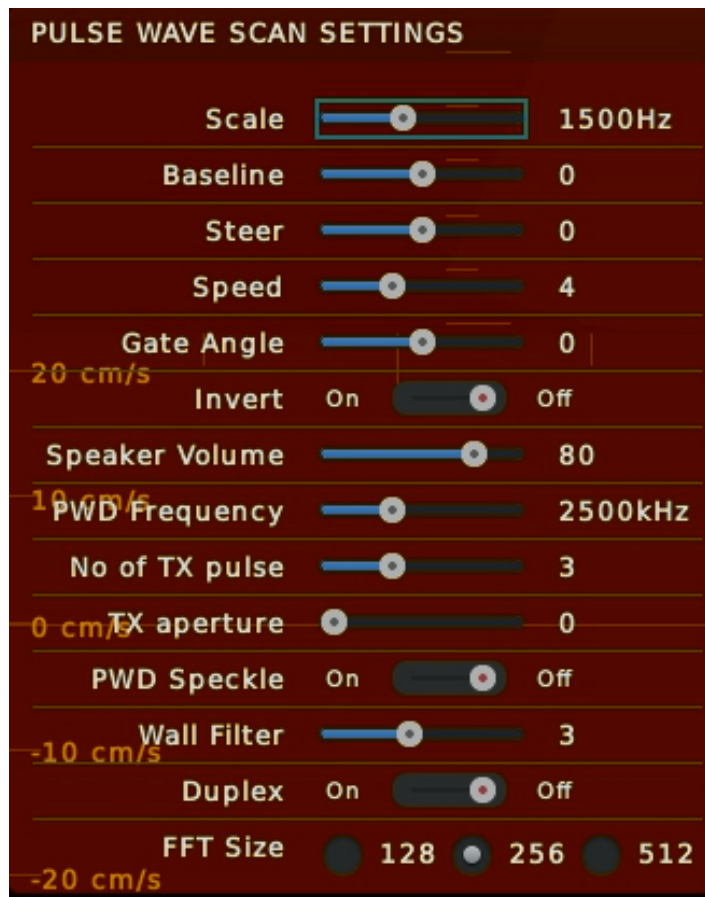

Scale	The range is probe specific AKA: Pulse repetition frequency low pulse repetition frequency to look at low velocities, high pulse repetition frequency reduces aliasing.
Baseline	Ranges from -75 to 75. No unit of measure. This is an offset of the scale from the middle region. For CFM, this option is only enable for Color Map = 0.
Steer	Supported on Linear probes only - steers the doppler beam, changes the ROI.
Speed	Scroll speed of the time domain.
Gate Angle	Changes the angle of the W gate.
Invert	Inverts spectrum around baseline
Speaker Volume	Adjusts the speaker volume
PWD Frequency	Probe specific range - depends on the connected transducer.
No of TX Pulse	1 to 7 Selects the number of transmit pulses per Doppler beam. More pulses provides a wider beam, more acoustic power, increases the sensitivity but decreases the resolution



## 6: Manipulating Images

TX Aperture	0 - 64. Increments by 2.
PWD Speckle	Speckle filter for the velocity waveform
Wall Filter	0 - 7 Used to remove the low frequency reverberation of an arterial wall motion.
Duplex	Enable live PW with B-Mode
FFT Size	Fast Fourier Transform - Larger FFT sizes provide higher spectral resolution but take longer to compute.

## 6: Manipulating Images

## 7: Measuring Images

The EVO auto calculates distance and area measurements.

### Taking Distance Measurements

To take distance measurements, complete the following:

1. Press the Caliper key to freeze the image. Using the touch pad, move the cursor to the location where you want to start measuring. Tap the touch pad to set the start position.
2. Move the cursor again and tap the touch pad again to complete a linear measurement. A label will appear at the end of the line indicating the length

Note: If the labels are too big or small, you can adjust the font size. Press **Edit (F6)**, then **Font+(F1)** or **Font- (F2)**.

### To associate a distance table to the measurement:

After taking a measurement:

1. Press F4 to view Table
2. Select the species from the first drop down.
3. Select the measurement from the lower drop down. Press Enter. The coordinating result (fetal days) will appear below the measurement.

**Note** – If a measurement table has been selected before measuring, the calculation is automatically applied to the measurement.

4. Continue taking measurements by pressing the F2 (DIST) key and repeating steps 2 and 3 until you are done. Press Save to save any images.
5. Press the Caliper key to return to active scanning.

### Taking Area Measurements

To take area measurements, complete the following:

1. Press the CALIPER key to freeze the image, and then press the F3 key (AREA) to display the crosshairs on the screen.
2. Move the crosshairs to the far boundary of the measurement area, and then press the SELECT key to mark the origin.

## 7: Measuring Images

3. Using the touchpad move the crosshairs in a circular direction and delineate the measurement area until you return to the starting position.
4. Press the SELECT key to end the measurement and display the size.  
The text box turns black.
5. Continue taking measurements by pressing the F3 (AREA) key and repeating steps 2 and 3 until your done, and then press the FREEZE key to return to active scanning.

## PW doppler: PI / RI calculation

1. From PW mode, with an image acquired, press the CALIPER key.

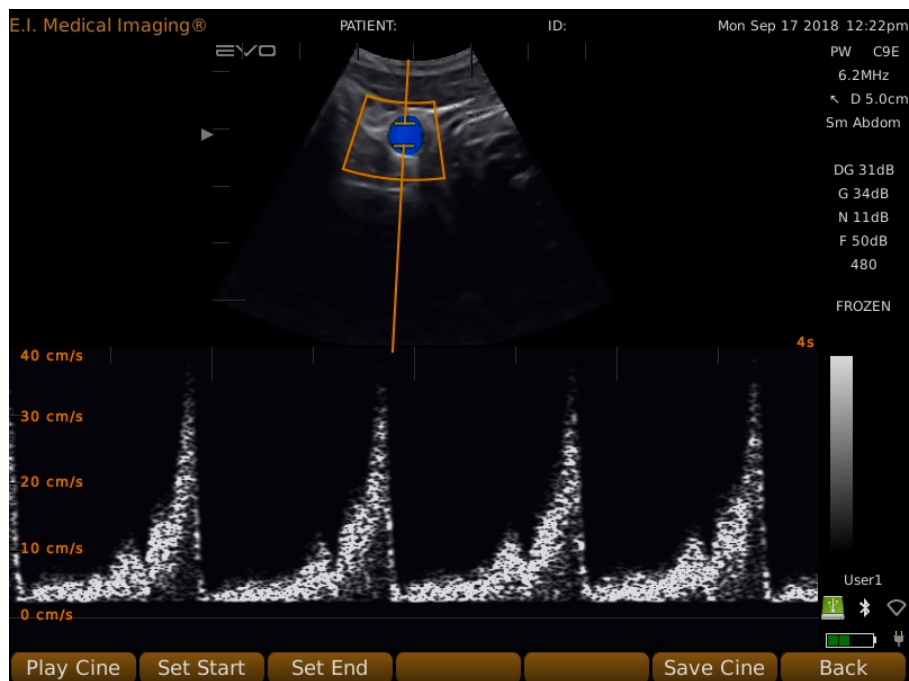

7: Measuring Images

2. Select Calcs (press F4)

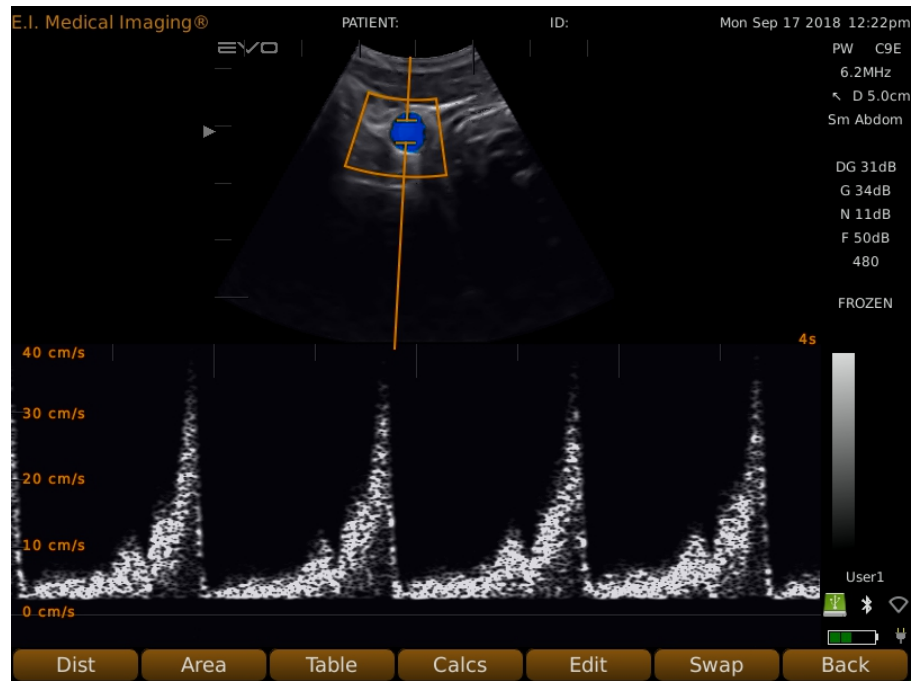

3. Select PI RI SD (press F2).



7: Measuring Images

4. This prompts you to trace one (1) cardiac cycle of the PW trace.

Press the SELECT key to set the starting point, then use the touchpad to follow the top of the PW waveform .



5. Press the SELECT key to complete the measurement and display the results.

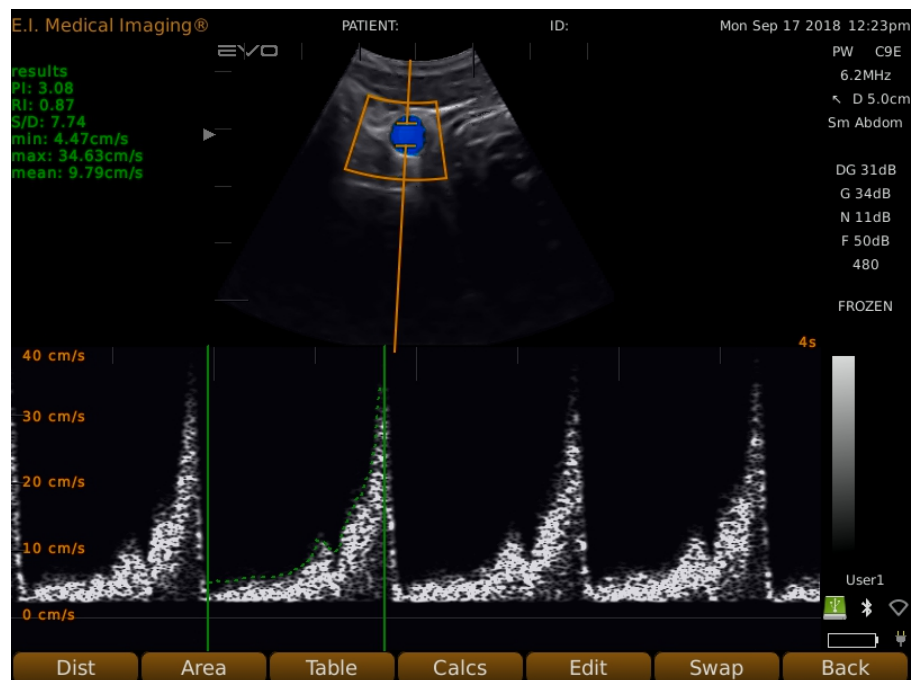

## 8: Exporting Files

There are two ways to export files from the EVO: (1) on a USB memory stick and (2) via wireless file sharing.

### Saving Files to a USB Memory Stick

1. Insert the memory stick where you want to save the files into one of the USB ports on the back of the EVO.
2. Navigate to the USB Menu: Press the  super key, F2 Setup, F1 USB. The dialog below will display.  
Note: if you do not have a current patient, the last option will not appear.

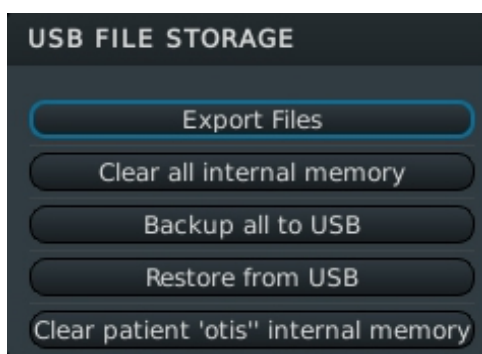

3. In this example, we were doing an exam for the patient Otis.  
To pick and choose which files to export, select Internal storage location and Export Files.  
The next screen will appear (continued on next page).

## 8: Exporting Files

You can select individual files from the list or check Select All at the top of the screen

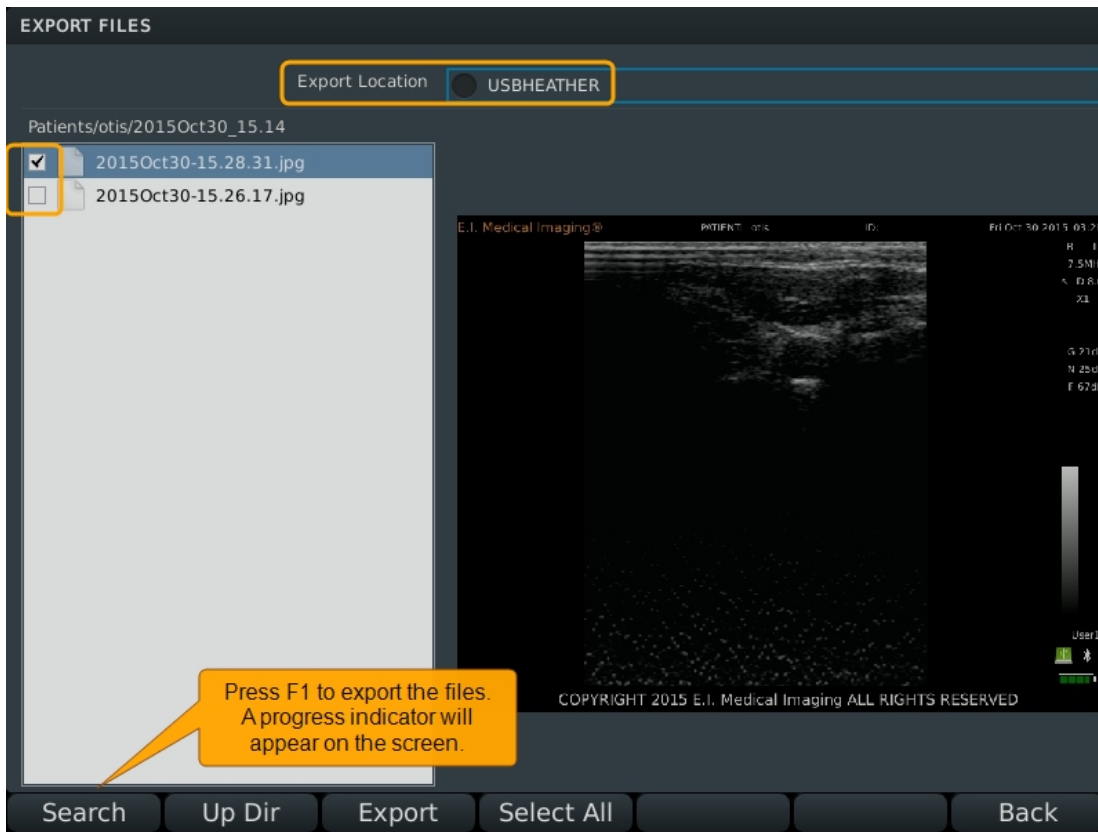

4. The files will save to the USB thumb drive in a folder structure by patient and date. If you save files without activating a patient record, they will be saved into a folder named Unassigned.



## File Sharing

You can share files from the EVO across a wireless network.

### Setting up the EVO

1. On the EVO, enable WiFi. You can connect to a local network or use direct connection. In this example, we're connecting to a local network. For more details about WiFi setup, see [Enabling WiFi on page 50](#) in the Configuration chapter.
2. Once the EVO is connected to the wireless network, enable File Sharing.

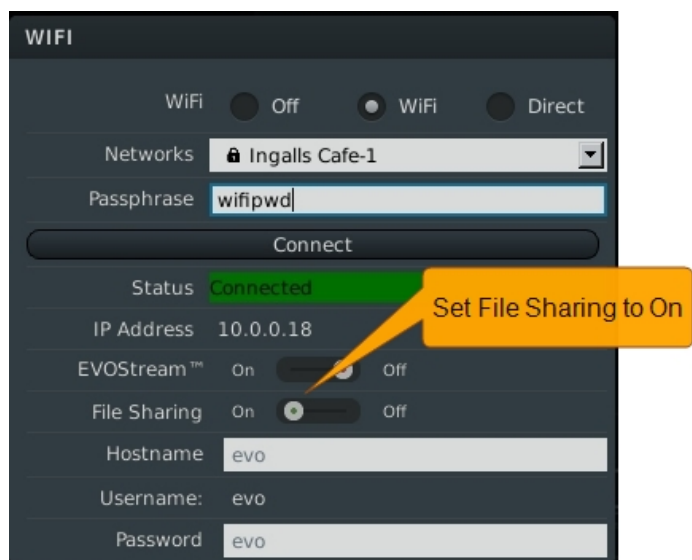

### From your PC

Once wireless is enabled on you EVO, you'll be able to see it from your PC. Access it by mapping a drive to the device.

1. On your PC, go to Computer > Map Network Drive (from Computer right-click and select Map Network Drive).
2. Fill in folder as \\<ip address>\data, using the IP address of the EVO.  
example: **\\10.3.2.117\data**

3. Select Connect Using different credentials; click Finish.

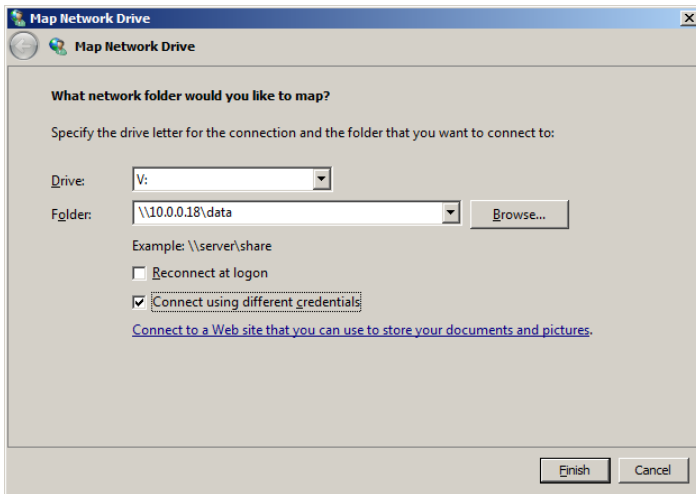

4. You'll be prompted to authenticate to the EVO. Log in with the WiFi username and password. Below we show the defaults. Click OK and the drive will display the directories on the EVO where images and cineloops are stored.

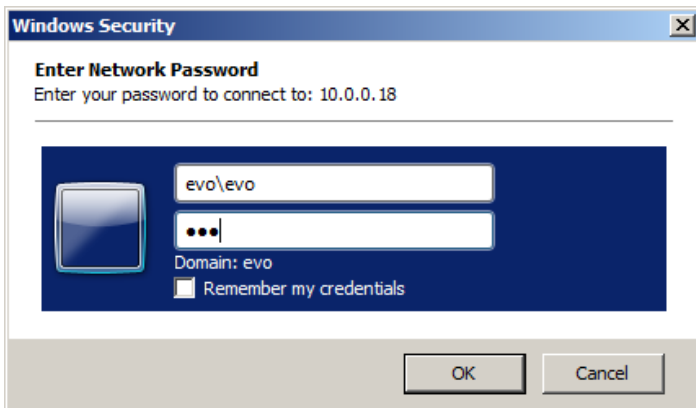

5. The drive will appear with directories as shown.  
NOTE: If your windows explorer settings are set to display hidden folders, you may see a few more folders.

## 8: Exporting Files

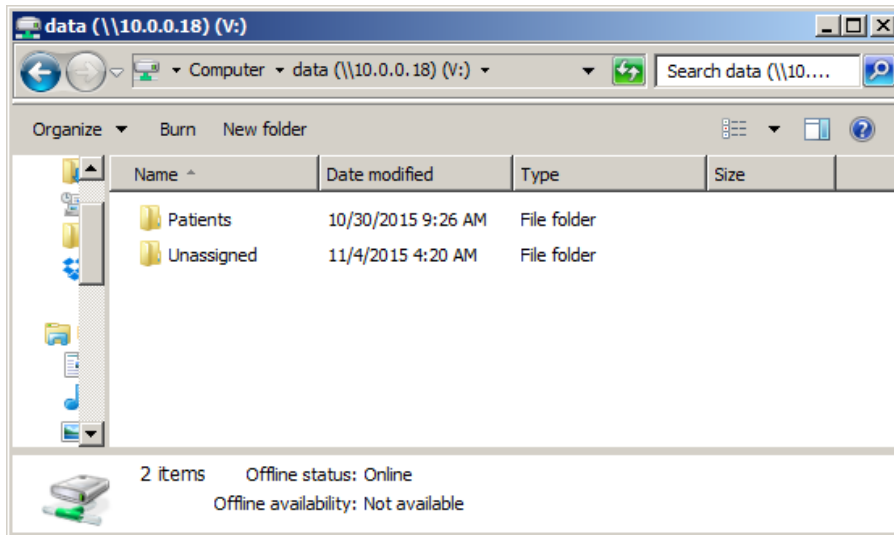

## 9: EVOStream - Sharing live Images

EVOStream lets you share the live video feed to an iOS® or Android™ device.

There are two ways of connecting to an EVO from your wireless device.

- Configure your phone and EVO to connect to the same WiFi network
- Or configure the EVO to supply its own WiFi (WiFi Direct) and have your device connect to that network.

Sample view on an iPad®.



## Connecting over WiFi Direct

1. Power on the EVO
2. Enable WiFi.

To access the WiFi settings: press: , **F2, F3 ( Super Button, Setup, WiFi)**  
The WiFi dialog will appear as shown below.



You can also click on the WiFi Icon in the status panel; just tap on the touch pad to launch the WiFi dialog

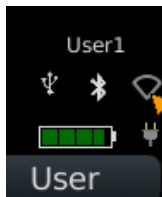

3. By default, WiFi is disabled; click ON to enable.
4. In the WiFi dialog, select the Direct radio button on the first line. This should auto-populate the SSID with EVO and the Passphrase Galileo1. These are default values that you may change if you want customize your network (for example, if you don't want other people to connect to your EVO, you may want to select a different password, or if you have multiple EVOs, you may each give them a different SSID), but you don't need to.
5. Click the Activate Network button. The status line should change to Connected.
6. Set Streaming to On to enable video streaming.
7. At this point your EVO is configured to stream over WiFi direct.

## Configuring iPhone® or iPad®

Download EVOStream™ App from Apple iTunes.

1. Click the Settings icon.
2. Select WiFi; this should bring up a list of networks.
3. You should see EVO (unless you changed the SSID in step 3 above) from that list. Select it.
4. You'll be prompted for the network passphrase (Galileo1 unless you changed it). Once you have entered the correct passphrase, your iPad should connect to the EVO Network. Exit Settings.
5. Launch the EVOStream App.
6. It should auto-detect the unit and start display the video stream from the EVO.

## Configuring an Android™ Device

Download EVOStream™ App from Google Play.

1. Click the Settings icon.
2. Select WiFi; this should bring up a list of networks.
3. You should see EVO (unless you changed the SSID in step 3 above) from that list. Select it.
4. You'll be prompted for the network passphrase (Galileo1 unless you changed it). Once you have entered the correct passphrase, your Android should connect to the EVO Network. Exit Settings.
5. Launch the EVOStream App.
6. It should auto-detect the unit and start display the video stream from the EVO.

# 10: Advanced System Operations

## Updating System Firmware

The system firmware contains all operating software for the system. E.I Medical Imaging recommends you keep your system updated to the latest version of the firmware to take advantage of new features and enhancements. Firmware file names have a .fw extension. For example: 01.04.00001.fw

Updating your system involves:

1. Identifying your current system version
2. Downloading the new version from <http://learn.eimedical.com/ibex-evo-firmware-update>
3. Installing the new version on your system.

## Identifying System Firmware Version

Access the Info dialog to determine the version of firmware currently running on your system. The info dialog is displays information about the hardware and firmware versions loaded on your EVO. This information can be useful when contacting E.I. Medical Imaging.

To access the Info dialog, press:



**F2 , F4, F3 (Super key, Setup, System, Info)**

INFO	
S/N	2016020400054
MFG	26101-0138
FW Version	1.5.0.19
FPGA Version	0x0552
FPGA Build	12
BEFO Revision	49381
SCAN Revision	49329
PROC Revision	49296
IMAG Revision	49092
CFMAP Revision	49296
PWDOP Revision	48585
Lua Version	V05.14, 2018-04-04
Total Runtime	317:43:44
Probe Type	CL13E
Probe PCB	2
Probe S/N	15037377
Close	

S/N	The serial number of the system.
MFG	The serial number of the board.
FW Version	The current version of the firmware running the system.
FPGA Version	Part of the firmware.
Lua Version	Part of the firmware.
Total Runtime	The total runtime in hours, minutes and seconds.
Probe Type	Reflects the attached probe type (same as the type in the upper right of the screen) .
Probe PCB	PCB hardware revision of the probe; may be useful for service calls.
Probe S/N	Serial number of the attached probe.

## Downloading New System Firmware

The obtain new firmware updates

1. Go to the <http://learn.eimedical.com/ibex-evo-firmware-update>
2. Log in to your E.I. Medical Imaging user account and select the User Downloads link to enter the Secure Download Area. You can register for an account on the Home Page.
3. Select the system type under the Select Category area to view the downloadable version for the system.



4. Select the Firmware Version link for your system type.
5. Click the .fw filename link to download the file.
6. Follow your computer system's instructions for saving the file.
7. Download the Installation Instructions (Ibex\_Firmware\_Upgrade\_Procedure.pdf) file.

## Installing EVO System Firmware

To install the system firmware, complete the following:

1. Load the upgrade file on a thumb drive (USB memory stick) and insert into the lower EVO USB port.
2. Hold the power button while powering on; release when the keyboard starts blinking.
3. Allow the scanner to boot and follow on screen prompts.

**Note:** To recover the EVO from a corrupted firmware update hold the power button down until the keyboard backlight begins to flash and release. Reinitiate the FW update and ensure there is sufficient power connected.

## Resetting your EVO

To access the Reset Dialog, press:

, **F2**, **F4**, **F2**(Super key, Setup, System, Reset)



Reset User	Press this to reset the currently selected user and exam type to factory defaults.
Reset All	Resets all users.
Reset System	Restores the system to factory defaults and erases all saved images.

## Resetting the System

To reset the system:

1. Access the Reset Dialog. Press , **F2**, **F4**, **F2**(Super key, Setup, System, Reset)
2. Select Reset System. A warning will appear.  
 Press Yes to create a backup  
 Press No to proceed without a backup  
 Press Cancel to exit without resetting

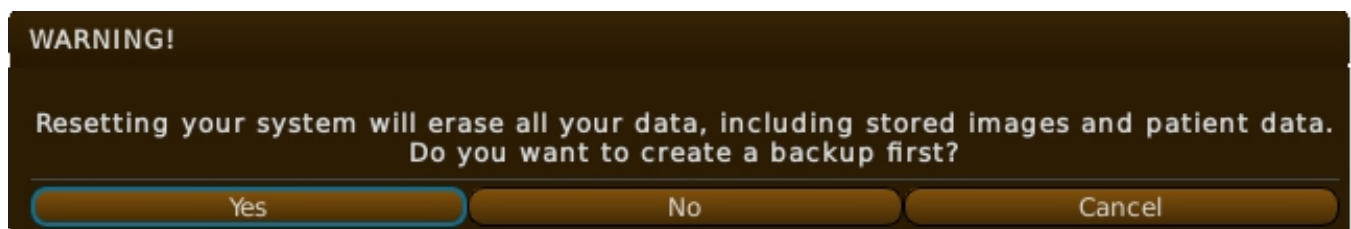

## Restoring a Backup

To restore a backup, load a properly formatted flash drive into the USB port.

1. From system shutdown hold the power button until the keyboard flashes then release.
2. Allow the system to cycle until it comes to a screen with a dialog box asking to Choose Upgrade

## 10: Advanced System Operations

3. Press F7 Cancel
4. Press F4 Backup
5. Depending on file size this may take up to 60 minutes
6. This same process can be used to restore the files by simply choosing the F5 Restore option rather than the F4 Backup option.

# 11: Cleaning and Maintaining the EVO

Make sure you clean your EVO ultrasound system and associated transducers after every use. Routine cleaning and maintenance will help ensure the prolonged life of your system. While the EVO ultrasound is a ruggedized ultrasound device, certain precautions should be used in the care of the system. Do not use any abrasive cleaners on either your ultrasound system or associated transducers

**Caution:** Connect the probe to ensure the most water resistant seal for the connector.

To clean, ensure the following:

- Close and LOCK the battery door before cleaning.
- To clean the LCD panel, use a soft cloth with an ammonia based (common window cleaner) cleaning agent.
- The EVO can be wiped down with a damp cloth.
- For disinfecting the system, Sporicidin<sup>®</sup> is recommended.
- Allow the system to air dry or wipe down with a clean, dry towel

## Disinfectant List

The following are approved disinfectants to use on E.I. Medical Products . Effective 2/1/2018.

NOTE: Disinfectants must be mixed per manufacturer's directions

### EVO System | Probes/Transducers | Goggles:

<b>OK</b> to use	Bleach Durvet Chlorhexidine Isopropyl Alcohol Nolvasan Protex Sporicidin Transeptic
<b>DO NOT</b> use	Oxivir Quatricide Virkon S

### ICE Extension Handle:

<b>OK</b> to use	Durvet Chlorhexidine Nolvasan Protex Quatricide Transeptic
<b>DO NOT</b> use	Bleach Isopropyl Alcohol Oxivir Sporicidin Virkon S

Protex and Transeptic are available from Choice Medical Systems, Inc., St. Petersburg, FL 727-347-8833

## InSite2 / InSite 3 Headset Care and Maintenance

To clean, ensure the following:

Using a gentle shower, rinse your InSite2 / InSite 3 headset to remove large amounts of debris

- Use a damp cloth to wipe down any excess debris from the headset
- Allow the headset to air dry or wipe down with a clean, dry towel

## Linear Transducer Care and Maintenance

To clean, ensure the following:

- Submerge only the transducer end in water and clean with a dry towel.
- Do not use any coarse cleaning tools (wire brush, scrub brush, etc.) on the face of the transducer.

**Caution:** Caution – Ensure probe connectors are dry and free of debris before connecting to the EVO.

- DO NOT use mineral oil on any Ibex transducers.
- To disinfect the Linear probe, use one of the disinfectants listed above [Disinfectant List on page 101](#).

## Warranty

### THREE YEAR LIMITED WARRANTY

Limited Warranty This Limited Warranty is provided only to you as the original retail purchaser of the shipped E.I. Medical Imaging IBEX EVO Diagnostic Ultrasound Scanner (the Product), and to no other person. E.I. Medical Imaging warrants to you that for a period of three (3) years with respect to labor and for a period of three (3) years with respect to parts, the Product will be free from defects in materials and/or workmanship.

### THREE YEAR LIMITED WARRANTY

Limited Warranty Transducers, batteries and associated accessories all carry a three (3) year limited warranty from the date of purchase. E.I. Medical Imaging warrants to you that for a period of three (3) year with respect to labor and for a period of three (3) years with respect to parts, the Product will be free from defects in materials and/or workmanship.

Your Exclusive Remedy, E.I. Medical Imaging's entire liability and your exclusive remedy under this Limited Warranty shall be, at E.I. Medical Imaging's option, either Repair or Replacement of the Product within the specified warranty period. IN NO EVENT DOES THIS WARRANTY COVER DEFECTS OR MALFUNCTIONS DUE DIRECTLY OR INDIRECTLY TO ACCIDENT, MISUSE, OR NEGLIGENCE OF THE PRODUCT, TAMPERING WITH OR ANY INDICATION THAT THE SYSTEM HAS BEEN OPENED BY ANY NON-COMPANY APPROVED INDIVIDUAL OR SERVICE CENTER, OR AN ACT OF GOD.

Disclaimer of All Other Warranties Except as specifically provided above, there are no express warranties or claims or representations made by E.I. Medical Imaging regarding the Product. Any implied warranties, including implied warranties against claims that the product infringes on property rights of third parties, patent rights, implied warranties of fitness for a particular purpose or use, and implied warranties of merchantability, shall terminate three (3) years from the date of purchase.

Limitation of Liability To the maximum extent allowed by applicable law, in no event will E.I. Medical Imaging nor anyone else who has been involved in the creation, production or delivery of the product be liable to you or any other person for any direct, indirect, consequential or incidental damages, or any special or punitive damages (for example, damages for loss of profits or business interruption) arising out of the use of or inability to use the Product, a defect in the Product, or the failure of the product to perform, even if E.I. Medical Imaging has been advised of the possibility of such claims or damages. In no event will E. I. Medical Imaging be liable, regardless of the basis of the claim or action, for any amount exceeding the purchase price actually paid for the Product. Some states do not allow the exclusion or limitation of incidental or consequential damages, so the above limitations or exclusions may not apply to you.

Repair Warranty Any repair work performed by E.I. Medical Imaging shall be warranted with respect to parts and labor to be free from defect for a period of (30) thirty days.

## Warranty

Obtaining Warranty Service All Warranty repair work shall be performed by E. I. Medical Imaging's employees at the factory or by an Authorized Service Center. In the event that the Product requires service, please contact E.I. Medical Imaging, or other authorized service provider, to obtain a Return Materials Authorization (RMA) number. This number must accompany your Product upon return in order to obtain service on your unit. You the purchaser are responsible FOR ALL FREIGHT CHARGES ASSOCIATED WITH WARRANTY SERVICE.

This Limited Warranty gives you specific Legal Rights; you may also have other rights which vary from state to state.



## Appendix - Fetal Tables

- Alpaca Biparietal on page 106
- Alpaca Thoracic Height on page 106
- Bovine Crown Rump Length on page 107
- Bovine Eye Orbit on page 108
- Bovine Biparietal Diameter - External on page 108
- Bovine Trunk Diameter on page 109
- Buffalo (Bubalus bubalis) Amnionic Vesicle Diameter on page 110
- Buffalo (Bubalus bubalis) Biparietal Diameter on page 110
- Buffalo (Bubalus bubalis) Crown Rump Length on page 110
- Canine Less than 40 days Crown Rump Length on page 110
- Canine Less than 40 days Gestational Sac Diameter on page 111
- Canine More than 40 days Head Diameter on page 111
- Cat More than 40 days Body Diameter on page 111
- Cat More than 40 days Head Diameter on page 111
- Fallow Deer Chest Depth on page 112
- Fallow Deer Crown Rump Length on page 112
- Fallow Deer Head Length on page 112
- Equine Biparietal on page 112
- Equine Amnion on page 112
- Goat Anglo-Nubian Crown Rump Length on page 113
- Goat -DairyBiparietal on page 113
- Goat - Pygmy Biparietal on page 114
- Goat -ToggenburgBiparietal on page 114
- Llama Biparietal BPD on page 115
- Llama Thoracic Height on page 116
- Sheep Booroola Merino Biparietal on page 116
- Sheep Booroola Merino Thoracic Depth on page 117
- Sheep Finn Biparietal on page 117
- Sheep - Hair Crown Rump Length on page 118
- Sheep - Suffolk Biparietal on page 118
- Swine Crown Rump Length on page 118

**Alpaca Biparietal**

Source: Prediction of Gestational Age by Ultrasonic Fetometry in Llamas (Lama glama ) and Alpacas (Lama pacos): Francisca J. Gazitua, Paulina Corradini, German Ferrando, Luis A. Raggi, Victor H. Parraguez - Animal Reproduction Science 66 (2001) 81-92

mm	days
8	32
9	37
10	42
11	47
12	51
13	56
14	61
15	65
16	70
17	75
18	80
19	84
20	89
21	94
22	99
23	103
24	108
25	113
26	117
27	122
28	127
29	132
30	136
31	141
32	146
33	150
34	155
35	160
36	165

mm	days
37	169
38	174
39	179
40	184
41	188
42	193
43	198
44	202
45	207
46	212
47	217
48	221
49	226
50	231
51	236
52	240
53	245
54	250
55	254
56	259
57	264
58	269
59	273
60	278
61	283
62	287
63	292
64	297
65	302
66	306
67	311
68	316
69	321
70	325
71	330
72	335

**Alpaca Thoracic Height**

Source: Prediction of Gestational Age by Ultrasonic Fetometry in Llamas (Lama glama ) and Alpacas (Lama pacos): Francisca J. Gazitua, Paulina Corradini, German Ferrando, Luis A. Raggi, Victor H. Parraguez - Animal Reproduction Science 66 (2001) 81-92

mm	days
10	34
11	39
12	44
13	49
14	55
15	60
16	65
17	71
18	76
19	81
20	86
21	92
22	97
23	102
24	108
25	113
26	118
27	124
28	129
29	134
30	139
31	145
32	150
33	155
34	161
35	166
36	171
37	176
38	182

mm	days
39	187
40	192
41	198
42	203
43	208
44	213
45	219
46	224
47	229
48	235
49	240
50	245
51	250
52	256
53	261
54	266
55	272
56	277
57	282
58	287
59	293
60	298
61	303
62	309
63	314
64	319
65	324
66	330
67	335

**Bovine Crown Rump Length**

Source: Sonographic Fetometry in the Bovine: W. Kahn - Theriogenology May 1989 VOL.31 NO.5 pages 1105-1121

mm	days
8	31
10	32
11	33
12	34
14	35
15	36
16	37
18	38
20	39
21	40
23	41
24	42
26	43
28	44
30	45
31	46
33	47
35	48
37	49
39	50
41	51
43	52
45	53
47	54
49	55
52	56
54	57
56	58
59	59
61	60
63	61

mm	days
66	62
68	63
71	64
73	65
76	66
79	67
81	68
84	69
87	70
90	71
92	72
95	73
98	74
101	75
104	76
107	77
110	78
113	79
117	80
120	81
123	82
126	83

**Bovine Biparietal Diameter - External**

Source: Fetometry & Fetal Heart Rates Between Day 35 & 108 in Bovine Pregnancies Resulting from Transfer of Either MOET, IVP-co-culture or IVP-SOF Embryos: S.P. Breukelman, J.M.C. Reinders, et al. - Theriogenology:61 (2004) 867-882

mm	days
7	40
8	42
9	44
10	46
11	48
12	50
13	52
14	54
15	56
16	58
17	59
18	61
19	63
20	65
21	67
22	69
23	71
24	73
25	75
26	77
27	79
28	80
29	82
30	84
31	86
32	88
33	90
34	92
35	94

mm	days
36	96
37	98
38	100
39	102
40	103
41	105
42	107
43	109
44	111
45	113
46	115
47	117
48	119
49	121
50	123
51	124
52	126
53	128
54	130
55	132
56	134
57	136
58	138
59	140
60	142
61	144
62	146
63	147
64	149
65	151
66	153
67	155
68	157
69	159
70	161
71	163
72	165

mm	days
73	167
74	168
75	170
76	172
77	174
78	176
79	178
80	180
81	182
82	184
83	186
84	188
85	189
86	191
87	193
88	195
89	197
90	199
91	201
92	203
93	205
94	207
95	209

**Bovine Eye Orbit**

Source: Ultrasonic Imaging and Animal Reproduction: 1998 Cattle Book 3: O.J. Ginther page 190-191

mm	days
4	60
5	65
6	70
7	75
8	80
9	85
10	90
11	95
12	100
13	105
14	110
15	115
16	120
17	125
18	130
19	140
20	150
21	155
22	160
23	170
24	180
25	195
26	210
27	240

**Bovine Trunk  
Diameter**

Sonographic Fetometry in  
the Bovine: W. Kahn -  
Theriogenology May 1989  
VOL.31 NO.5 pages 1105-1121

mm	days
3	31
4	33
5	34
6	36
7	37
8	39
9	41
10	42
11	44
12	45
13	47
14	48
15	50
16	51
17	53
18	54
19	56
20	57
21	59
22	60
23	61
24	63
25	64
26	66
27	67
28	68
29	70
30	71
31	72
32	74
33	75
34	76

mm	days
35	78
36	79
37	80
38	82
39	83
40	84
41	85
42	87
43	88
44	89
45	90
46	92
47	93
48	94
49	95
50	96
51	98
52	99
53	100
54	101
55	102
56	104
57	105
58	106
59	107
60	108
61	109
62	110
63	112
64	113
65	114
66	115
67	116
68	117
69	118
70	119
71	121

mm	days
72	122
73	123
74	124
75	125
76	126
77	127
78	128
79	129
80	130
81	131
82	132
83	133
84	134
85	135
86	136
86	137
87	138
88	139
89	140
90	141
91	142
92	143
93	144
94	145
95	146
96	147
97	148
98	149
99	150
100	151
101	152
102	153
103	154
104	155
106	156
107	157
108	158

mm	days
109	159
110	160
111	161
112	162
113	163

**Buffalo  
(Bubalus bubalis)  
Amnionic Vesicle  
Diameter**

Source: Ultrasonographic Fetometry and Determination of Fetal Sex in Buffaloes (Bubalus bubalis): A. Ali & S. Fahmy - Animal Reproduction Science 106 (2008) pages 90-99

mm	days
13	35
15	36
16	37
17	38
19	40
21	41
22	42
23	43
24	45
25	46
26	47
27	49
28	50
29	52
30	56
31	57

**Buffalo  
(Bubalus bubalis)  
Biparietal Diameter**

Source: Ultrasonographic Fetometry and Determination of Fetal Sex in Buffaloes (Bubalus bubalis): A. Ali & S. Fahmy - Animal Reproduction Science 106 (2008) pages 90-99

mm	days
12	56
13	60
14	63
15	67
16	70
18	74
19	77
21	81
22	84
24	88
25	91
27	95
29	98
31	102
33	105
35	109
37	112
40	116
42	119
45	123
47	126
50	130
52	133
55	137
58	140

**Buffalo  
(Bubalus bubalis)  
Crown Rump Length**

Source: Ultrasonographic Fetometry and Determination of Fetal Sex in Buffaloes (Bubalus bubalis): A. Ali & S. Fahmy - Animal Reproduction Science 106 (2008) pages 90-99

mm	days
9	28
11	30
12	32
13	34
14	35
15	37
16	39
17	41
18	42
20	44
21	46
22	48
24	49
25	51
27	53
28	55
29	56
31	58
33	60
34	62
36	63
38	65
40	67
41	69
43	70

**Canine  
Less than 40 days  
Crown Rump Length**

Source: Performing Ultrasound to Evaluate Pregnancy: CVC Proceedings Baltimore, MD - April 1, 2009 [veterinarycalendar.dvm360.com/avhc/content/printContentPopup.jsp?id=600754]

mm	days
11	30
13	31
16	32
20	33
23	34
27	35
30	36
33	37
37	38
40	39
43	40

**Canine  
Less than 40 days  
Gestational Sac  
Diameter**

Source:  
Performing Ultrasound to  
Evaluate Pregnancy: CVC  
Proceedings Baltimore, MD -  
April 1, 2009  
[veterinarycalendar.dvm360.  
com/avhc/content/printCo  
ntentPopup.jsp?id=600754]

mm	days
10	26
12	27
14	28
15	29
17	30
19	31
20	32
22	33
24	34
25	35
27	36
29	37
30	38
32	39

**Canine  
More than 40 days  
Head Diameter**

mm	days
13	40
14	41
15	43
16	44
17	46
18	47
19	49
20	50
21	52
22	53
23	55
24	56
25	58
26	59
27	61
28	62
29	64
30	65

**Cat  
More than 40 days  
Body Diameter**

mm	days
17	40
18	41
19	42
20	43
21	44
22	45
23	46
24	47
25	49
26	50
27	51
28	52
29	53
30	54
31	55
32	56
33	57
34	58
35	60
36	61
37	62
38	63
39	64
40	65
41	66

**Cat  
More than 40 days  
Head Diameter**

mm	days
15	41
16	43
17	46
18	48
19	51
20	53
21	56
22	58
23	61
24	63
25	66

**Fallow Deer Chest Depth**

Source: Current Therapy in Large Animal Theriogenology 2: Robert S. Youngquist & Walter R. Threlfall - Saunders/Elsevier Publishers 2007 page 961

mm	days
12	50

**Fallow Deer Crown Rump Length**

Source: Current Therapy in Large Animal Theriogenology 2: Robert S. Youngquist & Walter R. Threlfall - Saunders/Elsevier Publishers 2007 page 961

mm	days
32	50
118	65

**Fallow Deer Head Length**

Source: Current Therapy in Large Animal Theriogenology 2: Robert S. Youngquist & Walter R. Threlfall - Saunders/Elsevier Publishers 2007 page 961

mm	days
17	50
28	65

**Equine Biparietal**

Source: Maternal Age and Parity Influence Ultrasonographic Measurements of Fetal Growth in Dutch Warmblood Mares: W.K. Hendriks, B Colenbrander, et al. - Animal Reproduction Science 115 (2009) 110-123

mm	days
12	100
13	105
14	110
15	120
16	125
17	135
18	140
19	150
20	160
21	165
22	175
23	185
24	195
25	205
26	220
27	230
28	250
29	270
30	290
31	330

**Equine Amnion**

Source: Developed by E.I. Medical Imaging.

mm	days
14	14
15	14
16	15
17	15
18	15
19	15
20	16
21	16
22	17
23	17
24	18
25	18
26	19
27	20
28	21
29	22
30	23
31	24
32	25
33	27
34	28
36	30
37	31
38	32
39	32
40	33
41	33
42	34
43	34
44	35
45	35
46	36
47	36
48	36



mm	days
49	37
50	37
51	37
52	37
53	38
54	38
55	39
56	39
57	39
58	40
59	40
60	40
61	41
62	41
63	41
64	42
65	42
66	42
67	43
68	43
69	43
70	44
71	44
72	44
73	45
74	45
75	45
76	

**Goat**  
**Anglo-Nubian Crown**  
**Rump Length**

Source: Determination of Early Pregnancy & Embryonic Growth in Goats by TRANSRECTAL Ultrasound Scanning: M.F. Martinez, P. Bosch, & R.A. Bosch - Theriogenology 49:1555-1565 1998

mm	days
5	21
6	22
8	23
9	24
10	25
12	26
13	27
14	28
15	29
17	30
18	31
19	32
21	33
22	34
23	35
25	36
26	37
27	38
28	39
30	40

**Goat -Dairy**  
**Biparietal**

mm	days
8	41
9	43
10	45
11	46
12	48
13	50
14	52
15	54
16	55
17	57
18	59
19	61
20	63
21	65
22	66
23	68
24	70
25	72
26	74
27	75
28	77
29	79
30	81
31	83
32	85
33	86
34	88
35	90
36	92
37	94
38	95
39	97
40	99
41	101
42	103

mm	days
43	105
44	106
45	108
46	109

**Goat -  
Pygmy Biparietal**

Source: Ultrasonic Biparietal Diameter of Second Trimester Pygmy Goat Fetuses: J.K. Reichle & G.K. Haibel - Theriogenology April 1991 VOL.35 NO. 4 pages 689-694

mm	days
36	98
37	100

**mm days**

6	36
7	38
8	40
9	42
10	44
11	46
12	48
13	50
14	52
15	54
16	56
17	59
18	61
19	63
20	65
21	67
22	69
23	71
24	73
25	75
26	77
27	79
28	81
29	84
30	86
31	88
32	90
33	92
34	94
35	96

**Goat -  
Toggenburg  
Biparietal**

Source: Current Therapy in Large Animal Theriogenology 2: Robert S. Youngquist & Walter R. Threlfall - Saunders/Elsevier Publishers 2007 pages 550-551

**mm days**

35	85
36	87
37	89
38	90
39	92
40	94
41	95
42	97
43	98
44	100

**mm days**

5	36
6	38
7	39
8	41
9	43
10	44
11	46
12	48
13	49
14	51
15	53
16	54
17	56
18	57
19	59
20	61
21	62
22	64
23	66
24	67
25	69
26	71
27	72
28	74
29	75
30	77
31	79
32	80
33	82
34	84

**Llama**

**Biparietal BPD**

Source: Prediction of Gestational Age by Ultrasonic Fetometry in Llamas (Lama glama ) and Alpacas (Lama pacos): Francisca J. Gazitua, Paulina Corradini, German Ferrando, Luis A. Raggi, Victor H. Parraguez - Animal Reproduction Science 66 (2001) 81-92

mm	days
7	30
8	34
9	39
10	43
11	47
12	52
13	56
14	60
15	64
16	69
17	73
18	77
19	82
20	86
21	90
22	95
23	99
24	103
25	107
26	112
27	116
28	120
29	125
30	129
31	133
32	138
33	142
34	146
35	150

mm	days
36	155
37	159
38	163
39	168
40	172
41	176
42	181
43	185
44	189
45	193
46	198
47	202
48	206
49	211
50	215
51	219
52	224
53	228
54	232
55	237
56	241
57	245
58	249
59	254
60	258
61	262
62	267
63	271
64	275
65	280
66	284
67	288
68	292
69	297
70	301
71	305
72	310

mm	days
73	314
74	318
75	323
76	327
77	331
78	335

**Llama**

**Thoracic Height**

Source: Prediction of Gestational Age by Ultrasonic Fetometry in Llamas (Lama glama) and Alpacas (Lama pacos): Francisca J. Gazitua, Paulina Corradini, German Ferrando, Luis A. Raggi, Victor H. Parraguez - Animal Reproduction Science 66 (2001) 81-92

mm	days
7	30
8	34
9	39
10	44
11	48
12	53
13	58
14	62
15	67
16	72
17	76
18	81
19	86
20	91
21	95
22	100
23	105
24	109
25	114
26	119
27	123
28	128
29	133
30	137
31	142
32	147
33	152
34	156
35	161

mm	days
36	166
37	170
38	175
39	180
40	184
41	189
42	194
43	199
44	203
45	208
46	213
47	217
48	222
49	227
50	231
51	236
52	241
53	245
54	250

**Sheep Booroola Merino Biparietal**

Source: Real-time Ultrasound Imaging for Predicting Ovine Fetal Age: L Sergeev, D.O. Kleemann, et al. - Theriogenology September 1990 VOL. 34 NO.3

mm	day
16	50
17	52
18	54
19	56
20	58
21	60
22	62
23	64
24	66
25	68
26	70
27	72
28	73
29	75
30	77
31	79
32	81
33	83
34	85
35	87
36	89
37	91
38	93
39	95
40	97
41	99
42	101
43	103
44	105
45	107

mm	day
46	109
47	111
48	113
49	115
50	117
51	119

**Sheep Booroola  
Merino Thoracic  
Depth**

Source: Real-time Ultrasound  
Imaging for Predicting Ovine  
Fetal Age: L Sergeev, D.O.  
Kleemann, et al. -  
Theriogenology September  
1990 VOL. 34 NO.3

mm	day
20	50
21	51
22	52
23	53
24	54
25	56
26	57
27	58
28	59
29	60
30	61
31	63
32	64
33	65
34	66
35	67
36	69
37	70
38	71
39	72
40	73
41	75
42	76
43	77
44	78
45	79
46	81
47	82
48	83
49	84

mm	day
50	85
51	87
52	88
53	89
54	90
55	91
56	93
57	94
58	95
59	96
60	97
61	99
62	100
63	101
64	102
65	103
66	105
67	106
68	107
69	108
70	109
71	111
72	112
73	113
74	114
75	115
76	117
77	118
78	119

**Sheep  
Finn Biparietal**

Source Real Time Ultrasonic  
Biparietal Diameter of  
Second Trimester Suffolk &  
Finn Sheep Fetuses: G.K.  
Haibel & N.R. Perkins -  
Theriogenology November  
1989 VOL.32 NO. 5 pages 863-  
869

mm	days
8	36
9	38
10	40
11	42
12	44
13	45
14	47
15	49
16	51
17	53
18	55
19	57
20	58
21	60
22	62
23	64
24	66
25	68
26	70
27	71
28	73
29	75
30	77
31	79
32	81
33	82
34	84
35	86
36	88
37	90

mm	days
38	92
39	94
40	95
41	97

**Sheep - Hair Crown  
Rump Length**

mm	days
12	29
14	30
20	31
23	32
24	33
30	34
34	35
38	36
41	37
44	38
49	39
52	40
54	41
60	42
63	43
64	44
71	45

**Sheep - Suffolk  
Biparietal**

Source: Real Time Ultrasonic Biparietal Diameter of Second Trimester Suffolk & Finn Sheep Fetuses: G. K. Haibel & N.R. Perkins - Theriogenology November 1989 VOL.32 NO. 5 pages 863-869

mm	days
10	41
11	42
12	44
13	46
14	48
15	50
16	51
17	53
18	55
19	57
20	59
21	61
22	62
23	64
24	66
25	68
26	70
27	71
28	73
29	75
30	77
31	79
32	80
33	82
34	84
35	86
36	88
37	89
38	91
39	93

mm	days
40	95
41	97
42	99
43	100

**Swine Crown Rump  
Length**

Source: Current Therapy in Large Animal Theriogenology 2: Robert S. Youngquist & Walter R. Threlfall - Saunders/Elsevier Publishers 2007 page 755

mm	days
20	25
28	30
35	35
50	40
65	45
88	50
110	55
131	60
152	65
159	70
166	75
186	80
206	85
223	90
240	95