

Electronics[®]

Party-line data link: page 119

Fast Fourier speeds signal processing: page 124

Transceiver packs in more channels: page 133

April 15, 1968

\$1.00

A McGraw-Hill Publication

Below: Matrix scanning
for color television, page 92

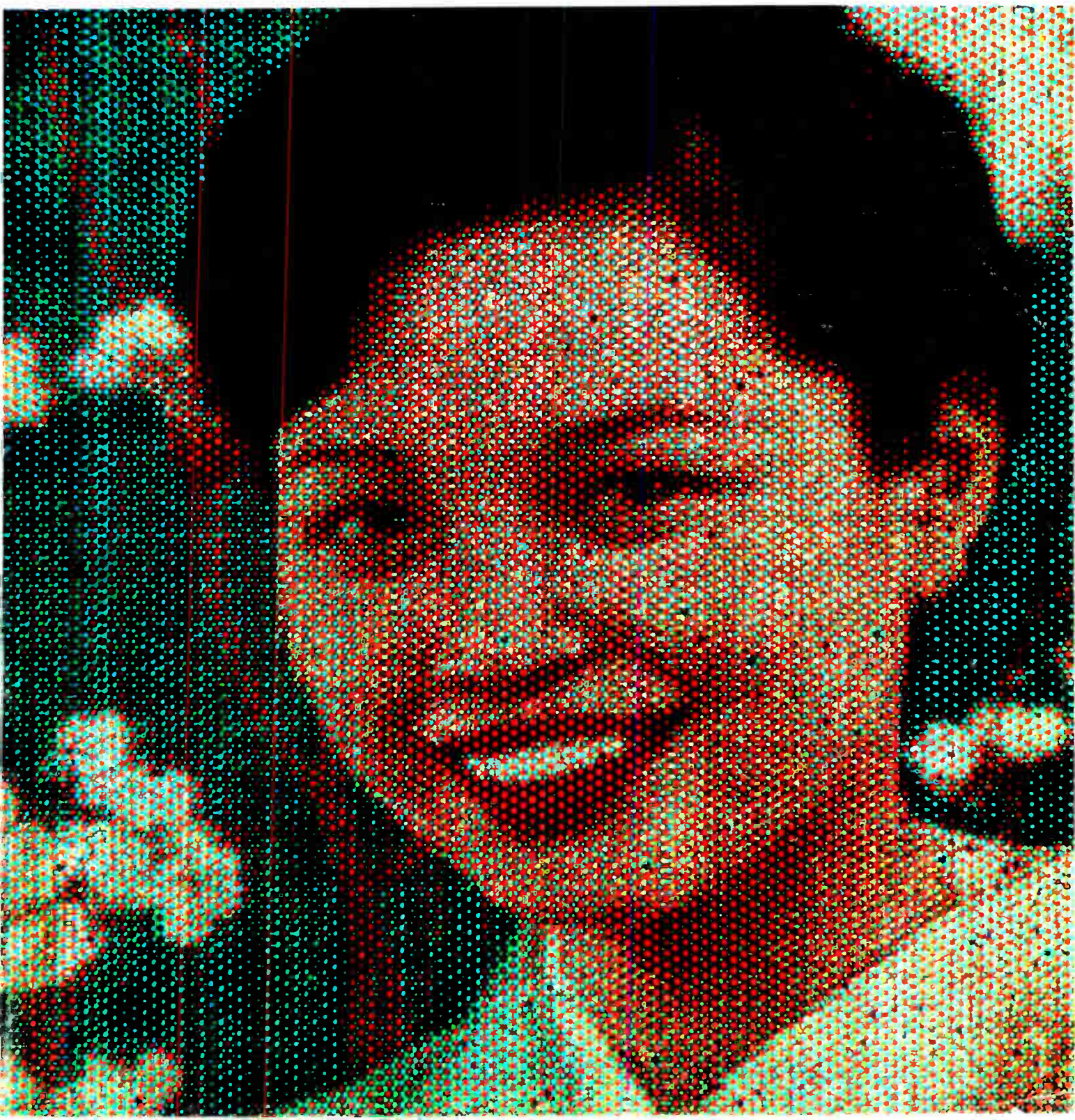

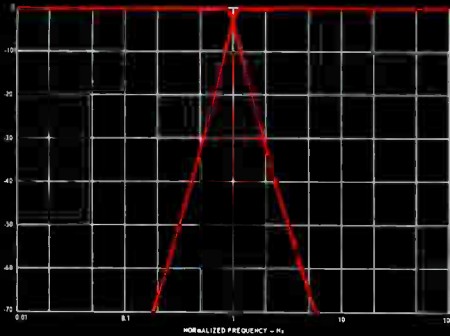

High and Low pass

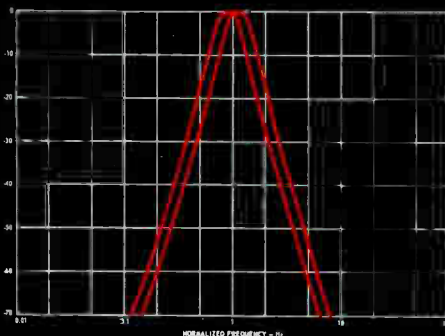

Band Pass Minimum (26%) and Octave Bandwidths

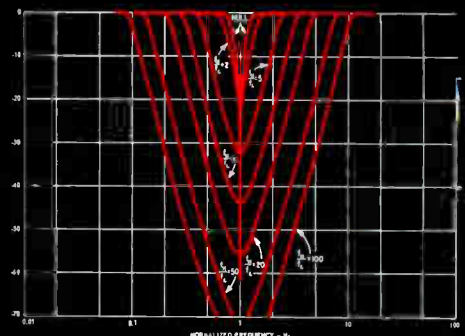

Band reject, "Null", and various ratios of high-to-low cutoff

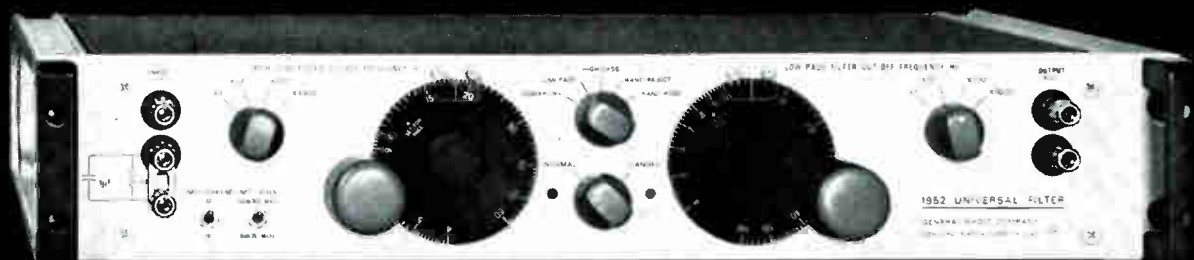

1952 Universal Filter . . . \$950. in USA

Precision in a variable filter

You don't have to sacrifice precision for the versatility of a variable filter. The new GR 1952 Universal Filter gives you sharp cutoff-rate, flat pass-band filtering with a unique selection of operating conditions.

The 1952 offers four *switch-selected* filtering modes: low-pass, high-pass, band-reject, and band-pass. High and low filters are fourth-order Chebyshev approximations with ± 0.1 dB pass-band ripple and *initial* cutoff rate of at least 30 dB per octave. Since all switching is done within the instrument, these fine characteristics are maintained in all modes and at all frequencies from 4 to 60,000 Hz.

For convenience and accuracy in band-pass and band-reject operations, the
Circle 900 on reader service card

high and low filters can be gang-tuned (with a front-panel switch) to maintain constant-percentage bandwidth. Minimum bandwidth in the band-pass mode is a mere 26% of center frequency (nearly 1/3 octave), and a "null" (infinite attenuation) characteristic is provided in the band-reject mode.

For complete information, write General Radio Company, W. Concord, Massachusetts 01781; telephone (617) 369-4400; TWX 710 347-1051.

GENERAL RADIO

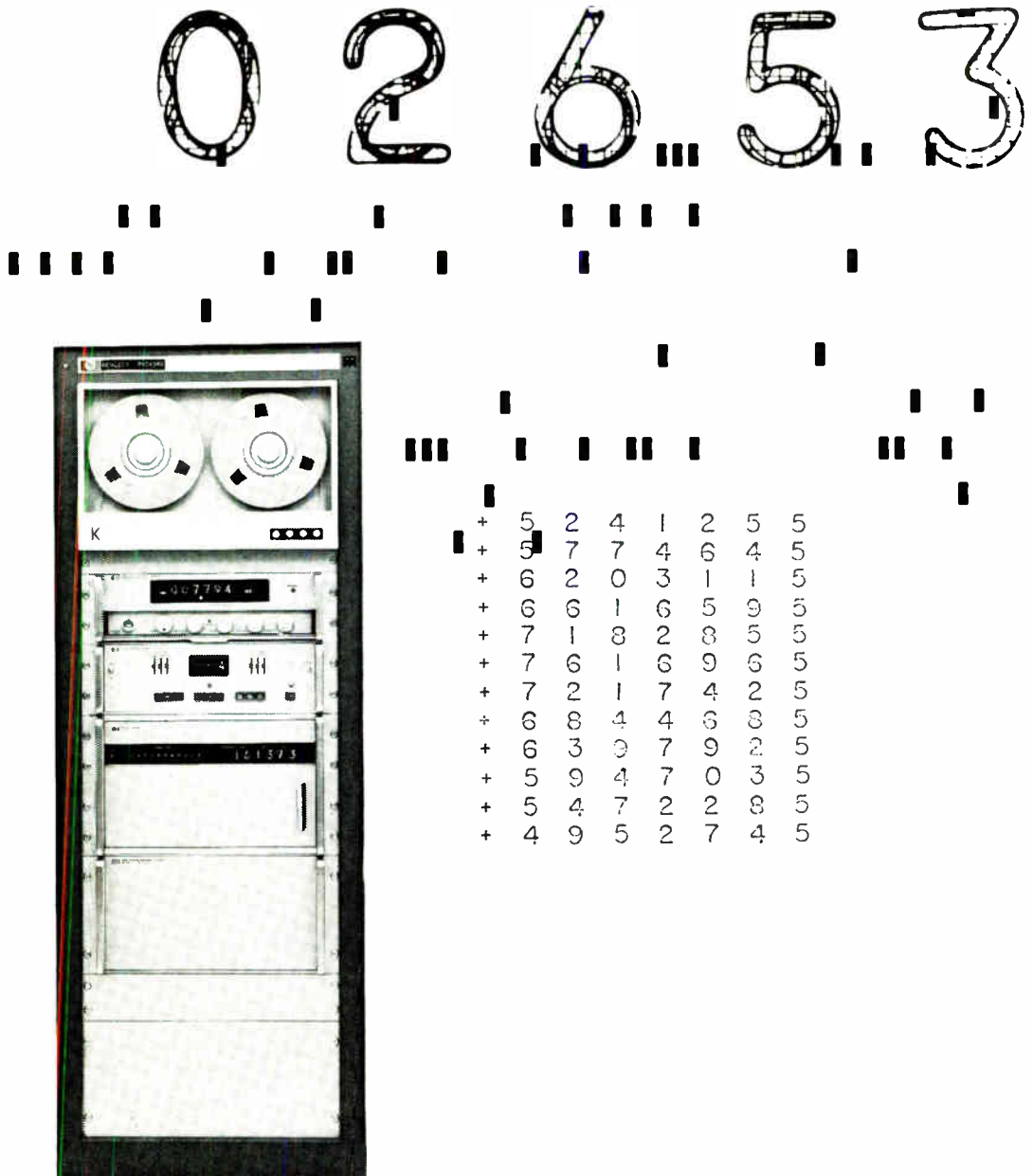
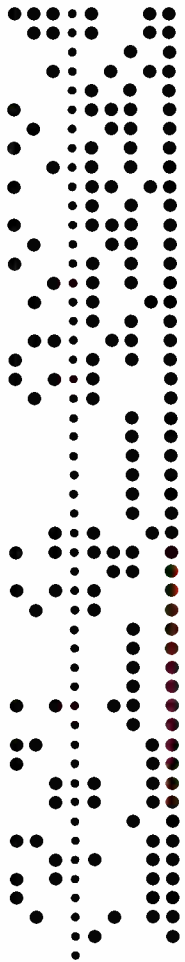

	+	5	2	4	1	2	5	5
	+	5	7	7	4	6	4	5
	+	6	2	0	3	1	1	5
	+	6	6	1	6	5	9	5
	+	7	1	8	2	8	5	3
	+	7	6	1	6	9	6	5
	+	7	2	1	7	4	2	5
	+	6	8	4	4	6	8	5
	+	6	3	0	7	9	2	5
	+	5	9	4	7	0	3	5
	+	5	4	7	2	2	8	5
	+	4	9	5	2	7	4	5

The perfect data acquisition system:

HP has exactly what you want... at the price you want.

Hewlett-Packard's data acquisition line spans the complete capability spectrum—all with off-the-shelf availability. From inexpensive data systems to on-line data reduction—and everything in-between. Your standard system is tailored to your own specific measurement needs. No costly special engineering before you take delivery. It's field-proved, and the safest buy in

the industry. Prices range from \$8,000 to \$47,000.

The popularity of the HP 2010 Series demonstrates the flexibility of HP data acquisition systems; over 500 in use today. The new 2012 Series now adds unmatched speed, accuracy and noise immunity to the HP line. HP systems offer up to nine different output devices, including printers, typewriters, tape and card punches and magnetic tape recorders.

HP also has combined a measuring system with an HP computer in the standard 2018 Data Acquisition Systems. These systems give you full control of your measurements, with *on-line, real-time answers*.

Looking for the perfect data acquisition system? You can save time and money by calling your local HP field engineer or writing Hewlett-Packard, Palo Alto, Calif. 94304; Europe: 54 Route des Acacias, Geneva.



06809

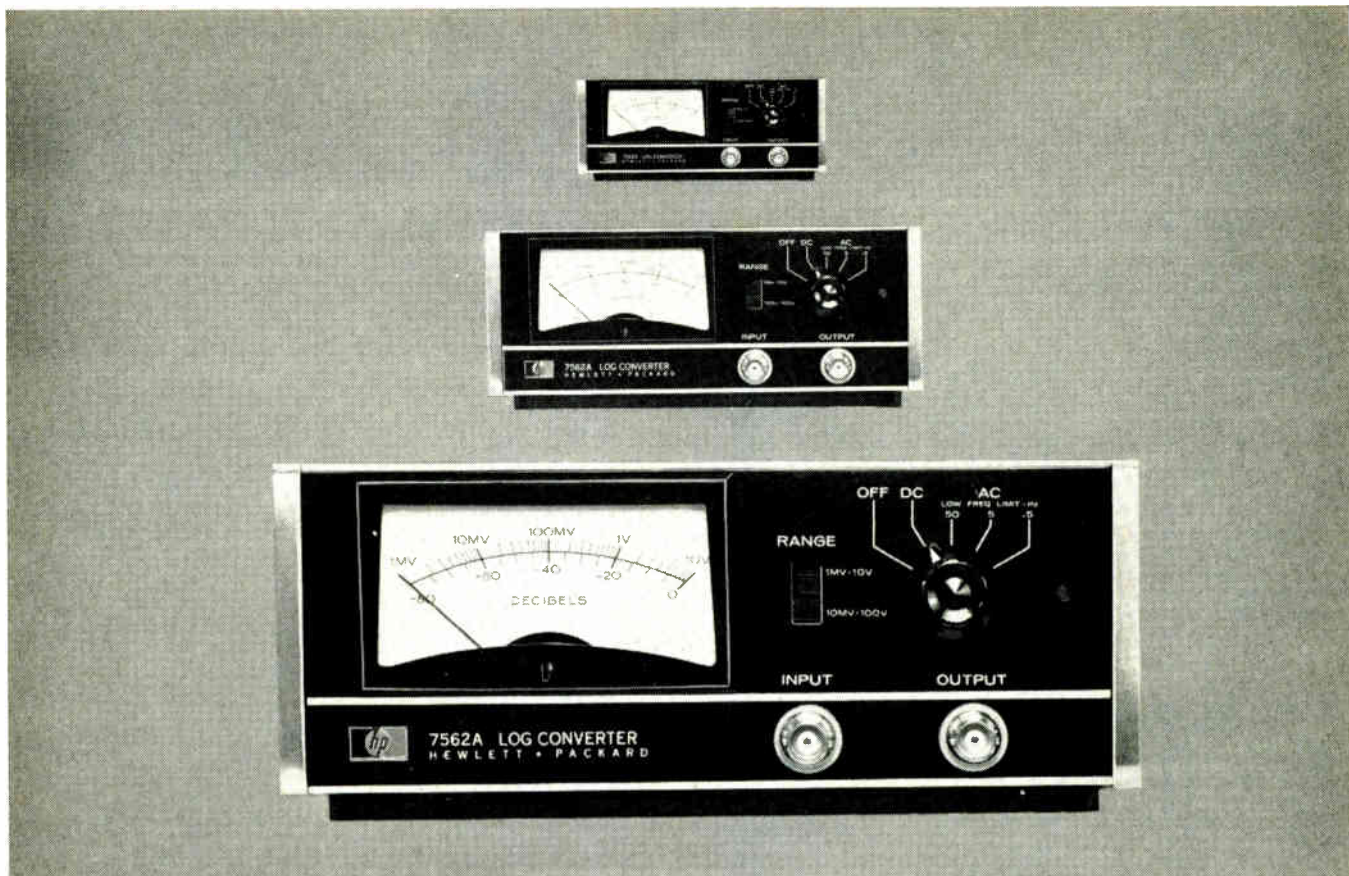

These ABC's spell more log converter performance.

You get more with the Hewlett-Packard 7562A Logarithmic Converter than with any other instrument of its kind. It provides DC logarithmic voltage output from AC or DC input signals, with 80 dB dynamic range, true RMS detection for increased accuracy and unprecedented 0.5 Hz to 100 kHz frequency coverage, in three ranges. Two input voltage ranges 1 mv-10 V or 10 mv-100 V. Fast response to 2 μ s DC rise time and 60 dB/sec AC slewing speed.

The 7562A is ideal for a wide range of demanding

A.
0.5 Hz to 100 kHz frequency range

B.
80 dB dynamic range

C.
True RMS

applications such as gain-frequency plotting with X-Y recorders, vibration analysis and semi-log or log-log plotting. Reliability is assured with rugged, compact, solid-state construction (including use of IC's). Use with scopes, X-Y and strip-chart recorders. A perfect companion for the new HP 3305A Logarithmic Sweep Oscillator. Price: \$995.

For more information, call your local HP field engineer or write Hewlett-Packard, Palo Alto, California 94304; Europe: 54 Route des Acacias, Geneva.

HEWLETT  PACKARD

GRAPHIC RECORDERS

News Features

Probing the News

- 157 Electronic traffic control
163 Simulators set to take off
171 Navy drafts standard hardware

Electronics Review

- 45 **Integrated electronics:** Military cool to plastic IC's; Motorola readies fast line of IC's; Unpackaged chips business picks up
48 **Instrumentation:** Monsanto designs instrument with solid state display; New way to test crystals
50 **Medical electronics:** Automatic EKG machine
52 **Advanced technology:** Tunable laser
54 **Communications:** Television via laser
56 **Consumer electronics:** Radiation dangers
60 **Military electronics:** TFX woes
63 **Industrial electronics:** Security guard
64 **Manufacturing:** No computer for IC processing
65 For the record

Electronics Abroad

- 275 **Great Britain:** Coils on track control trains; Laser simulates tank gun
276 **West Germany:** Kibitzing capsule carries electronic equipment
277 **Canada:** Government slates domestic communications satellite
277 **Soviet Union:** Russians near mass production of integrated circuits
277 **Japan:** Radio-controlled bulldozers; Canon calculator has American-made IC packages
280 **Italy:** Telephone monitor cuts off long-distance calls

New Products

- 193 **Punched cards on the ropes?**
206 **Components review**
206 Connectors for flat cable
210 Simpler wire-wrapping panel
215 **Subassemblies review**
215 Wang offers desk calculator
218 Buffer handles fast data
223 **Instruments review**
223 Linear IC tester checks 22 values
225 Data recorder is portable
228 Wattmeter has high accuracy
231 **Industrial electronics review**
231 Controller for special uses
235 Servo recorder built to last
237 **Microwave review**
237 Flexible cable replaces waveguide
240 Magnetron for cool ovens
243 **Semiconductors review**
243 IC requires one power supply
246 Diode sensitive to magnetism

Title R registered U.S. Patent Office; © copyright 1968 by McGraw-Hill Inc. All rights reserved, including the right to reproduce the contents of this publication, in whole or in part.

Technical Articles

- Advanced technology** 92 **Setting the stage for flat-screen tv**
Experimental color set converts standard signals with pulsewidth modulation
Satoshi Shimada, Sony Corp.
- Circuit design** 104 **Designer's casebook**
▪ Gate-to-source resistor stabilizes FET regulator
▪ Power transistor's r-f gain measured by brief pulse
▪ Amplifier flattens ripple in d-c regulator
- Design theory** 108 **Narrowing the margin of error**
Minimizing common-mode deviations of data amplifiers by combining op amps
Robert I. Demrow, Analog Devices Inc.
- Industrial electronics** 119 **Saving money on data transmission as signals take turns on party line**
Single two-wire cable connects all stations of a control or monitoring installation
James W. Cofer Jr., Georgia Institute of Technology
- Computers** 124 **FFT—Shortcut to Fourier analysis**
Mathematics yields faster ways to extract information from complex waveforms
Richard Klahn and Richard R. Shively, Bell Telephone Laboratories
- Instrumentation** 130 **Making it in pictures**
Electric field intensity can be mapped on pre-sensitized Polaroid film
Keigo Iizuka, Harvard University
- Communications** 133 **Airborne military transceiver finds room in crowded spectrum**
Artful design keeps intermodulation distortion low in 280,000-channel unit
I.P. Magasiny, RCA Defense Communications Systems

Departments

- 4 Readers Comment
8 People
14 Meetings
16 Meeting Preview
23 Editorial Comment
25 Electronics Newsletter
67 Washington Newsletter
254 New Books
258 Technical Abstracts
262 New Literature
267 Newsletter from Abroad

Electronics

Editor-in-Chief: Donald Christiansen

Associate managing editors

Technical: Stephen E. Scrupski

News: Robert Henkel

Copy: Sally Powell

Senior associate editors

Joseph Mittleman, Harry R. Karp

Department editors

Avionics & Space: Alfred Rosenblatt

Computers: Wallace B. Riley

Communications: William Buccì

Consumer electronics: John D. Drummond

Design theory: Joseph Mittleman

Industrial electronics: Harry R. Karp

Instrumentation: Carl Moskowitz

Military electronics: Richard Gundlach

Solid state: Mark B. Leeds

Regional bureaus

Domestic

Boston: James Brinton, manager; Robin Carlson

Los Angeles: Lawrence Curran, manager; Burton Bell

New York: Howard Wolff, manager

San Francisco: Walter Barney, manager; Peter Vogel

Washington: Robert Skole, manager; William D. Hickman, Paul Dickson

Foreign

Bonn: John Gosch

London: Michael Payne

Tokyo: Charles Cohen

Copy editors

James Chang, Frederick Corey, James Darby, Larry Miller

Graphic design

Art director: Saul Sussman

Assistant art directors: Ann Mella, Valerie Betz

Production editor: Arthur C. Miller

Editorial secretaries: Claire Benell, Lynn Emery, Kay Fontana, Patricia Gardner, Lorraine Longo, Barbara Razulis, Frances Vacca

McGraw-Hill News Service

Director: Arthur L. Moore; Atlanta: Fran Ridgway; Chicago: Bruce Cross;

Cleveland: Arthur Zimmerman; Dallas: Marvin Reid;

Detroit: James Wargo; Houston: Robert E. Lee; Los Angeles: Michael Murphy

Pittsburgh: Louis Gomolak

San Francisco: William F. Arnold

Seattle: Ray Bloomberg; Washington: Charles Gardner, Daniel B. Moskowitz,

Herbert W. Cheshire, Seth Payne, Warren Burkett, William Small

McGraw-Hill World News Service

Bonn: Robert Dorang; Brussels: George Williamson; Hong Kong: Wes Perry;

London: John Shinn; Mexico City: Gerald Parkinson; Milan: Ronald Taggiasco, Jack Star;

Moscow: Howard Rausch; Paris: Robert E. Farrell, Peter Kilborn;

Rio de Janeiro: Leslie Warren; Tokyo: Marvin Petal

Reprints: Susan Nugent

Circulation: Milton Drake

Publisher: Gordon Jones

Electronics: April 15, 1968, Vol. 41, No. 8

Published every other Monday by McGraw-Hill, Inc. Founder: James H. McGraw 1860-1948.

Printed at 99 North Broadway, Albany, N.Y. 12207; second class postage paid at Albany, N.Y.

Executive, editorial, circulation and advertising addresses: McGraw-Hill Building, 330 W. 42nd Street, New York, N.Y. 10036. Telephone (212) 971-3333. Teletype TWX N.Y. 710-581-4235. Cable address: MCGRAWHILL N.Y.

Subscriptions solicited only from those professionally engaged in electronics technology. Subscription rates: qualified subscribers in the United States and possessions and Canada, \$8.00 one year, \$12.00 two years, \$16.00 three years; all other countries \$25.00 one year. Non-qualified subscribers in the U.S. and possessions and Canada, \$25.00 one year; all other countries \$50.00. Air freight service to Japan \$50.00 one year. Single copies: United States and possessions and Canada, \$1.00; all other countries, \$1.75.

Officers of McGraw-Hill Publications: Joseph H. Allen, President; Bayard E. Sawyer, Executive Vice-President; J. Elton Tuohig, Senior Vice-President-Operations; Vice Presidents: John R. Callahan, Editorial; John M. Holden, Marketing; Paul F. Cowie, Circulation; Angelo R. Venezian, Production; Jerome D. Luntz, Planning & Development; Robert M. Wilhelmy, Controller.

Officers of the Corporation: Shelton Fisher, President and Chief Executive Officer; John L. McGraw, Chairman; L. K. Goodrich, Executive Vice President; R. E. Slaughter, Donald C. McGraw, Jr., Senior Vice Presidents; Daniel F. Crowley, Senior Vice President and Treasurer; John J. Cooke, Vice President and Secretary.

Title © registered in U.S. Patent Office; © Copyright 1968 by McGraw-Hill, Inc. All rights reserved. The contents of this publication may not be reproduced either in whole or in part without the consent of copyright owner.

Subscribers: The publisher, upon written request to our New York office from any subscriber, agrees to refund that part of the subscription price applying to copies not yet mailed. Please send change of address notices or complaints to Fulfillment Manager; subscription orders to Circulation Manager, Electronics at address below. Change of address notices should provide old as well as new address, including postal zip code number. If possible, attach address label from recent issue. Allow one month for change to become effective.

Postmaster: Please send form 3579 to Fulfillment Manager, Electronics, P.O. Box 430, Hightstown, New Jersey 08520

Readers Comment

In search of protection

To the Editor:

I am afraid that Petar Volkov's SCR regulator [Feb. 5, p. 88] will not always work properly; at least, it will not work with a good transformer. For instance, I am working on an amplifier intended for 120 watts rms at audio frequencies, using an output transformer and two 2N3055 transistors. I found that it needed 42 volts d-c at full load, about 5 amperes. I calculated the power transformer output as 45 volts rms; a 5,000-microfarad input capacitor would do, and the transformer output impedance, seen from the secondary, is about 0.5 ohm. With no load, the power supply's output would be about 60 volts d-c. However, this is too high—an input signal would kill one transistor and then a 115-volt collector-to-emitter voltage would kill the other transistor. Therefore, regulation was needed and Volkov's design seemed a likely candidate.

But after making some calculations I found that if the voltage was just under the desired 42 volts at the output, the SCR of Volkov's circuit would conduct before a phase angle of 40° was reached, and the input's peak voltage would charge the capacitor to 65 volts—back to the original undesired condition. Thus, a huge time constant would be necessary, and the resistor would cause much undesired heat. So I am looking for something else. Perhaps an ordinary transistor and a diode in lieu of the SCR of Volkov's design, or a two-capacitor arrangement.

Allain Le Solleuz

Brest,
France

The author replies:

As I understand it, you need a protection against voltage rise during no load periods.

A classical solution of this problem is not to use a C-input filter at all (as you and I did, I guess), but rather an L-input filter supplied with the necessary bleeder.

If weight and volume are to be kept to a minimum, then I suggest you use the SCR regulator in my

Add **Sprague Series 7400A** to your prints for **Series 74N TTL circuits.** They're pin-for-pin identical.

SERIES 74N	FUNCTION	SPRAGUE PART NO.
SN7400N	Quad 2-Input NAND	USN-7400A
SN7401N	Quad 2-Input NAND (No Collector Load)	USN-7401A
SN7402N	Quad 2-Input NOR	USN-7402A
SN7410N	Triple 3-Input NAND	USN-7410A
SN7420N	Dual 4-Input NAND	USN-7420A
SN7430N	Single 8-Input NAND	USN-7430A
SN7440N	Dual 4-Input NAND Buffer	USN-7440A
SN7450N	2-Wide 2-Input Expandable AND-OR-INVERT	USN-7450A
SN7451N	2-Wide 2-Input AND-OR-INVERT	USN-7451A
SN7453N	4-Wide 2-Input Expandable AND-OR-INVERT	USN-7453A
SN7454N	4-Wide 2-Input AND-OR-INVERT	USN-7454A
SN7460N	Dual 4-Input Expander	USN-7460A
SN7470N	D-C Clocked J-K Flip Flop	USN-7470A
SN7472N	J-K Master Slave Flip Flop	USN-7472A
SN7473N	Dual J-K Master Slave Flip Flop:	
—	Single chip, pin 11 GND	USN-7473A
—	Single chip, pin 7 GND	USN-74107A
SN7474N	Dual D-Type Edge-Triggered Flip Flop	USN-7474A
—	Dual AC Clocked J-K Flip Flop	USN-7479A

Series 5400, full-temperature-range equivalents in 14 pin flat-packs, are also available for rapid delivery from Sprague.



Don't spend another week without calling Sprague.

For complete technical data on Series 5400 and 7400A circuits, write to Technical Literature Service, Sprague Electric Co., 35 Marshall St., North Adams, Mass. 01247

SPRAGUE WORCESTER...the world's finest microcircuit facility



Sprague and ® are registered trademarks of the Sprague Electric Co.

Bolt a new **METERMATE** to any panel meter

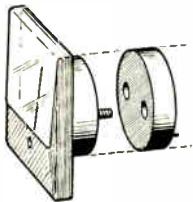

- ... it's a single-ended D.C. voltmeter
- ... it's a high impedance differential voltmeter
- ... it's a log scale D.C. voltmeter
- ... it's a log ratiometer D.C. voltmeter
- ... it's a "you-name-it-we've-got-it" meter

Now standard panel meters read voltage at high source impedances. METERMATES for various functions mount flush at the rear of the meter and fit within the length of the meter terminals — take no extra space, install easily. Ranges are altered simply by changing one external resistor value.

METERMATES are available as individual units or with companion meters in a complete selection of types and ranges. Call your Philbrick/Nexus sales representative for complete specifications, prices and applications assistance. Or write, Philbrick/Nexus Research, 22 Allied Drive at Route 128, Dedham, Massachusetts 02026.



PHILBRICK/NEXUS RESEARCH

A TELEDYNE COMPANY



circuit, followed by a transistor d-c stabilizer. Here the scr regulator is used only to cut the power dissipation in the transistor d-c stabilizer (as much as 50%).

I must warn you that this scr regulator has a ripple in the output; this is inherent in its trigger operating nature. But such a d-c voltage is good for loads like relays, signal lamps, electromagnetic valves and small d-c motors.

Petar Volkov

Zagreb,
Yugoslavia

Seen in a different light

To the Editor:

The particular point we wish to make pertains to the cover picture on your March 4th issue and your comments on page 81 as follows. "On the cover, six of these arrays are appropriately lighted to depict a running figure." A casual examination of the front cover reveals that the picture has been assembled from six photographs of the same matrix rather than from six matrices.

This may appear to be a minor objection, but, examined more closely, it has deeper significance. There are only a few manufacturers with proven capabilities of fabricating light-emitting diode arrays and the relative capabilities of these companies are largely determined by their ability to improve emission efficiency and display area. The display device on your cover is one-sixth of the area shown; it is x-y addressed and, therefore, multiple exposures were used to create the photographs—with multiple exposures the apparent brightness can

be artificially altered; not all segments are illuminated and, in fact, eight of the diodes are not illuminated in any of the pictures. Through the use of art work and scientific photography a deceptively attractive display has been assembled.

Bowmar Canada Ltd. in 1965 fabricated a 7 x 9 matrix of infrared diodes on a single 0.2" x 0.3" substrate and, the same year, a matrix of red-emitting gallium arsenide-phosphide diodes of equal size. Subsequently we have developed monolithic arrays of gallium phosphide diodes with individual access which permit simultaneous exposure of each data point. The status of our display laboratory in the North American marketplace hinges on our ability to build advanced display devices.

While we realize that modern advertising will always present an exaggerated impression of the state of the art, we feel that your editorial comments should be carefully weighed to prevent presentations of the form described above.

Robert D. Rinehart
Vice president, Operations
Bowmar Canada Ltd.

As Robert Rinehart says, even the most casual examination of the cover shows that the same matrix was used six times. We did not expect our readers to draw the inference, from our description, that six different matrices were used.

Readers' letters should be addressed:
To the Editor,
Electronics,
330 West 42nd Street, New York,
N.Y. 10036

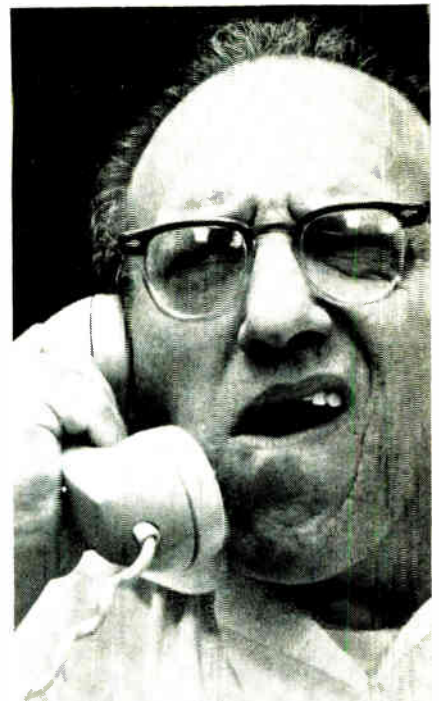

**"Four to six weeks
for power supply
delivery?"**

Forget it!

**Acopian will ship
any of their
62,000 different
AC to DC plug-in
power supplies
in just 3 days!"**

This catalog lists 62,000 models of AC to DC plug-in power supplies available for shipment in just three days. Choose the exact outputs you need. Singles or duals, regulated or unregulated. Write or phone for your free copy.



Name _____
Title _____
Company _____
City _____
State _____ Zip _____



Acopian Corp., Easton, Penna. 18042
Phone: (215) 258-5441

SUBSCRIPTION SERVICE

Please include an Electronics Magazine address label to insure prompt service whenever you write us about your subscription.

Mail to: Fulfillment Manager
Electronics
P.O. Box 430
Hightstown, N.J. 08520

To subscribe mail this form with your payment and check new subscription renew my present subscription

Subscription rates: qualified subscribers in the U.S.: 1 year \$8; two years, \$12; three years, \$16. Non-qualified: 1 year \$25. Subscription rates for foreign countries available on request.

CHANGE OF ADDRESS

ATTACH LABEL HERE

If you are moving, please let us know five weeks before changing your address. Place magazine address label here, print your new address below.

name _____

address _____

city _____

state _____

zip code _____

collage 29

The Year of the Marathons ...

one for Bikela
two for us!

1964, to most everyone, is best remembered as the year in which Bikela Abebe of Ethiopia won the Olympic marathon in the record time of 2h.12m.11.2s.



Without wishing to denigrate this achievement, it should be noted that 1964 was also the year in which Motorola was party to a space shot that set many marathon records. The shot was Mariner 4, launched at Mars in November, 1964. One of the records is for long distance communications: signals were received from more than two million miles out in space. The second record is for distance traveled. Mariner 4 traveled more than 350-million miles just getting to Mars; and kept going strong, logging more than 1.5-billion miles before finally being shut down by JPL in late December of 1967. While NASA/JPL deserve most of the credit for these records, we want the world to know that it was our CW transponder and Flight Command subsystem that made vital contributions to the communications and guidance of the now ancient Mariner, thereby making these records possible. Just about the time Mariner 4 celebrated its third anniversary, the boys at JPL commanded it to break lock on the guide star which had been controlling its attitude throughout most of its journey, and all systems, including ours were still in fine shape. If these monumental achievements don't impress you, our Aerospace Center communications people would like you to write and tell them what does.

KEEPING SAM IN LINE

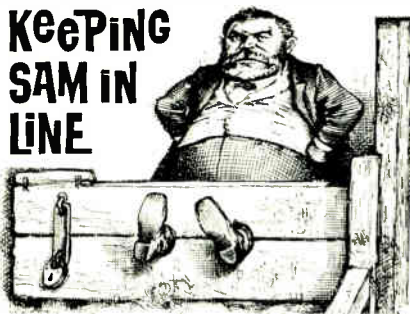

Does your small tactical missile wander aimlessly about the sky, seemingly more interested in sight-seeing than hitting whatever you aimed it at? Well, now

you can simmer down. Our Guidance Systems R&D experts have bread-boarded some highly advanced ideas for improving the guidance system of SAM, a small tactical missile its deployers would like to keep on target. The improvements are in the realm of doppler modulation techniques which help attain more rapid acquisition and improved range resolution. Some achievements are: an advanced phase monopulse antenna, multiple modulation techniques that operate with a single illuminating radar system mode, and improved microwave integrated circuits. If you have a SAM of your very own... or a Gus, a Ben, or even a Farley, maybe we can help guide it. Send a missive to the Guidance Programs Office at our Aerospace Center.

Shape Up, Infidels!

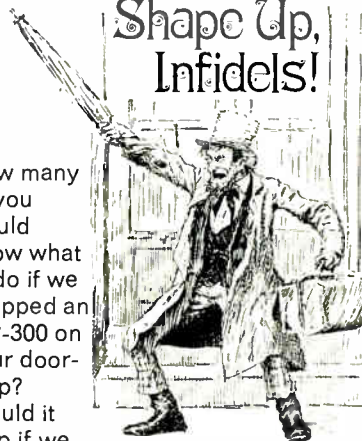

How many of you would know what to do if we dropped an MR-300 on your doorstep?

Would it help if we told you it is also called the AN/FRC-147(V)? Probably not; so listen. The MR-300 is the world's greatest solid state microwave equipment. That's because it has silicon transistors for ultra-reliability, a 2-watt long-life klystron that assures a full 1-watt (+ 30 dbm) power output to the antenna, a 600 channel capacity using SSB multiplex or equivalent loading, a low noise receiver featuring optional tunnel diode amplifier, and lots of other nice things. Write to the Microwave Program Office at our Chicago Center for a stirring spec sheet. Who knows, we just might leave an MR-300 on your doorstep. So be prepared.

Aerospace Center Dept. 2008
8201 E. McDowell Rd., Scottsdale
Arizona 85252, Phone (602) 947-8011
Chicago Center Dept. 985
1450 N. Cicero Ave., Chicago,
Illinois 60651, Phone (312) 379-6700



MOTOROLA

Government Electronics Division

People

The Electronic Systems division of the TRW Systems Group is changing its ways, says Paul F. Glaser, 41, the division's new assistant general manager for projects. He notes that where the division—as well as the entire systems group—has traditionally been in the space business, with its few-of-a-kind production requirements, there is a thrust now to get into more sustained production. “One of the division's changes of pace has been toward hardware production and away from the image we have of being an analysis and study house.” To back up this change, the division is adding a facility in Manhattan Beach, Calif., which will have 500,000 feet of manufacturing space.



Glaser

“We're developing a capability for quick reaction—an ability to turn designs into hardware with a short turnaround time. An increasingly larger amount of our efforts are going into avionics systems, including electronic countermeasures equipment. We're doing this because we foresee such things as v/stol aircraft and the supersonic transport requiring command, control, and communications systems as complex as those used in some of the space systems we provide.”

New direction. Glaser concedes that NASA's fiscal plight has been a factor in reorienting his division. “We're now building spaceborne programmers and data processors, but we've also made proposals on this kind of equipment for aircraft that could lead to reasonably high production volumes.” Glaser estimates deliverable hardware now represents about 20% of the division's business; he expects that figure to double in five years.

He also predicts drastic changes in electronic equipment design over the next decade because of the influence of large-scale integration. Glaser says TRW officials had



The ML-EE64Y is the smallest 10 kv (peak) switch tube—and the smallest 10 kv (peak) regulator tube you can buy. ML-EE64Y gives you up to 36 free cubic inches per tube, and doesn't require a socket. It offers you a 12 amp peak current, high signal sensitivity, and a simple BeO heat sink with no other cooling required. The ML-EE64Y provides tabs for simple, low-cost connection. For complete data, write to Machlett—the tube specialist most responsive to customer needs—today. The Machlett Laboratories, Inc., 1063 Hope Street, Stamford, Connecticut 06907.

Why use this tube...for high voltage switching or voltage regulation...when this one is better?

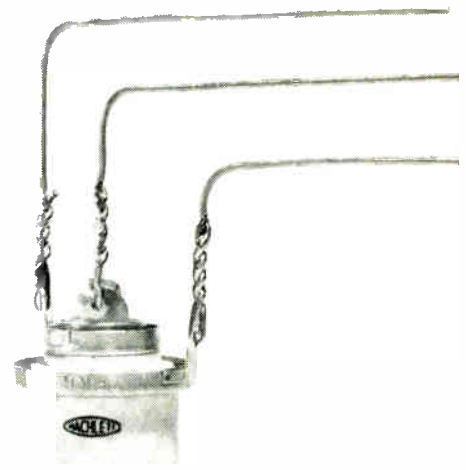
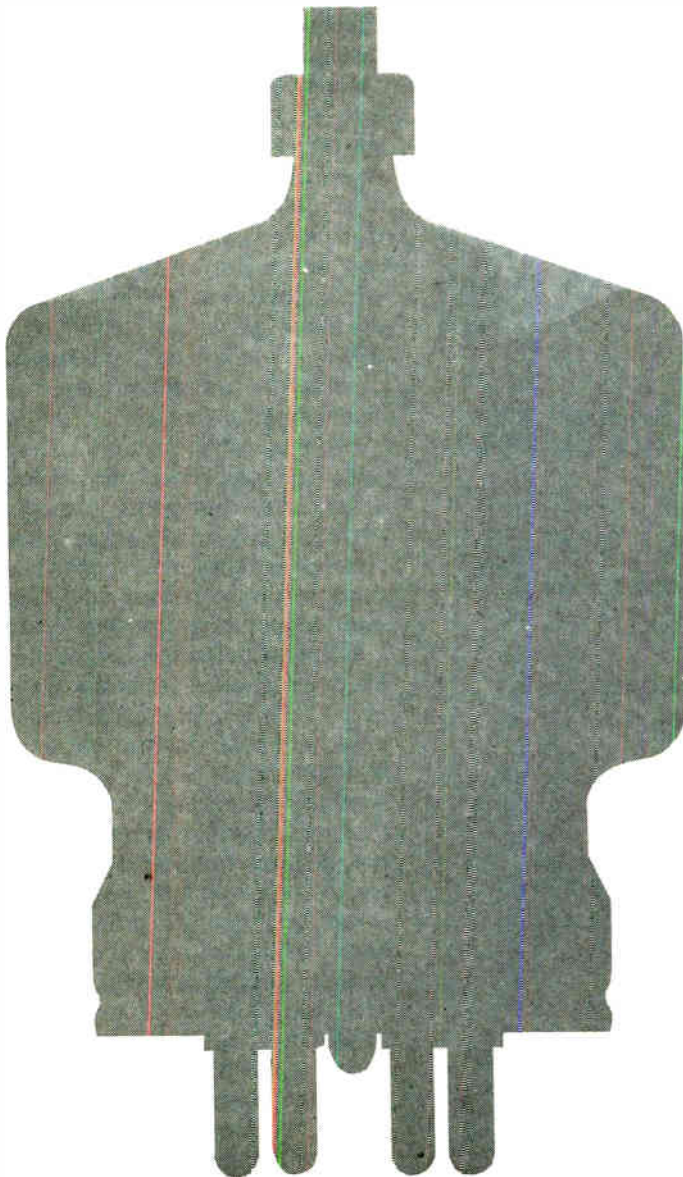

ML-EE64Y
Actual size.



THE MACHLETT LABORATORIES, INC.

A SUBSIDIARY OF RAYTHEON COMPANY

Breakthrough by Dearborn!



100 μ F @ 50 V

in 1" x 3³/₁₆" metal-encased

METALLIZED POLYCARBONATE-FILM CAPACITORS

⊕ Capacitance range of Dearborn DIMIE® Series now extended to almost 18 times higher than previously-available values!

⊕ A new order of size and stability in capacitors for critical low-voltage miniaturized circuits.

⊕ Rated for operation at temperatures to +125 C without derating.

⊕ Low loss characteristics, high current-carrying capabilities—ideally suited for specialized a-c and r-f applications.

For complete technical information, write to Dearborn Electronics, Inc., Box 530, Orlando, Fla. 32802.

Dearborn Electronics, Inc.
(a subsidiary of the Sprague Electric Company)

FOREMOST IN FILM CAPACITORS

10-7101R1

People

this in mind when they worked out plans for the new home for 4,400 Electronic Systems division employees.

"We wanted to bring engineering and manufacturing very close together," Glaser says, "because there's such a close tie between the chemist, physicist, designer, and manufacturer. It will be hard to say where physics stops and manufacturing begins."

Walter B. LaBerge, who has just stepped into the top post at the Philco-Ford Corp.'s electronics

group, is convinced defense spending is about to level off—perhaps even taper off. This thrusts upon the new Philco-Ford vice president the task of channeling his divisions' resources to provide the nonmilitary area with an increasing share.



LaBerge

"Fortunately," says the 44-year-old LaBerge, "our six defense, space, and industrial electronics divisions have long experience in communications and digital handling, experience that is in growing demand in the civilian sector."

Emphasis. LaBerge, who has a Ph.D. in physics from the University of Notre Dame, is quick to point out that defense needs will still run high. "We've learned two lessons in Vietnam. First, we know that we'll have to continue putting our defense dollars into weapons for that kind of war. Second, command and control problems—tactical, strategic, and logistic—will receive greater emphasis." This, adds the Philco-Ford executive, is right down the alley of two of his divisions, WDL and Communications and Electronics.

The company is already applying the antenna technology used to track satellites for the communications subsystem of the Bay area (San Francisco-Oakland) rapid transit system, and for work related to California's water resources.

In less time than it takes to read this page, you could learn to use this new Universal Impedance Bridge.

Ready? One, two, three, go.

2. Adjust the range switch for an on-scale reading.



3. Obtain a null with the CRL dial. Now, read your measurement.

1. Select the function you want.

Nothing to it. No interacting controls to adjust and readjust. No multipliers. No non-linear dials. AUTO-BALANCE eliminates all that.

This new Hewlett-Packard Bridge is the first one that takes human beings into account as well as impedance. It's made for engineers who don't have time for a half-hour refresher course every time they want to use it.

You get direct digital readout of all C, R, and L values. Indicator lights show up-scale or down-scale unbalance. Decimal point and an equivalent circuit are automatically indicated. No problem with false or sliding nulls either: unique electronic AUTO-BALANCE takes care of that.

For a D or Q measurement, just switch from AUTO to low or high D or Q and turn the DQ control until you obtain another null. Simple. Particularly for low Q and high D cases.

So if you're the kind of engineer who's tired of complicated impedance bridges, Hewlett-Packard has your number: Model 4260A, \$550.

Ask your Hewlett-Packard field engineer for a demonstration. Or write us for complete specs: Palo Alto, California 94304. Tel. (415) 326-7000. Europe: 54 Route des Acacias, Geneva.

HEWLETT  **PACKARD**
An extra measure of quality.

1844

TO YOU DESIGNERS DEDICATED TO BUILDING SIMPLER, LOWER-COST SILICON POWER CIRCUITS

Nowadays, complementary symmetry is the way to go when you're after more economy and less complexity in the power portions of your industrial circuit designs.

You get all the circuit-simplifying advantages of direct-coupled, complementary symmetry plus realize a higher degree of frequency stability in both ac and dc-driven loads without the addition of expensive, impedance-matching driver transformers.

And Motorola has the broadest 3-to-30-ampere, NPN/PNP silicon power transistor line available anywhere for the widest range of cost-cutting, direct-coupled application possibilities in the industry — 27 silicon power pairs . . . headed by the unique 30 A, 200 W units . . . in your choice of voltage, gain and power capability.

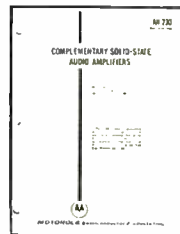
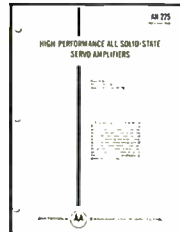

(AN225, AN230)

Complement your new design prototypes with one of Motorola's 3-to-30-ampere silicon power pair kits . . . available for a limited time for 30% below list price! We'll include two informative industrial application notes: "High-Performance All Solid-State Servo Amplifiers," and "Complementary Solid-State Audio Amplifiers" that discuss at length phase shift reduction and easy conversion to transformerless operation. Just fill in and mail the coupon to receive this outstanding "3-to-30 offer".

Pair up with silicon power!

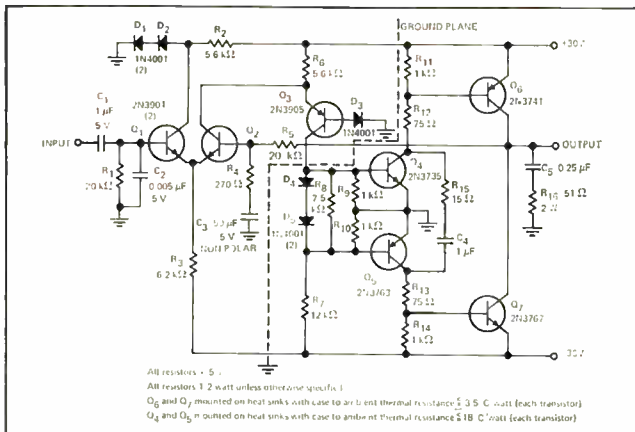

COMPLEMENTARY SILICON POWER SERVO AMPLIFIER

Both ac and dc-driven loads can be utilized with this simple, compact amplifier which will drive 20 V (RMS) in a 40 Ω load, giving an output of 10 W. Voltage gain at 25°C is 37 dB and gain variation over -55° to +100°C operating range is within ± 5 dB. Power gain is 60 dB (min). Harmonic distortion is less than 5% at all levels up to 20 V (RMS) and is typically less than 1% at 25°C.

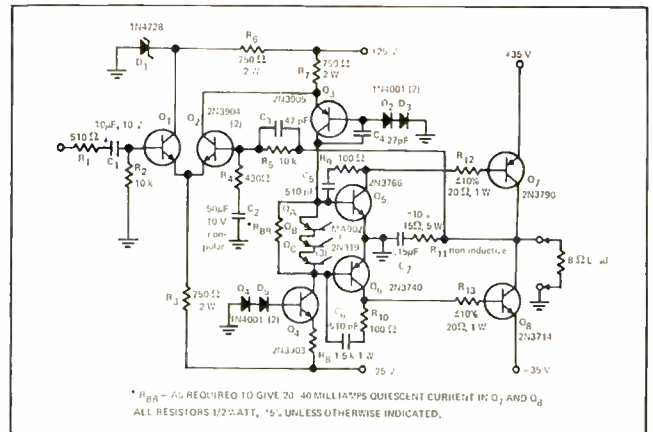

COMPLEMENTARY SILICON POWER 50 W AUDIO AMPLIFIER

Excellent frequency response — 5 cycles to 300 kHz — is obtainable with this industrially-oriented amplifier. It can provide 65 W at 20 Hz, 72 W at 1 kHz and 68 W at 20 kHz. Flat frequency response results from 100 Hz to 20 kHz, being down only 0.35 dB at 20 Hz. Phase shift is 18° at 20 Hz and 6° at 20 kHz.

-where the priceless ingredient is care!



...OUR COMPLEMENTS.

MOTOROLA 3-TO-30 A COMPLEMENTARY SILICON POWER

I _c Max. Amps	V _{CE0} Volts (sus)	Package	Type		h _{FE} @ I _c	P _d Watts	V _{CE(sat)} @ I _c Volts (max)	f _T MHz	NPN/PNP Regular Combination Price (1-99)
			NPN	PNP					
3	40 60 80	Case 77	2N4921	2N4918	20/100 @ 500 mA	30	0.6 @ 1 A	3	\$ 2.98
			2N4922	2N4919					
			2N4923	2N4920					
	40 40 60 60 80	TO-5	2N3506	2N3867	40/200 @ 1.5 A	6	0.75 @ 1.5 A	60	26.50
			2N4237	2N4234	30/150 @ 0.25 A		0.6 @ 1 A	3	5.25
			2N3507	2N3868	40/200 @ 1.5 A		0.75 @ 1.5 A	60	29.95
			2N4238	2N4235	30/150 @ 0.25 A		0.6 @ 1 A	3	6.35
			2N4239	2N4236	30/150 @ 0.25 A		0.6 @ 1 A	3	7.05
4	40 60 80	Case 77	2N5190	2N5193	25/100 @ 1.5 A	30	0.6 @ 1.5 A	4	3.58
			2N5191	2N5194					
			2N5192	2N5195					
	40 60 80	TO-66	2N4910	2N4898	20/100 @ 0.5 A	25	0.6 @ 1 A	3	3.50
			2N4911	2N4899					
			2N4912	2N4900					
5	40 40 60 60 80 80	TO-3	2N4913	2N4904	25/100 @ 2.5 A	87.5	1.0 @ 2.5 A	4	5.75
			2N5067	2N4901	20/80 @ 1 A		0.4 @ 1 A		4.55
			2N4914	2N4905	25/100 @ 2.5 A		1.0 @ 2.5 A		7.05
			2N5068	2N4902	20/80 @ 1 A		0.4 @ 1 A		5.55
			2N4915	2N4906	25/100 @ 2.5 A		1.0 @ 2.5 A		9.80
			2N5069	2N4903	20/80 @ 1 A		0.4 @ 1 A		7.10
10	60 60 80 80	TO-3	2N3713	2N3789	25/90 @ 1 A	150	1.0 @ 4 A	4	13.30
			2N3715	2N3791	50/150 @ 1 A		1.0 @ 5 A		17.20
			2N3714	2N3790	25/90 @ 1 A		1.0 @ 4 A		15.35
			2N3716	2N3792	50/150 @ 1 A		1.0 @ 5 A		21.60
15	60	TO-3	2N3055	2N4908	20/70 @ 4 A	115	1.1 @ 4 A	1	11.15
30	40 60	TO-3	2N5301	2N4398	15/60 @ 15 A	200	1.0 @ 15 A	4	18.10
			2N5302	2N4399					21.10

"3-30" PAIR-UP-WITH-SILICON-POWER OFFER

The silicon power pairs below are offered at 30% below regular, combination, NPN/PNP, 1-99 list prices. Pair me up with a:

- ___ 3 A, 80 V 2N4923/4920 Kit . . . Special "3-30" kit price \$ 2.75
- ___ 3 A, 80 V 2N4239/4236 Kit . . . Special "3-30" kit price \$ 4.95
- ___ 4 A, 80 V 2N5192/5195 Kit . . . Special "3-30" kit price \$ 4.15
- ___ 4 A, 80 V 2N4912/4900 Kit . . . Special "3-30" kit price \$ 3.50
- ___ 5 A, 80 V 2N5069/4903 Kit . . . Special "3-30" kit price \$ 4.95
- ___ 10 A, 80 V 2N3714/3790 Kit . . . Special "3-30" kit price \$10.75
- ___ 30 A, 40 V 2N5301/4398 Kit . . . Special "3-30" kit price \$12.65

All kits include AN225 on Servo Amplifiers and AN230 on Audio Amplifiers.

Send me data sheets on the _____ A, _____ V devices.

Name _____ Title _____

Company _____ Div./Dept. _____

Address _____ City _____ State _____ Zip _____

(Be sure to include check for appropriate kit ordered payable to Motorola Inc. Mail to Motorola Semiconductors, Box 955, Phoenix, Arizona, 85001. Offer void after June 1, 1968.)

"3-30" PAIR-UP-WITH-SILICON-POWER OFFER



MOTOROLA Semiconductors

Application For

FET SWITCHES

PROBLEM: Use one flat pack to switch two ± 10 V signals . . . and drive with 5 V logic.

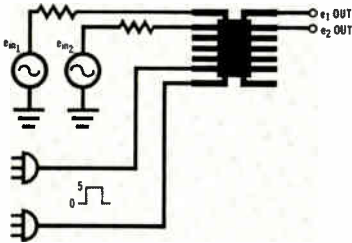

REQUIRED: Two switching channels completely contained in one package . . . Delay less than $1 \mu S$. . . Inverting logic (logic low — switch OFF) . . . $-55^\circ C$ to $+125^\circ C$ operation.

GIVEN

1. $e_{in} \pm 10$ V.
2. DTL logic — output swing is 5 V.
3. Available power supplies: +5 V, +10 V, -20 V.

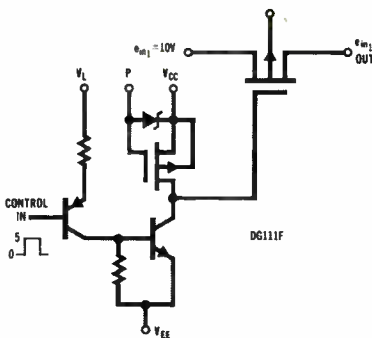

SOLUTION: Siliconix DG111F - Both channels complete in one package, MOS FET switch and bipolar driver . . . no other parts needed. Connect DTL output to driver input, ground "R", V_{CC} to +10, P and V_{EE} to -20, apply e_{in} to source and drain is output.

Tight packaging your hang up? Contact us for applications assistance or write for our free FET Switch and Driver Data Packet.



Siliconix incorporated

1140 W. Evelyn Ave. • Sunnyvale, CA 94086
Phone (408) 245-1000 • TWX: 910-339-9216

Meetings

Southwestern Conference and Exhibition, IEEE; Sheraton Lincoln Hotel, Houston, April 17-19.

Symposium on Automation Techniques in Industry, Institution of Electronics and Radio Engineers; Paisley, Scotland, April 17-19.

State of the Art Seminar: Components and Devices in System Applications, Purdue University; Lafayette, Ind., April 19-May 25.

Conference on Switching Techniques, IEEE and Institution of Electrical Engineers, Institution of Electronic and Radio Engineers; London, April 21-25.

Conference for Protective Relay Engineers, Texas A&M, University; College Station, Texas, April 22-24.

Chemical and Petroleum Instrumentation Symposium, Instrument Society of America; Hotel du Pont, Wilmington, Del., April 22-23.

Frequency Control Symposium, U.S. Army Electronics Command; Shelburne Hotel, Atlantic City, N.J., April 22-24.

Region III Meeting, IEEE; Fontainebleau Motor Hotel, New Orleans, April 22-24.

American Power Conference, IEEE and Illinois Institute of Technology; Sherman House, Chicago, April 23-25.

Fiber Optics History Technology and Applications, Society of Photo Optical Instrumentation Engineers; Holiday Inn, Baltimore, Md., April 29-30.

Relay Conference, National Association of Relay Manufacturers and School of Electrical Engineering, Oklahoma State University; Stillwater, Okla., April 23-24.

Cybernetics Conference, IEEE; Munich, West Germany, April 23-26.

Spring Joint Computer Conference, American Federation of Information Processing Societies; Atlantic City, N.J., April 30-May 2.

Symposium and Equipment Show, American Vacuum Society; Grand Hotel, Anaheim, Calif., May 1-3.

Human Factors in Electronics Symposium, IEEE; Marriott Twin Bridges Motor Hotel, Washington, May 6-7.

National Conference on Aerospace Meteorology, American Institute of Aeronautics and Astronautics; New Orleans, May 6-9.

Technical Conference and Exhibit, American Society for Quality Control; Sheraton Hotel, Philadelphia, May 6-8.

Electronic Components Technical Conference, IEEE; Everglades Hotel, Marriott Twin Bridges Motor Hotel, Washington, May 8-10.*

Short Courses

Data communications for management control, the American University, Washington, May 20-23; \$175.

Computer-aided testing and failure diagnostics of solid state systems, University of Wisconsin, Madison, May 23-24; \$50.

Digital control fundamentals, Milwaukee School of Engineering, Milwaukee, June 3-7; \$150.

Call for papers

Conference on Tube Techniques, IEEE; United Engineering Center Auditorium, New York, Sept. 17-19. May 15 is deadline for submission of abstracts to George Freedman, The Raytheon Co., Microwave Power Tube Division, Willow St., Waltham, Mass. 02154

Ultrasonics Symposium, IEEE; Statler-Hilton Hotel, New York, Sep. 25-27. July 15 is deadline for submission of abstracts to R.W. Damon, Sperry Rand Research Center, 100 North Rd., Sudbury, Mass. 01776

Allerton Conference on Circuit and System Theory, IEEE; Allerton House, Monticello, Ill., Oct. 2-4. Aug. 1 is deadline for submission of abstracts to T.N. Trick, Department of Electrical Engineering, University of Illinois, Urbana, Ill. 61801

Circuit Theory Symposium, IEEE; Hilton Plaza Hotel, Miami Beach, Fla., Dec. 4-6. Aug. 1 is deadline for submission of papers to B. K. Kinariwala, Department of Electrical Engineering, University of Hawaii, Honolulu, Hawaii 96822.

* Meeting preview on page 16.

**Is there an AC digital
voltmeter anywhere
that can measure this
waveform accurately?**

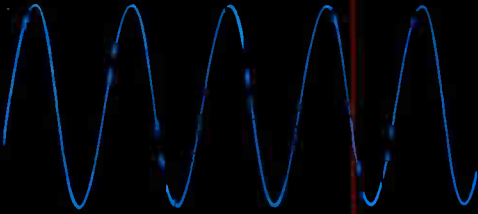

..... And this one too?

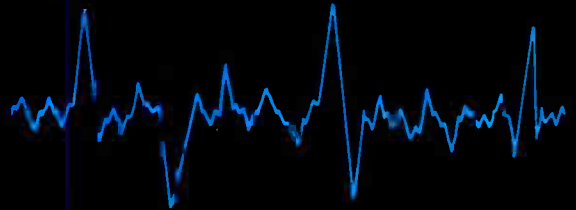

**There is now! The new Fluke 9500A
true rms automatic digital voltmeter reads these
complex waveforms to an accuracy of $\pm 0.05\%$.
And if you know your AC's, that's progress.**

Another DVM on the market? Usually that's good for a ho-hum. But as we've said above, if you know your ac's, that's not the case with the new Fluke 9500A. It's the first automatic ac voltmeter capable of reading and digitally presenting the true rms value of any input—regardless of waveform—to 0.05% absolute accuracy (50 Hz to 10 KHz).

Frequency response is broad, 20 Hz to 700 KHz. The Model 9500A accepts voltage from .001 to 1100 volts rms in five ranges, each with 20% overranging. Range selection is automatic or manual. Crest factor of 10 virtually eliminates effects from voltage spikes or pulse trains.

Low capacitance, high resistance input minimizes loading effects.

Self-calibration is automatic whenever the instrument is turned on. On-line self-calibration is either automatic or manual, selectable by front panel switching. All controls and indicators, conveniently located on the front panel, are easy to use and understand. Complete control of the 9500A is possible from a remote facility if desired.

Price of the Model 9500A, including rack adapter, is \$2,485. Extra cost options include a probe input (\$75), rear panel BNC input (\$50), and 1-2-4-8 or 1-2-2-4 BCD digital outputs (\$195). For

complete information, please call your full service Fluke sales engineer (see EEM), or write directly to us here at the factory.

Fluke, Box 7428, Seattle, Washington 98133. Phone: (206) 774-2211. TWX: 910-449-2850. In Europe, address Fluke International Corp., P.O. Box 5053, Ledeborstraat 27, Tilburg, Holland. Telex: 844-50237. In the U.K., address Fluke International Corp., P.O. Box 102, Watford Herts, England.



Circle 15 on reader service card

ALPHANUMERIC, DIGITAL AND SPECIAL READOUTS



Sixteen segments; full alphanumeric presentation; 65,000 character combinations.

Seven segments; 10 digits, 11 alphabetic characters, plus decimal point/degree sign.

Special characters produced to order.

ALL WITH OPTIMUM CONTRAST AND ALL FROM TUNG-SOL

Optimum contrast in Tung-Sol readouts results from the molecularly bonded, flush-surface filter. The use of a new 20 mil lamp sharply reduces the load factor while maintaining good brilliance. Heat is minimized and reliability is substantially improved. Tung-Sol readouts are designed to be inter-mixed. All characters have the same vertical dimension for accurate in-line display. Viewing angle is 150°. Displays can be supplied in color.

MOUNTING FLEXIBILITY

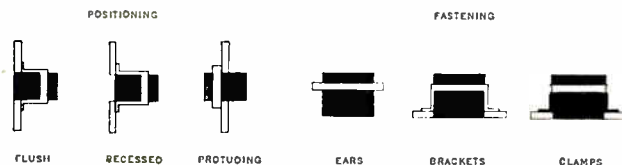

Write for fully explanatory brochure T-431. Tung-Sol Division, Wagner Electric Corporation, One Summer Avenue, Newark, New Jersey 07104.

TUNG-SOL®
OPTIMUM CONTRAST
READOUTS

© REG. T.M. WAGNER ELECTRIC CORPORATION

Meeting preview

New spirit

The Electronic Components Conference, threatened with extinction a few years ago by the onrush of complex monolithic integrated circuit technology, is again back in the thick of things, with thick films. Along with the regular sessions on materials, packaging, and manufacturing, this year's conference, scheduled for Washington, May 8 to 10, will, for the first time, have two thick-film sessions.

Better performance. Among the speakers in this area will be Brian Dale, chief engineer at Sylvania's Semiconductor division, whose paper will cover the use of thick-film packaging techniques for fitting beam-lead devices to both hybrid microcircuits and inexpensive carriers. This is a process that eliminates double packaging, and makes possible air-isolated circuit components, resulting in improved high-frequency performance.

Other topics to be covered in the thick-film sessions are cermet resistors, screen-printed capacitors and high Q dielectrics.

Also scheduled is a session on integrated components and filters. In this session three Boeing engineers, V.C. Hughes, O.R. Mulkey, and M.H. Williamson, will describe how a thin-film hybrid technique was used to fabricate 17 different audio frequency RC filters with tolerances of 0.1%.

Filter design. In the same session, J.M. Giannotto, a researcher with the U.S. Army Electronics Command, will discuss the use of energy-trapping techniques in acoustical filter design. He will cover the deposition of both thin films of cadmium sulfide and resonators on quartz wafers, a process that obtains the electrical performance of conventional filters while cutting size.

Two Westinghouse engineers, M.B. Shamash and S.G. Konsowski, will describe their work in packaging in a paper on the use of nonporous thin-film dielectrics and shadow printing of high-resolution conductors.

For further information contact William S. Hepner Jr., Electronic Industries Association, 2001 Eye Street NW, Washington, D.C. 20006

We make planar power.

Not excuses.

hFE	V _{CEO}	I _C (max.)	V _{CE(sat)}	P _T	SWITCHING TIME				TYPE
					t _{on} ns	t _{off} ns	(<i>a</i>) I _C A	(<i>a</i>) I _B mA	
25 min. (@ 2A, 10V)	40V	3A	0.5V max. (@ 1A, 0.1A)		35	75	1.5	150	2N4225
80 min. (@ 3A, 10V)		5A	0.75V max. (@ 3A, 0.3A)		40	±00	3.0	300	B-143002, 5, 8 B-143017, 20, 23
20 min. (@ 5A, 10V)	40 to 80V	10A	1V max. (@ 5A, 0.5A)	25W to 50W	225	600	10	1,000	B-144002, 5, 8 B-145002, 5, 8 B-146002, 5, 8
15 min. (@ 10A, 5V)		15A	1.5V max. (@ 15A, 3A)	100W 60W					B-148002, 3, 5 B-155002, 3, 5
20 min. (@ 10A, 5V)	60 to 100V	20A	1.5V max. (@ 20A, 4A)	100W 60W	B-148003, 1, 4 B-155003, 1, 4				

(SATURATED SWITCHING TEST CIRCUIT DIAGRAM FOR B-148000 & B-155000)

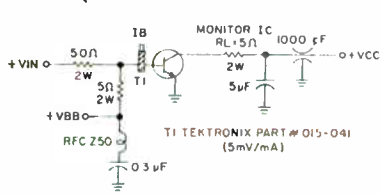

Maximum Switching Times: $t_c \leq 25$ ns;
 $t_r \leq 200$ ns; $t_s \leq 300$ ns; $t_f \leq 300$ ns.
Test Conditions: $V_{in} = 70V$ when generator with 50Ω internal impedance is terminated in a 50Ω load. $V_{BE} = -5V$; $V_{CC} = 55V$; $I_C \approx 10A$; $I_{B1} \approx 1A$; $I_{B2} \approx 1A$; $t_p = 400$ ns; $f = 720$ Hz.

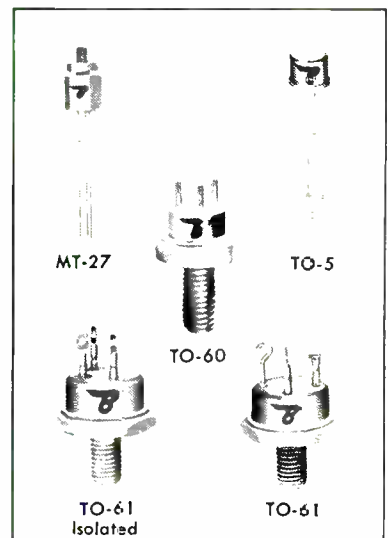

Ever been handed the line: "Seems we have every type but the one you want—could we interest you in something else?" Excuses, excuses. It's nice to know Bendix doesn't need to make them. Fact is, you never have to compromise when selecting our silicon planar power transistors. We make over 100 different types, in 8 different packages, with collector currents of 3, 5, 10 and 20 amps, rated V_{CEO}'s from 40 to 100 volts. Contact us for postradiation gain data.

All Bendix planar power transistors are SOAR (Safe Operating Area) specified to prevent second

breakdowns. A real time-saver in designing your power amplifier, inverter, converter and regulator circuits.

If you are in the market for radiation-resistant transistors, silicon power mesas, DC voltage regulators or 35- and 60-volt plastic power transistors, odds are we can meet your requirements there, as well. Excuses? Not from Bendix. We're the Power Specialists. More information? Call our nearest sales office, or write: Semiconductor Division, The Bendix Corporation, Holmdel, New Jersey 07733.

Bendix Electronics



Chicago—(312) 637-6929; Dallas—(214) 357-1972; Detroit—(313) 548-2120; East Northport, N.Y.—Harry Friedman Co. (516) 692-2839; Great Neck, N.Y.—H. V. Sales Co. (516) HU 7-1142; Greenwich, Conn.—(203) 859-7797; Holmdel, N.J.—(201) 946-9400; Lexington, Mass.—(617) 861-8350; Los Angeles—(213) 776-4100; Minneapolis—(612) 926-4633; Orlando, Fla.—(304) 241-6559; Rochester, N.Y.—(716) 266-5550; Runnemede, N.J.—(609) 933-2550; Seattle—Ray Johnston Co., Inc. (206) LA 4-5170; Export—Cable: "Bendixint," 605 Third Avenue, New York, (212) 973-2121; Ottawa, Ont.—Computing Devices of Canada, P.O. Box 508 (613) 829-1800; San Juan, Puerto Rico—Southern International Sales Co. 723-3879.

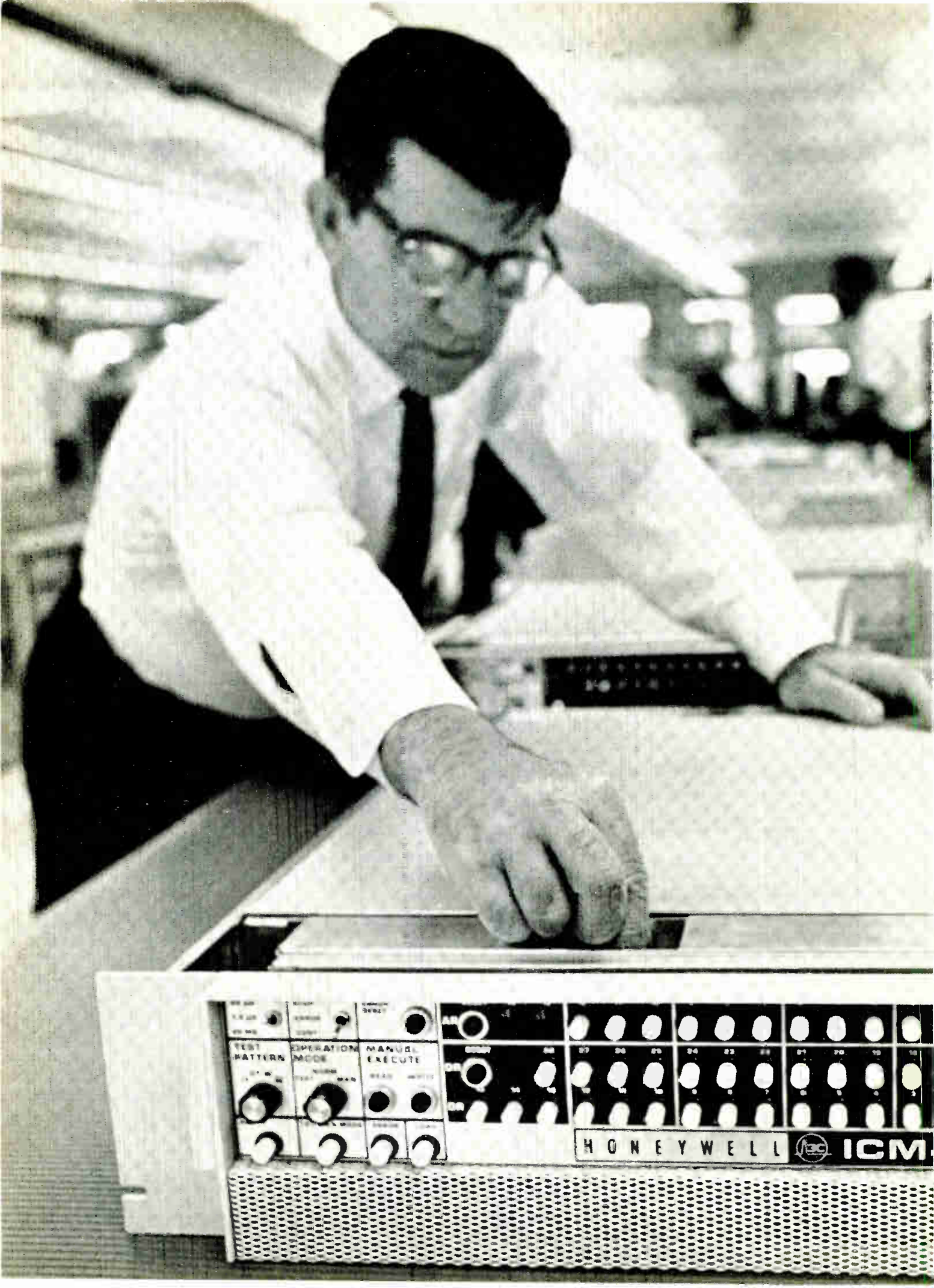

TEST MATTERS
OPERATION MODE
MANUAL EXECUTE

00 01 02 03 04 05 06 07 08 09 10

HONEYWELL ICM



3-week delivery...

**on the standard 1 μ -sec
I/C memory system
that packs 1/2 million
bits in a single
5 1/4" high unit.**

That's the ICM-40. A fast, highly reliable core memory system that's ready to meet your system requirement.

And when you say so, we'll give you 3-week CFS (Certified Fast Shipment) under our accelerated shipment plan.

What's more, the ICM-40 is a standard product... a proven performer with over 5,000 hours of life test without failure. Plus, some 400 actual installations; same success rate. What you'd expect from the most experienced memory maker.

I/C Construction — The ICM-40 is a 1 microsecond, full-cycle, magnetic core memory designed for operation as a high-speed random-access store. It is a basic system module that takes maximum advantage of the high reliability and low power consumption of integrated circuitry.

Packaging — Compactness and a high degree of maintainability are achieved in the ICM-40 design by packaging all of the circuitry on readily accessible, removable circuit modules.

Capacity — The ICM-40 packs nearly 1/2 million bits in a single 5 1/4" high module. The basic unit can be specified for up to 16K words, 4-26 bits per word. It's big brother, the ICM-40E with capacities of 32K words, 4-78 bits per word is available with 60-day CFS.

If you've drawn a block marked "core memory" recently, why not find out more about the ICM-40/40E. You'll be pleased by their versatility. And the standard-product pricing. And our Certified Fast Shipment commitment.

Now, don't you think it's about time you called us? Or, write Honeywell, Computer Control Division, Old Connecticut Path, Framingham, Massachusetts 01701.

Honeywell

 **COMPUTER CONTROL
DIVISION**

Circle 19 on reader service card

RECAP:

21.

4500 BIPOLAR MICROMATRIX™ ARRAY

Starting October 9, 1967, a new family of bipolar micromatrix arrays is being introduced. The 4500 series consists of 4500, 4501, 4502, 4503, 4504, 4505, 4506, 4507, 4508, 4509, 4510, 4511, 4512, 4513, 4514, 4515, 4516, 4517, 4518, 4519, 4520, 4521, 4522, 4523, 4524, 4525, 4526, 4527, 4528, 4529, 4530, 4531, 4532, 4533, 4534, 4535, 4536, 4537, 4538, 4539, 4540, 4541, 4542, 4543, 4544, 4545, 4546, 4547, 4548, 4549, 4550, 4551, 4552, 4553, 4554, 4555, 4556, 4557, 4558, 4559, 4560, 4561, 4562, 4563, 4564, 4565, 4566, 4567, 4568, 4569, 4570, 4571, 4572, 4573, 4574, 4575, 4576, 4577, 4578, 4579, 4580, 4581, 4582, 4583, 4584, 4585, 4586, 4587, 4588, 4589, 4590, 4591, 4592, 4593, 4594, 4595, 4596, 4597, 4598, 4599, 4600.

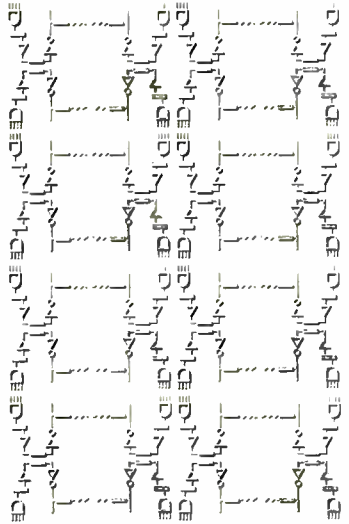

PARTECH INC.

CIRCLE READER SERVICE NUMBER 121

22.

3320 MOS 64-BIT, 4-PHASE SHIFT REGISTER

Starting October 9, 1967, a new family of MOS shift registers is being introduced. The 3320 series consists of 3320, 3321, 3322, 3323, 3324, 3325, 3326, 3327, 3328, 3329, 3330, 3331, 3332, 3333, 3334, 3335, 3336, 3337, 3338, 3339, 3340, 3341, 3342, 3343, 3344, 3345, 3346, 3347, 3348, 3349, 3350, 3351, 3352, 3353, 3354, 3355, 3356, 3357, 3358, 3359, 3360, 3361, 3362, 3363, 3364, 3365, 3366, 3367, 3368, 3369, 3370, 3371, 3372, 3373, 3374, 3375, 3376, 3377, 3378, 3379, 3380, 3381, 3382, 3383, 3384, 3385, 3386, 3387, 3388, 3389, 3390, 3391, 3392, 3393, 3394, 3395, 3396, 3397, 3398, 3399, 3400.

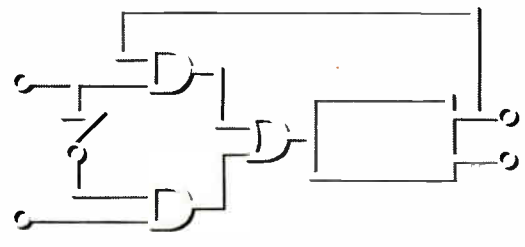

PARTECH INC.

CIRCLE READER SERVICE NUMBER 122

23.

3705 8-CHANNEL MOS MULTIPLEX SWITCH

Starting October 9, 1967, a new family of MOS multiplex switches is being introduced. The 3705 series consists of 3705, 3706, 3707, 3708, 3709, 3710, 3711, 3712, 3713, 3714, 3715, 3716, 3717, 3718, 3719, 3720, 3721, 3722, 3723, 3724, 3725, 3726, 3727, 3728, 3729, 3730, 3731, 3732, 3733, 3734, 3735, 3736, 3737, 3738, 3739, 3740, 3741, 3742, 3743, 3744, 3745, 3746, 3747, 3748, 3749, 3750, 3751, 3752, 3753, 3754, 3755, 3756, 3757, 3758, 3759, 3760, 3761, 3762, 3763, 3764, 3765, 3766, 3767, 3768, 3769, 3770, 3771, 3772, 3773, 3774, 3775, 3776, 3777, 3778, 3779, 3780, 3781, 3782, 3783, 3784, 3785, 3786, 3787, 3788, 3789, 3790, 3791, 3792, 3793, 3794, 3795, 3796, 3797, 3798, 3799, 3800.

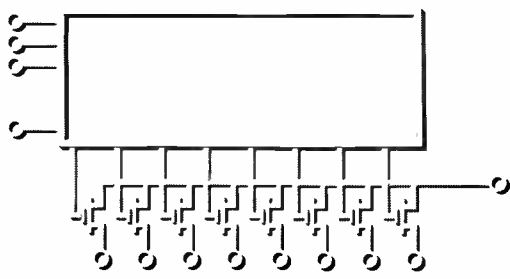

PARTECH INC.

CIRCLE READER SERVICE NUMBER 123

24.

μA722 PROGRAMMABLE D/A-A/D CONVERTER CURRENT SOURCE

Starting October 9, 1967, a new family of programmable D/A-A/D converters is being introduced. The μA722 series consists of μA722, μA723, μA724, μA725, μA726, μA727, μA728, μA729, μA730, μA731, μA732, μA733, μA734, μA735, μA736, μA737, μA738, μA739, μA740, μA741, μA742, μA743, μA744, μA745, μA746, μA747, μA748, μA749, μA750, μA751, μA752, μA753, μA754, μA755, μA756, μA757, μA758, μA759, μA760, μA761, μA762, μA763, μA764, μA765, μA766, μA767, μA768, μA769, μA770, μA771, μA772, μA773, μA774, μA775, μA776, μA777, μA778, μA779, μA780, μA781, μA782, μA783, μA784, μA785, μA786, μA787, μA788, μA789, μA790, μA791, μA792, μA793, μA794, μA795, μA796, μA797, μA798, μA799, μA800.

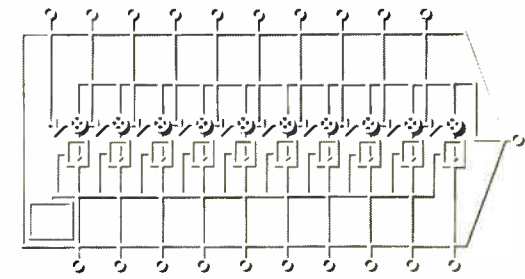

PARTECH INC.

CIRCLE READER SERVICE NUMBER 124

Fairchild is introducing a new integrated circuit every week. The last two months look like this.



4510 DUAL FOUR-BIT COMPARATOR

25. The 4510 is a dual in-line package (DIP) integrated circuit which provides a dual four-bit comparator. It is designed to compare two 4-bit binary numbers and to indicate the magnitude relationship between them. The 4510 is available in both standard and low-power versions. It is fabricated in silicon on a ceramic carrier and is compatible with standard TTL logic.

The 4510 has two 4-bit data inputs, A and B, and two 4-bit data outputs, Y and Z. The Y output is high when A is greater than B, and the Z output is high when B is greater than A. The 4510 also has two enable inputs, EN1 and EN2, which can be used to disable the comparator. The 4510 is available in both standard and low-power versions. It is fabricated in silicon on a ceramic carrier and is compatible with standard TTL logic.

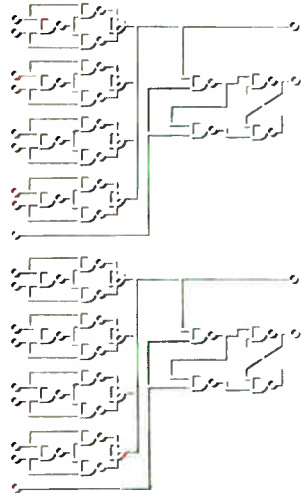

CIRCLE READER SERVICE NUMBER 115

9034 256-BIT READ-ONLY MEMORY

26. The 9034 is a 256-bit read-only memory (ROM) integrated circuit. It is designed to store 256 bits of data and to provide a means for reading the data. The 9034 is available in both standard and low-power versions. It is fabricated in silicon on a ceramic carrier and is compatible with standard TTL logic.

The 9034 has a 16-bit address input and a 256-bit data output. The address input is used to select one of the 256 bits of data stored in the memory. The data output is the selected bit. The 9034 is available in both standard and low-power versions. It is fabricated in silicon on a ceramic carrier and is compatible with standard TTL logic.

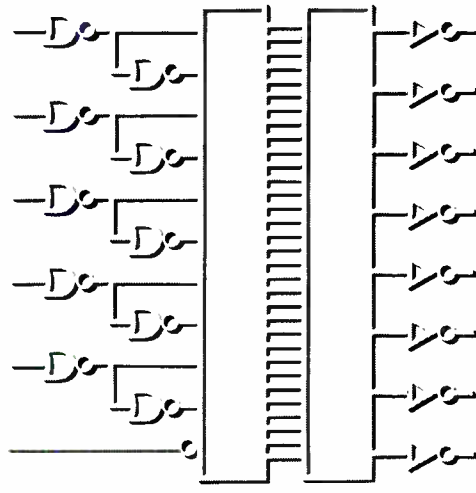

CIRCLE READER SERVICE NUMBER 126

3750 10-BIT MOS-LSI D/A CONVERTER

27. The 3750 is a 10-bit MOS-LSI D/A converter integrated circuit. It is designed to convert a 10-bit digital input into an analog output. The 3750 is available in both standard and low-power versions. It is fabricated in silicon on a ceramic carrier and is compatible with standard TTL logic.

The 3750 has a 10-bit digital input and an analog output. The digital input is used to select one of the 10 bits of data stored in the memory. The analog output is the selected bit. The 3750 is available in both standard and low-power versions. It is fabricated in silicon on a ceramic carrier and is compatible with standard TTL logic.

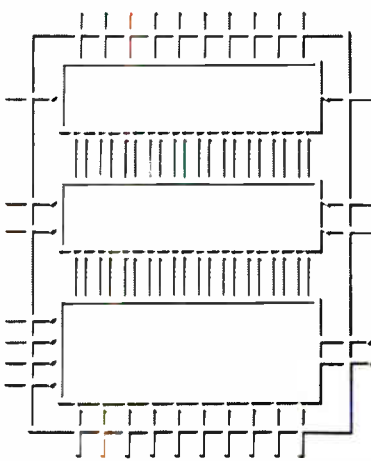

CIRCLE READER SERVICE NUMBER 127

9624/9625 INTERFACE CIRCUITS

28. The 9624 and 9625 are interface circuits integrated circuits. They are designed to provide a means for interfacing a microprocessor to a peripheral device. The 9624 is available in both standard and low-power versions. It is fabricated in silicon on a ceramic carrier and is compatible with standard TTL logic.

The 9624 and 9625 have a 16-bit address input and a 16-bit data output. The address input is used to select one of the 16 bits of data stored in the memory. The data output is the selected bit. The 9624 and 9625 are available in both standard and low-power versions. It is fabricated in silicon on a ceramic carrier and is compatible with standard TTL logic.

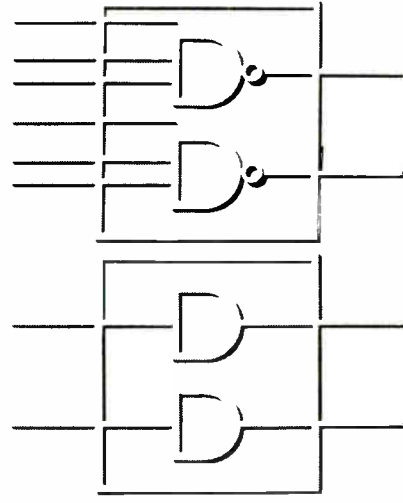

CIRCLE READER SERVICE NUMBER 128

Which IC Test System does all these things?

DIAGNOSTIC COMPUTER PROGRAMS automatically check out system operation.

DATALOG A FORCING FUNCTION, such as the input threshold level of a flip-flop needed to produce a specified output.

TYPED SUMMARY SHEETS. Whenever desired. No interruption in testing. Give total units tested per test station, test yields and bin yields.

DIRECT ENGLISH data logging type-out, showing job name, serial number, test number, decimal point and units.

ABSOLUTE SOURCE CONTROL. Sources can be turned ON or OFF and changed in value in any sequence with variable delays from 100 μ sec. to as long as you please.

DATALOG at any test station—without slowing down classification tests at any other station.

MULTIPLEXING. Several jobs simultaneously. Any assigned, at any time, to any test station.

AUTOMATIC SELF-CHECKING assures accurate data transfer between operator, teletypewriter, computer and test instrument.

VERY COMPLEX TEST SEQUENCES can be programmed, yet preparation of simple tests can be learned in two hours.

FAST TESTING. 1.5 msec per test. If crosspoint is changed, 5 msec. 10 msec on the lowest current scales.

GROWING LIBRARY of improved software packages to insure against obsolescence.

TEN-YEAR GUARANTEE for all instrument plug-in circuitry (it's almost all plug-in).

NO ADJUSTMENT OR CALIBRATION POINTS. (Eternal vigilance is the price you pay for a single adjustment.)

OPEN AND SHORTED CONNECTIONS and OSCILLATIONS are automatically detected. System stops when a selected consecutive number of these occur.

COMPLETE FRONT PANEL DISPLAY at any desired step, simultaneously indicating all crosspoint connections, forced values, measured limits, binning decisions—everything about each test.

MINIMIZED REPETITIVE INSTRUCTIONS for the operator through data libraries, variable word length programming, and autotyping.

PROGRAMMABLE CURRENT LIMITS for each source at each test.

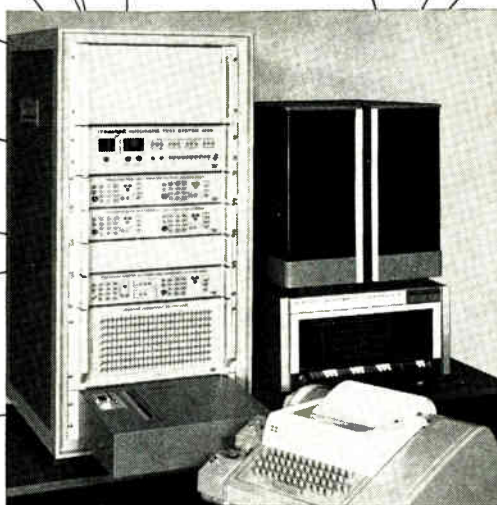

This one.

(complete for only \$65,000)

This is our J259 computer-operated Automatic Circuit Test System. It includes a general-purpose digital computer, teletypewriter, test instrument (comprising modular elements: 24 x 8 crosspoint matrix, four volt-

age sources, measurement system, and test deck), complete software package, and courses in IC testing, system operation, and maintenance. TERADYNE, 183 Essex St., Boston, Mass. 02111 Phone (617) 426-6560.

TERADYNE

Editorial comment

A little knowledge

Shock waves from the report issued by the Logistics Management Institute earlier this year have spread beyond the Defense Department, where it was commissioned, to touch the entire industry. The institute asserted that profits for defense contractors based on percentage of total capital investment are significantly lower than those of contractors not involved with the Government. And furthermore, the report said, even those lower profits are declining. The LMI report suggested that the Government be urged to back off on controls for high-risk projects.

The Defense Department asked the Electronic Industries Association for its comments on the study; during EIA meetings in Washington last month, the report was alternately praised and pummeled.

A study that yielded contrary results was made by M.L. Weidenbaum, an economics professor at Washington University. It concludes that the large defense companies (North American Rockwell, Lockheed, General Dynamics, McDonnell Douglas, Grumman, and Thiokol Chemical) earn higher profits than nondefense firms of similar size. Weidenbaum's data shows that defense profits have grown steadily higher than nondefense profits over the past decade.

These conflicting conclusions could be attributed, in part, to the measurement techniques. Weidenbaum used net profits after taxes as a percent of stockholders' investment (return on net worth). But defenders of the LMI report suggest that it is unfair to compare all the companies involved in the LMI study with the giant aerospace firms.

Congressman Chet Holifield (D., Calif.), commenting on the LMI study, emphasizes that the figures were obtained from many individual company profit figures—some of them considerably higher than the average reported.

Providing still another viewpoint, Robert Higdon, a vice president of the Chase Manhattan Bank, notes: "Classically, profit opportunities attract competition which drives down prices. Defense contractors interviewed by LMI stated that the primary reason for defense profit being lower than commercial profits was the severity of competition." Higdon thinks this is not necessarily bad, noting that under free-enterprise concepts, marginal companies will drop out, leaving the field to the more competent.

Many companies would like a more detailed breakdown of the LMI report—into companies and categories—to help them see where they fit into the picture. Others are content with the ambiguities of the report. In this group was one company that believes the study has generated a "credible image" which might generate some Government action that would reduce the controls on high-risk projects.

Other dissenters to further analysis of the LMI report

were saying, off the record, at the Washington parley that it might cast doubt on LMI's conclusions. We disagree. Additional analysis would benefit the entire industry. The Logistics Management Institute has conducted a number of studies for the Defense Department and its recommendations have been factored into the procurement regulations. We think this respected study group would be the first to agree that more light should be shed on its report.

After Vietnam

Hanoi's response to President Johnson's enunciation of a shift in U.S. policy encourages the hope that direct discussions can be arranged between representatives of North Vietnam and the United States. It may be months or years before the war is ended but now, at least, we've caught a glimmer of light at the end of the tunnel.

The current peace maneuvers bring the question of "After Vietnam, what?" into sharp focus. A year ago, a committee of the Electronic Industries Association tackled it. Its report*, issued last month, postulated a "most probable course of events."

The EIA study group believed that the U.S. would "continue its present policy of escalation, with the aim of achieving a political settlement or ultimately forcing a military settlement to the conflict." The study group sought to describe the market environment at the war's end for companies now in the defense/space business and to measure the impact on systems procurement and research and development. Its conclusions:

- After the war, defense expenditures will return to a level which would have been reached had there been no conflict. NASA spending will decline throughout the war.
- Programs will be deferred if they aren't related to Vietnam and for some this may mean their demise.
- Electronics expenditures will undergo no significant decline despite individual program losses in the short term. The latter will be offset by other programs and by an increasing electronics content in all programs, so that the long-term prospects for electronics are good.

Of the many programs that will be deferred while the war continues, research and development projects are most vulnerable. Before leaving his post as Secretary of Defense, Robert McNamara told Congress that special efforts were being made to cull out marginal R&D programs and to defer to "future years" all projects whose postponement would not have a seriously adverse effect on the future military capabilities of the U.S.

Congressman Joseph Karth (D., Minn.) put it aptly when he warned against the U.S. slipping into a "let technology wait" mood, while the war is being fought.

Programs that are deferred lose momentum and key personnel. An infusion of funds may often not be enough to revive moribund programs. Karth calls for a continuing investment in R&D in the U.S. to provide a continuing payoff, not only for a sound defense posture but to find a cure for our social ills. The point is well taken. In war or peace we cannot bypass technology.

*The Post-Vietnam Defense and Space Market Environment

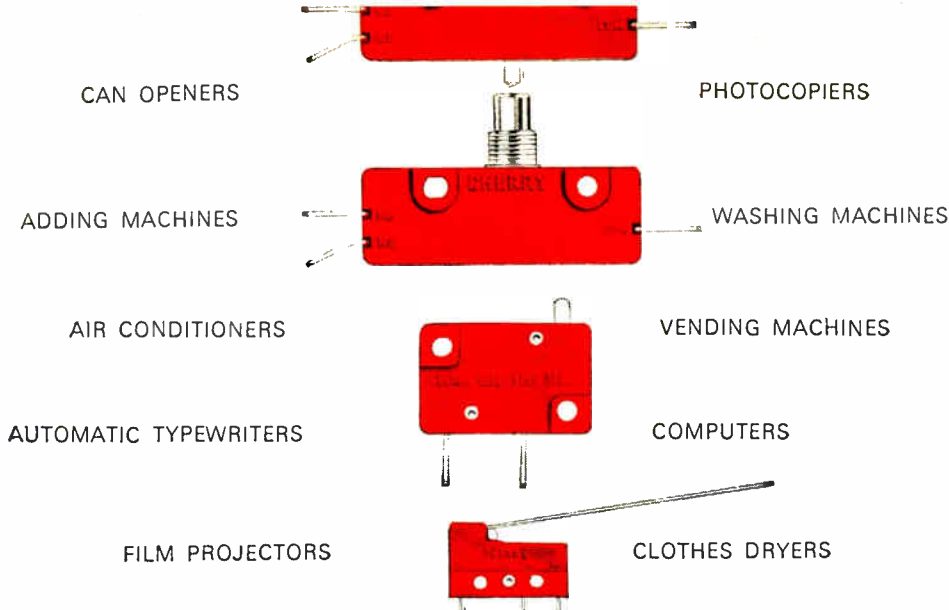

CAN OPENERS

PHOTOCOPIERS

ADDING MACHINES

WASHING MACHINES

AIR CONDITIONERS

VENDING MACHINES

AUTOMATIC TYPEWRITERS

COMPUTERS

FILM PROJECTORS

CLOTHES DRYERS

want to start something?

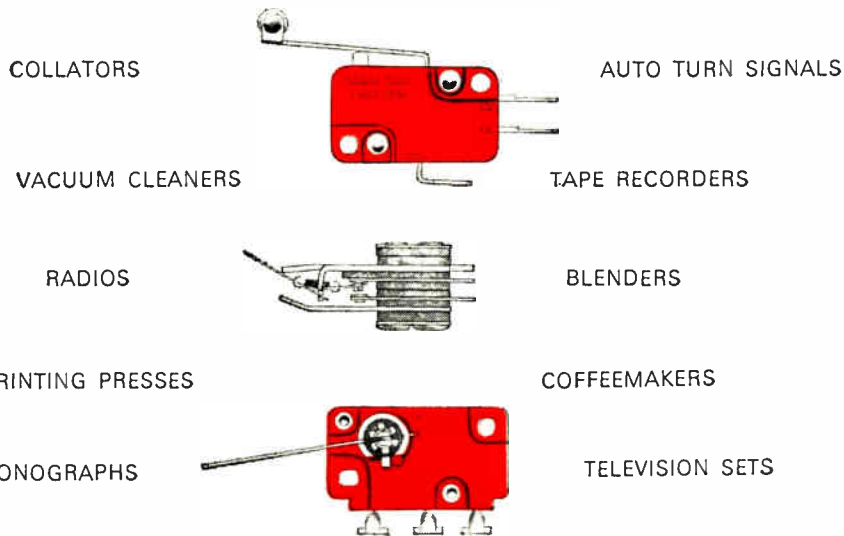

COLLATORS

AUTO TURN SIGNALS

VACUUM CLEANERS

TAPE RECORDERS

RADIOS

BLENDERS

PRINTING PRESSES

COFFEEMAKERS

PHONOGRAPHS

TELEVISION SETS

specify Cherry long-life switches.

This year, 17 million products will start with Cherry switches. Product designers like Cherry's long-life coil-spring mechanism. Production people find high-overtravel Cherry switches install much easier. If you are looking to start something and need operating forces as low as 1¼ grams or electrical ratings as high as 25 amps, check CHERRY.



Check our complete line. Send for the new pocket-size Cherry "Switch Selector Guide."



CHERRY

CHERRY ELECTRICAL PRODUCTS CORP. • 1656 Old Deerfield Road • Highland Park, Illinois 60035

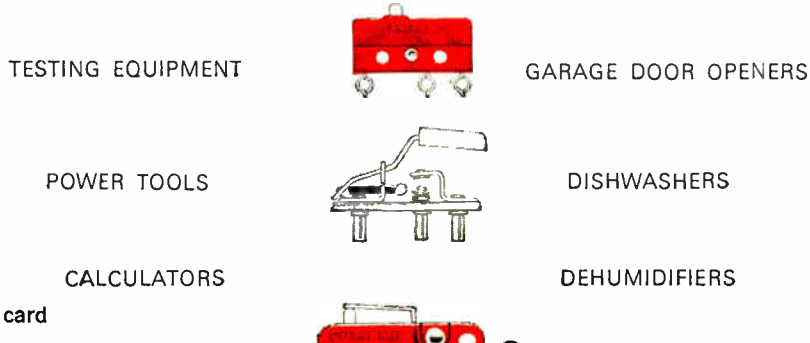

TESTING EQUIPMENT

GARAGE DOOR OPENERS

POWER TOOLS

DISHWASHERS

CALCULATORS

DEHUMIDIFIERS

Circle 24 on reader service card

Electronics Newsletter

April 15, 1968

Siliconix to offer microwave FET's

Field effect transistors are not only bucking the trend to integrated circuits but are widening their scope of operation. The latest advance lifts commercial FET's into the ultrahigh- and microwave-frequency ranges. Siliconix has developed a junction device with a maximum frequency of 1.5 gigahertz, plus a gain of 6,500 micromhos and a noise level of under 4 decibels.

This frequency capability, triple that of rival off-the-shelf units, is achieved by "twisting the basic geometric pattern," according to J. B. Compton, designer of the device. He expects the method to yield 3-Ghz devices by next year and says the technique is applicable all the way up to 10 Ghz.

Siliconix is aiming its new unit at communications applications, including radio, telemetry, and low-noise amplifying systems, but will also sell the chip in unpackaged form to hybrid-circuit users. The price will be under \$6 each in lots of 100.

IC diode arrays get lift from air isolation

Fairchild Semiconductor is using a planar air-isolation technique to produce monolithic diode arrays that perform at the level of discrete arrays. The firm, which next month will introduce 16-diode and dual eight-diode arrays incorporating the new approach, says the isolation of the integrated-circuit elements is superior to anything achieved with dielectric, hybrid chip-and-wire, or other approaches.

The isolation—involving a fine glass that is sedimented onto the front of the wafer and an additional support wafer—is laid down after the device elements are formed. It provides glass-encapsulation protection as well as normal oxide protection. As a result, an epitaxial layer is left between top metallization and the p and n regions, with succeeding layers of oxide, aluminum, and glass interposed between bottom layers and the backing wafer.

Hal Clausen, senior marketing engineer for Fairchild, says the technique is applicable to all monolithic IC's, yields higher reliability, accommodates batch processing, requires fewer assembly operations, provides greater pin and layout freedom, and produces more uniform electrical characteristics. He further declares that the method will make discrete diode arrays obsolete.

TTL bandwagon

As transistor-transistor logic (TTL) finds its way into more integrated circuits, the race to get more of the action heats up. Motorola Inc., which announced its own TTL circuits late last year plus expansion of its second-sourced Sylvania SUHL 2 line [Electronics, Oct. 2, 1967, p. 179], is preparing a TTL entry styled after Texas Instruments' 5400/7400 series. The Semiconductor Products division in Phoenix is making circuits now, but it will be "a few months," says one Motorola official, before they are available.

Meanwhile, in nearby Scottsdale, little Dickson Electronics intends to "have a fling" at making TI's 7400 series, as its president, Donald Dickson, puts it. He says that if his firm gets good enough yields, shipments could begin late this year in the company's first venture into the monolithic IC arena.

Electronics Newsletter

Pentagon weighs use of satellites in limited war

The Pentagon is considering a quasi-tactical application for the long-haul strategic satellite communications system that will eventually replace the Initial Defense Communications Satellite System. **The proposal calls for the use of individual synchronous satellites in the system as regional communications centers in a limited war.** The satellites would connect several ground stations in the theater of operations.

A Defense Communications Agency spokesman, Air Force Lt. Col. Ralph Backes, described a hypothetical regional system, called Seasat, for Southeast Asia satellite, at an American Institute of Aeronautics and Astronautics conference in San Francisco last week.

Tv interests gird for spectrum battle

Watch for broadcasting interests to wage a last-ditch battle to keep land mobile radio users from "encroaching" on frequencies reserved for television. **It's now clear that the FCC will reallocate some uhf frequencies or will order channel sharing.** The tv industry got the message this month when FCC chairman Rosel H. Hyde, in his strongest statement yet on the issue, bluntly told the National Association of Broadcasters, **"It's likely that additional use will have to be made of spectrum space allocated to television."**

Broadcasters are planning to launch independent studies of land mobile. They aim to stress to the FCC, Congress, and the public that the frequencies now assigned land mobile users are not being shared efficiently. They also want to push the FCC to study the possible use of higher frequencies for land mobile communications.

Alaska tries to put messages in orbit

Alaska is trying hard to get satellite communications service. State legislative and communications officials will talk in Washington May 1 with representatives of the FCC, Comsat, the State Department, and the Presidential Task Force on Communications. **Alaska could either build a ground station and tie into the Pacific Intelsat system—which would allow communications to Washington State, Hawaii, and Japan and other Far Eastern points—or tie into the U.S. domestic satellite pilot system expected to be in service by 1970-71.** The domestic system is expected to be sanctioned in the next month or so.

Addenda

Computer manufacturers will lose many lucrative maintenance contracts on Government automatic data processing equipment if the General Accounting Office has its way. GAO, Congress's fiscal watchdog, contends that Government agencies could save money if they used their own computer maintenance personnel. Leaving out many specialized military computers, the GAO calculated that Federal agencies now spend about \$50 million annually for maintenance contracts on computers owned by the Government. . . . While foreign bids are still due on the giant Intelsat 4 communications satellite, one domestic firm has already released information on its bid. Lockheed Missiles and Space has proposed a barrel-shaped satellite 9 feet wide and 16 feet high, weighing 1,075 pounds. . . . **Six unidentified firms have been asked by Lockheed-California to bid on the job of integrating the avionics hardware for its L-1011 airbus. That varies from the usual way of equipping commercial airliners, in which the airframe manufacturer negotiates with customers directly to meet their avionics needs.**

Integrated Circuit

IDEAS

FROM SYLVANIA

**Increase computer speed and reliability...
cut size and costs at same time.**

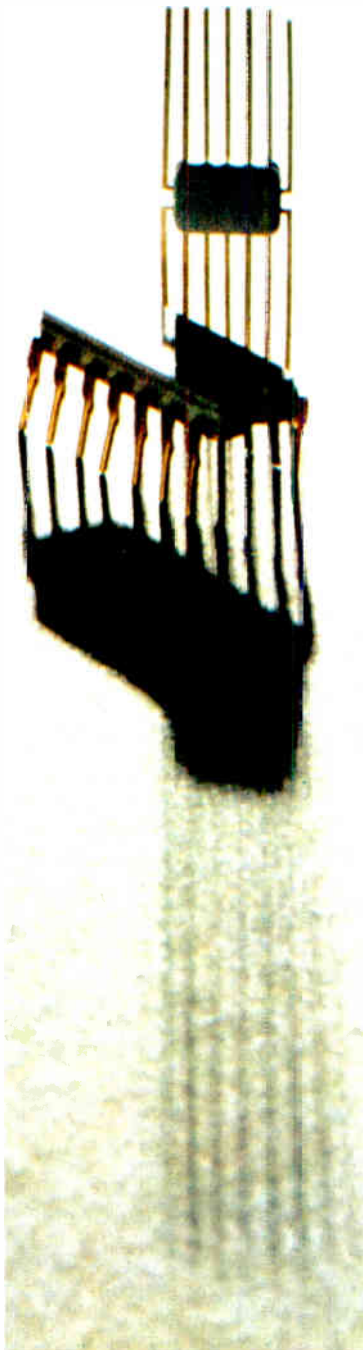
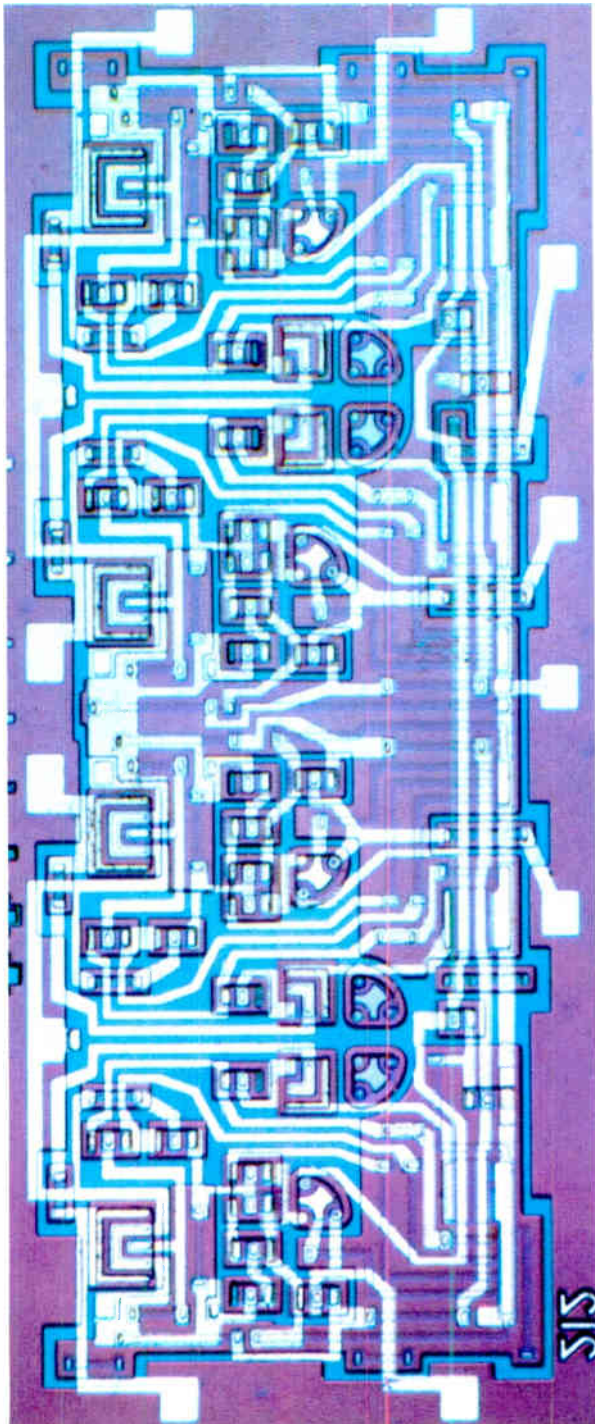

You get all these system improvements when you design around Sylvania monolithic digital functional arrays.

Sylvania monolithic arrays come in the familiar 14-lead package—in-line or flat pack—you know so well with our SUHL™ circuits. Easy to plug into conventional circuit boards.

The big difference is packaging density—more functions per package, less pins per function and higher speed. Monolithic arrays, typical of today's most modern MSI (medium-scale integration) technology, give you in single compact units such as basic computer subsystems as adders, frequency dividers, registers and memories which work at faster speeds, use less power, need fewer connections and cost less than discrete IC subsystems.

Table 1 gives you an idea of the degree to which a computer can be simplified, reduced in size and made more efficient by use of Sylvania arrays.

In addition, our arrays significantly improve total system performance and reliability. Consider some of their advantages.

(Continued on next page)

This issue in capsule

IC Types

SUHL™ I and II, the industry's fastest and most complete TTL line.

IC Packaging

Molded plastic packaging lowers IC costs.

Hybrid Microcircuits

Active trim assures repeatability at low cost.

IC Applications

World's largest aircraft uses some of world's smallest IC systems.

Manager's Corner

LSI is on its way, but MSI is here today.

TABLE 1. MONOLITHIC DIGITAL FUNCTIONAL ARRAYS VS. CONVENTIONAL ICs

Typical Computer Subsystems	Sylvania Monolithic Digital Functional Arrays				Conventional Integrated Circuits			
	Number of Packages	Number of Equivalent Discrete Components	Speed (nsec)	Power (Milliwatts)	Number of External Connect'ns	Equivalent Number of IC Gates	Power (A) (Milliwatts)	(B) No. of External Connect'n
Basic Single Stage Fast Adder With Anticipated Carry	1	73	14	120	14	18	180	64
Four Bit Anticipated Carry Adder	4	292	35	480	56	72	720	252
Four Bit Ripple Carry Adder	4	264	60	400	32	36	540	132
Eight Bit Anticipated Carry Adder	12	704	45	1040	168	172	1460	602
Eight Bit Ripple Carry Adder	8	528	120	800	112	72	1080	252
Decade Frequency Divider	1	116	DC to 30 MHz	150	6	40(C)	600(C)	140(C)
Four Bit Register (Bus Transfer Output)	1	87	15	120	12	25	350	89
Four Bit Register (Cascade Pullup Output)	1	94	15	120	11	25	350	89

(A) Based on Average of 15 mw per NAND/NOR and Average of 5mw per AND-NOR Expansion.

(B) Based on Average of 4 Gates per 14-Lead Package.

(C) Using 4 Sylvania JKs and a Pulse Shaping Gate, the Package Count would be 5 and Interconnections 37. Average Power Drain would be 190 mw.

FUNCTIONAL ARRAYS, TYPICAL CHARACTERISTICS (+25°C, +5.0 Volts)

Function	Type Nos.	t_{pd} (nsec)	Avg. Power (mw)	Noise Immunity + (volts)-	**Military (-55°C to +125°C) Prime FO	**Industrial (0°C to +75°C) Prime FO	Std. FO	Std. FO
Full Adder	SM-10, SM-11, SM-12, SM-13	sum 22 carry 10	90	1.0	1.0	20	10	20
Dependent Carry Fast Adder	SM-20, SM-21, SM-22, SM-23	sum 22 carry 10	125	1.0	1.0	20	10	20
Independent Carry Fast Adder	SM-30, SM-31, SM-32, SM-33	sum 22 carry 10	125	1.0	1.0	20	10	20
Carry Decoder	SM-40, SM-41, SM-42, SM-43	2	25	1.0	1.0			
Decade Frequency Divider	SM-50, SM-52	30 MHz	120	1.0	1.0	15		15
Four Bit Storage Register Bus Transfer Output	SM-60, SM-61, SM-62, SM-63	20	30/bit	1.0	1.0	20	10	20
Four Bit Storage Register Cascade Pullup Output	SM-70, SM-71, SM-72, SM-73	20	30/bit	1.0	1.0	20	10	20
16-Bit Scratch Pad Memory	SM-80, SM-81, SM-82, SM-83	25	250	1.0	1.0	40	20	40

*Minimum toggle frequency **Minimum fan-out

Integrated circuit structure for 8-stage fast adder.

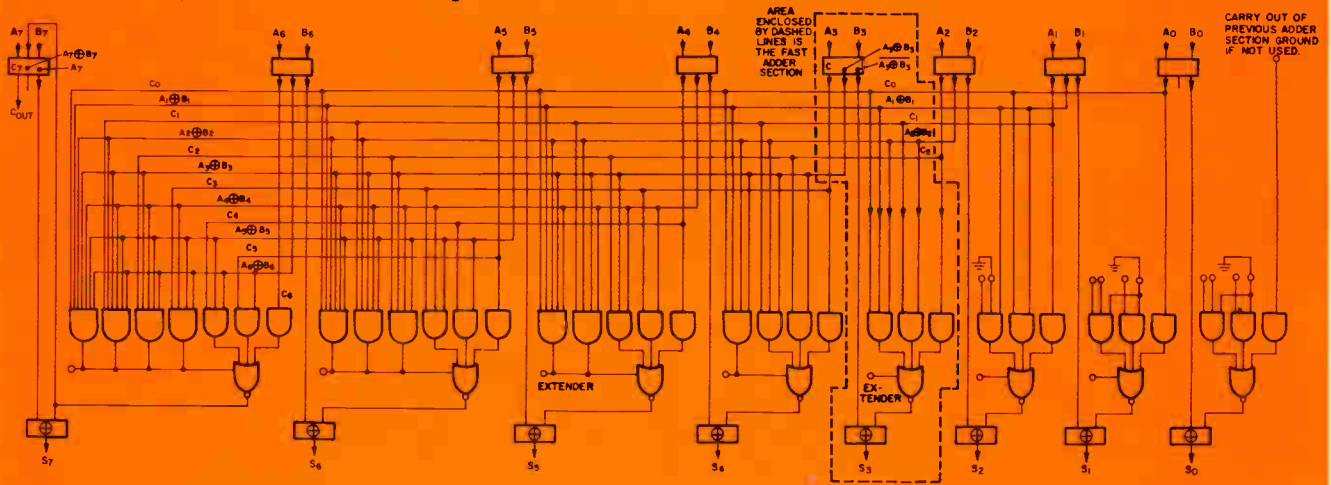

8-stage anticipated carry fast adder made from SM-20, SM-30 and SM-40 monolithic digital functional arrays.

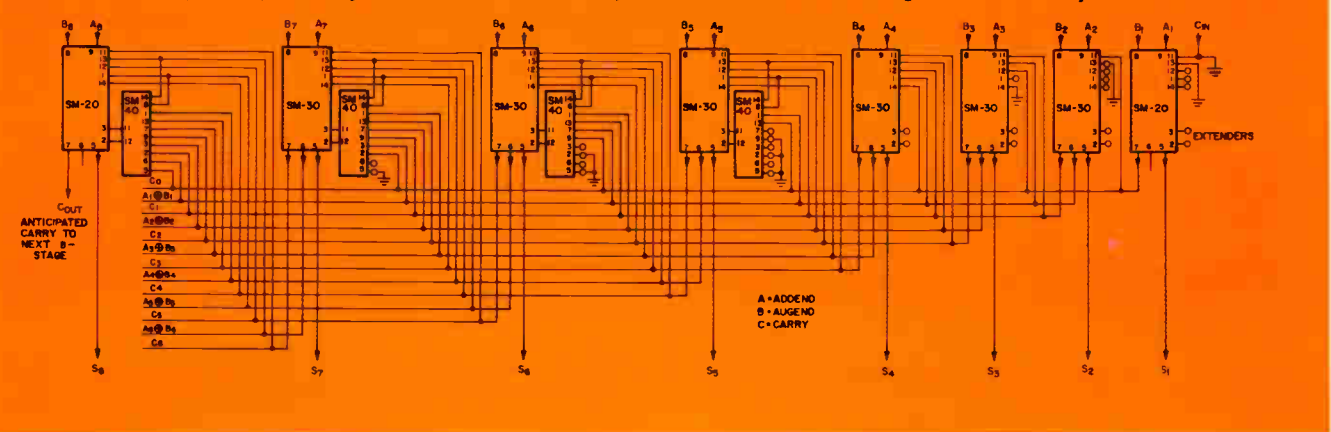

This

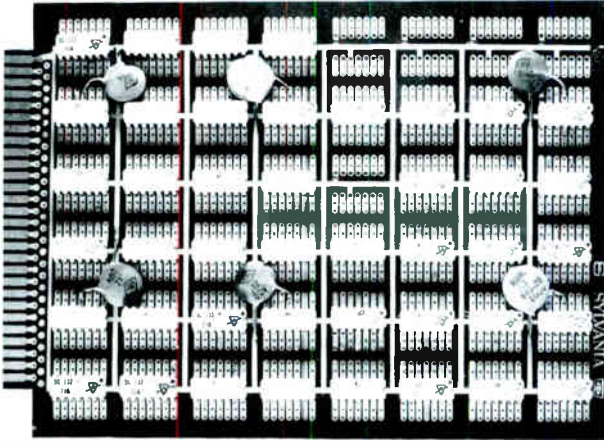

plus this

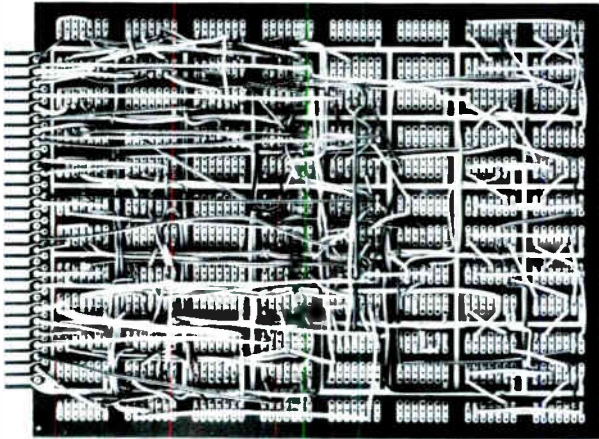

equals this

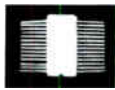

Complex Sylvania monolithic array (below, in 28-lead package) performs all the functions of the double-sided discrete-component IC circuit board, above. Available soon, it will be much more economical to produce in volume.

An array system puts more of its essential connections inside the basic 14-lead package. So there's less external wiring, and therefore a lower assembly cost, as the diagram (above) indicates.

Arrays provide more equivalent gating functions per pin: about 2 gates per pin typical in our SM-60 four-bit storage register.

Because signal paths are shorter, arrays reduce propagation-delay time and give better control of t_{pd} paths.

An array design, as opposed to a discrete-IC-board unit, has less backwiring. Shorter current paths reduce cross-talk, external noise pickup, self-induced ($L \frac{di}{dt}$) noise as well as power-supply-decoupling requirements. And metallization assures better "dress" between individual components, and thus better control of inter-component-connection electrical characteristics.

Sylvania now has, or is developing, arrays for every stage of a computer:

Arithmetic	Control	Memory	Input/Output
Adders: SM-10, -20, -30, -40	BCD* counter	16-bit scratch-pad memory, SM-80	BCD* to 7-line translator
4-bit universal shift register*	Binary counter	4-bit storage register, SM-60, -70	

*Presently in engineering development stage.

Our monolithic digital functional arrays—their numbers and functions—are shown on page 2 opposite. Tear it out and save it for reference.

CIRCLE NUMBER 300

Now SUHL™ ICs in molded plastic packages give you reliability plus economy.

More SUHL integrated circuits for the dollar, along with other advantages for you in performance and reliability. That's the big reason to consider these TTL's now in a new modern molded plastic package.

Our SUHL circuits are still available in ceramic flat packs and dual in-line plug-in packages. But now SUHL is available in molded plastic packages with glassivated wires and chips, providing an inert interface between the plastic and the active device... a Sylvania extra. In this package, our SUHL circuits meet the needs of design engineers more economically than ever before.

SUHL types in this newest package include the AND-NOR, NAND/NOR and J-K flip-flop families. All are temperature rated for operation over the 0-75°C range. The glass-coated chips are moisture-proof and are fully protected from contamination by foreign matter. Heat dissipation capability is equivalent to that of a ceramic flat-pack.

With the new molded plastic package, tinned rectangular leads are spaced 100 mils apart and are canted to facilitate automatic machine insertion in circuit boards.

Leads are attached to chips using aluminum-to-aluminum ultrasonic bonding methods. Because there is no trimetal interface (silicon can represent the extra metal), there is no possibility of self-generated bond failure due to "purple plague".

And where cost economy is important, these units offer dependable SUHL circuitry at the lowest prices ever. Sylvania passes along to the user the savings accrued through more efficient assembly processes. So you get our familiar high-quality SUHL circuits in an efficient package at the right price.

CIRCLE NUMBER 301

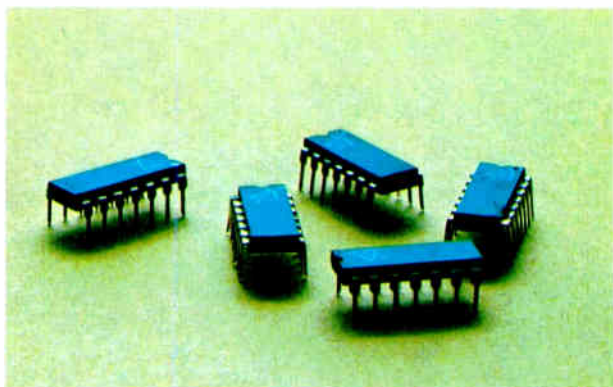
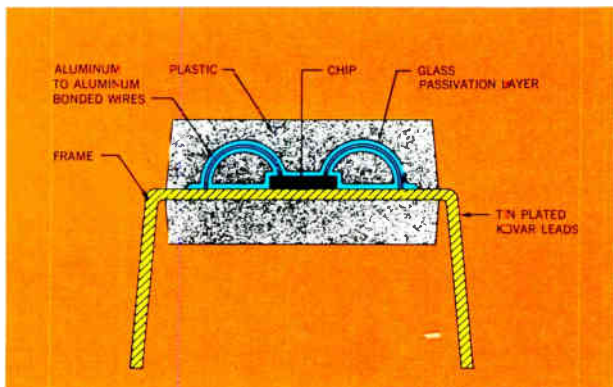

SUHL™ I and II IC's—the runaway favorites in TTL— now offer some 160 different types.

SUHL I TYPICAL CHARACTERISTICS (+25°C, +5.0 Volts)									
Function	Type Nos.	t_{pd} (nsec)	Avg. Power (mw)	Noise Immunity +(volts)-	**Military (-55°C to +125°C) Prime FO Std. FO		**Industrial (0°C to +75°C) Prime FO Std. FO		
NAND/NOR Gates									
Dual 4-Input NAND/NOR Gate	SG-40, SG-41, SG-42, SG-43	10	15	1.1	1.5	15	7	12	6
Single 8-Input NAND/NOR Gate	SG-60, SG-61, SG-62, SG-63	12	15	1.1	1.5	15	7	12	6
Expandable Single 8-Input NAND/NOR Gate	SG-120, SG-121, SG-122, SG-123	18	15	1.1	1.5	15	7	12	6
Dual 4-Input Line Driver	SG-130, SG-131, SG-132, SG-133	25	30	1.1	1.5	30	15	24	12
Quad 2-Input NAND/NOR Gate	SG-140, SG-141, SG-142, SG-143	10	15	1.1	1.5	15	7	12	6
Triple 2-Input Bus Driver	SG-160, SG-161, SG-162, SG-163	15	15	1.1	1.5	15	7	12	6
Triple 3-Input NAND/NOR Gate	SG-190, SG-191, SG-192, SG-193	10	15	1.1	1.5	15	7	12	6
AND-NOR Gates									
Expandable Quad 3-Input OR Gate	SG-50, SG-51, SG-52, SG-53	12	30	1.1	1.5	15	7	12	6
Expandable Dual Output Dual 2-Input OR Gate	SG-70, SG-71, SG-72, SG-73	12	20/gate	1.1	1.5	15	7	12	6
Exclusive-OR with Complement	SG-90, SG-91, SG-92, SG-93	11	35	1.1	1.5	15	7	12	6
Expandable Triple 3-Input OR Gate	SG-100, SG-101, SG-102, SG-103	12	25	1.1	1.5	15	7	12	6
Expandable Dual 4-Input OR Gate	SG-110, SG-111, SG-112, SG-113	12	20	1.1	1.5	15	7	12	6
Non-Inverting Gates									
Dual Pulse Shaper/Delay-AND Gate	SG-80, SG-81, SG-82, SG-83	11	30/gate	1.1	1.5	15	7	12	6
Dual 4-Input AND/OR Gate	SG-280, SG-281, SG-282, SG-283	11	38/gate	1.0	1.5	10	5	8	4
AND Expanders									
Dual 4-Input AND Expander	SG-180, SG-181, SG-182, SG-183	< 1	0.9/gate	1.1	1.5				
Dual 2 + 3 Input AND/OR Expander	SG-290, SG-291, SG-292, SG-293	7	15/gate	1.0	1.5				
OR Expanders									
Quad 2-Input OR Expander	SG-150, SG-151, SG-152, SG-153	4	20	1.1	1.5				
Dual 4-Input OR Expander	SG-170, SG-171, SG-172, SG-173	3	5	1.1	1.5				
Flip-Flops									
Set-Reset Flip-Flop	SF-10, SF-11, SF-12, SF-13	20MHz*	30	1.1	1.5	15	7	12	6
Two Phase SR Clocked Flip-Flop	SF-20, SF-21, SF-22, SF-23	20MHz*	30	1.1	1.5	15	7	12	6
Single Phase SRT Flip-Flop	SF-30, SF-31, SF-32, SF-33	15MHz*	30	1.1	1.5	15	7	12	6
J-K Flip-Flop (AND Inputs)	SF-50, SF-51, SF-52, SF-53	20MHz*	50	1.1	1.5	15	7	12	6
J-K Flip-Flop (OR Inputs)	SF-60, SF-61, SF-62, SF-63	20MHz*	55	1.1	1.5	15	7	12	6
Dual 35MHz J-K Flip-Flop (Separate Clock)	SF-100, SF-101, SF-102, SF-103	35MHz*	55/FF	1.0	1.5	11	6	9	5
Dual 35MHz J-K Flip-Flop (Common Clock)	SF-110, SF-111, SF-112, SF-113	35MHz*	55/FF	1.0	1.5	11	6	9	5
SUHL II TYPICAL CHARACTERISTICS (+25°C, +5.0 Volts)									
NAND/NOR Gates									
Expandable Single 8-Input NAND/NOR Gate	SG-200, SG-201, SG-202, SG-203	8	22	1.0	1.5	11	6	9	5
Quad 2-Input NAND/NOR Gate	SG-220, SG-221, SG-222, SG-223	6	22	1.0	1.5	11	6	9	5
Dual 4-Input NAND/NOR Gate	SG-240, SG-241, SG-242, SG-243	6	22	1.0	1.5	11	6	9	5
Single 8-Input NAND/NOR Gate	SG-260, SG-261, SG-262, SG-263	8	22	1.0	1.5	11	6	9	5
AND-NOR Gates									
Expandable Dual 4-Input OR Gate	SG-210, SG-211, SG-212, SG-213	7	30	1.0	1.5	11	6	9	5
Expandable Quad 3-Input OR Gate	SG-250, SG-251, SG-252, SG-253	7.5	43	1.0	1.5	11	6	9	5
Expandable Triple 3-Input OR Gate	SG-300, SG-301, SG-302, SG-303	7	36	1.0	1.5	11	6	9	5
Expandable Dual Output Dual 3-Input OR Gate	SG-310, SG-311, SG-312, SG-313	7	30/gate	1.0	1.5	11	6	9	5
AND Expanders									
Dual 4-Input AND Expander	SG-180, SG-181, SG-182, SG-183	< 1	0.9/gate	1.1	1.5				
OR Expanders									
Quad 2-Input OR Expander	SG-230, SG-231, SG-232, SG-233	2	28	1.0					
Dual 4-Input OR Expander	SG-270, SG-271, SG-272, SG-273	2	6.7	1.0	1.5				
Flip-Flops									
Dual 50 MHz J-K Flip-Flop (Separate Clock)	SF-120, SF-121, SF-122, SF-123	50MHz*	55/FF	1.0	1.5	11	6	9	5
Dual 50MHz J-K Flip-Flop (Common Clock)	SF-130, SF-131, SF-132, SF-133	50MHz*	55/FF	1.0	1.5	11	6	9	5
50MHz J-K Flip-Flop (AND Inputs)	SF-200, SF-201, SF-202, SF-203	50MHz*	55	1.0	1.5	11	6	9	5
50MHz J-K Flip-Flop (OR Inputs)	SF-210, SF-211, SF-212, SF-213	50MHz*	55	1.0	1.5	11	6	9	5

MONOLITHIC LINEAR AMPLIFIERS TYPICAL CHARACTERISTICS (+25°C)									
Function	Type Nos.	Supply Voltages	Power Dissipation (mW)	Input Impedance	Output Impedance	Output Signal Swing Vp-p	-3db Freq. MHz	Voltage Gain (db)	Temperature Range
Wide Band Video Amplifier	SA-20, SA-21	+24V	450	1.6K	1.5	13.0	100	21	-55°C to +125°C
High Gain Operational Amplifier	SA-40, SA-41 SA-42, SA-43	+12 to +6 and -6 to -3	80/40	25K	125	10.0	1.2	69	-55°C to +125°C 0°C to +75°C
Amplifier/Limiter/Discriminator	SA-500, SA-501	+10 to +5.5	125	2.5K	15K	2.8	6	75	-55°C to +125°C

Our Sylvania SUHL I and II lines offer you more different types of TTLs to do more different jobs—faster and better—than any comparable TTL line in the industry. For your convenience, the list (left) is color-coded to the IC diagrams on this page. Tear it out and save it for reference.

Applications engineers estimate that 80% of new computer designs call for TTL. And our SUHL line—Sylvania Universal High-level Logic—is the industry's acknowledged leader in TTL, the line that other manufacturers admit to copying.

Speed is the most important advantage, of course. Our SUHL II flip-flops, for example, provide up to 50 MHz switching speed, as little as 6 nsec propagation delay time (t_{pd}) while retaining extremely high noise immunity.

Shown here is a full list of SUHL I and II TTL logic elements available to you, all color-coded to the appropriate diagrams. (The chart at bottom, listing linear amplifiers, is not color coded.) Our monolithic digital functional arrays are listed on page 2 with an article on the subject.

SUHL circuits are still the fastest TTL's; in addition to maintaining good switching speeds, they keep waveform integrity under varying loads and fluctuating temperatures.

Every Sylvania TTL element is fully and automatically tested on our specially designed Multiple Rapid Automatic Test Of Monolithic Integrated Circuits (MR. ATOMIC) equipment to assure that you get the performance you pay for every time. All units, except as noted, are available in 14-lead flat-pack style or dual in-line packages.

CIRCLE NUMBER 302

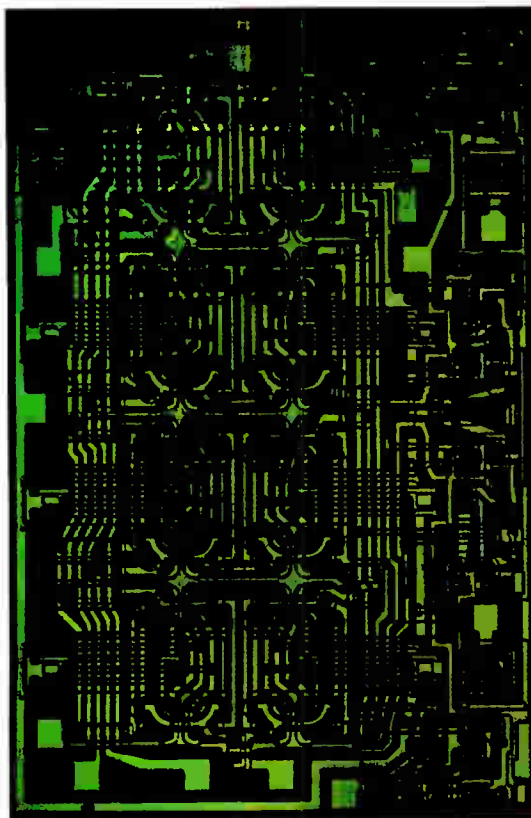

SM-80, 16-bit scratch-pad memory.

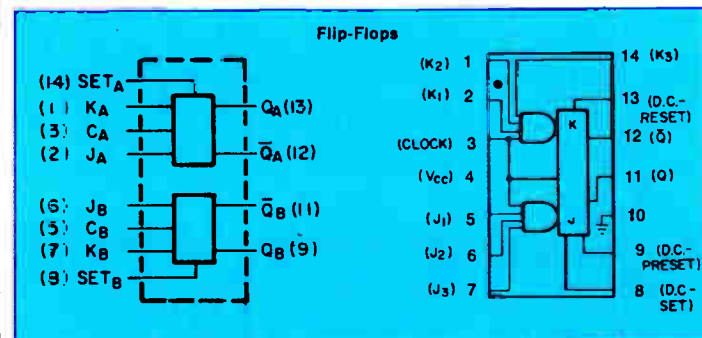
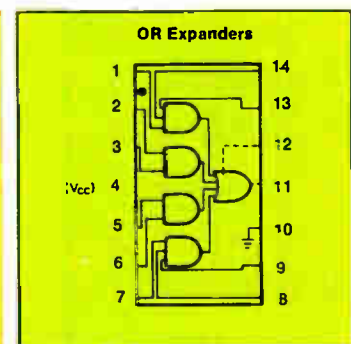
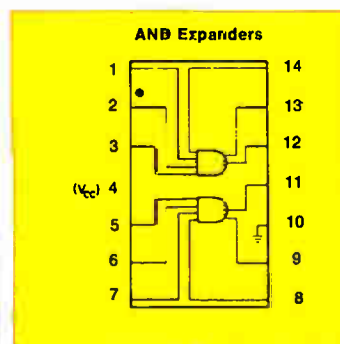
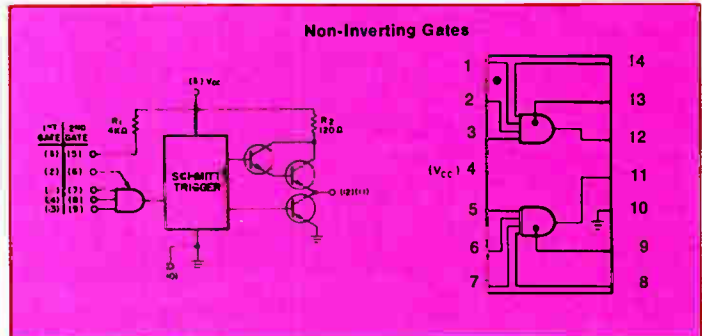
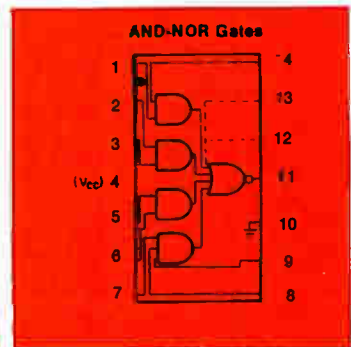
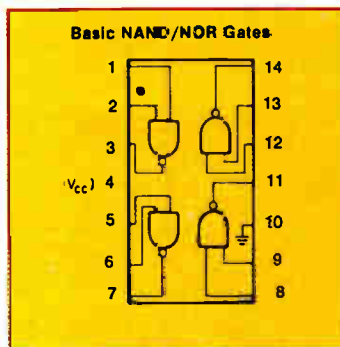
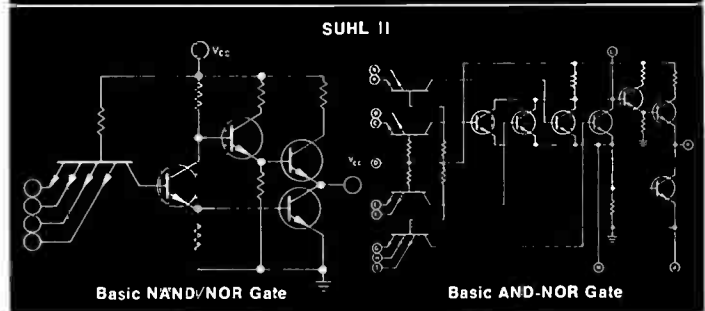
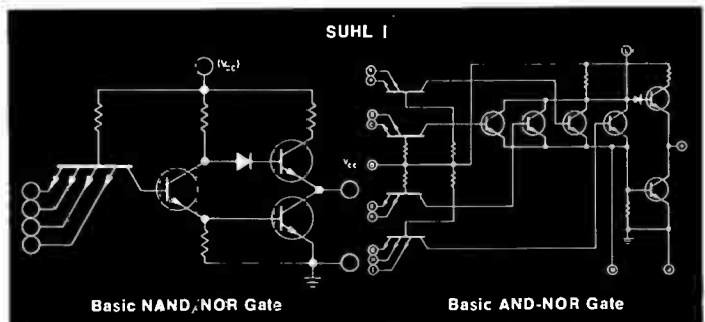

Custom microcircuits: repeatability at low cost through active trim.

Now, through active trim of hybrid microcircuits, Sylvania can meet exact requirements for repeatability of quiescent DC level balance.

Until recently, electronic circuit designers would first select circuit topology and then, to fulfill their specific requirements, would compute active and passive device values. With that approach, circuit performances could fall within a wide range of values, sometimes resulting in poor production yield.

To improve yield, previous options open to the design engineer were either to select tightly toleranced components or to specify adjustable elements to bring circuit performance within acceptable limits. These choices often lead either to relatively higher cost or to larger package size.

But now, with the conventional microcircuit, Sylvania individually trims passive components to final value through the use of a null-detecting bridge. Passive component trimming can achieve the desired circuit performance characteristics.

Final adjustment is effected after active components have been attached and after the circuit has been energized. During this final trim, the rate and amount of abrasion is controlled by monitoring the circuit characteristic of interest. This trim allows the circuit designer to work with broader tolerance of individual circuit elements. Such a technique can be cost-effective since in-process yields are substantially increased as individual component tolerances are relaxed.

As one example of an active trim application, let's take a photocell signal amplifier. It is used in a char-

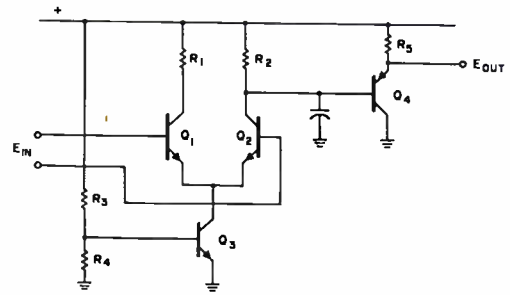

Figure 2—Equivalent circuit diagram of photocell signal amplifier.

acter recognition system where the quiescent DC level from a matrix of cells has to be balanced. A requirement is that the output of each amplifier must be held at a fixed DC value from unit to unit. The actual circuit is shown in Figure 1. Figure 2 is an equivalent schematic.

The output voltage level is established by the output of a differential amplifier. The emitters of the differential transistor pair (Q1 and Q2) are connected to a transistor current source (Q3). The level of current is fixed by the values of resistors R3 and R4 to set a bias for Q3.

After all required adjustments have been made, this circuit is energized and R4 is adjusted to a predetermined value of output voltage. Since in the thick film technology screened resistors are fired to value below the desired nominal, R4 may be increased in value by using air-abrasive trim techniques to effect a geometry change. As the value of R4 is increased, the operating point of Q3 is changed causing the increase in collector current. As the voltage drop in R2 changes, DC level at the output of the emitter follower approaches the required level.

This represents just one example of how Sylvania meets the need for inexpensive hybrid microelectronic circuits tailored to your operational requirements.

CIRCLE NUMBER 303

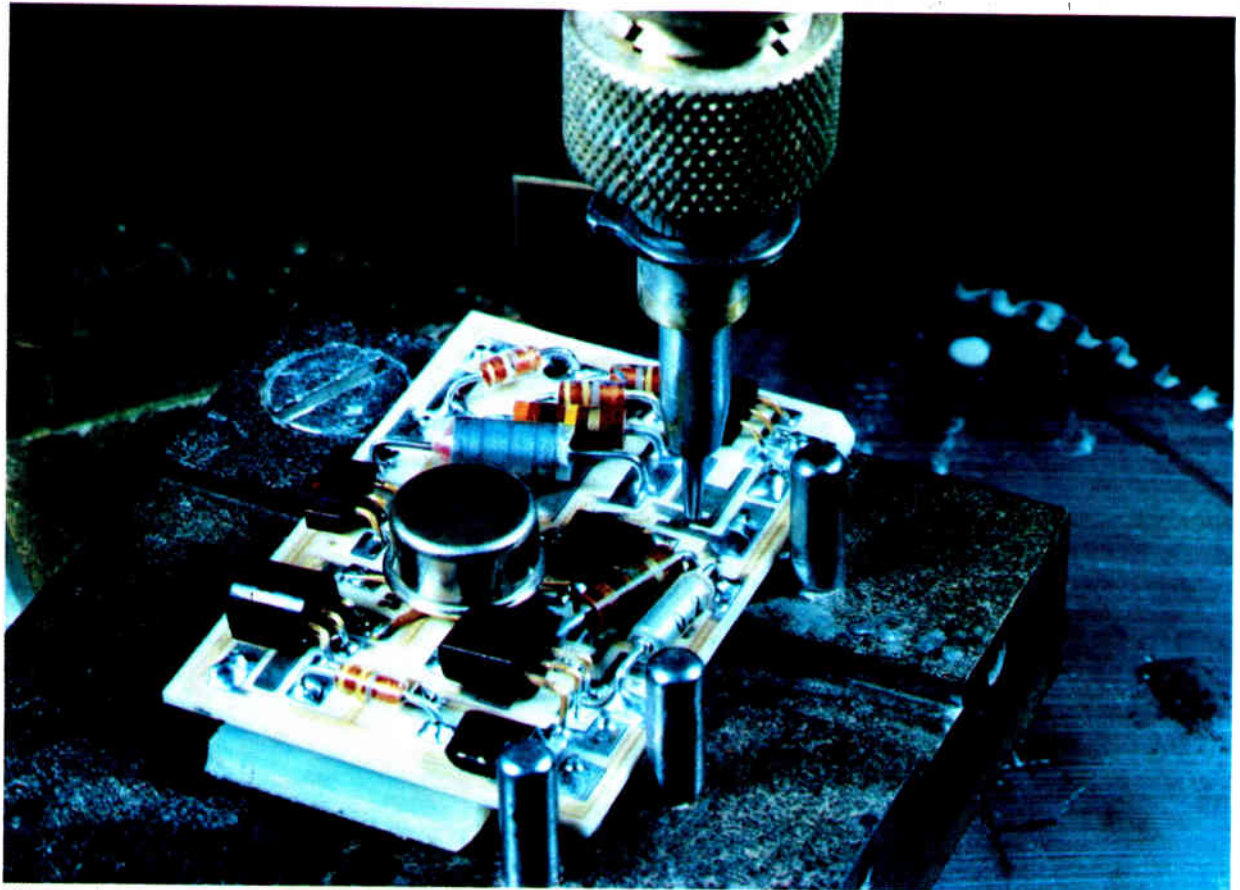

Figure 1—Air-abrasive trim techniques are used to precisely adjust circuit operating characteristics.

Largest aircraft will rely on some of world's smallest, fastest ICs: Sylvania SUHL™ II.

World's largest aircraft, U.S. Air Force C-5A Galaxy built by Lockheed-Georgia Company of Marietta, Ga., employs Sylvania SUHL II high-speed IC logic elements in its self-checking Malfunction Detection, Analysis and Recording (MADAR) subsystem, its station-keeping equipment (SKE) radar subsystem and its landing gear proximity switch control units.

The Lockheed C-5A Galaxy will not only be the world's largest aircraft. It will also be one of the world's most self-sufficient.

Through its Malfunction Detection, Analysis and Recording (MADAR) subsystem, the aircraft continuously monitors over 600 critical test points during take-off, flight and landing. If a defect occurs, the defective subsystem's number lights up on the flight engineer's instrument panel. Then for a diagnostic check, the flight engineer calls for a live waveform and views it adjacent to comparative ideal waveforms projected on a screen from a random-access memory bank, and takes corrective measures. And as he makes manual diagnoses and corrections, MADAR continues monitoring other test points automatically.

The MADAR subsystem is designed around Sylvania SUHL II ultra-high-speed integrated circuits. Our SUHL II ICs also accomplish essential logic functions in the synchronizer unit of the aircraft's station-keeping equipment (SKE) and in the landing gear proximity switch control system. The SKE system is a low-frequency (doppler) radar which automatically maintains the correct relative flight position of every aircraft in a fleet. The landing-gear proximity switch senses the position of the landing gear and landing-gear housing doors, controls their sequence of operation and informs the crew of any malfunction.

The MADAR control and sequencer uses about 450 SUHL II ICs; the SKE synchronizer has some 378.

How important are they? Says Lockheed:

"By using integrated circuits and . . . thick-film hybrid circuits, the size and weight of these systems has been greatly reduced while reliability increased. Development of either system without integrated circuits would have been impractical; the complexity of

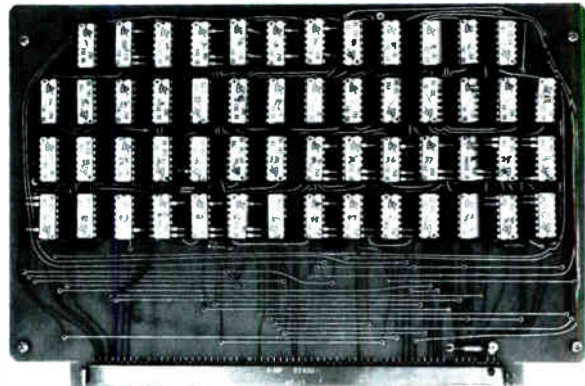

One of ten printed IC mounting boards used in Galaxy's station-keeping equipment (SKE) synchronizer.



Artist's conception of C-5A in flight. Aircraft is designed to carry 100,000 pounds of payload for 6300 miles, and up to 265,000 pounds for shorter distances. It will be 82 yards long with a wingspan of 74 yards.

discrete component designs, to accomplish the required logic functions, would have resulted in units too large and heavy and too unreliable to use on aircraft."

What more can we say?

CIRCLE NUMBER 304



Use Sylvania's "Hot Line" inquiry service, especially if you require full particulars on any item in a hurry. It's easy and it's free. Circle the reader service number(s) you're most interested in; then fill in your name, title, company and address. We'll do the rest and see you get further information by return mail.

BUSINESS REPLY MAIL

No Postage Stamp Necessary if Mailed in the United States

FIRST CLASS
Permit No. 2833
Buffalo, N.Y.

POSTAGE WILL BE PAID BY

Sylvania Electric Products Inc.
Sylvania Electronic Components
1100 Main Street
Buffalo, New York 14209

Dept. C4 4

**LSI...around the corner.
But MSI is here now.**

We've all heard tales of the girl who rejects the nice boy next door while she waits for Prince Charming . . . and winds up an old maid.

Right now in the computer business, medium-scale integration (MSI)—in the form of monolithic digital functional arrays—is in the position of the nice boy next door, while LSI is Prince Charming.

MSI devices are something *we make and you can use*—today, without redesign of your present circuit configurations. LSI is still in the future both as to volume manufacture and practical application.

There's an unfortunate tendency in this industry to "announce" something when it's on the drawing board, and to say it's "in stock" when a prototype has been produced. (By that definition, Sylvania could claim we have LSI devices "in stock", because we have produced and are testing prototypes with over 100 functions on a chip.) But we don't believe in that; when we say we have something "in stock", we mean we have a device that works and that we can deliver in quantity within a matter of days.

And we *do* have MSI devices in stock. Such devices will be the basis of practical computer designs for the next five years or so. Any computer manufacturer who passes up MSI to wait for LSI is likely to find himself in the situation of the girl waiting for Prince Charming. Left out.

Our MSI monolithic arrays, available in the familiar TO-85 14-lead flat pack or 14-lead dual-in-line plug-in package, provide in general from 20 to 50 gating functions on a single chip with a single layer of metallization. These devices are fully compatible with existing monolithic logic; they interface with present-day systems without major redesign effort on your part.

Larger-scale integration—which we're working on—refers to a functional device with more than 100 functions, created by multiple-layer interconnections using metallized fixed connective patterns. This will bring

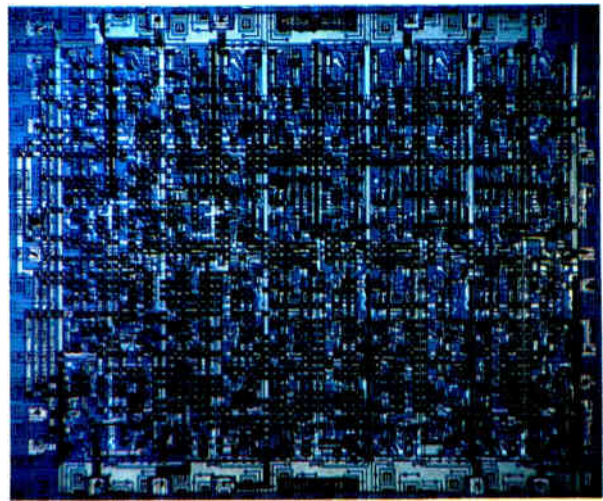

Sylvania LSI chip: over 1200 components, 100 logic functions.

about a technique in which—on a 500-gate 2-inch wafer—by selection and rejection only functioning gates are wired. This could yield 400 or more functions in a single package . . . the beginning of the "computer-on-a-wafer" concept.

But such devices—to produce in volume and to be used practically—will require much more sophistication on the part of both manufacturer and user than the present state of the art permits. To produce them will require the ability to create an extremely high yield of usable functions on a wafer, excellent control of multiple-layer interconnection techniques and very complex testing and packaging procedures. Equipment and process requirements will be elaborate and costly.

More significantly, the engineering required by the computer designer, builder and user must be advanced to a far higher level than present technologies demand. Builders must understand the importance of these differences before committing themselves to an approach.

So . . . LSI is coming. But meanwhile, MSI in the form of functional arrays is the practical solution to *today's* computer design problems.

Harry Luhrs

H. M. Luhrs
Product Marketing Manager
Integrated Circuits

This information in Sylvania Ideas is furnished without assuming any obligations.

SYLVANIA
A SUBSIDIARY OF
GENERAL TELEPHONE & ELECTRONICS

NEW CAPABILITIES IN: ELECTRONIC TUBES • SEMICONDUCTORS • MICROWAVE DEVICES • SPECIAL COMPONENTS • DISPLAY DEVICES

C4

NAME _____
PLEASE PRINT

TITLE _____

COMPANY _____

ADDRESS _____

CITY _____ STATE _____ ZIP _____

Circle Numbers Corresponding to Product Item

- 300
- 301
- 302
- 303
- 304

Please have a Sales Engineer call



HOT LINE INQUIRY SERVICE

Need information in a hurry? Clip the card and mail it. Be sure to fill in all information requested. We'll rush you full particulars on any item indicated.

You can also get information using the publication's card elsewhere in this issue. Use of the card shown here will simplify handling and save time.



I'm tough

And 15,000 hours says I'm tough

Clifton's long life synchros have exceeded 15,000 hours of continuous testing and remained within specification. Clifton will guarantee a minimum of 5,000 hours for almost any application and, depending upon the end use, may guarantee them much longer.

These synchros retain all the high accuracy or torque of standard Clifton synchros. In fact, you can order them right out of the Clifton catalog without forfeiting a single catalog parameter except friction which is raised slightly. NO PENALTY in phase shift, impedance

angle, torque or input power and only a slight increase in cost over standard synchros. Compare these features with other long life synchros on the market today.

For further information call your local Clifton Sales Office or 215 622-1000 or write 5050 State Road, Drexel Hill, Pa. 19026.

CLIFTON 
DIVISION OF LITTON INDUSTRIES

When the name of the game is



Type MMC, 1/20 watt, RNR50

Type CCM, 1/10 watt, RNR55

No one matches the performance superiority of IRC metal film resistors, or their capability and flexibility to meet a variety of reliability requirements.

Take these four sizes, for example. They meet or exceed all of the performance and environmental requirements of both MIL-R-10509 and MIL-R-55182. Standard tolerances are as tight as $\pm 0.10\%$ ($\pm 0.05\%$ on specials) and temperature coefficients are as close as $\pm 25\text{ppm}/^\circ\text{C}$.

When the best military grade resistor isn't good enough, and the screening route to increase survival probability has been decided upon, IRC has the capability, the facilities and the experience to deliver resistors screened to any meaningful specification. The best can be made better.

If the best must be better yet, IRC, under its Program for Assured Reliability, can also supply

SCREENING

IRC is in a league by itself



Type CCA, 1/8 watt, RNR60



Type CCB, 1/4 watt, RNR65

these four units to meet your choice of three maximum failure rates—0.1%, 0.01% and 0.001%. Failure rate levels depend on the degree of screening, process control, acceptance and life tests required.

When your design requires reliability—be it screening, control, data, or documentation (or any combination)—look to IRC to supply metal film resistors matched to your cost and performance needs.

NEW APPLICATIONS HANDBOOK. Ask for a copy of "An Analysis of Screening." This informative handbook explains all the techniques employed by IRC to achieve varying degrees of resistor reliability.



For samples, prices, and data on any IRC metal film resistors, write: IRC, Inc., 401 North Broad Street, Philadelphia, Pa. 19108.



DIVISION OF TRW INC.

New connectors. New standardization.

JT concepts have really branched out at Bendix.

Now—to the thousands of JT users who like the advantages of rear-release crimp contacts—Bendix offers the opportunity to standardize. It'll ease operation, installation and maintenance problems in the field. Cut back on spares and application tools. And you'll enjoy the inherent benefits of size and weight savings, reliability and extended connector life. You liked rear-release crimp contacts so well, we're putting them in all kinds of connectors in all kinds of shapes. Rectangular connectors, cylin-

dricial connectors, printed circuit connectors, rack and panel connectors. All with solder or filter contact options. A full variety of shell sizes and types. Many insert patterns with 12-, 16-, 20-, 22- and 22M contacts. Double-density models with up to 128 contacts. Plus some entirely new designs coming your way soon. If you haven't tried them by now, you should. They'll grow on you. Write Electrical Components Division, The Bendix Corporation, Sidney, New York 13838.

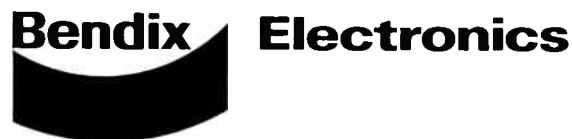





MEET THE DECISION MAKERS...

Four CVC High Vacuum Systems with AutoMate™ Control!

Just touch the start button, AutoMate does the rest. The AutoMate Control on your CVC system controls pumping cycles automatically—as fast and accurate as your best technician. The cycling decision is

made and carried out in response to pressure in the system—you get the same results in your pumpdown every time. For full details, write Consolidated Vacuum Corporation, Rochester, New York 14603.

	CV-144	CV-164	CV-18	CV-1104
APPLICATIONS	Electronic and Optical Thin-Film Deposition, Environmental Studies	Electronic and Optical Thin-Film Deposition, Environmental Studies	Electronic and Optical Thin-Film Deposition, Environmental Studies	Electronic and Optical Thin-Film Deposition, Environmental Studies
CHAMBER	14" Pyrex Bell Jar	18" Pyrex Bell Jar	18" Pyrex Bell Jar	24" or 30" Stainless Steel Bell Jar
DIFFUSION PUMP	4" BlueLine	6" BlueLine	6" BlueLine	10" BlueLine
BAFFLE	Choice of multi-coolant or liquid nitrogen	Choice of multi-coolant or liquid nitrogen	Choice of multi-coolant or liquid nitrogen	Choice of multi-coolant or liquid nitrogen
EVAPORATION POWER SUPPLY RATING (Continuous Duty/20% duty)	2 KVA/3.9 KVA	2 KVA/3.9 KVA	2 KVA/3.5 KVA	4 KVA/8 KVA

New CV-1104 System With AutoMate™ Control



CVC

A BELL & HOWELL COMPANY



See us at NEPCON East, Booth 324 June 4-6, The Coliseum



save
installation time!
save panel space!

with Allen-Bradley terminal blocks
factory assembled in 6-foot lengths

Yes, Allen-Bradley factory assembles 6-foot sections of Bulletin 1492 terminal blocks for your convenience. You save on installation time because you don't perform the time-consuming block-by-block assembly. Merely count the required number of mounted terminals, slide them beyond the end of the solid wooden backing strip, and snap off as shown. The notched metal mounting channel breaks cleanly—no sawing or filing.

Further, these sturdy white nylon terminal blocks are real space savers. A wide variety of terminals is available to handle wire up to size 1/0. Fuse blocks and switches are also available. For 600-volt jobs Style C blocks are supplied, while even more compact Style F blocks are used for 300-volt applications. Both Styles C and F mount on identical channels. By the way, individual blocks can be removed easily without disturbing adjacent blocks so assemblies can be modified quickly to meet the changing job needs.

Your local Allen-Bradley appointed distributor has these 6-foot lengths of terminal blocks in his stock. Please contact him so that he can show you their many features. Or write to Henry G. Rosenkranz, Allen-Bradley Co., 110 W. Greenfield Ave., Milwaukee, Wisconsin 53204 and ask for Publication 6109. In Canada: Allen-Bradley Canada Ltd. Export Office: 630 Third Ave., New York, N. Y., U.S.A. 10017.

1067M-8



ALLEN-BRADLEY
QUALITY MOTOR CONTROL

Circle 41 on reader service card

Meet the MICRO SWITCH Quality Assurance Department

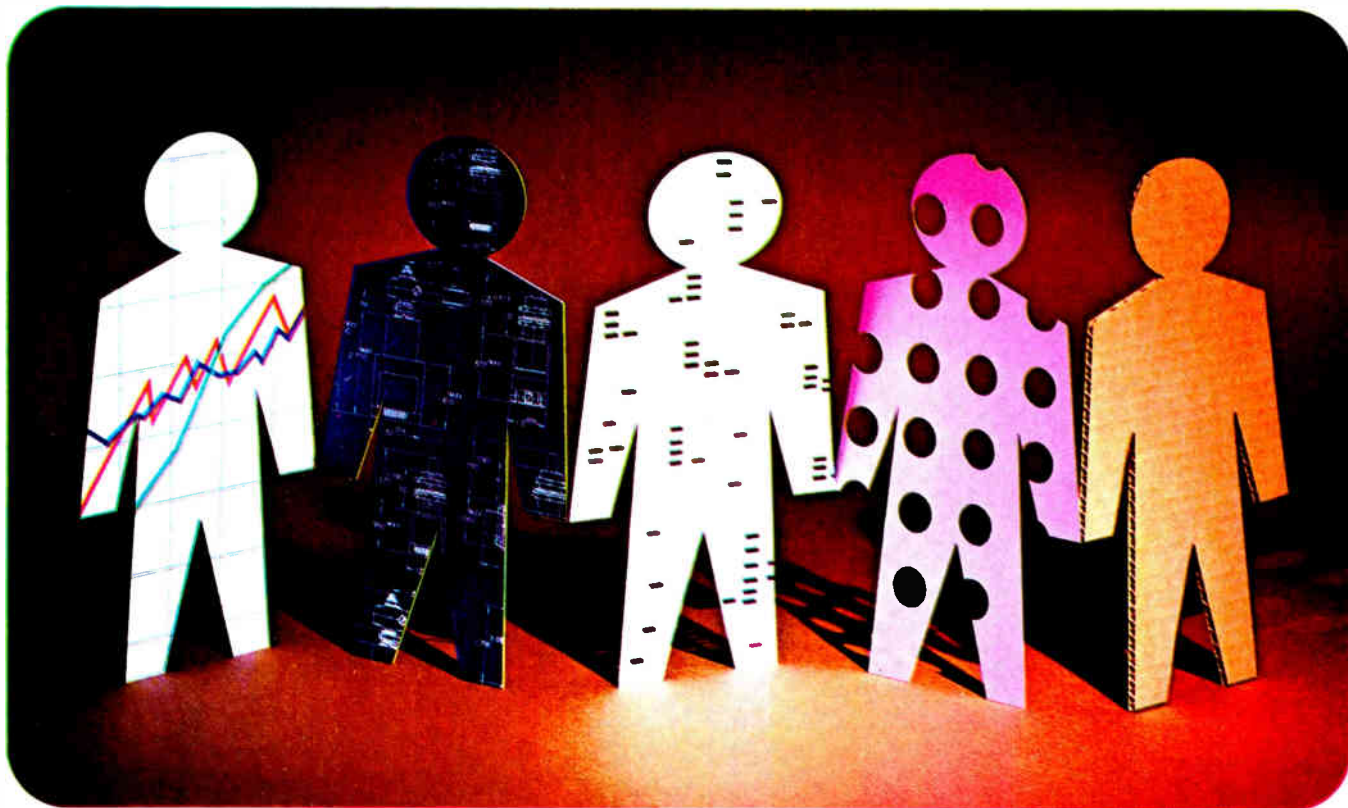

Left to right: vice president, design engineer, computer programmer, punch press operator, and shipping clerk.
Not present for picture: All the other employees of MICRO SWITCH.

Quality Assurance for the customer is everyone's business at MICRO SWITCH. It is the result of a total concern for the details that make up customer satisfaction. It starts with top management and permeates the entire organization, involving every step of manufacture—from raw materials and design on through production and shipping.

The emphasis at MICRO SWITCH is on the prevention of defects, rather than simply their detection.

The Quality Assurance program is designed to assure reliability *before* manufacturing begins. It includes such procedures as: a periodic calibration system for all measuring equipment, a strict vendor rating system, extensive documentation to cover all details in advance, and innovative operator self-checking procedures.

Most important, our experienced, highly trained personnel have a personal concern for customer satisfac-

tion. They know it's the little things that count.

What does this elaborate program mean to you? Dependability. The knowledge that each switch will hold up as well in your equipment as it does in our grueling laboratory tests. We're more careful to make you more sure.

To find out for yourself the many ways MICRO SWITCH is more careful, write for our booklet, "Quality Assurance for our Customers." No obligation, of course.



MICRO SWITCH

FREEPORT, ILLINOIS 61032

A DIVISION OF HONEYWELL

HONEYWELL INTERNATIONAL • Sales and service offices in all principal cities of the world. Manufacturing in United States, United Kingdom, Canada, Netherlands, Germany, France, Japan.

THIS BOOKLET CONTAINS COMPLETE DATA, PLUS "HOW-TO-USE" IDEAS FOR THE WORLD'S MOST ADVANCED I/C LOGIC FAMILY!



IT'S YOURS FOR THE ASKING!

Most data brochures contain specification sheets for all of the devices in the line. So does this one — for 56 MECL* II integrated circuits (29 different circuit designs). But, it also includes applications information, right on the data sheet, for each circuit. And, that's not all . . . there's 10-pages devoted solely to the unique and interesting design philosophy of emitter-coupled logic. Then, to make it the highly-practical design tool that it is, this new MECL Data Brochure is designed for perpetual updating . . . New circuit information can be added easily; and, there's room for the MECL 300/350 series brochures that are currently in use.

Yes, the MECL Data Brochure is Extraordinary in many ways . . . but then, so is the MECL line of integrated logic circuits. We felt that the world's fastest, most-advanced full complement line of digital integrated circuits deserved more than just ordinary technical data treatment . . . so, we prepared this special approach for you.

It's Yours for the Asking! Just drop us a line on your company letterhead, at P.O. Box 955, Phoenix, Arizona 85001.

*Trademark of Motorola Inc.

-where the priceless ingredient is care!



MOTOROLA
Semiconductors



A word to the do-it-yourself module builder:

Don't.

Buy our J Series modules instead.

The J Series is our new family of general purpose, all integrated circuit logic modules. Their performance almost matches that of our famous T Series modules, but they cost about 25% less. They're made to the same dimensions as the T Series, with the same 52 pin connectors, so they're physically interchangeable. We make them for our own seismic recorder systems, so they're rugged and reliable. Now, as of January, you can buy them (com-

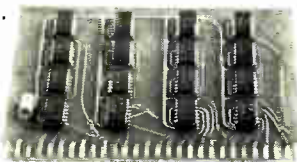

These will cost you less.

plete with mounting hardware, racks and power supplies, if you wish) in any of 25 different functions.

And save yourself the time and cost of making your own: designing, assembling, testing, new procedures, new equipment, new personnel, additional training, to say nothing of the added paper work.

If you're building systems, you must have better things to do than go into the module assembly business. Such as reading our J Series catalog.

It's free.

SDS
Scientific Data Systems,
Santa Monica, California

Electronics Review

Volume 41

Number 8

Integrated electronics

Plastic IC's still 4-F

Despite manufacturers' claims about the ruggedness of plastic-packaged integrated circuits and their suitability for military applications, the Pentagon remains unconvinced. Reliability testing by Government groups, though not exhaustive, has failed to establish a basis for acceptability, according to defense officials.

But the prospect of realizing tremendous cost savings by buying plastic-encapsulated devices in place of metal-can versions has prompted the Government to call a meeting of solid state experts to tackle the question. The experts will be asked to come up with an answer, or at least a basis for evaluation.

Charged atmosphere. The conference, at which Federal officers and makers' representatives will confront one another, promises to be stickier than one might suspect. The ordinary give-and-take of such meetings will be inhibited not only by the conferees' widely differing viewpoints, but by earlier insinuations of incompleteness in the claims made for plastic IC's and by pressure from the higher echelons of Government.

On the Government side will be representatives of the armed services, NASA, the Army's Harry Diamond Laboratories, and the Jet Propulsion Laboratory, among others. Among the companies invited to the mid-May meeting in Washington are all the vendors of plastic IC's, including the big four—Texas Instruments, Motorola, Fairchild, and Signetics—plus such users as Autonetics, which, incidentally, has been conducting extensive tests on the devices for the past few months.

[Electronics, April 17, 1967, p. 101].

Background. Plastic-encapsulated IC's, which have been around for a few years now, have recently been aggressively promoted by many makers for use in military jobs now open only to metal-can circuits. These firms implied that the devices' moisture resistance, while not as good as that of the hermetically sealed metal-can units, was sufficient for most applications.

Since the plastic IC's usually cost only half as much as their metal-can counterparts, Government pur-

under less than worst-case conditions.

No yardstick. However, since there are no specific standards for IC performance, and because each Government service and agency has its own reliability criteria, the issue can't be easily resolved. In fact, some Government spokesmen indicate an acceptance of the plastic packaged product based on the special needs of their department or agency. The Government's attitude right now seems to be that the plastic units can't be flatly rejected on

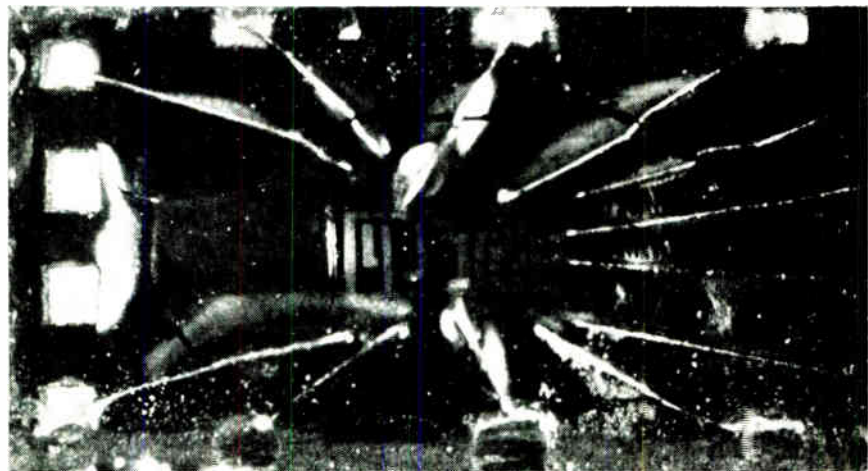

Fracture. Stress caused by shrinkage is serious enough to snap the interconnection wires on this plastic-packaged IC. Note the crack (dark oval) around the package.

chasing agents, beset by budget problems, have strenuously urged their acceptance by the various Federal groups responsible for reliability evaluation. But these groups have tested them under conditions the metal devices must withstand, and have found that the plastic units fail in most cases, usually because of an insufficient moisture barrier. The failures occur typically after long-term (560 hours or more of operation) testing, indicating a cumulative breakdown. The failure rate is often 100%, even after months of satisfactory performance

the basis of the tests made so far, and that future evaluation programs should be carried out in a more coordinated manner than the earlier tests.

This general attitude won't lighten the atmosphere at the meeting. One Government official asserts that the absence of published results of long-term testing by makers is "fairly clear evidence that the plastic IC's still aren't suitable." He also criticized the short-term testing the firms do as unrealistic, and said that "if makers invested as much money into the plastic materials as

they spend promoting the ic's, they'd probably come up with a suitable encasement."

Cloudy specs? The producers, on the other hand, continue to imply that plastic devices can handle most military tasks. Some have ventured that the specifications the Government issues are unrealistic and stem from the days of vacuum tubes.

One executive expressed the industry's view this way: "On the one hand, Uncle Sam tells us to use state-of-the-art devices, and the Pentagon issues a directive encouraging the use of microelectronics. On the other hand, we're instructed to use qualified parts wherever possible and we're confronted with specs that were set up for older technologies, or by no specs at all."

First with the fastest

Engineers at the Semiconductor Products division of Motorola Inc. have been working for some three years toward the one-nanosecond speed capability they think ultrahigh speed computers will require. Now it appears the division will be the first supplier to break that barrier with a line of integrated circuits—the first three devices in its third-generation emitter-coupled-logic family. Later, the family will include at least one device incorporating large-scale integration. The first entries in the MECL 3 line [Electronics, Nov. 13, 1967, p. 26] are now in pilot production and initial orders will be filled from this operation.

For now, Motorola will introduce a dual four-input OR/NOR gate with a typical propagation delay of about one nanosecond into a 50-ohm load; a quad two-input NOR gate with the same properties and a master-slave flip-flop exhibiting a maximum delay of 1.5 nanoseconds into a 50-ohm load. With lighter loads—500 ohms at 5.2 volts—both the dual and the quad will show a typical propagation delay of just 0.8 nanoseconds. Both devices have only one layer of metallization; the flip-flop uses two layers.

On schedule. Further down the

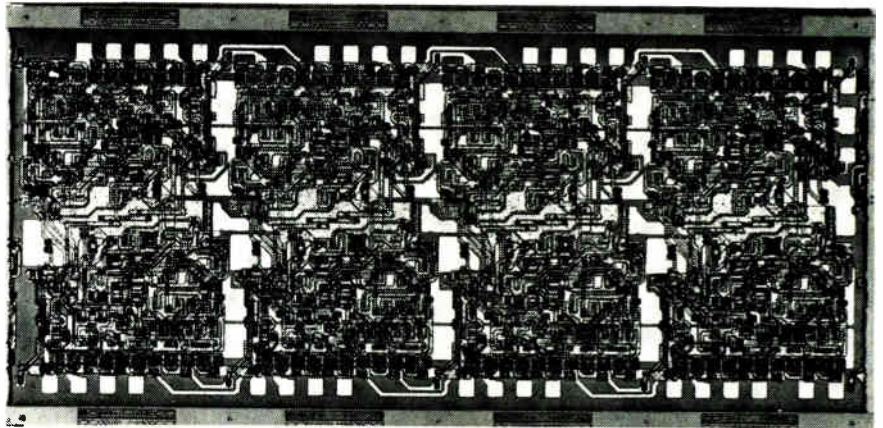

On the chip. Motorola will soon offer this large-scale integrated eight-bit adder as part of its regular line. The circuit contains 448 components.

line is an eight-bit adder that has 448 components laid on a 53-by-119-mil chip using a three-layer metallization scheme. Walter Seelbach, Motorola's manager of ic research and development, estimates the adder will be ready for production in the third or fourth quarter. He said the line will also eventually include such entries as a scratch-pad memory array and a left-to-right shift register. "But for the first half of this year we'll be concentrating on the initial three parts."

Seelbach thinks Motorola is six months to a year ahead of other semiconductor manufacturers in this ultrahigh speed capability. He describes the market for MECL 3 as "tremendous."

Seelbach also believes there will be a military market. But now MECL 3 will be specified for temperatures ranging from 0° to 75° C—short of the -55° to 125° specified by the military.

High toggle frequency. "Hooked up as a binary counter, the flip-flop will be able to toggle in the 350-to-400-megahertz range," Seelbach notes. He says the previous high in toggle frequency in production circuits is the 85-Mhz figure at which Motorola's MECL 2 line is specified. He adds that the 50- and 500-ohm terminations for the dual four and quad two devices are equivalent to direct-current fanouts of 12 and 4, respectively.

Each of the three devices will go into a 170-by-250-mil hermetically sealed ceramic flatpack having 14 leads. The package design, new to Motorola, incorporates a stud that

is perpendicular to the plane of the leads, which serves as both a thermal and electrical connection. "To remain flexible," explains Seelbach, "and to be able to dissipate more power down the road, we had to have better thermal characteristics in the package. Only about 7° C per watt are dissipated between the chip junction and the end of the stud. Standard flatpacks without the stud dissipate between 100° and 200° per watt inside the package. If the user mounts properly to the stud, he could get as little as 25° per watt dissipated in the package."

Michael Callahan, manager of research and development for ic devices and processes, cites some of the processing sophistication required to reach a speed of one nanosecond. "We had to develop shallow junctions—less than one-micron deep except for collector-substrate junctions. Most other current-mode logic junctions are a little deeper. Deposition also requires tight controls. Aluminum tends to go into solution with silicon and we don't want this penetration. So we use aluminum alloys that slow down this tendency and limit the metal's penetration."

Keep them small. Callahan says that individual transistors in the ic's must operate at 1 to 2 gigahertz, and must be very small to minimize the junction capacitances essential for high speed. Resistors must also be small. "The largest is 0.5 mil wide to keep parasitics down."

Regarding passivation, he ex-

plains further that oxide integrity is "excellent—less than three pinholes per wafer on the average. When we first started, pinholes were 10 times greater and we had to monitor every run. We're now down to monitoring just once a day." Motorola won't reveal yield data for any circuit, but Seelbach says, "If it weren't where it should be, he wouldn't be announcing the product."

The Phoenix division holds the basic patents on emitter-coupled logic, and Seelbach says the soon-to-be-introduced third generation is logically compatible with MECL 1 and 2 families without any interface circuitry. Prices have not yet been established.

Going naked

A number of semiconductor makers have been selling unpackaged chips—both discrete devices and integrated circuits—for quite a few years, but until recently most of them haven't been advertising the bare chips.

Several factors have contributed to this reluctance, especially on the part of the bigger vendors: the market is small (estimated at \$25 million a year); small orders are typical, and vendors have felt they would be giving away some of their secrets if they made a regular business of selling unencapsulated dice.

That reluctance appears to be on the wane, principally because the market is mushrooming rapidly as hybrid-circuit suppliers step up their demand for chips they package later. The larger semiconductor manufacturers are reassessing their positions, and one—the Semiconductor Products division of Motorola Inc.—plans to introduce a line of standard unpackaged silicon transistors as its first aggressive move to get a bigger share of the business [Electronics, April 1, p. 26].

Military orders. The devices chosen—14 in all—are Motorola's most popular npn and pnp discrete transistors. One of the prime reasons for Motorola's move, says Leo Lehner, manager of product mar-

keting at the Phoenix division, has been a big jump in demand from hybrid-circuit suppliers in the past year. He says this demand has been fueled mainly by the military's desire to integrate.

"Monolithic ic's can't meet all the requirements the military wants integrated. People have designed a lot of equipment with military-specification parts in discrete form," explains Lehner, "and now the military says integrate, so the equipment maker goes the hybrid route and has a primary position as a bidder." Some of the more popular npn silicon transistors Lehner cited in this category are the 2N2217, 2N2218, and 2N2219, all of which are covered by Motorola's unencapsulated line. The pnp counterparts are the MSC2907A and 2906 switching and amplifier transistors. Motorola substitutes the prefix MSC for the 2N prefix.

Other devices in the line are npn and pnp low-level amplifiers (MSC2484 and 3251, respectively); npn and pnp high-voltage switching and amplifier transistors (MSC3501 and 3637); npn and pnp radio-frequency amplifiers (MSC918 and 4957); npn and pnp core drivers (MSC3725 and 3467); and npn and pnp low-level switches (MSC2369 and 3546).

Joining the fun. Lehner says that Texas Instruments Inc. and the Raytheon Co. have been selling standard unpackaged chips for at least a year, and it's known that Fairchild's Semiconductor division, the National Semiconductor Corp. and the Signetics Corp. are also in the business. But none of the others appears to be pursuing the market with as much gusto as Motorola. Lehner notes that standard zener diode chips will be coming next from Motorola, to be followed by unencapsulated ic's.

Meanwhile, a new firm, Intersil Inc. of Cupertino, Calif., will begin selling as its first product a complete line of unpackaged flip-chip transistors and n-channel junction field-effect transistors.

National's marketing manager, Donald Valentine, says, "We've just been quietly selling a few dice. We never imagined anyone noticed us—much less Motorola." He says

the firm sells 15 of its prime ic's and about 25 discrete transistors in chip form, and has been stocking dealers for the past six months.

Signetics has been selling unpackaged ic chips for three years, and officials there report no reluctance to do so, but neither is there any intention to introduce off-the-shelf dice.

Lehner says the military systems in which the chips are ultimately used, such as missile and guidance systems and airborne computers, involve fairly complicated technology. As a result, Motorola can get 75% to 80% of the price it asks for the same device in a metal can. "The idea of the game is not economy at all," he says. "The hybrid or multichip circuit supplier wants these chips for size reasons, technology, and to win bids."

"If he wants to make a 100-volt ic, or a fancy r-f mixer, he can't do it with a monolithic ic, so he has to go the multichip route."

Microselling. Lehner expects most of Motorola's chip sales to be in quantities of thousands, but the division isn't overlooking smaller orders. Chips in the standard transistor line will be shipped in containers for as few as 10 dice; another carrier accommodates 1,000. In both, the passivated dice fit in individual recessed compartments. A glass lid slides flush over the "bins," preventing movement of the chips in shipping and allowing the buyer to see them without opening the compartment.

Ronald Camp, Motorola product planner for silicon transistors, says buyer sophistication has done a lot to break down Motorola's earlier reluctance to sell chips. "We had to go through a learning cycle with the customer on testing, bonding, and application. Maybe he didn't know how to bond well and he'd blame us for supplying a bad chip. Now the customer is generally more knowledgeable in all these areas."

Wafers from which the chips are taken are tested only to the minimum specification for a device, but Camp points out that there will be almost no differences in the maximum ratings of the devices as chips or in packages.

Instrumentation

Lighting own way

Ever since the introduction of cold-cathode indicating tubes, instrument makers have been designing them into their products. But the Monsanto Co., whose electronic instruments group is a relative newcomer, has now decided to follow an independent line: adaptation of its own research on solid state displays. The company believes it has struck pay dirt with a light-emitting diode array. The array is used as the numerical readout in an experimental counter/timer.

Fred Katzman, who heads the instruments group, says the array represents the first time the feasibility of a solid state readout has been demonstrated as an integral

part of a digital test-and-measuring instrument.

Boon. The advantages are considerable. Since each element in the array lights when it is forward biased with a current of about 10 to 100 milliamperes at about 1.5 volts, the displays are compatible with integrated circuits. Conventional displays, using cold-cathode indicators, aren't compatible because the tubes require about 100 volts. What's more, the displays can be driven directly from a dual in-line ic, while tube displays need a separate power supply and driver for each digit.

Not only are drivers, high-voltage supply, and tubes eliminated, but, says George M. MacLeod, director of the Monsanto Electronic Special Products division, "the solid state displays have longer life, greater strength, less heat genera-

tion, no parallax, and faster switching time." He claims the array eliminates the radio-frequency interference traditionally associated with gas-discharge tubes.

Each light-emitting diode array can combine numbers, letters, and symbols.

Says MacLeod: "No cold-cathode tube or similar readout could provide the full alphabet because there just isn't enough depth to include 26 letters."

Proof of the pudding. Monsanto modified one of its general-purpose counter/timers with the diodes. The conventional five-digit cold-cathode display was replaced with a red numeric display of gallium-arsenide phosphide diodes.

The diodes had proved reliable after several years of use singly as indicator lights on other Monsanto products. Even though the array's light output of 115 foot-lamberts is significantly less than a cold-cathode tube's 200 foot-lamberts, it is sufficient under ordinary operating conditions. Moreover, the diode array offers superior contrast.

There still is a barrier: the cost now is about \$165 per digit. However, Monsanto believes that refined production techniques will make the cost competitive with conventional displays, which cost between \$20 and \$70 per digit.

In phase

The growing sophistication of radio transmission has generated a corresponding need for quartz crystals that can give very precise frequency separation. That need, in turn, is producing a new generation of highly accurate instruments to test and measure crystal capabilities.

Conferees at the Army Electronics Command's 22nd annual Frequency Control Symposium will get a liberal helping of such devices to go with their salt water taffy when they gather in Atlantic City, N.J., next week. The Army itself has come up with one of these instruments, the Western Electric Co. another, and the Hewlett-Packard Co. has computerized

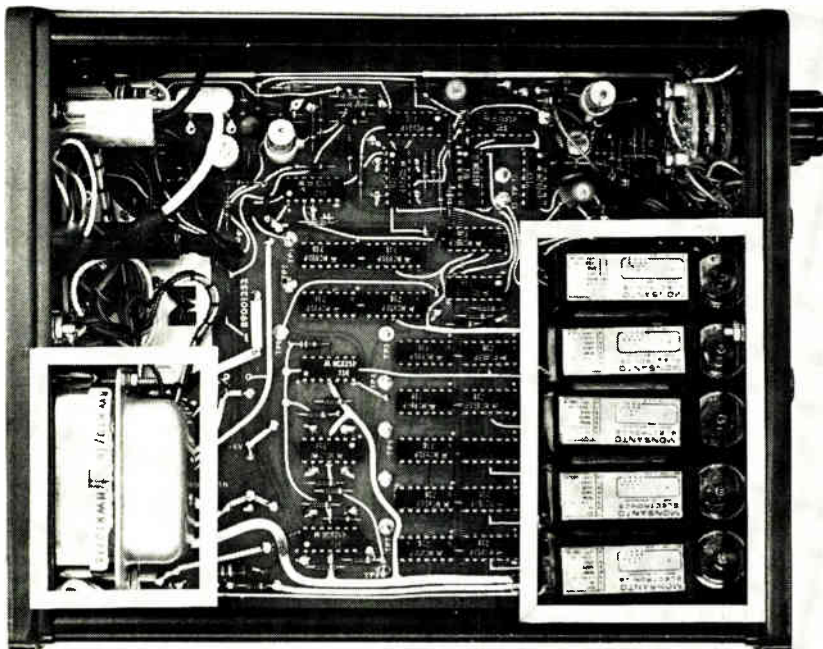

Replacement. Monsanto developed this counter/timer to prove the feasibility of a solid state display in an instrument. The light-emitting diode array eliminates power supply, drivers, and tubes of conventional cold-cathode readout displays. The electronics that have been eliminated are outlined in the photo above.

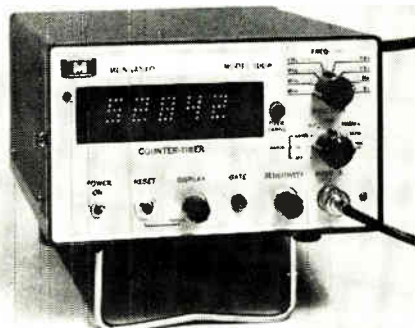

Boost IC op amp power with Helipot's miniature hybrid amplifier.



Actual Size

Here's how it performs:

- 2.5 watt output
- 30 MHz bandwidth
- $\pm 16V$ voltage swing
- less than 90° phase shift
- -55 to $+125^\circ C$ operation
- foldback short circuit immunity
- protects op amp and power supply from overload reflections

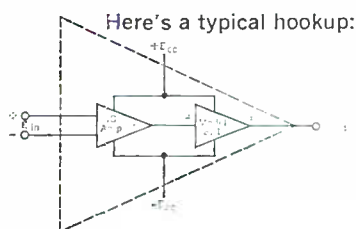

Here's the price:

\$35.00—1 to 9 quantity. Delivered from stock



The new Model 821 is a hybrid, cermet thick film power amplifier which drives load resistances as small as 100 ohms to within 4 volts of the supply voltage from d-c to 30 MHz. Its combination of

unity voltage gain and wide bandwidth permits boosting the power of an IC amplifier without affecting its other performance capabilities. In addition, the Model 821's ability to block all overload reflections results in the prevention of heat generated errors in the op amp and allows immediate recovery upon overload removal.

Completely self-contained, this fully sealed power amplifier is only 0.170" high, occupies just 0.5 sq. inches of board space, and is compatible with both flat pack and dual in-line IC packages.

Ask your local Helipot sales representative for complete information on the Model 821.

Beckman
INSTRUMENTS, INC.
HELIPOT DIVISION
FULLERTON, CALIFORNIA • 92634

INTERNATIONAL BRANCHES: GENEVA, MUNICH; GLENCOE, SCOTLAND; TOKYO, PARIS; APETOWN, LONDON, MEXICO CITY

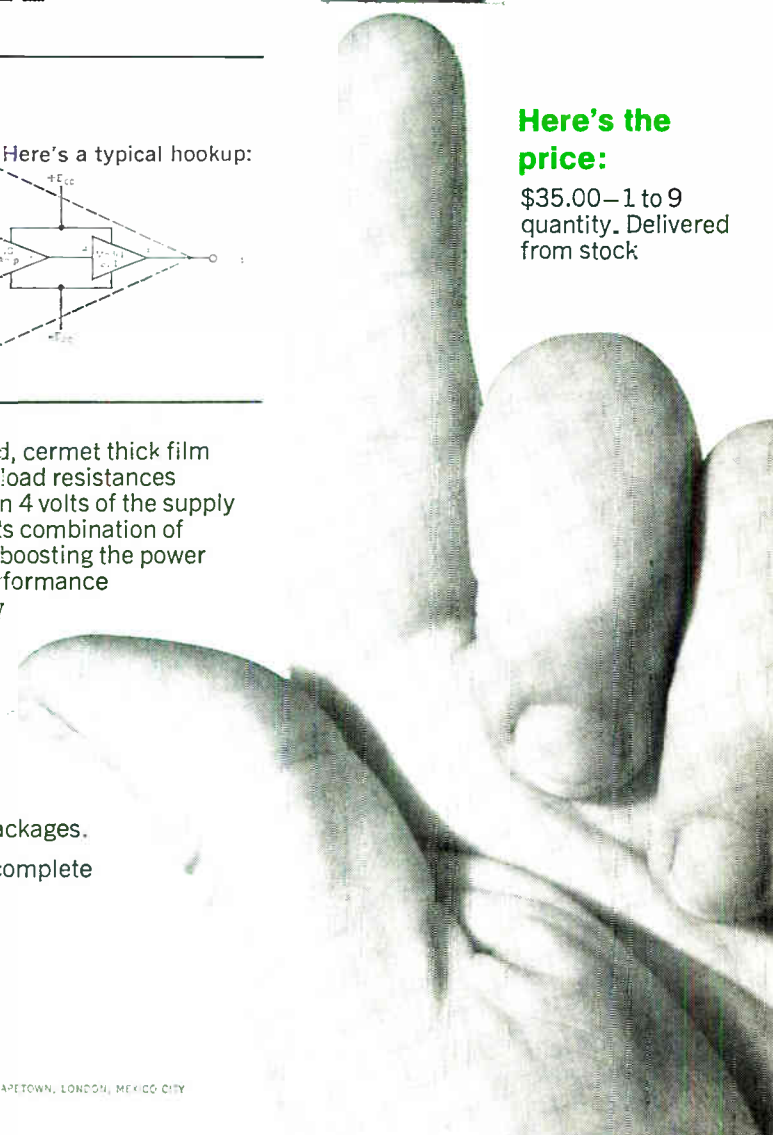

the whole shooting match.

In-house. The Army's development was spurred by increasing military use of suppressed-carrier single-sideband transmission, a mode that requires precise crystals in the lower reaches of the high-frequency range. The instrument, a highly developed, well-buffered oscillator, bases its correction signal on phase-shift information rather than less accurate frequency data.

The device is extremely sensitive because it works passively: it measures a crystal tickled with only 0.1-¹⁵ watt and can be used with most commercially available bridges. What's more, it can measure a 100-megahertz crystal to within 0.1 hertz and is self-checking. Made under license by Parzen Research Inc. of Westbury, N.Y., the tester will be described at the symposium by O.P. Layden, A.D. Ballato, and C.L. Shibla of the Army's Electronics Command.

Familiar ring. A similar technique has been used by Western Electric's North Andover, Mass., laboratories. The method developed there by Robert P. Grenier sends a synthesizer's signal through the crystal into a calibrated phase detector. That frequency passing through the crystal with the least phase shift is the resonant frequency. By locking the synthesizer to that frequency and displaying it on an oscilloscope, the crystal's resonant point can be determined.

This technique, Grenier believes, will cut resonance uncertainty from about four parts in a million to one part in 10 million. The technique may go on the production line later this year, he adds.

Automated. The Hewlett-Packard innovation, from its labs' piezoelectric department, could bring a new look to the IEEE's specs for crystal testing, drawn up in 1957. H-P's new method, according to C.A. Adams, co-author of a paper on it with D.L. Hammond and Albert Benjaminson, uses the IEEE pi network with a vector voltmeter to make phase measurements instead of the traditional amplitude measurement. From those measure-

ments, frequency and impedance are derived.

"When the crystal is in perfect resonance," explains Adams, "the phase goes to zero. The voltage ratio in the pi network gives you the voltage amplitude ratio. When you take a small computer and hook it up to the vector voltmeter you simply program what you want to look at in the frequency range—the impedance or resonance spectrum, for example."

With a knowledge of these parameters all equivalent circuit parameters (L , R , C , and C_0 as stated by the IEEE) can be computed, Adams says.

Medical electronics

Eliminating the paper work

For every heart disorder a cardiologist uncovers with his electrocardiogram machine, he must scrutinize yards of the EKG's paper tape, searching for abnormalities in the tell-tale wiggly lines. The slow process suffices when the doctor has but one patient to examine. But with doctors now pressing for mass

screenings to uncover heart troubles early, the tape-monitoring task could become Herculean. The Humetrics division of the Thiokol Chemical Corp. has now developed an EKG machine whose signals can be interpreted by a technician. It signals only when it locates something wrong. If it finds so much as a hint of an abnormality, the patient is referred to a cardiologist.

The unit—called an Electrocardio-analyzer (ECA)—is similar in function to two other machines, which monitor heart sounds rather than the EKG signal. One, the Cardioscan, is from Humetrics also and was designed for children [Electronics, Dec. 13, 1965, p. 38], and the other, for adults, was developed by Tokyo Shibaura Electric Co. (Toshiba) of Japan [Electronics, Jan. 9, 1967, p. 252].

Mass action. The new Humetrics device takes about a minute to complete the test and Humetrics officials believe more than 50 persons an hour can be monitored.

The instrument not only differentiates between normal and abnormal EKG patterns but also pinpoints the abnormal parameters. Electrocardiographic signals from the patient are picked up by electrodes attached to the arms, legs, and chest.

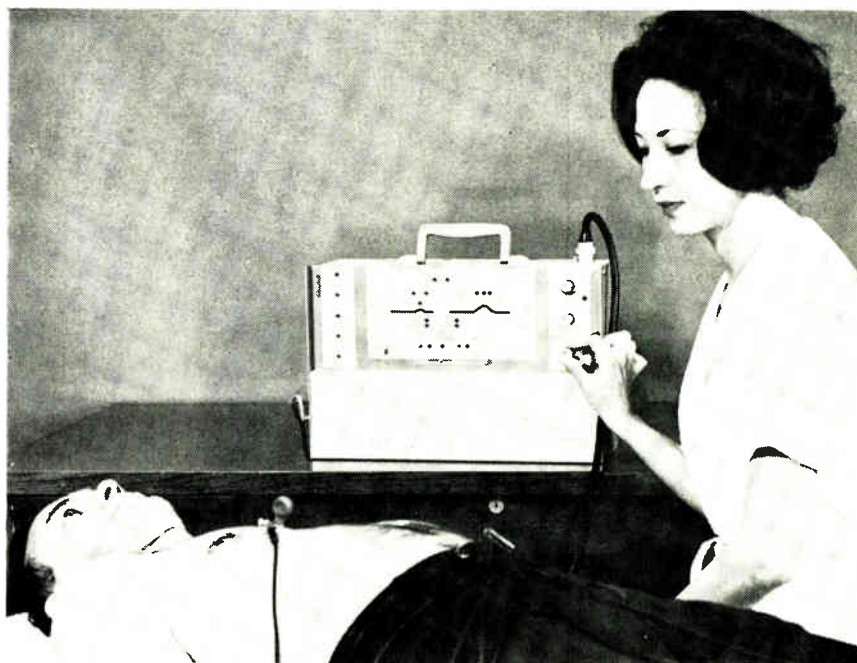

Quick check. Mass screening for heart defects can be performed by this EKG machine, which reports only an abnormal signal.

DON'T THINK IN TERMS OF GATES WHEN YOU DESIGN ENCODING OR DECODING CIRCUITRY.

THINK DIODE MATRICES.

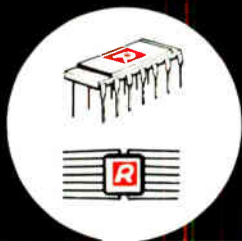

Now you can encode... decode... or time-share both functions...
inexpensively, efficiently, easily, and without fear of cross-coupling.
Use Radiation dielectrically isolated diode matrix integrated circuitry.
Readily available in dual in-line and TO-84 flatpack configurations.

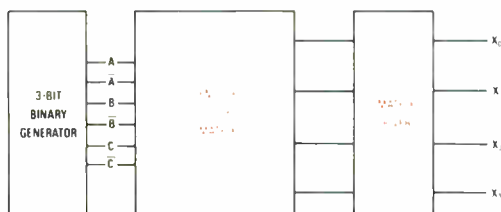

Suppose you need a three-bit binary output encoded into a four-bit binary shift code. Why use *five* AND gates and *four* OR gates? Simply combine these nine gate functions into *one* RM-30 six by eight diode matrix and save both time and money.

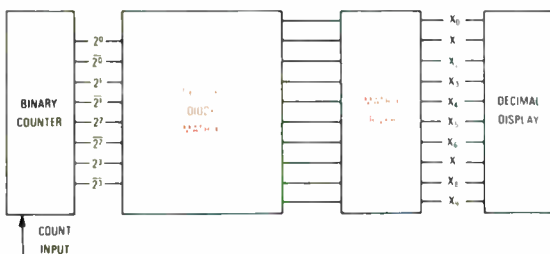

Why use ten logic gate packages to decode from binary to decimal for display read-out? Use only *two* RM-84 eight by five diode matrices. It makes no difference what weighted binary code you are working with. Radiation diode matrices can be easily customized to match.

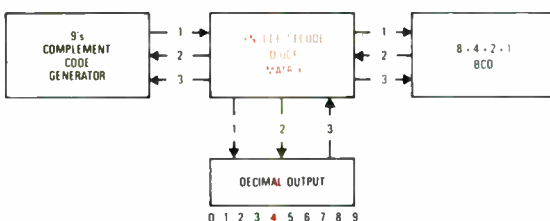

When one logic code must be converted to several other codes for processing, think diode matrices! Specify only *four* RM-84 diode matrices and form a 16 by 10 matrix array. Six conversions can be performed by this single bi-directional array... replacing approximately 80 logic elements.

You never have to think in terms of gates again. Think Radiation diode matrices!

Radiation stocks a complete line of dielectrically isolated diode matrices, easily customized to your particular encode-decode needs. These can be combined with Radiation interface circuits to provide the most economical, convenient and reliable diode logic available today.

Contact your nearest Radiation sales office to find out how inexpensive diode matrix integrated circuitry really is. You'll be surprised how fast we can deliver, too.



RADIATION
INCORPORATED
SUBSIDIARY OF HARRIS-INTERTYPE CORPORATION
MICROELECTRONICS DIVISION

Sales Offices: 600 Old Country Road, Garden City, N.Y. 11530, (516) 747-3730 — 2600 Virginia Avenue, N.W., Washington, D.C. 20037, (202) 337-4914 — 6151 W. Century Boulevard, Los Angeles, Calif. 90245, (213) 670-5432 — P.O. Box 37, Melbourne, Florida 32901, (305) 727-5430 — International Sales, Marketing Department, P.O. Box 37, Melbourne, Florida 32901, (305) 727-5430



KEPCO MULTIRATED POWER MODULES

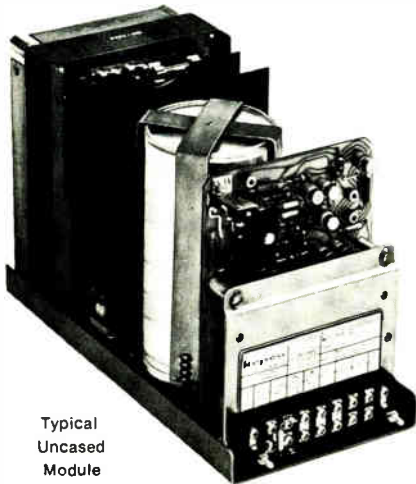

Typical
Uncased
Module

Kepco's new "PAR" Power Supply modules are available in voltages from 4 volts to 60 volts, adjustable $\pm 5\%$ about the nominal. Two current ratings apply for each module, one for temperatures to 65°C and a higher rating for the usual industrial environment of 40°C . Regulation, line: 0.005%, load: 0.01%, temperature coefficient 0.01% per $^\circ\text{C}$, ripple 0.25 mV rms — modules may be controlled from 0 to their nominal band with linear current derating. Size $6\frac{3}{4}'' \times 4\frac{3}{4}'' \times 10\frac{3}{8}''$ — rack mounts available too.

MODEL	OUTPUT VOLTS	OUTPUT CURRENT at ambient temp		PRICE
		65 $^\circ\text{C}$ †	40 $^\circ\text{C}$ †	
PAR-4	4 $\pm 5\%$	0-9.0	0-11.0	\$195.00
PAR-7	7 $\pm 5\%$	0-8.0	0-10.0	195.00
PAR-12	12 $\pm 5\%$	0-5.5	0-7.0	195.00
PAR-15	15 $\pm 5\%$	0-4.6	0-6.0	195.00
PAR-24	24 $\pm 5\%$	0-3.4	0-4.0	195.00
PAR-28	28 $\pm 5\%$	0-3.1	0-3.7	195.00
PAR-36	36 $\pm 5\%$	0-2.3	0-2.8	195.00
PAR-48	48 $\pm 5\%$	0-1.8	0-2.3	195.00
PAR-60	60 $\pm 5\%$	0-1.5	0-2.0	195.00

†Uncased; ††Cased

For Kepco's brand new Catalog B-678 containing complete specifications and extensive applications notes, write Dept. R-14



131-38 SANFORD AVE. • FLUSHING, N.Y. 11352
• (212) 461-7000 • TWX # 710-582-2631 •

Electronics Review

Lee Baessler, Humetrics director of engineering, says this system presents a standard lead input to the analysis circuitry. In EKG recordings, 13 leads are used to make various physiological measurements [Electronics, July 10, 1967, p. 105]. In the ECA unit, a five-lead configuration using electrodes has been developed. These leads measure such parameters as P amplitude, P polarity, P width, PR interval, Q amplitude, Q width, R amplitude, S amplitude, and others [Electronics, July 10, 1967, p. 104] to determine if they are within acceptable limits.

To make certain the EKG signal is not giving false information, Humetrics incorporated special circuitry to prevent analysis when excessive baseline drift or 60-cycle interference exists. Abnormally high or low heart rates also prevent correct analysis and an auxiliary display alerts the operator to this condition.

In the cards. The instrument is contained in a 17-by-11½-by-7½-inch case weighing 28 pounds. All circuitry is contained on four printed cards incorporating Signetics micrologic and Philbrick operational amplifier components.

At \$9,300 per instrument, Humetrics officials foresee large use of the ECA by industrial concerns, health institutions, schools, offices, and professional and amateur athletic teams.

Growing bananas. Heart of the achievement was the successful growth of a single crystal of barium sodium niobate ($\text{Ba}_2\text{NaNb}_5\text{O}_{15}$), humorously called bananas by the developers. This crystal is not damaged by laser light as other materials have been, and its ability to generate harmonics is far superior to anything so far developed.

Up to now the best continuous tuning—achieved using electro-optic techniques—has only covered a bandwidth of ± 45 Ghz [Electronics, Nov. 13, 1967, p. 58]. Parametric oscillators using other crystals such as lithium niobate could only tune pulsed light beams.

Efficiency of the new parametric oscillator is about 1% though the developers are confident of increasing efficiencies to at least 10% and perhaps 20%. What remains now is to improve stabilization techniques.

Selecting mirrors. In the Bell Laboratories set-up, a bananas crystal, placed in the cavity of an yttrium aluminum garnet (YAG) laser, doubles the 1.06-micron output frequency, providing the 0.53 micron pump frequency. The green beam then is focused by a lens and directed at a temperature-controlled bananas crystal. Inside the crystal it interacts with the internal electrical fields and produces two coherent waves, the sum of whose frequencies equals its own frequency.

Although no attempt was made to suppress one of the output frequencies, this could be done easily by choosing the proper mirrors that, along with the second bananas crystal, form the parametric oscillator cavity.

For parametric oscillation to occur, the pump and two harmonic frequencies must move in synchronization through the crystal. That condition can only be met in a nonlinear optic crystal, where the index of refraction varies with crystal temperature and with the frequency (dispersion) and polarization (birefringence) of the light. In the bananas crystal there's a temperature at which dispersion and birefringence offset each other for a particular pump and pair of generated frequencies so that all three are in

Advanced technology

Pick a color

Tuning a coherent light oscillator continuously through the visible light spectrum down through the infrared has finally become possible. A team at Bell Telephone Laboratories has built a continuous parametric optical oscillator that converts green light (0.53 microns) over a wavelength range covering 0.98 to 1.16 microns. The same oscillator can cover an even wider band of frequencies—30,000 gigahertz—extending from 0.4 to 4 microns (violet to far i-r).

EH LEADS THE PULSER REVOLUTION

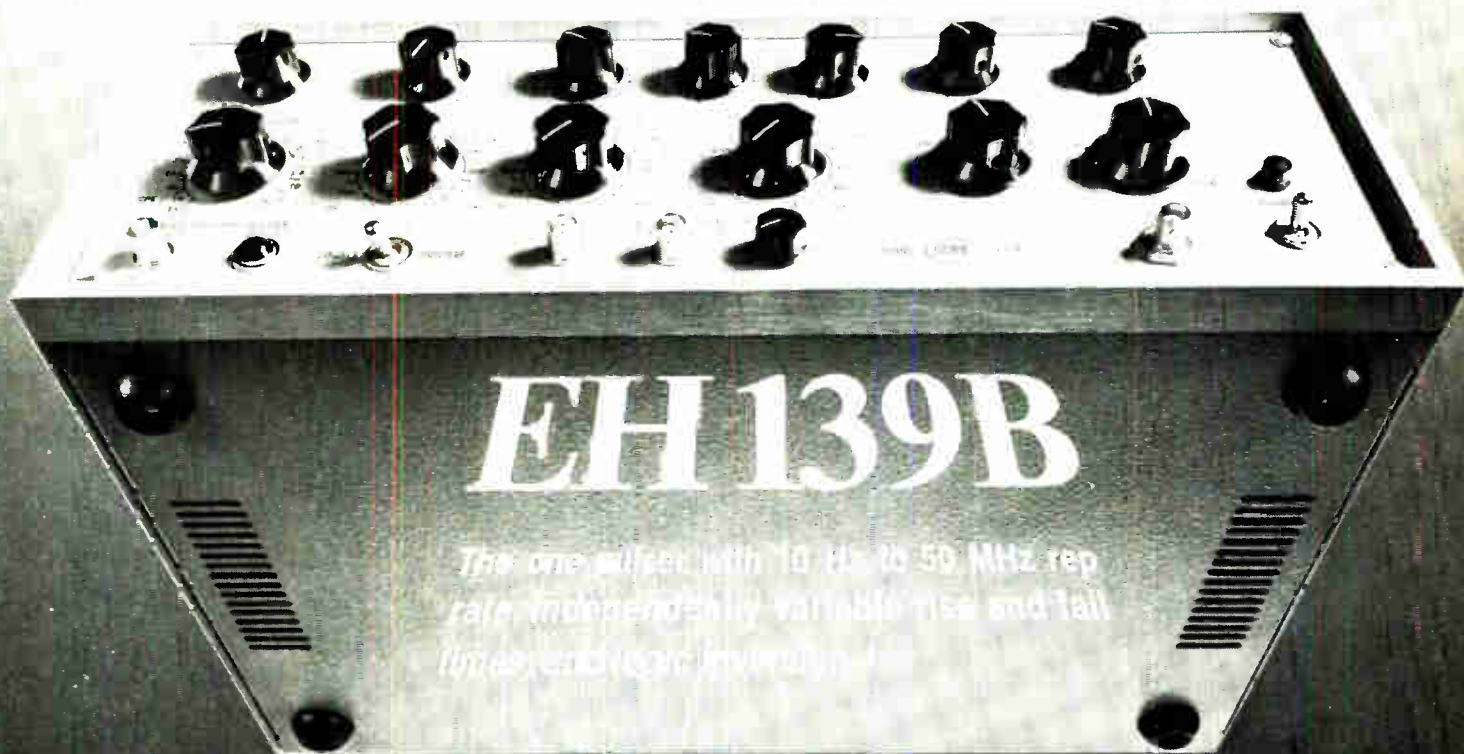

Name what you want in your next pulser — the E-H 139B has it. Broad operating range (the first pulser with a 10Hz to 50MHz rep rate.) ± 30 MV to 10 V output. Pulse width and delay variable from 10 ns to 10 ms. Plus a unique baseline offset feature which allows the pulse train to be adjusted off zero up to 2 volts in either polarity.

Chances are, this versatile pulser can do the work of three or four pulsers you are now using for IC or logic testing applications. Let us show you how.



E-H RESEARCH LABORATORIES, INC.

163 Adeline Street • Gaithersburg, Maryland 94607 • (415) 834-3030 • TWX 910-366-7258

In Europe: E-H Research Laboratories (Ned) N.V., Box 1018, Eindhoven, The Netherlands, Telex 51116

In Japan: Iwatsu Electric Co. Ltd., No. 710, 2-Chome Kugayama Suginami-Ku, Tokyo Japan

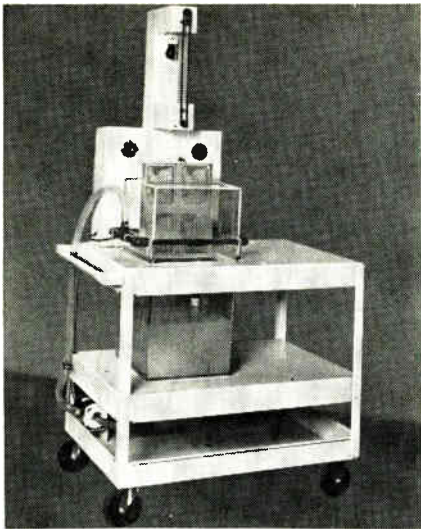

"fine line" etcher

for prototypes—limited runs

Model No. 201 (illus.), etches two 11" x 14" one-sided boards or one 11" x 14" two-sided board: **\$795** Pat. applied for

**ETCH YOUR OWN
P C BOARDS
AUTOMATICALLY**
(in less than 5 minutes)

from this →
to 11" x 14"

Shown Actual Size



- No cooling or venting required!
- Etches as fine as .001"!
- Cuts costs in half—saves time!
- Complete photo processing instructions!
- Work is illuminated while etching!
- No patterning . . . minimum undercutting!

NOW IN USE BY:

AMP, Inc.
Ampex Corp.
Atomic Energy Com.
Bendix
Charles Bruning
Esso Research
General Dynamics
General Electric
IBM
ITT
Lear Siegler
Magnavox
Micro Switch
NASA
Owens-Illinois

Sprague Electric
Union Carbide
U.S. Air Force
Western Electric
Whirlpool
M.I.T.
Oklahoma State U.
Purdue Univ.
Washington Univ.
Univ. of Calif.
Univ. of Chicago
Univ. of Colorado
Univ. of Georgia
Univ. of Hawaii
Univ. of Penn.

CYCLO-TRONICS, INC.

3858 N. CICERO — CHICAGO, ILL. 60641
TELEPHONE: (312)-282-6141

Electronics Review

step. Then the pump gives up its energy to the harmonics, which grow into coherent waves.

The members of the development team are Joseph E. Geusic, Hyman J. Levinstein, Jerry Rubin, Shobha Singh, R.G. Smith, and Le Grand Van Uitert.

Communications

Taming the CO₂ laser

The use of lasers to beam television signals over short distances is a relatively easy stunt performed at several labs. But training the beam at a target millions of miles away is something else again. Stability problems with the laser and attenuation of the beam by the atmosphere play havoc with the signal. Researchers at the Hughes Aircraft Co. have taken a significant, albeit small, step (18 miles) in that direction.

The team at the firm's Malibu, Calif., labs have built a carbon-dioxide laser system that beams a tv signal the 18 miles between the lab and Baldwin Hills. The received signals, using optical heterodyning techniques, are good enough to meet industry standards for commercial transmission, says Frank Goodwin, head of the research team and a senior member of the technical staff. The signal-to-noise ratio has been measured at 60 decibals in the f-m mode.

Long shot. The CO₂ laser is suitable for such long-haul transmission, says Goodwin. Carbon-dioxide designs have the highest power potential of existing lasers—outputs up to several thousand watts have already been reported. And the laser's wavelength, 10.6 microns (far infrared), is relatively immune to atmospheric attenuation. During a hazy day, attenuation of a visible beam might reach 100 db; but for the 10.6-microns laser, it's only about 15 to 20 db between the lab and Baldwin Hills, he says.

In addition, the efficiency of CO₂ lasers is much greater (10% to 15%) than that of lasers in the visible spectrum (less than 0.1% for an argon ion laser, for example). Finally, Goodwin says the far infrared is of interest because atmospheric turbulence, which disturbs the coherence of visible light, does not significantly degrade coherence at 10.6 microns.

Goodwin believes existing lasers could handle the transmission of a real-time tv signal from Mars using no more than 100 watts of power.

Taking pains. The researchers went to great lengths to stabilize the output frequency, isolating the laser acoustically by suspending it in a spring system and hermetically sealing it. This eliminated vibration from the floor or turbulence from air currents.

The Hughes system consists of two identical lasers—the transmitter oscillator at Baldwin Hills and the receiver local oscillator at Malibu. The video input to the trans-

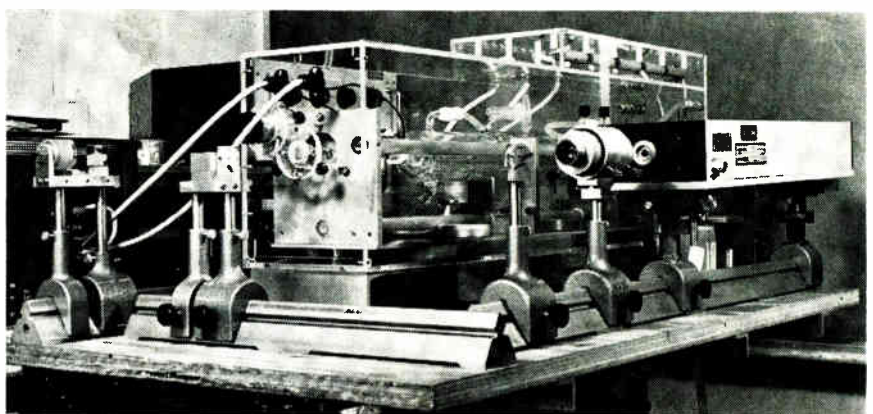

Over the air. Hughes designed this laser system for transmitting tv signals over an 18-mile link. The next step? Maybe Mars.

TRW

LVA diode...

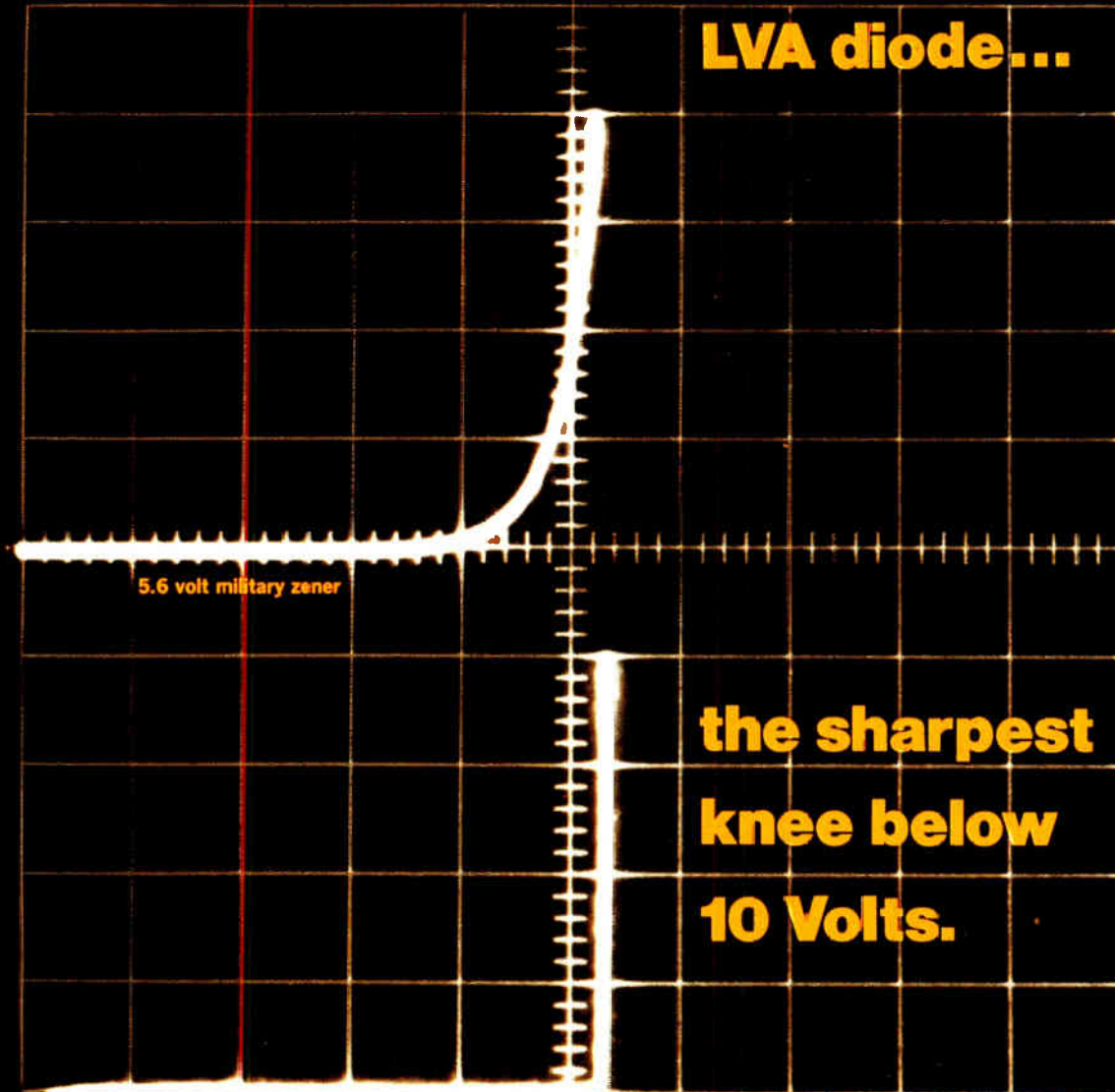

5.6 volt military zener

New TRW 5.6 Volt LVA zener

**the sharpest
knee below
10 Volts.**

Tektronix type 575. 1V/div horizontal, 1mA/div vertical

Low operating currents... ultra low leakage

Take a close look at the lower scope trace. The sharp knee comes from low field emission leakage all the way out to breakdown, and extremely tight regulation at low current levels after breakdown.

No other zener can approach the LVA performance below 10

volts. You get low operating currents plus ultra low leakage in a single device.

The Low Voltage Avalanche zener is available in 10 values from 4.3 volts to 10 volts. Delivery is off-the-shelf from authorized TRW distributors, or contact TRW Semiconductors, 14520 Aviation

Boulevard, Lawndale, Calif. 90260. Phone (213) 679-4561. TWX 910-325-6206. TRW Semiconductors is a subsidiary of TRW INC.

TRW[®]

Model 1100 Semiconductor Test System



*New
automatic system
offers high current
transistor
and diode
testing capabilities
at minimum cost!*

The new Test Equipment Corporation Model 1100 test system gives the budget-conscious user more testing capability per dollar than any available system. It features 100 amp pulse gain measurements, 1 kilovolt breakdown voltage capability and reverse leakage current measurements to 100 picoamps.

In addition, the Model 1100 automatically sequences through five tests and logs resulting data on paper tape. Out-of-limit measurements are printed in red. This versatile system may be expanded to include either a Tally 420PR-24 punched tape or IBM 526 card punch.

Write today for technical and pricing information.

TEC offers test system design and engineering capabilities and on request will quote systems to meet specific user requirements.

Test Equipment

CORPORATION
P.O. BOX 20215, DALLAS, TEXAS 75220 • 214/357-6271

mitter comes from either a vidicon camera or a commercial tv set. It is sent through a modulator driver before entering the electro-optical modulator housed inside the transmitter oscillator cavity. This modulator is a gallium arsenide crystal 5 centimeters long with its end faces polished and coated with an antireflection material.

Goodwin says frequency modulation in the laser is produced when the phase of the light is modulated.

"We achieve f-m by driving the modulator inside the laser oscillator itself," Goodwin notes.

The technique has its drawbacks, however. Putting the gallium arsenide crystal inside cuts output power from a typical 10 watts, to about 1 or 2 watts. Hughes is already working on a wideband modulator outside the cavity that might support many tv channels; the present system is limited to one. By then, the researchers plan to transmit digitally, but they will continue to use heterodyning because of the tremendous sensitivity it provides.

The modulated signal is fed to transmitter optics, across the 18-mile span to Malibu, and into the receiver optical system. Both the transmitter and receiver optics are 3-inch-diameter off-axis parabolic reflecting telescopes.

Cold storage. Receiver optics focus the beam down onto the mercury-doped germanium detector, which is housed in a dewar and kept at 21°K with liquid nitrogen. This is where heterodyne mixing takes place. A beam provided by the laser local oscillator is superimposed on the detector and added to the incoming signal.

The i-f amplifier, with a center frequency of 30 megahertz, and an 8-Mhz bandwidth, follows the detector. From the amplifier, the signal is fed to a discriminator, to which is attached a television monitor to display the received image. Part of the discriminator output drives an automatic frequency controller. This locks the receiver local oscillator 30 Mhz away from the frequency of the transmitter laser, which is 2.8×10^{13} hertz. Goodwin says the frequency changes only about 3 parts in 2.8 million. The

entire system represents an investment of about \$20,000 in hardware.

Consumer electronics

Radiating worry

Concern over radiation from consumer and industrial products is spreading out in almost as many directions as the radiation itself. But color television sets, which started the whole thing, are still the source of most of the worry.

The latest reactions to these waves of apprehension include the following:

- The cloak of anonymity has been lifted from the color tv sets tested for radiation leakage earlier this year.

- Industry and Government are taking the first steps toward adoption of common standards for detecting and measuring radiation.

- The radiation protection bill passed by the House and a tougher Administration-sponsored bill will get hearings next month by the Senate Commerce and Labor Committee.

- The National Association of Government Employees is starting to question limits set for air traffic controllers who watch radar scopes.

- Studies of potential laser damage are being extended after an initial survey showed that about 10,000 workers may be exposed to dangerous laser beams.

Naming names. The National Center for Radiological Health, after a little prodding, disclosed the brand names of the 1,124 sets tested and how they scored. The initial report didn't mention any company names; the center said that to do so could be misleading, because the survey covered only sets owned by Public Health Service employees in the Washington area. Only after the press demanded the brand names under the recently enacted Freedom of Information Law did the center open up the books. The survey showed that 6% of the sets produced excessive radiation. The test results

SYNTRON Series

150 C-B

**Silicon
Controlled
Rectifiers**

**235 Amperes RMS
25 to 1200* PRV**

FORWARD CONDUCTING

- $I_{t\text{ avg}}$ —AVERAGE FORWARD CURRENT (RMS) AT 25°C. (LIMITED BY TEMPERATURE) 150 A.
- V_{tm} —MAXIMUM PEAK FORWARD VOLTAGE DROP AT 25°C. AT 500 A. PEAK 180° CONDUCTION ANGLE 1.7 V.
- I_h —TYPICAL HOLDING CURRENT AT 25°C. 100 MA
- $I_{t\text{ sm}}$ —MAXIMUM PEAK ONE CYCLE SURGE CURRENT 3000 A.
- $I_{t^2 t}$ — I^2t FOR FUSING FOR TIMES ≥ 1.5 MILLISECONDS. 37 000 A² SEC
- I_{dm} —MAXIMUM FORWARD LEAKAGE CURRENT AT 125°C. AND EBO. 25 MA
- t_{off} —MAXIMUM OFF TIME AT 125°C. 40 μ SEC.
- t_{on} —TYPICAL ON TIME. 10.5 μ SEC
- t_r —TYPICAL RISE TIME. 3.25 μ SEC.
- t_d —TYPICAL DELAY TIME. 7.25 μ SEC
- Θ_{J-C} —MAXIMUM THERMAL RESISTANCE, JUNCTION TO CASE (DC). 0.2 C./W
- T_j —OPERATING JUNCTION TEMPERATURE. 125°C.
- T_{strg} —STORAGE TEMPERATURE. —40 C to 150 C

BLOCKING

- I_{rm} —MAXIMUM REVERSE LEAKAGE CURRENT AT 125°C. AND PRV. 25 MA
- dv/dt —MINIMUM CRITICAL EXPONENTIAL RATE OF RISE OF FORWARD BLOCKING VOLTAGE. 100 V./ μ SEC.

TRIGGERING

- V_{gt} —MAXIMUM GATE VOLTAGE TO TRIGGER AT 25°C. 2.5 V.
- V_{gt} —TYPICAL GATE VOLTAGE TO TRIGGER AT 25°C. 1.3 V.
- V_{gt} —TYPICAL GATE VOLTAGE TO TRIGGER AT 125°C. 0.9 V.
- I_{gt} —MAXIMUM GATE CURRENT TO TRIGGER AT 25°C. 200 MA
- I_{gt} —TYPICAL GATE CURRENT TO TRIGGER AT 25°C. 100 MA
- P_{gm} —MAXIMUM PEAK GATE POWER. 10.0 W.
- $P_{g\text{ avg}}$ —AVERAGE GATE POWER. 2.0 W
- I_{gm} —MAXIMUM PEAK GATE CURRENT. 2.0 A.
- V_{gm} —MAXIMUM PEAK GATE VOLTAGE (FORWARD). 10.0 V.
- MAXIMUM PEAK GATE VOLTAGE (REVERSE). 5.0 V.

*1300 Volt Transient Rating



SYNTRON
A DIVISION OF
FMC CORPORATION
© 241 Lexington Ave.
Homer City, Pa. 15748
Telephone 412-479-8011

Name/Title _____
Company _____
Street _____
City/State _____ Zip _____

- Please send information on:
- Series 150 C-B Silicon Controlled Rectifiers
 - Silicon Rectifiers
 - Selenium Rectifiers
 - Selenium Surge Suppressors

68R2



**Last
Tuesday
morning
a lot of people
on Pleasant
Avenue were
glum.**

But not "Smiling" Sam Price. He's one of the Twelve Cranks on Pleasant Avenue. And last Tuesday he found a lousy connection in a Trygon Liberator Power Supply that was coming off the line! It made his day!

The point is, of course, that loused-up Liberators never leave Trygon. Not with Sam Price and his un-merry men around. Their job is finding problems for us; so you don't get any problems from us.

Sam's pet, the Liberator, gives you the ultimate in IC and transistor system power in minimum size at lowest possible cost. Wide slot adjustment ranges with voltages up to 160v. Output current levels up to 40 Amp (3½") and 70 Amp (5¼"). .005% regulation/.5 mv ripple/3mv P-P noise/.01% stability/extremely low output impedance/MIL Spec. performance / integral slide mounting/automatic load share paralleling/overvoltage protection.

And you can be sure of this. Every Trygon Liberator Power Supply comes off the line under Sam's baleful eye. Order one and see.



Trygon Power Supplies
111 Pleasant Avenue, Roosevelt, L.I., N.Y. 11575
Trygon GmbH 8 Munchen 60, Haidelweg 20, Germany

are shown at the right.

The test revealed some extremely high radiation leakage. Of the 66 sets leaking radiation above the accepted safe level of 0.5 milliroentgens per hours (mr/hr), 38 sets registered above 1.0 mr/hr, and three others actually hit 12.5 mr/hr—the maximum reading on the test instrument. Center engineers believe the actual readings on these sets were much higher. The three hot sets were a Setchell-Carlson, a Zenith, and a Magnavox. The Magnavox had an RCA shunt regulator tube and a Sylvania picture tube and was operating at excessively high voltage.

Twenty-three sets gave readings of between 1.0 and 2.0, five between 2.0 and 3.75, ten between 3.75 and 12.5, and three over 12.5.

The survey said the probable primary sources of X-radiation emissions were the high-voltage shunt regulator tube, the high-voltage rectifier tube, and the picture tube. However, in two sets, no specific source could be identified.

Do it yourself. James G. Terrill, the director of the center, said the Washington survey included too few sets to yield an accurate nationwide estimate. He estimated, however, that 700,000 to 1.4 million color tv sets in the U.S. leak excessive radiation.

But instead of starting a nationwide campaign to halt the leakage, the center is working with manufacturers to make certain that all new sets are tested before leaving the factory. Because of the shortage of trained technicians who are properly equipped with devices to detect and measure radiation, the center is only recommending that owners take their sets to a repair shop to make sure the high voltage is set at the proper level. This usually reduces the radiation.

The survey found that four brands—RCA, Zenith, Magnavox, and Setchell-Carlson—made up 86% of the number of sets leaking excessive radiation. There were no General Electric sets that leaked excessive amounts, obviously because GE tracked down and adjusted its faulty receivers after they set off the big scare last year.

X-ray emission from color tv

Brand name	Total sets surveyed	Sets above safety standards
RCA	360	20
Zenith	162	19
Sylvania	100	0
Motorola	75	4
GE	72	0
Sears	71	1
Magnavox	69	10
Philco	45	0
Airline	33	1
Admiral	30	0
Westinghouse	19	0
Heath	18	0
Dumont	16	0
Penncrest	15	1
Setchell Carlson	13	8
Packard Bell	7	0
Muntz	6	0
Curtis Mathis	4	0
Delmonico	2	1
Symphonic	2	1
Bradford	2	0
Clairtone	1	0
AMC	1	0
Panasonic	1	0
Total	1,124	66

Manufacturers of brand named sets

Sears	Warwick Electric, Toshiba
Airline	Hoffman Products, Hayakawa, Magnavox, Wells-Gardner, Hoffman Electronics
Penncrest	Wells-Gardner, Matsushita, Westinghouse, Clairtone
Muntz	TV Corp. of America
Bradford	Wells-Gardner, Matsushita
Clairtone	Westinghouse, Wells-Gardner, RCA
AMC	Clairtone
Panasonic	Matshushita

At the same time the center was preparing to disclose the manufacturers' names, it was sponsoring a conference in Washington on detecting and measuring X-radiation from color tv receivers. Up to now, there have been no uniform methods of detecting or measuring it. Although there are no definite plans yet, the center and the Electronic Industries Association will probably organize a committee to work out recommendations.

Question of control. Although industrial trade unions made some noises about worker protection after the GE reports, one of the first unions seriously looking into the matter is the National Association of Government Employees, which represents air traffic controllers.

Alan J. Whitney, executive vice president of the union, in testimony before Congressional committees, has implied that the Federal Aviation Administration's radiation

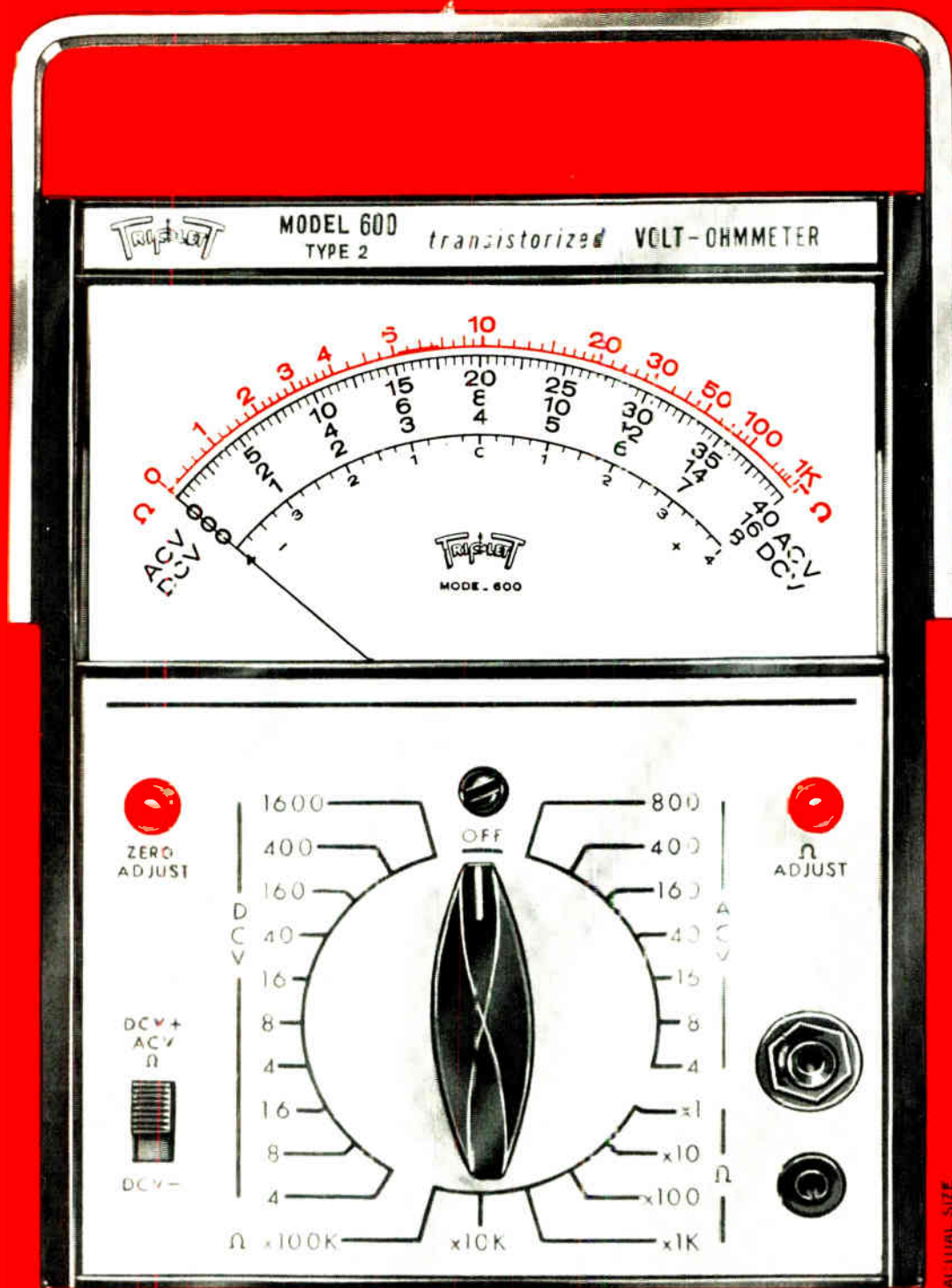

NEW SOLID STATE VOLT-OHMMETER

1. F-E-T CIRCUITRY—PORTABLE BATTERY OPERATED WITH 11 MEGO- Ω M INPUT IMPEDANCE (FIELD EFFECT TRANSISTOR). STABLE: LOW DRIFT.
2. ONE SELECTOR SWITCH—MINIMIZES CHANCE OF INCORRECT SETTINGS AND BURNOUTS. DC POLARITY REVERSING.
3. HUMAN ENGINEERED FOR EASE OF USE. CLEAN UNCLUTTERED SCALE, EXCELLENT RANGE OVERLAP, FOR MORE ACCURATE READINGS.



Model 600 on stand handle leather case \$14.70

Model 600 TVO
Transistorized Volt-Ohmmeter

\$82.

Suggested U.S.A. User Net
Available Now At Your
Local Distributor

TRIPLET

ELECTRICAL INSTRUMENT COMPANY
BLUFFTON, OHIO

ACTUAL SIZE

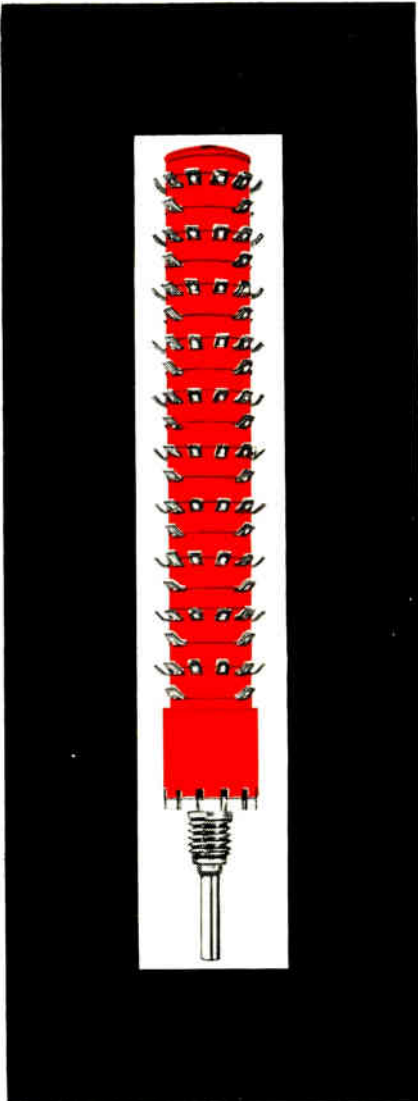

LESS THAN 18¢ PER CIRCUIT

The new Daven "X" switch has been life tested for 50,000 cycles of rotational life with no failure carrying a .500 amp load at 125°C.

The 10 deck, 1 pole, 12 position per deck model shown, sells for only \$21.45 or \$.17875 per circuit in 100 pc quantities.

We build switches like no one else can!



DIVISION OF THOMAS A. EDISON INDUSTRIES
GRENIER FIELD, MANCHESTER, N.H. 03103
(603) 669-0940 • TWX 603-623-4938

safeguards are inadequate. The FAA's "maximum exposure" to ionizing radiation is 100 milliroentgens a week. Based on a 40-hour week, this equals 2.5 mr/hr. The generally accepted safe level, as noted, is 0.5 mr/hr.

Hard light. In another area, a survey made by the Public Health Service's National Center for Urban and Industrial Health in Cincinnati disclosed that 60% of laser workers in the scientific instrument industry faced potential risk of eye damage or serious burns. The figure was based on a study on the use of 267 lasers in 43 plants in Massachusetts. The survey is now being extended to New Jersey and later will move to California.

The survey called laser safety requirements surprisingly lax. For example, only about 45% of the firms required eye shielding in laser areas, and about 25% of the goggles provided are inadequate. Only a few plants had laser warning signals or signs. At the same time that this report was released, the newly formed laser subdivision of the EIA voiced approval of the radiation control bill passed by the House, which covers lasers, and organized a committee to work on laser safety studies and promotion.

Military electronics

Back to the drawing board

Less than a month after Robert S. McNamara closed the door on his Pentagon office for the last time, his successor slammed the door on one of the former Defense Secretary's most cherished dreams—a military aircraft that would be almost everything to almost everyone.

McNamara had nursed the controversial craft—originally designated the TFX—through several modifications and had staked his reputation as a managerial genius on its success.

But the bubble burst late last month when one of the plane's prime missions was dropped. Defense Secretary Clark Clifford decided that the brass had been right all along: the Navy version, the F-111B, was, among other things, too heavy to be effectively flown from a carrier deck.

And just a few hours after the Defense Department's decision, the Senate Armed Services Committee axed the fiscal 1969 funds earmarked for the production of 30 F-111B's. The Congressmen in-

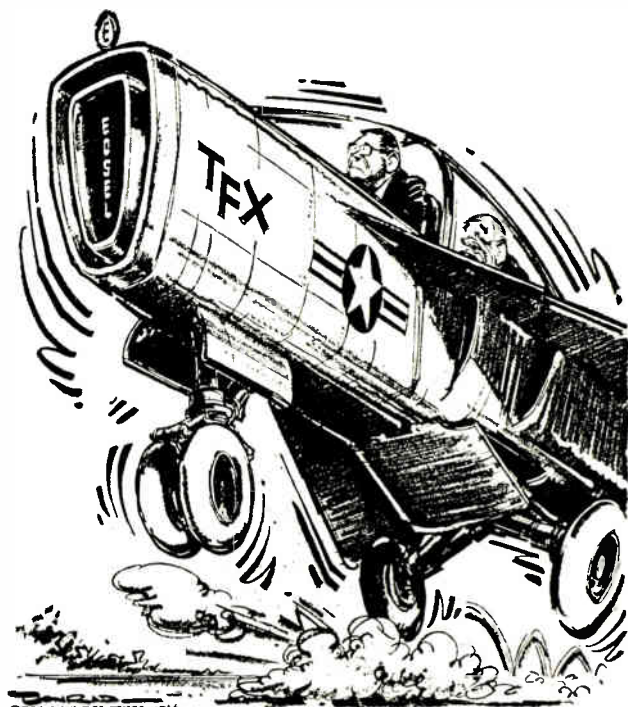

Reprinted by permission of Reister-Tribune Syndicate

TRON RECTIFIER FUSES

*for the
Protection
of
Solid State
Devices*



TRON fuses are especially designed for the protection of Solid State Devices . . . such as semi-conductor rectifiers, SCR's, thyristors and the like—or wherever a very fast acting fuse is needed.

They provide extremely fast opening on overload and fault currents, with great limitation of the let-thru current.

If each diode is protected by a TRON fuse, the fuse will open very quickly when the current drawn exceeds the rating of the diode.

Thus when a short-circuit occurs in a diode the fuse opens and takes that diode out of the circuit. This protects other good diodes in the rectifier which might otherwise be damaged.

TRON fuses are available in a wide range of physical dimensions and in sizes from 1/2 to 1000 amperes in voltage ratings up to 600.

For full information and time-current characteristic charts, ask for BUSS Bulletin HLS.

BUSSMANN MFG. DIVISION, McGraw-Edison Co., St. Louis, Mo. 63107

**FOR MODERN ELECTRICAL
PROTECTION . . . INSIST ON**

SUPPLIED THE ECONOMICAL WAY
... THRU DISTRIBUTORS
BUSS QUALITY
FUSES

NEW
SERIES 20
DIGICATOR[®]

with the
1/4" PROFILE



**TOTAL COST
PER
CHARACTER**

\$7.95
IN QUANTITY

INCLUDES:

- ★ LAMPS
- ★ POLARIZED FILTER
- ★ BEZEL
- ★ MOUNTING STUDS

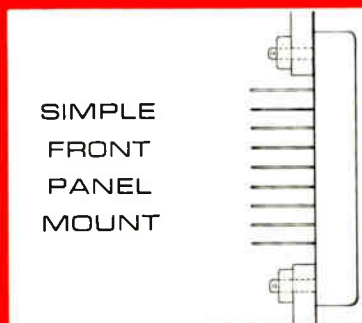

FEATURES:

- ★ Brilliant 1-inch high characters
- ★ Readable at 50 feet—in bright daylight ambient
- ★ Low Current
- ★ Low Voltage
- ★ 1,000,000 hours lamp life
- ★ No costly rectangular front panel cutouts

DISCON CORPORATION

4250 NORTHWEST 10th AVE. • FT. LAUDERDALE, FLORIDA 33309
PHONE (AREA CODE 305) 565-5511

sisted that the Pentagon instead come up with a new craft that would use the same Phoenix missile system and engine as the F-111B, but would be much lighter and more maneuverable and would be designed strictly for naval operations.

Substitute. Early this month, the Senate reached a compromise with the Navy and Pentagon by providing nearly \$300 million for development of the alternate model during fiscal 1969; this includes funds for additional F4J fighters as an interim craft. Four aircraft companies—Ling-Temco-Vought, Grumman Aircraft, North American Rockwell, and McDonnell Douglas—are already working on designs. The timetable now calls for the project to reach its contract-definition phase by January.

The furor over the Navy version was still going on when trouble struck the Air Force version, the F-111A. Two of the first six planes sent to Thailand for combat trials were lost during sorties against North Vietnam.

Clifford, who has had to devote a lot of his time to F-111 problems during his first 30 days on the job, immediately grounded the other four planes, dispatched an investigating team to Thailand, and ordered more extensive testing of the F-111A's remaining in the States. Air Force officials, eager for a scapegoat, hinted that the plane's terrain-following radar may have contributed to at least one of the crashes. The true cause may not be known for several weeks.

Thumbs down. The F-111 program experienced an earlier setback late last year when Britain canceled a large order for the planes as part of its retreat from a worldwide military role. Only the Australians still plan to buy the craft, and only in limited numbers.

Nevertheless, McNamara's plan for a versatile aircraft isn't yet a complete washout. The difficulties with the F-111A will undoubtedly be worked out. Work on the bomber version, the FB-111, is progressing, and the plane appar-

ently will be a success even though it's limited by a small bomb load. And the reconnaissance version, the RF-111, seems a sure success.

Industrial electronics

Change in the guard

Security at many plants is about as old-fashioned as the technology within is modern. At some installations, security still means a lonely codger checking identification cards at the front gate.

Bernard M. Van Emden, head of Litton Industries' Applied Technology division's Security Identification Laboratory, thinks electronics can do the job better, faster, and probably cheaper. He's designed a system that uses magnetically encoded ID cards that would be difficult for even the gang from television's "Mission Impossible" to forge.

In or out. The card is inserted into a card reader, which scans the encoded data. Called an Auto-guard, the reader can be connected to an alarm system that would be sounded if the encoded data isn't correct. Connected to an automatic door, the reader would signal the unlocking mechanism when the data is correct.

The card, called Magna-Badge, is about the same size as a credit card and is encoded in one of two ways: for small amounts of data—up to 130 bits—a circular track is used; for large amounts of data—up to 800 bits—a multitrack, lineal configuration is used. The data can be erased and the card can be encoded as often as necessary. Photographs and other visual data can also be placed on the card.

"Duplicating any part of the system," says Van Emden, "would be a very expensive and time-consuming operation. Besides which, you must first know the code structure, and that can only be obtained from someone on the inside."

Recording data. The encoder can be a simple keyboard that is manually operated or a printer that is

... and NOW THE **TOTALLY** NEW 5700 SERIES **DECODER / DRIVER**

★ **MEDIUM
SCALE
INTEGRATION**



★ **INTEGRAL
HIGH
CURRENT
DRIVER**



★ **BCD to 7
LINE with
and without
MEMORY**

★ **COMPACT
PACKAGE
(Plug-In Model
Only 1"x1"x.35)**

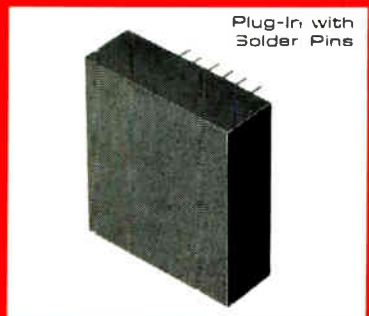

FEATURES:

- ★ Decodes and directly drives all available 7 segment incandescent readouts — up to 80 MA per segment
- ★ Complete package — no additional components required

DISCON CORPORATION

4250 NORTHWEST 10th AVE. • FT. LAUDERDALE, FLORIDA 33309
PHONE (AREA CODE 305) 565-5511

You can selectively transfer 216 circuits with these two Ledex switches and only 10 wires

As you can see from the diagram, our Selector Switches can do a lot of work in a small space. And they'll do many different jobs, some smaller, some larger. That's why they are known by many different names.

To some engineers a Ledex Switch is a programmer or a batch accumulator. To others it's a light dimmer or binary-to-decimal converter. To you it might be a sequencer, a thermo-couple scanner, a memory pulse decoder, a destruct switch or an intervalometer.

We have 36 stock models, 28 and 100 VDC, to give you a quick start on your prototype. Or, if you've got a special problem, our engineers will come up with a custom model.

Our 36-page catalog tells all about Ledex Switches. For your copy just drop us a note. Or, call and we'll talk about your special application.

Write for catalogs on Rotary Solenoids, Push-Pull Solenoids, Stepping Motors and Rectifiers. Also check our "Package Control Service" for black box and timed switching solutions.

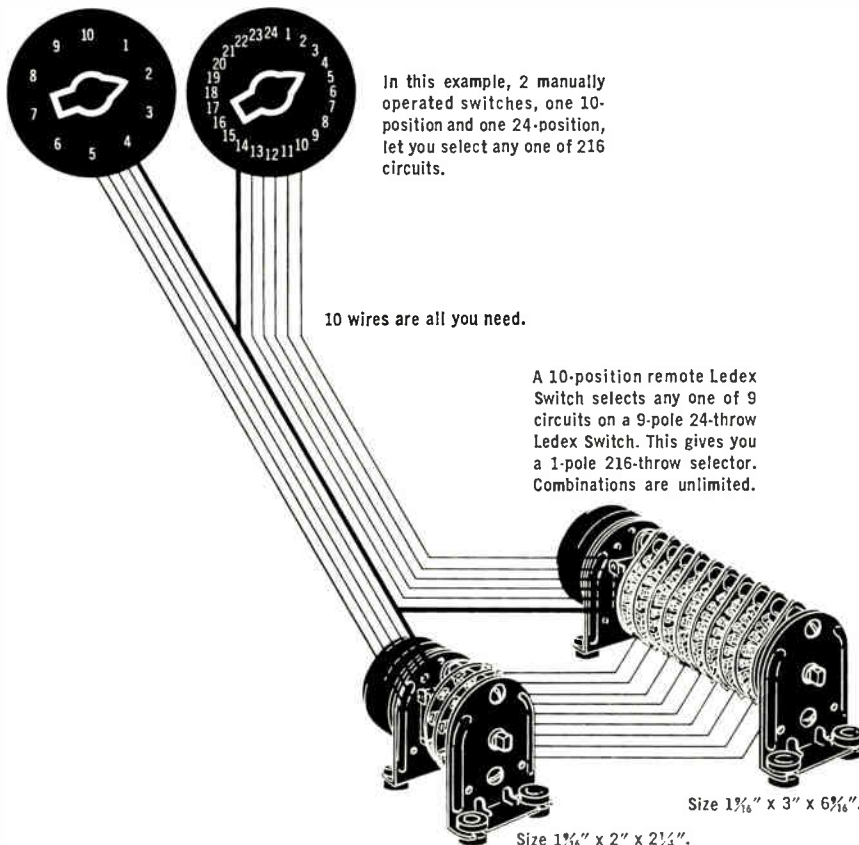

LEDEX DIVISION, LEDEX INC.
133 Webster Street, Dayton, Ohio 45402 • phone (513) 224-9891
Custom Circuitry & Controls

controlled by an on-line computer. The price of the simplest system—including encoder, card, and card reader—is about \$500; cost increases with complexity.

Litton is also looking into fingerprint identification. The company is seeking to code a print digitally and then code this magnetically on the card.

Van Emden sees other possibilities for the system. For example, the Magna-Badge system could be used as a time card when coupled with an electric clock containing a readout device. Other potential applications include elevator systems in which the Autoguard could be set for certain floors, and library systems in which book-checkout procedures are controlled.

A paper will be presented on this system at the National Symposium on Law Enforcement Science and Technology in Chicago, April 18.

Manufacturing

Turned off on real time

Last fall, officials at ITT Semiconductor asked themselves whether their integrated circuit production would grow enough by the mid-70's to justify the use of a real-time computer system to control testing, inspection, and processing. The answer, after a joint study by IRT and the Burroughs Corp., is no.

When IRT started the study last November [Electronics, Nov. 13, p. 52], Irwin A. Horowitz, director of information systems, said, "If our concept proves feasible, IRT will spend about \$10 million for extensive centralized computer IC test equipment in the next five years."

However, the Horowitz team found that a real-time system using two large digital computers would be too expensive. For one thing, the study showed that about 80% of the money would have to be spent for interface gear, the equipment that serves as the real-time link between the computers and the test and production stations.

Off line. Horowitz is now look-

ing at an off-line system that uses centralized digital computers but isn't in real time. Each station will have a tape machine to accumulate test and production results. The tapes can then be scrutinized by off-line computers.

Triggered by a computer, an adapter on the tape machine reverses direction so that segments of the tape can be used to reprogram a station to test a different batch of IC's. Horowitz thinks the two- or three-hour delay in getting reports will be more than offset by the potential savings of several million dollars.

For the record

The big picture. Among the new developments unveiled at the National Association of Broadcasters' show in Chicago this month was a 3-by-4-foot color television display system suitable for use as a studio monitor. The system, developed by General Electric, operates on a proprietary principle called color selection. GE, which says the display could be expanded to 6 by 8 feet, will begin selling the system next year at \$35,000.



Groovy. CBS Laboratories, under the direction of Peter C. Goldmark, has developed a seven-inch record that plays for two hours on each side. The record, which has a frequency response of up to 5,000 hertz—not good enough for high-fidelity reproduction—runs at a speed of $8\frac{1}{3}$ rpm. CBS, also developed a thinner stylus and special playback unit for the record. The longer playing time was obtained by squeezing in 700 grooves per inch.

Now from Sprague!

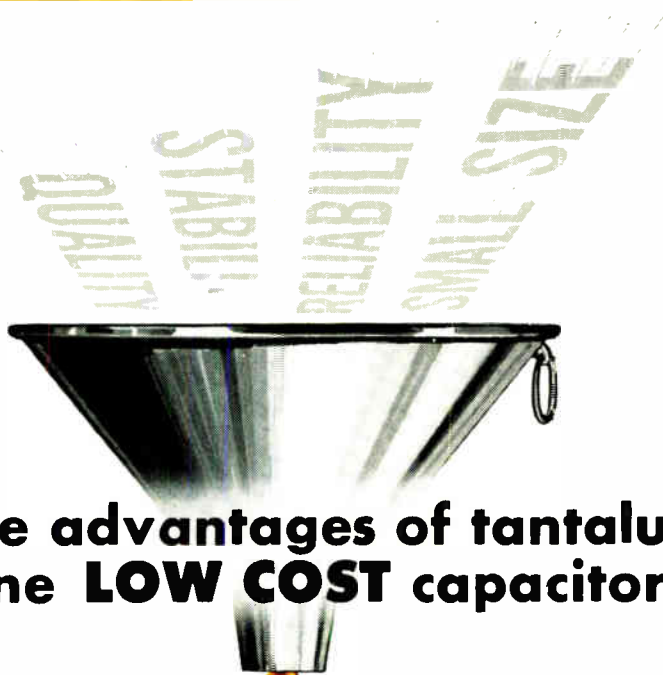

All the advantages of tantalum in one **LOW COST** capacitor!

EPOXY-DIPPED TANTALEX[®] CAPACITORS . . .

For industrial, commercial, and entertainment electronic applications where tantalum capacitors were previously too expensive!

— Type 196D Solid-electrolyte Tantalum Capacitors have special epoxy-dip coating which keeps costs down without sacrifice in dependability. Positively seals capacitor section while providing excellent electrical insulation. Protects against mechanical damage in handling.

— Radial lead design for plug-in mounting on printed wiring boards. The .250" lead spacing will fit standard .125" grids.

— High stability—very little capacitance change, even at outer limits of operating temperature range.

— Low dissipation factor of these capacitors permits higher ripple currents.

— Meet environmental test conditions of Military Specification MIL-C-26655B.

— Prime capacitance and voltage ratings. Based on rating popularity of other types of solid tantalum capacitors.

— Designed for continuous operation at temperatures from -55°C to $+85^{\circ}\text{C}$.

For complete technical data, write for Engineering Bulletin 3545 to Technical Literature Service, Sprague Electric Company, 35 Marshall Street, North Adams, Massachusetts 01247.

**Now available for fast delivery
from your Sprague Industrial Distributor**

SPRAGUE COMPONENTS

CAPACITORS
TRANSISTORS
RESISTORS
INTEGRATED CIRCUITS
THIN-FILM MICROCIRCUITS
INTERFERENCE FILTERS

PACKAGED COMPONENT ASSEMBLIES
FUNCTIONAL DIGITAL CIRCUITS
MAGNETIC COMPONENTS
PULSE TRANSFORMERS
CERAMIC-BASE PRINTED NETWORKS
PULSE-FORMING NETWORKS

SPRAGUE[®]
THE MARK OF RELIABILITY

*Sprague and ® are registered trademarks of the Sprague Electric Co.

MINIATURE SIZE RELAY □ **CONTACT RATINGS:** Contact Material: Rhodium. Maximum Voltage (Volts): 50 VDC, 150 VAC. Maximum Current: Switch, .500 amp. Carry, 2.5 amps. Maximum Power (Watts, DC): 6 Watts. Resistive or properly suppressed (VA, AC): 10 VA. Maximum Resistance Initial: 100 milliohms. End-of-life: 2 ohms. Peak Breakdown Voltage: 300 volts rms. Life & Reliability At Rated Load: 20×10^6 operations. Dry Circuit: 500×10^6 operations. **OPERATING PARAMETERS:** Speed: Depending on sensitivity and number of poles, the speed for miniature size relays is from 1 msec to $2\frac{1}{2}$ msec, including contact bounce and coil time. Insulation Resistance: Coil to ground: 50 megohms (min). Coil to contact: 500 megohms (min). Temperature Range: -50°C to $+105^{\circ}\text{C}$. Vibration: 10G @ 10-55 cycles/sec (open or closed). Shock: 15G (min).

STANDARD SIZE RELAY □ **CONTACT RATINGS:** Contact material: Rhodium. Maximum Voltage (volts): 150 VDC, 250 VAC. Maximum Current: Switch, 1.5 amps. Carry, 6 amps. Maximum Power (Watts, DC): 25 watts. Resistive or properly suppressed (VA, AC): 40 VA. Maximum Resistance, Initial: 50 milliohms. End-of-life: 2 ohms. Peak Breakdown Voltage: 500 volts rms. Life & Reliability. At Rated Load: 20×10^6 operations. Dry Circuit: 500×10^6 operations. **OPERATING PARAMETERS:** Speed: Depending upon sensitivity and number of poles, the speed for standard size relays, including contact bounce and coil time, is: $2\frac{1}{2}$ msec to 6 msec. Insulation Resistance, Coil to ground: 100 megohms (min). Coil to contact: 2000 megohms (min). Temperature Range: -50°C to $+105^{\circ}\text{C}$. Vibration: 10G @ 10-55 cycles/sec (open or closed). Shock: 15G (min).

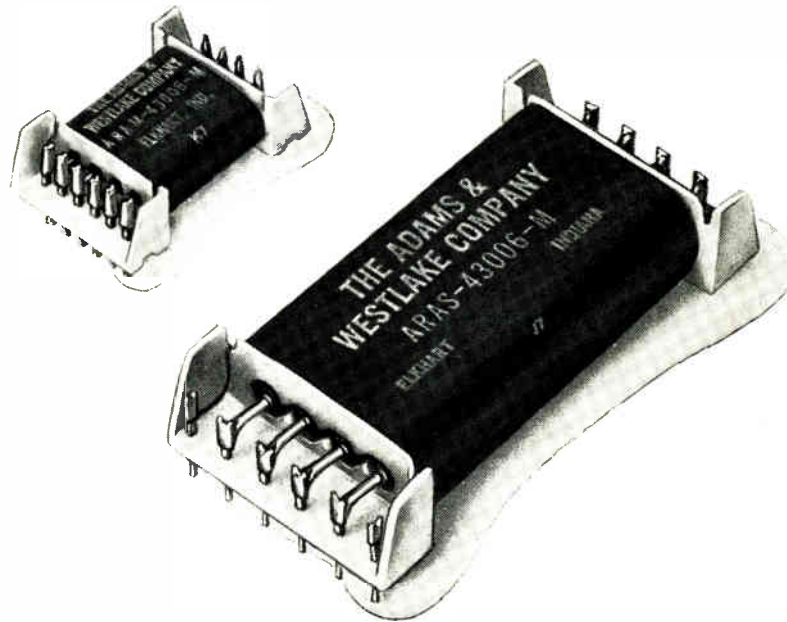

**If one of these
dry reed relays
won't do the job,
Call us.**

You'll find a new line of dry reed relays at Adlake. Both standard and miniature sizes. Single, double, and 4-pole design. But if we don't have the relay you need, don't give up on Adlake. We can work with you in solving your circuit design problem. Just call us and we'll put you in touch with an engineer who spe-

cializes in dry reeds. He can help you develop the relay that's best suited to your needs. In addition to dry reeds, we have the world's most complete line of mercury-wetted and mercury-displacement relays. So don't forget our telephone number. It's the one to remember when quality and service count.



THE ADAMS & WESTLAKE COMPANY
A SUBSIDIARY OF **ALLIED PRODUCTS CORPORATION**

Elkhart, Indiana, U.S.A. 46514 • (219) 264-1141
TWX 219 522 3102 • TELEX 25-8458 • CABLE ADLAKE

Washington Newsletter

April 15, 1968

U.S. maps 10-year oceanology effort

The Administration will soon issue a white paper spelling out the major details of a plan to make the 1970's a decade of international ocean exploration. The paper will disclose that the U. S. is willing to spend from \$3 billion to \$5 billion on the program over the decade if other countries agree to make substantial contributions. Informal talks with other nations, including the Soviet Union, indicate they are interested.

The domestic U. S. oceanographic program is now funded at about \$500 million annually. If approved, the new project would push U.S. spending in this field to \$1 billion a year.

L.A. studies aimed at clearing the air

The Government, stepping up its efforts to help solve urban communications problems, has chosen Los Angeles as the site for two pilot projects.

The Office of Telecommunications Management is cooperating with Los Angeles officials in a study of the city's communications administration. The second project, aimed at hitting upon the "best possible utilization" of the frequency spectrum, is a joint effort of the city, the Office of Telecommunications Management, the FCC, and the President's task force on communications policy.

IC makers start work on Sentinel

Hybrid integrated-circuit makers are feeling the first impact of production dollars in the Sentinel antiballistic missile program. RCA, Motorola, and Texas Instruments have received \$5 million each for IC production and preproduction engineering. The Army estimates that 7 to 9 million IC's will be needed for the computers and radar.

Most of the initial production money, \$85.5 million, will go for electronic systems and components. Raytheon is getting \$19 million for the missile site radar, General Electric \$1.7 million for the perimeter acquisition radar, and Lockheed Electronics \$1.7 million for data processing equipment. The direct payment to the prime contractor, Western Electric, is \$28 million. The contracts are for six months, ending September 30.

Comsat gets start on worldwide net

Comsat has taken the first step toward a permanent worldwide tracking network. Operated full time, the network will replace the tracking and control now performed part time on communications antennas. Acting on behalf of the Intelsat Consortium, Comsat has just contracted for a tracking station in Fuchino, Italy, that has a 44-foot antenna dish. The Fuchino station was made available when the Italian communications network put a new facility into operation at a nearby site. The newer station has a 90-foot dish.

Intelsat expects other older stations to become available as soon as newer facilities go on line.

Intelsat 3.5 bidding reopened by Comsat

Comsat has rejected the only bid it received on the Intelsat 3.5 communications satellite—from TRW Inc.—and is now asking for new proposals by April 22. It's relaxing two specifications to attract more industry interest this time around. The new ground rules call for delivery in 15 months, against 12 in the earlier specs, and bidders now have a choice of offering

Washington Newsletter

either the originally specified configuration of one broad earth beam and two spot (squinted) beams of 6° each, or only two spot beams.

In rejecting the TRW bid, Comsat called the offer unresponsive to the request for proposals. TRW had said its first satellite would be ready in 15 months instead of a year, and Comsat indicates that other companies would have bid if this longer delivery time had originally been allowed. Insiders feel TRW probably figured that even though it was exceeding the delivery schedule, it would, as sole bidder, win the contract by default.

Pentagon cools it on IC designs

The Defense Department is standing by its pledge to maintain a hands-off attitude toward integrated-circuit designs. It appears that military officials are now concerning themselves only with the form, fit, and function of IC devices, not with their design.

This is in keeping with the Pentagon's policy paper on microelectronics issued last April, a document that bars interference in the relationship between systems designer and IC supplier. As long as a system's performance is up to specifications, the Pentagon is staying out of the way.

One industry official comments: "We're enjoying this now, but I don't know how much longer they can carry it off. My guess is not much longer—maybe a year."

Controversial F-12 heating up another election campaign?

The F-12 supersonic fighter, which sparked a political controversy during the 1964 Presidential campaign, may do it again in '68.

From a battle within the Pentagon between civilian backers of the F-106X and Air Force supporters of the F-12, the struggle is suddenly mushrooming into a political issue. Both sides have been busy lining up support in Congress, with the Pentagon's civilian officials openly declaring they'll fight Congressmen who'd kill the F-106X program to pave the way for the F-12.

The Air Force, which wants the F-12 as the interceptor for the Airborne Warning and Control System (Awacs), picked up valuable ground when the Senate Armed Services Committee cut back the F-106X program. The committee trimmed from the fiscal 1967 budget \$24 million that was earmarked for modifying the F-106 with new electronics and missiles.

Second uhf meeting stalemated, but Lee will try, try again

FCC Commissioner Robert E. Lee is a determined man. A strong advocate of uhf television, he tried again this month to get tv-receiver manufacturers to agree to detent the uhf tuners on their sets [Electronics, March 18, p. 69], but the Chicago meeting ended in a stalemate. A conference of tv makers called by Lee last month flopped because few firms attended. But Lee isn't giving up; he plans to call a third meeting next month, this one in Washington.

Uhf broadcasters are trying to get set makers to adopt new, solid state all-channel tuners, but the manufacturers claim the devices would only add to the cost of the sets and would have no sales value. An additional problem is that only an estimated third of all present sets are equipped with automatic frequency controls, devices providing the fine tuning that detent tuners generally need.

Lee's purpose in pressing for these meetings is to get set manufacturers to act voluntarily on this matter. The FCC can force them to detent uhf tuners, but only after a lengthy rule-making process.

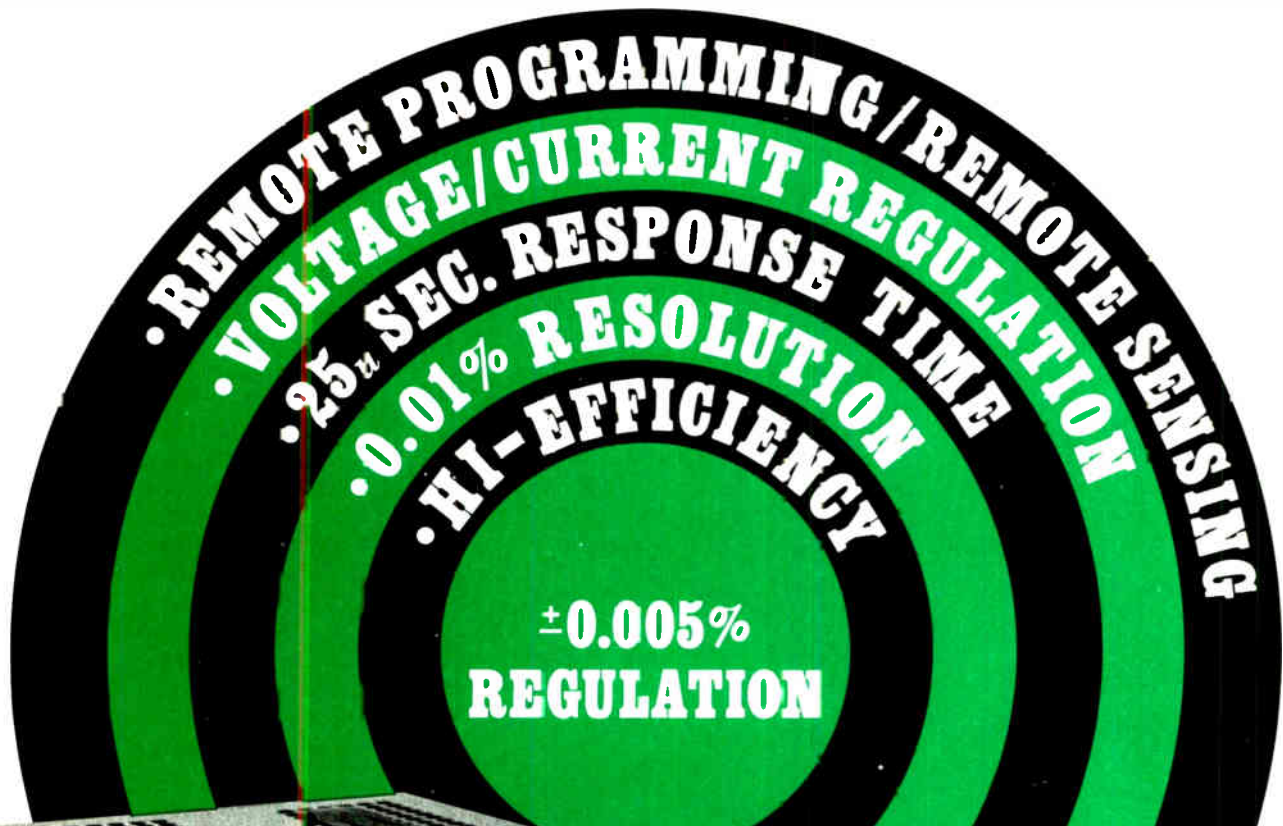

The QRC solves the size / power / regulation problem by combining all silicon, low-voltage series regulator circuitry with high-speed transistor switching techniques.

Sorensen High Performance QRC Series:

The QRC Series covers a wide target area without performance trade offs. Standard features include excellent regulation for voltage and current, fast response time ($\leq 25\mu\text{sec.}$), and surprisingly small size for power outputs to 1200 watts at ambient temperatures to 71°C .

Some laboratory power sources offer high power levels, but are bulky and, by today's standards, are unregulated. Others offer excellent regulation specifications, but are inefficient and, if high-power levels are desired, become large heat sinks. Sorensen QRC's are high efficiency, compact power sources which have excellent performance characteristics with prices

starting at \$325. Seven models are available from stock, covering the range of 0-40Vdc at currents to 30 amperes.

Additional features resulting from the utilization of sophisticated regulation techniques include low ripple ($\leq 1\text{mV r.m.s.}$); output voltage and current resolutions of 0.01% and 0.05%, respectively; remote programming in both the voltage and current modes; remote-sensing and a solid state automatic-crossover indicator.

Contact your local Sorensen representative or: Raytheon Company, Sorensen Operation, Richards Avenue, Norwalk, Connecticut 06856, TWX 710-468-2940.

RAYTHEON

for more data on this versatile instrument . . . **Call Sorensen: 203-838-6571**

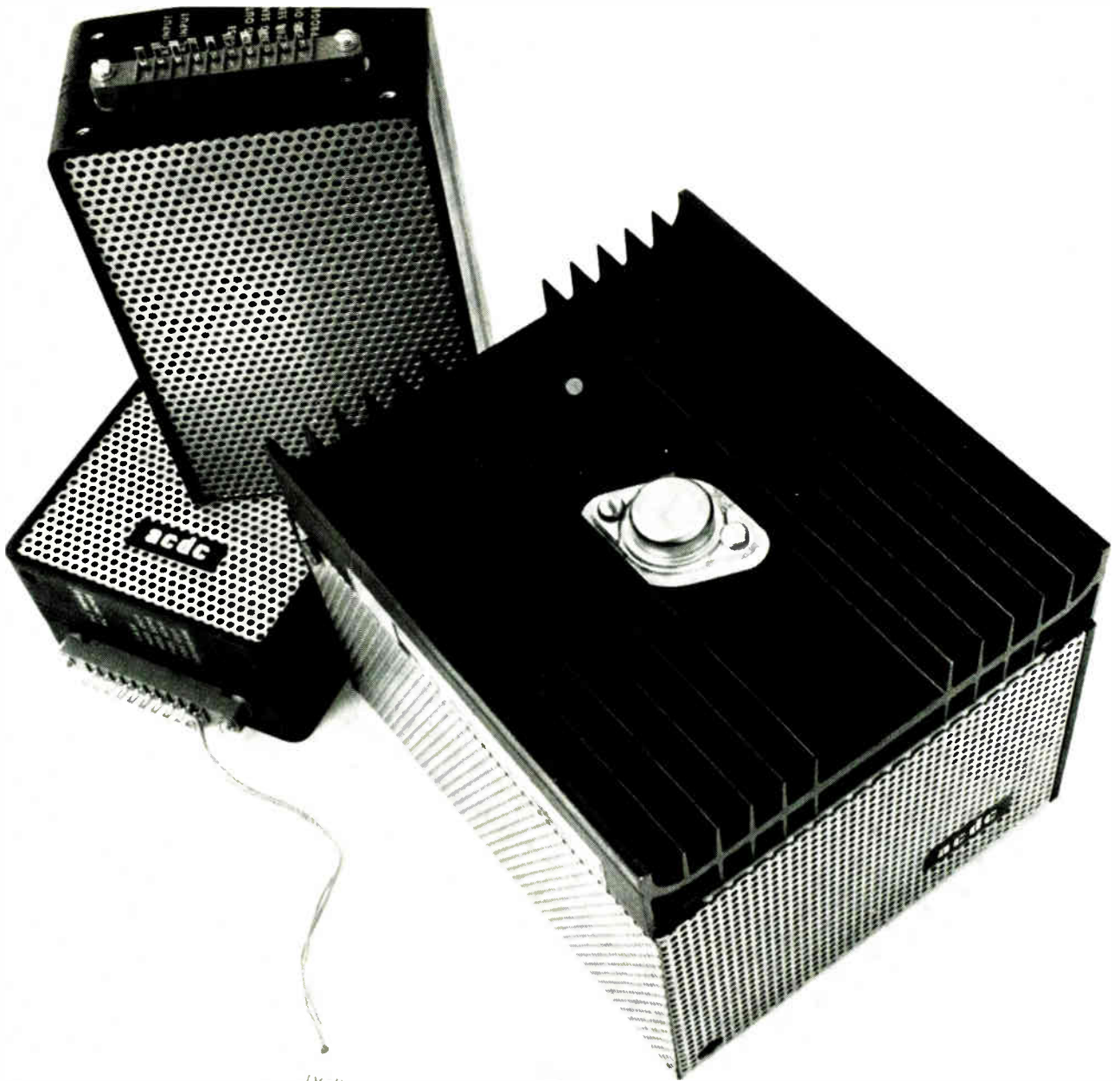

DC Power Supply Modules
**GUARANTEED
FOREVER**

acdc electronics inc.

acdc: Now in its third year of forever.

If you'd like to have our 1968 catalog, write to ACDC Electronics, Inc.,
2979 Ontario Street, Burbank, California 91504. Or telephone (213) 849-2414.

NO CONTEST if you're looking for 1 to 2 watts of continuous audio power

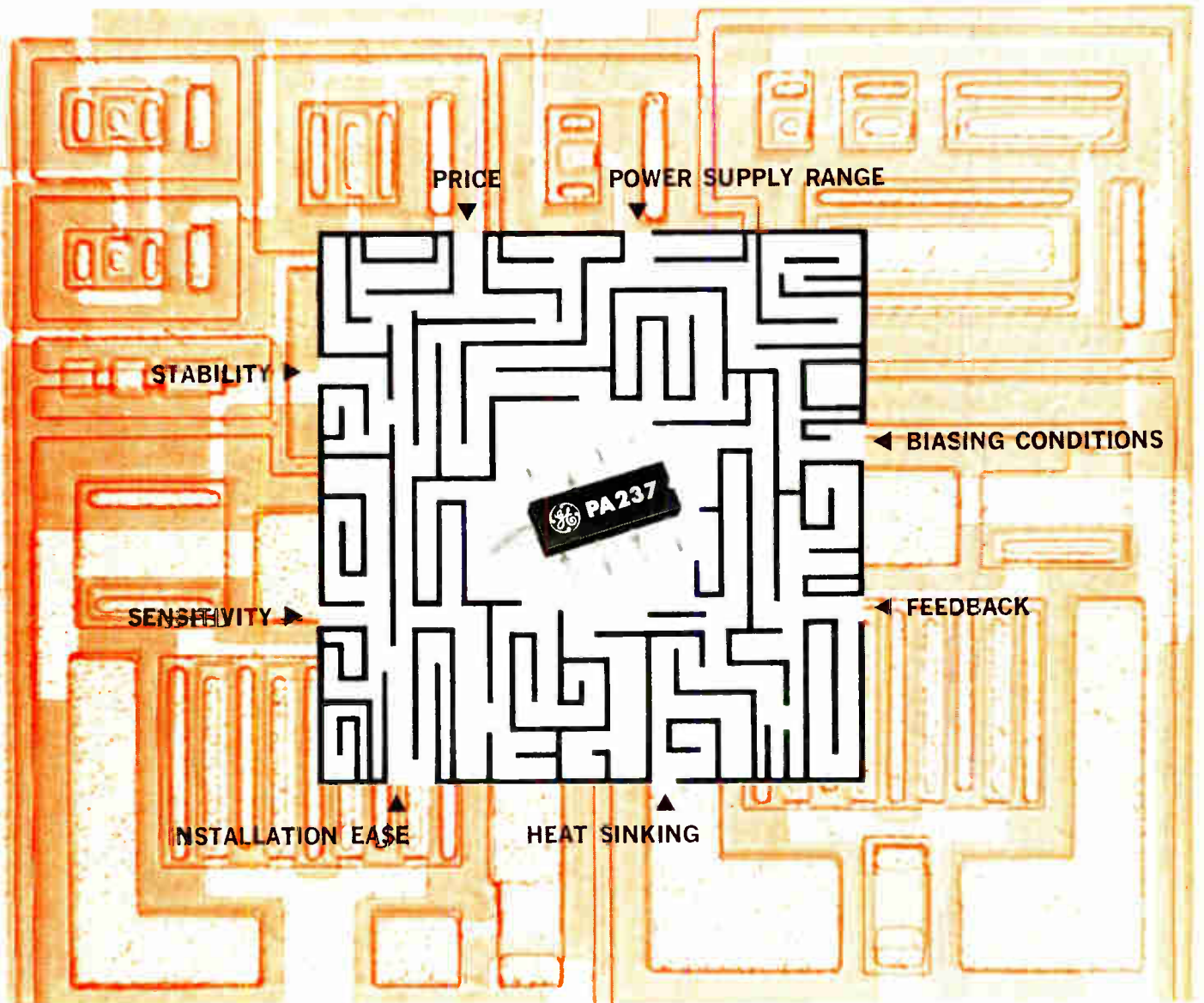

See for yourself why General Electric's silicon monolithic IC's
can't be beat.

No matter what your application, the PA234 or PA237 probably fits . . . and you save on design expense. See if you can draw a path from the feature most important to you, to the PA237 amplifier in the center of the puzzle. If you can get to the center, the PA237 is right for you. If you want to prove it to yourself, tell us your expected application and we'll send you a free PA237 to put to the test. Simply tear out this page and send it with your name, address, title, company, and PA237 application to Product Manager, Monolithic Audio Amplifiers, General Electric Company, Northern Concourse Office Bldg., North Syracuse, N.Y.

For more facts, turn the page. ▶

SEMICONDUCTOR PRODUCTS DEPARTMENT

GENERAL  ELECTRIC

Save design expense. Take advantage of the PA237's application versatility.



Because General Electric's PA237 operates over a supply voltage range of 9 to 27 volts, you can probably use this one circuit for most of your applications and save money. It is capable of delivering up to two watts of power to resistive or inductive loads. (Pictured actual size.)

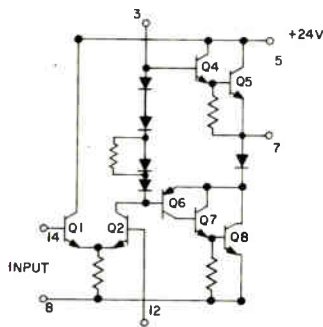

The PA237, shown in this circuit diagram, converts 8 mV of input signal to 2W of continuous, low distortion output power.



General Electric's PA234 gives you the lowest total cost for a 1-watt amplifier function through a combination of low device cost and minimum number of outboard components. (Shown actual size.)

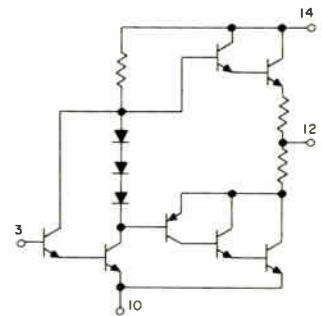

PA234 audio amplifier delivers 1 watt of continuous power to a 22-ohm load from a 22-volt supply.

Now you can use a single IC for most of your audio applications by simply varying its bias.

General Electric PA237 silicon monolithic audio amplifier is designed to have its biasing network external to the chip. Thus appropriate biasing for any power supply from 9- to 27-volts is readily achieved.

External biasing permits operation with Class A, Class A-B, or Class B output modes. The input may be biased for voltage or current sources as well as differential signals.

In addition to the PA237's wide range of supply voltage and bias alternatives, feedback may be applied to the amplifier to allow adjustment of stability, input and output

impedance and amplifier sensitivity. Simple AC and DC feedback networks are employed to provide excellent stability with frequency and temperature.

General Electric's 1- and 2-watt low-distortion amplifiers are packaged in an 8-lead dual-in-line plastic package with a tab for transferring heat to a printed circuit board. This means easy insertion into the P.C. board and easy heat sinking too. **General Electric's PA234** is the ultimate in low cost 1-watt monolithic audio IC's. Its low cost plus the least number of outboard components of any audio amplifier on

the market makes the PA234 the most economical alternative for achieving one watt of audio power.

Both General Electric's PA234 and PA237 offer you outstanding performance and top reliability in a wide range of circuit applications. These varied uses include phonographs, dictating equipment, tape player/recorders, and TV, AM, and FM receivers. Plus: the PA237 can drive inductive loads or provide voltage regulation for 1% typical over a 9- to 27-volt range. For more information on how GE can save you design expense and cash outlay circle number 515.

Here are some other outstanding GE semiconductors on which you can depend.

Industry's most predictable UJT saves time and money.

Stand-off ratio spread $\pm 3\%$!!
Oscillator frequency shift .6% max.
(-15°C to $+65^{\circ}\text{C}$)

GE's D5K1 and D5K2 planar complementary unijunction transistors offer greater stability and uniformity than any UJT previously available. They have characteristics of standard unijunction transistors except that, being complementary, their currents and voltages are of opposite polarity. For most applications, polarity is unimportant.

The D5K1 and D5K2 combine planar and integrated circuit techniques resulting in a much tighter intrinsic-standoff ratio distribution and lower saturation voltage. This gives them both a new high level of performance predictability versus temperature.

Timing stability of 0.5% is achievable without the necessity of expensive temperature testing on individual devices to determine the compensating resistor. For more details **circle number 516**.



1200-volt, 400-amp PRESS PAK silicon rectifier costs less.

If you want a high power silicon rectifier diode with the same proved, all-diffused construction of the A90 series, General Electric offers the A390 PRESS PAK. The package innovation delivers far more continuous current than comparable stud-mounted devices, and it's smaller, too.

The new PRESS PAK package, using pressure contacts, allows double-side cooling to significantly reduce thermal resistance and, therefore, increase current ratings about 60%. Result: You get more average amps per dollar.

Light weight, hermetically-sealed PRESS PAK also features reversibility of mounting, thus eliminating the need for special reverse polarity units. And it complements many SCR's already in the PRESS PAK package. For more details, **circle number 517**.



Now you can custom tailor UJT characteristics to meet your specific needs.

With General Electric's D13T1 and D13T2 programmable unijunction transistors (PUT) you can now program unijunction characteristics such as η , R_{BB} , I_P , and V_P to your specific needs by adding two external resistors.



Generally, the D13T gives programmability without increasing circuit complexity. In fact, it often reduces circuit cost. And the PUT offers tight parameter specifications, high sensitivity, low unit cost, low leakage current, low peak point current, low forward voltage, and fast, high-energy trigger pulse too.

D13T2 is specifically characterized for long interval timers and other applications requiring low leakage and low peak point current. The D13T1 has been characterized for general use where low peak point current is not essential. **Circle number 518**.

For more information on these and other General Electric semiconductor products, call or write your GE sales engineer or distributor, or write General Electric Company, Section 220-63, 1 River Road, Schenectady, N. Y. 12305. In Canada: Canadian General Electric, 189 Dufferin St., Toronto, Ont. Export: Electronic Component Sales, IGE Export Division, 159 Madison Ave., New York, N. Y. 10016.

SEMICONDUCTOR PRODUCTS DEPARTMENT

GENERAL  **ELECTRIC**

Circle 75 on reader service card →

A completely new instrument from Supply with plug-in conversion

Buy the basic LS Series

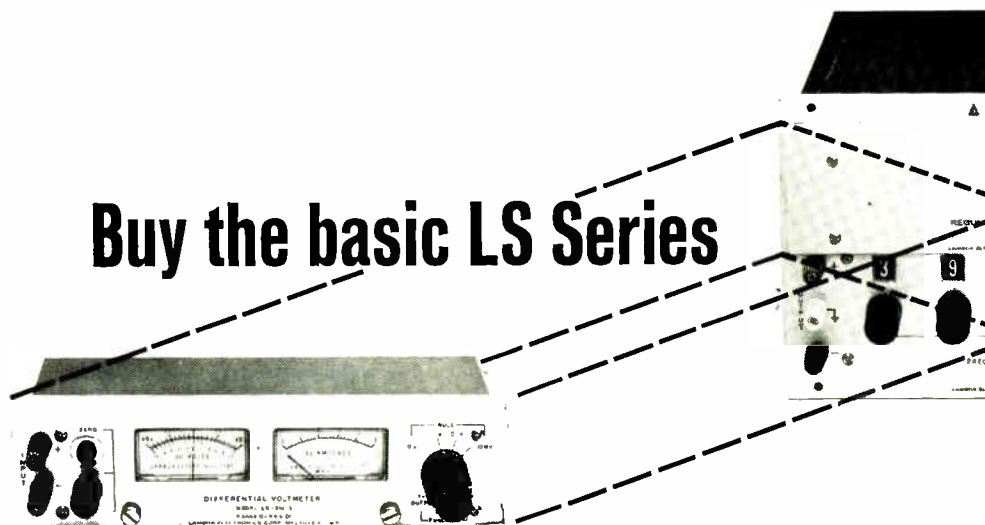

With this plug-in accessory it becomes a High Precision Power Differential Voltmeter that obsoletes any instrument now offered for this service

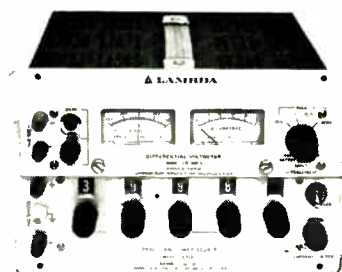

Basic Non-Metered Model	Voltage Range	Max. Amps at Ambient of ⁽¹⁾				Price ⁽²⁾	Diff. VM Accessory	
		30°C	40°C	50°C	60°C		Model	Price
LS-511	0-10VDC	2.8A	2.5A	2.1A	1.7A	\$375	LS-DM1	\$85
LS-512	0-20VDC	1.8A	1.6A	1.3A	1.1A	375	LS-DM2	85
LS-513	0-40VDC	1.0A	0.9A	0.75A	0.6A	375	LS-DM3	85
LS-515	0-120VDC	0.33A	0.29A	0.25A	0.21A	375	LS-DM5	85
LS-516	0-250VDC	0.1A	0.09A	0.08A	0.07A	380	LS-DM6	85

¹ Current rating applies over entire voltage range. Ratings based on 55-65 Hz operation.

² This price is for Precision Power Source only. Addition of Differential Voltmeter Accessory Plug-In (next two columns) is necessary for unit to function as High Precision Power Differential Voltmeter.

- **Draw power as you measure voltage**—The first and only differential voltmeter to furnish high stability power output while being used as a voltmeter . . . no need for a separate power supply.
- **2 meters**—Monitor both voltage and current simultaneously and continuously.
- **Guaranteed for 5 years**—The only 5-year guarantee that includes labor as well as parts. Guarantee applies to operation at *full published specifications*.
- **All-silicon design** for maximum reliability
- **Convection-cooled** for convenience and reliability . . . no blowers or heat sinks.
- **5 voltage ranges**: 0-10, 0-20, 0-40, 0-120, 0-250VDC—Wide selection of ranges to suit your specific needs.
- **Illuminated Digital Readout Millimatic^(TM) gang dialing**—5 digital voltage dials with automatic decade turnover provides convenient precise adjustment.
- **Only 5 1/4" high**—Convenient half rack size for rack or bench use.
- **0.01% + 1mV accuracy**
- **Stability 0.001% + 100μV for 8 hours**

- **Completely protected**: short-circuit proof; continuously adjustable automatic current limiting
- **Overvoltage protection** available as low cost add-on accessory
- **Rubber Feet** provided for bench use.

Power Supply specifications for Voltmeter same as for Power Supply—see next page

OVERVOLTAGE PROTECTION

For Use With	Model	Adj. Volt. Range	Price
LS-511 (0-10VDC)	LHOV-4	3-24 V	\$35
LS-512 (0-20VDC)	LHOV-4	3-24 V	\$35
LS-513 (0-40VDC)	LHOV-5	3-47 V	\$35
LS-514 (0-120VDC)	LHOV-6	3-70 V	\$35

 **LAMBDA**
ELECTRONICS CORP.
515 BROADHOLLOW ROAD, MELVILLE, L.I., NEW YORK 11748 - (516) 894 4200
A  SUBSIDIARY

VEECO HIGH VACUUM EQUIPMENT/LAMBDA POWER SUPPLIES

Lambda... High Precision Power to Power Differential Voltmeter

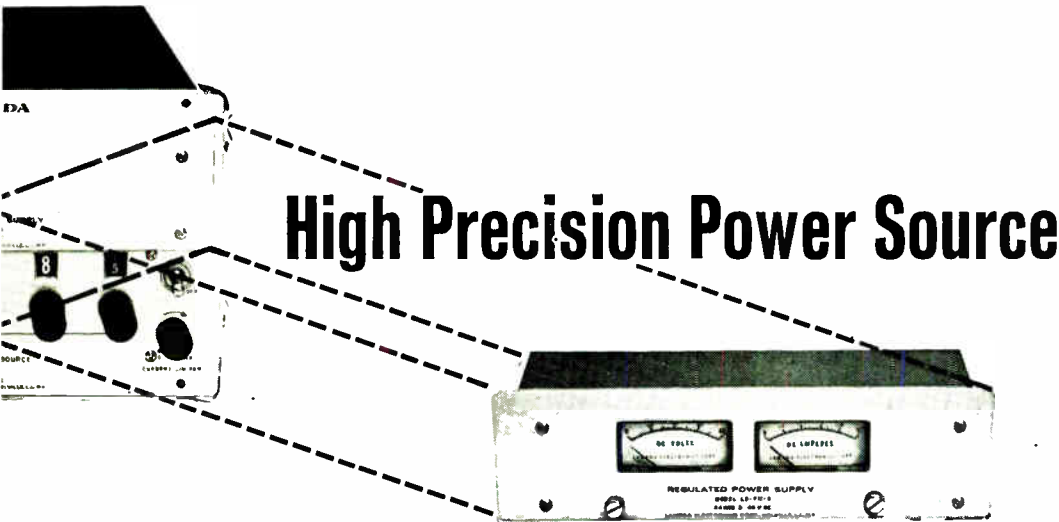

With this plug-in accessory it becomes a **Metered High Precision Power Supply** that offers all these features

Basic Non-Metered Model	Voltage Range	Max. Amps at Ambient of (1)				Price(2)	Metered Accessory	
		30°C	40°C	50°C	60°C		Model	Price
LS-511	0-10VDC	2.8A	2.5A	2.1A	1.7A	\$375	LS-FM1	\$55
LS-512	0-20VDC	1.8A	1.6A	1.3A	1.1A	375	LS-FM2	55
LS-513	0-40VDC	1.0A	0.9A	0.75A	0.6A	375	LS-FM3	55
LS-515	0-120VDC	0.33A	0.29A	0.25A	0.21A	375	LS-FM5	55
LS-516	0-250VDC	0.1A	0.09A	0.08A	0.07A	380	LS-FM6	55

1 Current rating applies over entire voltage range. Ratings based on 55-65 Hz operation.

2 This price is for non-metered Precision Power Source. Addition of Metered Accessory Plug-In (next two columns) is necessary to have Metered High Precision Power Supply.

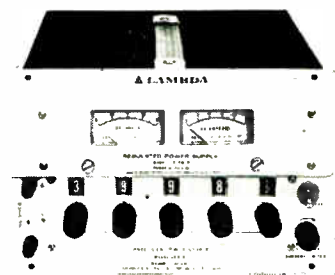

- **0.0005% plus 100 μV regulation**—Best of any 'high stability' power supply in this price range.
- **Ripple**—35μV rms; 100μV p=p.
- **Twice the power** in a convenient 1/2-rack package
- **2 meters**—Monitor both voltage and current simultaneously and continuously.
- **Guaranteed for 5 years**—The only 5-year guarantee that includes labor as well as parts. Guarantee applies to operation at full published specifications.
- **Multi-Current-Rated** for 30°C, 40°C, 50°C, 60°C —Covers temperatures most often encountered in laboratory work.
- **5 voltage ranges:** 0-10, 0-20, 0-40, 0-120, 0-250VDC—Wide selection of ranges to suit your specific needs.
- **Illuminated Digital Readout Millimatic™ gang dialing**—5-digital voltage dials with automatic decade turnover provides convenient precise adjustment.
- **Only 5 1/4" high**—Convenient half rack size for rack or bench use.
- **0.01% + 1mV accuracy**
- **Stability 0.001% + 100μV for 8 hours**

- **All-silicon design** for maximum reliability
- **Convection-cooled** for convenience and reliability . . . no blowers or heat sinks.
- **Remote programming** by changes in voltage or resistance for convenience in systems, test equipment and automatic equipment applications.
- **Auto Series/Auto Parallel** with Master-Slave tracking
- **Constant I/Constant V** by automatic crossover
- **Completely protected:** short-circuit proof; continuously adjustable automatic current limiting
- **Overtoltage protection** available as low cost add-on accessory
- **Rubber Feet** provided for bench use.

OVERTOLTAGE PROTECTION

For Use With	Model	Adj. Volt. Range	Price
LS-511 (0-10VDC)	LHOV-4	3-24 V	\$35
LS-512 (0-20VDC)	LHOV-4	3-24 V	\$35
LS-513 (0-40VDC)	LHOV-5	3-47 V	\$35
LS-514 (0-120VDC)	LHOV-6	3-70 V	\$35

Quick guide to bright, legible, wide angle readouts

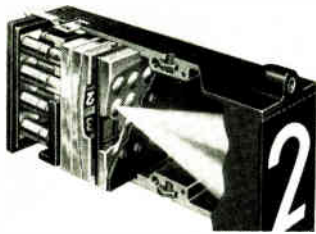

Series 360H Displays 2" high characters easily read from over 50'. Yet unit is just 3" H x 2" W x 7.75" D. New lens system provides bright, crisp display.



CRT Display 10-gun CRT projects single-plane digital or word displays onto fluorescent screen. Easy reading, even in direct sunlight. Wide viewing angle. Ideal for instrumentation applications.

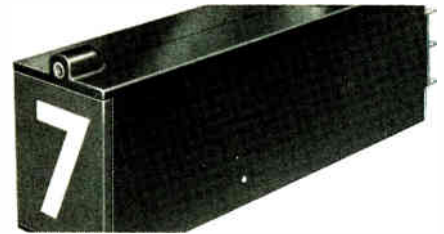

Series 160H Exceptionally large viewing area (1.56" H x 1.12" W for overall size). New lens system increases character brightness; reduces chance of reading error. Message lines may be displayed simultaneously with symbols.

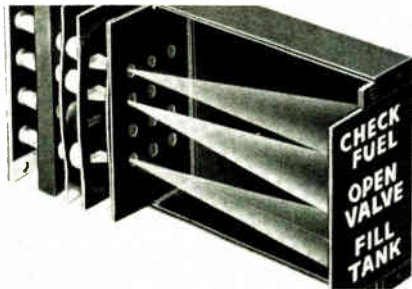

Series 80 Large screen unit particularly suited for annunciator applications . . . factory call systems, production control boards, etc. Message or character 3 3/8" high; can easily be read at 100', 160° viewing angle.

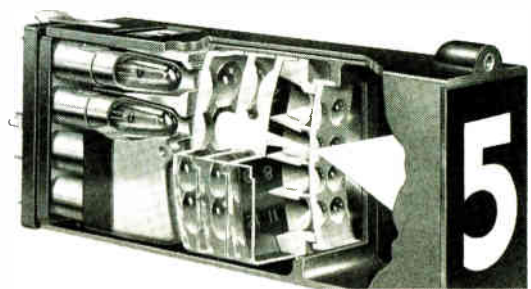

Series 10H It's the world's most popular readout. And we've improved it. New lens system increases character brightness 4 times. Greater clarity at wider angles and longer distances, even under high ambient light. .937" H x .937" W viewing area. Mil-spec version also available.



Series 345 IEE's smallest rear-projection readout. Viewing area .38" H x .34" W. Based lamps. Low cost. Individual readouts plug into permanently wired housing for quick message change. Easy front panel access.

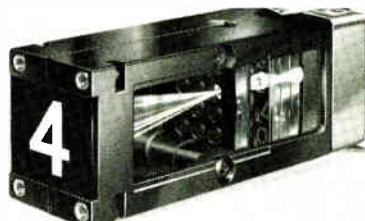

Series 120H Miniature (.62" H x .62" W) rear-projection readout. New lens system increases character brightness 50%. Easily read from 30' even with high ambient light. Quick disconnect lamp assembly for speedy lamp replacement.



Series 220H Miniature, plug-in, rear-projection readout meets MIL-R-39027. .62" H x .62" W viewing area. Special lens system increases character brightness 50%. Excellent readability from wide angles and long distances.



Series 875 Miniature, 24-position, rear-projection readout with .62" H x .62" W viewing area. Overall size just 1.39" H x .90" W x 3.095" D. Exceptional character brightness and clarity. Quick disconnect lamp assembly for easy replacement.

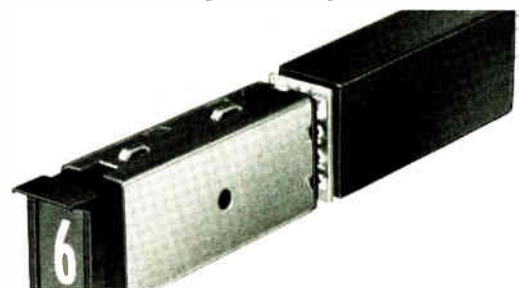

IC Driver/Decoders Small, solid-state units for IEE Series 10H, 120H, 220H, 340 and 360 readouts. All models accept a variety of binary codes for decimal conversion. Take normal signal voltage. Draw less than 2 ma. (Many options, including memory.)

Any characters desired. Any colors or combinations. Any input, BCD or decimal. Any input signal level. Any mounting, vertical or horizontal. Many sizes. Many configurations. Many options and accessories. Many brightness choices. Long lamp life (to 100,000 hours).



TTL Trends

from Texas Instruments

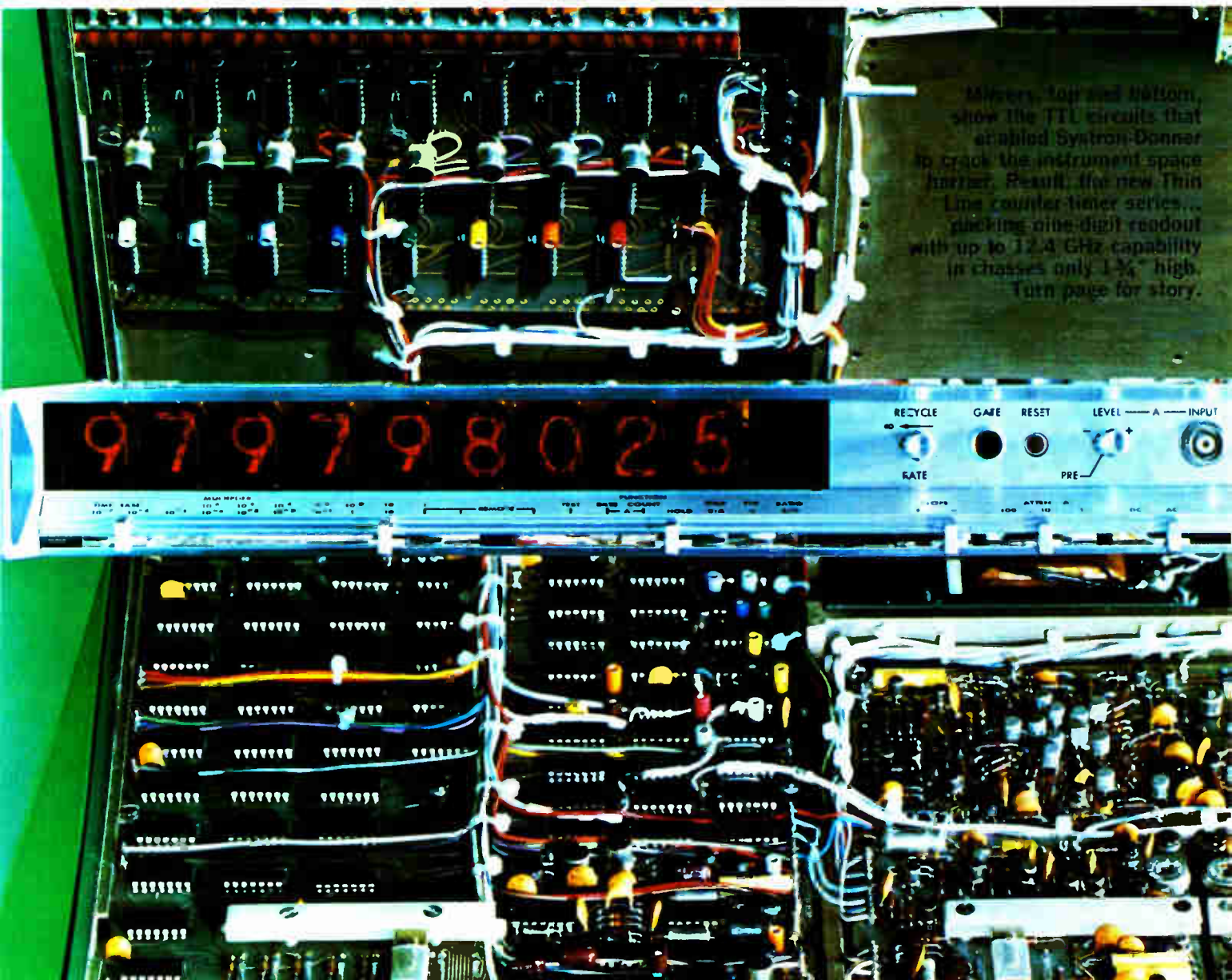

Micros, top and bottom, show the TTL circuits that enabled Syston-Donner to crack the instrument space barrier. Result: the new Thin Line counter-timer series... packing nine-digit readout with up to 12.4 GHz capability in chassis only 1 3/4" high. Turn page for story.

3 new shift registers expand industry's broadest logic line

These complex-function TTL shift registers are far more than basic registers. Applications include shift counters, Johnson and ring counters, and shift-register generator counters.

These registers incorporate additional gating as well as input and output connections, and are recommended for many storage and counting applications in addition to such shift functions as serial-to-parallel, parallel-to-serial, right-shift and left-shift operations. In all cases, substantial savings in packages, interconnections, design time and overall costs will be realized.

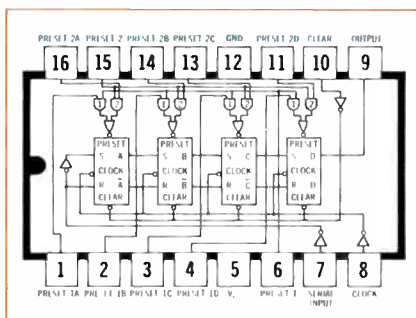

SN7494 4-bit shift register

This parallel entry, serial shift register includes four AND-OR-INVERT gates, four inverter drivers, and four R-S master-slave flip-flops. The result is a versatile circuit which performs right-shift operations as a serial-in, serial-out register or as a dual source parallel-to-serial converter.

All flip-flops may be cleared simultaneously – independently of

clock input. Also, the circuit has asynchronous loading capability from two strobe-controlled sources.

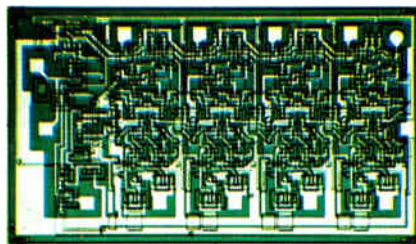

SN7495 4-bit shift-right, shift-left register

This parallel or serial-input shift register incorporates four AND-OR-INVERT gates, one AND-OR gate, six inverter-drivers, and four R-S master slave flip-flops.

This versatile register can be used in a wide variety of applications, including serial-in, right-shift/left-shift, and parallel loading operations.

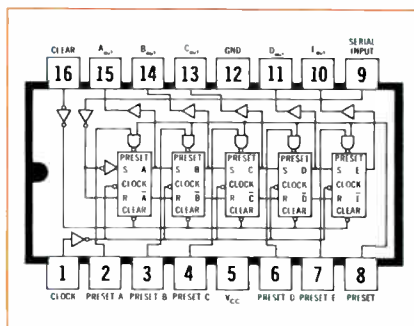

SN7496 5-bit shift register

This register consists of five R-S master/slave flip-flops, with gates and inverter drivers, connected

as a shift register to perform parallel-to-serial or serial-to-parallel conversion of binary data. Since both inputs and outputs to all flip-flops are accessible, parallel-in/parallel-out and serial-in/serial-out operations may be performed.

A common clear line and strobe-controlled, individual presets permit loading of any binary information into the register. Preset is independent of the state of the clock input.



A note from you, on your company letterhead, will bring this goldmine of information . . . data sheets on these 3 new shift registers plus application information on all our 54/74 counters and shift registers... a data book on the entire 74 N complex-function family ... and finally, an in-depth 48-page brochure covering all 54/74 TTL integrated circuits. Just address your letterhead request to Texas Instruments, Incorporated, MS980, P.O. Box 5012, Dallas, Texas 75222.



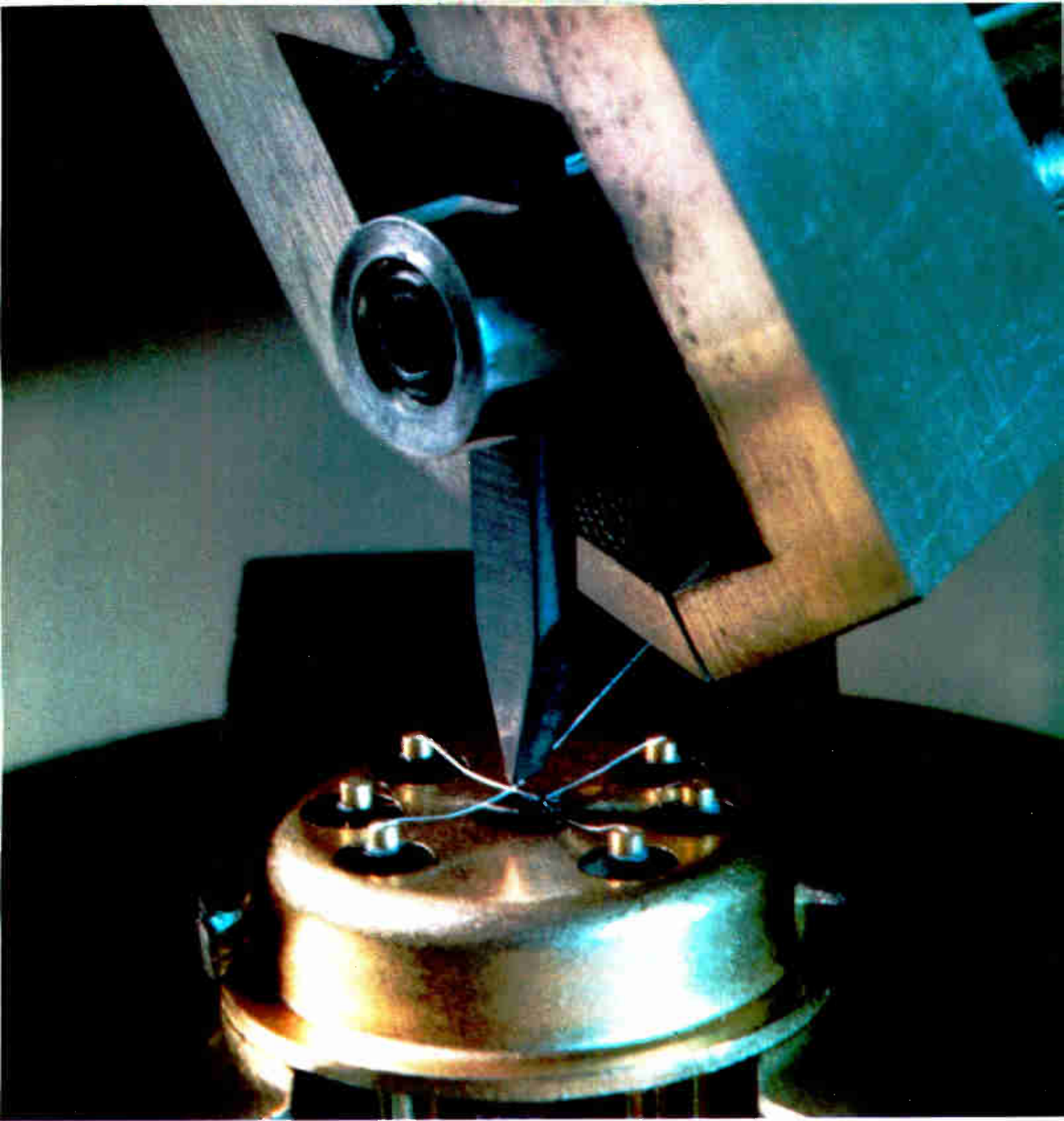

Craftsmanship in hard materials...an industry standard

HIGH PRECISION TUNGSTEN CARBIDE BONDING TOOLS, SUCH AS THE ONE SHOWN IN THIS 13X MAGNIFICATION OF AN ULTRASONIC LEAD BONDING OPERATION, WERE PIONEERED AND INTRODUCED AS PRODUCTION DEVICES BY TEMPRESS . . . IN 1963, THE TEMPRESS CAPILLARY TUBE, AN INDUSTRY STANDARD . . . IN 1967, THE ULTRASONIC BONDING TOOL, AN INDUSTRY STANDARD. The techniques and the specialized machinery developed to produce such precision products from ultra-hard materials have not been duplicated; quite probably will not be, for they are a result of the unique combination of Tempress people and the

Tempress philosophy. To meet its responsibilities, Tempress maintains a continuing expansion program, limited only by strict adherence to the Tempress Standard of Excellence. (It requires as long as 11 months to train an operator for certain operations.) The same uncompromising standard is applied to Tempress Automatic Scribing Machines and to the entire growing family of Tempress miniature assembly tools and production equipment.

LEAD BONDING, DUAL MET. COURTESY OF UNION CARBIDE ELECTRONICS



TEMPRESS

Tempress Research Co., 566 San Xavier Ave., Sunnyvale, Calif. 94086



Try this \$580 EAI Digital Measuring System for two weeks—FREE!

Now—you can get the EAI 6200 DVM on a two week memo billing to prove the performance claims for yourself. We bet you'll keep it, but if we lose there's no obligation. Just tell us your reasons!

What are the claims? First it's a great dc DVM, with features like automatic polarity, 100 microvolt resolution, pushbutton ranging, 1000 volt overload protection and $\pm 0.1\%$ accuracy (± 1 digit); and a few more you'll find for yourself.

What makes it a DIGITAL MEASURING SYSTEM? Low cost modules that create an ac DVM and a counter. Not just any counter, but a 10 MHz crystal controlled counter and time interval meter that can totalize and measure period—all for only \$210. For ac measurements, there's a 20 Hz—100 KHz converter good to 300 volts

with a 1 megohm input impedance and packaged in a compact plug-in module for only \$250.

For you systems-minded people, a rack-mounted version called the 6210, with a BCD output option, costs a little less—\$550 as a DVM.

Interested? Call us—collect—at 201-229-4400 extension 6200 with a consignment purchase order and we'll ship you one for a two week trial (if you're in the US, that is... we do have to limit the offer to continental US only). Or ask for more specs...they'll be return mailed to you.

EAI Electronic Associates, Inc., West Long Branch, New Jersey

**Semiconductor
test system.
Computer-control:
\$59,900.**

The 600C is the top of our Series 600 Test System line. And, spec for spec, it's the best system in its price range. It consists of a basic Series 600 system, a rack-mounted PDP-8 computer, an ASR-33 teletypewriter, a control panel, and a software package. Our Series 600 is a high-speed test system for transistors, diodes and reference diodes. It can perform 100 digital readout or Go/No-Go tests a second: Leakage. Breakdown voltage. Latching voltage. DC gain ratio. Saturation voltage. Base turn-on voltage. The whole parametric package. It's suited for production testing, incoming inspection, quality control, reliability and general engineering testing. Series 600 equipment starts at \$18,900. We also have a magnetic disc programmed system that sells for \$40,950. And, of course, the computer-controlled 600C priced at \$59,900. You can get information on the whole series, plus specs and options, just by calling Fairchild collect at (408) 735-5461. Ask for Frank Wilber.

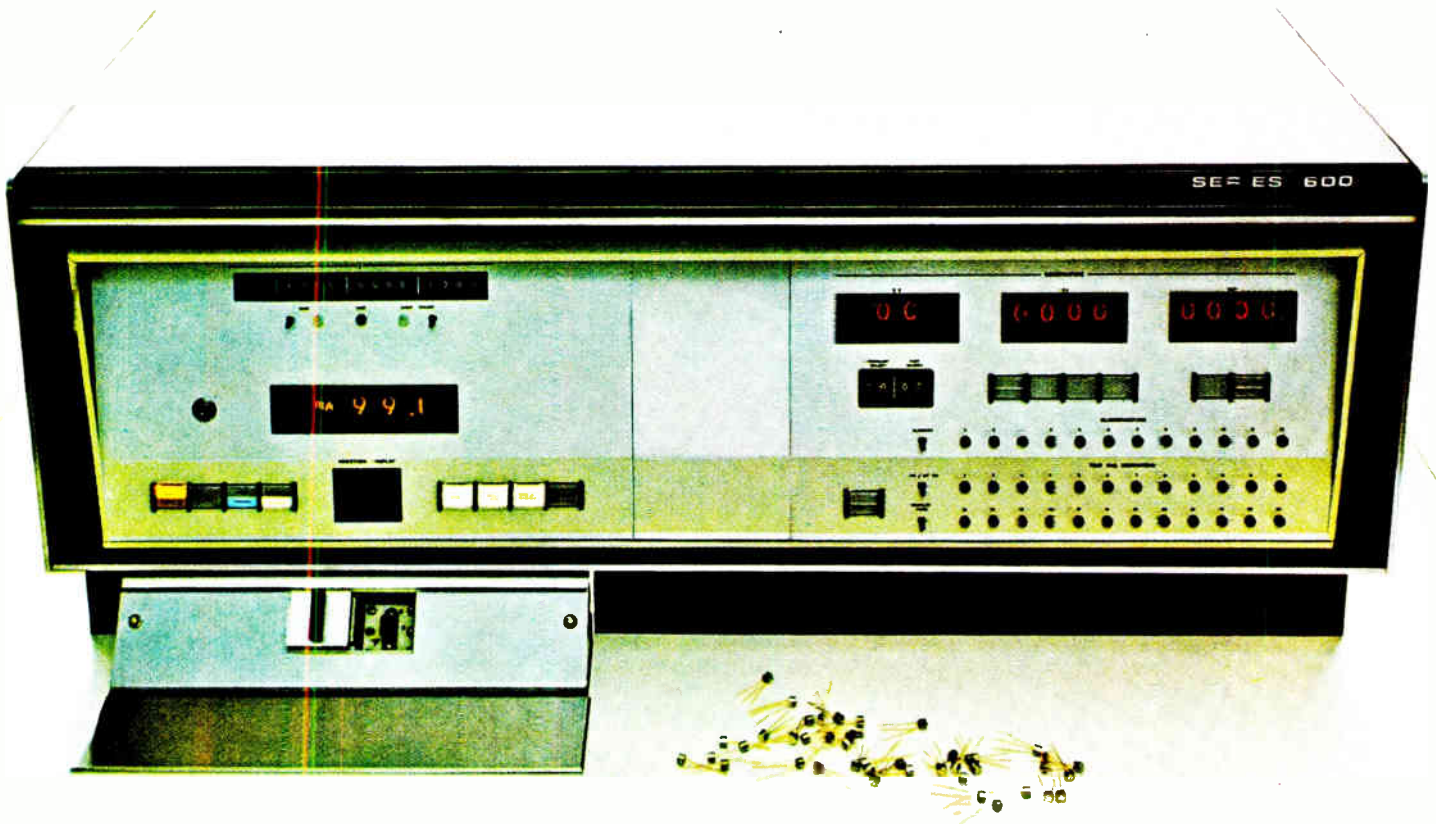

THE OVER-ACHIEVER...

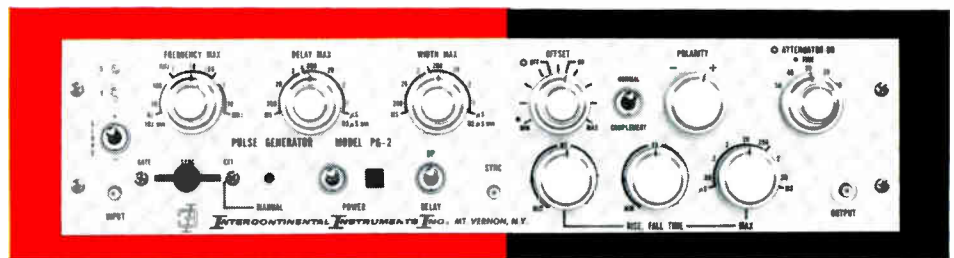

No other solid state pulser for under \$1,000. gives you as much as our Model PG-2. Buy it for production test and you find that the development lab people prefer it for most of their development work and systems engineers keep designing it into test and operational systems. It shows up everywhere and everywhere it excels.

Maybe it's the PG-2's performance: prf to 20 MHz from 1 Hz in the double pulse mode; 16 MHz at full $\pm 20V$ amplitude. Rise/fall from 10 ns to 20 ms with greater than 100:1 dynamic range between them. Widths from 35 ns to 200 ms; delay from 0 to 200 ms; DC-offset 0 to $\pm 5V$.

Or its operating flexibility: single or double pulses, normal or complement, sync pulse, plus manual one-shot. Continuously variable prf, amplitude, width, delay, rise time, fall time, DC-offset, input threshold and sensitivity. The PG-2 can be gated or triggered from DC to 10 MHz. And it is DC-coupled so that there are no low frequency or duty cycle limitations. And probably the PG-2's outstanding reliability, operating simplicity and rugged solid state design help.

Model PG-2. Our over-achiever. \$925, f.o.b. Mt. Vernon, New York. Delivery off the shelf.

Where can it over-achieve for you?

Chronetics, Inc., 500 Nuber Avenue, Mt. Vernon, New York (914) 699-4400; in Europe: 39 Rue Rothschild, Geneva, Switzerland (022) 31 81 80. Sales Offices throughout the free world; see EEM or EBG.



PRODUCTS OF
CHRONETICS

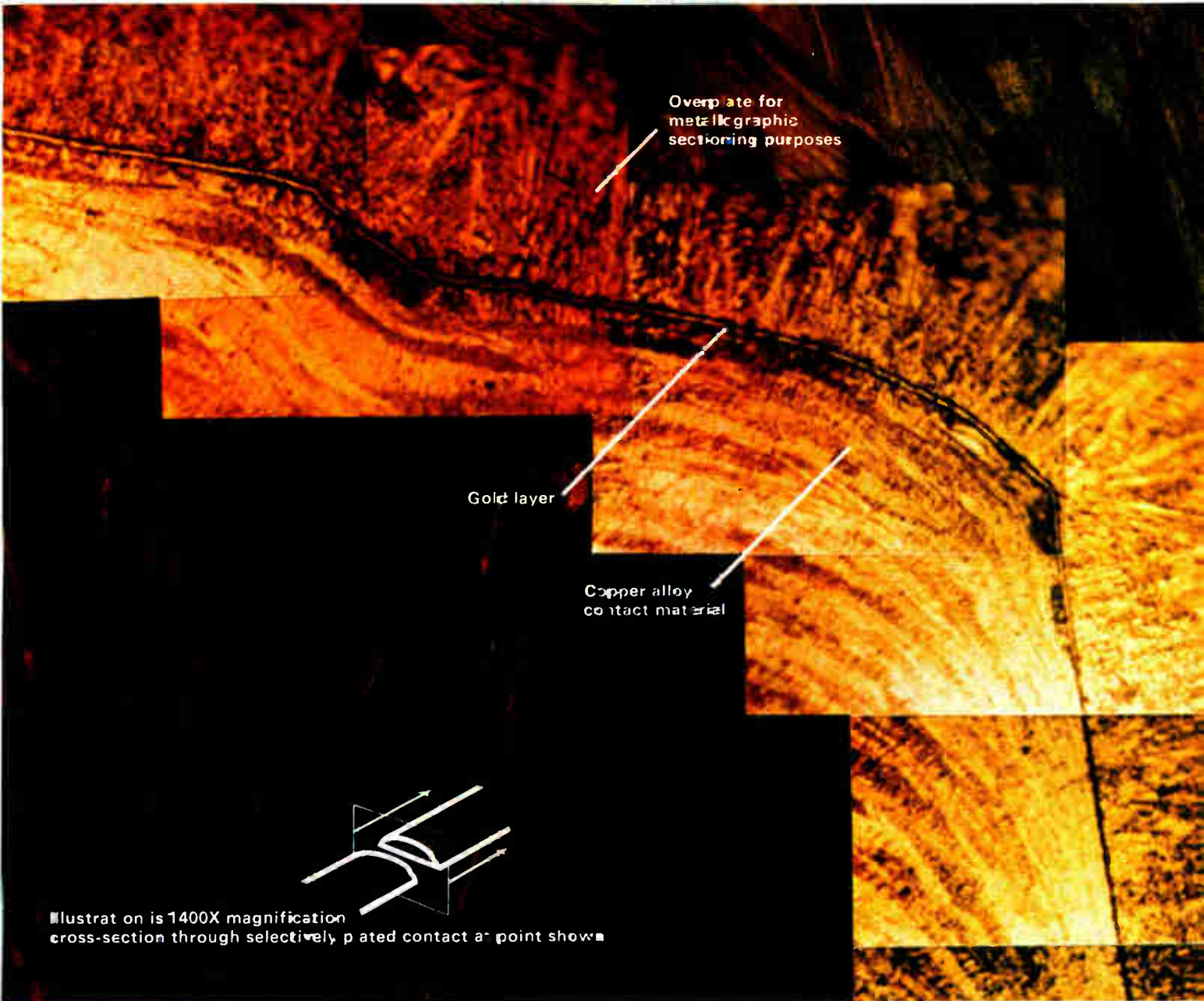

Overplate for metallographic sectioning purposes

Gold layer

Copper alloy contact material



Illustration is 1400X magnification cross-section through selectively plated contact at point shown

CINCH PUTS THE GOLD ONLY WHERE YOU NEED IT

IN THE AMOUNT YOU WANT—With Cinch selective plating you benefit from reduced gold content and the absolute control of gold thickness at the contact area. The result is a better connector at lower cost . . . that also helps reduce the U.S. gold drain.

In conventional barrel plating, the amount of gold deposited at any point is a function of the geometry of the part and cannot be accurately controlled from part to part. To compensate, excessive gold deposits must be used, but there is still no guarantee that every part will receive the minimum gold plate specified, due to the random nature of the process.

Cinch continuous process selective plating deposits the same controlled amount of gold on every contact. Only the contact area is plated, reducing gold consumption as much as 60%.

A wide range of Cinch connectors is available with selectively plated contacts. For information on how selective plating can provide you with a better product at lower cost, write to Cinch Manufacturing Company, 1501 Morse Avenue, Elk Grove Village, Illinois 60007.

C-6814

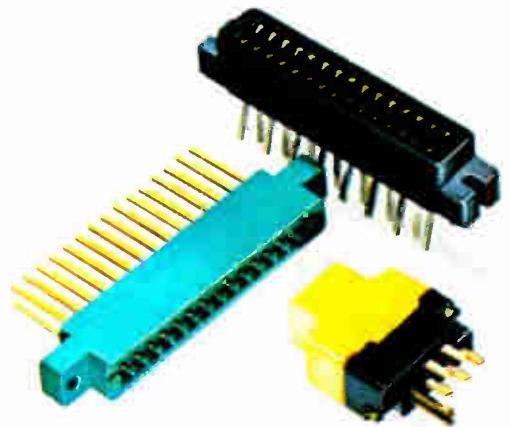

CINCH
DIVISION OF UNITED-CARR



CONSISTING OF CINCH MANUFACTURING COMPANY, CINCH-GRAFIK, CINCH-MONADNOCK, CINCH NULINE, UCINITE (ELECTRONICS) AND PLAXIAL CABLE DEPT

Circle 85 on reader service card



**SEE THIS
PINHOLE?**

**General Electric's
Helium Leak Detector
will find a leak
one ten-thousandth its size.**

Our Helium Mass Spectrometer Leak Detector's sensitivity is like horsepower in a big car. Most of the time you have more than you really need; but when you *do* need it, it's there.

Specifically, our units are sensitive to at least 2×10^{-11} std. cc/sec. Put another way, GE equipment will—in less than one second—detect leakage that's at a rate of an ounce of helium in *ten* years.

But sensitivity is only part of our story. We'd

like the chance to tell you about our two-years-guaranteed spectrometer tube filament; our reliable, long-life, solid-state circuitry; our models' ease of operation and servicing; our constant sensitivity; our all-welded, stainless steel high-vacuum system.

And then some. Check the reader service card, or write us direct for full particulars on manual model LC-10 or automatic model LC-20. We have a product we're proud of.

VACUUM PRODUCTS BUSINESS SECTION

GENERAL  ELECTRIC

SCHENECTADY, N. Y. 12305

LC-2

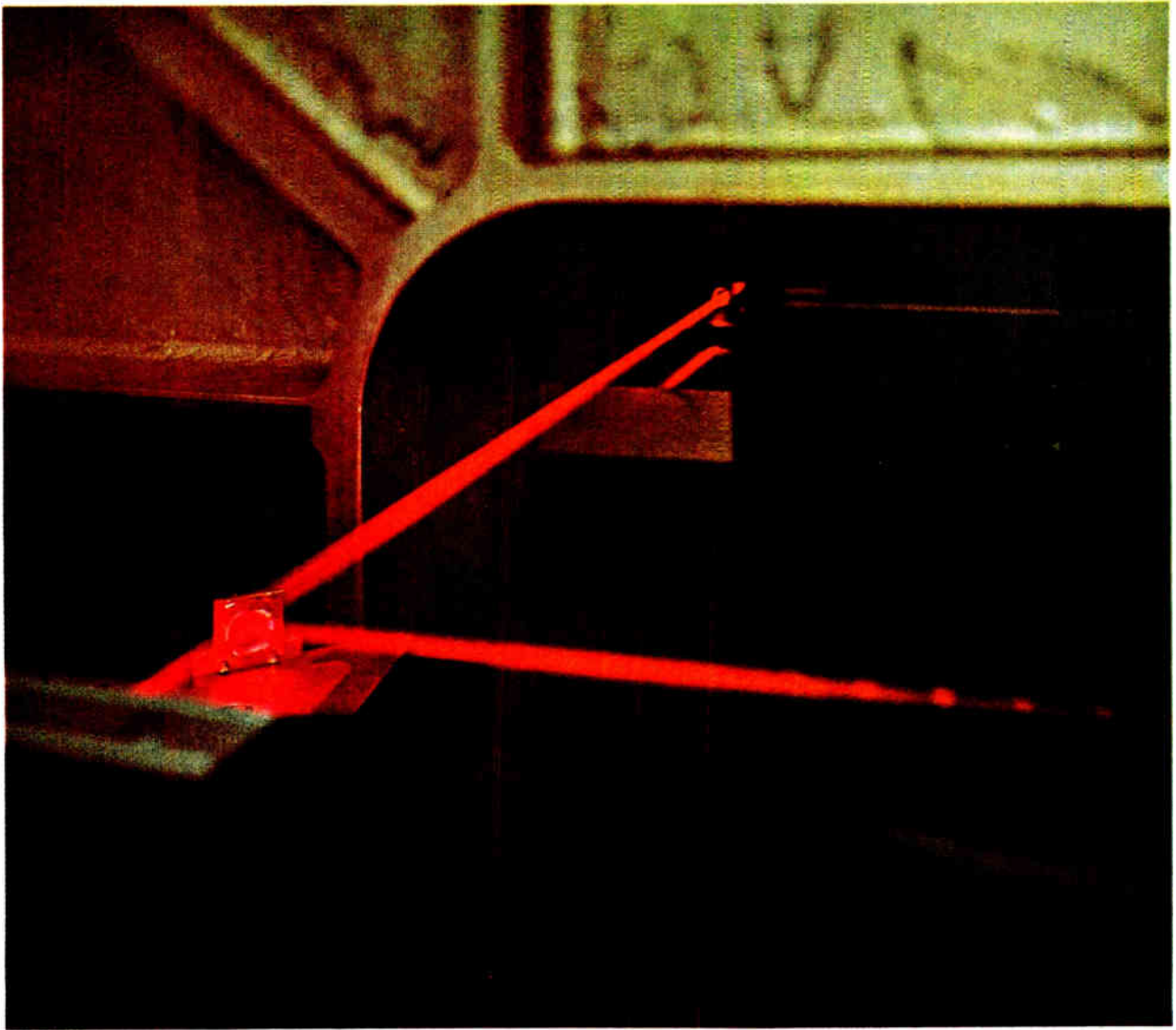

Only ITT has laser-controlled IC mask making.

Another reason to buy from "The Predictables."

Mask variations used to mean performance variations in Series 930 DTL. Now ITT initiative has eliminated the problem. An exclusive laser-controlled, fully automated mask making machine assures absolute repeatability of masks and of circuit performance.

ITT's machine, representing an order of magnitude improvement over older processes, holds mask registration tolerances to ± 122 silicon atoms (based on the crystal lattice constant). It is tape programmed, with memory storage capacity of 10,000 separate semiconductor devices, and it can complete a matched set of up to nine masks in as little as 10 minutes.

If you think all Series 930 DTL

circuits of the same type should act the same, the solution is simple: buy them from "The Predictables." ITT predictability also extends to diodes, rectifiers, and silicon planar transistors. Ask for a quote on any or all. They are on-the-shelf at your ITT distributor. ITT Semiconductors is a division of International Telephone and Telegraph Corporation, 3301 Electronics Way, West Palm Beach, Florida.

semiconductors **ITT**

FACTORIES IN FLORIDA • CALIFORNIA • MASSACHUSETTS • ENGLAND • FRANCE • GERMANY • PORTUGAL • AUSTRALIA

Now, absolute measurement of low intensity light signals

with the EG&G Spectroradiometer System

EG&G's new series of high sensitivity detector heads allow use of the Model 580/585 Spectroradiometer System for absolute measurements of low intensity, pulsed or CW, light signals. These new detector heads, which incorporate photomultiplier tubes, complement the existing line of vacuum tube detector heads by providing approximately five decades of additional system sensitivity.

The Model 585-66 Detector Head encompasses a spectral range from 200-750 mu (ultraviolet-visible) and senses irradiant powers as low as 9×10^{-13} watts/cm²-mu and irradiant energies as low as 9×10^{-13} joules/cm²-mu at 450 mu.

The Model 585-63A Detector Head is now contained in a thermoelectrically cooled chamber (using EG&G thermoelectric modules) to minimize thermionic dark current and the resultant noise.

A separate controller unit assures constant chamber temperature. With a spectral range from 700-1200 mu (near infrared), the 585-63A detects irradiant powers as low as 5×10^{-12} watts/cm²-mu and irradiant energies as low as 5×10^{-12} joules/cm²-mu at 800 mu.

The new detector heads are provided with a regulated power supply and an internal calibration feature to ensure a stable sensitivity. Utilizing standards traceable to NBS, a complete 580/585 Spectroradiometer System is calibrated to its sensitivity versus wavelength thereby permitting absolute irradiant measurements of both continuous and pulsed (as fast as 1 ns) light sources.

Energy and average power measurements are obtained directly from the multi-decade meter of the Indicator Unit or from an external recorder. Provision is also made for output to an oscilloscope for pulsed sources.

Applications with the new high sensitivity detector head include measurements of phosphors, chemical reaction, electroluminescence, emissivity and reflectivity of surfaces, biochemical analysis, and other low level signals.

If you'd like more information on the EG&G Spectroradiometer System, or for that matter on any of our products, such as thyatrons, krytrons, spark gaps, flash tubes, thermoelectric modules, transformers, chokes, trigger modules, photodiodes, picoammeters, flash and strobe equipment, or light instrumentation, write: EG&G, Inc., 166 Brookline Ave., Boston, Massachusetts 02215. Tel: 617-267-9700. TWX: 617-262-9317.

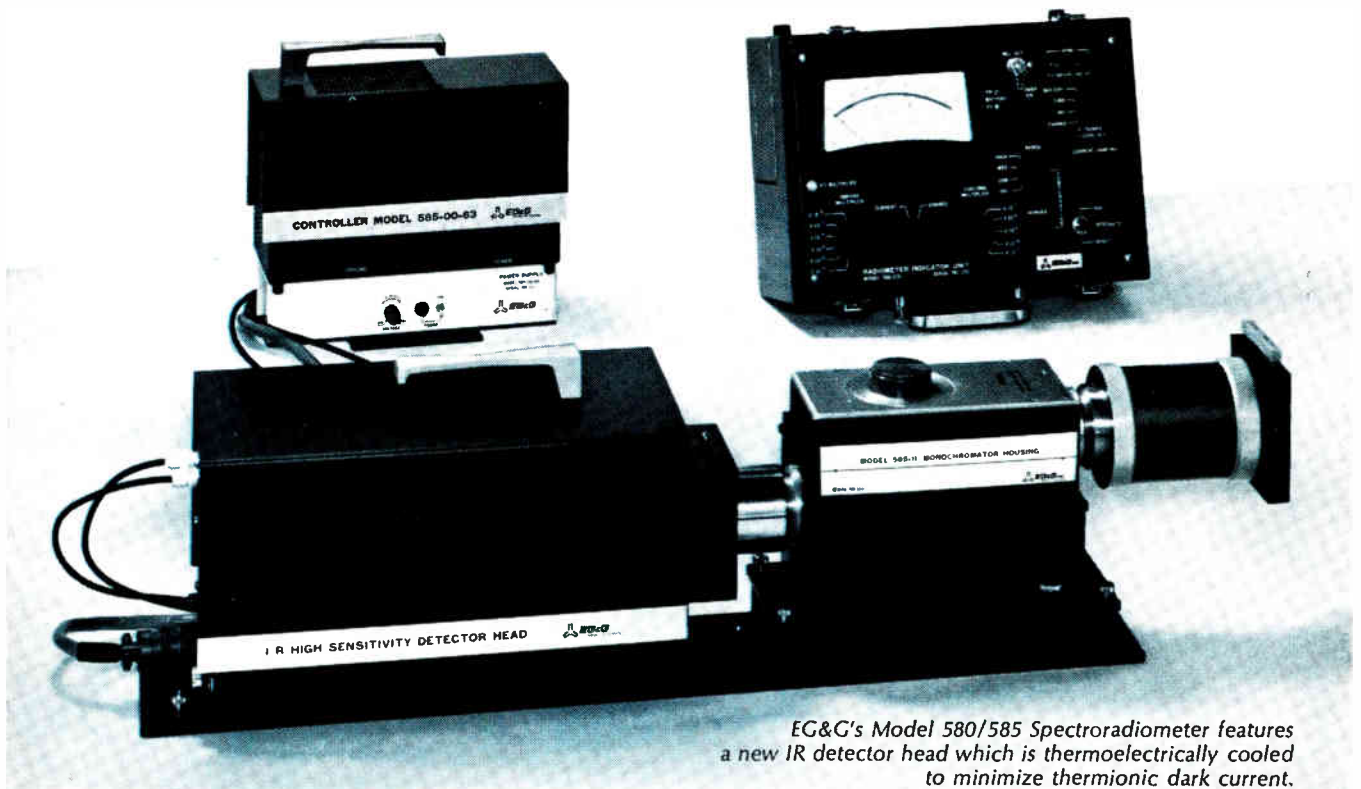

EG&G's Model 580/585 Spectroradiometer features a new IR detector head which is thermoelectrically cooled to minimize thermionic dark current.

Oak's design engineers are impatient . . . nothing is ever quite good enough. They figure improved products today mean better circuits tomorrow. Take these: ♦ Oak-manufactured Rotary Solenoids and Selectors for multiple switching functions in limited space under severe operating and environmental conditions. ♦ Molded Pushbuttons designed specifically for computers, communications and other panel equipment. ♦ Rotary Switches with molded diallyl phthalate stators and rotors, Unidex™ indexing. ♦ Lever Switch with molded diallyl phthalate type "A" stator for miniaturization, versatility in a small area. Plus these—Rocker Thumbwheel, Pushbuttons, Lever and Slide Switches. Oak offers widest selectivity in quality switches for industrial, commercial or military requirements. In fact, Oak has more switches that meet MIL-S-3786 than all other manufacturers combined—over 24 switch products. The next switch manufacturer has six. In addition, Oak offers sub-assembly service to save you production time and costs. These are only highlights of a small part of the complete Oak line of components. Send today for Catalog 24.

**DESIGNED FOR TOMORROW'S
CIRCUITS!**

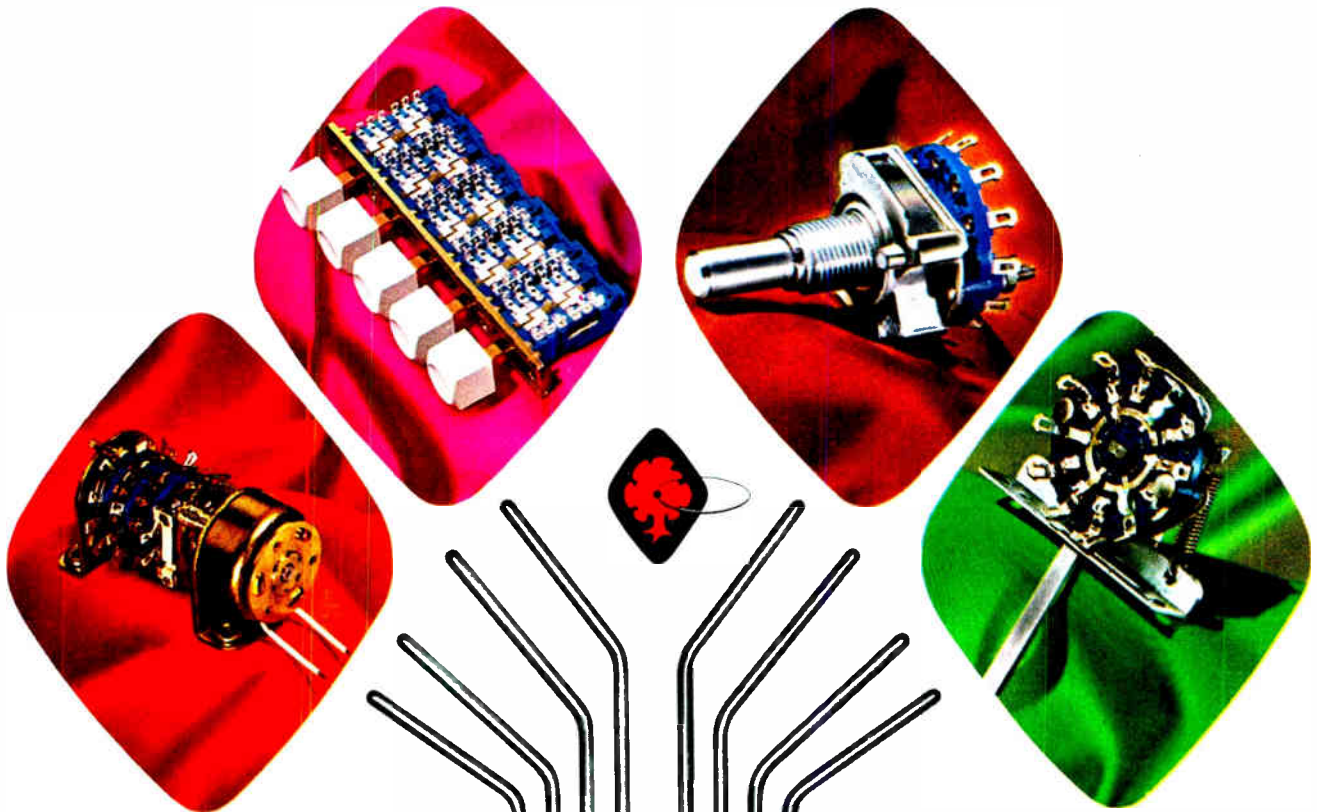

Ph: 815-459-5000 TWX: 910-634-3353

OAK

CABLE ADDRESS: OAKMANCO

MANUFACTURING CO.

A DIVISION OF OAK ELECTRO/NETICS CORP

CRYSTAL LAKE, ILLINOIS 60014



Compliments of a friend – a complete multimeter at less than \$3000

We think you'll agree that it's pretty friendly of Cimron to put out such a flexible instrument for so little. But it's typical of the philosophy that has always guided Cimron – customer concern. You need the most sophisticated instruments to do your work under a variety of changing conditions. And the Model 6653 gives you a great sendoff for both systems applications and laboratory or production testing. You get 5-digit readout including overrange, with an accuracy of $\pm 0.01\%$ f.s. $+0.01\%$

of reading for six months or longer. You'll save on calibration costs. Sample rates up to 300 per second; automatic polarity and automatic ranging; AC, ohms, millivolts. And look! You also get auto ranging through six millivolt and DC ranges. It's especially hard to beat all those Cimron customer concern features like remote control and printout, maintainable plug-in pc boards, and accessible calibration and test points. Write Cimron®, Dept. B-106, 1152 Morena, San Diego, Calif. 92110.

LEAR SIEGLER, INC.



CIMRON DIVISION

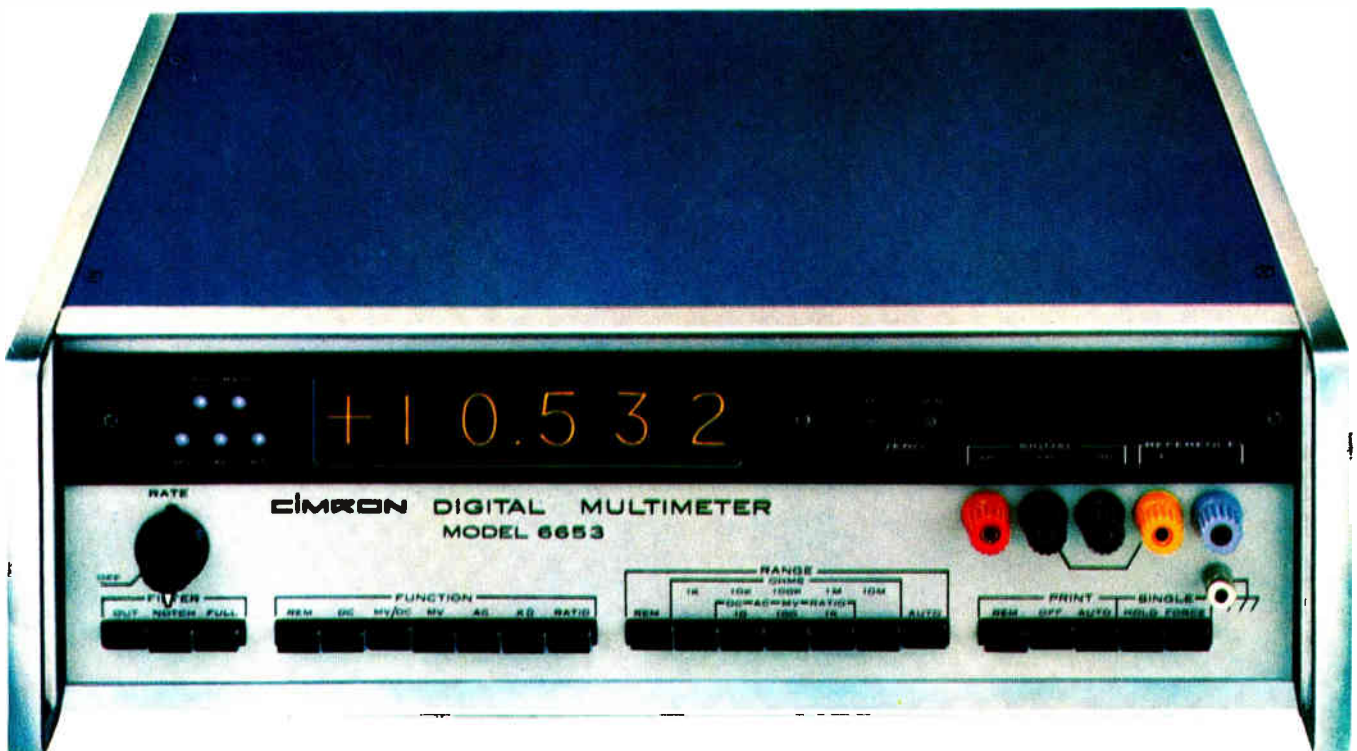

Technical Articles

**Experimental flat-screen
color television**
page 92

Electronics



SCR's, and 4,000 transistors. The screen (shown in part on the cover) has a 100-inch diagonal.

Consumer electronics engineers look forward to flat-screen color television because it will eliminate high voltages, the danger of X rays and implosions, and misconvergence of electron beams. To learn about the problems that might crop up in building a flat-screen set of conventional size, Sony has constructed a giant experimental receiver that uses 78,000 light bulbs, 260

**Understanding common-
mode errors**
page 108

The operational amplifier means different things to different engineers. For example, used as an inverting amplifier, it is free from common-mode error but does not give exceptionally high gain. In a noninverting configuration, its gain is high but common-mode error is present. In this article, the first of two on this subject, the author shows how amplifier design can minimize common-mode error.

**Party-line
data link**
page 119

Cabling can be an expensive item in a data-transmission system. A new method of linking transmitters to their corresponding receivers one at a time over a single two-wire cable reduces these costs. The technique also employs low-cost logic gates and flip-flops. The system can send analog or digital messages, using a binary code to address transmitter-receiver pairs.

**Airborne transceiver
for the military**
page 133

A critical problem in airborne communications is electromagnetic compatibility. Now a high-frequency transceiver crams 280,000 voice channels in the bandwidth used by older sets for only 28,000. It can reject a signal 120 db above that of the tuned signal and only 50 kilohertz away from it, permitting efficient operation in crowded-frequency situations where strong interfering signals are close by. The new set also performs dynamic tests on itself.

**Coming
April 29**

- Automatic in-flight checkout
- Integrated circuits in Japan



Setting the stage for flat-screen tv

Experimental tubeless color set uses 78,000 light bulbs;
converts standard signals with pulse-width modulation

By Satoshi Shimada

Sony Corp., Tokyo

A television receiver with 78,000 light bulbs, 260 scr's, 4,000 transistors, and a power supply that delivers 300 amperes at 30 volts can hardly be called ready for home use. But the only way of discovering the kind of problems that would crop up in developing a small flat-screen color receiver was for Sony to build the giant 8-foot-diagonal set.

The color tv receiver has its 78,000 lamps in an x-y matrix—300 in each of 260 lines. The most important innovation in the system is the conversion of standard video signals into pulses for digitally scanning the x-y matrix with pulse-width modulated signals.

The receiving circuits use a standard color tv tuner that picks up broadcast signals and delivers the red, green, and blue color signals that normally drive the electron guns in the color tv tube. Three video amplifier channels then deliver the three signals to the horizontal video driver blocks.

These blocks convert the color signals into pwm signals for driving the lamps. The bulbs are staggered from line to line and each bulb is part of two color trios; each trio forms a triangle over two lines. Thus 600 pwm channels (200 color-trio channels) are connected to the 600 lead wires of the video panel.

The bigger they are . . .

Many engineers have completed prototypes of smaller displays, ranging from perhaps 12×24 elements, or 20×20 . But the circuitry for these is far simpler than that for full-scale displays: there are no problems of high current, mistriggering, and sync or signal regeneration, and it's not difficult to delay either sync or video signals through a small number of steps in a line with a relatively short delay.

In the color video panel, the vertical and horizontal conductors cross in a matrix. At each crossing is a picture element—a lamp and a diode connected in series. The diode keeps a signal current injected into a crossing from dividing and flowing into any other crossing.

Ironically, tungsten lamps will yield a good picture only with a tricolor scheme; satisfactory black-and-white reproduction with bare lamps is impossible. When tungsten lamps are dimmed, their temperature declines and their light becomes reddish. Lens-cap filters limit transmitted light to red, green or blue wavelengths and make it possible to reproduce white or gray.

Sharp, but not smooth

The 78,000 ordinary tungsten pilot lights form 26,000 red-green-blue trios. Though this is less than 1/10 the number of elements on a conventional color tube, the picture resolution isn't hurt as much as one might think. In the x-y video panel, completely independent information is injected into each light bulb. In a picture tube, the electron-beam spot is ordinarily large enough to cover three or four of the holes in the shadow mask. Furthermore, in the tube, reproduction of areas with white-peak brightness is hurt by increases in spot size, which cause the phenomenon known as blooming. However, blooming can't occur in the color video panel, because each bulb gets information independently from its neighbors. This keeps the picture surprisingly sharp.

Another advantage over the tube is that colors can't be misregistered. In the tube, beams are aimed at colors and may misland or misconverge. But in the video panel, signals are fed directly to colors and thus always stay in proper relationship.

On the other hand, the picture produced by the panel's 26,000 trios isn't as smooth as that of the picture tube, which has about 350,000 elements.

Interlaced scan can't be used, because there are only 260 horizontal lines. However, non-interlaced

Closeup. Sony's color video panel, left, uses incandescent lamps with filter caps for the red-green-blue color trios.

Getting the whole picture

Sony's color video panel uses light bulbs arranged in a matrix with 260 horizontal lines of 300 lamps each. The lines are staggered to form red-green-blue color trios spanning two lines.

A television signal is picked up by a standard receiver and the three color signals are separated from the audio and synchronization signals.

The color signals are sampled in the XS blocks, which generate pulse-width modulated signals with a constant amplitude but a width proportional to the intensity of each color signal.

For zero intensity (black), the pulses have zero width. For maximum intensity, the pulses are about 100 microseconds wide. The eye integrates the light and perceives lamps that stay on longer as being brighter than lamps on for less time.

The sampling pulses are taken from a delay line and gated by signals from the $2T_H$ switch (bottom center), which keeps the sampling pulses in proper synchronization.

The vertical synchronization pulses start the display at the top. The horizontal lines are turned on, one at a time, by scr's connected to each line. An eight-phase generator applies power to the scr anodes. An scr turns on when the pulse is applied to its gate, either through the YP y-line pulser multivibrator circuits or through another scr directly above it. The horizontal lines stay on for twice the horizontal scan time.

The eight-phase generator is needed to turn the pairs of lines on in succession and to turn the scr's off by disconnecting their anode supply. With eight phases the scr's have enough time to dissipate their stored charge before they are to be turned on again. If fewer phases were used, the off times might not be long enough to allow the charges to dissipate, and the scr might turn on again when the anode supply was reconnected without waiting for the proper gating signal.

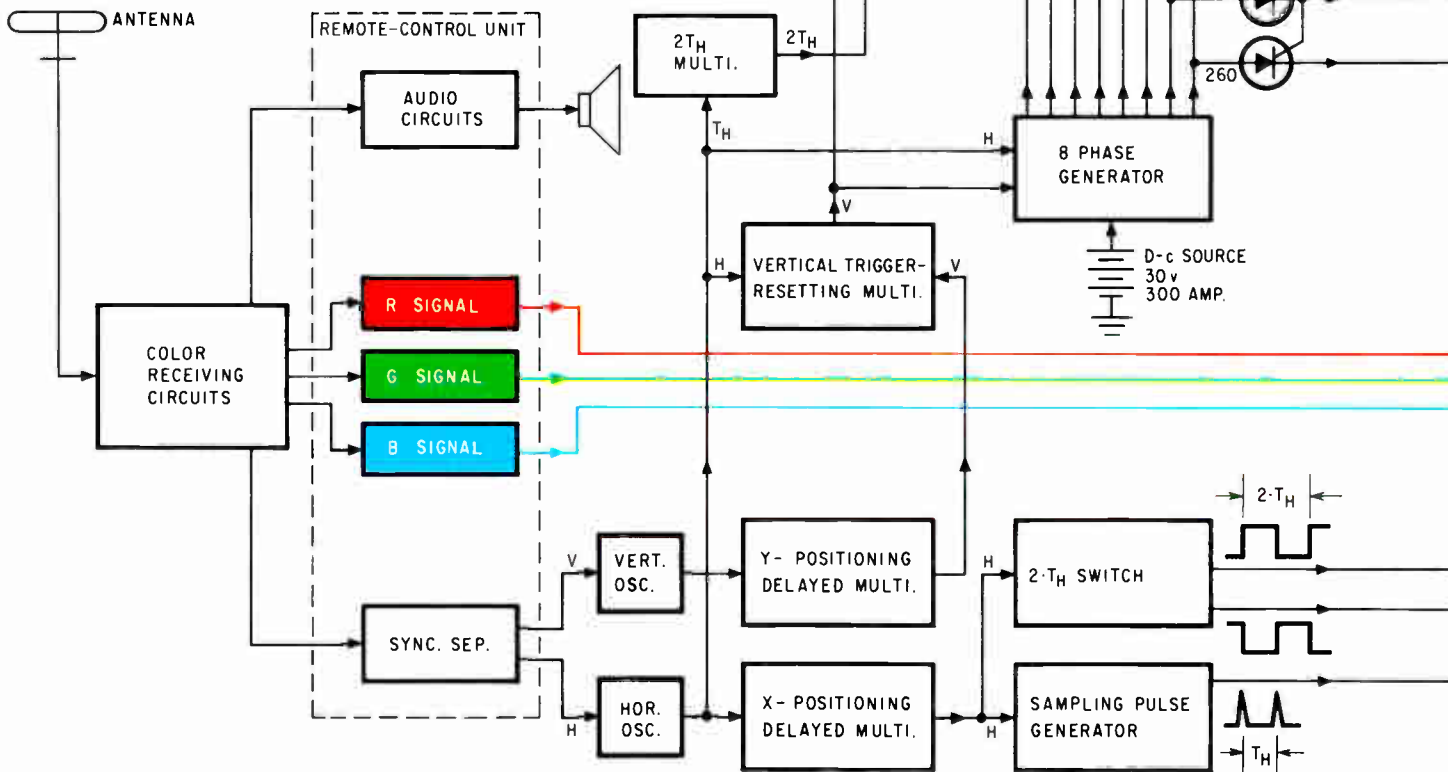
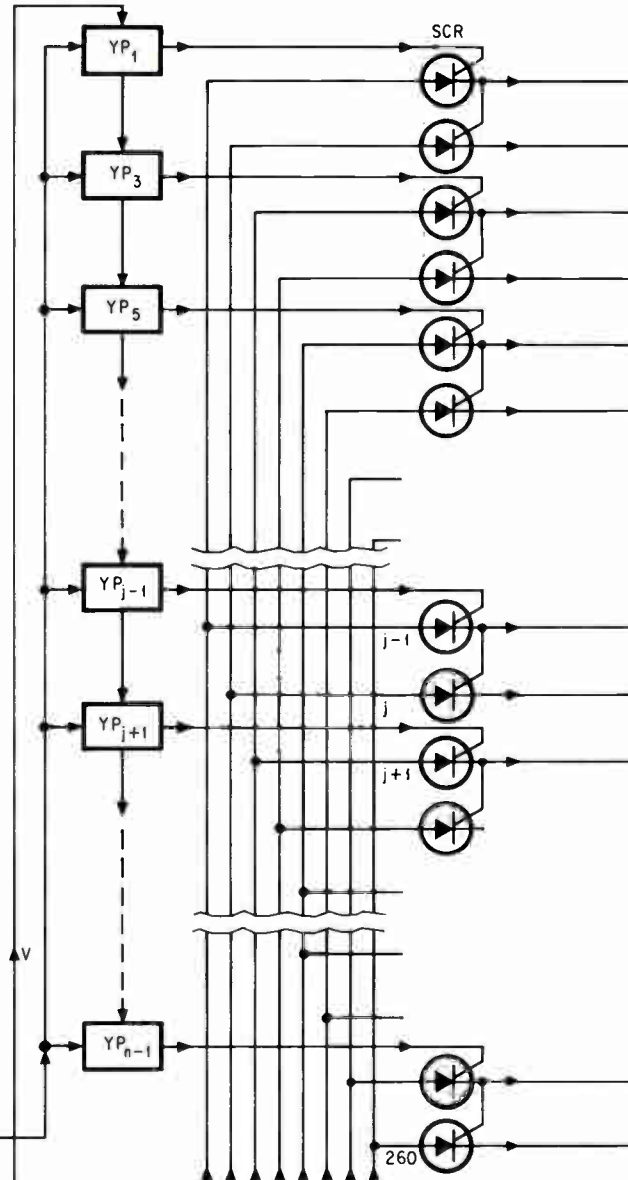

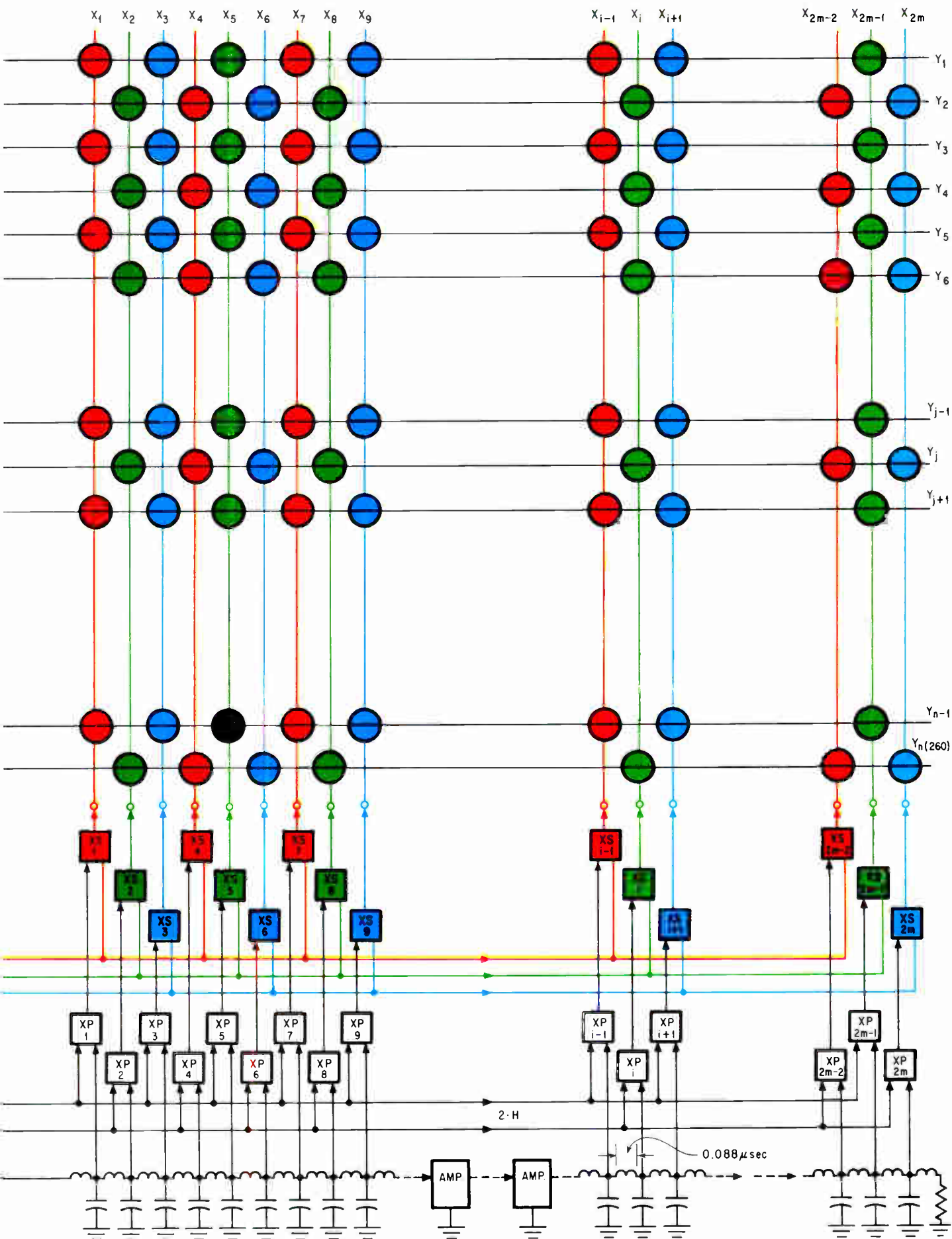

scan can provide reception that's satisfactory even though it isn't up to normal standards. Non-interlaced scan is used in the small Sony video tape recorder designed for home use.

Time to get samples

The video signal must be sampled to convert it to the multichannel signals required to drive the color video panel. With 300 lamps in each horizontal line, picture information from the original signal for any one lamp must be sampled within an interval less than $1/300$ times the horizontal period of 63.5 microseconds, or about $0.2 \mu\text{sec}$. The sampling interval is thus 0.05 to $0.1 \mu\text{sec}$.

Sampling pulses are supplied to each pwm block through a lumped constant L-C delay line with individual sections consisting of a series inductance of 5.6 microhenries and a shunt capacitor of 1,400 picofarads. The delay time of each step is $52.5 \mu\text{sec}$ divided by 600 channels, or $0.088 \mu\text{sec}$.

After every 24 channel delay steps, a delay of $2.1 \mu\text{sec}$, an amplifier was inserted.

The pulses would survive without amplification for a slightly larger number of delays—although 48 would probably be too many. However, since there are repeating cycles of three colors and individual x lines are connected to alternate y lines, it's desirable to choose a number divisible by both two and three. The size of the x-output transistors makes it convenient to line up about 24 x drive-circuits on a single printed-circuit board. If pulses are regener-

ated between the output of one board and the input of the next, then all boards can be identical.

A steady gain

The pwm signal can be obtained with simple circuits. The amplifiers are saturating transistor switches that are either in saturation or off, so that gain doesn't vary between channels. Because amplifier output efficiency approaches 100% and collector dissipation is low, there is a good chance that circuits can be integrated.

With the color video panel, the pulse repetition frequency is half the horizontal frequency, or $15.75/2$ equals 7.88 kilohertz. The signal varies from zero to maximum amplitude, and for black the pulses have zero width—no current flows in the lamps. Lamp voltage is constant, and the longer the bulb is on the brighter the image appears to the eye, which integrates the light to create the sensation of intensity.

With pwm, each picture element's duty cycle is 600 times better than it would be if each element were turned on and off before the next one on the line; the same brightness can be produced with less power.

For example, if an on-off scan was used in a 260 by 300 element array, each element would operate on a $1/260 \times 300$, or $1/78,000$, duty cycle. But with pwm, the duty cycle is increased 2×300 times, making it $1/130$, or 600 times better. In comparison, television tubes have a duty cycle of $1/350,000$,

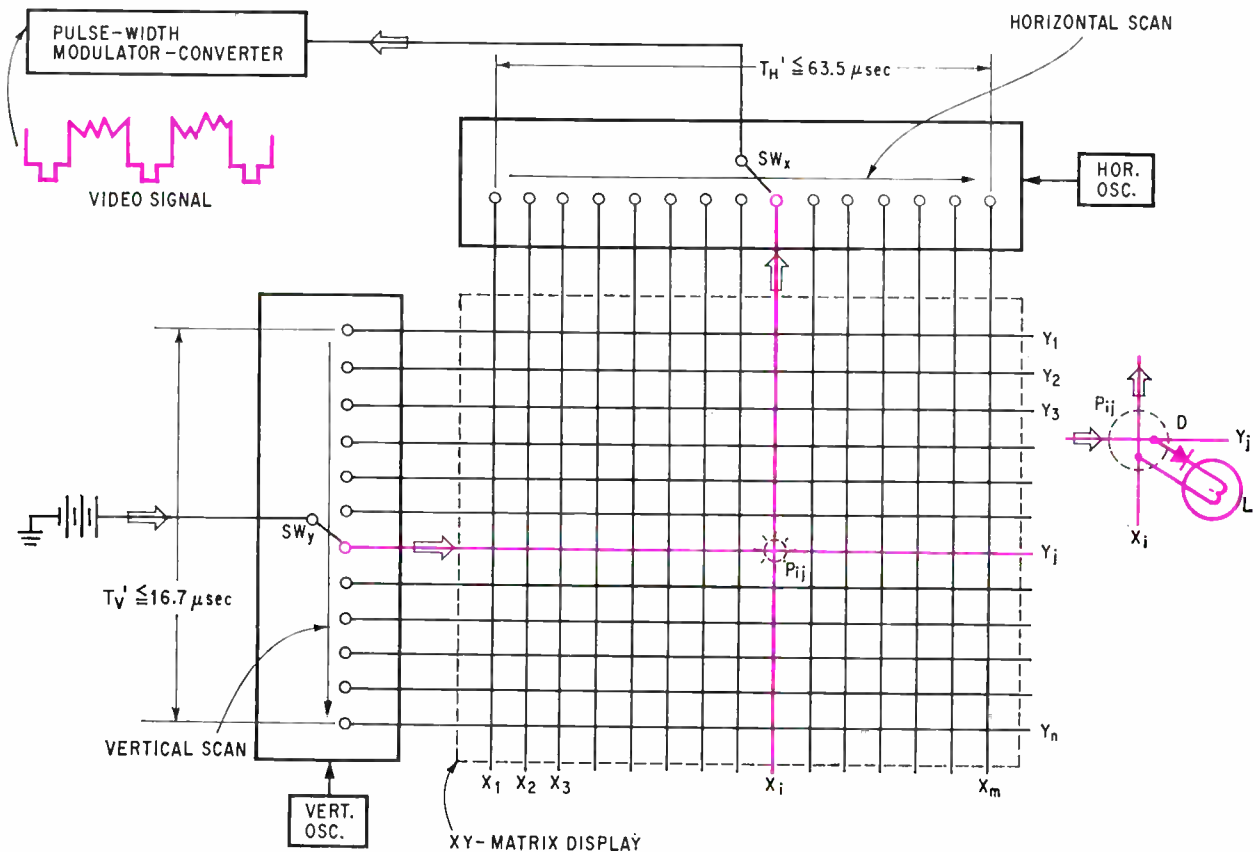

Cross at the light. A basic lamp matrix is driven by horizontal and vertical line switches. The diode in series with the lamp prevents the current from taking sneak paths through other lamps.



Wide smile. The color video panel, shown with its power supply, right, measures about five by six feet. The message displayed at the top of the screen is generated through a separate channel.

since each picture element is turned on and off in succession.

In the practical circuit configuration for the pwm sampling and holding method, for each x channel there are six semiconductor devices—five transistors and one diode. This isn't a large number of components if circuits are to be integrated. The number of circuit blocks needed is twice the number of lamps on a line, or 600.

Because of the arrangement with 600 sample and hold units, sampling for a given x line is done only once for every second y line, so that sampling is done only at every second pulse.

The amplitude samples are converted into ramps, whose amplitude is proportional to that of the original. Ramp basewidth is also proportional to the original amplitude. By slicing the ramps near the base line, a pwm signal proportional to the original amplitude is recovered. These varying-width signals drive the lamps.

The lamp current isn't constant while the pulse is applied. Lamp voltage, as noted, is constant. The lamp current varies during the 10 μ sec or so that it takes for the lamp to reach steady state, but then is approximately constant. After the lamp is turned

off, brightness fades rapidly, but a faint afterglow continues for several milliseconds. Light output falls to zero, though, before the end of the frame, which lasts 16.7 msec.

These rise and decay characteristics are nonlinear, and are different for each color. If uncorrected, these differences would unbalance the color signals. Correction is applied by simple curve-shaping circuits with diodes to give segment approximation of desired characteristics in the three video amplifiers. Circuits of this type have long been used in analog computers as curve generators, and in television cameras for gamma correction.

Easy work

The lamps for red have a d-c rating of 2.0 volts and 30 milliamperes. Lamps used for green have a d-c rating of 1.5 volts and 30 ma. Lamps used for blue have a d-c rating of 1.5 volts and 70 ma. However, the lamps aren't used at their rated current and voltage levels.

The lamps are operated only for a maximum duty cycle of 0.7%—at 30 volts for 100 μ sec maximum out of each 16.7 μ sec. The peak current for the red lamps is 400 ma, for the green lamps 600 ma, and

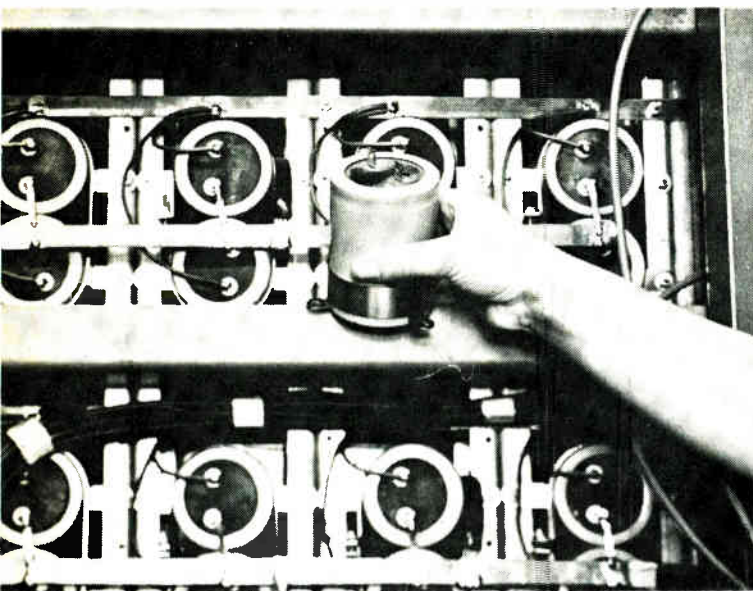

Nearly a farad. The power-supply filter uses 100 capacitors of 8,000 microfarads each for a total of 0.8 farad.

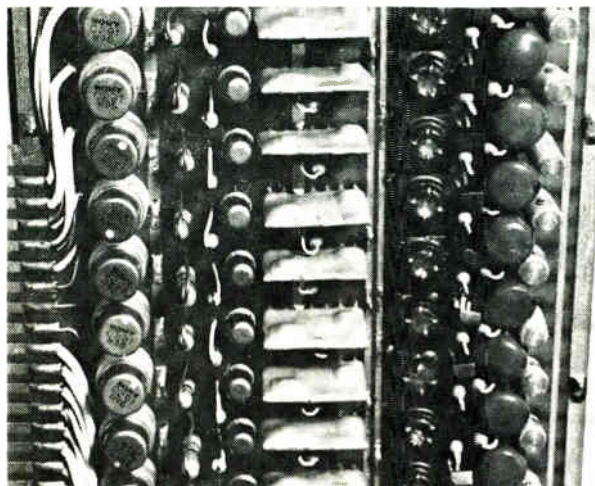

Pulse source. The pulse-width modulator is built around dipped hybrid integrated circuits, center.

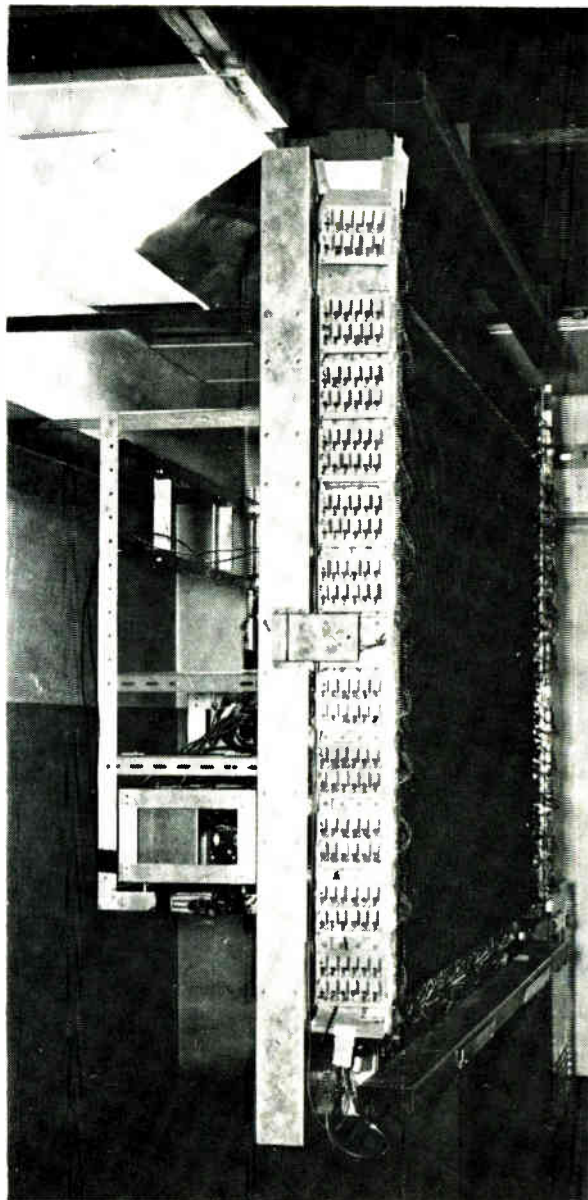

Side view. The color video panel has drive circuits at the rear and around the edges.

peak current for the blue lamps is 1,000 ma.

Each output transistor in the x channels is operated at a duty cycle of 0 to 75%. These transistors are operated in the pwm mode at a period of twice the horizontal-line time, or $2T_H$, with the peak currents of the lamps. For this type of operation, the dissipation of the output transistors in the various channels run in the range of 100 to 300 milliwatts. Neither the current value nor dissipation is much of a problem; the output transistors in the x channels are operated without heat sinks.

Enter the SCRs

For y line switching there are n switches, which go on and off in succession with overlapping on-times of T_H , and with total on-time of $2T_H$. The entire process repeats at intervals with a period of T_V , which is 1/60 second.

However, unlike the x-line switches, the y-line switch must handle high values of pulse current. For each line the maximum pulse current equals the sum of the current flowing into 300 crosspoints— $(0.4 + 0.6 + 1.0)$ amp \times 300 channels/3 is 200 amps peak.

Since this pulse current flows with a maximum duty ratio of 0.7% for high light white raster during a repetitive period of $T_V = 16.7$ msec, the time average value of current and the loss in the switching devices aren't excessive. But pnp or npn devices rated for handling the 200-amp peak current aren't available. One could get by with perhaps five to 10 power transistors in parallel for each line, but for a system with 260 lines this means it would be necessary to use something like 1,300 to 2,600 power transistors—and there isn't really room to fit them all in. Space and cost would be terrible, and besides

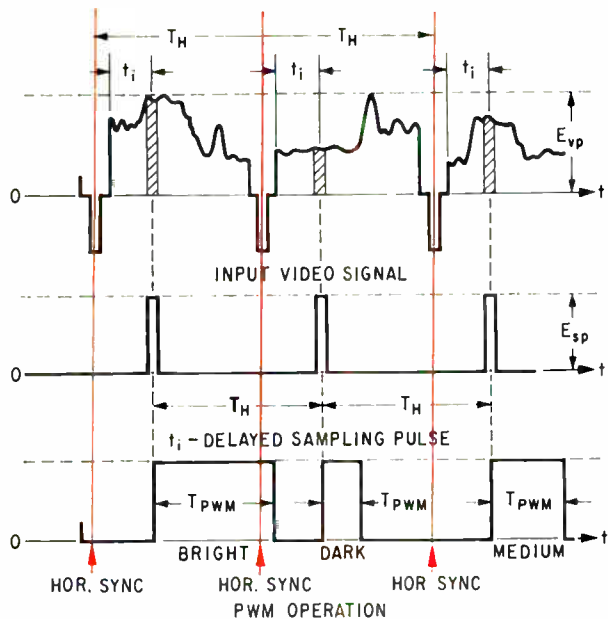

Just a sample. The sampling pulses produce pwm signals corresponding to the video signal amplitudes.

this a brute-force way of attacking the problem.

Switching 200 amps on the y line requires a device with extremely low saturation resistance—such as a silicon-controlled rectifier.

The scr can turn on with very small trigger power. However, there isn't any good way to turn it off without turning off the d-c power supply connected to their anode circuit. Therefore, an additional power switching circuit must be connected between each scr and the d-c power supply. The power switching circuit consists of a multiphase square-wave generator with at least two phases—in this circuit, eight phases are used.

After the anode power supply has been turned off, there may be trouble when it is turned on again; because of stored charges, current may start to flow

even though no gate pulse has been applied to the scr. It is thus necessary to increase the number of phases of the power supply, and keep the device off long enough so that the stored charges have enough time to dissipate.

The prototype video color panel has an eight-channel, eight-phase power pulse generator for current switching. Each phase has a pulse width of $2T_{H1}$, and, repeats with a period of $8T_{H1}$, so that the scr's are held off for about $380 \mu\text{sec}$. Individual phases are shifted from their neighbors by precisely T_{H1} .

Alternate y lines are triggered by a multivibrator delay train. The line is turned on, and a d-c trigger signal is also applied from this line to the following y line. The second y scr cannot trigger, though, because voltage has not yet been applied from the eight-phase power supply. Thus, only a total of 130 multivibrators are needed. Multivibrators are synchronized by pulses with a period of twice the horizontal scan time, $2T_{H1}$.

At precisely the correct time for the start of a y line, voltage is applied, the scr turns on, and the x-line transistors start injecting power into the x lines.

Adjusting the picture

When a y line switches on, the load is the current in x_1 only; the load then increases, until at a time T_{H1} later it reaches the peak—a maximum of 200 amps. The load then declines until at a time $2T_{H1}$ after y_j was first switched, it has fallen to about zero. The waveform is thus a symmetrical triangular pulse. During this period the next y switches on and adds to the power supply load. Currents in the two adjacent y lines overlap with a shift of T_{H1} .

Among the x_i pwm waveforms are those with a pulse width that exceeds one T_{H1} and those that have a pulse width of $100 \mu\text{sec}$. These occur at the white-peak points in the picture. Taking these circumstances into consideration, the engineers de-

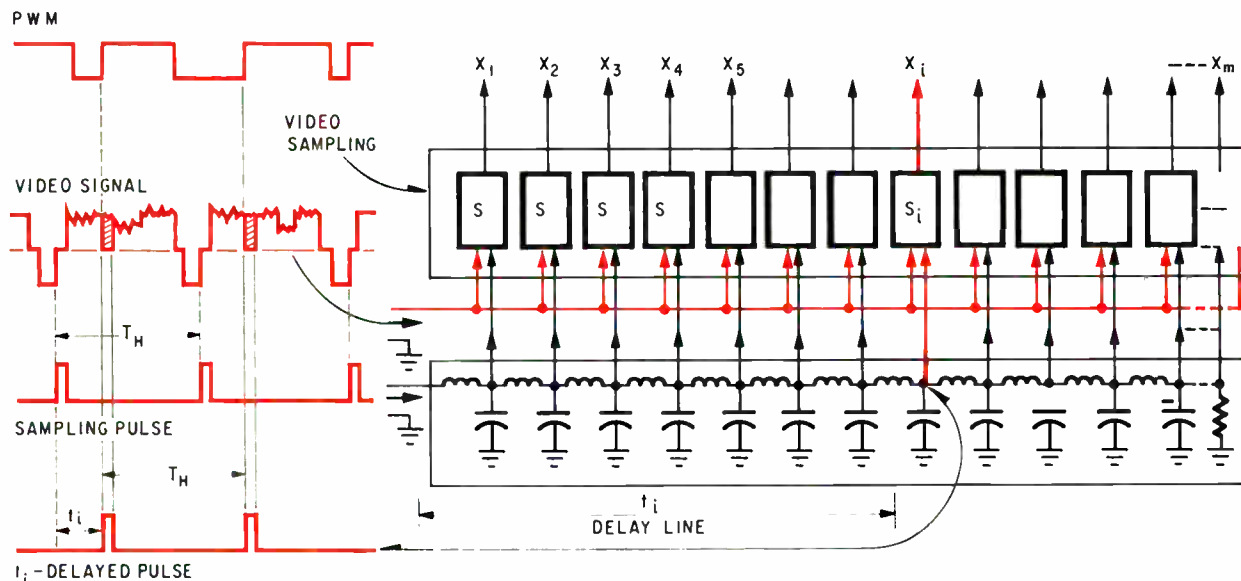

Delay pulse. The sampling pulses are delayed for each column of lamps and the pulse-width modulated signals thus turn on the lamps in succession across a horizontal line.



Plug-ins. Lamps are inserted in blocks for final assembly. However, since lamp ratings are different, red, green and blue lamps are not interchangeable.

signed the power supply for the entire color video panel to be able to supply a load of 30 volts at 300 amps, or about 10 kva maximum. For d-c smoothing of the power line, 100 individual capacitors of 8,000 microfarads each—totalling 0.8 farads—are arranged on the rear of the panel behind the lamps. One must also provide for correctly centering the reproduced picture. To do this, an adjustable x-positioning multivibrator delay is inserted between the horizontal synchronizing oscillator and the sampling-pulse generator.

In the same manner, a y-positioning multivibrator delay is needed for vertical centering. Furthermore, it is necessary to finely adjust the starting point of the first y channel so that the delayed vertical synchronizing pulse coincides precisely with the horizontal synchronous position.

A hope for the future

Anyone who has had experience with tungsten filament light sources might worry that the lamp's light decays too slowly for this application. But this isn't a problem with the miniature lamps of the type used for dial lights. Luminance decay of these lamps is sufficiently short compared with the 16.7 msec vertical scanning period of the television signal, because small filaments cool quickly.

Of course, one hope for future display panels is a p-n light-emitting junction. If an electroluminescent diode could now be produced more cheaply

than the lamp plus a diode, perhaps by LSI techniques, and made to produce the desired red-green-blue trio, then there would be no need for tungsten filament lamps. But today's diodes aren't bright enough, and blue luminescent diodes can't yet be produced. Also, costs are high and yields poor.

The light could also be obtained from a gas discharge, and the diodes would then become unnecessary. When three glow tubes are connected in series, there will be no discharge unless three times the single tube-exciting voltage is applied to the series connection. To bypass the desired crosspoint, the current flowing between the two driving lines must flow through at least three other crosspoints.

Because of the gas tube characteristic, approximately three times the voltage required to break down one lamp is required to break down three in series. Because of this inherent selection mechanism, a voltage slightly more than sufficient to break down one lamp will result in breakdown, or glow, of the lamp at the crosspoint, and no current will flow through sneak paths. The first studies actually were with a neon lamp matrix panel—a local part of the red matrix with only 40×50 , or 2,000, elements was operated successfully before the neons were eliminated in favor of the incandescents. But, still, a flat-package gas tube may eventually be practical, using phosphors to achieve the different colors.

The human eye is rather tolerant of chromaticity errors in the blue region. This is fortunate, because radiation in the blue region is low for tungsten filament lamps. A cyanic-blue filter cap is used on the blue lamps to pass the emitted blue light. This allows the operating current to be held low and keeps lamp life at the same high level as that of the other color lamps. Green with good color saturation can be obtained with the green filter.

Problems, problems

The color video panel still has problems of uniformity, cost, life, and applications.

Display uniformity is poor compared with that of a conventional picture tube. The random dot-by-dot nonuniformity caused by variations in the brightness of individual lamps can be eliminated for practical purposes by tightening the lamp specifications, but this isn't the worst problem.

Variations among the drive levels of x_i or y_j channels cause "stripes" that resemble the runs in nylon stockings. With pwm operation, the variations among channels caused by differences among the transistors become small enough to neglect. But this method of operation doesn't eliminate variations caused by differences among capacitors and resistors, and there is a great need for much tighter specifications to eliminate these errors.

The system is also expensive. The color video panel has 260 scr's, 180 power transistors, 1,500 medium-power transistors, 2,500 small plastic-package transistors—mostly in hybrid integrated circuits—and 1,000 small diodes, also mostly in hybrid integrated circuits. And it has the healthy appetite for as much as 10 kva.

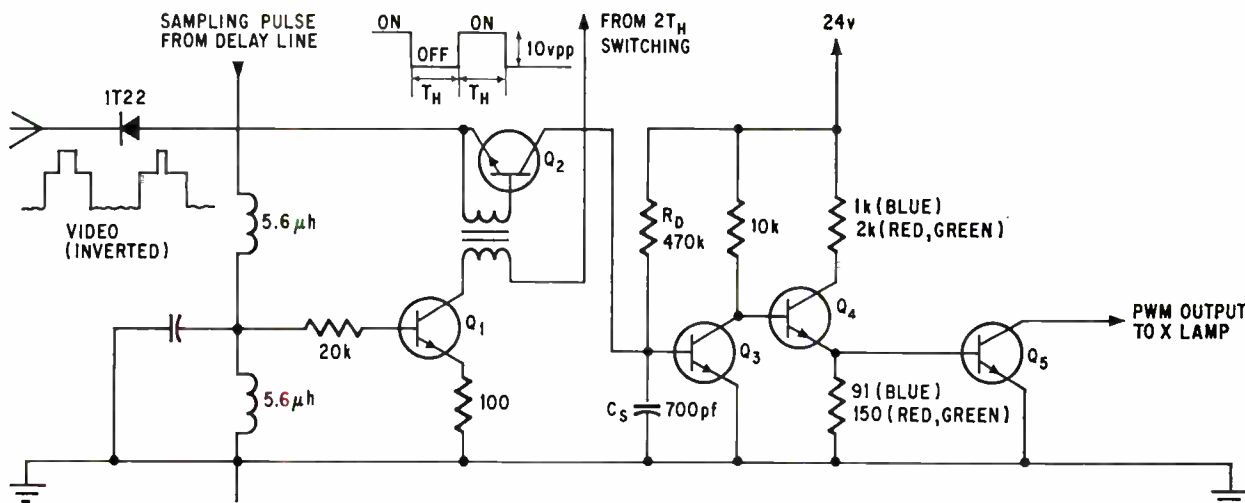

Sample and pulse. The sampling and pulse-width modulation of the video signal is done with the combination of transistors Q_1 and Q_2 . The three transistors to the right amplify the pulse-width modulated signals.

Money, money

The lamps and diodes and cross-grid construction into which they are plugged for display account for about 75% of the total materials cost. The semiconductors in the circuit account for about 10% of the materials cost, and other circuit components the remaining 15%. If this system were to be made into a commercial product in its present form, it would have to cost about 100 times more than a conventional color tv set. On the other hand, it would cost about the same as a color display of comparable size using projection methods, and the projection display can be viewed in a lighted room.

An early doubt regarding the 100-inch color video panel was: would the life of the bulbs be so short that the filaments would be continually burning out? Even at low temperatures, when the light from the bulbs appears reddish, it's possible to obtain enough blue light with the proper color filters. Lamps with high current ratings were therefore chosen, and the input power was increased. Since the lamps are rich in red wavelengths, red current levels are lowest. Green is a little higher and blue lamps are driven the hardest. The system has an average lamp life of 5,000 hours.

But with a total of 78,000 lamps, if lifetime is homogeneous so that at 5,000 hours half are burned out, then at 10 hours 80 lamps (about 0.1%), at 100 hours 800 lamps (1%), and at 1,000 hours 8,000 lamps (10%) will probably burn out. This might mean that every few minutes one will have to change a lamp.

On the other hand, if lamp life doesn't vary the color video panel would operate without incident for 5,000 hours.

The distribution of life among lamps isn't known. But as long as the lamps burn out in random positions the effect isn't serious. A more serious problem is that some of the lamps are far brighter than their neighbors and stand out as prominent points. But dark points where lamps have burned out are like very small freckles, and are much less noticeable

than one might think—like a speck of dust on the face of a conventional picture tube.

For practical purposes one can neglect burned-out lamps until their number reaches about 1% of the total, and then replace all the defective ones at once. With the lamps now used, this must be done after about 200 to 300 hours of operation. The ability to operate this long between regular maintenance periods means that the system is suitable in this respect for practical applications.

Putting it to use

There are many closed-circuit television applications for which this display could be teamed with a color video tape recorder or color television camera. When considering applications for the color video panel, one must remember an extremely important characteristic: when a raster sweep is used on a conventional picture tube, both horizontal and vertical retrace time is needed. It isn't normally possible to use these intervals for display.

With the color video panel, non-retrace-time scanning is feasible, and it's relatively simple to display completely independent information—such as alphanumeric characters—that are derived from separate sources. In this display, the horizontal retrace interval isn't put to use, but the photo on page 97 shows a character display, picked up by a conventional tv camera, inserted above the picture display during the vertical retrace interval.

The author



Satoshi Shimada is manager of advanced tv technology—display and cameras—in the development division at Sony. A 1953 graduate of the Tokyo Institute of Technology, Shimada joined Sony in 1959 and developed the company's first 8-inch transistorized tv receiver. He also developed Sony's 5-inch micro tv, which went on the market in 1962.

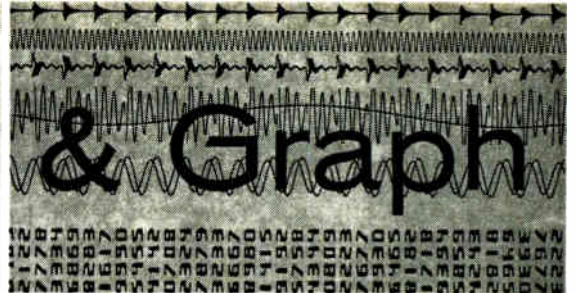
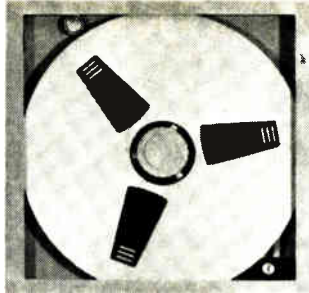

Whatever your recording needs—from magnetic tape to oscillography—you will find described here precisely the “right” instrument to meet them. Compare their respective advantages with those of *any* competitive recorders, and you will also discover why CEC continues to be the recognized leader in data instrumentation.

In addition, CEC also markets a complete line of accessories and signal conditioners.

VR 5000 Recorder/Reproducer—CEC's most advanced new recorder, the VR 5000 has established two important breakthroughs. 1. A *maximum time base error of ± 400 nanoseconds at 120 ips*. Because of this improvement in time base error, the ultimate in real-time restoration of data is now possible. And tapes made on data acquisition recorders under severe environmental conditions can be successfully reduced with correct time base restored. 2. A *flutter correction capability five times more efficient* than that of the next best recorder available today. Consequently, the VR 5000 is the only recorder that offers Dual Inertia, or the ability to translate the ideal system concept into a working reality—high mass recording and low mass reproduce.



- Unequaled phase lock range.
- Close Loop Drive without pinch rollers.
- Positive Air Pressure (Patent Pending) tape loop for reel perturbation isolation eliminates vacuum bin problems.
- Bi-Directional electrically switched 7-speed drive provides the fastest start/stop times available on any instrumentation transport.
- Tape speed accuracy of $\pm .05\%$ with tape servo, machine-to-machine.
- Air Guides eliminate rotating elements in tape path.

VR 3300 Recorder/Reproducer—Unmatched for applications where ruggedness and mobility must be combined with outstanding performance.

- 100 cps to 300 KHz direct frequency response; dc to 20 KHz FM frequency response.
- Dual capstan drive system provides closed-loop speed and tension control equal to standard laboratory systems.
- Interchangeable record and reproduce electronics and heads with CEC's VL 2810 Continuous Loop Recorder/Reproducer.
- Six-speed record/reproduce system.



VR 3700 Recorder / Reproducer—This recorder has special CEC magnetic heads which extend its frequency range to 2.0 MHz—plus 500 KHz for FM—at the traditional cost of a 1.5 MHz unit. The first and only 2.0 MHz laboratory recorder that combines versatility and reliability at a budget price.

- Magnetic recording heads guaranteed to exceed 1000 hours. CEC's unique, solid metal pole-tip design has eliminated the inherent deficiencies of lamination and rotary head design.
- Failsafe DC Capstan Drive assures dramatically-improved flutter and TDE performance.



- All-Electric Tension Control. Solid-state amplifiers for improved linear tension control and greater reliability.
- 15-inch reel capacity.
- Automatic 8-speed transport with electrically selectable electronics.
- Phase-lock capstan control electronics included for improved speed accuracy.
- Convertible from wideband to midband recording. New plug-in heads offer easy interchange of headstacks up to 42-channel capacity.

VR 3400 Recorder/Reproducer

—Identical in specifications to the VR 3700 transport but with midband electronics. However, should eventual data handling requirements call for a 2.0 MHz response, the VR 3400 may be converted to a VR 3700 by a simple exchange of heads and electronics. This modestly-priced recorder will readily meet the vast majority of laboratory requirements.



Type 5-133 Recording Oscillograph—

This versatile oscillograph is essentially two instruments in one. Reason: the 5-133 utilizes two galvanometer magnet assemblies. The galvo recording lamp intensity is individually controlled so as to permit recording from either magnet assembly, or both, as desired. Two data setups can be made at one time and recorded simultaneously, or be made alternately and recorded sequentially utilizing full chart width for each. The 5-133 is available in 12-, 24-, 36-, and 52-channel configurations. There are 5 recording modes—3 direct-writing and 2 develop-out. And being of modular design, the unit is readily adaptable to additional or future instrumentation.

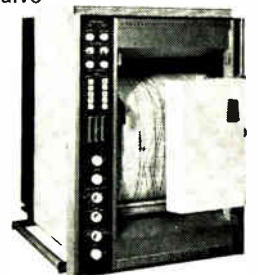

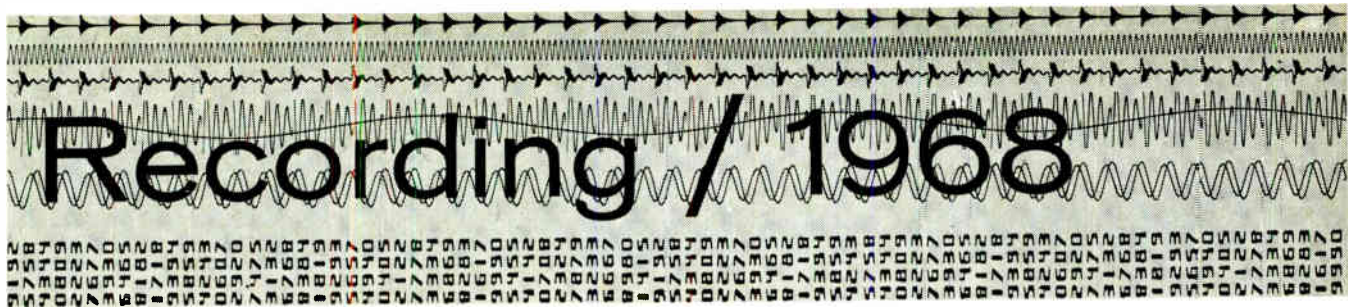

Type 5-124 Recording Oscilloscope—

Shown with the DataFlash Takeup Accessory which requires only 1 second to readout, the 5-124 has become a new "must" for industry. Portable, easy to operate, this instrument offers big recorder capability in a small-size, low-cost package. The 5-124 provides up to 18-channel print-out recording, and record-drive systems with options from 0.25 ipm to 128 ips.

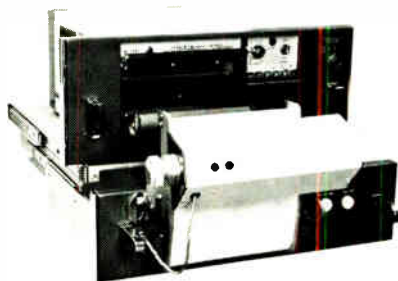

Type 5-126 Recording Oscilloscope—The new "best buy" in oscillography. At a price hundreds of dollars less than any comparable instrument, the 5-126 offers the basic capabilities of a light beam oscillograph at a cost approaching that of a direct writing recorder. With CEC's 7-380 Galvanometer, this portable unit will record from dc to 1 KHz. Its tungsten light source assures optimum trace quality and lamp light, minimum cost and maintenance, instant operation with complete safety. Nine channels produce vivid data traces on 7-inch-wide paper. Records by direct print-out upon exposure to ambient light, thus eliminating the need for chemical processing. And, due to CEC's simplified front-loading system, no spooling or threading of paper is required.



Type 5-119 Recording Oscilloscope—A truly universal oscillograph, the 5-119 has become a popular, proven performer for

laboratory, mobile, airborne and marine use. Both dc and ac powered models are available. The 5-119 accepts all three types of record magazines, DATAFLASH®, DATARITE®, and conventional, making it possible to utilize every known photographic technique on either the 36- or 50-trace models.



Type DG 5510 Thermal Writing Recorder

—This 8-channel recorder brings a significant advance in performance and reliability to direct-writing oscillography. The basic 5-510 recorder is a self-contained instrument with driver amplifiers and power supply capable of accepting a wide range of high-level input signals. Interchangeable plug-in attenuator/pre-amplifiers are available to further extend the input range. It employs a heated writing stylus to deliver sharp contrast rectilinear traces on CEC's DATATRACE® Thermal-Sensitive Paper.



Other outstanding features include: Solid-state electronics • Immediate readout • Superior frequency response • Calibrated zero suppression • Cabinet mounting, including dolly for complete mobility.

Type DG 5000 Recording System—new from CEC—is an assembly of standard product building blocks systemized into a complete configuration, thus providing overall capability from transducer to display. Since the DG 5000 will accept any

CEC oscillograph, or any of the accessories, it may be tailor-made to virtually any configuration—or economically expanded to meet future configuration requirements. This fully flexible system will deliver up to 52 recording channels with light-beam galvanometers or 8 channels for thermal writing. Applications include industry, aerospace and medical science, or any operation calling for the acquisition and precise measurement of dynamic or static data.



Type DG 5511 Thermal Writing Recorder

—CEC's unique, solid-state DG 5511—the first low-cost, portable direct-writing recorder—provides capabilities formerly achieved only through multiple instruments. Plug-in signal conditioners are available to accommodate a wide range of voltage inputs. No preamp is needed for high-level signals. Converts from high-level inputs by a simple change of plug-in attenuator/amplifier units. The DG 5511 combines ease of operation with a high degree of resolution on heat-sensitive paper.



For full information about these products, call your nearest CEC Field Office, or write Consolidated Electrodynamics, Pasadena, California 91109. A subsidiary of Bell & Howell. Bulletin Kit 1712-X3.

CEC/DATA INSTRUMENTS

BELL & HOWELL

Designer's casebook

Designer's casebook is a regular feature in Electronics. Readers are invited to submit novel circuit ideas, packaging schemes, or other unusual solutions to design problems. Descriptions should be short. We'll pay \$50 for each item published.

Gate-to-source resistor stabilizes FET regulator

By Bill Birnbaum

Industrial Scientific Research, Orange, Calif.

Field effect transistors, like the old vacuum-tube pentodes, are used to make d-c power supplies constant-current sources. Connected in series between the load and the supply, the FET will, when there's no gate voltage, maintain a constant current through the load despite changes in the supply voltage.

But where the FET is biased by the direct connection of gate to source, wide temperature variations can cause changes in the FET's drain-to-source resistance and drastically alter current flow.

In such cases, a resistor can be placed between the source and gate connection. With this configuration, changes in the resistor's voltage drop caused by swings in drain-to-source current de-

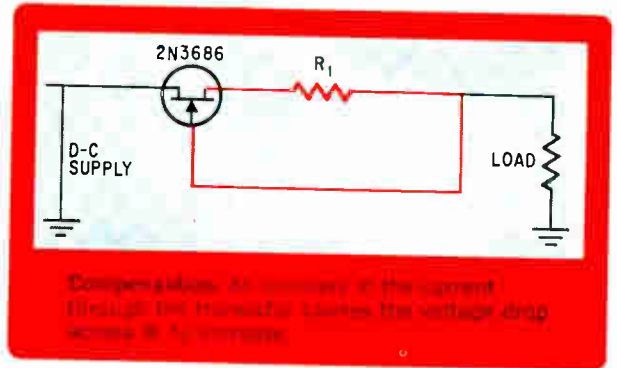

velop a bias on the FET that holds the current steady. Current through the FET—the same current that flows in the load—is thus affected by both temperature and gate voltage, as expressed by the equation:

$$\Delta I_{DS} = \Delta I_{DST} + \Delta I_{DSG}$$

where I_{DS} is the total change in drain-to-source currents, I_{DST} is that change caused by temperature, and I_{DSG} the change attributable to gate voltage. When the drain-to-source current's relationship with the gate voltage, $I_{DSG} = g_m V_{GS}$, is inserted in the equation, the result is:

$$I_{DS} = I_{DST} + g_m V_{GS}$$

Since $V_{GS} = -I_{DS} R_1$ —with the negative sign indicating that an increase in drain voltage makes the gate more negative—the equation can now be written in terms of I_{DS} and I_{DST} .

$$I_{DS} = I_{DST} - g_m I_{DS} R_1$$

After transposing, it becomes

$$I_{DS} = \frac{I_{DST}}{1 + g_m R_1}$$

This equation indicates how R_1 and the transistor's g_m minimize the effect a temperature change has on the drain-to-source current.

The larger the resistor, the greater the regulating effect, but too large a value limits the current in the transistor to a few microamps, lowers the device's avalanche breakdown, and thereby narrows the range of d-c supplies the FET can regulate.

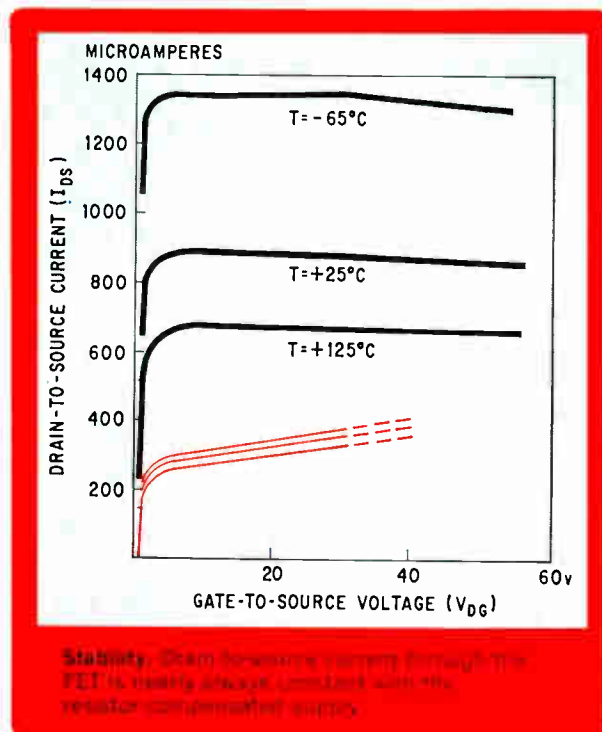

Power transistor's r-f gain measured by brief pulse

By Octavius Pitzalis Jr.

U.S. Army Electronics Command, Fort Monmouth, N.J.

The frequency at which a power transistor's gain-bandwidth product becomes unity is calculated from a current-gain measurement made at a lower frequency. If the calculated frequency, commonly called f_T , is to be meaningful, the measured current gain should be made while the transistor is operating at its recommended current and voltage levels. Unfortunately, the power dissipated at these levels raises a transistor's temperature to a point where leakage currents multiply and internal resistances increase. These changes make it impossible to measure, with any accuracy, such a delicate parameter as the transistor's current gain.

By pulsing d-c currents and voltages into the transistor for a few microseconds and measuring the current gain during this interval, high temperature and its adverse effects are prevented from

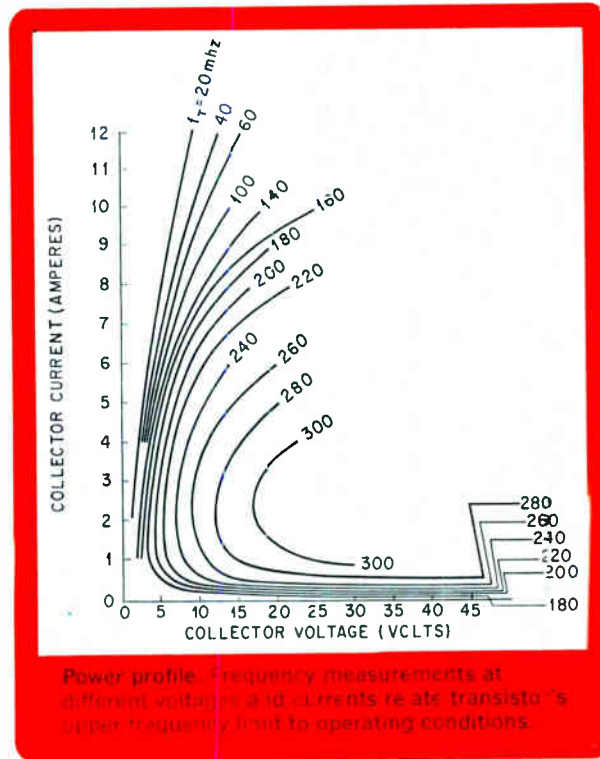

Power profile. Frequency measurements at different voltages and currents relate transistor's upper frequency limit to operating conditions.

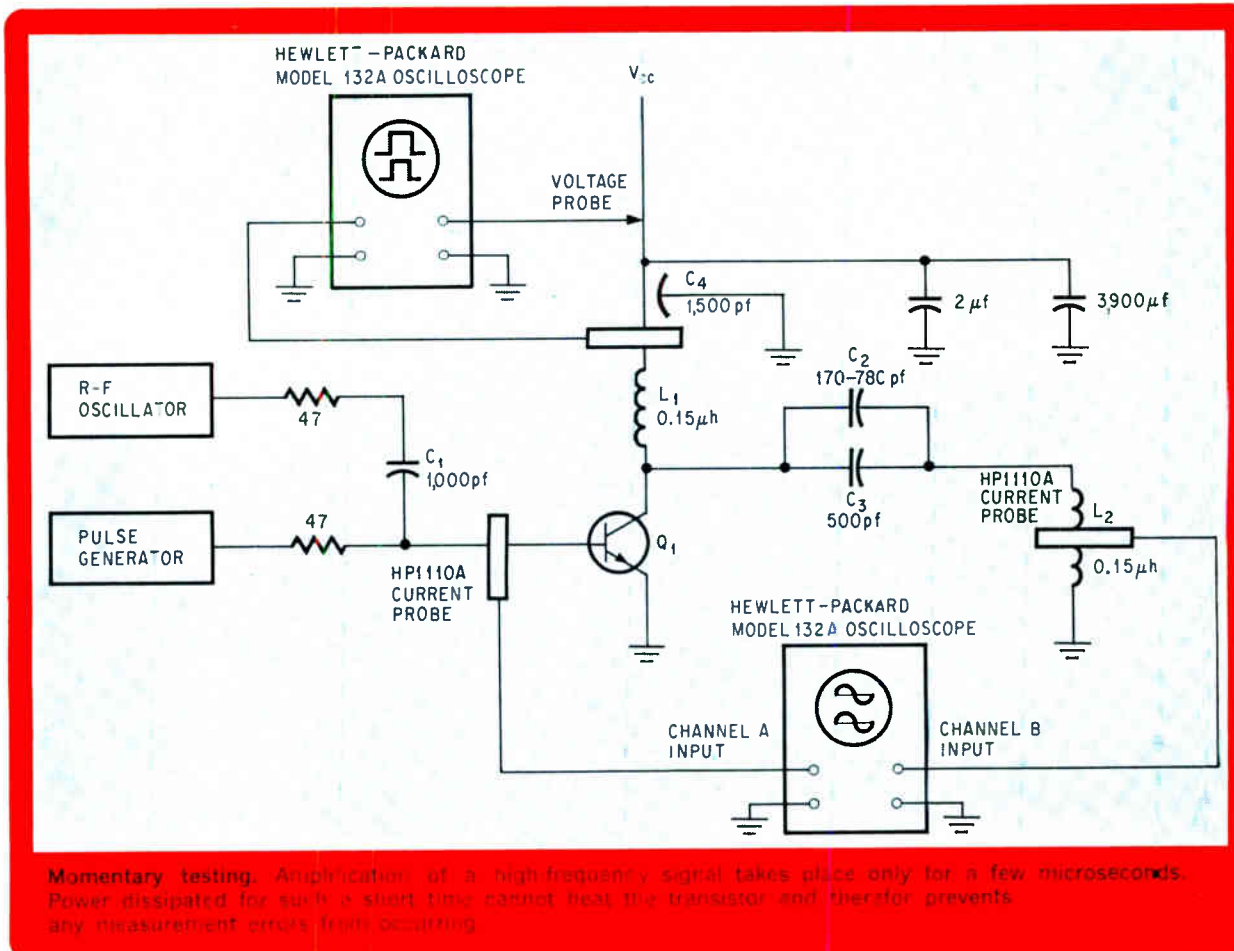

Momentary testing. Amplification of a high-frequency signal takes place only for a few microseconds. Power dissipated for such a short time cannot heat the transistor and therefore prevents any measurement errors from occurring.

causing any detectable measurement error.

A 35-megahertz signal is coupled from the r-f oscillator through capacitor, C_1 , into the base of the transistor. It is not amplified, however, until one of the 10-microsecond pulses, supplied every millisecond by the pulse generator, biases Q_1 into conduction. When the momentary amplification takes place the resultant signal is shorted to ground through the series resonant circuit consisting of C_2 , C_3 and L_2 . The inductance L_2 is a $\frac{3}{4}$ -inch length of #16 bus wire insulated so that no shorting takes place with the probe clipped on. This short, the required output for a current-gain measurement, can be adjusted for any frequency by varying C_2 . The inductance, L_1 , prevents r-f currents from entering the d-c supply. Its voltage drop and any others that might occur during the pulse are overcome by the charge that exists on capacitor, C_4 . Monitoring the collector voltage and current is, nevertheless, necessary and is best done

with a voltage probe, a dual-beam scope and a current probe.

When collector current, i_c , and base current, i_b , are measured on that portion of the frequency-gain curve when the gain is dropping 6 db/octave the following relationship is valid:

$$f_T = f \left(\frac{i_c}{i_b} \right)$$

where f_T = frequency at which the transistor's gain-bandwidth product is unity

i_c = a-c collector current

i_b = a-c base current

f = frequency at which i_c and i_b are measured

The two current measurements are made with a dual-beam oscilloscope and the frequency of the input signal is read directly on the oscillator's dial.

Amplifier flattens ripple in d-c regulator

By Irvin Budych

Borg Instruments, Delavan, Wisc.

Ripple in the output of a rectifier that uses a capacitive input filter can be removed by a simple and inexpensive transistor amplifier. By taking a portion of the input ripple voltage, and amplifying it with

a transistor, an inverted collector signal is obtained. Adding this signal to the ripple voltage neutralizes the input and the amplifier reduces any variations in the output to zero. It is as effective in choking ripple as a large inductor and yet does not lower the high output voltage of the capacitive filter.

The small signal needed for neutralization is taken off the line through C_1 and fed into a high impedance circuit comprised of R_1 and R_2 . After amplification by Q_1 , the signal—inverted now by the transistor—is coupled through C_2 onto the reference voltage at the base of Q_2 . Riding there, it reduces all the ripple in the regulator to zero.

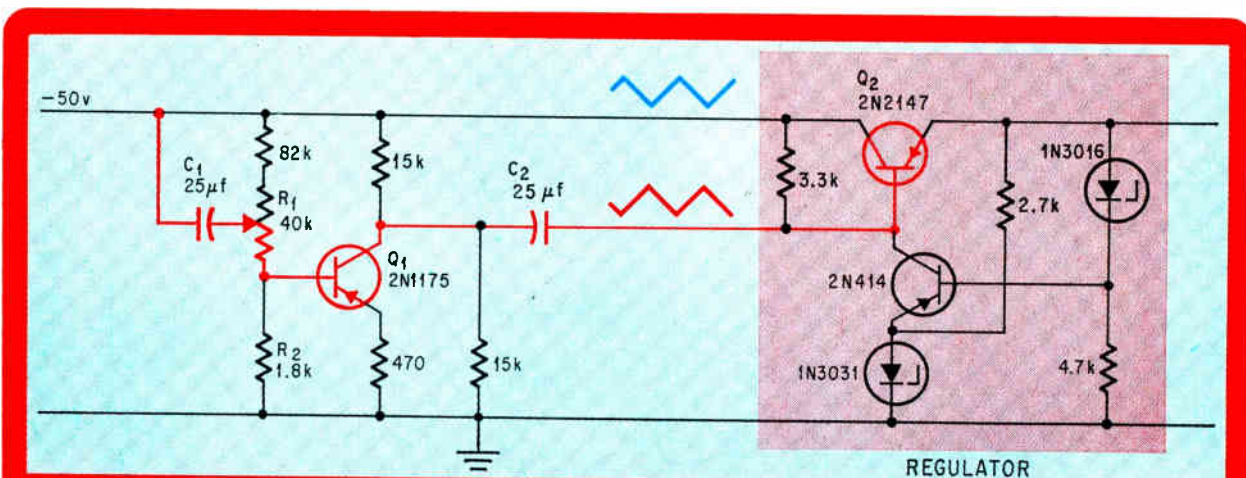

Forward neutralization. A portion of the ripple voltage is amplified and routed into the series regulator. There it nullifies the ripple voltage. With the values shown for capacitors C_1 and C_2 , the circuit is able to start immediately without any warmup period.

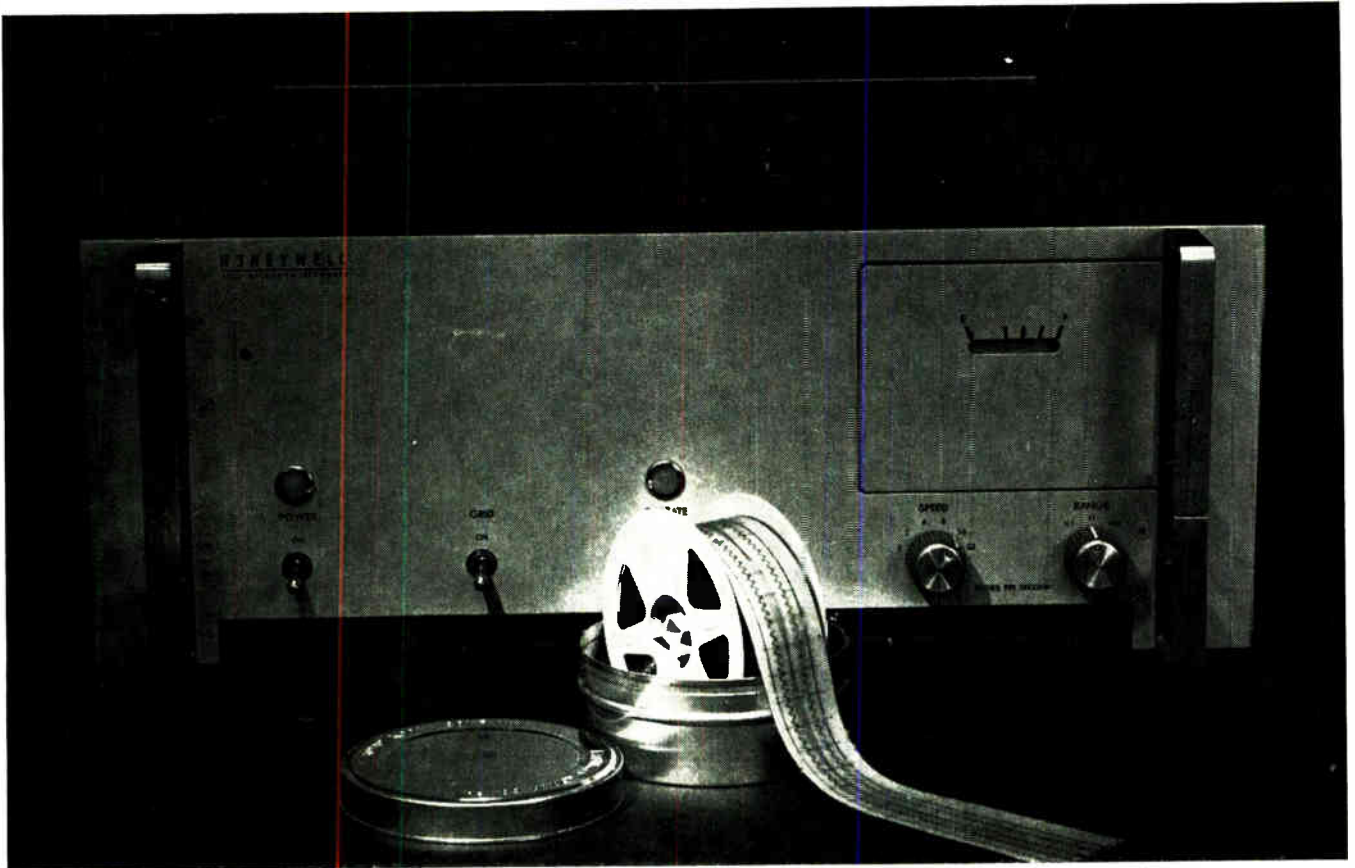

Easily installed, the new Microfilm Recorder Accessory makes high-quality archival records on inexpensive 35mm film.

Like to cut cost of oscillographic recording up to 95% with a simple microfilm attachment? Here's Honeywell's solution:



8 rolls (1500')
Standard recording paper
\$283.00



150' of film
(equivalent of 1500')
\$14.00

A rewarding investment, our new Model 2400 Microfilm Recorder Accessory lets you make permanent dynamic records at up to 1/20th of the cost of using direct-write paper. It will record data on film simultaneously with your Visicorder oscillograph's paper record, or can be operated so only a microfilm record is obtained.

You save money, and you save space because microfilm makes for convenient storage and easy access to data for analysis and reference. Viewing and reproduction can be handled by any of a large number of units currently available.

Better resolution, too! In addition to being economical, the Microfilm Accessory lets you record data at speeds not possible on direct-write oscillographs. When used with our Model 1508 Visicorder, for example, you could record data on the paper record at 120 ips, the instrument's fastest paper speed. At the same time, the Microfilm Accessory could record the identical data at an equivalent paper speed of 320 ips for greater resolution of the data.

For maximum recording versatility, you have three methods of recording when your Visicorder is equipped with the Microfilm Accessory: microfilm only, direct-write only, and combined microfilm and direct-write. Depending on the importance and/or dura-

tion of the data to be recorded, you can choose the proper method with a simple, three-position switch.

The Model 2400 is easily mounted above a rack-mounted Visicorder, and can be factory or field-installed. Film is contained in a plug-in magazine that can be removed and replaced in about 10 seconds; extra accessory magazines are available.

Fits these Famous Honeywell Visicorders:

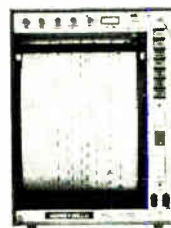

Model 1612

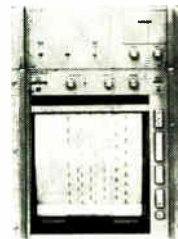

Model 1912
(Shown with
Microfilm Accessory)



Model 1508

Available for immediate delivery, the Microfilm Recorder Accessory is another example of how Honeywell's broad line, backed by local sales and service, can provide the *precise* solution to your instrumentation problems. For full details, call Mr. Don Anderson (collect) at: (303) 771-4700, or write: Honeywell, Test Instruments Division, P.O. Box 5227
Denver, Colorado 80217.

Honeywell

Honeywell engineers sell solutions

Narrowing the margin of error

Common-mode deviations that alter the outputs of data amplifiers can be minimized by combining inverting and noninverting op amps

By Robert I. Demrow

Analog Devices Inc., Cambridge, Mass.

Engineers designing with differential operational amplifiers must continually reckon with common-mode error—a part of the difference in the voltage at the two input terminals that introduces discrepancies into the output. If they don't make allowances for the problem or act to minimize it, all calculations and measurements will be faulty.

An ideal differential amplifier with two input voltages, e_A and e_B , should respond only to the difference between them, e_n . Thus,

$$-e_n = (e_A - e_B) = \frac{e_o}{A}$$

where A is the amplifier's open-loop voltage gain, and e_o is the output voltage. If $e_A = 10$ volts and $e_B = 10.002$ volts, for example, the effective input is 2 millivolts and the ideal differential amplifier responds only to that signal.

In practice, however, the differential signals are distorted by common-mode error, resulting from a voltage common to both input terminals, a factor usually attributed to imperfections in the input circuit's symmetry. Unequal gains behind the amplifier's inverting and noninverting terminals are one cause, for instance.

A more realistic expression of a differential amplifier's response, therefore, must take into account the degree to which the common-mode voltage is rejected—a factor represented by CMRR, or common-mode rejection ratio. This practical expression takes the form

$$e_n = e_B - e_A = -\frac{e_o}{A} + \frac{e_{CM}}{CMRR}$$

where $e_{CM} = (e_A + e_B)/2$.

Common-mode rejection CMR is expressed in a logarithmic form:

$$CMR = 20 \log_{10} |CMRR|$$

The accuracy of differential amplifiers can thus be limited by both A and CMRR. And in any ampli-

fier, common-mode error can vary with frequency or voltage level. A circuit's over-all CMRR depends upon the inequality of the amplifier's internal gain, common-mode input resistance, and any deviations from the values calculated for the external resistors.

Joining forces

The error can be minimized by combining inverting and noninverting op-amp circuits to form a differential amplifier. The inverting type develops a negligible error because the common-mode signal here is in the microvolt-to-millivolt region. However, this circuit provides low input impedance, particularly when wide bandwidths are required, and a noninverting op amp is therefore needed for most applications. This is where common-mode error becomes important.

The differential amplifier combining inverting and noninverting circuits can be used to eliminate ground-loop potentials and can act as a bridge amplifier measuring strain, force, pressure, temperature, and other physical variables. A further description of inverting, noninverting, and differential

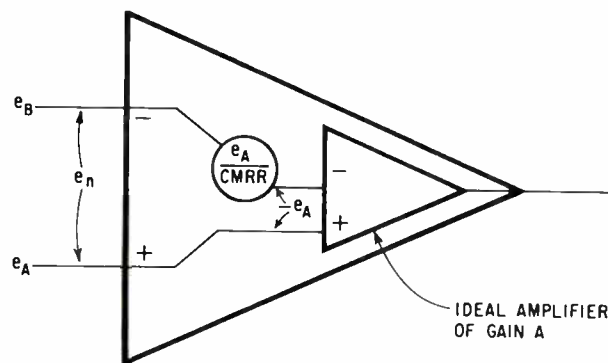

Common-mode error. Voltage e_n represents the difference between input voltages e_A and e_B . The common-mode error, shown as a source in series with e_B , is proportional to e_n .

circuits appear in "Amplifying remarks," p. 110.

Although the transistors used in an operational amplifier are elaborately matched and are gain-stabilized by internal feedback, there may nevertheless be a gain difference between inverting and noninverting channels of one part in 10,000, or 0.01%; this holds even for quite expensive units. Run-of-the-mill field effect transistor op amps have gain mismatches of 0.1% caused by circuit imbalance resulting from the high output conductance of FETs.

But consider an economy amplifier with a nominal open-loop gain of 10,000 and a gain error between its inverting and noninverting signal channels of one part in 10,000. The noninverting gain might then be 10,000 and the inverting gain only 9,999. If both input terminals are connected to a 10-volt common-mode source, the noninverting terminal creates an output of $10 \times 10,000$ volts while the inverting produces $10 \times 9,999$ volts. The net effect is an output of $10(10,000 - 9,999)$, or 10 volts. Thus, the common-mode output $V_{O_{cm}}$ can be represented by $V_{cm}(A_2 - A_1)$, which ideally would be zero, but for this amplifier is 10 volts.

The factor $(A_2 - A_1)$ is called the common-mode gain, G_{cm} , because the 10-volt common-mode output can be regarded as having been produced by multiplying the common-mode input voltage, 10 volts, by this gain: $V_{O_{cm}} = V_{cm} \times G_{cm}$.

Sum of the parts

Complete circuits may also exhibit a common-mode gain. Even a circuit with an ideal op amp having identical inverting and noninverting gains can develop a common-mode error when common-mode voltage is applied in unequal proportions to its inverting and noninverting terminals.

The differential configuration relies on the voltage divider effects $R_2/(R_1 + R_2)$ and $R_4/(R_3 + R_4)$ to apply equal fractions of the common-mode voltage to the inverting and noninverting terminals. If these fractions are identical, no differential component of common-mode voltage is created and the amplifier develops no common-mode output. This, of course, assumes a perfect amplifier in which $A_1 = A_2$.

But if off-the-shelf resistors with 0.1% tolerance are used for R_1 , R_2 , R_3 , and R_4 , a resistance error for the worst case may make $R_4/(R_3 + R_4)$ larger than its theoretical value, and $R_2/(R_1 + R_2)$ smaller than this same value. There will be a net fraction of common-mode voltage e_{cm} applied differentially between the amplifier's input terminals, and this will be amplified by a noninverting gain factor of $(R_1 + R_2)/R_1$ to create a common-mode output error proportional to the resistance tolerances.

The worst-case distribution of resistance errors occurs when the four feedback resistors assume new values of $R_1(1 - K)$, $R_2(1 + K)$, $NR_1(1 + K)$, and $NR_2(1 - K)$, where K is the resistor tolerance, and N is the multiplier.

Common-mode rejection ratio is defined as the ratio of closed-loop, or normal-mode, gain, $G_{cl} =$

Continued on p. 112

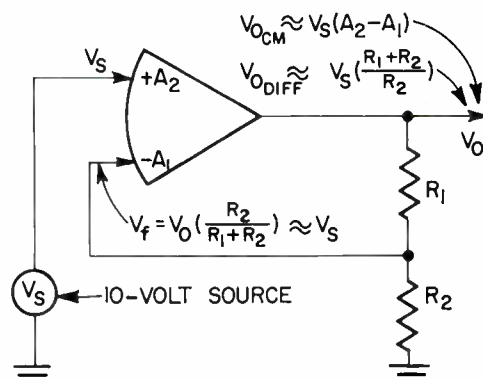
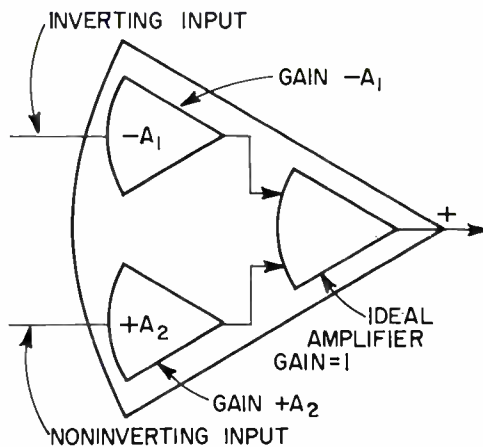

COMMON-MODE OUTPUT, $V_{O_{CM}} = V_S A_2 \frac{V_O R_2}{R_1 + R_2} A_1$

BUT $V_O(\frac{R_2}{R_1 + R_2}) \approx V_S$ (FOR $A_2 \gg 1$) SO $V_{O_{CM}} \approx V_S(A_2 - A_1)$. POSTULATING $V_{O_{CM}} = V_S(\text{C-M GAIN})$, THEN $(A_2 - A_1) = \text{COMMON-MODE GAIN}$; ALSO, EQUIVALENT C-M INPUT ERROR BECOMES $e_{cm} = V_{O_{CM}} \div A$, WHERE A IS AVERAGE GAIN $\frac{A_1 + A_2}{2}$

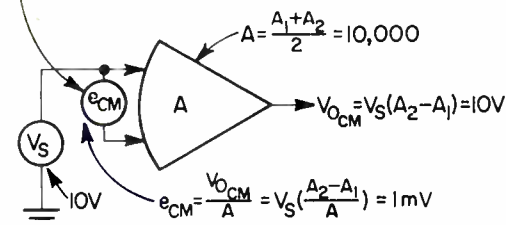

CMRR = $\frac{\text{DIFF GAIN}}{\text{C-M GAIN}} = \frac{A}{A_2 - A_1} = 10,000$

OR = $\frac{\text{C-M INPUT}}{\text{C-M INPUT ERROR}} = V_S \div V_S(\frac{A_2 - A_1}{A})$

= $\frac{A}{A_2 - A_1} = 10,000$

Defining error. Inequality of inverting and noninverting gains is the basis for common-mode error (top). A common-mode output proportional to gain inequality (center) is represented by a differential component of common-mode input, e_{cm} , applied between amplifier's input terminals (bottom). Value of hypothetical error source, e_{cm} , is common-mode voltage divided by CMRR.

Amplifying remarks

There are three amplifier designs the engineer must understand if he is to build functional circuits.

Inverting. This is the best known and probably the most versatile op amp. Its closed-loop gain, V_o/V_s , has a value very nearly equal to the negative value of the ratio of feedback to input resistor, R_f/R_i . If the op amp's internal, or open-loop, gain is high, say 10,000 volts/volt and upwards, the error voltage, V_e , at the summing junction, S, is very small—less than 1 millivolt for a gain of 10,000 volts output. In effect, therefore, point S remains within a whisker of ground potential—really at a virtual ground—so that input signal current I_{sig} is very nearly V_s/R_i . More accurately, I_{sig} is $(V_s - V_e)/R_i$, and V_e is just a few microvolts.

Because the summing junction is assumed to be at ground potential, the inverting circuit's input impedance is equal to input resistance, R_i .

Stray capacitance—rarely less than 1 picofarad—in parallel with feedback resistance R_f , limits the circuit's bandwidth to a frequency that makes the leakage reactance $1/2\pi f_c C$ equal to R_f . This bandwidth, restricted to $f_c = 1/2\pi R_f C$, not only affects frequency but influences gain and input impedance.

High input impedance requires a large R_i . If the amplifier has to operate at high closed-loop gain, however, feedback resistance R_f must be higher than the input resistance in the ratio, $R_f = \text{gain} \times R_i$. If the input impedance has to be 1 megohm to avoid source-loading effects, for instance, and a 60-decibel (1,000:1) closed-loop gain is required, the feedback resistance becomes $1,000 \times 1 \text{ megohm} = 1,000 \text{ megohms}$. The frequency at which the reactance of a 1-pf leakage capacitance equals 1,000 megohms is only about 160 hertz, which makes a pretty spectacular bandwidth limitation. Actually, 1,000-megohm high-stability resistors don't exist, so a circuit such as the one at the bottom of this page is required for this level of gain.

The inverting circuit is usually unsuited for applications involving high input impedance; a noninverting configuration is much more appropriate here. By using low-value resistors in its gain determining network, the noninverting design circumvents the bandwidth problem besides achieving a substantially high input impedance.

The inverting circuit holds certain advantages over the noninverting arrangement, of course. It operates with one input terminal grounded, and provides a means for obtaining long-term stability with a chopper amplifier. Also, the inverting configuration obviates any common-mode errors and operates with inputs of several thousands of volts.

Noninverting. In the noninverting amplifier, a very high input impedance is achieved by opposing the input signal, V_s , with a feedback voltage, V_f , of almost equal magnitude. The amplifier's net differential drive signal, represented as an error voltage, V_e , is then equal to the difference between input and feedback voltages, and may be a matter of millivolts or even microvolts in high-gain amplifiers. With only millivolts across the amplifier's differential input resistance, R_{IN} , the signal current drawn from the source is proportionately low,

CAPACITANCE STRAYS LIMIT BANDWIDTH

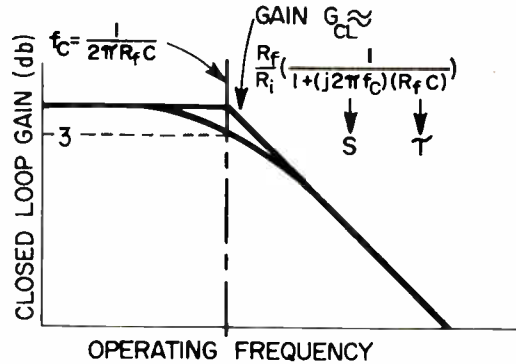
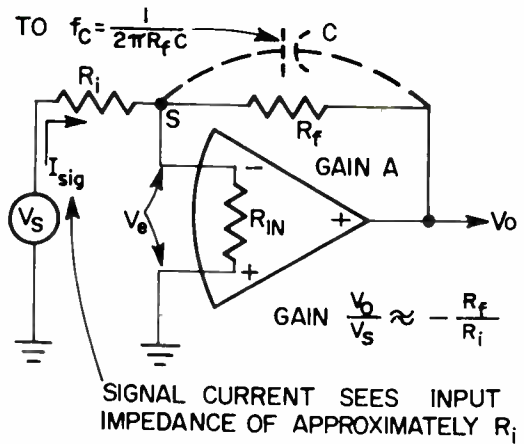

STRAY CAPACITANCE C SHUNTS R_f AND LIMITS MAXIMUM GAIN AND INPUT IMPEDANCE FOR GIVEN FREQUENCY

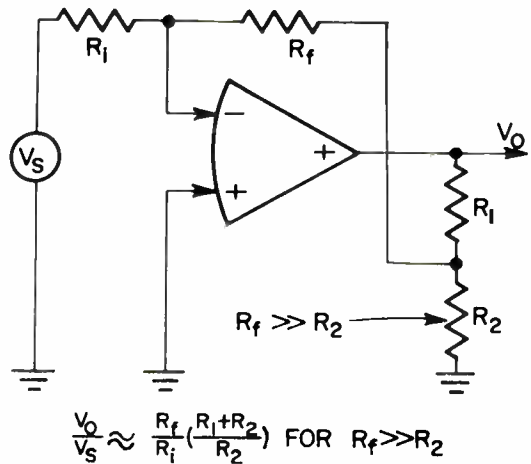

Bandwidth limiter. Bandwidth, gain, and input impedance of inverting circuit (top) are limited by the stray capacitance shunting the feedback resistor. Gain in the closed-loop curve (center) rolls off at 6 db/octave when operating frequency makes reactance of C smaller than R_f .

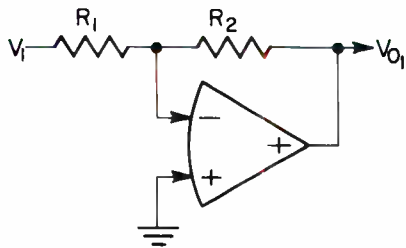

INVERTING OUTPUT

$$V_{O1} = -V_1 \left(\frac{R_2}{R_1} \right)$$

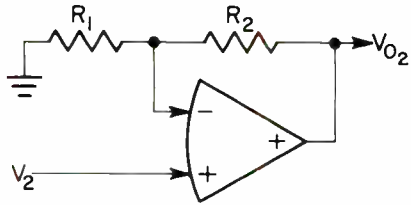

NONINVERTING OUTPUT

$$V_{O2} = V_2 \left(\frac{R_2 + R_1}{R_1} \right)$$

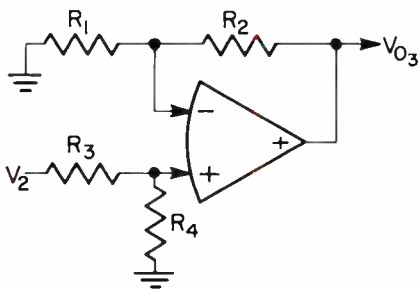

NONINVERTING OUTPUT WITH INPUT ATTENUATION

$$V_{O3} = \left(\frac{R_4}{R_3 + R_4} \right) (V_2) \left(\frac{R_2 + R_1}{R_1} \right)$$

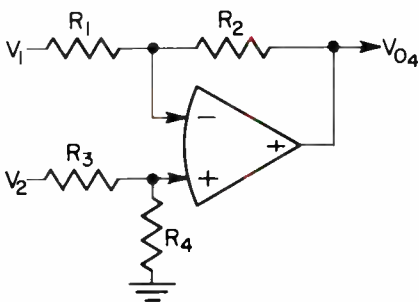

COMBINED NONINVERTING AND INVERTING OUTPUTS

$$V_{O4} = V_{O1} + V_{O3}$$

$$V_{O4} = -V_1 \frac{R_2}{R_1} + V_2 \left(\frac{R_4}{R_3 + R_4} \right) \left(\frac{R_1 + R_2}{R_1} \right)$$

MAKE $R_3 = NR_1$
AND $R_4 = NR_2$

$$V_{O4} = -V_1 \frac{R_2}{R_1} + V_2 \left(\frac{NR_2}{NR_1 + NR_2} \right) \left(\frac{R_1 + R_2}{R_1} \right)$$

$$V_{O4} = -V_1 \frac{R_2}{R_1} + V_2 \frac{R_2}{2R_1} = \frac{R_2}{R_1} (V_2 - V_1)$$

and this gives the effect of an artificially boosted input impedance. So far as the signal source is concerned, the amplifier draws an input current of only $(V_s - V_i)/R_{IN}$, rather than V_s/R_{IN} , and input resistance is raised from R_{IN} to approximately $AR_{IN} \times R_2/(R_1 + R_2)$, where A is the open-loop gain. More accurately, input impedance becomes $R_{IN} (1 + A\beta)$ in parallel with R_{cm} , where β is the feedback fraction $R_2/(R_1 + R_2)$ and R_{cm} is the common-mode input resistance, or the resistance from input terminal to ground.

When a typical operational amplifier with a 10^6 open-loop gain and a 1-megohm input resistance is connected in a noninverting circuit with a closed-loop gain, $(1/\beta)$, of 50, the bootstrapped input resistance R_i is 1 megohm $\times (1 + 10^6/50) = 20,000$ megohms. The artificially increased input resistance is frequently far higher than the amplifier's common-mode input resistance, R_{cm} , or resistance from input to ground.

Consequently, it's the common-mode input resistance rather than the bootstrapped differential input resistance that sets the ultimate limit on source-loading effects. Nevertheless, an operational amplifier with a 1-megohm differential input resistance often has a common-mode input resistance of 1,000 megohms, so that this configuration does make a high-input-resistance amplifier.

Internal amplifier bandwidth limitations are much more likely to set performance levels than external stray capacitances.

Although the gain-setting resistors, R_1 and R_2 , are shunted by leakage capacitance, the bandwidth limitation for the noninverting circuit isn't as stringent as the one for the inverting. The noninverting amplifier's input resistance is independent of feedback resistance values, but does depend upon their ratio. Actual input resistance is $R_i = R_{IN} (1 + A\beta)$ paralleled by the common-mode input resistance, R_{cm} . Closed-loop gain, $1/\beta = (R_1 + R_2)/R_2$, can therefore be made arbitrarily high without designing in high resistance values.

For example, a noninverting amplifier can produce a closed-loop gain of 1,000 if R_1 equals 999 ohms and R_2 equals 1 ohm. If the amplifier's open-loop gain, A , is 10^6 , input resistance is raised by a factor of $(1 + 10^6/10^3)$, or 1,000; the effect of the 1-pf stray capacitance shunting the 999-ohm R_1 is negligible.

In practice, the R_1 and R_2 values are determined by the amplifier's ability to supply them with sufficient current without depriving the external circuit of its load current. A typical amplifier's output rating is ± 10 volts, 5 milliamperes, and if 4 ma is reserved for the load circuit, the minimum value for $(R_1 + R_2)$ is 10 volts/1ma = 10,000 ohms. Therefore, the values of R_1 and R_2 become 9,990 ohms and 10 ohms, respectively. Even so, the 1-pf leakage doesn't begin to roll off the closed-loop gain much below $f_c = \frac{1}{2} \pi 10^4 \times 10^{-12} = 15$ Mhz.

The input voltage capability of the noninverting amplifier is certainly no greater, and usually less, than the voltage of the supply lines. Thus a noninverting ampli-

Merger. One-amplifier differential circuit combines inverting and noninverting operation. Arrangement is economical but tends to exhibit the worst features of the two circuits upon which it is based. Also, it's difficult to vary gain without introducing common-mode errors.

SIGNAL CURRENT, $I_{sig} = \frac{V_e}{R_{IN}} = \frac{V_o}{A} \left(\frac{1}{R_{IN}} \right)$; ($R_{CM} \gg R_{IN}$)

INPUT RESISTANCE, R_i , SEEN BY SOURCE = $\frac{V_S}{I_{sig}}$

$$\therefore R_i = \frac{V_S}{I_{sig}} = \frac{V_S}{V_o} (AR_{IN}) \approx \frac{R_2}{R_1 + R_2} (AR_{IN}) \approx A\beta R_{IN}$$

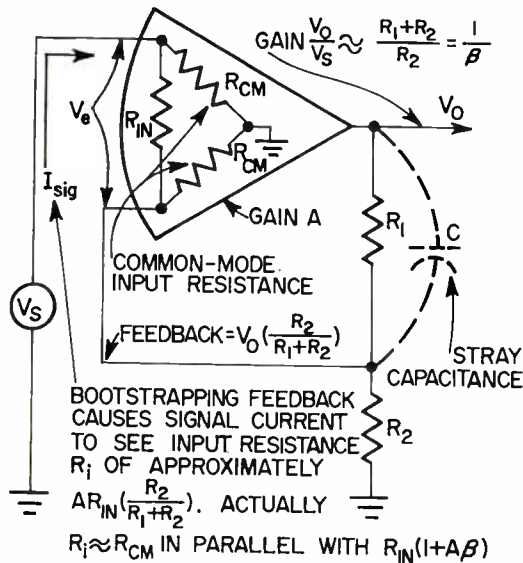

fier operating from a ± 15 -volt d-c supply is limited to a maximum input voltage of less than ± 15 volts—a severe restriction in some applications.

Differential. A combination of noninverting and inverting circuits strikes a compromise between the main features of the two types—but not the best features. The differential amplifier is subject to the disadvantages of both component circuits.

The advantages of the inverting amplifier, as summarized in this article, include immunity from common-mode errors, the ability to operate from high input voltages, and ease of design with chopper-stabilized amplifiers. All of these are sacrificed in the differential arrangement. Similarly, the advantages of the noninverting amplifier—ultrahigh input impedance, a lack of bandwidth limitations, and high gain—are also lost in the differential design.

However the single amplifier differential combination does have several advantages. Among these are the ability to measure differential signals with moderate closed-loop gains from 1 to several thousands—a means for improving the CMRR of the basic amplifier by compensation, and lower drift and noise than multiple-amplifier schemes.

Feedback helps. Noninverting circuit applies feedback to bootstrap input impedance, and provides high gain without compromising bandwidth. Input voltage range is less than unit's supply voltage, and circuit is subject to common-mode error.

R_2/R_1 , to the common-mode gain, $G_{cm} = 4KR_2/(R_1 + R_2)$. Thus the CMRR for a single-amplifier circuit is $(1 + R_2/R_1)/4K$. However, the circuit's differential gain, R_2/R_1 appears explicitly in this CMRR expression, which may now be rewritten as $(1 + G_{cl})/4K$. The circuit's CMRR thus improves with closed-loop gain but declines with K , the resistor tolerance error.

For example

With a circuit using 0.1% resistors and operating at a closed-loop gain of 100, the CMRR becomes $(1 + 100)/4 \times 0.001$, or approximately 25,000:1.

If the same circuit were to measure a 100-mv signal superimposed on a 10-volt common-mode level, the common-mode error would be $10/25,000/100$ mv, or 0.4 mv. The error would thus be 0.4% of the 100-mv signal. But this analysis reflects only the common-mode error stemming from imperfect resistors. The amplifier's internal gain inequality is another source of common-mode error, and it must be considered by the designer.

The amplifier's internal gain, $(A_2 - A_1)$, and $CMRR_A = A/(A_2 - A_1)$, apply equally to both the amplifier and the differential circuit in which it's connected. Accordingly, if the specification sheet shows the amplifier's CMRR to be 25,000, the additional common-mode error in measuring 100 millivolts superimposed on the 10-volt common-mode level is $10/25,000/100$ mv, or another 0.4%.

In the worst case, therefore, where the common-mode errors caused by external resistance deviations and amplifier gain inequalities are present simultaneously, the total error would be 0.8%.

The CMRR resulting from both factors is calculated in the same way as the net resistance of two parallel branches:

$$\text{total CMRR} = \frac{CMRR_R \times CMRR_A}{CMRR_R \pm CMRR_A}$$

where $CMRR_R$ and $CMRR_A$ are the separate values for resistance and gain errors, respectively.

Offsetting gains

A useful design trick here is to trim the external resistors so that the resulting common-mode gain has an opposite polarity to the common-mode gain caused by the amplifier's unequal inverting and noninverting gains. This technique makes, say $CMRR_R$ negative and $CMRR_A$ positive, eliminating common-mode output and producing an infinite CMRR. The same result can be inferred from the equation for total CMRR, since the denominator in this expression, $CMRR_R \pm CMRR_A$, would be reduced to zero.

In a bipolar-transistor amplifier, as opposed to a FET-input unit, this method can boost the over-all CMRR by a factor ranging from 10 to perhaps 100. There are hazards, however. If the external resistors drift away from their tweaked-up values, for in-

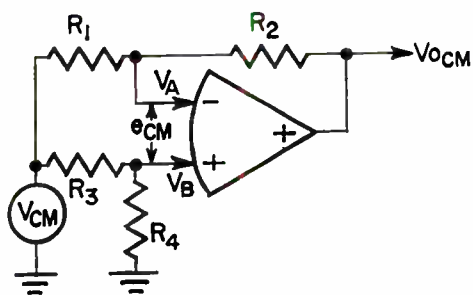

COMMON-MODE GAIN IS

$$G_{CM} = V_{O_{CM}} / V_{CM} = \left(\frac{R_2}{R_1 + R_2} - \frac{R_4}{R_3 + R_4} \right) \left(\frac{R_1 + R_2}{R_1} \right)$$

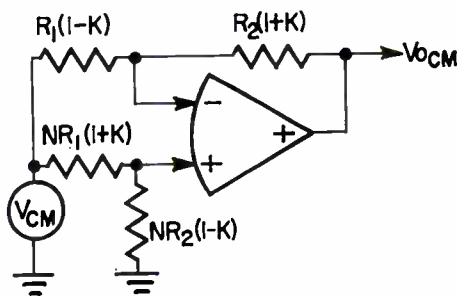

COMMON-MODE GAIN IS

$$CMRR \approx \frac{1 + R_2/R_1}{4K} \approx \frac{1 + G_{CL}}{4K}$$

Resistance variation. Unequal common-mode voltages, V_{cm} , are applied to inverting and noninverting terminals when external resistors deviate from assigned values (left). Worst-case common-mode error is proportional to four times the resistor tolerance fraction K ; $CMRR$ improves with closed-loop gain (right).

stance—either through temperature instability or aging—the amplifier's common-mode compensation will also drift. The compensating method depends upon the constancy of the amplifier's internal $CMRR$, but this parameter varies in response to several factors. For example, $CMRR_A$ decreases in a p-channel FET when the device's applied common-mode voltage increases. It also varies with output loading; the higher the load the lower the gain. Finally, it reflects the long-term aging of internal resistors and semiconductors.

The designer must therefore familiarize himself with the amplifier's common-mode characteristics, and should make sure that his external resistors have long-term and temperature-induced drift characteristics appropriate to his accuracy needs.

In practice, it's possible to tweak up a differential amplifier to a near-perfect circuit $CMRR$ level by making one or another of the resistors slightly variable, or by adding a small amount of trimming resistance in series or parallel. However, it's extremely difficult to build a variable-gain differential amplifier capable of a high $CMRR$. It's just about impossible to replace R_2 and R_4 with a ganged pair of variable resistors and secure the same $CMRR$ because of the difficulty of maintaining good tracking between these feedback resistors. Careful common-mode trimming would come untweaked.

Another source of common-mode error is the unbalancing effect of the amplifier's own common-mode input resistance, R_{cm} , the resistance seen between input terminal and ground. Because the common-mode resistances between ground and the inverting and noninverting terminals are, in effect, placed in parallel with feedback resistors R_2 and R_4 , they modify the common-mode voltage applied to the two input terminals. These resistances are theoretically equal, but in practice are never identical.

Errors due to common-mode resistance are minimized by selecting small values for R_2 and R_4 compared with the nominal R_{cm} level, or by using an amplifier with very high common-mode input resistance, such as the FET or varactor bridge. Even

recently developed high-performance differential-transistor amplifiers feature 10^9 ohms common-mode impedance. Errors due to 1,000-megohm R_{cm} values shunting 100-kilohm feedback resistances (R_2 and R_4) amount to only about a 0.01% net resistance deviation. Further, because both R_2 and R_4 are simultaneously shunted by just about equal common-mode values, the net unbalancing effect is unimportant.

Unbalanced source resistance

Besides internal gain inequality, feedback-resistor tolerances, and the shunting effect of the amplifier's common-mode input resistance, unbalanced source resistance in series with the amplifier's input terminals can cause common-mode error in a differential circuit. For instance, if the signal trans-

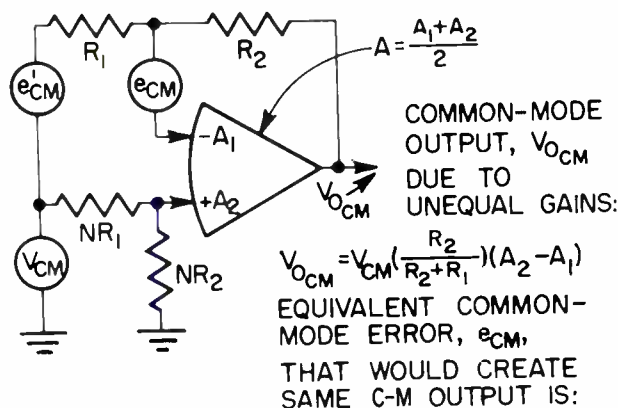

$$e_{CM} = \frac{V_{O_{CM}}}{A} = V_{CM} \left(\frac{R_2}{R_2 + R_1} \right) \left(\frac{A_2 - A_1}{A} \right)$$

$$CMRR = \frac{\text{COMMON MODE VOLTAGE INPUT } (V_{CM})}{\text{COMMON MODE INPUT ERROR } (e_{CM})}$$

$$CMRR = V_{CM} \div V_{CM} \left(\frac{A_2 - A_1}{A} \right) = \frac{A}{A_2 - A_1}$$

Matching errors. Amplifier's internal common-mode error due to gain inequality reflects a $CMRR$ to the circuit's input that is equal to that amplifier's own $CMRR$: $A / (A_2 - A_1)$.

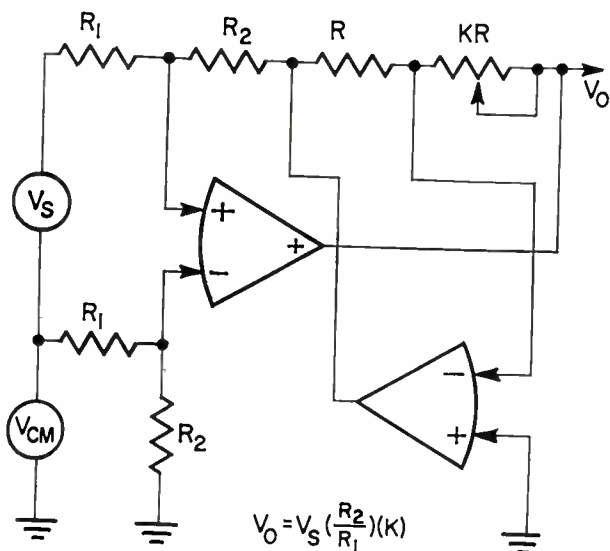
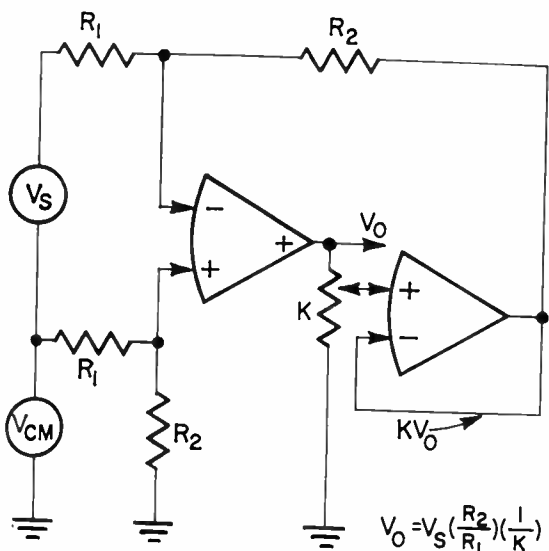
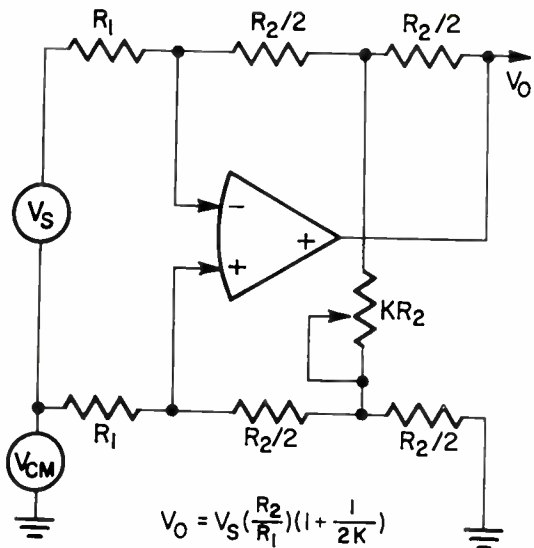

ducer is operated with one of its output terminals grounded, point A in the diagram on page 115, its internal resistance or impedance is placed in series with the amplifier's inverting terminal. The two signal lines introduce further series resistance, but imbalance remains if the source resistance is appreciably higher than the signal-line resistances. The net imbalance is represented as R_u in the schematic.

It's theoretically possible to introduce a compensating resistance into the noninverting line to cancel the effect of R_u , but this can be a difficult job in practice. What happens when the amplifier is switched sequentially to read the output from an array of different transducers, each with different amounts of imbalance? Or what happens when signals are developed by an inductive-type transducer, such as a tape-recorder head, whose internal impedance varies with ground-loop and common-mode frequency? In both these instances, and in many others, common-mode errors cannot be completely compensated.

Actually, the degree of common-mode error doesn't depend upon the absolute value of resistance imbalance, but is proportional to the ratio of source resistance imbalance R_u to amplifier input resistance R_{em} , R_u/R_{em} . The higher the amplifier's common-mode input resistance, R_{em} , the smaller the common-mode error. The best tack to take, therefore, in the absence of external common-mode compensation techniques, is to make the amplifier's common-mode input resistance as high as possible.

Amplifiers are typically rated—regarding common-mode characteristics—on the basis of their source resistance imbalance; this R_u value is often 1,000 ohms. To provide 10^6 CMRR with such a value requires a minimum common-mode input resistance of $R_{em} = \text{CMRR} \times R_u = 10^9$ ohms. If the amplifier is to be used to measure 10-mv signals against a 5-volt common-mode background, the equivalent common-mode input error, e_{em} , becomes $5/10^6$, or $5\mu\text{v}$. The percentage error, $100\% \times e_{em}/V_s$, works out to a value of $100\% \times 5 \times 10^{-6}/10^{-2} = 0.05\%$.

Attenuating effect

The amplifier's finite differential input resistance is usually smaller than its common-mode input resistance, and this creates an attenuating effect when the device is used to measure signals from sources with appreciable internal resistances or impedances. This attenuating effect, in turn, causes a measuring

Adjusting gain. Although a single resistor is all that's needed to adjust gain of circuit at top without altering common-mode balance, six high-stability resistors are needed in the feedback circuit. Gain varies nonlinearly with K . Center circuit uses only four feedback resistors, but requires an auxiliary amplifier for unloading resistor K . Gain here also varies nonlinearly with K . Circuit at bottom provides linear gain variation with aid of auxiliary amplifier, and uses five feedback resistors.

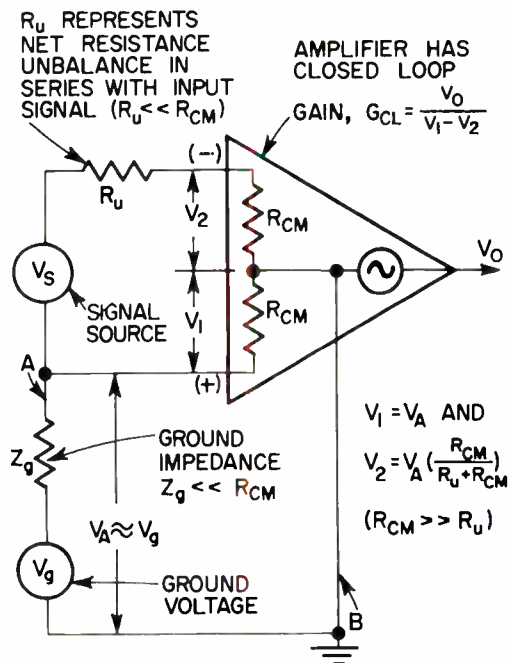

$$CMRR = \frac{\text{DIFF GAIN}}{\text{C-M GAIN}} \approx \frac{G_{CL}}{(G_{CL})(R_u/R_{CM})}$$

Single-end source. Differential method can reject common-mode errors when working with single-ended sources, although resistance imbalance impairs the rejection process. Over-all CMRR is boosted by selecting a very high common-mode input resistance compared with the resistance imbalance.

discrepancy called source-loading error, an error equal to R_s/R_{IN} where these symbols represent source resistance and the differential input resistance of the amplifier.

With a 1,000-ohm total source resistance and a typical amplifier, the differential input resistance R_{IN} must be higher than 10^6 ohms if the loading error is to be held below 0.1%. Percentage loading error equals $100\% \times R_s/R_{IN}$.

Not only then must the amplifier's common-mode input resistance be very high to reduce common-mode errors caused by source imbalance but the differential input resistance must be very high to hold down source-loading errors.

Other error sources

Drift is a major factor in measurement accuracy. If an amplifier with a $2 \mu\text{V}/^\circ\text{C}$ maximum drift operates over the temperature range of 25°C to 35°C , the equivalent input error is $10 \times 2 = 20 \mu\text{V}$, which creates—for 10-mv signals—a further $100\% \times 20 \times 10^{-6}/10^{-2} = 0.2\%$ measuring error.

Current drift, or pump-out current, must also be considered when the source impedance is appreciable. If the total source impedance is 10,000 ohms, for instance, the input error caused by a 300 picoamperes/ $^\circ\text{C}$ current drift for a $\pm 10^\circ\text{C}$ range is $10,000 \times 300 \times 10^{-12} \times 10 = 30 \mu\text{V}$, or a $100\% \times 30 \times 10^{-6}/10^{-2} = 0.3\%$ measuring error.

A source impedance of 10^4 ohms could create

serious loading errors, and, if single-ended, substantial common-mode errors, too.

Differential configurations with two separate op amps can generally handle the problem of common-mode error better than any single-amplifier circuits. A differential design based on two noninverting amplifiers benefits from this type of circuit's high input impedance and relative immunity to capacitance strays. Likewise, a differential circuit based on two inverting amplifiers can remain immune to internal common-mode error with high input voltages.

Common-mode error due to external resistance deviations decreases in the noninverting circuit with closed-loop gain; in the inverting configuration, CMRR is constant. But gain equalities within the two amplifiers in the noninverting design cause error. In the design based on two noninverting amplifiers, closed-loop gain can be varied in proportion to the output amplifier's feedback resistor.

Key spec

The specification that really inhibits the use of conventional op amps in differential data-measuring circuits is common-mode rejection. Unfortunately, there are few useful operational amplifiers with a CMRR beyond 500,000:1; those op amps emphasizing CMRR tend to suffer from high cost or some other parameter deficiencies.

However, for more practical applications where the signal source is a low-impedance thermocouple or strain-gage bridge, no currently available operational-amplifier model fits the CMRR requirements set forth and at the same time features high stability, open-loop gain, input impedance, and fast response at moderate cost.

There's therefore a need for a data amplifier designed from the ground up. This device would achieve adequate performance at reasonable cost and the op amps used as building blocks cannot meet cost and performance specs if such features are required as 10^6 CMRR, 2,000 maximum gain, 10^9 and 10^7 common-mode and differential-input impedance, and $2 \mu\text{V}/^\circ\text{C}$ drift.

A differential amplifier that's immune to common-mode errors caused by resistance deviations appears at the bottom of page 116. However this design is still subject to gain inequality between the two amplifiers.

The error analysis reveals that the circuit has unity common-mode gain when the two amplifiers are considered separately. And because both amplifiers have this same unity common-mode gain, the common-mode output measured between the output terminals is theoretically zero. This means that the common-mode differential gain is also zero, and the circuit's common-mode rejection ratio is theoretically infinite.

Galvanometers, relays, coils, and other isolated loads can be driven directly from the push-pull output with near-perfect immunity to resistor-induced common-mode errors. But an added stage of differential amplification is needed for single-ended loads.

For an error-cancelling circuit followed by a

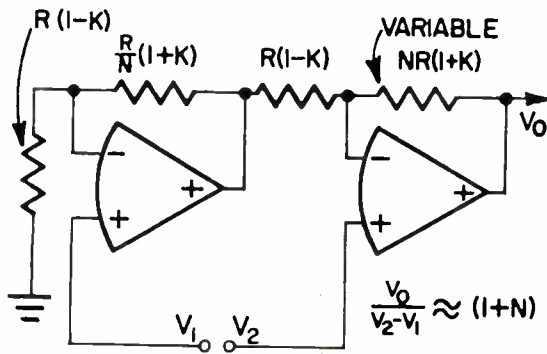

COMMON-MODE GAIN = $4K$

$$CMRR = \frac{\text{DIFF GAIN}}{\text{C-M GAIN}} = \frac{1+N}{4K} = \frac{G_{CL}}{4K}$$

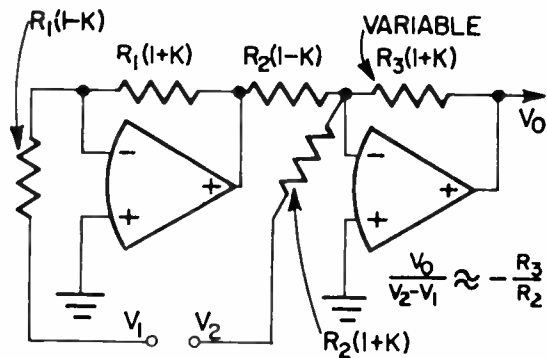

COMMON-MODE GAIN = $4KG_{CL}$

$$CMRR = \frac{\text{DIFF GAIN}}{\text{C-M GAIN}} = \frac{R_3/R_2}{4KR_3/R_2} = \frac{1}{4K}$$

Pairing amplifiers. Coupling two noninverting amplifiers gives differential circuit high input impedance and a CMRR that improves with closed-loop gain. However, the circuit is susceptible to amplifier's internal common-mode errors, has limited input voltage range, and requires isolated power supplies when based on chopper-stabilized amplifiers (left). Alternative circuit (right) uses two inverting amplifiers, has constant CMRR for external resistance deviations, handles high input voltages, is immune to common-mode error of individual amplifiers, and can be based on chopper-stabilized amplifiers without needing special power supplies. However, input resistance is limited to the value used for R_1 .

differential-to-single-ended-interface amplifier the over-all gain of the two cascaded stages is given by

$$\text{Gain (A)} \times \text{Gain (B)}$$

and the total CMRR is $\text{Gain (A)} + \text{Gain (B)}/4K$.

The circuit's common-mode performance can be maximized by assigning most of the gain to the first stage; in fact, fractional gain for the second stage appears to improve CMRR considerably.

This advantage can't be pushed too far without running into another source of difficulty. Designing the first stage for high gain will either restrict the level of common-mode voltage or cramp the circuit's dynamic signal swing.

Because the individual amplifiers used in the first

stage operate with unity common-mode gain, their output signals vary around the common-mode level, V_{cm} , of the input. If, for example, V_{cm} is 9.5 volts, and the amplifiers are built for a ± 10 -volt output rating, the maximum output signal swing can't be greater than $10 - 9.5$ or 0.5 volts.

A circuit with 100:1 first-stage gain couldn't handle input signals larger than 0.5/100, or 5 mv, without driving the output into the stops. Large input signals could only be handled either by using lower values of first-stage gain or by reducing the common-mode level upon which these signals are superimposed.

The future trend for improved CMRR in amplifier circuits will come from improved technology in

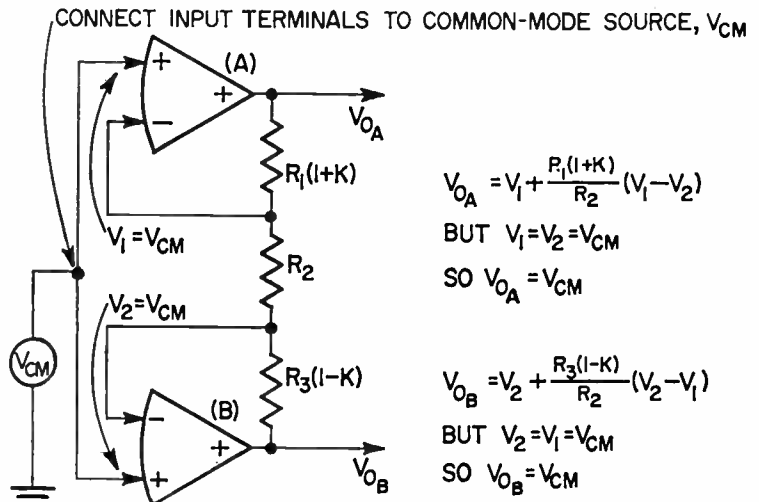
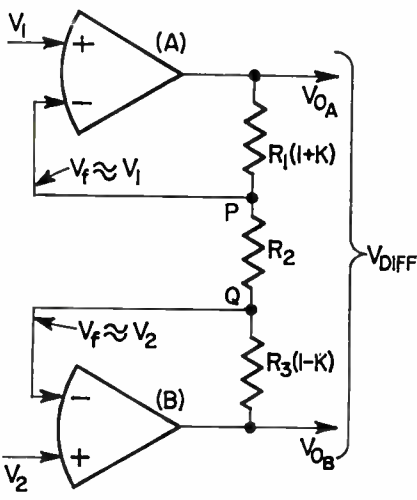

$$V_{OA} = V_1 + \frac{R_1(1+K)}{R_2}(V_1 - V_2)$$

$$\text{BUT } V_1 = V_2 = V_{CM}$$

$$\text{SO } V_{OA} = V_{CM}$$

$$V_{OB} = V_2 + \frac{R_3(1-K)}{R_2}(V_2 - V_1)$$

$$\text{BUT } V_2 = V_1 = V_{CM}$$

$$\text{SO } V_{OB} = V_{CM}$$

Differential immunity. Differential circuit is immune to common-mode errors caused by resistance deviations, but remains susceptible to the amplifier's internal common-mode errors. It can drive galvanometers, relays, magnetic coils, and other isolated loads without requiring conversion to single-ended output.

resistor and transistor manufacture, and innovation in circuit design.

In the area of thin- and thick-film resistors long-term stabilities of better than 5 ppm per year and very close ratio temperature tracking, less than 1 ppm/°C, will improve circuit CMRR.

Monolithic manufacturing techniques with both bipolar and field effect pairs should improve the voltage feedback ratio balance on bipolar transistors and result in both higher ratios of small forward trans-conductance to output conductance of an FET and closer matching with a resultant higher CMRR capability for the amplifier.

Another article in a subsequent issue will describe the problems of ground loops, and the use of operational amplifiers to solve them.

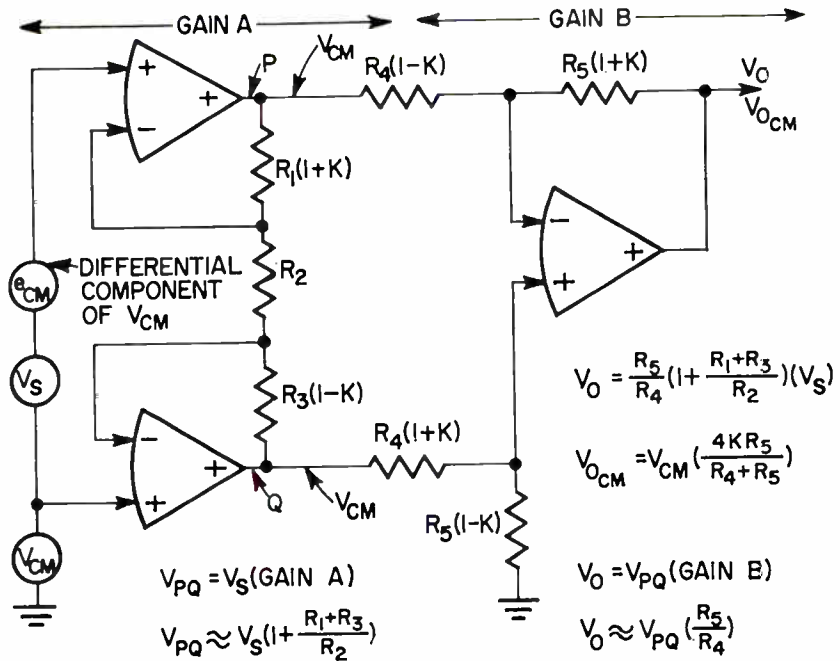

SECOND STAGE CONVERTS V_{CM} AT P AND Q INTO COMMON-MODE OUTPUT $V_{0CM} = V_{CM} \left(\frac{4KR_5}{R_4 + R_5}\right)$

DIFFERENTIAL COMPONENT OF V_{CM} AT INPUT, e_{CM} , IS C-M OUTPUT DIVIDED BY OVER-ALL DIFFERENTIAL GAIN; $e_{CM} = V_{0CM} / [(\text{GAIN A})(\text{GAIN B})]$

$$e_{CM} = V_{CM} \left(\frac{4KR_5}{R_4 + R_5}\right) / \left[\left(1 + \frac{R_1 + R_3}{R_2}\right) \left(\frac{R_5}{R_4}\right)\right] = V_{CM} \left(\frac{4KR_5}{R_4 + R_5}\right) \left(\frac{R_4}{R_5}\right) \left(\frac{1}{\text{GAIN A}}\right)$$

↓ GAIN A ↓ GAIN B

$$\text{OVER-ALL CMRR} = \frac{V_{CM}}{e_{CM}}$$

$$\text{CMRR} = V_{CM} \div \left(\frac{V_{CM} \left(\frac{4KR_5}{R_4 + R_5}\right)}{\text{GAIN A}}\right)$$

$$\text{CMRR} = \frac{\text{GAIN A}}{4K} \left(1 + \frac{R_5}{R_4}\right)$$

$$\text{CMRR} = \frac{\text{GAIN A}}{4K} (1 + \text{GAIN B})$$

(GAIN A)(GAIN B)=100		CMRR
GAIN A	GAIN B	$\frac{\text{GAIN A}}{4K} (1 + \text{GAIN B})$
0.1	1000.0	100.1/4K
1.0	100.0	101/4K
10.0	10.0	110/4K
100.0	1.0	200/4K
1000.0	0.1	1100/4K

Converting an output. Right-hand differential stage develops single-ended output from push-pull input. Arrangement provides high input impedance and permits the use of low-value, high-tolerance resistors for wide bandwidth and maximum CMRR. Chart lists advantages of having first stage contribute most of the gain. But the superimposition of output signals at P and Q onto the common-mode voltage, V_{cm} , cramps dynamic range or signal gain or both. If the common-mode voltage approaches maximum amplifier output voltage, the circuit develops only small signal excursions at P and Q; large excursions would drive the first-stage amplifiers into saturation.

The author



Robert I. Demrow, a staff engineer at Analog Devices, has the job of finding new applications for operational amplifiers, evaluating the devices' performance, and checking out problems. He received his MSEE from Northeastern University in 1958, and has worked for GE, the Foxboro Co., and Honeywell.

Bibliography

- D.B. Schneider, "Designing for Low Level Inputs," Neff Instrument Corp., Electronic Industries, January 1961.
- L.V. Mayhead, "The Measurement of Small Signals in the Presence of Common Mode Interference," Digital Measurements Ltd., Electronic Engineering, July 1962.
- A.S. Buchman, "Noise Control in Low Level Data Systems," Electromechanical Design, September 1962.
- E.L. Stewart, "Ground Loops (Electrical): The General Case and an Example," Analog Report No. 15, July 1963.
- R.B. Fradella, "Isolating the Causes of Common-Mode Noise," Electronic Design, August 1963.
- Peter Pohl, "Common-Mode Rejection," Dynamic Instrumentation, 1963.
- D.H. Sheingold, "Grounding Low-Level Instrumentation Systems—A Coherent Philosophy," Electronic Instrument Digest, January-February 1966.
- Ronald R. Jennings, "Source and Load Impedance: Effects on Closed-Loop Characteristics," U.S. Naval Avionics Facility, Electro-Technology, September 1966.
- Jim Rose, "Straight Talk About Data Amplifiers," EDN Magazine, Nov. 23, 1966.
- Ralph Morrison, "EID Surveys the Scope of Instrumentation Amplifiers," Dynamics Instrumentation Company, Electronic Instrument Digest, March 1967.
- "Instrumentation Amplifiers: A Survey," Electromechanical Design, March 1967.
- Morton H. Levin, "Advantages of Direct-Coupled Differential Data Amplifiers," Hewlett-Packard Journal, July 1967.
- Richard Y. Moss II, "Errors in Data Amplifier Systems," Hewlett-Packard Journal, July 1967.
- "Minimizing Common-Mode Noise," Control Engineering Data File 117, July 1967.
- "Application Notes for Differential DC Amplifiers," Dynamics Instrumentation Company.
- "Differential Amplification," Applications ZA-102, Zeltex, Inc.
- "Floating Power Supplies," Applications ZA-103, Zeltex, Inc.
- Ralph Morrison, "Selecting a Differential Amplifier," Dynamics Instrumentation Company.
- Ralph Morrison, "Shielding and Grounding for Instrumentation Systems," Dynamics Instrumentation Co.

Be a lighting bug collector...

Surprise your friends . . .
Impress your boss.

More important, have all the engineering scoop on miniature lamps available when you need it.

That's what our lighting bug program is all about. Getting technical data on Chicago Miniature lamps where it can assist you the most. In your files, ready to be applied on any application that comes up. We have all the species.

Miniatures, sub-miniatures, hardware lighted devices and specially engineered varieties. Aerospace, aircraft, appliance, communication, computer and business machine, control panel and switch, instrumentation, optical, marine, medical, radio, TV, telephone, transportation . . . name your application and chances are, we've got a miniature or subminiature lamp that will do the job better.

Get your personal lighting bug collection. Send for it, today.

Even if you don't have any friends.

For application assistance, contact your Chicago Miniature Sales Representative. For off-the-shelf delivery, contact your local Authorized Chicago Miniature Electronic Distributor.

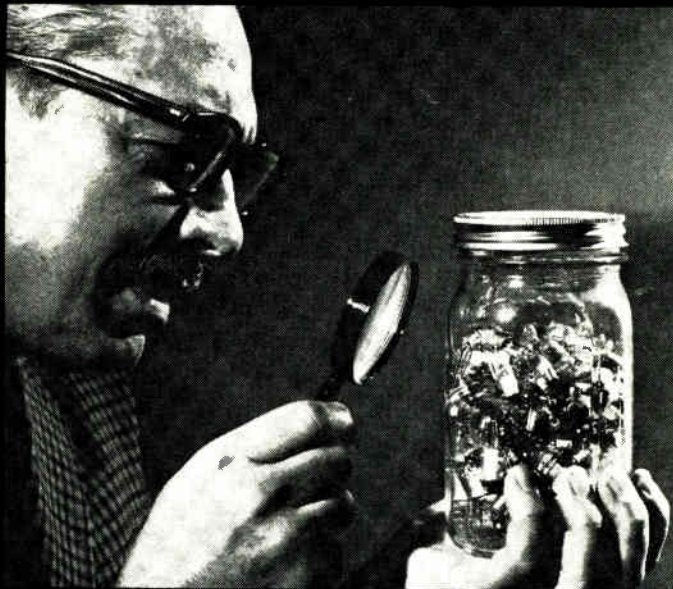

Chicago Miniature Lamp Works

4433 N. Ravenswood Ave., Chicago, Illinois 60640, (312) 784-1020



Saving money on data transmission as signals take turns on party line

Proposed system uses a single two-wire cable to connect all stations of a control or monitoring installation, and gives each transmitter and receiver its own listed number in binary code

By James W. Cofer Jr.

Georgia Institute of Technology, Atlanta

Even before the copper strike, when wire cost less, the long runs of data-transmission cabling in a control system made up a big part of the system's cost. To make matters worse, installation costs far more than the cable itself. For example, the over-all cost ranges from 50 cents to \$1.50 a running foot for three-conductor, 14-gauge, armored cable—depending on terrain and other conditions—even though the cable itself costs only about 5 cents a foot. Thus, a major goal in digital monitoring and control systems has been a simple data-transmission method that's stingy with wire.

This goal seems feasible with a new system that can be made from readily available, low-cost, digital components such as flip-flops and logic gates. The method, which looks especially good for smaller installations, does away with the need for individual lines to each station. Only one two-wire cable—one wire for data bits and the other for timing pulses—is necessary.

Called a circulating pair, the two wires (three if an earth ground isn't satisfactory) are run close to each transmitter and receiver. Short runs of other wire pairs connect these stations to the circulating pair.

The author



James W. Cofer Jr. received a bachelor's degree in electrical engineering from the Georgia Institute of Technology in 1967. He is an assistant research engineer in the electronics division of Tech's experiment station and continues his studies part-time.

Any transmitter and any receiver can be hooked to the line anywhere along its length, giving extreme flexibility for system installation. Alternatively, all transmitters may be relatively close at one end of the circulating pair and all receivers clustered at the other, or transmitters may be connected along the line and the receivers grouped at one end. Or receivers may be divided into groups, each group installed on a console for surveillance by plant operators. Each station has its own binary address and handles only those messages intended for it, no matter where it is.

Call information

The system can be used for both analog and digital transmission, but only an arrangement with all-digital inputs will be described. A key part of any configuration is the scanner that generates address codes to connect transmitters and receivers.

The address scanner clears previously sent codes from the system, addresses corresponding pairs of transmitters and receivers in sequence, then idles long enough for the messages to be sent and received. The scanner does this until all pairs have communicated, then repeats the cycle.

To clear the data line, the scanner sends a series of binary ones—1111. The address code, though, is a series of binary 1's and 0's, each series corresponding to an address built into the transmitter-receiver pairs. For a system with 15 such pairs and one clear word, the 16 code combinations can be obtained with four binary bits. That is, $2^4 = 16$. In the message itself, every fourth bit must be a 0 to prevent the appearance of the all-1's sequence that would clear the system.

The scanner produces a string of binary pulses whose length is the sum of the clear, address, and message words. The system in this example, with 15 pairs, one clear word, and a six-bit message, requires a 16-pulse sequence as represented by
 1111 AAAA XXX0 XXX0

where the 1's are the clear word, the A's the address word, which can assume all binary combinations (0000 to 1110) except 1111, and the X's the message, which can assume all binary values, with, as noted, 0's always in every fourth position.

Ringing up

The pulses come from a ring counter driven by a fixed-frequency digital clock, as shown in the schematic for the address scanner [see p. 121]. The ring counter is an eight-stage shift register whose outputs are fed back into the opposite inputs. Each stage of the shift register is a standard J-K flip-flop with capacitively coupled inputs for set and reset.

Each time a pulse from the digital clock enters the ring counter, one of the eight flip-flops changes to its other state, emitting a pulse and thereby advancing the ring counter. Thus, the ring counter has 16 states, and for every pulse from the digital clock, a different one of the ring counter's 16 outputs will emit a pulse in the time sequence 1,2,3,4 . . . 15,16,1,2 . . . These pulses drive not only the next ring-counter stage but also other electronics in the system.

Pulse-positions 1 through 8 place the clear word and the address code—that is, 1111AAAA—on the data line. A single flip-flop clear-word generator, connected through an or gate to the data line, is cut on by pulse 1 from the ring counter and shut off by pulse 5. It allows four 1's to be produced in all transmitters and receivers to clear out previous address codes.

The address generator—a four-bit counter—advances one bit every time it receives an input pulse from one output of the ring counter. (The selection of output 3 to do this is arbitrary.) With this input

the address generator develops a unique code combination for each successive group of 16 pulses from the digital clock. Thus, in sequence, it develops 15 unique codes—0000 to 1110. The 1111 combination—clear-word code—is kept from developing by a d-c signal that resets the counter to 0000. When the four 1's are present they instantly operate through the AND gate to provide the reset signal.

Ring-counter output 5, the one that has shut off the clear-word generator, causes the code stored in the address generator to be read out in parallel into the shift register. Pulse 5 also moves one of the bits just entered in the shift register onto the data line, and pulses 6, 7, and 8—via a three-input monostable multivibrator—send the other three address code bits onto the line in sequence. Finally, pulse 9 removes any binary-1 voltage placed on the data line by the scanner. Having addressed a transmitter-receiver pair, the scanner now remains off the line for the next eight pulses, which are the message.

Getting ready

The transmitter for handling a six-bit message word is also made of flip-flops, capacitively coupled inputs for set and reset, and logic gates [see p. 122]. The address detector—four flip-flops—on the transmitter senses the clear word and then the address code.

The address for the transmitter is coded by the way the four dashed-line inputs of the lower AND gate are connected to the four flip-flops. For example, to build in an address of 1100, the two inputs of the AND gate are connected to the true (binary 1) outputs of the first two flip-flops, and the other two inputs of the gate are wired to the complementary (binary 0) outputs of the third and fourth flip-flops. This code is built in when the transmitter is wired, and can be changed only by rearranging the connections.

The transmitter must first clear its address detector of previous codes so it can receive its own

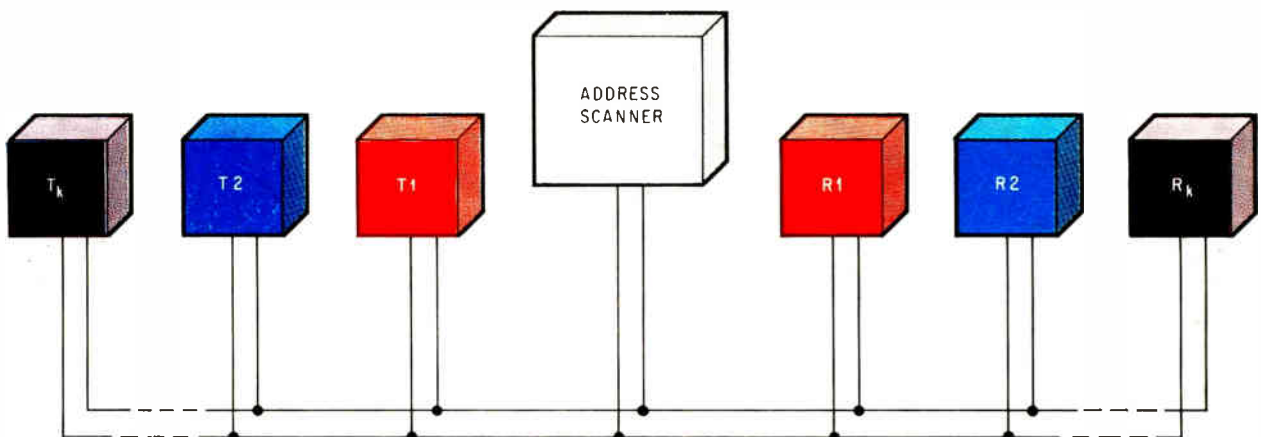

Circulating pair. Two wires connect all transmitters and receivers but only one transmitter and receiver talk at a time.

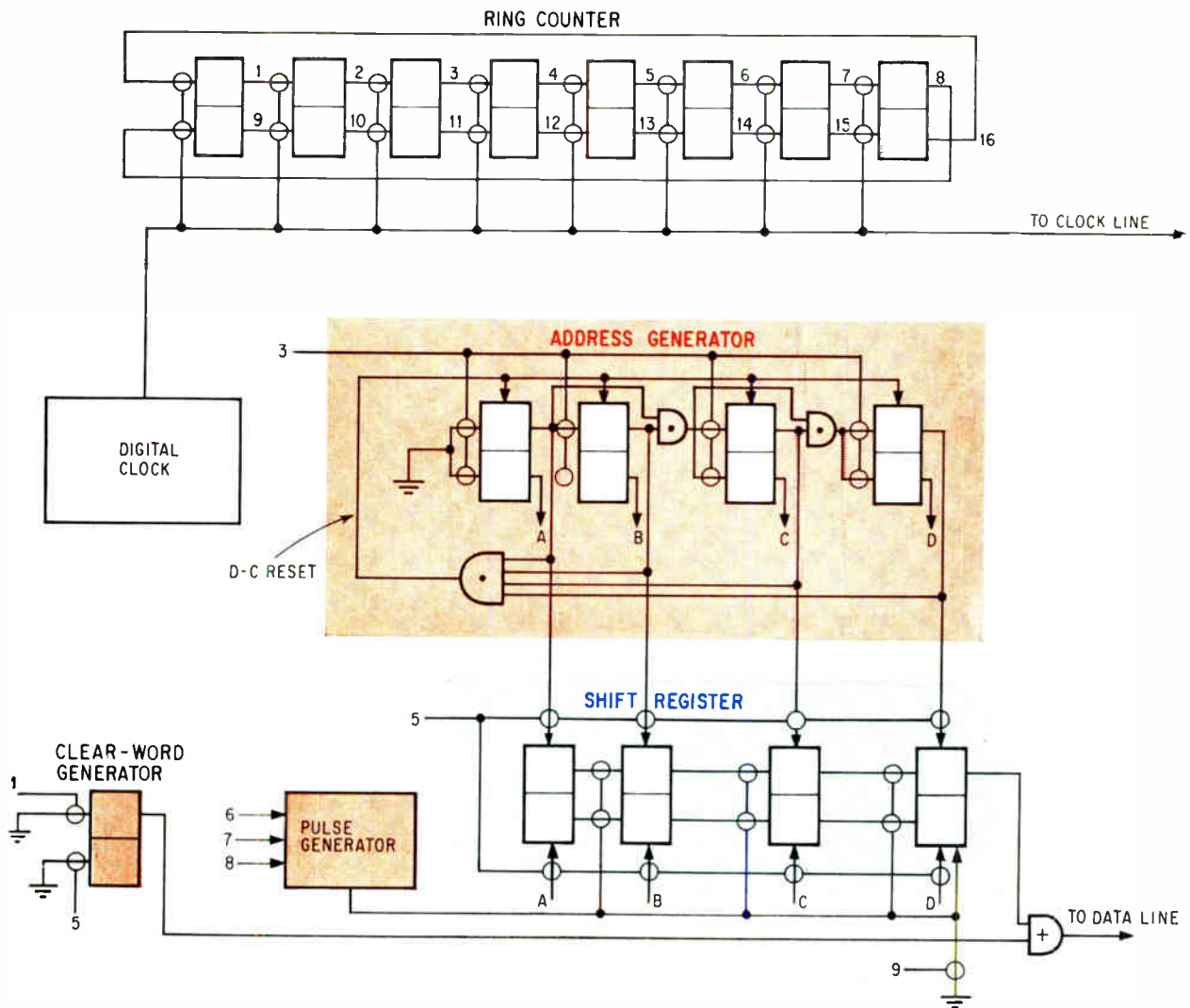

Address scanner. The scanner generates a clear-word code, then an address code to connect corresponding pairs of transmitters and receivers.

code. This is done by the address detector and the upper AND gate to the left of the detector. This AND gate is permanently connected to the four true outputs of the flip-flops. When the first bit of the clear word arrives at the address detector, it sets the flip-flop on the far right to 1. This 1 shifts left and sets the adjacent flip-flop to 1 when the next 1 in the clear word arrives at the right flip-flop. The sequence continues until all four flip-flops contain a 1. That is, the address register has now sensed the arrival of the clear word. The AND gate then emits a d-c signal to reset the address detector.

Moving the bits

The detector is now ready for its second job—responding to its address. If the code sent down the data line is 1100, then, in this example, the lower AND gate produces a pulse that loads eight bits—the six of the message and the two extra 0's—into the lower shift register.

The next eight clock pulses move these eight bits onto the data line to be detected by the cor-

respondingly addressed receiver. The last 0 is transmitted to ensure that the shift register flip-flops respond properly.

To prevent the transmitter's address detector from answering a binary sequence in the message word that could be the same as the address code, the detector must be shut off after it receives its four-bit address. This is done by a "4" counter,

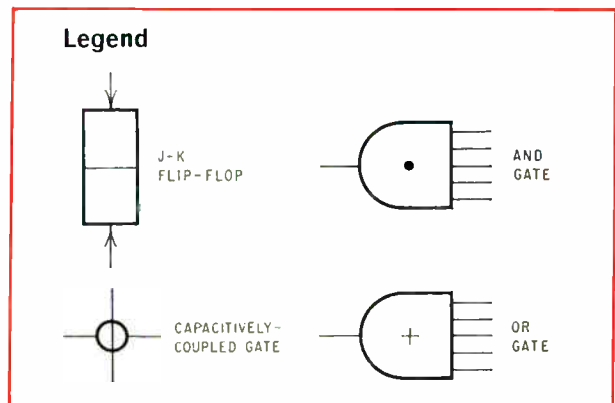

Talking in turn

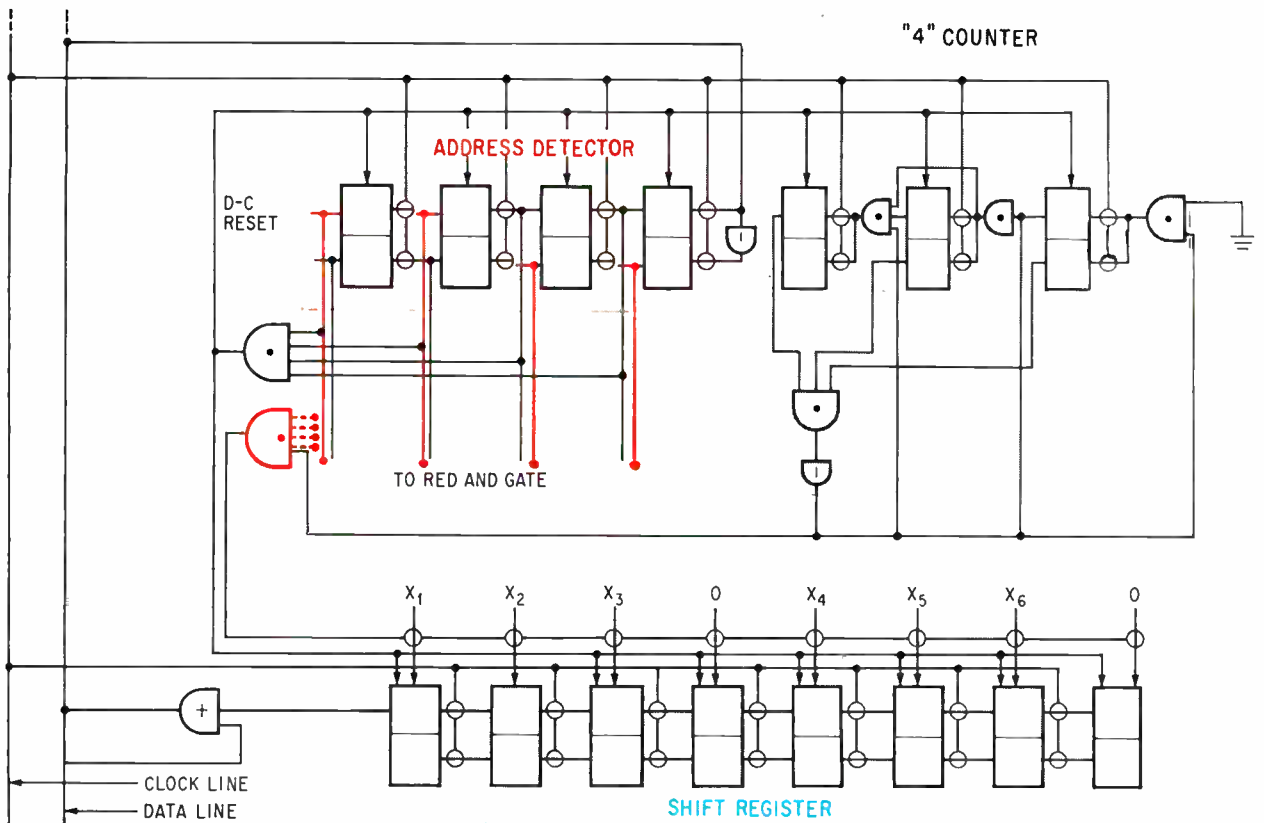

Digital transmitter. Turned on when it senses its unique address code, the transmitter then puts the binary message on the data line.

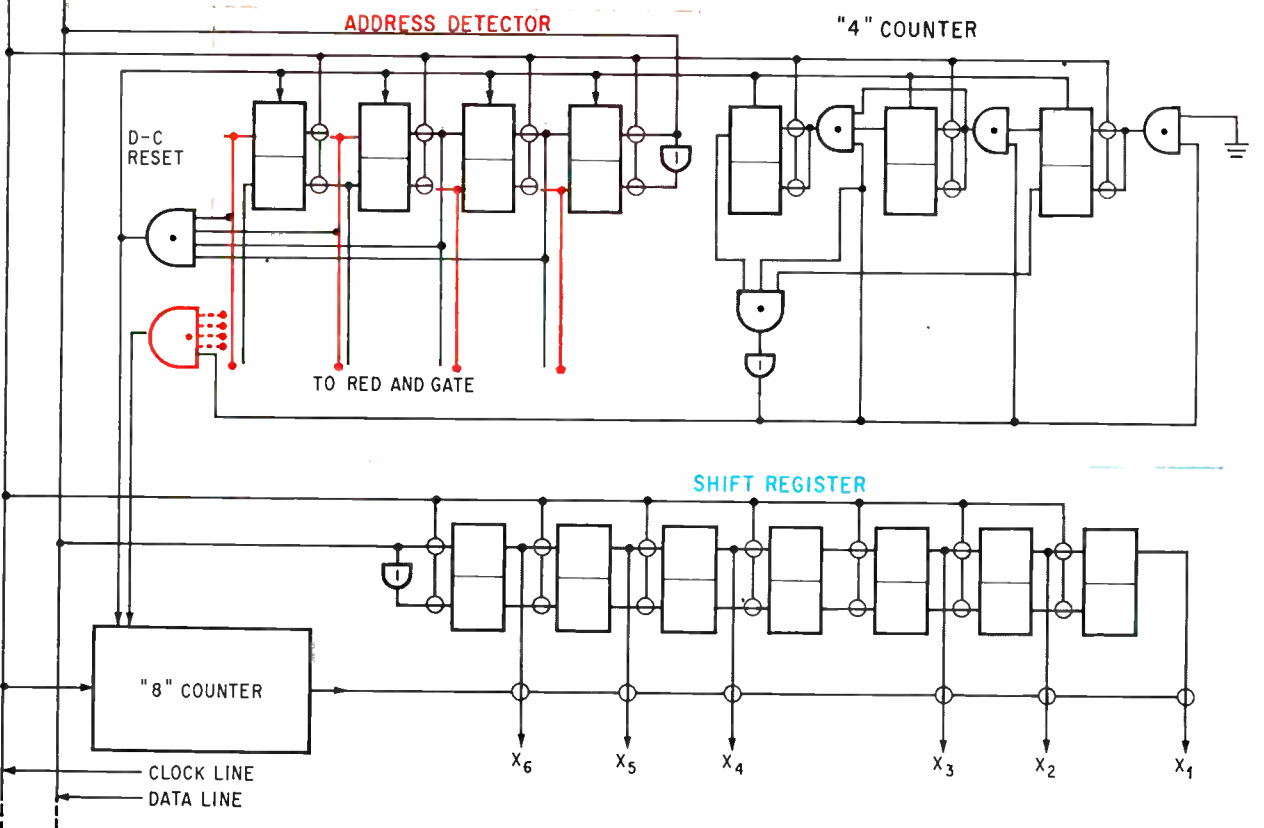

Digital receiver. Storing the message serially, the receiver's shift register reads out in parallel when it senses the last pulse.

the three-flip-flop counter at the upper right. When the "4" counter contains the code 100, the binary equivalent of 4, it places a 0 on one input of the lower AND gate and cuts off the address detector. Simultaneously, this 0 is fed back to the AND gates associated with each stage of the "4" counter. The counter then shuts off, and can be restored to 000 only by the same d-c reset signal that detects the presence of the 1111 sequence, or clear word.

Sensing the message

The receiver, opposite page, is similar to the transmitter. In fact, the two circuits' clear-word and address detectors and three-bit "4" counters are identical.

The receiver senses and stores the message-word pulses from the data line. The eight-bit message sequence is detected serially by the seven-stage shift register, the first pulse coming in at the left and shifting to the right with each succeeding pulse. Only seven of the eight transmitted bits have to be stored in the receiver because, as noted, the last 0 in the sequence isn't part of the message.

After the seven-bit message has been sensed by the register, the "8" counter, at the lower left, emits a pulse that causes all stored bits to be read out in parallel. The "8" counter operates like the "4" counter, except that it has four flip-flops so it can produce the output pulse when the counter contains 1000, the binary equivalent of eight. All bits on the line pass through the receiver register, but parallel readout takes place only when the proper address is present.

Finding sequence length

The number of pulse positions, p , required for one sequence can be found from the formula

$$p = 2n + \left(\frac{nm}{n-1} \right)$$

where n —the length of the clear or address codes—is the number of binary bits needed to distinguish the number of circuits, k , as determined from $2^n = k + 1$, and m is the message word length before the extra 0's are inserted to prevent the appearance of the clear-word code. The factor $(n - 1)$ tells how many bits in m can be used in sequence before a 0 is inserted.

If the parenthetical expression in the formula doesn't result in an integer, then m is extended with enough 0's to make the term equal the next highest integer divisible by n . The number of flip-flops in the ring counter is half the number of pulse positions in the total sequence.

For the arrangement described previously, the number of pulse positions is

$$2 \times 4 + \left(\frac{4 \times 6}{4-1} \right) = 8 + \left(\frac{24}{3} \right) = 8 + 8 = 16$$

and the ring counter thus has eight flip-flops.

For a system that also has 15 circuits ($n = 4$), but uses a message length, m , of eight bits, then

$$\left(\frac{nm}{n-1} \right) = \frac{4 \times 8}{3} = \frac{32}{3} = 10 \frac{2}{3}$$

This won't work. The next highest integer divisible by 4, of course, is 12. Thus the sequence requires $8 + 12 = 20$ pulse positions and looks like

1111AAAAXXX0XXX0XX00

The next-to-last 0 has been added to fill out the message word. For this system, the ring counter needs $20/2 = 10$ flip-flops.

To complete a cycle of sending a message to all stations requires pk pulses, where p is determined as above and k is the number of transmitter-receiver pairs. For the arrangement in the main example, $pk = 15 \times 16 = 240$ pulses. The value pk helps establish the pulse frequency of the digital clock. If, for example, the installation requires that any change in any input appear at its corresponding receiver within five seconds, then the clock rate is

$$CR = pk/T = 240/5 = 48 \text{ pulses per second.}$$

For such a system, a 60 pps clock rate would probably be used because it is easily synchronized with power-line frequency.

A choice idea

This idea for multiplexing data from many input stations over a single two-wire line (and a ground) can be used in many ways. The binary message word needn't be for a numerical value; it could represent the states (on-off) of a group of switches that indicates the operational status of a piece of equipment. The station pairs, instead of being interrogated continuously, could get a burst of pulses only once every few minutes.

Used with a larger digital data acquisition system or with a computer control installation, the data link's receiver-readout register could be part of the computer or connected to it. These receivers would store inputs at their own rate, and the computer could interrogate them at a different rate, depending on its own needs and priorities. For example, the computer wouldn't have to wait while pulses are accumulated from a turbine flow meter.

However, the system won't be feasible for encoded digital transmission from the measurement site of such analog-process variables as temperature, pressure, and level until someone develops an analog-to-digital converter and storage register small and cheap enough to be installed at each transmitter. Several makers of controls are investigating this area, and are looking to large-scale integrated circuits as an answer. How soon these devices appear on the market depends on the economics of LSI on the one hand and user demand for digital sensors on the other.

FFT—shortcut to Fourier analysis

Mathematics, not electronics, enables engineers to develop faster ways of extracting information from complex waveforms

By Richard Klahn and Richard R. Shively

Bell Telephone Laboratories, Whippany, N.J.

Major advances made by engineers in producing faster data-processing systems usually stem from the development of electronic devices. But this is not the case with signal- and data-analysis applications involving Fourier transformation techniques. Here, the advances have been triggered not by electronics, but by mathematics.

Fourier transformation is a useful tool in extracting the information contained in many kinds of waveforms—such as seismic waves, electro-encephalograms, and data signals telemetered from deep space. Many approaches have been taken to find the energy content of these frequencies. One familiar and inexpensive method calls for a bank of filters. But this is an analog approach, which is inherently limited in resolution and flexibility. Although digital techniques are better, they are difficult to apply. The straightforward digital form of the Fourier transform, for example, has proved costly in computer time. However, this has changed.

Cooley, Tukey and the FFT

About three years ago, the International Business Machines Corp.'s James W. Cooley and Bell Telephone Laboratories' John W. Tukey developed a technique for rapidly computing the spectral components of a waveform containing many frequencies. Their mathematical innovation, which has come to be known as the fast Fourier transform (FFT) reduced the computational effort required to obtain discrete Fourier transform coefficients of digital data, and made practical the use of digital-computing systems in a number of design problems, data analysis applications, and signal processing functions. To the engineer concerned with the filtering of data, or determining the spectral distribution of power in an electrical signal, the Cooley-Tukey technique is as important as any piece of hardware.

This led to the development of FFT programs for general-purpose computer systems as more and more engineers wanted to use the Fourier transforms. But even with FFT, general-purpose computers are impractical for some applications that involve large amounts of data and require results in a reasonable amount time. For example, real-time signal processing of information demands a very fast execution rate. And this holds true for simulation studies involving random data and requiring thousands of transformations. For such applications, special-purpose processors organized to execute the algorithm would be far better than general-purpose computers running FFT programs.

From a computer designer's standpoint, FFT permits some interesting specialized designs in processors that, as a result, have much shorter execution times than are obtainable on general-purpose computers built with the same kind of components. For example, because the computation involves an arithmetic sequence that is always the same, an arithmetic section's speed can be closely matched to that of a memory, allowing an overlap of arithmetic operations and memory transfers. Moreover, both units could handle the real and imaginary portions of complex values in parallel, thereby saving processing and transfer time.

Factor of hundreds

Without the FFT algorithm, the number of arithmetic operations required to compute the discrete Fourier transform from N samples is proportional to N^2 . With the FFT algorithm, however, the number of operations becomes proportional to $N \log_2 N$. Therefore the factor of improvement is

$$N^2 / (N \log_2 N) = N / \log_2 N,$$

which is approximately 100 for $N = 1,024$ and more than 600 for $N = 8,192$ —the capacity of the processor's memory.

The algorithm attains its speed because it shares

intermediate results to the greatest possible extent. Without the FFT, each Fourier coefficient is computed itself, using all the input samples.

The Fourier series can be expressed in both continuous and discrete form. In continuous form, the Fourier series can be written as an infinite series of either real or complex terms. The sum of the infinite series is exactly equal to the original function; a finite sum is an approximation. In real form, the Fourier series is expressed as a summation of an infinite series from zero to plus infinity. A periodic waveform is described in terms of a fundamental frequency and various harmonics, or multiples of the fundamental, and can include a d-c term. Phase differences between the harmonics are accounted for by the presence of both sine and cosine terms in the series. The period of the fundamental equals the period of the waveform.

A complex form is obtained from the real form by expressing the sine and cosine terms as the sum and difference of complex exponentials:

$$\sin kx = \frac{1}{2j} [\exp(jkx) - \exp(-jkx)]$$

$$\cos kx = \frac{1}{2} [\exp(jkx) + \exp(-jkx)]$$

After substituting the exponentials, algebraic manipulations result in a doubly infinite summation—from minus infinity to plus infinity. Each term in

the summation is the product of two numbers—an amplitude derived from the coefficients, and an exponential that expresses the phase.

Sampled signal

The digital or discrete form of the Fourier series is analogous to the complex continuous form, except that it deals with uniformly spaced samples extending over a specified interval of the waveform. The closer together the samples are taken, the more accurately the resulting series represents the original waveform. Because the method is digital, it cannot operate directly on the continuous waveform. Moreover, practical equipment precludes the extension of this method to positive or negative infinity. The sum of the finite series, considered as coefficients of successive harmonic frequencies, is an approximation to the original waveform:

$$f(t) \approx \sum_{n=0}^N \Lambda(n) \exp(j\omega_n t)$$

The n th Fourier coefficient, $D(n)$, with a set of N samples taken at uniform intervals throughout a segment of a waveform, is obtained by multiplying each sample by a number $\exp(-j2\pi ns)/N$, adding the products, and dividing the sum by N . The number s is the index of a particular sample during the computation of one summation for a particular co-

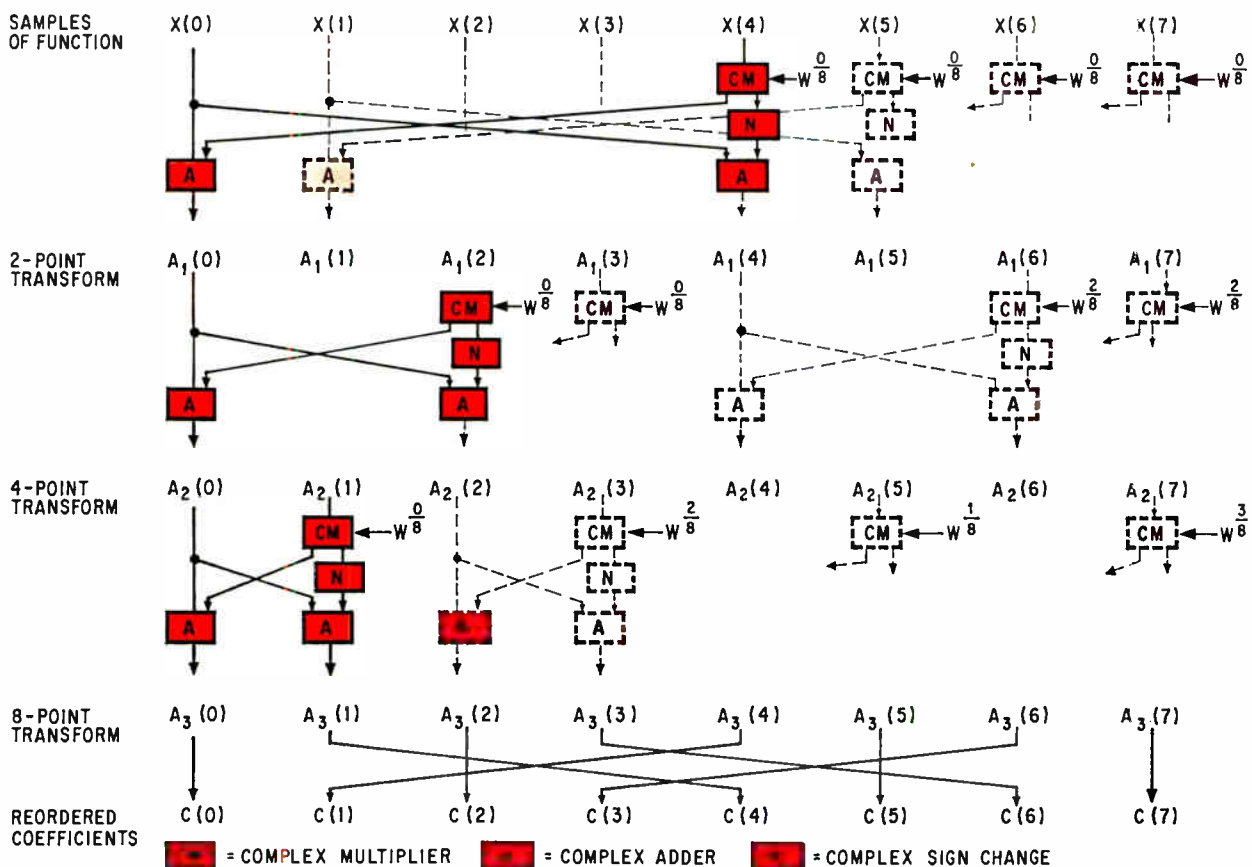

Transform procedure. The fast Fourier transform first combines pairs of samples into two-point transforms, then turns these into four-point transforms, and so on, until a single transform is obtained based on all the original samples.

Digging out buried signals

A small, two-year-old company in Palo Alto, Calif.—Time/Data Corp.—was the first to market a special-purpose computer designed specifically for Fourier analyses. Just a few short months ago, Time/Data delivered its first three machines to the Environmental Sciences Service Administration, the Air Force, and the University of California's Brain Research Institute.

Called the Time/Data 100, the computer's job is to find biochemical, radar, sonar, seismic, or other signals that are buried in noise—and to find them in real time. The computer does this by calculating the Fourier coefficients of the complex waveform in which the signals are buried. Other jobs the machine can perform are auto- and cross-correlation, auto- and cross-spectrum analysis convolution, and averaging functions.

Lost and found. In 1942, mathematicians G.C. Danielson and Cornelius Lanczos published an algorithm—a method of calculation—for a rapid Fourier transform. But for some unknown reason the process was somehow “lost.” Only when Cooley and Tukey revealed their own fast Fourier transform in 1965 was the older algorithm rediscovered.

The Cooley-Tukey algorithm set off a flurry of renewed interest in computer-assisted Fourier analysis. The Bell Telephone Laboratories' signal processor, designed by authors Klahn and Shively, also incorporates the algorithm [Electronics, Sept. 4,

1967, p. 40], and is being used for research. Bell Labs doesn't intend to market the machine.

Sylvania Electric Products Inc., developed a similar machine for digitizing speech signals, and the International Business Machines Corp. is also working on one [Electronics, Oct. 30, 1967, p. 26].

Ten-year project. Time/Data's machine is the brainchild of mathematician Edwin Sloane, who got the idea while working on the distant-early-warning-line (Dewline) project at the Massachusetts Institute of Technology's Lincoln Laboratory. Sloane spent 10 years developing the algorithm, which he calls the rapid Fourier transform—so-called to distinguish it from Cooley's and Tukey's fast Fourier transform. Sloane's algorithm is based on the Danielson-Lanczos method. The rapid Fourier transform compares the input waveform with a series of sinusoidal “templates” of various frequencies previously wired into the machine.

Says Sloane: “The integral of the product of two sine waves in phase is larger than any other integral involving sine waves out of phase or of different frequencies.”

The transform takes advantage of redundancies in the sine and cosine functions. Sloane and Martin Fletcher, Time/Data's vice president in charge of engineering, chose to take advantage of these redundancies to gain speed, by “pipeline” processing. This arithmetic technique uses several small fast



Excavator. Time/Data Corp.'s special-purpose Fourier analyzer extracts signals buried in noise.

adders or multipliers in series, each one working on the result of the preceding unit. Thus, as the last unit in the string starts work on its part of a problem, the first unit is several steps ahead of it.

Time/Data claims its method is simpler than the Cooley-Tukey approach, which is based on a set of nested multiplications.

Data by the block. The Time/Data machine can accept analog data at frequencies up to 20 kilohertz, which it promptly converts to eight-bit digital words, or it can accept direct digital input at up to 200,000 words per second. The data is stored in a core memory containing 4,096 18-bit words.

Time/Data's machine accepts data for one second, provided neither channel takes in more than 1,000 samples. When data comes in faster than that, only the first 1,000 samples are accepted before the input is shut off; at the 200,000 bit/sec rate, for example, the input is active for only 5 milliseconds and idle for 995 msec. But, in general, during any one-second interval, the machine accepts one block of data, processes the previous block, and clears the block before that, in analog or digital form. The Bell Labs' machine, on the other hand, can accept up to 8,192 samples in as short an interval as 8.2 msec; it could easily process 1,000 samples in 30 msec. There is a drawback, however: the shorter the sampling interval, the poorer the resolution of the output.

Sloane emphasizes that speed is not the only important consideration. The Bell Labs' machine must be used in conjunction with a computer that actually collects the samples, perhaps multiplexed from several sources. The computer requires a program to collect the data and transfer it to the processor, to fetch the Fourier coefficients after they have been computed, and to transfer them to the outside world. The Time/Data machine is a total system that needs no computer, although it can be linked to one if desired.

"We have a powerful analysis tool for signal processing," says Sloane, "which can be used directly for a wide variety of applications—biomedical instrumentation, for example, or structural analysis, antisubmarine warfare, acoustics, radio physics, meteorology, and even astronomy."

A few extras. Outlook for the IBM development is that it will follow the general approach of the Bell Labs design, with perhaps a few added features for speed. For example, the Bell Labs multiplier design, with a substantial addition of hardware, could multiply two complex numbers almost instantaneously. IBM's Federal Systems division is working on a design in connection with a military application; a commercial version may come later.

Sylvania's machine, like Bell Labs, is for research, but the company may decide to market it later. It was originally designed as a simulator to study radar signal processing and communication problems, and is now being used to simulate modems (modulators-demodulators) in military systems. In some respects it resembles the Bell Labs machine, in the techniques it used to achieve high speed. But like Time/Data's new computer, Sylvania's machine can stand alone.

—Wallace B. Riley
Computers Editor

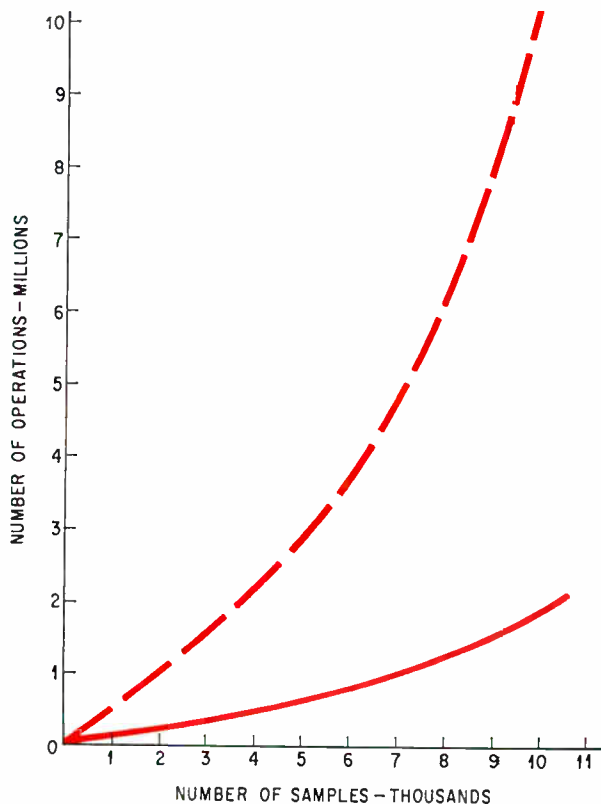

Starting improvement. Solid line shows number of operations required when computing with FFT, as compared with conventional form (dashed line).

efficient; s therefore takes on all values in the range 0 to $N - 1$ for each value of n , which also eventually covers the same range.

The coefficient of the first term is simply the average value of all the samples—their sum divided by N . Rather than omit the exponential multiplier, it is set to $+1$ by making $n = 0$. This is why n and s range from 0 to $N - 1$ instead of from 1 to N . Equally important, this setting simplifies hardware implementation.

The process can be described as:

$$A(n) = \frac{1}{N} \sum_{s=0}^{N-1} f(s) \exp(-j2\pi ns)/N$$

Considering the workload

The computational effort depends on both the number of samples of the original function and the frequency spectrum that must be represented. Without the fast Fourier transform, these Fourier coefficients would have to be calculated for each frequency separately. Each coefficient would require the summation of N real and N imaginary quantities, each of which is the product of a sample value and a trigonometric weight. In the case of a real function, only $N/2$ coefficients have to be calculated—those more than half the sampling frequency are complex conjugates of those below. Thus, a total of $2N \cdot N/2 = N^2$ products would be required to compute the coefficients.

If a fine spectral resolution is required over a

large bandwidth, the number of computations could become very large. This is because the sampling frequency must be at least twice the highest frequency present in the signal, and the number of samples is proportional to the reciprocal of the frequency resolution. Unless the sampling frequency restriction is adhered to, a spurious Fourier transform will be derived from the samples, possibly leading to negative frequencies. This is illustrated by stagecoach wheels in motion pictures which appear to move backward because the frame rate of the film—the sampling frequency—is less than twice the frequency with which the wheel spokes pass a given reference position. Their reverse motion corresponds to a negative “spoke frequency.”

Thus, to determine the power spectrum of a signal having a bandwidth of 1,000 hertz with a frequency resolution of 2 hz, an analysis must have a sampling rate of at least 2,000 hz and a record length of 1/2 second, so that $N = 1,000$. For this case, the Fourier transformation requires the formation and summation of a million terms.

Halving and doubling

Basically, the FFT algorithm calls for combining the Fourier coefficients for two interleaved sets of samples to yield the coefficients for the composite set. Thus, the coefficients for the even-numbered samples and those for the odd-numbered samples can produce a single set of coefficients for all the samples.

In the same way, coefficients derived from samples 0, 4, 8, 12, . . . can be combined with coefficients from samples 2, 6, 10, 14 . . . to produce the

even-numbered coefficients. Odd-numbered coefficients result from combining the coefficients of samples 1, 5, 9, 13, . . . and 3, 7, 11, 15, . . .

Thus, each set of coefficients is the equivalent of two subsets—derived from half the number of samples. The ultimate subdivision of a single set of coefficients is N subsets, each containing only one coefficient that describes the waveform, but very poorly. These coefficients are none other than the original samples.

Reversing this process, then, the samples can be combined into pairs, then quadruples, then octets, and so on, until a single set of coefficients based on the entire set of samples is obtained. The procedure is iterative. The FFT's speed comes from executing fewer operations, using this iterative procedure, on the same data that the conventional Fourier transform uses.

The process used to compute the n th Fourier coefficient for a set of N samples is thus applied twice to alternate samples—once each to the odd-numbered and the even-numbered samples. But this time the multiplication is by $\exp(-j4\pi ns)/N$, instead of $\exp(-j2\pi ns)/N$, and the result for each half-set of samples is doubled. Then, multiplying the half-result for the odd-numbered samples by $\exp(-j2\pi n)/N$, adding the even-numbered half-result, and dividing by 2 gives the same result as was originally obtained for the full set of samples, for half the final set of Fourier coefficients. The other half of the final set is obtained by subtracting the odd half-result from the even half-result after the multiplication.

These half-result operations are equivalent to a

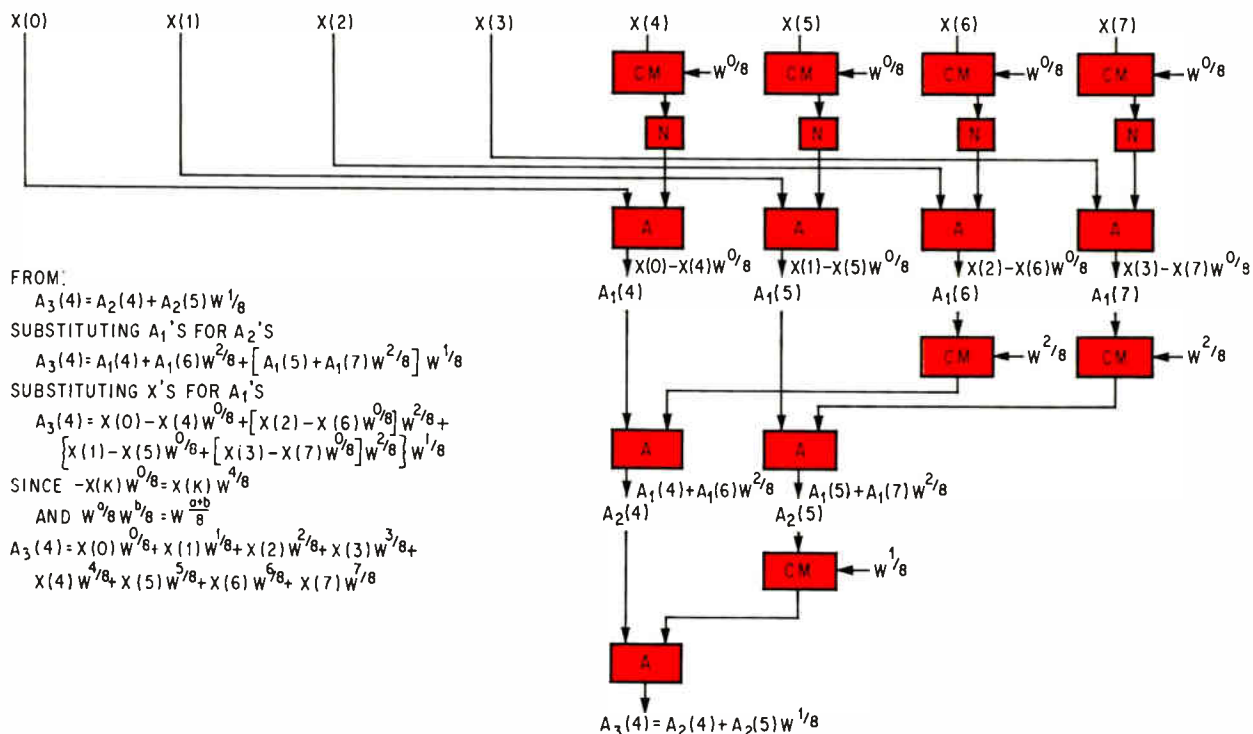

Working backward. Every sample is involved in the computation of any given output, yet without extensively duplicating the work. Equations at left outline the procedure and the substitutions that take place.

single interleaved set, and can be expressed by

$$\text{even: } A_0(n) = \frac{2}{N} \sum_{s=0}^{N/2-1} f(2s)W^{2ns/N}$$

$$\text{odd: } A_1(n) = \frac{2}{N} \sum_{s=0}^{N/2-1} f(2s+1)W^{2ns/N}$$

These are for a fixed value of n ; the sample number s varies from 0 to $N-1$, and W stands for $\exp(-j2\pi)$. The magnitude of this expression is always equal to $+1$, but W is always raised to a fractional power, so that the multiplier is a complex root of $+1$.

The two groups of Fourier coefficients are

$$A(n) = \frac{1}{2}[A_0(n) + A_1(n)W^{n/N}]$$

$$A\left(n + \frac{N}{2}\right) = \frac{1}{2}[A_0(n) - A_1(n)W^{n/N}]$$

where n varies from 0 to $(N/2) - 1$. This process is repeated over and over for finer and finer interleaved sets until two sets are finally interleaved into a single series.

This procedure is also applied to the half-sets of samples, by computing quarter-results on alternating quarter-sets. If N is a power of 2, this dissection process should occur $\log_2 N$ times, which would bring it down to the point where coefficients can be computed from individual samples of the original record.

Therefore, starting with N samples, each of which is a "series" with only one term, the equations are applied over and over again. Each iteration halves the number of series and doubles the number of terms. This form of the algorithm is sometimes called decimation-in-time form. Other forms have been proposed—for example, one called decimation-in-frequency.

An important consequence of this approach is that the results of each iteration can be stored in the same memory space from which the input to the iteration was taken—destroying the previous results. Another consequence: the final Fourier coefficients are not in consecutive order. The rearrangement of the coefficients, which follows a simple pattern, is nevertheless extremely difficult to program on a general-purpose computer. Indeed, half the execution time in a typical FFT program is spent on rearranging the final results, which involves much manipulation and testing of index values.

Computing with FFT

A rather short record of only eight samples illustrates the principles of FFT. Because W represents the complex exponential, it is found that $W^{0/8} = +1$ and $W^{4/8} = -1$, and that $W^{(8M+n)/8} = W^{n/8}$ for any integer value of M .

The FFT computational procedure, one form of which is diagramed on page 125, first uses pairs of the original samples to obtain simple two-point transforms based on two of the original samples.

For example, samples $X(0)$ and $X(4)$ are combined to get $A_1(0)$ and $A_1(4)$:

$$A_1(0) = X(0) + X(4)W^{0/8} = X(0) + X(4)$$

$$A_1(4) = X(0) - X(4)W^{0/8} = X(0) - X(4)$$

The quantities $A_1(0)$ and $A_1(4)$ represent estimates of the d-c term and first harmonic. The same mathematical procedure makes other estimates of the d-c and first harmonic from each pair of original samples, obtaining the four two-point transforms $A_1(0)$ through $A_1(7)$.

Pairs of two-point transforms are then combined to obtain four-point transforms $A_2(0)$ through $A_2(7)$. Again, the arithmetic operations are similar, except that the spacing between pairs is halved, and different powers of W are used in the complex multiplications. The final step for an eight-point record determines the A_3 terms that are the desired complex Fourier coefficients within a scale factor of $1/8$.

Although the diagram shows only the real component computations, the imaginary components are computed concurrently with the same procedure.

All of the eight-point Fourier coefficients may be obtained from this rather simple process, and the components can be verified by working back through the process, as shown in the diagram on the opposite page. This computational procedure can be extended to transform data records of any length, provided the number of samples is a power of 2. For all cases, the calculations require $\log_2 N$ iterations. The first iteration uses W raised to the zero power, or simply $+1$, and later iterations use fractional powers of the coefficient. Each basic operation of the computation involves one complex multiplication, one sign change, and two complex additions. In general, for a record length of N samples, each iteration requires $N/2$ basic operations. Thus, the entire process requires a total of $N/2 \log_2 N$ basic operations, compared with N^2 real multiplications when FFT isn't used. The graph on page 127 illustrates the dramatic effect FFT has on computational efficiency when N is large.

The authors



Richard Klahn, a member of the technical staff at Bell Labs, has worked primarily on computer organization and on antenna steering projects.



Richard R. Shively, also on the technical staff, has been working on radar-signal processing and the Nike X computer since 1963. He has a doctorate from the University of Illinois, and was at IBM before joining Bell Laboratories.

Making it in pictures

Electric field intensity can be mapped on presensitized Polaroid film; method is quicker, simpler, and more accurate than mechanical scanning

By Keigo Iizuka

Harvard University, Cambridge, Mass.

The only way at present for engineers to map an electric field is to mechanically scan it, point by point, with a small probe. The technique has its drawbacks. It's time-consuming, recording isn't continuous, and the original field can be disturbed by the probe's lead wires and supports. Microwave holography would be a solution, but there's no convenient microwave analog to the photographic plate.

However, standard Polaroid film can do the job. This method, based on the temperature dependence of the developing process in uniformly exposed film, has proved to be inexpensive, accurate, and remarkably uncomplicated. A field's intensity can be mapped simply by holding the film in the field for less than a minute.

The Polaroid film is first presensitized by a brief exposure to uniform light. The developing process is started, and the film, still in its packet and shielded from light, is then placed in the microwave field.

The Polacolor Type 58 film employed here is normally used for taking 4-by-5-inch color pictures and consists of negative and positive layers and a developing reagent. The negative, the positive, and a pod of developer are pulled through the rollers of a Model 500 Polaroid 4x5 Land film holder. This breaks the pod and releases the viscous processing reagent in a thin layer between the negative and positive.

The film starts to develop as soon as it comes into contact with the reagent. Immediately after the

reagent is spread, the film is placed in the microwave field, where an image is formed on it.

The electric-field component in the plane of the film produces a heating effect in the exposed silver-halide grains by inducing a current in them. The temperature rises by an amount proportional to the square of the field intensity, and because of this, the thermal field produced in the film exactly represents the intensity distribution of the electromagnetic field. The localized heating in the grains leads to localized increases in the rate of diffusion of the developing reagent to the grain sites, thus speeding the chemical development in the heated portions of the film.

The developer is removed from the film before the normal developing time has elapsed. The film at that point holds a visible pattern corresponding to the field's intensity distribution.

The film's sensitivity to microwaves can be controlled in three ways. In the first, the pre-exposure temperature is brought down to a level ensuring the maximum deposition of the silver-halide grains. Experimental results put this optimum temperature in the vicinity of 25° to 35°F.

To achieve this level, it's best to chill the film to the temperature of dry ice before inserting it into the microwave field, since the film is warmed by the ambient temperature during the exposure process. Care should be taken not to cool the reagent pod, however, because it solidifies at around 32°F.

Second, the color of the light to which the film is pre-exposed influences its sensitivity to microwaves. The film's emulsion-coated negative contains dyes of different colors in nine separate layers. The time required for the developer of one of these dyes to reach the surface of the negative depends on the distance between the dye and the surface.

If the negative is pre-exposed to light of a wavelength that allows only that dye lying closest to the surface to emerge, development time will be relatively short; light of a different wavelength, of

The author

Keigo Iizuka, now a research fellow and lecturer at Harvard's Gordon McKay Laboratory, holds an MSEE from Kyoto University. He also received a master's degree in applied physics from Harvard in 1958, and a Ph.D. from the same institution in 1961.

course, will cause a longer development time.

Thus pre-exposure of the color film to cyan (blue) light results in a longer development time than does pre-exposure through a yellow filter. In effect, the thickness of the diffusion layer can be controlled this way.

In practice, pre-exposure to yellow light would be used for stronger microwave fields, cyan-colored light for weaker.

A simple box camera can be used to pre-expose the film. The camera is aimed at a sheet of white paper illuminated at 45° by two carbon arc lights ($5,600^\circ$ K); the incident illumination is measured by Kodak Neutral Test Card. The intensity of light reflected from the card is about 50 foot-candles. To obtain the cyan color, the film is first exposed through a blue filter (47) for $1/10$ second with a lens opening of F/9.5, and then through a green filter (61) for $1/5$ second with the same lens opening as for the first step.

The third method of enhancing film sensitivity

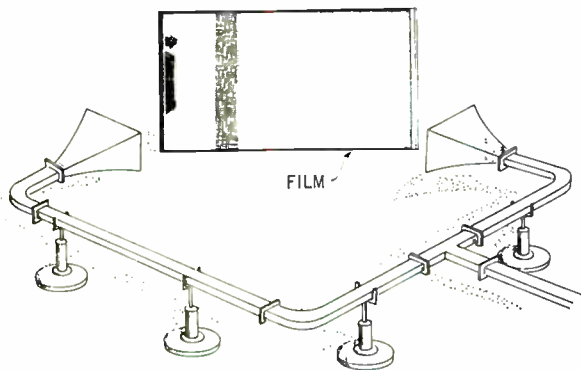

Between the horns. The Young's fringe pattern launched from two horns at an angle of 90° to each other can be mapped on a film packet at 45° to each horn with respect to the incident waves.

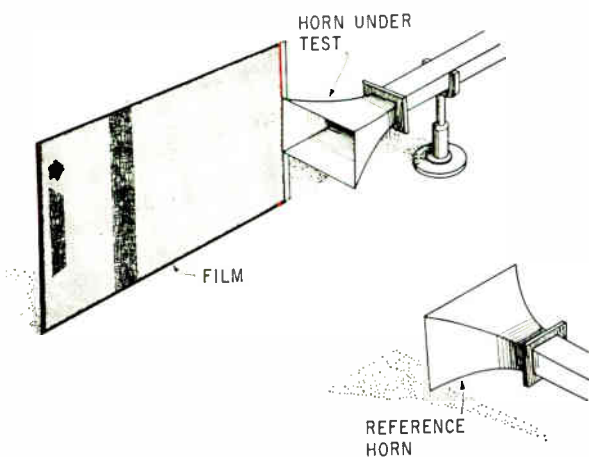

On the flank. Film is held against an edge of an X-band horn, parallel to the center axis, to map the horn's radiation pattern. The reference field is superimposed so that the distribution of the wave front can be observed.

is to place a metal reflector behind the film. This disturbs the original field, but the reflector permits maximum power dissipation of the microwaves in the film by adjustment of the distance between it and the film.

Black-and-white Polaroid film Types 52, 57, 55 P/N, and 107 are also suitable, but their sensitivity isn't as high as the color type's. When only a small area of measurement is needed, the eight-exposure color pack ($3\frac{1}{4}$ by $4\frac{1}{4}$ inches) is useful.

The method isn't limited to mapping electromagnetic fields. It should be applicable to the recording of any physical phenomenon capable of generating a thermal image. For example, the temperature distribution within the flame of a candle was successfully mapped by holding the film vertically in the flame. A distribution within the emulsion is generated, and this causes the film to form an "image" whose intensity is directly proportional to the flame's internal temperature distribution.

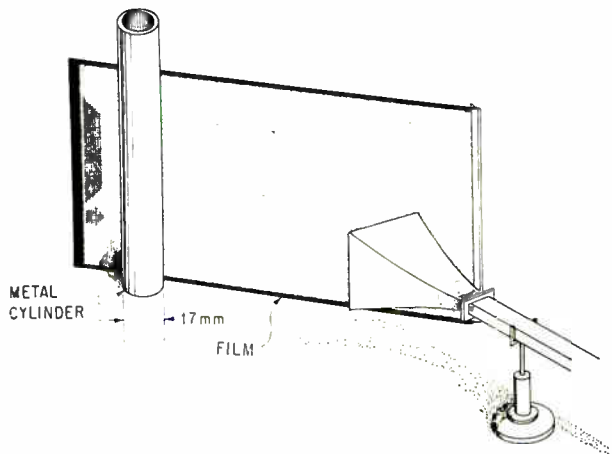

Scattered field. Film is used here to record field from a metal cylinder 17 millimeters in diameter. The E field is polarized in the direction of the cylinder's axis.

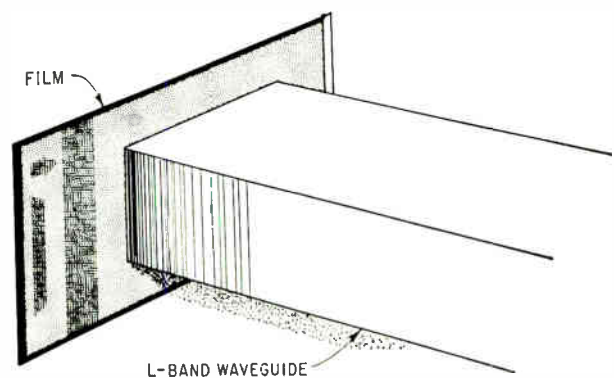

Covering the mouth. The field intensity distribution at the mouth of an open-ended L-band waveguide is recorded by placing a cooled film packet at that point.

this system
saved
one of our
customers...

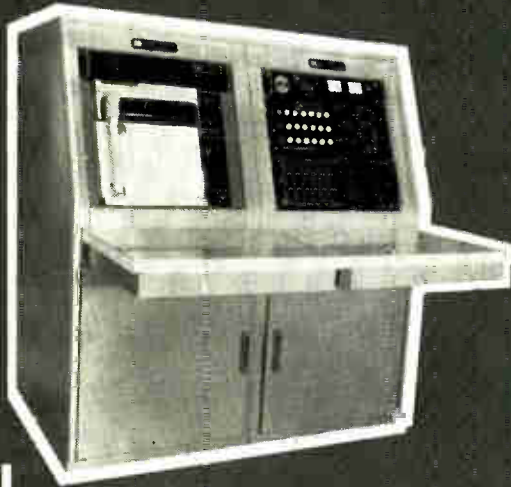

\$900,000

in
nine *
months

**model 130a
automatic spectrum
display & signal
recognition system**

Automatically scans and plots the 20 Hz to 1000 MHz spectrum in 18 bands in 2 minutes time—completely eliminating human error!

■ Automates entire interference sections of RFI/EMI specifications testing.

■ Accelerates electromagnetic site surveying; data completely reduced.

■ Permits fast scanning and plotting of attenuation measurements of filters, shielded enclosures and cases, and circuit cross-talk.

If you want to save money also, ask for complete information on the Model 130A. Available for sale or rental. RFI/EMI technician accompanies all equipment shipped from WEI.

*By the way, the average savings of all our customers is \$500,000.

670 Lolstrand Lane
Rockville, Maryland 20850
Tel. (301) 424-2900



WHITE

ELECTROMAGNETICS

INCORPORATED

Airborne military transceiver finds room in crowded spectrum

Through artful design that keeps intermodulation distortion extremely low, the ARC-104 transmits and receives high-frequency single sideband signals in 280,000 channels spaced only 100 hertz apart

By I.P. Magasiny

RCA Defense Communications Systems Division, Camden, N.J.

A newly developed high-frequency transceiver goes a long way toward solving the critical problem of electromagnetic compatibility in airborne communications. It can send and receive 280,000 voice channels in the bandwidth older transceivers used for only 28,000.

Known as the AN/ARC-104, and developed by RCA for the Naval Air Systems Command, the set can reject a signal as high as 120 decibels above that of the tuned signal and only 50 kilohertz away. These characteristics allow it to operate almost trouble-free in crowded communication areas where high-powered interfering signals are close by. Now in the production prototype stage, the transceiver is still being improved.

The ARC-104 can operate in a single sideband, frequency-shift-keying or amplitude-modulation-equivalent mode, transmitting 400 watts at peak-envelope or continuous-wave power.

Such improvements are made possible by:

- Eliminating all variable tuning circuits
- Synthesizing all frequencies from stable, phase-locked crystals
- Mixing with linear parametric amplifiers

- Using the same mixer injection frequencies for both transmitter and receiver
- Gating out noise before it generates spurious signals.

The ARC-104's other features are also impressive. It tunes automatically to any of 280,000 channels in a maximum of one second, has a mean time between failure of 7,500 hours, can be tested dynamically with built-in circuits, and can be taken apart and put back together in less than half an hour. Previous transceivers took as long as two minutes to tune, had mean times between failures ranging from 10 to 100 hours, and had no internal test circuits.

A standard of excellence

One of the keys to the low intermodulation distortion and low spurious output in the ARC-104 is the extreme stability and accuracy of the synthesizer, which generates frequencies accurate to 1 part in 10^9 per day and 1 part in 10^8 per month. This is achieved by using crystal oscillators and by phase-locking each to a single ultrastable crystal frequency standard. The synthesizer generates all frequencies either directly from the standard or from the oscillators.

Two types of circuits offered the high stability needed for the standard—either the Pierce or Meacham bridge oscillators. The former was picked because it did not require as close a control on the quartz crystal or as tight tolerances on circuit components. Because phase shifts within the oscillating circuit affect the oscillator's stability, components had to be carefully selected. To maintain stability in all weather and at all latitudes, the crystal is placed within a system of double ovens. The inner

The author



Irving Magasiny, manager of RCA's high frequency programs, has worked on the design of h-f single sideband equipment since 1965. He holds a master's degree from the University of Pennsylvania and has worked with Teledynamics Inc., Philadelphia, and with the Schaevitz Engineering Co., Pennsauken, N.J.

VARIABLE FREQUENCY OUTPUT $\left\{ \begin{array}{l} 33-38.9997 \text{ Mhz} \\ 83-104.9997 \text{ Mhz} \end{array} \right.$

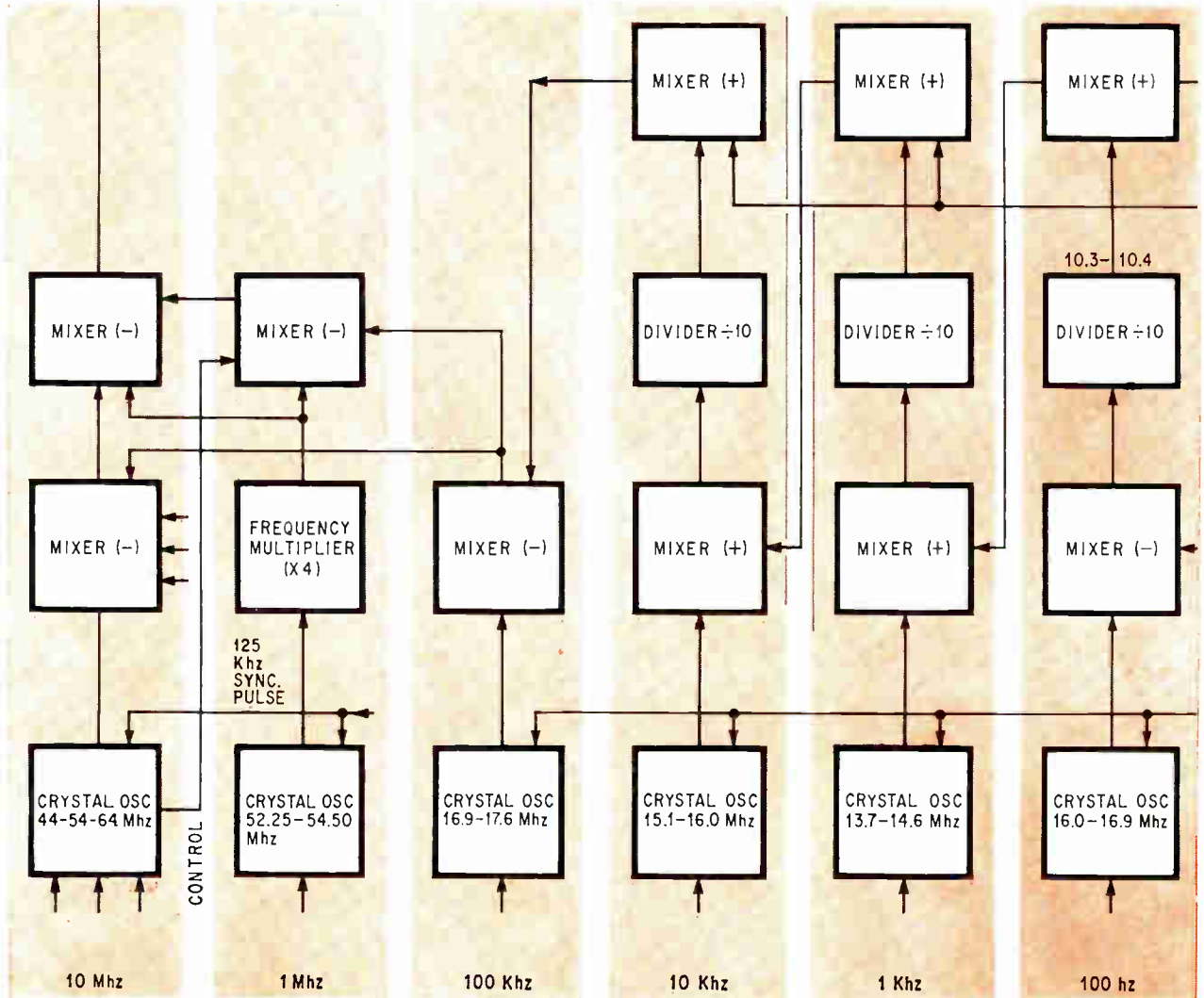

oven keeps the crystal at a temperature that varies by no more than a few milli-degrees. The outer oven keeps the temperature surrounding the inner one constant. Amplifier feedback of 20 to 25 db was necessary for the stable gain needed to control the oven temperatures. That feedback also insured immunity to noise within the amplifying loop and

protection against component variations. Temperature-compensated voltage-reference diodes are used throughout the amplifier, and d-c control is employed to avoid interference with synthesized frequencies.

The making of channels

Early versions of the ARC-104 synthesizer were digital, using bipolar or field effect transistors. Digital synthesizers lend themselves to circuit integration but at the frequencies required they weren't sufficiently reliable or stable resulting in jitter, microphonics, and spurious signals.

The synthesizer finally developed includes six decade oscillators; five of which have 10 crystals, and one has three. Decade oscillators correspond to the 100-hz, 1-khz, 10-khz, 100-khz, 1-Mhz and 10-Mhz digits of the 33 to 104.999-Mhz signal sent to the receiver and transmitter. A control signal from the tuning panel selects the appropriate frequency from each oscillator, which then locks on to the standard. Outputs are incrementally mixed, repetitively divided or multiplied, then mixed.

A long time in port

Work on the ARC-104 goes back all the way to mid-1962 when nca received a Navy research contract. In the following years, transceiver requirements and design approaches changed several times to take full advantage of the rapidly evolving technology. For instance, transistors were scrapped in favor of ic's and synthesizer requirements were upped from 1 khz to 100-hz frequency spacing.

Finally, nca built several experimental models and tested them under the direction of the Naval Air Development Center. Now nca has started qualification tests of the production prototype.

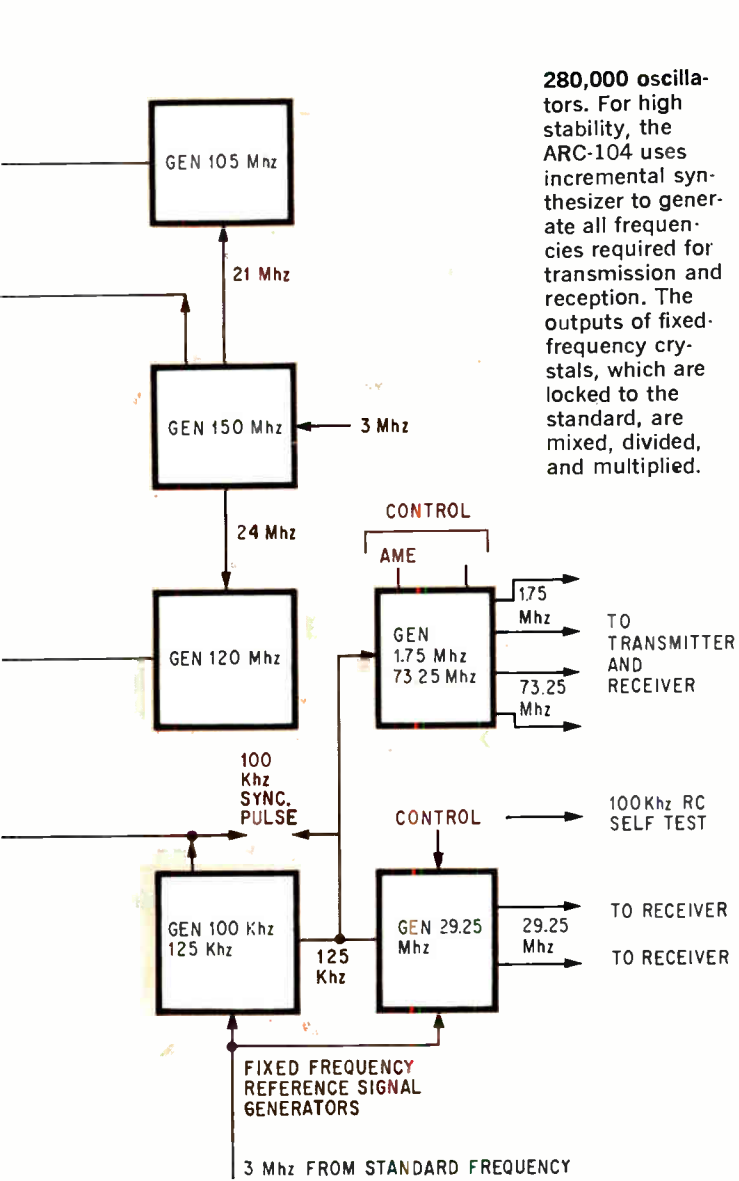

Both the receiver and transmitter in the ARC-104 use fixed frequencies of 1.75 and 29.25, and 73.25 Mhz for frequency translation, modulation, and demodulation. Crystal filters reduce spurious signals 120 db below these frequencies. The synthesizer itself uses internal local oscillator signals at 105 and 120, and 75 Mhz.

To generate decade frequencies, the synthesizer mixes the output of the 100-hz decade oscillator with the 120-Mhz signals then divides it by 10. The resulting 10.3 to 10.4-Mhz signal mixes with 105 Mhz, providing the local oscillator-injection signal for the 1-khz decade oscillator. Each successive divide-by-10 operation reduces the controlled frequency increments by 10. Crystal frequencies in the synthesizer are actually separated by 100 khz but frequency division by 1,000 (three divide-by-10's) achieves the desired 100-hz frequency spacing required in the transceiver.

The output signal of the 100-khz decade oscillator mixes with 1-Mhz increments derived in a similar manner from the 1-Mhz digit crystal oscillator, producing a low-band synthesizer output of 33 to 38.9

Mhz corresponding to antenna frequencies from 2.0 to 7.9 Mhz. Similarly, the 100-khz decade output mixes with the 10 Mhz-digit oscillator to ultimately produce outputs corresponding to antenna frequencies from 8 to 29.9 Mhz.

To prevent spurious couplings in the mixers, oscillator frequencies were carefully selected in relation to each other and to the fixed frequencies generated by the synthesizer. Each decade oscillator operates in a slightly different frequency range from the others.

Despite precautions, the synthesizer's variable frequency output is too high in spurious content and noise. Therefore, a phase locked oscillator in the receiver section boosts signal-to-noise ratio and reduces all spurious frequencies more than 120 db below the generated signals.

Turned on

Each crystal decade oscillator consists of the frequency selector, varactor controlled oscillator, sampling phase detector, and pulse shaper. Each section is designed to insure the highest accuracy and stability of synthesizer operation.

When a frequency is selected in the ARC-104, a control signal is sent on the appropriate lead to one of 10 p-i-n diodes in each decade oscillator. This switches on the diode, placing the desired crystal, bias network, and frequency-centering inductor in the circuit. Diode on-impedance is less than 10 ohms while its off-impedance is 10,000 ohms, thus insuring that all crystals except the one operating are completely out of the circuit.

The oscillator section includes two amplifier stages with feedback. It functions only when a low impedance is inserted in the emitter of the first stage. The inserted impedance consists of a varactor diode in series with the p-i-n diode, the crystal, and the center-frequency inductor. Thus, the emitter impedance is low only at the series-resonant point of the selected crystal. The varactor acts as the control in the loop, locking the crystal to its correct frequency.

At the same time that the control signal is sent to a crystal, a synchronizing pulse derived from the frequency standard and the pulse generator is transmitted to a blocking-oscillator, which shortens the pulse and sharpens its edges.

Finally, the shaped pulse closes a switch in the sampling phase-detector section of the oscillator, thereby connecting the oscillator output of the selected crystal frequency to a capacitor. The voltage is stored on the capacitor until the next pulse, and is also delivered to the varactor, which controls the crystal oscillator frequency. Varactor frequency control simplifies filter design, increases the ratio of capture to lock-range, and reduces the frequency modulation caused by ripple.

Receiver dynamics

The ARC-104 owes its ability to detect both strong and weak signals—even when high-power interfering signals are close by—to the high linearity

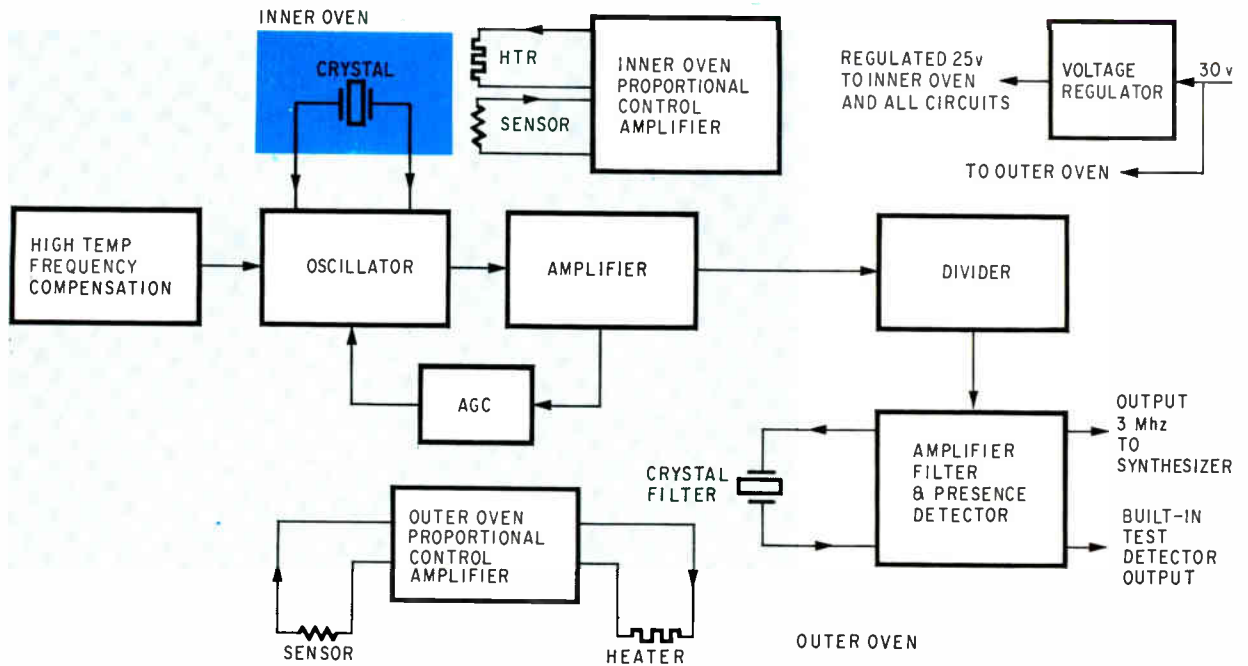

Stable generation. Frequency standard controlled by dual oven system is one key to ARC-104 linearity.

of its front end. A double-superheterodyne detection technique makes use of parametric amplifiers to convert r-f signals to higher intermediate frequencies. I-f signals are then passed through highly selective crystal filters to bring spurious signals down at least 120 db below tuned signals.

A varactor parametric up-converter is the only device now made with the linearity and noise figure

needed for the first mixer in the ARC-104 receiver. Because the voltage versus charge relations of the varactor diode is an almost perfect square-law function, input and injection signals produce only d-c, the fundamental input frequency, sum and difference frequencies, and second harmonics. Other mixer products are virtually nonexistent. Dynamic range is also helped by the varactor's

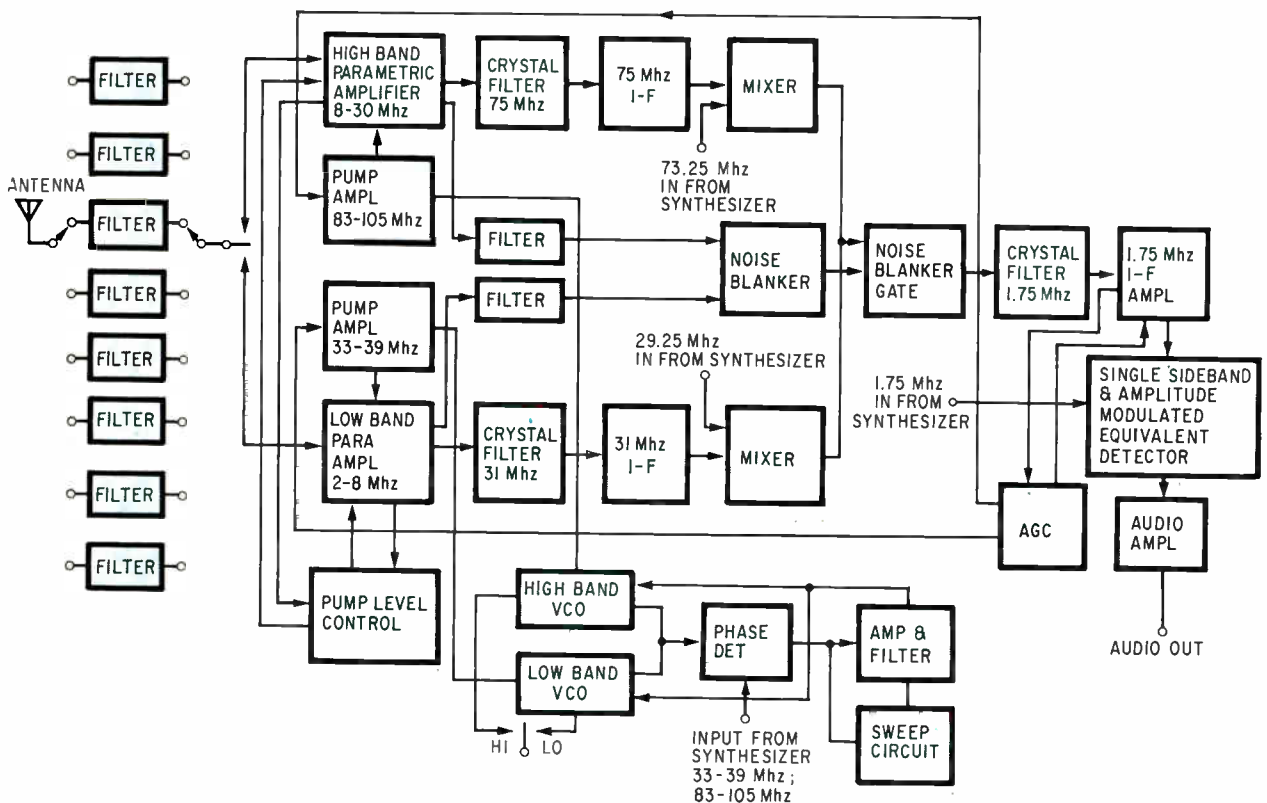

Receiver combination. Parametric up-converters and noise-blanking techniques keep spurious signals down.

ability to handle strong signals without breakdown and low signals without adding appreciable noise or attenuation.

A low noise amplifier pumps the varactors in the parametric device with a maximum 2-watt injection signal. Pump control is derived from an automatic level control circuit and automatic gain control detector (age). The automatic level-control circuit reduces the pump signal power if it exceeds the maximum required level while the age detector reduces the power if the intermediate frequency signal level increases. The i-f rejection filters eliminate pump noise amplified at 31-MHz or 75-MHz.

Input signals to the receiver section of the ARC-104 are selected with the help of eight bandpass filters, which eliminate the need for electrically

sistor oscillators (one for the low band, the other for the high band), a phase detector, a direct-coupled amplifier, a compensating network, a low-frequency sweep generator, and a sweep-inhibit and gate circuit. The sweep circuit tunes the oscillator so that it sweeps past and locks on to the synthesizer signal. The sweep-inhibit-and-gate circuit isolates the oscillator from interference.

In the first i-f section of the receiver, low band signals (2 to 7.9 MHz) are converted to 31 MHz, high band signals (8 to 29.9 MHz) to 75 MHz. Signals in either band are then converted to a second i-f frequency of 1.75 MHz, and passed through a noise-blanker gate and crystal filter.

The noise-blanking circuit, together with the parametric mixer, contributes in large part to the

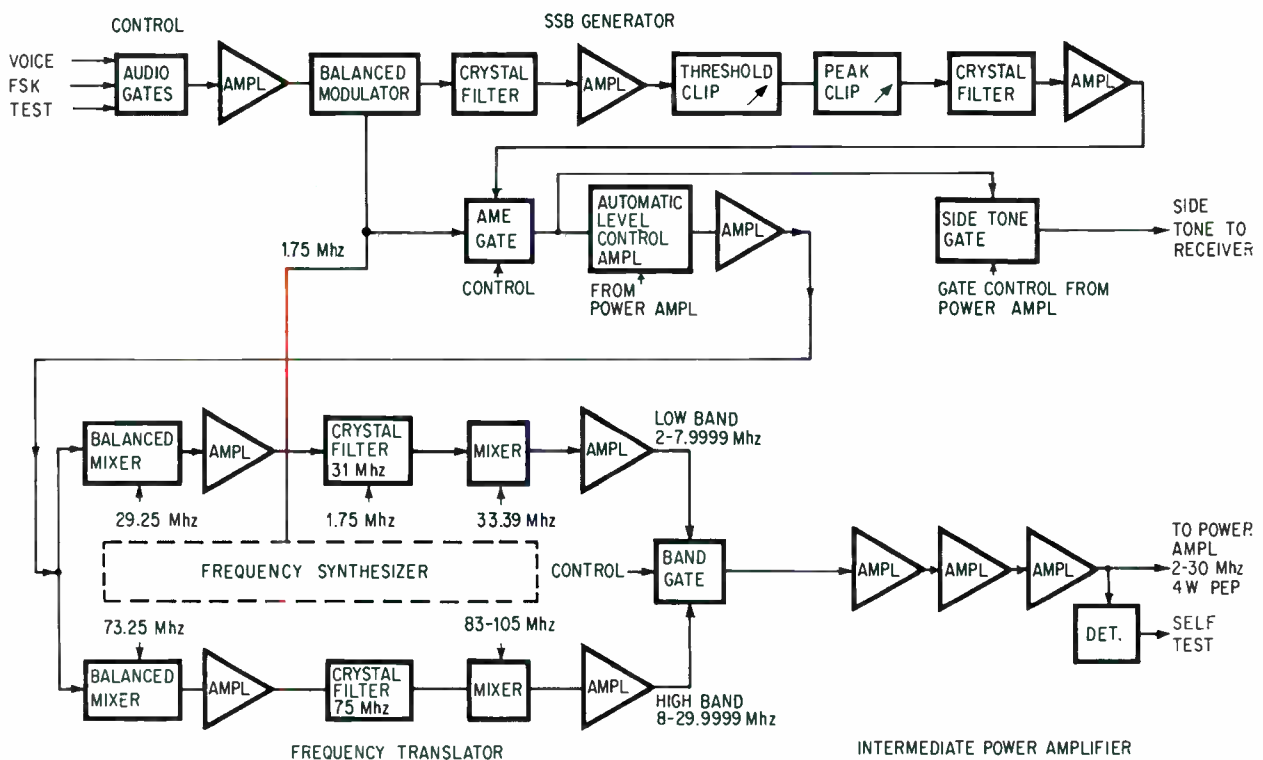

The way out. Transmitter exciter is broadband, untuned, low-noise, and low spurious signal circuit.

or mechanically tuned tracking circuits and also simplify remote control. The filters are designed so that the ratio of maximum- to minimum-pass-band frequencies is limited to 1½:1, thereby keeping the second harmonic at least 120 db below that of the input signal. The injection signals are far enough away from the passband frequencies so that they're sufficiently attenuated. After the appropriate band has been selected, signals can be tuned in precise 100-hz increments merely by changing the first injection signal.

Before mixing with the received signals, the variable frequency injection signals are processed in a buffer circuit, which improves their signal to noise ratio to greater than 40 db. This "clean up" circuit is composed of two voltage-controlled tran-

ARC-104's ability to operate in areas of high man-made and natural noise. The spectrally pure injection signals also minimize spurious output from the transmitter. The noise blanker recognizes impulse noise and gates it out of the circuit for about 800 microseconds. This prevents transients from ringing the 1.75-MHz crystal filter.

The pulse-detection circuit bypasses the first i-f filter and has much greater bandwidth. It recognizes impulse noise varying in intensity from 100 microvolts to 1 volt. An ic, logarithmic amplifier with 70-db gain at 1 MHz enables weak pulses to be detected. Once the pulse is detected, it triggers a flip-flop that generates an 800-μ pulse, tuning off the diode gate preceding the 1.75-MHz filter.

Because the logarithmic amplifier is broadband,

Report in 4 Seconds

Because the ARC-104 is designed to operate in aircraft, it's also designed to diagnose its own troubles, simplifying maintenance. Aided by detectors and indicators in each functional module, a test module consisting of 75 integrated circuit flatpaks allows an operator to quiz the set on its performance and get a report in four seconds. The module sets a magnetic latch indicator on the control panel if there's trouble and pinpoints the fault by also setting an indicator on the defective module.

Dynamic tests at any channel frequency in 100-kilohertz increments and in any operating mode are made on all parts of the transceiver. Fault indicators stay set even with power removed, requiring no current. They can be reset only by taking out the defective module. However, they don't have to be reset for the transceiver to continue operating.

During the tests, a 1,500-hertz signal applied to the exciter input produces a 400-watt peak envelope power signal that is dissipated in an internal 50-ohm carbon-resistor load. Output of the intermediate power amplifier, power amplifier, and power supply are checked by comparison with reference voltages.

While the exciter is being tested, its modulated 1.75-Mhz i-f output is used to check the receiver's second i-f and audio circuits. And an amplitude modulated r-f signal derived from the synthesizer's 100-khz generation and the 1,500-hz test signal connects to the receiver input. The receiver functional assembly has three fault indicators: for the synthesizer clean-up circuit, the front end, and the second i-f and audio circuits. Additional fault isolation down to individual circuit boards can be made.

it is vulnerable to jamming. To prevent unwanted noise blanking, the pulses generated by the flip-flop are counted and if they occur more than 75 times a second, a Schmitt-trigger circuit prevents them from reaching the diode gate. The Schmitt circuit doesn't allow the gate to open the signal circuit for more than 10% of the time.

Message center

Like the receiver, the ARC-104's transmitter exciter is a broadband, untuned, low-noise and low-spurious signal circuit. It accepts data or voice signals either from microphones or from military intercommunications sets such as the AN/AIC-14 or AN/AIC-25, producing either a single sideband, amplitude modulated equivalent, or frequency-shift-keyed signal of 2-watts-peak envelope power. Making up the exciter are a single sideband generator, frequency translator, and intermediate-power amplifier.

In the single sideband generator, voice, fsk, or test signals are gated through a circuit with ± 10 db of adjustable gain. Then the signals are amplified and modulated onto a 1.75-Mhz carrier with the carrier sideband removed. If amplitude-modulated equivalent transmission is used, the carrier is reinserted.

Part of the i-f signal goes to an automatic level

control amplifier and then to the frequency translator; part is gated off by a diode and is sent to the receiver i-f as a side tone that tells the operator whether the transmitter is operating properly.

In the translator, the modulated 1.75-Mhz carrier mixes with either a 29.25-Mhz injection signal (for transmission in the 2- to 7.9-Mhz band) or a 73.25-Mhz signal (for transmission in the 8- to 29.9-Mhz band). The low band i-f, 31 Mhz, and the high band i-f, 75 Mhz signals, are then filtered, mixed with the selected injection frequency that assigns them to a channel, amplified, and sent through a band-selector gate to the intermediate-power amplifier. Using the same injection frequencies in both receiver and exciter minimizes coupling and spurious signal generation.

In the exciter's final section, the intermediate-power amplifier boosts all signals to a 2-watt-peak envelope power level. Linear broadband amplification over the 2- to 30-Mhz band is attained in three stages by using negative feedback and broadband transformers that match impedance and couple the stages. The first two stages use a high-frequency overlay silicon power transistor (2N3375) and the third stage uses a similar transistor (2N2876).

Getting on and off the air

The last link in the ARC-104 is a broadband untuned, linear power amplifier that delivers 400-watt-peak envelope or e-w power with only 35 db intermodulation distortion. Spurious signals and noise are down 90 db. This is achieved by using broadband-output coupling transformers, a single 750-watt linear output tube, and an antenna filter. The tube was designed for high transconductance, low input capacity, and low peak grid-drive level requirements. It has a high thermal conduction anode that forms a low-resistance path to the amplifier's heat exchanger. The base plate supports the amplifier and serves as a heat sink.

There are eight broadband output transformers, one of which is automatically selected by a rotating bandswitch operated from the transceiver control panel. The transformer output then passes through a low-pass filter before transmission to remove spurious as well as second and higher harmonics. Power output is limited by the exciter's automatic-level-control amplifier, which is controlled by the transmitter output detector and adjustable threshold circuit.

Mounted with a blower, the ARC-104 set meets military Class 1 A requirements—it can operate up to 35,000 feet altitude over a temperature range of -55°C to $+55^{\circ}\text{C}$. Mounted without blower and cooled from an external system, the set meets Class II specifications—it can operate up to 70,000 feet altitude over a range of -55°C to $+71^{\circ}\text{C}$.

RCA has taken steps to obtain an output of 1-kilowatt-peak envelope power and e-w using a single tube. Another version of the transceiver permits twin and independent sideband operation with fsk or phase-shift keying multitone data as well as voice.

Go ahead. Take hold of the newest 10,000 pf high voltage vacuum fixed capacitor for induction heating.

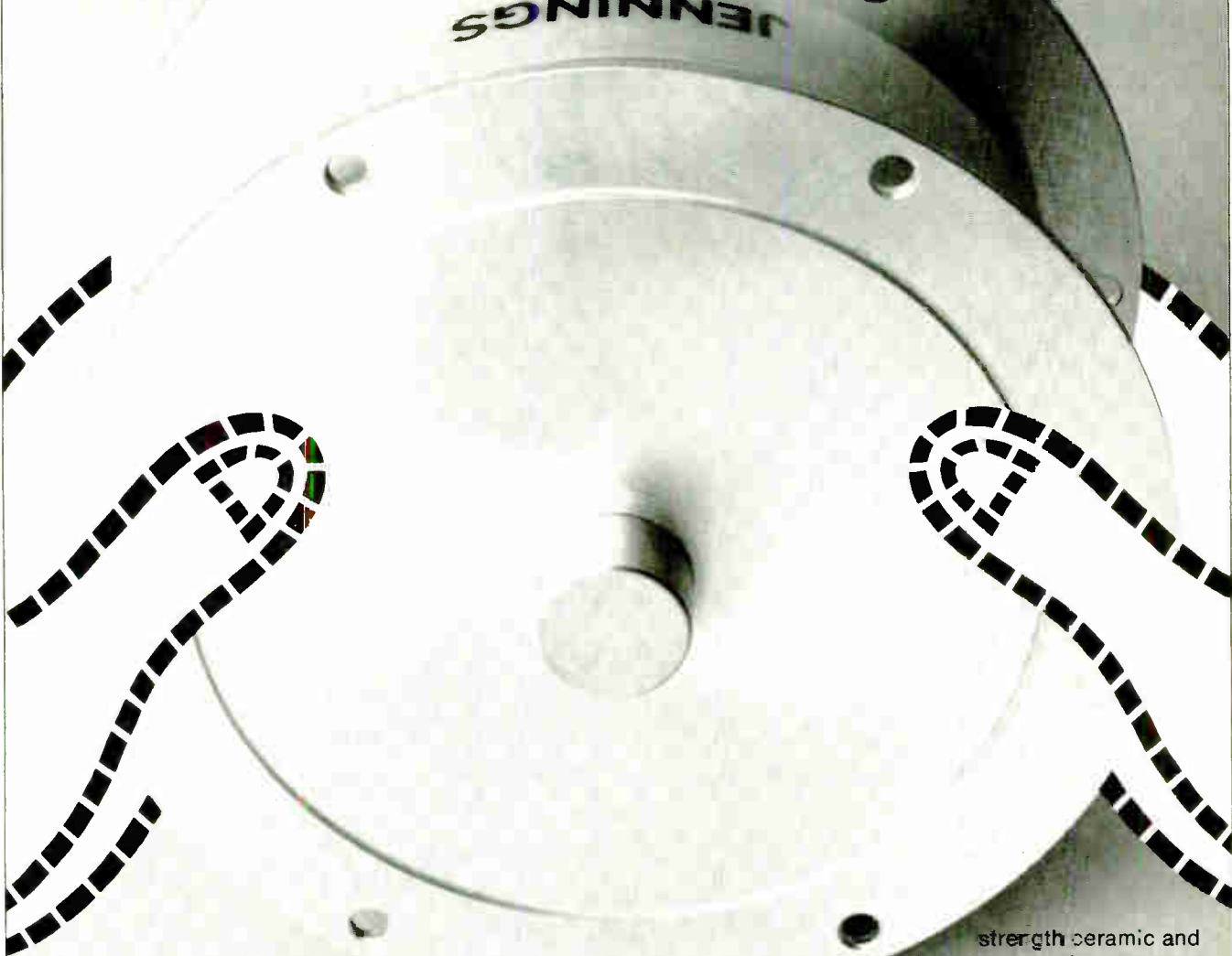

This is the actual size (6½ x 3¼) of the largest of two new unique vacuum fixed capacitor series from ITT Jennings. They were specifically designed for use in induction and dielectric heating equipment operating from low frequency through high frequency. Especially benefitted will be such applications as crystal growing, zone processing, rf sputtering, plastic sealing plastic preforms, and glue-line drying.

The result is the most outstanding combination of capacity, voltage and size ever created, and the greatest dollar value per KVA for plate blocking and tank circuit use.

This new CFSB series is characterized by high

strength ceramic and copper construction, very low losses, and low internal inductance.

Pertinent specifications include:

Capacity	5,000 or 10,000 pf
Peak test voltage (60 Hz)	10, 15 kv
Current rating (16 MHz)	95 amps rms
(1 MHz)	200 amps rms
Dissipation	Less than 10×10^{-5}
Internal inductance	Less than 10 nanohenries

You can find capacitors much bigger, but none better; the potentialities in both replacement and new design are obvious. For detailed information, write for Catalog No. 101. ITT Jennings, a division of International Telephone and Telegraph Corporation, 970 McLaughlin Avenue, San Jose, California 95108.

JENNINGS ITT

**Our story starts
with a very
superior
polyester film.**

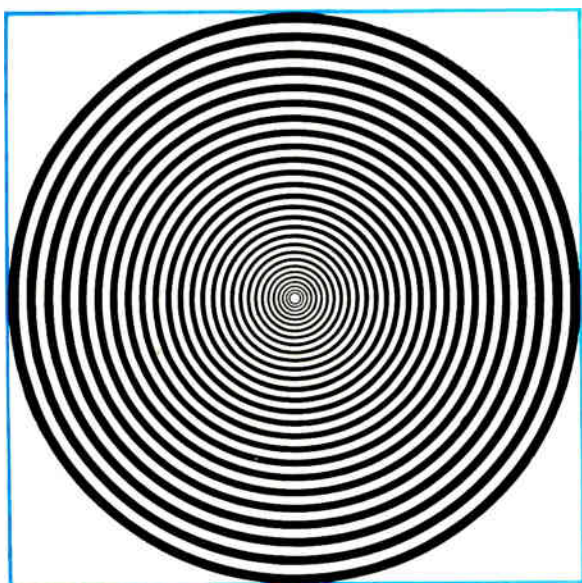

**To which we
add exceptional
dimensional
stability.**

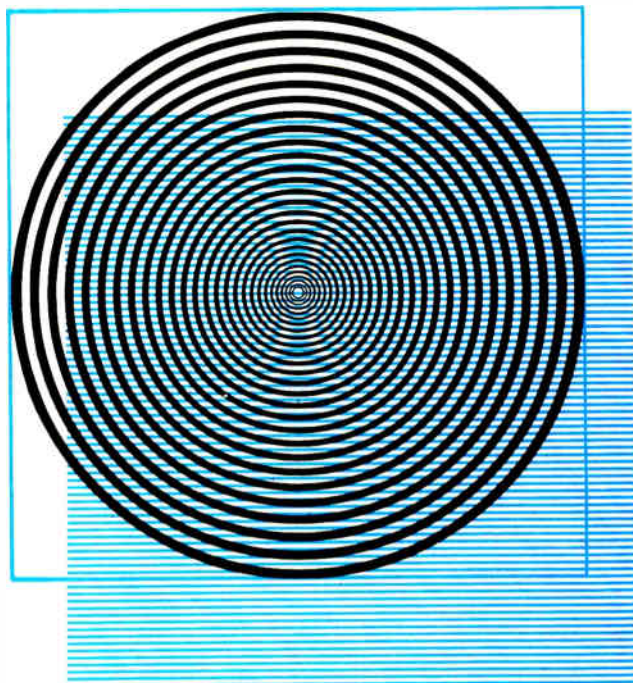

The best dimensional stability of any polyester film. An independent testing lab, DeBell & Richardson, Inc., tested calibrated lengths of Celanar and other polyester films at temperatures from 73F to 120F for over 24 hours. When measured, other films showed up to 77% greater thermal expansion than Celanar film.

And greater strength.

Celanar is the strongest balanced biaxially oriented plastic film commercially available.

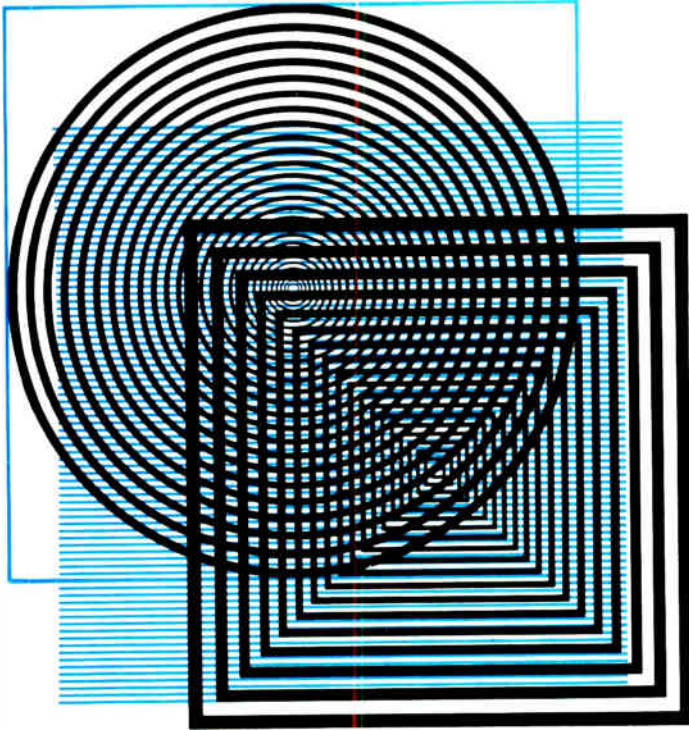

And insulation resistance.

An outstanding property of Celanar film is its high insulation resistance over a wide range of temperatures. Celanar has superior electrical properties, including excellent dielectric strength, dielectric constant and dissipation factor. Good reasons why Celanar is widely used as an insulating material in electrical insulation applications.

To bring you Celanar Film with a combination of properties unsurpassed for electrical uses.

Celanar polyester film offers a balance of electrical, mechanical, thermal and chemical properties that make it your best choice for applications from flexible circuits to wire-wrap. Want proof? Just mail the coupon.

Celanese Plastics Company
Dept. 133-D, P.O. Box 629
Linden, N.J. 07036

Yes, I want all the facts about Celanar film for electrical applications. And send me a FREE set of gratings printed on Celanar. (Laying one on top of the other produces Moiré patterns that confound the eye.)

Name _____ Title _____

Company _____

Address _____

City _____ State _____ Zip _____



CELANESE
PLASTICS COMPANY

Celanese®
Celanar®

Celanese Plastics Company is a division of Celanese Corporation.

**NEW
CORNING[®]
C3 Resistor.**

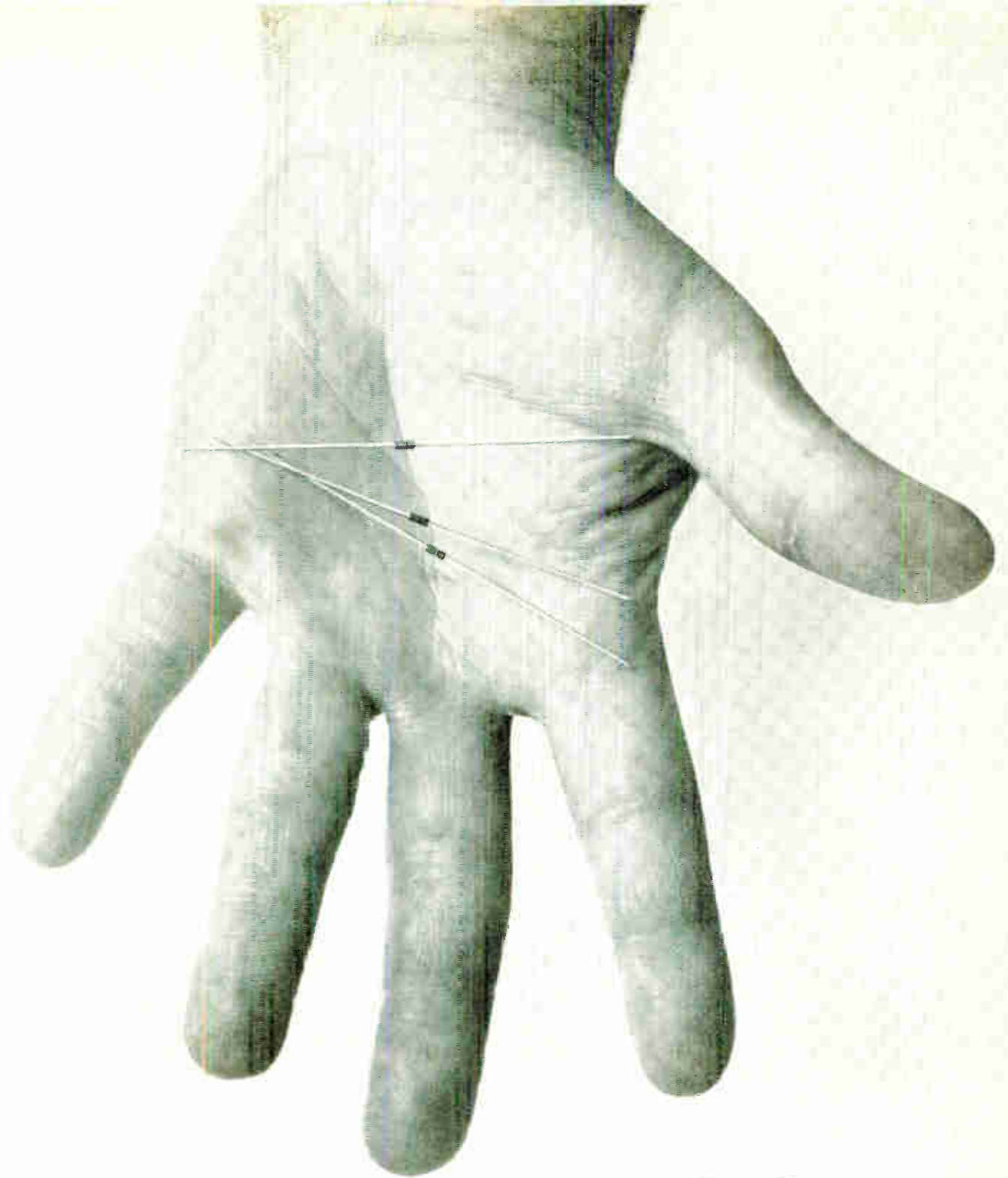

Small.

RN50/RC05 size. Clean lead length .150". Diameter 0.066" maximum. Put more per board.

Stable.

The proven, long-term stability of CORNING Glass Tin Oxide Film Construction.

Rugged.

Leads are beefy .020" dia. Eliminate handling and automatic insertion problems.

Terminated.

With reliable cap construction, not just soldered.

Performs.

Power ratings to 1/8 watt, 70°C. T.C.'s of 100 and 200 ppm. Values from 10 ohms to 150 K. Tolerances of 1, 2, 5 and 10%.

Handy.

Leads are 1½" for easier handling. Reeling is available.

Corning Glass Works
Electronic Products Division
Corning, N. Y. 14830

Gentlemen:

- Please forward data on new C3 Resistor.
- Please send samples of new C3 Resistor.

Name _____

Title _____

Firm _____

Address _____

City _____ State _____ Zip _____

CORNING
ELECTRONICS

Circle 143 on reader service card

Bounceproof... Chatterproof... Tamperproof... Dustproof... Moistureproof...

our mercury-wetted relays
are even goofproof!



Magnecraft mercury-wetted reed relays completely avoid contact erosion, bounce and chatter. That's because pre-adjusted contacts and a pool of mercury are hermetically sealed within an atmosphere of high pressure hydrogen in a glass capsule. Hermetic sealing also provides protection against dust, corrosive fumes, moisture and tampering. And, there's no maintenance. You can even store them indefinitely without deterioration.

There are 195 stock Magnecraft mercury-wetted and dry reed relays available in many styles as well as in the MPC Modular Package shown.

You can rely on Magnecraft to fill all your relay needs from our vast supply of 444 different stock relays including general purpose, telephone and power relays. All quickly delivered and at competitive cost. Just ask our customers.

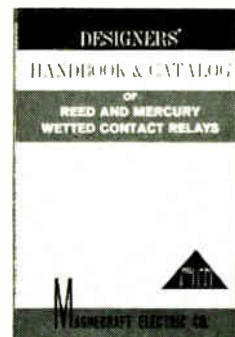

FREE! Designers'
Reed Relay Handbook
Yours for the asking.

Manufacturing Stock Relays for Custom Applications

Magnecraft[®] ELECTRIC COMPANY

5575 NORTH LYNCH AVENUE • CHICAGO, ILLINOIS 60630 • 312 • 282-5500 • TWX-910-221-5221



To 150° C

with Optimum Reliability and Low Cost.

As a result of new electrolytes and improved oxide film forming techniques, Extended Temperature Range Aluminum Electrolytic Capacitors are now available from CDE.

They feature Capacitance and DF stability, low DC leakage currents, high ripple current capability, and rugged design for stringent vibration and shock endurance.

Five types are now available (and more to come): UHT... (-55 to +150° C), UHL... (-55 to

+125° C) UHR... (-55 to +105° C) HNLH... (-80 to +110° C), and UFH... (-55 to +105° C).

CDE **CORNELL-DUBILIER**

50 Paris Street, Newark, N. J.

For units available for your design considerations, see following page.

To 150°C

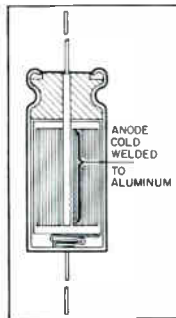

Featuring the exclusive CDE continuous cold weld connection of section to rod...insuring superior mechanical and electrical reliability. With far superior ESR to Temperature characteristics.

And with high ripple current capability, low DC leakage, Capacitance and DF stability, Low impedance, rugged design for vibration and shock endurance.

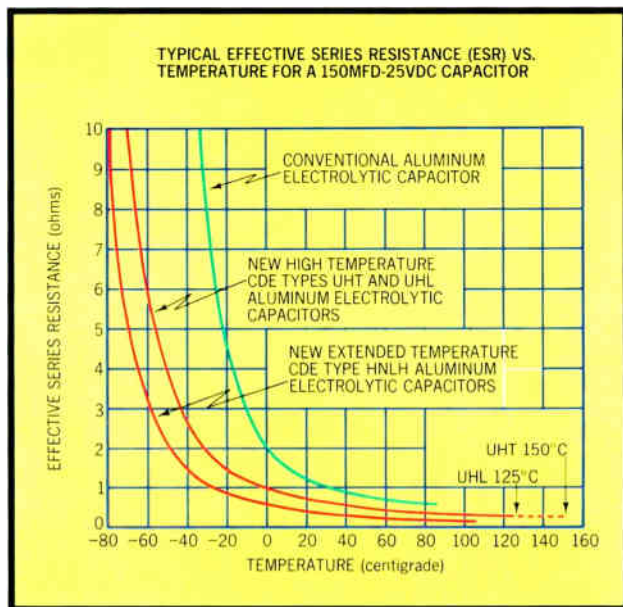

These units are now available for your design consideration:

UHT

Miniature Axial Lead Case Sizes: $\frac{3}{8}$ x $1\frac{5}{16}$ to $\frac{3}{8}$ x $2\frac{1}{16}$ ". Ratings: 3 mfd to 100 mfd, from 3 VDC to 100 VDC.

-55 to +150° C OPERATION

UHL

Miniature Axial Lead Case Sizes: $\frac{9}{32}$ x $1\frac{5}{16}$ to $\frac{3}{8}$ x $2\frac{1}{16}$ ". Ratings: 3.3 mfd to 1000 mfd, from 5 VDC to 200 VDC, designed to meet and exceed Mil C-39018/1. (Already stock standards on our Distributor's shelves.)

-55 to +125° C OPERATION

UHR

Large Axial Lead Case Sizes: $\frac{5}{8}$ x $1\frac{1}{8}$ to 1" x $3\frac{5}{8}$ ". Ratings: 10 mfd to 12,000 mfd, from 5 VDC to 200 VDC, designed to meet and exceed MIL C-39018/3. (Also available in -55 to +85° C specifications.)

-55 to +105° C OPERATION

HNLH

Miniature Axial Lead Case Sizes: $\frac{1}{4}$ x $\frac{5}{8}$ to $\frac{3}{8}$ x $1\frac{1}{2}$ ". Ratings: 1 mfd to 600 mfd, from 3 VDC to 150 VDC. (Already stock standards on our Distributor's shelves.)

-80 to +110° C OPERATION

DFH

Computer Grade Case Sizes: $1\frac{3}{8}$ x $2\frac{1}{8}$ to 3" x $8\frac{5}{8}$ ". Ratings: 5500 mfd to 300,000 mfd at 5 VDC 240 mfd to 9000 mfd at 150 VDC.

-55 to +105° C OPERATION

For your design considerations, ask for details from your local CDE Sales Engineering Office. Or write:

CDE **CORNELL-DUBILIER**

50 Paris Street, Newark, N. J.

In hope of doing each other some good

Kodak

CO₂ laser windows

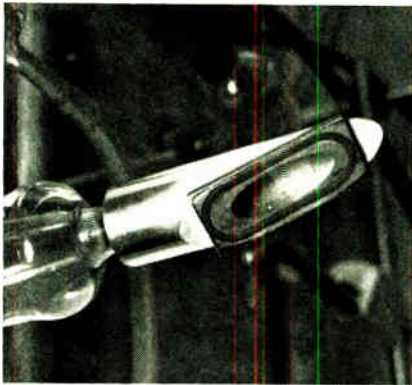

This Brewster-angle window in this CO₂ laser we own is made of KODAK

IRTRAN 4 Optical Material. So are many other people's CO₂ laser windows. There are also some CO₂ laser windows made of IRTRAN 2 Optical Material. That's cheaper but absorbs a bit more at 10.6 μ . Many such windows are made of optical materials which are still cheaper and can remain as clear as IRTRAN 4 Material. One of those needs only a window-cooling system to keep the absorbance down, but that can complicate design. The others likewise absorb no more than our stuff does and require no cooling either. Unlike ours, they can deteriorate by absorbing moisture from the air.

What's picked depends on what's important.

This particular window shows no damage after passing 100 watts/cm² over a 1 cm free aperture for 20 minutes of continuous-mode operation. We suspect that's peanuts compared with the energy that others are pushing through their Irtran windows. If so, they are not likely to tell us their purposes, but if they didn't need Irtran material they wouldn't use it, and if they weren't getting their money's worth they surely wouldn't keep that a secret from us.

To ask questions about KODAK IRTRAN[®] Optical Materials, phone 716-325-2000, ext. 5166, or write Eastman Kodak Company, Apparatus Division, Special Products Sales, Rochester, N.Y. 14650.

More than taking a picture

There is considerable difference between taking a picture and using photographic instrumentation to extend the observer's senses and perceptions. Except for certain special cases such as sports photography and the photographic part of lunar orbiters, we have chosen to leave the instrumentation manufacture to others. We make the film. Mostly this means 16mm, 35mm, or 70mm film. (Aerial cameras are something else again. Some of them run on 70mm film, but generally they want something wider.)

A certain amount of instrumentation photography still aims at a pleasing picture, it must be admitted. The rest of it just operates with the concepts that grew up around that aim.

The skilled practitioner in photographic instrumentation is assumed, however, to have learned more than what's covered in the basic photographic theory course. And we make him some films based on that assumption—three rather new ones, in particular. They are fast films.

Processed for normal pictorial photography, they provide a choice of gamma—the classical measure of photographic contrast—of 0.65, 0.70, or 0.85, with a speed of ASA 1000 or slightly higher. Unlike the films of yesterday, these are designed to do more than simply increase contrast with more development. In these the speed can also be raised. In one of them it can be raised all the way to 8000 if the subject can stand a gamma as high as 1.7.

Mind, we are speaking here not of just taking a picture at Exposure Index 8000 but of data captured by the hundreds or thousands of feet at E.I. 8000.

Whoever can figure out in advance whether his subject can stand a gamma of 1.7 is entitled to regard himself as pretty hot in photographic instrumentation. He far more than qualifies to receive our chart that shows which films can be adjusted to which speeds and which gammas and how. He has but to make his wishes known to Eastman Kodak Company, Instrumentation Products, Rochester, N.Y. 14650.

He might also wish to request Pamphlet P-29. It describes many other 16mm, 35mm, and 70mm black-and-white and color films and their various spooling specifications. Its chief attraction is not completeness (an unrealistic goal) but that it is mercifully thin.

Hard, shining mask



Your wife may think it odd that your company bought you this little mirror in a molded plastic case and paid more than she paid for the compact she carries in her purse.

And why are you washing it?

You wish to remove an accidental thumbprint. The thumbprint is on a surface of chromium 0.06 \pm 0.01 micron thick. Soap and water clean this chromium. Neither washing nor thumbs abrade it. On each and every one of these plates an attempt is made in our factory to abrade it intentionally. If you are going to abrade it when using it as a photomask for IC's, MSI's, or LSI's, we might as well abrade it first. Nothing happens, except that hidden defects may show up. If more than ten defects show up over the 1 $\frac{3}{4}$ -inch square central area of a 2" x 2" plate, it doesn't leave our door. Actually no more than 5% of those we release have more than six defects, and half have none at all.

This new KODAK Metal-Clad Plate C also comes in 2 $\frac{1}{2}$ " x 2 $\frac{1}{2}$ ", 3" x 3",

and 4" x 5". To find out about our defect tolerances for those sizes, just ask. We don't find it necessary to pack in inert gas. We can find no effect on etch time after one year of storage in atmosphere.



For etchants and a positive-working photoresist to put on this plate, you are on your own. You'll hear from us when we have something better to offer along those lines than what is currently on the market. It is in that little mirror that we shine right now. Even for lines and spaces down to one micron, depend on our dull, laborious dedication to quality. It pays off.

Details from *Industrial Photo Methods*, Eastman Kodak Company, Rochester, N.Y. 14650. Ask about KODAK Metal-Clad Plate N if you need that same quality with a negative-working photoresist over the chromium.

EASTMAN KODAK COMPANY An equal-opportunity employer

Chart yourself a foolproof RF shield:

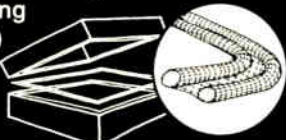
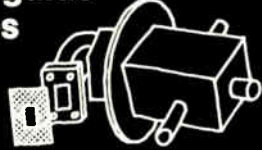
If you want to shield...

<p>Electrical connectors</p> 	<p>use Metex Porcupine Metalastic™ Its many contact points make this an ideal gasket for RFI/EMI. Silicone rubber provides a pressure and moisture barrier.</p>
<p>Metal boxes with flat mounting surfaces (no sealing problem)</p> 	<p>use Metex double round, single fin mesh strip. This is provided in many different metals and sizes.</p>
<p>Wave guide flanges</p> 	<p>use Metex Feltex™ material. Designed for wave guides, specifically provided for either pressurized or non-pressurized systems.</p>
<p>Electronic equipment (and cool it, too)</p> 	<p>use Metex Cool-Shield honeycomb panels. It's designed to meet specific attenuation requirements over specified frequency ranges. Many standard sizes and materials are available.</p>
<p>QUICKLY</p>	<p>call (201) 287-0800 for 48-hour premium service (for your rush rush requirements)</p>

For Free Samples, Prices and Literature on any or all of these RFI shielding materials—or for technical assistance on your particular requirements—write:

METEX Corporation
 970 New Durham Road, Edison, N. J. 08817
 (201) 287-0800 • TWX 710-998-0578
 West Coast Cal Metex Corp., 509 Hindry Ave., Inglewood, Calif.



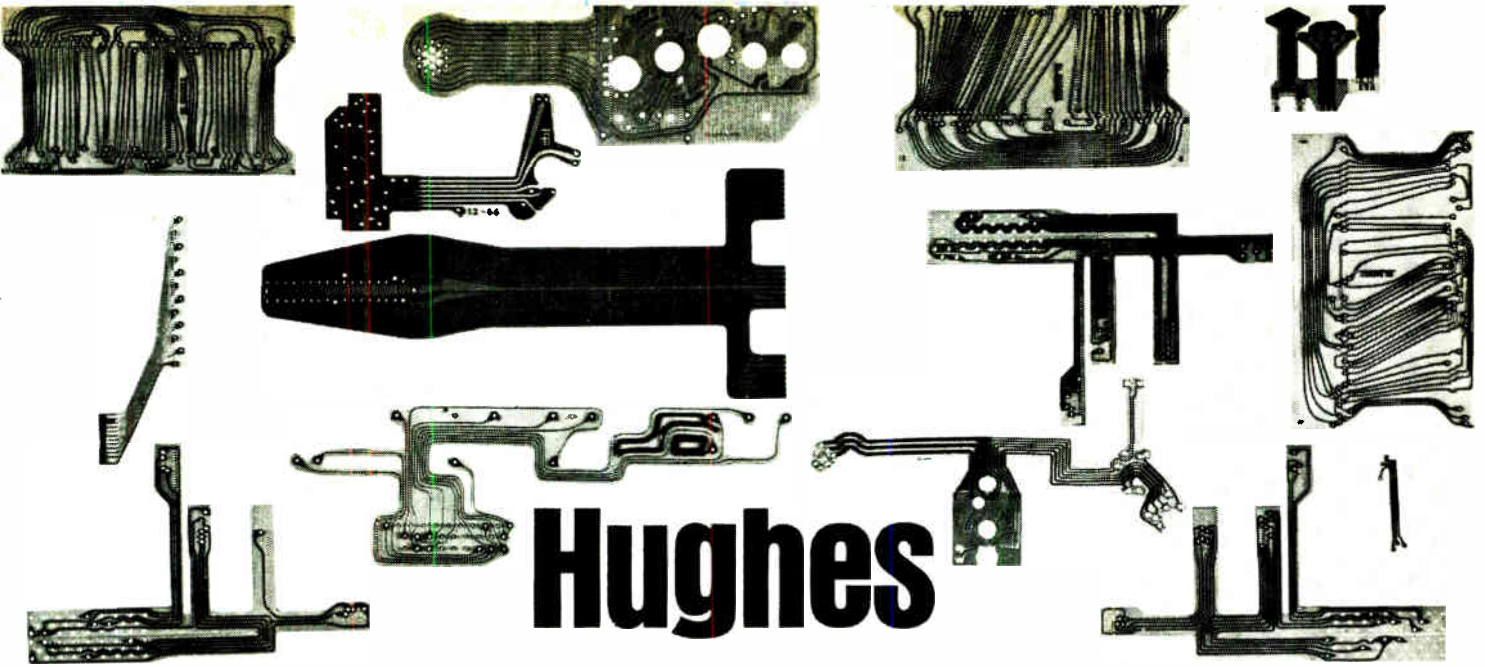

Hughes

lets you specify some great shapes in etched flexible flat cable...



and helps you put some new twists in the continuous kind

When your conductor system requires a circuit with three dimensional routing in a flat medium, or when your point-to-point wiring must exhibit simple or complex flexibility in a flat plane, or both — specify Hughes Contour™ Cable for the most advanced electrical interconnection systems available. ■ Hughes flexible etched flat cable designs and flexible flat continuous cable configurations are practically endless. They give you a design freedom and reliability unequalled in the industry, as well as answering all requirements of light weight, dense wiring systems and exact reproducibility in the most

demanding electronic systems. And termination poses no problems. The flat cable conductor itself can be used as the mating element, or the conductor may be mated with almost all existing circular or rectangular electrical connectors. ■ Regardless of your circuit problems, our application engineers can help you with specialized complete wiring interconnection systems for all military, industrial, or commercial applications. For engineering help or information contact Hughes Aircraft Company, Connecting Devices, 500 Superior Ave., Newport Beach, Calif. 92663. Phone 714-548-0671, TWX 714-642-1353.



HUGHES

HUGHES AIRCRAFT COMPANY
HUGHES CONNECTING DEVICES



COMPONENT CAPSULES

General Electric VTM's develop over 500 watts to give you a better ECM device

No other electronically tuned device on the market today can match GE Voltage Tunable Magnetrans for power output (over 500W) and conversion efficiency (to over 70%).

Magnetic shielding virtually ends degaussing effects in GE VTM's. Tube/equipment inter-

Highest volumetric efficiency at half the size—with GE wet slug capacitors

GE 69F900 wet slugs meet high-density application needs with highest volumetric efficiency of any capacitor. We halved the military (CL64) wet slug size, and essentially kept its electrical and performance traits.

The 69F900 has excellent capacitance retention at low temps . . . can be

Alnico 5-7 magnetic material—a great improvement over Alnico 5

GE Alnico 5-7 improves or equals performance of conventional Alnico-5—with reduced magnet length, smaller cross-section.

Alnico 5-7 has great advantage where space and weight must be minimal, and high demagnetization resistance is required.

Specify Volt-Pac® variable transformers for maximum life, minimum maintenance

Construction is the key to Volt-Pac's optimum performance. Here's why.

A spring-loaded, grain-oriented carbon brush means even contact, reduced wear. Self-lubricating nylon bearing lessens voltage selector friction.

Here are more features—Polyesterimide in-

Bonded heater version of popular 7077/7486 tube now available

The new GE16411 may solve your most perplexing oscillator problem.

This small planar triode provides low levels of oscillator side-band noise. A bonded heater addition makes the GE16411 useful under high shock, vibration conditions.

GE16411 recently made possible significant im-

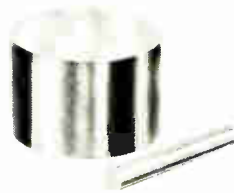
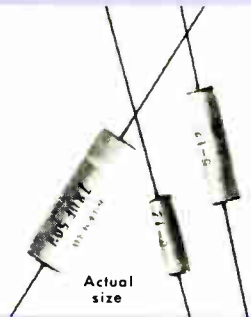

Manual uncased unit, exposed terminals

Actual size

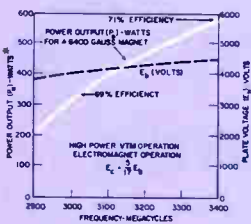

stored to -65°C . Operating range is -55°C to $+85^{\circ}\text{C}$. It's tough too—withstanding vibration to 2000Hz; 15G acceleration!

GE's new capacitor is fully insulated; has low, stable leakage current. Ratings are available from 6 to 60 volts; capacitance ranges from 0.5 to 450 μf .

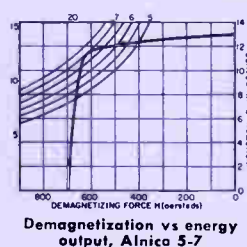

Demagnetization vs energy output, Alnico 5-7

sulation of coil windings gives extra reliability. Aluminum radiator and base evenly dissipate heat, extend life. Gold-plated track reduces possible heat build-up at brush contact, minimizes burn-out risks.

A-c voltage range of these autotransformers is zero to 100%, or 117% of fixed-input voltage without waveform distortion.

Manual or motor-operated Volt-Pacs can be ordered with or without enclosures, and with exposed or covered terminals. For more Volt-Pac facts, Circle Number 234.

provement in short-term, long-term stability characteristics in a spectrum-analyzer design.

It also provides direct retrofit fast warm-up capability for the 7077/7486 family—about 3 seconds to 90% of steady-state plate current.

The new triode is another example of how GE product improvements can aid you in designing reliable, top performing equipment. Circle Number 235 for more information.

face problems are minimal—each VTM can have an integral isolator designed for your system.

Airborne application features are: linear electronic tuning, rapid modulation, minimal power variation over the band, temperature compensation, and light, compact packaging.

GE VTM's are offered in low-, intermediate-, and high-power configurations for other microwave applications. Circle Number 231 for more details.

* Recent developmental model

RATING	CASE SIZE	VOLUME
50V, 30 μf	solid (CS12)	.341X.750 100%
	wet slug (CL64)	.281X.681 58%
	69F900	.145X.600 15%
15V, 80 μf	solid (CS12)	.341X.750 100%
	wet slug (CL64)	.281X.681 58%
	69F900	.145X.600 15%
6V, 180 μf	solid (CS12)	.279X.650 100%
	wet slug (CL64)	.281X.641 100%
	69F900	.145X.600 25%

Circle Number 232 for more data.

Typical applications for Alnico 5-7 are high-density meter movements; electron tube devices; compact loud speakers; motors and generators.

Let our engineers work with you to design a Cast Alnico 5-7 magnet for your application. Circle Number 233 for technical and ordering information.

A TECHNICAL DIGEST FOR INNOVATORS OF ELECTRONIC EQUIPMENT

High performance d-c motors for computer and peripheral jobs

New Hyper-Servo* d-c motors meet needs of single-capstan tape transports, disc packs, high-speed printers, card sorters and similar equipment.

Hyper-Servo motors offer **instant response**—to one millisecond!; up to 50 times more **frequency response** (band width)

*Trademark of General Electric Co.

Don't miss this one—smallest 50 mW, 2-amp relay on the market

It just takes 50 milliwatts to operate this extra small, 2-pole, 2-amp-relay.

Size-wise, this newest GE 150-grid relay is only 0.32" high, 0.31" wide, 0.61" long. And, it meets or exceeds MIL SPEC environmental, electrical requirements.

Micro-electronic circuit

Check these Darlington amplifiers for high gain

GE D16P monolithic Darlington amplifiers (D16P1, 2, 2N5305-8) with current gains as high as 70,000 are available in 2 housings. They offer dissipation capability of 400 mW or (with heatsink package) 900 mW.

D16P's high gain is ideal for preamplifier input stages requiring input

Nickel-cadmium batteries are rechargeable—last hundreds of times longer

Get lasting battery power and versatility suitable for many commercial and consumer applications. Types include sealed, pressure-relieved, and vented cells. Custom designs to your specifications are also available.

Nominal ratings range from 0.1 amp-hours to 4.0 amp-hours in sealed

New catalog has full information on GE panel instruments

What's your special requirement for panel instruments? Taut band suspension, special scales or colors, one percent accuracy?

Check General Electric—we're now offering the biggest selection of sizes, ratings, and models ever!

The new GE catalog, GEC-1076, gives you



Model 5BLG32HA1
(3.4" dia, 4.28" long)



Actual size



D16P



than standard d-c industrial motors.

Fast, repeatable acceleration is easy with: low rotor inertia, armature circuit inductance, resistance; high torque-to-inertia ratio, constant torque-per-ampere relationship, voltage constant. Circle **Number 236**.

Model 5BLG32HA1

Rated Armature Voltage	12 volts
Current	8 amps
Rated Torque	32 oz-in.
Rated Speed	2700 rpm
Rated Output	64 watts
Shunt Field	PM shunt
Arm. Circuit Inductance	82 μ H
Resistance	.43 ohms
V Constant	.0291 V Sec./Rad
Torque Constant	4.0 oz-in./amp
Arm. Inertia	.0028 oz-in. Sec ²
50 Milliseconds Pulse Torque	320 oz-in.
Pulse Current	80 amps
Time Constant Inertial	9.0 ms
Inductive	.19 ms
Torque/Inertia @ Rated V	40,000 Rad/Sec ²
Continuous RMS Current Rating	8 amps

applications are ideal for this relay because of its low operate power and compatible size.

Like all GE 150-grid relays, this 50 mW version is available with options. You can choose coil ratings for a wide range of system voltages, plus popular mounting forms and heater types.

Want more facts? Circle **Number 237**.

impedances of several megohms.

GE's D28C monolithic power Darlington also offers very high gain (60,000 typical at 200 mA) with higher power and current ratings. Dissipation is 1.2W in free air and 4.0W at 70C case. Continuous IC is 500 mA.

The high gain affords virtually unlimited applications including: power transistor drivers, touch switches, oscillators, amplifiers and buffers, plus audio output stages for TV, radio, and other audio equipment. Circle **Number 238**.

cells and up to 160 amp-hours in vented types at the one-hour rate.

GE nickel-cadmium cells feature unique construction providing a very high discharge rate capability. To find out more, Circle **Number 239**.

prices, technical and ordering information on the full line of General Electric panel meters, meter relays, controlling pyrometers and other related components. It also describes a sales and service army that backs up all your **SPECIAL** requirements. To order your free copy, Circle **Number 240**.

FOR THE NEW IDEAS IN ELECTRONICS, look to General Electric—your best single source for electronic components

ELECTRONIC COMPONENTS SALES OPERATION

GENERAL ELECTRIC

how big is a **micron?**

This page
could hold
6,914,128,443.75
round dots
one micron
in diameter

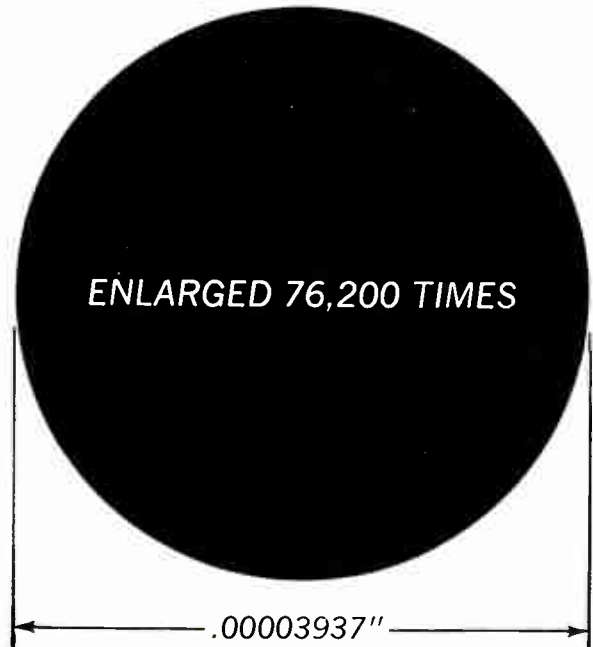

We etch metal to micron tolerances every day

Ultra-precise photomechanical reproduction of metal and glass parts is our business. We're very good at it. We've been precision etching on a quantity production basis since we made fire control reticles and other parts for the military in World War II. Now, with equipment like our new BMAPS computer-plotter system, we do it better and faster.

We picture a micron dot because we do work regularly to tolerances of microns, or even millionths of inches. As an example, with Buckbee-Mears electroforming we produce standard stock sieves down to 5 micron hole sizes, guaranteed accurate within ± 2 microns. These are shelf items, quantity produced. On hand-picked spe-

cial we can do better.

If you need a little less precision—for fewer dollars, of course—check our prices and delivery times for more routine etched metal or glass parts. We can make virtually any part that can be drawn on paper. Our prices are fair, and we think 10 days is long delivery.

Ask us about your requirements. We look upon ourselves as professional problem solvers. We have an impressive list of companies we have helped, and we'd like to add your name to the list. Call or write us today. The first man to talk to is Bill Amundson, our industrial sales manager.

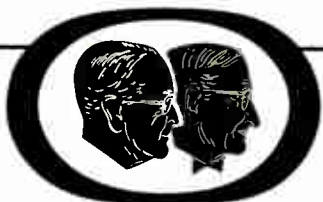

BUCKBEE-MEARS CO.

245 E. 6th St., St. Paul, Minnesota 55101 / (612) 227-6371

The world leader in precision photomechanical reproduction

New Tally HR 150 perforated tape readers run for reliability. With zero preventive maintenance, the reader is designed for a minimum life of 10,000 hours. In typical reader applications, minor failures would be experienced less than once a year. Day after day, month in, month out, these new readers will give you "full bore" performance without costly downtime.

These remarkable "state of the art" readers operate asynchronously

and bidirectionally at 150 characters per second and feature a compact, self-contained design, low noise level and essentially zero preventive maintenance. Heart of the new reader is a new stepping motor technique which permits true pulse by pulse operation and avoids the wear and tear caused by continuously moving parts.

Tape loading is easy and fast. Reeling tension arms can be locked upright for convenient tape threading. Rewind is bidirectional at 40



inches per second.

For full price, delivery, and technical information, please write Tom Tracy, Tally Corporation, 1310 Mercer Street, Seattle, Washington 98109. Phone: (206) MA 4-0760. In Europe and the U.K., address Tally, Ltd., 6a George Street, Croydon, Surrey, England. Phone: MUN 6838.

Circle 153 on reader service card

The Long Distance Runners...

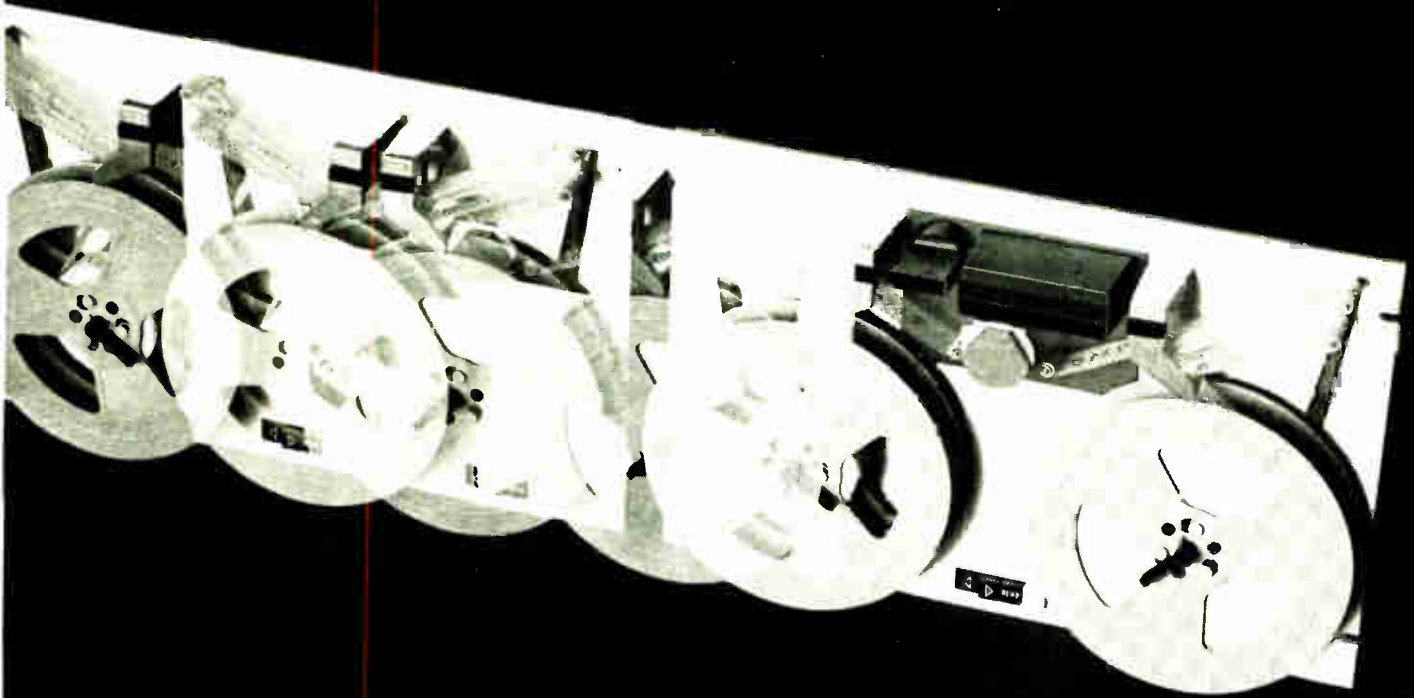

LASER PRODUCTION INTERFEROMETRY

... a new approach
to linear
measurement
provides
high-precision
production floor
inspection with
speed and
economy

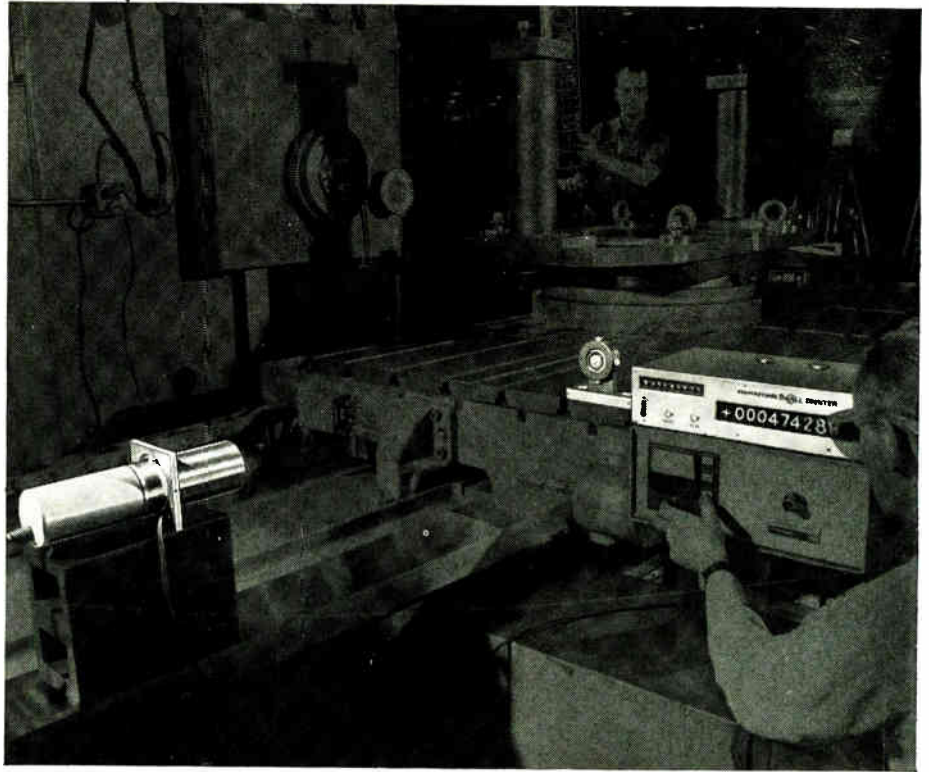

New compact optics puts interferometer in 3½-in. diameter tube, revolutionizes absolute long-length measurement on production work. Model 121, in a 16 in. long tube, is double-path interferometer with self-contained laser and power supply, designed for N/C machine tool calibration. Model 127, in 8-in. long tube, is single-path interferometer, operates with external single-mode helium-neon laser, designed for measuring machines or permanent installation on machine tools, for two-axis monitoring with single laser.

New portability—all components small enough to fit into an overnight case.

New high-speed counters designed and built by DoALL with micro-miniature integrated circuits. Bidirectional counters handle counting speeds to 10 Megahertz, ideally suited for fast target travel such as N/C machine rapid traverse. High-counting capability eliminates effect of shock or vibration.

New modular flexibility—extra modules extend the capability to suit job requirements. A plug-in computer conversion board changes the visual nixie tube display from ambient fringe count to direct readout in inches or centimeters. Also, modules are available to compensate for temperature and pressure variations in the operating environment.

New distance capability—the helium-neon laser handles measurements up to 100 ft. without repositioning.

New practical price—less than other instruments presently available to do the same work.

Find out for yourself what this new long-distance measurement system can do to cut the cost of quality control on production work. Call the nearest DoALL store. Ask for a demonstration in your plant on your work.

DoALL Company, Des Plaines, Ill. U.S.A., 60016 (in greater Chicago area)

Go with **DoALL** ... the Productivity People

From The Millimeter Men at TRG...



...the widest choice of components and instruments for millimeter systems anywhere

Getting the millimeter components you need for R&D systems can be time-consuming business. Especially if you are forced into do-it-yourself solutions. The Millimeter Men at TRG can spare you all this. They offer today's most comprehensive line of standard millimeter components. Variable and precision attenuators, wavemeters, slotted lines, phase shifters, terminations, antennas — whatever your system requires in the 12.4 to 220GHz range, TRG can supply it. We are also uniquely qualified to design special components, or assemble systems to your specifications. For widest choice — and uncompromising quality — look to TRG. Write for new short-form catalog to The Millimeter Men, TRG Division, Control Data Corporation, 404 Border Street, East Boston, Massachusetts 02128. Telephone 617-569-2110.



TRG Series 510 Precision Direct Reading Attenuator, a rotary vane type wave-guide covers the full wave-guide band with precise, repeatable attenuation values independent of operating frequency.



Circle 155 on reader service card

Tektronix 50-MHz dual-beam oscilloscope

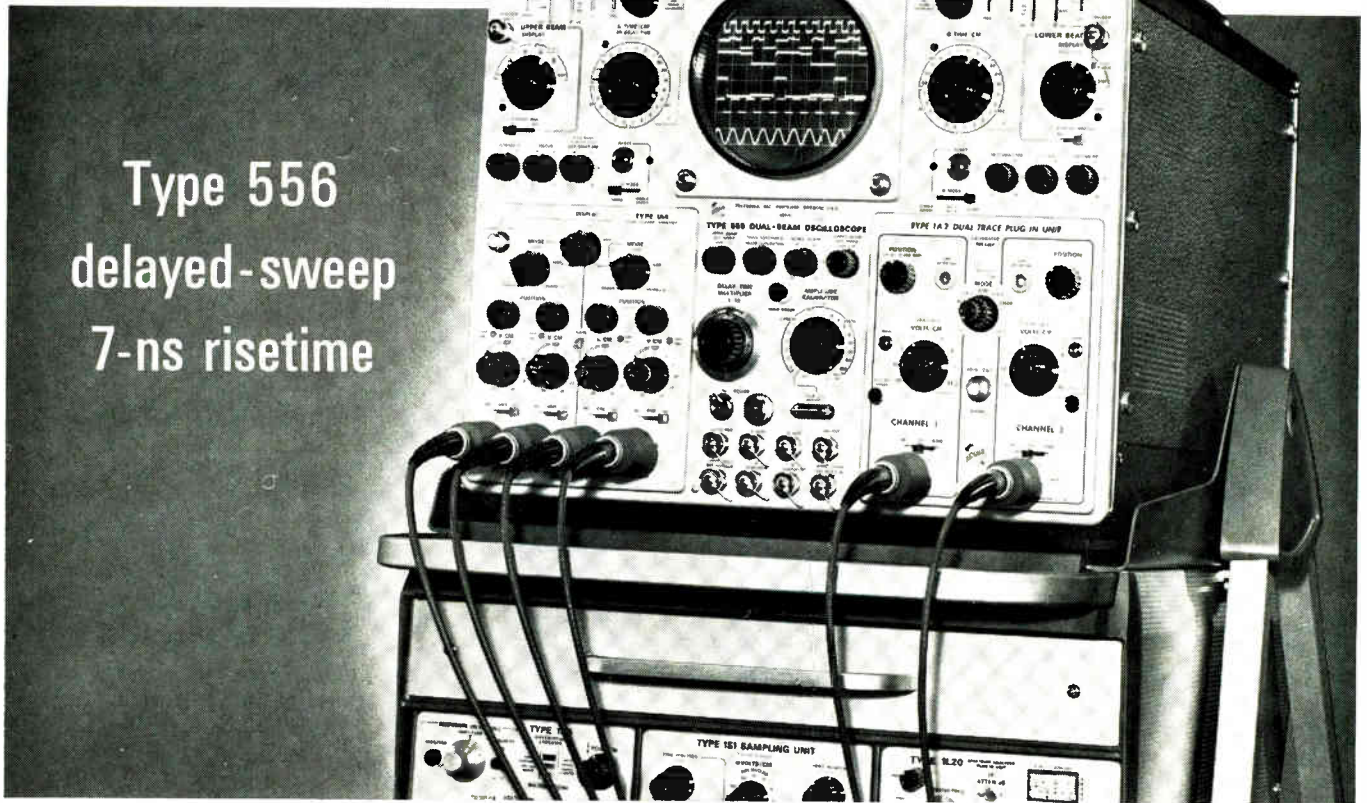

Type 556
delayed-sweep
7-ns risetime

The Tektronix Type 556 Dual-Beam Oscilloscope features 50-MHz bandwidth, calibrated sweep delay, 6 x 10 cm scan per beam and dual plug-in flexibility. Using two plug-ins at a time, the Type 556 offers many display combinations, including: dual-beam single-shot; multiple-trace; sampling and real-time; frequency and time; delaying and delayed sweep. The two independent horizontal deflection systems provide full bandwidth triggering and calibrated sweep speeds from 5 s/cm to 100 ns/cm, extending to 10 ns/cm with the X10 magnifier. The calibrated sweep delay range is from 100 ns to 50 seconds.

The Type 556 with the Type 1A4 Four-Channel Plug-in and the Type 1A2 Dual-Channel Plug-in provides up to six channels, each with 7-ns risetime and DC-to-50 MHz bandwidth. (Up to eight traces with two Type 1A4 Plug-ins.) You can also select from differential plug-ins with bandwidths to 50 MHz, TDR and sampling plug-ins with 90-ps risetime, and spectrum analyzer plug-ins that cover the spectrum from 50 Hz to 10.5 GHz.

For a demonstration, contact your nearby Tektronix field engineer or write: Tektronix, Inc., P. O. Box 500, Beaverton, Oregon 97005.

Type 556 Dual-Beam Oscilloscope	\$3250
Type 1A2 Dual-Trace Plug-in	\$ 340
Type 1A4 Four-Channel Plug-in	\$ 780
Type 205-2 Scope-Mobile® Cart	\$ 135

U.S. Sales Prices FOB Beaverton, Oregon

Multi-Trace

The six waveforms are time related digital pulses. The upper four displays are A Sweep (2 μ s/cm) with the Type 1A4 Four-Channel Plug-in. The lower two displays are B Sweep Delayed (100 ns/cm) with the Type 1A2 Dual-Trace Plug-in.

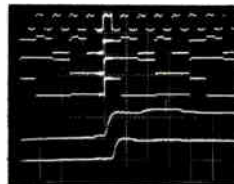

Sampling and Real-Time

The upper beam shows a square wave at 2 μ s/cm as applied to a Type 1A2 Dual-Trace Plug-in. The lower beam shows the risetime of the same pulse with the Type 1S1 Sampling Plug-in at 1 ns/cm.

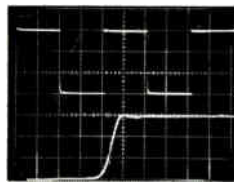

Frequency and Time

The upper beam shows the spectral output of a 200 MHz gated oscillator applied to the Type 1L20 Spectrum Analyzer; calibrated dispersion is 1 MHz/cm. The lower beam shows a real-time display of the 2.5 μ s gating pulse.

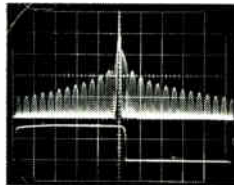

Multi-trace, differential,
sampling and spectrum analysis

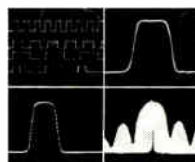

... in all Tektronix 530-540-550-series
plug-in oscilloscopes

Probing the News

Systems engineering

Electronic traffic control: can it make the grade?

Most engineers are optimistic, but unreliable hardware and high costs are creating many problems for the cities

By Howard Wolff

New York bureau manager

Inside every traffic engineer there's a systems designer screaming to get out. His frustration comes from looking at the infuriating tableaux that have become commonplace in American cities:

- A line of autos waits at a corner for the light to change even though nothing is moving through the intersection from the other direction.

- A string of signals along a broad, one-way avenue is set to keep things moving at 25 mph during the 5 o'clock crush when actual speed is 5 mph.

- Cars are backed up diffidently on a freeway entrance ramp as traffic on the freeway itself swooshes by at 60 mph.

Everyone agrees that there must be a better way. Virtually everyone agrees that electronic traffic control is the answer. But almost no two authorities agree on just what mix of available hardware—sensors, detectors, controllers, computers—can do the job best.

Better mousetraps. The people who design the equipment and those who buy it tend to operate on different wavelengths. The electronics engineers, in the words of one disgusted civil servant, "are obsessed with state of the art, with super-sensitive devices that can't be repaired by anyone who didn't go to MIT, and with the notion that money is no object." Adds another:

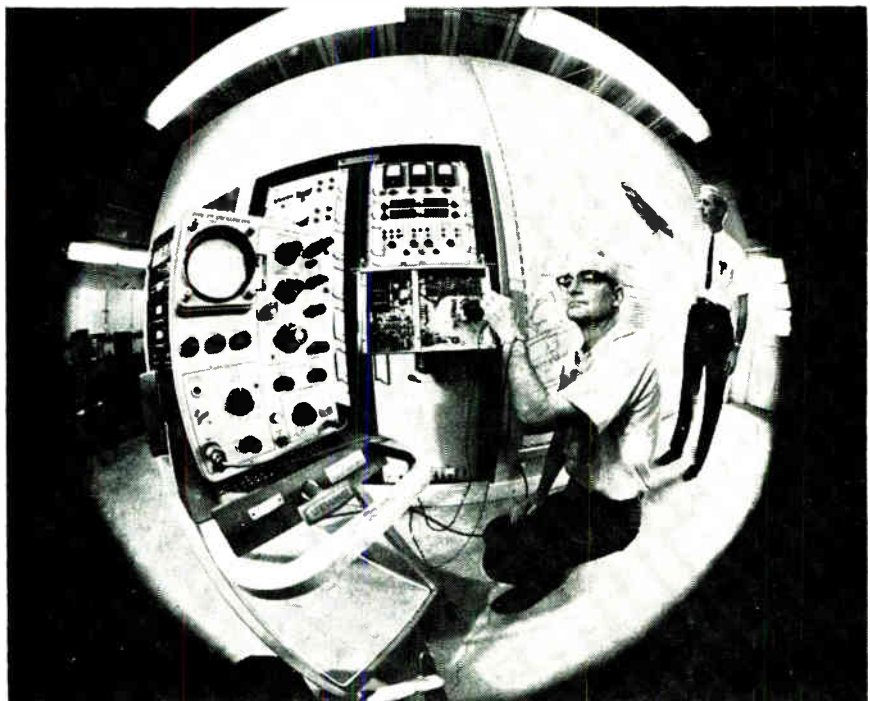

Eye of the storm. Bill Gemell of the Long Beach, Calif., traffic department checks one of city's four eight-year-old computers.

"They seem to consider traffic control a nice little market for stuff that was designed to find out if there's life on Mars."

In fairness to the EE's, though, it's a rare traffic man who knows what's available and what he wants. One of those rare ones is Henry A. Barnes, New York's outspoken traffic commissioner. Not only does he know what's available and how it's

being used around the world, but he also likes to talk about it.

"What the electronics industry needs," says Barnes, "is a system permitting cities to use their present street-corner controllers. Such a system should be modular, in increments of 100 intersections, to get the cost down to where smaller cities could afford the investment." And Barnes, still feisty after his un-

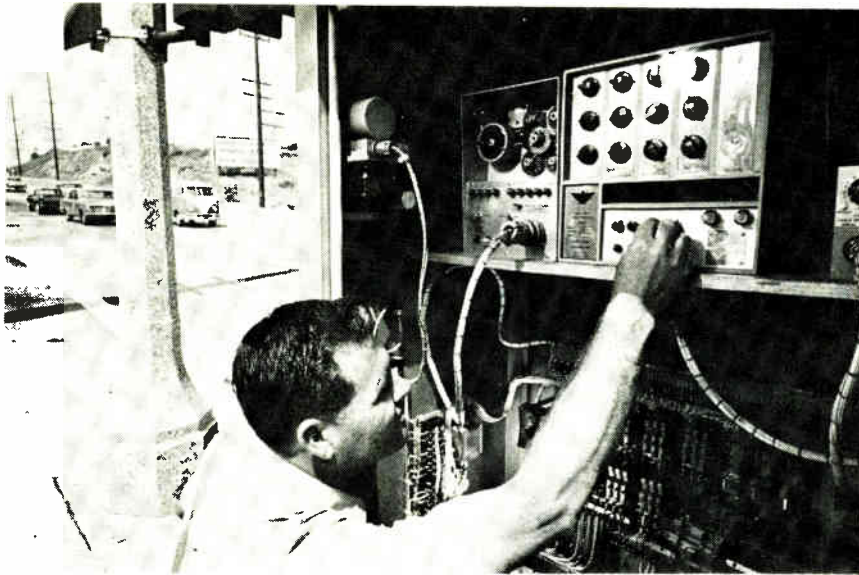

Man in the street. Long Beach's Don Riedel, traffic signal foreman, works on Eagle signal controller on Pacific Coast Highway.

happy, and much-headlined, three-year experience with the Sperry Rand Corp.'s Gyroscope division, is about to put his money where his mouth is: New York City plans to try out an International Business Machines Corp. system that incorporates controllers already installed on the city's corners.

I. Bumpy road

The Barnes-Sperry contretemps could well serve as the first chapter of a textbook on how not to do business with a municipal government. The \$5.4 million contract, awarded in 1965 and canceled last January, was to be Sperry's entree into the traffic field; in fact, the company is believed to have underbid experienced competitors by more than \$1 million because New York intended eventually to spend \$100 million on traffic control. The key to the situation appears to be changes made by Sperry in the original specifications, changes Barnes feared would leave the city open to lawsuits from the unsuccessful bidders. Not only that, but delivery of hardware was running more than two years late. "They just couldn't get the stuff to work," says Barnes. He also insists some equipment that was delivered was shoddily made. He says that on one controller shown to him by Sperry, he was able to loosen 23 screws with his thumbnail.

A considerable amount of hardware was called for. There were 1,052 detectors (which determine the presence of a vehicle); 1,397

sensors (which determine vehicle speed and direction); 2,693 controllers; 10 zone computers; and one central computer. It all would have been used to control 2,693 intersections, or less than 400 of the city's 6,000 miles of street. The sensors were to have been doppler-radar affairs mounted 17 feet above the pavement and operating in the S-band at 2,455 megahertz. But none was ever delivered; Barnes says Sperry couldn't get them to measure speed properly. All of the 58 controllers delivered failed. "The company then said it couldn't service them," adds Barnes. The computers were to have been digital Univac 413's; these machines are modifications of the 418.

Stuck in traffic. Sperry Gyroscope spokesmen refuse to talk. Barnes is more than willing. He says that Sperry considered the order peanuts when stacked beside giant Federal contracts, and tended to take engineers off the New York job for reassignment to those more lucrative projects. Furthermore, Barnes maintains, the company's lack of experience in the traffic field stuck out like a red light and "top management" failed to exercise proper supervision. Even an 11th hour management shuffle failed to save the contract.

In the words of one man close to the situation, "What Barnes says is pretty much the way it was. It would be kind to say a nice word about Sperry's role, but it's difficult to think of one."

II. Keeping the motor running

Meanwhile, IBM, one of the unsuccessful bidders for the New York contract, kept working quietly on a traffic control system of its own. What has emerged is a picture of simplicity and economy: an off-the-shelf model 1800 computer that interfaces with existing street-corner controllers.

Go west. IBM got its feet wet in San Jose, Calif., [Electronics, Nov. 14, 1966, p. 221]. The system was installed in 1965 using a model 1710 computer contributed by the company, but the city has since purchased a faster 1800 for \$200,000. Induction-loop sensors are imbedded in the pavement, setting up magnetic fields that are interrupted every time something metallic enters. Some of the loops are made by the Link group of the General Precision Systems Corp., some by RCA, and still others are homemade.

The computer, which can implement 128 timing patterns at each intersection, makes a total of six measurements.

Mecca. San Jose has become something of a star in the west for U.S. traffic men. They flock there to examine the traffic-control system in action and generally agree it's potentially one of the best around. Yet, many leave shaking their heads. The reason, in the words of one visitor: "Why don't they use the darned thing to control traffic? They kept showing me reams of statistics—numbers, numbers, numbers collected by the computer. They're so interested in proving that they saved the local drivers 1,500 seconds yesterday that they're ignoring the real reason the whole shebang exists."

The 1800 is so loaded down with engineering and statistical tasks that it's available for actual traffic control only a few hours a day. There appears to be disagreement within the traffic department on whether to control traffic or do research on traffic control.

In or over. The use in San Jose of buried loop detectors has contributed to an intrafraternity disagreement along the lines of buried vs. pole-mounted detectors. Backers of buried-loop devices say they're less likely to provide false measurements, are immune to weather, and are less expensive. The pole sitters

insist that such devices—ultrasonic or radar—are easier to install and maintain, don't interfere with buried cables and lines, and are capable of wider coverage. New York's Barnes points out that most of his streets have no foundations and therefore shift constantly, and that it's ridiculous to tie up traffic while burying the loop inductors or digging them up later for repairs.

Still, the majority appears to favor the loop. The Philco-Ford Corp.'s wtr. division in Palo Alto, Calif., is believed ready this summer to start selling a solid state loop, using metal oxide silicon integrated circuits. It's now being tested in Palo Alto and Oakland, Calif. However, Howard W. Carmack, assistant superintendent of Oakland's electrical department, feels that IC's are unnecessarily sophisticated for traffic controllers. Relays, he says, operate fast enough and aren't apt to go off half-cocked because of environmental noise.

The source. One can even get an argument that it's the computer, not the sensors and detectors, that counts in electronic traffic control. The man behind that argument, Oser I. Bermant of IBM, was also one of the men behind the San Jose installation.

His thesis is that problems arise when analog computers are used. Such machines, he maintains, can't tell when a sensor has gone wrong. Digital computers, on the other hand, can be programmed to check each detector or sensor continuously; when a failure is noted the computer can correct it or signal for repairs. "Digital computers have changed the game," says Bermant. "They can offer flexibility, analysis, and economy."

While Bermant's view could be called part of his job, the rate at which IBM is convincing cities that the digital route is the way to go lends extra weight. Wichita Falls, Texas, has 57 intersections under 1800 control; Portland, Ore., will link 85 intersections with an 1800 later this year; and Austin, Texas, will hook up 48 intersections, to be expanded to 200, with an 1800 in the fall. And, adds Bermant, IBM is going after "quite a few" additional contracts.

The other fork. Despite IBM's success, many cities are skeptical about the efficacy of computers in

What the auto makers say

Car makers have not only thought about electronic vehicle controls, they have pioneered in them, in line with the industry philosophy that in order to remain competitive, it is necessary to have as much advance knowledge of market conditions as possible. In the case of science and technology, this means wading right in at the research stage.

General Motors. GM's Research Laboratories have had programs on development of "automatic highways" since 1956. Included in GM's 1965 experimental Firebird III prototype car was an electronic steering system. Called Autoguide, the system included two pickup coils suspended beneath the forward end. They picked up signals from a cable imbedded in the road. The signals were ciphered by a small inboard computer and the car's steering system was automatically actuated to keep it on course.

GM also has constructed and tested in miniature an automobile control system. Utilizing sunken highway cable, the system allows for automatic vehicle spacing, steering, and collision prevention—by slowing and, if necessary, stopping a car when it gets too close to one in front of it.

GM had an extensive program with RCA in 1959, which culminated in the construction of an experimental automatic highway system at the RCA labs in Princeton, N.J.

Last July, General Motors Research Laboratories received a \$493,000



Follow me. Experimental Route Guidance System provides head-up display mounted on dashboard to give directions.

Federal contract to develop hardware for and evaluate a highway route guidance system. The contract called for:

- Experiments and instrumentation needed for an objective evaluation of route guidance.
- Practical hardware to investigate the feasibility and cost of a national routing system.

In line with the contract, GM has submitted plans for the hardware, supposed to be ready this June. The guidance system will work this way:

At the start of a trip, the driver dials his destination code into route guidance equipment inside the car. The vehicle automatically transmits the code to roadside equipment at key points enroute. After processing the code, the roadside equipment signals the driver by visual display or electronic voice inside the car, and gives him proper routing instructions.

Ford. A recently established Department of Transportation Research and Planning at the company will study all phases of vehicular activity as it relates to the over-all environment.

Foster Weldon, who heads the department, says Ford's programs are built around video readout computer simulation techniques using mathematical models of the various factors that make up urban areas—physical, social, political, and economic.

A complete specification of the components—decision options—of a transportation system is fed into a series of computerized models that calculate transportation supply and demand relationships, interpret pricing, and predict effects of the system on growth and form of the region. Among the transportation systems under study is automatic vehicle control.—Vince Courtenay

We just took a great step backwards



(with three new, forward-looking unitized DVMs)

Trymetrics' new 4243 Digital Multimeter with AC, DC and OHM readings—auto polarity—full four digit—.01% (\$850) . . . a tremendous step backwards. And so are the 4240 DVM (\$695) and 4230 DVM (\$595).

We started with our Model 4100: stored display—precision .01%, four-digit DVM and its full range of plug-ins for the price of an ordinary 3-digit job—just \$740 with the $\pm 9.999v$ DC head; \$1045 with a complete multimeter head; and eight other plug-ins to choose from. For an encore, the only way to go was down.

Down \$195 to \$850 for the versatile 4243 Digital Multimeter: DC-AC-OHMS .01% — auto polarity $\pm 999.9mv$ to $\pm 999.9v$. Same 4-digit stored display—no plug-ins. Sorry—unless you don't need plug-ins.

Down again, \$155, to \$695, for the 4240 DVM. Same high accuracy, same stored display, same $\pm 999.9mv$ DC to $\pm 999.9v$ DC 4-digit measurements. But, no AC or OHMS—unless, of course you don't need AC or OHMS.

Once more, down, to \$595 for the Trymetrics 4230 DVM. Still the same precise 4-digit unit with readings $\pm 9.999v$ DC to $\pm 999.9v$ DC. Don't buy this one if you need to measure in the low millivolts.

You don't need true 4-digit readout with .01% accuracy at a 3-digit, .05% price? Sorry—but we can't keep backtracking forever. May we send you our new catalog that shows ALL our models, all our plug-in versatility, all our reasons for going backwards?

PRICES SLIGHTLY HIGHER IN EUROPE

TRYMETRICS
Corporation
A SUBSIDIARY OF IMYCON ELECTRONICS, INC.
204 Babylon Tpke., Roosevelt, L.I., N.Y. 11575
Phone 516-378-2800

. . . but the City of Angels gave up, went back to the old timeclocks . . .

general and digital equipment in particular. One is Seattle. Robert Warr, senior traffic engineer for signal systems there, says: "The electronics industry has offered a lot of fancy systems no one knows how to run. Computers have their place, but sometimes using a computer to control traffic is like using a shotgun to kill a fly."

All the same, Seattle is spending about \$100,000 a year on control equipment, the biggest project being conversion of 150 intersections in the central business district. That five-year program will be completed this year, with Automatic Signal, a division of Laboratory for Electronics Inc., the big supplier. Interestingly enough, Seattle's "shotgun" will be an analog machine.

Dallas Cooper, division superintendent of the Long Beach, Calif., Public Service department, has still another formula for success. "We've gotten pretty good results," he says, "because we've stayed with a proven system." That system includes four eight-year-old variable-frequency Eagle computers stuffed with vacuum tubes and loop detectors. There are four grids—the biggest involving 90 downtown signals—representing an investment of almost \$500,000.

Land of Lincoln. Illinois is funding, designing, and installing systems on main expressways surrounding Chicago with 90% of the money coming from Washington.

The original test was on Chicago's Eisenhower Expressway in April, 1961, and it was considered operational in November 1967 when Illinois installed control equipment on Chicago's Dan Ryan Expressway.

The system in Chicago is controlled by a General Electric GE/PAC model 4040 process computer, a machine that was originally sold as a data logger.

Chicago's system uses loop sensors to count the traffic, converting the count into traffic density, and uses traffic densities to control signal lights that regulate traffic flowing down entrance ramps into the expressway.

Comprehensive. Perhaps the most completely computerized traffic control is in Baltimore. The system, installed by Henry Barnes when he was traffic commissioner there, is now 10 years old and involves around 850 intersections—some outside the city. Seven Automatic Signal tube-driven analog computers do the controlling, and a variety of detectors—radar, loop, pressure, and sonic—are on the job. Norbert Nitsch, assistant commissioner in charge of signal engineering, says the system works "exceptionally well." Evidence of this is the fact that the U.S. Bureau of Public Roads says the system moves traffic so well that an expressway isn't needed by the city.

III. Red light

In one large city, all signals for electronic traffic control aren't go. Los Angeles is unconvinced.

Los Angeles' attitude is particularly surprising in view of its almost total dependence on the automobile. But a 28-signal system on Sunset Blvd. was switched back to timeclocks after two years, and the same thing was done after two-year trials on three principal east-west arteries—Wilshire Blvd., Olympic Blvd., and Sixth St. Says William Hutchinson, assistant city traffic engineer: "Recordings of traffic patterns at peak hours on those streets indicated they were predictable to the extent that we could rely on timeclocks."

Los Angeles used a TRW computer and peripheral sensing equipment. "The difficulty with the computer," says Hutchinson, "was that it would change the operational mode (signal patterns for the main artery as well as all cross streets) on the basis of what we would consider insufficient evidence. For example, during peak conditions the timing could be changed as often as every four or five minutes merely because a disproportionate amount of vehicles passed a particular point at a particular time."

IV. The searchers

Past, as historians like to point out, is prologue; no one knows this

better than engineers—traffic and electronic. So even as they argue gently about sensors, computers, and timeclocks, they are driving hard at test tracks and laboratories to make the future safer for mind and body of the Average American Motorist in his 400-horsepower Gaseater with the padded dashboard.

Detroit is the home of the National Proving Ground for Freeway Surveillance Control and Electronic Traffic Aids, which has tested various electronic traffic apparatus and systems since 1962.

The testing ground, a section of the John Lodge Freeway, is supported by the state of Michigan, Wayne County, city of Detroit, U.S. Bureau of Public Roads, and 13 other states.

Not here. In the 3.2-mile test stretch, traffic is directed by indicators above lanes that tell whether or not the lane should be used with either a red X or a green arrow. In conjunction with the lane signals, there is an electric signal board that indicates vehicular speed requirements for optimum traffic flow and safety.

Input data is gathered by closed circuit television cameras and ultrasonic sensors mounted on 14 freeway overpass bridges. The cameras provide ramp-to-ramp surveillance, and feed into a console bank of receivers at Proving Ground headquarters. All cameras are General Electric TE9 systems that span 30° left and right, have full tilt arc, and telephoto lens. Cost, including installation, came to \$10,000 per camera.

The sensors, made by the General Signal Co., bounce a pulse from the freeway. The return pulse is picked up and transmitted to a Control Data Corp. 8090 computer, which can assess vehicle count and speed with an accuracy of $\pm 20\%$.

Proving Ground engineers seek better detectors that will provide finer vehicle speed and count data. They suggest that doppler radar or light scan systems could be developed.

Reporting for this article was provided by Walter Barney and Peter Vogel in San Francisco, Bill Bell in Los Angeles, Ray Bloomberg in Seattle, Robin Carlson in Boston, Vince Courtenay in Detroit, Bruce Cross in Chicago, Barbara Koval in Pittsburgh, Bob Skole in Washington, and Mike Payne in London.

a quarter inch of infrared:

\$9.50

Order your samples now of this newest General Electric solid state lamp.

This new action-triggering device is called the SSL-4. It's a gallium arsenide solid state infrared lamp. A bit less than a quarter inch long (excluding leads), you can fit it almost anywhere. Use it in card readers and photo-electric applications. Also in counting devices, machine controls, safety and inspection devices and tape readers.

SSL-4 will withstand severe shock and vibration far better than any filament lamp. And it can be operated at up to one million cycles per second. So it's sure to play an important part in future computer design. And a look at the diagram below shows how it'll work with Semiconductor Product Dept.'s Photo-Darlington amplifier (L14B).

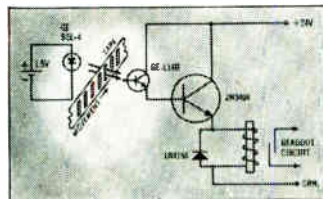

This is the third lamp in General Electric's growing SSL family. The others, SSL-1 and SSL-6, are 2-5 volt visible light sources operable to 10,000 cps. SSL-1, with a 60° viewing angle, is a perfect photocell driver. SSL-6 has a 180° viewing angle, ideal for indicating jobs.

Order Your Samples Now! You can use all three SSL lamps to save space, improve performance and reduce maintenance costs in your product. Find out how. Enclose your check, money order or purchase order for \$9.50 each with the coupon below. And do it now. *Sample offer on all SSL's ends June 30.*

For more information, send for free technical bulletins: #3-7384 (SSL-4), #3-8011 (SSL-1 and SSL-6).

Miniature Lamp Department

GENERAL ELECTRIC

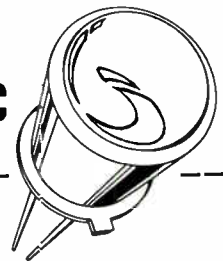

TO: General Electric Company
Miniature Lamp Department
P.O. Box 2422, Nela Park, Cleveland, Ohio 44112
Attn: J. D. McMullin

Please send me _____ new GE SSL-4 lamp(s) at \$9.50 each
Please send me _____ new GE SSL-1 lamp(s) at \$9.50 each
Please send me _____ new GE SSL-6 lamp(s) at \$9.50 each

Name _____

Company _____

Address _____

City _____ State _____ Zip _____

SOON OOO

Soon 0/0 landings (ceiling : 0/horizontal visibility : 0) through use of the new I.L.S. automatic landing system. Safety will now be determined by the precision of I.L.S. equipment. In order to test unquestionably its perfection, we have designed the most exceptional generator (Phase 3). This infallible instrument is a must in guaranteeing the workability of your I.L.S. system.

Immediately available : Type 310 - Phase 3 - I.L.S. generator.

- Accuracy :**
 - Frequency = 0,1 %
 - Amplitude balance 90/150 Hz -- Better than 0,02 dB (0,5 μ A)
 - Usually = 0,01 dB.
- Stability :**
 - Frequency = 5×10^{-3} %
 - Balance = 0,1 μ A
- Performance :**
 - Constant sum attenuator (90 or 150 Hz): 0 to 20 dB continuously (scale to every 0,01 dB).
 - Continuous frequencies variation = ± 3 %
 - Continuous variable phase = From sinus to co sinus.

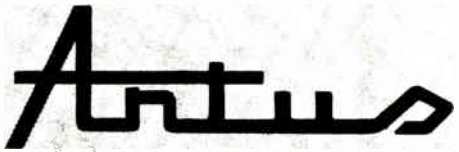
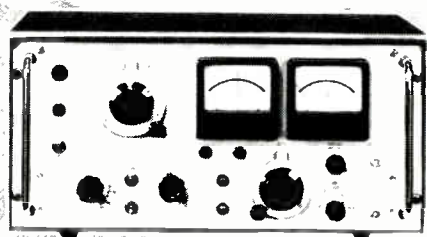

ARTUS ELECTRONIQUE 25, rue Ganneron - Paris 18^e - France (V.H.F. - U.H.F. - V.O.R. - I.L.S. Generators
Fifteen years experience of service to aerial navigation. (Agents in great demand in every country).

Simulators go to the head of the class

Airlines find electronic teachers cheaper, safer, and better than flight training, and will need more as new planes arrive

By Paul A. Dickson

Washington regional editor

During recent weeks, air carriers have been making what amount to mass purchases of the airbuses to be built by the Lockheed Aircraft Corp. and the McDonnell Douglas Corp. Eastern, Trans World Airlines, Delta, Northeast, and Great Britain's Airholding Ltd. have all signed up for L1011's or DC-10's.

But Lockheed and McDonnell Douglas aren't alone in their good fortune; producers of electronic simulators and visual aids also stand to benefit. For airlines are increasingly anxious to bring their flight-crew training down to earth.

For one thing, the skies are getting more crowded. For another, even more complex aircraft like the supersonic transport and the Boeing 747 are on the horizon. As a result, airlines are becoming more concerned about how to train their crews safely. Many now consider electronic simulators with realistic visual displays the most practical solution.

I. Safer, cheaper, and better

At a recent meeting of airline training officers in Washington, simulators versus in-flight training was a hot topic. Officials from a dozen or so carriers agreed that safety was the main argument for simulators, but the machines have lots of other advantages:

- **Economy.** The estimated cost of an hour's training in a 747 is more than \$2,000. An hour in a simulator costs only a small fraction of this and doesn't result in loss of passenger revenues.

- **Results.** "We can let a man do and learn things on the ground that he could never try in the air," says one official. And Frank Petee, the training manager at Allegheny Airlines, says, "In the case of a

Stand-ins

While airlines are getting ready to buy computer-controlled simulators, a complementary airborne scheme is also attracting attention.

The so-called stand-in simulator is a smaller aircraft rigged up to act like a larger one. Cornell Aeronautical Laboratories Inc., working under an Air Force contract, is modifying a Convair C-131 to give it the flight characteristics of much larger planes like the giant C-5A or the supersonic transport.

In the Cornell program, dubbed TIFS for total in-flight simulator, an extra cockpit is installed in the front of the Convair for the trainees. The existing cockpit is manned by two "safety pilots" who will take control in an emergency. An airborne computer, programmed with the characteristics of the larger aircraft, figures out how the smaller craft should act. Servos then drive flaps and other control surfaces to give the effect of the larger plane.

Cornell recently agreed to give commercial rights to the TIFS system to Aero Spacelines, a subsidiary of Unexcelled Inc. A spokesman for the company predicts sales of about 20 TIFS-type aircraft by 1972.

carrier like ours it isn't necessarily cheaper to use a simulator, but we rule out this factor because we feel they do a better job."

- **Convenience.** Flight crews can be ushered in and out of simulators around the clock without the red tape of flight clearances and other airport procedures.

Airlines are willing to pick up the first-class fares electronic firms are asking for sophisticated training devices. Over-all, U. S. airlines now have 56 simulators representing an investment of \$65 million to \$70 million. Most of these machines have been installed in the past five years. Before 1970, the carriers are expected to double their total investment by buying another 35 simulators. The new units will cost an average of \$2.5 million. General-aviation customers and overseas carriers will push the total market close to \$100 million.

Value added. Furthermore, the

advanced simulators will channel more money into other electronic training aids. For example, Pan American World Airways is thinking about using relatively simple procedural trainers controlled by a computer. The system would be used to prepare crews for a Boeing 747 simulator.

Although there are no projections for after 1970, there is every reason to believe that the market will continue to expand. A spokesman for the Air Transport Association sees two factors bolstering the upward trend: "The airlines are now becoming more and more dependent on simulators, and sales are tied to aircraft purchases, which are rising."

One manufacturer points out that in 1960 airlines might have had only one simulator apiece but are now averaging one for every 15 to 20 aircraft. The number of simulators could rise to one for every 10 to 15 aircraft when the 747 goes

NEW MAGNETIC RELAY plugs into your PC board!

NO Springs, NO Wiring,
NO Sockets, NO Soldering,
NO Mechanical Linkage

Printact®

Standard Series G
Latching Series LS/LD

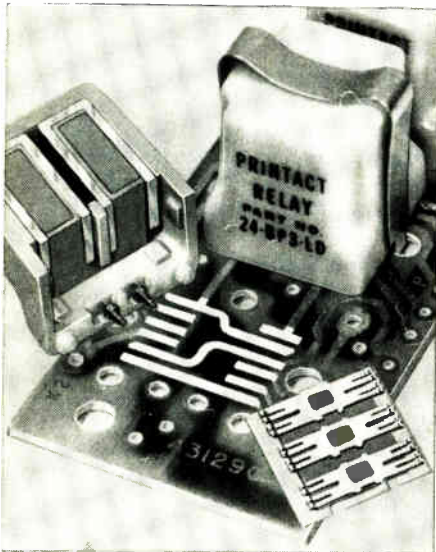

(actual size)

Plated Conductors on Your PC Board are the Fixed Contacts

Save SPACE, MONEY and MANHOOURS with these new small, lightweight, highly reliable Standard and Latching PRINTACT Relays.

Available with Bifurcated Palladium or Gold Alloy contacts for more than 10 million cycle 2 to 4* pole switching. Handles up to 2 amp. res. loads. Coils for 6, 12, 24 and 48 vdc at 500 mw. Operating temperature -30°C to $+95^{\circ}\text{C}$. Operate time 7 ms. The little gem is an 0.8 oz. $\frac{7}{8}$ " cube.

Quality features include: double-break contacts; balanced armature, enclosed housing, plug-in application; encapsulated coil; self-wiping contacts and inherent snap-action — saves sockets soldering, and wiring and the cost is lower than you think!

*Switches up to 4 form A plus B, or 4 form C.

For data and prices write or call:
212-EX2-4800

Executone

PRINTACT RELAY DIVISION
47-37 Austell Place
Long Island City, N.Y. 11101

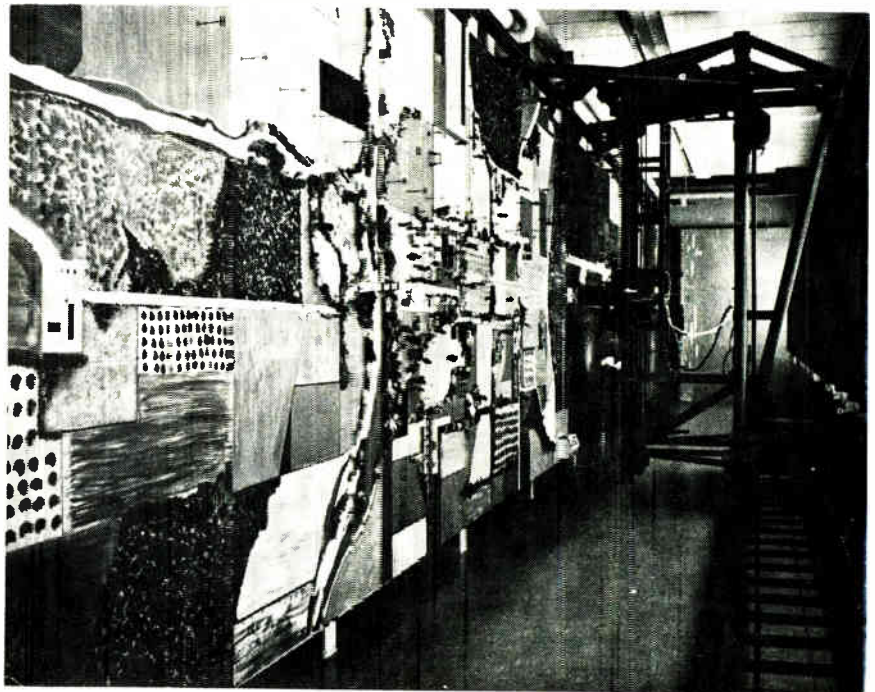
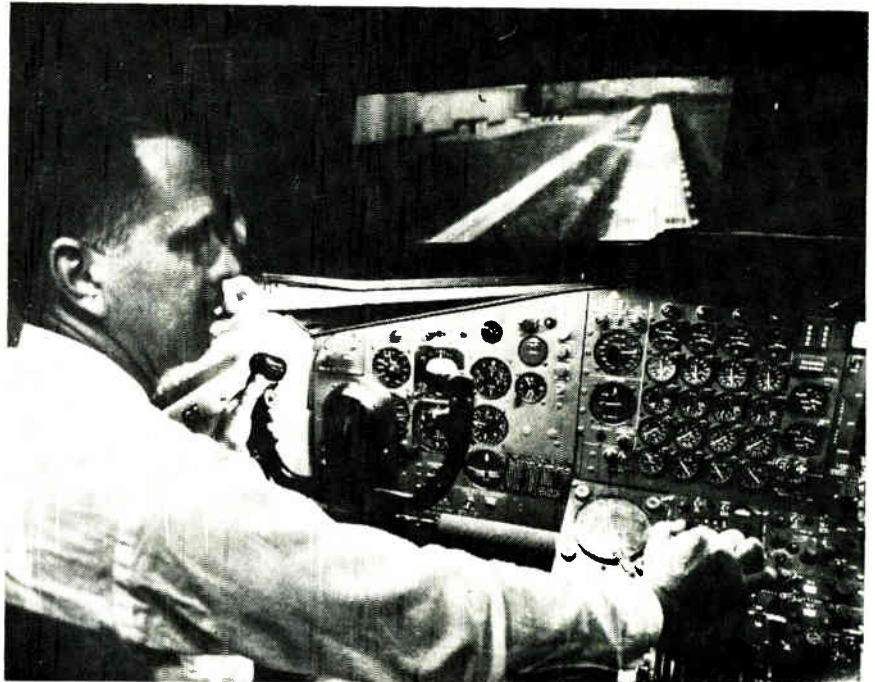

Truth in landing. The scale model of an airport runway looks like the real thing when viewed by TWA flight crews duplicating landings and takeoffs in simulator. Carriers are pushing for even better displays.

into full service. United Air Lines' experience at its flight training center in Denver typifies the carriers' new dependence on simulators. United, which now has 17 simulators, will receive another this month and has five on order: a Boeing 747 unit from the Link Group of the General Precision Equipment Corp. (with an option for another), two 747 simulators, a DC-8 machine, and a Boeing 727 unit from the Conduccion Corp.

Within a month United will select a visual system for the 747 machines from one of six competing firms. Herb Monroe, director of United's simulator division, says, "The visual system may be used with two or three existing simulators like the 727 or DC-8 units."

Monroe notes that the Denver center has already made room for a Concorde SST simulator and that by the end of the year contract requirements will have been defined.

Overtime. The center is using its simulators from 6:00 a.m. to midnight; the wee hours are reserved for maintenance. A United pilot now gets about 80% of his training in simulators.

The story is much the same at Pan Am. The line now has eight simulators at three training sites and will soon add a 747 simulator from Conductron to its facility at Kennedy International Airport in New York. Pan Am is now shopping for a visual system to supplement the 747 unit, and is considering adding visual aids to its older simulators. William Angleman, senior flight instructor, says the company is using its facility seven days a week, with only a few hours out for maintenance. Similar conditions prevail at other airlines.

II. Sight unseen

Although the market for simulators is maturing, the airlines are also getting more demanding. They're seeking more realism in the simulator cockpit and in the sound systems. However, the consensus is that the most pressing need is for better visual systems.

The airlines want improved visual training aids and have banded together to present their demands. Under the aegis of the ATA, eight lines have set up a committee and compiled a list of requirements for today's simulators and those to be developed for the SST and other advanced aircraft. Among the needs cited in a report issued earlier this year were visual representation of yaw and pitch and depiction of landing variables, such as engine reversing and braking. The committee would also like depiction of such operations as taxiing, docking, and circling.

The group requires a minimum field of view of 60° and has established specifications for resolution of the display.

Critics. The chairman of the ATA's training committee, John A. Walker, a Pan Am pilot, says: "Our ultimate goal is to do all flight training in simulators." However, there are only six visual systems for the 56 simulators now owned by the airlines.

Walter A. Moran, director of flight training at American Airlines, says existing visual simulators are "quite limited in terms of replac-

VICTOREEN METAL OXIDE GLAZE RESISTORS

the perfect high voltage resistor?



you be the judge!

HIGH OHMIC VALUES

(10 K ohms to 500 Megohms)

HIGH STABILITY

(Less than 1% full-load drift in 2000 hours; shelf life drift less than 0.1%/year)

HIGH PRECISION

(Tolerance of 1% and 2% all values; 0.5% in limited values)

HIGH VOLTAGE

(Voltages to 15 Kv with power ratings to 5 watts @ 70°C)

Victoreen's new MOX Series is a new generation of metal oxide glaze resistors. If they're not actually "perfect," at least they're ideal — for meter multipliers . . . high-voltage dividers and bleeders . . . high-voltage probes . . . electrostatic paint spray equipment . . . pulse forming networks, etc. Why fight it? You can't beat a metal oxide glaze resistor — now that you can get **Victoreen MOX resistors with values to 500 Megohms.**

A-1110

VICTOREEN INSTRUMENT DIVISION
10101 WOODLAND AVENUE · CLEVELAND, OHIO 44104
IN EUROPE: GROVE HOUSE, LONDON RD., ISLEWORTH, MIDDLESEX, ENGLAND



what's the winning combination?

Bell & Howell's matchless pair: 007 and 008 OPTimal OP AMPs

(ACTUAL SIZE)

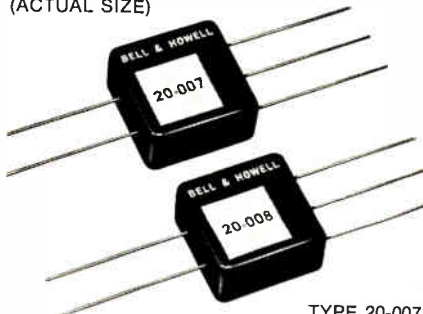

TYPE 20-007
general purpose Optimal op amp

TYPE 20-008
FET input Optimal op amp

They can't be matched in performance, size, and price. And paired, they make the winning combination for universal use. They are identical in package and lead configuration; check the specifications given below for performance and quality. Both have these internal features: voltage offset trim, frequency compensation, and input-output protection.

NOTE: Our quantity prices are based on the total number of units ordered, in any mix. Compared with other op amps of this size and high performance, the matchless pair is your best buy.

	20-007	20-008
Price (in quantities of 100, any mix)	\$16.50	\$26
Voltage offset	200 μ V	200 μ V
Input bias current	150 nA	10 pA
Common mode rejection	100 db	76 db
Gain band width (at 10 kHz)	20,000,000	20,000,000
Output current	5 mA	5 mA

CONTROL PRODUCTS DIVISION

BELL & HOWELL

Write or telephone. 706 Bostwick Avenue,
Bridgeport, Connecticut 06605.
Telephone: (203) 368-6751. Ask for Mr. Isdale.

ing the real world."

Deficiencies of the visual simulators are, then, the real stumbling block in making the simulator a total trainer for the airlines. And the problems are compounded by the lines' refusal to underwrite research and development in this area. Says one airline official, "An airline R&D program is called a purchase order."

Side order. About half a dozen firms are making visual systems, usually sold independently of the simulator. Systems cost from \$250,000 to more than \$800,000; the most expensive comes from the Dalto Electronics Corp. The company's equipment is currently the only visual system being ordered by an airline; TWA has contracted for a model 4000 wide-angle visual flight simulator.

Dalto has supplied visual simulation gear for such customers as Lockheed, NASA, the General Dynamics Corp., the Air Force, and the Navy. Robert Friedman, vice president and general manager, predicts a market for 40 visual systems among five major airlines alone during the next two years. These would be for existing and new simulators. Friedman says he expects Eastern, American, and Pan Am to announce purchases of Dalto equipment soon.

With interest now centering on visual simulation, several types of systems are competing:

- Dalto's DRC 4000. A high-resolution, closed-circuit, color television system whose camera follows the pilot's maneuvers as it scans a terrain model of a typical airport and its surroundings. The camera has a single wide-angle lens that picks up the image from the terrain model. The image is relayed into four identical window channels via a beam splitter in the camera. Each channel contains an image corresponding to the perspective that would be seen from a cockpit. Four high-resolution orthicon cameras scan the images to provide a four-window display in the simulator cockpit. The system presents such variables as take-off, approach, landing, taxiing, circling, and terminal parking.

- Link's variable anamorphic motion picture (VAMP) system. It uses 70-millimeter Todd-AO color motion picture film for training



Tilt. New generation of simulators like this one from Link have double the number of axes of motion freedom.

pilots in takeoffs and landings under limited visibility. The film is made in the course of flying an ideal pattern. Desired visibility conditions are added during processing. The system uses an anamorphic lens—one with greater magnification in one axis than in another—driven by a servo attached to the student's controls. If the student veers to the right of the proper landing path, the view of the runway appears as it would if he had made the error in flight. The Air Force will buy the first VAMP for use with an F4F simulator. Link offers the system as an option with its simulators for \$265,000.

- Conductron has a wide-angle optical system with map models of the ground or airport terrain made of photographic transparencies. The transparencies are spliced together in continuous belts approximately 12 feet wide by 52 feet long. Altitude changes are depicted by use of a zoom lens.

III. Dynamic Duo

There are more than a score of firms in the simulator business. But the commercial airline aircraft sector is still dominated by Link, which supplied 36 of the 56 machines now in service. The runner-up, the Curtiss-Wright Corp., has provided nine analog systems. Of the dozen simulators now on order by the airlines, about half will come from Link and the rest from Conductron.

Both companies are now using general-purpose rather than special-purpose computers in their simulators because their assignments are getting so complex. In the 727 units, 120 discrete and 40



TRW/Globe miniature d.c. motors



Precision engineered for airborne systems.

When you need precision motors and gearmotors, call on Globe. Most experienced designers do. Globe motors are designed and engineered for demanding applications. And the selection is unusually broad.

We will help analyze your system problem and recommend the optimum motor/gear train combination,

and even help you develop the next assembly (actuator, blower, pump, black box). Globe can suggest many methods to save power, space, weight in system design. Our specialty lies in motors and devices that operate reliably under all MIL conditions.

Whatever your airborne motor system need, call on Globe.

For detailed information on Globe capabilities and products, contact Globe Industries Division of TRW Inc. 2275 Stanley Avenue, Dayton, Ohio 45404. Phone (513) 222-3741.

TRW[®]

GLOBE

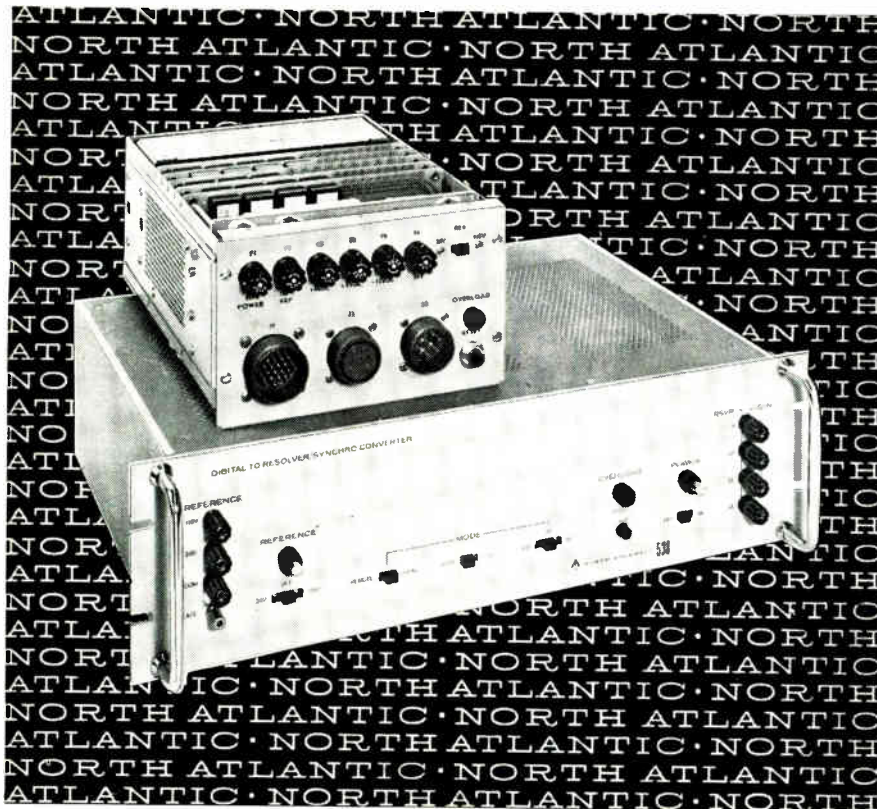

digital to resolver/synchro converters ... here's the next generation!

North Atlantic now brings you a new generation of solid-state digital-to-analog converters. They offer major advances in resolver/synchro conversion accuracy along with drift-free and stable performance unobtainable with currently available resistor/amplifier devices.

Typical of these new instruments are the Model 536 D/R and Model 537 D/S "shoebox" converters (11-13 bit) and the Model 538 D/R-S converter (14-17 bit). Both models use solid-state switched trigonometric transformers and feature input data storage registers thereby saving computer time. Conversion speed exceeds 10 microseconds. Built-in overload and short circuit protection assures trouble-free system integration and reliable on-line performance.

Your North Atlantic representative (see EEM) has complete specifications and application information. He'll be glad to show you how these new converters can be the answer to critical interface problems.



NORTH ATLANTIC industries, inc.
TERMINAL DRIVE, PLAINVIEW, NEW YORK 11803 • 516-681-8600

variable failures had to be programmed; the 747 simulators will have about 1,000 programmed malfunctions.

Link is using Scientific Data Systems Inc.'s Sigma 5 computer in the 747 simulators and Conduction is using Honeywell Inc.'s DDP-324 machine for its 747 orders. Thomas R. Bristow, assistant director of advanced trainers and simulators of Conduction's Missouri division, points out that the switch to a general-purpose computer allows a company to specify the best machines available and use manufacturer-supplied software. Software includes assembly programs and debugging routines as well as Fortran programs for updating the simulation program.

Link and Conduction are providing six axes in their 747 simulators double those of their 707 and DC-8 units. The gain will permit aircraft motion to be simulated with greater realism.

The greater complexity of the 747 and the SST will arise from more control surfaces, for example, as well as more radio and navigation aids. All this requires not only greater computer capacity but also more interfacing circuitry and sub-systems.

Customer's men. Both Link and Conduction would like to mass-produce simulators. But they find that it's impossible because of the equipment differences from airline to airline. Each carrier will wind up with a custom-designed unit. The same is true for visual attachments. Dalto's Friedman notes, "Everybody is asking for something entirely different, but that's the nature of this business and it will probably never change."

Monitor. The Federal Aviation Administration, which must qualify simulators to replace in-flight training, is all for the greater use of such systems. "We believe in them and encourage their maximum use," says Ralph Noltemeier, chief of the agency's flight technical program in the flight standards division. "Theoretically, it's possible to achieve a one-to-one transfer between the real world and the world of the simulator." But he points out that this depends on the development of motion cues in the simulator and on the visual attachments.



Vote ITT for the largest, longest, promptest Teflon^{*} insulated cable from Maine to California.

When you vote ITT, you're backing a machine that turns out Teflon insulated cable instead of political prose. Our new TFE extruder, largest in operation, makes longer lengths and larger gauges—up to 4/0—than any other. Of uniform quality, too. Lengths and sizes of TFE insulated cable that no one else can give you. In fact, the lengths are governed only by reel sizes.

ITT went to great lengths to get this machine. We think it's worth it because it helps us to provide uniform wire and cable in lengths and sizes that reduce your installation costs. Cast your vote where it counts.

Let us help solve your TFE insulated cable problems. ITT Wire and Cable Division, International Telephone and Telegraph Corporation, Clinton, Mass., 01510. In Europe: ITT Wire and Cable Division, Lister Road, Basingstoke, Hants, England.

*Dupont Trademark

WIRE AND CABLE **ITT**



WE'RE HANDING YOU A LINE...

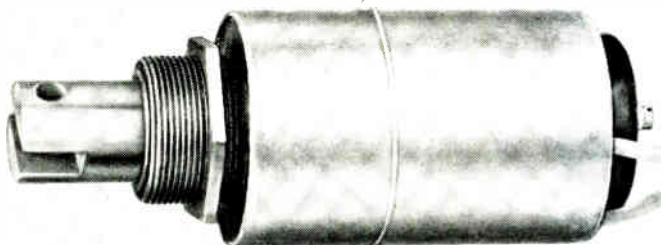
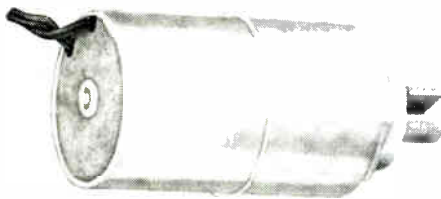

ELEVEN NEW GUARDIAN® TUBULAR SOLENOIDS TO FIT EVERY APPLICATION

From the tiny 7/16" diameter T3.5 to the jumbo 2" diameter T16, the Guardian tubular solenoid line answers every call for close-fit, easy-to-install, high performance solenoids. Clean design allows side-by-side mounting. Guardian tubular solenoids practically install themselves. Just insert threaded bushing through installation hole and tighten the furnished nut.

Available 6, 12, 24 and 115 VDC with pull-type operation ranging from 1 oz. to 30 lbs. capacity. Push-type also available. Life expectancy at rated load is 10^7 cycles minimum.

Drop a line for full specifications including pull-stroke graphs. Ask for Catalog TS.

GUARDIAN  **ELECTRIC**

GUARDIAN ELECTRIC MANUFACTURING COMPANY
1550 W. Carroll Avenue, Chicago, Illinois 60607

Navy drafts standard hardware

Service is using uniform electronic modules for fire-control system of Poseidon missile to relieve maintenance and logistics problems

Military commanders in the field—beset by the logistics and maintenance problems involved in using electronic equipment of varying age, condition, and complexity—pray often for standardization. However, designers are apostles of change, anxious to usher in improvements as quickly as they clear the laboratory.

In an effort to reconcile the divergent and parochial interests of both groups as efficiently as possible, the Navy's Special Projects Office is going at flank speed on a standard hardware program (SHR).

Number one. The Poseidon missile will be the first major project affected [Electronics, May 1, 1967, p. 35]. Initially, the program which is designed to standardize modular building blocks without sacrificing flexibility in circuit design will zero in on the missile's Mark 88 fire-control system.

The General Electric Co.'s Ordnance department at Pittsfield, Mass., is building the Mark 88 for the 31 submarines that will carry the Poseidon. The fire-control system on each craft will have about 16,000 electronics modules, some 5,000 of which will be made to SHR specifications. If all goes well, many other Navy projects will eventually adopt standard hardware.

I. Means to an end

What the Navy hopes to have when the Mark 88 goes operational in the early 1970's is a design so versatile that technological innovations can be incorporated at any point in the system's life. To achieve this, the physical and functional characteristics of the modules are standardized. However, the circuitry can evolve right along with technological developments. "I don't care whether vendors stuff a vacuum tube or a large-scale array inside, so long as the package does what it's supposed to," says a staff

engineer at the Special Projects Office. "All we want to specify is what the module must do and how it fits into the system."

In addition to keeping weapons systems up to date technically, the principal advantage of the standard hardware program is ease of maintenance. In most cases defective modules will simply be replaced by plug-in units that are physically identical.

Complications. Feathering the Navy's nest is proving to be a complex task for vendors. Notwithstanding the Special Project Office's boast about dealers' choice on circuitry, the rigid reliability requirements effectively dictate that advanced solid state technology be

applied. So far, most of the modules have been hybrid arrangements with both integrated circuits and discrete devices.

In developing the standard hardware program, the Navy has selected 136 electronic functions it considers widely applicable. Another 16 are under study and may well wind up in the Mark 88. An estimated two-thirds of the selected functions could be applied in other systems.

An electronic function is Navy jargon for a module's job assignment within the system. The possible variations are virtually limitless. Among other items in the Mark 88, there are: an isolation module with 19 direct-through connections; a 15-

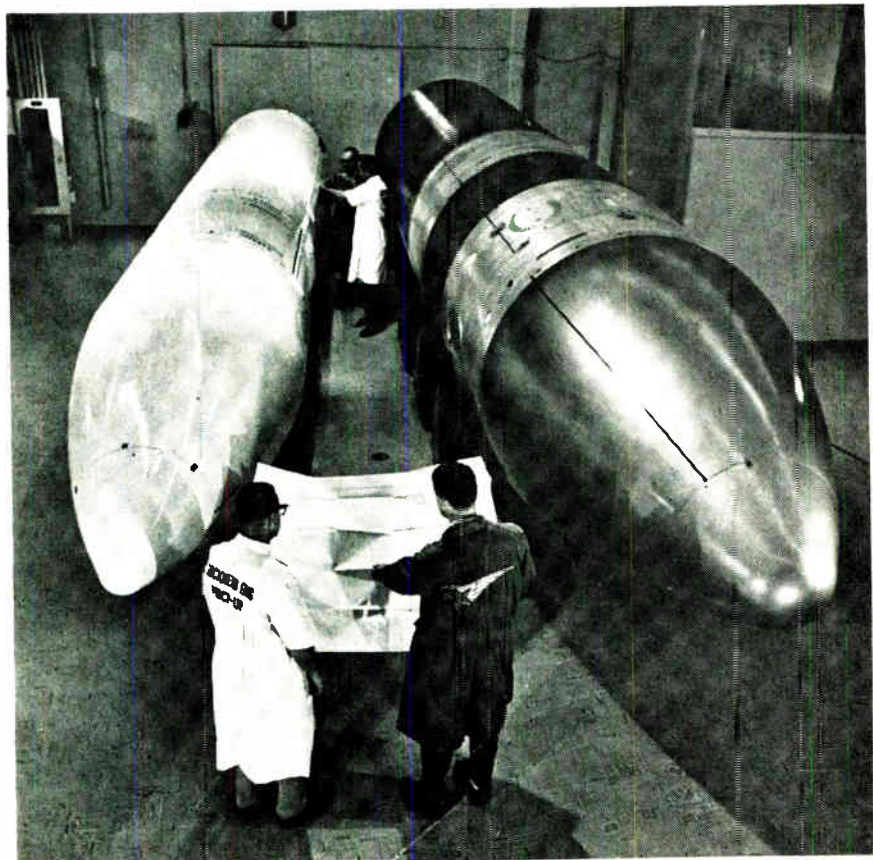

The long and the short of it. Poseidon missile at right is slated to replace the Polaris in 31 of the Navy's submarines. System will have Mark 88 fire-control gear incorporating 5,000 standard hardware modules.

A-to-D Converters

... up to 12 bits

... loaded with options



4½" x 2½" x ¾"

- High-frequency FET input amplifier.
- Bipolar or unipolar input signals of varying ranges.
- Parallel and serial outputs of binary or BCD codes.
- TTL logic for high speed and fanout drive capability.
- Resolution up to one part in 4096 (12 bits)
- Extended temperature capability.

Get any of these options easily in the Pastoriza Model ADC-12_{ic} analog-to-digital converter — without the usual delays and extra cost that "specials" always involve.

The 12-bit Model ADC-12_{ic} is a single-card, general purpose, integrated circuit A-to-D converter that accepts input voltages on command and converts them to a 12-digit binary code in 25 microseconds. The single card contains an input amplifier, precision reference supply, logic, weighing network, switching, comparison, and internal clock. Only external DC power is needed.

The Model ADC-12_{ic} 12-bit converter is just one of Pastoriza's many competitively priced A-to-D and D-to-A converters. All are available with a variety of different input options, resolutions, and output codes.

Write or call for more information on ADC TTL Series.

PASTORIZA
ELECTRONICS, INC.

385 Elliot St., Newton, Mass. 02164 • 617-332-2131

... big orders should lure more bids from industry ...

volt capacitor module; and a transformer module.

II. Second sources

Because of the volume lots involved, an ancillary advantage of standard hardware is that the Navy gets bids on modules from more vendors than usual. At the moment, 19 firms that are a cross-section of the electronic industry are qualified to build modules for the Mark 88. Thus, the isolation module that was developed by the Control Data Corp., Minneapolis, Minn., is also supplied by GE. Similarly, a diode unit developed by GE is also turned out by Globe-Union Inc., Milwaukee, Wisc., and Texas Instruments Incorporated, Dallas, Texas.

To become qualified to participate in the program, a company must first bid for a particular contract. Under such agreements, the firm is given a free hand on internal design. Reliability, performance, and packaging specifications are the only constraints.

Suppliers do a lot of reliability testing, including burn-in, on their own. After production, a number of units are picked at random for shipment to the Naval Ammunition Depot in Crane, Ind. Here, they are subjected to exhaustive environmental checks. Suppliers whose output passes these tests automatically become qualified bidders. However, should a spot check reveal deficiencies at any time, ven-

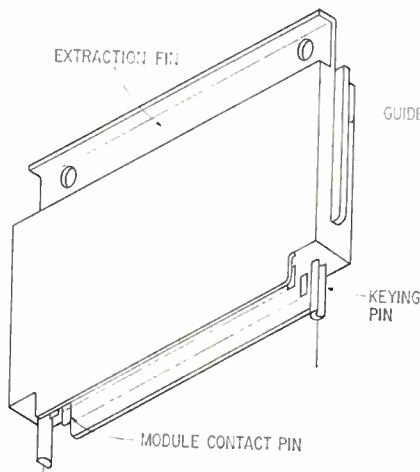

Starting point. The basic module in the Navy's standard hardware program measures 2.62 by 1.95 by .29 inches.

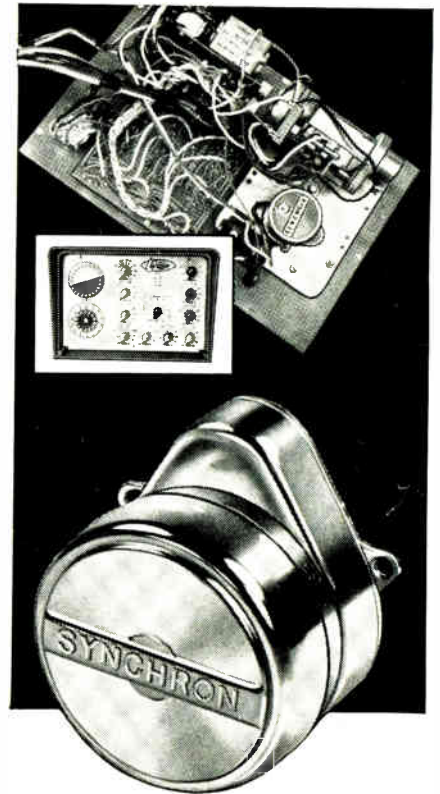

HOW SYNCHRON® MOTORS control this specialized TIME-DELAY RELAY

In this special design timer a Hansen SYNCHRON Motor drives the cam-type sequence timer for an electronic time-delay relay. When power is applied, SYNCHRON runs through the first three sequences; starts the time-delay relay, then stops. Relay performs a panel-adjustable delay period of 180-240 seconds, then returns power to the motor to complete the sequence. Special applications are easy to design, using SYNCHRON Motors. How about yours? Call or write Hansen, or your SYNCHRON representative, for brochure and all the facts.

SYNCHRON timing and control motors; 168 different speeds. Right, left or reversible rotations. 8, 20 or 30 oz.-in. torques; 220, 110 or 24 volts; 60, 50 or 25 cycles.

Visit Booth No. 1919, Design Engineering Show.

HANSEN

Manufacturing Co., Inc., Princeton, Ind. 47570

HANSEN REPRESENTATIVES: CAREY & ASSOCIATES, Houston and Dallas, Texas; R. S. HOPKINS CO., Sherman Oaks, Calif.; MELCHIOR ASSOCIATES, INC., San Carlos, Calif.; THE FROMM CO., Elmwood Park, Ill.; JOHN ORR ASSOCIATES, Grand Rapids, Mich.; H. C. JOHNSON AGENCY, INC., Rochester, N.Y.; WINSLOW ELECTRIC CO., Essex, Conn., Narberth, Pa., and New York, N.Y.
EXPORT DEPARTMENT: 64-14 Woodside Ave., Woodside, N.Y.

dors are knocked off the list. Getting back on involves repeating the original routine.

Double standard. In an effort to cut paperwork, the Navy decided to set only two environmental standards for modules. Class 1 covers temperatures from 0° to 60° C; in Class 2, the range is from -40° to 100° C. Modules are judged on their capacity to stand up under varying conditions of temperature, humidity, shock and vibration. For example, modules in both classes must be able to withstand a high degree of relative humidity at 44° C for 96 hours. Likewise, units must be able to take one-half sine pulse of shock for 11 milliseconds at 50 G's.

The Navy expects that competition will reduce the price of modules. So far, however, this has not been so. One standard logic module, for example, is now going for \$50 a shot. Officials hope an "acceptable" level will be reached this year when bids for the production contract are received. While they're not talking about what they consider acceptable—for fear of influencing prospective bidders—a \$5 price tag would appear to be in the ball park.

Commenting on the standard hardware program, an industry spokesman says: "Most companies will go for the concept but not without some reservations and nervousness. The idea is still new to them, and while it sounds good, there's a lot of skepticism." This source notes that electronic outfits realize that maintenance and logistics as well as responsiveness to changes in the state of the art are increasingly crucial concerns of the military services. He speculates that with the Pentagon enforcing functional modularity, it will eventually prove advantageous to apply such techniques in commercial hardware.

But not everyone views the standard hardware program as a millenium. "It sounds rather like the Navy's trying to make the industry into a job shop," says a source at a subcontractor on the Poseidon program.

Eventually, the Navy should be able to reach its low-cost goals because—in theory at least—vendors turning out standard hardware should be able to keep their lines open for longer runs. This factor

smaller-than-ever power modules!

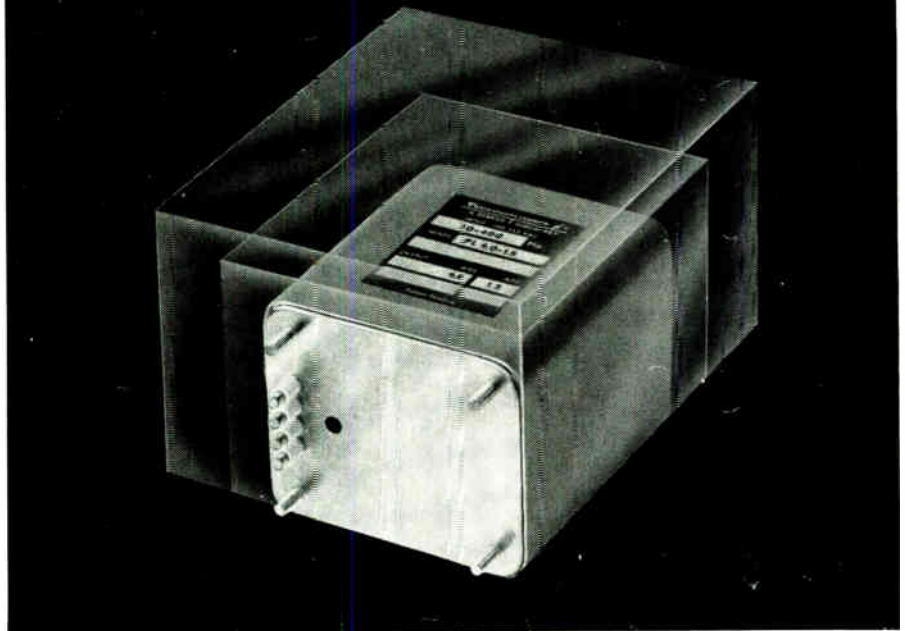

Of particular interest for up-to-the-minute computer and systems applications, Technipower's 1968 lines feature modules up to one half the size of standard competitive equivalents, as a result of unique design concepts. Three new series of ultra-compact, highly efficient modules are available now!

PL-80 Series — Regulated AC-DC Supplies

3.0 to 152 VDC, to 75 watts — Temperature rating 80°C

432 models, featuring 0.05% line and load regulation, 0.002% ripple, up to 20% output adjustment range. Designed to meet MIL environmental specifications.

HF-80 Series — Regulated AC-DC Supplies

2.8 to 1000 VDC, to 375 watts — Temperature rating 80°C

75 models (including models capable of 5 volts @ 50 amperes output), regulation, by high frequency transformation methods, $\pm(0.05\% + 5 \text{ mv})$ line, $\pm(0.10\% + 10 \text{ mv})$ load, 2:1 output adjustment range, series operation permissible. Incorporated EMI suppression components designed to meet MIL-I-6181D.

CD-95 Series — Regulated DC-DC Converters

2.8 to 1000 VDC, to 250 watts — Temperature rating 95°C

84 true converter models, full isolation between input and output for local regulated DC power. Regulation $\pm(0.05\% + 5 \text{ mv})$ line, $\pm(0.10\% + 10 \text{ mv})$ load, ripple 0.2% + 10 mv. 2:1 output adjustment range, series operation permissible. Incorporated EMI suppression components designed to meet MIL-I-6181D. Fully encapsulated, meets MIL environmental requirements.

Write for fully descriptive literature, which includes installation data and prices.



TECHNIPOWER

A BENRUS Subsidiary

Benrus Center, Ridgefield, Connecticut 06877

Phone: (203) 438-0333 TWX: 710-450-3631

Evaluate these new Babcock Relays in your system.

You'll find them
"ON THE SHELF"
at these
distributors!

AVNET ELECTRONICS CORPORATION
10916 Washington Boulevard
Culver City, California
Phone: (213) 870-0111, (213) 870-6141
TLX 674-354

344 Middlefield Road
Mountain View, California 94041
Phone: (415) 961-7700; TLX 34-8441

First National Bank Building, East
5301 Central Avenue N.E., Suite 1400E
Albuquerque, New Mexico 87108
Phone: (505) 265-7926; TLX 74-6459

2318 6th Avenue
Seattle, Washington 98121
Phone: (206) 623-8824; TLX 32-249

1729 North 28th Avenue
Phoenix, Arizona 85009
Phone: (602) 272-6821; TLX 66-750

1020 W. Ellsworth Avenue
Denver, Colorado 80223
Phone: (303) 623-6255; TLX 45-687

207 Cambridge Street
Burlington, Massachusetts 02103
Phone: (617) 272-3060

3901 Pace Court
Schiller Park, Illinois 60176
Phone: (312) 678-6310; TWX 312-678-2522

70 State Street
Westbury, L.I., New York 11590
Phone: (516) 333-8650; TLX 12-5928

4940 Viking Drive, Suite 208
Minneapolis, Minnesota 55435
Phone: (612) 920-5866; TWX 910-576-2784,
TLX 029-5250

87 Wingold Avenue
Toronto 19, Ontario, Canada
Phone: (416) 789-1838; TLX 02-29195

1505 Louvain Street West
Montreal 11, Quebec, Canada
Phone: (514) 0381-9127; TLX 01-20678

P. D. Q. ELECTRONICS CORPORATION
9559 Irontdale Avenue
Chatsworth, California 91311

Phone: (213) 882-0500; TWX 910-494-1235
POWELL ELECTRONICS, INC.
S. Island Road, P. O. Box 18765

Philadelphia, Pennsylvania 19101
Phone: (215) 724-1900; TWX 710-670-0465

10728 Hanna Street
Beltsville, Maryland 20705
Phone: (301) 474-1030; TWX 710-828-9710

P. O. Box 488
Fayetteville, Tennessee 37334
Phone: (615) 433-5737; TWX 810-380-3890

2049 W. Central Boulevard
Orlando, Florida 32805
Phone: (305) 423-8586; TWX 810-850-0155

Foreign Representation:

SWEDISH ELEKTROLINK AB
Stora Nygatan 39
Stockholm C, Sweden

Phone: 114595; Cable Teletink
A.E.M.G.P.
115 Avenue J. B. Clement

Boulogne s/Seine, France
Phone: 825-96-20; Telex: 842-27985

BODAMER GmbH
8022 Grunwald Bei Munchen
Keltenstr. 2a, West Germany
Phone: 471862

For price, delivery and application
data call Babcock collect.
Be sure to ask for Ext. 1000 when
placing your call.

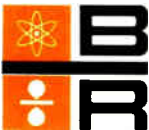

BABCOCK RELAYS

... the Navy wants to increase the number of throwaway modules ...

should reduce outlays for tooling, training, and related items. However, much will depend on just how many big programs are brought under the standard umbrella as well as on how much interchange proves practicable.

New home. Engineers at the Special Projects Office are optimistic about expanding the number of applications for standard hardware. And they are specifying that modules be used in several of the Poseidon's automatic fault-finding equipment and test sets to reduce the logistics base still further.

Officials in charge of two other big Navy programs plan to incorporate standard hardware modules. These programs are the Walleye air-to-ground missile system and the AN/BSQ-13 Sonar. Other designers, particularly those working on avionics and astronautics projects, are considered likely converts.

III. Missionary work

Navy engineers are confident other systems designers will be enlisted, citing these attractive advantages of standard hardware:

- Because of Navy assistance and

Third-generation fire control

The Mark 88 fire-control system has many complex assignments. It keeps the 16 Poseidon missiles carried by the submarine ready for launch, and stands by to feed in up-to-the-minute target data. Complicating the system's mission is the fact that each missile has a number—probably eight—of independently targetable nuclear warheads with total firepower equivalent to 20 million tons of TNT for lift off to areas as far as 5,000 miles away. In addition, the system must be failsafe and so encoded that it can be actuated only on the direct orders of the President. Finally, the Mark 88 must operate reliably in the hostile environment of the oceans' depths.

The Poseidon's Mark 88 fire-control system is being built by the General Electric Co.'s Ordnance department under a subcontract from the Lockheed Missile and Space Co., the prime contractor.

Number three. The Mark 88 is a third-generation fleet ballistic missile fire-control system. General Electric also built the Mark 80 for the early Polaris subs. The design of this equipment was an analog/digital arrangement and the gear was used in only 10 subs. The Mark 84, also made by GE, came next. It is basically a digital system.

The Mark 88, now in advanced design phase, will first be installed on the USS James Madison in 1969. Then 30 more of the subs now carrying the Polaris will be equipped with the Poseidon and will have Mark 88's installed during regular shipyard visits.

The entire Poseidon program is costing the Navy more than \$2 billion. In addition to the improved missile and the Mark 88, the system will carry new navigation gear.

In addition to its primary duties, the Mark 88 will compute missile motion at the time of launching, translate all data inputs to the missile, align the guidance system in azimuth, and set the missile's guidance timing.

Versatile. The multiple-targeting capability is the main operating distinction between the Mark 84 and the Mark 88. This capacity requires higher speed and accuracy in the digital geoballistic computer for targeting and target flexibility. This is provided by the rapid insertion of new target data and assignments into the guidance computer.

A fully automatic control system will prepare the missile for launching. The firing console will contain logic circuits that will initiate each launch step in sequence after the "Go Code" is fed in.

The entire firing sequence can be activated by pushing a button. During the firing sequence the control system will automatically check each missile's readiness. If a missile is faulty, it will be bypassed and the sequence continued. The operator can intervene manually at any point in the automatic sequence.

**Four
New
Babcock
Relays**

BR42

- Welded Crystal Can
- 2 Amp.—DPDT
- Single-Coil
- Universal Contacts
- To MIL-R-5757

BR30

- One-Inch Cube
- 4 PDT—1C Amp.
- Single-Coil
- All-Welded
- To MIL-R-6106

BR24

- Welded, Low Profile
- 10 Amp.—DPDT
- Single Coil
- Universal Contacts
- To MIL-R-5757

BR26

- We de# Half-Size
- 2 Amp.—DPDT
- Single-Coil
- Universal Contacts
- To MIL-R-5757



BABCOCK RELAYS
Babcock Electronics Corp.
3501 Harbor Blvd.
Costa Mesa, Calif. 92626
Telephone: (714) 540-1234

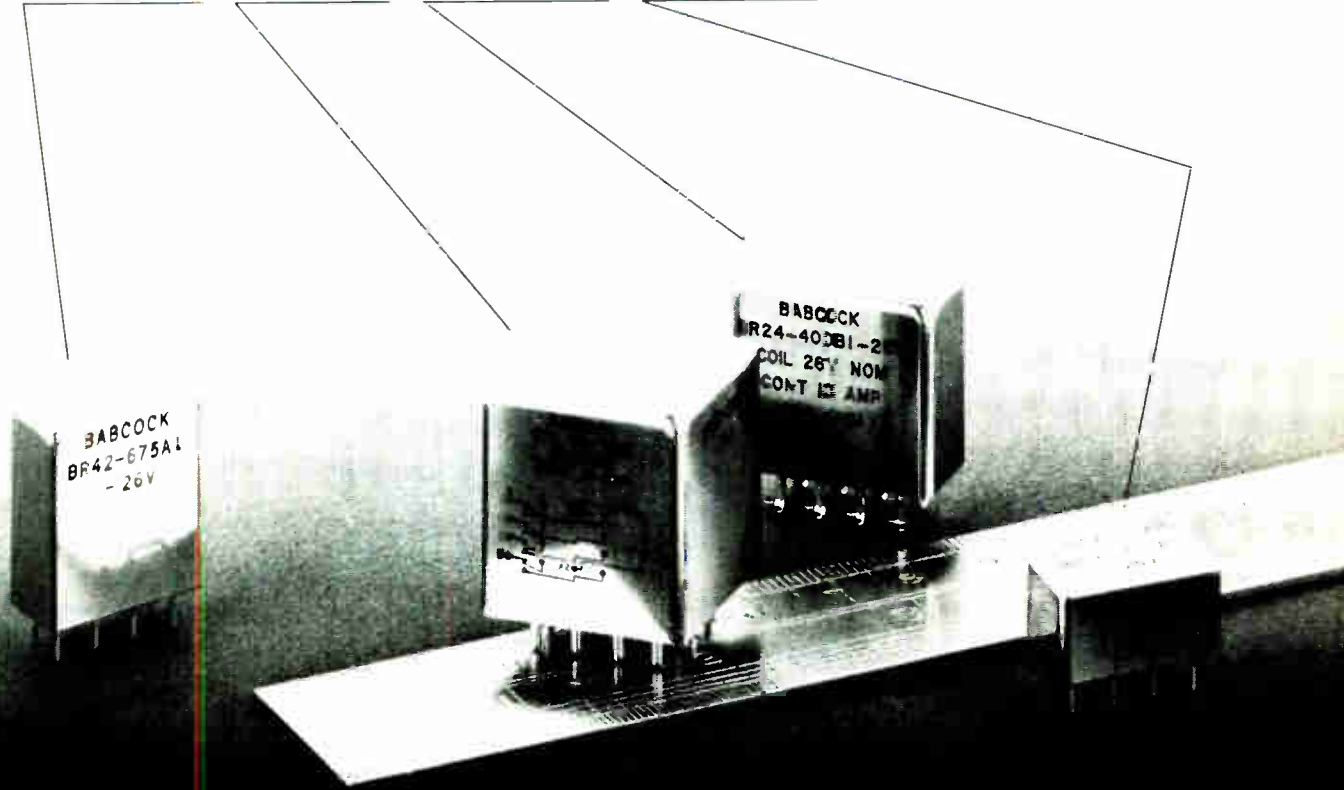

New: At significantly lower prices!
Still the same: Babcock quality
Where: At your Babcock distributor When: Now!

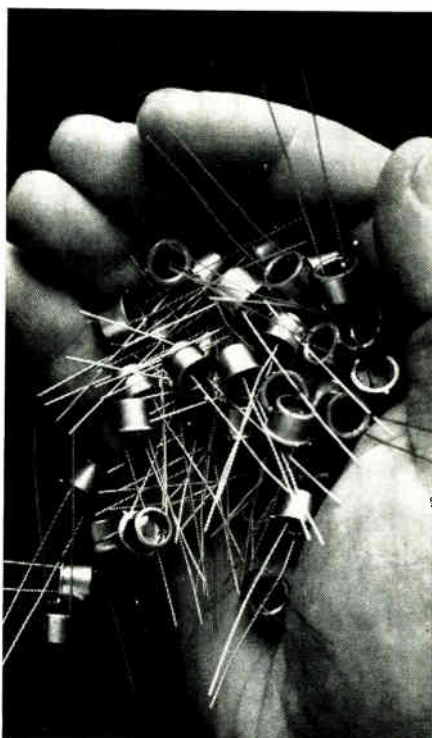
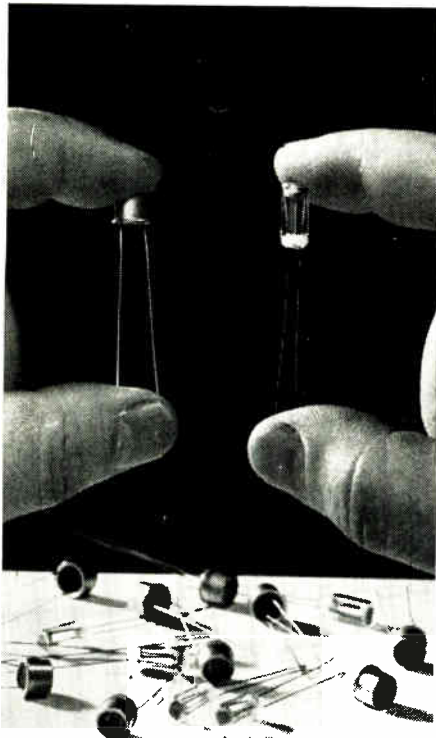

Need thirty different photocells? Or thousands exactly alike?

In either case, specify "Raytheon." Raytheon now offers standard and special types with cadmium sulfide or selenide sensors, TO-5 case or glass vial packaging, and a wide range of operating characteristics. These photocells are interchangeable with competitive types, available to MIL specifications, priced from 90¢ to \$1.60 in production quantities.

All Raytheon photocells feature: rugged mechanical construction, small size, light weight. Low noise, completely ohmic light-dependent vari-

able resistors, their characteristics and high voltage capabilities ensure fast switching, temperature stability and linear response to illumination.

Wide range of characteristics. Our CK1201, for example, features 150 ohms resistance at 100 ft. candles, rise-fall time of 3 and 60 ms, 75 mw power dissipation (maximum). And our CK1266 features 2500 ohms resistance at 100 ft. candles, rise-fall time of 1.5 and .6 seconds, and power dissipation of 100 mw maximum.

Send reader service card for data on the complete line of standard Raytheon photocells. Or tell us about your special requirements.
Raytheon Company, Components Division, Quincy, Mass. 02169.

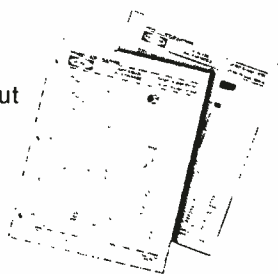

Industrial Components Operation — A single source for Circuit Modules/Control Knobs/Display Devices/Filters/Hybrid Thick-Film Circuits/Industrial Tubes/Optoelectronic Devices/Panel Hardware

the single-minded nature of the modules, development costs are relatively low.

- Design and test documentation are uniform; mechanical and electrical interfaces are standard.
- Potentially, there are broad applications for most modules.

Throwaways. Navy engineers are preoccupied with upping the number of modules that can be jettisoned rather than repaired when they fail. To this end, the Special Projects Office worked closely with the Naval Avionics Facility in Indianapolis, Ind., to determine which electronic functions lent themselves to broad applications—and hence standardization.

Only modules that can be specified by function are taken into the standard hardware program. Units thus chosen are generally considered nonrepairable. In cases where a custom module is required, it is thrown into a design-disclosed category. When this happens, the supplier must furnish detailed information on all components so the module can be repaired should the need arise. The Navy has also established a special category for modules equivalent to the standard throwaways but lacking applications outside the system for which they are designed. Depending on cost data that remain to be developed, such units may or may not be thrown away when they fail.

An important element in standard hardware's versatility is the design of the module. After a great deal of study, the Navy decided on a basic size: 2.62 inches wide, 1.95 inches high, and .29 inches thick. Height is not a variable, but width and thickness can be increased in increments of 3.0 and .3 inches, respectively.

Components like transformers for power-supply modules sometimes lead to deviations from the basic configuration. In such cases, design waivers are granted for thickness.

Lockout. A variety of key pins are used to prevent a module's being plugged into the wrong spot. For example, a delta arrangement would effectively preclude a unit's being jammed into a female receptacle with half delta guides.

A basic module width has 40 male contacts arranged in two rows. Contacts are spaced one-tenth of an inch apart in the grid pattern.

We guarantee performance of our vacuum production equipment.

We make systems for thin film deposition, for coating, and for encapsulation. When you buy a system from us, you get a turnkey operation; you get a team of design engineers who specialize in vacuum technology; you get fixtures and components to suit your specific processes. And you get the reputation of a major corporation that assures backup service long after the system is installed.

If your production plans include processing in vacuum, call on us: Varian Vacuum Division, Palo Alto, California; Zug, Switzerland; Georgetown, Ontario.

Varian Vacuum has the resources and experience to

tackle tough

vacuum processing jobs!



varian
vacuum division



Cold weld, encapsulation system built for Western Electric, seals 1000 crystals in every 8-hour shift; pump-down, 37 sec. to 10^{-7} Torr; full cycle <75 sec.

**When you hit the button,
everything in the vacuum
processing system works.**

At last... **VERSATILITY** in a reed relay

The Series 3500 terminals . . .

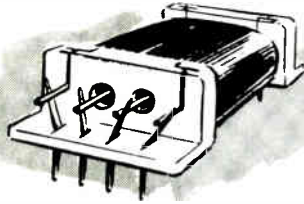

has printed circuit board mounting on 1 inch x .100 inch centers.

. . . or, when we slide a plate into our bobbin mold, circuit board mounting pins on 1 inch x .150 inch centers and is called Series 3600 . . .

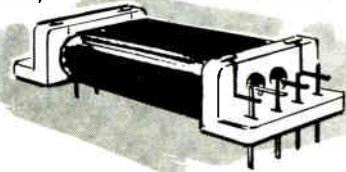

Both versions use our new assembly without requiring strip and its extra welds . . .

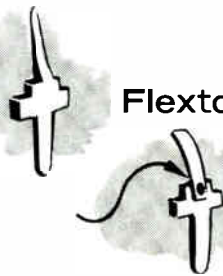

Flextop terminal to give stress-free reed an intermediate nickel "ribbon"

But, when you need a relay that plugs in and out without fuss, or just want an independent source for Berg Pin mounted relays, we add adapter blocks . . . and fill all your needs from stock!

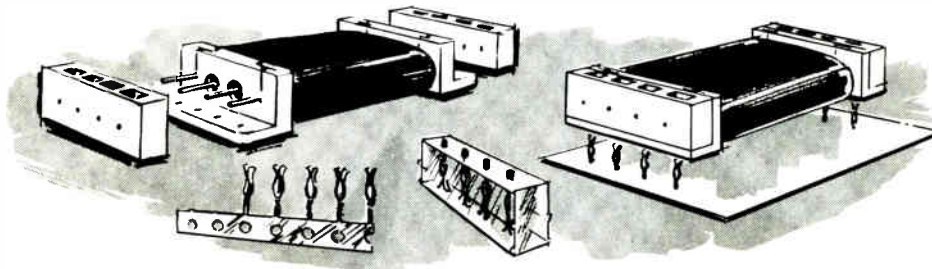

Either way you get a big bore bobbin that holds even the largest "miniature" reeds without sacrificing its unique fully recessed coil exposed magnet wire and

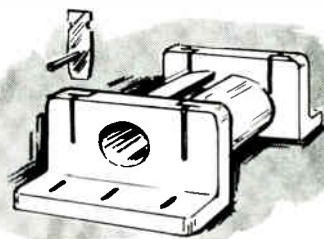

low .350 inch profile, and terminals that eliminate intermediate coil leads.

Call, write or check the reader service card for your copy of Hi-G bulletin #160. If you need application engineering assistance, an experienced Hi-G representative awaits your call. Telephone: 203-623-2481.

**Hi
G**
INCORPORATED

SPRING STREET & ROUTE 75 / WINDSOR LOCKS, CONNECTICUT 06096



**That's right. It's a commercial connector.
Our Molex Standard. Millions are finding their
way into some of the most exciting circuitry man
can imagine. For that's our business: creating
connectors that simplify
wiring. Speed produc-
tion. Assembly. Instal-
lation. Servicing.**

**For the men who are
looking for new ideas and
ways to cut costs.**

**In the area of one circuit to sixty
connections or more, Molex has the
product. And the design and engineer-
ing capabilities to solve the most com-
plex wiring and production problems . . .
fast! We'd like to talk to you about it.**

**If you would like a free sample of our
Molex connector, please
write or phone (312)
969-4550. You
can make con-
nections at . . .**



MCLEX PRODUCTS COMPANY
Downers Grove, Ill. 60615

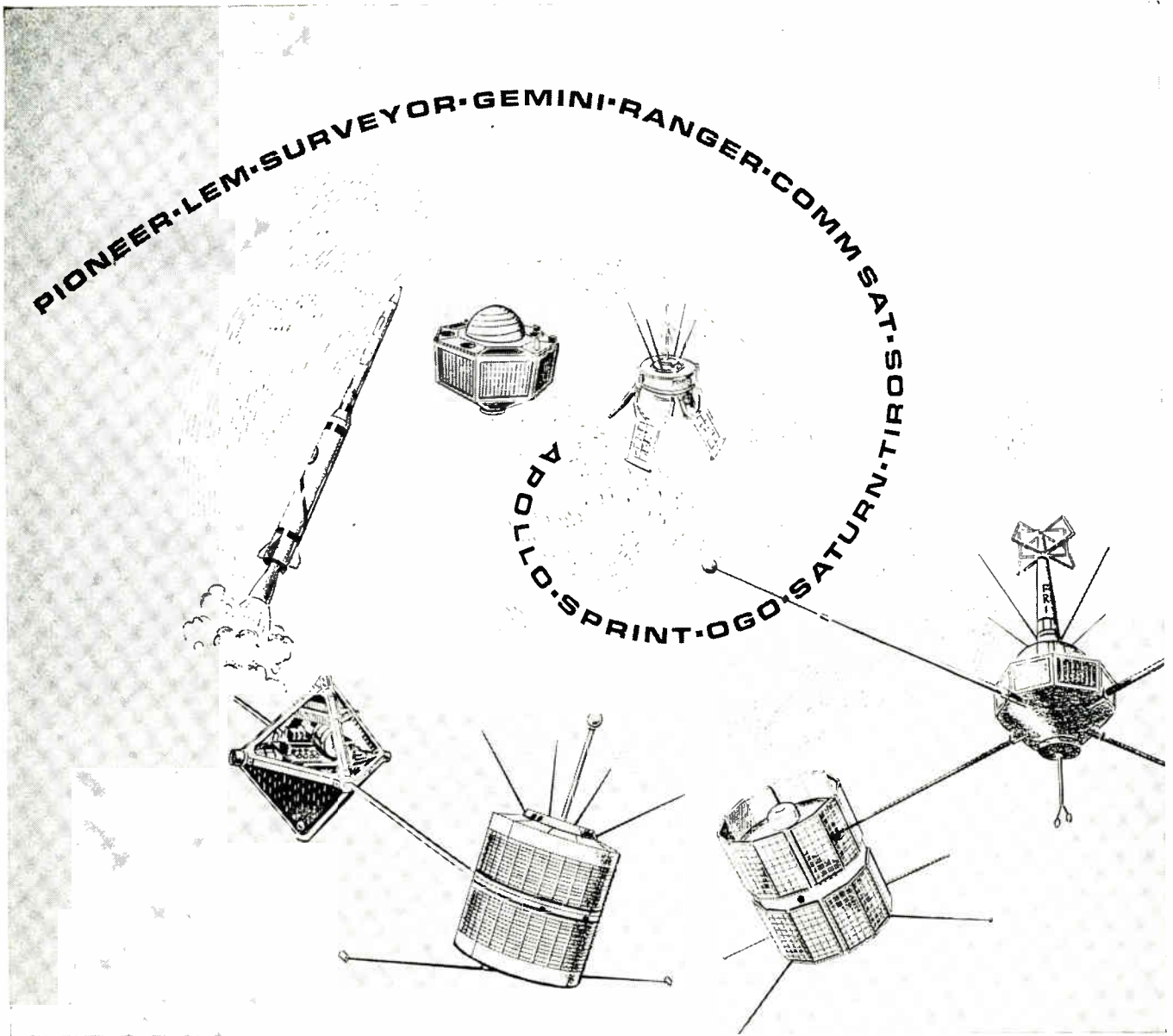

Vital. High Reliability.

In the bone-snapping cold of outer space electronic components are on their own... they *must* perform reliably. Increasingly stringent demands mean pushing technology to its limit.

McCoy has traditionally been a foremost manufacturer and supplier of the highest quality crystals, filters and oscillators for NASA and U.S. military services. To maintain this position has required constant advances in technology.

Our new research and development laboratory (with White Room facilities) is being built now to help McCoy meet the demand for even better products in the future. Coordination of engineering, manufacturing, quality control and management will keep us in the forefront in providing reliable products to meet customer specifications.

When high reliability components are needed, turn to the leader... McCoy. Engineering assistance is available of course. Write now for our new High Reliability literature.



OSCILLATORS



FILTERS



CRYSTALS



MCCOY ELECTRONICS COMPANY

MT. HOLLY SPRINGS, PENNSYLVANIA 17065

Tel. 717-486-3411 TWX: 510-650-3548

a subsidiary of OAK ELECTRO/NETICS CORP



it's only logical!

All RAY I and RAY II types are available, including dual J-K flip-flops (RF 100, RF 110, RF 120, RF 130 Series), single J-K flip-flops (RF 200, RF 210, RF 250, RF 260 Series), gates and drivers. Our T²L integrated circuits match up to the toughest electrical test limits in the industry. They feature our exclusive high alumina glass to Kovar seal (guaranteed to 5×10^{-8} cc/sec Helium). And they're available in quantity now. Order yours from your local Raytheon Distributor. It's only logical! Raytheon Company, Semiconductor Operation, 350 Ellis Street, Mountain View, California 94040 (415) 966-9211



Will Scotchpar® win the Ester award for the best film of the year?

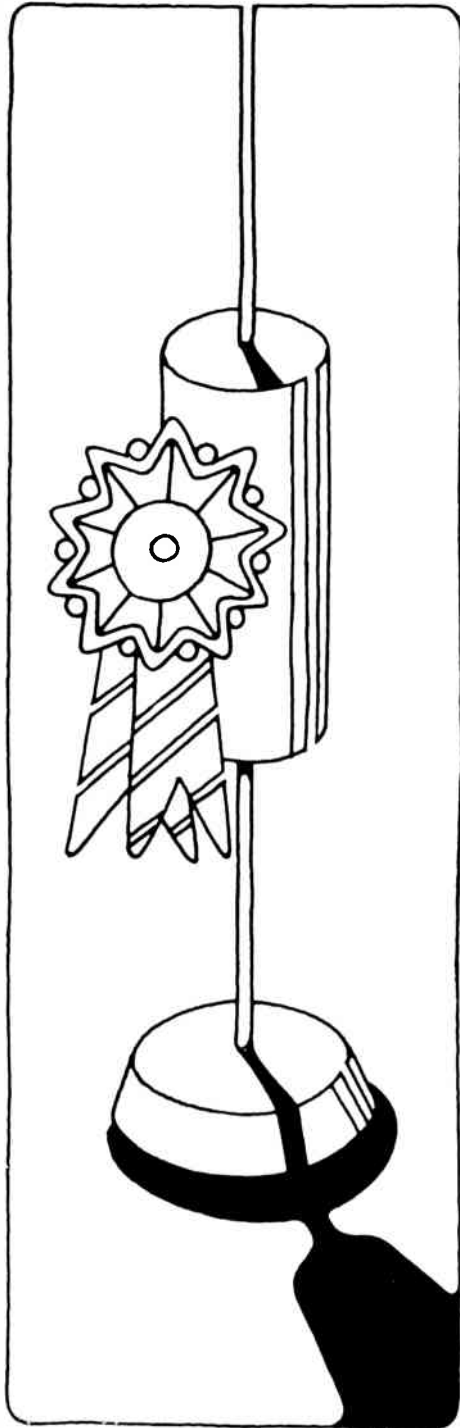

Based on the quality of polyester films, 3M's SCOTCHPAR should win at least as many votes among electrical manufacturers as the "big name" film.

There's nothing better than SCOTCHPAR for capacitors.

And there's nothing better than SCOTCHPAR as insulation for transformers, motors, wire and cable.

We have it in thin films and thick films.

SCOTCHPAR has high dielectric strength, great temperature stability, resistance to moisture and solvents. It's thin, tough, flexible and durable.

If you're going to use polyester film instead of a conventional insulation—and you should, to cut costs, save space, and improve product performance—vote for SCOTCHPAR. If you want SCOTCHPAR that's heat sealable, the name is SCOTCHPAK.®

A vote for SCOTCHPAR is a vote for quality and adaptability.

3M Company, Film & Allied Products Division, 3M Center, St. Paul, Minnesota 55101.

Scotchpar® **3M**
BRAND COMPANY

These are specialized TRACOR instruments designed for your specific needs.

FREQUENCY STANDARDS

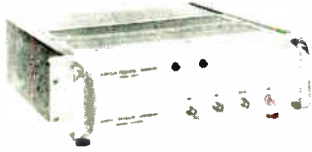

RUBIDIUM FREQUENCY STANDARD
 1×10^{-10} freq
 2×10^{-11} stnd dev/yr
 use Reader Service #315.



CRYSTAL STANDARDS
 5×10^{-11} /24 hours
 5 to 0.1 MHz
 use Reader Service #316.



CRYSTAL STANDARDS
 1×10^{-7} /24 hours
 LOW COST HOUSE STANDARD
 use Reader Service #317.

ULTRASTABLE CLOCKS AND DIVIDERS



PORTABLE RUBIDIUM ATOMIC CLOCKS
 5×10^{-12} /100 sec avg—37 pounds!
 use Reader Service #318.



CRYSTAL CLOCKS
 2×10^{-6} secs per day
 use Reader Service #319.



REFERENCE SIGNAL GENERATORS
 200 Hz-6.25 kHz
 use Reader Service #320.

VLF RECEIVERS—FREQUENCY/PHASE COMPARATORS



VLF TRACKING RECEIVER/COMPARATORS
 Continuous tuning 3.00 to 99.5 kHz
 use Reader Service #321.

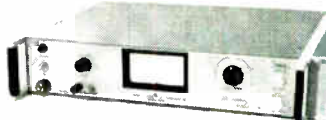

LINEAR PHASE/TIME COMPARATOR
 1 nanosecond time resolution
 0.01 cycle phase resolution
 use Reader Service #322.



FREQUENCY DIFFERENCE METER
 difference to 1×10^{11} , error multiplied by 10^4 .
 use Reader Service #323.

NOISE ANALYSIS



CONTINUOUSLY-VARIABLE PASSIVE FILTERS 15 Hz-672 kHz
 use Reader Service #324.

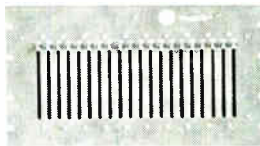

EQUALIZERS/SPECTRUM GENERATORS
 Up to 40 $\frac{1}{3}$ -octave increments
 use Reader Service #325.

OMEGA NAV SYSTEMS



VLF/OMEGA NAVIGATIONAL SYSTEMS
 For broad-area navigation
 use Reader Service #326.

NORTHERN SCIENTIFIC, INC.



DIGITAL MEMORY OSCILLOSCOPES and Pulse Height Analyzers
 use Reader Service #327.

ASTRO-SCIENCE CORP.



ASTRO-SCIENCE MULTI-CHANNEL AIRBORNE INSTRUMENTATION TAPE RECORDER/REPRODUCERS
 use Reader Service #328.

WESTRONICS INC.

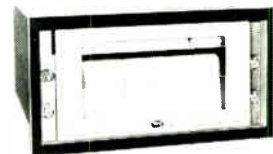

MULTIPOINT AND CONTINUOUS PEN CHART RECORDERS
 use Reader Service #329.

For a short-form catalog of TRACOR instruments, please use Reader Service #330.

Industrial Instruments Division



New! Solid state voltage sensors protect processes and equipment.

Positive response...plug-in convenience. P&B quality, too!

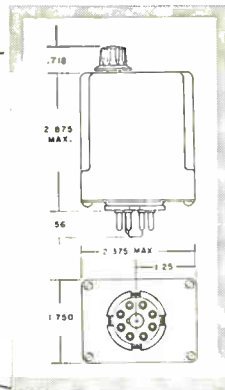

Sound an alarm, start or stop a motor, activate or cut off a system automatically with P&B's new series of voltage sensors. A sensitive solid state circuit "reads" changes in voltage. Over or under voltage deviations greater than predetermined levels cause an internal relay to operate . . . in 25 ms or less. Drop-out or pick-up is positive, and loads of 3 amperes at 120V AC resistive can be switched.

Three types are available: one with adjustable pick-up and drop-out; one with fixed pick-up and adjustable drop-out; one with fixed settings for both pick-up and drop-out. All models are available for either AC or DC operation. All have octal plugs.

Single lot prices for standard models, available from leading electronic parts distributors, range from \$22.70 to \$32.50. Today, call your P&B representative for complete information.

Specifications

Sensing Current Drain: Maximum of 3 ma.

Maximum Current Drain: After sensing: 30 ma.

Accuracy of Set Point: 1% after initial setting.

Reverse Polarity Protection: Yes, on DC types.

Operating Temperature: -40°C to +55°C.

Load Switching Relay Contacts:

2 Form C (DPDT). Rating: 3 amps 28V DC resistive; 120V AC resistive.

Mechanical Life: 10,000,000 operations.



Adjustable Pick-up and Drop-out

CS 38 Series

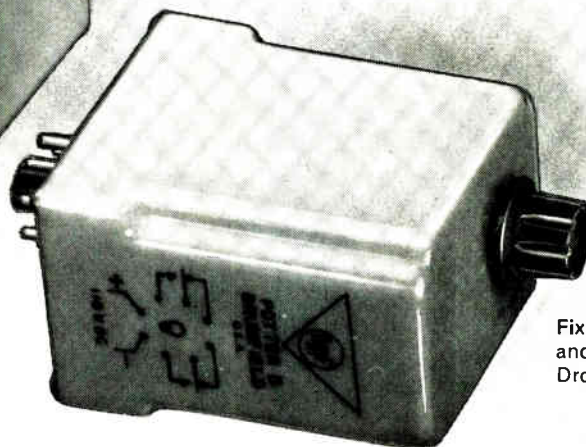

Fixed Pick-up and Adjustable Drop-out



POTTER & BRUMFIELD

Division of American Machine & Foundry Co., Princeton, Ind. 47570
Export: AMF International, 261 Madison Ave., New York, N.Y. 10016

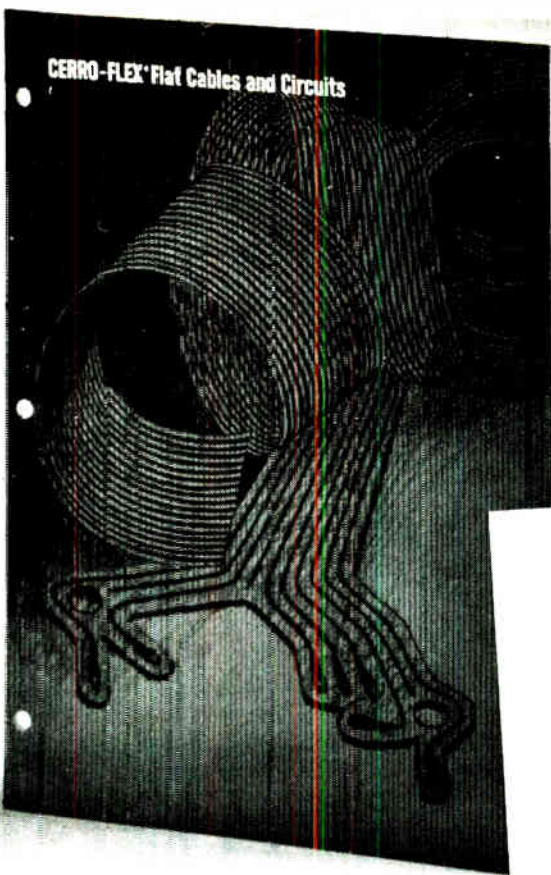

CERRO WIRE & CABLE CO.
DIVISION OF CERRO CORPORATION

**CERRO-FLEX
 PRODUCTS**

**TECHNICAL
 SERVICE
 DEPARTMENT**

330 BOSTON POST RD.
 OLD SAYBROOK, CONN. 06475
 (203) 389-4676

Get ideas here
 on flexible cables.

Get help here
 when you need it.

Our catalog on flat flexible cables and printed wiring will show you how to cut the cost, size and weight of your products. It will stimulate your thinking about this modern way to package electronic circuitry.

A Cerro-Flex® Technical Man can help you design your flexible circuit and fulfill your needs from our modern plant.

Send today for a copy of the Cerro-Flex Flat Cables and Circuits Catalog.

**Cerro-Flex Products, Cerro Wire & Cable Co.
 330 Boston Post Road, Old Saybrook, Conn. 06475**



Gentlemen:

- Please send me a copy of "Cerro-Flex Flat Cables and Circuits."
- Please have a Cerro-Flex Technical Man call.

Name

Title

Company

Address

CERRO
 WIRE & CABLE

The Wait Reducers! New Active Filters from BURR-BROWN



At Burr-Brown, computer-aided design and new modular assembly techniques combine to give you faster delivery of active filters . . . in most cases within two weeks of your order. And, you specify the exact performance you want from Burr-Brown's new line of 5 Hz to 20 kHz units. Custom units are available with frequencies as low as 0.1 Hz and as high as 100 kHz.

A variety of active filter types and response characteristics are available including:

TYPES

- low-pass
- high-pass
- band-pass
- band-rejection

CHARACTERISTICS

- Butterworth
- Tchebyscheff
- Bessel (linear phase)

Since the heart of the filter is the amplifier, Burr-Brown has the very finest building blocks, including its own IC op amp (patent pending). Because of the outstanding performance of Burr-Brown op amps you get active filters with superior characteristics at the lowest possible prices.

You also benefit from Burr-Brown's industry-leading technical staff. For the same experts who authored the Active RC Network Handbook, the basic industry reference on the use of operational amplifiers in filtering applications, supervise Burr-Brown's active filter facilities.

So, if you use active filters and you want a fast, dependable source of supply, call on Burr-Brown. You'll find Burr-Brown knows a little more and does a little more, because Burr-Brown has more to work with.

NEW 12-PAGE ACTIVE FILTER CATALOG



For your copy of the new applications-oriented Burr-Brown Active Filter Product Bulletin, contact your local Engineering Representative or use this publication's reader-service card. For Immediate Applications Assistance: simply phone (602) 294-1431 and ask to talk to your Burr-Brown Applications Engineer.

BURR-BROWN RESEARCH CORPORATION

International Airport Industrial Park • Tucson, Arizona 85706
TELEPHONE: 602-294-1431 • TWX: 910-952-1111 • CABLE: BBRCORP



Operational Amplifiers
Instrumentation Amplifiers
Function Modules
Active Filters
Analog Simulators
Geophysical Instruments

ENGINEERING REPRESENTATIVES: ALABAMA, HUNTSVILLE (205) 534-1648 / ARIZONA, PHOENIX (602) 254-6085 / CALIF., LOS ANGELES (213) 665-5181, SAN FRANCISCO (408) 244-1505 / COLO., DENVER (303) 388-4391 / CONN., EAST HARTFORD (203) 874-9222 / D.C., WASHINGTON (SEE MARYLAND) / FLORIDA, ORLANDO (305) 425-2764 / ILLINOIS, CHICAGO (312) 286-6824 / LA., NEW ORLEANS (504) 888-2266 / MD., SILVER SPRING (301) 588-8134 / MASS., BOSTON (617) 245-4870 / MICH., DETROIT (313) 358-3333 / MINN., MINNEAPOLIS (612) 781-1611 / MO., ST. LOUIS (314) 524-4800 / N.C., GREENSBORO (919) 273-1918 / N.J., CAMDEN (215) 925-8711

/ N.M., ALBUQUERQUE (505) 255-1638 / N.Y., ALBANY (518) 436-9649, BINGHAMTON (607) 723-9661, MT. VERNON (914) 968-2200, NEW HARTFORD (315) 732-3775, ROCHESTER (716) 473-2115 / OHIO, CINCINNATI (513) 761-5432, CLEVELAND (216) 237-9145, DAYTON (513) 277-8911 / PENN., PHILADELPHIA (SEE CAMDEN, N.J.), PITTSBURGH (412) 243-5655 / TEXAS, DALLAS (214) 357-6451, HOUSTON (713) 774-2568 / UTAH, SALT LAKE CITY (801) 466-8709 / VIRGINIA, (SEE MARYLAND) / WASH., SEATTLE (206) 767-4260 / CANADA, OOHNSVIEW, ONT., (416) 636-4910 — MONTREAL, QUE., (514) 739-6776 — OTTAWA, ONT., (613) 725-1288 — VANCOUVER, B.C., (604) 298-6242

Military and aerospace equipment demands proven reliability. That's why Dytronics specifies capacitors of MYLAR®

Dytronics Co., Inc., of Columbus, Ohio, makes Primary Phase Angle Standards that are used all over the world in all temperature extremes. Each precision unit uses 70 capacitors of MYLAR® polyester film. Why MYLAR? Here's what Paul Ryan, President, had to say: "Military and major aerospace facilities cannot afford equipment failure, and we must be sure of the

components we select. Hundreds of our Primary Phase Angle Standards are in military usage, and we are not aware of a single failure of capacitors of MYLAR...we feel that this is evidence of both the reliability and performance of MYLAR and we find that capacitors of MYLAR cost about the same as those made of paper."

MYLAR offers thermal stability from -70° to $+150^{\circ}$ C., plus excellent resistance to most chemicals and moisture.

MYLAR has high tensile and dielectric strength. Its unexcelled thinness has enabled manufacturers to reduce size and weight in capacitors.

Isn't that reason enough for you to consider capacitors of MYLAR in your designs? For additional information write to Du Pont, which offers the thinnest, most versatile range of capacitor dielectric materials available. Address: Du Pont Co., Room 5852B, Wilmington, Delaware 19898.

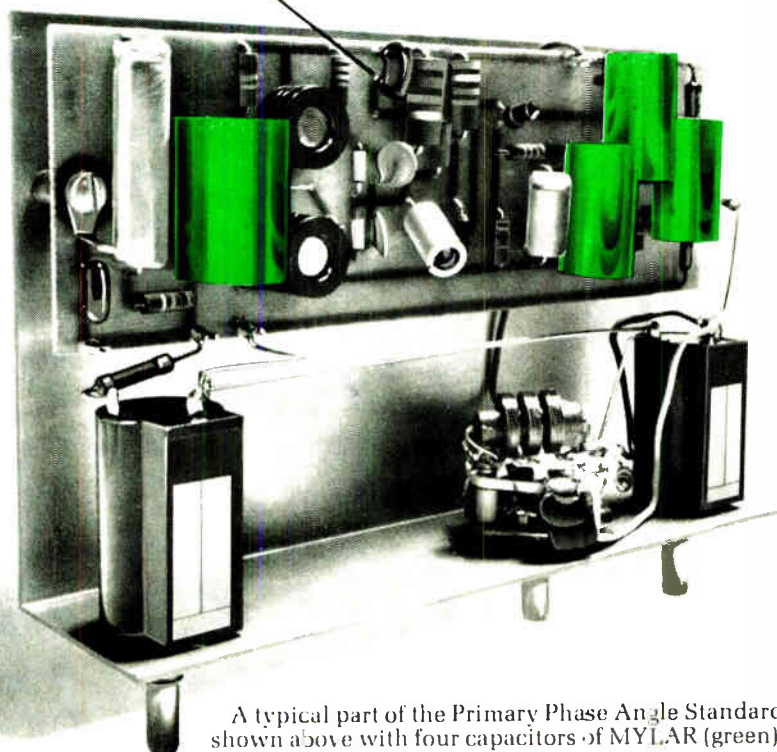
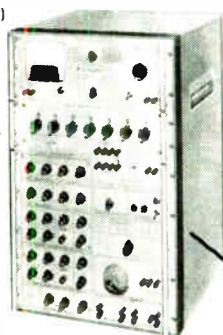

A typical part of the Primary Phase Angle Standard shown above with four capacitors of MYLAR (green).

NOW plug in up to
2048 bits, at a speed of
8 MHz for less than
5¢ per bit, with built-in
TTL interface.

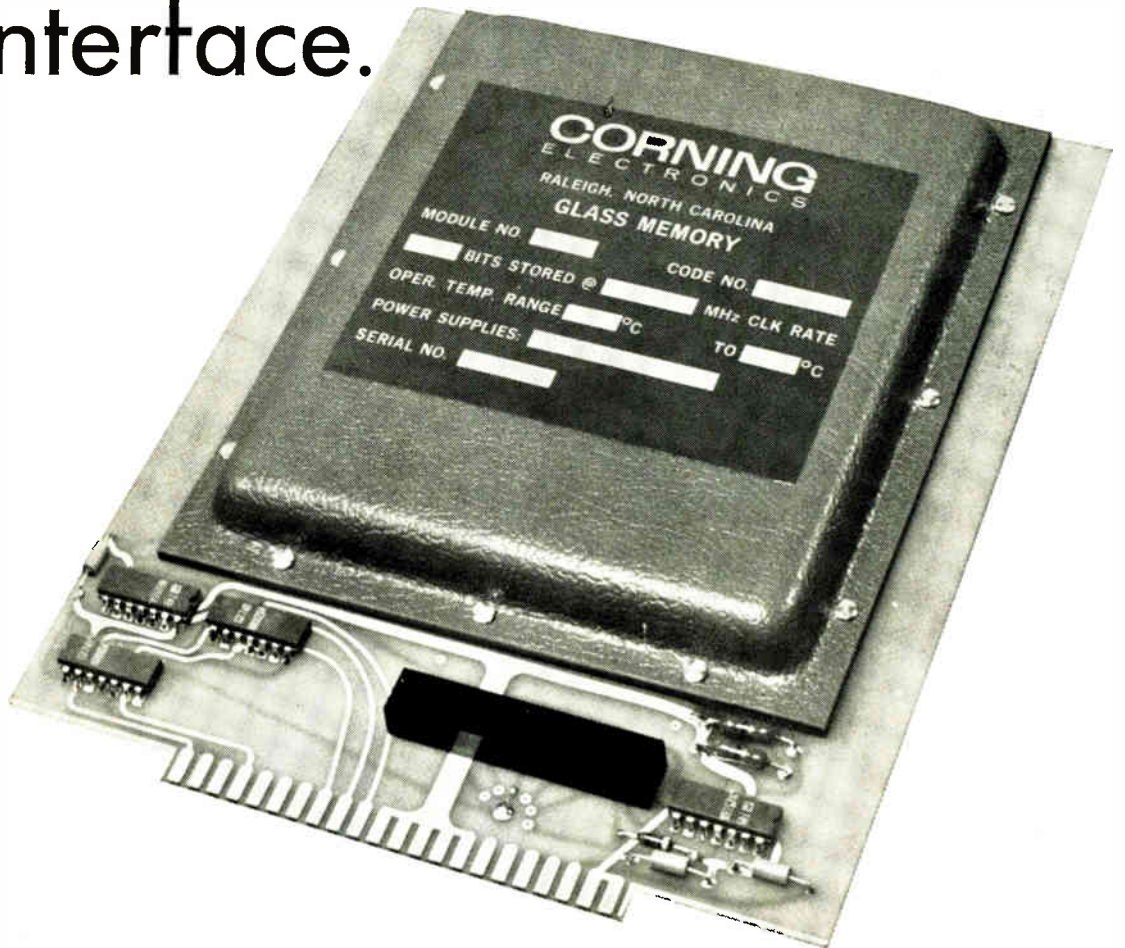

New Low Cost CORNING® Digital Glass Memory Modules.

Fast

Available Frequencies	Available Delay Time		
	64 μ sec.	128 μ sec.	256 μ sec.
4 MHz	256 Bits	512 Bits	1024 Bits
8 MHz	512 Bits	1024 Bits	2048 Bits

These are standard. Custom modules available up to 4096 bits and up to 16 MHz.

Easy. Just plug one in and you have serial storage. All the circuitry to interface with TT Logic is built in. You need no special power supplies, no voltage level shifters.

Low Cost. In the 1000 module bracket, for 2048 @ 8 MHz,

each bit costs less than a nickel. More modules—less cost. Even in 100 piece quantity, each bit costs less than a dime. And it's your only cost.

Stable. The medium is proven CORNING® Zero-TC glass.

Here now. These are performing products, not promised potential. Write for full data sheets, or to see our man with samples. Corning Glass Works, Electronic Products Div., Advanced Products Dept., Raleigh, N.C. 27602. Telephone (919) 828-0511, Ext. 262.

CORNING
 ELECTRONICS

How do most companies move a lightning-fast, long-memory, high-capacity computer?



They choose an on-time, precision-planning,
big-capacity van line.

Allied Van Lines safely moves more
computers (with long memories) than any
other mover.

Call the confident Allied Agent
in your area.



WHETHER or not you use Designer's Choice Logic, you have to admit that Signetics' idea of guaranteeing cross-family compatibility in integrated circuits can save you time and money in design.

PUBLISHED BY SIGNETICS:  THE RESPONSE/ABILITY COMPANY

NEW IC NIXIE DRIVER GETS UNGLOWING REPORT

Guaranteed 67V Breakdown

Signetics Corporation today announced the first monolithic IC Nixie Driver that permits Nixie* tube operation without excessive background glow and does not require any discrete external components for interfacing. "We've whipped the problem of getting a state-of-the-art 2.5-ohm centimeter process into production, so we can

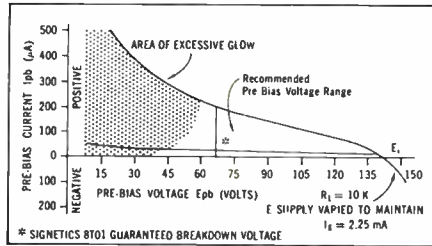

Pre-bias Voltage vs. Current Characteristics of a typical NIXIE Tube.

guarantee a 67V breakdown," a company spokesman said.

Officials also said that the new device, designated 8T01 Nixie Decoder/Driver, is the only one of its kind that will interface directly with all commonly used DTL and TTL circuits and drive Nixies directly. The new member of Signetics DCL family is offered in a 16-pin silicone DIP.

When told of this new device from Signetics, a competitive manufacturer stated, "Dammit."

*Nixie is a registered trade mark of the Burroughs Corp.

Big shift to new Shift Register

Unique Device Announced

"Your new shift register is the answer to my prayers."

That quote, from a Dallas designer, is typical of the response to Signetics' introduction of a new 4-Bit Shift Register in the DCL line, according to Bill Slaymaker, a Signetics Product Marketer.

"This device has a unique organization and functional capability," Slaymaker commented.

The new 8270/8271 4-Bit Shift Register is fully synchronous and offers parallel or serial input and output. The device operates at clock rates up to 20 MHz and has a mass reset line (in the 8271, a 16-pin configuration) that is independent of the clock. A unique feature is separate load and shift controls that make it unnecessary to gate the clock to inhibit the shift, thus eliminating clock skew problems. Power consumption is 40mW per binary.

The 8270/8271 is supplied in 14 lead flat pak, and 14 or 16 lead silicone DIP in both full MIL and industrial temperature ranges.

Signetics announces new publication

Signetics launched a new publication today, the DCL Bulletin. As you can see in the masthead the first issue is the 16th issue, the first fifteen issues having never been published. DCL has been famous and well-loved since 1966, so it would be just plain silly to call the first issue the first issue.

TODAY'S BUZZ WORD

"Designer's Choice Logic"
You didn't expect it to be "Fairchild"?

FOR SPEC SHEETS

Specifications on our new Nixie Driver and Shift Register are now available. Send for information on our complete DCL line. Write: Signetics, 811 East Arques Ave., Sunnyvale, Calif. 94086.

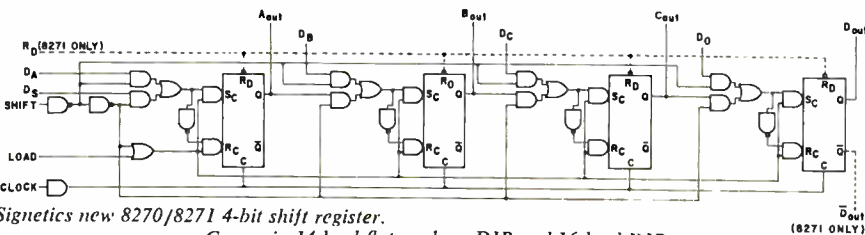

SIGNETICS SALES OFFICES: Fort Lee, New Jersey (201) 947-9870; Syracuse, New York (315) 469-1072; Richardson, Texas (214) 231 6344; Beverly Hills, California (213) 272-9421; Garden Grove, California (714) 636-4260; Wakefield, Massachusetts (617) 745-8200; Silver Springs, Maryland (301) 946 6030; Collingswood, New Jersey (609) 858 7864; Clearwater, Florida (813) 726-3734; Rolling Meadows, Illinois (312) 259-8300; Sunnyvale, California (408) 738 2710.

DISTRIBUTORS: Compare at all locations listed below. Semiconductor Specialists, Inc. (312) 279 1000; Terminal Hudson Electronics (212) 243-5200; Wesco Electronics (213) 684-0880; Wesco Electronics (405) 968-3475; Hammond Electronics (305) 241-6601; Avnet Electronics Corp. of Massachusetts (617) 272 3060; Pioneer Standard Electronics Inc. (301) 427-3300; Kieruluff Electronics (206) RO 3 5510; G. S. Marshall (213) 684-1530.

DOMESTIC REPRESENTATIVES: Jack Pyle Company (415) 349-1266. Compare Corporation at the following locations: Alabama (205) 539 8476; Arizona (602) 947-4336; California (213) 245-1172; California (415) 697-6244; Colorado (303) 781-0912; Connecticut (203) 288-9276; Florida (305) 855-3964; Illinois (312) 692 4125; Maryland (301) 484-5400; Massachusetts (617) 969 7140; Michigan (313) 357-5369; Minnesota (612) 922-7011; Missouri (314) 542-3399; New Jersey (609) 429-1526; New Mexico (505) 265-1020; New York (518) 436-8536; New York (607) 723 8743; New York (516) 921 9393; North Carolina (919) 724-0750; Ohio (216) 333-4120; Ohio (513) 878-2631; Texas (214) EM 3-1526; Texas (713) 667-3470; Washington (206) 763 1711.

INTERNATIONAL SALES: France, Germany, Italy, Belgium, Holland, Luxemburg, Spain - Sovcor Electronique, 11, Chemin de Ronde, Le Vesinet, (S & O) France. United Kingdom, Ireland, Sweden, Denmark, Norway, Switzerland, Austria, Portugal - Electrosil Ltd., Lakeside Estate, Colnbrook-By Pass Slough, Buckinghamshire. Great Britain Australia - Corning, 1202 Plaza Building, Australia Square, Sydney, N.S.W. 27-4318. Canada - Corning Glass Works of Canada, Ltd., Leaside Plant, Ontario, Canada (416) 421-1500. Israel - Optronix, P.O. Box 195, Ramat Gan, Israel 724 437. Japan - ASahi Glass Co., Ltd., Corning Products Sales Dept. No. 2, 3 Chome Marunouchi, Chiyoda-ku, Tokyo, Japan.



Amphenol just joined the 50 billion mile club

Some 54,000,000,000 miles ago Amphenol connectors started flying with the first commercial jet airliners. This experience helps us improve our connectors to meet rigid specifications on the new jets.

Our report on the Boeing 727 is available now. It documents reliability of MIL-C-5015, MIL-C-26500, MIL-C-26482, coaxial and rack and panel type con-

nectors. Our report gives performance data on these connectors and establishes various failure modes.

For a free copy, please request our report "Jet Aircraft Connector Field Failure Data" on your company letterhead. Amphenol Connector Division, Amphenol Corporation, 2801 South 25th Avenue, Broadview, Illinois 60153.

Circle 191 on reader service card



AMPHENOL

Barnstead elephant-sized demineralizers work for peanuts

Barnstead industrial demineralizers give you large quantities of process water at unusually low cost. Take this Barnstead Two-Bed model used by a major metals producer. It removes heavy concentrations of calcium and other troublesome impurities from 2,000 gallons of water per hour — at an operating cost of only a fraction of a cent per gallon. (Excluding initial demineralizer cost.) Operation, particularly regeneration, is easy and economical. A simple one-handle valve for all steps and a visible waste trough help prevent resin-wasting mistakes. An automatic purity controller assures water quality and tells when it's time to regenerate. Do you have a big demineralizing job to do?

Write for the Barnstead Catalog 160 describing demineralizers from 5 to 3,000 gph.

Barnstead

A DIVISION OF RITTER PFAUDLER CORPORATION
225 Rivermoor Street
Boston, Massachusetts 02132

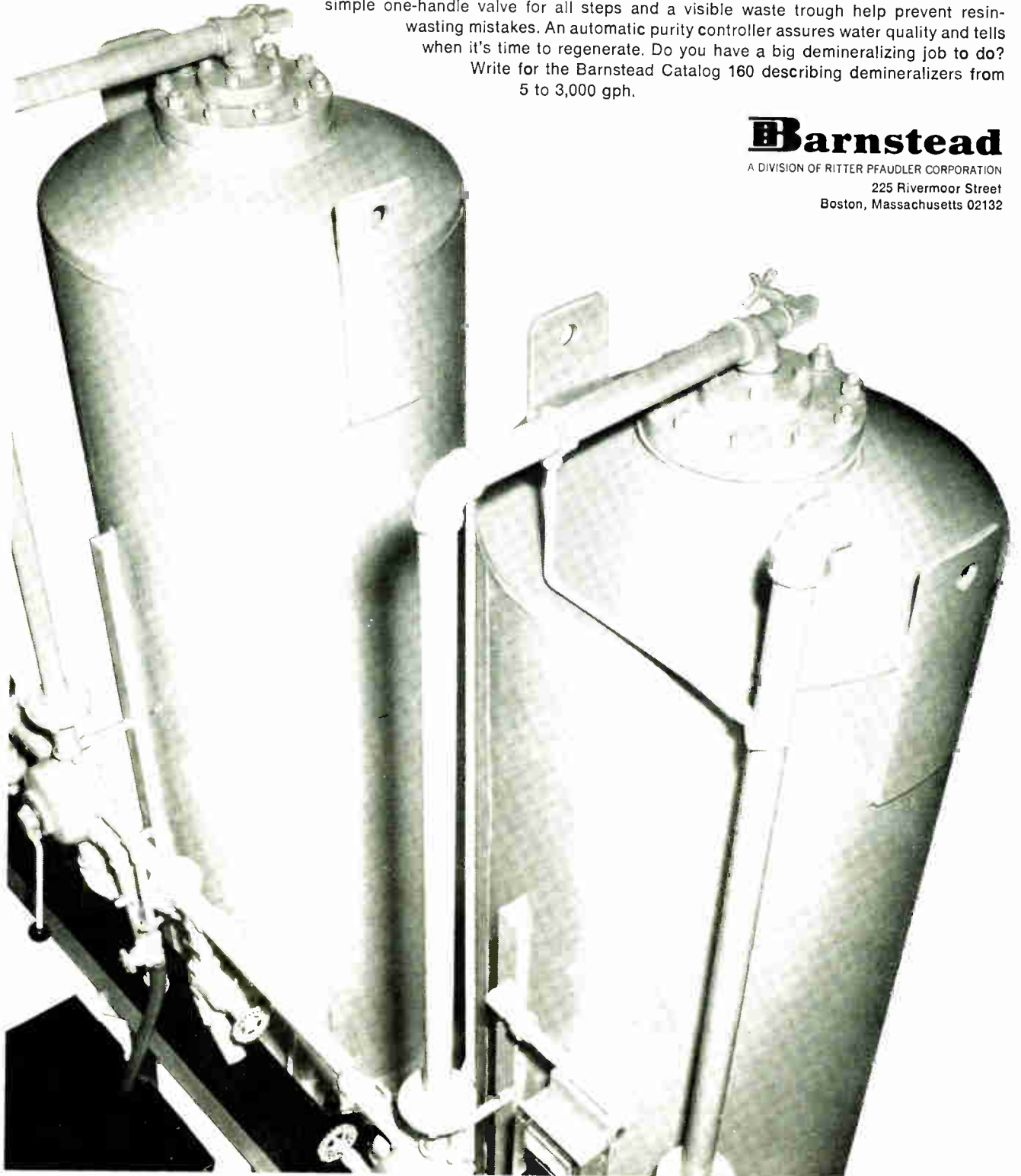

New Products

Computers

Punched cards on the ropes?

Fast, compact machines can transcribe data directly onto tape; optical character and magnetic readers are also in contention

By Wallace B. Riley

Computer editor

The admonition, "Do not bend, fold, staple or mutilate this card," may eventually take its place along-side such expressions as "Twenty-three skiddoo," and "All the Way With LBJ." And "eventually" may be just around the corner. Several recent developments indicate that the days of the punched card as a computer input medium may be numbered. Two machines, now on the market, can transcribe data directly from a keyboard to magnetic tape; an experimental magnetic-card system was recently announced, and cathode-ray tube units and optical character readers are arousing more and more interest in the computer industry.

Long run. The punched card as a medium for moving data in and out of automatic equipment is 81 years old. The present standard format—80 columns and 12 rows of positions for rectangular holes in a 0.007-inch-thick card 7 $\frac{3}{8}$ by 3 $\frac{1}{4}$ inches—has remained unchanged since 1928.

With this kind of longevity, the punched card isn't likely to disappear completely for many years. In fact, the number of punched cards used each year has been increasing an average 11% since 1962, almost entirely because of the explosive growth of the computer industry.

For one thing, 80% to 90% of the field relies on punched cards for input. For another, the cards cost only about a tenth of a cent. But the growth is expected to taper off to perhaps as little as 2% a year within five years because new kinds of machines are appearing, and interest is growing in other media such as disk packs—removable magnetic disks that share the bulk-storage advantages of magnetic tape but have the random-access characteristics of large disk files. Such developments are reducing the number of cards consumed per user. But for the moment, this at-

trition is more than offset by the increase in the number of users.

I. Bill of particulars

Interest in alternatives to the punched card is heightened by its numerous disadvantages, some of which are critical now that faster and faster computers are being produced. Among the drawbacks:

One shot. A card can be punched only once. If a keypunch operator makes a mistake, he has to start over on a new one.

Cozy. One card contains a maximum of 80 characters of data, except when unusual special codes

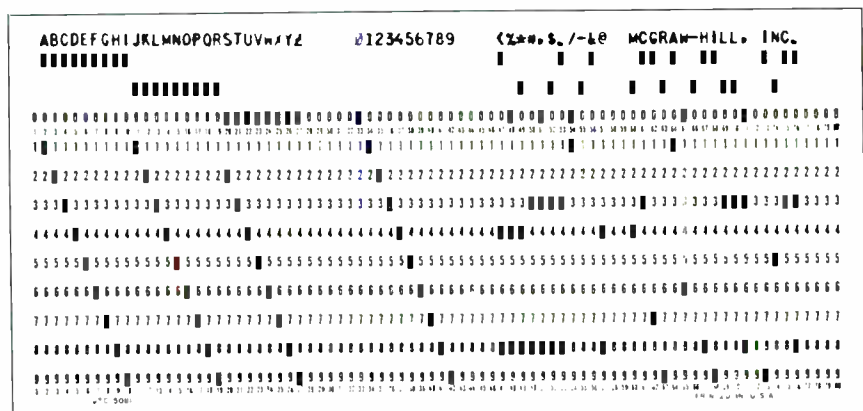

Code. In a conventional 80-column, 12-row punched card, a single punch in one of the nine numeric rows or zero zone represents one of 10 decimal digits. Numeric plus zone punches represent alphabet letters. Other combinations stand for a variety of special symbols.



In and out. The removable magnetic tape cartridge in Communitype's data communication system has capacity of 180,000 characters or 30,000 words.



Quick trick. With Honeywell's Keytape, data can be transcribed directly onto computer-ready magnetic tape through a keyboard.

are used. When record lengths require more than 80 characters, additional cards are necessary. However, only 60 to 70 characters can be used per card; the rest of the space is needed for codes that identify cards containing parts of a single record.

Inefficient. The 12-row Hollerith code used on most punched cards is highly redundant; only 64 characters are defined, out of a possible 4,096—an efficiency of about 1½%.

Slowpoke. Most card readers used as input devices with computers have a maximum speed of 400 to 800 cards per minute; a few can get up to 2,000 cpm. Even with every card packed full of data, the maximum possible input is only 2,667 characters per second—at least 40 times fewer than today's standard magnetic tapes. As a result, large-scale systems usually include one or more small peripheral computers that transcribe card data onto tape in a separate process. This lets the central processor work directly with magnetic tape.

Closet case. Any significant amount of data kept on punched cards for future use takes up a lot of storage space and is heavy.

Slow shuffle. Dropping a deck of cards may require a complete re-sorting—this means lost time, extra handling, and the possibility of damage or contamination of the cards.

Fallout. Cards tend to generate dust and lint in the machines that handle them. Specifications can minimize but not eliminate such difficulties.

Down time. A damaged or worn-out card can jam the machine processing it; the process must be stopped and a new card punched and inserted in its proper place before the job can be resumed.

Redeeming virtues. Of course, the punched card does have its good points. It can carry any kind of information, and the punches can be read visually if one knows the code. It can be read into the machine with only a simple computer program. What's more, the punched card has some actual advantages over other media. It can be separated from the file, mailed, or otherwise handled individually, and restored to the file at any time. And in many applications cards can be economically processed only

Punched cards then and now

During the 1880's the records of the Census Bureau were still being compiled by hand. But the growth of the U.S. made it apparent that existing techniques wouldn't provide the results of the 1890 census until well after 1900. As a result, a bureau statistician named Herman Hollerith set out to develop a mechanized tabulating system. His machines, first tested in 1887, were controlled by cards with three rows of 32 punch positions along the top edge, and three more rows along the bottom—a total of 192 possible positions for holes.

Stepping stone. The processing of the 1890 census with Hollerith's machines was so successful that he founded the Tabulating Machines Co. to develop and market the machines commercially. About 20 years later Hollerith's firm merged with the Computing Scale Co., a maker of butcher scales, and the Time Recorder Co., which produced time clocks for factories. The corporation was named the Computing, Tabulating, and Recording Co.

The merger wasn't particularly successful, and in 1912 a new president was brought in. He was 40-year-old Thomas J. Watson Sr., who had just left his job as sales manager at the National Cash Register Co. after a falling out with the chairman of the board. Watson succeeded in improving the company's fortunes and it prospered; in 1923 it changed its name to the International Business Machines Corp.

Solo. Then and for many years thereafter, IBM was the only company making card-controlled electric accounting machine. In addition, its name continues to be synonymous with punched cards. The company made the switch to electronic computers in the early 1950's over the objections of the elder Watson, who kept effective control of the concern until shortly before his death in 1956. Nevertheless, the company continued to turn out electric accounting machines, which still account for a substantial part of sales, although they have been largely eclipsed by computers.

once and then discarded.

II. No bargain either

The key punch, a machine used to transfer data manually from source documents to punched cards, also has drawbacks. It's a mechanical device subject to breakdowns and is very noisy and tiring to operate. The machine can't check the punched data; a separate verifier machine, usually requiring an additional operator, is necessary to ensure accuracy. Physically, the verifier is almost identical to the key punch, but has mechanical "feelers" instead of punches.

Only the International Business Machines Corp. makes key punches. A 1956 consent decree with the Justice Department requires IBM to make its design specifications available to anyone who wants, to build equipment to interface with IBM computers, but no one had taken advantage of this opportunity. However, several companies make other kinds of equipment that's compatible with IBM gear.

Lilliputians. The company insists that it has competition in this area. But only a half dozen or so firms make equipment for punching holes in cards, and such products—

with one exception—are all portable, hand-operated devices that wouldn't be suitable for volume production. For example, Taller and Cooper Inc., Brooklyn, makes a portable printing punch that works like a toy typewriter. A dial turns to the character to be punched, and a bar simultaneously drives the corresponding punch knives through the card and prints the character at the top of the card just like IBM's key punch does. The Taller and Cooper machine even has a tabulator that permits skipping over several columns at once.

The printing punch is marketed by Taller and Cooper and by the Wright Line division of the Barry-Wright Corp.; an agreement with the National Cash Register Co. is being negotiated. Taller and Cooper is also developing the only machine that has anything like the capability of an IBM key punch; it looks and works like a typewriter. The machine, an electrified version of the portable printing punch, is being developed under a contract with the U.S. Navy, which needs a compact and versatile unit to use in submarines and destroyers. It will be commercially available for about \$2,500 in about six months.



this is an antenna!

That's right! Concealed within this rugged rear view mirror is an omnidirectional V.H.F. antenna for the 148-174 Mc band. The Sinclair Mobile Mirror Antenna defies detection... prevents vandalism... eliminates special antenna mounting. Independent tests prove efficiency equal to—or better than a ¼ wave whip. V.S.W.R. is less than 1.5 to 1 at design frequency. Clip the coupon for FREE literature, including test data and prices.

so's this

It looks—and mounts—like a standard car radio antenna. Yet it conceals a rugged V.H.F. two-way radio antenna for the 148-174 Mc band. Each Sinclair Disguised Whip Antenna is perfectly "matched" to your specific frequency. This exact matching, combined with a 2.5 db gain, insures greater efficiency than any other disguised antenna now on the market. Clip the coupon for FREE literature, test data and prices.

SINCLAIR RADIO LABORATORIES

FREE LITERATURE

TO: SINCLAIR RADIO LABORATORIES, INC.
676 Ensminger Rd., P.O. Box 23
Tonawanda, New York 14150

Name: _____

Title: _____

Company: _____

Address: _____

City: _____

State: _____ Zip: _____

... not even Univac
builds key punches ...

IBM's electrically driven key punch is a sophisticated device; it feeds cards automatically and is capable of skipping and duplicating under control of a program drum that can be set up for any data format. The company's design and service have proved so good that no one has seen any percentage in taking on the giant in this area. And with the advent of machines that bypass punched cards and the prospect of a declining market, it's unlikely that anyone will want to develop anything in the future.

Dead issue. Not even the Univac division of the Sperry Rand Corp. builds key punches. Some years back, however, it did turn out machines that punched round holes in 90-column cards used in electric accounting machines and computers like the 1004 and 1050. But now that Univac's 9000 series of processors uses 80-column, IBM-format punched cards, the company has left the key punch field altogether.

III. New directions

Three years ago, a small company in upstate New York, the Mohawk Data Sciences Corp., making the first real effort to overcome the disadvantages of punched cards, brought out its data recorder, a machine with a keyboard almost identical to that of the key punch.

The operator keys in data as he would with a key punch, but the data is stored in a core memory until the record is completed. The data is then written at 200 bits per inch on a strip of seven-track magnetic tape that can be processed directly on a computer. The record can be verified on the same machine immediately after writing or later; errors can be corrected immediately without starting the record over. One reel of rolled-up tape, 2,400 feet long, taking up about a tenth of a cubic foot of storage space, can hold as much data as about 36,000 cards requiring more than 40 times the storage space. (This holds true if the data is recorded on the tape in essentially the same format as on the cards.) More sophisticated techniques can greatly increase the amount of data stored on the tape. And the tape

↓

↑

**ONLY
0.8 dB
INSERTION
LOSS**

**FROM ONLY
0.2 CUBIC INCHES OF FILTER**

Telonic's new *Miniature Bandpass Filters* offer two prime advantages to the designer—small volume and large performance. The 'scope trace above shows the actual bandpass of a Model TSA Filter that occupies .2 cu. inches, weighs less than ½ ounce, and can out-filter units 10 times its size. Insertion loss is only .8 dB, 30 dB form factor is 4.2, and the 3 dB bandwidth is 45 MHz wide.

SERIES TSA—CENTER FREQUENCIES 200 MHz to 600 MHz

A coupled resonator type using .01 dB Chebyshev distribution. 3 dB bandwidths may be specified from 1 to 15%. Insertion loss is minimal at any frequency. Dimensions: ¼" x 9/16" x 1½" - 3½".



SERIES TBS—CENTER FREQUENCIES 200 MHz to 2300 MHz

A tubular type filter with 2 to 8 sections providing 3 dB bandwidths from 1.5 to 20%. Low insertion loss and VSWR in the passband. Dimensions: ¼" diam. x 1½" - 5".



COMPLETE SPECIFICATIONS ON BOTH SERIES INCLUDED IN CATALOG 101A—
SEND FOR YOUR COPY.



Telonic ENGINEERING CO. A DIVISION OF
TELONIC INDUSTRIES, INC.
BOX 277 • LAGUNA BEACH, CALIF. 92652 • TEL.: 714 - 494-9401 • TWX: 910 - 596-1320

HERE'S HOW...

THE ELECTRONIC INDUSTRY IS USING THESE FAMOUS ULANO FILMS IN ULTRAMINIATURE MASK TECHNOLOGY AND COMPLEX PRINTED CIRCUITRY

Cut a piece of the desired film large enough to cover area to be masked. Tape it down firmly at the top with dull-side up.

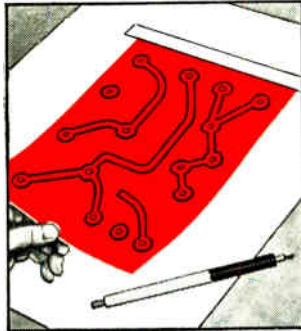

With sharp blade, outline the areas to be masked. Do not cut through the backing sheet. The Ulano Swivel Knife does the job quickly, easily.

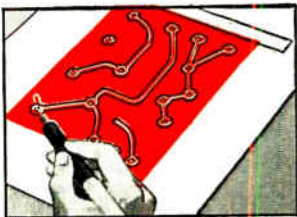

Using the tip of the blade, lift up a corner of the film thus separating it from the backing sheet.

Now carefully peel off the film as outlined leaving a completed mask, positive or negative, that corresponds exactly to the desired pattern.

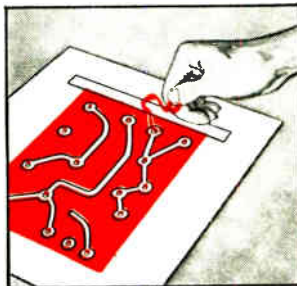

Ulano^{T.M.}

RUBYLITH^{T.M.}

AMBERLITH^{T.M.}

HAND CUT MASKING FILMS FOR THE GRAPHIC ARTS

ULANO RUBYLITH... a revolutionary knife cut red film is laminated to a stable transparent plastic backing sheet. The red film is "light safe" so that when contacted to a sensitized emulsion and exposed to a suitable light source, light passes through the cut-out portions only... not through the red film. ■ The polyester backing is absolutely stable... insures perfect register. ■ Special effects such as crayon tones, paste ups, berday sheets, and opaquing are easily combined with versatile ULANO RUBYLITH.

ULANO AMBERLITH... a companion to Rubylith serves as a color separation medium used as the master on camera copy board to secure negatives or positives.

A wide variety of Ulano films—in rolls and sheets—is readily available

Designed FOR YOUR PARTICULAR NEEDS

Ulano offers the most versatile line of hand-cut masking films, including:

.0075—RUBYLITH 75 DR* .005—RUBYLITH 5 DR†

.005—AMBERLITH 5 DA†

Where exact register assures a critical importance, you will find these new, thick, polyester based films the positive answer.

* Available in sheets only, cut to your specifications
† Available in rolls and sheets



WRITE TODAY on your letterhead for free special sample kit 1748

"Ulano"—"Rubylith"—"Amberlith" are registered trade marks of the Ulano Companies.

ulano

610 DEAN STREET, BROOKLYN, N.Y. 11238

In Europe: ULANO A.G., Untere, Heslibachstrasse No. 22, Kusnacht, Zurich, Switzerland

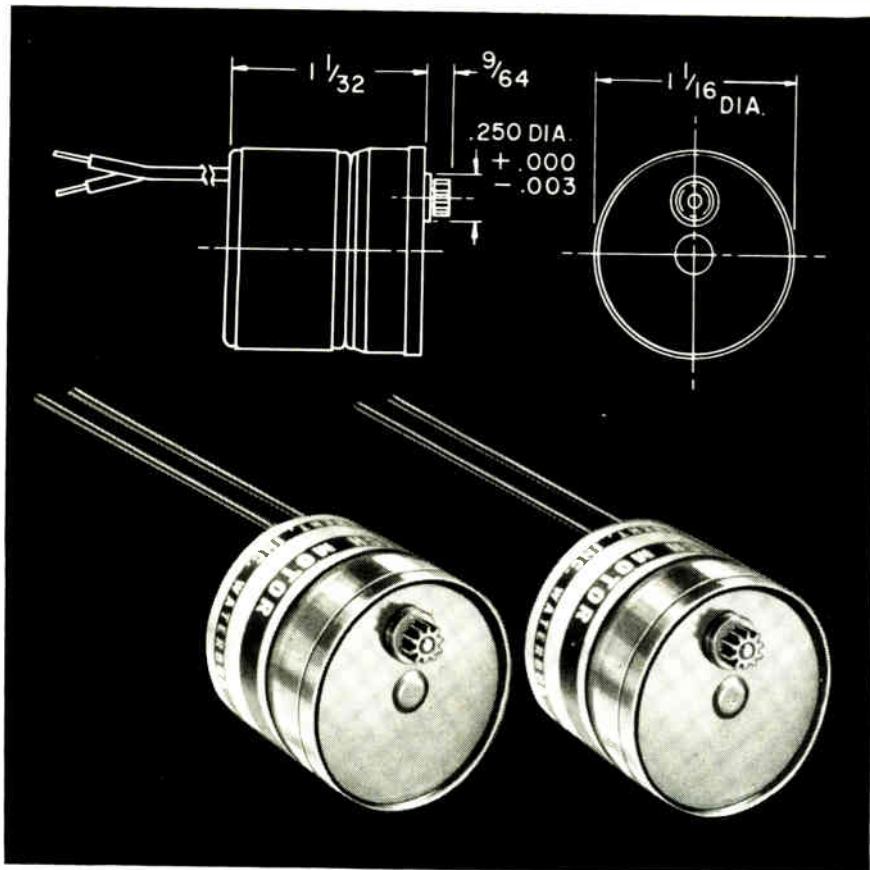

big inch!

New BIG INCH™ Synchronous Integrating Motors

Like peas in a pod but available in different speeds and voltage ratings. The HSI Series 33000 is approximately 1" x 1" small, yet unmatched for its size in precision, power, efficiency and low cost. It's the ideal drive for elapsed time indicators, stop clocks, pulsers, interrupters, timing devices, chart drives — and many other applications. Outstanding features include . . .

Fast Start/Stop: From dead stop to full speed in $\frac{1}{100}$ sec., stops instantly without coast.

High Torque: Higher than many motors twice its size.

Low Wattage: Only 1 watt input at rated voltages.

Sealed Gears: Permanently lubricated for long life.

Low Cost: Tooled for mass production.

Available in speeds of 360, 300, 60 and 3.6 RPM, 20V and 115V 60Hz.

SEND FOR NEW BULLETIN NO. 33-1



HAYDON SWITCH & INSTRUMENT, INC.

Where Optimum Performance is Standard

1500 Meriden Road, Waterbury, Conn. 06720 / Area Code (203) 756-7441

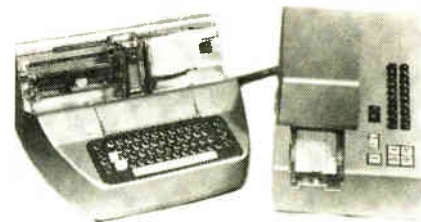

Sea duty. Navy will post this electric keypunch setup being built by Taller and Cooper to sub and destroyer fleet.

can be reused after the data is discarded.

Newcomers. The original model 1101 data recorder, first produced in 1965, has since been joined by a line of machines that provide: pooling of data from several keyboards onto one tape; data communications capability; and input from paper tape, punched cards, or a typewriter keyboard. Other models put longer records at higher density on nine tracks for compatibility with the newest computers. The machines are sold directly by the Mohawk Co. and, under a private-label arrangement, by National Cash Register.

The Mohawk machines, although pioneers, weren't the first of their kind. During the early 1950's Univac (then part of Remington Rand Inc.) marketed the Unityper, which recorded individual characters from a typewriter at low density on a metallic tape. Mechanical difficulties with the incremental drive and the difficulty of verifying the recorded data and correcting errors led Univac to withdraw the machine from the market.

Bigger buffers. Mohawk has recently been joined by Honeywell Inc., which introduced its Keytape machine this January. Keytape is the functional equivalent of the data recorder, but Honeywell claims a faster speed and the capacity to record at higher densities on seven-track tape. Honeywell's machine is essentially a standard tape drive like those used on computers, winding tape from reel to reel. The company says this is superior to Mohawk's technique in which the tape is unreel as it is written, dumped loosely into a bin, and wound at the end of the job.

Both Mohawk and Honeywell depend on the 80-character record length, just as punched cards do.

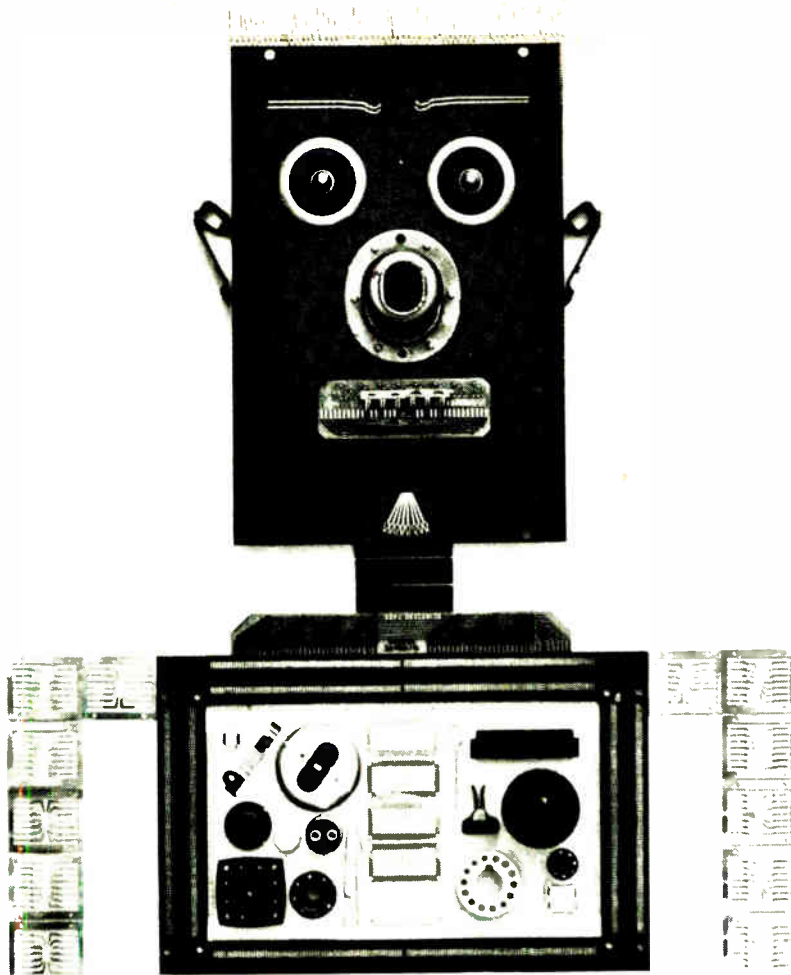

Sylvanians do as they're told.

Our living depends on it.

We turn out 50 million custom-fabricated parts a day. To exact specifications.

Including precision stamping of high-tolerance, miniature metal shapes.

Precision molding of intricate plastics parts.

Precision forming of wire for critical electronics.

Combining metals, plastics and wire into precision-built assemblies.

We live by our accuracy. After all, if we don't do what we're told, you

may not tell us anymore.

We've been doing it for over 17 years. On transistor leads, computer memory core frames, connectors, oen caps, aerosol spray tips, razor blade dispensers, integrated circuit frames. You name it.

We've got nine plants, the most advanced equipment, and the best engineers and die makers around to do it.

And we'll even help you design the part. Then we'll build the dies, produce the parts, and do the assembly. Exactly as we're told.

That means you get the parts you want, the way you want them, when you want them—probably at less cost than you could do it for yourself.

So the next time you need a custom fabricated part, call a Sylvanian and tell him what to do.

Sylvania Metals & Chemicals, Parts Division, Warren, Pa. 16365.

CUSTOM PARTS BY
SYLVANIA
GENERAL TELEPHONE & ELECTRONICS

MEET REQUIREMENTS BY USING HAMILTON PRECISION STRIP AND FOIL

The most critical performance requirements for thin metals can be met by Hamilton strip and foil. Regardless of these requirements of your thin metal application—strength, hardness, surface finish, optimum magnetic permeability or dimensional accuracy—you can get them all from Hamilton Precision Metals.

Every lot of Hamilton strip and foil is produced under rigid control of mechanical properties through alloy analysis, annealing and heat-treating; the closest dimensional control by means of X-Ray and Beta-Ray gages; superior surface finish through the use of diamond lapped work rolls and process cleanliness.

This same technical "know-how" goes into the processing of every one of our 7 proprietary metals, 12 pure metals and 112 commercial alloys rolled in thicknesses from 0.060" down to 0.000070" in widths up to 12" and continuous coils to 1000 lbs.

Write, wire or phone giving us the material you desire and the properties you need. We'll tell you how fast we can get it to you—in quantity! Or, write for our latest catalog containing our capabilities and engineering data on all our materials.



HAMILTON PRECISION METALS

Division of Hamilton Watch Company, Lancaster, Pa. 17604
Telephone 717-394-7161 TWX 717-560-4417

However, the machines can extend the record simply by increasing the size of the buffer memory. Honeywell intends to compete with Mohawk in replacing keypunches.

Another one. Sangamo Electric Co., of Springfield, Ill., is preparing a unit similar to the Mohawk and Honeywell machines for introduction later this spring along with related equipment for data communication applications. Sangamo recently acquired a California outfit—a move that attests to its heightened interest in data recording and related activities.

IV. Communications link

A magnetic recording device similar in several respects to the data recorder and the Keytape was introduced last fall by a New York firm, the Communitytype Corp. The machine transcribes data from a typewriter keyboard onto magnetic tape in a small cartridge and simultaneously makes a hard copy on the typewriter. If the typist makes an error, the typewriter and the tape can be back-spaced to correct it. The recorded data can be speedily transmitted over a telephone line, re-recorded on computer-compatible tape in a separate converting machine, or automatically recopied on the typewriter. An optional addressable memory unit, actually another piece of tape in a small desk-top housing, stores frequently used information; the data can be transcribed onto the cartridge tape without being repeatedly entered from the keyboard.

The Communitytype device is similar to the others in that it makes card punching unnecessary. But it is primarily a data communica-

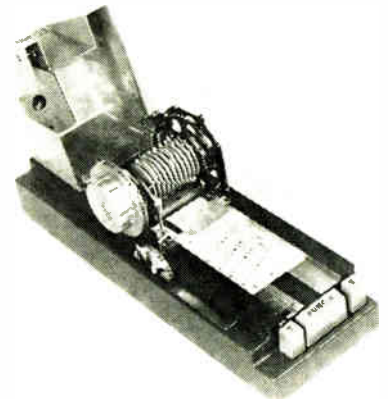

No toy. Taller and Cooper produces a portable unit that prints characters and makes punches just like IBM gear.

You simplify your RG Cable problems if you know in advance everything you should—like bend radius, VSWR, power handling capability, phase temperature, coefficients, dimensional stability and transmission unbalance, just to begin with. But if you're shy an answer or two, or you aren't sure of all the questions you should be asking, give our Engineering Service Department a call.

Over the years we've developed a staff that knows a little more, digs a little deeper, and has the answers to every RG cable question they have ever been asked. We've made more than 1,000 different types of flexible and RG Cable. We've accomplished more economical trade-offs than you can shake a

connector at. (That's another thing — are you sure your present connectors will give you the assembly characteristics you're looking for?) Our current stock is the largest and most varied in the business. Our Weekly Inventory Report is famous — and we'll be glad to put you on the mailing list. Our capability for specials is endless. And our knowledge and experience are at your disposal.

So get in touch with Times on your RG questions. That way you'll know us—as well as what we know. For our latest cable catalog, tech memos and stock list, write: Times Wire & Cable/a division of The International Silver Company, Wallingford, Conn or phone (203) 269-3381.

With RG Cable, it isn't who you know, it's what you know.

Ross Strait, Jr.
B.A., Physics

Jack Arbuthnot
B.S., Electrical Engineering

Russ Edmond
B.S. and M.S.,
Mechanical Engineering

Dave Peterson
B.S., Mathematics

Al Kushner
B.S.,
Mechanical
Engineering
M.S.,
Electrical
Engineering

Fred Baughman
Ph.D.,
Chemical Engineering

Nevell McDonald
B.S., Mechanical Engineering



Circle 201 on reader service card

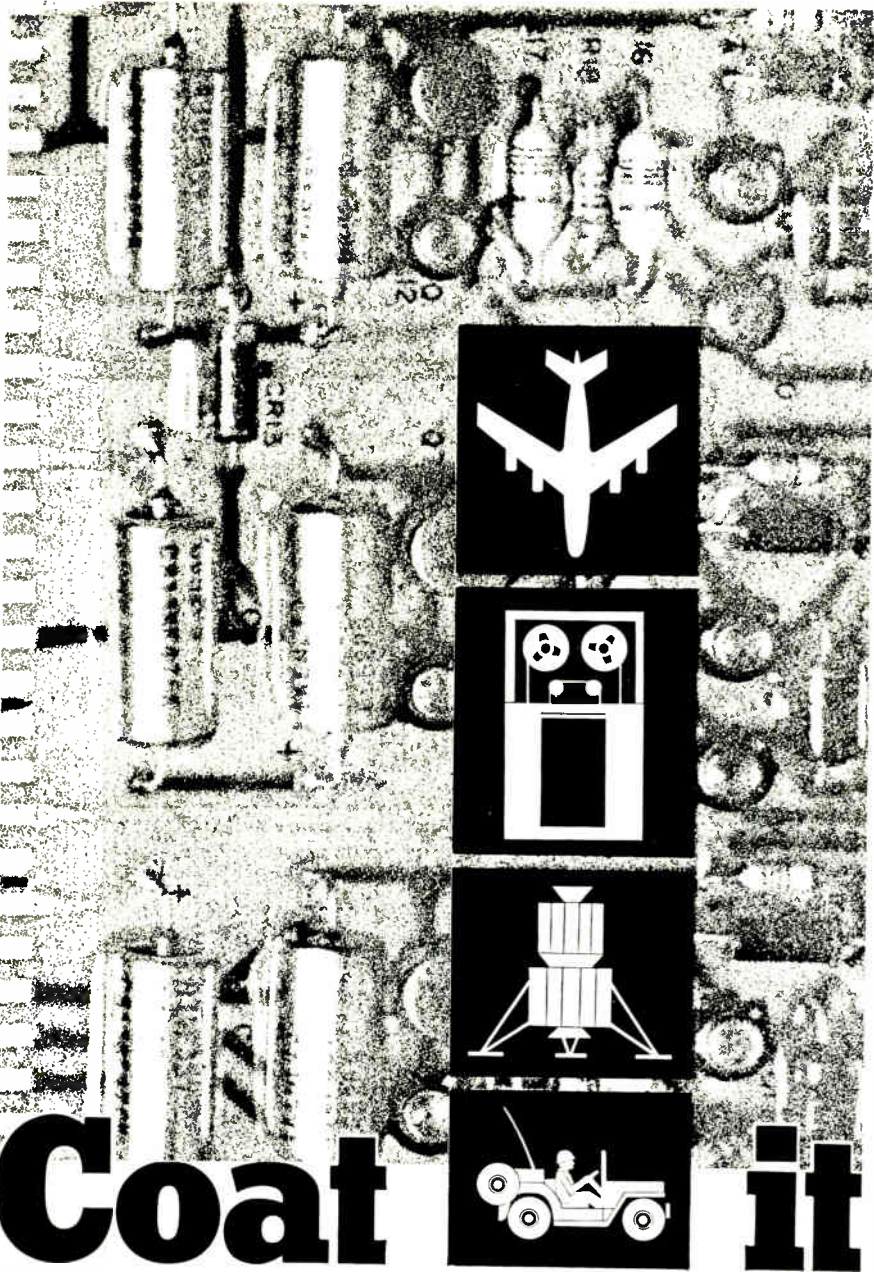

...with one of HYSOL's seven printed circuit coatings by Spray, Dip or Brush

HYSOL, the most experienced producer of printed circuit coatings, offers the widest range of coatings for commercial and military uses. HYSOL epoxy coatings PC12-007-M, PC16-M, PC23-M and PC26-M meet the rigid MIL-I-46058B requirements, and urethane coating PC22 meets NASA MSFC-SPEC-393 specification requirements. Testing in a complete electronic testing laboratory insures precise quality control.

HYSOL epoxy and urethane coatings are in use protecting circuits on military and commercial jet aircraft, aerospace vehicles, control, communication and EDP equipment. All HYSOL coatings are proven fungus resistant (MIL-E-5272) and all are transparent.

Write, wire or phone HYSOL, Dept. EM-48, Olean, New York 14760, for application engineering assistance. Ask for Printed Circuit literature.

HYSOL HYSOL DIVISION
THE DEXTER CORPORATION
See us at the Show Booth No. E41

... some machines read only single lines ...

tion device. Since its tape isn't computer-compatible, there must be an extra operation—over a telephone line or locally—to put the data into a form directly acceptable to a computer.

Cousin. A related device, primarily for communications but also applicable to computer inputs, is Digital Devices Inc.'s new buffer (see page 218), which uses a magnetostrictive delay line instead of a piece of magnetic tape as a temporary storage.

Univac recently developed a new kind of unit record that has many of the advantages of punched cards and few of the disadvantages [Electronics, March 18, p. 48]. It's a plastic card, able to store up to 100 times as much data, that's recorded magnetically like a standard punched card. The data can be erased and the card reused indefinitely. And the cards can be individually handled.

V. Look-see

Other potential threats to punched cards are optical character readers and magnetic-ink character readers. The latter form of recording is already used by most commercial banks for checks.

Optical character readers are made by several companies, including the Optical Scanning Corp., National Cash Register, Farrington Electronics Inc., IBM, the Control Data Corp., Recognition Equipment Inc., and the Philco-Ford Corp. Some machines read only single lines, while others can assimilate whole pages. Some read only stylized type fonts, other almost anything. "Most of the machines are quite expensive from a systems point of view," says Myron Angier, director of Honeywell's Special Products division, home of the Keytape machine. "They will eventually take over the unit record function that punched cards now handle, but we don't expect much competition from them for quite some time." Honeywell doesn't now make an optical character reader.

On display. Crt displays with associated light pens or keyboards offer another possible alternative to



TO-68

DOUBLE-ENDED VERSION

PNP GERMANIUM ALL PURPOSE POWER TRANSISTORS UP TO 65 AMPS FROM Solitron

Solitron offers 65 Amp Germanium Power Transistors in a TO-68 case or double-ended version. Both packages provide heavier leads than the TO-36 case for more efficient use of power. These high current devices are identified as the SDT 1800 and SDT 1900 Series, and include the JEDEC registered 2N2730-35 Series. Typical uses include motor speed controls, computer printers, welder-control circuits, inverters, converters, regulators and many other high current power supply and control applications.

A wide variety of other PNP Germanium Power Transistors, with current ratings up to 25 Amps, are available in a TO-3 case. Also, many general purpose and JAN qualified devices.

Type Number TO 68	Type Number DOUBLE ENDED VERSION	Breakdown Voltage		P _{tot}	SAT Voltage Max Rated I _c	
		V _{CE}	V _{BE}		V _{CE}	V _{BE}
MHT1808	MHT1908	80V	60V	15 m r 50A	1.25V	.45V
MHT1809	MHT1909	60V	45V	15 m r 50A	1.25V	.45V
MHT1810	MHT1910	40V	30V	15 m r 50A	1.25V	.45V
2N 2730	2N 2733	80V	60V	15 m r 65A	1.25V	.45V
2N 2731	2N 2734	60V	45V	15 m r 65A	1.25V	.45V
2N 2732	2N 2735	40V	30V	15 m r 65A	1.25V	.45V
SDT1860	SDT1960	80V	60V	20 m r 65A	1.25V	.30V
SDT1861	SDT1961	60V	45V	20 m r 65A	1.25V	.30V
SDT1862	SDT1962	40V	30V	20 m r 65A	1.25V	.30V

SOLITRON HAS COMPLETE FACILITIES FOR ALL TYPES OF ENVIRONMENTAL AND BURN-IN QUALIFICATION TESTING.

Dial 1-800-327-3243 for a "No Charge" telephone call and further information

*When you think of semiconductors ...
think Solitron!*

Solitron
DEVICES, INC.

1177 BLUE HERON BLVD. / RIVIERA BEACH, FLA. / TWX: (510) 952-6676

Lapp Entrance Insulators

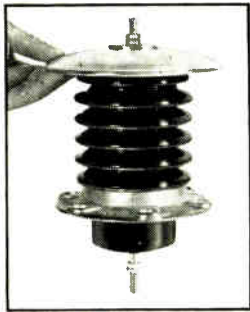

The sizes vary...
But our skills are always large.



Lapp skill in designing and building entrance insulators goes back over 43 years. We're big on design knowledge, ingenuity and ability to deliver the job... right to your requirements.

Standard designs, or special types, Lapp can produce entrance insulators for almost every electrical and mechanical requirement. Save your company time, money and searching... call in Lapp when your projects require entrance insulators, or antenna, or tower insulators.

Put Lapp skills to work for you... from design to delivery. Lapp Insulator Co., Inc., LeRoy, N. Y.

Lapp

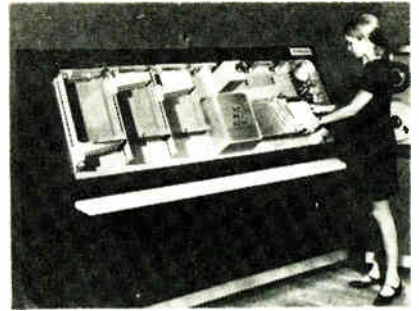

Op art. Optical Scanning's character reader can read single-line forms at a speed of 600 per minute.

punched cards. However, they too cost much more than conventional equipment, and hard copy isn't automatically available from a display. The principal advantage of crt's is their ability to provide on-line real-time access to a computer—a capacity fundamentally beyond punched-card systems.

Further development work on ocr's and crt's will make them more and more attractive as possible replacements for punched-card equipment. Meanwhile, another, less obvious alternative is a "keydisk" setup. Perhaps a machine could be built to enter data directly through a keyboard onto a portable disk pack. However, no one could use enough of this system's potential to justify its high cost. For one thing, a single disk pack holds about as much data as a reel of tape but is much more expensive. Its most effective application would probably be storing data from several keyboards running in parallel. Its random-access capability would separate the data from the various keyboards.

A way to take advantage of this pooling capability isn't evident now. Both Honeywell and Mohawk offer pooling devices as accessories to their machines, but the pooling operation is separate from the keyboard operation. First, the individual tapes are made, then several of them are pooled onto a single reel. Also, despite the recent rapid growth of the disk-pack industry, disk packs themselves are still a very small part of the total industry picture. They will remain so for some time, partly because of the vast prior installation of magnetic tapes as a bulk storage medium. Also, disk packs sell for \$490, as against \$25 to \$35 a reel for magnetic tape.

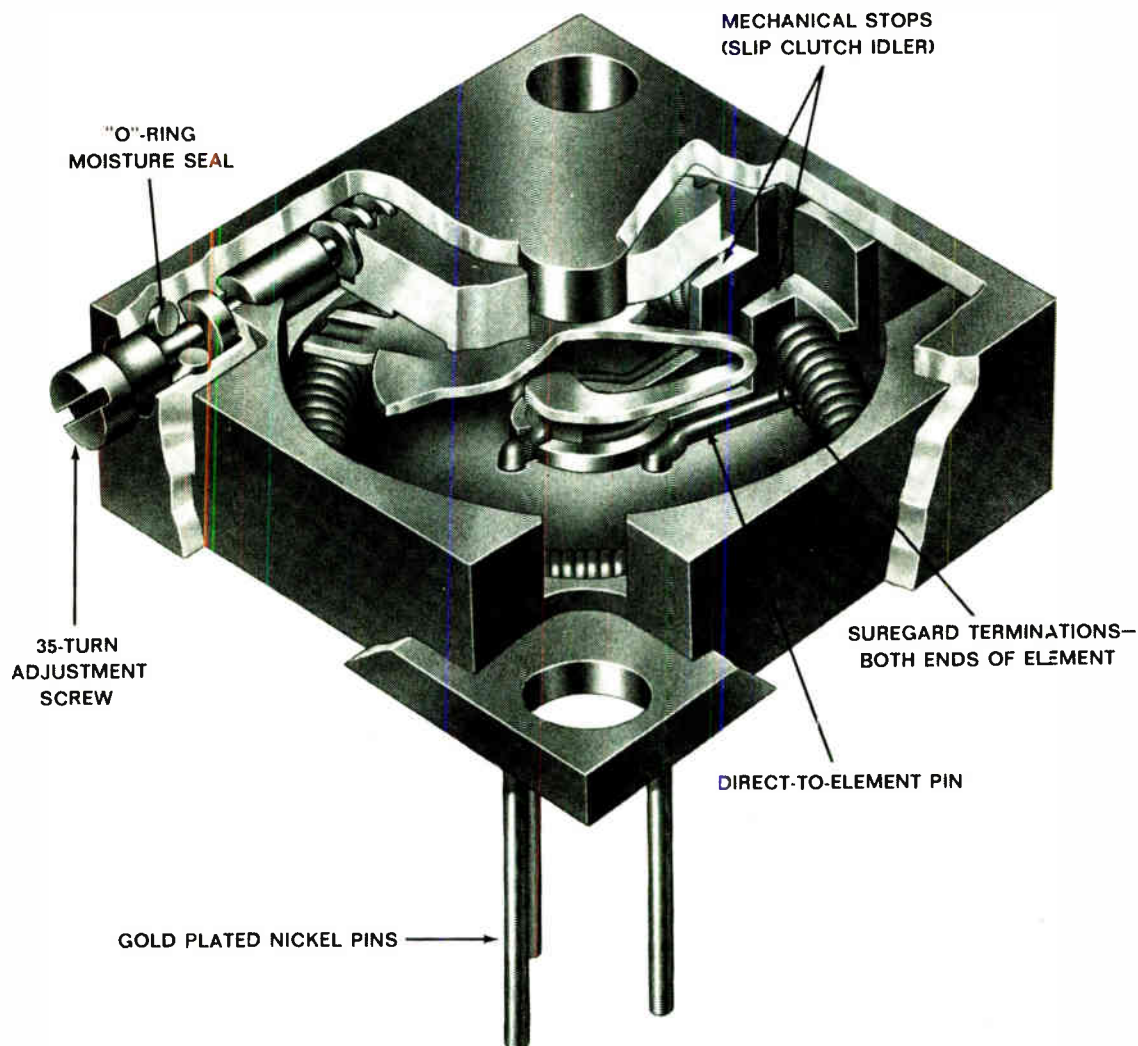

MISSING: a few connections **GAINED: new reliability at a bargain price**

Design omissions can be as important as additions in product performance. An inside look at the new DAYSTROM Squaretrim® 554 Series pot, for example, shows that intermediate pin connections have been eliminated. Two of the weldable base pins are affixed directly to the resistance element. The center pin pivots directly against the rotating tap assembly. Result? A simplified design which also lowers your cost. Made in accordance with MIL-R-27208, these half-inch units are rated for a full watt in still air at 70°C. Sealed models have passed Weston's 100% immersion test. Now thrifty-minded military, industrial or commercial users can have Squaretrim quality features at a bargain price. Write today for complete data and evaluation samples of our 550-555 Series potentiometers.

- Patented "wire in the groove" construction
- 10 ohm to 50K resistance range
- ±5% standard tolerance
- -55°C to +150°C temperature range
- Choice of pins, flexible leads, and screw configurations
- Choice of sealed and unsealed models
- Priced competitively

DAYSTROM potentiometers are another product of:

Weston Components Division, Weston-Archbald, Archbald, Pennsylvania 18403, a Schlumberger company

WESTON® prime source for precision . . . since 1888

New Components Review

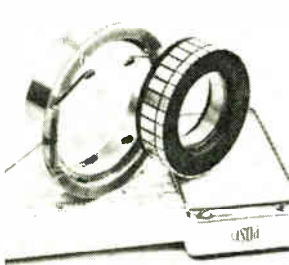

D-c torque motor 1700-040 develops 15 oz in. of peak torque with 65 w input. Frameless configuration allows the motor armature to be mounted directly to the driven load shaft. The motor is axially thin (0.40 in.) and o-d is 1.69 in. Rotor inertia is 0.007 oz/in./sec² and no load speed is 4500 rpm. Magnetic Technology Inc., 21001 Kittridge St., Canoga Park, Calif. 91303. [341]



High power baluns and impedance matching transformers are for applications in matching unbalanced transmitter outputs to balanced antennas or transmission lines. Models are available in 100, 500, and 1,000-w ratings for the 2-to 30-Mhz range. Model PB500 is rated at 500 w average power at maximum frequency. Kappa Networks Inc., 165 Roosevelt Ave., Carteret, N.J. 07008. [342]



Sensitive relays designated RBM MS 40 are spdt units that measure 1 1/8 x 1 1/8 x 1 1/8 in. They feature long life and low cost. Contact ratings are 2 amps non-inductive at 28 v d-c and coil power range is 0.050 to 1.0 w. The armature is common to the frame with 4-40 mounting and solder terminals. Controls Division, Essex Wire Corp., 131 Godfrey St., Logansport, Ind. [343]

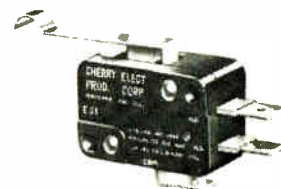

Miniature switch E33-90H features contoured form on integral hinged lever actuator for cam or slide actuation from either direction. It is rated 10 amps, 1/2 h-p 125/250 v a-c, but can also be furnished in 5 amp and 15 amp versions. Net cost (2,000 pieces) is \$0.437 each. Cherry Electrical Products Corp., 1650 Old Deerfield Rd., Highland Park, Ill. 60035. [344]

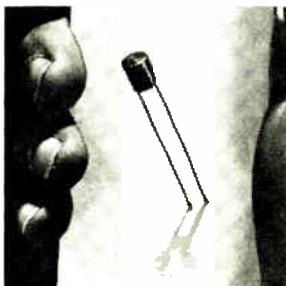

Miniature bobbin wirewound resistor WWP-225 is rated at 1/8 w in a temperature range from -55° to +125°C, derating to zero at 145°C. It stands 0.312 in. high by 0.250 in. diameter. It is available in tolerances from 0.05% to 1% within a resistance range of 0.1 ohm to 515 kilohms. Temperature coefficient is ±20 ppm/°C. Dale Electronics Inc., Box 609, Columbus, Neb. [345]



Miniature reed switch MR338 is a nitrogen gas-filled, center-gap, spst unit suited to permanent magnet or electromagnet operation. Rhodium contacts are rated 10 w d-c resistive, 12 v-a a-c resistive, and 0.003 amp. Minimum voltage breakdown is 1,500 v d-c. Price is \$1.24 in quantities of 100 pieces. Gordos Corp., 250 Glenwood Ave., Bloomfield, N.J. 07003. [346]



High deflection sensitivity and high brightness are features of the WX30764 electrostatically focused crt. The 5 1/2 x 4 1/2-in. tube, with a center line width of 0.015 in. (15 mil), is for oscillographic and data display applications. It has an aluminized, rectangular screen, weighs 3 1/4 lbs, and mounts in any position. Westinghouse Electronic Tube Division, Elmira, N.Y. 14902. [347]

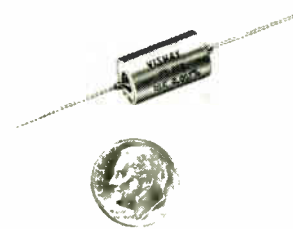

Resistor series HA is usable from d-c to 100 Mhz and above, with absolute tolerances to 0.001%, shelf stability of ±5 ppm/yr. Temperature coefficients are 0 ±1 ppm/°C (absolute), 0.5 ppm/°C (tracking) and 0.25 ppm/°C (matching). Price, in 100 lots, is \$5.70 each for the 0.01% HA412 units. Vishay Resistor Products, 63 Lincoln Highway, Malvern, Pa. 19355. [348]

New components

Cable assemblies get the thin look

First connector specifically designed for flat cable with 50-mil centers, features environmental shielding

Only about 4% of the wiring going into new aircraft and missile airframes is flat conductor cable. But according to industry estimates, this figure could soar to about 85% in 10 years if the right hardware is developed. Now Microdot Inc. believes it has come up with some of

that hardware.

According to Wendell Jacob, connector and cable products manager at Microdot, "Up till now, the only connectors available were warmed-over versions of some other kind of connector such as printed-circuit types, and they're for 100- or 75-mil

cable. In our Mark 220 connector we've developed the first unit for 50-mil centers."

Microdot first got interested in designing such a device after the firm was approached by a major aerospace manufacturer with its requirements for flat conductor-cable terminations. Then the McDonnell Douglas Corp. verified the need for the unit after performing a cost-weight study on aerospace cables and connectors for NASA. Finally, after Microdot had its in-house development program under way, it learned that the Army's Picatinny Arsenal was preparing a new military specification, now circulating



General purpose industrial relay style L is available with contact arrangements from spdt to 4 pdt and ratings from 5 to 10 amps. Contact resistance is rated at 0.05 ohm max. Ambient temperature range is -55° to $+85^{\circ}\text{C}$. Dielectric strength is 1,250 rms. Predicted mechanical life is 1 million operations. Price Electric Corp., E. Church & 2nd Sts., Frederick Md. 21701. [349]

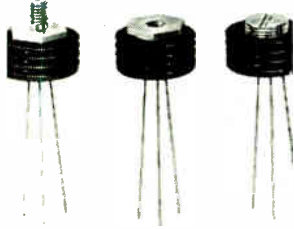

Radiator heat sinks feature a patented insert that fits on the heat sink case and makes a firm pressure contact to the rim, top and over 60% of the side surface. This assures a thermal conduction coefficient of 2 w/ $^{\circ}\text{C}$ from transistor case to heat sink. The HA-05R fits TO-5 cases; the HA18R, TO-18 cases. Horex Electronics Inc., 1729 21st St., Santa Monica, Calif. 90404. [350]



Power resistors series FP and XFP are for p-c board applications. They can be inserted in 0.050 or 0.070 diameter holes, and are 0.020 thick x 0.035 or 0.054 wide. Center-to-center distance of prongs on the terminals is variable from 0.5 to 2.5 in. Resistance range is from 0.2 ohm per in. to 1,000 ohms per in. Lectrohm Inc., 5560 Northwest Highway, Chicago, 60630. [351]



Glass-encased Neptune ceramic capacitors offer 10 to 10,000 pf in a case size of 0.250 x 0.095 in. The ceramic slug is both brazed to the lead-cap and encapsulated in an inert-gas atmosphere, thus preventing contamination. Units are available with a temperature coefficient of 30 ppm/ $^{\circ}\text{C}$. San Fernando Electric Mfg. Co., 1509 1st St., San Fernando, Calif. 91341. [352]



Ultraminiature tubular and flat thin-film metalized polycarbonate dielectric capacitors series 396-397 are available in 0.01 to 10 μf . They operate within the range of -55° to $+125^{\circ}\text{C}$ without voltage derating. Dissipation factor at $\pm 25^{\circ}$ is less than 0.5% at 1,000 hz. Leads are axially oriented. Gudeman Division, Gulton Industries Inc., 340 W. Huron St., Chicago 60610. [353]



Ten-turn precision wirewound Pixiepot has plastic shafts up to 1.8 in. long, minimum torque to 2.0 oz-in. Model 3253 has a resistance tolerance of $\pm 5\%$ over a standard range of 100 ohms to 100 kilohms. Linearity is $\pm 0.25\%$ and resolution for a 1-kilohm pot is typically 0.022. Duncan Electronics Div. of Systron-Donner Corp., 2865 Fairview Rd., Costa Mesa, Calif. 92626. [354]

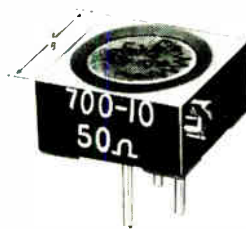

Wirewound trimmer style RT-24 type 700 meets environmental requirements of MIL-R-27208. It features positive clutch action that insures against damage to contact wiper and drive mechanism. It is available over a resistance range of 10 to 50,000 ohms, $\pm 5\%$ tolerance, and is rated 34 w at 85°C . IRC Inc., 401 N. Broad St., Philadelphia, Pa. 19108. [355]

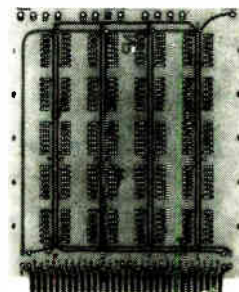

Plated-through-hole p-c boards facilitate mock-up circuitry. Four configurations available accept 14-pin dual in-line IC's, TO-5 packages, and discrete components. Extra holes are provided in the land areas for jumper wires to effect circuit hook-up. Circuit changes may thus be made easily and quickly. Midwest Circuits Inc., 1111 E. Excelsior Blvd., Hopkins, Minn. 55343 [356]

for industry comments, covering flat conductor cable connectors.

At the show. User requirements for flat cable connectors were outlined at a meeting of the Institute of Printed Circuits in New York last month. One user at the meeting says that while Microdot and the International Telephone & Telegraph Corp.'s Cannon Electric Division had connectors to show, neither meets all the requirements the users want.

However, he did say Microdot was the first company with enough courage to come up with a new connector for flat cable, and it came pretty close to the requirements

the users gave.

According to Jacob, the users aren't sure exactly what they want. He also attended the meeting and says the users are not in agreement, especially in the area of electromagnetic capability, so Microdot will try to incorporate environmental sealing inside the shell if it does not interfere with reliability. The users asked for this, along with a different kind of coupling mechanism—jack screw or snap lock coupler.

Jacob says Picatinny personnel indicated the Microdot design philosophy was sound, assured Microdot officials there would be a con-

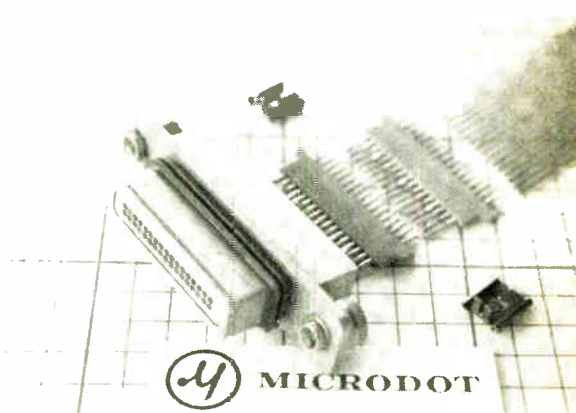

Housing. Connector shells are impact-extruded aluminum and are gold-plated—a requirement of the aerospace industry.

Bulova ovens are the smallest going



—but they do a big job!

Simply stated, the Bulova BDX series is the smallest and most versatile in the miniature oven field!

Now, for the details. External dimensions are just 1.5" x 1.19" x .46" (or up to .9375", for larger models). Yet, the BDX can hold 1 to 6 tubular devices such as diodes, capacitors or resistors, up to .25" in diameter and length.

Controller is an RFI-filtered snap-action thermostat, meeting MIL-I-6181B. You get the BDX with your components installed and encapsulated in fluoro-carbon blown polyurethane foam insulation and hermetically-sealed. Result: a unit with minimal thermal leak that will withstand the most severe shock and vibration specifications.

The BDX is available with stud mounting, printed circuit board mounting, flange mounting or captive nut. Temperature settings from 50°C to 100°C are available, with a range of operating voltages from 6.3 to 117 VAC or DC. Temperature stabilities are as fine as .5°C over a -55°C to 90°C with a power drain as low as 5 watts.

This is just one of a complete line of Bulova ovens, including bi-metal thermostat, transistor, solid state switched mercury, and AC or DC proportional controls. For more information, write today to Dept. E-28.

Try Bulova First!

FREQUENCY CONTROL PRODUCTS

ELECTRONICS DIVISION
OF BULOVA WATCH COMPANY, INC.

61-20 WOODSIDE AVENUE
WOODSIDE, N.Y. 11377, (212) DE 5-6000

208 Circle 208 on reader service card

... connector designed without sponsorship ...

tinuing market and substantiated that Microdot was the first firm they knew to be designing a connector strictly for flat cable. With this reassurance, Microdot proceeded with the Mark 220, without waiting for sponsorship to underwrite the development, which, says Microdot's John Redwine, is usually the way new connector developments are launched.

Same as before. The Mark 220 will incorporate the twist pin employed in all Microdot connectors rather than screw-machine-produced pins. Microdot is under license to the New Twist Corp. for this concept, in which the pin is made of 10 strands of 48-gauge to 50-gauge wire, and has an outside diameter of 0.0315 inch; the socket that accepts the pin has an inside diameter of 0.028 inch, so that the wider pin twists and elongates as it enters the socket, giving more positive electrical contact than screw-machine-made pins, Redwine says.

In the 220, pins and sockets are joined to their respective flat cable conductors in an insulator module made of diallyl phthalate. Redwine says the material was chosen because of its good temperature characteristics and good compressive strength. Microdot inserts the pins and sockets in their respective molded insulator modules, and the customer will join each half of the connector to the flat cable.

The mating call. Jacob points out that when the Mark 220 design was initiated, the company wanted to fashion it so that the entire flat cable could be mated to the insulator module—containing pins or sockets—in an automatic process independent of the type of connector shell that would ultimately house the mated pair. In this manner, he believes, the insulator module-to-cable termination can be done in a 30-second welding of pin or socket module to the wires in the cable. With round cables, as much as 10 to 15 minutes can be consumed in soldering individual wires to the connector. This production speedup will be as persuasive as potential weight savings in contributing to

ECCOSORB® COMPLETELY REVISED

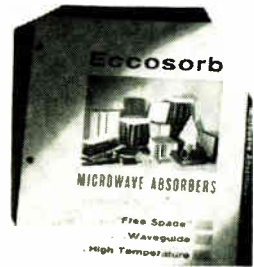

Six page folder in color describes and gives performance data on the complete line of Eccosorb® Microwave Absorbers for Free Space and Wave-guide.

Circle 512 on readers service card

ECCOSORB® ANECHOIC CHAMBERS NEW DESIGN 7

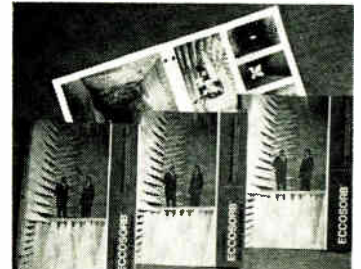

Illustrated folder gives details on anechoic and shielding performance of several new chambers used for antenna pattern, radar cross section, VSWR and RF compatibility measurements.

Circle 513 on readers service card

ECCOSHIELD® RF SHIELDING MATERIALS



Brand new six-page folder in color describes a complete line of Eccoshield products to combat RFI: conductive plastic sheet and gaskets, adhesives, coatings, caulking compounds, metallic foil—the works.

Circle 514 on readers service card

Emerson & Cuming, Inc.



CANTON, MASS.
GARDENA, CALIF.
NORTHBROOK, ILL.
Sales Offices
in Principal Cities

EMERSON & CUMING EUROPE N.V., Oevel, Belgium

Circle 209 on reader service card →

The first \$1500 digital multimeter that sells for \$895.

The new trio/lab Digital Multimeter Model 501 is the first battery-portable, automatic ranging and polarity, full-capability DMM ever offered — at any price.

State-of-the-art IC techniques, high sampling speeds, rugged construction, rechargeable ni-cad batteries . . . perfect for both field and bench use. This unique instrument is simplicity itself — just push a function button and read.

Trio Laboratories, Inc., 80 Dupont Street, Plainview, L. I., N. Y. 11803.

Tel: 516-681-0400, TWX: 510-221-1861.

Ranges: Voltage — DC/AC: 1 mv to 1 KV in 4 ranges
Current — DC/AC: 1 μ a to 1 A in 4 ranges
Resistance — 1 Ohm to 1 Megohm in 4 ranges

Accuracy: DC Volts, DC ma, Ohms, $\pm 0.1\%$ of reading + 1 digit
AC Volts, AC ma, $\pm 0.5\%$ of reading + 1 digit

Over-ranging: 100% with no loss of accuracy

Input Z: 10 Megohms

Mechanical: 4 $\frac{3}{8}$ " x 10 $\frac{1}{2}$ " x 10 $\frac{3}{4}$ " deep; 12 lbs.

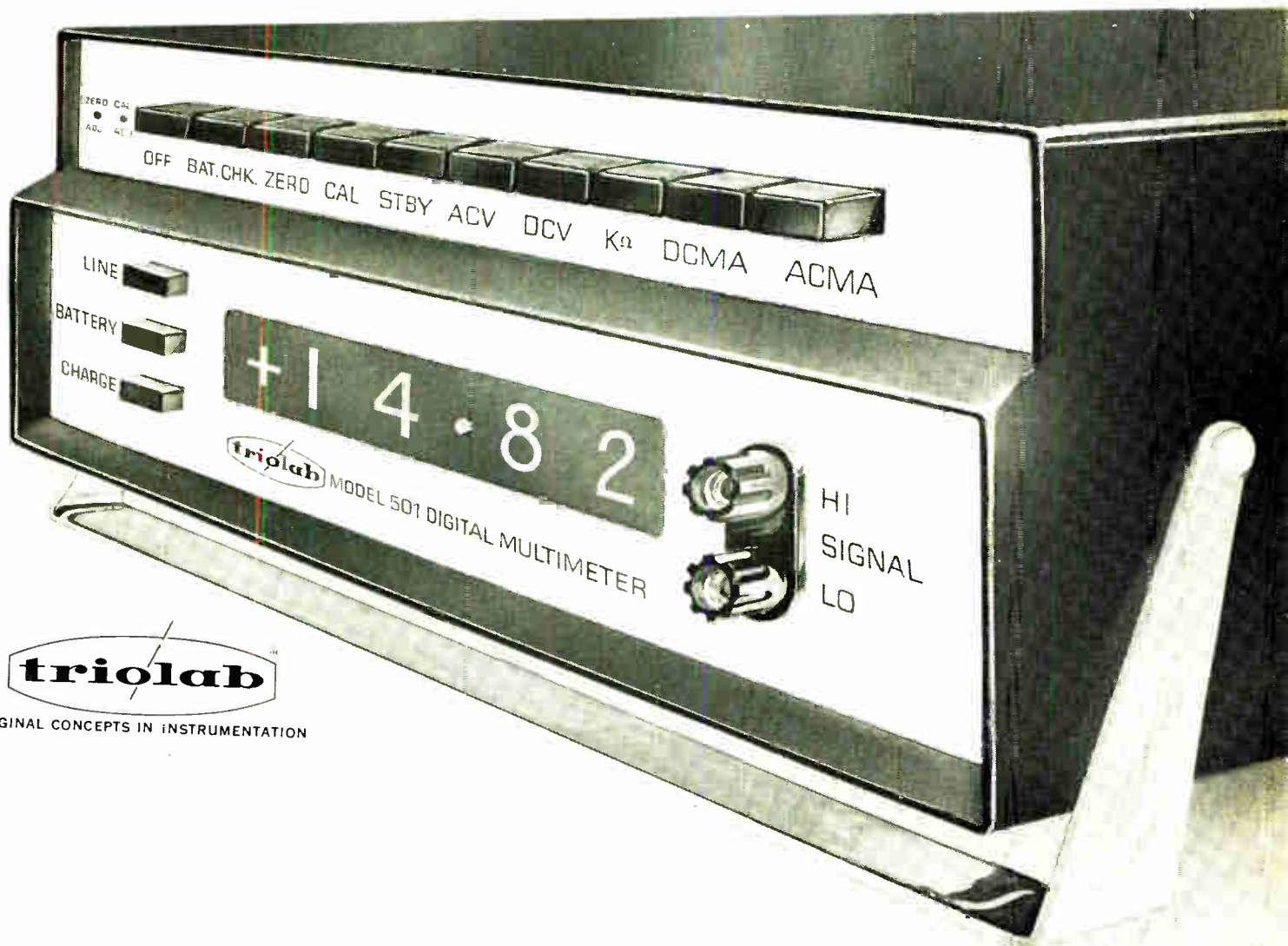

trio/lab

ORIGINAL CONCEPTS IN INSTRUMENTATION

We're Turning The Pot Industry On It's Ear!

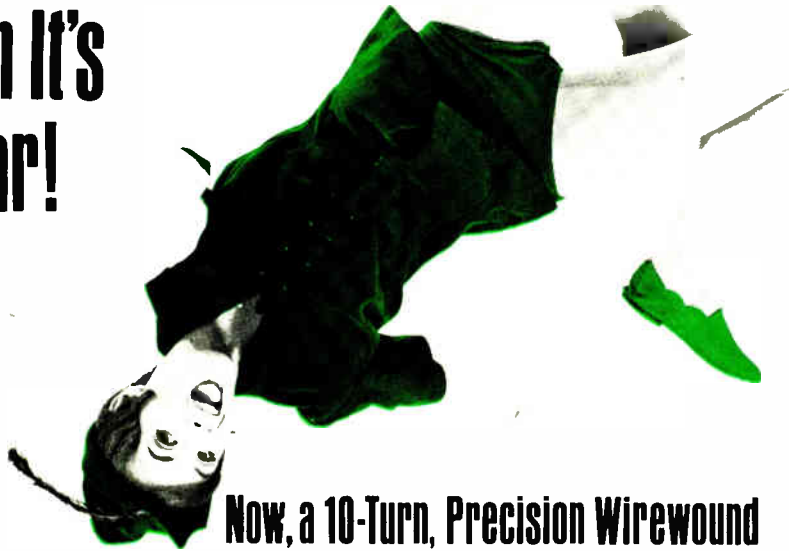

Now, a 10-Turn, Precision Wirewound

"PIXIEPOT"

T.M. (PAT. PEND.)

FOR AS LOW AS

\$3.97 EACH

That's right! The Duncan Model 3253 "PIXIEPOT" potentiometer is yours for as low as **\$3.97** each in production quantities and only **\$5.95** each for 1-24 units. Match the following "PIXIEPOT" features with any other similar pot on the market.

- **Length: ONLY 3/4"**
- **Diameter: ONLY 7/8"**
- **Linearity: " 0.25%**
- **Resistance Range: 100 ohms to 100K ohms**
- **Power Rating: 2 watts @ +20 C**
- **Temperature Range: -25°C to +85°C**
- **Resolution: Better than ANY wirewound pot TWICE its size!**
- **Slotted Stainless Steel Shaft**

A Duncan "PIXIEPOT" can save you dollars on your instrument and system requirements. If you want to know just how many, call or write us today. The full story on the "PIXIEPOT" will be in the mail to you within 24 hours.



DUNCAN electronics, inc.

A DIVISION OF SYSTRON-DONNER CORPORATION
2865 FAIRVIEW ROAD, COSTA MESA, CALIFORNIA 92626
Phone: (714) 545-8261

the predicted boom in flat conductor cable, Jacob adds.

Other uses. Microdot is considering a commercial/industrial version of the connector for such hardware applications as computers, but officials say they've just begun to study the most suitable material for the housing.

The connector is made in sizes from one inch to three inches wide, in increments of one-half inch, and accommodates from one to three stacked cables.

Specifications for the industrial version have not been fully worked out, Jacob says, because Microdot wants to encourage the industry to spell out its needs. Prototype devices for feasibility or research and engineering evaluation can be delivered in 8 to 10 weeks. Prices have not been firmly fixed, but Redwine estimates the devices will cost about \$1 per mated contact (one pin in one socket) plus housing costs—or about \$60 for a mated pair of 34-conductor units.

Microdot Inc., 220 Pasadena Ave., South Pasadena, Calif. 91030 [357]

New components

Taking complexity out of pin positions

Automatic wire wrapping
boosted by simpler, less
costly connection method

Despite the superiority of automatic wire wrapping over hand wiring, not everyone has climbed on the bandwagon. Although higher initial cost has kept some would-be users away, complex pin positioning has caused others to back off. Tolerances are so tight that the slightest error can lead to costly production delays.

Now, however, Litton Industries' Winchester Electronics division has developed what it calls AccurFrame packaging—a far simpler and less costly system of putting pins on a plate than conventional methods.



At home
on the
range.

417—the lightweight recorder for heavy duty field use

In the field or in a test range, the rugged, portable Lockheed 417 is right at home. Just as it is wherever there's data to record... in the air, on the seas and under them, in plants or labs or out in the wilds.

Weighs only 28 lbs. with battery — 30 lbs. under any comparable recorder. Measures 14"x15"x6" (fits under a plane seat).

Runs on 110/220v AC/DC or internal battery. Power consumption as low as 10w.

Accuracy matches large rack machines. Has phase-locked servo for precise speed control. Records on 7 channels, IF G compatible.

Tagged as low as \$7,000.



LOCKHEED

Lockheed Electronics Company, A Division of Lockheed Aircraft Corporation

Exclusive low-mass differential capstan drive gives precision recording even in rough field conditions. Simplified, maintenance-free mechanism works under vibration and in any position.

Frequency response: 100 kc direct, 10 kc FM.

Send for our catalog containing full details on the 417—one of a family of precision data recorders for land, ocean, air and space applications. Write: Boyd McKnight, Dept. E-4H, Lockheed Electronics Company, Edison, New Jersey.

Questions about data recording? Let's discuss. Call (201) 757-1600.

A new way to
dependable,
compact,
low-cost, digital
**COUNT AND
CONTROL**

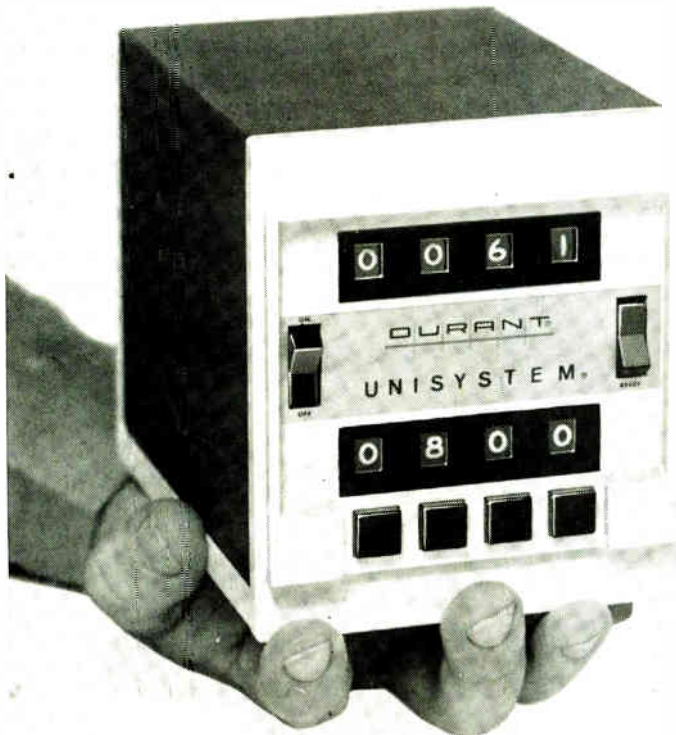

DURANT 49600 UNISYSTEM

The answer to a need for fast, accurate count or control in most industries — machine tool, textile, wire, boxboard, electrical, paper, lumber, printing, food, chemical, and other industries. Controls fluid metering, batching, testing, cutting, packaging; counts cartons, coil turns, lineal lengths, and units per bundle. Exceptionally dependable; count always retained in case of power failure.

Compact size permits space-saving desk mount or panel mounting. Choose 2, 3 or 4-digit predetermining and count levels. Also available in Splash and Dustproof models. Speed ranges from 0 to 30 cps (1800 cpm). Large, easy-to-read visual display

Easy push-button setting of predetermined number — preset value always retained, always visible. Instant electric reset from panel front, remote reset, or automatic cycle repeat. Setup and connecting is easy, too . . . rear panel terminals allow 49600 to be readily applied to a variety of operating functions.

See it demonstrated at your desk! Write for specifications.

DURANT[®]
MANUFACTURING COMPANY

622 North Cass Street
MILWAUKEE, WISCONSIN
In Europe: Durant (Europa) N.V. Barneveld, Netherlands
Visit Booth #362 at Design Engineering Show

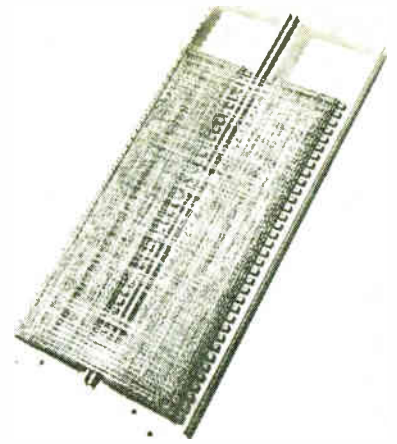

James Muller, Winchester's sales manager, says the AccurFrame method costs from 1 to 3 cents less per contact than other techniques.

Consisting of the company's HW series edge-board connectors, custom-designed positioning and wiring frame tools, and HW series contact-replacement kits, AccurFrame is merely an extension of the connector-molding technology. Conventional methods use multiple punching of close center holes in the plate-type assemblies.

Making the fit. With AccurFrame, two alignment holes, one round and one square, are molded into the base of the HW connector blocks. These fit over accurately-positioned guide pins, also one round and one square, on a master alignment tool. Each pin is independently measured from reference points and is within 0.001 inch true position. With the connectors in position, a frame is placed over the assembly and attached by machine screws to the connectors.

If the terminal posts become damaged during assembly or production, they can be replaced with the simple hand tools provided in the contact-replacement kit.

The HW connectors are precision molded of diallyl phthalate. The contacts are retained in the connector block by a 90° twist—resulting in a diagonal placement. Conventional methods of locking in the contacts—staking and dimpling—tend to weaken the contacts and lead to a high degree of breakage.

The price of AccurFrame is about 5.5 cents per contact, depending on the size and the number of frames produced.

Winchester Electronics, Main St. and Hillside Ave., Oakville, Conn. 06779 [358]

6455



How to Use E-CELL™ Timing and Integrating Components

The Bissett-Berman Components Division engineering staff answers four basic questions often asked about E-CELL* devices



Actual Size

$$\int_{I_1}^{I_2} \frac{dq}{dt} = t$$

1. What is an E-CELL device?

An E-CELL device is a new kind of circuit element that looks like a discrete electronic component but does the work of a complex assembly. Its main functional part is a center electrode, which is surrounded by an electrolyte; the metallic container also serves as the second electrode. In terms of its physical operation, an E-CELL unit is a reversible micro-coulometer, i.e., it converts the current-time integral of an electrical function into an equivalent mass integral (or the converse operation) up to a maximum of several thousand microampere-hours. Exactly one atom is transferred for each electron impressed on the E-CELL unit. Power drain is normally in the microwatt region. The mass integral can be read out at a known current, the time to read it out being proportional to the original integral. When a mass is given as part of the initial condition, this same process generates a precise time interval.

2. What does an E-CELL device do?

For timing applications a constant current is applied to a pre-charged E-CELL unit. The selected time delay is determined by a combination of the E-CELL type and the specific constant current being used. The range of timing is from seconds to months. The output voltage swing that occurs when the mass has been completely transferred is normally used as a bias transition with semiconductor devices.

For integration applications, an uncharged E-CELL unit accepts d-c, periodic, or random inputs in any wave-shape and stores these as the mass equivalent of a current-time integral. Readout is handled in essentially the same manner that the timing function is handled for a pre-charged E-CELL unit, i.e. the measured time required

to reach the point of the abrupt voltage swing, multiplied by the readout current, will be the accumulated charge integral. This could represent the total "count" of a series of events analogous to the input pulses.

3. When should I consider using an E-CELL device?

The scope of applications is as broad as timing and counting functions themselves. New uses are continually being devised. Here are two prime applications areas:

Control: You can use E-CELL devices in circuits for timing, gating, starting, stopping, delaying, relaying, monitoring, actuating, sequencing, measuring—wherever the control condition can be represented by an electronic signal.

Information Handling: You can use E-CELL devices in circuits for data capture, totaling and subtotaling time periods or discrete events, elapsed time logging, running time monitoring, out-of-limits logging, maintenance status reporting, real-time analog computing—wherever the input data can be represented by an electronic signal. Readout can be formatted as either analog or digital data.

4. What are some present production uses of E-CELL devices?

Fuzing and arming;
battery charging;
cardiac output integration;
sonobuoy scuttling;
high-power tube protection;
engine maintenance scheduling;
warranty monitoring;
time delay relays;
transistor aging racks;
program timer;
r-f level monitoring.

*Patents applied for.

Analogy of physical event or process

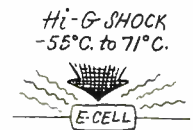
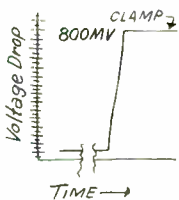
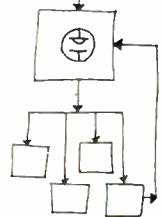

**BISSETT
BERMAN**

For technical information and application notes, contact: Components Division, The Bissett-Berman Corporation, 3860 Centinela Avenue, Los Angeles, California 90066. Telephone: Area Code 213, 390-3585.

Because of new ideas from Sanders . . .

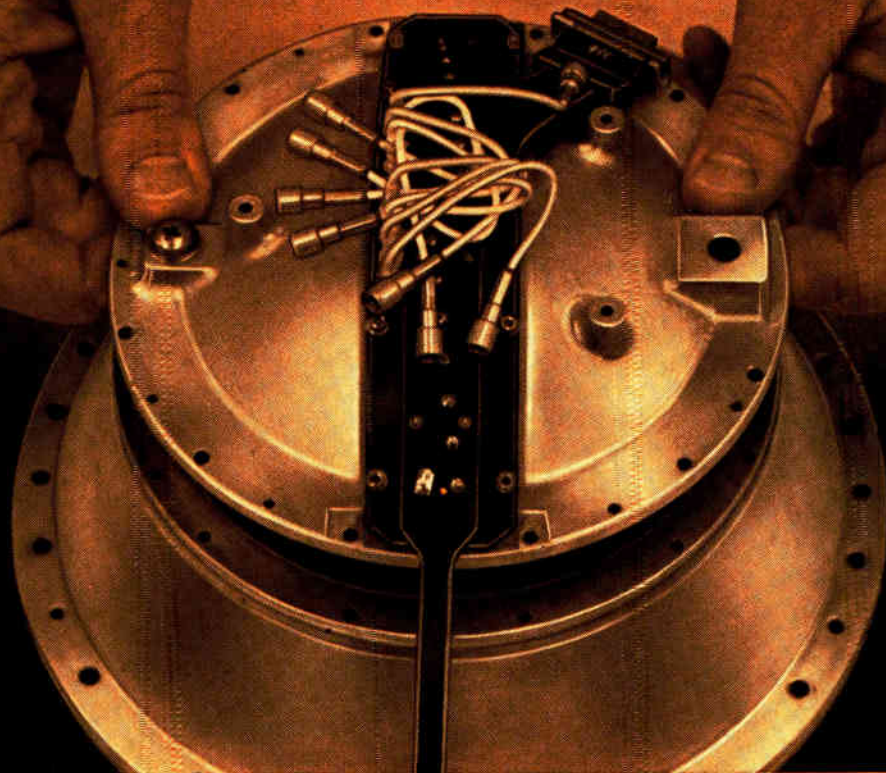

Flexprint® circuitry matches coax capacitance

There had to be a way to control and stabilize capacitance within a limited area.

By matching coaxial capacitance through careful selection of dielectric materials, constant capacitance can be predetermined and controlled through the entire FLEXPRINT Circuit.

The result is a lightweight, stable circuit that conforms to the spherical surface of the package, matches standard coaxial cable and connectors and is 100% reliable.

If you have a complex circuit problem with unique characteristics and no solution in sight, FLEXPRINT Circuitry may be the answer. Call or write Sanders Associates, Inc., FLEXPRINT Division, Grenier Field, Manchester, New Hampshire 03103. Phone: (603) 669-4615.

This sophisticated multi-layer circuit, used in the Northrop Nortronics Floated Ball inertial platform for the C-5A Galaxy,

is designed for extremely close tolerances. It utilizes fine-line etching and consists of two shields and one circuit layer. The circuit requires only $\frac{1}{3}$ the space of conventional cable and permits a 20% weight savings.

This totally encapsulated circuit provides constant capacitance values over a wide temperature range.

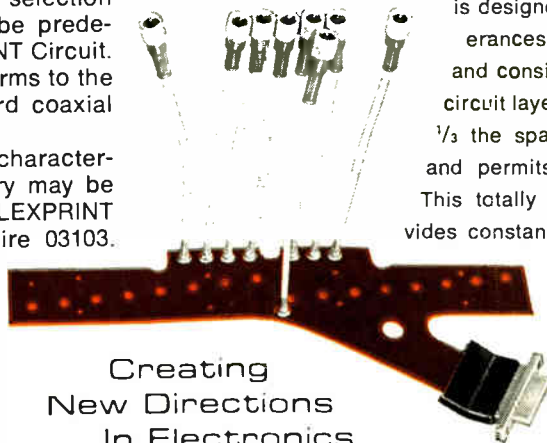

Creating
New Directions
In Electronics

SA  **SANDERS
ASSOCIATES, INC.**

FLEXPRINT DIVISION
GRENIER FIELD, MANCHESTER, NEW HAMPSHIRE

Circle 214 on reader service card

New Subassemblies Review



Bipolar logarithmic amplifier model 2369 occupies 0.5 cu in. Maximum error is $\pm 1\%$ typical. Features include current or voltage signal input, and 100 db dynamic range. Applications include non-linear bipolar function generation, and compression of transducer output. Price is \$71 each for 1-2, \$65 each for 3-9. Optical Electronics Inc., Box 11140, Tucson, Ariz. 85706. [381]

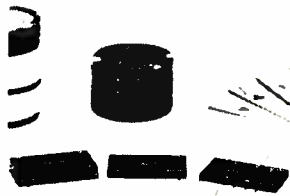

Lumped constant Chip Series delay lines serve low profile, high density packaging. Standard sizes range from 0.515 to 2.815 in length; width on all packages, 0.610. Thinness of the package is 0.110. Eleven basic models offer nsec delays from 2.5 to 50 in the 125-Mhz cut-off range. Valor Electronics Inc., 13214 Crenshaw Blvd., Gardena, Calif. 90249. [382]



Series 20 DiGiCator is a 7-segment, incandescent, lighted numeric readout. The multiple character display is contained in an integral package $\frac{1}{4}$ in. thick. Each character measures 1 in. high by $\frac{3}{16}$ in. and is readable to 50 ft in bright daylight ambients. Price is \$7.95 per character in 1,000 lots. Discon Corp., 4250 N.W. 10th Ave., Fort Lauderdale, Fla. 33309. [383]



Power module B3D converts 28 v d-c to any output voltage from 5 to 2,080 v d-c at 30 w. True hermetic sealing and encapsulation enables units to meet MIL-E-5272C at 100°C. Units feature isolation of inputs and outputs, and output voltage adjustment range of 12% from nominal. Price is \$304 up. Abbott Transistor Laboratories Inc., 5200 W. Jefferson Blvd., Los Angeles. [384]

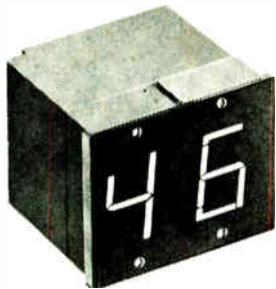

Dual digital display series NQT employs multiplexing techniques. The complete decoder-driver and display module is 1.97 in. high, 2.20 in. wide, 2 in. deep, and sells for less than \$19 per decade in production quantities. The unit will accept 4-line BCD inputs at 1C levels and requires only 105-125 v a-c power input. Mesa Co. Inc., 220 Mill St., Bristol, Pa. 19007. [385]

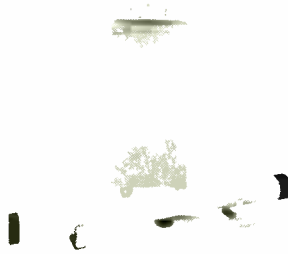

Carbon dioxide gas laser model CO2100, for cutting and slitting nonmetals, has a power output adjustable up to 100 w at a 10.6-micron wavelength. Specifications include a beam diameter of 1.5 cm, a beam divergence of less than 2 milliradians, and a focus spot size down to 0.004 in. in diameter. Price is \$11,900. Westinghouse Electric Corp., Box 8606, Pittsburgh, Pa. 15211. [386]

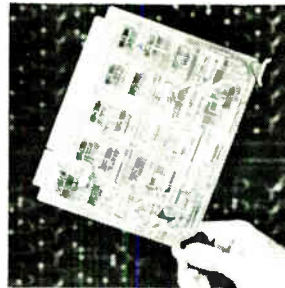

A compact modular converter can accept 6 BCD digits on 24 lines and convert them to 20-bit natural binary output. It facilitates decimal to binary conversion in such areas as programing switches, computer input typewriters, and BCD outputs from digital voltmeters to a computer. Price is \$390; delivery, 60 days. Texas Instruments Inc., P.O. Box 66027, Houston 77006. [387]



D-c power supply model 901, designed for energizing operational amplifiers, delivers 40 ma at ± 15 v. Up to 4 op amps, each with 10 ma max. supply current, can be operated simultaneously. The unit is encapsulated into a $2\frac{1}{2} \times 3\frac{1}{2} \times 7\frac{1}{8}$ in. d-c mounting module. Price is \$39 each in 10-piece lots; delivery, from stock. Analog Devices Inc., 221 Fifth St., Cambridge, Mass. 02142. [388]

New subassemblies

Wang offers grown-up calculator

380 System has 640-step programing capability on punched cards or cassette-loaded tape

When Olivetti unveiled its Programma 101 desktop calculator in 1965, it also unwrapped a fresh market for electronics. This new breed of machine incorporated the features of existing calculators—addition, subtraction, multiplication, and division—and added two key

characteristics of the digital computer: operation on a stored program (in this case magnetic cards with a 120-step program), and the ability to base an instruction to itself on the results of a previous instruction or a set of instructions. What's more, the 101 did all this

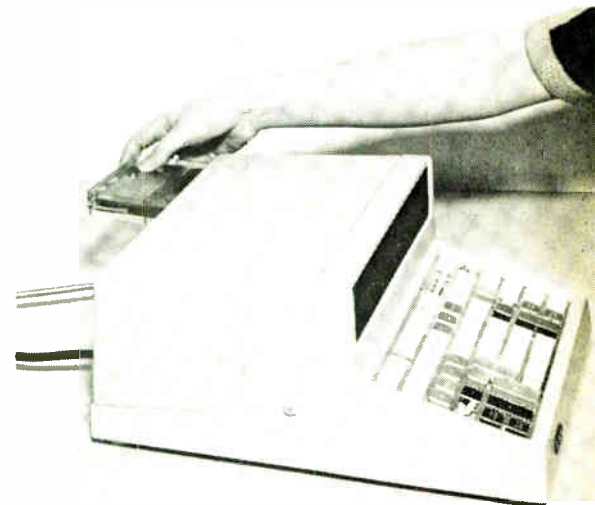

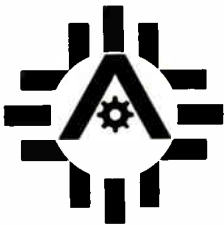

We're not the nation's best-kept secret any more!
Albuquerque . . . Sunshine. No crowds. No smog.
You can golf and ski on the same winter day.
Two universities, outstanding recreation outdoors.
Symphony, opera, much more, in unique New Mexico
Contact: Albuquerque Industrial Development Service
400-X Elm N.E., Albuquerque, New Mexico 87103



Circle 216 on reader service card

Our little black book has over 100,000 phone numbers.

You never had a black book like it. Over 1,500 pages. And those phone numbers!
More than 100,000 telling you who to call/where to go, for the over 4,000
different product categories listed and advertised in the yellow
pages of the Electronics Buyers' Guide.

It's the industry's one-stop shopping
center that lets you find the products
and services you need quickly.
You can depend on EBG.

Electronics Buyers' Guide

A McGraw-Hill Market Directed Publication,
330 West 42nd Street, New York, N.Y. 10036

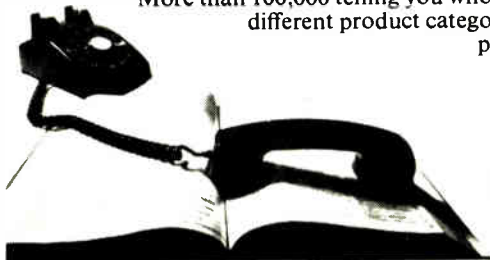

. . . new keyboard works with older units . . .

for only \$3,200.

Growing up. Since then, such calculators have become more and more common in offices. They've also become faster, smarter, and less expensive. Now Wang Laboratories Inc. of Tewksbury, Mass., has introduced another advance in the field: a 640-step programming capability, optional printout, and a program on cassette-loaded magnetic tape. Punched cards also can be used with the system—which is dubbed the 380—and it is compatible with other Wang units.

The system consists of a keyboard costing \$1,500, an electronics package called the 362E for \$2,295, and an electric typewriter for the printout priced at \$1,500. The total: \$5,295.

This calculator, says the company, fills a price gap in its product line, which includes machines costing from \$1,300 to \$10,000. The device can handle long programs and provide speeds up to 10 times faster than existing Wang models because of the tape capability. The tape itself, two-track and available in lengths of 80 to 640 steps, runs at 18 steps per second; the machine can use cassettes available from Wang or those already on the market.

Split. While the new keyboard can be used with other Wang electronics packages, the 362E offers more storage. It provides 12 storage registers, each including a plus or minus sign, decimal point position, and 12 digits. When only data is stored, each register may be split in half to provide up to 24 six-digit registers. The 12 registers also can serve as accumulators with floating addition and subtraction, positive and negative numbers, and results to 12 digits. And there are two additional accumulators standard for use with all Wang units.

The printout, on a 379-5 output typewriter, operates at 13 characters per second. Connected through the control unit to the keyboard, the printout can be controlled by the program or by the calculator's keyboard input.

Display. There's one other data output option—an oscilloscope—

The new Mann Type 1600 Pattern Generator produces circuit patterns, directly, at 10X final size...automatically

David W. Mann Company, long a recognized leader in the development of photomask systems, has added a new concept in automation and precision to high-volume photomask production... the Type 1600 Pattern Generator.

The Mann Type 1600 Pattern Generator is a fully automatic, computer-directed, highly accurate, and reliable system. It generates circuit patterns directly, at 10X final image size, without intermediate artwork generation and reduction. Turnaround time is greatly reduced, repeatability and reliability are assured, and the process is carried out in far less time than conventional methods. The circuit patterns produced by the 1600 are further photoreduced and repeated in a rectangular array to form a

photomask using a Mann Type 1480 Series Photorepeater.

The Type 1600 Pattern Generator features:

Input data on punched tape in either decimal or binary format.

Stage positional precision of ± 0.00001 inch over a 2 inch by 2 inch square area.

Stage positioning accuracy of ± 0.00005 inch over a 2 inch by 2 inch square area.

A maximum aperture size of 120 mils square per exposure for composing circuit pattern, a minimum of 0.5 mils.

High resolution... 650 lines/mm over the entire circuit pattern area.

A digital computer controls all automatic functions of the 1600 from punched tape input data. (Optional punched card or magnetic tape input is available.) Input data on the 8-channel punched tape includes: X and Y coordinates of the center of exposure, height and width dimensions of the rectangular exposure, and the angle of aperture rotation (an option) up to 89°. Height and width of the area exposed in a single flash on the 10X pattern may be varied in 240 discrete steps from 0.5 mils to 120 mils... a total of 57,600 sizes. The Mann Microset Scale for both the scanning and steper axes assures positional precision of ± 0.00001 inch.

We'd like to show you how the Mann Type 1600 Pattern Generator fits your requirements.

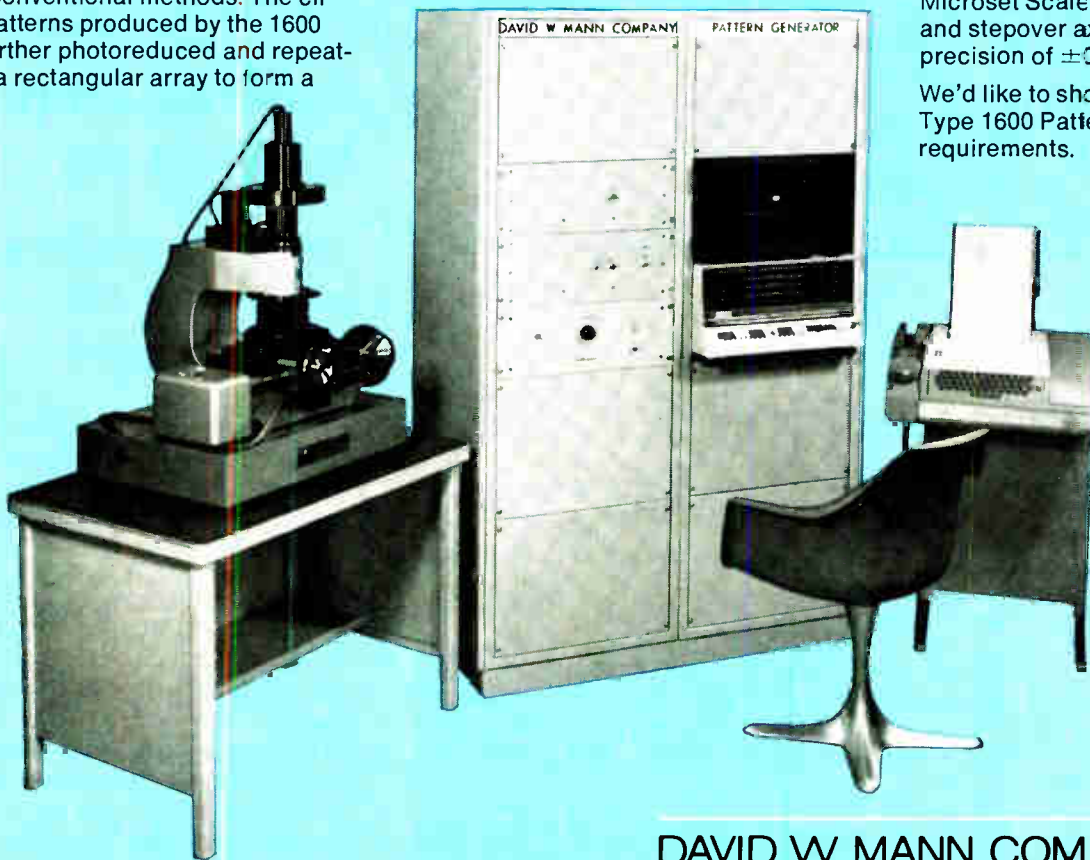

DAVID W. MANN COMPANY

Middlesex Tpke., Burlington, Mass. 01803. Tel. 617-272-5600

Now...fast, highly accurate, reliable, and fully automatic generation of IC patterns.

AC/DC SIGNAL SOURCE

Ballantine Model 421A Precision Calibrator with Model 2421 Error Computer

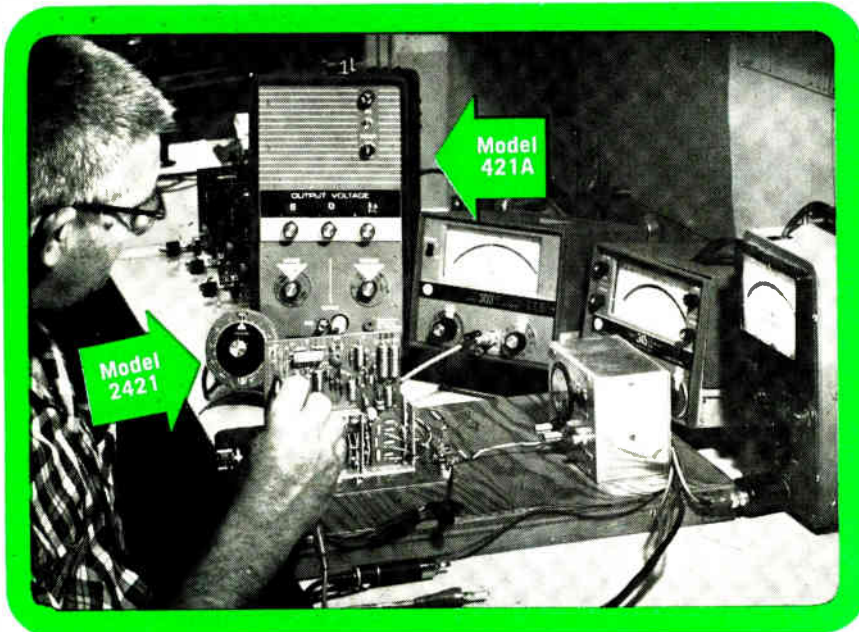

Model 421A provides an accurate, stable source of voltage in a typical production Q.C. set-up. Other instruments measure levels at several points. Model 2421 Error Computer speeds up measurements by changing the 421A output by an accurately indicated percentage.

Generates \pm DC, or AC at 400 or 1000 Hz, RMS or Peak-to-Peak

The Ballantine Model 421A Precision Calibrator provides an accurately known stable source of ac or dc voltage for calibration of voltage sensitive devices, or for measurements of gain or loss, or as a source for bridges or strain gauges. The output may be + or - dc, or it may be ac at 400 or 1000 Hz, rms or peak-to-peak. Accuracy to 111 volts ac or dc is 0.15%, and from 111 to 1110 volts ac is 0.3%. A high order of stability is obtained by monitoring the input to the attenuator with a bridge circuit whose output compensates for effects of changing line voltage, aging tubes and ambient temperature.

Model 2421 Error Computer is an optional accessory which, when connected to Model 421A, provides for a change in its output up to $\pm 5\%$, as read directly on the dial of the 2421. The device under calibration is fed its nominal voltage by setting the voltage knobs on Model 421A. The dial on the 2421 is then adjusted until the device reads its nominal voltage, and the % error of the device is then directly from the scale of the 2421.

Write for Brochure giving full Specifications

If you have a production line Q.C. requirement for a known stable source of dc or ac, and a means for measuring % deviation from a nominal value, the 421A Calibrator and 2421 Error Computer may be exactly what you need. Write us for full details today.

Prices: Model 421A, \$660; Model 2421, \$75.



BALLANTINE LABORATORIES INC.
Boonton, New Jersey

CHECK WITH BALLANTINE FIRST FOR DC AND AC ELECTRONIC VOLTMETERS/AMMETERS/OHMMETERS, REGARDLESS OF YOUR REQUIREMENTS. WE HAVE A LARGE LINE, WITH ADDITIONS EACH YEAR. ALSO AC/DC LINEAR CONVERTERS, AC/DC CALIBRATORS, WIDE BAND AMPLIFIERS, DIRECT-READING CAPACITANCE METERS, AND A LINE OF LABORATORY VOLTAGE STANDARDS FOR 0 TO 1,000 MHZ.

aimed primarily at the science-oriented user. It, too, can interface with other Wang calculators in line with the company's policy of introducing new models on a building-block concept to avoid letting its older equipment slip into obsolescence.

Up to four basic 380 keyboards can be used with each electronic package, and keyboards may be spotted up to 500 feet from the package.

Wang Laboratories Inc., Tewksbury, Mass. [389]

New subassemblies

Buffer talks fast but keeps still

Memory can put 4,800 bps on line, cutting costs; has no moving parts

Fast talkers don't usually save anyone money, but Digital Devices Inc. has developed one that does. It's a buffer without moving parts, the 60SE-2, that stores 8,192 bits, as 5- or 8-bit words, and, on command, dumps them on a line at up to 4,800 bits per second. This speed can cut costs of leasing a line, which are often based on how long it's used.

Information fed to the buffer enters a shift register, then goes in serial form to the memory, a magnetostrictive delay line. When the dump signal is received, the information is transferred into an output register and out to the line. The buffer is also used at the receiving end to accept data fast and feed it to slow devices, such as printers. The output can be serial or parallel. A device to adjust the data-output rate is optional.

Paul Bauer, a sales engineer at Digital, says he expects his first customers to be designers of teletypewriter installations. He says the delay-line buffer may eventually replace paper-tape buffers in large telecommunication centers.

Time for silence. The buffer can

Philco-Ford puts logic in a box

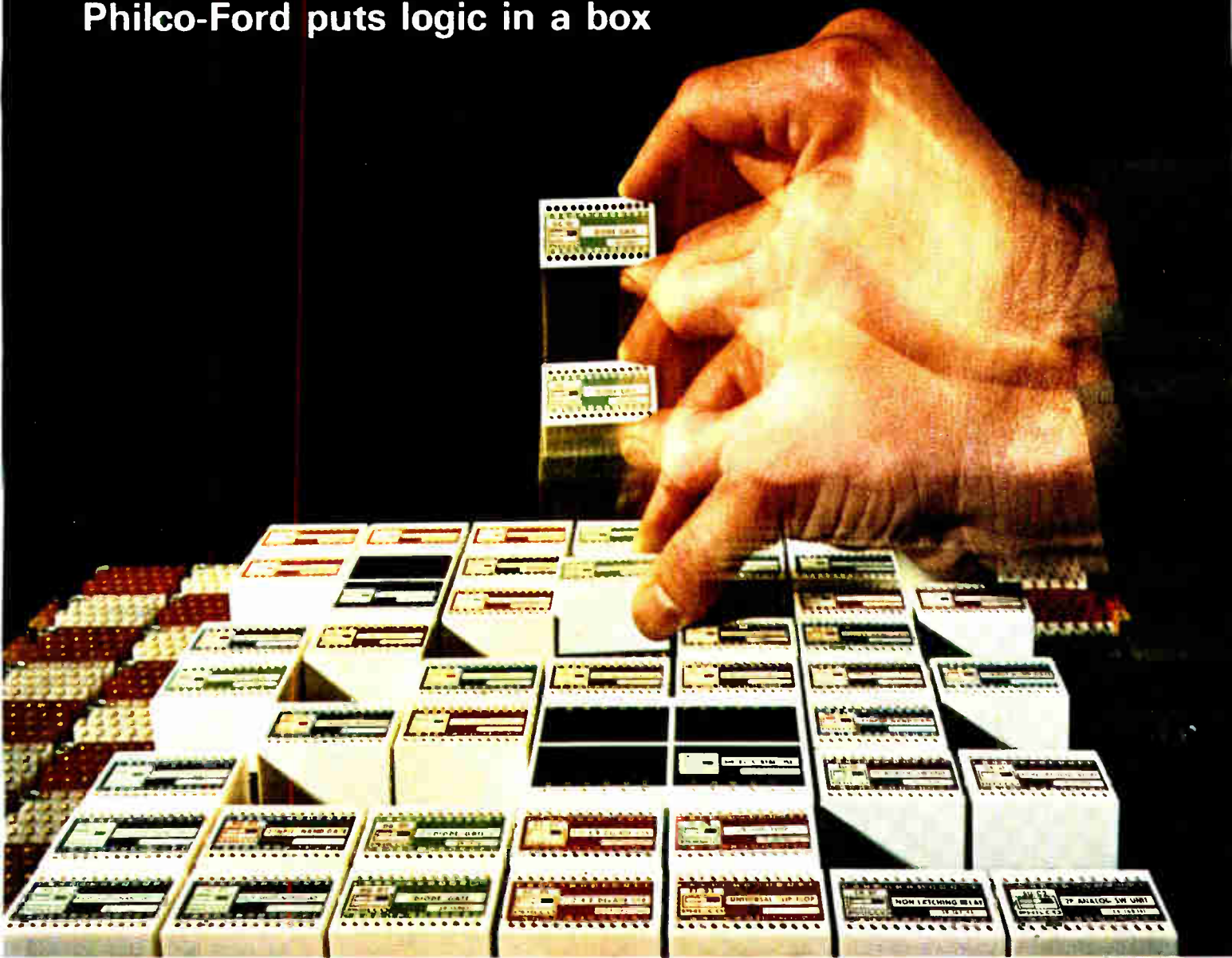

Now, you'll be pinning down your control system designs faster, easier, and with far greater economy

Over 200 micromodules from Philco-Ford's WDL Division stand ready to accept your system challenge. In compatible 5 to 40 MHz logic, standard DTL and T²L circuits, they contain some of the most sophisticated designs in today's state-of-the-art, including multiplexers, operational amplifiers, D-to-A and A-to-D circuits, and an extensive array of computer interfaces.

The micromodules employ monolithic IC's, using thin-film and discrete components only where necessary. A hard nylon cover keeps out dust, protects circuits against damage. Clearance holes at the top of the micromodule provide fast front-panel access to all input/output terminals. No need to troubleshoot from the back! A color-

coded label identifies module type at a glance.

The micromodule's modest dimensions, coupled with the complexity of the logic it contains, permits highly effective packaging density. A 180-module system can be mounted in a drawer only 3½" high by 19" wide. Modular systems fit readily into rack mounts, bench mounts, or portable instruments. In service for over three years at NASA's Manned Space Flight Center in Houston, WDL micromodules have compiled an excellent record of performance reliability. Write Product Sales Manager, WDL Division, Philco-Ford Corp., Mail Station C-41, 3939 Fabian Way, Palo Alto, California 94303. Or telephone (415) 326-4350, extension 6017.

ADD (Automated Design and Documentation) This Philco-Ford computer-programming service generates system documentation at a cost significantly below that of hand-prepared equivalents. The computer program error checks design input data, optimizes the arrangement and sequence of wiring instructions, calculates wire lengths, provides wire lists sorted by length and by name, and maintenance lists. The program is available to all users of Philco-Ford micromodules.



PHILCO-FORD CORPORATION
WDL Division • 3939 Fabian Way
Palo Alto, California • 94303

Circle 219 on reader service card

Play "Wee-Fils"®

THE NYTRONICS FILTER GAME

Match your custom filter requirements
to a Nytronics standard filter!

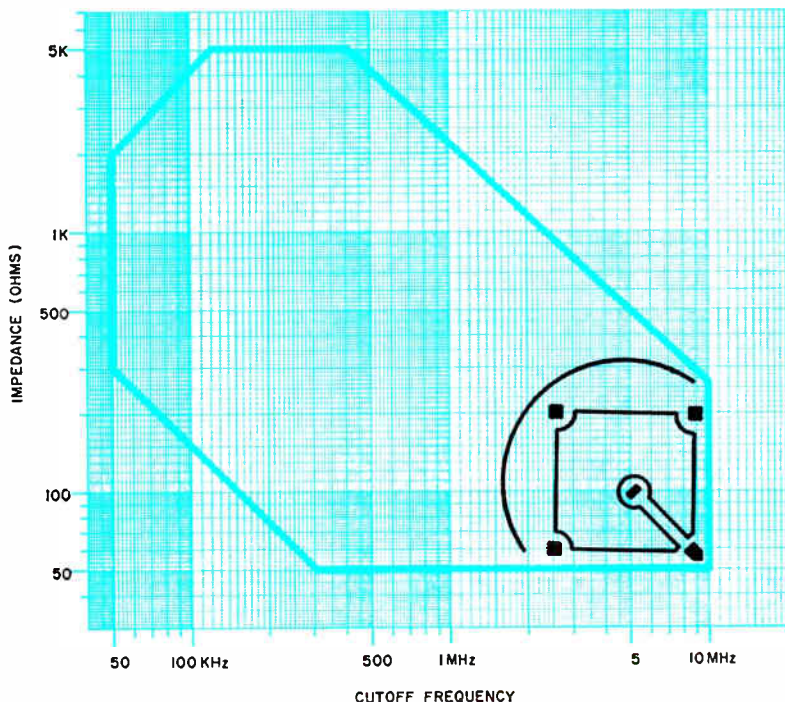

THE FEASIBILITY BALLPARK

Low-pass and high-pass Wee-Fils are available with 20, 35 or 50 db attenuation. Order Wee-Fils if your frequency-impedance characteristic falls in the feasibility ballpark.

Our in-house supplies of standard variable inductors and molded capacitors enables Nytronics to meet Wee-Fil orders with off-the-shelf components. And Wee-Fils offer all these features:

- Molded Construction
- Mil-Quality Components
- Specification Flexibility
- Small Size ■ Low Cost
- Rapid Delivery

Play Wee-Fils today. It might just be your most rewarding game in filter history.

ARE YOU IN THE BALLPARK?

To play in the Wee-Fil league, both input and output terminating impedances must be the same. Write for a set of detailed rules showing each filter and its attenuation—(normalized) frequency characteristic.

ARE YOU OUT OF THE BALLPARK?

Take heart. You may still be a winner. Nytronics offers custom filters too. Consult your nearest representative.



Third Avenue ■ Alpha, New Jersey 08866
(201) 454-1143 ■ TWX 201-855-2551

... buffer holds data

at remote sites ...

also be used to feed a computer. The longer a central processor is tied up, the higher the user's expense. By storing data or commands from a card or tape reader until they're complete, and then dumping them into the processor, the 608E-2 reduces processing time.

Other applications are being considered. For example, the buffers could be used for prolonged data storage at remote sampling sites where such conditions as weather, traffic, or pollution are measured. This would eliminate continuous communication with sites; the stored data would be transmitted periodically to a processing center on command.

Memory under stress. The magnetostrictive delay line holds an electrical signal 10 microseconds for every inch of wire.



Hang-up. Buffer is constructed for rack-panel mounting.

Certain alloys are deformed by a magnetic field. In a magnetostrictive line, the input signal passes through a coil and induces a magnetic field at one end of a nickel-alloy wire. The field induces a stress wave that travels in the wire at about the speed of sound. At the other end of the wire another coil produces a magnetic field that induces the output signal. In memory applications, this output is continually fed back to the delay-line input. Since the output is the second derivative of the input, integrators are used in the feedback loop.

Bauer says that where an engineer can live with millisecond access times and thousands-of-bits storage levels, magnetostrictive delay lines are the most efficient and economical memory.

The 608E-2 costs less than \$1,000 and is delivered in 12 weeks. It's compatible with most standard logic circuitry.

Digital Devices Inc., 200 Michael Dr., Syosset, N.Y. 11791 [390]

The first great meter that looks like one.

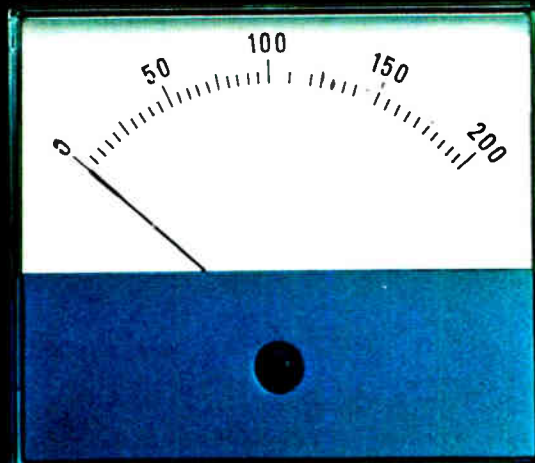

Don't let the good looks of Honeywell's MS Taut-Band Meter fool you.

What you see is a combination of functional advantages.

Modern curve.

The concave cover gives the meter a very contemporary look, all right.

But besides: By curving the cover, we minimized glare and shadows. That makes the meter easy to read.

Clean face.

We uncluttered the face by leaving out all the extraneous data. We

made the scale longer. We printed the numbers above the scale.

Very stylish.

But also very easy to read.

More window.

We made the sides of the cover out of crystal-clear Plexiglas, just like the front of the cover. That makes the whole meter sparkle.

It also brightens the dial by letting more light in.

The specs.

As for the insides of the meter, the Honeywell taut-band mechanism is completely frictionless, so it responds to even the slightest inputs.

Hysteresis-free, so its repeatability is near perfect.

Honeywell Series MS Taut-Band Meters come in 20 standard colors. In 33 standard ranges. And 3 sizes (1½", 2½" and 3½").

The price.

This is the taut-band meter that costs even less than a pivot-and-jewel meter.

So if you like it, there's nothing to keep you from having it.

(We'd like to send you a catalog. Write Honeywell Precision Meter Division, Manchester, New Hampshire 03105.)

The Classy Meter from Honeywell

It takes all kinds of meters to make the Honeywell line.

Small wonder:

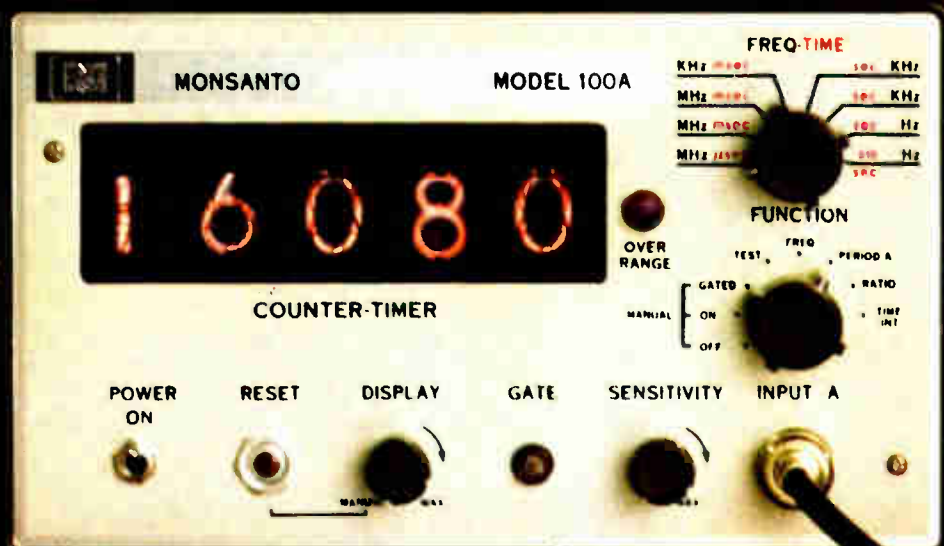

Our new "4th-generation" 12.5 MHz universal counter/timer. Wonderful versatility in a wonderfully small package — at an even more wonderfully small price.

With the new Model 100A you can measure average frequency, frequency ratio, single period or time interval, or count total events. It has a crystal-controlled clock, Monsanto integrated circuit construction, and built-in compatibility with a rapidly growing assemblage of accessory modules.

With its \$575* price tag (accessory modules are pegged at comparably modest rates) you can have big-league counter/timer performance at

costs never before possible. Small wonder we are selling (and delivering) Model 100A's just as fast as we can build them.

Call your local Monsanto field engineering representative for full technical details, or contact us directly at: Monsanto Electronics Technical Ctr., 620 Passaic Avenue, West Caldwell, New Jersey 07006. Phone (201) 228-3800; TWX 710-734-4334.

*U.S. Price, FOB West Caldwell, New Jersey

Monsanto
ELECTRONICS

New Instruments Review

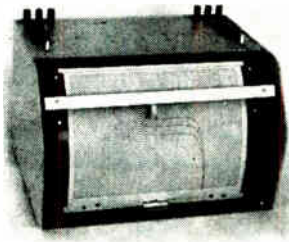

X-Y recorder model 30 records on $8\frac{1}{2} \times 11$ in. graph paper, with an accuracy of better than 1%. Pen slewing speed is 10 ips. Span is continuously variable from 100 mv/in. to 1 v/in. Input resistance is 100 kilohms, and the X and Y channels are electrically independent. Overall dimensions are 14 x 10 x 10 in. Yeiser Laboratories, 881 W. 18th St., Costa Mesa, Calif. 92627. [361]

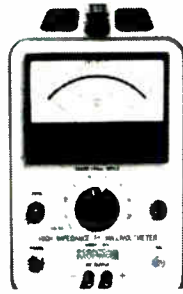

R-f millivoltmeter model 91K has an input impedance greater than 4 megohms shunted by 2.5 pf at frequencies up to 25 Mhz falling to about 1 megohm shunted by 2.5 pf at 100 Mhz. Frequency coverage is 0.5 to 600 Mhz with 8 ranges of sensitivity from 10 mv full scale to 30 v full scale in a 1-3-10 sequence. Price is \$680. Boonton Electronics Corp., Parsippany, N.J. 07054. [362]



Chatter and transfer detector model BR-650 monitors and indicates undesirable opening or closing of active circuit paths during dynamic environmental tests such as shock, acceleration and vibration. The unit provides 8 channels with 4 inputs per channel in either chatter or transfer mode. Bunker-Ramo Corp., Defense Systems Division, 8433 Fullbrook Ave., Canoga Park, Calif. 91304. [363]



Sweep and marker generator 1484A is a low cost, solid state unit. Frequencies may be selected up to 1 Ghz, and pulse markers, c-w and harmonic birdie markers, r-f turn-off markers and post-injection markers can be specified. A 4-position switch selects band positions, and remote control of bands and tuning can be provided. Kay Electric Co., Pine Brook, N.J. 07058. [364]

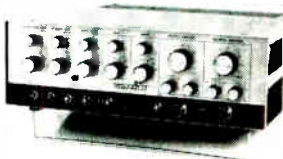

Pulse generator 113 has built-in burst capability. Two repetition rate oscillators are used. A h-f oscillator gives rep rates from 500 khz to 250 Mhz. A l-f oscillator (0.5 hz to 500 khz) is used to gate the h-f oscillator for 10 nsec to 10 μ sec bursts or as a trigger for low rep rates. Price is \$3,375. Datapulse Inc., 10150 W. Jefferson Blvd., Culver City, Calif. 90230. [365]



Capacitance bridge 273 operates on 9 ranges, from 0 through 120 pf to 0 through 12,000 μ f. Accuracy is $\pm 0.1\%$ on middle ranges, $\pm 0.3\%$ on the highest. Effects of lead resistance are eliminated by a 4-terminal kelvin connection, and a high value internal standard reduces effects of shunt capacitance. Electro Scientific Industries Inc., Science Park Dr., Portland, Ore. 97228. [366]

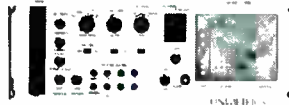

Digigraph converter model 1000 transforms perforated-tape data into analog voltages for plotting on X-Y or incremental advance recorders. Featuring logarithmic conversion of linear data, it has facilities for overlays of data from separate tapes and from different portions of the same tape for comparison and detailed analysis. Unimetrics Corp., 2712 S.W. Freeway, Houston 77006. [367]

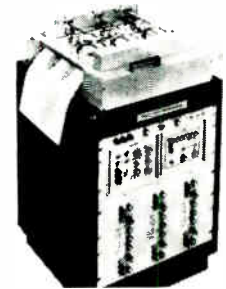

X-Y recorder 6756 has a 6-pen X-Y or T-Y recording capability. The X or paper axis can be driven with an analog input or on a time base by push button selection. Speed ranges are 0.5, 0.1, 0.2, 15, 1 and 2 in./sec, in./min., and in./hr. Each pen axis has 36 voltage ranges from 0.2 mv/in. to 100 v/in. Houston Instrument Div., Bausch & Lomb Inc., Bellaire, Texas 77401. [368]

New instruments

Linear IC tester checks 22 values

Measurement system serves the needs of both the design engineer and the circuit inspector

Trying to impose order on the chaos of parameter definitions and test procedures for linear integrated circuits bought from different makers, two engineers wound up designing their own low-cost linear ic tester.

Robert Bisey and Frederick Gans,

of the Grumman Aircraft Engineering Corp.'s Microelectronics Laboratory, began by defining 30 parameters and outlining how to measure each. Most of their definitions and tests are being included in MIL STD 883 [Electronics, Dec. 11, 1967, p. 26].

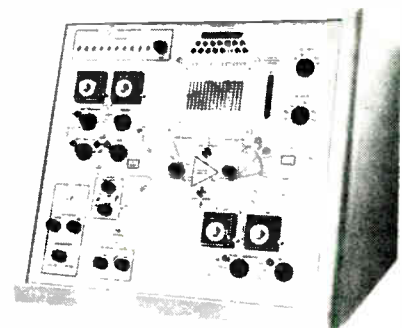

Circuit shown. Panel of 401 is schematic of test circuit.

Available ic test equipment, they found, was either too limited or too expensive for Grumman's use. Most instruments were built with a spe-

TAKE IT FROM BEETLE BAILEY:



FOR PANEL METERS, COUNT ON GENERAL ELECTRIC'S SALES AND SERVICE ARMY!

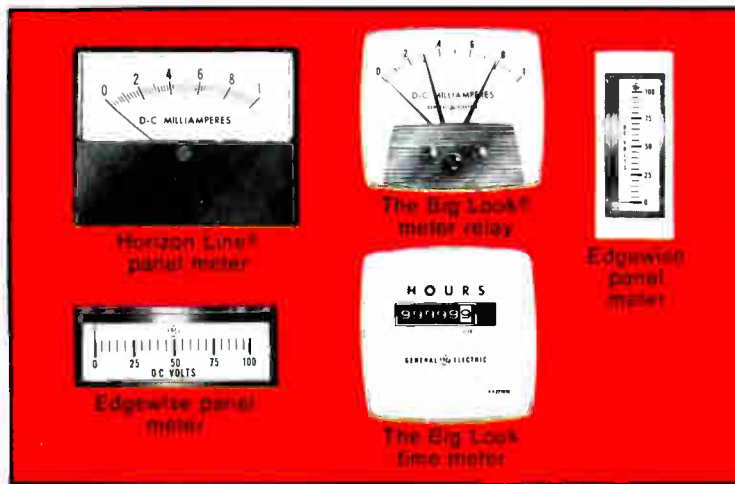
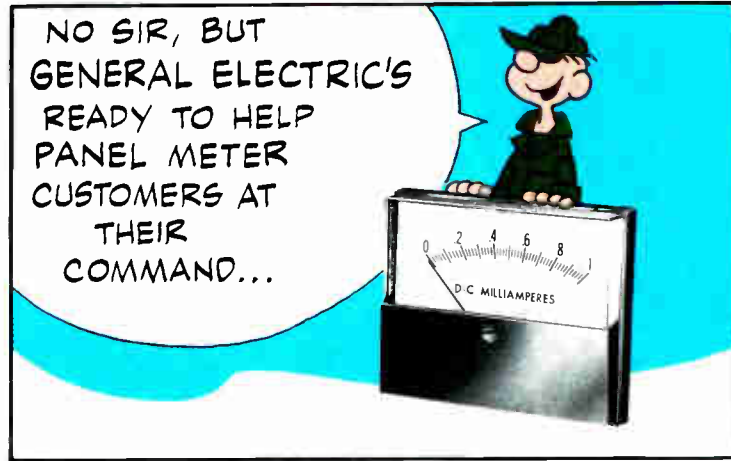
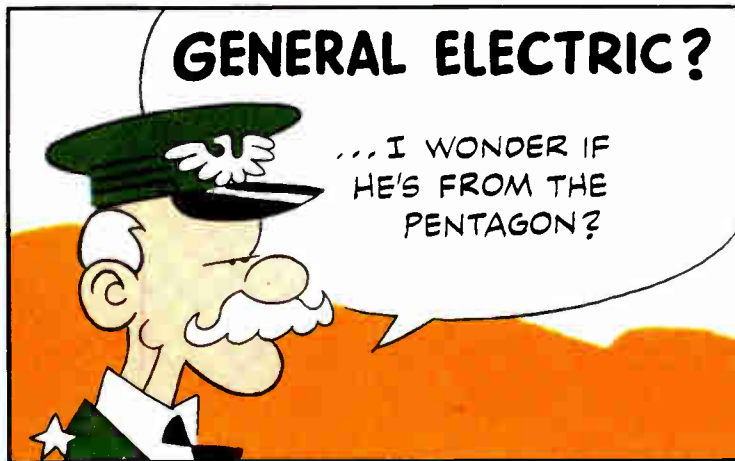
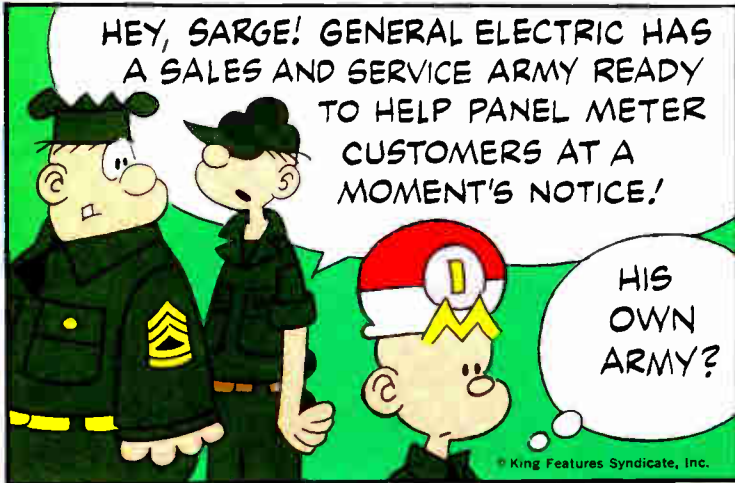

... just give the order. General Electric's Sales and Service Army is prepared to combat any panel meter problem with an arsenal of powerful, up-to-date weapons—a full line of quality panel meters and meter relays, expert application assistance, fast service across the country, and on-time delivery from a nationwide network of sales offices and distributors.

Why fight it? Surrender all your panel meter problems to General Electric's Sales and Service Army. Contact your GE Electronic Components Sales Office or your dependable General Electric panel meter distributor.

592-34

GENERAL  ELECTRIC

... schematic layout of 401 panel allows designer to see changes in test circuit as he makes them ...

cific maker's set of tests in mind, and there wasn't anything that could measure more than 15 parameters. So Bisey and Gans designed a unit that could measure 22 parameters, according to their own standards.

Now, under a licensing agreement Corp. will build and sell the Grumman tester, the Model 401.

Out of steps. The 401 handles any IC package because the circuit being tested is plugged into a socket mounted on a printed-circuit board. The board, in turn, is plugged into the tester. The operator electrically connects the IC leads to the test circuits with sliding switches on the 401's front panel. Tests can be run on the main types of linear IC's—single-ended input and output amplifiers, differential input and output amplifiers, and differential input and single-ended output amplifiers.

Bisey and Gans were thinking of the system designer when they laid out the front panel of the 401. Symbols, labels, switches and knobs are placed so the designer can see, schematically, the test circuit in use. And when he throws a switch, he knows immediately what part of the test circuit he's changing.

Rather than outlining test procedures step-by-step, the 401 instruction manual shows block diagrams of the 22 test circuits. This feature, combined with the panel layout, means easy and quick setups.

Yes or no. Besides being a design tool, the 401 is useful for making go-no go tests on large batches of IC's. P-c cards are made up for a variety of tests, and given to an inspector. For a given test, he plugs a card into the programmed-amplifier socket on the 401's front panel and the card by-passes the sliding switches and makes the necessary connections for the test. The inspector then just plugs an IC into the test socket, pushes a button, looks at a meter, and accepts or rejects the IC.

The designers of the 401 kept the price under \$2,500 by omitting input sources and readout devices on the grounds that the auxiliary

equipment needed to operate the tester would be available in most laboratories.

Most tests have been designed so results can be read as output voltages. The accuracy of the readings depends only on the accuracy of the auxiliary equipment.

Extra equipment can be bought with the 401, including: an oscilloscope with differential input, a d-c vacuum tube voltmeter, an a-c voltmeter, a dual voltage power supply, an audio oscillator for measurement of dynamic parameters, and a radio frequency generator for the measurement of bandwidth.

Integrated Circuit Measurement Corp.,
55 Northern Blvd. Greendale, N.Y.
11548 [369]

New instruments

Recorder can go to the action

Portable unit has four channels, operates on a-c or d-c, costs \$2,900

A scientific investigator working outside the laboratory has usually had to pay a high price for a recorder with more accuracy or channels than he needed because nothing else was available.

Engineers at the Sony Corp. had this researcher in mind when they designed the PFM-15 data recorder. It costs \$2,900, weighs 37 pounds, and can be powered by a 12-volt battery. It records, by frequency modulation, four channels of data on 1/4-inch magnetic tape. Associated with one channel is an audio amplifier and speaker, so the researcher can record his own play-by-play.

Variable power. Line voltage from 50 to 400 hertz at levels of 100, 110, 117, 125, 220, or 240 v will also power the PFM-15. Switching to a-c operation requires changing one module and setting a

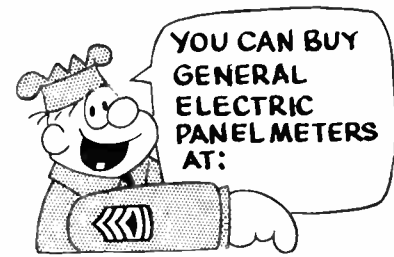

ALABAMA
Birmingham
Electronic Supplies, Inc.
Forbes Distributing Co.
Muntaville
Cramer/Huntsville
Egderly Instrument Labs, Inc.
Electro-Tech, Inc.

ARIZONA
Phoenix
Hamilton Electro of Arizona
Metcraft, Inc.

ARKANSAS
Little Rock
Carlton Bates Co.

CALIFORNIA
Culver City
Hamilton Electro Sales
Emeryville
General Electric Supply Co.
Glendale
JSD Engineering
Los Angeles
General Electric Supply Co.
Mettermaster, Inc.
ML View
Hamilton Electro Sales
Palo Alto
Kieruff Electronics
Redwood City
Fortune Electronics
Sacramento
Sacramento Elec. Supply Co.
San Diego
Kieruff Electronics
Hamilton Elect. of San Diego

COLORADO
Denver
Electronic Parts Co.
L. B. Walker Radio Co.

CONNECTICUT
Hamden
Cramer Electronics, Inc.
Hartford
General Electric Supply Co.

DISTRICT OF COLUMBIA
Washington
Cramer/Washington
Siberia Radio & Electronics

FLORIDA
Ft. Lauderdale
Cramer/Florida Electronics
Jacksonville
General Electric Supply Co.
Orlando
Electro-Tech, Inc.
West Palm Beach
Mountain Electronics

GEORGIA
Atlanta
Electronic Supply Co.
General Electric Supply Co.
Jackson Electronic Supply Co.

AUGUSTA
General Electric Supply Co.

MAPEVILLE
Electro-Tech, Inc.

ILLINOIS
Chicago
Allied Radio
J. G. Bowman & Co.
Peoria
Henricks Elec. Co.
Schiller Park
Pace Electronics Supplies
Springfield
Bruck Electronics, Inc.

INDIANA
Evansville
Ohio Valley Sound, Inc.
Fort Wayne
Fort Wayne Electronic Supply Co.
Indianapolis
General Electric Supply Co.
Graham Electronics
Peerless Elec. Supply Co.

IOWA
Cedar Rapids
Hupp Electric Motors, Inc.
Iowa City
Hupp Electric Motors, Inc.

KANSAS
Wichita
Radio Supply Co.

KENTUCKY
Louisville
P. I. Burks Co.
General Electric Supply Co.

LOUISIANA
Baton Rouge
Sterling Electronics
Lafayette
Ralphs of Lafayette
New Orleans
Argo Marine Supply
New Orleans Electric
Supply, Inc.
Sterling Electronics, Inc.

MARYLAND
Baltimore
Cramer/Baltimore
Egderly Instrument Laboratories

MASSACHUSETTS
Boston
General Electric Supply Co.
Gerber Radio Supply Co.
Cambridge
E-T Instruments & Controls, Inc.
Lawrence
Alco Electronics
Needham
Instruments, Inc.
Newton
Cramer Electronics, Inc.
Springfield
T. F. Cushing, Inc.

MICHIGAN
Detroit
General Electric Supply Co.
Farmdale
Ram Meter, Inc.
Kalamazoo
Warren Radio Co.
Muskegon
Fitzpatrick Electric Supply Co.
Southfield
S. Sterling Co.

MINNESOTA
Minneapolis
Electronic Center, Inc.
Lew-Bonn Co.

MISSISSIPPI
Jackson
Egderly Instrument Supply, Inc.

MISSOURI
Joplin
Norman Elec. Supply Co., Inc.
Kansas City
General Electric Supply Co.
Radio Labs, Inc.
University City
Olive Industrial Electronics, Inc.

NEBRASKA
Lincoln
Scott-Lewis
Omaha
Scneider Elec. & Equipment Co.

NEW JERSEY
Roselle
E-T Instruments & Controls, Inc.
Scratch Plains
TST Electronics

NEW MEXICO
Albuquerque
Electronic Parts Co., Inc.
Sterling Electronics, Inc.

NEW YORK
Elmhurst
Cramer/ESCO
Elmsford
Hibwhite Radio Corp.
Glens Falls
Glens Falls Electric Supply Co.
Great Neck
Adam Instrument
Latham
Latham Electric Supply Corp.
Liverpool
WEI, Inc.
New York City
E-T Instruments & Controls, Inc.
Hudson Electric Sales Co.
Power Instrument Control Sup.
Byram
Mather, Evans and Diehl, Inc.

NORTH CAROLINA
Charlotte
Hixie Radio Supply Co., Inc.
Greensboro
General Electric Supply Co.
Southeastern Radio Supply
Raleigh
Southeastern Radio Supply Co.

OHIO
Akron
Sun Radio
Birmingham
General Electric Supply Co.
United Radio, Inc.
Cleveland
Christie Laboratories, Inc.
General Electric Supply Co.
Pioneer Standard Electronics, Inc.
Columbus
Buckeye Electronic Distri., Inc.
Dayton
Pioneer Standard/Sreppo
Toledo
Hillstead Electric Supply
Warren Radio Co.
Warren
REM Electronics Supply Co.

OKLAHOMA
Oklahoma City
John H. Cole Co.

PENNSYLVANIA
Allentown
A. A. Peters, Inc.
Harrisburg
Radio Distributing Co.
McKeasport
Barco Radio Co.
Philadelphia
Almo Industrial/Electronics, Inc.
General Electric Supply Co.
Sunshine Scientific Inst.
Pittsburgh
Egderly Instrument Labs, Inc.
General Electric Supply Co.
York
Rosen Electronics

RHODE ISLAND
Providence
W. H. Edwards Co.

SOUTH CAROLINA
Charleston
Wholesale Radio Supply
Columbia
Dixie Radio Supply Co., Inc.
Greenville
Dixie Radio Supply Co., Inc.

TENNESSEE
Chattanooga
Electric Motor Sales and
Supplies
Harpe Electronic Distributors
Knoxville
Chemco Electronics
General Electric Supply Co.
Memphis
Elec. & Mech. Comp. Devices
Lavender Radio & TV
W & W Distributing Co.
Nashville
Electra Distributing Co.

TEXAS
Arlington
Arco Beta Electronics
Baumgart
Sterling Electronics, Inc.
Corpus Christi
Electronic Equip. & Engrg. Co.
Dallas
Contact Electronics
Graybar Electric Co.
El Paso
McNicol, Inc.
Houston
Buscher Electronic Equip. Co.
General Electric Supply Co.

UTAH
Salt Lake City
S. S. Ross, Inc.

VIRGINIA
Norfolk
Cabin Electronics, Inc.
Richmond
Meridian Electronics, Inc.
Roanoke
Peoples Radio & TV Supply Co., Inc.

WASHINGTON
Aberdeen
C&G Electronics
Seattle
Hamilton Electro Corp.
Instrument Laboratory, Inc.
Kieruff Electronics
Spokane
Ind. Instrument Supply Co.

WEST VIRGINIA
Martinsburg
Meyers Electronics, Inc.
Charleston
Chemcity Electronics
Mountain Electronics Co.
Mountain National Corp.
Huntington
Electronic Supply Co.
Mountain Electronics Co.

WISCONSIN
Appleton
General Electric Supply Co.
Green Bay
Beermaster Electric Co.
West Allis
Marsh Radio Supply Co.

ac circuit design starts with an oscillator...

START WITH THE BEST

Hewlett-Packard invented the first stable Wien-bridge oscillator. Now



they have added several design improvements to two new solid state oscillators — 0.5% (0.05 dB) flatness—FET's in the bridge for im-

proved stability — $<0.1\%$ (-60 dB) distortion—balanced output—sync in/out without degradation in specs. Now, choose from 17 hp oscillators—the widest choice in the industry!

The new hp 204C Oscillator has a frequency range of 5 Hz to 1.2 MHz, 5 Vrms output. The 204C can be operated with line power, mercury battery or a rechargeable battery pack. Price hp 204C, \$250-285.

The new hp 209A Oscillator generates simultaneous sine and square wave outputs over a frequency range of 4 Hz to 2MHz. Amplitudes are independently adjustable. Output voltage is 10 Vrms for sine wave; 20 V peak-to-peak for square wave. Price: hp 209A, \$320.

Start with the best! Get complete

information on the two new—or all 17 hp Oscillators—from your near-



est hp field engineer. Or, write to Hewlett-Packard, Palo Alto, California 94304. Europe: 54 Route des Acacias, Geneva.

HEWLETT **hp** PACKARD

SIGNAL SOURCES

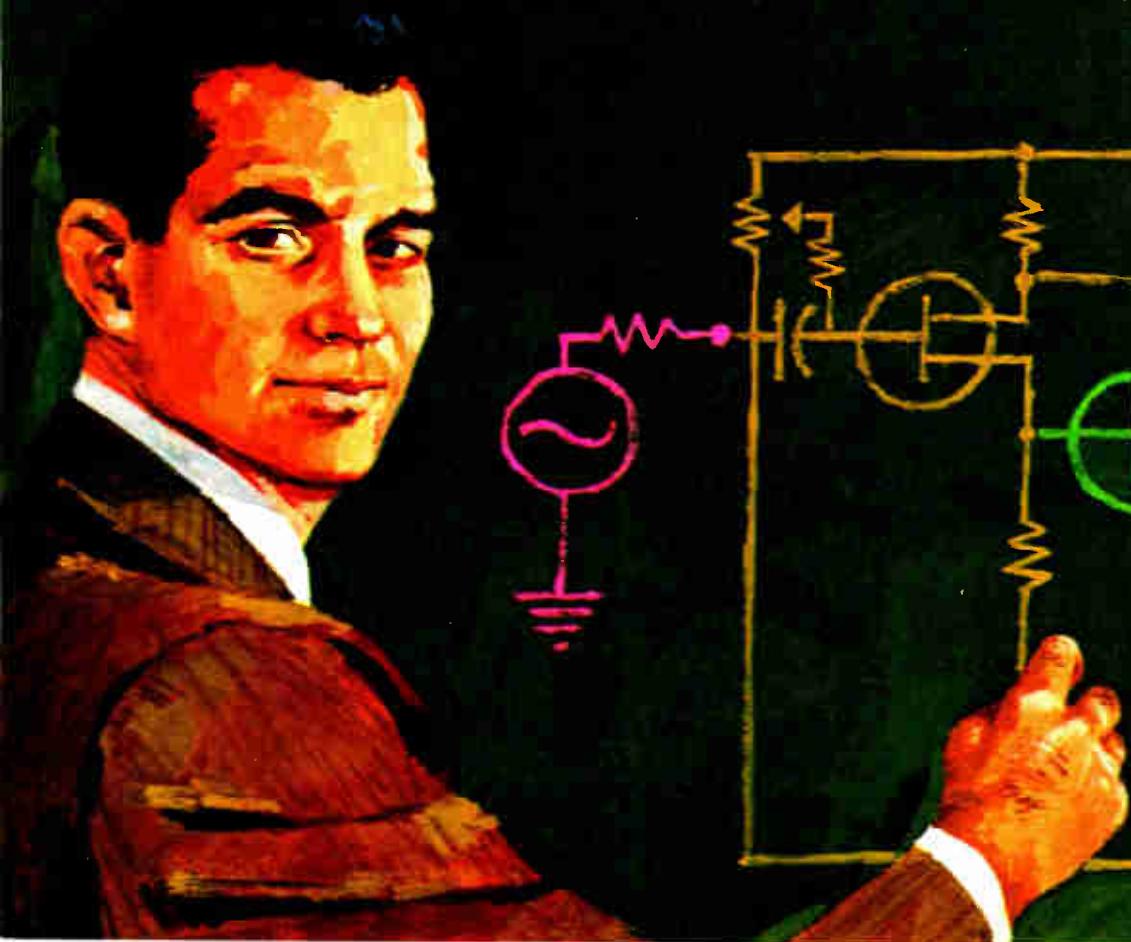



Heart beats. PFM-15 feeds the data, obtained with recorder in intensive-care ward, to averaging computer.

panel switch to the proper voltage.

The unit records linearly within ± 1 decibel from d-c to 2.5 kilohertz. The operator can extend the range to 5 kHz by making connections on one of the instrument's circuit cards. At this wider range, linearity is within $+1$ db and -2 db. The signal-to-noise ratio is 45 db, and crosstalk is -37 db. Total harmonic distortion is under 2.5% of full output, and the recorder has an input/output level meter and a level adjustment for each channel.

A servo system, used as the tape transport mechanism, maintains a constant tape speed of 7.5 inches per second.

Baby talk. Gerald Wade, a biomedical engineer with Hoffman-LaRoche Inc. (a large pharmaceutical house), has already put the PFM-15 to use. Hoffman is working with RCA to develop an automatic monitor and alarm system for the intensive care of premature infants. The system will measure such parameters as blood pressure and temperature continuously, and when any abnormal signal is received from the infant, an alarm will sound. The key to the system is knowing what are the normal and abnormal physiological signals from a premature infant, and what are artifacts.

To find out, Wade is using a PFM-15 in the intensive care unit of Columbia Presbyterian's Babies Hospital in New York. He records a variety of physiological signals and takes the tapes back to his lab at Hoffman, where he has another PFM-15, for analysis.

Sony/Instrumentation Data Prod., 2 Maud Graham Circle, Burlington, Mass. [370]



Why pay more for the "same" transformer? To find out, send for the informative booklet shown here.

Both of these transformers look alike...but they're not!

The \$25 transformer on the left is typical of the units which have established Raytheon's reputation for transformer quality in vital military systems.

The \$50 unit is a high reliability transformer. It costs more because it was designed to meet defined MTBF goals and manufactured in a separate, environmentally-controlled facility. This transformer also underwent rigorous screening and qualification testing to make certain it met the specified high reliability standards.

Raytheon is an experienced manufacturer of high reliability magnetic components, having participated in numerous NASA and DOD programs such as Apollo, Sert II, and MOL.

Get your free copy of the Raytheon transformer brochure shown above. It describes our high reliability facilities and programs. And it shows why Raytheon's high reliability transformers are well worth the difference in price. Send the reader service card or write directly to: Raytheon Company, Magnetics Operation, 180 Willow Street, Waltham, Mass. 02154.



CONSIDER COLORADO / INDUSTRIAL COLORADO

... where people have a reason to be more productive ... To work harder. To be conscientious and stable. To make more effort to do a good job for you.

Consider Colorado's labor force, 750,000 strong. Well-trained in widely diversified fields. People who are willing to work hard because there's a lot to live for in their State. A stimulating climate. A myriad of recreational activities easily accessible to all. Their attitude is reflected by unemployment compensation rates which are among the lowest in the nation.

Consider opinions of companies with multi-state facilities about Colorado employees. "An enthusiastic and cooperative group of employees." "A stable work force." "Less absenteeism." "Productivity higher than other divisions." The average employee in the 25 and older age group has better than a high school education. 10.7% of that group with 4 years of college, the highest percentage in the nation. Each year 80,000 workers improve themselves through adult education programs.

If these are qualities you want in your employees, consider Industrial Colorado for your expansion or relocation.

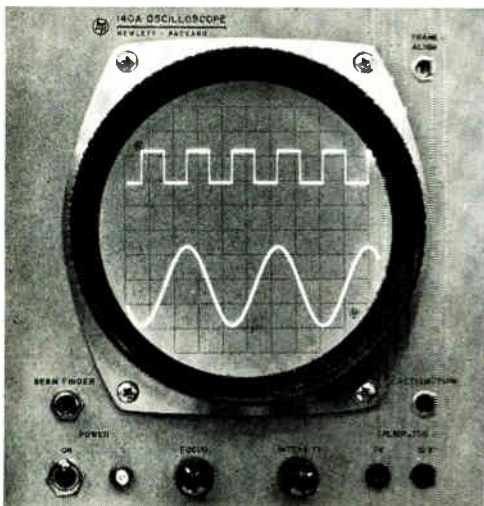
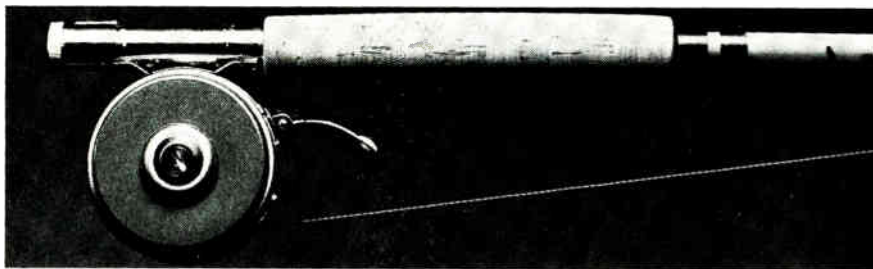
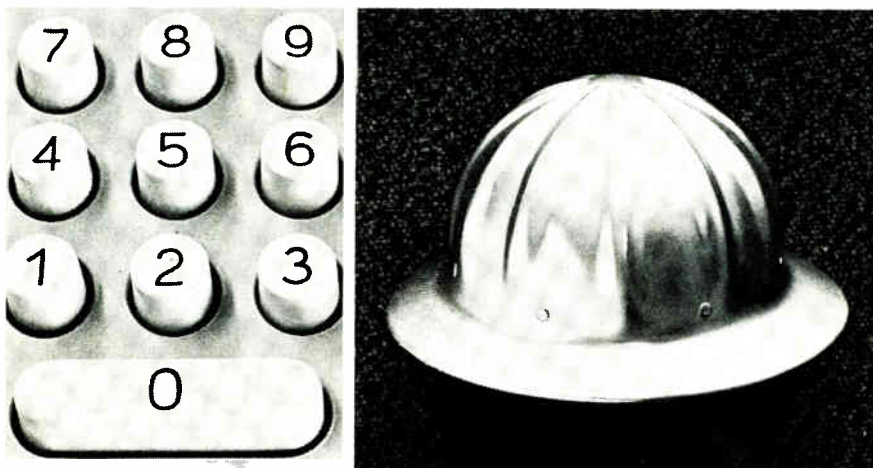

Skilled, unskilled, or highly specialized, Coloradans are well educated, conscientious, anxious to improve themselves and help their company—an asset to any employer. Write for a complimentary copy of Industrial Colorado, a revised-to-the-minute, factual, spiral-bound portfolio. It covers important considerations pertinent to plant expansion or relocation in any part of the State. Address inquiries to Ronald D. Lemon, Director, Industrial Research & Development, Division of Commerce and Development, 78 State Services Building, Denver, Colorado 80203.

New instruments

Wattmeter has 0.02% accuracy

Japanese calibrator uses feedback and three moving coils to increase linearity

It won't make electricity bills any easier to pay, but a new wattmeter from Japan may ensure that they're based on more accurate readings. Developed by Yokogawa Electric Works Ltd, as a calibration standard for wattmeters and watthour meters, the APR-2 has an accuracy of 0.02% and a repeatability of 10 parts per million. Hallmark Standards Inc., which will sell and service the unit in the U.S., claims the APR-2 is at least five times as accurate as present calibrators.

Like most wattmeters, the new device is a dynamometer; a moving coil on a shaft is arranged inside a fixed coil. To measure power dissipated by a load, the fixed coil is put in series with the load, and the moving coil is placed in parallel with it, so that the deflection of the moving coil is proportional to the product of current in and voltage across the load. The problem here is that as one coil rotates,

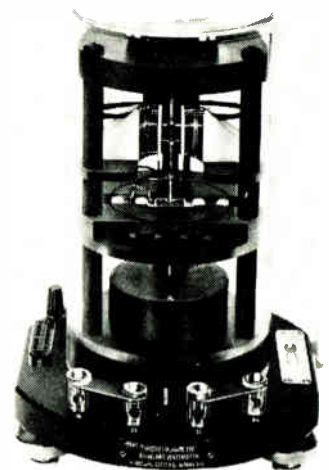

Converter. Isolation of the three moving coils allows use of feedback loop to reduce change in mutual inductance.

mutual inductance changes, and coil impedances change. As deflection increases, therefore, linearity decreases.

Spin stopper. In the APR-2, a feedback loop reduces deflection. There's a second moving coil inside another fixed coil on the instrument's shaft. When a 10-kilo-hertz signal is applied to this fixed coil, the resulting rotation of the shaft induces a current in the second moving coil. This current is amplified and then mixed with the 10-khz signal to produce a d-c signal, proportional to load power, that flows into an output resistor.

The mixed signal is also fed into a third moving coil situated between the poles of a permanent magnet. This signal tends to move the shaft in opposition to the rotation caused by signals from the load, and keeps the maximum deflection of the shaft under 0.05 degrees.

Isolation. Russell Brownell, engineering vice president at Hallmark, explains that the unit's accuracy stems from the fact that "power sensing, torque sensing, and deflection sensing are electrically isolated while being mechanically connected." Brownell says the feedback approach has been attempted before, but that the APR-2 is the first instrument to use three moving coils. Other feedback systems, he adds, use one or two coils and are plagued by interaction.

Accuracy is guaranteed up to 2 khz, and Hallmark says the unit gives good results up to 10 khz. It can handle 110 volts and 5 amps, and settling time between readings is less than 5 seconds.

Loss check. Although the APR-2 was designed for use in calibration labs, other applications are possible. Fuji Steel doesn't need 0.02% accuracy when it measures core loss, but it's doing the job with APR-2's anyway. Fuji uses the instrument's 0-to-1-volt d-c output to digitalize power readings.

The APR-2 comes in three parts—a converter that contains the dynamometer section, an amplifier, and a standard-resistance box. Cost is \$6,650, and delivery time is six months. Hallmark hopes to eventually build the units in the U.S.

Hallmark Standards Inc., 145 Library Lane, Mamaroneck, N.Y. 10543 [371]

Sweep

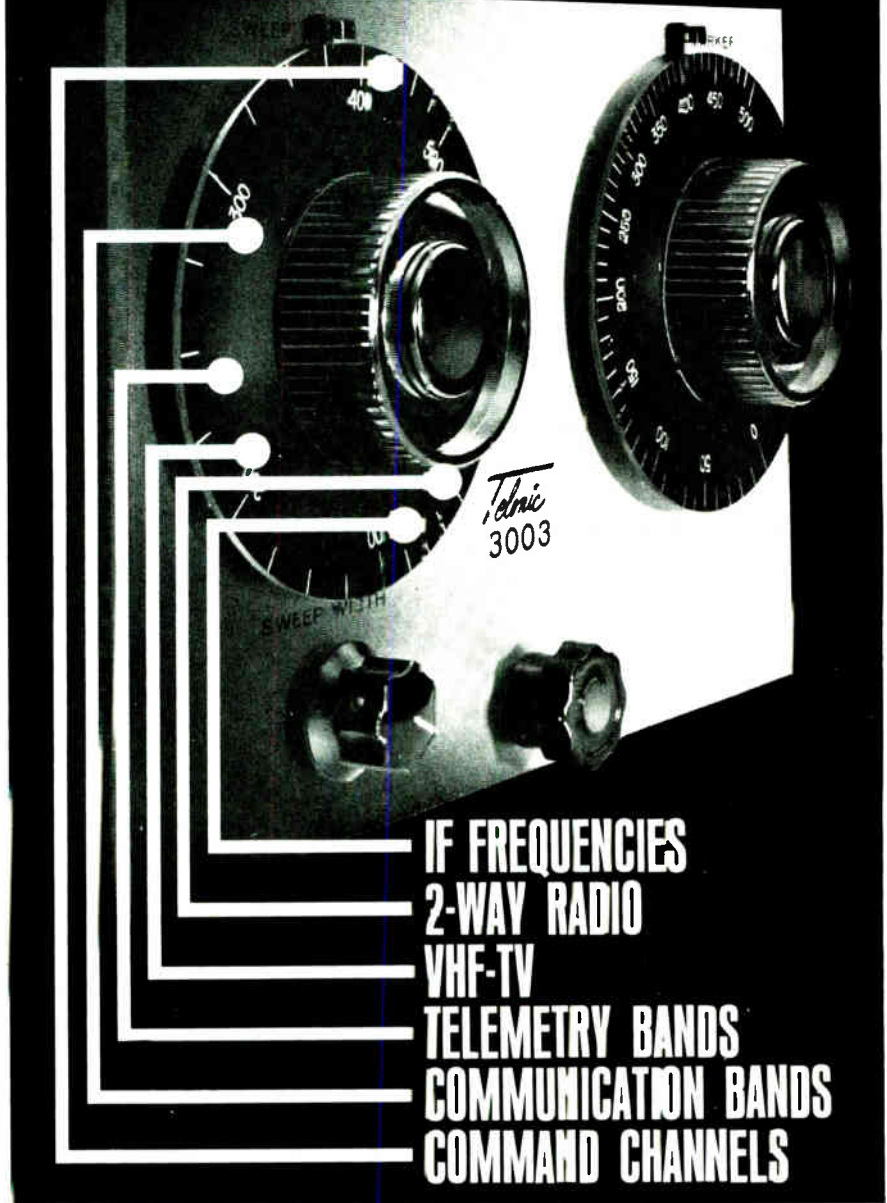

**IF FREQUENCIES
2-WAY RADIO
VHF-TV
TELEMETRY BANDS
COMMUNICATION BANDS
COMMAND CHANNELS**



Designed for Telonic's SM-2000 Sweep Generator, this new Model 3003-1 plug-in oscillator provides frequency coverage from 5 to 500 MHz, sweeping this entire range in one pass or any portion of it down to 500 kHz wide.

Using electronic tuning and all solid state circuits, the 3003-1 virtually doubles the capabilities of the SM-2000 Sweep Generator. In addition to wide range and sweep width, it also features variable rate for permanent recording applications and a variable birdy-type marker, providing frequency identification from 5-500 MHz.

SPECIFICATIONS

Frequency Range	5 MHz - 500 MHz
Sweep Width	500 kHz - 500 MHz
Output	.5 v RMS
Sweep Rate	.01 to 100 Hz, variable
Vernier Attenuation Range	6 dB min.
Linearity	1.5:1
Flatness @ max. sweep	+0.75 dB
@ 10% max. sweep	-0.5 dB

Full details plus Application Data in Catalog 70-A **Send for your copy.**

Telonic INSTRUMENTS Division of
Telonic Industries, Inc.

60 N. First Avenue • Beech Grove, Indiana 46107 • Tel.: (317) 787-3231 • TWX - 810-341-3202

Digitran made it big

about so big

Digitran perfected a simple idea... the thumbwheel switch. Making it was simple. Making it perfect was a big job. We did, and called it a Digiswitch®. After we made it perfect, we made it small. We call that a Miniswitch®.

 Making it small was a big job, too. It took lots of time, talent and money. But it was worth it. Miniswitch can help you save up to 50% of your panel space; give you accurate, dependable controls that are simple, easy to set and read; under any conditions, in any environment.

 At Digitran you can count on our know-how to help solve your most complex switching problems. We've the industry's most complete thumbwheel switch application library to prove it. Given the opportunity, we can probably save you both time and money.

 But don't take our word for it, find out for yourself. Send for a complete catalog on switches (big and little). From Digitran. The thumbwheel switch company you can count on.

THE DIGITRAN COMPANY

Subsidiary of Becton, Dickinson and Company 

855 S. Arroyo Pkwy./Pasadena, Calif. 91105

Tel: (213) 449-3110/TWX 910-588-3794

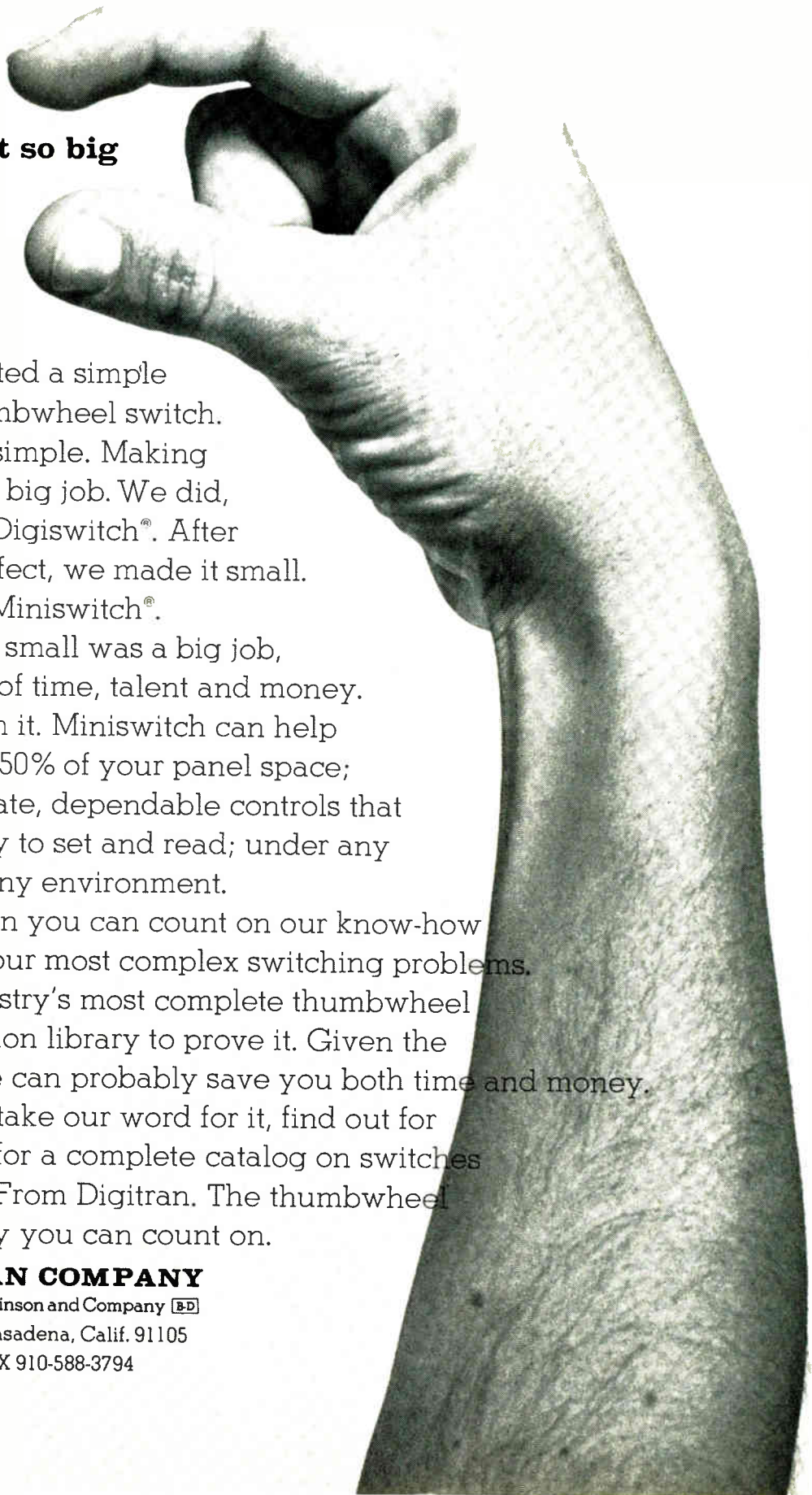

New Industrial Electronics Review



Plug-in SCR motor speed control 2100 is for d-c shunt wound motors. It consists of 2 plug-in modules that are readily removed without disconnecting wiring. Replacement is achieved in 30 sec by unskilled personnel. The unit covers d-c motors from 1/4 to 1 h-p at 115 v a-c; and 1/2 to 2 h-p, 220 v a-c input. Seco Electronics Corp., 1001 2nd St. South, Hopkins, Minn. 55343. [421]



Solid state Fanclad continuously varies fan and blower speeds from maximum to any desired lower speed within inherent shaded-pole or permanent split-capacitor capability. Standard thyristor modules FS-5 (5 amps, 120 v a-c, list price \$11.95) and FS-10 (10 amps, 120 v a-c, list price \$24.95) are available. Lutron Electronics Co., Emmaus, Pa. 18049. [422]



Electronic tachometers for both indication and alarm are offered in a wide choice of ranges calibrated directly in rpm, cps, mph, fpm, or special ranges. The line features accuracy of $\pm 1\%$ and linearity of $\pm 1\%$ over 9 ranges from 0 to 50 to 0 to 20,000 hz. Three sizes of meters are offered: 3 1/4, 4 1/2 and 5 1/2 in. API Instruments Co., Chesterland, Ohio 44026. [423]

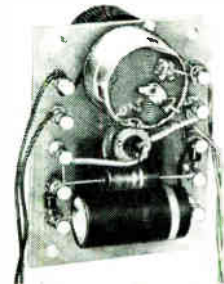

A-c motor speed control model MS-6A features feed-back for constant speed under varying load conditions, and a speed adjustment that enables a variation of speeds during operation. Input voltage is 117 v rms $\pm 10\%$, 50-60 hz. Output wave shape is 60 hz sine wave. Maximum load current is 6 amps. Price (1-25) is \$28 each. Oven Industries, Box 229, Mechanicsburg, Pa. [424]

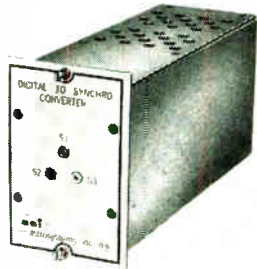

Solid state digital-to-synchro converter model DS800 is designed for simulation and industrial control. It accepts a 10-bit parallel binary input and provides a completely isolated synchro output at 11.8 v, 40 hz line-to-line, with accuracy of better than 30 minutes of arc, no load to full load, without adjustments. Astrosystems Inc., 6 Nevada Dr., New Hyde Park, N.Y. 11040. [425]

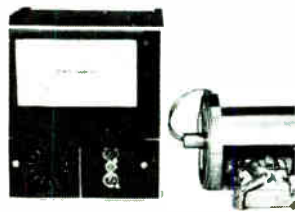

Noncontact instrument RMI-1500 is a solid state unit for measuring and controlling temperature on rotating machines, with a single sensor. Over its 0 to 1,500°F range, readability is a constant 1/2°F. Controller action is failsafe. Accuracy is 1% of full scale absolute. Units operate from 115 v, 60 hz. S. Himmelstein & Co., 2500 Estes Ave., Elk Grove Village, Ill. 60007. [426]

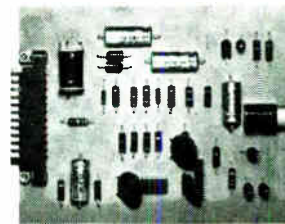

Alarm card series 625 is for single or multi-point temperature alarm applications. It can also be used as an on-off controller for 1 amp at 120 v a-c (spst). The unit uses a reed relay type of output for maximum reliability. It will accept a thermocouple input, resistance bulb or other d-c input signals. Price is \$45. Electronic Control Systems Inc., Fairmont, W. Va. 26554. [427]

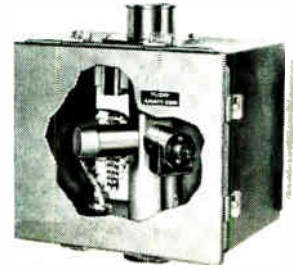

Fluid analyzer model 260, for industrial and processing uses, comes in ranges of 0 to 1 ppm and 0 to 300 ppm. It consists of an in-line sensor and indicator, and the two units may be located up to 500 ft apart. Standard model process fluid temperatures are up to 140°F, with optional temperature capability up to 450°F. Gam Rad Inc., 16825 Wyoming Ave., Detroit, Mich. [428]

New industrial electronics

Blind controller eyes special situations

Dropping extras, compensator based on operational amplifiers applies to large and small custom projects

When a process controller contains more than a customer wants to pay for, the supplier can forget about the sale or he can design a stripped-down version that competes with his own and other conventional lines.

Encouraged by customers' sug-

gestions, C. Kenneth Hines, general manager of the Control Products division of the Consolidated Electrodynamics Corp., a Bell & Howell company, took the second route. The result is a blind, three-mode, electronic analog controller with a basic price of \$265—more than one-

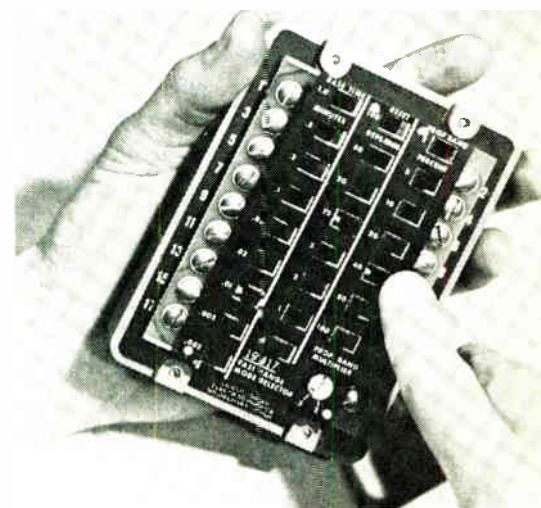

A New X-Y Recorder . . .

. . . analog controllers
introduce compensation . . .

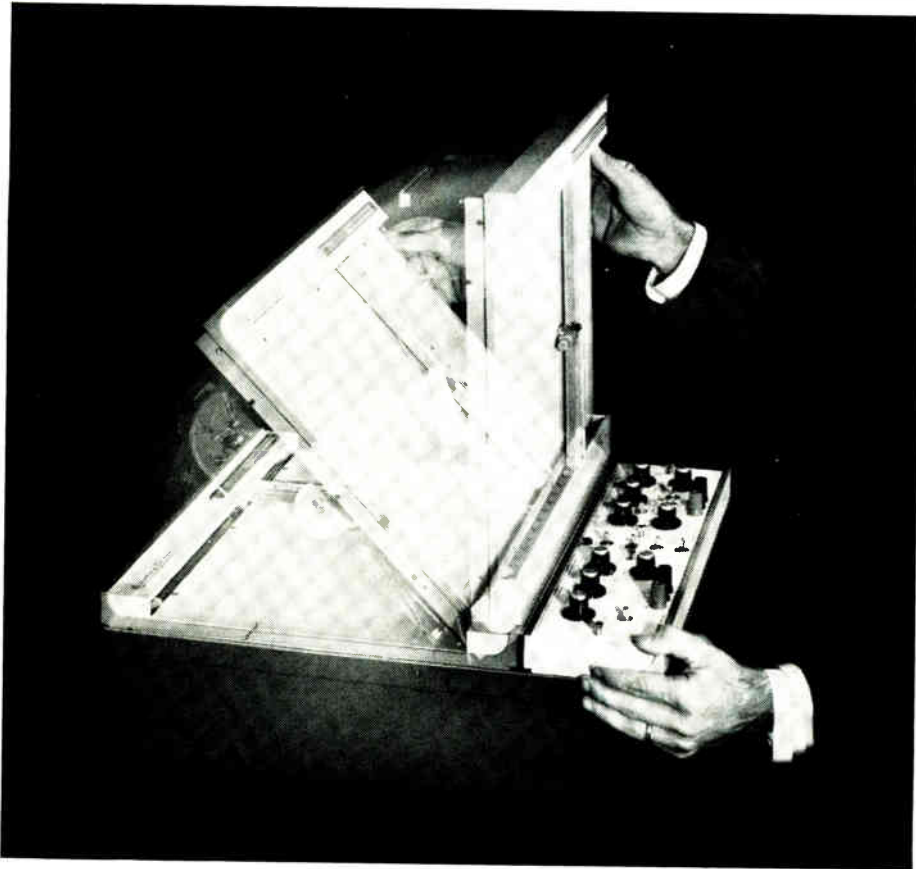

That's Easier To Operate

Easier to operate . . . easier to position . . . and meets top performance requirements. The *function/riter** recorder is more convenient than other X-Y plotters. You can operate this new TI recorder in five different positions to suit any application. Mount it in a 19-inch rack without adapters, stand it upright on a benchtop or position it flat with the writing surface horizontal, at a 45° or 90° tilt angle so you see the plot, even when you're sitting.

It's easy to change applications too. Three types of plug-in "function modules" allow you to plot inputs from 100 μ v to 50v, with time sweeps from 0.1 second/inch to 100 seconds/inch. All modules are interchangeable between X and Y axes. *Signal Input* module permits single-range millivolt recording. *Signal Control*

module offers 16 calibrated scale factors. *Time Base* module gives 10 time or voltage factors.

For more than four years, the servo system of the *function/riter* recorder has been use-proved in thousands of other TI instruments. Quieter operation of the vacuum hold down (for either 8½ x 11-inch or 11 x 17-inch paper), solid-state electronics, 20 inches/second slewing speed and accuracy of 0.2% of full scale are some of the other features that make this X-Y recorder an outstanding instrument to solve your plotting problems.

There's more to the story too. Find out by asking for complete data or a demonstration from your TI representative or the Industrial Products Division, P. O. Box 66027, Houston, Texas 77006 (713-349-2171).

*Trademark of Texas Instruments

TEXAS INSTRUMENTS
INCORPORATED

third less than that of conventional indicator controllers. The term blind means a controller that—unlike conventional counterparts—has no built-in indicators or recorders that add several hundred dollars to the cost and often can be superfluous.

Keeping each control loop at its preset value is accomplished with analog controllers that introduce just the right amount of dynamic compensation to counteract disturbances. Because different loops exhibit different dynamics—flow loops can be fast responding whereas temperature loops can be much slower—commercial controllers have adjustments that permit the selection of the amount of dynamic response to match the characteristics. This matching is called tuning.

Blind controllers have been around for years, particularly pneumatic versions. But there's more interest in them now because experienced users are finding control applications that involve both the dynamic compensation supplied by the controller and the computation supplied by other analog modules. If needed, the computed variable is displayed.

Field-proven. The blind controller, called Model 19-417, was developed about two years ago but has been used mainly as a module in larger systems. Some were sold as individual items, mainly to the Lubrizol Corp., whose engineers used the controllers in their engine test stands. Mostly unattended, these stands operate on a 24-hour basis to evaluate the company's chemical additives for lubricants and fuel. Because these additives must be tested under many conditions, the controllers receive programmed setpoints to keep engine speed, cooling-water temperature, and oil temperature at the selected values.

The blind controller has been used in a much larger application, too. A flow of cooling water on the runout table of a new hotstrip mill, built by the Youngstown Sheet & Tube Co. in East Chicago, Ind., is being manipulated by these instruments. To assure adequate cooling

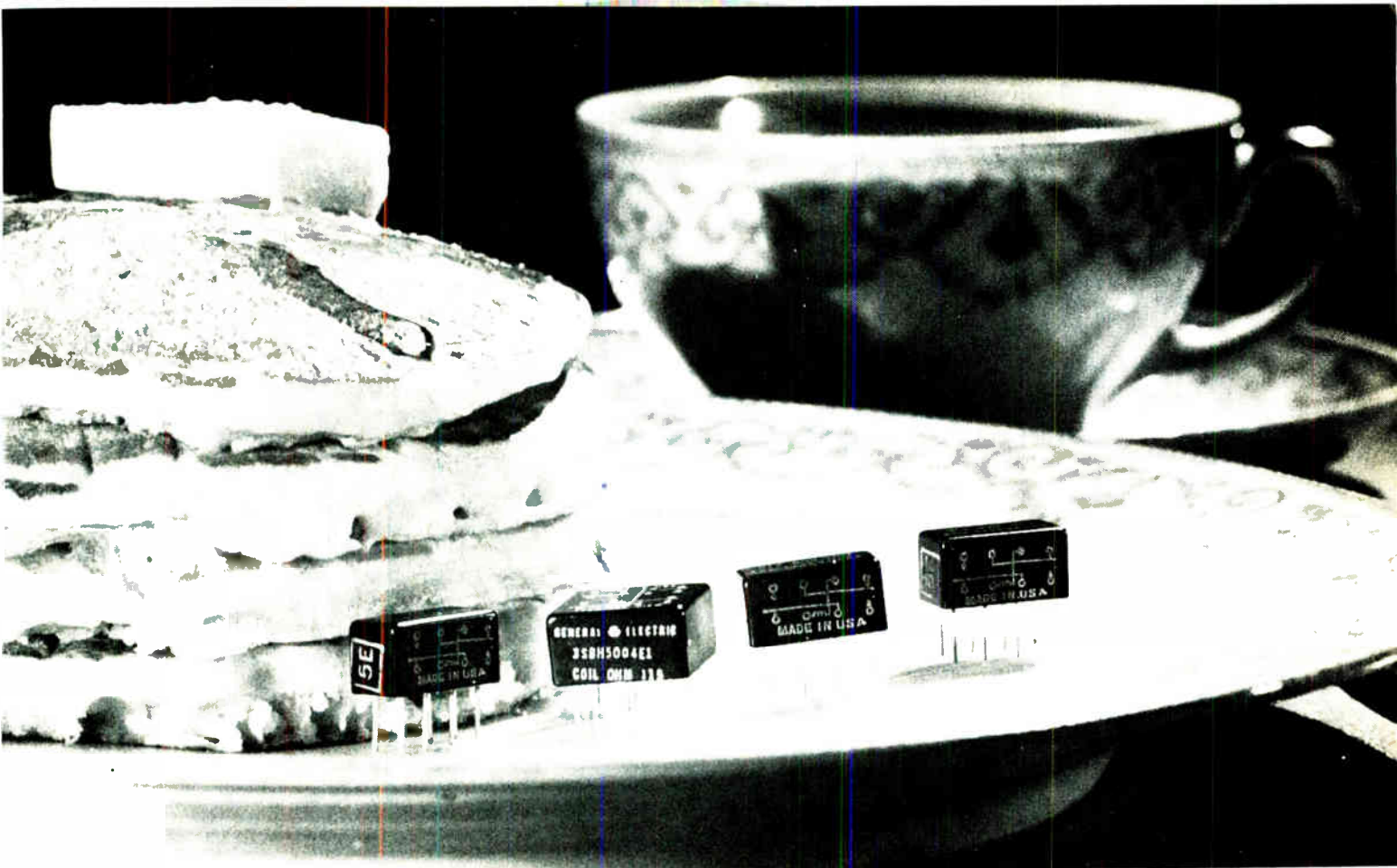

Flat as a pancake... and selling like hotcakes

And why not?

General Electric's new high performance 150-grid sealed relays are smallest where it counts most—only 0.320" high. What's more they come in 4 versions: 4 Form C, 2 Form C, 4 Form C AND-logic type, and a 50 milliwatt sensitivity 1 Form C (or 1A+1B).

Result: for the first time you can get really small size, a variety of forms to choose from, and exceptional performance all in one relay type.

These General Electric 150-grid space relays meet or exceed the environmental and mechanical specs of much larger Mil Spec micro-miniature relays. And compared to relays of comparable size, GE 150-grid space relays have 3 times the magnetic force and over twice the contact force of the nearest competitor.

Outstanding features include:

- High vibration capability
- Excellent minimum current switching ability
- Excellent thermal resistance
- High overload capability—can withstand 5 amps each contact and make and carry 10 amps for short periods
- No flux contamination because of all-welded construction and design.

For more information on the small relay that's going over big, contact your General Electric Electronic Components Sales Engineer. He can tell you more about them and help with your individual application. Or write for bulletin GEA-8042B, Section 792-41, General Electric Company, Schenectady, New York 12305.

Specialty Control Department, Waynesboro, Virginia

GENERAL  **ELECTRIC**

Circle 291 on reader service card

WE NEED MORE GOOD ENGINEERS

MITRE has immediate openings in the following areas:

■ Communications Engineers

Openings exist for communications engineers experienced in tactical communications systems. Interest and background are desired in systems analysis; design, installation and checkout of communications networks; modulation and signal processing techniques; switching systems; voice and data transmission and satellite communications and associated airborne and ground terminal hardware.

Project Engineers are needed for detailed engineering and specification of satellite communications systems.

MITRE has technical direction responsibility on such current communications systems as 490L Overseas Autovon, TACSATCOM, and Integrated Communication Navigation and Identification (ICNI). There are also openings for communications engineers on 407L, Tactical Air Control System, and related tactical communications projects.

■ National Range Support Systems Development

MITRE's mission is to assist the Air Force Systems Command in its development of the future systems requirements and instrumentation plans for the Eastern and Western Test Ranges. Systems-oriented planning and research activities include studies of range functional subsystems categories: radar, telemetry, optics, communications, and data processing.

■ National Airspace System

MITRE is currently augmenting its top-flight team of systems men in the suburban Washington, D.C. and Atlantic City, N.J. areas where FAA's prototype Air Traffic Control systems are now under development. Their mission: to provide the system engineering to the Federal Aviation Administration on the new National Airspace System — an air traffic control system for the

1970's. Their job encompasses such technical areas as broad level system analysis, computer program analysis, system specifications, system logical design and system test planning for design verification.

On this project you would have the opportunity to: translate system operational objectives into technical requirements for the system's subsystems; synthesize the technical characteristics of equipment subsystems of balanced reliability, and analyze alternatives; review and analyze, at the logic level, the design submissions of system hardware contractors; conduct design optimization studies with respect to cost, reliability, and technical suitability; or to synthesize software designs for a multiprocessing computer environment.

■ MITRE's Washington Operations also has unusual new openings for systems engineers in: Weather Systems, Defense Communications Systems and Information Systems. (We also conduct independent research in various new areas, e.g., low income housing, medical data processing, educational technology.)

If you have two or more years' experience and a degree in electronics, mathematics, or physics, write in confidence to Vice President — Technical Operations. The MITRE Corporation, Box 208BC, Bedford, Massachusetts 01730. Persons interested in Washington openings should write directly to Vice President — Washington Operations, The MITRE Corporation, P.O. Box 1202BC, Bailey's Crossroads, Va. 22041.

MITRE will be interviewing at the Spring Joint Computer Conference in Atlantic City from April 30 to May 2. We invite you to get in touch with us at (609) 344-7021.



An Equal Opportunity Employer (M & F)

Formed in 1958 . . . pioneer in the design and development of command and control systems . . . MITRE serves as technical adviser and systems engineer for the Electronic Systems Division of the Air Force Systems Command and provides technical assistance to other Government agencies, including the Department of Defense, the Department of Commerce, the Federal Aviation Administration and the Office of High Speed Ground Transportation of the Department of Transportation, and the National Aeronautics and Space Administration.

without wasting water, the controllers are joined with electronic analog computing modules. These provide both feed-forward and feedback regulation. As a result, the amount of water needed to cool the steel strip is adjusted precisely in each of 45 sections along the table according to the temperature, thickness, and speed at which the strip is moving.

Easy attachment. Control dynamics is accomplished with two operational amplifiers with adjustable resistance-capacitance networks. In this regard, the controller is not substantially electronically or functionally different from other controllers. But its small size, and availability via screw terminals to all salient portions of the circuit, simplify custom packaging and connection to additional circuits for computation and connection to a meter for display.

Unlike most analog controllers which have perhaps eight or 10 selectable values in each mode, the Model 19-417 has up to 516 discrete values. To get this high resolution, slide switches change the amount of resistance in the dynamics networks, the tuning-constant value being the sum of the values assigned to the individual switches. The proportional mode has seven slide switches, the reset mode eight, and the rate mode nine. For example, with its eight switches the (fast range) controller's reset mode can be tuned in 256 steps—its lowest value being 0.5 repeats per minute with one switch actuated, its highest 188 repeats per minute with all switches actuated.

Specifications

Output	1.5 ma d-c (or 0-10 v) into 2,800 ohms
Input	0 to 10 v at 200 kohms
Fast mode ranges	
Proportional band	1 to 318%
Reset mode	0.5 to 188 repeats per minute
Rate mode	0.002 to 1.88 minutes
Slow mode ranges	
Proportional band	1 to 318%
Reset mode	0.05 to 18.8 repeats per minute
Rate mode	0.02 to 18.8 minutes
List price	\$265
Options	
Internal relay for automatic/manual transfer	Add \$30
4 to 20 ma d-c output	Add \$10

Consolidated Electrodynamics Corp., a sub. of Bell & Howell Co., 706 Bostwick Ave., Bridgeport, Conn. 06605 [429]

New industrial electronics

Servo potentiometer charts many courses

Process-control recorder is built for easy service and a long life-span

Servo potentiometers are as important to process control as the controller is. And because they usually run around the clock, they must be trouble-free. Honeywell Inc. designed its newest recorder, the ElectroniK 111, so that it requires only routine servicing.

ElectroniK 111's automatic control units can be removed for servicing without interrupting the process. To make the recorder trouble-free, Honeywell used all-silicon circuitry, including the chopper and amplifier. Moreover, the input filter has a floating shield to minimize the effects of radiated noise, and a precision slidewire made of corrosion-resistant platinum alloy. The slidewire has a four-finger contact so that at least one finger maintains contact at all times.

Other features include an interchangeable chassis, and a lift-out chart transport.

User's choice. The recorder is available with three kinds of outputs; current, position, and time proportioning. It uses a 6-inch-wide chart that's available in drive speeds of 1, 2, 6, 10, 12, 20, 30, and 60 inches per hour. Circular charts come in 1, 4, 8, and 24 hours per revolution varieties.

The device comes as a circular or a strip-chart recorder; the characteristics are the same for both. Accuracy is $\pm 0.3\%$ of span; reproducibility, $\pm 0.15\%$ of span; dead band, 0.1% of span; response time, 5 seconds (15 seconds is optional); source resistance rating, 2,000 ohms max.; input impedance, infinite at balance, 200 kilohms min. off balance. The recorder operates in ambient temperatures up to 140°F, and costs from \$625 to \$1,000 depending upon control units. Delivery is 10 to 12 weeks.

Honeywell Inc., Industrial Div., MS 436, Fort Washington, Pa. 19034 [430]

SEVENTH INTERNATIONAL INSTRUMENTS ELECTRONICS AUTOMATION EXHIBITION

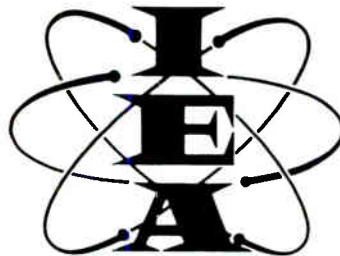

OLYMPIA LONDON ENGLAND 13-18 MAY 1968

Focus on Progress

New technologies are moulding the future of the World, and London is the global focal point in May '68.

The IEA Exhibition at Olympia is the largest and most comprehensive show of its kind ever staged; it covers the entire structure of the technologies on which all industry depends for the future.

The 1968 IEA deals in depth with the fast-changing science and engineering which has impressive impact on all forms of human activity . . . from the growing of wheat to the making of automobiles . . . from medicine to meteorology.

International IEA is world-embracing; this year there is a 15% increase in overseas participation and many countries are again presenting national 'prestige' displays. Covering 250,000 square feet of stand space, IEA will attract at least 12,000 overseas visitors. Share with them the broadening of their technological experience.



For your free Official Invitation Card and further details contact:

INDUSTRIAL EXHIBITIONS LIMITED, 9 ARGYLL STREET, LONDON, W1, ENGLAND

EECO 5000/6000 Series Photoblock Tape Readers...

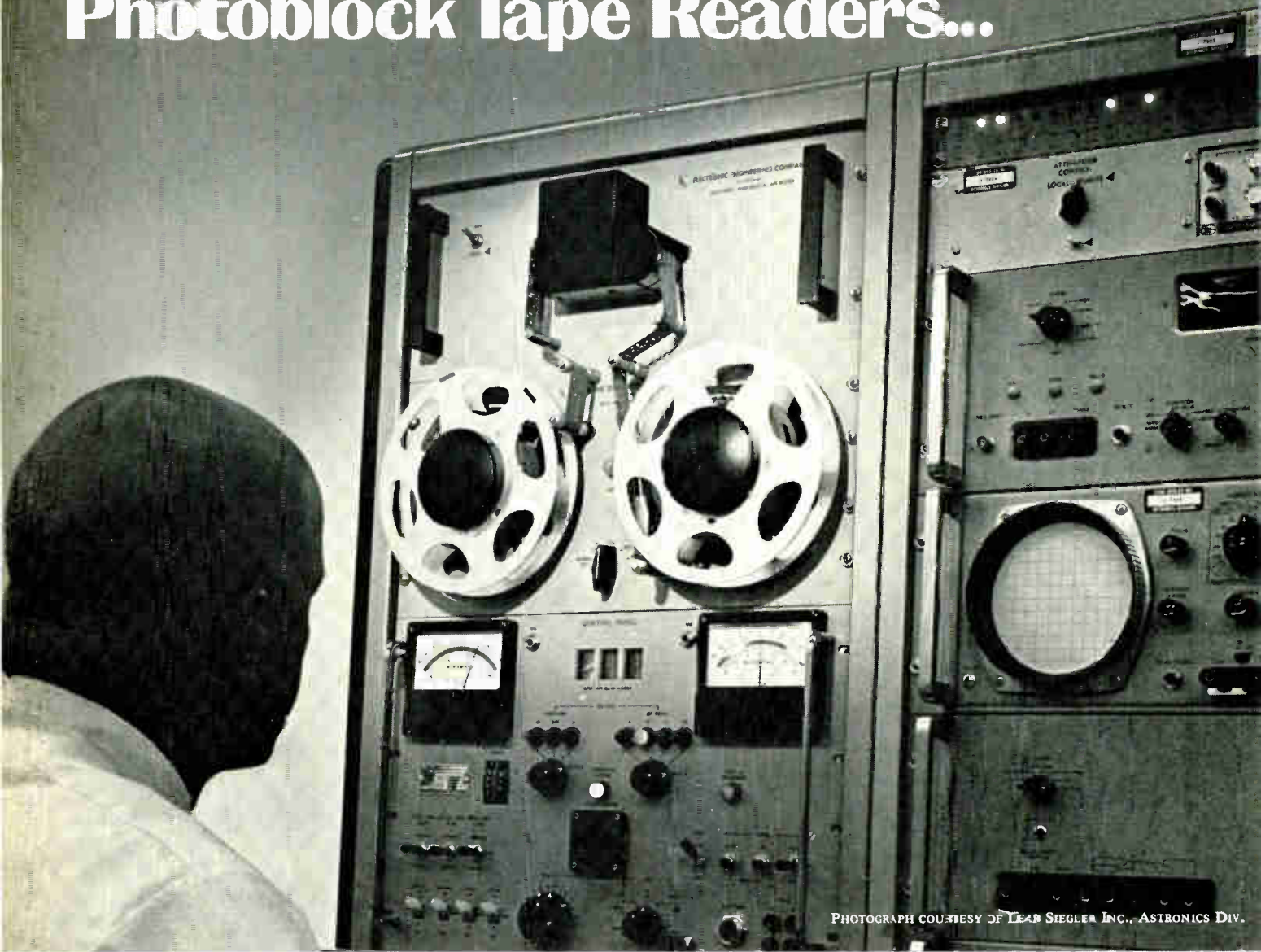

PHOTOGRAPH COURTESY OF TEAR SIEGLER INC., ASTRONICS DIV.

speed production testing

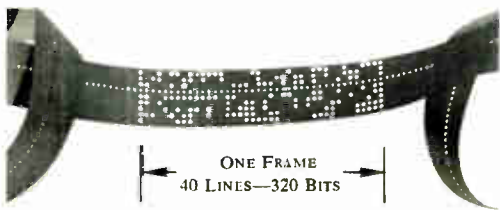

Segment of tape showing one 40 line block of data used to program instrument ranges and comparator limits.

EECO 5000/6000 Series Photoblock Tape Readers can be used to program a variety of electronic test instruments. Frequently, they are the most versatile, economical method of automating the production testing of electronic products.

Tape with 5 to 40 8-bit lines of test sequence data (40 to 320 bits) is photo-electrically read to program a particular test. The 5000 Series reads at rates to 12 blocks per second (100 lines/sec) ... the 6000 Series to 20 blocks per second (200 lines/sec). Twenty output options facilitate interface with present test instrumentation.

All EECO Photoblock Readers use solid state controls and step motor drives. EECO's *exclusive latching output option*, which keeps output lines "latched-in" between block advance commands, allows testing to continue while the tape is moving.

Compare EECO 5000/6000 Series Photoblock Readers for versatility, economy and reliability with such other programming methods as single line readers with buffer memories. Ask for data sheet and prices.



INSTRUMENTS DIVISION

ELECTRONIC ENGINEERING COMPANY OF CALIFORNIA

1601 EAST CHESTNUT AVENUE · SANTA ANA, CALIFORNIA 92701 · (714) 547-5501

New Microwave Review

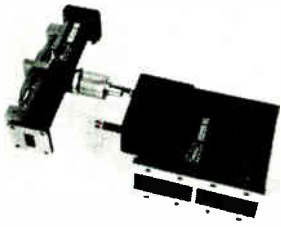

Tunable, low-noise parametric amplifier model APC-5 is compatible with C-band radar systems. It operates in the 5.4-to 5.9-Ghz range. It has a 20-Mhz instantaneous 3-db bandwidth. Noise figure is 3 db max. with 18 db of gain. Calibrated gain and frequency controls permit tuning with excellent repeatability. McLabs Inc., 3300 Hillview Ave., Palo Alto, Calif. 94304. [401]



High-Power, solid state voltage-tuned oscillators can be used as VTM and BWO replacements in military countermeasures systems as well as in commercial sweep oscillators. Units measure 1 x 1 x 2 in. The 28774-66 produces 200 mw across the 2 to 4 Ghz octave; the 287745-67, 20 mw over the 2.6-5.2 Ghz octave. Omni Spectra Inc., 24600 Hallwood Ct., Farmington, Mich. 48024. [402]

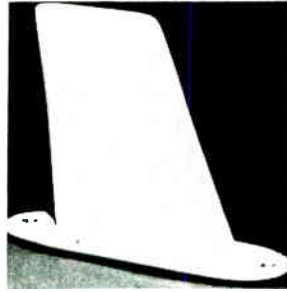

Vertically polarized L-band antenna L10-16 operates over the range of 975 to 1,225 Mhz. Impedance is 50 ohms; vswr, 1.5:1 or less. Radiation pattern is essentially omnidirectional. The unit is made of fiberglass and epoxy materials, and measures 3 3/8 in. high. Communications Components Corp., 1524 W. 15th St., Long Beach, Calif. 90813. [403]

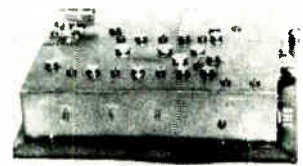

Two standard octave transistor preamplifiers, one covering 250 to 500 Mhz and the other 500 to 1,000 Mhz, are for military communication uses. Noise figures are 7.5 and 10.5 db, respectively. Both have input and output impedance of 50 ohms and gain of 13 to 17 db. Each features vswr of 2.3 to 1 max. Micro State Electronics, 152 Floral Ave., New Providence, N.J. 07974. [404]



Multiplex passive filter 18205 has a simple r-f input and affords 4 r-f output channels at 366, 377, 410 and 456.7 Mhz. Each output has a 3-db bandwidth at 1.0 Mhz. Channel insertion loss is less than 1.5 db (pass band). Rejection outside pass band is greater than 70 db at 18 Mhz. Microwave Cavity Laboratories Inc., 10 N. Beach Ave., LaGrange, Ill. 60525. [405]



The Eccoles target support columns fill the need for rugged low-reflectivity rotatable supports to hold targets or models during reflectivity measurements in a microwave anechoic chamber. A variety of sizes and shapes are available. Typically the dielectric constant is 1.03, and the loss tangent 0.0002. Price, on special quotation. Emerson & Cuming Inc., Canton, Mass. 02021. [406]

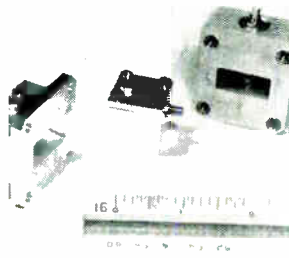

Semiconductor microwave oscillators using the IMPATT (impact avalanche transit time) principle and quietly delivering a nominal 60 mw c-w are for use at the fixed frequency of 10.525 Ghz in the public service radio location band. Typical applications include local oscillators and in low-power railroad monitoring. Varian Bomac Division, 8 Salem Road, Beverly, Mass. [407]

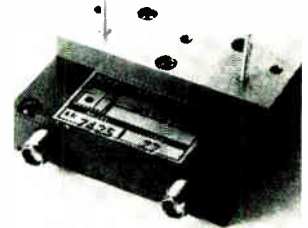

Compact, lightweight coaxial balanced mixer model AM-7425 features ease of diode replacement (by removal of 2 crystal caps), resulting in virtual elimination of system down-time. Frequency range is 1 to 2 Ghz; noise figure, 7.5 db typical; vswr, 1.5 max. Unit measures 2 x 2.10 x 0.75 in., weighs 3 oz. Alpha Industries Inc., 381 Elliot St., Newton Upper Falls, Mass. 02164. [408]

New microwave

Cable assembly takes a turn

Flexible waveguide exhibits characteristics as favorable as those of rigid units

The performance of microwave instrumentation has been limited by the connector so that it was almost impossible to use the device's full capability. The development of precision, 7-millimeter coaxial connectors helped in part. But these connectors performed only to spec-

ification when used with rigid air-lines. Consequently, many microwave instruments were unusually bulky.

Two developments from the Amphenol Corp. should eliminate this problem. The company has perfected the techniques for manufac-

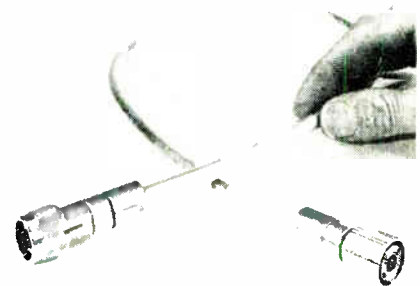

Dual mates. Semi-rigid aluminum jacket coaxial cable accommodates either precision 7-mm (at right) or type-N connectors.

Can you

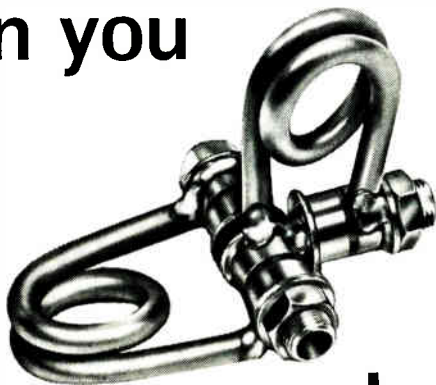

do this?

These new Johanson glass *capacitors* are designed to bridge the gap between conventional trimmers and high frequency air capacitors. They have high Q—low inductance; they have high RF current characteristics, they can be soldered together with components to simplify circuitry and they are *strong*.

Models include:



Series II: High RF voltage low cost units with $Q > 1200$ and $TC; 0 \pm 50$ ppm.



Johanson 7168: High voltage quartz capacitors which feature 7000 VDC; 2500 V peak RF at 30 mc and current capacity > 2 amps.

Also available are:

- Tuners and ganged tuners; linear within $\pm .3\%$
- Differential capacitors
- Mil spec capacitors
- Microminiature capacitors .075" diameter and .1-1 pf

Write today for full catalog.

Johanson MANUFACTURING CORPORATION

400 Rockaway Valley Road, Boonton, N. J. 07005 (201) 334-2676

Electronic Accuracy Through Mechanical Precision

Circle 296 on reader service card

Our little black book has over 100,000 phone numbers.

You never had a black book like it. Over 1,500 pages. And those phone numbers! More than 100,000 telling you who to call/where to go, for the over 4,000 different product categories listed and advertised in the yellow pages of the Electronics Buyers' Guide.

It's the industry's one-stop shopping center that lets you find the products and services you need quickly.

You can depend on EBG.



Electronics Buyers' Guide

A McGraw-Hill Market Directed Publication,
330 West 42nd Street, New York, N.Y. 10036

... designed electrically,
not mechanically ...

turing semi-rigid, aluminum-jacketed coaxial cable that retains its diameter while being bent and twisted. Amphenol's RF division has also developed a technique for mating precision 7-mm connectors with the cable. This technique can also be used with N-type connectors.

Besides giving flexibility to the microwave-instrument manufacturer, Amphenol's semi-rigid coaxial assemblies allow precision connectors to be used in aircraft. Coaxial cable removes the frequency restrictions on aircraft microwave systems that previously had to incorporate band-limited waveguides. In addition, the waveguides had to be preformed; the semi-rigid coaxial line can be bent and shaped as the cable is installed.

These semi-rigid cable assemblies are designed electrically and not mechanically as in the traditional approach. As a result, assemblies can be held to an impedance of 50 ± 0.5 ohms—roughly one-fifth the tolerance of the previous state-of-the-art for semi-rigid cable assemblies. Moreover, the maximum vswr (voltage standing wave ratio) is 1.15 at 12.4 gigahertz. The cable assemblies are available in four standard lengths—one, two, three, and four feet. However, other lengths are available on special order.

Previously, users of semi-rigid cable assemblies had to live with relatively large changes in impedance as the cable's diameter changed with bending. Also, the vswr changed if the center conductor shifted. For example, a change of 250 microns in the diameter of the cable could add as much as 0.2% to the cable assembly's vswr.

Amphenol's aluminum-jacket cable is built with a foamy material between the jacket and the polyethylene insulating core material. The foamy material allows accurate sizing of the cable to achieve the 50-ohm impedance without stressing the inner conductor.

Amphenol Corp., RF division, 33 E. Franklin St., Danbury, Conn. 06810 [409]

business trips rule out evening classes?



here's a practical way to update your knowl- edge of electronics

Are irregular hours, travel and family obligations keeping you from attending classes—even though you worry about becoming technically obsolescent? Check into the Special Programs in Electronics for Engineers developed by CREI, the Home Study Division of the McGraw-Hill Book Company.

These are not simply courses, but comprehensive programs in advanced electronics offering major electives in such fields as:

Communications Engineering, Aeronautical and Navigational, Television Engineering, Automatic Control Engineering, Missile and Spacecraft Guidance, Radar and Sonar Engineering, Nuclear Instrumentation and Control, Computers.

Industry-recognized CREI Programs make it possible for you to catch up on new developments in electronics through study in your own home, at your own pace,

your own schedule. Free book gives complete information and details of technical material covered. For your copy, mail coupon below or write: CREI, Home Study Division, McGraw-Hill Book Company, Dept. 1816-G, 3224 Sixteenth St., N.W., Washington, D.C. 20010.

Founded 1927



Accredited Member of the National Home Study Council



CREI, Home Study Division, McGraw-Hill Book Company
Dept. 1816-G, 3224 Sixteenth St., N.W.
Washington, D.C. 20010

Send me free brochure describing CREI Programs in Electronics for Engineers.

NAME _____ AGE _____

ADDRESS _____

CITY _____ STATE _____ ZIP CODE _____

COMPANY _____

TITLE _____

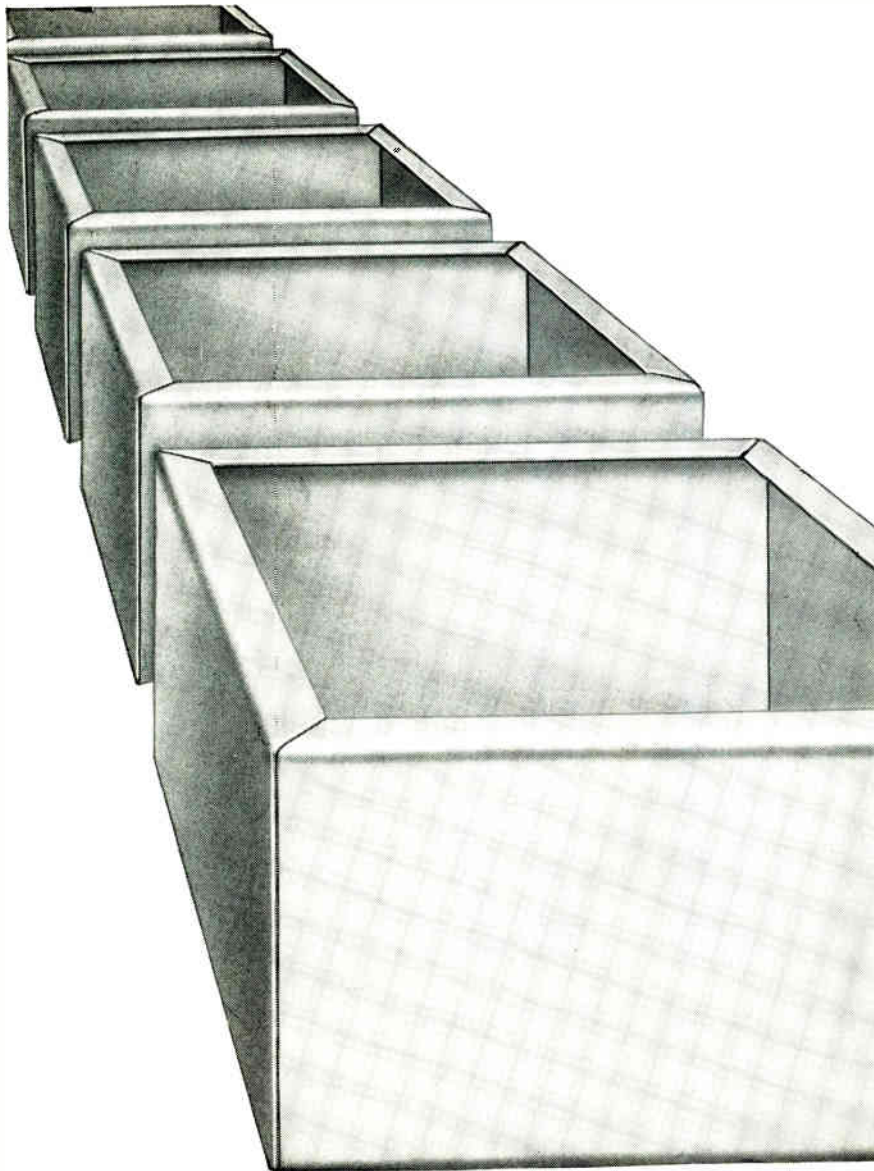

THIS IS "DIE-LESS DUPLICATING"!

Produce short runs of simple parts quicker than an order can be processed to get them "outside." Use Di-Acro "Die-Less Duplicating" equipment to cut stock to size and to form it with die-accuracy — without costly dies. Get full information in our new "Die-Less Duplicating" catalog. See your distributor, or write us — naturally!



New microwave

Japanese cook up cool oven with fins

Aluminum alloy dissipates
heat of magnetron that
delivers 600-watt output

The trick in using a microwave oven is to be able to bake a cake without baking the magnetron along with it.

Engineers at Japan's Matsushita Electric Industrial Co. have developed a magnetron for cooking applications that is convection cooled with aluminum-alloy fins. In most magnetron applications, heat is dissipated by forced-air or water cooling. By going to the convection technique, Matsushita has eliminated the need for fans, air ducts, air filters, and water pumps and

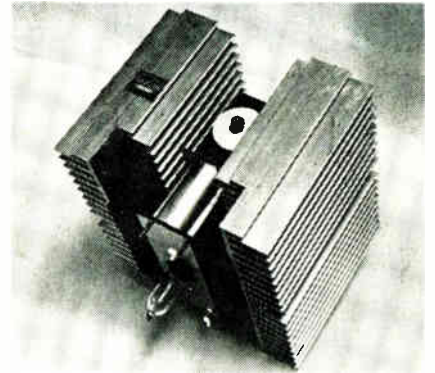

jackets. Moreover, since the technique is passive, power consumption and noise levels are low.

Serving up power. The company's magnetron delivers 600 watts of output power and, according to Matsushita, is the largest ever to be cooled with convection techniques.

The tube is a self-contained unit that need only be connected to a power supply. The oscillator tube, magnet, radiator, and filter circuits are in a single package. In operation, the anode and the aluminum-finned radiator are grounded, and 3 volts are supplied to the filament. Operating frequency is 2.45 gigahertz.

Matsushita Electric Industrial Co.,
Osaka, Japan [410]



HAWAII CALLS ENGINEERS

PEARL HARBOR NAVAL SHIPYARD needs Electronic, Electrical, Marine, Mechanical, General, Nuclear Power Engineers and Naval Architects

STARTING SALARIES: \$8,325 to \$13,619
depending on experience

Salaries include 15% cost-of-living allowance,
which is subject to change.

- Opportunities for professional growth, advancement.
- Pleasant living for you and your family.
- Pearl Harbor Naval Shipyard, the largest industrial organization in the Pacific, plays a vital role in today's nuclear Navy. The activities of the Yard create a broad range of assignments for engineers and naval architects.

Transportation to Hawaii and back provided for employees and their dependents. Household effects will be shipped at government expense. Transportation for home leave provided if employment agreement is renewed after three years.

These are career Civil Service positions with regular salary increases, generous benefits, liberal retirement plan, and will be filled on an Equal Opportunity basis. Send resume of professional experience or Standard Form 57 to:

PEARL HARBOR NAVAL SHIPYARD

(CODE 170)

BOX 400, FPO SAN FRANCISCO 96610

JFD announces

THE SMALLEST HIGH RF POWER CAPACITORS AVAILABLE!

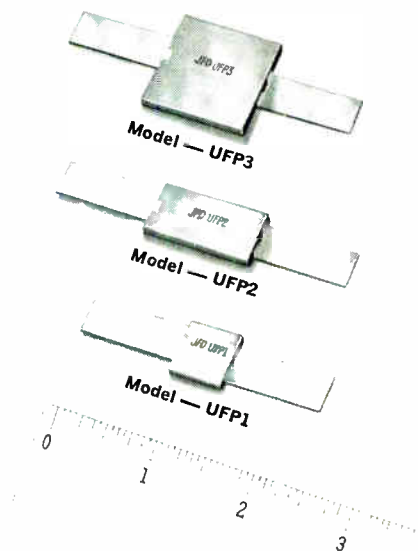

Uniceram – UFP Series

JFD's new Uniceram UFP Series offers the design engineer a broad line of miniaturized high voltage and high current fixed ceramic capacitors for use in RF circuits. These highly stable, small, reliable UFP's have been used up to 200 MHz. They are the ideal 'space-savers' for today's military communications, mobile, commercial broadcast and amateur radio transmitters.

UFP1's measure only 35/64" square X 11/64" thick. High Q 'Uniceram' proprietary ceramic material with special internal monolithic construction yields high power handling capabilities per unit volume. Glass encapsulation insures a moisture seal. Wide fine silver ribbon leads are used because of their low inductance and high RF current carrying capabilities.

- Typical ratings are 8 amps, 3,000 volts rms, 12 KVAR for 150 pf UFP1 over the frequency range of 2-30 MHz.

For additional information, write for catalog UNM-UFP-68.

JFD

"TODAY'S COMPONENTS BUILT FOR TOMORROW'S CHALLENGES"

JFD ELECTRONICS CO. / COMPONENTS DIVISION 15th Avenue at 62nd Street
Brooklyn, New York 11219 / Phone 212-331-1000
Offices and subsidiaries in principal cities, world-wide.

"SEE US AT HANNOVER FAIR, HANNOVER, GERMANY"—April 27th-May 5th.

60A, 1400V Controlled Avalanche Thyristors..

If you are visiting London for the Instruments, Electronics and Automation Exhibition (Olympia, May 13-18) call at the Mullard stand to see these thyristors, and a wide range of semiconductors, valves, tubes and components for industry.



...part of a range covering
1.0 to 62.5A, 100V to
1.4kV in 4 different series

Standard types, high temperature types, avalanche types and inverter grades—all readily available from Mullard at competitive prices.

Here are the details—

Avalanche Types Rated: 85°C Stud	Average Current Ratings	Up to 60A
	Min. Avalanche Voltage	Up to 1400V
High Temperature Types Rated: 110°C Stud	Average Current Ratings	Up to 11.5A
	Max. Crest Reverse Working Voltage	Up to 400V
Inverter Types Rated: 85°C Stud	Turn off time (up to 10A)	10 μs
	(up to 62.5A)	15 μs
	Max. Crest Reverse Working Voltage	Up to 500V
Standard Types Rated: 85°C Stud	Average Current Ratings	Up to 62.5A
	Max. Crest Reverse Working Voltage	Up to 1000V

Every designer should have a copy of the Mullard Quick Reference Guide containing information on thyristors, rectifiers, stacks and modules.

Also ask to be put on the mailing list of the Mullard Bulletin—a regular publication which gives details of new components and applications . . . the result of extensive research and development programs in the Mullard laboratories in England. Mullard employ 1,000 qualified scientists and engineers and have six major plants, with over 3 million square feet of floor space.

Write today for information on Mullard thyristors, and for the name of your local Distributor.

Mullard Limited, Mullard House, Torrington Place, London WC1, England.

U.S.A. enquiries to Mullard Inc., 100 Finn Court, Farmingdale, Long Island, New York. 11735 U.S.A.
Telephone: (516) 694-8989 Telex: 961455

Mullard LIMITED

New Semiconductors Review



Medium power DTL IC's in the CD2300 family come in 15 circuit types in 14-lead ceramic dual-in-line packages. They are directly interchangeable with the 980 and 830 series DTL IC's. Unit price in lots of 1,000 ranges from \$2.25 for a dual 4-input expander to \$3 for a clocked R-S flip-flop. RCA/Electronic Components, 415 S. Fifth St., Harrison, N.J. 07029. [436]

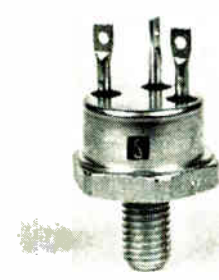

Complementary pairs of 20 amp and 10 amp npn and pnp silicon power transistors come in the isolated TO-61 case. Devices offer breakdown voltages up to 120 v, power dissipation of 50 w at 100°C and gain-bandwidth products of 30 Mhz minimum. Applications include high current amplifiers and bridge circuits. Solitron Devices Inc., 1177 Blue Heron Blvd., Riviera Beach, Fla. [437]

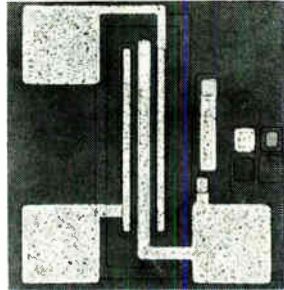

P-channel enhancement mode MTOS transistor MEM 556 is a high voltage device. It is suited for multiplexing, series and shunt chopping, and commutating. Features include 80-v max. operation and an off-to-on ratio of 2×10^6 . The unit shows less than 60% threshold shift with 25-v substrate biasing. General Instrument Corp., 600 W. John St., Hicksville, N.Y. 11802. [438]

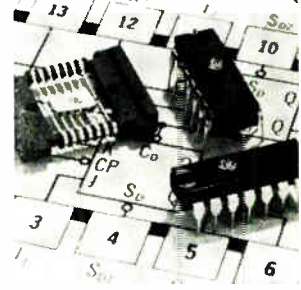

Four dual flip-flops (types SN15 9093,-94,-97,-99), 2 hex inverters (SN15 936,-37), and 3 fast-rise-time gates (SN15 949,-63,-61) have been added to the series 930/830 DTL IC line. All are available in flatpacks and ceramic and plastic dual in-line packages, and with military or industrial temperature ratings. Texas Instruments Inc., Box 5621, Dallas 75222. [439]

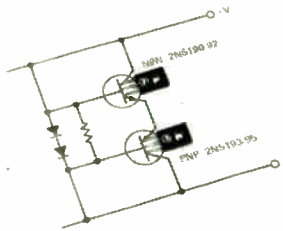

Silicon transistors 2N5190-95 are 4-amp npn/pnp units that eliminate the need for expensive matching transformers, and can handle up to 35 w of power. Thermopad construction—with a chip-to-heat sink thermal path of 0.030-in.—means low thermal resistance and minimum derating in chassis-mounting uses. Motorola Semiconductor Products Inc., Box 955, Phoenix, Ariz. 85001. [440]

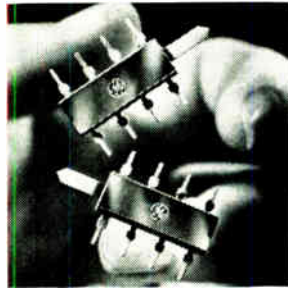

Monolithic IC audio amplifier PA234 delivers 1 watt of continuous power to either a 16- or 22-ohm speaker. It requires only 4 external components and is designed to operate from the power supply range of 9 to 25 v. Applications include usage in headphones, phonographs, tape players and tv receivers. General Electric Co., Electronics Park, Syracuse, N.Y. 13201. [441]



Thyristor SCR 260 is rated at 175 amps half-wave average. Among the major parameters is the forward blocking voltage through 1,500 v steady state, and a 300 v/ μ sec minimum dv/dt to rated voltage. Surge current rating is 5,000 amps. Price (25-99) is \$167 each for the 600-v unit, and \$509 for the 1,500-v unit. Westinghouse Electric Corp., Youngwood, Pa. 15697. [442]

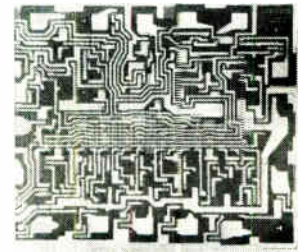

Decoder 9307 is a 28-gate circuit that features 4 inputs in 8421 BCD code and provides active high outputs for a 7-segment numerical display. The chip is sealed in an all-ceramic, 16-pin dual in-line package, with the 16 leads optimally arranged for p-c layouts. Maximum package size is 0.200 x 0.375 x 0.785 in. Fairchild Semiconductor, 313 Fairchild Dr., Mtn. View, Calif. 94041. [443]

New semiconductors

A logical approach to linear IC's

Line receiver and driver operate on single power supply; logic compatibility eliminates need for interface circuitry

Steering clear of the me-too approach to integrated circuits, the National Semiconductor Corp. is fast building a reputation as a first-of-a-kind ic maker. Its newest linear circuits to be sold off the shelf—a dual line driver (shown at right) and a dual line receiver—require

a single power supply and are compatible with transistor-transistor logic, diode-transistor logic, and resistor-transistor logic.

Similar standard circuits now on the market require two power supplies and external circuitry for interfacing with TTL, DTL, and RTL.

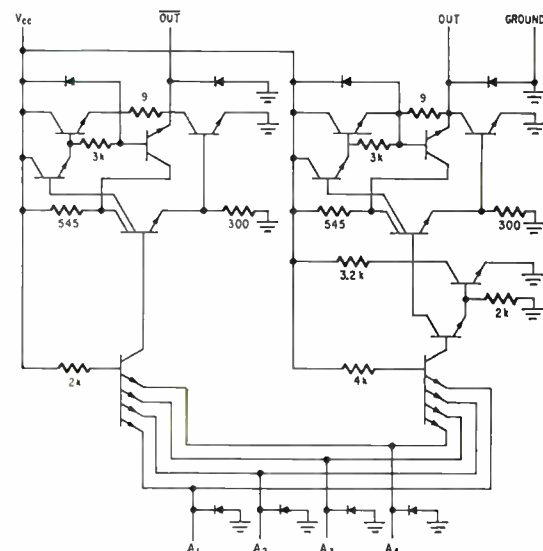

IT TAKES A LOT OF ADJECTIVES TO DESCRIBE THE SPACE VII..

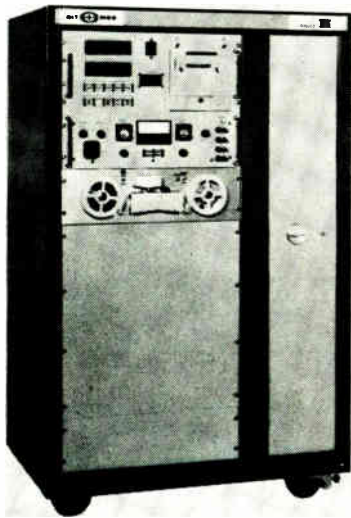

★ Adjectives like FAST, ACCURATE, FLEXIBLE, RELIABLE, VERSATILE, ECONOMICAL and MANEUVERABLE. If you doubt for one minute that a humble wiring system analyzer from the middle west can live up to these labels, then try testing this tester for yourself. It was designed and developed (after thorough lab and field testing) especially to meet today's demand for speed, accuracy, versatility and economy. DIT-MCO's Space VII operates on the fully automatic tape input and printout concept. Design and construction are of the highest quality. The "total speed" function of the Space VII gives you faster overall test time because of adaptation and hook-up ease, rapid tape feed, speed of test plus speed of fault determination time, scan time, error recording and printout.

WITH THIS ADVANCED SYSTEM you can test up to 2,000 terminations at a rate of more than 400 per minute! Electronic engineers who've tried it, call DIT-MCO's Space VII the best intermediate size testing system on the market. We won't disagree.



DIT-MCO INTERNATIONAL
A DIVISION OF XEBEC CORPORATION
5612 BRIGHTON TERRACE
KANSAS CITY, MISSOURI 64130
TELEPHONE (816) 363-6288 TELEX 42-6149

IT'S NO WONDER APPROXIMATELY 90% OF ALL MAJOR MANUFACTURERS IN THE COMPUTER AND AEROSPACE INDUSTRIES ARE SATISFIED USERS OF DIT-MCO SYSTEMS.

Circle 244 on reader service card

Our little black book has over 100,000 phone numbers.

You never had a black book like it. Over 1,500 pages. And those phone numbers! More than 100,000 telling you who to call/where to go, for the over 4,000 different product categories listed and advertised in the yellow pages of the Electronics Buyers' Guide.

It's the industry's one-stop shopping center that lets you find the products and services you need quickly. You can depend on EBG.

Electronics Buyers' Guide

A McGraw-Hill Market Directed Publication,
330 West 42nd Street, New York, N.Y. 10036



... line driver provides
differential output ...

Developed by National's director of advanced circuit development, Robert J. Widlar, and design engineer James Kubinec, the IC's are the DM7820 dual line receiver and the DM 7830 dual line driver. Both need only a 5-volt supply. They have built-in overvoltage, short-circuit, and overshoot protection. Compared with other IC's National Semiconductor's are less susceptible to environmental noise.

Difference counts. Line receivers attenuate a low-level logic signal, riding on a twisted wire pair, to prevent it from being smothered by common-mode voltage. Having a common-emitter input stage after the attenuator network, the receiver then processes the differential signal. The DM7820 differs in that it has a common-base amplifying stage instead of the common emitter, enabling the circuit to operate at a single, lower bias. Moreover, this leads to greater attenuation of the input.

National Semiconductor's line receiver has wired-on options at the output, termination resistors, and response time control, and accommodates independent channel strobing. Also, the circuit's output section contains a current-source arrangement that doesn't require pnp elements.

The dual line driver feeds twisted pair or coaxial transmission lines, and provides differential outputs for maximum signal-to-noise ratio. The DM7830 has a propagation delay of 60 nanoseconds for a 100 ohm-5,000 picofarad load, and has clamp diodes at both the input and output stages to prevent overshoots in the signal.

The military version of DM7820, designed to operate between -55° and $+125^{\circ}\text{C}$, is priced at \$24 in lots of 100; the industrial version, with a temperature range of 0° to 70°C , costs \$10 in similar quantities. The military version of the DM7830 is priced at \$16, and the industrial version at \$8. Both circuits are constructed with a zero-volt threshold level.

National Semiconductor Corp., 2975
San Ysidro Way, Santa Clara, Calif.
95051 [444]



NEW from Cramer



ADJUST-A-LOK STOOLS

Adjust to every worker like fine tools!

Cramer Adjust-A-Lok is immediately adjustable to any workers height. Just release the safety stop, and lift or lower. It can be done just that quick. Since fatigue is a critical factor in efficiency of seated workers, it's just good economics to provide tools that minimize fatigue. With Adjust-A-Lok every worker can find his own most comfortable and efficient level. 6 seat styles and 5 base types provide 30 available models. For more information: write V. P. Sales, Cramer Industries, Inc., 625 Adams, Kansas City, Kansas 66105.

Industrial supplier
inquiries invited



CRAMER INDUSTRIES INC.

A Subsidiary of USM Oil Co.
Cramer—The leader in style and quality

Circle 307 on reader service card

announcing the NL-5750 from NATIONAL[®]



Our lowest priced readout tube, \$3.95
in 1000 quantity.

- ultra long life ■ compact .530" diameter.
- .5" numeral height ■ two decimal points standard
- flexible leads with standoff spacer for ease of pc board insertion.

"Licensed by Burroughs Corporation"

NATIONAL

REQUEST
BULLETIN

ELECTRONICS, INC.
a varian subsidiary

PHONE: (312) 232-4300 • GENEVA, ILLINOIS 60134

Circle 308 on reader service card

Johnson Introduces Two NEW Components to save space, cut costs!

1. Save space with new, horizontal-mounting, printed circuit, type "U", machined-plate capacitors. Available in various sizes, with capacity values ranging from 1.2 pf to 24.5 pf, these tiny trimmers provide tuning accessibility from edge of board. Printed circuit boards can be close-spaced, resulting in compact equipment designs. TC—plus 45 ± 15 PPM/°C. "Q"—greater than 1500 at 1 MHz. All metal parts silver plated. Famous Johnson quality throughout.

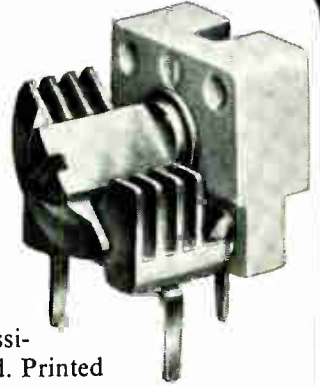

2. Cut costs with new,
Johnson RIB-LOC[™]

Tip Jacks that save production line time with *press-in* design. No mounting hardware to assemble or handle. Simple insertion tool presses Tip Jack into pre-drilled chassis hole for a secure mount that resists loosening and turning. Jack accepts 0.080" tip plug in a recessed, closed-entry type contact. Insulating body is molded of low-loss polyamide. Brass solder terminal is silver-plated and Iridited. Low cost.



**Write today for details
and complete specifications
on these new Johnson Components!**



E. F. JOHNSON COMPANY

3046 Tenth Ave. S.W., Waseca, Minnesota 56093

Circle 245 on reader service card

245

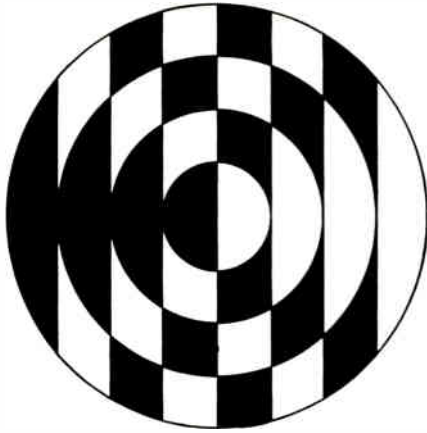

Electronics Engineers

Lockheed Missiles & Space Company is one of the largest electronics firms in the San Francisco bay area. Openings exist in a broad range of specialties and skills. Lockheed, in Sunnyvale, is deeply involved in many exciting, long-range programs in space, on land, and undersea. Such programs as Poseidon, Agena, Polaris, Deep Submergence Rescue Vehicle and advanced land vehicle systems; requiring people in all disciplines, at all levels. And, never before have benefits been more attractive. For more complete information, you are invited to write Mr. R. C. Birdsall, Professional Employment Manager, Post Office Box 504, Sunnyvale, California 94088. **LOCKHEED** MISSILES & SPACE COMPANY A GROUP DIVISION OF LOCKHEED AIRCRAFT CORPORATION Lockheed is an equal opportunity employer.

Circle 309 on reader service card

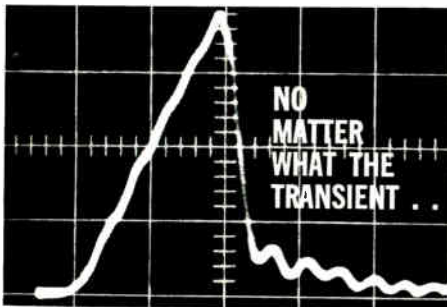

JOSLYN STOPS IT!

Joslyn Precision Spark Gaps act fast operate precisely at voltage breakdown specified every time no matter how long between transients will last virtually for the life of your product arresting capability spans wide current and voltage range complete protection . . . from stock or custom design. Just one of many surge arrester lines. Write or call today for full information on these and other electronic surge protectors.



JOSLYN
ELECTRONIC SYSTEMS

Division of Joslyn Mfg. and Supply Co.

SANTA BARBARA RESEARCH PARK
P.O. BOX 817 • GOLETA, CALIFORNIA 93017
TELEPHONE (805) 968-3551 44

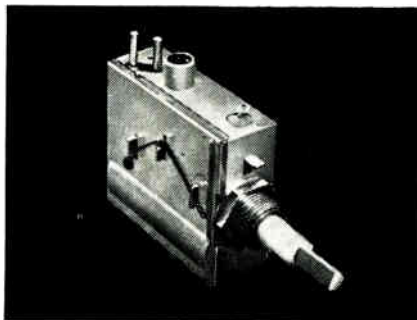

MITSUMI UHF TV TUNER

Far outrating the FCC and VDE specifications, which are widely prevailing in the World as telecommunication standards, the MITSUMI UHF tuner only radiates spurious signals less than 54 dB below the reference field strength. Material, plating, soldering, as well as the proprietary circuit design are the technical achievements by MITSUMI based on a long-term fundamental research.

Specifications	Model	UHF TV tuner UK-A32
Gain (dB)		-10 min.
Noise figure (dB)		14 max.
Image ratio (dB)		30 min.
IF rejection (dB)		60 min.
Frequency stability	Temperature Stability:	+300 kHz at 25~65°C -700
	Voltage stability:	±100 kHz at 11V ± 1.1V
Outer dimensions (mm)		51 × 62.5 × 24.5



MITSUMI

MITSUMI ELECTRIC COMPANY LIMITED
1056 Koadachi, Komae-machi, Kitatama-gun, Tokyo. Tel: 489-5333
Marienstrasse 12, Dusseldorf, W. Germany. Tel: 352701

MITSUMI ELECTRONICS CORPORATION
11 Broadway, New York 4, N. Y. 10004. Tel: HA-5-3085

Circle 310 on reader service card

New semiconductors

Diode from Japan crowds the Halls

Device's magnetic sensitivity is 100 times greater; flux determines the resistance

Challenging Hall-effect elements is a diode whose sensitivity to magnetism is 100 times greater—so sensitive that it is affected by the earth's field. The diode is the SMD, from Japan's Sony Corp.

The SMD is a two-terminal device that is less than half a centimeter long. It acts like a junction diode when put in a circuit that isn't exposed to magnetic flux. But when a magnetic field is present, the diode's forward resistance changes—the direction of the flux determines whether resistance increases or decreases. Reverse-bias characteristics, however, aren't influenced by a magnetic field.

Bending the path. Sony engineers make the SMD by doping the ends of a 3 x 0.6 x 0.4-millimeter block of germanium. One end is a p+ region and the other n+. The distance between these regions is much larger than their thickness. Next, a thin layer of an impurity, like nickel or copper, is deposited on the front of the block, forming a region where electrons and holes recombine rapidly. The mean lifetime of these electrons and holes determines the SMD's forward resistance.

Magnetic flux passing through

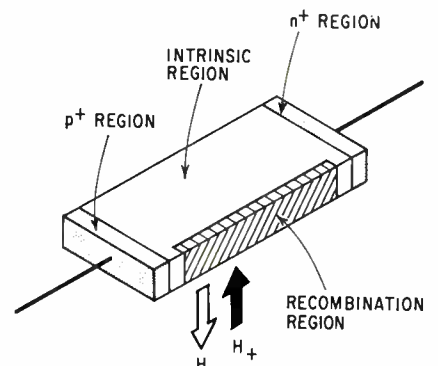

Controlling lifetime. Magnetic field determines diode resistance by bending carrier paths.

246 Circle 246 on reader service card

Electronics | April 15, 1968

If you *could look under the hood*
of a **Techni-Rite Pen Motor**
you would see a complete
Integrated Circuit Amplifier!



To a maker of specialized recorders — such as EKG's — it means:

1. **LOWER COST**
(no wiring, no circuit boards)
2. **EXTREME COMPACTNESS**
(Pen Motor with Amplifier is only 2" x 2 3/8" x 3")
3. **UNPARALLELED RELIABILITY**
(integrated circuitry)

Let Techni-Rite customize your recorder with this new Pen Motor/Amplifier combination. Select the single channel or multi-channel chart drive which suits your needs; add one or more of the off-the-shelf accessories such as Markers, Rewinders, Power Supplies, or Pre-Amplifiers and you will have the most modern, lowest cost and most saleable finished product — whether you make Medical Equipment, Industrial Devices, or what-have-you.

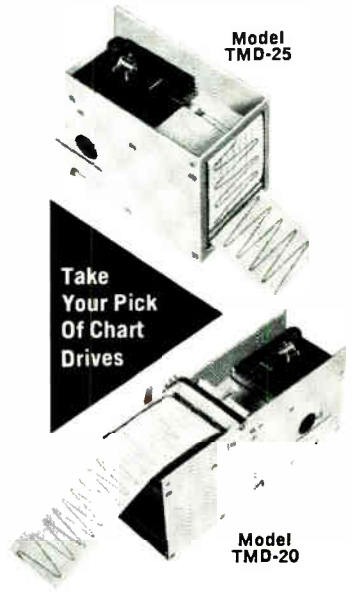

Write, phone or wire for complete details.

Techni-Rite Industrial Park
Warwick, R. I. 02887
Tel. (401) 737-2000 Telex 927725

techni-rite ELECTRONICS
INCORPORATED

Circle 311 on reader service card

Small — Positive Grip
MINIATURE
"Locking" Switches

Alco has managed to reduce the size of the handle on this unusual miniature switch series and still have a perfect grip. Currently available in single and double pole in maintained and momentary locking configurations. Designed for accident-proof applications. 6 amps @ 125 VAC.



FREE
12-PAGE
CATALOG
WRITE!

ALCOSWITCH

DIV. OF ALCO ELECTRONIC PRODUCTS INC., LAWRENCE, MASS.

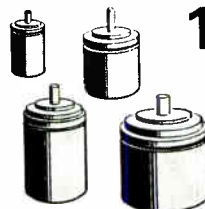

1001 uses for
STEPPER
MOTORS

Because their output is in discrete increments, Cedar stepper motors have many advantages over conventional motors for precise positioning applications. They are bi-directional and have high torque output. They can be run at high stepping rates or as slow as you wish. Because shaft rotation is incremental, damping is not required.

Some of the applications for which stepper motors have been used are: replace motor-tachometers in servo systems, control missile ailerons, shutter control on high-speed cameras, open loop positioner in checkout systems, high-speed counter in such applications as rapid firing weapons, replace ultra low-speed dc motors, incremental tape handlers, and digital-to-analog and analog-to-digital conversion equipment.

The uses for stepper motors are as unlimited as your imagination. New applications are constantly being discovered. What new use will you next make of stepper motors? Let us know about your ideas; we'll be happy to work with you.

Cedar Stepper Motors are available in sizes 5, 8, 11 and 15 in both permanent magnet and variable reluctance types, and with a wide variety of stepping angles. All meet the full requirements of MIL-E-5272. For free booklets on stepper motor application ideas, write or call:

CEDAR
ENGINEERING DIVISION

CONTROL DATA
CORPORATION

5806 West 36th Street, Minneapolis 16, Minnesota. Phone 929-1681

need know-how?



IOWA has that, too!

Talented, trainable men and women from its 32 colleges and universities and many vocational schools are one of the reasons electronic industries come to Iowa... and Iowa industries expand.

Some other important reasons: *Major Markets*... Chicago, Detroit, Milwaukee, Minneapolis, Kansas City and St. Louis are all in Iowa's front yard. *Water*... from the Mississippi, Missouri and many other Iowa rivers. *Transportation*... two navigable rivers, plus roads, rails and an air-line network to every conceivable point. *Management Time*... Iowa executives just naturally have more. They don't waste time commuting daily.

There's more. Fill out the handy coupon... we'll send all the facts. Fast!

(Confidential Reply Coupon)
IOWA DEVELOPMENT COMMISSION
Dept. 548, 250 Jewett Building
Des Moines, Iowa 50309



Name _____
Firm _____
Address _____
City _____ State _____ Zip _____

... four-diode bridge
has bilateral response ...

the diode, perpendicular to the broad surfaces of the block, deflect the carriers. When the carriers are pushed toward the recombination region, the lifetime of the electrons and holes decreases and resistance increases. When the flux direction is reversed, the carriers are steered away from the recombination region and resistance drops.

The competition. The diode's sensitivity is 1 millivolt per milliamp per gauss, compared to 0.001 to 0.01 mv for most Hall elements. Matsushita Electric Industrial Co. recently introduced a thin-film Hall element with a 0.02 mv sensitivity.

Despite having poorer detection ability than the SMD, Hall elements still have a future, according to George Kiriazides, sales manager for American Aerospace Controls, a maker of Hall elements. He predicts the SMD will open new areas but won't cut into those markets now dominated by Hall elements. His reasons: Hall elements are thinner, making them more versatile as probes, and they are bilateral, an important consideration in many measuring applications. He also points out that Hall elements have found a place in analog multipliers that the SMD isn't likely to fill.

Sony, however, is readying the SMD to compete with Hall elements by packaging a four-element bridge that is bilateral.

Heat problems. The SMD's one drawback is its sensitivity to temperature. For a 6-volt input and 1,000-oersted field strength, the current in the diode will rise parabolically from 0.5 ma to 5 ma for a 0°C to 80°C rise.

The maximum power dissipation of the SMD is 50 milliwatts, so, for some applications pulse operation will be necessary to limit heating.

Possible uses for the SMD are in magnetic detectors, brushless d-c motors, proximity switches, and noncontact switches. Sony will put the diode in a d-c motor that was designed for a tape recorder the company will introduce in the fall. The diode will be marketed by Sony for \$3 in quantity.

Sony Corp., 7-35 Kitashinagawa-ku, Tokyo, Japan [445]

**SUPERIOR
COAXIAL
ATTENUATORS**

prevent



burnout

The Model 10 Attenuator has an average power handling capacity of 10-35 W, and 10 kW peak. These medium power attenuators are commonly used to prevent burnout or overloading of sensitive equipment. They are calibrated at four points over their DC-1.5 GHz frequency range, and can also be used as standards of attenuation in loss measurements.

MODEL	NOM. ATTEN. (dB)	POWER INPUT	
		AV. (W)	PEAK (kW)
10-1	1	35	10
10-2	2	18	10
10-3	3	15	10
10-4	4	12	10
10-5 to 10-20	5-20	10	10

stainless steel Type N connectors assure maximum life with minimum wear. The custom made film resistors are artificially and stabilized to give maximum stability under peak pulse power and extreme temperature and humidity cycling.

Designers and
Manufacturers of Precision
Microwave Equipment
**WEINSCHEL
ENGINEERING**
Gaithersburg, Maryland

FREE BULLETINS OFFER YOU A CHOICE OF 315 OFF-THE-SHELF FERRITES.



Indiana General has the most complete line of ferrite materials and shapes in the world. Including materials, core sizes, and shapes not available as standard from any other manufacturer.

In all, we list 15 ferrite materials in 315 standard shapes and sizes including: cup cores; toroids; transformer C cores; rods and strips; E, I, U, and C cores; the international series of cup cores, and cross cores.

Chances are, any size, shape, or ferrite material you need is already listed in our Ferramic® Materials Bulletins. For your copy, write Mr. K. S. Talbot, Manager of Sales, Indiana General Corporation, Electronics Division/Ferrites, Keasbey, New Jersey.

INDIANA GENERAL 

Circle 314 on reader service card



YOU'RE
WHISTLING
IN THE
DARK . . .

. . . if you think that heart disease and stroke hit only the other fellow's family. No one is immune. Protect the hearts you love. For authoritative information, ask your Heart Association. For medical advice see your doctor. To safeguard your family . . .

GIVE...
so more will live
**HEART
FUND**



Contributed by the Publisher

Electronics | April 15, 1968

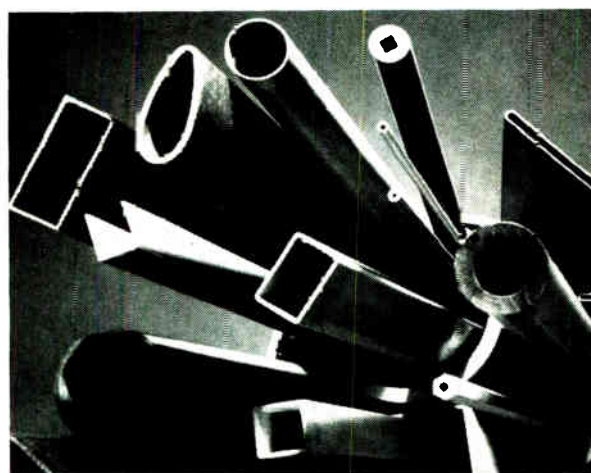

New Design Opportunities With Laminated Plastic Tube Shapes

Why be restricted to the use of round laminated plastic tubes? We make them in a wide variety of inside and outside contours—square, oval, hex, rectangular, and in angles and channels, even multi-cavity tubes. Wide range of grades, diameters and lengths. Complete fabrication facilities. Write for further information. Synthane Corporation 36 River Road, Oaks, Pa. 19456—or call (215) 666-5011.

SYNTHANE

CORPORATION  OAKS, PA. 19456

Laminated Plastic Sheets, Rods, Tubes and Fabricated Parts

Circle 249 on reader service card

249

O m n i -

The TERMI-BLOK[★] terminal junction system takes care of all your bussing. Feed-to and feed-thru. Replaces MS terminal strips and screw-type blocks. It's denser, lighter, more versatile, and more reliable. It succeeds where others fail. It's crimpable, insertible and extractible with MS tooling. Automated tooling's available for volume production. For more information write, AMP Inc., Harrisburg, Pa.

[★]Trade mark of AMP Incorporated

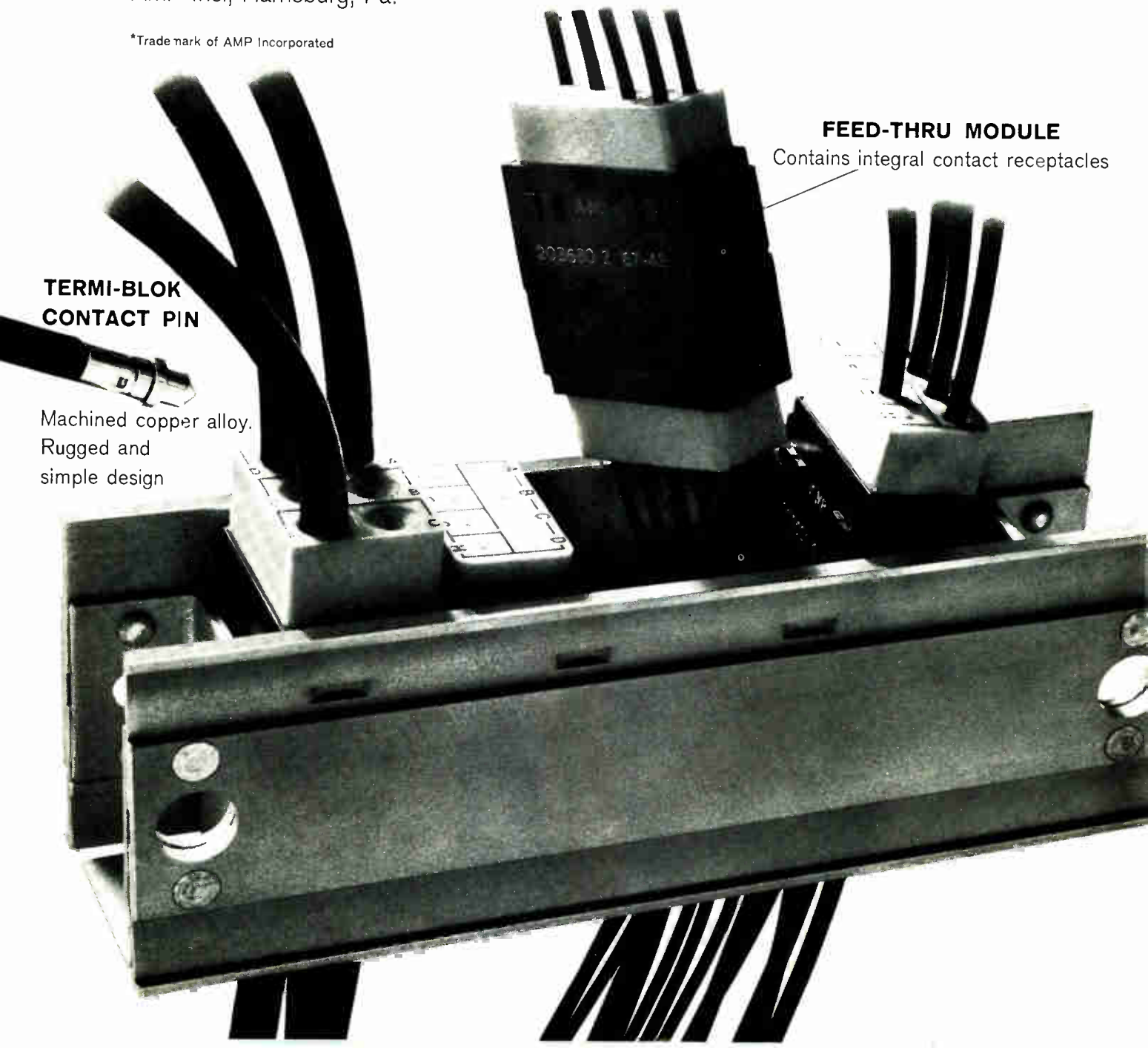

TERMI-BLOK CONTACT PIN

Machined copper alloy.
Rugged and
simple design

FEED-THRU MODULE

Contains integral contact receptacles

bus.

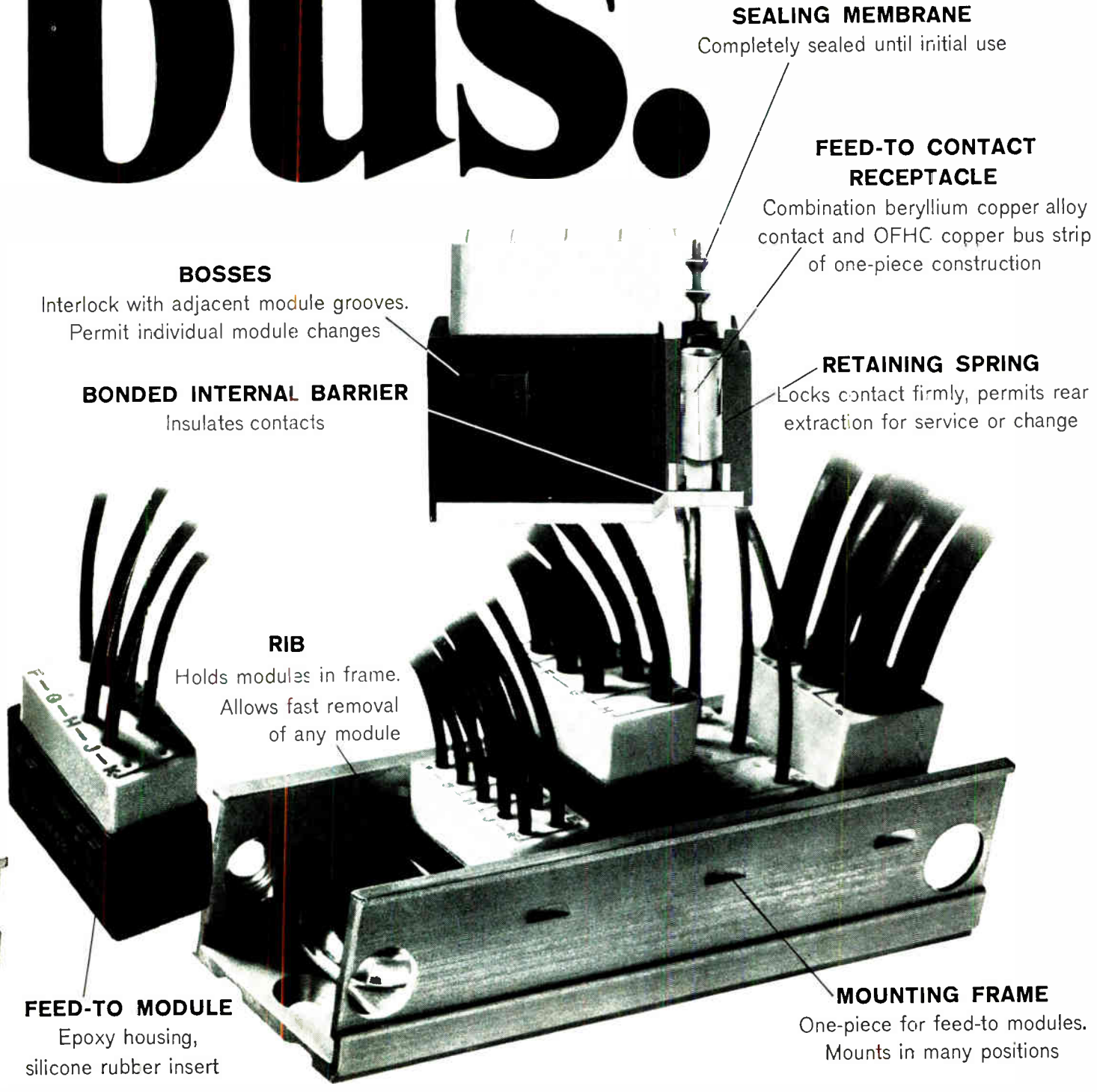

SEALING MEMBRANE

Completely sealed until initial use

FEED-TO CONTACT RECEPTACLE

Combination beryllium copper alloy contact and OFHC copper bus strip of one-piece construction

BOSSSES

Interlock with adjacent module grooves. Permit individual module changes

BONDED INTERNAL BARRIER

Insulates contacts

RETAINING SPRING

Locks contact firmly, permits rear extraction for service or change

RIB

Holds modules in frame. Allows fast removal of any module

FEED-TO MODULE

Epoxy housing, silicone rubber insert

MOUNTING FRAME

One-piece for feed-to modules. Mounts in many positions

AMP

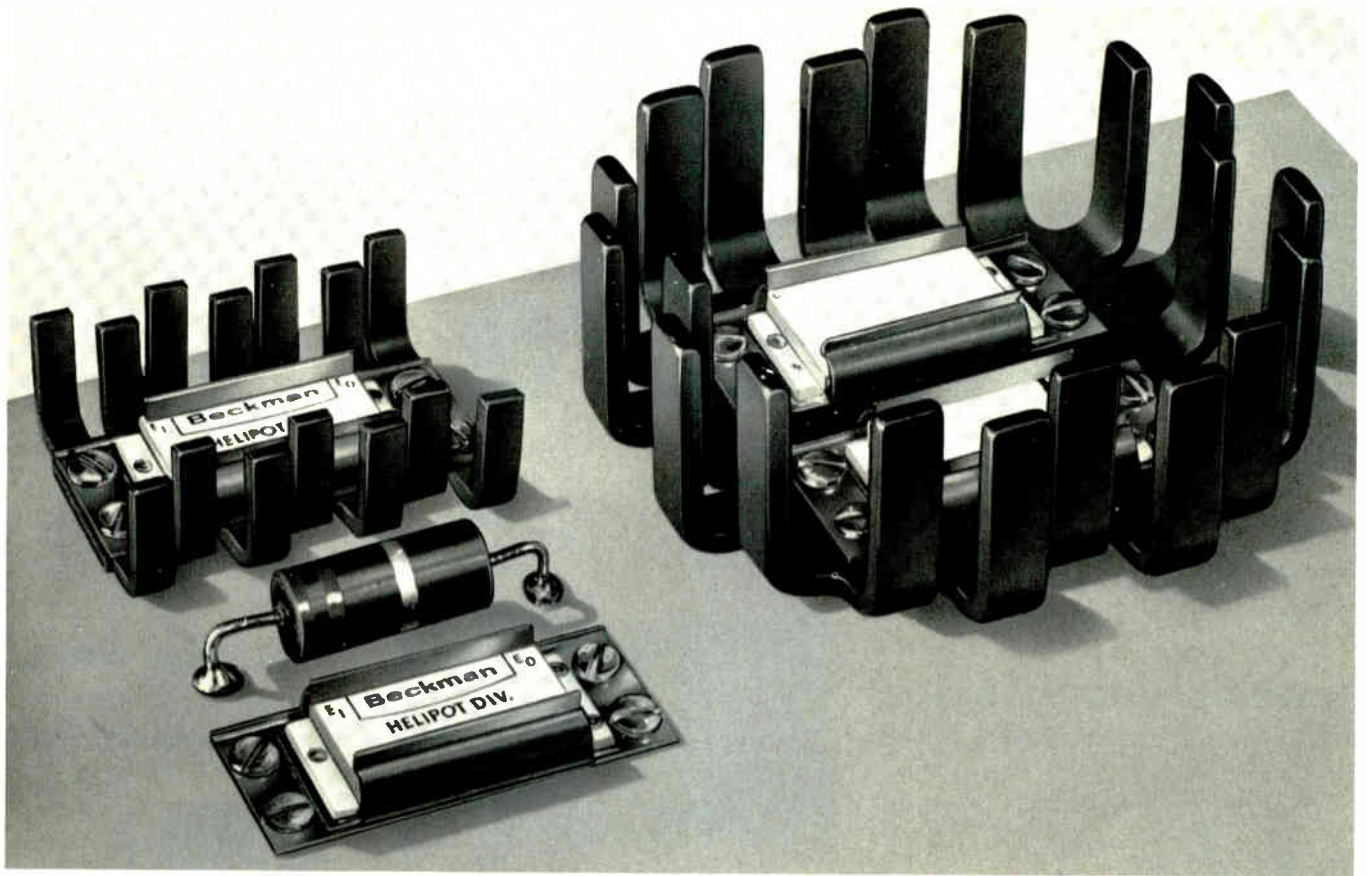

Cool off microcircuit devices with a choice of four new dissipator/retainers. Example: with natural convection, a typical microcircuit device dissipates 1.8 watts with case temperature rise of 103°C.

Add IERC's model LBOC2-61B and you dissipate 5 watts with the same case temperature rise. Retainer-clip may also be used alone to mount package to conduction plane.

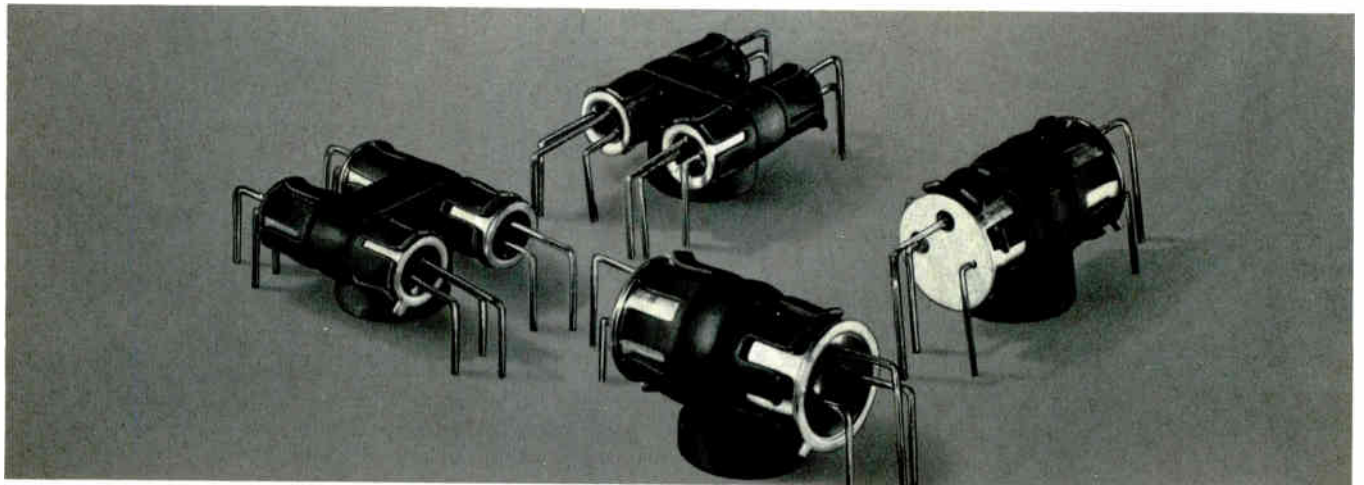

These special dual and quad Thermo-Link dissipators permit thermal mating of matched transistors. Thermo-Link retainers do exactly as their name says: They provide a thermal link between transistors and the chassis or heat sinks. They are also available with

.060" beryllium oxide washers which have the excellent thermal conductivity of aluminum, are electrically insulative and reduce normal mounting capacitance by $\frac{1}{2}$ to $\frac{1}{3}$. The washer is brazed to a brass slug or hex stud for mounting.

Need a non-hygroscopic finish with excellent dielectric properties, 50 K megohms insulation resistance and high heat emissivity? Use Insulube 448. It also protects against salt spray and fungus and other adverse environments.

Tips on cooling off hot semiconductors and microcircuits

Read on. Find out how circuit designers use IERC heat dissipators to protect and improve circuit performance of semiconductors and microcircuits.

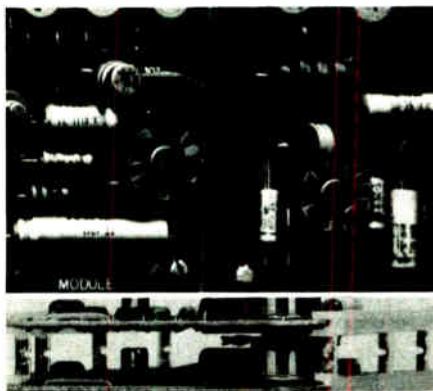

Fan Top Dissipators for TO-5 and TC-18 cases add almost nothing to board height. Don't need much room on the board either. Available for both metal and plastic cases. Spring fingers make installation simple. And Fan Tops cost just pennies.

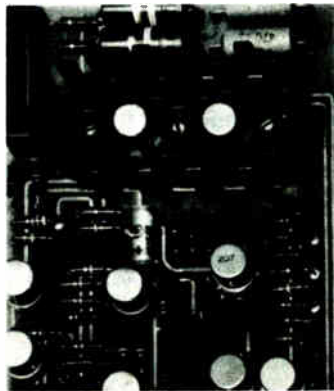

Help low-to-medium power transistors keep their cool with IERC's stagger-fingered LP's. Available in single or dual mounting for thermal mating of matched transistors. They fit both TO-5 and TO-18 cases.

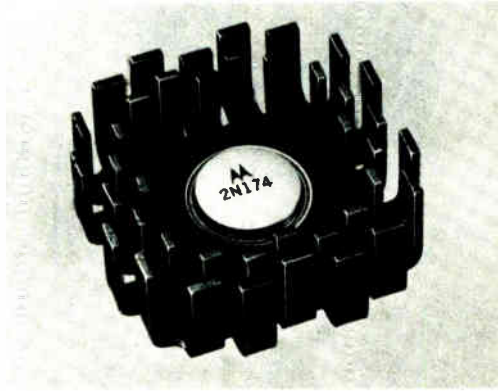

Cool power transistors and diodes with lightweight HP Series devices. High heat transfer rate. HP3 displaces only 9 cu.in. and weighs just 1.5 oz. Yet it dissipates as much heat as many finned extrusions requiring 13.5 cu.in. Two sizes for nesting or back-to-back use.



Keep TO-66 transistors cool with any of four IERC dissipators. The application shown is a 100-volt amplifier with four LB66B2B's dissipating 8 watts per transistor. Exclusive staggered-finger design. Choice of finish: black anodize or Insulube® 448 for positive insulation to 500 watts.

Got a tough one? Our engineers welcome your inquiry for more specific information. Write us on your company letterhead, please.

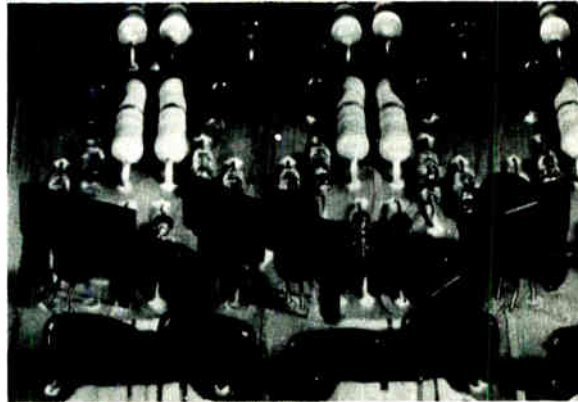

New "Universal" Spade Series for plastic transistors fits all D-case sizes. Spring clip allows for variation in case diameters. Excellent dissipation lets you boost operating power 33%. Both single and dual models as shown.

ierc
SEMICONDUCTOR
HEAT DISSIPATORS

INTERNATIONAL ELECTRONIC RESEARCH CORPORATION  A corporate division of Dynamics Corporation of America • 135 West Magnolia Blvd. • Burbank, Calif. 91502

CHECK THESE



Black-Box Solutions

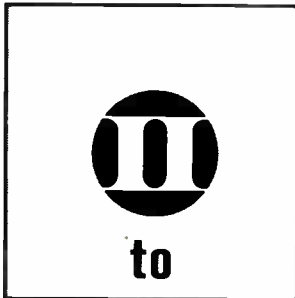

System Problems

Intronics' solid state MIL-quality function modules offer known performance and cost, plus compact and reliable solutions for system design problems.



➔ MULTIPLICATION/DIVISION/ SQUARE ROOT/SQUARING

- M101 — dc to 1kHz, 0.25% accuracy
 - M102 — dc to 100Hz, 0.1% accuracy
 - M201 — dc to 1MHz, 1% accuracy
- Size: (all units) 3.8 cu. in.

➔ IMPEDANCE BUFFERING

- FA101 — 10^{11} ohms in, 0.1 ohms out
0.005% linearity, dc to 200kHz band-
width
- Size: 0.8 cu. in.

➔ SAMPLE AND HOLD

- FS101 — 2 μ sec acquisition, 50 nsec
aperture time 0.1% accuracy
- Size: 1.5 cu. in.

➔ ELECTRONIC SWITCHES

- ES101 — 300 ns Ton, 50 ns T off,
 10^{10} ohms off impedance, error less
than 2mV
- Size: 0.8 cu. in.
- ES102 — Buffered switch, 10^6 ohms
input impedance, 0.1 ohms output
impedance
- Size: 1.5 cu. in.

Contact our applications engineering department
for your special requirements or mail this ad to:



intronics
57 Chapel St., Newton, Mass. 02158

Telephone: (617) 332-7350
TWX: (710) 335-6835

New Books

A welcome jump

Quantum Electronics
Amnon Yariv
John Wiley & Sons
478 pp. \$14.95

As published material on quantum electronics piles up at an alarming rate so, unfortunately, does the jargon. The "in" language makes it difficult and sometimes impossible for the beginner or nonspecialist to comprehend this important field. First-year graduate students—for whom this book is written—and working engineers seeking to break into the field will welcome this volume, which defines all the terminology and uses it consistently to draw together a wealth of fundamental data from a wide variety of sources.

By reviewing pertinent areas of quantum mechanics and magnetic resonance early in the text, the author lays the theoretical foundation for the advanced discussions that follow. A senior-undergraduate or first-year graduate course in the subject would help the reader to understand this complex subject, but are not absolutely essential.

The book covers optical resonators and laser oscillation; first the general theory and then the specifics or working systems. Included are solid state, gas, and semiconductor laser types. The author also ties together the many diverse aspects of electro-optics and nonlinear optics, topics that are often given isolated treatment in most literature on the subject. He introduces the electro-optic effect by discussing light propagation in crystals, with and without externally applied electric fields. Then he treats the applications in modulation and light deflection.

A section on nonlinear optics examines optical phenomena that involve energy flow between fields of different frequencies. It includes second harmonic generation, optical parametric oscillation, stimulated Brillouin scattering, and stimulated Raman scattering.

Yariv's volume, now in use at the California Institute of Technology, shows signs of careful organization; the problems at the end of each chapter add to its value for stu-

dents. For others, already active in quantum electronics, the book provides an excellent summary of the technology's fundamentals.

R. T. Denton

Bell Telephone Laboratories
Murray Hill, N.J.

Turning the heat off

Temperature Control
Myer Kutz
John Wiley & Sons Inc.
212 pp. \$10.95

Second to no other problem faced by designers and users of electronic devices, circuits, and systems, is thermal behavior—the effect temperature variations have on the equipment.

Kutz approaches the subject of controlling the thermal environment from the point of view of the electrical rather than the mechanical engineer. The book is oriented towards applications in computers, guidance and control systems, aerospace equipment, power networks, and modules, not turbines or engines.

Kutz's purpose is to relate the basic empirical and mathematical principles of heat transfer to specific engineering tasks. He covers the mechanisms of heat transfer, the ways of computing the transfer rate in common physical situations, and the thermal properties of basic materials and surfaces. He discusses materials and surfaces, methods of fixing heat-transfer rates, heat exchangers, and thermal-control systems. He also shows how to sense and excite temperature, explains the control of satellite temperatures, and describes the elements of electronic temperature-control systems.

Equipment covered includes electrical resistance elements, power semiconductors, thermostats, thermoelectric devices, and spacecraft systems. The mathematics expressing the relationships is differential and system-derived. This is something EE's should feel comfortable with, and is a long way from the oversimplified, half-explained algebraic treatments electronics engineers usually find

If you supply, serve or compete within the semiconductor field, you can benefit from locating your plant in the Western core of the industry. Here, in Santa Clara County, 14 semiconductor manufacturers prosper — two to 20 minutes apart.

Join the synergistic action sparked by top educational facilities, a business climate that welcomes entrepreneurs, and skilled labor that speaks your language. The \$6 billion Western electronics market is at your doorstep! Send for your free copy of a map pinpointing "The Semiconductor Industry in Santa Clara County", plus eye-opening facts on this technically-oriented industrial center. Write Ed Beaty, Chamber of Commerce, 499 South Murphy Avenue, Sunnyvale, California 94086.



this is
**SEMICONDUCTOR
TERRITORY...**

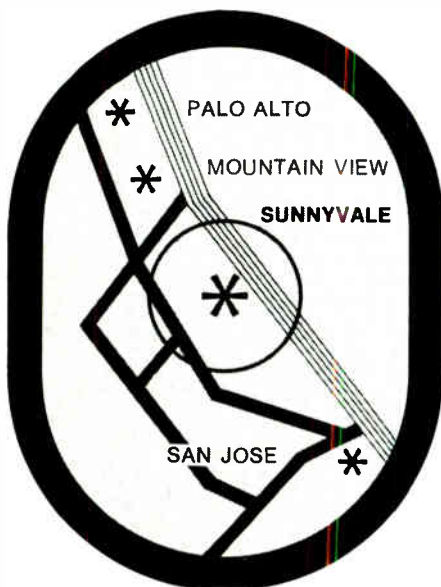

*a good place
to locate your
business*

SUNNYVALE CALIFORNIA

Circle 331 on reader service card

in thermodynamics texts.

In fact, the reader needn't even have a background in thermodynamics to understand the work and apply its principles; Kutz provides all the grounding necessary for the subject in three chapters on fundamentals.

J.B. Steuer

Reimers Electro-Steam Inc.

Unaccustomed as I am . . .

Presenting Technical Ideas
W.A. Mambert
John Wiley & Sons
216 pp., \$6.95

You don't have to be a technical man to be dull, but it helps. Anyone who has found his eyes closing while a speaker—all too often an engineer or scientist—drones on, will appreciate Mambert's effort to improve the communication of technical ideas to an audience.

Increasingly, engineers are required to explain complex ideas to their colleagues, to management, to government groups or to non-technically oriented audiences at a variety of seminars and meetings. In his preface, Mambert, who is on the communications staff of the International Business Machines Corp., states the obvious—you can't get ahead in business until you become adept at presenting technical ideas.

About three-quarters of the book is given to practical tips on analyzing the audience, defining the objectives, gathering information, writing the manuscript, preparing notes, using mechanical aids, rehearsing, and handling the unexpected during the delivery of a talk (Some-one snoring, perhaps?).

But the reader who takes to heart Mambert's 35 imperatives—which will make him a better communicator of technical ideas, says the author—will discover that he's being asked to restructure his personality. For example, among the fiats issued by Mambert are these: Develop empathy. Become an opportunist. Know thyself. Learn to walk alone. Learn how to break rules. Learn how far you can go. Operate with complete integrity. Be flexible. Be ruthless, sometimes. Love. Develop your sense of humor.

Urging the reader to develop a sense of humor is like telling him to develop sex appeal. Either he



**Cool
De-Fog
Exhaust
Circulate**

with Sanders MINICUBE®
Subminiature Blowers

Missile-bred reliability . . . space-saving one cubic inch size . . . 1.25 ounce lightweight . . . 2.2 cfm rated output . . . 6.3, 26 or 115 vac, 400 cps. Sanders MINICUBE Blower eliminates hot spots around electronic components . . . prevents fogging of optical devices. Solves a variety of problems in both military and commercial applications. Write for free literature. Sanders Associates, Inc., Instrument Division, Grenier Field, Manchester, New Hampshire 03103. Phone: (603) 669-4615. TWX: (710) 220-1845.



1" x 1" x 1";
2.2 cfm nominal;
1.25 ounces;
operating temperature
range: -55°C
to 125°C; typical life:
5000 hours; three
models available.

Creating
New Directions
In Electronics

F. M. SANDERS ASSOCIATES, INC.

SA  **SANDERS
ASSOCIATES, INC.**
INSTRUMENT DIVISION
GRENIER FIELD, MANCHESTER, NEW HAMPSHIRE

Circle 255 on reader service card

255

our adaptable conformist.

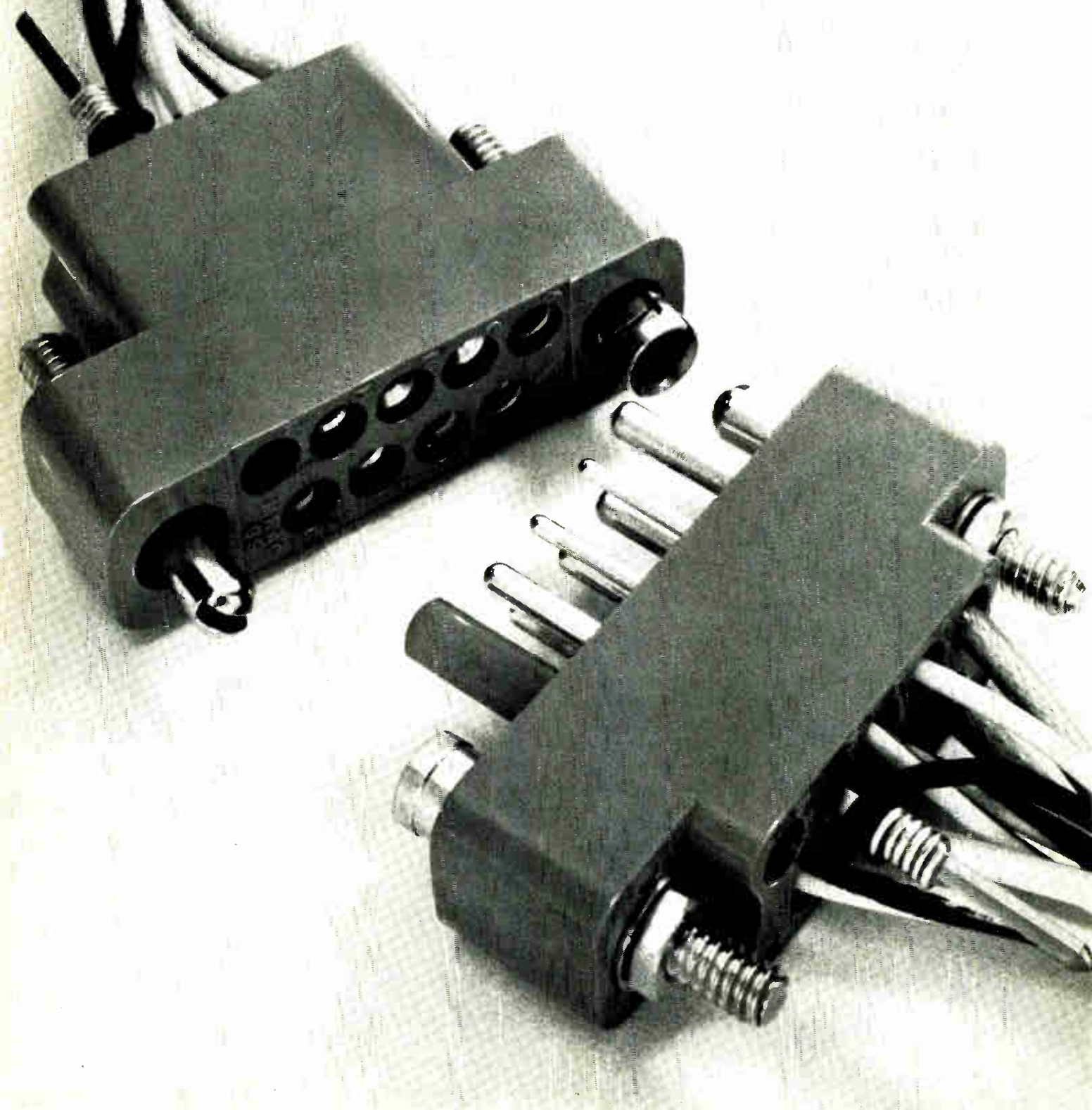

New Books

has it or he doesn't. Nonetheless, were a reader able to change his behavior, using the author's 35 precepts as his guide, he'd develop a calculating self-discipline that could carry him to sanctity or the White House. Or both.

Rare bit from Wales

Principles of Automatic Control
Martin Healey
D. Van Nostrand Co., Inc.
334 pp., \$9.00

Neophytes in the field of automatic control should read this book because of its careful organization of the standard technology. And experienced engineers should read it because the clarity and brevity of the presentation permits new insights to well-known subjects.

Healey, who teaches at the University College of South Wales and Monmouthshire, claims no technical originality nor contribution to the field. All he has done is write one of the best texts on the subject.

Included are the usual basic subjects on closed-loop control, but Healey goes beyond the fundamentals—with sections on statistics, nonlinear systems, sampled-data systems, state variable and matrices, computing and simulation.

Essential to an understanding of the advanced—and even the most basic—concepts of control, is a good grasp of mathematics. If the math involved in specific instances is complex, Healey provides the necessary material in a clear and succinct fashion.

The book contains an excellent exposition on statistics in closed-loop control. In just one page of text, the reader learns about stationary time series, ergodicity, and stochastic signals. Here is a precis of that page:

A stationary time series is a continuous function which has the same long-term properties at any time. A random noise signal from an electronic device is stationary time series; a single transient is not.

Statistical properties of a function can be found by considering a large number of similar signals on any one instant in time, termed an

ensemble value, or by considering one signal at a number of intervals of time, termed a time value. If these two properties are equal, the function is said to be ergodic. To be ergodic, the function must also be stationary.

A signal which has stationary properties but is not completely random—it has some definite probability as to its content—is called a stochastic signal. Limiting cases of stochastic signals are a predictable one like a sine wave, and a completely random one like white noise.

Bit-by-bit

Introduction to Computer Programming and Coding
Francis K. Walnut
Prentice-Hall Inc.
429 pp., \$17.30

Walnut's book on the basics of computer programming is aimed squarely at those unfamiliar with data processing techniques.

The first few chapters provide background on the principles and history of data processing, briefly describe binary and intermediate number systems, and summarize input-output methods.

When he moves on to coding, the author first defines machine language instructions, then introduces the reader to symbolic language. Brief mention is made of higher-order languages. Practical coding is discussed in relation to variable-word-length and fixed-word-length binary computers. The first machine is typical of small-scale commercial computers, the second of large-scale scientific units.

Among the subjects covered are input-output coding, loops, subroutines, serial-search procedures, and sorting. Walnut makes liberal use of flow charts to illustrate the various techniques. Problems—and answers—are presented after each chapter to review material covered.

The book will surely be of value to those engineers seeking a working knowledge of programming, but it may also serve as a refresher course for those practicing the art.

Stephen Strell
Computer consultant

The Winchester MRAC Series conforms to MIL-C-22857. Hoods, block and contacts are all certified. And *only* our MRAC connectors can make that claim!

Or provide such adaptability. Easily installed, readily removed contacts are ordered separately. So you can design your own circuitry—at substantial savings in time and labor. And our removable contacts are available in crimp, solder or shielded types. Or wire-wrap. Plus polarizing pins too.

More adaptability. You can intermix power, shielded signal and signal circuits in the same connector. With everything certified to MIL-C-22857.

We recommend the MRAC Series for applications such as computers, shipboard equipment, radar and ground support hardware. For details, and prototype quantities, check your local Winchester Distributor. Or write to: Winchester Electronics, Main St. and Hillside Avenue, Oakville, Connecticut 06779.

Specifications:	
Current rating: Up to 13 amps	
No. of contacts: 9, 14, 18, 20, 26, 34, 41, 42, 50, 66, 75, 104	
Contact Specifications:	
MIL-C-23216 No.	Catalog No.
MS17803-16-16	100B-1016P95
MS17803-16-20	100R-1020P95
MS17804-16-16	100B-51016S95
MS17804-16-20	100R-51020S95

WINCHESTER ELECTRONICS
LITTON INDUSTRIES

Teltronics 300 Series coherent amplifiers

simplify
ultra-low
signal
measurements



MODEL 300-A Coherent (lock-in) Amplifier reduces complexity and cost of measuring ultra-low level signals.

Radio astronomers, medical researchers and those scientists working with paramagnetic resonance or making subtle photometric studies can now simplify those measurements that require instrumentation capable of phase-locking with, identifying and measuring signals buried in the noise up to 50 dB or more.

Teltronics, Inc., has produced fundamentally simple solid state coherent amplifiers with genuinely needed features and lower overall prices.

Modulation Tuning Range: 1.5 Hz to 10 MHz, continuously or with plug-in field-adjustable tuners.

Adjustable-Q Filtering: From broadband to high selectivity.

Plug-In Preamplifiers: High or low impedance; single or differential inputs with 100 nV fs sensitivity.

Internal or External Reference: Reference channel can drive coaxial switch or chopper directly.

Price: \$1,400 to \$2,245 depending on preamplifier and tuning system.

Write for Technical Data



Teltronics, Inc.

Box 466, Nashua, New Hampshire 03060
(603) 889-6694 / Subsidiary of Roanwell Corporation

Technical Abstracts

Oceans of data

Electronics: the technological key
James C. Elms
NASA Electronics Research Center
Cambridge, Mass.

Exploring and exploiting earth resources places high demands on electronics technology, specifically for a variety of new sensors and for more efficient data management.

What electronics specialists will have to contend with can be seen from a typical earth-resource study of the future. The assignment is to sense, condense, transmit, and analyze information about conditions of the ocean.

This could be accomplished with a satellite that would interrogate thousands of beacons fixed on the ocean's surface and that would carry some sensors of its own. Each beacon would gather and transmit data on underwater characteristics to the satellite, which would retransmit all the data to a land-based collecting point. Typical measurements taken on board the satellite would be temperature, color, and surface roughness of a wide expanse of ocean.

Technology exists for transmitting information to a central point, but the required data rate might create a bandwidth problem. Selecting the pertinent data and compressing it could help. The main effort will be to analyze and interpret the data for the benefit of, typically, fishing, shipping, weather prediction, and recreation interests. Development of appropriate computer software seems the most likely route to rapid and accurate specialized interpretations.

Remote sensing of the ocean's surface presents an even greater technological challenge. To make accurate temperature measurements from the satellite would require precise radiometers operating in one or more infrared regions. Color sensing, however, is even more complicated. It will need scanning and amplitude recording in three, if not more, optical or near-optical regions to determine a color value. A measure of ocean roughness might best be made by active radar techniques at one or more

microwave frequencies with one or more polarizations.

Developing these sensors and finding ways to handle the resulting mass of data will take many years, and early hopes may wane before exploratory systems become operational.

Presented at the IEEE International Convention, New York City, March 18-21.

Which way to go?

Trends in the applications of microcircuits in industrial use
R.F. Eade
A.E.I. Automation Ltd.,
Leicester, England

Designers of industrial instruments and controls now have available a variety of microcircuits, based on different semiconductor technologies, that result in low-cost, off-the-shelf modules. Prices of standard integrated circuits have fallen rapidly over the past few years. In 1964 the cost of an IC version of a typical logic package was about 2½ times that of its discrete-component equivalent; in 1968, the cost of the IC version is about half.

Still, IC's have not made any great impact in the industrial field, except perhaps in computers. But the IC is now expected to have major effects on the business and customs of many electronic systems manufacturers.

First, the percentage of electronics in the prime cost of a system will increase when IC's are bought on the outside. Second, economics will force a systems maker to use the standard modules also available to his competitors. Third, when the systems maker believes that a custom IC is justified, he will commission a manufacturer to design and make the device—and will thereafter have to depend on that supplier.

Such considerations have led some systems companies to build up complete in-house facilities for microcircuit production. But this can be more expensive than most companies can afford unless they intend to become IC suppliers. An intermediate step is to arrange in-house facilities for the assembly and test

Why MARYLAND?

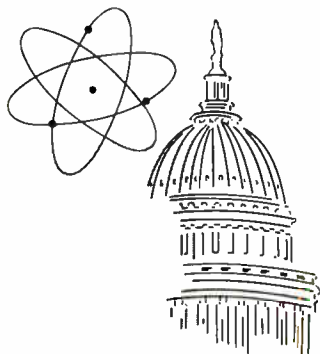

Proximity to federal agencies in Washington, D.C. affords the unique advantage of constant personal contact with government officials working with science-oriented industry. Such contact is an increasingly important locational criterion.

No other state is as convenient to as many Federal agencies as Maryland. For example, Maryland's major government scientific installations include NASA, AEC, NIH, the National Bureau of Standards, plus some 20 others.

Are there other reasons why R&D activities and science-oriented industries should consider locating in MARYLAND?

Yes... emphatically!

The availability of personnel, particularly engineers and scientists, is recognized as a chief criterion governing the location of any science-oriented industry.

There are almost 30,000 scientists and over 25,000 engineers living and working in Maryland and the District of Columbia.

There are 39 four-year colleges and universities in Maryland and the District of Columbia. Graduate and post-doctoral programs considered most significant to research and science industry are available.

Shouldn't you locate in MARYLAND?

Get All The Facts.

MARYLAND DEPARTMENT OF
ECONOMIC DEVELOPMENT
DIVISION E

State Office Bldg. • Annapolis, Md. 21404

Write, Wire Or Phone Collect

Circle 332 on reader service card

of special devices to meet internal requirements, but to buy such components as diffused chips from specialist manufacturers.

Presented at the Symposium on Applications of Microelectronics, the Institution of Electrical Engineers and the Institution of Electronic and Radio Engineers, University of Birmingham, England, March 27.

All in good time

Satellite multiaccess operation with pcm
K.W. Pearson
Standard Telecommunications
Laboratories Ltd.
Harlow, England

A communications satellite that hopes to compete with other transmission methods must be able to talk with several earth stations at essentially the same time. Such a multiaccess operation can separate signals either by frequency or time. Frequency division is more common now, but analysis shows that time-division multiple access using pulse-code modulation could be the better method if faster digital circuits can be developed.

With time division, only one signal is present at any moment and intermodulation among stations can't occur. Input levels from the earth stations to the satellite's transponder don't have to be equal, and the number of stations and number of channels in each can be readily varied.

Disadvantages of a pcm system would be that time division would require more radio-frequency power than frequency division, and that most earth stations, which now use frequency or amplitude modulation, would have to be converted to pcm.

In a time-division multiple-access system using pcm, the transmitted information, which would normally occupy an entire time slot, is compressed at the transmitter and expanded in the receiver. To do this, the digital pcm data is stored at the transmitter at its normal bit rate and extracted for transmission at a higher bit rate. The opposite is done at the receiver, to yield an essentially continuous message.

However, before time-division multiple access using pcm can rival frequency-division multiple access, a high logic speed must be attainable. A satellite with 1,200 channels will need a rate of 70 million to 100 million bits a second.



*Dependable
Power for
Communications
and Navigation*



Model
4S1250-1P
250 VA

UNITRON STATIC INVERTERS 28VDC to 400Hz

250VA Sine Wave Output

Lightweight • High efficiency • Overload and short-circuit protection • Tested to applicable RFI and environmental specifications • Stable frequency and voltage regulation.

From Unitron, one of a series of proven, highly reliable solid-state inverters. Stable 400 Hz 1 ϕ output; low noise and distortion. Operating temperature -55°C to $+55^{\circ}\text{C}$; altitude to 50,000 ft. Designed to meet electrical requirements of T.S.O.-C73. For ground support and airborne equipment including transceivers, Doppler navigation, artificial horizons, ADF, omni's, DME, weather radar, transponders and autopilots. Series also includes: 125 & 500 VA, 1 ϕ , and 750 VA, 3 ϕ , inverters.

Write today for complete information.

UNITRON

Division of Electric Machinery Mfg. Company
1624 N. FIRST ST.

GARLAND, TEXAS 75040 (214) 276-8591

Circle 259 on reader service card

259

Compact electronics package?

COOL IT...

...with a small size, long life, high output AiResearch fan.

Garrett-AiResearch special purpose fans are individually designed and custom built to deliver more flow and greater pressure rise with a minimum envelope size.

Take a typical AiResearch small size fan: computer-optimized for required performance under all operating environments; our own motor, engineered and manufactured for a perfect match to its fan; and up to 40 percent more airflow than any other ventilating fan of similar input, size, and weight.

Next time you need a ventilating fan for a very special airborne or ground electronics enclosure specify AiResearch. Available for high temperature and cryogenic applications, with flow rates and power requirements as specified. AiResearch Manufacturing Division, Torrance Facility, 2525 190th Street, Torrance, California 90509.

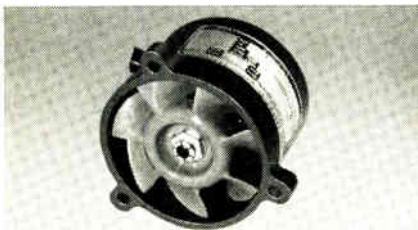
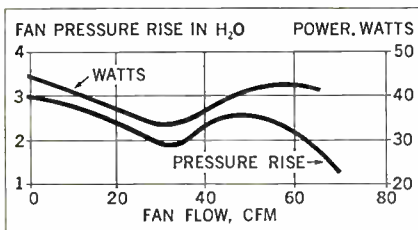

AIRESEARCH SPECIAL PURPOSE FANS



Technical Abstracts

Logic circuitry for such speeds is already in use experimentally, so one can expect a system accommodating up to 25 earth stations to be built soon.

Presented at the Colloquium on Pulse-Code Modulation, The Institution of Electrical Engineers, Electronics division, London, March 4.

Position wanted

The laser gyro
Frederick Aronowitz
Systems and Research Center
Honeywell Inc.
Minneapolis, Minn.

Most inertial navigation systems rely heavily on the integrating rate gyroscope to keep track of a vehicle's position in space. A new gyroscope, using the laser and general relativity for its operation, measures rotation in inertial space without the spinning mass found in conventional gyros. Since there is no mass, the laser gyro is unaffected by error-inducing acceleration forces. It also senses higher rates of rotation with greater accuracy, and does so at low cost, low power, and with no special cooling. It has a digital output.

The cavity configuration consists of several mirrors arranged so that energy from the laser point source is built up in the cavity in the form of two waves traveling in opposite directions. These waves can oscillate at different frequencies and amplitudes.

Since the point source is moving relative to inertial space, the light going around the ring-shaped cavity in the direction of rotation must travel a greater distance than the light going in the opposite direction.

The magnitude of this difference depends, among other things, on the cavity's rate of rotation and on the velocity of light. This change in optical path can also be considered to be a frequency difference.

Readout in the laser gyro is obtained by combining the waves to form a fringe pattern. The fringes move at the frequency difference rate and, hence, by summing fringe counts the gyro produces a digital output related to position.

Presented at the IEEE International Convention, New York City, March 18-21.

you can't beat this drum

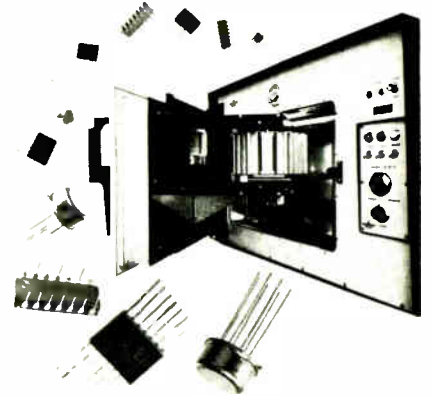

because it's an unbeatable test system

Delta's **CHARGER** is a new concept in manual testing of your integrated circuits.

Versatility is unbeatable; simply by changing test heads the **CHARGER** handles all common devices. A wide temperature range, -65° to $+150^{\circ}\text{C}$, is equalled only by much larger, more expensive testing units.

Accuracy is unbeatable; the same test position for each part insures only $\pm 0.25^{\circ}\text{C}$ deviation.

Repeatability is unbeatable; identical electrical parameters are guaranteed because every integrated circuit is measured from the same test socket.

Continuous throughput is unbeatable in an environmental manual handler; only the **CHARGER** lets you test an impressive 500 parts per hour!

You'll beat the drum, too, when you use a **CHARGER**. For the latest information, mail the request card today.



Delta Design, Inc.
8000 Fletcher Parkway
La Mesa, California 92042
Telephone (714) 465-4141



Summit
meeting
of the
international
electronic
industry



4th International
Exhibition of
Industrial Electronics
in the buildings of the
Swiss Industries Fair, Basle

4-8 March 1969

Circle 334 on reader service card

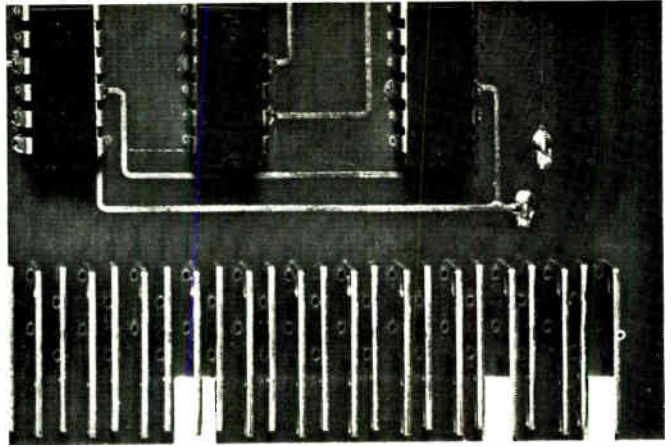

MicroVersaLOGIC

Designed for the
toughest applications.

Priced for the easiest.

MicroVersaLOGIC is the complete line of IC logic modules designed for the toughest applications, yet priced lower than other cards.

Built into MicroVersaLOGIC are small size, high reliability, and high performance. They give you assured performance at 5 megaHertz, leakproof ceramic DTL chips, and a filter capacitor on each card.

The complete MicroVersaLOGIC line gives you all the ready-made building blocks you need for anything from a register to an entire digital system, including plug-in power supplies and a broad line of system assemblies and accessories.

Our 40-page catalog can give you all the facts and possibilities of the MicroVersaLOGIC line, and our price list will prove to you how economically it can be yours. Just write.

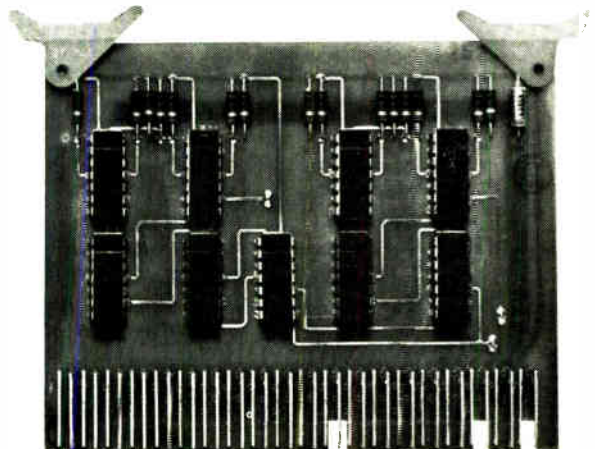

 **varian data machines**
a varian subsidiary

Formerly Decision Control, Inc.
1590 Monrovia Ave., Newport Beach, Calif.
TEL (714) 646-9371 TWX (910) 596-1358



One Gift Works Many Wonders
THE UNITED WAY

GIANNINI

on intervalometers

"Our programmable intervalometers can handle just about any sequencing operation you can think of, where precise timing is required. They're probably the most versatile gadgets of their type available."



The unit shown above, for example, is programmable in both time and mode. We make others where the sequence, too, can be programmed from the face of the unit. You can select the time interval, with 5% accuracy, from 100 milliseconds to 9.99 seconds, in 0.01 second increments. They are simple to operate, and extremely reliable.

These are the first programmable intervalometers, to be specifically designed for military airborne use. They meet the environmental requirements of MIL-STD-810. All the armature and stepping relays are manufactured by us, and conform to MIL-R-6106.

If you write us your needs or simply your name and address, we will mail you our data sheet, unless you are in a real rush, in which case please phone us at (213) 723-3371. Ask for Duane Manning."

Gabriel M. Giannini

Giannini

P.O. Box A-A, Irvine, California 92664 • (714) 540-9010
Plants in Whittier, Costa Mesa and San Diego
An Independent Company/An Equal Opportunity Employer

New Literature

A-c regulators. Electronic Research Associates, Inc., 67 Sand Park Rd., Cedar Grove, N.J. 07009. Catalog 153 describes a line of solid state, fast-acting a-c regulators.
Circle 446 on reader service card

Fixed coaxial attenuators. Weinschel Engineering, Gaithersburg, Md. 20760, offers a data sheet describing series 1 and 2 precision fixed coaxial attenuators available in 10 values from 3 to 80 db. [447]

Bimetal thermostat. Elmwood Sensors Inc., 1655 Elmwood Ave., Cranston, R.I. 02907. Snap-acting, precision bimetal thermostat No. 3450, measuring 0.390 x 0.625 in., is described in bulletin 900. [448]

Flexible printed circuitry. Sanders Associates Inc., Granier Field, Manchester, N. H. 03103. Electrical characteristics, design information and a variety of applications of Flexprint circuitry are described in a 14-page handbook. [449]

Module tester. Radio Engineering Laboratories, 29-01 Borden Ave., Long Island City, N.Y. 11101, has available literature on a module test fixture designed to be used in conjunction with its 2600 series radio relay equipment. [450]

Tunable oscillator. Solid State Electronics Corp., 15321 Rayen St., Sepulveda, Calif. 91343, offers a bulletin describing the model S-300 silicon transistor tunable oscillator. [451]

Laser system. Space Ordnance Systems Inc., 122 Penn St., El Segundo, Calif. 90245, has available a four-page brochure on its Macro-Pak portable neodymium laser system. [452]

Audio connectors. ITT Cannon Electric division of International Telephone and Telegraph Corp., 3208 Humboldt St., Los Angeles 90031, has published catalog AUD-4 covering a series of audio connectors. [453]

Transducers. Consolidated Controls Corp., Bethel, Conn. 06801. A single-sheet bulletin contains complete specifications and fully dimensioned drawings for pressure-to-pulse-rate output transducer type 41PF8. [454]

Head demagnetizer. Ampex Corp., 401 Broadway, Redwood City, Calif. 94063. Description, instructions and specifications of the model HD-16 hand-held head demagnetizer for instrumentation tape recorders are included in data sheet D083. [455]

Pulse height analyzer. Hamner Electronics Co., 1945 E. 97th St., Cleveland, Ohio 44106. Technical bulletin NC-15 describes a time-stable pulse

height analyzer for high-counting-rate applications. [456]

Push-button switches. Nexus Inc., Stamford, Conn. 06902. A six-page folder offers specifications on momentary and push-pull switches for military and commercial applications. [457]

Boron nitrides. The Carborundum Co., Niagara Falls, N.Y. 14300. A 12-page brochure includes detailed application information and tabular and graphical property data for Combat boron nitride solids, powders and coatings. [458]

Microwave packaging. Sage Laboratories Inc., 3 Huron Drive, Natick, Mass. 01760, has available a 40-page system designer's guide to microwave packaging. [459]

Flat ribbon cable. Spectra-Strip Corp., Box 415, Garden Grove, Calif. 92640, has issued a 12-page capabilities brochure and short-form product catalog on flat-ribbon cable and related products. [460]

Heat sink nomograph. Astrodyne Inc., 207 Cambridge St., Burlington, Mass. 01803, has published a nomograph that permits determination of total heat-sink area required for cooling semiconductor devices. [461]

Mass core memory. Ampex Corp., 401 Broadway, Redwood City, Calif. 94063. Specifications, functional block diagram and general description of the 20-million-bit model RM mass core memory are contained in brochure CO38. [462]

Sealed capacitors. Film Capacitors Inc., 100 Eighth St., Passaic, N.J. 07055, has issued an engineering bulletin covering type E4 polycarbonate hermetically sealed capacitors. [463]

Circular connectors. Elco Corp., Willow Grove, Pa. 19090. A 12-page catalog describes and illustrates in detail a complete line of circular connectors manufactured to conform to MIL-C-26500. [464]

Magnetic core memory. Ampex Corp., 401 Broadway, Redwood City, Calif. 94063. Description, user information and specifications of the model RG magnetic core memory are included in brochure CO34. [465]

A/D converter. Aero Geo Astro, a division of Aiken Industries Inc., 4810 Calvert Road, College Park, Md. 20740, offers a single-sheet bulletin on the model 801 analog-to-digital converter for economical conversion of analog data to 8 bits of binary data at a 1-Mhz word rate. [466]

MICO

NEW MODEL 885 SEVEN RATIO WIDE-RANGE ENGRAVER

NO. 885

FOR LONG AND
MULTI-LINE WORK

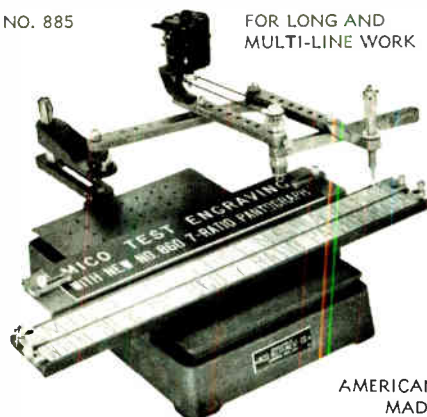

AMERICAN
MADE

- A time-saver for large plate work
- Engraves 3" x 19" area in one set-up.
- Seven pantograph ratios—from 1:5:1 to 6:1.
- Choice of 3-ball-bearing spindle assemblies for 1/4", 3/16" or taper-shank cutters.
- HSS, COBALT and Solid Carbide Cutters.
- Single and multi-line copy carriers for holding blanks 3/4" to 3 1/2" high.
- Accommodates Mico standard accessories.

Send for bulletins and prices

MICO INSTRUMENT CO.

77 Trowbridge St. Cambridge, Mass. 02138
Circle 335 on reader service card

BEST vacuum THERMOCOUPLES



Used by prominent instrument manufacturers in the U.S. and abroad for • true RMS measurement • transfer standards • sum and difference multipliers • low range UHF applications.

For example, a matched pair of Best thermocouples contributes to the outstanding accuracy of the 9500A

FLUKE
RMS
digital
voltmeter



If you are designing or manufacturing an AC instrument, why not make it true RMS?

Standard and UHF patterns; high output and square law models; matched pairs. See Sec. 5300, EEM. Catalog on request. For free application notes, write on company letterhead to

**BEST ELECTRICS DIV.
HARRY LEVINSON CO.**

1211 E. Denny Way, Seattle, Wash. 98122
Tel. (206) 323-5100 TWX 910-444-2154

New Literature

Low pass filter. Kappa Networks Inc., 165 Roosevelt Ave., Carteret, N.J. 07008. Bulletin 68-1 describes the model 552 series low pass filter designed for p-c board applications. [467]

Display terminal. Transistor Electronics Corp., Box 6191, Minneapolis 55424. Brochure 639 describes the Data-Screen display terminal, an input/output crt display system. [468]

Quartz crystals. Bulova Watch Co., 61-20 Woodside Ave., Woodside, N.Y. 11377, has published a 16-page illustrated catalog detailing its complete line of quartz crystal resonators from 1 khz to 150 Mhz. [469]

Converter. Airborne Accessories Corp., 1414 Chestnut Ave., Hillside, N.J. 07205. Bulletin PS-20 describes model 1000 millivolt to milliamp converter, a universal temperature transmitter with an accuracy of $\pm 0.2\%$. [470]

Coaxial slotted line. Alford Manufacturing Co., 120 Cross St., Winchester, Mass. 01890. Bulletin 703 describes a 3.5-mm coaxial slotted line for the 2- to 36-Ghz frequency range. [471]

Indicator lights. Dialight Corp., 60 Stewart Ave., Brooklyn, N.Y. 11237. Catalog L-203 presents a complete line of ultraminiature indicator lights for rear mounting in 3/8 in. clearance hole. [472]

High temperature adhesive. Aremco Products Inc., P.O. Box 145, Briarcliff Manor, N.Y. 10510. Product bulletin 516 deals with Ultra-Temp 516, a ceramic adhesive for use at temperatures up to 4,400°F. [473]

Filters. American Electronic Laboratories Inc., P.O. Box 552PC, Lansdale, Pa. 19446, has available a 16-page brochure delineating its line of standard and custom filters in the frequency range from 2 Mhz to 18 Ghz. [474]

I-f recorder test set. Radio Engineering Laboratories, 29-01 Borden Ave., Long Island City, N.Y. 11101, has released a bulletin covering an adjustable-bandwidth, i-f recorder test set. [475]

Fractional h-p motors. McLean Engineering Laboratories, Princeton, Junction, N.J. 08550. A six-page short form catalog on fractional h-p motors presents the company's line of MIL-Spec and commercial permanent split-capacitor motors. [476]

Xenon flashtubes. EG&G Inc., 160 Brookline Ave., Boston, Mass. 02215, has issued a catalog containing information and specifications for its expanding line of internally triggered xenon flashtubes. [477]

Monolithic capacitors

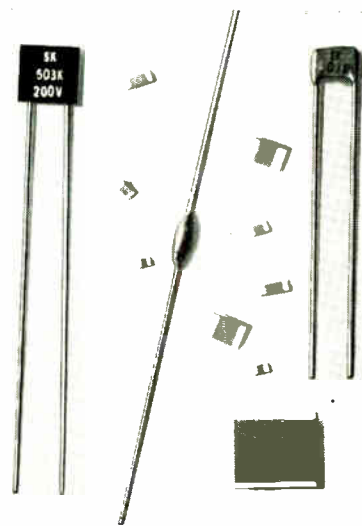

components and chips shown actual size

If you need microminiature size and the ultimate in reliability—you need SKottie monolithic capacitors.

SKottie monolithics provide the highest capacitance per unit volume available. And monolithic construction makes these capacitors practically immune to their environment. They offer the double protection of fused ceramic plus epoxy or phenolic encapsulation.

Both capacitors and chips are available in values ranging from 1.0 pf to 1.0 Mfd and higher in three dielectric materials. The chips are ideally suited for hybrid integrated circuits and can be soldered directly to the substrate. They can be supplied either tinned or untinned and also in special terminations other than silver. SKottie monolithic capacitors are available molded, dipped, or unencapsulated in both axial and radial lead configurations.

Write on your company letterhead for test samples. Ask for bulletin 6801 for more detailed information.

**SKOTTIE
ELECTRONICS, INC.**

Subsidiary of Renwell Industries, Inc.
Line St., Archbald, Penna. 18403
Ph: 717-876-1686 TWX: 510-656-2979

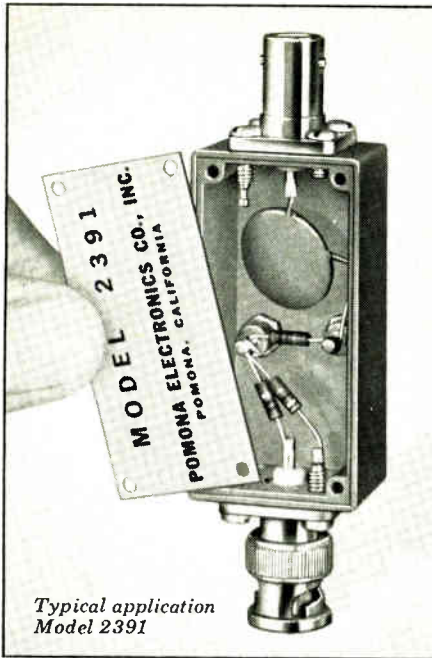

SHIELDED BLACK BOXES

To package,
protect and
SHIELD
custom test circuits

(voltage dividers, attenuators, isolation and impedance, networks, etc.). Rugged die-cast aluminum box with aluminum cover, available in 16 different connector combinations. Write for free catalog.

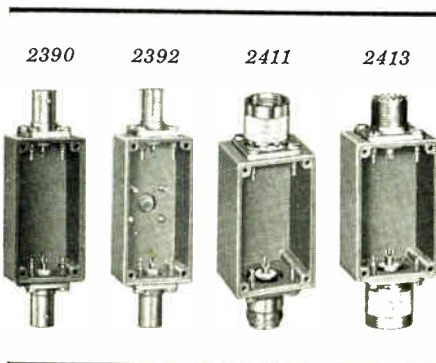

POMONA
ELECTRONICS CO., INC.
1500 E. Ninth Street, Pomona, Calif. 91766

New Literature

Strip chart recorders. Simpson Electric Co., 5200 W. Kinzie St., Chicago, Ill. 60644, has published a four-page folder giving complete details on the model 2750 precision low-speed strip chart recorders. [478]

H-f antenna systems. Delta Electronics Inc., 4206 Wheeler Ave., Alexandria, Va. 22304. An eight-page short-form catalog describes high power antenna switching matrices with manual and remote control for coaxial and balanced transmission lines. [479]

Inband signaling units. Quindar Electronics Inc., 60 Fadem Road, Springfield, N.J. 07081, has available bulletin 114 on its QT-QR-18 inband signaling units with plug-in adaptors for 600 or 10,000 ohms input/output impedance. [480]

Integrating microvoltmeter. Doric Scientific Corp., 7969 Engineer Road, San Diego, Calif. 92111. Bulletin D100-E illustrates and describes an automatic integrating microvoltmeter with transducer conditioning for physical and scientific measurement. [481]

Logic assemblies. Cambridge Thermionic Corp., 445 Concord Ave., Cambridge, Mass. 02138, announces a 96-page catalog providing detailed technical data on its complete line of integrated-circuit logic assemblies and accessories. [482]

Varactors. Micro State Electronics, 152 Floral Ave., Murray Hill, N.J. 07974. Bulletin D-103 covers a line of gallium-arsenide Micropill varactors for parametric amplifiers, harmonic generators, and switches. [483]

Coaxial diode limiters. Microwave Associates Inc., Burlington, Mass. 01803. Bulletin 7039 contains technical information on a series of broadband, fast-recovery, coaxial diode limiters. [484]

Power supply. Quindar Electronics Inc., 60 Fadem Rd., Springfield, N.J. 07081. Bulletin 138 covers the QP-17 solid state power supply designed to provide 1700 ma at 12 v d-c for supervisory control, telemetering, and audio tone equipment. [485]

Alternator/stator winder. Possis Machine Corp., 825 Rhode Island Ave. South, Minneapolis 55426. Two-page bulletin 6712 describes the model PAW-15A automatic alternator/stator winder. [486]

Motor speed controls. Sterling Electric Motors Inc., 5901 Telegraph Rd., Los Angeles 90022. A six-page technical bulletin describes new rotating and solid state variable frequency speed controls for one or more a-c slave motors. [487]

Pain killer.

If vendors have you in a pinch and another source of supply will help, turn to the Electronics Buyers' Guide. You'll find all the information you need on over 1,363 sources of power supplies, listed under 11 headings from *AC Regulated Power Supplies* to *Laser Power Supplies*.



Electronics Buyers' Guide
A McGraw-Hill Market Directed Publication,
330 West 42nd Street, New York, N.Y. 10036



EMPLOYMENT OPPORTUNITIES

The Scientists and Engineers served by Corcoran in the last year have found the difference between "a job" and "the job."

- Nationwide. Fee paid.
- Please airmail background to:

JOSEPH P. CORCORAN
Personnel Consultants

505 B Germantown Pike
Lafayette Hill, Pa. 19444
Member IEEE

CIRCLE 966 ON READER SERVICE CARD

CLASSIFIED ADVERTISING



SEARCHLIGHT SECTION

BUSINESS OPPORTUNITIES
USED OR SURPLUS EQUIPMENT

SURPLUS IBM EQUIPMENT

28 page catalog of powers supplies, light & switch panels, semiconductors, test equipment, IC's, optics, etc.

GADGETEERS SURPLUS ELECTRONICS, Inc.
5300 Vine St. Cincinnati, Ohio 45217

CIRCLE 967 ON READER SERVICE CARD

Minifluid DISPENSER

for miniature potting and encapsulating

Available in 3 sizes
6cc 10cc 30cc



\$34.00 UP

PHILIP FISHMAN COMPANY
7 CAMERON ST. WELLESLEY, MASSACHUSETTS 02181

CIRCLE 968 ON READER SERVICE CARD

RADAR SYSTEMS GROUND AND AIRBORNE, AUTOMATIC TRACKING ANTENNA SYSTEMS, NIKE AJAX, NIKE HERCULES, M-33, MSO-1A, MPS-19, MPS-9, SCR 584, TPS-1D, TPS-2B, FAA-ASR-2, AIRBORNE SYSTEMS A*P-N-84, APN-102, APS-20, APS-27, APS-45, DPN-19, DIGITAL COMPUTERS, IBM 650, IBM 704

LARGEST INVENTORY OF RADAR AND MICROWAVE EQUIPMENT IN THE WORLD.
RADIO RESEARCH INSTRUMENT CO.
45 WEST 45TH ST. N. Y. 10036 212-JU 6-4691

CIRCLE 969 ON READER SERVICE CARD

*Somebody—
Somewhere,*

needs your idle equipment!
Reach that buyer quickly and economically thru the

"SEARCHLIGHT SECTION"

*The meeting place of Used
Equipment Buyers and Sellers*

ELECTRONIC ENGINEERS

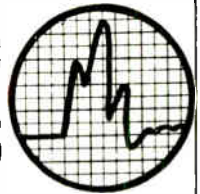

**Growth
Advancement
Salary
Recognition**

We will provide these ingredients for a strong design background in RF circuitry

Hoffman

ELECTRONICS CORPORATION

Send your resume to R. S. Lawrence
4323 Arden Drive, El Monte, Calif. 91734
... an equal opportunity employer ...

CIRCLE 970 ON READER SERVICE CARD

Today's brand new ocean opens your brand of engineering career opportunity.

Newport News, world's largest and most advanced shipbuilding company—involved with all today's revolutionary marine developments—has immediate career openings in all these engineering fields:

Mechanical Engineers
Electrical Engineers
Marine Engineers
Industrial Engineers
Naval Architects
Nuclear Engineers

Civil Engineers
Metallurgical Engineers
Data Programmers
Systems Analysts
Chemists
Laboratory Analysts

With an order backlog now over \$500,000,000, we're bidding for creative engineers who like challenges and personal responsibility. Write our employment manager, John J. Gaughan. You'll get fast action.



Newport News

SHIPBUILDING AND DRY DOCK COMPANY, NEWPORT NEWS, VIRGINIA

An Equal Opportunity Employer

CIRCLE 971 ON READER SERVICE CARD

**The new AO
StereoStar/ZOOM
Microscope
gives you high
resolution,
new convenience,
superior optics
and wide
magnification
range.**

Here are a few of the outstanding advantages that make the new AO[®] StereoStar/ZOOM Microscope the finest instrument of this type available today:

- Widest total magnification range: 3.5–210X
- High resolution to meet the most exacting needs
- The most convenient zoom control available
- Choice of five interchangeable, rotatable zoom power bodies
- Crisp, sharp images at all magnifications
- Extra large field of view and high eyepoint eyepieces
- Wide choice of stands for every purpose
- Long working distance
- Even illumination over the entire field
- Coolest operating illuminator.

See for yourself. Contact your AO Sales Representative for a demonstration, or write for our 24-page, full-color brochure on the newest in stereo microscopes—the AO StereoStar/ZOOM.

*TM Reg., American Optical Co.



**AO INSTRUMENT
COMPANY**

SCIENTIFIC INSTRUMENT DIVISION
BUFFALO, N.Y. 14215

Formerly Instrument Division of AMERICAN OPTICAL COMPANY

Circle 266 on reader service card

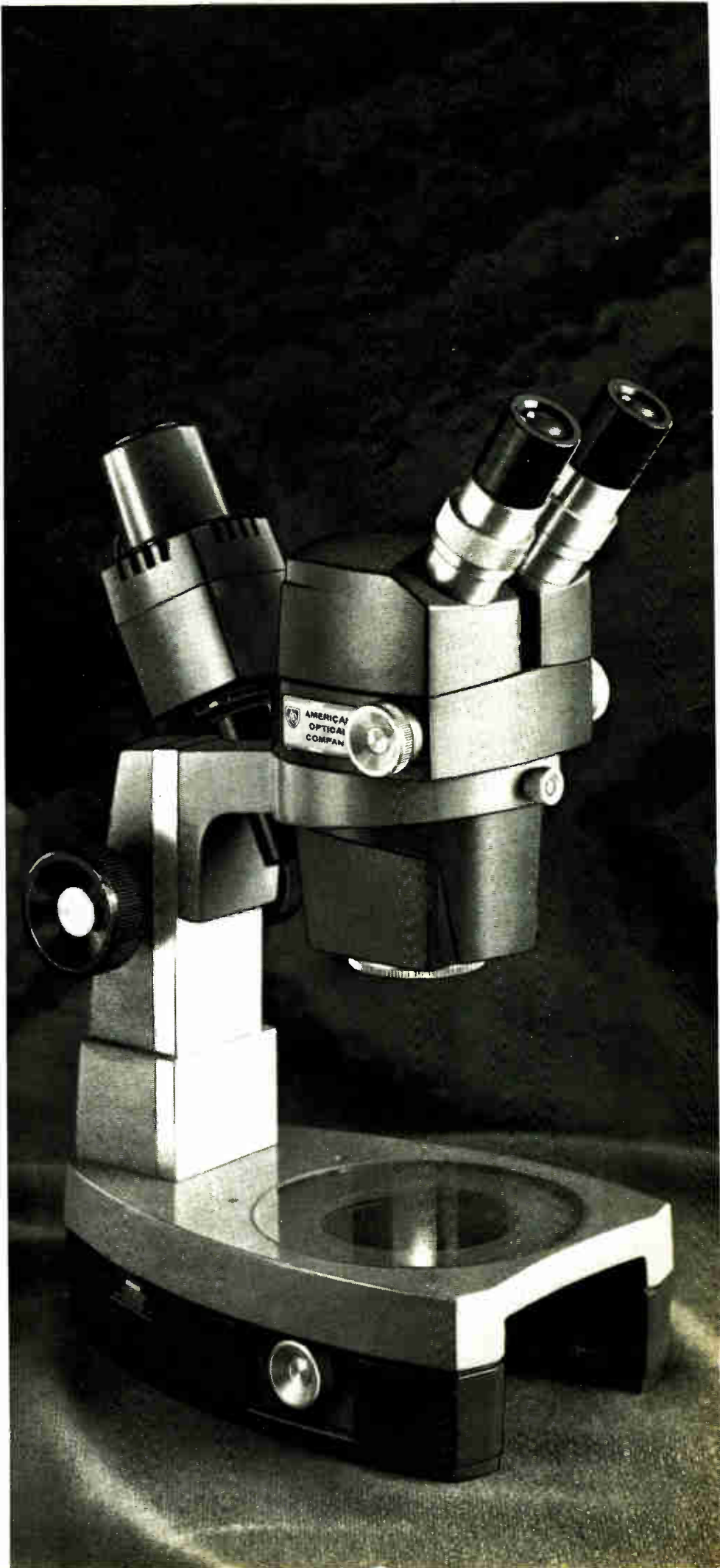

Newsletter from Abroad

April 15, 1968

France zeroes in on instruments . . .

The French government has launched the third in its series of moves to strengthen the domestic electronics industry through financial aid and mergers. The latest scheme, Plan Mesure, is designed to help instrument makers.

But industry leaders suspect the government won't back Plan Mesure with muscle. Their estimate is based on the mixed results of the other two drives. There has been considerable support for the computer industry under Plan Calcul, but the components effort, announced a year ago as Plan Composants, hasn't produced more than a few million dollars in aid.

There's little doubt that instrumentation is a sector where the French need help. The vast complex of state-run research organizations buys half of its measuring instruments abroad, almost entirely from the United States. The percentage of foreign-bought instruments is even higher in the private sector.

Plan Mesure will have a tough row to hoe. There are more than 50 manufacturers, many of them small, family-owned firms, jealous of their identity. In components, as a comparison, there are five major companies, two of which have merged their component activities.

. . . as Collins Radio decides to back out

French electronics executives are breathing easier now that the Collins Radio Co. has shelved for at least five years plans to build an instrument plant in France. Collins says it withdraw because of heavy new investments in the United States and the balance of payments deficit.

Many French industry leaders had viewed Collins' interest, abetted by the Finance Ministry, as a repeat of the great semiconductor assault when U.S. companies flooded the country.

Sanyo calculators shift to the MOS

Development of electronic calculators is getting to be a habit with the Japanese. The newest arrivals are the Sanyo Electric Co.'s 12-, 14-, and 16-digit models. The firm says it's the first in Japan to use bipolar diode-transistor logic for control and gate functions and metal-oxide-semiconductor shift registers for register and memory functions. Sanyo uses transistors and diodes to interface these two types of circuits and to interface the readout. Other Japanese calculators use cores, delay lines, or bipolar multivibrators where Sanyo uses the MOS shift registers.

The company will start domestic sales later this year but is already shipping export orders. The 12-digit model costs \$555, the 14-digit \$695, and the 16-digit \$830.

Symphonie officials fear U.S. parts ban

French and German managers of the Symphonie communications-satellite project are asking European companies to develop launcher components that would normally be supplied by U.S. firms. Symphonie will compete with the Comsat-controlled system sponsored by the International Telecommunications Satellite Consortium (Intelsat), and European space officials fear the U.S. will do everything possible to stall it—including slapping an embargo on American-made electronic components.

The parts in question would be used in the booster's apogee and

Newsletter from Abroad

perigee motors. And West Germany's Boelkow combine, contractor for Symphonie's third-stage guidance and control engines, has been trying lately to interest German companies in developing replacements.

Franco-German fears of a parts squeeze have so far been fed only by isolated incidents. A French company says it had to design its own traveling-wave tubes, for example, because the U.S. wouldn't grant export licenses to would-be American suppliers. And while U.S. firms are helping to develop noncommercial European scientific satellites, none has been permitted to offer even advisory aid to the teams vying for Symphonie contracts.

French seeking to end GE deal

General Electric Co., under President de Gaulle's pressure to get out of the French semiconductor business, is selling its 49% interest in the Societe Europeenne des Semiconducteurs, which it established in 1962 with the Compagnie Francaise Thomson Houston-Hotchkiss Brandt.

At the same time, GE is renegotiating a 50-year-old agreement with Thomson Houston in which the French company pays royalties for GE know-how covering a broad area. Lately, however, Thomson Houston has been increasingly dissatisfied. Although both parties feel that the agreement should be updated, they're miles apart on fees.

Some ranking Thomson Houston officials, however, want to get out of the accord altogether, and GE lawyers are now reviewing the phone-book-size agreement to establish Thomson Houston's withdrawal rights. Chances are the French company would have to pay GE a whopping termination fee.

Raytheon closing Italian tube plant

The 900 workers at the Raytheon-Elsi cathode-ray tube plant near Palermo, Sicily, are being laid off as the plant closes. The company blames sagging black-and-white set sales in 1967, with no improvement in sight, and the plant's distance from major set makers, most of which are in the north. The mass layoff has triggered some demonstrations and sympathy strikes.

Swiss, Germans soup up rocket

Switzerland's Contraves AG and West Germany's Dornier System GmH are developing a more powerful version of their Zenit research rocket. The new high-altitude rocket will have an operational ceiling of 180 miles and will be capable of carrying a payload of 110 pounds. The highest Zenit can now soar to is 123 miles, with a 55-pound payload—but at lower altitudes it can carry up to 280 pounds.

The two firms are eyeing the growing European market for space hardware—the European Space Research Organization alone will need about 200 instrument-carrying rockets over the next five years, West Germany itself about 70.

Addenda

The giant Russian exhibit at Rome's electronics show is casting political shadows. With general elections coming up, many Italian politicians view the Soviet effort as an attempt to help the nation's declining but still powerful Communist party. . . . The British Decca Navigator Co. has granted ITT the South American manufacturing and marketing rights to its sea and air navigation systems—subjects of a patent dispute between the firms [Electronics, July 10, 1967, p. 189].

NEW LOWER PRICES

NEW TEST DATA FOR CTS INDESTRUCTIBLE CERMET SEMI-PRECISION RESISTOR NETWORKS

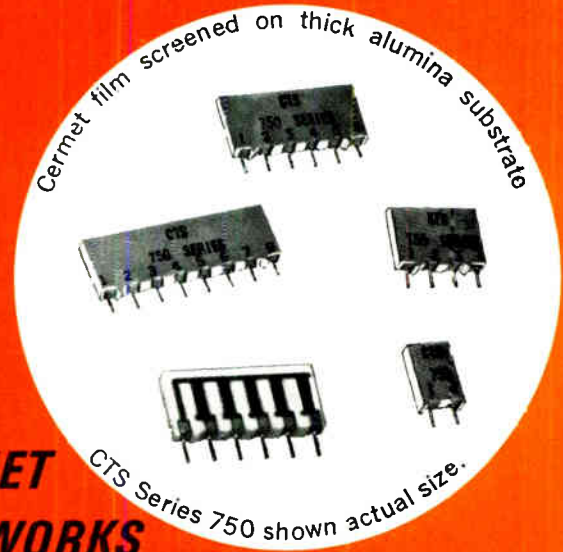

Series 750	2-Pin (1 Resistor)	4-Pin (3 Resistors)	6-Pin (5 Resistors)	8-Pin (7 Resistors)
Total Module Load	0.5 Watts	1.0 Watts	1.5 Watts	2.0 Watts
Approx. 10,000 cost	17¢ \$0.92 ea.	18¢ \$0.94 ea.	21¢ \$0.96 ea.	26¢ \$0.91 ea.

STANDARD MODULE SPECIFICATIONS FOR ALL SIZES	
Resistance Range	50 Ω to 100K Ω
Resistive Tolerance	$\pm 5.0\%$
TC	± 300 ppm/ $^{\circ}$ C
Load Life: 0.1 W per resistor at 70 $^{\circ}$ C, 1000 hrs. (Over 4,000,000 resistor hours)	$\pm 0.40\%$ Δ R max. $\pm 0.20\%$ Δ R av.
Moisture Resistance: .1 rated wattage at 70 $^{\circ}$ C, 90-98% humidity, 1000 hrs.	$\pm 0.50\%$ Δ R max. $\pm 0.20\%$ Δ R av.
Insulation Resistance: measured wet after moisture resistance test, 200 VDC	500 meg. Ω
Thermal Shock: 5 cycles, -63 $^{\circ}$ C to +125 $^{\circ}$ C, no load	$\pm 0.10\%$ Δ R max. $\pm 0.03\%$ Δ R av.
Short Time Overload: 2.5 times rated voltage, 5 sec.	$\pm 0.25\%$ Δ R max. $\pm 0.05\%$ Δ R av.
Low Temperature Exposure: -63 $^{\circ}$ C, 4 hrs.	$\pm 0.10\%$ Δ R max. $\pm 0.04\%$ Δ R av.
Terminal Strength: 5 lb. tensile & compression, 30 sec.	$\pm 0.10\%$ Δ R max. $\pm 0.03\%$ Δ R av.
Effect of Soldering: 63/37 solder, 246 $^{\circ}$ C, 2 sec.	$\pm 0.10\%$ Δ R max. $\pm 0.05\%$ Δ R av.

The data speaks for itself. Examine and judge its value for your application :

Extreme Stability and Reliability
High Power Capability: (Up to 1 watt per resistor)

- Space saving—a single module replaces up to 7 discrete resistors.
- Available in an infinite number of circuit combinations.
- Custom-built to your exact requirement.
- Ideally suited for cost-saving automatic handling.
- Cover coating unaffected by solvents.

founded 1896 Request Cermet Catalog

CTS
OF BERNE, INC.
BERNE, INDIANA

SUBSIDIARY OF
CTS CORPORATION • ELKHART, INDIANA

Extra cost options	
Resistance Range	10 to 49 Ω , 101K to 1 meg. Ω
Resistance Spread	Over 10 to 1
Resistive Tolerance	$\pm 0.5\%$, 1%, 2.5%
TC	± 150 ppm/ $^{\circ}$ C

We've got op amps like nobody's got op amps.

1. VERY LOW POWER

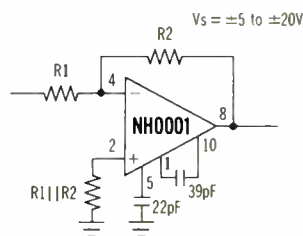

The typical dissipation of the NH0001 is but 1.8mW at $V_s = \pm 15V$ and 0.6mW at $V_s = \pm 6V$. Something of a record, no? And further, the mighty NH0001 will deliver over $\pm 10V$ into a 2K load from $V_s = \pm 15V$ supplies. It's priced at \$18.00 in 100 to 999 quantities.

2. GENERAL PURPOSE

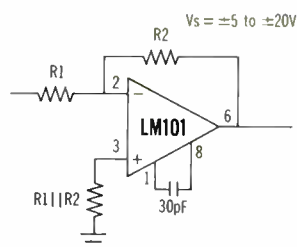

Old faithful LM101 is both general purpose and no-sweat in operation. It's short-circuit proof and has a large differential input voltage allowance. Moreover, frequency compensation is simple, and there is no latch-up problem. The price is \$10.00 in 100 to 999 quantities. (There is also a commercial version, the LM201, priced at \$8.80.)

3. FULLY COMPENSATED, GENERAL PURPOSE

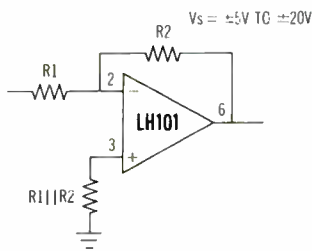

The LH101 is kin to the LM101. The essential difference is that all the required frequency compensation is *inside* the package. Current drain is low, even with the output saturated. There is no latch-up when common mode range is exceeded and there's continuous short circuit protection. Price for 100 to 999 is \$48.00. The commercial version LH201 is \$11.40.

4. HIGH SLEW RATE VOLTAGE FOLLOWER

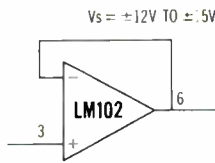

The LM102 voltage follower is the first monolithic amplifier that has combined low input current with high speed. Slew rate is $10V/\mu s$. The maximum input current is an incredible $10nA$. Input currents better than $10nA$ at $125^\circ C$ are guaranteed. The price: \$30.00 each in 100 to 999 quantities. The $-25^\circ C$ to $+85^\circ C$ LM202 is priced at \$12.00, LM302 commercial at \$5.40.

5. HIGH OUTPUT CURRENT

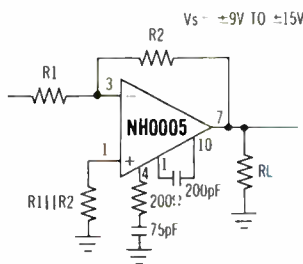

When we say high output current, we *mean* high. The output current on this, the NH0005, is $\pm 50mA$ into a 100Ω load. The price in 100 to 999 quantities is \$45.00. And there's a commercial version, the NH005C, priced at \$22.50.

6. VERY HIGH OUTPUT CURRENT, WITH BUFFER

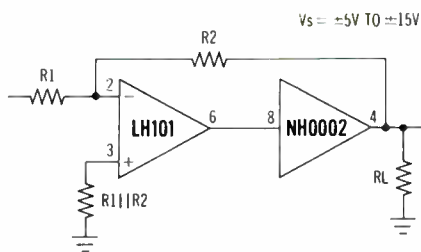

The NH0002 is something else. It has an output current of $\pm 300mA$ into a load of 50Ω . The NH0002 buffer is useful in the loop in all your high current op amp applications. The price is \$20.00 in 100 to 999 quantities.

If you'd like op amps like we've got, write National Semiconductor Corporation, 2975 San Ysidro Way, Santa Clara, California 95051.

National Semiconductor

This new idea ended an era in data recording.

August, 1967, Varian introduced to the world the electrostatic recorder: Statos™, first significant advance in its field in over 10 years. At a stroke, it obsoleted all other methods of graphic data recording.

Statos writing heads have up to 100 data styli per 40 mm. A simple thing. Statos has no moving parts except the paper drive. The signal is impressed on paper by a fixed recording head driven by transistorized preamps and IC digital logic. There is no arcing, burning or post-fixing of paper, nothing to introduce inertia into the writing system. Think what this does to operation. And reliability. With no pens to adjust, ink to spill, solutions to mix, Statos sets up in one minute. You have no galvanometers to calibrate or replace, and off-scale signals have no adverse effect on Statos whatsoever. And it uses blank paper. Prints its own chart as it records data. You change chart formats by switching rollers, and never have to stock more than one kind of paper.

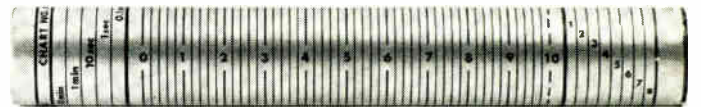
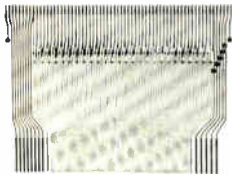

Typical Statos chart grid roller.

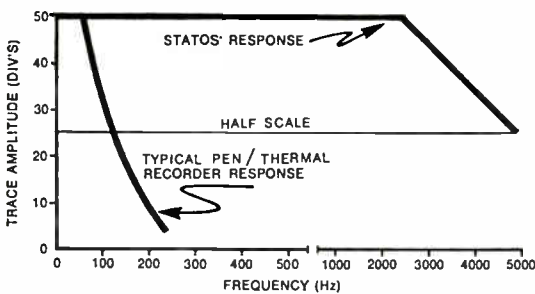

Frequency response and rise time. Compare response curves for pen/thermal recorders with Statos' full-scale amplitude past 1500 Hz. LBOs go higher, of course, but at the expense of accuracy—a parameter that remains constant in Statos. And while direct-writing recorders claim about 4 ms rise time between 10% and 90% of full scale, we go from 0% to 100% in 0.2 ms.

Accuracy, anyone? About the closest you get to an accuracy spec for a direct-writing recorder is "linearity." Here's what we say. At any frequency from DC to 1500 Hz, our written record shows the input signal's value within 1% of full scale, including effects of paper movement, plus non-linearity, plus hysteresis, plus overshoot...you name it!

Resolution. Statos has a digitized readout, but don't let that fool you. With over 50 styli to the inch, our writing head's pattern is fine enough to show any signal within our frequency limits. And our 50 cm/sec chart speed (250% that of direct-writing recorders) gives you the time-base resolution you need at higher frequencies (for instance, 25 cycles per inch of chart at 500 Hz).

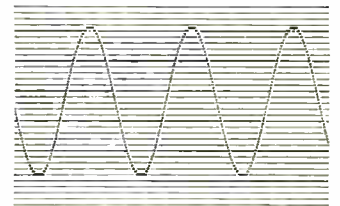

Actual size sine wave recorded on Statos.

One last word: versatile. With IC digital logic an integral part of its nature, Statos interfaces with computers as real-time output device (no D/A converter or buffer needed) or input monitor for either digital or analog data (since it accepts analog and/or BCD inputs). Its variable recording speed DC motor lets you slave paper speed to external test equipment. And more, much more. That's why we said all those other recorders are obsolete. They are. Statos did it. Send for data from Sales Manager, Varian Recorder Division, 611 Hansen Way, Palo Alto, California 94303. International offices in Zug, Switzerland and Sydney, Australia.



varian
recorder division

Statos.

The electrostatic recorder.

Statos III shown here is an 8-channel analog/digital rack-mounted model complete with preamps. Paper speeds from 0.05 to 50 cm/sec. Also in the Statos line, but not shown here, are:

Statos I, a 3-channel general purpose recorder, either desk-top or rack mounted. Four models are available, offering paper speeds to 50 cm/sec, a variety of input voltage ranges, and various combinations of analog and/or digital inputs.

Statos II, a binary event recorder, either desk-top or rack mounted. Three models are available, recording either 50, 75 or 100 simultaneous events at paper speeds to 50 cm/sec.





**lower
attenuation...**

**higher
power**

8" diameter flexible HELIAX® coaxial cable

8" Air dielectric HELIAX coax extends the advantages of flexible cable to very low attenuation or very high power applications that formerly required rigid transmission line.

Corrugated inner and outer copper conductors accommodate thermal expansion without the need for sliding contacts. End connectors mate with 6 1/8" EIA flanges and lock inner and outer conductors together to eliminate differential expansion.

The continuous, connector free cable assures freedom from the VSWR "spikes" associated with the periodic inner connectors of rigid line in a long feeder. Cable assemblies can easily be electrically tested on the reel to assure your exact system performance. For complete details write Andrew Corporation, 10500 West 153rd Street, Orland Park, Illinois 60462.

HJ 10-50 HELIAX COAXIAL CABLE

	At 30 MHz	At 600 MHz
Attenuation	.027 dB/100 ft	.15 dB/100 ft
Average Power	300 kW	58 kW
Other Power Ratings	For SSB, 200 kW PEP with antenna VSWR of 3:1 2 Megawatts Peak	TV transmitter power ratings, 223 kW at Channel 4 and 70 kW at Channel 35



2-68

Great Britain

Track record

Hard hit by the rise of the automobile, British Rail is constantly on the lookout for ways to run its trains more efficiently.

One long-off day, the government-owned railway hopes to have trains without engineers clicking along its tracks. But that will be at the end of the automation line. Meanwhile British Rail researchers have settled already on a technique—induction coils and binary coding—that they feel will work for a whole range of controls, from simple setups to complex systems.

British Rail expects to start trying out prototypes of its basic hardware before the end of the year on a 6½-mile test track. The line's researchers are at work also on a small computer to pair with their building-block units. How fast the mating will come depends in large measure on how well the coils perform in their first trials.

Looped. Basic to the system are groups of coils—up to 32 of them—connected in series to form a track loop. The coils will be mounted on the track's ties. On the train, there's a 50-kilohertz oscillator to excite the loop as the train passes over it. There's also a receiver to sense the magnetic fields set up by the coils.

The field direction can be either of two ways, depending on how the coil is connected into the loop. Thus the loop connections establish a 32-bit binary word to feed instructions from the track to the moving train. Binary "0's" and "1's" are sorted out by comparing the phase of the voltage pulses induced in the receiver as it passes over each coil on the track to the phase of the exciting oscillator output. The string of binary bits is then fed to decoding logic to extract the message for display.

Getting there. After it's proved out the fundamental system, British Rail most likely will use it first to signal unchanging information like general speed limits for track sections, spotting coil groups about every half-mile. The 32-bit word will probably include an 8-bit address, a 16-bit message, and an 8-bit ending that indicates the distance to the next coil group. This last is necessary because the system will be set up to fail safe. It will automatically put on the brakes if the train passes over a signal group without the engineer acknowledging the message.

The next probable step is adding switchable coil arrays that could feed changing information like free and occupied blocks from the track to the cab.

After that, fast trains will get their small computers. Fed with constants like the train's weight, its length, its running schedule, and its brake power—plus the general speed limits picked up from the coil groups on the track—the computer would continuously display the maximum permissible speed for the train in question. The computer further would compare actual speed with the acceptable one and apply brakes automatically if necessary.

Light brigade

Her Majesty's cost-effectiveness experts figure there's an outlay of \$180 every time the Royal Army fires a round of tank ammunition. With the current drive to hold down government spending, that means tank crews get very little live gunnery practice.

Even when live rounds are available, all that tank gunners can shoot at are targets on firing ranges, quite a different thing from enemy tanks whose crewmen have ideas of their own about what should—and shouldn't be—blasted into smithereens.

To get around these limitations on battle training, Britain's Ministry of Defense may turn to the laser. Later this month, the ministry very likely will order preproduction versions of a mock gunnery system it calls the "direct-fire weapons effects simulator"—essentially an infrared laser projector that "fires" at detectors on "enemy" tanks.

Smoke signals. Solartron Electronic Group Ltd., a subsidiary of Schlumberger Ltd., developed the system in collaboration with the ministry. Details are a military secret, but Solartron has disclosed that the laser "gun"—the company

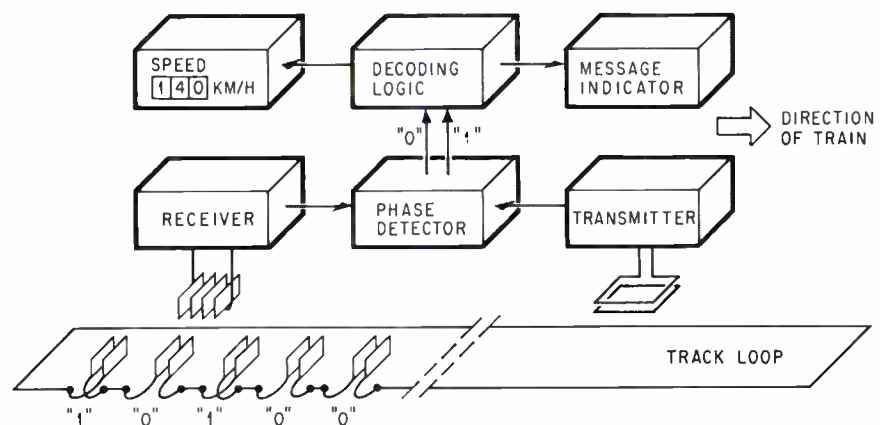

The connection. Binary code is set in track loop by the way that bit coils are wired into it. The system that British Rail has in mind will handle instructions with up to 32 bits.

says its infrared output is so low that it's harmless—mounts directly on the tank barrel. Detectors on the target tank actuate smoke bombs when there's a direct hit. Alternatively, the system can be set up so that the gunner sees a pair of flashing lights in his gunsight rather than a puff of smoke. For this effect, point-of-impact information is transmitted over a telemetry link from the target tank to the tank firing the laser.

Several other refinements give gunners an illusion of reality. For one thing, the straight-line laser path is offset to account for the trajectory of the type of ammunition being simulated. Further, the number of "rounds" available can be set into the transmitter so that a trigger-happy gunner runs out of shells as he would in battle.

The target apparatus, too, adds reality. It can be adjusted to reflect armor thickness so that a light "shell" smacking a heavy tank won't register a kill. The target detectors can be arranged to show whether shots are landing ahead of or behind the tank.

Sortie. It's a safe bet that other armies around the world are working on laser gunnery simulators. But none, apparently, has its system as far along as Solartron has. A ranking U.S. general, the company claims, rated the laser setup the most impressive gunnery simulator he'd ever seen. With that encouragement, Solartron will demonstrate the system to Pentagon officials this fall.

West Germany

Fit to be tied

Designers at Dornier GmbH seem to have crossed a helicopter with a barrage balloon to come up with their latest flying machine. Called the "Kibitzer," it's a tethered platform that uses rotor blades to lift as much as 120 pounds of electronic hardware to a height of nearly 1,000 feet and keep it there indefinitely.

Dornier engineers say the \$25,-

000 buoy-shaped platform, officially designated the DO-32K, can "fly" a variety of missions. Put a radar aboard, they explain, and the platform acts as a spotter of low-flying aircraft. Add a television camera and it becomes an observation station. Install a repeater and it turns into a communications-network link.

High wire. The tether, Dornier notes, could make an admirable long-wire antenna for low-frequency broadcasts. And the company's engineers are currently testing a direction-finding system whose antenna elements are mounted on the rotor blades.

Although the platform was developed under contract to the West German defense ministry, Dornier hopes to sell it eventually to broadcasters, weather watchers, and highway traffic controllers. The Kibitzer will make its debut later this month at the Hanover Air Show, and the German armed forces will get their first machines for tests and evaluation in the fall.

Hold it. The platform, powered by a pneumatically driven two-blade rotor, can climb up to its near 1,000-foot maximum altitude in five minutes. Once on station, it's held stabilized to within 1° by a system based on six gyros—two for each axis. The German subsidiary of the

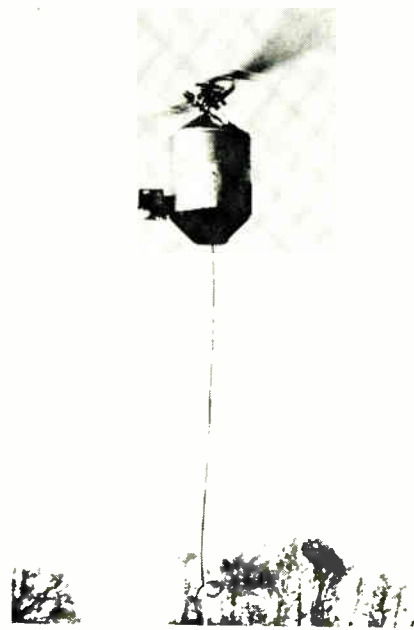

Tether's end. Capsule can climb to 1,000 feet to serve as lofty lookout.

Perkin-Elmer Corp. supplied the stabilization equipment.

To get unlimited air time for the platform, it's tied to its mobile ground carrier by a fuel hose as well as a tether. Fuel tanks on the platform can thus be continually replenished. If the air compressor system that drives the rotors konks out, the blades will free-wheel and the autogyro will prevent a crash landing.

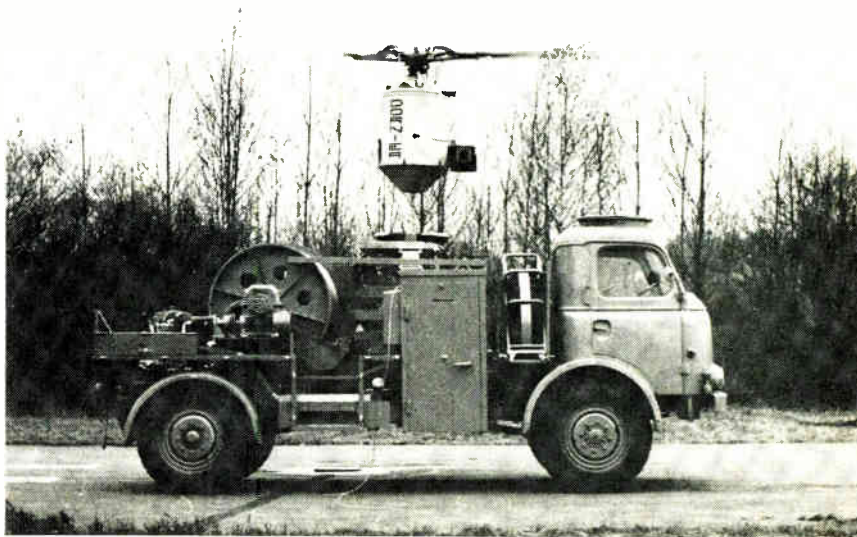

Ready to rise. West German kibitzing capsule for electronic gear rides its carrier to launching point.

Canada

Satellite in sight

Canada's chances of getting a domestic satellite communications network on the air by the early 1970's now seem better than ever.

As the government released its long-awaited White Paper on satellite communications early in April, Minister of Industry Charles Drury indicated there'd be no further heel-dragging in Ottawa on the effort to set up a \$100-million system. The initial reaction in Washington, whose accord is needed for the rockets to launch the satellites, implied there'd be little, if any, opposition.

Unless there's an unforeseen hitch, Drury will put enabling legislation for the scheme before the Canadian Parliament next fall. By then, the ruling Liberal Party should have settled back into the governmental groove after choosing a new leader to take over from retiring Prime Minister Lester Pearson.

High finance. What the government wants is a corporation that would make it partners with private enterprise. Finding them won't be hard. The country's common telecommunications carriers proposed much the same setup last year when they argued that Canada stake out a space claim soon [Electronics, June 26, 1967, p. 211]. Even earlier, a group backed by the Power Corp. of Canada had put in its bid to finance and operate a satellite network.

Still to be established is the division between government and private holdings in the upcoming corporation. R.M. MacIntosh, a Toronto banker, has been tapped to block out the financial and management structures. But whatever the share allotted for private interests, the government will retain control over operation.

Dozen? Essentially, the system called for in the White Paper is much like that proposed by the common carriers—two satellites parked in a stationary orbit over the equator at approximately the longitude of Winnipeg. But where

the earlier proposal called for 12 channels for each satellite, the government may decide to slash the number to four, although it has not ruled out the larger spacecraft. With four channels, Drury claims, the system could be operating by 1971. The larger system would take a year longer, the government figures. Each channel could carry one television signal or 1,200 telephone circuits.

Two consortiums, one headed by Northern Electric Ltd. and the other by RCA Victor Ltd. of Canada, have been asked to work out detailed proposals for the satellite system and submit them within six months. Each proposal will be submitted in two parts, one spelling out what the consortium sees as the hardware for the system, the other outlining the group's project-management schemes.

Meanwhile, Canadian space officials presumably will start negotiating with the U.S. for launch vehicles. Washington has been cool to Canada's plan for a domestic satellite system [Electronics, Sept. 4, 1967, p. 131]. Now that Canadian intentions to go ahead with the project are clear, though, the U.S. apparently will become more neighborly. Ottawa insists its domestic intentions don't run counter to the aims of the International Telecommunications Satellite Consortium and if it can convince Washington on that point there should be no problem.

Soviet Union

Integration drive

Western traders who keep a sharp eye on Russian industrial trends are now convinced that the Soviets are fast nearing mass production of integrated circuits.

Although Soviet planners haven't tipped their hand as to when and where, an Italian semiconductor specialist on the Moscow scene maintains that a big pilot production facility for silicon devices is under construction and scheduled to start up next year. Another West

European engineer insists, "In two years they'll be in full-scale production of integrated circuits."

Signs. There's plenty of evidence to back up these predictions. The Russians have begun offering semiconductor materials for export. Along with silicon, the Soviets want to sell gallium arsenide, indium antimonide and other hard-to-fabricate materials. An engineer who had a chance to test some Russian crystals calls them "comparable to those of Monsanto and other companies' products."

Experienced Westerners see an important clue in the Russians' recent interest in buying a family of computers—the Saab D22 seems to be the one they're eyeing hardest—with IC's. In the past, these traders say, the Soviets have bought single computers for specific uses. If they're negotiating for a whole line, the reasoning goes, it's because they expect to produce their own versions soon.

Countersigns. Although there's fairly general agreement that the Soviets are getting closer to volume IC output, some Moscow watchers say there are at least two major problems that still have to be solved.

One is slicing and polishing equipment for semiconductor wafers. According to a prospective buyer of Russian crystals, the export agency that peddles them invariably refuses to slice the doped silicon to buyers' specifications.

The other problem is yields. Although the Russians have been producing transistors since 1960 they apparently are still getting low yields. One Soviet engineer insists the lab he works for has paid the equivalent of \$40 for semiconductor devices that cost less than \$1 in Western countries.

Japan

New way to skin a cat

For many a sidewalk superintendent, the cat skinner rates as the most talented performer on a construction job. Perched atop his bull-

Now in
publication!

A Fully Documented Analysis of International Electronics

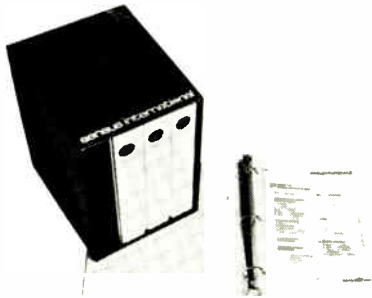

Four volumes of incisive data—by country—basic elements in planning and maintaining a position of marketing strength in the international electronics markets.

Updated regularly, information is gathered on the spot and covers all aspects of doing business in electronics in every major electronics market of the world. Tariffs, government policies, exchange controls, credit, trade unions, even the impact of smuggling are covered in these in-depth reports.

Send for complete, free information

sensus international

Please send me your free, descriptive literature.

Name _____

Title _____

Company _____

Street _____

City _____

State _____ Zip _____

SENSUS INTERNATIONAL
712 Montgomery Street,
San Francisco, Calif. 94111

If you can't wait,
call (415) 989-6973

dozer, feet and hands darting over a maze of pedals and levers, a skilled cat skinner is a highly-paid maestro of earthmoving.

Cat skinning, though, may soon be just another construction job. The Komatsu Manufacturing Co. has developed a bulldozer remote control that lets an untrained operator perform like a veteran. The remote operator, in fact, has the advantage of being able to see the front side of the blade. And he can handle jobs with his unmanned bulldozer that would be perilous to a cat skinner.

No man's land. Komatsu's earthmoving automation is getting its first use at a steel mill where hot slag has to be moved around. And like the West German radio-controlled scoop loader delivered earlier this year to the Karlsruhe nuclear research facility [Electronics, Feb. 5, p. 211], the Japanese machine can handle radioactive debris.

Since Komatsu hopes one day to see its radio control become fairly common, it has opted for a low-power transmitter—about 10 milliwatts—that needs no license. The transmitter operates in the 150-megahertz band and has frequency modulation. On the bulldozer, the transmitted commands are picked up by a double superhet receiver.

Handy. The control box, carried on a strap by the operator, doesn't duplicate the pedals and levers found in conventional bulldozers. Instead, there are two joysticks, one for directing the machine and one for working the blade. Switches control the less frequent functions, such as making throttle settings and turning the engine off and on.

Drive and blade commands are transmitted in a two-out-of-six frequency code, meaning there can be 15 different combinations. Logic circuits in the transmitter unit break up the joystick movements into individual commands.

Each joystick in effect controls one transmission channel since the drive and blade signals are transmitted one after the other on a time-shared basis every 50 milliseconds.

Separation. At the receiver, the pairs of modulation tones are separated by six filters and fed to a matrix to recover the command corresponding to the pair. The signals from the matrix control transistor power switches that drive pneumatic valves. They, in turn, control the hydraulic-control valves of the bulldozer.

Komatsu says it can now build the control system for about \$8,400, although the first model cost more than twice that much.



Sideline. Unskilled operator fiddling with joysticks can put bulldozer through its paces like a veteran cat skinner.

It adds up

For Japanese desk-calculator makers, it's not a matter of whether to shift to integrated circuits but when. And for the Canon Camera Co., the time is now. The company will start selling ic calculators in Japan on May 1. The machines will most likely make their bow in the U.S. sometime this fall.

Canon's move makes it the third major Japanese calculator producer—after the Hayakawa Electric Co. and the Sony Corp.—to get a line of ic models into production. But where Hayakawa counts on Japanese semiconductor suppliers for its kingpin circuits and Sony makes its own, Canon has turned to Texas Instruments.

The Canon calculators, designated the models 163 and 161S, are built around seven types of π diode-transistor-logic packages. Canon claims the packages are built to its specifications, but one competitor insists they're the same packages π supplies for the Singer Co.'s Friden printing calculator.

On the line. Whether specials or simply specially tested off-the-shelf packages, the ic's Canon is getting from π add up to a whopping order. Canon says it plans to produce some 1,500 ic machines a month, and each one will employ 170 π packages; this works out to 250,000 packages a month.

Along with the ic's, which are used for arithmetic, program, and control operations, the new calculators have discrete transistors to drive the readout displays. And there's a magnetic delay line that functions as five registers—three for arithmetic and two for memories. Both the displays—cold-cathode tubes—and the delay line are new items in Canon desk calculator equipment.

Comparable. The performance of the model 163 is said to match that of Hayakawa's CS-32A, also a 16-digit ic calculator. Average add and subtract time for the Canon machine is 0.01 second; average multiply and divide time is 0.2 second. In Japan, Canon will sell the model 161 for \$958, some \$14 less than the price Hayakawa lists for its CS-32A. Hayakawa has the

The Clearest Logic:

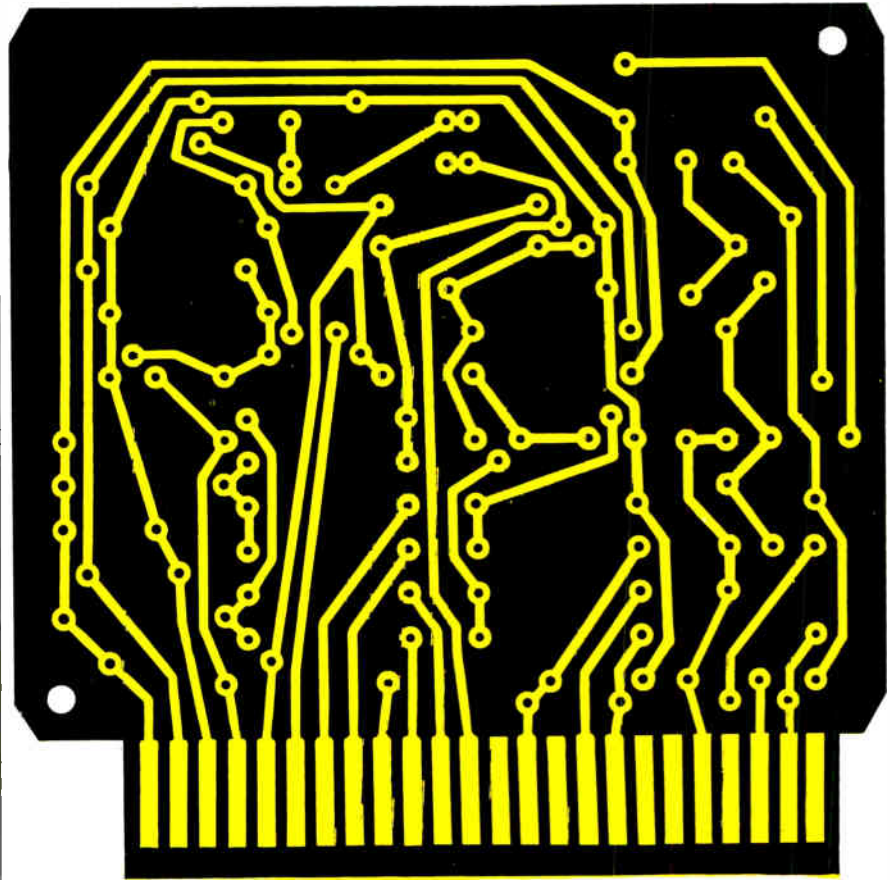

Logic modules are built on printed circuit cards. Hole location and front-to-back registration must be very accurate for machine assembly.

Hand assembly is costly. Plated thru-holes must provide positive continuity. **Rejects are costly.** Circuit boards for logic modules must be easily solderable. **Poor solderability is costly.** Printed circuit cards must be delivered in volume quantity for large-scale logic module production. **Time delays are costly.**

These are the reasons that Cinch-Graphik boards are built with such exacting precision. **Anything less is too costly.**

CINCH-GRAFIK

D I V I S I O N C F U N I T E D - C A R R

MEMBER



200 South Turnbull Canyon Road, City of Industry (Los Angeles), Calif. 91744 • Phone (213) ED 3-1201. Sales offices in 33 principal cities throughout the United States, Great Britain, Canada, Australia and West Germany.

CONSISTING OF CINCH MANUFACTURING COMPANY, CINCH GRAPHIK, CINCH-MOLADOCK, CINCH-SULINE, UCINITE (ELECTRONICS) AND PLAXIAL CABLE DEPT.

WHERE RELIABILITY & ACCURACY COUNT

INTERNATIONAL PRECISION RADIO CRYSTALS
70 KHz to 160 MHz

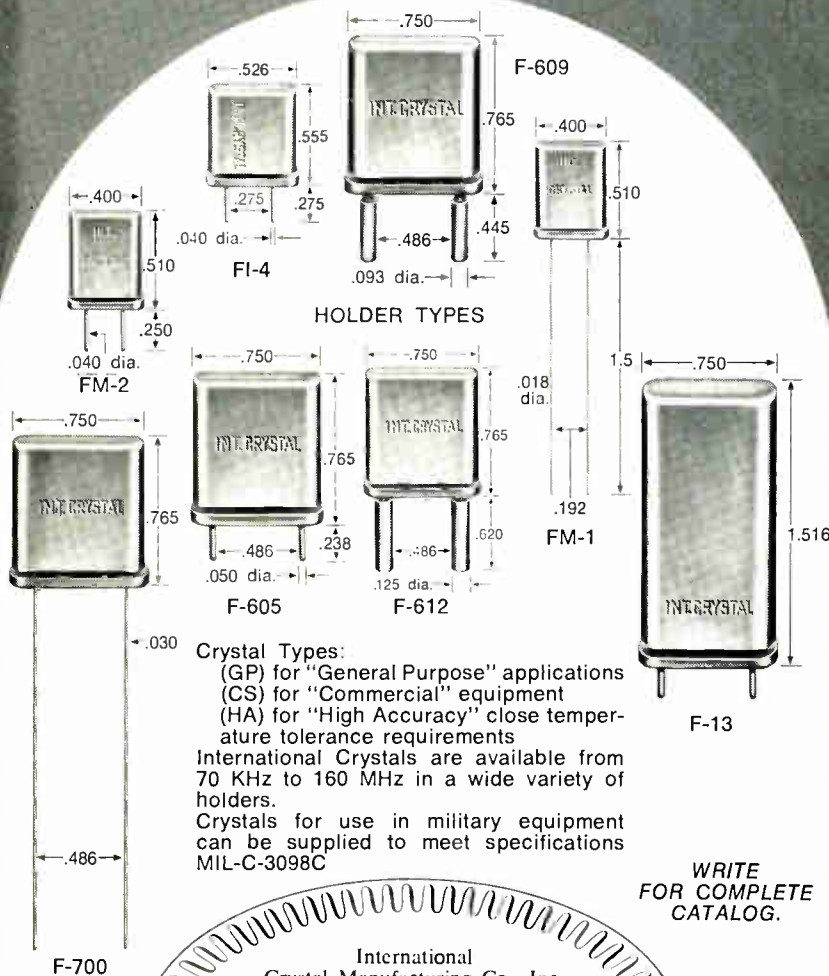

Crystal Types:
(GP) for "General Purpose" applications
(CS) for "Commercial" equipment
(HA) for "High Accuracy" close temperature tolerance requirements
International Crystals are available from 70 KHz to 160 MHz in a wide variety of holders.
Crystals for use in military equipment can be supplied to meet specifications MIL-C-3098C

WRITE FOR COMPLETE CATALOG.

International Crystal Manufacturing Co., Inc. guarantees every crystal against defective materials and workmanship for an unlimited time, when used in equipment for which they were specifically made.

INTERNATIONAL

CRYSTAL MFG. CO., INC.
10 NO. LEE • OKLA. CITY, OKLA. 73102

Electronics Abroad

edge, though, in size. Its calculator fits into a standard desk drawer; Canon's is a little too tall for drawer storage.

Canon's 161S, an economy version of the 163, omits many calculation features, such as automatic square root, and contains only one memory. It will sell in Japan for \$764.

Italy

Unkind cut

Italians have taken to long-distance direct dialing with gusto. It's fast becoming a national habit to ring up a distant relative from the nearest phone—as long as it's someone else's.

Enough subscribers have complained about unauthorized out-of-town calls that phone companies are taking a hard look at devices that make it require more than a furtive look to place a long-distance call. Small locks that put a subscriber's phone off limits for any kind of unauthorized call are on the market, but the country's phone manufacturers have their eyes on a more sophisticated attachment—one that cuts off the phone only when an unauthorized out-of-town call is attempted.

SGS-Fairchild, a major European semiconductor producer [Electronics, Nov. 27, 1967, p. 135], developed the attachment. It's built around a dozen integrated-circuit packages that essentially decode the dial pulses for the first digit of the called number. If the pulses are for a "1," a "9," or a "0"—all direct-dialed long-distance calls start with one of these—the decoding circuit actuates a relay that cuts the phone off the line forthwith—before the complete number can be dialed. Input to the attachment is from a transformer whose primary is wired across the phone's line.

The relay that normally disconnects the phone can be arranged so that the call goes through but an external monitor is alerted. There are also versions where a key can override the cutout relay.

Electronics advertisers

April 15, 1968

A C D C Electronics	70	Cornell-Dubilier Electronics	145, 146	General Electric Co.,	
Faust/Day, Inc. Adv.		Daniel & Charles, Inc.		Specialty Control Div.	233
Acopian Corp.	7	Corning Glass Works		Robert S. Cragin, Inc.	
Mort Barish Assoc.		Electronic Div.—Glass Memories	188	General Electric Co.,	
Adams & Westlake Co.	66	Rumrill-Hoyt, Inc.		Vacuum Products Business Section	86
Kasper & Assoc., Inc.		Corning Glass Works		Doe-Anderson Adv. Agcy., Inc.	
Aercom	OAS 14	Electronic Div.—Resistors	142, 143	General Radio Co.	2nd Cover
Grant Adv., Inc.		Rumrill-Hoyt Co., Inc.		Horton, Church & Goff, Inc.	
Alco Electronic Products, Inc.	247	Cramer Industries, Inc.	245	Giannini Voltex Co.	262
Marketronics Adv.		Bryan/Donald Adv., Inc.		Everett Assoc.	
Allen-Bradley Co.	41	C.S.F.	OAS 6	Guardian Electric Mfg. Co.	170
Fensholt Adv. Agcy.		SPI Agency		K & A Advertising	
Allied Van Lines, Inc.	189	CTS Corp.	269		
Young & Rubicam, Inc.		Burton Browne Advertising		Hamilton Watch Co.	200
AMP, Inc.	250, 251	Cutler-Hammer, International	OAS 11	Beaumont, Heller & Sperling, Inc.	
Garceau, Hallahan & McCullough, Inc.		Campbell Mithun, Inc.		Hansen Manufacturing Co.	172
Amphenol Corp., Connector Div.	191	Cyclo-Tronics, Inc.	54	Keller-Crescent Co.	
Marsteller, Inc.		Bernard J. Hahn & Associates		Haydon Switch & Instruments, Inc.	198
Andrew Corp.	274			Reynolds & Foster, Inc.	
Fensholt Adv., Inc.		Daven, Inc.	60	Hewlett Packard,	
AO Instrument Co.	266	Weston Assoc., Inc.		Colorado Springs Div.	3rd Cover
Fuller & Smith & Ross, Inc.		Dearborn Electronics, Inc.,	10	Tallant/Yates Adv., Inc.	
Artus Electronique	162	Sprague Electric Co. Div.		Hewlett Packard,	
Alain Perraud		Harry P. Bridge Co.		International Import Div.	11
Austron, Inc.	283	Delta Design, Inc.	260	Lennen & Newell, Inc.	
Don L. Baxter, Div. of		Pacific Publications		Hewlett Packard, Loveland Div.	226
Albert Frank-Guenther Law, Inc.		Di-Acro Corp., Division of	240	Tallant/Yates Adv., Inc.	
		Houdaille Industries, Inc.		Hewlett Packard,	
		Charles E. Brown Adv. Agcy.		F.L. Moseley Co. Div.	2
		Digitran Co., The	230	Lennen & Newell, Inc.	
		Smith-Klitten, Inc.		Hewlett Packard, Palo Alto Div.	1
		Discon Corp.	62, 63	Lennen & Newell, Inc.	
		Al Woodbury, Jr. & Assoc.		HI-G, Inc.	178
		Dit-Mco International Division of	244	Marketing Assistance, Inc.	
		Xebec Corp.		Honeywell, Computer Control Div.	18, 19
		Martin Fromm & Assoc., Inc.		Franklin P. Folts, Inc.	
		DoALL Company	154	Honeywell, PMD Div.	221
		Howard H. Monk and Assoc., Inc.		Batten, Barton, Durstine & Osborn, Inc.	107
		Dow Chemical Europe S.A.	OAS 21	Honeywell, Test Instruments Div.	107
		MacManus John & Adams S.A.		Campbell Mithun, Inc.	
		Duncan Electronics, Inc. Sub. of	210	Hughes Aircraft Co.	149
		Systron Donner Corp.		Footo, Cone & Belding	
		Helme Assoc., Inc.		Hull Corp.	OAS 18
		DuPont de Nemours Co., Mylar Div.	187	The Michener Co.	
		Batten, Barton, Durstine & Osborn, Inc.		Hysol Corp.	202
		Durant Manufacturing Co.	212	Barber & Drullard, Inc.	
		Franklin Mautner Adv.			
		Dynamco Ltd.	OAS 19		
		Leslie Ingham Assoc. Ltd.			
				Indiana General Corp., Ferrites Div.	249
				Griswold & Eshleman	
Babcock Relays Div. of				Industrial Electronic Engineers	76
Babcock Electronics Corp.	174, 175	Eastman Kodak Co.,	147	Van Der Boom, McCarron, Inc., Adv.	
Jansen Assoc., Inc.		Technical Corporate Adv.		Industrial Exhibitions, Ltd.	235
Ballantine Laboratories	218	Rumrill-Hoyt, Inc.		Walkley Hodgson, Ltd.	
Lang-Lawrence Adv., Inc.		E G & G, Inc.	88	Industrial Foundation of Albuquerque	216
Barnstead Subsidiary of		Culver Adv., Inc.		Geha-Paskind & Assoc., Inc.	
Ritter Pfaudler Corp.	192	E-H Research Laboratories, Inc.	53	INEL	261
Creamer, Trowbridge, Case &		Steedman, Cooper and		Mosse Annoncen A.G.	
Basford, Inc.		Busse Advertising		Intercontinental Instruments, Inc.	84
Beckman Instruments, Inc., Helipot Div.	49	Electronic Assoc., Inc.	82	J.S. Lanza & Associates	
Hixson & Jorgensen, Inc.		Ross Roy of New York, Inc.		International Crystal Mfg. Co.	280
Beckman Instruments		Electronics Buyers' Guide	264	Robert V. Freeland & Assoc.	
International, S.A.	OAS 12	Plansboard Adv., Inc.		International Electronic	
Hixson & Jorgensen, Inc.		Electronic Engineering Co. of California	236	Research Corp.	252, 253
Bendix Corp.	38, 39	Jansen Associates		Van Der Boom, McCarron, Inc., Adv.	
Electrical Components Div.		Emerson & Cuming, Inc.	208	Intronics, Inc.	254
MacManus, John & Adams, Inc.		Edwin F. Hall		Marketing Assistance, Inc.	
Bendix Corp.,		English Electric Valve Co. Ltd.	OAS 15	Iowa Development Commission	248
Semiconductor Products Div.	17	Allardyce Palmer, Ltd.		L.W. Ramsey Adv.	
MacManus, John & Adams, Inc.		Executone, Inc., Printact Relay Div.	164	I R C, Inc.	36, 37
Bissett-Berman Corp.	213	J.A. Richards		Gray & Rogers, Inc.	
S F Associates		Fairchild Instrumentation	83	ITT Jennings Mfg. Co.	139
Brush Instruments,		Faust/Day, Inc.		West, Weir & Bartel, Inc.	87
Div. of Clevite Corp.	284	Fairchild Semiconductor, Inc.	20, 21	ITT Semiconductors Div.	
Carr Liggett Adv., Inc.		Faust/Day, Inc.		Neals & Hickok, Inc.	
Buckbee-Mears Co.	152	Fieldtech, Ltd.	OAS 22	ITT Wire & Cable	169
Midland Assoc., Inc.		Crane, Norman, Craig & Kummel, Ltd.		West, Weir & Bartel, Inc.	
Bulova Watch Co., Electronics Div.	208	Fluke Manufacturing Co., John	15		
Frank Best Co., Inc.		Bonfield Associates			
Burr Brown Research Corp.	186	Garrett Corp., Airesearch Mfg. Div.	260		
N.A. Winter Adv. Agcy.		J. Walter Thompson Co.		J F D Electronics Co., Components Div.	241
Bussmann Mfg. Div. of		General Electric Co., Electronic		Delphi Adv., Inc.	
McGraw Edison Co.	61	Components Sales	150, 151, 224, 225	Johanson Mfg. Co.	238
Henderson Adv. Co.		Operation		Josephson, Cuffari & Co.	
		Robert S. Cragin, Inc.		Johnson Co., E.F.	245
		General Electric, IGE Export Div.	OAS 7	Midland Associates	
		Robert S. Cragin, Inc.		Joslyn, Inc.	246
		General Electric, Miniature Lamp Div.	161	Chace Co.	
		Batten, Barton, Durstine & Osborn, Inc.			
		General Electric Co.,		Kepeco, Inc.	52
		Semiconductor Products Div.	71, 72, 73	Weiss Advertising	
		Robert S. Cragin, Inc.			
				Lambda Electronics Corp.	74, 75
				Michel Cather, Inc.	
				Lapp Insulator Co.	204
				Wolff Associates	

Advertising Sales Staff

Frank E. LeBeau [212] 971-6464
Advertising Sales Manager

Wallis Clarke [212] 971-2187
Assistant to sales manager
Donald J. Austermann [212] 971-3139
Promotion Manager

Warren H. Gardner [215] LO 8-6161
Eastern Advertising Sales Manager

Atlanta, Ga. 30309: Michael H. Miller, 1375
Peachtree St., N.E.
[404] 892-2868

Boston, Mass. 02116: William S. Hodgkinson
McGraw-Hill Building, Copley Square
[617] CO 2-1160

Cleveland, Ohio 44113: William J. Boyle, 55
Public Square, [216] SU 1-7000

New York, N.Y. 10036
500 Fifth Avenue
Donald R. Furth [212] 971-3615
James R. Pierce [212] 971-3616
John A. Garland [212] 971-3617

Philadelphia, Pa. 19103:
Jeffrey M. Preston

Warren H. Gardner,
6 Penn Center Plaza,
[215] LO 8-6161

Pittsburgh, Pa. 15222: Warren H. Gardner,
4 Gateway Center, [412] 391-1314

Rochester, N.Y. 14534: William J. Boyle,
9 Greylock Ridge, Pittsford, N.Y.
[716] 586-5040

J. Bradley MacKimm [312] MO 4-5800
Midwest Advertising Sales Manager

Chicago, Ill. 60611: Robert M. Denmead,
J. Bradley MacKimm, Ralph Hanning,
645 North Michigan Avenue,
[312] MO 4-5800

Dallas, Texas 75201: Richard P. Poole, 1800
Republic National Bank Tower,
[214] RI 7-9721

Houston, Texas 77002: Kenneth George,
2270 Humble Bldg., [713] CA 4-8381

Detroit, Michigan 48226: Ralph Hanning
856 Penobscot Building
[313] 962-1793

Minneapolis, Minn. 55402: J. Bradley
MacKimm, 1104 Northstar Center
[612] 332-7425

St. Louis, Mo. 63105: Robert M. Denmead
The Clayton Tower, 7751 Carondelet Ave.
[314] PA 5-7285

James T. Hauptli [415] DO 2-4600
Western Advertising Sales Manager

Denver, Colo. 80202: Joseph C. Page, David
M. Watson, Tower Bldg., 1700 Broadway
[303] 255-5484

Los Angeles, Calif. 90017: Ian C. Hill,
John G. Zisch, 1125 W. 6th St.,
[213] HU 2-5450

Portland, Ore. 97204: James T. Hauptli,
218 Mohawk Building, 222 S.W. Morrison
Street, Phone [503] 223-5118

San Francisco, Calif. 94111:
James T. Hauptli, 255 California Street,
[415] DO 2-4600

Pierre Braude Tel: 225 85 88

European Director
88-90 Avenue Des Champs-Elysees, Paris 8

Brian Bowes Tel. Hyde Park 1451
United Kingdom and Scandinavia
34 Dover Street,
London W1

Milan: Robert Saidel
1 via Baracchini Phone: 86-90-656

Frankfurt/Main: Hans Haller
Elsa-Brandstroem Str. 2
Phone: 72 01 81

Geneva: 1, rue du Temple Phone: 31 95 60

Tokyo: George E. Olcott, 1, Kotohiracho
Shiba, Minato-Ku [502] 0656
Osaka: Ryoji Kobayashi 163, Umegae-cho
Kita-ku [362] 8771

Business Department

Wallace C. Carmichael, Manager
[212] 971-3191

Stephen R. Weiss, Production Manager
[212] 971-2044

Thomas M. Egan,
Assistant Production Manager [212] 971-3140

Dorothy Carmesin, Contracts and Billings
[212] 971-2908

Frances Vallone, Reader Service Manager
[212] 971-2865

NEW FROM AUSTRON



TFO-22 Series



PMC Series

Tuning-Fork Oscillators

Your low-frequency control requirements can be met most economically with Austron's TFO-22, designed to drive latest TTL or DTL micrologic devices. Features include wide temperature range and frequency range from 360 Hz to 10 kHz. The PMC is a rugged control device meeting severe shock and vibration MIL-SPEC requirements. Frequency range is from 2 kHz to 10 kHz. Write for details on Austron's complete oscillator line.



10214 NORTH INTERREGIONAL HIGHWAY, AUSTIN, TEXAS 78753 TELEPHONE (512) 454-2581

Circle 281 on reader service card

NEW! smallest axial shielded inductor available the "NANO-RED"

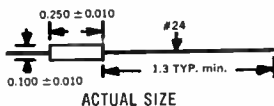

Range: 0.10 μ h to 1,000 μ h in 49 stock values

Size: 1/10 dia. by 1/4 lg.

Inductance Tolerance: $\pm 10\%$

This new "NANO-RED" offers the highest inductance to size ratio available in an axial shielded inductor. Exceptional "Q" and self-resonance characteristics. Max. coupling 2% units side by side. Non-flammable envelope. Designed to MIL-C-15305C. Operating temperature -55°C to 125°C .

Other Lenox-Fugle Subminiature Shielded Inductors:

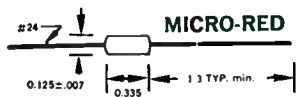

The "Micro-Red" is a shielded inductor that offers the largest inductance range in its size: 0.10 μ h to 10,000 μ h. "Q" to "L" ratio unsurpassed, with excellent distributed capacity. Inductance tolerance $\pm 10\%$. Designed to MIL-C-15305C. Stocked in 61 pre-designed values.



The "Mini-Red" offers the highest "Q" to "L" ratio available over inductance range 0.10 μ h to 100,000 μ h in its size. Inductance tolerance $\pm 10\%$ measured per MIL-C-15305C. Stocked in 73 pre-designed values.

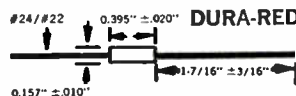

The "Dura-Red" is designed to MS-90537 with inductance range 0.10 μ h to 100,000 μ h with tolerance $\pm 10\%$. Stocked in 73 pre-designed values.



Data Sheets: write or phone

LENOX-FUGLE ELECTRONICS, INC.

100 Sylvania Place, South Plainfield, N. J. 07080

Telephone: Code 201, 756-1164

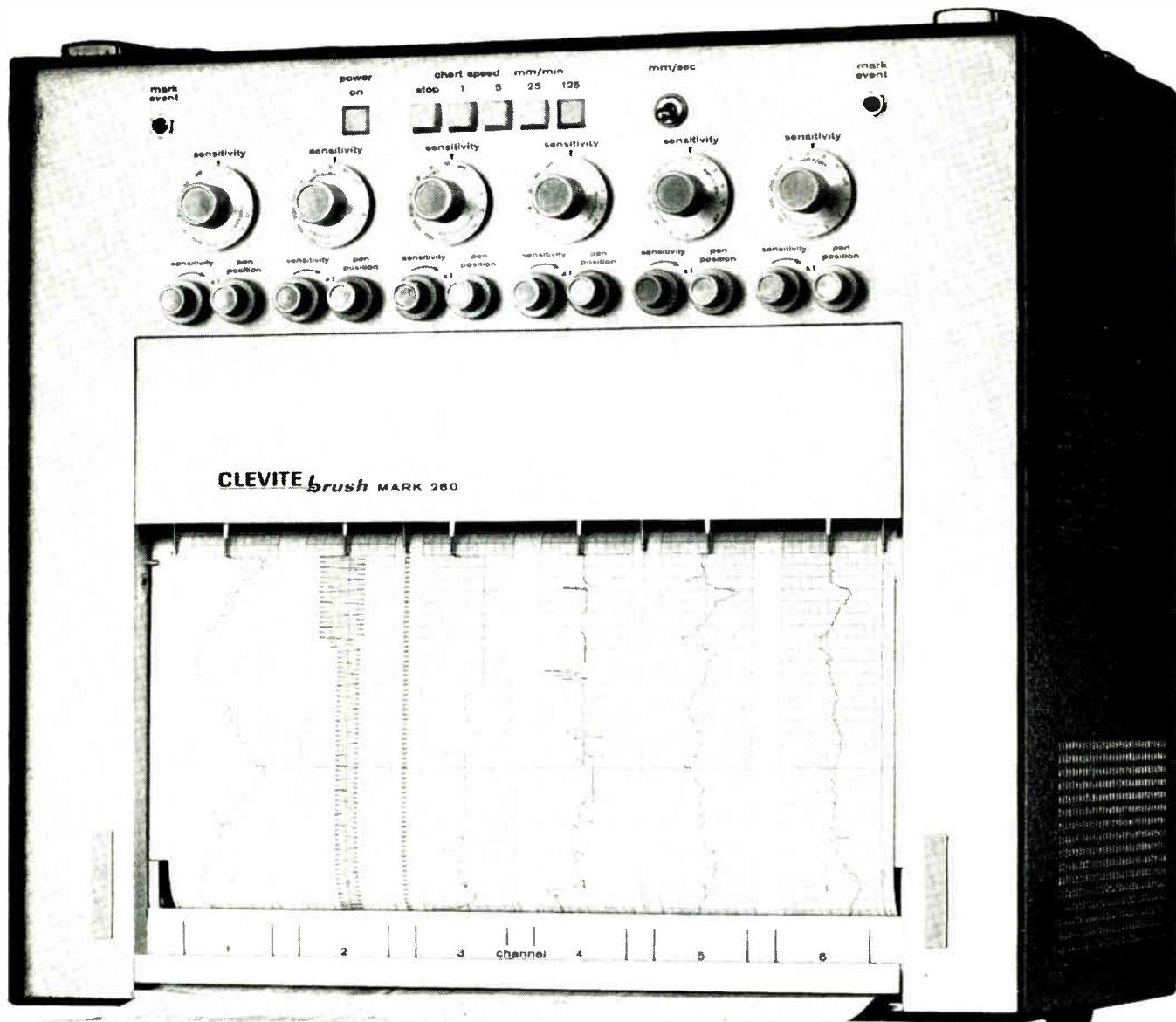

**\$4500 is a lot of money for a portable multi-channel recorder.
Or is it?**

It depends on *what* portable recorder you're talking about. Take that new Mark 260 up there. It costs \$4500. But it's a bargain. It has six analog channels, and four event channels. (That's more than you get with recorders twice as big . . . and a lot more expensive). It has the famous Brush patented pressurized ink-writing system. (No spatter, no puddles . . . crisp clear smudge-proof traces at any writing speed) . . . rugged, reliable solid state electronics. (Bounce it around a bit. We don't mind, and it doesn't either) . . . 8 pushbutton chart speeds (easy as changing stations on your radio) . . . 99½% accuracy (which is as good as our best, the Mark 200. And that's a Circle 284 on reader service card

good deal better than anything else on the market) . . . frequency response out to 150 Hz at usable amplitudes. Measurement range of 1 millivolt to 500 volts (covers anything you're likely to handle). ■ At \$4500 the new Mark 260 by Brush is the recorder bargain of the year. A full-color brochure is yours for the asking. Write: Clevite Corporation, Brush Instruments Division, 3773 Perkins, Cleveland, Ohio 44114.

CLEVITE BRUSH

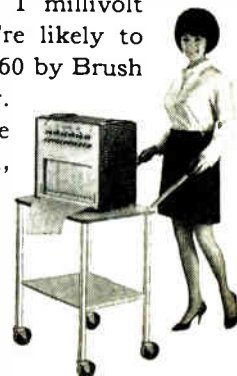

New All-Solid-State hp 1200 Scope System Sets New Standards of Performance for Your dc-500 kHz Measurements

Now you can upgrade your low frequency measurements with the new hp 1200 scope system for better performance, greater sensitivity and improved accuracy in the dc to 500 kHz range.

The hp 1200 scope system has an all-new design from the inside out to provide all-solid-state reliability and stability. Drift has essentially been eliminated to allow accurate measurements—even in the 100 μ V dc area. Controls on the front panel have been grouped to give faster measurements, quicker set-up, direct dial readout even when using the magnifier.

Choose from four models to get single or dual trace 100 μ V/cm sensitivity, or single or dual trace 5 mV/cm sensitivity. The 100 μ V scopes have 17 calibrated ranges in 1-2-5 sequence with vernier for continual adjustment between ranges. (The 5 mV scopes have 12 calibrated ranges.) All four

models have large 8 x 10 cm internal graticule CRT's, single-ended or differential input on all ranges, complete triggering versatility, external horizontal input, dc-coupled Z-axis, beam-finder—many of the features you normally associate only with high frequency scopes.

All four models are available as lightweight (< 25 pounds) cabinet or 5 $\frac{1}{4}$ " high rack mounts. Power consumption of 33 watts eliminates need for cooling fans.

For details on how you can increase your measurement confidence and your measurement accuracy in the low frequency range, contact your nearest hp field engineer. Ask him about the new hp 1200 scope system. Or, write to Hewlett-Packard, Palo Alto, California 94304. In Europe: 54 Route des Acacias, Geneva.

Circle 901 on reader service card

	1200A/AR*	1202A/AR*	1205A/AR*	1206A/AR*
Number of Channels	2	1	2	1
Maximum Vertical Sensitivity	100 μ V/cm	100 μ V/cm	5 mV/cm	5 mV/cm
Common Mode Rejection (Differential)	100 dB	100 dB	50 dB	50 dB
X-Y Capability	Identical Amplifiers (17 ranges)	17 vertical vs. 4 horizontal ranges	Identical Amplifiers (12 ranges)	12 vertical vs. 4 horizontal ranges
Price	\$990	\$790	\$875	\$715

* AR indicates 5 $\frac{1}{4}$ " rack mount model

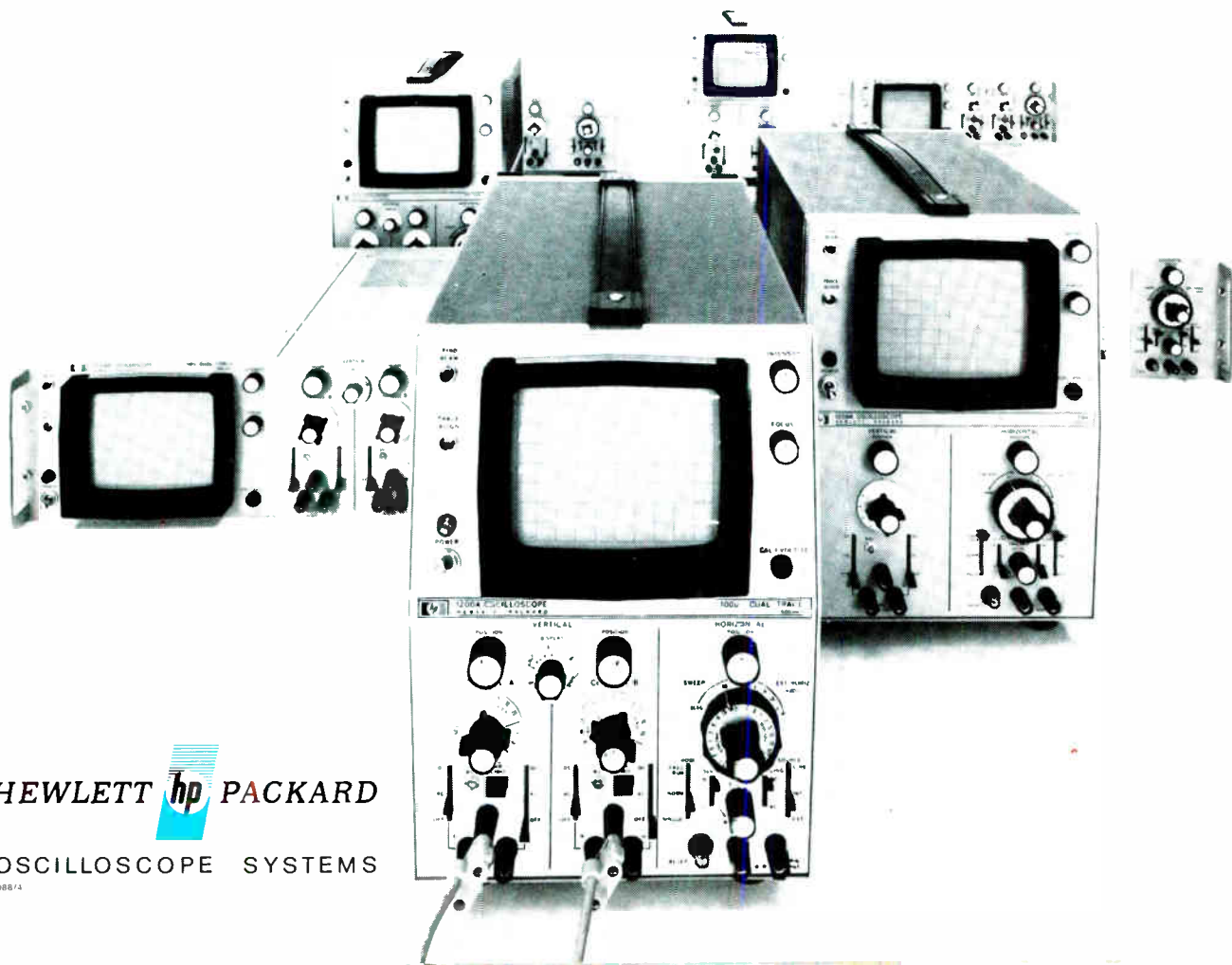

HEWLETT **hp** PACKARD

OSCILLOSCOPE SYSTEMS

08874

RCA hard-tube modulators... for nanosecond service

Now, nanosecond switching time, low inductance, and low capacitance come naturally for L-, C-, X-, and S-band radar with RCA-4630 and 4634 Cermolox® tubes. Representative of RCA's capability in hard-tube modulator service, these conduction-cooled, beam power tubes are especially suitable for high-package-density airborne applications where μ sec modulation of reactive loads is required at high duty factors. Cermolox construction achieves a new high in tight characteristic control for ultra-reliable systems.

RCA-4630 is rated for 17 kV DC plate voltage. Its reliable matrix cathode permits a peak plate current rating of 40.0 amperes at a duty factor of 12.5 per cent and a pulse duration of 2 μ sec. RCA-4634 is rated for 7000 volts. Its peak plate current rating ranges from 8.0 amperes at 2 μ sec pulse length and 0.05 per cent duty factor to 0.6 amperes at a DC level.

Your RCA Representative can tell you more about these hard-tube modulators and how their characteristics and cooling methods can be tailored to your space configurations. Technical data from Commercial Engineering, Section D-319-Q, RCA Electronic Components, Harrison, New Jersey 07029. Also available from your RCA Industrial Tube Distributor.



RCA-4630 and 4634 are typical of the compact, rugged units available from RCA for use as hard-tube modulators.

RCA