

Lindon City Council Staff Report

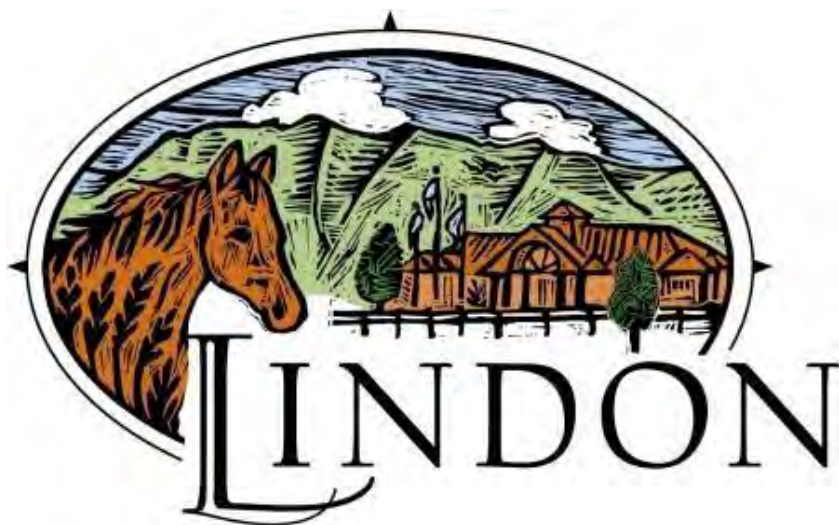

Prepared by Lindon City
Administration

October 1, 2019

Notice of Meeting of the Lindon City Council

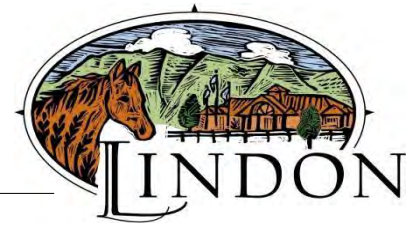

The Lindon City Council will hold a meeting beginning with at work session at 6:00 p.m. on Tuesday, October 1, 2019 in the Lindon City Center Council Chambers, 100 North State Street, Lindon, Utah. The agenda will consist of the following:

Scan or click here for link to download agenda & staff report materials:



WORK SESSION – 6:00 P.M. - Conducting: Jeff Acerson, Mayor

1. **Discussion Item: Employee Compensation Programs.** (40 minutes)

The Lindon City Council will review and discuss various aspects of the Lindon City Employee Compensation Programs.

2. **Discussion Item:** Development options for Anderson Farms residential area. (20 minutes)

Councilmember Vanchiere requested additional discussion with the full Council regarding development options for the Anderson Farms residential area.

REGULAR SESSION – 7:00 P.M. - Conducting: Jeff Acerson, Mayor

Pledge of Allegiance: By Invitation

Invocation: Jeff Acerson

(Review times are estimates only)

1. **Call to Order / Roll Call**

(2 minutes)

2. **Presentations and Announcements**

(5 minutes)

a) Comments / Announcements from Mayor and Council members.

b) Presentations: Employee Recognition Award (2019 3rd Quarter); Gary Hoglund and Alex Roylance will be recognized.

3. **Approval of minutes:** The regular City Council meeting of September 17, 2019, will be reviewed. (5 minutes)

4. **Open Session for Public Comment** (For items not on the agenda)

(10 minutes)

5. **Consent Agenda** — (Items do not require public comment or discussion and can all be approved by a single motion.) (5 minutes)

There are no consent agenda items for approval.

6. **Public Hearing — General Plan Amendment; Ordinance #2019-14-O.**

The City Council will review and consider Ordinance #2019-14-O to amend the Lindon City General Plan to include the updated 2019 Moderate-Income Housing Plan. (30 minutes)

7. **Review & Action — Bid Award; North Union Canal Piping**

The City Council will review and consider whether to award the low bid of \$748,924.45 by NeZhoni Construction, LLC for the North Union Canal Piping project. This project is partially grant funded. (20 minutes)

8. **Discussion Item — Fireworks Restrictions.**

The City Council will review and discuss the current firework restrictions and areas within the City where firework discharges are prohibited. No motions will be made. (20 minutes)

9. **Presentation — Overview of Fire/EMS Services.**

Orem City Fire Chief, Scott Gurney, and Deputy Fire Chief, Jason Earl, will give a general overview of Fire/EMS services provided to Lindon City and answer any questions the Council may have. Lindon is starting its 11th year of a 20-year contract with the City of Orem for Fire/EMS and dispatch services. (20 minutes)

Council Reports:

- | | |
|---|--------------------|
| A) MAG, COG, UIA, Utah Lake Commission, ULCT, NUVAS, IHC Outreach, Budget Committee | - Jeff Acerson |
| B) Public Works, Irrigation water/canal company boards, City Buildings | - Van Broderick |
| C) Planning Commission, Board of Adjustments, General Plan, Budget Committee | - Matt Bean |
| D) Public Safety, Emergency Management, Economic Development, Tree Board | - Carolyn Lundberg |
| E) Parks & Recreation, Lindon Days, Transfer Station/Solid Waste, Cemetery | - Mike Vanchiere |
| F) Admin., Historic Commission, PG/Lindon Chamber, Budget Committee | - Jake Hoyt |

Administrator's Report

(10 minutes)

Adjourn

All or a portion of this meeting may be held electronically to allow a council member to participate by video conference or teleconference. Staff Reports and application materials for the agenda items above are available for review at the Lindon City Offices, located at 100 N. State Street, Lindon, UT. For specific questions on agenda items our staff may be contacted directly at (801)785-5043. City Codes and ordinances are available on the City web site found at www.lindoncity.org. The City of Lindon, in compliance with the Americans with Disabilities Act, provides accommodations and auxiliary communicative aids and services for all those citizens in need of assistance. Persons requesting these accommodations for city-sponsored public meetings, services programs or events should call Kathy Moosman at 801-785-5043, giving at least 24 hours-notice.

CERTIFICATE OF POSTING:

I certify that the above notice and agenda was posted in three public places within the Lindon City limits and on the State (<http://pmn.utah.gov>) and City (www.lindoncity.org) websites.

Posted by: /s/ Adam M. Cowie, City Administrator

Date: September 27, 2019; Time: 3:30 p.m.; Place: Lindon City Center, Lindon Police Dept., Lindon Community Center

WORK SESSION – 6:00 P.M. - Conducting: Jeff Acerson, Mayor

1. **Discussion Item: Employee Compensation Programs.** *(40 minutes)*
The Lindon City Council will review and discuss various aspects of the Lindon City Employee Compensation Programs.
2. **Discussion Item:** Development options for Anderson Farms residential area.
Councilmember Vanchiere requested additional discussion with the full Council regarding development options for the Anderson Farms residential area. *(20 minutes)*

No motion is necessary.

LINDON CITY PAY RANGES FY 2012-2013

Range	Step 1	Step 2	Step 3	Step 4	Step 5	Step 6	Step 7	Step 8	Step 9	Step 10	Step 11	Step 12	Step 13	Step 14	Step 15	Step 16	Range
1	8.32	8.54	8.78	9.02	9.27	9.51	9.78	10.05	10.32	10.60	10.89	11.19	11.49	11.81	12.13	12.46	1
2	8.78	9.02	9.27	9.51	9.78	10.05	10.32	10.60	10.89	11.19	11.49	11.81	12.13	12.46	12.80	13.15	2
3	9.27	9.51	9.78	10.05	10.32	10.60	10.89	11.19	11.49	11.81	12.13	12.46	12.80	13.15	13.51	13.88	3
4	9.78	10.05	10.32	10.60	10.89	11.19	11.49	11.81	12.13	12.46	12.80	13.15	13.51	13.88	14.26	14.65	4
5	10.32	10.60	10.89	11.19	11.49	11.81	12.13	12.46	12.80	13.15	13.51	13.88	14.26	14.65	15.05	15.46	5
6	10.89	11.19	11.49	11.81	12.13	12.46	12.80	13.15	13.51	13.88	14.26	14.65	15.05	15.46	15.88	16.32	6
7	11.49	11.81	12.13	12.46	12.80	13.15	13.51	13.88	14.26	14.65	15.05	15.46	15.88	16.32	16.76	17.22	7
8	12.13	12.46	12.80	13.15	13.51	13.88	14.26	14.65	15.05	15.46	15.88	16.32	16.76	17.22	17.69	18.17	8
9	12.80	13.15	13.51	13.88	14.26	14.65	15.05	15.46	15.88	16.32	16.76	17.22	17.69	18.17	18.66	19.17	9
10	13.51	13.88	14.26	14.65	15.05	15.46	15.88	16.32	16.76	17.22	17.69	18.17	18.66	19.17	19.69	20.23	10
11	14.26	14.65	15.05	15.46	15.88	16.32	16.76	17.22	17.69	18.17	18.66	19.17	19.69	20.23	20.79	21.35	11
12	15.05	15.46	15.88	16.32	16.76	17.22	17.69	18.17	18.66	19.17	19.69	20.23	20.79	21.35	21.93	22.54	12
13	15.88	16.32	16.76	17.22	17.69	18.17	18.66	19.17	19.69	20.23	20.79	21.35	21.93	22.54	23.15	23.78	13
14	16.76	17.22	17.69	18.17	18.66	19.17	19.69	20.23	20.79	21.35	21.93	22.54	23.15	23.78	24.43	25.09	14
15	17.69	18.17	18.66	19.17	19.69	20.23	20.79	21.35	21.93	22.54	23.15	23.78	24.43	25.09	25.78	26.49	15
16	18.66	19.17	19.69	20.23	20.79	21.35	21.93	22.54	23.15	23.78	24.43	25.09	25.78	26.49	27.21	27.96	16
17	19.69	20.23	20.79	21.35	21.93	22.54	23.15	23.78	24.43	25.09	25.78	26.49	27.21	27.96	28.72	29.50	17
18	20.79	21.35	21.93	22.54	23.15	23.78	24.43	25.09	25.78	26.49	27.21	27.96	28.72	29.50	30.31	31.13	18
19	21.93	22.54	23.15	23.78	24.43	25.09	25.78	26.49	27.21	27.96	28.72	29.50	30.31	31.13	31.98	32.86	19
20	23.15	23.78	24.43	25.09	25.78	26.49	27.21	27.96	28.72	29.50	30.31	31.13	31.98	32.86	33.76	34.68	20
21	24.43	25.09	25.78	26.49	27.21	27.96	28.72	29.50	30.31	31.13	31.98	32.86	33.76	34.68	35.62	36.59	21
22	25.78	26.49	27.21	27.96	28.72	29.50	30.31	31.13	31.98	32.86	33.76	34.68	35.62	36.59	37.60	38.62	22
23	27.21	27.96	28.72	29.50	30.31	31.13	31.98	32.86	33.76	34.68	35.62	36.59	37.60	38.62	39.67	40.76	23
24	28.72	29.50	30.31	31.13	31.98	32.86	33.76	34.68	35.62	36.59	37.60	38.62	39.67	40.76	41.87	43.02	24
25	30.31	31.13	31.98	32.86	33.76	34.68	35.62	36.59	37.60	38.62	39.67	40.76	41.87	43.02	44.18	45.39	25
26	31.98	32.86	33.76	34.68	35.62	36.59	37.60	38.62	39.67	40.76	41.87	43.02	44.18	45.39	46.63	47.91	26
27	33.76	34.68	35.62	36.59	37.60	38.62	39.67	40.76	41.87	43.02	44.18	45.39	46.63	47.91	49.22	50.56	27
28	35.62	36.59	37.60	38.62	39.67	40.76	41.87	43.02	44.18	45.39	46.63	47.91	49.22	50.56	51.94	53.36	28
29	37.60	38.62	39.67	40.76	41.87	43.02	44.18	45.39	46.63	47.91	49.22	50.56	51.94	53.36	54.81	56.31	29
30	39.67	40.76	41.87	43.02	44.18	45.39	46.63	47.91	49.22	50.56	51.94	53.36	54.81	56.31	57.85	59.43	30
31	41.87	43.02	44.18	45.39	46.63	47.91	49.22	50.56	51.94	53.36	54.81	56.31	57.85	59.43	61.05	62.71	31
32	44.18	45.39	46.63	47.91	49.22	50.56	51.94	53.36	54.81	56.31	57.85	59.43	61.05	62.71	64.43	66.19	32
33	46.63	47.91	49.22	50.56	51.94	53.36	54.81	56.31	57.85	59.43	61.05	62.71	64.43	66.19	67.99	69.85	33
34	49.22	50.56	51.94	53.36	54.81	56.31	57.85	59.43	61.05	62.71	64.43	66.19	67.99	69.85	71.75	73.72	34
35	51.94	53.36	54.81	56.31	57.85	59.43	61.05	62.71	64.43	66.19	67.99	69.85	71.75	73.72	75.72	77.79	35
Range	Step 1	Step 2	Step 3	Step 4	Step 5	Step 6	Step 7	Step 8	Step 9	Step 10	Step 11	Step 12	Step 13	Step 14	Step 15	Step 16	Range



Example: PD Officer, Range 17, \$21.43 to \$32.13

step (year)						
1	21.43					
2	22.65					
3	23.89					
4	25.20					
5	26.79	26.79	26.79	26.79	26.79	26.79
(merit %)	3%	2.50%	2%	1.50%	1%	0.50%
6	27.59	27.46	27.33	27.19	27.06	26.92
7	28.42	28.15	27.87	27.60	27.33	27.06
8	29.27	28.85	28.43	28.01	27.60	27.19
9	30.15	29.57	29.00	28.43	27.88	27.33
10	31.06	30.31	29.58	28.86	28.16	27.47
11	31.99	31.07	30.17	29.29	28.44	27.60
12	32.95	31.84	30.77	29.73	28.72	27.74
13		32.64	31.39	30.18	29.01	27.88
14			32.02	30.63	29.30	28.02
15			32.66	31.09	29.59	28.16
16				31.56	29.89	28.30
17				32.03	30.19	28.44
18				32.51	30.49	28.58
19					30.79	28.73
PD 1: 20					31.10	28.87
21					31.41	29.02
22					31.73	29.16
23					32.04	29.31
24					32.37	29.45
PD 2: 25						29.60
26						29.75
27						29.90
28						30.05
29						30.20
Pre-2011: 30						30.35
31						30.50
32						30.65
33						30.81
34						30.96
Post-2011: 35						31.11
36						31.27
37						31.43
38						31.58
39						31.74
40						31.90
41						32.06
42						32.22

FINAL BUDGET COMPENSATION PROGRAMS

Lindon City Pay Ranges FY 2019-2020

Range	Step 1	Step 2	Step 3	Step 4	Step 5
A	7.25	7.62	8.01	8.42	8.85

Range	Step 1	Step 2	Step 3	Step 4	Mid	High	Range
1	9.21	9.72	10.25	10.81	11.48	13.78	1
2	9.72	10.25	10.81	11.41	12.12	14.53	2
3	10.25	10.81	11.41	12.04	12.80	15.34	3
4	10.81	11.41	12.04	12.71	13.50	16.20	4
5	11.41	12.04	12.71	13.41	14.25	17.08	5
6	12.04	12.71	13.41	14.15	15.03	18.05	6
7	12.71	13.41	14.15	14.93	15.87	19.04	7
8	13.41	14.15	14.93	15.75	16.75	20.10	8
9	14.15	14.93	15.75	16.65	17.66	21.18	9
10	14.93	15.75	16.65	17.56	18.65	22.35	10
11	15.75	16.65	17.56	18.52	19.68	23.61	11
12	16.65	17.56	18.52	19.57	20.78	24.93	12
13	17.56	18.52	19.57	20.62	21.91	26.27	13
14	18.52	19.57	20.62	21.75	23.14	27.74	14
15	19.57	20.62	21.75	22.99	24.41	29.27	15
16	20.62	21.75	22.99	24.25	25.76	30.91	16
17	21.75	22.99	24.25	25.58	27.19	32.61	17
18	22.99	24.25	25.58	27.01	28.69	34.41	18
19	24.25	25.58	27.01	28.50	30.28	36.33	19
20	25.58	27.01	28.50	30.08	31.96	38.34	20
21	27.01	28.50	30.08	31.75	33.73	40.46	21
22	28.50	30.08	31.75	33.52	35.60	42.68	22
23	30.08	31.75	33.52	35.35	37.58	45.05	23
24	31.75	33.52	35.35	37.32	39.65	47.55	24
25	33.52	35.35	37.32	39.38	41.85	50.18	25
26	35.35	37.32	39.38	41.55	44.15	52.95	26
27	37.32	39.38	41.55	43.85	46.59	55.89	27
28	39.38	41.55	43.85	46.29	49.18	58.98	28
29	41.55	43.85	46.29	48.84	51.90	62.24	29
30	43.85	46.29	48.84	51.55	54.78	65.70	30
31	46.29	48.84	51.55	54.40	57.79	69.31	31
32	48.84	51.55	54.40	57.41	61.00	73.16	32
33	51.55	54.40	57.41	60.58	64.38	77.21	33
34	54.40	57.41	60.58	63.96	67.94	81.48	34
35	57.41	60.58	63.96	67.48	71.69	85.99	35
Range	Step 1	Step 2	Step 3	Step 4	Mid	High	Range

2019-2020

FINAL BUDGET

LINDON

COMPENSATION PROGRAMS

Lindon City Position Schedule

Department	Position	FLSA	Range	Status	# Emp.
Administration & Finance	Accounts Payable Clerk	Non-Ex	11	FT	1
Administration & Finance	Assistant Treasurer	Non-Ex	14	FT	0
Administration & Finance	City Administrator	Exempt	31	FT	1
Administration & Finance	Clerk I	Non-Ex	8	PT	1
Administration & Finance	Facilities Manager	Non-Ex	16	FT	1
Administration & Finance	Finance Director	Exempt	26	FT	1
Administration & Finance	Management Intern	Non-Ex	5	Temp	1
Administration & Finance	Recorder	Non-Ex	21	FT	1
Administration & Finance	Treasurer	Non-Ex	20	FT	1
Administration & Finance	Utilities Clerk	Non-Ex	11	FT	1
Building	Building Inspector	Non-Ex	17	FT	1
Building	Building Insp/Code Enforcement	Non-Ex	17	FT	0
Building	Chief Building Official	Exempt	21	FT	1
Court & Legal	City Attorney	Exempt	30	FT	1
Court & Legal	Clerk I	Non-Ex	8	PT	1
Court & Legal	Court Clerk	Non-Ex	13	FT	1
Court & Legal	Legal Secretary	Non-Ex	9	PT	1
Court & Legal	Municipal Court Judge	Non-Ex	26	PT	1
Parks & Recreation	Aquatics Center Assistant Manager	Non-Ex	3	Temp	1
Parks & Recreation	Aquatics Center Cashier	Non-Ex	A	Temp	12
Parks & Recreation	Aquatics Center Lifeguard	Non-Ex	A	Temp	130
Parks & Recreation	Aquatics Center Manager	Non-Ex	5	Temp	1
Parks & Recreation	Aquatics Center Supervisor	Non-Ex	1	Temp	6
Parks & Recreation	Aquatics Center Swim Team Coach	Non-Ex	5	Temp	1
Parks & Recreation	Aquatics Center Swim Instructor	Non-Ex	1	Temp	30
Parks & Recreation	Aquatics Center Water Safety Instr.	Non-Ex	5	Temp	1
Parks & Recreation	Comm. Ctr. Front Desk Attendant	Non-Ex	1	PT	3
Parks & Recreation	Comm. Ctr. Instructor	Non-Ex	*	PT	1
Parks & Recreation	Kitchen Aide	Non-Ex	A	PT	1
Parks & Recreation	Parks & Recreation Director	Exempt	25	FT	1
Parks & Recreation	Parks Superintendent	Non-Ex	17	FT	1
Parks & Recreation	Parks Maintenance Tech.	Non-Ex	13	FT	1
Parks & Recreation	Program Coordinator	Non-Ex	13	FT	1
Parks & Recreation	Program Coordinator	Non-Ex	9	PT	2
Parks & Recreation	Seasonal Laborer	Non-Ex	1	Temp	2
Parks & Recreation	Youth Sports Referee	Non-Ex	1	Temp	4
Parks & Recreation	Youth Sports Site Supervisor	Non-Ex	1	Temp	1
Planning	Assistant Planner	Non-Ex	16	FT	0
Planning	Associate Planner	Non-Ex	17	FT	1
Planning	Comm. Development Clerk II	Non-Ex	11	FT	1
Planning	Comm. Development Clerk I	Non-Ex	8	PT	1
Planning	Planning & Economic Dev. Director	Exempt	26	FT	1
Planning	Planning Intern	Non-Ex	5	Temp	1

FINAL BUDGET COMPENSATION PROGRAMS

Department	Position	FLSA	Range	Status	# Emp.
Police	Administrative Professional	Non-Ex	14	FT	1
Police	Corporal	Non-Ex	18	FT	2
Police	Crossing Guard	Non-Ex	1	PT	3
Police	Lieutenant	Non-Ex	23	FT	1
Police	Officer	Non-Ex	17	FT	9
Police	Police Chief	Exempt	27	FT	1
Police	Police Sergeant	Non-Ex	21	FT	2
Police	Police Secretary	Non-Ex	9	FT	1
Public Works	Administrative Secretary	Non-Ex	11	FT	1
Public Works	Clerk I	Non-Ex	8	PT	1
Public Works	Director of Public Works	Exempt	27	FT	1
Public Works	Engineer	Exempt	26	FT	1
Public Works	Engineer in Training (EIT)	Non-Ex	18	FT	0
Public Works	Equipment Operator	Non-Ex	12	FT	1
Public Works	Public Works Inspector	Non-Ex	17	FT	2
Public Works	Seasonal Laborer	Non-Ex	1	Temp	3
Public Works	Staff Engineer	Non-Ex	21	FT	1
Public Works	Storm Water Superintendent	Non-Ex	18	FT	1
Public Works	Storm Water Maintenance Tech.	Non-Ex	13	FT	1
Public Works	Streets Superintendent	Non-Ex	20	FT	1
Public Works	Utilities Technician	Non-Ex	13	PT	0
Public Works	Waste Water Superintendent	Non-Ex	20	FT	1
Public Works	Waste Water Maintenance Tech.	Non-Ex	13	FT	2
Public Works	Water Superintendent	Non-Ex	20	FT	1
Public Works	Water System Maintenance Tech.	Non-Ex	13	FT	3

The Police Lieutenant position has been proposed in this FY 2019-2020 Budget. However, it is not an additional employee, but will be filled by existing personnel.

Cost of Living Allowance

Cost of Living Allowance (COLA) increases may be considered each year when it is determined from an appropriate index that such an increase is warranted, and after considering the impact of such an increase on the City's budget. Seasonal and temporary positions which are filled prior to a COLA increase will not receive the increase until the next season.

Merit Increase

Employees may qualify for a merit increase as described in the Policies and Procedures Manual.

For employees who are between Steps 1 through 4 on the pay scale: if they score a 6.0 average or better on their performance evaluations they will be moved to the next step in the pay scale. For employees who are between Mid and High steps on the pay scale: they will be eligible to receive the full merit percentage increase approved by the City Council if they score an average of 8.0 or higher on their performance evaluation. Scoring less than 8.0 allows them to obtain a percentage of the merit increase as follows in the table below:

Table of Evaluation Scores and Merit Percent	
Final Score	Merit Percent
8 or higher	100%
7 - 7.9	90%
*6 - 6.9	70%
4 - 5.9	No Merit
1 - 3.9	Probation
*Range steps 1-5 must score 6.0 or higher for full merit.	

As an **EXAMPLE** of how the merit increase will apply for those above the Mid-point, but below the High-point in their range, the following will occur:

Range	Step 1	Step 2	Step 3	Step 4	Mid	High	Range
10	13.96	14.73	15.55	16.41	17.43	20.90	10

Example employee job position is in Range 10, and who's current pay is \$18.28 (between Mid-point and High-point), and who scored 7.6 on their performance evaluation. Based on the table above this score will enable the employee to be eligible for 90% of the merit increase approved by the City Council (example assumes a 1.6% merit increase). This is calculated as follows:

City Council Approved Merit Percentage multiplied by Merit Percent Evaluation Score, equals Merit Performance Increase Percentage:

$$1.6 \times 90\% = 1.44$$

Current hourly wage multiplied by Merit Performance Increase Percentage, equals amount of hourly increase to wage:

$$\$18.28 \times 1.44\% = \$0.26$$

Current hourly wage plus hourly increase to wage, equals new hourly wage:

$$\$18.28 + \$0.26 = \$18.54$$

With the new hourly wage of \$18.54 the employee will continue to be eligible for future merit performance increases until reaching the top of Range 10 (\$20.90). Once at the top of the range the employee will be eligible only for one-time merit pay bonuses based upon the same formulas above, but the hourly increase will be calculated for the entire year and paid in one lump sum. This one-time merit pay bonus is not added to the future annual salary for the employee and must be earned each year. The bonus pay is also subject to annual City Council approval based on budget constraints.

Annual Performance Evaluation Scores - Dept & Total City Average Scores

DEPARTMENT	2014	2015	2016	2017	2018	2019	2020	2021
Admin	9.03	8.97	8.68	8.64	8.71			
Parks and Rec	6.72	7.64	7.98	8.08	8.14			
Police	8.57	8.11	8.54	8.78	8.70			
Public Works	8.18	8.27	8.19	8.44	8.29			
Comm. Dev.	8.28	8.38	8.72	8.78	9.37			
City Average	8.25	8.23	8.37	8.53	8.52			

2017 = 18 different supervisors scoring subordinate employees. 57 total FT/perm PT

2018 = 21 supervisors scoring subordinate employees. 64 total FT/perm PT (excluding judge)

Typical Employee Benefits & Perks for Regular Full-time Employees at Lindon City

FY 2019-20

- Competitive Salary Ranges
- Utah State Retirement (URS) pension plan
 - Retire with annual pension until death (amounts based on salary and years of service); Vested after 4 years in system.
 - Death benefit (URS pays 75% of annual salary in lump sum)
 - Survivor/spouse pension benefit after 15 years
- 401k contribution = 1.5% of current wage. If employee contributes additional 1.5% the City will match that contribution (total of 3% from city)
- Health insurance premiums 100% paid by City. No current employee participation on monthly premiums. Choice of traditional PPO or HSA through PEHP / Mountain Star hospital networks.
- Dental = 50% premium paid by City for family coverage.
- Annual life insurance = \$50,000 for employee. Additional insurance options available at employee expense.
- 12 paid holidays per year (11 holidays + one personal day)
- 96 hours sick leave accrued per year
- 80 hrs vacation accrued annually years 1-10; 120 hrs accrued in yrs 11-20; 160 hours in yrs 21+
- Sick leave buy-back program: sell back up to 24 hours of sick leave after accruing minimum 288 hours of sick time (about 3 yrs of sick leave). Makes for a nice Christmas bonus as it's paid the end of November.
- One-time merit bonus pay for those maxed-out on salary range: If an employee has topped out on their pay scale this program allows the employee to receive a merit increase lump bonus at the end of the calendar year. It's not added as a salary increase.
- Differential Pay for specific professional certifications
- Long-term disability coverage paid by City
- Eye coverage available at employee expense
- Cafeteria Plan available for tax-exempt health/medical expenses
- Workers compensation coverage paid by City
- FICA/Social Security contributions
- \$150 per year uniform allowance for specific positions
- Annual Aquatics Center 30 punch pass. Additional passes discounted for employees
- Access to cardio/weight room at Community Center
- Up to 4 free facility rentals per year (pavilions, community center, etc.)
- As needed: Assigned work vehicles for specific positions (not take-home)
- As needed: City-paid cell phone, tablet/laptop, and other computer equipment
- Well maintained facilities/offices
- Good work relationships. Supportive elected officials. Great political climate with citizens (very rare community/political turmoil).
- Challenging projects of growing city.

Ideas for possible consideration to attract and retain employees:

- Continue to monitor pay amounts and pay ranges to stay above average compared to similar positions in other cities/counties. We've attempted to keep pay ranges a little above market average – but not leading the market in wage compensation.
 - Many positions appear to be falling below average compensation and will likely need adjustments in pay ranges this coming budget year (FY2020-2021)
 - Lifeguards, public works operators, seasonal laborers, etc.
 - An updated salary study will be prepared spring of 2020
- Continue offering high quality benefit package
- Apprentice program: hire senior high school and/or tech college or university students as PT employees, and if certain benchmarks achieved they'll be offered FT employment once graduated and/or trained.
 - Incentivize with tuition payment and/or reimbursement programs
 - Must commit to certain number of years on the job
- Tuition reimbursement (post graduation) / scholarship (pre graduation)
- Lump sum bonuses for years-on-the job. Incent to stay until a certain date in order to get bonus.
- Referral bonus / finder's fee: offer cash for any employee who refers an applicant that gets hired and works for min amount of time.
- Employee recognition or misc perks: food, gift cards, bonuses, awards, time off, social activities

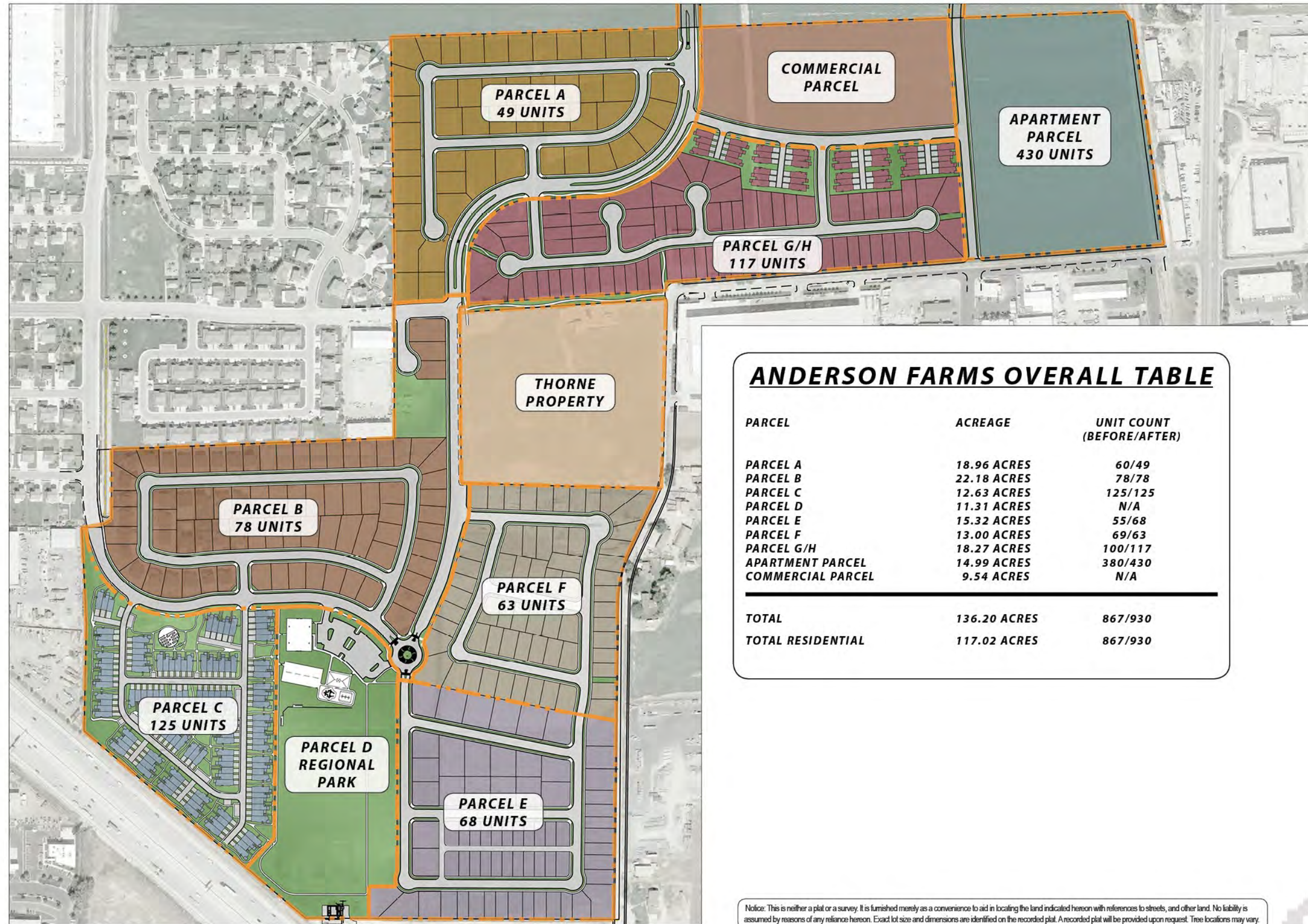

ANDERSON FARMS overall plan

LINDON CITY, UTAH COUNTY

07/12/19

19-0231



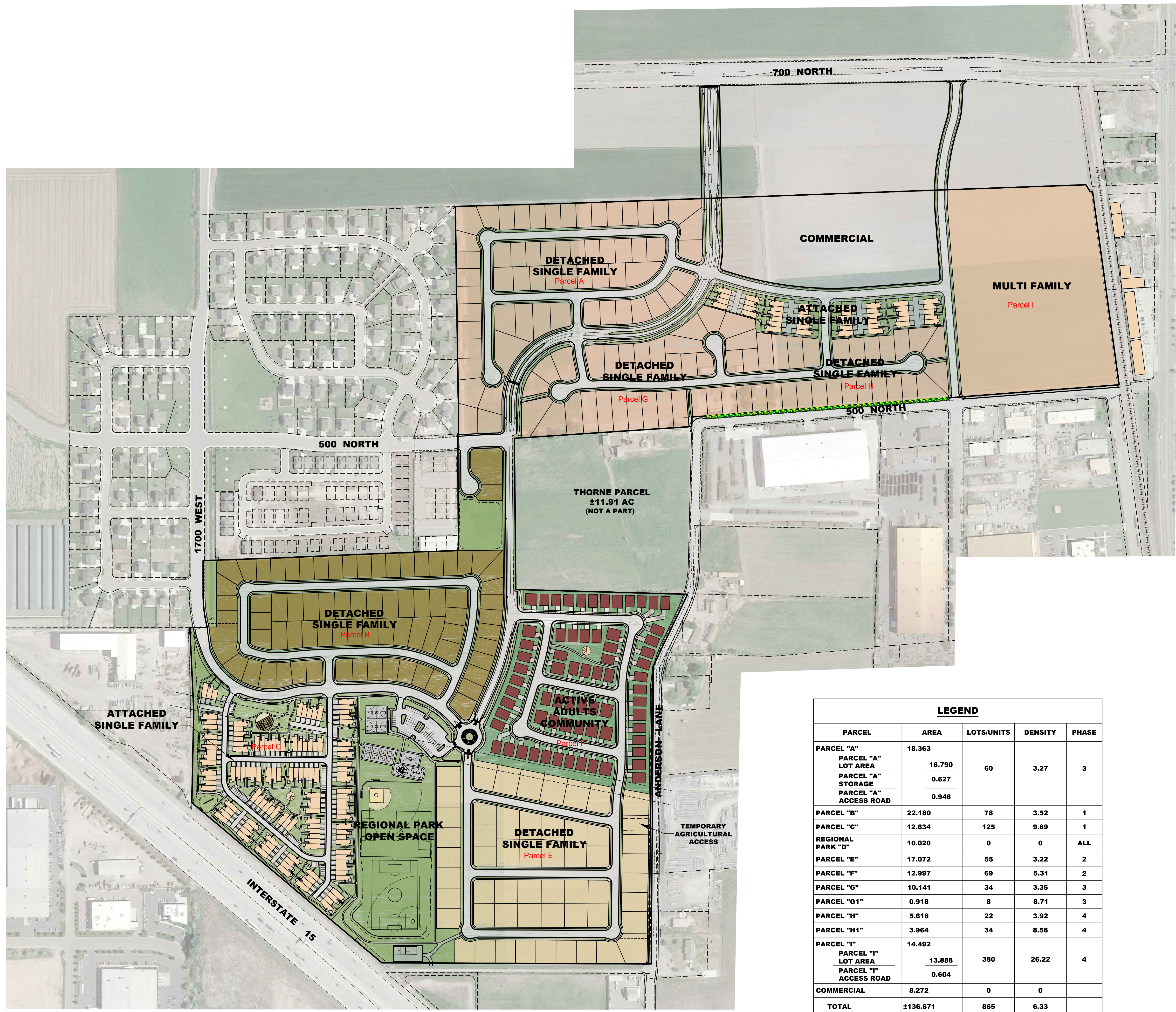
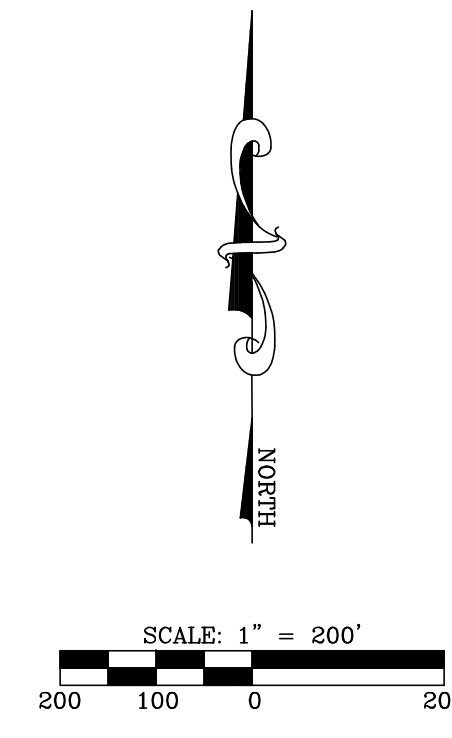

LEGEND				
PARCEL	AREA	LOTS/UNITS	DENSITY	PHASE
PARCEL "A"	18.363			
PARCEL "A" LOT AREA	16.790	60	3.27	3
PARCEL "A" STORAGE	0.627			
PARCEL "A" ACCESS ROAD	0.946			
PARCEL "B"	22.180	78	3.52	1
PARCEL "C"	12.634	125	9.89	1
REGIONAL PARK "D"	10.020	0	0	ALL
PARCEL "E"	17.072	55	3.22	2
PARCEL "F"	12.997	69	5.31	2
PARCEL "G"	10.141	34	3.35	3
PARCEL "G1"	0.918	8	8.71	3
PARCEL "H"	5.618	22	3.92	4
PARCEL "H1"	3.964	34	8.58	4
PARCEL "I"	14.492			
PARCEL "I" LOT AREA	13.888	380	26.22	4
PARCEL "I" ACCESS ROAD	0.604			
COMMERCIAL	8.272	0	0	
TOTAL	±136.671	865	6.33	

IVORY HOMES

3340 NORTH CENTER STREET
 LEHI, UT. 84043
 (801) 407-6800

ANDERSON FARMS
 LONDON, UTAH
EXHIBIT B - PROPERTY CONCEPT PLAN

REVISIONS	
1	
2	
3	
4	
5	

LEI PROJECT #: 2013-1845
 DRAWN BY: BLS
 CHECKED BY: GDM
 SCALE: 1" = 200'
 DATE: 5/2/2016
 EXHIBIT

REGULAR SESSION – 7:00 P.M. - Conducting: Jeff Acerson, Mayor

Pledge of Allegiance: By Invitation

Invocation: Jeff Acerson

Item 1 – Call to Order / Roll Call

October 1, 2019 Lindon City Council meeting.

Jeff Acerson
Van Broderick
Jake Hoyt
Carolyn Lundberg
Mike Vanchiere

Staff present: _____

Item 2 – Presentations and Announcements

- a) Comments / Announcements from Mayor and Council members.
- b) **Presentations:** Employee Recognition Award (2019 3rd Quarter); Gary Hoglund and Alex Roylance will be recognized.

Item 3 – Approval of Minutes

- Review and approval of City Council minutes: **September 17, 2019**

Minutes will be provided at a later date.

Item 4 – Open Session for Public Comment *(For items not on the agenda - 10 minutes)*

Item 5 – Consent Agenda – *Consent agenda may contain items which have been discussed beforehand and/or do not require significant discussion, or are administrative in nature, or do not require public comment. The Council may approve all Consent Agenda items in one motion, or may discuss individual items as needed and act on them separately.*

No consent agenda items for approval.

6. **Public Hearing — General Plan Amendment; Ordinance #2019-14-O.**

The City Council will review and consider Ordinance #2019-14-O to amend the Lindon City General Plan to include the updated 2019 Moderate-Income Housing Plan. (30 minutes)

See attached materials from the Planning Department.

Sample Motion: *I move to (approve, deny, continue) an amendment to the Moderate-Income Housing Plan chapter of the Lindon City General Plan as included in Ordinance #2019-14-O (or as presented, with changes).*

General Plan Amendment – Moderate-Income Housing Plan

<p>Date: October 1, 2019 Applicant: Lindon City Presenting Staff: Michael Florence</p> <p>Type of Decision: Legislative</p> <p>Planning Commission Recommendation: The planning commission unanimously recommended approval</p>	<p><u>MOTION</u> I move to (<i>approve, deny, continue</i>) an amendment to the Moderate-Income Housing Plan Chapter of the Lindon City General Plan 2019-14-O (or <i>as presented, with changes</i>).</p>
--	---

Overview:

The Lindon City Moderate Income Housing Plan provides a snap-shot into current demographic trends and provides estimates into future housing needs. In 2019, the Utah Legislature passed Senate Bill 34 which made changes to Utah Code 10-9a. These changes required municipalities **of the first, second, third and fourth classes to develop a “plan for moderate-income housing”** to be adopted by December 1, 2019 as part of a general plan amendment and to select 3 recommended strategies to develop moderate-income housing.

The State of Utah provided each municipality with affordable housing shortage gaps relative to their municipality. Those shortage gaps are found below and on page 27 of the Moderate-Income Housing Plan. Each municipality will have five years to work on closing the identified affordable housing shortage gaps and starting December 1, 2020 each municipality will be required to report yearly progress to the State.

Table 13

2018 Shortage	Renter Households	Affordable Rental Units	Available Rental Units	Affordable Units - Renter Households	Available Units - Renter Households
≤ 80% HAMFI	340	400	310	60	-30
≤ 50% HAMFI	170	115	45	-55	-125
≤ 30% HAMFI	120	30	10	-90	-110

Table 14

2016 Shortage	Renter Households	Affordable Rental Units	Available Rental Units	Affordable Units - Renter Households	Available Units - Renter Households
≤ 80% HAMFI	290	375	250	85	-40
≤ 50% HAMFI	170	90	50	-80	-120
≤ 30% HAMFI	130	65	35	-65	-95

Table 15

PROGRESS	Renter Households	Affordable Rental Units	Available Rental Units	Affordable Units - Renter Households	Available Units - Renter Households
≤ 80% HAMFI	50	25	60	-25	10
≤ 50% HAMFI	0	25	-5	25	-5
≤ 30% HAMFI	-10	-35	-25	-25	-15

From feedback when the council first reviewed the proposed Moderate-Income Housing Plan on August 20, 2019 and changes discussed at the planning commission meeting, staff made the following goal changes and updates:

- Evaluate the effectiveness of the R2 zone and if any regulations should be modified. In 2016 at a **“kick-off” meeting to update the general plan, the city council and planning commission held a joint** meeting where one of the topics of discussion was putting together a committee to research responsible options for infill development as well as strategic areas and criteria for possible higher density development. Discuss again the opportunities and need for such a committee.
- Evaluate whether the City would allow moderately higher density developments as part of a mixed commercial development that would be located in strategic commercial areas or centers to help with development potential.
- Discuss if impact fees reductions should apply to all affordable housing options, not just accessory apartments, as an incentive to help reduce housing barriers and promote affordable housing.
- Review the Standard Land Use Table to evaluate currently allowed housing options if there are additional opportunities for housing within each land use district.
- Meet with the Housing Authority of Utah County and discuss housing needs and partnership opportunities at an upcoming City Council work meeting. Also discuss with the housing authority future opportunities for new affordable housing units.
- ~~Further evaluate the inclusion of moderate-income housing as part of new developments. Further evaluate the inclusion of moderate-income housing as part of new development for municipal employees or other qualifying individuals.~~
- ~~Discuss opportunities for mortgage assistance programs available for qualifying individuals. Discuss opportunities in working with developers to provide mortgage assistance programs for city employees and other qualifying individuals.~~
- Discuss opportunities to work with non-profit housing groups to purchase homes as they become available on the market for re-sale as affordable housing.
- Knowing that Light Rail may still be in the future many years, study whether the City should help preserve property for Transit Oriented Development.
- Discuss how to help homeowners bring unapproved accessory apartments into compliance.
- Evaluate needed re-**investment into Lindon’s older neighborhoods through infrastructure** improvements, neighborhood clean-up, and code enforcement.

ORDINANCE NO. 2019-14-O

AN ORDINANCE OF THE CITY COUNCIL OF LINDON CITY, UTAH COUNTY, UTAH, AMENDING THE MODERATE-INCOME HOUSING PLAN CHAPTER OF THE LINDON CITY GENERAL PLAN AND PROVIDING FOR AN EFFECTIVE DATE.

WHEREAS, Utah State Code 10-9a-401 requires that each municipality prepare and adopt a comprehensive, long-range general plan; and

WHEREAS, Utah State Code 10-9a-401 requires, as part of the general plan, that municipalities include a plan for moderate-income housing growth; and

WHEREAS, Utah Senate Bill 34, which was passed in the 2019 Legislative Session, requires that municipalities by December 1, 2019 adopt an amendment to the Moderate-Income Housing Plan chapter of the general plan and requirements found therein which shall include a recommendation to implement three or more housing policy strategies; and

WHEREAS, the City Council is authorized by Utah State Code to prepare and adopt comprehensive and long-amendments to the general plan; and

WHEREAS, as per Utah State Code 10-9a-403, this amendment provides an analysis of how Lindon City will provide a realistic opportunity for the development of moderate-income housing within the next five years; and

WHEREAS, this amendment includes a recommendation to implement three or more strategic housing policies as required in Utah State Code 10-9a-403; and

WHEREAS, the proposed amendment is consistent with the goals of the Lindon City General Plan; and

WHEREAS, on September 24, 2019, the Planning Commission held a properly noticed public hearing to hear testimony regarding the general plan amendment; and

WHEREAS, after the public hearing, the Planning Commission further considered the proposed general plan amendment and housing requirements of Utah State Code and recommended that the Council adopt the attached Moderate-Income Housing Plan amendment to the general plan;

WHEREAS, the Council held a public hearing on October 1, 2019, to consider the recommendation and the Council received and considered all public comments that were made therein.

NOW, THEREFORE, BE IT ORDAINED by the City Council of the City of Lindon, Utah County, State of Utah, as follows:

SECTION I: Amendment. Amend the Lindon City General Plan Moderate-Income Housing Plan Chapter as follows:

~~MODERATE INCOME HOUSING PLAN~~

~~MODERATE INCOME HOUSING PLAN~~

~~INTRODUCTION~~

~~The availability of moderate income housing is an issue of City-wide concern. To this end Lindon City should provide a reasonable opportunity for a variety of housing, including moderate income housing, to meet the needs of people desiring to live in Lindon. Moderate income housing projects should be encouraged to allow persons with moderate incomes to benefit from and to fully participate in all aspects of neighborhood and community life in Lindon. This *Moderate Income Housing Plan* shall estimate the existing supply of moderate income housing located within the City, shall estimate the need for moderate income housing over the next five years, shall survey the existing residential zoning, shall evaluate existing zoning densities and how they affect opportunities for moderate income housing, and shall define Lindon's plan to provide for and encourage moderate income housing.~~

- ~~• "Moderate income housing" means housing occupied or reserved for occupancy by households with a gross household income equal to or less than 80% of the median gross income of the Utah County Metropolitan Statistical Area for households of the same size.~~

~~EXISTING SUPPLY OF MODERATE INCOME HOUSING~~

~~As of April 2010 Lindon City has approximately 2,404 residential dwelling units. Lindon has an estimated 488 multi-family housing units in the form of duplexes, triplexes, fourplexes, townhomes, condominiums, and accessory apartments. The vast majority of these units are rentals. (For the purposes of this section, it should be noted that many of the multi-family housing units would not fit the definition of moderate income housing at current market valuations.)~~

~~Lindon has an estimated 1,916 single-family homes. The City estimates that up to 10% of these homes would fit the definition of moderate income housing if sold on the open~~

market. This estimate would provide single-family housing for approximately 191 moderate income families.

~~ESTIMATE OF NEED OF MODERATE INCOME HOUSING OVER THE NEXT FIVE YEARS~~

Lindon's estimated population in April, 2010 was 10,070. Given the slow economy and depleted housing market in 2010, and based on a very conservative growth rate of 1% per year, Lindon will add 503 citizens over the next 5 years increasing the population to approximately 10,573 persons. This equates to 117 new households based on an average household size of 4.3 individuals (per 2000 Census).

The R-2 Overlay districts have a total remaining capacity of 81 units. When adopted, the R-3 ordinance required that a percentage of the single-family and retirement units constructed within the zone must be sold at moderate income sales prices. The single-family moderate income units have all been sold, but none of the moderate income retirement phase units have yet to be sold. This remaining amount of required moderate income retirement homes equals 16 units. This equals a total of 97 future moderate income units made possible through the R-2 overlay and R-3 zone. This figure does not take future accessory apartments into account that exceed the R-2 Overlay District allotments – which could also qualify as moderate income housing.

Past records from Utah County indicate that approximately 30% of the residents in the County have an annual income that falls within the moderate income range. By calculating 30% of the estimated 117 new households that will be created in Lindon over the next five years, the City would need to allow for approximately 35 moderate income housing units over the next five year period. Given these estimates, it appears that the 35 units are clearly allowed for by the Lindon City R-2 overlay and R-3 zoning ordinance - which have potential for 97 possible units as discussed above.

~~SURVEY AND EVALUATION OF EXISTING RESIDENTIAL ZONING~~

Currently residential areas within Lindon City are zoned into four different zoning districts. These are:

1. ~~R1-20 Zone – Allows single family homes on 20,000 sq. ft. lots or greater. Currently 26% of Lindon is zoned R1-20.~~
2. ~~R1-12 Zone – Allows single family homes on 12, 000 sq. ft. lots or greater. Currently 9% of Lindon is Zoned R1-12.~~
3. ~~R2 Overlay = Overlies both the R1-20 zone and the R1-12 zones and allows for up to 4 units per acre (prior to 2005, up to 6 units per acre were allowed). The R2 Overlay consists of all residential zones (35% of the city land area) and also applies to the R3 zone area (1% of the city land area).~~
4. ~~R3 Zone – Allows single family dwellings on higher density lots (averaging 10,000 sq/ft) and retirement oriented housing units at an approximate density of 5.5 units per acre. This zone accounts for 1% of the city land area.~~

~~Through a creative approach using owner-occupied accessory apartments, the R2 Overlay Zone, and the R3 Zone, Lindon has provided opportunities for the development and construction of accessory apartments, single family homes, twin homes, town homes, triplexes, and planned unit developments in residentially zoned property in Lindon. The purpose and intent of this zoning plan is to vary densities and spread multi-family units throughout the community. This provides affordability as well as diversity in housing stock. No single area is zoned exclusively for multi-family units. R2 overlay units can be developed in all residential zones assuming they meet the requirements and development standards of the ordinance. In addition, Lindon currently has 9% of the city zoned R1-12 which allows 12,000 sq. ft. lots and 1% zoned R-3, which allows for 10,000 sq/ft average lot sizes. These zones may be able to consist of smaller, more affordable lots.~~

Lindon City has also adopted ordinances to provide an opportunity for the construction and development of housing for the elderly, physically and mentally handicapped, and juveniles.

Through this established zoning plan it is Lindon's goal and policy to provide for a realistic opportunity to meet the moderate income housing needs of those desiring to live and participate in community life in Lindon.

PLAN TO PROVIDE FOR AND ENCOURAGE MODERATE INCOME HOUSING

Lindon City shall continue to allow and permit owner-occupied accessory apartments in all single family homes which are not part of an R2 Overlay project. This policy will promote the maintenance of existing accessory apartments in Lindon and encourage the construction of new apartments to provide an opportunity for low to moderate income residents to live, work, and participate in community life in Lindon.

Lindon City also understands the need to provide opportunities for home ownership for moderate income residents in Lindon. To this end Lindon has developed the R2 overlay ordinance and the R3 zone — which provides opportunities for multi-family units to be constructed, smaller lot sizes to be created, accessory apartments to be established, and moderate income sales to be required.

In addition, Lindon will consider the use of the following tools and techniques to provide opportunities for affordable single family and multifamily moderate income housing. These are:

1. Rehabilitation of existing underutilized housing stock.
2. Infrastructure expansion and rehabilitation that will facilitate the construction of moderate income housing.
3. Consideration of waiving construction related fees generally imposed by the municipality.

- ~~4. Utilization of state or federal funds or tax incentives to promote the construction and rehabilitation of moderate income housing.~~
- ~~5. Utilization of programs offered by the Housing Authority of Utah County within that agency's funding capacity as well as other public, private and non-profit housing agencies.~~
- ~~6. Utilization of affordable housing programs administered by the Department of Community and Economic Development and the Department of Housing and Urban Development (Federal Government).~~

Lindon City Moderate- Income Housing Plan

2019

Adopted _____

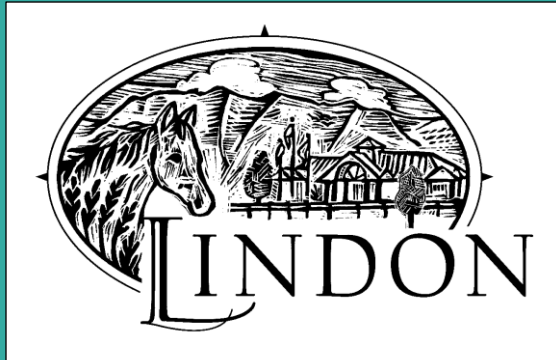

Table of Contents	
Executive Summary	3
Section 1	5
Introduction	5
Purpose of the Housing Plan	5
Vision	7
Regional Planning	7
Lindon City Background	8
Support of Moderate-Income Housing	8
Existing Supply of Moderate-Income Housing	8
Growth Patterns	9
Local Economy	11
Section II	12
Demographic Data and Analysis	12
Population History	12
5 and 10 Year Population Projections	16
Income Trends	16
U.S. Census Bureau 2017	17
Moderate Income Analysis	17
Housing Needs Assessment	20
Current Housing Stock.....	20
Housing Under Construction and Entitled but not Constructed.....	21
Current Housing Sales and Pricing	22
Available Land Percentages	22
Moderate Income Housing Analysis	23
Housing Cost Burdens	23
Utah Department of Workforce Services Gap Analysis and Housing Forecast	24
Section III	28
Regulatory Environment	28
Review of Current Zoning Districts	28
Regulatory Analysis of Potential Barriers to Moderate-Income Housing	28
Section IV	34
Compliance with Utah Code 10-9a-403 – Senate Bill 34 (2019)	34
Section V	37
Housing Goals and Continued Support of Moderate-Income Housing	37
Works Cited	38
Appendix	39

Executive Summary

The Lindon City Moderate Income Housing Plan provides a snap-shot into current demographic trends and provides estimates into future housing needs. In 2019, the Utah Legislature passed Senate Bill 34 which made changes to Utah Code 10-9a. These changes required municipalities of the first, second, third and fourth classes to develop a “plan for moderate-income housing” to be adopted by December 1, 2019 as part of a general plan amendment. Beginning December 1, 2020 and annually thereafter, the City shall complete an annual moderate-income housing report form and submit it to the State. The State will then monitor the ongoing yearly progress of meeting affordable housing goals within the municipality. Housing progress will be evaluated by the State and tied to future State Road capacity projects with State Transportation Funding (TF) and State Transportation Investment Funds (TIF) through the Utah Department of Transportation.

The State of Utah defines Moderate-Income Housing as “housing occupied or reserved for occupancy by households with a gross household income equal to or less than 80% of the median gross income for households of the same size in the county in which the city is located.” The Federal Department of Housing and Urban Development defines affordable housing as “any housing unit whose costs are less than or equal to 30% of a prospective occupant’s household income.”

Lindon City has a 2019 population estimate of approximately 11,447 residents and just over 3,000 housing units. Mountainland Association of Governments estimates that by 2029 Lindon City will have a population of 12,491 residents.

The following study shows that Lindon City has made significant progress in reducing the housing cost burden for 100%, 80%, 50% and 30% Area Median Income (AMI) ratios. The City has put in place past housing programs that have been successful. However, as Utah County continues to increase in population it will be important for the city to evaluate future housing opportunities.

As has been widely reported over the past few years, Utah in general is in need of additional affordable housing units. To help determine the moderate-income housing shortage for each municipality, the Utah Department of Workforce Services calculated the current need of available housing. Those housing shortage numbers for Lindon are provided in this report on pages 26.

During the 2019 Legislative Session, Utah Code 10-9a-403 was updated which requires most municipalities to recommend the selection of three strategic affordable housing development policies out of a list of twenty-three to incorporate. Lindon City currently incorporates some of these strategies as well selected others to work towards. The following five strategies have been selected:

- Create or allow for, and reduce regulations related to, accessory dwelling units in residential zones
- Reduce Impact Fees, as defined in Section 11-36a-102, related to low- and moderate-income housing
- Preserve existing moderate-income housing
- Utilize strategies that preserve subsidized low to moderate income units on a long-term basis
- Allow for alternative housing types or moderate-income residential development in commercial and mixed-use zones, commercial centers, or employment centers

The update to Utah Code 10-9a-403 also requires that municipalities update their General Plan Land Use and Transportation sections to coordinate growth with the Moderate-income housing element. Staff will be working to update these two sections of the Lindon General Plan next.

With the changes in State code and the requirement for yearly reporting, it is the expectation of the legislature that each municipality will make continued progress towards additional moderate-income housing. Below is a list of goals from Page 38 of the report that outlines opportunities for discussion and possible improvement to direct Lindon Housing policies:

- Evaluate the effectiveness of the R2 zone and if any regulations should be modified. In 2016 at a “kick-off” meeting to update the general plan, the city council and planning commission held a joint meeting where one of the topics of discussion was putting together a committee to research responsible options for infill development as well as strategic areas and criteria for possible higher density development. Discuss again the opportunities and need for such a committee.
- Evaluate whether the City would allow moderately higher density developments as part of a mixed commercial development that would be located in strategic commercial areas or centers to help with development potential.
- Discuss if impact fees reductions should apply to all affordable housing options, not just accessory apartments, as an incentive to help reduce housing barriers and promote affordable housing.
- Review the Standard Land Use Table to evaluate currently allowed housing options if there are additional opportunities for housing within each land use district.
- Meet with the Housing Authority of Utah County and discuss housing needs and partnership opportunities at an upcoming City Council work meeting. Also discuss with the housing authority future opportunities for new affordable housing units.
- Further evaluate the inclusion of moderate-income housing as part of new developments.
- Discuss opportunities for mortgage assistance programs available for qualifying individuals.
- Discuss opportunities to work with non-profit housing groups to purchase homes as they become available on the market for re-sale as affordable housing.
- Knowing that Light Rail may still be in the future many years, study whether the City should help preserve property for Transit Oriented Development.
- Discuss how to help homeowners bring unapproved accessory apartments into compliance.
- Evaluate needed re-investment into Lindon’s older neighborhoods through infrastructure improvements, neighborhood clean-up, and code enforcement.

Section 1

Introduction

Purpose of the Housing Plan

The purpose of the Lindon City Moderate Income Housing Plan is to comply with Utah State Code 10-9a-Part 4 and to plan for moderate income housing growth within Lindon City. This plan is adopted as an update to the Lindon City General Plan and will examine the current Lindon population, income, employment and housing trends and needs. In the past, Lindon City has come up with unique and pro-active ways of supporting affordable housing within the community either through the use of accessory apartments, creating new zoning districts for housing or modifying lot sizes and infrastructure standards. The study will also analyze the demographics and development patterns to create realistic goals to provide moderate income housing in the community. Utah Code 10-9a-103 requires that municipalities plan for moderate-income housing as a written document adopted by the municipalities legislative body that includes the following:

- an estimate of the existing supply of moderate-income housing located within the city;
- an estimate of the need for moderate income housing in the city for the next five years as revised biennially;
- a survey of total residential land use;
- an evaluation of how existing land uses and zones affect opportunities for moderate income housing; and
- a description of the city's program to encourage an adequate supply of moderate-income housing.

The terms moderate income housing and affordable housing are frequently used interchangeably in Utah, but they do not mean the same thing. Affordable housing is defined by U.S. Department of Housing and Urban Development as “any housing unit whose costs are less than or equal to 30 percent of a prospective occupant’s household income.” Under Utah Law, moderate-income housing has a precise definition found in Title 10, Chapter 9a, Part 1 of the Utah Code which states:

“housing occupied or reserved for occupancy by households with a gross household income equal to or less than 80% of the median gross income for households of the same size in the county in which the city is located”

During the 2019 legislative session, the Utah legislature passed Senate Bill 34 which requires communities to facilitate moderate income housing by updating their general plan by December 1, 2019. In drafting the moderate-income housing element, the City in its General Plan shall consider the Utah Legislature’s determination that municipalities shall facilitate a reasonable opportunity for a variety of housing, including moderate income housing (Utah Code 10-9a-403):

- to meet the needs of people of various income levels living, working, or desiring to live or work in the community; and
- to allow people with various incomes to benefit from and fully participate in all aspects of neighborhood and community life

The Utah Legislature also required municipalities to include an analysis of how the municipality will provide a realistic opportunity for the development of moderate-income housing within the next five years. The Legislature provided in State code twenty-three housing strategies by which a municipality of the population size of Lindon must make a recommendation to implement three. Starting in December 2020, each municipality will be required to annually review the general plan moderate-income housing element and submit a report to the Utah Department of Workforce Services describing the progress made in providing moderate-income housing.

Vision

To encourage a range of quality housing types and opportunities for individuals and families through all stages of life and incomes while continuing to maintain the City's unique rural character.

Regional Planning

Through the efforts of Envision Utah, Utah County municipalities, local universities, chambers of commerce and other local stake holder groups have kicked off a Utah Valley Visioning process to coordinate and plan for Utah County's future growth. In the coming decades, Utah County is expected to increase its population by one million residents with eighty-five percent of that growth coming internally from Utah County residents.¹ Lindon City understands that it will see the pressures of future population growth. Lindon City, elected and appointed officials, and residents are actively participating in this regional visioning process to ensure that Utah County continues to develop in a strategic manner that will benefit current and future residents. As a community that will be nearly built out in the next fifteen to twenty years, the City is committed to continuing to provide affordable housing while still maintaining the unique characteristics that have made Lindon the community that it is today.

The Gardner Policy Institute has reported "Utahns have always been inclined toward homeownership. No other state has a history of homeownership comparable to Utah. Since 1900, Utah is the only state where the homeownership rate has never fallen below 60 percent of households. But over the following seven years ownership rates declined steadily dropping to 70 percent in 2015. The rate continued to decline even in years of very low interest rates, strong economic growth, and favorable affordability. Finally, in 2016, there was a slight uptick in the homeownership rate to 71 percent. But the persistent decline from 2009 to 2015 caused many observers to wonder if housing preferences were shifting from homeownership to renting. Most of the attention focused on the millennial generation, the 25-34 year age cohort, a prime home buying age group."

"Nationally the homeownership rate for the 25-34 year age group has dropped from 45.6 percent in 2000 to 37 percent in 2016. Every state has experienced a decline and for some states it is clearly a result of lack of affordability. In California, only one in four households in the 25-34 age group were homeowners. Utah has fared much better. The rate has dropped from 56.3 percent in 2000 to 50.4 percent. Half of the millennial households in Utah are homeowners. Only two states have higher rates of homeownership for millennials than Utah: Iowa (53.2 percent), and Minnesota (52.1percent). The comparatively high homeownership rate for Utah's millennial generation suggests that affordability hasn't been a serious impediment to ownership. Although for some households, the burden of student debt has prevented homeownership. This debt burden is likely responsible for some of the decline in homeownership for the group as well as a slight shift in preferences toward apartment living."²

¹ Utah County Valley Visioning (<https://utahvalleyvisioning.org/project>)

² Wood, Eskic, and D.J. Benway."Gardner Business Review." (2018): 26.

Lindon City Background

Lindon City was established in 1850 and originally known as Stringtown because of the homes built along State Street. An old Linden tree growing in the town in 1901 inspired the current name. The City incorporated in 1924 for the purpose of providing a culinary water system.

Lindon City consists of approximately 8.56 square miles or 5,479 acres. As of 2019, the area zoned for residential is 2,060 acres which encompasses approximately 50% of the developable land area. Since 1924, when Lindon was incorporated, residential development was primarily single-family homes with average detached single-family lot sizes between 12,000 and 20,000 square feet. Lindon has always prided itself on maintaining its rural character even as it develops into a major city within Utah County.

Support of Moderate-Income Housing

Existing Supply of Moderate-Income Housing

As Lindon City has grown and developed it has strategically implemented moderate-income housing policies for residents with varying incomes. Just building density or more units will not satisfy the need for moderate-income housing. However, the City has pro-actively strived to implement moderate-income housing policies to help meet the need for moderate-income housing. Twenty years ago, the City amended its zoning code to allow for two new types of housing and to foster additional housing options. First, Lindon adopted a Residential R2 Overlay zone which allows up to four multi-family units within the R1-20 and R1-12 zones. Second, Lindon City has long supported the use of accessory apartments. Currently, all R1-20 and R1-12 single family property owners are allowed to have an accessory apartment by right. To help support moderate income, all property owners are required to sign an agreement with the City prior to the approval of an accessory apartment. The agreement caps the rental rates to comply with moderate income housing incomes. The City has approximately 192 legal accessory apartments.

Lindon City also has one trailer park with 25 mobile homes which help to provide affordable housing options. The City works with the property owner to make sure that the pad sites and trailers remain in a habitable condition.

In 2000, Lindon City and the Housing Authority of Utah County, partnered to provide housing for individuals with disabilities as part of the Housing and Urban Development (HUD) Section 8 voucher. The City provided the land for this development and the Olene Walker Housing Trust Fund provided the original funding, as did the Utah Division of Services for People with Disabilities (DSPD), the Utah County Home Program and the Housing Authority of Utah County. The home is located at 306 E. 400 N. and provides housing for three disabled individuals and is on land leased by the City for 99 years. The residents pay 30% of their income towards rent and a typical rent is \$473 per month.

The Housing Authority of Utah County also owns two duplexes in Lindon located at 50 S. 725 E. and 781 N. 400 W. which are rented to qualified income individuals. In 2018, they also provided rental subsidies of \$97,146 to twenty-one clients through the Section 8 Voucher program.

In 2006, Lindon City entered into a development agreement with Fieldstone homes, as part of the Creekside Meadows development. The agreement required 20% of the 120 single family homes in the development to be sold to individuals and families within moderate-income level and 30% of fifty-four units in the Creekside senior retirement community.

In 2013, the City has also adopted a Senior Housing Facility Overlay zone to support multi-family senior housing. Within this zone, approximately 272 units have been constructed and another 103 units have been entitled. While units at these facilities are not specifically targeted to an Area Median Income ratio they do take Utah County Section 8 housing vouchers.

In 2016, Lindon City signed a Master Development Agreement with Ivory Homes for an 880 residential unit development. This development provides a mix and variety of housing types (single family, townhomes, senior housing and multi-family apartments), lot sizes, and infrastructure modifications from typical standards.

Recently, the City has reduced both impact and utility rate fees for accessory apartments.

April 2019, the Lindon City Council amended its accessory apartment ordinance to allow for larger and taller detached apartments, up to 1,500 square feet and 30 feet in height, to help support additional accessory apartments in the community.

The Utah Department of Workforce Services Five-year Housing Calculator shows that Lindon currently shows the following affordable rental units (see Section II table 13):

- 400 units at 80% AMI
- 115 units at 50% AMI
- 30 units at 30% AMI

Growth Patterns

Similar to other communities along the Wasatch Front, Lindon City has seen significant growth in residential, commercial, and industrial construction over the past 10 years. As of 2019, many of the larger tracts of land in the commercial and residential area have been developed or are entitled for development. Much of the new residential development will occur to the west between State Street and Interstate 15 with the Anderson Farms development adding an additional 880 residential units. The City will continue to see residential development east of State Street as more infill development but not on the scale that has been seen in the past. The remaining commercial areas for development are located along the 700 N. corridor. The City expects this area to develop commercially as a gateway corridor to the community.

Figure 1

Population Change: 2010 to 2017

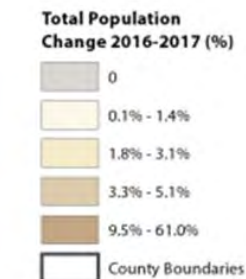

Kem C. Gardner Policy Institute

Figure 2

Over 50 percent of growth in 4 cities

Distribution of Population Growth in Utah County 2010 - 2017

Lehi city	16.6%	Mapleton city	1.9%
Saratoga Springs city	13.1%	Payson city	1.5%
Eagle Mountain city	11.4%	Elk Ridge city	1.5%
Orem city	10.6%	Lindon city	1.0%
Vineyard town	6.8%	Alpine city	0.9%
Pleasant Grove city	5.9%	Cedar Hills city	0.6%
Provo city	5.4%	Unincorporated	0.5%
Spanish Fork city	5.2%	Draper city (pt.)	0.4%
Springville city	4.1%	Woodland Hills city	0.2%
Highland city	3.8%	Genola town	0.2%
American Fork city	3.3%	Goshen town	0.0%
Santaquin city (pt.)	2.8%	Cedar Fort town	0.0%
Salem city	2.0%	Fairfield town	0.0%

Source: Gardner Policy Institute analysis of U.S. Census Bureau data

Figure 3

City Populations and Changes, Salt Lake and Utah Counties

Annual estimates reference July 1 of the estimate year.

Source: Kem C. Gardner Policy Institute

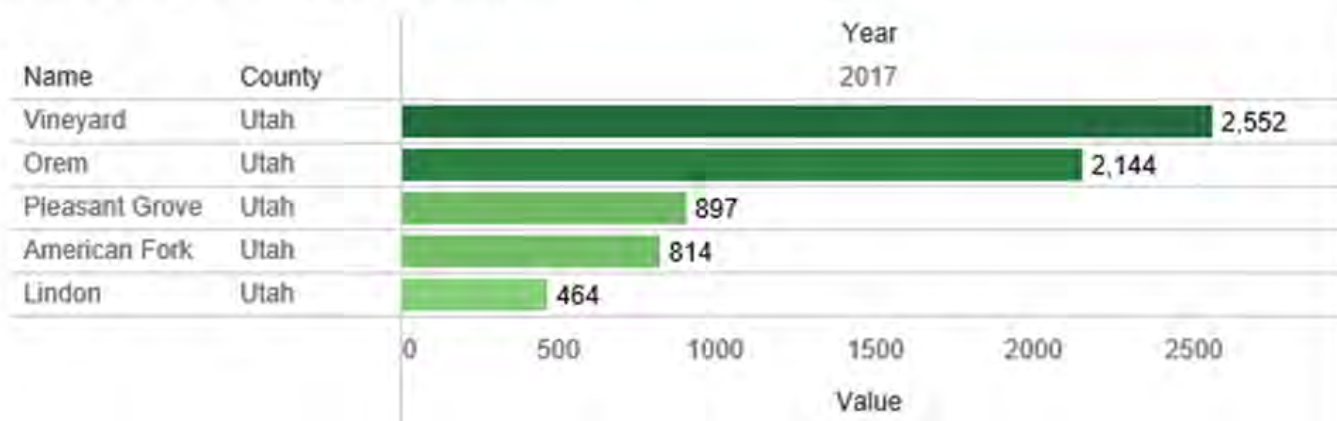

Local Economy

Lindon City has a strong commercial, industrial and employment base within the community. The commercial and industrial sectors are located between State Street and Utah Lake and encompass approximately 1,687 acres or 43% of the City. Residentially zoned properties encompass approximately 2,060 acres or 50% of the City. According to the American Community Survey, in 2016 Lindon City had 514 businesses within its boundaries. Mountainland Association of Governments (MAG) estimates that these businesses employ approximately 13,725 employees in Lindon in the following sectors:

- Industrial: 3,346
- Office: 7,537
- Retail: 2,291
- Other: 554

A decade prior in 2006, the U.S Census reported that Lindon City had 390 businesses which employed 7,336 individuals. By 2029 MAG estimates that businesses with the boundaries of Lindon City will employ approximately 16,8423 individuals.

Section II

Demographic Data and Analysis

Population History

As Lindon incorporated into a community in 1924, the articles of incorporation listed a population of 450 residents. By 1950, the population increased to 801 persons. By 2000, the population had reached 8,300 residents. The 2010 Census records show the population increased by this census to 10,094. The most recent 2017 population numbers, according to the American Community Survey, show Lindon's population at 10,968. By calculating the number of residential housing permits and household sizes for 2018 and the first half of 2019, city staff estimate Lindon's current population to be approximately 11,447. According to the Lindon General Plan, at build out, the City will have an estimated population between 15,000 and 17,000 residents.

The Kem C Gardner Policy Institute reports the following³:

- Utah County is projected to have the largest numeric increase in population, adding over one million new residents to reach 1.6 million by 2065. The Utah County population nearly approaches the population of Salt Lake County by 2065.
- The Utah County population is projected to increase by 177 percent from 2015 to 2065, ranking it as the third fastest growing county in the United States over the projection period.
- By 2065, 28% of the state's population will reside in Utah County.
- Cumulatively, over the next fifty years, 37 percent of the state's population growth is projected to be in Utah County. This means nearly 4 of every 10 new Utah residents will live in Utah County.
- Utah County is projected to add 382,000 new households, the most of any county.

Chart 1

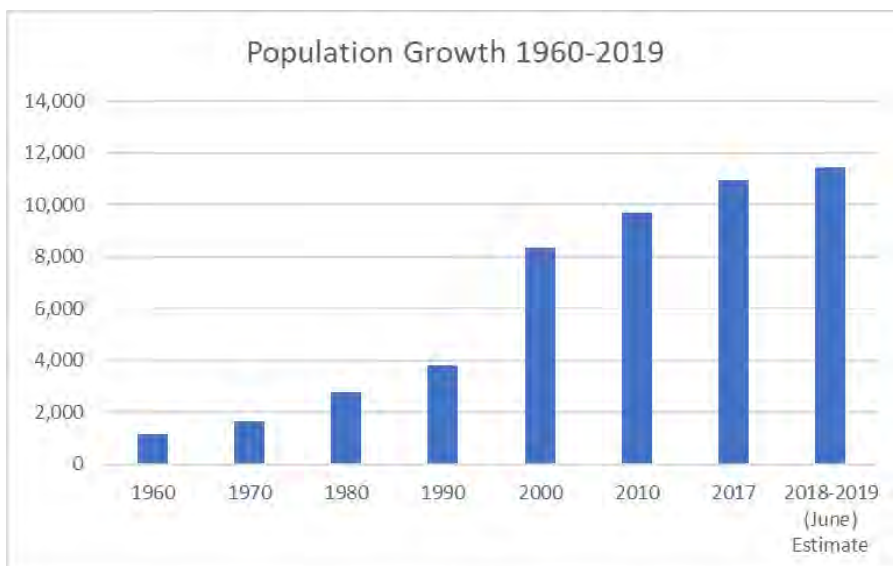

The largest population increase for Lindon, according to U.S. Census data, was between 1990 to 2000 where the City saw a 119% population gain and 1,089 residential housing units were constructed. The population that decade increased from 3,815 residents to 8,367 residents. The Average Annual Growth Rate between 1960 and 2018 was 38%.

Chart 2

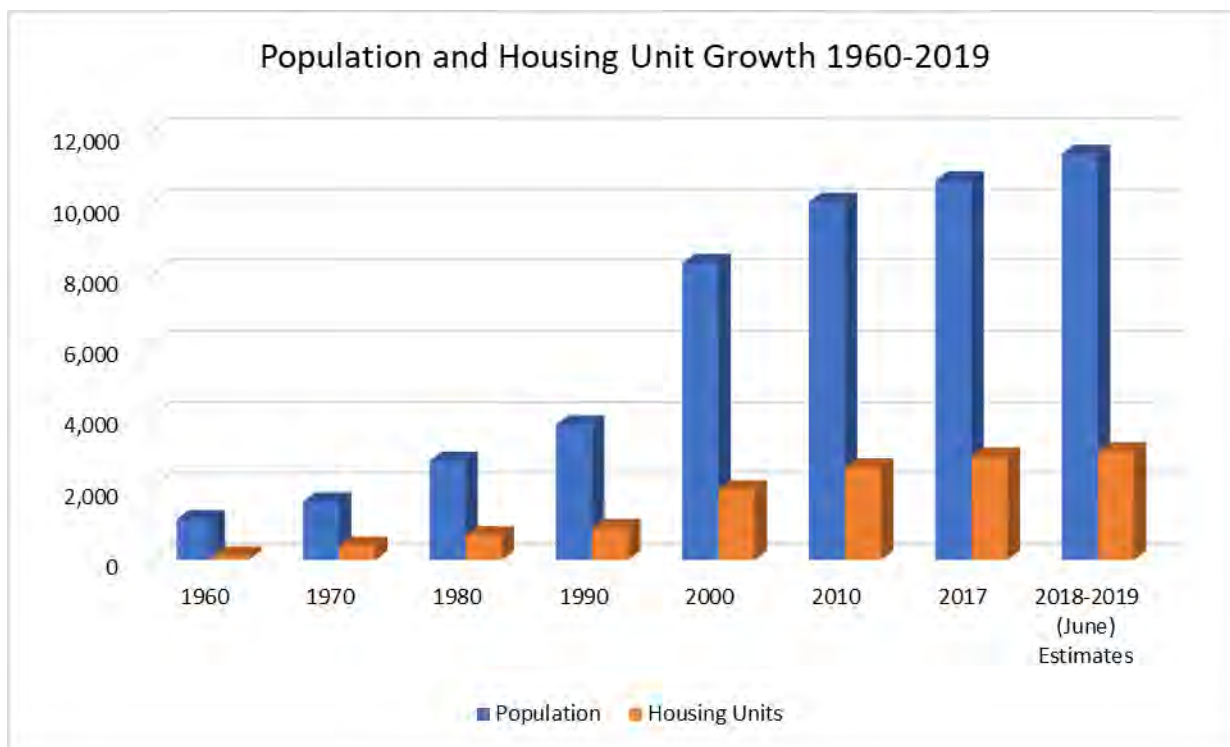

Table 1

	1960	1970	1980	1990	2000	2010	2017	2018-2019 (June) estimate
Population	1,150	1,644	2,794	3,815	8,367	10,094	10,968	11,447
Housing Units	127	399	700	900	1,989	2,608	2,914	3,064

U.S. Census Bureau through 2017. Staff estimate for 2018-2019

The following chart shows the Lindon City population and age breakdown from the 2010 Census and 2017 American Community Survey. The breakdown also compares Lindon City to Utah County to evaluate changes to population averages. A few items of note, it appears that the percentage of children under the age of five has decreased moderately. In reviewing the change from the 2000 Census to the 2010 Census, the under-five population decreased from 976 to 883 which is 10.5% decrease in population. However, with the addition of the Anderson Farm development, which will add an additional 880 residential units of townhomes, single family homes and multi-family apartments, the population age of under-five should increase over the next 3-5 years as that development is completed. Two other significant decreases are the population from ages 25-34 and then those over the age of 85. One assumption that could be made is that the 25-34 age population is priced out of the Lindon housing market but

³ Kem C Gardner Policy Institute. "Utah's Long-Term Demographic and Economic Projections Summary." (2017): 2.

as those individuals age and progress in their employment, their incomes increase, and they purchase homes in Lindon at the 45 to 54 age. One assumption for the 85 and older age classification is that those residents are looking at alternative housing choices where they may not have maintenance obligations.

Table 2

Population by age	Lindon			Utah County		
	2010	2017	Change	2010	2017	Change
Total Population	10,094	10,698	6.0%	516,654	576,496	11.6%
Under 5	883	630	-28.7%	58,362	57,798	-1.0%
5 to 9 years	1,058	1,064	0.6%	52,582	57,112	8.6%
10 to 14 years	1,184	1,229	3.8%	46,048	54,101	17.5%
15 to 19 years	1,099	1,363	24.02%	48,158	53,287	10.7%
20 to 24 years	693	856	23.52%	58,410	73,401	25.7%
25 to 34 years	1,075	941	-12.47%	88,102	82,562	-6.3%
35 to 44 years	1,264	1,303	3.09%	56,401	70,923	25.7%
45 to 54 years	1,269	1,505	18.60%	43,278	47,595	10.0%
55 to 59 years	452	469	3.76%	17,486	20,260	15.9%
60 to 64 years	372	462	24.19%	14,280	17,680	23.8%
65 to 74 years	441	533	20.86%	18,487	24,524	32.7%
75 to 84 years	223	331	48.43%	10,856	13,034	20.1%
85 years and over	81	63	-22.22%	4,114	4,219	2.6%
Median Age	26.2	26.9		25	24.5	

The following table compares the above population percentages by age from Lindon City, Utah County, the State of Utah and the United States. Interestingly, Lindon City's population exceeds the comparable averages in children 10 to 14 years old and teenagers from 15 to 19 years old. The numbers again show that Lindon City has a well below average of young adults from 25-34 years old. However, from the ages of 35-44 Lindon is comparable to the State and National averages and above average for those 45 to 54 years old.

Chart 3

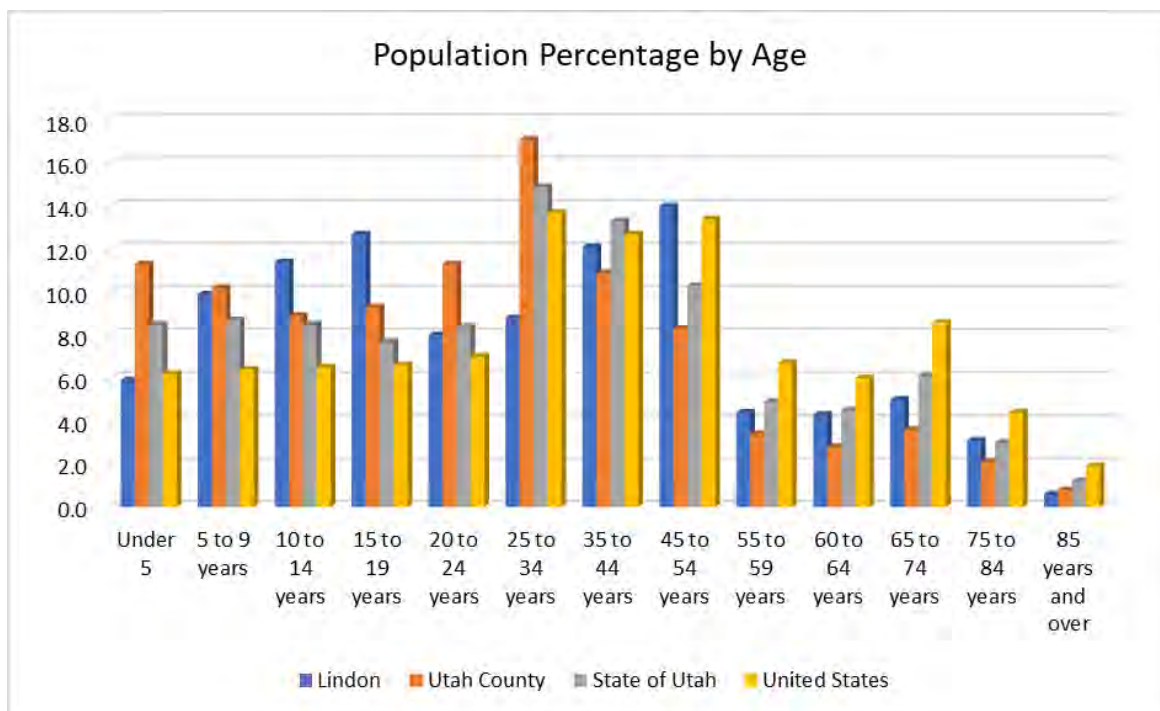

Table 3

Population by Percentage		
	2010	2017 Estimate
Under 5 years	8.7%	5.9%
5 to 9 years	10.5%	9.9%
10 to 14 years	11.7%	11.4%
15 to 19 years	10.9%	12.7%
20 to 24 years	6.9%	8.0%
25-34 years	5.2%	8.8%
35-44 years	12.5%	12.1%
45 to 54 years	12.6%	14.0%
55 to 59 years	4.5%	4.4%
60 to 64 years	3.7%	4.3%
65 to 74 years	4.4%	5.0%
75 to 84 years	2.3%	3.1%
85 years and over	0.8%	0.6%

While Lindon City continues to increase in population and new residential construction, the median household size has slowly decreased over the last twenty years. The Census defines a household as “all people who occupy a housing unit” regardless of relationship. The Census also measures family size. Family is defined by the Census as “a group of two people or more (one of whom is the householder) related by birth, marriage, or adoption and residing together; all such people (including related subfamily members) are considered as members of one family.” In 2000, the median household size was 4.28 individuals per household and has decreased to 3.97 in 2010 to a 2017 estimate of 3.88 in 2017. The average family size has also decreased from 4.20 in 2010 to 4.11 in the 2017 estimate. However, the decrease in median household size is typical to most of the surrounding communities of Lindon.

Table 4

	2013-2017 Average	2010 Census	2000 Census
Lindon	3.88	3.97	4.28
Pleasant Grove	3.57	3.68	3.90
American Fork	3.56	3.83	3.84
Orem – 84057 zip code	3.35	3.36	3.51
Utah County	3.61	3.57	3.59
State of Utah	3.14	3.10	3.01

5 and 10 Year Population Projections

The Utah Department of Workforce Services (DWS) has provided this information through their five-year housing projection calculator. DWS precalculated the 2024 estimated population of Lindon at 11,527 with an annual growth rate of 1.6%. According to Mountainland Association of Governments, Lindon’s population estimate in 2029 will be 12,491 residents.

Income Trends

The Bureau of Labor Statistics’ annual Consumer Expenditure Survey confirmed that housing was the single largest expense for the average American household.⁴ The following chart shows the 2017 estimated distribution of income for the 2,914 housing units in Lindon City. The median household income for Lindon is \$81,789

Chart 4

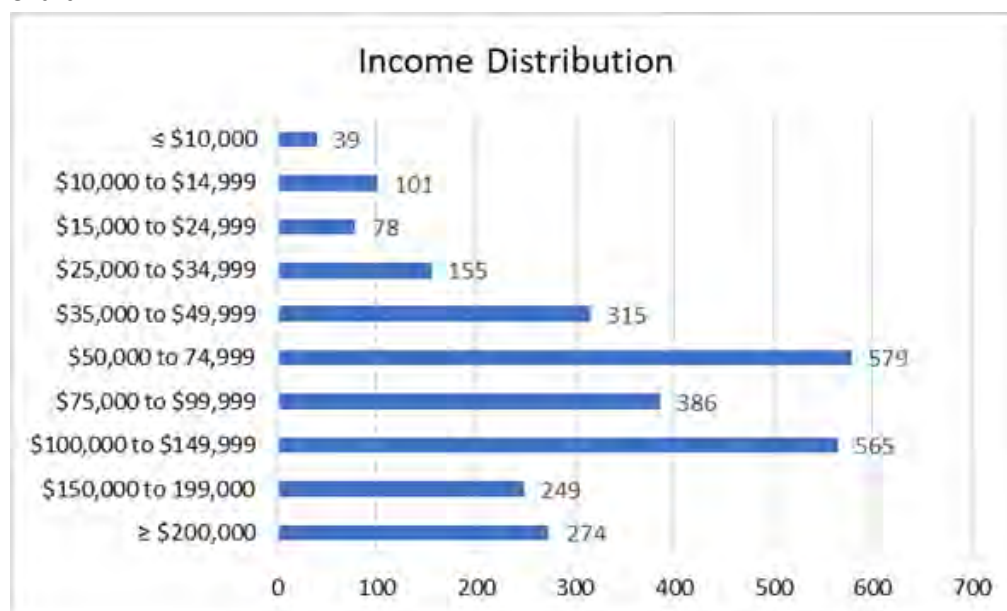

⁴ U.S. Bureau of Labor Statistics. (2016, Aug. 30). News release: Consumer expenditures – 2015 [USD16-1768]. Washington, DC: Government Printing Office. Retrieved on 12/21/16 from <https://www.bls.gov/news.release/pdf/cesan.pdf>

According to the Census Bureau, income measurements are based off of the income received in the preceding calendar year for each person in the household that is fifteen years and older. The following table identifies the changes in median income and compares those to Utah County, the State of Utah and the United States.

Table 5

Comparable Median Incomes			
	2000	Change	2017 Estimate
Lindon	\$62,321	31%	\$81,789
Utah County	\$45,833	46%	\$67,042
State of Utah	\$45,726	43%	\$65,325
United States	\$50,046	15%	\$57,652

U.S. Census Bureau *2010 income data not available

Table 6

Comparable Income Analysis – North Utah County	Median Household Income
Orem	\$58,077
Pleasant Grove	\$66,881
American Fork	\$70,926
Eagle Mountain	\$74,885
Vineyard	\$79,543
Lindon	\$81,789
Lehi	\$85,794
Cedar Hills	\$97,039
Alpine	\$112,727
Highland	\$128,938

U.S. Census Bureau 2017

Moderate Income Analysis

According to the U.S. Department of Housing and Urban Development: “families who pay more than 30% of their income for housing, including utilities, are considered cost burdened and may have difficulty affording necessities such as food, clothing, transportation and medical care.” Moderate Income Housing is defined by the State of Utah as “housing occupied or reserved for occupancy by households with a gross household income equal to or less than 80% of the median gross income for households of the same size in the county in which the city is located.” This means that only housing units affordable at each interval between zero and 80 percent of the AMI are identified as moderate-income housing. The 2016 median Utah County household gross income, according to the United States Census and Utah Department of Workforce Services, is \$64,321. Below is a breakdown of the Utah County income levels related to household size.

“Affordability of Rental Housing takes \$47,000 in income to rent the typical two-bedroom apartment unit in Salt Lake and Utah counties. This assumes 30 percent of the household income goes to rent. In 2017, the median rent for the typical two-bedroom apartment was \$1,195 in Salt Lake County and \$1,183 in Utah County.”⁵

⁵ Wood, Eskic, and D.J. Benway. “Gardner Business Review.” (2018): 27.

The American Planning Association reports that “wages have not increased proportionally to housing costs. After adjusting for inflation, wages are only 10 percent higher in 2017 than they were in 1973 (with annual wage growth just below 2.0 percent). During that same period, the cost of housing increased almost 30 percent nationally.”⁶

Regarding residential construction costs, the American Planning Association reports “As the cost per square foot to build housing continues to increase, a greater number of units built by the private market have moved to higher rent or for-sale units while losing lower rent or for sale units. With the average cost per square foot for new construction in the \$150 to \$300 range (geography dependent), it is impossible to build a new 1,500-square-foot single-family house that is affordable to households earning the U.S. median income of \$57,652 (in 2017) without a public subsidy in the form of land, money, or both. Unfortunately, many of the state and federal programs are limited to assisting only those households at 60 percent area median income (AMI) or less. The reality is that housing is often unaffordable to households earning up to 120 percent AMI (and higher in many markets). A tiered approach to the provision of subsidies and economic incentives, especially at the local level, is necessary to ensure the construction and preservation of a wide range of affordable housing types in our nation’s communities. Scaling back the size of newly constructed housing offers some cost savings provided the minimum buildable lot size is reduced accordingly to realize a savings on land acquisition. Homes in the 900- to 1,200-square-foot range are becoming more commonplace, but the trend in America is still toward larger houses. According to the U.S. Census, the size of the average single-family house increased from 1,535 square feet in 1975 to 2,169 square feet in 2010—an increase of 41 percent.”⁷

Table 7

Household Size	Percent AMI – Utah County 2017 American Community Survey Estimates			
	100%	80%	50%	30%
1	\$29,369	\$23,495	\$14,819	\$8,810
2	\$55,321	\$44,256	\$27,660	\$16,596
3	\$64,713	\$51,770	\$32,356	\$19,413
4	\$72,283	\$57,826	\$36,141	\$21,684

Using the average Lindon household size of 3.88 and data from the above table, the average 80% moderate household of four earns \$57,826. Taking the HUD recommendation of spending no more than 30% of income on housing costs (mortgage, utilities, insurance) the recommended monthly maximum mortgage or rent payment for a four-person household would \$1,445. Using the median Utah County Income, the below table breaks down the recommended maximum mortgage or rent payments for each AMI ratio.

Table 8

AMI Breakdown for a 4-person household			
AMI Breakdown	AMI Median Utah County Household Income	30% Yearly Housing Cost	30% Monthly Mortgage/Rent
100% AMI	\$72,283	\$21,684	\$1,973
80% AMI	\$57,826	\$17,347	\$1,445
50% AMI	\$36,141	\$10,842	\$903
30% AMI	\$21,684	\$6,505	\$542

⁶ American Planning Association. “Housing Policy Guide.” (2019): 4-5.

⁷ American Planning Association. “Housing Policy Guide.” (2019): 5.

The following tables were published by UtahRealEstate.com and the Kem C. Gardner Policy Institute and outlines important index information in the number of homes sold as well as the price threshold for qualifying for an affordable home in Utah County.

Figure 3
Housing Affordability Index, Utah County
 (single family, condominiums, and townhomes)

Year	Median Income	Mortgage Rate	Price Threshold for Affordable Home	Number Affordable Homes Sales	Total Homes Sales	Percent of Sales Affordable (HOI)
2000	\$45,770	8.05%	\$122,726	1,095	3,751	29.2%
2005	\$47,428	5.87%	\$158,368	2,993	6,770	44.2%
2012	\$58,425	3.66%	\$251,498	4,577	5,984	76.5%
2016	\$69,799	3.65%	\$300,368	6,839	8,817	77.6%

Source: UtahRealEstate.com.

Wood, Eskic, and D.J. Benway."Gardner Business Review." (2018): 20.

Figure 4
Affordable Housing Thresholds for Median Income Household

	2005	2012	2016
Davis	\$189,691	\$296,684	\$331,026
Salt Lake	\$162,592	\$253,342	\$295,526
Utah	\$158,368	\$251,498	\$300,368
Washington	\$165,220	\$211,208	\$266,343
Weber	\$164,105	\$232,570	\$271,789

Source: U.S. Census Bureau and Kem Gardner Policy Institute.

Wood, Eskic, and D.J. Benway."Gardner Business Review." (2018): 22.

Housing Needs Assessment

Current Housing Stock

The American Community Survey estimates that in 2017, Lindon City had an estimate of 2,914 housing units and of those 2,747 were occupied. The ACS also reports in 2017 that the City has approximately 459 rentals units. The total number of rental units is often difficult to determine since, at any time, someone may rent their home or condominium unit. However, for a rental breakdown, as of Spring 2019, the City has on record 192 accessory apartments, 326 senior housing units and a number of rental properties located in the R2 Overlay zones. The below charts show the number of units by year constructed as well as the owner-occupied housing values

Chart 5

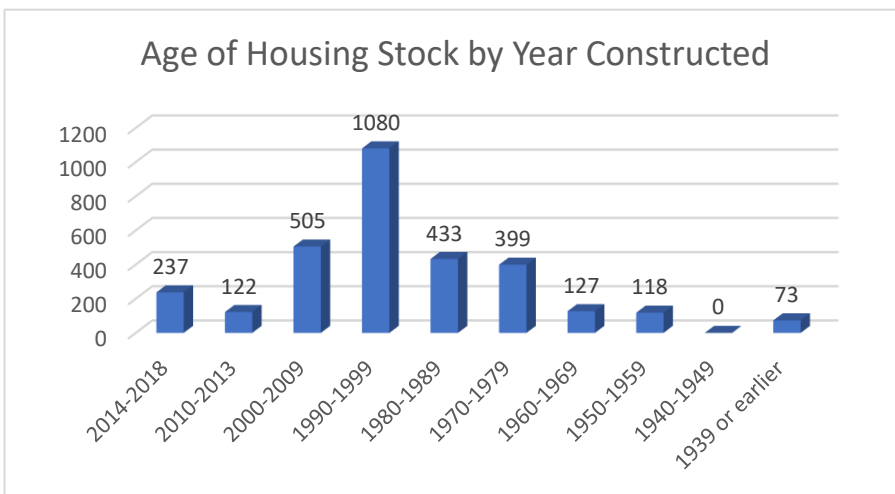

American Community Survey 2017 and Lindon City Residential Permit Numbers

Chart 6

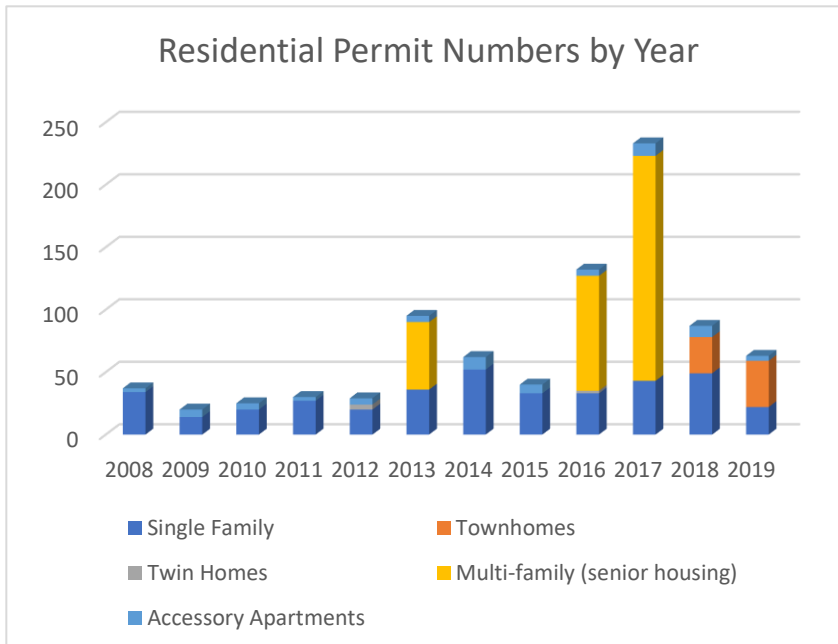

Chart 7



American Community Survey 2017

Housing Under Construction and Entitled but not Constructed

Table 9

Under Construction	Number of Units	Type
Anderson Farms		
Plat A	30	Single Family
Plat B	48	Single Family
Parkview Towns	125	Townhomes
Gardens	62	Senior Housing
Estates	56	Single Family
Emery View	3	Single Family
Fryer Lane	2	Single Family
Williamson Farms	10	Single Family
Ken's Cove Plat A	7	Single Family
Entitled		
Maxfield Meadows	2	Single Family
Maxfield Hallow	7	Single Family
Ray's Circle	5	Single Family
Remaining Lots at Anderson Farms	559	Single Family, Townhomes, Multi-Family
Lindon Ridge Senior Apartments	103	Senior Housing
Total	1,019	

Current Housing Sales and Pricing

The Daily Herald published an article in August 2019 with data from the Utah Association of Realtor that showed the median home price in Utah County was \$335,000. In June 2018, the median home price in was \$315,000 and in June 2017, it was \$273,000. In June 2010, the median price of \$197,000.⁸ According to the American Community Survey, the 2017 median owner-occupied value of a home in Lindon was \$361,800 with a median monthly owner cost of \$1,903. An August 2019 review of currently listed properties for sale from zillow.com and utahrealestate.com show the average listing price of a home currently is between \$613,000 and \$634,000. The data was averaged from 34 homes on the market with Zillow.com and 27 homes on the market with utahrealestate.com.

Available Land Percentages

Lindon City consists of approximately 5,479 acres of which 3,744 are developable parcels. The percentage of land developed in Lindon City is approximately 89%. The below chart and table break down the various zoning districts and developable land by acres.

Chart 8

Lindon City Land Use

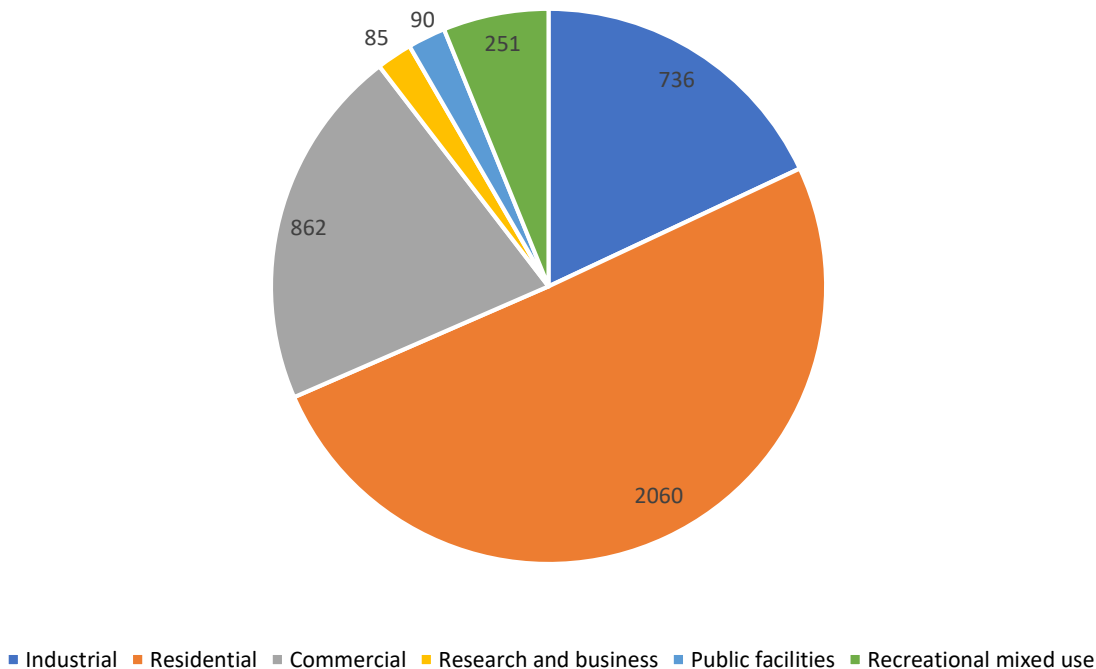

⁸ Johnson, Stacy. "What is Utah County's Median Home Price and What Will it Buy?" Daily Herald 7 Aug. 2019

Table 10

Zoning Districts	Area (in acres)	Developable Acres	Overall Zone Percentage
*Residential	2060	146	50%
Industrial	736	82	18%
Commercial	862	176	21%
Research and Business	85	12	2%
Public Facilities	90		2%
Recreational Mixed Use - West	251		6%
Total	4085	417	

*The residential district does not calculate residential located in commercial zones

Moderate Income Housing Analysis

Housing Cost Burdens

City staff used Census data to compile the monthly housing costs as a percentage of household income over a twelve-month period provided in Chart 9. This chart reveals that approximately 20% of Lindon households use more than 30% of their monthly income on housing. In tables 11, 12 and 13 the Department of Workforce Services broke down this data further showing housing cost burdens for both renters and homeowners. DWS’s analysis shows slightly higher percentage rates then calculated by city staff, but in both scenarios the housing cost burdens are less than 30% and show a decrease over time.

Chart 9

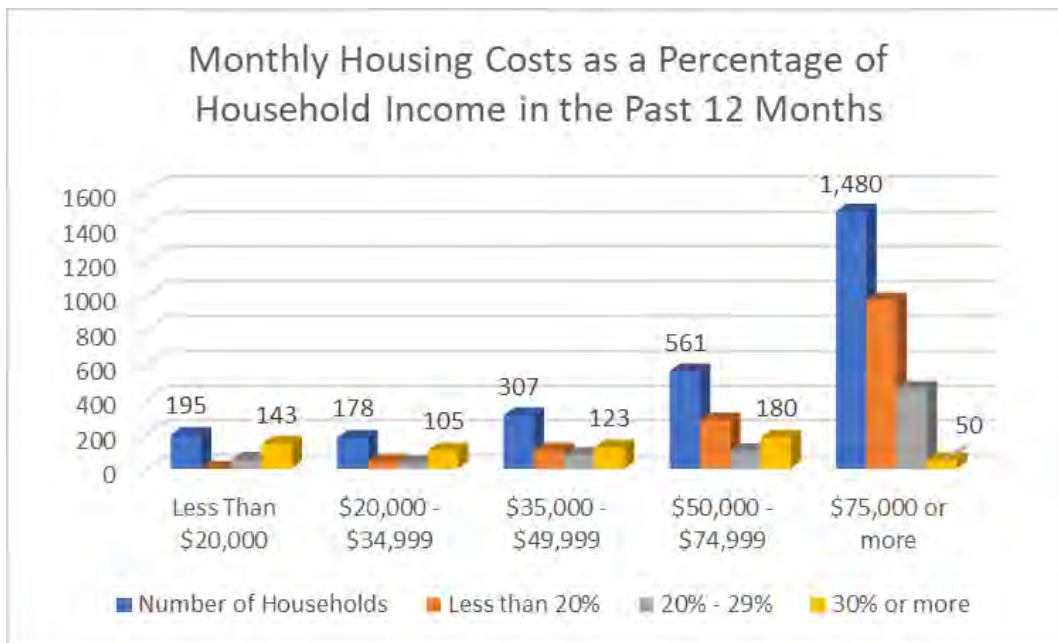

Table 11

Average Housing Cost Burden			
Table B25064 Table B25088 Table B25119	2009 American Community Survey	2017 American Community Survey	2024 Projection
Ratio of the municipality's median rent to the median RENTER household income in the municipality	34.0%	29.4%	27.5%
Ratio of the municipality's median mortgage to the median OWNER household income in the municipality	25.2%	24.5%	23.1%

Table 12

Approximate Housing Cost Burden Ratio at HUD's 80%, 50%, and 30% Income Limits Based			
Table B25088 Table B19019	2009 American Community Survey	2017 American Community Survey	2024 Projection
Ratio of median rent in the municipality to 100% of the median income of a family of 4 in the county	20.9%	15.6%	13.0%
Ratio of median rent in the municipality to 80% of the median income of a family of 4 in the county	26.1%	19.5%	16.2%
Ratio of median rent in the municipality to 50% of the median income of a family of 4 in the county	41.8%	31.2%	26.0%
Ratio of median rent in the municipality to 30% of the median income of a family of 4 in the county	69.6%	52.0%	43.3%

Utah Department of Workforce Services Gap Analysis and Housing Forecast

The following tables were provided by the Utah Department of Work Force Services as part of their five-year housing calculator specific to each municipality. The data analyzes Lindon's housing shortage for population level ratios. The State did not calculate or provide information on the shortage of affordable owner-occupied housing units needed at any income level. Instead they provided information on the rental housing cost burdened population levels. According to the Utah Department of Workforce Services, it is up to the local municipality to decide how they are going to help reduce the cost burden ratio either through owner occupied or rental housing.

The above numbers in table 12 show that the City has seen significant progress in reducing the rental housing cost burden and barriers to affordable housing. If projections hold true only the 30% income ratio will be above 30% by 2024.

Housing in general for a 50% and 30% AMI are typically not provided by the development community. These types of housing models typically require significant government assistance, particularly HUD and State agencies, in providing incentives. New housing at the 80% ratio is often easier for smaller communities to achieve through the use of density bonuses, fee waivers or other local incentives.

The following tables, provided by the Utah Department of Workforce Services, calculate Lindon's rental housing shortage for the current biennium. From 2016 to 2018 the City has made progress in providing affordable rental units. The following conclusions were made in evaluating the tables:

80% AMI Progress

- The number of affordable units at the 80% AMI level increased and there is sufficient to meet the demand, however those units are not available for this income ratio.

50% AMI Progress

- While the population of rental households at this level stayed the same, the number of units increased but the availability of those units decreased

30% AMI Progress

- The number of rental households decreased at this level but so did the number of affordable and available rental units

As previously discussed, Lindon's population is expected to increase to 11,527 by 2024 and to 12,491 by 2029. Using the 2018 estimated population of 11,447, Lindon is expected to add an additional 942 residents by 2029. Taking the median household size of 3.88 and dividing that into the ten-year increase in population, Lindon will need to provide 242 new housing units over this time period. As indicated in the section on Available and Future Housing stock, Lindon has under construction or has entitled 1,019 housing units. However, none of these newly constructed or entitled units are not targeted to moderate-income levels.

The following tables, provided by Utah Department of Workforce Services, indicate the shortage of moderate-income rental units for Lindon City.

As indicated in table 13, the City currently has a shortage of 265 available affordable rental units compared to the number of renter households seeking affordable rental housing.

Table 13

2018 Shortage	Renter Households	Affordable Rental Units	Available Rental Units	Affordable Units - Renter Households	Available Units - Renter Households
≤ 80% HAMFI	340	400	310	60	-30
≤ 50% HAMFI	170	115	45	-55	-125
≤ 30% HAMFI	120	30	10	-90	-110

Table 14

2016 Shortage	Renter Households	Affordable Rental Units	Available Rental Units	Affordable Units - Renter Households	Available Units - Renter Households
≤ 80% HAMFI	290	375	250	85	-40
≤ 50% HAMFI	170	90	50	-80	-120
≤ 30% HAMFI	130	65	35	-65	-95

Table 15

PROGRESS	Renter Households	Affordable Rental Units	Available Rental Units	Affordable Units - Renter Households	Available Units - Renter Households
≤ 80% HAMFI	50	25	60	-25	10
≤ 50% HAMFI	0	25	-5	25	-5
≤ 30% HAMFI	-10	-35	-25	-25	-15

The figures in the below two figures, by the Gardner Institutes Gardner Business Review, identify the number of affordable homes constructed within Utah County cities between 2005-2016 and the number of apartments by percentage of income.

Figure 5
Number of Affordable New Homes in Utah County by Zip Code

Zip Code	2005		2012		2016		Change in Affordable New Homes 2005-2016	City
	Affordable New Homes	Total New Homes	Affordable New Homes	Total New Homes	Affordable New Homes	Total New Homes		
84003	39	354	45	116	76	260	37	American Fork/Highland
84004	7	112	0	8	1	6	-6	Alpine
84005	116	460	58	124	211	458	95	Eagle Mountain
84013	3	83	7	17	9	18	6	Cedar Fort/Fairfield
84020	3	107	2	19	1	8	-2	Draper
84042	5	30	2	8	1	12	-4	Lindon
84043	152	1201	269	592	64	472	-88	Lehi
84045	105	560	106	263	190	527	85	Saratoga Springs
84057	6	89	8	17	51	84	45	Orem
84058	5	42	77	170	114	325	109	Orem/Vineyard/Pleasant Grove
84062	131	724	13	42	45	109	-86	Cedar Hills
84097	2	77	0	2	0	5	-2	Orem
84601	4	76	11	16	6	43	2	Provo
84604	4	126	19	35	1	12	-3	Provo
84606	32	249	3	12	13	37	-19	Provo
84651	25	149	30	52	25	85	0	Payson/Elk Ridge
84653	13	78	4	21	28	90	15	Woodland Hills
84655	7	58	19	22	69	123	62	Santaquin
84660	100	398	76	117	58	171	-42	Spanish Fork
84663	98	272	67	104	73	102	-25	Springville
84664	4	26	11	49	9	42	5	Mapleton
Total	869	5,404	830	1818	1,046	2,995	177	
	16.1%		45.7%		34.9%			

Source: Metrostudy.

Figure 6
Percent Share of Rental Units by Rent in Provo-Orem Metropolitan Area
(gross rent in 2015 dollars)

	2005	2015
Less than \$400	5.7%	8.0%
\$400 to \$599	8.5%	4.2%
\$600 to \$799	30.8%	22.0%
\$800 to \$999	19.3%	18.5%
\$1,000 to \$1,199	10.8%	19.0%
\$1,200 to \$1,399	11.1%	9.4%
\$1,400 to \$1,599	7.0%	8.3%
\$1,600 to \$1,799	2.3%	6.7%W
\$1,800 to \$1,999	0.3%	0.6%
\$2,000 to \$2,199	1.4%	1.9%
\$2,200 to \$2,399	1.0%	0.3%
\$2,400 or more	1.8%	1.1%
Total	100.0%	100.0%
Median Rent	\$852	\$971

Note: Gross rent includes utilities.

Source: JCHS, Harvard, American Community Survey.

Section III

Regulatory Environment

Review of Current Zoning Districts

Lindon City has nine zoning districts which allow for varying residential uses, types, and densities. These districts make up approximately 53% of the land within Lindon City. Below is a list of the zoning districts:

- R1-12,000
- R1-20,000
- R2
- R3
- Anderson Farms Planned Development Zone
- Residential/Business District Overlay Zone
- Planned Residential Development
- Care Center Facilities Overlay
- Senior Housing Facility Overlay
- Multiple Use District

In analyzing how the current regulations impact the availability of affordable housing and potential barriers below is a discussion of those themes:

Lindon City has developed ordinances that allow for a variety of housing types including single family homes, townhomes, accessory apartments, senior housing, and rental housing. As part of this report, the City has reviewed its regulations to determine what barriers have already been reduced as well as those that may exist that affect the availability of affordable housing. Below is a summary of regulations where the City may improve:

Regulatory Analysis of Potential Barriers to Moderate-Income Housing

R2 Overlay Zone

Within the R2 Overlay zone, Lindon City allows for accessory apartments and multiple units per lot for twin homes, tri-plex's, townhomes and condominiums. While accessory apartments are allowed by right, multiple unit developments in the R2 zone require a 750-foot buffer between developments as well as each district limits the number of units per district. A majority of the districts have reached either the density or spacing cap and don't allow further development other than accessory apartments. The City should evaluate the current effectiveness of the R2 zone and whether development regulations should be modified. See R2 map on the next page.

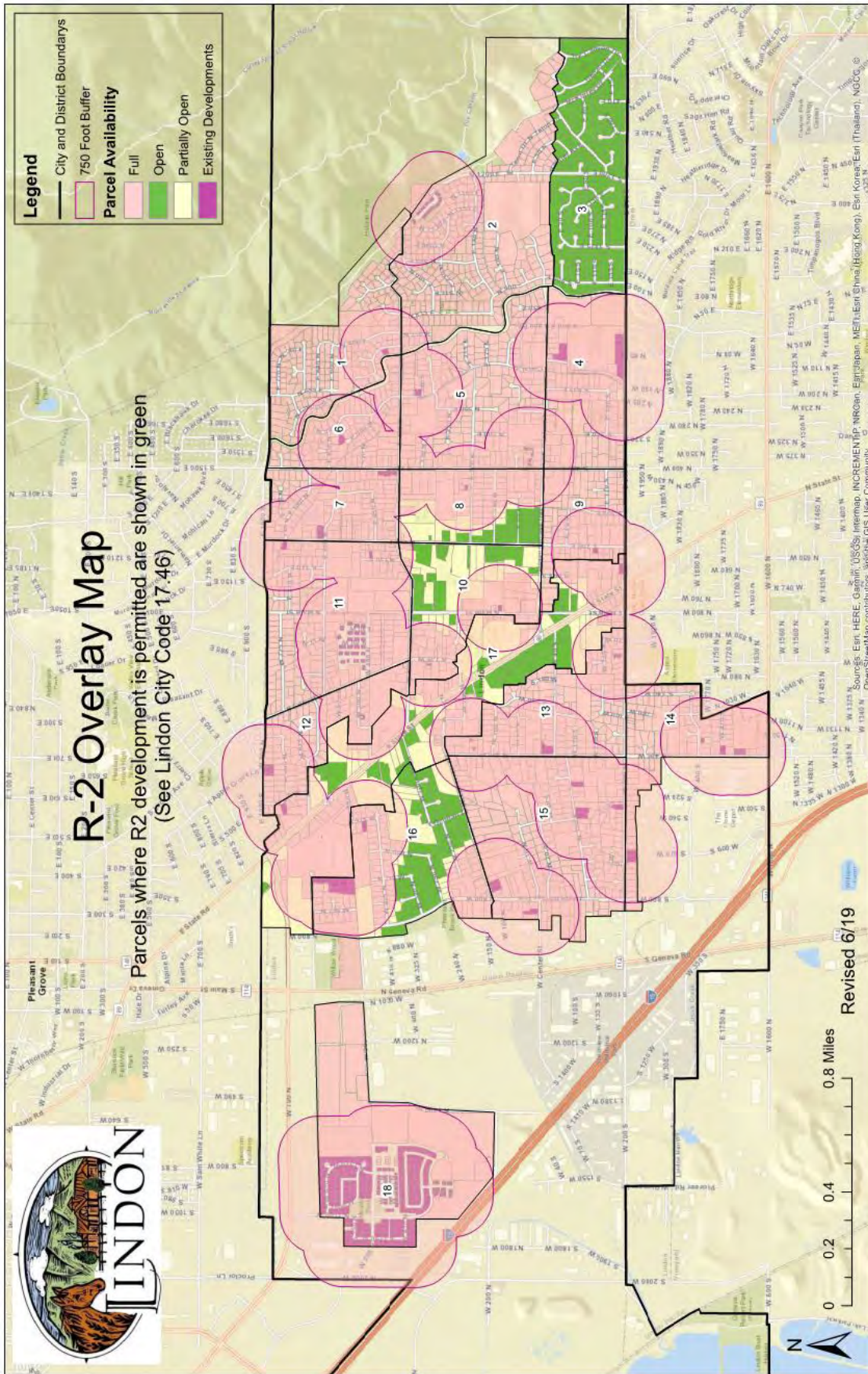

Impact Fees and Utilities

In 2011 the City reduced the park impact fee for accessory apartments from \$4,500 to \$1,500. In 2019, the City also eliminated the monthly utility base rate fee for accessory apartments. Accessory apartments are only required to pay the parks (\$1,500), fire (\$152) and police (\$162) impact fees. The City specifically reduced the park fee to help promote the use of accessory apartments. The City should evaluate if impact fees for all affordable housing options should be reduced to help fund and promote affordable housing by the end of 2020.

Standard Land Use Table and Ordinance Review

The Lindon City Standard Land Use Table describes the types of housing allowed in each zone. Over the next year the City should perform a review of the Standard Land Use Table and its zoning ordinances to evaluate if there are additional opportunities to allow for housing within each land use district.

Development Standards

In 2016, Lindon City and Ivory Homes entered into a development agreement for an 880-unit housing development that allowed for a mix of housing types that includes single family, townhomes, senior housing, and apartments. For this development, the City amended its lot size and infrastructure development standards to include smaller and varying lots sizes and more narrow right-of-way widths in order to reduce development costs and promote a mix of housing types and options. Where appropriate, the City may evaluate on a case by case basis modifications to its infrastructure development standards in order to promote affordability and reduce costs.

Multi-family Development

Currently, other than the R2 Overlay zone, Senior Overlay zone, and the Anderson Farms Planning Development zone traditional multi-family housing is not allowed. The Anderson Farms PD zone, requires a minimum 100 acres of land to development and the R2 Overlay zone is nearly built out. The only residential uses allowed in commercial zones are care taker facilities, residential care facility, transitional victim home, assisted living center, rest home, nursing home, convalescent facility, and retirement centers. The City may want to develop a zoning district or modify existing zoning that allows for moderate residential densities in strategically targeted areas and which are context sensitive to the surrounding uses and areas. These areas would typically be located near commercial zones and mass transit stops and may be infill type development. As the City studies bus rapid transit opportunities with other northern Utah County cities there could be some potential opportunities for housing along State Street. Salt Lake and South Salt Lake are currently master planning for an initiative called “Life on State” to bring residential back to State Street in specifically targeted areas. Orem is also seeing an increase in constructing new mixed-use development along State Street. If residential were allowed in Commercial General zones, residential uses should have a commercial component to any development to keep in harmony with the intent of the commercial zone.

There is a planning concept called the “Missing Middle” which allows building types such as duplexes, fourplexes and bungalow courts to provide diverse housing options and also supports walkable communities. Below is a model of the types of “Missing Middle” housing as well as pictures of such housing types.

Figure 7



Figure 8



Mixed Use Developments

For commercial centers, there has been a recent push by the development community to include a housing component as part of commercial development. Mixed-use development is an effort to strengthen the commercial component while providing residents with more inclusive neighborhood living.⁹ In essence, the housing helps to ensure long term viability of the development as well as establishes a built-in clientele and employment centers. Lindon City has begun to develop such a plan with the Anderson Farms development by Ivory Homes and the future Lindon Village zoning. The City may see interest from developers to include some additional residential mixed with new commercial along 700 N. and State Street. The commercial component could be either horizontal or vertical mixed use. Examples of horizontal mixed use are the Riverstone Development in Couer D'Alene, Idaho and Orange County, California.

Figure 9

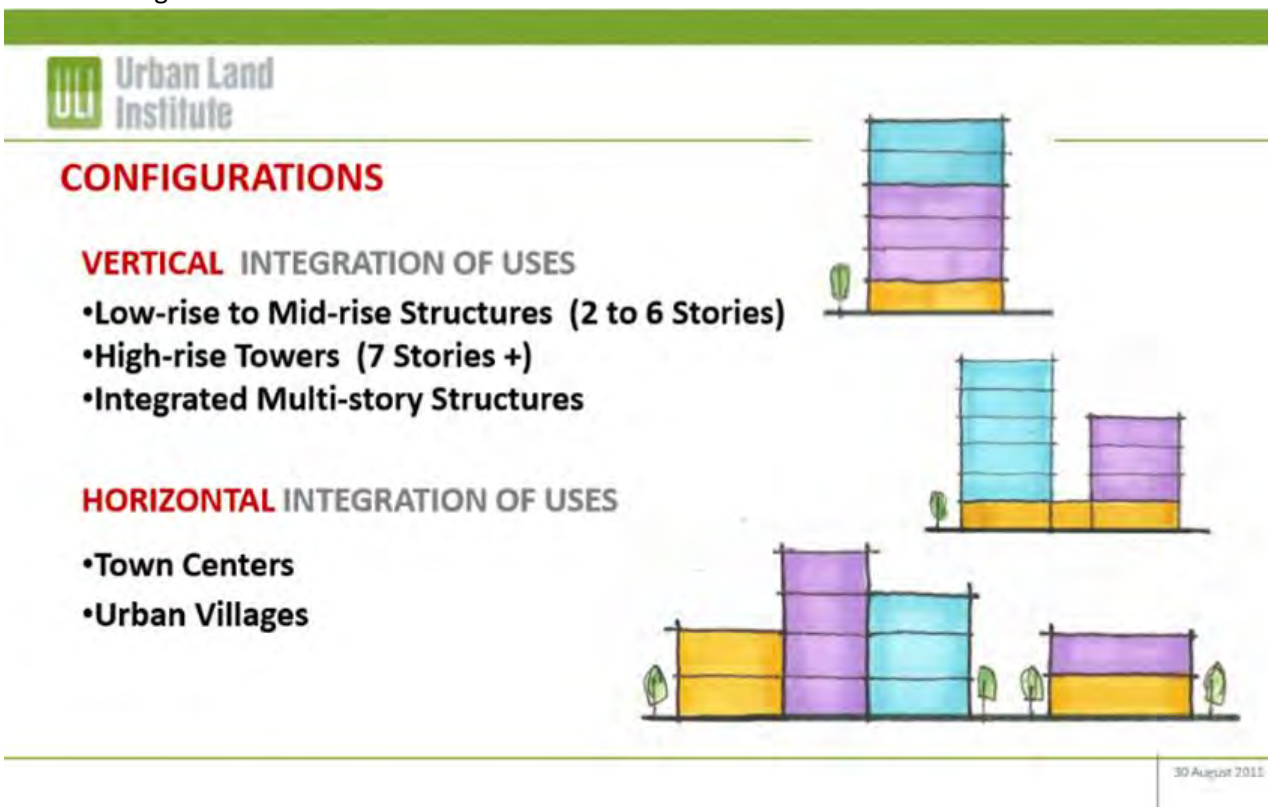

⁹ Blackwell, Tim. "How Multifamily is Blending Retail with Residential." 14 June 2016, [Property Management Insider](https://www.propertymanagementinsider.com/how-multifamily-is-blending-retail-with-residential).
<https://www.propertymanagementinsider.com/how-multifamily-is-blending-retail-with-residential>

Figure 10



52

Strafford Publishing 2014

Figure 11

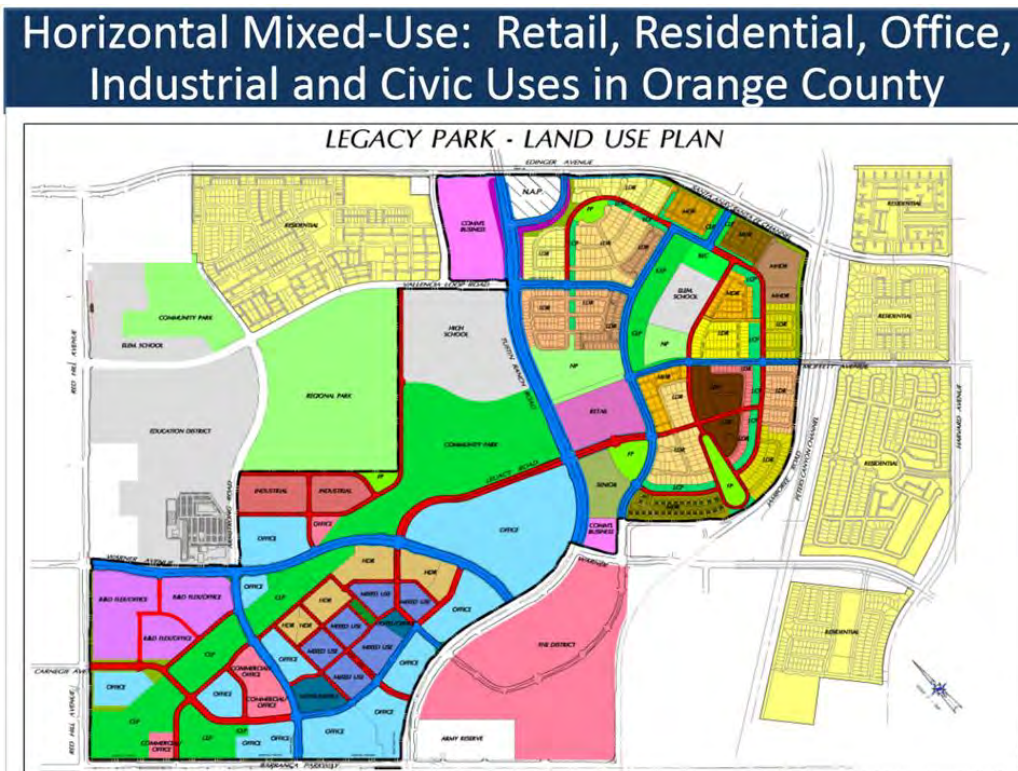

Strafford Publishing 2014

Section IV

Compliance with Utah Code 10-9a-403 – Senate Bill 34 (2019)

The Utah Legislature passed Senate Bill 34 during the 2019 legislative session which required municipalities to update their moderate-income housing plans as well as select three housing affordability strategies from a list of 23 to implement in their community. Lindon City has selected the following five strategies for implementing affordable housing in the community:

1. Create or allow for, and reduce regulations related to, accessory dwelling units in residential zones

Lindon City has allowed for accessory apartments since approximately 1998. The City has promoted the use of accessory apartments to help increase the affordability housing options within Lindon City. Accessory apartments are allowed by right in each residential zone and are encouraged and promoted by the City. Lindon City allows for three types of accessory apartments: attached, substantially attached and detached.

Specific outcomes the goal intends to accomplish: Records show that the City has approximately 192 approved accessory apartments but the number probably far exceeds this with the total amount of apartments currently not permitted by the City. The City continues to encourage additional legal accessory apartments.

A description of how the entity will monitor its annual progress toward achieving the goal: The City continually monitors the effectiveness of accessory apartments and tracks the total number of apartments on a yearly basis.

A description of the resources the entity must allocate to complete this goal: The City advertises and actively promotes the use of accessory apartments. The City provides a handout to help homeowners navigate planning and building improvements. Since this is a well-established housing policy and goal in Lindon no further resources should need to be allocated.

A description of the barriers, if any, the entity is encountering in working towards the goal: The City provides three types of accessory apartments which are attached, substantially attached (with a walkway, breezeway or covered porch) and detached. In April of 2019, Lindon City amended its accessory apartment ordinance to allow for two story detached accessory apartments and as well increased the allowable square footage to 1,500 square feet or 30% of the primary structure. The City has not encountered any recent barriers.

2. Reduce Impact Fees, as defined in Section 11-36a-102, related to low- and moderate-income housing

Lindon City actively promotes accessory apartments to meet the low- and moderate-income housing requirements of the State of Utah. Owners who desire to have an accessory apartment sign an agreement with the City that they will not charge in excess of the 80% Utah County Area Median Income. In 2011, Lindon City reduced park impact fees for all accessory apartments from \$4,500 to \$1,500. Other impact fees for police (\$162) and fire (\$152) are nominal and do not seem to be a barrier to encouraging additional affordable housing units.

Specific outcomes the goal intends to accomplish: The City hopes to increase the number of accessory apartments and keep them affordable to renters.

A description of how the entity will monitor its annual progress toward achieving the goal: The City regularly updates impact fee studies and evaluates utility rates.

A description of the resources the entity must allocate to complete this goal: Since this is a well-established housing policy and goal in Lindon no further resources should need to be allocated.

A description of the barriers, if any, the entity is encountering in working towards the goal: The City has not encountered any recent barriers.

3. Preserve existing moderate-income housing

Between 2002-2004, Lindon City purchased three homes adjacent to the Lindon City Center complex. The rents for those three homes range \$1,250-\$1,300 per month. The homes were constructed between 1961 and 1973 and are at least four bedrooms and 1,200 square feet. The rents that the City charges are below the 80% Area Median Income. The City has no current plans to demolish these homes and will continue to use them for affordable housing.

Specific outcomes the goal intends to accomplish: The City intends to continue to provide moderate-income housing opportunities through moderate-income rents using the three homes purchased by the City.

A description of how the entity will monitor its annual progress toward achieving the goal: The city will ensure that the rents continue to stay at or below the 80% moderate-income level

A description of the resources the entity must allocate to complete this goal: The City budgets yearly for the maintenance and upkeep of the homes to ensure that they are safe and habitable.

A description of the barriers, if any, the entity is encountering in working towards the goal: The City has not encountered any recent barriers.

4. Utilize strategies that preserve subsidized low to moderate income units on a long-term Basis

In addition, In 2000, Lindon City and the Housing Authority of Utah County, partnered to provide housing for individuals with disabilities as part of the Housing and Urban Development (HUD) Section 8 voucher. The City provided the land for this development and the Olene Walker Housing Trust Fund provided the original funding, as did the Utah Division of Services for People with Disabilities (DSPD), the Utah County Home Program and the Housing Authority of Utah County. The home is located at 306 E. 400 N. and provides housing for three disabled individuals and is on land leased by the City for 99 years. The residents pay 30% of their income towards rent and a typical rent is \$473 per month.

The Housing Authority also owns two duplexes in Lindon, and provided rental subsidies of \$97,146 to twenty-one clients through the Section 8 Voucher program in 2018.

Specific outcomes the goal intends to accomplish: Continue to provide housing for individuals with special needs as well as income restrictions

A description of how the entity will monitor its annual progress toward achieving the goal: The City will continue to actively work with the Housing Authority of Utah County to support their affordable housing program in Lindon City.

A description of the resources the entity must allocate to complete this goal: The City provided the land and entered into a long-term 99-year lease for the housing for people with disabilities. The Housing Authority of Utah County provides the maintenance of the home.

A description of the barriers, if any, the entity is encountering in working towards the goal: The City has not encountered any recent barriers. Additional housing is needed but the City will continue to work with the Housing Authority of Utah County as opportunities arise.

5. Allow for alternative housing types or moderate-income residential development in commercial and mixed-use zones, commercial centers, or employment centers

In 2013, Lindon City created the Senior Housing Facility Overlay zone that allowed for senior housing (55+) with the General Commercial and Mixed Commercial zones. This allows seniors to remain and age in the community. The ordinance allows multi-family senior housing at a density of 30 units per acre and a parking reduction to 1.10 stalls per unit. Under this overlay zone, developers have constructed 326 senior housing units in commercial zones with another 103 units entitled.

Specific outcomes the goal intends to accomplish: To provide housing opportunities for senior residents of the city to age in place in the community. To provide housing that is located in commercial zones that are in proximity to the State Street bus route as well as commercial businesses, medical facilities, and the Lindon Senior Center.

A description of how the entity will monitor its annual progress toward achieving the goal: The City will continue to support alternative housing types such a multi-family senior housing in commercial zones and centers.

A description of the resources the entity must allocate to complete this goal: The City has provided the zoning mechanism for senior housing opportunities in commercial zones.

A description of the barriers, if any, the entity is encountering in working towards the goal: Developers may run into barriers when petitioning to rezone property for the Senior Housing Overlay if the use is incompatible with surrounding uses. This is why the City has preferred to see such housing facilities be developed in or adjacent to commercial centers.

Section V

Housing Goals and Continued Support of Moderate-Income Housing

Over the next five years Lindon City will continue to help support goals of reducing the housing cost burden for current and future residents through sound housing policies as listed in this report and research future opportunities as listed below. The City will also work to increase the availability of moderate-income housing and closing the housing gap as identified in the Five-year Housing Projection Calculator in Section II.

As discussed in Section III, the City should review the below items by the end of 2020 to evaluate if regulatory barriers can be reduced to support affordable housing in Lindon City.

- Evaluate the effectiveness of the R2 zone and if any regulations should be modified. In 2016 at a “kick-off” meeting to update the general plan, the city council and planning commission held a joint meeting where one of the topics of discussion was putting together a committee to research responsible options for infill development as well as strategic areas and criteria for possible higher density development. Discuss again the opportunities and need for such a committee.
- Evaluate whether the City would allow moderately higher density developments as part of a mixed commercial development that would be located in strategic commercial areas or centers to help with development potential.
- Discuss if impact fees reductions should apply to all affordable housing options, not just accessory apartments, as an incentive to help reduce housing barriers and promote affordable housing.
- Review the Standard Land Use Table to evaluate currently allowed housing options if there are additional opportunities for housing within each land use district.
- Meet with the Housing Authority of Utah County and discuss housing needs and partnership opportunities at an upcoming City Council work meeting. Also discuss with the housing authority future opportunities for new affordable housing units.
- Further evaluate the inclusion of moderate-income housing as part of new developments.
- Discuss opportunities for mortgage assistance programs available for qualifying individuals.
- Discuss opportunities to work with non-profit housing groups to purchase homes as they become available on the market for re-sale as affordable housing.
- Knowing that Light Rail may still be in the future many years, study whether the City should help preserve property for Transit Oriented Development.
- Discuss how to help homeowners bring unapproved accessory apartments into compliance.
- Evaluate needed re-investment into Lindon’s older neighborhoods through infrastructure improvements, neighborhood clean-up, and code enforcement.

Works Cited

American Planning Association. "Housing Policy Guide." (2019): 4-5.

Blackwell, Tim. "How Multifamily is Blending Retail with Residential." 14 June 2016, Property Management Insider. <https://www.propertymanagementinsider.com/how-multifamily-is-blending-retail-with-residential>

Gardner Business Review. "What Rapidly Rising Prices Mean for Housing Affordability." (2018).

Kem C. Gardner Policy Institute. "Utah's Long-Term Demographic and Economic Projections Summary." (2017): 2.

Johnson, Stacy. "What is Utah County's Median Home Price and What Will it Buy?" Daily Herald 7 Aug. 2019

U.S. Bureau of Labor Statistics. (2016, Aug. 30). News release: Consumer expenditures – 2015 [USDL-16-1768]. Washington, DC: Government Printing Office. Retrieved on 12/21/16 from <https://www.bls.gov/news.release/pdf/cesan.pdf>

Utah County Valley Visioning (<https://utahvalleyvisioning.org/project>)

Wood, Eskic, and D.J. Benway. "Gardner Business Review." (2018): 26-27.

Appendix

- Utah Department of Workforce Services five-year housing calculator – Lindon City

Section 1: Population by tenure in Lindon city

Table B01003 Table B25008	2009 American Community Survey	2017 American Community Survey	Annual Growth Rate (Slope)	2024 Projection	Difference between 2017 and 2024
Total Population: (ACS Table B01003)	10,215	10,761	112	11,527	766
Total Population in occupied housing units (ACS Table B25008)	10,088	10,646	114	11,438	792
Total Population in owner- occupied housing (ACS Table B25008)	9,102	8,916	20	8,846	-70
Total Population in renter- occupied housing (ACS Table B25008)	986	1,730	94	2,592	862

Source 1: U.S. Census Bureau. Table B01003: Total population. American Community Survey.

Source 2: U.S. Census Bureau. Table B25008: Total population in occupied housing units by tenure. American Community Survey.

Section 2: Supply of housing units by structure type in Lindon city

Table B25001 Table B25032	2009 American Community Survey	2017 American Community Survey	Annual Growth Rate (Slope)	2024 Projection	Difference between 2017 and 2024
TOTAL HOUSING UNITS (ACS Table B25001)	2,349	2,914	76	3,423	509
Total occupied units (ACS Table B25032)	2,268	2,747	57	3,118	371
Owner-occupied structures (ACS Table B25032)	2,046	2,288	34	2,450	162
1 unit, detached	1,891	2,088	25	2,213	125
1 unit, attached	111	147	5	165	18
2 units	0	21	4	49	28
3 or 4 units	35	0	-2	-22	-22
5 to 9 units	0	0	0	0	0
10 to 19 units	0	0	0	0	0
20 to 49 units	0	0	0	0	0
50 or more units	9	0	-2	-12	-12
Mobile homes	0	32	4	57	25
Boat, RV, van, etc.	0	0	0	0	0
Renter-occupied structures (ACS Table B25032)	222	459	23	668	209
1 unit, detached	143	248	15	386	138
1 unit, attached	55	37	-8	-3	-40
2 units	16	125	13	229	104
3 or 4 units	8	18	-1	3	-15
5 to 9 units	0	0	0	0	0
10 to 19 units	0	0	-1	-5	-5
20 to 49 units	0	7	0	6	-1
50 or more units	0	0	0	0	0
Mobile homes	0	24	4	52	28

Boat, RV, van, etc.	0	0	0	0	0
---------------------	---	---	---	---	---

Source 1: U.S. Census Bureau. Table B25001: Total housing units. American Community Survey.

Source 2: U.S. Census Bureau. Table B25032: Tenure by units in structure. American Community Survey.

Section 3: Housing occupancy in Lindon city

Table B25003 Table B25081	2009 American Community Survey	2017 American Community Survey	Annual Growth Rate (Slope)	2024 Projection	Difference between 2017 and 2024
Total households in occupied housing units (ACS Table B25003)	2,268	2,747	57	3,118	371
Total households in owner-occupied housing (ACS Table B25003)	2,046	2,288	34	2,450	162
With a Mortgage (ACS Table B25081)	1,570	1,500	1	1,532	32
Without a Mortgage (ACS Table B25081)	476	788	33	918	130
Total households in renter-occupied housing (ACS Table B25003)	222	459	23	668	209

Source 1: U.S. Census Bureau. Table B25003: Tenure. American Community Survey.

Source 2: U.S. Census Bureau. Table B25081: Mortgage status. American Community Survey.

Section 4: Housing vacancy in Lindon city

Table B25004	2009 American Community Survey	2017 American Community Survey	Annual Growth Rate (Slope)	2024 Projection	Difference between 2017 and 2024
Total vacant units (ACS Table B25004)	81	167	18	305	138
For rent (ACS Table B25004)	0	6	1	13	7
Rented, not occupied (ACS Table B25004)	0	0	0	0	0
For sale only (ACS Table B25004)	0	73	12	175	102
Sold, not occupied (ACS Table B25004)	81	17	-3	-14	-31
For seasonal, recreational, or occasional use (ACS Table B25004)	0	48	4	62	14
For migrant workers (ACS Table B25004)	0	0	0	0	0
Other vacant (ACS Table B25004)	0	23	4	69	46

Source 1: U.S. Census Bureau. Table B25003: Tenure. American Community Survey.

Section 5: Average household size in Lindon

Table B25010	2009 American Community Survey	2017 American Community Survey	2024 Projection
Average Household Size (ACS Table B25010)	4.45	3.88	3.67
Average Owner Household Size (ACS Table B25010)	4.45	3.9	3.61
Average Renter Household Size (ACS Table B25010)	4.44	3.77	3.88

Source 1: U.S. Census Bureau. Table B25010: Average household size of occupied housing units by tenure. American Community Survey.

Section 6: Monthly housing costs in Lindon city

Table B25088 Table B25064	2009 American Community Survey	2017 American Community Survey	Annual Growth Rate (Slope)	2024 Projection	Difference between 2017 and 2024
Total owner-occupied housing unit costs (ACS Table B25088)	\$1,473	\$1,521	\$5	\$1,623	\$ 102
Units with a mortgage (ACS Table B25088)	\$1,867	\$1,903	-\$6	\$1,898	\$ (5)
Units without a mortgage (ACS Table B25088)	\$445	\$509	\$5	\$529	\$ 20
Median gross rent (ACS Table B25064)	\$1,217	\$1,052	-\$17	\$912	\$ (140)

Source 1: U.S. Census Bureau. Table B25088: Median monthly owner costs (renters), by mortgage status. American Community Survey.

Source 2: U.S. Census Bureau. Table B25064: Median gross rent (Dollars). American Community Survey.

Section 7: Median household income in Lindon city

Table B25119	2009 American Community Survey	2017 American Community Survey	Annual Growth Rate (Slope)	2024 Projection	Difference between 2017 and 2024
Median household income (ACS Table B25119)	\$84,485	\$81,789	-\$61	\$84,655	\$ 2,866
Owner-occupied income (ACS Table B25119)	\$89,044	\$93,125	\$234	\$98,709	\$ 5,584
Renter-occupied income (ACS Table B25119)	\$42,976	\$42,896	\$102	\$39,790	\$ (3,106)

Source 1: U.S. Census Bureau. Table B25119: Median household income that past 12 months by tenure. American Community Survey.

Section 8: Utah County Area Median Income (AMI)*

Table B19019 Table B19119	2009 American Community Survey	2017 American Community Survey	Annual Growth Rate (Slope)	2024 Projection	Difference between 2017 and 2024
------------------------------	---	---	----------------------------------	--------------------	--

Median HOUSEHOLD income (ACS Table B19019)	\$0	\$67,042	\$4,950	\$108,972	\$ 41,930
1-person household	\$27,923	\$30,846	\$262	\$31,581	\$ 735
2-person household	\$49,796	\$56,697	\$811	\$61,817	\$ 5,120
3-person household	\$53,462	\$66,940	\$1,579	\$76,861	\$ 9,921
4-person household	\$63,469	\$78,937	\$1,453	\$83,981	\$ 5,044
5-person household	\$70,657	\$83,880	\$1,489	\$92,553	\$ 8,673
6-person household	\$75,407	\$88,642	\$1,465	\$96,881	\$ 8,239
≥ 7-person household	\$80,546	\$102,132	\$2,389	\$115,554	\$ 13,422
Median FAMILY income (ACS Table B19119)	\$63,310	\$73,543	\$1,175	\$79,481	\$ 5,938
2-person family	\$47,865	\$56,153	\$949	\$62,245	\$ 6,092
3-person family	\$59,984	\$69,217	\$1,221	\$75,713	\$ 6,496
4-person family	\$69,900	\$80,998	\$1,210	\$84,275	\$ 3,277
5-person family	\$75,311	\$84,583	\$1,178	\$90,205	\$ 5,622
6-person family	\$78,293	\$90,425	\$1,260	\$97,505	\$ 7,080
≥ 7-person family	\$80,854	\$101,546	\$2,302	\$114,580	\$ 13,034

Source 1: U.S. Census Bureau. Table B19019: Median household income that past 12 months by household size. American

Community Survey.

Source 2: U.S. Census Bureau. Table B19119: Median family income in the past 12 months by family size. American Community

Survey.

*NOTE: AMI is calculated at the COUNTY level.

UCA 10-9a-408(2)(c)(i)

Calculate the municipality's housing gap for the current biennium by entering the number of moderate-income renter households, affordable and available rental units from TABLE 1 below:

2018 Shortage	Renter Households	Affordable Rental Units	Available Rental Units	Affordable Units - Renter Households	Available Units - Renter Households
≤ 80% HAMFI	340	400	310	60	-30
≤ 50% HAMFI	170	115	45	-55	-125
≤ 30% HAMFI	120	30	10	-90	-110

Calculate the municipality's housing gap for the previous biennium by entering the number of moderate-income renter households, affordable and available rental units from TABLE 2 below:

2016 Shortage	Renter Households	Affordable Rental Units	Available Rental Units	Affordable Units - Renter Households	Available Units - Renter Households
≤ 80% HAMFI	290	375	250	85	-40
≤ 50% HAMFI	170	90	50	-80	-120
≤ 30% HAMFI	130	65	35	-65	-95

Subtract Table 2 from Table 1 to estimate progress in providing moderate-income housing

PROGRESS	Renter Households	Affordable Rental Units	Available Rental Units	Affordable Units - Renter Households	Available Units - Renter Households
≤ 80% HAMFI	50	25	60	-25	10
≤ 50% HAMFI	0	25	-5	25	-5
≤ 30% HAMFI	-10	-35	-25	-25	-15

UCA 10-9a-408(2)(c)(ii)

Report the number of all housing units in the municipality that are currently subsidized by each level of government below:

Municipal Government:	3	Subsidized by municipal housing programs
State Government:	0	Subsidized by Utah's OWHLF multi-family program
Federal Government:	0	Subsidized by the federal Low-Income Housing Tax Credit (LIHTC) program

UCA 10-9a-408(2)(c)(iii)

Report the number of all housing units in the municipality that are currently deed-restricted for moderate-income households in the box below:

3

SECTION II: The provisions of this amendment and the provisions adopted or incorporated by reference are severable. If any provision of this general plan amendment is found to be invalid, unlawful, or unconstitutional by a court of competent jurisdiction, the balance of the general plan shall nevertheless be unaffected and continue in full force and effect.

SECTION III: Provisions of other ordinances and general plan provisions in conflict with this ordinance and general plan amendment to the Moderate-Income Housing Plan and the provisions adopted or incorporated by reference are hereby repealed or amended as provided herein.

SECTION IV: This ordinance shall take effect immediately upon its passage and posting as provide by law.

PASSED and ADOPTED and made EFFECTIVE by the City Council of Lindon City, Utah, this _____ day of _____, 2019.

Jeff Acerson, Mayor

ATTEST:

Kathryn A. Moosman,
Lindon City Recorder

SEAL

7. **Review & Action — Bid Award; North Union Canal Piping**

The City Council will review and consider whether to award the low bid of \$748,924.45 by NeZhoni Construction, LLC for the North Union Canal Piping project. This project is partially grant funded.

(20 minutes)

The North Union Canal piping project consists of replacing approximately 1,700 linear feet of the deteriorating concrete-lined canal sections with a 48” reinforced concrete pipe with associated cleanout manholes, transition structures, and other work needed to complete the project. Piping of the canal will help to conserve water lost through seepage and evaporation, increase efficiency of operating and maintaining the canal, increase safety (enclosing an open canal), and decreasing potential for flooding.

Lindon City and the North Union Irrigation Company were awarded a Water Smart Grant through the U.S. Bureau of Reclamation in the amount of \$258,922 with the City and North Union Irrigation Company matching the grant with an additional \$315,000 (\$573,922 total). Approximately \$472,653 is available for construction after factoring costs for project administration, environmental review, and engineering design/engineering administration.

The low bid (out of 4 bidders) to complete these project is \$748,924.45 by NeZhoni Construction, LLC. Staff recommends using approximately \$276,271 from the Water Fund balance to make up the difference in construction cost to complete this specific piping project.

See attached slides for more information.

Sample Motion: *I move to (approve, continue, not approve) the bid award for the North Union Canal piping project as presented (or as presented with changes).*

City of Lindon North Union Canal Enclosure
 BID FORM
 Project # 50-18-055
 Printed: September 25, 2019
 Begin Date: November 1, 2019
 End Date: March 30, 2020

City of Lindon North Union Canal Enclosure September 24, 2019				ENGINEER'S ESTIMATE		NEZHON CONSTRUCTION, LLC		VANCON, INC		S & L, INC		CONDIE CONSTRUCTION COMPANY	
Item #	Description	Unit	Quantity	Unit Price	Amount	Unit Price	Amount	Unit Price	Amount	Unit Price	Amount	Unit Price	Amount
Schedule A													
1A	Mobilization	LS	1	\$16,000.00	\$16,000.00	\$28,310.49	\$28,310.49	\$45,000.00	\$45,000.00	\$40,000.00	\$40,000.00	\$70,290.00	\$70,290.00
2A	Furnish, Install, and Maintain, Storm Water Pollution Prevention	LS	1	\$2,000.00	\$2,000.00	\$7,077.62	\$7,077.62	\$1,000.00	\$1,000.00	\$8,000.00	\$8,000.00	\$7,314.00	\$7,314.00
3A	Remove and Dispose of Existing Concrete Canal Lining	LF	785	\$2.50	\$1,962.50	\$9.00	\$7,065.00	\$16.00	\$12,560.00	\$13.00	\$10,205.00	\$9.40	\$7,379.00
4A	Remove and Dispose of Corrugated Metal Pipes	LS	1	\$300.00	\$300.00	\$3,000.00	\$3,000.00	\$1,250.00	\$1,250.00	\$3,000.00	\$3,000.00	\$5,769.00	\$5,769.00
5A	Furnish Pipe Imported Initial Backfill Material	TON	790	\$20.00	\$15,800.00	\$20.00	\$15,800.00	\$30.00	\$23,700.00	\$23.00	\$18,170.00	\$23.80	\$18,802.00
6A	Furnish, Place, and Compact Pipe Imported Foundation Material	TON	140	\$25.00	\$3,500.00	\$20.00	\$2,800.00	\$30.00	\$4,200.00	\$30.00	\$4,200.00	\$32.80	\$4,592.00
7A	Excavate for, Furnish, Install, Backfill, and Compact 48" Class III RCP	LF	764	\$165.00	\$126,060.00	\$185.00	\$141,340.00	\$195.00	\$148,980.00	\$180.00	\$137,520.00	\$164.00	\$125,296.00
8A	Excavate for, Cast in Place, Backfill, and Compact Transition Structure 3 (Reservoir Outlet)	LS	1	\$15,000.00	\$15,000.00	\$17,750.00	\$17,750.00	\$16,000.00	\$16,000.00	\$18,000.00	\$18,000.00	\$33,840.00	\$33,840.00
9A	Excavate for, Cast in Place, Backfill, and Compact Transition Structure 4 (Reservoir Inlet)	LS	1	\$150,000.00	\$150,000.00	\$20,900.00	\$20,900.00	\$16,500.00	\$16,500.00	\$22,000.00	\$22,000.00	\$33,969.00	\$33,969.00
10A	Furnish, Install, Backfill, and Compact 72" Manhole	EA	3	\$7,000.00	\$21,000.00	\$4,810.17	\$14,430.51	\$5,500.00	\$16,500.00	\$5,500.00	\$16,500.00	\$5,782.00	\$17,346.00
11A	Surface Restoration and Seeding	SF	6,112	\$3.00	\$18,336.00	\$2.10	\$12,835.20	\$2.00	\$12,224.00	\$0.75	\$4,584.00	\$0.80	\$4,889.60
				Total	\$369,958.50	Total	\$271,308.82	Total	\$297,914.00	Total	\$282,178.00	Total	\$329,486.60
Schedule B													
1B	Mobilization	LS	1	\$16,000.00	\$16,000.00	\$30,448.78	\$30,448.78	\$37,000.00	\$37,000.00	\$40,000.00	\$40,000.00	\$54,497.00	\$54,497.00
2B	Traffic Control	LS	1	\$4,000.00	\$4,000.00	\$12,686.99	\$12,686.99	\$30,000.00	\$30,000.00	\$25,000.00	\$25,000.00	\$4,293.00	\$4,293.00
3B	Stormwater Pollution Prevention Plan	LS	1	\$2,000.00	\$2,000.00	\$7,612.19	\$7,612.19	\$1,000.00	\$1,000.00	\$7,500.00	\$7,500.00	\$6,881.00	\$6,881.00
4B	Remove and Dispose of Existing Concrete Canal Lining	LF	247	\$2.50	\$617.50	\$9.00	\$2,223.00	\$16.00	\$3,952.00	\$15.00	\$3,705.00	\$9.40	\$2,321.80
5B	Remove and Dispose of Corrugated Metal Pipes	LS	1	\$150.00	\$150.00	\$1,500.00	\$1,500.00	\$950.00	\$950.00	\$5,000.00	\$5,000.00	\$5,769.00	\$5,769.00
6B	Furnish Imported Pipe Bedding and Initial Backfill Material	TON	590	\$20.00	\$11,800.00	\$20.00	\$11,800.00	\$30.00	\$17,700.00	\$23.00	\$13,570.00	\$23.80	\$14,042.00
7B	Furnish, Place, and Compact Pipe Imported Foundation Material	TON	110	\$25.00	\$2,750.00	\$20.00	\$2,200.00	\$30.00	\$3,300.00	\$30.00	\$3,300.00	\$32.80	\$3,608.00
8B	Excavate for, Furnish, Install, Backfill, and Compact 48" Class III RCP	LF	564	\$180.00	\$101,520.00	\$185.00	\$104,340.00	\$180.00	\$101,520.00	\$180.00	\$101,520.00	\$154.00	\$86,856.00
9B	Remove and Dispose of Existing Asphalt	SF	368	\$3.00	\$1,104.00	\$9.00	\$3,312.00	\$2.00	\$736.00	\$5.00	\$1,840.00	\$0.50	\$184.00
10B	Remove and Dispose of Existing Fence	LF	342	\$5.00	\$1,710.00	\$6.64	\$2,270.88	\$3.00	\$1,026.00	\$7.00	\$2,394.00	\$3.60	\$1,231.20
11B	Remove and Dispose of Manhole and Remove and Salvage 18" Meter to City	LS	1	\$1,500.00	\$1,500.00	\$2,000.00	\$2,000.00	\$1,500.00	\$1,500.00	\$1,200.00	\$1,200.00	\$404.00	\$404.00
12B	Excavate for, Cast in Place, Backfill, and Compact Transition Structure 1 (200 South Outlet)	LS	1	\$15,000.00	\$15,000.00	\$17,550.00	\$17,550.00	\$15,000.00	\$15,000.00	\$20,000.00	\$20,000.00	\$35,624.00	\$35,624.00
13B	Excavate for, Cast in Place, Backfill, and Compact Transition Structure 2 (200 South Inlet)	LS	1	\$20,000.00	\$20,000.00	\$22,700.00	\$22,700.00	\$25,000.00	\$25,000.00	\$24,000.00	\$24,000.00	\$64,728.00	\$64,728.00
14B	Furnish and Install 6' Chainlink Fence	LF	12	\$35.00	\$420.00	\$33.00	\$396.00	\$25.00	\$300.00	\$65.00	\$780.00	\$152.00	\$1,824.00
15B	Remove and Relocate Double 6' Swing Gate	LS	1	\$500.00	\$500.00	\$495.00	\$495.00	\$700.00	\$700.00	\$1,800.00	\$1,800.00	\$1,906.00	\$1,906.00
16B	Furnish, Install, Backfill, and Compact 72" Manhole	EA	1	\$7,000.00	\$7,000.00	\$4,810.17	\$4,810.17	\$6,000.00	\$6,000.00	\$5,500.00	\$5,500.00	\$5,934.00	\$5,934.00
17B	Furnish, Install, Backfill, and Compact 96" Manhole	EA	1	\$11,000.00	\$11,000.00	\$9,310.91	\$9,310.91	\$18,000.00	\$18,000.00	\$12,000.00	\$12,000.00	\$12,857.00	\$12,857.00
18B	Furnish and Install 200 South Grate	EA	1	\$1,000.00	\$1,000.00	\$750.00	\$750.00	\$7,500.00	\$7,500.00	\$9,500.00	\$9,500.00	\$2,296.00	\$2,296.00
19B	Connect Existing 6" PVC Drain Pipe to 48" RCP	LS	1	\$1,250.00	\$1,250.00	\$2,400.00	\$2,400.00	\$2,500.00	\$2,500.00	\$2,500.00	\$2,500.00	\$1,687.00	\$1,687.00
20B	Furnish and Install 4" Double Cleanout w/ Manhole Cone Section w/ Ring and Cover	EA	1	\$1,900.00	\$1,900.00	\$2,706.67	\$2,706.67	\$6,500.00	\$6,500.00	\$5,000.00	\$5,000.00	\$4,010.00	\$4,010.00
21B	Furnish and Install 8" Steel Casing for Future Sewer Connection	LS	1	\$2,000.00	\$2,000.00	\$1,500.00	\$1,500.00	\$2,000.00	\$2,000.00	\$4,500.00	\$4,500.00	\$2,324.00	\$2,324.00
22B	Cut and Cap 18" Pressure Irrigation Line w/ Thrust Block	LS	1	\$4,800.00	\$4,800.00	\$2,000.00	\$2,000.00	\$3,000.00	\$3,000.00	\$2,200.00	\$2,200.00	\$3,831.00	\$3,831.00
23B	Fill Existing Canal	LS	1	\$500.00	\$500.00	\$50,000.00	\$50,000.00	\$5,000.00	\$5,000.00	\$10,000.00	\$10,000.00	\$9,495.00	\$9,495.00
24B	Surface Restoration and Landscaping	SF	4,512	\$3.00	\$13,536.00	\$2.10	\$9,475.20	\$5.00	\$22,560.00	\$1.75	\$7,896.00	\$0.80	\$3,609.60
				Total	\$222,057.50	Total	\$304,487.79	Total	\$312,744.00	Total	\$310,705.00	Total	\$330,212.60
Schedule C													
1C	Mobilization	LS	1	\$13,000.00	\$13,000.00	\$17,312.78	\$17,312.78	\$14,000.00	\$14,000.00	\$22,477.05	\$22,477.05	\$11,667.00	\$11,667.00
2C	Traffic Control	LS	1	\$3,000.00	\$3,000.00	\$7,213.66	\$7,213.66	\$10,000.00	\$10,000.00	\$14,984.70	\$14,984.70	\$859.00	\$859.00
3C	Stormwater Pollution Prevention Plan	LS	1	\$2,000.00	\$2,000.00	\$4,328.20	\$4,328.20	\$1,000.00	\$1,000.00	\$7,492.35	\$7,492.35	\$4,093.00	\$4,093.00
4C	Remove and Dispose of Existing Concrete Canal Lining	LF	460	\$2.50	\$1,150.00	\$9.00	\$4,140.00	\$16.00	\$7,360.00	\$14.00	\$6,440.00	\$9.40	\$4,324.00
5C	Furnish Imported Granular Fill Material	TON	710	\$18.00	\$12,780.00	\$20.00	\$14,200.00	\$20.00	\$14,200.00	\$22.00	\$15,620.00	\$14.90	\$10,579.00
6C	Furnish Imported Pipe Bedding and Initial Backfill Material	TON	480	\$20.00	\$9,600.00	\$20.00	\$9,600.00	\$30.00	\$14,400.00	\$24.00	\$11,520.00	\$23.80	\$11,424.00
7C	Furnish Imported Pipe Foundation Material	TON	90	\$25.00	\$2,250.00	\$20.00	\$1,800.00	\$30.00	\$2,700.00	\$30.00	\$2,700.00	\$32.80	\$2,952.00
8C	Excavate for, Furnish, Install, Backfill, and Compact 48" Class III RCP	LF	453	\$165.00	\$74,745.00	\$185.00	\$83,805.00	\$180.00	\$81,540.00	\$180.00	\$81,540.00	\$150.00	\$67,950.00
9C	Remove and Dispose of Existing Fence	LF	649	\$5.00	\$3,245.00	\$4.40	\$2,855.60	\$3.00	\$1,947.00	\$7.00	\$4,543.00	\$3.60	\$2,336.40
10C	Furnish and Install 6' Chain Link Fence	LF	474	\$35.00	\$16,590.00	\$33.00	\$15,642.00	\$25.00	\$11,850.00	\$33.00	\$15,642.00	\$26.40	\$12,513.60
14C	Furnish, Install, Backfill, and Compact 72" Manhole	EA	1	\$7,000.00	\$7,000.00	\$4,620.20	\$4,620.20	\$6,000.00	\$6,000.00	\$5,500.00	\$5,500.00	\$5,782.00	\$5,782.00
15C	Surface Restoration and Seeding	SF	3,624	\$3.00	\$10,872.00	\$2.10	\$7,610.40	\$2.00	\$7,248.00	\$1.75	\$6,342.00	\$0.80	\$2,899.20
				Total	\$156,232.00	Total	\$173,127.84	Total	\$172,245.00	Total	\$194,801.10	Total	\$137,379.20

NOTE: Highlighted numbers indicate a mathematical discrepancy in the submitted bid.

Schedule A & B Total	\$592,016.00	\$575,796.61	\$610,658.00	\$592,884.00	\$659,699.20
Schedule A, B & C Total	\$748,248.00	\$748,924.45	\$782,903.00	\$787,685.10	\$797,078.40

North Union Canal piping project 2019-2020



Background

- **North Union Canal**
 - Constructed between 1852 to 1864
 - Concrete liner added between 1940 to 1950. Patched periodically.
 - Maintenance historically funded by dues collected from water share holders within the North Union Irrigation Company
- Lindon City is now largest share holder
 - Approx. 1.1 **BILLION** gallons of water per year
 - Over 2,608 secondary water connections

North Union and Provo Bench Canals

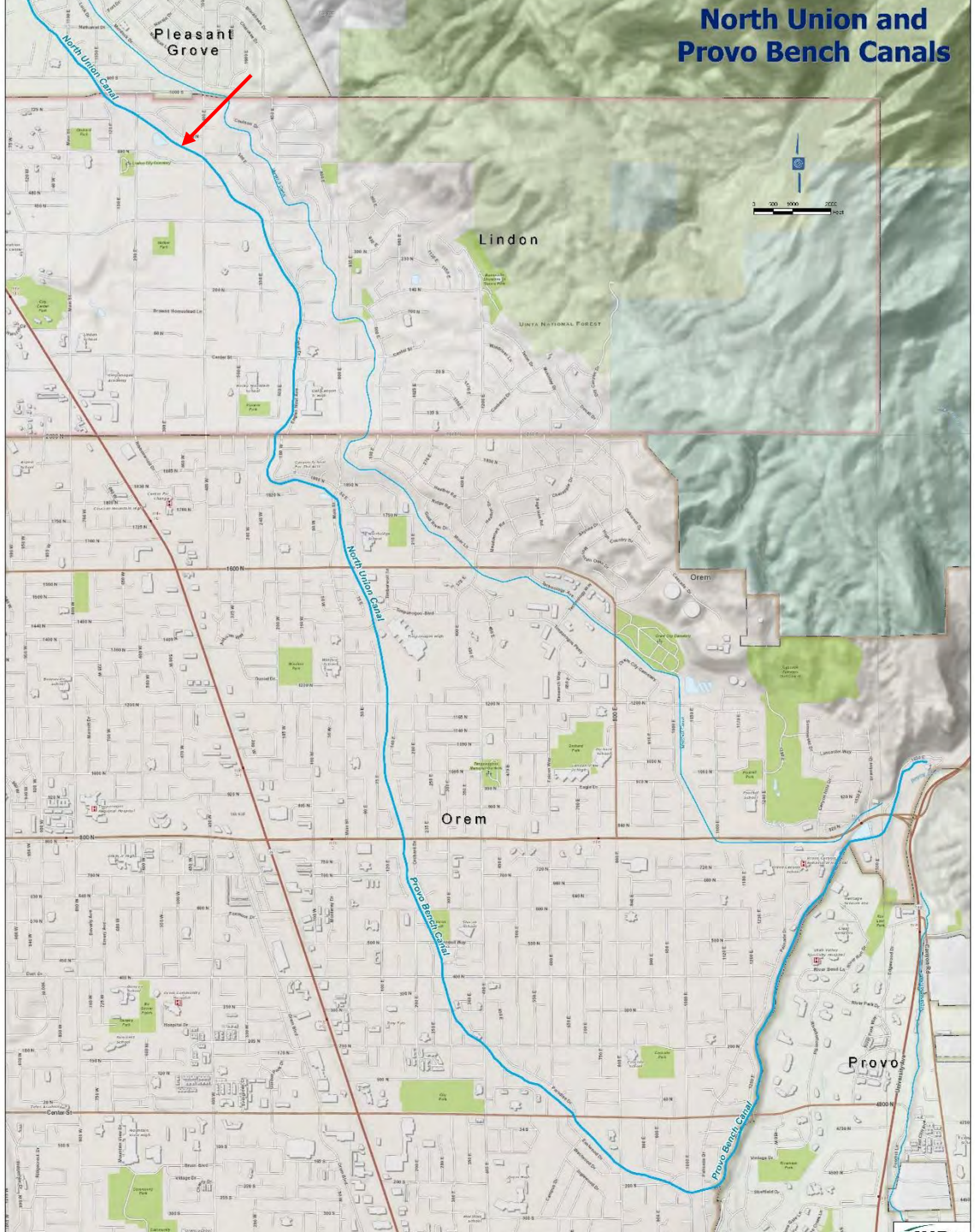

The Pressurized Irrigation System

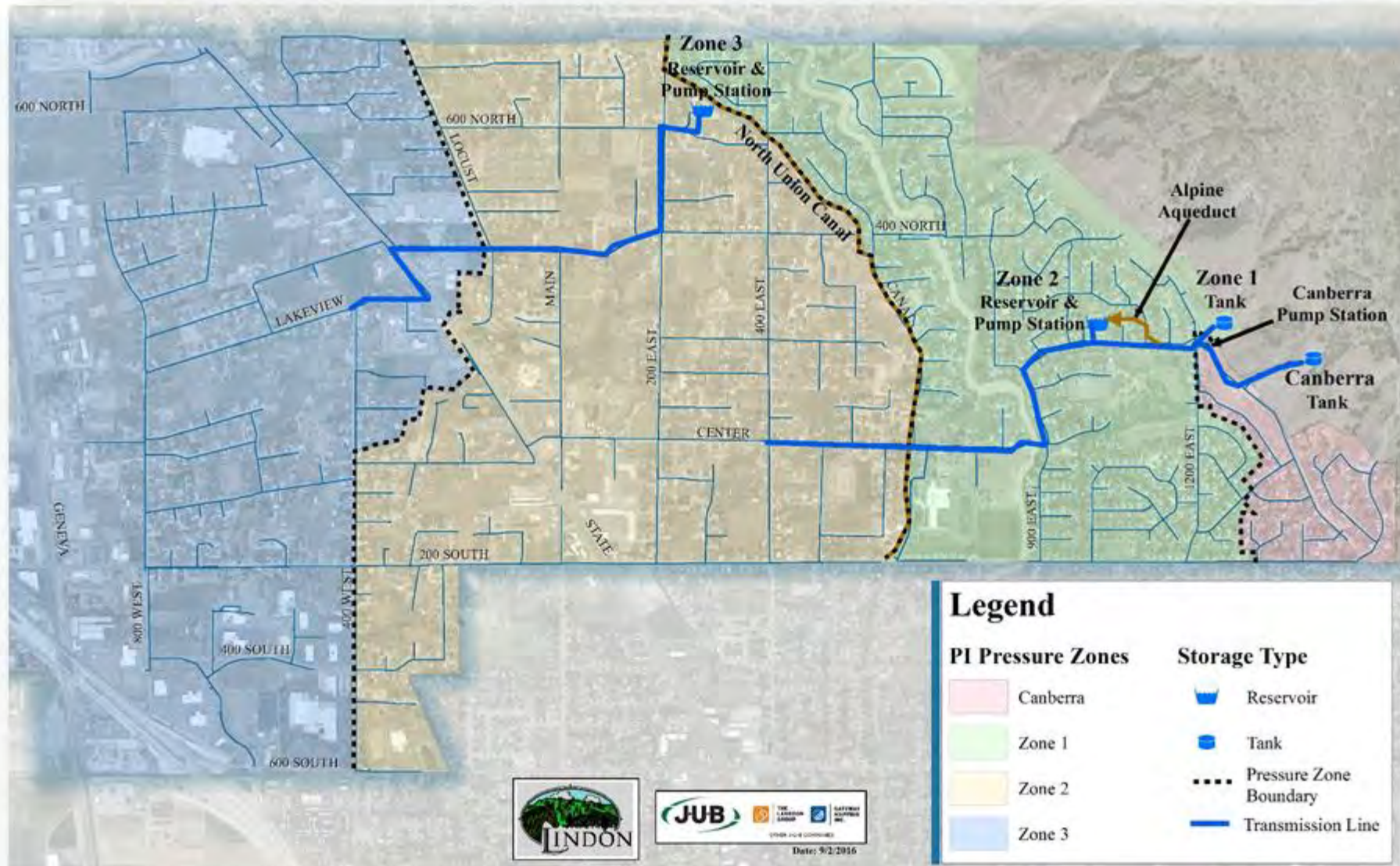



1.1 Billion Gallons...



Enough water to fill
Lavell Edwards
Stadium.....

7.5 times!

Need? Why are we doing this?

- **Water conservation**
 - Failing concrete liner
 - Seepage; evaporation; breach of water
 - **31% water loss** just in Lindon section (2016 NRCS Water Loss Study)
 - 74% of water loss was between 400 East and inlet to irrigation reservoir
- **Preserve and Protect Infrastructure**
 - Single largest source of secondary water delivery to Lindon City
- **Ease of Maintenance**

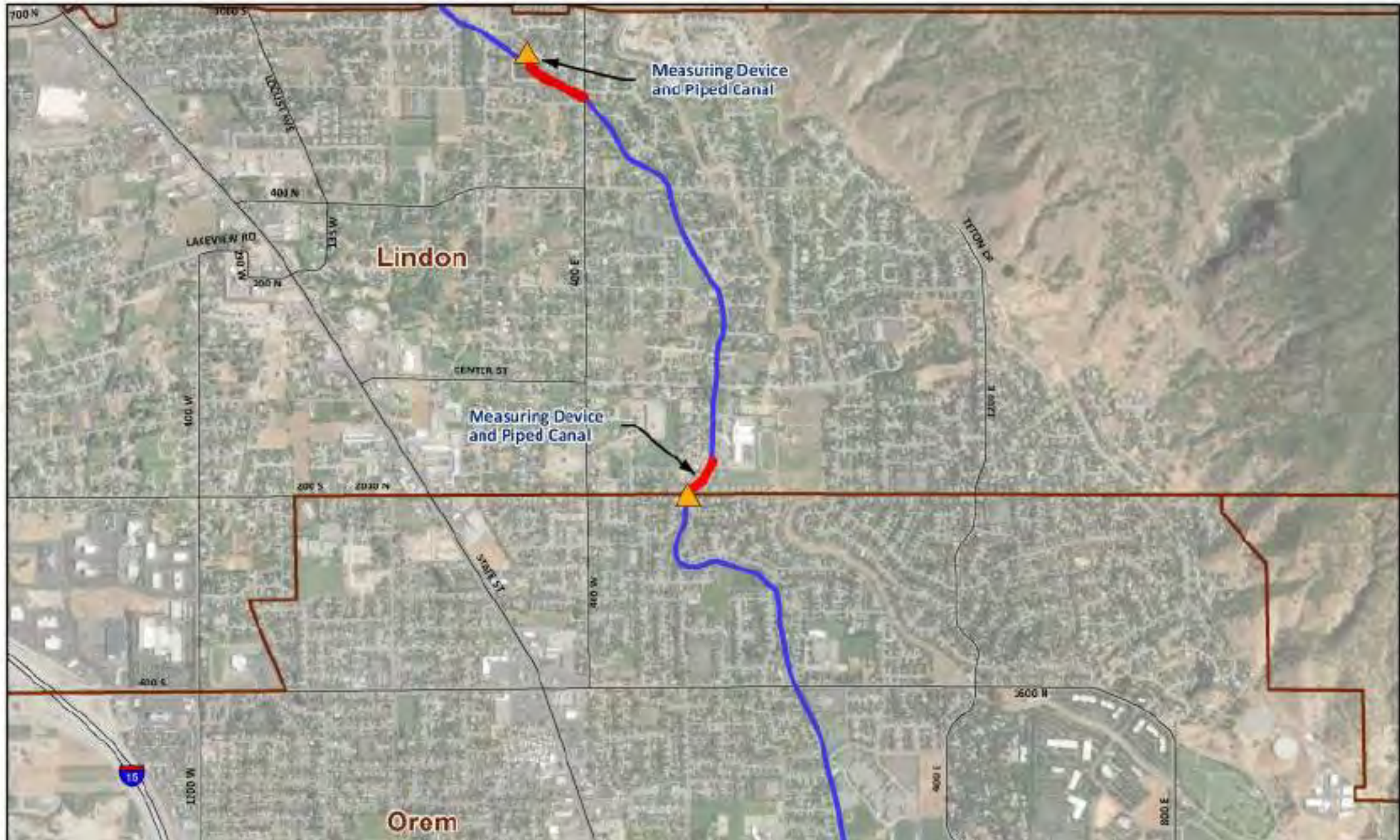

2015



Cracking in the concrete liner causes water to seep into adjacent yards and properties.



2015





2015





2016





2016-17



2016-17

Bureau of Reclamation – WaterSMART grant

- August 2017 - BOR awarded \$258,922 grant
- Lindon City and North Union Irrigation Company contributing approx. \$315,000
 - TOTAL PROJECT FUNDING: \$573,922
 - Approx **\$472,653** is available for construction

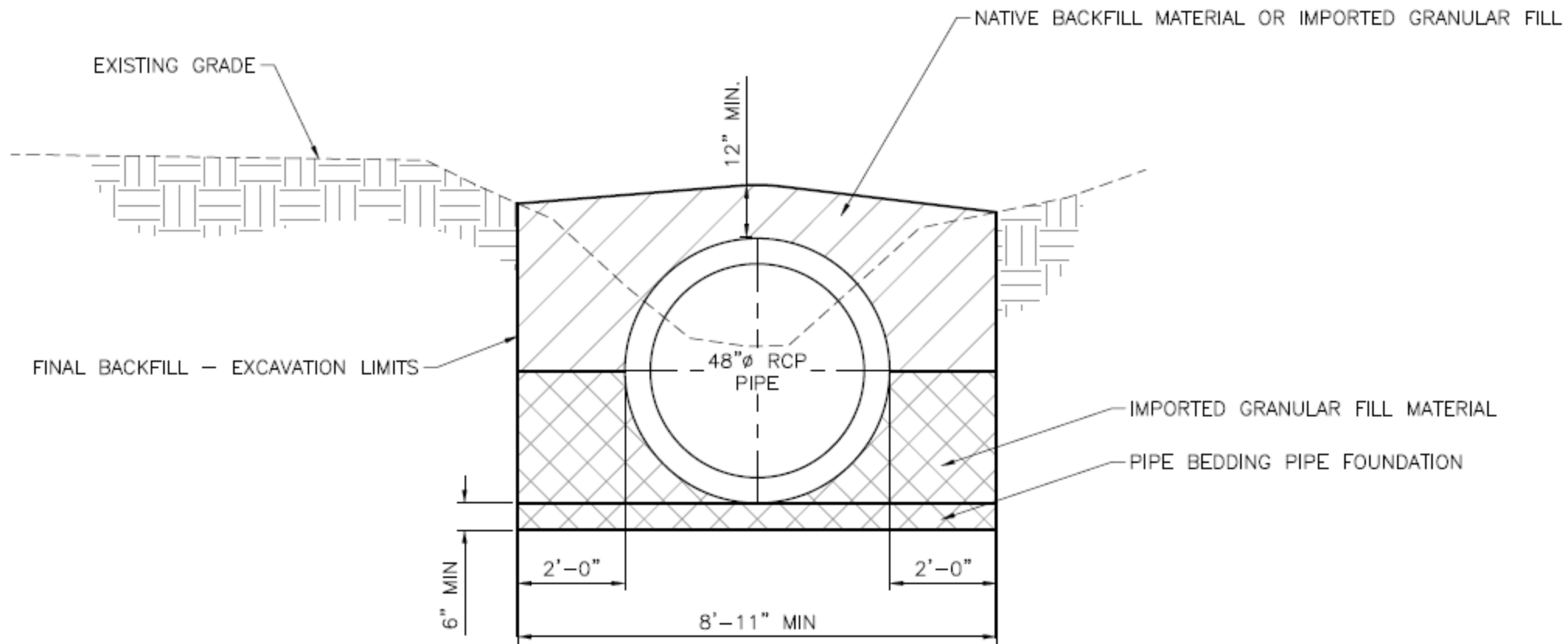



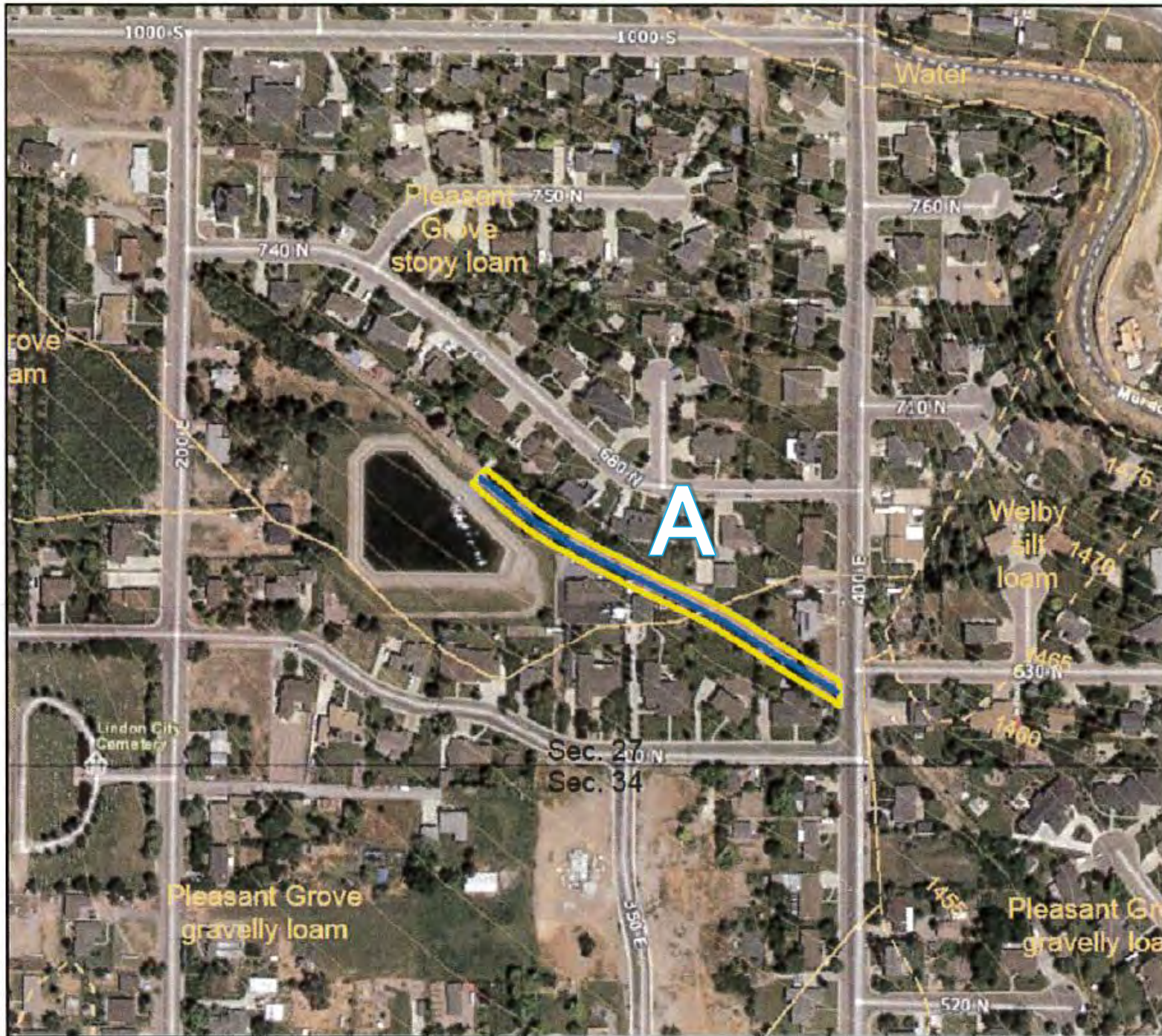



Bureau of Reclamation – WaterSMART grant

- August 2017 - BOR awarded \$258,922 grant
- Lindon City and North Union Irrigation Company contributing approx. \$315,000
 - TOTAL PROJECT FUNDING: \$573,922
 - Approx **\$472,653** is available for construction
- Low Bid for sections A & B is \$575,796.61 (difference of \$103,143.61)
- Low Bid for sections A, B & C is \$748,924.45 (difference of \$276,271.45)

Piping Under Design or to Remain		Lenth of Pipe (ft)		
Under Design	200 S to 100 S	905		
Remain	400 N to 400 E	1855		
Under Design	400 E to 300 E	805		
New Piping		Lenth of Pipe (ft)	Cost per Foot	Cost
100 S to Center Street		555	\$700.00	\$388,500.00
Center Street to 75 N		420	\$600.00	\$252,000.00
110 N to 175 N		250	\$600.00	\$150,000.00
185 N to 300 N		940	\$500.00	\$470,000.00
350 N to 400 N		300	\$700.00	\$210,000.00
300 E to 200 E		690	\$500.00	\$345,000.00
		Total		\$1,815,500.00
Repiping Existing		Lenth of Pipe (ft)	Cost per Foot	Cost
75 N to 110 N		380	\$600.00	\$228,000.00
175 N to 185 N		135	\$600.00	\$81,000.00
300 N to 350 N		410	\$500.00	\$205,000.00
		Total		\$514,000.00
		Total Piping and Re-Piping		\$2,329,500.00

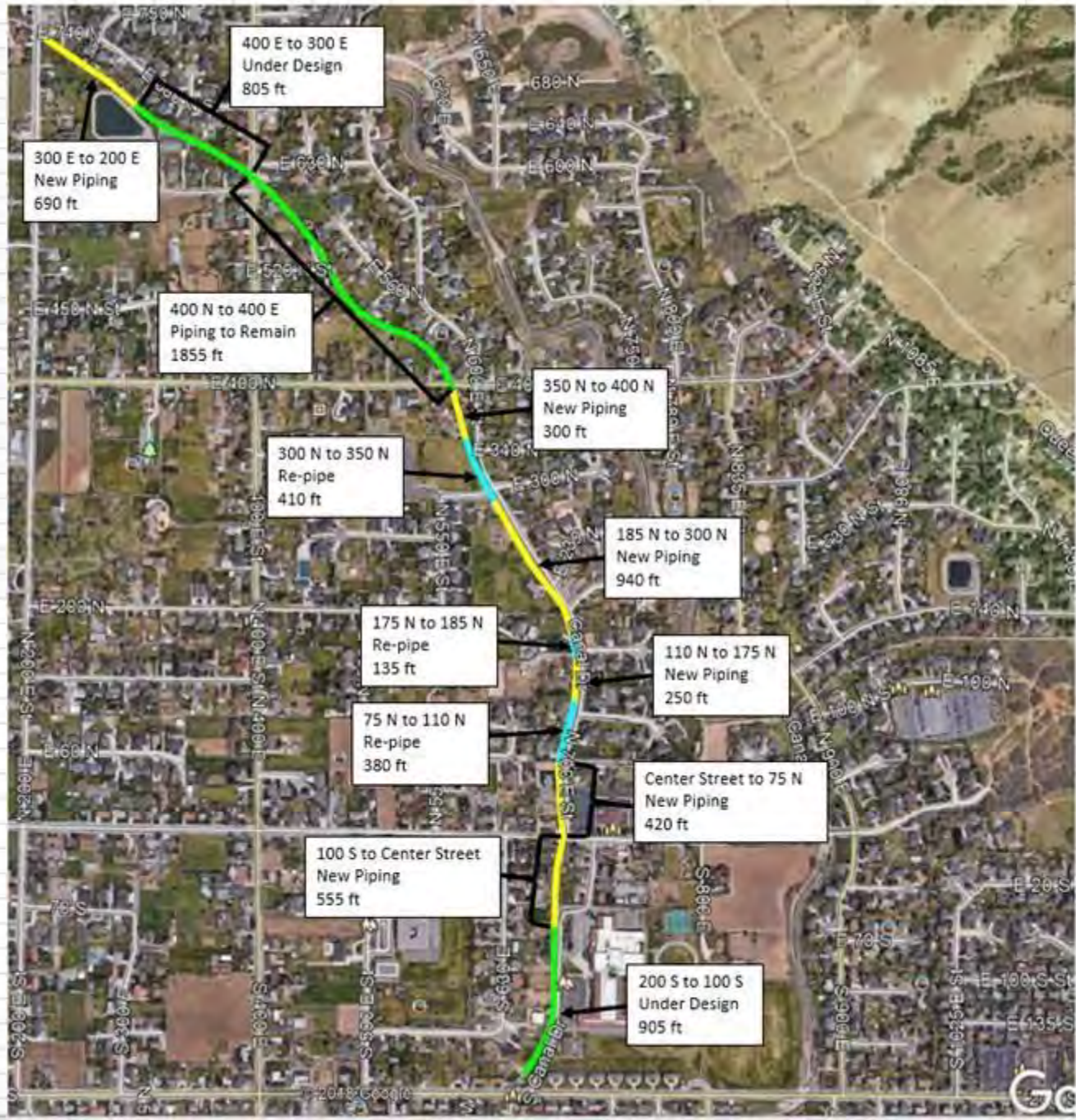

2016-17 Estimated costs

	Governmental Funds						Proprietary Funds						Total All Funds
	General	RDA	PARC Tax	Roads CIP	Parks CIP	Debt Svc	Water	Sewer	Garbage	Storm	Recreation	Telecomm.	
Beginning Balances	2,498,124	900,286	762,487	2,485,548	1,016,019	-	6,026,885	2,564,500	34,922	990,375	324,985	17,609	17,621,740
Revenues													
Program revenues													
Charges for services	2,479,397						2,598,200	1,647,360	510,000	1,030,000	760,450	54,000	9,079,407
Impact Fees	74,000			60,000	260,000		132,000	90,000		95,000			711,000
Grants and contributions	174,360										6,300		180,660
General revenues													
Property taxes	2,160,069												2,160,069
Sales tax	4,555,600												4,555,600
Other taxes	1,594,000	295,000	630,000	450,000									2,969,000
Other	744,295	19,300	15,000	10,000			409,100	49,000		10,200			1,256,895
Total revenues	11,781,721	314,300	645,000	520,000	260,000	-	3,139,300	1,786,360	510,000	1,135,200	766,750	54,000	20,912,631
Transfers In	-	-	-	300,000	11,000	1,145,199	-	-	-	-	1,137,900	-	2,594,099
Expenses													
General government	3,874,990	61,070											3,936,060
Public safety	4,242,293												4,242,293
Streets	450,080			184,000									634,080
Parks and recreation	950,575		611,290										1,561,865
Capital projects	-	30,000		1,300,000	295,200								1,625,200
Debt Service	-					1,145,199							1,145,199
Water							2,624,848						2,624,848
Sewer								2,288,326					2,288,326
Solid Waste									510,550				510,550
Storm Water Drainage										754,953			754,953
Recreation Fund											2,224,555		2,224,555
Telecomm. Fund												54,000	54,000
Total expenses	9,517,938	91,070	611,290	1,484,000	295,200	1,145,199	2,624,848	2,288,326	510,550	754,953	2,224,555	54,000	21,601,928
Transfers Out	2,188,099	150,000	246,000	-	10,000	-	-	-	-	-	-	-	2,594,099
Ending Balances	2,573,808	973,516	550,197	1,821,548	981,819	-	6,541,337	2,062,534	34,372	1,370,623	5,080	17,609	16,932,443
Percent Change	3.0%	8.1%	-27.8%	-26.7%	-3.4%	0.0%	8.5%	-19.6%	-1.6%	38.4%	-98.4%	0.0%	-3.9%

GENERAL FUND:

	Fund Bal.	% of Rev.
6/30/2019	2,498,124	22.87%
6/30/2020	2,573,808	24.40%

GENERAL FUND LIMITS:

ending max	2,636,681	25.0%
ending min	527,336	5.0%

Example General Fund Balance Levels based on projected revenues for:

	2018-2019	2019-2020
25%	2,730,249	2,636,681
24%	2,621,039	2,531,214
22%	2,402,619	2,320,279
20%	2,184,199	2,109,345
18%	1,965,779	1,898,410

10-year (2029) Projected Water Infrastructure Costs

TOTAL			\$ 19,195,000		\$ 2,856,000		\$ 16,339,000
Category	Sub-Category Description		Estimated Cost	% From Impact Fees	Impact Fee Cost	% From City Funds	City Cost
Capacity Increase							
	Source	New Well (1800 gpm)	\$ 2,100,000	67%	\$ 1,407,000	33%	\$ 693,000
	Storage	New Tank (1.5 MG)	\$ 2,100,000	67%	\$ 1,407,000	33%	\$ 693,000
	Transmission						
Replace Aged Infrastructure							
	Distribution	Annual Water System Replacement (\$552k / yr)	\$ 5,520,000	0%	\$ -	100%	\$ 5,520,000
	Distribution	Annual Secondary Water System Replacement (\$65k / yr)	\$ 650,000	0%	\$ -	100%	\$ 650,000
	Source	Pipe North Union Canal	\$ 2,100,000	2%	\$ 42,000	98%	\$ 2,058,000
O & M							
		AMR (Automated Meter Reading)	\$ 990,000	0%	\$ -	100%	\$ 990,000
		SCADA Improvements	\$ 1,000,000	0%	\$ -	100%	\$ 1,000,000
		Annual Source Metering Upgrades (\$10k/yr)	\$ 100,000	0%	\$ -	100%	\$ 100,000
		Water Quality Sampling Stations	\$ 60,000	0%	\$ -	100%	\$ 60,000
		Water Distribution Meter Upgrades	\$ 825,000	0%	\$ -	100%	\$ 825,000
New State Requirements							
		PI Metering	\$ 3,750,000	0%	\$ -	100%	\$ 3,750,000

Considerations for construction:

- Conserve water / reduce water loss
- Reduce possible property damage / liability from flooding or seepage
- Increase safety (no open ditch)
- Maintain operability of critical infrastructure

Staff Recommends awarding the low bid of \$748,924.45 for all three segments (A, B & C) using approx. \$276,271 from the Water Fund balance.

Timeline

Milestone / Task / Activity	Planned Start Date	Planned Completion Date
Environmental Compliance review	10/2018	3/2019
Engineering Design	10/2018	3/2019
Permitting, Bidding and Award Contract	3/2019	4/2019
Contractor Equipment, Supplies, and Mobilization	10/2019	10/2019
Construction of Pipeline	10/2019	4/2020
Inspection and Testing of the Pipeline	4/2020	5/2020

8. Discussion Item — Fireworks Restrictions.

The City Council will review and discuss the current firework restrictions and areas within the City where firework discharges are prohibited. No motions will be made. (20 minutes)

Lindon City has imposed a fireworks restriction for certain areas of the city since 2011-12. A resolution was passed each year to consider the restrictions and whether they should continue. In 2013 the area of fireworks restrictions was enlarged with more lots being included in the restricted area. In 2014 the city approved a permanent resolution prohibiting fireworks in these specific areas without having to renew the resolution each year.

During the 2019 fireworks season the City received some concerns regarding areas in the city that may not be included in the fireworks restriction area. Councilmember Lundberg requested that the matter be discussed to see if changes need to be made.

Summary of the city's resolution and State codes:

Lindon City Fireworks Discharge Restrictions: Lindon City has a permanent fireworks restriction in place (Resolution 2014-4-R). Restricted areas include mountain foothills and all land west of Interstate-15, including the Lindon Marina. This also includes all "Undeveloped Land" within the City Limits as well as all City parks.

On the east side of town restrictions include all areas within an approximate distance of 500 feet from the U.S. Forest Service or BLM lands. This includes the Dry Canyon Trail head and the 1200 East Horse Transfer Station. In the interest of clarity, these boundary restrictions were set using existing city roads which are at least 500 feet from designated lands. Please reference the maps below for exact boundaries.

Fireworks are regulated by the State of Utah in addition to City regulations. Here are the basic rules:

- Fireworks may be discharged between the hours of 11 am and 11 pm on the following dates except as noted: July 2-July 5 (July 4 hours extended to midnight), July 22-25 (July 24 hours extended to midnight), December 31 (11 am-1 am Jan 1), and Chinese New Year (11 am-1 am the following day).*
- Fireworks are not allowed in Lindon City Parks.*
- No fireworks can be discharged over or onto the property of another without consent of the person owning or controlling the property.*
- If you start a fire, accidentally or intentionally, with legal or illegal fireworks, in any area of Utah, you will be held responsible for the cost to fight the fire and any damages it causes.*

See attached materials.

No motion is necessary.

Lindon City Fireworks Restriction Foothills

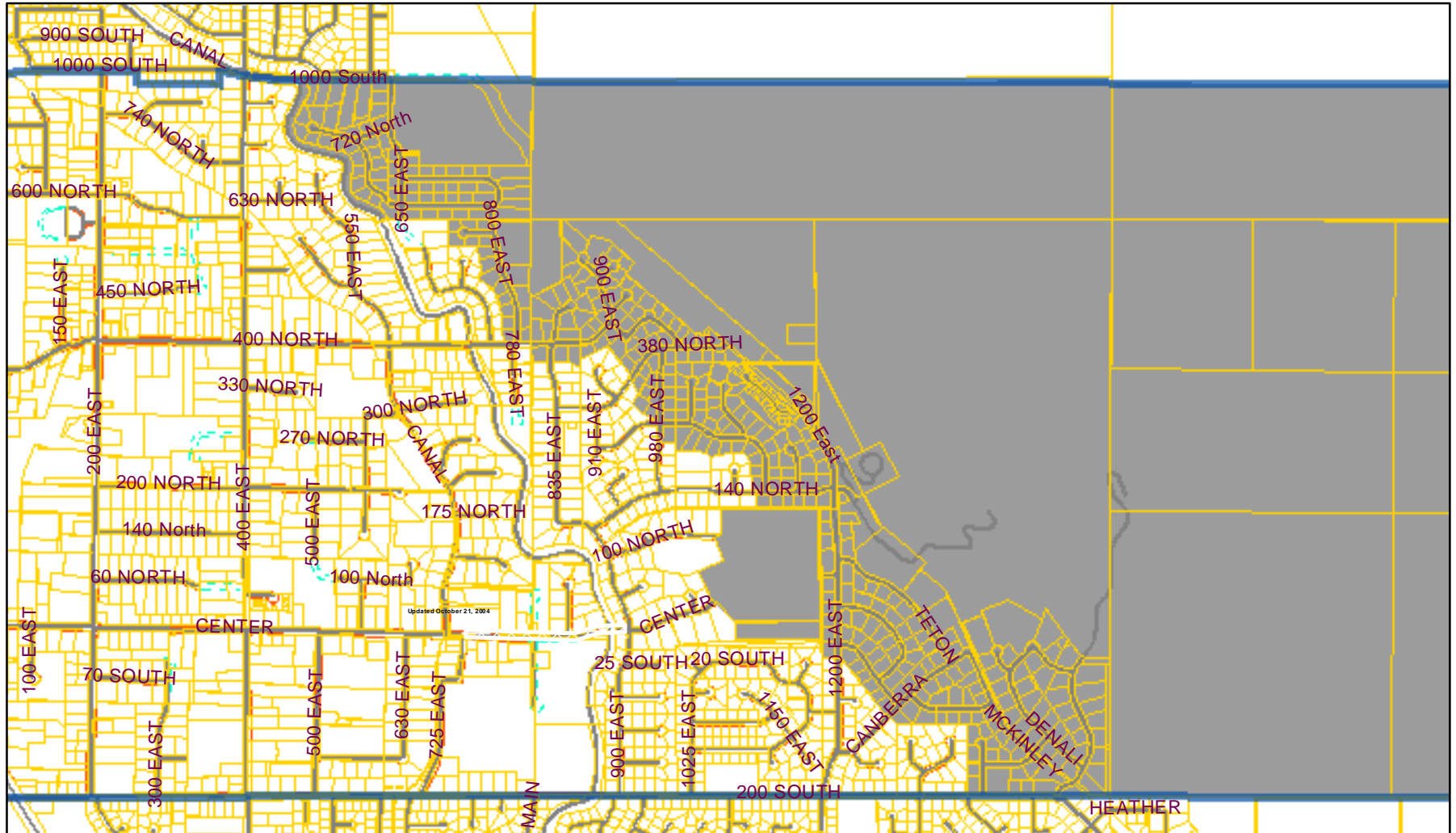

Lindon City
100 North State Street
Lindon, UT 84042-1808

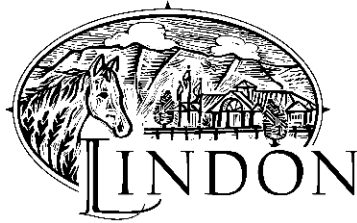

TEL 801-785-7687
FAX 801-785-4510

March 11, 2013

PUBLIC NOTICE

Proposed 2013 Fireworks Restrictions

In 2012 significant fire dangers existed along the urban/wild-land interface areas on the Lindon foothills. The Lindon City Council passed a Resolution restricting the discharge of any firework, including fireworks such as sparklers, ground flowers and small fountains in certain designated areas of the city. Those areas included all land west of Interstate 15 within Lindon City limits, including the Lindon Marina. It also included all "Undeveloped Land" within City Limits and all City Parks. On the east side of town restrictions included all areas within an approximate distance of 500 feet from the undeveloped foothills and U.S. Forest Service or BLM lands. This included the Dry Canyon Trailhead and the 1200 East Horse Transfer Station.

In order to increase safety and clarify which streets and neighborhoods are within the restricted zone, the City Council has held three public meetings to consider adoption of a modified firework restriction area for the 2013 season. Original proposals suggested restrictions on *all* properties above the Murdock Canal. However, after extensive discussion, the proposed boundaries of the firework restriction area have been modified to a smaller area more similar to what was adopted in 2012. **YOUR PROPERTY IS WITHIN THE PROPOSED FIREWORKS RESTRICTED AREA.** Please see map on reverse side. Parcels shaded in black color are proposed to be added to the firework restricted area. Parcels shaded in gray color were included in the restricted area last year. Parcels in white are not within the restricted area. The City Council desires feedback on the proposed boundaries.

TIME & PLACE OF HEARING:

The City Council will hold a public meeting on this item on **Tuesday, March 19, 2013**. The meeting will start at 7:00 p.m. in the Lindon City Center, 100 North State Street, Lindon, UT. Any person having interest in this matter may attend and be heard during a public meeting, or may submit testimony in writing to be entered into the record.

City Codes and ordinances are available on the City web site found at www.lindoncity.org. The City of Lindon, in compliance with the Americans with Disabilities Act, provides accommodations and auxiliary communicative aids and services for all those citizens in need of assistance. Persons requesting these accommodations for City-sponsored public meetings, services programs or events should call Kathy Moosman at 785-5043, giving at least 24 hours notice.

9. **Presentation — Overview of Fire/EMS Services.**

Orem City Fire Chief, Scott Gurney, and Deputy Fire Chief, Jason Earl, will give a general overview of Fire/EMS services provided to Lindon City and answer any questions the Council may have. Lindon is starting its 11th year of a 20-year contract with the City of Orem for Fire/EMS and dispatch services.
(20 minutes)

See attached materials from Orem Fire Dept.

This fiscal year Lindon will pay Orem approximately \$1.5 million for Fire and EMS services and fire/ems dispatch services. We appreciate the Orem Fire staff coming to give this overview of the services they provide to Lindon.

No motion is necessary.

STATE OF THE FIRE DEPARTMENT

PROUDLY SERVING LINDON CITY
SINCE 2008

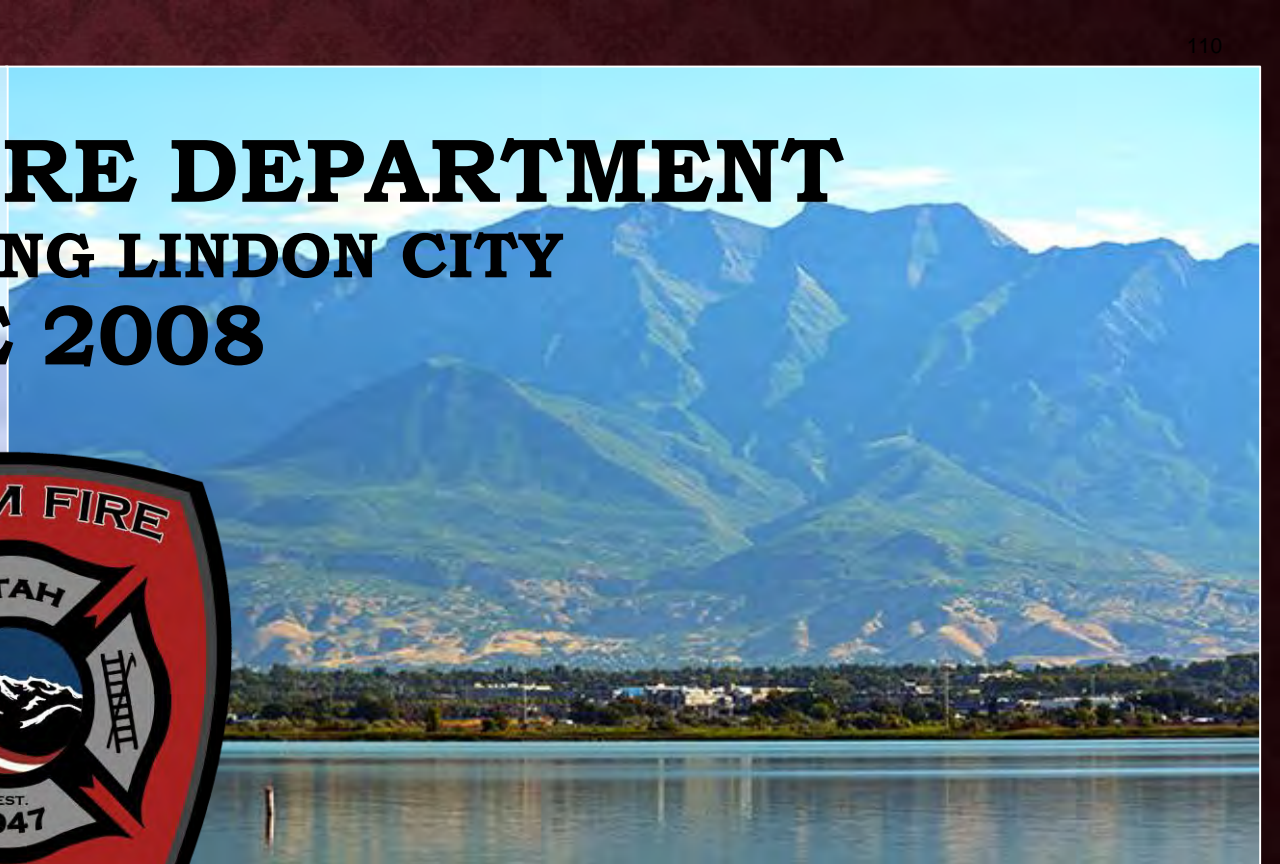

LONG-TIME PARTNERSHIP



OFD LINDON TOTAL STATION RESPONSES

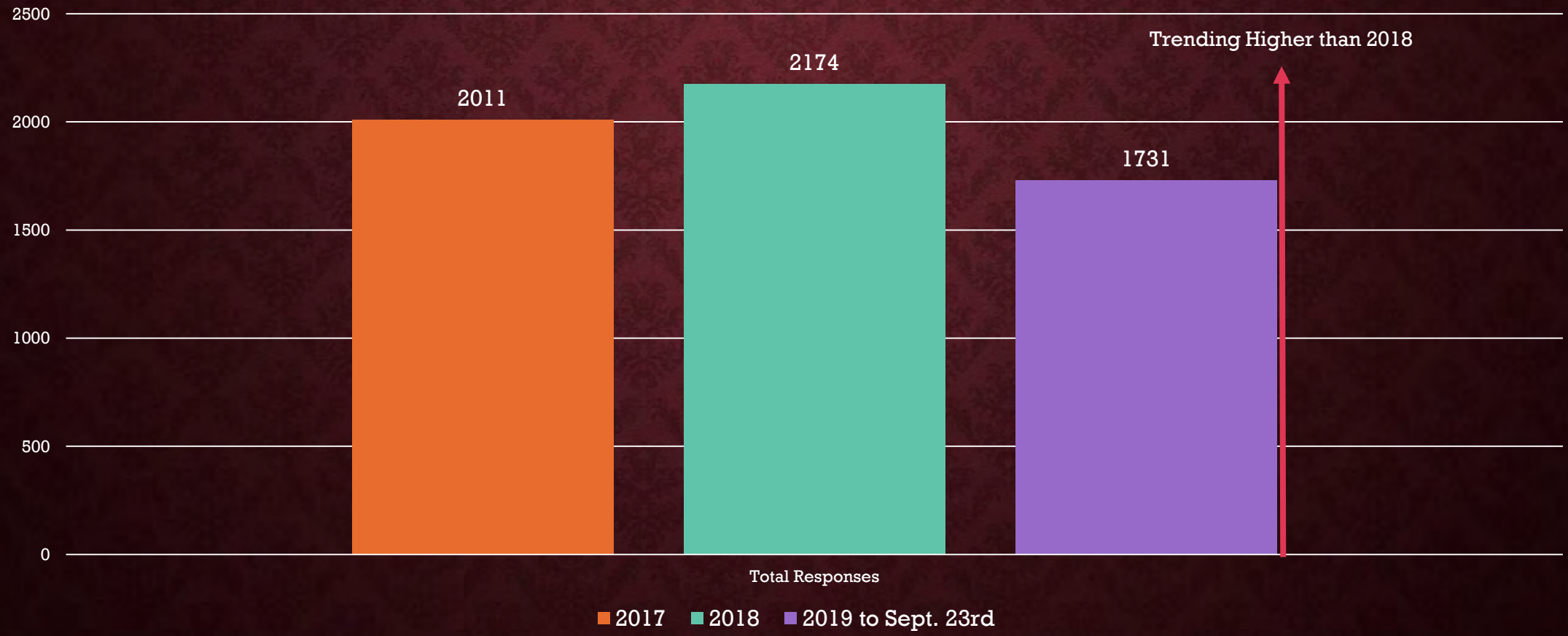

OFD LINDON RESPONSE DATA 2018-2019

2019	Engine 35 Responses In Lindon	MA 35 Responses in Lindon	Engine 35 Responses in Orem	MA 35 Responses in Orem	Engine 35 Mutal-Aid to PG, AF, Lehi	MA 35 Mutual-Aid to PG, AF, Lehi	Orem Responses to Lindon	Total
Q1 Jan-Mar	179	159	43	95	5	6	72	559
Q2 Apr-Jun	208	190	57	80	8	7	80	630
Q3 Jul-Sep	184	160	48	80	4	4	62	542
Q4 Oct-Dec								
Total	559	499	144	250	17	17	233	1,731

2018	Engine 35 Responses In Lindon	MA 35 Responses in Lindon	Engine 35 Responses in Orem	MA 35 Responses in Orem	Engine 35 Mutal-Aid to PG, AF, Lehi	MA 35 Mutual-Aid to PG, AF, Lehi	Orem Responses to Lindon	Total
January	59	47	14	27	0	1	29	177
February	43	37	12	20	0	1	12	125
March	55	51	14	25	1	3	31	180
April	62	47	9	20	0	1	34	173
May	54	49	17	41	0	0	27	188
June	57	41	12	33	3	1	31	178
July	62	49	24	29	5	4	25	198
August	66	67	11	27	3	2	30	206
September	70	65	15	37	0	1	26	214
October	60	55	16	33	3	2	18	187
November	52	50	12	26	3	2	19	164
December	65	55	15	27	4	2	16	184
Total	705	613	171	345	22	20	298	2174

OFD LINDON RESPONSE SERVICES

- All Hazard Response Capability
 - EMS, Structure Fire, Wildland Fire, HazMat, Technical Rescue, Trench, Ice Rescue, Structural Collapse, and Water Rescue.



DRY CANYON FIRE 2019

- Contained to 10 Acres
 - Cooperative Fire Suppression
 - Fire Suppression Resources
 - OFD Lindon Station as Primary Station
 - 3 Orem Fire Stations
 - 1 PG Station
 - 1 AF Station
 - Ut. Co. Fire
 - U.S. Forest Service
 - Orem PD
 - Lindon PD
 - No injuries reported to civilians or firefighters.
 - No property damage or equipment damage was reported.



COMMUNITY RELATIONS

Help with the Lawn!

St. 35 saw a resident in need.



Home Improvement!

St. 35 recognized an urgent need and jumped into action.

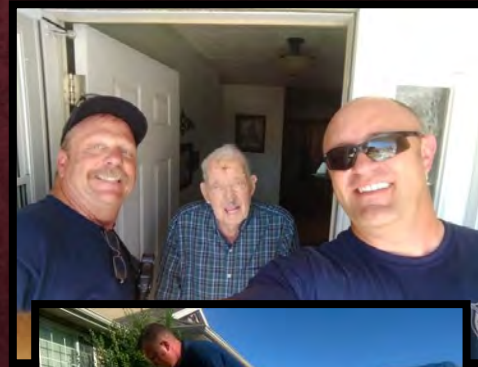

Help at School!

St. 35 enjoys reading time and all interactions with the kids.



COMMUNITY PARTICIPATION

Maeser Preparatory Academy

Each year, St. 35 shares a pizza day with the students.



Lindon Safety Week

Each year, St. 35 participates with Safety Week.



OTHER LINDON EVENTS

- St. 35 participates in events and activities all year long.
 - Station tours
 - School career days
 - Thanksgiving service
 - Fireworks event safety
 - When the crew sees a need, they are quick to respond.



THANK YOU FOR THE OPPORTUNITY TO SERVE



Council Reports:*(20 minutes)*

- A) MAG, COG, UIA, Utah Lake Commission, ULCT, NUVAS, IHC Outreach, Budget Committee - Jeff Acerson
- B) Public Works, Irrigation water/canal company boards, City Buildings - Van Broderick
- C) Planning Commission, Board of Adjustments, General Plan, Budget Committee - Matt Bean
- D) Public Safety, Emergency Management, Economic Development, Tree Board - Carolyn Lundberg
- E) Parks & Recreation, Lindon Days, Transfer Station/Solid Waste, Cemetery - Mike Vanchiere
- F) Admin., Historic Commission, PG/Lindon Chamber, Budget Committee - Jake Hoyt

Administrator's Report*(10 minutes)***Misc. Updates:**

- October newsletter article: Adam Cowie - Article due to Kathy Moosman by end of September
- Vote by Mail Ballots will be mailed the week of Oct. 14th
- Sewer back up claim on 200 East
- PG/Lindon Chamber – business recognition
- Misc. Items

Upcoming Meetings & Events:

- Oct 25th – Halloween Carnival at Community Center
- November 5th – General Election
- November 8-18th – fall clean-up w/dumpsters available to the public

ADJOURN