

pro[®]ense

CE

Operating instructions
Flow sensors

FTS100-1001
FTS200-1001

80281868 04 / 2019

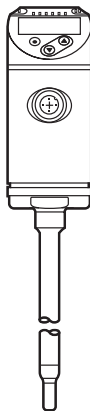

by Automationdirect.com

Contents

1 Preliminary note.....	4
2 Safety instructions	4
2.1 For the scope of validity cULus:	5
3 Functions and features	5
4 Function	6
4.1 Operating modes (ModE)	6
4.2 Select the medium (MEdI)	7
4.3 Define the internal pipe diameter (diA)	7
4.4 Customer-specific calibration (CGA)	8
4.5 Switching function	9
4.6 Analog function	10
4.7 Frequency output	12
4.8 Measured value damping (dAP)	13
4.9 Color change display (coLr)	13
5 Mounting	14
5.1 Installation position	15
5.2 Interference in the pipe system	17
5.3 Alignment	18
6 Electrical connection	19
7 Operating and display elements	21
8 Menu	22
8.1 Main menu	22
8.2 Initialisation menu (INI)	24
8.3 Extended functions (EF) – Basic settings (CFG)	25
8.4 Min/Max memory (MEM) – Display (DIS)	27
9 Set-up	28
10 Parameter setting	29
10.1 Parameter setting in general	29
10.1.1 Switch between the menus	30
10.1.2 Change to the process value display (RUN mode)	30
10.1.3 Locking / Unlocking	30
10.1.4 Timeout	30

10.2	Settings for volumetric flow monitoring	31
10.2.1	Define the operating mode	31
10.2.2	Define the internal pipe diameter	31
10.2.3	Configure the limit value monitoring for flow for OUT1	32
10.2.4	Configure the limit value monitoring for flow for OUT2	32
10.2.5	Configure the frequency signal for flow for OUT1	32
10.2.6	Configure the frequency signal for flow for OUT2	32
10.2.7	Configure the analog output for flow for OUT2	33
10.3	Settings for temperature monitoring	33
10.3.1	Configure the limit value monitoring for temperature for OUT2	33
10.3.2	Configure the frequency signal for temperature for OUT2	33
10.3.3	Configure the analog output for temperature for OUT2	33
10.4	User settings (optional)	34
10.4.1	Configuration of the standard display	34
10.4.2	Set the standard unit of measurement for flow	34
10.4.3	Select the medium	34
10.4.4	Configure color change display	34
10.4.5	Setting the output logic	34
10.4.6	Set the measured value damping	35
10.4.7	Setting the switching delays	35
10.4.8	Set output status in fault condition	35
10.4.9	Calibration of the curve of measured values	35
10.5	Service functions	36
10.5.1	Read min/max values	36
10.5.2	Reset all parameters to factory setting	36
11	Operation	36
11.1	Read the process value	36
11.2	Read the set parameters	37
12	Technical data	37
13	Troubleshooting	37
14	Servicing	38
15	Factory setting	38

1 Preliminary note

Technical data, approvals, accessories and further information at www.automationdirect.com.

- ▶ Instructions
- > Reaction, result
- [...] Designation of keys, buttons or indications
- Cross-reference



Important note

Non-compliance may result in malfunction or interference.



Information

Supplementary note.

CAUTION

Warning of personal injury.
Slight reversible injuries may result.

2 Safety instructions

- The device described is a subcomponent for integration into a system.
 - The manufacturer of the system is responsible for the safety of the system.
 - The system manufacturer undertakes to perform a risk assessment and to create a documentation in accordance with legal and normative requirements to be provided to the operator and user of the system. This documentation must contain all necessary information and safety instructions for the operator, the user and, if applicable, for any service personnel authorised by the manufacturer of the system.
- Read this document before setting up the product and keep it during the entire service life.
- The product must be suitable for the corresponding applications and environmental conditions without any restrictions.
- Only use the product for its intended purpose (→ Functions and features).
- Only use the product for permissible media (→ Technical data).
- If the operating instructions or the technical data are not adhered to, personal injury and/or damage to property may occur.

- The manufacturer assumes no liability or warranty for any consequences caused by tampering with the product or incorrect use by the operator.
- Installation, electrical connection, set-up, operation and maintenance of the unit must be carried out by qualified personnel authorised by the machine operator.
- Protect units and cables against damage.

2.1 For the scope of validity cULus:

The device shall be supplied from an isolating transformer having a secondary Listed fuse rated either

- a) max 5 amps for voltages 0~20 Vrms (0~28.3 Vp) or
- b) 100Vp for voltages of 20~30 Vrms (28.3~42.4 Vp).

The device shall be connected only by using any Listed (CYJV/7) or R/C (CYJV2/8) cord in respect of Condition of Acceptability, having suitable ratings.

3 Functions and features

The unit monitors liquids and gases.

It detects the process categories flow and medium temperature.

Application area

- Air
- Water
- Glycol solutions (reference medium: 35 % ethylene glycol solution)

Selection of the medium to be monitored → 10.4.3.



This is a class A product.

The unit may cause radio interference in domestic areas.

- ▶ If required, take appropriate EMC screening measures.

4 Function

- The unit detects flow based on the calorimetric measuring principle.
- The unit also detects the medium temperature.
- The unit displays the current process value.
It generates 2 output signals according to the parameter setting:

OUT1: 2 selection options	Parameter setting
- Switching signal for flow limit values	→ 10.2.3
- Frequency signal for flow	→ 10.2.5
OUT2: 6 selection options	Parameter setting
- Switching signal for flow limit values	→ 10.2.4
- Switching signal for temperature limit values	→ 10.3.1
- Analog signal for flow	→ 10.2.7
- Analog signal for temperature	→ 10.3.3
- Frequency signal for flow	→ 10.2.6
- Frequency signal for temperature	→ 10.3.2

Before starting measurement initial settings must be done.

4.1 Operating modes (ModE)

The unit provides two selectable operating modes for flow measurement:



Operating mode	Medium	Display unit
LIQU	Liquids	fps, gpm, cfm
GAS	Air	fps, gpm, cfm



On initial power up, the factory default setting for [ModE] is LIQU and is not available to be changed to GAS until any setting value for medium [MEdI] and internal pipe diameter [diA] is first entered. Then [ModE] can be selected and changed to GAS.



gpm and cfm measurement is valid only for round pipes or air ducts up to 16 inches in internal diameter. For larger pipe or duct sizes and other shapes such as rectangular ducts **only fps measurement will produce accurate results**. In this case set the internal pipe diameter [diA] to 16 and standard unit of measurement [uni] to fps.

-  The selected operating mode has no effect on the temperature measurement, only absolute values in °F are indicated.
-  The parameter settings are saved in the respective operating mode, i.e. when the operating mode is changed, the settings are not lost.
-  If the operating modes LIQU or GAS are selected:
 - ▶ Define the medium and the internal pipe diameter (→ 10.2.1).
 - ▶ If required, calibrate curve of measured values (→ 10.4.9).

4.2 Select the medium (MEdi)

The unit has characteristic curves for different media. Depending on the operating mode, the following media can be selected in the menu (→ 10.4.3):

Medium	Operating mode	
	LIQU	GAS
H2O	x	
GLYC	x	
AIR		x

-  ▶ Define the medium before setting output parameters.

4.3 Define the internal pipe diameter (diA)

In the operating modes LIQU and GAS the internal pipe diameter has to be entered to define the volumetric flow (→ 10.2.2).

4.4 Customer-specific calibration (CGA)

Via the calibration factor CGA the sensor can be adjusted to a reference flow in the application.

The customer-specific calibration allows changing the gradient of the curve of measured values. It influences the display and the outputs.

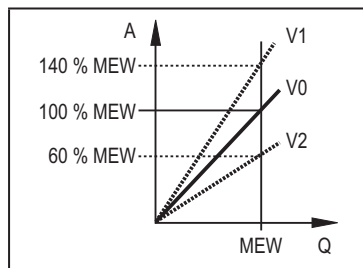

- A = Operating value for display and output signals
- Q = Flow
- MEW = Final value of the measuring range
- V0 = Curve of measured values at factory setting
- V1, = Curve of measured values after calibration
- V2 =

The change in the gradient is indicated in percentage.

Factory setting: CGA = 100 %.

After a change the calibration can be reset to factory setting (→ 10.5.2).



Depending on the set CGA factor, it may not be possible to use the complete measuring range.

4.5 Switching function

OUTx changes its switching status if it is above or below the set switching limits (flow or temperature). Hysteresis or window function can be selected. Example of flow monitoring:

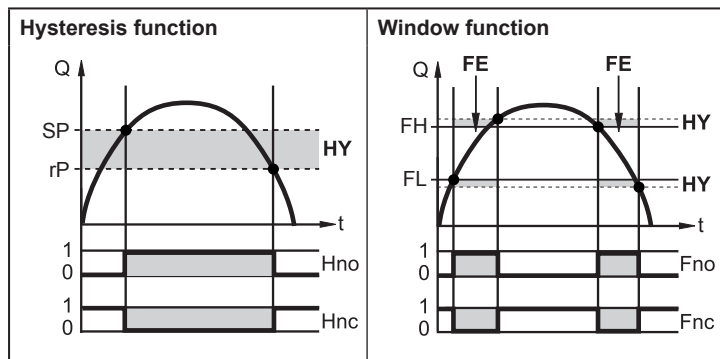

SP = set point

rP = reset point

HY = hysteresis

Hno = hysteresis NO (normally open)

Hnc = hysteresis NC (normally closed)

FH = upper limit value

FL = lower limit value

FE = window

Fno = window NO (normally open)

Fnc = window NC (normally closed)



When the hysteresis function is set, the set point SP and the reset point rP are defined. The rP value must be lower than the SP value. The distance between SP and rP is at least 4 % of the final value of the measuring range (= hysteresis).

If only the set point is changed, the reset point is changed automatically; the difference remains constant.



When set to the window function the upper limit value FH and the lower limit value FL are defined. The distance between FH and FL is at least 4 % of the final value of the measuring range. FH and FL have a fixed hysteresis of 0.25 % of the final value of the measuring range. This keeps the switching status of the output stable if the flow rate varies slightly.

4.6 Analog function

The unit provides an analog signal that is proportional to the flow quantity or the medium temperature.

Within the measuring range the analog signal is 4...20 mA.

The measuring range is scalable:

- [ASP2] determines at which measured value the output signal is 4 mA.
- [AEP2] determines at which measured value the output signal is 20 mA.



Minimum distance between [ASP2] and [AEP2] = 20 % of the final value of the measuring range.

If the measured value is outside the measuring range or in the event of an internal error, the current signals indicated in figure 1 are provided.

For measured values outside the display range or in case of a fault, messages are displayed (UL, OL, Err; → 13).

The analog signal in case of a fault is adjustable (→ 10.4.8):

- [FOU] = On determines that the analog signal goes to the upper final value (22 mA) in case of an error.
- [FOU] = OFF determines that the analog signal goes to the lower final value (3.5 mA) in case of an error.

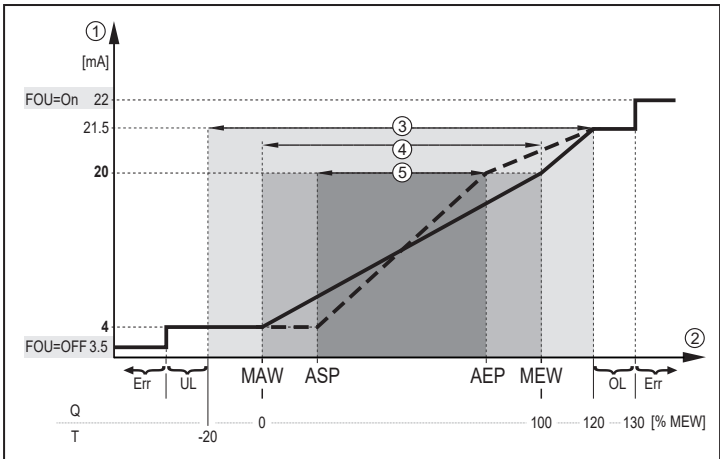

Figure 1: Characteristics of the analog output according to the standard IEC 60947-5-7.

Q: Volumetric flow

T: Medium temperature

MAW: Initial value of the measuring range for non-scaled measuring range

MEW: Final value of the measuring range for non-scaled measuring range

ASP: Analog start point with scaled measuring range

AEP: Analog end point with scaled measuring range

UL: Below the display range

OL: Above the display range

Err: The unit is in the error state

① Analog signal

② Measured value (flow or temperature)

③ Display range

④ Measuring range

⑤ Scaled measuring range

4.7 Frequency output

The unit provides a frequency signal that is proportional to the volumetric flow and the medium temperature.

Within the measuring range the frequency signal is between 0 and 100 Hz for the factory setting.

The frequency signal is scalable:

- [FrPx] determines the frequency signal in Hz provided when the upper measured value (MEW or FEPx) is reached.

The measuring range is scalable:

- [FSP2] determines the lower temperature value from which a frequency signal is provided.



FSP2 is not adjustable for flow measurement.

- [FEPx] determines at which measured value the frequency signal is FrPx.



Minimum distance between [FSP2] and [FEP2] = 20 % MEW.

If the measured value is outside the measuring range or in the event of an internal error, the frequency signals indicated in figure 2 are provided.

For measured values outside the display range or in case of a fault, messages are displayed (UL, OL, Err; → 13).

The frequency signal in case of a fault is adjustable (→ 10.4.8):

- [FOU] = On determines that the frequency signal goes to the upper final value (130 % FrPx) in case of an error.
- [FOU] = OFF determines that the frequency signal is 0 Hz in case of an error.

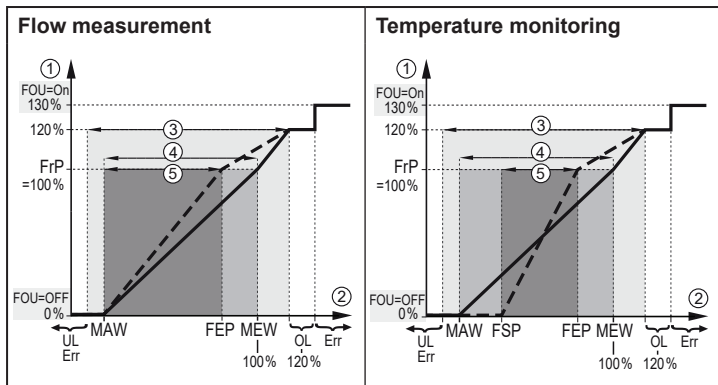

Figure 2: Output curve frequency output

- MAW: Initial value of the measuring range for non-scaled measuring range
- MEW: Final value of the measuring range for non-scaled measuring range
- FSP: Frequency start point with scaled measuring range (only temperature)
- FEP: Frequency end point with scaled measuring range
- FrP: Frequency signal for upper measured value
- OL: Above the display range
- Err: The unit is in the error state

- ① Frequency signal (FrP at factory setting = 100 Hz)
- ② Measured value (flow or temperature in % MEW)
- ③ Display range
- ④ Measuring range
- ⑤ Scaled measuring range

4.8 Measured value damping (dAP)

The damping time enables setting how many seconds after the output signal has reached 63 % of the final value if the flow value changes suddenly. The set damping time stabilises the outputs and the display. The signals [UL] and [OL] (→ 13 Troubleshooting) are defined under consideration of the damping time.

4.9 Color change display (coLr)

The color of the characters in the display can be set via the parameter [coLr] (→ 10.4.4). With the set parameters rED (red) and GrEn (green), the display is

permanently set to one color. If the parameters rxou and Gxou are set, the color of the characters changes depending on the process value:

	OUT1	OUT2	Color change to ...
Parameter settings	r1ou	r2ou	red
	G1ou	G2ou	green

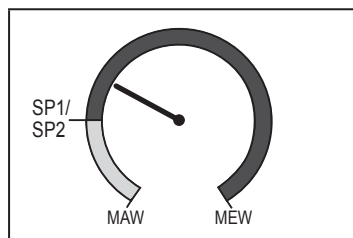

Hysteresis function:
Color change if process value is above the set point

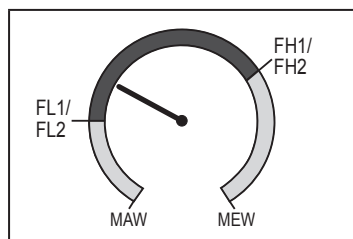

Window function:
Color change if process value is within the window range

MAW = initial value of the measuring range, MEW = final value of the measuring range

5 Mounting

⚠ CAUTION

For medium temperatures above 122 °F some parts of the housing can heat up to over 149 °F.

> Risk of burns.

► Protect the housing against contact with flammable substances and unintentional contact.

- ▶  Ensure that the system is free of pressure during installation.
- ▶ Ensure that no media can leak at the mounting location during installation.

Accessory progressive ring mounting fittings can be ordered separately from www.automationdirect.com.

- ▶  Observe the instructions of the mounting accessories.
- ▶ When using the accessory mounting fittings use a thread sealer that is compatible with the media if required by the application.

5.1 Installation position

General

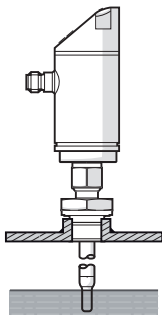

The sensor tip must be completely surrounded by the medium.

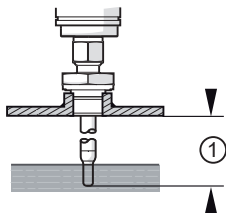

Internal pipe diameter (diA)	① Minimum immersion depth
< 4.7 inch	0.6 inch
≥ 4.7 inch	1/8 diA

Table 1: Immersion depth of the probe

- ▶  Observe maximum flow rates of 9.85 ft/sec for liquid and 328 ft/sec for air.

Recommended

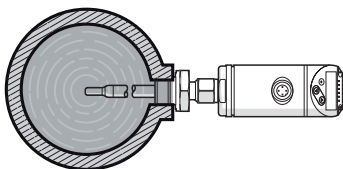

For horizontal pipes: mounting from the side.

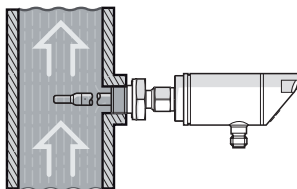

For vertical pipes: mounting in the rising pipe.

Conditionally possible

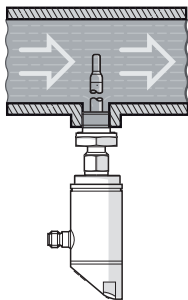

Horizontal pipe / mounting from the bottom: if the pipe is free from build-up.

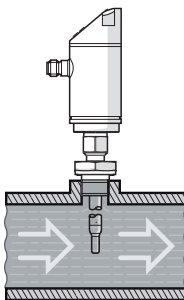

Horizontal pipe / mounting from the top: if the pipe is completely filled with medium.

Not allowed

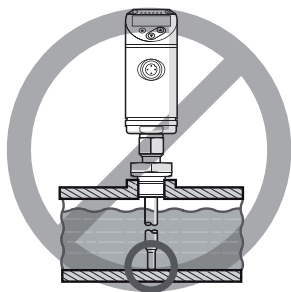

The sensor tip must not be in contact with the pipe wall.

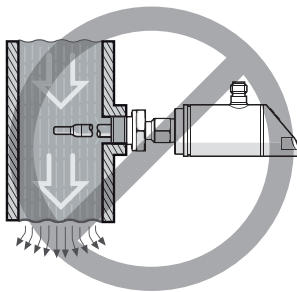

Do not mount in downpipes that are open at the bottom.



Mounting in downward flow pipes in pressurized, closed loop systems is possible.

5.2 Interference in the pipe system

Components integrated in the pipes, bends, valves, reductions, etc. lead to turbulence of the medium. This affects the function of the unit.

► Adhere to the distances between sensor and sources of interference:

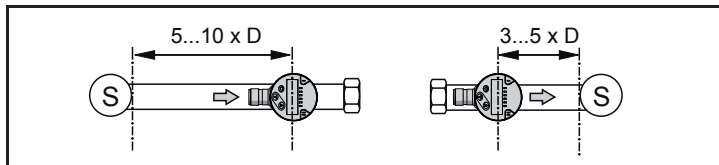

D = pipe diameter; S = sources of interference

5.3 Alignment

- ▶ To achieve the optimum measuring accuracy: mount the sensor in a way that the flow direction goes from the larger key surface (1) to the smaller key surface.

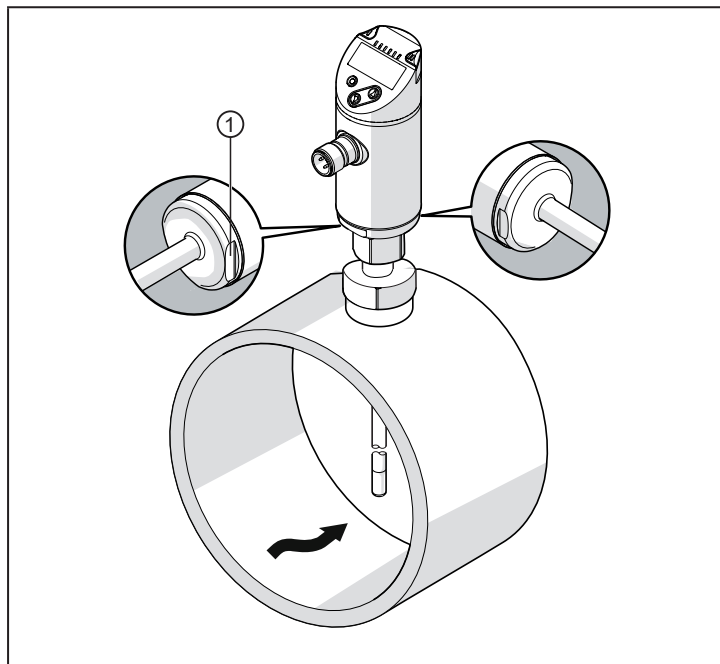

For easier readability of the display the sensor housing can be rotated by 345° with regard to the process connection.

! Do not go beyond the end stop.

6 Electrical connection



The unit must be connected by a qualified electrician.

The national and international regulations for the installation of electrical equipment must be adhered to.

Voltage supply according to EN 50178, SELV, PELV.

- ▶ Disconnect power.
- ▶ Connect the unit as follows:

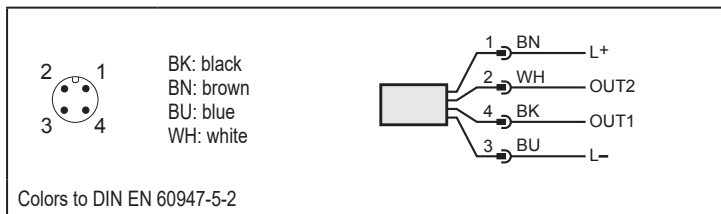

Sample circuits:

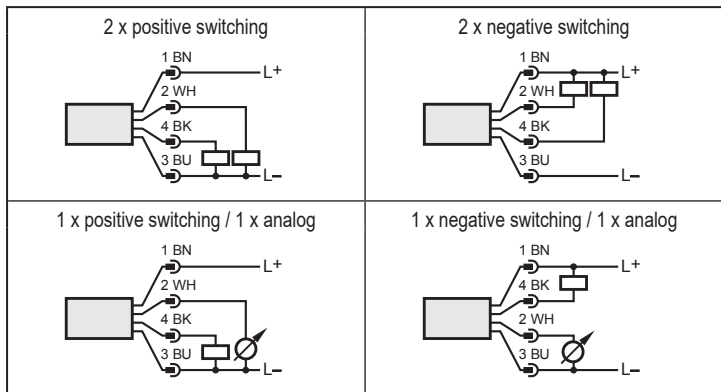

Pin 1	L+
Pin 3	L-
Pin 4 (OUT1)	<ul style="list-style-type: none"> • Switching signal: limit flow value • Frequency signal for flow
Pin 2 (OUT2)	<ul style="list-style-type: none"> • Switching signal: limit flow value • Switching signal: limits for temperature • Analog signal for flow • Analog signal for temperature • Frequency signal for flow • Frequency signal for temperature

7 Operating and display elements

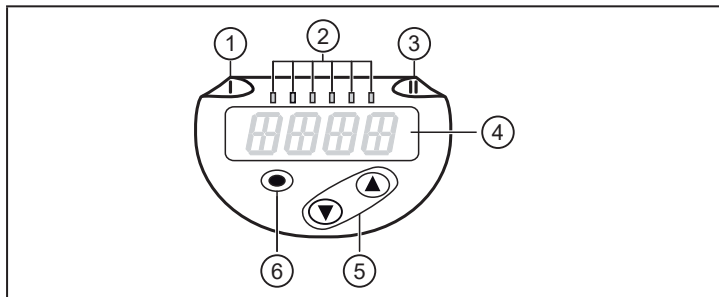

1, 2, 3: Indicator LEDs

- LED 1 = switching status OUT1 (lights if output 1 is switched)
- LED 2 = process value in the indicated unit of measurement: fps, gpm, cfm, °F, 10³
- LED 3 = switching status OUT2 (lights if output 2 is switched)

4: Alphanumeric display, 4 digits

- Indication of the current process values in red or green characters → 4.9.
- Display of the parameters and parameter values

5: Buttons up [▲] and down [▼]

- Select parameter
- Change parameter value (hold button pressed)
- Change of the display unit in the normal operating mode (Run mode)
- Lock / Unlock (buttons pressed simultaneously > 10 seconds)



6: Button [●] = Enter

- Change from the RUN mode to the main menu
- Change to the setting mode
- Acknowledge the set parameter value

8 Menu

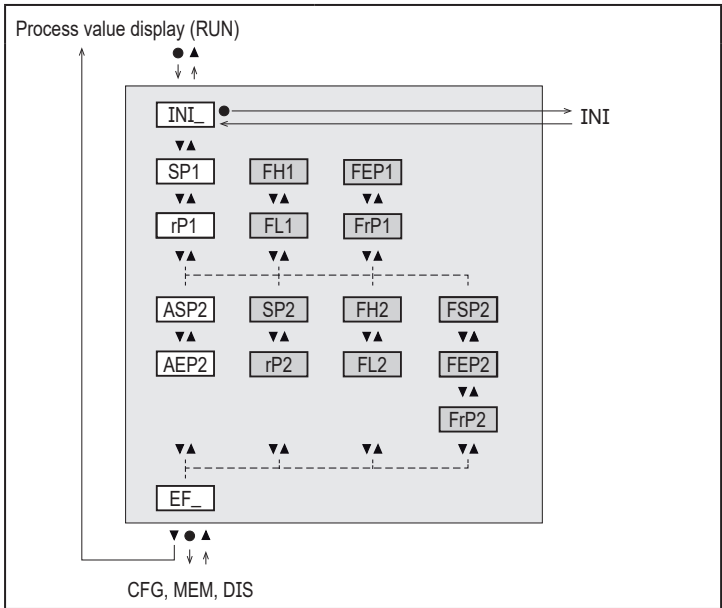
8.1 Main menu



-  Parameters with white background are indicated in case of factory setting (→ 15).
-  Parameters with grey background are indicated depending on the operating mode [ModE] and output functions [ou1] and [ou2].

Explanation main menu

INI	Opening of the initialization menu.
EF	Extended functions. Opening of the lower menu level.
Switching output with hysteresis function:	
SP1	Set point OUT1.
rP1	Reset point OUT1.
SP2	Set point OUT2.
rP2	Reset point OUT2.
Switching output with window function:	
FH1	Upper limit for window OUT1.
FL1	Lower limit for window OUT1.
FH2	Upper limit for window OUT2.
FL2	Lower limit for window OUT2.
Frequency output:	
FEP1	End point for flow OUT1.
FrP1	Frequency at the end point (FEP1) OUT1.
FEP2	End point for flow or temperature OUT2.
FrP2	Frequency at the end point (FEP2) OUT2.
FSP2	Start point for temperature OUT2, only for SEL2 = TEMP.
Analog output:	
ASP2	Analog start point at OUT2 = flow or temperature value at which the output signal is 4 mA.
AEP2	Analog end point at OUT2 = flow or temperature value at which the output signal is 20 mA.

8.2 Initialisation menu (INI)

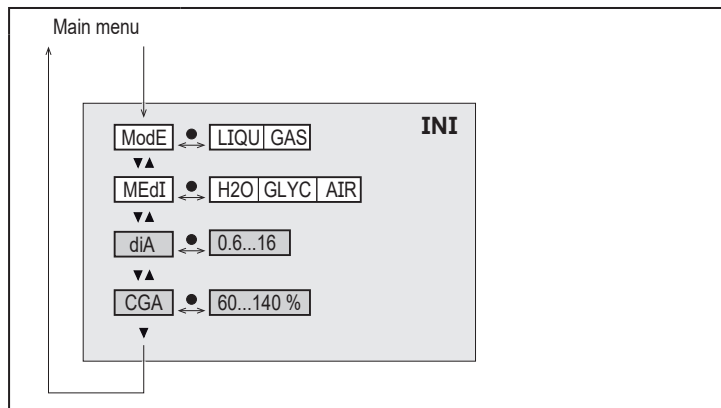

- Parameters with white background are indicated in case of factory setting (→ 15).
- Parameters with grey background are displayed depending on the operating mode [ModE].

Explanation initialisation menu (INI)

ModE	Selection of the operating mode for flow measurement: LIQU = Display of absolute process values (liquids) GAS = Display of absolute process values (air)
MEdI	Medium selection
diA	Setting the internal pipe diameter in inch.
CGA	Calibration of the measurement graph (pitch)

8.3 Extended functions (EF) – Basic settings (CFG)

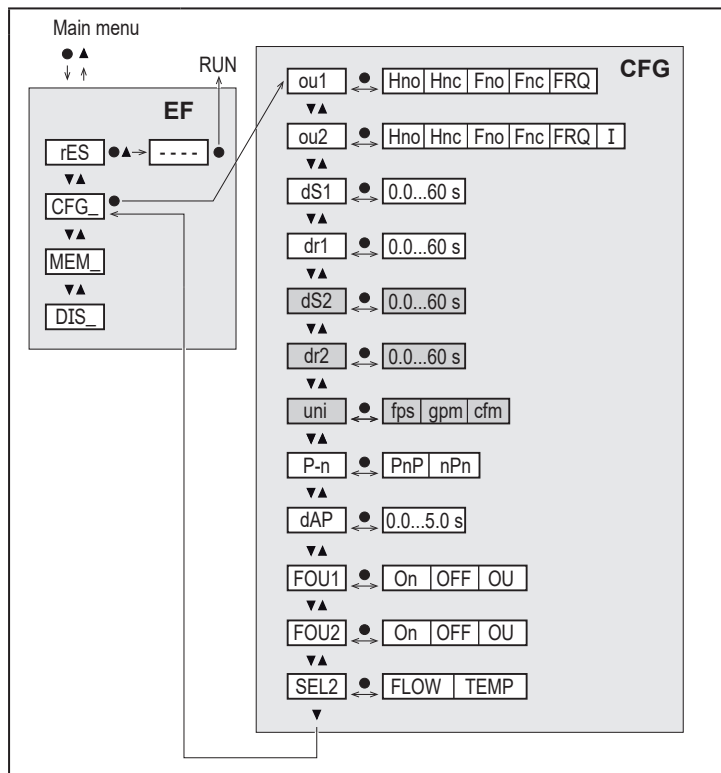

- Parameters with white background are indicated in case of factory setting (→ 15).
- Parameters with grey background are indicated depending on the operating mode [ModE] and output functions [ou1] and [ou2].

Explanation extended functions (EF)

rES	Restore factory setting
CFG	Submenu basic settings
MEM	Submenu min/max memory
DIS	Submenu display settings

Explanation basic settings (CFG)

ou1 / ou2	Output functions OUT1 / OUT2 Hno = Hysteresis function normally open Hnc = Hysteresis function normally closed Fno = Window function normally open Fnc = Window function normally closed FRQ = Frequency output I = Analog signal 4...20 mA
ds1 / ds2	Switch-on delay on OUT1 / OUT2
dr1 / dr2	Switch-off delay on OUT1 / OUT2
uni	Standard unit of measurement for flow
P-n	Output logic: pnp / npn
dAP	Measured value damping (only for flow)
FOU1 / FOU2	Behavior of output OUT1 / OUT2 in case of an error
SEL2	Standard unit of measurement for evaluation via OUT2

8.4 Min/Max memory (MEM) – Display (DIS)

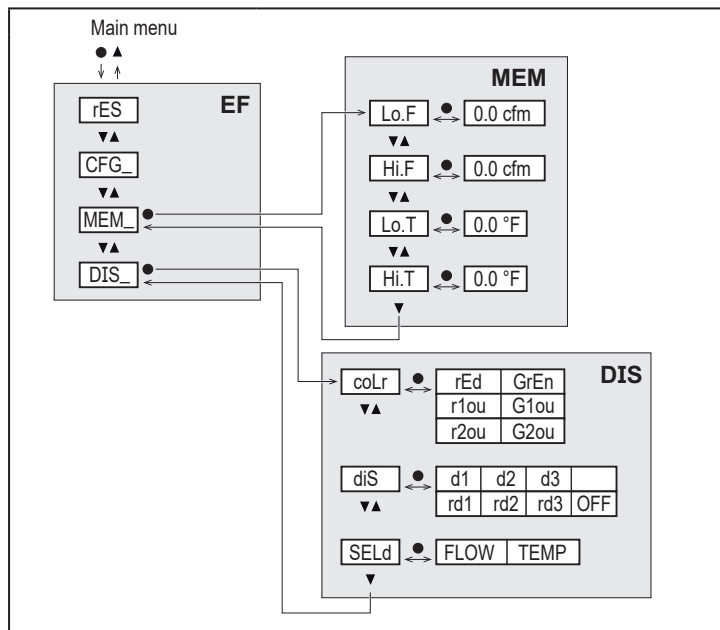

Explanation min/max memory (MEM)

Lo.F	Min. value of the flow measured in the process
Hi.F	Max. value of the flow measured in the process
Lo.T	Min. value of the temperature measured in the process
Hi.T	Max. value of the temperature measured in the process

Explanation display settings (DIS)

coLr	Color configuration of the display rEd = Display always red GrEn = Display always green r1ou = Display red in case of switched output OUT1 G1ou = Display green in case of switched output OUT1 r2ou = Display red in case of switched output OUT2 G2ou = Display green in case of switched output OUT2
diS	Update rate and orientation of the display d1 = update of the measured values every 50 ms. d2 = update of the measured values every 200 ms. d3 = update of the measured values every 600 ms. rd1, rd2, rd3 = display as for d1, d2, d3; rotated by 180°. OFF = the measured value display is deactivated in the Run mode.
SELd	Standard display: flow or medium temperature

9 Set-up

After power on and expiry of the power-on delay time, the unit is in the normal operating mode. It carries out its measurement and evaluation functions and generates output signals according to the set parameters.

During the start up delay time the outputs are switched as programmed:

- ON with normally open function (Hno / Fno)
- OFF with normally closed function (Hnc / Fnc)
- OFF for frequency output (FRQ)
- 20 mA for current output (I)

10 Parameter setting

CAUTION

For medium temperatures above 122 °F some parts of the housing can heat up to over 149 °F.

> Risk of burns.

- ▶ Do not touch the device with your hands.
- ▶ Use another object (e.g. a ballpoint pen) to carry out settings on the unit.

Parameters can be set before installation or during operation.

 If you change parameters during operation, this will influence the function of the plant.

- ▶ Ensure that there will be no malfunctions in your plant.

During parameter setting the unit remains in the operating mode. It continues to monitor with the existing parameter until the parameter setting has been completed.

10.1 Parameter setting in general

1. Change from the RUN mode to the main menu	[●]
2. Select the requested parameter	[▲] or [▼]
3. Change to the setting mode	[●]
4. Change the parameter value	[▲] or [▼] > 1 s
5. Acknowledge the set parameter value	[●]
6. Return to the RUN mode	> 30 seconds (timeout) or press [▲] + [▼] simultaneously until the RUN mode is reached.

 By pressing [▲] + [▼] simultaneously you exit the setting mode without saving the changed parameter.

10.1.1 Switch between the menus

1. Change from the RUN mode to the main menu	[●]
2. Select the parameter EF	[▼]
3. Change to sub-menu EF	[●]
4. Select the parameters CFG, MEM, DIS	[▼]
5. Change to the sub-menus CFG, MEM, DIS	[●]
6. Return to the next higher menu level	Press [▲] + [▼] simultaneously

10.1.2 Change to the process value display (RUN mode)

There are 3 possibilities:

I.	Wait for 30 seconds (→ 10.1.4 Timeout).
II.	Press [▲] until the RUN mode is reached.
III.	Press [▲] + [▼] simultaneously until the RUN mode is reached.

10.1.3 Locking / Unlocking

The unit can be locked electronically to prevent unintentional settings.

On delivery: not locked.

Locking	<ul style="list-style-type: none">▶ Make sure that the unit is in the normal operating mode.▶ Press [▲] and [▼] simultaneously for 10 s until [Loc] is displayed.
Unlocking	<ul style="list-style-type: none">▶ Make sure that the unit is in the normal operating mode.▶ Press [▲] and [▼] simultaneously for 10 s until [uLoc] is displayed.

10.1.4 Timeout

If no button is pressed for 30 s during parameter setting, the unit returns to the operating mode with unchanged values.

10.2 Settings for volumetric flow monitoring



- ▶ Select the operating mode [ModE] first before doing all the other settings (→ 10.2.1).

 On initial power up, the factory default setting for [ModE] is LIQU and is not available to be changed to GAS until any setting value for medium [MEdI] and internal pipe diameter [diA] is first entered. Then [ModE] can be selected and changed to GAS.

 For the operating modes GAS and LIQU, the flow values are set in the unit defined in [uni].

- ▶ If necessary, change the unit before setting the flow values.

10.2.1 Define the operating mode

<p>▶ Select [ModE] and define the operating mode: GAS, LIQU.</p> <p> A medium and an internal pipe diameter must be entered for the operating modes LIQU and GAS. The unit displays [≡≡≡≡] to force these entries:</p> <ul style="list-style-type: none">▶ Press [●].> [MEdI] is displayed.▶ Define the medium.> [diA] is displayed.▶ Define the internal pipe diameter in inches. <p> A change of the operating mode leads to a restart of the unit. The settings are saved in the respective operating mode, i.e. after a change of the operating mode the settings are not lost.</p>	Menu INI: [ModE]
---	---------------------

10.2.2 Define the internal pipe diameter

<p>▶ Select [diA] and define the internal pipe diameter: 0.6...16 inch.</p> <p> gpm and cfm measurement is valid only for round pipes or air ducts up to 16 inches in internal diameter. For larger pipe or duct sizes and other shapes such as rectangular ducts only fps measurement will produce accurate results. In this case set the internal pipe diameter [diA] to 16 and standard unit of measurement [uni] to fps.</p>	Menu INI: [diA]
--	--------------------

10.2.3 Configure the limit value monitoring for flow for OUT1

<ul style="list-style-type: none">▶ Select [ou1] and set the switching function: Hno, Hnc, Fno or Fnc <ol style="list-style-type: none">1. When the hysteresis function is selected:<ul style="list-style-type: none">▶ Select [SP1] and set the value at which the output is set.▶ Select [rP1] and set the value at which the output is reset.2. When the window function is selected:<ul style="list-style-type: none">▶ Select [FH1] and set the upper limit value of the window.▶ Select [FL1] and set the lower limit value of the window.	Menu CFG: [ou1] Main menu: [SP1] [rP1] [FH1] [FL1]
---	--

10.2.4 Configure the limit value monitoring for flow for OUT2

<ul style="list-style-type: none">▶ Select [SEL2] and set FLOW.▶ Select [ou2] and set the switching function: Hno, Hnc, Fno or Fnc <ol style="list-style-type: none">1. When the hysteresis function is selected:<ul style="list-style-type: none">▶ Select [SP2] and set the value at which the output switches.▶ Select [rP2] and set the value at which the output is reset.2. When the window function is selected:<ul style="list-style-type: none">▶ Select [FH2] and set the upper limit value of the window.▶ Select [FL2] and set the lower limit value of the window.	Menu CFG: [SEL2] [ou2] Main menu: [SP2] [rP2] [FH2] [FL2]
---	--

10.2.5 Configure the frequency signal for flow for OUT1

<ul style="list-style-type: none">▶ Select [ou1] and set FRQ.▶ Select [FEP1] and set the flow value at which the frequency set in FrP1 is provided.▶ Select [FrP1] and set the frequency: 100 Hz...1000 Hz.	Menu CFG: [ou1] Main menu: [FEP1] [FrP1]
---	--

10.2.6 Configure the frequency signal for flow for OUT2

<ul style="list-style-type: none">▶ Select [SEL2] and set FLOW.▶ Select [ou2] and set FRQ.▶ Select [FEP2] and set the upper flow value at which the frequency set in FrP2 is provided.▶ Select [FrP2] and set the frequency: 100 Hz...1000 Hz.	Menu CFG: [SEL2] [ou2] Main menu: [FEP2] [FrP2]
---	--

10.2.7 Configure the analog output for flow for OUT2

<ul style="list-style-type: none">▶ Select [SEL2] and set FLOW.▶ Select [ou2] and set the function: I = flow-proportional current signal 4...20 mA▶ Select [ASP2] and set the flow value at which the output signal is 4 mA.▶ Select [AEP2] and set the flow value at which the output signal is 20 mA.	Menu CFG: [SEL2] [ou2] Main menu: [ASP2] [AEP2]
--	--

10.3 Settings for temperature monitoring

10.3.1 Configure the limit value monitoring for temperature for OUT2

<ul style="list-style-type: none">▶ Select [SEL2] and set TEMP.▶ Select [ou2] and set the switching function: Hno, Hnc, Fno or Fnc <p>1. When the hysteresis function is selected:</p> <ul style="list-style-type: none">▶ Select [SP2] and set the value at which the output switches.▶ Select [rP2] and set the value at which the output is reset. <p>2. When the window function is selected:</p> <ul style="list-style-type: none">▶ Select [FH2] and set the upper limit value of the window.▶ Select [FL2] and set the lower limit value of the window.	Menu CFG: [SEL2] [ou2] Main menu: [SP2] [rP2] [FH2] [FL2]
---	--

10.3.2 Configure the frequency signal for temperature for OUT2

<ul style="list-style-type: none">▶ Select [SEL2] and set TEMP.▶ Select [ou2] and set FRQ.▶ Select [FSP2] and set the lower temperature value at which 0 Hz is provided.▶ Select [FEP2] and set the upper temperature value at which the frequency set in FrP2 is provided.▶ Select [FrP2] and set the frequency: 100 Hz...1000 Hz.	Menu CFG: [SEL2] [ou2] Main menu: [FSP2] [FEP2] [FrP2]
---	--

10.3.3 Configure the analog output for temperature for OUT2

<ul style="list-style-type: none">▶ Select [SEL2] and set TEMP.▶ Select [ou2] and set the function: I = temperature-proportional current signal 4...20 mA▶ Select [ASP2] and set the temperature value at which the output signal is 4 mA.▶ Select [AEP2] and set the temperature value at which the output signal is 20 mA.	Menu CFG: [SEL2] [ou2] Main menu: [ASP2] [AEP2]
---	--

10.4 User settings (optional)

10.4.1 Configuration of the standard display

<ul style="list-style-type: none">▶ Select [SEld] and determine the standard unit of measurement:<ul style="list-style-type: none">- FLOW = the current flow in the standard measuring unit is displayed.- TEMP = the current medium temperature in °F is displayed.▶ Select [diS] and set the update rate and orientation of the display:<ul style="list-style-type: none">- d1, d2, d3: update of the measured values every 50, 200, 600 ms.- rd1, rd2, rd3: display as for d1, d2, d3; rotated by 180°.- OFF = the measured value display is deactivated in the Run mode. <p> The LEDs remain active even if the display is deactivated. Error messages are displayed even if the display is deactivated.</p>	Menu DIS: [SEld] [diS]
---	------------------------------

10.4.2 Set the standard unit of measurement for flow

<ul style="list-style-type: none">▶ Select [uni] and set the unit of measurement: cfm, gpm, fps. <p> gpm and cfm measurement is valid only for round pipes or air ducts up to 16 inches in internal diameter. For larger pipe or duct sizes and other shapes such as rectangular ducts only fps measurement will produce accurate results. In this case set the internal pipe diameter [diA] to 16 and standard unit of measurement [uni] to fps.</p>	Menu CFG: [uni]
---	--------------------

10.4.3 Select the medium

<ul style="list-style-type: none">▶ Select [MEdI] and define the medium to be monitored: H2O, GLYC, AIR. <p> Depending on the operating mode different media are available (→ 4.2).</p> <ul style="list-style-type: none">▶ Define the medium before setting output parameters.	Menu INI: [MEdI]
--	---------------------

10.4.4 Configure color change display

<ul style="list-style-type: none">▶ Select [coLr] and define the color of the process value display: rEd, GrEn, r1ou, r2ou, G1ou, G2ou (→ 4.9).	Menu DIS: [coLr]
---	---------------------

10.4.5 Setting the output logic

<ul style="list-style-type: none">▶ Select [P-n] and set PnP or nPn.	Menu CFG: [P-n]
--	--------------------

10.4.6 Set the measured value damping

▶ Select [dAP] and set the damping constant in seconds (Tvalue 63 %): 0...5 s (→ 4.8).	Menu CFG: [dAP]
--	--------------------

10.4.7 Setting the switching delays

▶ Select [dSx] and set the delay for switching OUTx in seconds: 0...60 s. ▶ Select [drx] and set the delay for resetting OUTx in seconds: 0...60 s.	Menu DIS: [dS1] [dS2] [dr1] [dr2]
--	---

10.4.8 Set output status in fault condition

▶ Select [FOU1] or [FOU2] and set the value: 1. Switching output: - On = output 1 / output 2 switches ON in case of an error. - OFF = output 1 / output 2 switches OFF in case of an error. - OU = output 1 / output 2 switches irrespective of the fault as defined with the parameters. 2. Frequency output: - On = frequency signal: 130 % of FrP1 / FrP2 (→ 4.7). - OFF = frequency signal: 0 Hz (→ 4.7). - OU = frequency signal output continues to run without changes. 7. Analog output: - On = the analog signal goes to the upper fault value (→ 4.6). - OFF = the analog value goes to the lower fault value (→ 4.6). - OU = the analog signal corresponds to the measured value.	Menu CFG: [FOU1] [FOU2]
--	-------------------------------

10.4.9 Calibration of the curve of measured values

▶ Select [CGA] and set a percentage between 60 and 140 → 4.4. (100 % = factory calibration).	Menu INI: [CGA]
--	--------------------

10.5 Service functions

10.5.1 Read min/max values

<ul style="list-style-type: none">▶ Select [Lo.x] or [Hi.x]. [Lo.F] = minimum flow value , [Hi.F] = maximum flow value [Lo.T] = minimum temperature value , [Hi.T] = maximum temperature value <p>Delete memory:</p> <ul style="list-style-type: none">▶ Select [Lo.x] or [Hi.x].▶ Keep [▲] or [▼] pressed.> [----] is displayed.▶ Briefly press [●]. <p> It is recommended to delete the memories as soon as the unit operates under normal operating conditions for the first time.</p>	Menu MEM: [Lo.F] [Hi.F]
--	-------------------------------

10.5.2 Reset all parameters to factory setting

<ul style="list-style-type: none">▶ Select [rES] and press [●].▶ Keep [▲] or [▼] pressed.> [----] is displayed.▶ Briefly press [●]. <p> We recommend noting down your own settings before carrying out a reset .</p>	Menu EF: [rES]
---	-------------------

11 Operation

After power on, the unit is in the RUN mode (= normal operating mode). It carries out its measurement and evaluation functions and provides output signals according to the set parameters.

11.1 Read the process value

It can be preset whether flow or temperature is indicated as default (→ 10.4.1 Configuration of the standard display).

A standard unit of measurement can be defined for the flow measurement (gpm, cfm or fps → 10.4.2).

The display can be changed to another display unit in addition to the preset standard display:

- ▶ Press [▲] or [▼].
- > The display changes, the indicator LEDs indicate the current display unit.

- > After 30 seconds the display changes to the standard display.

11.2 Read the set parameters

- ▶ Briefly press [●]
- ▶ Press [▼] to select the parameter.
- ▶ Briefly press [●]
- > The currently set value is displayed for 30 s. Then the unit returns to the process value display.

12 Technical data

Technical data and scale drawing at www.automationdirect.com.

13 Troubleshooting

The unit has many self-diagnostic options. It monitors itself automatically during operation.

Warnings and error states are displayed, even when the display is switched off.

Display	Type	Description	Troubleshooting
Err	Error	• Unit faulty / malfunction.	▶ Replace the unit.
No display	Error	• Supply voltage too low. • Setting [diS] = OFF.	▶ Check the supply voltage. ▶ Change the setting [diS] → 10.4.1.
PArA	Error	Parameter setting outside the valid range.	▶ Check parameter setting.
Loc	Warning	Setting pushbuttons on the unit locked, parameter change rejected.	▶ Unlock the unit → 10.1.3.
UL	Warning	Below the display range. Temperature value < - 20 % MEW (→ 4.6).	▶ Check temperature range. ▶ Repeat low-flow adjustment.
OL	Warning	Above the display range: measured value > 120 % of MEW (→ 4.6).	▶ Check flow range / temperature range. ▶ Repeat high-flow adjustment.

Display	Type	Description	Troubleshooting
SC1	Warning	Switching status LED for OUT1 flashing: short circuit OUT1.	► Check switching output OUT1 for short-circuit or excessive current.
SC2	Warning	Switching status LED for OUT2 flashing: short circuit OUT2.	► Check switching output OUT2 for short-circuit or excessive current.
SC	Warning	Switching status LEDs for OUT1 and OUT2 flashing: short circuit OUT1 and OUT2.	► Check switching outputs OUT1 and OUT2 for short-circuit or excessive current.

MEW = final value of the measuring range

14 Servicing

- From time to time check the sensor tip visually for build-up.
- Clean with soft cloth. Stubborn build-up, for example lime can be removed using a common vinegar cleaning agent.

15 Factory setting

Parameter	Factory setting	User setting
SP1	20 %	
rP1	15 %	
FH1	20 %	
FL1	15 %	
FEP1	100 %	
FrP1	100 Hz	
SP2	40 %	
rP2 (FLOW)	35 %	
rP2 (TEMP)	38 %	
FH2	40 %	
FL2 (FLOW)	35 %	
FL2 (TEMP)	38 %	

Parameter	Factory setting	User setting
FSP2	0 %	
FEP2	100 %	
FrP2	100 Hz	
ASP2	0 %	
AEP2	100 %	
diA	----	
ou1	Hno	
ou2	l	
dS1	0 s	
dr1	0 s	
dS2	0 s	
dr2	0 s	
uni	gpm	
P-n	PnP	
dAP	0.6 s	
MEdl	H2O	
FOU1	OFF	
FOU2	OFF	
SEL2	FLOW	
CGA	100 %	
ModE	LIQU	
coLr	rEd	
diS	d2	
SEld	FLOW	

The percentage values refer to the final value of the measuring range (MEW).