

EWN-8258FAT1HA

EWN-8250FGT1HA

Datasheet V1.2

BT Mesh Soc Module

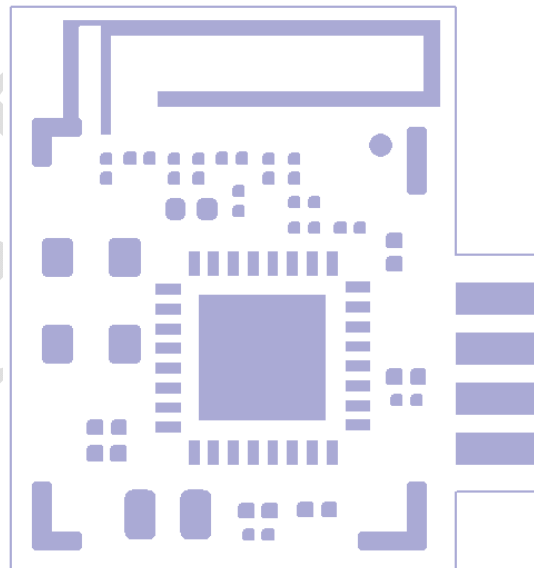

Contents

1	General Specifications	3
2	Features	3
3	System Block Diagram	4
4	PHY Specification	4
5	Other Specifications	6
6	DC Specifications	6
7	Module configurations	7
8	Pin Definition	9
9	Module Photos	10
10	Key material list	10
11	Package Information	11
12	Reference design	12
12.1	RF	12
12.2	Power supply requirement	13
12.3.1	Interface interference	14
12.3.2	The main chip interferes with DDR	15
13	Revision History	17

1 General Specifications

EWN-8258FAT1HA/EWN-8250FGT1HA is Bluetooth LE + IEEE802.15.4 multi-standard wireless SoC solution with internal Flash and audio support, which combines the features and functions needed for all 2.4GHz IoT standards into a single SoC. RoHS-compliant and 100% lead (Pb)-free.

2 Features

- ❖ Bluetooth 5 Compliant
- ❖ BLE transceiver embedded
- ❖ Embedded hardware acceleration for Elliptical curve cryptography (ECC) used in BLE 4.2 and above
- ❖ Program memory: internal 512kB Flash(EWN-8250FGT1HA)/
1MB Flash (EWN-8258FAT1HA).
- ❖ Data memory: 48kB on-chip SRAM (EWN-8250FGT1HA)/
64kB on-chip SRAM (EWN-8258FAT1HA).
- ❖ Write protect all or portions of memory
- ❖ Multi firmware encryption methods for anti-cloning protection
- ❖ Embedded hardware AES and AES-CCM
- ❖ Multiple stage power management to minimize power consumption
- ❖ SWS independent Download and Debug interface
- ❖ 14bit 6-channel SAR ADC
- ❖ I/O : PWM、GPIO

3 System Block Diagram

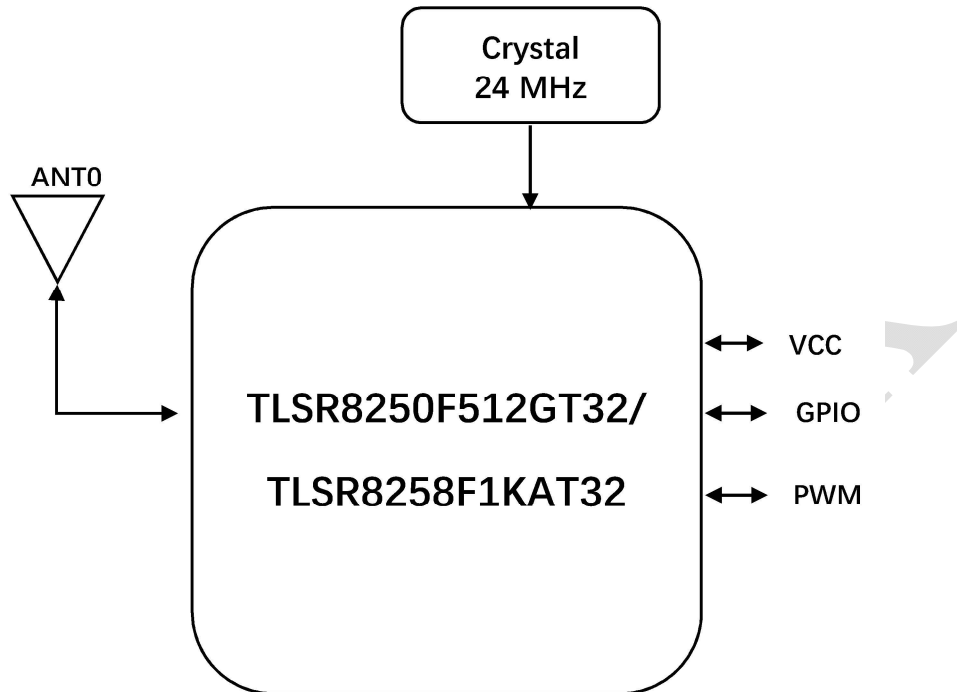

Fig 1 System Block Diagram

4 PHY Specification

Table 1 Bluetooth RF Parameters

Protocol	BT5.0
Interface	PWM
Frequency	2402 MHz ~ 2480MHz (Programmable in 1MHz step)
Data rate	BLE 1Mbps, ±250KHz deviation

Table 2 RX Performance

Item	Sym.	Min.	Typ.	Max.	Unit	Condition
BLE 1Mbps RF_Rx performance (± 250KHz deviation)						
Sensitivity	1Mbps		-95		dBm	
Frequency Offset Tolerance		-250		+300	KHz	
Co-channel rejection			-11		dB	Wanted signal at -67dBm
Image rejection			37		dB	Wanted signal at -67dBm
In-band blocking rejection (Equal Modulation Interference)	+1/-1 MHz offset		1/3		dB	Wanted signal at -67dBm
	+2/-2 MHz offset		37/39		dB	
	>=3 MHz offset		42		dB	

Table 3 TX Performance

Item	Sym.	Min.	Typ.	Max.	Unit	Condition
BLE 1Mbps RF_TX performance						
Output power, maximum setting			10		dBm	
Output power, minimum setting			-45		dBm	
Programmable output power range			55		dB	
Modulation 20dB bandwidth			2.5		MHz	

5 Other Specifications

Table 4 other Specifications

Operating Temperature	-40°C~+105°C
Storage Temperature	Module: -40°C~+105°C Package: -20°C~+70°C
Operating Humidity	RH 95%(Non-Condensing)
Storage Humidity	RH 95%(Non-Condensing)
Humidity level	Level 3

6 DC Specifications

Table 5 DC Specifications

Item	Sym.	Min.	Typ.	Max.	Unit	Condition
VDD_3.3V	V _{BAT}	1.8	3.3	3.6	V	3.3V Supply Voltage
RX current	I _{RX}	-	5.3	-	mA	whole chip
TX current	I _{TX}	-	4.8	-	mA	whole chip @0dBm with DCDC
TX current	I _{TX}	-	20	-	mA	whole chip @10dBm with DCDC
Deep sleep with	I _{deep1}		1		uA	8kB SRAM retention
			1.2		uA	16kB SRAM retention
			1.4		uA	32kB SRAM retention
	I _{deep2}		0.4		uA	without SRAM retention

7 Module configurations

Module Size (Unit: mm): 13.50(±0.2) *14.30(±0.3)*2.4(±0.2)

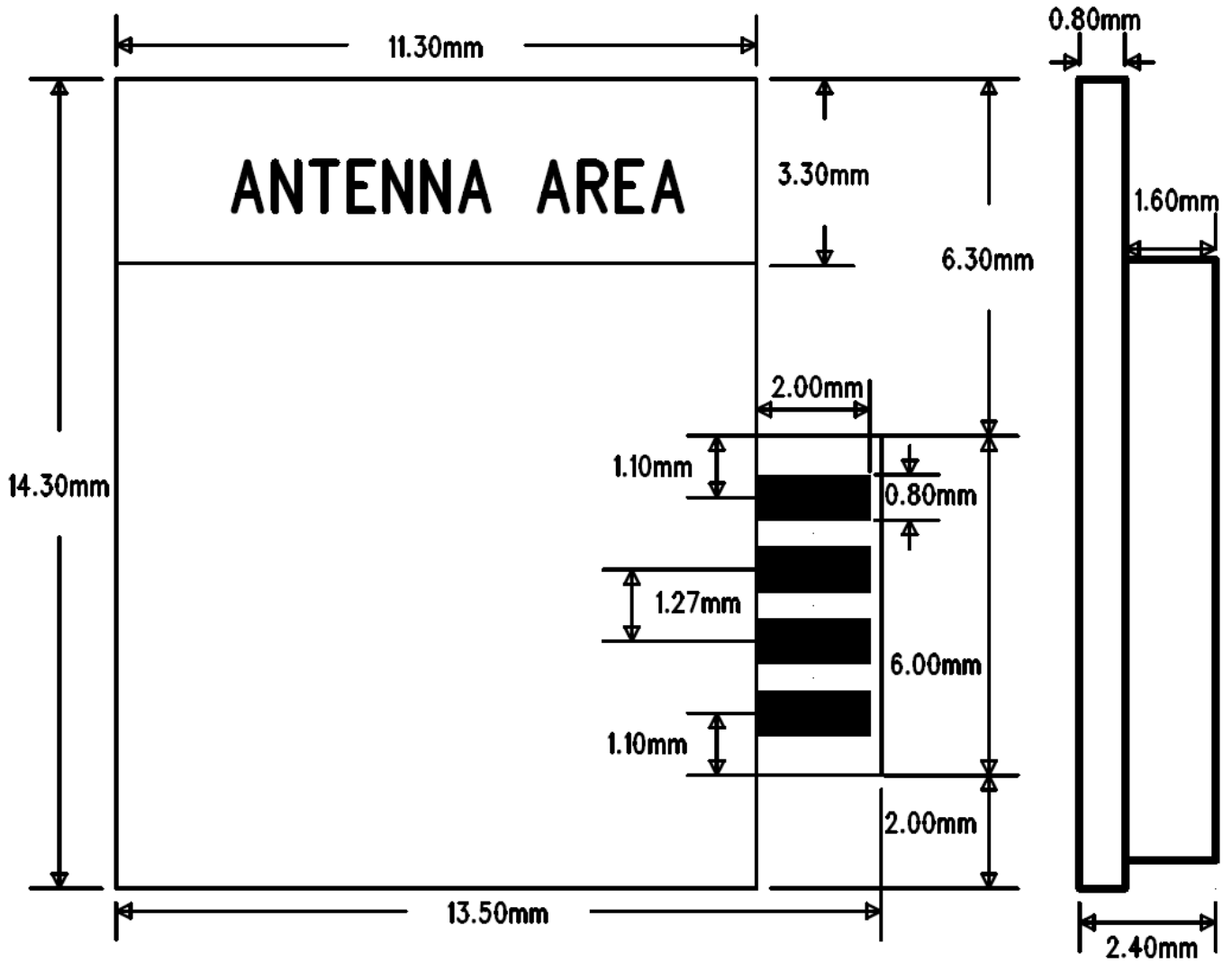

Fig 2 Top View Module Size

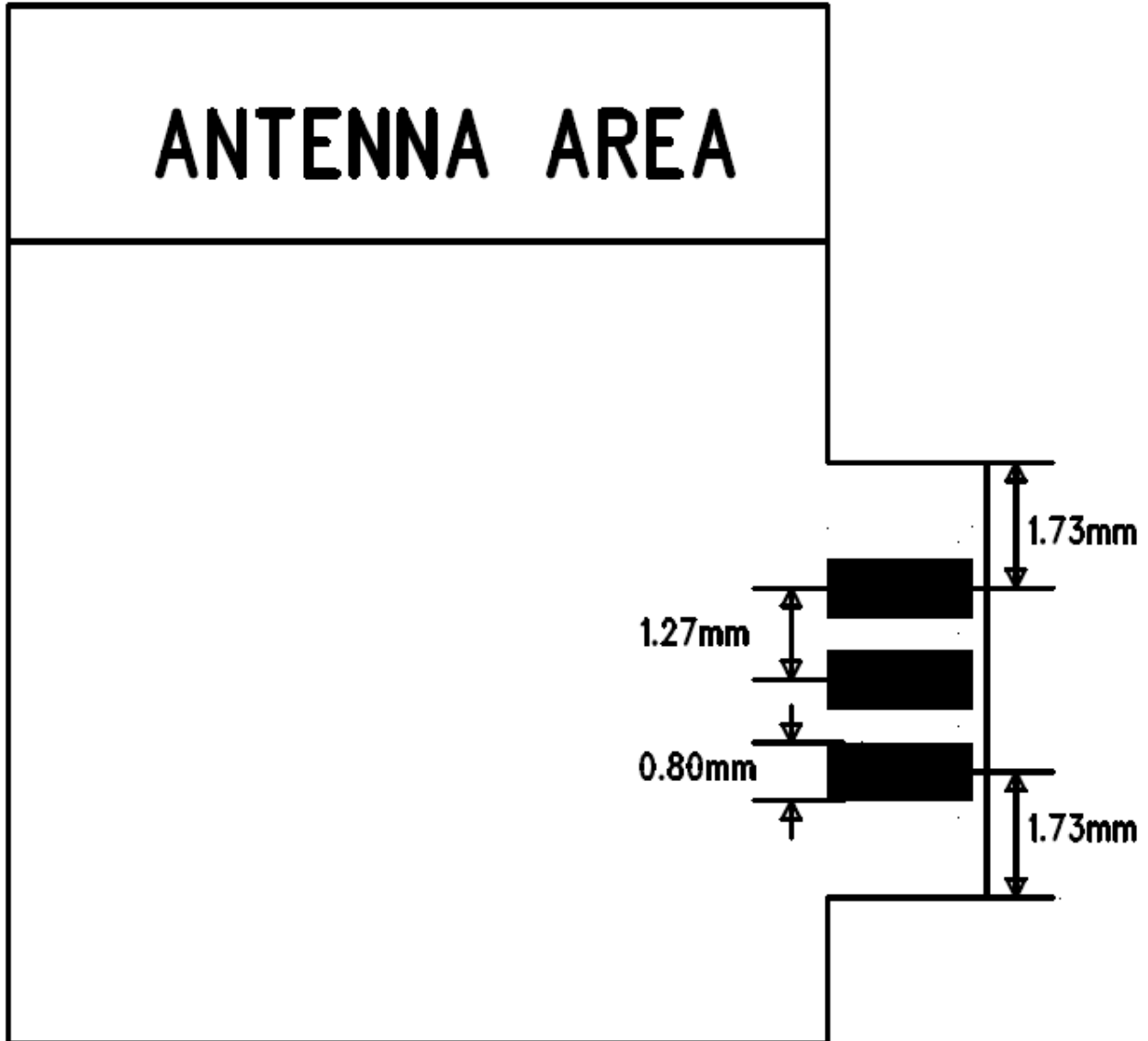

Fig 3 EWN-8258FAT1HA Bottom View Module Size

8 Pin Definition

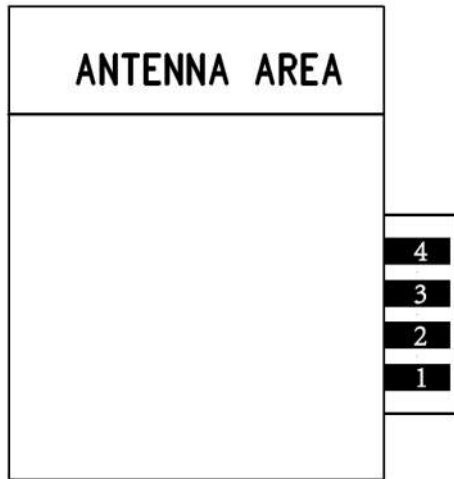

Fig 4 Top view

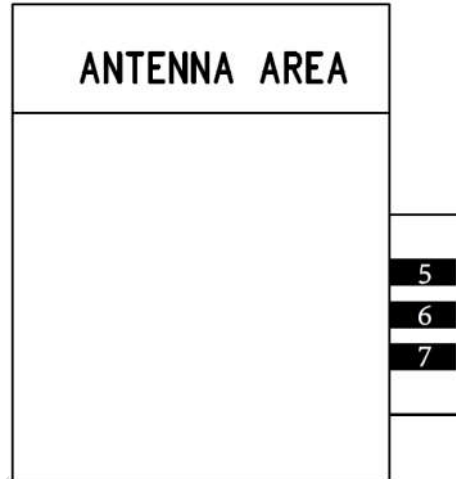

Fig 5 Bottom view

Table 6 the hardware Pin definition of the module

Table 6 EWN-8258FAT1HA Pin definition

PIN	Definition	IC Pin	Description
1	VBAT	/	Supply power 1.8V-3.3V ;
2	PWM4	PB4	PWM output for LED drive ; SAR ADC Input ; General I/O port ;
3	PWM5	PB5	PWM output for LED drive ; General I/O port ;
4	PWM2	PC4	PWM output for LED drive ; General I/O port ;
5	PWM1	PC3	PWM output for LED drive ; SAR ADC Input ; General I/O port ;
6	PWM0	PC1	PWM output for LED drive ; General I/O port ;
7	GND	/	Module power reference

Notes:

1. Download Interface use SWS test point on bottom view.
2. Only SWS interface can be used for debugging firmware.

9 Module Photos



Fig 6 Top View



Fig 7 Bottom View

10 Key material list

Table 7 Key material list

Type	Model	Footprint	QTY.
Crystal	24MHz 12pF 20ppm	3225	1PCS
Inductance	10uH	0805	1PCS
IC	TLSR8250F512GT32 (only for EWN-8250FGT1HA)	QFN32	1PCS
IC	TLSR8258F1KAT32 (only for EWN-8258FAT1HA)	QFN32	1PCS

11 Package Information

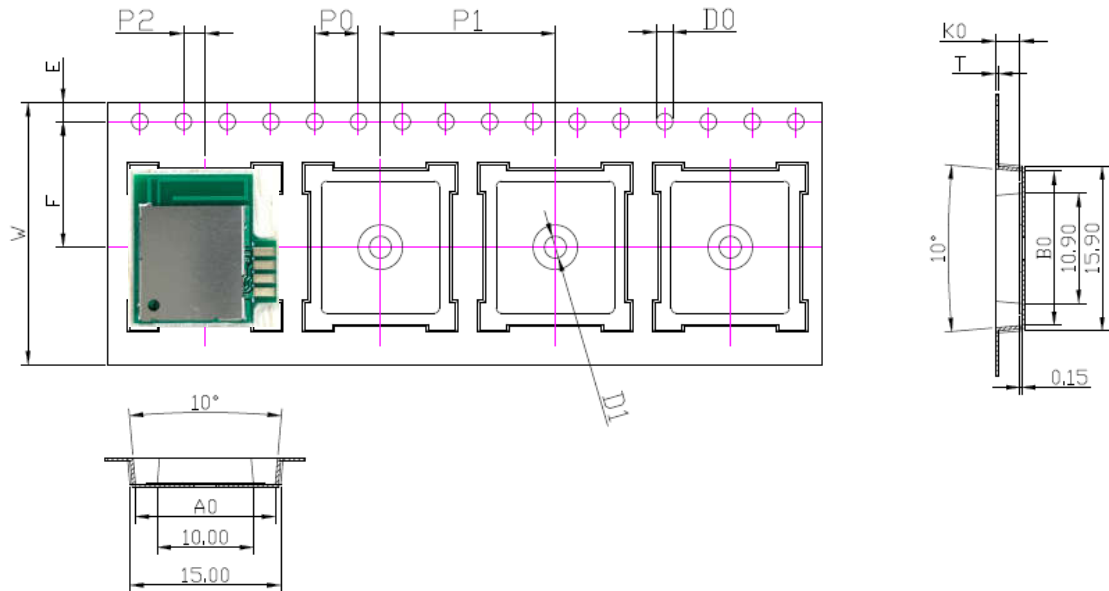

FIG 5 Carrier size

Reel dimension : D=38cm 1500PCS Modules Per Reel

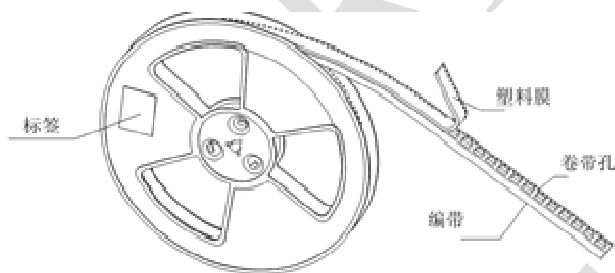

FIG 6 Reel



FIG 7 Reel figure

12 Reference design

12.1 RF

a) Under the antenna and in the two directions indicated by the arrow, avoid covering the ground, routing and placing metal components. It is better to directly hollow out the PCB in this area.

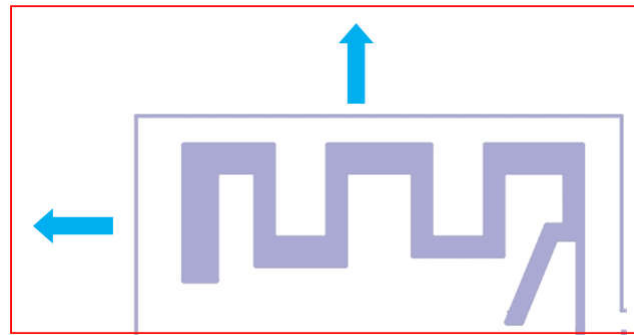

Fig 8 Antenna

b) It is recommended not to use any components within 30mm of the module antenna area, and the module baseboard should also avoid wiring and covering the ground as much as possible.

c) It is strongly recommended that the user place the antenna of the Bluetooth module close to the edge of the backplane as far as possible when laying out the PCB, as shown in the figure below, so as to ensure the good performance of the antenna.

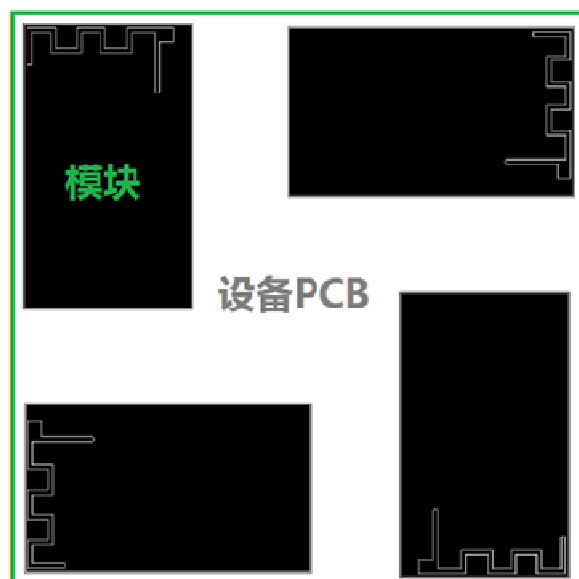
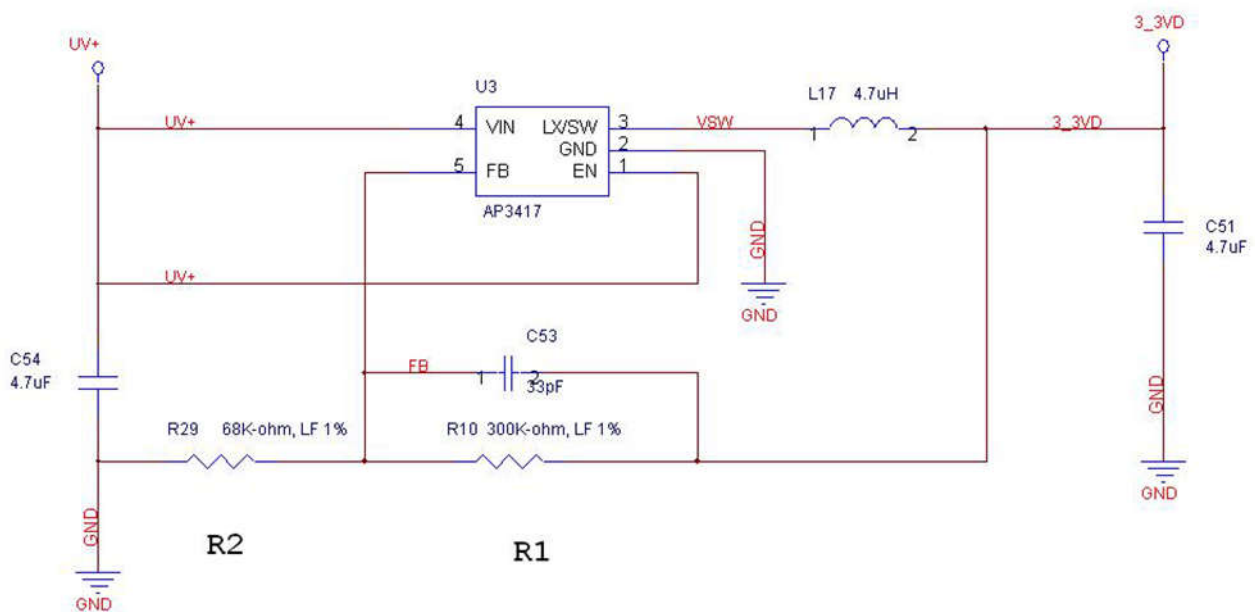

Fig 9 Recommended PCB layout

12.2 Power supply requirement

The module power supply voltage is DC+3.3V. The power supply design needs to consider the output current and power interference. The power supply current design needs to reserve 50mA. To avoid the +3.3V power supply from interfering with other circuits on the motherboard, it is recommended to supply to the module using the regulator circuit alone. the recommended DC-DC circuit structure shown in the figure below. A 4.7uF~10uF capacitor is connected in parallel at 3_3VD output to filter out the interference. A bead is connected in series at 3_3VD output. The bead and capacitor must be placed as close to the module as possible. If you need to share +3.3V with other circuits, consider whether the current of the shared power supply is sufficient.



$$V_o = 0.6 * (1 + R1/R2) = 0.6 * (1+300K/68K) = 3.3V$$

Step-Down Regulator, Vfb=0.6V, 1A, 1.8MHz, ADJ, LF

Fig 10 Power supply Circuit schematic

12.3 Motherboard interference avoidance

Motherboard interference comes from: high-speed data interface (HDMI), the Operating frequency of main chip, DDR, DC-DC power supply. The method of avoiding interference according to the characteristics of various signals is also different. The main methods of interference avoidance include:

1. keeping away from the source of interference;
2. Adding shields to avoid interference leakage;
3. Reasonable layout to eliminate interference.

12.3.1 Interface interference

When HDMI uses the 74.2MHz frequency, its 33x frequency is in the 2.4G band of BT, which will seriously interfere with the BT signal. If the HDMI frequency is 148.5MHz, although the 16x frequency is not in the BT band, the isolation of the frequency is not good, and the BT signal will be interfered to some extent. If the distance between the HDMI interface and the BT module on the PCB is less than 5cm, the HDMI output display will interfere with the BT signal, resulting in problems such as BT connection failure and throughput drop. Therefore, keep the location of the BT module away from the HDMI port on the hardware layout to avoid interference.

At the same time, if the BT antenna is built-in the motherboard, its placement must also be carefully considered to be far from the interface interference. If the antenna is placed in an incorrect position, even if the module is shielded, the interference signal is coupled through the antenna, which will eventually result in a lower BT throughput. (Note: In addition to interference, the placement of the internal antenna should also evaluate the effect of the metal interface, motherboard, and housing material on the antenna impedance.)

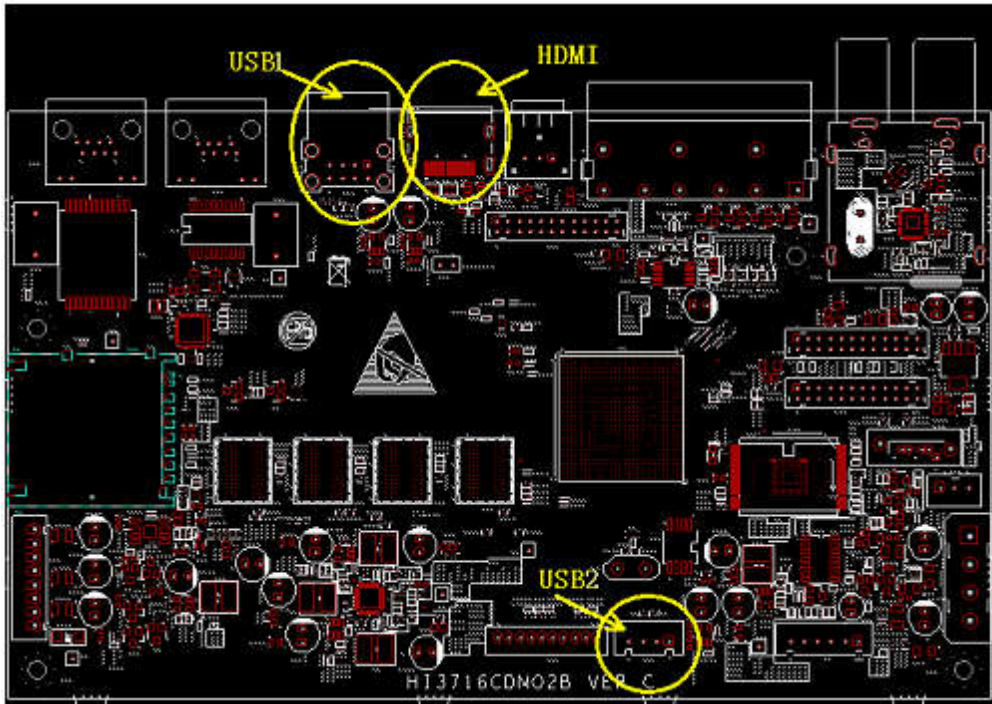

Fig 11 HDIM and USB interference

12.3.2 The main chip interferes with DDR

Because the main chips operate at about 800MHz or DDR2 operate at 667MHz, 3x frequency of 800MHz and 4x frequency of 667MHz are near 2.4GHz band. It must to place BT modules and antennas far away from the main chip and DDR. It is strongly recommended that the main chip be isolated from the DDR by a shield. As shown in the figure below.

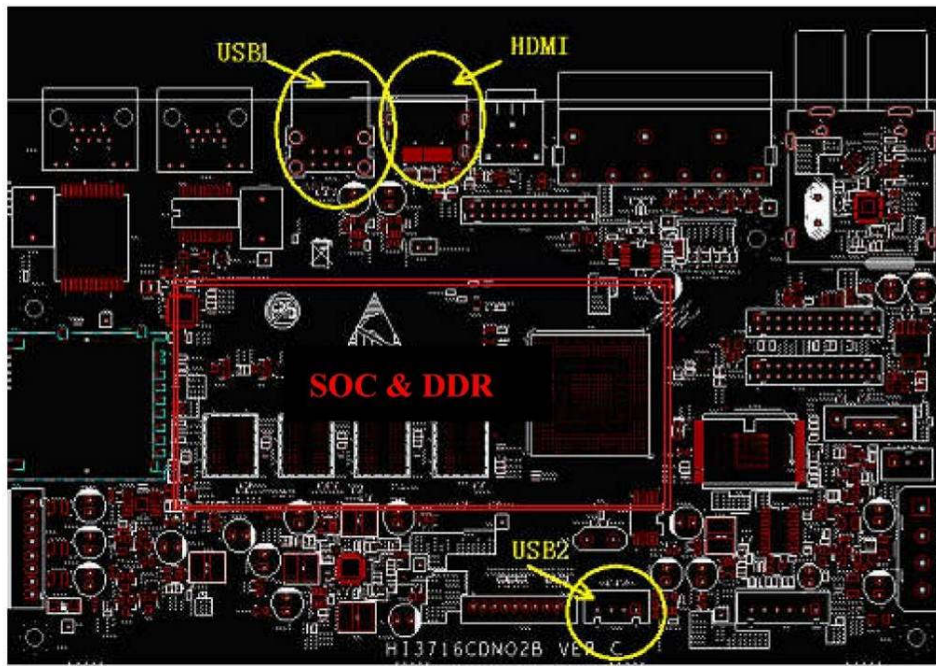

Fig 12 Main chip and DDR interference

12.4 Recommended secondary reflux temperature curve

The number of reflux shall not exceed 2 times, and the tin feeding height of the half hole of the module shall be no less than 1/4.

The lead-free reflux curve requirements of BT module products are shown in figure 13 :

Stage	Note	Pb-free assembly
Average ramp-up rate	T_L to T_p	3 °C / second max.
Preheat	Temperature min (T_{smin})	150°C
	Temperature max (T_{smax})	200°C
	Time (t_{smin} to t_{smax})	60 – 120 seconds
Time maintained above	Temperature (T_L)	217°C
	Time (t_L)	60 – 150 seconds
Peak package body temperature (T_p)		T_p must not exceed the specified classification temp($T_c=245$ C).
Time (t_p) within 5°C of the specified classification temperature (T_c)		30 seconds
Ramp-down rate (T_p to T_L)		6 °C / seconds max.
Time 25°C to peak temperature		8 minutes max.

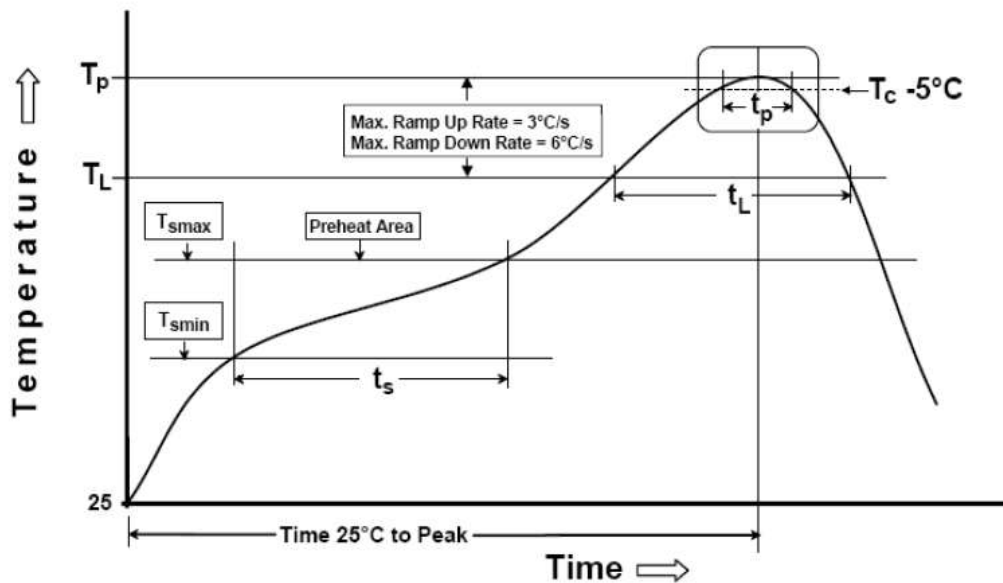

Fig 13 Furnace temperature curve

Note:

1. The maximum furnace temperature of the module is 260°C, don't exceed this temperature.
2. The gold plating thickness of the module pad is 2u".

13 WARNING

13.1 FCC WARNING

This device complies with part 15 of the FCC Rules. Operation is subject to the following two conditions: (1) this device may not cause harmful interference, and (2) this device must accept any interference received, including interference that may cause undesired operation.

Any changes or modifications not expressly approved by the party responsible for compliance

could void the user's authority to operate the equipment.

NOTE: This equipment has been tested and found to comply with the limits for a Class B digital device, pursuant to Part 15 of the FCC Rules. These limits are designed to provide reasonable protection against harmful interference in a residential installation. This equipment generates, uses and can radiate radio frequency energy and, if not installed and used in accordance with the instructions, may cause harmful interference to radio communications. However, there is no guarantee that interference will not occur in a particular installation.

If this equipment does cause harmful interference to radio or television reception,

which can be determined by turning the equipment off and on, the user is encouraged to try to correct the interference by one or more of the following measures:

- Reorient or relocate the receiving antenna.
- Increase the separation between the equipment and receiver.
- Connect the equipment into an outlet on a circuit different from that to which the receiver is connected.
- Consult the dealer or an experienced radio/TV technician for help.

To maintain compliance with FCC's RF Exposure guidelines, This equipment should be installed and operated with minimum distance between 20cm the radiator your body: Use only the supplied antenna.

13.2 IC Caution

Radio Standards Specification RSS-Gen, issue 5

- English:

This device contains licence-exempt transmitter(s)/receiver(s) that comply with Innovation, Science and Economic Development Canada's licence-exempt RSS(s). Operation is subject to the following two conditions:

This device may not cause interference.

This device must accept any interference, including interference that may cause undesired operation of the device.

RF exposure statement:

The equipment complies with IC Radiation exposure limit set forth for uncontrolled environment. This equipment should be installed and operated with minimum distance 20cm between the radiator and your body.

- French:

Cet appareil contient des émetteurs / récepteurs exemptés de licence conformes aux RSS (RSS) d'Innovation, Sciences et Développement économique Canada. Le fonctionnement est soumis aux deux conditions suivantes:

Cet appareil ne doit pas causer d'interférences.

Cet appareil doit accepter toutes les interférences, y compris celles susceptibles de provoquer un fonctionnement indésirable de l'appareil.

Déclaration d'exposition RF:

L'équipement est conforme à la limite d'exposition aux radiations de la IC établie pour un environnement non contrôlé. Cet équipement doit être installé et utilisé avec une distance minimale de 20 cm entre le radiateur et votre corps.

14 Revision History

Revision	Release Date	Summary	Revised by
V1.0	2020-11-25	First release	Guo.QL
V1.1	2021-3-12	Added EWN-8250FGT1HA	RUAN
V1.2	2021-3-19	Updated 9 Module Photos	RUAN

EARDATEK

Federal Communication Commission Statement (FCC, U.S.)

This equipment has been tested and found to comply with the limits for a Class B digital device, pursuant to Part 15 of the FCC Rules. These limits are designed to provide reasonable protection against harmful interference in a residential installation. This equipment generates, uses and can radiate radio frequency energy and, if not installed and used in accordance with the instructions, may cause harmful interference to radio communications. However, there is no guarantee that interference will not occur in a particular installation. If this equipment does cause harmful interference to radio or television reception, which can be determined by turning the equipment off and on, the user is encouraged to try to correct the interference by one of the following measures:

- Reorient or relocate the receiving antenna.
- Increase the separation between the equipment and receiver.
- Connect the equipment into an outlet on a circuit different from that to which the receiver is connected.
- Consult the dealer or an experienced radio/TV technician for help.

This device complies with Part 15 of the FCC Rules. Operation is subject to the following two conditions: (1) This device may not cause harmful interference, and (2) this device must accept any interference received, including interference that may cause undesired operation.

FCC Caution:

Any changes or modifications not expressly approved by the party responsible for compliance could void the user's authority to operate this equipment.

IMPORTANT NOTES

Co-location warning:

This transmitter must not be co-located or operating in conjunction with any other antenna or transmitter.

OEM integration instructions:

This device is intended only for OEM integrators under the following conditions:

The transmitter module may not be co-located with any other transmitter or antenna. The module shall be only used with the external antenna(s) that has been originally tested and certified with this module.

As long as the conditions above are met, further transmitter test will not be required. However, the OEM integrator is still responsible for testing their end-product for any additional compliance requirements required with this module installed (for example, digital device emissions, PC peripheral requirements, etc.).

Validity of using the module certification:

In the event that these conditions cannot be met (for example certain laptop configurations or co-location with another transmitter), then the FCC authorization for this module in combination with the host equipment is no longer considered valid and the FCC ID of the module cannot be used on the final product. In these circumstances, the OEM integrator will be responsible for re-evaluating the end product (including the transmitter) and obtaining a separate FCC authorization.

End product labeling:

The final end product must be labeled in a visible area with the following: "Contains Transmitter Module FCC ID: 2AMM6-825X1HA".

Information that must be placed in the end user manual:

The OEM integrator has to be aware not to provide information to the end user regarding how to install or remove this RF module in the user's manual of the end product which integrates this module. The end user manual shall include all required regulatory information/warning as show in this manual.

Integration instructions for host product manufacturers according to KDB 996369 D03 OEM Manual v01

2.2 List of applicable FCC rules

FCC Part 15 Subpart C 15.247 & 15.207 & 15.209

2.3 Specific operational use conditions

The module is a BLE module with BLE 2.4G function.

Operation Frequency: 2402~2480MHz

Number of Channel: 40

Modulation: GFSK

Type: PCB Antenna

Gain: 0.5 dBi Max.

The module can be used for mobile or applications with a maximum 2dBi antenna. The host manufacturer installing this module into their product must ensure that the final composite product complies with the FCC requirements by a technical assessment or evaluation to the FCC rules, including the transmitter operation. The host manufacturer has to be aware not to provide information to the end user regarding how to install or remove this RF module in the user's manual of the end product which integrates this module. The end user manual shall include all required regulatory information/warning as show in this manual.

2.4 Limited module procedures

Not applicable. The module is a Single module and complies with the requirement of FCC Part 15.212.

2.5 Trace antenna designs

Not applicable. The module has its own antenna, and doesn't need a host's printed board microstrip trace antenna etc.

2.6 RF exposure considerations

The module must be installed in the host equipment such that at least 20cm is maintained between the antenna and users' body; and if RF exposure statement or module layout is changed, then the host product manufacturer required to take responsibility of the module through a change in FCC ID or new application. The FCC ID of the module cannot be used on the final product. In these circumstances, the host manufacturer will be responsible for re-evaluating the end product (including the transmitter) and obtaining a separate FCC authorization

2.7 Antennas

Antenna Specification are as follows:

Type: PCB Antenna

Gain: 0.5 dBi

This device is intended only for host manufacturers under the following conditions:

The transmitter module may not be co-located with any other transmitter or antenna;

The module shall be only used with the internal antenna(s) that has been originally tested and certified with this module. The antenna must be either permanently attached or employ a 'unique' antenna coupler.

As long as the conditions above are met, further transmitter test will not be required. However, the host manufacturer is still responsible for testing their end-product for any additional compliance requirements required with this module installed (for example, digital device emissions, PC peripheral requirements, etc.).

2.8 Label and compliance information

Host product manufacturers need to provide a physical or e-label stating "Contains FCC ID: 2AMM6-825X1HA" with their finished product.

2.9 Information on test modes and additional testing requirements

Operation Frequency: 2402~2480MHz

Number of Channel: 40

Modulation: GFSK

Host manufacturer must perform test of radiated & conducted emission and spurious emission, etc according to the actual test modes for a stand-alone modular transmitter in a host, as well as for multiple simultaneously transmitting modules or other transmitters in a host product.

Only when all the test results of test modes comply with FCC requirements, then the end product can be sold legally.

2.10 Additional testing, Part 15 Subpart B disclaimer

The modular transmitter is only FCC authorized for FCC Part 15 Subpart C 15.247 & 15.207 & 15.209 and that the host product manufacturer is responsible for compliance to any other FCC rules that apply to the host not covered by the modular transmitter grant of certification. If the grantee markets their product as being Part 15 Subpart B compliant (when it also contains unintentional-radiator digital circuitry), then the grantee shall provide a notice stating that the final host product still requires Part 15 Subpart B compliance testing with the modular transmitter installed.