



# 350 Cable Survey System

## System Manual

Covers DeepView Software Version 5.x.x  
and Firmware Version 3.7

TSS (International) Ltd  
1, Garnett Close  
Greycaine Industrial Estate  
Watford, Herts, WD24 7GL  
Telephone +44 (0)1923 470800  
Facsimile +44 (0)1923 470842  
**24 hr Customer Support +44 (0)7899 665603**  
e-mail: [tssmail@tss-int.com](mailto:tssmail@tss-int.com)

The information in this Manual is subject to  
change without notice and does not represent  
a commitment on the part of TSS (International) Ltd

Document P/N 402197  
Issue 2.4  
January 2008



INVESTOR IN PEOPLE

---

**CAUTIONARY NOTICE**

This System Manual contains full installation and operating instructions and is an important part of the 350 System. This Manual should remain easily available for use by those who will install, operate and maintain the System.

**WARNINGS and CAUTIONS**



Where appropriate, this Manual includes important safety information. Safety information appears as **WARNING** and **CAUTION** instructions.

You must obey these instructions:

- ❑ **WARNING** instructions alert you to a potential risk of death or injury to users of the 350 System.
- ❑ **CAUTION** instructions alert you to the potential risk of damage to the 350 System.

For your convenience, the Table of Contents section includes copies of all the **WARNING** and **CAUTION** instructions contained in this Manual.



**Technical Support and contact information**

TSS (International) Ltd  
1 Garnett Close,  
Greycaine Industrial Estate,  
Watford,  
Herts,  
WD24 7GL

Tel:	+44 (0)1923 470800
Fax:	+44 (0)1923 470842
Out of UK Hours Technical Helpline:	+44 (0)7899 665603
These hours are:	4:30pm - 7:45am Monday to Friday and 12:30pm Friday to 7:45am Monday



**1 INTRODUCTION**

1.1 System Description - - - - - 1-5

1.2 Principle of Operation - - - - - 1-6

1.3 Quick Start for SDC Users - - - - - 1-7

1.4 Warranty - - - - - 1-7

**2 SYSTEM OVERVIEW**

2.1 Scope of Delivery - - - - - 2-2

2.2 Unpacking and Inspection - - - - - 2-4

2.3 Surface Components - - - - - 2-5

2.4 Sub-sea Components - - - - - 2-9

    2.4.1 Sub-sea Electronics Pod - - - - - 2-9

    2.4.2 Sensing Coils - - - - - 2-11

        2.4.2.1 Sensing Coil Components- - - - - 2-12

    2.4.3 Altimeter - - - - - 2-13

        2.4.3.1 Alternative Altimeter Types. - - - - - 2-13

    2.4.4 Remotely Operated Vehicles - - - - - 2-14

**3 PHYSICAL INSTALLATION**

3.1 SDC Installation - - - - - 3-2

3.2 Sub-sea Installation - - - - - 3-3

    3.2.1 SEP - - - - - 3-3

    3.2.2 Sensing Coils - - - - - 3-5

        3.2.2.1 Assembling the Coils - - - - - 3-6

        3.2.2.2 Mounting the Coils - - - - - 3-9

    3.2.3 Altimeter Installation - - - - - 3-11

3.3 Installation Check List - - - - - 3-13

**4 ELECTRICAL INSTALLATION**

4.1 Sub-sea Components - - - - - 4-2

    4.1.1 Ground Connections - - - - - 4-3

    4.1.2 Care of Sub-sea Connectors - - - - - 4-4

    4.1.3 Sub-sea Electronics Pod - - - - - 4-4

        4.1.3.1 Power Requirement- - - - - 4-5

    4.1.4 Sensing Coils - - - - - 4-7

    4.1.5 Sub-sea Altimeter - - - - - 4-8

        4.1.5.1 Direct connection to the SEP - - - - - 4-9

        4.1.5.2 Connection to the SDC - - - - - 4-9

    4.1.6 Roll/Pitch Sensor - - - - - 4-10

4.2 Surface Display Computer - - - - - 4-11

    4.2.1 Power Connection - - - - - 4-11

    4.2.2 Communication Link SEP to SDC - - - - - 4-11

        4.2.2.1 Alternative Communication Methods - - - - - 4-14

    4.2.3 Interface to Data Logger - - - - - 4-16

    4.2.4 Interface to Video - - - - - 4-17

**5 SYSTEM CONFIGURATION**

5.1 Software Installation - - - - - 5-2

5.2 Power-on Procedure - - - - - 5-3

---

5.3 DeepView For Windows - System Configuration	-5-5
5.3.1 SEP type	-5-5
5.3.2 Communication ports	-5-6
5.4 Print Configuration	-5-8
<b>6 OPERATION SOFTWARE</b>	
6.1 Configuration	-6-2
6.1.1 Survey Parameters	-6-2
6.1.1.1 Tone Frequency	-6-2
6.1.1.2 Threshold-	-6-2
6.1.1.3 Coil Separation	-6-2
6.2 DeepView for Windows Operating Controls	-6-2
6.2.1 How to Use DeepView for Windows	-6-2
6.2.1.1 DeepView File Menu Options	-6-7
6.2.1.2 Run/ Display screen	-6-8
6.2.1.3 Forward Search Screen-	6-12
6.2.1.4 Other Windows	6-14
6.2.1.5 Configuration Options-	6-18
6.2.2 Survey Parameters	6-18
6.2.2.1 Altimeter	6-20
6.2.2.2 External Data Logging	6-22
6.2.2.3 Load Factory Defaults-	6-23
6.2.2.4 Video Overlay Setup	6-23
6.2.3 DeepView for Windows Icon Tools	6-25
6.2.4 DeepView for Windows Function Keys	6-27
6.3 After the Dive	6-28
6.4 Replaying a Log File	6-29
6.5 Quality Control	6-31
<b>7 OPERATING PROCEDURE</b>	
7.1 Before the Survey	-7-2
7.1.1 Personnel and Equipment Availability	-7-2
7.1.2 Tone Frequency	-7-3
7.1.3 Survey Requirements	-7-3
7.1.4 Installation Requirements	-7-3
7.2 During the survey	-7-4
7.2.1 Safety and Pre-dive checks	-7-6
7.2.2 Data Logging	-7-6
7.2.3 Replay Logged Data	-7-7
7.3 Data Formats	-7-8
7.3.1 External Logging Format	-7-8
7.3.1.1 Co-ordinates and Signals Format	-7-8
7.3.1.2 Forward Search mode	7-10
7.3.2 Internal Logging Format	7-12
7.3.3 Altimeter Data Format	7-14
7.3.3.1 Datasonics PSA 900 and PSA 9000-	7-15
7.3.3.2 Ulvertech Bathymetric System	7-15
7.3.3.3 Simrad UK90	7-16
7.3.3.4 OSEL Bathymetric System	7-16



- 7.3.3.5 Trittech SeaKing Bathy 704 - - - - - 7-17
- 7.4 After the Survey - - - - - 7-19
- 7.5 Operational Considerations - - - - - 7-20
  - 7.5.1 Operating Performance - - - - - 7-20
  - 7.5.2 Sources of Error - - - - - 7-21
    - 7.5.2.1 ROV Handling - - - - - 7-21
    - 7.5.2.2 Electrical Interference- - - - - 7-26
- 7.6 ROVs - - - - - 7-29
  - 7.6.1 Speed of Operation - - - - - 7-29
  - 7.6.2 Altitude above the Seabed - - - - - 7-29
  - 7.6.3 Tracked ROV - - - - - 7-29

8 SYSTEM SPECIFICATIONS

- 8.1 Specifications - - - - - -8-2
  - 8.1.1 Surface Display Computer - - - - - -8-2
  - 8.1.2 Sub-sea Electronics Pod - - - - - -8-4
  - 8.1.3 Search Coil Array - - - - - -8-4
- 8.2 Performance - - - - - -8-5
- 8.3 System Trials - - - - - -8-6
  - 8.3.1 Trials Configuration and Procedure - - - - - -8-6
  - 8.3.2 Results - - - - - -8-8
    - 8.3.2.1 Accuracy - - - - - -8-8
- 8.4 Update Rate - - - - - -8-9

9 MAINTENANCE

- 9.1 Circuit Description - - - - - -9-2
  - 9.1.1 Sensing Coils - - - - - -9-3
  - 9.1.2 Sub-sea Electronics Pod - - - - - -9-4
    - 9.1.2.1 Analogue-to-Digital Converter - - - - - -9-4
    - 9.1.2.2 Processor Board - - - - - -9-5
    - 9.1.2.3 Power Supply- - - - - -9-7
  - 9.1.3 Current Loop - - - - - -9-7
- 9.2 Disassembly and Reassembly - - - - - -9-9
  - 9.2.1 Surface Display Computer - - - - - -9-9
  - 9.2.2 Sub-sea Electronics Pod - - - - - -9-9
  - 9.2.3 Coil Cable Continuity - - - - - 9-15
- 9.3 Fault Identification - - - - - 9-16
  - 9.3.1 Fault on a Single Channel - - - - - 9-17
  - 9.3.2 Communications Failure - - - - - 9-18
  - 9.3.3 Poor Tracking Performance - - - - - 9-21
  - 9.3.4 Altimeter Failure - - - - - 9-22

10 SYSTEM DRAWINGS

A OPERATING THEORY

- A.1 Electromagnetic Fields - - - - - A-2
- A.2 Field Detection - - - - - A-2
- A.3 Signal Isolation - - - - - A-3
- A.4 Calculation - - - - - A-4

---

A.4.1 Survey Mode	- A-5
A.4.2 Forward Search Mode	- A-7
A.4.3 Skew Measurement	- A-8
<b>B OPTIONS</b>	
B.1 Dualtrack System	B-2
B.1.1 The Equipment	-B-2
B.1.2 The Differences	-B-3
B.1.3 Scope of Delivery	-B-4
B.1.4 Physical Installation	-B-6
B.1.4.1 Search-coils	-B-6
B.1.4.2 Sub-sea Pods	-B-6
B.1.5 Electrical Connection	-B-7
B.1.5.1 System Configuration	-B-9
B.1.5.2 System Operation	B-10
B.1.6 Power Supply Requirement	B-10
B.2 Training	B-11
B.2.1 Part 1: Foundation Course	B-11
B.2.2 Part 2: Operators and Engineers Course	B-12
<b>C CABLES AND TONES</b>	
C.1 Tone Injection	C-2
C.1.1 Frequency Selection	-C-2
C.1.2 Connection to the cable	-C-2
C.1.2.1 Short cables	C-2
C.1.2.2 Long cables	C-3
C.1.2.3 Fibre-optic Cables	C-3
C.1.2.4 General Connection Requirements	C-4
C.1.3 Seawater Return Path	-C-4
<b>D ALTIMETER</b>	
D.1 Overview	D-1
D.2 Installation	D-2
D.2.1 Electrical Connection	-D-2
D.2.2 Serial Output	-D-2
D.2.3 Mounting	-D-3
D.2.4 Maintenance	-D-4
D.2.5 Test in Air	-D-4
D.2.6 Internal Settings	-D-4
D.3 Theory of Operation	D-5
D.3.1 Operating Principles	-D-5
D.3.1.1 Speed of Sound	D-6
D.3.1.2 Terminology	D-6
D.3.1.3 Propagation Loss	D-7
D.3.1.4 Limitations	D-7
D.3.2 Technical Description	-D-8
D.3.2.1 Power Supply	D-8
D.3.2.2 Transmitter	D-9
D.3.2.3 Receiver	D-9



D.3.2.4 Sensor Circuitry - - - - - D-10  
D.3.2.5 Digital Circuitry - - - - - D-10  
D.3.2.6 Averaging Algorithm - - - - - D-11  
D.3.2.7 Optional Modem - - - - - D-11  
D.4 Part Numbers - - - - - D-11  
D.5 Drawings - - - - - D-12

**E COIL TESTER**

E.1 Pre-Operation - - - - - E-3  
    E.1.1 Coil Calibration Constants - - - - - E-3  
E.2 Operation - - - - - E-5  
    E.2.1 Frequency Selection - - - - - E-7  
E.3 Fault Identification - - - - - E-8  
E.4 Battery Replacement - - - - - E-8  
E.5 Maintenance - - - - - E-9  
E.6 Specification - - - - - E-9

**F REFERENCE**

F.1 Survey Details - - - - - F-3  
F.2 System Configuration Details - - - - - F-3

Figure 2–1 Components of the 350 Cable Survey System	2-2
Figure 2–2 Surface Display Computer	2-5
Figure 2–3 SDC Display	2-6
Figure 2–4 SDC PC Console	2-6
Figure 2–5 Components of a coil triad	2-12
Figure 3–1 SEP mounting arrangement	3-4
Figure 3–2 The coil array reference line	3-5
Figure 3–3 Construction of the starboard coil triad	3-7
Figure 3–4 Coil mounting components	3-9
Figure 3–5 Effects of altimeter horizontal offset	3-12
Figure 4–1 System interconnection diagram	4-2
Figure 4–2 SDC Rear panel with key to ports	4-11
Figure 4–3 Link detail shown using the same orientation as in Figure 4–4	4-15
Figure 4–4 Link location on the SEP processor board	4-15
Figure 5–1 DeepView for Windows - System Configuration Wizard	5-5
Figure 5–2 DeepView for Windows - Summary	5-7
Figure 5–3 DeepView for Windows- Print Configuration	5-8
Figure 6–1 An example of a File Option menu	6-7
Figure 6–2 An example of the Print Configuration via Windows Notepad	6-8
Figure 6–3 DeepView - Run Window	6-9
Figure 6–4 DeepView - Forward Search Window	6-12
Figure 6–5 Scope Window	6-14
Figure 6–6 Spectrum Analyser Window	6-14
Figure 6–7 System Errors window	6-15
Figure 6–8 Terminal window	6-17
Figure 6–9 System Configuration	6-18
Figure 6–10 Threshold does not apply to vertical coils.	6-19
Figure 6–11 Altimeter Configuration	6-21
Figure 6–12 Altimeter Test	6-22
Figure 6–13 External Output Configuration and Serial Port menu	6-23
Figure 6–14 Video Overlay Setup	6-24
Figure 6–15 Video Overlay Signal	6-24
Figure 6–16 Video Overlay Enable/Disable button	6-25
Figure 6–17 DeepView function keys	6-28
Figure 6–18 Replay a log file screen	6-29
Figure 6–19 Replay toolbar keys	6-30
Figure 7–1 Using the forward search mode	7-5
Figure 7–2 ROV positioning errors	7-21
Figure 7–3 ROV roll errors	7-23
Figure 7–4 Sloping target	7-25
Figure 7–5 Curved target	7-28
Figure 8–1 Vertical range measurement accuracy	8-5
Figure 8–2 Trials site	8-7
Figure 9–1 Simplified interconnection diagram – Sub-sea installation	9-2
Figure 9–2 Simplified schematic of the current-loop	9-8
Figure 9–3 Processor Board layout	9-11
Figure 9–4 ADC Board layout	9-12
Figure 9–5 Power Supply Board layout	9-13
Figure 9–6 Orientation of the coil connector end-cap	9-14



Figure 9–7 Single channel failure	9-17
Figure 9–8 Communications failure – CHART 1	9-18
Figure 9–9 Communications failure – CHART 2	9-19
Figure 9–10 Communications failure – CHART 3	9-20
Figure 9–11 Poor tracking performance	9-21
Figure 9–12 Altimeter failure – CHART 1	9-23
Figure 9–13 Altimeter failure – CHART 2	9-24
Figure 10–1 490234 Sub-sea Electronics Pod - Overall diagram	10-2
Figure 10–2 401105 Coil Pre-amp	10-3
Figure 10–3 401104-1 Analogue to Digital Conversion	10-4
Figure 10–4 401104-2 Analogue to Digital Conversion - ADC1	10-5
Figure 10–5 401104-3 Analogue to Digital conversion – ADC 2	10-6
Figure 10–6 401104-4 Analogue to Digital conversion – ADC 3	10-7
Figure 10–7 401103-1 Processor Board	10-8
Figure 10–8 401103-2 CPU Core	10-9
Figure 10–9 401103-3 Processor Board - Comms	10-10
Figure 10–10 401103-4 Processor Board - ADC Interface	10-11
Figure 10–11 490221 350CE Cable Survey System Assembly (110V)	10-12
Figure 10–12 B930476 350CE 3-axis coil cable assembly	10-13
Figure 10–13 B930473 ROV Tail Assembly	10-14
Figure A–1 Lines of magnetic flux	A-2
Figure A–2 Simplified signal path	A-3
Figure A–3 Frequency ‘windows’	A-4
Figure A–4 The effect of incident angle on coil response	A-5
Figure A–5 Coil response as incident angle varies	A-5
Figure A–6 Determination of relative angle using two coil voltages	A-6
Figure A–7 Target location using two coil pairs	A-7
Figure A–8 Forward Range Calculation	A-7
Figure A–9 Vehicle following target with skew angle	A-8
Figure A–10 Skew angle measurement	A-9
Figure B–1 Surface Display Computer	B-4
Figure B–2 Sub-sea components of the TSS 350 System	B-4
Figure B–3 Sub-sea components of the TSS 440 System	B-5
Figure B–4 Electrical interconnection of sub-sea components	B-7
Figure C–1 Tone injection – Short cables	C-3
Figure C–2 Tone injection – Long cables	C-3
Figure D–1 Mounting arrangement	D-3
Figure D–2 Switch S1 layout	D-5
Figure D–3 Reassembly of the unit.	D-5
Figure D–4 Speed of Sound meter	D-6
Figure D–5 Block Diagram	D-12
Figure D–6 Internal wiring	D-13
Figure D–7 Temperature sensor wiring	D-13
Figure D–8 ALT-250 / TSS underwater splice p/n 601824A	D-14
Figure D–9 ALT-250 free cable	D-15
Figure D–10 PCB layout - top	D-16
Figure D–11 PCB - top	D-16
Figure D–12 PCB layout - bottom	D-17
Figure D–13 PCB bottom	D-17

Figure E-1 350 System Parameters Configuration screen - - - - - E-4



Table 2–1 Components of the 350 Cable Survey System- - - - -	2- 3
Table 4–1 Power and Communications cable - - - - -	4- 7
Table 4–2 RS232 connection to COM2 - - - - -	4- 10
Table 4–3 Ideal twisted pair characteristics for successful communication - -	4- 12
Table 4–4 Power and Communications cable – 2-wire current loop connections	4- 13
Table 4–5 Power and Communications cable – 4-wire current-loop connections	4- 13
Table 4–6 Power and Communications cable – RS232 connections - - - - -	4- 13
Table 4–7 Link settings for LK1 to LK5- - - - -	4- 15
Table 4–8 RS232 connection for a data logger - - - - -	4- 17
Table 6–1 DeepView Menu Commands - - - - -	6- 3
Table 6–2 Internal Data Logging- - - - -	6- 7
Table 6–3 System errors format - - - - -	6- 16
Table 6–4 Terminal Window toolbar - - - - -	6- 17
Table 6–5 Factory System Defaults - - - - -	6- 23
Table 6–6 DeepView Toolbar - - - - -	6- 25
Table 6–7 Run Window Toolbar - - - - -	6- 27
Table 6–8 Replay toolbar function keys - - - - -	6- 30
Table 7–1 External Output format - Survey Mode - - - - -	7- 8
Table 7–2 QC check code meaning – Survey mode - - - - -	7- 10
Table 7–3 External logging format – Forward search mode- - - - -	7- 10
Table 7–4 QC check code meaning – Forward search mode - - - - -	7- 11
Table 7–5 Internal logging format – Survey co-ordinates - - - - -	7- 12
Table 7–6 Internal logging format – Forward search mode - - - - -	7- 13
Table 7–7 Internal logging format – Signals packet- - - - -	7- 14
Table 7–8 Altimeter output format – TSS and Datasonics- - - - -	7- 15
Table 7–9 Altimeter output format – Datasonics with pressure transducer- - -	7- 15
Table 7–10 Altimeter output format – Ulvertech Bathymetric system - - - - -	7- 16
Table 7–11 Altimeter output format – Simrad UK90 - - - - -	7- 16
Table 7–12 Altimeter output format – OSEL bathymetric system - - - - -	7- 17
Table 7–13 Trittech SeaKing Bathy format - - - - -	7- 18
Table 8–1 Vertical measurement errors - - - - -	8- 8
Table 8–2 Lateral measurement errors- - - - -	8- 9
Table 9–1 Connections to the coil cable - - - - -	9- 15
Table B–1 Components of the Dualtrack System- - - - -	B- 5
Table C–1 Effects of tone frequency choice - - - - -	C- 2
Table D–1 Altimeter Specification - - - - -	D- 1
Table D–2 Power/ data connector pinout- - - - -	D- 2
Table D–3 Switch S1 settings - - - - -	D- 4
Table D–4 Testpoints - - - - -	D- 8
Table D–5 Part numbers - - - - -	D- 11
Table E–1 350 System Subsea Parameters - - - - -	E- 5
Table E–2 350 System Connector Cable Identification - - - - -	E- 6
Table E–3 350 System Operating Parameters - - - - -	E- 7
Table E–4 Coil Tester Frequency settings and expected coil voltages - - - - -	E- 7

## GLOSSARY

Item	Definition as used throughout this Manual
ROV	Remotely operated vehicle. Any form of sub-sea or surface vehicle supporting the 350 System during survey operations.
SDC	Surface display computer. The configuration, control and display computer supplied by TSS to operate the 350 System.
SEP	Sub-sea electronics pod. The single electronics housing for the sub-sea installation.
COV	Target depth of cover. The SDC computes this as VRT-ALT
ALT	Coil altitude above the seabed. This could be measured by a sub-sea altimeter connected either directly to the SEP or through an umbilical to the SDC. Where there is no altimeter fitted to the System, ALT could contain a fixed coil height that you specify during the configuration procedure.
FWD	Forward range measured to the target in when in forward search mode.;

**AMENDMENTS**

OLD ISSUE NO.	NEW ISSUE NO.	DATE	DETAILS
2.3	2.4	15.01.2008	Added 350 Coil Tester section to Appendix E
2.2	2.3	14.06.2007	Updated default comms to RS232. Included 350 drawings in manual.
2.1	2.2	16.02.2006	Corporate branding changes and SDC9 updates.
2.0	2.1	19.12.2003	Revised for latest software.
-	2.0	25.07.2000	First issue to cover SDC8 / DeepView / 440.



# 1 INTRODUCTION

The TSS 350 Cable Survey System is a complete package of equipment that you may install on board a remotely operated sub-sea vehicle (ROV). The System provides a convenient and uncomplicated method for performing accurate submarine surveys on a tone-carrying cable. The burial state of the target has no effect on System operation.

This Manual describes the Type 2 TSS 350 Cable Survey System.

The Type 1 System differs only in the design of the sub-sea electronics pod (SEP) and does not allow the System to be combined with the sub-sea components of a TSS 340 or 440 System for operation in Dualtrack mode. The Type 1 System is no longer available from TSS.

The 350 System includes a display and control computer that you should install where you may see its screen easily while you operate the ROV. The display includes information to help you guide the ROV along the course of the target. This Surface Display Computer (SDC) makes all acquired survey data available to external data logging equipment.

The 350 System operates in real time and provides accurate measurements at a rate that allows deployment on board faster ROVs. The measurement technology used by the System also allows it to operate out of water with no degradation in performance, range or accuracy. You may therefore use the System for land-based or amphibious survey applications.

This System Manual contains full installation and operating instructions and is an important part of the 350 System. You should ensure the Manual remains easily available for use by those who will install, operate and maintain the System.

When supplied new, the sub-sea components are all fully sealed and depth rated to the specifications listed in Section 8. To maintain the specified depth rating throughout the lifetime of the System, follow the maintenance and care instructions included in Section 9.

Provided you follow the installation, operating and maintenance instructions included throughout this Manual, the 350 System will maintain its specified measurement accuracy with no need for further factory re-calibration.

Installation and operation of the 350 System are not complex tasks. However, you should spend time to familiarise yourself with the contents of this Manual before you start to install or use the System. Time spent identifying the task sequence now will help to have the System operational in the minimum of time.

---

### WARNINGS and CAUTIONS

Where appropriate, this Manual includes important safety information, which appears as WARNING and CAUTION instructions. You must obey these instructions:





**WARNING** instructions alert you to a potential risk of death or injury to users of the 350 System.

**CAUTION** instructions alert you to the potential risk of damage to the 350 System.

Throughout this Manual, measurements conform to the SI standard of units.

For your convenience, this Manual includes several sections, each of which describes specific features of the 350 System:

*You should read sections 1 to 4 before you attempt to install the 350 System:*

---

- Section 1** contains introductory notes to describe the TSS 350 System.
- Section 2** describes the 350 Cable Survey System and its sub-assemblies.
- Section 3** explains how to install the surface and the sub-sea components correctly.
- Section 4** explains how to complete the electrical interconnection between the surface and the sub-sea components. This section also explains how you should select and establish a suitable communication method between the surface and sub-sea installations.

*You should read sections 5 to 7 before you use the 350 System to perform a survey:*

---

- Section 5** explains how to configure the 350 System for a particular installation by using the DeepView display software.
- Section 6** describes how to operate the 350 System during a survey by using the DeepView display software. The software allows easy access to all the facilities that you might require during a target survey.
- Section 7** explains how to use the 350 System before, during and after a survey operation. It also explains some of the factors that may affect the performance of the 350 System during a survey.
- Section 8** provides a full set of hardware specifications for the standard 350 System. This section also shows the operational capabilities of the 350 System under ideal survey conditions.

*You should read section 9 if the 350 System fails to operate normally due to a suspected fault condition:*

---

- Section 9** provides a brief circuit description of the sub-sea components, and includes flow charts to help you identify and eliminate faults by board replacement. It also includes the mechanical and electrical drawings for the System.
- Section 10** contains the technical drawings for the system.

Follow the advice and instructions in Section 9 if you suspect a failure of the 350 System. If you cannot correct the problem, contact TSS for technical assistance. The title

## 1 – Introduction

---



page of this Manual includes the contact details for TSS (International) Ltd . TSS also operates a 24-hour emergency customer support service managed by trained and experienced engineers. Please make certain you have read Section 9 of this Manual and that you have a full description of the suspected fault condition *before* you contact TSS for technical assistance.

*For reference, this Manual also contains Appendices that provide additional information about the 350 System:*

---

**Appendix A** describes the operating theory of the 350 System.

**Appendix B** describes the options available for use with the System:

- The Analogue Output feature that you may use to provide control signals for an automatic steering feature on a tracked ROV.
- Use of the TSS 350 System when combined with the sub-sea components of a TSS 440 Pipe and Cable Survey System and controlled by a single SDC. This is called the TSS Dualtrack.
- A specialised TSS training programme available for those who may be involved in any survey that uses the 350 System.

**Appendix C** gives some basic information and instructions for injecting a tone onto a cable.

**Appendix D** gives operating and service information for the TSS ALT-250.

**Appendix F** includes a sample Configuration Log sheet, and drawings to show the Run and Forward Search windows for use with the 350 System.

## 1.1 SYSTEM DESCRIPTION

---



### WARNING

The protection provided by the 350 System might be impaired if you use the equipment in a manner not specified by TSS. For safety reasons, always follow the instructions and advice included throughout this Manual. If necessary, contact TSS for technical advice.

TSS has designed the 350 Cable Survey System primarily for use in surveying operations on submarine cables. In this application the System measures, displays and records the position of the target relative to the ROV, and its depth of cover beneath the seabed.

Operation of the TSS 350 System is unaffected by the burial state of the target cable, the presence of non-ferrous metallic objects, or the heading of the search ROV.

The TSS 350 System consists of a surface control and display computer and the depth rated components of the sub-sea installation:

#### *Surface Display Computer*

---

You should use the SDC to configure and control the 350 System. It communicates with the sub-sea installation using bi-directional signals transmitted through the ROV umbilical.

By interpreting the signals from the sub-sea installation, the SDC generates a clear graphical display that helps you to guide the ROV towards the target and then to follow a course immediately above it.

Simultaneously, the SDC uses one of its four serial data ports to transmit the real time survey information to an external data logging system.

#### *Sub-sea installation*

---

The sub-sea installation includes the following components:

- ❑ A sub-sea electronics pod (SEP)
- ❑ Two coil triads, each of which supports three identical receiving coils
- ❑ A sub-sea altimeter
- ❑ Mounting components to install the coil components on the ROV
- ❑ Cables you will need to interconnect the sub-sea components of the 350 System.

All sub-sea components of a new installation have a depth rating to the specifications listed in Section 8. The main label of the SEP also confirms the depth rating of this component. Provided you exercise all proper maintenance procedures explained in Section 9, the sub-sea components will retain their specified depth rating throughout their working life.

Refer to sub-section 2.4 for descriptions of the main sub-sea components of the 350 System.

During survey operations, the sub-sea installation measures the target co-ordinates. These are:

- The vertical range to the target (VRT).
- The lateral offset of the target relative to the centre of the coil array (LAT).
- The altitude (ALT) of the coil array above the seabed, and the depth of target cover (COV). To make these measurements, the 350 System must receive altitude information from an altimeter. Alternatively, where the design of the ROV allows for a constant coil height, you may configure the System with this information instead.
- The angle of skew (SKEW) between the target and the coil array.
- The forward range to the target (FWD) when you operate the System in its forward search mode. You *must* supply altitude measurements to the System before this feature can operate.

The SEP performs the signal processing functions necessary to generate accurate survey data using a powerful algorithm developed especially for this application. Communication signals from the sub-sea installation therefore include all the relevant survey information with no need for additional processing by the SDC.

The 350 System operates continuously in real time and provides accurate measurements at a rate that allows deployment on board faster ROVs. The System displays the information that it acquires in a clear graphical format on the SDC. The SDC also makes the same information available for serial transmission to an external logging system.

When supplied new, the SEP, the coils, cables and other sub-sea components are all fully sealed and depth rated. To maintain their approved depth rating throughout the lifetime of the System, follow the installation, operating, care and maintenance instructions included throughout this Manual. Provided you follow the instructions included throughout this Manual, the 350 System will maintain its specified measurement accuracy with no need for further factory re-calibration.

## 1.2 PRINCIPLE OF OPERATION

The TSS 350 Cable Survey System uses an array of six identical sensing coils arranged in two coil triads to detect the alternating magnetic fields that surround a tone-carrying cable. The directional characteristics of the individual sensing coils in each triad enable the System to locate the relative position of the target cable.

The method used by the 350 System to locate and survey the target cable is insensitive to the effects of:

- Variations in the magnitude of tone current
- Terrestrial magnetism
- Burial condition of the target cable
- The presence of non-ferrous metallic objects in the search area.

### 1.3 QUICK START FOR SDC USERS

This manual describes the operation of a 350 Cable Survey System used with the latest Surface Display Computer. This software is based on Windows 2000, and a new control program called Deepview for Windows. This new SDC is compatible *only* with a 440 Pipe and Cable survey system when used in a Dualtrack configuration. For users who have used the older generation of DOS software, the software will be simple to operate, however there are the following important differences:

- Windows user interface. The setting up of survey parameters, external logging etc. is now performed via menus and dialogs.
- New forward search screen.
- Highly improved video overlay.
- Internal logging improved.
- Dualtrack configuration requires a 350 and 440 unit; the 340 is no longer supported.

The 350 SEP has not changed: the communications protocols, pinouts and ratings are exactly the same. For this reason, both the old and new SDCs can be used with a standalone 350.

### 1.4 WARRANTY

TSS (International) Ltd warrants the 350 Cable Survey System to be free of defects in materials or workmanship for one year beginning on the date when the equipment was shipped from the factory or from an authorised distributor of equipment manufactured by TSS (International) Ltd .



To ship the units between installation sites or to return them to TSS (International) Ltd or an authorised distributor for repair, package them with care. TSS (International) Ltd recommends that you should retain the original packing case for this purpose.

The use of improper packing for shipping any part of this equipment will void the warranty.

For information concerning the proper return location and procedure, contact TSS (International) Ltd or an authorised distributor. The title page of this Manual lists the contact details for TSS (International) Ltd .

The responsibility of TSS (International) Ltd in respect of this warranty is limited solely to product replacement or product repair at an authorised location only. Determination of replacement or repair will be made by TSS (International) Ltd personnel or by personnel expressly authorised by TSS (International) Ltd for this purpose.

This warranty will not extend to damage or failure resulting from misuse, neglect, accident, alteration, abuse, improper installation, non-approved cables or accessories, or operation in an environment other than that intended.



In no event will TSS (International) Ltd be liable for any indirect, incidental, special or consequential damages whether through tort, contract or otherwise. This warranty is expressly in lieu of all other warranties, expressed or implied, including without limitation the implied warranties of merchantability or fitness for a particular purpose. The foregoing states the entire liability of TSS (International) Ltd with respect to the products described herein.

Contact TSS (International) Ltd for information if further cover is required beyond the warranty period.

## 2 SYSTEM OVERVIEW

*You should read this section of the Manual before you unpack or install the 350 System.*

This section tells you about the important checks and inspections that you should make when you first receive the TSS 350 System. It also includes a brief description of the main items supplied as standard with the System.

If you must ever exchange any of the System sub-assemblies, please make certain you include a full description of the part you require with your order. If possible, also include the part number of the component you require and the serial number of the relevant sub-assembly.

---

### **2.1 Scope of Delivery** **Page 2**

Describes the items supplied as part of the standard TSS 350 Cable Survey System.

---

### **2.2 Unpacking and Inspection** **Page 4**

Explains the inspections and checks that you should make as you unpack the TSS 350 System.

---

### **2.3 Surface Components** **Page 5**

Describes in detail the surface components of the standard TSS 350 System.

---

### **2.4 Sub-sea Components** **Page 9**

Describes in detail the sub-sea components of the standard TSS 350 System.



## 2.1 SCOPE OF DELIVERY

The 350 System includes various sub-assemblies that you must interconnect properly before the System will work.

Figure 2–1 shows a typical stand-alone configuration for the 350 System that has the SDC installed on a surface vessel and the sub-sea components mounted on the ROV. Table 2–1 identifies the individual components of the installation.

Optionally, you may use the 350 System as part of a Dualtrack installation. In this mode, a single SDC controls the operation of the 350 Cable Survey System when its sub-sea components are connected to a TSS 440 Pipe and Cable Survey System. Refer to Appendix B.2 for instructions to connect and configure the 350 System within a Dualtrack installation.

Figure 2-1: Components of the 350 Cable Survey System

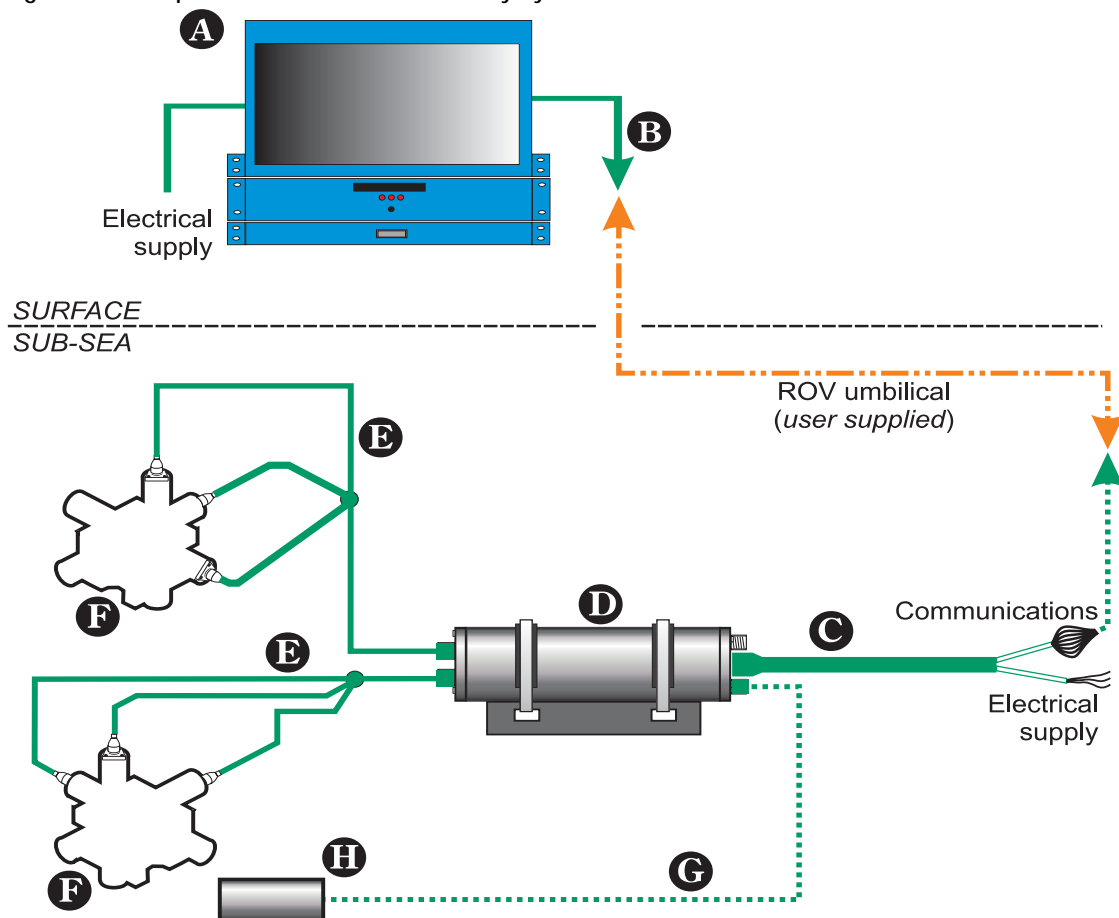

Sub-sections 2.3 and 2.4 below provide detailed descriptions of the surface and the sub-sea components of the 350 System

Table 2-1: Components of the 350 Cable Survey System

Item	Description
<b>A</b>	Surface display computer (SDC) with: <ul style="list-style-type: none"> <li>❑ DeepView for Windows display and logging software pre-installed on the internal hard disk.</li> <li>❑ Auto-range power supply that accepts AC supply voltages in the range 85 to 265V (47 to 63Hz) at 250VA maximum.</li> <li>❑ Modular 19" rack-mountable Industrial PC, VDU and keyboard/trackpad combination.</li> <li>❑ 40GB of storage disk space.</li> <li>❑ CD-ROM drive.</li> <li>❑ 2 x USB ports on front panel of Industrial PC.</li> <li>❑ Current-loop interface card (externally configurable).</li> <li>❑ Video overlay card and dual-head graphics card.</li> </ul>
<b>B</b>	Data cable for connection between the SDC and the ROV umbilical
<b>C</b>	Power and data cable (or 'ROV Tail') that connects the SEP to the ROV umbilical and power distribution system
<b>D</b>	Depth rated Sub-sea Electronics Pod (SEP)
<b>E</b>	Port and starboard coil connection cables
<b>F</b>	Port and starboard coil triads. These each include three identical coils arranged so that the starboard triad is a mirror image of the port triad.
<b>G</b>	Altimeter connection cable for the altimeter type in use
<b>H</b>	Sub-sea altimeter



### CAUTION

Earlier versions of the 350 System and sub-sea altimeter were depth rated to 1000 metres only. **DO NOT** use these earlier versions of hardware for surveying targets at depths greater than 1000 metres.

You may recognise the two types of SEP easily:

- Type 1 SEPs that have a 1000 metres depth rating show a visible end-cap thickness of 6mm. They also have serial numbers with three digits.
- Type 2 SEPs that have a 3000 metres depth rating show a visible end-cap thickness of 11mm. They also have serial numbers with four digits.
- The 3000 metre depth-rated altimeter is stainless steel with a bright finish. The earlier 1000 metre depth-rated version had a black finish.
- You may use a Datasonics altimeter with the 350 System. The Datasonics PSA 900 has a depth rating to 2000 metres, and the PSA 9000 has a depth rating to 6000 metres.

End cap thickness = 11mm  
if depth rating = 3000 m

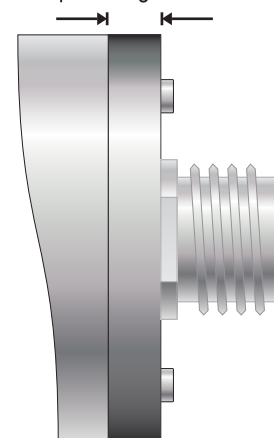

### 2.2 UNPACKING AND INSPECTION

TSS performs a series of careful examinations and tests on the electrical function and mechanical integrity of the 350 System during manufacture and before dispatch. Special shock protecting cases safeguard the System during transit so that it should arrive without damage or defect.



**Retain the original transit cases so that you may use them if you must transport the 350 System for any reason. You will invalidate the warranty if you use improper packing during transportation.**

As soon as possible after you have received the 350 System, check all items against the shipping documents. Perform a careful visual examination of all sub-assemblies and inspect them for any damage that might have occurred during transportation.

Notify TSS (International) Ltd immediately if there are parts or sub-assemblies missing from your shipment. If you see any damage to the System, file a claim with the insurers and inform TSS. The title page of this Manual lists the contact details for TSS (International) Ltd. TSS also operates a 24-hour emergency telephone support line managed by trained and experienced TSS engineers.

To avoid loss or damage to any components of the System, store all sub-assemblies safely in their transit cases until you need to install them. Obey the environmental limits for storage listed in Section 8 for all sub-assemblies.

### 2.3 SURFACE COMPONENTS

The SDC receives and processes information from the sub-sea installation. Its display provides clear information to help you guide the ROV along the course of the target.

Simultaneously, the SDC makes the same survey information available at one of its serial ports for recording by an external data logger.

Figure 2-2: Surface Display Computer



The main functions of the SDC are:

- ❑ **To communicate with the sub-sea installation.**  
The method of communication used between the SDC and the SEP is user selectable. The SDC has an external switch on the rear of the PC unit and the SEP has internal links. Refer to sub-section 4.2.2.1 for details instructions on communication configuration.
- ❑ **To configure and control the 350 System.**  
The SDC uses the Windows 2000 operating environment. DeepView for Windows software is used to configure the System after installation, and to operate the System during a survey. Refer to Sections 5 and 6 for full instructions to use this software.
- ❑ **To display the survey measurements graphically.**  
The display on the SDC shows information that helps you to guide the ROV along the course of the target. Refer to Section 6 for a description of the display features.  
  
There are two options available for displaying information on an external video monitor. The first is to repeat the SDC display at a remote location using SVGA signals provided on a 15-way high density D-type connector. The second is the video overlay which is transmitted as composite video or S-Video in either PAL or NTSC. Refer to sub-section 4.2.4 for instructions to use this feature.
- ❑ **To send the acquired data to an external data logger.**  
The SDC allows you to log survey data externally (for use by post-processing

engineers) and internally (to provide a simple record of the survey that you may replay through the SDC).

You may also use the SDC and DeepView for Windows software to control a Dual-track installation. Refer to Appendix B for details.

The SDC is a ruggedised IBM-compatible computer mounted in a purpose-designed shock protecting transit case. The design of the transit case allows you to operate the SDC by removing the front and the rear access panels. Alternatively, you may remove the SDC from the transit case and mount it in a 19-inch instrument rack if this arrangement is more appropriate.

Refer to sub-section 3.1 for full instructions to install the SDC.



**Pay particular attention to the warning and caution notices that are included within the SDC installation instructions.**

The SDC has a keyboard/trackpad combination mounted in a retractable 1U tray. You may use this to enter commands and System configuration parameters. The keyboard can be hidden when the system has been configured and it is not in use.

The SDC uses a 15 inch flat panel colour display also mounted in a 1U retractable tray, shown in Figure 2–3.

Figure 2-3: SDC Display

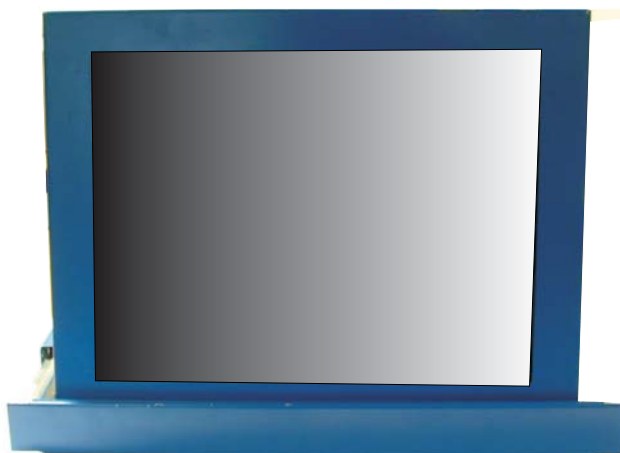

Figure 2–3 shows the flat panel screen in it's active position. When not in use, it can be hidden in the 19" rack to create additional space in the rack.

Figure 2-4: SDC PC Console



The front panel on the 1U PC console, shown in Figure 2–4, contains the power switch, 2 x USB ports and HDD, power and current loop indicator LEDs.

This module contains all permanent cards required to operate the SDC with the sub-sea components.

When TSS (International) Ltd dispatches the 350 System, the SDC will have the current version of the DeepView graphical display software pre-loaded onto its hard disk.

Refer to Sections 5 and 6 for instructions to use this operating software.

**CAUTION**

You may adversely and seriously affect the operating functions of the 350 System if you load unauthorised software onto the SDC hard disk, or if you attempt to use such software with the SDC. You will invalidate the warranty if you attempt to install or use unauthorised software with the SDC.

Do not load any unauthorised software onto the SDC. If you are in any doubt about the SDC software, contact TSS for advice.

**CAUTION**

You might destroy logged data and program files on the SDC if you allow computer viruses to infect the unit.

Computer viruses can pass from one computer to another when you transfer files, either directly through a cable or by disk. To protect the SDC against this type of damage, always take the following precautions:

- Never try to use unauthorised software with the SDC.
- Never power-on or reset the SDC with a diskette loaded into its floppy disk drive or CD loaded into its CD-ROM drive.
- Use an external PC running up-to-date anti-virus software to check diskettes or CDs before you use them with the SDC. Use only virus-free diskette or CDs with the SDC. You may install appropriate and approved virus protection software on the SDC if you prefer. To maintain full effectiveness you must keep this type of protection up to date.
- Do not use any diskette or CDs with the SDC if you are unsure whether it is free from viruses.
- **DO NOT** power-on the SDC if you suspect a virus has infected it.

TSS takes every possible precaution to prevent virus infection before shipment. If you suspect your SDC has become virus infected, contact TSS for advice and then arrange to return the SDC to TSS for repair.

The SDC accepts an AC electrical supply in the range 85 to 265V (47 to 63Hz) through a 3-pin IEC power inlet port. The SDC will configure itself automatically to the appropriate electrical supply when you power-on the unit.

### 2.4 SUB-SEA COMPONENTS

The sub-sea installation comprises the following component parts:

- A Sub-sea Electronics Pod (SEP)
- A coil array with six identical sensing coils arranged in two coil triads
- Frame components to mount the coils onto the ROV
- A sub-sea altimeter
- Cables to interconnect the sub-sea components of the 350 System and to connect them to the ROV electrical distribution system.

#### 2.4.1 Sub-sea Electronics Pod

The SEP performs several functions:

- Power supply conditioning for the sub-sea components of the 350 System
- High-speed data acquisition and digital signal processing
- Data acquisition from a sub-sea altimeter connected to the SEP 'Altimeter' port
- Calculation of all target co-ordinates
- Communication with the SDC through the ROV umbilical using whichever communication method you have established for the System.

Non-volatile memory within the SEP stores certain installation-specific parameters that the SEP needs. You may examine and change these configuration parameters remotely from the SDC – refer to Section 6.2 for instructions to configure the System.

EPROM memory devices within the SEP store the software that controls all the SEP functions.

There are two versions of the SEP available that differ only in their electrical supply requirements. A label on the SEP identifies the electrical supply required by the unit:

- The standard SEP operates from a single phase AC electrical supply (45 to 65Hz) in the range 110V to 120V (maximum power demand 3.1A when used in a Dual-track installation). There is a 2A quickblow fuse on the PSU Board inside the SEP. You must provide additional fuse protection for the equipment by fitting a 3.15A quickblow fuse between pin 3 of the Power/Comms cable and the supply live. Refer to sub-section 4.1.3.1 for instructions to connect power to the SEP.
- Optionally, TSS can supply a SEP configured to operate from a single phase AC electrical supply (45 to 65Hz) in the range 220V to 240V (maximum power demand 1.8A when used in a Dualtrack installation). You must include a 2A quickblow fuse in between pin 3 of the Power/Comms cable and the supply live if your System uses a 240V nominal electrical supply.





**CAUTION**

You might damage the SEP if you attempt to operate it from an incorrect electrical supply. Pay careful attention to the requirements of the SEP and provide a supply of the correct rating.

A switched-mode supply inside the SEP generates the conditioned and stabilised DC supplies required by the sub-sea electronics. The input to the switched mode supply includes a line fuse accessible inside the SEP.

The SEP is a sealed unit with six ports:

**On one end-cap:**

- ❑ **Power/comms.**  
This port accepts the AC electrical supply from the ROV. It also carries the communication signals that pass between the sub-sea installation and the SDC.
- ❑ **Altimeter.**  
You may connect the TSS or the Datasonics sub-sea altimeter directly to this port. The port provides DC power to operate these types of altimeter and a signal path for their RS232 communications.
- ❑ **Aux Output.**  
You must use this port to connect the 350 SEP to the 440 System if you intend to use your 350 System in a Dualtrack installation. Refer to Appendix B for a description of the Dualtrack System. If you do not make any electrical connections to the 'Aux Output' port you must leave the blanking plug securely attached to it.
- ❑ **Sensor**  
The 350 System does not use this port. Leave the blanking plug securely attached to the Sensor port.

**On the other end-cap:**

There are two electrically identical connection ports for connection to the two coil triads. **You must connect each coil to its correct port on the SEP.** Refer to sub-section 4.1.4 for instructions to connect the coils.



**CAUTION**

You might damage the SEP if you leave any port exposed to sea water during deployment on the ROV, even if you are not using the 350 System.

You must fit the supplied blanking plugs to any port on the SEP that you will not be using during ROV deployment.

Refer to sub-section 3.2.1 for instructions to install the SEP on the ROV.



Important hardware and software differences exist between the Type 1 and the Type 2 SEP and these units are NOT interchangeable. You may identify the Type 2 SEP described throughout this Manual by the 'AUX OUTPUT' port on one end-cap. The Type 1 SEP does not include this port.

Contact TSS for advice if you wish to upgrade an existing Type 1 System to a Type 2 System so that you may use it within a Dualtrack installation. Refer to Appendix B for a description of the Dualtrack System.

### 2.4.2 Sensing Coils



TSS supplies the coil triads already assembled and ready for you to install on the ROV. Labels identify each triad as either the port or the starboard unit – you must install the coil triads on their correct side of the ROV.

During a cable survey, the signals detected by the coils might fall to extremely low levels (less than 5 $\mu$ V). To improve the overall signal-to-noise ratio received by the SEP, each sensing coil has a low-noise pre-amplifier built into its connector assembly.



---

#### CAUTION

TSS matches the coils and their pre-amplifiers carefully during manufacture. The individual coils have no user-serviceable parts inside. DO NOT open the coils or remove their connector assemblies for any reason.

During the manufacturing process, TSS calibrates each coil carefully with its associated pre-amplifier. The coils require no further calibration after manufacture.

The measurement process of the 350 Cable Survey System relies upon triangulation using the coil separation distance and information derived from the received signals. For this process to work accurately you must install and connect the coils correctly. Refer to sub-section 3.2.2 for important instructions on how to construct the coil triads and mount them on an ROV.

### 2.4.2.1 Sensing Coil Components

Figure 2–5 shows the components of a single coil triad. Note that you will use an additional clamp and bolts to secure the coil triad to the mounting bar – see sub-section 3.2.2.2 for details. Figure 2–5 does not show the additional clamp and bolts.

Figure 2–5: Components of a coil triad

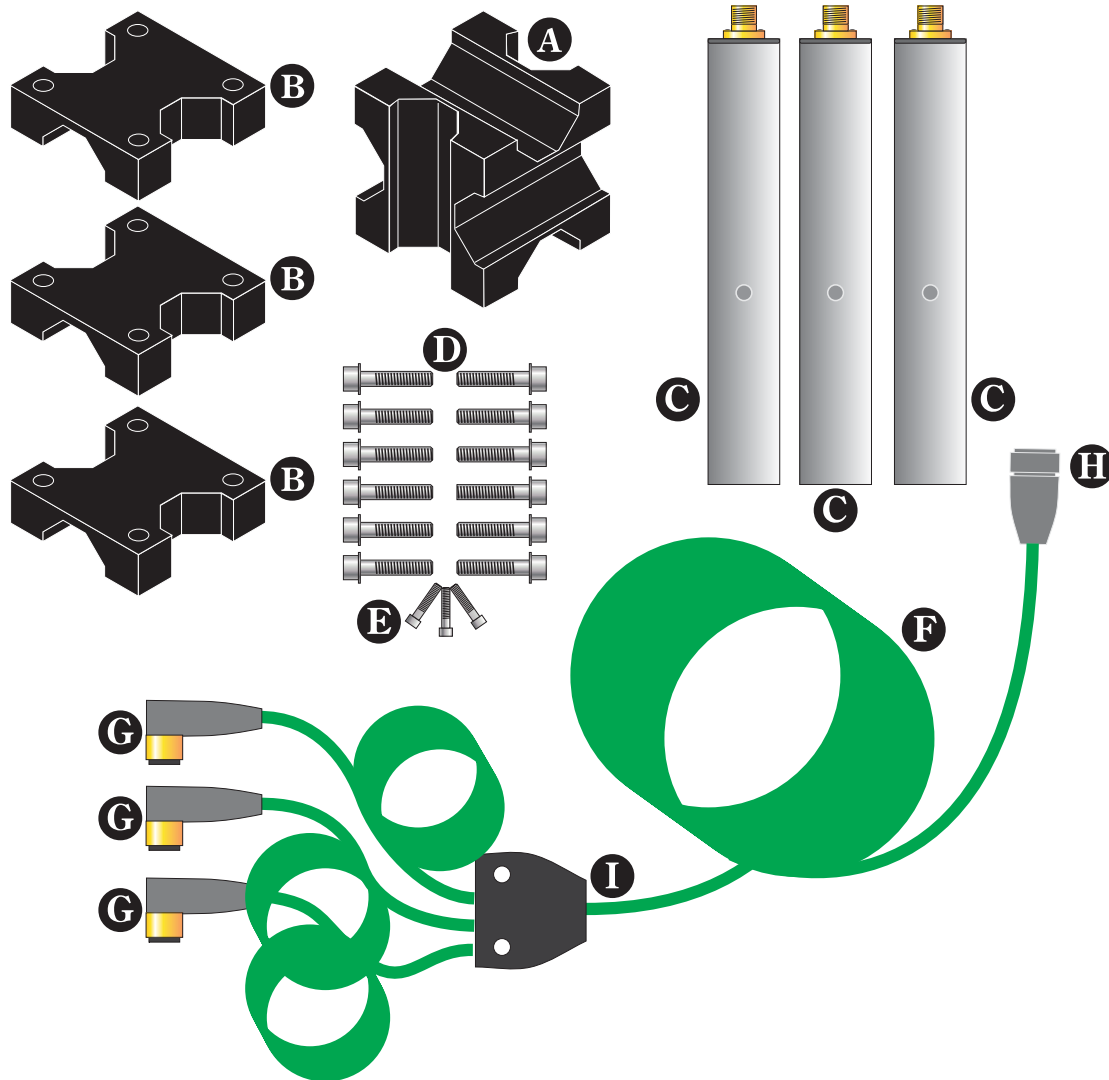

**A B** The coil triad consists of a central alignment support block **A** and three separate clamps **B**, all manufactured from nylon.

**C D E** All sensing coils in the array are nominally identical, with any slight differences compensated by a calibration procedure during manufacture. The windings of the sensing coils **C** are inside sealed cylinders. To maintain the correct relative positions of the coils, each cylinder has a recess machined into its surface that engages with a locating screw **E** in the alignment support block. The clamps **B** and their bolts **D** secure the three coils into the alignment support block. Additional horizontal and vertical grooves machined into the block allow you to mount the assembled coil triad onto the support bar.

**F G H I** The standard connection cable **F** is 4 metres long. Three 8-way connectors **G** terminate the cable and allow connection to the sensing coils. A single 12-way connector **H** allows connection to the SEP. The cable splice is inside a sealed junction **I**, which has mounting holes so that you may attach it to the coil mounting bar.

See Section 3 for full instructions to assemble the coils and mount them onto an ROV.

### 2.4.3 Altimeter

The main function of the 350 System is to locate and survey a target laying on or buried beneath the seabed.

If the 350 System measures the altitude of its coil array above the seabed, then it can also deliver a good estimation of the depth of target cover. A sub-sea altimeter can supply such altitude measurements to the 350 System.



**You should remember that an altimeter measures to a point on the seabed directly beneath its transducer face. This single-point measurement may not be the same as the local mean seabed level.**

**This means that uneven seabed topography might degrade the quality and accuracy of depth of cover measurements derived using a single altimeter.**

**For surveys where you must measure an accurate and certifiable target burial depth, you should use an independent seabed profiling system. Log the measurements from such a system separately and then use the post-processing operation to merge them with data acquired by the 350 System.**

On some types of tracked ROV, you may arrange to keep the coil array of the 350 System at a fixed height above the seabed. In these circumstances, you could avoid the need for an altimeter by configuring the SDC to use a fixed coil height.

The standard 350 System includes a sub-sea altimeter. You will need to install this unit on the ROV frame close to the centre of the coil array. Refer to sub-section 3.2.3 for instructions to install the altimeter on the ROV, and sub-section 4.1.5 for instructions to connect it directly to the SEP.

Refer to Section 6.2.2.1 for instructions to configure the altimeter after installation.

#### 2.4.3.1 Alternative Altimeter Types.

If you cannot connect the TSS or the Datasonics altimeter directly to the SEP for any reason, the SDC can accept serial data from the alternative units listed in sub-section 4.1.5.

If you use an alternative type of altimeter, you must provide a separate power supply to operate it. You must also connect its RS232 signals to an available SDC serial communication port.

Because the RS232 signals from the altimeter are for use over distances of only 15 metres, you must use an existing multiplexed link between the ROV and the surface vessel to carry your altimeter signals to the SDC.

Refer to sub-section 4.1.5.2 for instructions to connect an altimeter to the SDC.

Refer to Section 5 for instructions to configure the altimeter after installation.

### *2.4.4 Remotely Operated Vehicles*

The type and size of ROV you use for a survey will depend on the specific application and on the capabilities of the survey vessel.

You may deploy the 350 System on a wide range of ROVs including:

- Free-flying ROVs of differing size and type
- Tracked ROVs or crawlers
- Trenching ploughs
- Towed sleds

See Section 3 for detailed instructions and recommendations concerning the physical installation of the sub-sea components of the 350 System.

---

## 3 PHYSICAL INSTALLATION

This section of the Manual explains how to install the surface and the sub-sea components of the TSS 350 System.

During the installation procedure, you should make a written record of certain parameters and retain them with the survey log for reference during the post-processing operation. The DeepView display software on the SDC allows you to examine the System parameters and to create a printed copy that you may retain with the survey records.

There are many different types and size of survey vessel and ROV and it would be impossible for this Manual to cover all installation possibilities. The instructions in this section therefore represent a set of general guidelines and recommendations that experience has proved effective.



### IMPORTANT

Note that you cannot regard certain aspects of the 350 installation procedure as optional: The instructions relating to coil location, orientation and mounting configuration are of critical importance to the successful operation of the 350 System. You must follow these instructions.

### 3.1 SDC Installation

Page 2

You may use the SDC while it remains mounted in the shock-protecting transit case, or you may install the SDC in a 19-inch instrument rack. You should install the SDC where you can see and operate it easily.

### 3.2 Sub-sea Installation

Page 3

The success of any survey performed by the 350 System relies heavily on the care you exercise when you install its sub-sea components.

### 3.3 Installation Check List

Page 13

This post-installation checklist helps you to avoid some common errors and omissions when you install the 350 System.

## 3.1 SDC INSTALLATION



### WARNING

You must take precautions to secure the SDC when you store and operate this unit in its transit case.

Protect personnel from the hazard of falling equipment and protect the unit from damage when the survey vessel moves due to the action of waves.

Install cables away from walkways and secure them so they do not present a hazard to personnel.



### CAUTION

To avoid potential damage to the SDC, make certain it has sufficient ventilation to dissipate the heat that it generates during normal operation.

If you mount the SDC in a 19-inch instrument rack you must allow a minimum 30mm clearance between the top of the SDC and any other equipment mounted directly above it in the rack. Also, allow a minimum 100mm space between the SDC rear panel and the rear of the instrument rack to allow for connectors and cable routing

The SDC is a ruggedised IBM-compatible computer supplied by TSS in a shock-protecting transit case. You may operate the SDC in this transit case, or you may install it into a 19-inch shock-protecting instrument rack. TSS does not supply the fixings that you will need to install the SDC in a 19-inch instrument rack.



If you intend to change the communication method used by the 350 System, make the necessary changes to the SDC *before* you install it into the instrument rack. Refer to sub-section 4.2.2 for instructions to change the SDC communication method.



### CAUTION

You might damage the SDC if you allow it to overheat. To operate the SDC inside its transit case, release and remove the front and the rear access panels of the transit case to allow effective ventilation and heat dissipation.

Although the SDC uses solid state electronics, the hard-disk drive and parts of the display panel are susceptible to damage through shock or sustained vibration. You must therefore exercise some care when you select a suitable location for this unit:

- ❑ Install the SDC where you have easy access to the controls. Choose a position for the SDC that allows you to see the screen easily while you operate the ROV.
- ❑ If you do not mount the SDC in an instrument rack, use the original SDC transit case to provide shock protection for the unit. Secure the transit case so that it cannot slide or fall with movements of the vessel.
- ❑ Make certain there is sufficient ventilation space above the SDC to remove the heat that it generates during normal operation. If necessary, use an electric fan to provide additional ventilation.

- Do not subject the SDC to extremes of temperature or humidity, or to severe vibration or electrical noise. Never allow the SDC to become wet.



Obey the environmental limits listed in sub-section 8.1.1 when you store and operate the SDC.

## 3.2 SUB-SEA INSTALLATION

The care that you take when you install the sub-sea components of the 350 System will have a significant influence on the accuracy of survey data. Read the following instructions carefully and ensure that you have all the necessary parts and tools available before you attempt to install the System.

The following instructions apply only to the standard components of the sub-sea installation.

### 3.2.1 SEP

The sub-sea electronics pod has a hard anodised aluminium housing to ensure its specified depth rating. Do not open the SEP during the installation procedure unless you need to change the communication method used by the System. Sub-section 4.2.2.1 explains how to change the communication method.



If you need to open the SEP to set a different communication method, do this *before* you install the SEP on board the ROV. To preserve the seals, always follow the instructions to disassemble and reassemble the SEP housing carefully. You will find these instructions in sub-section 9.2.2.

There is a nylon mounting block attached to the SEP. This block provides a safe and secure method to mount the housing to the ROV frame.



#### CAUTION

You might damage the anodised surface of the SEP housing if you attempt to secure it to the ROV without using the proper mounting block. Corrosion will occur rapidly if you damage the protective anodising of the SEP housing.

Do not remove the mounting block from the SEP housing. Do not attempt to secure the SEP housing directly to the ROV framework without using the mounting block

The mounting block has machined slots that allow you to strap the complete housing and block assembly firmly to the ROV frame. Stainless steel strapping is ideal for this purpose. See Figure 3–1 below for details.

It is safe to mount the SEP in any orientation.



Mount the SEP housing according to the following guidelines:

- ❑ Eliminate any possibility of snagging or damage to the SEP housing by installing it inside the outer limits of the ROV frame.
- ❑ Locate the SEP housing so that you may install the cables easily between the sub-assemblies of the 350 System.
- ❑ Do not apply sharp bends or other mechanical stresses to the cables during installation or operation. Route the cables between the components of the sub-sea installation, and use plastic clips to secure them to the ROV frame.
- ❑ On small ROVs, position the SEP close to the centre of buoyancy to avoid upsetting the ROV trim.
- ❑ Tighten the mounting straps firmly so that the SEP housing cannot move under the influence of ROV vibration or currents in the water.
- ❑ Refer to sub-section 4.1 for instructions to make the electrical connections between the sub-sea components.

Figure 3-1: SEP mounting arrangement

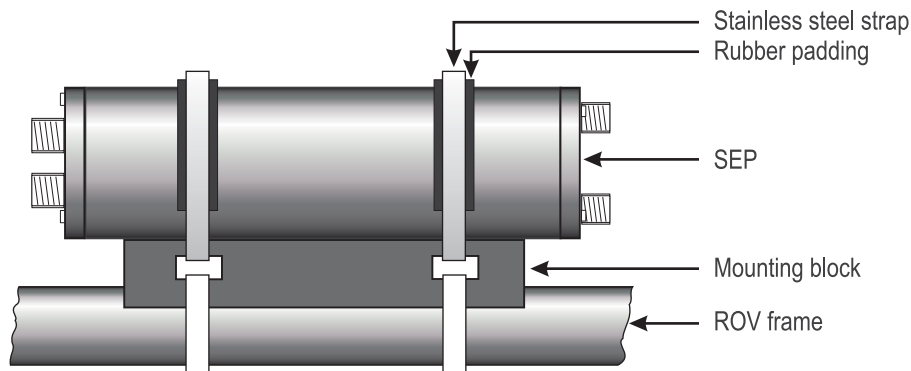

### 3.2.2 Sensing Coils

Each sensing coil in the array detects the alternating magnetic fields associated with the tone current in the cable, and supplies an output voltage to the SEP proportional in amplitude to the received magnetic field strength. Because the output voltage is derived from the tone on the cable, it is at the same frequency. Circuitry within each sensing coil applies signal conditioning and pre-amplification.



#### **CAUTION**

The waterproof characteristics of the coils might degrade if you open them.

The pre-amplifier boards contain no user-serviceable parts. To avoid degrading the depth rating of the sensing coils, do not remove their end-caps.

All vertical range measurements to the target position are relative to the coil reference line. This line, shown in Figure 3–2, joins the centres of the port and the starboard lateral coils.

Measurements of lateral offset are relative to the centre of the coil array and are positive if the target is to starboard and negative if it is to port.

Figure 3–2: The coil array reference line

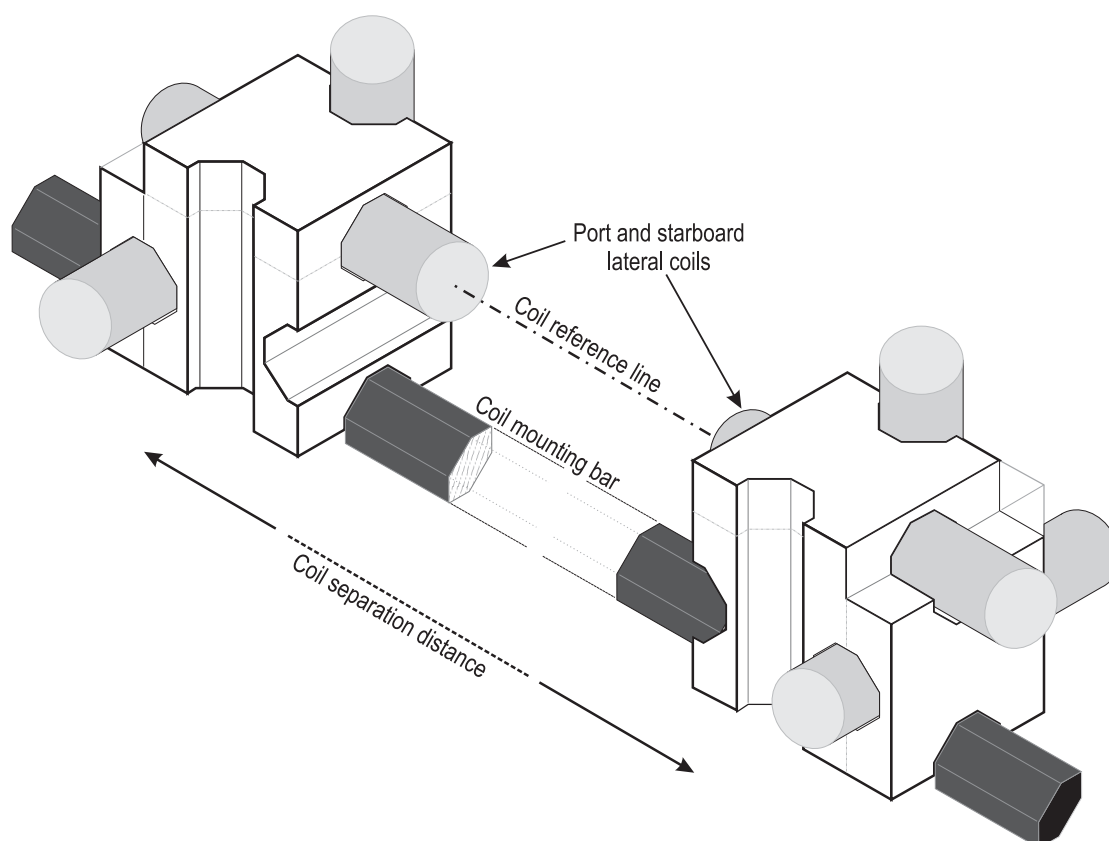

### 3.2.2.1 Assembling the Coils

TSS dispatches the 350 System with both coil triads already assembled.



Labels identify the port and starboard coil triads and indicate their correct mounting orientation. The coil triads are NOT interchangeable. You MUST install them on the ROV in their proper orientation. This installation detail is critical to the correct operation of the 350 System.

There are two numbers stamped onto the brass end cap of each sensing coil. These numbers are the four-digit serial number and the five-digit calibration constant. Record these numbers for use during the System configuration procedure described in sub-section 6.2.2. Appendix F includes a suitable form to record these important details.

You will need to refer to the following coil re-assembly instructions only if you have disassembled a coil triad – for example to fit a new a sensing coil.

If the coil assemblies are both complete as supplied by TSS, mount them on the ROV as instructed in sub-section 3.2.2.2.

To re-construct the coils after you have disassembled them you will need:

- ❑ An area of clear deck space at the front of the ROV
- ❑ A 3mm hexagonal key
- ❑ A 6mm hexagonal key



When you reassemble a coil triad, you MUST follow these instructions carefully. You cannot expect the 350 System to deliver accurate survey measurements unless you re-construct the coil triads correctly.

Figure 3-3: Construction of the starboard coil triad

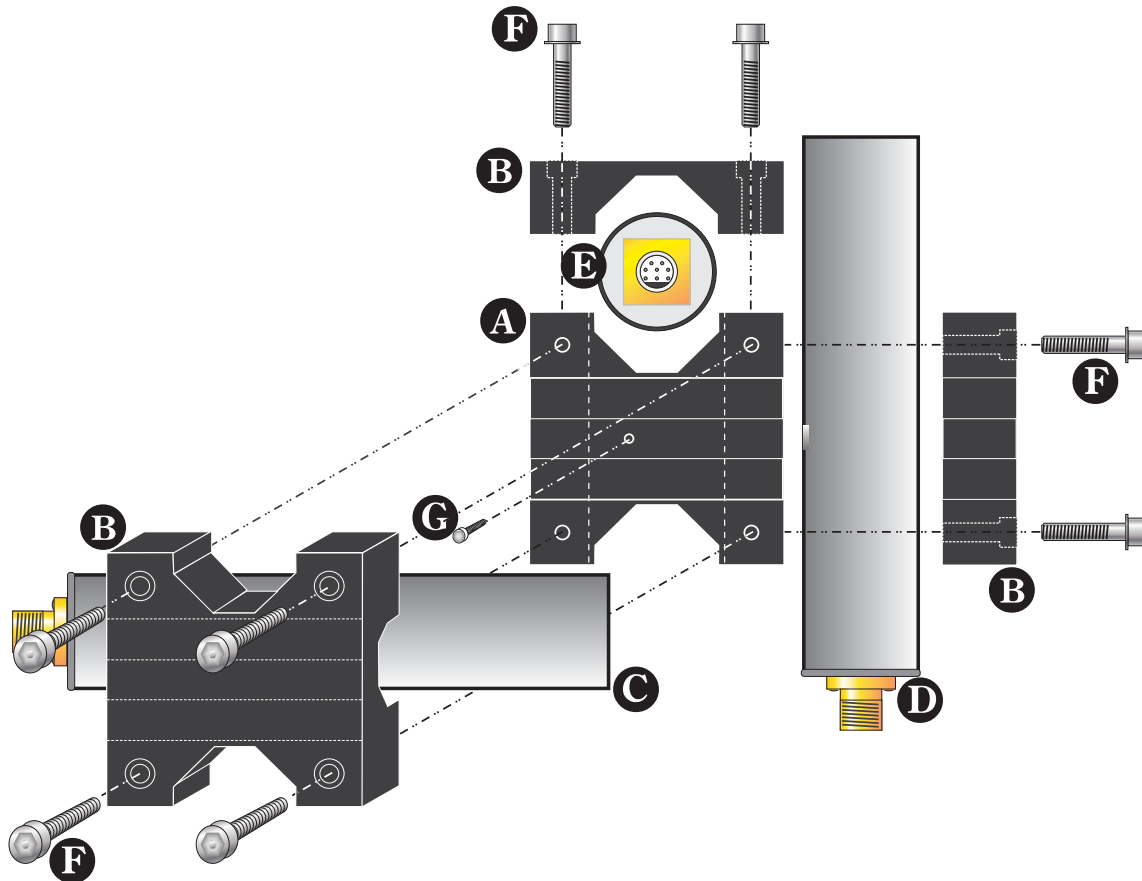

The following instructions describe the construction of the *starboard* coil triad (the port coil triad is a mirror image of this). Refer to Figure 3-3.

1. Place the centre support block **A** on a clear, flat deck-space. Turn the block so that there is a groove running left-to-right on the top face as shown in Figure 3-3.

**Fit the lateral coil first:**

2. Insert an M5 x 12mm screw **G** into the hole near the centre of the top groove. Use a 3mm hexagonal key to tighten the screw lightly.
3. Turn the lateral coil **C** so that the 8-way connector is towards the left-hand side of the centre block as shown. Place the coil into the groove so that the head of the M5 screw engages with the recess in the coil body.
4. Place a clamping block **B** against the coil and insert four M8 x 50mm bolts **F**. Use a 6mm hexagonal key to tighten the bolts evenly until the block supports the coil properly. **Do not over tighten these bolts.**

**Fit the fore-aft coil:**

5. Insert an M5 x 12mm screw into the right-hand groove of the centre block. Use a 3mm hexagonal key to tighten the screw lightly.

6. Turn the fore-aft coil **D** so that it is to the right-hand side of the centre block with its 8-way connector pointing towards you as shown in Figure 3–3. Fit the coil to the groove so that the head of the M5 screw engages with the recess in the coil body. If necessary, tilt the assembly to the left to prevent the coil falling from the groove.
7. Place a clamping block **B** against the coil and insert four M8 × 50mm bolts. Use a 6mm hexagonal key to tighten the bolts evenly until the block supports the coil properly. **Do not over tighten these bolts.**

**Fit the vertical coil:**

---

8. Insert an M5 × 12mm screw into the vertical support groove that is farthest from you and use a 3mm hexagonal key to tighten the screw lightly.
9. Turn the vertical coil **B** so that the 8-way connector is at the top. Fit the coil to the groove so that the head of the M5 screw engages with the recess in the coil body. If necessary, tilt the assembly forward slightly to prevent the coil falling from the groove.
10. Place a clamping block **B** against the coil and insert four M8 × 50mm bolts. Use a 6mm hexagonal key to tighten the bolts evenly until the block supports the coil properly. **Do not over tighten these bolts.**

This completes construction of the starboard coil triad.

Assemble the port coil triad in the same order. Note that the port coil triad is a mirror image of the starboard:

- ❑ The lateral coil must be oriented and assembled with its 8-way connector pointing to the right.
- ❑ The fore-aft coil must be located in the left-hand side of the centre block during assembly, with its 8-way connector pointing towards you.

### 3.2.2.2 Mounting the Coils

Figure 3-4: Coil mounting components

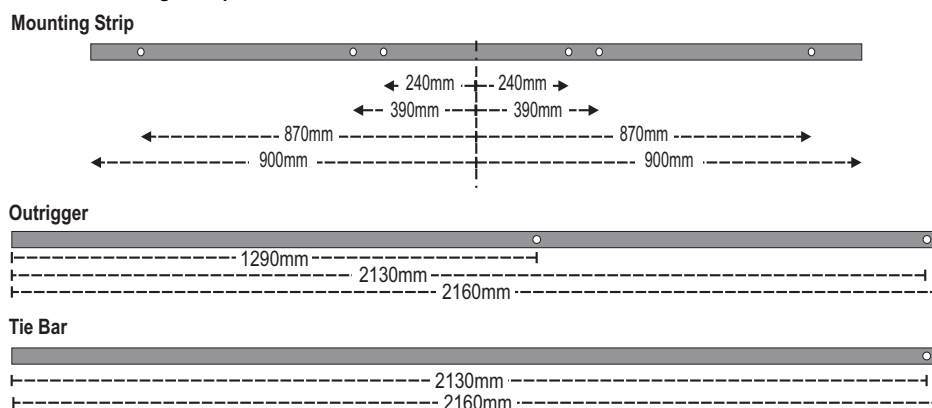

#### WARNING

The coil triads are heavy. To avoid personal injury, always use help when you lift or move the assembled coil array.



#### CAUTION

*If you mount the 350 System on the same ROV as a TSS 440 Pipe and Cable Survey System.*

With drive current applied to the search-coils of the 440 System, large induced voltages can appear across the sensing coils of the 350 System.

Later versions of the 350 sensing coils included diode protection to avoid damage to the coil preamplifiers. Refer to Appendix B.2 for details.



The accuracy of measurements made by the 350 System might degrade if any of the following affect the characteristics of the electromagnetic field radiated from the target:

- The proximity of any material that is more conductive than the seawater. This includes a metal or carbon-fibre ROV frame.
- The proximity of any large magnet such as that of an actuator.
- The presence of any conductive material between the coil triads that electrically shortens the coil separation distance.

It is not possible to predict how the measurements will degrade when any of these effects is present. To help avoid these effects, mount the coil triads at least 0.5 metres from the ROV body.

The sensing coil triads are heavy. Ensure the mounting arrangements provide a rigid and sturdy support to prevent the array moving or vibrating independently of the ROV.

Mount the coils on the front of the ROV at a height that protects them from collision damage without degrading their vertical detection range. Typically, they will be

approximately one metre above the lowest point on the ROV. Allow a minimum distance of 0.5 metres between the coil triads and the ROV body.

Figure 3–4 shows the coil mounting kit with the following items:

- A mounting bar 2.0 metres long with a cross-section 72 x 70mm.

There are flat surfaces machined into the bar. These extend for a distance of 500mm from both ends so that, in these areas, the bar has an octagonal cross-section.

The bar has a receptacle groove 170mm long machined at the centre of one face. Make certain this receptacle is at the bottom when you install the bar onto the ROV. The receptacle is there to accept a small TSS altimeter if the System includes one.

- Two clamping blocks identical to those used in the coil assembly (item **B** in Figure 3–3).
- Eight M8 x 50mm A4 stainless steel bolts. These are identical to items **F** in Figure 3–3.

#### **Coil mounting method:**

---

Note that when properly mounted both coil triads have:

- Their vertical coils towards the front of the ROV, with their connectors at the top.
  - Their fore-aft coils farthest from the ROV centre-line with their connectors pointing towards the rear.
  - Their lateral coils in the top groove of the centre block, with their connectors pointing inboard.
1. Use stainless steel U-bolts to attach the mounting bar to the front of the ROV. Adjust the mounting bar until it is level and centred relative to the ROV. Tighten the U-bolts firmly to stop the bar moving or vibrating during survey operations.
  2. Fit the port coil triad to the port end of the mounting bar where the machined flats give the bar an octagonal cross section. Locate the coil assembly so that the mounting bar engages in the lateral groove at the bottom of the centre support block. **The coil triad will be a very tight fit against the mounting bar and might be difficult to install.** There are arrows on the coil identification label to show the forward direction of the coil triad.
  3. Use a clamping block to secure the bottom of the port coil triad to the mounting bar. Use a 6mm hexagonal key to tighten the four M8 bolts *lightly*. Do not tighten these bolts fully until you have installed the complete coil array and you have set the coil separation distance.
  4. Follow the same procedure explained in paragraphs 2 and 3 above and fit the starboard coil triad to the starboard end of the mounting bar.
-

5. The design of the mounting bar allows you to adjust the distance between the coil triads anywhere from approximately 1 metre to nearly 2 metres while maintaining their correct alignment.

Slide the two coil triads on the mounting bar until they are at the correct separation distance (between 1m and 1.76m). Make certain the coils are equally spaced about the ROV centre line. Tighten all the securing bolts of both clamping blocks evenly. **Do not over tighten these bolts.**



The coil identification labels have reference marks to simplify measurement of the coil separation distance. Measure and record the distance between the reference marks so that you may configure the DeepView with this important information.

Also, record the serial numbers and calibration constants for each of the six sensing coils. You will find these numbers stamped on the brass end caps of the individual sensing coils.

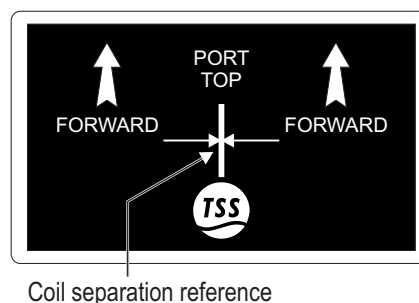

Refer to sub-section 4.1.4 for instructions to complete the electrical installation of the coil triads.

Appendix C includes an example of a form that you may use to record the coil separation distance, the coil serial numbers and their calibration constants. **This is important information that you must use to configure the 350 System correctly.**

### 3.2.3 Altimeter Installation

When you use an altimeter with the 350 System, install it according to the following guidelines:

- ❑ Install the altimeter as close as possible to the centre of the coil array.
- ❑ Make certain the altimeter has a clear vertical view to the seabed across its entire beam width.
- ❑ When you select a position for the altimeter, make allowance for its *minimum* measurement range capability.
- ❑ Measure and record any vertical offset between the transducer face of the altimeter and the reference line of the coil array (as defined in Figure 3–2). You will use this information to configure the display software.
- ❑ Use stainless steel clips to secure the altimeter to the ROV frame so that it does not move or vibrate independently.
- ❑ Do not install the altimeter at the opposite end of the ROV to the coils. If you do not follow this advice, there is a possibility that the survey data will contain errors caused by pitch of the ROV or uneven seabed topography. See the explanation below for details.



Errors can arise in the measurement of depth of cover caused by horizontal offset between the altimeter and the centre of the coil array. In the example shown in Figure 3–5 there are altimeters located at ‘A’ and ‘B’. Because of the seabed topography beneath the ROV, both altimeters supply totally different measurements of altitude. Note that, although the measurements of target position supplied by the 350 System remain accurate, errors in depth of cover measurements will vary according to the altimeter position and the seabed topography.

Figure 3–5: Effects of altimeter horizontal offset

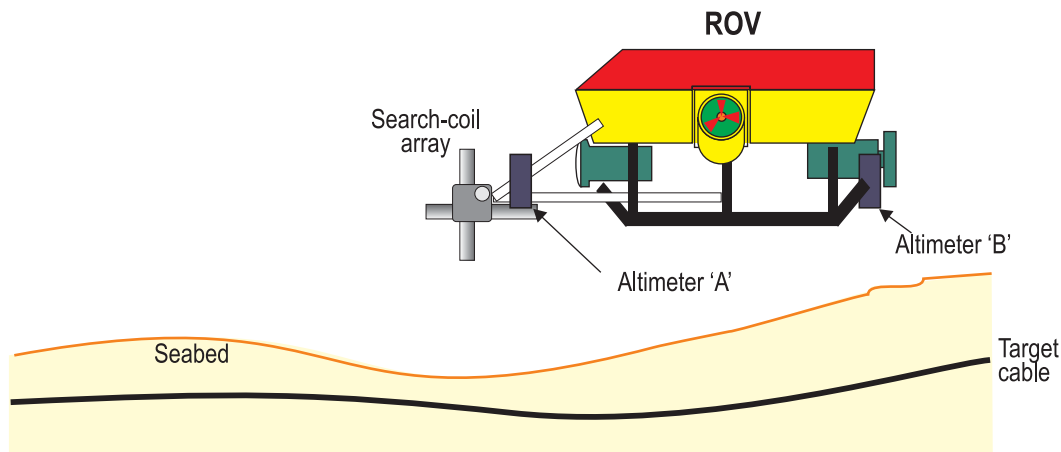

The SDC display software cannot compensate for any horizontal offset that exists between the altimeter and the centre of the coil array. You should install the altimeter near the centre of the coil array in both the lateral and the fore-aft directions.



### IMPORTANT

The altimeter provides information that is *valid only* for a point immediately beneath its transducer face. When you survey over uneven seabed, TSS strongly recommends that you use a scanning profiling system to determine the accurate seabed level.

With the altimeter mounted correctly, the 350 System will provide additional information and features:

- It will supply accurate depth of cover measurements with the target centred under the coils.
- It will be able to operate in the ‘Forward Search’ mode. In this mode, the System can estimate the range to a target that lies along an intersecting course ahead of the ROV. See Section 6 for relevant details of the SDC display software, and refer to Appendix A for a detailed description of the principle of forward range measurement.

---

### 3.3 INSTALLATION CHECK LIST

- ❑ Follow all the installation instructions in this Manual carefully.
- ❑ Mount the coil triads in the correct orientation and in the correct place on board the ROV. Ensure the coil array is central on the ROV.
- ❑ Protect the coil array from collision damage by mounting it approximately one metre above the lowest point on the ROV.
- ❑ Make certain there is at least 0.5 metres clearance between the coils and the ROV body.
- ❑ Do not allow any free movement in the coil triads, the SEP, the altimeter or the cables.
- ❑ Always use the nylon mounting block when you install the SEP.
- ❑ When you select a location to install the altimeter, consider its minimum range measurement specification.
- ❑ Avoid installing your altimeter where there is a significant horizontal offset distance between it and the coil array. Make certain there is less than 1.0 metres vertical offset between the altimeter and the coil array.
- ❑ Record all installation-specific configuration details in the Survey Log.



### 4 ELECTRICAL INSTALLATION

This section of the Manual explains how to connect the SDC and the sub-sea components of the standard 350 System. You should attempt the electrical installation only after you have followed the instructions in Section 3 to install the sub-assemblies of the 350 System.

Also included in this section are detailed instructions that tell you how to change the communication method used between the SDC and the SEP.



The standard 350 System uses 2-wire current-loop communications. To select an alternative communication method you must change the settings of links inside the SEP and the external switch on the SDC Converter Card.

If you need to change the communication method you *must* make the necessary link adjustments inside the SEP *before* you mount it onto the ROV.

#### 4.1 Sub-sea Components

Page 2

To gain the best performance from the 350 System, you must interconnect the sub-sea components of the System properly. This sub-section explains how to do this.

*Refer to Appendix B for instructions to connect the System as part of a Dualtrack installation.*

#### 4.2 Surface Display Computer

Page 11

The SDC includes the DeepView for Windows™ graphical display and logging software that allows you to configure and control the 350 System.

This sub-section explains the mandatory and optional connections to the SDC. It also explains how to change the communication method between the surface and the sub-sea components of the 350 System.

## 4.1 SUB-SEA COMPONENTS



### WARNING

There is a risk of death or serious injury by electric shock when you work on the electrical distribution system of the ROV. Only a competent engineer who has the relevant training and experience must make any connections to the ROV electrical distribution system.

Power-off the ROV and isolate the mains electrical supply before you connect the 350 System to the electrical distribution system. Observe all relevant local and national safety regulations while you work on the ROV and on the 350 System.

Do not reconnect the mains electrical supply to the ROV or to the 350 System until you have completed all work and you have fitted all safety covers and ground connections.

This sub-section explains how to complete the electrical installation of the sub-sea components.

Figure 4-1: System interconnection diagram

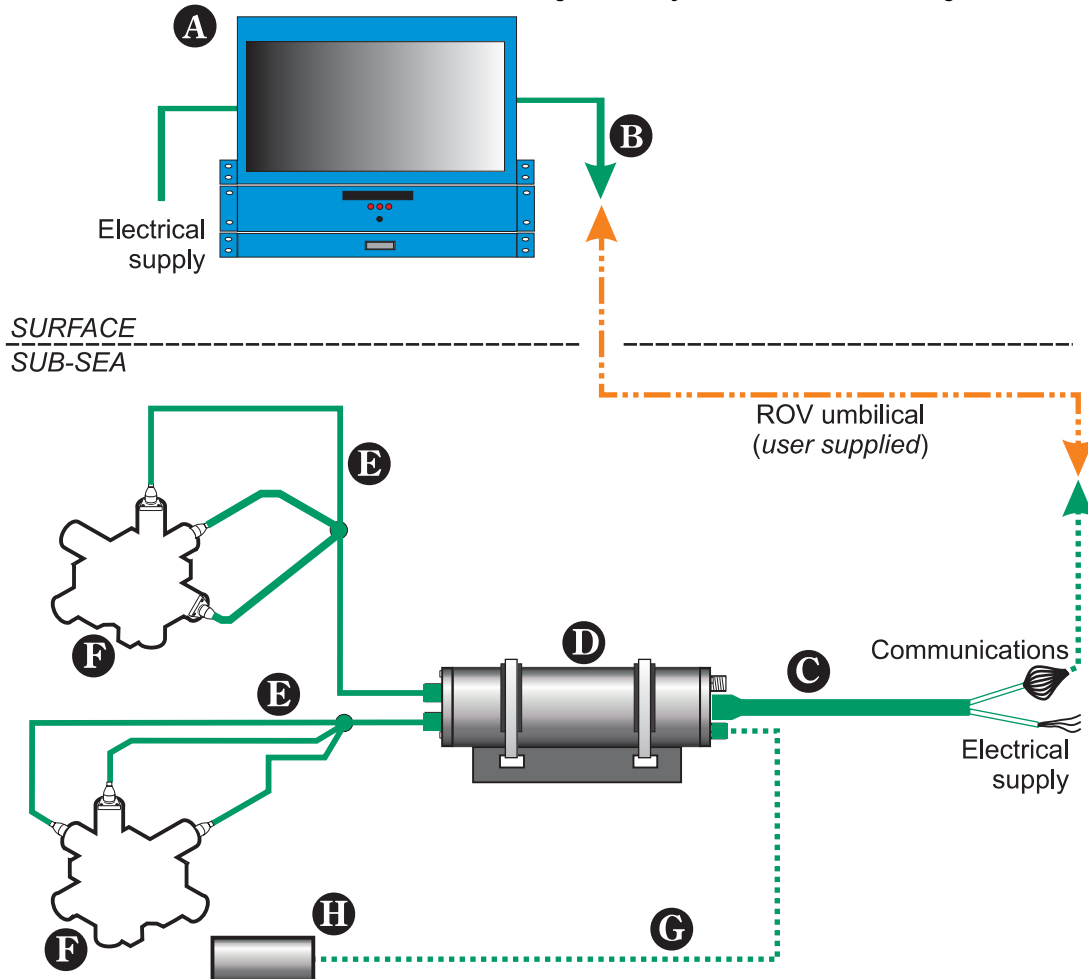

- A** The SDC accepts an AC electrical supply in the range 85 to 265V (47 to 63Hz). The power demand is approximately 250VA.
- B** Data communications from the SDC to the ROV umbilical. These can be 2-wire or 4-wire 20mA digital current loop, or RS232. The default configuration is RS232.
- C** Power and communications cable (or 'ROV Tail') from the ROV to the SEP. This cable has cores to carry the communication signals that pass between the SEP and the SDC, and power cores for connection to the ROV electrical distribution system. Refer to Table 4-1 for details of the cable.  
The maximum current drawn from the supply is approximately 3.1A (at 110V to 120V AC) when the SEP is installed within a TSS Dualtrack System. When operating as a stand-alone 350 System, the SEP draws approximately 0.3A from a 110V to 120V AC supply.
- D** All sub-sea connections are to sealed ports on the SEP. You must fit a proper blanking plug to any port that does not have a connector before you deploy the System underwater.
- E** The coil connection cables each have a single 12-way connector for connection to the SEP, and three 8-way right-angled connectors for connection to the detection coils. You must connect the three short branches of the cables to the correct coils in each triad as identified by their attached labels 'vertical', 'lateral' and 'fore-aft'.
- F** There are three identical detection coils in each triad. Note the serial number and calibration code on each coil to check that the SDC software includes the correct details.
- G** Figure 4-1 shows the altimeter cable connecting directly to the SEP. You may connect the RS232 signals from the altimeter to the ROV multiplexer and pass them independently through the umbilical to the surface vessel. If you use this method, extract the signal from the demultiplexer and apply them to the COM2 serial port on the SDC.
- H** You may connect the TSS or Datasonics altimeter types directly to the SEP at the 'Altimeter' port as shown. You may use other types of altimeter with the System if you prefer.

### 4.1.1 Ground Connections



#### CAUTION

To prevent severe corrosion of the sub-sea components, you *must* make adequate grounding provisions for them. If corrosion occurs throughout the System, performance will degrade and eventual catastrophic failure will occur.

You must provide a good ground connection at sea water potential on pin number 2 of the 8-way 'Power/Comms' port of the SEP. Use good waterproof connectors or splices to make the connection.

If you provide the 350 System with an inadequate ground connection, parts of the System will act as 'sacrificial anodes' and will slowly decay during sub-sea operations. This will occur whether or not you use the 350 System.

To prevent corrosion affecting the System in this way, you must connect pin 2 of the 8-way SEP 'Power/Comms' port locally to the ROV using a ground connection at sea water potential.



#### **IMPORTANT**

To ground the SEP use only a local grounding point on the ROV frame. Do not use a core within the umbilical to ground the 350 System because there will inevitably be a potential difference between the ROV and the surface vessel.

These grounding provisions hold the 350 System at the same electrical potential as the sea water. This prevents the occurrence of electrochemical action between the System and the sea water and minimises galvanic corrosion.

### 4.1.2 Care of Sub-sea Connectors

To ensure reliable operation and to extend the life of the sub-sea installation, take the following precautions to care for the sub-sea connectors used throughout the 350 System:

1. Keep both the connector and socket free from debris and salt build up.
2. Use soap and clean fresh water to wash the connectors, and then rinse them with isopropyl alcohol (IPA). Allow the connectors to dry thoroughly in air before you reassemble them.

Lubricate the mating face of the connectors with a very light spray of **3M Silicone Oil** or **Dow Corning #111** valve lubricant or equivalent. **Do not use grease.**



#### CAUTION

Some silicone lubricants will crystallise when you subject them to sea water under pressure. When this happens, the seals of the connector will degrade and allow water to penetrate.

To avoid damage to the connectors, use only the lubricant oils mentioned above, or equivalent oils that the manufacturer approves specifically for use on deep-sea connectors and seals. When you apply the lubricant oil, use a very thin coating only.

### 4.1.3 Sub-sea Electronics Pod

The SEP performs all the following functions:

- ❑ Supplying power for the sub-sea installation
- ❑ Signal processing
- ❑ Calculating the target co-ordinates
- ❑ Communicating with a sub-sea altimeter connected directly to the SEP
- ❑ Communicating with the SDC through the ROV umbilical
- ❑ Interfacing with the TSS 440 Pipe and Cable Survey Systems (when you use the 350 System within a Dualtrack installation).

The SEP has six ports that allow connection to the various sub-sea components of the installation.

#### **On one end cap:**

- ❑ Port coil triad connection
- ❑ Starboard coil triad connection

### On the other end cap:

---

- ❑ Power input and communications link
- ❑ Altimeter connection
- ❑ Connection for a TSS attitude sensor. *The current version of 350 software does not support this facility. DO NOT remove the blanking plug from this port.*
- ❑ Auxiliary input connection (for use when you use the 350 System in a Dualtrack installation). *Refer to Appendix B for appropriate instructions.*



#### CAUTION

Water could enter the SEP through any port that does not have a connector fitted. To avoid damage from water ingress, you must fit the correct blanking plug supplied by TSS to protect any unused port on the SEP.

Before you assemble any electrical couplings in the sub-sea installation, inspect the pins and receptacles of all connectors for signs of damage, contamination or corrosion. Follow the instructions in sub-section 4.1.2 to clean and care for the connectors.

Tighten the connector locking collars by hand only – **do not over tighten these connectors.**

#### 4.1.3.1 Power Requirement

The standard SEP requires an AC electrical supply in the range 110V to 120V (45 to 65Hz) to operate. The maximum current drawn from the supply is 0.3A for a stand-alone 350 System, or 3.1A if the System is part of a TSS Dualtrack installation.

Optionally, you may request an SEP that operates from an AC electrical supply in the range 220V to 240V (45 to 65Hz). This type of SEP draws a maximum supply current of 0.1A for a stand-alone 350 System or 1.8A when the System is part of a TSS Dualtrack installation. Contact TSS if you require a 350 System that operates from the nominal 240V electrical supply.



#### WARNING

Protection provided by the equipment might be impaired if you attempt to operate it from an incorrect supply voltage. Operate the SEP only from an electrical supply of the correct rating.



#### WARNING

The supply connector is a safety feature that allows the System to be isolated easily from the electrical supply. Hand tighten the power connection only. Position the connector to allow easy access for disconnection.

The SEP 'Power/Comms' port accepts the AC electrical supply from the ROV and passes the bi-directional communications between the SEP and the SDC. All electrical and communication connections to the SEP are through the Power and Communications cable, or 'ROV tail'. Table 4–1 lists the pins of the connector on the Power and Communications cable, together with the relevant core colours. Refer to this



table as you make the connection to the ROV electrical distribution system. All cores in the cable are 1.34mm<sup>2</sup> cross-section.

Table 4-1: Power and Communications cable

Connector Pin Number (and Wire number)	Function	Core colours
1 (N)	Supply neutral line/L2	Blue
2 (E)	ROV ground (refer to sub-section 4.1.1)	Green/Yellow
3 (L)	Supply 110V live/L1	Brown
Pin 4 (wire number 1)	Comms 1	Orange
Pin 5 (wire number 2)	Comms 2	White
Pin 6 (wire number 3)	Comms 3	Red
Pin 7 (wire number 4)	Comms 4	Yellow
Pin 8 (no connection)	Spare – Linked internally to the cable screen	–
(wire identity S)	Link this wire to the cable screen	Green

\*Refer to sub-section 4.2.2 for details of the communication connections.

Lay the Power and Communications cable from the ROV electrical distribution system to the SEP. Route the cable along fixed ROV frame members and use cable clips to secure it at regular intervals. Avoid applying any sharp bends or other points of mechanical stress along the cable.



Follow the important advice listed in sub-section 4.1.2 concerning the care of connectors.

Connect the Power and Communications cable to the 8-way male ‘Power/Comms’ port on the SEP. Tighten the knurled locking collar by hand only. **Do not over tighten this connector.**



### CAUTION

It is very important to provide a good ground connection on pin number 2 of the cable. A poor or a missing connection will severely degrade the performance of the 350 System.

You must make all connections to the ROV using waterproof connectors or splices of good quality.

### 4.1.4 Sensing Coils

Each coil triad includes three identical but electrically independent sensing coils aligned mutually at right angles and supported in a purpose-designed mounting block. You *must* connect these coils correctly to their respective channels on the SEP.

TSS supplies two cables that you must use to connect the coils to the SEP. Each cable has a sealed junction block and three short tails terminated with 8-way right-angled connectors that attach to the coils. Labels identify the three tails and help you to connect them to the appropriate sensing coil. The cables are identical and interchangeable.

Each coil cable has a sealed junction block where the three short tails connect to the main branch of the cable. This block has holes that you should use to attach the block to the coil mounting bar on the ROV.

There are two 12-way ports on the SEP that accept the connectors of the coil cables. A label on the SEP end cap identifies the port and starboard couplings for the coils.



**You must connect the lateral, vertical and fore-aft sensing coils to their correct 8-way connectors on the cable tails. Labels identify the cable tails to help you do this.**

**The 350 System cannot measure the position of the target if you connect the coils incorrectly.**

Signal levels detected by the sensing coils may be extremely low (less than 5µV). You must therefore take care to establish good cable connections when you install the System. Follow the instructions and recommendations concerning the care of sub-sea connectors in sub-section 4.1.2. Tighten all locking collars by hand – **do not over tighten these connectors.**



**Route the cables from the coils to the SEP by securing them along the ROV body using cable clips. Avoid introducing any sharp bends or other points of stress, and ensure that the cables are safe from potential damage from manipulators, thrusters or other equipment on the ROV.**

### 4.1.5 Sub-sea Altimeter

#### CAUTION



**If you do not use the Altimeter port on the SEP, you must fit the correct blanking plug supplied with the System to protect it from contact with sea water. The correct blanking plug is TSS P/N 202208.**

**If you do not fit this blanking plug, rapid corrosion of the port will occur and the port will fail. Sea water will enter the SEP through the corroded port to cause total failure of the SEP.**

#### CAUTION



**The 6-way SEP ports for connecting the altimeter and the attitude sensor are identical. To avoid possible damage and to ensure correct operation, connect the altimeter *only* to the 'Altimeter' port identified by a label on the SEP end cap. This version of the 350 System does not use the 'Sensor' port and you must ensure there is a correct blanking plug fitted to it during sub-sea operations.**

Choose one of the two available methods that you may use to connect the altimeter:

1. Direct connection to the SEP. Refer to sub-section 4.1.5.1.

The SEP provides a DC power supply to drive the Datasonics altimeter if you connect it to the 'Altimeter' port on the SEP.

2. Connection through the umbilical to the SDC. Refer to sub-section 4.1.5.2.

Available for use with all types of altimeter compatible with the 350 System.

These altimeters use RS232 communications. To send their signals through the umbilical, you must add them to the ROV multiplex unit and extract them at the surface. You must also provide a separate power supply for the altimeter.

Generally, these types of altimeter have different data formats. Refer to sub-section 7.3.3 for details of these formats.

### 4.1.5.1 Direct connection to the SEP

Route the cable from the Datasonics altimeter to the SEP. Secure the cable at regular intervals along fixed frame members of the ROV. Avoid introducing any sharp bends or other points of mechanical stress along the cable.



Follow the important advice listed in sub-section 4.1.2 concerning the care of connectors.

Connect the cable to the 6-way 'Altimeter' port of the SEP. Tighten the knurled locking collar by hand only. **Do not over tighten this connector.**

Use the SDC display software to configure the 350 System for use with the Datasonics altimeter connected to the SEP. Refer to Section 6 for appropriate instructions.

### 4.1.5.2 Connection to the SDC

Make the following provisions if you intend to use one of the compatible alternative altimeters with the 350 System:

- Connect the altimeter to an available SDC serial port. Note that, because the altimeters use RS232 communications, they cannot transmit their signals farther than approximately 15 metres. Therefore, you must add the altimeter signals to the ROV multiplexer and then extract them at the surface. You must then convert the signals to RS232 for application to the SDC.
- Provide a separate power supply to drive the altimeter.

Refer to the manual supplied by the altimeter manufacturer for relevant connection details.

Connect the RS232 altimeter signals to the SDC through the 9-way D-type female serial port. The pin designations for this port are as follows:

Table 4-2: RS232 connection to COM2

Altimeter signal	SDC COM2 pin connection
RS232 data from altimeter	Pin 2 (receive)
RS232 data to altimeter	Pin 3 (transmit). <i>Necessary for use only with the OSEL Bathymetric System, where communications must be bi-directional.</i>
RS232 common	Pin 5 (ground)

## 4.1.6 Roll/Pitch Sensor



### CAUTION

Water could enter the SEP through any port that does not have a connector fitted.

The current version of the 350 System cannot use information from an attitude sensor. Therefore, you *must* fit the correct blanking plug supplied by TSS to the 'Sensor' port on the SEP. The correct blanking plug is TSS P/N 202208.

If you do not fit this blanking plug, rapid corrosion of the port will occur and the port will fail. Sea water will enter the SEP through the corroded port to cause total failure of the SEP.

The Roll/Pitch Sensor option is not yet available for use with the 350 System. Do not make any connection to the SEP 'Sensor' port. Leave the blanking plug fitted to this port.

### 4.2 SURFACE DISPLAY COMPUTER

Refer to sub-section 2.3 for a description of the SDC and Section 9 for a minimum specification.

The following sub-sections 4.2.2 to 4.2.4 explain the various connections that you may make to the SDC.



#### CAUTION

You must route all cables to the SDC through the rear of the transit case. You must open and remove the rear panel of the case to allow this.

Figure 4-2: SDC Rear panel with key to ports

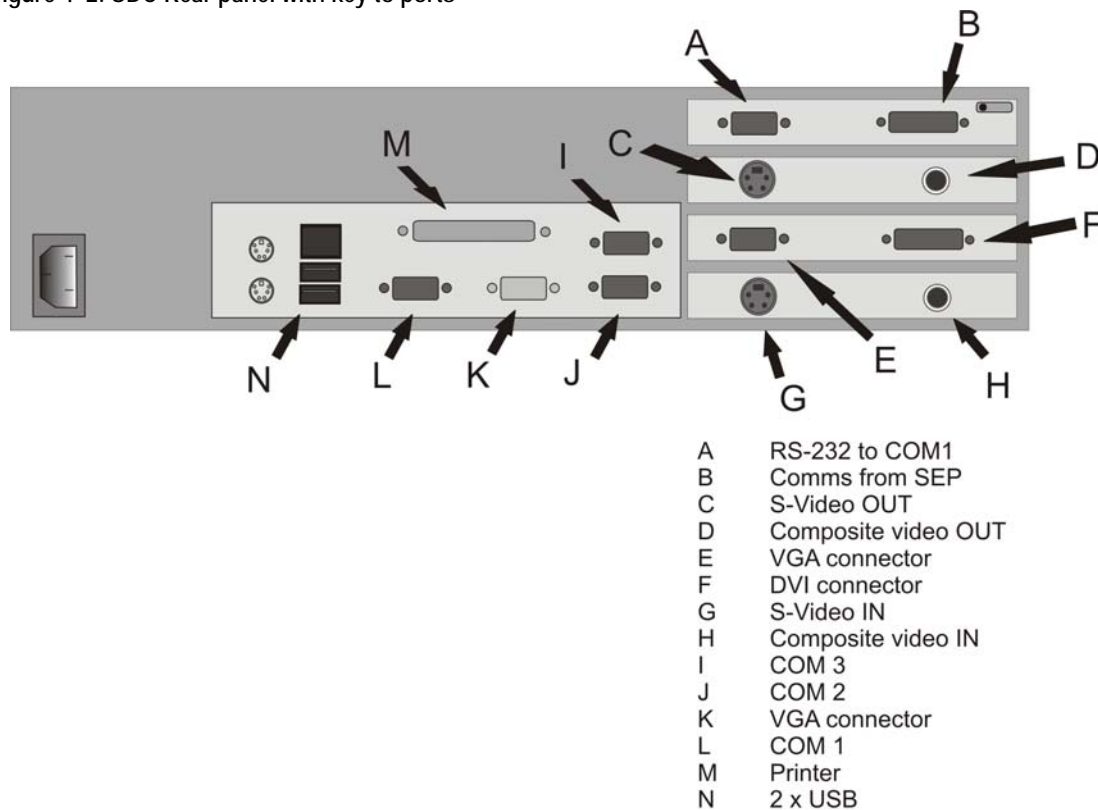

#### 4.2.1 Power Connection

Connect AC electrical power to the SDC through the 3-core electrical supply cable and standard 3-pin IEC electrical inlet.

The SDC has an auto ranging power supply unit that configures itself automatically to use an electrical supply in its acceptable range 85 to 265V AC (47 to 63Hz).

#### 4.2.2 Communication Link SEP to SDC

Use the SDC port – ‘COMMS FROM POD’

The standard communication link between the SDC and the sub-sea installation of the 350 System uses RS232. This is a 3-wire link suitable only for communication over distances up to 15 metres. You may use this method to transmit data to the sur-

vey control room using the ROV multiplexer and an existing data link to the survey control room.

The Systems default parameters for communication between the SDC and the SEP are 9600 baud with 8 data bits, 2 stop bits and no parity.



These communication settings are valid even when you use 2-wire or 4-wire current-loop communications. This is because the SDC converts between current-loop and RS232 communications through a special converter card. All communication between the SDC and the sub-sea installation passes through the relevant SDC serial port.

Communication lines between the SDC and the sub-sea components are opto-isolated at both ends.

There are two further methods that you may use to establish successful communication between the SDC and the sub-sea components of the 350 System:

- 2-wire 20mA digital current-loop

If the umbilical cable is of good quality, experience has shown that you may use this communication method successfully through transmission distances up to 1000 metres.

2-wire 20mA digital current-loop is carried on a twisted pair within the ROV umbilical. To avoid possible communication conflicts, the SDC acts as the 'Master' and the SEP acts as the 'Slave' in this link.

To ensure reliable communications through the umbilical, select a twisted pair that has the following characteristics:

Table 4-3: Ideal twisted pair characteristics for successful communication

Twisted pair characteristic	Ideal value
Overall resistance	Less than 200Ω
Core size	0.5 to 1.0mm <sup>2</sup>
Inter-conductor capacitance	Less than 100pF per metre

- 4-wire 20mA digital current-loop

You should select this method when the umbilical link to the ROV is longer than 1000 metres, or where you cannot establish reliable communication using a 2-wire current-loop.

You will need to reconfigure the SDC and the SEP to use this communication method. Refer to sub-section 4.2.2.1 for instructions to do this.

After you have made the necessary changes in the SEP and the SDC, perform a simple communication check.

The following tables show the connections that you must make between the SEP and the SDC for each of the three communication methods. Refer to sub-section 4.1.3 and Table 4–4 on page 13 for details of the connections that you must make between the SEP and the ROV electrical distribution system.

Table 4–4: Power and Communications cable – 2-wire current loop connections

SEP Power/Comms port Pin number	Function		SDC 'COMMS FROM POD' (15 way) pin connection
4	CL-	↔	3
5	CL+	ROV umbilical	4

Table 4–5: Power and Communications cable – 4-wire current-loop connections

SEP Power/Comms port Pin number	Function		SDC 'COMMS FROM POD' (15-way) Pin connection
4	CL+ Input	↔	3
5	CL- Input	ROV umbilical (Tx in SDC)	4
6	CL+ Output	(Tx in SEP)	5
7	CL- Output		6

Table 4–6: Power and Communications cable – RS232 connections

SEP Power/Comms port Pin number	Function		SDC 'COMMS FROM POD' (15-way) Pin connection*
4	Tx output from SEP	↔	3
5	Rx input to SEP	Data cable	4
6	Common		5

\* You may connect RS232 communications directly to the 9-way D-type serial communication port COM1 on the SDC.

To use current-loop communications you must reserve either one or two conductor pairs in the ROV umbilical for the exclusive use of the 350 System. The System includes a cable that you should use to connect the 'COMMS FROM POD' port on the SDC to the twisted pairs in the ROV umbilical. The cable has a 15-way D-type connector for connection to the SDC 'COMMS FROM POD' port, and open tails for connection to the umbilical at a junction box.

See Tables 4–4 to 4–6 for the connection details of the 15-way D-type connector fitted to this cable.

When you connect the communication cable to the SDC, ensure that the supplied jumper cable is fitted between the 'RS232 TO COM1' and the 'COM1' port on the SDC.

If you use RS232 communications through an existing multiplexed link, you may connect directly from your de-multiplexer to the SDC 'COM1' at the 9-way D-type connector.



## 4.2.2.1 Alternative Communication Methods



### WARNING

There is a risk of death or serious injury by electric shock when you work inside the SDC, the SEP or the PSU.

Only a competent engineer who has the relevant training and experience should open any part of the 350 System.

Power-off and isolate the equipment from the mains supply voltage before you open any part of the 350 System. Observe all relevant local and national safety regulations while you perform any maintenance work on the 350 System.

Re-fit all safety covers and ground connections to the 350 System before you re-connect the equipment to the mains electrical supply.

Many components within the SDC are susceptible to damage due to electrostatic discharge. You must take precautions against such damage: These precautions include the use of a grounded conductive mat and wrist-strap. TSS (International) Ltd will not accept responsibility for any damage caused by failure to take such precautionary measures.

The standard communication link between the SDC and the sub-sea installations of the 350 System uses RS232. This is suitable for communication up to distances of 15 metres. This method is practical where a multiplexed communication link already exists between the ROV and the surface vessel, for example where you use a fibre-optic umbilical cable.

The alternative communication methods are:

- 4-wire 20mA digital current-loop

Suitable for use with umbilical cables longer than 1000 metres, or where the quality of the umbilical cable prevents effective use of the standard 2-wire method.

In practice, the 4-wire method should be suitable for use with umbilical cables up to 4000 metres long if the umbilical is of good quality.

- 2-wire 20mA digital current-loop

If the umbilical cable is of good quality, experience has shown that you may use this communication method successfully through transmission distances up to 1000 metres.

### Configure the SEP



### CAUTION

Many components inside the SEP are susceptible to damage due to electrostatic discharge. You must take precautions to prevent such damage whenever you open the SEP. These precautions include the use of a grounded conductive mat and wrist-strap.

**TSS will not accept responsibility for any damage caused by failure to take such measures.**

**If you need to select a different communication method, change the settings of links inside the SEP *before* you install it on board the ROV.**

Follow the instructions in sub-section 9.2.2 to open the SEP and gain access to the circuit cards.

Identify the Processor Board and locate the five links LK1 to LK5 as shown in Figure 4–4.

Figure 4–3: Link detail shown using the same orientation as in Figure 4–4

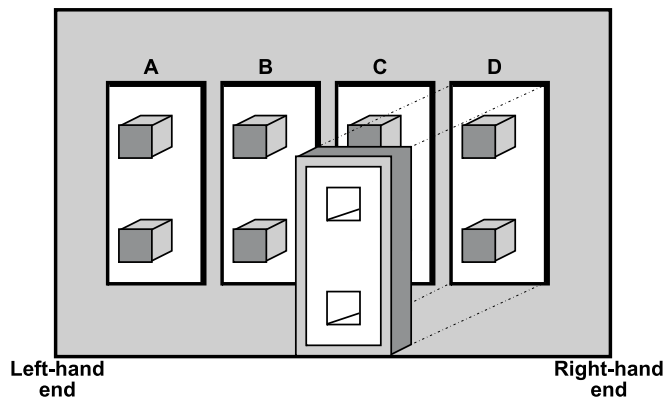
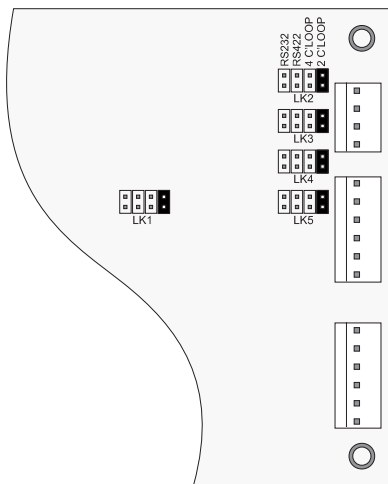

Figure 4–4: Link location on the SEP processor board



The links LK1 to LK5 are identical. Each set of links has a jumper that connects pairs of pins ‘A’ to ‘D’ as appropriate. Remove each of these jumpers from LK1 to LK5 in turn and fit them on the link pins appropriate for the selected communication method:

Table 4–7: Link settings for LK1 to LK5

Communication method	Pin pairs (see Figure 4–3)
RS232	A
RS422	B

Table 4-7: Link settings for LK1 to LK5

Communication method	Pin pairs (see Figure 4-3)
4-wire 20mA digital current-loop	C
2-wire 20mA digital current-loop (standard)	D



All five links have the same identification sequence and must be set identically. **DO NOT FORGET** to set the jumper on link LK1, which is located away from links LK2 to LK5 on the board.

Once you have set all the links, follow the instructions in sub-section 9.2.2 to re-assemble the SEP.



It is a good idea to keep the links on the spare Processor Board set identically to the Converter Card in the SDC. This avoids potential communication problems if you need to replace the Processor Board from the field support kit during a survey.

## Configure the SDC

### WARNING

There is a risk of death or serious injury by electric shock when you work inside the SDC or the SEP.

Only a competent engineer who has the relevant training and experience should open the SDC or the SEP.

Power-off and isolate the equipment from the mains electrical supply before you open the SDC or the SEP. Observe all relevant local and national safety regulations while you perform any maintenance work on the 350 System.

Re-fit all safety covers and ground connections to the 350 System before you re-connect the equipment to the mains electrical supply.



You do not need to change the setting on the Converter Card if you use RS232 communications connected directly to a 9-way D-type serial port of the SDC.

To change the communication method you will need to configure the external switch on the Current Loop Converter Card of the SDC.



After you have changed the communication method, perform a communications check between the SDC and the sub-sea installation.

You must perform a communication check as part of the pre-dive tests. Refer to sub-section 7.2.1 for details of the recommended pre-dive test procedure.

### 4.2.3 Interface to Data Logger

During normal survey operations, the 350 System acquires data at a rate of approximately 1MB per hour. You should arrange to record the official survey log on a suitable data logger.

For your convenience and for test purposes, the 350 System can also create a logged record internally on the SDC hard disk. Data stored using the internal logging facility does not possess the same format as that transmitted to the external data logger, and you should not use it as the primary survey log. Internal logging allows you to record the survey and then to 'replay' the file subsequently using DeepView on the SDC. You cannot replay external log files through the SDC in this way.



**The internal logging facility on the 350 System is for your convenience and for test purposes only. Do not use it as the principal survey logging tool.**

**Unless otherwise stated, this Manual describes the external logging facility of the 350 System.**

Refer to sub-section 7.3.2 for a description of the format that the 350 System uses to log data.

Make a connection between the 350 System and an external data logger using an available 9-way D-type serial communication port on the SDC. The pin designations of this port are as follows:

Table 4–8: RS232 connection for a data logger

Signal to Data Logger	COM-3 on the SDC
RS232 input to data logger	Pin 3 (transmit)
RS232 common	Pin 5 (ground)

### 4.2.4 Interface to Video

*Use the SDC ports 'COLOUR CV IN' and 'COLOUR CV OUT', or 'MONO CV IN' and 'MONO CV OUT', or 'S-VIDEO IN' and 'S-VIDEO OUT'*

1. Video input – Use appropriate input port for your format (COLOUR CV IN, MONO CV IN, or S-VIDEO IN) These are clearly marked on the reverse panel of the SDC. The standard SDC accepts video input in PAL or NTSC format from a camera mounted on the ROV. Apply the video signal to the SDC through the appropriate video input port. TSS supplies CV cables (dual phono to phono) and a pair of BNC to phono adapters to assist video connection with the 350 System.



**Note that you cannot display the video channel on the SDC screen.**

The SDC mixes video images from the sub-sea camera with graphical information generated by the SEP. You may view the composite image through the appropriate video output port.

2. Video output – Use appropriate output port for your format (COLOUR CV OUT, MONO CV OUT, or S-VIDEO OUT)  
The format of the SDC video output signal will match that of the input video signal. That is if your input is PAL, then the output will be PAL. Similarly if your input is NTSC then the output will be NTSC. Further the video output will reflect the specific connections used i.e if the video input is monochrome CV, the output will be monochrome CV and will be provided via the 'MONO CV O/P' port (similarly col-

our CV input will provide via the 'COLOUR CV O/P', and S-Video output will be provided via the 'S-VIDEO O/P').



**Note** A monochrome CV input may be applied to the 'COLOUR CV IN' to allow the colours of the overlay graphics to be viewed, however colour aberrations in the video output may be visible.

You may connect this signal to a standard video monitor using 75Ω screened cable. The output can drive a single monitor or multiple monitors if you add a suitable video drive amplifier.

### 5 SYSTEM CONFIGURATION



Before you power-on the SDC and the sub-sea components of the 350 System, make certain that:

- You have installed the surface and sub-sea components correctly as instructed in Section 3.
- You have made all electrical connections within the System using the correct cables as instructed in Section 4.
- You have established an appropriate communication method between the surface and the sub-sea components.

The SDC has all the software that you will need to operate the 350 System already installed. This section of the Manual describes the features of this 'DeepView for Windows' display software that you must use to configure the 350 System.

Although you may access the majority of commands by using an appropriate sequence of key presses on the SDC keyboard, you will find it easier to use the software if you use a suitable pointing device such as the trackpad supplied with the System.

In these instructions, key press sequences appear in square brackets. For example, 'press [SHIFT]+[F4]' means to press the Shift key and the function key F4 together.

These instructions assume you are reasonably familiar with the Microsoft Windows 2000 operating environment and that you know how to select commands and options by clicking with the buttons on the pointing device.

This section of the Manual explains how to start the SDC and use the DeepView System Configuration Wizard to establish the correct operating configuration for the 350 System.

---

#### **5.1 Software Installation** **Page 2**

How to install DeepView for Windows on an additional PC.

---

#### **5.2 Power on Procedure** **Page 3**

How to start operation of the sub-sea and surface installations of the 350 System.

---

#### **5.3 DeepView For Windows - System Configuration** **Page 5**

How to use DeepView for Windows to configure the 350 System for a survey operation.

---

#### **5.4 Print Configuration** **Page 8**

It is important to print details of the 350 System configuration at the start and end of a survey.

## 5.1 SOFTWARE INSTALLATION

The SDC supplied with the 350 System already has the DeepView for Windows software installed on its hard disk together with the Microsoft Windows 2000 operating system needed to run it.

TSS (International) Ltd supplies a CD containing the DeepView for Windows software with the 350 System. You may install this software, under licence, on a separate PC to support the main installation on the SDC or to replay an internally logged data file. The following instructions explain how to install the software on a separate PC.



If you do not need to install the software on a PC or on the SDC, go directly to sub-section 5.2 for instructions to begin using the 350 System and DeepView for Windows.

To install the software it is recommended that you read the readme.txt file on the CD provided which will be updated with any enhancements or issues to be aware of prior to installing the software:

1. Insert the supplied CD into the CD-ROM drive of your PC.
2. The software should start automatically. If it does not, within the Windows environment select 'My Computer' and the respective drive for your CD-ROM drive. Within the contents of the CD-ROM you will find a README file and a setup program which will automatically install the software.
3. To use DeepView for Windows, double click on the TSS icon that the Install Shield places on your Windows 2000 desktop.



Take the following precautionary measures to maintain the SDC and your PC in optimal condition:

Check all the drives on your PC for viruses using current versions of an approved anti-virus program.

Perform a Windows Scandisk and a Defrag session regularly.

Follow the correct procedures to close down Windows and power-off the SDC and your PC.

NEVER install unauthorised software on the SDC.

NEVER make any alterations to the Windows registry unless you are entirely certain that you know what you are doing, and have backed up the registry files 'system.dat' and 'user.dat'. Inappropriate modifications to the Windows registry can prevent the SDC from operating.

### 5.2 POWER-ON PROCEDURE



During its initialisation, DeepView for Windows searches for a valid initialisation file on the SDC hard disk. If the file exists and the SDC receives compatible data packets from the SEP, DeepView for Windows will begin to operate using the configuration details stored in the initialisation file. If DeepView for Windows does not find the initialisation file or if there are no compatible data packets arriving from the SEP, it will start the System Configuration Wizard to help you establish reliable communications.

For this reason it is usually better to power-on the sub-sea installation before you power-on the SDC.

#### **Power-on the sub-sea components of the 350 System:**

---

All electrical power for the sub-sea components arrives through a single cable into the PSU, which generates the following stabilised and conditioned DC supplies:

- All supplies necessary to operate the SEP
- Power for a suitable sub-sea altimeter connected directly to the SEP. If you connect your altimeter to the SDC instead then you must provide a separate power supply for it.
- Drive current for the 20mA digital current-loop

Refer to sub-section 4.1 for instructions to make the electrical connections to and between the sub-sea components of the 350 System. The System starts to operate when you provide the correct electrical supply to the PSU.

Power-on the sub-sea components of the 350 System. At the SDC, the power switch, CD-ROM drive, USB ports and indicator LEDs should be visible.

Check that the 'C/LOOP' LED shows red to indicate the presence of the 20mA drive current in the communication current-loop. Because the SEP generates this drive current, the LED should show red even before you power-on the SDC. By showing red, the LED provides two important visual checks on the System:

- It confirms that the SEP is receiving electrical power from the ROV.
- Because the LED is in series with the current-loop, it proves the loop is intact. *Note that the LED shows only that the current-loop is intact – it does NOT indicate that there are successful communications passing between the SDC and the SEP.*



The 'C/LOOP' LED will show red only if you use either of the two available current-loop communication methods – it will not illuminate if you use the RS232 communication method.



### **Power-on the SDC:**

---

Check that you have connected an AC electrical supply of the correct rating to the three-pin IEC mains inlet on the SDC (refer to sub-section 4.2 for instructions to connect power to the SDC).

Remove any disks that might be loaded into the drives. Operate the power switch to power-on the SDC.

After you power-on the SDC, the 'POWER' LED should show green and the 'HDD' LED should flicker green as the SDC begins an initialisation sequence that lasts approximately a minute. The SDC will launch Microsoft Windows and the DeepView for Windows display software automatically after it has completed the initialisation sequence.

Provided the software launches successfully, you will see the DeepView for Windows opening splash screen. DeepView for Windows will then search for an initialisation file on the SDC that includes details of the previous operating configuration. If the software finds the initialisation file and the SDC receives data packets from the SEP that are compatible with that file, then it will begin to operate using the same configuration. Otherwise, DeepView for Windows will launch the System Configuration Wizard that allows you to define the operating parameters used by the System.



To start the display software from Windows, select Start➔PROGRAMS➔DeepView for Windows➔DeepView for Windows.

The SDC is provided with a keyboard/trackpad combination. You may use a mouse or the supplied trackpad to select commands and options from within DeepView for Windows. You may use the keyboard to enter commands.

Under some circumstances, DeepView for Windows may not be able to communicate with the SEP even though the 'C/LOOP' LED is showing red. This might occur, for example, if the characteristics of the umbilical cable are unsuitable for use with 2-wire current-loop communications. You may then have to reconfigure the 350 System to use a different communication method – see sub-section 4.2.2. See also the fault identification sequences described in sub-section 9.3.

### 5.3 DEEPVIEW FOR WINDOWS - SYSTEM CONFIGURATION

Before you can use the 350 System for the first time you must configure the software. This procedure can be enabled to run every time you open DeepView for Windows or if your setup is consistent it can be disabled and accessed via “System Configuration Wizard” from the configuration menu when DeepView is operational. The options that you are able to configure are the following:

Figure 5–1: DeepView for Windows - System Configuration Wizard

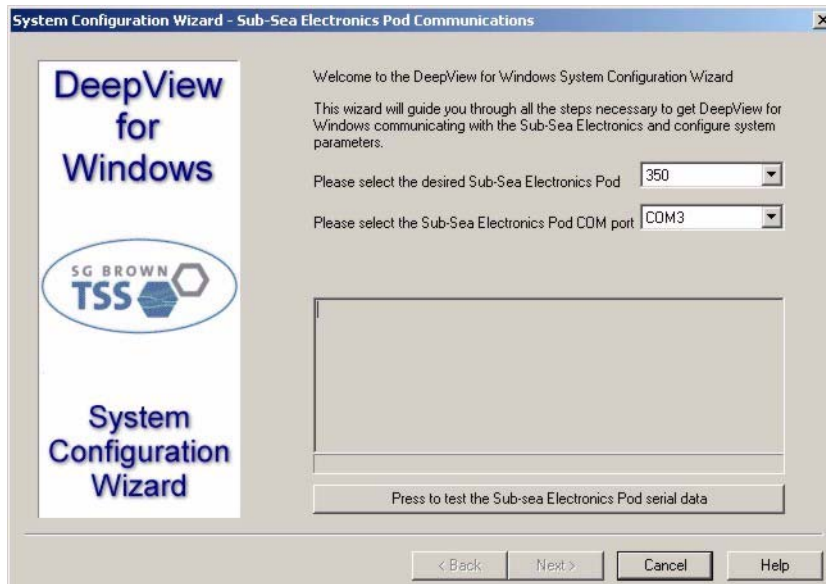

#### 5.3.1 SEP type

Define whether there is no SEP, a stand alone 440, 350 or whether it is part of a Dual-track System. This setting determines the data format that DeepView for Windows expects to receive from the sub-sea installation and sets the style of Run Window that the software will use to display the System measurements.

There are four options for setting the SEP type:

- ❑ **No SEP**  
Use this option to operate DeepView for Windows with no SEP connected. This might be necessary, for example, if you wish to use DeepView for Windows to replay data on a separate PC.
- ❑ **440**  
Use this option to control a stand-alone 440 System.
- ❑ **350**  
Use this option to control a stand-alone 350 System.
- ❑ **Dualtrack**  
Use this option to control a Dualtrack System comprising an interconnected 440 and 350 System controlled from the same SDC. You should use this option even if you intend to use only one of the Systems during the survey.

### 5.3.2 Communication ports

Define the serial communication ports and their communication parameters. The SDC uses the serial communication ports to communicate with the SEP and with external devices such as the sub-sea altimeter and a data logger.



During System Configuration the only port that you have to specify is the Communication to the Sub Sea Electronic Pod (or SEP). Below is outlined a list of the COM Ports and their default assignments.

The SDC has five serial communication ports that it uses to communicate with external and peripheral equipment. The standard assignments for these ports are as follows. You may change these if necessary.

- COM1 is used to pass serial communications between the SEP and the SDC. DeepView uses a serial port for this purpose even if you set the 350 System to use current-loop communications. The SDC includes the hardware necessary to convert between these standards.



Note that the current-loop communications connects through a jumper link from the current-loop converter card. If you decide to use an alternative serial communications port for the primary communications circuit, then you must also move the link connection to the alternative serial port.

- COM2 (labelled 'ALTIMETER' on the rear connector panel of the SDC) is used to accept serial data from any compatible altimeter that is not connected directly to the SEP. The maximum range for RS232 communications is 15 metres. Therefore, to connect an altimeter to the SDC you must add its signals to an existing multiplexed data link in the ROV umbilical and then extract them at the surface. Refer to sub-section 6.2.2.1 for instructions to configure an altimeter and set its communication parameters.
- COM3 (labelled 'LOG O/P' on the rear connector panel of the SDC) is used to connect the SDC to a separate user-supplied data logger. You should use a data logger to record the survey measurements acquired by the 350 System. Refer to sub-section 6.2.2.2 for instructions to configure DeepView for data logging and to set appropriate communication parameters.
- COM5 (is not available on the rear connector panel of the SDC) is used by the SDC to communicate with the video overlay card.

DeepView for Windows allows you to set the communication parameters for each of the serial ports. Choose settings that are appropriate for the connected equipment – refer to the technical manuals of the attached equipment if necessary. Note that the standard communication parameters for COM1, the communication link between the SDC and the SEP are set to operate at 9600 baud using 8 data bits, two stop bits and no parity.



The update rate for your System will reduce if you set a lower baud rate for this communication link. You should consider reducing the baud rate for this link only if you experience persistent communication problems caused by an umbilical cable of poor quality. Ideally, in these circumstances you should swap to using an umbilical cable of good quality instead.

At this point the software will provide an analysis of the data status and will provide you with a summary screen of the findings that it has established.

Figure 5–2: DeepView for Windows - Summary

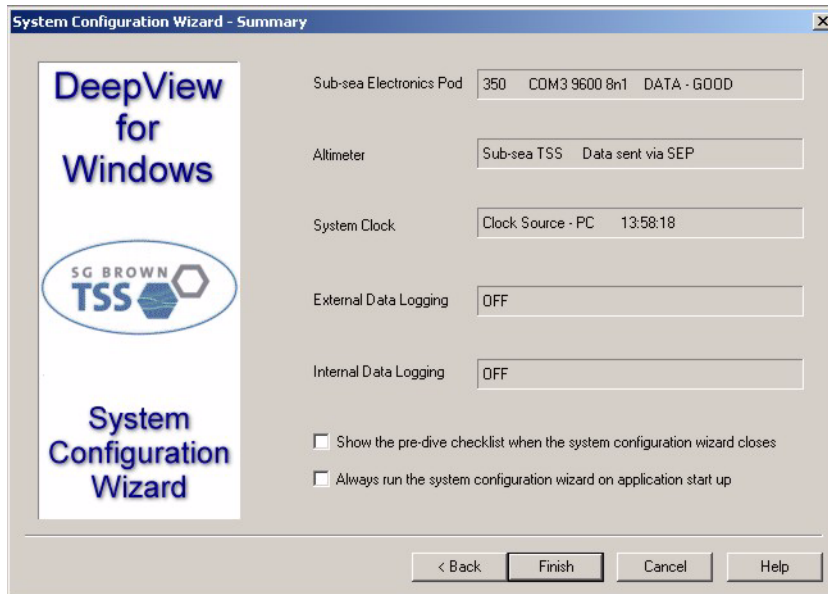

DeepView will now be configured to operate with the 350 System.

Before clicking on 'Finish' you have tick options to select:-

- Show the pre-dive checklist when the System Configuration Window is closed.
- Whether the System Configuration Wizard runs when DeepView for Windows starts.



If the box is checked, the System Configuration Wizard will be run when DeepView for Windows starts. If the box is not checked and if a configuration file is available, the configuration file will be used to configure DeepView for Windows.

DeepView stores the configuration details automatically in an initialisation file when DeepView is closing down. This allows the System to establish the same configuration when you next power-on the SDC – provided it recognises the data format arriving from the SEP as being compatible with the stored configuration details. This means that you should power-on the SEP before you power-on the SDC.

## 5.4 PRINT CONFIGURATION

It is important to print details of the 350 System configuration at the start and end of a survey. This information is also duplicated in section 6.2.1.1, which outlines the operating of DeepView for Windows.

Select File→Print Configuration to send a copy of the System Configuration to the Windows Notepad application. You may edit the details and print them from this application. An example of the print configuration via Windows notepad.

Figure 5-3: DeepView for Windows- Print Configuration

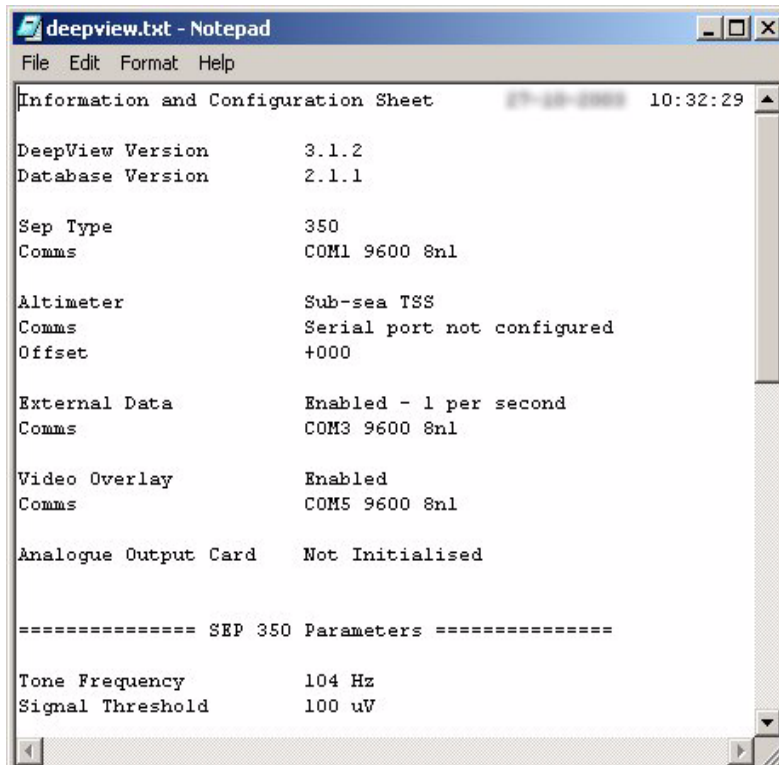

The ability to print the configuration is an important feature of DeepView. It allows you to create a permanent written record of the configuration to supplement the survey logs.

Full analysis and post-processing of the raw data can be effective only if you retain a record of the 350 System configuration at the time of the survey. Appendix C includes a suitable form for you to record these details.





# 6 OPERATION SOFTWARE

The SDC has all the software that you will need to operate the 350 System already installed and configured to start automatically when you power-on the SDC. This section of the Manual describes the features of this display software that you must use to operate the 350 System.



**Before you attempt to use the 350 System during a survey, make certain you have followed all the instructions in this Manual to install, connect and configure the System properly. You cannot acquire valid survey data unless you have carried out these operations correctly.**

This section of the Manual explains how to use the 350 System to conduct a survey. The instructions consist of a sequence of suggested procedures that begins with the pre-dive checks that you should complete and finishes with some suggested procedures to close down the 350 System safely and efficiently.



**Refer to sub-section 5.2 for instructions to power-on the 350 System.**

## 6.1 Configuration

**Page 2**

An overview of configuring DeepView for Windows and parameters that are used during a survey.

## 6.2 DeepView for Windows Operating Controls

**Page 2**

A detailed explanation of the menu functions, toolbar controls and display features of the DeepView for Windows 'Run Window'.

## 6.3 After the Dive

**Page 28**

How to close DeepView for Windows and power-off the 350 System correctly after completion of the survey. This is important – if you do not follow the correct procedure to close DeepView and Windows you might corrupt some of the data files on the SDC hard disk.

## 6.4 Replaying log files

**Page 29**

An explanation of how to replay an internal log file through the SDC, and an explanation of the additional toolbar facility.



## 6.1 CONFIGURATION

TSS (International) Ltd has designed the 350 System and Deepview for Windows to be easy to use. A System Configuration Wizard guides you quickly through the procedure to choose the SEP type and communication parameters. However, some important parameters must be entered before the survey can begin.

### *6.1.1 Survey Parameters*

To follow we have listed some key parameters that will be required to be set prior to and during the survey. Details of setting these parameters are covered in the software details in section 6.2.

Configure the 350SEP with the following information:

#### *6.1.1.1 Tone Frequency*

Set this value to the same frequency as that present on the cable. The range is from zero to 200Hz. This value must be set accurately, or the system will not find the tone.

#### *6.1.1.2 Threshold*

Set an appropriate value for threshold.

High settings will make the 350 System less sensitive to noise but will also decrease its operating range. The default setting of 100 $\mu$ V has proved to be suitable for the majority of survey operations.

If you are in any doubt about threshold, leave the setting at its default value.

#### *6.1.1.3 Coil Separation*

Section 3.2.2 explains how to install the two coil triads on the ROV and adjust the separation distance. Enter the separation distance in cm. The accuracy of the survey depends on this parameter being entered correctly.

## 6.2 DEEPVIEW FOR WINDOWS OPERATING CONTROLS

TSS (International) Ltd has designed DeepView for Windows to provide full functionality when you use a pointing device, such as a mouse or the supplied trackball, to select commands and controls. You may also access many software features by using the SDC keypads.



**The instructions that follow assume you to be reasonably familiar with the Microsoft Windows operating environment. If necessary, refer to a relevant Windows user guide, such as the one that accompanies the SDC, for instructions to use Windows.**

### *6.2.1 How to Use DeepView for Windows*

This sub-section explains how to use the software commands and tools during a survey. The instructions refer to the Run Window and to the various secondary windows described throughout this section. DeepView includes an on-line Help structure that summarises the advice and instructions included here. There is also a simple 'Help' panel, accessible by pressing function key [F1] from the Run Window, to list the func-

tion key short cuts that select some of the commands and tools described below. Sub-section 6.2.4 lists the function keys available for use in the 440 mode.

Follow the advice throughout Section 7 for a survey procedure using the 350 System.

### Menu commands

Table 6–1 lists the commands available on the DeepView Menu Bar, together with their hotkey access codes and function keys if applicable.



Table 6–1: DeepView Menu Commands

Menu item	Sub-menu, [hot key access] and Function key	Description
File	Open /Close Replay File [F2]	Specify the name and location of an existing internally logged file that you wish to replay through DeepView for Windows. The Replay Window includes the same features and as the Run Window and operates in a similar way. A button on the DeepView for Windows toolbar performs the same function as this command. You cannot use DeepView for Windows to replay externally logged files.
	New Log File [F3]	Specify the name and location of a new file to accept the internal logging record. File names can have up to 255 characters. They can include spaces but must exclude the characters \ / : * ? " < > and  . A button on the DeepView for Windows toolbar also performs the same function as this command. Refer to sub-section 6.4. for a description of data logging.
	Close Log File [Ctrl + F3]	If you have an internal logging file open, use this command to close it. Once you have closed the file, you cannot open it again to add more data.
	Backup Configuration	This will prompt you with a dialog box to provide a name to save the current parameters set to a file that can be accessed at a later date.
	Restore Configuration	This will provide you with a list of any previously saved configuration files that you can load.
	Print Configuration	Use this command to send a copy of the 350 System configuration to windows Notepad. You should print the configuration details from that application at the start of the survey and again at the end of the survey. Retain the hard copy prints with the survey records.
	Exit	Use this command to exit the DeepView program and return to the Windows operating environment.

Table 6-1: DeepView Menu Commands (Continued)

Menu item	Sub-menu, [hot key access] and Function key	Description
<b>View</b>	Run Window [Ctrl + R]	Select this command to open or close the DeepView Run Window. You may resize and move the Run Window on the SDC screen after you open it. The normal condition is for the Run Window to be closed when you start DeepView. A button on the DeepView for Windows toolbar performs the same function as this command.
	Forward Search Window [Ctrl + F]	This function is described in section 6.2.1.3.
	Toggle Height Scale [Ctrl + H]	Use this command to modify the available selection of displayable vertical ranges. The vertical ranges vary between the 350 and the 440 systems and are as follows:  350 mode: 0m to 2m, 5m, 15m or 30m  440 mode: 0m to 2m and 0m to 5m.
	Toggle Swath Width [Ctrl + W]	Use this command to alter the swath range for the 350. The available ranges are 0m +/-2m, 0m to +/-5m and 0m to +/-15m.
	Scope and Spectrum Analyser Window	Use this command to open or close the Scope and Spectrum Analyser Window. A button on the DeepView for Windows toolbar performs the same function as this command. The normal condition is for the Scope and Spectrum Analyser Window to be closed when you start DeepView for Windows. <b>Note that the data string transmitted from the SEP to the SDC extends significantly in length when you open the Scope and Spectrum Analyser Window. This will reduce the data update rate. You should therefore keep this window closed unless you require it.</b>
	System Errors Window	Use this command to open or close the System Errors Window described in sub-section 6.2.1.4. A button on the DeepView for Windows toolbar performs the same function as this command. The normal condition is for the System Errors Window to be closed when you start DeepView for Windows.
	Terminal Window [TAB]	Use this command to open or close the Terminal Window described in sub-section 6.2.1.4. A button on the DeepView for Windows toolbar performs the same function as this command. The normal condition is for the Terminal Window to be closed when you start DeepView for Windows.
	Video Overlay Enable [Ctrl + V]	Use this command to select the Video Overlay function. A button on the DeepView for Windows toolbar performs the same function as this command. The video overlay feature allows the SDC to accept input from a video camera and to output the video image overlaid with the target co-ordinates and steering information.

Table 6–1: DeepView Menu Commands (Continued)

Menu item	Sub-menu, [hot key access] and Function key	Description
<b>C</b> onfiguration	System parameters [Shift + F2]	This command displays a dialog panel that allows you to establish the type of SEP and the serial communications parameters. Refer to the following sections for relevant details and instructions.
	Altimeter [Shift + F3]	This command displays a dialog panel that allows you to establish the physical and serial communications parameters of an altimeter used with the 350 System. Refer to sub-section 6.2.2.1 for relevant details and instructions. The System Configuration Wizard also displays a similar dialog panel.
	External Output [Shift + F5]	This command displays a dialog panel that allows you to configure the SDC output to an external data logger. Set the type of data packet and its update rate, and the serial port communication parameters. Note that you must establish appropriate parameters for the external output if you wish to use the video overlay option, even if you do not intend to use the external data logging features.
	Analogue Output [Shift + F6]	Not used.
	Run Background Compensation [Shift + F7]	This command is not applicable to the 350.
	Seawater Compensation [Shift + F8]	This command is not applicable to the 350.
	Load factory Defaults [Shift + F9]	This will prompt you with a caution box to confirm that you would like to reset the software back to the original factory defaults. This will eliminate any user parameters that have been previously configured.
	Video Overlay Setup [Shift + F10]	Refer to sub-section 6.2.2.4 for a description of the video overlay feature.
	System Configuration Wizard [Ctrl + F10]	This selection will return you to the set-up options screen that you have viewed when opening up the software. Use of this option will result in all of the parameters being reset to default.
<b>W</b> indow	Cascade [ALT][W][C]	Use this command to arrange the various operating windows so that they overlap but with their title bars visible. This does not affect the Diagnostics Window or the Target Tracking Window.
	Tile Horizontally [ALT][W][H]	Use this command to arrange the various operating windows so that they are next to each other horizontally. This arrangement allows you to see the entire area of each window, although DeepView might resize the windows to fit the available area. This does not affect the Diagnostics Window or the Target Tracking Window.
	Tile Vertically [ALT][W][V]	Use this command to arrange the various operating windows so that they are next to each other vertically. This arrangement allows you to see the entire area of each window, although DeepView might resize the windows to fit the available area. This does not affect the Diagnostics Window or the Target Tracking Window.
<b>H</b> elp	DeepView [ALT][H][D]	Use this command to open the on-line Help structure that explains the features of DeepView. The Help structure also includes some simple fault finding advice for the sub-sea components.

Table 6-1: DeepView Menu Commands (Continued)

Menu item	Sub-menu, [hot key access] and Function key	Description
	Pre-dive Checklist [ALT][H][P]	Use this command to open the on-line Help structure that explains the checks you should make on the 350 System before you start a survey. Sub-section 7.2.1 also lists and explains these checks. You may access the checklist from within the DeepView Help structure.
	About DeepView [ALT][H][A]	This command displays the version number of DeepView.



**It is recommended that you save a configuration file for each survey. You can then restore this configuration file to give the settings for the next job.**

### 6.2.1.1 DeepView File Menu Options

This section outlines the various displays that have been explained in the previous tables.

#### File Options

Open/Close, New Log File, Backup and Restore Configuration options bring up a standard windows file location box. In the example used is the Open Log Menu.

Figure 6-1: An example of a File Option menu

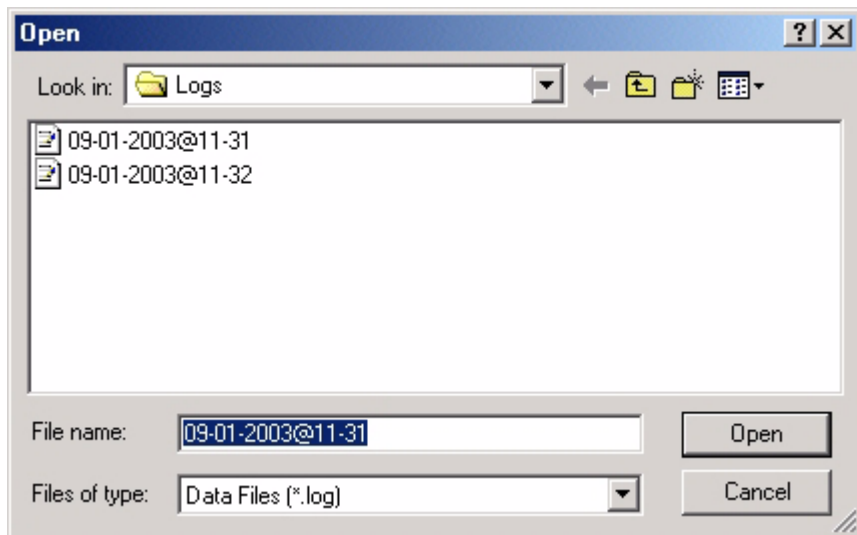

Table 6-2: Internal Data Logging

#### B) Internal Data-logging

*Note that, when enabled, internal logging must record up to approximately 1MB of data per hour. Ensure that the receiving disk has sufficient free space to accept this volume of data.*

**Logging Enable:** You must enable internal logging before you can use it. This is done by selecting 'New Log File' from the File options. The factory default is for internal logging to be disabled. Logging should also be turned off when the survey is complete.

**Logging Format:** The records of the internal logging format include alternately the co-ordinates and the signals data (see sub-section 7.2.2) When you enable internal logging, by default the SDC logs all records. The SDC adds a 'time' field to the start of logging and updates this at intervals of one minute. It obtains this information from the SDC system clock.

You may add short comments (up to 40 characters in length) to the internal logged record by pressing the annotate button on the Run Display screen. The SDC time-tags and includes the comments in the internal log. The external logging record is unaffected by these annotations.



**Note that you may measure how much disk space is available on the SDC by going to 'My Computer' selecting the hard disk and right clicking on the trackpad button or pointing device and selecting 'properties'.**

#### Print Configuration

Select File → Print Configuration to send a copy of the System Configuration to the Windows Notepad application. You may edit the details and print them from this application.

Figure 6–2: An example of the Print Configuration via Windows Notepad

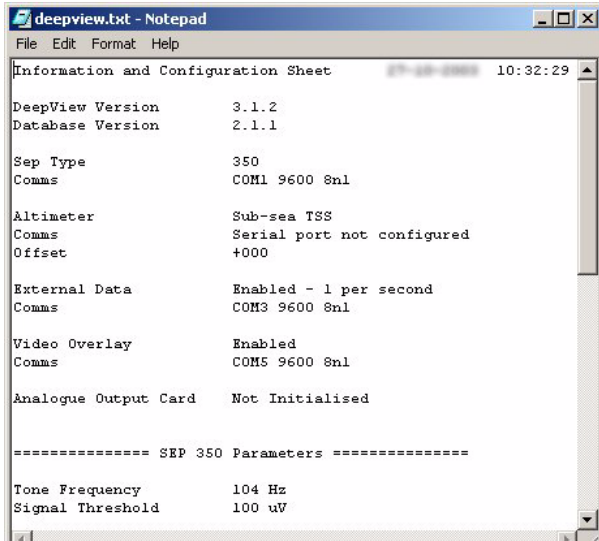

The ability to print the configuration is an important feature of DeepView. It allows you to create a permanent written record of the configuration to supplement the survey logs.

Full analysis and post-processing of the raw data can be effective only if you retain a record of the 350 System configuration at the time of the survey. Appendix F includes a suitable form for you to record these details.

## 6.2.1.2 Run/ Display screen

### Main Window

The Run Window is the most important and informative display of the 350 System. Anyone who will operate or maintain the System should therefore spend some time to make themselves familiar with the layout of the window and the information that it shows.

A fold-out drawing of the Run Window is included at the back of this Manual. Open the drawing and refer to it as you read the following description.

Figure 6–3: DeepView - Run Window

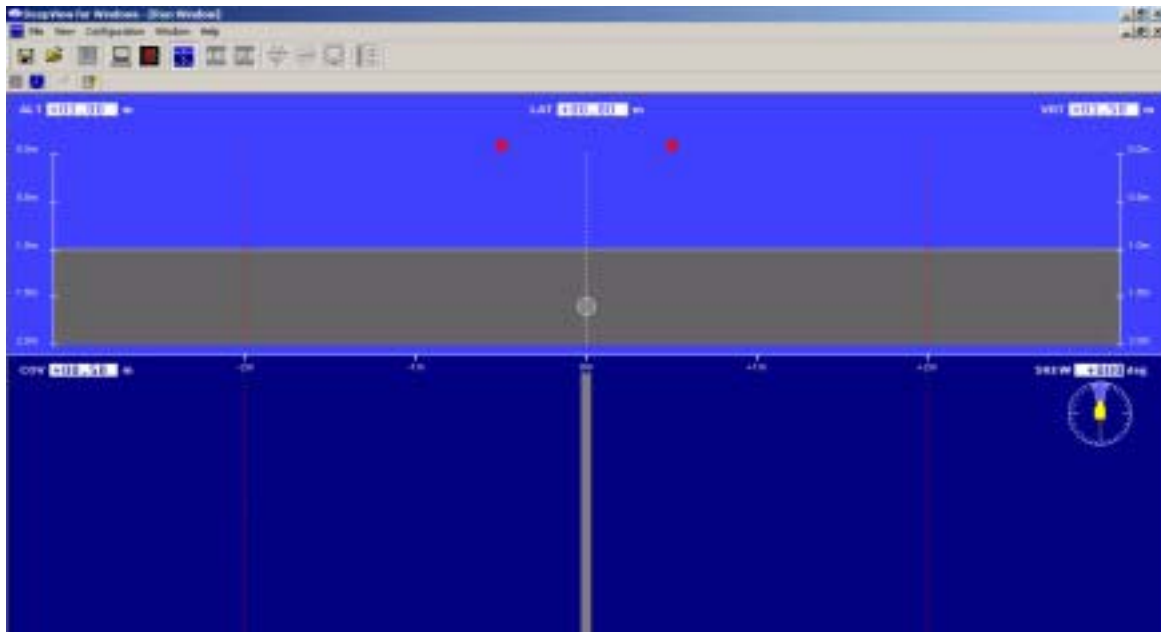

### Controls and Features of the Run Window

#### Controls

- The **Title Bar** shows the names of the program and of the window. The right-hand end includes the standard buttons to minimise, maximise and close the main DeepView window.
- The **Menu Bar** includes the five menu headers described under ‘Menu commands’ on Page 2. To access the menu and sub-menu commands, click on them or use the appropriate hot-key combination – [ALT]+[*underlined hot-key characters*]. The Menu Bar also includes buttons to minimise, maximise and close the Run Window.
- The **DeepView Toolbar** includes the buttons described in section 6.2.3. This section outlines the various displays that have been explained in the previous tables. These tools control the functions of the DeepView for Windows program.
- The **Run Window Toolbar** includes the buttons described under ‘Run Window tools’ on Page 8. These tools control functions within the Run Window only.

#### Features – Rear Elevation pane

The rear elevation pane is immediately below the Run Window Toolbar and occupies approximately 30% of the area with the window fully maximised. It has a light blue background and shows the target **A** as a circle of fixed diameter, a vertical broken white line **B** that represents the fixed centre-line of the ROV and the two search-coil arrays **C**.

The circle **A** moves horizontally and vertically in the pane as the relative position of the target changes. The scale **D** provides a visual reference so that you may estimate the vertical distance between the coil array and the target. CTRL H switches between 30, 15, 5 and 2 metre vertical display scales.



When the 350 System includes a properly configured altimeter, the top edge **(P)** of the solid grey area shows the position of the seabed relative to the coil array. This area expands and contracts vertically with changes in ROV altitude above the seabed. If the design of the ROV allows you to configure the 350 System with a fixed coil height, the seabed indicator will remain fixed at this altitude.

The Run Window includes a series of data fields **(Q)** that indicate the instantaneous measurements of coil altitude (ALT) above the seabed, lateral offset (LAT) of the target relative to the centre line, vertical range to the target (VRT) and target depth of cover (COV). The 350 System measures VRT and LAT directly, with positive measurements of LAT representing a starboard offset relative to the centre line. Measurements of ALT arrive from an altimeter, or represent the fixed coil height if this is applicable. DeepView calculates the value displayed in the COV field using  $COV = VRT - ALT$  so that positive values indicate a target that is buried. All measurement are in units of centimetres.

The solid white line **(G)** that separates the rear elevation pane from the 'snail trail' pane (described below) has gradations every 1m or 5m, depending on the swath width.

Two broken red lines **(H)** extend down the window at  $\pm 2m$  of lateral offset. These show the lateral limits of a quality control envelope applied by DeepView. To support efficient post-processing on data acquired by the 350 System, the software sets the quality control flag in the data output when the target is outside this envelope. Refer to sub-section 6.5 for a complete description of the quality control features.

### Features – 'Snail Trail' pane

The snail trail pane is immediately below the rear elevation pane and occupies approximately 60% of the screen area with the window fully maximised. It has a dark blue background and indicates the lateral offset of the target, relative to the ROV centre line **(B)**, for the most recent updates.

Two data panels **(L)** and **(M)** show the received signal voltages. In Run mode, the voltages shown are measured simultaneously on the port vertical (PV), port lateral (PL), starboard vertical (SV) and starboard lateral (SL) coils. The digital display panel **(M)** uses scientific notation to display the signal voltages in units of microvolts ( $\mu V$ ). The bargraphs **(L)** use a logarithmic scale. The use of scientific notation and log. scales allows strong and weak signals to be displayed simultaneously without the need to change scale.

The red dotted lines on **(L)** show the threshold (section 6.1.1.2); on the drawing this is the default setting of  $100\mu V$ . When the signal falls below the threshold value, the bargraph turns red.

Panel **(I)** displays the SEP details, System Clock, System Errors, External Output, Internal log status. Panel **(J)** shows the skew of the vehicle (the heading relative to the cable).

A thick coloured line **(K)** indicates the target position relative to the ROV centre line. As the survey starts, this line extends upwards from the bottom of the screen until it reaches a point near the top of the snail trail pane. The top of the line then continues

to move to the left and right as the lateral offset of the target changes while the remainder of the line scrolls vertically downwards in a ‘waterfall’ style of display.

Segments of the line **⑩** can have any of three colours:

**Light grey** Good signals supplied by the coils. The target is covered.

**Dark grey** Good signals supplied by the coils. The target is exposed.

If the System receives no altitude information, a good target signal will always appear as a light grey line.

**Dark blue** The lateral range is outside 2m. Note that if the target moves outside the lateral range of the display (swath width), the pipe will turn red: increase the swath width to rectify this.

### Features – Status bar

---

The status bar **⑪**, located directly below the snail trail pane, alerts you to the operating status of DeepView and the 350 System. It includes the following information:

❑ **Communication status.**

This shows the DeepView operating mode (440 or 350) and the validity of serial communications between the SDC and the SEP. For successful operations in the 350 mode this should always show ‘350 Data GOOD’.

❑ **System time.**

The system time is derived from the SDC system clock.

❑ **System errors.**

The status bar shows the total number of uncleared system errors registered by DeepView. Use the System Errors Window, described in sub-section 6.2.1.4, to see details of all the system errors registered since you powered-on the SDC, up to a maximum of 600 lines.

### Logging status.

Two fields in the status bar indicate the ON/OFF condition of the external output (used for logging to a user-supplied data logger and to provide information for use by the optional video overlay feature) and the internal logging.

### Toggle Height Scale

---

Dependent upon specific survey requirements, the Height Scale Display **⑫** on the Run Window can be modified. For example, if a small target is being tracked a reduced height scale may be required. This feature provides the user with control over the displayed height range.

The vertical ranges for the 350 System are either 0m to 2, 5, 10 or 15m.

## Toggle Swath Width

Dependent on survey conditions, the lateral offset scale **G** can be changed between 2m and 15m. Note that the quality envelope will still be at  $\pm 2m$ .

### 6.2.1.3 Forward Search Screen

The Forward Search screen provides a useful facility for ROV pilots: as described in 7.2, this facility helps the pilot to steer the ROV on a track that intercepts the charted course of the target cable. It is intended that the heading of the ROV is approximately perpendicular to the track of the cable.

Used in this way, the 350 System will detect the target ahead of the ROV and will display an estimate of the forward range between the coil array and the target.



The forward range estimate relies upon information supplied by the coil array and the altimeter. You cannot access this facility unless the system receives altitude information from an altimeter or unless you have configured the software to use a fixed coil height. See Appendix A for a description of the operating theory behind this function.

Figure 6-4: DeepView - Forward Search Window

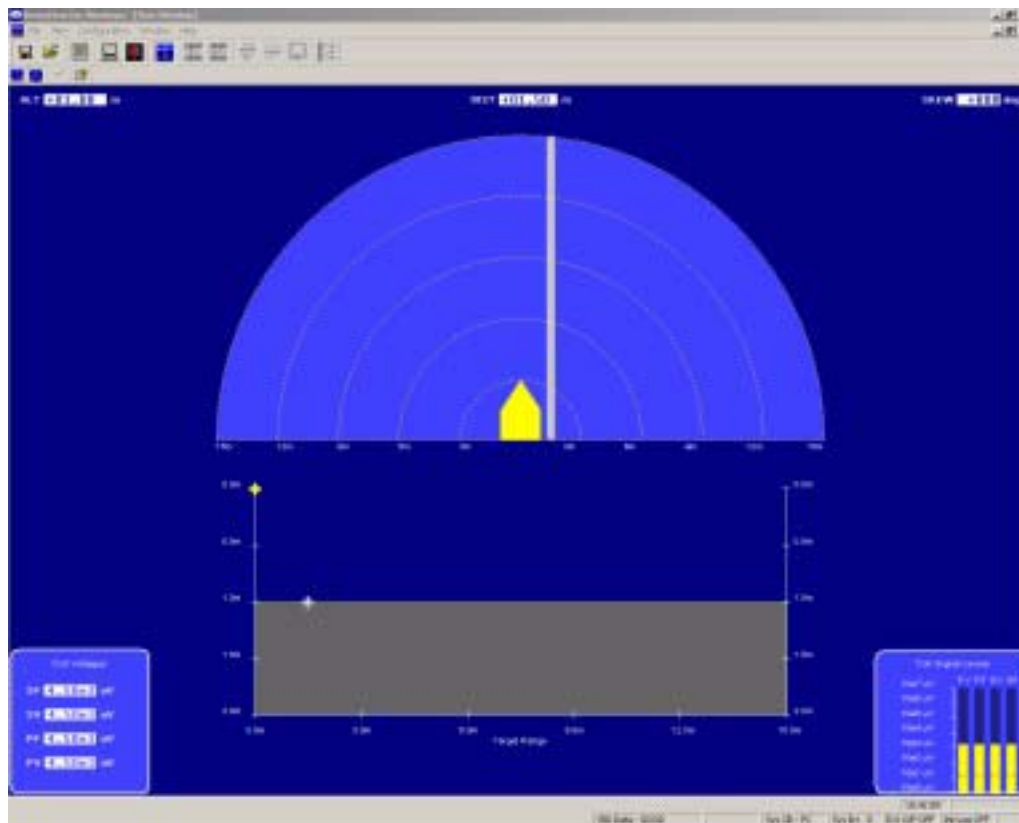

## Controls and Features of the Forward Search Window

### Heading Display

The main part of the screen shows the ROV **B**, from above, and circles **C** concentric with the ROV every 3m, to a maximum radius of 15m. A yellow arrow in the centre of

the circles shows the ahead direction of the ROV. Superimposed on this is a representation of the cable **A**, showing its distance from the ROV and its relative heading.

The altitude, skew and distance to the target **B** are all shown at the top of the screen. The “ALT” field gives the height (taking into account any offset) above the seabed as measured by the subsea altimeter. If the system is configured to use a fixed coil height, this value will be steady and reflect this value. The skew angle gives the difference in heading between the vehicle and the cable: a positive value indicates that the ROV must be steered towards the port side to become perpendicular to the cable. The distance to target (FWD) gives an approximate reading of the distance, in m, between the ROV and cable, measured between a point directly below the ROV on the seabed, and the point on the cable which is directly ahead of the ROV.

### Vertical Display

---

The lower part of the screen shows the positions of the ROV, seabed and target in the vertical direction. The process of estimating the forward range of the target requires the System to assume that the target is uncovered and lying on the seabed. For this reason, the target (represented by the grey cross **A**) is always shown on top of the line **B** representing the seabed. The vertical scale of this diagram **C** can be changed using the “Toggle Height Scale” in the “View” menu, or the shortcut key [CTRL]-[H].

The distance to target is also shown on the graph as the line **D**. This distance is always measured along the seabed, and is not the shortest distance from the ROV to the target.

This window also displays the signal bars **J** and coil voltages **I** as shown on the Run/ Display screen. However, the vertical and fore-aft coil voltages are displayed in place of the vertical and lateral signal voltages. By observing these values (in particular the bargraph display), an experienced ROV pilot can detect and steer towards a target before any other indication appears on the Forward Search display.

## 6.2.1.4 Other Windows

### Scope and Spectrum Analyser Window

Deepview for Windows can show signal data received using either 'oscilloscope' or 'spectrum analyser' displays.

Figure 6-5: Scope Window

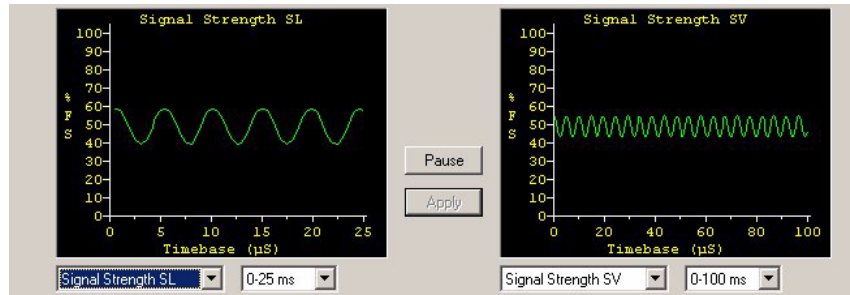

The above screen shows an example of the 350 Oscilloscope Window with panels for two active channels, Starboard Vertical and Starboard Lateral.

During operation, each of these display panels shows the signal voltage measured on their respective channels against a horizontal time scale and a vertical scale of percentage of full scale or  $\mu\text{V}$ . In the example above, two panels are showing different timebase scales: both represent the same frequency of approximately 100Hz.

Unless the signal from the target cable is very strong, you are unlikely to see a clearly defined sine-wave oscillogram.

Figure 6-6: Spectrum Analyser Window

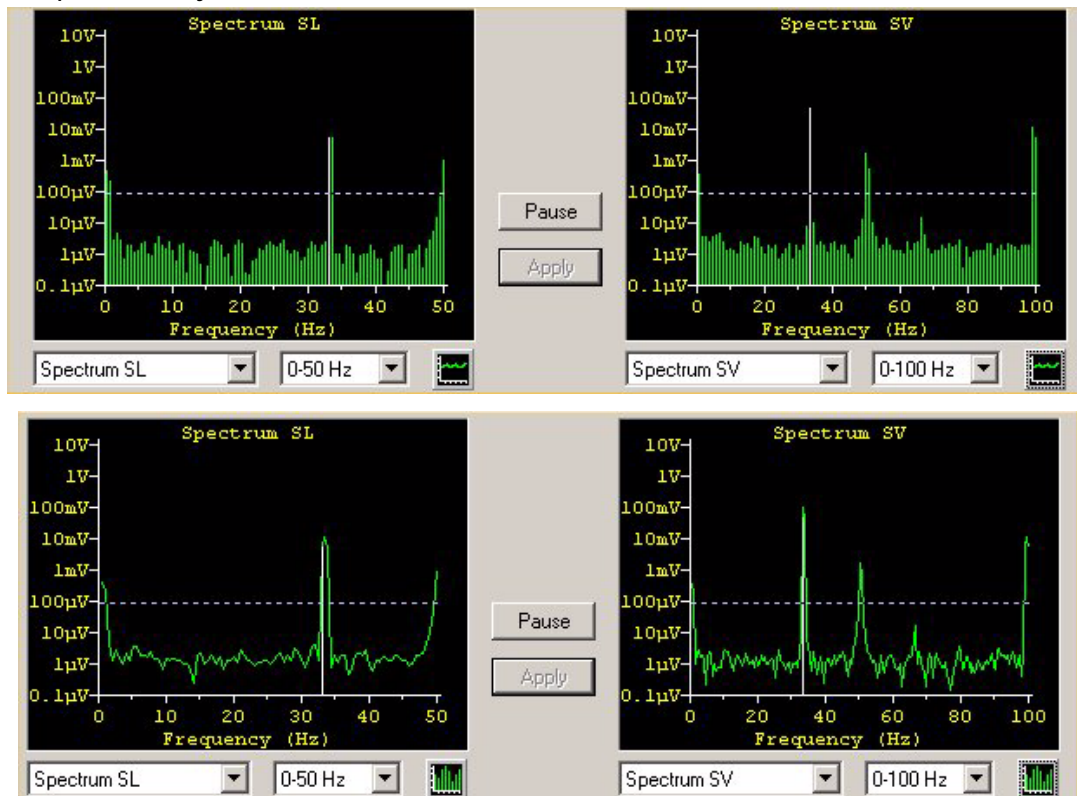

The above screen shows an example of the 350 Spectrum Analyser Window with panels for two active channels, Starboard Vertical and Starboard Lateral. This shows the system tracking a 33Hz tone. The trace shows the expected peak at 33Hz, a peak at 50Hz (produced by the mains power frequency) and harmonics of these frequencies at 66, 99 and 100Hz.

During operation each of these display panels shows the signal voltage measured on their respective channels against a horizontal time scale and a vertical scale in volts. Note that the vertical scale is logarithmic: each division represents a 10 times increase in voltage. The frequency axis can be either 25, 50, 100 or 200Hz. Select a suitable axis to allow the tone frequency to be displayed. The data can be displayed in two formats: either a graph drawn with a continuous line or bars representing the strengths of each 1Hz band. To change between the two views, press the small graph button to the bottom right of each graph.

The tone frequency is also shown on the display as a vertical white line. This can assist in adjusting the tone frequency set in the Survey Parameters (section 6.1.1.1) to that present on the cable. The threshold is also shown as a horizontal dotted line. In the drawing, this is at the default setting of 100µV.



Using and understanding the Spectrum Display is critical to setting up and using the 350 Cable Survey System. It allows a check to be made that the tone frequency can be distinguished from background noise. It also allows the presence of noise sources to be determined and identified.

### System errors

The System Errors window, shown in Figure 6–7, displays a list of all errors and events reported by the 350 System. The list includes cleared and uncleared errors. The window can include up to 600 lines of text, with a scroll bar that allows you to search through the list. When the list includes 600 lines of text, DeepView for Windows will delete the oldest message in the list to provide room for any new ones.

Figure 6–7: System Errors window

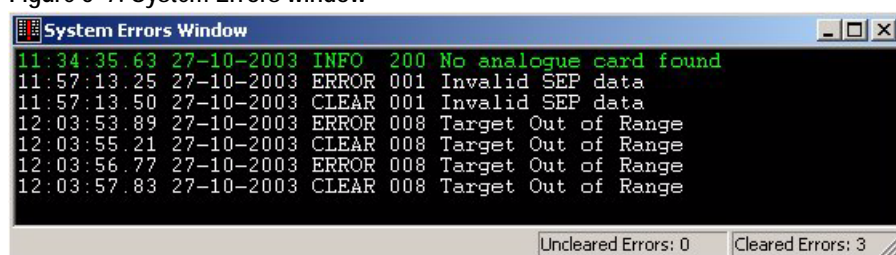

```
System Errors Window
11:34:35.63 27-10-2003 INFO 200 No analogue card found
11:57:13.25 27-10-2003 ERROR 001 Invalid SEP data
11:57:13.50 27-10-2003 CLEAR 001 Invalid SEP data
12:03:53.89 27-10-2003 ERROR 008 Target Out of Range
12:03:55.21 27-10-2003 CLEAR 008 Target Out of Range
12:03:56.77 27-10-2003 ERROR 008 Target Out of Range
12:03:57.83 27-10-2003 CLEAR 008 Target Out of Range
Uncleared Errors: 0 Cleared Errors: 3
```

The lines of text always have the format described in Table 6–3.

Table 6-3: System errors format

<u>hhmmss.ss</u>	<u>dd-mm-yyyy</u>	<u>SSSSS</u>	<u>NNN</u>	<u>{Error description}</u>
Time of the message line (Note 1)	Date of the message line (Note 1)	Error status field = either ERROR or CLEAR (Note 2)	Three-digit error number with leading zeros as needed	Text field containing up to 40 characters containing a description of the error or of the error being cleared

**Notes:**

1. Time and date information in the message line comes from the SDC system clock.
2. The five character Error Status field can contain ERROR, CLEAR or EVENT.
3. The message line can have any of four colours against the black background:
  - White indicates a cleared error.
  - Red indicates an uncleared error.
  - Yellow indicates an event.
  - Green indicates an information message.

The System Errors window includes a status line that has two data fields. These show the total number of cleared and uncleared errors since you started DeepView for Windows.

## Terminal Window

The Terminal Window, shown in Figure 6-8, allows you to send and view data to and from the SEP and the altimeter. It has a toolbar, a client area that displays black text against a white background, and a status bar.

The figure shows the Terminal Window displaying data packets from the 350 SEP in the client area. If you select the altimeter as the active serial device, the client area will show data packets from this device instead.

Figure 6-8: Terminal window

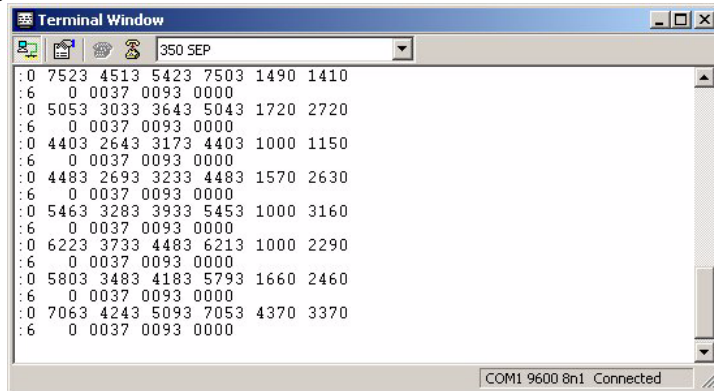





Table 6-4: Terminal Window toolbar

Button	Function	Explanation
	Enable/Disable SEP polling	This button has a toggle action that pauses and resumes SEP polling with alternate presses. With this button deselected, DeepView does not send the necessary characters that request data packets from the SEP.
	Terminal properties [ALT][T]	Use this button to set the serial communication parameters for the active serial device.
	Connect	This button allows you to connect the terminal to the active serial device.
	Hang Up	This button allows you to disconnect the terminal from the active serial device.

There is also a drop-down box that allows you to select the active serial device from among those available. This box includes the option to use the Terminal Window as a 'dumb terminal' if necessary (also accessible by pressing [ALT][Down arrow] then release [ALT]).

The status line shows the communication port settings for the active serial device.

### Video Overlay Enable

Enabling Video Overlay is covered in section 6.2.2.4 along with details of the configuration options available.



## 6.2.1.5 Configuration Options

### Standard parameters

This option should be selected to configure the system parameters information.

Figure 6–9: System Configuration

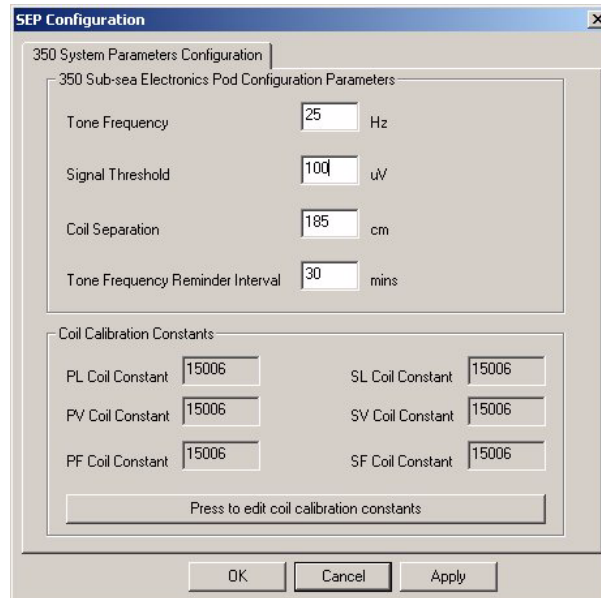

## 6.2.2 Survey Parameters

This dialog contains the main parameter which the 350 SEP requires to track the tone and find the position of the cable. To carry out an accurate survey, these parameters must be entered correctly.

### Tone Frequency

Set the tone frequency to the same frequency as the one on the cable. Enter the frequency of the tone in units of Hz. The system accepts values from zero to 200Hz. Note that the rejection capabilities of the system allow you to set the tone frequency accurately. An error of  $\pm 1$ Hz or more in setting the frequency could cause the system to reject the tone.

You may improve the performance of the System in the presence of background noise by using the Spectrum Analyser (Section 6.2.1.4) display to select a suitable tone frequency.

### Signal Threshold

Threshold is an absolute value in microvolts. The 350 system considers targets to be out of range if signals from them are below the threshold setting.

You should determine the correct setting for the threshold empirically, considering the level of noise present in the survey environment. Low values for threshold will yield an improvement in the operating range, but will make the System more susceptible to noise.

Figure 6–10: Threshold does not apply to vertical coils.

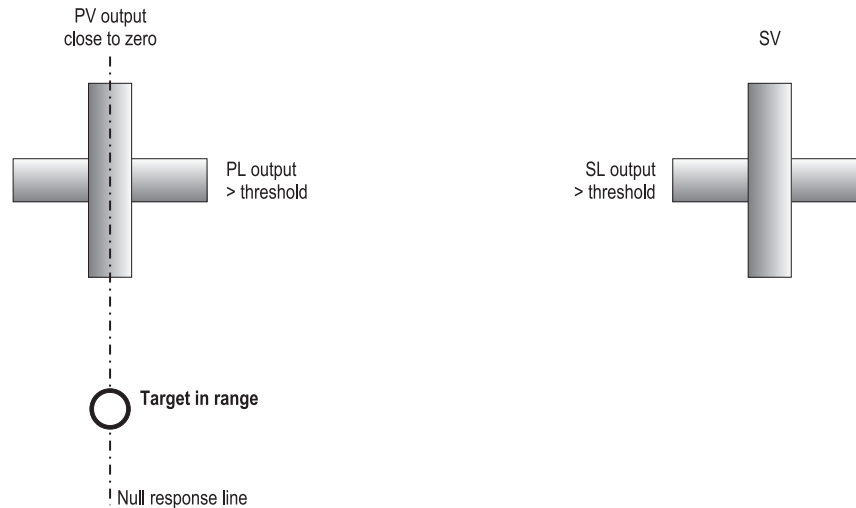

Note that the setting for the threshold applies *only* to the signals from the lateral coils (in Run mode). This is because the null-response from the vertical coils extends vertically downwards from the centre of each coil triad. Any target close to this null-response line will not produce an output from the vertical coil even when located very close to it. For the same reason, the threshold applies only to the fore-aft coils in the Forward Search mode.

### Coil Separation

Set the tone frequency to the same frequency as the one on the cable. Enter the frequency of the tone in units of Hz. The system accepts values from zero to 200Hz. Note that the rejection capabilities of the system allow you to set the tone frequency accurately. An error of  $\pm 1$ Hz or more in setting the frequency could cause the system to reject the tone.

You may improve the performance of the System in the presence of background noise by using the Spectrum Analyser (Section 6.2.1.4) display to select a suitable tone frequency.



The coil separation distance is a very important parameter. The accuracy of survey measurements delivered by the 350 system depends on the accuracy with which you measure this parameter.

Refer to Section 3.2.2 for instructions to mount the coils and adjust their separation distance.

### Tone Frequency Reminder Interval

To avoid potential deterioration in quality or loss of survey data you should perform a regular check on the received tone signal and on the level of background noise.

Deepview provides three facilities that you may use to check on the quality of received signals:

- The Run/Display screen (Section 6.2.1.2) and the Forward Search screen (Section 6.2.1.3) both include a display of the signal voltages received on each channel.
- The Spectrum analyser (Section 6.2.1.4) display shows a clear representation of the received tone signal and the level of noise frequencies across the received band.
- The oscilloscope display shows the actual received signal after amplification but before signal processing. You may use this display to check for the effects of coil saturation (Section 6.2.1.4).

At a pre-set interval, the System will remind you to check the tone frequency. Use the System Parameters to set a suitable value for the reminder interval, up to a possible 360 minutes. The default setting is 30 minutes. A setting of zero switches off the reminder facility, but you should not use this setting.

### **Coil Calibration Constants**

---

During manufacture of the 350 system, TSS takes every care to match the coils and their pre-amplifiers to each other. However, there will inevitably be some small residual differences between individual sensing coils.

Each of the sensing coils supplied by TSS has an identification plate that includes a calibration constant. The 350 system requires this information so that it can compensate for the residual differences between sensing coils.

During the coil installation process (Section 3.2.2), you should have recorded the calibration constants for each of the six coils, together with their serial numbers and locations. The Configuration Log form in Appendix F includes a suitable space for you to record these details.

TSS supplies the System with the port and starboard coil triads already assembled, and with the SDC configured with the relevant calibration details. Use the System Parameters window to check the calibration values are correctly configured.

If you exchange a sensing coil for any reason, enter the new five digit value for the calibration constant in the relevant box on the screen. **Do not change any other values.**

Each of the six calibration constants will be different, and you must enter them carefully. The numbers include an error-checking element that helps to ensure valid data entry.

#### *6.2.2.1 Altimeter*

The Altimeter option allows you to change the altimeter configuration for specific installations and to view data transmitted by an altimeter connected directly to the SEP.

To view data transmitted by an altimeter connected to an SDC serial communication port, use the Terminal Window described in sub-section 6.2.1.4.

Figure 6–11: Altimeter Configuration

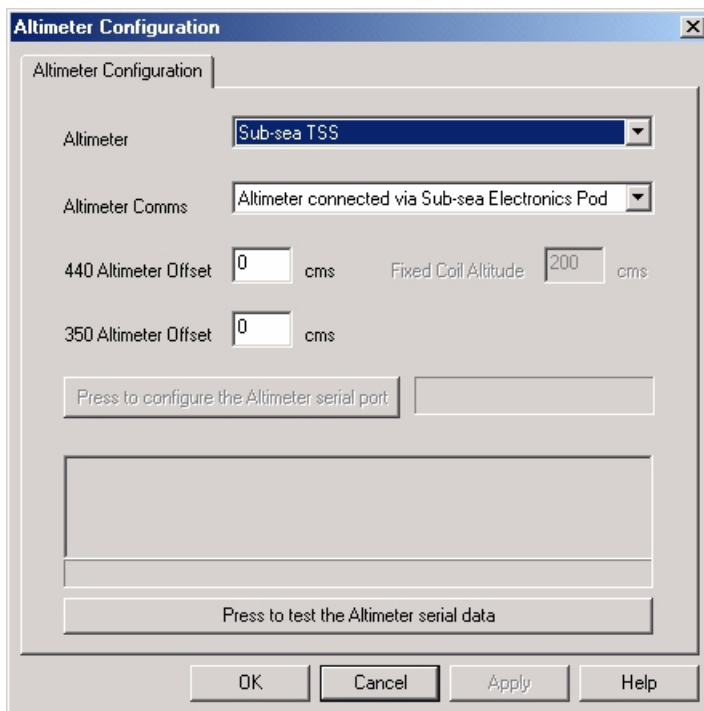

Use the Altimeter Configuration Window to set appropriate parameters for your altimeter:

Altimeter	<input type="checkbox"/> Disabled <input type="checkbox"/> Fixed coil height <input type="checkbox"/> Sub-sea TSS* ( <i>see altimeter comms below</i> ) <input type="checkbox"/> PSA 900** <input type="checkbox"/> PSA 900 + depth** <input type="checkbox"/> PSA 9000** <input type="checkbox"/> Ulvertech Bathy <input type="checkbox"/> Simrad UK90 <input type="checkbox"/> OSEL Bathy <input type="checkbox"/> SeaKing Bathy 704 <input type="checkbox"/> Hyspec 305
Altimeter Comms	<input type="checkbox"/> Altimeter connected via Sub-sea Electronics Pod (for altimeters marked * and ** above) <input type="checkbox"/> Altimeter connected direct to a COM port (for altimeters marked ** and all other altimeters above)
Fixed coil altitude	If there is no altimeter fitted and the design of the ROV allows the coils to remain at a fixed altitude above the seabed, enter this altitude in centimetres.
Altimeter offset	Enter the height difference, in centimetres, between the reference line of the 350 coil array and the transducer face of the altimeter. Use a positive value if the altimeter is above the coils.

The Altimeter Configuration Window allows you to select an SDC serial communication port that you will use to accept data from the altimeter and to set its communication parameters. Note that the 440 and 350 systems can have different offsets. Although a single altimeter is present, its height above the 350 and 440 coils will be different.

The altimeter test allows you to see the serial data transmitted by an altimeter connected to the SDC. The values shown will not have any meaning until the altimeter is immersed in water.

Figure 6–12: Altimeter Test

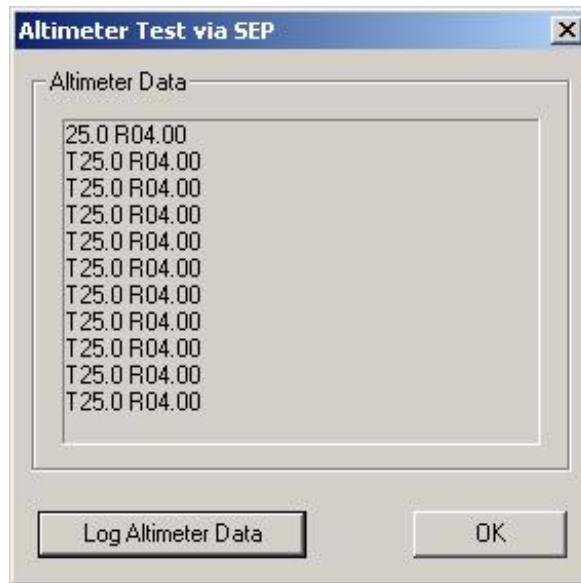

Refer to sub-section 7.3.3 for a description of the data formats supplied by the compatible altimeters.

### 6.2.2.2 External Data Logging

DeepView for Windows allows you to record the survey data acquired by the 350 System in two ways:

#### A) External Output Configuration

*Note that external logging is defaulted to on.*

<b>Output type:</b>	In 350 mode, the system always outputs a sentence which combines the signal and coordinate information. See sub-section 7.2.2 for a description of these data formats.
<b>Output Rate:</b>	The SDC can transmit data to the data logger at either four records or one record per second. The default setting is four records per second. You should consider the available storage space and the desired linear track resolution for the survey before you decide between these alternatives.
<b>External Output Enabled</b>	This box must be checked to enable the external output. If it is enabled, then a tick will appear against the "external output" item in the "configuration" menu.
<b>Configure External Serial Port</b>	Options to configure, COM Port, Baud Rate, Data Bits, Parity and Stop Bits. See Figure 6–13.

Figure 6–13: External Output Configuration and Serial Port menu

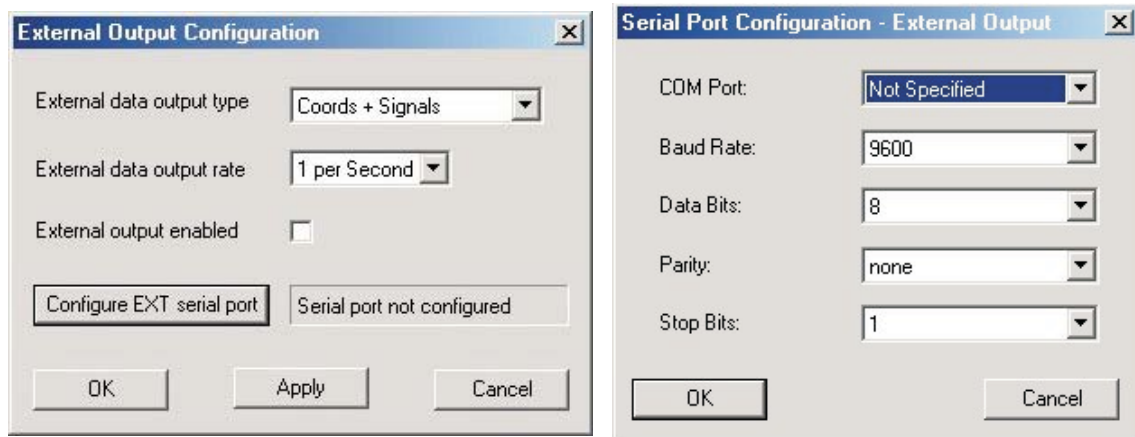

### 6.2.2.3 Load Factory Defaults

Selecting this option will present a dialog box. Acceptance of this dialog will result in the SEP settings being returned to their factory defaults. Certain parameters within DeepView will also be returned to their default states (see Table 6–5).

Table 6–5: Factory System Defaults

Parameter	Default Value
Tone Frequency Reminder Interval	30 mins
Video Overlay Parameters	COM5, 9600, 8, n, 1
External Output Comms Parameters	COM3, 9600, 8, n, 1
External Output Packet	Coords + signal, 4/second
Altimeter Comms Parameters	COM port not specified, 9600, 8, n, 2
Altimeter Type	Disabled
Altimeter Offset	0 cm

### 6.2.2.4 Video Overlay Setup

The video overlay feature was updated for version 8 SDC. It operates in the similar way as the previous overlay by receiving a video signal arriving from a user supplied subsea camera and overlaying it with the DeepView for Windows information specified by the user via the Video Overlay Configuration. The Video Overlay Setup menu is available via the Configuration options and provides the options illustrated below in Figure 6–14.

The video overlay has two possible modes. The first mode is where a copy of the SDC screen (the Runview) is overlaid on the video output. This is selected with the "Duplicate Runview" checkbox. The other mode is where selected information, for example the VRT and target position, are overlaid. The positions and colours of each of these elements can be fully controlled by the user.

Figure 6–14: Video Overlay Setup



Dependent upon the user's requirements they can enable/disable specific information.

As shown, they are also able to set the colours of Text, Signal Bars, Signal Trail and LAT Bar, modify video mode and input/output connection.

These additional options provide the user with more control over the display to improve ease of use.

The display overlaid on the external monitor from the DeepView software is shown in Figure 6–15. The video signal will be displayed behind this survey information where the black background is currently shown.

Figure 6–15: Video Overlay Signal

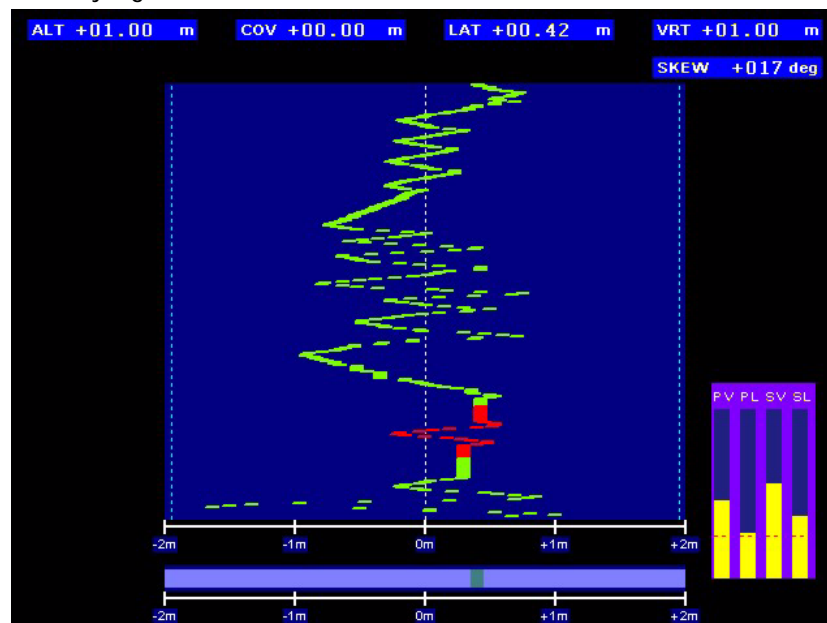

The Overlay feature can be enabled/disabled either from the View options or by using the icon on the toolbar.

Figure 6–16: Video Overlay Enable/Disable button



### 6.2.3 DeepView for Windows Icon Tools

Table 6–6 shows and explains the command buttons on the DeepView for Windows toolbar. You may access these command buttons by clicking on them with the trackpad or external pointing device. A tooltip appears to remind you of the button functions if you hover the pointer over a button, with the same information also appearing in the status bar. You may also access some of the button functions by pressing the appropriate function key from the Run Window. Sub-section 6.2.4 lists all the available function keys that you may use in the 350 mode.

Table 6–6: DeepView Toolbar









Button	Function and Function key	Explanation
	Terminal Window	This button performs the same function as the <u>V</u> iew → Terminal Window command described above. The button has a toggle action so that the window will open and close with alternate presses. The normal condition is for the Terminal Window to be closed when you start to use DeepView. Refer to sub-section 6.2.1.4 for a full description of the Terminal Window.
	System Errors Window	This button performs the same function as the <u>V</u> iew → System Errors Window command described above. The button has a toggle action so that the window will open and close with alternate presses. The normal condition is for the System Errors Window to be closed when you start to use DeepView. Refer to sub-section 6.2.1.4 for a full description of the System Errors Window.
	Run Window	This button performs the same function as the <u>V</u> iew → Run Window command described above. The button has a toggle action so that the window will open and close with alternate presses. The normal condition is for the Run Window to be closed when you start to use DeepView.
	440/350 mode	These buttons are available only if you operate the 350 System as part of a Dualtrack installation when you may use them to select the operating mode. When you press either of these buttons, Dualtrack enables the relevant SEP and disables the other. The Run Window changes to suit the selected operating mode. Refer to appendix B.1 for a description of Dualtrack.
	440 coil drive Function key [F5]	This button is not relevant to the 350 System. It will be available if you are operating the 350 as part of a Dualtrack installation: refer to the 440 System Manual for further details.
	Background compensation	This button is not relevant to the 350 System. It will be available if you are operating the 350 as part of a Dualtrack installation: refer to the 440 System Manual for further details.







Table 6-6: DeepView Toolbar (Continued)

Button	Function and Function key	Explanation
	Video overlay Function key [F3]	This button has a toggle action that enables and disables the video overlay with alternate presses. Refer to sub-section 6.2.2.4 for details of the video overlay option.
	Analogue output	This button has a toggle action that enables and disables the analogue output with alternate presses.  NOTE: this option is now obsolete.

### Run Window tools

Table 6–7 shows and explains the command buttons on the Run Window toolbar. You may also access some of the button functions by pressing the appropriate function key from the Run Window. Sub-section 6.2.4 lists all the available function keys that you may use in the 350 mode.

Table 6–7: Run Window Toolbar

Button	Function	Explanation
	Show Run Window	When in Forward Search mode (Section 6.2.1.3), switch to Run/ Display mode.
	Show Forward Search Window	When in Run/Display mode (Section 6.2.1.2), switch to Forward Search mode.
	Annotations	This button opens the text annotation feature available when you are creating an internal logging file. You may use the feature to add text comments, of up to 40 characters in length, to the file. The comments will appear in the status bar during replay of the file. The feature will not be available unless you have configured DeepView to generate an internal logging file.
	Help	This button has a toggle action that opens and closes the DeepView function help panel described in sub-section 6.2.4.

### 6.2.4 DeepView for Windows Function Keys

Sub-section explains the menu commands and toolbar buttons available from within DeepView for Windows. You may access some of these commands and tools directly by pressing the appropriate function key on the SDC. As a simple memory aid, press the function key [F1] to see the help dialog panel shown in Figure 6–17. Note that this dialog panel is NOT part of the DeepView for Windows on-line Help support.

Press any key to close the help dialog panel.

Figure 6-17: DeepView function keys

Run Window Function Keys	
F1	Show Function Key Help
F2	Open/Close Replay File
Shift+F2	System Parameters Configuration
F3	Create New Internal Log File
Shift+F3	Altimeter Configuration
Ctrl+F3	Close Internal Log File
Shift+F4	System Time Configuration
F5	440 Coil Drive On/Off
Shift+F5	External Output Configuration
F6	350 Toggle Fwd Search/ Run View
Shift+F6	Analogue Output Configuration
Ctrl+F6	Toggle 440/350 SEP (Dualtrack Mode)
Shift+F7	440 Run Background Compensation
Shift+F8	Seawater Compensation
Shift+F9	Load Defaults
Shift+F10	Video Overlay Configuration
Ctrl+F10	System Configuration Wizard
Ctrl+F	Toggle Forward Search On/Off (350)
Ctrl+H	Toggle SEP Height Range
Ctrl+R	Toggle Run View On/Off
Ctrl+V	Toggle Video Overlay On/Off
Ctrl+W	Toggle SEP Width Range (350)

Press any key to dismiss

**Notes:**

1. Function key combinations [CTRL]-[F6], [CTRL]-[F7] and [F5] are valid only when you use the 350 System in a Dualtrack installation.

## 6.3 AFTER THE DIVE

Perform the following tasks after you complete a survey using the 350 System:

1. **Print the configuration.**  
Select File⇒Print Configuration to send a copy of the 350 System configuration details to Window Notepad. Use this separate application to print the details so that you may retain them with the survey records.
2. **Close the logging files.**  
Select File⇒Close Log File to close the internal log file (if you have made one during the survey). Command the external data logger to stop logging data from the 350 System.
3. **Exit DeepView for Windows.**  
Select File⇒Exit to exit the program. If necessary, use Windows Explorer to copy the internally logged file to a separate disk to accompany the survey records. You might need to compress the file using a separate program before you can transfer it to a diskette.
4. **Exit Windows and power-off the SDC.**  
Select Start⇒Shut Down..., then choose 'Shut down' and press OK to close the

Windows operating environment. Wait while Windows closes and then power-off the SDC when the screen tells you that it is safe to do so.



### CAUTION

**DO NOT power-off the SDC until it is safe to do so otherwise Windows™ will log the fact that it was incorrectly closed. This will cause the SDC to enter a diagnostic check automatically when you next operate it, extending the time that it takes for the 350 System to become operational after power-on.**

**If you power-off the SDC before Windows has closed properly, you might corrupt some of the data logging files from the survey.**

#### 5. Power-off the sub-sea installation.

If you power-off the sub-sea installation before you close DeepView for Windows, the program will register a communications failure.

#### 6. Check the 350 System.

After you recover the ROV, perform all the post-survey checks and make any necessary repairs to the 350 System before you store it. This helps to ensure the System will be ready for immediate deployment when needed again. Use a fresh water hose to wash deposits of salt and debris off the System.

Refer to Section 7 for a suggested survey procedure using the 350 System.

### 6.4 REPLAYING A LOG FILE

When you start to replay a log file an additional tool bar appears at the top of the run window.

Figure 6–18: Replay a log file screen

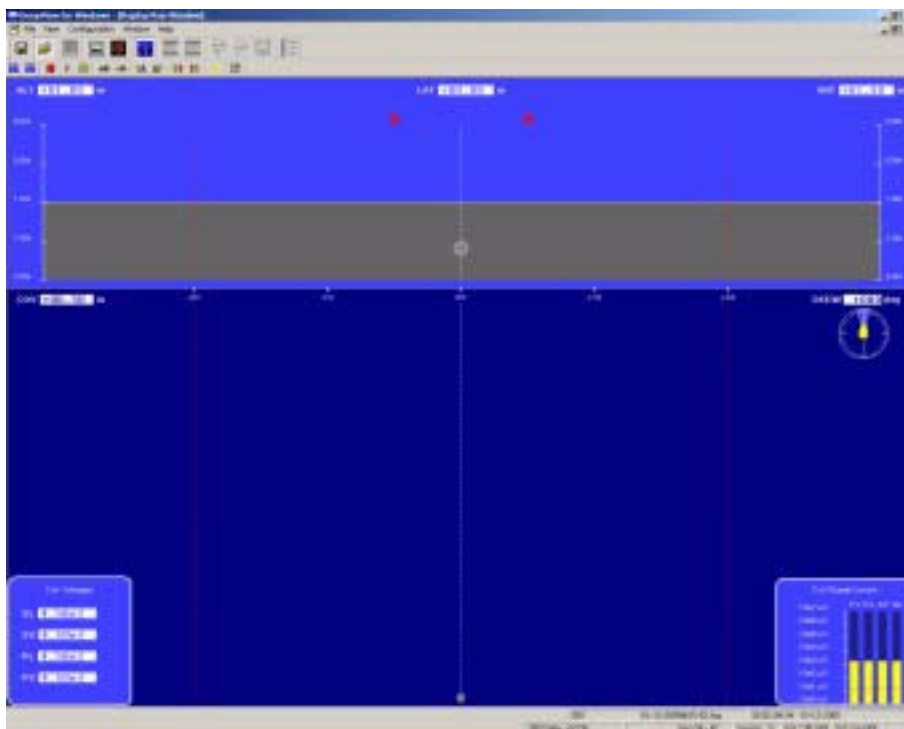



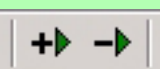
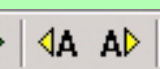
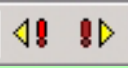



Figure 6–19: Replay toolbar keys



Table 6–8: Replay toolbar function keys

Button	Function	Explanation
	Toggle height scale Function key	
	Toggle swath width Function key	
	Stop / Play / Pause Function keys	
	Increase / Slow down replay speed Function keys	
	Jump to previous / next annotation Function keys	
	Jump to previous / next event Function keys	
	Goto time Function key	
	Help button	Same as ctrl-F1

### 6.5 QUALITY CONTROL

The Quality Control function of the 350 System defines an envelope within which the measurements meet the specifications for accuracy listed in Section 8.

Whenever the co-ordinates of the target fall outside the limits of the Quality Control envelope, the following occurs:

- The target shown on the Run Display screen changes colour.
- A message appears on the screen to identify the reason for quality control failure.
- The output strings to an external data logger include the quality control indicator and identification number. The two-digit identification number allows post-processing engineers to identify the quality control failure. Refer to sub-section 7.3.1 for details of the QC check code.
- The audible alarm on the SDC sounds (if you have enabled this feature).

The extremities of the Quality Control envelope are as follows:

#### **A) Lateral extremities:**

---

If the target falls outside a swath range of  $\pm 2.0\text{m}$  from the centre of the coil array, then the Quality Control flag will be set. These extremities appear on the Run Display screen as two vertical broken red lines.

#### **B) Vertical extremity:**

---

If the signal strength on either of the lateral sensing coils falls to below  $50\mu\text{V}$ , then the Quality Control flag will be set.



The quality control flag does NOT mean that the measurements contain errors. It merely indicates to the post-processing team that the vertical range to target or the lateral offset has exceeded pre-defined limits. The post-processing engineers can use this flag to help them analyse the acquired data more easily.



### 7 OPERATING PROCEDURE

In common with other items of precision equipment, you may rely on the quality of data gathered by the 350 System only if you follow the correct operating procedures when you use it.

This section of the Manual considers the role that the 350 System plays within an overall survey operation. The sub-sections follow a typical survey operation in sequence: It begins with the preparation necessary before the survey, includes some operational considerations, and ends with some suggestions for the effective use of the quality control information.



This is an important section of the 350 Manual and contains information to help you complete a survey operation successfully. However, you should always follow specific advice and instructions provided by the survey planning team if these conflict with the suggestions in this Manual.

If necessary, contact TSS for advice on operational and technical issues concerning the 350 System. The title page of this Manual lists the contact details for TSS (International) Ltd. The DeepView Help system also lists the contact details of TSS offices in Aberdeen and Houston.

---

#### 7.1 Before the Survey Page 2

Details that must be considered during the period leading up to a survey. This sub-section will be of particular interest to Survey Planners and their clients.

---

#### 7.2 During the survey Page 4

The correct operating procedure for the 350 System during a survey. The level of System-specific information included in this sub-section will be useful to engineers directly involved with the survey operation.

---

#### 7.4 After the Survey Page 19

To maintain the 350 System in good working order it is important to perform these simple tasks after you complete the survey and recover the ROV.



To allow for meaningful analysis of the acquired data, the 350 System allows you to keep a record of the System configuration during a survey. The operating software DeepView generates this information and makes it available for editing and printing through the Windows™ Notepad application.

---

#### 7.5 Operational Considerations Page 20

Some potential sources of error that you might encounter during a survey and some suggestions for avoiding them.

---

#### 7.6 ROVs Page 29

The 350 System is suitable for installation and use on board a wide range of ROV types.



## 7.1 BEFORE THE SURVEY

You should include the following considerations in the survey planning scheme:

1. **Personnel and equipment availability.**

Check the availability of a working 350 System and a TSS-trained operator for the period of the survey. *Refer to sub-section 7.1.1.*

2. **Tone frequency.**

Choose a frequency for the tone, taking into account details such as the length of the cable and the noise levels in the received bandwidth of the 350 System. *Refer to sub-section 7.1.2.*

3. **Survey requirements.**

Define the type of survey and consider the possible compromise between acceptable measurement accuracy and the time it takes to complete the survey. *Refer to sub-section 7.1.3.*

4. **Installation requirements.** *Refer to sub-section 7.1.4*



Contact TSS for advice if necessary. You will find the contact details for TSS (International) Ltd on the title page of this Manual.

### *7.1.1 Personnel and Equipment Availability*

When used properly, the TSS 350 System is a precision survey tool that provides valuable and detailed survey data to describe the track of a conductive target through the survey area.

It is in the interest of the Survey Planners to ensure that appropriate personnel attend one of the TSS Training Courses. Two levels of 350 Training Course are available. Refer to Appendix B.2 for a description of each course.

Ensure that a 350 System in good working order and with a complete kit of spare parts will be available at the time of the survey operation.

### 7.1.2 Tone Frequency

Your choice of tone frequency that you inject onto the target cable should take account of several factors, including:

- ❑ Specific requirements of the survey planning team.
- ❑ The length of the target cable.  
The distributed capacitance between the cable and sea water attenuates high tone frequencies more rapidly than low tone frequencies. For this reason, surveys on long cables might be easier to conduct if you select a frequency near the lower end of the acceptable range. However, the 350 System is more sensitive to high frequencies than low, and the System can therefore detect the cable at a greater range when you select a high frequency tone.
- ❑ Noise in the survey area.  
High levels of background noise will reduce the ability of the 350 System to calculate the target co-ordinates accurately, particularly when the tone exists at a low amplitude. Use the Scope and Spectrum Analyser window of DeepView to find a relatively quiet part of the band and try to set a tone frequency within that region of the band.

Refer to Appendix C.1 for further relevant details.

### 7.1.3 Survey Requirements

During the early stages, the survey planning team will need to define the type of data required from the survey:

- ❑ The 350 System can complete a quick and simple check on the track and depth of cover of a target by making a series of widely spaced measurements.
- ❑ Alternatively, to work to the highest achievable accuracy, you might need to stop the ROV at carefully specified intervals to perform accurate measurements on the target and to measure the mean seabed level with a separate profiling system.



The 350 System always delivers measurements of the highest achievable accuracy under the given conditions. The compromise that you need to make between survey accuracy and operating speed arises from the need to manoeuvre and measure the position of the ROV with greater precision when you demand a sharper survey resolution.

### 7.1.4 Installation Requirements

Before starting a survey the survey planning team should define the installation requirements of the 350 System. They should consider:

- ❑ The type of ROV to be used and where the SEP and the coils will be mounted.  
The 350 System is suitable for use on most types of ROV, including towed sleds. TSS can offer further advice if necessary.

- ❑ Which communication method to use between the SEP and the SDC. This will depend upon the characteristics of the umbilical cable. See Section 4 for guidance.
- ❑ Whether to use an altimeter or a rapid update profiler, and their location on the ROV.
- ❑ The type and capacity of data logger, and its connection and communication requirements. Check that the data logger will be compatible with the data format supplied by the 350 System.
- ❑ TSS recommends that you should generate a written or printed copy of the System configuration before and again after the survey. This will be useful source of reference during the data analysis phase of the survey. This recommendation means you should arrange to connect a suitable printer to the SDC LPT1 port.
- ❑ The on board facilities for creating, displaying and recording video images from a sub-sea camera mounted on the ROV. Consider using the video facilities to record the installation procedure of the 350 System.

The standard 350 System includes a field support kit (FSK) for use with the sub-sea installation. Only engineers who have attended Part 2 of the relevant TSS training course should use the FSK.

## 7.2 DURING THE SURVEY



**This sub-section lists and explains a basic series of suggested operations and procedures to include in a survey that uses the 350 System. However, you should always follow the specific requirements of the survey planning team, who may require you to modify or add to these procedures. Contact TSS for advice if necessary.**

The DeepView Run Window, described in sub-section 6.2.1.2, provides access to all the facilities you will need during a survey that involves the 350 System. By referring to this window and other features of DeepView, perform the survey:

- 1. Safety and pre-dive checks.**  
Make a series of checks on the installation before you deploy the ROV. See sub-section 7.2.1.
- 2. Print the System configuration details.**  
Select File ➔ Print Configuration in the DeepView toolbar to send a copy of the 350 System details to the Windows™ Notepad application. You should print the details from this application and save the printed copy with the survey records.
- 3. Deploy the ROV.**  
Begin the survey with the ROV close to the expected target position.
- 4. Check signals from the SEP.**  
Use the Scope and Spectrum Analyser window again to confirm that the SEP is receiving signals (tone, mains frequency, harmonics and noise) on all channels. Check for valid signals from the sub-sea altimeter.

### 5. Manoeuvre the ROV over the target.

Use the forward search feature of DeepView to locate a target that crosses the path of the ROV and then use the signal strength bars and the Run Window to steer along its course.

Figure 7-1: Using the forward search mode

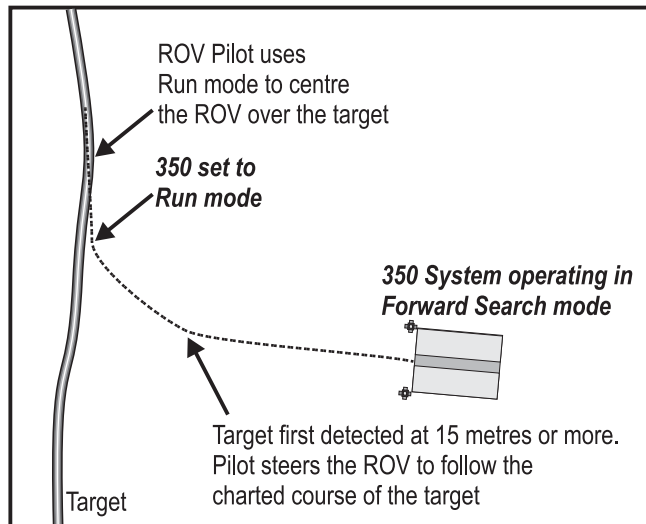

### 6. Perform the main survey:

- ❑ Log all survey data. The main function of the 350 System is to acquire and log survey data for subsequent analysis. DeepView can log data both internally, on the SDC hard disk, and externally to a data logger. You should use the external data logging facility to store the primary survey log. *See sub-section 7.2.2.*
- ❑ Perform regular checks on the signal received at the tone frequency. Take any action necessary to restore deteriorating performance.
- ❑ Operate the ROV and the 350 System so as to control those factors that might degrade the survey results. Refer to sub-section 7.3 for some important operational considerations.

### 7. On completing the survey.

Perform a series of simple procedures to safeguard the logged data and maintain the 350 System in good condition ready for the next survey. *Refer to sub-section 7.4.*

### 7.2.1 Safety and Pre-dive checks

This section describes a series of checks that you should perform on the 350 System before you deploy the ROV and start the survey. Perform these checks carefully, noting any safety issues as you do so:

- ❑ Check the installation of the coil array (section 3.2.2). Ensure that the coil connectors will not be fouled by any manipulators etc., or damaged as the ROV is recovered. Ensure the coil separation distance has been measured correctly, and entered into the top end display software (section 6.1.1.3).
- ❑ Check that all cables are undamaged and secured.
- ❑ Ensure the survey will not exceed the depth rating of the SEP. Most systems are rated to 3000m, but check the warning on Page 3.
- ❑ Ensure all subsea connectors are mated correctly (section 4.1.2) and that blanking plugs are fitted to any unused ports.
- ❑ Check that DeepView has been configured with the coil calibration constants correctly (section 6.2.2)

To check the operation of the system:

- ❑ Use the frequency spectrum display of the 350 System (see sub-section 6.2.1.4) and check that the SDC receives signals correctly on all channels. Repeat this test with the ROV in the water.
- ❑ Perform an altimeter test (sub-section 6.2.2.1) and check that the SEP or SDC receives data packets correctly from the altimeter. Repeat the test in water.



#### CAUTIONS

**Make certain the SDC and its connection cables are secured so that they cannot fall or present a hazard to personnel.**

**Allow only properly qualified engineers to work on the 350 System.**

**The supply connector is a safety feature that allows the system to be isolated easily from the electrical supply. Hand tighten the connector only. Position the connector to allow easy access for disconnection.**

**Ensure there are proper blanking plugs fitted to any unused ports on the SEP.**

Details of the pre-dive checks are also available in the DeepView on-line help system.

### 7.2.2 Data Logging

To provide the post-processing engineers with a detailed account of the survey it is important to maintain a full log of events as they occur during a survey.

The survey log should therefore include:

- ❑ The data logged to an external logger
- ❑ The video recording of the 350 System installation and configuration procedures (if one has been made)
- ❑ The video recordings from cameras on board the ROV
- ❑ Details of any events, such as ROV collisions, that may have occurred during the survey, and the effect that they may have had upon the survey. You should also record any corrective action taken.
- ❑ Printed or hand-written sheets containing the System configuration details that were taken at the start and at the end of the survey
- ❑ Any other information requested by the survey planning team

### 7.2.3 Replay Logged Data

You cannot use the display software on the SDC to replay externally logged files.

To replay a previously logged data file you have to select Open/Close Replay file [F2] from the file option from within DeepView for Windows. This will provide you with the following dialog box to select the file you require. The location of these files by default is a Logs folder within the DeepView for Windows directory, but this can be changed by the user to another directory, or to a floppy disk in drive A of the SDC.

- ❑ Externally logged data files include data packets of fixed length that supply all the information required for a full analysis of the survey. The file includes target co-ordinates, signal values and important quality control information generated by the 350 System during the survey. You should use this logging method to generate the primary survey recording.

Externally logged files will usually be stored on a separate data logger along with files generated by other items of survey equipment. The data logger will time stamp data packets that it receives so that the records may be synchronised accurately during the analysis operation. For this reason, DeepView does not include a time field in the external data packets. Refer to sub-section 6.2.2.2 for a description of the external logging format.

- ❑ Internally logged files are of variable length and include all data transmitted to the SDC by the SEP (target co-ordinates, signal values and, possibly, information needed by the Scope and Spectrum Analyser window). The data packets also include comment lines that describe the SEP type and other System information, a time stamp and any text annotations supplied by the user. The internal logging format does NOT include the quality control information.

Refer to sub-section 7.3.2 for a description of the internal logging format.

The internal logging facility is for test purposes and for the convenience of operators only. You should not use it to record the main survey log.





4. The lateral offset (LAT) is measured from the centre of the coil array. Positive values indicate a target to starboard of the centre line. The field will contain question marks if the target is out of range.
5. The vertical range to target (VRT) is the distance between the centre line of the coil array and the target. There are several conditions that will cause the field to contain question marks:
  - The target is out of range
  - The 350 System cannot compute an accurate position for the target
  - Coil saturation has occurred because the tone signal is too strong.
6. Coil altitude (ALT) information comes from an altimeter if the System includes one. Otherwise, the information in this field will be the fixed coil height if available. The field will contain question marks if there is no fixed height or altimeter information available.
7. The SDC calculates the target depth of cover (COV) using  $COV = VRT - ALT$ . A positive value indicates the target is covered. Zero or negative values indicate an exposed target. There are several conditions that will cause the field to contain question marks:
  - The target is out of range
  - The 350 System cannot compute an accurate position for the target
  - Coil saturation has occurred
  - There is no fixed coil height or information available to the SDC from an altimeter
8. The skew angle in the range -90 to +90 degrees. This field will contain question marks if the System cannot measure skew angle. Zero skew is the ideal situation where the ROV aligns on the same heading as the direction of the target. Skew is positive when ROV heading is to starboard of the target direction.
9. The signal strengths, in microvolts, measured on channel 1 (starboard lateral – SL), channel 2 (starboard vertical – SV), channel 3 (port lateral – PL), channel 4 (port vertical – PV), channel 5 (starboard fore-aft – SF) and channel 6 (port fore-aft – PF).

Information included in the above signal strength fields may have a very large dynamic range, extending from less than 1 $\mu$ V to more than 7 volts. To allow for simple encoding of this range, the System displays and logs values using scientific notation:

The signal value format is: abbc where the actual value is a.bb e+c  $\mu$ V

For example:



- The field +1234 represents a value of  $1.23 \times 10^4$  microvolts (or 12.3 mV). The SDC would display this on the Run Display screen as +1.23e4 in the lower left-hand data panel.
  - The field +2416 represents a value  $2.41 \times 10^6$  microvolts (or 2.41 volts). The SDC would display this on the Run Display screen as +2.41e6 in the lower left-hand data panel.
10. The QC check code provides additional status information that explains any occurrence of the QC flag being set. The check code consists of a two-digit number in the range 01 to 07 and 99 with the meanings defined in Table 7-2.

Table 7-2: QC check code meaning – Survey mode

QC Check Code	Meaning
00	Target in range. SL and PL $\geq 50\mu\text{V}$ ; LAT $\leq \pm 2\text{m}$ . Quality flag is RESET.
01	Target in range. SL or PL $< 50\mu\text{V}$ ; LAT $\leq \pm 2\text{m}$ . Quality flag is SET.
02	Target in range. SL or PL $\geq 50\mu\text{V}$ ; LAT $> \pm 2\text{m}$ . Quality flag is SET.
03	Target in range. SL or PL $< 50\mu\text{V}$ ; LAT $> \pm 2\text{m}$ . Quality flag is SET.
04	Starboard tracking data only; LAT = ????, VRT = ????, SKEW = ???. Quality flag is SET.
05	Port tracking data only; LAT = -????, VRT = ????, SKEW = ???. Quality flag is SET.
06	Skew angle not available. Skew angle = ???. Quality flag is SET.
07	Saturation in one or more coils. Quality flag is SET. The SDC displays a warning banner on the Run Display screen.
99	Target out of range. VRT and LAT = ????. SKEW = ???. Quality flag is SET.

### 7.3.1.2 Forward Search mode

The string is 48 characters long with individual field definitions as follows. The SDC logs all distances in units of centimetres and signal voltages in units of microvolts using the scientific notation. The values in the packet are rounded and it is possible that they will not precisely match those on the Forward Search screen.

Table 7-3: External logging format – Forward search mode

Start character (Note 1)	FO	WWW	AAAA	1111	2222	3333	4444	5555	6666	QQ	[CR]	[LF]
Packet identifier (Note 2)												
QC flag (Note 3)												
Space character												
Forward search range (Note 4)												
Space character												
Coil altitude (Note 5)												
Space character												
Signal strength on channel 1 (Note 6)												
Space character												
Signal strength on channel 2 (Note 6)												
Space character												
Signal strength on channel 3 (Note 6)												
Space character												
Signal strength on channel 4 (Note 6)												
Space character												
Signal strength on channel 5 (Note 6)												
Space character												
Signal strength on channel 6 (Note 6)												
Space character												
QC check code (Note 7)												
Carriage return line-feed termination												

### Notes:

1. The Start character is a colon.
2. 'F' identifies a packet from the Forward search mode. The SDC transmits this type of packet whenever it is displaying the Forward Search screen.
3. The Quality Control (QC) flag will be a space character when RESET, or a question mark (?) when SET. See also the QC check code later in this packet.
4. The forward search range (FWD) is measured from the reference line of the coil array (identified in Figure 3–2). There are several conditions that will cause the field to contain question marks:
  - The target is out of range
  - The 350 System cannot compute an accurate position for the target
  - Coil saturation has occurred because the tone signal is too strong
5. Coil altitude (ALT) information comes from an altimeter if the System includes one. Otherwise, the information in this field will be the fixed coil height if available. Forward search mode is available only if information is available concerning the height of the coils above the seabed, and so this field will always contain information.
6. The signal strengths, in microvolts, measured on channel 1 (starboard lateral – SL), channel 2 (starboard vertical – SV), channel 3 (port lateral – PL), channel 4 (port vertical – PV), channel 5 (starboard fore-aft – SF) and channel 6 (port fore-aft – PF).

Information included in the above signal strength fields may have a very large dynamic range, extending from less than 1 $\mu$ V to more than 7 volts. To allow for simple encoding of this range, the System displays and logs values using the scientific notation explained on page 9.

7. The QC check code provides additional status information that explains any occurrence of the QC flag being set. The check code consists of a two-digit number with the meanings defined in Table 7–4.

Table 7–4: QC check code meaning – Forward search mode

QC Check Code	Meaning
00	Target in range. SF and PF $\geq 50\mu$ V; LAT $\leq \pm 2$ m. Quality flag is RESET.
07	Saturation in one or more coils. Quality flag is SET.
08	Target in range. SF or PF $< 50\mu$ V. Quality flag is SET.
99	Target out of range. FWD = 9999. Quality flag is SET.

### 7.3.2 Internal Logging Format

Data packets transmitted by the SEP fall into two categories – ‘co-ordinates’ and ‘signals’. The SEP transmits them sequentially so that either packet ‘A1’ or ‘A2’ below immediately precedes packet ‘B’.

#### A1) Co-ordinates Data Packet – Survey mode

The string is 23 characters long with individual field definitions as follows. The SDC logs all distances in units of centimetres and skew angles in units of degrees. The values in the packet are rounded and it is possible that they will not precisely match those on the Run Display screen.

Table 7-5: Internal logging format – Survey co-ordinates

	:	NAAAA±BBBB	CCCC±DDDD	[CR]	[LF]
Start character (Note 1)					
Number of coils (Note 2)					
Coil altitude (Note 3)					
Lateral offset (Note 4)					
Space character					
Vertical range to target (Note 5)					
Skew angle (Note 6)					
Carriage return line-feed termination					

Notes:

1. The Start character is a colon.
2. The number of coils in the 350 System is always 6.
3. Coil altitude (ALT) information comes from an altimeter if the System includes one. Otherwise, the information in this field will be the fixed coil height if available. If there is no altitude information available the field will contain three space characters and a zero.
4. The lateral offset (LAT) is measured from the centre of the coil array. Positive values indicate a target to starboard of the centre line. The field will contain question marks if the target is out of range.
5. The vertical range to target (VRT) is the distance between the reference line of the coil array (identified in Figure 3–2) and the target. The value is always positive. There are several conditions that will cause the field to contain question marks:
  - The target is out of range
  - The 350 System cannot compute an accurate position for the target
  - Coil saturation has occurred because the tone signal is too strong

6. Skew angle between the target and the ROV in the range  $-90^{\circ}$  to  $+90^{\circ}$ . Zero skew is the ideal situation where the ROV aligns on the same heading as the direction of the target. Skew is positive when the ROV heading is to starboard of the target direction. The field will contain question marks if the 350 System cannot measure the skew angle.

### A2) Co-ordinates Data Packet – Forward Search mode

The string is 23 characters long with individual field definitions as follows. The SDC logs all distances in units of centimetres and skew angles in units of degrees. The values in the packet are rounded and it is possible that they will not precisely match those on the Forward Search screen.

Table 7-6: Internal logging format – Forward search mode

	Start character (Note 1)	Number of coils (Note 2)	Coil altitude (Note 3)	Forward search range (Note 4)	Skew angle (Note 5)	Carriage return line-feed termination
	:	NAAAA	±0000	±CCCC	±DDDD	[CR] [LF]
			Not used - Field contains zeros			

#### Notes:

1. The Start character is a colon.
2. The number of coils in the 350 System is always 6.
3. Coil altitude (ALT) information comes from an altimeter if the System includes one. Otherwise, the information in this field will be the fixed coil height if available. Forward search mode works only if information is available concerning the height of the coils above the seabed, and so this field will always contain information.
4. The forward search range to the target (FWD) is the estimated distance from the coil array to the target. There are several conditions that will cause the field to contain question marks:
  - The target is out of range
  - The 350 System cannot compute an accurate position for the target
  - Coil saturation has occurred because the tone signal is too strong
5. Skew angle between the target and the ROV in the range  $-90^{\circ}$  to  $+90^{\circ}$ . Zero skew is the ideal situation where the ROV aligns on the same heading as the direction of the target. Skew is positive when the ROV heading is to starboard of the target

direction. The field will contain question marks if the 350 System cannot measure the skew angle.

## B) Signals Data Packet (both operating modes)

The string is 34 characters long with individual field definitions as follows. The SDC logs all signal voltages in units of microvolts.

Table 7-7: Internal logging format – Signals packet

Start character (Note 1)	:	0	1111	2222	3333	4444	5555	6666	[CR]	[LF]					
Signals packet identifier (zero character)															
			Signal strength on channel 1 (Note 2)	Space character	Signal strength on channel 2 (Note 2)	Space character	Signal strength on channel 3 (Note 2)	Space character	Signal strength on channel 4 (Note 2)	Space character	Signal strength on channel 5 (Note 2)	Space character	Signal strength on channel 6 (Note 2)		Carriage return line-feed termination

### Notes:

1. The Start character is a colon.
2. The signal strengths, in microvolts, measured on channel 1 (starboard lateral – SL), channel 2 (starboard vertical – SV), channel 3 (port lateral – PL), channel 4 (port vertical – PV), channel 5 (starboard fore-aft – SF) and channel 6 (port fore-aft – PF).

Information included in the above signal strength fields may have a very large dynamic range, extending from less than 1µV to more than 7 volts. To allow for simple encoding of this range, the System displays and logs values using the scientific notation explained on page 9.

Each time the SEP receives a single carriage-return line-feed sequence from the SDC, it transmits either packet 'A1' or packet 'A2', followed immediately by packet 'B'.

### 7.3.3 Altimeter Data Format

You may use certain types of altimeter manufactured by Datasonics, Ulvertech, Simrad and OSEL with the 350 System.

Refer to sub-section 4.1.5 for instructions to connect one of these alternative types of altimeter to the SDC. You may connect the Datasonics unit either to the SDC 'ALTIMETER' COM2 port or directly to the SEP 'Altimeter' port.

You must configure the display software to use your altimeter type. Refer to the instructions in sub-section 6.2.2.1 for instructions to do this.

The descriptions below include the individual data formats and the RS232 parameters for each type of altimeter that you may use with the 350 System. Except for the OSEL altimeter, transmission starts immediately after power-on.

Note that DeepView removes all spaces present in the altimeter string before interpretation. This is because the UK90 format sometimes includes extra spaces which are not defined in its specification. This removal of spaces applies to all types of altimeters which are connected directly to the SDC.

### 7.3.3.1 Datasonics PSA 900 and PSA 9000

The transmission formats for the TSS altimeter, and the Datasonics PSA 900 and PSA 9000 are identical. They transmit data at 2400 baud using 7 data bits, 1 start bit, 1 mark bit and 1 stop bit.

Table 7-8: Altimeter output format – TSS and Datasonics

Txx.x	Ryy.yy	[CR]	[LF]
Altimeter temperature °C	Space character	Altitude (metres) above the seabed	Carriage return line-feed termination

If the Datasonics PSA 900 includes the optional pressure transducer, the data string becomes:

Table 7-9: Altimeter output format – Datasonics with pressure transducer

Dnn.n	Txx.x	Ryy.yy	[CR]	[LF]
Altimeter depth (metres)	Space character	Altimeter temperature °C	Space character	Altitude (metres) above the seabed
				Carriage return line-feed termination

### 7.3.3.2 Ulvertech Bathymetric System

The Ulvertech Bathymetric system transmits data at 9600 baud using 8 data bits, 1 stop bit and no parity.

Table 7-10: Altimeter output format – Ulvertech Bathymetric system

xxxxxx	,	yyyy	[CR]	[LF]
Water column depth of altimeter (centimetres)	Comma character	Altitude (centimetres) above the seabed	Carriage return line-feed termination	

### 7.3.3.3 Simrad UK90

The Simrad UK90 transmits data at 4800 baud using 8 data bits, 2 stop bits and no parity.

Table 7-11: Altimeter output format – Simrad UK90

Daaa	.aa	Abb.bb	Abb.bb	Tcc	Pdddd	Veeee	Wf.fff	Hgg	[CR]	[LF]			
Water column depth of altimeter (metres)	Space character	Altitude (metres) above the seabed (Note 1)	Space character	Sea water temperature °C	Space character	Surface air pressure	Space character	Sound velocity in sea water	Space character	Relative density of the sea water	Space character	Surface installation height above sea level	Carriage return line-feed termination
						(Note 2)							

**Notes:**

1. The Simrad UK90 altimeter measures altitude at twice the rate that it measures depth. It therefore includes the altitude field twice in each data packet, separated by a space character. Both altitude fields will contain similar values because it is unlikely the altitude will change significantly during the short interval between the two measurements.
2. The contents of these output data fields are set externally and have no effect on operation of the 350 System.

### 7.3.3.4 OSEL Bathymetric System

The OSEL Bathymetric system transmits data at 9600 baud using 8 data bits, 1 stop bit and no parity.

Table 7-12: Altimeter output format – OSEL bathymetric system

xxxxxx	,	yyy	[CR]	[LF]
Water column depth of altimeter (centimetres)		Comma character		
		Altitude (centimetres) above the seabed		
			Carriage return line-feed termination	



The OSEL altimeter must receive the interrogating character uppercase 'D' from the SDC before it transmits each data string. The communication link between the OSEL altimeter and the SDC must therefore be bi-directional. The SDC transmits the interrogating character automatically when configured to use the OSEL altimeter.

### 7.3.3.5 Tritech SeaKing Bathy 704

The SeaKing Bathy system transmits data continuously using RS232 communications at 9600 baud.



Table 7-13: Tritech SeaKing Bathy format

+AAAA	BBBBBBBBBB	+CCCC	DDDDDDDD	EEEEEEEEEE	-FFFF	GGGG	
Internal temperature (×0.1°C)	Digiquartz pressure (×10 <sup>-5</sup> PSIa)	Digiquartz temperature (×0.01°C)	Raw digiquartz pressure (counts)	Raw digiquartz temperature (counts)	Local oscillator calibration (Hz)	Conductivity (×100 µmhos)	
+HHHH	HJJJJ	JKKKKK	+LLLL	LLLLLLLL	MMMM	NNNNNNNNNN	PPPPPPPP
Conductivity temperature (×0.01°C)	Conductivity salinity (parts per 10 <sup>7</sup> )	Velocity of sound (× 10 <sup>-1</sup> m/s)	Altimeter reading (20ns clock counts) (Note 1)	Bathymetric system devices — Refer to altimeter manual	Depth (mm)	Time at start of scan (hhmmss.cc)	

Notes:

1. The SDC performs the following calculation to calculate the altitude above the seabed:

$$\text{Altitude} = ((\text{Altimeter reading} \times 200\text{ns}) \times \text{velocity of sound}) \div 2$$

For example, if the count were 162712, then:

$$\text{Altitude} = ((162712 \times 200\text{ns}) \times 1475) \div 2 = \mathbf{24.000 \text{ metres}}$$

This is the true distance from the transducer face of the altimeter to the seabed.

### 7.4 AFTER THE SURVEY

To maintain the 350 System in good condition you should perform the following important tasks after you complete the survey and recover the ROV:

- ❑ Print the System configuration details again. Select File➔Print Configuration in the DeepView toolbar to send a copy of the 350 System details to the Windows™ Notepad application. Save the printed copy with the survey records.
- ❑ Recover the ROV.
- ❑ Close the internal and external log files and create backup copies of them. Include a copy of the external log file with the survey records.
- ❑ Power-off the 350 System.
- ❑ Use a fresh water hose to wash salt and debris off the ROV-mounted components of the 350 System. Inspect all components, cables and connectors of the installation carefully and make any repairs necessary.
- ❑ Check the contents of the field support kit and order any parts needed to replenish it.

## 7.5 OPERATIONAL CONSIDERATIONS

### *7.5.1 Operating Performance*

Together with the skilful operation of the 350 System, two major factors influence the response and the performance of the System during survey operations:

#### **1. Frequency of the target tone**

---

You may minimise the effects of background noise by selecting a tone that is in a relatively quiet part of the received band of frequencies. The Scope and Spectrum Analyser window of DeepView helps you make this selection. Refer to sub-section 6.2.1.4 for a description of this window.

#### **2. Coil arrangement on the ROV**

---

The performance of the 350 System depends heavily on the mounting arrangements of the coil array. You need to consider two factors carefully when you use the System:

- Because the 350 System uses trigonometry to determine the target co-ordinates, the accuracy of its survey measurements will improve with larger coil separation distances. However, by installing the coil triads farther apart you might find it difficult to manoeuvre the ROV.
- Large masses of ferromagnetic material can distort the magnetic fields that the 350 System uses to survey the target. There is usually an abundance of such materials in the ROV body.

You should install the coil array where it is at least 0.5 metres away from the ROV body. The installation instructions provided in this Manual describe a configuration of the 350 System that combines ease of deployment with optimal performance.

#### **Summary:**

The logged data packets include a Quality Control flag to identify data that might show degraded accuracy. Refer to sub-section 7.3.1 for a description of the Quality Control feature.

Use all the information and facilities available from the 350 System to identify any drop in System performance so that you may take effective and appropriate corrective action.

### 7.5.2 Sources of Error

There are other error sources that might degrade System performance. You should make yourself aware of these so that you may take action to avoid them or to reduce their effect on survey results.

These error sources fall within two categories:

- ROV handling – See sub-section 7.5.2.1.
- Electrical interference – See sub-section 7.5.2.2.

#### 7.5.2.1 ROV Handling

The following paragraphs describe the potential sources of error that might arise as a result of unskilled or inappropriate operation of the ROV. These include:

- The relative positions of the ROV and the target.
- ROV trim and skew.
- The position of the altimeter.

#### ROV Position over the Target

Figure 7–2 illustrates how errors in the measurement of depth of cover might occur when you survey a target that is partially buried beneath an uneven seabed.



Note that errors such as these arise from inaccuracies in measurements made by the altimeter and *not* to any errors in measuring the vertical range to target.

Figure 7-2: ROV positioning errors

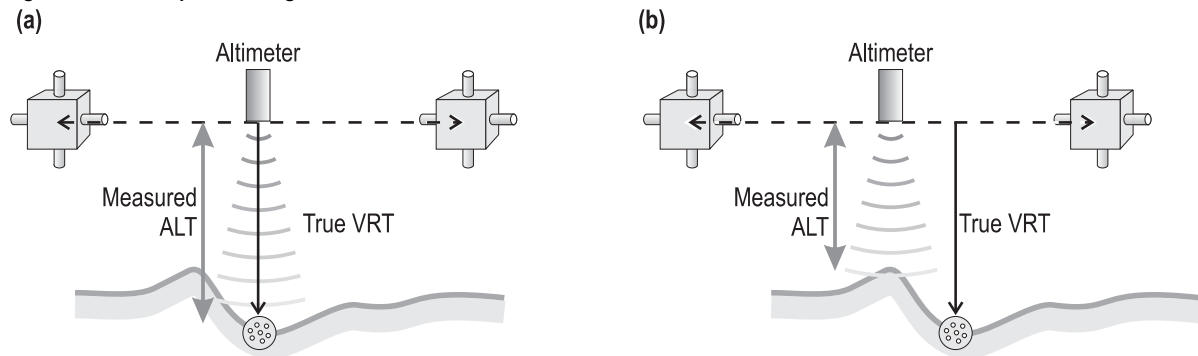

- **Flying with no lateral offset**

Figure 7–2(a) shows the best condition achievable when you use a single altimeter: The ROV is level and is flying with the altimeter located directly over the target.

Under these conditions the depth of cover measurements are accurate.

- **Flying with Lateral Offset**

In Figure 7–2(b), the lateral offset of the ROV has placed the altimeter to one side of the target so that it measures its altitude above one of the trench walls. Conse-

quently, the altimeter delivers information that will not allow accurate assessment of the depth of target cover.

It is therefore important to ensure that:

- You install the altimeter correctly according to the instructions in sub-section 3.2.3.
- You locate the altimeter near the centre of the coil array.
- You operate the ROV so that, as far as possible, the target remains positioned centrally beneath the coil array.

It is important also to recognise that, under the above conditions, these errors affect only the *depth of cover* measurements.

### Summary:

Install the altimeter correctly at the centre of the coil array.

Pay careful attention to the relative position of the ROV over the target.

Be aware of any errors that may arise from the local seabed topography.

For surveys where the depth-of-cover information is critical, consider using a scanning profiler to survey the seabed on either side of the target. You may then merge information from the profiler with measurements from the 350 System during the survey analysis operation.

### The effects of roll, pitch and skew

In severe cases of roll such as shown in Figure 7–3, errors might appear in the vertical range and lateral offset measurements on the target.

Figure 7-3: ROV roll errors

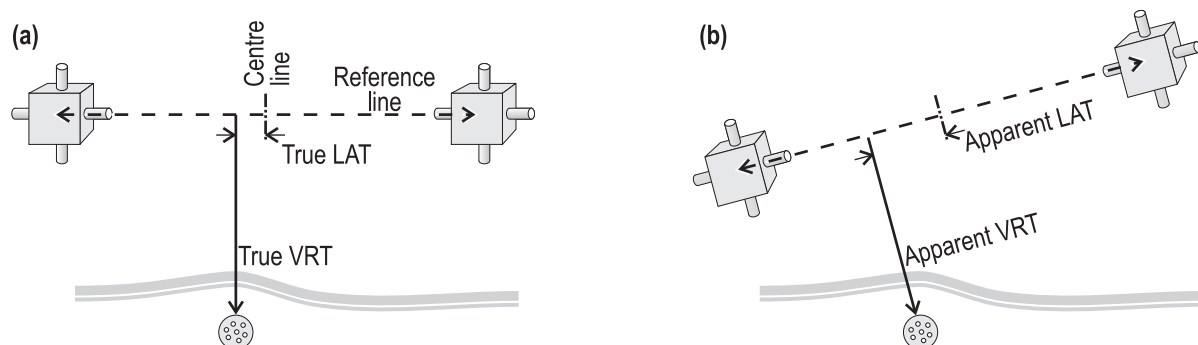

Figure 7–3(a) shows the ideal condition where the ROV is level over the target. In these conditions, the measurements for VRT and LAT will be accurate and valid.

Figure 7–3(b) shows the same situation, but with 15° roll applied to the ROV. If left uncorrected, under these conditions errors will exist in the measurements of both the vertical range and the lateral offset.

For a target located centrally beneath the coil array as shown, the displayed value for lateral offset will contain an error as follows:

$$\text{Error} = Z.\sin (\text{Roll angle})$$

Where  $Z$  is the vertical distance between the coils and the target.

For example, measurements on a target located 1.0 metre below the centre of the coil array will include a lateral offset error of 0.17 metres with  $10^\circ$  of roll applied to the ROV.

Measurements of VRT performed by the 350 System will remain relatively unaffected by small angles of roll. Under the conditions described in the above example, the vertical measurement will contain an error of only 15mm caused by the ROV attitude.

If left uncorrected, angles of pitch will affect:

- The accuracy of the forward range estimate.
- The depth-of-cover measurement accuracy.

The accuracy of vertical range measurements might degrade if large angles of skew exist between the coil array and the target. This is because the effective coil separation distance decreases as the angle opens.

If there is a slight crosscurrent in the survey area, it may be possible to perform the survey only with a small angle of skew present. Under these circumstances, the System will continue to supply valid data with skew angles up to  $\pm 15^\circ$ . If you know that this condition will prevail in the survey area, assess the degree of error by conducting dry-land test measurements on a sample of the target with applied skew.

The Run Window of DeepView displays the measured angle of skew between the ROV and the target when operating in the 350 mode.

**Summary:**

Inaccuracies in vertical range measurements made by the System will increase by no more than 3.5% for roll angles up to  $\pm 15^\circ$ .

Where possible, operate the ROV throughout a survey with an even trim and with no angle of skew between the ROV and the target.

**Slope**

---

When you use the 350 System to survey a cable that ascends or descends a steep slope, you should understand how measurements of depth of cover may degrade in accuracy. Figure 7–4 illustrates this situation.

Figure 7-4: Sloping target

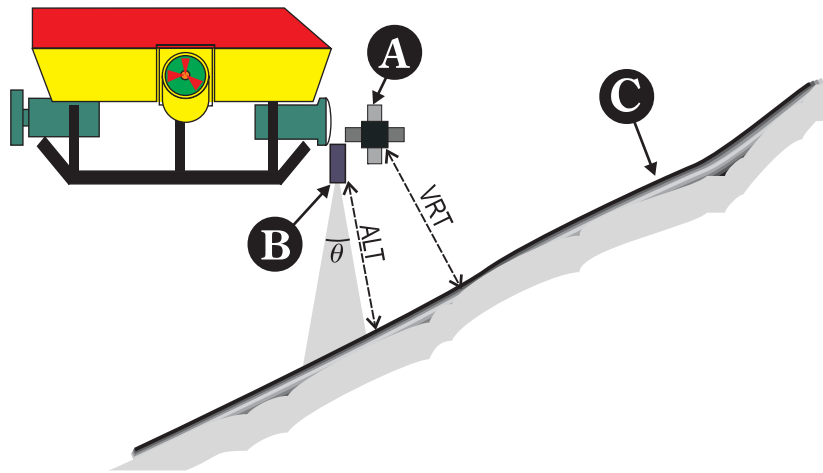

In Figure 7-4 the coil array **A** measures the shortest distance to the target **C**.

Similarly, the measurements of ALT will be the shortest distance between the altimeter and the seabed within the beamwidth of the altimeter **B**.

The depth of cover  $COV = VRT - ALT$ . However, because the seabed is sloping, the measurements of VRT and ALT are valid for different locations on the seabed. Because of this, errors will appear in the depth-of-cover measurements. Errors of this type will be larger if the altimeter and the coil array are at opposite ends of the ROV.

Since the slope of the seabed will vary unpredictably, there might be some random elements of error in all these measurements.

### Summary:

Be aware of the potential measurement errors that might appear when operating over a sloping target.

Make certain there is a negligible fore-aft offset distance between the coil array and the transducer face of the altimeter. Angles of slope less than half the beamwidth of the altimeter will not affect the measurements in this way.

Reduce the potential errors caused by a sloping seabed by operating the ROV as close as possible to the seabed.



### *7.5.2.2 Electrical Interference*

The 350 System is **unaffected** by the following factors:

- Changes of ROV heading
- Any local static magnetic field
- Acoustic noise
- The presence of platforms, rigs or other vessels in the vicinity.

This sub-section describes the sources of interference that might affect the 350 System.

You may estimate the level of background noise by examining the Scope and Spectrum Analyser window of DeepView. If the noise level is so high so that it masks the tone frequency, take whatever action you can to reduce or eliminate the noise.

#### **The ROV**

---

Other items of electrical equipment on board the ROV, for example the thrusters, might represent a powerful source of electrical noise. If these noise components are at a sufficiently high level, they might mask the relatively weak signals associated with the target tone.

Signal discrimination by the 350 System is extremely good. It removes noise from the calculation process by examining only a very narrow window of frequencies with the tone at its centre. However, where noise levels centred on the tone frequency are very high, they might degrade the performance of the 350 System and affect the accuracy of its survey measurements.

The Scope and Spectrum Analyser window of DeepView will show those bands where noise is at a minimum. You may then adjust the frequency of the target tone to fall within one of these quieter bands.

#### **Summary:**

Use the SDC display software to check all channels of the 350 System with all electrical equipment on the ROV operating. Select a tone frequency centred on a part of the band that has low noise levels.

Investigate any severe noise sources before you start the survey and reduce or eliminate them if possible.

Use the display software to perform regular checks on the quality of tone signal.

#### **Vibration**

---

Mechanical vibration of the coil triads could create a noise signal at a relatively low level as the coils move relative to local magnetic fields. This noise would exist across a broad band of frequencies centred on the frequency of vibration.

Where vibration is fast and severe, the resultant induced signals could interfere with the signal from the target cable.

Slow movements, such as those of the ROV manoeuvring, will have a negligible effect since the resulting induced voltages will be at a frequency below the pass-band of the 350 System.

### **Summary:**

Follow the installation instructions throughout this Manual. Ensure the coil mounting arrangements provide a rigid support that damps vibrations quickly.

Operate the ROV at a speed that avoids the onset of vibration.

Select a tone frequency that does not coincide with the frequency of vibration.

### **Power-carrying Cables**

---

If you use the 350 System to survey power cables that carry high currents, the coils might experience saturation. If this occurs, the System will be unable to calculate the position of the target.

The most effective way to cure this problem is to remove power from the cable or to operate the ROV at a greater distance from the target.

### **Impressed-current Cathodic Protection**

---

When surveying near sub-sea pipes or metallic structures that use impressed-current cathodic protection, the 350 System might suffer from noise pick-up. Provided the tone frequency is different from that of the cathodic protection the System will be able to discriminate between the two.

Use the display software to confirm whether such noise breakthrough is occurring.

### **Summary:**

Perform regular checks on signal quality and on the signal-to-noise ratio by using the SDC display software.

If cathodic protection currents present a problem, arrange to switch off the current while you perform the target survey. The interference will disappear immediately although the protection afforded by the current will remain for some time afterwards.

### **Operating over Ferrous Rock Dumps**

---

Operating the 350 System over a ferrous rock deposit or dump might affect measurements. This is because the ferrous content of the rock will introduce a random distortion to the magnetic fields radiated by the tone-carrying cable.

This distortion varies with the nature of the rock and there is no way to predict the magnitude of errors introduced.

### **Summary:**

Where possible avoid conducting a survey in areas where the rock formations have a significant ferrous content.

Be aware of a possible degradation in measurement accuracy when operating the 350 System near ferrous rock dumps.

### Earth Return Path

If the tone-carrying cable runs parallel with and close to a good conductor, this arrangement might introduce a shorter earth return path for the tone current. In very severe cases, the shorter return path might cause errors to appear in measurements made by the 350 System.

In these conditions, the characteristics of the return path are uncertain, making it impossible to predict the magnitude of errors.

#### Summary:

Be aware that errors might exist in data acquired by the 350 System when you operate it over saturated sand or where a nearby conductive structure, such as a pipeline, runs alongside the cable.

### Curved Target Course

If the target cable has been laid along a course that includes loops or curves as shown in Figure 7-5, the magnetic fields radiated by the tone will be distorted unpredictably throughout the affected areas.

Under these conditions, the measurement accuracy of the 350 System will degrade unpredictably.

Figure 7-5: Curved target

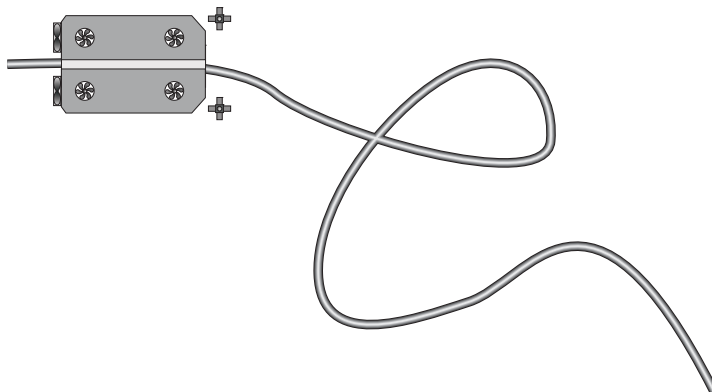

#### Summary:

Be aware that errors might exist in data acquired by the 350 System when you use it to survey targets that do not follow an approximately straight course.

### 7.6 ROVs

You may use the 350 System with most types and size of ROV, and you may operate it at depths down to its maximum specified depth rating. The standard installation described in this Manual provides a high degree of accuracy and a useful measurement range, together with ease of deployment.

It is important to install the 350 System properly by following the instructions included throughout this Manual. The System will supply valid survey data only if you follow these installation and operating instructions, which allow you to install the System on most types of ROV.

#### *7.6.1 Speed of Operation*

The 350 System delivers measurements to a data logger continuously at a rate that allows deployment on the faster ROVs. This is sufficient to maintain a high track resolution under all normal operating conditions.

#### *7.6.2 Altitude above the Seabed*

The vertical detection range of the 350 System is limited by the frequency and magnitude of the target tone.

Where you will use the System to track a weak current at low frequency you should fly the ROV as near to the seabed as possible, while avoiding damage, so that the coils remain close to the target. If your ROV has an automatic facility for maintaining altitude, you may use it.

#### *7.6.3 Tracked ROV*

You may install the 350 System on tracked ROVs. This type of ROV should allow you to set a fixed coil height.

If you mount the System on an ROV of this type, locate the coils approximately one metre above the seabed.



### 8 SYSTEM SPECIFICATIONS

Along with a detailed specification of the 350 System and its major assemblies, this section of the Manual also includes a chart to show the measurement accuracy that the System can deliver under ideal operating conditions.



While revising this 350 System Manual, TSS has made every effort to ensure that the specifications included are correct.

However, in line with the TSS policy of continual product development and improvement, TSS (International) Ltd reserves the right to change equipment specifications without notice. Refer to TSS for advice if necessary.

#### **8.1 Specifications** **Page 2**

---

Detailed hardware specifications for the major components of the 350 System.

#### **8.2 Performance** **Page 5**

---

A graphical illustration of the range performance envelope of the 350 System for one particular combination of tone frequency and current.

#### **8.3 System Trials** **Page 6**

---

Details and results of trials conducted using the 350 System to investigate and confirm the accuracy of measurement.

#### **8.4 Update Rate** **Page 9**

---

You must take care when you merge data supplied by the 350 System with information from other sources.

## 8.1 SPECIFICATIONS



Where given, UK imperial conversions of dimensions and weights are to two decimal place accuracy.

### 8.1.1 Surface Display Computer

#### SDC-Type 9:



To take advantage of developments in computer technology, TSS (International) Ltd has updated the design of the SDC since the first introduction of the original 350 Cable Survey System. The software used by the 350 System is the first in the series to operate in the Windows 2000 environment, therefore earlier SDCs will not have the capability to operate this system correctly.

Processor:	VIA Nehemiah 1GHz processor running Windows 2000
RAM size:	96 MB
Hard disk size:	Minimum 40 GB
CD-RW Drive:	x52 speed CD-RW drive
Ports:	Four serial RS232 One parallel LPT1 Colour composite video in/out S-video in/out TSS current loop in/out DVI connector 2 x 15-way VGA connectors.
Keyboard:	1U tray-mounted keyboard/trackpad combination.
Monitor:	Modular 15 inch flat-panel LCD colour display.
Overall size:	555(w) x 280(h) x 550(d) mm (including transit case) {21.85 x 11.02 x 21.65 inches}
Weight:	Circa. 25kg {51.11 pounds} (including transit case)
Power input voltage:	85 - 265V (47 to 63Hz) auto-ranging
Power consumption:	250W maximum
Temperature range:	(Operating) 0° to 50°C {32°F to 122°F}
Relative humidity:	10% to 95% R.H. non-condensing at 40°C
Vibration resistance:	5 to 17Hz 2.5mm double amplitude displacement. 17 to 500Hz 1.5g peak-to-peak





### 8.1.2 Sub-sea Electronics Pod

#### SEP-Type 2:

Size:	Ø140 × 460mm* {Ø5.51 × 18.11 inches}	
Weight:	In air	10kg {22.05 pounds}
	In water	2kg {4.41 pounds}
Input voltage:	110 to 120V AC 45 to 65Hz Maximum power demand 3.1A when in a Dualtrack installation	
	<i>Option</i> – 220 to 240V AC 45 to 65Hz Maximum power demand 1.8A when in a Dualtrack installation	
Operating temperature:	0° to 30°C {32° to 86°F}	
Communication:	2-wire 20mA digital current-loop. 4-wire 20mA digital current-loop. RS232. Selectable by internal links.	
Depth rating:	3000 metres {9843 feet}	
Finish:	Hard black anodised aluminium	
Connections:	ROV	3 metres cable length
	Umbilical	One or two twisted pairs, or multiplexer.

*\*Allow up to 300mm {11.81 inches} extra for connector clearance.*

### 8.1.3 Search Coil Array

Sensing coil size:	Ø68 × 340mm each {Ø2.68 × 13.39 inches}	
Quantity:	Six sensing coils arranged in two coil triads with polyurethane alignment and mounting blocks.	
Weight:	In air	3.5kg {7.72 pounds} per sensing coil
	In water	2.4kg {5.29 pounds} per sensing coil
Depth rating:	3000 metres {9843 feet}	
Material:	Polyurethane	
Connection cables:	Two required – 4 metres long (8 metre option available).	

## 8.2 PERFORMANCE

Figure 8–1 defines the vertical range measurement accuracy of the 350 System for the stated conditions of tone current – i.e. 30mA at 25Hz.

Figure 8–1: Vertical range measurement accuracy

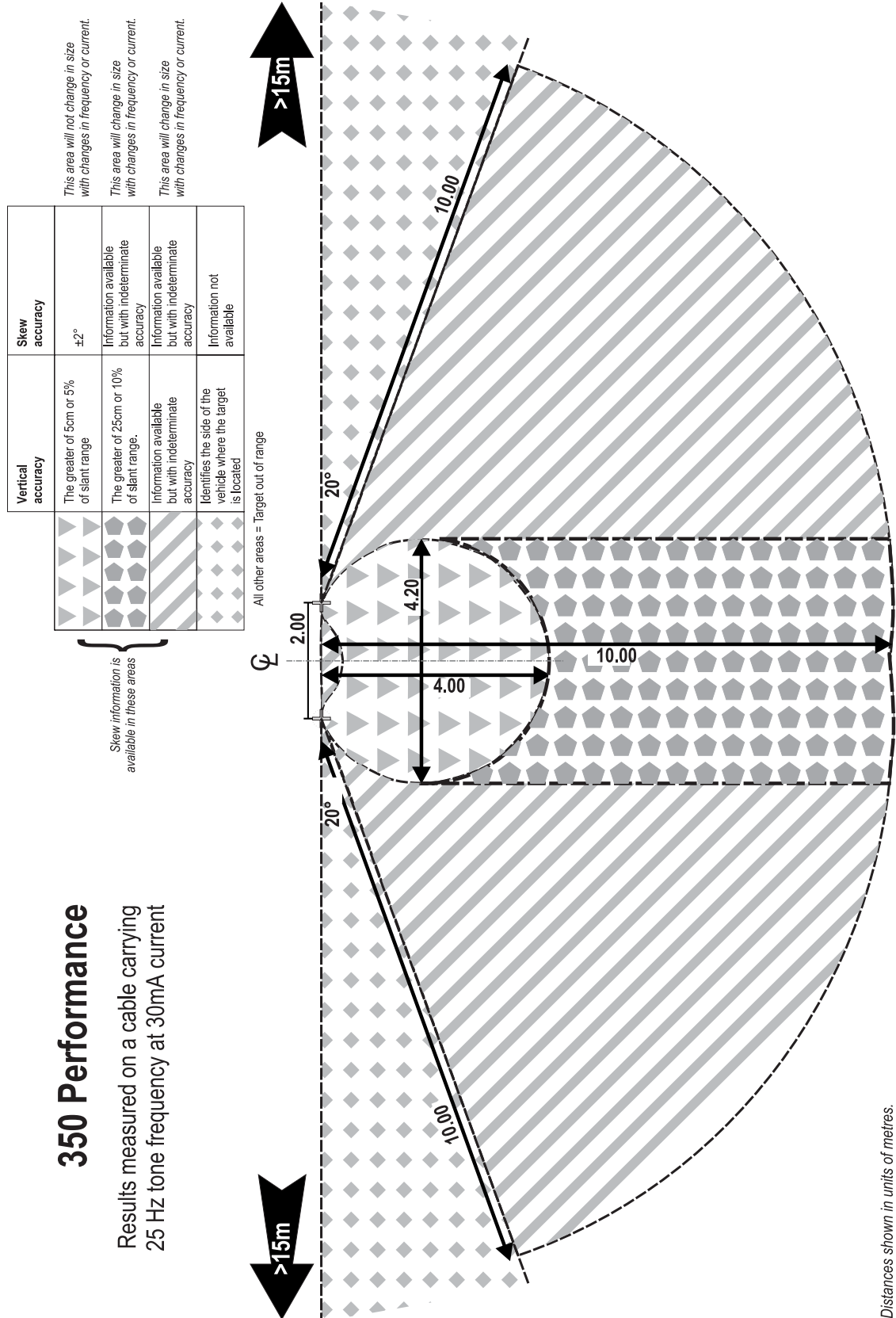

The frequency and amplitude of the tone current may affect the range measurement capability and noise performance of the 350 System. Changes to the current and frequency will not affect the accuracy of measurements made by the System.

The range information shown in Figure 8–1 applies *only* where the tone current at the point of measurement is 30mA at a frequency of 25Hz.

### 8.3 SYSTEM TRIALS

This sub-section includes the practical results obtained using the 350 System at a carefully established test site. The trials included measurements over a  $\pm 8$  metre lateral offset and a vertical range of 5 metres.

#### *8.3.1 Trials Configuration and Procedure*

The test site included the largest cable loop that could be laid in the available area (see Figure 8–2). Equipment for use in the trials procedure included:

- A standard TSS 350 Cable Survey System.
- A hydraulic platform to support the coils of the 350 System.
- A loop of wire 60 metres in diameter as shown in Figure 8–2.
- A TSS Tone Generator to supply the cable loop with tone current at various amplitudes and frequencies.

TSS conducted the tests using the central straight run of cable that spanned the diameter of the loop. This arrangement reduced any effect that the current return path around the outside of the loop may have had upon readings.

With the hydraulic platform located at the centre of the loop and the coil array positioned centrally over the test cable, the platform could raise and lower the coils to pre-determined heights. The test procedure also specified the cable movements necessary to simulate various lateral offsets.

Figure 8-2: Trials site

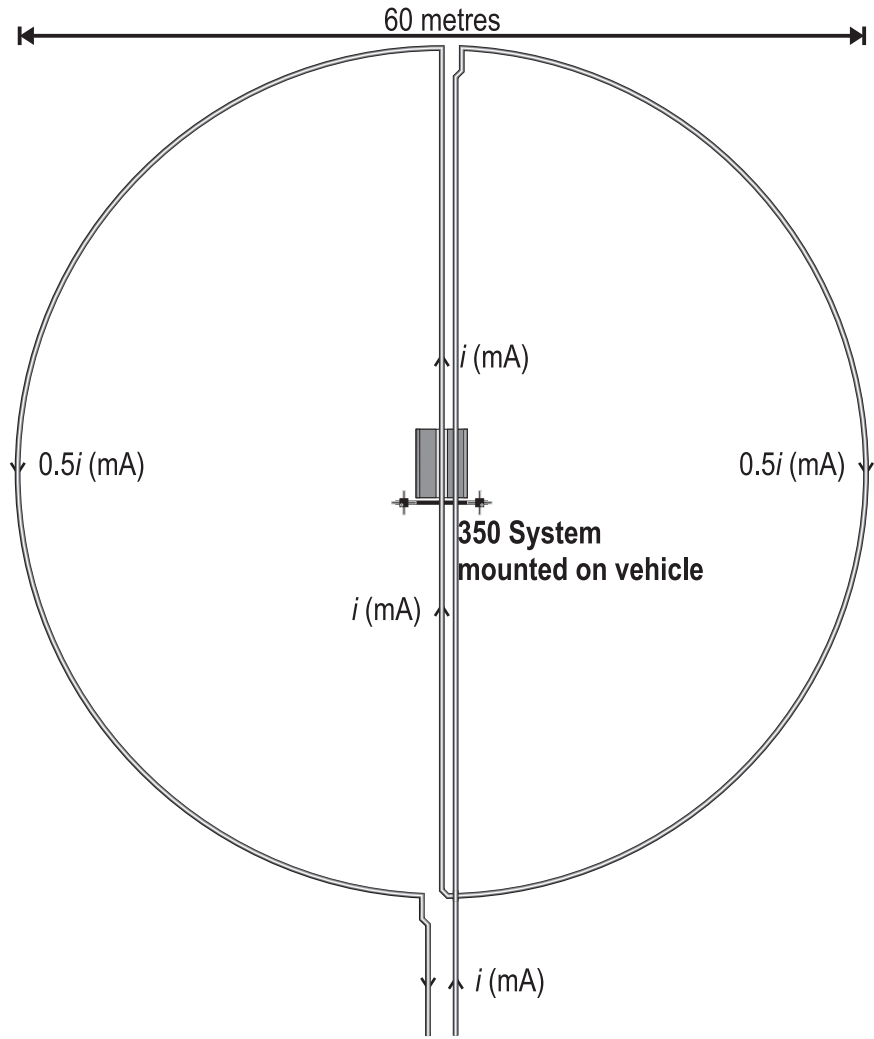

## 8.3.2 Results

### 8.3.2.1 Accuracy

Tables 8–1 and 8–2 below show details of the errors measured in the vertical and lateral offsets between the target cable and the centre of the coil array.

#### Notes:

1. Positive values show that the vertical range or the lateral offset indicated by the 350 System was greater than the distance measured using a tape measure.
2. The response of the 350 System proved to be symmetrical about its central axis. The following tables therefore show only the response to the port side.
3. Lateral offsets, vertical range, and errors are all listed in units of centimetres.
4. ‘o/s’ signifies that the 350 System switched to one-sided calculations – to indicate which side the cable lay but not its offset distance.



Tables 8–1 and 8–2 indicate the measurement accuracy that you may achieve using the 350 System under ideal conditions. These tables are for general information only – you should not use them to correct measurements you have already taken.

Table 8–1: Vertical measurement errors

Vertical range	Lateral offset																
	-800	-600	-400	-300	-250	-220	-200	-180	-160	-140	-120	-100	-80	-60	-40	-20	0
500	-129	-95	-58	-27	-27	-28	-26	-22	-15	-14	-10	-10	-9	-7	-6	-2	-1
400	-89	-74	-37	-12	-12	-11	-9	-6	-4	-4	-2	-4	-5	-4	0	3	5
350	-72	-64	-34	-11	-11	-7	-3	-2	-1	1	2	2	1	3	4	7	8
300	-48	-44	-24	-7	-5	-2	0	2	1	2	3	2	2	1	5	8	11
250	-19	-34	-22	-7	-4	-3	-1	0	1	2	4	3	4	4	4	4	6
200	-29	-27	-16	-4	-2	1	2	3	1	4	5	4	2	1	2	1	7
180	o/s	o/s	-15	-4	-2	-1	1	2	3	5	5	5	3	2	-1	2	6
160	o/s	-10	-14	-3	-2	0	2	2	2	2	3	4	3	2	0	4	6
140	o/s	o/s	-9	-2	0	2	3	3	3	5	6	6	5	3	0	2	4
120	o/s	o/s	-4	-1	1	3	4	4	5	4	3	4	4	4	2	4	4
100	o/s	o/s	1	1	0	1	2	3	3	4	6	4	3	1	0	2	1

Table 8-2: Lateral measurement errors

Vertical range	Lateral offset																
	-800	-600	-400	-300	-250	-220	-200	-180	-160	-140	-120	-100	-80	-60	-40	-20	0
500	-48	-1	13	12	18	12	8	9	10	5	3	3	3	1	-1	-5	-
400	-9	-3	19	13	16	12	8	1	12	4	5	4	5	1	-2	-5	-
350	9	14	14	13	15	12	8	9	11	4	5	4	5	1	-2	-5	-
300	45	28	18	15	15	12	8	9	9	4	4	4	4	1	-3	-6	-
250	146	46	17	15	14	14	8	9	9	4	4	4	4	2	-3	-6	-
200	239	60	22	18	16	14	10	10	9	3	4	4	3	1	-4	-6	-
180	o/s	o/s	24	18	16	14	11	10	10	3	4	5	3	0	-4	-6	-
160	o/s	149	32	23	18	15	12	11	11	4	5	5	2	0	-5	-7	-
140	o/s	o/s	35	23	12	16	15	11	12	4	5	5	2	-1	-5	-7	-
120	o/s	o/s	58	26	25	16	17	11	14	5	7	5	2	-1	-5	-8	-
100	o/s	o/s	81	36	29	17	19	12	16	5	8	5	2	-2	-7	-8	-

### 8.4 UPDATE RATE

You may set the rate at which the 350 System supplies measurements to an external data logger to either one or four records per second.

Update rates available from independent seabed profiling Systems may be different from the update rate you have set for the 350 System. If your ROV includes both these systems, you must allow for their different update rates when you analyse the survey data.



### 9 MAINTENANCE

You will find it easier to identify and clear a fault on the 350 System if you have a full understanding of the location of the individual sub-assemblies, and of the way they interact. This section helps you to maintain and service the System by describing the main internal components of the sub-sea installation.



---

#### **WARNING** **ELECTRICAL HAZARD**

Mains power supply voltages can cause death or serious injury by electric shock.

Only a competent engineer who has received the relevant training and experience should perform maintenance work on electrical equipment.

Power-off and isolate the equipment from the electrical supply before you work on any equipment that uses a mains power supply. Arrange to discharge any power supply storage capacitors safely.

Observe all relevant local and national safety regulations while you perform any maintenance work on electrically powered equipment.

Do not connect the equipment to an electrical supply until you have refitted all safety covers and ground connections.

---

#### **9.1 Circuit Description**

**Page 2**

The simple descriptions of circuit boards in the SEP assist you in the identification of a potential fault. Refer to the circuit diagrams in section 10 while you read the descriptions.

---

#### **9.2 Disassembly and Reassembly**

**Page 9**

To maintain the depth rating of the sub-sea installation, follow these instructions carefully to disassemble and reassemble the SEP.

---

#### **9.3 Fault Identification**

**Page 16**

These flow charts should help engineers to identify and correct a fault condition on the SEP quickly and efficiently. The standard System includes a field support kit with replacement circuit boards and components to help reduce downtime if a fault develops.



## 9.1 CIRCUIT DESCRIPTION

The sub-sea installation consists of two principal parts:

- The array of sensing coils
- The Sub-sea Electronics Pod (SEP).

Additionally, the sub-sea installation might include an altimeter.

Figure 9–1 shows how these are interconnected.

Figure 9–1: Simplified interconnection diagram – Sub-sea installation

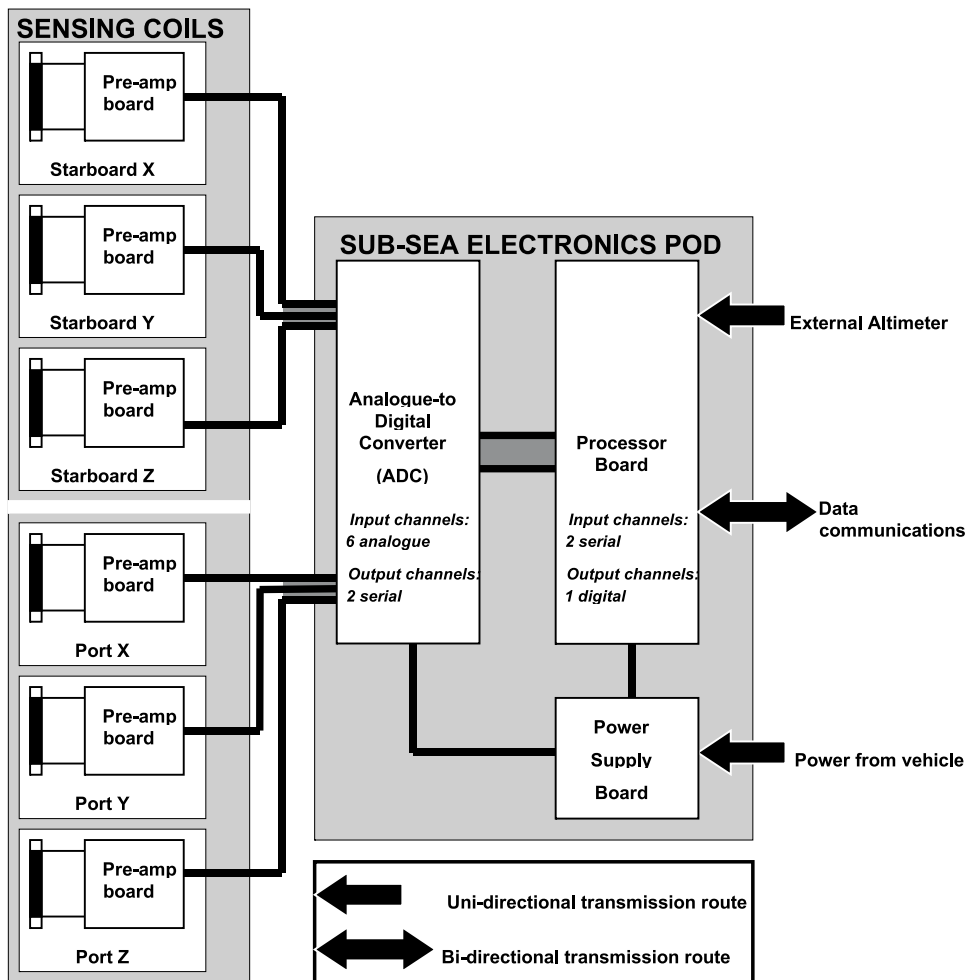

section 10 includes the electrical drawings for the System.

### 9.1.1 Sensing Coils

See drawing number 401105 in sub-section 10

The coil array includes six identical and electrically independent sensing coils, each of which includes an internal pre-amplifier board. Drawing number 401105 shows the pre-amplifier board for a single coil. The pre-amplifier board receives power through the coil connection cable.



---

#### CAUTION

Any water entering the coil housing will cause permanent damage to the coil winding and to the pre-amplifier board.

TSS matches and calibrates the pre-amplifier boards carefully to their specific coil windings during manufacture. You must not remove these items from the coil housings, which contain no user-serviceable parts.

To avoid damage to the coils, do not remove the brass end-caps from the coil housings. You will invalidate the warranty if you open a coil housing for any reason.

Connection between the coil winding and the input to the pre-amplifier is through a 2-pin Molex connector PL1. Signals from the coil windings arrive at the input to a low-noise buffer amplifier U1 that provides two functions:

- Four different gain settings. TSS establishes these settings during manufacture by setting link LK1.
- Low-pass filtering with a cut-off frequency of 300Hz.

The diode assemblies D1 and D4 provide input protection. The buffered signals from the coils then arrive at a band-pass filter formed by U2 and U3 to improve noise attenuation. This filter arrangement has a pass band from 7.2Hz to 318Hz.

U4 and U6 provide low noise programmable amplification with absolute gain settings of  $\times 1$ ,  $\times 2$ ,  $\times 4$ , or  $\times 8$  according to the control voltages on pins 1 and 2 of the coil connector PL2.

The output from the amplifier U4 splits, with one half inverted by U5, to provide a differential signal output on pins 3 and 4 of PL2. This differential signal passes through a twisted pair in the coil connection cable to the SEP input.

Power supplies for the pre-amplifier board enter through PL2 pin 5 (+12V) and pin 6 (-12V), with the ground connection on pin 7.

## *9.1.2 Sub-sea Electronics Pod*

The SEP provides all the power supply, signal processing and communication functions for the sub-sea installation of the 350 System.

### *9.1.2.1 Analogue-to-Digital Converter*

See drawing number 401104 in sub-section 10.

Differential analogue signals from the port coil triad arrive at the input to the SEP on PL2 pins 3/4 (lateral), pins 5/6 (fore-aft) and pins 7/8 (vertical).

Similarly, the differential analogue signals from the starboard coil triad arrive at the input to the SEP on PL3 pins 3/4 (lateral), pins 5/6 (fore-aft) and pins 7/8 (vertical).

The connectors PL2 and PL3 also carry the +12V and –12V supplies, used by the pre-amplifier boards, on pins 9 and 10 respectively.

The SEP uses three separate dual-channel ADCs to perform the analogue-to-digital conversions. This process happens simultaneously on all six input channels. Each of the ADCs is identical – drawing 401104-2 shows a single dual-channel arrangement for the starboard lateral and vertical coils. Drawings 401104-3 and 401104-4 show the port lateral and vertical coil ADC, and the port/starboard fore-aft coil ADC respectively.

For simplicity, the following description includes only the two ADC channels shown in drawing 401104-2. The description is also valid for the other channels:

U2/U3 and U4/U5 buffer the differential input signals from each coil before they pass to their appropriate differential input channels of the ADC U1. Except for the application of some low-pass anti-aliasing filtering, no signal processing occurs before the ADC.

The diode array D1–D8 provides protection for both differential ADC input channels.

The ADC device U1 is an 18-bit dual-channel converter that must receive low-noise signals and power supplies. The ADC has separate analogue and digital grounds to support this requirement.

In drawing 401104-2, 'Region 1a' is the low-noise analogue section of the ADC board with all its power supply lines filtered and conditioned. Additionally, the digital signals that pass between the ADC board and the Processor Board are opto-isolated to reduce noise conduction.

The serial output from the ADC, which appears at pin 15 of U1, is a multiplexed combination of the two input channels. Pin 13 of U1 supplies a gate-control signal to identify which of the two input channels is currently being transmitted.

Pin 16 of U1 provides a frame-sync signal to identify the start and end of each 18-bit ADC output sequence.

Opto-isolators U10 and U11 protect the serial data, gate-control, and frame-sync outputs before they pass through a ribbon cable to the Processor Board.

Opto-isolated digital inputs to the ADC are:

- Analogue and digital power-down APD/DPD (through U12) to control the ADC mode of operation. The ADC Board uses these for its self-calibration during initialisation.
- The clock signal from the Processor Board (through U13).
- Pre-amp gain control (through U14) to set the absolute gain of the pre-amplifier using U6 of the Coil Pre-amplifier Board (see drawing 401105).

### *9.1.2.2 Processor Board*

See drawing 401103 in section 10.

The Processor Board consists of three sub-sections:

- The ADC Interface (drawing 401103-4)
- The Processor Core (drawing 401103-2)
- The communications interface (drawing 401103-3)

#### **1. ADC Interface (see drawing 401103-4).**

---

The ADC Interface takes the three serial data lines from the ADC Board and multiplexes them onto one processor bus.

The three serial data inputs 'SD1', 'SD2' and 'SD3' arrive at the ADC Interface through pins 3, 7 and 11 respectively of PL5. 'SD1' contains the starboard lateral and vertical channels, 'SD2' contains the port lateral and vertical channels and 'SD3' contains both fore-aft channels. The gate-control and frame-sync signals for each channel arrive at pins 4/6, 8/10 and 12/14 of PL5.

The ADC Interface uses three separate and identical channels to process all three serial data inputs simultaneously. For each channel, the serial data that originates from one coil passes into serial-to-parallel buffers under the control of the frame-sync and clock signals.

When these buffers are loaded fully with data, an interrupt signal causes the processor to read each parallel port U53–U55 in turn. The processor knows which of the two coils in each channel is being read, by the state of the gate-control signal that is included as bit number 18 of the parallel output.

Once the processor has read the output buffers, data from the other coil in each channel passes into the buffers to be read by the processor.

Since all three channels on the ADC Interface run from the same clock, they will remain synchronised perfectly and will always maintain the correct timing relationships.

## **2. Processor Core (see drawing 401103-2).**

---

Data from the ADC Interface arrives at the Digital Signal Processor (DSP) U1.

The DSP operates with four parallel bytes of zero wait state SRAM forming 32-bit words. It reads its program from EPROM U12 at power-on and copies it into RAM for execution in a manner similar to a PC 'booting' from a disk.

Byte-wide E<sup>2</sup>PROM U11 provides non-volatile parameter storage, and PLD U5 implements primary decoding.

SCC devices U17 and U18 handle communications to and from the SEP: U17 handles communications with the SDC and the direct communications from the sub-sea altimeter. This version of the SEP does not use U18.

Buffer U57 provides the gain control signals for the pre-amplifiers and the ADC control signals APD, DPD and CMODE.

## **3. Communications Interface (see drawing 401103-3).**

---

U19 and U20 opto-isolate the current-loop signals that pass between the SEP and the SDC.

U22, U23, U24 and U25 respectively control the RS232, 2-wire and 4-wire current-loop communications. The settings of links LK1 to LK5 select among four options (see sub-section 4.2.2.1 for instructions to change the communications method). *Note that the current version of SDC does not support the fourth method, RS422 communications.*

Opto-isolators U28 and U29, and ICs U31 and U32 support direct communications to the SEP from an altimeter.

### 9.1.2.3 Power Supply

Power for the sub-sea components of the 350 System comes from the ROV electrical distribution system. The standard configuration for the sub-sea 350 System accepts an electrical supply in the range 110 to 120V at 45 to 65Hz. An alternative SEP is available from TSS for use with installations that must operate from an electrical supply in the range 220 to 240V.



---

#### WARNING

Do not attempt to modify the SEP to use an incorrect electrical supply. A label on the SEP identifies the correct SEP operating voltage.

The power supply circuit provides conditioned and stabilised voltages of +24V, +15V, –15V and +5V to drive all the components of the sub-sea installation (the SEP, the coil pre-amplifiers and an altimeter connected to the SEP).

Cooling of the supply is by direct thermal conduction to the SEP housing assisted by a small fan.



---

#### WARNING

There is a danger of electric shock from mains voltages on the Power Supply board.

Do not open the SEP with power connected. Except for the fuse on its input, the Power Supply board is NOT field repairable. You must renew the Power Supply board as a complete unit if you suspect it has developed a fault.

### 9.1.3 Current Loop

When you configure the System to use the 2-wire current-loop communications method, the SEP and the SDC share a twisted pair in the umbilical. To avoid possible contention, the 350 System assigns 'Master' status to the SDC, and 'Slave' status to the SEP.

Immediately after you power-on the 350 System, the SEP transmits a short 'banner' message to the SDC and then waits for commands to arrive. Other than its initial banner message, the SEP will not transmit data until it receives a carriage-return signal from the SDC.

The SEP Processor Board generates current at 20mA for the communication loop. The 'COMMS' LED on the SDC is in series with the current-loop and therefore confirms that the communication loop is intact when it shows red. Note that the COMMS LED does NOT confirm successful communication between the SEP and SDC, but shows only that the loop is intact.

Figure 9–2 shows a simplified schematic of the current-loop, including the optically isolated I/O ports at both ends of the umbilical cable.

Figure 9-2: Simplified schematic of the current-loop

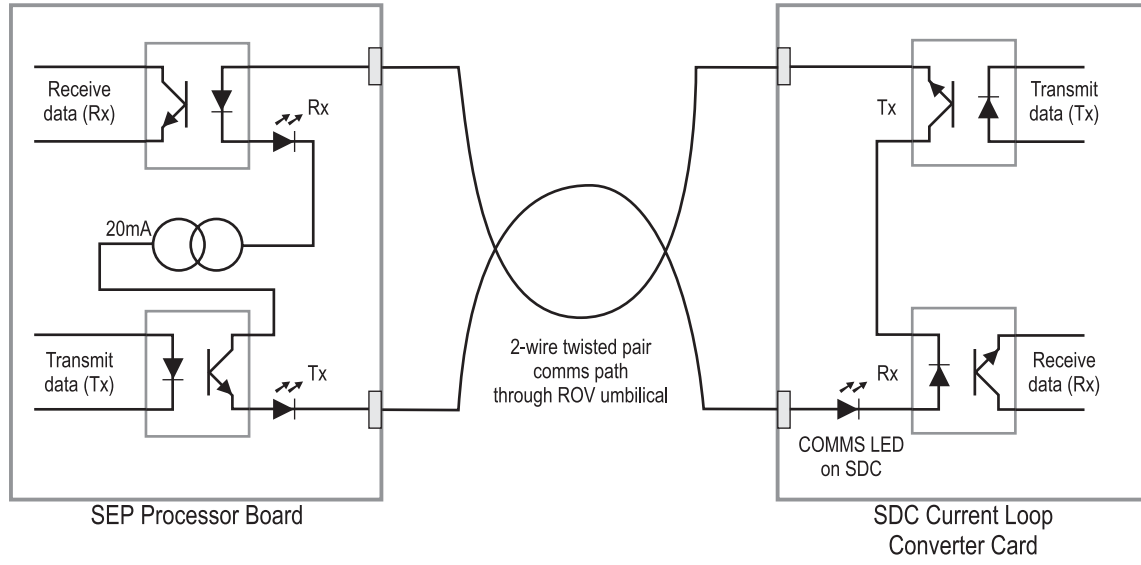

### 9.2 DISASSEMBLY AND REASSEMBLY



#### WARNING ELECTRICAL HAZARD

Mains power supply voltages can cause death or serious injury by electric shock.

Only a competent engineer who has received the relevant training and experience should perform maintenance work on electrical equipment.

Power-off and isolate the equipment from the electrical supply before you work on any equipment that uses a mains power supply. Arrange to discharge any power supply storage capacitors safely.

Observe all relevant local and national safety regulations while you perform any maintenance work on electrically powered equipment.

Do not connect the equipment to an electrical supply until you have refitted all safety covers and ground connections.

#### 9.2.1 Surface Display Computer



#### CAUTION

Many components within the SDC are susceptible to damage due to electrostatic discharge. You must take precautions against such damage: These precautions include the use of a grounded conductive mat and wrist-strap. TSS (International) Ltd will not accept responsibility for any damage caused by failure to take such precautionary measures.



The following instructions are valid for the SDC Type 9 that the 350 Cable Survey System is shipped with. The 350 System will not work with earlier versions of our SDCs due to this being the first system to operate under the Windows™ environment. Contact TSS (International) Ltd for advice if necessary.

You will NOT need to disassemble the SDC if you must change the communication settings. It is externally configurable using a tristate switch on the Converter Card.

#### 9.2.2 Sub-sea Electronics Pod



#### CAUTION

Many components within the SEP are susceptible to damage due to electrostatic discharge. You must take precautions against such damage: These precautions include the use of a grounded conductive mat and wrist-strap. TSS will not accept responsibility for any damage caused by failure to take such precautionary measures.

To disassemble and reassemble the SEP you will need the following tools and facilities:

- A clean anti-static work area
- A 3mm hexagonal key



- A 2.5mm hexagonal key

**Remove the 'Power/Comms' end-cap:**

---

1. Use the 3mm hexagonal key to release and remove the four M4 × 12mm A4 stainless-steel screws that secure the end-cap to the housing.
2. Use the 2.5mm hexagonal key to remove the two button head screws from their threaded holes near the edge of the end-cap.
3. Insert two of the M4 × 12mm screws into the holes vacated by the button head screws and tighten them by hand until you feel resistance.
4. Use the 3mm hexagonal key to tighten the two M4 × 12mm screws alternately so that they lift the end-cap away from the SEP housing.
5. After you have screwed the two jacking screws home, use your fingers to ease the end-cap away from the SEP housing. Note that a partial vacuum may form inside the housing and this may make it difficult to remove the end-cap. **Do not insert any hard or sharp instruments into the gap to act as a lever because this may scratch the surface, following which corrosion will occur.**
6. Remove the two jacking screws from the end-cap.
7. Do not allow strain to develop on the internal connectors as you ease the end-cap away from the SEP housing. Disconnect the 8-way and the 6-way internal connectors by pressing their two side-clips together and pulling the plugs and sockets apart.
8. Disconnect the ground strap by pulling the spade connector and receptacle apart.

**Remove the coil connector end-cap:**

---

9. Remove the four M4 × 12mm A4 stainless-steel screws as before. Substitute two of these screws in place of the two button head screws to jack the end-cap away from the SEP housing. Remove the jacking screws from the end-cap.
10. Remove the end-cap carefully – note that it carries all the circuit board assemblies. Handle this assembly with care. Pull the end-cap carefully until the entire assembly is free of the SEP housing and place it on the clean anti-static work surface. Save the pack of desiccant that is wedged underneath the circuit-board assembly and store it in a warm dry place while you work on the circuitry.
11. The Processor Board is located on one side of the central support block, and the ADC and the Power Supply boards are located together on the other side.

To remove and reinstall any of the boards perform the following:

### Processor Board (see Figure 9–3):

#### IMPORTANT NOTE

The Processor Board holds calibration data for the ADC Board. Therefore, you must renew the Processor Board and the ADC Board together if you suspect either is faulty. You will degrade System performance if you do not follow this advice.

1. Unclip and release the 4-way ‘Primary Comms’ connector PL2. Unclip and release the 8-way connector PL1. Unclip and release the 34-way connector PL5.
2. Use a 3mm hexagonal key to release and remove the eight M4 × 14mm stainless steel screws that secure the board to the support block and remove the Processor Board.
3. Refit the board by reversing the above procedure.

Figure 9–3: Processor Board layout

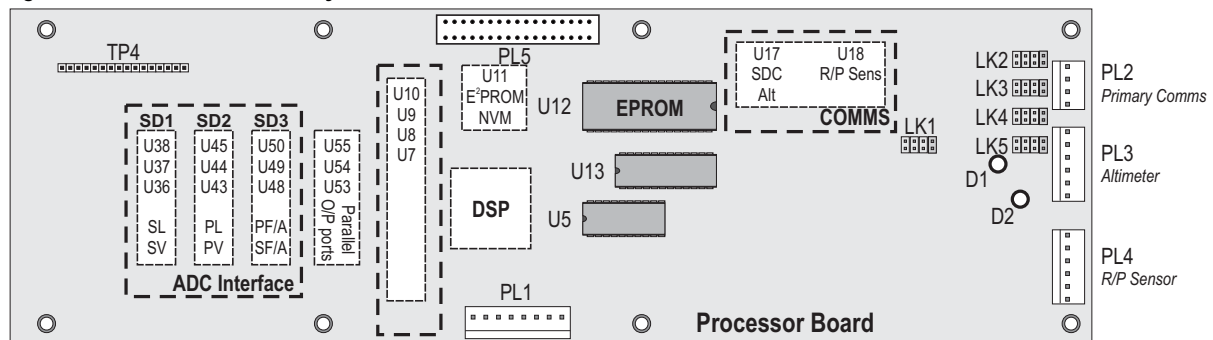

## ADC Board (see Figure 9–4):

### IMPORTANT NOTE

The Processor Board holds calibration data for the ADC Board. Therefore, you must renew the Processor Board and the ADC Board together if you suspect either is faulty. You will degrade System performance if you do not follow this advice.

1. Unclip and release the 34-way connector PL1. Unclip and release the two 11-way connectors PL2 and PL3.
2. Use the 3mm hexagonal key to release the four M4 × 12mm screws that secure the ADC Board to the support block. Remove the ADC Board.
3. Refit the board by reversing the above procedure.

Figure 9–4: ADC Board layout

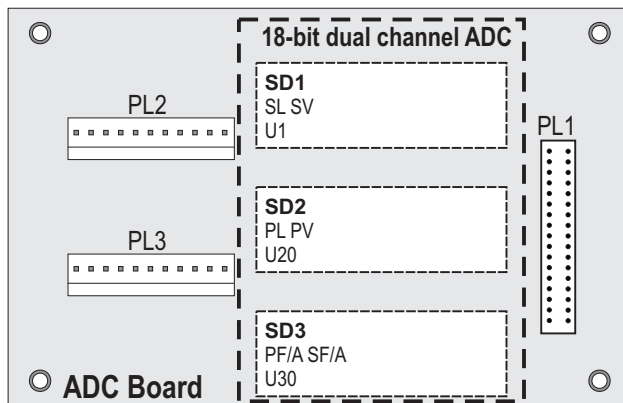

### Power Supply Board (see Figure 9–5):

1. Release and remove the insulating cover that protects the Power Supply board. Unclip and release the 10-way connector. Unclip and release the 5-way connector that is near the 2A fuse.
2. Use the 3mm hexagonal key to release the four M4 × 12mm screws that secure the Power Supply board to the support block. Remove the Power Supply board. Retain the four insulated spacers and all insulated inserts.
3. Check the 20mm 2A fastblow fuse on the Power Supply board and fit a new one if it has failed. Investigate the cause of any repeated fuse failure.
4. Refit the board by reversing the above procedure. Make certain that you refit all the insulated spacers and inserts when you reassemble the Power Supply board to the support block. Refit the insulating cover over the Power Supply board.

Figure 9–5: Power Supply Board layout

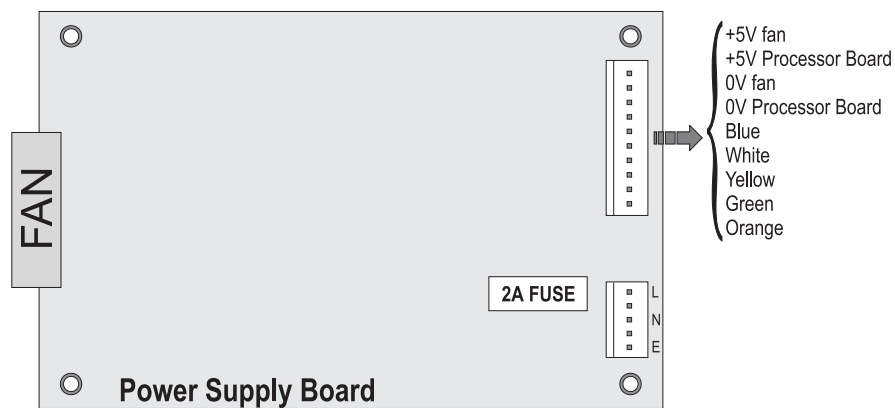

#### CAUTION

Do not attempt to modify the Power Supply board so that it operates from an incorrect electrical supply.

### Reassemble the SEP:

1. Check the condition of the two rubber O-rings that seal each of the end-caps. Clean or renew them if necessary. Apply a thin smear of approved lubricant to the rings to ensure they make an efficient seal when you reassemble the SEP. **For this purpose, use the same type of lubricant that you use for the sub-sea electrical connectors – refer to sub-section 4.1.2 for these important instructions.**
2. Orientate the circuit board assemblies on the support block:

Place the empty SEP housing left-to-right in front of you. Make certain that the short grounding lead inside the SEP housing is towards the right-hand end of the housing. **You must insert the coil connector end-cap into the housing from the opposite end to the grounding lead.**

Align the end-cap and the electronics assembly so that the two external connectors are horizontal and the Processor Board faces towards you (see Figure 9–6).

Figure 9–6: Orientation of the coil connector end-cap

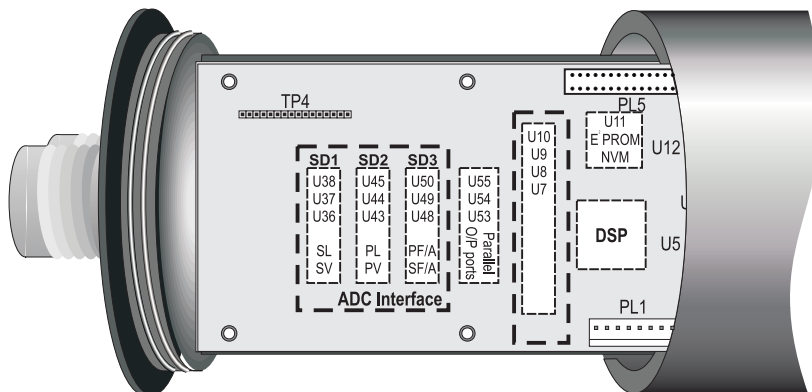

3. Place the desiccant pack inside so that it fits between the Processor Board and the SEP housing. Make certain that there are no trapped wires or components and push the end-cap home.
4. Carefully align the end-cap to the SEP housing so that the four securing screws will engage properly. If necessary, turn the end-cap slightly to achieve perfect alignment. Ensure that the two holes for the button head screws align with the hardened stainless steel inserts on the end of the SEP housing.
5. Insert the four M4 × 12mm A4 stainless steel screws and use the 3mm hexagonal key to tighten them evenly. Insert both button head screws and tighten them lightly.
6. Reconnect the ground wire, the 8-way and the 6-way connectors on the ‘Power/Comms’ end-cap. Make certain both locking clips on each of the connectors engage properly.
7. Align and engage the ‘Power/Comms’ end-cap into the SEP housing. Make certain both holes for the button head screws align with the hardened stainless steel inserts in the end of the SEP housing.
8. Make certain there are no trapped wires and press the end-cap home. Twist the end-cap slightly if necessary to achieve perfect alignment of the screw holes. As you replace the end-cap, the SEP housing may become slightly pressurised which may make the cap difficult to replace. **Do not apply excessive force.**
9. Insert the four M4 × 12mm A4 stainless steel screws and use the 3mm hexagonal key to tighten them evenly. Insert both button head screws and tighten them lightly.

### 9.2.3 Coil Cable Continuity

Table 9–1 lists the pin-to-pin connections in the coil cables. You may use this information to test the continuity of the cable during maintenance work.

Table 9–1: Connections to the coil cable

Sensing coil 8-way connector			SEP 12-way connector	
Description	Pin No		Pin No	Description
G0 – Pre-amp gain control line	1	→	1	G0 – Pre-amp gain control line
G1 – Pre-amp gain control line	2	→	2	G1 – Pre-amp gain control line
Signal + (Lateral)	3	→	3	Lateral coil signal +
Signal –(Lateral)	4	→	4	Lateral coil signal –
Signal + (Fore-aft)	3	→	5	Fore-aft coil signal +
Signal –(Fore-aft)	4	→	6	Fore-aft coil signal –
Signal + (Vertical)	3	→	7	Vertical coil signal +
Signal –(Vertical)	4	→	8	Vertical coil signal –
+12V supply in	5	→	9	+12V supply out
–12V supply in	6	→	10	–12V supply out
Analogue ground	7	→	11	Analogue ground
			12	Screen chassis

The two cables are identical. Although you may interchange the coils, you **must** couple the vertical, lateral and fore-aft coils to their correct 8-way connectors on the cable. Labels identify the cable tails.

### 9.3 FAULT IDENTIFICATION

The remainder of this section includes advice and a series of flow charts to help you locate a fault in the sub-sea components of the 350 System.



TSS has gathered considerable experience with the 350 System in many survey operations and under a variety of conditions, and has used this experience to compose the following flow charts.

If your System fails, perform the following checks *before* you call TSS engineers for assistance.

1. Check that you have installed the 350 System correctly according to the instructions in Sections 3 and 4.
2. Check that the configuration of the 350 System is correct. Refer to sub-section 6.2.2 for details of the System Parameters dialog.
3. Check that you have connected all cables correctly.
4. Check that the correct electrical supplies are available to the SDC and the SEP.
5. Identify the fault symptoms as clearly as possible, and apply the appropriate fault identification routine from the following list:

Fault on a single channel only – see sub-section 9.3.1.

Communications failure – see sub-section 9.3.2.

Poor tracking performance – see sub-section 9.3.3.

Altimeter failure – see sub-section 9.3.4.

### 9.3.1 Fault on a Single Channel

Figure 9-7: Single channel failure

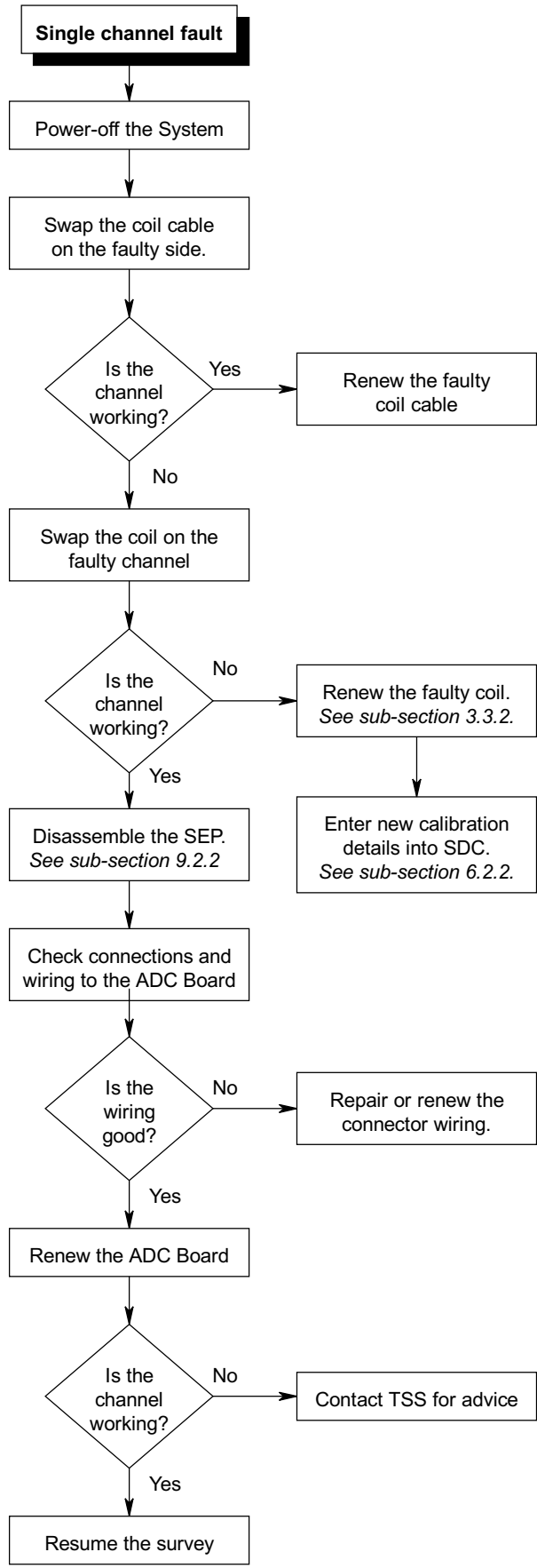



### 9.3.2 Communications Failure

Figure 9-8: Communications failure – CHART 1

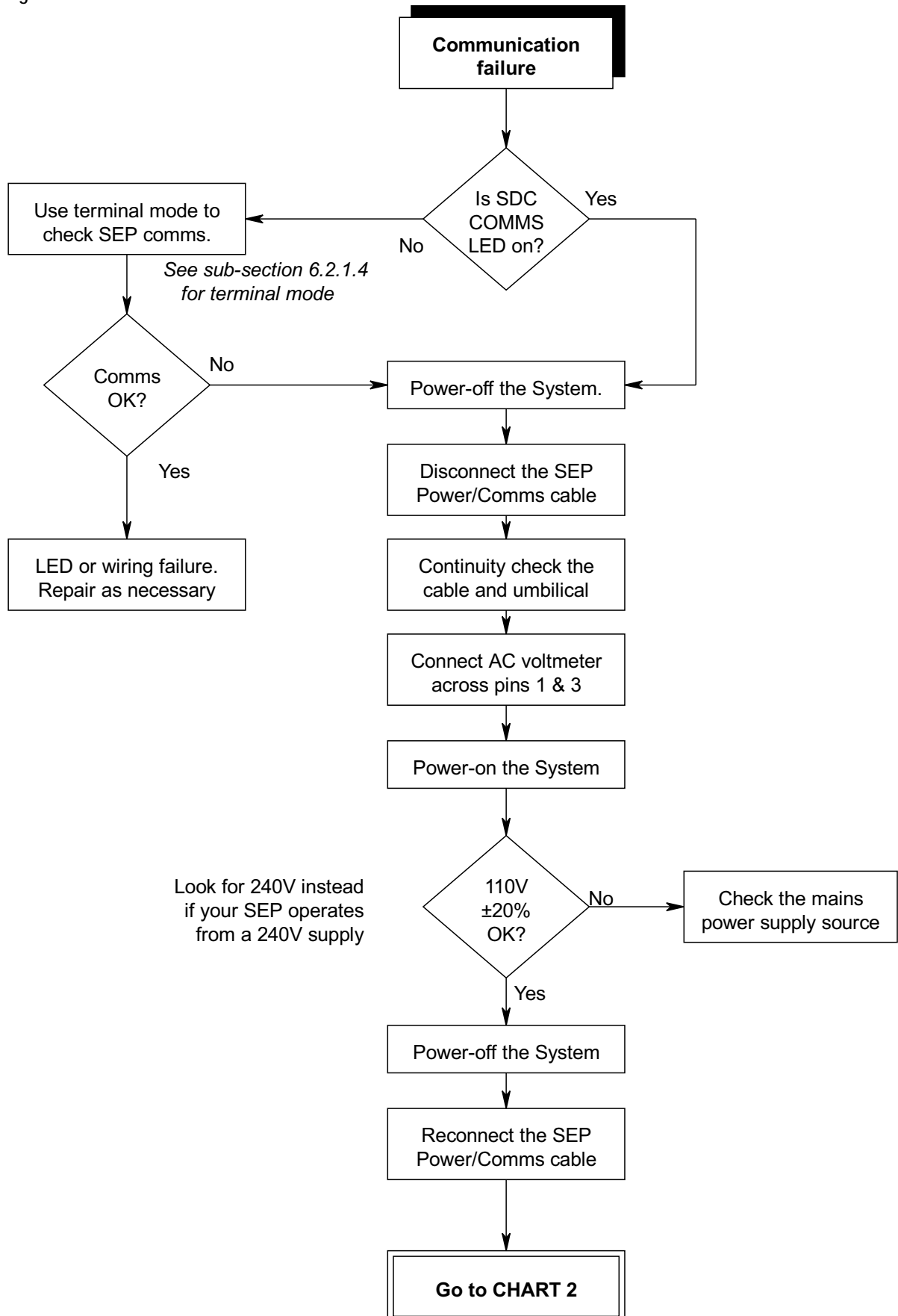

Figure 9-9: Communications failure – CHART 2

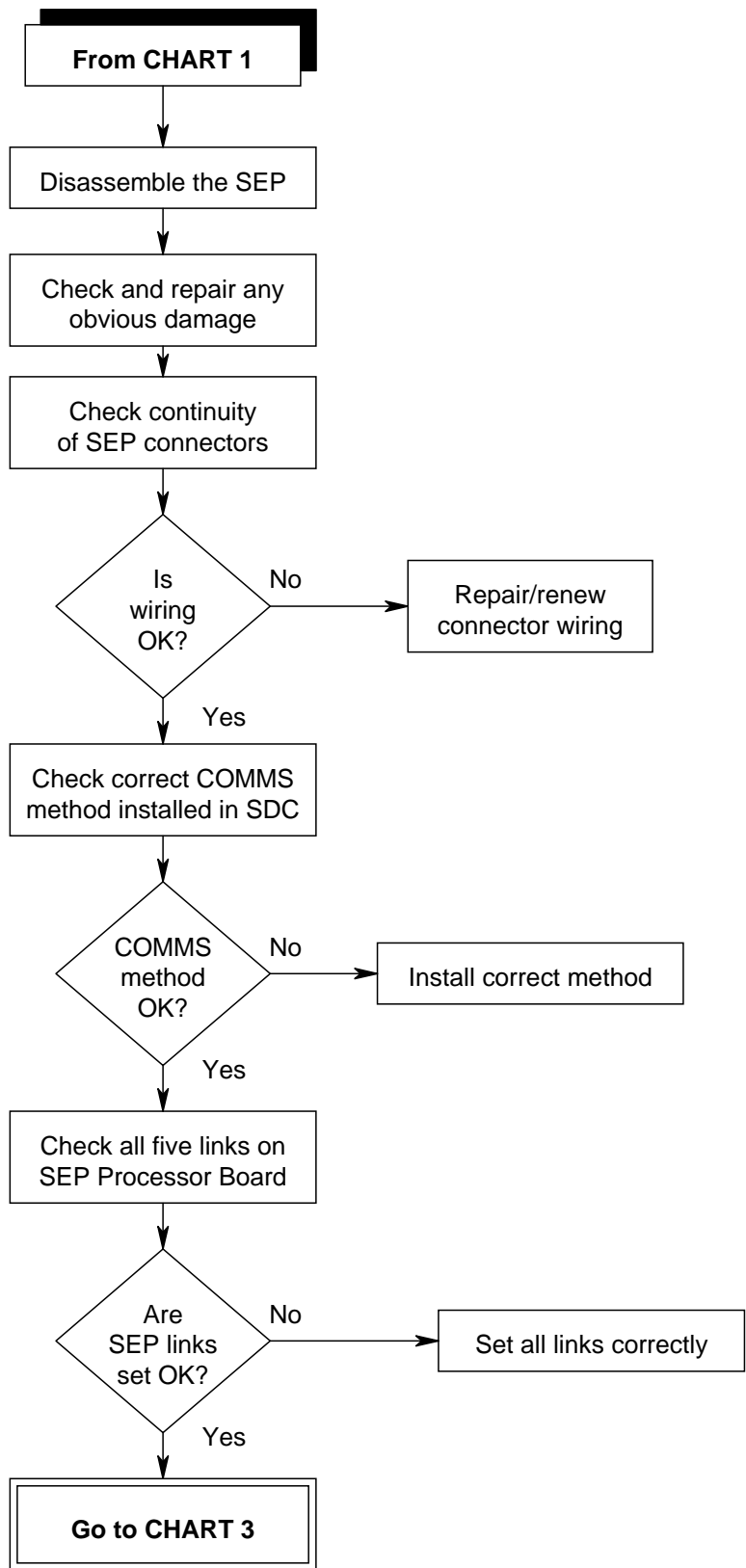
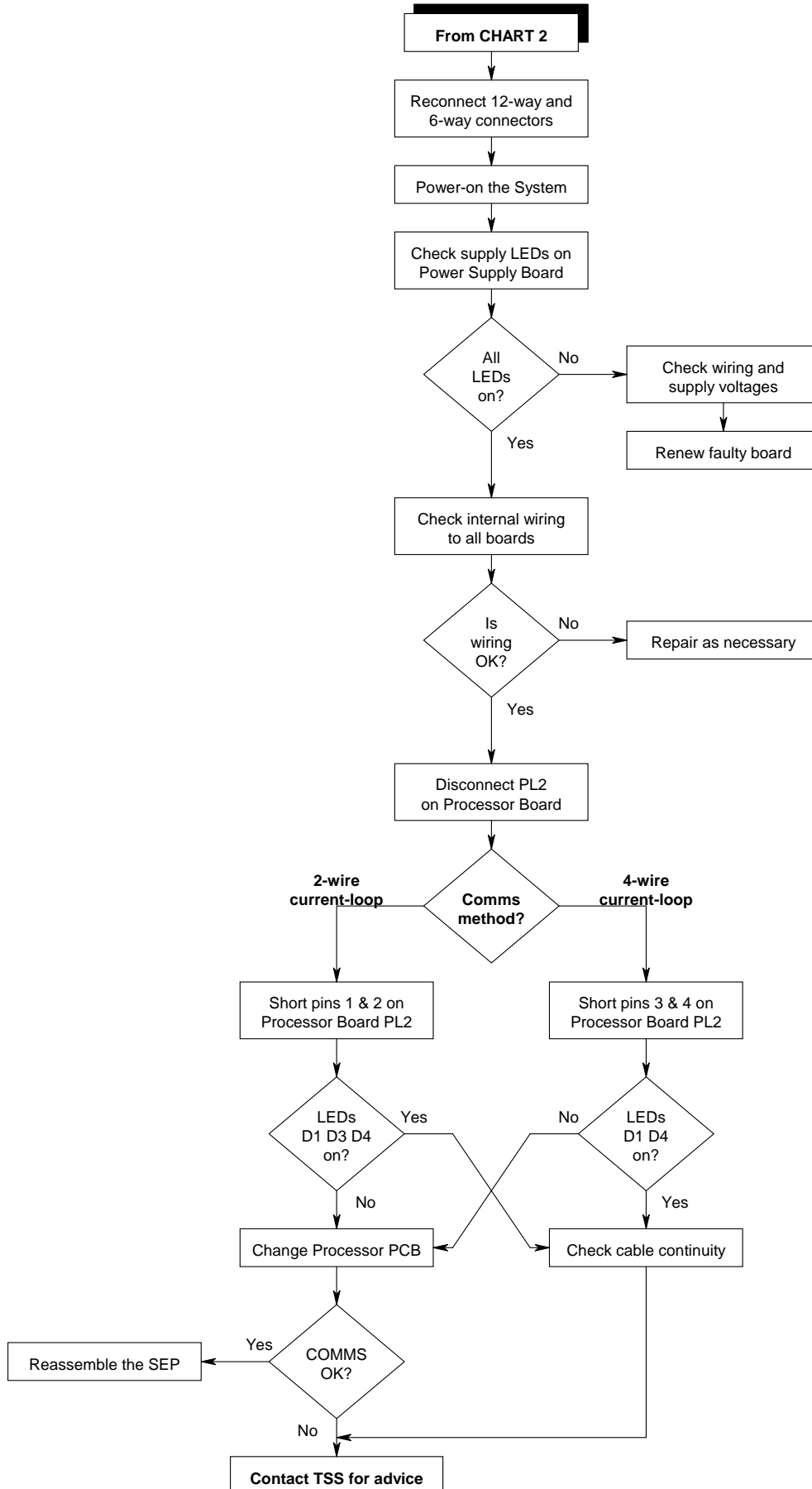
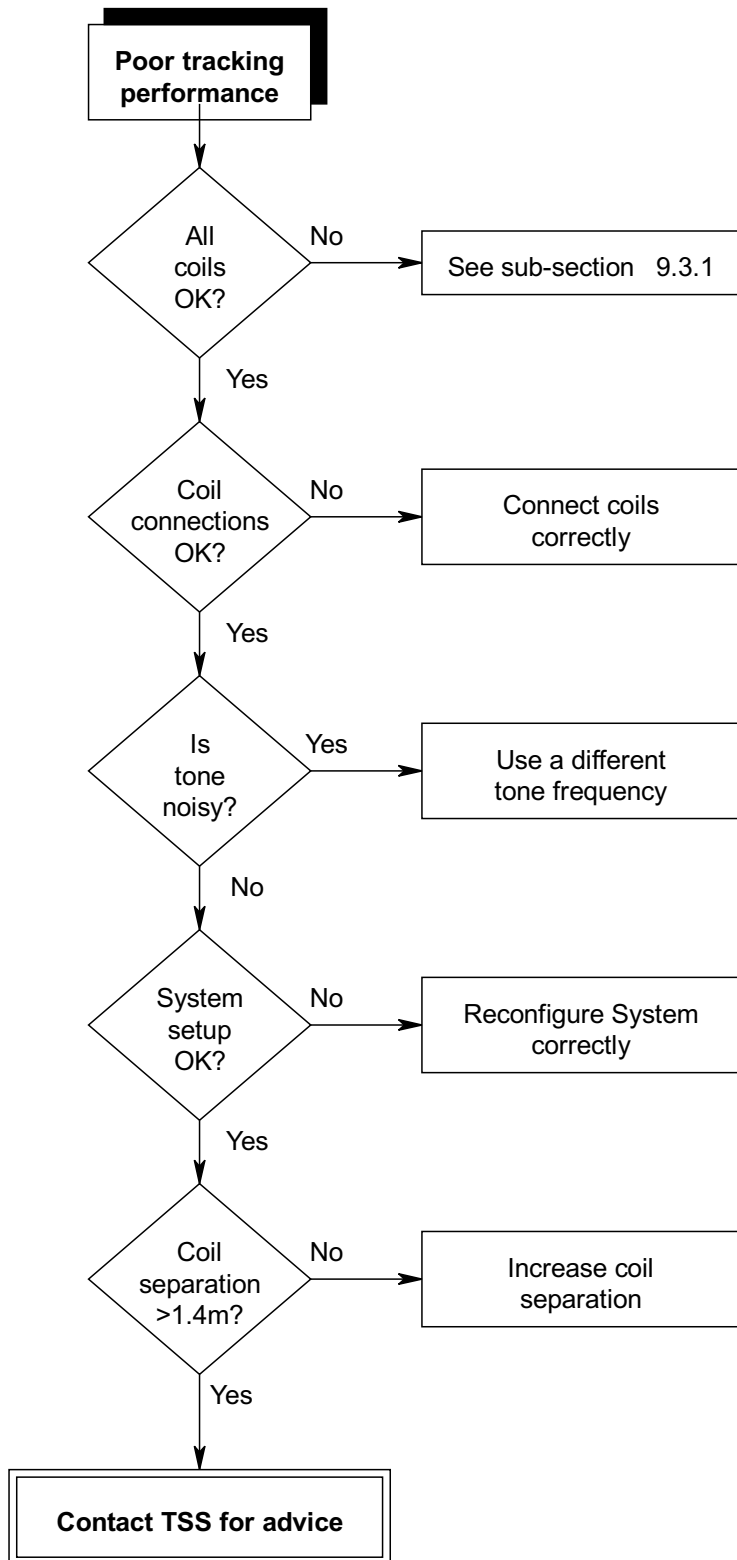

Figure 9-10: Communications failure – CHART 3



### 9.3.3 Poor Tracking Performance

Figure 9-11: Poor tracking performance



### *9.3.4 Altimeter Failure*

These flow charts should help you to identify a fault with the TSS or the Datasonics altimeter connected directly to the SEP. Refer to the altimeter manual for further assistance if necessary.

If a fault develops when you use an alternative altimeter connected to the SDC COM2 port, check it using the terminal mode and check the data strings against those listed in sub-section 7.3.3. Refer to sub-section 6.2.1.4 for details of the terminal mode.

If there are no data strings from the altimeter, check the RS232 parameters and the wiring. Refer to the altimeter manual for specific servicing details.

Figure 9-12: Altimeter failure – CHART 1

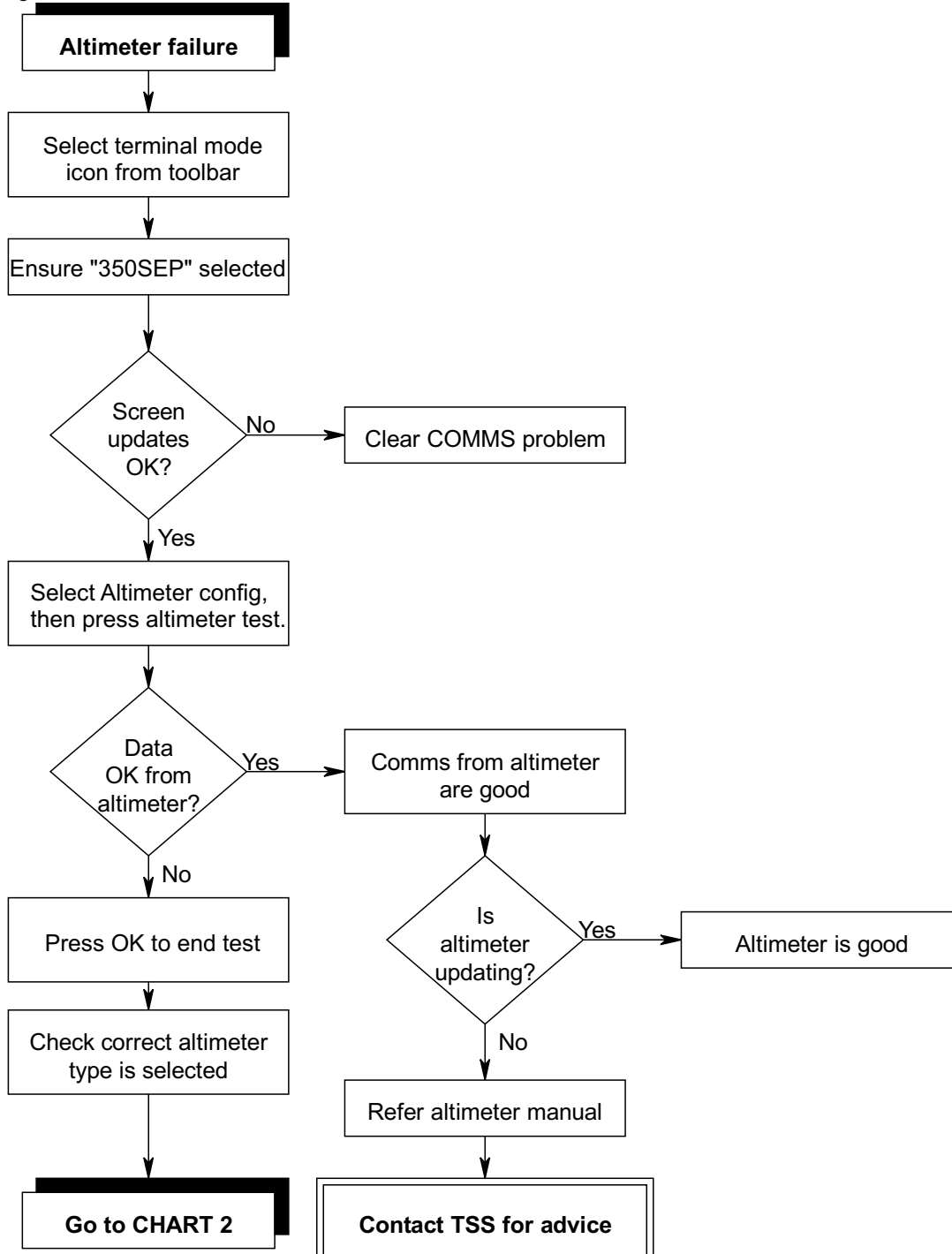
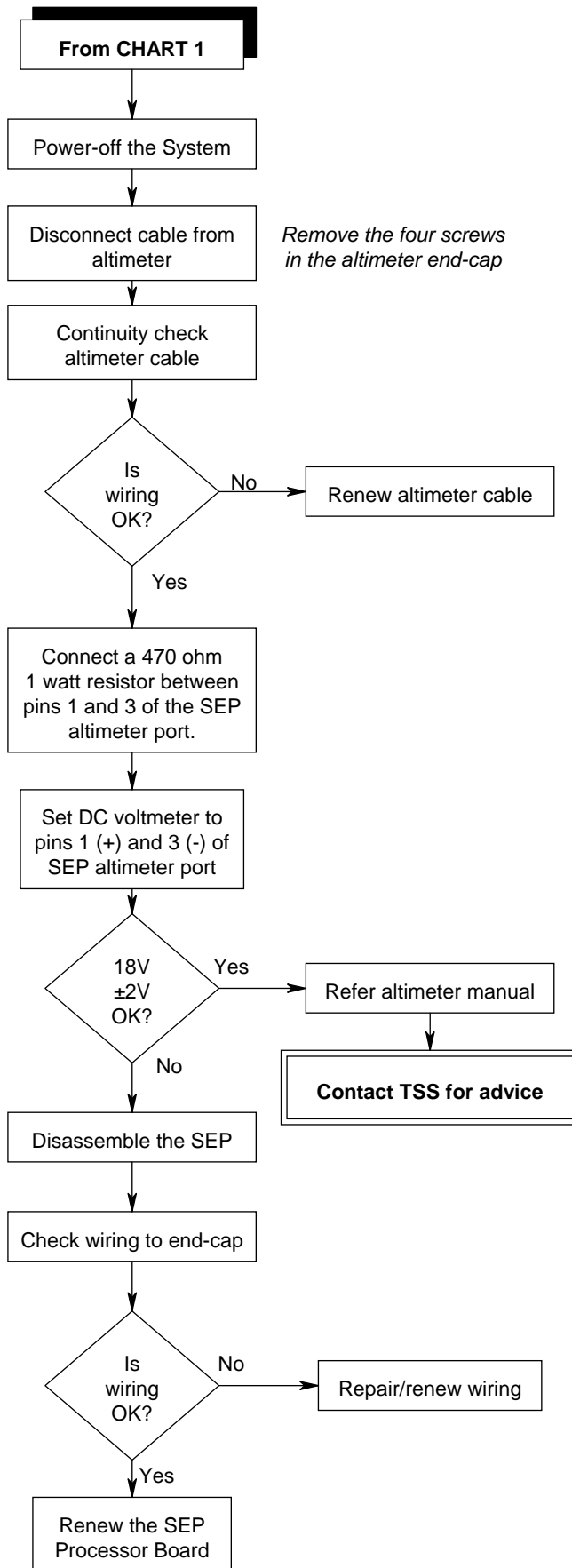

Figure 9-13: Altimeter failure – CHART 2









## 10 SYSTEM DRAWINGS

Drawing Number	Description	Stainless Steel Drawing Number*
<b>Electrical Drawings</b>		
490234	Sub-sea Electronics Pod – Overall diagram	
401105	Coil pre-amplifier	
401104-1	Analogue to Digital conversion	
401104-2	Analogue to Digital conversion – ADC 1	
401104-3	Analogue to Digital conversion – ADC 2	
401104-4	Analogue to Digital conversion – ADC 3	
401103-1	Processor Board	
401103-2	Processor Board – CPU Core	
401103-3	Processor Board – Comms	
401103-4	Processor Board – ADC Interface	
<b>Mechanical Drawings</b>		
490221	350CE Cable Survey System Assembly (110v). This drawing is also applicable to Part Number 490222 (240v) Assembly	490223 (110v) 490224 (240v)
B930476	350CE 3-axis coil cable assembly	
B930473	ROV Tail Assembly – 4.0m standard	

\* Stainless Steel Drawing Numbers included in this table for information only. For details and specification see the corresponding Standard Product Drawing Number.

Figure 10-1: 490234 Sub-sea Electronics Pod - Overall diagram

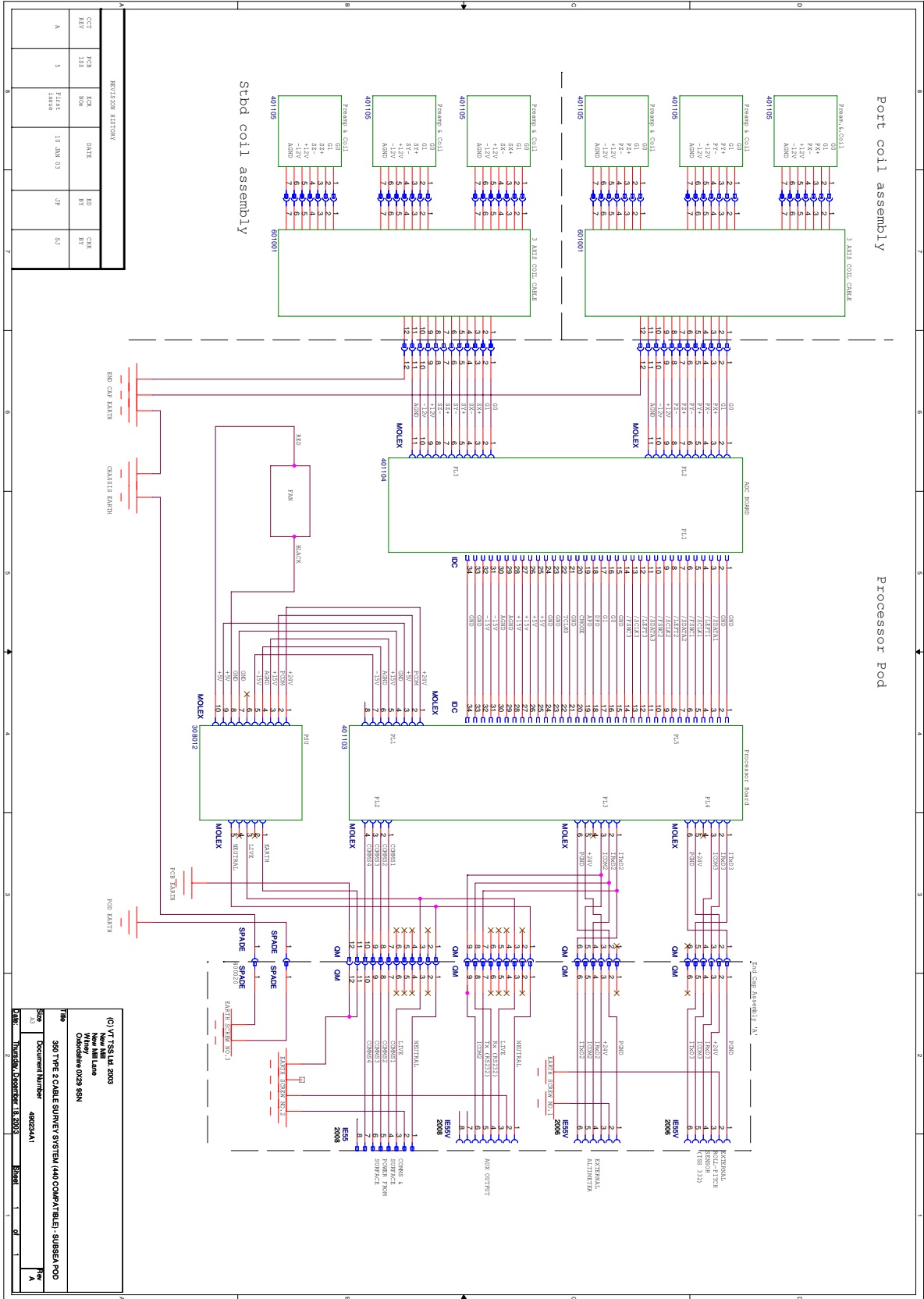

REVISION HISTORY			
NO	DATE	BY	CHK
1	10 JUN 03	JP	BJ

(C) TSS Ltd 2003 New Mill Lane Chesham Oxon SN8	
350 TYPE 2 CABLE SURVEY SYSTEM (440 COMPATIBLE) - SUBSEA POD	490234
TSS Part Number Description 18-2003	490234

Figure 10-2: 401105 Coil Pre-amp

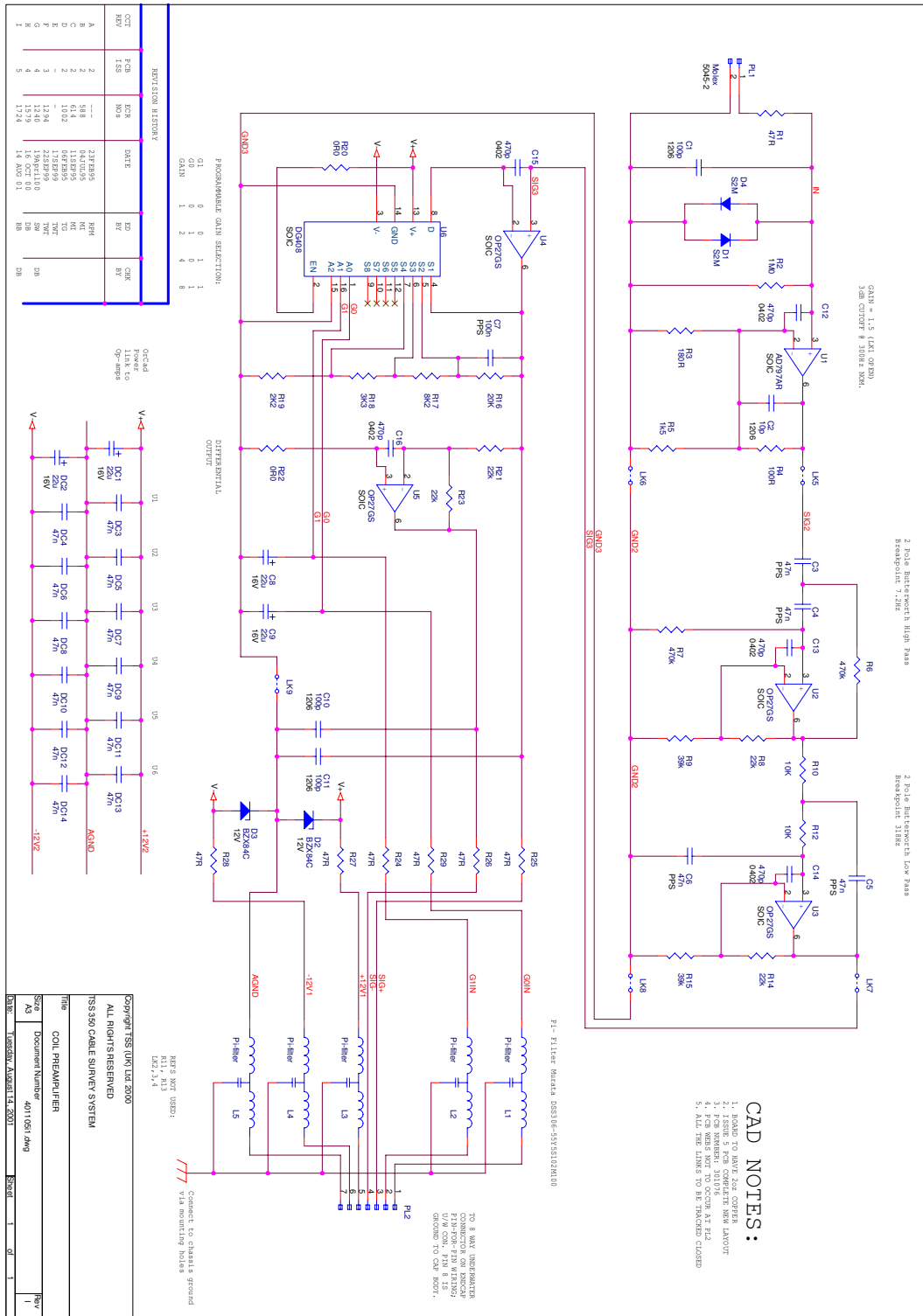
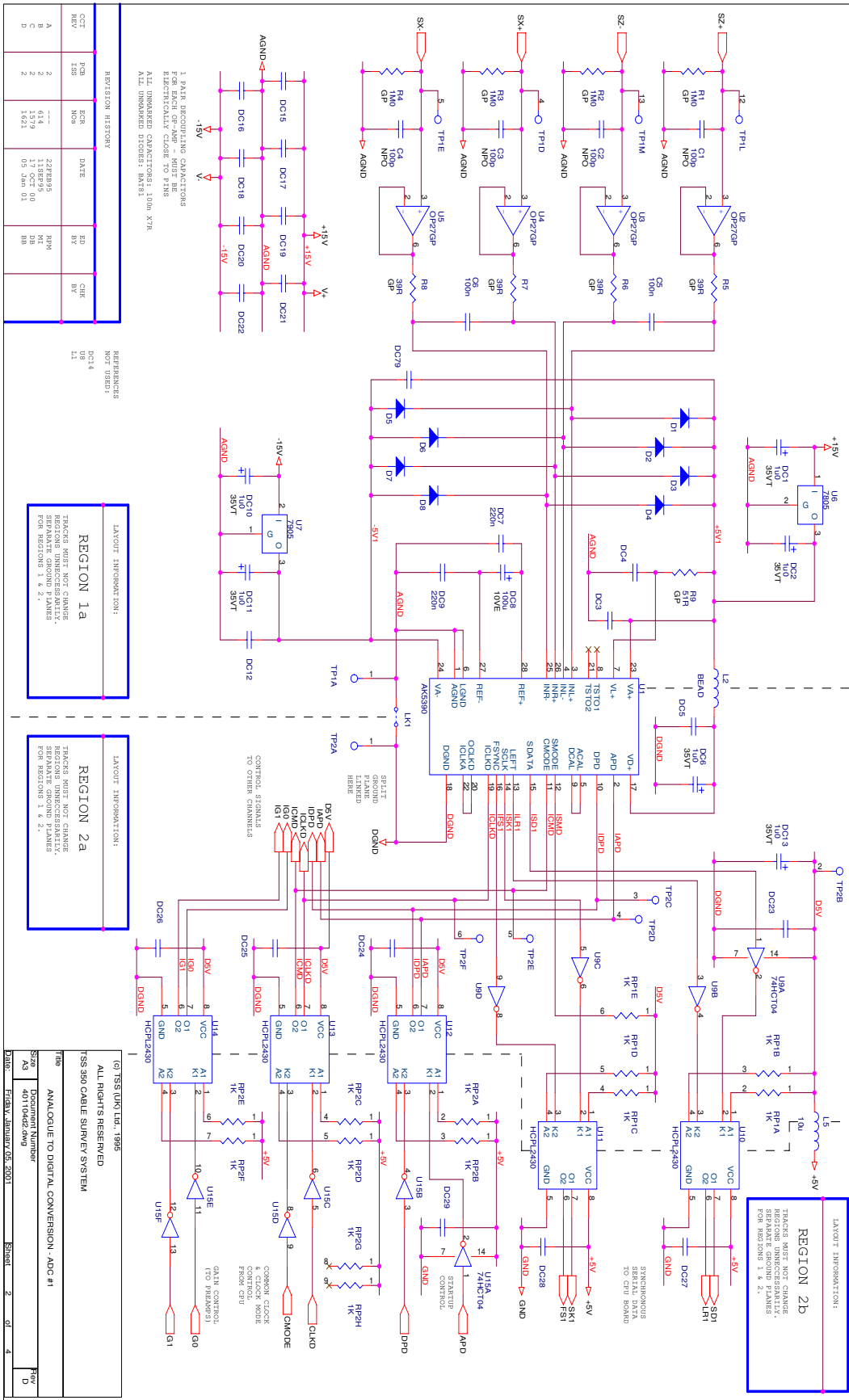



Figure 10-4: 401104-2 Analogue to Digital Conversion - ADC1



REVISION HISTORY					
REV	PCN	ECN	DATE	BY	CHK
A	130	N/A	22/08/95	BT	BT
B	2	614	11/08/95	BT	BT
C	2	1379	17/02/00	BT	BT
D	2	1324	01/04/01	BT	BT

REFERENCES	
DC14	NOT USED
U8	U8

LAGOUT INFORMATION:  
 REGION 1a  
 TRACKS MUST NOT CHANGE  
 REGIONS UNNECESSARILY  
 FOR REGIONS 1 & 2.

LAGOUT INFORMATION:  
 REGION 2a  
 TRACKS MUST NOT CHANGE  
 REGIONS UNNECESSARILY  
 FOR REGIONS 1 & 2.

LAGOUT INFORMATION:  
 REGION 2b  
 TRACKS MUST NOT CHANGE  
 REGIONS UNNECESSARILY  
 FOR REGIONS 1 & 2.

TSS (UK) Ltd. 1995			
ALL RIGHTS RESERVED			
TSS 990 CABLE SURVEY SYSTEM			
ANALOGUE TO DIGITAL CONVERSION - ADC #1			
SIZE	REVISION NUMBER	DATE	REV
A0	130	22/08/95	1
A1	1379	17/02/00	2
A2	1324	01/04/01	3
A3	1324	01/04/01	4

Figure 10-5: 401104-3 Analogue to Digital conversion - ADC 2

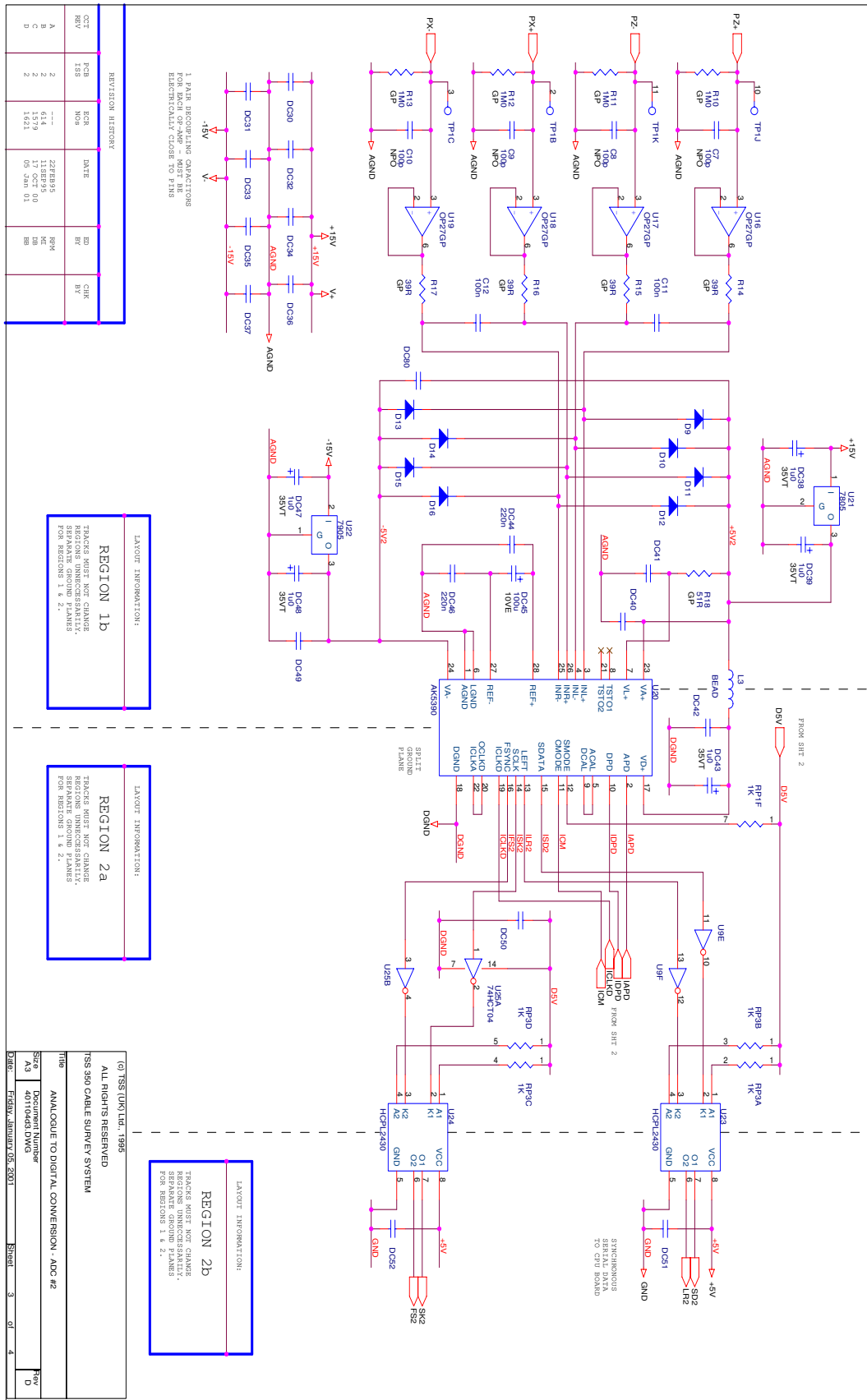

Figure 10-6: 401104-4 Analogue to Digital conversion – ADC 3

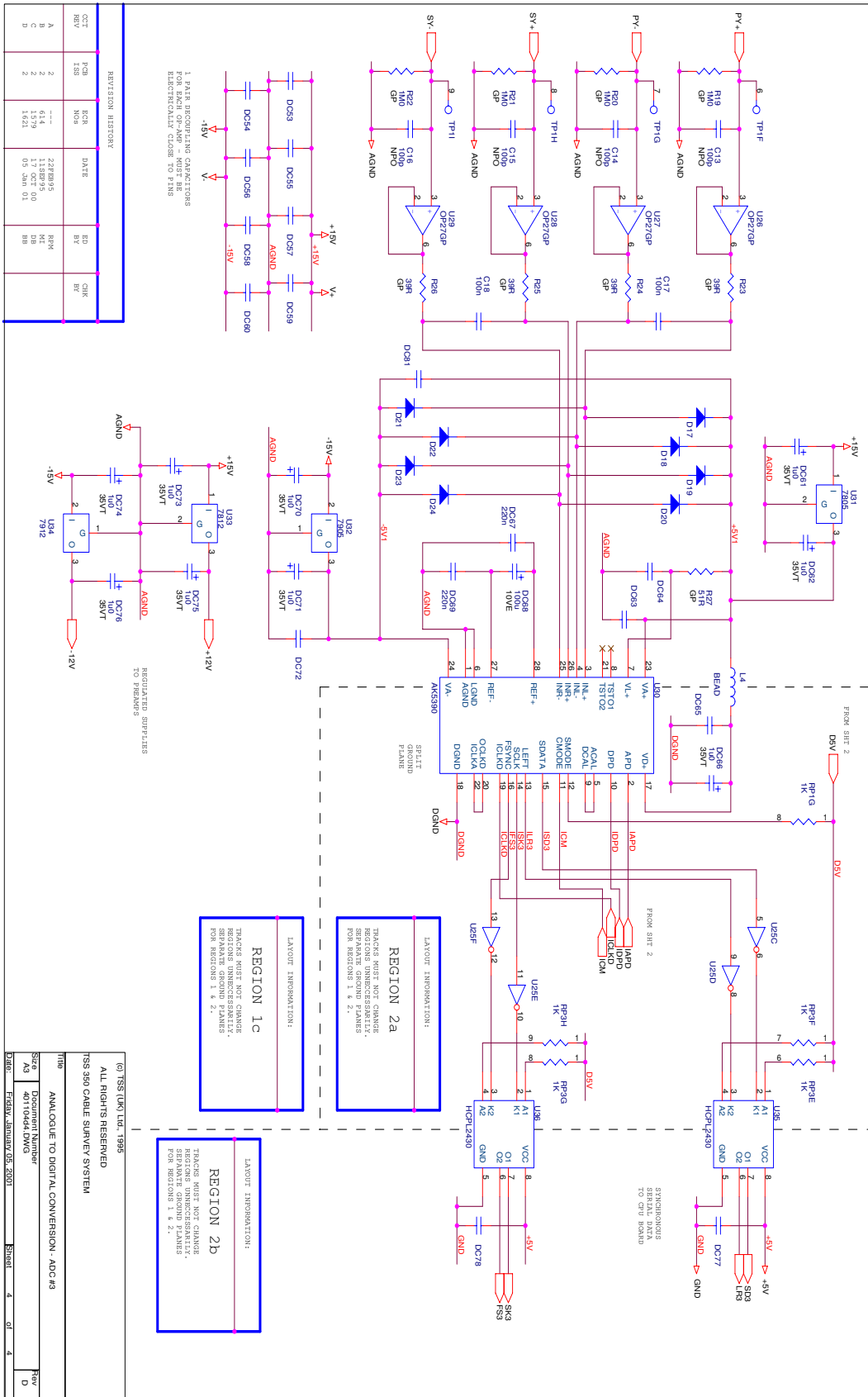



Figure 10-7: 401103-1 Processor Board

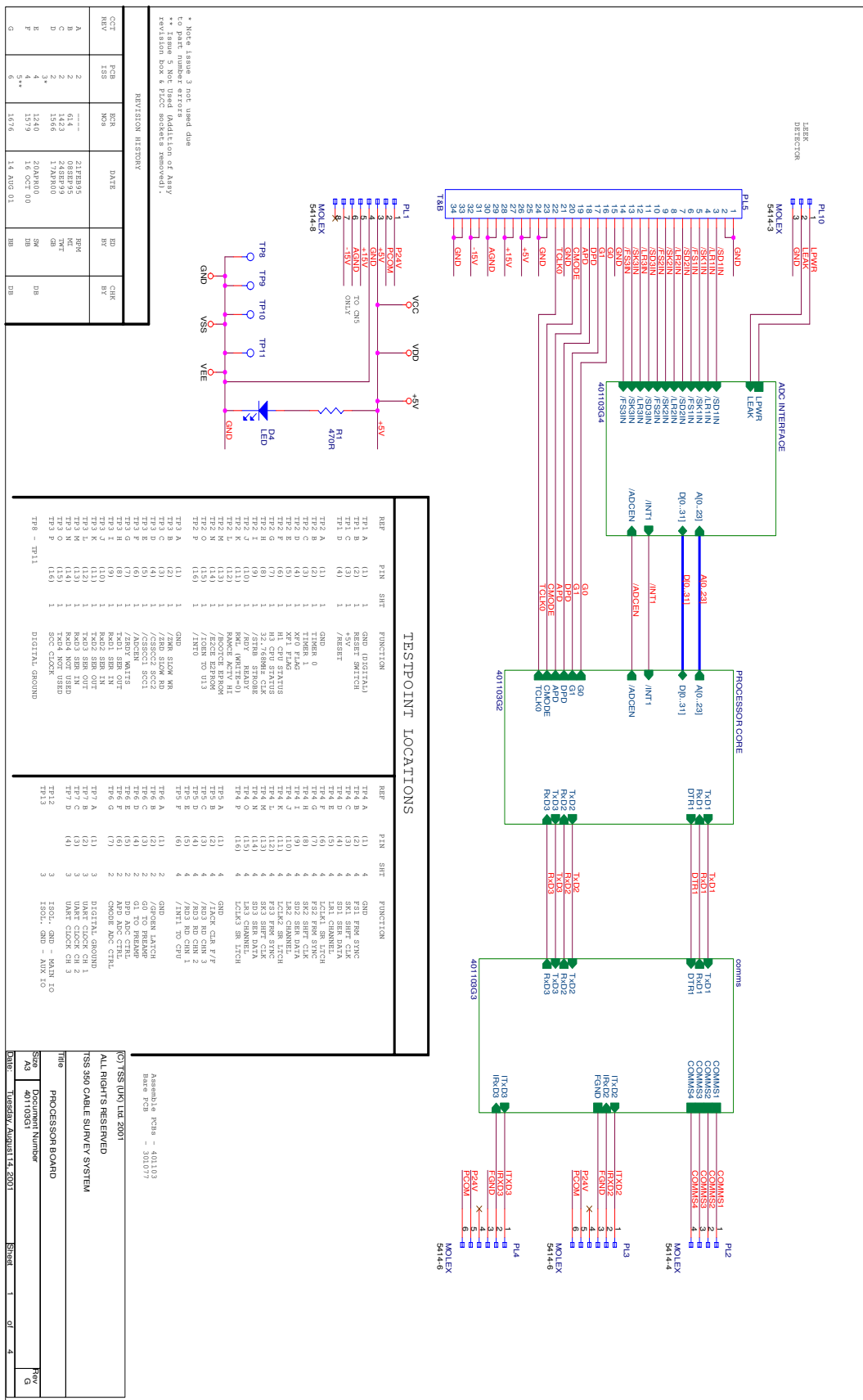

Figure 10-8: 401103-2 CPU Core

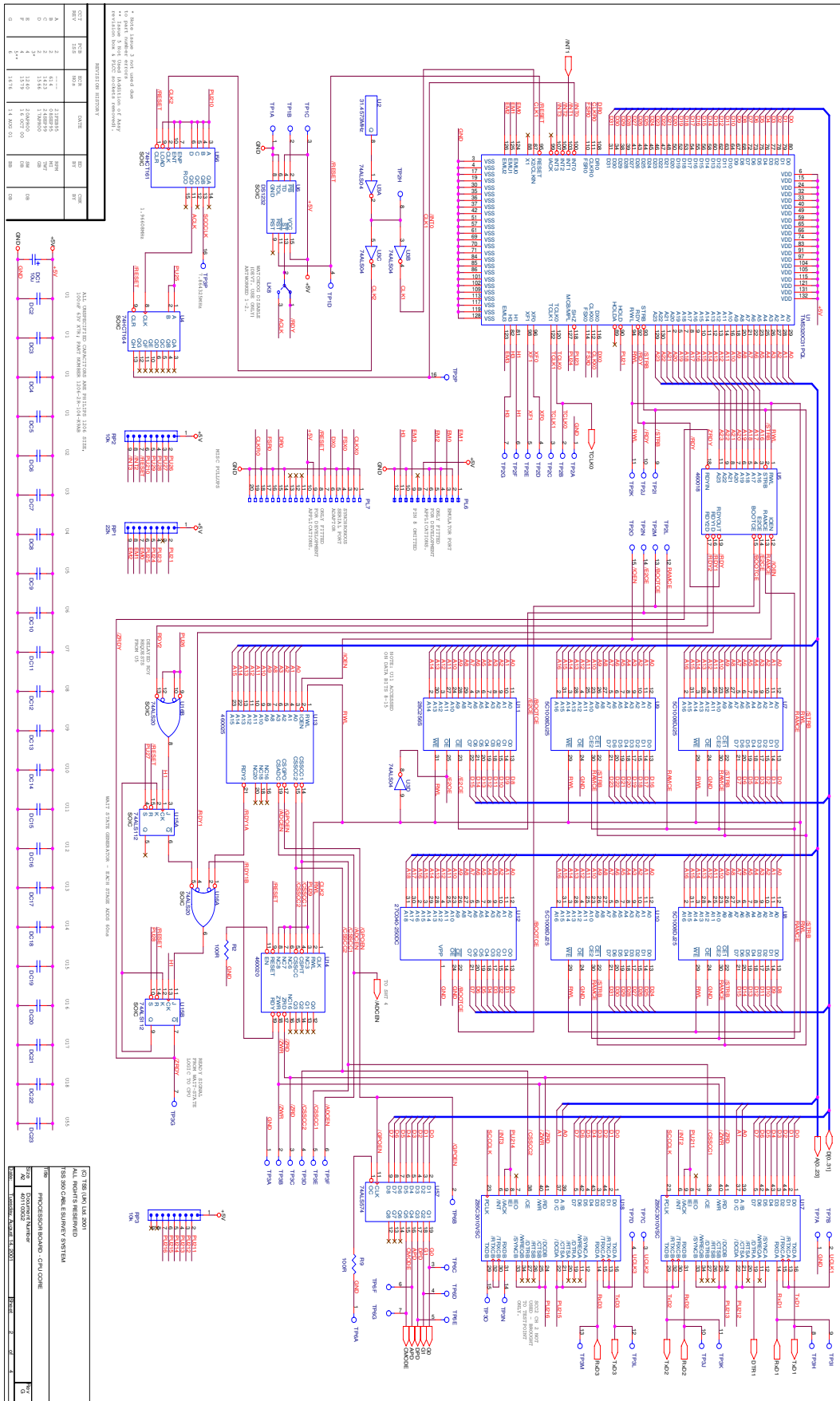

Figure 10-9: 401103-3 Processor Board - Comms

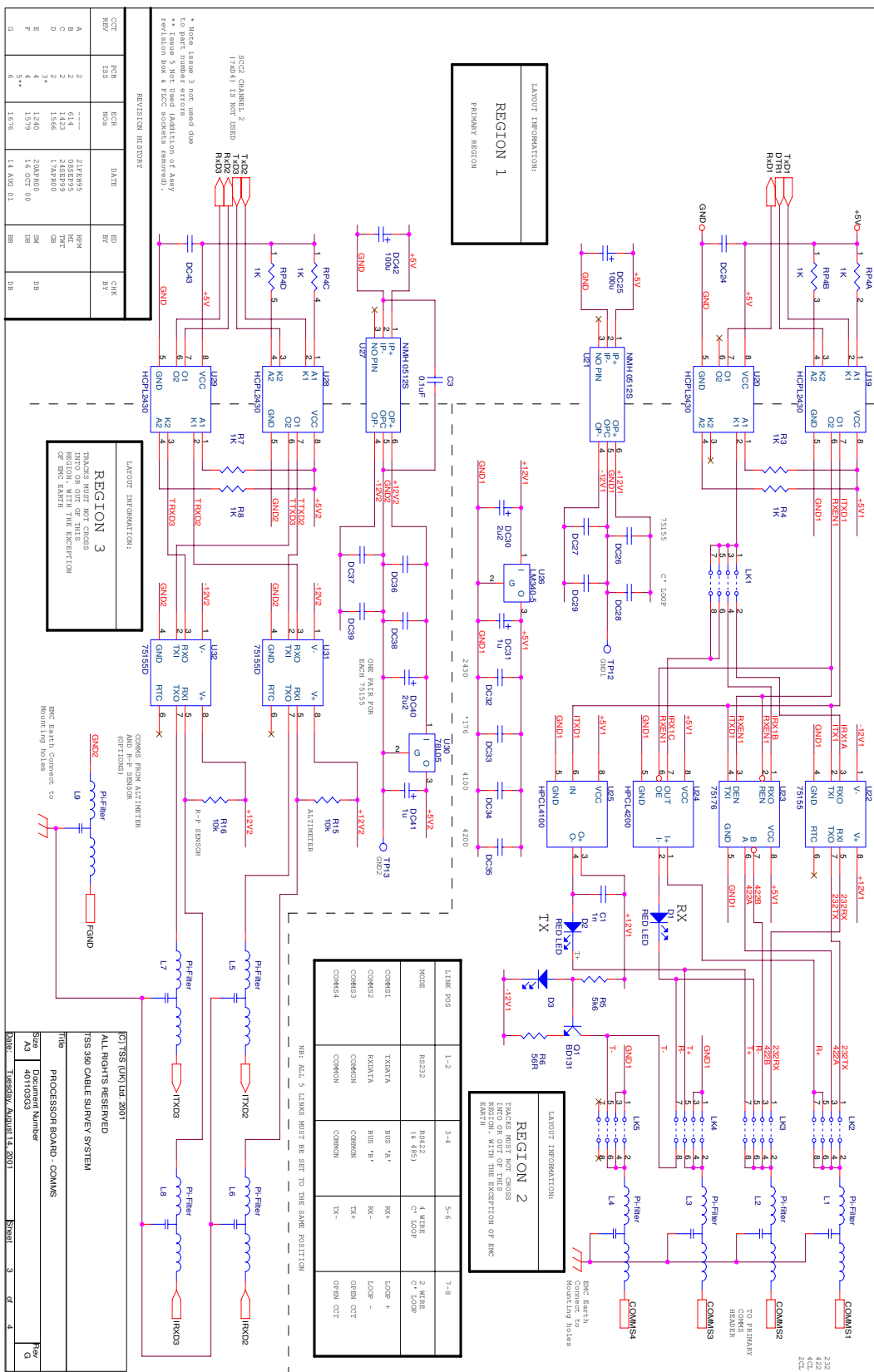
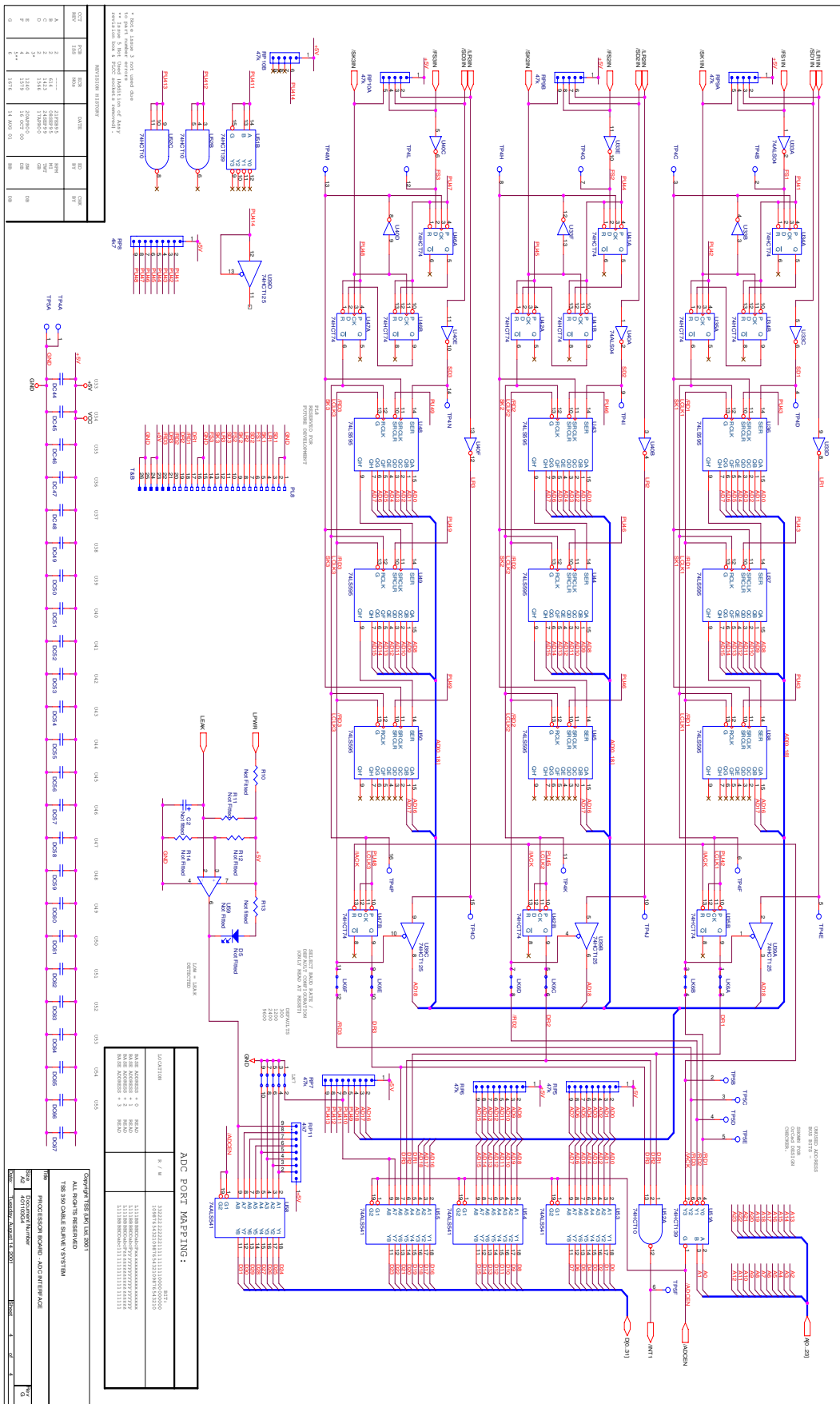

Figure 10-10: 401103-4 Processor Board - ADC Interface



REV	DATE	BY	CHKD	APPV
1	12/10/10	...	...	...
2	12/10/10	...	...	...
3	12/10/10	...	...	...
4	12/10/10	...	...	...
5	12/10/10	...	...	...
6	12/10/10	...	...	...
7	12/10/10	...	...	...
8	12/10/10	...	...	...
9	12/10/10	...	...	...
10	12/10/10	...	...	...

ADIC: ADIC0  
 ADIC1: ADIC1  
 ADIC2: ADIC2  
 ADIC3: ADIC3  
 ADIC4: ADIC4  
 ADIC5: ADIC5  
 ADIC6: ADIC6  
 ADIC7: ADIC7

REV	DATE	BY	CHKD	APPV
1	12/10/10	...	...	...
2	12/10/10	...	...	...
3	12/10/10	...	...	...
4	12/10/10	...	...	...
5	12/10/10	...	...	...
6	12/10/10	...	...	...
7	12/10/10	...	...	...
8	12/10/10	...	...	...
9	12/10/10	...	...	...
10	12/10/10	...	...	...

REV	DATE	BY	CHKD	APPV
1	12/10/10	...	...	...
2	12/10/10	...	...	...
3	12/10/10	...	...	...
4	12/10/10	...	...	...
5	12/10/10	...	...	...
6	12/10/10	...	...	...
7	12/10/10	...	...	...
8	12/10/10	...	...	...
9	12/10/10	...	...	...
10	12/10/10	...	...	...

REV	DATE	BY	CHKD	APPV
1	12/10/10	...	...	...
2	12/10/10	...	...	...
3	12/10/10	...	...	...
4	12/10/10	...	...	...
5	12/10/10	...	...	...
6	12/10/10	...	...	...
7	12/10/10	...	...	...
8	12/10/10	...	...	...
9	12/10/10	...	...	...
10	12/10/10	...	...	...

REV	DATE	BY	CHKD	APPV
1	12/10/10	...	...	...
2	12/10/10	...	...	...
3	12/10/10	...	...	...
4	12/10/10	...	...	...
5	12/10/10	...	...	...
6	12/10/10	...	...	...
7	12/10/10	...	...	...
8	12/10/10	...	...	...
9	12/10/10	...	...	...
10	12/10/10	...	...	...

REV	DATE	BY	CHKD	APPV
1	12/10/10	...	...	...
2	12/10/10	...	...	...
3	12/10/10	...	...	...
4	12/10/10	...	...	...
5	12/10/10	...	...	...
6	12/10/10	...	...	...
7	12/10/10	...	...	...
8	12/10/10	...	...	...
9	12/10/10	...	...	...
10	12/10/10	...	...	...

REV	DATE	BY	CHKD	APPV
1	12/10/10	...	...	...
2	12/10/10	...	...	...
3	12/10/10	...	...	...
4	12/10/10	...	...	...
5	12/10/10	...	...	...
6	12/10/10	...	...	...
7	12/10/10	...	...	...
8	12/10/10	...	...	...
9	12/10/10	...	...	...
10	12/10/10	...	...	...

REV	DATE	BY	CHKD	APPV
1	12/10/10	...	...	...
2	12/10/10	...	...	...
3	12/10/10	...	...	...
4	12/10/10	...	...	...
5	12/10/10	...	...	...
6	12/10/10	...	...	...
7	12/10/10	...	...	...
8	12/10/10	...	...	...
9	12/10/10	...	...	...
10	12/10/10	...	...	...

REV	DATE	BY	CHKD	APPV
1	12/10/10	...	...	...
2	12/10/10	...	...	...
3	12/10/10	...	...	...
4	12/10/10	...	...	...
5	12/10/10	...	...	...
6	12/10/10	...	...	...
7	12/10/10	...	...	...
8	12/10/10	...	...	...
9	12/10/10	...	...	...
10	12/10/10	...	...	...

Figure 10-11: 490221 350CE Cable Survey System Assembly (110V)

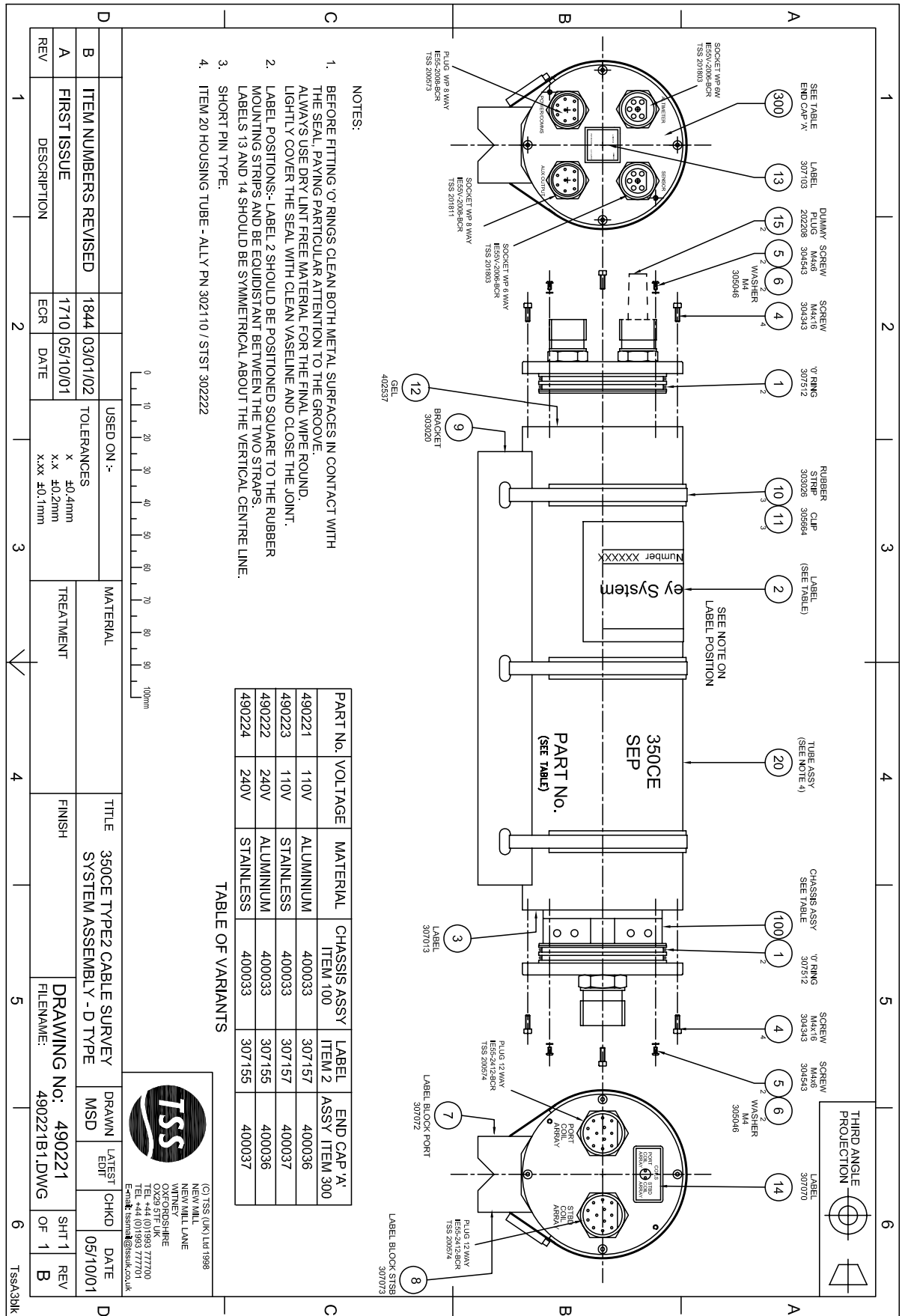

- NOTES:**
- BEFORE FITTING 'O' RINGS CLEAN BOTH METAL SURFACES IN CONTACT WITH THE SEAL, PAYING PARTICULAR ATTENTION TO THE GROOVE. ALWAYS USE DRY LINT FREE MATERIAL FOR THE FINAL WIRE ROUND. LIGHTLY COVER THE SEAL WITH CLEAN VASELINE AND CLOSE THE JOINT.
  - LABEL POSITIONS:- LABEL 2 SHOULD BE POSITIONED SQUARE TO THE RUBBER MOUNTING STRIPS AND BE EQUIDISTANT BETWEEN THE TWO STRAPS. LABELS 13 AND 14 SHOULD BE SYMMETRICAL ABOUT THE VERTICAL CENTRE LINE.
  - SHORT PIN TYPE.
  - ITEM 20 HOUSING TUBE - ALLY PN 302110 / STST 302222

**TABLE OF VARIANTS**

PART No.	VOLTAGE	MATERIAL	CHASSIS ASSY ITEM 100	LABEL ASSY ITEM 2	END CAP 'A' ITEM 300
490221	110V	ALUMINIUM	400033	307157	400036
490223	110V	STAINLESS	400033	307157	400037
490222	240V	ALUMINIUM	400033	307155	400036
490224	240V	STAINLESS	400033	307155	400037

REV	DESCRIPTION	ECR	DATE	USED ON :-	TOLERANCES	MATERIAL	TREATMENT	TITLE	FINISH	DRAWING No.:	FILENAME:	DRAWN/MSD	LATEST/EDIT	CHKD	DATE	SHT 1 OF 1	REV
A	FIRST ISSUE		05/10/01		X ±0.4mm X.X ±0.2mm X.XX ±0.1mm			350CE TYPE2 CABLE SURVEY SYSTEM ASSEMBLY - D TYPE		490221	490221B1.DWG				05/10/01		B
B	ITEM NUMBERS REVISED	1844	03/01/02														

(C)TSS (UK) LTD 1998  
 NEW MILL  
 NEW MILL LANE  
 WINDYBUSH  
 OX29 5TE UK  
 TEL +44 (0)1993 77700  
 TEL +44 (0)1993 77701  
 Email: [tsst@tss.co.uk](mailto:tsst@tss.co.uk)

Figure 10-12: B930476 350CE 3-axis coil cable assembly

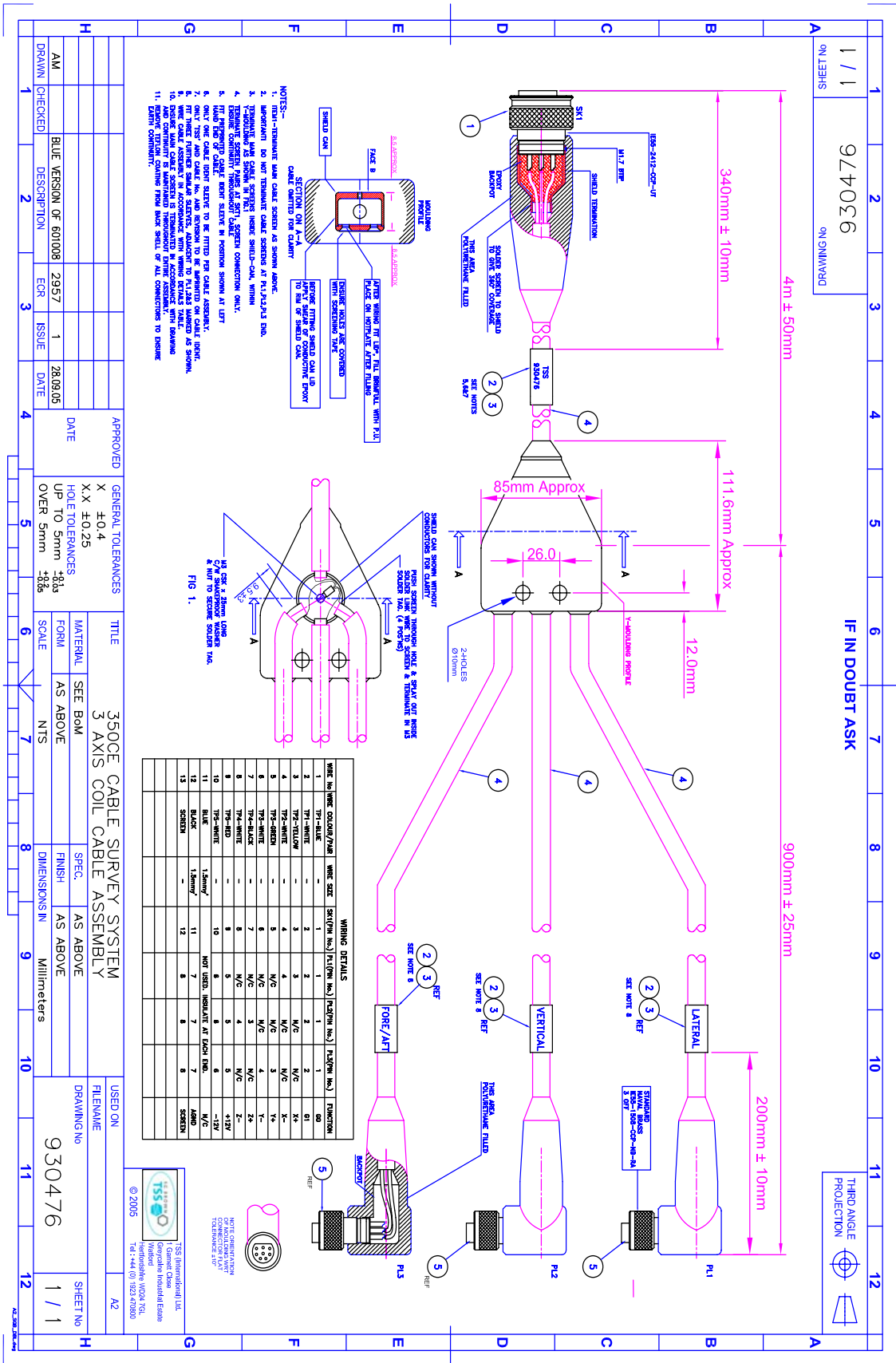
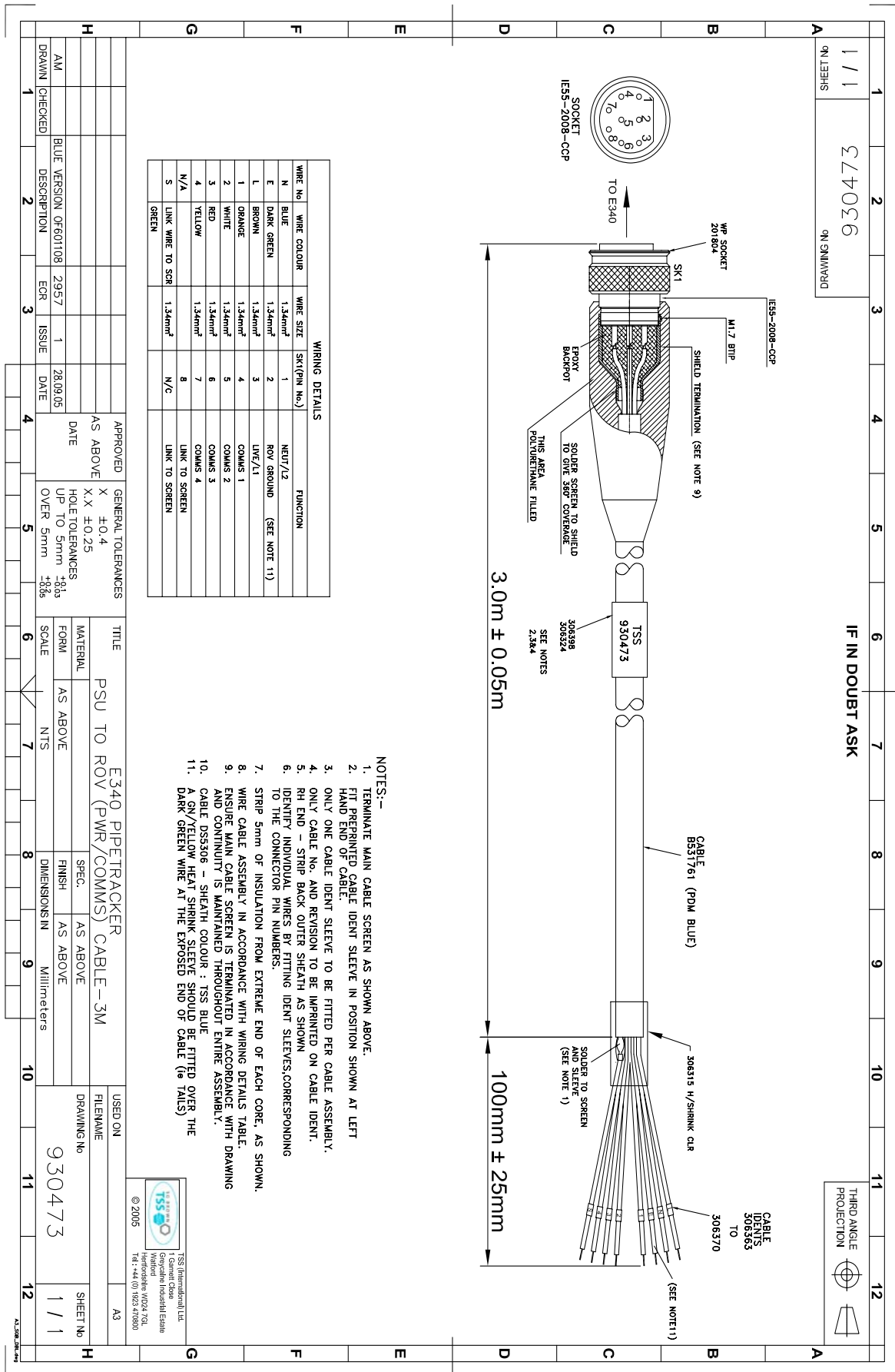

Figure 10-13: B930473 ROV Tail Assembly



### A OPERATING THEORY

The 350 System locates a target by:

1. Detecting the alternating magnetic fields associated with tone currents injected onto the cable.
2. Isolating the tone frequency from background noise.
3. Calculating the position of the target cable from the relative strengths of the signals on each channel.

This appendix describes these processes.

---

#### **A.1 Electromagnetic Fields** **Page 2**

Magnetic fields surround any current-carrying conductor. These must be alternating fields produced by a tone current so that the 350 System can detect them.

---

#### **A.2 Field Detection** **Page 2**

The System uses an array of sensitive coils on the ROV to detect the alternating magnetic fields from the target cable.

---

#### **A.3 Signal Isolation** **Page 3**

The 350 System receives signals across a wide band of frequencies. These include noise together with the desired tone frequency. The System uses powerful signal processing techniques to reduce or eliminate background noise.

---

#### **A.4 Calculation** **Page 4**

Combinations of signals on the six channels allow the 350 System to deliver measurements of target co-ordinates, forward search range, and the angle of skew.



## A.1 ELECTROMAGNETIC FIELDS

The 350 System uses an array of sensing coils to detect the presence of alternating magnetic fields and applies complex and powerful signal-processing techniques to locate the origin of these magnetic fields.

Alternating magnetic fields exist around any conductor that carries an alternating current and are of a strength that varies directly with the instantaneous magnitude of the current.

Figure A-1: Lines of magnetic flux

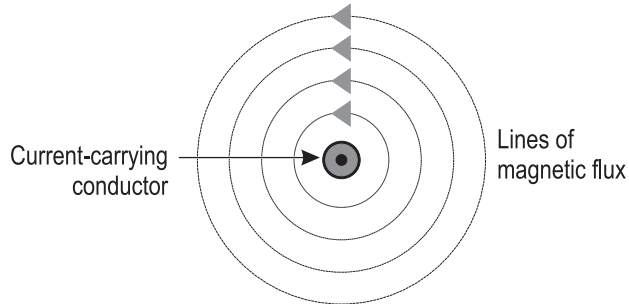

Figure A-1 shows the situation when a conductor carries a current. In this example, the conductor appears in cross-section with conventional current flow rising upwards out of the page. As the current begins to flow, lines of magnetic flux expand concentrically from the centre of the conductor with their polarity in an anti-clockwise direction as shown. The strength of the flux varies inversely with distance from the conductor.

When the amplitude of current varies, the flux lines will expand or collapse simultaneously. The flux lines will reverse polarity when the current changes direction.

## A.2 FIELD DETECTION

Each sensing coil of the 350 System consists of a very large number of turns of fine copper wire wound around a ferrous metal core. The continuously changing magnetic fields that exist around a tone-carrying conductor act upon the sensing coils and induce in them an alternating voltage  $v$ . This voltage varies in magnitude according to the following relationships:

$$v \propto \frac{1}{d} \quad v \propto f \quad v \propto i$$

Where  $d$  = distance from the conductor to the sensing coil  
 $f$  = frequency of current in the conductor  
 $i$  = magnitude of current in the conductor

**A.3 SIGNAL ISOLATION**

Marine survey environments suffer from significant levels of background noise produced by other electrical systems on board the ROV. The 350 System must remove this noise from the coil signals before it can perform meaningful calculations.

This noise reduction process involves many stages, including:

**1. BAND-PASS FILTERING:**

Signals received by the coils may be extremely weak – possibly less than 5µV in amplitude. Each of the six windings in the coil array therefore includes a precision pre-amplifier and filter board to apply amplification and signal conditioning before it transmits the signals to the relatively noisy environment on board the ROV. The pre-amplifier can vary its overall gain automatically according to circumstances.

An additional function of the pre-amplifier board is to apply high-pass and low-pass filtering. This function limits the pass-band of signals that arrive at the SEP to between 7.2Hz and 300Hz.

**2. Frequency spectrum analysis**

The SEP converts the analogue signals supplied by the coils to an 18-bit digital format for processing by the digital signal processor (DSP). Figure A–2 shows a simplified block diagram of the signal path for three of the six channels in the 350 System.

Figure A-2: Simplified signal path

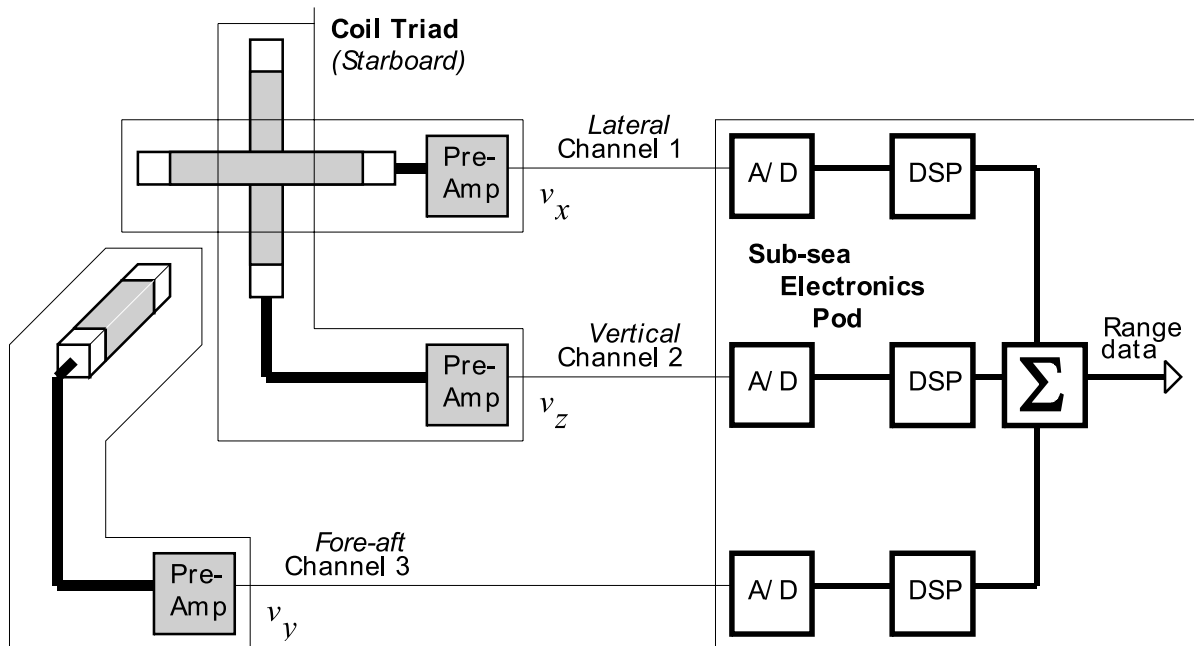

The SEP samples the supplied signals approximately 1000 times per second and uses powerful signal processing techniques to determine the spectrum of received frequencies.

After processing the signals in this way, the SEP divides the entire received spectrum into narrow ‘windows’ as shown in Figure A–3. The System stores the instantaneous signal amplitude for each of these ‘windows’ in a series of memory locations.

Figure A-3: Frequency 'windows'

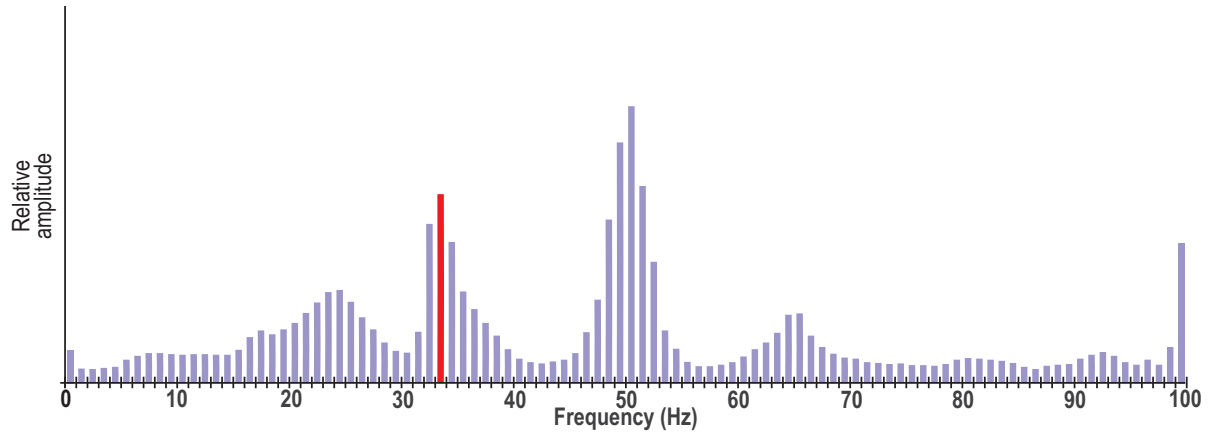

This process isolates the various frequency components in a signal very effectively so that the System can distinguish the tone frequency easily from among the background noise. The SDC display software provides a Frequency Spectrum feature similar to Figure A-3, with the tone frequency identified as a solid red bar. The example in Figure A-3 shows the tone frequency at 33Hz.

See sub-section 6.2.1.4 for a more detailed description of the complete Frequency Spectrum display.

## A.4 CALCULATION

By using an array of two coil triads, the 350 System avoids potential sources of measurement error caused by changes in the amplitude of the tone signal. Calculations performed by the 350 System provide three modes of operation:

### 1. Survey mode:

The SDC displays the vertical range to target and the lateral offset of the target relative to the centre of the coil array. If the System receives altitude information or you have specified a fixed coil height, this mode can also supply measurements of altitude and target depth of cover.

See sub-section 6.2.1.2 for a full description of the Run Display screen.

### 2. Forward Search mode:

The SDC can display an *estimate* of the range to a tone-carrying cable that lies along an intersecting course ahead of the ROV. This facility allows you to use the 350 System to conduct a search for a target in the survey area.

See sub-section 6.2.1.3 for a full description of the Forward Search screen.

### 3. Skew Measurement mode:

The SDC displays and transmits the angle of skew measured between the track of the target and the ROV heading. Ideally, there should be no angle of skew present during a survey.

The SDC displays all measurements relative to the ROV. They might therefore contain errors if you operate the ROV with some angle of roll or pitch.

You may pass measurements made using any available mode to an external data logger for subsequent analysis.

See Sections 5 and 6 for a description of the SDC software. Refer to Section 7 for instructions to use the 350 System during a survey.

**A.4.1 Survey Mode**

To measure the target co-ordinates (vertical range and lateral offset), the 350 System uses signals from only the vertical and the lateral sensing coils in each coil triad.

Given a known frequency and magnitude of current in the conductor, the amplitude of signal voltage delivered by each coil winding will depend upon the relative angle between the coil and the conductor.

Figure A-4: The effect of incident angle on coil response

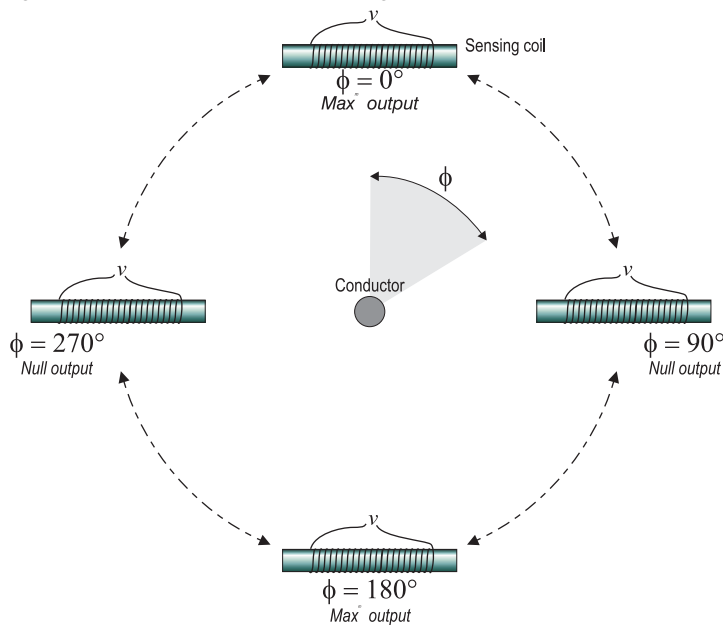

Figure A-4 shows the cross-section of a conductor carrying an alternating current that has a constant peak amplitude and frequency.

Figure A-5: Coil response as incident angle varies

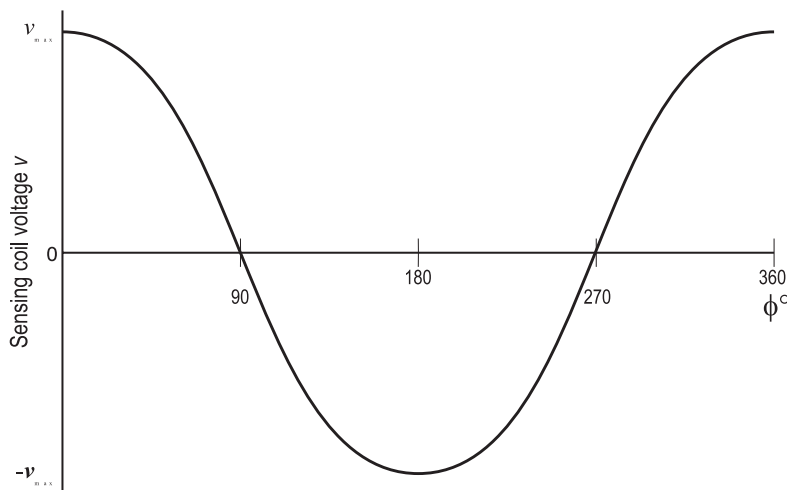

Figure A–5 shows the relationship that exists between the signal voltage  $v$  received by the coil in Figure A–4 and the angle  $\phi$  between the coil and the conductor:

$$v \propto \cos \phi$$

- There will be no output (a null condition) when the conductor lies along the major axis of the sensing coil ( $\phi = 90^\circ$  or  $\phi = 270^\circ$ ).
- There will be maximum output when the conductor is on a line perpendicular to the major axis ( $\phi = 0^\circ$  or  $\phi = 180^\circ$ ).
- In all other conditions the coil output will be at some intermediate value between maximum and zero as defined in Figure A–5.

The 350 System uses two coils arranged at right angles to extend the coverage through a full  $360^\circ$ . By comparing the relative outputs from the two coils, the System can determine the angle between the centre of the coil pair and the target as shown in Figure A–6.

Figure A–6: Determination of relative angle using two coil voltages

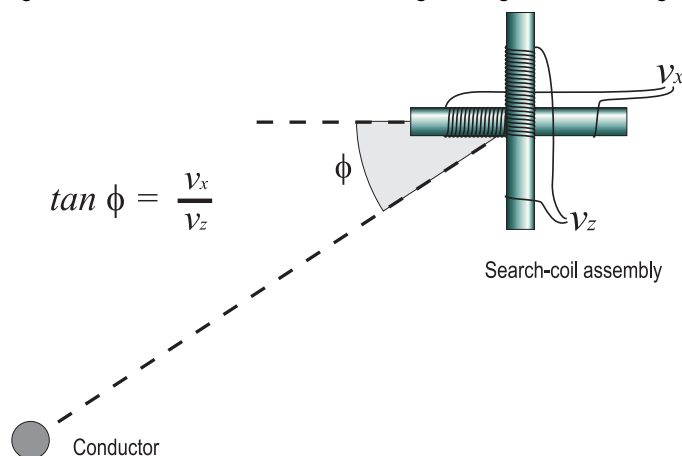

In Figure A–6 the two independent windings of the coil assembly supply signal voltages  $v_x$  (lateral coil) and  $v_z$  (vertical coil). The System uses these to derive the angle  $\phi$  between the coil assembly and the conductor:

$$\tan \phi = \frac{v_x}{v_z}$$

Since TSS calibrates and matches the coil windings during manufacture, any changes to the tone frequency or current will have an equal effect on all coils. The ratio of their output voltages (and therefore the evaluation of  $\phi$ ) will therefore remain constant.

Figure A-7: Target location using two coil pairs

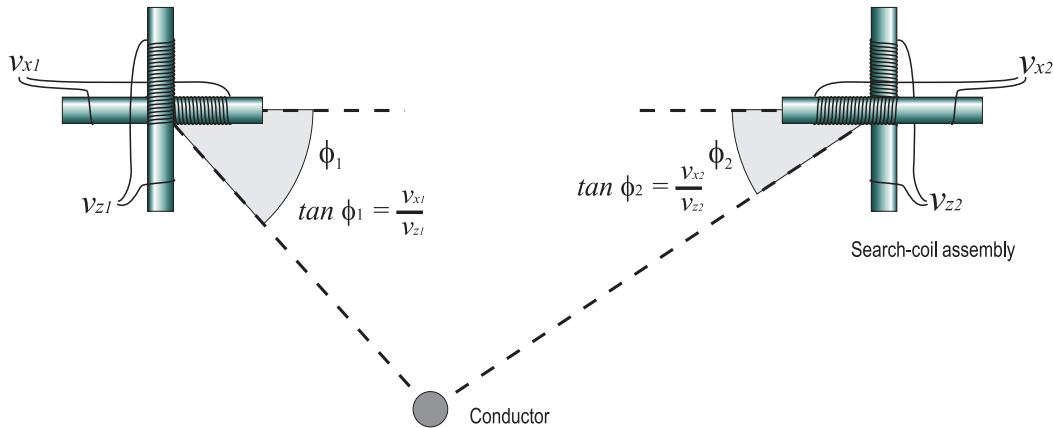

The 350 System uses an array of two coil pairs to determine the *position* of the target cable. Figure A-7 shows this situation.

The SEP measures the strength of signals simultaneously on each of the four channels  $v_{x1}/v_{z1}$  and  $v_{x2}/v_{z2}$  and determines the target location by triangulation. The SEP extracts the co-ordinates for lateral offset and vertical range, and transmits these through the umbilical to the SDC.

**A.4.2 Forward Search Mode**

If the 350 System receives input from an altimeter, it can use this information to estimate the range to a tone-carrying cable that lies along an intersecting course ahead of the ROV.

You may find this facility useful if you are searching for a target in the survey area. You may use the display to steer the ROV towards the expected position of the target at a near-perpendicular angle and then switch to the run mode to steer a course along the target.

Figure A-8: Forward Range Calculation

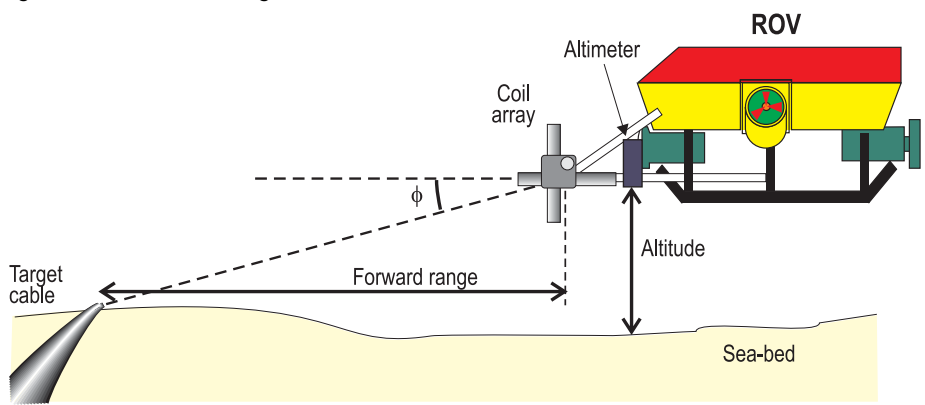

When operating in the Forward Search mode, the 350 System uses signals from the vertical and the fore-aft coils.

Signals from the relevant coil pair allow the 350 System to determine the search angle  $\phi$  to the target cable in the same way as described in sub-section A.4.1 above.

The System then uses this information, together with the measured altitude of the ROV, to estimate the forward range:

$$\text{Forward range} \cong \frac{\text{Altitude}}{\tan \phi}$$

It is important to note that this range is an *estimate* only. Factors that affect the accuracy of this estimate are:

- The flatness of the seabed topography.  
The calculation assumes that the height of the coils relative to the target cable is the same as the altitude measured by the altimeter. Errors caused by uneven seabed topography are likely to be larger at greater forward ranges. The accuracy of the estimate will degrade further with a target buried beneath the seabed.
- Operating the ROV with pitch.  
Any angle of pitch will affect the forward search angle  $\phi$  directly. The magnitude of errors caused by angles of pitch increases rapidly with forward range.

### A.4.3 Skew Measurement

The Run Display screen includes a graphical element that shows the angle of skew between the ROV and the target cable (see sub-section 6.2.1.2 for further details of this display feature). The System uses the lateral and the fore-aft coils on one side of the array to measure skew.

Figure A–9 shows a survey ROV above the target cable. A small angle of skew exists between the target and the ROV.

The 350 System measures the target co-ordinates as explained in sub-section A.4.1 above. These measurements retain the specified accuracy for that part of the target directly between the two coil triads.

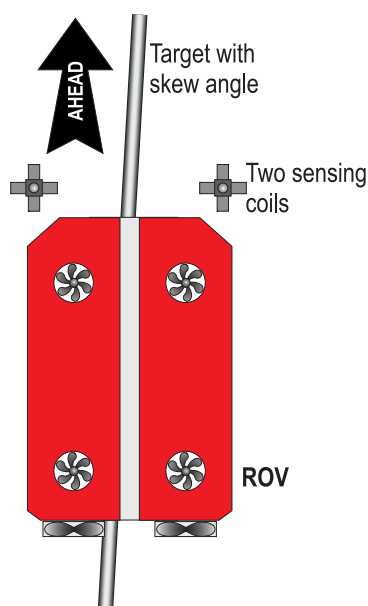

Figure A–9: Vehicle following target with skew angle

The example of Fig A–10 shows the target with a skew angle  $\theta$  and the output voltages from the lateral coil ( $v_x$ ) and the fore-aft coil ( $v_y$ ) in the port coil triad.

Signal voltages supplied by the coil will be at a maximum with the major axis of the coil perpendicular to the target. A coil lying parallel to the course of the target will give a very weak output. The peak amplitude of output voltage will vary with the sine of the relative angle between the major axis of the coil and the target cable.

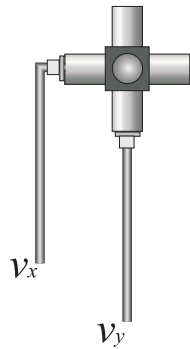

Figure A-10: Skew angle measurement

Because of this relationship, the System can determine the angle of skew  $\theta$ .

$$\theta = \text{atan} \frac{v_y}{v_x}$$

The skew measurement method described does not require you to locate the coil triad directly over the target cable. It can work to the specified accuracy over a considerable swath range.

The convention used by the 350 System is to define positive skew with the ROV rotated clockwise relative to the target.

The SDC displays measurements of skew only with the System operating in the Survey mode.





### B OPTIONS

The description throughout the main part of this Manual relates to the standard 350 Cable Survey System. Such a System provides all the facilities you will need to survey a target lying on or buried beneath the seabed.

For some applications, the 350 System may be more effective if you specify it with one or more of the available options.

This appendix describes the options that TSS (International) Ltd can supply for use with the 350 Cable Survey System:

- Combined 'Dualtrack' installation with a TSS 350 System
- Engineer training

#### **B.1 DualTrack System**

**Page 2**

To provide a survey system that has greater flexibility, the 350 System can be connected to a TSS (International) Ltd 440 Pipe and Cable Survey System. Combined operation of the two Systems extends the range of applications for which either System can be used.

#### **B.2 Training**

**Page 11**

TSS (International) Ltd offers comprehensive operator and engineer training for the 350 Cable Survey System.

## B.1 DUALTRACK SYSTEM



### CAUTION

You might cause permanent damage to the sub-sea installations of the 440 or the 350 System if you operate them from an incorrect electrical supply voltage.

The standard sub-sea components of both Systems operate from a nominal 110V AC electrical supply. Both Systems are available with the option to operate from a nominal 240V AC electrical supply. When you interconnect the 440 and the 350 Systems within a Dualtrack installation *you must operate both from the same electrical supply.*

Throughout this sub-section, 'the 440 Manual' refers to the TSS (International) Ltd 440 Pipe and Cable Survey System Manual (TSS document P/N 402196 check).

This part of Appendix B describes the features of a TSS (International) Ltd 'Dualtrack' System that combines the 440 and the 350 Survey Systems on board an ROV. It includes all information specific to a Dualtrack installation and provides cross references that help you locate more detailed information in the relevant product Manual.



You must consider the Manuals for the TSS 440 and the 350 Systems valid in all respects except for those areas listed in sub-section B.1.2 below. TSS recommends that all personnel who will install, use and maintain the equipment should read and thoroughly understand the 350 System Manual and the 440 Manual.

### *B.1.1 The Equipment*

The Dualtrack equipment described in this sub-section consists of the following:

- ❑ Sub-sea components of a TSS 350 Cable Survey System.
- ❑ Sub-sea components of a TSS 440 Pipe and Cable Survey System.
- ❑ A single SDC to provide configuration, control and communications functions for both sets of sub-sea components.
- ❑ Product Manuals, interconnection cables and mounting components for all three sub-sea electronics pods.



The 350 requires to have the latest firmware (version 3.7 or later) EPROM. This can be confirmed in the terminal mode of DeepView for Windows, when the System is initiated a banner is displayed that will identify the version number.

TSS (International) Ltd supplies the System with Microsoft Windows 2000 and the DeepView for Windows graphical display software already installed and configured to run automatically when you power-on the SDC. DeepView for Windows can operate in all modes necessary to use the Dualtrack System.

The sub-sea components and the SDC supplied with the Dualtrack System are exactly as described in the relevant parts of the 350 System Manual and the 440 Manual, except for those differences listed in sub-section B.1.2 below.

### B.1.2 The Differences

Note the following important issues when you install the Dualtrack System:

#### 1 Scope of Delivery

---

Sub-section B.1.3 lists the standard items supplied with the Dualtrack System.

#### 2 Physical installation

---

Refer to sub-section 3.2 of this Manual for instructions to install the sub-sea components of the TSS 350 System.

Refer to Section 3 of the 440 Manual for instructions to install the sub-sea components of the 440 System.

You must take special precautions regarding the placement of the search coils when you install the Dualtrack System on board an ROV.

Sub-section B.1.4 describes the special precautions you must make when you install the Dualtrack System.

#### 3 Electrical connection

---

To make the most efficient use of the ROV umbilical, the Dualtrack System uses only two wires for all communications between the surface and the sub-sea installations. See sub-section B.1.5 for details of the special electrical connection requirements necessary to support this communication arrangement.

Where necessary, you may use 4-wire or RS232 communications instead.

Note that, in a Dualtrack System, you *must* connect the altimeter *only* to the ALTIMETER port of the 440 SEP, or to an SDC serial port. **Do not connect the altimeter to the 350 SEP.**

#### 4 Operation

---



**In a Dualtrack installation, you cannot operate the 440 and the 350 Systems simultaneously.**

DeepView for Windows allows you to switch between the 440 and the 350 operating mode easily and quickly. The Run Window and its status bar will show the current operating mode.

#### 5 Power requirement

---

Sub-section B.1.6 includes details of the power supply requirements for the sub-sea components of the Dualtrack System.

### *B.1.3 Scope of Delivery*

Dualtrack includes the following major sub-assemblies:

Figure B-1: Surface Display Computer



Figure B-2: Sub-sea components of the TSS 350 System

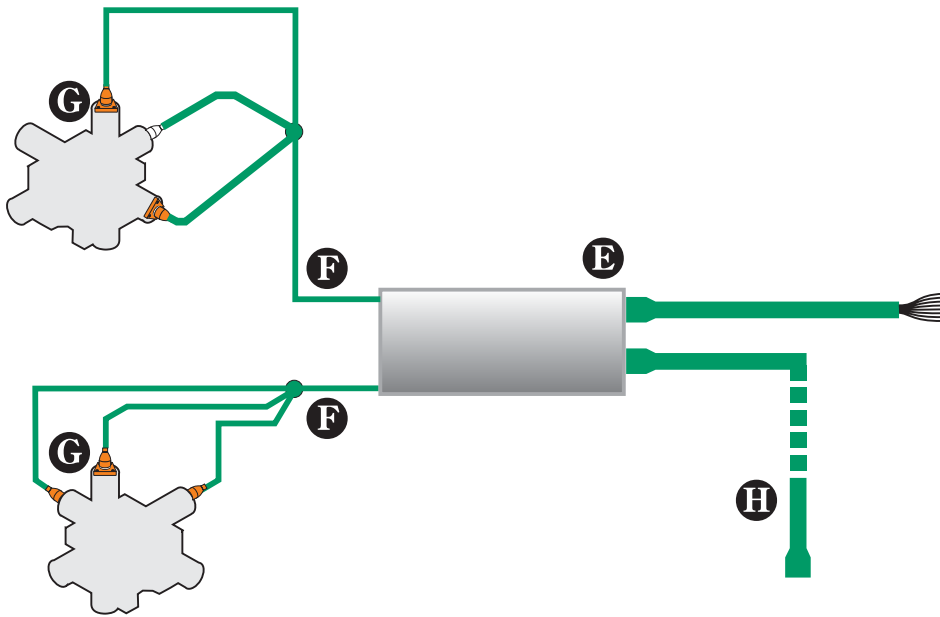

Figure B-3: Sub-sea components of the TSS 440 System

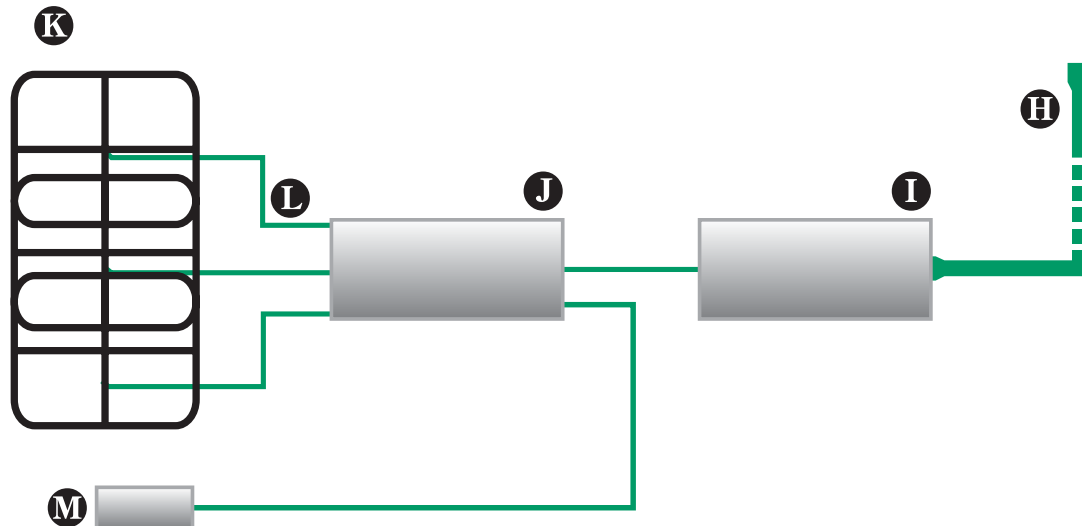

Table B-1: Components of the Dualtrack System

Item	Description
------	-------------

Refer to Figure B-1:

<b>A</b>	Surface Display Computer (SDC) pre-loaded with Microsoft Windows™ 2000 and the DeepView for Windows display software.
<b>B</b>	Retractable keyboard/ trackpad combination.
<b>C</b>	Modular PC console.
<b>D</b>	Modular 15" LCD display.

Refer to Figure B-2:

<b>E</b>	Sub-sea Electronics Pod (350 SEP) for the TSS 350 Cable Survey System.
<b>F</b>	Two connection cables with waterproof connectors for the port and the starboard coil triads.
<b>G</b>	Port and starboard coil triads.
<b>H</b>	TSS 440-to-350 link cable (TSS P/N 601814). The cable is 2.5 metres long and has waterproof connectors at both ends.

Refer to Figure B-3:

<b>I</b>	Sub-sea Power Supply Pod (440 PSU) for the 350 Cable Survey System.
<b>J</b>	Sub-sea Electronics Pod (440 SEP) for the 350 Cable Survey System.
<b>K</b>	Coil array comprising three TSS search-coils.
<b>L</b>	Three connection cables with waterproof connectors for the array of search-coils.
<b>M</b>	Sub-sea altimeter with connection cable and waterproof connector. <i>This altimeter provides information for use by the entire Dualtrack System.</i>

Also included with the Dualtrack System but not shown are:

- Trackball for use with the SDC and the DeepView for Windows software.
- TSS 350 Cable Survey System Manual – TSS P/N 402196 current issue.
- TSS 440 Cable Survey System Manual – TSS P/N 402197 current issue.
- Mounting components for the coil triads of the 350 System (see Section 3.2.2 of this Manual for details).
- Mounting components for the search coils of the 440 System (see Section 3 of the 440 Manual for details).
- Mounting components for all three electronics housings of the Dualtrack System.

### ***B.1.4 Physical Installation***

#### ***B.1.4.1 Search-coils***

Follow the instructions in sub-section 3.2.2 of this Manual to install the mounting bar and coil triads of the 350 System.

Follow the instructions included in sub-section 3.2.2 of the 440 Manual to install the mounting frame and the coil array of the TSS 440 System.



---

#### **CAUTION**

With drive current applied to the coils of the 440 System, large induced voltages can appear across the coils of the 350 System. Later versions of the 350 search coils, stamped with the letters 'DT' on the end cap, include diodes to protect them from damage caused by these induced voltages.

If your System includes coils that have no diode protection, you should ensure that there is a clearance of more than 0.75 metres between the coils of the 350 System and the coils of the 440 System. Contact TSS (International) Ltd for advice if necessary.

#### ***B.1.4.2 Sub-sea Pods***

The Dualtrack System includes three sub-sea pods:

- The PSU for the 440 System.
- The SEP for the 440 System.
- The SEP for the 350 System.

Follow the instructions in section 3.2 of the 440 Manual to install the 440 SEP and 440 PSU.

Follow the instructions included in sub-section 3.2.1 of this Manual to install the 350 SEP.

### B.1.5 Electrical Connection

It is very important that you should interconnect the sub-sea components exactly as described in Figure B–4 and the instructions below.



**IMPORTANT**

If the Dualtrack System is an upgrade to an existing 440 System, you must open the 440 SEP and set it to use RS232 communications. Refer to sub-section 4.2.2.1 of the 440 Manual for instructions to change the communication method used by the 440 SEP.

Figure B-4: Electrical interconnection of sub-sea components

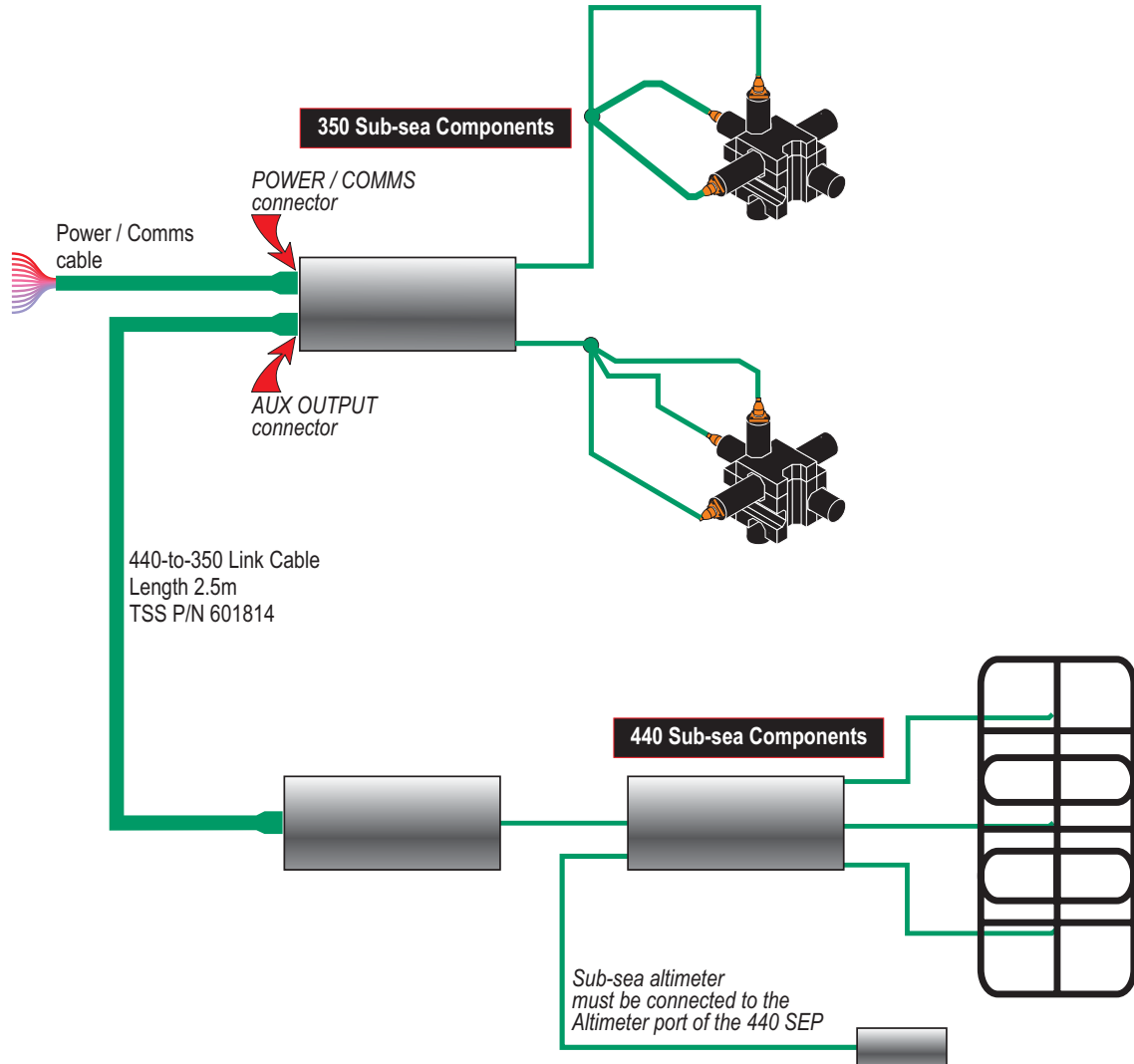

**CAUTION**

To avoid damage to either of the SEPs, make certain that you fit the blanking plugs supplied by TSS (International) Ltd to any unused ports.

Failure to take this precaution might allow water to penetrate the SEP housings, following which total circuit failure will occur.



### Connect the TSS 440 sub-sea components:

1. Complete the physical installation of the 440 search-coils as described in sub-section 3.2.2 of the 440 Manual. Route the coil connection cables to the correct ports on the 440 SEP. Use plastic cable clips to secure the cables to the fixed framework of the ROV.
2. Install the altimeter near the centre of the 440 search-coil array as described in sub-section 3.2.3 of this Manual. Route the cable from the altimeter to the 440 SEP and follow the instructions in sub-section 4.1.5.1 of this Manual to connect it. Use plastic cable clips to secure the cable to the ROV frame.



#### IMPORTANT

The Dualtrack System uses one altimeter only. You *must* connect the altimeter to the **ALTIMETER** port on the 440 SEP, or to an SDC serial port.

If you connect the altimeter to the **ALTIMETER** port of the 350 SEP the Dualtrack System will not operate correctly.

3. Connect the 440 SEP to its PSU as described in its Manual.

### Connect the TSS 350 sub-sea components:

4. Complete the physical installation of the 350 coil triads as described in sub-section 3.2.2 of the 350 Manual. Route the coil connection cables to the correct ports on the 350 SEP. Use plastic cable clips to secure the cables to the ROV framework.
5. Connect the 350 SEP to the ROV electrical supply by following the instructions in sub-section 4.2.1 of this Manual.



#### CAUTION

You might cause permanent damage to the sub-sea installations of the 440 or the 350 System if you operate them from an incorrect electrical supply.

The standard sub-sea components of both Systems operate from a nominal 110V AC electrical supply. Optionally, both Systems are available for operation from a nominal 240V AC electrical supply.

*When you interconnect the 350 and the 350 Systems within a Dualtrack installation, you must operate both Systems from the same electrical supply.*

6. Connect the communications conductors of the 350 Power/Comms cable to the ROV umbilical. Note that the Dualtrack System would normally use 2-wire current-loop communications to the SDC to reduce the demand for twisted pairs in the umbilical. However, where necessary, you may use 4-wire or RS232 communications instead. Refer to Tables 4-4, 4-5 and 4-6 in this Manual for appropriate connection details.

### Connect the 350 System to the 440 System:

---

7. Use the 440-to-350 Link Cable (TSS P/N 601814) to connect the 8-way 'Power/Comms' connector on the 440 PSU to the AUX OUTPUT port on the 350 SEP. This link uses RS232 communications at 9600 baud.

Note that the connectors at each end of the cable are of a different design. You cannot reverse the cable when you make this connection.

Refer to sub-section 4.1.2 in this Manual for instructions to care for and assemble the sub-sea connectors. Make all interconnections between the sub-sea assemblies and tighten the locking collars by hand. Do not over tighten the sub-sea connectors.

### Connect the SDC to the umbilical cable:

---

8. Refer either to sub-section 4.2.2 of this Manual or to the 440 Manual for instructions to complete the connection using the selected communication method.

#### *B.1.5.1 System Configuration*

The DeepView for Windows software allows you to configure and control both Systems in a Dualtrack installation.



If you are installing Dualtrack operation as an upgrade to an existing 440 or 350 System:

Ensure your SDC is capable of running Microsoft Windows™ 2000 and the DeepView for Windows software. Contact TSS (International) Ltd for advice if necessary.

In a Dualtrack System, the 440 SEP must communicate using RS232. If your 440 SEP uses 2-wire or 4-wire communications, refer to sub-section 4.2.2.1 of this Manual and set RS232 communications *before* you install the SEP on the ROV.

Follow the instructions in sub-section 5.1 of this Manual to install the software onto your SDC.

To configure the Dualtrack System properly you must complete the following actions.

1. Use the DeepView for Windows System Configuration Wizard to configure the 440 and the 350 Systems correctly. Select Dualtrack for the SEP type. Refer to sub-section 6.2.2 of this Manual for instructions to configure the 350 System. Refer to the 440 Manual for instructions to configure that System.



#### **IMPORTANT**

You *must* select Dualtrack as the SEP type even if you intend to use only one of the Systems during the survey.

2. Take care to enter all details completely and correctly. Set appropriate altimeter offsets for the 440 and the 350 Systems.

### B.1.5.2 System Operation

When supplied as part of a complete Dualtrack System the SDC will have all the software necessary to operate already installed and tested. After power-on the SDC will perform an initialisation sequence and DeepView for Windows will then start automatically.

Contact TSS for advice if you wish to upgrade an existing 440 or 350 System to a Dualtrack.

1. Refer to this Manual and the 440 Manual for instructions to use DeepView for Windows in its 440 and 350 modes.
2. Use the selection buttons on the DeepView for Windows tool bar to select either the 440 or the 350 operating mode. These buttons are available for use only if you select Dualtrack as the SEP type in the System Configuration Wizard. The buttons are mutually exclusive – you cannot operate the installation with the 440 System and the 350 System operating simultaneously. 
3. DeepView for Windows annotates the internal logging file with the operating mode so that it can replay the file correctly.



**Note that the external logging file changes its format when you switch between the 440 and the 350 mode. Be aware that this might cause problems with the data logger and its software.**

### B.1.6 Power Supply Requirement

---



#### CAUTION

**You might cause permanent damage to the sub-sea installations of the 440 or the 350 System if you operate them from an incorrect electrical supply.**

**The standard sub-sea components of both Systems operate from a nominal 110V AC electrical supply. Optionally, both Systems are available for operation from a nominal 240V AC electrical supply.**

**When you interconnect the 440 and the 350 Systems within a Dualtrack installation, you must operate both Systems from the same electrical supply.**

Specifications for the Dualtrack System are as listed in Section 8.1 of the relevant Manual for the 440 and 350 Systems.

Note that the sub-sea components of the Dualtrack System must operate from the same nominal supply voltage (either 110V or 240V AC as appropriate).

The maximum current consumption for the Dualtrack System is 3.1A at 110V AC nominal electrical supply or 1.8A at 240V AC nominal electrical supply.

### B.2 TRAINING

The TSS 350 Cable Survey System is a precision ‘front line’ survey tool. To exploit the full potential of the System, all personnel involved with a survey that uses the 350 System – from the initial planning stages to final data presentation – should possess a sound understanding of the performance of the System and its application.

To support this recommendation, TSS (International) Ltd has developed two levels of training course to provide for the needs of those who will be involved with a survey that uses the 350 System. For efficiency, TSS limits the maximum number of participants for each course to four.

On successful completion of the training course, the participants will be asked to complete a written test. Provided they demonstrate an acceptable level of understanding at this test, they will receive a numbered Training Certificate.

#### *B.2.1 Part 1: Foundation Course*

The Foundation Course meets the needs of all personnel who will be involved with the 350 System, such as Survey Managers, Operation Managers, ROV Managers, Surveyors, Party Chiefs, Data Processors and Clients’ Representatives.

Participants will receive comprehensive course notes. The course duration is approximately four hours and covers the following:

- ❑ System overview
- ❑ Principles of operation
- ❑ Initial installation
- ❑ Software overview and interfacing with other equipment
- ❑ Operational considerations and limitations
- ❑ Practical demonstration

On completion of the Foundation Course, participants will have gained an understanding of the operating theory of the 350 System. They will also be aware of the considerations necessary at the pre-survey, operations, data acquisition and data processing phases of a survey that uses the 350 System.

### *B.2.2 Part 2: Operators and Engineers Course*

This course is a continuation of the Foundation Course and provides for operators and engineers who use the 350 System during a survey, for example ROV Supervisors, ROV Pilots and Offshore Technicians.

The course duration is approximately two hours and covers the following:

- Use of the System as part of a Dualtrack installation
- Pod disassembly and reassembly
- Circuit board functions
- Signal analysis within the SEP
- Advanced fault finding
- Regular maintenance procedures
- System test procedures

Participants in this part of the training course should possess a basic understanding of electronics.

On completion of this part of the training course, participants should have gained a good understanding of the hardware and circuit functions of the 350 System. To demonstrate that they have understood the technical training, there will be an opportunity for course participants to find realistic sample faults introduced by the engineer who is running the course.

### C CABLES AND TONES

The target cable must carry a suitable tone signal before the 350 System can detect it. This tone signal should have the following characteristics:

- It should be easy for the 350 System to identify it among other signals that the target cable or other cables in the survey area might be carrying.
- It should have a frequency within a 'quiet' part of the pass band of the 350 System.
- The tone current should be of sufficient amplitude to provide a signal that is above the background noise level.

The 350 System can survey cables of any length. You may improve the effectiveness of the System if you select a suitable tone frequency and current for the specific cable. This appendix offers some basic advice on a method for injecting a tone onto a target cable so that you may use the 350 System to perform the survey.

TSS can supply a tone generator for use with the 350 System. Refer to TSS for advice if necessary.

## C.1 TONE INJECTION

The TSS 350 Cable Survey System is an active cable location system that detects the magnetic fields associated with a tone carried on the cable.

To perform a survey on a cable, the 350 System can use any tone frequency up to a maximum of 200Hz. In theory therefore, the System could be used to survey a live power cable because of the mains frequency ‘tone’ that it carries. In practice however this may not be possible or desirable for the following reasons:

- The tone must be single-phase.
- There may be many local sources of interference at the same frequency.

By injecting a tone onto a cable, you may select a frequency in the range 10Hz to 200Hz that is relatively free from interference. Refer to sub-section 6.2.2 for instructions to change the detection frequency of the 350 System.

### C.1.1 Frequency Selection

Selection of a suitable tone frequency and current will depend upon specific circumstances. Note the following guidelines:

Table C-1: Effects of tone frequency choice

	Advantage	Disadvantage
Increased tone frequency	Increased detection ranges available from the 350 System.	Decreased transmission distance for the tone along the cable length.
Increased tone current	Increased detection ranges available from the 350 System.	Increased noise generation in repeaters of fibre-optic cables.

Generally, a low frequency is better for long cable runs and a high frequency is better for short cable runs.

To avoid strong interference affecting the survey, the 350 System provides some advanced signal monitoring facilities. These allow you to examine the spectrum and to set a tone frequency in a region of relatively low background noise.

### C.1.2 Connection to the cable

Throughout the length of the cable, the tone-carrying conductor must be insulated from sea water. Where applicable, provide a good ground connection at the end of the cable farthest from the current source.

#### C.1.2.1 Short cables

For short cables (of less than approximately 100km, depending upon the capacitance of the cable) you will need access to both ends of the cable:

Figure C-1: Tone injection – Short cables

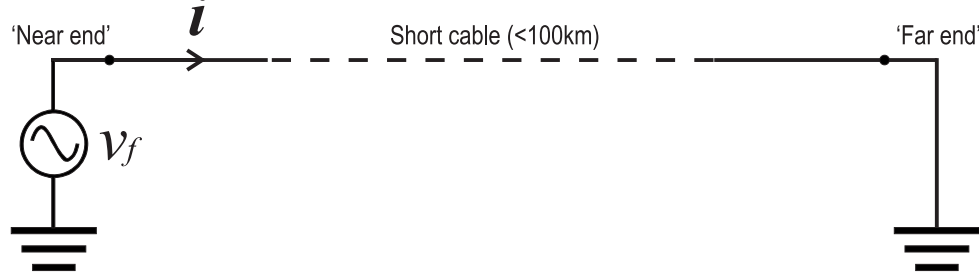

You must connect the tone generator  $v_f$  between the near end of the cable and a good ground point. At the far end of the cable, you must connect the tone-carrying conductor to a good ground point to provide an effective signal return path.

*C.1.2.2 Long cables*

As shown in Figure C-2, the conductors possess some small capacitance to the environment that surrounds the cable. If the cable is long (greater than approximately 100km) then the tone signal will find a return path through the distributed capacitance  $C_c$  of the cable. The impedance of this path reduces as the tone frequency increases.

Figure C-2: Tone injection – Long cables

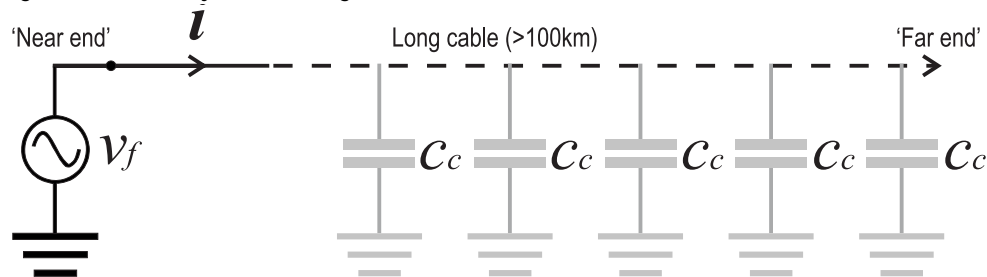

Under these circumstances, it is not always necessary to make a separate ground connection at the far end of the cable. However, you will reduce the effects of tone leakage by connecting the far end of the cable to a good grounding point.



The capacitance of the conductors extends throughout the length of the cable. This represents a progressive short circuit that means less tone current flows at the far end of the cable than at the near end. The detection range of the 350 System depends upon the current flowing at the tone frequency. It follows therefore that the measurement range of the 350 System decreases with the distance from the point of tone injection.

*C.1.2.3 Fibre-optic Cables*

In most cases, fibre-optic cables carry at least one conductor to supply power for the repeaters or to act as a dedicated tone-carrying facility.

Alternatively, when there is no other conductor available, the armoured covering of a fibre-optic cable can be used to carry the tone, provided it is insulated from ground.

The owner of the fibre-optic cable will usually specify the maximum level of tone current that the cable can tolerate. This is to limit the amount of noise that may be generated within repeaters along the cable.





The 350 System cannot be used to survey a fibre-optic cable unless the cable can carry an electrical tone through a conductive core or through its insulated armoured covering.

#### *C.1.2.4 General Connection Requirements*

- ❑ Always use good grounding connections throughout the installation to avoid introducing mains related frequencies onto the cable.
- ❑ You must separate the return path from the outgoing tone current. Do not use a separate conductor in the same cable to provide a return path.
- ❑ Do not allow the tone current to exceed the maximum rating for cable circuits that have repeaters.

#### *C.1.3 Seawater Return Path*

If the far end of the cable is in the water, then the sea water itself can provide the signal return path. To use this method, you should attach a sacrificial anode to the exposed cable core and seal the cable against water ingress at the far end.

## D ALTIMETER

### D.1 OVERVIEW

This appendix contains operating and service instructions for the ALT-250 sonar altimeter. The ALT-250 is a high resolution sub-sea echo sounder designed to accurately determine the height of sub sea instrumentation from the seabed.

The unit is supplied ready configured to use with TSS detection products.

The unit produces a narrow beam acoustic sonar pulse that “illuminates” a small section of the seabed. The travel time for the pulse to be reflected from the seabed is measured using a high stability timer and converted to distance in meters for output to the serial port where can be recorded by the SEP, or transmitted to the SDC. Noise rejection algorithms allow the altimeter to be used for short range measurements even in areas of high suspended sediment.

The electronics are housed in a corrosion resistant hard anodised aluminium pressure case which can withstand depths up to 3000 metres dependent on the model.

A PRT100 temperature sensor is offered as standard and the reading is appended to the output data string. A 7 way connector provides power and data to and from the altimeter.

Table D-1: Altimeter Specification

Transmit Frequency	250kHz
Transmit pulse width	40 microseconds
Beam width	9°, conical
Pulse repetition rate	5/second
Maximum range	30m
Minimum range	0.8m
Digital output	RS232 with switchable baud rates of 2400 or 9600 (other options available if required)
Resolution	1cm
Power requirement	8 TO 24 VDC (24VDC for modem option)
Supply current	50mA @ 17VDC
Maximum depth	3000m (dependent on depth sensor if fitted)
Mating connector	Impulse LPMIL-7-MP Inline
Distance accuracy	76.2mm diameter, (87mm max) X 205mm
Temperature accuracy	±0.5°C standard.

## D.2 INSTALLATION

### D.2.1 Electrical Connection

The 7 way bulkhead connector is protected by the plastic end cap which also prevents the connector turning and loosening the pressure seal between the connector and the pressure housing face.

The in-line connector, (male), must first be lubricated by smearing silicone lubricant or other compatible silicone grease on all the pins. Ensure the lubricant does not cover any part of the acoustic transducer encapsulation as this will have a detrimental effect on the acoustic properties of the transducer. If silicone grease is inadvertently splashed over the transducer face, remove with a clean rag and wash with a mild detergent.

Ensure the connector pins are aligned correctly with the mating bulkhead connector before applying force as the connectors can be damaged if incorrectly mated. If resistance is felt when mating the connectors this means the pins are not aligned correctly in which case start again.

When the connector is disconnected; insert dummy plugs or smear with silicone grease if the connector is likely to be exposed to sea water or other corrosive element.

### D.2.2 Serial Output

The connector supplies power and data between the altimeter and a terminal or other device which can receive RS232 signal levels, for example the SEP. The internal switch, S1/3 allows the option of two different baud rates to be chosen. The standard baud rate options are 2400, (switch off) or 9600, (switch on) both with no parity, 8 data bits and one stop bit. For use with the 440 or 350 system, leave switch S1/3 in the off position for 2400 baud.

The output format is the standard TSS/Datasonics string: see section 7.3.3 for details.

Table D-2: Power/ data connector pinout

Pin No	Wire Colour	Function
1	Black	Power 0V
2	White	Aux input ground (optional)
3	Red	+24VDC Power input
4	Green	RS-232 Ground
5	Blue	External trigger in (optional)
6	Brown	RS-232 Transmit output
7	Yellow	Aux signal (optional)

### *D.2.3 Mounting*

Position the altimeter away from other acoustic instruments that may cause interference, this may be necessary even if the other instrumentation is operating at a different frequency due to the “near field” effect of the acoustic transmission.

Make sure the altimeter is positioned away from turbulence such as propeller noise or anything that could cause aeration in the water, (acoustic signals are greatly attenuated by the interface between sea water and air bubbles).

Figure D-1: Mounting arrangement



Mount the altimeter using part number 305676, as shown in figure D-1, or a secure mounting bracket with, rubber protective sleeve around the altimeter body, making sure the altimeter transducer is the nearest point to the seabed, in other words there must be no metal work that could conduct the acoustic signal to the transducer by-passing the water column. Remember the minimum range is 0.8 metres therefore if an under range data output is to be avoided mount the altimeter at least 0.8 metres above the bottom.

Make sure the altimeter is mounted perpendicular to the horizontal flying position of the sub sea vehicle, the beam angle is limited to 9° therefore any misalignment has a detrimental effect on the operation of the altimeter. Ensure the mounting is secure and not liable to vibration or movement.

Although the specification quotes 9° beam width the coverage area may increase at minimum range due to the “side lobes” produced by the acoustic transducer. This can be caused by a strong reflector close to the altimeter being reflected before the main beam echo is received thus causing the object to be seen before the main beam is reflected off the seabed. This situation would cause a reduced range to be recorded.

Make sure the anodised aluminium finish is not damaged as this will cause corrosion when the instrument is next deployed.

Connect an optional safety leash from the altimeter end cap using a stainless steel 8mm bolt and two washers. Make sure the M8 bolt does not protrude to the aluminium bulkhead as this will damage the anodising.

## D.2.4 Maintenance

The altimeter should be immersed in fresh water if it is not to be used in the next couple of days then placed in a dry environment. Inspect the transducer face and clean with a mild detergent if the transducer face is not clean. It is important to ensure the transducer face is clean to ensure maximum efficiency of acoustic energy into seawater. Ensure no silicone grease from the connector is allowed to come into contact with the transducer face.

## D.2.5 Test in Air

The altimeter should first be tested in air to ensure its correct operation. This can be done by connecting the unit to +24VDC, or 8-24VDC if switch mode operation is selected, and reading the serial output data with a PC terminal emulation program such as Hyper Terminal.

The range data output should read R99.99E when the unit is in air whilst temperature, (Txx.x), should read air temperature. The altimeter should emit a “ticking” sound at a rate of 5 per second thus confirming the transmitter is working and that the power supply is sufficient to power the altimeter. If the voltage is too low to power the altimeter the serial data will still output data but there will be no ticking sound.

The high frequency used for the altimeter is greatly attenuated in air therefore the signal is not able to travel more than approximately 1 metre, (indicated) in air, although the signal can be seen on an oscilloscope at TP7. The pre-deployment check should consist of rubbing the transducer face when the range serial output should change from 99.99 to an erratically changing value.

## D.2.6 Internal Settings

Ensure the internal switch is in the correct position: this should already be set for 2400 baud for use with the TSS 440 and 350.

If the internal switch needs changing, make sure the housing is clean and free from debris before unscrewing the captive retaining ring ensuring water or debris does not enter the pressure housing when the transducer and electronics are separated.

As the electronics board is lifted from the housing make sure the interconnecting cable is free and is not caught on components causing strain on the connector and wires.

Table D-3: Switch S1 settings

1	Internal input select On: TTL input, Off: RS-232 level input
2	Internal/ external trigger On: External, Off: Internal (default)
3	Baud rate select On: 9600, Off: 2400 (default)
4	Step-up power supply disable On: 17-24V input, Off: 8-24V input (default)

Figure D-2: Switch S1 layout

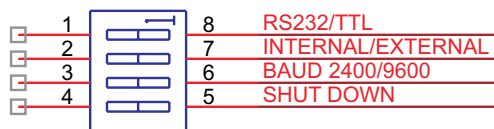

When the switch has been switched to the correct position the electronics board can be inserted into the pressure housing first ensuring the interconnecting cable is free alongside the printed circuit board. Ensure the board is slid down so the end of the board sits to one side of the internal cable at the bulkhead connector taking care not to damage the internal anodised finish of the O ring seal area as the PCB is slid down, (see figure D-3).

Figure D-3: Reassembly of the unit.



Ensure the rubber “O” rings are free from contamination and if necessary remove and clean the O rings and grooves before re-greasing with silicone or compatible O ring grease.

The area around the O rings must be meticulously clean to ensure a good pressure seal when the unit enters the water. Inspect with a magnifying glass to make sure the surface of the O ring and housing are clean.

### D.3 THEORY OF OPERATION

This section describes the operation of the ALT250. The theory describes the general principles of acoustics and the technical description covers the basic operation of the altimeter. Do not attempt to repair the altimeter unless you are an experienced electronics technician used to working with surface mount components.

#### *D.3.1 Operating Principles*

The altimeter determines the round trip time of the Sonar pulse travelling from the transducer through the water column then reflected off the seabed and received back at the transducer. The time the Sonar pulse takes to make this journey equates to the two way distance. The distance can be determined by comparing the measured time to the known speed of sound in water then dividing by 2 to get the one way distance.

The speed of sound in water varies according to conditions, (due mainly to salinity and temperature). The altimeter defaults to 1480 metres/second which is a default average for speed of sound in sea water.

### *D.3.1.1 Speed of Sound*

The altimeter uses a high accuracy timer to measure the flight time of an acoustic pulse. The timer is accurate to 1 $\mu$ s, (0.74mm @1480metres/second), which is the speed of sound, (SOS), default value, however this speed of sound value is dependent on many factors and requires an accurate “VP” meter or CTD instrument to determine the exact value during the operation, (see figure D–4).

Figure D–4: Speed of Sound meter



The change in SOS is mainly due to temperature where a change of  $\pm 1^{\circ}\text{C}$  in sea water temperature causes a change of approximately  $\pm (0.0018 \times \text{SOS})$  metres/second, e.g. a SOS measurement taken at  $10^{\circ}\text{C}$  is 1480m/s but would change to  $\sim 1506.64\text{m/s}$  at  $20^{\circ}\text{C}$ . Note: this is a very approximate calculation and is included only to demonstrate the effect that temperature has on VP.

The SOS is also affected, to a lesser extent, by changes in salinity and depth. There are many different formulae for calculating SOS; for more information consult one of the many books on this subject for example Robert J.Urick’s “Principles of Underwater Sound”.

The Altimeter temperature reading is not used in the SOS calculation. The default SOS is 1480m/s; if a different value is required simply apply a correction to the serial output as follows:  $(\text{SOS}/1480) \times \text{Range reading}$ .

### *D.3.1.2 Terminology*

There are many acoustic terms associated with underwater acoustics and associated technology; here are just some of them:

- ❑ Sonar Equation: The transmitter sound source should be greater than all the losses due to range, reflector, and sea water absorption plus the threshold value required at the receiver. The altimeter is designed for losses over 30 metres.
- ❑ Transducer: Converts electrical energy into sound or sound into electrical energy. This is housed within the potting compound of the altimeter.
- ❑ Transducer beam width: The area of sound when plotted to the half power point in front of the transducer. This applies both to transmit and receive modes.
- ❑ VP: Velocity of propagation or speed of sound

- ❑ Noise level: Acoustic sounds in sea water due to ships, hydraulics, or other sonar equipment.
- ❑ Reflectivity: the attenuation of the transmitted sonar pulse due to the material/ angle of the reflector, (in this case the seabed).
- ❑ DB: This is the term Decibel which is used to express sound level in relation to a reference level, usually 1 micro Pascal at 1 metre. This can be negative when expressing receiver sensitivity or positive if expressing transmitted sound level.
- ❑ Absorption: The loss due to sea water which increases for higher frequency.
- ❑ Reverberation: Received signals due to various scatterers of sonar signals such as sea surface, tiny particles in the sea water and bottom reflections. This can be heard on old war films as the slowly decaying quivering tonal blast following the ping of an echo sounder. The altimeter locks on to the first signal and rejects the following reverb.
- ❑ PRT100: Platinum Resistance Thermometer which consists of a platinum wire calibrated for 100 ohms at 0°C and 138.5 ohms at 100°C. Accuracy is  $\pm 0.15^\circ\text{C}$  for a class A device as used in the altimeter.
- ❑ Pressure sensor: Device for measuring depth in sea water. Consists of a strain gauge element which converts pressure to an electrical signal.
- ❑ Switch mode power supply: Circuitry within the altimeter which boosts the supply voltage to the required level.
- ❑ TVG: Time Varying Gain. This is applied to the sonar signal to compensate for range and absorption losses in sea water. The altimeter TVG signature is stored in the non-volatile memory of the microcontroller.

### *D.3.1.3 Propagation Loss*

The propagation loss describes the weakening of sound between a point 1 metre from the surface of the transducer and a point at distance from that point in the water column.

The propagation loss consists of spreading or ranging loss and loss due to attenuation in sea water. The altimeter is designed to normalise these losses by applying a varying gain, (TVG), to the sonar receiver.

Circuitry within the altimeter rejects near field signals from transducer side lobes to enable detection of minimum range values.

### *D.3.1.4 Limitations*

The altimeter must not be used alongside instruments operating at or near the same frequency. The power supply should be DC with good regulation; the altimeter is designed for worst case power supply electrical noise by the use of analogue filters at the DC power input, however, noise at or near the Sonar frequency may cause problems.



The altimeter housing is hard anodised to protect from corrosion in sea water and for limited protection from mishandling. The anodised surface must not be damaged as this will cause corrosion to develop leading to eventual failure of the pressure housing.

The altimeter can be affected by transmission of sound through the supporting structure leading to an erroneous range value that is less than the correct range therefore to ensure this does not happen make sure the altimeter is de-coupled mechanically from the structure by using rubber inserts or similar.

The range of the unit is limited; however, it is possible to pick up reflections which are called “multiples”. These multiple reflections give the impression of a good range being received by the altimeter but are, in fact, pulses received from the previous transmission that have travelled to the bottom or sea surface and been reflected in time for the reception time of the latest transmission. The result is a range that should be outside the range of the altimeter appearing as a good range.

The ships echo sounder should be checked to determine if ranges from the altimeter are multiples from an over range water column.

Mount the altimeter at least 0.8m from the bottom of the sub sea vehicle; any range less than 0.8m will show as an error; however multiples can still be received.

### *D.3.2 Technical Description*

The altimeter circuitry is divided into several sub systems to enable a clearer understanding of the system. The sub systems are all manufactured on one printed circuit board.

Test points are available to aid faultfinding and commissioning. The circuitry uses miniature surface mount components therefore great care must be taken to avoid damaging the circuitry. Do not short connections as probes are inserted. The following points are present:.

Table D-4: Testpoints

TP 1	Spare connection for MONO8 interface.
TP 2	Timer input to micro from sensor/ sonar receiver MUX.
TP 3	Raw sonar signal before bandpass but after sonar receiver.
TP 4	Sonar receiver output signal (positive pulse).
TP 5	Detected sonar signal (negative pulse).
TP 6	High voltage Tx signal across acoustic transducer.
TP 7	Transmitter Tx pulse TTL drive.

#### *D.3.2.1 Power Supply*

Input voltage can range between 8-24VDC providing the SHDN signal is high; (S1/5 is off). If the power supply is known to be constantly above 17VDC switch S1/5 can be switched on thus disabling the dc-dc converter to conserve power.

The dc-dc converter is also controlled by an automatic switch which puts the circuit in SHDN mode if the DC input is higher than 15.7VDC.

The transmitter voltage is regulated to 12.9VDC to allow operation of the transmitter driver chip which requires at least 12VDC to operate, (the driver output will go open circuit if the voltage falls below this).

The digital 5Vsupply is fed from a normal linear regulator. This supply inhibits the dc-dc converter if it falls below approximately 4.5VDC.

Smoothing reservoir capacitors are used at the DC input and also at the +5VDC line to eliminate any noise that is passed from the power supply.

### *D.3.2.2 Transmitter*

The microcontroller generates a TTL signal pulse at TP7 which determines operating frequency and pulse length, both these parameters are programmed into the microcontroller's flash memory and can be altered if necessary, by the manufacturer, using the programming input header J4.

The transmitter power section is interfaced to the microcontroller signal level by a power driver which is designed to switch high current signals via the two MOSFET transistors IC15 & IC17 through the step up transformer T1 or optionally T2.

The secondary inductance of the transformer and the capacitance of the transducer components form a tuned circuit at the operating frequency thus forming a high amplitude sine wave. Fine tuning of the transmitter output is achieved by adding capacitors to C43 and C47, (working voltage of the capacitors are 1000VDC).

The transmitter is inhibited if the +5VDC supply falls below 4.5VDC.

The transformer secondary inductance and tuning capacitors are kept out of the receiver path by steering diodes. A damping resistor R45 reduces ringing from the transducer when the transmitter pulse is removed.

### *D.3.2.3 Receiver*

The same transducer is used to receive and transmit therefore protection diodes in series with a resistor protect the sensitive receiver circuit when transmission occurs.

TVG is applied to the signal before being fed to a band pass filter set to the operating frequency. The signal is then demodulated and fed to a threshold detector.

Gain control lines GAIN1-8 are fed from the microcontroller and provide TVG control of the receiver; this enables received signals varying over a wide dynamic range to be received. The initial sensitivity of the system is controlled by the microcontroller which switches an attenuator into circuit reducing the amplitude of the signal before reaching the receiver.

Signal BLANK, from the microcontroller controls the attenuator for the initial reception period which is set at a nominal 1 metre during which period high amplitude signals from side lobes and near field objects are attenuated.

The output of the receiver is fed to a comparator which has two threshold settings set by the microcontroller. The initial threshold is set approximately 4dB higher for this period thus allowing echo signals to be received even when direct signals are still being received from the effect of transducer ringing.

The detected receiver signal is fed to a capture timer on the microcontroller which stops the timer on the negative edge of the received pulse.

The same timer channel is also used to read the temperature/depth transducer; this is carried out by a multiplexer connected to both circuits and controlled by the microcontroller.

#### *D.3.2.4 Sensor Circuitry*

The sensor circuitry is a complete front end for the measurement of passive sensors such as temperature and pressure using an advanced chopping technique to remove low frequency interference. The analogue sensor signal is converted into a digital format and read by the microcontroller. The sensor interface converts to 12 bit accuracy.

A three phase technique is used to measure system offset, reference and finally the sensor signal. Good long term stability is assured by the auto calibration process carried out by the microcontroller to determine changes in offset and reference for each measurement period.

The sensor circuitry is located close to the sensor to reduce resistance between sensor and electronics; however, even the small resistance changes due to temperature effect etc. are corrected by software using the offset and reference measurements.

The chopping technique filters out any spurious noise generated by internal or external circuits.

The accuracy of the sensor is determined by the accuracy of the temperature or depth sensor itself and the reference resistor R1. Corrections can also be made in the microcontroller to achieve greater accuracy. The reference resistor is currently a 100R resistor 0.01% < 0.6ppm/°C accuracy which equates to an initial accuracy of  $\pm 0.01R$  or 0.026°C plus temperature drift which is negligible.

#### *D.3.2.5 Digital Circuitry*

The digital circuitry comprises the microcontroller and serial communication plus associated circuitry. The microcontroller operates at a speed of 8MHz and is used to process all transmission and receive functions in conjunction with the associated hardware.

The firmware for the microcontroller, (68HC908KX8), can be programmed using the mini "MONO8" connector at J4. This connector allows the micro to be programmed in-situ using its flash memory to retain the data when power is removed.

Standard tools from Motorola are available that allow the manufacturer to program via this connection without the need to connect to the power supply.

The serial data is converted to RS232 levels in the digital section where the usual protection diodes etc. are situated.

The +12VDC for the RS232 interface is derived from the transmitter +12VDC and the minus -12VDC from a +12VDC to -12V DC-DC converter circuit.

### *D.3.2.6 Averaging Algorithm*

The microcontroller uses a moving weighted averaging algorithm to ensure that any momentary noise or interference from the Sonar signal does not appear as a range at the data output. This is achieved by giving each new range a weight of 25% while the previous range is given a weight of 75%. If the new range differs significantly from the old the new range will be replaced with the old. If more than two unacceptable ranges are received the next new range is accepted. Each new range occurs approximately 0.2 second apart.

### *D.3.2.7 Optional Modem*

Position IC1 is for an optional modem module. This module receives the serial data from the altimeter and superimposes the data on to the +24VDC power cable; this allows the altimeter to connect using just two cable cores over long cables using FSK modem technology. To use this option the power supply must be +24VDC. Switch S1 switch 3 and switch 4 to the on position to select 9600 baud and dc-dc converter inhibit.

## D.4 PART NUMBERS

Table D-5: Part numbers

500292	Altimeter, subsea TSS-ALT-250 (no cable or accessories)
500294	As above, detection kit (includes bracket 601824A)
500295	Altimeter, including 3m pigtail 601826A
601824A	Cable ALT-250 to TSS 350/440 SEP (3m)
601825A	Cable ALT-250 to TSS 350/440 SEP (7m)
601826A	Pigtail (3m)
601827A	Pigtail (7m)
402321	Separate manual
307558	O-Ring
402608	Carton
200809	Mini wet-pluggable free lead, LPMIL-7-MP200809
305676	Mounting kit



Figure D-6: Internal wiring

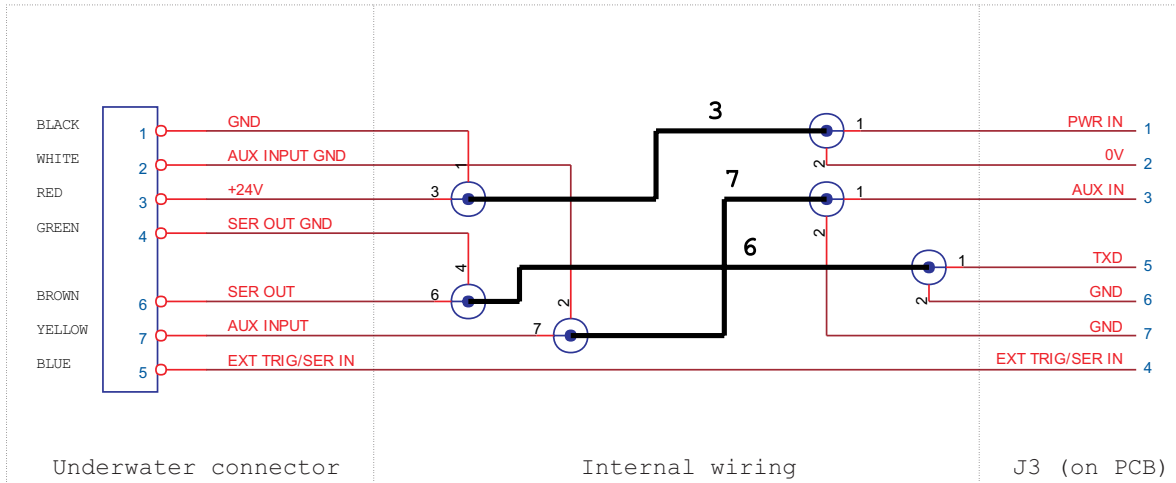

Figure D-7: Temperature sensor wiring

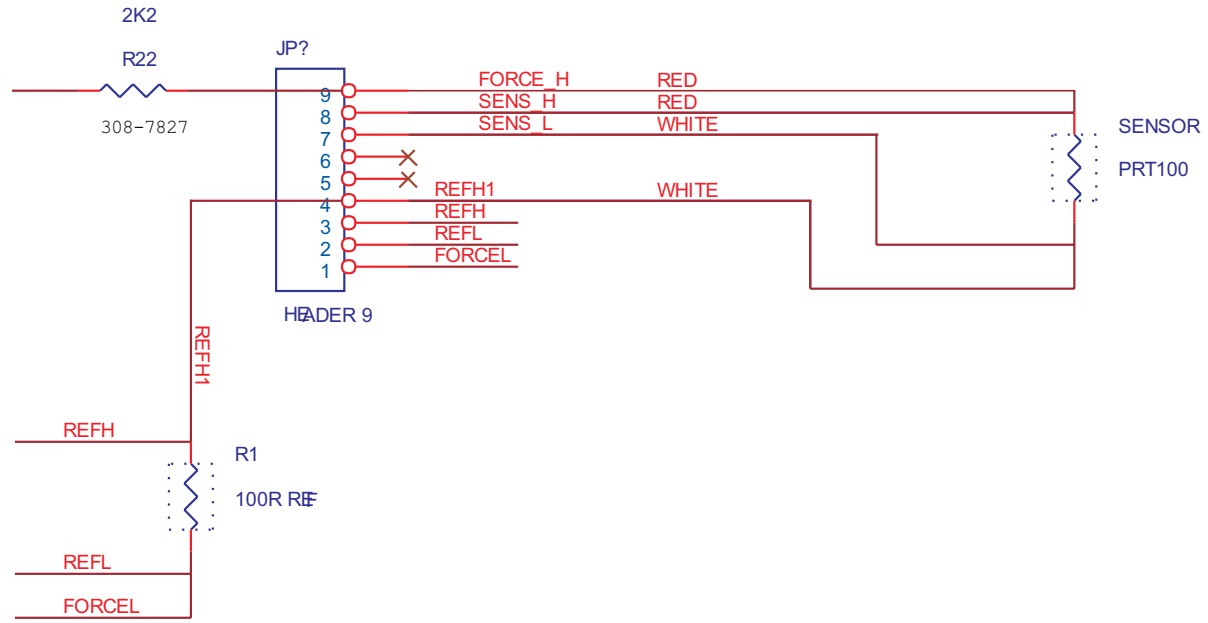

Figure D-8: ALT-250 / TSS underwater splice p/n 601824A

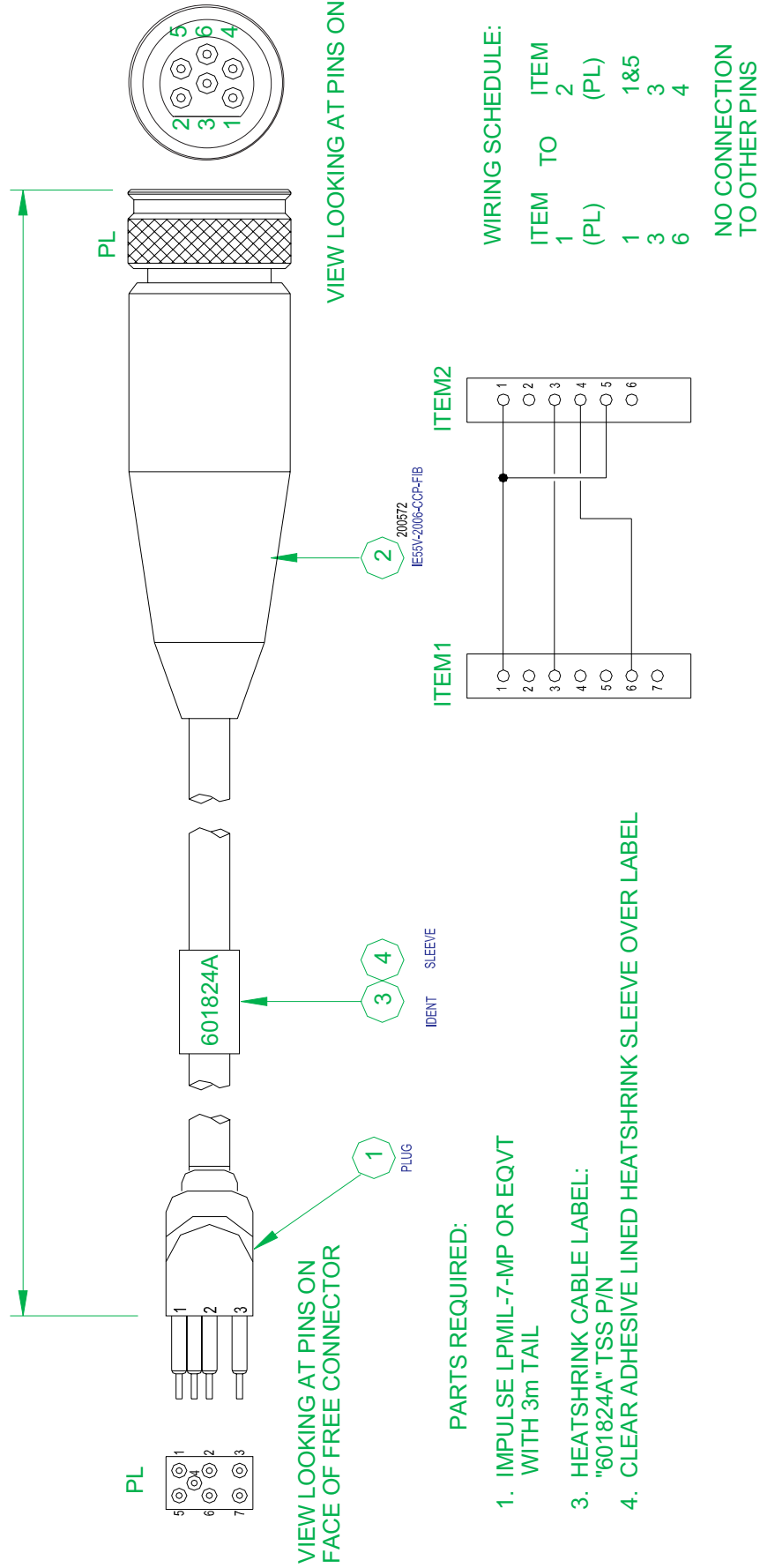

Figure D-9: ALT-250 free cable

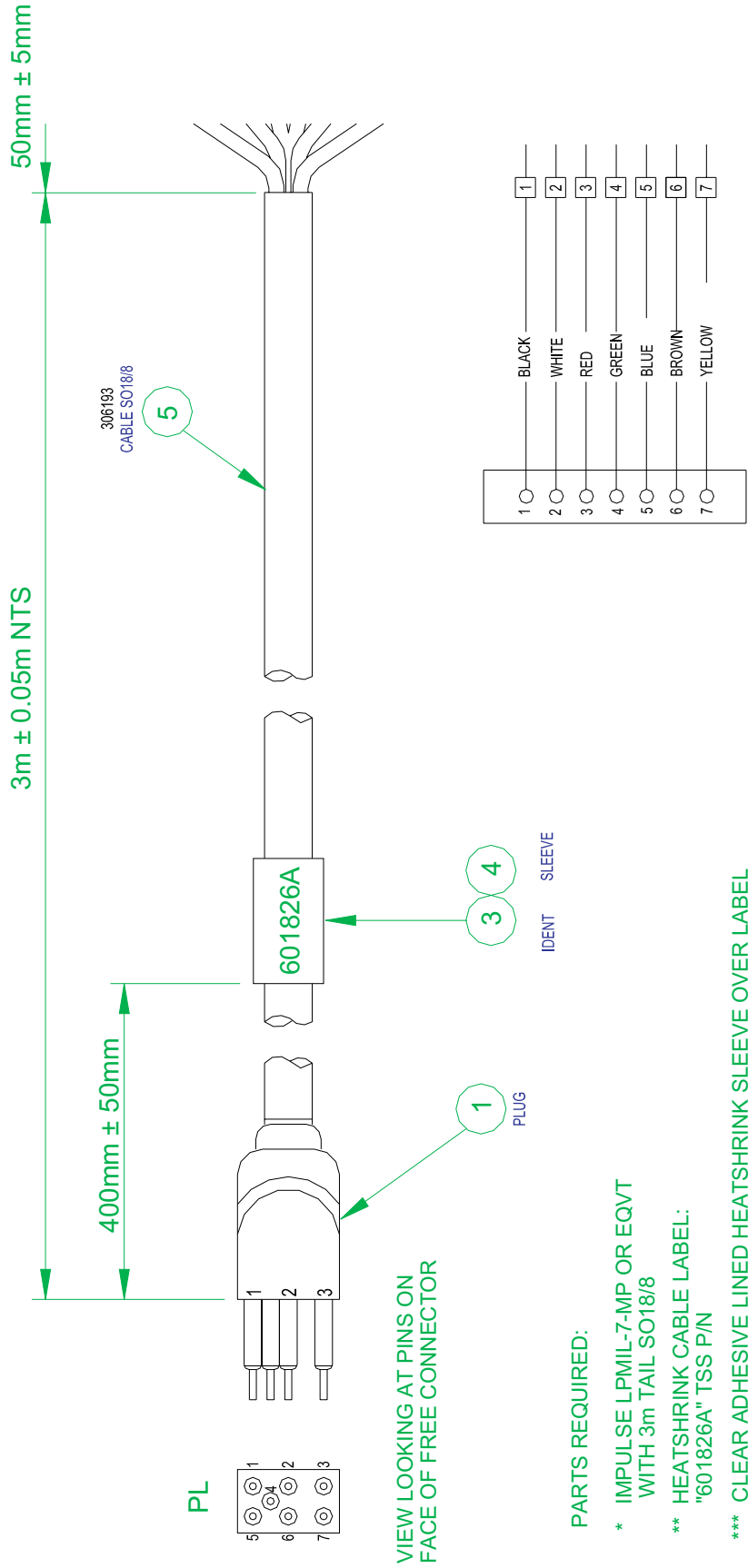



Figure D-10: PCB layout - top

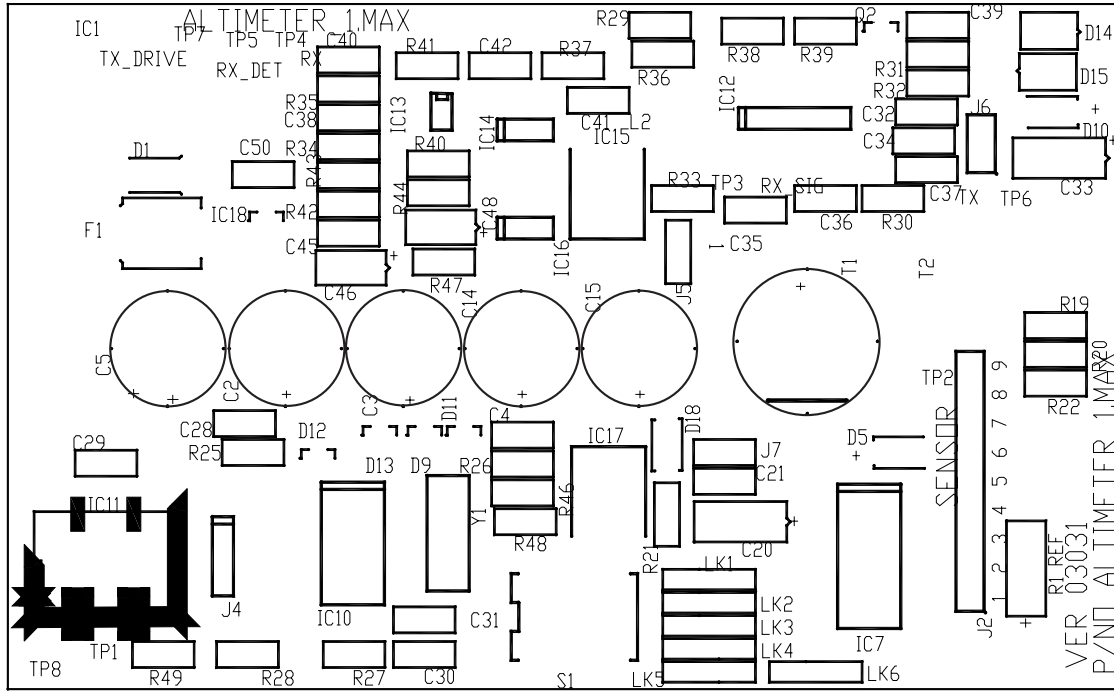

Figure D-11: PCB - top

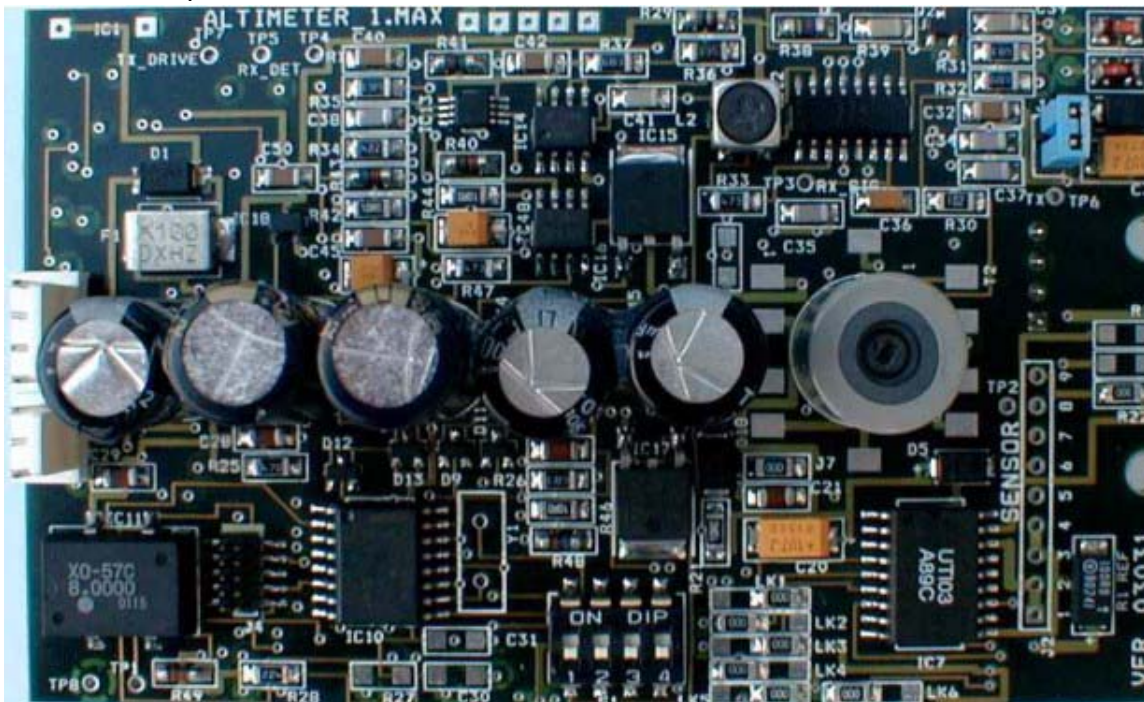

Figure D-12: PCB layout - bottom

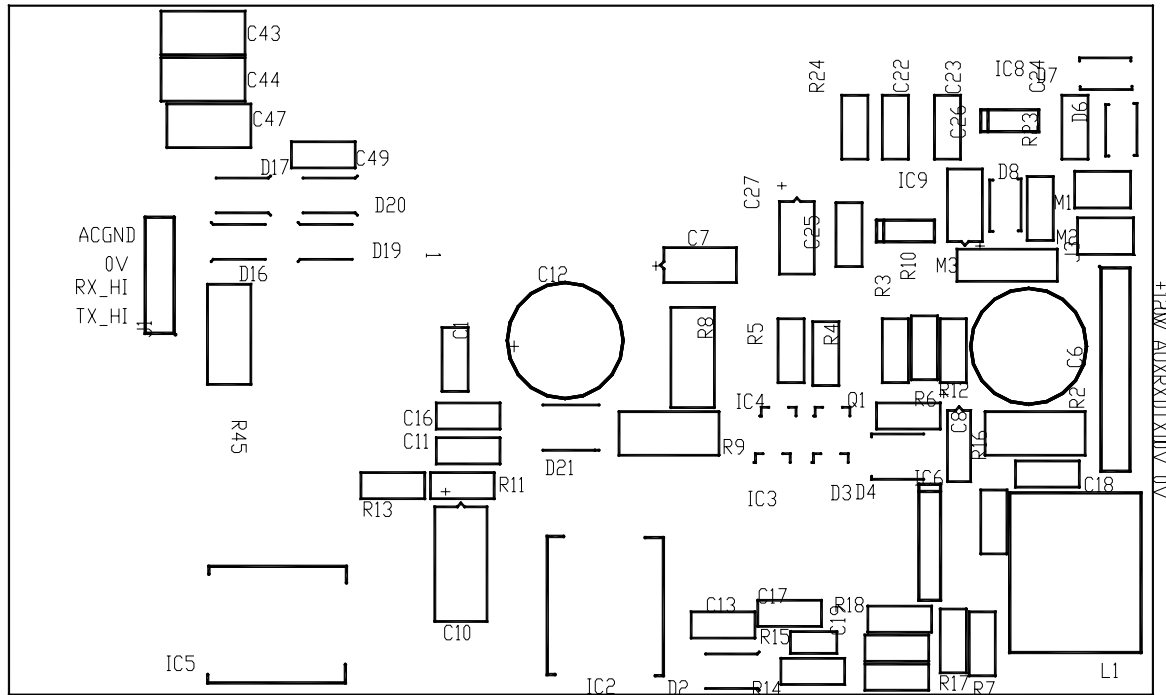
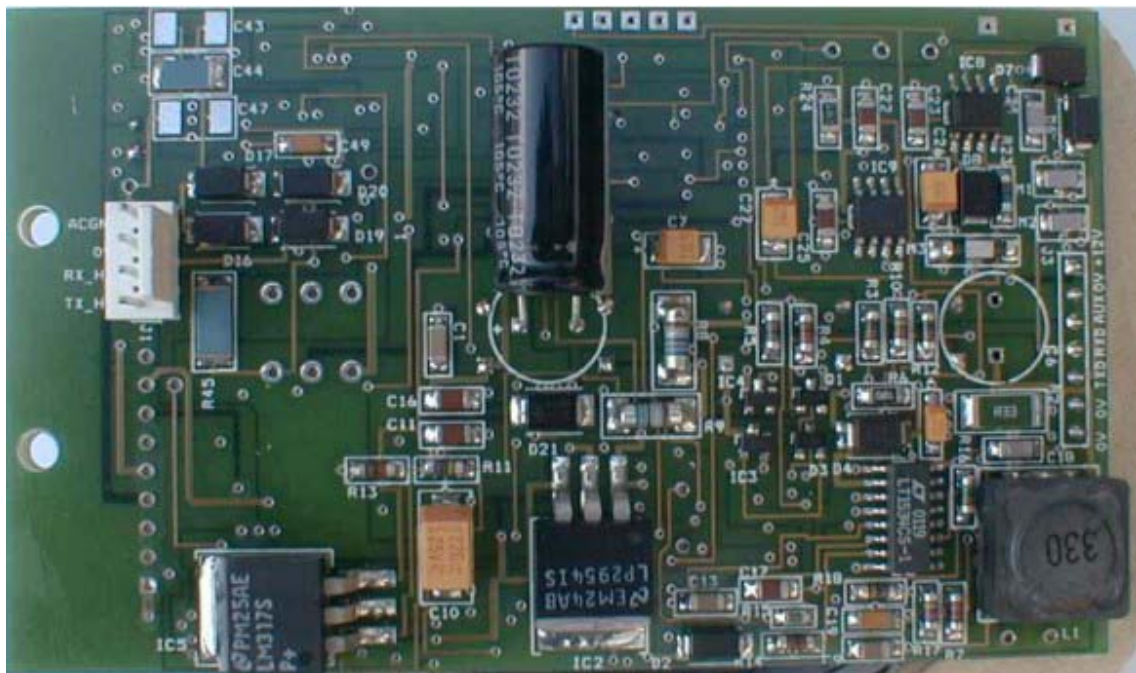

Figure D-13: PCB bottom





### E COIL TESTER

The Coil Tester is a convenient and uncomplicated solution to confirm the 350 Cable Survey System is functioning in the correct manner. This is achieved by generating a localised and controlled alternating magnetic field.

The Coil Tester provides the following benefits:

- ❑ A quick and simple method for testing the individual search coils of 350 Cable Survey System and the associated cables, connectors and circuitry.
- ❑ A circular recess in body to securely house a search coil.
- ❑ Momentary action push-on/release-off power and battery test switch.
- ❑ Tester condition LED.
- ❑ Due to the Coil Tester being powered by a 9V alkaline battery, it is completely portable and self-contained.
- ❑ Protected to IP65 preventing water ingress when operating in exposed environments.

To achieve accurate results the Coil Tester should be used with a fully calibrated 350 Cable Survey System with the Surface Display Computer (SDC) configured with the coil calibration constants stamped onto each coil.

It is important to have a thorough working knowledge of the 350 Cable Survey System and clear understanding of the information outlined in this section prior to using the Coil Tester.

All instructions outlined in this section should be followed to prevent misuse of, or damage to, the Coil Tester.

#### **E.1 Pre-Operation**

**Page 3**

The 350 Cable Survey System needs to be correctly configured prior to using the Coil Tester. If not, it will provide degraded results.

To achieve accurate results from the 350 Cable Survey System coil calibration constants provided by TSS (International) Ltd need to be entered using the SDC.

#### **E.2 Operation**

**Page 5**

Operating instructions for the 350 Cable Survey System can be found in Section 6.

The Coil Tester is used in conjunction with the 350 Cable Survey System to identify any potential faults with the system search coils.

#### **E.3 Fault Identification**

**Page 8**

If the Coil Tester provides inaccurate results it may be faulty. This section outlines the steps to take if a fault is suspected.

**E.4 Battery Replacement****Page 8**

The Coil Tester provides a facility to identify when the battery needs to be replaced.

**E.5 Maintenance****Page 9**

It is important to ensure the Coil Tester is correctly maintained to ensure correct operation.

**E.6 Specification****Page 9**

Outlines the Coil Tester specification.

### E.1 PRE-OPERATION

Prior to using the Coil Tester:

- Read the complete 350 Cable Survey System Manual.
- Install the 350 System according to the instructions provided in Section 3 Physical Installation and Section 4 Electrical Installation.
- Ensure the coil calibration constants configured on the Surface Display Computer (SDC) correspond to the values displayed on the brass connector flanges of the search coils.

#### *E.1.1 Coil Calibration Constants*

TSS takes care during manufacture to ensure the coils and pre-amplifiers are matched. However, there will inevitably be some residual differences between individual sensing coils.

Each of the sensing coils supplied by TSS has an identification plate that includes a calibration constant. The 350 Cable Survey System requires this information to compensate for the residual differences between the search coils.

During the coil installation process record the following information:

1. The calibration constants for each of the six search coils.
2. The serial number of each of the six search coils.
3. All search coil positions.

This information can be recorded on the Configuration Log Form in Appendix F.



To access the 350 System Configuration dialog press [\[SHIFT+F2\]](#)

TSS supply the 350 System with port and starboard coil triads assembled and the coil calibration constants already configured in the Surface Display Computer (SDC), as shown in Figure E–1 below. However, ensure the values displayed in 350 System Parameters Configuration screen correspond to the values stamped on the brass connector flanges of the search coils.

Figure E-1: 350 System Parameters Configuration screen

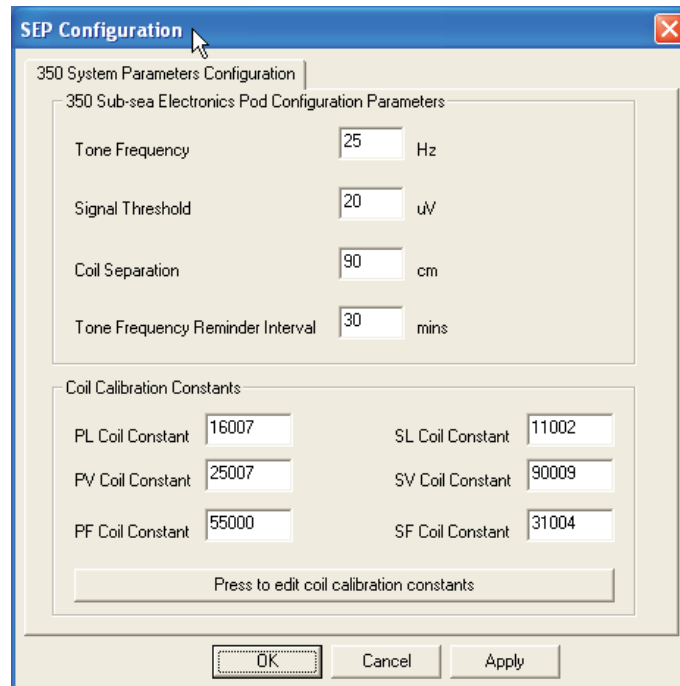

If a search coil is replaced, the new 5-digit value for the calibration constant must be entered for the relevant search coil. This will not affect the operation of any of the other remaining search coils.

Each of the six coil calibration constants will be different and ensure they are entered correctly. The numbers include an error-checking element helping to ensure valid data entry.

When the calibration constants have been correctly entered into the SDC, click OK to accept the configuration. If the parameters have changed, the new values will be downloaded to the 350 Subsea Electronics Pod (SEP).

### E.2 OPERATION

The Coil Tester is supplied with default settings of 25Hz. To change the frequency specified, see Section E.2.1.

Operation of the Coil Tester is very simple procedure outlined in the following steps:

1. Power on the 350 System and ensure the Surface Display Computer (SDC) is connected to DeepView to confirm the test results. Ensure the coil calibration constants have been entered correctly and the 350 System is setup correctly (see section E.1.1).
2. Select the Terminal Window into view and set focus to this window. Press [CTRL+U]. This will display a warning message stating that continuing will stop communication with the SEP. Click 'YES' and the 350 Terminal Menu will be displayed.
3. Press [2] to access the Pre-amp Gain Menu. There are two fields on this screen outlined in Table E–1 below.

Table E-1: 350 System Subsea Parameters

Parameter	Options	Required Setting
Pre-amp Gain	1,2,3 and 4	4
Pre-amp Autogain	ON or OFF	OFF



To cycle through the available options press [SPACE] bar. Press [ENTER] to accept settings.

4. As outlined above, set the Pre-amp Gain to 4, Pre-amp Autogain to OFF.
5. When the pre-amp gain and autogain have been set, a chevron will be displayed on screen.
6. Press [4] to enter the Data Window/FFT Size Menu. Set the tone frequency to 25Hz and press [ENTER] to accept the selection and return to the Terminal Menu.
7. Press [9] to exit the Terminal menu.
8. To re-establish communication with the 350 System, press the Enable/disable polling on the Terminal Window toolbar. Scrolling data will be displayed on screen to identify the system is operating correctly.
9. Place the Coil Tester over the end of the search coil so the end of the coil is seated fully into the circular recess of the tester.



10. Note which coil is being tested. This will be defined on the attached connector cable, as outlined in Table E–1 below.

Table E–2: 350 System Connector Cable Identification

Connector ID	Description
SV	Starboard Vertical
SL	Starboard Lateral
PV	Port Vertical
PL	Port Lateral
SF	Starboard Fore/Aft
PF	Port Fore/Aft

\*To test the port or starboard fore/aft coils, the forward search must be used

11. On the Coil Tester press and hold the circular power switch. The battery condition indicator LED should first show orange as the unit performs a self test and then, approximately one second later, shows green. If the LED goes red or doesn't illuminate at all, this indicates that the battery power is low. If necessary, follow the instructions in Appendix E.4 to replace the battery.

12. While continuing to press the power switch, check the SDC screen and confirm that the channel being tested shows a signal strength of 1.0 to 1.5e6. The digital display at the bottom left hand corner of the Run Display screen should show a value between 1e6 and 1.5e6.

13. Move to the Frequency Spectrum Display either from the Run Display screen or from the Forward Search Display screen. You may use the Frequency Spectrum display to examine raw signals received by the six search coil channels. The horizontal axis of the display represents the frequency. The default view is 25Hz. It is recommended that the frequency scale is raised to 50Hz to view the results. The logarithmic vertical axis shows the absolute magnitude of signals at each frequency within the displayed band. This screen will confirm that the tested channel is receiving the tone at a frequency of 25Hz. After the results have been confirmed, toggle through the frequency range to return it to the default scale of 25Hz.

14. If the Run Display screen does not show the expected values, follow the guidelines included in Section E.5.

15. Repeat steps 4 to 12 for the remaining channels of the 350 System.

16. After completing the coil test procedure for all six channels, restore the 350 System to the original tone frequency for the survey. It is important to reset the pre-

amp gain and autogain to default settings. Repeat steps 2 and 3 using the values outlined below.

Table E-3: 350 System Operating Parameters

Parameter	Required Setting
Pre-amp Gain	4
Pre-amp Autogain	ON

17. Press [9] to exit the Terminal Menu.

18. To re-establish communication with the 350 System, press the Enable/disable polling button on the Terminal Window toolbar. Scrolling data will be displayed on screen to identify the system is operating correctly.

### *E.2.1 Frequency Selection*

Tests can be run at different frequencies ranging from 25Hz to 21Hz. To do this, remove the Coil Tester end cap and adjust the Frequency Selection Switch.

When supplied by TSS, the Coil Tester will be set to its default position five and 25Hz. It is strongly recommended that a default test is carried out using this frequency setting.

It is important to be aware that changing the frequency will change the coil voltage results achieved. The expected coil voltages for the available frequency outputs are explained in Table E-4.

Table E-4: Coil Tester Frequency settings and expected coil voltages

Switch Position	Frequency Output	Coil Voltage
5	25Hz +/- 0.0025Hz	1.0 to 1.5e6
4	24Hz +/- 0.0025Hz	0.94 to 1.44e6
3	23Hz +/- 0.0025Hz	0.89 to 1.39e6
2	22Hz +/- 0.0025Hz	0.83 to 1.33e6
1	21Hz +/- 0.0025Hz	0.79 to 1.29e6

### E.3 FAULT IDENTIFICATION

If the signal strength displayed on the Run Display screen does not show 1.0 to 1.5e6 at 25Hz for all channel check the following:

- ❑ Check the condition of the battery in the coil tester. Press the power button and confirm a constant green light. If a red or unlit LED is indicated, it is necessary to replace the battery.
- ❑ Check the display screen of the SDC is showing the channel under test. Note that to display the port and starboard fore-aft channels (PF and SF respectively) the Forward Search screen must be selected.
- ❑ Check that the 350 System has been configured correctly with the coil calibration constants for all six search coil channels. Check the values displayed on the SDC correspond to their proper physical channels.
- ❑ Check the Frequency Spectrum Display to make certain that all six channels are receiving spurious signals from sources such as noise, mains frequency pickup, etc. If there are no received signals, investigate a possible fault condition by referring to Section 9 Maintenance.

### E.4 BATTERY REPLACEMENT

The Coil Tester includes a battery condition LED. Press the battery test switch on the coil tester and check the LED first shows orange and then, after a short delay, shows green. The LED should remain green while the switch is pressed to indicate the battery is in good condition.

If the LED goes red or doesn't illuminate, replace the battery.

To replace the battery complete the following steps:

1. Unscrew the battery compartment end cap.
2. Remove the battery from its positioned secure clip.
3. Replace with a new battery and connect the battery connector.
4. Screw the battery compartment door back into place.
5. Press and hold down the power battery switch on the coil tester and confirm that the battery condition LED shows the battery to be in a good condition.

The battery life for continuous use is estimated to be thirteen hours or three years in stand-by mode.

### E.5 MAINTENANCE

The Coil Tester requires minimal maintenance. However, it is important to ensure the endcap O-ring is free from damage to maintain the IP65 waterproof standard classification. The following tasks should be carried out to ensure the O-ring remains in good condition:

1. Keep the grooves for the O-ring clean. Avoid any cuts, nicks or splits on any of the rubber surfaces. Renew the connector O-ring if it has deteriorated or becomes damaged.
2. Lubricate the O-rings with a light spray of 3M silicone oil or Dow Corning #111 valve lubricant or equivalent. When applying the lubricant oil use only a thin coating.

### E.6 SPECIFICATION

Overall Size:	209mm x 92mm
Weight (inc battery):	0.8kg
Power Supply:	PP3 9v, 550mA hours
Power Consumption:	42mA @ 9V
Tone Frequency:	25Hz (default) to 21Hz
Waterproof:	IP65
Battery Consumption - Constant Operation:	13 hrs
	Standby: 3 years



## F REFERENCE

This appendix contains reference information that may be useful to operators of the 350 System:

<b>Configuration log sheet:</b>	To be used during System installation and configuration. The information recorded on the log sheet allows the post-processing engineers to perform a more accurate assessment of the survey data from the 350 System. A copy of the sheet must therefore be retained with the Survey Log. Make copies of the master log sheet if more are required. <b>Complete this log both before and after every survey, and file it with the survey records.</b>
<b>Run Display Screen:</b>	Refer to section 6.2.1.2 for a full description of the Run Display screen. Refer to the fold-out drawing of a Run Display screen included in this appendix.
<b>Forward Search Screen:</b>	Refer to section 6.2.1.3 for a full description of the Forward Search screen. Refer to the fold-out drawing of a Forward Search screen included in this appendix.



**F.1 SURVEY DETAILS**

Survey vessel [] Date [] .....  
Survey vehicle [] .....  
Site [] .....  
Client [] .....  
Project number [] .....

**F.2 SYSTEM CONFIGURATION DETAILS**

SDC S/N [] Software version [] .....  
SEP S/N [] Firmware version [] .....  
Coil details: SL – S/N [] Calibration constant [] .....  
SV – S/N [] Calibration constant [] .....  
PL – S/N [] Calibration constant [] .....  
PV – S/N [] Calibration constant [] .....  
SF – S/N [] Calibration constant [] .....  
PF – S/N [] Calibration constant [] .....  
Coil separation distance []cm .....  
Altimeter source [] Altimeter-S/N-[]Enabled? [Y] [N] .....  
Altimeter Offset []cm Fixed coil altitude []cm .....  
External logging rate [4] [1]-per second .....  
Target type [] .....  
Magnitude of tone current-at-source []mA Tone frequency []Hz .....  
Reminder interval []mins Threshold setting []µV .....  
Audible alarm enabled? [Y] [N] .....  
Survey completed by [] .....

TSS 350 Training Certificate Number [] Date of training []





**A**

ALT 1-6  
Altimeter 2-13  
    Configuration 6-20  
    Connection See SEP Altimeter port  
    Connection to SDC 4-9  
    Connection to SEP 4-9  
    Data format 7-15  
    Depth rating 2-3  
    Dualtrack See Dualtrack  
    Installation 3-11  
Altimeter test 6-22  
Altitude of ROV See ALT  
Analogue output 6-26

**B**

Burial Depth see COV

**C**

Care of connectors 4-4  
Cathodic protection 7-27  
Coils 2-11  
    Calibration constant 3-6, 6-20  
    Circuit description 9-3  
    Connection 4-7  
    Directional response A-5  
    Dualtrack see Dualtrack  
    Installation 3-5  
    Orientation 3-6  
    Reference line 3-5  
    Separation distance 3-11, 6-19  
    Serial number 3-6  
    Triad assembly 3-6  
COMMS LED 5-3  
Communication method  
    SDC 4-16  
    SEP 4-14  
Communications  
    Dualtrack see Dualtrack  
Connection  
    Care of connectors 4-4  
    Coils 4-7  
    Ground 4-3  
    SDC see SDC  
    Sub-sea power 4-5  
Connector care 4-4  
Corrosion prevention 4-3  
COV 1-6  
Curved target course 7-28

**D**

Data Fields  
    Signal voltage 7-9  
Data fields 7-8  
    Signal voltages 7-14  
    Target coordinates 7-9, 7-12  
Data logging 6-22  
    Connection 4-16  
    External logging format 7-8  
    Forward search mode 7-10  
    Internal logging format 7-12  
    Replay 6-29  
    Survey mode 7-8  
Depth of target cover see COV  
Depth rating  
    Recognition 2-3  
Display Software  
    Frequency Spectrum see Spectrum  
    Display  
    Oscilloscope  
        See Oscilloscope  
    Run Mode 6-8  
    Run Mode see Display software  
Display software  
    Coil calibration 6-20  
    Coil separation distance 6-19  
    Configuration file 6-3  
    Default configuration 6-23  
    Forward search mode  
    Starting from DOS 5-4  
    System configuration 5-8, 6-8  
    Terminal window 6-16  
    Threshold 6-2, 6-18  
    Tone frequency 6-18  
Display software  
    System errors 6-15  
Dualtrack B-2  
    440 communication method B-9  
    Altimeter installation B-8  
    Coils installation B-6  
    Communication method B-9  
    Display software B-3  
    SDC B-5  
    SEP connection B-7  
    SEP interconnection B-9  
    Supply voltage B-8, B-10  
    Upgrade of an existing System B-9

## E

Earth return path 7-28  
 Error sources 7-21  
   Vehicle pitch 7-24  
   Vehicle position 7-21  
   Vehicle roll 7-23  
 Errors  
   Interference 7-26  
 External logging format see Data logging

## F

Forward range to target see FWD  
 Forward search mode 3-12, 7-5, A-7  
   Altimeter within 6-12  
   Data fields 7-10  
 Frequency spectrum display A-3  
 FWD 6-13

## I

Installation  
   Altimeter see Altimeter  
   Coils 3-5  
   Dualtrack see Dualtrack  
   SEP see SEP  
 Interference 7-26  
 Internal logging format see Data logging

## L

LAT 3-5, 6-10  
 Lateral offset see LAT  
 LED 5-3

## N

Noise 7-21  
   Cathodic protection 7-27  
   Curved target course 7-28  
   Earth return path 7-28  
   Ferrous rock deposits 7-27  
   Power cable surveys 7-27  
   Vehicle noise 7-26  
   Vibration 7-26

## O

Operating theory A-1  
 Oscilloscope 6-14

## P

Power  
   Dualtrack see Dualtrack

SEP 9-7

## Q

Quality Control 6-10  
 Quality control 6-31  
   Envelope 6-31  
   envelope 8-5  
   flags 7-8

## R

ROV altitude see Altimeter  
 Run display screen A-5  
   Skew A-8  
 Run mode  
   Coil drive 6-11

## S

Saturation 7-11  
 SDC 2-5  
   COM 2 altimeter port 4-9  
   Communication method 4-16  
   Communication ports 5-6  
   Initialisation 5-4  
   Power connection 4-11  
   Servicing 9-9  
   Video ports 4-17  
   Virus protection 2-8  
 Search angle A-7  
 Sensor port 4-5, 4-10  
 SEP 1-5, 2-9, 4-4  
   Altimeter port 4-9  
   Blanking plugs 4-5, 4-8, 4-10  
   COM 3 data logging port 4-16  
   Communication method 4-14  
   Depth rating 2-3  
   Disassembly and reassembly 9-9  
   Grounding 4-3  
   Installation 3-3, 4-11  
   Mounting block 3-3  
   Power connection 4-5  
   Power requirements 9-7  
   Sensor port 4-5, 4-10  
 Servicing  
   SDC 9-9  
 Skew 6-10, 6-13, A-8  
 Spectrum Display 6-14  
 Status bar 6-11  
 Subsea Electronics Pod See SEP

### T

- Target coordinates 1-6
- Theory of operation A-1
- Threshold 6-2
- Tone
  - configuring 6-18

### V

- Vehicle 7-29
  - Altitude 7-29
  - Speed of operation 7-29
  - Tracked vehicle 7-29
- Video 4-17
- Video Overlay
  - Setup 6-23
- Video overlay
  - Connection 4-17
- Viruses 2-8
- VRT 3-5

