



INSTRUMENTS

AirLink 7010 Gas Monitor Operator's Manual

Part Number: 71-0537

Revision: P2

Released: 7/13/21

www.rkiinstruments.com

Product Warranty

RKI Instruments, Inc. (Manufacturer) warrants its products to be free of defects in workmanship and materials—under normal use and service—for one year from the date of purchase from the manufacturer or from the product's authorized reseller.

The manufacturer is not liable (under this warranty) if its testing and examination disclose that the alleged defect in the product does not exist or was caused by the purchaser's (or any third party's) misuse, neglect, or improper installation, testing or calibrations. Any unauthorized attempt to repair or modify the product, or any other cause of damage beyond the range of the intended use, including damage by fire, lightning, water damage or other hazard, voids liability of the manufacturer.

Any repaired or replaced product or part has either a 90-day warranty or the remainder of the initial warranty period (whichever is longer).

Table of Contents

Chapter 1: Introduction	5
Overview	5
About the AirLink 7010 Gas Monitor	5
About this Manual	6
Specifications	7
Chapter 2: Description	8
Front Panel	8
Terminal Board	9
Internal Components	10
Chapter 3: Installation	11
Mounting the AirLink 7010 Gas Monitor	11
Wiring the AirLink 7010 Gas Monitor	13
Chapter 4: Startup and Operation	22
Power On/Off	22
Holding Channels	24
LED Functionality	24
Chapter 5: Setup Mode	25
Overview	25
Entering Setup Mode	25
Channel Settings	25
Relay Settings	29
View System Information	30
Exiting Setup Mode	31
Chapter 6: Advanced Configuration Menu	32
Overview	32
Entering the Advanced Configuration Menu	32
Adjusting the LCD Contrast	32
Restore Factory Default Settings	33
Relay Setup	34
Modbus Setup	35
WireFree Setup	36
Exiting the Advanced Configuration Menu	37

Chapter 7: Maintenance	38
Calibration Mode.....	38
Relay Test Mode.....	38
Troubleshooting.....	39
Chapter 8: Parts List	41
Appendix A: Relay Operation	42
Appendix B: RS-485 Modbus Output	38
Modbus Terms.....	45
Register Map.....	46

Chapter 1: Introduction

Overview

This chapter briefly describes the AirLink 7010 Gas Monitor. This chapter also describes the *AirLink 7010 Gas Monitor Operator's Manual* (this document). Table 1 at the end of this chapter lists the specifications for the AirLink 7010.

About the AirLink 7010 Gas Monitor

The AirLink 7010 can receive up to 32 WireFree sensors (depending on the radio's configurations) or up to 28 WireFree sensors and up to four 4-20mA wired sensor assemblies. All configured channels are displayed every three seconds (scanned). When one channel indicates a gas reading, the monitor locks to that channel. If two or more channels are indicating a gas reading, the monitor scans those channels every three seconds. The user can manually scan channels by pressing *SCAN* or *ADD* to move forward through channels or *SUB* to move backward through channels. The scanned channel will stay at that channel for one minute and then go back to normal scanning.

All channels can be configured to detect WireFree gas sensor assemblies, or up to four wired (4-20mA) sensor assemblies. The last four channels (29-32) can be configured to accept a 4-20mA signal. By default, the system comes with the first 28 channels configured for WireFree sensor assemblies and the last four channels configured for wired sensor assemblies. Any channel can be turned “off”, and any channel can be configured to any valid WireFree address, 1-255.

There are four 5 Amp relays with 4 Amp fuses. The fourth relay may be configured as a Fault relay. This Fault relay will activate if any Fault is generated by the monitor or if any sensor that the monitor is configured to monitor goes into Fault. The Fault relay is removed from any further configurable options from Channel Setup—leaving only three relays for each channel. All relays can be configured to be either latching or auto resetting. The relays can be configured with different set points for alarm conditions for each channel, allowing each channel to have their own gas level set points.

An optional strobe and/or horn can be ordered. The strobe is installed on the top of the housing and is wired into the first relay. The horn is installed on the bottom of the housing and is wired into the second relay.

All relays have a 10% of value of hysteresis on the set points. This prevents the relays from rapidly switching on and off during a potentially jumpy gas sensor reading. Once the threshold value of a relay is reached, the relay is activated. However, the AirLink 7010 screen will not lock on the channel with a triggered relay while the reading is below the Relay Set Point (the user must scroll through the channels to find the channel with a triggered relay). When the gas reading decreases below the threshold value, the relay must be 90% of the initial threshold value to deactivate.

About this Manual

The *AirLink 7010 Gas Monitor Operator's Manual* uses the following conventions for notes, cautions, and warnings:

NOTE: Describes additional or critical information.

CAUTION: *Describes potential damage to equipment.*

WARNING: *Describes potential danger that can result in injury or death.*



Caution: refer to accompanying documentation

~ Vac (AC voltage)

--- Vdc (DC voltage)

Specifications

Table 1 lists specifications for the AirLink 7010.

Table 1: AirLink 7010 Specifications

Description	Specification
Input Power	110/240V ~ or 12 - 35 V _ _ _
Current Draw	175 mA max at 24 VDC (monitor without sensor assemblies); 6.6 Watts max
Operating Temperature	-22°F to 158°F (-30°C to 70°C)
Input Signal	<ul style="list-style-type: none"> • Up to 32 WireFree sensor assemblies OR • Up to 28 WireFree sensor assemblies and up to 4 4-20 mA input sensor assemblies
Output	RS-485 Modbus
Construction (housing)	Fiberglass with clear window (NEMA 4)
Dimensions	27.8 in. H x 10 in. W x 6.5 in. D (70.6 cm H x 25.4 cm W x 16.5 cm D)
Weight	10 lbs.
Mounting	4 mounting feet (6" W x 12.25" T); 1/4" diameter max mounting bolt/screw size
User Controls	Program buttons: RESET/ESC, SCAN/HOLD, MENU, ADD, SUB
Display	Graphical LCD (128x64), transfective, sunlight readable, LED backlight
Relays	<ul style="list-style-type: none"> • 4 relays with 4A fuses • SPDT, Form C (common, normally open, and normally closed contacts)
Radio Options	<ul style="list-style-type: none"> • 2.4 GHz, ISM, 125 mW OR • 900 MHz, 200 mW
Standard Accessory	Operator's manual (this document)
Optional Accessories	<ul style="list-style-type: none"> • Strobe • Horn

Chapter 2: Description

Front Panel

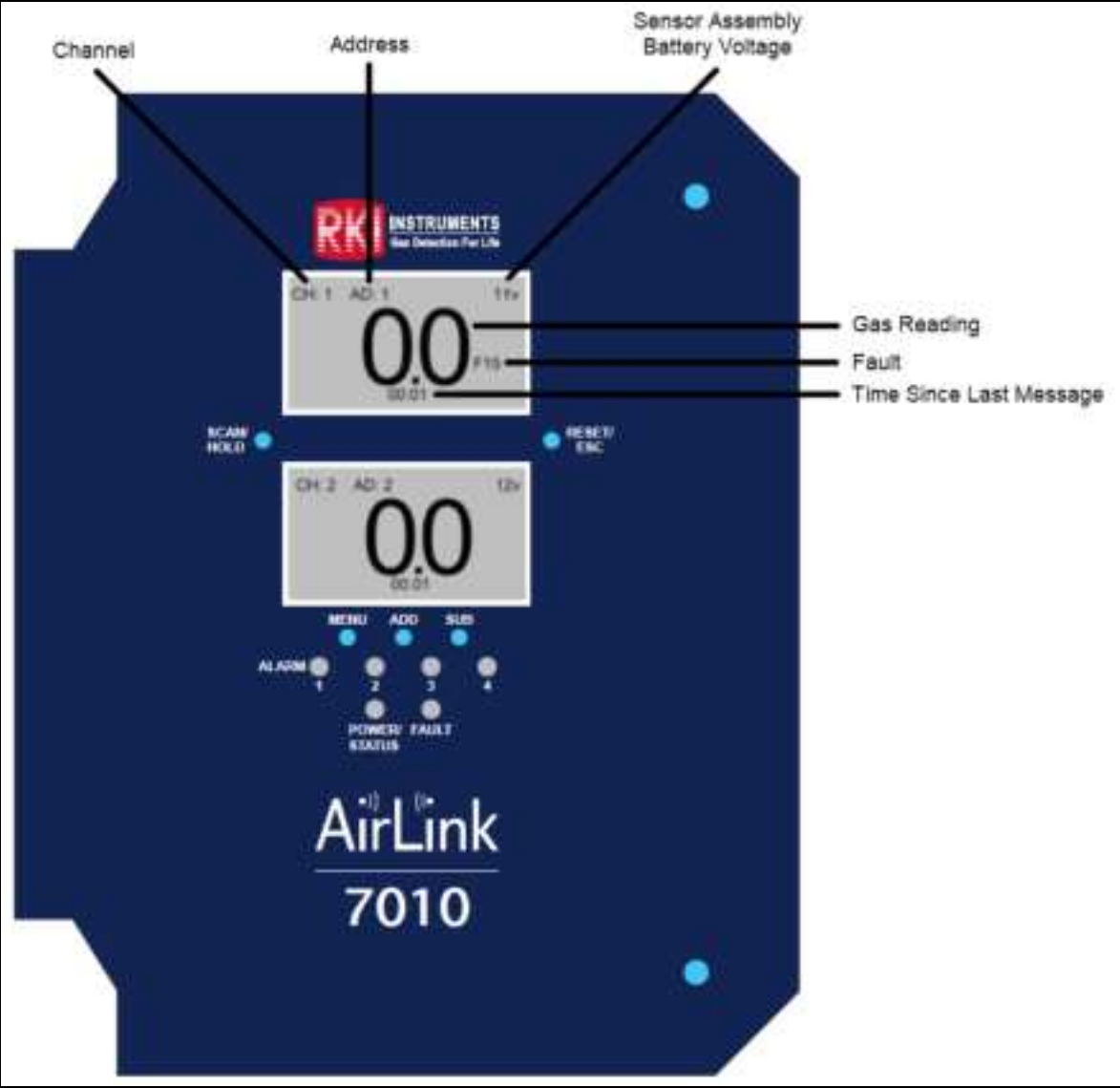

Figure 1: Front Panel

Terminal Board

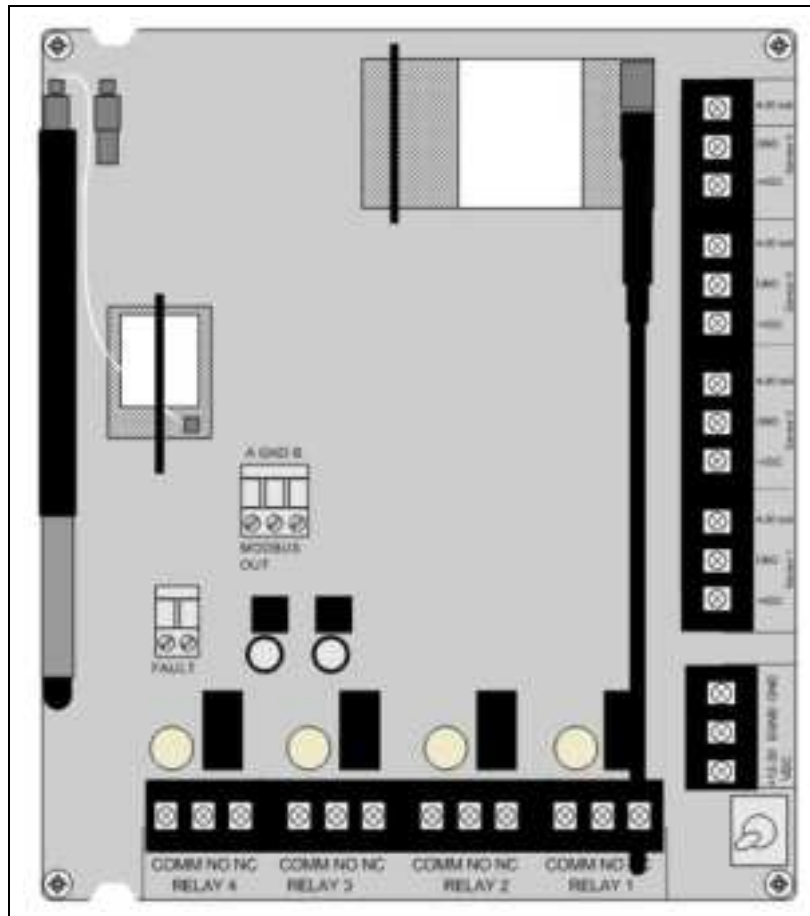

Figure 2: Terminal Board

Internal Components

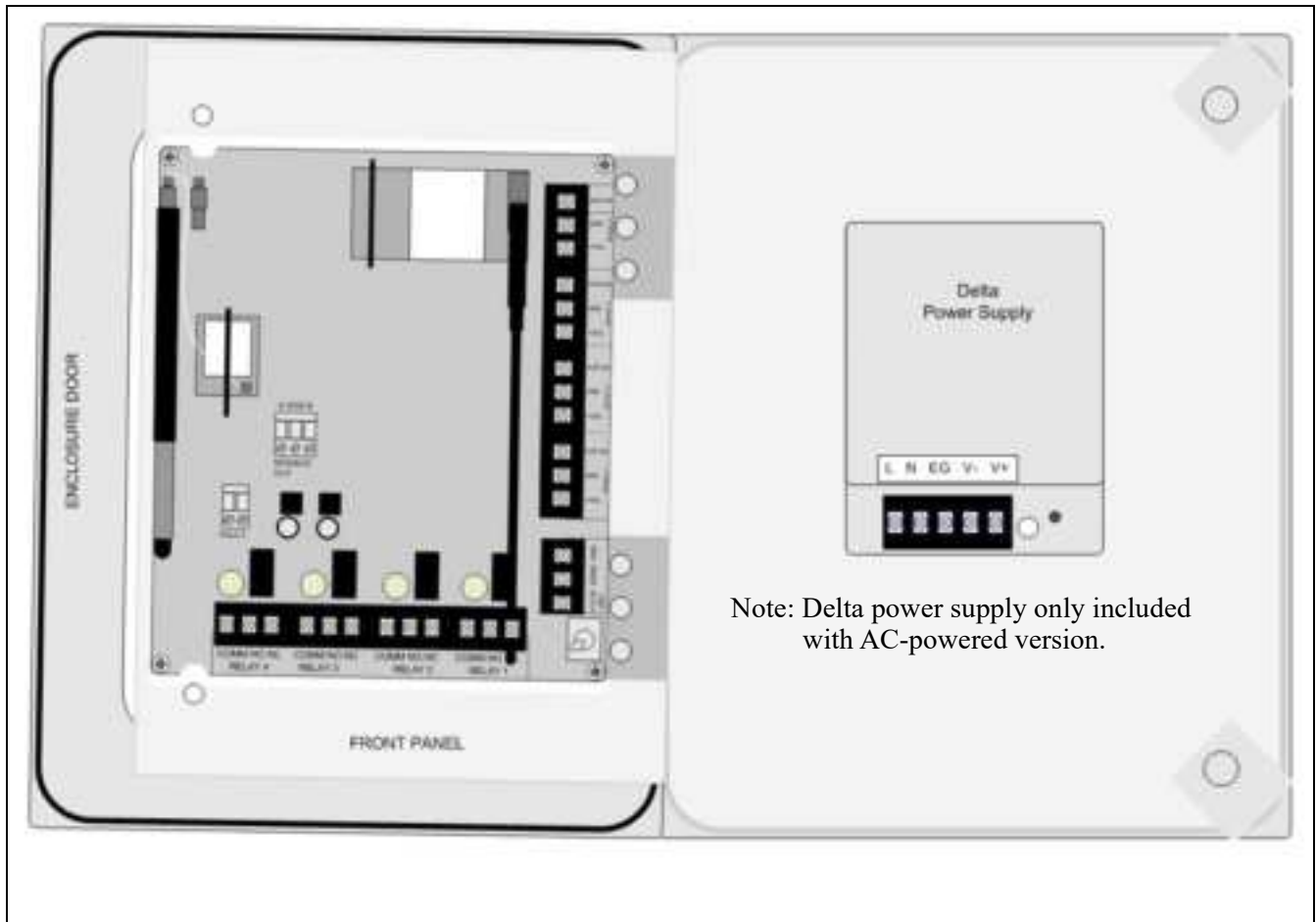

Figure 3: Internal Components

Chapter 3: Installation

Mounting the AirLink 7010 Gas Monitor

1. Select the mounting site. When you select the mounting site, consider the following factors:
 - Is an AC or DC power source available?
 - Is a vertical surface available to mount the AirLink 7010?
 - Is there enough room to open the housing door and make wiring connections?
 - Are the display screen and status lights visible?
2. Close and latch the housing door.
3. Prepare the selected mounting site as required to mount the AirLink 7010. It should be mounted at eye level (4 1/2 to 5 feet from the floor). Refer to Figure 4 for the outline and mounting dimensions.
4. Position the monitor on the vertical mounting surface.
5. Insert maximum 1/4" bolts or screws through the slots in the mounting feet at each corner of the housing to secure the housing to the mounting surface.

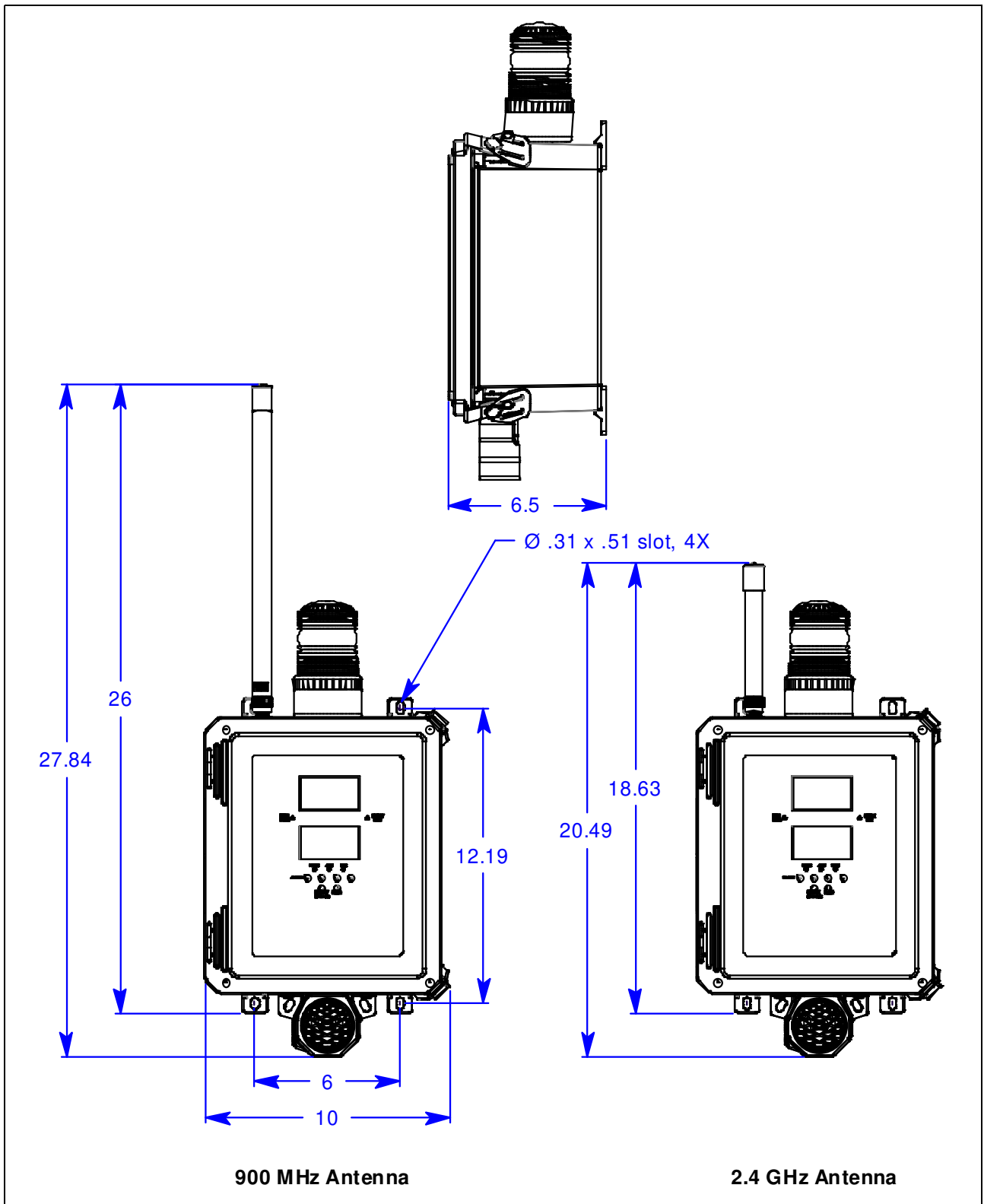

Figure 4: Outline and Mounting Dimensions

Wiring the AirLink 7010 Gas Monitor

This section describes procedures for DC power source wiring, AC power source wiring, Modbus out wiring, fault indicator wiring, sensor connection, and relay wiring.

The following wiring connections must be made before starting up the AirLink 7010.

CAUTION: *The internal components can be static sensitive. Use caution when opening the enclosure and handling internal components.*

WARNING: *Make all connections to the AirLink 7010 before you plug in or turn on the AC or DC power source. Before you make any wiring adjustments, always verify that all power sources are not live.*

Connecting a DC Power Source

NOTE: The AirLink 7010 is configured for AC or DC operation, depending on how it is ordered. If you are using AC power as the primary power source, go to the next section, “Connecting an AC Power Source”.

Provide a clean and stable 12-35 VDC. Failure to do so may cause the unit (and any wired sensors that are connected to the unit) to not operate properly.

Voltage spikes higher than 35 VDC may damage the unit.

1. Open the enclosure box to expose the Front Panel.
2. Unscrew the two thumb screws on the Front Panel.
3. Open the Front Panel so that the Terminal Board is exposed (back of Front Panel).
4. Locate the Power Terminal (on the lower right side of the Back Panel) and connect the DC-live wire (red) to the terminal marked “+12-35 VDC”.
5. Connect the DC-ground wire (black) to the terminal marked “GND”.
6. If desired, connect an Earth Ground wire (green) to the terminal marked “EGND” (required for surge suppression).

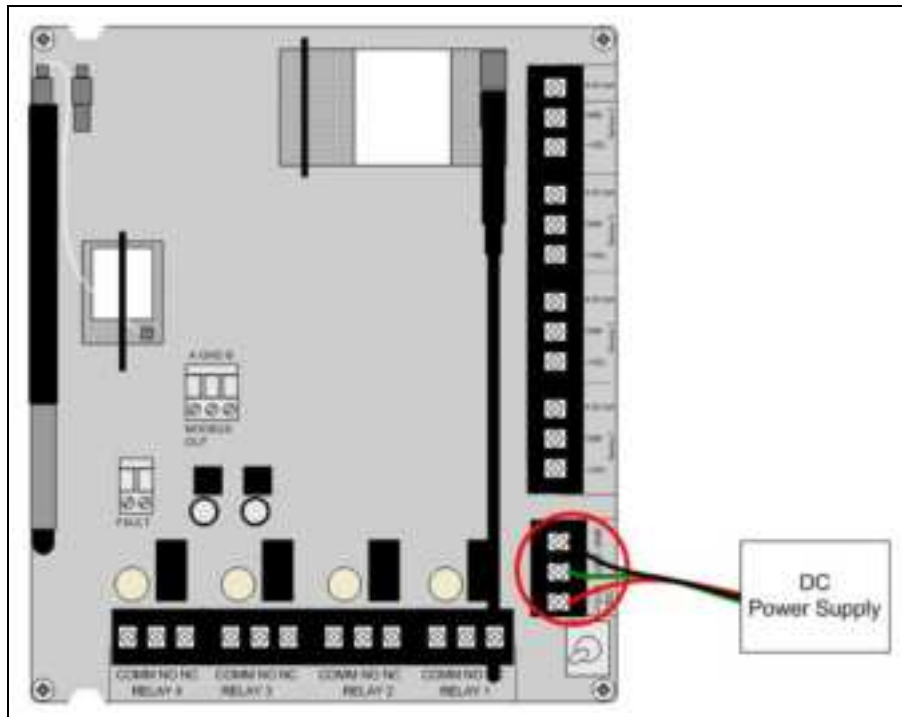

Figure 5: DC Wiring

7. Close the Front Panel.
8. Screw in the thumb-screws.
9. Close the enclosure box.
10. Clamp down the enclosure latches.

Connecting an AC Power Source

NOTE: The AirLink 7010 is configured for AC or DC operation, depending on how it is ordered. If you are using DC power as the primary power source, go to the previous section, “Connecting a DC Power Source”.

WARNING: Verify that the power source is unplugged or turned off before you continue with this procedure.

1. Open the enclosure box to expose the Front Panel.
2. Unscrew the two thumb-screws on the Front Panel.
3. Open the Front Panel so that the AC (Delta) Power Supply is exposed.

4. The power supply is factory wired to the Terminal Board.

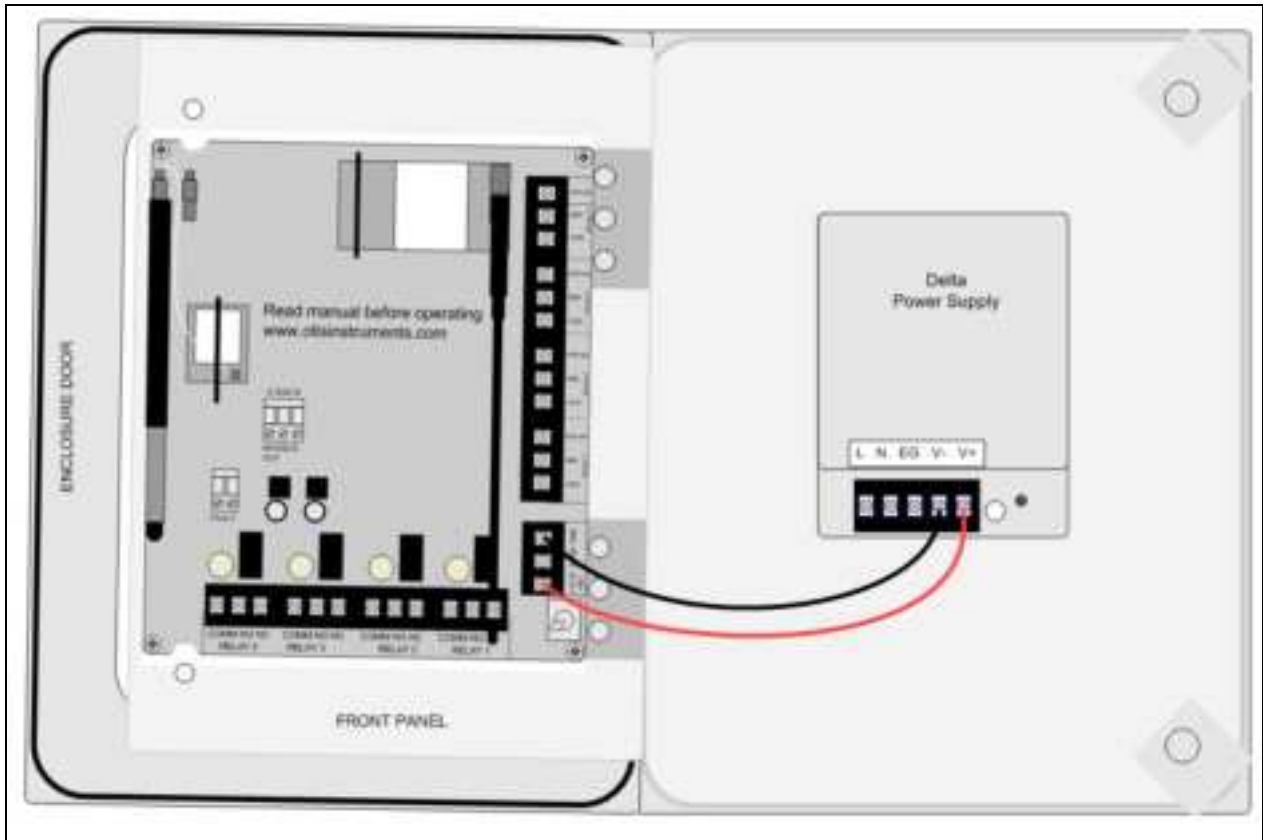

5. For versions that came with a pre-wired AC line cord: there are three wires (black, white and green) pre-wired from the Delta power supply terminals “L” (AC Load IN), “N” (AC Neutral IN), and “EG” (Chassis GND or Earth GND). This set of wires will be used to plug into an AC power outlet ONCE ALL WIRING CONFIGURATIONS ARE COMPLETE.

6. For versions that did not come with a pre-wired AC line cord:
 - Connect a line wire from the AC power source to the power supply's "L" terminal.
 - Connect a neutral wire from the AC power source to the power supply's "N" terminal.
 - Connect a ground wire from the AC power source to the power supply's "EG" terminal.

NOTE: If the AirLink 7010 was not ordered with any housing holes, at least one hole will have to be drilled to bring in AC power.

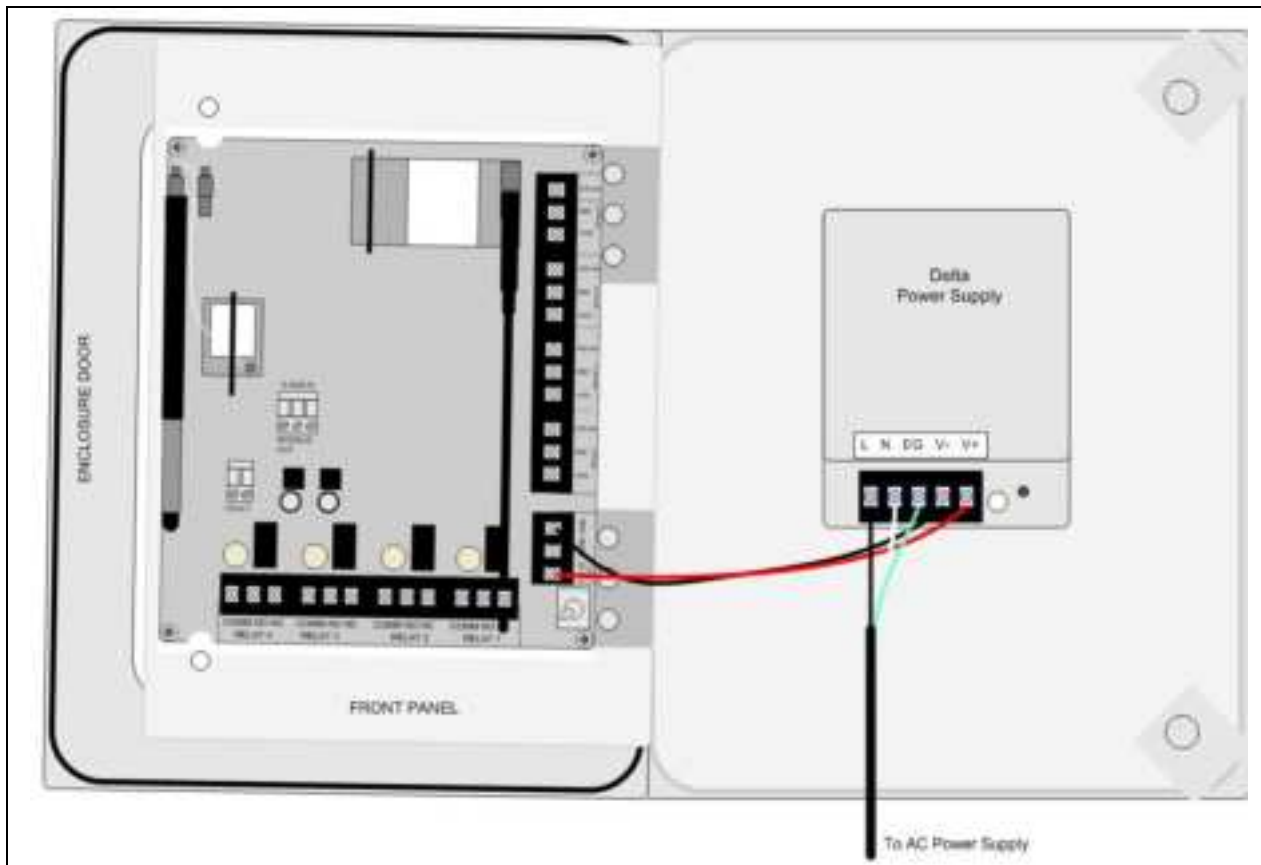

Figure 6: AC Wiring

7. Close the Front Panel.
8. Screw in the thumb-screws.
9. Close the enclosure box.
10. Clamp down the enclosure latches.

RS-485 Modbus Wiring (Modbus Out)

1. Open the enclosure box to expose the Front Panel.
2. Unscrew the two thumb-screws on the Front Panel.
3. Open the Front Panel so that the back of the Terminal Board is exposed.
4. Locate the Modbus Out Terminal Block.
5. Connect the yellow wire from a DB-9 connector (or the connector-type that best suits your application) to the terminal labeled “A” on the Modbus Out Terminal Block.
6. Connect the white wire from a DB-9 connector to the terminal labeled “GND” on the Modbus Out Terminal Block.
7. Connect the brown wire from a DB-9 connector to the terminal labeled “B” on the Modbus Out Terminal Block.
8. Plug the DB-9 connector into a PLC.

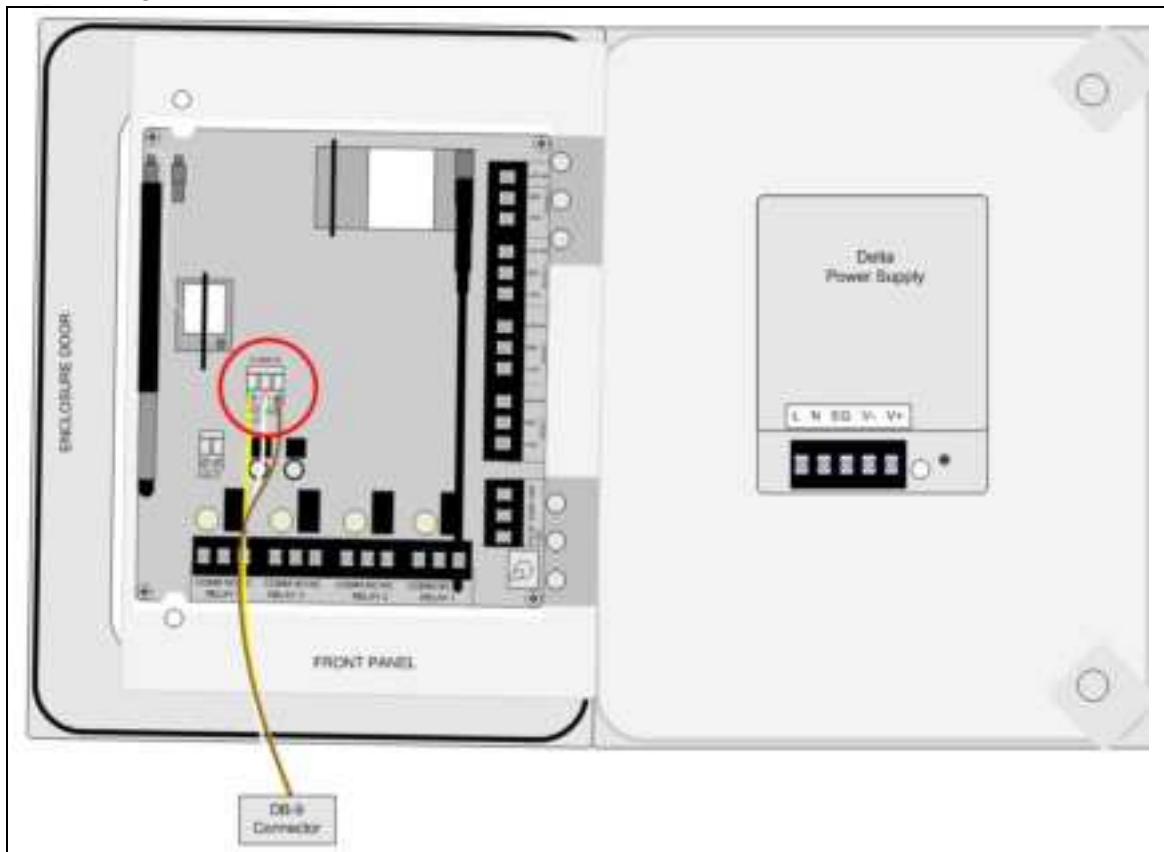

Figure 7: Modbus Out Wiring

9. Close the Front Panel.
10. Screw in the thumb-screws.
11. Close the enclosure box.
12. Clamp down the enclosure latches.

Fault Indicator Connection

The Fault terminal provides an output to power some form of Fault indicator. The Fault terminal is wet contact, uses the same supply voltage that is fed into the board, provides 500 mA maximum, and is a DC only output.

The fault terminal's failsafe operation can be configured as described in step 4 on page 34.

1. Open the enclosure box to expose the Front Panel.
2. Unscrew the two thumb-screws on the Front Panel.
3. Open the Front Panel so that the back of the Terminal Board is exposed.
4. Locate the Fault Terminal Block on the terminal board.
5. Connect a positive (red) wire to the terminal labeled "+".
6. Connect a negative (black) wire to the terminal labeled "-".

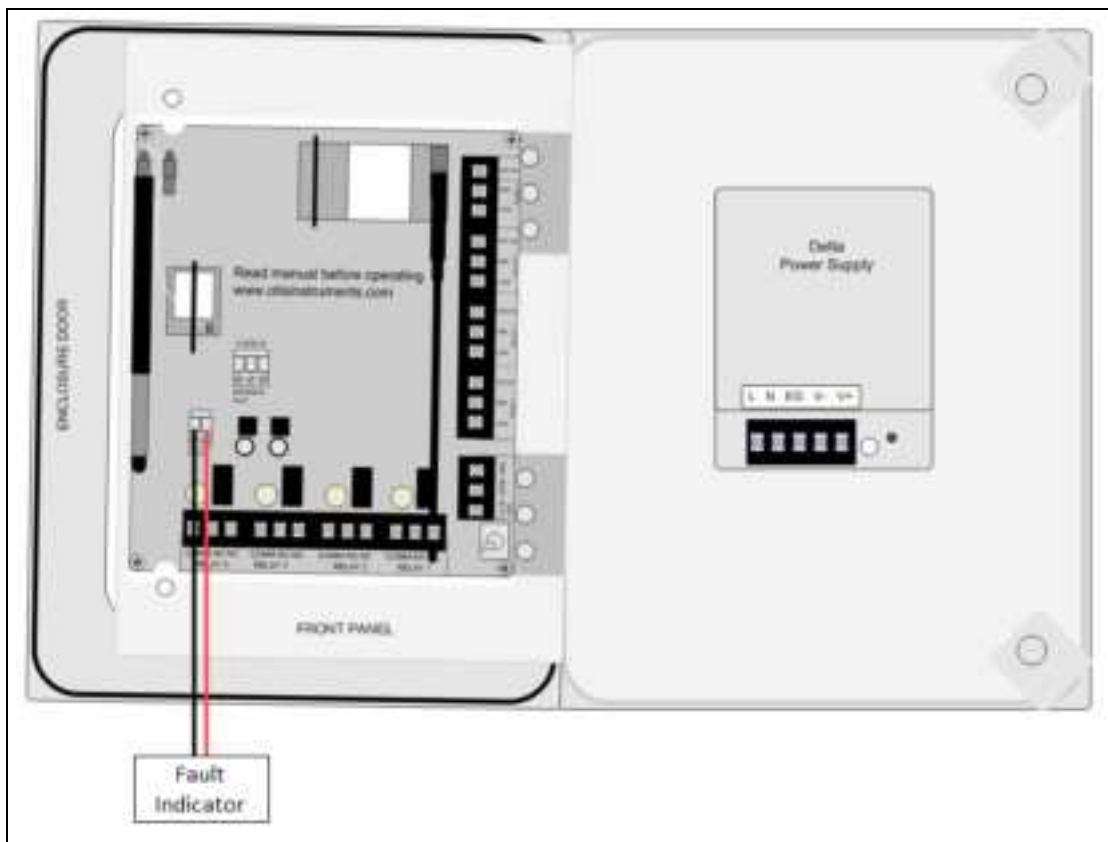

Figure 8: Fault Indicator Wiring

Connecting Sensors

The AirLink 7010 allows up to 32 WireFree sensor assemblies or up to 28 WireFree sensor assemblies and 4 wired 4-20 mA type sensor assemblies to be monitored.

1. Open the enclosure box to expose the Front Panel.
2. Unscrew the two thumb-screws on the Front Panel.
3. Open the Front Panel so that the back of the Terminal Board is exposed.
4. Locate the Sensor Terminal Blocks on the Terminal Board.
5. For each of up to 4 wired 4-20 mA type sensor assemblies:
 - Connect the sensor assembly's positive (red) wire to the terminal labeled "+VDC".
 - Connect the sensor assembly's signal (green) wire to the terminal labeled "4-20 mA".
 - Connect the sensor assembly's neutral (black) wire to the terminal labeled "GND".

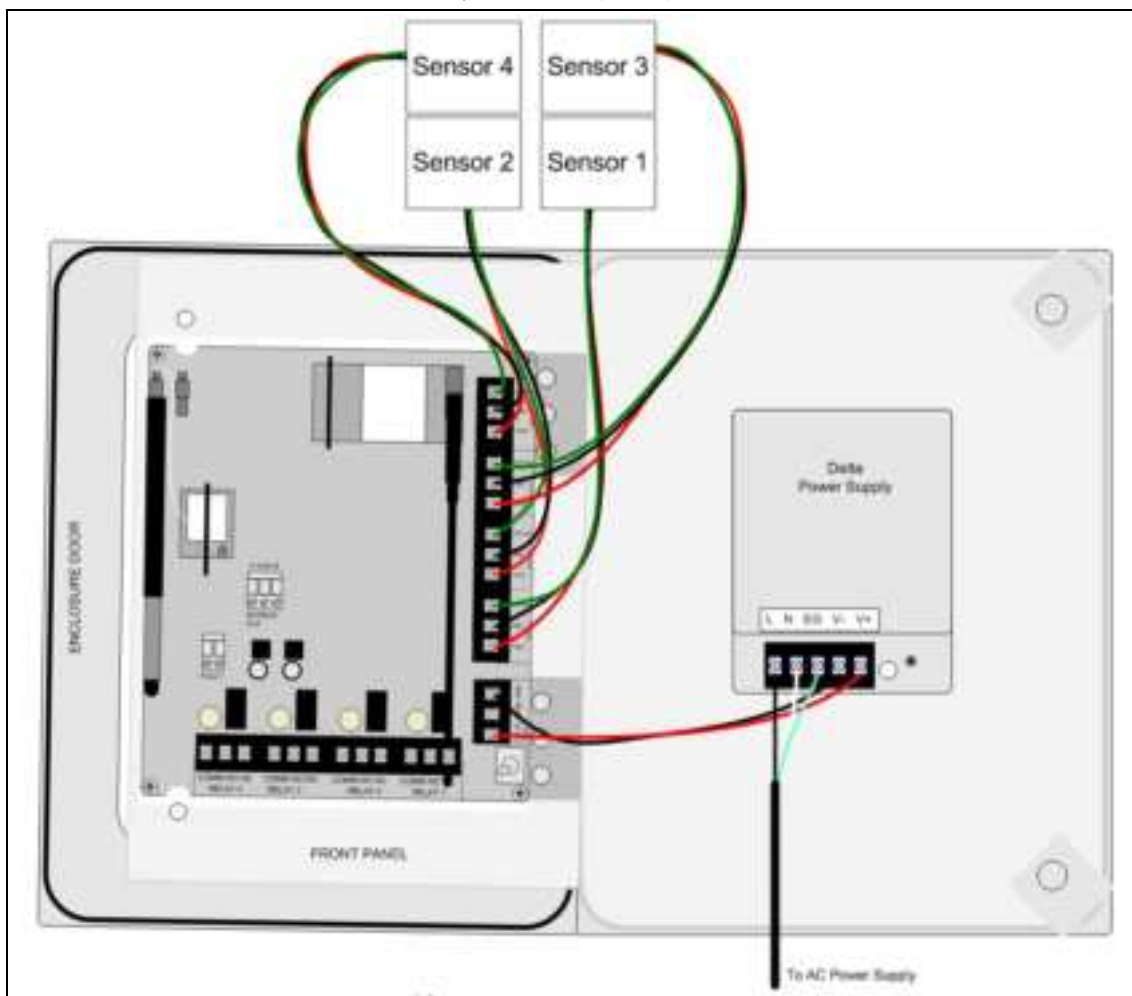

Figure 9: Sensor Wiring

Relay Wiring

The AirLink 7010 has four relays. Each of the four relays may be setup as Normally Open (NO) or Normally Closed (NC). See page 42 for more explanation about relay actuation.

NOTE: If installed, the strobe is factory wired to the Relay 1 terminals and the horn is factory wired to the Relay 2 terminals.

1. Open the enclosure box to expose the Front Panel.
2. Unscrew the two thumb-screws on the Front Panel.
3. Open the Front Panel so that the back of the Terminal Board is exposed.
4. Locate the Relay Terminal Blocks on the Terminal Board.
5. Connect the alarm device's "+ (H)" terminal to the **NO** or **NC** terminal on the relay terminal block.

NOTE: It is recommended that the relay connections are wired as normally-open (NO). However, normally-closed (NC) wiring configurations provide an inherent fail-safe and may be preferred.

6. Connect the alarm device's "- (N)" terminal to an external power source's "- (N)" terminal.
7. Connect the external power source's "+ (H)" terminal to the COM terminal on the relay terminal block.

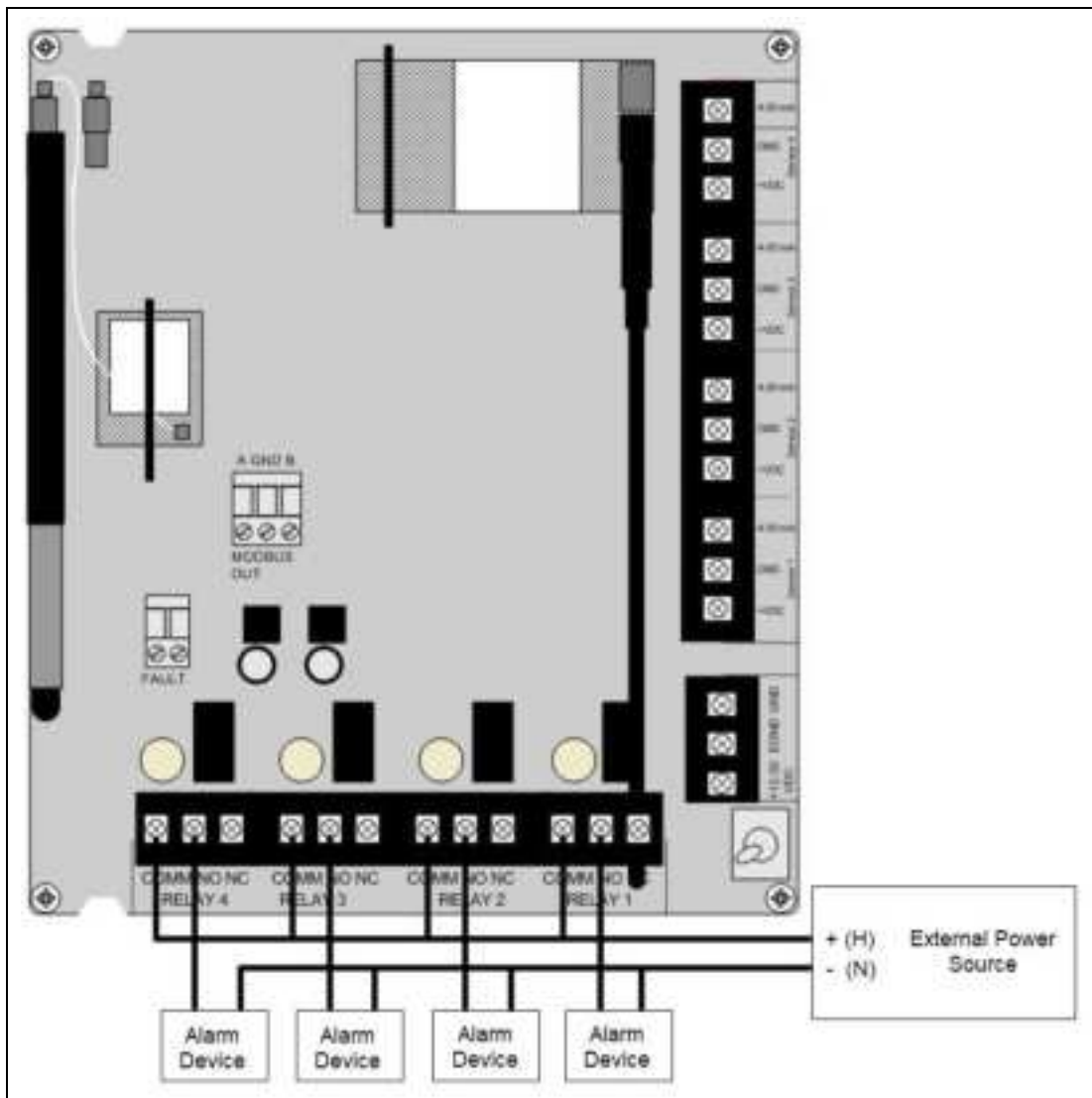

Figure 10: Relay Wiring

Chapter 4: Startup and Operation

Power On/Off

Powering on the device activates its functions. When powered on, the device is fully functional and access to system and settings menus is allowed.

CAUTION: *The internal components can be static sensitive. Use caution when opening the enclosure and handling internal components.*

Once power is supplied to the AirLink 7010—by being plugged into an AC outlet or by being wired to a DC power supply—the display screen and LEDs will illuminate.

To cycle the Terminal Board power, flip the Power Switch (located on the lower right side of the Terminal Board) to the OFF (and then ON) position.

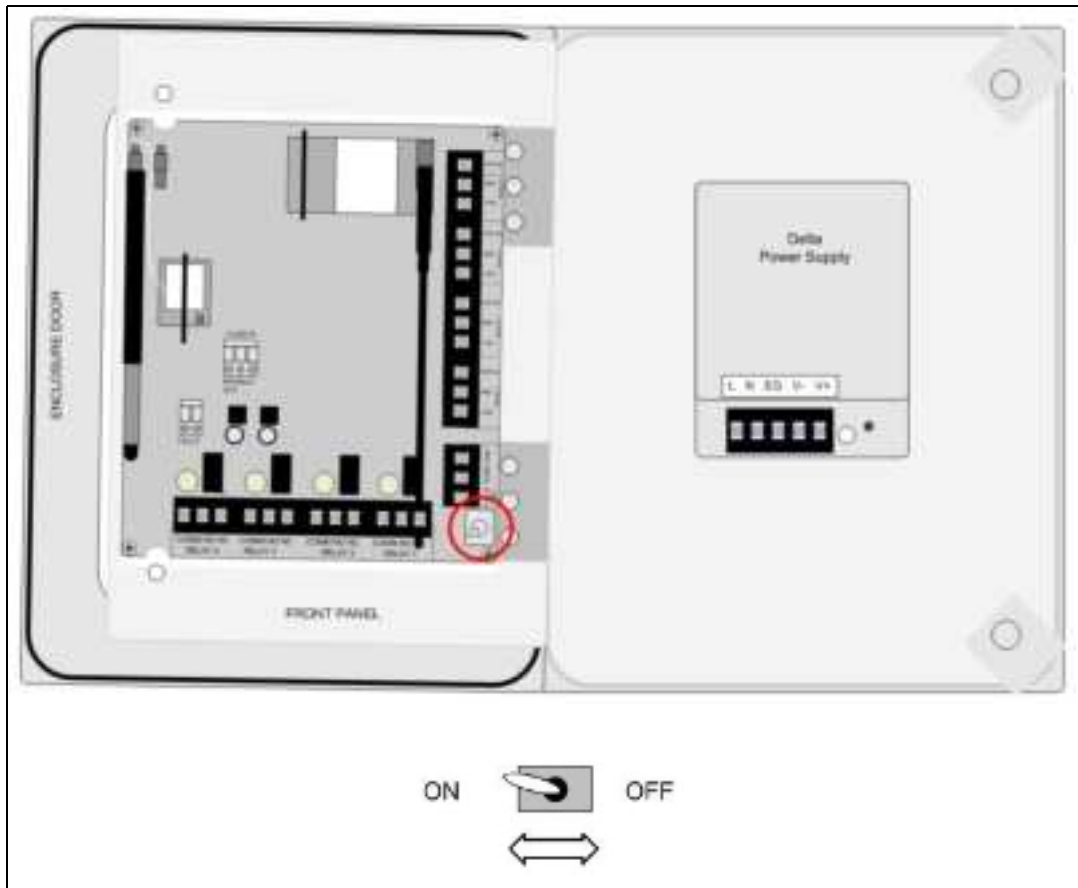

Figure 11: Power Switch Location

Normal Operation

The AirLink 7010 can monitor up to 32 WireFree sensor assemblies or up to 28 WireFree sensor assemblies and up to 4 wired sensor assemblies.

When in Normal Operating Mode, configured channels are scanned through, 2 channels at a time, every 3 seconds.

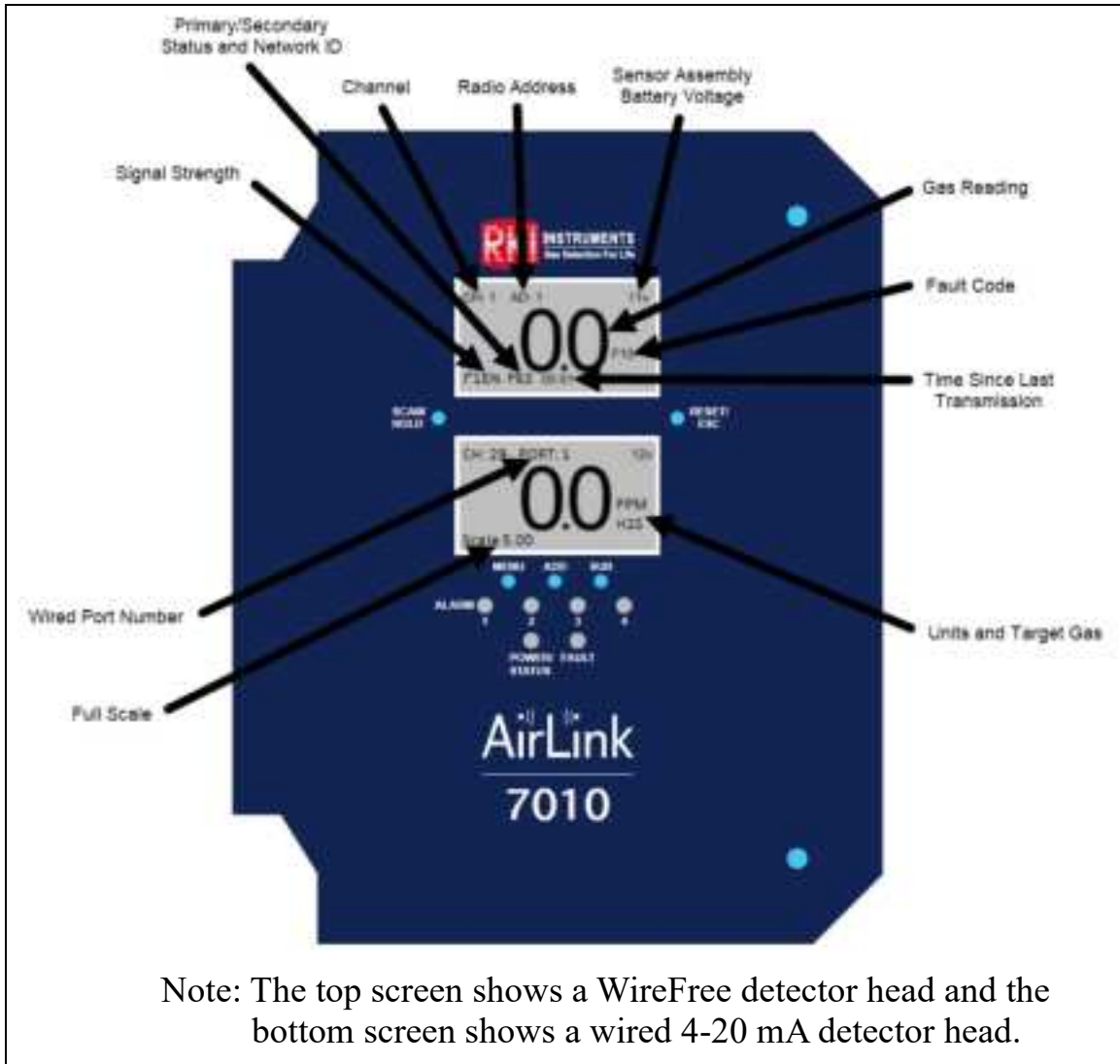

Figure 12: Normal Operating Mode

Holding Channels

This feature can be used to monitor a select channel, rather than the continuous scanning of channels while in Normal Operating Mode.

1. Open the enclosure box.
2. Locate *SCAN/HOLD* on the Front Panel.
3. Press *SCAN/HOLD* once to “freeze” the channel scan sequence.
4. Press *ESC* to return to Normal Operating Mode.

NOTE: The device will automatically return to Normal Operating Mode after five minutes of inactivity.

5. Close the enclosure box.
6. Clamp down the enclosure latches.

LED Functionality

LED	Color / Status	Description
ALARM 1	off	No alarm condition has occurred on relay 1 since the last reset or power up
	solid red	An alarm condition is currently happening on relay 1
	blinking red	An alarm condition has occurred on relay 1, but condition has now gone
ALARM 2	off	No alarm condition has occurred on relay 2 since the last reset or power up
	solid red	An alarm condition is currently happening on relay 2
	blinking red	An alarm condition has occurred on relay 2, but condition has now gone
ALARM 3	off	No alarm condition has occurred on relay 3 since the last reset or power up
	solid red	An alarm condition is currently happening on relay 3
	blinking red	An alarm condition has occurred on relay 3, but condition has now gone
ALARM 4	off	No alarm condition has occurred on relay 4 since the last reset or power up
	solid red	An alarm condition is currently happening on relay 4
	blinking red	An alarm condition has occurred on relay 4, but condition has now gone
Fault	off	No Fault condition has occurred on any sensor unit since the last reset or power up
	solid orange	A Fault condition is currently happening on at least one sensor unit
POWER/STATUS	red	A Fault condition is occurring on the monitor
	blue	Normal Operating Mode

1. Press and release *RESET/ESC* to clear an alarm indication once the alarm condition has cleared.

Chapter 5: Setup Mode

Overview

This mode is used for: Channel Settings (On/Off, Wired/WireFree, gas, range, decimals, radio address), Relay Settings (On/Off, Decreasing/Increasing, Value, Latching/Auto Resetting), and System Information.

NOTE: Each channel must be set up individually.

NOTE: To save any changes and exit Setup Mode at any time, press ESC. The AirLink 7010 automatically saves any changes and returns to Normal Operating Mode 15 minutes after the last button press.

Entering Setup Mode

1. Open the enclosure box.
2. From Normal Operating Mode, press and hold *MENU*, *ADD*, and *SUB* for 5 seconds to enter Setup Mode.

Channel Settings

1. Channel Selection: Once in Setup Mode, press *ADD* (increase) or *SUB* (decrease) to select the channel you want to set up (1-32).

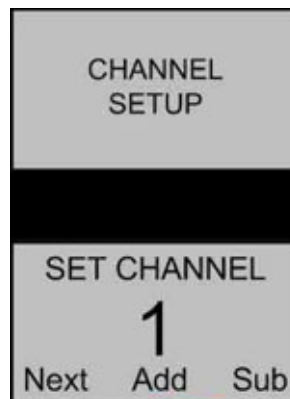

NOTE: To view system information, scroll up from channel 32 or down from channel 1.

2. Press *MENU* (Next).

3. Channel On/Off: Press *ADD* or *SUB* to change the state of the channel to On or Off.



4. Press *MENU* (Next).
5. Wired/WireFree (for channels 29-32 only): Press *ADD* or *SUB* to change the channel type to Wired or WireFree.

NOTE: Any sensors wired directly to the AirLink 7010 must be set up on channels 29-32.

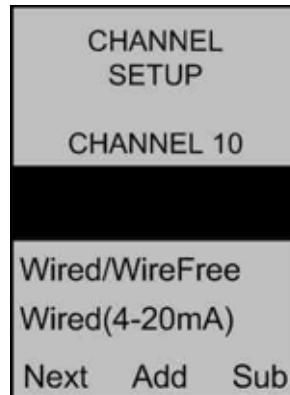

6. Press *MENU* (Next).

7. Sensor Type (wired only): Press *ADD* or *SUB* to select a sensor type. The choices are: H2S, SO2, O2, CO, C12, CO2, LEL, VOC, FEET, HCl, NH3, H2, CLO2, HCN, F2, HF, CH2O, NO2, O3, INCHES, 4-20, None, Degrees C, Degrees F, CH4, NO, PH3, HBr, Eto, CH3SH, AsH3, R410A, R1234, R32, SF6, SiH4, B2H6, BF3.

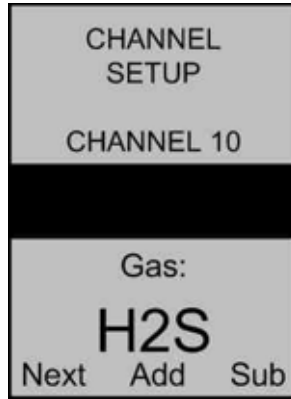

8. Press *MENU* (Next).
9. Sensor Scale (wired only): Press *ADD* (increase) or *SUB* (decrease) to select a sensor scale (1-65,000).

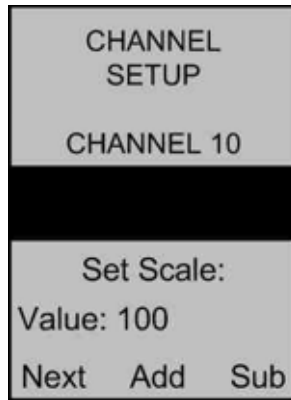

10. Press *MENU* (Next).

11. Decimals (wired only): Press *ADD* (increase) or *SUB* (decrease) to set the number of decimals. The number of decimals available depends on the sensor scale.
- 3 decimals: Scale 1 or less
 - 2 decimals: Scale 10 or less
 - 1 decimal: Scale 100 or less
 - 0 decimals: Scale greater than 100 (decimal screen does not appear in this case)

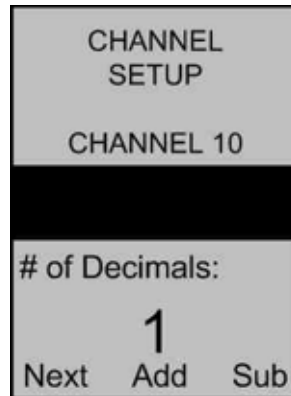

12. Press *MENU* (Next).

13. Radio Address (wirefree only): Press *ADD* (increase) or *SUB* (decrease) to set to radio address (1-255).

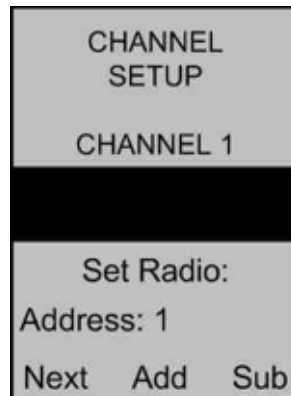

14. Press *MENU* (Next).

Relay Settings

See page 42 for more explanation about relay actuation.

1. Relay On/Off: Press *ADD* or *SUB* to manipulate the relay's On/Off status. The On/Off status affects whether a relay is active on the selected channel or not.

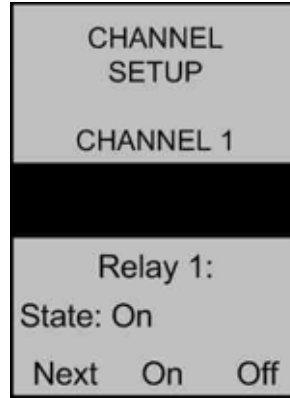

2. Press *MENU* (Next).
3. Relay Increasing/Decreasing: Press *ADD* or *SUB* to manipulate the relay's Increasing/Decreasing status.

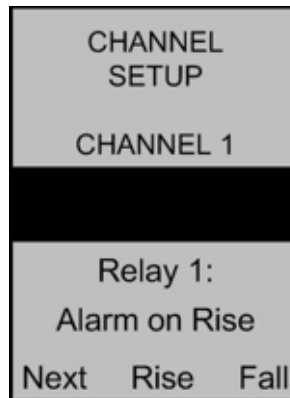

4. Press *MENU* (next).
5. Relay Threshold: Press *ADD* (increase) or *SUB* (decrease) to manipulate the threshold value (1-65,000).

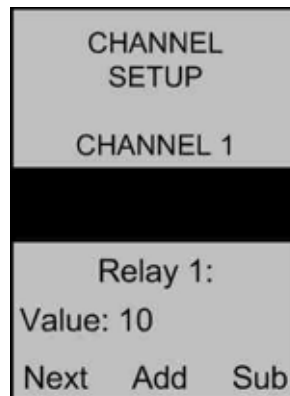

6. Press *MENU* (Next).
7. Relay Latch/Auto Reset: Press *ADD* or *SUB* to manipulate the relay's Latching/Auto Reset status.



8. Press *MENU* (Next).
9. Repeat step 1 through step 8 for the remaining relays.
10. Once all four relays have been setup, the display screen will show the following:

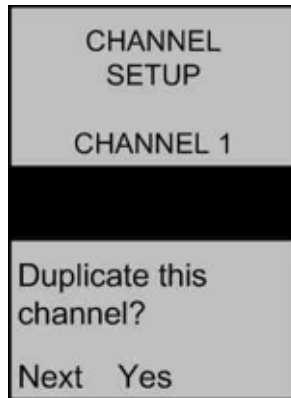

11. Based on the specific application, choose one of the following steps to complete:
 - Press *MENU* (Next) to setup the next channel (or continue to system information)
 - Press *ADD* (Yes) to duplicate the settings to all consecutive channels—and *ADD* (Yes) again to confirm the operation
 - Press *ESC* to exit Setup Mode

View System Information

After the last channel is set, press *MENU* to view the system's information, including the:

- Build Date (Example: 01/01/2011)
- Serial # (Example: H00001)
- Radio (type)
- Radio error

Exiting Setup Mode

Complete the following steps to exit Setup Mode at any time.

1. Press *ESC* at any time to exit Setup Mode.
2. Close the enclosure box.
3. Clamp down the enclosure latches.

NOTE: The AirLink 7010 automatically saves any changes and returns to Normal Operating Mode 15 minutes after the last button press.

Chapter 6: Advanced Configuration Menu

Overview

This mode is used to: adjust LCD contrast, restore factory default settings, set up the fault relay, set up global Modbus parameters, and set up WireFree parameters.

Entering the Advanced Configuration Menu

1. Open the enclosure box to expose the Front Panel.
2. Cycle the unit's power (turn OFF, then ON). For instructions on how to cycle the unit's power, see page 22.
3. When the RKI Logo is shown on the Display Screen, press *MENU*.

NOTE: The AirLink 7010 automatically saves any changes and returns to Normal Operating Mode 15 minutes after the last button press.

Adjusting Contrast

1. Press *ADD* (increase) or *SUB* (decrease) to manipulate the screen's LCD contrast.

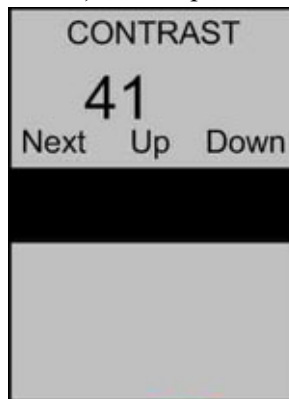

2. Press *MENU*.

Adjusting the Lower Screen's LCD Contrast

1. Press *ADD* (increase) or *SUB* (decrease) to manipulate the lower screen's LCD contrast.

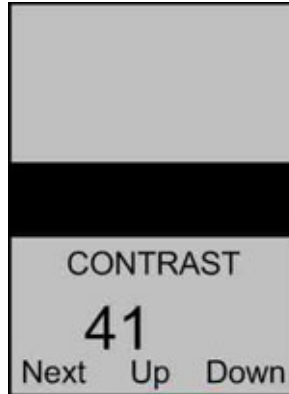

2. Press *MENU*.

Restore Factory Default Settings

1. Press *ADD* or *SUB* (Yes/No—as indicated on the display screen) to set the unit back to the factory's default settings. To leave the settings as they are, press *MENU* (Next).

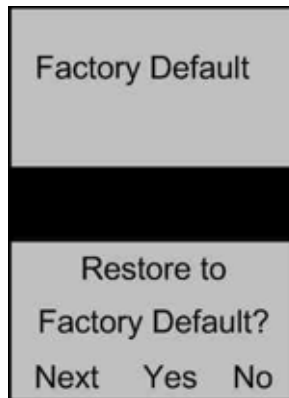

Factory settings are:

- Channels 1-28 set to WireFree
- Channels 29-32 set to Wired
- Relays set at "10, 15, 20 and 25"
- All relays set to "Auto Reset" / "Increasing"
- Modbus Output Baud set at 9600
- Radio Timeout set to 10 minutes
- Network ID set to 5
- Secondary Monitor

Relay Setup

1. Set Fault Relay: Press *ADD* or *SUB* (Yes/No—as indicated on the display screen) to setup Relay 4 as the Fault Relay. To leave the setting as it is, press *MENU* (Next).

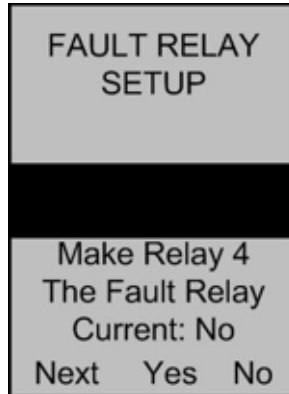

NOTE: With this feature enabled, if any Fault occurs (on any channel) the Fault Relay is engaged. In addition, Relay 4 is removed from all setup options.

2. Failsafe: Press *ADD* or *SUB* (Yes/No—as indicated on the display screen) to setup Relay 1 as failsafe (or not failsafe). To leave the setting as it is, press *MENU* (Next).

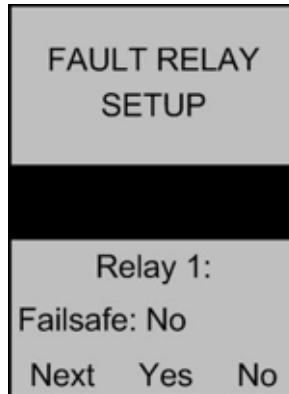

3. Repeat step 2 for Relays 2, 3, and 4.
4. Fault Terminal Failsafe: Press *ADD* or *SUB* (Yes/No—as indicated on the display screen) to setup the Fault terminal as failsafe (or not failsafe). To leave the setting as it is, press *MENU* (Next).

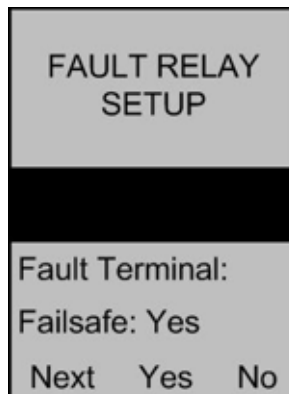

Modbus Setup

1. Global Modbus Address: Press *ADD* (increase) or *SUB* (decrease) to manipulate the global Modbus Address setting (between 1 and 247).

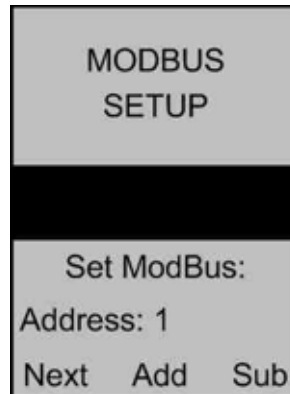

2. Press *MENU* (Next).
3. Global Baud: Press *ADD* (increase) or *SUB* (decrease) to manipulate the global Baud setting to: 4800, 9600, or 19200.

NOTE: Baud default is 9600.

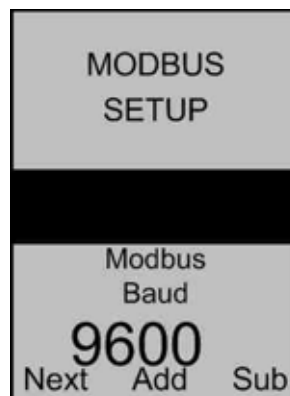

4. Press *MENU* (Next).

WireFree Setup

1. Radio Timeout: Press *ADD* (increase) or *SUB* (decrease) to manipulate the Radio Timeout setting (between 6 and 255 minutes).

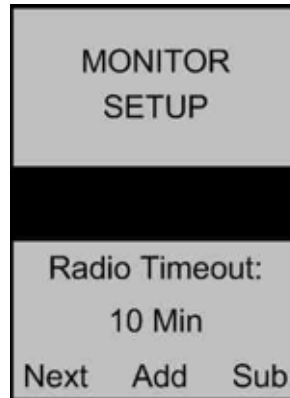

2. Press *MENU* (Next).
3. Network Channel: Press *ADD* (increase) or *SUB* (decrease) to manipulate the Network Channel setting (between 1 and 52 for 900 MHz networks; between 1 and 78 for 2.4 GHz networks).

NOTE: All monitors and sensor assemblies must have the same Network Channel in order to communicate.

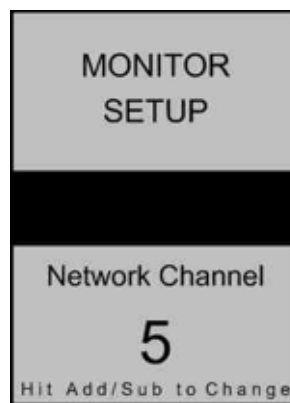

4. Press *MENU* (Next).
5. Primary/Secondary: Press *ADD* or *SUB* to switch the monitor to “Primary” or “Secondary”.

NOTE: There can only be one Primary monitor on a network. All other monitors must be set up as Secondary monitors.

If an AirLink 7010 is set as a Secondary monitor when there is no Primary monitor, the AirLink 7010 will go into a Fault 15 status. The POWER/STATUS LED will be green if the monitor becomes the Primary monitor; otherwise the POWER/STATUS LED will be blue.

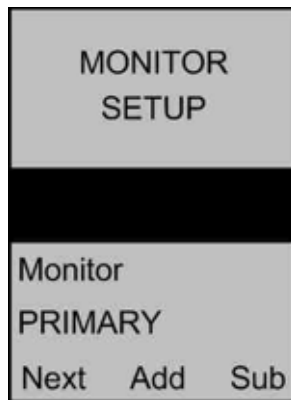

6. Press *MENU* (Next) to return to Normal Operating Mode.

Exiting the Advanced Configuration Menu

1. Press *ESC* at any time to exit the Advanced Configuration Menu.
2. Close the enclosure box.
3. Clamp down the enclosure latches.

NOTE: The AirLink 7010 automatically saves any changes and returns to Normal Operating Mode 15 minutes after the last button press.

Chapter 7: Maintenance

Calibration Mode

Entering Calibration Mode disables the relays and allows the sensors to be calibrated without triggering alarms. Once in Calibration Mode, the unit will remain in this state for two hours—unless *RESET/ESC* is pressed.

1. Open the enclosure box to expose the Front Panel.
2. To enter Calibration Mode, from Normal Operating Mode, press and hold *MENU* for 5 seconds.
3. Once in Calibration Mode, the display screen will show “CAL” on the upper right side.

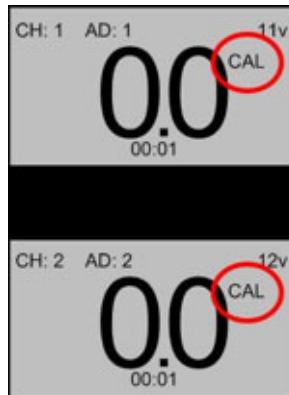

4. To return to Normal Operating Mode, press *RESET/ESC*.

NOTE: If *RESET/ESC* is not pressed, the unit will remain in Calibration Mode for two hours.

5. Close the enclosure box.
6. Clamp down the enclosure latches.

Relay Test Mode

Relay Test Mode activates each relay and can be used to determine whether or not the relays and attached alarms are functioning properly.

1. Open the enclosure box to expose the Front Panel.
2. To enter Relay Test Mode, from Normal Operating Mode, press and hold *RESET/ESC*.
3. Starting with Relay 1, the relays will activate in 5-second intervals.
4. To return to Normal Operating Mode, release and press *RESET/ESC*.
5. Close the enclosure box.
6. Clamp down the enclosure latches.

Troubleshooting

Table 2 describes symptoms, probable causes, and recommended actions for the most common problems you may encounter with the AirLink 7010.

NOTE: This troubleshooting guide describes AirLink 7010 problems only. See the detector head operator's manuals for preventive maintenance procedures that apply to the detector heads installed on your AirLink 7010.

Table 2: Troubleshooting the AirLink 7010

Condition	Probable Causes	Recommended Action
F1 (Only for T3A/VOC Pro with Radio)	The top card has lost communication with the digital sensor board (the board potted into the sensor housing).	1. Check the connections and/or try new digital sensor board.
F3 (battery powered detector only)	The Low Power IR sensor is beyond repair.	1. Replace the IR sensor.
F4	<ul style="list-style-type: none"> The top card is losing communication to the analog sensor board On T3A/VOC Pro units, F4 means that the Analog to Digital Conversion (ADC) on the analog sensor board is not communicating to the digital sensor board. On the AirLink 6900, F4 means the top card is not communicating with the analog sensor board. For IR sensors, the sensor element itself could be the issue. Also, there might not be an issue because sometimes sensor assemblies will show F4 for a few seconds after boot up. This is normal and is due to the boot up of the sensor element itself. 	<ol style="list-style-type: none"> Check the orientation of the analog sensor board and/or try a new analog sensor board. Check the connections from the top card all the way to the analog sensor board. If that does not fix the fault, try replacing the analog sensor board and/or the sensor housing.
F5	The sensor assembly did not zero correctly.	<ol style="list-style-type: none"> Confirm that no gas is present. Replace the sensor.
F6	The sensor assembly did not auto cal correctly.	<ol style="list-style-type: none"> Confirm the gas concentration is correct and that it is flowing to the sensor. Replace the sensor.

Table 2: Troubleshooting the AirLink 7010 (Continued)

Condition	Probable Causes	Recommended Action
F8	There are 2 sensor assemblies with the same address trying to communicate with the monitor.	1. Make sure all sensor assemblies have unique addresses.
F9	The monitor has not received a communication from the faulting sensor assembly address for the timeout period set on page 36.	1. Check the sensor assembly for a dead battery, broken antenna, bad antenna cable, missing antenna, obstacle, weather, etc.
F10 (4-20 mA wired detector only)	When using a monitor with wired sensor assemblies attached, the sensor is not communicating with the monitor. The problem could be that the sensor assembly is not connected properly, or there may be board issues with the sensor or monitor.	1. Check all connections. Use a current meter inline to see if the current is correct.
F11 (battery powered detector only)	The IR sensor is changing temperature too quickly.	1. The sensor will clear once the temperature stops changing too quickly.
F13 (4-20 mA wired detector only)	When using a monitor with a 4-20mA wired connection, F13 may appear when the sensor assembly is in a fault condition.	1. Since it is 4-20mA, the monitor does not know the exact fault condition. Therefore, check the sensor assembly to see what the fault is and then consult other items in this chart for a solution.

Chapter 8: Parts List

Table 3 lists the part numbers and descriptions for replacement parts and accessories offered for the AirLink 7010 Gas Monitor.

Table 3: Parts List, AirLink 7010 Gas Monitor

Part No.	Description
18-0107RK	Conduit hub (3/4 in.)
51-0040-RED	Strobe/horn, 20 - 28 VDC, Cl. I Div. 1 Zone 1
71-0537	AirLink 7010 Gas Monitor Operator's Manual (this document)

Appendix A: Relay Operation

Relays are offered in certain RKI devices for the purpose of activating alarms, horns, and other equipment upon the detection of gas.

There are two key terms to remember when using relays.

- Deactivated: refers to a relay in its normal state
- Activated: refers to a relay in an alarm state

“Dry” Contact and “Wet” Contact Relays

In regard to power, there are two types of relays.

1. Dry Contact Relays: This type of relay does not provide power to the equipment attached to it (i.e. if there is a light hooked up to this type of relay, it must be powered by another source).
2. Wet Contact Relays: This type of relay does provide power to the equipment attached to it (i.e. if a light was hooked up to this type of relay, it would be powered by the relay). When using a Wet Contact Relay, power should run through the “COMM” terminal to the end equipment.

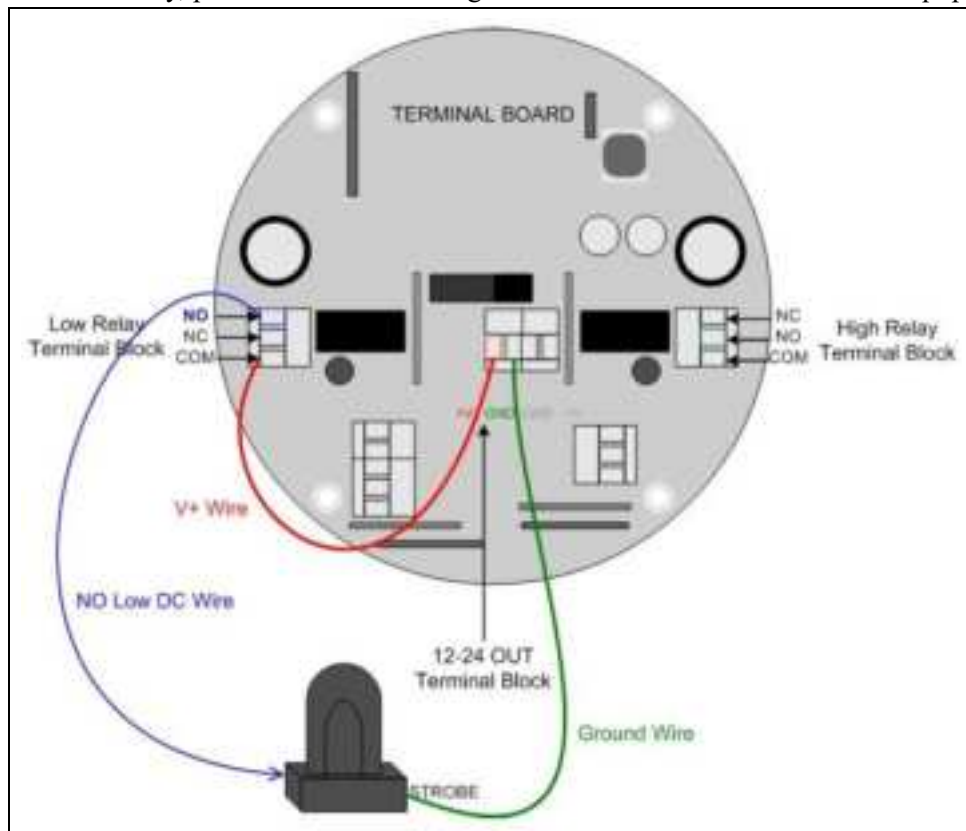

Figure 13: “Dry” Contact Relay Configured as a “Wet” Contact

Failsafe Setting's Effect on Normally-Open/Normally-Closed Contacts

If Failsafe is set to No, the relays are de-energized in normal operation and energize when the appropriate alarm circuit is activated. The NO (normally open) relay contacts are open during non-alarm operation and close when the appropriate alarm condition occurs. The NC (normally closed) relay contacts are closed during non-alarm operation and open when the appropriate alarm condition occurs.

If Failsafe is set to Yes, the relays are energized in normal operation and de-energize when the appropriate alarm circuit is activated. The NO (normally open) relay contacts are closed during non-alarm operation and open when the appropriate alarm condition occurs. The NC (normally closed) relay contacts are open during non-alarm operation and close when the appropriate alarm condition occurs.

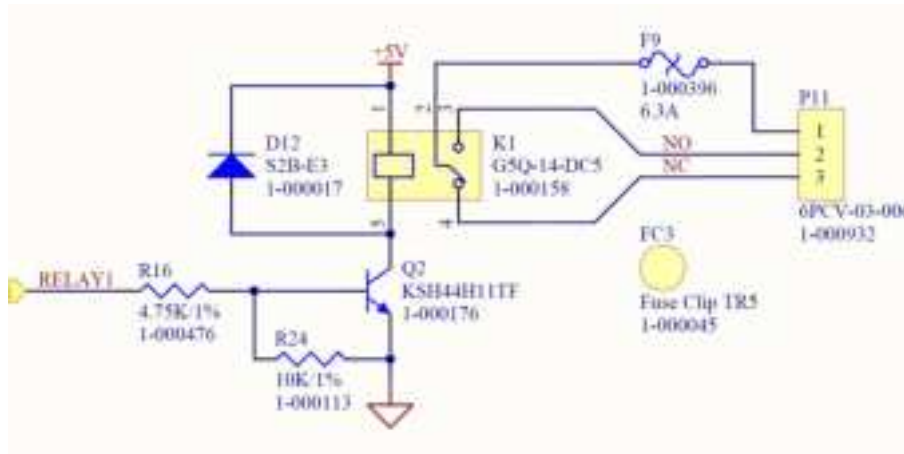

Figure 14: Relay Circuit Schematic

Appendix B: Introduction to 4-20 mA Current Loop Signals

This appendix is only an introduction. The information should serve as a brief overview of 4-20 mA current loop signal ranges and should not be considered a complete reference for proper implementation or use.

Industry standards pertaining to 4-20 mA current loop signals and other aspects of electronics are assumed to be known by the technician. For proper connection to a controller or Programmable Logic Controller (PLC), refer to the manufacturer's specific manual or instructions for that device.

Overview

When using 4-20 mA wired output signal devices, the 4-20 mA defines the current loop analog signal range, with 4 mA representing the lowest end of the range and 20 mA the highest. The relationship between the current loop and the gas value is linear. In addition, the VOC Pro uses values below 4 mA to indicate special status conditions, as shown below:

4-20 mA Ranges	
Current	Detector Status
2.5 mA	Sensor Fault
3 mA	Sensor in Menu Mode
3.5 mA	Sensor in Calibration Mode

The 4 mA allows the receiving controller/PLC to distinguish between a zero signal, a broken wire, or an unresponsive instrument. Benefits of 4-20 mA convention are that it is: an industry standard, low-cost to implement, can reject some forms of electrical noise, and the signal does not change value around the "loop" (as opposed to voltage). The key advantage of the current loop is that the accuracy of the signal is not affected by a potential voltage drop in the interconnected wiring. Even with significant resistance in the line, the current loop VOC Pro will maintain the proper current for the device, up to its maximum voltage capability.

Only one current level can be present at any time. Each device that operates via a 4-20 mA current loop signal must be wired directly to the controller. Units that are wired in a daisy chain configuration for the 4-20 mA current loop signal will not properly transmit data communications to the controller.

Calculations

$$I_{(4-20)} = \left(\frac{(16)(\text{value})}{\text{scale}} \right) + 4$$

$I_{(4-20)}$ = Current of loop, measured in mA

value = ppm (or %) of gas concentration

scale = full scale of sensor

Measuring Current

If the value measured is 0 mA, then: the loop wires are broken, the sensor assembly is not powered up, the sensor assembly is malfunctioning, or the controller is malfunctioning. A digital multi-meter (DMM), or current meter, may be used in conjunction with the controller and/or to test the 4-20 mA current loop signal. To measure the current, place the meter probes in line with the current loop.

Appendix C: RS-485 Modbus Output

Modbus Terms

Modbus: RTU

Setting: Baud Rate = 9600

Data Bits: 8

Parity: None

Stop Bits: 1

Time Out: 1000 ms

Device Address: 1-247

Data Type: Holding Registers

Start Address: The first register the user would like to view (must be between 1-255)

Length: Depends on the number of addresses the user would like to view

Scan Rate: 1000 ms

Data Format: Hex, Decimal, Float

Register Map

AirLink 7010 Modbus Register Map

Register Address (Hexadecimal)	Register Address (Decimal)	Data Description	R/W	Length (In Bits)	Units	Valid Response
Radio Data						
1	1	Channel 1 Radio Address	R/W	16	INTEGER	Radio Address (1-255)
2	2	Channel 2 Radio Address	R/W	16	INTEGER	Radio Address (1-255)
3	3	Channel 3 Radio Address	R/W	16	INTEGER	Radio Address (1-255)
4	4	Channel 4 Radio Address	R/W	16	INTEGER	Radio Address (1-255)
5	5	Channel 5 Radio Address	R/W	16	INTEGER	Radio Address (1-255)
6	6	Channel 6 Radio Address	R/W	16	INTEGER	Radio Address (1-255)
7	7	Channel 7 Radio Address	R/W	16	INTEGER	Radio Address (1-255)
8	8	Channel 8 Radio Address	R/W	16	INTEGER	Radio Address (1-255)
9	9	Channel 9 Radio Address	R/W	16	INTEGER	Radio Address (1-255)
A	10	Channel 10 Radio Address	R/W	16	INTEGER	Radio Address (1-255)
B	11	Channel 11 Radio Address	R/W	16	INTEGER	Radio Address (1-255)
C	12	Channel 12 Radio Address	R/W	16	INTEGER	Radio Address (1-255)
D	13	Channel 13 Radio Address	R/W	16	INTEGER	Radio Address (1-255)
E	14	Channel 14 Radio Address	R/W	16	INTEGER	Radio Address (1-255)
F	15	Channel 15 Radio Address	R/W	16	INTEGER	Radio Address (1-255)
10	16	Channel 16 Radio Address	R/W	16	INTEGER	Radio Address (1-255)
11	17	Channel 17 Radio Address	R/W	16	INTEGER	Radio Address (1-255)
12	18	Channel 18 Radio Address	R/W	16	INTEGER	Radio Address (1-255)
13	19	Channel 19 Radio Address	R/W	16	INTEGER	Radio Address (1-255)
14	20	Channel 20 Radio Address	R/W	16	INTEGER	Radio Address (1-255)
15	21	Channel 21 Radio Address	R/W	16	INTEGER	Radio Address (1-255)
16	22	Channel 22 Radio Address	R/W	16	INTEGER	Radio Address (1-255)
17	23	Channel 23 Radio Address	R/W	16	INTEGER	Radio Address (1-255)
18	24	Channel 24 Radio Address	R/W	16	INTEGER	Radio Address (1-255)
19	25	Channel 25 Radio Address	R/W	16	INTEGER	Radio Address (1-255)
1A	26	Channel 26 Radio Address	R/W	16	INTEGER	Radio Address (1-255)
1B	27	Channel 27 Radio Address	R/W	16	INTEGER	Radio Address (1-255)
1C	28	Channel 28 Radio Address	R/W	16	INTEGER	Radio Address (1-255)
1D	29	Channel 29 Radio Address	R/W	16	INTEGER	Radio Address (1-255)
1E	30	Channel 30 Radio Address	R/W	16	INTEGER	Radio Address (1-255)
1F	31	Channel 31 Radio Address	R/W	16	INTEGER	Radio Address (1-255)
20	32	Channel 32 Radio Address	R/W	16	INTEGER	Radio Address (1-255)
21	33	Channel 1 Reading	R	32	FLOAT	Any valid sensor reading
23	35	Channel 2 Reading	R	32	FLOAT	Any valid sensor reading

25	37	Channel 3 Reading	R	32	FLOAT	Any valid sensor reading
27	39	Channel 4 Reading	R	32	FLOAT	Any valid sensor reading
29	41	Channel 5 Reading	R	32	FLOAT	Any valid sensor reading
2B	43	Channel 6 Reading	R	32	FLOAT	Any valid sensor reading
2D	45	Channel 7 Reading	R	32	FLOAT	Any valid sensor reading
2F	47	Channel 8 Reading	R	32	FLOAT	Any valid sensor reading
31	49	Channel 9 Reading	R	32	FLOAT	Any valid sensor reading
33	51	Channel 10 Reading	R	32	FLOAT	Any valid sensor reading
35	53	Channel 11 Reading	R	32	FLOAT	Any valid sensor reading
37	55	Channel 12 Reading	R	32	FLOAT	Any valid sensor reading
39	57	Channel 13 Reading	R	32	FLOAT	Any valid sensor reading
3B	59	Channel 14 Reading	R	32	FLOAT	Any valid sensor reading
3D	61	Channel 15 Reading	R	32	FLOAT	Any valid sensor reading
3F	63	Channel 16 Reading	R	32	FLOAT	Any valid sensor reading
41	65	Channel 17 Reading	R	32	FLOAT	Any valid sensor reading
43	67	Channel 18 Reading	R	32	FLOAT	Any valid sensor reading
45	69	Channel 19 Reading	R	32	FLOAT	Any valid sensor reading
47	71	Channel 20 Reading	R	32	FLOAT	Any valid sensor reading
49	73	Channel 21 Reading	R	32	FLOAT	Any valid sensor reading
4B	75	Channel 22 Reading	R	32	FLOAT	Any valid sensor reading
4D	77	Channel 23 Reading	R	32	FLOAT	Any valid sensor reading
4F	79	Channel 24 Reading	R	32	FLOAT	Any valid sensor reading
51	81	Channel 25 Reading	R	32	FLOAT	Any valid sensor reading
53	83	Channel 26 Reading	R	32	FLOAT	Any valid sensor reading
55	85	Channel 27 Reading	R	32	FLOAT	Any valid sensor reading
57	87	Channel 28 Reading	R	32	FLOAT	Any valid sensor reading
59	89	Channel 29 Reading	R	32	FLOAT	Any valid sensor reading
5B	91	Channel 30 Reading	R	32	FLOAT	Any valid sensor reading
5D	93	Channel 31 Reading	R	32	FLOAT	Any valid sensor reading
5F	95	Channel 32 Reading	R	32	FLOAT	Any valid sensor reading
61	97	Channel 1 Mode	R	16	ENUMERATION	0-7 See Mode Enumeration Below
62	98	Channel 2 Mode	R	16	ENUMERATION	0-7 See Mode Enumeration Below
63	99	Channel 3 Mode	R	16	ENUMERATION	0-7 See Mode Enumeration Below
64	100	Channel 4 Mode	R	16	ENUMERATION	0-7 See Mode Enumeration Below
65	101	Channel 5 Mode	R	16	ENUMERATION	0-7 See Mode Enumeration Below
66	102	Channel 6 Mode	R	16	ENUMERATION	0-7 See Mode Enumeration Below
67	103	Channel 7 Mode	R	16	ENUMERATION	0-7 See Mode Enumeration Below
68	104	Channel 8 Mode	R	16	ENUMERATION	0-7 See Mode Enumeration Below
69	105	Channel 9 Mode	R	16	ENUMERATION	0-7 See Mode Enumeration Below
6A	106	Channel 10 Mode	R	16	ENUMERATION	0-7 See Mode Enumeration Below
6B	107	Channel 11 Mode	R	16	ENUMERATION	0-7 See Mode Enumeration Below
6C	108	Channel 12 Mode	R	16	ENUMERATION	0-7 See Mode Enumeration Below

6D	109	Channel 13 Mode	R	16	ENUMERATION	0-7 See Mode Enumeration Below
6E	110	Channel 14 Mode	R	16	ENUMERATION	0-7 See Mode Enumeration Below
6F	111	Channel 15 Mode	R	16	ENUMERATION	0-7 See Mode Enumeration Below
70	112	Channel 16 Mode	R	16	ENUMERATION	0-7 See Mode Enumeration Below
71	113	Channel 17 Mode	R	16	ENUMERATION	0-7 See Mode Enumeration Below
72	114	Channel 18 Mode	R	16	ENUMERATION	0-7 See Mode Enumeration Below
73	115	Channel 19 Mode	R	16	ENUMERATION	0-7 See Mode Enumeration Below
74	116	Channel 20 Mode	R	16	ENUMERATION	0-7 See Mode Enumeration Below
75	117	Channel 21 Mode	R	16	ENUMERATION	0-7 See Mode Enumeration Below
76	118	Channel 22 Mode	R	16	ENUMERATION	0-7 See Mode Enumeration Below
77	119	Channel 23 Mode	R	16	ENUMERATION	0-7 See Mode Enumeration Below
78	120	Channel 24 Mode	R	16	ENUMERATION	0-7 See Mode Enumeration Below
79	121	Channel 25 Mode	R	16	ENUMERATION	0-7 See Mode Enumeration Below
7A	122	Channel 26 Mode	R	16	ENUMERATION	0-7 See Mode Enumeration Below
7B	123	Channel 27 Mode	R	16	ENUMERATION	0-7 See Mode Enumeration Below
7C	124	Channel 28 Mode	R	16	ENUMERATION	0-7 See Mode Enumeration Below
7D	125	Channel 29 Mode	R	16	ENUMERATION	0-7 See Mode Enumeration Below
7E	126	Channel 30 Mode	R	16	ENUMERATION	0-7 See Mode Enumeration Below
7F	127	Channel 31 Mode	R	16	ENUMERATION	0-7 See Mode Enumeration Below
80	128	Channel 32 Mode	R	16	ENUMERATION	0-7 See Mode Enumeration Below
81	129	Channel 1 Battery	R	32	FLOAT	Sensor Input Voltage(>= 0.0)
83	131	Channel 2 Battery	R	32	FLOAT	Sensor Input Voltage(>= 0.0)
85	133	Channel 3 Battery	R	32	FLOAT	Sensor Input Voltage(>= 0.0)
87	135	Channel 4 Battery	R	32	FLOAT	Sensor Input Voltage(>= 0.0)
89	137	Channel 5 Battery	R	32	FLOAT	Sensor Input Voltage(>= 0.0)
8B	139	Channel 6 Battery	R	32	FLOAT	Sensor Input Voltage(>= 0.0)
8D	141	Channel 7 Battery	R	32	FLOAT	Sensor Input Voltage(>= 0.0)
8F	143	Channel 8 Battery	R	32	FLOAT	Sensor Input Voltage(>= 0.0)
91	145	Channel 9 Battery	R	32	FLOAT	Sensor Input Voltage(>= 0.0)
93	147	Channel 10 Battery	R	32	FLOAT	Sensor Input Voltage(>= 0.0)
95	149	Channel 11 Battery	R	32	FLOAT	Sensor Input Voltage(>= 0.0)
97	151	Channel 12 Battery	R	32	FLOAT	Sensor Input Voltage(>= 0.0)
99	153	Channel 13 Battery	R	32	FLOAT	Sensor Input Voltage(>= 0.0)
9B	155	Channel 14 Battery	R	32	FLOAT	Sensor Input Voltage(>= 0.0)
9D	157	Channel 15 Battery	R	32	FLOAT	Sensor Input Voltage(>= 0.0)
9F	159	Channel 16 Battery	R	32	FLOAT	Sensor Input Voltage(>= 0.0)
A1	161	Channel 17 Battery	R	32	FLOAT	Sensor Input Voltage(>= 0.0)
A3	163	Channel 18 Battery	R	32	FLOAT	Sensor Input Voltage(>= 0.0)
A5	165	Channel 19 Battery	R	32	FLOAT	Sensor Input Voltage(>= 0.0)
A7	167	Channel 20 Battery	R	32	FLOAT	Sensor Input Voltage(>= 0.0)
A9	169	Channel 21 Battery	R	32	FLOAT	Sensor Input Voltage(>= 0.0)
AB	171	Channel 22 Battery	R	32	FLOAT	Sensor Input Voltage(>= 0.0)

AD	173	Channel 23 Battery	R	32	FLOAT	Sensor Input Voltage(>= 0.0)
AF	175	Channel 24 Battery	R	32	FLOAT	Sensor Input Voltage(>= 0.0)
B1	177	Channel 25 Battery	R	32	FLOAT	Sensor Input Voltage(>= 0.0)
B3	179	Channel 26 Battery	R	32	FLOAT	Sensor Input Voltage(>= 0.0)
B5	181	Channel 27 Battery	R	32	FLOAT	Sensor Input Voltage(>= 0.0)
B7	183	Channel 28 Battery	R	32	FLOAT	Sensor Input Voltage(>= 0.0)
B9	185	Channel 29 Battery	R	32	FLOAT	Sensor Input Voltage(>= 0.0)
BB	187	Channel 30 Battery	R	32	FLOAT	Sensor Input Voltage(>= 0.0)
BD	189	Channel 31 Battery	R	32	FLOAT	Sensor Input Voltage(>= 0.0)
BF	191	Channel 32 Battery	R	32	FLOAT	Sensor Input Voltage(>= 0.0)
C1	193	Channel 1 Sec Since Last Message	R	16	INTEGER	-1-32768 Seconds, -1 = no transmissions. Staying 0 = timeout
C2	194	Channel 2 Sec Since Last Message	R	16	INTEGER	-1-32768 Seconds, -1 = no transmissions. Staying 0 = timeout
C3	195	Channel 3 Sec Since Last Message	R	16	INTEGER	-1-32768 Seconds, -1 = no transmissions. Staying 0 = timeout
C4	196	Channel 4 Sec Since Last Message	R	16	INTEGER	-1-32768 Seconds, -1 = no transmissions. Staying 0 = timeout
C5	197	Channel 5 Sec Since Last Message	R	16	INTEGER	-1-32768 Seconds, -1 = no transmissions. Staying 0 = timeout
C6	198	Channel 6 Sec Since Last Message	R	16	INTEGER	-1-32768 Seconds, -1 = no transmissions. Staying 0 = timeout
C7	199	Channel 7 Sec Since Last Message	R	16	INTEGER	-1-32768 Seconds, -1 = no transmissions. Staying 0 = timeout
C8	200	Channel 8 Sec Since Last Message	R	16	INTEGER	-1-32768 Seconds, -1 = no transmissions. Staying 0 = timeout
C9	201	Channel 9 Sec Since Last Message	R	16	INTEGER	-1-32768 Seconds, -1 = no transmissions. Staying 0 = timeout
CA	202	Channel 10 Sec Since Last Message	R	16	INTEGER	-1-32768 Seconds, -1 = no transmissions. Staying 0 = timeout
CB	203	Channel 11 Sec Since Last Message	R	16	INTEGER	-1-32768 Seconds, -1 = no transmissions. Staying 0 = timeout
CC	204	Channel 12 Sec Since Last Message	R	16	INTEGER	-1-32768 Seconds, -1 = no transmissions. Staying 0 = timeout
CD	205	Channel 13 Sec Since Last Message	R	16	INTEGER	-1-32768 Seconds, -1 = no transmissions. Staying 0 = timeout
CE	206	Channel 14 Sec Since Last Message	R	16	INTEGER	-1-32768 Seconds, -1 = no transmissions. Staying 0 = timeout
CF	207	Channel 15 Sec Since Last Message	R	16	INTEGER	-1-32768 Seconds, -1 = no transmissions. Staying 0 = timeout
D0	208	Channel 16 Sec Since Last Message	R	16	INTEGER	-1-32768 Seconds, -1 = no transmissions. Staying 0 = timeout
D1	209	Channel 17 Sec Since Last Message	R	16	INTEGER	-1-32768 Seconds, -1 = no transmissions. Staying 0 = timeout
D2	210	Channel 18 Sec Since Last Message	R	16	INTEGER	-1-32768 Seconds, -1 = no transmissions. Staying 0 = timeout
D3	211	Channel 19 Sec Since Last Message	R	16	INTEGER	-1-32768 Seconds, -1 = no transmissions. Staying 0 = timeout
D4	212	Channel 20 Sec Since Last Message	R	16	INTEGER	-1-32768 Seconds, -1 = no transmissions. Staying 0 = timeout
D5	213	Channel 21 Sec Since Last Message	R	16	INTEGER	-1-32768 Seconds, -1 = no transmissions. Staying 0 = timeout
D6	214	Channel 22 Sec Since Last Message	R	16	INTEGER	-1-32768 Seconds, -1 = no transmissions. Staying 0 = timeout
D7	215	Channel 23 Sec Since Last Message	R	16	INTEGER	-1-32768 Seconds, -1 = no transmissions. Staying 0 = timeout
D8	216	Channel 24 Sec Since Last Message	R	16	INTEGER	-1-32768 Seconds, -1 = no transmissions. Staying 0 = timeout
D9	217	Channel 25 Sec Since Last Message	R	16	INTEGER	-1-32768 Seconds, -1 = no transmissions. Staying 0 = timeout
DA	218	Channel 26 Sec Since Last Message	R	16	INTEGER	-1-32768 Seconds, -1 = no transmissions. Staying 0 = timeout
DB	219	Channel 27 Sec Since Last Message	R	16	INTEGER	-1-32768 Seconds, -1 = no transmissions. Staying 0 = timeout
DC	220	Channel 28 Sec Since Last Message	R	16	INTEGER	-1-32768 Seconds, -1 = no transmissions. Staying 0 = timeout
DD	221	Channel 29 Sec Since Last Message	R	16	INTEGER	-1-32768 Seconds, -1 = no transmissions. Staying 0 = timeout
DE	222	Channel 30 Sec Since Last Message	R	16	INTEGER	-1-32768 Seconds, -1 = no transmissions. Staying 0 = timeout
DF	223	Channel 31 Sec Since Last Message	R	16	INTEGER	-1-32768 Seconds, -1 = no transmissions. Staying 0 = timeout
E0	224	Channel 32 Sec Since Last Message	R	16	INTEGER	-1-32768 Seconds, -1 = no transmissions. Staying 0 = timeout

E1	225	Channel 1 Sensor Type	R	16	ENUMERATION	0-31	See Sensor Type Enumeration Below
E2	226	Channel 2 Sensor Type	R	16	ENUMERATION	0-31	See Sensor Type Enumeration Below
E3	227	Channel 3 Sensor Type	R	16	ENUMERATION	0-31	See Sensor Type Enumeration Below
E4	228	Channel 4 Sensor Type	R	16	ENUMERATION	0-31	See Sensor Type Enumeration Below
E5	229	Channel 5 Sensor Type	R	16	ENUMERATION	0-31	See Sensor Type Enumeration Below
E6	230	Channel 6 Sensor Type	R	16	ENUMERATION	0-31	See Sensor Type Enumeration Below
E7	231	Channel 7 Sensor Type	R	16	ENUMERATION	0-31	See Sensor Type Enumeration Below
E8	232	Channel 8 Sensor Type	R	16	ENUMERATION	0-31	See Sensor Type Enumeration Below
E9	233	Channel 9 Sensor Type	R	16	ENUMERATION	0-31	See Sensor Type Enumeration Below
EA	234	Channel 10 Sensor Type	R	16	ENUMERATION	0-31	See Sensor Type Enumeration Below
EB	235	Channel 11 Sensor Type	R	16	ENUMERATION	0-31	See Sensor Type Enumeration Below
EC	236	Channel 12 Sensor Type	R	16	ENUMERATION	0-31	See Sensor Type Enumeration Below
ED	237	Channel 13 Sensor Type	R	16	ENUMERATION	0-31	See Sensor Type Enumeration Below
EE	238	Channel 14 Sensor Type	R	16	ENUMERATION	0-31	See Sensor Type Enumeration Below
EF	239	Channel 15 Sensor Type	R	16	ENUMERATION	0-31	See Sensor Type Enumeration Below
F0	240	Channel 16 Sensor Type	R	16	ENUMERATION	0-31	See Sensor Type Enumeration Below
F1	241	Channel 17 Sensor Type	R	16	ENUMERATION	0-31	See Sensor Type Enumeration Below
F2	242	Channel 18 Sensor Type	R	16	ENUMERATION	0-31	See Sensor Type Enumeration Below
F3	243	Channel 19 Sensor Type	R	16	ENUMERATION	0-31	See Sensor Type Enumeration Below
F4	244	Channel 20 Sensor Type	R	16	ENUMERATION	0-31	See Sensor Type Enumeration Below
F5	245	Channel 21 Sensor Type	R	16	ENUMERATION	0-31	See Sensor Type Enumeration Below
F6	246	Channel 22 Sensor Type	R	16	ENUMERATION	0-31	See Sensor Type Enumeration Below
F7	247	Channel 23 Sensor Type	R	16	ENUMERATION	0-31	See Sensor Type Enumeration Below
F8	248	Channel 24 Sensor Type	R	16	ENUMERATION	0-31	See Sensor Type Enumeration Below
F9	249	Channel 25 Sensor Type	R	16	ENUMERATION	0-31	See Sensor Type Enumeration Below
FA	250	Channel 26 Sensor Type	R	16	ENUMERATION	0-31	See Sensor Type Enumeration Below
FB	251	Channel 27 Sensor Type	R	16	ENUMERATION	0-31	See Sensor Type Enumeration Below
FC	252	Channel 28 Sensor Type	R	16	ENUMERATION	0-31	See Sensor Type Enumeration Below
FD	253	Channel 29 Sensor Type	R	16	ENUMERATION	0-31	See Sensor Type Enumeration Below
FE	254	Channel 30 Sensor Type	R	16	ENUMERATION	0-31	See Sensor Type Enumeration Below
FF	255	Channel 31 Sensor Type	R	16	ENUMERATION	0-31	See Sensor Type Enumeration Below
100	256	Channel 32 Sensor Type	R	16	ENUMERATION	0-31	See Sensor Type Enumeration Below
101	257	Channel 1 Gas Type	R	16	ENUMERATION	0-127	See Gas Enumeration below
102	258	Channel 2 Gas Type	R	16	ENUMERATION	0-127	See Gas Enumeration below
103	259	Channel 3 Gas Type	R	16	ENUMERATION	0-127	See Gas Enumeration below
104	260	Channel 4 Gas Type	R	16	ENUMERATION	0-127	See Gas Enumeration below
105	261	Channel 5 Gas Type	R	16	ENUMERATION	0-127	See Gas Enumeration below
106	262	Channel 6 Gas Type	R	16	ENUMERATION	0-127	See Gas Enumeration below
107	263	Channel 7 Gas Type	R	16	ENUMERATION	0-127	See Gas Enumeration below
108	264	Channel 8 Gas Type	R	16	ENUMERATION	0-127	See Gas Enumeration below
109	265	Channel 9 Gas Type	R	16	ENUMERATION	0-127	See Gas Enumeration below
10A	266	Channel 10 Gas Type	R	16	ENUMERATION	0-127	See Gas Enumeration below

10B	267	Channel 11 Gas Type	R	16	ENUMERATION	0-127 See Gas Enumeration below
10C	268	Channel 12 Gas Type	R	16	ENUMERATION	0-127 See Gas Enumeration below
10D	269	Channel 13 Gas Type	R	16	ENUMERATION	0-127 See Gas Enumeration below
10E	270	Channel 14 Gas Type	R	16	ENUMERATION	0-127 See Gas Enumeration below
10F	271	Channel 15 Gas Type	R	16	ENUMERATION	0-127 See Gas Enumeration below
110	272	Channel 16 Gas Type	R	16	ENUMERATION	0-127 See Gas Enumeration below
111	273	Channel 17 Gas Type	R	16	ENUMERATION	0-127 See Gas Enumeration below
112	274	Channel 18 Gas Type	R	16	ENUMERATION	0-127 See Gas Enumeration below
113	275	Channel 19 Gas Type	R	16	ENUMERATION	0-127 See Gas Enumeration below
114	276	Channel 20 Gas Type	R	16	ENUMERATION	0-127 See Gas Enumeration below
115	277	Channel 21 Gas Type	R	16	ENUMERATION	0-127 See Gas Enumeration below
116	278	Channel 22 Gas Type	R	16	ENUMERATION	0-127 See Gas Enumeration below
117	279	Channel 23 Gas type	R	16	ENUMERATION	0-127 See Gas Enumeration below
118	280	Channel 24 Gas Type	R	16	ENUMERATION	0-127 See Gas Enumeration below
119	281	Channel 25 Gas Type	R	16	ENUMERATION	0-127 See Gas Enumeration below
11A	282	Channel 26 Gas Type	R	16	ENUMERATION	0-127 See Gas Enumeration below
11B	283	Channel 27 Gas Type	R	16	ENUMERATION	0-127 See Gas Enumeration below
11C	284	Channel 28 Gas Type	R	16	ENUMERATION	0-127 See Gas Enumeration below
11D	285	Channel 29 Gas Type	R	16	ENUMERATION	0-127 See Gas Enumeration below
11E	286	Channel 30 Gas Type	R	16	ENUMERATION	0-127 See Gas Enumeration below
11F	287	Channel 31 Gas Type	R	16	ENUMERATION	0-127 See Gas Enumeration below
120	288	Channel 32 Gas Type	R	16	ENUMERATION	0-127 See Gas Enumeration below
121	289	Channel 1 Fault	R	16	ENUMERATION	0-15 See Fault Enumeration below
122	290	Channel 2 Fault	R	16	ENUMERATION	0-15 See Fault Enumeration below
123	291	Channel 3 Fault	R	16	ENUMERATION	0-15 See Fault Enumeration below
124	292	Channel 4 Fault	R	16	ENUMERATION	0-15 See Fault Enumeration below
125	293	Channel 5 Fault	R	16	ENUMERATION	0-15 See Fault Enumeration below
126	294	Channel 6 Fault	R	16	ENUMERATION	0-15 See Fault Enumeration below
127	295	Channel 7 Fault	R	16	ENUMERATION	0-15 See Fault Enumeration below
128	296	Channel 8 Fault	R	16	ENUMERATION	0-15 See Fault Enumeration below
129	297	Channel 9 Fault	R	16	ENUMERATION	0-15 See Fault Enumeration below
12A	298	Channel 10 Fault	R	16	ENUMERATION	0-15 See Fault Enumeration below
12B	299	Channel 11 Fault	R	16	ENUMERATION	0-15 See Fault Enumeration below
12C	300	Channel 12 Fault	R	16	ENUMERATION	0-15 See Fault Enumeration below
12D	301	Channel 13 Fault	R	16	ENUMERATION	0-15 See Fault Enumeration below
12E	302	Channel 14 Fault	R	16	ENUMERATION	0-15 See Fault Enumeration below
12F	303	Channel 15 Fault	R	16	ENUMERATION	0-15 See Fault Enumeration below
130	304	Channel 16 Fault	R	16	ENUMERATION	0-15 See Fault Enumeration below
131	305	Channel 17 Fault	R	16	ENUMERATION	0-15 See Fault Enumeration below
132	306	Channel 18 Fault	R	16	ENUMERATION	0-15 See Fault Enumeration below
133	307	Channel 19 Fault	R	16	ENUMERATION	0-15 See Fault Enumeration below
134	308	Channel 20 Fault	R	16	ENUMERATION	0-15 See Fault Enumeration below

135	309	Channel 21 Fault	R	16	ENUMERATION	0-15 See Fault Enumeration below
136	310	Channel 22 Fault	R	16	ENUMERATION	0-15 See Fault Enumeration below
137	311	Channel 23 Fault	R	16	ENUMERATION	0-15 See Fault Enumeration below
138	312	Channel 24 Fault	R	16	ENUMERATION	0-15 See Fault Enumeration below
139	313	Channel 25 Fault	R	16	ENUMERATION	0-15 See Fault Enumeration below
13A	314	Channel 26 Fault	R	16	ENUMERATION	0-15 See Fault Enumeration below
13B	315	Channel 27 Fault	R	16	ENUMERATION	0-15 See Fault Enumeration below
13C	316	Channel 28 Fault	R	16	ENUMERATION	0-15 See Fault Enumeration below
13D	317	Channel 29 Fault	R	16	ENUMERATION	0-15 See Fault Enumeration below
13E	318	Channel 30 Fault	R	16	ENUMERATION	0-15 See Fault Enumeration below
13F	319	Channel 31 Fault	R	16	ENUMERATION	0-15 See Fault Enumeration below
140	320	Channel 32 Fault	R	16	ENUMERATION	0-15 See Fault Enumeration below
141	321	Channel 1 On/Off	R/W	16	ENUMERATION	0 – 1, 0 means off, 1 means on
142	322	Channel 2 On/Off	R/W	16	ENUMERATION	0 – 1, 0 means off, 1 means on
143	323	Channel 3 On/Off	R/W	16	ENUMERATION	0 – 1, 0 means off, 1 means on
144	324	Channel 4 On/Off	R/W	16	ENUMERATION	0 – 1, 0 means off, 1 means on
145	325	Channel 5 On/Off	R/W	16	ENUMERATION	0 – 1, 0 means off, 1 means on
146	326	Channel 6 On/Off	R/W	16	ENUMERATION	0 – 1, 0 means off, 1 means on
147	327	Channel 7 On/Off	R/W	16	ENUMERATION	0 – 1, 0 means off, 1 means on
148	328	Channel 8 On/Off	R/W	16	ENUMERATION	0 – 1, 0 means off, 1 means on
149	329	Channel 9 On/Off	R/W	16	ENUMERATION	0 – 1, 0 means off, 1 means on
14A	330	Channel 10 On/Off	R/W	16	ENUMERATION	0 – 1, 0 means off, 1 means on
14B	331	Channel 11 On/Off	R/W	16	ENUMERATION	0 – 1, 0 means off, 1 means on
14C	332	Channel 12 On/Off	R/W	16	ENUMERATION	0 – 1, 0 means off, 1 means on
14D	333	Channel 13 On/Off	R/W	16	ENUMERATION	0 – 1, 0 means off, 1 means on
14E	334	Channel 14 On/Off	R/W	16	ENUMERATION	0 – 1, 0 means off, 1 means on
14F	335	Channel 15 On/Off	R/W	16	ENUMERATION	0 – 1, 0 means off, 1 means on
150	336	Channel 16 On/Off	R/W	16	ENUMERATION	0 – 1, 0 means off, 1 means on
151	337	Channel 17 On/Off	R/W	16	ENUMERATION	0 – 1, 0 means off, 1 means on
152	338	Channel 18 On/Off	R/W	16	ENUMERATION	0 – 1, 0 means off, 1 means on
153	339	Channel 19 On/Off	R/W	16	ENUMERATION	0 – 1, 0 means off, 1 means on
154	340	Channel 20 On/Off	R/W	16	ENUMERATION	0 – 1, 0 means off, 1 means on
155	341	Channel 21 On/Off	R/W	16	ENUMERATION	0 – 1, 0 means off, 1 means on
156	342	Channel 22 On/Off	R/W	16	ENUMERATION	0 – 1, 0 means off, 1 means on
157	343	Channel 23 On/Off	R/W	16	ENUMERATION	0 – 1, 0 means off, 1 means on
158	344	Channel 24 On/Off	R/W	16	ENUMERATION	0 – 1, 0 means off, 1 means on
159	345	Channel 25 On/Off	R/W	16	ENUMERATION	0 – 1, 0 means off, 1 means on
15A	346	Channel 26 On/Off	R/W	16	ENUMERATION	0 – 1, 0 means off, 1 means on
15B	347	Channel 27 On/Off	R/W	16	ENUMERATION	0 – 1, 0 means off, 1 means on
15C	348	Channel 28 On/Off	R/W	16	ENUMERATION	0 – 1, 0 means off, 1 means on
15D	349	Channel 29 On/Off	R/W	16	ENUMERATION	0 – 1, 0 means off, 1 means on
15E	350	Channel 30 On/Off	R/W	16	ENUMERATION	0 – 1, 0 means off, 1 means on

15F	351	Channel 31 On/Off	R/W	16	ENUMERATION	0 – 1, 0 means off, 1 means on
160	352	Channel 32 On/Off	R/W	16	ENUMERATION	0 – 1, 0 means off, 1 means on
161	353	Channel 1 Relay 1 On/Off	R/W	16	ENUMERATION	0 – 1, 0 means off, 1 means on
162	354	Channel 2 Relay 1 On/Off	R/W	16	ENUMERATION	0 – 1, 0 means off, 1 means on
163	355	Channel 3 Relay 1 On/Off	R/W	16	ENUMERATION	0 – 1, 0 means off, 1 means on
164	356	Channel 4 Relay 1 On/Off	R/W	16	ENUMERATION	0 – 1, 0 means off, 1 means on
165	357	Channel 5 Relay 1 On/Off	R/W	16	ENUMERATION	0 – 1, 0 means off, 1 means on
166	358	Channel 6 Relay 1 On/Off	R/W	16	ENUMERATION	0 – 1, 0 means off, 1 means on
167	359	Channel 7 Relay 1 On/Off	R/W	16	ENUMERATION	0 – 1, 0 means off, 1 means on
168	360	Channel 8 Relay 1 On/Off	R/W	16	ENUMERATION	0 – 1, 0 means off, 1 means on
169	361	Channel 9 Relay 1 On/Off	R/W	16	ENUMERATION	0 – 1, 0 means off, 1 means on
16A	362	Channel 10 Relay 1 On/Off	R/W	16	ENUMERATION	0 – 1, 0 means off, 1 means on
16B	363	Channel 11 Relay 1 On/Off	R/W	16	ENUMERATION	0 – 1, 0 means off, 1 means on
16C	364	Channel 12 Relay 1 On/Off	R/W	16	ENUMERATION	0 – 1, 0 means off, 1 means on
16D	365	Channel 13 Relay 1 On/Off	R/W	16	ENUMERATION	0 – 1, 0 means off, 1 means on
16E	366	Channel 14 Relay 1 On/Off	R/W	16	ENUMERATION	0 – 1, 0 means off, 1 means on
16F	367	Channel 15 Relay 1 On/Off	R/W	16	ENUMERATION	0 – 1, 0 means off, 1 means on
170	368	Channel 16 Relay 1 On/Off	R/W	16	ENUMERATION	0 – 1, 0 means off, 1 means on
171	369	Channel 17 Relay 1 On/Off	R/W	16	ENUMERATION	0 – 1, 0 means off, 1 means on
172	370	Channel 18 Relay 1 On/Off	R/W	16	ENUMERATION	0 – 1, 0 means off, 1 means on
173	371	Channel 19 Relay 1 On/Off	R/W	16	ENUMERATION	0 – 1, 0 means off, 1 means on
174	372	Channel 20 Relay 1 On/Off	R/W	16	ENUMERATION	0 – 1, 0 means off, 1 means on
175	373	Channel 21 Relay 1 On/Off	R/W	16	ENUMERATION	0 – 1, 0 means off, 1 means on
176	374	Channel 22 Relay 1 On/Off	R/W	16	ENUMERATION	0 – 1, 0 means off, 1 means on
177	375	Channel 23 Relay 1 On/Off	R/W	16	ENUMERATION	0 – 1, 0 means off, 1 means on
178	376	Channel 24 Relay 1 On/Off	R/W	16	ENUMERATION	0 – 1, 0 means off, 1 means on
179	377	Channel 25 Relay 1 On/Off	R/W	16	ENUMERATION	0 – 1, 0 means off, 1 means on
17A	378	Channel 26 Relay 1 On/Off	R/W	16	ENUMERATION	0 – 1, 0 means off, 1 means on
17B	379	Channel 27 Relay 1 On/Off	R/W	16	ENUMERATION	0 – 1, 0 means off, 1 means on
17C	380	Channel 28 Relay 1 On/Off	R/W	16	ENUMERATION	0 – 1, 0 means off, 1 means on
17D	381	Channel 29 Relay 1 On/Off	R/W	16	ENUMERATION	0 – 1, 0 means off, 1 means on
17E	382	Channel 30 Relay 1 On/Off	R/W	16	ENUMERATION	0 – 1, 0 means off, 1 means on
17F	383	Channel 31 Relay 1 On/Off	R/W	16	ENUMERATION	0 – 1, 0 means off, 1 means on
180	384	Channel 32 Relay 1 On/Off	R/W	16	ENUMERATION	0 – 1, 0 means off, 1 means on
181	385	Channel 1 Relay 1 High/Low	R/W	16	ENUMERATION	0 - 1, 0 means low, 1 means high
182	386	Channel 2 Relay 1 High/Low	R/W	16	ENUMERATION	0 - 1, 0 means low, 1 means high
183	387	Channel 3 Relay 1 High/Low	R/W	16	ENUMERATION	0 - 1, 0 means low, 1 means high
184	388	Channel 4 Relay 1 High/Low	R/W	16	ENUMERATION	0 - 1, 0 means low, 1 means high
185	389	Channel 5 Relay 1 High/Low	R/W	16	ENUMERATION	0 - 1, 0 means low, 1 means high
186	390	Channel 6 Relay 1 High/Low	R/W	16	ENUMERATION	0 - 1, 0 means low, 1 means high
187	391	Channel 7 Relay 1 High/Low	R/W	16	ENUMERATION	0 - 1, 0 means low, 1 means high
188	392	Channel 8 Relay 1 High/Low	R/W	16	ENUMERATION	0 - 1, 0 means low, 1 means high

189	393	Channel 9 Relay 1 High/Low	R/W	16	ENUMERATION	0 - 1 ,0 means low, 1 means high
18A	394	Channel 10 Relay 1 High/Low	R/W	16	ENUMERATION	0 - 1 ,0 means low, 1 means high
18B	395	Channel 11 Relay 1 High/Low	R/W	16	ENUMERATION	0 - 1 ,0 means low, 1 means high
18C	396	Channel 12 Relay 1 High/Low	R/W	16	ENUMERATION	0 - 1 ,0 means low, 1 means high
18D	397	Channel 13 Relay 1 High/Low	R/W	16	ENUMERATION	0 - 1 ,0 means low, 1 means high
18E	398	Channel 14 Relay 1 High/Low	R/W	16	ENUMERATION	0 - 1 ,0 means low, 1 means high
18F	399	Channel 15 Relay 1 High/Low	R/W	16	ENUMERATION	0 - 1 ,0 means low, 1 means high
190	400	Channel 16 Relay 1 High/Low	R/W	16	ENUMERATION	0 - 1 ,0 means low, 1 means high
191	401	Channel 17 Relay 1 High/Low	R/W	16	ENUMERATION	0 - 1 ,0 means low, 1 means high
192	402	Channel 18 Relay 1 High/Low	R/W	16	ENUMERATION	0 - 1 ,0 means low, 1 means high
193	403	Channel 19 Relay 1 High/Low	R/W	16	ENUMERATION	0 - 1 ,0 means low, 1 means high
194	404	Channel 20 Relay 1 High/Low	R/W	16	ENUMERATION	0 - 1 ,0 means low, 1 means high
195	405	Channel 21 Relay 1 High/Low	R/W	16	ENUMERATION	0 - 1 ,0 means low, 1 means high
196	406	Channel 22 Relay 1 High/Low	R/W	16	ENUMERATION	0 - 1 ,0 means low, 1 means high
197	407	Channel 23 Relay 1 High/Low	R/W	16	ENUMERATION	0 - 1 ,0 means low, 1 means high
198	408	Channel 24 Relay 1 High/Low	R/W	16	ENUMERATION	0 - 1 ,0 means low, 1 means high
199	409	Channel 25 Relay 1 High/Low	R/W	16	ENUMERATION	0 - 1 ,0 means low, 1 means high
19A	410	Channel 26 Relay 1 High/Low	R/W	16	ENUMERATION	0 - 1 ,0 means low, 1 means high
19B	411	Channel 27 Relay 1 High/Low	R/W	16	ENUMERATION	0 - 1 ,0 means low, 1 means high
19C	412	Channel 28 Relay 1 High/Low	R/W	16	ENUMERATION	0 - 1 ,0 means low, 1 means high
19D	413	Channel 29 Relay 1 High/Low	R/W	16	ENUMERATION	0 - 1 ,0 means low, 1 means high
19E	414	Channel 30 Relay 1 High/Low	R/W	16	ENUMERATION	0 - 1 ,0 means low, 1 means high
19F	415	Channel 31 Relay 1 High/Low	R/W	16	ENUMERATION	0 - 1 ,0 means low, 1 means high
1A0	416	Channel 32 Relay 1 High/Low	R/W	16	ENUMERATION	0 - 1 ,0 means low, 1 means high
1A1	417	Channel 1 Relay 1 Set Point	R/W	32	FLOAT	Any number 65000 or less and higher than 0
1A3	419	Channel 2 Relay 1 Set Point	R/W	32	FLOAT	Any number 65000 or less and higher than 0
1A5	421	Channel 3 Relay 1 Set Point	R/W	32	FLOAT	Any number 65000 or less and higher than 0
1A7	423	Channel 4 Relay 1 Set Point	R/W	32	FLOAT	Any number 65000 or less and higher than 0
1A9	425	Channel 5 Relay 1 Set Point	R/W	32	FLOAT	Any number 65000 or less and higher than 0
1AB	427	Channel 6 Relay 1 Set Point	R/W	32	FLOAT	Any number 65000 or less and higher than 0
1AD	429	Channel 7 Relay 1 Set Point	R/W	32	FLOAT	Any number 65000 or less and higher than 0
1AF	431	Channel 8 Relay 1 Set Point	R/W	32	FLOAT	Any number 65000 or less and higher than 0
1B1	433	Channel 9 Relay 1 Set Point	R/W	32	FLOAT	Any number 65000 or less and higher than 0
1B3	435	Channel 10 Relay 1 Set Point	R/W	32	FLOAT	Any number 65000 or less and higher than 0
1B5	437	Channel 11 Relay 1 Set Point	R/W	32	FLOAT	Any number 65000 or less and higher than 0
1B7	439	Channel 12 Relay 1 Set Point	R/W	32	FLOAT	Any number 65000 or less and higher than 0
1B9	441	Channel 13 Relay 1 Set Point	R/W	32	FLOAT	Any number 65000 or less and higher than 0
1BB	443	Channel 14 Relay 1 Set Point	R/W	32	FLOAT	Any number 65000 or less and higher than 0
1BD	445	Channel 15 Relay 1 Set Point	R/W	32	FLOAT	Any number 65000 or less and higher than 0
1BF	447	Channel 16 Relay 1 Set Point	R/W	32	FLOAT	Any number 65000 or less and higher than 0
1C1	449	Channel 17 Relay 1 Set Point	R/W	32	FLOAT	Any number 65000 or less and higher than 0
1C3	451	Channel 18 Relay 1 Set Point	R/W	32	FLOAT	Any number 65000 or less and higher than 0

1C5	453	Channel 19 Relay 1 Set Point	R/W	32	FLOAT	Any number 65000 or less and higher than 0
1C7	455	Channel 20 Relay 1 Set Point	R/W	32	FLOAT	Any number 65000 or less and higher than 0
1C9	457	Channel 21 Relay 1 Set Point	R/W	32	FLOAT	Any number 65000 or less and higher than 0
1CB	459	Channel 22 Relay 1 Set Point	R/W	32	FLOAT	Any number 65000 or less and higher than 0
1CD	461	Channel 23 Relay 1 Set Point	R/W	32	FLOAT	Any number 65000 or less and higher than 0
1CF	463	Channel 24 Relay 1 Set Point	R/W	32	FLOAT	Any number 65000 or less and higher than 0
1D1	465	Channel 25 Relay 1 Set Point	R/W	32	FLOAT	Any number 65000 or less and higher than 0
1D3	467	Channel 26 Relay 1 Set Point	R/W	32	FLOAT	Any number 65000 or less and higher than 0
1D5	469	Channel 27 Relay 1 Set Point	R/W	32	FLOAT	Any number 65000 or less and higher than 0
1D7	471	Channel 28 Relay 1 Set Point	R/W	32	FLOAT	Any number 65000 or less and higher than 0
1D9	473	Channel 29 Relay 1 Set Point	R/W	32	FLOAT	Any number 65000 or less and higher than 0
1DB	475	Channel 30 Relay 1 Set Point	R/W	32	FLOAT	Any number 65000 or less and higher than 0
1DD	477	Channel 31 Relay 1 Set Point	R/W	32	FLOAT	Any number 65000 or less and higher than 0
1DF	479	Channel 32 Relay 1 Set Point	R/W	32	FLOAT	Any number 65000 or less and higher than 0
1E1	481	Channel 1 Relay 1 Latch/Unlatch	R/W	16	ENUMERATION	0 - 1 ,0 means unlatch, 1 means latch
1E2	482	Channel 2 Relay 1 Latch/Unlatch	R/W	16	ENUMERATION	0 - 1 ,0 means unlatch, 1 means latch
1E3	483	Channel 3 Relay 1 Latch/Unlatch	R/W	16	ENUMERATION	0 - 1 ,0 means unlatch, 1 means latch
1E4	484	Channel 4 Relay 1 Latch/Unlatch	R/W	16	ENUMERATION	0 - 1 ,0 means unlatch, 1 means latch
1E5	485	Channel 5 Relay 1 Latch/Unlatch	R/W	16	ENUMERATION	0 - 1 ,0 means unlatch, 1 means latch
1E6	486	Channel 6 Relay 1 Latch/Unlatch	R/W	16	ENUMERATION	0 - 1 ,0 means unlatch, 1 means latch
1E7	487	Channel 7 Relay 1 Latch/Unlatch	R/W	16	ENUMERATION	0 - 1 ,0 means unlatch, 1 means latch
1E8	488	Channel 8 Relay 1 Latch/Unlatch	R/W	16	ENUMERATION	0 - 1 ,0 means unlatch, 1 means latch
1E9	489	Channel 9 Relay 1 Latch/Unlatch	R/W	16	ENUMERATION	0 - 1 ,0 means unlatch, 1 means latch
1EA	490	Channel 10 Relay 1 Latch/Unlatch	R/W	16	ENUMERATION	0 - 1 ,0 means unlatch, 1 means latch
1EB	491	Channel 11 Relay 1 Latch/Unlatch	R/W	16	ENUMERATION	0 - 1 ,0 means unlatch, 1 means latch
1EC	492	Channel 12 Relay 1 Latch/Unlatch	R/W	16	ENUMERATION	0 - 1 ,0 means unlatch, 1 means latch
1ED	493	Channel 13 Relay 1 Latch/Unlatch	R/W	16	ENUMERATION	0 - 1 ,0 means unlatch, 1 means latch
1EE	494	Channel 14 Relay 1 Latch/Unlatch	R/W	16	ENUMERATION	0 - 1 ,0 means unlatch, 1 means latch
1EF	495	Channel 15 Relay 1 Latch/Unlatch	R/W	16	ENUMERATION	0 - 1 ,0 means unlatch, 1 means latch
1F0	496	Channel 16 Relay 1 Latch/Unlatch	R/W	16	ENUMERATION	0 - 1 ,0 means unlatch, 1 means latch
1F1	497	Channel 17 Relay 1 Latch/Unlatch	R/W	16	ENUMERATION	0 - 1 ,0 means unlatch, 1 means latch
1F2	498	Channel 18 Relay 1 Latch/Unlatch	R/W	16	ENUMERATION	0 - 1 ,0 means unlatch, 1 means latch
1F3	499	Channel 19 Relay 1 Latch/Unlatch	R/W	16	ENUMERATION	0 - 1 ,0 means unlatch, 1 means latch
1F4	500	Channel 20 Relay 1 Latch/Unlatch	R/W	16	ENUMERATION	0 - 1 ,0 means unlatch, 1 means latch
1F5	501	Channel 21 Relay 1 Latch/Unlatch	R/W	16	ENUMERATION	0 - 1 ,0 means unlatch, 1 means latch
1F6	502	Channel 22 Relay 1 Latch/Unlatch	R/W	16	ENUMERATION	0 - 1 ,0 means unlatch, 1 means latch
1F7	503	Channel 23 Relay 1 Latch/Unlatch	R/W	16	ENUMERATION	0 - 1 ,0 means unlatch, 1 means latch
1F8	504	Channel 24 Relay 1 Latch/Unlatch	R/W	16	ENUMERATION	0 - 1 ,0 means unlatch, 1 means latch
1F9	505	Channel 25 Relay 1 Latch/Unlatch	R/W	16	ENUMERATION	0 - 1 ,0 means unlatch, 1 means latch
1FA	506	Channel 26 Relay 1 Latch/Unlatch	R/W	16	ENUMERATION	0 - 1 ,0 means unlatch, 1 means latch
1FB	507	Channel 27 Relay 1 Latch/Unlatch	R/W	16	ENUMERATION	0 - 1 ,0 means unlatch, 1 means latch
1FC	508	Channel 28 Relay 1 Latch/Unlatch	R/W	16	ENUMERATION	0 - 1 ,0 means unlatch, 1 means latch

10

1FD	509	Channel 29 Relay 1 Latch/Unlatch	R/W	16	ENUMERATION	0 - 1, 0 means unlatch, 1 means latch
1FE	510	Channel 30 Relay 1 Latch/Unlatch	R/W	16	ENUMERATION	0 - 1, 0 means unlatch, 1 means latch
1FF	511	Channel 31 Relay 1 Latch/Unlatch	R/W	16	ENUMERATION	0 - 1, 0 means unlatch, 1 means latch
200	512	Channel 32 Relay 1 Latch/Unlatch	R/W	16	ENUMERATION	0 - 1, 0 means unlatch, 1 means latch
201	513	Channel 1 Relay 2 On/Off	R/W	16	ENUMERATION	0 - 1, 0 means off, 1 means on
202	514	Channel 2 Relay 2 On/Off	R/W	16	ENUMERATION	0 - 1, 0 means off, 1 means on
203	515	Channel 3 Relay 2 On/Off	R/W	16	ENUMERATION	0 - 1, 0 means off, 1 means on
204	516	Channel 4 Relay 2 On/Off	R/W	16	ENUMERATION	0 - 1, 0 means off, 1 means on
205	517	Channel 5 Relay 2 On/Off	R/W	16	ENUMERATION	0 - 1, 0 means off, 1 means on
206	518	Channel 6 Relay 2 On/Off	R/W	16	ENUMERATION	0 - 1, 0 means off, 1 means on
207	519	Channel 7 Relay 2 On/Off	R/W	16	ENUMERATION	0 - 1, 0 means off, 1 means on
208	520	Channel 8 Relay 2 On/Off	R/W	16	ENUMERATION	0 - 1, 0 means off, 1 means on
209	521	Channel 9 Relay 2 On/Off	R/W	16	ENUMERATION	0 - 1, 0 means off, 1 means on
20A	522	Channel 10 Relay 2 On/Off	R/W	16	ENUMERATION	0 - 1, 0 means off, 1 means on
20B	523	Channel 11 Relay 2 On/Off	R/W	16	ENUMERATION	0 - 1, 0 means off, 1 means on
20C	524	Channel 12 Relay 2 On/Off	R/W	16	ENUMERATION	0 - 1, 0 means off, 1 means on
20D	525	Channel 13 Relay 2 On/Off	R/W	16	ENUMERATION	0 - 1, 0 means off, 1 means on
20E	526	Channel 14 Relay 2 On/Off	R/W	16	ENUMERATION	0 - 1, 0 means off, 1 means on
20F	527	Channel 15 Relay 2 On/Off	R/W	16	ENUMERATION	0 - 1, 0 means off, 1 means on
210	528	Channel 16 Relay 2 On/Off	R/W	16	ENUMERATION	0 - 1, 0 means off, 1 means on
211	529	Channel 17 Relay 2 On/Off	R/W	16	ENUMERATION	0 - 1, 0 means off, 1 means on
212	530	Channel 18 Relay 2 On/Off	R/W	16	ENUMERATION	0 - 1, 0 means off, 1 means on
213	531	Channel 19 Relay 2 On/Off	R/W	16	ENUMERATION	0 - 1, 0 means off, 1 means on
214	532	Channel 20 Relay 2 On/Off	R/W	16	ENUMERATION	0 - 1, 0 means off, 1 means on
215	533	Channel 21 Relay 2 On/Off	R/W	16	ENUMERATION	0 - 1, 0 means off, 1 means on
216	534	Channel 22 Relay 2 On/Off	R/W	16	ENUMERATION	0 - 1, 0 means off, 1 means on
217	535	Channel 23 Relay 2 On/Off	R/W	16	ENUMERATION	0 - 1, 0 means off, 1 means on
218	536	Channel 24 Relay 2 On/Off	R/W	16	ENUMERATION	0 - 1, 0 means off, 1 means on
219	537	Channel 25 Relay 2 On/Off	R/W	16	ENUMERATION	0 - 1, 0 means off, 1 means on
21A	538	Channel 26 Relay 2 On/Off	R/W	16	ENUMERATION	0 - 1, 0 means off, 1 means on
21B	539	Channel 27 Relay 2 On/Off	R/W	16	ENUMERATION	0 - 1, 0 means off, 1 means on
21C	540	Channel 28 Relay 2 On/Off	R/W	16	ENUMERATION	0 - 1, 0 means off, 1 means on
21D	541	Channel 29 Relay 2 On/Off	R/W	16	ENUMERATION	0 - 1, 0 means off, 1 means on
21E	542	Channel 30 Relay 2 On/Off	R/W	16	ENUMERATION	0 - 1, 0 means off, 1 means on
21F	543	Channel 31 Relay 2 On/Off	R/W	16	ENUMERATION	0 - 1, 0 means off, 1 means on
220	544	Channel 32 Relay 2 On/Off	R/W	16	ENUMERATION	0 - 1, 0 means off, 1 means on
221	545	Channel 1 Relay 2 High/Low	R/W	16	ENUMERATION	0 - 1, 0 means low, 1 means high
222	546	Channel 2 Relay 2 High/Low	R/W	16	ENUMERATION	0 - 1, 0 means low, 1 means high
223	547	Channel 3 Relay 2 High/Low	R/W	16	ENUMERATION	0 - 1, 0 means low, 1 means high
224	548	Channel 4 Relay 2 High/Low	R/W	16	ENUMERATION	0 - 1, 0 means low, 1 means high
225	549	Channel 5 Relay 2 High/Low	R/W	16	ENUMERATION	0 - 1, 0 means low, 1 means high
226	550	Channel 6 Relay 2 High/Low	R/W	16	ENUMERATION	0 - 1, 0 means low, 1 means high

227	551	Channel 7 Relay 2 High/Low	R/W	16	ENUMERATION	0 - 1 ,0 means low, 1 means high
228	552	Channel 8 Relay 2 High/Low	R/W	16	ENUMERATION	0 - 1 ,0 means low, 1 means high
229	553	Channel 9 Relay 2 High/Low	R/W	16	ENUMERATION	0 - 1 ,0 means low, 1 means high
22A	554	Channel 10 Relay 2 High/Low	R/W	16	ENUMERATION	0 - 1 ,0 means low, 1 means high
22B	555	Channel 11 Relay 2 High/Low	R/W	16	ENUMERATION	0 - 1 ,0 means low, 1 means high
22C	556	Channel 12 Relay 2 High/Low	R/W	16	ENUMERATION	0 - 1 ,0 means low, 1 means high
22D	557	Channel 13 Relay 2 High/Low	R/W	16	ENUMERATION	0 - 1 ,0 means low, 1 means high
22E	558	Channel 14 Relay 2 High/Low	R/W	16	ENUMERATION	0 - 1 ,0 means low, 1 means high
22F	559	Channel 15 Relay 2 High/Low	R/W	16	ENUMERATION	0 - 1 ,0 means low, 1 means high
230	560	Channel 16 Relay 2 High/Low	R/W	16	ENUMERATION	0 - 1 ,0 means low, 1 means high
231	561	Channel 17 Relay 2 High/Low	R/W	16	ENUMERATION	0 - 1 ,0 means low, 1 means high
232	562	Channel 18 Relay 2 High/Low	R/W	16	ENUMERATION	0 - 1 ,0 means low, 1 means high
233	563	Channel 19 Relay 2 High/Low	R/W	16	ENUMERATION	0 - 1 ,0 means low, 1 means high
234	564	Channel 20 Relay 2 High/Low	R/W	16	ENUMERATION	0 - 1 ,0 means low, 1 means high
235	565	Channel 21 Relay 2 High/Low	R/W	16	ENUMERATION	0 - 1 ,0 means low, 1 means high
236	566	Channel 22 Relay 2 High/Low	R/W	16	ENUMERATION	0 - 1 ,0 means low, 1 means high
237	567	Channel 23 Relay 2 High/Low	R/W	16	ENUMERATION	0 - 1 ,0 means low, 1 means high
238	568	Channel 24 Relay 2 High/Low	R/W	16	ENUMERATION	0 - 1 ,0 means low, 1 means high
239	569	Channel 25 Relay 2 High/Low	R/W	16	ENUMERATION	0 - 1 ,0 means low, 1 means high
23A	570	Channel 26 Relay 2 High/Low	R/W	16	ENUMERATION	0 - 1 ,0 means low, 1 means high
23B	571	Channel 27 Relay 2 High/Low	R/W	16	ENUMERATION	0 - 1 ,0 means low, 1 means high
23C	572	Channel 28 Relay 2 High/Low	R/W	16	ENUMERATION	0 - 1 ,0 means low, 1 means high
23D	573	Channel 29 Relay 2 High/Low	R/W	16	ENUMERATION	0 - 1 ,0 means low, 1 means high
23E	574	Channel 30 Relay 2 High/Low	R/W	16	ENUMERATION	0 - 1 ,0 means low, 1 means high
23F	575	Channel 31 Relay 2 High/Low	R/W	16	ENUMERATION	0 - 1 ,0 means low, 1 means high
240	576	Channel 32 Relay 2 High/Low	R/W	16	ENUMERATION	0 - 1 ,0 means low, 1 means high
241	577	Channel 1 Relay 2 Set Point	R/W	32	FLOAT	Any number 65000 or less and higher than 0
243	579	Channel 2 Relay 2 Set Point	R/W	32	FLOAT	Any number 65000 or less and higher than 0
245	581	Channel 3 Relay 2 Set Point	R/W	32	FLOAT	Any number 65000 or less and higher than 0
247	583	Channel 4 Relay 2 Set Point	R/W	32	FLOAT	Any number 65000 or less and higher than 0
249	585	Channel 5 Relay 2 Set Point	R/W	32	FLOAT	Any number 65000 or less and higher than 0
24B	587	Channel 6 Relay 2 Set Point	R/W	32	FLOAT	Any number 65000 or less and higher than 0
24D	589	Channel 7 Relay 2 Set Point	R/W	32	FLOAT	Any number 65000 or less and higher than 0
24F	591	Channel 8 Relay 2 Set Point	R/W	32	FLOAT	Any number 65000 or less and higher than 0
251	593	Channel 9 Relay 2 Set Point	R/W	32	FLOAT	Any number 65000 or less and higher than 0
253	595	Channel 10 Relay 2 Set Point	R/W	32	FLOAT	Any number 65000 or less and higher than 0
255	597	Channel 11 Relay 2 Set Point	R/W	32	FLOAT	Any number 65000 or less and higher than 0
257	599	Channel 12 Relay 2 Set Point	R/W	32	FLOAT	Any number 65000 or less and higher than 0
259	601	Channel 13 Relay 2 Set Point	R/W	32	FLOAT	Any number 65000 or less and higher than 0
25B	603	Channel 14 Relay 2 Set Point	R/W	32	FLOAT	Any number 65000 or less and higher than 0
25D	605	Channel 15 Relay 2 Set Point	R/W	32	FLOAT	Any number 65000 or less and higher than 0
25F	607	Channel 16 Relay 2 Set Point	R/W	32	FLOAT	Any number 65000 or less and higher than 0

12

261	609	Channel 17 Relay 2 Set Point	R/W	32	FLOAT	Any number 65000 or less and higher than 0
263	611	Channel 18 Relay 2 Set Point	R/W	32	FLOAT	Any number 65000 or less and higher than 0
265	613	Channel 19 Relay 2 Set Point	R/W	32	FLOAT	Any number 65000 or less and higher than 0
267	615	Channel 20 Relay 2 Set Point	R/W	32	FLOAT	Any number 65000 or less and higher than 0
269	617	Channel 21 Relay 2 Set Point	R/W	32	FLOAT	Any number 65000 or less and higher than 0
26B	619	Channel 22 Relay 2 Set Point	R/W	32	FLOAT	Any number 65000 or less and higher than 0
26D	621	Channel 23 Relay 2 Set Point	R/W	32	FLOAT	Any number 65000 or less and higher than 0
26F	623	Channel 24 Relay 2 Set Point	R/W	32	FLOAT	Any number 65000 or less and higher than 0
271	625	Channel 25 Relay 2 Set Point	R/W	32	FLOAT	Any number 65000 or less and higher than 0
273	627	Channel 26 Relay 2 Set Point	R/W	32	FLOAT	Any number 65000 or less and higher than 0
275	629	Channel 27 Relay 2 Set Point	R/W	32	FLOAT	Any number 65000 or less and higher than 0
277	631	Channel 28 Relay 2 Set Point	R/W	32	FLOAT	Any number 65000 or less and higher than 0
279	633	Channel 29 Relay 2 Set Point	R/W	32	FLOAT	Any number 65000 or less and higher than 0
27B	635	Channel 30 Relay 2 Set Point	R/W	32	FLOAT	Any number 65000 or less and higher than 0
27D	637	Channel 31 Relay 2 Set Point	R/W	32	FLOAT	Any number 65000 or less and higher than 0
27F	639	Channel 32 Relay 2 Set Point	R/W	32	FLOAT	Any number 65000 or less and higher than 0
281	641	Channel 1 Relay 2 Latch/Unlatch	R/W	16	ENUMERATION	0 - 1 ,0 means unlatch, 1 means latch
282	642	Channel 2 Relay 2 Latch/Unlatch	R/W	16	ENUMERATION	0 - 1 ,0 means unlatch, 1 means latch
283	643	Channel 3 Relay 2 Latch/Unlatch	R/W	16	ENUMERATION	0 - 1 ,0 means unlatch, 1 means latch
284	644	Channel 4 Relay 2 Latch/Unlatch	R/W	16	ENUMERATION	0 - 1 ,0 means unlatch, 1 means latch
285	645	Channel 5 Relay 2 Latch/Unlatch	R/W	16	ENUMERATION	0 - 1 ,0 means unlatch, 1 means latch
286	646	Channel 6 Relay 2 Latch/Unlatch	R/W	16	ENUMERATION	0 - 1 ,0 means unlatch, 1 means latch
287	647	Channel 7 Relay 2 Latch/Unlatch	R/W	16	ENUMERATION	0 - 1 ,0 means unlatch, 1 means latch
288	648	Channel 8 Relay 2 Latch/Unlatch	R/W	16	ENUMERATION	0 - 1 ,0 means unlatch, 1 means latch
289	649	Channel 9 Relay 2 Latch/Unlatch	R/W	16	ENUMERATION	0 - 1 ,0 means unlatch, 1 means latch
28A	650	Channel 10 Relay 2 Latch/Unlatch	R/W	16	ENUMERATION	0 - 1 ,0 means unlatch, 1 means latch
28B	651	Channel 11 Relay 2 Latch/Unlatch	R/W	16	ENUMERATION	0 - 1 ,0 means unlatch, 1 means latch
28C	652	Channel 12 Relay 2 Latch/Unlatch	R/W	16	ENUMERATION	0 - 1 ,0 means unlatch, 1 means latch
28D	653	Channel 13 Relay 2 Latch/Unlatch	R/W	16	ENUMERATION	0 - 1 ,0 means unlatch, 1 means latch
28E	654	Channel 14 Relay 2 Latch/Unlatch	R/W	16	ENUMERATION	0 - 1 ,0 means unlatch, 1 means latch
28F	655	Channel 15 Relay 2 Latch/Unlatch	R/W	16	ENUMERATION	0 - 1 ,0 means unlatch, 1 means latch
290	656	Channel 16 Relay 2 Latch/Unlatch	R/W	16	ENUMERATION	0 - 1 ,0 means unlatch, 1 means latch
291	657	Channel 17 Relay 2 Latch/Unlatch	R/W	16	ENUMERATION	0 - 1 ,0 means unlatch, 1 means latch
292	658	Channel 18 Relay 2 Latch/Unlatch	R/W	16	ENUMERATION	0 - 1 ,0 means unlatch, 1 means latch
293	659	Channel 19 Relay 2 Latch/Unlatch	R/W	16	ENUMERATION	0 - 1 ,0 means unlatch, 1 means latch
294	660	Channel 20 Relay 2 Latch/Unlatch	R/W	16	ENUMERATION	0 - 1 ,0 means unlatch, 1 means latch
295	661	Channel 21 Relay 2 Latch/Unlatch	R/W	16	ENUMERATION	0 - 1 ,0 means unlatch, 1 means latch
296	662	Channel 22 Relay 2 Latch/Unlatch	R/W	16	ENUMERATION	0 - 1 ,0 means unlatch, 1 means latch
297	663	Channel 23 Relay 2 Latch/Unlatch	R/W	16	ENUMERATION	0 - 1 ,0 means unlatch, 1 means latch
298	664	Channel 24 Relay 2 Latch/Unlatch	R/W	16	ENUMERATION	0 - 1 ,0 means unlatch, 1 means latch
299	665	Channel 25 Relay 2 Latch/Unlatch	R/W	16	ENUMERATION	0 - 1 ,0 means unlatch, 1 means latch
29A	666	Channel 26 Relay 2 Latch/Unlatch	R/W	16	ENUMERATION	0 - 1 ,0 means unlatch, 1 means latch

29B	667	Channel 27 Relay 2 Latch/Unlatch	R/W	16	ENUMERATION	0 - 1, 0 means unlatch, 1 means latch
29C	668	Channel 28 Relay 2 Latch/Unlatch	R/W	16	ENUMERATION	0 - 1, 0 means unlatch, 1 means latch
29D	669	Channel 29 Relay 2 Latch/Unlatch	R/W	16	ENUMERATION	0 - 1, 0 means unlatch, 1 means latch
29E	670	Channel 30 Relay 2 Latch/Unlatch	R/W	16	ENUMERATION	0 - 1, 0 means unlatch, 1 means latch
29F	671	Channel 31 Relay 2 Latch/Unlatch	R/W	16	ENUMERATION	0 - 1, 0 means unlatch, 1 means latch
2A0	672	Channel 32 Relay 2 Latch/Unlatch	R/W	16	ENUMERATION	0 - 1, 0 means unlatch, 1 means latch
2A1	673	Channel 1 Relay 3 On/Off	R/W	16	ENUMERATION	0 - 1, 0 means off, 1 means on
2A2	674	Channel 2 Relay 3 On/Off	R/W	16	ENUMERATION	0 - 1, 0 means off, 1 means on
2A3	675	Channel 3 Relay 3 On/Off	R/W	16	ENUMERATION	0 - 1, 0 means off, 1 means on
2A4	676	Channel 4 Relay 3 On/Off	R/W	16	ENUMERATION	0 - 1, 0 means off, 1 means on
2A5	677	Channel 5 Relay 3 On/Off	R/W	16	ENUMERATION	0 - 1, 0 means off, 1 means on
2A6	678	Channel 6 Relay 3 On/Off	R/W	16	ENUMERATION	0 - 1, 0 means off, 1 means on
2A7	679	Channel 7 Relay 3 On/Off	R/W	16	ENUMERATION	0 - 1, 0 means off, 1 means on
2A8	680	Channel 8 Relay 3 On/Off	R/W	16	ENUMERATION	0 - 1, 0 means off, 1 means on
2A9	681	Channel 9 Relay 3 On/Off	R/W	16	ENUMERATION	0 - 1, 0 means off, 1 means on
2AA	682	Channel 10 Relay 3 On/Off	R/W	16	ENUMERATION	0 - 1, 0 means off, 1 means on
2AB	683	Channel 11 Relay 3 On/Off	R/W	16	ENUMERATION	0 - 1, 0 means off, 1 means on
2AC	684	Channel 12 Relay 3 On/Off	R/W	16	ENUMERATION	0 - 1, 0 means off, 1 means on
2AD	685	Channel 13 Relay 3 On/Off	R/W	16	ENUMERATION	0 - 1, 0 means off, 1 means on
2AE	686	Channel 14 Relay 3 On/Off	R/W	16	ENUMERATION	0 - 1, 0 means off, 1 means on
2AF	687	Channel 15 Relay 3 On/Off	R/W	16	ENUMERATION	0 - 1, 0 means off, 1 means on
2B0	688	Channel 16 Relay 3 On/Off	R/W	16	ENUMERATION	0 - 1, 0 means off, 1 means on
2B1	689	Channel 17 Relay 3 On/Off	R/W	16	ENUMERATION	0 - 1, 0 means off, 1 means on
2B2	690	Channel 18 Relay 3 On/Off	R/W	16	ENUMERATION	0 - 1, 0 means off, 1 means on
2B3	691	Channel 19 Relay 3 On/Off	R/W	16	ENUMERATION	0 - 1, 0 means off, 1 means on
2B4	692	Channel 20 Relay 3 On/Off	R/W	16	ENUMERATION	0 - 1, 0 means off, 1 means on
2B5	693	Channel 21 Relay 3 On/Off	R/W	16	ENUMERATION	0 - 1, 0 means off, 1 means on
2B6	694	Channel 22 Relay 3 On/Off	R/W	16	ENUMERATION	0 - 1, 0 means off, 1 means on
2B7	695	Channel 23 Relay 3 On/Off	R/W	16	ENUMERATION	0 - 1, 0 means off, 1 means on
2B8	696	Channel 24 Relay 3 On/Off	R/W	16	ENUMERATION	0 - 1, 0 means off, 1 means on
2B9	697	Channel 25 Relay 3 On/Off	R/W	16	ENUMERATION	0 - 1, 0 means off, 1 means on
2BA	698	Channel 26 Relay 3 On/Off	R/W	16	ENUMERATION	0 - 1, 0 means off, 1 means on
2BB	699	Channel 27 Relay 3 On/Off	R/W	16	ENUMERATION	0 - 1, 0 means off, 1 means on
2BC	700	Channel 28 Relay 3 On/Off	R/W	16	ENUMERATION	0 - 1, 0 means off, 1 means on
2BD	701	Channel 29 Relay 3 On/Off	R/W	16	ENUMERATION	0 - 1, 0 means off, 1 means on
2BE	702	Channel 30 Relay 3 On/Off	R/W	16	ENUMERATION	0 - 1, 0 means off, 1 means on
2BF	703	Channel 31 Relay 3 On/Off	R/W	16	ENUMERATION	0 - 1, 0 means off, 1 means on
2C0	704	Channel 32 Relay 3 On/Off	R/W	16	ENUMERATION	0 - 1, 0 means off, 1 means on
2C1	705	Channel 1 Relay 3 High/Low	R/W	16	ENUMERATION	0 - 1, 0 means low, 1 means high
2C2	706	Channel 2 Relay 3 High/Low	R/W	16	ENUMERATION	0 - 1, 0 means low, 1 means high
2C3	707	Channel 3 Relay 3 High/Low	R/W	16	ENUMERATION	0 - 1, 0 means low, 1 means high
2C4	708	Channel 4 Relay 3 High/Low	R/W	16	ENUMERATION	0 - 1, 0 means low, 1 means high

2C5	709	Channel 5 Relay 3 High/Low	R/W	16	ENUMERATION	0 - 1 ,0 means low, 1 means high
2C6	710	Channel 6 Relay 3 High/Low	R/W	16	ENUMERATION	0 - 1 ,0 means low, 1 means high
2C7	711	Channel 7 Relay 3 High/Low	R/W	16	ENUMERATION	0 - 1 ,0 means low, 1 means high
2C8	712	Channel 8 Relay 3 High/Low	R/W	16	ENUMERATION	0 - 1 ,0 means low, 1 means high
2C9	713	Channel 9 Relay 3 High/Low	R/W	16	ENUMERATION	0 - 1 ,0 means low, 1 means high
2CA	714	Channel 10 Relay 3 High/Low	R/W	16	ENUMERATION	0 - 1 ,0 means low, 1 means high
2CB	715	Channel 11 Relay 3 High/Low	R/W	16	ENUMERATION	0 - 1 ,0 means low, 1 means high
2CC	716	Channel 12 Relay 3 High/Low	R/W	16	ENUMERATION	0 - 1 ,0 means low, 1 means high
2CD	717	Channel 13 Relay 3 High/Low	R/W	16	ENUMERATION	0 - 1 ,0 means low, 1 means high
2CE	718	Channel 14 Relay 3 High/Low	R/W	16	ENUMERATION	0 - 1 ,0 means low, 1 means high
2CF	719	Channel 15 Relay 3 High/Low	R/W	16	ENUMERATION	0 - 1 ,0 means low, 1 means high
2D0	720	Channel 16 Relay 3 High/Low	R/W	16	ENUMERATION	0 - 1 ,0 means low, 1 means high
2D1	721	Channel 17 Relay 3 High/Low	R/W	16	ENUMERATION	0 - 1 ,0 means low, 1 means high
2D2	722	Channel 18 Relay 3 High/Low	R/W	16	ENUMERATION	0 - 1 ,0 means low, 1 means high
2D3	723	Channel 19 Relay 3 High/Low	R/W	16	ENUMERATION	0 - 1 ,0 means low, 1 means high
2D4	724	Channel 20 Relay 3 High/Low	R/W	16	ENUMERATION	0 - 1 ,0 means low, 1 means high
2D5	725	Channel 21 Relay 3 High/Low	R/W	16	ENUMERATION	0 - 1 ,0 means low, 1 means high
2D6	726	Channel 22 Relay 3 High/Low	R/W	16	ENUMERATION	0 - 1 ,0 means low, 1 means high
2D7	727	Channel 23 Relay 3 High/Low	R/W	16	ENUMERATION	0 - 1 ,0 means low, 1 means high
2D8	728	Channel 24 Relay 3 High/Low	R/W	16	ENUMERATION	0 - 1 ,0 means low, 1 means high
2D9	729	Channel 25 Relay 3 High/Low	R/W	16	ENUMERATION	0 - 1 ,0 means low, 1 means high
2DA	730	Channel 26 Relay 3 High/Low	R/W	16	ENUMERATION	0 - 1 ,0 means low, 1 means high
2DB	731	Channel 27 Relay 3 High/Low	R/W	16	ENUMERATION	0 - 1 ,0 means low, 1 means high
2DC	732	Channel 28 Relay 3 High/Low	R/W	16	ENUMERATION	0 - 1 ,0 means low, 1 means high
2DD	733	Channel 29 Relay 3 High/Low	R/W	16	ENUMERATION	0 - 1 ,0 means low, 1 means high
2DE	734	Channel 30 Relay 3 High/Low	R/W	16	ENUMERATION	0 - 1 ,0 means low, 1 means high
2DF	735	Channel 31 Relay 3 High/Low	R/W	16	ENUMERATION	0 - 1 ,0 means low, 1 means high
2E0	736	Channel 32 Relay 3 High/Low	R/W	16	ENUMERATION	0 - 1 ,0 means low, 1 means high
2E1	737	Channel 1 Relay 3 Set Point	R/W	32	FLOAT	Any number 65000 or less and higher than 0
2E3	739	Channel 2 Relay 3 Set Point	R/W	32	FLOAT	Any number 65000 or less and higher than 0
2E5	741	Channel 3 Relay 3 Set Point	R/W	32	FLOAT	Any number 65000 or less and higher than 0
2E7	743	Channel 4 Relay 3 Set Point	R/W	32	FLOAT	Any number 65000 or less and higher than 0
2E9	745	Channel 5 Relay 3 Set Point	R/W	32	FLOAT	Any number 65000 or less and higher than 0
2EB	747	Channel 6 Relay 3 Set Point	R/W	32	FLOAT	Any number 65000 or less and higher than 0
2ED	749	Channel 7 Relay 3 Set Point	R/W	32	FLOAT	Any number 65000 or less and higher than 0
2EF	751	Channel 8 Relay 3 Set Point	R/W	32	FLOAT	Any number 65000 or less and higher than 0
2F1	753	Channel 9 Relay 3 Set Point	R/W	32	FLOAT	Any number 65000 or less and higher than 0
2F3	755	Channel 10 Relay 3 Set Point	R/W	32	FLOAT	Any number 65000 or less and higher than 0
2F5	757	Channel 11 Relay 3 Set Point	R/W	32	FLOAT	Any number 65000 or less and higher than 0
2F7	759	Channel 12 Relay 3 Set Point	R/W	32	FLOAT	Any number 65000 or less and higher than 0
2F9	761	Channel 13 Relay 3 Set Point	R/W	32	FLOAT	Any number 65000 or less and higher than 0
2FB	763	Channel 14 Relay 3 Set Point	R/W	32	FLOAT	Any number 65000 or less and higher than 0

2FD	765	Channel 15 Relay 3 Set Point	R/W	32	FLOAT	Any number 65000 or less and higher than 0
2FF	767	Channel 16 Relay 3 Set Point	R/W	32	FLOAT	Any number 65000 or less and higher than 0
301	769	Channel 17 Relay 3 Set Point	R/W	32	FLOAT	Any number 65000 or less and higher than 0
303	771	Channel 18 Relay 3 Set Point	R/W	32	FLOAT	Any number 65000 or less and higher than 0
305	773	Channel 19 Relay 3 Set Point	R/W	32	FLOAT	Any number 65000 or less and higher than 0
307	775	Channel 20 Relay 3 Set Point	R/W	32	FLOAT	Any number 65000 or less and higher than 0
309	777	Channel 21 Relay 3 Set Point	R/W	32	FLOAT	Any number 65000 or less and higher than 0
30B	779	Channel 22 Relay 3 Set Point	R/W	32	FLOAT	Any number 65000 or less and higher than 0
30D	781	Channel 23 Relay 3 Set Point	R/W	32	FLOAT	Any number 65000 or less and higher than 0
30F	783	Channel 24 Relay 3 Set Point	R/W	32	FLOAT	Any number 65000 or less and higher than 0
311	785	Channel 25 Relay 3 Set Point	R/W	32	FLOAT	Any number 65000 or less and higher than 0
313	787	Channel 26 Relay 3 Set Point	R/W	32	FLOAT	Any number 65000 or less and higher than 0
315	789	Channel 27 Relay 3 Set Point	R/W	32	FLOAT	Any number 65000 or less and higher than 0
317	791	Channel 28 Relay 3 Set Point	R/W	32	FLOAT	Any number 65000 or less and higher than 0
319	793	Channel 29 Relay 3 Set Point	R/W	32	FLOAT	Any number 65000 or less and higher than 0
31B	795	Channel 30 Relay 3 Set Point	R/W	32	FLOAT	Any number 65000 or less and higher than 0
31D	797	Channel 31 Relay 3 Set Point	R/W	32	FLOAT	Any number 65000 or less and higher than 0
31F	799	Channel 32 Relay 3 Set Point	R/W	32	FLOAT	Any number 65000 or less and higher than 0
321	801	Channel 1 Relay 3 Latch/Unlatch	R/W	16	ENUMERATION	0 - 1 ,0 means unlatch, 1 means latch
322	802	Channel 2 Relay 3 Latch/Unlatch	R/W	16	ENUMERATION	0 - 1 ,0 means unlatch, 1 means latch
323	803	Channel 3 Relay 3 Latch/Unlatch	R/W	16	ENUMERATION	0 - 1 ,0 means unlatch, 1 means latch
324	804	Channel 4 Relay 3 Latch/Unlatch	R/W	16	ENUMERATION	0 - 1 ,0 means unlatch, 1 means latch
325	805	Channel 5 Relay 3 Latch/Unlatch	R/W	16	ENUMERATION	0 - 1 ,0 means unlatch, 1 means latch
326	806	Channel 6 Relay 3 Latch/Unlatch	R/W	16	ENUMERATION	0 - 1 ,0 means unlatch, 1 means latch
327	807	Channel 7 Relay 3 Latch/Unlatch	R/W	16	ENUMERATION	0 - 1 ,0 means unlatch, 1 means latch
328	808	Channel 8 Relay 3 Latch/Unlatch	R/W	16	ENUMERATION	0 - 1 ,0 means unlatch, 1 means latch
329	809	Channel 9 Relay 3 Latch/Unlatch	R/W	16	ENUMERATION	0 - 1 ,0 means unlatch, 1 means latch
32A	810	Channel 10 Relay 3 Latch/Unlatch	R/W	16	ENUMERATION	0 - 1 ,0 means unlatch, 1 means latch
32B	811	Channel 11 Relay 3 Latch/Unlatch	R/W	16	ENUMERATION	0 - 1 ,0 means unlatch, 1 means latch
32C	812	Channel 12 Relay 3 Latch/Unlatch	R/W	16	ENUMERATION	0 - 1 ,0 means unlatch, 1 means latch
32D	813	Channel 13 Relay 3 Latch/Unlatch	R/W	16	ENUMERATION	0 - 1 ,0 means unlatch, 1 means latch
32E	814	Channel 14 Relay 3 Latch/Unlatch	R/W	16	ENUMERATION	0 - 1 ,0 means unlatch, 1 means latch
32F	815	Channel 15 Relay 3 Latch/Unlatch	R/W	16	ENUMERATION	0 - 1 ,0 means unlatch, 1 means latch
330	816	Channel 16 Relay 3 Latch/Unlatch	R/W	16	ENUMERATION	0 - 1 ,0 means unlatch, 1 means latch
331	817	Channel 17 Relay 3 Latch/Unlatch	R/W	16	ENUMERATION	0 - 1 ,0 means unlatch, 1 means latch
332	818	Channel 18 Relay 3 Latch/Unlatch	R/W	16	ENUMERATION	0 - 1 ,0 means unlatch, 1 means latch
333	819	Channel 19 Relay 3 Latch/Unlatch	R/W	16	ENUMERATION	0 - 1 ,0 means unlatch, 1 means latch
334	820	Channel 20 Relay 3 Latch/Unlatch	R/W	16	ENUMERATION	0 - 1 ,0 means unlatch, 1 means latch
335	821	Channel 21 Relay 3 Latch/Unlatch	R/W	16	ENUMERATION	0 - 1 ,0 means unlatch, 1 means latch
336	822	Channel 22 Relay 3 Latch/Unlatch	R/W	16	ENUMERATION	0 - 1 ,0 means unlatch, 1 means latch
337	823	Channel 23 Relay 3 Latch/Unlatch	R/W	16	ENUMERATION	0 - 1 ,0 means unlatch, 1 means latch
338	824	Channel 24 Relay 3 Latch/Unlatch	R/W	16	ENUMERATION	0 - 1 ,0 means unlatch, 1 means latch

16

339	825	Channel 25 Relay 3 Latch/Unlatch	R/W	16	ENUMERATION	0 - 1, 0 means unlatch, 1 means latch
33A	826	Channel 26 Relay 3 Latch/Unlatch	R/W	16	ENUMERATION	0 - 1, 0 means unlatch, 1 means latch
33B	827	Channel 27 Relay 3 Latch/Unlatch	R/W	16	ENUMERATION	0 - 1, 0 means unlatch, 1 means latch
33C	828	Channel 28 Relay 3 Latch/Unlatch	R/W	16	ENUMERATION	0 - 1, 0 means unlatch, 1 means latch
33D	829	Channel 29 Relay 3 Latch/Unlatch	R/W	16	ENUMERATION	0 - 1, 0 means unlatch, 1 means latch
33E	830	Channel 30 Relay 3 Latch/Unlatch	R/W	16	ENUMERATION	0 - 1, 0 means unlatch, 1 means latch
33F	831	Channel 31 Relay 3 Latch/Unlatch	R/W	16	ENUMERATION	0 - 1, 0 means unlatch, 1 means latch
340	832	Channel 32 Relay 3 Latch/Unlatch	R/W	16	ENUMERATION	0 - 1, 0 means unlatch, 1 means latch
341	833	Channel 1 Relay 4 On/Off	R/W	16	ENUMERATION	0 - 1, 0 means off, 1 means on
342	834	Channel 2 Relay 4 On/Off	R/W	16	ENUMERATION	0 - 1, 0 means off, 1 means on
343	835	Channel 3 Relay 4 On/Off	R/W	16	ENUMERATION	0 - 1, 0 means off, 1 means on
344	836	Channel 4 Relay 4 On/Off	R/W	16	ENUMERATION	0 - 1, 0 means off, 1 means on
345	837	Channel 5 Relay 4 On/Off	R/W	16	ENUMERATION	0 - 1, 0 means off, 1 means on
346	838	Channel 6 Relay 4 On/Off	R/W	16	ENUMERATION	0 - 1, 0 means off, 1 means on
347	839	Channel 7 Relay 4 On/Off	R/W	16	ENUMERATION	0 - 1, 0 means off, 1 means on
348	840	Channel 8 Relay 4 On/Off	R/W	16	ENUMERATION	0 - 1, 0 means off, 1 means on
349	841	Channel 9 Relay 4 On/Off	R/W	16	ENUMERATION	0 - 1, 0 means off, 1 means on
34A	842	Channel 10 Relay 4 On/Off	R/W	16	ENUMERATION	0 - 1, 0 means off, 1 means on
34B	843	Channel 11 Relay 4 On/Off	R/W	16	ENUMERATION	0 - 1, 0 means off, 1 means on
34C	844	Channel 12 Relay 4 On/Off	R/W	16	ENUMERATION	0 - 1, 0 means off, 1 means on
34D	845	Channel 13 Relay 4 On/Off	R/W	16	ENUMERATION	0 - 1, 0 means off, 1 means on
34E	846	Channel 14 Relay 4 On/Off	R/W	16	ENUMERATION	0 - 1, 0 means off, 1 means on
34F	847	Channel 15 Relay 4 On/Off	R/W	16	ENUMERATION	0 - 1, 0 means off, 1 means on
350	848	Channel 16 Relay 4 On/Off	R/W	16	ENUMERATION	0 - 1, 0 means off, 1 means on
351	849	Channel 17 Relay 4 On/Off	R/W	16	ENUMERATION	0 - 1, 0 means off, 1 means on
352	850	Channel 18 Relay 4 On/Off	R/W	16	ENUMERATION	0 - 1, 0 means off, 1 means on
353	851	Channel 19 Relay 4 On/Off	R/W	16	ENUMERATION	0 - 1, 0 means off, 1 means on
354	852	Channel 20 Relay 4 On/Off	R/W	16	ENUMERATION	0 - 1, 0 means off, 1 means on
355	853	Channel 21 Relay 4 On/Off	R/W	16	ENUMERATION	0 - 1, 0 means off, 1 means on
356	854	Channel 22 Relay 4 On/Off	R/W	16	ENUMERATION	0 - 1, 0 means off, 1 means on
357	855	Channel 23 Relay 4 On/Off	R/W	16	ENUMERATION	0 - 1, 0 means off, 1 means on
358	856	Channel 24 Relay 4 On/Off	R/W	16	ENUMERATION	0 - 1, 0 means off, 1 means on
359	857	Channel 25 Relay 4 On/Off	R/W	16	ENUMERATION	0 - 1, 0 means off, 1 means on
35A	858	Channel 26 Relay 4 On/Off	R/W	16	ENUMERATION	0 - 1, 0 means off, 1 means on
35B	859	Channel 27 Relay 4 On/Off	R/W	16	ENUMERATION	0 - 1, 0 means off, 1 means on
35C	860	Channel 28 Relay 4 On/Off	R/W	16	ENUMERATION	0 - 1, 0 means off, 1 means on
35D	861	Channel 29 Relay 4 On/Off	R/W	16	ENUMERATION	0 - 1, 0 means off, 1 means on
35E	862	Channel 30 Relay 4 On/Off	R/W	16	ENUMERATION	0 - 1, 0 means off, 1 means on
35F	863	Channel 31 Relay 4 On/Off	R/W	16	ENUMERATION	0 - 1, 0 means off, 1 means on
360	864	Channel 32 Relay 4 On/Off	R/W	16	ENUMERATION	0 - 1, 0 means off, 1 means on
361	865	Channel 1 Relay 4 High/Low	R/W	16	ENUMERATION	0 - 1, 0 means low, 1 means high
362	866	Channel 2 Relay 4 High/Low	R/W	16	ENUMERATION	0 - 1, 0 means low, 1 means high

363	867	Channel 3 Relay 4 High/Low	R/W	16	ENUMERATION	0 - 1 ,0 means low, 1 means high
364	868	Channel 4 Relay 4 High/Low	R/W	16	ENUMERATION	0 - 1 ,0 means low, 1 means high
365	869	Channel 5 Relay 4 High/Low	R/W	16	ENUMERATION	0 - 1 ,0 means low, 1 means high
366	870	Channel 6 Relay 4 High/Low	R/W	16	ENUMERATION	0 - 1 ,0 means low, 1 means high
367	871	Channel 7 Relay 4 High/Low	R/W	16	ENUMERATION	0 - 1 ,0 means low, 1 means high
368	872	Channel 8 Relay 4 High/Low	R/W	16	ENUMERATION	0 - 1 ,0 means low, 1 means high
369	873	Channel 9 Relay 4 High/Low	R/W	16	ENUMERATION	0 - 1 ,0 means low, 1 means high
36A	874	Channel 10 Relay 4 High/Low	R/W	16	ENUMERATION	0 - 1 ,0 means low, 1 means high
36B	875	Channel 11 Relay 4 High/Low	R/W	16	ENUMERATION	0 - 1 ,0 means low, 1 means high
36C	876	Channel 12 Relay 4 High/Low	R/W	16	ENUMERATION	0 - 1 ,0 means low, 1 means high
36D	877	Channel 13 Relay 4 High/Low	R/W	16	ENUMERATION	0 - 1 ,0 means low, 1 means high
36E	878	Channel 14 Relay 4 High/Low	R/W	16	ENUMERATION	0 - 1 ,0 means low, 1 means high
36F	879	Channel 15 Relay 4 High/Low	R/W	16	ENUMERATION	0 - 1 ,0 means low, 1 means high
370	880	Channel 16 Relay 4 High/Low	R/W	16	ENUMERATION	0 - 1 ,0 means low, 1 means high
371	881	Channel 17 Relay 4 High/Low	R/W	16	ENUMERATION	0 - 1 ,0 means low, 1 means high
372	882	Channel 18 Relay 4 High/Low	R/W	16	ENUMERATION	0 - 1 ,0 means low, 1 means high
373	883	Channel 19 Relay 4 High/Low	R/W	16	ENUMERATION	0 - 1 ,0 means low, 1 means high
374	884	Channel 20 Relay 4 High/Low	R/W	16	ENUMERATION	0 - 1 ,0 means low, 1 means high
375	885	Channel 21 Relay 4 High/Low	R/W	16	ENUMERATION	0 - 1 ,0 means low, 1 means high
376	886	Channel 22 Relay 4 High/Low	R/W	16	ENUMERATION	0 - 1 ,0 means low, 1 means high
377	887	Channel 23 Relay 4 High/Low	R/W	16	ENUMERATION	0 - 1 ,0 means low, 1 means high
378	888	Channel 24 Relay 4 High/Low	R/W	16	ENUMERATION	0 - 1 ,0 means low, 1 means high
379	889	Channel 25 Relay 4 High/Low	R/W	16	ENUMERATION	0 - 1 ,0 means low, 1 means high
37A	890	Channel 26 Relay 4 High/Low	R/W	16	ENUMERATION	0 - 1 ,0 means low, 1 means high
37B	891	Channel 27 Relay 4 High/Low	R/W	16	ENUMERATION	0 - 1 ,0 means low, 1 means high
37C	892	Channel 28 Relay 4 High/Low	R/W	16	ENUMERATION	0 - 1 ,0 means low, 1 means high
37D	893	Channel 29 Relay 4 High/Low	R/W	16	ENUMERATION	0 - 1 ,0 means low, 1 means high
37E	894	Channel 30 Relay 4 High/Low	R/W	16	ENUMERATION	0 - 1 ,0 means low, 1 means high
37F	895	Channel 31 Relay 4 High/Low	R/W	16	ENUMERATION	0 - 1 ,0 means low, 1 means high
380	896	Channel 32 Relay 4 High/Low	R/W	16	ENUMERATION	0 - 1 ,0 means low, 1 means high
381	897	Channel 1 Relay 4 Set Point	R/W	32	FLOAT	Any number 65000 or less and higher than 0
383	899	Channel 2 Relay 4 Set Point	R/W	32	FLOAT	Any number 65000 or less and higher than 0
385	901	Channel 3 Relay 4 Set Point	R/W	32	FLOAT	Any number 65000 or less and higher than 0
387	903	Channel 4 Relay 4 Set Point	R/W	32	FLOAT	Any number 65000 or less and higher than 0
389	905	Channel 5 Relay 4 Set Point	R/W	32	FLOAT	Any number 65000 or less and higher than 0
38B	907	Channel 6 Relay 4 Set Point	R/W	32	FLOAT	Any number 65000 or less and higher than 0
38D	909	Channel 7 Relay 4 Set Point	R/W	32	FLOAT	Any number 65000 or less and higher than 0
38F	911	Channel 8 Relay 4 Set Point	R/W	32	FLOAT	Any number 65000 or less and higher than 0
391	913	Channel 9 Relay 4 Set Point	R/W	32	FLOAT	Any number 65000 or less and higher than 0
393	915	Channel 10 Relay 4 Set Point	R/W	32	FLOAT	Any number 65000 or less and higher than 0
395	917	Channel 11 Relay 4 Set Point	R/W	32	FLOAT	Any number 65000 or less and higher than 0
397	919	Channel 12 Relay 4 Set Point	R/W	32	FLOAT	Any number 65000 or less and higher than 0

399	921	Channel 13 Relay 4 Set Point	R/W	32	FLOAT	Any number 65000 or less and higher than 0
39B	923	Channel 14 Relay 4 Set Point	R/W	32	FLOAT	Any number 65000 or less and higher than 0
39D	925	Channel 15 Relay 4 Set Point	R/W	32	FLOAT	Any number 65000 or less and higher than 0
39F	927	Channel 16 Relay 4 Set Point	R/W	32	FLOAT	Any number 65000 or less and higher than 0
3A1	929	Channel 17 Relay 4 Set Point	R/W	32	FLOAT	Any number 65000 or less and higher than 0
3A3	931	Channel 18 Relay 4 Set Point	R/W	32	FLOAT	Any number 65000 or less and higher than 0
3A5	933	Channel 19 Relay 4 Set Point	R/W	32	FLOAT	Any number 65000 or less and higher than 0
3A7	935	Channel 20 Relay 4 Set Point	R/W	32	FLOAT	Any number 65000 or less and higher than 0
3A9	937	Channel 21 Relay 4 Set Point	R/W	32	FLOAT	Any number 65000 or less and higher than 0
3AB	939	Channel 22 Relay 4 Set Point	R/W	32	FLOAT	Any number 65000 or less and higher than 0
3AD	941	Channel 23 Relay 4 Set Point	R/W	32	FLOAT	Any number 65000 or less and higher than 0
3AF	943	Channel 24 Relay 4 Set Point	R/W	32	FLOAT	Any number 65000 or less and higher than 0
3B1	945	Channel 25 Relay 4 Set Point	R/W	32	FLOAT	Any number 65000 or less and higher than 0
3B3	947	Channel 26 Relay 4 Set Point	R/W	32	FLOAT	Any number 65000 or less and higher than 0
3B5	949	Channel 27 Relay 4 Set Point	R/W	32	FLOAT	Any number 65000 or less and higher than 0
3B7	951	Channel 28 Relay 4 Set Point	R/W	32	FLOAT	Any number 65000 or less and higher than 0
3B9	953	Channel 29 Relay 4 Set Point	R/W	32	FLOAT	Any number 65000 or less and higher than 0
3BB	955	Channel 30 Relay 4 Set Point	R/W	32	FLOAT	Any number 65000 or less and higher than 0
3BD	957	Channel 31 Relay 4 Set Point	R/W	32	FLOAT	Any number 65000 or less and higher than 0
3BF	959	Channel 32 Relay 4 Set Point	R/W	32	FLOAT	Any number 65000 or less and higher than 0
3C1	961	Channel 1 Relay 4 Latch/Unlatch	R/W	16	ENUMERATION	0 - 1, 0 means unlatch, 1 means latch
3C2	962	Channel 2 Relay 4 Latch/Unlatch	R/W	16	ENUMERATION	0 - 1, 0 means unlatch, 1 means latch
3C3	963	Channel 3 Relay 4 Latch/Unlatch	R/W	16	ENUMERATION	0 - 1, 0 means unlatch, 1 means latch
3C4	964	Channel 4 Relay 4 Latch/Unlatch	R/W	16	ENUMERATION	0 - 1, 0 means unlatch, 1 means latch
3C5	965	Channel 5 Relay 4 Latch/Unlatch	R/W	16	ENUMERATION	0 - 1, 0 means unlatch, 1 means latch
3C6	966	Channel 6 Relay 4 Latch/Unlatch	R/W	16	ENUMERATION	0 - 1, 0 means unlatch, 1 means latch
3C7	967	Channel 7 Relay 4 Latch/Unlatch	R/W	16	ENUMERATION	0 - 1, 0 means unlatch, 1 means latch
3C8	968	Channel 8 Relay 4 Latch/Unlatch	R/W	16	ENUMERATION	0 - 1, 0 means unlatch, 1 means latch
3C9	969	Channel 9 Relay 4 Latch/Unlatch	R/W	16	ENUMERATION	0 - 1, 0 means unlatch, 1 means latch
3CA	970	Channel 10 Relay 4 Latch/Unlatch	R/W	16	ENUMERATION	0 - 1, 0 means unlatch, 1 means latch
3CB	971	Channel 11 Relay 4 Latch/Unlatch	R/W	16	ENUMERATION	0 - 1, 0 means unlatch, 1 means latch
3CC	972	Channel 12 Relay 4 Latch/Unlatch	R/W	16	ENUMERATION	0 - 1, 0 means unlatch, 1 means latch
3CD	973	Channel 13 Relay 4 Latch/Unlatch	R/W	16	ENUMERATION	0 - 1, 0 means unlatch, 1 means latch
3CE	974	Channel 14 Relay 4 Latch/Unlatch	R/W	16	ENUMERATION	0 - 1, 0 means unlatch, 1 means latch
3CF	975	Channel 15 Relay 4 Latch/Unlatch	R/W	16	ENUMERATION	0 - 1, 0 means unlatch, 1 means latch
3D0	976	Channel 16 Relay 4 Latch/Unlatch	R/W	16	ENUMERATION	0 - 1, 0 means unlatch, 1 means latch
3D1	977	Channel 17 Relay 4 Latch/Unlatch	R/W	16	ENUMERATION	0 - 1, 0 means unlatch, 1 means latch
3D2	978	Channel 18 Relay 4 Latch/Unlatch	R/W	16	ENUMERATION	0 - 1, 0 means unlatch, 1 means latch
3D3	979	Channel 19 Relay 4 Latch/Unlatch	R/W	16	ENUMERATION	0 - 1, 0 means unlatch, 1 means latch
3D4	980	Channel 20 Relay 4 Latch/Unlatch	R/W	16	ENUMERATION	0 - 1, 0 means unlatch, 1 means latch
3D5	981	Channel 21 Relay 4 Latch/Unlatch	R/W	16	ENUMERATION	0 - 1, 0 means unlatch, 1 means latch
3D6	982	Channel 22 Relay 4 Latch/Unlatch	R/W	16	ENUMERATION	0 - 1, 0 means unlatch, 1 means latch

3D7	983	Channel 23 Relay 4 Latch/Unlatch	R/W	16	ENUMERATION	0 - 1 ,0 means unlatch, 1 means latch
3D8	984	Channel 24 Relay 4 Latch/Unlatch	R/W	16	ENUMERATION	0 - 1 ,0 means unlatch, 1 means latch
3D9	985	Channel 25 Relay 4 Latch/Unlatch	R/W	16	ENUMERATION	0 - 1 ,0 means unlatch, 1 means latch
3DA	986	Channel 26 Relay 4 Latch/Unlatch	R/W	16	ENUMERATION	0 - 1 ,0 means unlatch, 1 means latch
3DB	987	Channel 27 Relay 4 Latch/Unlatch	R/W	16	ENUMERATION	0 - 1 ,0 means unlatch, 1 means latch
3DC	988	Channel 28 Relay 4 Latch/Unlatch	R/W	16	ENUMERATION	0 - 1 ,0 means unlatch, 1 means latch
3DD	989	Channel 29 Relay 4 Latch/Unlatch	R/W	16	ENUMERATION	0 - 1 ,0 means unlatch, 1 means latch
3DE	990	Channel 30 Relay 4 Latch/Unlatch	R/W	16	ENUMERATION	0 - 1 ,0 means unlatch, 1 means latch
3DF	991	Channel 31 Relay 4 Latch/Unlatch	R/W	16	ENUMERATION	0 - 1 ,0 means unlatch, 1 means latch
3E0	992	Channel 32 Relay 4 Latch/Unlatch	R/W	16	ENUMERATION	0 - 1 ,0 means unlatch, 1 means latch
3E1	993	Channel 29 Select Wired or Radio	R/W	16	ENUMERATION	0 - 1 ,0 means wired, 1 means radio
3E2	994	Channel 30 Select Wired or Radio	R/W	16	ENUMERATION	0 - 1 ,0 means wired, 1 means radio
3E3	995	Channel 31 Select Wired or Radio	R/W	16	ENUMERATION	0 - 1 ,0 means wired, 1 means radio
3E4	996	Channel 32 Select Wired or Radio	R/W	16	ENUMERATION	0 - 1 ,0 means wired, 1 means radio
3E5	997	Channel 29 Max Scale	R/W	16	INTEGER	1—65000
3E6	998	Channel 30 Max Scale	R/W	16	INTEGER	1—65000
3E7	999	Channel 31 Max Scale	R/W	16	INTEGER	1—65000
3E8	1000	Channel 32 Max Scale	R/W	16	INTEGER	1—65000
3E9	1001	Channel 29 Min Scale	R/W	16	INTEGER	-70-0
3EA	1002	Channel 30 Min Scale	R/W	16	INTEGER	-70-0
3EB	1003	Channel 31 Min Scale	R/W	16	INTEGER	-70-0
3EC	1004	Channel 32 Min Scale	R/W	16	INTEGER	-70-0
3ED	1005	Channel 1 Time Since Last Nulled	R	16	UINT	Number of days since last nulled. (Added in Firmware 5.1.3)
3EE	1006	Channel 2 Time Since Last Nulled	R	16	UINT	Number of days since last nulled. (Added in Firmware 5.1.3)
3EF	1007	Channel 3 Time Since Last Nulled	R	16	UINT	Number of days since last nulled. (Added in Firmware 5.1.3)
3F0	1008	Channel 4 Time Since Last Nulled	R	16	UINT	Number of days since last nulled. (Added in Firmware 5.1.3)
3F1	1009	Channel 5 Time Since Last Nulled	R	16	UINT	Number of days since last nulled. (Added in Firmware 5.1.3)
3F2	1010	Channel 6 Time Since Last Nulled	R	16	UINT	Number of days since last nulled. (Added in Firmware 5.1.3)
3F3	1011	Channel 7 Time Since Last Nulled	R	16	UINT	Number of days since last nulled. (Added in Firmware 5.1.3)
3F4	1012	Channel 8 Time Since Last Nulled	R	16	UINT	Number of days since last nulled. (Added in Firmware 5.1.3)
3F5	1013	Channel 9 Time Since Last Nulled	R	16	UINT	Number of days since last nulled. (Added in Firmware 5.1.3)
3F6	1014	Channel 10 Time Since Last Nulled	R	16	UINT	Number of days since last nulled. (Added in Firmware 5.1.3)
3F7	1015	Channel 11 Time Since Last Nulled	R	16	UINT	Number of days since last nulled. (Added in Firmware 5.1.3)
3F8	1016	Channel 12 Time Since Last Nulled	R	16	UINT	Number of days since last nulled. (Added in Firmware 5.1.3)
3F9	1017	Channel 13 Time Since Last Nulled	R	16	UINT	Number of days since last nulled. (Added in Firmware 5.1.3)
3FA	1018	Channel 14 Time Since Last Nulled	R	16	UINT	Number of days since last nulled. (Added in Firmware 5.1.3)
3FB	1019	Channel 15 Time Since Last Nulled	R	16	UINT	Number of days since last nulled. (Added in Firmware 5.1.3)
3FC	1020	Channel 16 Time Since Last Nulled	R	16	UINT	Number of days since last nulled. (Added in Firmware 5.1.3)
3FD	1021	Channel 17 Time Since Last Nulled	R	16	UINT	Number of days since last nulled. (Added in Firmware 5.1.3)
3FE	1022	Channel 18 Time Since Last Nulled	R	16	UINT	Number of days since last nulled. (Added in Firmware 5.1.3)
3FF	1023	Channel 19 Time Since Last Nulled	R	16	UINT	Number of days since last nulled. (Added in Firmware 5.1.3)
400	1024	Channel 20 Time Since Last Nulled	R	16	UINT	Number of days since last nulled. (Added in Firmware 5.1.3)

20

42B	1067	Channel 31 Time Since Last Calibrated	R	16	UINT	Number of days since last Calibrated. (Added in Firmware 5.1.3)
42C	1068	Channel 32 Time Since Last Calibrated	R	16	UINT	Number of days since last Calibrated. (Added in Firmware 5.1.3)
Modbus and Build Data						
1771	6001	Modbus Address	R/W	16	INTEGER	1 – 247
1772	6002	Modbus Baud Rate	R/W	16	INTEGER	Any Valid Baud Rate. See Below.
1773	6003	Month	R	16	INTEGER	1 – 12
1774	6004	Day	R	16	INTEGER	1 – 31
1775	6005	Year	R	16	INTEGER	2009 –
1776	6006	Serial Number Character	R	16	ENUMERATION	0 – 52 See Serial Number below
1777	6007	Serial Number	R	32	LONG INT	1 – 99999
Settings in Startup Menu						
177A	6010	Can Change Startup Menu Options	R	16	ENUMERATION	0 – 1, 1 can change startup menu items. 0 cannot change.
177B	6011	Restore to Factory Default	R/W	16	ENUMERATION	When read will be 0. When you want to restore write a 1.
177C	6012	Relay 4 as Fault Relay	R/W	16	ENUMERATION	0 – 1, 0 means normal relay, 1 means Fault Relay
177D	6013	Relay 1 Fail Safe	R/W	16	ENUMERATION	0 – 1, 0 means not Fail Safe, 1 means Fail Safe
177E	6014	Relay 2 Fail Safe	R/W	16	ENUMERATION	0 – 1, 0 means not Fail Safe, 1 means Fail Safe
177F	6015	Relay 3 Fail Safe	R/W	16	ENUMERATION	0 – 1, 0 means not Fail Safe, 1 means Fail Safe
1780	6016	Relay 4 Fail Safe	R/W	16	ENUMERATION	0 – 1, 0 means not Fail Safe, 1 means Fail Safe
1781	6017	Fault Terminal Fail Safe	R/W	16	ENUMERATION	0 – 1, 0 means not Fail Safe, 1 means Fail Safe
1782	6018	Radio Timeout	R/W	16	INTEGER	6-255. This is the timeout in minutes.
1783	6019	Network Channel	R/W	16	INTEGER	1–78
1784	6020	Primary Secondary	R/W	16	ENUMERATION	0 – 1, 0 means Primary, 1 means Secondary.
Relays in Alarm State						
1785	6021	Relay 1 is in Alarm	R	16	ENUMERATION	0 – 1, 0 means not in Alarm, 1 means in Alarm
1786	6022	Relay 2 is in Alarm	R	16	ENUMERATION	0 – 1, 0 means not in Alarm, 1 means in Alarm
1787	6023	Relay 3 is in Alarm	R	16	ENUMERATION	0 – 1, 0 means not in Alarm, 1 means in Alarm
1788	6024	Relay 4 is in Alarm	R	16	ENUMERATION	0 – 1, 0 means not in Alarm, 1 means in Alarm
1789	6025	Fault Relay is in Alarm	R	16	ENUMERATION	0 – 1, 0 means not in Alarm, 1 means in Alarm
178A	6026	Channels 1-32 in Alarm	R	32	ENUMERATION	Each bit corresponds to a Channel. 1 means in Alarm
178C	6028	Not used on 32 Channel 7010		32		
178E	6030	Reset Relays	R/W	16	ENUMERATION	Reads always a 0. Write 1 to reset the relays.
178F	6031	Channels in Fault	R	16	ENUMERATION	0 – 3, 0 no fault, 1 fault 1-16, 2 fault 17-32, 3 fault on both
1790	6032	Not used on 32 Channel 7010		16		
1791	6033	Fault: There is another Primary Monitor	R	16	ENUMERATION	0-1, 0 means no fault, 1 means there is another Primary
1792	6034	Put into Cal Mode	R/W	1	ENUMERATION	0-1, 0 means not in Cal Mode (Added in Firmware 5.1.6)
17A5	6053	Monitor supply voltage	R	32	FLOAT	Supply voltage in volts, only accurate up to about 12 volts (Added in Firmware 5.1.3)
Signal Strength (Section Added in Firmware 5.1.5)						
1839	6201	Channel 1 RSSI	R	16	INTEGER	0-100% Receive Signal Strength
183A	6202	Channel 2 RSSI	R	16	INTEGER	0-100% Receive Signal Strength
183B	6203	Channel 3 RSSI	R	16	INTEGER	0-100% Receive Signal Strength
183C	6204	Channel 4 RSSI	R	16	INTEGER	0-100% Receive Signal Strength

183D	6205	Channel 5 RSSI	R	16	INTEGER	0-100% Receive Signal Strength
183E	6206	Channel 6 RSSI	R	16	INTEGER	0-100% Receive Signal Strength
183F	6207	Channel 7 RSSI	R	16	INTEGER	0-100% Receive Signal Strength
1840	6208	Channel 8 RSSI	R	16	INTEGER	0-100% Receive Signal Strength
1841	6209	Channel 9 RSSI	R	16	INTEGER	0-100% Receive Signal Strength
1842	6210	Channel 10 RSSI	R	16	INTEGER	0-100% Receive Signal Strength
1843	6211	Channel 11 RSSI	R	16	INTEGER	0-100% Receive Signal Strength
1844	6212	Channel 12 RSSI	R	16	INTEGER	0-100% Receive Signal Strength
1845	6213	Channel 13 RSSI	R	16	INTEGER	0-100% Receive Signal Strength
1846	6214	Channel 14 RSSI	R	16	INTEGER	0-100% Receive Signal Strength
1847	6215	Channel 15 RSSI	R	16	INTEGER	0-100% Receive Signal Strength
1848	6216	Channel 16 RSSI	R	16	INTEGER	0-100% Receive Signal Strength
1849	6217	Channel 17 RSSI	R	16	INTEGER	0-100% Receive Signal Strength
184A	6218	Channel 18 RSSI	R	16	INTEGER	0-100% Receive Signal Strength
184B	6219	Channel 19 RSSI	R	16	INTEGER	0-100% Receive Signal Strength
184C	6220	Channel 20 RSSI	R	16	INTEGER	0-100% Receive Signal Strength
184D	6221	Channel 21 RSSI	R	16	INTEGER	0-100% Receive Signal Strength
184E	6222	Channel 22 RSSI	R	16	INTEGER	0-100% Receive Signal Strength
184F	6223	Channel 23 RSSI	R	16	INTEGER	0-100% Receive Signal Strength
1850	6224	Channel 24 RSSI	R	16	INTEGER	0-100% Receive Signal Strength
1851	6225	Channel 25 RSSI	R	16	INTEGER	0-100% Receive Signal Strength
1852	6226	Channel 26 RSSI	R	16	INTEGER	0-100% Receive Signal Strength
1853	6227	Channel 27 RSSI	R	16	INTEGER	0-100% Receive Signal Strength
1854	6228	Channel 28 RSSI	R	16	INTEGER	0-100% Receive Signal Strength
1855	6229	Channel 29 RSSI	R	16	INTEGER	0-100% Receive Signal Strength
1856	6230	Channel 30 RSSI	R	16	INTEGER	0-100% Receive Signal Strength
1857	6231	Channel 31 RSSI	R	16	INTEGER	0-100% Receive Signal Strength
1858	6232	Channel 32 RSSI	R	16	INTEGER	0-100% Receive Signal Strength
Diagnostics Data						
2704	9988	Reset	R/W	16	INTEGER	Read 0. If user sets to 1, resets the unit.
2705	9989	Serial Receive Good Count	R	16	UINT	0 – 65535
2706	9990	Serial Receive Error Count	R	16	UINT	0 – 65535
2707	9991	Serial Transmit Good Count	R	16	UINT	0 – 65535
2708	9992	Serial Transmit Error Count	R	16	UINT	0 – 65535
2709	9993	Radio Receive Good Count	R	16	UINT	0 – 65535
270A	9994	Radio Receive Error Count	R	16	UINT	0 – 65535
270B	9995	Radio Transmit Good Count	R	16	UINT	0 – 65535
270C	9996	Radio Transmit Error Count	R	16	UINT	0 – 65535
270D	9997	Uptime Days	R	16	UINT	0 – 65535
270E	9998	Uptime Hours	R	16	UINT	0 – 65535
270F	9999	Uptime Minutes	R	16	UINT	0 – 65535

MODE SENSOR	MODE
0	NORMAL
1	NULL
2	CALIBRATION
3	RELAY
4	Radio ADD
5	Diagnostic/ Batt
6	Advanced Menu
7	Admin Menu

Serial Number Char	Char
1	A
2	B
3	C
4	D
5	E
6	F
7	G
8	H
9	I
10	J
11	K
12	L
13	M
14	N
15	O
16	P
17	Q
18	R
19	S
20	T
21	U
22	V
23	W
24	X
25	Y
26	Z
27	AA
28	AB
29	AC
30	AD
31	AE
32	AF

Valid Baud Rates
4800
9600
19200

NUM	SENSOR
0	EC
1	IR
2	CB
3	MOS
4	PID
5	TANK
6	4-20
7	SWITCH
8	Unknown
30	WF190
31	None Selected

FAULT	FAULT
0	None
1	Sensor Timeout
2	Sensor reading below null (152 Model Only)
3	Replace sensor element (LPIR Only)
4	ADC not responding
5	Null Failed
6	Cal Failed
7	Low pump flow (Changed in 5.1.5, unused previously)
8	Two Sensors Same Address
9	Sensor Radio Timeout
10	When Sensor is wired, it means no sensor is connected
11	Rapid temperature change (LPIR Only)
12	Sensor Element Restarting (LPIR Only)
13	Unspecified Error on sensor unit. Shown only on Monitor
14	No Primary Monitor at Sensor Head
15	Monitor Fault

GAS TYPE NUM	GAS
0	H2S
1	SO2
2	O2
3	CO
4	CL2
5	CO2
6	LEL

24

33	AG
34	AH
35	AI
36	AJ
37	AK
38	AL
39	AM
40	AN
41	AO
42	AP
43	AQ
44	AR
45	AS
46	AT
47	AU
48	AV
49	AW
50	AX
51	AY
52	AZ

7	VOC
8	FEET
9	HCI
10	NH3
11	H2
12	ClO2
13	HCN
14	F2
15	HF
16	CH2O
17	NO2
18	O3
19	INCHES
20	4-20
21	Not Specified
22	C°
23	F°
24	CH4
25	NO
26	PH3
27	HBr (Firmware 5.1.3)
28	EtO (Firmware 5.1.3)
29	CH3SH (Firmware 5.1.3)
30	AsH3 (Firmware 5.1.3)
31	R410A (Firmware 5.1.3)
32	R1234YF (Firmware 5.1.3)
33	R32 (Firmware 5.1.3)
34..N	Future Gases