



Fall Protection

3M™ DBI-SALA® Fall Protection Full Line Catalogue | 2018/2019

Harnessing safety through science.



Fall protection made for what matters most.

Every day on your job, you climb to new heights with two things in mind: getting your work done well and returning home safely to those you love. Our job? Helping you get there.

With the high-performance DBI-SALA® Brand, 3M is a leader for safety at height, developing and delivering world-class fall protection solutions to workers on job sites all over Canada. That's why, when you gear up and climb with 3M™ DBI-SALA® Products, you can focus on what matters most: your work, your safety and your family.



The ABC's of fall protection

A typical Personal Fall Arrest System (PFAS) incorporates three components, often described as the ABC's of fall protection. The anchorage/anchorage connector, body support and connecting device—when used together—form a complete system for maximum worker protection. But don't forget the other important components of a comprehensive fall protection program: descent and rescue, education and fall protection for tools.



A

Anchorage

are a secure point of attachment. Anchorage connectors vary by industry, job, type of installation and structure. They must be able to support the intended loads and provide a sufficient factor of safety for fall arrest.

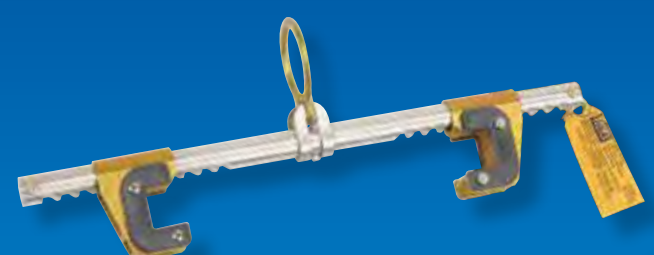

B

Body support

harnesses distribute fall forces over the upper thighs, pelvis, chest and shoulders. They provide a connection point on the worker for the personal fall arrest system.



C

Connectors

such as energy-absorbing lanyards or self-retracting lifelines connect a worker's harness to the anchorage.



D

Descent and rescue

devices are used to raise or lower a fallen injured worker to safety or retrieve him from a confined space.

E

Education

is essential. We offer a variety of training and consultative services to fit your needs.

F

Fall protection for tools

helps make work environments safer and more productive by reducing dropped object incidents.

Table of contents

Education..... 10-11

Harnesses..... 12-41

Belts, workseats and accessories..... 42-43

Fall protection for tools.....44-69

Energy-absorbing lanyards..... 70-81

Positioning lanyards 82-83

Self-retracting lifelines..... 84-97

Vertical systems..... 98-109

Horizontal systems..... 110-117

Engineered systems..... 118-123

Anchorage connectors124-137

Flexiguard™ Solutions 138-151

Confined space rescue..... 152-169

Rescue and descent 170-181

Netting and guardrail systems 182-191

Part number and page index192-200



We've worked in your industry for decades.

We climb the rigs in the oil and gas fields. We straddle the I-beams on construction sites. We attend the 5 a.m. toolbox safety discussions with transportation personnel. And we review tie-off challenges on top of wind turbine nacelles hundreds of feet in the air.

At 3M Fall Protection, we work hard to understand the challenges you face before we design your equipment. That's how we go beyond compliance to produce the broadest, most innovative, high quality fall protection equipment for the world's most vital industries.



Wind energy

To address safety needs in this growing industry, we created specialized 3M™ DBI-SALA® ExoFit™ NEX Wind Energy Harnesses and Force2 Lanyards, as well as unique rescue and escape systems such as the Rollgliss™ Rescue and Escape System R550.

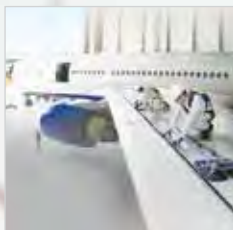

Transportation

We developed dozens of specialized products, from Uni™line Horizontal Systems for railcar loading, to custom access Flexiguard™ Solutions for semi-truck servicing. We've even designed a patented fall arrest-rated Mobi-Lok™ Self-Contained Vacuum Anchor System for aviation workers.



We've been
where you're
going.



Oil and gas

We pioneered “retractable” lifeline technology in the 1940s, “sealed retractable” technology specifically for the oil and gas fields, and products tested to -48.3°C to meet the IP68 seal rating. In addition, we developed specialized equipment and training for a wide array of emergency escape devices.

Mining

We developed specialized harnesses to address miners’ specific needs as well as 3M™ DBI-SALA® Flexiguard™ Solutions to protect them while doing maintenance on oversized mining industry trucks. Additionally, our industry-leading mining anchors maximize versatility and ease-of-use for workers.



Construction

No two construction sites are the same. That complexity is why we work closely with contractors to help us fine-tune our design on key products such as the 3M™ DBI-SALA® Nano-Lok™ edge Self-Retracting Lifeline—used at sites where sharp edges are hazardous and foot level tie-off is needed.

We listened to steel erectors and created shoulder caps that protect the webbing on our latest harnesses. Our EZ Line™ Horizontal Lifeline System is extremely user-friendly and features the world's only retractable design.



General industry

Every day, thousands of manufacturing and facility workers around the world don their safety gear and head out to do their job. Whether you're processing, milling, finishing, inspecting or doing routine maintenance, 3M Fall Protection has you covered. Our specialty Advanced Confined Space Equipment, Nano-Lok™ edge Self-Retracting Lifelines, ExoFit™ STRATA™ and ExoFit™ NEX Harnesses, ShockWave Lanyards, Lad-Saf™ Ladder Safety Systems and innovative guardrail and netting products are just a few of the many solutions we offer.



Utility, telecom and municipalities

We proactively innovate equipment specifically for these unique industries, like our Advanced Confined Space Equipment and our Cynch-Lok™ and Safflok™ Pole Anchors. Our arc flash products feature Kevlar®/Nomex® fibers and include the first arc flash self-retracting lifeline. Our redesigned SEAT-BELT™ Lineman Belt is made with 100% top grain leather from Red Wing, MN.



Elevated education. Applied to working at heights.

Proudly partnered with



3M Fall Protection Group

We are an industry leader in fall protection and high angle rescue training and a proud member of the 3M team.

We take pride in the creation and delivery of our services across geographies training workers at height. Whether it's delivering end-user training or an FPG Certified Instructor Program, we put all of our effort, resources and expertise into every service we provide.

With a wide variety of course offerings, we can assist you with programs in fall protection and high angle rescue or we can apply our specific knowledge to deliver a tailored program to your organization.

Our programs have the support, recognition, endorsement and accreditation from a variety of companies, groups, associations and governing bodies. Contact our office to learn more.

At-height work is at the core of what we do. Regardless of your industry and company size, our expertise can help enhance safety practices in organizations like yours, including:

- manufacturing
- construction (residential, commercial, industrial)
- transportation (including railroads & airlines)
- mining
- oil & gas and energy
- power generation & distribution
- telecom
- theatrical rigging
- government & regulatory

Call 1-888-FALLPRO or visit www.fallprogroup.com to learn more.



Open enrollment and on-site courses available.

Training Centres in Mississauga and Calgary. Meets CSA requirements.

Certified Instructor Programs

Interested in delivering training to your workers? Get the training backed and supported by the leader in fall protection training.

Teach the latest content and materials through our FPG Certified Instructor Program, which is continuously updated and maintained. Our leading approach takes your present training abilities and combines it with our program methodology to create a winning solution for delivering training to your workers or for your independent training group.

In addition to training, 3M Fall Protection Group is a technical resource for many training standards organizations. We are on the executive committee for the CSA Standards Z259 on Fall Protection and we also work with and provide training to government OH&S Officers in Canada and OSHA Compliance Officers in the U.S.

Take advantage of our experience and dedication to training by attending one of our programs delivered at our training location or yours. If you need added flexibility, we currently offer open enrollment courses in Calgary, Edmonton and Mississauga. Contact us to discuss your needs and let us make a plan that fits your group.



Programs We Offer

General Fall Protection

- Essentials
- Comprehensive
- Advanced
- Leadership
- Oil Sands
- Working at Heights
(Meets Ontario training standard)

Specialized Fall Protection

- Equipment Inspection
- Wood Pole Climbing
- Tower Climbing
- Railroad Bridge Climbing & Inspection
- Temporary HLL Installation
- Dropped Objects Prevention

General High Angle Rescue

- Technical Rescue Level I
- Technical Rescue Level II
- Technical Rescue Level III

Specialized High Angle Rescue

- Railroad Bridge
- Tower
- Wind Energy
- Theatre
- Emergency Evacuation
- Pole Top

Confined Space

- Entrant and Attendant
- Rescue



Full-Body Harnesses

Harnesses



When you're 75 feet (23 m) off the ground, your harness is more than just your safety connection – it's everything.

The right safety harness provides comfort and confidence, and directly affects the user's productivity, as well as gives them versatility to do what needs to be done on the job site. 3M™ DBI-SALA® Harnesses have earned a reputation as top body harnesses for maximum comfort, freedom of movement and ease-of-use.

We've launched innovations such as the spring-loaded, stand-up back D-ring, Delta™ No-Tangle pad, locking quick connect buckles and the Revolver™ Torso Adjuster. While many of our harnesses can be used on most jobs, we also manufacture harnesses for specific uses within different industries, like Construction, Oil and Gas, Transportation, Utilities/ Telecommunications and Wind Energy.

Best of all, you can rest assured all of our industry-leading harnesses meet applicable CSA standards and regulations.



Choosing your harness

Look for quality in these features when selecting your harness.

1 Dorsal connection

The fall arrest attachment point must be located on the back, positioned between the shoulder blades. Your harness must always include a dorsal attachment point, but some may also allow you to attach SRLs without pulling up the webbing or impeding use of the D-ring, like with our EZ Link™ Technology.



2 Webbing

Webbing is an important factor in the durability and safety of the harness. Ensure that the webbing is strong enough to endure rough use, exposure to sunlight and other elements without tearing or fraying. Specialty applications such as welding and electrical maintenance require the use of Nomex®/Kevlar® fibres or nylon that offers fire resistance or arc flash protection.

3 Adjusting points

Whether you wear a harness four hours a day or 14, it needs to fit right for safety and comfort. Harnesses with adjusting points on the legs, waist (belt models), chest and torso allow a better fit.

4 Leg straps

Depending on worker preference, leg strap fasteners may be available in different styles, including:



Tongue Buckle



Pass-Through Buckle



Quick-Connect Buckle

5 Pelvic support

A sub-pelvic strap provides additional support, security and comfort for the user. Properly positioned, it better distributes forces during a fall.



6 Book-style labels

Book-style labels put product and inspection information at the workers' fingertips. Pages may include sizing, operating instructions, inspection log, warning labels and compliance information. These labels promote quick inspection, compliance and safety.



7 Stitching

Double box stitching provides maximum strength and durability. It's sewn-in quality you can trust.



8 Padding

Cushioned shoulder, leg and hip pads keep the pressure off, providing extra worker comfort for long hours of wear. In a fall, they absorb shock and help distribute your weight. They may be built-in to avoid slipping or may be removable.

9 Seat slings

A removable seat sling provides job versatility and added comfort during long hours of use.



10 Impact indicators

Impact indicators provide immediate notice that the worker and harness have been in a fall. This feature promotes safety and proper inspection.



11 Lanyard keepers

A lanyard keeper provides a place to park your lanyard when not in use. It helps prevent tripping and entanglement for enhanced safety.

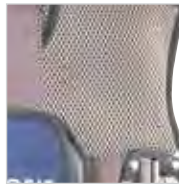

12 Breathable linings

Breathable linings, like those found in ExoFit™ Harnesses, wick moisture away from your body, so you stay dry and comfortable in heat or cold.

13 Trauma straps

Suspension trauma straps are easily deployed and hook together in seconds, allowing you to stand up while suspended in harness with one or both feet to relieve leg trauma.

3M™ DBI-SALA® Full-Body Harness Sizing Chart

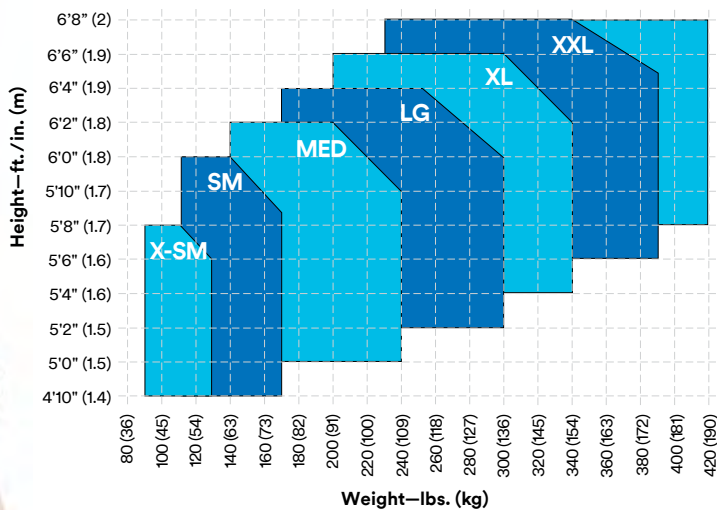

Which 3M™ DBI-SALA® Harness is right for you?

ExoFit™ STRATA™ Harness | The light-wearing full-body harness that's ideal for those who wear personal SRLs. (See page 16)

ExoFit™ NEX Harness | The gold standard in comfort, function and durability. (See page 20)

ExoFit™ Harness | The original comfort harness. (See page 30)

Delta™ Harness | The workhorse of the industry: Durable, convenient and comfortable. (See page 34)

Types of harnesses

3M™ DBI-SALA® Harnesses are available in different types, with various features, depending on their intended use.



Multi-purpose harness

This type typically includes extra attachment points which allow work in a variety of situations. The belt and pad provide additional back lumbar support, positioning rings and tool carrying options.



Work positioning harness

These harnesses have positioning D-rings located on the hips for use with pole straps or work positioning lanyards, which allow hands-free operation. Harnesses of this kind may include integral waist belts.



Ladder climbing harness

Harnesses with a frontal attachment point, for connection to permanent ladder safety systems.



Descent control harness

These harnesses typically have frontal attachment points for use with descent control devices.



Confined entry/retrieval harness

One attachment point located on each shoulder strap facilitates upright retrieval from confined spaces.



Suspension/rigging harness

These harnesses typically include extra attachment points such as back, front and side D-rings, which allow use in a variety of climbing, positioning, descent and rescue applications.

3M™ DBI-SALA® ExoFit™ STRATA™ Full-Body Harness

The safety harness that won't weigh you down.

“Lighten up.” It's what at-height workers have been trying to do for decades. That's why we created the 3M™ DBI-SALA® ExoFit™ STRATA Full-Body Harness. It features a first-of-its-kind load distribution system that literally takes the weight off workers' shoulders, resulting in a harness that is more comfortable, cooler and lighter to wear.

- 1 Tech-Lite™ Aluminum Side & Dorsal D-Rings
Secure your safety

Maximize reliability without adding extra weight.

- 2 EZ-Link™ Quick SRL Adapter
Gets you connected quickly

Simplifies connecting and disconnecting your personal self-retracting line.

- 3 LIFTech™ Load Distribution System
Frees your shoulders

Redistributes the weight of the harness to your center of gravity to dramatically reduce fatigue.

- 4 PolarMesh™ Padding
Keeps your back cool

Allows greater airflow to your back, providing superior breathability to keep you cool.

- 5 Revolver™ Vertical Torso Adjuster
Unleashes your mobility

Easily stores excess webbing, locking it in place and out of your way while maintaining the perfect fit.

- 6 Tri-Lock Revolver Connectors
Lock down loose ends

Store additional excess webbing and provide an extra layer of security around your legs.

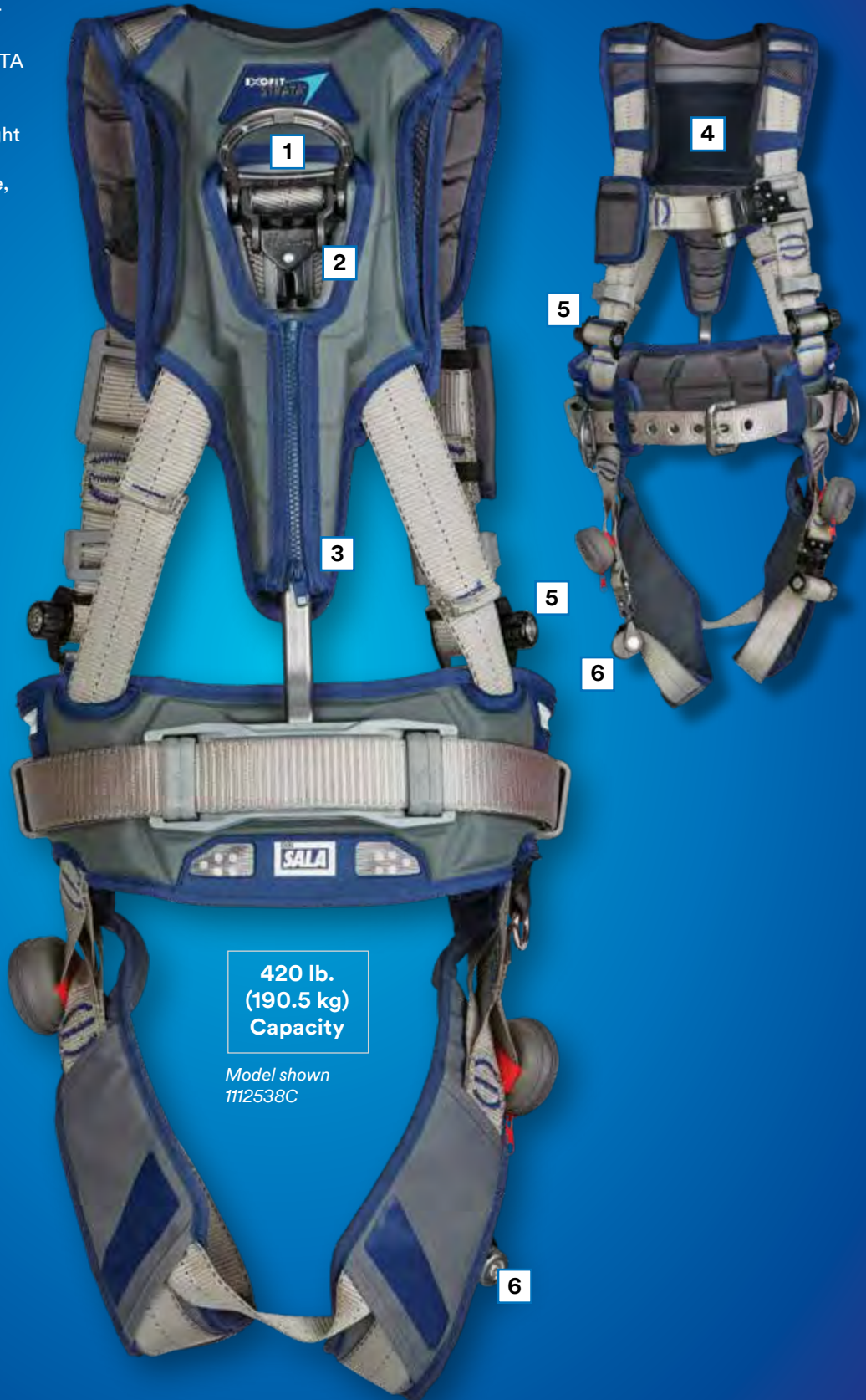

420 lb.
(190.5 kg)
Capacity

Model shown
1112538C

3M™ DBI-SALA® ExoFit™ STRATA™

Construction-Style Harnesses



1112538C

ExoFit™ STRATA™ Construction-Style Harness

Tri-Lock Revolver™ Buckles, back and side D-rings. (XLarge)

1112535C Small

1112536C Medium

1112537C Large



1112553C

ExoFit™ STRATA™ Construction-Style Harness

Duo-Lok™ Quick-Connect Buckles, back and side D-rings. (XLarge)

1112550C Small

1112551C Medium

1112552C Large



1112543C

ExoFit™ STRATA™ Construction-Style Harness

Tri-Lock Revolver Buckles, back, front and side D-rings. (XLarge)

1112540C Small

1112541C Medium

1112542C Large



1112568C

ExoFit™ STRATA™ Construction-Style Harness

Tongue buckle leg straps, back and side D-rings. (XLarge)

1112565C Small

1112566C Medium

1112567C Large

3M™ DBI-SALA® ExoFit™ STRATA™

Tower-Climbing Harnesses

1112583C

ExoFit™ STRATA™ Tower-Climbing Harness

Tri-Lock Revolver Buckles, aluminum front, back and side D-rings, removable seat sling with positioning D-rings. (XLarge)

1112580C Small

1112581C Medium

1112582C Large



1112588C

ExoFit™ STRATA™ Tower-Climbing Harness

Tongue buckle leg straps, aluminum front, back and side D-rings, removable seat sling with positioning D-rings. (XLarge)

1112585C Small

1112586C Medium

1112587C Large



Harnesses

3M™ DBI-SALA® ExoFit™ STRATA™

Vest-Style Harnesses without LIFTech™ Technology



1112478C

ExoFit™ STRATA™ Vest-Style Harness

Aluminum back D-rings, Tri-Lock Revolver™ Quick-Connect Buckles, comfort padding. (XLarge)

1112475C Small

1112476C Medium

1112477C Large

1112479C 2X



1112483C

ExoFit™ STRATA™ Vest-Style Positioning Harness

Aluminum back and side D-rings, Tri-Lock Revolver™ Quick-Connect Buckles, comfort padding. (XLarge)

1112480C Small

1112481C Medium

1112482C Large

1112484C 2X



1112533C

ExoFit™ STRATA™ Vest-Style Climbing Harness

Aluminum back, front and side D-rings, tongue buckle leg straps, Tri-Lock Revolver™ chest strap, comfort padding. (XLarge)

1112530C Small

1112531C Medium

1112532C Large

1112534C 2X



1112493C

ExoFit™ STRATA™ Vest-Style Harness

Aluminum back, front, and side D-rings, Tri-Lock Revolver™ Quick-Connect Buckles, comfort padding. (XLarge)

1112490C Small

1112491C Medium

1112492C Large

1112494C 2X



1112523C

ExoFit™ STRATA™ Vest-Style Harness

Aluminum back and side D-rings, tongue buckle leg straps, Tri-Lock Revolver™ chest strap, comfort padding. (XLarge)

1112520C Small

1112521C Medium

1112522C Large

1112524C 2X



1112503C

ExoFit™ STRATA™ Vest-Style Harness

Aluminum back and side D-rings, Duo-Lok™ Quick-Connect Buckles, comfort padding. (XLarge)

1112500C Small

1112501C Medium

1112502C Large

1112504C 2X



3M™ DBI-SALA® ExoFit™ NEX Plus Full-Body Harness

The ultimate full-body comfort harnesses

Evolutionary. When you wear a 3M™ DBI-SALA® ExoFit™ NEX Full-Body Harness, you're wearing one of the most advanced harnesses in the industry. That's because it's the culmination of everything at-height workers loved and everything we learned from creating the ExoFit™ and ExoFit™ XP, plus the incorporation of enhanced materials and industry-first innovations.

Comfort

True to our NEX mission, we manufacture these harnesses using materials that won't add unnecessary weight.

Function

When speed and efficiency are project requirements, ExoFit™ NEX will provide the freedom and confidence to function at your maximum potential.

Durability

ExoFit™ NEX Harnesses are designed using materials that last.

1 Auto-resetting lanyard keepers

Conveniently reposition the auto-resetting lanyard keepers along chest area of harness webbing.

2 Hybrid comfort padding

Lightweight, moisture wicking and breathable padding won't move or slip, always keeping the wearer comfortable.

3 Tech-Lite™ Aluminum D-rings

Extremely lightweight alloy commonly used in military and aerospace offers a higher level of security and comfort.

4 Integrated trauma straps

Provide an adjustable, continuous loop for post fall, minimizing suspension trauma.

5 Duo-Lok™ Quick-Connect Buckles

Lightweight one-handed use with memory-fit web-lock ensures fast, non-slipping connections.

6 Ultra-soft edging

Moves with you. Doesn't rub or chafe.

7 Integrated easy-link SRL adapter

Lets you quickly and easily connect and disconnect personal SRLs.

8 Protective shoulder caps

Provide protection and comfort when carrying heavy materials.

9 Reflective material

For greater visibility in dark and dangerous environments, reflective material is integrated on legs, chest, shoulders and back.

10 Built-in carrying pocket

Conveniently holds and protects a cell phone, camera or other items.

11 REPEL Technology Webbing

Water repellent to reduce attraction of mold and dirt—also has up to 5 times more abrasion resistance.

12 Revolver Vertical Torso Adjusters



13 Stand-up dorsal D-ring

Patented spring-loaded design automatically stands-up, ensuring fast, easy and safe connections to your fall arrest system.

Superior X-design

A single piece of material in the shape of an X wraps around the wearer for the ultimate in comfort, security and no-tangle donning.



420 lb.
(190.5 kg)
Capacity

Model shown
1140160C



3M™ DBI-SALA® ExoFit™ NEX/ ExoFit™ NEX Plus

Vest-Style Full-Body Harnesses

Vest-Style Harnesses are the most universal, with multiple configurations and connection point options. They're used across a wide variety of industries.



1140112C ExoFit™ NEX Plus Vest-Style Harness

Aluminum front and back D-rings, locking quick-connect buckles. (XLarge)

1140109C Small

1140110C Medium

1140111C Large



1140106C ExoFit™ NEX Plus Vest-Style Harness

Aluminum back D-ring, locking quick-connect buckles. (XLarge)

1140103C Small

1140104C Medium

1140105C Large



1140118C ExoFit™ NEX Plus Vest-Style Harness

Aluminum back and side D-rings, locking quick-connect buckles. (XLarge)

1140115C Small

1140116C Medium

1140117C Large



1113070C ExoFit™ NEX Vest-Style Harness

Aluminum back and shoulder D-rings, locking quick-connect buckles. (XLarge)

1113061C Small

1113064C Medium

1113067C Large



1140124C ExoFit™ NEX Plus Vest-Style Harness

Aluminum front, back and side D-rings, locking quick-connect buckles. (XLarge)

1140121C Small

1140122C Medium

1140123C Large

3M™ DBI-SALA® ExoFit™ NEX/ExoFit™ NEX Plus

Crossover-Style Harnesses

A front-mounted D-ring makes the crossover-style ideal as a rescue harness and for ladder climbing applications.



1113100C ExoFit™ NEX Crossover-Style Harness

Aluminum front and back D-rings, locking quick-connect buckles. (XLarge)

1113091C Small

1113094C Medium

1113097C Large



1140202C ExoFit™ NEX Plus Crossover-Style Harness

Aluminum front, back and side D-rings, locking quick-connect buckles. (XLarge)

1140199C Small

1140200C Medium

1140201C Large

Harnesses

3M™ DBI-SALA® ExoFit™ NEX Plus

Tower Climbing Harnesses

Tower climbing models are built to keep workers comfortable during extended hours in harness. Tool loops are ideal for carrying equipment.

1140172C

ExoFit™ NEX Plus Tower Climbing Harness

Aluminum front, back and side D-rings, locking quick-connect buckles with sewn-in hip pad and belt, removable seat sling with positioning D-rings. (XLarge)

1140169C Small

1140170C Medium

1140171C Large



A removable seat sling adds even more comfort, for those who wear them all day long.

3M™ DBI-SALA® ExoFit™ NEX Plus

Construction- Style Harnesses

Made for general construction work, these harnesses have excellent tool-carrying capability, sewn-in hip pad and removable body belt.



Capability

Integrated EZ-Link™ SRL Adapter lets you quickly and easily connect and disconnect personal SRLs.



Comfort

Keep your back D-ring in place with the anti-slide feature stitched into the harness webbing.



Convenience

Reposition the auto-resetting lanyard keepers along chest area of harness webbing.



1140160C

ExoFit™ NEX Plus Construction- Style Harness

Aluminum back and side D-rings, locking quick-connect buckles with sewn-in hip pad, removable belt. (XLarge)

1140157C Small

1140158C Medium

1140159C Large



1140166C

ExoFit™ NEX Plus Construction- Style Harness

Aluminum front, back and side D-rings, locking quick-connect buckles, sewn-in hip pad, removable belt. (XLarge)

1140163C Small

1140164C Medium

1140165C Large



1140184C

ExoFit™ NEX Plus Construction- Style Harness

Aluminum back and side D-rings, tongue buckle legs, sewn-in hip pad, removable belt. (XLarge)

1140181C Small

1140182C Medium

1140183C Large

3M™ DBI-SALA® ExoFit™ NEX

Global Wind Energy Harnesses

People around the world rely on our wind industry harnesses because they meet the major global compliance standards including ANSI, OSHA, CSA and CE.

1113218

ExoFit™ NEX Global Wind Energy Harness

Aluminum front, back and side D-rings, locking quick-connect buckles and sewn-in hip pad with belt and lumbar wear protection. (XLarge)

1113215 Small

1113216 Medium

1113217 Large

1113213

ExoFit™ NEX Global Wind Energy Harness

Aluminum front, back and side D-rings, locking quick-connect buckles. (XLarge)

1113210 Small

1113211 Medium

1113212 Large



Replaceable lumbar protector

The lumbar protector is easily replaced in the field when worn or damaged.



Radio holster

Conveniently holds and protects a radio, cell phone, or other items.



Back view

3M™ DBI-SALA® ExoFit™ NEX

Mining Vest-Style Harnesses

We've designed these harnesses specifically to allow miners to conveniently carry the equipment they need to get the job done.

1113199C

ExoFit™ NEX Mining Vest-Style Harness

Aluminum back D-ring, locking quick-connect buckles, integrated hip padding with belt and miner's equipment straps. (XLarge)

1113195C Small

1113196C Medium

1113197C Large



Back view

Harnesses

3M™ DBI-SALA® ExoFit™ NEX

Oil & Gas Full-Body Harness

The ExoFit™ NEX Oil & Gas Full-Body Harnesses combine the industry-first innovations of the ExoFit™ NEX Harness with the additional features developed specifically for the needs of the on- and offshore drilling markets.

1113298C

ExoFit™ NEX Oil & Gas Harness

18 in. (45.7 cm) D-ring extension, derrick attachments, hip pad & belt with rigid seat sling (XLarge).

1113295C Small

1113296C Medium

1113297C Large



1113293C

ExoFit™ NEX Oil & Gas Harness

18 in. (45.7 cm) D-ring extension, derrick attachments, quick-connect chest buckle, hip pad & belt with lumbar D-ring and soft seat sling (XLarge).

1113290C Small

1113291C Medium

1113292C Large



3M™ DBI-SALA® ExoFit™ NEX

Rope Access & Rescue Harnesses

Complex jobs are easier when your equipment is suited to the task. That's why the ExoFit™ NEX Rope Access & Rescue Harnesses incorporate some of the most advanced technologies in the industry. These multi-use harnesses incorporate specialized designs, components and hardware to optimize rope rescue and industrial rope access work. This makes them ideal for the professional performing rescue and emergency services, industrial rope access and rigging, wind energy and tower maintenance—as well as for arborist activities.

1113348C

ExoFit™ NEX Rope Access & Rescue Harness

REPEL Technology Webbing, Tech-Lite™ Aluminum Front, Back and Side D-rings, Duo-Lok™ Quick-Connect Buckles and hybrid comfort padding. (XLarge)

1113345C Small

1113346C Medium

1113347C Large



1113373C

ExoFit™ NEX Blackout Rope Access & Rescue Harness

REPEL Technology Webbing, Tech-Lite™ Aluminum Front, Back and Side D-rings, Duo-Lok™ Quick-Connect Buckles and hybrid comfort padding. (XLarge)

1113370C Small

1113371C Medium

1113372C Large



3M™ DBI-SALA® ExoFit™ NEX Arc Flash Full-Body Harness

The ultimate full-body comfort harness

Complete confidence. It's what you need to get the job done around high voltage electricity or hot-work, like welding. You need gear that's proven and built for the task. That's why the ExoFit™ NEX Arc Flash Full-Body Harness features flame resistance and non-conductive construction on top of all the comfort, function and durability features of the original ExoFit™ NEX Full-Body Harness. It meets arc flash standard specifications for personal climbing equipment as well as ANSI Z359 and CSA requirements.

1 Flame-resistant webbing

Nomex® fibre exterior with Kevlar® fibre core and thread provides 7,000 lb. (3,175.1 kg) strength and ultimate flame resistance.

2 Revolver™ Vertical Torso Adjusters

Simple and fast adjustments that eliminate loose ends and lock into place, preventing slippage.

3 PVC Coated Tech-Lite™ Aluminum D-rings

Non-conductive, extremely lightweight aluminum alloy hardware offers the highest level of comfort and security.

4 Flame-resistant trauma straps

Provide an adjustable, continuous loop for post fall, minimizing suspension trauma.

5 Integrated insulators

Leather insulators behind exposed hardware prevent contact with body during "hot" situations.

6 Ultra-soft edging

Moves with you. Doesn't rub or chafe.

Arc flash rated

Tested to perform in accordance with ASTM F887 standard for personal climbing equipment.



420 lb.
(190.5 kg)
Capacity

On all models

7 Arc flash hybrid padding

Lightweight shoulder, hip and leg padding always keeps the wearer comfortable.

8 Auto-resetting lanyard keepers

Conveniently reposition the auto-resetting lanyard keepers along chest area of harness webbing.

9 Reflective material

Integrated on legs, chest, shoulders and back for greater visibility and safety.

10 Built-in carrying pocket

Conveniently holds a cell phone, camera or other items.

11 Duo-Lok™ Quick-Connect Buckles

Lightweight aluminum, one-handed use with memory fit web lock ensures fast, non-slipping connections.

12 Stand-up dorsal D-ring

Non-conductive, extremely lightweight PVC-coated aluminum D-ring is spring loaded for fast and easy connections.

Also available in web loop configurations.

Model shown
1113318C



3M™ DBI-SALA® ExoFit™ NEX Arc Flash

Vest-Style Full-Body Harnesses

1103088C

ExoFit™ NEX Arc Flash Harness

With Nomex®/Kevlar® fibre web, PVC coated aluminum back D-ring, locking quick-connect buckles, comfort padding. (XLarge)

1103085C Small

1103086C Medium

1103087C Large



1113338C

ExoFit™ NEX Arc Flash Harness

With Nomex®/Kevlar® fibre web, PVC coated aluminum back D-ring, coated pass-through buckles, comfort padding. (XLarge)

1113335C Small

1113336C Medium

1113337C Large



1103073C

ExoFit™ NEX Arc Flash Positioning Harness

With Nomex®/Kevlar® fibre web, PVC coated aluminum back and side D-rings, locking quick-connect buckles, comfort padding. (XLarge)

1103070C Small

1103071C Medium

1103072C Large



1113328C

ExoFit™ NEX Arc Flash Rescue Harness

With Nomex®/Kevlar® fibre web, dorsal web loop and front rescue loops, locking quick-connect buckles, comfort padding. (XLarge)

1113325C Small

1113326C Medium

1113327C Large



1113333C

ExoFit™ NEX Arc Flash Climbing Harness

With Nomex®/Kevlar® fibre web, PVC coated aluminum front, back and side D-rings, locking quick-connect buckles, comfort padding. (XLarge)

1113330C Small

1113331C Medium

1113332C Large



3M™ DBI-SALA® ExoFit™ NEX Arc Flash

Construction-Style Harnesses

With integrated hip pad and body belt, these harnesses have excellent tool-carrying capabilities, allow work positioning and provide added back support.



1113318C

ExoFit™ NEX Arc Flash Construction Harness

With Nomex®/Kevlar® fibre web, PVC coated aluminum back and side D-rings, locking quick-connect buckles, sewn-in hip pad and belt, comfort padding. (XLarge)

1113315C Small

1113316C Medium

1113317C Large



Lineman Belts and Harnesses

D Size		Belt Sizing					
		Minimum		Center Hole		Maximum	
in.	cm	in.	cm	in.	cm	in.	cm
D18	46	32	81	36	91	40	102
D19	48	33	84	37	94	41	104
D20	51	34	86	38	97	42	107
D21	53	36	91	40	102	44	112
D22	56	37	94	41	104	45	114
D23	58	38	97	42	107	46	117
D24	61	40	102	44	112	48	122
D25	64	41	104	45	114	49	124
D26	66	42	107	46	117	50	127
D27	69	44	112	48	122	52	132
D28	71	45	114	49	124	53	135
D29	74	46	117	50	127	54	137
D30	76	47	119	51	130	55	140

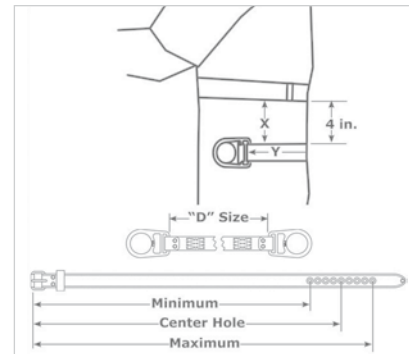

Where to measure to determine the correct “D” size for a Lineman’s Belt:

X = Distance from waist or top of hip bone to where Lineman’s Belt is worn.

Y = Measurement is from front of hip bone around the back to the front of the other hip bone. This measurement is the “D” size.

ExoFit™ NEX Arc Flash Harness with 2D Belt				
Small	1113675C – D20	1113676C – D21	1113677C – D22	1113678C – D23
Medium	1113681C – D22	1113682C – D23	1113683C – D24	1113684C – D25
Large	1113688C – D25	1113689C – D26	1113690C – D27	–
XLarge	1113691C – D25	1113692C – D26	1113693C – D27	–

Full-Body Arc Flash Harnesses

1113760C ExoFit™ NEX Rope Access/Rescue Harness - Arc Flash

PVC coated aluminum front, suspension, back, and side D-rings, locking quick-connect buckles, Nylon/Kevlar® fibre web, Kevlar® fibre hybrid padding, leather insulators. (Size XLarge)

1113757C Small

1113758C Medium

1113759C Large



1113692C ExoFit™ NEX Lineman Arc Flash Harness with 2D Belt

PVC coated steel back D-ring, locking quick-connect buckle leg straps, Nomex®/Kevlar® fibre webbing and comfort padding (size XLarge) with 100% top grain leather 2D Lineman Belt. (Size D26)

1113676C Small D21

1113682C Medium D23

1113688C Large D25



3M™ DBI-SALA® ExoFit™ Plus Full-Body Harness

The industry's first comfort harness

The ExoFit™ Harness is the design that changed what workers expect from a harness.

Comfort. It's the one word that best defines the 3M™ DBI-SALA® ExoFit™ Harness, our original comfort fit harness. It features a single piece of material that wraps around you in the shape of an X, donning without tangling and providing comfortable security. ExoFit™ even remembers your adjustments, so you can snap three buckles and get to work. Shoulder, hip and leg padding is built-in, so it can't slip. A breathable lining guarantees you'll stay dry and comfortable all day long.

1 Ultra-soft edging

Moves with you without rubbing or chafing.

2 Torso buckles

Hold straps firmly in place, adjust easily and complete the 5-point adjustment system.

3 Cushioned leg and hip straps

Comfortable and offer additional security during a fall.

4 Quick-connect buckles

Provide one-handed operation for fast, easy donning.

5 Cushioned shoulder pads

Help minimize pressure on shoulders. Designed so they won't slip or slide off your shoulder.



420 lb.
(190.5 kg)
Capacity

Model shown
1140004C

6 Integrated easy-link SRL adapter

Lets you quickly and easily connect and disconnect personal SRLs.

7 Breathable lining

Immediately draws moisture away, keeping you dry and comfortable.

8 Easy-grip end tabs

Something secure to hang on to when adjusting the straps.

9 Anti-tear ballistic nylon

Abrasion-resistant for rugged strength and durability. Twice the endurance of standard nylon or polyester.

10 Reflective piping

Enhances visibility in low light conditions.

11 Back D-ring

Keeps you upright every time. 5,000 lb. (2,268 kg) minimum tensile strength.



3M™ DBI-SALA® ExoFit™/ExoFit™ Plus

Vest-Style Harnesses

Vest-style harnesses are the most universal, with multiple configurations and connection point options. They're used across a wide variety of industries.



1140010C

ExoFit™ Vest-Style Harness

Front and back D-rings, loops for belt, quick-connect buckles. (XLarge)

1140007C Small

1140008C Medium

1140009C Large



1140004C

ExoFit™ Vest-Style Harness

Back D-ring, loops for belt, quick-connect buckles. (XLarge)

1140001C Small

1140002C Medium

1140003C Large



1140022C

ExoFit™ Vest-Style Harness

Front, back and side D-rings, loops for belt, quick-connect buckles. (XLarge)

1140019C Small

1140020C Medium

1140021C Large



1108581C

ExoFit™ Vest-Style Harness

Back and side D-rings, loops for belt, quick-connect buckles. (XLarge)

1108575C Small

1108576C Medium

1108577C Large

3M™ DBI-SALA® ExoFit™

Crossover-Style Harnesses

A front-mounted D-ring makes the crossover-style ideal for ladder climbing and rescue applications.



1108682C

ExoFit™ Crossover-Style Harness

Front and back D-rings, loops for belt, quick-connect buckles. (XLarge)

1108675C Small

1108676C Medium

1108677C Large



1108706C

ExoFit™ Crossover-Style Harness

Front, back and side D-rings, loops for belt, quick-connect buckles. (XLarge)

1108700C Small

1108701C Medium

1108702C Large

Harnesses

3M™ DBI-SALA® ExoFit™/ExoFit™ Plus

Construction-Style Harnesses

Made for general construction work, these harnesses have excellent tool-carrying capability, a sewn-in hip pad and removable body belt.



1140058C

ExoFit™ Plus Construction-Style Harness

Back D-ring, sewn-in back pad and belt with side D-rings, quick-connect buckles. (XLarge)

1140055C Small

1140056C Medium

1140057C Large



1110478C

ExoFit™ Construction-Style Harness

Back D-rings, sewn-in hip pad and belt with side D-rings, tongue buckle legs. (XLarge)

1110475C Small

1110476C Medium

1110477C Large

1108519C

ExoFit™ Construction-Style Harness

Back D-ring, sewn-in back pad and belt with side D-rings, quick-connect buckles. (XLarge)

1108516C Small

1108517C Medium

1108518C Large

1108979C

ExoFit™ Construction-Style Harness

Back and front D-ring, sewn-in back pad and belt with side D-rings, quick-connect buckles. (XLarge)

1108977C Small

1108978C Medium

1108975C Large

3M™ DBI-SALA® ExoFit™/ExoFit™ Plus

Wind Energy Harnesses

People around the world rely on our wind industry harnesses because they meet the major global compliance standards including ANSI, OSHA, CSA and CE.



Reinforced lumbar area for added back support. Tool loops allow you to keep your tools close at hand.



Integrated trauma straps minimize suspension trauma after a fall.



Harnesses

Extra tough tubular web encases sub-pelvic webbing for added wear resistance for straddling beams.



1102388C

ExoFit™ Wind Energy Harness

Quick-connect buckle legs, PVC coated front, back and side D-rings, sewn-in hip pad and belt with tool loops. (XLarge)

1102385C Small

1102386C Medium

1102387C Large



1102343C

ExoFit™ Wind Energy Harness

Quick-connect buckle legs, PVC coated front, back and side D-rings. (XLarge)

1102340C Small

1102341C Medium

1102342C Large



1140070C

ExoFit™ Plus Tower Climbing Harness

Front and back D-rings, belt with back pad and side D-rings, removable seat sling with positioning D-rings, quick-connect buckles. (XLarge)

1140067C Small

1140068C Medium

1140069C Large



1100533C

ExoFit™ Iron Worker's Harness

Back D-ring, sewn-in back pad and belt with side D-rings, reinforced seat straps, tongue buckle legs. (XLarge)

1100530C Small

1100531C Medium

1100532C Large

3M™ DBI-SALA® Delta™ Full-Body Harness

Innovative, full-body support for more than two decades.

Toughness. Versatility. These are qualities expected of you, so you should expect nothing less from your safety harness. Delta™ Harnesses combine a number of industry-first innovations with popular features that have made it an industry workhorse that's as tough as those who wear them.

Delta™ Harnesses have a shape of their own, so you can don them quickly and easily. And they support your back and hips while bearing heavy loads to maximize your comfort.

1 Tangle-free design

Defining the Delta™ name, the patented triangular design creates a frame that allows the harness to fall into place when donned.

2 Delta™ Comfort Hip Pad

Improved ergonomic fit constructed with a soft, breathable, comfortable interior that supports your back and hips.

3 Tech-Lite™ Quick-Connect Buckles

Lightweight aluminum alloy buckles for fast and easy connections.

4 Impact indicator

Provides a visual alert that the harness has been involved in a fall and simplifies safety inspections.



420 lb.
(190.5 kg)
Capacity

Model shown
1110575C

5 REPEL Technology Webbing

Water repellent to reduce attraction of mold and dirt—also has more abrasion resistance.

6 Lanyard keepers

Hold your unused snap hooks and help reduce trip hazards.

7 Revolver™ Vertical Torso Adjuster

Simple and fast adjustment that eliminates loose ends and locks into place, preventing slippage.

8 Stand-up dorsal D-ring

Patented spring-loaded design automatically stands-up, ensuring fast, easy and safe connections to your fall arrest system.



3M™ DBI-SALA® Delta™

Vest-Style Harnesses

Vest-style harnesses are the most universal, with multiple configurations and connection point options. They're used across a wide variety of industries.

Delta™ Harnesses feature detachable shoulder padding (not shown).



1101781C
Delta™ Vest-Style Harness
 Back and shoulder D-rings, pass-through buckles. (Universal Size)
 1101254C Tongue Buckles
 11010602C Quick-Connect Buckles
 1101781C Pass-Through Buckles (pictured)



1102000C
Delta™ Vest-Style Harness
 Back D-ring, tongue buckle leg straps. (Universal Size)
 1102000C Tongue Buckles (pictured)
 11010600C Quick-Connect Buckles
 1103321C Pass-Through Buckles



1102008C
Delta™ Vest-Style Harness
 Side and back D-ring, tongue buckle leg straps. (Universal Size)
 1102008C Tongue Buckles (pictured)
 11010625C Quick-Connect Buckles
 1103875C Pass-Through Buckles



1102090C
Delta™ Vest-Style Harness
 Back and front D-rings, quick-connect buckles. (Universal Size)
 1107807C Tongue Buckles
 1102090C Quick-Connect Buckles (pictured)
 1112126C Pass-Through Buckles



1102001C
Delta™ Vest-Style Harness
 Back D-rings, parachute adjuster leg straps. (Universal size)

Harnesses

3M™ DBI-SALA® Delta™

Construction-Style Harnesses

Made for general construction work, these harnesses have excellent tool-carrying capability, a sewn-in hip pad and removable body belt.

1110578C

Delta™ Construction-Style Harness

Back and side D-rings, quick-connect buckle legs and chest strap, belt with sewn-in back pad. (XLarge)

1110575C Small

1110576C Medium

1110577C Large (pictured)

1101656C

Delta™ Construction-Style Harness

Vest-style, back and side D-rings, belt with sewn-in back and shoulder pads, tongue buckle leg straps. (XLarge)

1102201C Small

1101654C Medium

1101655C Large (pictured)

1107809C

Delta™ Construction-Style Harness

Front, back and side D-rings, belt and hip pad, tongue buckle leg. (XLarge)

1107805C Small

1107802C Medium

1107801C Large

1103512C

Delta™ Construction-Style Harness

Back and side D-rings, pass-through buckles, loop for belt. (Universal Size)

1103513C

Delta™ Construction-Style Harness

Back D-ring, pass-through buckles, loops for belt. (Universal Size)



1101655



1110577

1103525C

Delta™ Construction-Style Harness

Back and side D-rings, tongue buckle legs, loops for belt. (Universal Size)

1103526C

Delta™ Construction-Style Harness

Back D-ring, tongue buckle legs, loops for belt. (Universal Size)

3M™ DBI-SALA® Delta™

Crossover-Style Harnesses

A front-mounted D-ring makes the crossover-style ideal for ladder climbing and rescue applications.

1102950C

Delta™ Crossover-Style Harness

Back and front D-rings, tongue buckles legs. (Universal Size)

1102950C Tongue Buckles (pictured)

110700C Quick-Connect Buckles

1102010C Pass-Through Buckles



1102950



1110725

1110725C

Delta™ Crossover-Style Harness

Back, front and side D-rings, quick-connect buckles. (Universal Size)

1103375C Tongue Buckles

1110725C Quick-Connect Buckles (pictured)

1103270C Pass-Through Buckles

1101812C

Delta™ Crossover-Style Harness

Front and back D-rings, pass-through legs, belt and hip pad with side D-rings. (XLarge)

1101809C Small

1101810C Medium

1101811C Large

Delta™ Harnesses feature detachable shoulder padding (not shown).



Harnesses

1106452C

3M™ DBI-SALA® Delta™ Iron Worker's Harness

Vest-style, back D-ring, adjustable belt support straps with clips, body belt with permanently attached pad, shoulder pads, accessory clips, wear layer web on seat sling, pass-through leg straps. (XLarge)

1106453C Small

1106451C Medium

1106450C Large



Back view

1107778C

Delta™ Tower Climbing Harness

Vest-style, front and back D-ring, belt with 4 in. (10.2 cm) wide pad and side D-rings, two tool pouch D-rings, seat sling with positioning D-rings, tongue buckle legs. (XLarge)

1107776C Small

1107777C Medium

1107775C Large



1103352C

Delta™ Tower Climbing Harness

Crossover-style, front D-ring, belt with 4 in. (10.2 cm) wide pad and side D-rings, two tool pouch D-rings, seat sling with positioning D-rings, tongue buckle legs. (XLarge)

1103355C Small

1103351C Medium

1103350C Large

3M™ DBI-SALA® Delta™

Arc Flash Harnesses

When high voltage electricity is a concern, your safety harness absolutely shouldn't be. That's why every 3M™ DBI-SALA® Delta™ Arc Flash Harness has been tested to perform in accordance with the stringent ASTM F887 Standard Specification for Personal Climbing Equipment.



1110752C

Delta™ Arc Flash Harness

7,000 lb. (31.1 kN) nylon web, no metal above the waist, front and back web loop, pass-through buckle legs, leather insulators. (XLarge)

1110754C Small

1110750C Medium

1110751C Large



1110782C

Delta™ Arc Flash Harness

7,000 lb. (31.1 kN) nylon web, back web loop, quick-connect buckles, leather insulators, rescue loops. (XLarge)

1110788C Small

1110780C Medium

1110781C Large

1110774C Small with belt/pad and side D-rings



1110820C
Delta™ Arc Flash Harness
 With Nomex®/Kevlar® fibre web, vest-style, back web loop, quick-connect buckles. (Universal Size)



1110940C
Delta™ Arc Flash Harness
 With Nomex®/Kevlar® fibre web, cross-over style, PVC coated hardware, front, back and side D-rings. (Universal Size)



1110830C
Delta™ Arc Flash Harness
 With Nomex®/Kevlar® fibre web, PVC coated hardware, back D-ring, pass-through leg straps. (Universal Size)

1150058C
Delta™ Arc Flash Kit
 Includes 1110752C Delta™ Arc Flash Nylon Harness with web loop and Arc Flash Energy-Absorbing Lanyard, 6 ft. (1.8 m) (1240861), with bag. (XLarge)
 1150054C Kit with Large harness (1110752C)

Delta™ Harnesses feature detachable shoulder padding (not shown).



Harnesses

3M™ DBI-SALA® Delta™ Vest

Hi-Vis Reflective and Non-Reflective Workvest Harnesses

Safety is a top priority any time of day. That's why our sleeveless waist-length vests feature a built-in harness for high visibility while working at-height, day or night. They meet CSA Z259.10 for high visibility vests.



1111580C

Delta™ Vest Hi-Vis Reflective Harness

Orange workvest-style harness, reflective, back D-ring, quick-connect legs. (Universal Size)



1111584C

Delta™ Vest Hi-Vis Reflective Harness

Yellow workvest-style harness, reflective, back D-ring, quick-connect legs. (Universal Size)

1107420C

Delta™ Vest Hi-Vis Reflective Harness

High visibility yellow workvest-style harness, reflective, back D-ring, tongue buckle legs. (Universal Size)

1107416C

Delta™ Vest Hi-Vis Non-Reflective Harness

Blue cotton workvest-style harness, non-reflective, back D-ring, tongue buckle legs. (Universal Size)

1107404C

Delta™ Vest Hi-Vis Reflective Harness

High visibility orange workvest-style harness, reflective, back D-ring, tongue buckle legs. (Universal Size)

3M™ DBI-SALA® Delta™

Harnesses for Hot Work Use

Stay safe even when things heat up. Featuring heat-resistant and flame-retardant Nomex®/Kevlar® fibre webbing, these harnesses have a 371.1° C char temperature.



1105475C

Delta™ Harness for Hot Work Use

Vest-style, with Nomex®/Kevlar® fibre web, back D-ring, with non-conductive/spark hardware, pass-through buckle leg straps, loops for belt. (Universal Size)

1104775C

Delta™ Harness for Hot Work Use

Crossover-style, front, back and side D-rings, with Nomex®/Kevlar® fibre web, pass-through buckle leg straps, loops for belt. (Universal Size)

1104625C

Delta™ Harness for Hot Work Use

Vest-style, back D-ring, with Nomex®/Kevlar® fibre web, pass-through buckle leg straps, loops for belt. (Universal Size)

1109975

Delta™ Harness for Hot Work Use

Vest-style, back D-ring, with Nomex®/Kevlar® fibre web, quick-connect buckles, loops for belt. (Universal Size)

Delta™ Resist

Webbing Harnesses

Protect against grease, oil, dirt and grime with integrated Resist Technology (polyurethane coated webbing).



1110990C

Delta™ Harness Webbing Harness

Vest-style, back D-ring, tongue buckle legs. (Universal Size)

Delta Harnesses feature detachable shoulder padding (not shown).

Belts, Workseats & Accessories

3M™ DBI-SALA®

Workseats

1001190 Bosun Chair

12 in. x 24 in.
x 1 in. (30.5 cm
x 61 cm x 2.5 cm)
board, cushion
and side snaps.



1001140 Bosun Chair only

12 in. x 24 in. x 1 in.
(30.5 cm x 61 cm x 2.5 cm) board.



1001005 Work Seat

With board, tongue buckle belt and
pad, suspension D-rings, adjustable
leg/shoulder strap. (XLarge)

1001001 XSmall

1001002 Small

1001003 Medium

1001004 Large

1001090 Harness Seat Sling

8 in. (20.3 cm) wide, belt attachment
loops and D-rings.

1001378 Suspended Workman's Chair

Polyester webbing,
alloy steel connectors,
weight capacity of
up to 420 lbs.
(190.5 kg).



Lineman Belts



Achieve the maximum in comfort,
freedom of movement and ease
of use with our ergonomically
designed belts.

See pages 28 and 29 for more
information.

Tongue Buckle Belts



1000025C Tongue Buckle Belt

Side D-rings, 3 in. (7.6 cm) pad.
(XLarge)

1000022C Small

1000023C Medium

1000024C Large

1000055

Delta™ Tongue Buckle Belt

No D-ring, no pad. (XLarge)

1000052 Small

1000053 Medium

1000054 Large



1000005C

Tongue Buckle Belt

back D-ring, 3 in. (7.6 cm) pad.
(XLarge)

1000002C Small

1000003C Medium

1000004C Large

1000165C

Tongue Buckle Belt

With floating D-ring, no pad. (XLarge)

1000162C Small

1000163C Medium

1000164C Large

1000717

ExoFit™ Tongue Buckle Belt

No D-ring, no pad. (XLarge)

1000708 Small

1000709 Medium

1000716 Large

Customize your 3M™ DBI-SALA® Harnesses

Promote your company brand by customizing
your harnesses with a logo label (minimum order
of 12 units required).

- Same style of harness required, order can be in multiple sizes.
- One logo per harness.
- Logos on Delta Harnesses: Black on clear background, sublimation transferred.
- Logos on ExoFit NEX™ Harnesses: Custom logo and embroidery, multiple colors to choose from.





3M™ DBI-SALA® Suspension Trauma Safety Straps

Relief. It can make a big difference when you're suspended in your safety harness. It's why every worker should be equipped with Suspension Trauma Safety Straps. They easily deploy and hook together in seconds, allowing a suspended worker to stand up in harness with one or both feet to relieve downward pressure. They're compact, lightweight and compatible with most harness brands in the field.



9501403C Suspension Trauma Safety Straps

One pair, connects to most harnesses.



9505712 Flame-Resistant Suspension Trauma Safety Straps

One pair, connects to most harnesses.

1150174 Harness Hydration System

50 oz. (29.6 mL) capacity, compatible with all 3M™ DBI-SALA® Harnesses.



9511597 Harness and Lanyard Bag

3M™ DBI-SALA® Bag 7-1/2 in. wide x 6-1/2 in. deep x 15-1/2 in. long (19 cm x 16.5 cm x 39.4 cm), holds a harness and lanyard or 50 ft. (15.2 m) of 5/8 in. (0.6 cm) rope.



9500468 Offshore Life-Jacket

Offshore Orange Life-Vest, back opening for harness, safety whistle, 62 sq. in. (157.5 cm) of SOLAS (Safety of Life at Sea) grade reflective tape, foam-filled head support collar with two vertical adjustable straps, hinged back panel for comfort.



5900892 Pouch with Belt Loops

Velcro closure (blue color)



5900891 Pouch with Belt Loops

Clip and Velcro closure (blue color)

9505515 Lumbar Wear Pads

Removable lumbar wear pad for 3M™ DBI-SALA® ExoFit™ NEX Wind Energy Harness Belt. (Large, XLarge, XXLarge)

9505504 Small, Medium



1150037 Dorsal Web Cover

Helps protect dorsal webbing on harness while climbing or descending a ladder such as in wind turbine towers.



9511632 Qty 2 Attachment Breakaway Lanyard Keeper

Plastic ring with Velcro used to "park" lanyard when not in use.



9502006 Foam Shoulder Pad

Sold one each, two required per harness.



1231117C D-ring Extension

D-ring at one end, snap hook at other x 18 in. (46 cm).



9501207 3M™ DBI-SALA® Delta™ Comfort Pad

Attaches to most harnesses to provide wrap-around comfort.



Fall Protection
for Tools

Fall Protection for Tools



Aiming for a zero-drop policy.

Protecting workers takes more than just keeping them from falling. From construction sites to oil rigs, 3M™ DBI-SALA® Fall Protection for Tools makes work environments safer and more productive by drastically reducing falling object incidents that can result in personal injury, equipment damage, and tool loss.

Certified and tested.

Our drop prevention solutions are designed with the craft in mind, and are third-party tested in the harshest possible conditions – extreme heat, cold, moisture, corrosion and abrasion. We conduct dynamic and static strength tests, both in the field and in our ISO 9001-certified manufacturing facilities to ensure you get high quality and reliable fall protection for tools.

Watch 3M™ DBI-SALA® Fall Protection for Tools in action: <http://bit.ly/FPFTVideos>.

Fall Protection for Tools

Attachment Points

3M™ DBI-SALA® D-Rings

- D-rings can be attached to virtually any tool under 5 lbs. (2.3 kg) or 2 lbs. (0.9 kg) using our Quick-Wrap Tape (see page 47).
- Creates an attachment point in less than a minute.
- Dual D-rings allow for 100% tool tie-off during tool transfers.



Part #	Description	Load rating	Quantity	Non-conductive
1500003	D-ring 0.5 in. x 2.25 in. (1.3 cm x 5.7 cm)	2 lbs. (0.9 kg)	10 Pack	No
1500004	D-ring 0.5 in. x 2.25 in. (1.3 cm x 5.7 cm)	2 lbs. (0.9 kg)	100 Pack	No
1500005	D-ring 0.5 in. x 2.25 in. (1.3 cm x 5.7 cm) non-conductive	2 lbs. (0.9 kg)	10 Pack	Yes
1500006	D-ring 0.5 in. x 2.25 in. (1.3 cm x 5.7 cm) non-conductive	2 lbs. (0.9 kg)	100 Pack	No
1500007	D-ring 1 in. x 3.5 in. (2.5 cm x 8.9 cm)	5 lbs. (2.3 kg)	10 Pack	No
1500008	D-ring 1 in. x 3.5 in. (2.5 cm x 8.9 cm)	5 lbs. (2.3 kg)	50 Pack	No
1500001	Dual D-ring small	2 lbs. (0.9 kg)	10 Pack	No
1500002	Dual D-ring small	2 lbs. (0.9 kg)	100 Pack	No



3M™ DBI-SALA® Quick-Wrap Tape

- Heavy duty 1 in. (2.5 cm) wide tape conforms to the shape of whatever it is applied to.
- Used with our D-Rings (see page 46) and Tool Cinch Attachments (see page 48) to create instant tethering points on virtually any tool.
- Made from a self-fusing silicone rubber that leaves no adhesive or residue behind.
- Inner fiberglass webbing increases the strength of the tape and makes the tape resistant to sharp objects.

Part #	Description	Quantity	Length
1500174	Quick wrap, yellow	1	108 in. (274.3 cm)
1500175	Quick wrap, yellow	10	108 in. (274.3 cm)
1500168	Quick wrap, blue	1	108 in. (274.3 cm)
1500169	Quick wrap, blue	10	108 in. (274.3 cm)
1500171	Quick wrap, blue, 2x length	1	216 in. (548.6 cm)
1500172	Quick wrap, blue, 2x length	10	216 in. (548.6 cm)

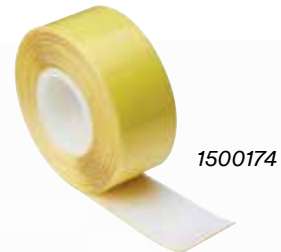
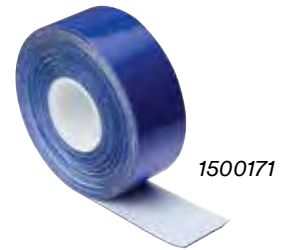
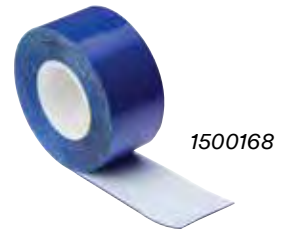

Fall Protection for Tools

3M™ DBI-SALA® Tool Cinch Attachments

- Tool Cinch Attachments feature a cinch design that allows users to quickly secure equipment up to 35 lbs. (15.9 kg) or 80 lbs. (36.3 kg).
- Stabilization wings can be used to keep Tool Cinch Attachments in place using our Quick-Wrap Tape (see page 47).

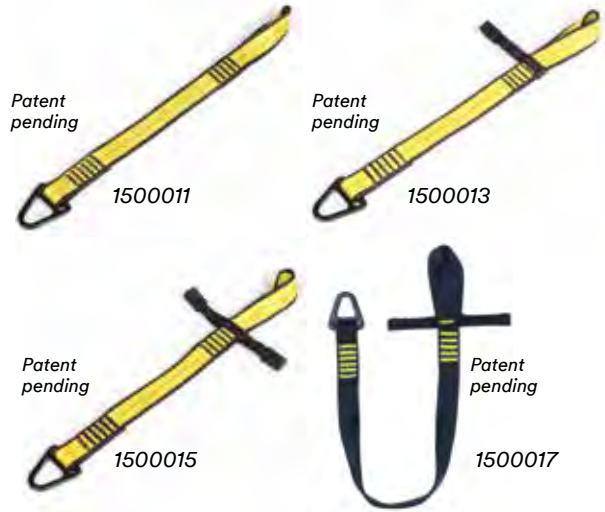

Part #	Description	Load rating	Stabilization wings
1500015	V-Ring attachment point, stabilization wing	35 lbs. (15.9 kg)	2
1500016	V-Ring attachment point, stabilization wing	35 lbs. (15.9 kg)	2
1500013	V-Ring attachment point, stabilization wing	35 lbs. (15.9 kg)	1
1500014	V-Ring attachment point, stabilization wing	35 lbs. (15.9 kg)	1
1500011	V-Ring attachment point, stabilization wing	35 lbs. (15.9 kg)	None
1500012	V-Ring attachment point, stabilization wing	35 lbs. (15.9 kg)	None
1500017	V-Ring attachment point, stabilization wing	80 lbs. (36.3 kg)	2
1500018	V-Ring attachment point, stabilization wing	80 lbs. (36.3 kg)	2

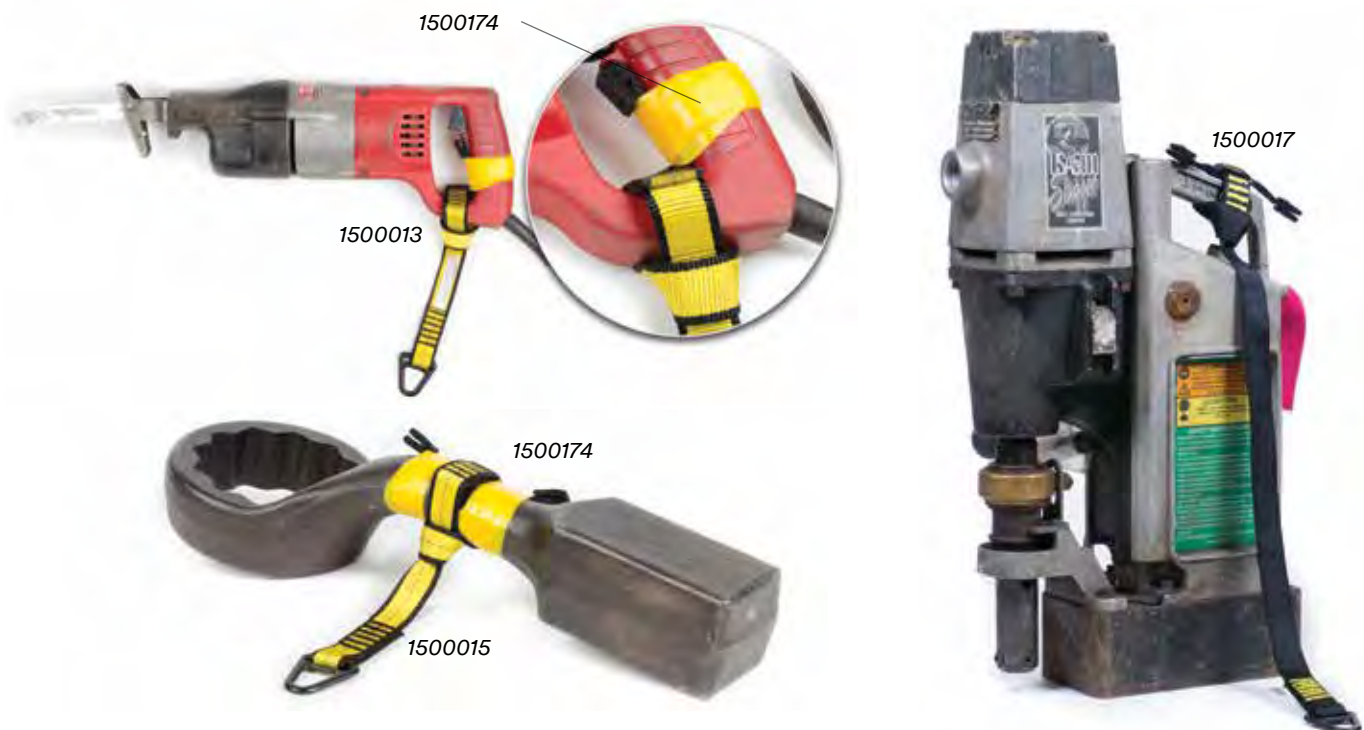

3M™ DBI-SALA®

Heat Shrink

- Protect your investment and connection point!
Heat Shrink protects our Quick-Wrap Tape (see page 47) from abrasives and harsh work environments.
- Heat Shrink links reduce in size by 200% when heat is applied.



Part #	Description	Quantity
1500019	Heat Shrink 0.75 in. x 1.75 in. (1.9 cm x 4.5 cm)	25
1500020	Heat Shrink 1 in. x 1.75 in. (2.5 cm x 4.5 cm)	25
1500021	Heat Shrink 1.5 in. x 2 in. (3.8 cm x 5.1 cm)	25
1500022	Heat Shrink 2 in. x 4 in. (5.1 cm x 10.2 cm)	10
1500023	Heat Shrink 3 in. x 4 in. (7.6 cm x 10.2 cm)	10

D-Ring Cord

1500009

- Easily cinches to tools weighing up to 5 lbs. (2.3 kg).
- Simply pass the loop end of a D-Ring Cord through a pre-drilled hole or closed handle to create an attachment point.
- Extremely durable and reusable.
- Comes in a pack of 10.

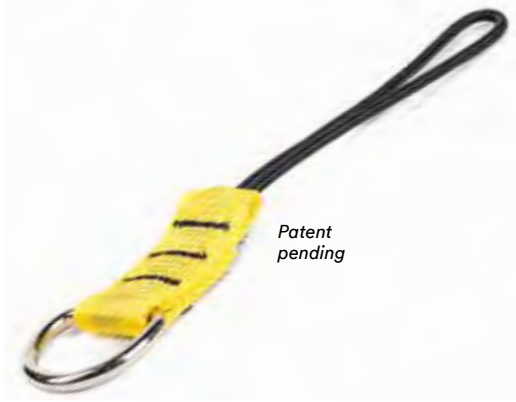

Fall Protection for Tools

3M™ DBI-SALA®

Quick Spins

- Simply slides onto the handle of a tool in seconds.
- Swivel spin top makes them tangle-resistant.
- Reusable and suitable for non-conductive use.
- Comes in packs of 10.

Patented



Part #	Description	Load rating
1500027	Small 0.6 in. (1.5 cm)	1 lbs. (0.5 kg)
1500028	Medium 0.8 in. (2 cm)	1 lbs. (0.5 kg)
1500029	Large 1 in. (2.5 cm)	1 lbs. (0.5 kg)
1500030	X-Large 1.2 in. (3.1 cm)	1 lbs. (0.5 kg)
1500031	Pen Holder 0.3 in. (0.8 cm)	-
1500032	Pen Holder with Coil 0.3 in. (0.8 cm)	-
1500033	Permanent Marker 0.5 in. (1.3 cm)	-
1500034	Permanent Marker with Coil 0.5 in. (1.3 cm)	-



1500028



1500030

Micro D-Ring

1500010

- Designed to allow for easy tethering of small devices such as cell phones, cameras and radios.
- Adheres to most surfaces creating an attachment point in seconds.
- Load rated for 2 lbs. (0.9 kg) when used with 1500060 (see page 53).
- Uses 3M very high bond adhesive.
- Comes in packs of 10.



3M™ DBI-SALA®

Quick Rings

- Quick Rings are an economical solution for tethering tools quickly.
- Allow many tools up to 2 lbs. (0.9 kg) to be made tether-ready.
- Ring pliers can be used to simplify quick ring installation.
- Comes in packs of 25.

Part #	Description	Load rating
1500024	Quick Ring, Small 0.75 in. (1.9 cm)	2 lbs. (0.9 kg)
1500025	Quick Ring, Medium 1 in. (2.5 cm)	2 lbs. (0.9 kg)
1500026	Quick Ring, Large 1.5 in. (3.8 cm)	2 lbs. (0.9 kg)



Fall Protection for Tools

Tool Lanyards

3M™ DBI-SALA®

Bungee Tethers



1500047



1500049

Part #	Description	Load rating	Length (relaxed)	Length (stretched)
1500047	Hook2Loop Bungee Tether	15 lbs. (4.5 kg)	32 in. (81.3 cm)	47 in. (119.4 cm)
1500048	Hook2Loop Bungee Tether (10 pack)	15 lbs. (4.5 kg)	32 in. (81.3 cm)	47 in. (119.4 cm)
1500049	Medium-Duty Hook2Loop Bungee Tether	35 lbs. (15.9 kg)	31 in. (78.7 cm)	52 in. (132.1 cm)

Engineered to last.

Built to be more durable and longer-lasting than the competition, our bungee tethers are third-party load rated and thoughtfully designed to prevent dropped objects.



Self-Locking carabiner

The Hook2Loop Bungee Tether features a self-locking carabiner that prevents accidental opens and automatically closes.



Competitor non-locking carabiners

Non-locking carabiners can be disconnected with a simple twist, potentially resulting in an accidental drop.

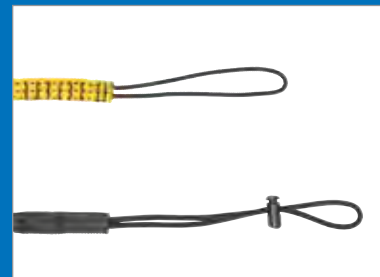

Competitor barrel locks

Many competitive bungee-tether bottoms often utilize a barrel lock. These barrel locks can pose risks as they allow for improper tethering of tools.

3M™ DBI-SALA®

Coil Tethers

An industry-first innovation.

Easy to clean and out of the way—exactly what a tether should be. The lightweight vinyl construction and ultra-compact design of our Coil Tethers makes them an ideal alternative to classic bungee tethers. Since we first introduced them to the marketplace, we've continued to refine and improve our line of coil lanyards with feedback from actual workers in the field.

1500159

Hook2Hook Coil Tether with Swivel

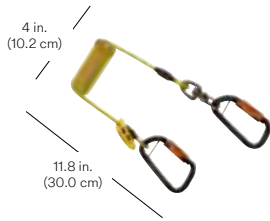

1500067

Trigger2Trigger Coil Tether

- Ideal for use from Wristband.



1500059

Clip2Clip Coil Tether

- Non-conductive
- Ideal for use from Wristband.

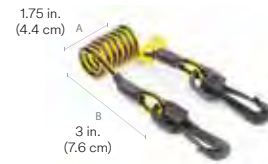

1500065

Hook2QuickRing Coil Tether with Tail

- Use with hammers and other long-handled tools.
- Available as a combo with our Hammer Holster (see page 59).

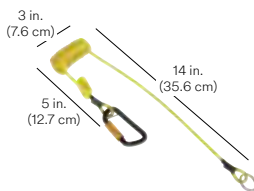

1500060

Clip2Loop Coil Tether

- Secure cameras, cell phones, radios and other small objects.
- Works well with our Micro D-ring (see page 50).



1500178

Hard Hat Tether

- Simple installation and removal.
- Patented clip holds stronger when force is applied to it.



Part #	Description	Quantity	Load rating	Length (relaxed)	Length (stretched)
1500159	Hook2Hook Coil Tether with Swivel	1	5 lbs. (2.3 kg)	4 in. (10.2 cm)	62 in. (157.5 cm)
1500160	Hook2Hook Coil Tether with Swivel	10	5 lbs. (2.3 kg)	4 in. (10.2 cm)	62 in. (157.5 cm)
1500067	Trigger2Trigger Coil Tether	1	5 lbs. (2.3 kg)	1.75 in. (4.4 cm)	24 in. (70 cm)
1500068	Trigger2Trigger Coil Tether	10	5 lbs. (2.3 kg)	1.75 in. (4.4 cm)	24 in. (70 cm)
1500059	Clip2Clip Coil Tether	10	2 lbs. (0.9 kg)	1.75 in. (4.4 cm)	24 in. (70 cm)
1500065	Hook2Quick Ring Coil Tether with Tail	1	2 lbs. (0.9 kg)	3 in. (7.6 cm)	62 in. (157.5 cm)
1500066	Hook2Quick Ring Coil Tether	10	2 lbs. (0.9 kg)	3 in. (7.6 cm)	62 in. (157.5 cm)
1500060	Clip2Loop Coil Tether	10	2 lbs. (0.9 kg)	7 in. (17.8 cm)	34 in. (86.4 cm)
1500178	Hard Hat Tether	10	4 lbs. (1.8 kg)	4 in. (10.2 cm)	34 in. (86.4 cm)

Fall Protection for Tools

3M™ DBI-SALA®

Retractor

1500069

- Compatible with a number of our Tool Holsters, Wristbands and Tool Pouches.
- Inner 132 cm (52 in.) steel coil allows automatic retraction when not in use.
- 0.7 kg (1.5 lbs.) load rating.



5 lbs. Tool Retractor

1500156

- Secure tools up to 5 lbs.
- Minimize tangling & tripping hazards.
- Reduce line twisting.



Harness Adapter

1500161

- Designed to be used with new 5 lb. tool retractor
- Can be used on products with black & gold carabiner



Trigger2Trigger Lanyards

- Thumb-controlled trigger snaps on both sides of these lanyards are easy to operate, even while wearing gloves.
- Trigger snaps swivel, making them tangle-resistant.

Part #	Quantity	Load rating	Length
1500053	1	10 lbs. (4.5 kg)	12 in. (30.5 cm)
1500054	10	10 lbs. (4.5 kg)	12 in. (30.5 cm)
1500055	1	10 lbs. (4.5 kg)	24 in. (60.9 cm)
1500056	10	10 lbs. (4.5 kg)	24 in. (60.9 cm)
1500057	1	10 lbs. (4.5 kg)	36 in. (91.4 cm)
1500058	10	10 lbs. (4.5 kg)	36 in. (91.4 cm)



Top to bottom:
1500057, 1500055,
1500053



Medium-Duty Hook2Loop Lanyard

1500050

- Features an aluminum double-action twist-lock carabiner to prevent accidental opens.
- Works well with medium-duty tool cinch (see page 48).

Part #	Load rating	Length
1500050	35 lbs. (15.9 kg)	72 in. (182.9 cm)

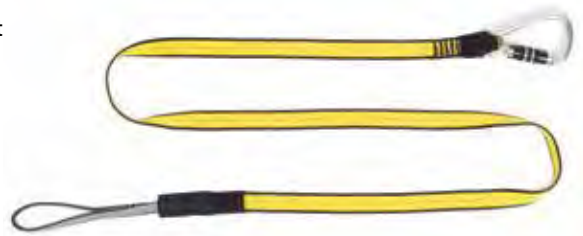

3M™ DBI-SALA®

Heavy-Duty Hook2Loop Lanyard

1500051

- Features an aluminum double-action twist-lock carabiner to prevent accidental opens.
- Works well with heavy-duty tool cinch (see page 48).

Part #	Load rating	Length
1500051	80 lbs. (36.3 kg)	72 in. (182.9 cm)



Heavy-Duty Hook2Rail Lanyard

1500052

- Features an aluminum double-action twist-lock carabiner to prevent accidental opens.
- Large double-action twist-lock rail carabiner.
- Works well with heavy-duty tool cinch (see page 48).

Part #	Load rating	Length
1500052	80 lbs. (36.3 kg)	72 in. (182.9 cm)



Fall Protection for Tools

Tool Holsters

3M™ DBI-SALA®

Smart Holsters

Your tools, at the ready.

Safer. Easier. It's not often that your job can be both, but 3M™ DBI-SALA® Smart Holsters are engineered for exactly that. These next generation tool pouches feature intelligent productivity features that are designed to keep your tool right where you want it at all times.

High-Visibility Reflectors

Products equipped with our high-visibility reflectors are always easy to identify and locate, even when left in dark spaces. The highly reflective material stitched into the front and back of the holster makes it easily detectable with a flashlight even in low-light conditions.



The faster, smarter way to holster

Our technology speeds up your workflow and reduces how often your tools need to be holstered. This powerful magnetic tool staging system allows tools to simply stick to the holster, ensuring the tool you need is always at the ready.



Bottom drain vent

You're at your best when your tools are too. The integrated drain vent in our Smart Holsters protects your tools from rusting and your holster from dry rot. Even in rainy weather conditions, the drain vent helps keep the holster dry by allowing water to pass through at all times.



3M™ DBI-SALA®

Single and Dual Tool Holsters

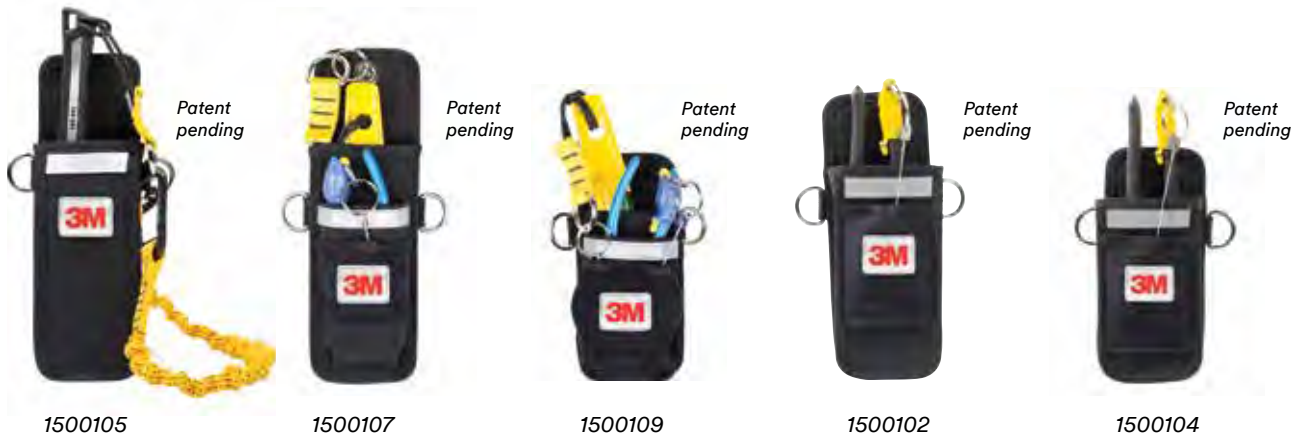

[1] Hook2Loop Bungee Tether sold separately.

- Single and Dual Tool Holsters are equipped with D-rings that are load rated for 5 lbs. (2.3 kg).
- Several variants of these holsters come with Retractors (indicated below) (see page 54). Retractors are load rated for 1-1/2 lbs. (0.7 kg).
- Single and dual tool holsters feature High-Visibility Reflectors and the Magnetic Tool Staging System.
- A bottom drain vent allows the holster to perform even in wet conditions.

Part #	Description	Retractors included	Attachment
1500103	Single Tool Holster	None	Harness
1500104	Single Tool Holster with Retractor	1x	Harness
1500101	Single Tool Holster	None	Belt
1500102	Single Tool Holster with Retractor	1x	Belt
1500105	Extra-Deep Single Tool Holster	None	Belt
1500108	Dual Tool Holster	None	Harness
1500109	Dual Tool Holster with Retractors	2x	Harness
1500106	Dual Tool Holster	None	Belt
1500107	Dual Tool Holster with Retractors	2x	Belt

Fall Protection for Tools

3M™ DBI-SALA® Tape Measure Holsters

- Designed to be used with virtually any tape measure, or the optional tape measure sleeve, allowing tape measures to be safely tethered and holstered.
- Includes a Retractor (see page 54).
- The tape measure sleeve conforms to the size of nearly every tape measure.
- Features High-Visibility Reflectors.

Part #	Description
1500098	Tape Measure Holster with Retractor
1500099	Tape Measure Sleeve
1500100	Tape Measure Holster with Retractor and Sleeve Combo



Back of holster



1500099 Patent pending

Large Tape Measure Sleeve

1500165

- Compliment to existing 25 ft. Tape Measure Sleeve.
- Provides a solution for most large tape measures used on a job site.



Pouch Holster with Retractor

1500095

- Quickly holster tape measures and other small tools.
- Includes a Retractor (see page 54).



Patent pending

Scaffold Wrench Holster with Retractor

- Quickly holster scaffold wrenches while working at height.
- Features High-Visibility Reflectors.

Part #	Description
1500096	Scaffold Wrench Holster with Retractor
1500097	Scaffold Wrench Holster with Retractor and Hook2Loop Bungee Tether



Patent pending



Back of holster features pouch for Safety Retractor (see page 54). Rear feed system allows retractor to tie off a scaffold wrench while staying out of the way.

3M™ DBI-SALA® Hammer Holster

- The Hammer Holster allows for the safe holstering of virtually any hammer under 5 lbs. (2.3 kg).
- D-ring on the side of the holster is load rated for 5 lbs. (2.3 kg).
- The 1500094 combo comes with a 1500065 Hook2Quick Ring Coil Tether (see page 55) that is specially designed for use with the Hammer Holster. The Hook2Quick Ring Coil Tether is load rated for 2 lbs. (0.9 kg).
- During transport, the Hammer Holster can be locked shut with a hook and loop strap. While being used, the strap can be locked up allowing for easy hammer access and holstering.

Part #	Description
1500093	Hammer Holster
1500094	Hammer Holster & Hook2Quick Ring Coil Tether



Patent pending

Top: Hammer Holster is locked, preventing hammer from slipping out.

Bottom: Hammer Holster is unlocked, making it suitable for active use.

Adjustable Radio Holster

- Holster adjusts to fit virtually any hand-held radio, cell phone, and many other devices.
- Can be worn from belt or harness.
- A Micro D-Ring (see page 52) can be placed on the back of a device, and can then be tethered to a D-ring on the front of the Adjustable Radio Holster using a 1500065 Clip2Loop Coil Tether (see page 53).

Part #	Description
1500088	Adjustable Radio Holster
1500089	Adjustable Radio Holster, Clip2Loop Coil Tether and Micro D-Ring



Patent pending

1500088

1500060

Can be worn from a belt or harness.

Spray Can/Bottle Holster

- Flexible neoprene holster allows for quick tethering of bottles and spray cans.
- 1500092 comes with 1500059 Clip2Clip Coil Tether (see page 53).

Part #	Description
1500091	Spray Can/Bottle Holster
1500092	Spray Can/Bottle Holster and Clip2Clip Coil Tether



Fall Protection for Tools

3M™ DBI-SALA® Battery Holster/Sleeve

1500090

- Unique sleeve design conforms to the size of virtually any drill battery.
- Sleeve is cinched to the drill, allowing the drill to be tethered off while being used at height.
- 10 lb. (4.5 kg) load rating.



1500049

3M™ DBI-SALA® Comfort Tool Belt

- Extra padding provides superior comfort compared to many other tool belts.
- Modular approach allows user to customize their own holster and pouch system.

Part #	Waist size	Size
1500110	28 in.-36 in. (71 cm-91 cm)	S-M
1500111	36 in.-44 in. (91 cm-112 cm)	L-XL
1500112	44 in.-52 in. (112 cm-132 cm)	2X-3X



Utility Tool Belt

- Padded Cordura provides for durability and comfort.

Part #	Waist size	Size
1500113	28 in.-46 in. (71 cm-117 cm)	S-L
1500114	40 in.-54 in. (102 cm-137 cm)	XL-3X



Belt Loops

- 1500115 is used for tying off tools from a belt, while the 1500117 is used for staging tools.

Part #	Description	Load rating	Quantity
1500115	Belt loop D-ring	5 lbs. (3.2 kg)	1
1500116	Belt loop D-ring	5 lbs. (3.2 kg)	10
1500117	Belt loop trigger	5 lbs. (3.2 kg)	1
1500118	Belt loop trigger	5 lbs. (3.2 kg)	10



Fall Protection for Tools

Tool Pouches

3M™ DBI-SALA®

Small Parts Pouches

Patented



1500123

1500121

1500120

1500122

1500119

- Innovative self-closure system traps objects inside, making it nearly impossible for objects to fall out once placed in the bag.
- Easy to retrieve objects since no opening or closing is necessary.
- Compatible with most tool belts.

Part #	Description
1500123	Small Parts Pouch, extra deep canvas black
1500121	Small Parts Pouch, canvas orange
1500120	Small Parts Pouch, canvas camo
1500122	Small Parts Pouch, vinyl yellow
1500119	Small Parts Pouch, canvas black



Belt loops located on back of pouch.



The Small Parts Pouch is designed for small parts such as nuts, bolts, screws and nails.



Items are placed inside the pouch, at which point they are immediately secured by the self-closure system.



Even when the pouch is flipped vertically, the pouch traps objects inside, making it nearly impossible for them to fall out.

3M™ DBI-SALA® Utility Pouch

- Features two outside pockets for storing spud wrenches and two inner pockets for storing additional tools.
- Tools can be tethered to D-rings on the inside and outside of the pouch.
- Adjustable side-release closure system helps prevent objects from falling out when the pouch isn't being used.



Part #	Product variant
1500132	Utility Pouch
1500130	Utility Pouch with Zipper Closure

Inspection Pouch

1500131

- Designed for the safe transport and use of most multi-meters, air monitors, and other portable testing devices.
- A unique patent pending adjustable opening can be used to create a hands-free workstation off the hip or chest.
- Can be worn off a belt, or over the shoulder using the included shoulder strap.



Hands-free workstation from belt or shoulder.

Patent pending

Tool Pouches

- Constructed from a heavy-duty canvas with an inner lining to help prevent punctures.
- Multiple inner pockets accommodate a number of tools while an integrated D-ring makes tethering tools incredibly easy.
- Available in standard and extra-deep variations.
- The standard pouch uses a hook and loop closure system that can be locked open during use.
- The extra-deep Tool Pouch features a magnetic closure system as well as a side-release buckle.



Part #	Width	Height	Retractors/triggers
1500124	7.5 in. (19.1 cm)	11 in. (27.9 cm)	-
1500125	7.5 in. (19.1 cm)	11 in. (27.9 cm)	2 retractors
1500126	7.5 in. (19.1 cm)	11 in. (27.9 cm)	2 triggers
1500127	8.75 in. (22.2 cm)	13 in. (33 cm)	-
1500128	8.75 in. (22.2 cm)	13 in. (33 cm)	2 reactors
1500129	8.75 in. (22.2 cm)	13 in. (33 cm)	2 triggers

Fall Protection for Tools

Spill Control Buckets

3M™ DBI-SALA®

Safe Buckets

With an integrated closure system that helps prevent dropped objects, our Safe Buckets are designed to be the perfect companion for workers at height carrying heavy loads.

Closure systems

Every Safe Bucket features either a unique, patent-pending drawstring or a locking hook and loop closure system that acts as an extra layer of spill-protection during transport and lifting. Colourful indicator tabs provide quick visual cues to indicate whether the bucket is in lockdown mode or easy-access mode.



Built-in connection points

The Safe Bucket was engineered for use with tools at height, and includes multiple connection points for tethering.

High-quality canvas and vinyl

Safe Buckets are available in both heavy-duty canvas and vinyl variants that are load rated for 100 lbs. (45.4 kg) and 250 lbs. (113.4 kg) respectively.



1500134



1500140



3M™ DBI-SALA®

Standard Safe Bucket Models

Integrated carabiner and hoisting strap

Instead of rope, which is susceptible to fraying, a heavy-duty hoisting/shoulder strap is built into every Safe Bucket. Each bucket is also equipped with a high-quality and lightweight aluminum twist-lock carabiner load rated for 30 kN (6,700 lbs.). There is no need to worry about a knot failing, or a non-locking carabiner which may slip off at a connection point.



Puncture resistance

Where you work, durability is non-negotiable. That's why every Safe Bucket features hard composite plating at the bottom to protect it from accidental punctures. A leather sleeve also covers the inserts, protecting them from the elements and harsh work environments.



Part #	Load rating	Closure system	Body material	Height/diameter	Capacity
1500134	100 lbs. (45.4 kg)	Hook and loop	Canvas	15 in./12.5 in. (38 cm/31.75 cm)	1840 in. ³ (4673.6 cm ³)
1500133	100 lbs. (45.4 kg)	Drawstring	Canvas	15 in./12.5 in. (38 cm/31.75 cm)	1840 in. ³ (4673.6 cm ³)
1500140	250 lbs. (113.4 kg)	Hook and loop	Vinyl	15 in./12.5 in. (38 cm/31.75 cm)	1840 in. ³ (4673.6 cm ³)
1500139	250 lbs. (113.4 kg)	Drawstring	Vinyl	15 in./12.5 in. (38 cm/31.75 cm)	1840 in. ³ (4673.6 cm ³)

Fall Protection for Tools

3M™ DBI-SALA®

Hard-Body Safe Bucket Insert

1500141

- Converts a standard soft-body Safe Bucket into a hard-body Safe Bucket.
- Our reusable hard-body Safe Bucket insert keeps your Safe Bucket standing upright, making it easier to stage tools and stay productive.
- Integrated inner pockets allow tools to be holstered and organized quickly.



5 Gallon Safe Bucket

1500135

- Used to transport standard 5 gallon (18.9 L) buckets.
- 5 gallon (18.9 L) plastic buckets clip into the Safe Bucket with a unique hook system.
- When not being used, the Safe Bucket can be flattened for easy storage.
- Unique patent pending locking hook and loop closure system helps ensure that there are no accidental spills during lifting and transportation.
- 100 lb. (45.5 kg) load rating.



3M™ DBI-SALA® Long Safe Buckets

- Transport scaffolding and longer tools safely and easily with our Long Safe Buckets.
- More effective than hand-to-hand transportation or using rope with hitch knots.
- Hook and loop top closure system helps keep poles secure during lift.
- Equipped with a double twist-action locking carabiner for maximum safety.

Part #	Length	Closure system	Load rating
1500136	48 in. (122 cm)	Hook and loop	100 lbs. (45.4 kg)
1500137	72 in. (183 cm)	Hook and loop	100 lbs. (45.4 kg)
1500138	120 in. (305 cm)	Hook and loop	100 lbs. (45.4 kg)

1500136



Fall Protection for Tools

3M™ DBI-SALA® Pullaway Wristbands

Pullaway wristbands are designed for those who work around rotating or moving equipment. They feature an elastic strap to conform to the wearer's wrist size automatically and come in standard and slim variants.



Pullaway Wristband



Slim Pullaway Wristband



Part #	Description	Qty.	Load rating
1500070	Pullaway Wristband, small	1	5 lbs. (2.3 kg)
1500071	Pullaway Wristband, small	10	5 lbs. (2.3 kg)
1500072	Pullaway Wristband, medium	1	5 lbs. (2.3 kg)
1500073	Pullaway Wristband, medium	10	5 lbs. (2.3 kg)
1500074	Pullaway Wristband, large	1	5 lbs. (2.3 kg)
1500075	Pullaway Wristband, large	10	5 lbs. (2.3 kg)
1500076	Pullaway Wristband, small (slim)	1	5 lbs. (2.3 kg)
1500077	Pullaway Wristband, small (slim)	10	5 lbs. (2.3 kg)
1500078	Pullaway Wristband, medium (slim)	1	5 lbs. (2.3 kg)
1500079	Pullaway Wristband, medium (slim)	10	5 lbs. (2.3 kg)
1500080	Pullaway Wristband, large (slim)	1	5 lbs. (2.3 kg)
1500081	Pullaway Wristband, large (slim)	10	5 lbs. (2.3 kg)

3M™ DBI-SALA® Adjustable Wristbands



Adjustable Wristband

Our adjustable wristband uses a hook and loop system to adjust to any wrist size. An elastic band helps ensure a comfortable fit.



Adjustable Wristband with Cord

Adjusts to any wrist size using a hook and loop system. A built-in cord is used to quickly attach and stage tools directly to the wristband.



Adjustable Wristband with Retractor

Adjusts to any wrist size. A built-in retractor with an attached trigger can be used to quickly work with many hand tools.

Part #	Description	Qty.	Load rating
1500082	Adjustable Wristband	1	5 lbs. (2.3 kg)
1500083	Adjustable Wristband	10	-
1500084	Adjustable Wristband with Cord	1	5 lbs. (2.3 kg)
1500085	Adjustable Wristband with Cord	10	-
1500086	Adjustable Wristband with Retractor	1	1.5 lbs. (0.7 kg)
1500087	Adjustable Wristband with Retractor	10	-



Energy-Absorbing Lanyards

Energy-Absorbing Lanyards

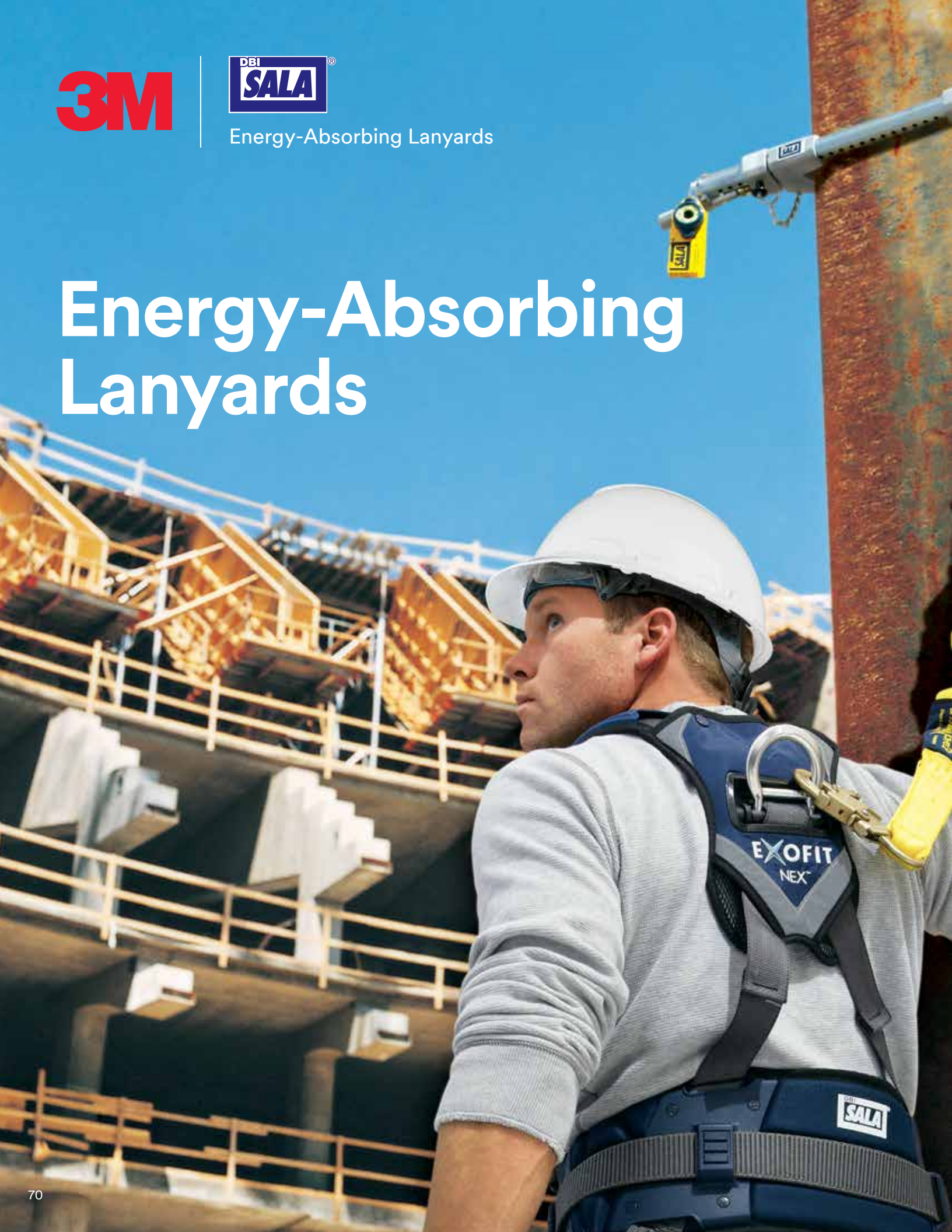

Built for toughness and exceptional performance.

When your workers connect to a 3M™ DBI-SALA® Energy-Absorbing Lanyard or Positioning Lanyard, they're connecting to a product that offers innovative features and reliable performance when it's needed the most. Your crew also benefits from a highly lightweight and durable fall arrest, restraint or positioning lanyard that's designed to be easy to use.

Our lanyards are made from the highest quality materials that meet or exceed rigorous safety standards. That's why workers around the world rely on them to be the best in safety, ease-of-use and durability.

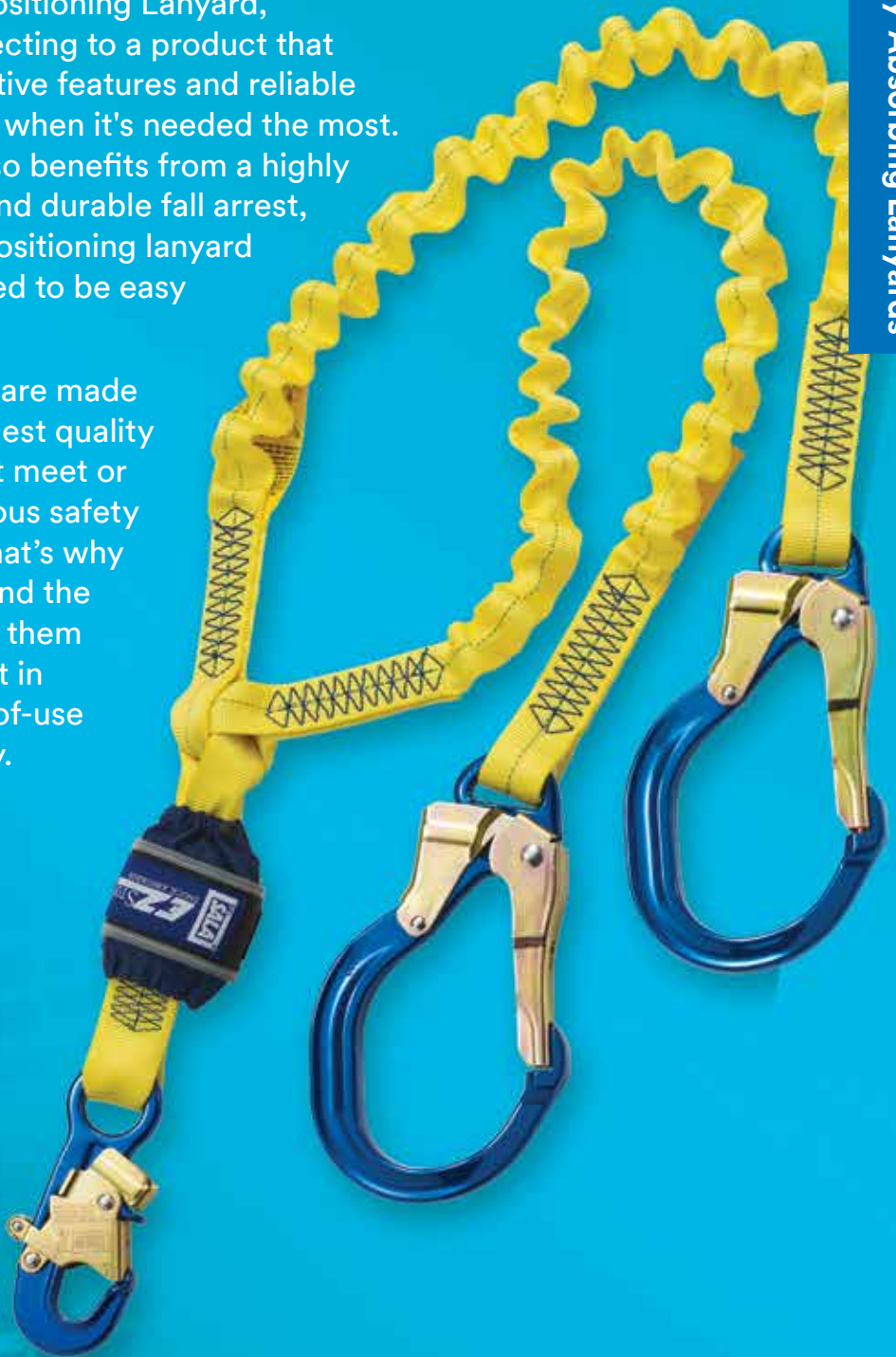

Choosing a lanyard

Look for quality in these features when selecting a lanyard.

1 Webbing

Webbing must be strong enough to endure rough use and exposure to sunlight and other elements, without tearing or fraying. Nomex®/Kevlar® with fibre webbing should be used for applications such as welding or arc flash hazards. Webbing may also be coated with polyurethane for protection against grease, oil and grime. Cable lanyards offer extra durability and are ideal if you're working in abrasive or high-heat environments.

2 Impact indicators

Impact indicators let you see if an energy absorber has been involved in a fall. Once an energy absorber has been deployed, the lanyard must be removed from service immediately and destroyed.

3 Connector/hook

Patented 3M™ DBI-SALA® Snap Hooks are popular because they allow one-handed use and won't pinch your thumbs or fingers. Lanyards can also be fitted with larger hooks or carabiners, for connection to larger anchorages.

4 Length

The standard lanyard length is 6 ft. (1.8 m), but both shorter and longer lanyards are available. A lanyard should be long enough to be user-friendly, but kept as short as possible to minimize the free fall distance.

5 Energy absorber

Lanyards used as part of a personal fall arrest system must contain an energy absorbing unit that limits fall arrest forces during a fall to less than 1,800 lbs. (8 kN). Most designs keep forces below 900 lbs. (4 kN) for added safety. Energy absorbers come in pack or tubular styles to meet your preference.



Types of Lanyards



Pack-Style Energy-Absorbing Lanyards

These basic lanyards include a pack-style energy absorber and offer a variety of leg types (web, cable, or with Kevlar® fiber). They dissipate energy, limiting the forces on your body during a fall.



Tubular-Style Energy-Absorbing Lanyards

These lanyards feature an internal energy absorber that dissipates the energy of a fall. This style is available in both a traditional fixed length design and a "stretch" style that expands and contracts.



Twin-Leg Lanyards

Two lanyards that are connected at one end. This style of lanyard is used to provide 100% tie-off, allowing you to stay protected when moving from one location to another.



Positioning Lanyards

Lanyards without energy absorbers, such as rope or web lanyards and chain rebar assemblies, are designed for positioning or restraint applications.

5

Steel and aluminum rebar lock hooks

Patent-pending, locking gate/nose design for maximum strength and security.

Fits around most structures with a 2-1/2 in. (63.5 mm) gate opening to maximize inner diameter.

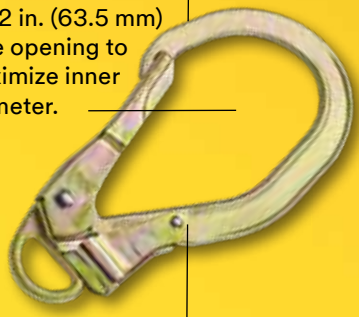

Ergonomic design for enhanced functionality and to better fit in the palm of your hand.

Workers prefer 3M™ DBI-SALA® Snap Hooks



One-handed operation makes our Snap Hooks the most popular in the industry. You can operate them with your gloves on or off, all without your fingers getting in the way!
All our lanyards feature 3,600 lb. (16 kN) rated gates, meeting rigorous CSA standards.

Lanyard hook options

Standard Hook
3/4 in. (19 mm) gate opening - 3,600 lb. (16 kN) gate strength.

Aluminum Rebar Hook
2-1/4 in. (57 mm) gate opening - 3,600 lb. (16 kN) gate strength.

Flat Steel Rebar Hook
2-1/2 in. (63.5 mm) gate opening - 3,600 lb. (16 kN) gate strength.

Saflok Max™ Steel Rebar Hook
3 in. (76.2 mm) gate opening - 3,600 lb. (16 kN) gate strength.



Saflok™ Tower Hook
4-5/16 in. (116.8 mm) gate opening - 1600 lb. (16 kN) gate strength.



Aluminum Rebar Lock Hook
2-1/2 in. (63.5 mm) gate opening - 3,600 lb. (16 kN) gate strength.



Steel Rebar Lock Hook
2-1/2 in. (63.5 mm) gate opening - 3,600 lb. (16 kN) gate strength.



2000113 - Saflok™ Steel Carabiner
1-3/16 in. (30 mm) gate opening - 3,600 lb. (16 kN) gate strength.



2000114 - Saflok™ Steel Carabiner
2-3/16 in. (55.5 mm) gate opening - 3,600 lb. (16 kN) gate strength.



WrapBax™ Hook
3/4 in. (19 mm) gate opening - 5,000 lb. (22 kN) gate strength.



Tie-Back Carabiner
3/4 in. (19 mm) gate opening - 5,000 lb. (22 kN) gate strength.



Specialty Lanyards



Tie-Back Lanyards
When a qualified anchorage connector is not available, a tie-back lanyard acts as both a connecting means and an anchorage connector, reducing inventory and cost.



Lanyards for Arc Flash and Hot Work Use
Special material with Kevlar® fiber has an 426°C char temperature rating, exceptional cut resistance and is ideal for high temperature environments or those requiring arc flash protection.



Lanyards for Foot Tie-Off
These lanyards can be used at your feet, allowing a 12 ft. (3.7 m) free fall and maintaining forces below 1,800 lbs. (8 kN). Also use for 6 ft. (1.8 m) falls for heavier workers up to 420 lbs. (190 kg).



Fall-Restricting Device
Unique device cinches around a wood pole during a “cut out” preventing user from falling to the ground and allowing user to regain footing.

Energy-Absorbing Lanyards

3M™ DBI-SALA® ShockWave2

Energy-Absorbing Lanyards

Avoid trips and snags on the job with ShockWave2. It's uniquely designed to expand and contract (1.8-1.4 m) in reaction to a worker's movements, and the tubular web stays out of your way when not in use. A built-in impact indicator provides easy visual evidence if the energy has been impact loaded through a fall or improper use. It limits the average fall arresting forces to 900 lbs. (4 kN)

1244321C ShockWave2 Lanyard

Single-leg with snap hook and steel rebar hook x 6 ft. (1.8 m)

1244406C ShockWave2 Lanyard

Twin-leg with snap hooks at each end x 6 ft. (1.8 m)

1244412C ShockWave2 Lanyard

Twin-leg with snap hook and flat steel rebar hooks x 6 ft. (1.8 m)

1244448C ShockWave2 Twin-Leg Lanyard

Twin-leg with snap hook and Safflok™ Max Hooks on leg ends x 6 ft. (1.8 m)

1244409C ShockWave2 Twin-Leg Lanyard

Twin-leg with snap hook and aluminum rebar hooks on leg ends x 6 ft. (1.8 m)

1244306C ShockWave2 Lanyard

Single-leg with snap hooks at each end x 6 ft. (1.8 m)



Rescue Lanyards

These lanyards incorporate an integrated D-ring to help facilitate the rescue of a fallen worker.

1244456 ShockWave2 Rescue Lanyard

Twin-leg with snap hook and steel rebar hooks on leg ends, D-ring for rescue or Self-Retracting Lifeline (SRL) attachment x 6 ft. (1.8 m)



Arc Flash Lanyards

Constructed from unique materials, these lanyards have Nomex®/Kevlar® fiber and are ideal for high heat environments or for electrical work when arc flash is a concern. Meets arc requirements of ASTM F887.

1244610C ShockWave2 Arc Flash Lanyard

With Nomex®/Kevlar® fiber single-leg with snap hooks x 6 ft. (1.8 m)



1244611C ShockWave2 Arc Flash Lanyard

With Nomex®/Kevlar® fiber single-leg with snap hook and web loop x 6 ft. (1.8 m)



1244630C ShockWave2 Arc Flash Lanyard

With Nomex®/Kevlar® fiber twin-leg with snap hooks x 6 ft. (1.8 m)



1244631C ShockWave2 Arc Flash Web Loop Twin-Leg Lanyard

With Nomex®/Kevlar® fiber twin-leg with choker and snap hooks on leg ends x 6 ft. (1.8 m)



Web Loop Lanyards

Simply choke off to back D-ring or to dorsal web loop. Reduces weight and is ideal for electrical applications where no metal above the waist is preferred.

1244310C ShockWave2 Web Loop Lanyard

Single-leg with snap hook at one end and web loop at the other x 6 ft. (1.8 m)



3M™ DBI-SALA® EZ Stop™

Energy-Absorbing Lanyards

EZ Stop™ Lanyards use a controlled tearing action when subjected to fall arrest forces. They limit the average arresting forces to 900 lbs. (4 kN) or less. These lanyards feature 1 in. (2.5 cm) polyester web construction (unless specified differently), double locking snap hooks, a durable nylon energy absorber cover and various lengths and hook options to fit your job.

Single-Leg Lanyards

1246011C EZ Stop™ Lanyard

Single-leg with snap hooks at each end x 6 ft. (1.8 m)



1246234C EZ Stop™ Adjustable Lanyard

Adjustable length with snap hooks x 6 ft. (1.8 m)



1246200C EZ Stop™ Lanyard

Elastic leg, 1 in. (2.5 cm) web, snap hooks at ends, x 6 ft. (1.8 m)



1246188C EZ Stop™ Lanyard

7/23 in. (0.5 cm) vinyl coated cable, snap hook at each end x 6 ft. (1.8 m)

1246101C EZ Stop™ Single-Leg Lanyard

Snap hook and Safflok Max Hook x 6 ft. (1.8 m)

1246177C EZ Stop™ Energy Absorber

Add in-line to a non-energy absorbing lanyard for fall arrest applications. Snap hook at one end, D-ring at other x 14.5 in. (36.8 cm)



Twin-Leg Lanyards

1246022C EZ Stop™ Twin-Leg Lanyard

Snap hooks at each end x 6 ft. (1.8 m)



1246196C EZ Stop™ Twin-Leg Lanyard

Elastic leg and snap hooks at each end x 6 ft. (1.8 m)

1246021C EZ Stop™ Twin-Leg Lanyard

Snap hook and aluminum rebar hooks at leg ends x 6 ft. (1.8 m)

1246024C EZ Stop™ Twin-Leg Lanyard

Snap hook and steel rebar hooks at leg ends x 6 ft. (1.8 m)

1246113C EZ Stop™ Twin-Leg Lanyard

Snap hook at one end, Safflok™ Max Steel Rebar Hook (7.6 cm gate opening) at leg ends x 6 ft (1.8 m)

1246193C EZ Stop™ Lanyard

Elastic legs, aluminum snap hook and aluminum rebar hooks at leg ends x 6 ft. (1.8 m)



3M™ DBI-SALA® EZ Stop™ E6 Lanyards

1246435C
6 ft. (1.8 m) elastic web E6 double-leg 100% tie-off with aluminum snap hook at center, aluminum Comfort Grip rebar hooks at leg ends

1246436C
6 ft. (1.8 m) web E6 double-leg 100% tie-off with aluminum snap hook at center, aluminum Comfort Grip rebar hooks at leg ends

1246437C
6 ft. (1.8 m) web E6 single-leg with aluminum snap hook at one end, aluminum Comfort Grip rebar hook at leg end

1246441C
4 ft. (1.2 m) elastic web E6 double-leg 100% tie-off with aluminum snap hook at center, aluminum Comfort Grip rebar hooks at leg ends

1246442C
4 ft. (1.2 m) web E6 double-leg 100% tie-off with aluminum snap hook at center, aluminum Comfort Grip rebar hooks at leg ends

1246443C
4 ft. (1.2 m) web E6 single-leg with aluminum snap hook at one end, aluminum Comfort Grip rebar hook at leg end

Energy-Absorbing Lanyards

3M™ DBI-SALA® EZ Stop™

E4/E6 Combo Lanyards

1246375C

EZ Stop™ Lanyard

S/A II web 6 ft. (1.8 m) E4/6, 9502116 snap hook ends, CSA

1246376C

EZ Stop™ Lanyard

S/A II web 6 ft. (1.8 m) E4/6, 9505254 snap hook ends, CSA

1246377C

EZ Stop™ 100% Tie-Off Lanyard

S/A II web 100% 6 ft. (1.8 m) E4/6, 9502116 snap hooks, 2 2000210 steel rebar hook with locking nose ends, CSA

1246378C

EZ Stop™ 100% Tie-Off Lanyard

S/A II web 100% 6 ft. (1.8 m) E4/6, 9505254 snap hook, 2 2000209 aluminum rebar hook with locking nose ends, CSA

1246379C

EZ Stop™ Adjustable Lanyard

S/A II web adj 6 ft. (1.8 m) E4/6, 9502116 snap hook ends, CSA

1246380C

EZ Stop™ Adjustable Lanyard

S/A II web adj 6 ft. (1.8 m) E4/6, 9505254 snap hook ends, CSA

1246381C

EZ Stop™ Adjustable 100% Tie-Off Lanyard

S/A II web 100% adj 6 ft. (1.8 m) E4/6, 9502116 snap hooks, 2 2000210 steel rebar hook with locking nose ends, CSA

1246382C

EZ Stop™ Adjustable 100% Tie-Off Lanyard

S/A II web 100% adj 6 ft. (1.8 m) E4/6, 9505254 snap hook, 2 2000209 aluminum rebar hook with locking nose ends, CSA

1246383C

EZ Stop™ Tie-Back Lanyard

S/A II tie b 6 ft. (1.8 m) E4/6, 9502116 snap hook ends, CSA

1246384C

EZ Stop™ Tie-Back Lanyard

S/A II tie b 6 ft. (1.8 m) E4/6, 9505254 snap hook ends, CSA

1246385C

EZ Stop™ Tie-Back 100% Tie-Off Lanyard

S/A II tie b 100% 6 ft. (1.8 m) E4/6, 9502116 snap hooks, 2 2000210 steel rebar hook with locking nose ends, CSA

1246386C

EZ Stop™ Tie-Back 100% Tie-Off Lanyard

S/A II tie b 100% 6 ft. (1.8 m) E4/6, 9505254 snap hook, 2 2000209 aluminum rebar hook with locking nose ends, CSA

1246387C

EZ Stop™ Lanyard

S/A II el 6 ft. (1.8 m) E4/6, 9502116 snap hook ends, CSA

1246388C

EZ Stop™ Lanyard

S/A II el 6 ft. (1.8 m) E4/6, 9505254 snap hook ends, CSA

1246389C

EZ Stop™ 100% Tie-Off Lanyard

S/A II el 100% 6 ft. (1.8 m) E4/6, 9502116 snap hooks, 2 2000210 steel rebar hook with locking nose ends, CSA

1246390C

EZ Stop™ 100% Tie-Off Lanyard

S/A II el 100% adj 6 ft. (1.8 m) E4/6, 9505254 snap hook, 2 2000209 aluminum rebar hook with locking nose ends, CSA

1246391C

EZ Stop™ Lanyard

S/A II web 4 ft. (1.2 m) E4/6, 9502116 snap hook ends, CSA

1246392C

EZ Stop™ 100% Tie-Off Lanyard

S/A II web 100% 4 ft. (1.2 m) E4/6, 9502116 snap hooks, 2 2000210 steel rebar hook with locking nose ends, CSA

1246393C

EZ Stop™ 100% Tie-Off Lanyard

S/A II web 100% 4 ft. (1.2 m) E4/6, 9505254 snap hook, 2 2000209 aluminum rebar hook with locking nose ends, CSA

1246394C

EZ Stop™ Lanyard

S/A II el 4 ft. (1.2 m) E4/6, 9505254 snap hook, 2 2000209 aluminum rebar hook with locking nose ends, CSA

1246395C

EZ Stop™ 100% Tie-Off Lanyard

S/A II el 100% 4 ft. (1.2 m) E4/6, 9502116 snap hooks, 2 2000210 steel rebar hook with locking nose ends, CSA

1246396C

EZ Stop™ 100% Tie-Off Lanyard

S/A II el 100% 4 ft. (1.2 m) E4/6, 9505254 snap hook, 2 2000209 aluminum rebar hook with locking nose ends, CSA

3M™ DBI-SALA® EZ Stop™ Modular Lanyards

Reduce the cost of ownership with the industry's first modular lanyard: EZ-Stop Modular Lanyards. It allows components to be replaced individually rather than purchasing an entirely new unit. It's easy to use with a patented, one-handed quick-connect design and unique connectors for maximum versatility.

Components can be changed in the field to accommodate various tasks.

- Leg lengths and materials.
- Single-leg to twin-leg.
- Larger or smaller-sized hooks.

1246040C EZ Stop™ Modular Lanyard

Modular web leg connector at one end, aluminum snap hook at other end x 6 ft. (1.8 m)

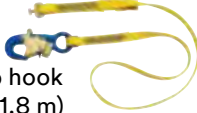

1246041C EZ Stop™ Modular Lanyard

Modular web leg connector at one end, snap hook at other end x 6 ft. (1.8 m)

1246042C EZ Stop™ Modular Lanyard

Modular elastic leg, modular connector at one end, snap hook at other end x 6 ft. (1.8 m)

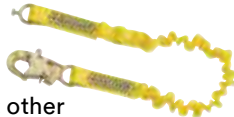

1246043C EZ Stop™ Modular Lanyard

Modular elastic leg, modular connector at one end, aluminum snap hook at other end x 6 ft. (1.8 m)

1246044C EZ Stop™ Arc Flash Modular Lanyard

With Kevlar® fiber reinforced leg, modular connector at one end, snap hook at other end x 6 ft. (1.8 m)



1246045C EZ Stop™ Modular Lanyard

Modular web legs, twin-leg, modular connector at one end, steel rebar hook (6.4 cm gate opening) at leg ends x 6 ft. (1.8 m)

1246046C EZ Stop™ Modular Lanyard

Modular web legs, twin-leg, modular connector at one end, steel rebar hook (6.4 cm gate opening) at leg ends x 6 ft. (1.8 m)

1246047C EZ Stop™ Modular Lanyard

Modular elastic legs, twin-leg, modular connector at one end, steel rebar hook (6.4 cm gate opening) at leg ends x 6 ft. (1.8 m)

1246048C EZ Stop™ Modular Lanyard

Modular elastic legs, twin-leg, modular connector at one end, aluminum rebar hook (6.4 cm gate opening) at leg ends x 6 ft. (1.8 m)



1246049C EZ Stop™ Arc Flash Modular Lanyard

Modular Kevlar® fiber leg, twin-leg, modular connector at one end, steel rebar hook (6.4 cm gate opening) at leg ends x 6 ft. (1.8 m)

1246050C EZ Stop™ Modular Lanyard

Modular WrapBax™ Web Leg, modular connector at one end, WrapBax Hook at other end x 6 ft. (1.8 m)



1246060C EZ Stop™ Modular Shock Pack

Modular energy absorber, modular connector at one end, aluminum snap hook at other end.



1246061C EZ Stop™ Modular Shock Pack

Modular energy absorber, modular connector at one end, snap hook at other end.

EZ Stop™ Tie-Back Lanyards

When a qualified anchorage connector is not available, a tie-back lanyard acts as both a connecting means and an anchorage connector.

1246085C EZ Stop™ Tie-Back Lanyard

Single-leg with floating D-ring for tie-back, snap hooks at ends x 6 ft. (1.8 m)

1246070C EZ Stop™ Tie-Back Lanyard

Twin-leg with floating D-rings for tie-back, snap hooks at ends x 6 ft. (1.8 m)

1246088C EZ Stop™ Tie-Back Lanyard

Single-leg with floating D-ring for tie-back, snap hook and aluminum rebar hook x 6 ft. (1.8 m)



1246071C EZ Stop™ Tie-Back Lanyard

Twin-leg with floating D-rings for tie-back, snap hook and aluminum rebar hooks at leg ends x 6 ft. (1.8 m)

1246072C EZ Stop™ Twin-Leg Tie-Back Lanyard

Twin-leg with floating D-rings for tie-back, snap hook and steel rebar hook at leg ends x 6 ft. (1.8 m)



1246089C EZ Stop™ Tie-Back Lanyard

Single-leg with floating D-ring for tie-back, snap hook and steel rebar hook x 6 ft. (1.8 m)

EZ Stop™ Resist Lanyards

1246226C EZ Stop™ Resist Lanyard

Single-leg polyurethane coated web, snap hooks x 6 ft. (1.8 m)



Energy-Absorbing Lanyards

3M™ DBI-SALA® EZ Stop™

Lanyards with Comfort Grip

1246432C

6 ft. (1.8 m) elastic web double-leg 100% tie-off with aluminum snap hook at center, aluminum Comfort Grip rebar hooks at leg ends



1246433C

6 ft. (1.8 m) web double-leg 100% tie-off with aluminum snap hook at center, aluminum Comfort Grip rebar hooks at leg ends

1246434C

6 ft. (1.8 m) web single-leg with aluminum snap hook at one end, aluminum Comfort Grip rebar hook at leg end

1246438C

4 ft. (1.2 m) elastic web double-leg 100% tie-off with aluminum snap hook at center, aluminum Comfort Grip rebar hooks at leg ends

1246439C

4 ft. (1.2 m) web double-leg 100% tie-off with aluminum snap hook at center, aluminum Comfort Grip rebar hooks at leg ends

1246440C

4 ft. (1.2 m) web single-leg with aluminum snap hook at one end, aluminum Comfort Grip rebar hook at leg end



3M™ DBI-SALA® EZ Stop™

Lanyards for Arc Flash and Hot Work Use

Constructed from unique materials, these lanyards are ideal for high heat environments or for electrical work when arc flash is a concern. Meets arc requirements of ASTM F887.

1246306C

EZ Stop™ Arc Flash Lanyard

Single-leg with Nomex®/Kevlar® fiber web with snap hooks x 6 ft. (1.8 m)

1246352

EZ Stop™ Arc Flash Lanyard

Adjustable web twin-leg Force2™ with Nomex®/Kevlar® fiber webbing and shock pack, aluminum snap hook at center, Saflok™ Tower Hooks at leg ends x 6 ft. (1.8 m)

1246321

EZ Stop™ Arc Flash Lanyard

Twin-leg Force2 with adjustable Nomex®/Kevlar® fiber webbing, aluminum snap hook and aluminum rebar hooks at leg ends x 6 ft. (1.8 m)

1246310C

EZ Stop™ Arc Flash Lanyard

With polyurethane coated web, web loop at one end, snap hook at the other end x 6 ft. (1.8 m)

1246311C

EZ Stop™ Arc Flash Lanyard

Polyurethane coated web, web loop at one end, snap hook at other end x 6 ft. (1.8 m)

1246320

EZ Stop™ Arc Flash Lanyard

Twin-leg Force2 with adjustable Nomex®/Kevlar® fiber webbing and snap hooks at ends x 6 ft. (1.8 m)

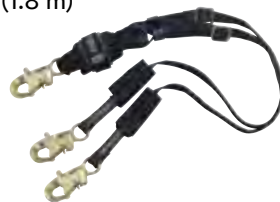

1246306C

1246317

EZ Stop™ Arc Flash Lanyard

With Nomex®/Kevlar® fiber adjustable webbing and snap hooks at ends x 6 ft. (1.8 m)

1246318

EZ Stop™ Arc Flash Lanyard

Force2 with Nomex®/Kevlar® fiber adjustable webbing and snap hook at one end and aluminum rebar hook at the other end x 6 ft. (1.8 m)



3M™ DBI-SALA® EZ Stop™

Retrax™ Lanyards

Unique spring technology retracts and expands from 2-1/2 ft.-6 ft. (0.8 m-1.8 m) in reaction to user's movements.

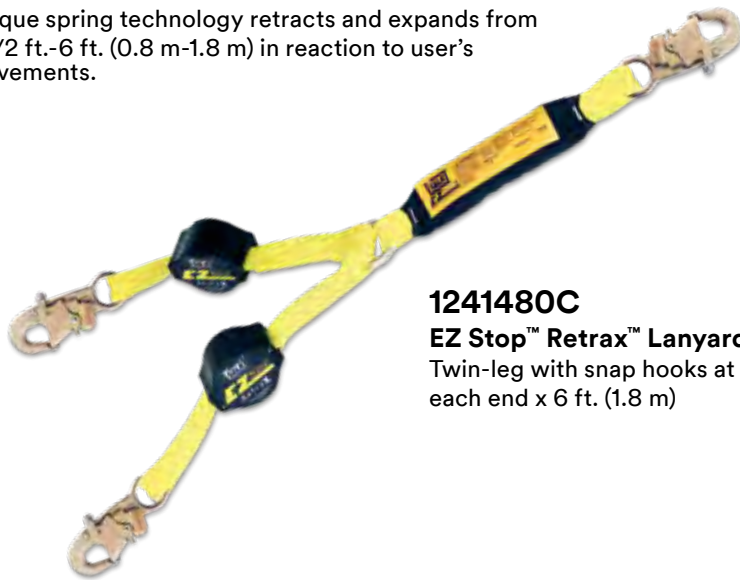

1241480C

EZ Stop™ Retrax™ Lanyard

Twin-leg with snap hooks at each end x 6 ft. (1.8 m)



1241460C

EZ Stop™ Retrax™ Lanyard

Single-leg with snap hooks at each end x 6 ft. (1.8 m)

3M™ DBI-SALA® EZ Stop™

Leading Edge Energy-Absorbing Lanyards

Engineered for sharp edges, these lanyards incorporate edge certified cable construction and offer Force2 foot-level tie-off ability (for maximum 3.6 m free fall).



1246066

EZ Stop™ Leading Edge Lanyard

Single-leg with snap hooks at each end x 6 ft. (1.8 m)

1246178

EZ Stop™ Leading Edge Lanyard

Twin-leg with aluminum snap hook at center and aluminum locking rebar hooks at leg ends x 6 ft. (1.8 m)

1246261

EZ Stop™ Leading Edge Lanyard

Single-leg with snap hook at one end, steel rebar hook at the other end x 6 ft. (1.8 m)

1246068

EZ Stop™ Leading Edge Lanyard

Twin-leg with aluminum snap hooks at center and at each leg x 6 ft. (1.8 m)

Energy-Absorbing Lanyards

3M™ DBI-SALA® Force2

Energy-Absorbing Lanyards

Ideal when there is no overhead anchorage and your only option is to tie off at your feet, these lanyards limit average forces below 1,800 lbs. (8 kN) It can be used as a standard lanyard up to a 6 ft. (1.8 m) free fall for workers that require a capacity of 311 lbs.-420 lbs. (141 kg-190 kg)

1246167 Force2 Lanyard

Single-leg with snap hooks at each end x 6 ft. (1.8 m)



1246159 Force2 Lanyard

Twin-leg with snap hook and flat steel rebar hooks at leg ends x 6 ft. (1.8 m)



1246161 Force2 Lanyard

Twin-leg with snap hooks at each end x 6 ft. (1.8 m)

1246414 Force2 Lanyard

Single-leg with snap hook at one end, Aluminum Comfort Grip Rebar Hook at leg end x 6 ft. (1.8 m)

1246143 Force2 Lanyard

Twin-leg with snap hook at one end, Saflok™ Max Steel Rebar Hook (7.6 cm gate opening) at leg ends x 6 ft (1.8 m)



1246413 Force2 Lanyard

Twin-leg with snap hook at one end, Aluminum Comfort Grip Rebar Hook at leg ends x 6 ft (1.8 m)

1246415 Force2 Lanyard

Twin-leg with snap hook at one end, Aluminum Comfort Grip Rebar Hook at leg ends x 6 ft (1.8 m)

1246147 Force2 Lanyard

Twin-leg, elastic webbing with snap hooks at ends x 6 ft. (1.8 m)



1246130 Force2 Energy Absorber

Energy absorber only, snap hook on one end, D-ring on other end x 1.4 ft. (0.4 m)

1246145 Force2 Lanyard

Elastic legs, twin-leg, aluminum hook x 6 ft. (1.8 m)

1246272 Force2 Lanyard

Twin-leg, rope legs, steel rebar hooks x 6 ft. (1.8 m)

1246273 Force2 Lanyard

Rope, twin-leg, aluminum snap hook at one end, aluminum rebar (6.4 cm gate opening) at ends x 6 ft. (1.8 m)



3M™ DBI-SALA® WrapBax™ 2

Tie-Back Lanyards

Reduce inventory. Simplify inspections and training. The WrapBax™ 2 eliminates the need for a separate anchorage connector, improving both your bottom line and compliance. It offers a unique 5,000 lb. (22 kN) hook and heavy-duty webbing for abrasion resistance. Limits the average arresting force to 900 lbs. (4 kN) or less.



1246229C
WrapBax™ 2 Tie-Back Lanyard

Single-leg with snap hook and 5,000 lb. (22 kN) WrapBax™ Hook x 6 ft. (1.8 m)



1246080
WrapBax™ 2 Tie-Back Lanyard

Twin-leg with snap hook and 5,000 lb. (22 kN) WrapBax™ Hooks at leg ends x 6 ft. (1.8 m)

1246173
WrapBax™ 2 Tie-Back Lanyard

Single-leg Force2™ with snap hook and 5,000 lb. (22 kN) WrapBax™ Hook x 6 ft. (1.8 m)

1246075
WrapBax™ 2 Tie-Back Lanyard

Twin-leg Force2 with snap hook and 5,000 lb. (22 kN) WrapBax™ Hooks at leg ends x 6 ft. (1.8 m)

3M™ DBI-SALA® Force2

Wind Energy Lanyards



1246153
Force2 Wind Energy Lanyard

Twin-leg with elastic web, snap hook and aluminum rebar hooks at leg ends, integrated rescue D-rings x 6 ft. (1.8 m)

1246032
Force2 Wind Energy Lanyard

Twin-leg with elastic webbing, aluminum snap hook and rebar hooks at leg ends, Tech-Lite™ Rescue D-rings, nylon shock pack with PVC cover x 6 ft. (1.8 m) Global compliance OSHA, ANSI and CE.

1246030
Force2 Wind Energy Lanyard

Twin-leg with elastic web, snap hook and steel rebar hooks at leg ends x 6 ft. (1.8 m)



1246152
Force2 Wind Energy Lanyard

Twin-leg with elastic web, snap hook and Saflok™ Max Hooks on leg ends, integrated rescue D-rings x 6 ft. (1.8 m)

1246151
Force2 Wind Energy Lanyard

Twin-leg with Hi-Vis elastic webbing, aluminum snap hook and aluminum rebar hooks on ends, integrated rescue D-rings x 6 ft. (1.8 m)

Positioning Lanyards

3M™ DBI-SALA®

Positioning Web Lanyards

Lanyards without energy absorbers, such as rope or web lanyards and chain rebar assemblies, are designed for positioning or restraint applications.

1 in. (2.5 cm) polyester web construction for durability that will last. Available in various lengths.

1231016C Web Lanyard

Single-leg with 1 in. (2.5 cm) polyester web, adjustable length and snap hooks at each end x 6 ft. (1.8 m)



1231106C Web Lanyard

Single-leg with 1 in. (2.5 cm) polyester web and snap hooks at each end x 6 ft. (1.8 m)

1231104C Web Lanyard

Single-leg with 1 in. (2.5 cm) polyester web and snap hooks x 4 ft. (1.2 m)



1231117C D-ring Extension

1.5 ft. (0.5 m) D-ring extension with snap hook at one end, D-ring at other end.

3M™ DBI-SALA®

Trigger X Tie-Back Adjustable Rope Positioning Lanyard

Get the versatility you need with the 3M™ DBI-SALA® Trigger X Adjustable Rope Positioning Lanyard. This ANSI rated positioning lanyard has three work modes and is available in multiple configurations. Smooth and precise adjustments on the abrasion resistant rope put you in a position to succeed.

1234102C

Rebar Hook, Blue, 8ft. (2.4 m), CSA

1234103C Rebar Hook, Blue, 8ft. (2.4 m), CSA

1234104C Snap Hook, Blue, 8ft. (2.4 m), CSA

1234105C Rebar Hook, Blue, 6ft. (1.8 m), CSA

1234106C Snap Hook, Blue, 6ft. (1.8 m), CSA

1234107C Rebar Hook, Blue, 6ft. (1.8 m), CSA

Chain & Web Rebar Positioning Lanyards

Made of twist link chain or polyester web for strength and durability. A variety of hook options provide a safe and compatible connection to many types of structures.

5920059 Chain Rebar Assembly

With snap hooks and swiveling aluminum rebar hook at center x 23 in. (58 cm)



5920050 Chain Rebar Lanyard

Chain rebar assembly with snap hooks and swiveling flat steel rebar hook at center x 20.5 in. (52 cm)

5920080 Chain Rebar Lanyard

Chain rebar assembly with snap hooks and aluminum rebar hook at center x 20.5 in. (52 cm)

5920200C Chain Rebar Lanyard

Chain rebar assembly with swiveling Saflok Max™ steel rebar hook and Zorbit™ at center, snap hooks at leg end x 26.5 in. (0.6 m)

5920201C Chain Rebar Lanyard

Chain rebar assembly with swiveling Saflok Max™ steel rebar hook and Zorbit™ at center, snap hooks at leg ends x 26.5 in. (0.6 m)

1231380 Web Rebar Assembly

With snap hooks and aluminum rebar hook at center x 18 in. (45 cm)



2108403 Spreader Hook

Use with large carabiner to form a positioning assembly that is short and compact. Steel hooks with self-locking/closing 3,600 lb. (16 kN) gates.



3M™ DBI-SALA® Cynch-Lok™

Fall-Restricting Devices

Real world challenges demand real world solutions. That's why we worked directly with actual pole climbers to develop Cynch-Lok™ Fall-Restricting Devices. You can effortlessly adjust and cinch it around the pole during a "cut-out" and easily hitch-hike poles (move or jump the strap upwards past obstacles) with a hand position that's comfortable.

Exterior straps can easily be swapped out in the field depending on pole size, eliminating the need for multiple systems. Cynch-Lok™ meets CSA Z259.14 standards for Type A and AB (dry, wet and icy poles) and ASTM F887.

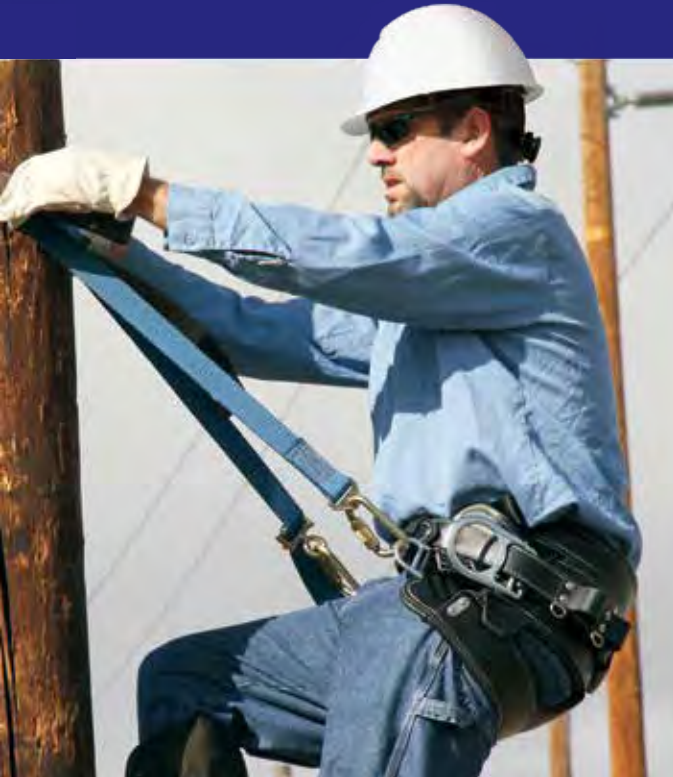

Positioning Lanyards

1204057

Cynch-Lok™ Rope for Distribution Poles

Pole Size (Dia/Circ): Min 5-1/2 in./17-1/2 in. (14 cm/44.4 cm)-Max 18-1/2 in./58 in. (20.3 cm/147.3 cm), Weight: 4.8 lbs. (2.1 kg)



1204058

Cynch-Lok™ Rope for Transmission Poles

Pole Size: (Dia/Circ): Min 5-1/2 in./17-1/2 in. (14 cm/44.4 cm)-Max 30-1/2 in./96 in. (77.5 cm/243.8 cm), Weight: 5.3 lbs. (2.4 kg)

1204075

Cynch-Lok™ Web for Distribution Poles

Pole Size (Dia/Circ): Min 5-1/2 in./17-1/2 in. (14 cm/44.4 cm)-Max 18-1/2 in./58 in. (20.3 cm/147.3 cm), Weight: 4.9 lbs. (2.2 kg)



1204076

Cynch-Lok™ Web for Transmission Poles

Pole Size: (Dia/Circ): Min 5-1/2 in./17-1/2 in. (14 cm/44.4 cm)-Max 30-1/2 in./96 in. (77.5 cm/243.8 cm), Weight: 5.4 lbs. (2.4 kg)

Cynch-Lok™ Replacement Components

1200110

Cynch-Lok™ Replacement Strap for Distribution Poles

Pole Size (Dia/Circ): Min 5-1/2 in./17-1/2 in. (14 cm/44.4 cm)-Max 18-1/2 in./58 in. (20.3 cm/147.3 cm), Weight: 1.9 lbs. (0.86 kg)



1200115 (not shown)

Cynch-Lok™ Replacement Rope Interior Strap

Weight: 2.9 lbs. (1.3 kg)

1200136 (not shown)

Cynch-Lok™ Replacement Web Interior Strap

Weight: 3 lbs. (1.3 kg)

1204077 (not shown)

Cynch-Lok™ Left Carabiner Conversion Kit - Web

1204074 (not shown)

Cynch-Lok™ Left Carabiner Conversion Kit - Rope

1200111

Cynch-Lok™ Replacement Strap for Transmission Poles

Pole Size: (Dia/Circ): 5-1/2 in./17-1/2 in. (14 cm/44.4 cm)-Max 30-1/2 in./96 in. (77.5 cm/243.8 cm), Weight 2.4 lbs. (1.1 kg)

Additional Positioning Lanyards

1234080

Adjustable rope positioning lanyard with rope adjuster and aluminum carabiners on ends x 8 ft. (2.4 m)



1234071

Adjustable rope positioning lanyard with rope adjuster and aluminum snap hook on one end and carabiner on the other x 8 ft. (2.4 m)



1234070

Adjustable rope positioning lanyard with rope adjuster and steel snap hook on one end and carabiner on the other x 8 ft. (2.4 m)





Self-Retracting Lifelines

Self-Retracting Lifelines

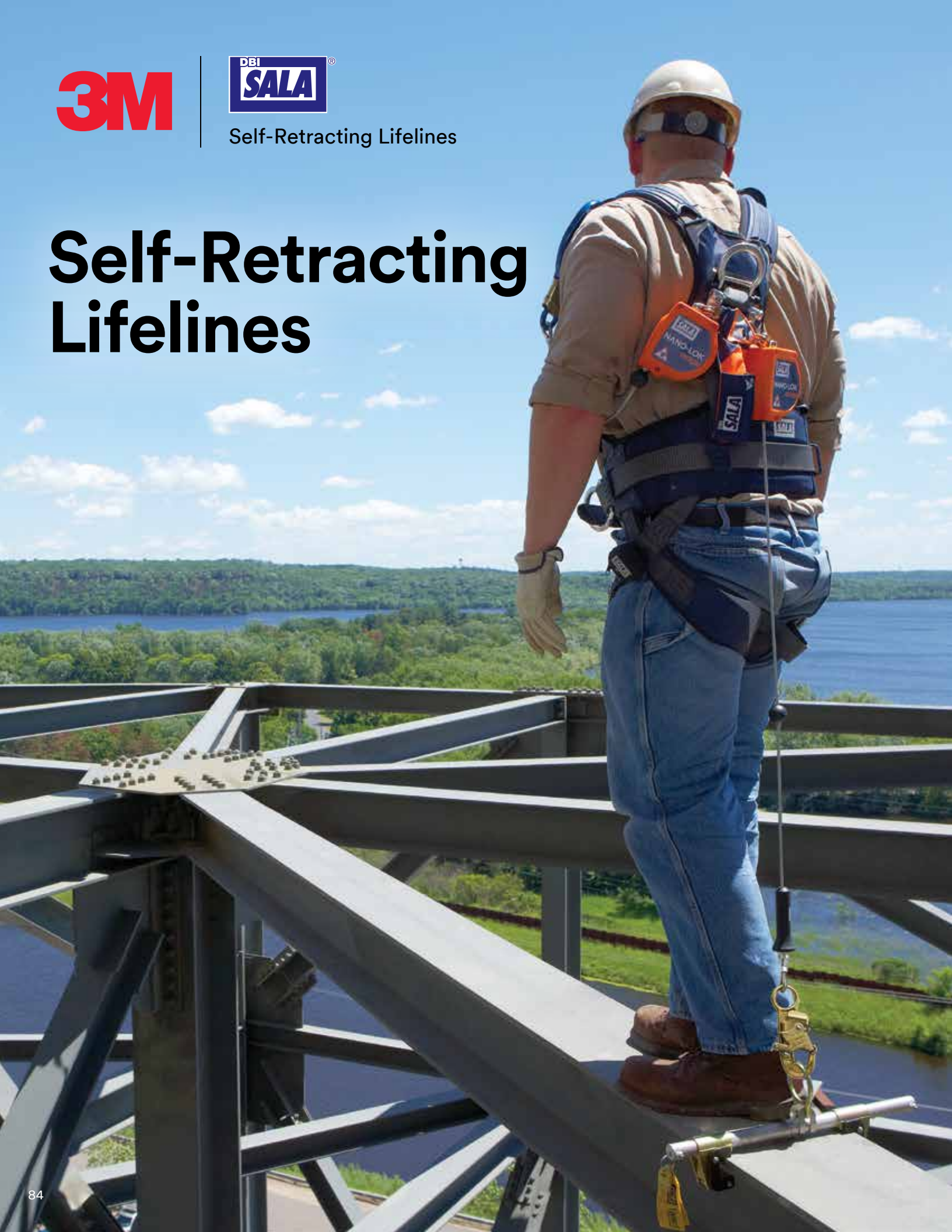



Leadership at heights. Applied to harnessing safety through science.

When there's nothing between you and the ground, you need a reliable, advanced Self-Retracting Lifeline (SRL) to have your back, every time. We developed the world's first SRL over 60 years ago and have continued to create innovative advances in lifeline systems that are used globally.

We've pioneered many industry-firsts, including the 3M™ DBI-SALA® Nano-Lok™ edge Self-Retracting Lifeline, which is specifically designed for foot level tie-off and sharp edge applications often found in construction. As an industry leader in SRLs, we know the importance of ergonomic design and ease-of-use for direct connection to most harnesses.

Whether your application requires single or twin-leg configurations, mounting to an overhead anchor or for connection directly to the harness, there are numerous models available for nearly every application.

3M™ DBI-SALA® Nano-Lok™

Self-Retracting Lifeline

Keep safe while hardly noticing you're wearing an SRL at all. The Nano-Lok SRL is ergonomically designed for ease-of-use and is ideal for direct connection to most harnesses. It stays out of the way and can be easily used as a lanyard replacement. Nano-Lok™ SRL locks quickly—stopping a fall within inches. In addition, tension is always kept on the lifeline, which reduces dragging, snapping and trip falls.

1 Twin-leg anchorage connector

Attach two SRLs directly to back of most harnesses; installs to web—leaves dorsal D-ring open for other equipment or rescue; design provides snug fit to worker's back; interchangeable SRLs allow versatility and replacement options.

2 Centrifugal brake

Stops falling worker within inches—reduces fall distances and average arresting forces to 900 lbs. (4 kN) or less; replaces lanyard and improves safety.

3 Impact-resistant housing

High-strength housing provides maximum durability.

4 Impact indicator

Integrated energy absorber provides visual indication of a fall.

5 RFID equipped

Helps track equipment and manage safety inspection programs.

Model shown
3101283

- Extremely compact & lightweight
- 420 lb. (190.5 kg) weight capacity
- Wide variety of configurations



Direct-to-harness connection

Single-Leg or twin-leg connectors install underneath the webbing on most harnesses.

- Leaves D-ring open for other equipment or rescue.
- Provides snug fit to workers back—eliminates nuisance flopping.
- Lower attachment point keeps housing at shoulder level vs. head level.



Self-Retracting Lifelines

3M™ DBI-SALA® Nano-Lok™ Self-Retracting Lifelines

Nano-Lok™ Self-Retracting Lifelines		Canada Part #
Single Leg	Nano-Lok™ Self-Retracting Lifeline with Steel Snap Hook and Carabiner x 6 ft. (1.8 m)	3101221
	Nano-Lok™ Self-Retracting Lifeline with Steel Snap Hook and Steel Carabiner x 6 ft. (1.8 m)	3101245
	Nano-Lok™ Self-Retracting Lifeline with Aluminum Carabiner (Captive Eye) and Single-Leg Quick Connector x 6 ft. (1.8 m)	3101230
	Nano-Lok™ Self-Retracting Lifeline with Aluminum Rebar Hook and Single-Leg Quick Connector x 6 ft. (1.8 m)	3101232
	Nano-Lok™ Self-Retracting Lifeline with Steel Snap Hook and Single-Leg Quick Connector x 6 ft. (1.8 m)	3101233
	Nano-Lok™ Self-Retracting Lifeline with Single-Leg Quick Connector and Steel Rebar Hook x 6 ft. (1.8 m)	3101234
	Nano-Lok™ Self-Retracting Lifeline with Aluminum Rebar Hook x 6 ft. (1.8 m)	3101255
	Nano-Lok™ Self-Retracting Lifeline with Aluminum Comfort Grip Rebar Hook x 6 ft. (1.8 m)	3101671
	Nano-Lok™ Self-Retracting Lifeline with Aluminum Comfort Grip Rebar Hook on the leg end x 6 ft. (1.8 m)	3101676
Twin Leg	Nano-Lok™ Twin-Leg Self-Retracting Lifeline with Steel Rebar Snap Hooks at Leg Ends x 6 ft. (1.8 m)	3101198
	Nano-Lok™ Twin-Leg Self-Retracting Lifeline with Twin-Leg Fixed Quick Connector and two Aluminum Rebar Hooks x 6 ft. (1.8 m)	3101291
	Nano-Lok™ Twin-Leg Self-Retracting Lifeline with Twin-Leg Quick Connector and two Aluminum Rebar Hooks x 6 ft. (1.8 m)	3101283
	Nano-Lok™ Twin-Leg Self-Retracting Lifeline with two Steel Snap Hooks and Twin-Leg Connector x 6 ft. (1.8 m)	3101285
	Nano-Lok™ Twin-Leg Self-Retracting Lifeline with Steel Rebar Snap Hook and Single-Leg Quick Connector x 6 ft. (1.8 m)	3101286
	Nano-Lok™ Twin-Leg Self-Retracting Lifeline with Twin-Leg Fixed Quick Connector and two Steel Rebar Hooks x 6 ft. (1.8 m)	3101294
	Nano-Lok™ Twin-Leg Quick-Connect Self-Retracting Lifeline with two Aluminum Locking Rebar Hooks x 6 ft. (1.8 m)	3101313
	Nano-Lok™ Twin-Leg Quick-Connect Self-Retracting Lifeline with two Aluminum Comfort Grip Rebar Hooks x 6 ft. (1.8 m)	3101668
	Nano-Lok™ Twin-Leg Quick-Connect Self-Retracting Lifeline with two Aluminum Comfort Grip Rebar Hooks x 6 ft. (1.8 m)	3101669
	Nano-Lok™ Twin-Leg Quick-Connect Self-Retracting Lifeline with two Aluminum Comfort Grip Rebar Hooks x 6 ft. (1.8 m)	3101670
Nano-Lok™ Twin-Leg Quick-Connect Self-Retracting Lifeline with two Aluminum Comfort Grip Rebar Hooks x 9 ft. (2.7 m)	3101672	



3101245



3101230



3101232



3101233



3101234



3101255



3101285



3101286



3101313

Self-Retracting Lifelines

3M™ DBI-SALA® Nano-Lok™ Extended Length Self-Retracting Lifelines

Nano-Lok™ Extended Length SRL		Canada Part #
Single Leg	Nano-Lok™ Extended Length, with snap hook and quick connector for harness mounting x 10 ft. (3 m)	3101598
	Nano-Lok™ Extended Length, with snap hook and swiveling anchor loop with carabiner x 10 ft. (3 m)	3101599
	Nano-Lok™ Extended Length, with aluminum carabiner and swiveling anchor loop with aluminum carabiner x 10 ft. (3 m)	3101600
	Nano-Lok™ Extended Length, with aluminum comfort grip rebar hook and quick connector for harness mounting x 9 ft. (2.7 m)	3101678
Twin Leg	Nano-Lok™ Extended Length, with snap hook and quick connector for harness mounting x 10 ft. (3 m)	3101628
	Nano-Lok™ Extended Length, with aluminum carabiners and quick connector for harness mounting x 10 ft. (3 m)	3101629
	Nano-Lok™ Extended Length, with and steel rebar hooks, quick connector for harness mounting x 9 ft. (2.7 m)	3101634



3M™ DBI-SALA® Nano-Lok™ Tie-Back Self-Retracting Lifelines

Nano-Lok™ Tie-Back SRL		Canada Part #
Single Leg	Nano-Lok™ Tie-Back, 5,000 lb. gated snap hook with swiveling anchor loop only x 9 ft. (2.7 m)	3101372
	Nano-Lok™ Tie-Back, 5,000 lb. gated snap hook with aluminum carabiner x 9 ft. (2.7 m)	3101369
	Nano-Lok™ Tie-Back, 5,000 lb. gated snap hook with single leg quick connector x 9 ft. (2.7 m)	3101370
	Nano-Lok™ Tie-Back, 5,000 lb. gated snap hook with steel carabiner x 9 ft. (2.7 m)	3101371
Twin Leg	Nano-Lok™ Tie-Back, 5,000 lb. gated snap hook with twin leg quick-connector x 9 ft. (2.7 m)	3101378
	Nano-Lok™ Tie-Back, 5,000 lb. gated snap hook with fixed D-ring connector x 9 ft. (2.7 m)	3101377



3M™ DBI-SALA® Nano-Lok™

Arc Flash Self-Retracting Lifelines



	Lifeline hook											Anchorage type				Canada Part #
	Steel Snap Hook	Steel Swiveling Snap Hook	Steel Rebar Hook	Steel Rebar Look Hook	Aluminum Captive Carabiner	Aluminum Rebar Hook	Aluminum Rebar Lock Hook	Dielectric Web Loop	11' Tie-Back	Single-Leg Interface	Twin-Leg Interface	Steel Carabiner	Web Leg w/ Alum. Snap Hook			
8 ft. Single Leg	■													3101541		
		■								■				3101542		
			■							■				3101543		
				■						■				3101544		
					■					■				3101545		
						■				■				3101546		
							■			■				3101547		
		■								■			■	3101548		
8 ft. Twin Leg		■												3101566		
			■									■		3101567		
				■								■		3101549		
					■							■		3101550		
						■						■		3101551		
							■					■		3101552		
								■				■		3101553		
									■			■		3101554		
Bucket Truck													■	3101555		
													■	3101569		
													■	3101578		
													■	3101579		

Designed specifically for utility applications.

- 8 ft. (2.4 m) working length.
- With Nomex®/Kevlar® fibre web lifeline and reinforced edges for superior wear resistance and durability.
- Features an arc flash industry logo to easily identify the product application.
- Arc flash compliant, tested to 40 cal/cm². Meets ASTM F887.
- Meets or exceeds industry standards.



Self-Retracting Lifelines

3M™ DBI-SALA® Nano-Lok™

for Hot Work Use Self-Retracting Lifelines



	Lifeline hook											Anchorage type			Canada Part #
	Steel Snap Hook	Steel Swiveling Snap Hook	Steel Rebar Hook	Steel Rebar Look Hook	Aluminum Captive Carabiner	Aluminum Rebar Hook	Comfort Grip Rebar Hook	Aluminum Rebar Lock Hook	9 ft. Tie-Back	Single-Leg Interface	Twin-Leg Interface	Steel Carabiner			
6 ft. Single Leg	■												3101506		
		■								■			3101507		
			■							■			3101508		
				■						■			3101509		
					■					■			3101510		
						■				■			3101511		
							■			■			3101677		
		■								■			3101512		
6 ft. Twin Leg												■	3101513		
												■	3101352		
												■	3101354		
		■											3101514		
			■									■	3101505		
				■								■	3101516		
					■							■	3101517		
						■						■	3101518		
							■					■	3101519		
								■				■	3101520		
								■			■	3101328			

This unique SRL was tested to 8 calories, ensuring durability in applications like welding, grinding and torching.

It is reinforced with Kevlar® fibre to withstand sparks, weld splatter and other high heat exposure.

- 6 ft. (1.8 m) working length
- Universal hot work icon to quickly and easily identify hot work products.
- Equipped with RFID.
- Meets or exceeds industry standards.



3M™ DBI-SALA® Nano-Lok™ edge

Self-Retracting Lifeline

The Nano-Lok™ edge SRL is specifically designed for foot level tie-off and sharp edge applications. It uses an innovative combination of lifeline material, energy absorption, and its harness connection to reduce forces on both the wearer and the edge. This technology allows Nano-Lok™ edge to meet the most stringent safety standards. It's available in single and twin-leg units, and it's orange so you'll know it's the right gear for the job.

1 Easy-to-install connector

Providing 360 degrees of rotation, the direct-to-harness connection provides seamless integration of the energy absorber and leaves the D-ring open for rescue or other equipment.

2 Impact-resistant housing

Lightweight thermoplastic housing provides maximum durability.

3 Global sharp edge icon

Our universal icon makes identification of sharp edge product quick and easy.

4 Tough and flexible galvanized cable lifeline

The 8 ft. (2.4 m) of 3/16 in. (5 mm) cable provides maximum range of motion, durability, and cut resistance.

5 Integrated, backpack-style energy absorber

The energy absorber and connector work together to limit forces on both the worker and the impacted edge. Backpack design stays tight to the harness and evenly disperses the unit's weight.



Model shown
3500232

3M™ DBI-SALA® Nano-Lok™ edge Self-Retracting Lifelines

In your line of work, anchoring at your feet may be the only option. Traditional equipment is not designed for this application, and slack could literally trip you up. The Nano-Lok™ edge SRL is specifically designed for foot level tie-off, virtually eliminating that hazard. Not only that, but this lifeline is designed with sharp edges in mind and takes the guesswork out of your work. The technology speaks for itself.

You can find more detailed information on how the Nano-Lok™ edge SRL keeps you safe on our website. Visit 3M.ca/FallProtection



Model shown
3500216

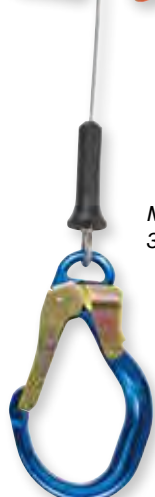

Product selection guide

	Lifeline hook										SRL
	Tie-back	Alum. Comfort Grip Hook	Alum. Rebar Lock Hook	Steel Rebar Lock Hook	Alum. Rebar Hook	Steel Rebar Hook	Steel Snap Hook	Steel Swivel Snap Hook	Alum. Captive Carabiner	Alum. Snap Hook	Canada Part #
Twin Leg	■	■		■	■						3500235
											3500259
				■							3500234
					■						3500250
						■					3500253
							■				3500232
Single Leg								■			3500233
									■		3500236
										■	3500237
	■										3500220
		■									3500260
			■								3500223
				■							3500219
					■						3500251
						■					3500252
							■				3500217
							■			3500218	
								■		3500221	
									■	3500222	

*All versions are 8 ft. (2.4 m) in length except tie-back models. Tie-back versions are 9 ft. (2.7 m)

3M™ DBI-SALA®

Sealed-Blok

Self-Retracting Lifeline

Grease, dirt and moisture are just part of your job. Keeping them from affecting the performance of your SRL is ours. These sealed SRLs are constructed from heavy-duty, corrosion-resistant materials, and incorporate a patented concept that separates all dynamic components—including the motor spring and brake—from foreign elements.



Sealed design

Meets IP68 and IP69K rating.

5

6

7

1

3400902C
Model shown

1 Carrying handle

Built-in design for easy transport—certified as secondary fall arrest rated anchorage point.

2 Galvanized & stainless steel cable

Abrasion resistant and corrosion-resistant lifeline options.

3 Self-locking swivel hook

- Limits lifeline twisting
- Integrated impact indicator
- 3,600 lb. (16 kN) gate reduces accidental disengagements (“roll-out”)

4 Fast-Line™ Cable Lifeline Replacement System

Provides the user with ability to replace the lifeline in the field.

5 Pivoting anchorage loop

Centers the load.

6 Aluminum housing

Provides exceptional strength durability and corrosion resistance.

7 Aluminum cast cover

2

3

4

Anti-ratcheting design

Stays locked on rigid and non-rigid (horizontal lifeline) anchors.

420 lb. (190.5 kg) weight capacity (All non-RSQ models)

Higher capacity for operator and tools (option).

Self-Retracting Lifelines

3M™ DBI-SALA® Sealed-Blok

Self-Retracting Lifelines

Product selection guide

	Lifeline material	Hook material	Includes mounting bracket	Retrieval capability	RSQ capacity	310 lb. (141 kg) weight capacity	420 lb. (189 kg) weight capacity	15 ft. (4.5 m)	30 ft. (9.1 m)	50 ft. (15.2 m)	85 ft. (25.6 m)	130 ft. (39.6 m)	175 ft. (53.3 m)	
CSA	Galvanized cable	Steel					■	3400825C	3400800C					
							■			3400900C	3400863	3400968	3400653	
				■			■		3400850C					
				■			■				3400920C	3400875	3400980	3400663
				■	■	■	■				3400940C	3400913	3401005	
				■	■	■	■				3400930C	3400887	3400992	
		■	■				■		3400853C					
		■	■				■			3400923C	3400876	3400981		
		Stainless steel cable	Stainless steel				■	3400827C	3400802C					
							■			3400902C	3400865	3400970	3400655	
							■				3400932C	3400889	3400994	
				■			■			3400852C				
				■			■				3400922C	3400879	3400984	3400661
				■	■	■	■				3400942C	3400915	3401007	
		■	■				■		3400858C					
		■	■				■			3400942C	3400883	3400988		
	Weight						12 lbs. (5.5 kg)	18 lbs. (8 kg)	29 lbs. (13 kg)	44 lbs. (20 kg)	60 lbs. (27 kg)	114 lbs. (51.7 kg)		
	Sealed design						Sealed	Sealed	Sealed	Sealed	Sealed	Sealed		
	Fast-Line								Standard	Standard	Standard	Standard		
	Approximate length						10.2 in. (25 cm)	11.5 in. (29 cm)	13.3 in. (34 cm)	16 in. (41 cm)	18.7 in. (48 cm)	16.8 in. (42.7 cm)		
	Approximate width						7.6 in. (19 cm)	9.4 in. (24 cm)	10.4 in. (27 cm)	9.9 in. (25 cm)	11.7 in. (30 cm)	14 in. (35.6 cm)		
	Approximate height						4.3 in. (11 cm)	5.4 in. (14 cm)	6.9 in. (18 cm)	6.7 in. (17 cm)	7.2 in. (18 cm)	12.3 in. (31.2 cm)		



Fast-Line™ Cable Lifeline Replacement System allows the lifeline assembly to be replaced out in the field.

Self-Retracting Lifelines

Other models available; please contact us.

3M™ DBI-SALA® Fast-Line™

Cable Replacement Assemblies



3900105

Galvanized Cable with Plated Hook

Fast-Line™ Galvanized Replacement Cable Assembly x 50 ft. (15 m)

3900108 85 ft. (25.5 m)

3900112 130 ft. (39 m)

3900107

Stainless Steel Cable with Stainless Steel Hook

Fast-Line™ Stainless Steel Replacement Cable Assembly x 50 ft. (15 m)

3900111 85 ft. (25.5 m)

3900114 130 ft. (39 m)

Self-Retracting Lifelines

3M™ DBI-SALA® Ultra-Lok Self-Retracting Lifelines

Rugged durability. Extremely lightweight. These SRLs are engineered to help deliver everything you need to maximize your safety, efficiency and comfort. Stainless steel components, an anti-ratcheting brake system and a semi-sealed design result in a system that's truly built to last.

- 1 Top swivel**
Limits lifeline twisting for smoother operation.
- 2 Thermoplastic housing**
Lightweight, compact and durable.
- 3 Ergonomic cable handle**
Provides added comfort and ease-of-use when making connections.
- 4 Multiple lifeline options**
Galvanized or stainless steel cable, nylon or Nomex®/Kevlar® web, or Vectran™ rope for ultimate jobsite flexibility.
- 5 Self-locking swivel hook**
Limits lifeline twisting.
- 6 Impact indicator**
Provides visual indication of fall arrest.
- 7 3,600 lb. (16 kN) gate**
Reduces chances of accidental disengagement (“roll-out”).

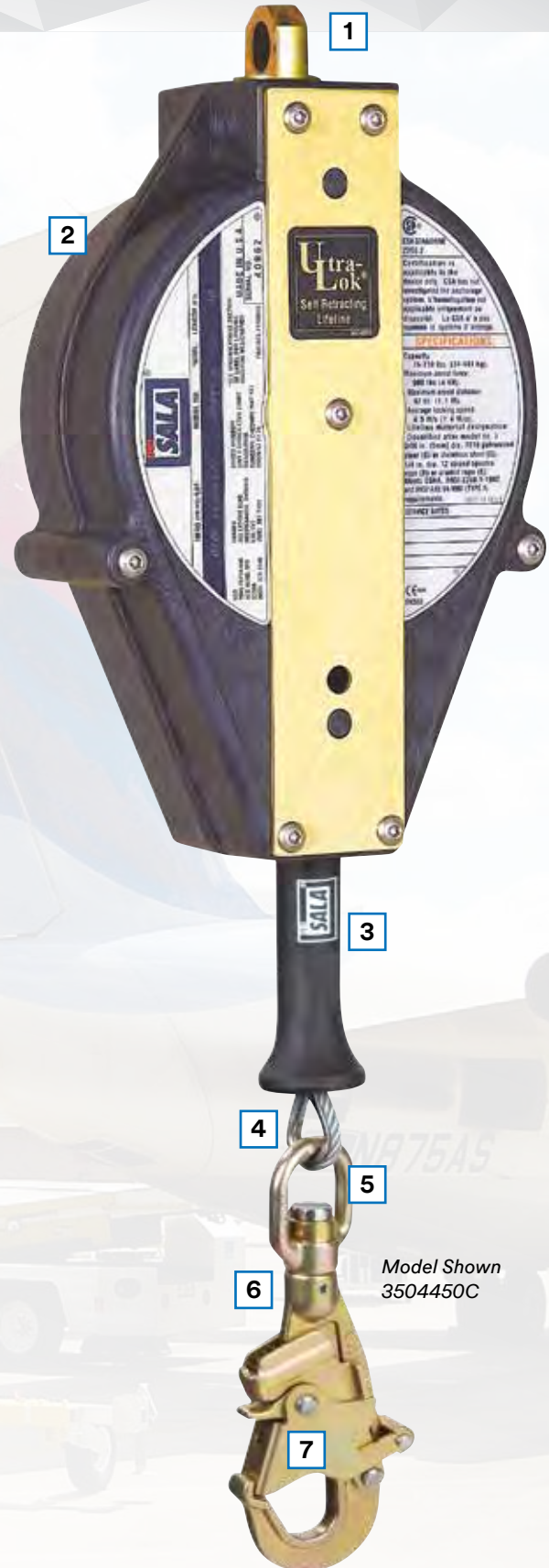

Model Shown
3504450C

3M™ DBI-SALA® Ultra-Lok

Self-Retracting Lifelines

Like our Sealed-Blok, the Ultra-Lok Lifeline also extends and retracts, so you can move about freely at normal speeds within a recommended working area. Should a fall occur, a speed-sensing brake system (1.3 m/sec.) will activate, stopping the fall and reducing the imposed forces to 900 lbs. (4 kN) or less.



3103108C Ultra-Lok Web SRL

Nylon web lifeline models weigh less, making them more comfortable and less abrasive to objects around system x 11 ft. (3.3 m)



3504500C Ultra-Lok Leading Edge SRL

Unique design incorporates larger diameter 30 ft. (9.1 m) of 7/32 in. (5.5 mm) cable and an in-line energy absorber for the demands of leading edge applications.



3103175C Ultra-Lok Arc Flash SRL

Kevlar®/Nomex® lifeline offers the ultimate in spark, fire resistance and electrical conductivity for utility, welding, cutting and torching applications x 11 ft. (3.3 m)



3501104 Ultra-Lok 3-Way SRL

50 ft. (15.2 m) of 3/16 in. (4.7 mm) galvanized steel wire rope with 3-way emergency retrieval winch, mounting bracket, swiveling snap hook and anchorage carabiner.

Self-Retracting Lifelines

Lifeline material	Hook style	Hook throat size (in.)	Rated gate capacity (lbs.)	Swivel hook	Compatible with order picker mount**	Leading edge	RSQ	SRL weight capacity (lbs.)	11 ft.	15 ft.	20 ft.	30 ft.	50 ft.	55 ft.	85 ft.	
									(3.4 m)	(4.6 m)	(6.1 m)	(9.1 m)	(15.2 m)	(16.7 m)	(26 m)	
Galvanized cable	Steel carabiner	5/8	3,600	■				310			3504445C	3504446C	3504463C			
	Steel hook	5/8	3,600	■		■		310		3504422C		3504500C		3504600C		
		3/4	3,600	■			■	310			3504433C	3504430C	3504450C		3504485C	
Stainless steel cable	Steel hook	3/4	3,600	■			■	310					3504551C			
		310			3504434C	3504431C	3504451C		3504486C							
	Stainless steel hook	3/4	3,600	■			■	310				3504552C				
				■			310			3504437C	3504432C	3504452C		3504487C		
Vectran rope	Steel hook	3/4	3,600	■				310			3504438C		3504480C			
Nylon web	Steel carabiner	11/16	3,600					310			3103209C					
			3,600	■			420	3103119C								
	Stainless steel carabiner	11/16	3,600					310			3103214C					
	Aluminum rebar hook	2 1/4	3,600		■			420	3103110C							
	Steel hook	5/8	3,600	■	■			420	3103108C							
				■	■			420	3103120C							
				■				310		3103208C						
				■				420	3103107C							
							310			3103207C						
Stainless steel hook	3/4	3,600	■	■			420	3103136C								
			■				310		3103212C							
Kevlar®/Nomex® Fibre web	Steel hook	5/8	3,600	■	■			310	3103175C							
				■				310		3103275C						
Approximate web SRL weight									39 lbs. (18 kg)	-	5.5 lbs. (2.5 kg)	-	-	-	-	
Approximate cable (galv) SRL weight									8 lbs. (3.6 kg)	11 lbs. (5 kg)	9 lbs. (4.1 kg)	11 lbs. (5 kg)	15 lbs. (6.8 kg)	30 lbs. (13.6 kg)	33 lbs. (15 kg)	

Self-Retracting Lifelines

3M™ DBI-SALA®

Smart Lock Self-Retracting Lifelines

Our smartest SRLs yet. From reducing nuisance lockups, to simplifying inspections, every detail of the new 3M™ DBI-SALA® Smart Lock Self-Retracting Lifelines is designed to help increase your productivity, safety and convenience.

3503800

Vertical (overhead), Galvanized Cable, Blue, 30 ft.

3503801 Stainless Steel Cable, Blue, 30 ft.

3503803 Galvanized Cable, Blue, 20 ft.

3503804 Stainless Steel Cable, Blue, 20 ft.

3503820 Rope, Blue, 35 ft.

3503821 Stainless Steel Cable, Blue, 35 ft.

3503823 Stainless Steel Cable, Blue, 50 ft.

3503824 Galvanized Cable, Blue, 50 ft.

3503802

Horizontal (Leading Edge), Galvanized Cable, Blue, 20 ft.

3503822 Galvanized Cable, Blue, 30ft.



3M™ DBI-SALA® Talon™

Self-Retracting Lifelines

An extremely compact SRL that's lighter, stronger and safer. Talon™ Self-Retracting Lifelines feature an all-metal anti-ratcheting braking system that stops the fall within inches and reduces the forces imposed on the user to safe levels. Because of our unique brake system, you can maintain a normal work pace and not be interrupted with constant lockups.

- Lightweight design – under 3 lbs. (1.4 kg)
- Built-in connector for direct attachment to harness.
- Compact size and weight for comfort and convenience.

3101001C

Talon™ Quick-Connect Self-Retracting Lifeline

1 in. (2.5 cm) nylon web with swivel snap hook and quick connector for harness mounting x 8 ft. (2.4 m)



3101009C

Talon™ Order Picker Self-Retracting Lifeline

1 in. (2.5 cm) nylon web with swivel snap hook and cab-mount order picker connector x 8 ft. (2.4 m)



3101300C

Talon™ Tie-Back Quick-Connect Self-Retracting Lifeline – Web

1 in. (2.5 cm) nylon web with tie-back hook and quick connector for harness mounting x 9.5 ft. (2.9 m)



3101006C

Talon™ Quick-Connect Self-Retracting Lifeline – Web

1 in. (2.5 cm) nylon web with quick connector and 9510057 Flat Steel Rebar Hook with 2-1/2 in. (63.5 mm) gate opening x 8 ft. (2.4 m)



Self-Retracting Lifelines

Twin-Leg Self-Retracting Lifelines

Work safer with greater mobility. The Talon™ Twin-Leg SRL allows you to “leap-frog” while moving from one location to another. Each lifeline works independently, extending up to 6 ft. and automatically retracting, providing fall protection and mobility 100% of the time.

- Twin-leg SRL provides continuous protection.
- Built-in anchorage connector for direct attachment to harness or anchorage.
- Compact size and weight for comfort and convenience.
- Replaces a lanyard with the convenience of a retractable lifeline.
- All Talon™ Twin-Leg SRLs include Delta™ Comfort Pad and 2 ea. Lanyard Keepers

3102100

Talon™ Twin-Leg Tie-Back Quick-Connect Self-Retracting Lifeline – Web

Tie-back type twin-leg lifelines with 1 in. (2.5 cm) nylon web and tie-back hooks, quick connector for harness mounting x 7.5 ft. (2.3 m)



3102115

Talon™ Twin-Leg Tie-Back Quick-Connect Self-Retracting Lifeline

Tie-back type twin-leg lifelines with 1 in. (2.5 cm) nylon web and tie-back hooks, quick connector for harness mounting x 7.5 ft. (2.3 m) 420 lb. (190.5 kg) capacity.





Vertical Systems

Vertical Systems



You don't need to leave that feeling of security on the ground when you climb with our gear. 3M™ DBI-SALA® Vertical Systems are designed to offer added security, climbing mobility and productivity while meeting the CSA Z259.2.4 and 2.5 standards. Our products complement your ability to work while prioritizing worker safety.

Types of vertical lifeline systems

A vertical fall protection system allows the worker to move up and down the entire height of the lifeline rather than having to disconnect and find new tie-off points along the way. Some important considerations when selecting a system include:

Portable or permanent

Temporary jobs require lightweight and easy-to-use portable systems with synthetic lifelines that can be moved from one location to another. If a structure is accessed often, such as a ladder or tower, a permanent solution, such as Lad-Saf™ Flexible Cable Ladder Safety System is a better choice. Permanent systems require corrosion-resistant galvanized or stainless steel lifelines.

Mobile or fixed

Mobile rope grab or ladder sleeve designs automatically follow the user for easy operation. Fixed devices allow the user to fix the unit in place for positioning or restraint applications.



Vertical Systems

3M™ DBI-SALA® Lad-Saf™

Flexible Cable Ladder Safety Systems

Make your structure permanently safe and accessible with the easy-to-use Lad-Saf™ Flexible Cable System. It consists of a top and bottom bracket that act as anchors for a steel cable that runs the length of the climbing area. The Lad-Saf™ X3 Sleeve, attached by a carabiner to the harness, arrests falls by locking onto the cable.

Welded or bolted. Straight or curved ladders. Wood, concrete or steel structures. A variety of rung clamp sizes and styles. With so many optional configurations, these versatile and economical safety solutions are ideal for many applications.

1 Standard top bracket

Galvanized top bracket with mounting hardware. For systems up to 499 ft. (152 m) high, fits up to 1-1/8 in. (2.8 cm) rung diameter and attaches to three rungs. Includes built-in energy absorber.

2 Standard bottom bracket

Fits up to 1-1/8 in. (2.8 cm) rung diameter and attaches to two rungs. Galvanized bottom bracket includes built-in tension indicator.

3 Cable guide

Non-metallic cable guide with mounting hardware. For systems up to 199 ft. (60.6 m), fits up to 1-1/8 in. (2.8 cm) rung diameter. Recommend one every 25 ft. (7.6 m)

4 Cable lifeline

Galvanized cable, 3/8 in. (9.5 mm) diameter, 1 × 7 type. Last three digits in part number indicate length.

5 Lad-Saf™ X3 Detachable Cable Sleeve

Climbing sleeve for better climbing performance and fall protection.



Easy to climb

The Lad-Saf™ X3 Sleeve automatically follows the climber during ascent or descent. In the event of a fall, the sleeve immediately locks onto the cable and remains locked until the user can regain his footing.

Tension indicator

Integrated tension-indicating bottom bracket takes the guesswork out of installation.

Customizable

Hundreds of different brackets, styles and configurations to suit almost any application.

Corrosion-resistant construction

Galvanized and stainless steel construction stands up to harsh environments for added longevity.

Energy-absorbing design

Integrated energy-absorbing top bracket reduces forces imposed on ladder structure during a fall.

Protected from wear

Intermediate cable guides prevent cable wear against the ladder while permitting the climber to bypass without disconnecting.

6100090
3M™ DBI-SALA® Lad-Saf™
Bottom Bracket

Standard galvanized bottom bracket with mounting hardware. Fits up to 1-1/8 in. (2.8 cm) rung diameter, attaches to two rungs, built-in tensioning device.



6100400
Lad-Saf™ Cable Guide

Non-metallic cable guide with mounting hardware. For systems up to 199 ft. (60.6 m), fits up to 1-1/8 in. (2.8 cm) rung diameter. Recommend one every 25 ft. (7.6 m)



6100515 Cable Guide (L-shaped) and hardware for systems over 200 ft. (61 m)

Lad-Saf™ Cable Lifeline

Durable high strength steel construction. Galvanized construction stands up to harsh environments for maintenance free longevity.



6116280
Lad-Saf™ Top Bracket

Standard galvanized top bracket with mounting hardware. For systems up to 499 ft. (152 m) high, fits up to 1-1/8 in. (2.8 cm) rung diameter, attaches to three rungs, built-in energy absorber.

6116410 Standard Top Bracket and hardware for systems over 500 ft. (152.4 m)



6160054
Lad-Saf™ X3
Detachable
Cable Sleeve

For use with 3/8 in. (9.5 mm) diameter 1 × 7 or 7 × 19 solid core cable. Comes with 2000112 carabiner.



6160030 Lad-Saf X2 Sleeve for use with 3/8 in. (9.5 mm) or 5/16 in. (8 mm) cables

Cable Lifeline general specifications and materials

	6110XXX	6152XXX	6130XXX	6154XXX
Diameter	3/8 in. (9.5 mm)	3/8 in. (9.5 mm)	3/8 in. (9.5 mm)	3/8 in. (9.5 mm)
Strand	1 × 7	1 × 7	7 × 19	7 × 19
Steel	Galvanized	Stainless	Galvanized	Stainless
Preformed	Left, Regular Lay	Left, Regular Lay	Right, Regular Lay	Right, Regular Lay
Compliance	ASTM A475	ASTM A368	RR-W-410	RR-W-410
Breaking strength	15,400 lbs. (68.5 kN) minimum	18,000 lbs. (80 kN) minimum	14,400 lbs. (64 kN) minimum	12,000 lbs. (53 kN) minimum

Last three digits in part number indicate length.



3M™ DBI-SALA® Lad-Saf™

Wood Pole (Bolt-On) Ladder Safety System

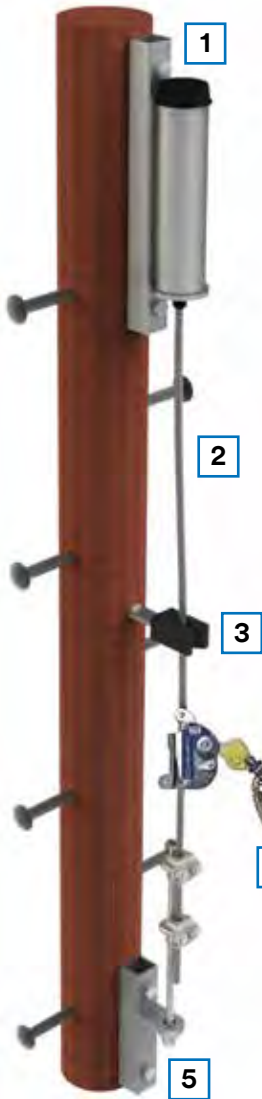

1 6116224
Top Bracket

Bolt-on top bracket with built-in energy absorber and fasteners.

2 6110000
Cable Lifeline

Galvanized cable, 3/8 in. (9.5 mm) diameter, 1 × 7 type. Last three digits in part number indicate length.

3 6100140
Cable Guide

Galvanized cable guide. Recommend one every 25 ft. (7.6 m)

4 6160054
Lad-Saf™ X3 Detachable Cable Sleeve

One-handed attachment or removal from the cable delivers fast, easy and safe connections.

5 6100045
Bottom Bracket

Galvanized bottom bracket with built-in tensioner. Bolts to wood pole.

3M™ DBI-SALA® Lad-Saf™

Steel Pole Ladder Safety System

6100035
Bottom Bracket

Galvanized bolt-on bottom bracket with built-in tensioner.

6100136
Cable Guide

Flexible stainless steel cable guide support.

Angle iron, clamp-on, and steel pole weld-on systems also available. Call us today.



3M™ DBI-SALA® Lad-Saf™ Ladder Accessories



6116336 Grab Bar Extension

Slides into Top Bracket (6116054) of fixed ladder safety system and provides the user with a tie-off point (for lanyard) when connecting or disconnecting from the system's lifeline.

6116054 Top Bracket Assembly

For use with 6116336 (replaces standard 6116280 Top Bracket).



6147000 Telescoping Extension

Self-contained ladder safety system can be returned to its stored position when not in use below the opening so it can be covered.

Telescoping top bracket with hardware.

Galvanized cable lifeline.

Counterweight to tension lifeline.

Order by length—last three digits in part number indicate length. 10 ft.-170 ft. lengths available (3.1 m-51.8 m)



6116038 Ladder Mast

Galvanized removable extension with pulleys, mounting bracket for winch/SRL.

6116027 Galvanized Bottom Mounting Bracket

Attaches 6116038 to ladder.

6116026 Ladder Anchor Post

Galvanized removable extension with eye-bolt anchor to attach 3-way SRL.

6116027 Galvanized Bottom Mounting Bracket

Attaches 6116026 to ladder.

5901980 Ladder Gate

Protects you from the dangers (and liability) of unauthorized ladder access.

Fits ladder widths up to 20 in. (50.8 cm). Mounting hardware included.

Aluminum construction 8 ft. (2.4 m) height x 36 in. (91.4 cm) width.

Powering your climb.



Climb smarter—not harder—with the 3M™ DBI-SALA® Powered Climb Assist System. It helps workers climb internal ladders on tall wind energy towers by reducing the weight they carry themselves. The result is less fatigue and enhanced climbing longevity to power you through the work day.

3M™ DBI-SALA® Powered Climb Assist System for Wind Energy

Designed to be used in conjunction with a ladder safety system, such as the LadSaf™ Vertical System with Sleeve. It includes top and bottom pulley assemblies, wire cable, wire cable grip, motor control assembly and cable tensioning system.

Adjustable force settings

Motor control unit provides five discrete force level settings.

Adapts to environment

System provides a unique “adaptive” motor control system that adjusts to environmental conditions and climbing speed.

Effortless ascent and descent

Personalized system adjustment of 55-120 lbs. (25-55 kg) for a wide range of climbing styles and user weights.

Simple installation

Plug-n-play portable motor control unit design enables simple installation to cable tensioning unit. Plug the unit into the power outlet and you’re ready to climb!

Global compatibility

System accommodates a power supply range of 110-240 Vac, 50-60 Hz (optional power cords available to match receptacles).

Maximum portability

20 lb. (9 kg) portable motor control unit is easily transported to support multiple systems and towers.

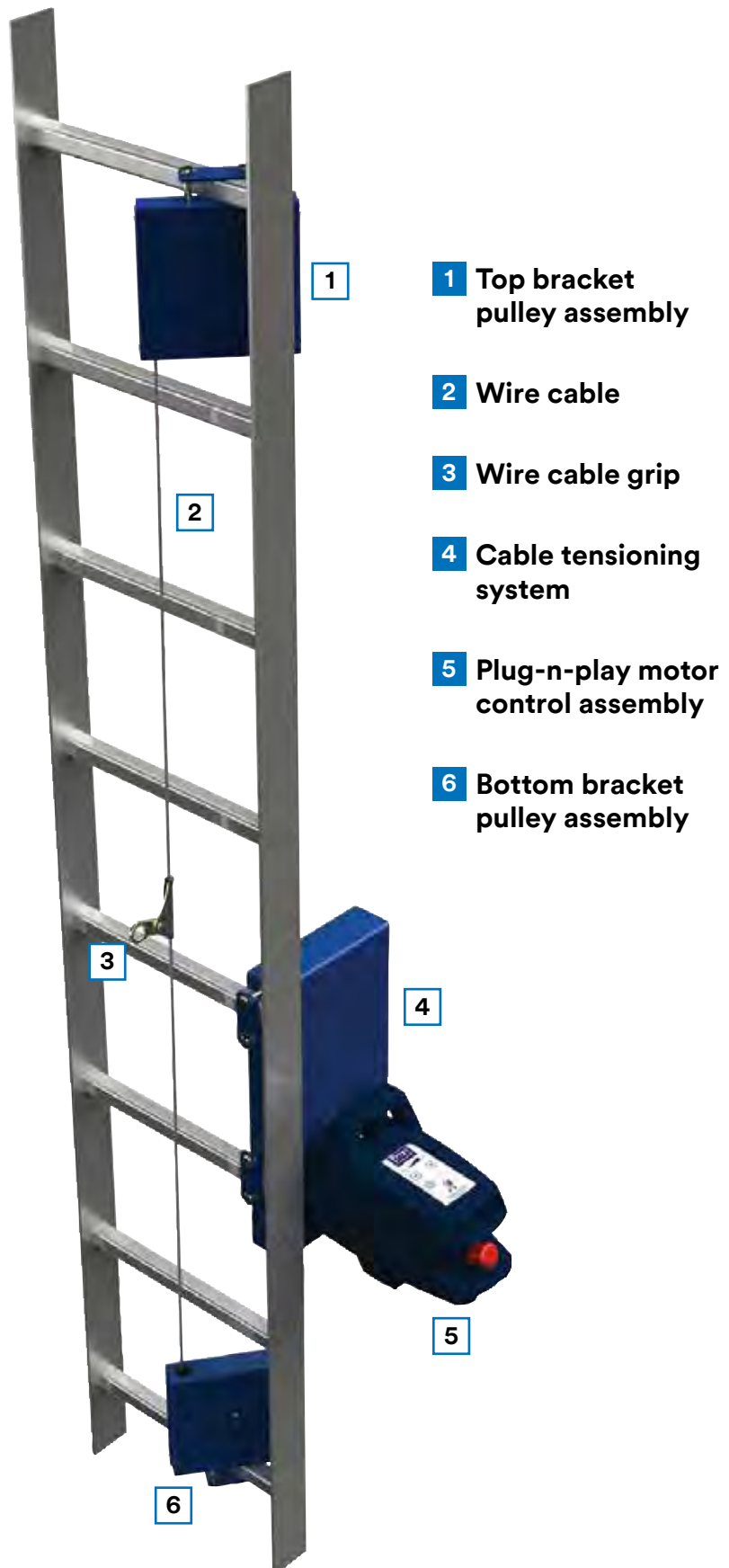

1 Top bracket pulley assembly

2 Wire cable

3 Wire cable grip

4 Cable tensioning system

5 Plug-n-play motor control assembly

6 Bottom bracket pulley assembly

Vertical Systems

3M™ DBI-SALA® Powered Climb Assist System

Tower Kit



1 6160039
Tower Kit

2 6160041
Tensioning Assembly

3 6160040
**Top & Bottom
Bracket Pulley
Assemblies**

4 6100031
**Wire Cable Swage
Connections**

5 6160027
Wear Pad Kit
Nylon pads, stainless steel
screws, and drill bit and tap.

6 6160028
Wire Cable
3/16 in. (4.8 mm) x 656 ft.
(200 m). 7 x 19 strand core.
Galvanized steel wire.

Portable Motor Control



6160051
Motor Control Assembly
Lightweight and portable at
approximately 20 lbs. (9 kg).
Globally compliant 120-240 Vac,
50-60 Hz. Operating
temperature range: -22° F-131° F
(-30° C-55° C). IP54 rating.

9506929 Power Cord
(NEMA 5-15P)

Accessories

6160026
Wire Cable Grip with Carabiner
Carabiner: 11/16 in. (17.7 mm) gate opening, 3,600 lb.
(16 kN) gate strength, with captive eye installed.
Wire Cable Grip: 3/16 in. (4.8 mm) cable sleeve.



6160024
**Twin-Leg Lanyard Assembly
with Wire Cable Grip (optional)**
Two Carabiners: 11/16 in. (17.7 mm) gate opening,
3,600 lb. (16 kN) gate strength, with captive eye
installed. Wire Cable Grip: 3/16 in. (4.8 mm) cable
sleeve. Webbing: Yellow nylon, 7/8 in. (22.2 mm)
width x 11-1/4 in. (285.8 mm) length.

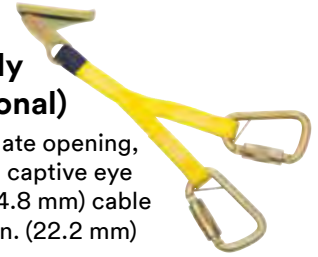

9600068
Wire Cable Cutter
Length: 28 in. (711 mm) shear-type manual wire
rope and cable cutter. Weight: 4.75 lbs. (2.15 kg)



9600069
Hand Operated Swager
OEM: Huskie, Model EP-410.
Output: 12 ton. Weight: 13 lbs. (5.9 kg)
Length: 23 in. (584.2 mm)
Jaw Opening: 1 in. (25.4 mm)



9600003
Swage Die Kit
U-style shaped die set—specifically
designed for Cable Swage Connection
(6100031).



3M™ DBI-SALA®

SSB Climb Assist System

Achieve a safer, easier climb even in complex work environments. Our SSB Climb Assist System—with external counterweight—supports workers' motions and provides fall protection while climbing lengthy ladders and towers. It's ideal for on- and offshore drilling platforms where conditions can make climbing ladders hazardous.

Added safety

Counterweight includes a runaway brake as a backup safety measure.

Ultimate flexibility

No limit to length of system.

Enhanced durability

Aluminum housing and steel drum resist corrosion.

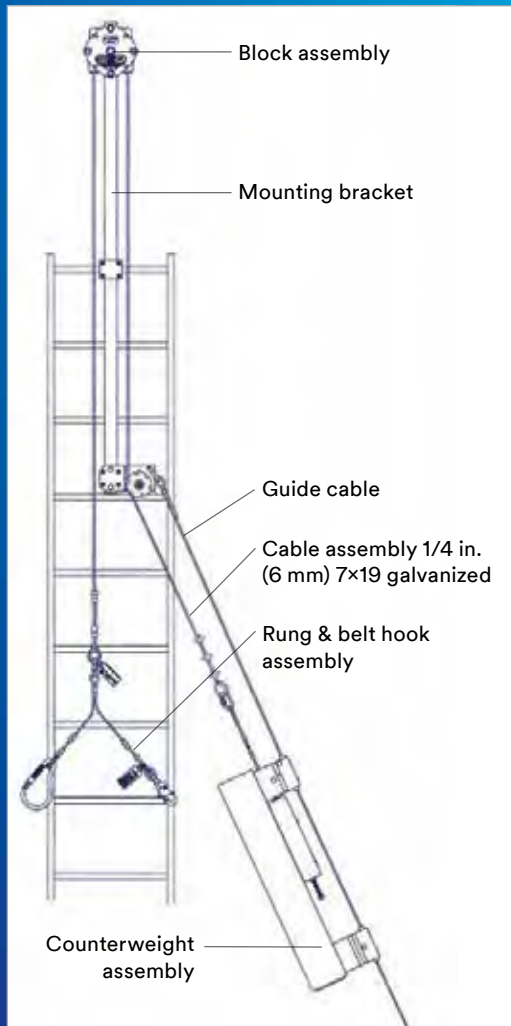

1 3511063

SSB Safety Block

Climb assist main block pulley assembly.

2 3512000

Lifeline Assembly

Galvanized 1/4 in. (6.3 cm) 7 × 19 cable assembly with rung and belt hook (last three digits in part number signify length).

3530000 Stainless Steel Lifeline Assembly

3 3511783

Mounting bracket

Attaches safety block to structure. Fits round rungs up to 3/4 in. (1.9 cm) diameter or square rungs up to 9/16 in. (1.4 cm) per side.

3511785 Mounting bracket, fits round rungs over 3/4 in. (1.9 cm) up to 1-1/2 in. (3.8 cm) diameter or square rungs over 9/16 in. and up to 1-1/2 in. (3.8 cm) per side

3511645 Rung Belt Assembly

4 3511598

Counterweight Assembly

80 lb. (36.3 kg) counterweight with integrated runaway brake system.



Rope Grabs

5003050C

3M™ DBI-SALA® Rope Grab Kit

Complete rope grab system in a bag for convenient compliance and safety on the job. Kit includes:

- Mobile Rope Grab (5000335C)
- Energy-Absorbing Lanyard (1240007C)
- Lifeline x 50 ft. (15.2 m) (1202794C)
- Counterweight (5901583)
- Tie-Off Adapter (1003000C)
- Carrying Bag (9511597)

5003100C Rope Grab Kit with 100 ft. (30 m) Lifeline (1202844C) and Carrying Bag. (9503806)



Flexible Counterweight

Flexible counterweight pouch with web loop choker filled with 6 lbs.

5901583 Counterweight

5.7 lb. (2.6 kg) flexible counterweight keeps lifeline taught. Heavy-duty nylon construction. Built-in web loop for easy attachment to lifeline. Compact and portable design. Equipped with RFID.



Rope Lifelines

Blended Rope Lifeline Assemblies feature additional abrasion and UV resistance for added durability, longevity and safety. Various styles and lengths are available to suit any need.

Lifeline material	Hook style	Lifeline diameter (inch/mm)	30 ft. lifeline (9 m)	50 ft. lifeline (15 m)	75 ft. lifeline (22 m)	100 ft. lifeline (30 m)	150 ft. lifeline (46 m)
Polyester/polypropylene blend	Snap hook at one end	5/8 in. (15.9 mm)	1202754C	1202794C	1202821C	1202844C	1202879C
	Snap hook at both ends	5/8 in. (15.9 mm)	1202753C	1202790C	1202823C	1202842C	1202878C



*Custom sizes available.



Horizontal Systems

Horizontal Systems

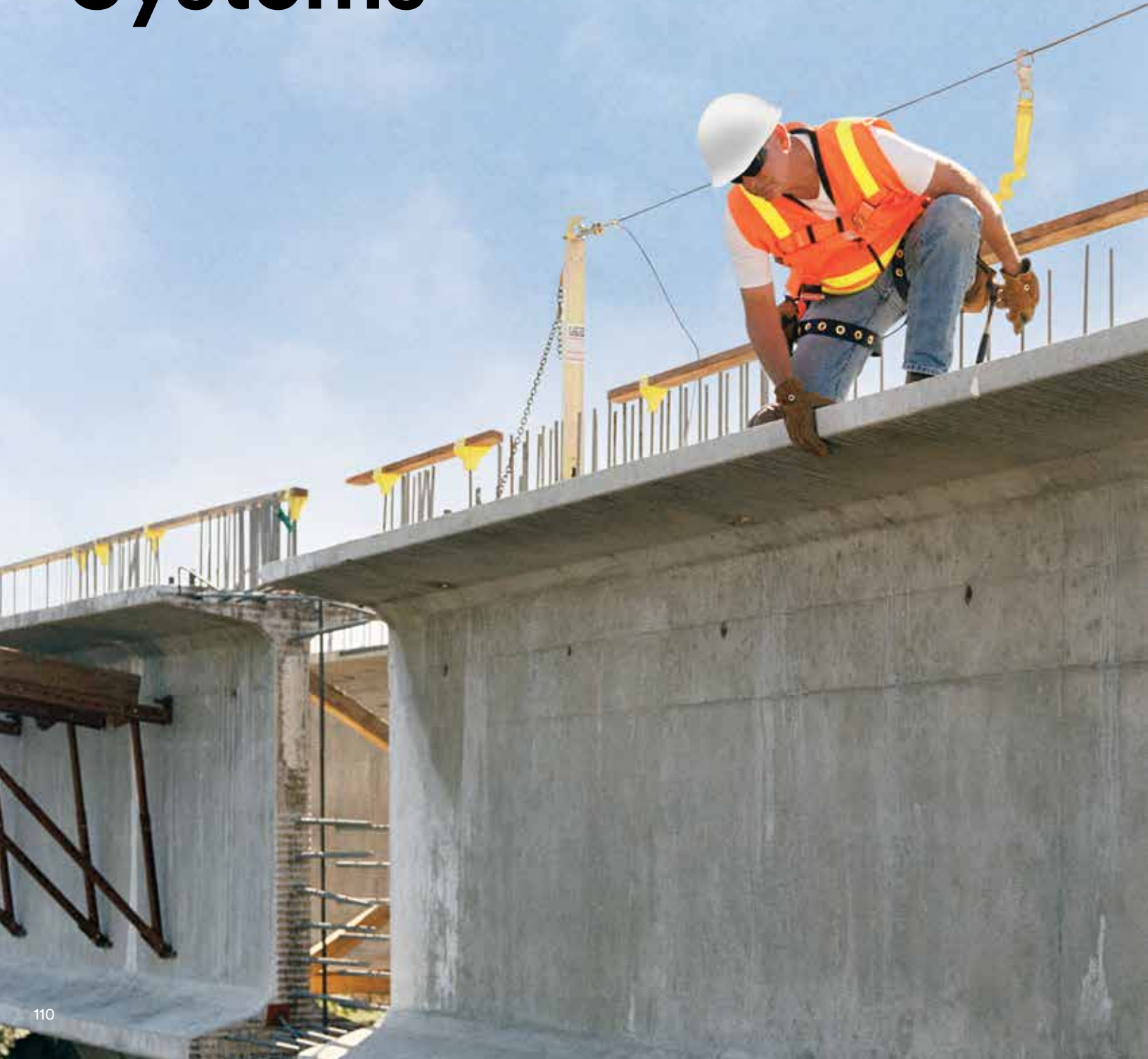

Horizontal lifeline systems that deliver mobility and fall protection for at height workers.

3M is proud to engineer a wide variety of horizontal lifeline (HLL) systems to maximize mobility, productivity and fall protection for every worker – no matter what the job calls for. These safety systems are used to protect workers operating in the horizontal plane who may not have continuous access to suitable lifeline anchorage points.

How to choose a horizontal lifeline system

An HLL may appear to be a basic line strung between two anchors but it is much more than that. It is critical to choose a horizontal system that has been precision engineered and rigorously tested to meet industry standards. Other important considerations when selecting a system include:

Anchorage structure

The structure your system must attach to, such as an I-beam, rebar stud, concrete column or roof can dictate the type of specialized system required.

Portable or permanent

Temporary jobs require lightweight and easy-to-use portable systems that can be moved from one location to another. If a hazardous work area is accessed often, such as a rooftop, a permanent solution like Uni™line may be a better choice.

Clearance requirements

The distance between the work area and the next level or obstruction is often called “fall clearance,” and this is a critical factor when choosing your system. Anchorage height, type of lifeline and length are just a couple of factors that will affect the required clearance needed.

Lifeline type

Synthetic lines are extremely lightweight and compact, while galvanized or stainless steel options offer enhanced corrosion and abrasion resistance.

Number of users

Always consider the number of workers required get the job done and choose a system that can accommodate those personnel safely.



Horizontal Systems

3M™ DBI-SALA® SecuraSpan

Horizontal Lifeline (HLL) Systems

Extremely lightweight and portable, these systems incorporate a modular, multi-base design that accommodates a wide range of steel and concrete beams.

- Interchangeable stanchions are ideal for both steel and concrete applications.
- Extremely lightweight and portable for fast and easy setup and use.
- Single and multi-span options available for jobsite customization.
- Pass-through bracket design provides 100% continuous protection.
- Integrated Zorbit™ Energy Absorber limits forces on structure.
- Capacity of two workers per span, up to six workers for multi-span system.
- Durable and corrosion-resistant construction.
- Inquire about perpendicular applications.

Steel I-Beam applications

- Single clamp and wing nut design.
- All adjustments made from top of beam.
- Fits flanges 6 in.-12 in. wide, 2-1/4 in. thick. (15.2 cm-30.5 cm, 5.7 cm)
- Optional bases for 18 in., 24 in. and 36 in. widths. (45.7 cm, 60.9 cm and 91.4 cm)



Concrete rebar & shear stud applications

- Simply attach with torque wrench.
- Simple chain tie-back connection.
- Fits 1/2 in.-1 in. diameter (1.3 cm-2.5 cm) (#4-#8 rebar) and 4 in.-12 in. (10 cm-30.5 cm) center to center.

7400460

SecuraSpan I-Beam Horizontal Lifeline System

Complete single span system includes two Stanchions (7400047) and cable assembly with tensioner and Zorbit™ Energy Absorber. 60 ft. (18.3 m).

7400420 20 ft. (6.1 m) SecuraSpan I-Beam HLL System

7400430 30 ft. (9.1 m) SecuraSpan I-Beam HLL System

7400440 40 ft. (12.2 m) SecuraSpan I-Beam HLL System

7400450 50 ft. (15.2 m) SecuraSpan I-Beam HLL System



Shown with intermediate stanchion—must order separately.

7400660

SecuraSpan Rebar/Shear Stud Horizontal Lifeline System

Complete single span system includes two Stanchions (7400215) and cable assembly with tensioner and Zorbit™ Energy Absorber. 60 ft. (18.3 m).

7400620 20 ft. (6.1 m) SecuraSpan Rebar/Shear Stud HLL System

7400630 30 ft. (9.1 m) SecuraSpan Rebar/Shear Stud HLL System

7400640 40 ft. (12.2 m) SecuraSpan Rebar/Shear Stud HLL System

7400650 50 ft. (15.2 m) SecuraSpan Rebar/Shear Stud HLL System



Shown with intermediate stanchion—must order separately.

Concrete Loop Rebar Applications

An easy-to-install system for pre-stressed concrete beams, this attaches directly to the loop rebar. With integrated “bypass” brackets, the system can be configured to run indefinitely.

- Simple hook and loop with wing nut.
- Fits 1/2 in.-4-1/2 in. dia. (1.3 cm-11.4 cm) (#4-#12 rebar).
- Adjusts to fit 3-1/2 in.-8 in. (8.9 cm-20.3 cm) tall loop with 3 in. (7.6 cm) or greater spacing.

7400360

3M™ DBI-SALA® SecuraSpan Loop Rebar Horizontal Lifeline (HLL) System

Complete single span system includes two Stanchions (7400045) and cable assembly with tensioner and Zorbit™ Energy Absorber. 60 ft. (18.3 m).

7400320 20 ft. (6.1 m) SecuraSpan Loop Rebar HLL System

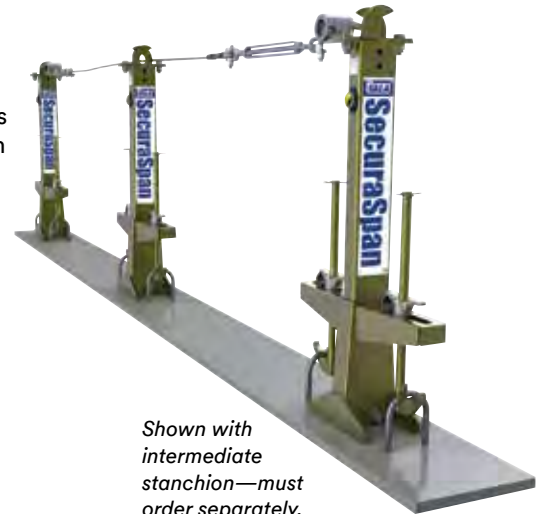

Shown with intermediate stanchion—must order separately.

3M™ DBI-SALA® SecuraSpan System Components

I-Beam System Components



7400047

Stanchion with I-Beam Base
Fits 6 in.-12 in. (15.2 cm-30.5 cm) flange.

7400055

Stanchion with I-Beam Base
Fits 12 in.-18 in. (30.5 cm-45.7 cm) flange.

7400056

Stanchion with I-Beam Base
Fits 18 in.-24 in. (45.7 cm-61 cm) flange.

7400057

Stanchion with I-Beam Base
Fits 24 in.-36 in. (61 cm-91.4 cm) flange.

7400001

I-Beam Stanchion
Fits up to 2-1/4 in. (5.7 cm) thick, 6 in.-12 in. (15.2 cm-30.5 cm) wide.

7400052

I-Beam Base Only
Fits 6 in.-12 in. (15.2 cm-30.5 cm) flange.

7400073

I-Beam Stanchion
Fits up to 3-3/8 in. (8.57 cm) thick, 6 in.-12 in. (15.2-30.5 cm) wide.

7400008

Intermediate Bypass Bracket Kit

Perpendicular I-Beam System Components



7400087

Stanchion with Perpendicular I-Beam Base
No tie back, fits 8 in.-14 in. (20.32 cm-35.56 cm) flange.

7400086

Perpendicular I-Beam Base Only
Fits 8 in.-14 in. (20.32 cm-35.56 cm) flange.

7400089

Perpendicular Pass-Through Kit

See product instruction manual for complete clearance information.

Lifeline options for all systems — Cable assembly with turnbuckle and Zorbit, lengths available in 10 ft. (3 m) increments. Cable assemblies over 60 ft. (18.3 m) include two Zorbit™ Devices.

Rebar System Components



7400215

Stanchion with Rebar/Shear Stud Base
Pass-through and end anchor brackets.

7400214

Tie-Back Base and Chain Assembly

7400053

End-Anchor Retro-Fit Kit
With Rebar/Shear Stud Base, tie-back assembly, end-anchor and Pass-Through Bracket.

7400054

Intermediate Retro-Fit Kit
With Rebar/Shear Stud Base and Pass-Through Bracket.

Loop System Components



7400045

Stanchion with Loop Rebar Base and Pass-Through Bracket



7605063

3M™ DBI-SALA® EZ Line™ Retractable Horizontal Lifeline (HLL) System

Speed up your productivity on the job. EZ Line™ Retractable Horizontal Lifeline System is an easy to use lifeline system that you can install, remove and store extremely fast. Its innovative retractable design eliminates large and bulky coils of cable that are difficult to set up, relocate and store.

- Built-in winch for fast and easy setup, use and dismantling.
- 40 ft. (12.2 m) retractable system can be set at any length
- Built-in pre-tension and impact indicators simplify setup and inspection.
- Extremely lightweight at 33% lighter than conventional systems.
- Two worker capacity.

7600002 Replacement EZ Line™ Handle Assembly

See product instruction manual for complete clearance information.

Horizontal Systems

3M™ DBI-SALA® Sayflin

Cable Horizontal Lifeline (HLL) Systems

The Sayflin Cable System is highly portable and ideal for situations where welding, sparks or harsh environments are present, or where minimal clearance exists. Complete system includes cable lifeline assembly with wedge grip termination, tensioner and Zorbit™ Energy Absorber.

See product instruction manual for complete clearance information.



- Durable all-metal system can be left in place for long periods of time.
- Portable system can be reused over and over again.
- Cable lifeline with tensioner and energy absorber.
- Use with any 5,000 lb. (22 kN) anchorage devices.
- Capacity of two workers.
- 20 ft.-100 ft. lengths available. (6.1 m-30.5 m)

Sayflin Cable HLL Systems

20 ft. (6.1 m)	30 ft. (9.1 m)	40 ft. (12.2 m)	50 ft. (15.2 m)	60 ft. (18.3 m)	70 ft. (21.3 m)	80 ft. (24.4 m)	90 ft. (27.4 m)	100 ft. (30.5 m)
7602020	7602030	7602040	7602050	7602060	7602070	7602080	7602090	7602100

Horizontal Systems

3M™ DBI-SALA® SecuraSpan

Pour-in-Place Horizontal Lifeline Systems

The SecuraSpan Pour-in-Place System installs to column tops, providing an overhead tie-off point during the decking process. The stanchion slides into the embedded pour-in-place sleeve and does not require “tie-back” for fast installation.

- Lightweight and portable for fast and easy setup and use.
- Single and multi-span options with unlimited length for jobsite customization.
- Pass-through design provides 100% continuous protection.
- Integrated Zorbit™ Energy Absorber limits forces on worker and structure.
- Capacity of two workers per span, up to six workers for multi-span system.
- Durable and corrosion-resistant construction.

Complete system includes two Stanchions (7400203), and cable assembly with tensioner and Zorbit™ Energy Absorber.



See product instruction manual for complete clearance information.

20 ft. (6.1 m)	30 ft. (9.1 m)	40 ft. (12.2 m)	50 ft. (15.2 m)	60 ft. (18.3 m)
7400220	7400230	7400240	7400250	7400260

Pour-in-Place Accessories

7400203
Stanchion Assembly
7-1/2 ft. (2.3 m) tall.

7400200
Intermediate Bracket
For pour-in-place stanchion.

7400201
Concrete Sleeve
For pour-in-place stanchion.

7400211
Clamp-On Vertical Base
Zinc-plated steel construction, clamps to existing vertical steel and concrete structures.



7400218
Bolt-On Vertical Base
Zinc-plated steel construction, bolts to vertical steel and concrete structures.



7400225 Stainless steel version

7400222
Weld-On Vertical Base
Steel C-channel construction, welds to vertical steel structures.



8530267
Bolt-On Floor Base
Zinc-plated steel construction. Bolts to steel and concrete horizontal surfaces.



Horizontal Lifeline Components

- Allows use of standard 5,000 lb. (22 kN) rated anchors.
- Lightweight and compact for easy setup and use.
- Simple design makes integration into system fast and easy.

3M™ DBI-SALA® Zorbit™ Kits

7401013
Zorbit™ Energy Absorber Only

7401031
Zorbit™ Energy Absorber
With three shackles, bolts, nuts.

7401032
Zorbit™ Energy Absorber
With three shackles, bolts, nuts, turnbuckle.

7401033
Zorbit™ Energy Absorber
With three shackles, bolts, nuts, turnbuckle, thimbles, cable clips.

7600580
Zorbit™ Energy Absorber
With three shackles, bolts, nuts, turnbuckle, thimbles, cable clips with wedge grip, two O-rings.



3M™ DBI-SALA® Permanent Horizontal Lifelines (HLL)

Take the guesswork and complexity out of safety. Our permanent horizontal lifeline systems aren't just remarkably easy to use—they're easy to install with the support of our network of certified installers. They provide everything from site assessment to final installation and training.

Pre-engineered or customized. Straight or curved. Flexible or rigid. Whether it's over a railcar or tanker truck, on a rooftop or in the rafters of an arena, these versatile systems provide superior continuous fall protection without conflicting with other building systems.

3M™ DBI-SALA® Sayflineline Multi-Span Horizontal Lifeline Systems

The Sayflineline Multi-Span System is a simple and safe permanent Horizontal Lifeline HLL system designed for "off-the-shelf" user installation. It is completely customizable, including span length, total system length and even final installation position.

- Provides 100% continuous protection for two workers.
- Unique one-piece sleeve bypasses intermediates and freely moves where you have to work.
- Customize to suit job site, 180 ft. (54.9 m) max length, 30 ft. (9.1 m) max span.
- Unique brackets can be installed above, even with, or below the user.
- System includes lifeline, intermediate bracket (one per 9.1 m span), termination hardware, tensioner and two Zorbit™ Energy Absorbers. Order sleeve and additional intermediates separately.

Horizontal Systems

**Custom sizes available.*



Sayflineline Multi-Span HLL Systems

	20 ft. (6.1 m)	40 ft. (12.2 m)	60 ft. (18.3 m)	80 ft. (24.4 m)	100 ft. (30.5 m)	120 ft. (36.6 m)	140 ft. (42.7 m)	160 ft. (48.8 m)	180 ft. (54.9 m)
Galvanized	7603020	7603040	7603060	7603080	7603100	7603120	7603140	7603160	7603180

Sayflineline Accessories

7608001

Intermediate Bracket, multi-span system.

7608002

Sayflink™ Sleeve for Sayflineline Multi-Span System.



Engineered Systems

Engineered Systems

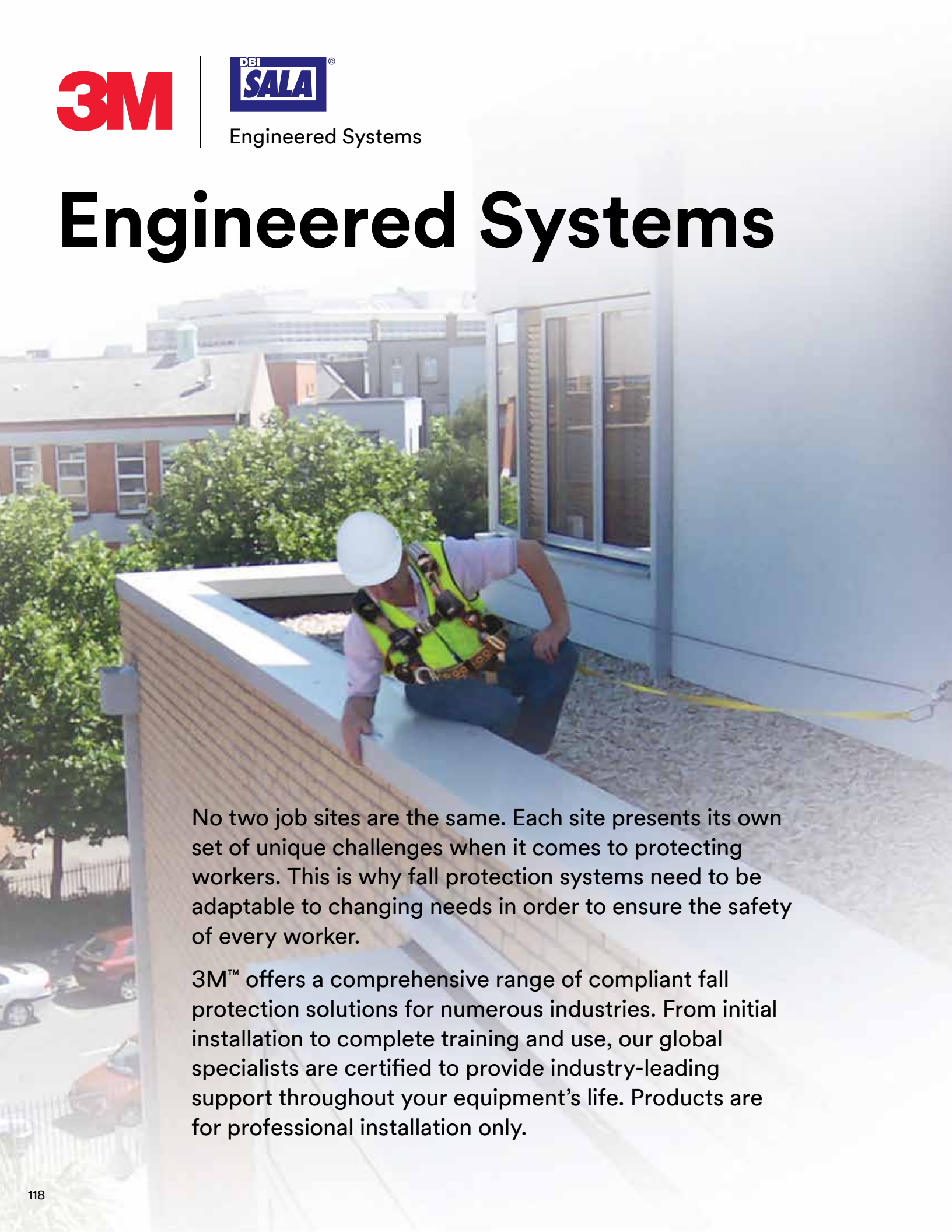

No two job sites are the same. Each site presents its own set of unique challenges when it comes to protecting workers. This is why fall protection systems need to be adaptable to changing needs in order to ensure the safety of every worker.

3M™ offers a comprehensive range of compliant fall protection solutions for numerous industries. From initial installation to complete training and use, our global specialists are certified to provide industry-leading support throughout your equipment's life. Products are for professional installation only.

3M™ DBI-SALA® RoofSafe

Anchor and Cable Systems

Enhance worker safety and productivity on new or existing rooftops. RoofSafe Anchor and Cable Systems are horizontal lifeline systems that allow for continuous, uninterrupted access to all areas of a roof with work restraint or fall arrest protection. They can be installed on standing seam, composite and built-up roofing systems and multiple flat roofing and membrane roofing systems. For maintenance tasks in localized areas, they can also be used as a single point of anchor.

In the event of a fall, the RoofSafe Anchor breaks open, deploying the unique and patented absorbing system, which reduces the forces generated on the roof structure to less than 1,350 lbs. (6 kN), the lowest of any of its kind on the market.

The ultimate in modular system design

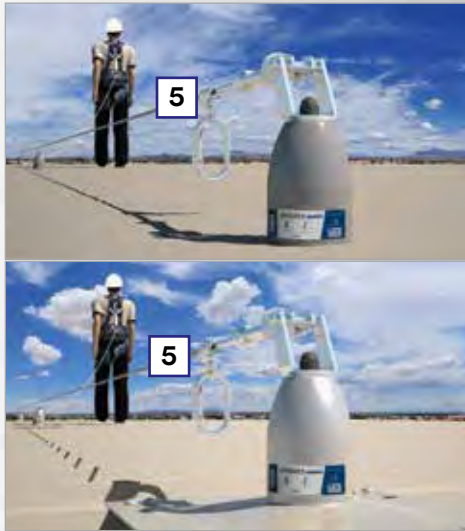

1 Lightweight durability

Constructed from high grade aluminum to reduce overall weight and shipping costs.

2 Modular construction

In the unlikely event that the anchor is deployed, the modular design allows for replacement of the top module.

3 Weatherproof design

The RoofSafe Anchor for flat roofing systems is designed for weatherproofing with built-up tar, maintaining the integrity of the building.

4 Enhanced mobility

High quality 316 stainless steel cable offers excellent freedom of movement to navigate corners and building contours.

5 Minimal penetrations

The system spans up to 50 ft. (15.2 m), minimizing the need for intermediate supports.

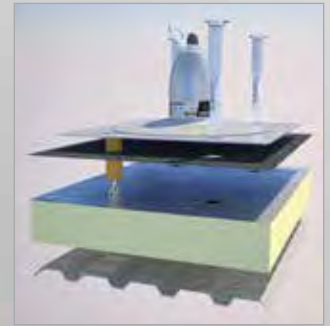

Save time and money with the toggle fixing method for flat roofing systems. It speeds up installation and reduces thermal bridging, so less heat is lost from the building.



Engineered Systems

3M™ DBI-SALA® RoofSafe

Rail System

Great aesthetics. Uncompromising safety. The RoofSafe Rail System is a cost-effective solution for roof fall protection, roof access, and as an anchor point for suspended work positioning for external façade access, inspection and maintenance on modern building projects. It meets the requirements of both abseil and fall protection standards and can be fixed to the roof system with minor penetrations or using clamps.

- The only direct-to-roof rail system that can facilitate changes in direction and roof slopes.
- Allows multiple users to efficiently execute more complex maintenance tasks such as suspended rope access work.
- Even load distribution ensures that even if one user falls, the integrity of the roof system will not be compromised.
- Solid design ensures no deflection or unnecessary loading of anchor points during use, giving the user complete confidence even on roof pitches greater than 15 degrees.
- Four-wheel attachment carriage runs effortlessly along the extruded aluminum rail, providing user-friendly ease of use.
- Lightweight modular system comes in 10 ft. (3 m) and 20 ft. (6 m) sections that are easy to transport and handle on-site.



Top quality

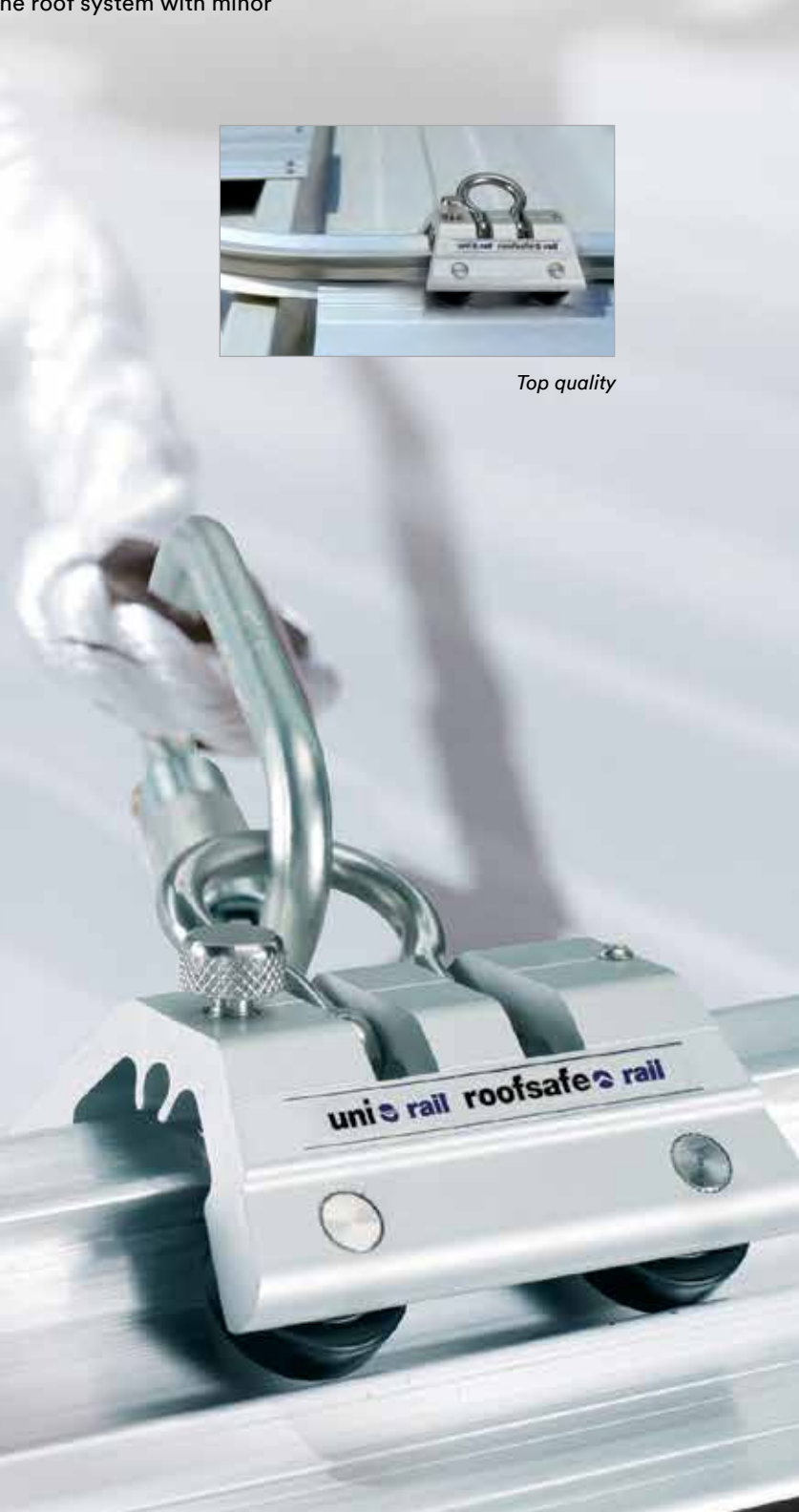

3M™ 8 mm Cable System

Enhance modern building projects, refurbishments or industrial safety applications. This high quality fall restraint system provides both excellent value and functionality through its free-flowing bypass capability. Fit it to steel beams, concrete, brickwork and a variety of roof constructions using our RoofSafe™ Anchors. It can also support multiple workers for both fall arrest and fall restraint work applications.



1 Durable cable

The single 5/16 in. (8 mm) cable provides a discreet and unobtrusive solution to fall protection. Electro-polished stainless steel (316) components provide long-term corrosion resistance.

2 Long spans

The 3M™ 8 mm System can span up to 40 ft. (12 m) between support brackets. Supports two users, up to 310 lbs. (140.6 kg) each, per span.



- A broad range of mounting bracket options allows navigation of corners.
- Optional travelers available to be used on either side of the line without removing and reattaching.
- In-line energy absorbers reduce load transfer to the structure in the event of a fall.
- Minimal moving parts and high grade materials ensure long life expectancy and low cost of ownership, adding up to a sound investment.

Engineered Systems



3M™ 8 mm Overhead Traveler

Move safely. Move freely. Maximize productivity. It's all made possible by the 3M™ 8 mm Overhead Traveler. It passes freely over intermediate brackets, ensuring complete freedom of travel and movement for the user.

1 Sealed bearings

Sealed bearings in the carriage wheels of the 3M™ 8 mm Overhead Traveler reduce the need for maintenance.

2 Long-term corrosion resistance

Electro-polished stainless steel (316) components provide long-term corrosion resistance.

- High tensioned stainless steel cable supports heavy fall arrest devices when required and reduces cable deflections.
- In-line energy absorbers reduce load transfer to the structure in the event of a fall.
- Available as a single- or multi-span system for distances up to 100 ft. (30 m). Supports two users, up to 310 lbs. (140.6 kg) each, per span.
- Strong intermediate cable supports allow the system to span greater distances for long bay work areas and permit free passage of the 3M™ 8 mm Overhead Traveler.



3M™ DBI-SALA® Uni™ Rail

Horizontal System

Simplicity and safety. Two qualities that should go hand-in-hand. That's why we've engineered the Uni™ Rail Horizontal System to protect workers from fall hazards with a simple, continuous and functional anchorage system.

- Fits a wide range of structures, supporting both fall arrest and fall restraint applications. With spans up to 20 ft. (6 m), it supports two users, up to 310 lbs. (140.6 kg) each, per span.
- High-grade aluminum alloy and 316 stainless steel components help system withstand harsh environments.
- The main rail is designed to resist thermal expansion and contraction, which would otherwise cause the rail to buckle.
- Modular design makes it easy to install and specify.



3M™ DBI-SALA® Glyde-Saf™

Glyde-Saf™ HD is the ultimate in overhead fall protection on the market. The unique enclosed overhead track system enables smooth and uninterrupted travel for one or two users while working at heights. This rigid rail system can be installed for use indoors or outdoors to support aircraft and vehicle maintenance hangers, manufacturing facilities, rail car applications, warehousing and storage areas, performing art centers and arenas, and other related activities.

Rail Assembly

High grade steel construction. 2-user rated, 420 lbs. (190.5 kg)/user. Max allowable span is 50 ft. (15.2m). Allowable 6 ft. (1.8m) cantilever 10 ft. (3.0 m), Indoor.

20 ft. (6.1 m) Rail Assembly, Indoor

10 ft. (3.0 m) Rail Assembly, Outdoor

20 ft. (6.1 m) Rail Assembly, Outdoor



End Stop Plate Kit

- Kit contains a powder coated plate and mounting hardware for attaching to each end of the rail assemblies
- High grade steel construction



Trolley Assembly

- High grade steel construction
- Corrosive resistant, zinc plating
- Stainless Steel wheel bearings
- Long lasting nylon wheels for smooth travel



Seam Kit

- High grade, zinc plated hex head bolts
- High grade, nylon top insert, zinc plated hex nuts





Anchorage connectors

Anchorage Connectors





Your gear is only as good as the safety anchor it is connected to. This is why 3M helps workers do their jobs with confidence by manufacturing anchorage connectors that have been rigorously tested to meet or exceed industry standards.

We offer a complete line of anchorage connectors so that you can work with the total peace of mind that you've got the best gear available for the job. Each of our anchor systems are specifically manufactured to meet your unique applications.

The type of anchor you need depends on the type of work being done. Anchorages are sold by what they connect to (general/all-purpose, steel, concrete, roof, mining or specialty), whether they are fixed or mobile, or whether they are permanent or portable. Each anchor must provide a secure point of attachment whether the application is steel, concrete or roof-based and be capable of supporting your fall protection system loads.



Anchorage Connectors

3M™ DBI-SALA®

General Anchorage Connectors

Extremely versatile anchors are simply choked-off to the anchorage structure, to provide a fast and safe 5,000 lb. (22 kN) tie-off point for your personal fall protection system.

1003000C

Web Tie-Off Adapter

Pass-through design. 1-3/4 in. (4.4 cm) polyester strength member with 3 in. (7.6 cm) wide polyester wear pad x 3 ft. (0.9 m)



1003006C Web Tie-Off Adapter, pass-through type x 6 ft. (1.8 m)

1002103 Adjustable Web Tie-Off Adapter, pass-through type x 3 ft. (0.9 m)

1002106 Adjustable Web Tie-Off Adapter, pass-through type x 6 ft. (1.8 m)

1002010 Web Tie-Off Adapter, pass-through type x 10 ft. (3 m)

5900550

Cable Tie-Off Adapter

Pass-through design. 7 x 19 3/8 in. (9.5 mm) stainless steel cable with O-rings x 4 ft. (1.2 m).



5900551 Cable Tie-Off Adapter, pass-through type x 6 ft. (1.8 m)

5900552 Cable Tie-Off Adapter, pass-through type x 10 ft. (3 m)

1002202

Tie-Off Adapter for Hot Work Use

Reinforced with Kevlar® fiber webbing; ideal for high heat environments, pass-through type with 1-3/4 in. (4.4 cm) polyester strength member x 6 ft. (1.8 m).



1002200 Tie-Off Adapter, with Kevlar® fiber, pass-through type x 3 ft. (0.9 m)

1002201 Tie-Off Adapter, with Kevlar® fiber, pass-through type x 4 ft. (1.2 m)

1201390

Web Scaffold Choker

Choker style attaches to 3 in. (7.6 cm) diameter anchorage. 1 in. (2.5 cm) polyester strength member x 17 in. (43 cm).



1201391 Web Scaffold Choker x 24 in. (61 cm)

1201421 Web Scaffold Choker with coated hardware

1002106 Adjustable Web Tie-Off Adapter, pass-through type x 6 ft. (1.8 m)

Saflok™ Carabiners can be found on page 73.



3M™ DBI-SALA® Saflok™

Mining Anchors

Maximize fall protection for mine workers with our Saflok™ Mining Anchors. These ANSI and OSHA-certified anchors are designed for use with friction rock bolts in a variety of different mining applications.

The Hybrid Mining Swivel Anchor is intended to stay in one spot, while the Mining Bolt Anchor with Swiveling O-Ring offers the flexibility to move from location to location within the mine. Both are durable, lightweight and easy to install and remove, and can be used with many existing 39 mm or 47 mm friction rock bolts.

Saflok™ Mining Bolt Anchor with Swiveling O-Ring

The Mining Bolt Anchor with Swiveling O-Ring is an anchorage connector for fall arrest, restraint, work positioning, personnel riding and rescue systems. The anchor's end termination expands two wedges to secure the anchor in a 39 mm or 47 mm friction rock bolt—a feature exclusive to 3M Fall Protection.

2100154

Mining Bolt Anchor with Swiveling O-Ring (47 mm)

Specifications:

- Swivel ring: forged steel.
- End termination: stainless steel.
- Main support cable: aircraft cable.
- Stop sleeve: stainless steel.
- Trigger: aluminum.
- Spring: zinc-plated steel.
- Product variance and strengths: 5,000 lbs. (22 kN)
- Certifications: ANSI Z359.1-2007, ANSI Z359.7-2011, OSHA 1926.502

2100153 Mining Bolt Anchor with Swiveling O-Ring (39 mm)



18.5 in. (47 cm)



38 mm/47 mm

Saflok™ Hybrid Mining Swivel Anchor

The Hybrid Mining Swivel Anchor is an anchorage connector for fall arrest, restraint, work positioning, rope access and rescue systems. Rotation of the bolt moves the end termination out or in to expand or contract two wedges within a 39 mm or 47 mm friction rock bolt. When the wedges are fully contracted, the anchor can be removed from the friction rock bolt for reuse. The swivel ring is the connection point and can swivel for use.

2100172

Stainless Steel Hybrid Mining Swivel Anchor (47 mm)

Specifications:

- Swivel ring: forged steel/ stainless steel.
- End termination: stainless steel.
- Cable: aircraft cable.
- Compression bushing: polyethylene.
- Retaining bushing: zinc-plated steel/ stainless steel.
- Bolt: zinc-plated steel/ stainless steel.
- Wedges: stainless steel.
- Sleeves: zinc-plated steel/ stainless steel.
- Product variance and strengths: 5,000 lbs. (22 kN)
- Certifications: ANSI Z359.1-2007, ANSI Z359.7-2011, OSHA 1926.502

2100155 Hybrid Mining Swivel Anchor (39 mm)

2100156 Hybrid Mining Swivel Anchor (47 mm)

2100171 Stainless Steel Hybrid Mining Swivel anchor (39 mm)

11.5 in. (29.2 cm)



38 mm/47 mm



Anchorage Connectors

3M™ DBI-SALA®

Steel Anchorage Connectors

Extremely versatile anchors for steel that are lightweight and compact, providing an easy to install and safe 5,000 lb. (22 kN) tie-off point for your personal fall protection system.

2104701

Glyder 2 Sliding Beam Anchor

Provides complete horizontal mobility on I-beams, overhead attachments or at your feet (use with Force2 Energy-Absorbing Lanyard when used at your feet).

- Wear pads eliminate metal-to-metal contact, for smooth operation.
- Integrated ratcheting adjustment system for easy installation.
- Dual beam grip adjustment prevents twisting and turning.
- Extremely lightweight at only 3.7 lbs. (1.66 kg).
- User capacity of 420 lbs. (190.5 kg).
- Fits flange 3-1/2 in.-14 in. (8.9 cm-35.5 cm) wide and up to 1-1/4 in. (3.2 cm) thick.



2110941

Glyder Sliding Beam Anchor

The original Glyder has most of the features of Glyder 2, except the adjustment system is a detent pin type and fits larger beam sizes. Fits flange 6 in.-18 in. (15.2 cm-45.7 cm) wide and up to 2-1/2 in. (6.3 cm) thick.



2100159

Fixed Beam Anchor

It installs in seconds to the beam structure in any orientation, with final tightening using a built-in adjustment handle. Ideal as a single-person anchor point or as end-anchors for a Sayline™ Horizontal Lifeline System. Fits up to 1-1/2 in. (3.8 cm) thick beam flange, 2-1/2 in.-12 in. (6.3 cm-30.5 cm) wide.

2108407 Fixed Beam Anchor, fits up to 1-1/2 in. (3.8 cm) thick x 2-1/2 in.-18 in. (6.3 cm-45.7 cm) wide beam flange

2108408 Fixed Beam Anchor, fits up to 1-1/2 in. (3.8 cm) thick x 2-1/2 in.-24 in. (6.3 cm-61 cm) wide beam flange

2108410 Fixed Beam Anchor, fits up to 1/2 in.-2-1/2 in. (1.3 cm-6.3 cm) thick x 12 in.-36 in. (30.5 cm-91.4 cm) wide beam flange



2103143C

3M™ DBI-SALA® Trolley for I-Beam

The trolley is for use with self-retracting lifelines on horizontal beams and has been engineered for ease-of-use and superior performance. It glides effortlessly along the beam and provides horizontal mobility.

- Attachable anywhere along beam, including midpoint.
- Non-corrosive double-shielded wheelbearingsaremaintenance-free.
- Trolley guards protect the wheels from damage and keep beam clear of debris.
- Fits 3 in.-8 in. (7.6 cm-20.3 cm) flange width and thickness up to 11/16 in. (1.7 cm)

2104550

Steel Plate Anchor

This plate anchor offers a compact, reliable attachment to 3/8 in.-1 in. (0.9 cm-1.2 cm) thick plate steel for connecting your lanyard, vertical lifeline system or self-retracting lifeline.

- Easy to use set-screw design ensures positive and safe connection.
- Complete with integral D-ring tie-off point.
- Durable, corrosion-resistant zinc-plated steel construction.



8800023

Tandem Pulley

For 3/8 in.-1/2 in. (0.9 cm-1.2 cm) rope or cable.



2104710

3M™ DBI-SALA® Sliding Beam Anchor

- 360-degree swiveling D-ring optimizes your mobility on the beam.
- Corrosion resistant construction meets ANSI standards for weather, environmental and storage conditions.
- Dual ratcheting adjustment buttons are accessible above the beam, while locking mechanism is located on the side to reduce accidental engagement.
- Compact size and lightweight materials.
- Snap-in design of wear pads allows them to be replaced quickly in the field.



2104711 Small, CE, 1 Each

2104712 Small, Pallet 64 Units

2104713 Large, Pallet 32 Units

2104715 Large, 1 Each

2104716 Large, CE, 1 Each

2110815 Replacement Wear Pads

2110816 Replacement Wear Pads

2101634

D-Ring Anchorage Plate

The D-Ring Anchorage Plate can be bolted or welded to a structure, offering a compact, reliable connection point for your fall protection system.

- Two 1/2 in. (1.2 cm) diameter attachment holes.
- Cadmium-plated steel D-ring.
- Raw steel anchorage plate.
- Plate size: 1/4 in. x 2 in. x 4-1/2 in. (0.6 cm x 5 cm x 11.4 cm)

2101636 D-Ring Anchorage Plate with 304 stainless steel D-ring and anchorage plate

2101638 D-Ring Anchorage Plate with 316 stainless steel D-ring and anchorage plate

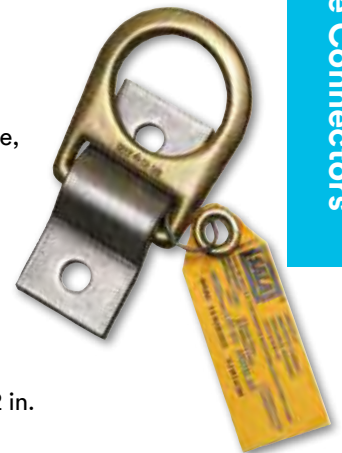

Anchorage Connectors

3M™ DBI-SALA®

Concrete Anchorage Connectors

Extremely versatile anchors for concrete that are lightweight and compact, providing an easy-to-install and safe 5,000 lb. (22 kN) tie-off point for your personal fall protection system.

2100085C

Saflok™ Concrete Wedge Anchor

Portable and reusable concrete anchor installs quickly and easily using standard concrete tools, providing a fast and safe tie-off point.

- Exclusive quick-release button for fast removal.
- Unique forged connection ring provides a compatible tie-off point.
- Shielded load cable and chock release cables.
- Exclusive pivoting easy-grip handle.



2100102

Saflok™ Toggle Anchor

Portable and reusable anchor installs in just seconds to concrete or steel for horizontal, vertical, or overhead applications, providing a compatible, fast and safe tie-off point.

- Activator cable provides toggle mode selection (Open or Lock).
- Toggle position indicator visually notifies user if locked or unlocked.
- Swiveling D-ring provides a compatible tie-off point.

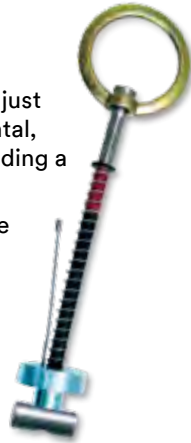

2100050

Concrete Anchor Strap

Our disposable concrete anchor strap provides a temporary anchorage on concrete forms and is extremely easy to install and use.

- Loop slips over rebar, then concrete is poured over. When no longer needed, simply cut strap and discard.
- Durable 1-3/4 in. (4.4 cm) polyester construction x 3-1/2 ft. (1 m). Full length wear pad for abrasion resistance.
- D-ring provides compatible tie-off point.



2100053 Concrete Anchor Strap with D-ring, 48 in. (1.2 m)

2100061 Concrete Anchor Strap, no D-ring, 3-1/2 ft. (1 m)

2104568

Concrete D-Ring Anchor

A simple, versatile and safe concrete anchor solution for use in temporary or permanent applications, providing a safe tie-off point.

- Reusable D-ring assembly.
- Rugged design for harsh environments.
- Safe “hook-up” indicator notifies user of proper installation.
- Install into 11/16 in., 18 mm or 3/4 in. holes—only standard drill bits needed.



2104561 Concrete D-Ring Anchor with 5 additional bolts

2104562 Concrete D-Ring Anchor with 11 additional bolts

2100066 10-pack of Replacement Bolts for Concrete D-Ring Anchor

2101004C

Concrete Detent Anchor

A versatile, simple and safe concrete anchor utilizing pre-installed sockets, enabling the user to connect and disconnect from the anchorage by simply pressing a button.

- Use for floor, wall or ceiling type applications.
- Provides convenient tie-off points wherever needed.
- Push-button operation for fast and easy operation.
- Socket includes cover cap to hide recess, blending into the decor.



2101000C Concrete Detent Socket and cap only

2101002C Concrete Detent Pin only

2100152 Concrete Pour-in-Place Anchor

2100169 Pour-in-Place Detent Anchor Assembly with detent pin and socket



2190074

3M™ DBI-SALA® Construction Roof Anchor

This anchor provides workers with a quick, easy and safe anchorage point during pre-cast concrete work.

- For use with horizontal Smart Lock SRL (leading edge).
- Swivels 360 degrees offering complete freedom of movement.
- Also use as end anchors for a temporary horizontal lifeline.
- Built-in ratchet securing system—no special tools required.

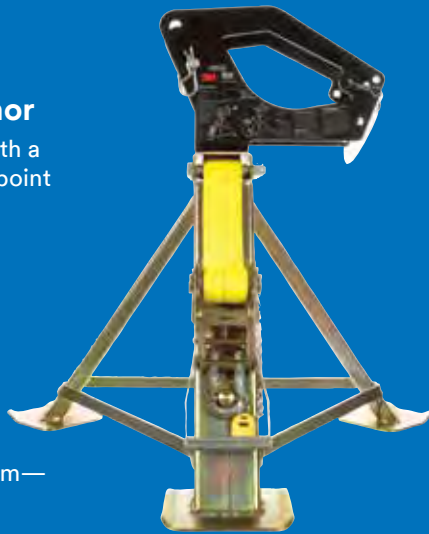

2104816

Drop-Through Anchor

10 ft. (3.0 m) drop-through anchor with swiveling D-ring for concrete and steel, fits 1-1/2 in. to 1-3/4 in. dia. hole (38.1 to 44.5 mm) with a minimum thickness of 4 in. (101.6 mm).

2104819 Anchor x 2 ft.
(0.6 m)

2104818 Anchor x 6 ft.
(1.8 m)

2104817 Anchor x
8.5 ft. (2.6 m)

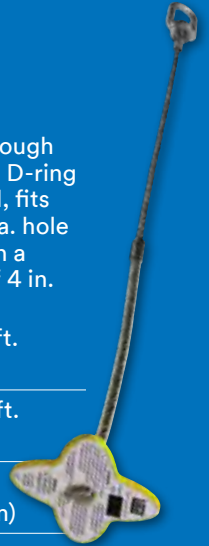

8523178

Concrete Parapet Anchor

Portable anchorage connector developed for use in locations where a low parapet wall provides an anchor site for a energy-absorbing lanyard or self-retracting lifeline.

- Non-penetrating design eliminates site damage.
- Adjustment range 1 in.-14.5 in. (2.5 cm-36.8 cm) wide.
- No tools required for installation.



1231305C

Saflok™ Max Web Anchor

Anchor can be directly connected to many concrete wall forms to provide a tie-off point for your system. Web anchor strap with large opening, Saflok™ Max Hook at one end, D-ring at other x 1.5 ft. (45 cm)

Anchorage Connectors

3M™ DBI-SALA®

Roof Anchorage Connectors

Wood or steel. Residential or commercial. Flat or sloped. No matter what type of roof you're working on, your fall protection system needs specialized components to keep you safe without causing damage to the structure. Our easy-to-use kits and anchorage devices provide the perfect solution and meet the latest OSHA and ANSI standards.

7611904

Roofer's Fall Protection Kit

Complete fall protection system in a bag for convenient compliance and safety on the job. Kit includes:

- Delta™ Full-Body Harness (1103513C)
- Sayflin™ 50 ft. (15.2 m) Horizontal Lifeline (7600505)
- Two Reusable Roof Anchors (2103673)
- Rope Adjuster with Energy-Absorbing Lanyard (1246059C)
- 50 ft. (15.2 m) Lifeline (1202794C)
- Counterweight (5901583)
- Carrying Bag (9503806)



2103673

Portable Reusable Roof Anchor

For use on flat or sloped wood roofs. Installs with twelve 16D nails or six 1/4 in. x 2-1/2 in. bolts. Can be used with horizontal lifeline systems for added versatility.



2103677

Portable Reusable Roof Anchor

For use on flat or sloped wood roofs. Installs with three grade 5, 5/16 in. x 3 in. lag screws. Compact design is extremely easy to transport, install, dismantle and store.



2104541

Permanent Roof Anchor with Detachable D-Ring

Removable D-ring assembly allows you to leave behind the clamp assembly and then shingle over it, reusing the D-ring at another location. Fits 2 x 6 to 2 x 8 roof truss, joist or rafter.



2104542 Anchor, fits 2 x 10 to 2 x 12

2104540 Anchor, fits 2 x 4

2103670

Permanent Roof Anchor with flashing and cap

Clamps onto roof truss up to 2 x 8 size and comes complete with flashing to prevent leakage and D-ring cap for aesthetics. Provides fall protection during initial construction as well as for future homeowner.



2103671 Permanent Roof Anchor with flashing and cap, fits 2 x 10 to 2 x 12

2190073

Portable/Reusable Standing Seam Roof Anchor

Attaches to sloped or flat structural standing seam roofs. Telescoping adjustment fits 12 in., 24 in., 30 in., 32 in. and 36 in. seam spacing.

Swivels 360 degrees and designed for use with the Smart Lock SRL (Order SRL separately).



2100185

Freestanding Counterweight Anchor

Freestanding system is easily placed on top of the roof surface to provide a tie-off point for one worker. A swiveling D-ring integrated into the assembly allows the worker to move freely 360 degrees. Lifting kit also available.



7200439 45 lb. (20 kg)

Single Replacement Counterweight

2100133

Roof Top Anchor with extra large baseplate for metal, concrete and wood

All assembled kits include an extra large baseplate and an integrated anchorage point for one user fall arrest. Permanent anchor assembly is designed for 26 gauge or thicker corrugated metal decking with ribs 10 in. (254 mm) to 20 in. (508 mm) apart, 5/8 in. (16 mm) CDX plywood or concrete. Minimum concrete compressive strength of 3,000 PSI (21 MPa). Minimum thickness of 6-1/2 in. (16.5 cm) for chemical anchors. Minimum thickness of 5-1/2 in. (14 cm) for mechanical anchors.



Anchorage Connectors

2100138

3M™ DBI-SALA® Standing Seam Roof Anchor
Kit includes a baseplate and an integrated anchorage point for one user fall arrest. Permanent anchor assembly designed specifically for standing seam roofs.

7241204 “Z” Maxi Clamp Kit, 4-pack, for bulb-type standing seams

7241206 “E” Maxi Clamp Kit, 4-pack, for double fold standing seams

7241208 “U” Maxi Clamp Kit, 4-pack, for single fold standing seams



A supplement of fasteners, clamps and rivets is available for installation on a variety of roofing profiles.

2100139

Roof Top Anchor for membrane type roofs

All assembled kits include a baseplate and an integrated anchorage point for one user fall arrest. Permanent anchor assembly fastens through the membrane—up to 12 in. (300 mm)—insulation and into the metal sheathing, wood sheathing or concrete.



2100140 Anchor for PVC Roofs

2100142 Anchor for Bitumen Roofs

7241182 Toggle Bolt Kit, 6 in. (150 mm), 4-pack

7241183 Toggle Bolt Kit, 12 in. (300 mm), 4-pack

2190071

Reusable Swiveling Roof Anchor

Provides 360 degrees of mobility and protection on sloped or flat wood and metal decking. For use with Smart Lock SRLs (order separately). May also be used as end-anchors for horizontal lifeline system.



3505694

Reusable Swiveling Roof Anchor

Provides 360 degrees of mobility and protection on sloped wood roofs. Includes 30 ft. (9.1 m) (3504430B) Ultra-Lok SRL.



3505695 Reusable Swiveling Roof Anchor with 50 ft. (15.2 m) (3504450) Ultra-Lok SRL

2103690

3-Man Reusable Swiveling Roof Anchor

- Installs to sloped wood roof structures.
- Fast and easy screw installation; Fastener kit included.
- Three built-in swiveling D-ring anchor points.
- Durable and corrosion resistant construction.
- Compact and lightweight design.
- Adjustable feet and legs.
- 54 in. (137.2 cm) height when full extended.
- Portable and reusable.



3M™ DBI-SALA® Saflok™

Wood Pole and Steel Structure Anchor Systems

2104803

Provides wood pole climber with 100% fall protection, allowing installation of anchor and lifeline to top of pole from the ground. Quickly and safely climb prior to connecting work positioning system.



- Compatible with most hot stick poles.
- Includes anchor tube with installation/removal tool.
- 80 ft. (24 m), 5/8 in. (16 mm) dielectric rope and two carabiners.
- Rope grab with energy-absorbing lanyard.
- Chain tensioner, web loop and carrying bag.

2104811 Saflok™ Steel Structure Fall Arrest System with anchor tube, installation/removal tool, 80 ft. (24 m), 5/8 in. (16 mm) high dielectric rope, carabiner, rope grab with energy-absorbing lanyard, rescue loop sling and carrying bag

2104802 Saflok™ Pole Anchor System with anchor tube, 80 ft. (24 m), 5/8 in. (16 mm) high dielectric rope, installation/removal tool, one carabiner, rope grab with integrated energy-absorbing lanyard & carrying bag

3M™ DBI-SALA®

Remote Anchoring System



2104527

Provides a safe means to anchor a fall protection device to an overhead location beyond normal reach.

- Pole adjusts from 6 ft.-12 ft. (1.8 m-3.6 m)
- Tie-off adapter tool for installation of anchorage device.
- Hook attachment tool for installation of 3,600 lb. (16 kN) gated snap hooks.
- Tie-off adapter x 3 ft. (0.9 m) and carrying bag.

2104528 System with 8 ft.-16 ft. (2.4 m-4.8 m) adjustable pole

2104529 Snap Hook Connector Tool for 3,600 lb. (16 kN) gated hooks

2104530 System, 6 ft.-12 ft. (1.8 m-3.6 m) adjustable pole with original and 3,600 lb. (16 kN) gated hook tools

2104531 System, 8 ft.-16 ft. (2.4 m-4.8 m) adjustable pole with original and 3,600 lb. (16 kN) gated hook tools

2100090

Perimeter Limiter Leading Edge Anchor

Freestanding, non-penetrating anchor is ideal for concrete decking construction and provides overhead anchorages for up to two users.

- Large foam filled trailer tires won't go flat and provide easy movement.
- Rotating 7-1/2 ft. (2.3 m) mast and anchorage arm for added freedom of movement.
- Pre-drilled holes for accessory rescue winches or job site boxes.
- Additional weights and taller mast can be added for job site flexibility.

2100091 9-1/2 ft. (2.9 m) Mast for perimeter limiter

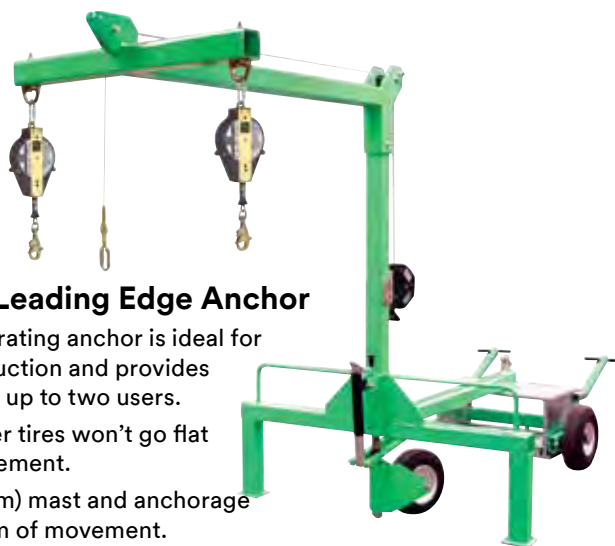

2100080

Door/Window Jamb Anchor

Non-penetrating anchor is lightweight and portable, requiring no tools for attachment. Adjustable opening ranging from 21.5 in.-51.5 in. (54.6 cm-130.8 cm). Rated for 3,600 lb. (16 kN)



3M™ DBI-SALA® Mobi-Lok™ Self-Contained Vacuum Anchor System

Whether you need a broken strobe replaced atop a jumbo jetliner, or it's simply time for routine maintenance, your workers should only have to focus on one thing: getting the job done right. The Mobi-Lok™ Self-Contained Vacuum Anchor (SCVA) system allows your workers to conveniently anchor to virtually any smooth, non-porous surface—enabling them to work where they need to without compromising their fall protection safety.

1 Audio alarm warning system

2 Convenient carrying handle

3 Secure anchor point

4 Aviation rated electronics

Intrinsically safe

5 Vacuum level indicator

6 Shop air quick connect

7 Surface friendly

Skydrol-resistant, EPDM rubber seal (Aviation model)

8 Fits small fuselage

Pad conforms to fuselage as small as 6 ft. (1.8 m) in diameter

9 Optional cylinder attachment

Increases portability



Freedom to work.

A worker connected to a Mobi-Lok™ System can move about freely and confidently without compromising safety. It's engineered and rated for fall arrest applications (up to 140.6 kg max), but it can also be used in a fall restraint application to maximize versatility.

Connections in seconds.

The Mobi-Lok™ System eliminates the need to drill or weld to create a secure anchor point. Instead, your crew can get connected with minimal effort in just a few seconds—improving productivity and reducing downtime.

Completely mobile.

At just 19.9 lbs (9.0 kg), the Mobi-Lok™ System is both easy to use and easy to transport between the tarmac and the holding area.

Globally compliant.

Every Mobi-Lok™ model is OSHA, CE and AS/NZS compliant and is independently tested and approved for fall arrest applications when operated according to provided instructions.

Comprehensive backup system.

To enhance worker safety, the Mobi-Lok™ System features a comprehensive backup system. If the compressed air source is lost, a persistent audio alarm and vacuum level indicator alert the worker while check valves maintain the vacuum seal.

3M™ DBI-SALA® Mobi-Lok™

Self-Contained Vacuum Anchor Systems

Horizontal lifeline-ready

Two Mobi-Lok™ units can be connected using a horizontal lifeline (HLL) to create a continuous anchor point for up to two people.



Product specifications

	Shop air powered	Shop air/gas powered
Main support assembly	Anodized aluminum	
Vacuum seal pad material - aviation	EPDM	
Vacuum seal pad material - general industry	Polybutadiene	
Electronics	4 AA lithium batteries	
Shop air requirements	80 psi-150 psi	
Compressed gas bottle requirements	—	3,000 psi, 48 in ³
Dimensions	22 in. x 22 in. x 6 in. (55 cm x 55 cm x 15 cm)	
System weight	17.4 lbs. (7.8 kg)	19.9 lbs. (9.0 kg)
Capacity	310 lbs. (140 kg); One person	
Surface temperature range	-20°F to 140°F (-29°C to 60°C)	
Vacuum anchor static capacity	3,375 lbs. (15 kN)	

Product selection guide

Components	Aviation	General industry
Mobi-Lok™ SCVA assembly (shop air powered)	2200107	2200094
Mobi-Lok™ SCVA assembly with on board bottle attachment (shop air or gas powered)	2200108	2200095
Secondary pad assembly (optional)	2200109	2200096
Secondary pad hose (optional) – 50 ft. (15 m)	2200130	
Aviation HLL kit (includes secondary pad, 40 ft. HLL, and secondary pad 50 ft. hose)	2200123	—
80 ft. (24 m) 2-person HLL system	2200401	—
100 ft. (30 m) 4-person HLL system	2200180	—
150 ft. (45 m) 4-person HLL system	2200181	—
Compressed gas cylinder (bottle sold separately)	2200078	
Aviation Kit (includes Mobi-Lok™ SCVA assembly and bottle)	2200122	—
Carry case included		

System selection guide

	Aviation	General industry
Standard unit for fall arrest/restraint	2200108 or 2200107	2200095 or 2200094
40 ft. (12 m) HLL system	2200108+2200123 or 2200107+2200123	2200095+2200124 or 2200094+2200124
80 ft. (24 m) HLL system	2200108*2+2200401+2200109+2200130 or 2200107*2+2200401+2200109+2200130	2200095*2+2200401+2200096+2200130 or 2200094*2+2200401+2200096+2200130

Recommended lanyard is 1246170



Flexiguard™ Solutions

Flexiguard™ Solutions

Maximum safety to give you peace of mind. Flexiguard™ is designed to meet the requirements of your specific application.

Durable

Powder-coated, anodized high strength alloy.
Specifically engineered for extra tall and wide applications.
Enclosed rail to help keep debris out (weather elements).
100% fall arrest rated tie-off from the ground up.
SAE J429 Grade 8 hardware with zinc yellow Chromate-plated finish.

Portable

Lightweight design—easily moved by minimal personnel.
Most allow for positioning by a forklift or other service vehicle.
Heavy-duty stabilization for use on uneven ground.

Versatile

Indoor and outdoor use.
Multiple overhead anchor points on systems that are designed for multiple users.
Provides a large, safe working area — working radius from rail is 6 ft. (1.8 m) or 30 degrees.
Rigid anchor points have no deflection or sag, reducing fall clearance requirements.
Systems can be permanently mounted (where applicable).
Flexiguard™ custom solutions meet the needs of specific and challenging work environments.









We help make worker safety a priority. From our researchers and developers to our industry-leading installation, training services and annual inspections, 3M offers unique solutions for unique needs.

Our global engineering and manufacturing teams test and certify each product to ensure it meets, and often exceeds the latest regulatory requirements.



Ideal applications include:

TRANSPORT	CONSTRUCTION	UTILITIES
		
OIL AND GAS	MINING	WIND ENERGY
		

Flexiguard™ Solutions

3M™ DBI-SALA® SafRig™ System

Maximize safety while maintaining portability. The Flexiguard™ SafRig™ Fall Protection System is ideal for applications that require a large work area in a limited space. The smaller frame allows trucks to be parked side-by-side during use but does not require the weight of the vehicle as the anchoring force. The 360 degree rotational boom provides a 5 ft. (1.5 m) working offset, and has the capacity to provide fall protection or a rescue system for one person. Forklift pockets simplify moving the system around a job site. Depending on the type of base, these systems are ANSI, OSHA and CE compliant.

SafRig™ Systems

- Periscoping rotation handle included for turning system into working position.
- Counterweight base solutions available with or without concrete.
- Each type of system comes rescue-ready with inclusion of pulleys and the winch mounting plate.

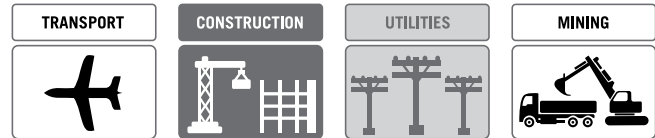

SafRig™ with Outrigger Base

Base	Anchor height	Offset	PPE	# of Users	Part #
15 ft. (4.5 m) x 15 ft. (4.5 m)	20 ft. (6.1 m)	5 ft. 10 in. (5.3 m)	not included	1	8530607

SafRig™ with Counterweight Base and PPE Kit

Base	Anchor height	Offset	PPE	Concrete	# of Users	Part #
4 ft. 6 in. (1.4 m)	20 ft. (6.1 m)	5 ft. 9 in. (5.3 m)	not included	with	1	8530606
4 ft. 6 in. (1.4 m)	20 ft. (6.1 m)	5 ft. 9 in. (5.3 m)	not included	without	1	8530619



*PPE Kit includes: 20 ft. (6.1 m) Ultra-Lok Self-Retracting Lifeline with Saflok™ Carabiner and 25 ft. (7.6 m) tagline.

3M™ DBI-SALA® Counterweight Jib

Indoor and outdoor maintenance is simpler and safer with our Counterweight Jib System. Featuring a 360 degree rotating jib, this portable solution provides optimal mobility and fall protection safety for one person. Forklift pockets are strategically located on all four sides of the base to ensure ease of mobility and placement between job sites. The base also contains four heavy-duty lifting rings for transport by a crane. These systems are ANSI and OSHA compliant.

Counterweight Jib Systems

- Periscoping rotation handles included for turning system into working position.
- Counterweight base solutions available with or without concrete.
- Installed rail with trolley.

Anchor height	Offset	Concrete	# of Users	Part #
16.75 ft. (5.1 m)	8 ft. (2.4 m)	without	1	8517750
16.75 ft. (5.1 m)	8 ft. (2.4 m)	with	1	8517751
20.67 ft. (6.3 m)	8 ft. (2.4 m)	without	1	8517752
20.67 ft. (6.3 m)	8 ft. (2.4 m)	with	1	8517753
23.67 ft. (7.2 m)	8 ft. (2.4 m)	without	1	8517754
23.67 ft. (7.2 m)	8 ft. (2.4 m)	with	1	8517755

No-Base Systems

- Attach to supporting, fixed structure (e.g. on I-Beam) on the job site.
- Mounting clamps, plates and hardware included with systems.
- System rotates 180 degrees and locks every 7.5 degrees.
- Installed rail with trolley.

Boom height	Offset	# of Users	Part #
TBD by end user	20 ft. (6.1 m)	1	8530433

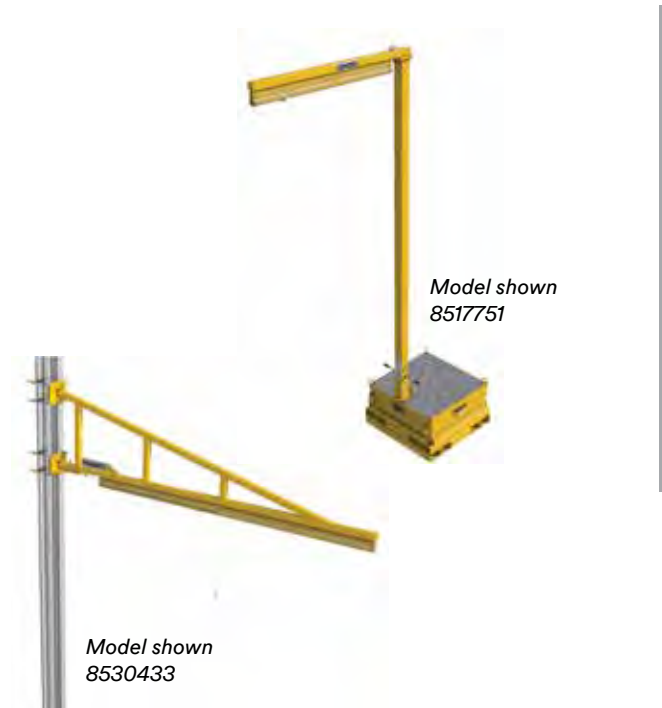
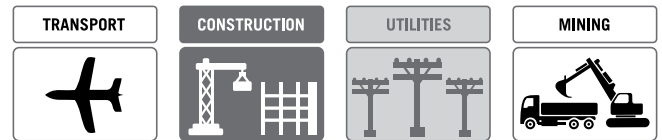

Flexiguard™ Solutions

Flexiguard™ Solutions

3M™ DBI-SALA® Engineered Modular Unit

Simplify adjustment and maximize flexibility without sacrificing safety. The highly customizable Flexiguard™ Engineered Modular Unit makes it possible.

This modular system features a lightweight design, allowing for easy mobility around the job site with a pallet jack or forklift. With three adjustable height models and one fixed height version—plus three mounting options—there is a configuration to fit virtually any need.

The 360 degree rotation mast allows for a 6 ft. (1.8 m) working radius from the anchor point. These systems are ANSI and OSHA compliant.

Engineered Modular Unit Systems

- Rotation handle included for turning system into working position.
- Installed rail with trolley.
- Rotational locking pin includes adjustments at every 11 degrees.

Fixed Height Systems

Anchor height	Offset	# of Users	Part #
21 ft. (6.4 m)	7 ft. (2.1 m)	1	8530571

Adjustable Height Jib Systems

Anchor height	Offset	Concrete	# of Users	Part #
10 ft.-15 ft. (3.05 m-4.57 m)	7 ft. (2.1 m)	n/a	1	8530557
13 ft.-20 ft. (3.96 m-6.10 m)	7 ft. (2.1 m)	n/a	1	8530558
15 ft.-25 ft. (4.57 m-7.62 m)	7 ft. (2.1 m)	n/a	1	8530559
15 ft.-25 ft. (4.57 m-7.62 m)	7 ft. (2.1 m)	without	2	8530538*

Base Configurations

Base type	Concrete	Part #
Flush floor mount	n/a	8530564
Top floor mount	n/a	8530565
5,000 lb. (2,268 kg) Counterweight	n/a	8530566
5,000 lb. (2,268 kg) Counterweight	without	8530621

*Includes counterweight base without concrete.

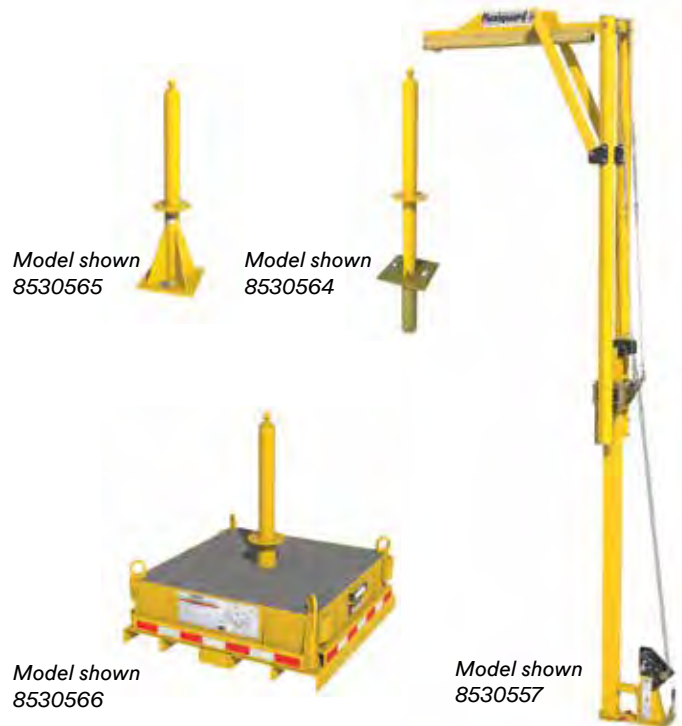
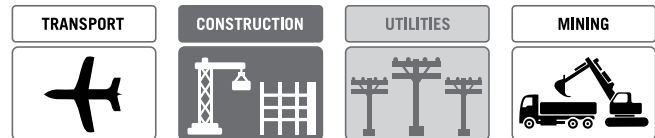

3M™ DBI-SALA® Counterweighted System

Create an overhead anchor point for multiple workers with ease. The Counterweighted System is a portable solution designed for counterbalancing by concrete or other means, allowing for close positioning to the work surface without obstructing the equipment being accessed. These systems are ANSI and OSHA compliant.

Counterweighted Systems

- Provide effective/economical means of anchoring overhead.
- Includes systems with and without the concrete counterweight on base of unit.
- Ideal in areas with no overhead obstructions and door height restrictions.
- System includes one rail with two trolleys.
- System includes heavy-duty leveling jacks and tag line assist.

Anchor height	Rail width	Offset	Weighted	# of Users	Part #
22 ft. (6.7 m)	32 ft. (9.8 m)	8 ft. (2.4 m)	not included	2	8517760
22 ft. (6.7 m)	32 ft. (9.8 m)	8 ft. (2.4 m)	included	2	8517761
22 ft. (6.7 m)	42 ft. (12.8 m)	8 ft. (2.4 m)	not included	2	8517762
22 ft. (6.7 m)	42 ft. (12.8 m)	8 ft. (2.4 m)	included	2	8517763

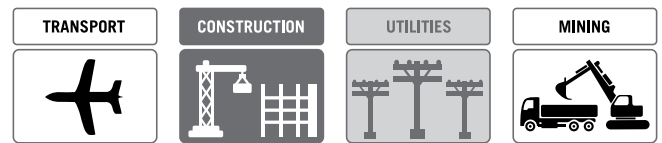

Model shown
8517760

Flexiguard™ Solutions

Flexiguard™ Solutions

3M™ DBI-SALA® C-Frame System

A versatile fall arrest solution for working at height, the C-Frame System is designed to be moved manually or with the use of a tow bar and service vehicle. It requires some clearance under the equipment being accessed to accommodate outrigger support legs. These systems are ANSI, OSHA and CE compliant.

Adjustable Height Systems

- Adjustable by manually cranking winch.
- Most often used in areas with no overhead obstructions or door height restrictions.
- System includes heavy-duty leveling jacks.
- Each system includes one rail with two trolleys.



Anchor height	Rail width	Wheels	# of Users	Part #
12.5 ft.-19 ft. (3.8 m-5.85 m)	10 ft. (3 m)	16 in. (0.4 m) Pneumatic	2	8517701
12.5 ft.-19 ft. (3.8 m-5.85 m)	20 ft. (6.1 m)	16 in. (0.4 m) Pneumatic	2	8517705
17.5 ft.-28.75 ft. (5.3 m-8.8 m)	15 ft. (4.6 m)	16 in. (0.4 m) Pneumatic	2	8517707
17.5 ft.-28.75 ft. (5.3 m-8.8 m)	20 ft. (6.1 m)	16 in. (0.4 m) Pneumatic	2	8517709

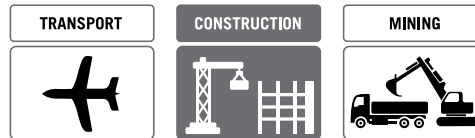

3M™ DBI-SALA® A-Frame System

The A-Frame System provides a secure anchor point on portable structures to give workers increased coverage and protection. Depending on the configuration, this system has the capacity to provide fall protection for up to two workers and can be easily moved from one job site to the next—providing safe and reliable fall protection where you need it. These systems are ANSI, OSHA and CE compliant.

Fixed Height Systems

- Provide effective/economical means of anchoring overhead.
- Each system contains a single rail rated for two users.
- Ideal in areas with no overhead obstructions or door height restrictions.
- System includes heavy-duty leveling jacks.

Anchor height	Rail width	Wheels	# of Users	Part #
15 ft. (4.6 m)	15 ft. (4.6 m)	16 in. (0.4 m) Caster	2	8517790
15 ft. (4.6 m)	20 ft. (6.1 m)	16 in. (0.4 m) Caster	2	8517791
15 ft. (4.6 m)	30 ft. (9.1 m)	16 in. (0.4 m) Caster	2	8517792
20 ft. (6.1 m)	15 ft. (4.6 m)	16 in. (0.4 m) Caster	2	8517793
20 ft. (6.1 m)	20 ft. (6.1 m)	16 in. (0.4 m) Caster	2	8517794
20 ft. (6.1 m)	30 ft. (9.1 m)	16 in. (0.4 m) Caster	2	8517795
30 ft. (9.1 m)	15 ft. (4.6 m)	16 in. (0.4 m) Caster	2	8517796
30 ft. (9.1 m)	20 ft. (6.1 m)	16 in. (0.4 m) Caster	2	8517797
30 ft. (9.1 m)	30 ft. (9.1 m)	16 in. (0.4 m) Caster	2	8517798

Adjustable Height Systems

- Can be adjusted using overhead crane, forklift or powered systems.
- Each system contains two rails for bypassing trolleys.
- Ideal in areas with overhead obstructions and door height limitations where lowering the overall height of the A-Frame is a requirement.
- System includes heavy-duty leveling jacks.

Anchor height	Rail width	Wheels	# of Users	Part #
16 ft.-22.5 ft. (4.9 m-6.9 m)	20 ft. (6.1 m)	16 in. (0.4 m) Pneumatic	2	8517780
16 ft.-22.5 ft. (4.9 m-6.9 m)	30 ft. (9.1 m)	16 in. (0.4 m) Pneumatic	2	8517781

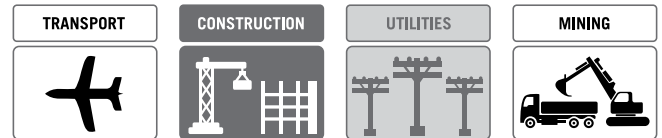

Flexiguard™ Solutions

3M™ DBI-SALA® Freestanding Ladder System

Easy access. 100% fall protection from the ground up. Achieve both for up to two users for the duration of the work with our Freestanding Ladder System. System configurations include guardrails and the use of multiple SRLs. These models are ANSI, OSHA and CE compliant.

Adjustable Height Systems

- Manual height adjustment via winch assembly.
- Multiple height adjustment ranges available.
- All systems include a fall arrest bar for accessing ladder.
- System includes heavy-duty leveling jacks.



Platform height	System type	Wheels	# of Users	Part #
10.75 ft.-15.5 ft. (3.3 m-4.7 m)	Portable ladder	16 in. (0.4 m) Pneumatic	2	8517715
14.5 ft.-23 ft. (4.4 m-7.0 m)	Portable ladder	16 in. (0.4 m) Pneumatic	2	8517717
18.25 ft.-31 ft. (5.6 m-9.4 m)	Portable ladder	16 in. (0.4 m) Pneumatic	2	8517719



Model shown
8517715

3M™ DBI-SALA® Sky Anchor System

Increase coverage and protection with the secure anchorage point of a Sky Anchor Solution. All systems are rated for one-person use and provide 360 degree mobility within the safe working radius from the anchor point. All available systems incorporate a collapsible design for easy setup, as well as a variety of bases for securing the system onto any job site. These systems are ANSI and OSHA compliant.



Sky Anchor Systems

- Lightweight aluminum construction.
- Collapsible design.
- 360 degree mast rotation.
- 6 ft. (1.8 m) safe working radius from anchor.

Anchor height	Offset	# of Users	Part #
21.25 ft. (6.5 m)	6 ft. (1.8 m)	1	8530387

Sky Anchor Base Configurations

- Each base option can be used with each Sky Anchor option.
- Each base option is rated for one user.

Base image	Base type	Part #
	Top floor mount	8530210
	Core mount sleeve	8530314
	Flush floor mount	8530162*

*Base Cap option can be used with this base.

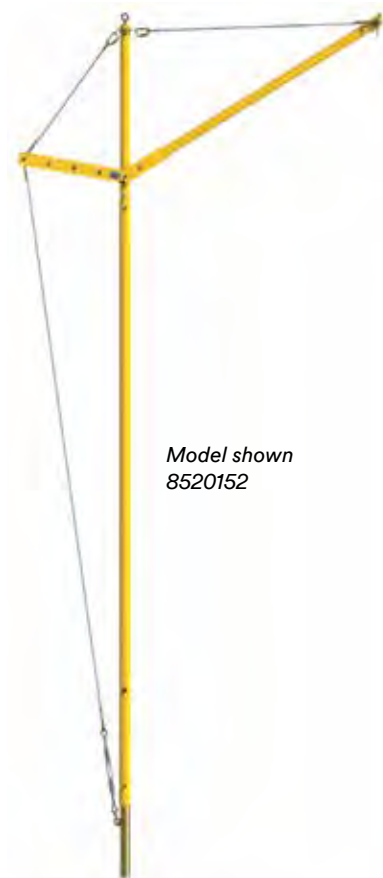
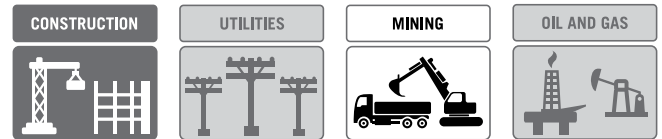

Model shown
8520152

Flexiguard™ Solutions

3M™ DBI-SALA® Supported Ladder System

Provide for safe access and maintenance of transportation vehicles across a wide variety of different applications and environments with our portable Supported Ladder System.

This unique solution offers the best in passive and active fall protection. The work platform is fully enclosed by guardrails for superior passive fall protection and easily accessible through two spring-loaded swing gates.

You can also access the working surface of the vehicle through one spring-loaded gate while tied off to the active fall arrest rail. This system is ANSI and OSHA compliant.

Supported Ladder System

- Heavy-duty steel base design with an aluminum platform and fall arrest rail.
- Work platform is covered in a non-slip material.
- System equipped with two heavy-duty stabilizing jacks and two retracting outriggers that can be set without having to go beneath the work surface.



Platform height	Platform length	Platform width	Rail length	Wheels	# of Users	Part #
9 ft. (2.7 m)	9 ft. (2.7 m)	3 ft. (0.9 m)	12 ft. (3.7 m)	8 in. (0.2 m) Urethane	1	8530397



3M™ DBI-SALA® Box Frame

Conveniently secure a fall arrest rigid rail in areas with limited space or inadequate overhead structure. Our Box Frame Systems are built to accommodate a specific area or piece of equipment and can be designed as permanent or portable frames, allowing for easy relocation. These systems are ANSI and OSHA compliant.

Fixed Height Systems

- Provide effective/economical means of anchoring overhead.
- Ideal in areas with no overhead obstructions or door height restrictions.

Anchor height	Width	Rail length	Wheels	# of Users	Part #
14 ft. (4.3 m)	14 ft. (4.3 m)	Dual rail 15-1/2 ft. (4.7 m) each	16 in. (0.4 m) Pneumatic	2	8530345
30 ft. (9.1 m)	20 ft. (6.1 m)	Dual rail 32 ft. (9.8 m) each	16 in. (0.4 m) Pneumatic	2	8530427

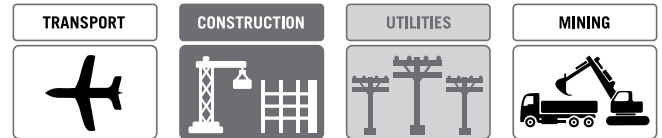

Adjustable Height System

- Adjustable using overhead crane, forklift or powered systems.
- Pin height selection system.
- Ideal in areas with overhead obstructions and door height limitations.

Height	Width	Length	Wheels	# of Users	Part #
12 ft.-18 ft. (3.7 m-5.5 m)	12 ft. (3.7 m)	Single rail 20 ft. (6.1 m)	12 in. (0.3 m) Rubber	2	8530288

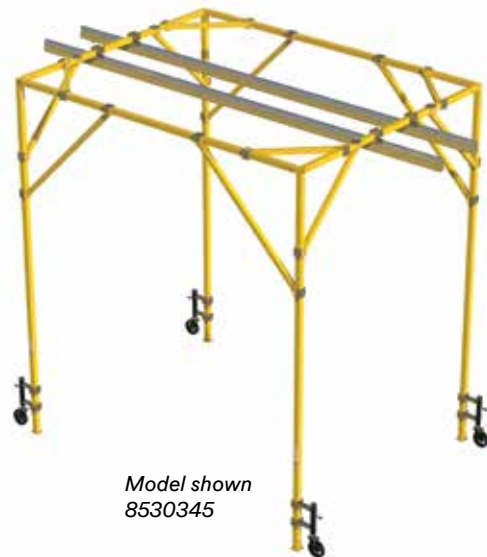

Model shown
8530345

Flexiguard™ Solutions





3M™ DBI-SALA® Trailer & Hitch-Mounted Anchor Systems

One simple solution. Endless versatility. Our Trailer & Hitch-Mounted Systems are DOT-rated portable systems that can be attached to a service vehicle hitch receiver for transport to a job site. They provide a standalone solution, leveraging an integrated counterweight or easy attachment to a truck or service vehicle with minimal setup required before use. These systems incorporate overhead anchorage points up to 22 ft. (6.7 m) for a maximum of two users, and are OSHA and ANSI compliant.

Fixed Height Systems

- Trailer and Hitch mounted solutions are DOT rated to maximize portability and versatility to and from job site.
- System quickly raises and lowers with integrated winch and handle.
- System includes heavy-duty stabilizing jacks.

Anchor height	Width	# of Users	Part #
21-1/2 ft. (6.6 m)	7.2 ft. (2.2 m)	2	8530624
21-1/2 ft. (6.6 m)	7 ft. (2.1 m)	2	8530690
22 ft. (6.7 m)	6.5 ft. (2.0 m)	2	8530691

TRANSPORT 	CONSTRUCTION 	UTILITIES 	MINING 
---	--	---	--

Accessory	Applies to	Part #
Drive Clutch Assembly	8530624, 8530690, 8530691	8548000
Job Box	8530690	8530678
Outrigger Pads	8530690, 8530691	8548050



Model shown
8548000



Model shown
8548050



Model shown
8530678



Model shown
8530624
Attachment
not included



Model shown
8530690
Attachment
not included



Model shown
8530691
Truck not
included



Flexiguard™ Solutions



Confined Space Rescue

Confined Space Rescue



Helping you breathe easy, even in tight spaces. That's the confidence and peace-of-mind that comes from having a customized and reliable confined space rescue system at hand. Our extensive line of high-quality, rugged systems are trusted by safety engineers and site directors alike – helping rescue workers in confined spaces quickly and flawlessly. Meeting applicable industry standards, each confined space rescue system and compliance.

What to look for in a confined space rescue system:

Ease-of-use

Your systems must provide you with the ability to handle a crisis simply, flawlessly and immediately. During an emergency, time is of the essence.

Mechanical systems

Lifeline type and length are just a few of the options you may need to consider. In some situations, a back-up system may be required.

Durability

All system components must be made from quality materials strong enough to endure rough handling and exposure to the elements.

Versatility

Your system should be adjustable and adaptable to extreme environments and uneven terrain. A modular design is also helpful, allowing you to add to the system over time.

Strength

Your system must be rated for your application, such as fall arrest, rescue, man-riding or material handling. Choose one that maximizes strength and minimizes weight.

Portability

Your system should be lightweight and easy to transport, set up and store.



3M™ DBI-SALA®

Davit Arm System Components

Variable offset davits are designed for use where multiple offset masts are required. The variable offset masts may be equipped with front mounted and/or back mounted winches or Self-Retracting Lifelines (SRLs) and feature an anchor point rated up to 5,000 lbs. (22 kN), depending on pin position. For applications with overhead clearance restrictions, the adjustable height of the variable offset masts can eliminate the need for custom length masts and mast extensions. Quick-connect/release pins allow for fast and easy setup, dismantle and transport.

1 Winch

Davits can be equipped with both primary and secondary (back-up) mechanical devices for added flexibility.

2 Quick-mounting brackets

Simple detent-style winch mounting brackets make installation fast and efficient. (See page 169 for options.)

3 3-way SRL

Davits can be equipped with both primary and secondary (back-up) mechanical devices for added flexibility.

4 Lower mast extensions

Allow the user to increase the overall anchorage height of the system.

5 Base options

Several portable and fixed base options are available for complete versatility.

6 Variable offset mast

Adjustable length of davit ensures lifelines are always centered over confined space.

7 Built-in pulleys

Route lifelines of two mechanical devices for smooth, efficient operation.

8 Fall arrest anchorage

Up to a 5,000 lb. (22 kN) rated anchor point for fall arrest device.

9 Adjustable height

Eliminates the need for custom length masts and extensions.

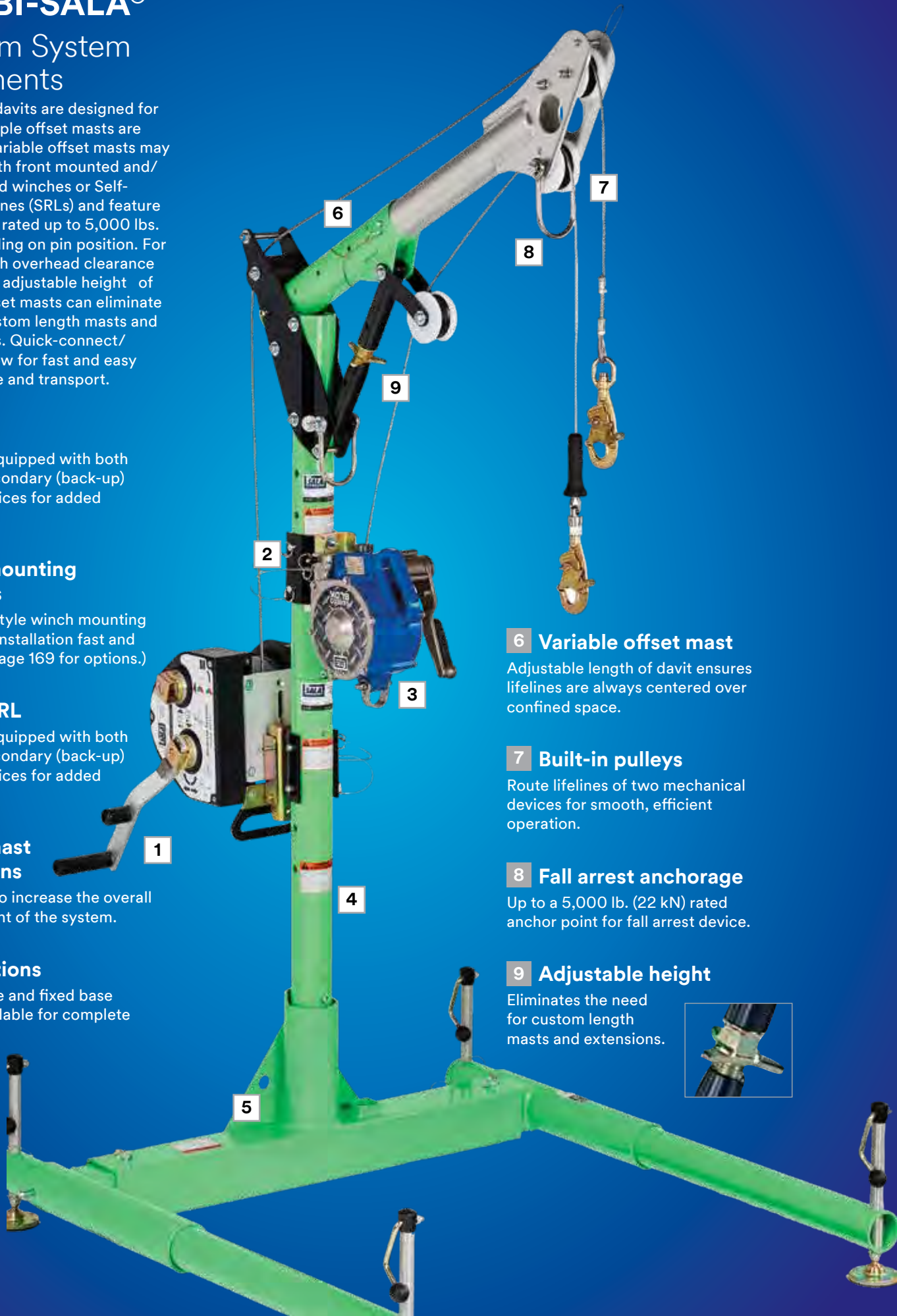

3M™ DBI-SALA®

One-Piece Adjustable Offset Davit Masts

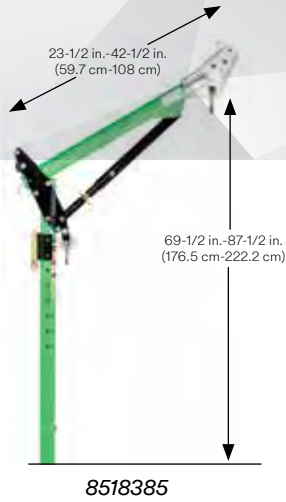

Adjustable offset davit mast	66 in.-76 in. (167.6 cm-193 cm)	78 in.-88 in. (198.1 cm-223.5 cm)	90 in.-100 in. (228.6 cm-254 cm)	69-1/2 in.-87-1/2 in. (176.5 cm-222.2 cm)	81-1/2 in.-91-1/2 in. (207 cm-232.4 cm)	93-1/2 in.-111-1/2 in. (237.5 cm-282.2 cm)
11-1/2 in.-27-1/2 in. (29.2 cm-69.8 cm)	8518382	8518383	8518384			
23-1/2 in.-42-1/2 in. (59.7 cm-108 cm)				8518385	8518386	8518387

Offset Davit Masts & Lower Mast Extensions

Customize either one of these davit masts with up to two Lower Mast Extensions. The extensions provide the flexibility to change the overall mast height of your system. Custom lengths are also available. Call us for details.

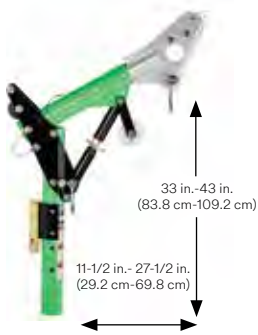

8518001 11-1/2 in.-27-1/2 in. Adjustable Offset Davit Mast

(includes winch mount bracket)
Combine this one-piece davit mast with up to two lower mast extensions to increase the anchorage height. Combined extension length cannot exceed 90 in. (228 cm).

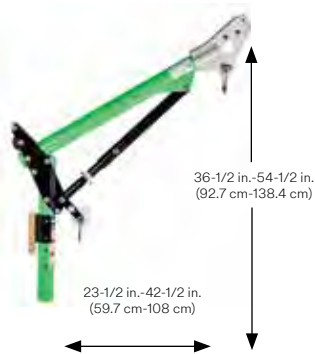

8518006 23-1/2 in.-42-1/2 in. Adjustable Offset Davit Mast

(includes winch mount bracket)
Combine this one-piece davit mast with up to two lower mast extensions to increase the anchorage height. Combined extension length cannot exceed 78 in. (198 cm)

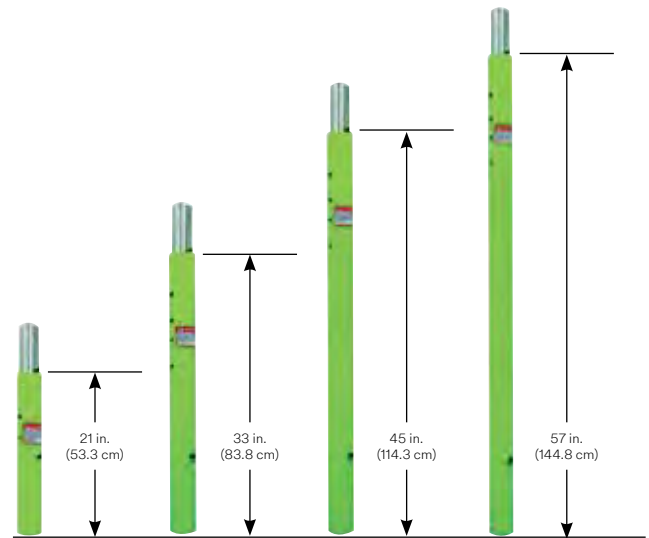

8518509	21 in. (53.3 cm)	Lower Mast Extension
8518002	33 in. (83.8 cm)	Lower Mast Extension
8518003	45 in. (114.3 cm)	Lower Mast Extension
8518004	57 in. (144.8 cm)	Lower Mast Extension

Bags and Accessories



8513330 Carrying Bag

Bag with protective plastic liner for Adjustable Offset Davit Masts.

8513564 Bag with protective plastic liner for Adjustable Offset Davit Mast, with Lower Mast Extension.

3M™ DBI-SALA®

Fixed Bases

Fixed Bases work with a variety of Davit Arm and Mast Extensions. They allow for easier setup and teardown, making them an ideal solution for work areas where a base can be permanently installed to an existing structure.





8516190
Floor Mount Sleeve
Zinc-Plated

Mild steel construction. Mounts to horizontal concrete or steel structure. Comes with PVC sleeve liner.

Weight: 13 lbs. (5.9 kg)

8518347 Floor Mount Sleeve, stainless steel construction

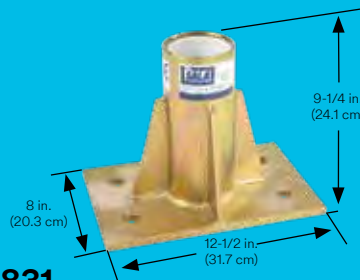

8512831
Center Mount Sleeve
Zinc-Plated

Mild steel construction. Mounts to existing steel by welding or bolting. Comes with PVC sleeve liner.

Weight: 13 lbs. (5.9 kg)

8516563 Center Mount Sleeve, stainless steel construction

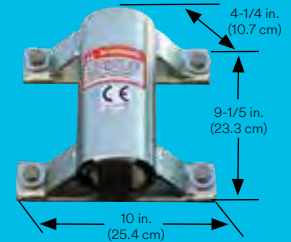

8518348
Wall Mount Sleeve 304
Stainless Steel

304 stainless steel construction. Compact design creates minimum intrusion into work space. Mounts to vertical concrete or steel structures. Comes with PVC sleeve liner.

Weight: 12 lbs. (5.5 kg)

8516191 Wall Mount Sleeve, zinc-plated mild steel construction

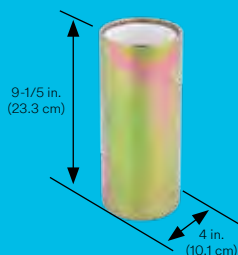

8510109
Core Mount Sleeve

Zinc-plated mild steel construction. Designed for slip-in installation into 4 in. (10.1 cm) core hole in concrete or in an existing steel structure. Comes with PVC sleeve liner.

Weight: 8 lbs. (3.6 kg)

8510110 Core Mount Sleeve, stainless steel construction

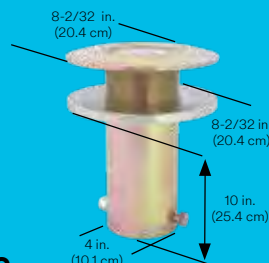

8515162
Deck Mount Sleeve

Zinc-plated mild steel construction. Designed to slip into a 4 in. (10.1 cm) hole in existing flooring. Flush mount design allows passage of traffic and eliminates trip hazards when not in use. Comes with PVC sleeve liner, plastic stopper and mounting hardware – mounts to thicknesses from 1/4 in.-2 in. (6.4 mm-50.8 mm).

Weight: 17 lbs. (7.7 kg)

8515834 Deck Mount Sleeve, stainless steel construction



8510316
Floor Mount Sleeve

Mild steel construction. Recessed fastener pockets allow for bolt-in installation into existing concrete or steel structure. Flush mount design allows passage of traffic and eliminates trip hazards when not in use. Comes with PVC sleeve liner.

Weight: 21 lbs. (9.5 kg)

8512827 Flush Floor Mount Sleeve, stainless steel construction

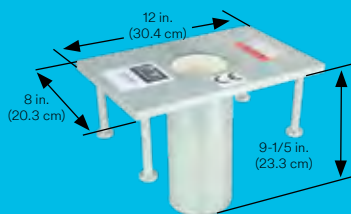

8510311
Flush Floor Mount Sleeve

Mild steel construction. Comes with pins for fresh concrete and cast-in-place concrete anchors for new construction or renovation. Flush mount design allows passage of traffic and eliminates trip hazards when not in use. Comes with PVC sleeve liner.

Weight: 21 lbs. (9.5 kg)

8512828 Flush Floor Mount Sleeve, stainless steel construction

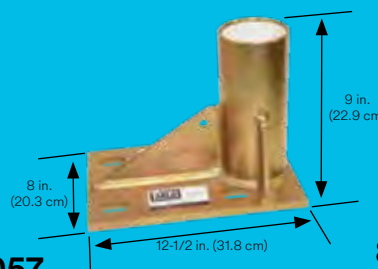

8510057
Offset Floor Mount Sleeve

Zinc-plated mild steel construction. Mounts to horizontal concrete or steel structure. The offset design allows for maximum reach of the mast being used. Comes with PVC sleeve liner.

Weight: 25 lbs. (11.3 kg)



8510827
Heavy-Duty Sleeve Cap

Stainless steel construction, used with permanent mounted sleeves when installed in high traffic or other severe service locations.

Weight: 1.2 lbs. (0.54 kg)

8510826 Heavy-Duty Sleeve Cap, zinc-plated mild steel construction

3M™ DBI-SALA®

Hoist Systems

Adaptability and portability. They're both essential to successful manhole or confined space entry and retrieval. That's why we've engineered our Hoist Systems with lightweight materials like high-strength aluminum and made them adjustable and extendable to meet the specific needs of your job site. If you're not sure what you need, please call us and we'll create your customized solution to maximize ease-of-rescue—even in complex environments.



Confined Space Rescue

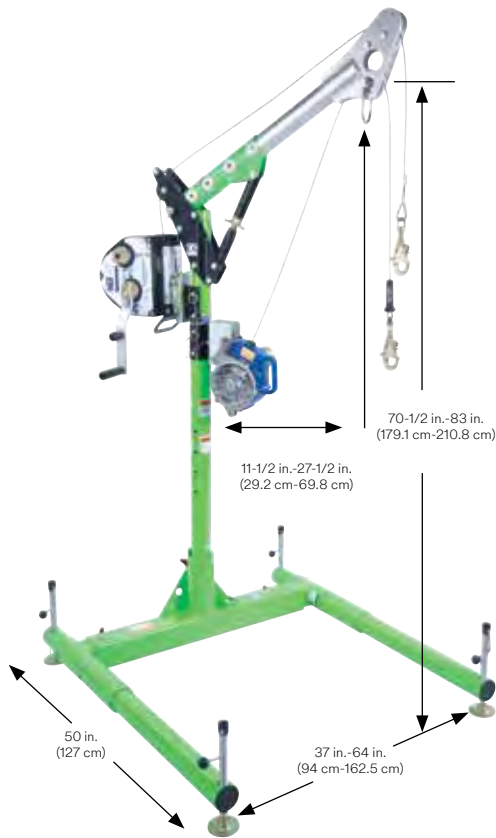

8300009

3M™ DBI-SALA® 5-Piece Hoist System

Davit arm and base system includes 11-1/2 in.-27-1/2 in. (29.2 cm-69.8 cm) Adjustable Offset Upper Mast (8518001), 33 in. (83.8 cm) Lightweight Lower Mast (8518002), and 3-Piece Lightweight Base (8518005). Includes winch mounting bracket. Order winch and Self-Retracting Lifeline separately.
Weight: 100 lbs. (45.5 kg)

Bags and Accessories

8518270

5-Piece Equipment Cart

Transport the 5-Piece System with maximum ease over smooth or rough terrain. Ideal for tight storage situations.

8518513 Set of two carrying bags for 5-Piece Hoist System (8300009)



8518040

5-Piece Hoist System

Davit arm and base system includes 23-1/2 in.-42-1/2 in. (59.7 cm-108 cm) Adjustable Offset Upper Mast (8518006), 33 in. (83.8 cm) Lightweight Lower Mast (8518002), and 3-Piece Lightweight Base (8518008). Includes winch mounting bracket. Order winch separately.
Weight: 137.5 lbs. (62.3 kg)

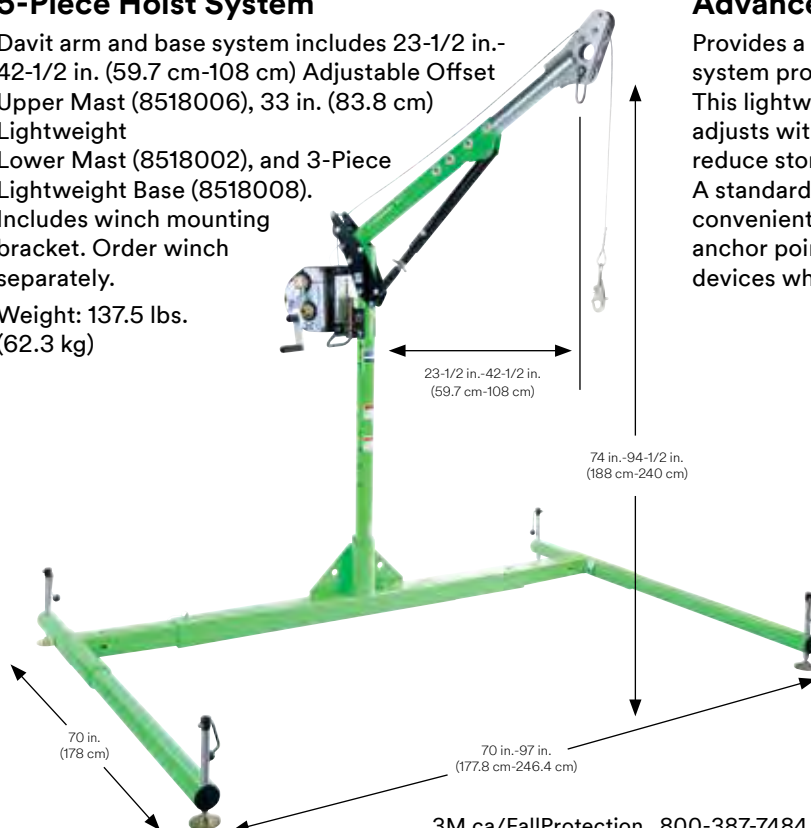

8530352

Advanced™ 4-in-1 Davit Guard System

Provides a basic hoist and a passive restraint guardrail system protecting companion workers and bystanders. This lightweight aluminum structure assembles and adjusts without tools. It features a collapsible base to reduce storage and transport space. A standard tie-off point provides a convenient 5000 lb. (22 kN) anchor point for fall arrest devices where required.



Confined Space Rescue

3M™ DBI-SALA®

Portable Bases

Portable Bases work with a variety of Davit Arm and Mast Extensions. They're ideal when you need to move and access various confined space areas. Bases are lightweight, easy to transport, set up and use.

8518005

3-Piece Portable Base

Adjustable base for 27-1/2 in. (69.8 cm) maximum offset davit mast.

8518008 3-Piece Portable Base. Adjustable base for 42-1/2 in. (108 cm) maximum offset davit mast

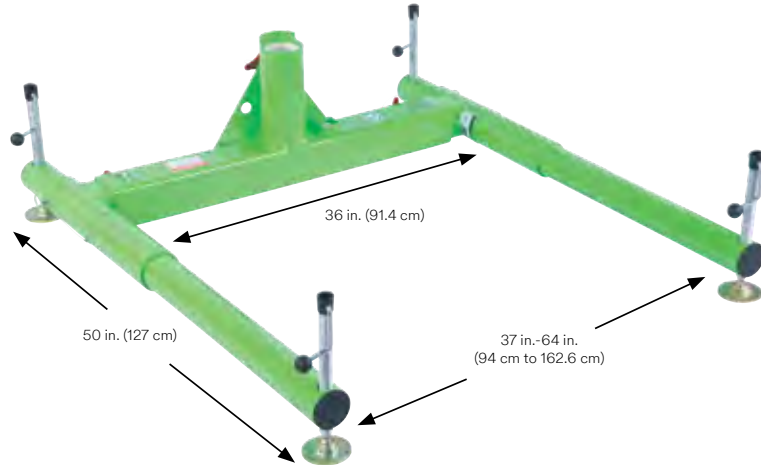

8513565

Carrying Bag

Bag with protective plastic liner for 3-Piece Davit Base (8518005).



8510323

Barrel Mount Sleeve with 3.5 in. (89 mm) Opening



Mild steel construction. Eight independent clamping screws allow temporary installations over edges of shoring cans, walls and other structures. Comes with PVC inner liner. Custom fit openings available.

8510429 Barrel Mount Sleeve with 3 in. (76.2 mm) opening, stainless steel

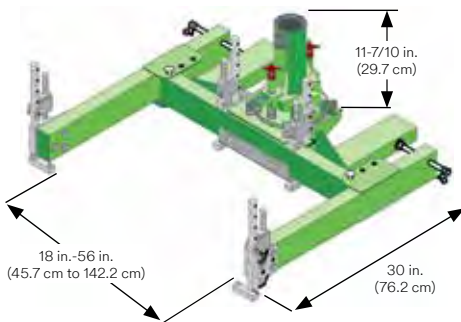

8519377

External Tank Cover

Comes with Adjustable Sleeve Assembly (8511232). Used on manways with a flange structure that the unit may be secured onto. This collar can clamp onto 6 in. (15.2 cm) max thick flange.

Weight: 82 lbs. (37.2 kg)

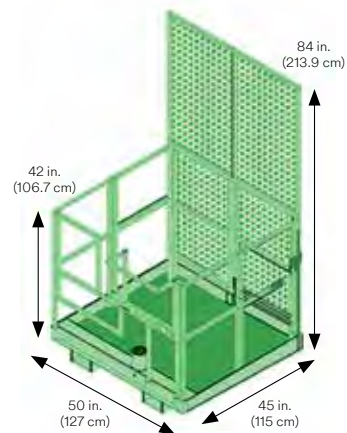

8510568

Forklift Basket

Designed to convert your forklift into a versatile confined space and fall arrest work platform. Add a davit mast and winch/Self-Retracting Lifeline to the basket and you're ready to go. Lightweight aluminum construction and tool-free assembly simplifies setup, transport and storage. Durable powder coated finish with anti-slip finish on walking surfaces. Includes spring-loaded gate.

Weight: 215 lbs. (98 kg)

8512285

Adjustable Barrel Mount Sleeve

Designed for shoring, wall and parapet applications. Standard unit accommodates wall thicknesses up to a maximum of 24 in. (60.9 cm), with shorter or longer adjustment tubes available on request. Anodized, welded aluminum with zinc-plated steel hardware with inner sleeve.

8510715 Adjustable Barrel Mount Sleeve for 0 in.-12 in. opening.

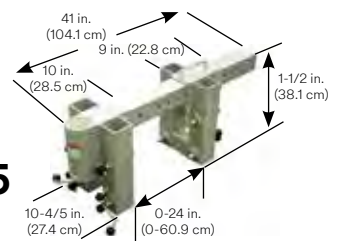

8510501

3M™ DBI-SALA® Manhole Collars

17-1/2 in. (44.5 cm) Manhole Collar, fits 18 in.-20 in. (45.7 cm-50.8 cm) diameter. Provides a Portable Davit Base by simply fitting within manhole opening. Powder coated aluminum construction with PVC sleeve liner.

8510520 19-1/2 in. (49.5 cm) Manhole Collar fits 20 in.-22 in. (50.8 cm-55.8 cm) diameter

8510457 21-1/2 in. (54.6 cm) Manhole Collar fits 22 in.-24 in. (55.8 cm-60.9 cm) diameter

8510163 23-1/2 in. (59.7 cm) Manhole Collar fits 24 in.-26 in. (60.9 cm-66 cm) diameter

8510633 25-1/2 in. (64.7 cm) Manhole Collar fits 26 in.-28 in. (66 cm-71.1 cm) diameter

8510632 27-1/2 in. (69.8 cm) Manhole Collar fits 28 in.-30 in. (71.1 cm-76.2 cm) diameter

8510546 29-1/2 in. (74.9 cm) Manhole Collar fits 30 in.-32 in. (76.2 cm-81.2 cm) diameter

8512994 33-1/2 in. (83.1 cm) Manhole Collar fits 34 in.-36 in. (86.3 cm-91.4 cm) diameter



8514461

Vehicle Hitch Mount Sleeve

Designed to install into a 2 in. (5.1 cm) hitch receiver on an attendant vehicle to provide a portable anchor point for confined space entry, rescue and fall arrest systems. Assembly for a maximum 42-1/2 in. (108 cm) Offset Davit Mast.

8510140 Assembly for a maximum 27-1/2 in. (69.8 cm) Offset Davit Mast

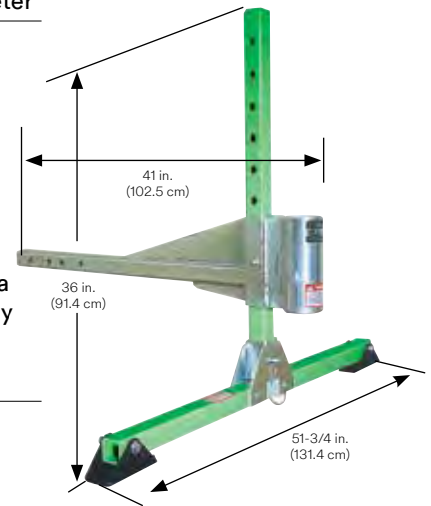

3M™ DBI-SALA®

Tripods

Our Tripods are constructed of lightweight tubular aluminum with a rugged steel head assembly. The UCT Series Tripods can be combined with up to three pulleys to accommodate a variety of winches and fall arrest devices, meeting a wide range of confined space entry/retrieval and rescue requirements. Quick-release pins positively locate components at all adjustment points for tool-free setup and adjustment.

1 Mechanical devices

Can support up to three winches or Self-Retracting Lines (SRLs) for complete flexibility.

2 Quick-connect bracket

Allows fast and easy attachment of mechanical devices.

3 Safety chain

Provides added support and strength for demanding confined space applications.

4 Top mounted pulley system

Mount up to three pulleys to route mechanical device lifelines for smooth operation.

5 Secondary anchor point

5,000 lb. (22 kN) anchor point for secondary fall arrest system.

6 Aluminum construction

Extremely lightweight yet durable construction for ease-of-use and longevity.

7 Telescoping legs

Provide fast adjustment and cannot disengage, for added worker satisfaction.

8 Adjustable height legs

Fast and easy detent pin-style adjustment allows for precise height setting.

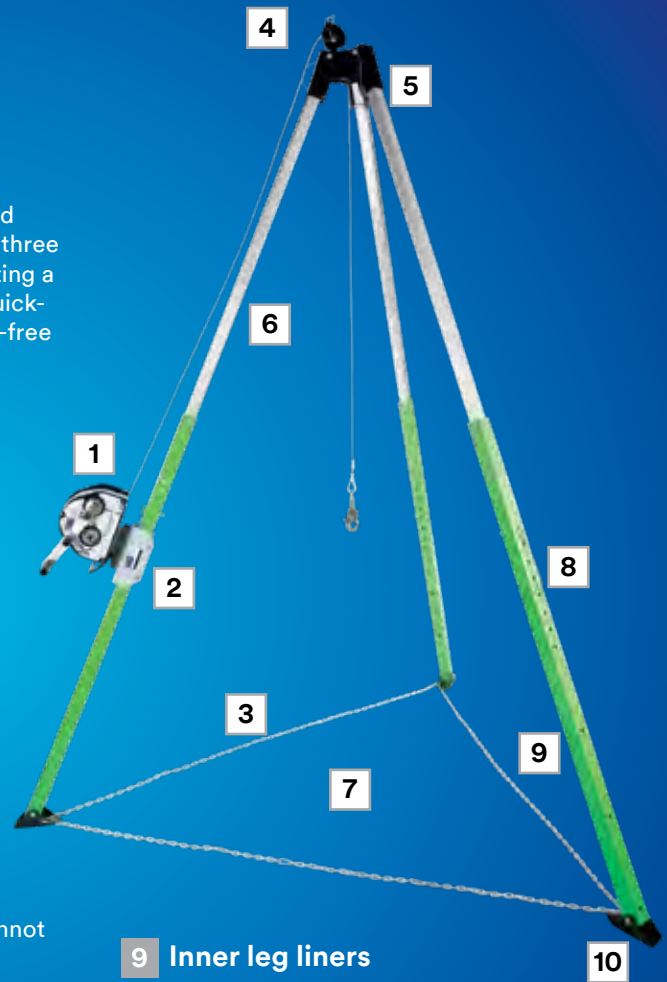

9 Inner leg liners

Allow for smooth positive connection and operation of leg adjustment.

10 Foot pads

Include sharp points for biting into soft ground and/or uneven terrain.

3M™ DBI-SALA® Advanced™ Tripod

Part #	Tripod	Height	Capacity	Lifeline Type	Lifeline Length	Lifeline
8000014	Aluminum Tripod	7 ft. (2.1 m)	350 lbs. (159 kg)			
8000015	Aluminum Tripod	9 ft. (2.7 m)	350 lbs. (159 kg)			
8300030	Aluminum Tripod with Salalift™ II Winch	7 ft. (2.1 m)	350 lbs. (159 kg)	Galvanized Cable	60 ft. (18 m)	1/4" (6.4mm) dia. 7×19 Galvanized Aircraft Wire Rope
8301055	Tripod, Salalift™ II Winch and Sealed-Blok™ 3-Way SRL	7 ft. (2.1 m)	Winch/Tripod = 350 lbs. (159 kg), SRL = 75-310 lbs. (34-141 kg)	Galvanized Cable	Winch = 60 ft. (18 m) SRL = 50 ft. (15.2 m)	Winch = 1/4" (6.4mm) dia. 7×19 Galvanized Aircraft Wire Rope, SRL = 3/16" (5mm) dia. 7×19 Galvanized Aircraft Wire Rope
8301050	Aluminum Tripod with Sealed-Blok™ 3-Way SRL	7 ft. (2.1 m)	75-310 lbs. (34-141 kg)	Galvanized Cable	50 ft. (15.2 m)	3/16" (5mm) dia. 7×19 Galvanized Aircraft Wire Rope
8301056	Tripod, Salalift™ II Winch and Sealed-Blok™ 3-Way SRL	7 ft. (2.1 m)	Winch/Tripod = 350 lbs. (159 kg), SRL = 75-310 lbs. (34-141 kg)	Stainless Steel Cable	Winch = 60 ft. (18 m), SRL = 50 ft. (15.2 m)	Winch = 1/4" (6.4mm) dia. 7×19 Stainless Steel Aircraft Wire Rope, SRL = 3/16" (5mm) dia. 7×19 Stainless Steel Aircraft Wire Rope

8000014

3M™ DBI-SALA® Advanced Aluminum Tripod

- 7 ft. (2.1 m) aluminum tripod
- Telescoping adjustable locking legs
- Built-in pulley system
- Rubber safety shoes with spiked edges
- Safety leg support chain
- Integrated 5,000 lb. (22 kN) eyebolt anchor points
- Quick connect winch/SRL mount bracket
- Equipped with i-Safe™

Winch and SRL not included—order separately.



8513158

3M™ DBI-SALA® UCT-300 7 ft. (2.13 m) Tripod

- Lightweight, durable aluminum construction with powder coat finish.
- Includes quick-connect winch mount bracket— can accommodate up to three brackets.
- Includes top mounted pulley system— can accommodate up to three pulleys.
- Telescoping adjustable locking legs for easy setup.
- Fast detent pin-style adjustment and locking.
- Inner plastic liners provide smooth adjustment.
- Foot pads include sharp points for biting into soft ground or uneven terrain.
- Safety chain for added support, strength and safety.
- 5,000 lb. (22 kN) built-in head mounted anchor point.
- Capacity: 450 lbs. (204.1 kg)

8513159 UCT-1000 Tripod, 10 ft. (3 m)

Winch and SRL not included—order separately.



8512292

Winch/SRL Mounting Bracket for Tripod (8513159)



Attaches to the leg tube with quick-release pins for tool-free setup and adjustment.

Weight: 5.2 lbs. (2.4 kg)

8510224

Winch/SRL Mounting Bracket for Tripod (8513158)



Attaches to the leg tube with quick-release pins for tool-free setup and adjustment.

Weight: 3 lbs. (1.4 kg)

Also see accessories on page 169 for additional bracket options.

8512293

Top Pulley Assembly for UCT Series Tripods



Pulleys are mounted on top of the head assembly to route mechanical device's lifeline over and into confined space area.

Weight: 1.6 lbs. (0.73 kg)

Accessories

8513330

Carrying Bag for 10 ft. (3 m) Tripod with protective plastic liner (8513159).

8513329 Carrying Bag for 7 ft. (2.1 m) tripod with protective plastic liner (8513158)



3M™ DBI-SALA®

Cantilever Rescue System

From roof edges and parapets to guardrails, cliffs and bridges, complex situations require versatile rescue systems. Our Cantilever Rescue System quickly and easily converts the 10 ft. (3.05 m) Tripod (8513159) into high-angle rescue equipment. Using the rigid wheel pad supplied with the kit, the Cantilever System can be anchored with a service vehicle's weight, weight rack or with a single anchor point.

1 Aluminum construction

Extremely lightweight yet durable construction for ease-of-use and longevity.

2 Quick-mount bracket

Allows fast and easy attachment of mechanical devices.

3 Wheel pad

Provides easy means to anchor system with service vehicle's weight or weight rack kit.



4 Adjustable height legs

Fast and easy detent pin-style adjustment allows for precise height setting.

5 Telescoping legs

Provide fast adjustment and cannot disengage, for added worker satisfaction.

6 Leg support system

Provides tripod leg support to use in cantilever rescue configuration.



8530257

Cantilever Rescue System

Complete with 10 ft. (3.05 m) Tripod (8513159), Rigid Wheel Pad (8515620) and attachment hardware, Weight Rack Kit (8515631), Leg Support System (8514540) and Top Mount Pulley (8515150).

Winch not included—order separately.

8515150 Top Mount Pulley for Cantilever System

Allows system to handle two mechanical devices (winch and self-retracting lifeline).

Weight: 3.4 lbs. (1.5 kg)

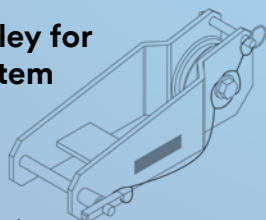

8515631 Cantilever Weight Rack Kit

Use the weight rack in conjunction with the cantilever Rescue System (8512297) if there is not sufficient space for the attendant vehicle. *Weight plates sold separately.*

Weight: 36 lbs. (16.3 kg)

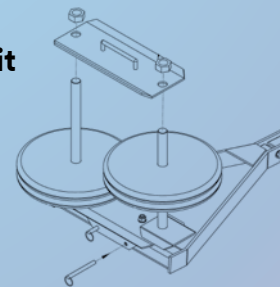

3M™ DBI-SALA®

Pole Hoist System

The Pole Hoist attaches with a carabiner on the universal bracket to a suitable anchor point, allowing you to work in any direction from any angle. It has a unique swivel head that rotates 360 degrees, providing flexibility in both vertical and horizontal confined space entries. Two systems that adjust from either 4 ft.-7 ft. (1.2 m-2.1 m) or 6 ft.-10 ft. (1.8 m-3 m) are available for job site flexibility and to better position the attendant in close working quarters. Custom lengths are also available. Please call us for details.



8530253

Extendable Pole Hoist 6 ft.-10 ft. (1.8 m-3 m)

Extension with swivel head and winch mounting bracket, T-bar leg assembly and hardware/fasteners.

Weight: 14 lbs. (6.4 kg)

8530252 Extendable Pole Hoist
4 ft.-7 ft. (1.2 m-2.1 m).
Weight: 12 lbs. (5.4 kg)



Pole Hoist Accessories

8520777

Clamp-On Anchor for Pole Hoists

Designed to secure to a vertical or horizontal flange up to 6 in. (15.2 cm) thick and provide an anchorage point to connect a pole hoist device to.



2104550

Steel Anchor Plate with D-Ring

This plate anchor offers a compact, reliable attachment to 3/8 in.-1 in. (0.9 cm-2.5 cm) thick plate steel for connecting your lanyard, vertical lifeline system or self-retracting lifeline.



8513330

Carrying Bag

For 6 ft.-10 ft. pole hoist.

8513329 Carrying Bag for 4 ft.-7 ft. (1.2 m-2.1 m)
pole hoist



Confined Space Rescue

3M™ DBI-SALA®

Portable Fall Arrest Posts

Enhance protection. Maintain mobility. Our Portable Fall Arrest Post makes it possible for up to three workers on top of transformers or other types of vertical platforms with potential fall hazards. It's compact and easy to transport and set up at only 38 lbs. (17.2 kg). The system features a telescopic design and three swiveling anchor points, delivering 360 degrees of protection and mobility. Portable and fixed bases maximize versatility on your job site.

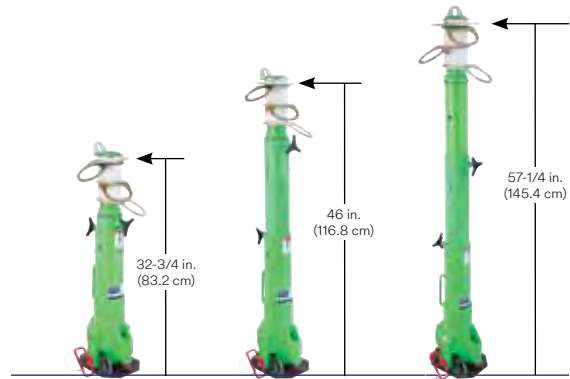

Telescopic design: Overall height can be adjusted from 32-3/4 in.-57-1/4 in. (83.2 cm-145.4 cm)

8516691 Portable Fall Arrest Post

- Three independent swiveling tie-off points.
- 360 degrees of protection for three workers.
- Telescopic design; 32-3/4 in.-46 in.-57-1/4 in. (83.2 cm-116.8 cm-145.4 cm).
- Lightweight and durable aluminum construction.
- Leveling screws plumb system on inclines up to 15 degrees.
- Built-in anchor ring for horizontal lifeline attachment.
- Portable and fixed bases provide complete job site versatility.



Weight: 38 lbs. (17.5 kg)

8516693 Rescue Davit Arm for Portable Fall Arrest Post

The optional Rescue Davit Arm assembles easily to our Portable Fall Arrest Post, providing simple and efficient rescue and material handling capabilities. It's made with lightweight aluminum materials for easy transportation and setup.

Weight: 20.5 lbs. (9.3 kg)

8516691 post not included—order separately.

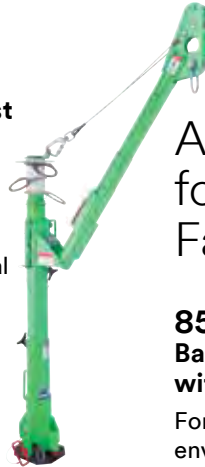

8516996 14 ft. (4.2 m) Uni-Anchor Fall Arrest Post

The 14 ft. (4.2 m) Uni-Anchor Fall Arrest Post mounts using Uni-Anchor plates and extends up to 14 ft. (4.2 m) to provide a 1-man-rated fall arrest anchor point.

Weight: 71 lbs. (32.3 kg)

Anchor Bases for Portable Fall Arrest Post

8517412 Bare Steel Uni-Anchor with Tie-Off Anchors

For use in closed environments without chemical or moisture exposure.

Weight: 11.6 lbs. (5.3 kg)



8510816 Weld-On Mounting Plate

Unplated mild steel construction.

Weight: 11.6 lbs. (5.3 kg)

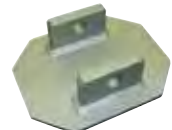

8517413 Incline Adapter with Tie-Off Anchor

Permanently weld to inclined surface.

Weight: 24 lbs. (10.9 kg)



Accessories

8516692 14 in. (356 mm) Anchor Post Extension

Provides option to tie-off one worker at an increased height of 68-1/2 in. (174 cm)

Weight: 5 lbs. (2.2 kg)



8517565 Carrying Bag

Heavy-duty carrying bag for Portable Fall Arrest Post.



8516997 Uni-Anchor I-Beam Base

Portable anchor clamps to I-beams.

Weight: 56 lbs. (25.5 kg)



3M™ DBI-SALA®

Mechanical Systems

Retrieving incapacitated workers and bringing them to safety makes the mechanical device one of the most critical parts of your rescue system. Choosing the right lifeline type and length are just a few of the options. In some situations, you may need a secondary or backup system, too.

1 Digital Winches

- Man rated 450 lb. (204 kg) capacity.
- Digital usage indicator tracks drum revolutions to determine service intervals.
- Triple redundant braking system for added safety.
- Sealed bearings at all contact points.
- Two gear ratio options of 4:1 and 9:1.
- Power drive option available.
- Three sizes accommodate 70 ft.-300 ft. (21 m-91 m) lengths.
- Cable and rope lifelines with swiveling snap hook and overload indicator.
- Carrying handle for easy transport.
- Corrosion-resistant, zinc-plated steel or anodized aluminum hardware.

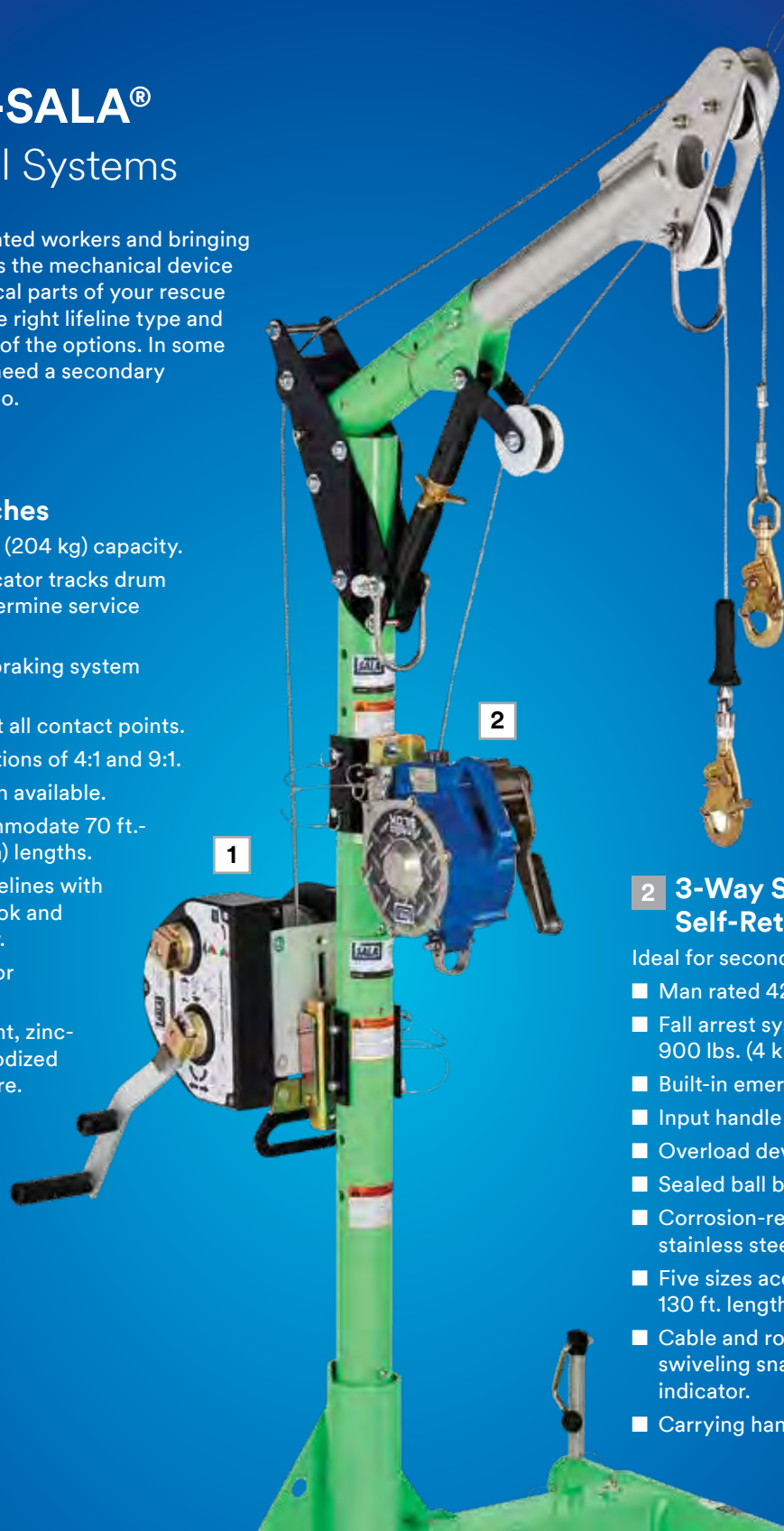

2 3-Way Sealed-Blok Self-Retracting Lifeline

- Ideal for secondary or back-up.
- Man rated 420 lb. (190 kg) capacity.
 - Fall arrest system limits forces to 900 lbs. (4 kN).
 - Built-in emergency retrieval winch.
 - Input handle with primary brake.
 - Overload device in winch drive.
 - Sealed ball bearings.
 - Corrosion-resistant aluminum and stainless steel construction.
 - Five sizes accommodate 30 ft.-130 ft. lengths (9 m-40 m).
 - Cable and rope lifelines with swiveling snap hook and impact indicator.
 - Carrying handle for easy transport.



Salalift II Winches

- Man rated 350 lb. (159 kg) capacity.
- Overload clutch.
- Gear ratio of 6:1.
- Free-wheel mode.
- Shielded ball bearings.
- Lengths from 60 ft.-120 ft. (18 m-36.5 m) available.
- Cable and rope lifelines with swiveling snap hook and impact indicator.
- Carrying handle for easy transport.
- Corrosion-resistant construction.
- Quick-mount bracket and carrying bag.

3M™ DBI-SALA® Winches



Digital Winch

Salalift™ II Winch

Drive type	Lifeline type	Mounting bracket	Winch bag	Digital winch	Salalift II Winch	50 ft. (15.2 m)	60 ft. (18 m)	90 ft. (27 m)	120 ft. (36.5 m)	140 ft. (42 m)	190 ft. (58 m)	240 ft. (73 m)	290 ft. (88 m)
Power drive*	Galvanized steel	■		■			8518567	8518568		8518588	8518589	8518610	8518611
	Stainless steel	■		■			8518565	8518566		8518586	8518587	8518608	8518609
	Technora rope	■		■			8518571						
Removable handle	Galvanized steel	■		■			8518560	8518561		8518581	8518582	8518603	8518604
		■	■		■		8102060	8102009	8102005				
	Stainless steel	■		■			8518558	8518559		8518579	8518580	8518601	8518602
		■	■		■		8102022	8102011	8102007				
	Technora rope	■		■			8518564						
		■	■		■		8102050						
Cable model weight						-	30-1/2 lbs. (13.8 kg)	32-1/2 lbs. (14.7 kg)	38-1/2 lbs. (17.5 kg)	40 lbs. (18.4 kg)	43 lbs. (19.5 kg)	50 lbs. (22.6 kg)	53-1/2 lbs. (19.5 kg)
Technora rope model weight						27 lbs. (12.2 kg)	27 lbs. (12.2 kg)						

The Salalift™ II Winch includes a mounting bracket and carrying bag.

*Power drive units require Overload Protection Clutch (8512936)—not included.

3-Way Self-Retracting Lifelines



3-Way Sealed-Blok SRL - RSQ

3-Way Ultra-Lok SRL

3-Way Sealed-Blok SRL

Cable type	Sealed-Blok	Sealed-Blok without bracket	Sealed-Blok/RSQ	Ultra-Lok	30 ft. (9.1 m)	50 ft. (15.2 m)	85 ft. (25.9 m)	130 ft. (39.6 m)	175 ft. (52.5 m)
Galvanized steel	■				3400853C	3400923C	3400876	3400981	
		■			3400850C	3400920C	3400875	3400980	3400663
			■			3400940C	3400913	3401005	
				■		3501104			
Stainless steel	■				3400858C	3400926C	3400883	3400988	
		■			3400852C	3400922C	3400879	3400984	3400661
			■			3400942C	3400915	3401007	
				■		3501105			

3M™ DBI-SALA®

Winch Brackets and Accessories

8518506 Adjustable Ladder Bracket

Designed to allow use of the ladder section(s) 8518507 with various base, sleeve and mast options. Installs over mast/extension.



8517567 Padded Carrying Bag

For digital winch.



8518507 8 ft. Ladder Section

Complete with connector channels and positive pin locks. Can be connected to additional ladders (up to five sections) for a maximum length of 32 ft. (9.75 m).

8518508 4 ft. (1.2 m)
Ladder Section



8512936 Overload Protection Clutch

Features a maximum working load of 450 lbs. (204.1 kg)



8510207 Winch/SRL Adapter with Flat Back

To attach 3M DBI-SALA Winch/SRL to structures.



1001210 Retrieval Wristlets

Rescue/retrieval design is ideal for connection to victim's wrists for narrow extractions. Yoke wristlets attached to Y-lanyard with D-ring at end x 2 ft. (0.6 m)

1001220 Attached with an O-ring at one end x 18 in. (0.46 m)



8516824 Quick-Release Mounting Bracket

For Upper and Lower Masts.



1231460 Y-Lanyard

Rescue/retrieval design ideal for use with harness incorporating shoulder D-rings. Spreader bar with snap hooks at ends, D-ring at center x 2 ft. (0.6 m)

1231470 Y-Lanyard without spreader bar x 2 ft. (0.6 m)





Rescue and Descent

Rescue and Descent





Choosing rescue and descent systems.

The type of job site, anchor location, working load and limit, and ease of use are all important factors in choosing the proper rescue and descent system.

A single rescue and descent system cannot efficiently handle every scenario – a rescue and descent system that performs well for one application might not be right for a different application. This is why we offer rescue and descent systems for multiple applications and multiple skill levels.

3M™ DBI-SALA® Rollgliss™ R550 Rescue and Descent Device

Keep rescues simple with the Rollgliss™ R550 Rescue Unit. It's among the lightest, most compact, and easy-to-use designs in its class. It offers the choice of rescue, evacuation, or the versatility of assisted rescue with lifting capabilities. When every second counts, count on the R550.



Super tough nylon makes the R550 rescue wheel lightweight and durable. Its ergonomic design gives the user a better grip and more control.

1 Drill adapter

Provides a mechanical option to raise a victim. Compatible with most cordless hand drills.

2 Cast aluminum housing

Lightweight and extremely durable cast housing.

3 Bi-directional hub

Rope descends from either side which brings one hook up as the other goes down, allowing for immediate use after each descent.

4 Anchorage

Used to anchor the device with either a carabiner or sling.

5 Integrated rope ears

Allows for greater descent speed control in assisted rescues.

6 Dual brakes

Automatic descent with added security, safety and peace of mind.

7 Durable rope

3/8 in. (9.5 mm) static kernmantle Rope. NFPA - L rated for durability.

8 Lifeline hook

Patented self-locking snap hook is industry preferred and compatible with our Remote Anchoring System for remote rescue capabilities.

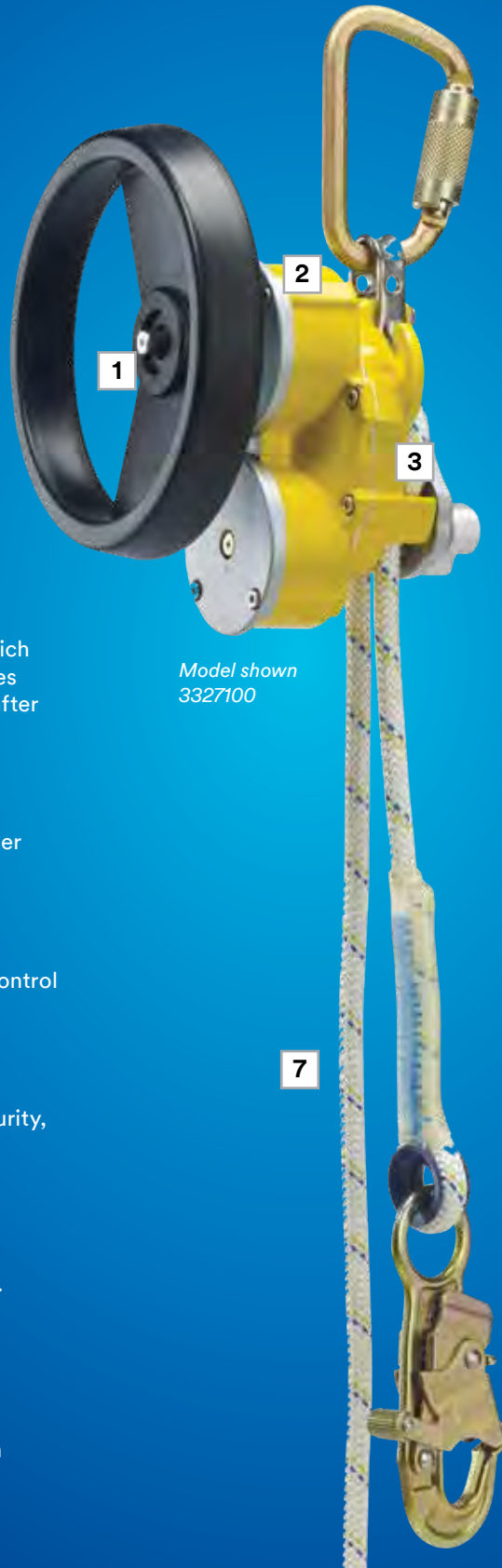

Model shown
3327100

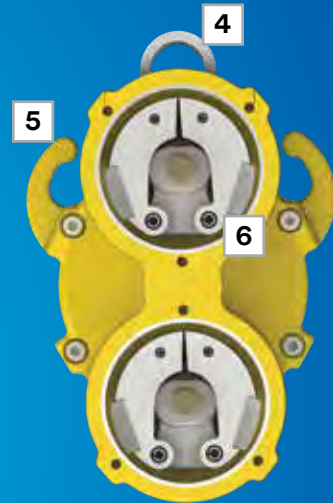

Extremely compact

The R550 is the lightest, most compact unit in its class.

Multiple length options

Lengths between 50 ft. (15 m) and 500 ft. (152 m). Rope bag included with each model.

Two-person capacity

Can be used from heights up to 1,640 ft. (500 m) for one user at 310 lbs. (141 kg) or 575 ft. (175 m) for two users totaling 620 lbs. (282 kg).

Optional Ladder Bracket

Sold separately (3320014).

3M™ DBI-SALA® Rollgliss™ R550 Rescue Units

Includes carabiner (two), 4 ft. (1.2 m) anchor sling and rope bag.

Part #	Length	Weight
3327050	50 ft. (16 m)	11.9 lbs. (5.4 kg)
3327100	100 ft. (31 m)	13.8 lbs. (6.2 kg)
3327150	150 ft. (46 m)	15.7 lbs. (7.1 kg)
3327200	200 ft. (61 m)	17.6 lbs. (8 kg)
3327275	275 ft. (84 m)	20.5 lbs. (9.3 kg)
3327300	300 ft. (92 m)	21.4 lbs. (9.7 kg)
3327325	325 ft. (100 m)	22.4 lbs. (10.1 kg)
3327350	350 ft. (107 m)	23.8 lbs. (10.8 kg)
3327400	400 ft. (122 m)	25.7 lbs. (11.6 kg)
3327450	450 ft. (137 m)	27.6 lbs. (12.5 kg)
3327500	500 ft. (153 m)	29.5 lbs. (13.4 kg)



Rollgliss™ R550 Escape Units

Includes carabiner (two), 4 ft. (1.2 m) anchor sling and rope bag.

Part #	Length	Weight
3325100	100 ft. (31 m)	12.7 lbs. (5.7 kg)
3325200	200 ft. (61 m)	16.5 lbs. (7.5 kg)
3325275	275 ft. (84 m)	19.4 lbs. (8.8 kg)
3325300	300 ft. (92 m)	20.3 lbs. (9.2 kg)

Rollgliss™ R550 Rescue Units with Case

Includes edge protector, 4 ft. (1.2 m) anchor sling (two), 2.5 ft. (0.7 m) anchor sling, pulley, rope grab, carabiner (three), rope bag, and humidity case.

Part #	Length	Weight
3326100	100 ft. (31 m)	35.3 lbs. (16 kg)
3326300	300 ft. (92 m)	42.9 lbs. (19.4 kg)
3326350	350 ft. (107 m)	44.8 lbs. (20.3 kg)



9508289

Fully sealed case provides 10 year minimum storage life. External humidity indicator allows user to inspect the seal without opening case.

Accessories

9506162

Rope Bag



3320003

Edge Protector with Carabiner



9504733

Pulley



AC202D/O

Rope Grab



3320014

Ladder Bracket



9508289

Humidity Case



2000112

Carabiner
11/16 in.
(1.7 cm) gate



2000114

Carabiner
2-3/16 in.
(5.5 cm) gate



8900298

Rescue Pole
4 ft. to 16 ft.
(1.2 to 4.9 m) aluminum extension pole, over-sized aluminum connection hook with 2-1/4 in. gate opening (57.1 mm) and carrying bag.



Rescue and Descent

Model shown
3400930C



Model shown
3504550C

3M™ DBI-SALA® RSQ

Dual-Mode Descent

Our exclusive RSQ Dual-Mode Descent is a built-in rescue operation feature allowing you to work and rescue with the same equipment. That means a lower cost of ownership without compromising on safety. It includes:

- Standard fall arrest mode
- Automatic descent mode
- Remote/assisted descent activation options
- As featured on Sealed-Blok RSQ and Ultra-Lok™ RSQ Self-Retracting Lifelines

Sealed-Blok RSQ Self-Retracting Lifelines

3400932C

Sealed-Blok RSQ SRL

50 ft. (15 m) of 3/16 in. (5 mm) stainless steel wire rope with swivel snap hook, RSQ dual-mode, anchorage carabiner, 4 ft. (1.2 m) cable tie-off adapter.

3400889

Sealed-Blok RSQ SRL

85 ft. (25.5 m) of 3/16 in. (5 mm) stainless steel wire rope with swivel snap hook, RSQ dual-mode, anchorage carabiner, 4 ft. (1.2 m) cable tie-off adapter.

3400994

Sealed-Blok RSQ SRL

130 ft. (39 m) of 3/16 in. (5 mm) stainless steel wire rope with swivel snap hook, RSQ dual-mode, anchorage carabiner, 4 ft. (1.2 m) cable tie-off adapter.

Ultra-Lok RSQ Self-Retracting Lifelines

3504550C

Ultra-Lok RSQ SRL

50 ft. (15.2 m) of 3/16 in. (5 mm) galvanized steel wire rope with swivel snap hook and RSQ dual-mode.

3504552C

Ultra-Lok RSQ SRL

50 ft. (15.2 m) of 3/16 in. (5 mm) stainless steel wire rope with swivel snap hook and RSQ dual-mode.

Fall Arrest Mode



Assisted rescue by pole



Assisted rescue by hand



These assisted rescue options “engage” the descent mode. Traditional assisted rescue operations may also be conducted.

Automatic Descent Mode



Self-rescue/descent



Rescue and Descent

Rescue and Descent

3M™ DBI-SALA® Sealed-Blok RSQ SRL

Assisted Rescue Accessories

3500201C

Remote Anchoring System Pole

6-12 ft. (1.8-3.6 m) with Assisted Rescue Tool.

3500202C

Remote Anchoring System Pole

8-16 ft. (2.4-4.8 m) with Assisted Rescue Tool.

3500200C

Assisted Rescue Tool only

(If you already have a System Pole.)



Ultra-Lok RSQ SRL

Assisted Rescue Accessories

3500101

Remote Anchoring System Pole

6-12 ft. (1.8-3.6 m) with Assisted Rescue Tool.

3500102

Remote Anchoring System Pole

8-16 ft. (2.4-4.8 m) with Assisted Rescue Tool.

3500100

Assisted Rescue Tool only

(If you already have a System Pole.)

3M™ DBI-SALA® Rollgliss™

R350 Rescue and Positioning Device

The Rollgliss™ R350 System provides efficient hauling, but more importantly, very controlled lowering (a finger and thumb are all that is required to hold a load).

8902004 Rollgliss™ R350 Rescue System, 50 ft. travel/200 ft. of 3/8 in. rope (15.25 m/61 m), 3:1 ratio with pulleys, rope control device, anchor strap, carabiner and carrying bag

8902006 Rollgliss™ R350 Rescue System, 100 ft. travel/400 ft. of 3/8 in. rope (30.5 m/122 m), 3:1 ratio with pulleys, rope control device, anchor strap, carabiner and carrying bag

Other lengths available in 10 ft. (3 m) increments. Accessories including 2:1, 4:1 and 5:1 pulleys are also available.



3M™ DBI-SALA® Rollgliss™

3303000

Rollgliss™ Descender

Help personnel make a quick, safe escape with the Rollgliss™ Descent Device. Either vertical or sloped descent models are available to provide complete versatility and flexibility for any job site or work environment.

- Simple design for easy installation and use.
- No power source or special skills or tools required.
- Simply connect to harness and step off structure for evacuation.
- Use repeatedly without factory servicing after user inspection.
- Corrosion-resistant construction for maximum durability.
- Wire rope lifeline for added durability in extreme environments.
- Automatic retraction.



Rescue and Descent

3M™ DBI-SALA® Rollgliss™

Rollgliss™ Rescue Positioning Device

Service buildings, bridges and dams with the simple safety of the Rollgliss™ Rescue Positioning Device. Featuring a speed-sensing lock that allows you to manually lock off the device once you reach a work level, it serves both as a rescue system and has features for raising, lowering and positioning during normal work activities. Either the user or a second standby worker can operate it for enhanced versatility.

- Pre-rigged for quick and easy installation and use.
- No special tools, power source or extensive skills needed.
- Built-in brake stops a fall should user lose control.
- Lock-out mechanism allows user to stop/start anywhere.
- 3:1 or 4:1 lifting ratio configurations available.
- Durable, corrosion-resistant construction.

3602050 Rollgliss™ Rescue Positioning Device, 50 ft. travel/260 ft. of 3/8 in. rope (15.25 m/79.3 m), 4:1 ratio with pulleys, rope anchor straps, two carabiners and carrying bag

3602100 Rollgliss™ Rescue Positioning Device, 100 ft. travel/510 ft. of 3/8 in. rope (30.5 m/155.5 m), 4:1 ratio with pulleys, rope anchor straps, two carabiners and carrying bag

3302002 Rescue Sling



Descent type	Lifeline material	Speed	115 ft. (35 m)	200 ft. (61 m)
Vertical	Galv	Low	3303000	
	SS	Low	3303002	
Sloped	Galv	Low		3303021

Sloped low speed models also include linkage, guide cable sleeve and suspension bars. Sloped high speed models include linkage, braking trolley and suspension bars.

3M™ DBI-SALA® Rollgliss™

R250 Rescue Kit

8900292

The system is simple, yet completely safe and efficient. It enables the rescuer to remove a person from danger without putting themselves at risk by descending to them.

- 33 ft. (10 m) travel length.
- Kit is easily transported in backpack-style bags.
- Takes only a few minutes to set up and perform a rescue.
- Rescue is performed safely from above victim.
- Kit includes all necessary components for safe rescue.

8900293 Rollgliss™ Rescue Kit with 66 ft. (10 m) travel length

8900294 Rollgliss™ Rescue Kit with 99 ft. (30 m) travel length



3601490

Sealed Tension Limiter

Unique device attaches to man-riding system in-line between the person and the raising/lowering line to warn operator and limit forces on an entangled worker.

- Limits loading on person to 400 lbs. (182 kg) to prevent severe injury when entangled.
- High visibility line is easy to see should deployment occur.
- Portable and lightweight for easy transport and quick setup.

Always use a separate back-up fall protection device with this system.



8516294

Rollgliss™ Rescue Ladder

The Rollgliss™ Rescue Ladder provides a way to assist rescue after a fall has occurred. It can be anchored to a structure and dropped down to the victim's level, so they can climb either up or down to safety. The ladder can be used by any able-bodied victim not incapacitated by the fall.

- Available in 8 ft. (2.4 m) sections.
- Extra sections can be added together for longer length.
- Includes three carabiners for attachment.



8516316

Rollgliss™ Rescue Ladder Anchor

Accessory plate for mounting rescue ladder to a davit arm or single anchorage point.



Rescue and Descent

3M™ DBI-SALA® Rollgliss™

Technical Rescue Line

Find everything you need for rigging—from single descent systems to flying foxes—in our Rollgliss™ Technical Rescue line. It complements our already-established line of industrial rescue systems, including pre-rigged rescue kits like the Rollgliss™ R350 and others.

Descenders

8700388

Double Stop Descender Range

Anodized gold/blue aluminum, suits 12.5-13.0 mm rope

8700387 Anodized gold aluminum, suits 10.5-12mm rope



Rigging plates

2189983

Rigging Plate Range

Large rectangular, anodized gold, 14 rigging points.



2103189

Fisk Descender

- Gentle flow for 19 in. (48.3 cm) of lifeline to pass through the descender.
- Large radius for smoother descent and less wear to lifeline.
- Reduction in rope hockling and torsional twist.
- Durable 304 stainless steel construction.



3M™ DBI-SALA® Rollgliss™

Accessories

1234081

Adjustable Rope Positioning Lanyard

Steel carabiner on one end and rope adjuster with steel carabiner at the other end x 8 ft. (2.4 m).

1234080 Aluminum carabiner on one end and rope adjuster with aluminum carabiner at the other end x 8 ft. (2.4 m)



3M™ DBI-SALA®

Carabiners and Quick Links

Carabiners



2000117



2000114



2000025

Quick Links



9509238



	Part #	Description	Material	Gate opening	Locking mechanism	Minimum breaking strength
ANSI	2000117	Medium offset D fall arrest carabiner, captive eye, ANSI rated	Steel	3/4 in. (19 mm)	Autolock, double action	5,000 lbs. (22 kN)
	2000114	Extra large parabiner fall arrest carabiner, captive eye, ANSI rated	Steel	2.13 in. (54 mm)	Autolock, double action	7,875 lbs. (35 kN)
	2000025	Medium parabiner fall arrest carabiner, ANSI rated	Alum	3/4 in. (19 mm)	Autolock, triple action	5,000 lbs. (22 kN)
Quick links	9509238	Delta style quick link	Steel	1/4 in. (7 mm)	Manual closing screw	10,125 lbs. (45 kN)

3M™ DBI-SALA®

Ascenders

8700522

Retrofit Chest Ascender

Anodized gold aluminum, retrofit with rope size of 7/16 in.-1/2 in. (10.5 mm-13 mm)



8900249

Rollgliss™ 13 mm Rope Control Device



Netting and Guardrails

Netting and Guardrails

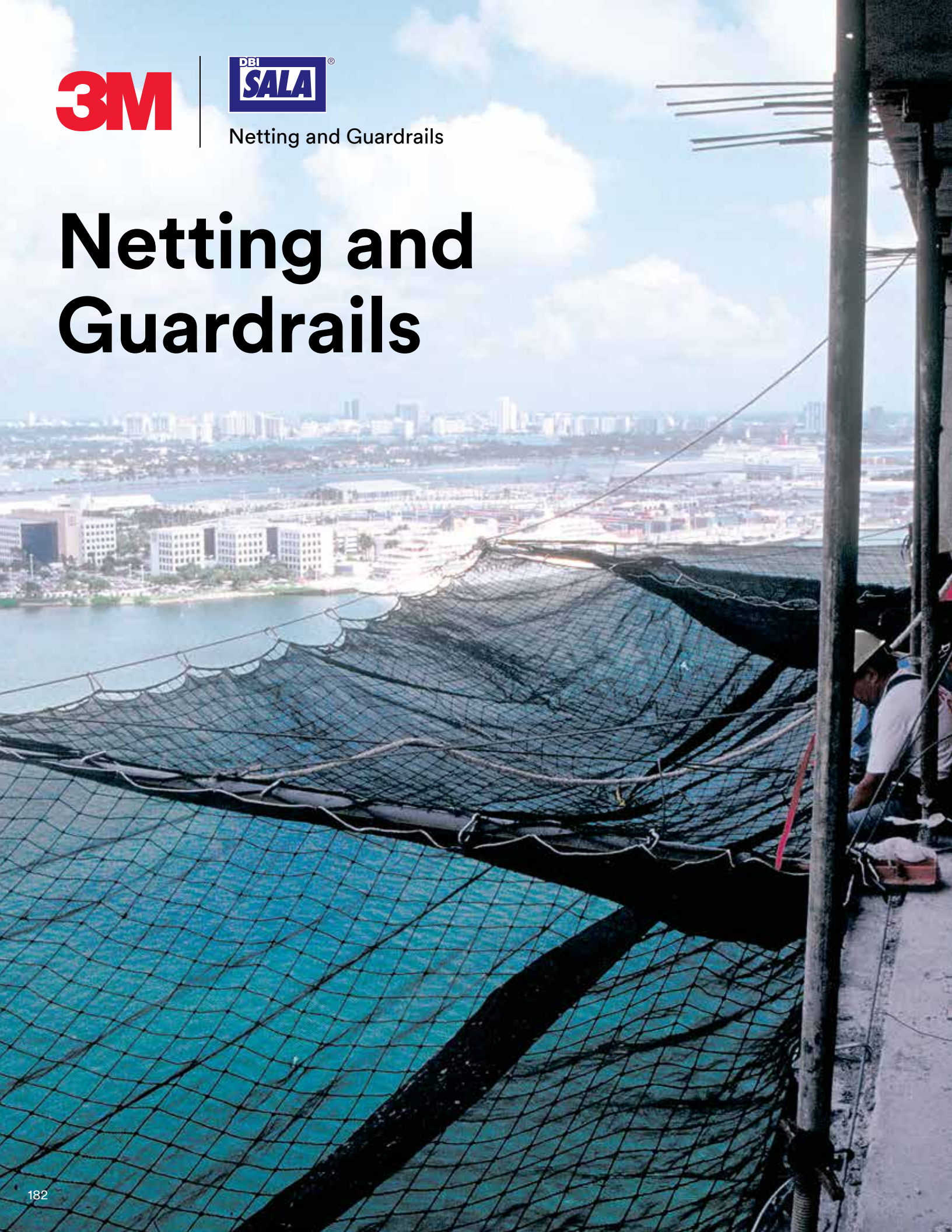



The confidence of knowing there's a 3M™ DBI-SALA® Netting or Guardrail System to protect you – even if it's never used.

Our nets and guardrails provide passive fall protection, meaning they help keep workers safe without any active involvement needed.

Our portable and permanent guardrail systems are extremely simple to set up and offer numerous configurations for accommodating your needs. We also manufacture many types of netting for various applications that can be customized to meet specific jobsite requirements.

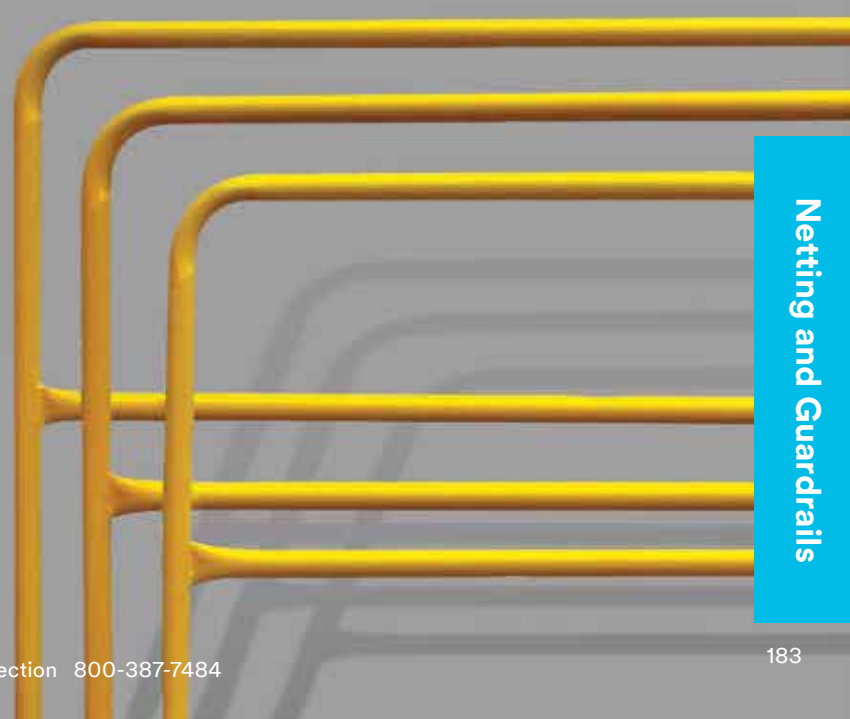

Netting and Guardrails

Choosing a netting system

Look for quality in these features when selecting netting.

Quality material

3M™ DBI-SALA® Netting is rot-proof, mildew-proof and has UV protection for longer lasting service. While typical netting materials are polypropylene and nylon, we only use nylon. Flame-retardant protection can be applied at the factory for added safety and long wear.

Adjustability

Our patented Adjust-A-Net System is the only personnel net on the market that can be adjusted to fit the work area.

Mesh sizes and liners

Meshes are available in many sizes and strengths, depending on the job. Some nets come with liners, so they catch both personnel and debris. The most common debris net mesh size is 1/8 in. (3 mm). A typical personnel net mesh size is 3-1/2 in. (87.5 mm). The diamond-shaped design dissipates strain throughout the net.

Anchoring points and ease of installation

Our netting systems are available with the related cable and hardware for installation to steel or concrete. They're lightweight and easy to handle for fast, safe installation and shifting from floor to floor.

Snap hooks

Featuring a staggered system of lashed-in snap hooks, our netting systems allow for quick and easy connections.

Additional size configurations, hardware kits and accessories are available. For more information, contact customer service at 3mfallprotection@mmm.com.



Personnel/Debris Nets

3M™ DBI-SALA® Border Guard™ System

Conveniently and economically enhance confidence and productivity at your building site. This exclusive system is the first lightweight debris/personnel system made for rigging nets around the perimeter of new concrete buildings. It allows single floor attachment for closer protection at the pour level. Unlike alternative systems, it comes in convenient units and installs with sturdy hardware that's half the weight of the old style net systems.

- Meets ANSI and OSHA standards for debris containment and for falls by personnel of 10 ft. (3 m) or less.
- Easily installed, from one level without a crane or special equipment.
- Non-destructive floor clamps easily attach to concrete slabs.
- Nets extend 10 ft. (3 m) out from floor edge.

Border Guard Starter Kit

1 ea. net, 4 in. (10 cm) black mesh with 1/8 in. (3.2 mm) debris liner and snap hooks, 2 ea. floor clamps, 2 ea. 10 ft. (3 m) arms, 2 ea. 1/2 in. (12.7 mm) shackles, 8 ea. bolts, 6 ea. cable assemblies, 2 ea. straps with cam buckles.

10 ft. x 10 ft. (3 m x 3 m)	10 ft. x 15 ft. (3 m x 4.6 m)	10 ft. x 25 ft. (3 m x 7.6 m)	15 ft. x 30 ft. (3 m x 9 m)
4100089	4100091	4100006	4100151

Also available are starter kits with column bases. 2 arms, 2 concrete/I-beam column clamps, net and hardware.

4100047 Starter Kit, 10 ft. x 25 ft. (3 m x 7.6 m),
column base

4100155 Starter Kit, 10 ft. x 30 ft. (3 m x 9 m),
column base

4100005

Border Guard Corner Kit

1 ea. 12 ft. x 12 ft. x 17 ft. (3.6 m x 3.6 m x 5.2 m) net, 4 in. (10 cm) black mesh with 1/8 in. (3.2 mm), debris liner and snap hooks, 1 ea. cable assembly.

4100157 Hardware Pack

Border Guard Add-On Kit

1 ea. net, 4 in. (10 cm) black mesh with 1/8 in. (3.2 mm) debris liner and snap hooks, 2 ea. floor clamps, 1 ea. 10 ft. (3 m) arm, 1 ea. 1/2 in. (12.7 mm) shackle, 4 ea. bolts, 3 ea. cable assemblies, 1 ea. strap with cam buckle.

10 ft. x 10 ft. (3 m x 3 m)	10 ft. x 15 ft. (3 m x 4.5 m)	10 ft. x 25 ft. (4.5 m x 9 m)	10 ft. x 30 ft. (6 m x 12 m)
4100092	4100093	4100007	4100153

Also available are Add-On Kits with column bases. 1 arm, 1 concrete/I-beam column clamp, net and hardware.

4100141 Add-On Kit, 10 ft. x 10 ft. (3 m x 3 m),
column base

4100140 Add-On Kit, 10 ft. x 15 ft. (3 m x 4.6 m),
column base

4100139 Add-On Kit, 10 ft. x 25 ft. (3 m x 7.6 m),
column base

4100156 Add-On Kit, 10 ft. x 30 ft. (3 m x 9 m),
column base



Border Guard Stanchion

Netting and Guardrails

Personnel Nets

Personnel nets are designed to catch workers in unprotected areas such as bridges, buildings, towers, dams, silos, atriums, shafts, stairwells and skylights.

3M™ DBI-SALA® Adjust-A-Net with optional debris liner

Four basic Adjust-A-Net models fit any size or shaped work spaces. You can shrink one down for compact areas, reduce one side or the other for long, narrow applications, or snap two together for the largest areas. Adjust-A-Net personnel nets must be erected so that workers can never fall more than 25 ft. (7.5 m).

- Adjustable straps allow 50% reduction of its original size.
- 3-1/2 in. (8.7 cm) mesh size provides better protection.
- Special coating protects from UV light, resists abrasion and bonds all convergent points.
- Built-in test cords allow evaluation of integrity.
- Rugged steel snap hooks placed every 48 in. (1.2 m)
- Available attached debris liner with 1/8 in. (3.2 mm) mesh.
- Long-wearing, high-tenacity nylon is tested to 17,500 lbs. (70 kN)

Size	10 ft. x 5 ft. (3 m x 1.5 m)	10 ft. x 10 ft. (3 m x 3 m)	10 ft. x 15 ft. (3 m x 4.5 m)	15 ft. x 30 ft. (4.5 m x 9 m)	20 ft. x 40 ft. (6 m x 12 m)	25 ft. x 50 ft. (7.5 m x 15 m)	30 ft. x 60 ft. (9 m x 18 m)
No debris liner				4100100	4100101	4100102	4100103
Debris liner	4100406	4100405	4100404	4100400	4100401	4100402	4100403



4102003

Flying Form Net

These are made for today's multi-story buildings that use "flying forms" to construct concrete floors. Even though there are no tie-off anchorages above, it protects workers while they're placing the forming deck.

- One time installation.
- Passive fall arrest and debris retention.
- UV-protected nylon mesh.
- Specify custom size.



4102002

Pour-in-Place Net

Our Pour-in-Place Nets provide personnel fall protection on unprotected floor openings. They're designed to cover small voids such as stairwells, mechanical chases or elevator shafts, by being poured into the concrete. 8 ft. x 100 ft. (2.4 m x 30.5 m), no border, black. Custom sizes are available.

- Passive fall arrest and debris retention.
- Durable nylon mesh.
- Fast, easy removal.

4102001 Pour-in-Place Net, 8 ft. x 50 ft. (2.4 m x 15.4 m), no border, black

Debris Nets

Debris nets catch lightweight construction debris, tools and building materials. They help prevent injury to workers, pedestrians, structures and materials below. Unlike hard hats, which protect only the head, debris nets offer protection from falling objects for the whole person. Perimeter debris nets meet OSHA and ANSI standards.

3M™ DBI-SALA® Vertical Debris Net

Its highly visible, bright orange mesh protects workers near building edges as a guardrail, and replaces mid-rail and toe boards, making it less expensive and easier to install. Designed for use with traditional cable setups, the nets are easy to remove, relocate, handle and store. Snap-on cable clips are available for easy attachment to the cables. The bottom edge of the net is quickly secured using a power tool that fires a nail into the tie-down plate.

- UV-resistant, fire-retardant.
- Exceeds OSHA's 200 lb. (90 kg) strength requirements and New York City construction codes.

Net color	Attachment kit	48 in. x 100 ft.	48 in. x 150 ft.	60 in. x 100 ft.
Orange		4100200	4100202	4100201
	■	4100300		4100301
Blue		4100204		4100205
	■	4100304		4100305

4100003 Attachment Kit, 50 clips & 20 tie-down plates

4100275 Cable Ties, 20 in. nylon, 250 lbs., 25-pack



4102000

Floor-to-Ceiling Debris Net

Our floor-to-ceiling panels provide complete containment of project debris and are strong enough to meet guardrail requirements for personnel. Debris panels are easily connected to a top and bottom cable and are reusable throughout the life of the project. Multiple floors can be protected, prior to cleanup, and then nets can be rotated upward, ahead of the cladding or glazing operations. 3-layer netting, with snap hooks, 9 ft. 6 in. tall x 30 ft. wide (2.9 m x 9.15 m).

4195436 Floor-to-Ceiling Fastener Plates, 16-pack

Custom sizing available—please call 800-326-6146.



3M™ DBI-SALA®

Rack Guard Adjustable Nets

Gray, fire-retardant with borders.

Model #480 — 4 in. x 4 in. mesh — 4,000 lb. load rating

4101575 9 ft. 4 in. x 12 ft. (2.84 m x 3.65 m)	4101579 20 ft. 8 in. x 12 ft. (6.29 m x 3.65 m)
4101576 9 ft. 4 in. x 16 ft. (2.84 m x 4.87 m)	4101583 20 ft. 8 in. x 16 ft. (6.29 m x 4.87 m)
4101577 9 ft. 4 in. x 20 ft. (2.84 m x 6.09 m)	4101585 20 ft. 8 in. x 20 ft. (6.29 m x 6.09 m)
4101578 12 ft. 4 in. x 12 ft. (3.75 m x 3.65 m)	4101580 25 ft. x 12 ft. (7.62 m x 3.65 m)
4101581 12 ft. 4 in. x 16 ft. (3.75 m x 4.87 m)	4101584 25 ft. x 16 ft. (7.62 m x 4.87 m)
4101582 12 ft. 4 in. x 20 ft. (3.75 m x 6.09 m)	4101586 25 ft. x 20 ft. (7.62 m x 6.09 m)
4101562 16 ft. 4 in. x 12 ft. (4.96 m x 3.65 m)	4101571 27 ft. 8 in. x 12 ft. (8.41 m x 3.65 m)
4101563 16 ft. 4 in. x 16 ft. (4.96 m x 4.87 m)	4101572 27 ft. 8 in. x 16 ft. (8.41 m x 4.87 m)
4101564 16 ft. 4 in. x 20 ft. (4.96 m x 6.09 m)	4101573 27 ft. 8 in. x 20 ft. (8.41 m x 6.09 m)
4101565 18 ft. 4 in. x 12 ft. (5.57 m x 3.65 m)	4101574 30 ft. 8 in. x 12 ft. (9.32 m x 3.65 m)
4101566 18 ft. 4 in. x 16 ft. (5.57 m x 4.87 m)	4101623 30 ft. 8 in. x 16 ft. (9.32 m x 4.87 m)
4101567 18 ft. 4 in. x 20 ft. (5.57 m x 6.09 m)	4101568 25 ft. x 25 ft. (7.60 m x 7.60 m)
	4101550 9 ft. 4 in. x 12 ft. (2.84 m x 3.65 m)
	4101551 9 ft. 4 in. x 16 ft. (2.84 m x 4.87 m)

Model #245 — 2 in. x 2 in. mesh — 2,500 lb. load rating

4101552 9 ft. 4 in. x 20 ft. (2.84 m x 6.09 m)	4101560 20 ft. 8 in. x 20 ft. (6.29 m x 6.09 m)
4101553 12 ft. 4 in. x 12 ft. (3.75 m x 3.65 m)	4101555 25 ft. x 12 ft. (7.62 m x 3.65 m)
4101556 12 ft. 4 in. x 16 ft. (3.75 m x 4.87 m)	4101559 25 ft. x 16 ft. (7.62 m x 4.87 m)
4101557 12 ft. 4 in. x 20 ft. (3.75 m x 6.09 m)	4101561 25 ft. x 20 ft. (7.62 m x 6.09 m)
4101587 16 ft. 4 in. x 12 ft. (4.96 m x 3.65 m)	4101596 27 ft. 8 in. x 12 ft. (8.41 m x 3.65 m)
4101588 16 ft. 4 in. x 16 ft. (4.96 m x 4.87 m)	4101597 27 ft. 8 in. x 16 ft. (8.41 m x 4.87 m)
4101589 16 ft. 4 in. x 20 ft. (4.96 m x 6.09 m)	4101598 27 ft. 8 in. x 20 ft. (8.41 m x 6.09 m)
4101590 18 ft. 4 in. x 12 ft. (5.57 m x 3.65 m)	4101599 30 ft. 8 in. x 12 ft. (9.32 m x 3.65 m)
4101591 18 ft. 4 in. x 16 ft. (5.57 m x 4.87 m)	4101621 30 ft. 8 in. x 16 ft. (9.32 m x 4.87 m)
4101592 18 ft. 4 in. x 20 ft. (5.57 m x 6.09 m)	4101622 30 ft. 8 in. x 20 ft. (9.32 m x 6.09 m)
4101554 20 ft. 8 in. x 12 ft. (6.29 m x 3.65 m)	4101593 25 ft. x 25 ft. (7.60 m x 7.60 m)
4101558 20 ft. 8 in. x 16 ft. (6.29 m x 4.87 m)	4101594 25 ft. x 30 ft. (7.60 m x 9.12 m)
	4101595 25 ft. x 36 ft. (7.60 m x 10.94 m)

Rack Hardware Kits

4101502 Flush Mount/Starter Kit (60 ft.) 1/4 in. wire cable, (4) 3/8 in. eyebolts, (8) 1/4 in. cable clamps, (4) 1/4 in. thimbles, (50) 5/16 in. snap hooks, (2-packs) 20 in. ties, (4) flush clamps
4101500 Flush Mount/Add-On Kit (60 ft.) 1/4 in. wire cable, (4) 3/8 in. eyebolts, (8) 1/4 in. cable clamps, (4) 1/4 in. thimbles, (50) 5/16 in. snap hooks, (2-packs) 20 in. ties, (2) flush clamps
4101506 Offset Mount/Starter Kit (115 ft.) 1/4 in. wire cable, (8) 3/8 in. eyebolts, (16) 1/4 in. cable clamps, (8) 1/4 in. thimbles, (100) 5/16 in. snap hooks, (1-pack) 20 in. ties, (4) offset clamps
4101505 Offset Mount/Add-On Kit (115 ft.) 1/4 in. wire cable, (8) 3/8 in. eyebolts, (16) 1/4 in. cable clamps, (8) 1/4 in. thimbles, (100) 5/16 in. snap hooks, (1-pack) 20 in. ties, (2) offset clamps
4101503 Extension Starter Kit — flush (2) extensions, (2) diagonal braces, (2) flush clamps, (2) backstay braces
4101501 Extension Add-On Kit (1) extension, (1) backstay brace
4101504 Extension Starter Kit — offset (2) extensions, (2) diagonal braces, (2) offset clamps, (2) backstay braces





3M™ DBI-SALA® Conveyor Adjustable Nets

Black, fire-retardant with borders.

Model #130 — 1 in. x 1 in. mesh — 1,000 lb. load rating

4100016 9 ft. x 25 ft. (2.74 m x 7.62 m)

4100015 9 ft. x 50 ft. (2.74 m x 15.24 m)

4100018 3 ft. x 25 ft. (0.91 m x 7.62 m)

4100017 3 ft. x 50 ft. (0.91 m x 15.24 m)

Conveyor Hardware Kits

4100020 Box Shaped Guard Kit (25 ft. or 50 ft. run) (220 ft.) 1/4 in. wire cable, (8) 3/8 in. eyebolts, (4) 3/8 in. turnbuckles, (8) 1/4 in. thimbles, (16) 1/4 in. cable clamps, (100) 5/16 in. snap hooks, (1-pack) 9 in. ties

4100019 Side Guard Kit (25 ft. or 50 ft. run) (110 ft.) 1/4 in. wire cable, (4) 3/8 in. eyebolts, (2) 3/8 in. turnbuckles, (2) 1/4 in. thimbles, (8) 1/4 in. cable clamps, (100) 5/16 in. snap hooks, (1-pack) 9 in. ties

4195161 Optional J-Guide for 5/8 in. or 1/2 in. threaded rod

Netting and Guardrails

3M™ DBI-SALA® Portable Guardrail System

This system acts as a barrier preventing personnel from falling to lower levels, thus eliminating the fall hazard. This system can protect employees with little or no training, special maintenance or gear.

- Free-standing system eliminates surface penetration.
- Built-in rail and toe board receptacles allow for infinite configurations.
- Rubber pad provides skid resistance and protects the roof surface.
- Ergonomic handles allow for easy transportation and setup.
- Fast and easy set-screw installation, insert rail and tighten.
- Corrosion-resistant construction for longevity.
- Custom colors available upon request.

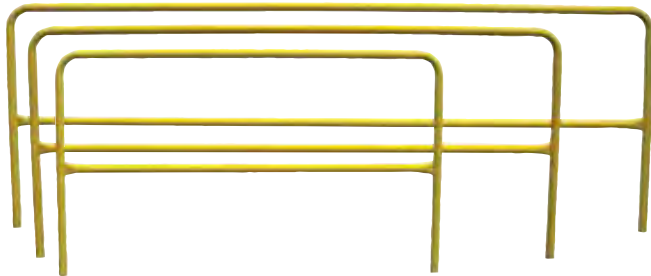
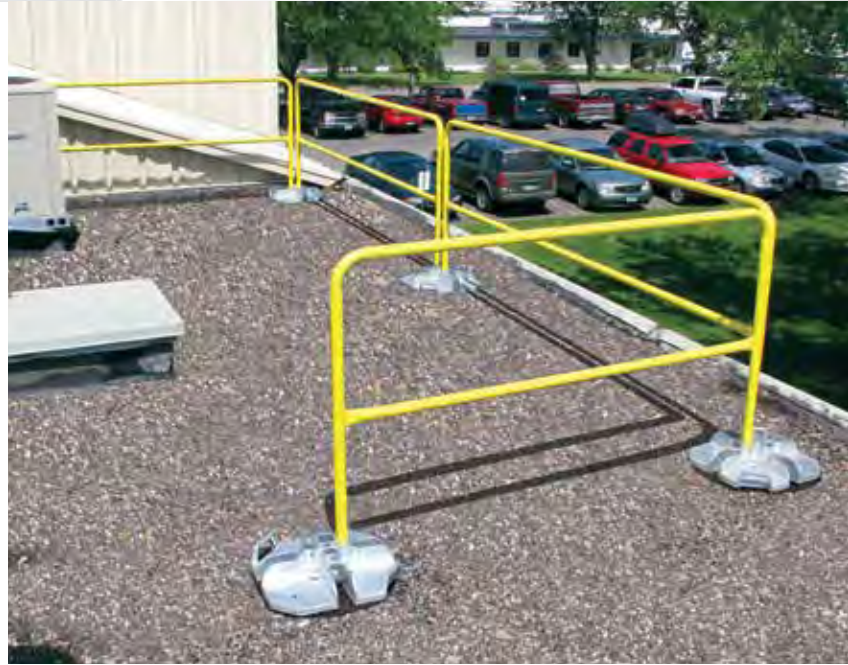

7900061

Guardrail

6 ft. (1.8 m) Guardrail Section, steel, powder coated.

7900062 8 ft. (2.4 m) Guardrail Section

7900063 10 ft. (3 m) Guardrail Section

7900067 6 ft. (1.8 m) Guardrail Section, galvanized

7900069 8 ft. (2.4 m) Guardrail Section, galvanized

7900068 10 ft. (3 m) Guardrail Section, galvanized

7900060

Guardrail Base

Galvanized Base assembly for guardrail system, 70 lbs. (32 kg)



7900005

Guardrail Splice Kit

Powder coated steel splice kit allows user to connect customized shortened rail sections together.



7900007

Guardrail Gate

Powder coated steel swing gate, adjustable from 23 in.-38 in. (58.4 cm-96.5 cm)



Guardrail Accessories

7900008

Guardrail Roof Hatch Kit

Includes: (4 ea.) 7900060 Guardrail Bases, (1 ea.) 7900007 Guardrail Gate, (3 ea.) 7900005 Guardrail Splice Kits, (3 ea.) 7900061 6 ft. (1.8 m) Rails.

7900054

Guardrail Base Transport Cart

Accommodates 4 bases (not shown).

7901000

3M™ DBI-SALA® Portable Construction Guardrail Stanchion

This system acts as a barrier, preventing personnel from falling to lower levels, thus eliminating the fall hazard. This system can protect employees with little or no training, special maintenance or gear.

- Mounts in both parapet and edge grab configurations for jobsite versatility.
- Rapid clamping system expands from 6 in.-24 in. (15.2 cm-61 cm)
- Durable zinc-plated finish for corrosion resistance and longevity.
- Supports both top and mid-rail guardrails, and toe boards when used in edge grab configuration.
- Use with standard wood 2×4's or other common guardrail materials.



Parapet configuration



Edge grab configuration

Part Number and Page Index

SKU	Page #	SKU	Page #	SKU	Page #
1000052	42	1231460	169	1500023	49
1000053	42	1231470	169	1500024	51
1000054	42	1234070	83	1500025	51
1000055	42	1234071	83	1500026	51
1000708	42	1234080	83, 180	1500027	50
1000709	42	1234081	180	1500028	50
1000716	42	1246012	109	1500029	50
1000717	42	1246030	81	1500030	50
1001001	42	1246032	81	1500031	50
1001002	42	1246075	81	1500032	50
1001003	42	1246080	81	1500033	50
1001004	42	1246130	80	1500034	50
1001005	42	1246143	80	1500047	52
1001090	42	1246145	80	1500048	52
1001140	42	1246147	80	1500049	52
1001190	42	1246151	81	1500050	54
1001210	169	1246152	81	1500051	55
1001220	169	1246153	81	1500052	55
1001378	42	1246159	80	1500053	54
1002010	126	1246161	80	1500054	54
1002103	126	1246167	80	1500055	54
1002106	126	1246173	81	1500056	54
1002200	126	1246272	80	1500057	54
1002201	126	1246273	80	1500058	54
1002202	126	1246317	78	1500059	53
1003000	109	1246318	78	1500060	53
1003221	24	1246320	78	1500065	53
1109975	40	1246321	78	1500066	53
1113210	23	1246352	78	1500067	53
1113211	23	1246413	80	1500068	53
1113212	23	1246414	80	1500069	54
1113213	23	1246415	80	1500070	68
1113215	23	1500001	46	1500071	68
1113216	23	1500002	46	1500072	68
1113217	23	1500003	46	1500073	68
1113218	23	1500004	46	1500074	68
1122256	74	1500005	46	1500075	68
1150037	43	1500006	46	1500076	68
1150174	43	1500007	46	1500077	68
1200110	83	1500008	46	1500078	68
1200111	83	1500009	49	1500079	68
1200115	83	1500010	50	1500080	68
1200136	83	1500011	48	1500081	68
1201390	126	1500012	48	1500082	69
1201391	126	1500013	48	1500083	69
1201421	126	1500014	48	1500084	69
1202794	109	1500015	48	1500085	69
1204057	83	1500016	48	1500086	69
1204058	83	1500017	48	1500087	69
1204074	83	1500018	48	1500088	59
1204075	83	1500019	49	1500089	59
1204076	83	1500020	49	1500090	60
1204077	83	1500021	49	1500091	59
1231380	82	1500022	49	1500092	59

SKU	Page #	SKU	Page #	SKU	Page #
1500093.....	59	1500168.....	47	2104712.....	129
1500094.....	59	1500169.....	47	2104713.....	129
1500095.....	58	1500171.....	47	2104715.....	129
1500096.....	58	1500172.....	47	2104716.....	129
1500097.....	58	1500174.....	47	2104802.....	135
1500098.....	58	1500175.....	47	2104803.....	135
1500099.....	58	1500178.....	53	2104811.....	135
1500100.....	58	2000025.....	181	2104816.....	131
1500101.....	57	2000112.....	173	2104817.....	131
1500102.....	57	2000114.....	173, 181	2104818.....	131
1500103.....	57	2000117.....	181	2104819.....	131
1500104.....	57	2100050.....	130	2105682.....	134
1500105.....	57	2100080.....	135	2108403.....	82
1500106.....	57	2100090.....	135	2108407.....	128
1500107.....	57	2100091.....	135	2108408.....	128
1500108.....	57	2100102.....	130	2108410.....	128
1500109.....	57	2100133.....	133	2110815.....	129
1500110.....	61	2100138.....	134	2110816.....	129
1500111.....	61	2100139.....	134	2110941.....	128
1500112.....	61	2100140.....	134	2189983.....	180
1500113.....	61	2100142.....	134	2190071.....	134
1500114.....	61	2100152.....	130	2190073.....	133
1500115.....	61	2100153.....	127	2190074.....	131
1500116.....	61	2100154.....	127	2200078.....	137
1500117.....	61	2100155.....	127	2200094.....	137
1500118.....	61	2100156.....	127	2200095.....	137
1500119.....	62	2100159.....	128	2200096.....	137
1500120.....	62	2100169.....	130	2200107.....	137
1500121.....	62	2100171.....	127	2200108.....	137
1500122.....	62	2100172.....	127	2200109.....	137
1500123.....	62	2100185.....	133	2200122.....	137
1500124.....	63	2101634.....	129	2200123.....	137
1500125.....	63	2101636.....	129	2200130.....	137
1500126.....	63	2101638.....	129	2200180.....	137
1500127.....	63	2103189.....	180	2200181.....	137
1500128.....	63	2103670.....	133	2200401.....	137
1500129.....	63	2103676.....	133	3101198.....	87
1500130.....	63	2103677.....	133	3101221.....	87
1500130.....	64, 65	2103690.....	134	3101230.....	87
1500131.....	63	2104527.....	135	3101232.....	87
1500132.....	63	2104528.....	135	3101233.....	87
1500133.....	65	2104529.....	135	3101234.....	87
1500134.....	64, 65	2104530.....	135	3101245.....	87
1500135.....	66	2104531.....	135	3101255.....	87
1500136.....	67	2104541.....	133	3101283.....	87
1500137.....	67	2104550.....	129	3101285.....	87
1500138.....	67	2104550.....	165	3101286.....	87
1500139.....	65	2104561.....	130	3101291.....	87
1500141.....	66	2104562.....	130	3101294.....	87
1500156.....	54	2104566.....	130	3101313.....	87
1500159.....	53	2104568.....	130	3101328.....	89
1500160.....	53	2104701.....	128	3101352.....	89
1500161.....	54	2104710.....	129	3101354.....	89
1500165.....	58	2104711.....	129	3101369.....	88

SKU	Page #	SKU	Page #	SKU	Page #
3101370.....	88	3102100.....	97	3500101.....	176
3101371.....	88	3102115.....	97	3500102.....	176
3101372.....	88	3302002.....	178	3500217.....	91
3101377.....	88	3303000.....	177	3500218.....	91
3101378.....	88	3303000.....	178	3500219.....	91
3101505.....	89	3303002.....	178	3500220.....	91
3101506.....	89	3303021.....	178	3500221.....	91
3101507.....	89	3320003.....	173	3500222.....	91
3101508.....	89	3320014.....	173	3500223.....	91
3101509.....	89	3325100.....	173	3500232.....	91
3101510.....	89	3325200.....	173	3500233.....	91
3101511.....	89	3325275.....	173	3500234.....	91
3101512.....	89	3325300.....	173	3500235.....	91
3101513.....	89	3326100.....	173	3500236.....	91
3101514.....	89	3326300.....	173	3500237.....	91
3101516.....	89	3326350.....	173	3500250.....	91
3101517.....	89	3327050.....	173	3500251.....	91
3101518.....	89	3327100.....	173	3500252.....	91
3101519.....	89	3327150.....	173	3500253.....	91
3101520.....	89	3327200.....	173	3500259.....	91
3101541.....	89	3327250.....	173	3500260.....	91
3101542.....	89	3327300.....	173	3501104.....	95, 168
3101543.....	89	3327325.....	173	3501105.....	168
3101544.....	89	3327350.....	173	3503800.....	96
3101545.....	89	3327400.....	173	3503801.....	96
3101546.....	89	3327450.....	173	3503802.....	96
3101547.....	89	3327500.....	173	3503803.....	96
3101548.....	89	3400653.....	93	3503804.....	96
3101549.....	89	3400655.....	93	3503820.....	96
3101550.....	89	3400661.....	93	3503821.....	96
3101551.....	89	3400661.....	168	3503822.....	96
3101552.....	89	3400663.....	93, 168	3503823.....	96
3101553.....	89	3400863.....	93	3503824.....	96
3101554.....	89	3400865.....	93	3505694.....	134
3101555.....	89	3400875.....	93, 168	3505695.....	134
3101566.....	89	3400876.....	93, 168	3511063.....	107
3101567.....	89	3400879.....	168	3511598.....	107
3101569.....	89	3400883.....	93	3511645.....	107
3101578.....	89	3400883.....	168	3511783.....	107
3101579.....	89	3400887.....	93	3512000.....	107
3101598.....	88	3400889.....	93, 174	3530000.....	107
3101599.....	88	3400913.....	93, 168	3601490.....	179
3101600.....	88	3400915.....	93, 168	3602050.....	178
3101628.....	88	3400968.....	93	3602100.....	178
3101629.....	88	3400970.....	93	3900105.....	93
3101634.....	88	3400980.....	93	3900107.....	93
3101668.....	87	3400981.....	93	3900108.....	93
3101669.....	87	3400984.....	93	3900111.....	93
3101670.....	87	3400988.....	93	3900112.....	93
3101671.....	87	3400992.....	93	3900114.....	93
3101672.....	87	3400994.....	93, 174	4100003.....	186
3101676.....	87	3401005.....	93	4100005.....	185
3101677.....	89	3401007.....	93	4100006.....	185
3101678.....	88	3500100.....	176	4100007.....	185

SKU	Page #	SKU	Page #	SKU	Page #
4100015.....	189	4101559.....	188	5920050.....	82
4100016.....	189	4101560.....	188	5920059.....	82
4100017.....	189	4101561.....	188	5920080.....	82
4100018.....	189	4101562.....	188	6100031.....	106
4100019.....	189	4101563.....	188	6100035.....	102
4100020.....	189	4101564.....	188	6100090.....	101
4100089.....	185	4101565.....	188	6100136.....	102
4100091.....	185	4101566.....	188	6100140.....	102
4100092.....	185	4101567.....	188	6100400.....	101
4100093.....	185	4101568.....	188	6100515.....	101
4100100.....	185	4101571.....	188	6110000.....	102
4100101.....	185	4101572.....	188	6116026.....	103
4100102.....	185	4101573.....	188	6116027.....	103
4100103.....	185	4101574.....	188	6116038.....	103
4100139.....	185	4101575.....	188	6116054.....	103
4100140.....	185	4101576.....	188	6116224.....	102
4100141.....	185	4101577.....	188	6116280.....	101
4100151.....	185	4101578.....	188	6116336.....	103
4100153.....	185	4101579.....	188	6116410.....	101
4100156.....	185	4101580.....	188	6147000.....	103
4100157.....	185	4101581.....	188	6160024.....	106
4100200.....	186	4101582.....	188	6160026.....	106
4100201.....	186	4101583.....	188	6160027.....	106
4100202.....	186	4101584.....	188	6160028.....	106
4100204.....	186	4101585.....	188	6160030.....	101
4100205.....	186	4101586.....	188	6160039.....	106
4100275.....	186	4101587.....	188	6160040.....	106
4100300.....	186	4101588.....	188	6160041.....	106
4100301.....	186	4101589.....	188	6160051.....	106
4100304.....	186	4101590.....	188	6160054.....	101
4100305.....	186	4101591.....	188	6160054.....	102
4100400.....	185	4101592.....	188	7241182.....	134
4100401.....	185	4101593.....	188	7241183.....	134
4100402.....	185	4101594.....	188	7241204.....	134
4100403.....	185	4101595.....	188	7241206.....	134
4100404.....	185	4101596.....	188	7241208.....	134
4100405.....	185	4101597.....	188	7400001.....	113
4100406.....	185	4101598.....	188	7400045.....	113
4101500.....	188	4101599.....	188	7400045.....	113
4101501.....	188	4101621.....	188	7400047.....	113
4101502.....	188	4101622.....	188	7400052.....	113
4101503.....	188	4101623.....	188	7400053.....	113
4101504.....	188	4102000.....	186	7400054.....	113
4101505.....	188	4102001.....	185	7400055.....	113
4101506.....	188	4102002.....	185	7400056.....	113
4101550.....	188	4102003.....	185	7400073.....	113
4101551.....	188	4195161.....	189	7400086.....	113
4101552.....	188	4195436.....	186	7400087.....	113
4101553.....	188	5900550.....	126	7400089.....	113
4101554.....	188	5900552.....	126	7400200.....	116
4101555.....	188	5900891.....	43	7400201.....	116
4101556.....	188	5900892.....	43	7400203.....	116
4101557.....	188	5901583.....	109	7400211.....	116
4101558.....	188	5901980.....	103	7400214.....	113

SKU	Page #	SKU	Page #	SKU	Page #
7400215	113	7900062.....	190	8515162	157
7400218	116	7900063.....	190	8515631.....	164
7400220	116	7900067.....	190	8516190.....	157
7400222	116	7900068	190	8516191.....	157
7400230	116	7900069.....	190	8516294.....	179
7400240	116	7901000	191	8516316.....	179
7400250	116	8000014	163	8516563.....	157
7400260	116	8000015	162	8516691.....	166
7400320	113	8102009.....	168	8516692.....	166
7400360.....	113	8102011.....	168	8516693.....	166
7400420	112	8102022.....	168	8516824	169
7400430.....	112	8102050.....	168	8516996.....	166
7400440.....	112	8102060	168	8516997	166
7400450.....	112	8151834.....	157	8517412.....	166
7400460.....	112	8300009.....	159	8517413.....	166
7400620.....	112	8300030	162	8517565.....	166
7400630.....	112	8301050.....	162	8517567.....	169
7400640.....	112	8301055.....	162	8517701.....	144
7400650.....	112	8301056.....	162	8517705.....	144
7400660.....	112	8510057.....	157	8517707.....	144
7401013.....	116	8510109.....	157	8517709	144
7401031.....	116	8510110.....	157	8517715.....	146
7401032.....	116	8510140.....	161	8517717.....	146
7401033.....	116	8510163.....	161	8517719	146
7600002.....	114	8510207	169	8517760	143
7600580.....	116	8510224	163	8517761.....	143
7602020	115	8510311.....	157	8517762.....	143
7602030.....	115	8510316.....	157	8517763.....	143
7602040.....	115	8510323	160	8517780	145
7602050	115	8510457	161	8517781.....	145
7602060.....	115	8510501.....	161	8517790	145
7602070	115	8510520.....	161	8517791.....	145
7602080.....	115	8510546.....	161	8517792.....	145
7602090.....	115	8510568.....	160	8517793.....	145
7602100.....	115	8510632.....	161	8517794	145
7603020.....	117	8510633.....	161	8517795.....	145
7603040.....	117	8510816.....	166	8517796	145
7603060.....	117	8510826.....	157	8517797.....	145
7603080.....	117	8510827	157	8517798	145
7603100.....	117	8512285	160	8518001.....	155
7603120	117	8512292	163	8518002.....	155, 159
7603140.....	117	8512293	163	8518003.....	155
7603160.....	117	8512827.....	157	8518004.....	155
7603180.....	117	8512828	157	8518005.....	160
7605063.....	114	8512831.....	157	8518006.....	155, 159
7608001.....	117	8512936.....	169	8518008.....	159, 160
7608002.....	117	8512994	161	8518009.....	155
7611904.....	132	8513158.....	163	8518040.....	159
7900005.....	190	8513159.....	163	8518270	159
7900007.....	190	8513330	155, 163, 165	8518347	157
7900008	190	8513564	155	8518348	157
7900054.....	190	8513565	160	8518382.....	155
7900060.....	190	8514461.....	161	8518383.....	155
7900061.....	190	8515150.....	164	8518384.....	155

SKU	Page #	SKU	Page #	SKU	Page #
8518385.....	155	8530565.....	142	1101654C.....	36
8518386.....	155	8530566.....	142	1101655C.....	36
8518387.....	155	8530571.....	142	1101656C.....	36
8518506.....	169	8530621.....	142	1101781C.....	35
8518507.....	169	8530624.....	150	1101809C.....	37
8518508.....	169	8530678.....	150	1101810C.....	37
8518513.....	159	8548050.....	150	1101811C.....	37
8518558.....	168	8700387.....	180	1101812C.....	37
8518559.....	168	8700388.....	180	1102000C.....	35
8518560.....	168	8700522.....	181	1102001C.....	35
8518561.....	168	8800023.....	129	1102008C.....	35
8518564.....	168	8900249.....	181	1102010C.....	37
8518565.....	168	8900292.....	179	1102090C.....	35
8518566.....	168	8900293.....	179	1102201C.....	36
8518567.....	168	8900294.....	179	1102340C.....	33
8518568.....	168	8900298.....	173	1102341C.....	33
8518571.....	168	8902004.....	176	1102342C.....	33
8518579.....	168	8902006.....	176	1102343C.....	33
8518580.....	168	9500468.....	43	1102385C.....	33
8518581.....	168	9501207.....	43	1102386C.....	33
8518582.....	168	9502006.....	43	1102387C.....	33
8518586.....	168	9503806.....	109	1102388C.....	33
8518587.....	168	9504733.....	173	1102950C.....	37
8518588.....	168	9505504.....	43	1103070C.....	27
8518589.....	168	9505515.....	43	1103071C.....	27
8518601.....	168	9505712.....	43	1103072C.....	27
8518602.....	168	9506162.....	173	1103073C.....	27
8518603.....	168	9508289.....	173	1103085C.....	27
8518604.....	168	9509238.....	181	1103086C.....	27
8518608.....	168	9511597.....	43, 109	1103087C.....	27
8518609.....	168	9511632.....	43	1103088C.....	27
8518610.....	168	9600003.....	106	1103270C.....	37
8518611.....	168	9600068.....	106	1103321C.....	35
8519377.....	160	9600069.....	106	1103350C.....	38
8520777.....	165	1000002C.....	42	1103351C.....	38
8523178.....	131	1000003C.....	42	1103352C.....	38
8530162.....	147	1000004C.....	42	1103355C.....	38
8530210.....	147	1000005C.....	42	1103375C.....	37
8530252.....	165	1000022C.....	42	1103512C.....	36
8530253.....	165	1000023C.....	42	1103513C.....	36
8530257.....	164	1000024C.....	42	1103525C.....	36
8530267.....	116	1000025C.....	42	1103526C.....	36
8530288.....	149	1000162C.....	42	1103875C.....	35
8530314.....	147	1000163C.....	42	1104625C.....	40
8530345.....	149	1000164C.....	42	1104775C.....	40
8530352.....	159	1000165C.....	42	1105475C.....	40
8530387.....	147	1003000C.....	126	1106450C.....	38
8530397.....	148	1003006C.....	126	1106451C.....	38
8530427.....	149	1100303C.....	32	1106452C.....	38
8530538.....	142	1100530C.....	33	1106453C.....	38
8530557.....	142	1100531C.....	33	1107404C.....	40
8530558.....	142	1100532C.....	33	1107416C.....	40
8530559.....	142	1100533C.....	33	1107420C.....	40
8530564.....	142	1101254C.....	35	1107775C.....	38

SKU	Page #	SKU	Page #	SKU	Page #
1107776C.....	38	111584C.....	40	1112587C.....	17
1107777C.....	38	1112126C.....	35	1112588C.....	17
1107778C.....	38	1112475C.....	18	1113055C.....	21
1107801C.....	36	1112476C.....	18	1113061C.....	21
1107802C.....	36	1112477C.....	18	1113064C.....	21
1107805C.....	36	1112478C.....	18	1113067C.....	21
1107807C.....	35	1112479C.....	18	1113070C.....	21
1107809C.....	36	1112480C.....	18	1113076C.....	21
1108516C.....	32	1112481C.....	18	1113091C.....	21
1108517C.....	32	1112482C.....	18	1113094C.....	21
1108518C.....	32	1112483C.....	18	1113097C.....	21
1108519C.....	32	1112484C.....	18	1113100C.....	21
1108575C.....	31	1112490C.....	18	1113195C.....	23
1108576C.....	31	1112491C.....	18	1113196C.....	23
1108577C.....	31	1112492C.....	18	1113197C.....	23
1108581C.....	31	1112493C.....	18	1113199C.....	23
1108675C.....	31	1112494C.....	18	1113290C.....	24
1108676C.....	31	1112500C.....	18	1113291C.....	24
1108677C.....	31	1112501C.....	18	1113292C.....	24
1108682C.....	31	1112502C.....	18	1113293C.....	24
1108700C.....	31	1112503C.....	18	1113295C.....	24
1108701C.....	31	1112504C.....	18	1113296C.....	24
1108702C.....	31	1112520C.....	18	1113297C.....	24
1108706C.....	31	1112521C.....	18	1113298C.....	24
1108975C.....	32	1112522C.....	18	1113315C.....	27
1108977C.....	32	1112523C.....	18	1113316C.....	27
1108978C.....	32	1112524C.....	18	1113317C.....	27
1108979C.....	32	1112530C.....	18	1113318C.....	27
1110475C.....	32	1112531C.....	18	1113325C.....	27
1110476C.....	32	1112532C.....	18	1113326C.....	27
1110477C.....	32	1112533C.....	18	1113327C.....	27
1110478C.....	32	1112534C.....	18	1113328C.....	27
1110575C.....	36	1112535C.....	17	1113330C.....	27
1110576C.....	36	1112536C.....	17	1113331C.....	27
1110577C.....	36	1112537C.....	17	1113332C.....	27
1110578C.....	36	1112538C.....	17	1113333C.....	27
1110600C.....	35	1112540C.....	17	1113335C.....	27
1110602C.....	35	1112541C.....	17	1113336C.....	27
1110625C.....	35	1112542C.....	17	1113337C.....	27
1110700C.....	37	1112543C.....	17	1113338C.....	27
1110725C.....	37	1112550C.....	17	1113345C.....	25
1110750C.....	38	1112551C.....	17	1113346C.....	25
1110751C.....	38	1112552C.....	17	1113347C.....	25
1110752C.....	38	1112553C.....	17	1113348C.....	25
1110752C.....	39	1112565C.....	17	1113370C.....	25
1110754C.....	38	1112566C.....	17	1113371C.....	25
1110774C.....	38	1112567C.....	17	1113372C.....	25
1110780C.....	38	1112568C.....	17	1113373C.....	25
1110781C.....	38	1112580C.....	17	1113675C.....	29
1110782C.....	38	1112581C.....	17	1113676C.....	29
1110820C.....	39	1112582C.....	17	1113677C.....	29
1110830C.....	39	1112583C.....	17	1113678C.....	29
1110940C.....	39	1112585C.....	17	1113681C.....	29
1110990C.....	40	1112586C.....	17	1113682C.....	29

SKU	Page #	SKU	Page #	SKU	Page #
1113683C.....	29	1140164C.....	22	1246046C.....	77
1113684C.....	29	1140165C.....	22	1246047C.....	77
1113688C.....	29	1140166C.....	22	1246048C.....	77
1113689C.....	29	1140169C.....	22	1246049C.....	77
1113690C.....	29	1140170C.....	22	1246050C.....	77
1113691C.....	29	1140171C.....	22	1246060C.....	77
1113692C.....	29	1140172C.....	22	1246061C.....	77
1113693C.....	29	1140181C.....	22	1246070C.....	77
1113757C.....	29	1140182C.....	22	1246071C.....	77
1113758C.....	29	1140183C.....	22	1246072C.....	77
1113759C.....	29	1140184C.....	22	1246085C.....	77
1113760C.....	29	1140199C.....	21	1246088C.....	77
111580C.....	40	1140200C.....	21	1246089C.....	77
1122306C.....	74	1140201C.....	21	1246101C.....	75
1140001C.....	31	1140202C.....	21	1246113C.....	75
1140002C.....	31	1150054C.....	39	1246177C.....	75
1140003C.....	31	1150058C.....	39	1246188C.....	75
1140004C.....	31	1202753C.....	109	1246193C.....	75
1140007C.....	31	1202754C.....	109	1246196C.....	75
1140008C.....	31	1202790C.....	109	1246200C.....	75
1140009C.....	31	1202794C.....	109	1246226C.....	77
1140010C.....	31	1202821C.....	109	1246229C.....	81
1140019C.....	31	1202823C.....	109	1246234C.....	75
1140020C.....	31	1202844C.....	109	1246306C.....	78
1140021C.....	31	1202878C.....	109	1246310C.....	78
1140022C.....	31	1202879C.....	109	1246311C.....	78
1140055C.....	32	1231016C.....	82	1246375C.....	76
1140056C.....	32	1231104C.....	82	1246376C.....	76
1140057C.....	32	1231106C.....	82	1246377C.....	76
1140058C.....	32	1231117C.....	43	1246378C.....	76
1140067C.....	33	1231305C.....	131	1246379C.....	76
1140068C.....	33	1232117C.....	82	1246380C.....	76
1140069C.....	33	1241460C.....	79	1246381C.....	76
1140070C.....	33	1241480C.....	79	1246382C.....	76
1140103C.....	21	1244310C.....	74	1246383C.....	76
1140104C.....	21	1244321C.....	74	1246384C.....	76
1140105C.....	21	1244406C.....	74	1246385C.....	76
1140106C.....	21	1244409C.....	74	1246386C.....	76
1140109C.....	21	1244412C.....	74	1246387C.....	76
1140110C.....	21	1244448C.....	74	1246388C.....	76
1140111C.....	21	1244610C.....	74	1246389C.....	76
1140112C.....	21	1244611C.....	74	1246390C.....	76
1140115C.....	21	1244630C.....	74	1246391C.....	76
1140116C.....	21	1244631C.....	74	1246392C.....	76
1140117C.....	21	1246011C.....	75	1246393C.....	76
1140118C.....	21	1246021C.....	75	1246394C.....	76
1140122C.....	21	1246022C.....	75	1246395C.....	76
1140123C.....	21	1246024C.....	75	1246396C.....	76
1140124C.....	21	1246040C.....	77	1246432C.....	78
1140157C.....	22	1246041C.....	77	1246433C.....	78
1140158C.....	22	1246042C.....	77	1246434C.....	78
1140159C.....	22	1246043C.....	77	1246435C.....	75
1140160C.....	22	1246044C.....	77	1246436C.....	75
1140163C.....	22	1246045C.....	77	1246437C.....	75

SKU	Page #	SKU	Page #	SKU	Page #
1246438C.....	78	3400858C.....	168	3504551C.....	95
1246439C.....	78	3400900C.....	93	3504552C.....	95
1246440C.....	78	3400902C.....	93	3504552C.....	174
1246441C.....	75	3400920C.....	93	3504600C.....	95
1246442C.....	75	3400920C.....	168	5002042C.....	109
1246443C.....	75	3400922C.....	93	5003050C.....	109
2100085C.....	130	3400922C.....	168	5003100C.....	109
2101000C.....	130	3400923C.....	93	5920200C.....	82
2101002C.....	130	3400923C.....	168	5920201C.....	82
2101004C.....	130	3400926C.....	168	9501403C.....	43
2103143C.....	129	3400930C.....	93	AC202D/0.....	173
3101001C.....	97	3400932C.....	93		
3101006C.....	97	3400932C.....	174		
3101009C.....	97	3400940C.....	93		
3101300C.....	97	3400940C.....	168		
3103107C.....	95	3400942C.....	93		
3103108C.....	95	3400942C.....	168		
3103108C.....	95	3500200C.....	176		
3103110C.....	95	3500201C.....	176		
3103119C.....	95	3500202C.....	176		
3103120C.....	95	3504422C.....	95		
3103136C.....	95	3504430C.....	95		
3103175C.....	95	3504431C.....	95		
3103175C.....	95	3504432C.....	95		
3103207C.....	95	3504433C.....	95		
3103208C.....	95	3504434C.....	95		
3103209C.....	95	3504437C.....	95		
3103212C.....	95	3504438C.....	95		
3103214C.....	95	3504445C.....	95		
3103275C.....	95	3504446C.....	95		
3400800C.....	93	3504450C.....	95		
3400802C.....	93	3504451C.....	95		
3400825C.....	93	3504452C.....	95		
3400827C.....	93	3504463C.....	95		
3400850C.....	93	3504480C.....	95		
3400850C.....	168	3504485C.....	95		
3400852C.....	93	3504486C.....	95		
3400852C.....	168	3504487C.....	95		
3400853C.....	93	3504500C.....	95		
3400853C.....	168	3504550C.....	95		
3400858C.....	93	3504550C.....	174		

▲WARNING

Compliant fall protection and emergency rescue systems help prevent serious injuries associated with fall events. Users must read and understand the User Instructions provided with the product, and must be properly trained by their employers in the safe use of these systems before using them, per CSA standards and provincial legislation. Misuse or failure to follow warnings and instructions may result in serious personal injury or death. For proper use, see supervisor, User Instructions, or call 800-387-7484

Notes

Notes

Notes



3M Fall Protection
Personal Safety Division
260 Export Blvd
Mississauga, ON L5S 1Y9
Canada

1 800 387-7484
3MFallProtection-CA@mmm.com
3M.ca/FallProtection

3M, DBI-SALA, Cynch-Lok, Delta, Duo-Lok, EZ Line, EZ Link, ExoFit, EZ Stop, Fast-Line, Flexiguard, Lad-Saf, LIFTech, Mobi-Lok, Nano-Lok, PolarMesh, Retrax, Revolver, Saflok, Salalift, Sayflite, SEAT-BELT, STRATA, Talon, Tech-Lite, Uni 8, Uni Rail, and Zorbit are trademarks of 3M. Used under license in Canada.

© 3M 2018.
1805-12045