

All-Wave Radio

JANUARY

1938

25
CENTS



Push-Button Tuning

In A. F. C. Receiver



A One-Man Mast

For Ham and DXer



Newcomer's Xmitter

For Phone and C. W.



Simple 5-Meter Rig

For Phone Work

OFFICIAL ORGAN
RADIO SIGNAL SURVEY LEAGUE

THE NEW AWR-RSSL

DX Reception Citations

ARE NOW BEING ISSUED!

ESTABLISH PROOF OF YOUR
DX ABILITY BEYOND DOUBT
IN ANY OR ALL THREE OF
THE FOLLOWING BANDS:

**SHORT WAVE BROADCAST
STANDARD BROADCAST
AMATEUR PHONE**



OFFICIAL CITATION ISSUED TO S. W. BROADCAST DXERS.
(APPROXIMATELY 1/9 ACTUAL SIZE—COLOR BLUE)



OFFICIAL CITATION ISSUED TO BROADCAST BAND DXERS.
(APPROXIMATELY 1/9 ACTUAL SIZE—COLOR GREEN)



OFFICIAL CITATION ISSUED TO AMATEUR PHONE DXERS.
(APPROXIMATELY 1/9 ACTUAL SIZE—COLOR BROWN)

Listeners, the world over, are now eligible to apply for individual citations, stating definitely their own DEGREE of DXing ability in each specific Band. Based on an entirely new and sound merit rating system, these DX CITATION CERTIFICATES are issued by ALL-WAVE RADIO only after qualifying verifications have been carefully checked and certified to by a judging body, composed of members of the staff of ALL-WAVE RADIO and the directors of the RADIO SIGNAL SURVEY LEAGUE, in accordance with the regulations. CITATIONS start with "FIRST DEGREE" based on the minimum requirements, and advance in ascending order (SECOND DEGREE, etc.) according to the applicant's record of accomplishments! Every DX CITATION CERTIFICATE of ascending degree carries a complete list of previous qualifying verifications in addition to those warranting its own issuance. An individual, duplicate record of verifications is kept on file, at RSSL Headquarters!

Distinctive, Dignified and Authoritative. The certificates, measuring 8½ by 11 inches, are printed on heavy high grade Bond paper with engraved borders and background each of the three being a different color and ready for separate framing. All certificates are mailed flat. DX RECEPTION CITATIONS **CANNOT BE PURCHASED!** CERTIFICATES ARE ISSUED AT NO COST TO THE APPLICANT OTHER THAN A SMALL POSTAGE FEE!

For complete information regarding the new AWR-RSSL Citation Certificates as well as the rules and regulations governing their issuance see page 517 of "October, 1937" ALL-WAVE RADIO or send a self-addressed stamped envelope to:

CITATION DIVISION:
RADIO SIGNAL SURVEY LEAGUE
16 EAST 43 STREET, NEW YORK, N. Y.



ANNOUNCING!

ALL-WAVE RADIO'S "Practical Radio Manual" will be off the press February 1st—a brand new publication of over 144 pages, unquestionably the finest book ever offered free by any radio publisher. Up to the high standard maintained by the publishers of one of radio's leading magazines, this handsome volume answers the question "How Can I Become a Radio Amateur?" However, its appeal is not only to those wishing to become amateurs but to everyone interested in radio.

Barb & Ernest Series Complete!

In addition to its wealth of other material, this new book contains for the first time, the complete series that attracted so much attention—"Barb & Ernest, Embryo Radio Hams." Here is a book that will prove a real help in passing the government amateur license examination. Far different from the usual cut and dried lessons, questions and answers, etc., this series was written in answer to specific questions arising in the minds of two typical embryo hams—in short a personalized course.

Sets for the Amateur and Experimenter

From 5 meters up to 200 meters, outstanding set construction articles have been selected from A-W-R—complete with photos, parts lists, diagrams and construction plans—nothing has been omitted to make simple the building of efficient, yet inexpensive receivers and transmitters.

Theory Made Easy

IF you have wondered just "what makes the wheels go 'round'" in your set, here is the perfect explanation. Radio theory is covered from coils and condensers to superhets in language both clear and clean cut; yet as absorbing as any novel—a complete and interesting outline of the essential radio fundamentals.

Actual Questions and Answers

CCAREFULLY selected answers to actual "Queries" from readers cover the very problems that puzzle you. In fact, the vast wealth of "permanent-value" material which appeared in All-Wave Radio has been carefully sifted and the cream of it presented in this handy bound form for preservation and handy reference.

"Practical Radio Manual" Not for Sale!

THIS valuable manual cannot be purchased. Instead, the handsome book of over 144 pages, profusely illustrated, will be sent **FREE** and Postpaid with each new subscription to A-W-R. If the initial orders are only 10% of the expressed interest, the first edition won't last long. **QUICK** action is necessary. Use coupon below. Present subscribers may likewise secure the book if they wish by **EXTENDING PRESENT SUBSCRIPTION** for another year.

ALL WAVE RADIO, 16 E. 43rd Street, New York

Send me the free copy of A-W-R PRACTICAL RADIO MANUAL as soon as it is off the press (Feb. 1st) and enter my subscription for one year. I enclose \$2.50 in full payment.

RUSH!

Good Only in
USA, Canada,
South America

NameStreet

CityState

If now a subscriber, check here and we will extend present subscription for an additional year.

If you do not wish to cut this page, copy on your own letterhead.

All-Wave Radio

COPYRIGHT 1938 BY MANSON PUBLICATIONS CORP.
16 EAST 43RD ST. NEW YORK, N. Y.

EDITED BY M. L. MUHLEMAN

VOL. 4, NO. 1

JANUARY, 1938

COVER ILLUSTRATION

WILLARD BOHLEN, W2CPA, DEMAREST, N. J., AT WORK WITH A SOLDERING IRON ON THE UNDERSIDE OF A TRANSMITTER CHASSIS. THIS IS THE WORKSHOP WHERE MANY OF THE ALL-WAVE RADIO TRANSMITTERS AND RECEIVERS ARE CREATED.

CONTENTS

THE AWR AUTOMATIC	By G. S. Granger	6
SIMPLE A.C.-D.C. 5-METER TRANSMITTER	By Guy Forest	10
A TWO-TERMINAL OSCILLATOR	By Engineering Dept., RCA-Radio- tron	13
NEWCOMER'S C.W.-PHONE TRANSMITTER	By C. Watzel, W2AIF, and W. Bohlen, W2CPA	14
60 FEET—20 BUCKS	By E. T. Turney, W2APT	18
HAMFEST	By W8QMR	19
GLOBE GIRDLING	By J. B. L. Hinds	20
CHANNEL ECHOES	By Zeh Bouck	25
R.S.S.L. NEWS	26
DX RECEPTION CITATIONS	27
NIGHT-OWL HOOTS	By Ray LaRocque	28
BROADCAST DX FORECAST	By Ray LaRocque	30
SCALES BY PHOTOGRAPHY	By Emil Buchwald	31
QUERIES	32
HAMMARLUND SUPER-PRO CONSOLE RECEIVER ...	A Proving Post Review	33
BACKWASH	34
SHORT-WAVE BROADCAST STATION LIST	36
BOOK REVIEWS	41
ON THE MARKET	42
INDEX TO ADVERTISERS	58

OFFICIAL ORGAN OF THE RADIO SIGNAL SURVEY LEAGUE

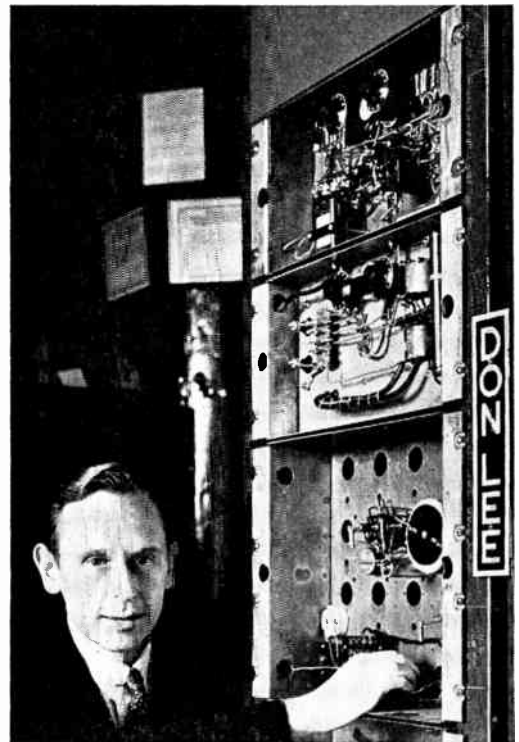

HARRY R. LUECKE, DIRECTOR OF TELEVISION OF THE DON LEE BROADCASTING SYSTEM, ADJUSTS A RESISTOR IN A RECENTLY PERFECTED PART OF THE NEW DON LEE DIRECT PICKUP TELEVISION EQUIPMENT. THIS EQUIPMENT WILL BE PUT IN REGULAR USE EARLY IN 1938, THROUGH STATION W6XAO.

PUBLISHED MONTHLY by the Manson Publications Corporation, 16 East 43rd Street, New York, N. Y. Entered as second-class matter August 27, 1935, at the Post Office, New York, New York, under the Act of March 3, 1879. Additional entry as second-class matter, at East Stroudsburg, Pa., August 27, 1936. M. L. Muhleman, President and Secretary; Edwin W. Lederman, Vice President and Treasurer.

SUBSCRIPTIONS: Yearly subscription rate: \$2.50 in the United States and Canada; \$3.00 in foreign countries. Single copy price, 25 cents. Four weeks' notice is required for a change of address. In requesting a change, kindly give both the new and the old address.

NEWSSTAND COPIES: ALL-WAVE RADIO is distributed by the American News Company who make every effort to supply copies at all points where there is a demand. If you have had difficulty in obtaining ALL-WAVE RADIO where you reside communicate with our Circulation Department who will see to it that your local newsstand is supplied with copies.

MANUSCRIPTS: All manuscripts, except those definitely contracted for, are submitted at the author's risk and cannot be returned unless accompanied by sufficient postage. However the editors are always on the lookout for new material, and readers are invited to submit manuscripts for consideration. Notification of the acceptance or rejection of a manuscript is given within three weeks after receipt.

ADVERTISING OFFICES: Eastern Advertising Manager, Sanford L. Cahn, ALL-WAVE RADIO, 16 East 43rd Street, New York, N. Y. Telephone: MUrray Hill 8761-2. Midwest Advertising Manager, Charles O. Stimpson, ALL-WAVE RADIO, 608 South Dearborn Street, Chicago, Ill. Telephone: WABash 1903.



100 BLANKS TO EACH PAD

FOR THE

R.S.S.L.

MEMBER

• **REPORT FORM BLANKS** •

New in principle, these Report Form blanks have been specially designed for the recording of information essential in carrying on the work of the R.S.S.L. Printed in green ink on white bond paper, 8½x11 records can be made in either pencil or ink—each sheet covering a full week's report

\$1.00 Per Pad • Postpaid

ARE YOU ELIGIBLE FOR MEMBERSHIP IN THE RADIO SIGNAL SURVEY LEAGUE?

There is only one requisite for Membership, namely: That you be sincere in your desire and efforts to assist the league in fulfilling its public service of "improving domestic and international radio transmission and reception conditions." Here is an opportunity to help make radio history and at the same time do a real public service.

JOIN THE R.S.S.L. TODAY! NO FEE! A POST CARD WILL FETCH YOUR APPLICATION BLANK.



• **QSL CARDS** •

No QSL Cards have, as yet, been prepared. In order that members may retain the individuality of their QSL Cards and at the same time indicate their association with the R.S.S.L., a Matrix ("Mat") has been prepared from which a metal cast can be readily made of the R.S.S.L. emblem at low cost. "Mats" can be had for either "Negative" (above) or "Positive" (right) type emblem. They are practically indestructible and are familiar to almost all printers. Be sure to specify "negative" or "positive." Above illustrations are actual size!

"MATS" 25c Each Postpaid

METALETTE R.S.S.L. SEALS

Are gummed on one side. Blue embossed on Silver. Same size as above illustration. They have the handsome appearance of real metal. Can be used on stationery, letterheads, QSL cards, etc.

25 Seals 15c • Postpaid

IMPORTANT: Above supplies may be purchased by **R.S.S.L. members ONLY!** Be sure to give your Monitoring Station number with order. No orders sent C.O.D. Be sure to enclose check, stamps or M.O. with order and send to:

RADIO SIGNAL SURVEY LEAGUE
 16 East 43 Street. New York, N. Y.

MEMBER STATIONERY



Every member will be proud to use this handsome R.S.S.L. Members' Stationery for his radio correspondence. Printed in blue ink on 8½ x 11 white bond paper, it bears the Radio Signal Survey League's official emblem.

Note: Those who prefer to design their own stationery or who would like to add the R.S.S.L. emblem to stationery they already have can secure "Mats" (Matrices) of the above two illustrations (actual size). For details see section headed "QSL CARDS."

100 Sheets 50c

• 250 Sheets \$1.00



THE AWR AUTOMATIC

A High-Fidelity Receiver With Push-Button Tuning and A. F. C.

By G. S. GRANGER

THE latest thing in radio today is the push-button-tuned receiver that operates in the manner of a slot machine . . . you push a lever and get Charlie McCarthy, The Shadow, Jack Benny, or whatever your wishes may be, instantaneous, and without so much as a thought to station frequencies; and with less physical labor than it takes to lift the evening newspaper. It's colossal, it's

convenient—and it's fun pushing buttons.

Heretofore the constructor has been unable to do much, if anything, with automatically-tuned receivers; first, because no push-button switch has been available on the open market, and, second, because there has been a total lack of pertinent information on the practical application of a.f.c. (automatic frequency control) to receivers of this type.

That situation is now changed—or will be shortly—for Yaxley will have one or more types of push-button switches on the market about the time you read this article, or soon afterwards. As for automatic frequency control, its application is quite simple once you get the hang of it. But rather than make the reader stand the trials of experimentation with its attendant series of failures before success is achieved, we have ironed out all the ripples beforehand. We are, as a consequence, pleased to offer here a fool-proof, pre-tuned receiver, with push-button control and a.f.c.

Design For Living Rooms

We started on the assumption that a receiver of this nature would be used only for the reception of local radio programs, and should therefore have splendid audio quality and be of such a design that its final structure would carry out

the primary convenience of the push-button tuning. This suggested armchair tuning, but brought up the problem of obtaining adequate baffle area for the loudspeaker without excessive cabinet size. The more we thought of having the speaker in the same cabinet with the receiver chassis, the less we liked it, for in that event if the entire unit were to be placed alongside our favorite chair, the sound radiation would be directed away from rather than toward us.

Considering these points, the logical answer was to construct the receiver in two units—an armchair cabinet containing the receiver chassis only, with push buttons and volume control on top, within easy reach, and a separate cabinet for the loudspeaker which could be placed in some other part of the room, with the grille facing "the audience."

But it seemed senseless to go to the trouble of building up a special speaker cabinet when Jensen has a whole flock of specially-designed Peri-dynamic units which can be purchased in knock-down form and assembled at home in a matter of minutes. So we selected the KM-12 unit, which uses a 12-inch permanent magnet dynamic speaker housed in an attractive bass-reflex enclosure. It is shown in one of the accompanying illustrations.

Vertical Chassis

As will be seen from the photos, the receiver chassis is mounted on two supporting brackets, and assumes a vertical rather than a horizontal position, with

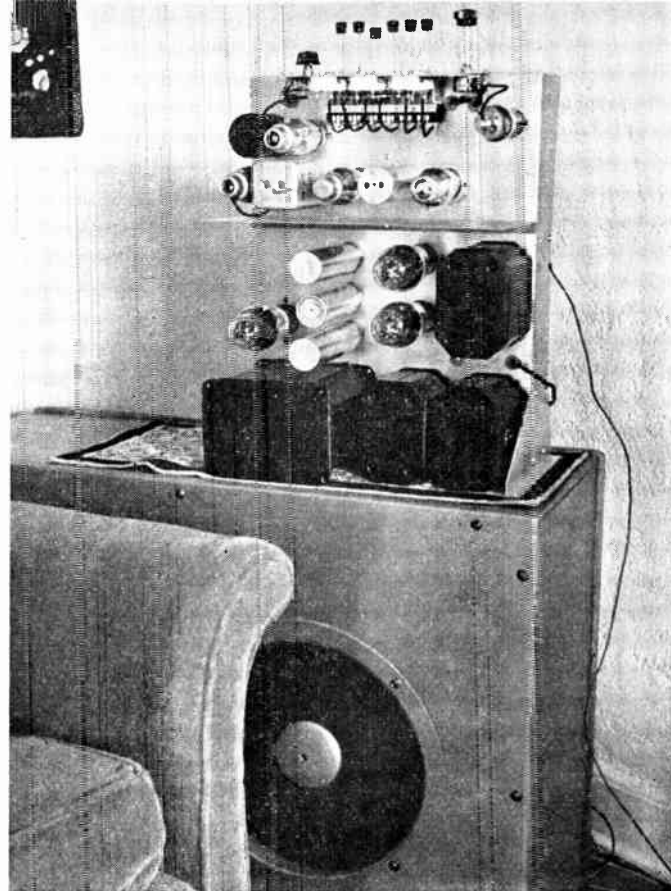

The AWR Automatic receiver resting atop the Jensen Peri-dynamic reproducer which is part of the equipment. Note that chassis assumes a vertical position, with push-button switch at top.

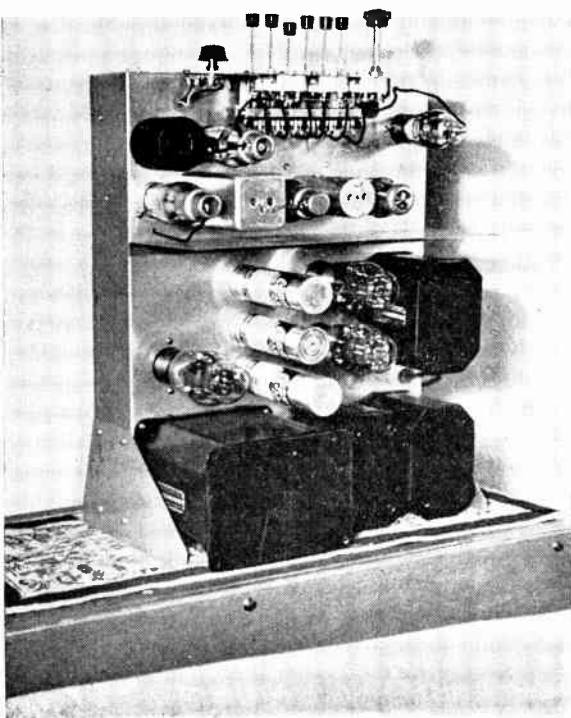

Another view of the receiver. Note vertical support brackets. The push-button switch and subsidiary controls are mounted on a special bracket.

the push buttons, volume control and selectivity switch at the top. It is designed to fit into a relatively small cabinet—which we shall describe next month—that fits nicely against the arm of a chair or couch. The chassis is connected to the speaker by a two-wire lead. Of course, the constructor can change things around to suit himself. The brackets, for instance, can be dispensed with and the chassis mounted in a horizontal position. In this case the push-button switch will assume a horizontal position, but can readily enough be mounted vertically if desired.

The details of construction which follow cover a superheterodyne type receiver. The set-builder's choice of tuning systems sometimes favors the simple tuned radio-frequency circuit, especially if the tuner is followed by a high-fidelity audio-frequency amplifier and a good loudspeaker. For this receiver, the superheterodyne circuit was selected so that push-button tuning in its simplest form with automatic frequency control might be used.

The important elements of the superheterodyne are the heterodyne oscillator, the first detector or mixer, the intermediate amplifier, and the second detector. In the receiver constructed, no preamplification of the signal ahead of the mixer was desired since it would complicate the tuning mechanism and possibly increase selectivity to a point where side-band cutting might reduce high-frequency audio response in the output from the speaker. Besides, the gain of the circuit without preamplification is adequate for all local station reception.

Push-Button System

Push-button tuning was made possible in simple form through the utilization of a new Yaxley tuning switch, which handles two tuning condenser circuits. Reference to the schematic diagram will show six tuning condensers (C1, C2, C3, C4, C5, C6) connected to grid No. 4 of the 6A8G mixer section for signal tuning, and six more condensers, carrying the same symbols, connected through a small blocking condenser to grid No. 2 of the 6A8G for oscillator tuning. It will be noted that each of these two banks of condensers has one set of plates connected together and these common terminals connect to grids No. 4 and No. 2 respectively of the 6A8G tube. The other groups of plates for all six condensers in each bank connect to the Yaxley switch terminals.

The Yaxley switch is arranged so that when a button is depressed, a short-circuiting shoe closes the connection between three terminals. One of these three terminals connects to ground, one is connected to one set of tuning condenser plates in the bank tuning the oscillator

TABLE I

Station Frequency	Typical Station	Approx. Tuning Capacity, Mmfd.
570	WMCA	335
660	WEAF	265
710	WOR	220
760	WJZ	185
810	WNYC	160
860	WABC	145
1010	WHN	105
1100	WBIL	80
1250	WNEW	55
1550	WQXR	30

Note: Since the trimmer condensers have comparatively wide capacity ranges, a single type will cover a wide frequency range and therefore take in intermediate station frequencies not listed above.

section of the 6A8G, and the other terminal connects to one set of tuning condenser plates in the group tuning the r.f. signal or mixer section of the 6A8G tube. Thus, when a button is pushed down, two of the tuning condensers are connected to ground, thus completing two tuned circuits with their corresponding mixer and oscillator coils. All of the other condenser sections remain open or "floating" so that they play no part in tuning.

The limit of this system is six stations—the number of push buttons on the Yaxley switch. The receiver described does not have a continuously variable condenser and dial in addition to the push-button-connected condensers, although a two-gang variable condenser can readily be substituted for one pair (one condenser in each group of six) of trimmer condensers to provide manual tuning.

The method of mounting the switch and connecting the condensers is shown in the accompanying illustrations. Dual trimmer condensers are used in the pre-tuned system, although single trimmers may be used if desired. A single bank, therefore, is made up of three dual condensers rather than six single ones. The two sections of each dual condenser are used in the same circuit; that is, both in the oscillator circuit, or both in the mixer circuit—not one in the oscillator and one in the mixer. Thus, the two sections of a single dual condenser might be C1 and C2 in either the oscillator or mixer circuits, but not C1 in the oscillator circuit and C1 in the mixer circuit. This is important, for if the two sections of a single dual condenser are used to tune the mixer and oscillator to a single station, the coupling between the sections will cause oscillation.

Condenser Data

It should be noted from the photos and sketches that all of the trimmer condensers which tune the oscillator section

Under-chassis view of the AWR Automatic, showing location of parts. Note position of the oscillator trimmer condensers just below the push buttons.

are mounted under the chassis, while those which tune the signal or r.f. section are mounted on a bracket which places them above the chassis. There should be some form of shielding between these two condenser groups or oscillation will take place. The condenser groups must not be mounted close together unless one group is enclosed in a shield.

The condensers used were selected for coverage on stations below 1000 kc. There are two tuning sections mounted in one ceramic block in the G type Meissner trimmer units employed so that each group of six tuning condensers is made up of three of the Meissner G type units. For complete coverage of the broadcast band, it is suggested that the trimmer condensers be selected through reference to Table I which shows the approximate tuning capacity which should be employed in the r.f. and oscillator circuits to tune to given broadcast-band frequencies. The distributed capacities in wiring have been taken into account in making up this table.

The intermediate-frequency amplifier is of the variable selectivity type where response can be made broad or sharp by switching in or out an over-coupling winding on the primary of the first i.f. transformer. For high-fidelity response, the selectivity switch should be in the position shown in the schematic diagram.

The A.F.C. System

The combination detector, a.v.c. and automatic frequency control discriminator circuit is simple and requires little explanation. It will be noted in the schematic diagram that a 6H6G double diode detector is used with a split

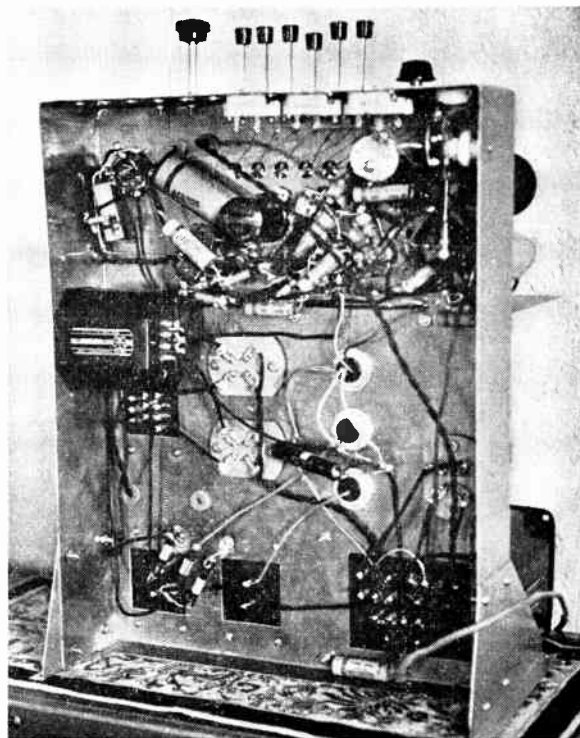

After alignment of the i.f. amplifier, the test oscillator should be connected to the antenna lead and to the chassis. Connect the by-passed cathode of the 6H6G temporarily to ground to kill the a.f.c. With the push button that connects the highest capacity pair of trimmer tuning condensers to ground depressed, the test oscillator should be set to the frequency of the highest wavelength station desired. Adjust the trimmer condenser which tunes the oscillator section of the 6A8G until the test oscillator signal is picked up, and then tune the trimmer very carefully for exact resonance. Next adjust the r.f. trimmer tuning condenser for maximum output of the test oscillator signal. Repeat this process for the five remaining push button positions with their separate pairs of trimmer condensers. Then remove the test oscillator and reconnect the antenna. Each of the

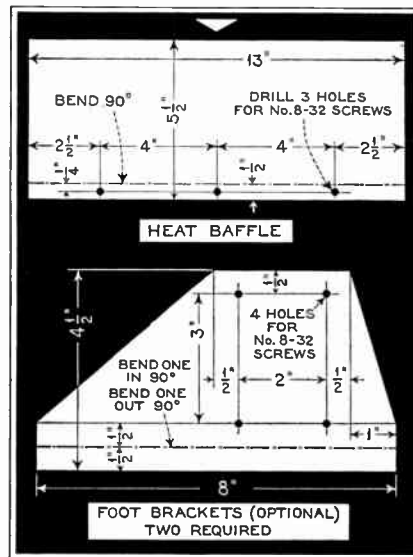

Details of heat baffle and foot brackets.

six stations thus pre-tuned should be received instantaneously upon pressing down the proper push button.

A.F.C. Adjustment

The next step is the final adjustment of the automatic frequency control system. Open the ground end of the 400-ohm cathode bias resistor in the 6J7G control tube circuit and insert in series with it a d.c. milliammeter with a range of 0 to 10 milliamperes. Record the current flowing with the set turned on and with the 6H6G by-passed cathode still grounded. Now remove the ground from the by-passed cathode and permit a.f.c. voltage (if any) to get to the grid of the 6J7G tube. With a broadcast signal tuned in by depressing one of the push buttons, the 6J7G cathode current should again be noted. If all circuits have been

(Continued on page 50)

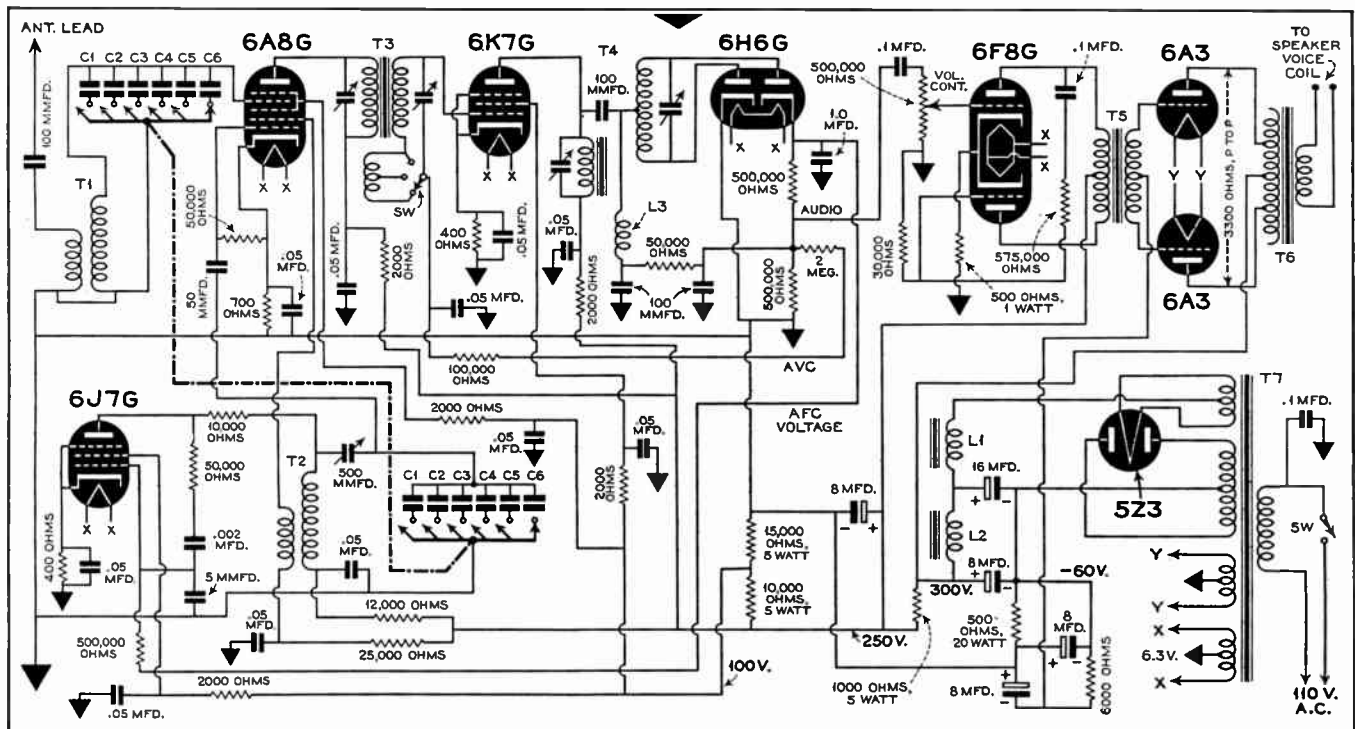

Complete schematic diagram of the AWR Automatic. Parts list is given below.

AEROVOX

(Resistors)

- 3—500,000 ohms, 1/2 watt, type 1097
- 3—400 ohms, 1/2 watt, type 1097
- 1—75,000 ohms, 1/2 watt, type 1097
- 5—2000 ohms, 1/2 watt, type 1097
- 2—100,000 ohms, 1/2 watt, type 1097
- 2—50,000 ohms, 1/2 watt, type 1097
- 2—250,000 ohms, 1/2 watt, type 1097
- 1—30,000 ohms, 1/2 watt, type 1097
- 1—10,000 ohms, 1 watt, type 1098
- 1—50,000 ohms, 1 watt, type 1098
- 1—25,000 ohms, 1 watt, type 1098
- 1—12,500 ohms, 1 watt, type 1098
- 1—500 ohms, 1 watt, type 1098
- 1—15,000 ohms, 5 watts, type 931
- 1—10,000 ohms, 5 watts, type 931
- 1—1000 ohms, 5 watts, type 931
- 1—500 ohms, 15 watts, type 933

(Condensers)

- 3—100 mmfd. mica, type 1467
- 1—.002 mfd. mica, type 1467
- 1—50 mmfd. mica, type 1467
- 12—.05 mfd., 400 v. paper, type 484
- 3—.01 mfd., 400 v. paper, type 484
- 1—1.0 mfd., 200 v. paper, type 284

- 1—8 mfd., 450 v. electrolytic, type GL450-8
- 1—8-8.8 mfd., 475 v. electrolytic, type GL475-8-8.8
- 1—16 mfd., 475 v. electrolytic, type GL475-16

ALADYN

- 1—H103 i.f. transformer, 465 kc. (T3)
- 1—A200c i.f. transformer, 465 kc. (T4)

AMERICAN RADIO HARDWARE

- 3—4-prong sockets
- 5—octal sockets

HAMMARLUND

- 1—type RFC-85 r.f. choke, 85 mh. (L3)

JENSEN

- 1—Peri-dynamic Reproducer, type ST-381
- 1—A12-PM dynamic speaker, type ST-363

(Above items compose the KM-12 unit)

MEISSNER

- 1—type 6N62 shielded ant. coil (T1)
- 1—type 4243 shielded osc. coil (T2)
- 2—type G15211 double trimmer condensers, 200-600 mmfd. (see text)
- 2—type G15224 double trimmer condensers, 170-410 mmfd. (see text)

- 2—type G13297 double trimmer condensers, 50-180 mmfd. (see text)
- 1—type A17032 single oscillator trimmer, 520-960 mmfd.

RAYTHEON

- 1—type 6J7G
- 1—type 6A8G
- 1—type 6K7G
- 1—type 6H6G
- 1—type 6F8G
- 2—type 6A3
- 1—type 5Z3

UNITED TRANSFORMER

- 1—type PA-233 pp. interstage trans. (T5)
- 1—type PA-168 pp. output trans., 3300 ohms p. to p. (T6)
- 1—type PA-428 power trans., 450 v., 250 ma. (T7)
- 2—type PA-40 filter choke, 12 h., 200 ma. (L1, L2)

YAXLEY

- 1—type Y500MP 500,000-ohm volume control, with power switch
- 1—6-button station-selector switch

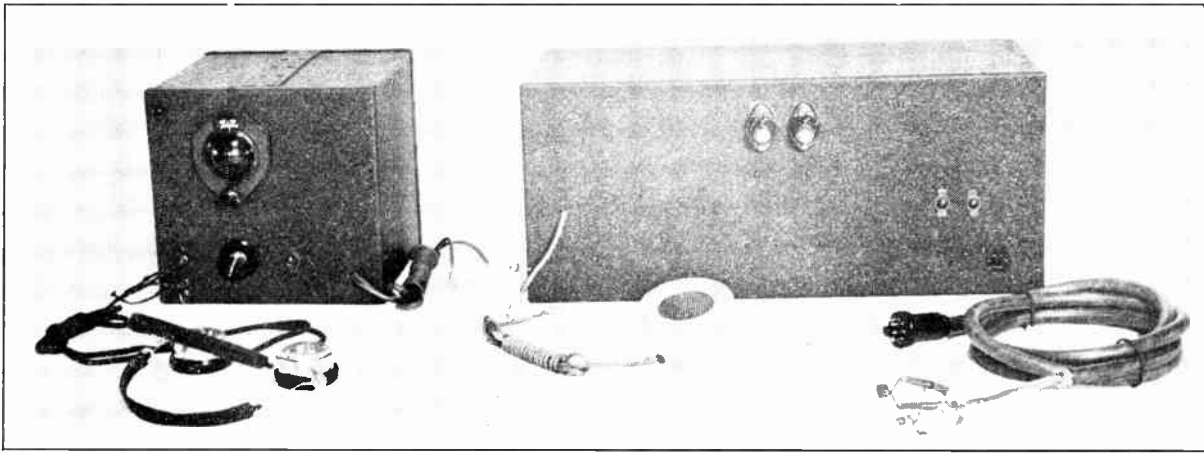

THE COMPLETE TRANSMITTER WITH HOME-MADE MIKE IS SHOWN AT THE RIGHT. THE COMPANION RECEIVER AT THE LEFT WILL BE DESCRIBED NEXT MONTH.

SIMPLE A. C.-D. C. 5-METER TRANSMITTER

THREE-TUBE RIG IDEAL FOR LOCAL PHONE WORK

By GUY FOREST

THIS transmitter was designed for one end of a two-way radio-telephone circuit, particularly for emergency work. The objects in the design were a unit adaptable to either mobile or fixed operation, an assembly as simple and rugged as possible, and an output of a few watts with a minimum of demand for operating power.

The Design

The frequency of the transmitter is set during construction, and there are no tuning condensers or other adjustments. A 6A6 dual-triode tube consti-

tutes a self-excited oscillator whose frequency stability, due to a novel arrangement of the grid circuit, is exceptionally good. At the same time, a relatively high plate efficiency has been attained with a resonant-line plate circuit. The 6A6 is modulated by a 41 audio pentode, driven by a 6J7 speech amplifier and a home-made magnetic microphone. A Genemotor fits in the layout so that the transmitter can be powered entirely from a 6-volt storage battery. This feature is especially valuable during an emergency when a transmitter needs be independent

of the domestic power supply. However, a 110-volt a.c. power pack will serve to push the transmitter, at other times, with somewhat more convenience and less expense per kwh.

Details of the panel and subpanel layout appear in Fig. 1. Should the transmitter be intended solely for fixed operation, the cover box may be omitted, also the flanges on the panel, and the latter put on 19-inch relay-rack mounting. Two glazed porcelain standoff insulators do duty for antenna lead-ins through the panel, and one as plate-circuit support on the subpanel. A wire is fastened under the screw head up inside each insulator body and is brought back, air-insulated, through a hole in the metal. The filter condenser, C4, is a standard-size dual 8-8 mfd. electrolytic, 1 $\frac{3}{8}$ -in. diameter by 5 $\frac{1}{4}$ -in. long. It is fixed by means of a mounting ring in the hole indicated, extending 4 inches above the subpanel.

The Circuit

In Fig. 2 is the circuit diagram for the transmitter. The microphone, M, is a converted Baldwin loudspeaker unit. Take off the cover plate of the unit and cut in it a 2-in. circular hole, getting rid of the threaded nipple. Fasten a piece of grill cloth, and a piece of 16-mesh bronze screen, under the cover plate when it is replaced. Use a 5-ft. single-wire shielded cable between the microphone and 6J7 input, grounding the shield both to chassis and microphone frame. The speaker unit, thus converted, is an

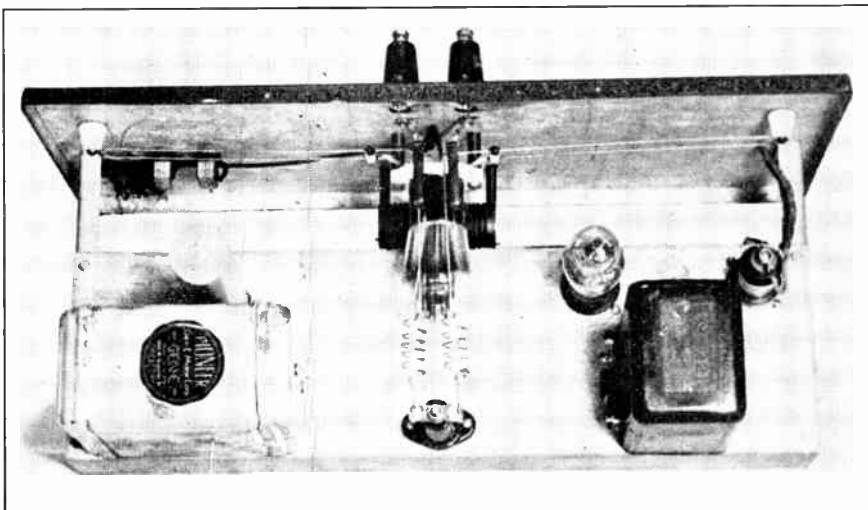

Top view of the complete 5-meter transmitter. The oscillator tube and associated coils occupy the central position. The audio equipment is at the right, the 6-volt Genemotor at the left.

excellent microphone for the close talking and handling incident to portable operation.

The 6J7 speech amplifier is resistance-coupled to the 41 pentode modulator, and the latter modulates the 6A6 by way of the output transformer, T.

Power connections to the transmitter are made through the octal socket on the panel. One cable consists of 6 feet of 2-wire No. 14 heavy rubber-covered cable, having 3-in. battery clips at one end and an octal plug at the other. The socket pins are connected in parallel, as shown, in order to minimize voltage drop at the contacts. The two toggle switches on the panel control independently the filament current to the tubes, and the motor driving current. The octal socket automatically takes care of connections when changing from one type of power supply to the other. Both the motor and generator are disconnected and left free when the power-pack cable is inserted. The latter cable consists of a 4-wire conductor, 6 feet long, soldered to an octal plug as indicated. The filament switch on the transmitter panel functions as before, but independent control of plate voltage must be done in the power-pack unit, if and as necessary.

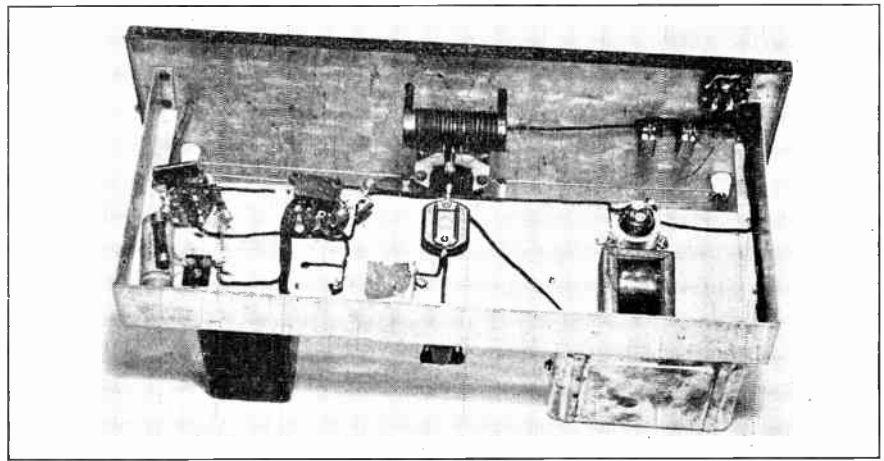

Bottom view of transmitter from rear, showing location of parts below deck. The coil mounted on the front panel, at the center, is L1 in the schematic diagram below. The bus wires forming L2 can be seen directly underneath the coil in the above photo.

The filter choke, L3, and the filter condenser, C4, remain active in the circuit irrespective of the source of power.

Details of Oscillator

It is important that the details of the oscillator circuit, Fig. 3, be followed closely. The dimensions, and the accessory fittings, of the circuit help to deter-

mine the oscillation frequency. To arrive at different frequencies in the 5-meter band the numbers of turns on the plate-loading coils, and the number of turns on the grid coil, may be adjusted in accordance with Table I. Small adjustments of frequency can be made by spreading lengthwise the turns of the plate loading coils and trimming off any excess wire beyond the supporting insulator. For general use, if no wave-meter or frequency meter is available, the circuit had best be trimmed for the middle of the band, or 58 mc.

The plate circuit is constructed of No. 14 tinned, hard-drawn copper busbar. Experiments proved that this was better than 1/8 or 3/16-in. copper tubing. Each side of the plate "line" starts at, and is supported by, a plate terminal on the Isolantite socket. It makes a return bend at the 5/8-in. Steatite stud insulator, and turns at right angles to run back over the tube to the porcelain standoff insulator. The small 1/4-in. diameter by 3/4-in. long Isolantite insulators which brace the line are made from the ceramic body of an IRC Type F1 metallized resistor. Melt off the metal end caps and draw out the central filament of the resistor. Nick the ceramic body around its middle with a file or abrasive wheel, and break between thumbs in the manner of breaking glass tubing. This yields the two 3/4-in. lengths. Pass a loop of thread down the central hole, using a fine wire loop for a needle; then tie the insulator between the "line" wires as shown, and melt a drop of paraffine or beeswax on the knots for greater rigidity.

Data on Grid Coil

The grid coil is wound on thin bakelite tubing. The ends of the coil are left free—the grids of the 6A6 tap across some 20% of the total turns. Consequently, due to step-down transformer action, the tube capacities affect only slightly the frequency. A very stable

LEGEND

- M—Baldwin magnetic loudspeaker unit, converted to mike
- C1—paper bypass 1 mfd., 200 volts
- C2—paper bypass .04 mfd., 400 volts
- C3—molded mica .001 mfd.
- C4—dual electrolytic 8-8 mfd., 450 volts
- C5—molded mica .0005 mfd.
- R1—2000 ohms, 1 watt
- R2—2 megohms, 1 watt
- R3—.5 megohm, 1 watt
- R4—1 megohm, 1/2 watt
- R5—1000 ohms, 1 watt

- R6—5000 ohms, 1 watt
- L1—long-line grid coil (see text)
- L2—resonant-line plate circuit (see text)
- L3—filter choke, 10 h., 100 ma.
- SW1—s.p.s.t. toggle switch
- SW2—s.p.s.t. toggle switch
- G—Genemotor, 6-volt d.c. input, 250-volt, 50 ma. d.c. output.
- I—glazed porcelain standoff insulators, 1 1/2" high
- T—audio output transformer, pentode 41 tube to 10,000-ohm load

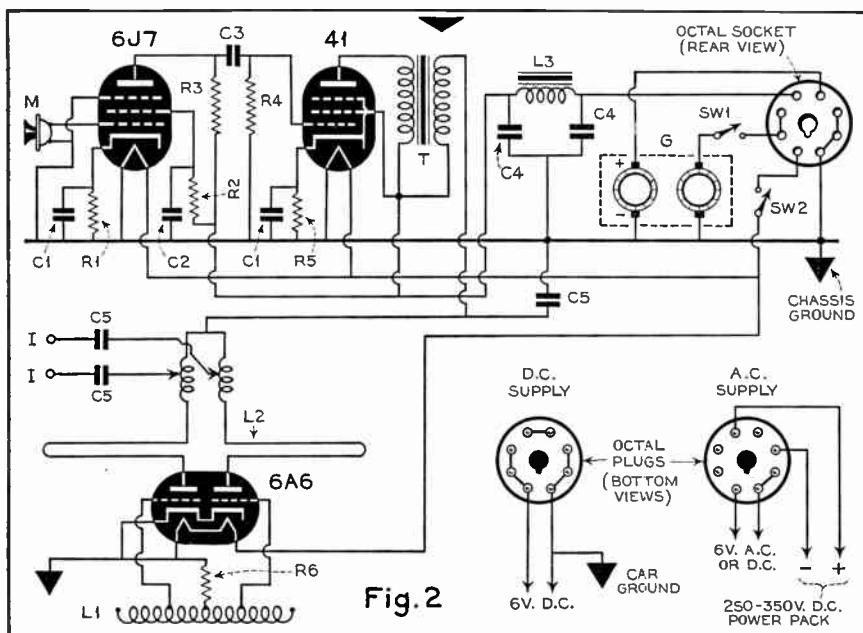

Complete schematic diagram of the 5-meter transmitter. The arrangement is simple and straightforward. Parts values are given in the Legend above.

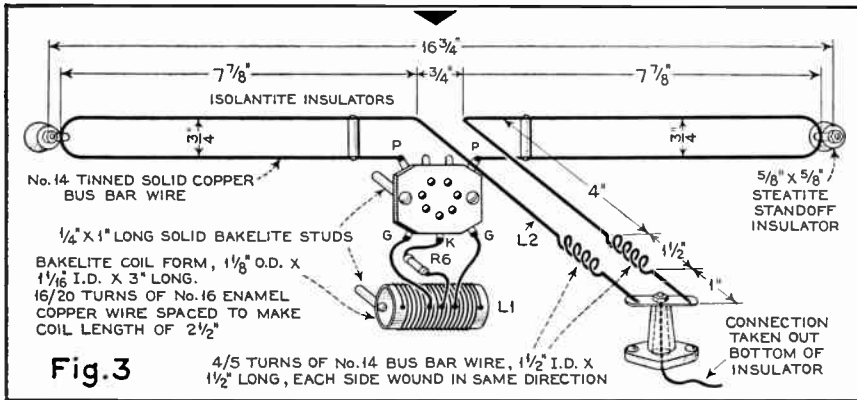

Fig. 3 Complete details of the oscillator circuit, showing the manner in which the plate and grid circuit coils are formed and connected to the socket for the 6A6 oscillator tube.

oscillator results, one whose frequency stays put during modulation. The turns on the grid coil are spaced approximately the diameter of the wire, and the ends of the wire are simply hooked through holes in the coil from the cut off. The entire coil and form should be dipped in a 50-50 mixture of melted beeswax and rosin, chiefly for the purpose of keeping the turns in place. Paraffine can be used, if necessary.

If the transmitter is used in a car, care must be exercised with the 6-volt cable connections, to have the same wire go to car ground as goes to chassis ground. Depending on the car battery polarity, it may be necessary to reverse the output leads of the Genemotor. The positive generator lead, of course, must go to the plates of the tubes. The polarity of the battery-cable clips, once correctly ascertained, must be observed.

With the wiring completed and checked, connect the transmitter to power and allow the filaments to heat. Turn on the plate voltage and check for oscillation with a neon bulb at the 6A6 plate terminal. Coupling to the antenna is made through the blocking condensers, C5. These are supported on busbar extending from the rear of the panel insulators.

The Antenna System

A recommended antenna system is outlined in Fig. 4, one which is easy to excite and which has good radiating properties. In a car, only the upper half of the antenna system may be installed and the lower half eliminated. The best point for coupling the antenna to the oscillator usually will be near the middle of the plate loading coil. Using a small flash-

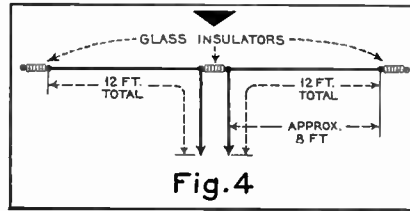

Fig. 4 Antenna system recommended for the 5-meter transmitter. A vertical antenna is preferable but a horizontal one will do.

light bulb, or 0-.25-ampere range r.f. ammeter in series at one lead-in insulator, the antenna system should be shortened or lengthened symmetrically, six inches at a time, for maximum current. It is a good idea to check the plate current on the 6A6, finally. The value should be 20 to 30 milliamperes, at 250 volts plate supply; or, in proportion at other plate voltages. If too far out of line an improper load will result on the 41, with consequent poor modulation.

The total drain of the transmitter on a 6-volt battery is approximately 5 amperes. The power output, measured in the antenna, ranges from 2 to 5 watts, depending on the plate voltage input. The transmitter works readily in true duplex radiophone communication, given a reasonable strength for receiving; or, on weaker signals, two-way contact can be had simply by throwing off the generator switch while listening.

(A companion receiver, specifically designed for use in conjunction with the Ultra-High-Frequency Transmitter, will be described by Mr. Forest in the February issue.—Editor.)

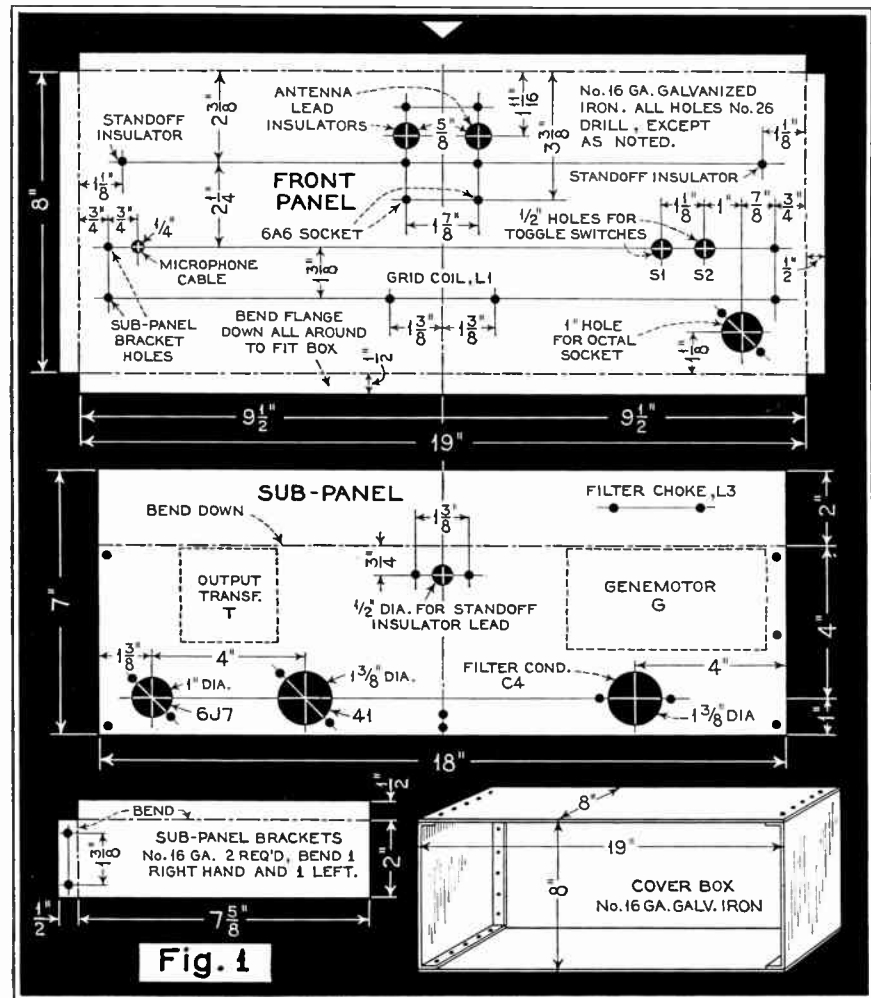
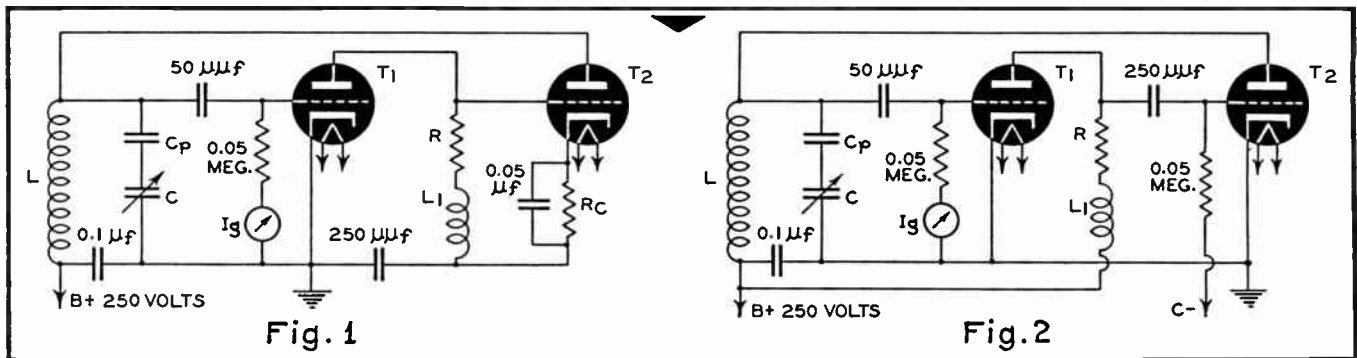

Fig. 1 Layouts and dimensions for the 5-meter transmitter front panel, sub-panel, sub-panel brackets and cover box.

TABLE I

Mc.	Turns Grid Coil	Turns Plate Coils
56	20	5.0
58	18	4.5
60	16	4.0

A TWO-TERMINAL OSCILLATOR



Oscillator circuits that require but two connections for waveband switching, making them of value as converter oscillators in multi-band receivers.

By ENGINEERING DEPT., RCA-RADIOTRON

THIS article describes a simple, reliable, two-terminal r.f. oscillator whose output voltage is substantially constant over a reasonable range of frequencies. For a given ratio of maximum-to-minimum tuning capacitance, this oscillator may furnish less output voltage than conventional oscillators, but the ease with which adjustments can be made, the uniformity of the output voltage, and the simplicity of coil design, are desirable features.

Three Variations

Three variations of the circuit are shown in Figs. 1, 2, and 3. In these circuits, the output of T_1 feeds the grid of T_2 ; the output of T_2 feeds the grid of T_1 . Thus, the action of T_2 is analogous to that of the tickler in a conventional tickler-feedback circuit. Fig. 1 represents a direct-coupled arrangement. In this circuit, signal and bias for T_2 are obtained directly from T_1 . Because of the direct coupling, the internal plate resistance of one tube is connected in series with the internal plate resistance of the other; hence, the B-supply voltage is divided between T_1 and T_2 . In the circuit of Fig. 2 and of Fig. 3, capacity coupling between T_1 and T_2 is used; hence, nearly full B-supply voltage is applied to each tube. Fig. 2 differs from Fig. 3 merely in the manner in which B-supply voltage is fed to T_2 .

In determining the value of R , tune the oscillator to the low-frequency end of the high-frequency band and adjust the value of R for nearly maximum output. Tune the oscillator to the high-frequency end of that band and adjust L_1 for the same output that was obtained at the low-frequency end. Now, measure oscillator amplitude over the tuning range of the waveband; a convenient measure of oscillator amplitude is the value of oscillator grid current I_g . It

may be necessary to change these values of R and L_1 in order to obtain a suitable compromise between desired values of tuning range, oscillator amplitude, and uniformity of output. When the values of R and L_1 are determined in this manner, they need not be changed when the oscillator is switched to any of the lower frequency bands. In these bands, oscillator amplitude is independent of the value of L_1 and is nearly constant over the tuning range of the band.

For a given amplitude of oscillation, the tuning range of this oscillator circuit may be less than that of a conventional feedback circuit because of the high minimum capacitance introduced into the tank circuit by T_2 . The shunt-feed circuit of Fig. 3 is suggested as a means of reducing this minimum capacitance. In this circuit, the series combination of C_c and the output capacitance of

T_2 is connected across the tank circuit; the entire output capacitance of T_2 is connected across the tank circuit in the series-feed circuit of Fig. 2. A disadvantage of the shunt-feed scheme of Fig. 3 is that the plate voltage of T_2 is reduced by an amount equal to the voltage drop across R_p . Thus, for the same B-supply voltage, increased tuning range is obtained at the expense of reduced oscillator voltage.

Typical values of R and L_1 are 200 ohms and 1.5 microhenries, respectively. These values are suggested as guides; final values should be determined by test. The condensers C_p are used to isolate the high voltage from the tuning condenser C ; condenser C_p may be a padding condenser when the oscillator tracks with a signal circuit in a superheterodyne receiver. The bias on the

(Continued on page 48)

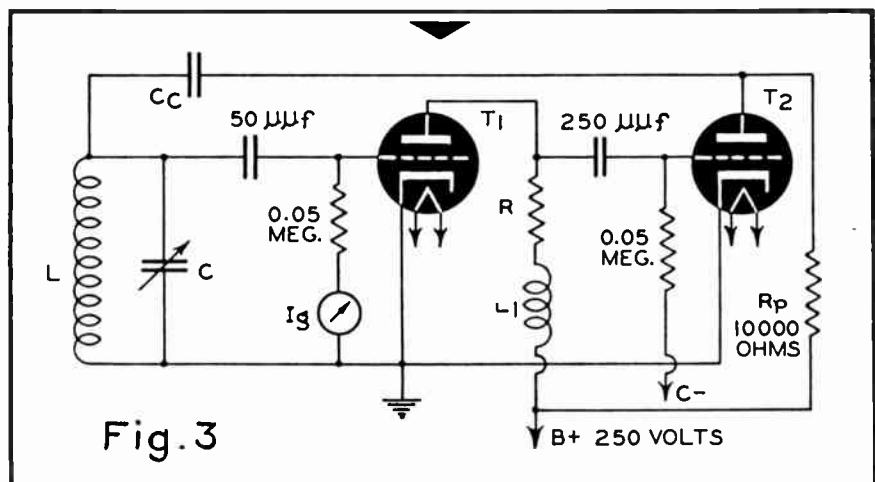

A third variation of the two-terminal oscillator circuit. This one employs shunt feed. A disadvantage of this system is that the plate voltage on the tube T_2 is reduced appreciably by the drop across R_p . However, this circuit provides a wider tuning range.

NEWCOMER'S C.W.-PHONE TRANSMITTER



FRONT-PANEL VIEW OF THE COMPLETED NEWCOMER'S C. W.-PHONE TRANSMITTER.

Self-Contained Rig For 10- to 160-Meter Operation

By C. WATZEL, W2AIF, and W. BOHLEN, W2CPA

THE present tendency in transmitters is toward extreme compactness in design, with all components self-contained in a single cabinet. The physical size and power requirements of such a transmitter depend, of course, on the power output desired and whether or not phone operation is contemplated. The addition of audio equipment sufficient for 100-per cent modulation requirements of any given c.w. transmitter entails both additional size and expense. Grid modulation of a final stage, either of the control- or suppressor-grid type, may be accomplished with a minimum of additional audio equipment, but lowers the phone output to but a fraction of the c.w. output. This method of modulation is satisfactory for high-power finals but reduces the phone power to too low a figure when the final tube is small.

Completely Self-Contained

The transmitter presented in this article is a practical compromise between the various factors entering into the design of any transmitter. While a single receiver-size cabinet contains the entire job, the transmitter is complete in itself, containing a crystal-controlled r.f. section, speech amplifier-modulator and power supply for both these sections. The input to the final stage runs between 40 to 45 watts, for c.w. operation, on all bands from 10 to 160 meters. The input to the final runs 20 to 25 watts, 100-per cent modulated, also for all bands. The resulting power outputs are sufficient for satisfactory operation on these bands,

depending, of course, on the conditions prevailing at the time of operation, amount of QRM encountered, location and effectiveness of the antenna.

This little transmitter will also serve as a driver for a high-power final stage running at inputs upward to several hundred watts. This high-power final stage may be separately modulated with a high-power modulator, or may serve as a linear amplifier, using no audio equipment outside of that contained in the small transmitter. In this way the original transmitter need not be discarded or even changed when the eventual jump to high power is made. As a standard 8 $\frac{3}{4}$ " x 19" rack panel is employed, the entire unit may be incorporated into the rack or cabinet of the high-power job. The only interconnections required would be a two-wire link between this transmitter unit and the high-power final unit.

As but a single power supply could be contained in a cabinet of this size, it was necessary that the final amplifier tube and the modulator tube, or tubes, work at the same plate voltage. Also it was felt desirable that the transmitter be adaptable to operation from a storage battery for portable or emergency work. This called for operation at a relatively low voltage. For a final solution of this design problem an 807 for r.f. amplifier, 6N7 for modulator, together with a dual-voltage power supply were found suit-

able. The new type 807 is rated up to 100 ma. plate current at 475 volts for phone operation or 600 volts for c.w. The 6N7 is a duo-triode tube of the metal type. Operated as a push-pull Class B amplifier it will furnish 10 watts of audio. The power supply will provide either 350 or 450 volts at 250 ma. For phone operation the entire transmitter is run at 350 volts, which is only slightly high for the 6N7 modulator tube. For c.w. operation, with the audio section switched out, the 807 is operated at the full 450 volts.

The R. F. Section

The diagram, Fig. 1, is divided into the three electrical sections; r.f., audio and power. A pair of 6F6 metal pentodes furnish adequate excitation on all bands down to, and including, 10 meters. When the 807 is operated on the crystal frequency the second 6F6 is cut out of circuit with the switch, SW. For operation on the second or fourth harmonic of the crystal both 6F6s are employed.

The design of this r.f. section is straightforward. No neutralization is required except for the 807, as the second 6F6, when switched in, is only used as a frequency multiplier. The 807 is neutralized by means of a very small condenser tapped very near the end of the plate coil. This condenser is actually of the mica trimmer type. The plates are bent at almost a right angle

so that there is an air gap between the two plates.

Keying is accomplished in the cathode lead of the 807 stage. The cathode bias resistor, R7, and its bypass condenser, C10, act as an effective key click filter, so that in most cases additional filter is not required to eliminate the clicks.

The plate condenser, C12, is of the split-stator type. For 10-meter operation the switch is left open to reduce the minimum capacity. For operation on all other bands except 160 the switch may be either closed or open. For 160 meters it is necessary to close the switch to obtain the maximum total capacity of 100 mmfd. The use of this switch permits of low C in the plate tank on 10 meters, where it is necessary for efficient operation, and high C on 160 meters where high C is necessary for proper phone operation and minimization of harmonics.

Due to the variety of antennas this transmitter will have to work with, no antenna-tuning system was incorporated. A fixed link is wound on each coil for low-impedance coupling to either a low-impedance line, such as EO1 cable, Basset cable or twisted pair, or else to a separate antenna tuning unit.

The Audio Section

The entire audio section is composed of but two tubes and three transformers. One 6N7, as mentioned before, is used as a Class B modulator with an output of ten watts. The other 6N7 has its grids and plates paralleled and is biased to run as a Class A amplifier tube. In order to keep the cost down a double-button carbon microphone is employed, so that no additional speech amplification is

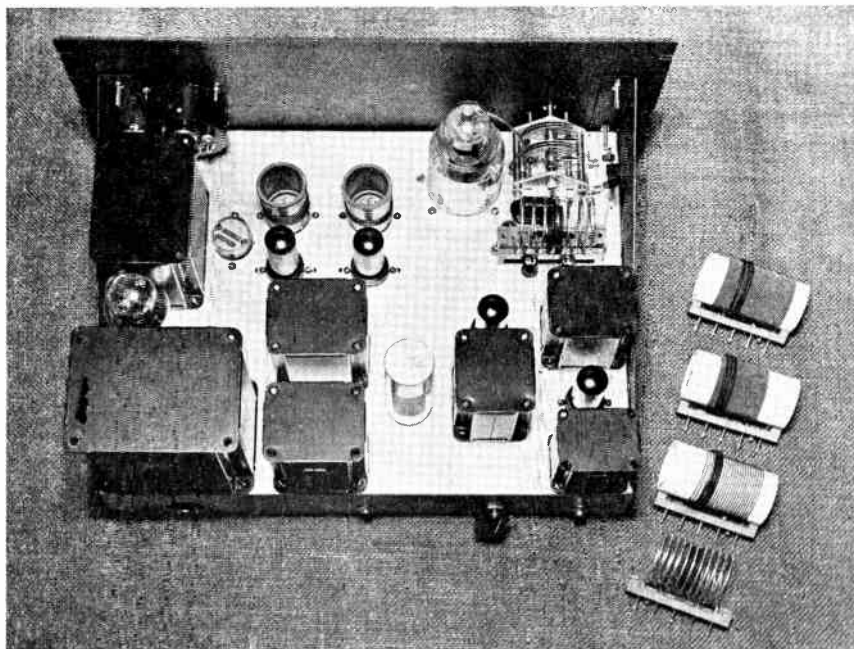

Top view of the transmitter chassis, showing location of components. Compare this with the chassis layout drawing on page 16. The 20, 40, 80 and 160-meter coils for the final tank circuit are also shown.

necessary other than that provided by the single 6N7. An inexpensive double-button microphone, kept in good condition, will furnish an excellent degree of quality. The fact that a relatively low voltage gain is required throughout the audio section with this type of microphone eliminates any worries about feedback, either r.f. or a.f. It is not even necessary to use a shielded microphone cord, although one is recommended just "in case." It is also well to use a shielded microphone plug, and one of this type is specified.

Microphone batteries are always a

nuisance, not only for their mounting difficulties but because they run down at the most embarrassing moments. Voltage for the microphone is taken from the power supply in this transmitter. R10 and R11 form a combined power-supply bleeder and source for microphone voltage. R10, which is a 500-ohm, wire-wound potentiometer, is mounted on the rear of the chassis. Turning the knob will provide any microphone voltage from 0 up to about $3\frac{1}{2}$ volts. This control also serves as a gain control, eliminating the necessity for any other gain control in the audio circuits.

A crystal microphone, Velotron or other low-gain type may be used with the addition of a small pre-amplifier. The pre-amp may be plugged into the microphone jack, using a low-impedance line of 200 ohms. The microphone transformer, T, is tapped so that any input impedance of 50 to 500 ohms may be obtained. This input transformer, incidentally, is of the hum-balanced type, minimizing any coupling between it and the power supply.

The Power Supply

The lower section of Fig. 1 shows the power supply and switching arrangements. The power transformer, T4, has a primary tap in order to obtain the two different secondary voltages of 350 and 450 volts. The "Fone-CW" switch, SW1, performs a dual function. One section switches the plate voltage to the audio tubes. The other section switches the line voltage to either tap on the power transformer. In this way the correct plate voltage is always obtained when throwing the "Fone-CW" switch.

SW3, marked "filament" switch, is the main line switch for the entire trans-

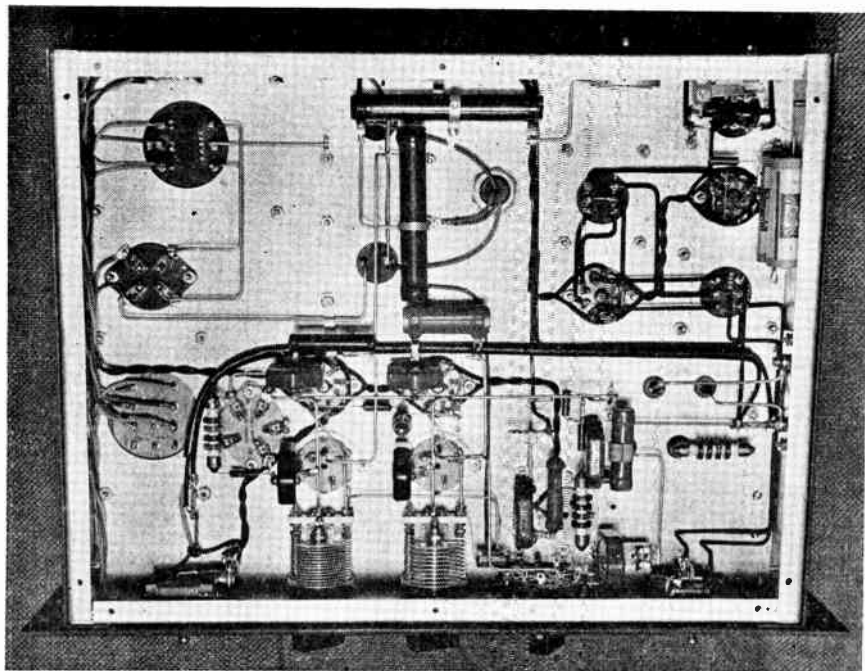

Under-chassis view of the transmitter. Note positions of tuning condensers C1 and C5 which are controlled from the front panel.

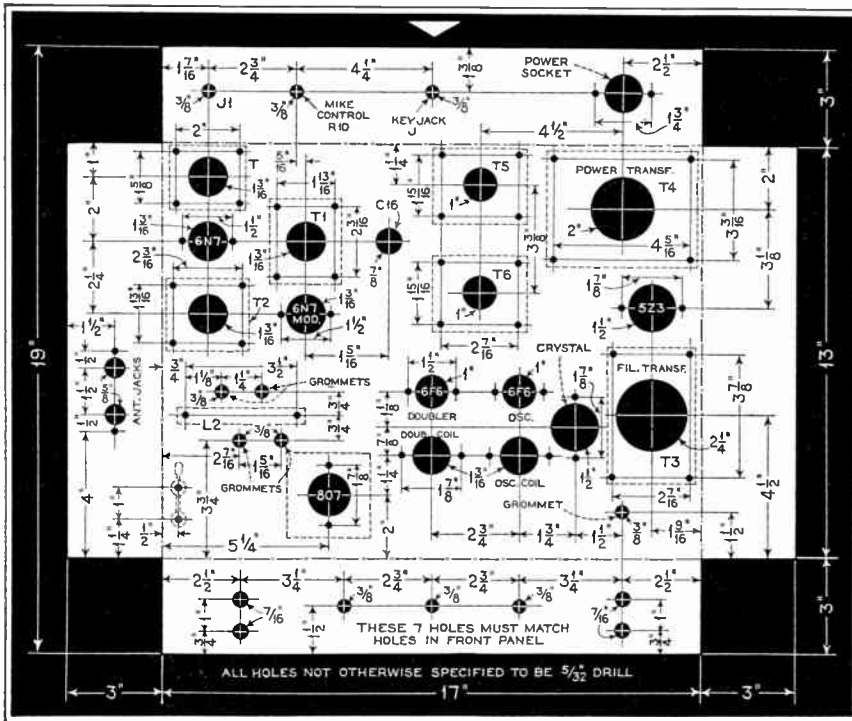

Layout and drilling details of chassis for the Newcomer's Transmitter. All necessary dimensions are given.

mitter. In this way it is impossible to apply plate voltage to any of the tubes without their heaters being energized.

The plate switch, SW2, is also dual purpose. One section switches the power transformer. The other section switches on and off the light in the milliammeter, M. One of the new illuminated meters of the Simpson line is used for reading the 807 plate current. The small pilot light below the meter is connected to the heater circuit so that it lights up when SW3 is thrown. Then, when the plate switch, SW2, is thrown the light in the meter comes on, indicating plate voltage is "on." In addition to making the scale of the meter more readable, regardless of light conditions in the shack, the meter light provides a very effective "pilot light."

Battery Operation

No switching is necessary in order to adapt the transmitter to battery operation. This is accomplished automatically by placing the proper plug into the "power" socket on the rear of the chassis. The plug illustrated in Fig. 1 is for a.c. operation. The a.c. line cord is attached to two prongs of the plug. A jumper between two of the other prongs connects one side of the 6.3 volt winding on T3 to the heater circuit, the other side being connected all the time. In this way it is impossible to either apply the battery voltage to the filament transformer secondary winding or to connect the filament and plate transformers to the a.c. line with the battery voltages plugged in.

For battery operation one of the new

Mallory "Vibrapacks" is employed. This will provide up to 300 volts at 100 ma. The heaters are run directly from the storage battery for this type of operation. As the Vibrapack has a common connection for minus high voltage and one side of the battery, this idea has been continued in the transmitter. One side of the heater circuit is directly grounded. This greatly simplifies connections for both a.c. and battery operation. For operation in a car, for instance, the transmitter chassis may be connected to the car body regardless of which side of the battery is grounded in that particular car.

Complete data on battery operation will be given next month, including the connections of the battery cable and plug and the switching system necessary for battery operation. The relatively high current drawn by the Vibrapack makes switching directly in the battery leads to the pack necessary, rather than in the transmitter itself.

Design and Layout

The three sections of the transmitter

are separated on the chassis. The 807 stage is in the left front corner. The switch which parallels the sections of the plate condenser, C12, is a midget knife switch of the s.p.s.t. variety which has been remounted on a pair of small standoff insulators. These particular insulators came with the two National octal Isolantite sockets.

The bypass condenser, C13, is actually a part of the tank circuit, so it is mounted above the chassis between the frame of C12 and the center solder lug of the coil base. C2 and C6 are also part of their respective tank circuits, and should be treated as such.

The neutralizing condenser, C9, is mounted under the chassis. As described before, it is of the mica trimmer variety with the plates bent at almost right angles to provide an air gap and lessen the capacity.

The tube and coil directly to the right of the 807 stage are for the doubler stage, while the next tube and coil are for the crystal stage. The crystal is mounted on the chassis directly alongside the latter tube and coil. As the coils in the crystal and doubler stages are never operated on the same band it is permissible to mount them as close as they are without shielding. The tuning condensers for these two exciter stages are mounted under the chassis, directly in front of their respective coil sockets.

The right hand HRO dial at the bottom of the panel tunes the oscillator condenser, C1. The middle one tunes the doubler condenser, C5. The left hand one of these dials turns the doubler switch SW. An HRO type knob is also used for this switch for the sake of uniformity in appearance. The layout of the r.f. section permits of very short leads in both the tank circuits and between the stages. No interstage shielding is required except for the tube shield on the 807. This is a National type J-30 coil shield with the top cut off.

Under no circumstances ground the metal shells of the 6F6 tubes. The exciter stage will not operate properly if this is not done.

The audio section of the transmitter is located at the rear left corner of the chassis. The input transformer is in this

Layout and dimensions of the front panel for the Newcomer's Transmitter. This panel is of the "relay-rack" type, with standard mounting slots.

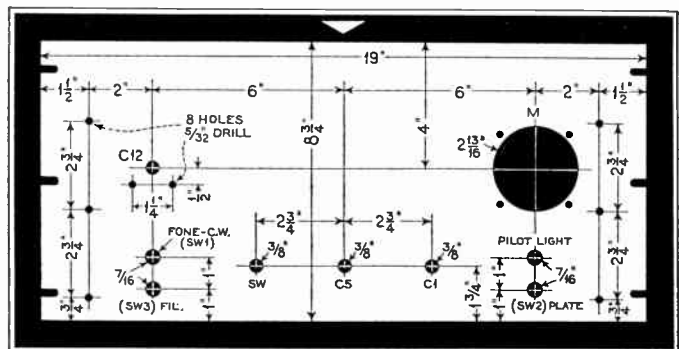

corner, with the speech amplifier tube in front and the modulation transformer, T2, in front of that. The modulator tube and interstage transformer, T1, are at the side toward the right. This lay-

out provides extremely short leads in this section, as the microphone jack, J1, is on the back of the chassis directly below the input transformer and the modulation transformer is close to the 807 stage.

The power supply section is at the right rear of the chassis. The power transformer is in the corner, filament transformer, T3, toward the front and the filter chokes, T5 and T6, toward the rear center. The dual filter condenser, C16, although it appears to be of the electrolytic type, is not. It is the new paper dielectric type PE. It is rated at

600 volts d.c. working volts, 1200 volt test. Thus there is no danger that the high voltage of 450 used for c.w. operation will blow the filter condensers.

The filament pilot light and three control switches, SW1, SW2, and SW3, are symmetrically located at the lower left and right sides of the panel. The one directly under the large tuning dial at the left is SW1, while the lower one is the plate switch, SW2. The filament switch, SW3, is directly under its pilot light in the right hand corner.

(Continued on page 49)

AMERICAN RADIO HARDWARE

- 2—octal wafer sockets No. 1600
- 1—4-prong wafer socket
- 1—6-prong wafer socket
- 2—banana type plugs No. 120
- 2—banana type plug jacks No. 125

BLILEY

- 1—type HF20 20-meter crystal
- 1—type B5 40-meter crystal
- 1—type LD2 80-meter crystal
- 1—type LD2 160-meter crystal

CORNELL-DUBILIER

- 5—type 9-6S1 mica .01 mfd. (C, C4, C10, C11, C13)
- 2—type 9-6D2 mica .002 mfd. (C2, C6)
- 2—type 5W-5Q5 mica .00005 mfd. (C3, C7)
- 1—type 9-6T1 mica .0001 mfd. (C8)
- 2—25 mfd. 50-volt electrolytic type ED-3250 (C14, C15)
- 1—type PE-B6808 dual 8-8 mfd. paper (C16)

IRC

- 1—10,000 ohm ½ watt carbon (R)
- 1—50,000 ohm 1 watt carbon (R2)
- 1—10,000 ohm 1 watt carbon (R6)
- 1—300 ohm 10 watt carbon (R7)
- 1—2500 ohm ½ watt carbon (R9)

KENYON

- 1—type T1 microphone transformer (T)
- 1—type T251 interstage transformer (T1)
- 1—type T451 modulation transformer (T2)
- 1—type T376 filament transformer (T3)
- 1—type T655 power transformer (T4)
- 1—type T506 swinging choke (T5)
- 1—type T152 smoothing choke (T6)

NATIONAL

- 5—type XR5 coil forms (L, L1)
- 2—5-prong isolantite sockets for above coils
- 3—type XR13 coil forms (L2)
- 5—type PB5 coil plugs for above coils
- 1—type XB5 coil base for above coils
- 1—type STH200 tuning condenser (C1)
- 1—type ST100 tuning condenser (C5)
- 1—type TMS50D tuning condenser (C12)
- 1—type M30 neutralizing condenser (C9) (see text)
- 1—type 0 dial
- 3—type HRO dials
- 4—type R-100 r.f. chokes (RFC, RFC1, RFC2, RFC3)
- 1—type J30 tube shield (see text)
- 2—isolantite octal sockets

PAR-METAL

- 1—type SC128 single cabinet
- 1—type 15215 chassis 13"x3"x17"
- 1—type SB713 pair of brackets
- 1—type 3679 aluminum panel 8¾"x19"

RCA-RADIOTRON

- 2—type 6F6
- 2—type 6N7
- 1—type 807
- 1—type 5Z3

SHURE

- 1—type 3B double-button carbon microphone

SIMPSON

- 1—model 27S illuminated rectangular meter, 0-150 ma., d.c.

WARD LEONARD

- 1—50,000 ohm, 10 watt (R1)
- 2—4,000 ohm, 25 watt (R3, R5)
- 1—20,000 ohm, 10 watt (R4)
- 1—25,000 ohm, 25 watt (R8)
- 1—50,900 ohm, 50 watt (R11)

YAXLEY

- 1—type A-1 keying jack (J)
- 1—type 702-B microphone jack (J1)
- 1—type 75 key plug (P)
- 1—type 76 microphone plug (or 76A shielded) (P1)
- 1—type 1315L 2-circuit, 1-gang, 5-point switch (SW)
- 1—type A 500-ohm potentiometer (R10)
- 1—pilot light bracket

MISCELLANEOUS

- 1—6-prong cable connector
- 1—a.c. cord
- 1—s.p.s.t. toggle switch (SW3)
- 1—d.p.s.t. toggle switch (SW2)
- 1—d.p.d.t. toggle switch (SW1)

COIL SPECIFICATIONS

Band	Form	807 Plate Coils (L2)					Oscillator and Doubler (L, L1)			
		Turns	Winding Length	Wire Size	Neutralizing Tap Turns	Link Turns	Form	Turns	Winding Length	Wire Size
10	Air	7	2½"	#12 bare	1	4, inside	XR5	3¾	½"	#20 dsc
20	Air	11	2½"	#12 bare	2	4, inside	XR5	8	5/8"	#20 dsc
40	XR13	20	2"	#20 dsc	3	3, outside	XR5	15	1"	#20 dsc
80	XR13	35	1½"	#20 dsc	4	3, outside	XR5	31	close	#20 dsc
160	XR13	65	2¾"	#20 dsc	5	3, outside	XR5	65	close	#24 dsc

Notes: Number of link turns to match antenna used. Locate link near neutralizing tap. Neutralizing taps are from grid end. Airwound plate coils are mounted on National PB-5 bases.

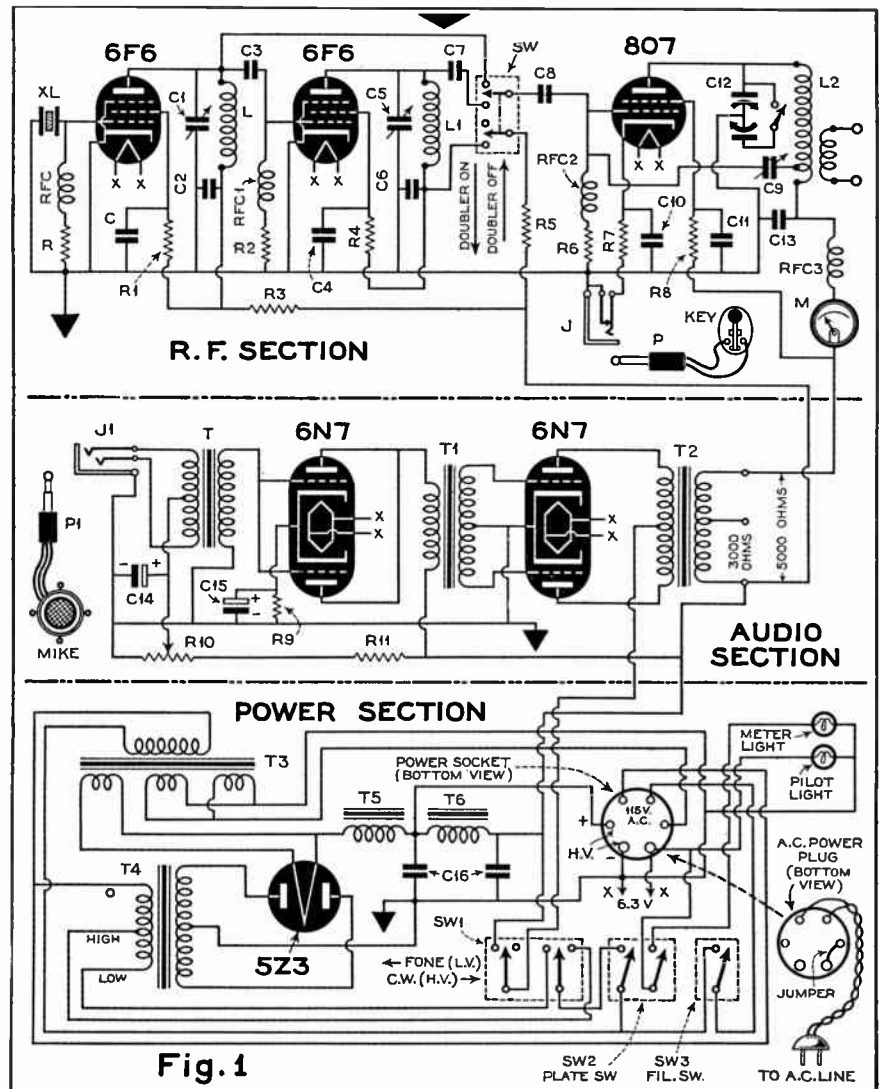

Fig. 1

Complete interconnected schematic diagram of the three units composing the Newcomer's Transmitter. The power section input is wired to a special socket which permits operation from a 6-volt-operated Vibrapack.

60 FEET--

ONE-MAN ANTENNA MAST FOR SLIM POCKETBOOKS

IT doesn't seem possible but we actually did it and it's a one-man proposition, from start to finish. The only need of more help in assembling and erecting the mast is when speed is of prime importance.

For years the thought of a sixty-footer has troubled the dreams of many an amateur. Who of us hams hasn't lain awake nights wondering how he was going to get that old signal squitter up high enough and in the clear so that his signals would bend Aussie and Zedder R-meter needles? Who among us but what has, while traveling through the country or city, become awe-struck at the sight of a towering mast supporting a swell antenna? And many a night we have called and called some super-dx only to hear him come back to our neighbor who happened to have a better sky hook for his pet antenna.

Much has been written and many have been the arguments pro and con about beams, flat-tops, single wires and zepps, but there is no doubting the fact that most of our modern antennas will work miracles if they are up in the clear.

Materials Required

And so to our one-man mast. The materials necessary are:

- 56—Carriage bolts, $\frac{3}{4}$ " x 9"
 - 12—One-inch eyes mounted on 2" x 2" plates
 - 12—Ten-foot 2 by 3 fir beams
 - 1—12 x 12 railroad tie or other suitable mast base
 - 4—Five-foot fence posts of 4 by 4s for guy wire supports
 - 1—can red lead mixed in oil
- Necessary paint, washers, insulators, guy wire, etc.

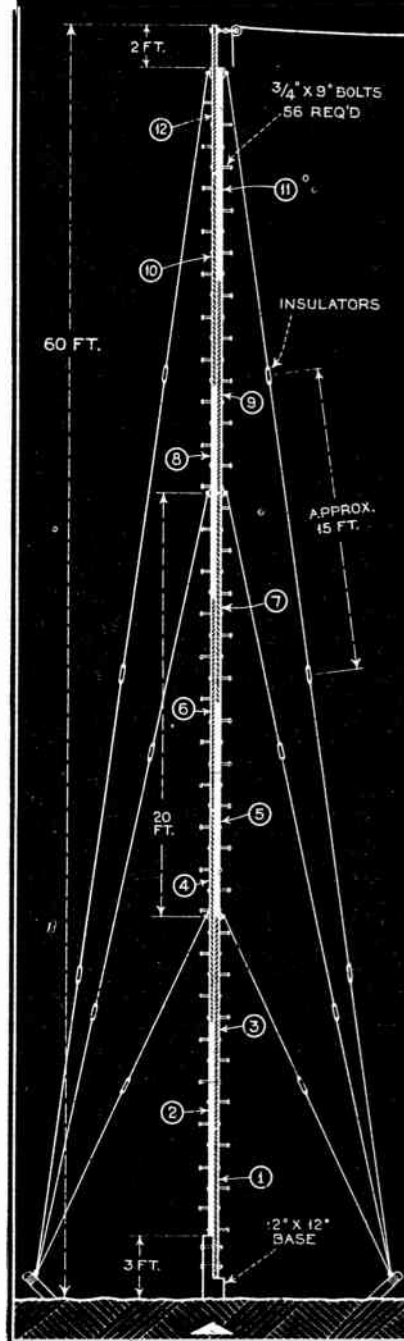

FIG. 1

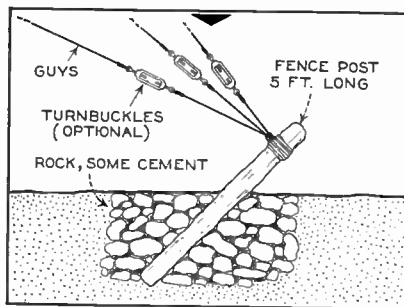

FIG. 3.

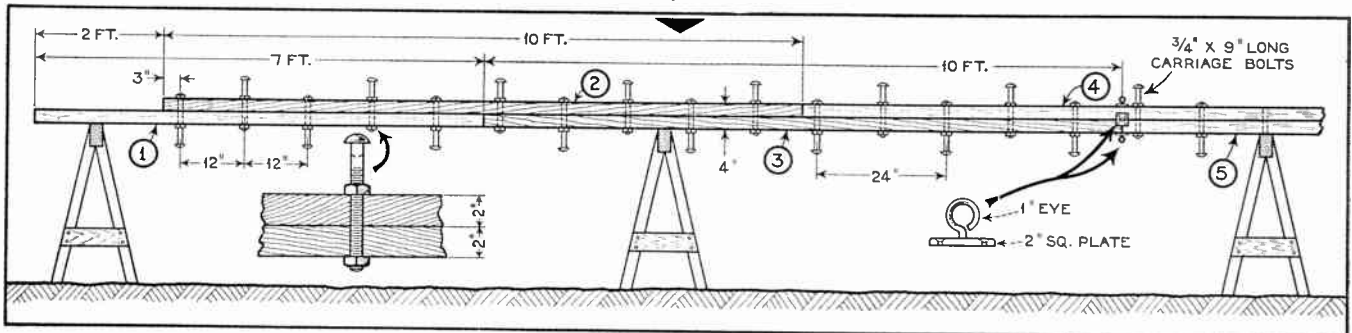

FIG. 2.

20 BUCKS

By E. T. TURNEY • W2APT
2718 McIntosh St., Elmhurst, N. Y.

The Construction

The first step in the construction is to completely assemble the mast with its associated equipment, on the ground. If some spare saw horses are available they can be used to work on for drilling, etc. All necessary holes are drilled and all bolts and eye plates are fastened in place. Incidentally, these eye-plates are used to hold the guys, so be sure that they are securely fastened in place. The use of some good, husky round-head wood screws is recommended. These plates are placed at twenty-foot intervals from the base end of the mast.

There are three sets of guy wires, said wire being No. 14 galvanized, such as used by the phone company. We picked up what we needed in the local junk yard, for two bucks.

Fig. 1 shows in detail a section of the mast with all units in their correct place. After the mast is completely assembled, carefully number the wood beams so that they may be returned to their original position as the stick goes up.

The base should be painted with two coats of creosote to prevent dry rot and lengthen the life of the mast. Set it about six feet deep in a combination of concrete and stone. Pour some of the concrete around the bottom of the hole first. When the base is set (allow the concrete about four days to dry) pour a light coat of cement on top to prevent any soil coming in contact with the wood.

Now that the pole has all the necessary mechanical labor completed, take it apart and after shellacking all the knots, give the whole business a good coat of lead and oil paint, the body of which should be of the ratio of 1 part lead to four parts oil. Give all the iron a coat of red lead.

(Continued on page 50)

Hamfest

By W8QMR ex-2PI • LU4S

PRETTY soon we'll have more certificates plastered around the shack than we have QSLs. At present we have an AARS, ORS and OO. This last—Official Observer—has a utilitarian value. It is accompanied with a nice flock of stamped penny postcards for sending out to hamlets who use buzz saws for rectifiers, check their xtals with a tape measure, borrow their notes from a bird cage and figure that WWV stands for wine, wimmen and vice. By pasting a piece of paper over the printed side, these cards come in very handy for minor bits of personal correspondence.

◆
WE PROPOSE ANOTHER "Q" signal—QBK. As a question—"Can I break-in on you?" As a statement—"You can break-in on me—I can work break-in." Of course, we already use the simple BK as an order to break-in—for instance to cut short a call. But this does not necessarily mean that break-in operation would be practical throughout the QSO. The Q-sig, QBK has real utility.

◆
SPEAKING OF break-in operation, many operators try to reduce the wallop in one's own receiver when working spot frequency without a relay, by cutting down on the length of the receiving antenna. This is all wet—the proper procedure is to lengthen it. If enough signal can be picked up, the tubes will block with a subdued thump. But if a very short aerial is used, the Hammarlund-NC-RMEX will Sky-ride clean off the bench! Another idea which is strictly contrary to Hoyle is to switch to a.v.c., even though the b.f.o. is on. With delayed a.v.c. and an adequate sensitivity control, the signal can be kept comfortably audible just below the point where the automatic-volume-control action cuts in; and the receiver goes completely blotto, but without violent eruption, on the leading edge of every dot you transmit.

Of course this is no problem at all to a lot of hamlets working "spotty" frequency—where 3742.5 kc. is plussminus five kc.

◆
CY CONNOLLY, W4DVO, SCM in the Southeastern Division, has wangled a special frequency from Pop "Dixie"

QBK . . . SPOTTY FREQUENCY . . . DX LEADS . . . VIPROPLEXED

Jones (W4IR of Squinch Owl fame) and when the rock arrives will be heard as WLRB. Which reminds us that we might as well clear the hooks on Florida chatter.

W4DDM, on Davis Island, Tampa, has installed a Mims signal squirter. This makes antenna number seven or eight—almost one for each transmitter. The cost of electricity runs pretty high in Tampa—which bothers DDM not at all, the power company being pretty much bossed by DDM senior.

Speaking of signal squirters, we decided the W4EDD ten-meter job in the November issue—on the cover and in a special article. We logged EDD the other morning working "Gene", F8KI, in Bellevue, France, and his signal kicked the needle of our R meter clean over against the pin—and we're hardly on the great circle between Coral Gables and France. Some of these signal squirters must have nozzles like a lawn spray!

W4AWO, SNCS for Florida, is held down by two ops who are also in charge of the RCS coastal station WOE, at Palm Beach. And do they know how to control a net!

Bill Burkhart, W4DLH ("four dark lean horses") of Goulds, Fla., reports some interesting QSOs, and sends along

dope well worth turning over to the gang. "I worked KAIME, P. I., at 910a. EST. He is on phone and came in Q5R6 on 14,240 kc. Was QSO with PK1GL (Q5R5), Java, at 836a, his phone frequency being about the same as KAIME's. Was QSO for an hour the other afternoon with SU1CH. His phone frequencies are 14,304 and 14,400. SU1CH, Cairo, Egypt, pounds through Q5R8-9! Another late afternoon QSO is SV1KE. Athens, Greece on a frequency of 14,275 kc."

DLH also passes along the following memos gleaned from his QSOs: Two South Africans were worked around midnight Eastern Standard Time. They were ZS1AL, Capetown, on 14,050 kc. (Q5R5), and ZS5M in Glencoe, on about 14,325 kilocycles and was Q5R7.

Thanks a lot, Bill; 73 and hope to hear from you again soon!

◆
THE VENEZUELAN Radio Club (headquarters in Caracas, with an RCA transmitter) is staging a DX contest for the some 200 Venezuelan amateurs starting January 14th, 1938. The first half, for code transmission, will last for four days, and the second half, for phone work, will

(Continued on page 40)

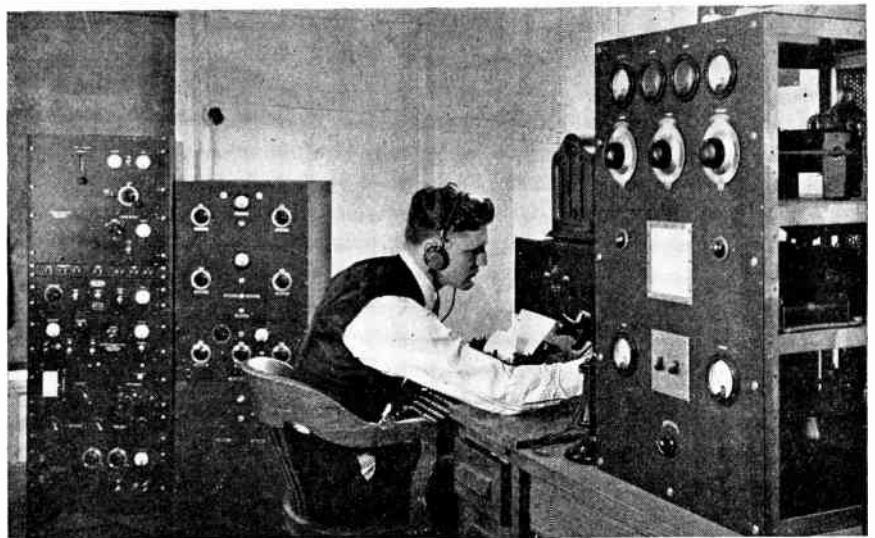

Army amateur station W2SC.WLN, Governors Island, New York City. As clean and snappy as the operating from this shack.

Globe Girddling

By J. B. L. HINDS

AS many queries are still received regarding International Reply Coupons, we will repeat in part the information on this subject contained in the July 1936 issue of ALL-WAVE RADIO.

International Reply Coupons (I.R.C.) may be purchased at any post office for nine (9) cents each. They are stamped with the location and date of issue at the time of purchase.

The Coupons are valid in all countries belonging to the Universal Postal Union, which includes practically every country in the world with the exceptions of the Laccadive and Maldive Islands, and the Government of Latakia.

A Reply Coupon, upon presentation at a post office in any of the member countries will entitle the person presenting the coupon to receive, without charge, a postage stamp or postage stamps of that country, of sufficient value to prepay a letter of the first unit of weight from the country in which the Coupon is exchanged to the country which issued it.

It may be added that, under the provisions of the Universal Postal Union Convention, the right is reserved for any country to require that the Reply Coupons and the articles of correspondence for the prepayment of which they are to be exchanged be presented at the same time.

INTERNATIONAL REPLY COUPONS . . . STATION FOR SINGAPORE . . . TGWA FREQUENCIES . . . RADIO MANILA ON 9570 . . . SPANISH WAR STATIONS . . . VP3THE

NEW STATIONS

KC	Meters	Call	Location
41000	7.32	W2XOY	Albany, New York
17800	16.85	TGWA	Guatemala City, Guatemala
15170	19.78	TGWA	Guatemala City, Guatemala
11840	25.34	CSW4	Lisbon, Portugal
10600	28.30	ZIK2	Belize, British Honduras, C.A.
10220	29.35	PSH	Rio de Janeiro, Brazil
9580	31.32	OAX5C	Ica, Peru
6480	46.30	H11L	Santiago de los Caballeros, R.D.
6122	49.00	OAX6A	Arequipa, Peru
5970	50.25	OAX4P	Huancayo, Peru

STATION CHANGES

New Frequency	New Call	Old Call	Old Frequency
11900	CD1190	CB1199	11990
11890		TPA3	11885
11718		TPA4	11720
11040	CSW2	CSW	11040
9940	CSW3	CSW	9940
9650	CS2WA	CT1AA	9650
8930		COKG	6200
6335		OAX1A	6150
6206		H18Q	6240
6180		TG2	6310
6170		XEXA	6133

STATIONS DELETED

KC	Meters	Call	Reason
9523	31.50	Radio Liberté	Irregular
9450	31.75	TGWA	Not in service
7380	40.65	Radio Liberté	Irregular
6445	46.55	YVQ	Radiophone service only
6000	50.00	HJ1ABC	Not in service
5980	50.17	HJ2ABD	Not in service
3750	80.00	HCK	Radiophone service only

NON-AUTHENTICATED STATIONS

Frequency	Call	Location
17700	PZF	Dutch Guiana (Jan.)
15650	JFZ	Japan (Oct.)
14010	VK5DI	Australia (Oct.)
9950	COCU	Cuba (Jan.)
9700	COCA	Cuba (Jan.)
9625	JFO	Japan (Dec.)
9565	HP5S	Panama (May)
7600	HC1RJ	Ecuador (May)
7200	HC1AJ	Ecuador (May)
7100		Mexico (Nov.)
7000	XEME	Mexico (Jan.)
6600	HI6H	Dom. Rep. (May)
6128	OAX7A	Peru (May)
6120	HP5Z	Panama (June)
6050	XFKM	Mexico (Nov.)
6015	PR48	Brazil (Jan.)
6000	OAX5A	Peru (May)
5835	YV5RR	Venezuela (Nov.)
4820	HJ7ABB	Colombia (Dec.)

It is obvious that if a listener desires a station verification card, an International Reply Coupon should accompany his report to the station, unless it is indicated in our station list that no I.R.C. is required.

Radiophone and Experimental Stations

TYE1, 18090 kc., Paris, France, heard on West Coast testing at 5:15 p. m.

GBU, Rugby, England, heard on Long Island testing with New York at 4:30 p. m.

TPZ, 12120 kc., Alger, Algeria, heard in up-state New York on special broadcast 5:30 to 6 p. m.

YVQ, Maracay, Venezuela, heard on West Coast phoning New York at 6:56 p. m.

PPQ, 11670 kc., Rio de Janeiro, Brazil, heard irregularly in Ontario, Canada, between 6:30 and 10 p. m.

W2XGB, 17310 kc., Hicksville, N. Y., Press Wireless, Inc., tests and transmits music 9:30 to 11:30 a. m. and 1 to 3 p. m. daily except Saturday and Sunday. Heard in Ohio and Massachusetts.

CNR, Rabat, Morocco, heard on Long Island broadcasting music and calling Paris between 12:15 and 1 p. m.

KEI, 9490 kc., Bolinas, California, relays N.B.C. programs to Hawaii between 12 and 1 a. m. Heard on West Coast.

CGA4, 9330 kc., Drummondville, Quebec, Canada, heard in West Point, N. Y., contacting GCB, Rugby, England, at 6:35 p. m.

KKZ, 13690 kc., Bolinas, California, heard in Mexico City, relaying broadcast at 7:30 p. m.

Broadcasters

ZTJ, 9606 kc., Johannesburg, South Africa, is being heard in all parts of North America daily except Saturday and with excellent signal strength. While no call letters have as yet been heard for the above frequency, it is being carried in the station list as shown above as a matter of convenience, until the facts are known. It is understood that this transmitter has a power of 22 kw. instead of 5 kw. as previously stated.

JZI, 9535 kc., Nazaki, Japan, has replaced JZK, 15160 kc. on the Overseas programs, with the exception of the broadcasts from 12:30 to 1:30 a. m. and 8 to 9 a. m. which are being broadcast over JZJ, 11800 kc., which station carries these programs, and whose signals



Specimen of the new veri card being issued to listeners reporting TGW and TGWA.

are coming into the United States with good volume and clarity. From reports received JZI is not getting out very well on the 31-meter band.

JVO, 10375 kc., radiophone station at Nazaki, is heard irregularly on 4:30 to 5:30 p. m. Overseas programs.

JDY, 9925 kc., Dairen, Manchukuo, is on the air with broadcasts as early as 5:30 a. m.

JVT, 6750 kc., Nazaki, is heard often broadcasting news and music between 2 and 2:30 a. m.

JFO, is reported by several as being the call of Japanese station heard on 9625 or 9630 kc. and mentioned in this section in December.

JVH, 14600, Nazaki, Japan, broadcasts from 7 p. m. to 1 a. m., some nights continuously during this period, and others in one-hour periods.

JVN, 10660 kc., broadcasts Tokyo stocks at 1:40 a. m.

JIB, 10530 kc., Taihoku, Taiwan, was heard recently by the writer between 9 and 10 a. m. broadcasting in Japanese and signing off at 10 a. m. No music.

"Radio Manila"

KZRM, called "Radio Manila," has the assigned frequencies of 11840 kc. and 9570 kc. as listed. Advice from station is that they have been operating of late on 9570 kc. only, but are about to test further on 11840 kc. Letter verification has been received by the writer covering reception on 11840 kc., for reports on earlier tests made on that frequency.

KZRM is owned and directed by Erlanger and Galinger, Inc., Manila, and is on the air week days from 5 to 9 a. m. and from 4:30 to 6 p. m. except Saturday when their morning program closes at 10 a. m. On Sundays they are on the air from 4 to 10 a. m. only.

The short-wave transmitter is an RCA 1-kw. job. Programs are broadcast in English, Spanish and Filipino dialect from four studios atop the Insular Life Building. The owners of the station state that while their short-wave broadcasts are intended primarily for listeners in the Philippine Islands, yet they naturally enjoy receiving reports from as distant points as possible.

VPD2, 9540 kc., Suva, is the only short-wave broadcaster in the Fijian area and operates Monday to Saturday, inclusive, from 10:30 p. m. to midnight, Suva time, or 5:30 to 7 a. m., E.S.T. Mr. R. K. Harris of the Broadcasting Department states that on the whole the station appears to render a good service in any part of the world if the numerous listeners' reports received are any indication. They welcome reports from all listeners.

The Department of Commerce bulletin states that plans are announced to erect a short-wave station at Singapore, powerful enough to cover all of Malaya.

LA VOZ DE LA ESFERA

YV5 RI-1370 KC

YV5 RJ-6250 KC



SUEGART & CIA.

CARACAS-VENEZUELA S.A.

P. O. BOX, 1908

This Venezuelan veri has gold call letters on a blue background.

The new station is expected to be on the air early in 1938.

Europeans

SPW, 13635 kc., and SPD, 11535 kc., Warsaw, Poland, are now simultaneously broadcasting enlarged programs for North America between 6 and 7 p. m. on week days and 6 and 8 p. m. on Sundays, which are more desirable hours and when conditions for good reception are more favorable.

Directional aerials are being used. SPW transmits with 10 kw. and SPD with 2 kw. power. The station advises that QSL cards, artistically designed, will be forwarded in reply to every report sent to the following address: Polskie Radio, 5 Mazowiecka Street, Warsaw, Poland.

PCJ, 9590 kc., Hilversum, Holland, broadcasted its jubilee programs on November 16, 17 and 18 from 8 to 10:30

and 11 p. m. in celebration of its 10th anniversary on the air.

The programs were very enjoyable ones and up to the standard for the "Happy Station," being directed and announced by the genial Chief Announcer, Edward Startz, who holds an enviable reputation for his entertaining and unique programs and who has many warm friends in all countries of the world.

2RO-4, 11810 kc., and 2RO-3, 9635 kc., Rome, Italy, have changed schedules. The morning transmissions are broadcast on 11810 kc. and the afternoon and evening programs on 9635 kc. The broadcasting activities of Rome have been greatly extended. The South American broadcasts will now be transmitted daily from 6 to 7:30 p. m. and the popular North American programs will be broadcast from 7:30 to 9 p. m. daily instead of 6 to 7:30 p. m. as heretofore.

CSW, Lisbon, Portugal, has returned to the air with 10 kw. power and operating daily as CSW4 on 11840 kc., CSW2 on 11040 kc. and CSW3 on 9940 kc. Station is owned and operated by the Ministry of Public Works and Communications of the Portuguese Government and broadcasts daily to the Portuguese Colonies; Cape Verde, Guine, S. Tome e Principe, Angola, Mozambique, Macau e Timor, Goa Damao e Dieu, and to the Portuguese abroad.

Director of station, Captain Henrique Galvao; Chief Engineer, Manuel Bivar.

HBL, 9345 kc., HBO, 11402 kc. and HBJ, 14535 kc. are on League of Nations broadcasts. HBO and HBJ are on transmissions to Australia and New Zealand on Monday of each week, 2:45 to 3:15 a. m. and 3:15 to 3:45 a. m., respectively. These hours hold good for November but may be altered in December and subsequent months on account of seasonal changes.

HBO and HBL are on transmissions for North and South America on Friday

LAST MINUTE FLASHES

SPW, 13635 kc., SPD, 11535 kc., Warsaw, Poland, uses melody chime from the opera "The Haunted Castle" by Stanislas Moniuszko; as opening theme: Interval.

The Cubans are like "jumping beans." Be sure you hear the call of the one you tune in. COBC last heard close to 9900 kc.

Radio Nacional, Salamanca, Spain, mails replies from Grand Central Annex post office, New York, but gives no information of value.

OZF, 9520 kc., Skanileback, Denmark, only Danish transmitter broadcasting at present. On air from 2 to 6 p. m. Berne lists show OZG 11805 kc. and OXY 6060 kc. assigned.

CS2WA, 9650 kc., Lisbon, Portugal, will put on special broadcast for members of International DXers Alliance, January 14th, 1938, from 7 to 8 p. m.

XEME, Merida, Yucatan, Mexico, is on 7010 kc.

TIJ, San Jose, Costa Rica, heard broadcasting evenings on 5830 kc.

HJ7ABD, 9630 kc. Bucaramanga, Colombia, is on air 12 to 1 p. m. and 6 to 11 p. m.

PZH, 6788 kc., Paramaribo, Dutch Guiana, reported heard at 6800 kc.

VP3THE, Terry Holden Expedition, British Guiana, announces exact frequency as 13740 kc.

of each week. HBO from 2 to 2:15 p. m. and HBL from 2:30 to 2:45 p. m., 7:30 to 7:45 p. m. and from 8 to 8:15 p. m.

The Swiss broadcasts on Saturday nights are scheduled from 6:45 to 8 p. m. over HBJ, 14535 kc. and HBO, 11402 kc. to December 18th, inclusive, and over HBL, 9345 kc. and HBP, 7797 kc. beginning December 19th at the same hours.

"Radio Liberte," 7380 kc., and 9523 kc., have been deleted from lists. While heard occasionally there is no regular schedule and from the fact that no replies have been received from reports sent so far as can be learned, it is thought best not to retain in lists.

RNE, 12000 kc. and RKI, 15040 kc., Moscow, U.S.S.R., are on the air at various times during the day and night with broadcasts in German, French, Italian and other languages, but the hours are so badly split up for the days of the week that it is thought best not to list them.

"War Stations"

Radio Nacionales, 10370 kc., Salamanca, Spain, is rather keeping the listeners guessing as to its frequency, as is the case with all of those war broadcasters. Station shifts upward to 10410 and better. Some believe the transmission is a rebroadcast of EAJ43 or vice versa. Others believe it shifts to about 11030 kc. or that a like broadcast is on that frequency. Replies from these war stations are few and far between and usually unsatisfactory.

Radio Espanol, heard near 6129 kc. between 7 and 9:15 p.m. Insurgent war station, possibly Radio Guardia or some other war station, which may be at any place or time.

At the end of their short-wave news broadcast one evening, the British Broadcast Company announced that in addition to their regular program journal sold for 10/ (shillings), a special India paper edition of a lighter weight was available

for mailing to South Africa or isolated sections where mail took longer than 28 days to reach. This light-weight edition is air mailed for 15/6 (15 shillings 6 pence) to those interested. So far as is known, this is the first case of a radio station preparing a specially printed edition for transmission by air mail.

In September "Globe Girdling" mention was made of improvements to be made in facilities of Radio Coloniale, Paris. Recent reports received from listeners state that station has been heard testing on 11840 kc. A recent letter from Radio Coloniale gives advice that they are soon to begin tests on one of their transmitters of greater power. They regret that at this time they cannot give full details of the changes in frequencies but state that the trials will be announced over the air.

South Americans

HJ1ABE, Cartagena, Colombia, although assigned to 4860 kc. for operation, is still on 9500 kc. temporarily, according to report from the station, with a view of securing an opening on 9720 kc.

HJ7ABD, Bucaramanga, Colombia, is not an additional station as many supposed. While improved facilities have been installed, this transmitter takes the place of HJ2ABD, 5980 kc., at that location, the call and frequency having been changed to HJ7ABD, 9630 kc.

OAX4P, 5970 kc., Huancayo, Peru, known as Radio "Andina Juin" and operated by Senor J. Alberto Madueno, Cuzco 25, Huancayo, is being heard on the air late at night although considerable QRM impedes its progress in getting out in the open. This station has been carried in non-authenticated block on 6122 kc.

OAX5C, 9580 kc., Ica, Peru, has been added to lists. Some listeners say station is called "Radio Lima" and others "Radio Universal." It is said to play the selection "Estrellita" when closing at 11:30 p. m.

OAXIA, 6150 kc., Chilayo, Peru, has changed frequency to 6335 kc., according to numerous reports from listeners and consequently we are making changes in station list.

PSH, 10220 kc., Rio de Janeiro, Brazil, is now on the air daily transmitting programs from 7 to 9 p. m. English announcements made for each number and requests made for reports from listeners as to receiving conditions. PSH relays the programs of PRF4 on long wave 940 kc. Complete address shown in station list. This station appears in November complete list as operating in radiotelephone service.

HC1PM, 5725 kc., Quito, Ecuador, state they have temporarily gone off the air on short waves, but expect to be back on Saturday evenings as per schedule shown, as soon as necessary repairs are completed.

YVQ, 6445 kc., Maracay, Venezuela, is in radiophone service only and has been removed from broadcast list.

HCK, 3750 kc., Quito, Ecuador, is being used by government in phone service only and has, therefore, been removed from broadcast list and will be subsequently shown in complete list.

HJ1ABC, 6000 kc., Quibdo, Colombia, is no longer in service, being badly damaged by storm which swept that area. At present there is no intention of replacing the station.

A new transmitter with 5 kw. output and owned and operated by the government of Colombia will soon be on the air on the 62-meter band. Call letters, location, and exact frequency, with other details, will be furnished later.

Holden Expedition

VP3THE, near 13750 kc., British Guiana, is heard by many listeners in conversation with 20-meter stations between 6 and 11 p.m. This station is with the Terry Holden Expedition. It is understood to be operating with RCA equipment and with 1½ kw. generator for power, and is putting out a fine signal.

It is reported that the station is set up permanently at Ishertin. A small portable transmitter will be transported into the jungles with advance party and communication will be made with the base camp.

CXA8, 9640 kc., is located at Colonia, instead of Montevideo, Uruguay, and relays the programs of long-wave station LR3, Radio Belgrano, Buenos Aires, Argentina, according to reports received. Station signs off at 11 p.m. and is said to use a record of many languages including English.

YV5RJ, 6250 kc., Caracas, Venezuela, called La Voz de La Esfera, is sending out a new veri card. Station is operated

Veri colorul—blue, white and magenta, with printing in black.

by Suegart and Cia, and address is P.O. Box 1908.

The Colombian government has granted license to Sociedad Lamus and Rivera for construction and installation of a commercial radio broadcasting station at Ibaque and tests authorized on 4740 kc. (63.29 meters) with a power of 501 watts. Call letters not given.

CEC, 10670 kc., Santiago, Chile, has recently been heard on the air after a long silence.

HC2CW, 8404 kc., Guayaquil, Ecuador, has been reported heard on 8620 kc., and later on 9310 kc.

CXA2, 6000 kc., Montevideo, Uruguay, reported heard near 6002 kc.

CD1190, 11900 kc., is the call and frequency of the station at Valdivia, Chile, shown in station lists as *CB1199* on 11900 kc. Veri card received shows station is called Radio Sur, and relays the programs of CD69 on 690 kc. and is owned and operated by C. Kaehler and Company, Ltd., Studios, Oficinas 14-18 Edificio Wachsmann.

PRA8, Pernambuco, Brazil, which was deleted from lists in July 1937 is reported heard on or near 6015 kc. in early evening and signing off about 9 p.m. This station was formerly operated by the Radio Club of Pernambuco on 6040 kc. and was known as "The Voice of the North."

HJ7ABB, 4820 kc., Bucaramanga, Colombia, will be on the air in December or the early part of January 1938. Station owned and to be operated by Hijos de B. Bueno, Sucs, and to be called "Santander Broadcasting." Will have modern studios and facilities and operate one long and one short-wave transmitter. Station has no connection with HJ7ABD, now operating on 9630 kc.

PZF 17650 to 17700 kc., Paramaribo, Surinam (Dutch Guiana), reported heard with test programs between 3 and 4:45 p.m. on Sundays and announcing address as Government Radio Service, Paramaribo. Station will be listed in non-authenticated block.

OAX6A, 6122 kc., Arequipa, Peru, is on the air and listed in this issue. Address; Munoz Majar, Casilla 293, Arequipa.

CB1170, 11700 kc., Santiago, Chile, is working between 11680 and 11690 kc., evidently to avoid interference with HP5A. Although the call may be other than as above stated, it will be allowed to remain in list along with CB615 on 12300 kc. until facts regarding changes are learned.

Cubans

COCM, Havana, Cuba, carried in list at 9840 kc., is being heard as this comment is written at about 9790 kc.

COBC, 9350 kc., Havana, Cuba, at this writing is being bothered with code near 9090 kc. The Cubans seem to be

C. D. 69

ONDA LARGA
690 K. C.

Estacion de 1.ª Cat.



C.D. 1190

ONDA CORTA
11900 K. C. (25 m.)

Estacion de 1.ª Cat.

Trasmisiones Simultáneas de: 11 a 14 — 16 a 19 — 20 a 23 horas (CE Time)

RADIO SUR

Voz de Valdivia para todo Chile y América

DIRECCION:
BOX 642
VALDIVIA
CHILE

CHILE

ESTUDIOS:
OFICINAS 14-18
EDIFICIO WACHSMANN
— TEL. 641 —

Agradecemos altamente su amable comunicación sobre nuestras transmisiones y nos complacemos en enviarle un cordial saludo, reiterándole nuestra más distinguida consideración.

C. KAEHLER Y CO. LTDA.
CONSTRUCTORES Y PROPIETARIOS

This veri card from Chile is a wopper, measuring 4¾ by 6½ inches, life size. The calls and the station background are in red. The card is white with remainder of printing in black.

JANUARY ACE REPORTERS

Mrs. F. W. Alfred, VE8G3, London, Ontario, Canada
 Wm. Bell, Monroe, La.
 W. E. Blanchard, W3E1, Bangor, Maine
 D. E. Brown, W4H113, Queens Village, N. Y.
 H. L. Batchelder, Chicago, Ill.
 T. G. Brawley, W9I6, Greenville, Ohio
 E. H. Clark, W3OKI, Hollister, Calif.
 Davis Crittenden, W3G6, South Swansea, Mass.
 Ed Cash, Detroit, Mich.
 H. C. Chesnut, Plattsburg, N. Y.
 E. A. Conly, Wilmington, Delaware
 Edward Davis, W4H151, Brooklyn, N. Y.
 Harry F. Deibert, W5H12, Walnutport, Pa.
 Wm. Doniger, Cedarhurst, N. Y.
 Morgan Foshay, New York City, N. Y.
 William R. Goetz, W4H161, Brooklyn, N. Y.
 Edwin G. Grainger, W5F2, Syracuse, N. Y.
 John E. Gill, Dorchester, Mass.
 Don I. Gross, W. Asheville, N. C.
 G. J. Glasspool, Southampton, England
 Ray Gallagher, San Jose, Calif.
 Jack Holterman, W4H148, Flushing, N. Y.
 Harry Honda, Los Angeles, Calif.
 J. Herbert Hyde, Elmwood, Conn.
 Paul Hulquist, Tucson, Ariz.
 Robert Jones, W8H1, Coshocton, Ohio
 Stanley Koenig, New York City, N. Y.
 Bill King, W30D3, Silverton, Oregon
 C. F. Keirstead, W3F5, Framingham, Mass.
 R. E. G. Langton, Port Hammond, B. C., Canada
 L. R. McPherson, Chicago, Illinois
 Mrs. LeRoy Merritt, Johnstown, Pa.
 R. B. Oxrieder, W6H5, State College, Pa.
 H. Orlaw, Edmonton, Alberta, Canada
 J. F. Pichler, W22N4, Santa Fe, N. M.
 Clive C. Peterson, Phillipsburg, St. Martin, N.W.T.
 F. M. Pow, VE24M1, South Edmonton, Alberta, Canada
 H. Francis Shea, East Machias, Maine
 J. V. Saxton, W4H48, Bronx, New York City, N. Y.
 F. W. Stockbridge, Westboro, Mass.
 Ernest Sandquist, Downey, Calif.
 T. D. Smith, W17R1, Burnet, Texas
 Homer E. Sink, Dayton, Ohio
 Theo. C. Smith, W5F8, Ogdeusburg, New York
 Harold I. Tucker, W4G20, West Point, N. Y.
 J. Gorham Underhill, W3F62, No. Attleboro, Mass.
 Alonzo Velasco, Mexico City, Mexico
 Howard Wilson, Jr., Ithaca, New York
 LeRoy Waite, W4F11, Ballston Spa, N. Y.
 Kendall Walker, W30D1, Yamhill, Oregon
 Douglas Worcester, Honolulu, Hawaii
 Ashley Wolcott, San Francisco, Calif.
 Mr. and Mrs. Ralph E. Weikal, Pratt, Kas.

pretty much on the move, although it is not quite the proper date for moving.

COCQ, 9750 kc., Havana, Cuba, has been reported heard on 9810 kc., close to 9100 kc for several days, and finally on about 9680 kc., close to TGWA. It will remain in list at original frequency until definite advice is obtained as to where it intends to broadcast. A late report advises COCQ is going back on 9750 kc.!

COCO, 6010 kc., Havana, Cuba, with its strong harmonic on 12020 kc., is getting out fairly well.

COKG, 6200 kc., Santiago, Cuba, has moved to approximately 8930 kc. and is shown in station list on that frequency until the actual location is determined. This is the station which was mentioned in the December issue as COKE or COKC.

COCA, 9700 kc., a new Cuban station heard testing. Address said to be Galiano No. 102, Havana.

COCU, another new Cuban station reported soon to be on 6590 kc. and 9950 kc. relaying programs of CMCU, long wave, 1290 kc. Studios located at Estrada Palma No. 25 La Vibora, Havana.

COBX, 9200 kc., Havana, Cuba, said to use "The Peanut Vendor" as an opening and closing selection.

Central Americans

TGWA, 17800, 15170, 11760 and 9685 kc., Radiodifusora Nacional, Guatemala City, Guatemala, is being heard with excellent signals and programs. While the schedules in station list are tentative, they will give the approximate time on the air. The above frequencies carry the programs of long-wave station TGW, at present on 1230 kc., power 1250 watts in the antenna, RCA type 1-D transmitter.

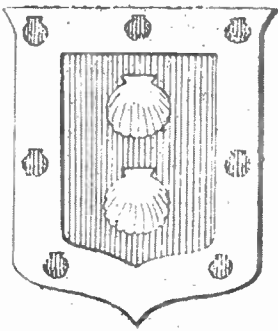

H I UNO L

RADIOEMISORA NACIONAL "EL DIARIO"

SANTIAGO DE LOS CABALLEROS
REPUBLICA DOMINICANA
Calle "Presidente Trujillo" Np. 97, altos

6 4 8 0
SUCIOS

TELEFONO
8 - 8 - 0

4 6 . 3 0
METROS

Veri from HILL, Dominican Republic. Printing in red and blue.

antenna-380 foot self-supporting vertical tower. TGWA short-wave transmitters are RCA Type ET-4310, 10 kw. power. Antennas for the two higher frequencies are nearly non-directional, the other directional.

Identification at opening and closing of any broadcast period is a marimba playing a simple melody over three times, the station announcement being made over the music on the second time through the strain. All reports answered and no I.R.C. necessary. Short-wave programs are always announced in both English and Spanish. Mr. J. B. McElroy is Chief Engineer of both TGW and TGWA and the output speaks well for his ability.

YNLF, Managua, Nicaragua, the 1000-watt mystery station, is still being carried in station list on 9595 kc., although no report of its being heard has been received for some time. Any reliable information regarding this station would be welcome.

YNLG, 6325 kc., Managua, Nicaragua, was changed from 8505 kc. to the above mentioned frequency in December, by reason of the numerous reports that it was transmitting on 6325. Several reports indicate it is back up around 8500 kc. again, announcing as "Radio Pilot." We will await direct advice from the station before changing again.

TIPG, 6410 kc., San Jose, Costa Rica, has been heard several times transmitting near 11950 kc., but still remains on its original frequency most of the time. No definite advice has been received regarding the transmissions on the 25-meter band.

ZIK2, 10600 kc., Belize, British Honduras, C. A., has been transferred from non-authenticated block to station list. ZIK2 is a government-operated station in charge of Mr. D. Fairweather, Superintendent. Letter verification has been received by one listener with advice that cards will be printed when they begin a regular schedule. The transmitter is a 600-A Collins with 250 watts power. Reports would indicate that the fre-

quency is 10590 kc. although in late announcements 10600 kc. is given. News items of interest to British residents are broadcast.

HP5L, 11740 kc., David, Panama, is still off the air, through a chain of circumstances over which the owner had no control, but the prospects are that it will return to the air before long on the schedule as listed. It is hoped that definite advice may be given at an early date.

TG2, 6310 kc., Guatemala City, Guatemala, has been changed in station list to 6180 kc. Advice has been received from Guatemala that TG1 is at present on long wave, 1510 kc., and TG2 on 6180, testing to locate a clear channel. They also state that they are duplicating TG1 and TG2 in the City of Quezaltenango, Guatemala, calls to be TGQ, long wave and TGQA, short wave. Frequencies as yet not determined but November 10th was opening date for the transmitters operating under test conditions.

The calls have been heard since that date in connection with broadcasts of TG1 and TG2. The frequencies of TGQ and TGQA will, therefore, depend upon the final selection of frequencies by TG1 and TG2.

TI2RS, 6900 kc., San Jose, Costa Rica, transmits daily except Sunday from 9:30 to 11 p.m. This station is also used on 40 meters working with amateurs after 11 p.m. and after 5:15 p.m. on Saturdays.

HI1L, 6480 kc., Santiago de los Caballeros, Dom. Rep., is now shown complete as to details in station list. Veri cards are being received by listeners.

HID, 9505 kc., Ciudad Trujillo, Dom. Rep., has shifted to 9290 kc. but it will not be changed in list until more definite information has been received. There appears to be a difference in opinion among listeners as to the call. Some believe it HIT or HIG on another frequency.

Mexicans

XEBT, 6000 kc., Mexico, D.F., ad-

vise they are making some improvements in their facilities and will soon increase the power of long-wave station XEB to 25 kw. and the short-wave station to 1½ kw.

XEXA, 6133 kc., Mexico City, has been changed in frequency to 6170 kc.

"Radiodifusora del Pueblo," 7100 kc., Guadalajara, Mexico, remains close to 7100 kc. with its 200-watt Collins transmitter. No call has as yet been assigned.

The station transmitting nightly between 6980 and 7000 kc. is reported by several as XEME, Merida, Mexico, which was deleted from lists in March 1937. It announces regularly as "General Electric." It is interfered with by code at times.

U. S. Stations

W3XAU, 9590 kc., Philadelphia, is on the air until 8 p.m. PCJ, Hilversum, Holland, on this frequency begins its broadcasts at 8 p.m., so there is now no confliction on program time on the air.

W2XE, New York, N. Y., carries revised schedules on 21520 kc., 17760 kc., 15270 kc. and 11830 kc.

W1XAL, Boston, Mass., 15250 kc., 11790 kc. and 6040 kc. carries the regular programs as taken from last schedules of that station. Special test transmissions will be carried at various times on 21460 kc., and 15250 kc. and 11790 kc.

Amateur Phones

The following is a list of 20-meter amateur phone stations not previously reported or listed:

Country	Frequency	Calls	Time Heard
Australia	LF	VK2VA	1:45 a.m.
Australia	LF	VK3NG	1:10 a.m.
Australia	LF	VK5AW-5GL	5:45-6:13 a.m.
Australia	LF	VK7YL	5:50 a.m.
Africa (South)	LF	ZT6Y-ZS6S	11:20-11:45 p.m.
Africa (South)	HF	ZU6AF-ZS5M-ZS3F	11:50 p.m.-12:16 a.m.
Africa (South)	HF	ZU6AL-ZU5M	10:45-11:30 p.m.
Africa (South)	HF	ZT5S	10:00 p.m.
Africa (South)	LF	ZU6P-ZS1AL-ZS2N	10:15-11:00 p.m.
Alaska	AB	K7FBE	10:40 p.m.
Canary Islands	HF	EA8AE	10:30 p.m.
Brazil	LF	PY8AD	10:34 p.m.
Chile	LF	CE3DW	7:32 p.m.
Dom. Rep.	LF	HI3N	7:00-11:00 p.m.
Holland	LF	PAOBE	2:15 p.m.
Honduras	HF	HR5C	10:05 p.m.
Haiti	AB	HH2G	4:55 p.m.
Haiti	LF	HH2LD-HH2N	8:00-10:00 p.m.
Labrador	HF	VO6D	8:13 p.m.
Madagascar	LF	FB8AB	10:30 p.m.
Mexico	HF	XE4BGI	10:00 p.m.
Mexico	LF	XE1CC	12:12 a.m.
Norway	LF	LA4P	12:30 p.m.
Porto Rico	AB	K4EJF	11:29 p.m.
Venezuela	LF	YV5ABF	11:00 p.m.

OX2QY, 14368 kc., Reindeer Point, Greenland, MacGregor Arctic Expedition reported heard by many listeners between 8 a.m. and 9 p.m. and near 11 p.m.

EA9AH, 14030 kc., Tetuan, Spanish

(Continued on page 48)

Channel Echoes

By ZEH BOUCK

WE venture to predict that interference on the short-wave bands from diathermy machines will be drastically reduced within a year and completely eliminated in the not remote future. Not that the FCC will modify its clause which forbids action against radiations which do not convey intelligence. The FCC is often proscribed when dealing with matters of intelligence. But somehow or another a law against excessive radiation by non-intelligence conveying apparatus will be enacted. The reason for this will be the fact that diathermy machines are now seriously interfering with commercial radio services, which, of course, have a Gargantuan finger in the pie at Washington. The fact that these contraptions have rip-sawed through a nation's short-wave entertainment for two years is of no consequence. But when commercial interests spend millions of dollars buying up acreage remote from highways (to eliminate auto ignition interference) and even isolated from the airplanes (to cut down QRM from aircraft engines) and then have transmissions broken up by a treatment on Mrs. Murphy's sciatica two hundred miles away, something is going to be done about it. The Netcong, N. J., layout of the A. T. and T. is a typical isolated receiving post. Such a location has been practically impregnable to noise in the past, due largely to the fact that even a thunder storm a few miles behind the arrays produces little static due to the highly directional effect of the antennas. But with diathermys to the right of them and diathermys to the left of them, volleying and blundering, and arrays now aimed for reception from many directions, the matter becomes serious. On a single short-wave band we have often counted more than 100 diathermy radiations, many of them smack on an international commercial fone channel.

Also, the actual utility of diathermy treatment is still a moot point in the medical profession. So far as we can find out the only real good ever accomplished by the average installation was the electrocution of a physician administering the treatment.

WELL, DOC BRINKLEY got himself all worked up over the fact that the Duke

DYINGTHERMY . . . A MATTER OF RECORD . . . RADIODORS . . . SMOTHER TONGUES

of Windsor cancelled his trip to the U.S.A. He told the world over XERA that it sort of appeared as if we had insulted the ex-King and the Duchess. It was almost as if the Doc had lost a patient, though we don't recall that Del Rio was on the tentative itinerary of the Duke. Personally we have always liked the Prince of Wales, the King and the Duke. We didn't object to his umpty umpt pieces of luggage, nor to the sumptuous appointments reserved for him on his proposed trans-Atlantic trip. But when his boat puts in to England to pick up a few gallons of special English water with which to make the Duke's tea, it occurs to us that the welcome which would have been accorded him by the American workers (and unemployed) whose conditions of living he was to investigate, might not have been wholly sympathetic.

AS WE HAVE observed before, the more ruthless the foreign nation, the more languages she will employ in an endeavor to explain her acts of aggression to a critical world. The extent of her guilt bears a direct ratio to the number of languages used for the purpose of propaganda. Japan now broadcasts in seven tongues—including the mother tongue and six smother tongues.

FOR THOSE WHO enjoy classical and semi-classical music as a night-cap—or along with one—we recommend the following schedules:

WENR	11:15 pm. CST	Sun. thru Fri.
WBZ	12 midnight EST	" " "
WBZA	" " "	" " "
WGY	" " "	Mon. " "
KYW	" " "	Sun. " "
KDKA	" " "	" " "
KOA	11:15 p.m. MST	" " "
KGO	12 midnight PST	" " "
WTAM	" " EST	" " "
WMAL	" " "	" " "

These programs can also usually be heard on the associated short-wave channels. The music consists of Victor recordings, and the program is entitled "The Music You Want to Hear When You Want It"—an RCA-Victor sponsored program, but next to no advertising as the records speak for themselves.

An occasional high-light is a recreated Caruso record—Caruso's voice with new orchestra accompaniment. It can really be described as thrilling. The tenor, whose voice has not since been matched, might be there before a microphone, infinitely more vital than his body, which more than legend has it, slumbers in its Italian sarcophagus in a miraculous state of preservation.

(Continued on page 46)



This is not the Philharmonic Orchestra broadcasting from an NBC studio in Radio City. And the horn ain't a loudspeaker. See text.

RADIO SIGNAL SURVEY LEAGUE NEWS

ON the whole, the survey on the signals of the American Legion Emergency Station, WANC, at Jamestown, N. Y., was satisfactory, and a complete report will go forward to Mr. F. P. Rogers, Chief of the Emergency Unit, as soon as the work is completed at headquarters.

But this does not mean that we are completely satisfied with the number of reports received. There could, and should, have been many more, even though WANC was probably not audible in many of the southern and western states. It raises the old point which we have stressed many times before—that a report is desirable irrespective of whether or not the signals upon which the survey is being made can be heard. It is just as important to know where a station is *not* being heard as it is to know where it is being heard. Without this data, it is quite impossible to prepare a complete and accurate analysis for the station in question.

There is no doubt, also, that many members ignore the surveys, and this has been one of our toughest problems. Many Sectional Managers spend money on postage in a vain attempt to get the members under their supervision to take an active part in the survey work. This should not be necessary in the first place, although the efforts of these Sectional Managers are greatly appreciated.

The more active members have asked why we do not conduct more surveys than we do. The answer is that until headquarters can be assured of complete coverage, and active participation in all surveys by the majority of members, it is inadvisable to undertake the surveys if the League cannot deliver the goods.

We realize at the same time that interest in the work might be intensified were we to let off the brakes and give her the gas—to the extent of conducting a number of special and varied surveys each month and trust that the response would justify the undertaking. There is no end to what the League can do providing the members actively participate in the work.

The year 1937 has been one of organization for the League. The year 1938 should be one of activity. Though we have marked time on many important subjects, it has been advantageous to the extent that we now know fairly well what can and what can not be done, what should and should not be done, and

THE WANC OFFICIAL SURVEY . . . SURVEY JACK-UP . . . NEW PLANS FOR 1938 FORMULATED . . . FIRST ANNOUNCEMENTS ON DX RECEPTION CITATIONS . . . W26P1

NEW R.S.S.L. MEMBERS

ARKANSAS

Fred Charles Rains, North Little Rock — W5-14N1

CALIFORNIA

Ralph Adams, Compton—W6-29M32
Benton Wilson, Compton—W6-29M31
Preston Bates, Lindsay—W6-29L2
Henry Engarde, Los Angeles—W6-29M30
Herbert C. Scott, Los Angeles—W6-29M33
Jack Fitzgerald, San Jose—W6-31J17

COLORADO

Wayne E. Buckley, P.M., Marshall Pass—W9-22L1

CONNECTICUT

Harold Paul Massey, New Haven—W1-4G23

ILLINOIS

Thomas Eugene Barske, Chicago—W9-11H56
Gail Thomas Beyer, Chicago—W9-11H55
William M. Hummel, Chicago—W9-11H59
E. Lohmar, Chicago—W9-11H62
Lester Pardini, Chicago—W9-11H54
Joseph Bernard Seiler, Chicago—W9-11H57
Richard Spiralko, Chicago—W9-11H58
Charles Clifford Trezise, Chicago—W9-11H63
Thomas George Grey, Lyons—W9-12H10

INDIANA

Arthur Hodgson Gard, Frankfort—W9-10K16
Kenneth Bailey, Gary—W9-11H60

IOWA

A. H. Anderson, Belmond—W9-15H1
Byron L. Friend, Des Moines—W9-15H2

KANSAS

Warren Ford, Leonardville—W9-16K1
Charles Grassman, Pratt—W9-18L1

KENTUCKY

Bob Taglauer, Covington—W9-10K15

MAINE

Ethan W. Brown, Norway—W1-3E10
Grace A. Sthen, Portland—W1-3E11
Robert E. Sthen, Portland—W1-3E12

MARYLAND

Joseph Lester Burton, Baltimore—W3-5J23
William A. Garrison, Baltimore—W3-5J24

MASSACHUSETTS

Charles T. Florentine, Jr., Allston—W1-3F64
John J. Marshall, Dorchester—W1-3F71
Robert Skyten, E. Brookfield—W1-3F67
Theodore W. Austin, Longmeadow—W1-3G31
Victor Carozza, Lynn—W1-3F69
Roy E. Pichette, Northampton—W1-4F15
William Wood, Jr., North Andover—W1-3F68
Robert Little, Waverly—W1-3F66

MICHIGAN

Carroll J. Spring, Grand Rapids—W8-10G4
John L. DeWolfe, Jackson—W8-10H16
Earl C. Sibson, Jackson—W8-10H17

MINNESOTA

Bill Hawland, Minneapolis—W9-15F4
Othmar William Bauer, St. Cloud—W9-15F5

NEW HAMPSHIRE

Richard Brown, Concord—W1-3F70
Harold F. Eastman, Peterborough—W1-3F65

NEW JERSEY

Harry A. Bremer, Jersey City—W2-4H179
George A. Traver, Jersey City—W2-4H175
Howard J. Blind, Westfield—W2-4H181

NEW YORK

John Stapleton, Albany—W2-4F14
Joseph E. Opalka—Amsterdam—W8-4F13
James J. Reilly, Bayside—W2-4H173
John Bann, Brooklyn—W2-4H176
Morton Brody, Brooklyn—W2-4H174
Benjamin Saul Greenberg, Brooklyn — W2-4H180

Conrad John Klauk, Buffalo—W8-7G14
Hervey V. Weller, Flushing, L. I.—W2-4H178
Joseph J. Smith, Hicksville—W2-4H182
Peter Rohrs, North Pelham—W2-4H183
Frederick P. Groll, Queens Village—W2-4H177
Steve Jako, Tarrytown—W2-4G24
Walter Schwab, New York City—W2-4H170

OHIO

Harold Kinsley, Cleveland—W8-8H29
Kurt Stabenau, Cleveland—W8-8H28
James Walter Hepplewhite, Garfield Hts.—W8-8H27

OREGON

Tom Todd, Jr., Salem—W7-30D7

PENNSYLVANIA

Roy Laurence Gallagher, Butler—W8-7H2
Daniel Antrim, Philadelphia—W3-4H172
John William Mondrosch, Philadelphia—W3-4H171
John Herman Guthrie, Reynoldsville—W8-6H6

RHODE ISLAND

Arthur Snape, Lakewood—W1-3G30

TENNESSEE

Harry Hutchinson, Memphis—W4-12N3

VIRGINIA

Harold Benjamin Ellis, Richmond—W3-5K5

WASHINGTON

William L. Maris, Jr., Anacortes—W7-29B10
Jack B. Norman, Anacortes—W7-29B11
Bob A. Carter, Ephrata—W7-26C7
Raymond F. Crisp, Spokane—W7-26C6

WISCONSIN

Bob Yeager, Madison—W9-12G16
William DeBuhr, Port Washington—W9-12G17
Melvin W. Werking, Port Washington—W9-12H9

NEW FOREIGN MEMBERS

BERMUDA

Hugh Thurston Clarke, Hamilton—VP9-9A3

CANADA

W. K. Angus, Edmonton, Alberta—VE4-24A10
Ronald Gunner Bullock, Red Deer, Alberta—VE4-24A12
Robert Clarke, Calgary, Alberta—VE4-24A11
Herman Orlaw, Vancouver, B. C.—VE5-29A7
Donald Rimmer, Ville St. Pierre—VE2-5D2

ENGLAND

Robert Hudson Broadbent, Huddersfield, Yorkshire—G57
Benjamin Cartmell, Preston, Lancashire—G58
John George Peter Butler, Portsmouth—G59
Sydney Leopard, Welling, Kent—G60
John Reginald Jacobs, Ipswich, Suffolk—G61
George Stanley Hawes, Barking, Essex—G62
Frederick C. W. Ridler, Worthing, Sussex—G63
John Mann, Blackheath, Birmingham—GE-11
E. Walker, Sheffield 8, Yorkshire—G2-1
Edward Roberts, Birkenhead, Cheshire—G64
Norman Heppell, West Hartlepool, Durham—G65
Percy Jones, Bolton, Lancashire—G13-1

NORTH IRELAND

William "Ollie" McGregor, Kesh, Fermanagh—G18-1

INDIA

H. Stanley Earle, Jhajha—VU 1

PHILIPPINE ISLANDS

Enrique del Castillo, Occ. Negros—KA-1

SOUTH AUSTRALIA

Joseph Coombs Linehan, Adelaide—VK-5

SWITZERLAND

John Gysin, Bienne—HB1

fairly well how the League and its various Divisions should be handled. Having this experience under our belt, we believe we can now build a strong and active League for the future.

We know, for one thing, that the method we have used for handling reports has been a poor one. We know that the system of reporting we use is not all that it should be. We know that a closer contact must be maintained between headquarters and our foreign members, and we know that a communications system is probably the only adequate answer to this problem. We know now many other things, all of which we have learned through the experience gained during 1937. Because we have learned a great deal, we have planned numerous alterations in the League structure which should make it stronger and prove of benefit to all members. These plans have been brewing over a period of months as we have watched the outcome of the few surveys we have conducted, and as we have studied the suggestions sent us in response to proposals we have made through these pages from time to time.

The new structure, and the plans we have for 1938, will be covered in detail in the forthcoming issue. This data will be of importance to all members, and we request that you go over it carefully when it appears. The information will form the basis of your activities for the coming year.

DX Citations

We are listing in a box on this page the names of those to whom the first few DX Reception Citation Certificates were issued. These Citations, as you know, are certified by the R.S.S.L., and all records are kept at R.S.S.L. Headquarters.

Mr. Rae Ellery has the distinction of

DX RECEPTION CITATIONS

Short-Wave Broadcast Bands

Eighth Degree

Henry V. Miner,
42 Royal St.,
Wollaston, Mass.

Third Degree

George J. Pasquale,
76 Hanover St.,
Wellsville, N. Y.

First Degree

Rodney White,
202 E. 10th St.,
Berwick, Pa.
Bill King, W30D3
604 N. 1st St.,
Silverton, Ore.
Robert F. Rowser,
Ammunition Depot, Qrts. A-51,
Mare Island, Calif.

Fred Atherton, W4F1,
23 Royce St.,
Rutland, Vt.

Rae Ellery,
Johnston St.,
Bulls, New Zealand

Homer Bohlender,
R. R. 2,
Brookville, Ohio

Amateur Phone Bands

Third Degree

Homer Bohlender,
R. R. 2,
Brookville, Ohio

First Degree

H. R. Kiger, W10K5,
2101 Wayne Ave.,
Dayton, Ohio
Wilbur Croston,
2737 Mahoning Rd., N. E.,
Canton, Ohio
Chris D. Jaffe, W52Z,
Algonquin Park,
Norfolk, Va.

being the first one in a foreign country to receive a Citation. Mr. Ellery is a New Zealander. A First Degree DX Reception Citation covering the Short-

Wave Broadcast Band has been issued to him.

Mr. H. V. Miner, of Wollaston, Mass., is the one and only person to whom an Eighth Degree Citation has been issued. Mr. Miner's only contender is George J. Pasquale, who holds a Third Degree certificate. Miner and Pasquale have given you fellows something to shoot at.

A Third Degree Citation covering reception in the Amateur Phone Bands has been issued to Homer Bohlender, of Brookville, Ohio. Mr. Bohlender also holds a First Degree Short-Wave Broadcast Band Citation—the only person so far who holds Citations covering two bands. Something else for you fellows to shoot at.

For the benefit of those wishing to obtain Citations, we again stress the point that it is necessary to establish adequate proof of reception of the stations listed in your application. Verification cards or letters of verification are considered adequate proof providing they carry your name and address. Otherwise send the original envelopes along with the cards or letters. If you do not wish to trust your veri cards to the mails, photostats of the cards will suffice providing the photostats show your name and address, on the card, as well as the call of the station.

It might be pointed out, however, that the average veri card is stiff enough to go through the mails in good shape. None received at headquarters so far have been damaged in transit.

1938 Memberships

New 1938 Membership Cards will be issued to all present R.S.S.L. members after the first of the year. Each member will receive by mail complete information as to the manner in which to make application for membership renewal.

R. S. S. L. MONITORING STATION W26P1



R.S.S.L. Monitoring Station W26P1, owned by Clyde Criswell, Mission Ranch, Phoenix, Ariz. The receiver at the right is a modified Scott with rear vision mirror and R meter. In the center is a Hallicrafters Ultra Sky Rider. The receivers at the left are for 5 and 10-meter work.

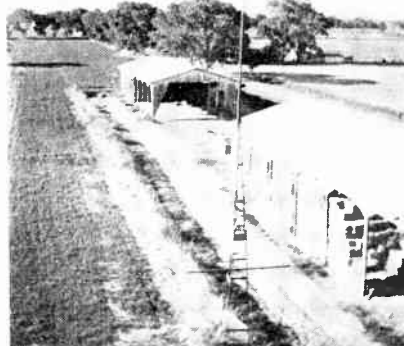

One of Criswell's 85-foot masts supporting a double doublet for the Scott receiver. Both towers are built of 20-foot 2 by 4's. Also shown are two of the 5000-ton hay racks at the ranch.



View of the shack and workshop where Mr. Criswell spends his time experimenting and listening-in on the air waves. One of Criswell's catches was the 25-watt u.h.f. mobile broadcasting unit, W10XV, which was cruising around Newark Airport at the time of reception.

Night-Owl Hoots

By RAY LA ROCQUE

NEW stations, contest news, letters, editorials, cheers, jeers, all important items that comprise this department each month are being given a back seat for the present while the Chief extends to all Night Owls throughout the world the very best greetings of the season and wishes for a prosperous and static-free New Year.

Actually, the first week of the contest is over as we compile the news for this department, but a few of the more distant reports have yet to reach us and we necessarily have to hold the scores until next month. The complete standing of members and teams after the first month of scoring will appear next month. This month will mark the deadline for new entries. After the end of January no new contestants will be accepted in the contest.

From Beach to Beach

XERB "took the air" recently on 730 kc. with a signal that doesn't pack the punch that its highly publicized 100,000 watts should. And behind XERB's existence lies a tale. It is alleged that XERB was financed by a couple of Los Angeles politicians with the idea of spouting words across the border and "piping" programs into Mexico from Hollywood for American listeners. One of these politicians, when informed by Mexican officials that this country forbids politi-

GREETINGS . . . BEACH OF ETIQUETTE? . . . NEW NRC OFFICERS . . . SIBERIAN ON 540
FCC FREQUENCY CHECKS . . . HIGH-NOON DX . . . 450 FEET—WHAM! . . . TIP SERVICE

STATION CHANGES, U.S.A.

NEW STATIONS	Location	Kc.	Power
—	Greenfield, Mass.	1210 kc.	250 w.
—	Poplar Bluff, Missouri	1310 kc.	100 w.

FREQUENCY	Kc.
KABR	1420-1930 kc.

POWER	Kc.
KABR	(1390) 100-500 w.
WBNS	(1430) 500-1000 w.

CALL LETTERS	Old Call	New Call	Location	Kc.
—	—	KGCI	Coeur d'Alene, Idaho	1370
—	—	KWLK	Longview, Wash.	780
WJAY	WCLE	—	Cleveland, Ohio	610
WMFN	WGRM	—	Grenada, Miss.	1210

STATION CHANGES, FOREIGN

NEW STATIONS	Location	Kc.	Power
—	Cucuta, Colombia	1270 kc.	—
—	Stagshaw, Gt. Brit.	1122 kc.	50000 w.
—	Warsaw No. 2, Poland	1384 kc.	7000 w.
—	Ille de France, Paris	968 kc.	2000 w.
CBF	Vercheres, P. Q., Can.	910 kc.	50000 w.
CBL	Hornby, Ontario	840 kc.	50000 w.
CFAR	Flin Flon, Manitoba	1370 kc.	100 w.
CFGP	Grand Prairie, Alb.	1200 kc.	100 w.
CMCK	Havana, Cuba	1030 kc.	—
I-1BA2	Bari, Italy	1357 kc.	1000 w.
XECL	Mexicali, Mexico	1100 kc.	—
RW54	Khaharovsk, U.S.S.R.	540 kc.	100000 w.

POWER	Kc.
Vipuri, Finl.	(527) 10000
Binchi, Bel.	(1492) 100-300
Brussels, Bel.	(620) 1500-15000
Konigsberg, Ger.	(1031) 10000-100000
Normandie, Fr.	(1113) 10000-5000
ON4RB	(932) 200-15000
2KA	(1160) 100-200
2WG	(1150) 200-2000
4CA	(1390) 100-200
4RO	(1330) 50-100

CALL LETTERS	Location	to
Milan	(1357)	to I1MI-2
Rome	(1258)	to I1RO-2
Turin	(1357)	to I1TO-2
CMOK	(1260)	to CMC
ON4ED	(1465)	to ON4EB

FREQUENCY	Kc.
CRCK	1050-950 kc.
CRCY	1420-960 kc.
TGW	1210-1230 kc.
I1MI-2	1340-1357 kc.
I1TO-2	1350-1357 kc.
2ZP	1060-1400 kc.
4QN	600-630 kc.
7ZI	630-600 kc.
ON4RW	1492-1500 kc.
Courtrai, Bel.	1465-1483 kc.
Grenoble, Fr.	583-593 kc.
Hilversum, Hol.	990-997 kc.

DELETED	Location	Kc.
Sharbeek, Belgium	Beziere, France	1500 kc.
Radio Vitus, France	Newcastle, G. B.	1122 kc.
—	—	800 kc.

cal broadcasting, and when informed by the FCC that no programs could be piped across the border, wanted his money back! As it had already been

spent in the construction of the transmitter at Long Beach, California, he got a Federal Court order impounding the transmitter and all other parts until a hearing could be held.

One dark night, it is said, someone got the guard inebriated, so to speak, and the morning sun's rays found the equipment resting firmly at Rosarito Beach, Mexico! XERB opened as scheduled, but their existence will be short-lived if the politician has anything to say about it. He has taken the matter to the State Department and from there it will go into diplomatic channels. At the head of XERB is M. Barbachano who is no "small fry" in border Light and Power Trusts. If you haven't logged XERB, do it now—for the dawn may find it missing from its choice spot on the dial—730 kilocycles!

With the Night Owls

A department devoted to choice selections from the mail of the month.

Robert Skyten, East Brookfield, Mass.: "There is a Spanish-speaking station on 710 kc. which at times nearly obliterates

BUNDABERG BROADCASTERS
PTY. LTD.



Studio and Office:
BOURBONG ST., BUNDABERG

Telephone 505

Manager: C. V. WOODLAND

Wavelength: 203 metres
Frequency: 1480 kilocycles
Aerial Power: 100 watts

"THE VOICE OF THE BURNETT"

Hours of Transmission

MONDAY to SATURDAY
7 a.m. to 8 30 a.m.
12-30 p.m. to 1.30 p.m.
5.30 p.m. to 10 p.m.

SUNDAY: 7 p.m. to 10 p.m.

An Aussie veri, in blue and brown, issued to Anthony Tarr, Seattle, Wash.

WOR's signal. It announces in Spanish. I heard an announcement and thought I heard the call CMCM but I'm not sure. Could you advise me further regarding this station?" (Your station is CMBL, Havana, using the old CMQ transmitter.—Chief).

Bill Stone, Toronto, Ontario: "CRCY is now on 960 kc. and still using the same call letters."

Harry Honda, Los Angeles, Calif.: "The NBC has inaugurated a special DX program to be aired Sundays from 3 to 4 a.m. on a different NBC station."

Anthony C. Tarr, Seattle, Washington: "I heard what was apparently a new station in CFGP on 1200 kc. He was working CJCA, another Alberta station. He did say Grand Prairie, and Alberta has plenty of prairies!"

Carl Eder, Sec'y. National Radio Club, Willmar, Minn.: "Please be advised that we, the following, Arthur J. Parfitt, Carl Eder, and Harry M. Gordon have resigned our respective positions as President, Secretary, and BCB Editor of the Globe Circlers DX Club, effective November 1, 1937. We feel that a harmonious state of affairs between us and the owner of the GCDXC can not exist, and we deem it advisable in the interests of the membership to step aside and let someone else assume our positions on the GCDXC staff to avoid quarrels or hard feelings that might come up in the future. We had the opportunity to acquire the National Radio Club and have taken over its management. The new NRC officers are: Arthur J. Parfitt, President; Robert Weaver, Vice president; Carl Eder, Secretary; Harold Wagner, Treasurer; Harry M. Gordon, Editor in Chief; Robert Weaver, BCB Editor, and Mrs. Anne Eder, Short Wave Editor."

Isaac T. Davis, Elkhart, Texas: "I consider this the best season for DX I have experienced yet! The Siberian on 540 kc. is RW54, Khabarovsk, U.S.S.R.



Group photo taken at recent NNRC Convention. First row, left to right: Carleton Lord, Ohio; Mrs. Dora Newcomb, Calif.; Lloyd S. Hahn, Maryland; Les Kraemer, New Jersey. Second Row, left to right: Lloyd French, Conn.; Arthur E. Foerster, Ind.; L. Collins, Ind. Third row, left to right: Earl Roberts, Ind.; Hal Robinson, Penn. (Host).

I am hearing him daily now with signals ranging from R5 to R8. He is often better than some of the Japs."

Frequency Checks

Last month we listed the frequency check programs scheduled for the second Monday and Tuesday of each month. This month we list the stations whose frequency is checked on the second Wednesday and Thursday of each month. All tests are for 20 minutes.

Every Second day	Wednesday	Every Second day	Thursday
2:00 WMFJ 1420 kc.	2:00 WSVS 1370 kc.	2:00 WKOK 1210 kc.	2:00 WRRAW 1310 kc.
2:10 WAIM 1200 kc.	2:10 WKOK 1210 kc.	2:20 WRRAW 1310 kc.	2:30 WJTN 1210 kc.
2:20 KVOL 1310 kc.	2:20 WRRAW 1310 kc.	2:30 WJTN 1210 kc.	2:40 WTEL 1310 kc.
2:30 WHBO 1370 kc.	2:30 WJTN 1210 kc.	2:40 WTEL 1310 kc.	2:50 WHIS 1410 kc.
3:00 WCPO 1200 kc.	2:40 WTEL 1310 kc.	2:50 WHIS 1410 kc.	3:00 WQAN 880 kc.
3:10 KFIZ 1420 kc.	2:50 WHIS 1410 kc.	3:00 WQAN 880 kc.	3:10 WLEU 1420 kc.
3:20 KOKO 1370 kc.	3:00 WQAN 880 kc.	3:10 WLEU 1420 kc.	3:20 WBLK 1370 kc.
3:20 WCLO 1200 kc.	3:10 WLEU 1420 kc.	3:20 WBLK 1370 kc.	3:30 WSAJ 1310 kc.
3:30 WRDW 1500 kc.	3:20 WBLK 1370 kc.	3:30 WSAJ 1310 kc.	3:40 WJBC 1290 kc.
3:30 WQBC 1360 kc.	3:30 WSAJ 1310 kc.	3:40 WJBC 1290 kc.	3:50 KGKL 1370 kc.
3:40 KAND 1310 kc.	3:40 WJBC 1290 kc.	3:50 KGKL 1370 kc.	WHAT 1310 kc.
3:40 KPLC 1500 kc.	3:50 KGKL 1370 kc.	WHAT 1310 kc.	WLAP 1420 kc.
3:50 WHBC 1200 kc.	4:00 KRIS 1330 kc.	4:00 KRIS 1330 kc.	WHDL 1400 kc.
3:50 KARK 890 kc.	4:00 KRIS 1330 kc.	4:00 KRIS 1330 kc.	KAWM 1500 kc.
4:00 WGPC 1420 kc.	4:00 KRIS 1330 kc.	4:00 KRIS 1330 kc.	WIMM 1210 kc.
4:00 KFIZ 1370 kc.	4:10 KAWM 1500 kc.	4:10 KAWM 1500 kc.	WMBS 1420 kc.
4:00 WHBU 1210 kc.	4:10 KAWM 1500 kc.	4:10 KAWM 1500 kc.	WBBW 1200 kc.
4:10 WJNO 1200 kc.	4:10 KAWM 1500 kc.	4:10 KAWM 1500 kc.	WBOW 1310 kc.
4:10 WBOE 1310 kc.	4:20 WPRR 1370 kc.	4:20 WPRR 1370 kc.	WRTD 1500 kc.
4:10 WCOE 880 kc.	4:20 WPRR 1370 kc.	4:20 WPRR 1370 kc.	WCBS 1420 kc.
4:20 WLB 1250 kc.	4:30 WPRR 1370 kc.	4:30 WPRR 1370 kc.	WPMV 1500 kc.
4:20 KSO 1430 kc.	4:30 WPRR 1370 kc.	4:30 WPRR 1370 kc.	WTTM 1230 kc.
4:20 WKU 1500 kc.	4:40 KRRV 1510 kc.	4:40 KRRV 1510 kc.	WGMV 1500 kc.
4:30 WOSU 570 kc.	4:40 KRRV 1510 kc.	4:40 KRRV 1510 kc.	WTTM 1230 kc.
4:30 KALB 1210 kc.	4:40 KRRV 1510 kc.	4:40 KRRV 1510 kc.	WTTM 1230 kc.
4:30 WEXL 1310 kc.	4:50 KGMV 1230 kc.	4:50 KGMV 1230 kc.	WTTM 1230 kc.
4:40 WHLB 1370 kc.	4:50 KGMV 1230 kc.	4:50 KGMV 1230 kc.	WTTM 1230 kc.
4:40 KPLT 1500 kc.	5:00 KERN 1370 kc.	5:00 KERN 1370 kc.	WTTM 1230 kc.
4:40 WJMS 1420 kc.	5:00 KERN 1370 kc.	5:00 KERN 1370 kc.	WTTM 1230 kc.
4:40 WIRD 1200 kc.	5:10 KGKO 1370 kc.	5:10 KGKO 1370 kc.	WTTM 1230 kc.
4:50 KFPR 1310 kc.	5:10 KGKO 1370 kc.	5:10 KGKO 1370 kc.	WTTM 1230 kc.
4:50 WBIG 1440 kc.	5:10 KGKO 1370 kc.	5:10 KGKO 1370 kc.	WTTM 1230 kc.
4:50 WTAX 1210 kc.	5:20 WTRC 1310 kc.	5:20 WTRC 1310 kc.	WTTM 1230 kc.
5:00 KFJB 1200 kc.	5:20 WTRC 1310 kc.	5:20 WTRC 1310 kc.	WTTM 1230 kc.
5:00 WEOA 1370 kc.	5:20 WTRC 1310 kc.	5:20 WTRC 1310 kc.	WTTM 1230 kc.
5:10 KPDN 1310 kc.	5:30 WTRC 1310 kc.	5:30 WTRC 1310 kc.	WTTM 1230 kc.
5:10 WZD 1020 kc.	5:30 WTRC 1310 kc.	5:30 WTRC 1310 kc.	WTTM 1230 kc.
5:20 KELD 1370 kc.	5:40 WTRC 1310 kc.	5:40 WTRC 1310 kc.	WTTM 1230 kc.
5:20 WWAYX 1200 kc.	5:40 WTRC 1310 kc.	5:40 WTRC 1310 kc.	WTTM 1230 kc.
5:30 KDLR 1210 kc.	5:40 WTRC 1310 kc.	5:40 WTRC 1310 kc.	WTTM 1230 kc.
5:30 WADC 1320 kc.	5:50 WTRC 1310 kc.	5:50 WTRC 1310 kc.	WTTM 1230 kc.
5:40 KRBC 1420 kc.	5:50 WTRC 1310 kc.	5:50 WTRC 1310 kc.	WTTM 1230 kc.
5:50 WSAU 1370 kc.	6:00 WTRC 1310 kc.	6:00 WTRC 1310 kc.	WTTM 1230 kc.
6:00 KFPL 1310 kc.	6:00 WTRC 1310 kc.	6:00 WTRC 1310 kc.	WTTM 1230 kc.
6:00 WFAM 1200 kc.	6:10 WTRC 1310 kc.	6:10 WTRC 1310 kc.	WTTM 1230 kc.
6:10 KLCN 1290 kc.	6:20 WTRC 1310 kc.	6:20 WTRC 1310 kc.	WTTM 1230 kc.
6:10 WEL 1420 kc.	6:20 WTRC 1310 kc.	6:20 WTRC 1310 kc.	WTTM 1230 kc.
6:20 KGBX 1230 kc.	6:30 WTRC 1310 kc.	6:30 WTRC 1310 kc.	WTTM 1230 kc.
6:20 WMP 1200 kc.	6:30 WTRC 1310 kc.	6:30 WTRC 1310 kc.	WTTM 1230 kc.
6:30 KABR 1420 kc.	6:30 WTRC 1310 kc.	6:30 WTRC 1310 kc.	WTTM 1230 kc.
6:30 KFXJ 1200 kc.	6:30 WTRC 1310 kc.	6:30 WTRC 1310 kc.	WTTM 1230 kc.

LAST-MINUTE FLASHES

Add to DX Calendar:

Sunday morning, Jan. 9, WCHV, Charlottesville, Va. (UDXC), 1420 kc., 2:00-3:00. Sunday morning, Jan. 23, CS2WA, Lisbon, Portugal (UDXC), 629 kc., 5:00-6:00. Every Sunday morning, KVOO, Tulsa, Okla., 1140 kc., 12:00-6:00. WTMJ, Milwaukee, Wis., 620 kc., 12:00-4:00.

Add to Eastern Forecast: Station ZNS, a new station in Nassau, Bahama Islands which is being heard nightly with an R8-9 signal throughout the east. 540 kc. and signs at 9 p.m. daily with "God Save The King."

Add to Western Forecast: Station ZJV in Suva, Fiji Islands, on 920 kc. signing off with "God Save the King" also, but at 4:00 a.m., EST. ZJV signal is weak and probably will not be heard except on the coastline—R2-3.

Credit is due to the following for the above last-minute items: Anthony C. Tarr, Seattle, Wash.; Al Bartholomew, Bradford, N. Y.; Ed Ayvazian, West Newton, Mass.; Richard Wright, Chicago, Ill.; and Richard Cooper, Kittanning, Penna.

Flash:—CMQ is now on 600 kc., which should please CBO and the CBC.

ALL-WAVE RADIO'S Time Table of DX Programs

(All schedules in E. S. T.)

Specials

SATURDAY MORNING, JAN. 1		
WTOC	Savannah, Georgia	1260 kc. 3:00-4:00
CHWX	Chilliwack, B. C. (NNRC)	780 kc. 2:45-4:00
SUNDAY MORNING, JAN. 2		
WJBO	Baton Rouge, La.	1120 kc. 2:00-4:00
CMAB	Pinar del Rey, Cuba (IDA)	1340 kc. 3:00-4:00
SUNDAY MORNING, JAN. 9		
WHIS	Bluefield, W. Va.	1410 kc. 2:30-3:30
WLH	Lowell, Mass.	1370 kc. 1:45-2:00
SUNDAY MORNING, JAN. 16		
WCCO	Minneapolis, Minn. (IDA)	810 kc. 3:00-4:00
KOBH	Rapid City, S. Dak. (UDXC)	1370 kc. 5:00-6:00
SUNDAY MORNING, JAN. 23		
WJBO	Baton Rouge, La.	1120 kc. 2:00-4:00
MONDAY MORNING, JAN. 24		
WHAM	Rochester, N. Y. (IDA)	1150 kc. 3:00-4:00
TUESDAY MORNING, JAN. 25		
KADA	Ada, Oklahoma	1200 kc. 2:45-3:15
SATURDAY MORNING, JAN. 29		
KGFW	Kearney, Nebraska	1310 kc. 6:00-6:30
FRIDAY MORNING, JAN. 28		
WLLH	Lowell, Mass.	1370 kc. 1:00-1:15
WEAU	Eau Claire, Wis.	1050 kc. 5:30-6:00
SUNDAY MORNING, JAN. 30		
CHWK	Chilliwack, B. C.	780 kc. 3:00-4:00
Regulars		
EVERY SATURDAY MORNING		
KRLC	Lewiston, Idaho	1390 kc. 3:00-4:00
EVERY SUNDAY MORNING		
KMTR	Los Angeles, Calif.	570 kc. 3:00-3:30
KMPC	Beverly Hills, Calif.	710 kc. 3:00-4:00

Kilocycling Around

So you don't like broadcast-band DXing because you have to stay up all night to get anything? Well take a glance at the following résumé of stations heard at high noon in Elkhart, Texas, by "Kilocycle Ike" Davis: The East coast is represented by WOR and WJZ with QRM from CMBL and WEW. Canadians CKY and CRCT and sometimes CFRB also break through, though there is much competition from XET. Many Cubans are heard with CMQ and CMK the strongest. "My record for mid-day reception," says Ike, "is 157 stations—stations on each channel of the broadcast band were heard, plus a few extra Mexicans on split frequencies. Mexicans are all over the dial with XEW and XEFO the strongest." That, my fellow Night Owls, is DX! . . . It seems that when a country begins changing its broadcasting stations around the dial, there is no stopping it. Take the case of the present set-up in Australia. One would think that after the many changes shown last month that the stations would remain stable for a while—but again this month we have several vital changes in the Australian list. Of the more important is the exchange of frequencies by 4QN and 7ZL. 4QN goes from 630 to 600, and 7ZL moves to 630 from 600 kc. These and other changes shown in the listings were sent to us by G. E. Botts, Hastings, New Zealand.

XELO is now on the air with 50 kilowatts on 670 kc. . . . WHAM's new vertical tower at Victor, N. Y., to be ready for use by the time you read this note, will extend 450 feet into the air. The tallest structure in western New York, it will be illuminated at each quarter mark with red lights with a flashing beacon at the top. Control of the entire

1420 K. C. **KBPS** 100 Watts



Owned and operated by the Student Body of
BENSON POLYTECHNIC SCHOOL
PORTLAND, OREGON

Your report of reception of KBPS -hecks with the station too

Veri from KBPS, Portland, Ore.,
issued to Anthony Tarr, Seattle,
Wash.

ALL-WAVE RADIO'S DX FORECAST FOR JANUARY

EASTERN NORTH AMERICA

General Forecast: January reception usually follows in the steps of December reception and features the Europeans. After this month they begin to slide down the ladder, so we advise getting them while the getting is good!

Specific Forecast

- T.A. 1st-31st, 12-3 a.m. and 5-7 p.m., R8. Each and every European station should be your target at these hours. Germans start at midnight, French and Italians at 1:45 or 2 a.m. Rennes (1040) and Radio Normandie (1113) are the best bets.
- JOAK-2 1st-31st, 5:30 to sunrise, R3. Japs should be better than "down under" stations this month. Others to try are: JOAK-1 (590), JBCK (850), JOIK (810).
- LR5 1st-31st, 6-10 p.m., R8. LR5's tremendous increase in volume, and the constant regularity of reception from this station leads us to choose it over the following Argentine's which also should be heard: LR1 (1070), LR4 (990), LR3 (950), LR6 (870), LS2 (1190), LRA (750), LS11 (1440).
- PRES 1st-31st, 6-8 p.m., R6. Good reception in localities remote from KDKA.
- YV5RA 1st-31st, 5:30-10 p.m., R6. Best before XEAW signs on. You might also try YV5RQ (882), and YV5RS (1300).
- CMQ 1st-31st, till 1 a.m., R9. Easily the best foreign station on the dial. Its signal makes hash of CBO even in areas not far removed from Ottawa! These Cubans are also audible on many occasions: CMX (920), CMBS (770), CMCF (815), CMBY (970), CM CJ (1110), CMCO (1200), CMBC (630), CMCM (850), CMCY (570), and CMCK (1050). And—oh yes—there's CMC on 1260 kc.
- XEW 1st-31st, 12-2 a.m., R8. Border stations using high power directed to the U.S.A. are not listed. Try for the following: NEMO (860), XERB (730), XET (690), XECL or NEPL (1100 kc.) a new station being heard from Mexicali, Mexico!
- XEFO 1st-31st, 1-2 a.m., R8. Daily program in English with prizes for best and most distant reports.
- TG-1 1st-31st, 8-11 p.m. or later, R6. We've given up TGAW. Not reported this year we've been taking it on the chin for predicting its reception. Sorry, Owlets, but the all-night programs were discontinued without advance notice and TGAW now signs off at 1 a.m. Sun. mornings. So we ask you to try TG-1 if you want Marimba music.
- TJPG 1st-31st, 7-12 p.m., R5. If you can ease into the crack between 620 and 630 kc. then you might get this one. It's worth a try.
- WKAQ 1st-31st, 6-7 p.m., R5. Best reception of WKAQ is just after dark when locals are not too strong.

WESTERN NORTH AMERICA

General Forecast: There will be a drop in signal strength over last month on signals from down under, but Jap signals will continue to be strong. Maybe a European or two may break through. Of course the ever present Latin Americans should be heard easily.

Specific Forecast

- 4YA 1st-31st, 4-6:30 a.m., R6. Other Zedders easily heard: 1YA (650), 3YA (720), 2YC (840), 2YA (570).
- JOIK 1st-31st, 6-7 a.m., R7. This and the following Japs should be easy catches for the western listeners: JOHK (770), JOAK-1 (590), JOAK-2 (870), JOBK-2 (940), JOHG (1050).
- 4QN 1st-31st, 5-6:30 a.m., unless otherwise stated, R5. This station as well as the following are the best bets for January: 4BH (1380), 2CO (670), 2NR (770), 2BL (740), 4QG (800), 3GI (830), 3AR (620), 7ZL (630), 2GZ (990) till 6, 4AK (1220), R4 or less: 2GB (870), 5CL (730), 7NT (710) on at 6, 3LO (770), and 5CK (640).
- KGU 1st-31st, 3-5 a.m., R6. Other Hawaiians: KHBC (1400) 3-4:30 a.m., R7-8, KGMB (1320) 4-5:30 a.m., R7-8.
- Rennes 1st-31st, 2-3 a.m., R5. This one and 1040 kc. Normandie on 1113 kc. are the only possibilities from France. Should have more chance of being heard in Southwest than in the North.
- Cologne 1st-31st, 2-3 a.m., R4. This German reported heard in Southwest when eastern reception good!
- YV5RA 1st-31st, R6. Just before XEAW comes on the air. Not heard very far north as a rule.
- LR1 1st-31st, 7-11 p.m., R6. Occasional reception when locals not too strong.
- PRES 1st-31st, 7-9 p.m., R7. Only in Southwest.
- WKAQ 12th only, 2:40-3 a.m., R8 (weaker in 1240 kc. Northwest).
- WNEL 8th only, 3:20-3:40 a.m., R8. (weaker in Northwest).
- KZRM 1st-31st, 5-7 a.m., R6. Add this new country to your list.
- RW54 1st-31st, 5-7 a.m., R8. Very good signal. A new country for many. This station erroneously reported as HAL last month for which both Tony Tarr and your humble Chief beg a thousand pardons. This signal travelling well inland and is reported R8 in Texas. RW32 on 556 kc. is also being heard, but not so well as the former.
- NEC 1st-31st, 12-1 a.m., R6. Announcements in Spanish. Can be identified by incessant announcements concerning MICKEY MOUSE!

lighting system will be governed by a photo-electric cell that will turn on the lighting system whenever snow, rain or other forces of nature destroy the normal light of day. . . The new CBL at Hornby will operate on 840 kc. and will replace CRCT when it is ready for operation—which should be around the first of the year. . . XEL'O's programs for American listeners every a.m. are verified with a very attractive picture card! . . . We received a veri card from WRNL on their tests, but Dick Wright (W11H6) of Chicago received his veri from them by telegram! . . . The new Cuban on

1030 kc. now relaying COCO seems to bear the call CMCK. What has happened to CMCX? . . . KAWM sent a very interesting souvenir of the "Indian Capital of America." . . . A new Mexican, in Mexicali, is operating on 1100 kc. The call seems to be definitely identified as XEPL. . . . CKLW is on the air till 4 a.m. daily thus becoming partially an all-nighter!

Cheers and Jeers

With the completion of the old year, that grand old club, the Newark News (Continued on page 45)

SCALES BY PHOTOGRAPHY

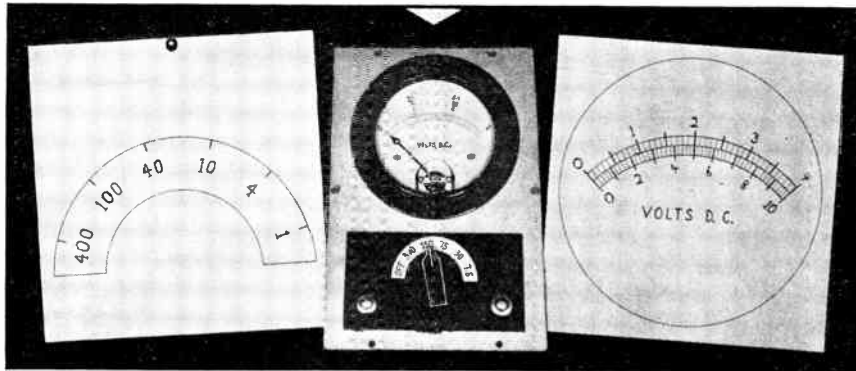

Two of the enlarged scale drawings, at left and right, and, in the center, actual scales made by photography.

Special Scales for Meters and Controls Easily Made

By EMIL BUCHWALD

Occasionally the experimenter or ham wishes a meter having a special scale, or perhaps an indicator for a control or a switch. These are not always available on the market; hence to fulfill the wish it is necessary to draw a scale, or indicator. This job appears more or less formidable depending on the reader's ability to draw small lines and figures. A steady hand and a good eye is necessary if the result is to have the appearance of a "factory made" job.

How it is Done

This difficulty, however, may be overcome with the aid of photography. The scale desired for a particular meter, for instance, is drawn three times normal size. This simplifies the drawing operation because large lines and figures are easy to make. Upon completion of the enlarged edition of the scale it is photographed and reduced one-third in size. The scale is cut out of the photo and pasted over the original meter scale. The finished product compares very favorably with the commercial product.

Not only meter scales, but any sort of dial indicator may be drawn on a large scale and reduced by photography. A small discrepancy on the large scale, which might occur during inking and printing, becomes negligible when it is photographed because of the reduction in size that takes place. Thus it is possible to take liberties with the dimensions when drawing the enlarged scale.

The Set-Up

This type of photography brings to mind a large commercial type of camera plus associated paraphernalia to do the job. This is not necessary however: the

family camera, which should be of the folding type, may be appropriated for the work. A piece of ground glass is necessary, also a portrait attachment. The portrait attachment is a lens designed to fit over the regular camera lens and creates additional magnification so that the camera may be placed closer to the object. If the portrait attachment is not available, an ordinary spectacle lens may be used so long as it is of the magnifying type. This may be fastened over the camera lens with two or three pieces of adhesive tape pasted on the edges of the lens.

So much for the magnifying lens. The next step is the scenery. First, a piece of newspaper is tacked on the wall upside down. A piece of white paper, exactly 3 x 6 inches in size, is tacked over the newspaper somewhere near the center. The newspaper, incidentally, should be several times the size of the white paper. A 100-watt lamp, or so, with a reflector, is directed on this set-

ting, the rest of the room being unlighted. This completes the "test" scenery.

The camera is now placed on a table so that the lens is level with the white paper. See Fig. 1. The back of the camera is removed and the ground glass fastened in place where the film normally rests. The glass may be fastened temporarily with adhesive tape. With the shutter open, also the stop setting, the camera is moved around the table until the picture on the ground glass becomes clear. It is necessary to manipulate the bellows also when doing this, that is, different "distance" settings must be tried. The adjustments are complete when the white piece of paper measures exactly 1 x 2 inches on the ground glass, and when the news print becomes clear enough to read.

With this combination the picture is reduced exactly one-third, and the fact that the newsprint can be read indicates that the picture has sufficient "sharpness." Incidentally, if you can

(Continued on page 46)

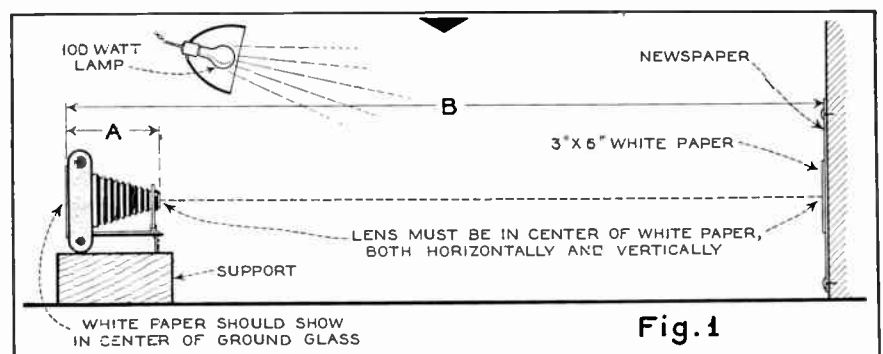

The set-up for photographing the enlarged drawings of special scales. Complete details are given in the accompanying text.

Queries

QUESTION NO. 48: My receiver has the usual single tone control, which seems to work on the high notes—that is, cuts them down or boosts them up. I should like to add a similar tone control for the bass notes, such as is found on some of the more expensive receivers.—A. O. L., East Orange, N. J.

Answer: That is not such an easy job. The receivers to which you refer probably have special and elaborate amplifying arrangements, employing resonant circuits, whereby certain frequencies, as desired, receive more than normal amplification. This is directly contrary to the more simple system, used in most receivers, where undesired frequencies receive less than normal amplification. If your receiver has a superabundance of highs, the bass can be accentuated by cutting down the highs and bringing up the amplification by turning up the volume control. Such a circuit is shown in Fig. 1-A, and is probably similar to that incorporated in your receiver. Condenser C has a value of .002 mfd. and the resistor is variable from zero to 500,000 ohms. At low resistor values, the condenser bypasses the high-frequency notes—the reactance of a condenser varying inversely with the frequency. In other words, at high frequencies the condenser tends to short circuit the secondary of the amplifying transformer, thus cutting down amplification. This tone control combination of condenser and resistor can be connected across the primary of the transformer as well—also across the

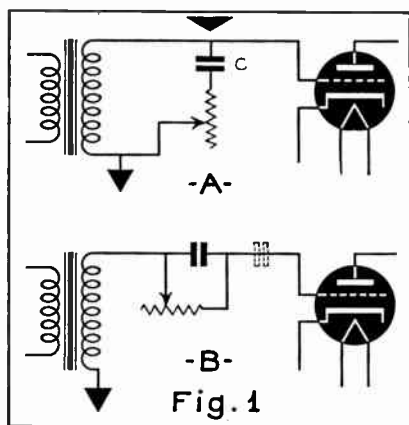

Fig. 1-A shows tone control circuit for reducing highs. Fig. 1-B is tone control circuit for reducing bass response. Dotted lines show the position of a coupling condenser in impedance or resistance coupled amplifiers.

TONE CONTROLS . . . CODE PRACTICE NOTE . . . SKIP EFFECT . . . LOOP ANTENNAS

THE primary purpose of the Queries Department is to solve the technical and semi-technical problems of our readers who feel they require such assistance. However, questions, so long as they are related to radio, need not be of a technical nature. Every question will be answered personally, by mail. A self-addressed and stamped envelope should be included. In questions concerning specific apparatus, it will be of considerable assistance to our technicians if the inquiry is accompanied with a wiring diagram, original operating instructions, and all relevant literature. While it is the desire of this department to be of assistance in all possible instances, it should be borne in mind that the manufacturer will occasionally be in a position to give better advice concerning his own product, and usually maintains a technical department at the service of those who purchase his equipment.

grids of push-pull tubes and across the plates of push-pull tubes.

Bass notes can be attenuated by reversing the process, as shown in Fig. 1-B. Here the condenser is in series with the grid circuit and is shunted by the resistor. The values are the same as in Fig. 1-A. With the resistor at maximum resistance, practically all of the audio-frequency voltage arrives at the grid through the condenser which offers a higher reactance to the low frequencies than to the high frequencies. Putting it differently, the high-frequency impulses pass through easily while the low-frequency impulses are considerably weakened. As the resistance is decreased, the condenser is gradually shorted out and the low notes pass through to the grid unattenuated.

If the amplifier has good bass and treble response, and the speaker is adequately baffled, a combination of Fig. 1 A and B will provide very effective independent control of bass and treble approaching that of special resonance amplifying systems. Fig. 1-B is also very useful in eliminating cabinet boom and drummy effects.

Question No. 49: In the August 1937 issue of ALL-WAVE RADIO you published an

article on a "Simple AC-DC Code Practice Set." I have built this up but get a rough a.c. note which I have been unable to improve. Is it possible to get a good, clean note?—H. M. C., Wallingford, Conn.

Answer: The oscillator of course is being operated on a.c. The a.c. note is due to insufficient filtering. While many will not find this note unpleasant, it can be improved by putting a small audio choke in series with the cathode of the 1-V tube. The primary or secondary of an audio-frequency amplifier transformer will do.

Question No. 50: When I tune my Midwest receiver to the ultra-short-wave band I am troubled by automobile ignition noise caused by passing cars. I am using an RCA "Spider-Web" antenna, erected in the clear atop my house. While I can receive W6XKG, Los Angeles, on 25,950 kilocycles, I am unable to receive my local ultra-short-wave station, W9XPD, at St. Louis, Mo.—J. W., Granite City, Ill.

Answer: We're sorry, but there is nothing you can do about the ignition noise. You are already using an effective noise-reduction antenna system. There is apparently no cure for automobile ignition interference from 15 meters down except isolation. The radiation at those frequencies will carry for a half mile or more. In other words, it is not localized around the lead-in, and therefore noise-reduction antenna systems are not effective.

You are unable to receive your local ultra-short-wave station for the simple reason that it is local. You are too near to it for indirect reception—in other words you are within the skip area—and not near enough for direct reception.

Question No. 51: I am a bug when it comes to experimenting with antennas, and have tried everything except a loop. I have a 7-tube 1937 model Airline receiver, and should like to try a loop with this set which I have equipped with an R-meter.—D. F. S., Greenville, Ill.

Answer: The loop antenna is not a very efficient aerial from the point-of-view of signal pick-up. Only its directional quality
(Continued on page 47)

HAMMARLUND SUPER-PRO CONSOLE RECEIVER

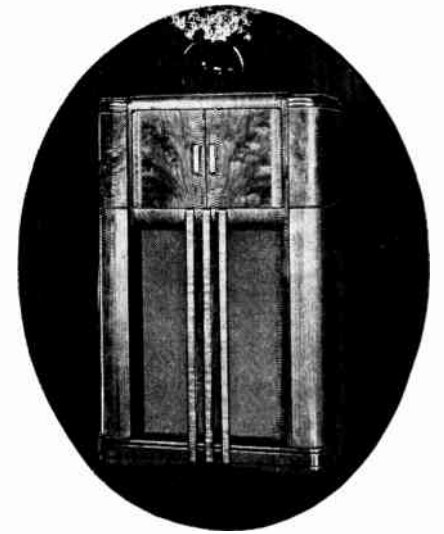

THE HAMMARLUND Super-Pro Console Receiver employs the standard Super-Pro chassis with a few minor changes. Generally speaking, the Console model is the standard receiver used in conjunction with a larger and more powerful loudspeaker, both of which are housed in a specially designed cabinet to provide improved low-frequency response.

The receiver proper differs from the standard model in the following respects: The heavy aluminum front panel is finished in walnut, and the knobs are of brown bakelite which match the panel finish. The tuning meter case is finished in bronze, and the band-change switch scale is brass with the same walnut finish. Letters and numerals engraved on the front panel are done in gold, which offers a pleasing contrast.

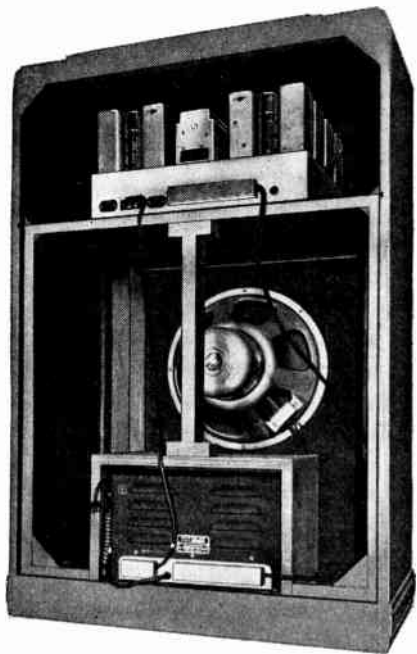

Fig. 1. Rear of the Console, with back partition removed, showing the bass reflex sound chamber. This is normally sealed.

A switch permitting use of phones or loudspeaker on the standard model has been replaced by a jack on the console model. When phones are plugged in, the loudspeaker is automatically silenced. The console model does not have a pitch control for the beat-frequency oscillator although the b.f.o. itself has been retained for use as a station finder or for the reception of c.w. code signals.

The loudspeaker is a Jensen 15-inch electro-dynamic unit, which has a much better frequency response than the smaller, 12-inch speaker supplied with the standard model Super-Pro. Striking acoustical performance is achieved with the new bass reflex sealed sound chamber in which the 15-inch speaker is placed. The bass reflex system increases the range of the loudspeaker approximately an octave.

The variable bandwidth control on the receiver, which permits the expansion of the acceptance band from 3 kc., or 3000 cycles, to the wide range of 16 kc., or 16,000 cycles, makes possible the reproduction of the entire musical range normally broadcast, through the improved loudspeaker system. Since the bandwidth control is continuously variable, any desired degree of response can be had to meet individual tastes.

A front view of the Super-Pro Console is shown at the top of this page. A rear view, with the back partition of the sound chamber removed, is shown in Fig. 1. The receiver chassis rests on top of the sound chamber and the combined power supply and power amplifier is built into a special compartment at the bottom of the cabinet. The large Jensen loudspeaker can be seen directly in the center of the sound chamber which, when enclosed by the back partition, has an area of 9750 cubic inches.

An idea as to the improvement gained by use of the bass reflex system can be had from the curves shown in Fig. 2. These show the relative response up to a frequency of 1000 cycles only, as it is at

the low frequencies that the bass reflex system takes hold.

The dotted line shows the response without bass reflex, with the back of the cabinet open. Note that response below 100 cycles is relatively poor and that an undesirable peak appears at approximately 130 cycles. This peak actually covers the range from 100 to 200 cycles and accounts for the "boominess" normally experienced.

The solid line indicates the improvement when the bass reflex system is employed—with back of sound chamber sealed. Note, for one thing, that the undesirable peak has been flattened out, and for another thing that the response at frequencies below 100 cycles is considerably increased. It will be seen that excellent response is had at frequencies as low as 40 cycles, which is not the case without the bass reflex system.

Thus, from 40 to 100 cycles, where "real" bass exists, the response is boosted considerably, while from 120 to 200
(Continued on page 48)

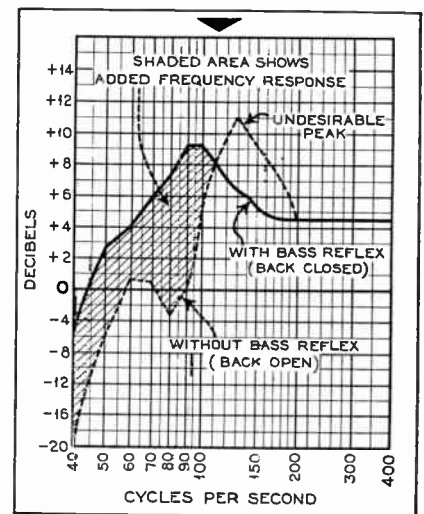

Fig. 2. These frequency curves show the distinct improvements gained in bass response and elimination of "boominess" when using the bass reflex system.

Backwash

THE ETERNAL QUEST

Editor: I have recently subscribed to ALL-WAVE RADIO and the last few copies which have thus come to me have pleased me very greatly. The whole magazine is very well-balanced in all respects with the best articles on timely topics in radio that I have been able to find.

A letter from Roy B. Rosenbury, RM3c, U.S.N.C.R., Canton, Ohio, has inspired this burst of literary effort from me because he has struck a note which is zero beat with the way I have felt for a long time. I too, like R.B.R., have built many receivers since 1922 when I first wound No. 20 wire on a Quaker Oats box and tickled a piece of galena. My file of magazines has grown to immense proportions and only once in a while do I see an article which approaches something "dandy." Somewhere there is always something that doesn't click so I take note of the good parts and pass on to more articles hoping that eventually I shall find something really fine.

This eternal quest for a good receiver which meets my own self-inspired requirements has kept me awake many a night while I mentally juggle tubes, coils and condensers into a myriad of combinations which only leaves me bewildered and sleepy. Recently I have decided upon something which I am now in the process of constructing in earnest. The main theme is versatility. I am concentrating on a method of arranging the component parts of a good superheterodyne in such a way that I can try different tube combinations, different I/C combinations as well as many different circuits including amplified a.v.c. and noise suppression, with practically no chassis alterations. This sounds difficult but when you get down to the real thing it is very simple. I would like to tell you more about this arrangement but first I should like to discuss features suggested by R.B.R.

R.B.R.'s superheterodyne would use metal tubes which would, of course, require octal sockets, which in turn meets my own requirements.

Plug-in coils are what I plan to use also. The switching from manual volume control to a.v.c. is easy to include and very nice to have.

A separate speaker also permits better baffle arrangement as well as abolishing any microphonics.

I like the National Drum Dial in which the figures are projected on a screen to eliminate parallax and make it easy to tune in a room with dim lights on at night. The vernier ratio is nothing remarkable but it is a smooth-action dial without backlash. It does not spin easily like many other dials but I don't care about this feature anyhow.

The jack for headphones is a simple and easy-to-apply addition to any receiver.

I have omitted to mention the features which I feel need more discussion and so I shall take them up next.

Bandspread, yes. Electrical and not mechanical bandspread as is so commonly found on many general coverage receivers. To do this efficiently I have devised a simple method of making a split stator variable condenser out of one of the standard ones available without weakening it mechanically or reducing its electrical efficiency. These condensers are bought as two-gang affairs and end up in what amounts to a four-gang affair of which one pair of the gang is used for one circuit and the other pair for another circuit. By this means I can gang the first detector and h.f. oscillator tuning and have either bandspread or general coverage within limits of the capacity of the condensers used.

A self-contained power supply is nice but not the best arrangement if one wants to eliminate all worry from hum when the headphones are used. And while building a pet receiver, why not make it so that batteries could be used with it on a vacation?

Eight tubes will do the job nicely in the line-up R.B.R. suggests but I am more in favor of using a lower i.f. (with a bit better gain) and one (or two) r.f. pre-selector stages. The r.f. can be regenerative or the 1st detector can be regenerative to provide better selectivity and nice gain. I feel that the r.f. will also greatly help the signal-to-noise ratio when working down to the very weak signals. Perhaps tube noise can be reduced by leaving out the regeneration as mentioned above and adding it to the i.f. if necessary. Besides, in some locations the broadcast band will be just as bad as image interference with a high i.f. Personally, I am going to use two stages of r.f. and try regeneration in the places mentioned above to see which I like best. Also, I want to try variation of the amount of h.f. oscillator injection in an effort to reduce the noise created by the shot-effect modulation of the i.f. I am going to include separate b.f.o. and use pentode power output also.

Now to get back to the versatile chassis layout. It has one drawback; rather a large chassis is needed. I have one about 10 by 19 inches or whatever the standard size is, with a three inch sub-base. The National dial is centered on the panel with one variable condenser gang on one side and the other on t'other. Both condensers are coupled with flexible insulated couplings and so arranged that they can be insulated from the chassis if necessary as with isolation required for a.v.c. in the r.f. stages. This mechanical detail also permits quick

and easy removal of the gangs entirely to use a larger or smaller capacity by merely unsoldering the connections and loosening the couplings and the mounting clamps.

The plug-in coils are each in an individual can with a very small variable condenser mounted in the top of the can to tune or trim. These plug in directly behind the condensers and right in front of their respective tubes.

The back of the chassis is given over to i.f. tubes and coils, detector, a.v.c., audio tubes, and two tubes and the diode transformer used in the Lamb noise circuit. I haven't tried either the Lamb or the Dickert circuit but a bit of rewiring will permit of either as wanted.

Any volume controls will run to the panel on insulated rods to place the control nearest the controlled tube.

I have a signal generator which I am going to use as a beat oscillator for the time being. It has been very satisfactory in the past few weeks. This arrangement will leave more space free on the chassis and not cause any crowding.

This is my pipe dream which is coming true as fast as I can buy parts and cut chassis holes. I am living at present in a d.c. district and so the final result awaits my removal to an a.c. supply. That will be in a bit over a month and so I guess I can stand it that long. I am going to try out the coil-condenser combinations with the tubes wired for d.c. and rewire them later. I am using Amphenol Steatite sockets for the r.f. tubes and trying to keep losses to the ultimate minimum. If this set works well at 30 megacycles I will be very happy.

During my four years of college I did little or no radio work and when I recently started to find out what new developments had transpired during the interim, I was at first bewildered, but now I am quite at home once more. The time seems ripe for me to learn the code and get on the air. The yen to talk to some of the British amateurs has got me in a strangle hold. I spent some time visiting a friend of mine who was building up a kilowatt amplifier for the final stage in his rig. While helping him I got a thrill talking to G6DL in Birmingham for about a half an hour one afternoon and at the end of the QSO I felt that we were good friends. We were using two 6L6G's at the time with about 50 to 60 watts input. The antenna was a beam affair of half waves bent to form a rectangle fed by a Johnson Q and a 400-ohm spaced two-wire line. I'll never forget how cold we were in that shack on top of a hill with the rain coming down in sheets! Some of my receiver ideas are inspired in part by my friend's displeasure with his own receiver. Of course you may have guessed that we were on 14 mc.

My wife is very patient with me. In fact very sympathetic. She doesn't complain about the mess I make on the floor because I clean it up. Even if I didn't she wouldn't complain. She is also trying to understand what goes on inside a radio and is beginning to make sense out of a circuit diagram. At present there is some awful QRN near here from some big slow-turning d.c. motor which blankets the whole short-wave spectrum. It ought to be banned by law. I built a portable rig with a loop and have located within a small area where I think it is but I haven't questioned the tenants in that building yet. If you know of a good approach please let me know about it. I'm afraid that those concerned with the offending motor are either uninterested or very unsympathetic and unintelligent.

Before I close I might add that my wife got a big kick out of Zeh Bouck's paragraph (November) concerning smut on the air. She thinks smut is F.B. if it is clever and not just plain dirty. You might pass this on to Bouck from an appreciative reader.

THURLOW M. GORDON, JR.,
53 EAST 66TH ST.,
NEW YORK, N. Y.

(Thank you for a very interesting letter. Your plans sound first rate, and we should like to hear more about the receiver when you have completed the initial design. By all means experiment with injector circuits. There is a great deal to be gained through intelligent design. There is no satisfactory approach to the QRN problem, it being one of human relations. But the local power company might assist you. We agree with Mrs. Gordon on the subject of dirty jokes, but we have yet to hear Bouck recount a clever one.—Editor)

QSL'S AND VERIES

Editor: Well, it looks like the SWL fan's hobby is just about ready to fold up; every day more and more hams are complaining about the cost of sending out QSL cards.

As the SWL fan knows, the fine thing about his hobby is the receiving of verification cards from broadcast and ham stations. Without the veries, there is no pleasure in it for him at all.

The argument is that the SWL has nothing invested in his equipment compared to the ham. Well, here is what the hobby of SWL has cost me:

Receiver	\$240.00
Antenna	7.50
Lightning Arrestors.....	2.00
Installing Ant. Rcvr.....	10.00
Spare Tubes	9.00
Typewriter	37.50
Desk	17.50
Headphones	3.50
	<hr/>
	\$327.00

I don't know what the ham spends for his equipment but I believe that this hobby of mine has cost me a nice piece of change. The reports I mail out cost me 13 cents each as I enclose a postal reply coupon in each one mailed. You can easily see that I must spend \$13.00 to mail 100 reports.

Yes, like W4H69 I have been stuck for quite a few International Reply Coupons. The figure of 13 cents a report is an average on the last 100 reports I mailed.

There should be a way for SWLs to know of the stations that do not verify.

ALBERT S. SPÜHLER,
3296 WEST 99TH STREET,
CLEVELAND, OHIO

(We don't believe the outlook is quite as dreary as you make it out to be, but there is a great deal in what you say. Even the Hams have QSL card trouble; many QSO's are ignored and many QSL cards never reach their destinations. We have no way of determining the percentage of Hams who do not verify SWL reports, but we are of the opinion that the majority will mail cards to SWLs who submit intelligent reports. Short-wave broadcast stations that do not verify are indicated in our monthly station list.—Editor)

RE STATION W8XWJ

Editor: It was with much interest that I read Perry Ferrell's article on "Ultra High" in the December issue of ALL-WAVE RADIO. My particular interest in such material lies, as you may remember, in the fact that I am responsible for the operation of W8XWJ in Detroit, which received prominent mention in your magazine several times.

Since interest in Ultra High broadcasting is definitely on the increase, which it should be in view of the new F.C.C. allocations, it was recently decided to increase the power of W8XWJ and to inaugurate a completely new and, as far as I know, unique programming policy for such a station.

During the first week of January 1938 we will take the air from W8XWJ with a brand new Western Electric 500-watt transmitter on 41,000 kc. New quarters for the station are being prepared now on the 45th floor of the building we have occupied with W8XWJ for the last two years. Our operating schedule is to be extended as follows:

Weekdays—
9:00 a.m. — 11:00 p.m., E.S.T.
Sundays—
10:00 a.m. — 5:00 p.m., E.S.T.

In addition to this change, we are planning and preparing to originate and broadcast only programs that are NOT being carried by WWJ, The Detroit News regular broadcast station, with the exception of a very few hours' programs weekly which will be duplicated because they are of intense interest to local listeners. This programming policy will give listeners an additional day's programs to select from. It will of course require that we have our own program and production department and studios, which will be located on the same floor, in the same building, as the transmitter. Incidentally, our Western Electric transmitter is the first of that type and power that has been sold for Ultra High broadcasting, and will differ from Western Electric's standard police transmitter in that it will have considerably better audio characteristics, lower carrier

noise level, and regular broadcast station speech-input equipment.

It is noted that under "Jottings" on page 665 of the same issue it is stated that 75 police channels will be assigned between 41,020 and 43,980 kc. This is incorrect since these 75 channels will be assigned to broadcast stations.

C. H. WESSER,
Chief Short-Wave Engineer,
W8XWJ, DETROIT, MICH.

(Many thanks for the information on the new setup. We'll be hearing you.—Editor)

RSGB FIVE-METER CONTEST

Editor: In connection with the RSGB 1938 five-meter contest, I arranged some concentrated tests with the British and others, in order to increase the possibilities that dx contacts will be made. Confirmation from G2HG has been received. Those interested might write to me late in December for final details, enclosing a reply envelope. Here is the proposed schedule:

The basic schedule will call for transmitting and listening periods on Sundays at 10 to 11 E.S.T. from mid-January to early March, with the dx stations transmitting during the first fifteen minutes and the U. S. stations during the second fifteen minutes, etc. Send mainly your call, with as little else as possible in order not to confuse identification.

Extending the time and the days beyond this basic schedule will be perfectly satisfactory. If a contact becomes possible, abandon the schedule and go ahead with the QSO.

The above will be for Europe and Africa. The Australian schedule, it is proposed, will take place mainly on Saturday afternoon at about 4 p.m. E.S.T., and the South American schedule at the same time on Sunday. I cannot be as certain about the proper time for the South American and the Australian tests, so extending the time seems to be the only solution. Television and other transatlantic reception seems definitely to be best in the late forenoon in the eastern half of the U. S., which indicates that the selected time should be about right.

E. H. CONKLIN, W9FM
512 N. MAIN STREET,
WHEATON, ILL.

"THAT MAN IS HERE AGAIN"

Editor: I have read with considerable interest the letter from Joseph A. Piechuta, in *Backwash* for December, though I don't altogether agree with him. He states, for instance, that Zeh Bouck's department wouldn't be missed. Frankly, I for one would miss it.

I concur that Bouck "is a crank, grouchy and pessimistic critic." In other words he's a critic. But in defense of Mr. Bouck, I cannot accept the statement: "Never a word is mentioned about the excellence of some programs, but condemnation over all he listens to." (Italics mine.) I have just gone over the *Channel Echoes* departments for the last 12 issues—January 1937 through December 1937—and find that Mr. Bouck praised 14 programs and con-

(Continued on page 58)

SHORT-WAVE BROADCAST STATION LIST

BOLD NUMERALS: MEGACYCLES. LIGHT NUMERALS: METERS. DOT (•): STATION DOES NOT VERIFY. DIAMOND (◆): STATION NOT IN USE.

Abbreviations: O—Opening; C—Closing; I—Interval; S—Signal; I.R.C.—International Reply Coupon. Schedules in E.S.T.

41.000 W2XHG 7.32	National Broadcasting Co., 30 Rockefeller Plaza, New York, N. Y. Daily 9 a.m.-12 midnight.	17.760 W2XE 16.89	Wayne, N. J. (see 21.520 mc.) Daily 6:30 p.m.-12 a.m.	15.110 DJL 19.85	Zeesen, Germany (see 17.760 mc.) Daily 12-2 a.m.; 8-9 a.m.; 10:40 a.m.-4:30 p.m.; Sunday 6-8 a.m.
41.000 W2XOY 7.32	Albany, New York. Address: General Electric Co., 1 River Road, Schenectady, N. Y. Irregular.	17.755 ZBW-5 16.90	Hong Kong, China. (see 9.525 mc.)	15.040 RKI 19.95	Radio Centre, Soltanka 12, Moscow, USSR. Call: "This is Moscow Calling." O-C: Internationale . Irregular. No I.R.C. required.
38.650 W2XDG 7.76	New York, N. Y. (see 41.000 mc.) Daily 9 a.m.-12 midnight.	15.530 HS8PJ 19.32	Bangkok, Siam. (see 19.020 mc.) Occasional Mondays 8-10 a.m.	14.970 LZA 20.04	Director General, Telegraphs and Telephones, Sofia, Bulgaria. O: Racherutza-(Bulgarian Folk Dance). C: National Anthem and Hymn of His Majesty the King. Weekdays 5-6:30 a.m.; 12-2:45 p.m.; Sundays 12 a.m.-4 p.m.
31.600 W1XKA 9.4	Boston, Mass. (see W1XK 9.570 mc.) Daily 7 a.m.-1 a.m.	15.440 XEBM 19.43	P. O. Box 50, Mazatlan, Mexico. Daily 9-10 a.m.; 1-2 p.m.; 8-10 p.m.	14.935 PSE 20.07	Rio de Janeiro, Brazil. (P) Phones LSL-WLK day irreg.; EDM-EHY 8 a.m. Broadcasts German program 4-4:10 p.m. Wednesdays (see 21.080 mc.)
31.600 W1XKB 9.4	Westinghouse Electric & Mfg. Co., Springfield, Mass. Daily 7 a.m.-1 a.m.	15.370 HAS-3 19.52	Director Radio, Hungarian Post, Gyali St., 22, Budapest, Hungary. I: Musical Box Melody; O: Bells ringing; C: Lord Bless the Hungarian (national anthem). Sunday 9-10 a.m.	14.600 JVH 20.55	Nazaki, Japan (see 21.520 mc.) 7 p.m.-1 a.m. Irregular.
31.600 W8XKA 9.4	Pittsburgh, Pa. (see W8XK 21.540 mc.) Daily 10 a.m.-12 Midnight.	15.360 DZG 19.53	Zeesen, Germany (see 17.760 mc.) Irregular.	14.535 HBJ 20.64	Radio Suisse, S.A., 12, Quai de la Poste, Geneva, Switzerland. No opening or closing selection (see HHO 11.402 mc.) Mon. 3:15-3:45 a.m. Australia L of N. Sat. 6:45-8 p.m. Swiss program.
31.600 W3XKA 9.4	Philadelphia, Pa. (see W3XAU 9:590 mc.) Daily 9 a.m.-10 p.m.	15.340 DJR 19.56	Zeesen, Germany (see 17.760 mc.) Daily 8-9 a.m.	14.480 DZH 20.75	Polkskie Radio, 5., Mazowiecka St., Warsaw, Poland. Weekdays 6-7 p.m. Sundays 6-8 p.m.
31.600 W8XWJ 9.4	4465 Penobscot Bldg., Detroit, Mich. Daily exc. Sun, 10:30 a.m.-5 p.m.	15.330 W2XAD 19.56	General Electric Co., 1 River Rd., Schenectady, N. Y.; O: Spark Discharge. C: Star Spangled Banner. Daily 11 a.m.-9 p.m.	13.635 SPW 22.00	TSS Awatea, Union Line S.S., Coy Head Office, Wellington, New Zealand. Daily 1-3 a.m., Sundays 6:40-7 p.m.
31.600 W2XDV 9.4	New York, N. Y. (see 21.520 mc.) Mon. to Fri. 6-11 p.m. Sat-Sun. 1:30-6 p.m.; 7-10 p.m.	15.320 OLR5B 19.58	Prague, Czechoslovakia. (see 21.450 mc.) Irregular (see 9.550-11.840 mc.)	13.600 ZMBJ 22.06	Ciudad Trujillo, Dom. Rep., W. I. (see 6.243 mc.) Daily exc. Sun. 11:40 a.m.-1:40 p.m.; 7:10-9:50 p.m.
26.100 GSK 11.49 ◆	British Broadcasting Corp., Broadcasting House, London W1, England. Big Ben strikes the hour according to arrangement program. C: God Save The King. I. Bow Bells.	15.310 GSP 19.60	Darenty, England (see 26.100 mc.) Daily 1:45-3:45 p.m.	12.500 HIN 24.00	Radio Service, Desmaras and Cia., Ltd., Casilla 761, Santiago, Chile, S.A. Daily 12-2 p.m. 5-8 p.m.
25.950 W6XKG 11.56	1417 So. Figueroa St., Los Angeles, Calif. Continuously 24 hours each day.	15.300 YDB 19.61	Soerabaja, Java. Daily 7:30 p.m.-2 a.m. (see 15.150 mc.)	12.300 CB615 24.39	Icelandic State Broadcasting Service, P. O. Box 547, Reykjavik, Iceland. First half English. C: Icelandic National Orchestra and chorus voices. Sundays 1:40-2:30 p.m.
21.550 GST 13.92 ◆◆	Darenty, England. (see 26.100 mc.)	15.290 LRU 19.62	Radio El Mundo, Malpu, 555, Buenos Aires, Argentina, S.A. O-C: English only. Daily 7-9 a.m.	12.235 TFJ 24.52	Zeesen, Germany (see 17.760 mc.) Irregular.
21.540 W8XK 13.92 ◆	Grant Bldg., Pittsburgh, Pa. O-C: Stars and Stripes Forever. Daily 6:45-9 a.m.	15.280 H13X 19.63	J. R. Saladin, Director of Radio Communications, Ciudad Trujillo, Dominican Republic. S: Bells. Weekdays 12:10-1:10 p.m.; Sundays 7:40-10:40 a.m.	12.130 DZE 24.73	Moscow, U.S.S.R. (see RKI, 15.040 mc.) Daily 10-11 p.m. Sun. 6-7 a.m.; 10-11 a.m.; 4-5 p.m.; Wed. 6-7 a.m.; 4-5 p.m.; Fri. 4-5 p.m.
21.530 GSJ 13.93 ◆	Darenty, England. (see 26.100 mc.) Daily 5:45-8:55 a.m.; 9:15 a.m.-10:30 a.m.	15.280 DJQ 19.63	Zeesen, Germany (see 17.760 mc.) Daily 12:05-5:45 a.m.; 6-8 a.m.; 8:10-10 a.m.; 4:50-10:45 p.m. Sunday 11:10 a.m.-12:25 p.m.	11.960 H12X 25.08	Ciudad Trujillo, Dom. Rep. (see 15.280 mc.) Tues. and Fri. 8:10-10:10 p.m. Sunday 7:40-10:40 a.m.
21.520 W2XE 13.94	485 Madison Ave., New York, N. Y. C: Star Spangled Banner. Mon. to Fri. 7:30-10 a.m. Sat-Sun. 8 a.m.-1 p.m.	15.270 W2XE 19.04	Wayne, N. J. (see 21.520 mc.) Mon. to Fri. 1-2:15 p.m.	11.900 CD1190 25.21	Casilla 642, Valdivia, Chile, S.A. Daily 10 a.m.-1 p.m., 3-6 p.m., 7-10 p.m.
21.520 JZM 13.94 ◆	Overseas Section, The Broadcasting Corp. of Japan, Tokyo, Japan. O-C: Kimigayo National Anthem. Musical chimes follow. (see 11.800-15.160 mc.)	15.260 GSI 19.66 ◆	Darenty, England (see 26.100 mc.) Daily 12:20-3:45 p.m.	11.900 XEW1 25.21	P. O. Box 2874, Mexico, D.F. S: 2 strokes gong. O-C: May Angels Guard Thee. Sun. 12:30-2 p.m. Mon., Wed., Fri. 3-4 p.m.; 7:30 p.m.-12 a.m.; Tues., Thurs. 9:30 p.m.-12 a.m.; Sat. 9 p.m.-12 a.m. (see 6.015 mc.)
21.470 GSH 13.97 ◆	Darenty, England. (see 26.100 mc.) Daily 5:45-8:55 a.m.; 9:15 a.m.-12 noon.	15.250 W1XAL 19.67	Boston, Mass. (see 21.460 mc.) Sun. 11 a.m.-12 noon. Mon. to Fri. 2:15-4 p.m.	11.900 OLR4D 25.21	Prague, Czechoslovakia (see 21.450 mc.) Irregular (see 9.550-11.840 mc.)
21.460 W1XAL 13.98	World Wide Broadcasting Corp., University Club, Boston, Mass. O: News, Blaze Away. C: Star Spangled Banner. Irregular.	15.243 TPA-2 19.68	Minister des Postes, Boulevard Haussmann, 98, Bld., Paris, France. I: Three tones F in Morse. O-C: La Marseillaise; S: chimes ¼ hours. Daily 6-11 a.m.	11.895 XEXR 25.22	Departamento Autonomo de Propaganda y Publicidad, Mexico, D. F. Daily 6-11:30 p.m.
21.450 OLR6A 13.99	Radiojournal, Praha XII, Fochova Tr. 16, Praha, (Prague) Czechoslovakia. O-C: Melody New World Symphony and Cathedral chimes. I: 9 note trumpet call, repeated. Irregular (see 9.550-11.840 mc.)	15.230 OLR5A 19.70	Philips Radio, Hilversum, Holland. Sun. 3-5 a.m. Ved. 8-11 a.m.	11.895 HP51 25.22	Emisora IIP51, Aguadulce, Panama. English—beginning and closing. I: three notes conk, thrice (9) ea. 30 mins. O-C: El Tambor de la Algeria. Daily 7:30-9:30 p.m. Veri cards free.
19.020 HS8PJ 15.77	Superintending Engineer, Post and Telegraph Dept., Technical Section, Bangkok, Siam. O: 3 chimes, English Mondays, 8:10 a.m.	15.220 PCJ 19.71	Pittsburgh, Pa. (see 21.540 mc.) Daily 9 a.m.-7 p.m.	11.880 XEXA 25.25	Pontoise, France (see 15.243 mc.) Daily 2-5 a.m. 12:15-6 p.m. Secretaria de Educacion Publica, Mexico, D. F. O-C: March of the Toys. Weekdays 8:30-11 a.m.; 2:30-4:30 p.m.; 7 p.m.-12 a.m.; Sun. 7 p.m.-12 a.m.
17.800 TGWA 16.85	Radiodifusora Nacional, TGWA, Guatemala City, Guatemala, C.A. O-C: Simple Melody, Marimba, repeated three times. (see 15.170-11.760-9.685 mc.) Week days 12:45-1:30 p.m. Sundays 12 noon-2:45 p.m. No IRC necessary.	15.210 W8XK 19.72	Daily 9 a.m.-7 p.m.	11.870 W8XK 25.26	Pittsburgh, Pa. (see 21.540 mc.) Daily 7-10 p.m.
17.790 GSG 16.86	Darenty, England. (see 26.100 mc.) Daily 3:15-5:25 a.m.; 5:45-8:55 a.m., 9:15-12 noon, 12:20-3:45 p.m.	15.200 DJB 19.74	Zeesen, Germany (see 17.760 mc.) Daily 12:05 a.m.-11 a.m.; 11:10 a.m.-12:25 p.m.; 4:50-10:45 p.m. Sunday 8-9 a.m.	11.860 YDB 25.29	Soerabaja, Java (see 15.150 mc.) Daily 10:30 p.m.-2 a.m.
17.785 JZL 16.87	Nazaki, Japan. (see 21.520 mc.) Irregular.	15.190 ZBW-4 19.75	Hong Kong, China (see 9.525 mc.)	11.860 GSE 25.29 ◆◆	Darenty, England. (see 26.100 mc.)
17.780 W3XAL 16.87	30 Rockefeller Plaza, New York, N. Y. Daily 8:55 a.m.-5:45 p.m.; 6-9 p.m.	15.183 RV96 19.76	Moscow, U.S.S.R. (see RKI 15.040 mc.) Irregular.	11.855 DJP 25.31	Zeesen, Germany (see 17.760 mc.) Irregular.
17.780 W9XAA 16.87 ◆	666 Lake Shore Drive, Chicago, Ill. S: 3 chimes each 15 minutes. O: Star Spangled Banner.	15.180 GSO 19.76 ◆	Darenty, England (see 26.100 mc.) Daily 3:15-5:25 a.m.; 5:45-8:55 a.m., 4-6 p.m.		
17.770 PHI 16.88	Philips Radio, Hilversum, Holland. Call: Seven languages. I: Metronome 80 beats per minute. C: National Anthem. Sun. 7:25-10:30 a.m. Mon., Tues., Thurs., Sat. 8:25-9:50 to 10:15 a.m. Fri. 8:25-11:30 a.m.	15.170 TGWA 19.78	Guatemala City, Guatemala (see 17.800-11.760-9.685 mc.) Weekdays 12:45-1:30 p.m. Sunday 12 noon-2:45 p.m. No IRC necessary.		
17.760 DJE 16.89	German Short Wave Station, Broadcasting House, Berlin, Germany. I: 9 musical notes. Folk Song. C: National Horst-Wessel Lied and Duetschlandlied. Daily 12:05 midnight-10 a.m.; Sunday 11:10 a.m.-12:25 p.m.	15.160 OLR5C 19.79	Prague, Czechoslovakia (see 21.450 mc.) Irregular (see 9.550-11.840 mc.)		
		15.160 XEWW 19.79	Mexico, D. F. (see 9.500 mc.) Daily 8 p.m.-12:30 a.m.		
		15.160 JZK 19.79	Nazaki, Japan (see 21.520 mc.) Irregular.		
		15.155 SM5SX 19.80	Royal Technical University, Stockholm, Sweden. Weekdays 11 a.m.-5 p.m.; Sunday 9 a.m.-5 p.m.		
		15.150 YDC 19.80	N.I.R.O.M., Koningsplein West 5, Batavia, Java, N.E.I. (Location-Soerabaja). Weekdays 5:30-10 a.m. (Sat. 11:30 a.m.) 6-7:30 p.m. 10:30 p.m.-2 a.m. Sunday 5:30-10 a.m. 7:30 p.m.-2 a.m.		
		15.140 GSF 19.82 ◆	Darenty, England (see 26.100 mc.) Daily 9:15 a.m.-12 noon.		
		15.121 HVJ 19.84	Stazione Radio HVJ, Citta del Vaticano, Vatican City. I: clock ticks 5 m. S: Bells. C: (spoken) Laudetur Jesus Christus. Weekdays 10:30-10:45 a.m.		

11.840 25.31	CSW4	Emissora Nacional, Ilha de Queilhas No. 2, Lisbon, Portugal. (see 11.040-9.940 mc.) O-C: A Portuguesa—National Anthem. Daily 1-2:10 p.m.	11.535 26.01	SPD	Warsaw, Poland (see 13.635 kc.) Weekdays 6-7 p.m. Sundays 6-8 p.m.	9.635 31.13	2RO-3	Rome, Italy. Daily 12:30-6 p.m. So. Am. 6-7:30 p.m. No. Am. 7:30-9 p.m. (see 11.810 mc.)
11.840 25.34	OLR4A	Prague, Czechoslovakia (see 21.450 mc.) Daily 2-2:15 p.m. Mon. & Thurs. 7-9:10 p.m.	11.435 26.23	COCX	P. O. Box 32, Havana, Cuba. S: 5 bells. English each ¼ hr. O-C: Pajarillo Barranqueno. Daily 8 a.m.-1 a.m.	9.630 31.15	HJ7ABD	Bucaramanga, Colombia, S.A. Daily 8-11 p.m.
11.840 25.34	KZRM	Erlander and Galinger, Inc., Insular Life Bldg., Manila, P. I. (see 9.570) Weekdays 5-9 a.m. Sat. to 10 a.m. 4:30-6 p.m., Sun. 4-10 a.m.	11.402 26.31	HBO	Geneva, Switzerland (see HBJ, 14.535 mc.) Mondays 2:45-3:15 a.m. Fridays 2-2:15 p.m. Saturdays 6:45-8 p.m. (Swiss program). Lisbon, Portugal (see 11.840-9.940 mc.) Daily 2:10-6 p.m.	9.608 31.23	ZTJ	Johannesburg, South Africa (see 6.097 mc.) 11:45 p.m.-12:45 a.m.
11.830 25.36	W2XE	Wayne, N. J. (see 21.520 mc.) Daily 2:30-6 p.m.	11.040 27.17	CSW2	Lisbon, Portugal (see 11.840-9.940 mc.) Daily 2:10-6 p.m.	9.600 31.25	RAN	Moscow, U.S.S.R. (see HKI, 15.040 mc.) Daily 7-9:15 p.m.
11.830 25.36	W9XAA	Chicago, Ill. (see 17.780 mc.) Week days 9 a.m.-6 p.m., Sun. 9-11 a.m., 1-5:30 p.m.	11.000 27.27	PLP	J. Sanders, Chief Emgr., Java Wireless Stations, Bandoeng, Java; D.E.I. Weekdays 4:30-10 a.m. (Sat. 11:30 a.m.); 6-7:30 p.m. 10:30 p.m.-2 a.m.; Sunday 4:30-10 a.m.; 7:30 p.m.-2 a.m.	9.600 31.25	KEYU	Universidad Nacional, Mexico, D.F. Daily 7-10 p.m.
11.820 25.38	XEBR	Apartado 68, Hermosillo, Con. Mexico. O-C: Over The Waves. Daily 1-4 p.m.; 9 p.m.-12 a.m.	10.960 27.37	JZB	Nazaki, Japan (see 21.520 mc.) Irregular.	9.600 31.25	CB960	Casilla 1342, Santiago, Chile, S.A. O: Babes in Toyland. C: Somewhere a Voice is Calling (organ). Daily 11:30 a.m.-2 p.m.; 9:30 p.m.-12 a.m. Veri Slow.
11.820 25.38	GSN	Daventry, England (see 26.100 mc.)	10.740 27.93	JVM	Nazaki, Japan (see 21.520 mc.) 4:30-7:30 a.m. Irregular.	9.595 31.27	HBL	Geneva, Switzerland (see HBJ, 9.345 mc.) Irregular.
11.810 25.40	2RO-4	5 Via Montello, Rome, Italy. O: Bells of Rome. C: Italian Royal March and Giovinetta. I: bird call—black cap bird (see 9.635 mc.) Daily 5-8:30 a.m., 10 a.m.-12:20 p.m.	10.670 28.12	CEC	Cia Internacional de Radio, Casilla 16-D, Santiago, Chile. Daily exc. Sat. and Sun. 7-7:30 p.m. (see CED, 10.330 mc.)	9.595 31.27	YNLF	Calles 15 de Set No. 206, Managua, Nicaragua, C.A. Daily 8-9 a.m.; 1-3 p.m.; 6:30-10:30 p.m. Veri—5c U. S. postage.
11.805 25.41	QXY	Skamleback, Denmark (see 6.060 mc.) Daily 5-10 p.m.	10.660 28.14	JVN	Nazaki, Japan (see 21.520 mc.) Daily 1:40-2:30 a.m., 4-7:45 a.m.	9.590 31.28	VK6ME	Amalgamated Wireless Ltd., Perth, West Australia. (Address 47 York St., Sydney, Australia). Daily exc. Sun. 6-8 a.m.
11.801 25.42	OER-3	Osterr. Radioverkehrs A.G., Johannesgasse 4h, Wien 1, Austria. Call: "Hier Radio Wien." I: Metro-nome—60 beats per m. Weekdays 9 a.m.-6 p.m. Sat. to 6 p.m.	10.600 28.30	ZIK2	Government Radio Station ZIK2. Wireless Branch, Post Office, Belize, British Honduras, C.A. Tues. Thurs., Sat. 7:30-7:45 p.m.	9.590 31.28	W2XE	Wayne, N. J. (see 21.520 mc.)
11.800 25.42	JZJ	Nazaki, Japan (see 21.520 mc.) Daily 12:30-1:30 a.m. 8-9 a.m.; 3-4 p.m.; 4:30-5:30 p.m.	10.370 28.93	EAJ43	Radio Naomancas, Salamanca, Spain. Daily 9-9:45 p.m.	9.590 31.28	W3XAU	1622 Chestnut St., Philadelphia, Pa. Daily 12 noon-8 p.m.
11.800 25.42	COGF	General Betancourt 51. (Playa) Mantanzas, Cuba. O-C: Vals Diana. Weekdays 1-4 p.m., 6-10 p.m. Sun. 9-10 p.m.	10.370 28.93	EAJ43	Radio Club Tenerife, Apartado 225, Santa Cruz, Tenerife, C.I. Daily 2:15-3:30 p.m.; 6-7 p.m.; 7:10-9:30 p.m.	9.590 31.28	VK2ME	Amalgamated Wireless, Ltd. 47 York St., Sydney, Australia. Clock strikes at hour, chimes ¼ hr. I: Kookaburra bird call. C: God Save The King. Sunday 1-3 a.m.; 5-9 a.m.; 9-11 a.m.
11.796 25.43	OAX5A	Avenida San Luis, Ica, Peru, S.A. O: March. "Relator". C: "Estrelita." Daily 12-4 p.m. 7-11:30 p.m.	10.370 28.93	EHZ	Tablero, Tenerife, C. I. Daily 3-4 p.m.; 6-8:15 p.m.	9.590 31.28	HP5J	Apartado 867, Panama City, Panama, C. A. News 6:30 p.m. O: Black-horse Troop March. C: Discipline Honor and Abnegacion. Weekdays 12-2 p.m.; 5-10:30 p.m. Sundays 10:30 a.m.-2 p.m.; 8-10 p.m.
11.795 25.43	DJO	Zeesen, Germany (see 17.760 mc.) Irregular.	10.350 28.98	LSX	Transradio Internacional, San Martin, 829, Buenos Aires, Argentina, S.A. C: San Lorenzo March. Irregular 5-8 p.m.	9.590 31.28	PCJ	Hilversum, Holland. (see 15.220 mc.) Sun. 2-3 p.m., 8:15-9:15 p.m. Mon. 9-10:30 p.m., Tues. 2-3 p.m., Wed. and Thurs. 8-10:30 p.m.
11.790 25.43	W1AXL	Boston, Mass. (see 21.460 mc.) Mon. to Fri. 4:45-6:30 p.m. Sat. 1:45-6:30 p.m. Sun. 2:45-6:30 p.m.	10.330 29.04	ORK	Director de Comunicaciones, Bruxelles, Belgium. I: Carrillon. O: Towards The Future. C: Brabantonne. Daily 1:30-3 p.m.	9.590 31.28	GSC	Daventry, England (see 26.100 mc.) Daily 6:20-8:30 p.m.; 9-11 p.m.
11.770 25.49	DJD	Zeesen, Germany (see 17.760 mc.) Daily 10:40 a.m.-4:30 p.m.; 4:50-10:45 p.m.	10.290 29.15	DZC	Bandoeng, Java, D.E.I. (see PLP, 11.000 mc.) Weekdays 5:30-11 a.m. (Sat. 11:30 a.m.); 6-7:30 p.m.; 10:30 p.m.-2 a.m.; Sundays 5:30-11 a.m.; 7:30 p.m.-2 a.m.	9.580 31.32	GSC	Daventry, England (see 26.100 mc.) Daily 6:20-8:30 p.m.; 9-11 p.m.
11.760 25.50	TGWA	Guatemala City, Guatemala, C.A. (see 17.800-15.170-9.685 mc.) Weekdays 12:45-1:30 p.m. Sundays 12 noon-2:30 p.m. Also irregular day or night. No IRC necessary.	10.260 29.24	PMN	Antofagasta, Chile (see CEC 10.670 mc.) Sat. and Sun. 7-7:20 p.m.	9.580 31.32	VK3LR	Australian Broadcasting Commission, G.P.O. Box 1686, Melbourne, Australia. O: Recording, song, Australian Lyre Bird. C: God Save The King. S—3 notes, gong; time signals and P.O. chimes. Sunday 3-7:30 a.m.; Mon. to Fri. 9:45 p.m.-2 a.m., 3:30-8:30 a.m.; Sat. 9:45 p.m.-2:30 a.m.; 3:30-9 a.m.
11.760 25.50	XETA	Apartado 203, Monterey, Mexico. Daily 7-11 p.m.	10.230 29.33	CED	Departamento de Proposanda do Brazil, Avenida Presidente Wilson 118, Dadio Dept, Ilo de Janeiro, Brazil. Daily 7-9 p.m.	9.580 31.32	OAX5C	Radio Universal, Avenida San Luis, Ica, Peru, S.A. Weekdays 11:30 a.m.-4 p.m.; 7-11:30 p.m.
11.760 25.50	OLR4B	Prague, Czechoslovakia (see 21.450 mc.) Irregular (see 9.550-11.840 mc.)	10.220 29.35	PSH	Chief of Radio Station CQN, Post Office Bldg., Macao (Portuguese) China. O: Maria de Fonte. C: National—A Portuguesa. Mon. and Fri. 7-8:30 a.m.	9.570 31.33	W1XK	Westinghouse Electric and Mfg. Co., Boston, Mass. O-C: Stars and Stripes Forever. Weekdays 6 a.m.-1 a.m. Sunday 8 a.m.-1 a.m.
11.750 25.53	GSD	Daventry, England (see 26.100 mc.) Daily 3:15-5:25 a.m.; 10:45 a.m.-12 noon; 12:20-3:45 p.m.; 4-6 p.m. 6:20-8:30 p.m.; 9-11 p.m.	10.135 29.60	CQN	Chief of Radio Station CQN, Post Office Bldg., Macao (Portuguese) China. O: Maria de Fonte. C: National—A Portuguesa. Mon. and Fri. 7-8:30 a.m.	9.570 31.33	W1XK	Westinghouse Electric and Mfg. Co., Boston, Mass. O-C: Stars and Stripes Forever. Weekdays 6 a.m.-1 a.m. Sunday 8 a.m.-1 a.m.
11.740 25.55	HP5L	Apartado 139, David, Chiriqui, Panama, C. A. Daily 4-7 p.m.	10.042 29.87	DZB	Zeesen, Germany (see 17.760 mc.) Irregular.	9.570 31.33	KZRM	Manila, P. I. (see 11.840 mc.) Weekdays 5-9 a.m. Sat. to 10 a.m., 4:30-6 p.m. Sun. 4-10 a.m.
11.730 25.57	XETM	Villahermosa, Mexico. Daily 6-11 p.m.	9.940 30.18	CSW3	Lisbon, Portugal (see 11.840-11.040 mc.) Daily 6-8 p.m.	9.565 31.36	YV3RB	Sr. Arturo Ramos Magli, Prop., Barquisimeto, Venezuela. Daily 11:30 a.m.-12:30 p.m.; 5:30-9:30 p.m.
11.730 25.57	PHI	Hilversum, Holland (see 17.770 mc.) Mon. Thurs. Fri. 7-8 p.m.	9.925 30.23	JDY	Dairen, Manchukuo, Japan. Daily 5:30-8 a.m.	9.562 31.38	OAX4T	Radio Nacional, Peruvian Government, Av. Petit Thouars 447, Lima, Peru. Daily 11:30 a.m.-1:30 p.m.
11.720 25.60	CJRX	Royal Alexandra Hotel, Winnipeg, Manitoba, Canada. Weekdays 6 p.m.-12 a.m. Sundays 5-10 p.m.	9.860 30.43	EAQ	P. O. Box 951, Madrid, Spain. O: La Verbena de la Paloma. C: Himno de Riego or Good Night Melody. Sat. 1-3:30 p.m. Daily 5:15-9:30 p.m.	9.560 31.38	DJA	Zeesen, Germany (see 17.760 mc.) Daily 12:05 a.m.-11 a.m.; 4:50-10:45 p.m.
11.718 25.61	TPA-4	Fontoise, France (see 15.243 mc.) Daily 6:15-8:15 p.m.; 10 p.m.-1 a.m.	9.840 30.49	COCM	Apartado 33, Havana, Cuba. Daily 8 a.m.-12 midnight.	9.558 31.41	XEFT	Av. Independencia 28, Veracruz, Mexico. S: Chimes, bugle calls or cuckoo horn. English at closing. O-C: Vals Poetico. Weekdays 10:30 a.m.-4:30 p.m.; 7:30 p.m.-12:30 a.m.; Sundays 9 p.m.-12:30 a.m.
11.718 25.60	CR7BH	Lourenco Marques, Portuguese East Africa (see CRTAA, 6.137 mc.) Weekdays 4:30-6:30 a.m.; 9:30-11 a.m.; 12:30-4 p.m. Sundays 5-7 a.m.; 10 a.m.-12:30 p.m.; 2-4 p.m.	9.750 30.77	COCQ	Calle 25, No. 445, Havana, Cuba. Weekdays 6:55 a.m.-1 a.m.; Sundays 6:55 a.m.-12:01 a.m.	9.550 31.41	YDB	Soerabaja, Java N.E.I. (see 15.150 mc.) Weekdays 5:30-10 a.m. (Sat. 11:30 a.m.) 6-7:30 p.m., 10:30 p.m.-2 a.m. Sun. 5:30-10 a.m. 7:30 p.m.-2 a.m.
11.710 25.62	YSM	Director de Comunicaciones, San Salvador, El Salvador, C. A. Daily 1:30-2:30 p.m.	9.685 30.98	6.685	Guatemala City, Guatemala, C. A. (see 17.800-15.170-11.760 mc.) Sunday 7:15-10 p.m., Mon., Tues., Thurs. 9-11 p.m., Wed. 9:30-10:15 p.m. Friday silent. Sat. 10 p.m.-1 a.m. No IRC necessary.	9.550 31.41	H15E	Sr. H. Chavez, Ciudad Trujillo, Dom. Rep., W. I. Irregular.
11.710 25.62	Philco	211-213D Rue Catinat, Saigon, Indo-China. Daily 6:30-9:30 a.m. News in French 9-9:10 a.m.	9.675 31.00	DZA	Radio Martinique, P. O. Box 136, Fort de France, Martinique, F.W.I. O-C: "La Marseillaise". Daily 6:30-7:50 p.m.	9.550 31.41	OLR3A	Prague, Czechoslovakia (see 21.450 mc.) Daily 2:30-4:30 p.m.
11.710 25.62	XEWB	Juarez 289, Guadalajara, Mexico. Daily 7-11 p.m.	9.670 31.02	T14NRH	Apartado 40, Heredia, Costa Rica, C.A. Daily 9-10 p.m.; 11:30 p.m.-12 a.m.; Sat. to 2 a.m.	9.545 31.44	HH2R	Port-au-Prince, Haiti, W.I. (see H112T, 11.570 mc.) Special programs irregular.
11.710 25.62	VK9MI	M. V. Kanimbla, McIlwraith and McEacham, Bridge St., Sydney, Australia. 11 p.m.-8 a.m. and later.	9.666 31.04	CR6AA	Caixa Postal 103, Lobito, Angola, Portuguese West Africa. I: 3 notes on piano; A-C-B. Portuguese, French and English. Wed. and Sat. 2:45-4:30 p.m.	9.540 31.45	VPD-2	Amalgamated Wireless, Ltd., Suva, Fiji Islands. C: God Save the King. Daily 5:30-7:00 a.m. No signals.
11.705 25.63	SBP	Chief Engineer, Motala, Sweden. Mon. to Fri. 1:20-2 a.m., 6-9 a.m., 11 a.m.-1:30 p.m., Sat. 1:20-2 a.m., 6 a.m.-1:30 p.m. Sun. 3 a.m.-1:30 p.m.	9.660 31.06	LRX	Buenos Aires, Argentina, S. A. (see LRU, 15.290 mc.) Daily 9:30 a.m.-11:30 p.m.	9.540 31.45	DJN	Zeesen, Germany (see 17.760 mc.) Daily 12:05 a.m.-10 a.m.; 4:50-10:45 p.m.
11.700 25.64	HP5A	P. O. Box 954, Panama City, Panama, C.A. O-C: "Anvil Chorus". Daily 11:45 a.m.-1 p.m., 6-10 p.m. Sundays—open at 10 a.m. Thurs., Fri., Sat.—open at 5 p.m.	9.650 31.09	CS2WA	Antonio Augusto de Aguirre, 144 Lisbon, Portugal. I: Cuckoo, 3 times. C:A Portuguesa (national anthem.) Tues., Thurs., Sat. 4-7 p.m.	9.535 31.46	JZI	Nazaki, Japan (see 21.520 mc.) Daily 3-4 p.m.; 4:30-5:30 p.m.
11.700 25.64	CB1170	Broadcasting Populares, Santiago, Chile, S.A. Daily 6-11 p.m.	9.645 31.10	HH3W	P. O. Box 117, Port-au-Prince, Haiti, W.I. S: 4 chime notes and siren each 15 min. before announcements, Daily exc. Sunday 1-2 p.m.; 7-8:30 p.m.	9.530 31.48	W2XAF	Schenectady, N. Y. (see W2XAD 15.330 mc.) Daily 4 p.m.-12 a.m.
11.570 25.93	HH2T	Societe Haitienne Radiodiffusion, P.O. Box 103, Port-au-Prince, Haiti, W.I. S: 4 tones gong 1-3-2-4. English and French O-C: The Swan. Special programs, irregular.	9.640 31.12	CXA8	Director, Colonia, Uruguay, S.A. Daily 6 p.m.-11 p.m.			

9.530 LKJ-1 31.48	Ministero de Commerce, Administrator des Telegraphes, Oslo, Norway. 1: Piano motif Grieg's Sigurd Jorsalfar. C: National—Yes, We Love This Country. Daily 5-8 a.m.; 11 a.m.-5 p.m.	8.795 HKV 34.13	Ministerio de Guerra, Military Service, Bogota, Colombia, S.A. Mon. and Thurs. news 7-7:30 p.m. Pinlay No. 3, Altos, Camaguey. Cuba. S—3 tone gong, each ¼ hr. English Ann. Each ¼ hr. O: "Allegiance March" C—None. Week days 10:30 a.m.-12:30 p.m. 7-10:30 p.m., Sat. 11 p.m., Sun. 10 a.m.-12:30 p.m.	6.630 HIT 45.25	Apartado 1105, Ciudad Trujillo, Dom. Rep., W.I. O-C: Anchero Aweigh. English. Daily exc. Sun. 12:10-1:40 p.m.; 6:10-8:40 p.m. DX 1st Sat. 11:10 p.m.-1:10 a.m.
9.525 ZBW-3 31.49	Hong Kong Broadcasting Committee, P.O. Box 200, Hong Kong, China. I-O-C: none. Weekdays 11:30 p.m.-1:15 a.m., Mon.-Thurs. 4-10 a.m., Tues., Wed., Fri., 3-10 a.m., Sat., 3-11 a.m., Sun. 9 p.m.-1:30 a.m., 3-9:30 a.m.	8.665 COJK 34.62	A Mejevsky, Gerente, Managua, Nicaragua, C.A. Daily 1-2:30 p.m.; 7:30-10:30 p.m. Veri—5c U. S. postage.	6.618 El Prado 45.33	Apartado 98, Riobamba, Ecuador, S.A. English ea. 15 mins. O: Bugle call. Thursday 9-11:15 p.m. Veri—5c U. S. postage.
9.524 FIQA 31.50	Tananarive, Madagascar (see 6.000 mc.) Daily 12:30-12:45 a.m.; 3:30-4:30 a.m.; 10-11 a.m. simultaneously on 6.000 mc.	8.580 YNIPR 34.97	Casilla 1166, Guayaquil, Ecuador, S.A. O-C: Sangre Ecuatoriana. Weekdays 11:30 a.m.-12:30 p.m.; 7-11 p.m. Sun. 3-5 p.m. Veri—5c U. S. postage.	6.580 "Radio Guardia Civil" 45.59	Tetuan, Spanish Morocco, Africa O: March of the Caliph. C: Spanish National Anthem. I and S: chimes. Daily 2-3 p.m.; 7-8 p.m.
9.520 OZF 31.51	Copenhagen, Denmark (see OXY 6.060 mc. Daily 2-6:45 p.m.	8.404 HC2CW 35.70	Radio Prieto ZP10, Asuncion, Paraguay, S.A. Daily 8-10 p.m. San Salvador, El Salvador, C. A. (see 11.710 mc.) Daily 9-11 p.m. P.O. Box 805, Guayaquil, Ecuador, S.A. S: Gong. O-C: El Corcevadado (Caricosa fox). Daily 11 a.m.-2 p.m.; 4:30-11 p.m. Veri—5c U. S. postage.	6.575 HCIVT 45.63	Apartado 1064, San Jose, Costa Rica, C. A. S: 4 notes on gong O-C: The Lost Chord—Organ. Tues., Thurs., Sat., 6-7 p.m. Religious Sundays 10 a.m.-7 and 8 p.m.; Thurs. 8 p.m.
9.516.6 HJ6ABH 31.52	Armenia, Colombia, S.A. O-C: The Spanish Soldiers. S: Blews on Marimba. News 7-10 p.m. Weekdays 8-11 a.m.; 6-10 p.m. Sundays 7-10 p.m.	8.110 ZPIO 37.00	Geneva, Switzerland (see 9.345 mc.) Sat. 6:45-8 p.m. Swiss program	6.550 TIRCC 45.81	Apartado 1064, San Jose, Costa Rica, C. A. S: 4 notes on gong O-C: The Lost Chord—Organ. Tues., Thurs., Sat., 6-7 p.m. Religious Sundays 10 a.m.-7 and 8 p.m.; Thurs. 8 p.m.
9.520 YSH 31.51	San Salvador, El Salvador, C.A. (see 11.710 mc.) Irregular.	7.894 YSD 38.00	Apartado 75, Puntarenas, Costa Rica, C.A. Weekdays 5-7 p.m.; 8:30-10 p.m. Sun. 4-5 p.m.	6.545 YV6RB 45.84	Apartado 34, Ciudad Bolivar, Venezuela, S.A. Daily 7:10 p.m.; Sun. 3-8 p.m.
9.520 XEDQ 31.51	Apartado 107, Guadalajara, Jalisco, Mexico. O-C: Mexican Dance—Jarabe Tapatio. Daily 12-4 p.m. 8 p.m.-12 a.m. Occasional DX Sunday 2-4 a.m.	7.797 HBP 38.49	Moscow, U.S.S.R. Daily 7-9:15 p.m. (see 15.040 mc.)	6.535 YNIGG 45.91	Managua, Nicaragua, C.A. Daily 6-10 p.m.; Veri—5c U. S. postage.
9.510 GSB 31.55	Davenport, England (see 26.100 mc.) Daily 3:15-5:25 a.m.; 12:20-3:45 p.m.; 4-6 p.m.; 6:20-8:30 p.m.; 9-11 p.m.	7.750 TI8WS 39.74	Nazaki, Japan (see 21.520 mc.) 3-7:30 a.m. Irregular.	6.520 YV4RB 46.01	Valencia, Venezuela, S.A. C: Bugle call, taps and off. Daily 11 a.m.-1:30 p.m.; 5:30-9:30 p.m.
9.510 HJU 31.55	Buenaventura, Colombia, S.A. O-C: Palmira. English each 5 mins. Mon., Wed., Fri. 12-2 p.m.; 8-11 p.m.	7.520 RKI 39.89	Apartado 485, Quito, Ecuador, S.A. Thursday 9-10 p.m. Veri—5c U. S. postage.	6.500 HIL 46.15	Apartado 623, Ciudad Trujillo, Dom. Rep. W.I. Daily 12-2 p.m.; 6-8 p.m.
9.510 HS8PJ 31.55	Bangkok, Siam (see 9.350-19.020 mc.) Mon. and Thurs. 8-10 a.m.	7.510 JVP 39.95	Departmento Autonomo de Publicidad, Mexico, D.F. Sun 7-8 p.m. No signals or O-C selection.	6.500 YVIRM 46.15	Maracaibo, Venezuela, S.A. Daily 6-9:30 p.m.
9.510 VK3ME 31.55	Amalgamated Wireless Ltd., 167-9 Queen St., Melbourne, Australia. S: chimes and striking on hour. C: God Save the King. Daily exc. Sun. 4-7 a.m.	7.411 HCICE 40.48	Santa Cruz, Tenerife, C.I. O-C: Lady of Spain. English on Saturdays only. Mon., Wed., Fri., Sat. 3:15-4:15 p.m.	6.482 HI4D 46.28	Ciudad Trujillo, Dom. Rep. W.I. Mon. & Sat. 11:55 a.m.-1:40 p.m.; 4:40-7:40 p.m.
9.505 HID 31.56	Director, Ciudad Trujillo, Dom. Rep., W.I. Daily 5:40 to 7:40 or 8:40 p.m.	7.380 XECR 40.85	Radio Club Tenerife, Apartado 225, Santa Cruz, Tenerife, C.I. O-C: Lady of Spain. English on Saturdays only. Mon., Wed., Fri., Sat. 3:15-4:15 p.m.	6.480 EDR-4 46.30	Radio Poste, Palma de Mallorca, Balearic Islands. Daily 4:30-5:15 p.m.
9.504 OLR3B 31.57	Prague, Czechoslovakia, (see 21.450 mc.) Irregular (see 9.550-11.840 mc.)	7.211 EA8AB 41.60	San Sebastian, Spain. (see 10.370 mc.) Daily 3-4 a.m., 8-10 a.m. 1:30-4 p.m., 5-7 p.m.	6.480 HIIL 46.30	Radioemisora Nacional "El Diario." Apartado 356, Santiago de los Caballeros, Dom. Rep., W. I. 1: Xylophone note O-C: Dominican National Anthem. Weekdays 7:8:30 a.m., 12-2 p.m., 5:30-9:30 p.m.
9.501 PRF5 31.58	P.O. Box 709, Rio de Janeiro, Brazil, S.A. I: three-note gong. C: Brazilian National Anthem. (see PSE 14.935 mc.) Daily exc. Sun. 4:45-5:45 p.m.	7.203 EAJ-8 41.64	El Coronel Jefe de Estado, de las Mayor de las Fuzcas, Militares, Apartado 124, Tetuan, Spanish Morocco, Africa. Daily 4:4-25 p.m.; 12-2:30 a.m. Irregular.	6.479 HI8A 46.30	Apartado 1312, Ciudad Trujillo, Dom. Rep., W.I. English each 15 mins. O-C: March General Alvarez Obregon. S: 2 strokes of bell. Daily 8:40-10:40 a.m.; 2:40-4:40 p.m.; Sat. 9:10-10:40 p.m.
9.500 HI5G 31.58	La Vega, Dominican Republic, W.I. Daily 6:40-8:40 a.m.; 10:40 a.m.-2:40 p.m.; 4:40-8:40 p.m.	7.200 YNAM 41.67	Radio Club Oceanica, Alfred T. Poria, Pres. Papete, Tahiti, Tues. and Fri. 11 p.m.-1 a.m.	6.450 HI4V 46.51	San Francisco de Macoris, Dom. Rep., W.I. Daily 11:40 a.m.-1:40 p.m.; 6:40-9:15 p.m.
9.500 XEWW 31.58	Apartado 2516, Mexico, D.F. Daily 9 a.m.-8 p.m.	7.177 CR6AA 41.80	Radio Club Oceanica, Alfred T. Poria, Pres. Papete, Tahiti, Tues. and Fri. 11 p.m.-1 a.m.	6.430 HIIS 46.66	P.O. Box 112, Santiago de los Caballeros, Dom. Rep., W.I. Daily 11:40 a.m.-1:40 p.m.; 5:40-7:40 p.m.
9.480 EAR 31.65	P. O. Box 951, Madrid, Spain. Daily 7:30-8 p.m. Tues., Thurs., Sat. 9:30-10 p.m.	7.030 EA9AH 42.67	Lobito, Portuguese West Africa (see 9.666 mc.) Wed. and Sat. 2:45-4:30 p.m.	6.420 YV6RC 46.73	Ciudad Bolivar, Venezuela, S.A. Daily 10:30 a.m.-1:30 p.m.; 4:30-9:30 p.m.
9.450 "Radio Fort de France" 31.75	Edouard Boullanger Fils, Fort de France, Martinique. Daily 11:30 a.m.-12:30 p.m.; 6:15-7:15 p.m.; 8-9 p.m.	6.975 HCETC 43.01	Radio Club Oceanica, Alfred T. Poria, Pres. Papete, Tahiti, Tues. and Fri. 11 p.m.-1 a.m.	6.410 TIPG 46.80	Apartado 225, San Jose, Costa Rica, C.A. O-C: Parade of the Wooden Soldiers. Daily 7:30-9:30 a.m.; 12-2 p.m.; 6-11:30 p.m.
9.440 HCODA 31.78	Guayaquil, Ecuador, S.A. Daily exc. Sunday 8-11 p.m. Veri—5c U. S. postage.	6.900 HI2D 43.48	El Coronel Jefe de Estado, de las Mayor de las Fuzcas, Militares, Apartado 124, Tetuan, Spanish Morocco, Africa. Daily 4:4-25 p.m.; 12-2:30 a.m. Irregular.	6.400 YV5RH 46.88	Apartado 1931, Caracas, Venezuela, S. A. Weekdays 11 a.m.-1:30 p.m.; 4:30-9:30 p.m.; Sun. 9:30 a.m.-1:30 p.m.; 5:7-30 p.m.
9.428 COCH 31.81	P.O. Box 41, Havana, Cuba. English each 15 mins. S: chimes 15 m. 2 blows gong adv. O-C: Organ: Maria My Own. Daily 8 a.m.-12 a.m.	6.900 TI2RS 43.48	Associated cia Dominicana, Ciudad Trujillo, Dom. Rep., W.I. Daily 6:40-8:40 a.m.; 10:40 a.m.-2:40 p.m.; 4:40-8:40 p.m.	6.375 YV5RF 47.10	Apartado 983, Caracas, Venezuela, S.A. C: Organ: Blue Danube. Daily 6:30-7:30 a.m.; 10:30 a.m.-1:30 p.m.; 4:30-10:30 p.m.
9.350 HS8PJ 32.09	Bangkok, Siam (see 19.020 mc.) Thursdays 8-10 a.m.	6.850 TIOW 43.80	Sr. Rogelia Sotela, Prop., San Jose, Costa Rica. Daily exc. Sun. 9:30-11 p.m.	6.360 YVIRH 47.17	P. O. Box 261, Maracaibo, Venezuela, S.A. O: Jealousie. C: Er Weicht der Sonne Nicht—march Weekdays 5:45-6:45 a.m.; 10:30 a.m.-1:30 p.m.; 3:30-10:30 p.m. English 10-10:30 p.m. Sunday 8:30 a.m.-2:30 p.m.
9.350 COBC 32.09	Apartado 132, Havana, Cuba. Daily 7 a.m.-12:30 a.m.	6.820 XGOX 43.99	P. O. Box 45, Port Limon, Costa Rica, C.A. Weekdays 10-11:30 p.m.; Sun. 2-3 p.m.	6.351 HRP1 47.24	Sr. Joaquin Mendoza, Director, San Pedro Sula, Honduras, C.A. Daily 12-2 p.m.; 8-10 p.m. Veri—5c U. S. postage.
9.345 HBL 32.10	Information Section, League of Nations, Geneva, Switzerland, Fridays 2:30-2:45 p.m.; 7:30-7:45 p.m.; 8-8:15 p.m. Sat. 6:45-8 p.m. Swiss Program.	6.800 HI7P 44.12	Central Broadcasting Committee of Kuomintang, Nanking, China. Chinese except English 8:15 a.m. E.S.T. O-C No regular selections. Weekdays 6:30-8:30 a.m. Sun. 7-9 a.m.	6.340 HIIX 47.32	Ciudad Trujillo, Dom. Rep., W.I. (see 15.280 mc.) Weekdays 12:10-1:10 p.m.; Tues. and Fri. 8:10-10:10 p.m.; Sun. 7:40-10:40 a.m.
9.340 OAX4J 32.12	Radio Internacional, Casilla 1166 Lima, Peru. C: Organ: Good Night Sweetheart. Daily 12.3 p.m.; 5 p.m.-1 a.m.	6.788 PZH 44.20	San Pedro de Macoris, Dom. Rep., W.I. Daily 12:10-1:40 p.m.; 7:40-9 p.m. Sun. 5:10-6:40 p.m. DX 2:40-3:40 a.m.	6.335 OAXIA 47.35	Sr. J Carlos Montjoy D., Casilla No. 9, Chiclayo, Peru, S.A. Daily exc. Sat. 8-11 p.m., Sat. 8 p.m.-12 a.m. Nazaki, Japan (see 21.520 mc.) irregular.
9.300 YNGU 32.27	Apartado 295, Managua, Nicaragua, C.A. Weekdays 12-2 p.m.; 5-6 p.m. Sun. 11 a.m.-12 noon. Veri—5c U. S. Postage.	6.780 HIH 44.25	Paramaribo (Surinam), Dutch Guiana, S.A. Weekdays 2:45-4:45, 5:45-9:45 p.m. Sun. 9:45-11:45 a.m. Veri slow.	6.330 JZG 47.39	Apartado 130, Havana, Cuba. Daily 7 a.m.-12 midnight.
9.200 COBX 32.61	San Miguel #194, Havana, Cuba. Daily 8 a.m.-11:30 p.m.	6.750 JVT 44.44	San Pedro de Macoris, Dom. Rep., W.I. Daily 12:10-1:40 p.m.; 7:40-9 p.m. Sun. 5:10-6:40 p.m. DX 2:40-3:40 a.m.	6.325 YNLG 47.43	Sr. Benjamin J. Guerra, L, Managua, Nicaragua. Daily 8-10 a.m., 1-2 p.m., 6 p.m.-12 a.m. Veri—5c U. S. postage.
9.125 HAT-4 32.88	Budapest, Hungary (see IAS-3, 15.370 mc.) Sun. and Wed. 7-8 p.m.; Sat. 6-7 p.m.	6.730 HI3C 44.58	Nazaki, Japan (see 21.520 mc.) 2-2:30 a.m.; 4:30-7:30 a.m. Irregular.	6.315 HIZ 47.51	Apartado 1092 and 771, Ciudad, Trujillo, Dom. Rep., W.I. Weekdays 11:10 a.m.-2:10 p.m.; 4:40-9:40 p.m. Sundays 11:40 a.m.-2:40 p.m.
9.080 COBZ 33.32	P.O. Box 866, Havana, Cuba. S-4 chimes. O-C: Record, "Popular Melodies" 7:45 a.m.-12:30 a.m. Sat. to 2 a.m.	6.720 PMH 44.64	Sr. Roberto Palli. B. La Romana, Dom. Rep., W.I. English announcements regular. Weekdays 12:10-2:10 p.m.; 6-10-11 p.m. Sun. 12:10-2:40 p.m.	6.300 YV4RD 47.62	Sr. Luis Croquer, Prop., Maracay, Venezuela, S.A. Weekdays 11:30 a.m.-12:30 p.m.; 5:30-9:30 p.m.
8.930 COKG 33.59	Apartado 137, Santiago, Cuba. Daily 5-6 p.m.; 9:30-10:30 p.m. Sunday 12:01-1 a.m.	6.690 TIEP 44.84	San Pedro de Macoris, Dom. Rep., W.I. Daily 12:10-1:40 p.m.; 7:40-9 p.m. Sun. 5:10-6:40 p.m. DX 2:40-3:40 a.m.	6.280 COHB 47.77	P. O. Box 85, Sancti-Spiritus, Santa Clara, Cuba. Weekdays 9-10 a.m., 12-10 p.m. Sun. 10 a.m.-10 p.m.
8.840 ZMBJ 33.94	Wellington, N. Z. (see 13.600 mc.) Sun. 6:40-7 p.m.; daily 1-3 a.m.	6.668 HC2RL 44.99	Paramaribo (Surinam), Dutch Guiana, S.A. Weekdays 2:45-4:45, 5:45-9:45 p.m. Sun. 9:45-11:45 a.m. Veri slow.	6.280 HIG 47.77	Av. Jose Trujillo No. 20, Ciudad Trujillo, Dom. Rep., W.I. Daily 7:10-8:40 a.m.; 12:40-2:10 p.m.; 8:10-9:40 p.m.
8.831 HCJBI 33.97	Casilla 691, Quito, Ecuador, S.A. O: March Patria I: 4 blows on gong. C: Ecuadorian National Anthem. Daily exc. Mon. 7:30-8:45 a.m. 11:30 a.m.-2:30 p.m. 5-10 p.m. (to 7 p.m. on 4.107 mc.; after 7 p.m. on 4.107 and 8.831 mc.) Veri—5c U. S. Postage.				

6.275 OAX4G Avda. Abancay, 915-923, Lima, Peru. S.A. C. Good Night Sweetheart. Daily 7-11:30 p.m. 47.81

6.270 YV5RP P. O. Box 508, Caracas, Venezuela, S.A. Daily 6-11:45 p.m. 47.85

6.250 YV5RJ Sr. Edmundo Suetart, Prop., P. O. Box 1908, Caracas, Venezuela, S.A. Daily 5:30-9:30 p.m. 48.00

6.243 HIN Calle Arzobispo Merino #97, Ciudad Trujillo, Dom. Rep., W.I. English each 15 mins. (see 12,500 mc.) Weekdays 11:40 a.m.-2:40 p.m.; 7:10-9:10 p.m. Sun. 11:10 a.m.-3:40 p.m. 48.05

6.235 HRD Sr. Tulio Castaneda, Director, La Ceiba, Honduras, C.A. English on the hour. O: Solo Tuyo. C: Intermezzo No. 1. Piano 10:58 p.m. Good Night Melody. No signals. Daily exc. Sun. 8-11 p.m. 48.11

6.230 YVIRG Radio Valera, Valera, Venezuela, S.A. S: 1 bell O-C: Local March. Daily 11 a.m.-12:30 p.m.; 5:30-9:30 p.m. 48.15

6.210 YVIRI Radio Coro, Coro, Venezuela, S.A. S: 4 marimba notes. Spanish Ann. each 15 m. O-C: March - The Three Colors. Daily 7:30-9:30 p.m. 48.31

6.206 H18Q Julio O. Garcia Alardo, Ciudad Trujillo, Dom. Rep., W.I. Daily 10:45 a.m.-2:40 p.m.; 4:40-8:40 p.m. 48.34

6.200 XEXS Secretaria de la Economia Nacional, Mexico, D.F. Daily 7-11 p.m. 48.39

6.190 H1IA P. O. Box 423, Santiago de los Caballeros, Dom. Rep., W.I. 1: Gong C: Anchors Aweigh. Daily 6:40 a.m.-4:40 p.m.; Thurs. and Sundays, 7:40-9:40 p.m. Band concerts. 48.47

6.180 TG2 Director General of Electrical Communications, Guatemala City, Guatemala, C.A. Irregular 3-9 p.m. No IRC Required. 48.54

6.170 XEXA Mexico, D. F. (see 11,880 mc.) Weekdays 8:30-11 a.m.; 2:30-4:30 p.m.; 7 p.m.-12 a.m. Sunday 7 p.m.-12 a.m. 48.62

6.160 VPB Radio Club of Ceylon and So. India. P. O. Box 282, Colombo, Ceylon. S: Time on hour, 6 pips. 1: Bow Bells, infrequently. Daily 6:30-11:30 a.m. Saturdays 12:30 p.m. 48.70

6.158 YV5RD Radio Venezuela, Caracas, Venezuela, S.A. 1: 5 strokes of bell. O-C: Triunfo Aereo. Weekdays 6:30-7:30 a.m.; 10:30 a.m.-1:30 p.m.; 3:30-10 p.m. Sun. 8:30 a.m.-10:30 p.m. 48.72

6.150 CJRO Winnipeg, Manitoba, Canada (see CJRX, 11,720 mc.) Weekdays 6 p.m.-12 a.m. Sundays 5-10 p.m. 48.78

6.150 H15N Moca, Dom. Rep., W.I. Daily 6:40-8:40 a.m.; 10:40 a.m.-2:40 p.m. 4:40-8:40 p.m. 48.78

6.145 HJ4ABE Medellin, Colombia, S.A. 1: Morse-letter "M" S: 4 chimes. Daily 9:30 a.m.-1 p.m.; 5-11:30 p.m. 48.82

6.140 W8XK Pittsburgh, Pa. (see 21,540 mc.) Daily 10 p.m.-1 a.m. 48.86

6.140 ZEB Bulawayo, Rhodesia, South Africa (see ZEC, 5,800 mc. for address). Sun. 3-5 a.m.; Tues. and Thurs. 1:15-3:15 p.m. 48.86

6.138 HJ4ABD Sr. Luis Emilio Mejia, Gerente, Medellin, Colombia, S.A. O-C: Part 4a William Tell (see 5,900-5,780 mc.) Weekdays 10 a.m.-2 p.m.; 4-11 p.m. Sun. 11 a.m.-3 p.m.; 7-11 p.m. Veri slow. 48.88

6.137 CR7AA P. O. Box 594, Lourenco Marques, Portuguese East Africa. O: A Maria de Fonte. C: A Portuguesa. Weekdays 12:15-1 a.m.; 4:30-6:30 a.m.; 9:30-11 a.m.; 12:30-4 p.m. Sundays 5-7 a.m.; 10 a.m.-12:30 p.m.; 2-4 p.m. 48.88

6.130 VP3BG Crystal Broadcasting Co., Philharmonic Bldgs., Georgetown, British Guiana, S.A. O: Serenade. C: Good Night My Love and God Save the King. Week-days 10:15-11:15 a.m. 3-7:45 p.m. Sundays 6:45-8:45 a.m.; 4:45-6:45 p.m. Veri slow. 48.94

6.130 ZGE Kuala Lumpur, Malaya States, S.S. Sun., Tues., Fri. 6:40-8:40 a.m. 48.94

6.130 LKJ1 Jeloy, Norway (see 9:530 mc.) Daily 11 a.m.-5 p.m. 48.94

6.130 COCD P. O. Box 2294, Havana, Cuba, English each 15 mins. O: In a Clock Store. C: Good Night. Weekdays 9 a.m.-1 a.m. Sundays 10 a.m.-8 p.m. (DX 1-3 a.m.) 48.94

6.130 VE9HX P. O. Box 998, Halifax, N.S., Canada. O-C: Oh Canada. Chimes 15 min. periods. Sun. 12 noon-11 p.m. Mon. to Fri. 7 a.m.-11 p.m. Sat. 11 a.m.-11 p.m. 48.94

6.125 CX44 Mercedes 823, Montevideo, Uruguay, S.A. Daily 8 a.m.-12 noon; 2-10 p.m. 48.98

6.122 OAX6A Munoz Najar 141, Casilla 293, Arequipa, Peru, S. A. 49.00

6.122 HP5H O-La Marcha de los Marino C-Nacional del Peru. Daily 7-11 p.m. Voice of the People, Panama City, Panama, C. A. Daily 7-10 p.m. 49.00

6.122 HJ3ABX Apartado 26-65, Bogota, Colombia, S.A. Weekdays 10:30 a.m.-2 p.m.; 5:30-11:30 p.m. Sundays 12-1:30 p.m.; 6-11 p.m. 49.00

6.120 XEFT Veracruz, Mexico (see 9,550 mc.) 49.02

6.120 W2XE Wayne, N. J. (see 21,520 mc.) 49.02

6.120 XEUZ F. J. Stavoll, Chief Engr., Radio Nacional, Mexico, D. F. S: 5 bells (chimes) O-C: Marcha Dragona. Daily 10 a.m.-1 p.m.; 7 p.m.-2 a.m. DX 1-2 a.m. 49.02

6.115 OLR2C Prague, Czechoslovakia (see 21,450 mc.) S: Bells. Irregular (see 9,550-11,840 mc.) 49.06

6.110 GSL Daventry, England (see 26,100 mc.) 49.10

6.110 XEGW Enrique Arzamendi, Gen'l. Mgr., Mexico, D.F. O-C: Vail a doId Aztee-march. Daily exc. Mondays 11 a.m.-4 p.m.; 7 p.m.-12 a.m. Mondays 9 a.m. 14 p.m. 49.10

6.109 VUC 1 Garstin Place, Calcutta, India. S: none. C: God Save The King. Daily 8 a.m.-12:30 p.m. 11 p.m.-12:30 a.m. 49.10

6.105.1 HJ6ABB Apartado 175, Manizales, Colombia, S.A. Daily 11 a.m.-1 p.m.; 5-8 p.m. Veri slow. 49.14

6.100 YUA Director, Bureau Central de Presse, Belgrade, Yugoslavia. S: Short tune on flute. O-C: National Anthem. Daily 12:45 a.m.-8:30 a.m., 1-6 p.m. 49.18

6.100 W9XF 20 N. Wacker Drive, Chicago, Ill. O-C: Star Spangled Banner. Daily 6-9:05 p.m.-1:05-2 a.m. 49.18

6.100 W3XAL Bound Brook, N. J. (see 17,780 mc.) Daily 9 p.m.-1 a.m. 49.18

6.097 ZTJ African Broadcasting Co., Inc., P. O. Box 4559, Johannesburg, South Africa. Physical session. O: Bugles-Reveille. C: Cook, House. 1: chimes. C: God Save The King. Sun. 4-5 a.m.; 12-15-3:15 p.m. Weekdays 12-12:45 p.m.; 3:15-5 a.m. and 9 a.m.-4 p.m. Daily 11:45 p.m.-12:45 a.m. 49.20

6.095 JZH Nazaki, Japan (see 21,520 mc.) Irregular. 49.22

6.090 CRCX Rural Route No. 4, Bowmansville, Ont., Canada. Weekdays 7:45 a.m.-5 p.m. Sunday, 10:45-5 p.m. 49.26

6.090 ZWB-2 Hong Kong, China (see 9,525 mc.) 49.26

6.090 XEBF Insurgentes 34, Jalapa, Mexico, Daily 7-11 p.m. 49.26

6.085.7 HJ5ABD Cali, Colombia, S.A. Daily 11 a.m.-2 p.m.; 6-11 p.m. 49.30

6.082 VQ7LO P. O. Box 777, Nairobi, Kenya, Colony, Africa. English used. C: God Save The King. Time signal 6 pips on hour. Daily exc. Sunday 5:30-6 a.m. Daily 11:15 a.m.-2:15 p.m. Tues. and Thurs. 8:15-9:15 a.m. 49.33

6.082 OAX4Z Lima, Peru (see OAX4T, 9,562 mc.) Daily 7-11:30 p.m. 49.32

6.080 W9XAA Chicago, Ill. (see 17,780 mc.) Weekdays 7:30-9 a.m., 6 p.m.-1 a.m. Sun. 11 a.m.-1 p.m., 6 p.m.-1 a.m. 49.34

6.080 ZHJ Penang Wireless Society Headquarters, 40 Perak Road, Penang, S.S. O: Chimes, Vocal song, "Land of Hope and Glory". C: "God Save the King". Weekdays 6:40-8:40 a.m. 49.34

6.080 VE9CS 743 Davis St., Vancouver, B.C., Canada. O: O Canada: C: God Save The King. S: 3 strokes gong. Sun. 12 noon-1:30 a.m. Mon., Thurs., Sat. 9:30 a.m.-8:30 p.m. Tues., Wed., Fri. 9:30 a.m.-2:30 a.m. 49.34

6.080 HP5F Hotel Carlton, Colon, Panama, C.A. Weekdays 11 a.m.-1 p.m.; 7-10 p.m.; Sun. 10:45-11:30 a.m. 7-10 p.m. 49.34

6.080 XEWW Apartado 2518, Mexico D.F. Irregular (see 9,500 mc.) 49.34

6.079 DJM Zeesen, Germany (see 17,760 mc.) Irregular. 49.35

6.075 XECU Hidalgo 579, Guadalajara Jal., Mexico. O-C: Ojos Tapatious. 1: Train in motion. Daily 9-11 a.m.; 1-4 p.m.; 8-11 p.m. or 12 a.m. Wien, Austria. (Alternates days with 11,801 kc.) Weekdays 9 a.m.-5 p.m. Sat. to 6 p.m. 49.38

6.072 OER-2 Apartado 317, Bogota, Colombia, S.A. C: Good Night Sweetheart. Daily 11 a.m.-2 p.m. 6-11 p.m. Veri Slow. 49.41

6.070.5 HJ3ABF P. O. Box 100, Maracaibo, Venezuela, S. A. Daily 8 p.m.-12 a.m. 49.42

6.070 YVIRD 16, Robb and Hinks Sts., Georgetown, British Guiana, S.A. S: Time signals, studio clock. O: The Bond of Friendship. C: Ted Lewis' Goodnight Melody and God Save 49.42

6.070 CFRX 37 Bloor St., West, Toronto, Ontario, Canada. Week days 7:30 a.m.-12 midnight. Sunday 10:30 a.m.-12 midnight. 49.42

6.065 XEXR Departamento Autonomo de Propaganda y Publicidad, Mexico, D. F. Daily 6-11:30 p.m. 49.46

6.065 SBO Motala, Sweden (see 11,705 mc.) Daily 1:30-5 p.m. 49.46

6.060 W8XAL Crosley Radio Corp., Cincinnati, Ohio. Daily 6 a.m.-8 p.m., 10 p.m.-2 a.m. 49.50

6.060 W3XAU Philadelphia, Pa. (see 9,590 mc.) Daily 8-11 p.m. 49.50

6.060 OXY Statradifonien, Heibergsgade 7, Copenhagen, Denmark. O: one gong stroke. C: There is a Winsome Land. Weekdays 1-6:30 p.m. Sun. 11 a.m.-6:30 p.m. 49.50

6.054.3 HJ6ABR Pereira, Caldas, Colombia, S. A. No English. Official March—El Hombre P'ayaso. C: Overture — Chorus Voices. No signals. Daily 9:30 a.m.-12 noon; 6:15-10 p.m. Daventry, England (see 26,100 mc.) 49.55

6.050 GSA 49.59

6.050 XEXF Secretaria de la Economia Nacional, Mexico, D. F. Daily 8 p.m.-12 a.m. 45.59

6.045 XETW Francisco I. Madero, 10, Tampico, Mexico. Daily 7 p.m.-12 a.m. 49.62

6.042.3 HJ1ABG Apartado 674, Barranquilla, Colombia S.A. S: 1 gong with chimes ea. 1/4 H. O-C: National Anthem. Daily 11 a.m.-11 p.m.; Sun. 11 a.m.-9 p.m. 49.65

6.040 YDA Tandjong Priok, Java N. E. 1. (see 15,150 mc.) Daily 7:30 p.m.-2 a.m. 49.67

6.040 W4XB Herald Bldg., Miami, Fla. Schedule not known. 49.67

6.040 W1XAL Boston, Mass. (see 21,460 mc. Mon. to Fri. 7-9 p.m. 49.67

6.030 OLR2B Prague, Czechoslovakia (see 21,450 mc.) Irregular. (see 9,550-11,840 mc.) 49.75

6.030 HP5B P. O. Box 910, Panama City, Panama, English and Spanish. O-C: March, Panama. No signals or bells. Daily 11:30 a.m.-1 p.m.; 5-10 p.m. 49.75

6.030 VE9CA Toronto General Trust Bldg., Calgary, Alberta, Canada. C: Lights Out. S: None. Weekdays 9 a.m.-1 a.m. Thurs. to 2 a.m. Sun. 12 noon-12:30 a.m. 49.75

6.030 XEBQ Astillero 35, Mazatlan, Mexico. Daily 8-11:30 p.m. 49.75

6.020 DJC Zeesen, Germany (see 17,760 mc.) Daily 10:40 a.m.-4:30 p.m.; 4:50-10:45 p.m. 49.83

6.020 XEUW Av. Independencia 98, Veracruz, Mexico. S: Marimba. O: March Victoria. C: La Golondrina. Daily 8 a.m.-12 midnight. 49.83

6.015 H13U Apartado 23, Santiago de los Caballeros, Dom. Rep., W.I. O-C: Organ Maria My Own. Weekdays 7:10-8:40 a.m.; 10:40 a.m.-1:40 p.m.; 4:40-9:40 p.m. Sun. 10:40 a.m.-1:40 p.m. only. 49.88

6.015 XEWI Mexico, D.F. (see 11,900 mc.) Irregular. 49.88

6.010 VK9MI M. V. Kanimba, Sydney, Australia (see 11,710 mc.) 11 p.m.-8 a.m. and later. 49.92

6.010 COCO P. O. Box 98, Havana, Cuba, English and Cuban. Daily 8 a.m.-10 p.m. 49.92

6.010 OLR2A Prague, Czechoslovakia (see 21,450 mc.) Irregular (see 15,230-11,840 mc.) 49.92

6.007 Radio Burma Independent Wireless, Rangoon, Burma. C: God Save the King. Daily 9:10-9:40 a.m. 49.94

6.005 HP5K P. O. Box 33, Colon, Panama, C.A. S: 3 chimes, ea. 15 m. O-C: Merry Widow Waltz. Daily exc. Sun. 7-9 a.m.; 11:30 a.m.-1 p.m.; 6-11 p.m. Sun. 10 a.m.-12 a.m. 49.96

6.005 CFCX P. O. Box 1690, Montreal, Quebec, Canada. Weekdays 7:44 a.m.-1 a.m. Sundays 9 a.m.-11:15 p.m. 49.96

6.005 VE9DN Montreal, Quebec, Canada (see CFCX, 6,005 mc.) Sat. 11 p.m.-12 a.m. Fall, winter and spring. 49.96

6.000 CX42 Rio Negro, Montevideo, Uruguay, S.A. O: Voluntary Trumpeter. C: Good Night Melody. Daily 10:30 a.m.-10:30 p.m. 50.00

6.000 XEBT P. O. Box 79-44 Mexico, D.F. 1: 3 blasts on cuckoo horn, Siren near closing. O: Las Mananitas. C: Lieberstraum. Daily 10 a.m.-12:15 a.m. 50.00

6.000 FIQA Director of Posts and Telegraphs Tananarive, Madagascar. Daily 12:30-12:45 a.m.; 3:30-4:30 a.m.; 10-11 a.m. 50.00

6.000 RV59 Moscow, U.S.S.R. (see RKI, 15,040 mc.) No I.R.C. required. 50.00

5.977 Radio Rua Capelo, 5, Lisbon, Portugal, OC: Our Lady of Fatima. 1: none. Daily 2:30-4:30 p.m. Sunday and Thursday 6-7 a.m. 50.19

5.970 OAX4P 50.25 5.969 HVJ 50.26 5.955 HJN 50.35	Cuzco 25, Iruancayo, Peru. S. A. Daily 12-1 p.m., 9 p.m.-12:30 a.m. Vatican City (see 15.121 mc.) 2-2:15 p.m. Sun. 5-5:30 a.m. Minister of Education Nacional, Bogota, Colombia. Daily 11 a.m.-2 p.m.; 5-10:30 p.m.	5.850 YVIRB 51.28	P.O. Box 37, Maracaibo, Venezuela, S.A. English and Spanish. O-C: Strike Up The Band. Daily exc. Sun. 10:45 a.m.-12:45 p.m.; 4:45-9:45 p.m. Sun. 8:45 a.m.-9:45 p.m.; Mon., Wed., Fri. 5:45-8:15 a.m. Tuess., Thurs., Sat. 5:45-9:45 a.m.	4.900 HJ3ABH 61.22	Apartado 565, Bogota, Colombia, S. A. I: 3 chime notes. Weekdays 11:30 a.m.-2 p.m. 6-11 p.m. Sunday 12-2 p.m.; 4-11 p.m.
5.940 TG2X 50.51	De la Policia Nacional, Guatemala City, Guatemala, C.A. Daily 4-6 p.m. Mon., Thurs., Sat. 10-11:30 p.m. Sundays 1-2 p.m. No I.R.C. required.	5.830 TIGPH 51.46	Apartado 800, San Jose, Costa Rica, C.A. C: Good Night Melody (Ted Lewis). Weekdays 8-11 p.m.	4.880 HJ4ABP 61.48	Emisora Claridad, Medellin, Colombia, S. A. Daily 8 a.m.-11 p.m.
5.930 P1C1 50.59	Curacaoeche Radio Vereeniging, Willemstad, Curacao, N.W.I. O: Electrical gong, 4 strokes and repeat 5 mins. O-C: National anthem. Weekdays 6:36-8:36 p.m. Sun. 10:36 a.m.-12:36 p.m.	5.813 TIGPH-2 51.61	Apartado 800, San Jose, Costa Rica, C.A. C: Good Night Melody. Daily 7-11 p.m.	4.860 HJ1ABE 61.73	Apartado 31, Cartagena, Colombia, S. A. O: Organ—Song of the Islands. English each hour; clock strikes the hour. C: Aloha Oe. Weekdays 11 a.m.-1 p.m. 6-10:30 p.m. Sun. 9 a.m.-3 p.m.
5.930 YVIRL 50.59	P.O. 247, Maracaibo, Venezuela, S.A. Weekdays 11 a.m.-1 p.m.; 4:30-9:30 p.m. Sun. 8:30 a.m.-2:30 p.m.	5.800 YV5RC 51.72	P.O. Box 2009, Caracas, Venezuela, S.A. I: 4 chimes. O-C: Official IBB March. Bugles, whistles before closing. Weekdays 7-8 a.m. 10:30 a.m.-1:45 p.m. 3:45-10:30 p.m. Sundays 8:30 a.m.-10:30 p.m.	4.841 HJ3ABD 61.97	Apartado 509, Bogota, Colombia, O: Pari Ti Rio Rita. C: Rio Rita and National Anthem. Weekdays 9 a.m.-2 p.m., 6 p.m.-12 a.m., Tues. and Thurs. to 3 p.m. Wed. and Fri. begin 5:30 p.m.
5.910 YV4RH 50.76 5.910 HH2S 50.76 5.905 T1LS 50.80	Valencia, Venezuela. S.A. Daily 8-11:30 p.m. Port-au-Prince, Haiti. W.I. (see 11.570 mc.) Daily 7-10 p.m. P.O. Box No. 3, San Jose, Costa Rica, C.A. S: none. O: Washington and Lee Swing. C: Adios Mi Chapparrita. Weekdays 12-3 p.m.; 6-11 p.m. Sundays irregular. Government Engineer. Mafeking, South Africa. Mon. to Fri. 1-2:30 p.m. Sun. 1:30-2:30 p.m. Medellin, Colombia, S.A. (see 6.138-5.780 mc.) Weekdays 10 a.m.-2 p.m.; 4-11 p.m. Sun. 11 a.m.-3 p.m.; 7-11 p.m. Veri slow.	5.800 ZEC 51.72	P.O. Box 792, Salisbury, Rhodesia, South Africa. Sun., 3-5 a.m.; Tues. and Fri. 1:15-3:15 p.m.	4.810 YDE2 62.37	Solo, Java, N.E.I. (see 15.150 mc.) Daily 6:30-11 a.m.; 5:45-6:45 p.m.; 10:30 p.m.-2 a.m.
5.900 ZNB 50.84	Medellin, Colombia, S.A. (see 6.138-5.780 mc.) Weekdays 10 a.m.-2 p.m.; 4-11 p.m. Sun. 11 a.m.-3 p.m.; 7-11 p.m. Veri slow.	5.780 HJ4ABD 51.90	All American Cables, Ltd., Casilla 2336, Lima, Peru, S.A. Signs on and off Morse code. No signals. English and Spanish. Wed., Sat. 9-11:30 p.m.	4.790 HJ2ABC 62.63	Sr. Pompilio Sanchez, Prop., Cucuta, Colombia, S.A. Daily 11 a.m.-12 noon, 6:30-9 p.m.
5.885 H19B 50.98	P.O. Box 95, Santiago de los Caballeros, Dom. Rep., W.I. O-C: Piano Solo—Vais Evocation. Weekdays 7:25-8:40 a.m.; 11:55 a.m.-2:10 p.m.; 4:55-7:40 p.m. Sundays 11:40 a.m.-2:40 p.m.	5.758 YNOP 52.10	Radio Bayer, Managua, Nicaragua, C.A. Weekdays 8:30-10:30 p.m. Veri—5c U. S. Postage.	4.780 HJ1ABB 62.76	Apartado 715 Barranquilla, Colombia, S.A. I: 3 chimes. S: 1 chime between advertisements. C: La Golondrina 7-9 a.m. 11-1 p.m., 5:30-10 p.m.
5.880 YV3RA 51.02	Barquisimeto, Venezuela (see YV3RB, 9.565 mc.) Daily 11:30 a.m.-12:30 p.m.; 5:30-9:30 p.m.	5.755 YV2RA 52.13	San Cristobal, Venezuela. English each 15 mins. S: 6 strokes gong. O-C: March, El Capitan. Weekdays 11:30 a.m.-12:30 p.m.; 5:30-9 p.m. Sun. 5:30-10 p.m.	4.740 HJ6ABC 63.29	Ibague, Colombia, S.A. Daily 6-11 p.m.
5.875 HRN 51.11	Tezucigalpa Honduras, C.A. C: Good Night Melody (Ted Lewis) Daily 7-10 p.m. Veris—10c U. S. cash. Veri slow.	5.725 HC1PM 52.40	P.O. Box 604, Quito, Ecuador, S.A. O-C: La Marcha de Aida. Saturdays 9-11 p.m.	4.660 HJ2ABJ 64.38	Santa Marta, Colombia, S.A. Daily 11:30 a.m.-2 p.m.; 5:30-10:30 p.m.
5.865 H11J 51.15	Apartado 204, San Pedro de Macoris, Dom. Rep., W.I. O-C: Waltz, Sweet Remembrance. English very seldom. S: none. Daily 11:40 a.m.-1:40 p.m.; 5:40-9:40 p.m.	5.713 TGS 52.51	Casa de Presidencial, Guatemala City, Guatemala, C.A. Sun., Wed., Fri. 6-8 p.m. No. I.R.C. necessary.	4.600 HC2ET 65.22	P.O. Box 824, Guayaquil, Ecuador, S.A. I: 12 chimes. Wed. and Sat. 9:15-10:45 p.m. Veri—5c U. S. postage.

HAMFEST

(Continued from page 19)

start at midnight January 21st and continue for the same period. (Time given is Venezuelan standard which is a half hour ahead of EST.) As we understand it, prizes will be given for the greatest mileages in authenticated QSOs. Here's a chance for some of you lads who need S. A. for a WAC.

A TIP TO THOSE of you having diode second detector superhets who may be kicking about the lack of single-signal effect without the crystal. Try turning up the sensitivity control (controlling volume on the audio end) as far as possible without distorting. This will often sharpen up the i.f. and considerably improve the sniggle-sniggle action.

w2PF FINALLY came through with the accompanying photo of W2SC-WLN, AARS net control station for the Second Corps Area, located on Governors Island, New York City. W2SC evidently agrees with us that the proper place for QSL cards is in a filing cabinet. At any rate, we hereby venture a minority opinion that they are a poor substitute for wall paper.

WE ASKED 2PF the other day why they shifted the Q-sigs all around at the International Radio Conference back in 1932. PF—an old timer from 1915 who recalls quite well the perfectly workable list of international abbreviations we used to have—suggested that they juggled a dozen or so letters just to show that they actually did some work. So we probably can expect a new list of Q-sigs when the various national representatives return from their Cairo junket in 1938.

THE OTHER EVENING, in reply to a CQ, we were QSO with W8EKJ. George Morris is an A-1 operator and sprays his dots with a mean bug. He paid us a compliment by coming back at something better than 40 words per minute, and we simply couldn't get it. There's no two ways about it—he had us viproplexed! Not his fault, but ours, and for the first time we had that well-known "sorri OM QRM bad ND CUAGN 73" feeling. It was a genuine struggle before we decided to practice what we preach and admit that we couldn't take it! We asked W8EKJ to QRS. We're glad we did. He put one weight back on the bug and

we carried on for a very pleasant hour. We're looking forward to dropping in on EKJ at his winter QTH in Jacksonville, Fla., a little later on.

And so, you young squirts and lids, humble yourselves once in a while and ask for a QRS. It's good for the ego. We can't all be McElroys—and even he can't take it much faster than 70 words per minute.

DEAR QMR: Abt this feud between the fone ops and the cw men. (And don't try to kid ureself tt there isn't ani such feud.) The fone ops don't like the cw ops becuz the cw ops don't like th fone men. And now I'll tell u why the cw men don't like the fone ops. Becuz human beings just naturally resent seeing other human beings making fools of themselves. Take a big he-man fone op with a basso profundo voice that would make Chaliapin's sound like a boy soprano. He sez something tt is supposed to be funny. Mebbe it is and mebbe it isn't. And he decides to laugh. What does he do? Does he heave a real bellow from somewhere abaft the midriff? Not he—this big he-man. Instead, he sez 'Hididdly dut!'—Yrs, HI.

BOOK REVIEWS

THE RADIO AMATEUR'S HANDBOOK, Fifteenth (1938) Edition, by the Headquarters Staff of the American Radio Relay League. Published by the American Radio Relay League, West Hartford, Conn. 564 pages, including 6-page topical index and a 116-page catalog section of amateur radio equipment. 600 illustrations with 73 charts and tables. Price, paper bound, \$1.00 in continental U. S. A., \$1.25 elsewhere; buckram bound, \$2.50.

The 1938 edition of *The Radio Amateur's Handbook* is an even more comprehensive treatment of the amateur short-wave field than its fourteen predecessors. As always, it represents the world's foremost authority in this field. The new volume contains 564 pages, approximately 290,000 words, 600 illustrations, 73 charts and tables, and 111 practical equations and formulas. It is probably the biggest volume of technical information ever produced to sell at its nominal cost.

Twelve men, each a specialist in some phase of amateur radio, collaborated over a period of four months in the production of the 1938 edition. This diversified authorship, combined with the method of arranging the material and understandable presentation, have resulted in a treatment of widely acceptable appeal.

New chapters have been added in the latest edition. One is a thorough treatment of workshop practice, covering the problems faced in working with raw material, assembling and wiring the component parts of station equipment. Constructional details on work benches, operating tables and transmitter racks are given. Another new chapter is devoted to the increasingly-important field of portable and emergency equipment. Designs are given for representative forms of emergency gear, with special attention paid to the power problem.

The chapters on fundamentals have been entirely re-written, with a new method of presentation. A new chapter on fundamental principles is aimed at those individuals, young or old, who have absolutely no knowledge whatsoever of electrical and radio phenomena but who demand a painless introduction to the subject. For the more advanced worker there has been included a chapter of definitions, values and computations useful in amateur work.

The remaining chapters have all been vigorously re-written, involving an entirely new text. Those dealing with apparatus construction contain the results of an extensive program of laboratory work in the production of representative receivers, transmitters, power supplies, etc., incorporating modern tried and proven circuits. In all of these circuits and the equipment built around them an obvious attempt has been made to avoid anything freaky or unreliable. As stated in the Foreword: "As

any practicing amateur is well aware, there is an almost infinite number of different ways of accomplishing a given result in the station—some good, some poor and many indifferent. Because of this, the editorial work has been basically that of selection. It has been necessary to eliminate from the enormous wealth of ideas on technique, methods and procedure, all those which have not proved themselves by successful application in practice."

Although not editorial matter, a feature of the *Handbook* which has been found to enhance its utility is the catalog section at the rear of the volume, where data and specifications on the manufactured components available to amateurs are conveniently located.

All in all, this new edition of the *Handbook* represents a monumental worth, a treatise of great value to all who have any association whatsoever with the technics of high-frequency radio communication. The new edition—accompanied, for the first time, by a Spanish translation being published in Buenos Aires—should find an even warmer welcome.

AUTOMATIC FREQUENCY CONTROL SYSTEMS, by John F. Rider. Stiff cloth covers, 5¼ by 7¾ inches, 142 pages, well illustrated. Published by John F. Rider, 1440 Broadway, New York, N. Y. Price \$1.00.

When the radio serviceman, to say nothing of the average engineer, got caught short on knowledge of the proper operation and use of the blossoming cathode-ray oscillograph, John Rider produced the only worthwhile text on the subject (*The Cathode-Ray Tube At Work*). With the sudden introduction of automatic frequency control systems in 1938 radio receivers, servicemen, and engineers, were again caught short on knowledge. And again Mr. Rider has come to the rescue with a book so complete and so well written that it will undoubtedly take its place alongside "*The Cathode-Ray Tube At Work*" as a standard reference work.

Automatic frequency control, more familiarly known as a.f.c., is by no means a simple affair. Circuit functioning is highly complex, and such engineering papers which have been delivered on the subject contain no simple explanations of such vital points as the manner in which differential voltages are developed in discriminator circuits or the manner in which a vacuum tube, used for oscillator frequency control purposes, is made to act as an artificial inductance. Consequently a.f.c. has remained a deep, dark mystery to all but a few.

If ever Mr. Rider should receive praise, he should for the cleverness and the simplicity of his explanations as to what goes on in an a.f.c. circuit, why it goes on, and what to do if it fails to go on as the

manufacturer intended it to. Mr. Rider has been considerate enough to include a chapter on fundamentals as an assistance in understanding and appreciating a.f.c. for those a bit rusty on basic electrical theory.

The basic operation of discriminator and control circuits is explained in great detail in the first part of the book. Many otherwise difficult points of functioning are definitely cleared up by the step-by-step breakdown of a complete circuit through the medium of simplified illustrations.

More than half the book is devoted to the application of the principles covered in the early chapters. The a.f.c. circuits to be found in the latest receivers are analyzed, and their operation explained. The various types of automatic and semi-automatic tuning systems are also considered, and their relationship to the a.f.c. system clearly demonstrated.

The last two chapters deal with actual servicing problems, the alignment of a.f.c. equipped receivers, and the precautions which must be observed in working on receivers incorporating this modern aid to quick, accurate tuning.

A book we are pleased to recommend to servicemen, amateurs, engineers, and experimenters.

THE CAUSES AND ELIMINATION OF RADIO INTERFERENCE, by Joseph E. Foster. Stiff cloth covers, 4 by 7 inches, 151 pages, well illustrated. Published by C. W. Nelson Company, South Braintree, Mass. Price \$1.50.

Based on his many years' experience in handling interference complaints for the Long Island Lighting Company, Mr. Foster provides in his book a comprehensive analysis of the radio interference problem from the viewpoint of the engineer. He tells how power company investigators go about locating sources of interference and explains what conditions either on the power distribution system or in the radio listener's home may be responsible for high noise level.

The first chapter deals with the fundamental principles underlying radio reception; chapter two, the causes of radio interference in the average home; and chapter three, radio interference caused by electric light and power lines.

The chapters following deal with interference caused by high-voltage transmission lines and feeders, street lighting circuits, and underground cables. The last chapter covers the relation between electric light and power companies and radio dealers and servicemen.

Radio interference engineers will undoubtedly find Mr. Foster's book valuable as a reference work. Being more of a group of case histories directly related to the power transmission field, the value of the book to servicemen is questionable.

ON THE MARKET

NEW KOOTIE KEY

A NEW TYPE Kootie Key, developed by the American Communications Corp., 1650 Broadway, New York, N. Y., is said to have the advantages of both the "bug" and straight key, with the added advantage that it is not tiring and does not require practice over long periods to master operation.

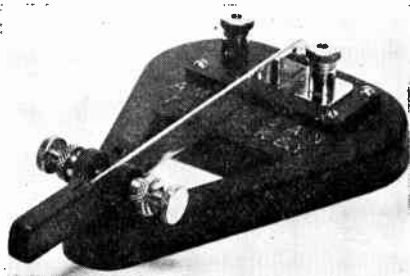

Contacts are of solid silver and are adjustable to meet individual requirements. The arm is made of phosphor bronze with molded bakelite handle. The degree of spring tension provided was determined after extensive research and development. ALL-WAVE RADIO.

RCA TYPE 814 TRANSMITTING TUBE

RCA RADIOTRON has introduced a new Transmitting Beam Power Amplifier designated as RCA-814.

Designed according to principles involving the use of directed electron beams, the 814 features low power absorption by the screen, and efficient suppressor action supplied by space-charge effects produced between the screen and the plate.



The resultant high power sensitivity makes this new tube especially suited for use as an r.f. power amplifier, oscillator, and frequency multiplier. In Class C service, it is capable of giving a power

output of 130 watts, or better, with a driving power of only 1.5 watts.

The filament draws 3.25 amperes at 10 volts. Typical operating voltages are: plate, 1250 volts; screen, 300 volts.

Mechanical features of the 814 include a ceramic base, top-cap plate connection to insure high insulation and low grid-plate capacity, and effective shielding to minimize the need for neutralization. ALL-WAVE RADIO.

BLILEY B5 CRYSTAL UNIT

BLILEY ELECTRIC CO., Union Station Bldg., Erie, Pa., have recently announced a new quartz crystal unit designated as the type B5, designed for the 40 and 20 meter amateur bands. It consists of a low frequency temperature coefficient quartz crystal, completely mounted and calibrated in a low-loss crystal holder specifically designed to take full advantage of the better characteristics of this new crystal.



Due to its smaller physical size, the crystal is not only more suitable for high frequencies, but an increase in overall dependability is brought about by the fact that a considerably higher electrode pressure can be employed. This high pressure obviously increases the mechanical stability, and at the same time effectively reduces the possibility of dirt entering the holder and influencing the performance of the crystal.

The B5 unit for 40 meters is said to have a higher activity, and will safely carry 35 per cent more crystal current than the LD2 40-meter crystal unit which it now replaces. The crystal is low drift, and has a maximum frequency temperature coefficient of 4 cycles/mc./°C.

The B5 crystal unit for 20 meters has a frequency temperature coefficient of less than 4 cycles/mc./°C., and having a high activity, it can be used in any conventional crystal oscillator circuit. This crystal will be of particular interest to amateurs working in the 10 and 20 meter bands, since high frequency stability will now be possible with a minimum number of frequency-multiplying stages. ALL-WAVE RADIO.

AEROVOX LINE-NOISE ELIMINATORS

OFFERING A WIDE choice of condenser, inductance and ground connection arrangements in the form of six convenient plug-in devices, Aerovox engineers have worked out solutions for practically every kind of

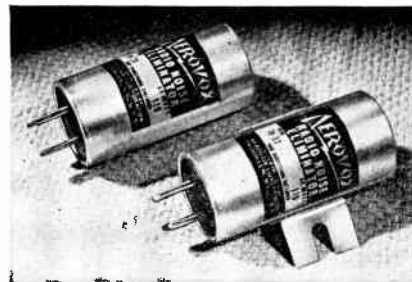

line noise. Five of the units plug in between appliance or the radio set, as the case may be. The sixth unit, in a sturdy rectangular case and provided with attachment plug, receptacle and ground binding post, is intended for exceptionally severe disturbances.

The selection of the proper type of filter is made positive by means of the Aerovox Noise Analyzer. This instrument contains the various filter circuits contained in the line-noise eliminators. A switch introduces any of these filter arrangements in the circuit. When best results are obtained, the switch setting indicates which type filter to use.

Literature on the Aerovox line noise filters and noise analyzer may be had by addressing Aerovox Corporation, 70 Washington St., Brooklyn, New York. ALL-WAVE RADIO.

BUD THREE-GANG MIDGET CONDENSERS

FOR THE FIRST time in radio history, three-gang midget condensers are appearing on the market. Rotor and stator plates are made of brass and securely soldered to their respective shafts. Mounted on ceramic bases $1\frac{3}{4}$ inches wide by $5\frac{1}{4}$ inches long, these units are supplied in several



popular capacity sizes, and should find many uses in transmitters, receivers and test equipment by amateurs and engineers. The manufacturer lists three-gang condensers of 20 mmfd. and 35 mmfd. capacity, each unit having plate spacings of .060 inch. A three-gang condenser with 100 mmfd. capacity and another with 140 mmfd. per section, each having a plate spacing of .023 inch, are also listed. ALL-WAVE RADIO.

NEW JEFFERSON TRANSFORMERS

TWO ADDITIONAL Vibrator Transformer units have been added to the transformer line made by the Jefferson Electric Company of Bellwood, Illinois. These are of

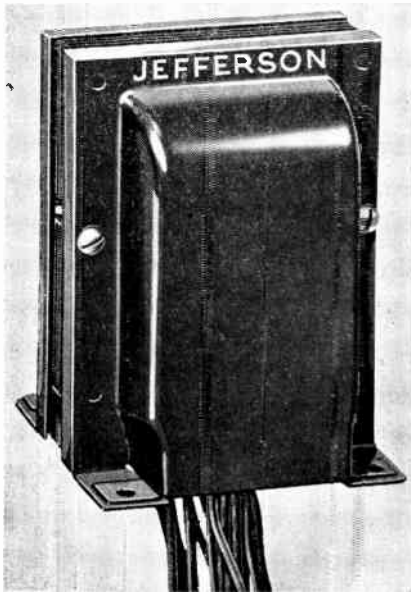

sturdy construction, designed for replacement in automobile receivers and for use with mobile or portable transmitters and receivers used in amateur work. Both these transformers are used in conjunction with a vibrator unit and rectifier to operate from a 6-volt d.c. source. Transformer 465-271 delivers 245 volts d.c. at 40 m.a., and the 465-281 Transformer delivers 295 volts d.c. at 45 m.a. or 270 volts d.c. at 67 m.a.

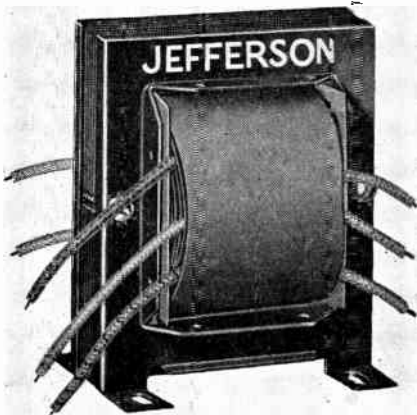

Two new Driver Transformers have also been designed especially to operate in Automatic Bias circuits, the idea having been developed in the Jefferson radio research laboratories. One of these new transformers drives two 210 tubes and the bias tubes, while the second transformer drives two 800's and the bias tubes. ALL-WAVE RADIO.

TURNER MODEL T9 XTAL MIKE

THE TURNER CO., Cedar Rapids, Iowa, has introduced a new crystal microphone, Model T9, with directional characteristics.

A new method of mounting the crystal unit has been developed which is said to prevent shock being transmitted directly to the unit. As a consequence, the T9 is quiet when moved during operation, and the possibilities of crystal breakage are almost entirely eliminated.

The frequency response is said to have been extended 18 per cent over previous models. The output level is -53 db.



The microphone is finished in black enamel contrasted with a bright chrome band around the unit and two chrome bands on the back of the case. The grill is chrome finished also.

Model T9 comes complete with 8 feet of cable and an adaptor, which fits it to any standard microphone stand. ALL-WAVE RADIO.

NEW IRC CENTER-TAP WIRE WOUND RESISTORS

CENTER-TAP IRC wire wound resistors with moulded insulation and incorporating many unique features have been announced for the jobbing trade by the International Resistance Company, 401 North Broad Street, Philadelphia, Pa. They are similar to the famous IRC Type MW Insulated Wire Wound Resistors. The new units are available in six popular ranges for modern service and amateur radio requirements.

The resistors are known as Type MW-2J. They are completely enclosed with



molded bakelite. A metal strip across the top, which is extended at the ends to serve as a mounting bracket, assists in exceptionally rapid heat dissipation. This strip may be removed easily if terminal mounting is desired. The units will carry up to 5 watts if mounted on a metal chassis with the mounting brackets and 2½ watts if mounted in the open air. Ranges now available through leading IRC jobbers include 10, 20, 50, 75, 100 and 200 ohms. ALL-WAVE RADIO.

IRC RESISTANCE INDICATOR

DESIGNED IN HANDY circular form for either bench use or panel mounting and continuously variable in a range from 0 to 1.0 megohm with a direct-reading calibrated dial, the new IRC Resistance Analyzer and Indicator just announced by the International Resistance Company, 401 N. Broad St., Philadelphia, Penna., will be found to be of great value for use wherever fixed and variable resistances are involved. It is a general utility instrument that will

prove useful to engineers, servicemen, experimenters and amateurs alike.

Among its many uses are: voltmeter multiplier; resistance or volume control analyzer for the measurement and determination of resistance values by either substitution or voltage measurement method; determination of the proper control or resistance value for best results in almost any radio circuit; wire wound rheostat or potentiometer (0 to 30,000 ohms); carbon rheostat or potentiometer (0 to 1 megohm); volume or tone control on radio sets; calibrated gain control or attenuator; voltage divider and countless others. A complete instruction manual prepared by IRC engineers and furnished with each instrument gives detailed information as to its use in a wide variety of work.

The Analyzer is controlled by a single knob. Electrically, it consists of two sections, the first comprising a heavy duty, wire wound rheostat type element from 0

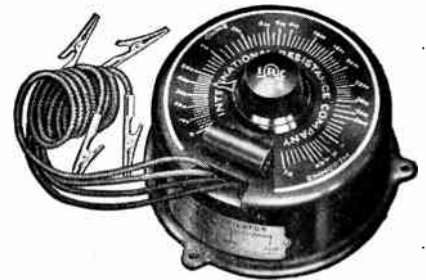

to 30,000 ohms. The second section is a specially designed Metallized type resistance element similar to that employed in IRC Metallized type Volume Controls. Its range is from 30,000 ohms to 1 megohm.

The instrument is equipped with four test leads having small-size alligator clips. It is furnished with three different fuses required for different applications as outlined in the instructions. The case is of durable bakelite, size 5 inches in diameter and standing 3 inches high. ALL-WAVE RADIO.

JOHNSON TYPE G CONDENSERS

E. F. JOHNSON CO., Waseca, Wis., type G condensers are designed for neutralization and for tuning high-frequency stages. They are also suitable for use in receiver construction.

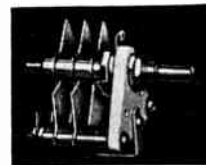

The end plate is Alsimag 196, resulting in low minimum capacity. The condenser is designed for either panel or chassis mounting. The plates are of heavy aluminum, buffed and rounded. A locking device is provided.

The type G condensers are available in seven different capacity ranges and with varying plate spacing. ALL-WAVE RADIO.

OHMITE PIE-WOUND PRECISION RESISTORS

OHMITE MANUFACTURING Company announces the new Riteohm "81," a vacuum impregnated, non-inductively pie-wound precision resistor of 1% accuracy and 1 watt rating. This unit extends the line of Ohmite precision resistances to values not reached by the Riteohm "71," the recently



announced vitreous enameled 1% resistor. The Riteohm "81," like the "71," is ideally suited for use in voltmeter multipliers, in laboratory equipment, radio and electrical test sets, and in many similar applications.

Vacuum impregnation is used on the Riteohm "81." This process consists of placing the wound unit in a sealed chamber which is then highly evacuated, withdrawing all the air between the turns and permitting the insulating and moisture-sealing compound to saturate completely the winding. This results in a hermetically sealed winding permanently protected against moisture and so solid as to transfer heat more rapidly than looser windings. The process also produces exceptionally high insulation resistance against voltage breakdown.

The Riteohm "81" is non-inductively wound, on a strong non-hygroscopic ceramic core, by reversing the direction of winding of alternate pies or sections. Distributed capacity is minimized and skin effect kept to a negligible value even at high radio frequencies. Diameter is only 9/16" and overall length approximately 2". Highly plated brass ferrules, studs and nuts, as well as soldering lugs are provided.

Bulletin No. 108, describing the Riteohm "81" and Riteohm "71," may be had from the Ohmite Manufacturing Company, 4835 W. Flournoy Street, Chicago, Illinois. ALL-WAVE RADIO.

SOLAR TYPE X TRANSMITTING CAPACITORS

HERE IS ILLUSTRATED one of the new "Solarex" Transmitting Capacitors for amateur use, manufactured by Solar Mfg. Corp., 599 Broadway, New York City.



The Solarex line, in eleven ratings from 1 mfd., 1000 d.c. operating volts to 2 mfd., 3000 d.c. operating volts, features high grade construction throughout. Sections are thoroughly impregnated in a special oil of

high dielectric characteristics and unusual stability under wide temperature variation. Black-sprayed metal containers and high grade porcelain stand-off insulators are used on all units. (Insulators, extending fully through the can tops, give ample protection beneath as well as on top).

A new catalog embracing the entire line of Solar Transmitting Capacitors may be had by writing the Company. ALL-WAVE RADIO.

CATHODE-RAY TUBES FOR TELEVISION

THE MORE CRITICAL requirements of television reception are being met by two new cathode-ray tubes recently developed and now made available by Allen B. DuMont Laboratories, Inc., of Upper Montclair, N. J. The Type 54-10-T has a 5-inch diameter screen and a maximum third anode voltage rating of 3000. The Type 144-10-T has a 6000-volt rating and a twelve-inch diameter screen.

Both of these tubes employ a unique design which prevents de-focusing of the spot when the video signal modulates the tube. This has heretofore been one of the difficulties with television reception, because when the cathode-ray tube was adjusted to give a sharp line at a certain value of signal, it blurred at other signal values. With these new DuMont television reception tubes a sharp focus is maintained at all values of applied video signal, giving a clearer-cut television picture.

The standard screen provides a pleasing green light. However, tubes are available on special order with a white screen giving a black-and-white picture.

Both tubes mentioned employ electrostatic focusing and deflection. Electrostatic focusing is believed by the DuMont engineers to be more practical than electromagnetic, since the latter requires an extremely constant current supply so that even the slightest line-voltage fluctuations can spoil the focus of the television picture. Also, electrostatic deflection is considered superior to electromagnetic because it is necessary to introduce distortion into an electromagnetic deflection circuit to compensate for the inductance of the magnetic deflecting coils. Also, electromagnetic deflection requires the use of an iron core coupling transformer with a flat frequency characteristic to about 160 kc. between the deflection amplifier and the deflection coils. This is necessarily expensive. However, the electrostatic deflection circuits are relatively simple. ALL-WAVE RADIO.

SUPREME MODEL 531—2" OSCILLOSCOPE

HERE IS A BASIC scope circuit utilizing a 2" tube which should be of special interest to hams and experimenters. Contains 2" tube and power supply, intensity and focus controls, input jacks to vertical and horizontal plates and an internal sinusoidal sweep supply with gain control. External linear sweep may be used. Can be used for visual alignment with addition of external vertical amplifier. Excellent "as is" for checking modulation percentage of ham transmitters and for other uses. ALL-WAVE RADIO.

C-D INTRODUCES UNIVERSAL MOUNTING

MECHANICAL DIFFICULTIES in mounting high-voltage filter capacitors are entirely eliminated with the universal mounting brackets introduced by the Cornell-Dubilier Electric Corporation. As the illustration shows, mounting in all positions is easily accomplished. Impregnated and filled with

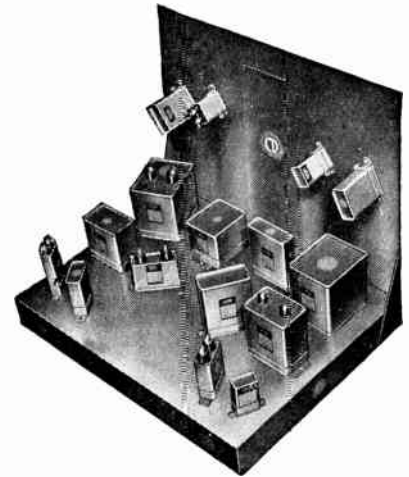

dykanol in hermetically sealed non-corrosive containers, the C-D type TJ-U high-voltage filter capacitors can be mounted in any position without altering or affecting the electrical characteristics of the unit. The universal mounting brackets are supplied at no extra cost with each C-D type TJ-U filter capacitor. For catalog listing of these new capacitors, write to the Cornell-Dubilier Electric Corporation, South Plainfield, New Jersey. ALL-WAVE RADIO.

MONARCH MULTIVIBRATOR

THE MONARCH MODEL 20 Multivibrator is a special instrument which greatly simplifies the procedure of aligning a radio receiver. It is not intended to supplant the usual signal generator for this purpose but rather to supplement it in such a way that the work is not only more accurately done but also with a very substantial saving in time.

While it is not primarily intended that the Multivibrator shall afford a measure of receiver sensitivity, it being thought that this function is best left with the signal generator, yet it will be found that as familiarity with the unit is gained a very fair estimate of sensitivity may be made.

The normal operation and utility of the Multivibrator is as follows: The i.f. amplifier, in the case of the superheterodyne, is aligned in the usual way. One trimmer, the oscillator trimmer, is then aligned on each band near the high-frequency end of the scale. This adjustment is also made with the usual signal generator and in such a manner that the dial pointer is made to agree with the scale. The customary ability to differentiate between the image signal and the proper signal must be had by the operator although if the wrong adjustment should be made the Multivibrator will quickly show it up on a later test. This is not always the case with-

(Continued on page 55)

NIGHT OWL HOOTS

(Continued from page 30)

Radio Club will have completed its tenth year of activity—"A Decade of Service to DXers." Were it for this factor alone we would have to dig deep into our bag of cheers, but the very friendly and efficient way in which it has carried on this service leaves us with an empty bag and still plenty of cheers to be passed around to its staff. Always the largest and most powerful body of broadcast-band DXers, the club has succeeded in maintaining a remarkably friendly relationship among its many members where many smaller clubs have failed with a much lesser task. Perhaps we are mistaken, but the secret of its success seems to lie chiefly in the keen editorship of Irving R. Potts, who has wisely refrained from bringing up any club conflicts in the bulletin. His good natured ribbing and his friendliness have been highly contagious and is reflected in just about every NNRC member who has made the acquaintance of the Chief Night Owl. Of course the club has many, many others whose guidance has brought the club along successfully through ten long and enjoyable DX seasons. To each and every officer and member of the Newark News Radio Club the Chief Night Owl, in behalf of all our Night Owls, sends his best wishes for continued success throughout many more decades to come!

One typical example of the NNRC policy is the manner in which it has refrained from entering a conflict which has rather needlessly arisen and is causing much ill-feeling among clubs and their members. We refer to the loud "hullabaloo" anent the situation referred to as "artificial veri." Every now and then, it seems that the clubs must have something to yell about—something which they swear is to be the downfall of DX.

We remember last season that "dishonest DXing" was supposed to be ruining DX. Well DX is still here and where are all those would-be dishonest DXers?

The same scare is now being pounded into DXers regarding "artificial veri." Listening to the screaming of clubs one is led to believe that there are hundreds of DXers verifying stations at a profit. But where are they? Thus far none of the clubs have been able to find any of them, and of course they never will, for they don't exist. The only three clubs performing a verification service are the Before Breakfast DX Club on ZBW, The Baltimore Chapter of the NNRC on the Daventry stations, and The Quixote Radio Club who forwards the reports to the stations, acting as an intermediary, eliminating the necessity of using International Reply Coupons invaluable to many South American stations. Now bring up these names and the clubs will say that their practices are strictly honorable, but it's those who are imitating them at a profit who are causing the trouble.

DX will survive—it always has. We cannot sum it up any neater than by quoting the following message from E. J. Shields of the QRC: "If listeners want it (the artificial veri), who, pray tell, shall deny them? And if they want it not, then what is there to be discussed?" There'll be no jeers for you this time, but please boys quit the bitterness because there just isn't any "bogy man" menacing our fine hobby.

The Chief Night Owl welcomes your items and tips and very interesting letters. He also invites you to take advantage of the use of his Card Index File containing a complete list of every broadcasting station in the world with many notations and interesting information on each card. If you have a difficult station to identify send a three-cent stamp to the Chief. He'll do his best to help you. Address Ray La Rocque, 28 Aetna St., Worcester, Mass.



CKMO veri. issued to Harry Honda, Los Angeles, Calif.

Use
YAXLEY
APPROVED RADIO
PRECISION PRODUCTS

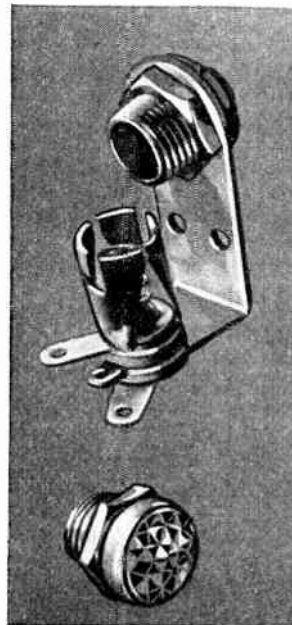

Play Safe— with YAXLEY Pilot Lights

DON'T run down batteries or run up light bills by leaving equipment turned on!

Don't try to change that final tank coil when it's "hot".

Use Yaxley Pilot Lights to tell you at a glance the condition of your rig.

Your distributor has Yaxley Pilot Lights, at 30c list (less bulb) in four colors of jewels:

Color	Screw Base	Bayonet Base
Amber	310-A	B-310-A
Clear	310-C	B-310-C
Green	310-G	B-310-G
Red	310-R	B-310-R

P. R. MALLORY & CO., Inc.
INDIANAPOLIS INDIANA
Cable Address—PELMALLO

Use
MALLORY
APPROVED RADIO
PRECISION PRODUCTS

Wishing you
a very merry
Christmas
AND THE HAPPIEST
OF **NEW YEARS!**

UTAH RADIO PRODUCTS CO.
CHICAGO, U. S. A.
TORONTO BUENOS AIRES
ONTARIO, CANADA (UCOA RADIO PRODUCTS CO.)
'16 YEARS OF LEADERSHIP'

CHANNEL ECHOES

(Continued from page 25)

This recreation has been accomplished in a highly interesting fashion. The accompanying illustration shows a recording scene in a Victor studio back before the days of microphone pick-up. The idea was to get as close to the horn as possible without climbing into it. The drums were in the background—and they might as well have been in the next room, for the methods and records of those days were incapable of reproducing such low frequencies. And the same held to a large extent for the highs. Thus the fiddles were parked at the very mouth of the megaphone to pick up the most of every illusive tremolo. However, the middle register, where Caruso's voice had wings, was recorded with really good fidelity. (We have some old records of Caruso, Melba, Tetrzzini, Louise Homer, etc., in which the voices are excellent.) The process of reorchestration is accomplished as follows:

An original perfect record is played, probably with scratch filter, and put through an amplifier to the recording head. The live orchestra in the studio is picked up in the conventional manner, amplified, and mixed with the voice. The music director uses headphones, one of which is tapped in on the record amplifier and one on the orchestra amplifier. Thus, in conducting, he is able to synchronize the accompaniment, by the usual direction, with Caruso's voice. The live orchestra plays in the same tempo and key as that on the original record, and there is, therefore, no discord. It is only an augmented orchestra. Actually the live orchestra is so much louder than that playing on the record, and its frequency range is so far extended, that the original orchestra is practically blotted out. The blending of voice and orchestra is done so skillfully that one would scarcely suspect that the recording was other than a regular recording session with the singer himself being present.

ECHO EFFECTS ON the 20-meter European stations are particularly pronounced this fall and winter, the most emphatic echoes being received from the German D-string. There is still a lot to be learned concerning echoes, and Germany could contribute somewhat to research along these lines, if, instead of permitting the studio cat to walk over the piano keys between schedules, a short-duration dot were transmitted every five seconds for oscillograph recording—along with the echo—in different parts of the world.

ISAAC T. DAVIS, of Elkhart, Texas, nomi-

nates all the serial skits from Ma Perkins to Lum and Abner as radiodors. While we're more or less inclined to agree with critic Davis, the prize is for a specific radiodor, and so he doesn't rate the free subscription this month. Another runner-up is Samuel Brodsky (RSSL 4H22) of New York City, who justly pans the True Story Hour over the NBC on Friday nights. As he puts it, "They tell a story, or rather part of one, and then you're supposed to guess the solution or go out and buy a copy of the magazine." We take it that critic Brodsky has never bought a copy (nor have we) which may or may not show how effective that type of plugging is.

The free sub goes to C. M. Houston, (RSSL-W16S4) Memphis, Tenn., who also identified (if our memory serves us) the gentleman appearing in the photo on this page for November. Writes critic Houston:

"Don't you remember the famous radio debate between Bishop Cannon of the M. E. Church South, and, I think, Jewett Shouse. The little man is the Bishop. [We recall now that we thought Shouse was a pretty good name for a wet.]

"As to smut on the air, you are away off balance. Suppose you let old Al Jolson plus Eddie Cantor spill filth? I agree with you that a little license is admirable, but give an inch— Some of us would have awfully red faces when the minister called and a blast of Rabelais shot out! [That's just when we'd begin to enjoy ourselves.]

"My radiodor is the way Edwin C. Hill slinks up with a plug for Luckies in the midst of his newscasting."

PHOTO-SCALES

(Continued from page 31)

read the small type on the ground glass it is a fair indication of good eyesight. The distance between the scenery and the camera is noted with a ruler, also the setting of the bellows on the camera. These distances are labeled "A" and "B" in Fig. 1. This data is recorded for future use.

Drawing the Scales

The meter is now taken apart and the scale removed. All dimensions are carefully noted, are multiplied by three and then applied to the drawing. For instance if the scale has a diameter of three inches, then the drawing should have a diameter of nine inches, and so forth. Only the blackest of inks should be used for the drawing and the best ink for this purpose is India ink. The drawing should be made on white, dull finish paper, as this photographs

better than the glossy paper. The lines should be drawn relatively heavy and wide, since the camera reduces the width of the lines also. The lines will appear quite thin and weak on the picture if they are not drawn heavy on the original. Any number of divisions and figures may be incorporated on the scale, this being dependent upon the type of work the meter is to be used for.

Taking the Shot

When the enlarged scale is completed it is ready for the camera. The conditions set forth in Fig. 1 are duplicated exactly, except that now the film rests in the camera instead of the ground glass, and the scenery is the enlarged meter scale in place of the newspaper. The distances "A" and "B" must be exactly the same as determined during the trial experiment. Using the smallest lens opening, or stop opening, set the shutter to "time" exposure. The 100-watt lamp is now turned on and waved around in back of the camera for about 30 seconds or so. This may be determined by experiment, but 30 seconds is about right for the average film and camera with a 100-watt lamp. It is best to take these pictures with electric light instead of daylight, since the latter is hard to control and difficulty may be experienced with the timing.

To insure a scale having the exact size as the original meter scale it is a good idea to make several exposures at different distance settings. For instance, suppose that in the trial setting, it was determined that the distance ("B" in Fig. 1) between the camera and the white paper is 25 inches in order to reduce the picture one-third. Minor errors are apt to occur during the setting of the camera and the bellows, and to correct this, it is well to take a picture at $24\frac{3}{4}$ inches, another at 25 inches, and still another at $25\frac{1}{4}$ inches. Thus three pictures will result having slightly different sizes, one of which will surely fit the original scale. After developing and printing, the correct size scale is chosen and cut out of the photo, which is then pasted over the original meter scale.

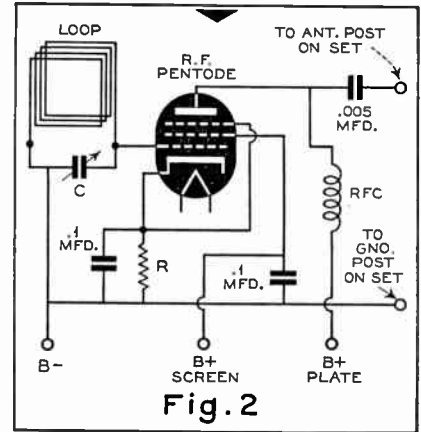

Loop aerial and separate r.f. stage which can be applied to the average receiver without wiring changes.

QUERIES

(Continued from page 32)

recommends it. Receivers employing loops are usually designed especially for use with this type of antenna. Only in this way can the best results be secured. Usually the loop is connected directly across grid and ground of the first tube,

and tuned just as if it were the secondary of an input transformer. Obviously this cannot be done with an ordinary set, as the single control tuning will track only with a coil having a certain value of inductance and distributed capacity. The chance of hitting the correct combination in a loop is rather remote. Also, the connection to the receiver in this manner is more complicated than an ordinary lead-in from a conventional antenna.

Loops are designed to cover specific wavebands—just as are coils. Large loops are more effective than small loops.

Everything
Sold on
Time
Payment



SAVE

Get the latest and finest radio equipment at rock-bottom prices. Use it while you're paying for it on convenient Monthly Payments—Terms as low as \$2 Down, \$2 a Month. Send for your free copy of Wards new 1938 Radio Catalog—the finest ever printed—and see for yourself how much you can save and how easily you can buy the radio equipment you want or need.

Mail the coupon NOW for your FREE copy!

MONTGOMERY WARD

MONTGOMERY WARD, DEPT. AR-1
CHICAGO, ILLINOIS

- | | |
|---|---|
| <input type="checkbox"/> Sound Systems and Equipment | <input type="checkbox"/> "Ham" Receivers and Supplies |
| <input type="checkbox"/> Inter-Communication Systems | <input type="checkbox"/> Testing Instruments and Books |
| <input type="checkbox"/> "Ham" Transmitters and Parts | <input type="checkbox"/> Replacement Supplies and Parts |

Send me my FREE copy of Wards new 1938 Radio Catalog. I am particularly interested in the equipment checked at left.

NAME

ADDRESS

CITY STATE

**YOU NEED THIS
NEW 1938 CATALOG**



The most complete line of racks, panels, cabinets, etc. You can build up almost anything from a short-wave receiver to a professional transmitter. Standardization of the units facilitates easy assembly of a real job of modern design and commercial appearance.

Write for Your FREE Copy Today!

PAR-METAL PRODUCTS CORP.
3521—41st ST., LONG ISLAND CITY, N. Y.

**WHEN A CONDENSER
OUTSELLS ALL OTHERS—**

That's News!

**CORNELL-DUBILIER
TYPE JR-508 IS
NOW THE FASTEST
SELLING ELECTROLYTIC**



- HERE ARE THE REASONS WHY:**
1. Higher peak voltage breakdown.
 2. Extremely low power factor.
 3. Negligible leakage characteristics.
 4. Accurate, full rated capacity.
 5. Small, compact and sturdy.
 6. Unconditionally guaranteed against internal corrosion.
 7. 27 years' experience behind the product.

MICA
PAPER
DYKANOL
WET & DRY ELECTROLYTIC

CORNELL - DUBILIER
ELECTRIC CORPORATION
1014 Hamilton Blvd,
So. Plainfield, New Jersey

However, the larger the loop the lower the frequency to which it can be tuned. Hence you can't do much with a loop below 200 meters. On the broadcast band, a loop can be used very effectively if correctly tuned and coupled to the receiver. We suggest the arrangement shown in Fig. 2. The loop is wound with ordinary bell wire, eight turns, no spacing, on a square form, three feet on a side. The tuning condenser should have a capacity of about 250 micromicrofarads. The tube can be any convenient r.f. pentode, such as the 6K7—convenience being determined by the power supply available. Very often power for this extra tube can be obtained from the receiver itself. The value of the cathode resistor, R, will of course be determined by the tube—and will be 350 ohms for a 6K7. The tube functions as an additional stage of radio-frequency amplification, the output of which is impedance-coupled to the input circuit of the receiver. A ground should not be connected to the receiver.

The loop is tuned to the signal frequency by the tuning condenser, C, and the set itself must be tuned to the same frequency. Loudest response will be had when the loop is pointed in the direction from which the signal is coming, and weakest when at right angles. The weakest adjustment, rather than the strongest, is used for direction finding. If the signal fades out altogether as the loop is rotated, the direction is taken as half way between the fade-out points. This is the more accurate method, as the area of best reception may cover ten or more degrees.

GLOBE GIRDLING

(Continued from page 24)

Morocco, broadcasts news and music between 8 and 8:20 p.m.

Mr. G. J. Glasspool, 30, Duke St., Southampton, Hants., England, would be pleased to exchange QSL cards with all.

Acknowledgement

We are afforded much pleasure by the continued support of the readers and listeners and extend our thanks for the numerous letters and reports received.

It will continue to be our pleasure to reply to your inquiries and assist in identifying unknown stations and station matters in general and to exchange information with all.

In case you are a member of the RSSL, kindly show your Monitoring number on your letters and reports.

Address your letters to Mr. J. B. L. Hinds, 85 Saint Andrews Place, Yonkers, New York, enclosing self-addressed

stamped envelope in case you desire a reply.

All questions of a technical nature should be forwarded to Queries Editor, ALL-WAVE RADIO, 16 East 43rd Street, New York, N. Y.

SUPER-PRO CONSOLE

(Continued from page 33)

cycles, where "boominess" exists, the response has been flattened out to reasonable limits. The use of the bass reflex system does not affect the response at the higher frequencies.

Our listening tests on the Super-Pro Console model supported the more complex technical analyses. Excellent bass response was evident, but not at the expense of the brilliance lent to orchestral music by the proper reproduction of the higher frequencies.

**TWO-TERMINAL
OSCILLATOR**

(Continued from page 13)

grid of T₂ is used to limit the plate current of T₂ to a safe value. This bias is not required under some conditions of operation.

Typical Setup

In a typical setup using the oscillator section of a 6A8 as tube T₁ and a 6J5-G as tube T₂ in the circuit of Fig. 2, a tuning range of 6.4 to 19.7 megacycles (a ratio of 1:3.08) was obtained. The oscillator amplitude throughout this range was approximately 100 microamperes. The coil used in this test had a Q of about 100. When the same equipment was used in the shunt-feed circuit of Fig. 3, a tuning range from 6.5 to 20.7 megacycles (a ratio of 1:3.18) was obtained. The oscillator grid current became approximately 55 microamperes, because of the comparatively low voltage on the plate of T₂.

No specific tube types are recommended for use with this circuit. Twin-triode types may be used in place of the separate tubes shown in Figs. 2 and 3. High output is obtained from tubes having high transconductance (g_m); however, such tubes usually have high capacitances, which curtail the tuning range. For high output, high g_m in one tube is just as effective as high g_m in the other tube, because of the ring arrangement of the circuit.

The two-terminal feature of this oscillator is an important one for applications which do not require the use of padding condensers. In these applications, the two-terminal oscillator simplifies the switching problem.

NEWCOMER'S XMITTER

(Continued from page 17)

The power socket, key jack, microphone jack and microphone voltage control are on the back edge of the chassis. The microphone jack should be mounted directly under the input transformer to avoid shielded leads to this transformer.

Construction

The mechanical construction of the transmitter is straightforward. Care should be taken in fitting the panel, chassis and brackets together. The brackets should be first mounted on the chassis. They should be fitted so that the bottom edges of the brackets are even with the bottom edges of the chassis. No chassis bottom plate should be used. The chassis, with brackets mounted, should next be slid into the cabinet and the panel screwed to the cabinet. With the chassis pushed up against the panel the four top mounting holes on the front of the brackets should be scribed through to the back of the panel. This will locate the chassis at exactly the right height in respect to the panel. As the top of the power transformer will just go under the cross piece at the front of the cabinet with the chassis flat on the cabinet bottom, this point should be watched. Incidentally, do not try to slide the chassis into the cabinet with the 807 in its socket. We did—with detrimental results.

The connections to the antenna link come out the side of the cabinet. A small piece of hard rubber is mounted at the left side of the chassis below the plate coil. Large holes, as shown in the drilling template, permit the jacks to clear the metal. Two similarly placed large size holes are drilled in the side of the cabinet. A pair of banana plugs, with extension pieces screwed on, bring the antenna connections through these holes. These extensions may be mounted on another small piece of hard rubber if desired. The stiffness of the plugs will keep the extensions clear of the sides of the cabinet holes without this extra piece, however.

The 807 in the final stage is operated "straight through" on all bands—even 10 meters. This stage may be operated on either the fundamental crystal frequency, its second harmonic or its fourth harmonic. A 40-meter crystal will permit operation on 10, 20 or 40, an 80-meter crystal will work 20, 40 or 80 while a 160-meter crystal will take care of 40, 80 or 160. When operation is on the crystal fundamental the doubler tube is switched out of circuit with switch SW. For har-

monic operation of the crystal frequency it is left in. The sockets for coils L and L1 are wired identically. This permits the coils for these two positions to be interchanged, reducing the number of coils necessary.

It is also possible to double the 807 for c.w. operation with good efficiency. This

is only necessary, however, when it is desired to operate on 10 meters with an 80-meter crystal or on 20 with a 160-meter crystal.

In order to secure upward modulation it is necessary to overdrive the 807 a little. The degree of excitation is controlled by tuning the crystal plate con-

NOT ~~\$12.50~~

NOT ~~\$7.50~~

NOT ~~\$6.00~~

NOT ~~\$5.00~~

NOT ~~\$4.00~~

NOT ~~\$2.25~~

NOT ~~\$1.75~~

BUT \$1.50

TAYLOR LEADS

Read! Trace the history of the 866, most widely used amateur tube. It proves Taylor leadership. In 1932 Taylor Tubes smashed profiteering tube prices by announcing the sale of quality 866's at the then fabulously low price of \$1.65. Naturally there were many who doubted the quality of this tube. Almost overnight, the Bronx cheers

of the doubters turned to wholehearted acclaim, when Amateurs—Engineers and Scientists, found Taylor 866's better tubes than all competitive makes. For five years the sales of Taylor 866's have led by a tremendous margin. And so it is with all other types. Taylor pioneered fair prices on all transmitting tubes. Due to Taylor's ceaseless effort, the prices on all types of amateur tubes have steadily decreased. At the same time, a broader guarantee on transmitting tubes has been established, through Taylor's aggressiveness. The result of this tireless fight for the Amateur is easily seen. "More Watts per Dollar," has become the magic slogan to greater Amateur accomplishment. This fearless call for quality at a fair price has broken the tyrannic circle of profit-plus prices on all Amateur gear. Taylor Tubes is proud of its loyal Amateur friends. Taylor accepts and holds high its leadership in the fight for genuine value in all types of Amateur equipment. Taylor Tubes will never fail in its trust.



"More Watts Per Dollar"

Taylor HEAVY CUSTOM BUILT DUTY **Tubes**

TAYLOR TUBES, INC., 2341 WABANSIA AVE., CHICAGO, ILLINOIS

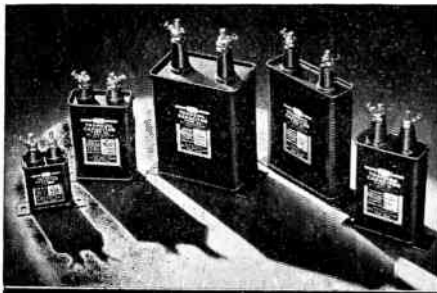

TRANSOIL

for transmitting

HIGHEST QUALITY OIL CAPACITORS

Ask for new complete
Transmitting Catalog
describing

TRANSOIL—SOLAREX—TRANSMICA

SOLAR
MFG. CORP.



599 BROADWAY
NEW YORK CITY

Ask your **JOBBER**
for the NEW

STANCOR

"HAMANUAL"
New Tubes . . . New Circuits

16 NEW TRANSMITTERS
5 WATTS TO 1000 WATTS

STANDARD TRANSFORMER
CORPORATION
850 BLACKHAWK STREET, CHICAGO

FREE CATALOG

↓ of our complete line of
short wave transmitting
equipment. New condensers, new
insulators, new sockets, antennas,
and many other interesting new
items. Write for Catalog 964L.

E. F. JOHNSON COMPANY

WASECA, MINNESOTA, U. S. A.

Export Office: 25 Warren St., New York
Cable: "SIMONTRICE"

Free RADIO Catalog

See the latest sensational radio developments in ALLIED'S new 1938 Radio Catalog! 61 new Knight Radios at amazingly low prices; 12,000 radio parts; 32 new Build-Your-Own kits; Amateur gear; P.A. systems; books, tools, etc. Write today for FREE copy!

ALLIED RADIO CORP.
833 W. Jackson Blvd. Chicago Dept. 4-A-8

denser, C1. C5 should *never* be detuned to reduce excitation, only C1. When operating phone it will be found that the position of C1 that gives greatest output from the 807 will also cause severe downward modulation. The output from the 807 should be reduced with C1 until upward modulation is secured.

With the second 6F6 quadrupling, there is not enough excitation to the 807 to overdrive it for phone operation. The 807 should, therefore, only operate on the fundamental crystal frequency or its second harmonic for phone. This makes it necessary to use a 20-meter crystal for 10-meter phone. For c.w. operation on 10 either a 20- or 40-meter crystal may be used.

Operation

With the particular components specified in the parts list, smooth operation should be experienced on all bands. The only change necessary from the specified data will be in the size and position of the link windings on the 807 plate coil, L2. These should be adjusted so that the proper current is drawn on the 807 in resonance with the antenna properly connected and tuned. The plate current on the 807 can run at a maximum of 95 ma. for c.w. This represents an input of a little over 40 watts with an output into the antenna of over thirty watts. For phone operation the plate current of the 807 should run at a maximum of 60 to 70 ma. The audio output of the 6N7 is only ten watts, so that the input to the 807 should not run much more than twice this figure, or twenty watts. The exact input will depend on the band used and operating conditions. A minimum phone carrier of about 15 watts should be secured on all bands.

The gain of the audio section is sufficient for operation with a high-gain double-button carbon microphone. The Shure Model 3B microphone is satisfactory from the standpoint of low cost, output and quality. These low cost carbon microphones provide a surprisingly high degree of quality. A crystal or dynamic microphone may always be used instead by the addition of a simple pre-amplifier, as mentioned before.

One easy way of checking the approximate output of the transmitter is to connect an ordinary lamp bulb across the antenna link. A 30-watt size will do for test in the c.w. position, while a 15-watt size will be more suitable for phone testing. This will also indicate what adjustments are necessary for proper upward modulation. The size of the antenna link will determine the loading effect of the bulb on the 807. The link should be adjusted for proper load on this tube when the correct size of lamp bulb is used.

AWR AUTOMATIC

(Continued from page 9)

tuned to resonance, there should be little or no difference in the cathode current reading from that originally recorded.

Now adjust the oscillator section trimmer tuning condenser slowly on both sides of the resonant point. On one side of resonance the 6J7G cathode current should rise and on the other side of resonance the cathode current should fall. If this rise and fall is not uniform on each side of resonance, the second i.f. transformer secondary tuning condenser should be adjusted by small steps until a uniform rise and fall in the 6J7G cathode current is noted as the oscillator section trimmer tuning condenser is adjusted above and below the resonant point. When uniformity is reached, the alignment can be considered complete and the 400-ohm cathode biasing resistor for the 6J7G control tube can be resoldered to chassis ground.

Final Check

As a final check on a.f.c. operation, the test oscillator can be connected to the antenna again. As the test oscillator is tuned toward the frequency for which the depressed button has been set, the test oscillator signal should be heard with normal volume as soon as the test oscillator frequency comes within about 7 kc. of the receiver tuning, and it should be heard until the test oscillator is tuned about 7 kc. beyond the frequency to which the receiver is tuned.

It is suggested that if the constructor is inexperienced in receiver alignment procedure, that he leave this part of the job to a local serviceman, who can make the necessary adjustments by following the above outline.

ONE-MAN MAST

(Continued from page 18)

used as it comes from the can. Allow at least a day to dry and then you are ready to put up the entire structure.

Raising the Stick

Place the 2 x 3 section marked No. 1 against the base and bolt it in place as in Fig. 2. Now climb up on the extending carriage bolts and bolt section No. 2 in place. Again following the same procedure, bolt section No. 3 in place.

It will now be necessary to have some temporary guys. The guy posts can be set at an angle, as in Fig. 3, and fastened permanently. They should be

placed about forty feet from the base. Then put section No. 4 in place and securely fasten the eye-plates in their correct position. We can now make fast our permanent guys at the twenty-foot level. It will be very wise to put guy wires every ten feet until the mast is completed so that there will be no sway while climbing. The temporary guys can all be removed after the job is completed. Continue adding sections until they are all bolted in place.

After the mast is completed, give it two coats of white lead and oil with some spar varnish mixed in (ratio 5:2:½). Do not use boiled linseed oil or the pole will turn yellow. Use only a good grade of raw linseed oil and Dutch Boy white lead for maximum finish. If these instructions are followed the pole will glisten like a new-born babe.

For a halyard it is well to use a good grade of rope, treated against exposure, in combination with a fool-proof galvanized pulley.

In closing it might be added that the writer, who weighs about 140 pounds, climbs the pole every year to paint it, and it still barely sways.

BELFAST-STRANRAER 9-CHANNEL ULTRA SHORT WAVE RADIO LINK

THE INAUGURATION by Sir Walter J. Womersley, M.P. Assistant Postmaster General, of the Belfast-Stranraer 9-channel Ultra-Short-Wave Radio Telephone Link on August 31st, 1937 marks one of the most outstanding achievements of today in the world of communications.

Although the use of ultra-short waves for commercial telephony is by no means new—an experimental service having been operated by the Post Office as long ago as 1932—this is the first application in Great Britain, or in fact in the world, of a system wherein as many as nine telephone channels are passed simultaneously over a single radio link.

This system is the outcome of many years of research by Standard Radio engineers into the technique of ultra-short-wave communication, coupled with long and arduous field trials. It is interesting to note, too, that the ultra-short-wave is by no means the limit of wavelength for communication purposes and that the researches of Standard Radio engineers into micro-rays resulted in the design and installation as long ago as 1933 of the Lypne-St. Inglevert Micro-Ray Link used by the Air Ministry, which operates on a wavelength of 17.4 cms. over an optical distance of 21.7 miles.

Foremost among the virtues of the ultra-short-waves is the possibility of transmitting wide bandwidths. The width of

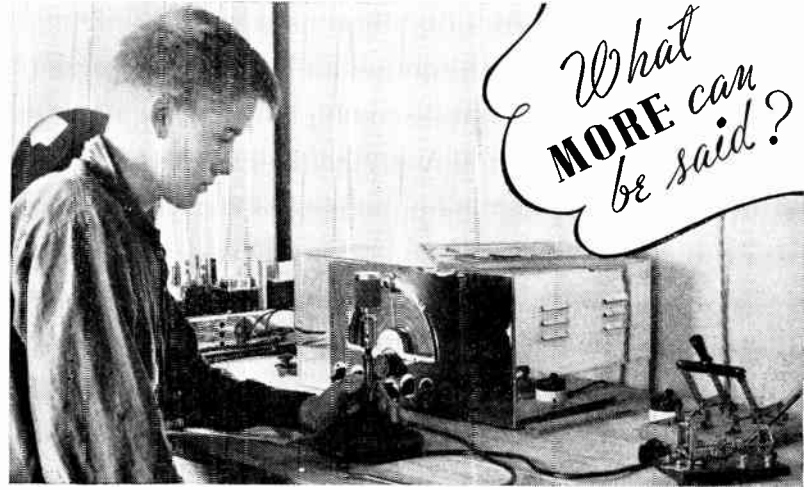

★ Tom Gross, chief radio operator of the Bowdoin College-Kent's Island 1937 scientific expedition to the frozen arctic, snapped operating one of the two McMurdo Silver MASTERPIECE V Receivers, says:

"The MASTERPIECE V chassis seen in the foreground, with the power amplifier and 18" loudspeaker in the rear, was the receiver designed for VE1IN's communication work. You installed Litz wound coils in all i. f. stages which resulted in an unbelievable degree of selectivity. The performance of both receivers was highly satisfactory."

When it is remembered that these were the only communication receivers taken to the arctic by VE1IN—that success of the expedition depended, and human lives were staked, on their never-failing performance—what more can we say?

But we can add that, good as was the MASTERPIECE V, the new MASTERPIECE VI and its slightly simplified version, the new "15-17" are tremendous improvements over the sets supplied to VE1IN.

If you want to start the New Year with something quite new in radio reception, you owe it to yourself to investigate McMurdo Silver Receivers. We think they have "everything." Their owners tell us they have. And, backed by twenty-six years of radio engineering experience—with over a decade alone of building receivers for scientific expeditions to jungles, antarctic and arctic—they've got to be good.

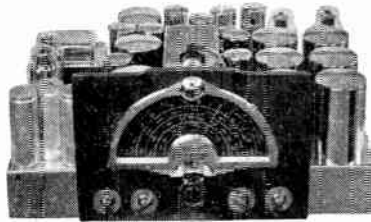

Custom Built Radio

McMURDO SILVER
MASTERPIECE

McMURDO SILVER CORP.,
2900-B South Michigan Blvd.

Chicago, Illinois

Send me full details on Masterpiece VI
 "15-17"

Name _____

Address _____

HAVE YOU A COMPLETE FILE OF ALL-WAVE RADIO?

CIRCUIT - DIAGRAMS • FORMULAE • CONSTRUCTIONS • TABLES • LISTS • QUESTIONS - ANSWERS • ETC.

COMPLETE AN INVALUABLE REFERENCE LIBRARY NOW!

A Limited Number of the Following Issues are available (First Come—First Served)

1935 Sept., Nov., Dec.
1936 Jan., Feb., March, April, May, July,
Aug., Sept., Oct., Nov., Dec.
1937 All issued to date.

15c EACH

**8 for
\$1.00**

POST-PAID

ORDER FROM ROOM 601, 16 EAST 43rd ST., NEW YORK, N. Y.

the band that can be transmitted increases as the wavelength is shortened, and it is for this reason mainly that high definition television stations all operate in this region, as they require a total bandwidth of as much as 6 megacycles.

The equipment is designed for unattended operation and is capable of complete remote control from the nearest telephone exchange. In addition it is provided with spare equipment, part of which is brought automatically into operation on the occurrence of any abnormal condition. Both transmitting and receiving equipments derive their whole power supply from the public supply mains, the only battery used in the equipment being that for the operation of the relay system. A Diesel-electric power plant is arranged so that in the event of failure of the public electricity supply, it will take over the load automatically approximately one minute after such failure and thus avoid serious interruption of the service.

PRINCIPLE OF OPERATION

Transmitter

Let it be assumed that the input of Channel No. 1 is supplied with sinusoidal tone of frequency f_1 kc. per second. This input modulates a channel-frequency oscillator having a frequency in the range 150 to 300 kc. per second, say, 155 kc.

per second, resulting in a carrier frequency of 155 kc. per second together with upper and lower sidebands of $(155 + f_1)$ and $(155 - f_1)$ kc. per second. If Channel No. 2, be supplied with a tone input of frequency f_2 , this will modulate an oscillator having a frequency of, say, 165 kc. per second, resulting in a carrier frequency of 165 kc. per second and upper and lower sidebands of $(165 + f_2)$ and $(165 - f_2)$ kc. per second. Similarly, Channel 3 may have a carrier frequency of 180 kc. per second, and so on to the ninth channel of which the carrier frequency might be 280 kc. per second.

The bands of frequencies derived from the 9 channels are now added together, producing in total a single frequency band extending from $(155 - f_1)$ kc. to $(280 + f_9)$ kc. per second. This total frequency band is now used to modulate the output of the ultra-short-wave transmitter having a carrier frequency in the neighborhood of 76,000 kc. and to produce by this means a lower side-band extending from $76,000 - (280 + f_9)$ kc. to $76,000 - (155 - f_1)$ kc., the carrier wave of 76,000 kc. and an upper side-band extending from $76,000 + (155 - f_1)$ kc. to $76,000 + (280 + f_9)$ kc. per second. This is the band of frequencies which is radiated by the aerial system.

The band of frequencies radiated by

the transmitting system, as described above, is delivered by the distant receiving aerial system to a superheterodyne type of receiver. The second detector of this receiver produces from the above input the original side-band extending from $(155 - f_1)$ kc. to $(280 + f_9)$ kc. This band of frequencies is then applied to a bank of 9 selecting circuits which operate as band-pass filters. The currents of frequency $(155 - f_1)$, 155 and $(155 + f_1)$ kc., will be passed by the first filter to a detector circuit which delivers the original frequency of f_1 kc. to the first channel. Similarly, the frequencies $(165 - f_2)$, 165 and $(165 + f_2)$ kc. will be passed by the second filter to a detecting circuit which delivers the original frequency f_2 to the second channel. In this manner the whole of the band of frequencies delivered by the second detector of the superheterodyne receiver will be split up, detected and delivered to the appropriate channel.

The carrier frequency of the ultra-short-wave transmitter is held constant within very close limits by a crystal-controller master oscillator while the beating oscillator of the superheterodyne receiver is similarly crystal controlled. By this means a high degree of selectivity may be attained in the receiver without any necessity of frequent retuning.

The foregoing explanation covers the transmission of 9 channels in one direction on a carrier wave of 76 megacycles approximately. For the reverse direction the circuits of the same 9 channels are transmitted on a carrier wave of 83 megacycles approximately.

Aerials

In order to minimize interference between the transmitting and receiving waves, the plane of polarization of the waves emitted by the transmitting aerial is at right angles to that of the waves received by the receiving aerial. At one terminal, therefore, the transmitter is equipped with an aerial system designed for vertical polarization, whereas the receiver is fitted with an aerial designed for horizontal polarization. At the other terminal the receiving aerial is vertically and the transmitting aerial horizontally polarized.

Receiver

The receiver is a superheterodyne, in the output of the second detector of which the 9 auxiliary carrier frequencies of the distant transmitter are present. Each auxiliary carrier, together with its sidebands, is separated out by means of fil-

"Hi-Lo" Transformers

by

KENYON

The trend in Modern Transmitter Design is definitely toward —

HIGHER EFFICIENCY . . .

LOWER POWER!

KENYON responds with a complete line of
High grade — LOW price Transformers

BE WISE AND KENYONIZE YOUR T20, TZ20 and 809 with KENYON T-378 Filament Transformer.

7.5 or 6.3 V. 7A C.T. 2000 V. Test Net Price \$3.00

See your Local Jobber or Dealer for Bulletin T-378

KENYON TRANSFORMER CO., INC.

840 Barry St., New York, N. Y. • Export Dept., 25 Warren St., N. Y. C.



KENYON T-378

YOURS FOR THE ASKING

Write us for your needs
in radio coils, I.F. transformers, etc.
Kits for Custom-Built Receivers
Big 32-Page Catalogue Free

MEISSNER MFG. CO.

Mt. Carmel

Dept. F

Illinois

ters, amplified and rectified to reproduce the original speech frequencies corresponding to the channel in question. After amplification these frequencies are passed out to the line at the required level.

It is easy to mix together 9 channels, but to separate them out again without noticeable crosstalk is a problem on its own. It is on the special design of the channel-selecting circuits, by means of which this end is achieved, that the successful operation of the whole system primarily depends.

General

It is quite evident that a fault in any part of the equipment common to all channels is serious, but the failure for any appreciable time of 9 channels is disastrous. The ultra-short-wave transmitter unit, being common to all 9 channels, is, therefore, provided in duplicate. The reserve unit is normally not under tension, but if a fault such as the failure of a tube occurs, the power supplies and the aerial are automatically switched from the service to the reserve unit and a fault signal is given to the distant remote-control point. That portion of the receiving equipment which is common to all 9 channels is similarly duplicated. In addition, the power supply is duplicated by an emergency plant which is switched in on failure of the public supply.

W2XNR HEARD IN ENGLAND

ACCORDING TO A REPORT recently received from England, the Western Electric police radio transmitter in Mount Vernon, N. Y., with only 50 watts output, has spanned the Atlantic Ocean to be heard by George Garvey, an amateur of 305 Mill Street, Liverpool. Using a receiver with only two tubes and an eight-foot indoor antenna, Mr. Garvey received clearly the voice transmission of Sergeant John Shields, directing his local police cars to a fire.

Chief Inspector Michael I. Silverstein, famous in police circles for his activities in prevention of crime and detection of criminals, displays with no small pride the letter he received from England, signed by Mr. Garvey who, much surprised at his unusual reception, immediately wrote for a confirmation.

"I have much pleasure," reads Garvey's letter, "in reporting reception of your radio station W2XNR on 36 M.C. approximately, at 4:32 p.m. G.M.T. The

message was 'W2XNR MOUNT VERNON POLICE. CALLING CARS 12 AND 7. REPORT TO ALARM OF FIRE AT 105 NORTH FULTON AVENUE. THE TIME 11:32 a.m. OPERATOR 6.' Reception was very clear and of good strength. My receiver uses only two tubes and for the antenna was using just eight feet of wire indoors. So you can see your station is putting out a swell signal over here. If you can check this report and find it correct, I certainly would be pleased to have a verification of my reception." (The five hours' difference between Eastern Standard Time and Greenwich Mean Time accounts for the two time figures.)

It develops that Sergeant Raymond Daley and Patrolmen Harold Turnbull and Melvin Foltz responded promptly to the fire alarm which receive this international attention, to discover a pile of burning leaves.

RMA PRESENTS REVISED FAIR TRADE RULES

PROPOSED FAIR TRADE practice rules for receiving set manufacturers are again under indefinite advisement by the Federal Trade Commission following the Commission's public hearing December 7. A large number of manufacturers and other interests participated.

The rules proposed last month by the Commission were formally "disapproved" by the Radio Manufacturers Association, and a revised draft, previously presented by RMA on February 9, plus additional rules to prohibit "spiffs," P.M.'s, and "dummy" tubes, was submitted by the Association.

The RMA recommendations were presented by James M. Skinner of Philadelphia, chairman of the Association's trade practice rules committee, who stated that the fair trade merchandising principles of the Commission and RMA rules were not at variance, but that the questions involved were ones of detail and verbiage.

Mr. Skinner submitted formal resolutions adopted unanimously at meetings November 17 at Chicago of the RMA Set Division and also Board of Directors "disapproving" the Commission's proposed rules and favoring the RMA draft of February 9, plus the additional rules on "spiffs" and "dummy" ballast tubes.

"We are happy to enter into a trade practice conference," Mr. Skinner told

READY FOR DELIVERY!

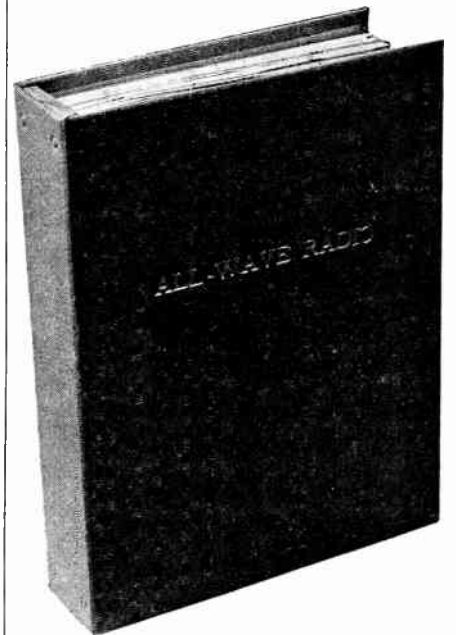

The Brand New AWR Binder

Custom built to accommodate 12 issues of ALL-WAVE RADIO, this excellently constructed binder embodies the following "up-to-the-minute" features:

- Handsome Maroon Simulated-leather Covering!
- Gold-embossed "ALL-WAVE RADIO" on Front Cover and Backbone.
- Sturdy, Rigid Covers!
- No Mutilation of Magazines with New Patented "SNAP-IN" Binding!
- Simple but Secure!
- Magazines Bound Individually!
- May be Removed Individually!
- Lies FLAT When Open!

\$1.25

Postpaid

Protect copies from tearing or possible loss and keep them handy for reference by ordering the handsome, new, AWR BINDER TODAY!

ALL-WAVE RADIO Dept. 11-B
16 E. 43 St., New York, N. Y.
Enclosed please find \$1.25 in Stamps
 M.O. Check for which please
RUSH one of the new ALL-WAVE RADIO
BINDERS to:

Name:

Address:

City: State:

ALADDIN Polyiron
Improves RECEPTION

New ALADDIN Polyiron I-F's give remarkable improvements in Selectivity, Sensitivity and Gain. Write now for FREE technical booklet and data.
Aladdin Radio Industries, Inc.
466aw W. Superior St., Chicago, Ill.

In Radio this is the sign of
QUALITY

Our Big Free Catalog of over 3000 items lists antenna kits, wire, jacks, plugs, x'mitting sockets and other items. The best that money can buy. Get your copy today!
BIRNBACH RADIO CO., INC.
145 Hudson St., Dept. AW-1.
New York, N. Y.

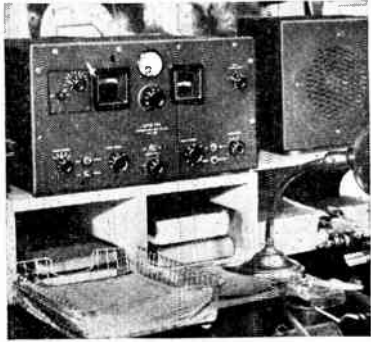

'PERFORMANCE IS TIP-TOP!'

"WITH our 'Super-Pro' receivers, we are able to constantly maintain unusually difficult schedules running 16 hours a day," says Stanley Wolf, chief operator, New York Herald Tribune wireless station. Mr. Wolf continues, "Day or night, rain or shine, these receivers are 'on their toes' offering tip-top performance." "Super-Pro" receivers feature 2 R.F. on all bands; electrical band spread; calibrated panel controls, etc. Mail coupon for new "38" catalog with further data!

HAMMARLUND MFG. CO., Inc. AW 1-38
424-138 W. 33 St., N. Y. City

() Please send me "38" catalog.

Name

Address

City State



HAMMARLUND

Canadian Office: 41 West Ave. No., Hamilton, Ontario

LEARN TO SEND AND RECEIVE CODE

Learn to send and receive code signals, like operators on ships at sea and at commercial and amateur land stations. Intercept distress signals, news flashes, bulletins, and dozens of other kinds of interesting radio communications.



MASTER TELEPLEX teaches you to receive code exactly the way the world's best operators do—by sound. A heavy waxed paper tape, running through a machine, operates an automatic key which sends messages to you, at any speed you desire. As you improve in speed, the machine sends faster, gradually preparing you for top-speed amateur and commercial signals. With the All Electric **MASTER TELEPLEX** you learn to send by sending, and the signals you send are repeated back to you, exactly as you sent them, thus enabling you to correct your own errors. We furnish a complete course, lend you the improved All Electric **MASTER TELEPLEX** and give you personal instruction with a **MONEY BACK GUARANTEE**. Send for our new **TELEPLEX FOLDER AW-1** today. **IT'S FREE!**

"HAM" SPECIAL STANDARD TELEPLEX
A highly efficient code teacher using heavy specially prepared waxed paper tape, having two rows of perforations. Write for Free folder W-1.

We are the originators of this type instrument

**R. C. Miller
TELEPLEX CO.**

72-76 Cortlandt St. New York City
TELEPLEX—The Magic Key of the Air Ways

the Commission, "to reach a common understanding as to accepted merchandising practice, to condemn those practices which cannot be accepted by our industry, and to agree to such rules of conduct as are to the advantage of both the industry and the public. The present meeting is the culmination of over two years of work by industry members to achieve a code of rules that will treat fairly and realistically, in the interest of the industry and the public, with those practices that are recognized to affect this industry.

"The trade practice rules committee felt that a tremendous achievement had been made in obtaining unanimous industry support to rules as broad and far-reaching as we submitted on February 9."

Special objection to the Commission's proposed rule requiring "origin and manufacture" of receiving sets to be identified was made in the RMA statement by Mr. Skinner. General merchandising practice in sale of many special brand products does not require labels of the manufacturers, Mr. Skinner pointed out, and manufacturers' names in such distribution convey no useful information to the purchaser.

Another general objection to the Commission's rules, voiced for RMA by Mr. Skinner, was against the requirement for details, in kilocycles, in advertising "all wave" sets.

Other RMA criticism of the Commission's rules was against the complex, vague and detailed advertising code proposed which, Mr. Skinner pointed out, would seriously restrict national advertising of radio.

"It should be strongly emphasized however," Mr. Skinner told the Commission, "that the differences between the rules we submitted and the version rewritten by the Commission are mostly differences in verbiage and not in principle. We feel strongly that our rules are less open to strained interpretations which we fear might be made at some time in the future by an entirely different Commission, which interpretations might put the industry under a tremendous handicap in conducting its business in what it believes to be an entirely fair and legitimate manner."

That the RMA recommendations were not a unanimous report was stated by Mr. E. F. McDonald, Jr., of Chicago, a member of the RMA committee. Mr. McDonald told the Commission he was not present at the Chicago meetings of

the Association and that he felt the word "origin" should be included in the proposed rules, to require set manufacturers to identify their merchandise.

"The public is entitled to know the name of the manufacturer," said Mr. McDonald.

Opposition to the proposed Commission requirement for identifying "origin and manufacture" of sets was detailed by A. S. Wells of Chicago, another director and committee member of RMA. No other industry rules and no law or court decision, Mr. Wells stated, require such identification of special brands.

"No deception to the public whatever is involved," said Mr. Wells, stating that special brand merchandise was sold generally throughout the United States and was a widespread commercial practice, recognized as legitimate and not deceptive.

Also opposing the Commission's proposed identification of "origin and manufacture" of sets was W. C. Fox, counsel of the National Retail Drygoods Association. He argued against any curtailment of private brands, a merchandising practice prevalent for years, he said.

"There is no deception of the public," Mr. Fox stated. "The proposed rule would upset established national channels and methods of distribution."

Support for the proposed rule on special brand merchandise was given by William H. Ingersoll representing the Electrical Appliance Dealers Association of New York.

"There is a great deal of hocus-pocus in the industry because of inadequate and improper markings of sets, and deception also in the number of tubes advertised," said Mr. Ingersoll, also asking for a rule to prevent improper advertising of excessive trade-in allowances. He cited the ineffectual results of the Feld-Crawford law in New York in its inability to effect uniform trade-in allowances.

Representing the Washington and also the National Better Business Bureaus, Miss Muchmore of Washington, also urged a rule on misleading advertising on trade-in allowances, declaring them a public deception.

The Commission was urged by O. Fred Rost of New York, editor of "Radio Retailing," to accept the RMA rules which he pronounced a tremendous step by the industry, and declared there were very few fundamental differences between the Commission and the RMA proposals. He said the Commission rules

AMERICAN

BIG THREE

American Code Reader List \$20
American Audio Oscillator List \$6.00
American Tele-Key List \$5.00
See them demonstrated at all good jobbers.

AMERICAN COMMUNICATIONS CORP.
1650 Broadway Dept. AW-1 New York, N. Y.

TEMCO TRANSMITTERS

May now be purchased from leading jobbers everywhere. Be sure to see them or request illustrated literature and technical data on 1000, 600, 350 and 100 watt models.

Transmitter Equipment Mfg. Co.
130 Cedar Street, Dept. AW-1,
New York, N. Y.

would increase manufacturers' expenses, change advertising and selling methods, and result in increased cost of radio to the public.

The Commission hearing lasted three hours and was conducted by Chairman George McCorkle and Assistant Chairman Henry Miller of the Commission's Trade Practice Conference Section. They announced that the various rules proposed would be considered further by the Commission, with no indication of when a final decision may come.

ON THE MARKET

(Continued from page 44)

out the Multivibrator. The Multivibrator output may then be attached to the receiver input or dummy antenna and all other trimmers and padders adjusted to give maximum indication on the output meter. The oscillator padder can be adjusted without rocking the gang condenser back and forth.

The alignment operation with the Multivibrator is a very convenient and rapid one. When the alignment is completed the sensitivity may be checked with the signal generator although a little experience will indicate what Multivibrator output setting corresponds to the required sensitivity and this operation may be eliminated. If the identical dummy antenna set-up is used the adjustment which is obtained with the Multivibrator will be the true and exact one and no further improvement in adjustment will be possible after switching back to the signal generator.

It will be found that the Multivibrator will instantly show any weak or dead spots on any band. This is true not only at a few isolated points but continuously over all of each band. Oscillator cross-overs will also show up immediately if the wrong adjustment of the oscillator trimmer was made. ALL-WAVE RADIO.

NEW LOW-PRICED RCA ANTENNA

A NEW, HIGHLY efficient low-cost antenna which is factory assembled and unusually easy to install has been introduced by the RCA parts division.

Known as the RCA 395, the new antenna will operate with receivers of all types and manufacture. Two supports, forty feet apart are all that is required for installation. To save additional time, all the parts, antenna wires, strain insulators,

junction box, and transmission line have been assembled and soldered at the factory.

The antenna proper is of the balanced doublet type and has been scientifically designed to act as an efficient pick-up medium, giving high signal strength over a very wide frequency range—of from 140 to 23,000 kilocycles. A new type transmission line conveys the signal to the receiver while the coupling unit matches the transmission line to the receiver input circuit.

While the new antenna does not have some of the exclusive features of the recently announced RCA Magic Wave Antenna, Model 395 is highly efficient and is particularly recommended for areas not bothered by unusual noise. ALL-WAVE RADIO.

AUDAX MICRODYNE PICKUP

AUDAX CO., 500 Fifth Avenue, New York, who developed the Microdyne relayed-frequency pick-up, announce that this magneto-inductive unit has now been made available in a low-priced model.

The considerable price reduction of this apparatus without appreciably lowering the quality of its performance will no doubt be welcomed by amateurs and sound men.

Audax Microdyne RF-1 is for records up to 12 inches with 10 inch overall length, and measures 8½ inches from center to needle. It may also be had with offset arm; a feather-touch relayed-frequency model, finished in black and silver. ALL-WAVE RADIO.

BRUSH "HUSHATONE"

THE BRUSH DEVELOPMENT CO. recently announced a new crystal-operated radio set accessory. This new device is known as the "Hushatone" (pillow-speaker). The unit is an ideal accessory for midget radio receivers as well as for the typical home radio. Persons enjoying a "Hushatone" do so by placing it under a pillow and reclining in a chair, on a couch, or in bed. A sick bed in the home or hospital is an ideal application for the "Hushatone."

Literature available by addressing Dept. H of The Brush Development Company, 3311 Perkins Ave., Cleveland, Ohio. ALL-WAVE RADIO.

TRANSDUCER COAXIAL CABLE

TRANSDUCER CORPORATION, RCA Building, New York, N. Y., has announced a new coaxial cable, "CO-X."

Necessity for such cable is found in a wide number of cases. Among these are



No. 467-451
Transformer for
Class B Driver.

"For Best Results
-- Use Jefferson
Transformers"

Those who have had widest radio experience with receivers, transmitters, amplifiers—know that the transformers used make a big difference—as Ted Cover confirms.

Jefferson Transformers have become the recognized standard for those demanding the highest efficiency and the most reliable service. . . . You can get Jefferson Transformers from your Parts Jobber—and if you want our complete catalog and manual of Amplifier Circuit Diagrams, just clip and mail the coupon below. JEFFERSON ELECTRIC COMPANY, Bellwood, Illinois. Canadian Factory: 535 College St., Toronto, Ont.

Get our latest Catalog 372-R and Manual of latest Amplifier Circuit Diagrams Free by filling in and mailing this coupon. Free by filling in and mailing this coupon.



JEFFERSON RADIO TRANSFORMERS

Jefferson Electric Company, Bellwood, Ill.

Mail latest Catalog 372-R and your free manual of New Amplifier Circuit Diagrams:

Name

Address

City and State



Designers and manufacturers of radio parts in steel, brass, copper, Mycalex. Ameroid, bakelite. Be sure you have our catalog of over 2000 parts!
AMERICAN
RADIO HARDWARE COMPANY, INC.
476 Broadway, New York City

JOBS in RADIO-TELEVISION

If you are seriously ambitious to make this fascinating, well-paying field your life work—if you have fair ability and are willing to train for success—write us. We'll tell you how we train men—how we fit them for good jobs, and help them get the jobs—how we qualify them to take exams for two Gov't. Licenses—how we prepare them for the glamorous future of television. A home-experiment course—with equipment furnished by us—followed by experience-training in our modern laboratories. The only independent school with 441-line electronic television equipment. Affiliated with Columbia basic network station KMBC. Address
MIDLAND TELEVISION, INC., 114A, Power & Light Bldg., Kansas City, Mo.

EASY STREET

ALL SIGNS POINT...

to the new **WHOLESALE** catalog. And the signs are \$\$\$ signs . . . dollars you save. "Hams" in the know swear by this free radio volume. Once you've got a copy, they say, you're right on Easy Street. Pages of **BIG NAME** radio parts in complete lines, test instruments and amateur apparatus. And topping all this, **Wholesale economy — prices to make you beam, a time payment plan that will never slow you down.** Send for your **FREE** copy of the new 1938 Wholesale Radio Catalog. The coupon is your free pass to Easy Street. Mail it now.

WHOLESALE RADIO SERVICE CO. INC.
 NEW YORK, N.Y. • CHICAGO, ILL. • ATLANTA, GA.
 100 SIXTH AVENUE • 901 W. JACKSON BLVD. • 430 W. PEACHTREE ST. N.W.
 BOSTON, MASS. • BRONX, N.Y. • NEWARK, N.J. • JAMAICA, L.I.

WHOLESALE RADIO SERVICE CO., INC.
 100 SIXTH AVENUE, NEW YORK, N. Y.
 Rush **FREE** 1938 Catalog No. 6940A8

Name.....
 Address.....
 City.....State.....

PASTE COUPON ON PENNY POST CARD



IMPROVED CONE STANDOFF INSULATORS

No.	Heights	List	Made of better ceramic, complete range of heights. Condenser, coils, tube sockets, etc., can be mounted with minimum labor. White glaze.
430	5/8"	10c	
431	1"	15c	
431J	1"	20c	
432	1 1/2"	20c	
432A	1 1/2"	25c	
433	2 1/4"	25c	
433J	2 3/4"	50c	

INSULATED BANANA TYPE PLUG



NEW! Features solderless Scrulok and non-collapsible Birmbach plug with special alloy springs. 3/8" diam. handle. Black, red, green, yellow.

404—Insulated Banana Plug...List \$.15
 392—Insulated Giant Plug 3/4" diam. handle, 1 1/4" long, in red or black. List\$.50

INSULATED BANANA PLUG JACK

Fits all type banana plugs. Insulated head 7/16" diam. In black, green, red, yellow.
 406—Insulated Banana Type Plug Jack. List\$.10
 407—Insulated Phone Tip Jack. List\$.10
 393—Insulated Giant Jack...List .40
 Many others in our free catalog.



BIRNBACH RADIO CO.
 145 HUDSON ST. BIRCO NEW YORK, N. Y.

antenna lead-ins; transmitting antenna transmission lines and feeders; lines between photo-electric cells and amplifiers; measuring instruments where high frequency losses or conductivity losses must be reduced to a minimum; galvanometers and electrometers; aircraft antenna lead-ins, etc. In short, any case in which freedom from disturbances or from pick-up, good shielding, low capacity, low resistance loss, and high accuracy of result are paramount. All of these needs are filled by the new product of Transducer Corporation, a flexible coaxial cable, "CO-X." This cable is reduced to its simplest components, that is, the inner conductor, a set of spacers, and the outer conductor which acts as a shield. This simplicity has been made possible by the design of the spacers and by the material used in their construction.

This material, called "Anhygron," is a striking innovation. It is said to be entirely free from conductivity variation due to atmospheric humidity, and has minimum weight which makes it distinctly superior to phenolic plastics which have the tendency to give high dielectric losses with the absorption of humidity. This new plastic is comparable to quartz without having its high cost and fragility.

These characteristics speak for themselves and show all the advantages and performance of "CO-X" cable without requiring any further comments. ALL-WAVE RADIO.

BOGEN SPEECH MODULATOR

A NEW MODULATOR AMPLIFIER, Model SM6, was recently introduced by David Bogen Company, Inc., 663 Broadway, New York City.

This company has sought in this model to insure hum-free operation by especial care with the filter circuits.

Plate will modulate 12 watts input to an oscillator or Class "C" amplifier; can be used to grid modulate an r.f. output stage up to 100 watts with low distortion content. Also useful as P. A. Amplifier with 6 watt output or to drive the 100-watt Booster Amplifier.

Input arranged for mixing one mike and one phonograph. Unit assembled on heavy gauge steel chassis, finished in durable black shrivel. Compact in size, ideal for amateurs. ALL-WAVE RADIO.

RADIO SERVICE MEN OF AMERICA, INC.

RADIO SERVICE MEN OF AMERICA, INC., is the name designated for the new national service men's association which has just been organized in Chicago.

This organization is new in every respect, and is run entirely by service men.

RAYTHEON
 AMATEUR TUBES
 RECOMMENDED BY LEADING PARTS JOBBERS

Under some old organization, it is said, the individual service man had little or nothing to say in the affairs of the central organization. Under the plans of the Radio Service Men of America, this fundamental defect in democratic organization is corrected.

Basically, it is anticipated that Radio Service Men of America, Inc., will function as a central source for gathering and disseminating information on developments in the radio field, that it will serve as a central liaison between the manufacturer and individual local service men's organizations, also that it will act as central headquarters for improving and promoting the welfare of the service man.

Mr. Joe Marty, with the active assistance of the Sales Managers Clubs, both eastern and western divisions, and a number of interested manufacturers has been busy contacting various service organizations in the east and middle west. Mr. Marty states that every group he has visited and explained the purpose of the Radio Service Men of America Inc., have assured him it meets with their approval and have promised 100% cooperation. Mr. Marty feels that every local service organization will appreciate the advantages of this central association and will want to become affiliated. This association, Mr. Marty points out, is aimed solely to render a service to each individual radio service man and is bound to have universal appeal.

Mr. Marty further states that numerous prominent men of all branches of the radio industry have expressed themselves as being in full sympathy with this movement and have promised their full support and cooperation with this new plan.

Local organizations or individual service men in cities where there is no organization are cordially invited to write for more details to: Mr. Joe Marty, Monadnock Block, Room 1533, Chicago.

NEW CATALOGS

UNITED ELECTRONICS TUBE BROCHURE

A BROCHURE detailing the specifications, ratings and general characteristics of their complete line of transmitting tubes and mercury rectifiers, has been made available by the United Electronics Co., 42 Spring St., Newark, N. J.

Plate characteristic curves are given for each tube type, together with mechanical dimensions, general ratings, etc. Four special oscillator tubes for ultra-high-frequency diathermy apparatus are also covered. ALL-WAVE RADIO.

NEW BURSTEIN-APPLEBEE CATALOG

BURSTEIN-APPLEBEE CO., 1012 McGee St., Kansas City, Mo., have available for free distribution their new 1938 Wholesale

WTEC manufactures the **MOST COMPLETE LINE OF RADIO TRANSFORMERS IN THE WORLD . . . Ask your local jobber for our new catalog No. P.S. 401.**

Buyers' Guide No. 54—an 8 by 11 inch catalog with 162 pages of radio, public-address, electrical and refrigeration equipment. Parts and equipment for the Amateur, Experimenter, Listener and Serviceman are included.

A handy chart which makes it easy to calculate what value of resistor to use for a specific purpose is printed on the back cover. ALL-WAVE RADIO.

LEEDS FALL & WINTER CATALOG

AN ATTRACTIVE 188-page Catalog and Buying Guide, listing radio equipment of every type for Amateurs, Servicemen, Experimenters and Laboratory Workers, has been issued by Leeds, 45 Vesey St., New York, N. Y. Included in the catalog is the complete line of General Radio standard equipment. Free copies are available upon request to Leeds. ALL-WAVE RADIO.

ANTENNA SYSTEM LITERATURE

THE ANTENNA NEEDS of any set, owner and locality can be readily met by means of the concise general catalog just issued by Technical Appliance Corp., 17 East 16th St., New York City. This literature covers several types of self-selecting all-wave antenna systems, the master antenna system for multiple outlets in apartment houses and even private dwellings, and a variety of couplers, wave traps and line-noise filters. Copy may be had from local jobber or from company direct. ALL-WAVE RADIO.

"CAPITOL RADIO" BROCHURE

A DISTINCTIVE and well illustrated brochure containing 46 pages, has been made available, free of charge, by the Capitol Radio Engineering Institute, Riggs Bank Building, Washington, D. C., to those seriously interested in radio as a livelihood.

Covered in this brochure is Capitol's Tested Plan for a Future in Practical Radio Engineering, and details on their Home Study, Residence, combination Home Study and Residence, and Evening Residence Courses. Details of their "Personalized" Instruction methods, and the scope of the courses are also outlined. ALL-WAVE RADIO.

"CLEAR RECEPTION"

UNDER THE TITLE of "Clear Reception," an attractive and mighty interesting folder is offered by Aerovox Corporation of 70 Washington St., Brooklyn, N. Y., on the subject of background noise suppression. This literature deals with the several ways in which noises reach a receiver, and how

they may be stopped either at the set itself or preferably at the noise source. Also featured are the several types of noise eliminators or filters now available. A copy may be had through any Aerovox jobber or from the manufacturer direct. ALL-WAVE RADIO.

HAMMARLUND 1938 CATALOG

HAMMARLUND MFG. CO., 424 West 33rd St., New York, N. Y., have issued their new 1938 Catalog of Precision Radio Products. It has a simplified design, permitting quick access to information about all products. In view of this, the engineer, the amateur and experimenter should again find the "38" catalog very helpful in his work.

In the "38" catalog, we find such additional items as the new neutralizing condensers, a new 100-mmf. double-spaced condenser, a new double-spaced single and dual micro condenser, the new "Super-Pro" console model receivers, etc.

You can obtain a free copy of this new catalog upon request to Hammarlund. ALL-WAVE RADIO.

NEW CINAUDAGRAPH CATALOG

THE CINAUDAGRAPH Corporation, of Stamford, Connecticut, has just announced the release of Catalog No. 137, describing in detail their new line of permanent magnet speakers. These speakers utilizing the famous magnetic steel alloy "Nipermag" in their construction, are amply illustrated and described in this book, with graphs showing frequency response curves and tables.



The "inside" story of the Magic Magnet Speakers, as contained in this catalog, will be of particular interest to engineers, sound men and radio servicemen. Copies can be obtained by addressing the Cinaudagraph Corporation in Stamford. ALL-WAVE RADIO.

NEW BIRNBACH CATALOG

A NEW LIST PRICE Birnbach Catalog, the first to be issued in 3 years, has just come off the press. Profusely illustrated and beautifully printed in 2 colors, it is said to be the most complete of its kind in this particular branch of the Radio Industry. Over



Is Radio . . . Just a Job to You?

If you can equip yourself with the necessary training . . . Radio can offer you a future no other industry can. Continuous new developments have created a need for technically trained men, who have kept their knowledge up with Radio's fast pace.

YOU CAN'T BLUFF YOUR WAY

CREI courses are planned only for serious-minded men who know that it takes Training to qualify for and to hold the big jobs and salaries that go with them. Let us suggest the course best suited for you and the easy ways of paying for it.

ILLUSTRATED CATALOG FREE

Mail Coupon Below for Your Copy.
CAPITOL RADIO ENGINEERING INST.
Dept. AW-1
14th and Park Road, N. W., Washington, D. C.

RIGHT NOW—WRITE NOW!

Capitol Radio Engineering Inst., Dept. AW-1
14th & PARK RD. N.W. WASHINGTON, D.C.
Please send me without obligation your Free Book
—"A Tested Plan for a Future in Practical Radio Engineering."

Name

Address

City State

LEEDS HAS ALL PARTS Necessary for Construction of "THE AWR AUTOMATIC" and "THE NEW-COMER TRANSMITTER"

The parts required may be obtained individually or in Kit form at
LEEDS

Complete Stock
of
Communication Receivers, Transmitters, Tubes, Microphones, Amateur Parts and Equipment.

No matter what you require
LEEDS HAS IT!

Service - Quality - Price

THE HEADQUARTERS STORE FOR AMATEURS

LEEDS 45A Vesey Street
New York City
The House of Radio

Tel. Cortlandt 7-2612 Cable Address: "RADLEEDS"

See Your Distributor for Sheets
Listing New Micamold Products



**MICAMOLD PRODUCTS
CORP.**

Flushing and Porter Aves. Brooklyn, N. Y.

For
HIGH-VOLTAGE
Jobs



Oil-filled capacitors. Compact. Inexpensive. Due to HYVOL—the new super-dielectric oil.

Same size and mounting as usual electrolytic. 1½" dia. Either 2¾" or 4½" tall.

Grounded can. May be insulated with insulator washer and can contact lug.

.5 to 4 mfd. 600, 1000 and 1500 v. D.C. working.

HYVOL HIGH-VOLTAGE CAPACITORS

For those compact transmitters or P.A. jobs or wherever higher voltages must be handled safely, dependably, economically, you will find these units just the thing. Also available in large round-can units and in rectangular units.



Typical of the versatility of the AEROVOX line in meeting your radio and allied requirements.

Ask . . .

your local jobber for latest catalog listing the AEROVOX line of condensers and resistors.



3,000 items are listed including a complete line of antennae and antenna accessories, insulators of all kinds, sockets, jacks and plugs. Wires, conductors and cables are covered in completeness. A free copy may be had by addressing Birnbach Radio Co., Inc., 145 Hudson Street, N. Y. C. ALL-WAVE RADIO.

MASTER ANTENNA SYSTEM MANUAL

A NEW MASTER Antenna System Manual just issued may be had from the local Taco jobber or by writing the Technical Appliance Corp., 17 East 16th St., New York City. This latest edition covers the profit-making possibilities of the master antenna system as applied not only to apartment houses and other large buildings, but also to individual dwellings wherein many radio set outlets are required. It deals with the theory, installation and operation of such a system, as well as the survey of buildings and estimating. ALL-WAVE RADIO.

WHOLESALE ATLANTA BRANCH EXPANDS

WHOLESALE RADIO Service Company's Atlanta branch has leased the entire building at 265 Peachtree Street, Atlanta, Georgia, for use as its new headquarters after January 15th, 1938.

The new building contains approximately 25,000 square feet of space and has been entirely modernized. In line with Wholesale's effort to provide the very latest in radios, test equipment, replacement parts and public address systems the new building will have a number of highly attractive demonstration salons, a fully equipped serviceman's department and a Sound Auditorium of the newest and most modern type. ALL-WAVE RADIO.

WIKK JOINS WHOLESALE BOSTON BRANCH

WHOLESALE RADIO SERVICE Company announces the appointment of W. Allen Stuart to take charge of "ham" activities in its new Boston branch at 110 Federal Street. Mr. Stuart has long been a resi-

dent of Newton, Mass., and for 11 years was assistant manager of the Boston store of the Sager Electrical Supply Company.

Mr. Stuart's well-known "ham" call is W1LKK. Long an active member of the Eastern Massachusetts Radio Club, he also holds the rank of Assistant Radio Aide (with Sergeant's rating) on the 160 meter net of the AARS (Army Amateur Radio System) of the 1st Corps Area. ALL-WAVE RADIO.

BACKWASH

(Continued from page 35)

demned 10 programs. (Is it possible Mr. Piechuta's memory is worse than that he attributes to Mr. Bouck?) Personally I'm disgusted with Bouck. I'm actually losing faith in him. If his proportion had been something like nine condemnations to one praise, he would have come a bit closer to actualities as they exist in our tripe-ridden air. Mr. Bouck is obviously losing his nerve. By far the greater part of condemnatory material appearing in *Channel Echoes* is submitted by readers, as "radio-dors"—and not conceived by its editor with the softening spine.

As to Mr. Hinds' quotation from a previous article by Bouck—said quotation being published in 1934—I have little to say, except to commend, as always, Mr. Hinds' good taste. If Bouck ever said that he received, or rather asked for a veri, I'm inclined to call Bouck a liar. There are simply no two ways about that. That is veries in the usual sense of the word. It is possible, and it seems to me probable, that Bouck was referring to QSLs as received in response to his own transmissions. He does get a kick out of these—always has, and probably always will—and keeps them filed in a perpetually expanding card file. He even sends them out himself. In fact, he sent one out today—with his sincere best regards—to Joseph A. Piechuta.

ZEH BOUCK,
MIDDLEBURG, N. Y.

(Okay—you can come out of the dog house now.—Editor)

INDEX TO ADVERTISERS

Aerovox Corporation	58	Micamold Manufacturing Co.	57
Aladdin Radio Industries Inc.	53	Midland Television, Inc.	55
Allied Radio Corporation	50	Montgomery Ward	47
American Communications Corp.	54	National Company, Inc.	Third Cover
American Radio Hardware Co.	55	Par-Metal Products Corp.	48
Birnbach Radio Company, Inc.	53, 56	Raytheon Production Corp.	56
Capitol Radio Engineering Inst.	57	Silver, Inc., McMurdo	51
Cornell Dubilier Corporation	48	Solar Manufacturing Corp.	50
Hallicrafters, Incorporated	Back Cover	Standard Transformer Corp.	50
Hammarlund Manufacturing Co.	54	Taylor Tubes, Inc.	49
Jefferson Electric Company	55	Teleplex Company	54
Johnson Company, E. F.	50	Transmitter Equipment Mfg. Co., Inc.	54
Kenyon Transformer Company	52	United Transformer Corp.	56
Leeds	57	Utah Radio Products Corp.	46
Mallory & Co., Inc., P. R.	45	Wholesale Radio Service Co., Inc.	56
Meissner Manufacturing Co.	52		

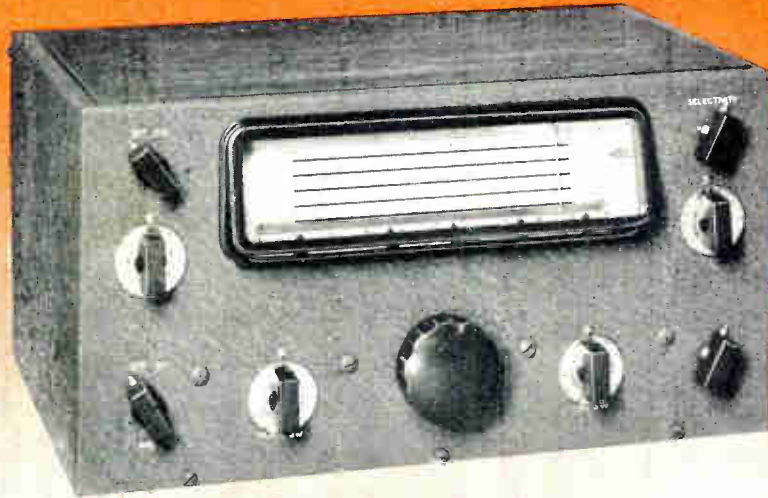

In these few short months the NC-80X has become part of the National tradition. Their advanced circuit details, including the wide-range crystal filter and high IF frequency for image rejection, have brought a new standard of performance to the low priced field. Their thoroughbred construction keeps that performance consistently high. And their convenience makes operation swift, accurate, and tireless.

NATIONAL NC-80X

National Company, Inc.
Malden, Mass.

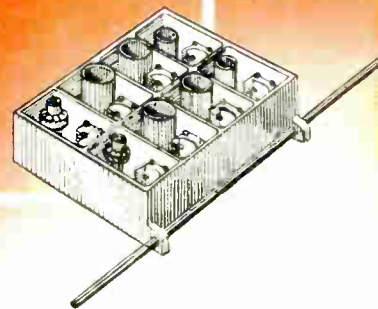

A page from the Hallicrafters Scrapbook



THE CONTROL BOARD OF WFBR, NBC station, of Baltimore, Md., showing panel installation of 1938 Super Skyrider.



HENRY HOFFMAN, operator for Rev. Father Paul Schulte, "Flying Priest of the Arctic," writes from his post in the Arctic waste—
 "With the Sky Challenger, low-power transmitters were received over a surprisingly long distance, where all other receivers I used this summer in the Hudson Bay failed."
 Hallicrafters receivers are also used in the Mac Gregor Expedition now in the Arctic regions.



ENRIQUE HIDALGO — CIE-FUEGOS, CUBA — Winner of second prize in the All-Wave B. C. DX contest with his new Super Skyrider. He says: "The receiver has created a sensation here where it has astonished every new listener."

T H U M B I N G through the Hallicrafters' Scrap Book, one cannot help being impressed by the widespread acceptance of Hallicrafters Communications Receivers. We are proud to show on this page a very few of the outstanding personalities who operate Hallicrafters receivers and their rigs... The very fact that Hallicrafters receivers figure so prominently in leading amateur, commercial and scientific stations is in itself a testimonial to the merits of these outstanding receivers.



W1KTC — BEATRICE HOLMAN, Belmont, Mass.: "The more I operate the Super Skyrider, the better I like it and I am only too glad to add my word of praise. Am on 10 meters at present and have heard plenty of DX this morning that I never copied before."



TED ROGERS—famous short wave radio columnist of the N.Y. World Telegram spins the dial of his Super Skyrider.



W2AMJ — FRANK LESTER, Bergenfield, N. J., at the controls of his 1938 Super Skyrider.



W3DTX — W. W. KELLUM, Washington, D.C., says: "I selected the Super Skyrider because it is one of the best receivers on the market today including price and performance. In a little over a month, I have worked more DX than ever before and have had good receivers in the shack."

All Hallicrafters' Receivers available on liberal time payments

the hallicrafters inc.

2605 Indiana Avenue, Chicago, U. S. A. • Cable Address "Hallicraft" Chicago
WORLD'S LARGEST BUILDERS OF AMATEUR COMMUNICATIONS RECEIVERS