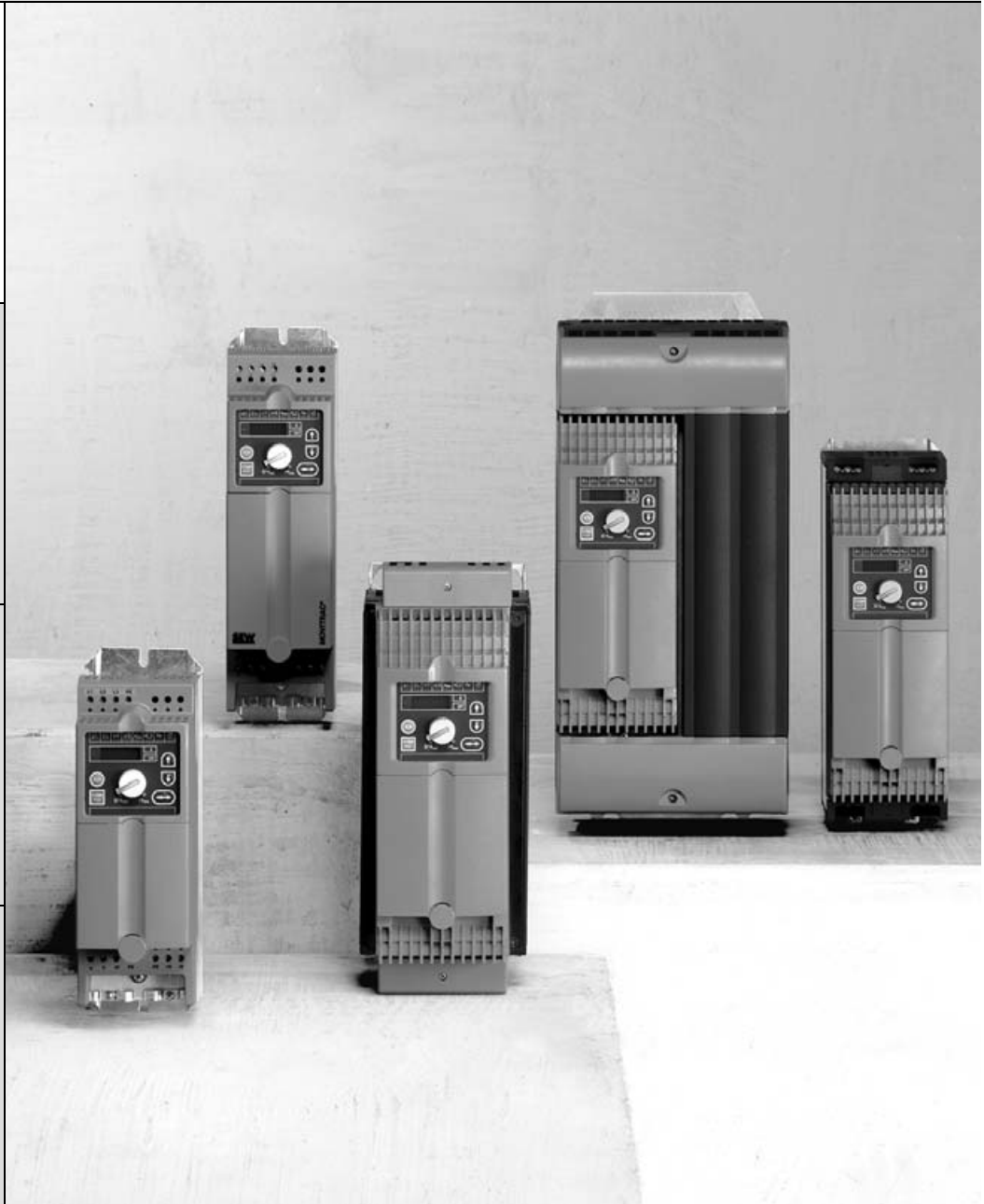
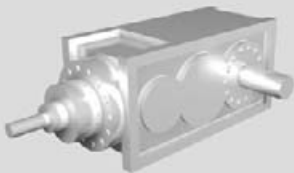




SEW
EURODRIVE



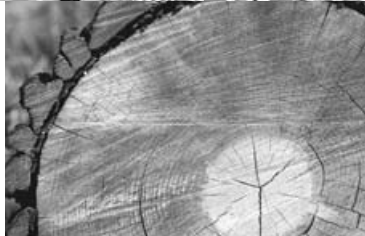
MOVITRAC[®] 07

GA320000

Edition 07/2004

11299126 / EN

Operating Instructions





1	Important Notes	4
2	Safety Notes	6
3	Unit Design	7
	3.1 Unit design	7
	3.2 Unit designation and scope of delivery	11
4	Installation	13
	4.1 Installation notes	13
	4.2 UL compliant installation	18
	4.3 Power shield clamp.....	19
	4.4 Touch guard.....	20
	4.5 Wiring diagram 230 V 0.37 ... 2.2 kW / 400 V 0.55 ... 4.0 kW.....	21
	4.6 Wiring diagram 230 V 3.7 ... 30 kW / 400 V 5.5 ... 45 kW.....	22
	4.7 Terminal assignment / Connection of the brake rectifier.....	23
	4.8 System bus (SBus) installation	24
5	Startup	25
	5.1 General startup instructions	25
	5.2 Preliminary work and resources.....	25
	5.3 Integrated operating panel	26
	5.4 Principles of operation with the integrated operating panel	27
	5.5 Manual Manual speed control module and external setpoint selection ..	29
	5.6 Startup using the integrated operating panel.....	32
	5.7 Starting the motor	34
	5.8 Loading a LOGODrive program	35
	5.9 Parameter list.....	36
6	Operation and Service	44
	6.1 Fault information	44
	6.2 List of faults (F-00 ... F-97).....	46
	6.3 List of warnings (r-17 ... r-32).....	48
	6.4 Status displays.....	48
	6.5 Unit status codes	49
	6.6 SEW-Electronics service.....	49
7	Technical Data	50
	7.1 CE marking, UL approval and C-Tick	50
	7.2 General technical data	51
	7.3 Technical data of MOVITRAC® 07	52
8	Change Index	82
9	Index	83



1 Important Notes

Safety and warning notes

Always follow the safety and warning notes in this publication!



Electrical hazard

Possible consequences: Severe or fatal injuries.



Hazard

Possible consequences: Severe or fatal injuries.



Hazardous situation

Possible consequences: Slight or minor injuries.



Harmful situation

Possible consequences: Damage to the unit and the environment.



Tips and useful information.



You must adhere to the operating instructions to ensure:

- Trouble-free operation
- Fulfillment of any rights to claim under limited warranty

Consequently, read the operating instructions before you start working with the unit!

The operating instructions contain important information about servicing. Therefore, keep the operating instructions close to the unit.

Designated use

MOVITRAC® 07 frequency inverters operate AC asynchronous motors. These motors must be suitable for operation with frequency inverters. Do not connect any other loads to the frequency inverters.



MOVITRAC® 07 frequency inverters are units intended for stationary installation in control cabinets. All instructions referring to the technical data and the permissible conditions where the unit is operated must be followed.

Do not start up the unit (take it into operation in the designated fashion) until:

- The machine complies with the EMC Directive 89/336/EEC
- The conformity of the end product has been determined in accordance with the Machinery Directive 89/392/EEC (with reference to EN 60204)

Operational environment

The following applications are forbidden unless measures are expressly taken to make them possible:

- Use in explosion-proof areas
- Use in environments with harmful substances:
 - Oils
 - Acids
 - Gases
 - Vapors
 - Dust
 - Radiation
 - Other harmful environments
- Use subject to mechanical vibration and shock loads in excess of the requirements in EN 50178
- If the inverter performs safety functions which have to guarantee the protection of machinery and people

Waste disposal

Please follow the latest instructions: Dispose of the following materials in accordance with the regulations in force:

- Electronics scrap (circuit boards)
- Plastic (housing)
- Sheet metal
- Copper



2 Safety Notes

Installation and startup



- **Never install damaged products or take them into operation.** Please submit a complaint to the transport company immediately in the event of damage.
- **Installation, startup and service work** on the unit only by **trained personnel**. The personnel must be trained in the relevant aspects of accident prevention and must comply with the regulations in force (e.g. EN 60204, VBG 4, DIN-VDE 0100/0113/0160).
- Follow the **specific instructions** during **installation** and **startup** of the motor and the brake!
- Make sure that **preventive measures** and **protection devices** correspond to the **applicable regulations** (e.g. EN 60204 or EN 50178).
Grounding the unit is a necessary protective measure.
Overcurrent protection devices are a necessary protective measure.
- **The unit meets all requirements for reliable isolation** of power and electronics connections in accordance with EN 50178. **All connected circuits** must also **satisfy the requirements for reliable isolation** so as to guarantee reliable isolation.
- Take **suitable measures** to ensure that the connected **motor does not start up automatically when the inverter is switched on**. To do this, you can connect binary inputs DI01 through DI03 to GND.
- Connection to the frequency inverter output is only permitted in size 0S, 0M and 0L when the output stage is inhibited.

Operation and servicing



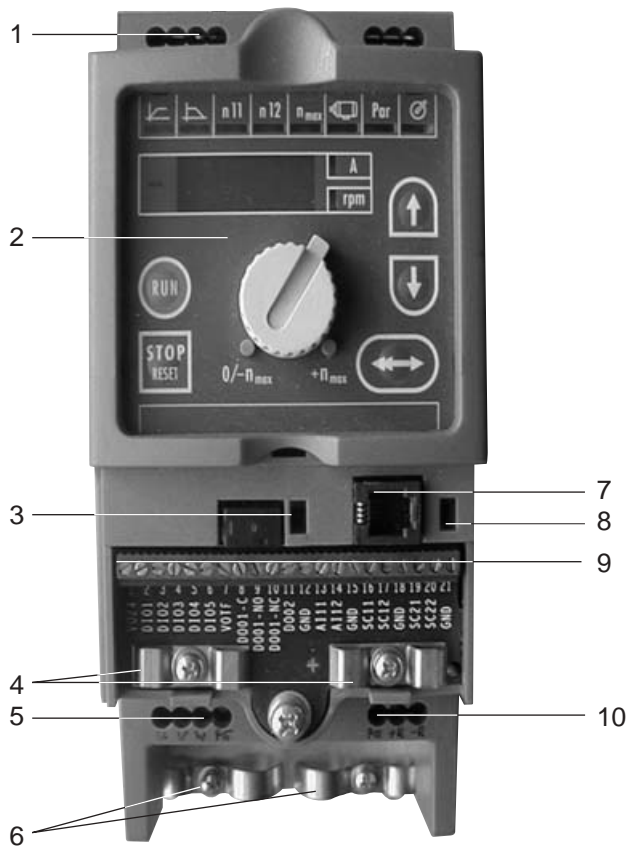
- **Dangerous voltages** are present at the **output terminals** and the **cables and motor terminals connected to them when the unit is switched on**. Dangerous voltages may also be present when the unit is inhibited and the motor at a standstill.
- The unit is **not** necessarily **deenergized** when the **LEDs and the 7-segment display are off**.
- **Safety functions inside the unit** or a **mechanical blockage** may cause the **motor to stop**. The **removal of the source of the malfunction** or a **reset** can result in an **automatic restart of the drive**. If, for safety reasons, this is **not permissible** for the driven machine, **disconnect the unit from the supply system** before correcting the fault.



3 Unit Design

3.1 Unit design

Sizes 0S, 0M, 0L



02978BXX

Figure 1: MOVITRAC® 07 unit design, sizes 0S, 0M, 0L

1. X1: Mains connection 3-phase: L1 / L2 / L3 / PE or 1-phase: L / N / PE
2. Operating panel
3. DIP switch S11 changeover U-signal / I-signal
4. Electronics shield clamp
5. X2: Motor connection U / V / W / PE
6. Power shield clamp
7. X11: RS-485 connection (only for service purposes)
8. DIP switch S12 for system bus terminating resistor
9. X10: Electronics terminal strip
10. X3: Braking resistor connection PE / R+ / R-



Sizes 1, 2S, 2

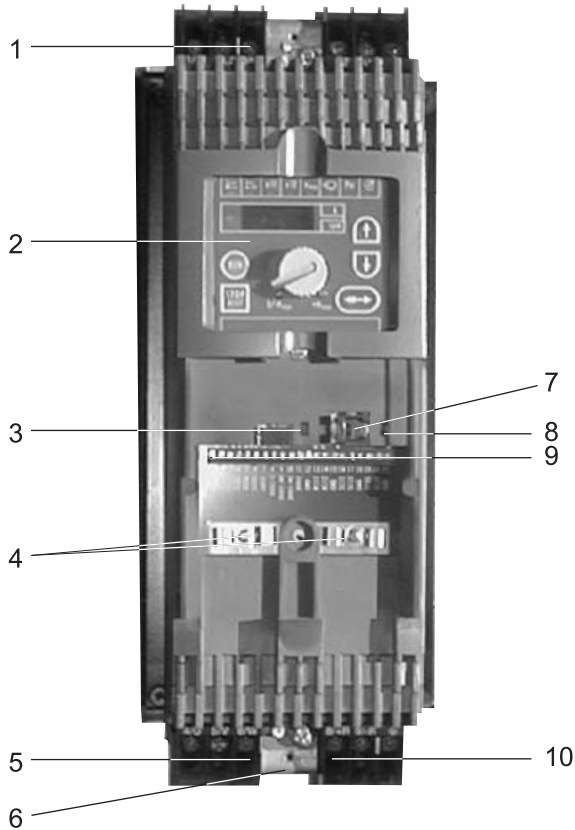


Figure 2: MOVITRAC[®] 07 unit design, sizes 1, 2S, 2 ^{05132AXX}

1. X1: Mains connection 3-phase: L1 / L2 / L3 / PE screw
2. Operating panel
3. DIP switch S11 changeover U-signal / I-signal
4. Electronics shield clamp
5. X2: Motor connection U / V / W / PE screw
6. Space for power shield clamp
7. X11: RS-485 connection (only for service purposes)
8. DIP switch S12 for system bus terminating resistor
9. X10: Electronics terminal strip
10. X3: Braking resistor connection R+ / R- / PE



Size 3

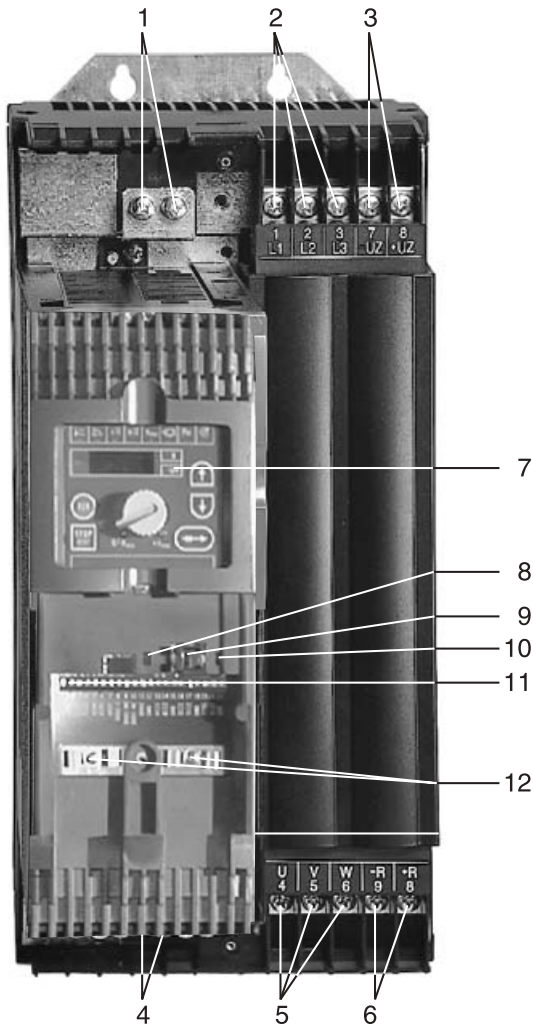


Figure 3: MOVITRAC® 07 unit design, size 3

05295AXX

1. PE connections
2. X1: Mains connection 3-phase: L1 (1) / L2 (2) / L3 (3)
3. X4: DC link circuit connection (not used)
4. PE connections (not visible)
5. X2: Motor connection U (4) / V (5) / W (6)
6. X3: Braking resistor connection R+ (8) / R- (9)
7. Operating panel
8. DIP switch S11 changeover U-signal / I-signal
9. X11: RS-485 connection (only for service purposes)
10. DIP switch S12 for system bus terminating resistor
11. X10: Electronics terminal strip
12. Electronics shield clamp



Size 4

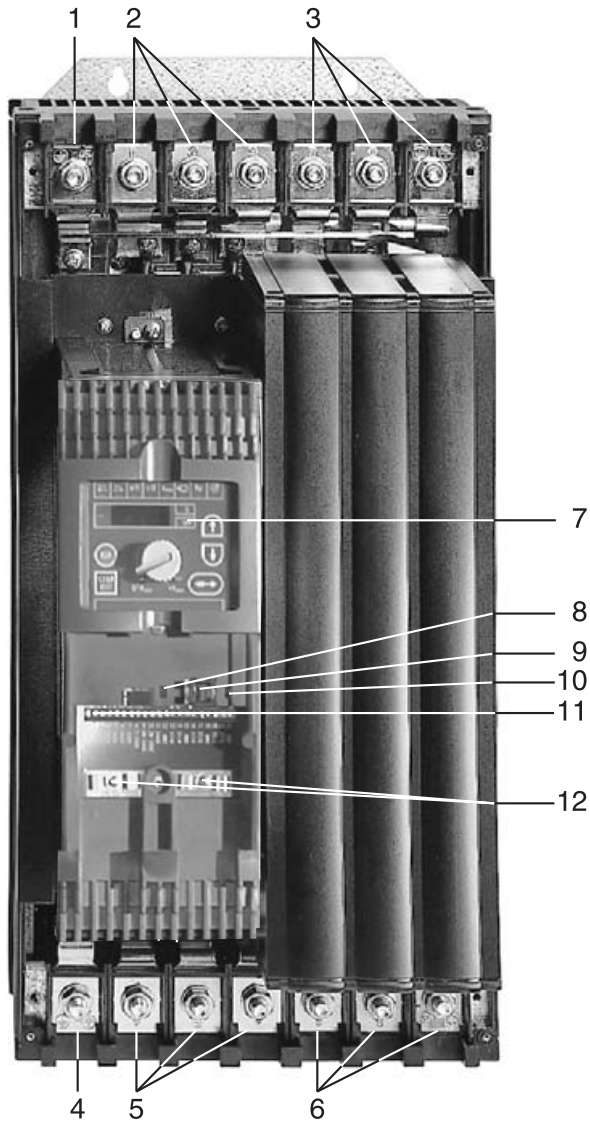


Figure 4: MOVITRAC® 07 unit design, size 4

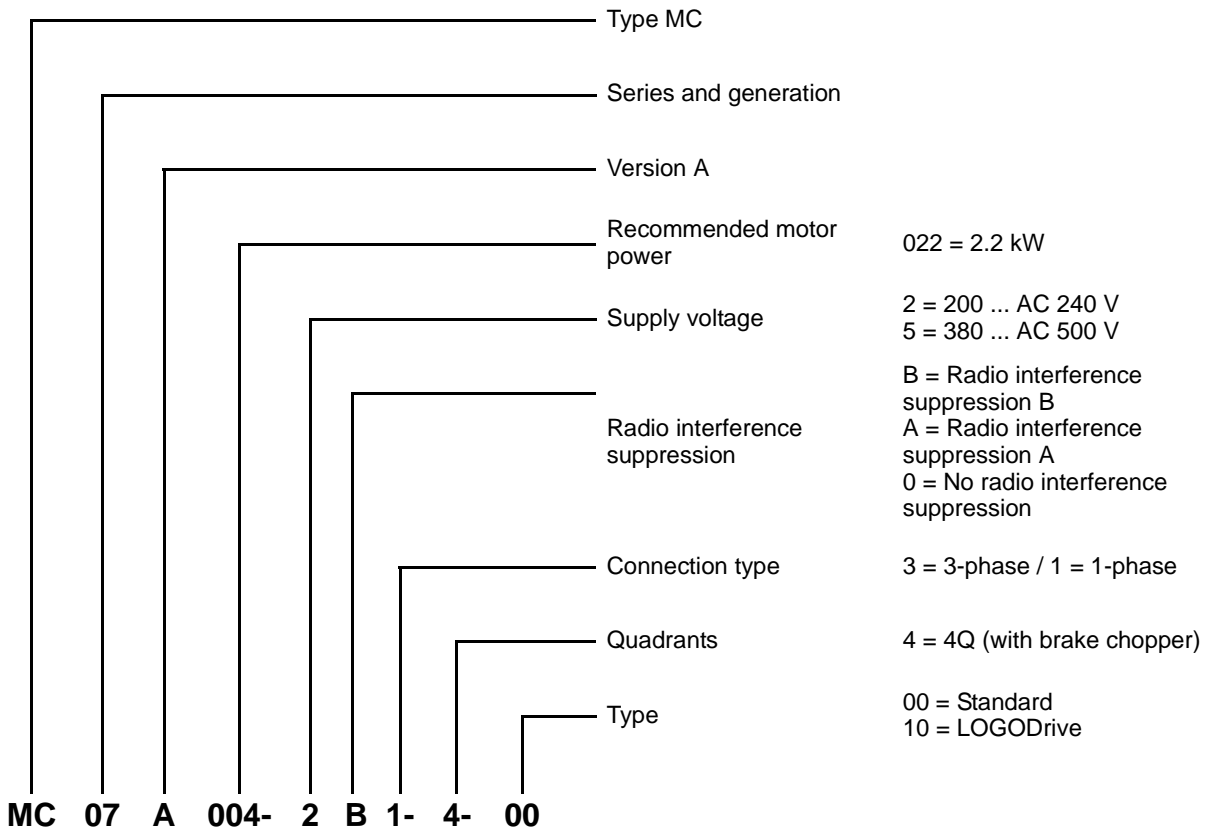
05296AXX

1. X2: PE connection
2. X1: Mains connection 3-phase: L1 (1) / L2 (2) / L3 (3)
3. X4: DC link circuit connection (not used)
4. X2: PE connection
5. X2: Motor connection U (4) / V (5) / W (6)
6. X3: Braking resistor connection R+ (8) / R- (9) and PE connection
7. Operating panel
8. DIP switch S11 changeover U-signal / I-signal
9. X11: RS-485 connection (only for service purposes)
10. DIP switch S12 for system bus terminating resistor
11. X10: Electronics terminal strip
12. Electronics shield clamp



3.2 Unit designation and scope of delivery

Sample unit designation



Sample nameplate



02940FXX

Figure 5: Sample nameplate



Scope of delivery of loose items

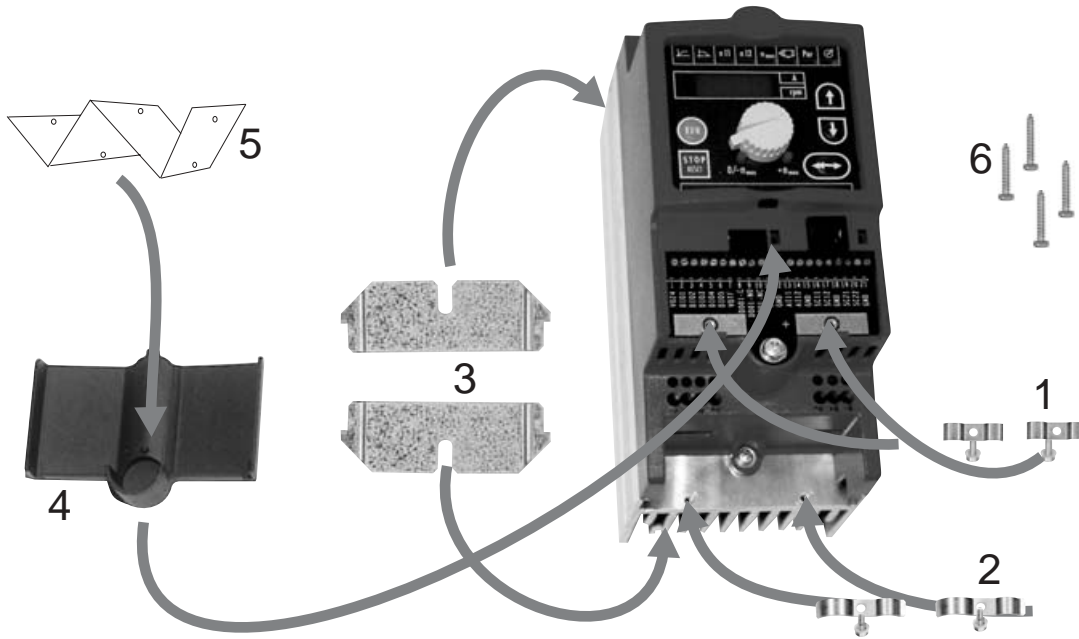


Figure 6: Scope of delivery of loose items for size 0

03000AXX

Scope of delivery of loose items for size					
0	1	2S	2	3	4
<ul style="list-style-type: none"> Shield clamps for motor and brake [2] Mounting feet for plugging into the heat sink [3] Retaining screws for optional braking resistor [6] 	<ul style="list-style-type: none"> Power shield clamp with retaining screws 	<ul style="list-style-type: none"> Mounting feet for plugging into the heat sink [3] 	<ul style="list-style-type: none"> Power shield clamp with retaining screws 	<ul style="list-style-type: none"> – 	<ul style="list-style-type: none"> Touch guard with retaining screws
<ul style="list-style-type: none"> Shield clamps for electronics cables (two clamps with one screw each) [1] Terminal cover [4] Information label for the rear of the terminal cover [5] 					



4 Installation

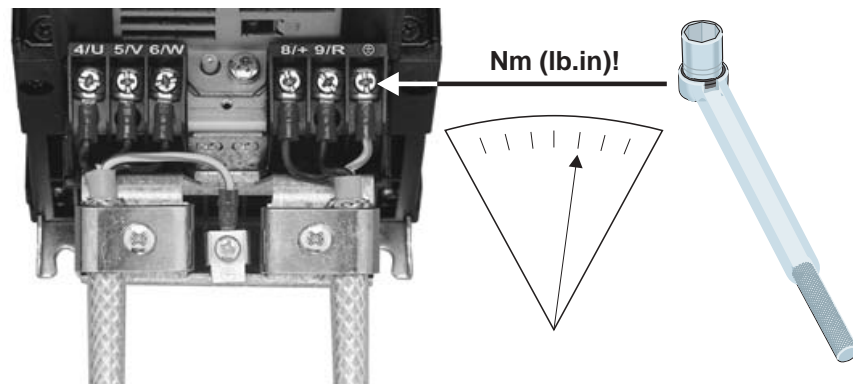
4.1 Installation notes



It is essential to comply with the safety notes during installation!

Tightening torques

- Only use **genuine connection elements**. Note the **permitted tightening torques** of MOVITRAC® 07 power terminals.
 - Size 0S/M/L → 0.5 Nm (4.4 lb.in)
 - Size 1 → 0.6 Nm (5.3 lb.in)
 - Size 2S/2 → 1.5 Nm (13.3 lb.in)
 - Size 3 → 3.5 Nm (31 lb.in)
 - Size 4 → 14 Nm (124 lb.in)



02475AXX

Figure 7: Observe the tightening torques

Recommended tools

- Use a screwdriver with a 2.5 mm wide blade for connecting the electronics terminal strip X10.

Minimum clearance and mounting position

- Leave **100 mm (4 in) clearance at the top and bottom** for optimum cooling. No lateral clearance required; the units can be lined up side-by-side. Make sure that the circulation of air is not disrupted by cables or other installation materials. Prevent the heated exhaust air from other units from blowing onto this unit. With sizes 4 and 5, do not install any components which are sensitive to high temperatures within 300 mm (11.81 in) of the top of the unit. Only install the units **vertically**. You must not install them horizontally, tilted or upside down.



Line choke

- When **more than four 3-phase units** or **more than one 1-phase unit** are connected to an **input contactor** designed for the total current, **insert a line choke in the circuit** to limit the inrush current.

Separate cable ducts

- Route power cables and electronics cables in separate cable ducts.

Input fuses and earth leakage circuit breakers

- Install **input fuses at the start of the supply system lead** after the supply bus junction. Use type D, DO, NH fuses or power circuit breakers.

Using an **earth-leakage circuit breaker as the sole protection device is not permitted**. Earth-leakage currents > 3.5 mA can arise during normal operation of the inverter.

PE input connection

- Connect the PE conductor according to the regulations of the country in question. Connect the protective earth connector of the motor to the PE terminal of the corresponding inverter.

Use grounding cables with a large cross section to ground all units to a common earth connection point or grounding bar by the shortest possible route.

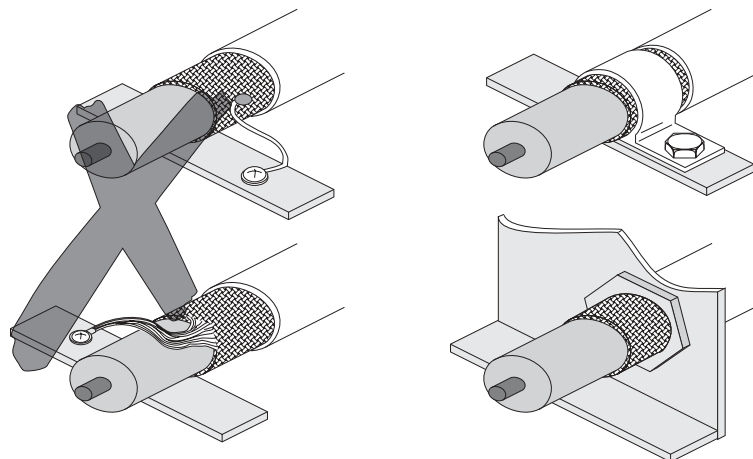
Make sure the connection between inverter and earthed metallic installation platform is conductive (wide area metal-on-metal contact between the heat sink and ground, e.g. unpainted control cabinet mounting panel). Use high-frequency compatible earthing strips.

Establish an equipotential bonding between system / control cabinet and drive / motor (e.g. through one-piece cable rack).

Earth-leakage currents > 3.5 mA can arise during normal operation of the inverter.

Shielding and earthing

- Shield the control cables.
- Connect the shield by the shortest possible route and make sure it is earthed over a wide area.
- You can ground one end of the shield via a suppression capacitor (220 nF / 50 V) to avoid ground loops.
- If using double-shielded cables, ground the outer shield on the inverter end and the inner shield on the other end.
- Provide high frequency compatible earthing for MOVITRAC® 07 and all additional units (wide area metal-on-metal contact between the heat sink and ground, e.g. unpainted control cabinet mounting panel).



00755BXX

Figure 8: Correct shield connection using metal clamp (shield clamp) or metal cable gland



- If possible, control cables and supply cables should intersect at right angles.
- You can also use earthed sheet-metal ducts or metal pipes to shield the cables.

IT systems

- SEW recommends using **earth-leakage monitors with a pulse code measuring process in voltage supply systems with a non-earthed star point (IT systems)**. This avoids mis-tripping of the earth-leakage monitor due to the earth capacitance of the inverter.

Contactor

- Only use contactors in utilization category AC-3 (IEC 158-1).

Cross sections

- Supply system lead: **Cross section according to nominal input current I_{system}** at rated load
 Motor cable: **Cross section according to rated output current I_N**
 Electronics cables: Maximum 1.5 mm² (AWG16) without conductor end sleeves
 Maximum 1.0 mm² (AWG17) with conductor end sleeves

Line lengths for single drives

The line lengths for size 0 are independent of the PWM frequency. The motor leads for sizes 1 through 4 depend on the frequency. The permitted motor cable lengths are listed in Sec. "Project Planning" of the MOVITRAC® 07 system manual.

Unit output

- Only connect an **ohmic/inductive load (motor); do not connect a capacitive load!**

ConnectionBraking resistor

- Shorten the cables to the required length.

Binary inputs / binary outputs

- **Binary outputs** are **short-circuit proof** and **interference-voltage-proof** up to 35 V. They can suffer irreparable damage from higher external voltages!

Interference emission

- Use shielded motor cables or HD output chokes for EMC-compliant installation.

Switched inductances

- Use suppressors to suppress interference on contactors, relays, solenoid valves, etc.
- The minimum distance to the inverter should be 150 mm.

Line filter

MOVITRAC® 07 frequency inverters have an integrated input filter as standard. They comply with the following limit value class to EN 55011 on the line side without further measures:

- **B**: 1-phase connection
- **A**: 3-phase connection
 - 230 V: up to 7.5 kW
 - 400/500 V: up to 11 kW



No EMC limits are specified for interference emission in voltage supply systems without an earthed star point (IT systems). The effectiveness of input filters is severely limited.



Flat-type braking resistor BW for size 0

Insert the braking resistor into the back of the heat sink. Install the braking resistor in the heat sink with the four screws provided.

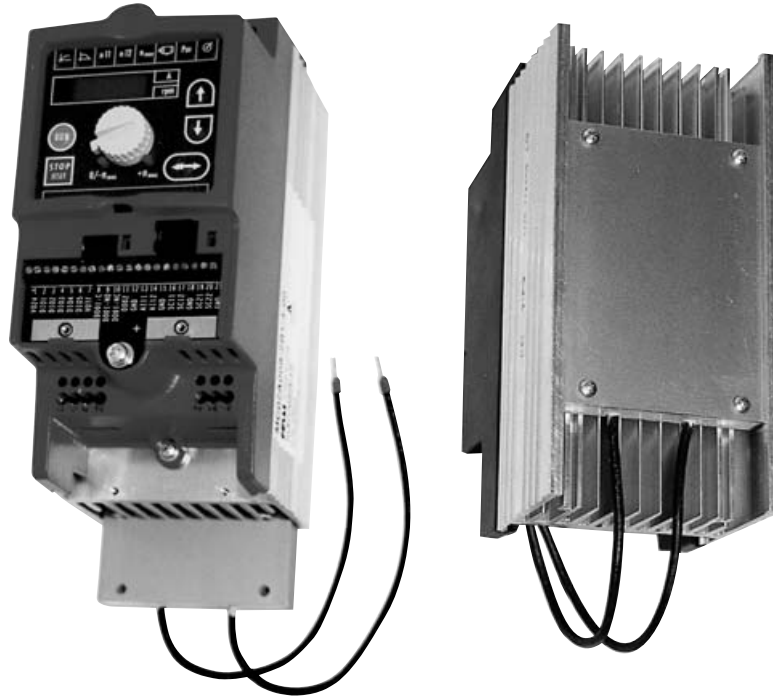
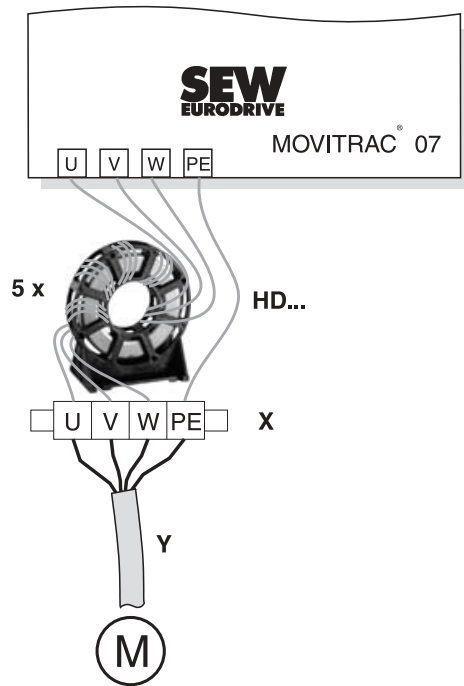


Figure 9: Installing the braking resistor BW

03164AXX



- HD output choke**
- Install the output choke close to MOVITRAC® 07 **beyond the minimum clearance**.
 - Always route all three phases (**not the PE!**) together through the output choke.
 - If the cable is shielded, the shield is **not** allowed to be routed through the output choke.



02979BXX

Figure 10: Connecting HD output chokes

With the **HD** output choke, the cable must be wrapped around the choke **5 times**.

Less than five loops are possible if the cable has a large diameter. To make up for this, two or three output chokes should be connected in series. Two output chokes should be connected in series if there are four loops, and three output chokes in series if there are three loops.



4.2 UL compliant installation

Please note the following points for UL compliant installation:

- Use only copper cables as connection cables with the following temperature ranges:
 - For MOVITRAC® 07 004 ... 300: Temperature range 60/75 °C.
 - For MOVITRAC® 07 370 and 450: Temperature range 75 °C.
- Necessary tightening torques of MOVITRAC® 07 power terminals: See installation notes.
- The inverters are only allowed to be operated on supply systems with a maximum phase-to-earth voltage of AC 300 V.
- The inverter is only allowed to be operated on IT systems if the phase-to-earth voltage of AC 300 V cannot be exceeded either during operation or in case of a fault.
- The MOVITRAC® 07 frequency inverter is only allowed to be operated on supply systems which can supply maximum values in accordance with the following table. Use only melting fuses. The performance data of the fuses must not exceed the values in the following table.

Maximum values / fuses

230 V units

MOVITRAC® 07	Max. supply current	Max. supply voltage	Fuses
004/005/008/011/015/022	AC 5000 A	AC 240 V	35 A / 250 V
037	AC 5000 A	AC 240 V	30 A / 250 V
055/075	AC 5000 A	AC 240 V	110 A / 250 V
110	AC 5000 A	AC 240 V	175 A / 250 V
150	AC 5000 A	AC 240 V	225 A / 250 V
220/300	AC 10000 A	AC 240 V	350 A / 250 V

400/500 V units

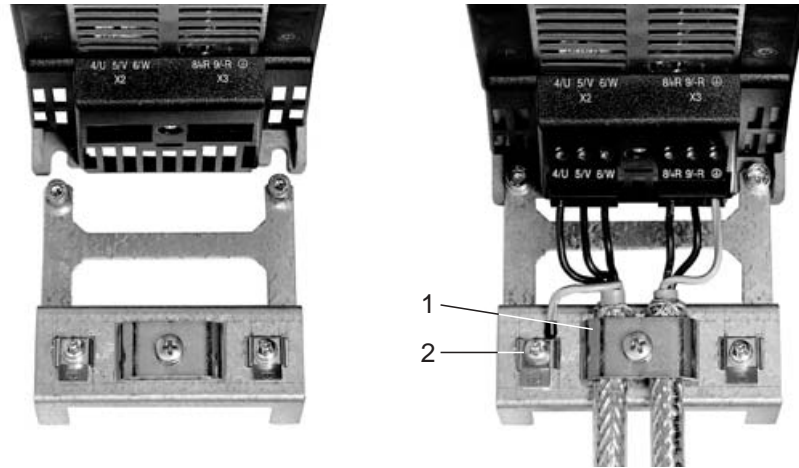
MOVITRAC® 07	Max. supply current	Max. supply voltage	Fuses
005/008/011	AC 5000 A	AC 500 V	15 A / 600 V
015/022/030	AC 5000 A	AC 500 V	35 A / 600 V
040	AC 5000 A	AC 500 V	45 A / 600 V
055/075	AC 5000 A	AC 500 V	60 A / 600 V
110	AC 5000 A	AC 500 V	110 A / 600 V
150/220	AC 5000 A	AC 500 V	175 A / 600 V
300	AC 5000 A	AC 500 V	225 A / 600 V
370/450	AC 10 000 A	AC 500 V	350 A / 600 V



4.3 Power shield clamp

Size 1

SEW-EURODRIVE supplies a power shield clamp as standard with MOVITRAC® 07 size 1. Install this power shield clamp together with the retaining screws of the unit.



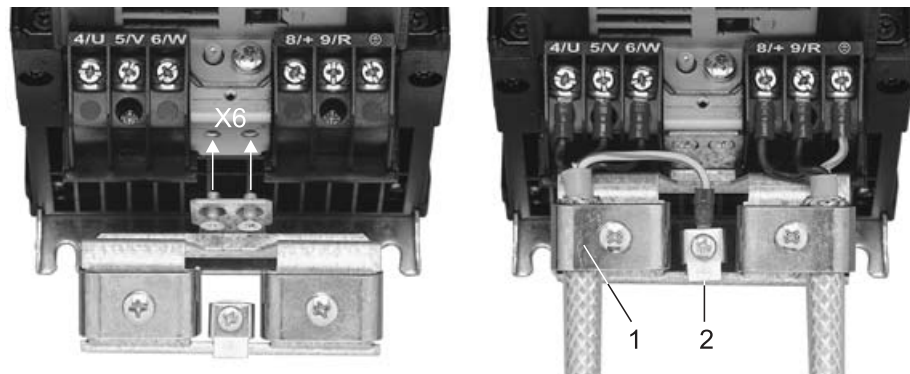
02012BXX

Figure 11: Power shield clamp for MOVITRAC® 07 size 1

1. Shield clamp
2. PE connection (⊕)

Size 2S / 2

SEW-EURODRIVE supplies a power shield clamp with two retaining screws as standard with MOVITRAC® 07 size 2S / 2. Install this power shield clamp together with the two retaining screws on X6.



01469BXX

Figure 12: Power shield clamp for MOVITRAC® 07 size 2S / 2

1. Shield clamp
2. PE connection (⊕)

Power shield clamps provide you with a very convenient way of installing the shield for the motor and brake cables. Install the shield and PE conductor as shown in the figures.



4.4 Touch guard

Size 2S

SEW-EURODRIVE supplies two touch guards for the DC link and braking resistor terminals as standard with MOVITRAC® 07 size 2S. Without touch guard, MOVITRAC® 07 size 2S has enclosure IP10. When the touch guard is installed, the unit has enclosure IP20.

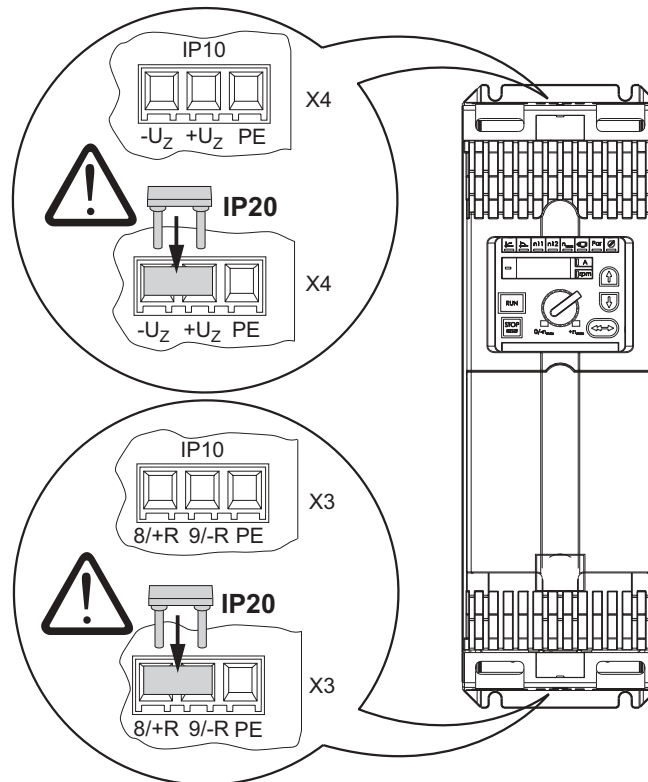


Figure 13: Touch guard for MOVITRAC® 07 size 2S

54447AXX

Size 4

SEW-EURODRIVE supplies two touch guards with eight retaining screws as standard with MOVITRAC® 07 size 4. Install the touch guard on both covers of the power section terminals.

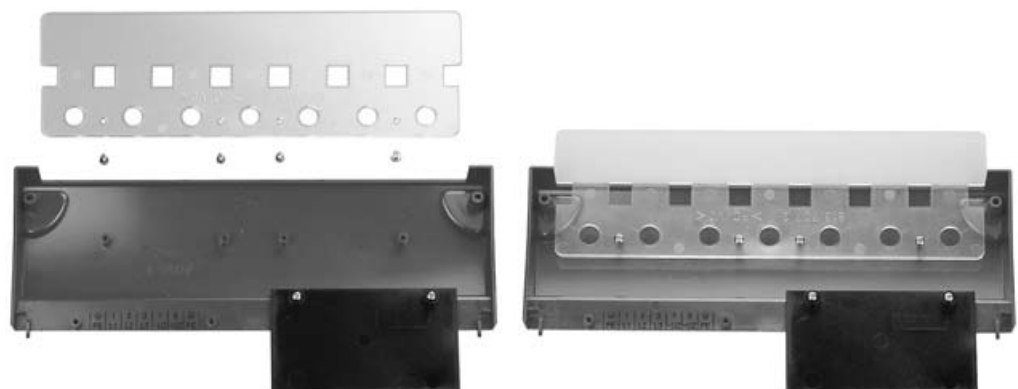


Figure 14: Touch guard for MOVITRAC® 07 size 4

01470BXX

When the touch guard is installed, MOVITRAC® 07 size 4 has enclosure IP10. The units have IP00 without touch guard.



Wiring diagram 230 V 0.37 ... 2.2 kW / 400 V 0.55 ... 4.0 kW

4.5 Wiring diagram 230 V 0.37 ... 2.2 kW / 400 V 0.55 ... 4.0 kW

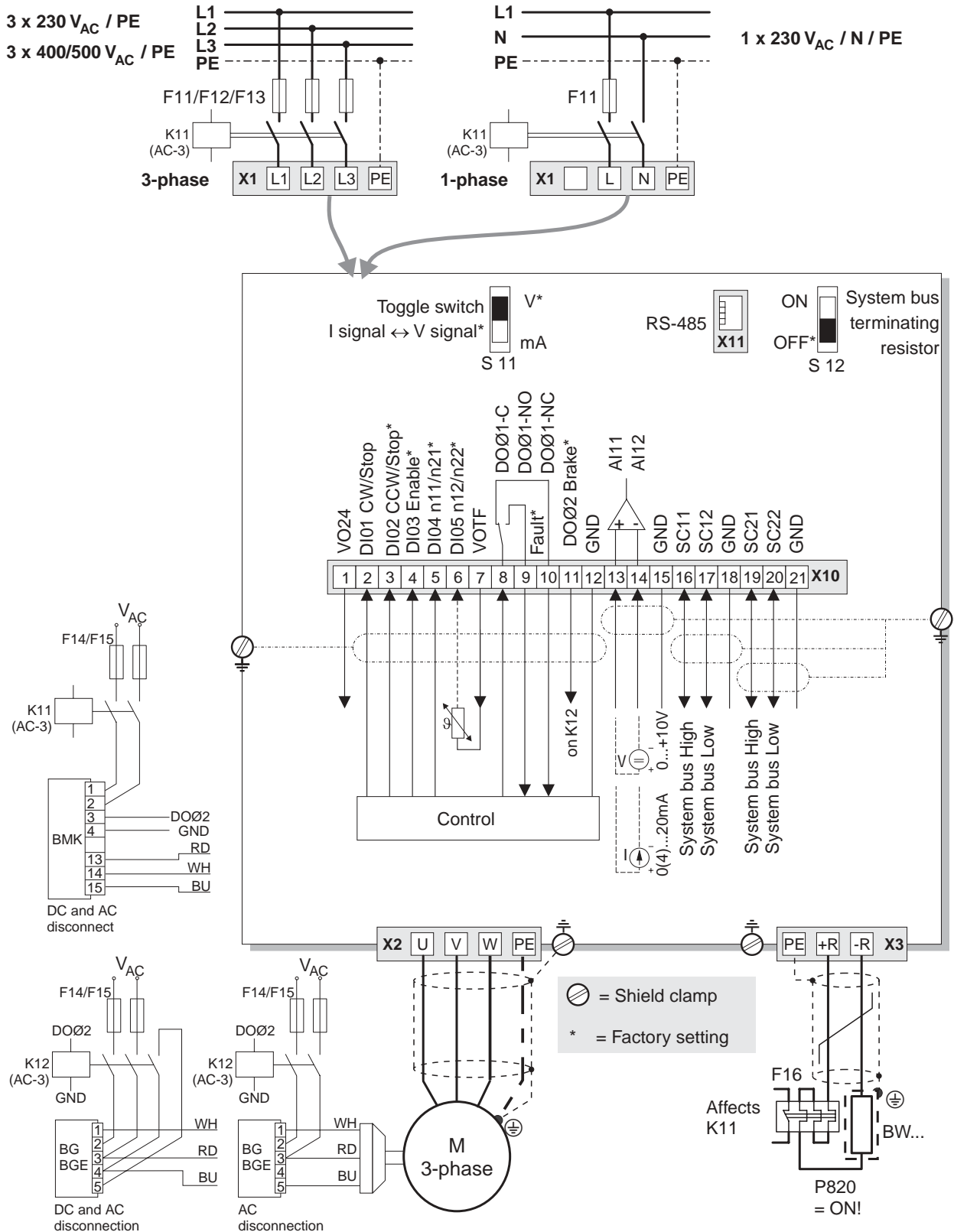


Figure 15: Wiring diagram for size 0

02943LEN



Installation

Wiring diagram 230 V 3.7 ... 30 kW / 400 V 5.5 ... 45 kW

4.6 Wiring diagram 230 V 3.7 ... 30 kW / 400 V 5.5 ... 45 kW

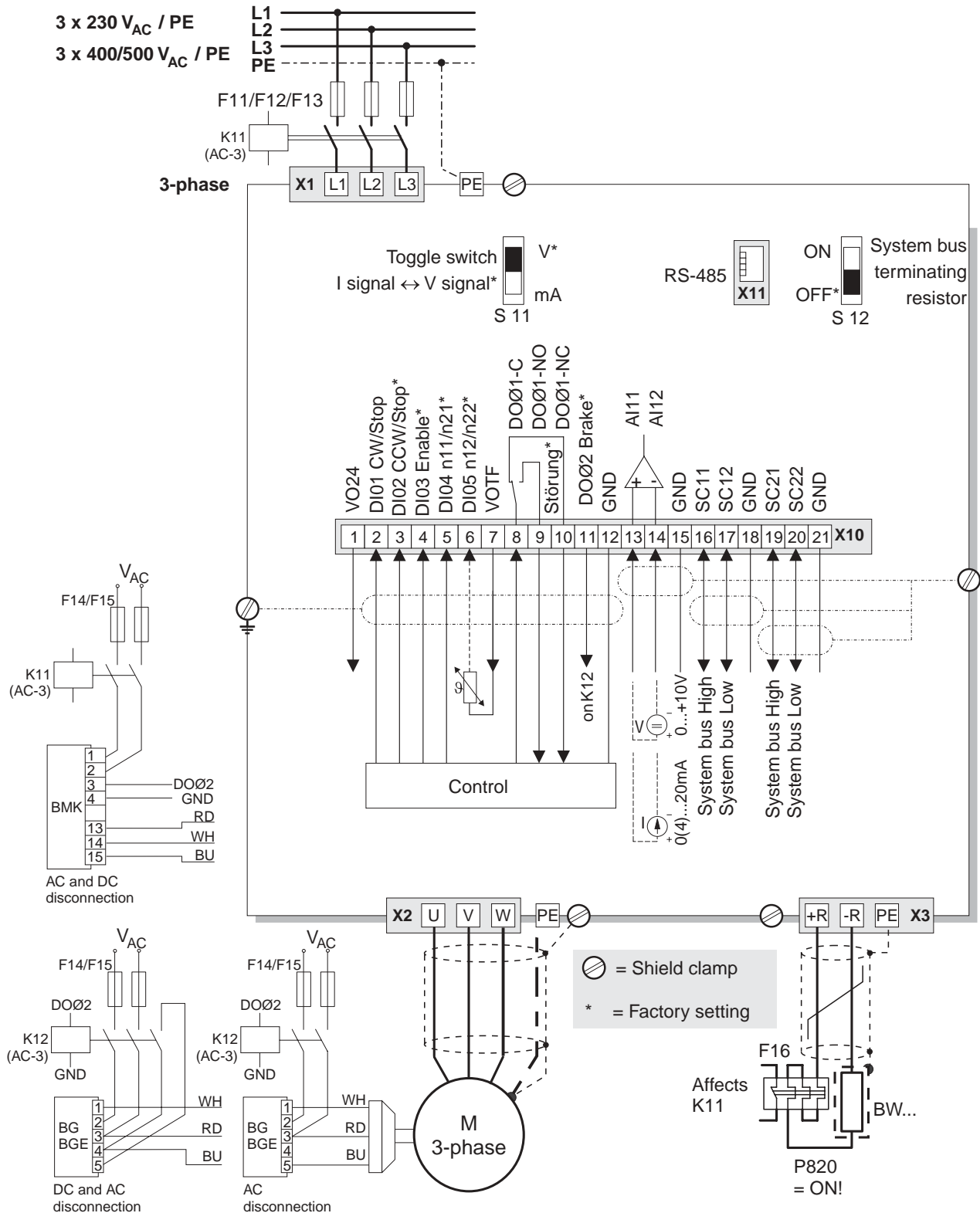


Figure 16: Wiring diagram for sizes 1 ... 4

05134CXX



4.7 Terminal assignment / Connection of the brake rectifier

Connection of the brake rectifier



A separate supply system lead is required for connecting the brake rectifier; supply from the motor voltage is not permitted!

Only use contactors in utilization category AC-3 (IEC 158-1) for K11 and K12.

Always switch off the brake on the DC and AC sides under the following conditions:

- All hoist applications
- Drives which require a rapid brake reaction time.

If the brake rectifier is installed in the control cabinet, route the connecting leads between the brake rectifier and the brake separately from other power cables. Routing together with other cables is only permitted if the other cables are shielded.

Note the corresponding connection regulations for brakes without BG/BGE or BME. Please refer to the publication "Drive Engineering - Practical Implementation, Vol. 4" for detailed information about SEW brakes.

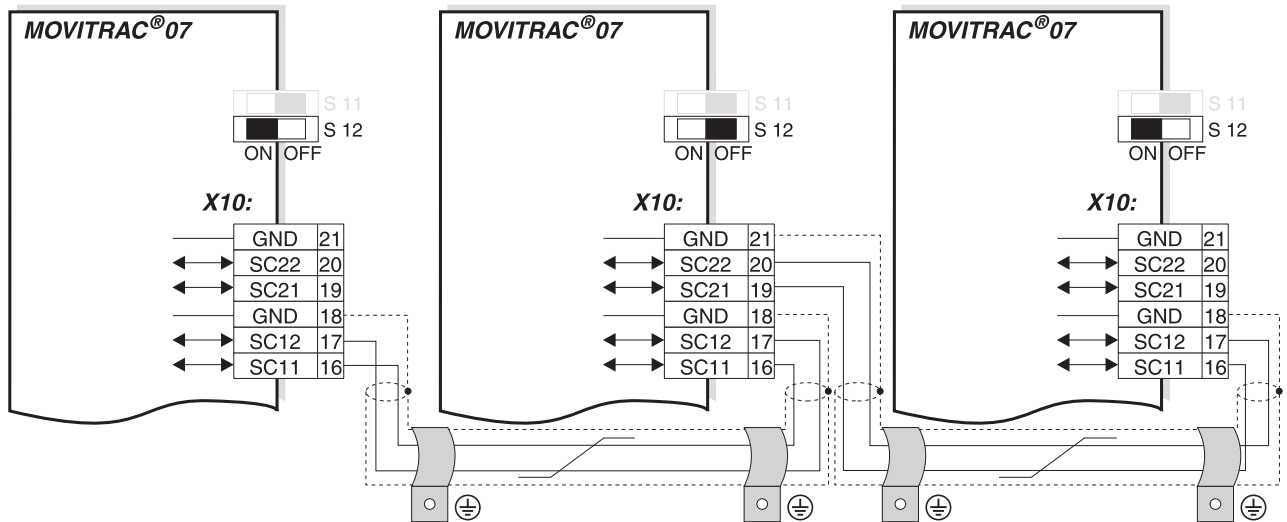
Functional description of the terminals

Terminal	Function	
X1	L1/L2/L3/PE L / N / PE	Mains connection
X2	U/V/W/PE	Motor connection
X3	PE/+R/-R	Braking resistor connection
X10:		
1	VO24	Auxiliary supply output +24 V (max. 50 mA)
2	DI01	Binary input 1, with fixed assignment CW/STOP
3	DI02	Binary input 2, factory set to CCW/Stop
4	DI03	Binary input 3, factory set to Enable
5	DI04	Binary input 4, factory set to n11/n21
6	DI05	Binary input 5, factory set to n12/n22 (TF can only be connected to DI05)
7	VOTF	Voltage supply for TF (PTC thermistor)
8	DO01-C	Binary output 1, factory set to "/Fault"
9	DO01-NO	Binary output 1, NO contact
10	DO01-NC	Binary output 1, NC contact
11	DO02	Binary output 2, factory set to "Brake released" ($I_{max} = 150 \text{ mA}$)
12	GND	Reference potential
13	AI11	Analog input 0 ... 10 V / 0(4) ... 20 mA
14	AI12	
15	GND	Reference potential
16	SC11	System bus high, incoming
17	SC12	System bus low, incoming
18	GND	Reference potential
19	SC21	System bus high, outgoing
20	SC22	System bus low, outgoing
21	GND	Reference potential
X11	RS-485	Service interface for UWS21A on PC or parameter module UBP11A

SC21 and SC22 are deactivated when S12 = ON. This is necessary in units at the end of the bus.



4.8 System bus (SBus) installation



05817AXX

Figure 17: MOVITRAC® 07 system bus connection


- GND = System bus reference
- SC22 = System bus low
- SC21 = System bus high
- SC12 = System bus low
- SC11 = System bus high
- S12 = System bus terminating resistor

SBus MOVITRAC® 07: Connect the terminating equipment to SC11/SC12. SC21/SC22 are only active when S12 = OFF.



5 Startup



Using the IN/OUT key : Press the key once to go further down into the menu structure (to select functions). To change to higher levels in the menu structure, press the key twice or make a long keypress.

5.1 General startup instructions



Strictly observe the safety notes during startup!

Prerequisite

Correct project planning of the drive is the prerequisite for successful startup.

MOVITRAC® 07 frequency inverters are factory set to be taken into operation with the SEW motor which is adapted to the correct power level (4-pole, 50 Hz).

You can connect the motor and start the drive immediately.



The startup functions described in this section are used to set the inverter so it is optimally adapted to the connected motor and to the given boundary conditions.

5.2 Preliminary work and resources

- Check the installation (Sec. Installation)).
- Connect the supply system and the motor. **Do not connect any signal terminals!**
- Switch on the power supply system.
- Display shows `stop`.
- Program the signal terminals.
- Set the parameters correctly (e.g. factory setting).
- Check the terminal assignment (→ P60_ (MOVITOOLS) / P60 (display)).
- Switch off the power supply system.
- Connect the signal terminals.
- Switch on the power supply system.





The inverter automatically changes parameter values once you perform a startup.




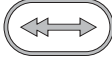



5.3 Integrated operating panel

Operation

The following basic principle applies: To start editing, press the  key once. To exit edit mode, press the  key twice.

Functions of the operating panel

The UP, DOWN and IN/OUT keys are used for navigating through the menu. The RUN and STOP/RESET keys are used for controlling the drive. The setpoint potentiometer is used for selecting setpoints.

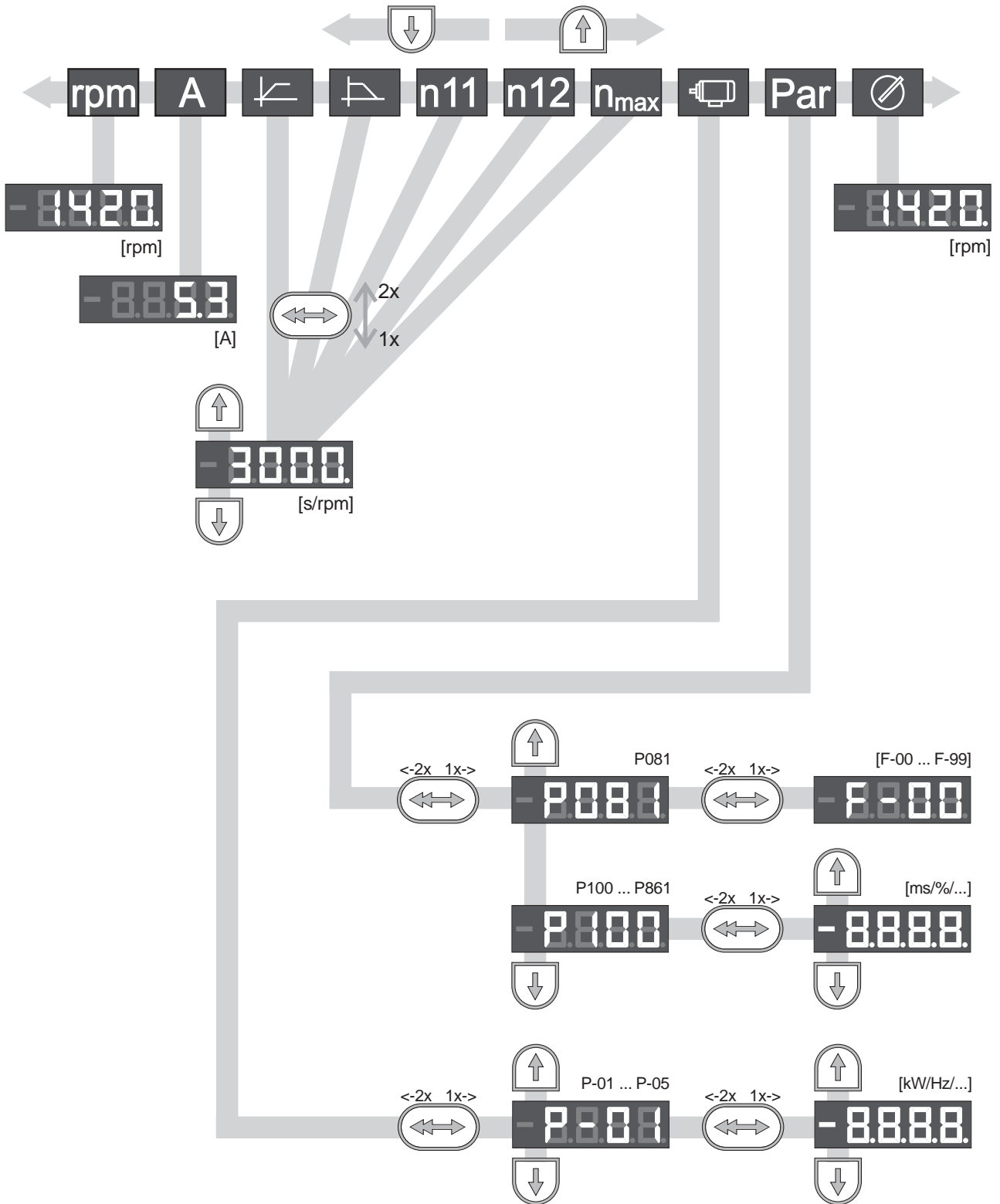
	"UP" to scroll through the symbols and to edit parameters.
	"IN/OUT" to activate/deactivate the symbols or parameter menus
	"DOWN" to scroll through the symbols and to edit parameters.
	Press "RUN" to start the drive.
	"STOP/RESET" to reset faults and stop the drive.



Stopping the drive with the STOP/RESET key is not a safety function. Switching the power off unlocks the inverter again and you can enable the inverter.



5.4 Principles of operation with the integrated operating panel














02968DXX

Figure 18: Principles of operation using the integrated operating panel (2x = press twice)



Available symbols





You can select the following symbols using the keys  and  :




Symbol	Function
	Displays the inverter status or (in "drive enabled" status) the calculated actual speed in [rpm]
	Displays the apparent output current in [A]
	Sets the acceleration ramp in [s]
	Sets the deceleration ramp in [s]
	Sets the maximum speed in [rpm]
	Sets the fixed setpoint n11 in [rpm]
	Sets the fixed setpoint n12 in [rpm]
	Motorstartup P-01 ... P-05
	Sets the inverter parameters
	Activates the manual speed control of the operating panel

Menu system

The LED integrated in the symbol lights up when you select a symbol. If a symbol only represents display values, the current display value appears immediately on the 7-segment display.

Editing parameters


After selecting the symbol  (display: P---), you can select the required parameter  by pressing  and  den gewünschten Parameter anwählen.

Pressing the  key once displays the number of the required parameter. To edit the parameter value, press the  key again. You can alter the value when the LED in the corresponding symbol flashes. The value takes effect when you exit edit mode by pressing the  key twice, or about 1 s after your last keypress.

Display

For the terminal assignment parameters (601 ... 604, 620, 621) you can select from preset combinations using parameters 60- and 62-. If you set a different combination with MOVITOOLS, the display shows ----.

Status displays

To display the status, select the  symbol. If the status is "Drive enabled", the calculated actual speed will be displayed.

- Drive "Controller inhibit": dIS (disable)
- Drive "No enable": StOP (Stop)
- Drive "Enabled": 8888 (actual speed)
- Factory settings being reactivated: SEt (Set)
- Current at standstill: dC



Fault indication If a fault occurs, the display changes to the symbol and shows the flashing fault code, e. g. F-11 (list of faults, see Sec. Operation and servicing).

Warnings Some parameters are not allowed to be altered in all operating states. If you try to do so, the following display appears: r-19 ... r-32. The display shows a code depending on the action, e.g. r-28 (controller inhibit necessary). See Sec. Operation and servicing for a list of warnings.

5.5 Manual Manual speed control module and external setpoint selection

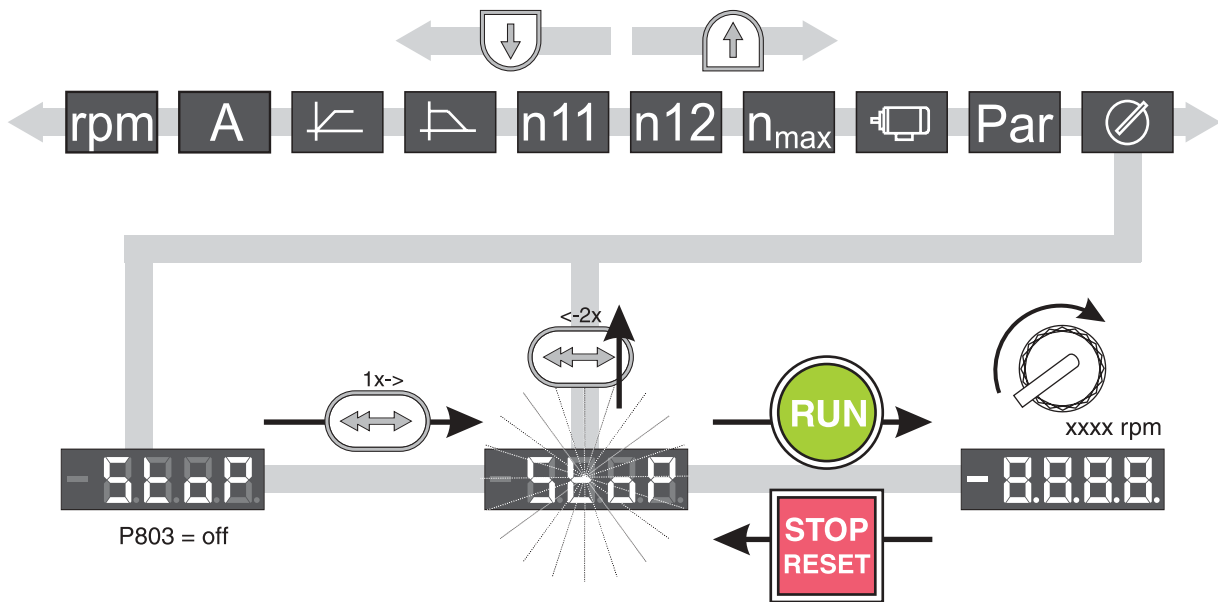
Manual speed control module of the operating panel (local manual operation): LED flashes

External setpoint selection

Control via:

- Terminals
- Serial interface
- Setpoint potentiometer on AI11/AI12

Manual speed control module



03158BXX

Figure 19: Manual setpoint adjustment (2x = press twice)

The only relevant parameters in "manual speed control module" operating mode are

- P122 local potentiometer mode
- "RUN" and "STOP/RESET" keys
- Setpoint potentiometer

An activated manual speed control module is indicated by flashing LEDs and .



You can limit the speed by setting the parameters *P301 Minimum speed* and *P302 Maximum speed*.

After a fault, you can perform a reset via terminal or interface by pressing the "STOP/RESET" key. After a reset, the "Manual speed control module" operating mode is active again. The drive remains stopped.

The *STOP* display flashes to indicate that you have to re-enable the drive by pressing the "RUN" key.

The *P760 Locking RUN/STOP keys* parameter does not have any effect in "manual speed control module" operating mode.

External setpoint selection

To enable the inverter, press the "RUN" key. To stop the inverter, press the "STOP/RESET" key. You can switch off the function of both keys using *P760 Locking RUN/STOP keys*.

Direction of rotation setpoint

You can specify the direction of rotation setpoint:

- "CW/STOP" and "CCW/STOP" in *P101 Control signal source = TERMINALS* or *P101 Control signal source = 3 WIRE-CONTROL*
- The polarity of the setpoint in the process data word in *P101 Control signal source = RS485 or SBus* and *P100 Setpoint source = RS485 or SBus*

Setpoint speed

You can assign the setpoint speed:

- The setpoint potentiometer (if *P121 Addition Setpoint Potentiom.* is set to ON)
- *P100 Setpoint source*
 - Fixed setpoints
 - Fixed setpoints with analog input
 - Process data word from SBus or RS-485 (RS-485 only for service purposes)
 - Motor potentiometer



Enable direction of rotation with RS-485 or SBus

The direction of rotation is determined by the setpoint if you set *P101 Control signal source* and *P100 Setpoint source* to RS485 or SBus (RS4-85 only for service purposes). You must enable the setpoint via SBus or RS-485 using the "CW/STOP" or "CCW/STOP" terminal. **SEW-EURODRIVE recommends to enable the setpoint using the "CW/STOP" terminal**, which has a fixed program setting, rather than with the programmable "CCW/STOP" terminal.

"CW/STOP" terminal	"CCW/STOP" terminal	Direction of rotation enable
0	0	Drive inhibited
1	0	CCW and CW (direction of rotation depends on the setpoint)
0	1	CCW and CW (direction of rotation depends on the setpoint)
1	1	Drive inhibited

The "CW/STOP" and "CCW/STOP" terminals determine the direction of rotation if

- *P101 Control signal source* is set to RS485 or SBus
- and
- *P100 Setpoint source* is set to
 - UNIPOL./FIX.SETPT
 - MOTOR POT
 - FIX SETP+AI1
 - FIX SETP*AI1
 - FREQUENCY INPUT

STOP/RESET



The STOP/RESET key has priority over enable via terminal or interface. If you stop a drive using the STOP/RESET key, you have to enable it again using the RUN key.



Switching the power supply system off and on re-enables the inverter!

You can perform a reset after a fault has occurred with a programmed fault response by pressing the STOP/RESET key. The drive is then inhibited and must be enabled using the RUN key.

RUN



If you stop the drive with the STOP/RESET key, the Stop display flashes. This indicates you have to enable the drive using the "RUN" key.



Startup

Startup using the integrated operating panel

5.6 Startup using the integrated operating panel

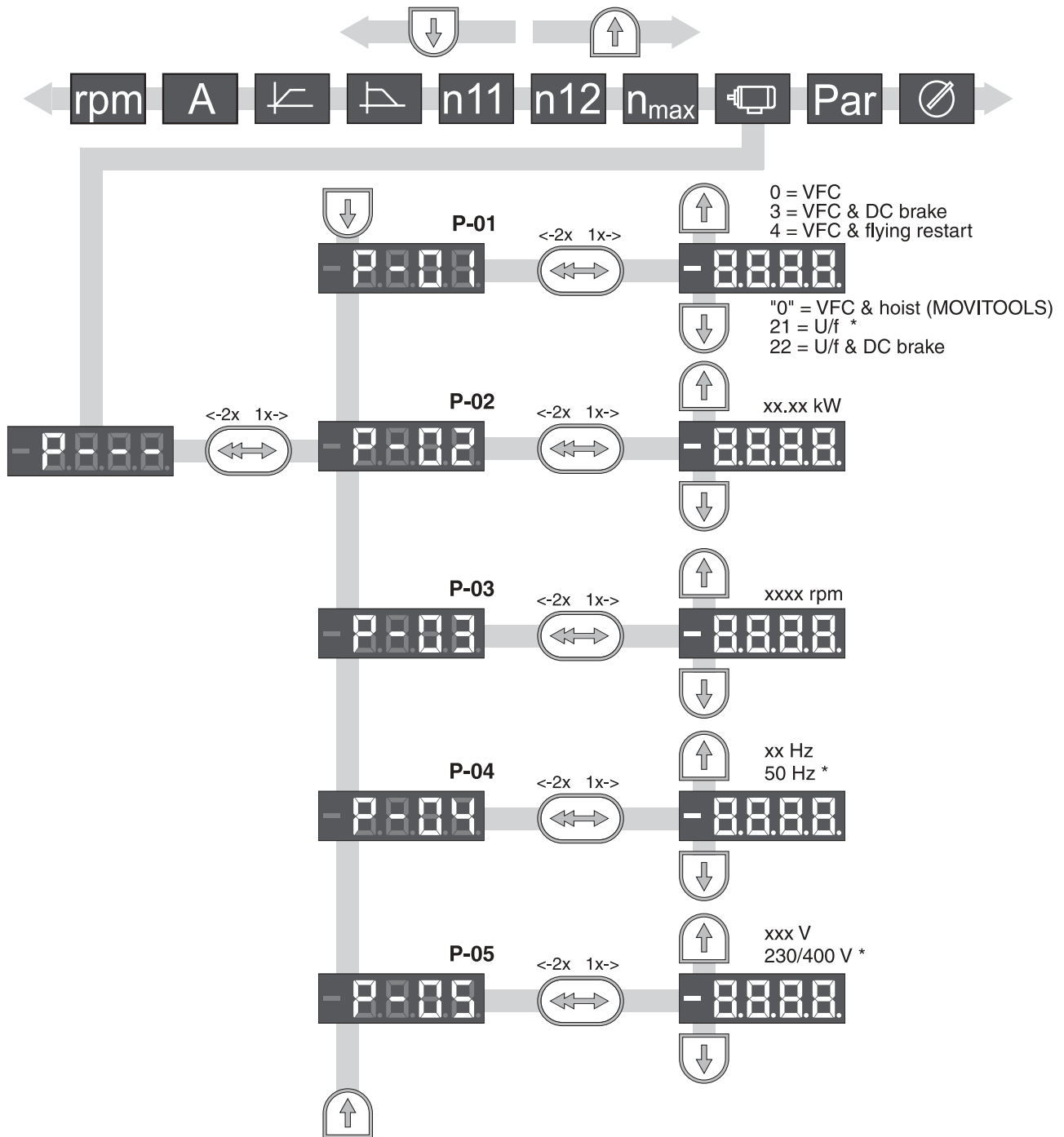


Figure 20: Startup using the integrated operating panel (2x = press twice / * = factory setting)

02975GXX


P-01 = Operating mode
P-02 = Rated motor power

P-03 = Rated motor speed
P-04 = Rated motor frequency

P-05 = Rated motor voltage



General information

If you do **not** connect the motor indicated in the motor selection table: **Enter parameters P-01 through P-05 correctly according to the nameplate** (access via ):


No.	Name	Range / factory setting	
P-01	Operating mode	0 3 4 21 22	VFC or VFC & HOIST (can only be set in MOVITOLS) VFC & DC BRAKE VFC & FLYING START V/f CHARACTER. V/f CHARACTER.& DC BRAKING
P-02	Rated motor power	0.25 0.37 0.55 ...	[kW] Factory setting: Rated motor power in kW corresponding to the rated inverter power If a smaller or a larger motor is connected (maximum difference one frame size), then a value must be selected which is as close as possible to the rated motor power.
P-03	Rated motor speed	10 ... Rated motor speed ... 5500 [rpm]	
P-04	Rated motor frequency	50 60	[Hz]
P-05	Rated motor voltage	50 ... 700 [V]	

Startup automatically sets the maximum speed P302 to the transition speed.

Activating startup

Prerequisites:


- Drive "No enable": Stop (Stop)

The startup procedure is not complete until you have returned to the main menu. To do so, press the  key.

VFC

The default operating mode setting is V/f. You must start up the inverter in VFC or VFC + DC BRAK. operating mode for:

- High torque
- Continuous duty at low frequencies
- Accurate slip compensation
- More dynamic properties

To choose VFC or VFC + DC BRAK. operating mode, select the symbol  in item P-01 to choose VFC or VFC & DC BRAK. operating mode.

Startup of group drives

V/f CHARACTER. operating mode allows for operating a group of asynchronous motors on one inverter. Please note:

- Select V/f operating mode
- Set the power of the largest motor
- Disable automatic adjustment P320
- Set IxR compensation P322 to zero
- Set slip compensation P324 to zero
- Set the current limitation to 1.5 times the total current of the motors

In this operating mode, the inverter operates without slip compensation and with a constant V/f ratio.



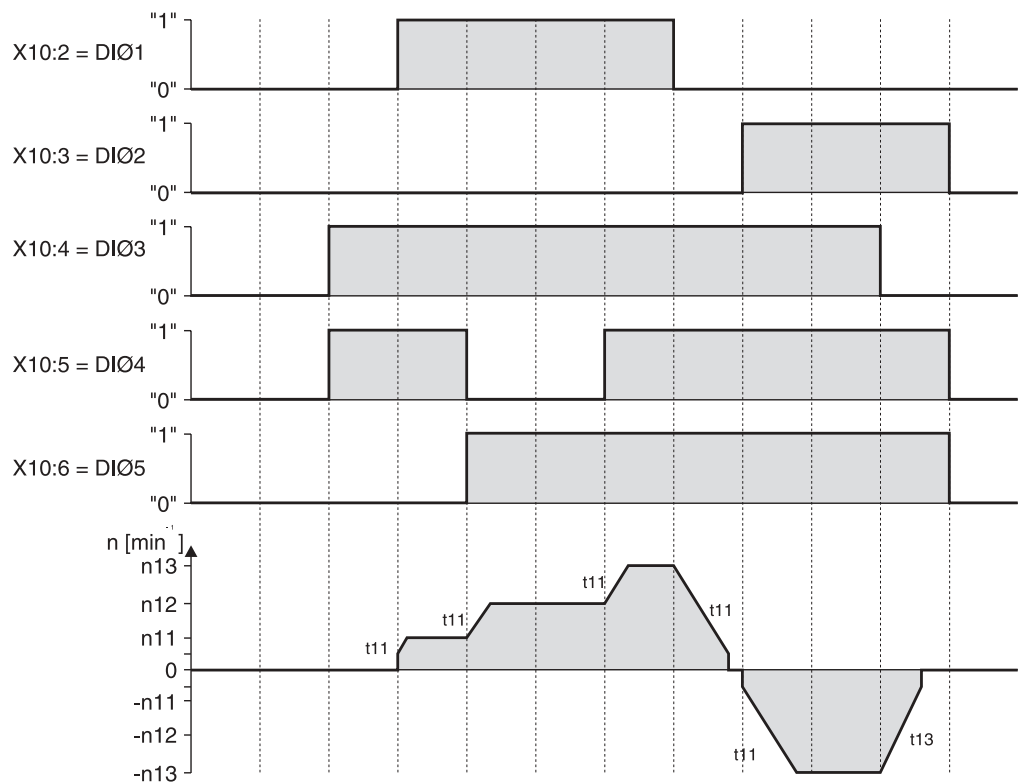
5.7 Starting the motor

Analog setpoints The following table shows which signals must be present on terminals X10:2 ... X10:4 (DIØ1 ... DIØ5) when the "UNIPOL./FIX.SETPT" setpoint is selected (P100). X10:4 (DIØ1 ... DIØ5) anliegen müssen.

Terminal Function	X10:13/14 Analog input	X10:2 CW/Stop	X10:3 CW/Stop	X10:4 Enable
/No enable	X	X	X	0
Enable and stop	X	0	0	1
Clockwise at 50 % n_{max}	5 V	1	0	1
Clockwise n_{max}	10 V	1	0	1
Counterclockwise at 50 % n_{max}	5 V	0	1	1
Counterclockwise n_{max}	10 V	0	1	1

X = any / 0 = Low / 1 = High

The following travel cycle shows by way of example how you start the drive with the wiring of terminals X10:2 ... X10:6 and the internal fixed setpoints.



02981ADE

Figure 21: Travel cycle with internal fixed setpoints

X10:2 = CW/Stop X10:4 = Enable/Rapid stop X10:6 = n12/n22
 X10:3 = CCW/Stop X10:5 = n11/n21



5.8 Loading a LOGODrive program

- Start MOVITOOLS® Manager.
- Connect the MOVITRAC® 07 unit to a vacant serial port on your PC using the UWS21A interface converter. Select this port in the PC COM Interface group.
- Connect the MOVITRAC® 07 to the power supply system.
- Click the Update button. The PC then looks for all connected units and displays them in the Connected Inverters list.
- Click the LOGODrive button.
- Load the required program by selecting File / Open.
- Compile and load the program by selecting Program / Translate and load.
- Start the program by selecting Program / Start.
- A decimal point next to the four digits on the display indicates that the inverter is currently processing a program.





5.9 Parameter list





All parameters that can also be displayed and edited via the **Par** symbol on the operating panel are indicated by a • in the "OP" (operating panel) column. If more than one value can be selected, the factory setting is highlighted in **bold**.

No.	OP	Index dec.	Name	Range / factory setting		Value after startup
				Display	MOVITOOLS®	
0_			Display values (read only)			
00_			Process values			
000			Speed (signed)	rpm	[rpm]	
002			Frequency (signed)		[Hz]	
004			Output current (value)		[% I _N]	
005			Active current (signed)		[% I _N]	
008			DC link voltage		[V]	
009			Output current	A	[A]	
01_			Status displays			
010			Inverter status	rpm	[Text]	
011			Operational status	rpm	[Text]	
012			Fault status	rpm	[Text]	
014			Heat sink temperature		[°C]	
02_			Analog setpoint			
020			Analog input AI1		[V]	
03_			Binary inputs			
031			Binary input DI01		CW/STOP (fixed assignment)	
032			Binary input DI02		CCW/STOP (factory setting)	
033			Binary input DI03		ENABLE/STOP (factory setting)	
034			Binary input DI04		n11/n21 (factory setting)	
035			Binary input DI05		n12/n22 (factory setting)	
036			Binary inputs DI01.. DI05		Binary display	



No.	OP	Index dec.	Name	Range / factory setting		Value after startup
				Display	MOVITOOLS®	
05_						
Binary outputs						
051			Binary output DO01		/FAULT (factory setting)	
052			Binary output DO02		BRAKE RELEASED (factory setting)	
053			Binary outputs DO01, DO02		Binary display	
07_						
Unit data						
070			Unit type		[Text]	
071			Rated output current		[A]	
076			Firmware basic unit		[Part number and version]	
08_						
Fault memory						
080	•	8366	Fault t-0	Fault code	Background information for previous faults.	
09_						
Bus diagnostics						
090			PD configuration		<ul style="list-style-type: none"> • 1 PD + PARAMETER • 1 PD • 2 PD + PARAMETER • 2 PD • 3 PD + PARAMETER • 3 PD 	
094	•	8455	PO1 setpoint		[hex]	
095	•	8456	PO2 setpoint		[hex]	
096	•	8457	PO3 setpoint		[hex]	
097			PI1 actual value		[hex]	
098			PI2 actual value		[hex]	
099			PI3 actual value		[hex]	
1__						
Setpoints / ramp generators						
10_						
Setpoint selection						
100	•	8461	Setpoint source	1 2 4 6 7 10 11	UNIPOL./FIX.SETPT RS-485 MOTOR POT FIX SETP+AI1 FIX SETP*AI1 SBus Frequency input	
101	•	8462	Control signal source	0 1 3 4	TERMINALS RS-485 SBus 3-WIRE CONTROL	
102	•	8840	Frequency scaling		Setting range 0.1 ... 10 ... 65.00 [kHz]	



No.	OP	Index dec.	Name	Range / factory setting		Value after startup
				Display	MOVITOOLS®	
11_			Analog input 1 (+10 V)			
110	•	8463	AI1 scaling	0.1 ... 1 ... 10		
112	•	8465	AI1 operating mode	0 1 5 6	3000 1/min (0 – 10 V) N-MAX (0 – 10 V) N-MAX (0 – 20 mA) N-MAX (4 – 20 mA)	
12_			setpoint potentiometer of the integrated operating panel			
121	•	8811	Addition setpoint potentiom.	0 1 2	OFF ON ON (EXCEPT FSP)	
122	•	8799	Local potentiometer mode	0 1 2	UNIPOL. CW UNIPOL. CCW BIPOL. CW +CCW	
13_			Speed ramps			
130	•	8807	Ramp t11 up	 0.1 ... 2 ... 2000 [s]		
131	•	8808	Ramp t11 down	 0.1 ... 2 ... 2000 [s]		
136	•	8476	Stop ramp t13	0.1 ... 2 ... 20 [s]		
138		8794	Ramp limit	0 1	NO YES	
15_			Motorized potentiometer			
150	•	8809	Ramp t3 up	0.2 ... 20 ... 50 [s]		
152	•	8488	Save last setpoint	off on	OFF ON	
16_			Fixed setpoints (set 1)			
160	•	8489	Internal setpoint n11	 0 ... 150 ... 5000 [rpm]		
161	•	8490	Internal setpoint n12	 0 ... 750 ... 5000 [rpm]		
162	•	8491	Internal setpoint n13	0 ... 1500 ... 5000 [rpm]		
163	•	8814	Internal setpoint n11 PI-controller	0 ... 3 ... 100 [% I _N]		
164	•	8815	Internal setpoint n12 PI-controller	0 ... 15 ... 100 [% I _N]		
165	•	8816	Internal setpoint n13 PI-controller	0 ... 30 ... 100 [% I _N]		




No.	OP	Index dec.	Name	Range / factory setting		Value after startup
				Display	MOVITOOLS®	
17_						
Fixed setpoints (set 2)						
170	•	8492	Internal setpoint n21	0 ... 150 ... 5000 [rpm]		
171	•	8493	Internal setpoint n22	0 ... 750 ... 5000 [rpm]		
172	•	8494	Internal setpoint n23	0 ... 1500 ... 5000 [rpm]		
173	•	8817	Internal setpoint n21 PI-controller	0 ... 3 ... 100 [% I _N]		
174	•	8818	Internal setpoint n22 PI-controller	0 ... 15 ... 100 [% I _N]		
175	•	8819	Internal setpoint n23 PI-controller	0 ... 30 ... 100 [% I _N]		
2_						
Controller parameters						
25_						
PI controller						
250	•	8800	PI controller	0 1 2	OFF ON NORMAL ON INVERTED	
251	•	8801	P-gain	0 ... 1 ... 64		
252	•	8802	Time constant n-control.	0 ... 1 ... 2000 [s]		
253	•	8465	PI actual value mode	1 5 6	0 ... 10 V 0 ... 20 mA 4 ... 20 mA	
254	•	8463	PI actual value scaling	0.1 ... 1.0 ... 10.0		
255	•	8812	PI sensor offset	0.0 ... 100.0 [%]		
3_						
Motor parameters						
30_						
Limits						
301	•	8516	Minimum speed	0 ... 15 ... 5500 [rpm]		
302	•	8517	Maximum speed	n_{max}	0 ... 1500 ... 5500 [rpm]	
303	•	8518	Current limit	0 ... 150 [% I _N]		
32_						
Motor adjustment						
320	•	8523	Automatic adjustment	off on	OFF ON	
321	•	8524	Boost	0 ... 100 [%]		
322	•	8525	IxR compensation	0 ... 100 [%]		
323	•	8526	Premagnetizing time	0 ... 2000 [ms]		
324	•	8527	Slip compensation	0 ... 500 [rpm]		
325	•	8834	No-load vibration damping	off on	OFF ON	



No.	OP	Index dec.	Name	Range / factory setting		Value after startup
				Display	MOVITOOLS®	
4_			Reference signals			
40_			Speed reference signal			
400	•	8539	Speed reference value	0 ... 750 ... 5000 [rpm]		
401	•	8540	Hysteresis	0 ... 100 ... +500 [rpm]		
402	•	8541	Delay time	0 ... 1 ... 9 [s]		
403	•	8542	Signal = "1" if:	0 1	n < n_{ref} n > n_{ref}	
45_			PI controller ref signal			
450	•	8813	PI actual value reference	0.0 ... 100.0 [%]		
451	•	8796	Signal = "1" if:	0 1	PI actual value < PI reference PI actual value > PI reference	
5_			Monitoring functions			
50_			Speed monitoring			
500	•	8557	Speed monitoring	0 3	OFF MOT&GENERATOR	
501	•	8558	Delay time	0 ... 1 ... 10 [s]		
6_			Terminal assignment			
60_			Binary inputs			
60-	•	8803	Binary inputs DI01 with fixed assignment CW/STOP.	0 1 2 3 4 5 6 7 8 -	DI02 CCW/STOP CCW/STOP CCW/STOP DOWN ENABLE CCW/STOP CCW/STOP RESET CCW/STOP CCW/STOP CCW/STOP TRL.INHIBIT (Deviating combination set with MOVITOOLS)	DI03 FIX SETPT SW.OVn11/n21 ENABLE ENABLE FIX SETPT SW.OVn11/n21 SETPOINT HOLDn11/n21 ENABLE EXT. FAULT ENABLE EXT. FAULT ENABLE DI04 SW.OVn11/n21 n11/n21 MOTOR POT UP MOTOR POT UP MOTOR POT DOWN EXT. FAULT FAULT RESET n11/n21 n11/n21 DI05 n12/n22 n12/n22 MOTOR POT n12/n22 n12/n22 FAULT TF RESP. n12/n22 CON-
601		8336	Binary input DI02		NO FUNCTION	
602		8337	Binary input DI03		ENABLE /STOP	
603		8338	Binary input DI04		CCW/STOP	
604		8339	Binary input DI05		CCW/STOP n11/n21 n12/n22 FIXED SETP. SELECT MOTOR POT UP MOTOR POT DOWN /EXT. FAULT FAULT RESET SETPOINT HOLD TF RESPONSE (only with DI05) CONTR. INHIBIT	



No.	OP	Index dec.	Name	Range / factory setting		Value after startup
				Display	MOVITOOLS®	
62_						
Binary outputs						
62-	•	8804	Binary outputs	0 1 2 3 4 5 6 7 8 9 -	DO01 /FAULT READY SPEED REFERENCE SP/ACT.VAL.COMP. /FAULT /FAULT /FAULT /FAULT PI ACT.VALUE REF (Deviating combination set with MOVITOOLS)	DO02 BRAKE RELEASED BRAKE RELEASED BRAKE RELEASED BRAKE RELEASED SPEED REFERENCE SP/ACT.VAL.COMP. READY ROT. FIELD ON PI ACT.VALUE REF BRAKE RELEASED
620		8350	Binary output DO01		NO FUNCTION /FAULT	
621		8351	Binary output DO02		READY OUTP. STAGE ON ROT. FIELD ON BRAKE RELEASED SPEED REFERENCE SP/ACT.VAL.COMP. PI ACT.VALUE REF.	
7_						
Control functions						
70_						
Operating modes						
700		8574	Operating mode (setting on the operating panel with  , P-01).	0 3 4 "0" 21 22	VFC 1 VFC 1 & DC BRAK. VFC & FLY.START VFC & HOIST (only with MOVITOOLS) V/f CHARACTER. V/f CHARACTER. & DC BRAK.	
71_						
Standstill current function						
710		8576	Standstill current function	0 ... 50 %	I_{Mot}	
72_						
Setpoint stop function						
720	•	8578	Setpoint stop function	off on	OFF ON	
721	•	8579	Stop setpoint	0 ... 30 ... 500 [rpm]		
722	•	8580	Start offset	0 ... 30 ... 500 [rpm]		
73_						
Brake function						
736	•	8828	Braking time	0.0 ... 0.1 ... 2 [s]		
76_						
Manual operation						
760	•	8798	Locking RUN/STOP keys	no yes	NO YES	



No.	OP	Index dec.	Name	Range / factory setting		Value after startup
				Display	MOVITOOLS®	
8_			Unit functions			
80_			Setup			
802	•	8594	Factory setting	yes no	FACTORY SETTING NO DELIVERY CONDITION	
803	•	8595	Parameter lock	off on	OFF ON	
804		8596	Reset statistic data		NO FAULT MEMORY	
81_			Serial communication			
810	•	8597	RS-485 address	0 ... 99		
811		8598	RS-485 group address		100 ... 199	
812		8599	RS-485 timeout delay		0 ... 650 [s]	
813	•	8600	SBus address	0 ... 63		
814		8601	SBus group-address		0 ... 63	
815		8602	SBus timeout delay		0 ... 650 [s]	
816	•	8603	SBus baud rate	0 1 2 3	125 kBaud 250 kBaud 500 kBaud 1000 kBaud	
82_			Brake operation			
820	•	8607	4-quadrant operation	off on	OFF ON	
83_			Fault responses			
830	•	8609	Response /EXT. FAULT	2 4	IMM. STOP/FAULT RAPID STOP/FAULT	
84_			Reset response			
840		8617	Manual reset		YES NO	
86_			Modulation			
860	•	8620	PWM frequency	0 1 2 3	4 kHz 8 kHz 12 kHz 16 kHz	
862	•	8751	PWM fix	yes no	YES NO	



No.	OP	Index dec.	Name	Range / factory setting		Value after startup
				Display	MOVITOOLS®	
87_			Fieldbus parameterization			
870		8304	Setpoint description PO1		NO FUNCTION (factory setting P872) SPEED (factory setting P871) MAX. SPEED RAMP CTRL. WORD 1 (factory setting P870) SPEED [%] PI-CONTROLLER SETPOINT	
871		8305	Setpoint description PO			
872		8306	Setpoint description PO3			
873		8307	Actual value description PI1		NO FUNCTION SPEED (factory setting P874) OUTP.CURRENT (factory setting P875) ACTIVE CURRENT STATUS WORD 1 (factory setting P873) SPEED [%] IPOS PI-DATA PI-CONTROLLER [%]	
874		8308	Actual value description PI2			
875		8309	Actual value description PI3			
876		8622	PO data enable		OFF ON	
9_			IPOS/LOGODrive parameters			
93_			IPOS/LOGODrive special functions			
931	•		Task 1/2	off on		
932			Task 2	off on		



6 Operation and Service

6.1 Fault information

Fault memory

The inverter stores the fault message in fault memory P080. The inverter does not save a new fault until the fault message has been acknowledged. The local operating panel shows the most recent fault. Whenever double faults occur, the value stored in P080 does not correspond to the value displayed on the operating panel. This may happen, for example, with F-07 DC link overvoltage followed by F34 Ramp timeout.

The inverter saves the following information when the malfunction occurs:

- Fault which has occurred
- Status of the binary inputs / binary outputs
- Operating status of the inverter
- Inverter status
- Heat sink temperature
- Speed
- Output current
- Active current
- Unit utilization
- DC link voltage

Switch-off responses

There are three switch-off responses depending on the fault.

Inhibit means: Output stage inhibited, reset required.

Immediate switch-off

The unit can no longer brake the drive. In the event of a fault, the output stage goes to high-resistance and the brake is applied immediately.

Rapid stop with inhibit

The inverter brakes the drive using stop ramp t13. The brake is applied when the *minimum speed P301* is reached. **The output stage goes to high-resistance.** If *P820 4-quadrant operation = OFF*, deceleration is not achieved with a ramp but by means of direct current braking.

Rapid stop without inhibit

The inverter brakes the drive using stop ramp t13. The brake is applied when the *minimum speed P301* is reached. If *P820 4-quadrant operation = OFF*, deceleration is not achieved with a ramp but by means of direct current braking.



Reset

A fault message can be acknowledged by:

- Manual reset on the operating panel (STOP/RESET key).
- Reset via input terminals, i.e. via an appropriately assigned binary input (DIØ2...DIØ5).
- Manual reset in MOVITOOLS® (*P840 Manual reset = YES* or the Reset button in the Status window).
- Switching the power supply off and on again. Recommendation: Observe a minimum switch-off time of 10 s for the supply system contactor.

The STOP/RESET key has priority over enable via terminal or interface.

You can perform a reset after a fault has occurred with a programmed fault response by pressing the STOP/RESET key. The drive is inhibited after a reset. You must enable the drive with the RUN key.

Current limit

The speed display starts to flash when the current limit is reached.



6.2 List of faults (F-00 ... F-97)

No.	Description	Response	Possible cause	Action
00	No fault			
01	Over-current	Immediate switch-off	<ul style="list-style-type: none"> Short circuit on output Output switching Motor too large Defective output stage Ramp limit (P138) switched off 	<ul style="list-style-type: none"> Rectify the short circuit Only switch when output stage inhibited Connect a smaller motor Consult SEW Service if the fault still cannot be reset Ramp limit (P138 = YES)
03	Ground fault	Immediate switch-off	<ul style="list-style-type: none"> Ground fault in motor Ground fault in inverter Ground fault in the motor lead Over-current (see F-01) 	<ul style="list-style-type: none"> Install a new motor Replace the MOVITRAC® 07 Rectify the ground fault See F-01
04	Brake chopper	Immediate switch-off	<ul style="list-style-type: none"> Too much regenerative power Braking resistor circuit interrupted Short circuit in braking resistor circuit Excessively high braking resistance Brake chopper defective Ground fault 	<ul style="list-style-type: none"> Extend deceleration ramps Check connection leads to the braking resistor Rectify the short circuit Check technical data of braking resistor Replace the MOVITRAC® 07 Rectify the ground fault
06	Supply system phase failure (only with three-phase inverter)	Immediate switch-off	Phase fault	Check supply system lead
07	DC-link over-voltage	Immediate switch-off	<ul style="list-style-type: none"> DC link voltage too high Ground fault 	<ul style="list-style-type: none"> Extend deceleration ramps Check connection leads to the braking resistor Check technical data of braking resistor Rectify the ground fault
08	Speed monitoring	Immediate switch-off	<p>Current controller is operating at the setting limit due to:</p> <ul style="list-style-type: none"> Mechanical overload Phase failure in supply system Phase failure in motor <p>Maximum speed for VFC operating mode exceeded</p>	<ul style="list-style-type: none"> Reduce load Increase delay time setting P501 Check current limitation Extend deceleration ramps Check mains phases Check motor cable and motor Reduce maximum speed
10	ILLOP	Emergency stop with inhibit	<ul style="list-style-type: none"> Incorrect command during running of program Incorrect conditions during running of program Function not in inverter / not implemented 	<ul style="list-style-type: none"> Check program Check program structure Use another function



No.	Description	Response	Possible cause	Action
11	Overtemperature	Rapid stop with inhibit	Thermal overload of inverter	<ul style="list-style-type: none"> Reduce load and / or ensure adequate cooling. If the braking resistor is integrated in the heat sink: Mount the braking resistor externally
17-24	System fault	Immediate switch-off	Inverter electronics disrupted, possibly due to effect of EMC	Check ground connections and shields; improve them if necessary. Contact SEW Service if this fault reoccurs.
25	EEPROM	Rapid stop with inhibit	Fault when accessing EEPROM	Call up default setting, perform reset and set parameters again. Contact SEW Service for advice if this fault reoccurs.
26	External terminal	Programmable	Read in external fault signal via programmable input	Eliminate specific cause of fault; reprogram terminal if necessary.
31	TF sensor	Rapid stop with inhibit	<ul style="list-style-type: none"> Motor too hot, TF sensor has tripped TF sensor of motor not connected or not connected properly Connection of MOVITRAC® 07 and TF interrupted on motor 	<ul style="list-style-type: none"> Let motor cool off and reset fault Check connections / links between MOVITRAC® 07 and TF
32	Index overrun	Emergency stop	Basic programming rules violated causing internal stack overflow	Check and correct user program
34	Ramp timeout	Immediate switch-off	<ul style="list-style-type: none"> Set rapid stop ramp time exceeded. The inverter signals F34 if you revoke the enable and the drive exceeds the rapid stop ramp time t13 by a certain time. 	<ul style="list-style-type: none"> Extend the ramp time Extend the stop ramp time
37	Watchdog timer	Immediate switch-off	Fault in system software sequence	Check ground connections and shields; improve them if necessary. Contact SEW Service if this fault reoccurs.
38	System software	Immediate switch-off	System fault	Check ground connections and shields; improve them if necessary. Contact SEW Service if this fault reoccurs.
43	RS-485 timeout	Rapid stop without inhibit ¹⁾	Communication between inverter and PC interrupted	Check connection between inverter and PC.
44	Unit utilization	Immediate switch-off	Unit utilization (Ixt value) excessive	<ul style="list-style-type: none"> Reduce power output Extend ramps If above points are not possible: Use a larger inverter



Operation and Service

List of warnings (r-17 ... r-32)


No.	Description	Response	Possible cause	Action
45	Initialization	Immediate switch-off with inhibit	Error during initialization	Contact SEW Service for advice.
47	System bus timeout	Rapid stop without inhibit ¹⁾	Fault during communication via system bus	Check system bus connection.
77	Control word	None	An external control has attempted to set an invalid automatic mode	<ul style="list-style-type: none"> Check serial connection to external control Check write values of external controller
81	Start condition	Immediate switch-off	Only in "VFC hoist" operating mode: The inverter could not inject the required amount of current into the motor during the pre-magnetization time: <ul style="list-style-type: none"> Rated motor power too small in relation to rated inverter power Motor cable cross section too small 	<ul style="list-style-type: none"> Check connection between inverter and motor Check startup data and repeat startup if necessary
82	Output open	Immediate switch-off	Only in "VFC hoist" operating mode: <ul style="list-style-type: none"> Two or all output phases interrupted Rated motor power too small in relation to rated inverter power 	Check connection between inverter and PC.
94	EEPROM checksum	Immediate switch-off	EEPROM defective	Contact SEW Service for advice.
97	Copy fault	Immediate switch-off	<ul style="list-style-type: none"> Parameter module disconnected during copying process Switching off/on during copying process 	Prior to acknowledging the fault: <ul style="list-style-type: none"> Load the factory setting or the complete data record from the parameter module

1) No reset required, fault message disappears after communication is reestablished

6.3 List of warnings (r-17 ... r-32)

No.	Description	Meaning
17	Function not implemented	Function does not exist in inverter
19	Parameter lock activated	Parameters cannot be altered
32	Enable	You cannot run the function in ENABLE status

6.4 Status displays

If you select the  symbol, the display shows the status. If the status is "Drive enabled", the calculated actual speed will be displayed.

State	Display
Drive "Controller inhibit"	dIS (disable)
Drive "No enable"	StoP (Stop)
Drive "Enabled"	8888 (actual speed)
Factory settings being reactivated	SEt (Set)
Current at standstill	dc



6.5 Unit status codes

You can read the unit status codes from status word 1.

Code	Meaning
0x0	Not ready
0x1	Controller inhibit
0x2	No enable
0x3	Standstill current active, no enable
0x4	Enable
0x8	Factory setting is active

6.6 SEW-Electronics service

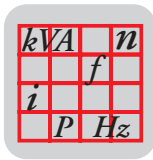
Hotline Service specialists from SEW-EURODRIVE are available 24 hours, 365 days a year under the Drive Service hotline phone number.

Just dial the prefix **+49 1805** and enter the letter combination **SEWHELP** via your phone keys. Instead, you can also dial **+49 1805 7394357**.

Send in for repair Please contact the **SEW electronics service if a fault cannot be rectified** (→ "Customer and spare parts service").

When contacting the SEW electronics service, always quote the digits of the service code so that our service personnel can assist you more effectively.

Please provide the following information when sending the unit in for repair:
Serial number (→ nameplate)
Unit designation
Brief description of the application (application, control via terminals or serial)
Connected motor (motor voltage, star or delta connection)
Nature of the fault
Accompanying circumstances
Your own presumption of what has happened
Unusual events which preceded the fault



7 Technical Data

7.1 CE marking, UL approval and C-Tick

CE marking

Low Voltage
Directive

MOVITRAC[®] 07 frequency inverters comply with the regulations of the Low Voltage Directive 73/23/EEC.

Electromagnetic
compatibility EMC

MOVITRAC[®] 07 frequency inverters are components of machines and systems. They comply with the EMC product standard EN 61800-3 *Variable-speed electrical drives*. If you want to apply the CE mark to the machine/system equipped with frequency inverters in accordance with the EMC Directive 89/336/EEC, observe the instructions regarding EMC compliant installation.

MOVITRAC[®] 07 frequency inverters have an integrated line filter as standard. They comply with the following limit value class to EN 55011 on the line side without further measures:

- **B:** 1-phase connection
- **A:** 3-phase connection
 - 230 V: 0,37 ... 7.5 kW
 - 400/500 V: 0,55 ... 11 kW



The CE mark on the nameplate shows that the product meets the requirements of the following directives:

- Low Voltage Directive 73/23/EEC
- EMC Directive 89/336/EEC

SEW-EURODRIVE provides a declaration of conformity if requested.

UL approval

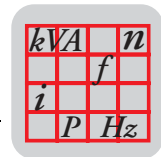


UL and cUL approval has been granted for the entire MOVITRAC[®] 07 series. cUL is equivalent to CSA approval.

C-Tick



C-Tick approval has been granted for the entire MOVITRAC[®] 07 series. C-Tick certifies conformity with the requirements of the ACA (Australian Communications Authority). The inverter must at least comply with class A limit to obtain approval to use the C-Tick mark. See Sec. [Installation] / [Installation notes.]

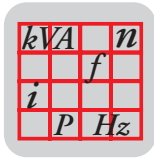


7.2 General technical data

The following technical data applies to all MOVITRAC 07 frequency inverters, irrespective of size.[®]

MOVITRAC [®] 07	All sizes
Interference immunity	Meets EN 61800-3
Interference emission with EMC-compliant installation	To limit value class <ul style="list-style-type: none"> • B: 1-phase connection • A: 3-phase connection <ul style="list-style-type: none"> – 230 V: 0.37 ... 7.5 kW – 400/500 V: 0.55 ... 11 kW To EN 55011 and EN 55014; complies with EN 61800-3
Discharge current	> 3.5 mA
Ambient temperature ϑ_U at $f_{PWM} = 4 \text{ kHz}$	230 V, 0.37 ... 2.2 kW 400/500 V, 0.55 ... 4.0 kW <ul style="list-style-type: none"> • $-10 \text{ }^\circ\text{C} \dots +50 \text{ }^\circ\text{C}$ at 100 % I_N • $-10 \text{ }^\circ\text{C} \dots +40 \text{ }^\circ\text{C}$ at 125 % I_N 230 V, 3.7 ... 30 kW 400/500 V, 5.5 ... 45 kW <ul style="list-style-type: none"> • $0 \text{ }^\circ\text{C} \dots +50 \text{ }^\circ\text{C}$ at 100 % I_N • $0 \text{ }^\circ\text{C} \dots +40 \text{ }^\circ\text{C}$ at 125 % I_N
Power reduction	3.0 % I_N per K to max. 60 °C
Climate class	EN 60721-3-3, class 3K3
Storage temperature ¹⁾	$-25 \text{ }^\circ\text{C} \dots +75 \text{ }^\circ\text{C}$
Transport temperature	$-25 \text{ }^\circ\text{C} \dots +75 \text{ }^\circ\text{C}$
Enclosure	IP20 Size 4 power connections: IP00, IP10 with Plexiglas cover mounted (supplied as standard)
Operating mode	Continuous duty (EN 60149-1-1 and 1-3)
Pollution degree	2 according to IEC 60664-1 (VDE 0110-1)
Altitude	$h \leq 1000 \text{ m}$ (3300 ft) <ul style="list-style-type: none"> • I_N reduction <ul style="list-style-type: none"> – 1 % per 100 m (330 ft) – From 1000 m to max. 4000 m (3300 ft to max. 13,200 ft) • V_N reduction <ul style="list-style-type: none"> – 3 V per 100 m (330 ft) – From 2000 m to max. 4000 m (6600 ft to max. 13200 ft) Over 200 m (6600 ft) only overvoltage class 2, external measures are required for overvoltage class 3. Overvoltage classes to DIN VDE 0110-1.
Resistance to vibration	To EN 50 178 / VDE 0160

1) If the unit is being stored for a long time, connect it to the mains voltage for at least 5 minutes every 2 years. Otherwise, the service life of the unit will be reduced.



7.3 Technical data of MOVITRAC® 07

230 V



51115AXX

Figure 22: MOVITRAC® 07 230 V units

Size	0S	0L	1	2	3	4
Power [kW / HP]	0.37 / 0.5 0.55 / 0.75 0.75 / 1.0	1.1 / 1.5 1.5 / 2.0 2.2 / 3.0	3.7 / 5	5.5 / 7.5 7.5 / 10	11 / 15 15 / 20	22 / 30 30 / 40
Mains connection	230 V / 1-phase 230 V / 3-phase		230 V / 3-phase			

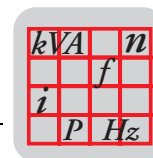
400/500 V



51116AXX

Figure 23: MOVITRAC® 07 400/500-V units

Size	0M	0L	2S	2	3	4
Power [kW / HP]	0.55 / 0.75 0.75 / 1.0 1.1 / 1.5	1.5 / 1.0 2.2 / 3.0 3.0 / 4.0 4.0 / 5.0	5.5 / 7.5 7.5 / 10	11 / 15	15 / 20 22 / 30 30 / 40	37 / 50 45 / 60
Mains connection	400/500 V / 3-phase					

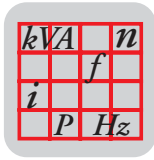


AC 230 V / 1-phase / size 0S / 0.37 ... 0.75 kW / 0.5 ... 1.0 HP



Figure 24: MOVITRAC® 07 / size 0S / 1-phase AC 230 V 51105AXX

MOVITRAC® MC07A (1-phase supply system)		004-2B1-4-..	005-2B1-4-..	008-2B1-4-..
Part number		826 951 3	826 952 1	826 953 X
Part number with LOGODrive		827 185 2	827 186 0	827 187 9
INPUT				
Supply voltage Permitted range	V_{mains}	1 x AC 230 V $V_{\text{mains}} = \text{AC } 200 \text{ V } -10 \% \dots \text{AC } 240 \text{ V } +10 \%$		
Supply frequency	f_{mains}	50/ 60 Hz +/- 5 %		
Rated system current, 1-phase At $V_{\text{mains}} = \text{AC } 230 \text{ V}$	100 % I_{mains} 125 % I_{mains}	AC 6.1 A AC 7.5 A	AC 8.5 A AC 10.2 A	AC 9.9 A AC 11.8 A
OUTPUT				
Output voltage	V_N	$3 \times 0 \dots V_{\text{mains}}$		
Recommended motor power under constant load (at $V_{\text{mains}} = \text{AC } 230 \text{ V}$)	P_{mot}	0.37 kW 0.5 HP	0.55 kW 0.75 HP	0.75 kW 1.0 HP
Recommended motor power under variable torque load or constant load without overload (with $V_{\text{mains}} = \text{AC } 230 \text{ V}$)	P_{mot}	0.55 kW 0.75 HP	0.75 kW 1.0 HP	1.1 kW 1.5 HP
Rated output current At $V_{\text{mains}} = \text{AC } 230 \text{ V}$	I_N	AC 2.5 A	AC 3.3 A	AC 4.2 A
Minimum permitted braking resistor value (4-Q operation)	R_{BRmin}	72 Ω		



Technical Data

Technical data of MOVITRAC® 07

MOVITRAC® MC07A (1-phase supply system)		004-2B1-4-..	005-2B1-4-..	008-2B1-4-..
GENERAL				
Power loss at I_N	P_V	45 W	55 W	65 W
Current limitation		125 % I_N continuous duty (fan / pump operation) 150 % I_N for maximum 60 seconds		
PWM frequency	f_{PWM}	4 / 8 / 12 / 16 kHz		
Speed range Resolution	n_A Δn_A	0 ... 5500 rpm 1 rpm		
Terminals		Terminals 2.5 mm ²		
Dimensions	W x H x D	90 x 185 x 150 mm 3.5 x 7.2 x 5.9 in		
Weight	m	1.5 kg 3.3 lb		

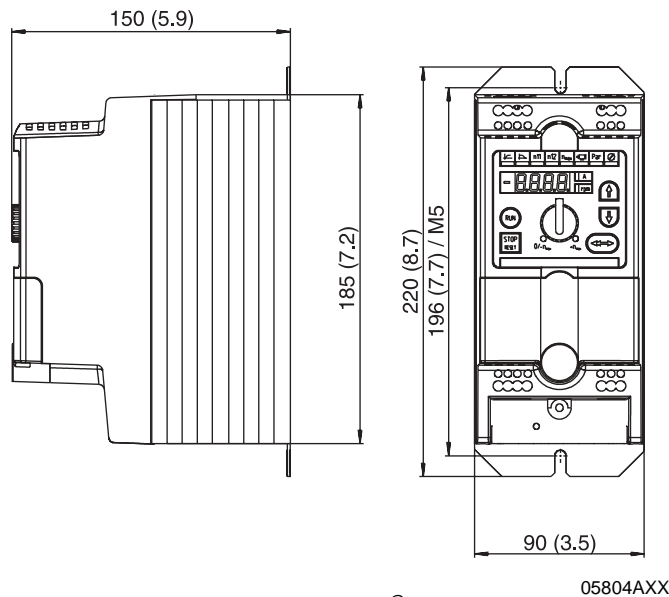
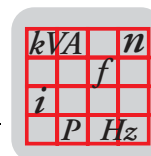


Figure 25: Dimensions, MOVITRAC® 07 size 0S

05804AXX

Provide 100 mm (4 in) clearance above and below the unit to ensure adequate cooling! There is no need for clearance at the sides. You can line up the units directly next to one another. Make sure that the circulation of air is not disrupted by cables or other installation materials. Prevent the heated exhaust air from other units from blowing onto this unit.

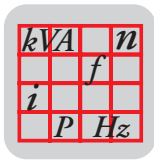


AC 230 V / 1-phase / size 0L / 1.1 ... 2.2 kW / 1.5 ... 3.0 HP



Figure 26: MOVITRAC® 07 / size 0L / 1-phase AC 230 V

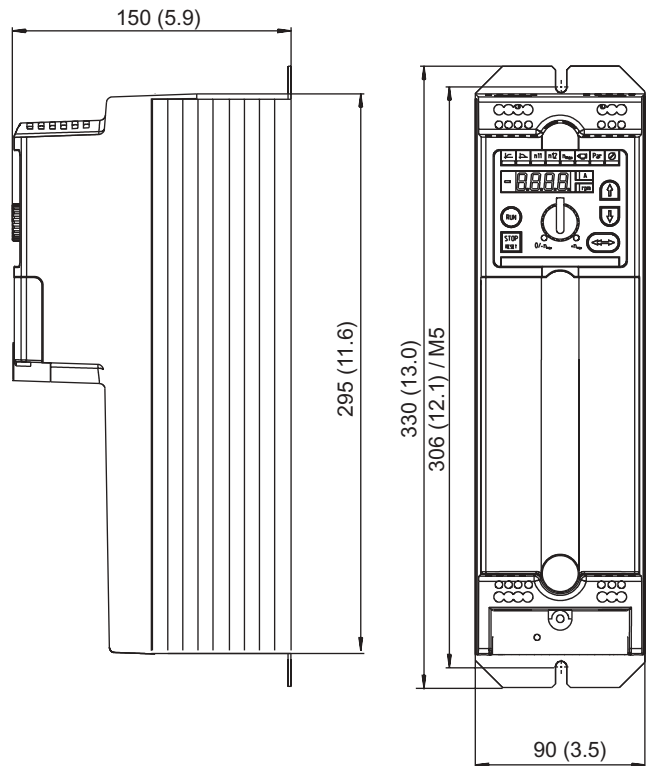
MOVITRAC® MC07A (1-phase supply system)		011-2B1-4-..	015-2B1-4-..	022-2B1-4-..
Part number		826 954 8	826 955 6	826 956 4
Part number with LOGODrive		827 188 7	827 189 5	827 190 9
INPUT				
Supply voltage	V_{mains}	1 x AC 230 V		
Permitted range		$V_{\text{mains}} = \text{AC } 200 \text{ V } -10 \% \dots \text{AC } 240 \text{ V } +10 \%$		
Mains frequency	f_{mains}	50/ 60 Hz +/- 5 %		
Rated system current, 1-phase At $V_{\text{mains}} = \text{AC } 230 \text{ V}$	100 % I_{mains} 125 % I_{mains}	AC 13.4 A AC 16.8 A	AC 16.7 A AC 20.7 A	AC 19.7 A AC 24.3 A
OUTPUT				
Output voltage	V_{N}	$3 \times 0 \dots V_{\text{mains}}$		
Recommended motor power under constant load (at $V_{\text{mains}} = \text{AC } 230 \text{ V}$)	P_{mot}	1.1 kW 1.5 HP	1.5 kW 2.0 HP	2.2 kW 3.0 HP
Recommended motor power under variable torque load or constant load without overload (with $V_{\text{mains}} = \text{AC } 230 \text{ V}$)	P_{mot}	1.5 kW 2.0 HP	2.2 kW 3.0 HP	3.0 kW 4.0 HP
Rated output current At $V_{\text{mains}} = \text{AC } 230 \text{ V}$	I_{N}	AC 5.7 A	AC 7.3 A	AC 8.6 A
Minimum permitted braking resistor value (4-Q operation)	R_{BRmin}	27 Ω		



Technical Data

Technical data of MOVITRAC® 07

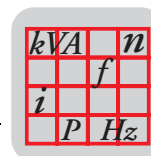
MOVITRAC® MC07A (1-phase supply system)		011-2B1-4-..	015-2B1-4-..	022-2B1-4-..
GENERAL				
Power loss at I_N	P_V	75 W	100 W	125 W
Current limitation		125 % I_N continuous duty (fan / pump operation) 150 % I_N for maximum 60 seconds		
PWM frequency	f_{PWM}	4 / 8 / 12 / 16 kHz		
Speed range Resolution	n_A Δn_A	0 ... 5500 rpm 1 rpm		
Terminals		Terminals 4 mm ²		
Dimensions	W x H x D	90 x 295 x 150 mm 3.5 x 9.5 x 5.9 in		
Weight	m	2.5 kg 5.5 lb		



54559AXX

Figure 27: Dimensions, MOVITRAC® 07 size 0L

Provide 100 mm (4 in) clearance above and below the unit to ensure adequate cooling! There is no need for clearance at the sides. You can line up the units directly next to one another. Make sure that the circulation of air is not disrupted by cables or other installation materials. Prevent the heated exhaust air from other units from blowing onto this unit.

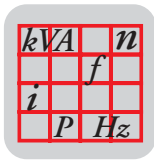


AC 230 V / 3-phase / size 0S / 0.37 ... 0.75 kW / 0.5 ... 1.0 HP



Figure 28: MOVITRAC® 07 / size 0S / 3-phase AC 230 V ^{51105AXX}

MOVITRAC® 07A (3-phase supply)		004-2A3-4-..	005-2A3-4-..	008-2A3-4-..
Part number		826 957 2	826 958 0	826 959 9
Part number with LOGODrive		827 191 7	827 192 5	827 193 3
INPUT				
Supply voltage Permitted range	V_{mains}	3 x AC 230 V $V_{\text{mains}} = \text{AC } 200 \text{ V } -10 \% \dots \text{AC } 240 \text{ V } +10 \%$		
Mains frequency	f_{mains}	50/ 60 Hz +/- 5 %		
Rated mains current, 3-phase At $V_{\text{mains}} = \text{AC } 230 \text{ V}$	100 % I_{mains} 125 % I_{mains}	AC 2.0 A AC 2.4 A	AC 2.8 A AC 3.4 A	AC 3.3 A AC 4.1 A
OUTPUT				
Output voltage	V_{N}	3 x 0 ... V_{mains}		
Recommended motor power under constant load (at $V_{\text{mains}} = \text{AC } 230 \text{ V}$)	P_{mot}	0.37 kW 0.5 HP	0.55 kW 0.75 HP	0.75 kW 1.0 HP
Recommended motor power under variable torque load or constant load without overload (with $V_{\text{mains}} = \text{AC } 230 \text{ V}$)	P_{mot}	0.55 kW 0.75 HP	0.75 kW 1.0 HP	1.1 kW 1.5 HP
Rated output current At $V_{\text{mains}} = \text{AC } 230 \text{ V}$	I_{N}	AC 2.5 A	AC 3.3 A	AC 4.2 A
Minimum permitted braking resistor value (4-Q operation)	R_{BRmin}	72 Ω		



Technical Data

Technical data of MOVITRAC® 07

MOVITRAC® 07A (3-phase supply)		004-2A3-4-..	005-2A3-4-..	008-2A3-4-..
GENERAL				
Power loss at I_N	P_V	45 W	55 W	65 W
Current limitation		125 % I_N continuous duty (fan / pump operation) 150 % I_N for maximum 60 seconds		
PWM frequency	f_{PWM}	4 / 8 / 12 / 16 kHz		
Speed range Resolution	n_A Δn_A	0 ... 5500 rpm 1 rpm		
Terminals		Terminals 2.5 mm ²		
Dimensions	W x H x D	90 x 185 x 150 mm 3.5 x 7.2 x 5.9 in		
Weight	m	1.5 kg 3.3 lb		

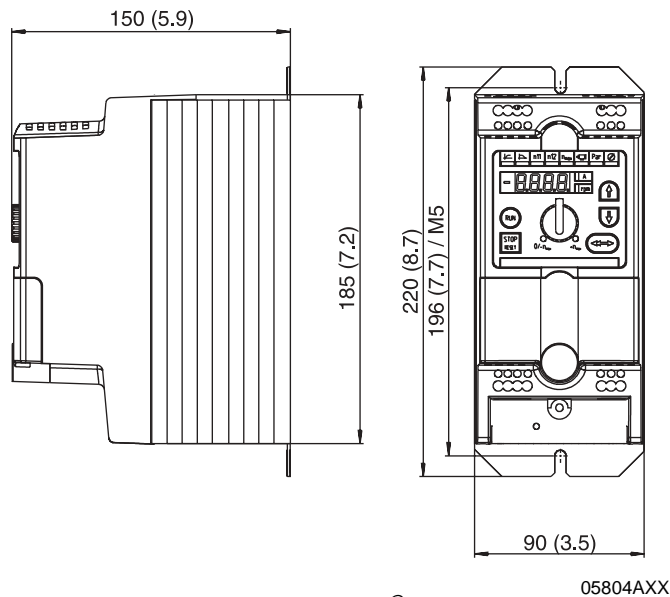
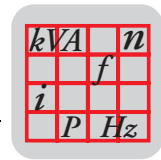


Figure 29: Dimensions, MOVITRAC® 07 size 0S

05804AXX

Provide 100 mm (4 in) clearance above and below the unit to ensure adequate cooling! There is no need for clearance at the sides. You can line up the units directly next to one another. Make sure that the circulation of air is not disrupted by cables or other installation materials. Prevent the heated exhaust air from other units from blowing onto this unit.

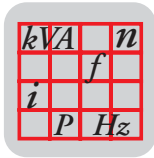


AC 230 V / 3-phase / size 0L / 1.1 ... 2.2 kW / 1.5 ... 3.0 HP



Figure 30: MOVITRAC® 07 / size 0L / 3-phase AC 230 V

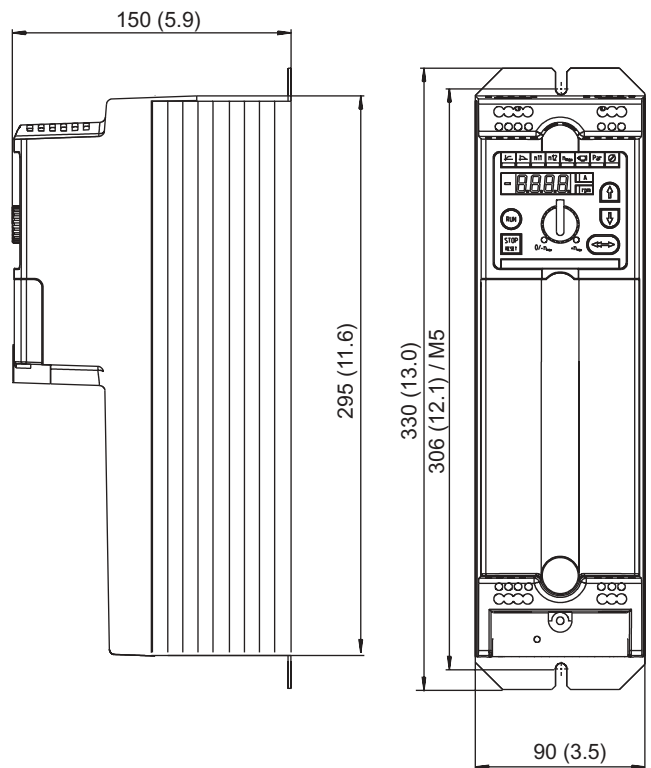
MOVITRAC® 07A (3-phase supply)		011-2A3-4-..	015-2A3-4-..	022-2A3-4-..
Part number		826 960 2	826 961 0	826 962 9
Part number with LOGODrive		827 194 1	827 195 X	827 196 8
INPUT				
Supply voltage	V_{mains}	3 x AC 230 V		
Permitted range		$V_{\text{mains}} = \text{AC } 200 \text{ V } -10 \% \dots \text{AC } 240 \text{ V } +10 \%$		
Mains frequency	f_{mains}	50/ 60 Hz +/- 5 %		
Rated mains current, 3-phase	100 %	AC 5.1 A	AC 6.4 A	AC 7.6 A
At $V_{\text{mains}} = \text{AC } 230 \text{ V}$	I_{mains}	AC 6.3 A	AC 7.9 A	AC 9.5 A
	125 %			
	I_{mains}			
OUTPUT				
Output voltage	V_{N}	3 x 0 ... V_{mains}		
Recommended motor power under constant load (at $V_{\text{mains}} = \text{AC } 230 \text{ V}$)	P_{mot}	1.1 kW 1.5 HP	1.5 kW 2.0 HP	2.2 kW 3.0 HP
Recommended motor power under variable torque load or constant load without overload (with $V_{\text{mains}} = \text{AC } 230 \text{ V}$)	P_{mot}	1.5 kW 2.0 HP	2.2 kW 3.0 HP	3.0 kW 4.0 HP
Rated output current	I_{N}	AC 5.7 A	AC 7.3 A	AC 8.6 A
At $V_{\text{mains}} = \text{AC } 230 \text{ V}$				
Minimum permitted braking resistor value (4-Q operation)	R_{BRmin}	27 Ω		



Technical Data

Technical data of MOVITRAC® 07

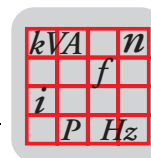
MOVITRAC® 07A (3-phase supply)		011-2A3-4-..	015-2A3-4-..	022-2A3-4-..
GENERAL				
Power loss at I_N	P_V	75 W	100 W	125 W
Current limitation		125 % I_N continuous duty (fan / pump operation) 150 % I_N for maximum 60 seconds		
PWM frequency	f_{PWM}	4 / 8 / 12 / 16 kHz		
Speed range Resolution	n_A Δn_A	0 ... 5500 rpm 1 rpm		
Terminals		Terminals 4 mm ²		
Dimensions	W x H x D	90 x 295 x 150 mm 3.5 x 9.5 x 5.9 in		
Weight	m	2.5 kg 5.5 lb		



54559AXX

Figure 31: Dimensions, MOVITRAC® 07 size 0L

Provide 100 mm (4 in) clearance above and below the unit to ensure adequate cooling! There is no need for clearance at the sides. You can line up the units directly next to one another. Make sure that the circulation of air is not disrupted by cables or other installation materials. Prevent the heated exhaust air from other units from blowing onto this unit.

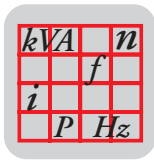


AC 230 V / 3-phase / size 1 / 3.7 kW / 5.0 HP



Figure 32: MOVITRAC® 07 / size 1 / 3-phase AC 230 V

MOVITRAC® 07A (3-phase supply)		037-2A3-4-..
Part number		827 278 6
Part number with LOGODrive		827 285 9
INPUT		
Supply voltage Permitted range	V_{mains}	3 x AC 230 V $V_{\text{mains}} = \text{AC } 200 \text{ V } -10 \% \dots \text{AC } 240 \text{ V } + 10 \%$
Mains frequency	f_{mains}	50/ 60 Hz +/- 5 %
Rated mains current, 3-phase At $V_{\text{mains}} = \text{AC } 230 \text{ V}$	100 % I_{mains} 125 % I_{mains}	AC 12.9 A AC 16.1 A
OUTPUT		
Output voltage	V_{N}	3 x 0 ... V_{mains}
Recommended motor power under constant load (at $V_{\text{mains}} = \text{AC } 230 \text{ V}$)	P_{mot}	3.7 kW 5 HP
Recommended motor power under variable torque load or constant load without overload (with $V_{\text{mains}} = \text{AC } 230 \text{ V}$)	P_{mot}	5.5 kW 7.5 HP
Rated output current At $V_{\text{mains}} = \text{AC } 230 \text{ V}$	I_{N}	AC 14.5 A
Minimum permitted braking resistor value (4-Q operation)	R_{BRmin}	27 Ω



Technical Data

Technical data of MOVITRAC® 07

MOVITRAC® 07A (3-phase supply)		037-2A3-4-..
GENERAL		
Power loss at I_N	P_V	210 W
Current limitation		125 % I_N continuous duty (fan / pump operation) 150 % I_N for maximum 60 seconds
PWM frequency	f_{PWM}	4 / 8 / 12 / 16 kHz
Speed range Resolution	n_A Δn_A	0 ... 5500 rpm 1 rpm
Terminals	Terminals	4 mm ²
Dimensions	W x H x D	105 x 315 x 144 mm 4.1 x 12.4 x 5.7 in
Weight	m	3.5 kg 7.7 lb

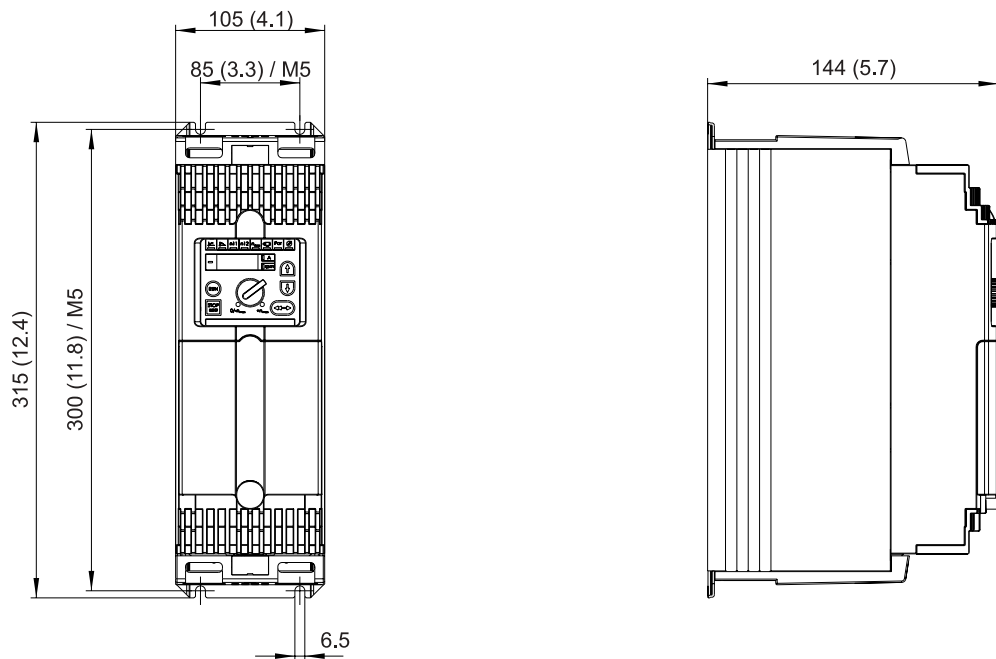
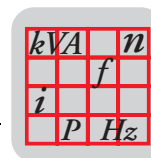


Figure 33: Dimensions, MOVITRAC® 07 size 1

05806AXX

Provide 100 mm (4 in) clearance above and below the unit to ensure adequate cooling! There is no need for clearance at the sides. You can line up the units directly next to one another. Make sure that the circulation of air is not disrupted by cables or other installation materials. Prevent the heated exhaust air from other units from blowing onto this unit.

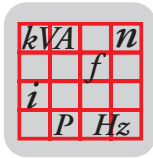


AC 230 V / 3-phase / size 2 / 5.5 ... 7.5 kW / 7.5 ... 10 HP



Figure 34: MOVITRAC® 07 / size 2 / 3-phase AC 230 V

MOVITRAC® 07A (3-phase supply)		055-2A3-4-..	075-2A3-4-..
Part number		827 279 4	827 280 8
Part number with LOGODrive		827 286 7	827 287 5
INPUT			
Supply voltage Permitted range	V_{mains}	3 x AC 230 V $V_{\text{mains}} = \text{AC } 200 \text{ V } -10 \% \dots \text{AC } 240 \text{ V } +10 \%$	
Mains frequency	f_{mains}	50/ 60 Hz +/- 5 %	
Rated mains current, 3-phase At $V_{\text{mains}} = \text{AC } 230 \text{ V}$	100 % I_{mains} 125 % I_{mains}	AC 19.5 A AC 24.4 A	AC 27.4 A AC 34.3 A
OUTPUT			
Output voltage	V_{N}	3 x 0 ... V_{mains}	
Recommended motor power under constant load (at $V_{\text{mains}} = \text{AC } 230 \text{ V}$)	P_{mot}	5.5 kW 7.5 HP	7.5 kW 10 HP
Recommended motor power under variable torque load or constant load without overload (with $V_{\text{mains}} = \text{AC } 230 \text{ V}$)	P_{mot}	7.5 kW 10 HP	11 kW 15 HP
Rated output current At $V_{\text{mains}} = \text{AC } 230 \text{ V}$	I_{N}	AC 22 A	AC 29 A
Minimum permitted braking resistor value (4-Q operation)	R_{BRmin}	12 Ω	



Technical Data

Technical data of MOVITRAC® 07

MOVITRAC® 07A (3-phase supply)		055-2A3-4-..	075-2A3-4-..
GENERAL			
Power loss at I_N	P_V	300 W	380 W
Current limitation		125 % I_N continuous duty (fan / pump operation) 150 % I_N for maximum 60 seconds	
PWM frequency	f_{PWM}	4 / 8 / 12 / 16 kHz	
Speed range Resolution	n_A Δn_A	0 ... 5500 rpm 1 rpm	
Terminals	Terminals	4 mm ²	6 mm ²
Dimensions	W x H x D	130 x 335 x 196 mm 5.1 x 13.2 x 7.7 in	
Weight	m	6.6 kg 14.6 lb	

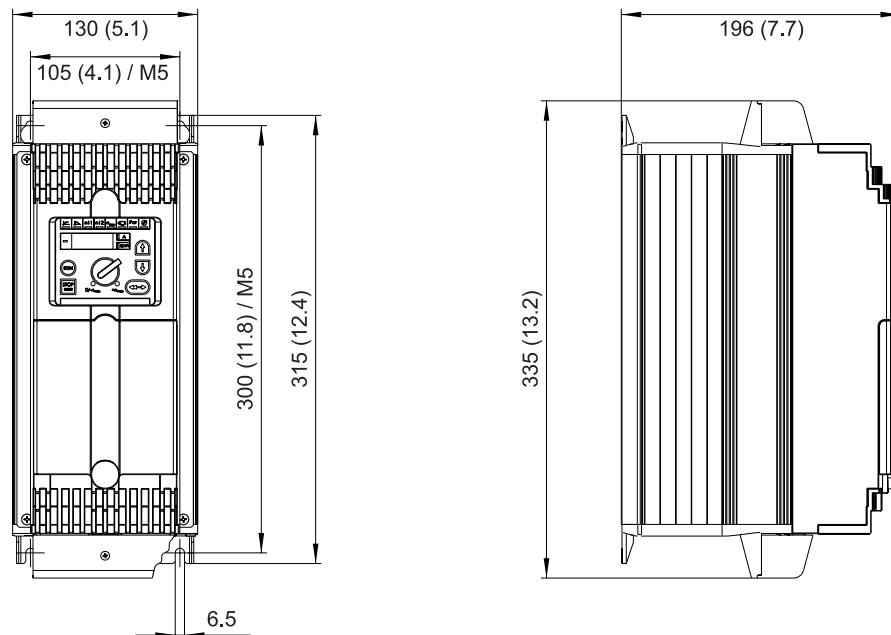
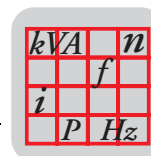


Figure 35: Dimensions, MOVITRAC® 07 size 2

05807AXX

Provide 100 mm (4 in) clearance above and below the unit to ensure adequate cooling! There is no need for clearance at the sides. You can line up the units directly next to one another. Make sure that the circulation of air is not disrupted by cables or other installation materials. Prevent the heated exhaust air from other units from blowing onto this unit.

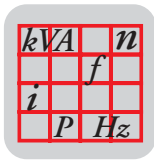


AC 230 V / 3-phase / size 3 / 11 ... 15 kW / 15 ... 20 HP



Figure 36: MOVITRAC® 07 / size 3 / 3-phase AC 230 V

MOVITRAC® 07A (3-phase supply)		110-203-4-..	150-203-4-..
Part number		827 281 6	827 282 4
Part number with LOGODrive		827 288 3	827 289 1
INPUT			
Supply voltage Permitted range	V_{mains}	3 x AC 230 V $V_{\text{mains}} = \text{AC } 200 \text{ V } -10 \% \dots \text{AC } 240 \text{ V } +10 \%$	
Mains frequency	f_{mains}	50/ 60 Hz +/- 5 %	
Rated mains current, 3-phase At $V_{\text{mains}} = \text{AC } 230 \text{ V}$	100 % I_{mains} 125 % I_{mains}	AC 40.0 A AC 50.0 A	AC 48.6 A AC 60.8 A
OUTPUT			
Output voltage	V_N	3 x 0 ... V_{mains}	
Recommended motor power under constant load (at $V_{\text{mains}} = \text{AC } 230 \text{ V}$)	P_{mot}	11 kW 15 HP	15 kW 20 HP
Recommended motor power under variable torque load or constant load without overload (with $V_{\text{mains}} = \text{AC } 230 \text{ V}$)	P_{mot}	15 kW 20 HP	22 kW 30 HP
Rated output current At $V_{\text{mains}} = \text{AC } 230 \text{ V}$	I_N	AC 42 A	AC 54 A
Minimum permitted braking resistor value (4-Q operation)	R_{BRmin}	7.5 Ω	5.6 Ω



Technical Data

Technical data of MOVITRAC® 07

MOVITRAC® 07A (3-phase supply)		110-203-4-..	150-203-4-..
GENERAL			
Power loss at I_N	P_V	580 W	720 W
Current limitation		125 % I_N continuous duty (fan / pump operation) 150 % I_N for maximum 60 seconds	
PWM frequency	f_{PWM}	4 / 8 / 12 / 16 kHz	
Speed range Resolution	n_A Δn_A	0 ... 5500 rpm 1 rpm	
Terminals	Terminals	10 mm ²	16 mm ²
Dimensions	W x H x D	200 x 465 x 218 mm 7.9 x 18.3 x 8.6 in	
Weight	m	15 kg 33.1 lb	

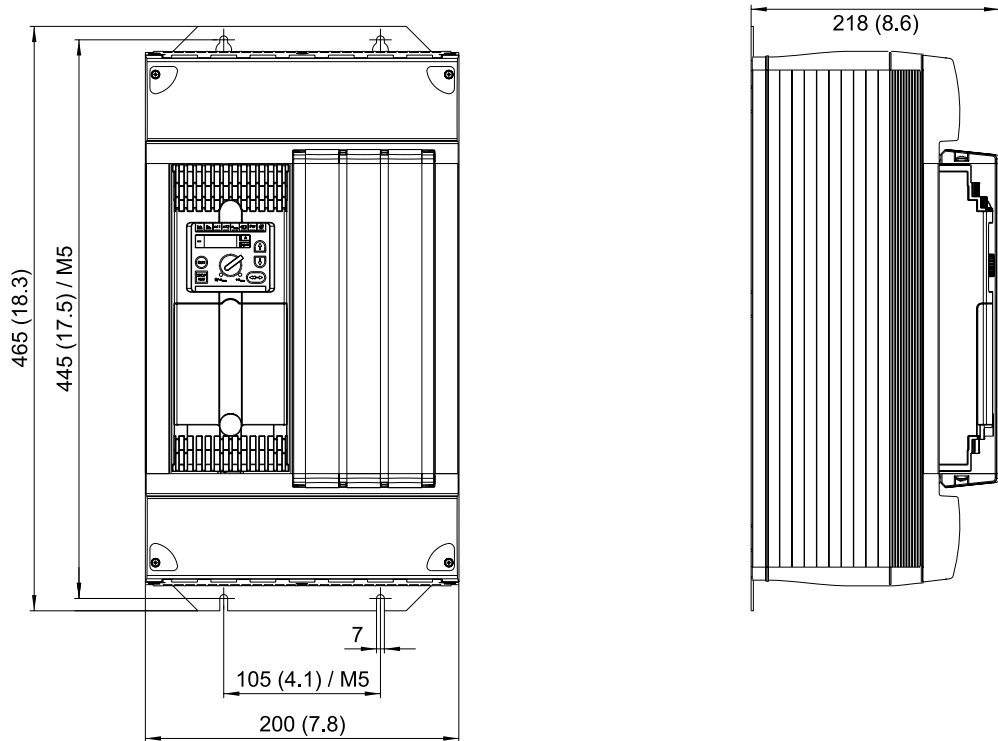
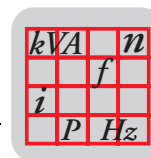


Figure 37: Dimensions, MOVITRAC® 07 size 3

05808AXX

Provide 100 mm (4 in) clearance above and below the unit to ensure adequate cooling! There is no need for clearance at the sides. You can line up the units directly next to one another. Make sure that the circulation of air is not disrupted by cables or other installation materials. Prevent the heated exhaust air from other units from blowing onto this unit.

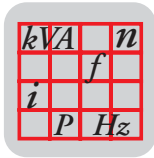


AC 230 V / 3-phase / size 4 / 22 ... 30 kW / 30 ... 40 HP



Figure 38: MOVITRAC® 07 / size 4 / 3-phase AC 230 V

MOVITRAC® 07A (3-phase supply)		220-203-4-..	300-203-4-..
Part number		827 283 2	827 284 0
Part number with LOGODrive		827 290 5	827 291 3
INPUT			
Supply voltage Permitted range	V_{mains}	3 x AC 230 V $V_{\text{mains}} = \text{AC } 200 \text{ V } -10 \% \dots \text{AC } 240 \text{ V } +10 \%$	
Mains frequency	f_{mains}	50/ 60 Hz +/- 5 %	
Rated mains current, 3-phase At $V_{\text{mains}} = \text{AC } 230 \text{ V}$	100 % I_{mains} 125 % I_{mains}	AC 72 A AC 90 A	AC 86 A AC 107 A
OUTPUT			
Output voltage	V_{N}	3 x 0 ... V_{mains}	
Recommended motor power under constant load (at $V_{\text{mains}} = \text{AC } 230 \text{ V}$)	P_{mot}	22 kW 30 HP	30 kW 40 HP
Recommended motor power under variable torque load or constant load without overload (with $V_{\text{mains}} = \text{AC } 230 \text{ V}$)	P_{mot}	30 kW 40 HP	37 kW 50 HP
Rated output current At $V_{\text{mains}} = \text{AC } 230 \text{ V}$	I_{N}	AC 80 A	AC 95 A
Minimum permitted braking resistor value (4-Q operation)	R_{BRmin}	3 Ω	



Technical Data

Technical data of MOVITRAC® 07

MOVITRAC® 07A (3-phase supply)		220-203-4-..	300-203-4-..
GENERAL			
Power loss at I_N	P_V	1100 W	1300 W
Current limitation		125 % I_N continuous duty (fan / pump operation) 150 % I_N for maximum 60 seconds	
PWM frequency	f_{PWM}	4 / 8 / 12 / 16 kHz	
Speed range Resolution	n_A Δn_A	0 ... 5500 rpm 1 rpm	
Terminals	Terminals	25 mm ²	35 mm ²
Dimensions	W x H x D	280 x 522 x 222 mm 11.0 x 20.6 x 8.7 in	
Weight	m	27 kg 59.5 lb	

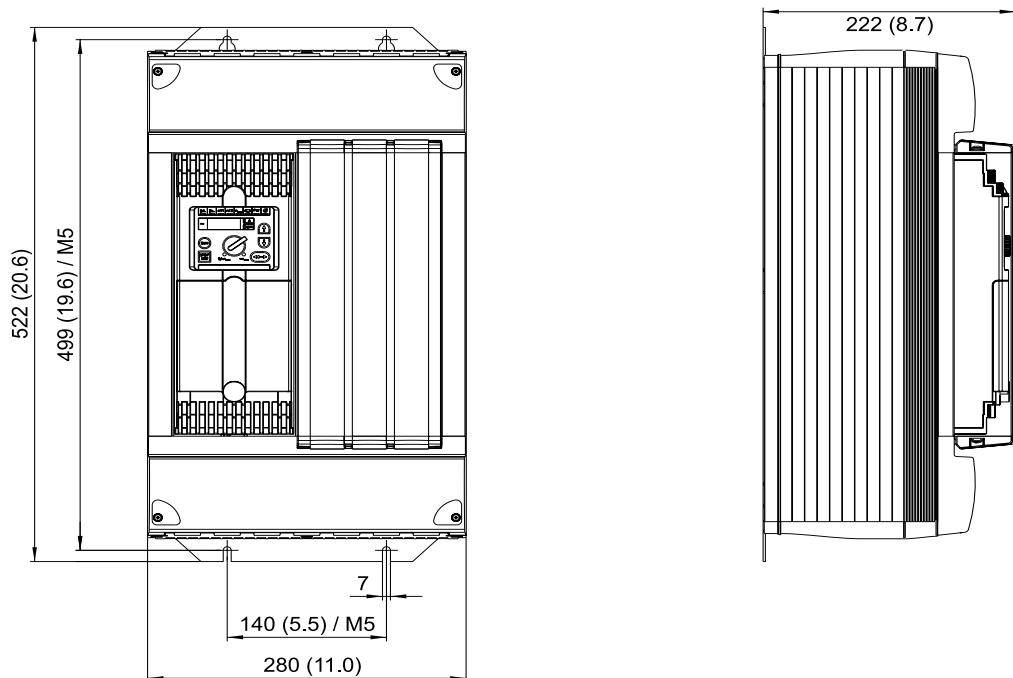
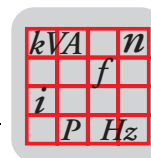


Figure 39: Dimensions, MOVITRAC® 07 size 4

05809AXX

Provide 100 mm (4 in) clearance above and below the unit to ensure adequate cooling! There is no need for clearance at the sides. You can line up the units directly next to one another. Make sure that the circulation of air is not disrupted by cables or other installation materials. Prevent the heated exhaust air from other units from blowing onto this unit.

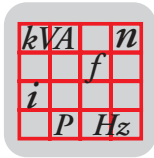


AC 400/500 V / 3-phase / size 0M / 0.55 ... 1.1 kW / 0.75 ... 1.5 HP

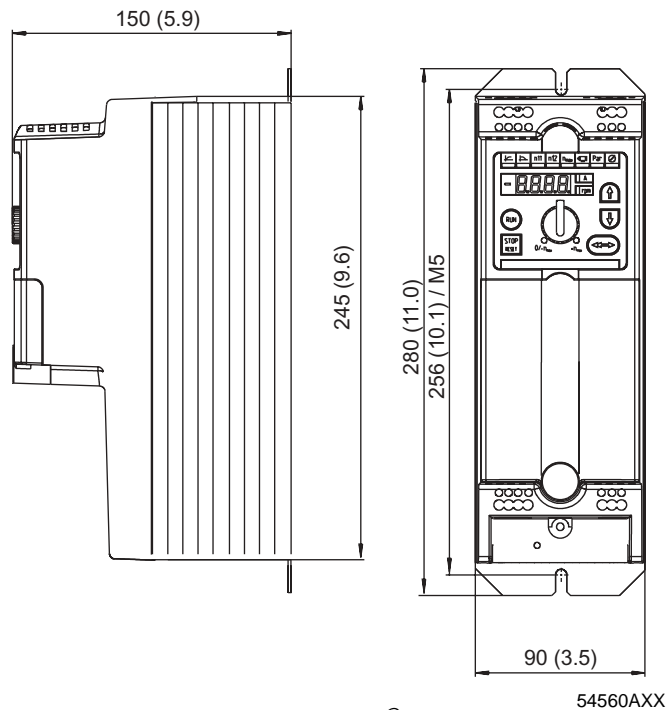


Figure 40: MOVITRAC® 07 / size 0M / 3-phase AC 400/500 V

MOVITRAC® 07A (3-phase supply)		005-5A3-4-..	008-5A3-4-..	011-5A3-4-..
Part number		827 247 6	827 248 4	827 249 2
Part number with LOGODrive		827 292 1	827 293 x	827 294 8
INPUT				
Supply voltage Permitted range	V_{mains}	3 x AC 400 V $V_{\text{mains}} = \text{AC } 380 \text{ V } -10 \% \dots \text{AC } 500 \text{ V } +10 \%$		
Mains frequency	f_{mains}	50/ 60 Hz +/- 5 %		
Rated mains current, 3-phase At $V_{\text{mains}} = \text{AC } 400 \text{ V}$	100 % I_{mains} 125 % I_{mains}	AC 1.8 A AC 2.3 A	AC 2.2 A AC 2.6 A	AC 2.8 A AC 3.5 A
OUTPUT				
Output voltage	V_{N}	3 x 0 ... V_{mains}		
Recommended motor power under constant load (at $V_{\text{mains}} = \text{AC } 400 \text{ V}$)	P_{mot}	0.55 kW 0.75 HP	0.75 kW 1.0 HP	1.1 kW 1.5 HP
Recommended motor power under variable torque load or constant load without overload (with $V_{\text{mains}} = \text{AC } 400 \text{ V}$)	P_{mot}	0.75 kW 1.0 HP	1.1 kW 1.5 HP	1.5 kW 2.0 HP
Rated output current At $V_{\text{mains}} = \text{AC } 400 \text{ V}$	I_{N}	AC 2.0 A	AC 2.4 A	AC 3.1 A
Minimum permitted braking resistor value (4-Q operation)	R_{BRmin}	68 Ω		



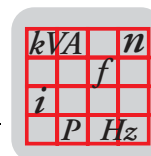
MOVITRAC® 07A (3-phase supply)		005-5A3-4-..	008-5A3-4-..	011-5A3-4-..
GENERAL				
Power loss at I_N	P_V	42 W	48 W	58 W
Current limitation		125 % I_N continuous duty (fan / pump operation) 150 % I_N for maximum 60 seconds		
PWM frequency	f_{PWM}	4 / 8 / 12 / 16 kHz		
Speed range Resolution	n_A Δn_A	0 ... 5500 rpm 1 rpm		
Terminals		Terminals 4 mm ²		
Dimensions	W x H x D	90 x 245 x 150 mm 3.5 x 9.6 x 5.9 in		
Weight	m	2.0 kg 4.4 lb		



54560AXX

Figure 41: Dimensions, MOVITRAC® 07 size 0M

Provide 100 mm (4 in) clearance above and below the unit to ensure adequate cooling! There is no need for clearance at the sides. You can line up the units directly next to one another. Make sure that the circulation of air is not disrupted by cables or other installation materials. Prevent the heated exhaust air from other units from blowing onto this unit.

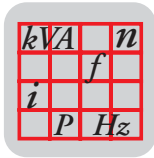


AC 400/500 V / 3-phase / size 0L / 1.5 ... 4.0 kW / 2.0 ... 5.0 HP



Figure 42: MOVITRAC® 07 / size 0L / 3-phase AC 400/500 V

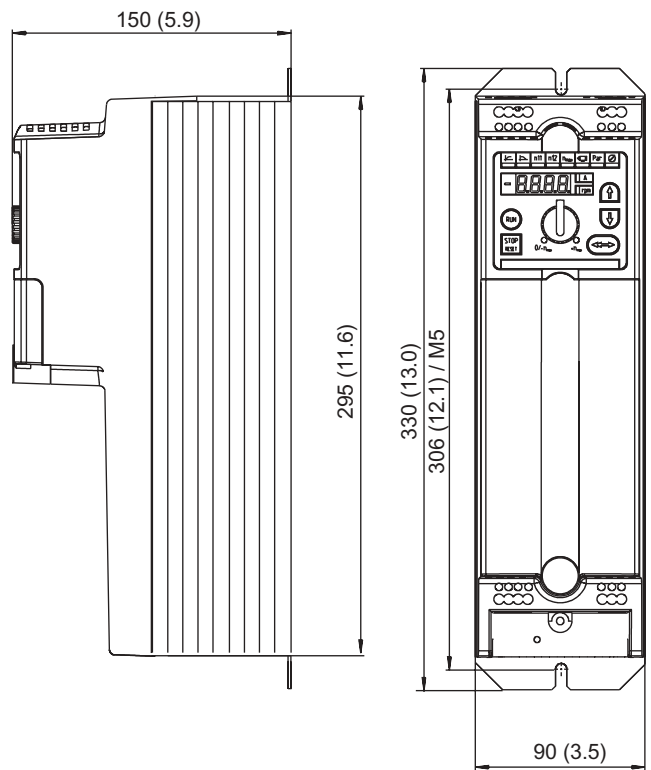
MOVITRAC® 07A (3-phase supply)		015-5A3-4-	022-5A3-4-	030-5A3-4-	040-5A3-4-
	
Part number		827 250 6	827 251 4	827 252 2	827 253 0
Part number with LOGODrive		827 295 6	827 296 4	827 297 2	827 298 0
INPUT					
Supply voltage Permitted range	V_{mains}	3 x AC 400 V $V_{\text{mains}} = \text{AC } 380 \text{ V } -10 \% \dots \text{AC } 500 \text{ V } +10 \%$			
Mains frequency	f_{mains}	50/ 60 Hz +/- 5 %			
Rated mains current, 3-phase At $V_{\text{mains}} = \text{AC } 400 \text{ V}$	100 % I_{mains} 125 % I_{mains}	AC 3.6 A AC 4.5 A	AC 5.0 A AC 6.2 A	AC 6.3 A AC 7.9 A	AC 8.6 A AC 10.7 A
OUTPUT					
Output voltage	V_{N}	3 x 0 ... V_{mains}			
Recommended motor power under constant load (at $V_{\text{mains}} = \text{AC } 400 \text{ V}$)	P_{mot}	1.5 kW 2.0 HP	2.2 kW 3.0 HP	3.0 kW 4.0 HP	4.0 kW 5.0 HP
Recommended motor power under variable torque load or constant load without overload (with $V_{\text{mains}} = \text{AC } 400 \text{ V}$)	P_{mot}	2.2 kW 3.0 HP	3.0 kW 4.0 HP	4.0 kW 5.0 HP	5.5 kW 7.5 HP
Rated output current At $V_{\text{mains}} = \text{AC } 400 \text{ V}$	I_{N}	AC 4.0 A	AC 5.5 A	AC 7.0 A	AC 9.5 A
Minimum permitted braking resistor value (4-Q operation)	R_{BRmin}	68 Ω			



Technical Data

Technical data of MOVITRAC® 07

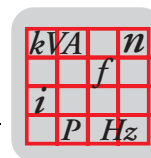
MOVITRAC® 07A (3-phase supply)		015-5A3-4-	022-5A3-4-	030-5A3-4-	040-5A3-4-
	
GENERAL					
Power loss at I_N	P_V	74 W	97 W	123 W	155 W
Current limitation		125 % I_N continuous duty (fan / pump operation) 150 % I_N for maximum 60 seconds			
PWM frequency	f_{PWM}	4 / 8 / 12 / 16 kHz			
Speed range Resolution	n_A Δn_A	0 ... 5500 rpm 1 rpm			
Terminals		Terminals 4 mm ²			
Dimensions	W x H x D	90 x 295 x 150 mm 3.5 x 11.6 x 5.9 in			
Weight	m	2.5 kg 5.5 lb			



54559AXX

Figure 43: Dimensions, MOVITRAC® 07 size 0L

Provide 100 mm (4 in) clearance above and below the unit to ensure adequate cooling! There is no need for clearance at the sides. You can line up the units directly next to one another. Make sure that the circulation of air is not disrupted by cables or other installation materials. Prevent the heated exhaust air from other units from blowing onto this unit.

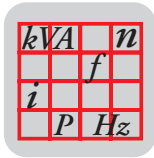


AC 400/500 V / 3-phase / size 2S / 5.5 ... 7.5 kW / 7.5 ... 10 HP



Figure 44: MOVITRAC® 07 / size 2S / 3-phase AC 400/500 V

MOVITRAC® 07A (3-phase supply)		055-5A3-4-..	075-5A3-4-..
Part number		827 254 9	827 255 7
Part number with LOGODrive		827 299 9	827 300 6
INPUT			
Supply voltage Permitted range	V_{mains}	3 x AC 400 V $V_{\text{mains}} = \text{AC } 380 \text{ V } -10 \% \dots \text{AC } 500 \text{ V } +10 \%$	
Mains frequency	f_{mains}	50/ 60 Hz +/- 5 %	
Rated mains current, 3-phase At $V_{\text{mains}} = \text{AC } 400 \text{ V}$	100 % I_{mains} 125 % I_{mains}	AC 11.3 A AC 14.1 A	AC 14.4 A AC 18.0 A
OUTPUT			
Output voltage	V_{N}	3 x 0 ... V_{mains}	
Recommended motor power under constant load (at $V_{\text{mains}} = \text{AC } 400 \text{ V}$)	P_{mot}	5.5 kW 7.5 HP	7.5 kW 10 HP
Recommended motor power under variable torque load or constant load without overload (with $V_{\text{mains}} = \text{AC } 400 \text{ V}$)	P_{mot}	7.5 kW 10 HP	11 kW 15 HP
Rated output current At $V_{\text{mains}} = \text{AC } 400 \text{ V}$	I_{N}	AC 12.5 A	AC 16 A
Minimum permitted braking resistor value (4-Q operation)	R_{BRmin}	47 Ω	



Technical Data

Technical data of MOVITRAC® 07

MOVITRAC® 07A (3-phase supply)		055-5A3-4-..	075-5A3-4-..
GENERAL			
Power loss at I_N	P_V	220 W	290 W
Current limitation		125 % I_N continuous duty (fan / pump operation) 150 % I_N for maximum 60 seconds	
PWM frequency	f_{PWM}	4 / 8 / 12 / 16 kHz	
Speed range Resolution	n_A Δn_A	0 ... 5500 rpm 1 rpm	
Terminals	Terminals	4 mm ²	
Dimensions	W x H x D	105 x 335 x 205 mm 4.1 x 13.2 x 8.1 in	
Weight	m	5.0 kg 11.0 lb	

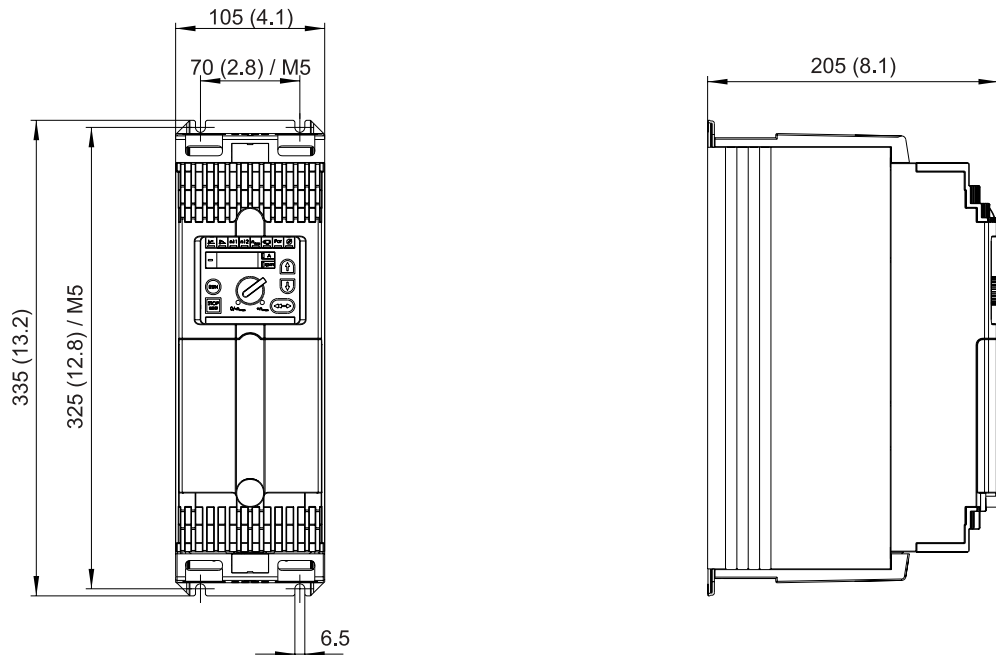
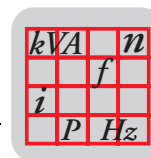


Figure 45: Dimensions, MOVITRAC® 07 size 2S

05811AXX

Provide 100 mm (4 in) clearance above and below the unit to ensure adequate cooling! There is no need for clearance at the sides. You can line up the units directly next to one another. Make sure that the circulation of air is not disrupted by cables or other installation materials. Prevent the heated exhaust air from other units from blowing onto this unit.

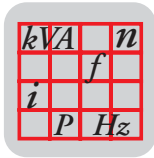


AC 400/500 V / 3-phase / size 2 / 11 kW / 15 HP



Figure 46: MOVITRAC® 07 / size 2 / 3-phase AC 400/500 V

MOVITRAC® 07A (3-phase supply)		110-5A3-4-..
Part number		827 256 5
Part number with LOGODrive		827 301 4
INPUT		
Supply voltage Permitted range	V_{mains}	3 x AC 400 V $V_{\text{mains}} = \text{AC } 380 \text{ V } -10 \% \dots \text{AC } 500 \text{ V } +10 \%$
Mains frequency	f_{mains}	50/ 60 Hz +/- 5 %
Rated mains current, 3-phase At $V_{\text{mains}} = \text{AC } 400 \text{ V}$	100 % I_{mains} 125 % I_{mains}	AC 21.6 A AC 27.0 A
OUTPUT		
Output voltage	V_{N}	3 x 0 ... V_{mains}
Recommended motor power under constant load (at $V_{\text{mains}} = \text{AC } 400 \text{ V}$)	P_{mot}	11 kW 15 HP
Recommended motor power under variable torque load or constant load without overload (with $V_{\text{mains}} = \text{AC } 400 \text{ V}$)	P_{mot}	15 kW 20 HP
Rated output current At $V_{\text{mains}} = \text{AC } 400 \text{ V}$	I_{N}	AC 24 A
Minimum permitted braking resistor value (4-Q operation)	R_{BRmin}	22 Ω



Technical Data

Technical data of MOVITRAC® 07

MOVITRAC® 07A (3-phase supply)		110-5A3-4-..
GENERAL		
Power loss at I_N	P_V	400 W
Current limitation		125 % I_N continuous duty (fan / pump operation) 150 % I_N for maximum 60 seconds
PWM frequency	f_{PWM}	4 / 8 / 12 / 16 kHz
Speed range Resolution	n_A Δn_A	0 ... 5500 rpm 1 rpm
Terminals	Terminals	4 mm ²
Dimensions	W x H x D	130 x 335 x 196 mm 5.1 x 13.2 x 7.7 in
Weight	m	6.6 kg 14.6 lb

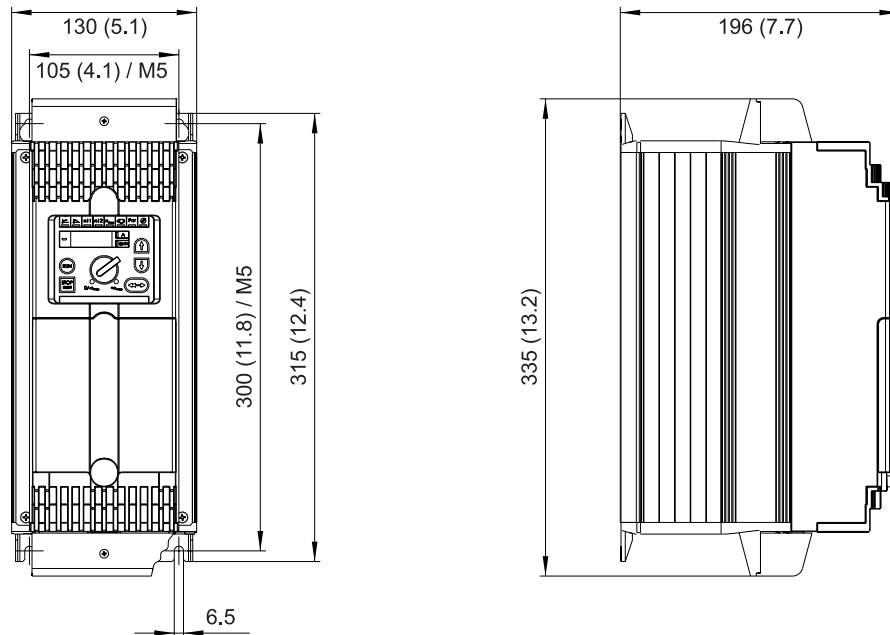
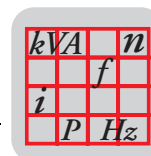


Figure 47: Dimensions, MOVITRAC® 07 size 2

05807AXX

Provide 100 mm (4 in) clearance above and below the unit to ensure adequate cooling! There is no need for clearance at the sides. You can line up the units directly next to one another. Make sure that the circulation of air is not disrupted by cables or other installation materials. Prevent the heated exhaust air from other units from blowing onto this unit.

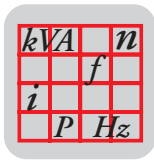


AC 400/500 V / 3-phase / size 3 / 15 ... 30 kW / 20 ... 40 HP



Figure 48: MOVITRAC® 07 / size 3 / 3-phase AC 400/500 V

MOVITRAC® 07 (3-phase supply system)		150-503-4-..	220-503-4-..	300-503-4-..
Part number		827 257 3	827 258 1	827,259 x
Part number with LOGODrive		827 302 2	827 303 0	827 304 9
INPUT				
Supply voltage	V_{mains}	3 x AC 400 V		
Permitted range		$V_{\text{mains}} = \text{AC } 380 \text{ V } -10 \% \dots \text{AC } 500 \text{ V } +10 \%$		
Mains frequency	f_{mains}	50/ 60 Hz +/- 5 %		
Rated mains current, 3-phase	100 %	AC 28.8 A	AC 41.4 A	AC 54.0 A
At $V_{\text{mains}} = \text{AC } 400 \text{ V}$	I_{mains}	AC 36.0 A	AC 51.7 A	AC 67.5 A
	125 %			
	I_{mains}			
OUTPUT				
Output voltage	V_{N}	3 x 0 ... V_{mains}		
Recommended motor power under constant load (with $V_{\text{in}} = 400 \text{ V}_{\text{AC}}$)	P_{mot}	15 kW 20 HP	22 kW 30 HP	30 kW 40 HP
Recommended motor power under variable torque load or constant load without overload (with $V_{\text{mains}} = \text{AC } 400 \text{ V}$)	P_{mot}	22 kW 30 HP	30 kW 40 HP	37 kW 50 HP
Rated output current	I_{N}	AC 32 A	AC 46 A	AC 60 A
At $V_{\text{mains}} = \text{AC } 400 \text{ V}$				
Minimum permitted braking resistor value (4-Q operation)	R_{BRmin}	15 Ω		12 Ω



Technical Data

Technical data of MOVITRAC® 07

MOVITRAC® 07 (3-phase supply system)		150-503-4-..	220-503-4-..	300-503-4-..
GENERAL				
Power loss at I_N	P_V	550 W	750 W	950 W
Current limitation		125 % I_N continuous duty (fan / pump operation) 150 % I_N for maximum 60 seconds		
PWM frequency	f_{PWM}	4 / 8 / 12 / 16 kHz		
Speed range Resolution	n_A Δn_A	0 ... 5500 rpm 1 rpm		
Terminals	Terminals	6 mm ²	10 mm ²	16 mm ²
Dimensions	W x H x D	200 x 465 x 218 mm 7.9 x 18.3 x 8.6 in		
Weight	m	15 kg 33.1 lb		

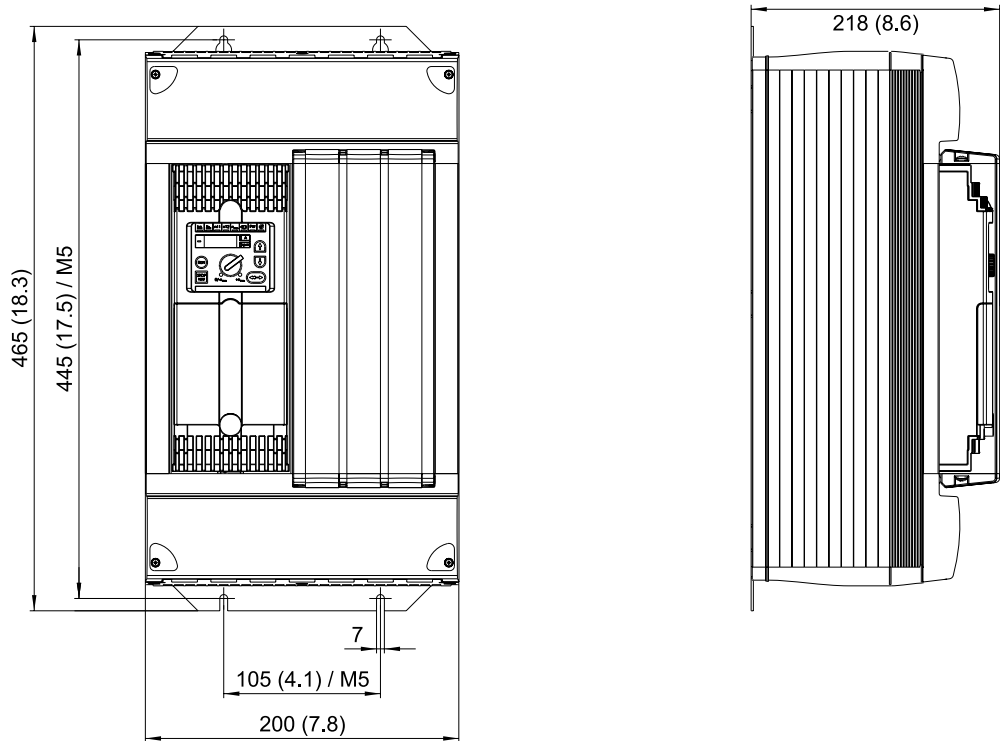
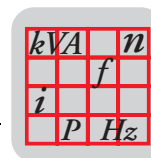


Figure 49: Dimensions, MOVITRAC® 07 size 3

05808AXX

Provide 100 mm (4 in) clearance above and below the unit to ensure adequate cooling! There is no need for clearance at the sides. You can line up the units directly next to one another. Make sure that the circulation of air is not disrupted by cables or other installation materials. Prevent the heated exhaust air from other units from blowing onto this unit.

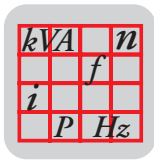


AC 400/500 V / 3-phase / size 4 / 37 ... 45 kW / 50 ... 60 HP



Figure 50: MOVITRAC® 07 / size 4 / 3-phase AC 400/500 V

MOVITRAC® 07 (3-phase supply system)		370-503-4-..	450-503-4-..
Part number		827 884 9	827 885 7
Part number with LOGODrive		827 886 5	827 887 3
INPUT			
Supply voltage Permitted range	V_{mains}	3 x AC 400 V $V_{\text{mains}} = \text{AC } 380 \text{ V } -10 \% \dots \text{AC } 500 \text{ V } +10 \%$	
Mains frequency	f_{mains}	50/ 60 Hz +/- 5 %	
Rated mains current, 3-phase At $V_{\text{mains}} = \text{AC } 400 \text{ V}$	100 % I_{mains} 125 % I_{mains}	AC 65.7 A AC 81.9 A	AC 80.1 A AC 100.1 A
OUTPUT			
Output voltage	V_{N}	3 x 0 ... V_{mains}	
Recommended motor power under constant load (with $V_{\text{in}} = 400 \text{ V}_{\text{AC}}$)	P_{mot}	37 kW 50 HP	45 kW 60 HP
Recommended motor power under variable torque load or constant load without overload (with $V_{\text{mains}} = \text{AC } 400 \text{ V}$)	P_{mot}	45 kW 60 HP	55 kW 75 HP
Rated output current At $V_{\text{mains}} = \text{AC } 400 \text{ V}$	I_{N}	AC 73 A	AC 89 A
Minimum permitted braking resistor value (4-Q operation)	R_{BRmin}	6 Ω	



Technical Data

Technical data of MOVITRAC® 07

MOVITRAC® 07 (3-phase supply system)		370-503-4-..	450-503-4-..
GENERAL			
Power loss at I_N	P_V	1200 W	1400 W
Current limitation		125 % I_N continuous duty (fan / pump operation) 150 % I_N for maximum 60 seconds	
PWM frequency	f_{PWM}	4 / 8 / 12 / 16 kHz	
Speed range Resolution	n_A Δn_A	0 ... 5500 rpm 1 rpm	
Terminals	Terminals	25 mm ²	35 mm ²
Dimensions	W x H x D	280 x 522 x 222 mm 11.0 x 20.6 x 8.7 in	
Weight	m	27 kg 59.5 lb	

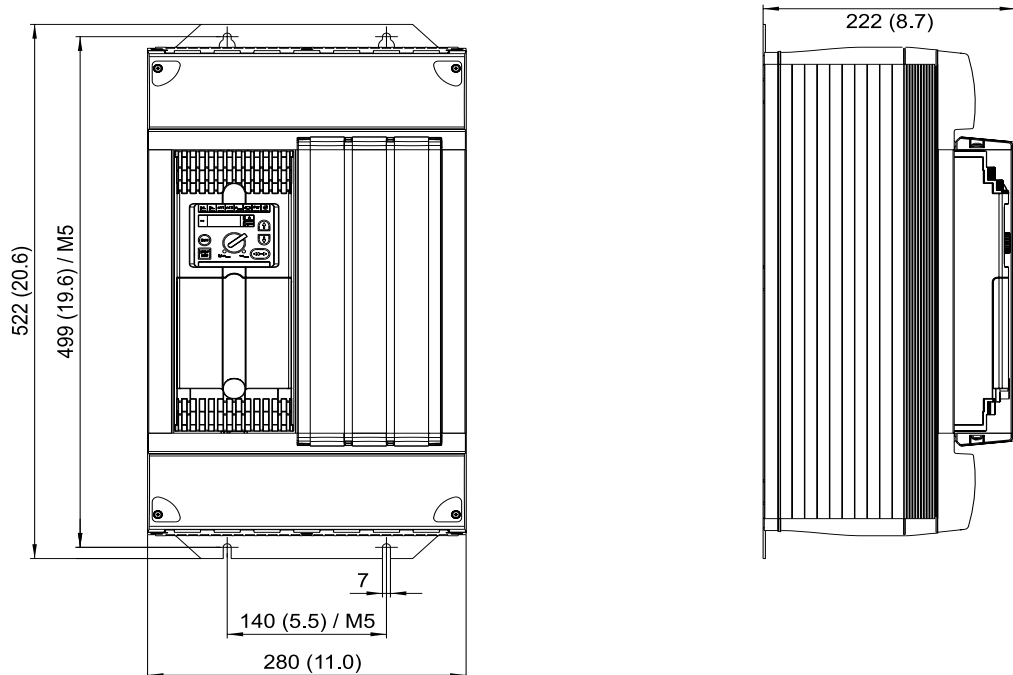
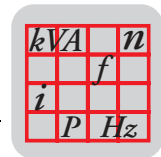


Figure 51: Dimensions, MOVITRAC® 07 size 4

05809AXX

Provide 100 mm (4 in) clearance above and below the unit to ensure adequate cooling! There is no need for clearance at the sides. You can line up the units directly next to one another. Make sure that the circulation of air is not disrupted by cables or other installation materials. Prevent the heated exhaust air from other units from blowing onto this unit.



MOVITRAC® 07 size 0S, 0M, 0L for support rail mounting (optional accessory)

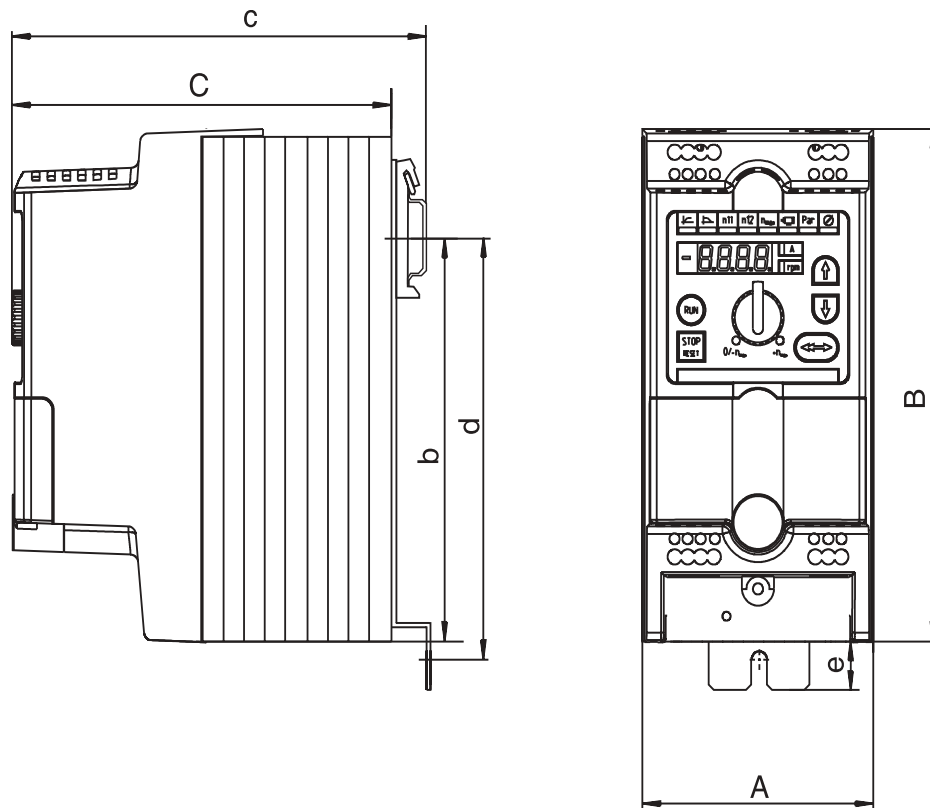


Figure 52: MOVITRAC® 07 dimensions for DIN rail mounting (optional accessory)

04329AXX

MOVITRAC® 07	AC 230 V	004	005	008	011	015	022	
Dimensions	A x B x C	90 x 185 x 150 mm 3.5 x 7.2 x 5.9 in			90 x 295 x 150 mm 3.5 x 9.5 x 5.9 in			
Mounting	b / c / d / e	141 mm / 162 mm / 152 mm (M4) / 14.75 mm 5.6 in / 6.4 in / 6.0 in (M4) / 0.6 in			250 mm / 162 mm / 261 mm (M4) / 14.75 mm 9.8 in / 6.4 in / 10.3 in (M4) / 0.6 in			
Size		0S			0L			
MOVITRAC® 07	400/500 V _{AC}	005	008	011	015	022	030	040
Dimensions	A x B x C	90 x 245 x 150 mm 3.5 x 9.7 x 5.9 in			90 x 295 x 150 mm 3.5 x 9.5 x 5.9 in			
Mounting	b / c / d / e	200 mm / 162 mm / 211 mm (M4) / 14.75 mm 7.9 in / 8.7 in / 8.3 in (M4) / 0.6 in			250 mm / 162 mm / 261 mm (M4) / 14.75 mm 9.8 in / 6.4 in / 10.3 in (M4) / 0.6 in			
Size		0M			0L			



8 Change Index

This information lists the changes in the individual chapters.

Unit Design

- Size 3: Legend has been corrected.
- Size 4: Legend has been corrected.
- Scope of delivery: Loose items / size 2S.

Installation

- The "Conductor end sleeves" section has been deleted.
- The "PE mains connection" section has been extended.
- The "Shielding and earthing" section has been extended.
- The "Switched inductances" section has been added.
- The "HD output choke" section has been extended.
- "UL-compliant installation" section : Data for MOVITRAC® 07 ...370 and ...450.
- The "Touch guard" section has been added for size 2S.

Startup

- Concerning "VFC", notes on the startup of group drives have been added.

Operation and Service

- The "Status displays" section has been added.
- The "Unit status codes" section has been added.

Technical Data

- Technical data for size 4 400/500 V have been added.



9 Index

A

Acceleration ramp	28
Activating startup	33
Actual speed	28
Ambient temperature	51
Analog setpoints	34
Apparent output current	28

B

Brake rectifier	23
Braking resistor	16
Braking resistors, connection	15

C

C-Tick	50
CE marking	50
Class B limit	15, 50
CSA	50
cUL	50

D

Deceleration ramp	28
Designated use	4
Digital control	34
DIN rail mounting	81
Direction of rotation	30
Direction of rotation setpoint	30

E

Earth leakage circuit-breaker	14
Earth-leakage monitors	15
Earthing	14
Editing parameters	28
Electromagnetic compatibility	50
Electronics service	49
EMC	50
EMC limits	15
Enable direction of rotation	31
Enclosure	51
Explosion-proof areas	5
External setpoint selection	29, 30

F

F-00 ... F-97	46
Fault indication	29
Fault information	44
Fault memory	44
Fixed setpoint n11	28
Fixed setpoint n12	28
Functional description of the terminals	23
Fuses, UL compliant installation	18

I

Immediate switch-off	44
Input contactor	14

Input fuses	14
Installation	13
Installation notes	13
Integrated operating panel	26
Interference emission	51
Inverter parameters	28
Inverter status	28
IT system	15

L

Line choke	14
Line filter	15
Line length	15
List of faults	46
List of warnings	48
Load	35
LOGODrive	35
Loose items	12
Low Voltage Directive	50

M

Manual operation	28
Manual speed control menu	28
Manual speed control module	29
Maximum speed	28
Menu system	28
Motor lead	15

O

Operating mode	32, 33
Operating panel	26
Operational environment	5
Output choke	17

P

Parameter list	36
PE input connection	14
Power reduction	51
Programming interface	35

R

r-19 ... r-32	48
Rapid stop	44
Reset	45
RS-485	31
RUN key	31

S

Safety Notes	6
Safety notes	4
SBus	31
Scope of delivery	12
Setpoint selection, external	29, 30
Setpoint speed	30
Shielding	14
Speed	30
Speed control module, manual	29



Starting the motor	34
Startup	25, 28, 32
Startup using the integrated operating panel	32
Status displays	28
STOP/RESET key	31
Supply current, UL compliant installation	18
Supply system lead	15
Supply voltage, UL compliant installation	18
Switch-off responses	44
Symbols, available symbols	28
T	
Technical data, general	51
Terminals, functional description	23
U	
UL approval	50
UL compliant installation	18
Unit design	7
Unit designation	11
Using the integrated operating panel	27
V	
VFC	33
W	
Warning instructions	4
Warning list	48
Warnings	29
Waste disposal	5
Wiring diagram	21, 22



Address List

Germany			
Headquarters Production Sales	Bruchsal	SEW-EURODRIVE GmbH & Co KG Ernst-Blickle-Straße 42 D-76646 Bruchsal P.O. Box Postfach 3023 · D-76642 Bruchsal	Tel. +49 7251 75-0 Fax +49 7251 75-1970 http://www.sew-eurodrive.de sew@sew-eurodrive.de
Service Competence Center	Central Gear units / Motors	SEW-EURODRIVE GmbH & Co KG Ernst-Blickle-Straße 1 D-76676 Graben-Neudorf	Tel. +49 7251 75-1710 Fax +49 7251 75-1711 sc-mitte-gm@sew-eurodrive.de
	Central Electronics	SEW-EURODRIVE GmbH & Co KG Ernst-Blickle-Straße 42 D-76646 Bruchsal	Tel. +49 7251 75-1780 Fax +49 7251 75-1769 sc-mitte-e@sew-eurodrive.de
	North	SEW-EURODRIVE GmbH & Co KG Alte Ricklinger Straße 40-42 D-30823 Garbsen (near Hannover)	Tel. +49 5137 8798-30 Fax +49 5137 8798-55 sc-nord@sew-eurodrive.de
	East	SEW-EURODRIVE GmbH & Co KG Dänkritzter Weg 1 D-08393 Meerane (near Zwickau)	Tel. +49 3764 7606-0 Fax +49 3764 7606-30 sc-ost@sew-eurodrive.de
	South	SEW-EURODRIVE GmbH & Co KG Domagkstraße 5 D-85551 Kirchheim (near München)	Tel. +49 89 909552-10 Fax +49 89 909552-50 sc-sued@sew-eurodrive.de
	West	SEW-EURODRIVE GmbH & Co KG Siemensstraße 1 D-40764 Langenfeld (near Düsseldorf)	Tel. +49 2173 8507-30 Fax +49 2173 8507-55 sc-west@sew-eurodrive.de
	Drive Service Hotline / 24 Hour Service		
Additional addresses for service in Germany provided on request!			
France			
Production Sales Service	Hagenau	SEW-USOCOME 48-54, route de Soufflenheim B. P. 20185 F-67506 Hagenau Cedex	Tel. +33 3 88 73 67 00 Fax +33 3 88 73 66 00 http://www.usocome.com sew@usocome.com
Assembly Sales Service	Bordeaux	SEW-USOCOME Parc d'activités de Magellan 62, avenue de Magellan - B. P. 182 F-33607 Pessac Cedex	Tel. +33 5 57 26 39 00 Fax +33 5 57 26 39 09
	Lyon	SEW-USOCOME Parc d'Affaires Roosevelt Rue Jacques Tati F-69120 Vaulx en Velin	Tel. +33 4 72 15 37 00 Fax +33 4 72 15 37 15
	Paris	SEW-USOCOME Zone industrielle 2, rue Denis Papin F-77390 Verneuil l'Étang	Tel. +33 1 64 42 40 80 Fax +33 1 64 42 40 88
Additional addresses for service in France provided on request!			
Algeria			
Sales	Alger	Réducom 16, rue des Frères Zaghoun Bellevue El-Harrach 16200 Alger	Tel. +213 21 8222-84 Fax +213 21 8222-84
Argentina			
Assembly Sales Service	Buenos Aires	SEW EURODRIVE ARGENTINA S.A. Centro Industrial Garin, Lote 35 Ruta Panamericana Km 37,5 1619 Garin	Tel. +54 3327 4572-84 Fax +54 3327 4572-21 sewar@sew-eurodrive.com.ar



Address List

Australia			
Assembly Sales Service	Melbourne	SEW-EURODRIVE PTY. LTD. 27 Beverage Drive Tullamarine, Victoria 3043	Tel. +61 3 9933-1000 Fax +61 3 9933-1003 http://www.sew-eurodrive.com.au enquires@sew-eurodrive.com.au
	Sydney	SEW-EURODRIVE PTY. LTD. 9, Sleigh Place, Wetherill Park New South Wales, 2164	Tel. +61 2 9725-9900 Fax +61 2 9725-9905 enquires@sew-eurodrive.com.au
Austria			
Assembly Sales Service	Wien	SEW-EURODRIVE Ges.m.b.H. Richard-Strauss-Strasse 24 A-1230 Wien	Tel. +43 1 617 55 00-0 Fax +43 1 617 55 00-30 http://sew-eurodrive.at sew@sew-eurodrive.at
Belgium			
Assembly Sales Service	Brüssel	CARON-VECTOR S.A. Avenue Eiffel 5 B-1300 Wavre	Tel. +32 10 231-311 Fax +32 10 231-336 http://www.caron-vector.be info@caron-vector.be
Brazil			
Production Sales Service	Sao Paulo	SEW-EURODRIVE Brasil Ltda. Avenida Amâncio Gaiolli, 50 Caixa Postal: 201-07111-970 Guarulhos/SP - Cep.: 07251-250	Tel. +55 11 6489-9133 Fax +55 11 6480-3328 http://www.sew.com.br sew@sew.com.br
Additional addresses for service in Brazil provided on request!			
Bulgaria			
Sales	Sofia	BEVER-DRIVE GmbH Bogdanovetz Str.1 BG-1606 Sofia	Tel. +359 2 9532565 Fax +359 2 9549345 bever@fastbg.net
Cameroon			
Sales	Douala	Electro-Services Rue Drouot Akwa B.P. 2024 Douala	Tel. +237 4322-99 Fax +237 4277-03
Canada			
Assembly Sales Service	Toronto	SEW-EURODRIVE CO. OF CANADA LTD. 210 Walker Drive Bramalea, Ontario L6T3W1	Tel. +1 905 791-1553 Fax +1 905 791-2999 http://www.sew-eurodrive.ca l.reynolds@sew-eurodrive.ca
	Vancouver	SEW-EURODRIVE CO. OF CANADA LTD. 7188 Honeyman Street Delta. B.C. V4G 1 E2	Tel. +1 604 946-5535 Fax +1 604 946-2513 b.wake@sew-eurodrive.ca
	Montreal	SEW-EURODRIVE CO. OF CANADA LTD. 2555 Rue Leger Street LaSalle, Quebec H8N 2V9	Tel. +1 514 367-1124 Fax +1 514 367-3677 a.peluso@sew-eurodrive.ca
Additional addresses for service in Canada provided on request!			
Chile			
Assembly Sales Service	Santiago de Chile	SEW-EURODRIVE CHILE LTDA. Las Encinas 1295 Parque Industrial Valle Grande LAMP RCH-Santiago de Chile P.O. Box Casilla 23 Correo Quilicura - Santiago - Chile	Tel. +56 2 75770-00 Fax +56 2 75770-01 ventas@sew-eurodrive.cl
China			
Production Assembly Sales Service	Tianjin	SEW-EURODRIVE (Tianjin) Co., Ltd. No. 46, 7th Avenue, TEDA Tianjin 300457	Tel. +86 22 25322612 Fax +86 22 25322611 gm-tianjin@sew-eurodrive.cn http://www.sew.com.cn



China			
Assembly Sales Service	Suzhou	SEW-EURODRIVE (Suzhou) Co., Ltd. 333, Suhong Middle Road Suzhou Industrial Park Jiangsu Province, 215021 P. R. China	Tel. +86 512 62581781 Fax +86 512 62581783 suzhou@sew.com.cn
Colombia			
Assembly Sales Service	Bogotá	SEW-EURODRIVE COLOMBIA LTDA. Calle 22 No. 132-60 Bodega 6, Manzana B Santafé de Bogotá	Tel. +57 1 54750-50 Fax +57 1 54750-44 sewcol@andinet.com
Croatia			
Sales Service	Zagreb	KOMPEKS d. o. o. PIT Erdödy 4 II HR 10 000 Zagreb	Tel. +385 1 4613-158 Fax +385 1 4613-158 kompeks@net.hr
Czech Republic			
Sales	Praha	SEW-EURODRIVE CZ S.R.O. Business Centrum Praha Luná 591 CZ-16000 Praha 6 - Vokovice	Tel. +420 a220121236 Fax +420 220121237 http://www.sew-eurodrive.cz sew@sew-eurodrive.cz
Denmark			
Assembly Sales Service	Kopenhagen	SEW-EURODRIVEA/S Geminivej 28-30, P.O. Box 100 DK-2670 Greve	Tel. +45 43 9585-00 Fax +45 43 9585-09 http://www.sew-eurodrive.dk sew@sew-eurodrive.dk
Estonia			
Sales	Tallin	ALAS-KUUL AS Paldiski mnt.125 EE 0006 Tallin	Tel. +372 6593230 Fax +372 6593231 veiko.soots@alas-kuul.ee
Finland			
Assembly Sales Service	Lahti	SEW-EURODRIVE OY Vesimäentie 4 FIN-15860 Hollola 2	Tel. +358 201 589-300 Fax +358 3 780-6211 http://www.sew-eurodrive.fi sew@sew.fi
Gabon			
Sales	Libreville	Electro-Services B.P. 1889 Libreville	Tel. +241 7340-11 Fax +241 7340-12
Great Britain			
Assembly Sales Service	Normanton	SEW-EURODRIVE Ltd. Beckbridge Industrial Estate P.O. Box No.1 GB-Normanton, West- Yorkshire WF6 1QR	Tel. +44 1924 893-855 Fax +44 1924 893-702 http://www.sew-eurodrive.co.uk info@sew-eurodrive.co.uk
Greece			
Sales Service	Athen	Christ. Boznos & Son S.A. 12, Mavromichali Street P.O. Box 80136, GR-18545 Piraeus	Tel. +30 2 1042 251-34 Fax +30 2 1042 251-59 http://www.boznos.gr info@boznos.gr
Hong Kong			
Assembly Sales Service	Hong Kong	SEW-EURODRIVE LTD. Unit No. 801-806, 8th Floor Hong Leong Industrial Complex No. 4, Wang Kwong Road Kowloon, Hong Kong	Tel. +852 2 7960477 + 79604654 Fax +852 2 7959129 sew@sewhk.com



Address List

Hungary			
Sales Service	Budapest	SEW-EURODRIVE Kft. H-1037 Budapest Kunigunda u. 18	Tel. +36 1 437 06-58 Fax +36 1 437 06-50 office@sew-eurodrive.hu
India			
Assembly Sales Service	Baroda	SEW-EURODRIVE India Pvt. Ltd. Plot No. 4, Gidc Por Ramangamdi · Baroda - 391 243 Gujarat	Tel. +91 265 2831086 Fax +91 265 2831087 mdoffice@seweurodriveindia.com
Technical Offices	Bangalore	SEW-EURODRIVE India Private Limited 308, Prestige Centre Point 7, Edward Road Bangalore	Tel. +91 80 22266565 Fax +91 80 22266569 sewbangalore@sify.com
	Mumbai	SEW-EURODRIVE India Private Limited 312 A, 3rd Floor, Acme Plaza Andheri Kurla Road, Andheri (E) Mumbai	Tel. +91 22 28348440 Fax +91 22 28217858 sewmumbai@vsnl.net
Ireland			
Sales Service	Dublin	Alperton Engineering Ltd. 48 Moyle Road Dublin Industrial Estate Glasnevin, Dublin 11	Tel. +353 1 830-6277 Fax +353 1 830-6458
Israel			
Sales	Tel-Aviv	Liraz Handasa Ltd. Ahofer Str 34B / 228 58858 Holon	Tel. +972 3 5599511 Fax +972 3 5599512 lirazhandasa@barak-online.net
Italy			
Assembly Sales Service	Milano	SEW-EURODRIVE di R. Blicke & Co.s.a.s. Via Bernini,14 I-20020 Solaro (Milano)	Tel. +39 2 96 9801 Fax +39 2 96 799781 sewit@sew-eurodrive.it
Ivory Coast			
Sales	Abidjan	SICA Ste industrielle et commerciale pour l'Afrique 165, Bld de Marseille B.P. 2323, Abidjan 08	Tel. +225 2579-44 Fax +225 2584-36
Japan			
Assembly Sales Service	Toyoda-cho	SEW-EURODRIVE JAPAN CO., LTD 250-1, Shimoman-no, Toyoda-cho, Iwata gun Shizuoka prefecture, 438-0818	Tel. +81 538 373811 Fax +81 538 373814 sewjapan@sew-eurodrive.co.jp
Korea			
Assembly Sales Service	Ansan-City	SEW-EURODRIVE KOREA CO., LTD. B 601-4, Banweol Industrial Estate Unit 1048-4, Shingil-Dong Ansan 425-120	Tel. +82 31 492-8051 Fax +82 31 492-8056 master@sew-korea.co.kr
Latvia			
Sales	Riga	SIA Alas-Kuul Katlakalna 11C LV-1073 Riga	Tel. +371 7139386 Fax +371 7139386 info@alas-kuul.ee
Lebanon			
Sales	Beirut	Gabriel Acar & Fils sarl B. P. 80484 Bourj Hammoud, Beirut	Tel. +961 1 4947-86 +961 1 4982-72 +961 3 2745-39 Fax +961 1 4949-71 gacar@beirut.com



Lithuania			
Sales	Alytus	UAB Irseva Merkines g. 2A LT-4580 Alytus	Tel. +370 315 79204 Fax +370 315 79688 irmantas.irseva@one.lt
Luxembourg			
Assembly Sales Service	Brüssel	CARON-VECTOR S.A. Avenue Eiffel 5 B-1300 Wavre	Tel. +32 10 231-311 Fax +32 10 231-336 http://www.caron-vector.be info@caron-vector.be
Malaysia			
Assembly Sales Service	Johore	SEW-EURODRIVE SDN BHD No. 95, Jalan Seroja 39, Taman Johor Jaya 81000 Johor Bahru, Johor West Malaysia	Tel. +60 7 3549409 Fax +60 7 3541404 kchtan@pd.jaring.my
Morocco			
Sales	Casablanca	S. R. M. Société de Réalisations Mécaniques 5, rue Emir Abdelkader 05 Casablanca	Tel. +212 2 6186-69 + 6186-70 + 6186-71 Fax +212 2 6215-88 srm@marocnet.net.ma
Netherlands			
Assembly Sales Service	Rotterdam	VECTOR Aandrijftechniek B.V. Industrieweg 175 NL-3044 AS Rotterdam Postbus 10085 NL-3004 AB Rotterdam	Tel. +31 10 4463-700 Fax +31 10 4155-552 http://www.vector.nu info@vector.nu
New Zealand			
Assembly Sales Service	Auckland	SEW-EURODRIVE NEW ZEALAND LTD. P.O. Box 58-428 82 Greenmount drive East Tamaki Auckland	Tel. +64 9 2745627 Fax +64 9 2740165 sales@sew-eurodrive.co.nz
	Christchurch	SEW-EURODRIVE NEW ZEALAND LTD. 10 Settlers Crescent, Ferrymead Christchurch	Tel. +64 3 384-6251 Fax +64 3 384-6455 sales@sew-eurodrive.co.nz
Norway			
Assembly Sales Service	Moss	SEW-EURODRIVE A/S Solgaard skog 71 N-1599 Moss	Tel. +47 69 241-020 Fax +47 69 241-040 sew@sew-eurodrive.no
Peru			
Assembly Sales Service	Lima	SEW DEL PERU MOTORES REDUCTORES S.A.C. Los Calderos, 120-124 Urbanizacion Industrial Vulcano, ATE, Lima	Tel. +51 1 3495280 Fax +51 1 3493002 sewperu@sew-eurodrive.com.pe
Poland			
Assembly Sales Service	Lodz	SEW-EURODRIVE Polska Sp.z.o.o. ul. Techniczna 5 PL-92-518 Lodz	Tel. +48 42 67710-90 Fax +48 42 67710-99 http://www.sew-eurodrive.pl sew@sew-eurodrive.pl
Portugal			
Assembly Sales Service	Coimbra	SEW-EURODRIVE, LDA. Apartado 15 P-3050-901 Mealhada	Tel. +351 231 20 9670 Fax +351 231 20 3685 http://www.sew-eurodrive.pt infosew@sew-eurodrive.pt
Romania			
Sales Service	Bucuresti	Sialco Trading SRL str. Madrid nr.4 011785 Bucuresti	Tel. +40 21 230-1328 Fax +40 21 230-7170 sialco@sialco.ro



Address List

Russia			
Sales	St. Petersburg	ZAO SEW-EURODRIVE P.O. Box 263 RUS-195220 St. Petersburg	Tel. +7 812 5357142 +812 5350430 Fax +7 812 5352287 http://www.sew-eurodrive.ru sew@sew-eurodrive.ru
Senegal			
Sales	Dakar	SENEMECA Mécanique Générale Km 8, Route de Rufisque B.P. 3251, Dakar	Tel. +221 849 47-70 Fax +221 849 47-71 senemeca@sento.sn
Serbia and Montenegro			
Sales	Beograd	DIPAR d.o.o. Kajmakalanska 54 SCG-11000 Beograd	Tel. +381 11 3046677 Fax +381 11 3809380 dipar@yubc.net
Singapore			
Assembly Sales Service	Singapore	SEW-EURODRIVE PTE. LTD. No 9, Tuas Drive 2 Jurong Industrial Estate Singapore 638644	Tel. +65 68621701 Fax +65 68612827 sewsingapore@sew-eurodrive.com
Slovakia			
Sales	Sered	SEW-Eurodrive SK s.r.o. Trnavska 920 SK-926 01 Sered	Tel. +421 31 7891311 Fax +421 31 7891312 sew@sew-eurodrive.sk
Slovenia			
Sales Service	Celje	Pakman - Pogonska Tehnika d.o.o. Ul. XIV. divizije 14 SLO – 3000 Celje	Tel. +386 3 490 83-20 Fax +386 3 490 83-21 pakman@siol.net
South Africa			
Assembly Sales Service	Johannesburg	SEW-EURODRIVE (PROPRIETARY) LIMITED Eurodrive House Cnr. Adcock Ingram and Aerodrome Roads Aeroton Ext. 2 Johannesburg 2013 P.O.Box 90004 Bertsham 2013	Tel. +27 11 248-7000 Fax +27 11 494-3104 dross@sew.co.za
	Capetown	SEW-EURODRIVE (PROPRIETARY) LIMITED Rainbow Park Cnr. Racecourse & Omuramba Road Montague Gardens Cape Town P.O.Box 36556 Chempet 7442 Cape Town	Tel. +27 21 552-9820 Fax +27 21 552-9830 Telex 576 062 dswanepoel@sew.co.za
	Durban	SEW-EURODRIVE (PROPRIETARY) LIMITED 2 Monaceo Place Pinetown Durban P.O. Box 10433, Ashwood 3605	Tel. +27 31 700-3451 Fax +27 31 700-3847 dtait@sew.co.za
Spain			
Assembly Sales Service	Bilbao	SEW-EURODRIVE ESPAÑA, S.L. Parque Tecnológico, Edificio, 302 E-48170 Zamudio (Vizcaya)	Tel. +34 9 4431 84-70 Fax +34 9 4431 84-71 sew.spain@sew-eurodrive.es
Sweden			
Assembly Sales Service	Jönköping	SEW-EURODRIVE AB Gnejsvägen 6-8 S-55303 Jönköping Box 3100 S-55003 Jönköping	Tel. +46 36 3442-00 Fax +46 36 3442-80 http://www.sew-eurodrive.se info@sew-eurodrive.se



Switzerland			
Assembly Sales Service	Basel	Alfred Imhof A.G. Jurastrasse 10 CH-4142 Münchenstein bei Basel	Tel. +41 61 41717-17 Fax +41 61 41717-00 http://www.imhof-sew.ch info@imhof-sew.ch
Thailand			
Assembly Sales Service	Chon Buri	SEW-EURODRIVE (Thailand) Ltd. Bangpakong Industrial Park 2 700/456, Moo.7, Tambol Donhuaroh Muang District Chon Buri 20000	Tel. +66 38 454281 Fax +66 38 454288 sewthailand@sew-eurodrive.co.th
Tunisia			
Sales	Tunis	T. M.S. Technic Marketing Service 7, rue Ibn El Heithem Z.I. SMMT 2014 Mégrine Erriadh	Tel. +216 1 4340-64 + 1 4320-29 Fax +216 1 4329-76
Turkey			
Assembly Sales Service	Istanbul	SEW-EURODRIVE Hareket Sistemleri Sirketi Bagdat Cad. Koruma Cikmazi No. 3 TR-34846 Maltepe ISTANBUL	Tel. +90 216 4419163 + 216 4419164 + 216 3838014 Fax +90 216 3055867 sew@sew-eurodrive.com.tr
USA			
Production Assembly Sales Service	Greenville	SEW-EURODRIVE INC. 1295 Old Spartanburg Highway P.O. Box 518 Lyman, S.C. 29365	Tel. +1 864 439-7537 Fax Sales +1 864 439-7830 Fax Manuf. +1 864 439-9948 Fax Ass. +1 864 439-0566 Telex 805 550 http://www.seweurodrive.com cslyman@seweurodrive.com
Assembly Sales Service	San Francisco	SEW-EURODRIVE INC. 30599 San Antonio St. Hayward, California 94544-7101	Tel. +1 510 487-3560 Fax +1 510 487-6381 cshayward@seweurodrive.com
	Philadelphia/PA	SEW-EURODRIVE INC. Pureland Ind. Complex 2107 High Hill Road, P.O. Box 481 Bridgeport, New Jersey 08014	Tel. +1 856 467-2277 Fax +1 856 845-3179 csbridgeport@seweurodrive.com
	Dayton	SEW-EURODRIVE INC. 2001 West Main Street Troy, Ohio 45373	Tel. +1 937 335-0036 Fax +1 937 440-3799 cstroy@seweurodrive.com
	Dallas	SEW-EURODRIVE INC. 3950 Platinum Way Dallas, Texas 75237	Tel. +1 214 330-4824 Fax +1 214 330-4724 csdallas@seweurodrive.com
Additional addresses for service in the USA provided on request!			
Venezuela			
Assembly Sales Service	Valencia	SEW-EURODRIVE Venezuela S.A. Av. Norte Sur No. 3, Galpon 84-319 Zona Industrial Municipal Norte Valencia, Estado Carabobo	Tel. +58 241 832-9804 Fax +58 241 838-6275 sewventas@cantv.net sewfinanzas@cantv.net

How we're driving the world

With people who think fast and develop the future with you.

With a worldwide service network that is always close at hand.

With drives and controls that automatically improve your productivity.

With comprehensive knowledge in virtually every branch of industry today.

With uncompromising quality that reduces the cost and complexity of daily operations.



With a global presence that offers responsive and reliable solutions. Anywhere.

With innovative technology that solves tomorrow's problems today.

With online information and software updates, via the Internet, available around the clock.

SEW-EURODRIVE
Driving the world



SEW
EURODRIVE

SEW-EURODRIVE GmbH & Co KG
P.O. Box 3023 · D-76642 Bruchsal / Germany
Phone +49 7251 75-0 · Fax +49 7251 75-1970
sew@sew-eurodrive.com

→ www.sew-eurodrive.com