

**SIEMENS**

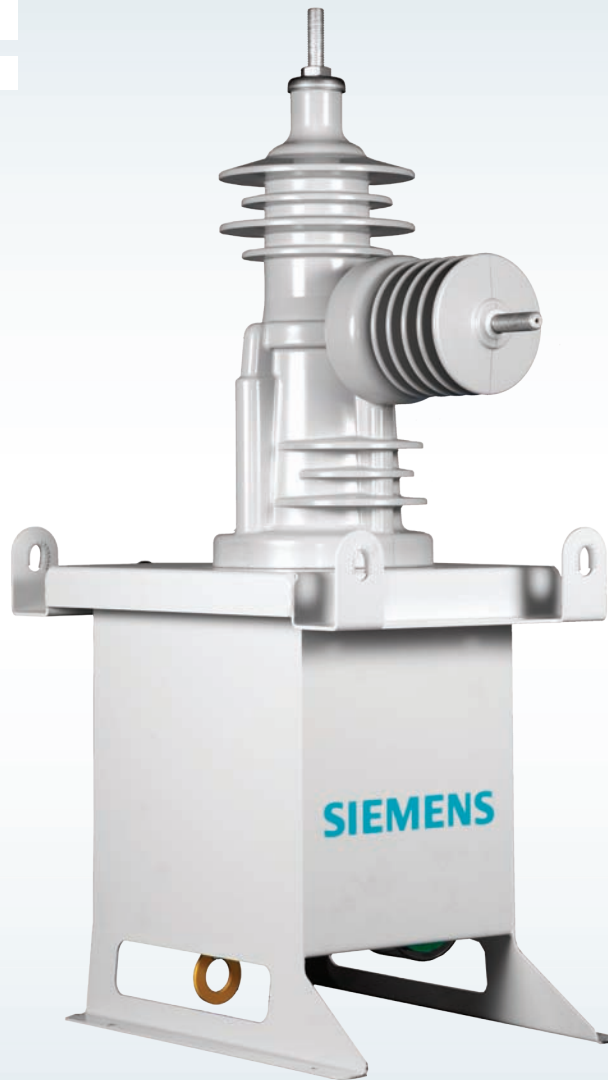

[www.usa.siemens.com/reclosers](http://www.usa.siemens.com/reclosers)

# Instruction manual

Type SDR 15.5 kV to 27 kV single-phase distribution recloser

Installation operation maintenance E50001-F710-A461-X-4A00

**Answers for infrastructure.**

|   |   |
|---|---|
|  | <b>⚠ DANGER</b>   |
|   | <p><b>Hazardous voltages.</b></p> <p><b>Will cause death, serious injury or property damage.</b></p> <p>Always de-energize and ground the equipment before maintenance. Read and understand this instruction manual before using equipment. Maintenance should be performed only by qualified personnel. The use of unauthorized parts in the repair of the equipment or tampering by unqualified personnel will result in dangerous conditions which will cause death, severe injury or equipment damage. Follow all safety instructions contained herein.</p> |

### Important

The information contained herein is general in nature and not intended for specific application purposes. It does not relieve the user of responsibility to use sound practices in application, installation, operation and maintenance of the equipment purchased. Siemens reserves the right to make changes in the specifications shown herein or to make improvements at any time without notice or obligation. Should a conflict arise between the general information contained in this publication and the contents of drawings or supplementary material or both, the latter shall take precedence.

### Qualified person

For the purpose of this manual a **qualified person** is one who is familiar with the installation, construction or operation of the equipment and the hazards involved. In addition, this person has the following qualifications:

- **Is trained and authorized** to de-energize, clear, ground and tag circuits and equipment in accordance with established safety procedures.
- **Is trained** in the proper care and use of protective equipment, such as: rubber gloves, hard hat, safety glasses or face shields, flash clothing, etc., in accordance with established safety practices.
- **Is trained** in rendering first aid.

Further, a qualified person shall also be familiar with the proper use of special precautionary techniques, personal protective equipment, insulation and shielding materials, and insulated tools and test equipment. Such persons are permitted to work within limited approach of exposed live parts operative at 50 volts or more, and shall, at a minimum, be additionally trained in all of the following:

- The skills and techniques necessary to distinguish exposed energized parts from other parts of electric equipment
- The skills and techniques necessary to determine the nominal voltage of exposed live parts
- The approach distances specified in NFPA 70E and the corresponding voltages to which the qualified person will be exposed
- The decision-making process necessary to determine the degree and extent of the hazard and the personal protective equipment and job planning necessary to perform the task safely.

## Note:

These instructions do not purport to cover all details or variations in equipment, nor to provide for every possible contingency to be met in connection with installation, operation or maintenance. Should further information be desired or should particular problems arise that are not covered sufficiently for the purchaser's purposes, the matter should be referred to the local sales office.

The contents of this instruction manual shall not become part of or modify any prior or existing agreement, commitment or relationship. The sales contract contains the entire obligation of Siemens Industry, Inc. The warranty contained in the contract between the parties is the sole warranty of Siemens Industry, Inc. Any statements contained herein do not create new warranties or modify the existing warranty.

## Table of contents

|                                       |         |
|---------------------------------------|---------|
| Introduction                          | 04 – 05 |
| General description                   | 06 – 13 |
| Receiving, handling and storage       | 14 – 15 |
| Installation and commissioning        | 16 – 21 |
| Operation                             | 22 – 24 |
| Maintenance                           | 25 – 26 |
| Technical data                        | 27 – 31 |
| Installation and commissioning report | 32 – 38 |
| Annex A                               | 39      |

# Introduction

## Introduction

These instructions apply to the single-phase distribution vacuum recloser type SDR and are intended to familiarize personnel with the mechanical design and function of the recloser. These instructions also include notes on operation and information concerning installation and maintenance.

The purpose of this manual is to assist the user in developing safe and efficient procedures for the installation, maintenance and use of the equipment.

Personnel must familiarize themselves as early as possible with the instructions and other documents provided in order to gather any further relevant information on the recloser and its features.

Should further information be desired, or should particular problems arise that are not covered in the operating instructions, the matter should be referred to the local Siemens sales office.

In written or verbal communications, please provide the serial number of the recloser, the complete description from the operating instructions, and use only the designations and numbers for sub-parts used in this instruction manual.

## Designated use

The recloser is deemed properly used when it is operated in accordance with the agreed terms and conditions of supply and technical data and also the equipment and special tools supplied are used exclusively for their intended purpose in accordance with the provisions of these operating instructions and applicable laws, codes, regulations and standards.

Any other use is forbidden, unless the consent of Siemens has been obtained.

If the above-mentioned conditions are not observed or the safety instructions are not followed, there can be danger from:



- High voltage
- Charged springs
- Falling and/or tipping parts
- Charged capacitors.

## Responsibility of the operator

In order to avoid incidents, mis-operation or equipment damage, the party responsible for transportation, installation, operation, maintenance and disposal of the recloser or of parts thereof must ensure that only qualified and instructed personnel are assigned to work. Before starting work, regularly thereafter and following any unusual occurrences, personnel shall be instructed concerning the possible hazards and the safety measures required.

Regulations and instructions for safety at work (together with instructions on action to be taken in the event of incidents and/or fire) shall be available to personnel.

Equipment and facilities required for safe work and also the personal protective equipment, clothing, etc., necessary for certain procedures shall be available and used. Only spare parts, lubricants and auxiliary materials approved by Siemens shall be used.

|   |   |
|---|---|
|  |  <b>DANGER</b>   |
|   | <p><b>Hazardous voltages.</b></p> <p><b>Will cause death, serious injury and property damage.</b></p> <p>Do not contact energized conductors.</p> <p>De-energize and ground high voltage conductors before working on or near them.</p> |

**Signal words**

The signal words “danger,” “warning” and “caution” used in this manual indicate the degree of hazard that may be encountered by the user. These words are defined as:

**Danger** - Indicates an imminently hazardous situation that, if not avoided, **will** result in death or serious injury.

**Warning** - Indicates a potentially hazardous situation that, if not avoided, **could** result in death or serious injury.

**Caution** - Indicates a potentially hazardous situation that, if not avoided, **may** result in minor or moderate injury.

**Notice** - Indicates a potentially hazardous situation that, if not avoided, **may** result in property damage.

**Hazardous procedures**

In addition to other procedures described in this manual as dangerous, user personnel must adhere to the following:

1. Always work only on de-energized equipment. Always de-energize the equipment before performing any tests, maintenance or repair. The equipment should be isolated, grounded and have all control power removed before performing any tests, maintenance or repair.
2. Always perform maintenance on the control cabinet only after the capacitors are discharged (see page 12).
3. Check to be certain the indicator flag (position indicator) is green, indicating that the switch unit is in the open position (see Figure 5 on page 9).
4. Always let an interlock device or safety mechanism perform its function without forcing or defeating the device.

**Field service operation and warranty issues**

Siemens can provide competent, well-trained field service representatives to provide technical guidance and advisory assistance for the installation, overhaul, repair and maintenance of Siemens equipment, processes and systems. Contact regional service centers, sales offices or the factory for details, or telephone Siemens field service at +1 (800) 347-6659 or +1 (919) 365-2200 outside the U.S.

For medium voltage customer service issues, contact Siemens at +1 (800) 347-6659 or +1 (919) 365-2200 outside the U.S.

# General description

## Recloser principle and design

Reclosers are used in distribution systems. Like circuit breakers, reclosers are used to make and break normal and fault currents. Reclosers are fully equipped with sensors and a controller to provide a means of protection and control. In case of a line fault, reclosers can break and make currents several times, thus avoiding longer network interruptions due to temporary faults.

Type SDR vacuum reclosers are outdoor devices designed for repeated opening and reclosing in case of a fault, as specified in ANSI/IEEE standard C37.60.

The vacuum recloser consists of two main components: the recloser switch and the controller. The single-phase type SDR vacuum recloser consists of a single-phase switch unit, mounted in a tank together with the cable-connected controller.

This instruction manual covers information related to the recloser switch unit and the controller. The instruction manual does not cover the switch unit mounting frame, control and protection relay or related accessories (for example, surge arresters, external voltage sensor, modems or radios).

For information pertinent to the mounting frame for the switch unit, refer to the frame installation drawing provided with the order specific drawings.

For information pertinent to the control and protection relay, refer to the manufacturer's instruction manuals.

The manufacture, design and testing of the vacuum recloser is based on current regulations and standards and state-of-the-art technology. The product conforms to the following standards:

- ANSI/IEEE C37.60/IEC 62271-111
- IEC 60255-11
- IEC 60255-21-1 Class I
- IEC 60255-21-2 Class I
- IEC 60255-21-3 Class I
- IEC 60255-22-1 Class III
- IEC 60255-22-2 Class IV
- IEC 60255-22-3 Class III
- IEC 60255-22-4 Class IV
- IEC 60255-22-5
- IEC 60255-22-6
- IEC 60255-25
- IEC 60255-5
- IEC 62271-1

**Note:** IEEE C37.60 and IEC 62271-111 are the same document (dual logo IEEE and IEC).

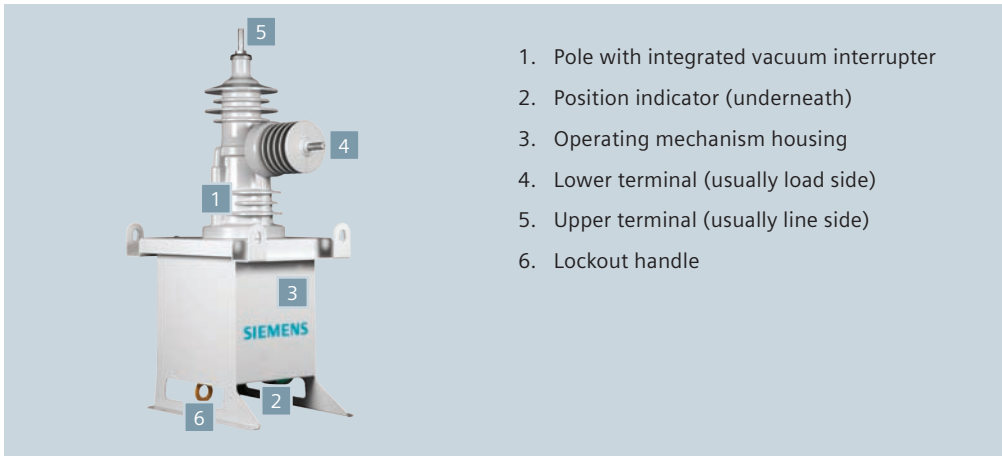

Figure 1: Single-phase recloser switch unit (front view)

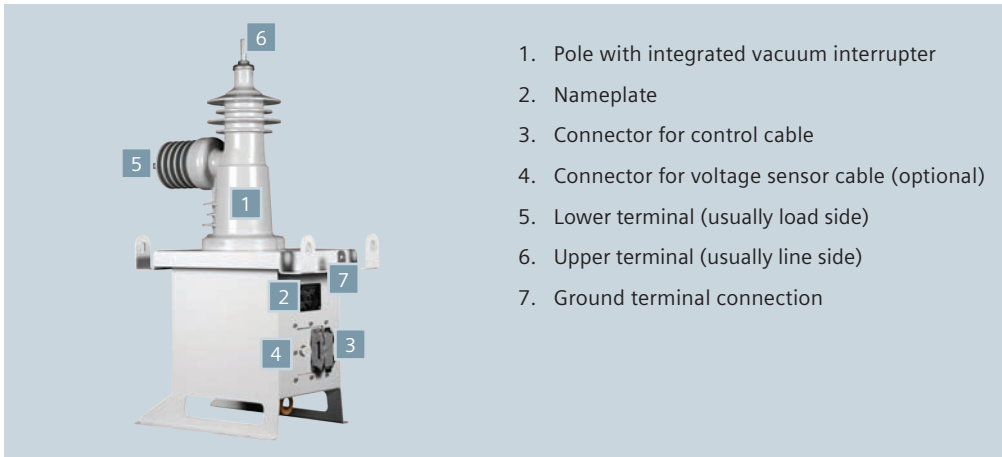

Figure 2: Single-phase recloser switch unit (rear view)

**Single-phase recloser switch unit with encapsulated vacuum interrupter**

The type SDR single-phase vacuum recloser is comprised of the pole, the operating mechanism and the operating mechanism housing. The operating mechanism housing with the support feet form the base of the recloser switch unit. The switch unit can be secured to the pole mounting frame.

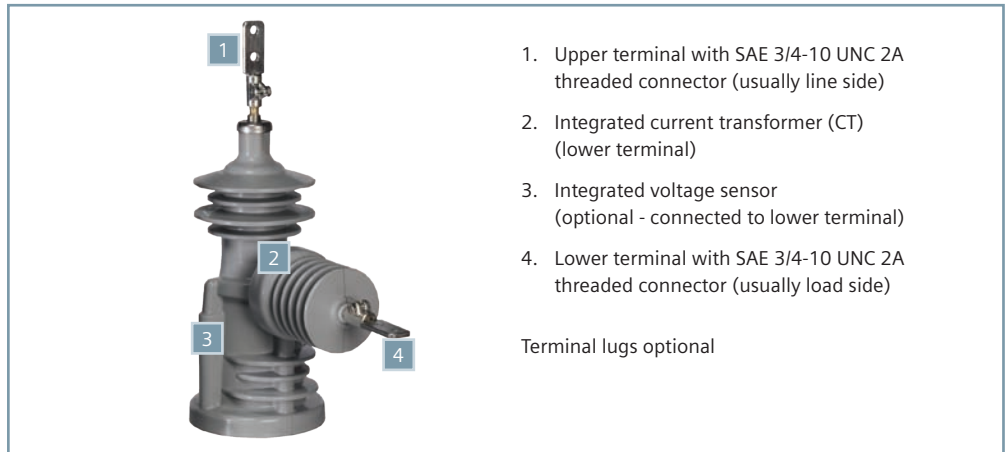

Figure 3: Pole with integrated vacuum interrupter

### Pole

The pole is molded using cycloaliphatic epoxy resin specially designed for outdoor use. The vacuum interrupter is encapsulated in the pole unit. In addition, each pole contains a current transformer and may also contain an optional voltage sensor, both monitoring the lower terminal.

### Current transformers (CTs)

The type SDR vacuum recloser is equipped with one integrated current transformer per pole. The current transformer is the conventional type (iron core magnetic) and has a ratio of 800:1. It is for protection purposes and optimized for operation with the controller (see controller on page 11). The secondary signal is based on IEC 60044-1 and the IEC accuracy is 0.5 VA 5P20.

The secondary wires of the CT are connected to a varistor for each pole in the switch unit. This prevents the occurrence of high voltages (due to open-circuit CT secondary) if the control cable is removed while the switch unit is in operation. Do not disable the varistor circuit. The signal transfer from the CTs to the controller is by the control cable. A separate cable is not required.



### Voltage sensor (optional)

The SDR vacuum recloser can be equipped with an integrated resistive voltage sensor (optional). The integrated resistive voltage sensor has a high level of accuracy and is used both for measurement and protection purposes. The ratio is adapted to operation with the controller (see controller on page 11) and provides a  $110 \text{ V}/\sqrt{3}$  secondary signal with rated primary voltage applied to the recloser.

The voltage sensor and CT outputs are coordinated with Siemens controllers. If a non-Siemens controller is used, it is the controller vendor's obligation to properly coordinate their controller with the voltage sensors and CTs provided in the type SDR distribution vacuum recloser.

An optional separate sensor cable equipped with special screening (shield) is used for the signal transfer from the voltage sensor to the controller. This results in a high level of accuracy and protection against disturbances. The sensor cable is connected at the back of the operating mechanism housing next to the control cable.

The secondary wires of the voltage sensor are connected to a varistor in the switch unit. This prevents the occurrence of high voltage on the sensor cable if the sensor cable is removed while the switch unit is in operation. Do not disable the varistor circuit.

### Operating mechanism

The operating mechanism for the vacuum interrupter is located in a separate metal housing. To meet the required fast reclosing cycles, a magnetic actuator with capacitors as energy storage drives the switch unit.

The operating mechanism is equipped with an anti-condensation space heater. It is operated together with the heating in the controller and controlled by a thermostat.

A mechanical position indicator is easily visible from the ground and shows the current switch position of the recloser (open = green, closed = red). The colored display is reflective in the dark when using a flashlight.

### Lockout handle

A lockout handle with ring protrudes from the operating mechanism housing. The ring is colored bright yellow and is therefore easily seen.

By pulling the lockout handle, the recloser opens and remains locked in this position. The locking has a dual electrical effect; it locks out both the controller and the electronics. It also mechanically locks the magnetic actuator for the recloser.

As long as the lockout handle is pulled out, it is not possible to close the switch unit electrically, whether locally or from a remote location. The interlocking is not reset until the lockout handle has been completely pushed in. After this, the switch unit can be closed electrically, either locally or remotely.

The switching is described in the Operation section of this instruction manual (see page 22).

**Note:** The lockout handle must be fully pushed in or the interlocking will prevent closing of the affected recloser.

| Recloser position | Color of position indicator |
|-------------------|-----------------------------|
| Closed            | Red                         |
| Open              | Green                       |

Table 1: Recloser position and indicator color



Figure 4: Single-phase operating mechanism (viewed from below)

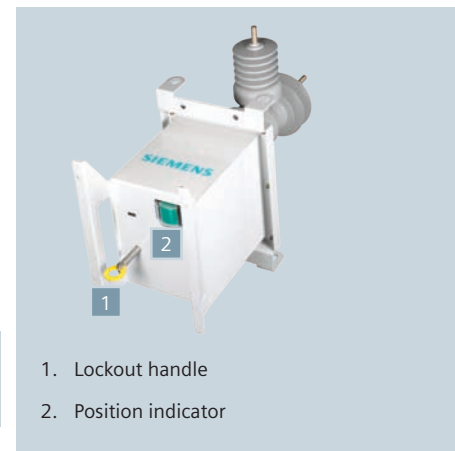

Figure 5: Single-phase operating mechanism with lockout handle pulled out (viewed from below)



1. Operations counter

Figure 6: Operations counter on the bottom of the switch unit

### Operations counter

A mechanical operations counter is installed at the bottom of the recloser switch unit. It records the total number of switching operations independently of the electrical recording in the controller. The operations counter is used to keep track of the total number of operations of the switch unit in case the controller is replaced or the electronic counter is reset in the controller.

### Mounting frame for recloser switch unit

A pole-mounting frame is used to install the recloser switch unit on an overhead line pole. The mounting frame can also optionally accommodate a load-side surge arrester. The following pole-mounting frame is available:

- The single-phase mounting frame (refer to Figure 7: Typical pole-mounting frame) with optional provision for load-side surge arrester.

For installation within a substation, a special mounting frame is available.

For pad-mounted applications, customized solutions are available.

Consult frame installation drawing provided with the order-specific drawings for information on mounting frames.



Single-phase frame

Figure 7: Typical pole-mounting frame

### Control and protection relays

The term type “SDR controller” refers to the control cubicle as described by the type SDR distribution recloser. The option for control and protection relays are brand specific.

This instruction manual includes information on the type SDR controller to supplement information in the control and protection relay instruction manuals.

The user should consult information on the control and protection vendor’s web site for information on the specific relay involved (see Annex A on page 39).

The type SDR single-phase controller may be ordered with multiple control and protection relay options. The optional relays include:

- Siemens type 7SR11 single-phase recloser control relay (standard control and protection relay option)
- Siemens type 7SR12 single-phase recloser control relay (for use with voltage sensing)
- Schweitzer Engineering Laboratories, Inc. type SEL-351RS Kestrel single-phase recloser control relay (includes internal power module and capacitors which operate the switch unit magnetic actuators; type SDR switch unit driver electronics [PCB2] and capacitors [PCB3] are not utilized).

Only the Siemens type 7SR11 control and protection relay option is illustrated in this instruction manual.

### Single-phase type SDR controller

The single-phase type SDR controller is equipped with integrated pole-mount brackets. It can be installed on the recloser pole or substation frame at an operating height as preferred by the user.

The single-phase type SDR controller is equipped with a lockable door with a provision for a padlock. The control and protection relay is mounted on the inside of the door in a mounting bracket that also contains an open and close pushbutton and three programmable, two-position switches. Inside of the controller are miniature circuit breakers, a ground fault circuit interrupter (GFCI) duplex outlet for a laptop, power supply (PS1), uninterruptible power supply (UPS) charge controller, printed circuit boards (PCB), rechargeable batteries and wiring connections.

The single-phase type SDR controller is equipped with a thermostat-controlled anti-condensation heater (space heater). The thermostat also controls the space heater in the switch unit. The heating is switched off above approximately 40° C.

PCB2: Switch unit driver (SUD): controls the magnetic actuator with monitoring of end positions, monitoring for broken cable and with discharge switch for the capacitors (PCB2 not included with the Schweitzer Engineering Laboratories, Inc. type SEL-351RS recloser control relay option).

PCB3: Capacitors for magnetic actuator (PCB3 not included with the Schweitzer Engineering Laboratories, Inc. type SEL-351RS recloser control relay option).

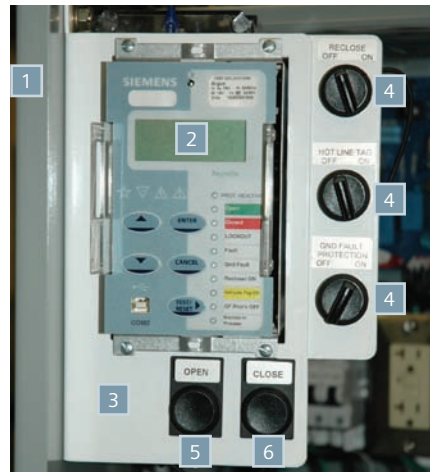

1. Door
2. Type 7SR11 single-phase control and protection relay (illustrated partially withdrawn)
3. Control relay mounting bracket
4. Programmable, two-position switch
5. Open pushbutton
6. Close pushbutton

Figure 8: Single-phase type SDR controller with door open

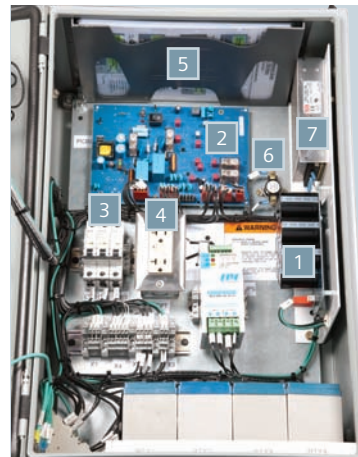

1. PCB3
2. PCB2
3. Miniature circuit breakers CB1, CB2 and CB3
4. Ground fault circuit interrupter (GFCI) duplex outlet
5. Document pocket
6. Heater thermostat
7. PS1 power supply

Figure 9: Single-phase type SDR controller upper view



1. Space heater
2. Batteries (four 12 Vdc, 7 AH)
3. Internal copper ground bar
4. Terminal blocks
5. Control cable connector
6. UPS charge controller

Figure 10: Single-phase type SDR controller lower view



## ⚠ WARNING

**Hazardous voltage.**

**Could result in serious injury or equipment malfunction.**

For maintenance work, the capacitor discharge switch on PCB2 must be in the "discharge capacitors" position (I). Do not work on the capacitor circuits when the red discharge LED is lit.

For normal operation, the capacitor discharge switch on PCB2 must be in the "operating" position (O).

### Discharge switch for the capacitors

The discharge switch on the switch unit driver (SUD) module/printed circuit board PCB2 serves to discharge the capacitors. In the "discharge capacitors" position (I), the capacitor charging operation is turned off and the capacitors are discharged via a resistor – discharge of the capacitors takes roughly one minute.

When capacitors are charged and the switch is changed from the "operating position" (O) to the "discharge capacitors" (I) position, the red LED next to switch illuminates.

When the discharging has reached a safe limit with a capacitor voltage below approximately 40 V, the LED no longer illuminates. Work on the capacitor circuits should only be performed once the LED no longer illuminates.

For normal operation, the switch must be brought into the "operating" position (O) as shown in Figure 11: PCB2 jumpers. In this position, the capacitors will be charged. The LED does not light up during normal operation.

Figure 11: PCB2 jumpers

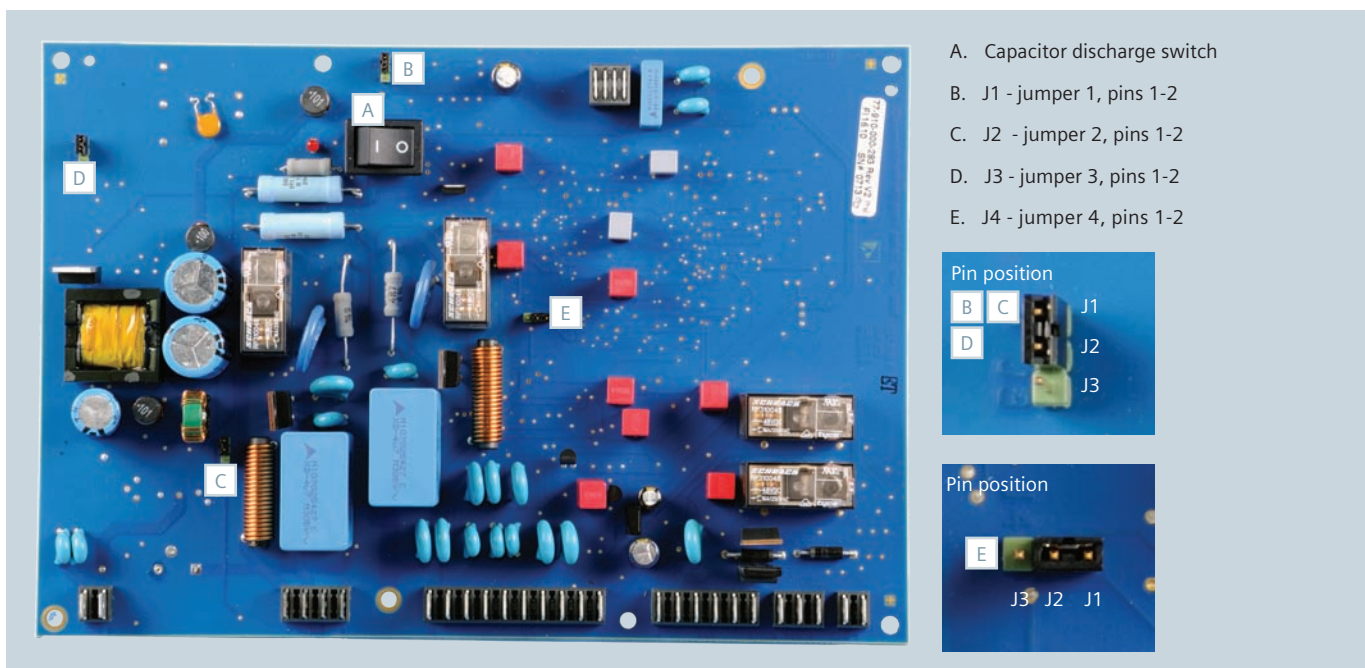

### Auxiliary power supply

The single-phase type SDR controller uses an internal 48 V bus, which is backed-up by rechargeable batteries as an uninterruptible power supply. The internal bus is energized by the power supply unit (PS1). It is connected to the auxiliary power provided on site, either through low-voltage supply or power transformer connected to the high-voltage line (optional). The charging of the batteries is controlled by the uninterruptible power supply (UPS) charge controller (for the location of UPS refer to Figure 10: Single-phase type SDR controller lower view on page 11.)

The incoming 120 Vac supply should be connected to the terminals on terminal block X1.

The power supply unit (PS1) is protected by the miniature circuit breaker CB1. Refer to Figure 19: Typical terminal block arrangement on page 21. CB1 also protects the ground fault circuit interrupter (GFCI) duplex outlet, which is supplied to provide power to the user's laptop computer.

The heaters are connected to the same incoming supply and are protected by the miniature circuit breaker CB2.

### Rechargeable batteries

Four 12 V batteries are supplied with the recloser. They are to be installed in series on site (see Installation and commissioning on page 18). The batteries are protected by the miniature circuit breaker CB3. The batteries provide a minimum of 24 hours stand-by operation at 20 °C from a fully charged initial condition.

If miniature circuit breaker CB3 opens or trips, it disconnects the control power for the controller and the controller will neither operate the recloser nor protect the network. Control and protection functions restart automatically by closing CB3.

If the batteries are not in use, they should be recharged at intervals of six months.

# Receiving, handling and storage

|   |   |
|---|---|
|  | <b>⚠ WARNING</b>  |
|   | <p><b>Heavy weight.</b></p> <p><b>Can result in death, serious injury or property damage.</b></p> <p>Obtain the services of a qualified rigger prior to hoisting the recloser switch unit to assure adequate safety margins in the hoisting equipment and procedures to avoid damage.</p> |

## Introduction

This portion of the manual covers the receiving, handling and storage instructions for type SDR vacuum recloser. This section of the manual is intended to help the user identify, inspect and protect the recloser prior to its installation.

## Receiving procedure

Make a physical inspection of the shipping container before removing or unpacking the recloser. Check for shipment damage or indications of rough handling by the carrier. Check each item against the manifest to identify any shortages.

## Shipping damage claims (when applicable)

Follow normal shipment damage procedures, which should include:

1. Check for visible damage upon arrival.
2. Visible damage must be noted on delivery receipt and acknowledged with driver's signature. Notation "Possible internal damage, subject to inspection" must be on delivery receipt.
3. Notify the Siemens field service at +1 (800) 347-6659 or +1 (919) 365-2200 outside the U.S.
4. Arrange for carrier's inspection. Do not move the unit from its unloading point.

### Handling procedure

1. Carefully remove the packing material from the recloser. Keep the shipping pallet for later use if the recloser is to be stored prior to its installation.
2. Inspect for concealed damage. Notification to carrier must take place within 15 days to assure prompt resolution of claims.
3. The recloser should be appropriately lifted to avoid damaging the recloser.
4. The palletted recloser can also be moved using a properly rated forklift vehicle. The pallets are designed for movement by a standard forklift.

### Storage procedure

Whenever possible, store the recloser indoors. The storage environment must be clean, dry and free of such items as: construction dust, corrosive atmosphere, mechanical abuse and rapid temperature variations.

### Space heating

Space heating for the controller must be used for both indoor and outdoor storage to prevent condensation and corrosion. The controller space heater should be connected to a 120 Vac auxiliary supply at terminal block X1 as discussed in "Connecting the auxiliary voltage supply" on page 20 of this instruction manual. (Refer to the wiring diagrams provided with the order specific drawings for terminal numbers and terminal block location.) After these connections have been made, circuit breaker CB2, as shown on Figure 9, must be switched to the "on" position.

# Installation and commissioning

|   |   |
|---|---|
|  | <b>⚠ DANGER</b>   |
|   | <p><b>Hazardous voltages.</b><br/>Will cause death, serious injury or property damage.</p> <p>To avoid electrical shock or burns, this equipment must be installed, operated and maintained only by qualified persons thoroughly familiar with the equipment, instruction manuals and drawings.</p> |

|   |   |
|---|---|
|  | <b>⚠ WARNING</b>  |
|   | <p><b>Heavy weight.</b><br/>Can result in death, serious injury or property damage.</p> <p>Obtain the services of a qualified rigger prior to hoisting the recloser switch unit to assure adequate safety margins in the hoisting equipment and procedures to avoid damage.</p> |

This section provides information about the installation and commissioning with regard to the following:

- Required documents
- Personnel requirements
- Tools, devices and expendable materials to be used
- Safety
- Recording/documentation.



## Mechanical installation

The following documents are required for installation:

- These operating instructions
- Order specific drawings
- Installation and commissioning report form (see page 32).

A responsible person (or supervisor) must be assigned to oversee the installation and commissioning work. This person must instruct personnel during installation and commissioning tasks, and check for compliance with the applicable safety procedures.

The installation and commissioning work must be performed by authorized personnel who must be qualified persons as described on page 2 of this instruction manual.

Suitable lifting apparatus in good working condition and transport vehicles with sufficient load-bearing capacity must be used for installation.

All safety regulations, including NFPA 70E and OSHA regulations, must be observed.

Installation and commissioning must be documented (see "Installation and commissioning report," page 32).

Torque requirements for all hardware are as follows:

- .38 inch: (31 lbf-ft  $\pm$  5 lbf-ft)
- .50 inch: (75 lbf-ft  $\pm$  9 lbf-ft)
- .62 inch: (120 lbf-ft  $\pm$  20 lbf-ft)
- .75 inch: (250 lbf-ft  $\pm$  40 lbf-ft).



Figure 12: Lifting of the switch unit

## Preparatory work

Both the installation and commissioning report (see page 32) and these installation instructions are based on the sequence of the work to be performed. The on-site conditions may result in deviations from the sequence shown.

The following preparatory work must be performed:

- Instruct installation and maintenance personnel with regard to:
  1. Safety
  2. Cleanliness at installation site
  3. Safety markings
  4. Dealing with incidents or unexpected conditions
- Check delivery documents for completeness
- Check all shipping units for shipping damage
- Inspect power pole ground conductor and install ground conductor, if necessary
- If installation is on a substation frame, check the foundation for the substation frame and install ground connection, if required.

## Mounting the recloser on the pole

The recloser is mounted in several steps. Refer to the frame installation drawing provided with the order specific drawings for information on mounting frames.

## Lifting the recloser switch units

Figure 12: Lifting of the switch unit shows the proper technique for lifting the single-phase switch unit. The lifting cables should be attached to all four lifting lugs and the lifting cables must not touch the encapsulated pole unit.



1. Lifting eye
2. Pole-mounting bracket

Figure 13: Lifting of control cubicle

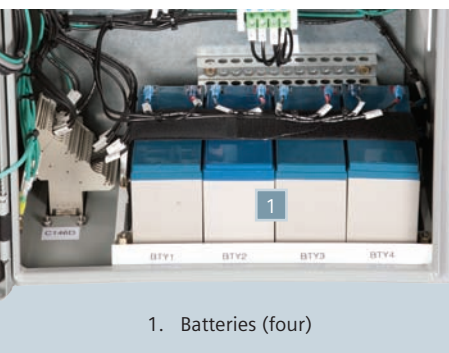

1. Batteries (four)

Figure 14: Installation of batteries

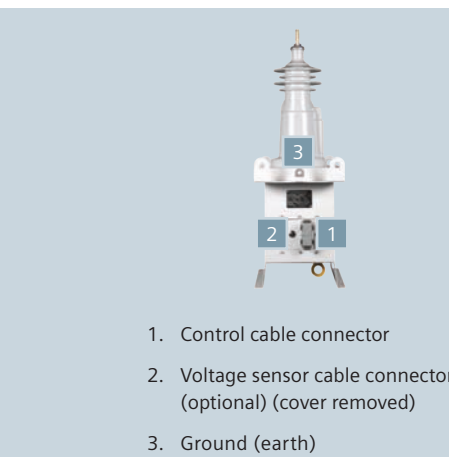

1. Control cable connector
2. Voltage sensor cable connector (optional) (cover removed)
3. Ground (earth)

Figure 15: Single-phase recloser switch unit connections rear view

### Installation of the single-phase type SDR controller on the pole

To attach the single-phase type SDR controller the following components are required:

- Two 0.75 inch mounting bolts with nuts and washers (length equal to pole diameter plus four inches; not included in scope of delivery)

- Single-phase type SDR controller

- Batteries.

1. Insert upper mounting bolt through the pole (hole spacing 28.5" (724 mm)).
2. Lift single-phase type SDR controller with two cables using the lifting eyes and fasten to the upper mounting bolt. Tighten nut by hand.
3. Align single-phase type SDR controller and insert lower mounting bolt through the pole and fasten.
4. Tighten bolted connections and check stability.
5. Install the four batteries with terminals facing towards the rear of the controller (per Figure 14) and secure with the hook and loop fastener strap.
6. First connect the positive terminal, then connect the adjacent terminals of two batteries using the short connecting cables and finally connect the negative terminal to the single-phase type SDR controller connection. Make sure the connections have the correct polarity (compare with the labeling on the cables).

**Note:** Avoid incorrect polarity of batteries. Connecting the rechargeable batteries with the wrong polarity will result in damage to the controller electronics (PCB2) and also misoperation of the recloser.

### Connection covers

The control and (optional) voltage sensor cable connections are supplied with covers at the recloser switch unit and controller. When connecting the cables, the covers should be stored in a clean and dry environment, such as the controller enclosure, in case of later use during disconnection of the cables.

### Electrical installation

The following must be carried out in order to establish the electrical connections:

- Establish the ground (earth) connection,
- Connect the recloser switch unit to the single-phase type SDR controller,
- Connect the auxiliary voltage, and
- Establish the high-voltage connection.

### Establishing the ground (earth) connection

Both the recloser switch unit and the single-phase type SDR controller must be connected to the pole ground (earth) or ground (earth) in the substation. If surge arresters are installed, these must also be securely grounded (earthed).

For correct grounding (earthing), the following must be observed:

- The recloser (switch unit plus single-phase type SDR controller) must be grounded (earthed) in accordance with local regulations and work practices.
- The cable to be used must be suitable for grounding (earthing). This particularly applies for the cross section of the grounding (earthing) cable and connections.
- The cables (control and optional voltage sensor cable) must be installed as close together as possible with the ground (earth) conductor (see Figure 17: Connection of cables and grounding (earthing) of recloser on page 19). Ideally they should be bundled together.

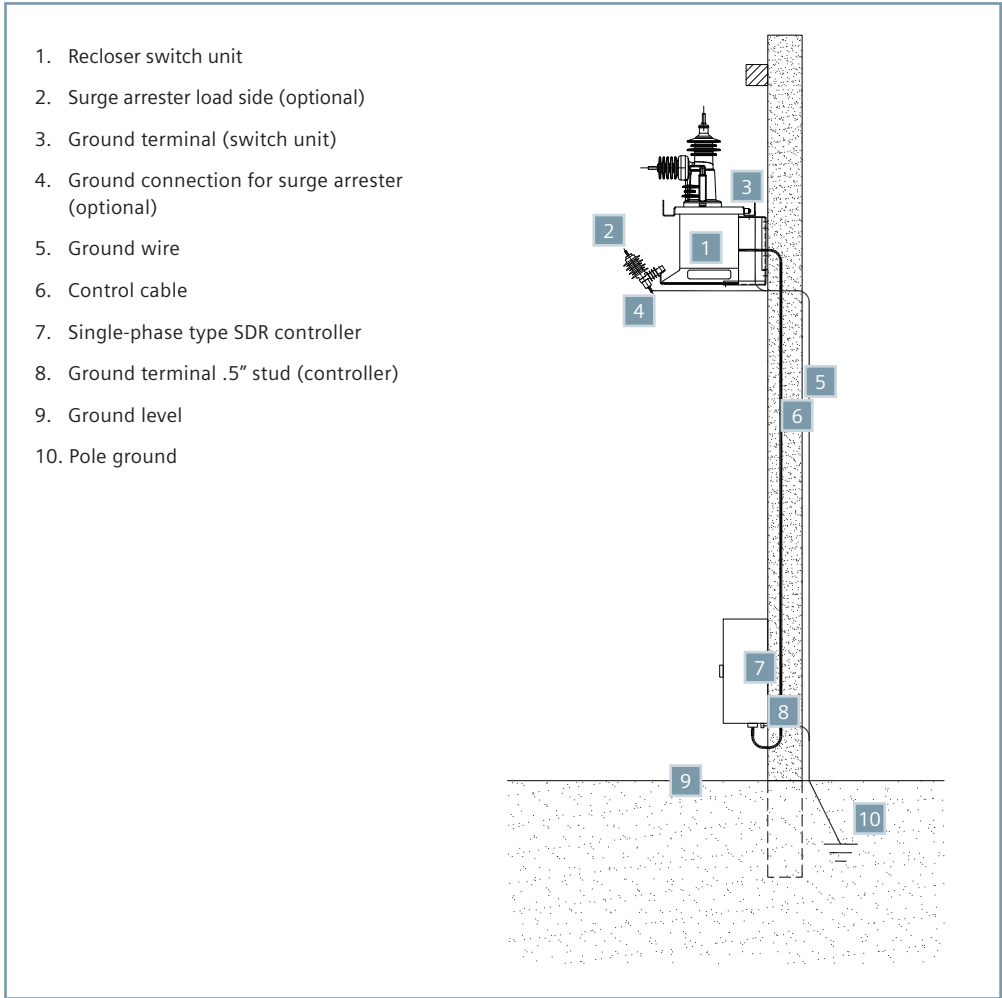

Figure 17: Connection of cables and grounding (earthing) of recloser

**Connect cables between recloser switch unit and single-phase type SDR controller**

1. Connect control cable to the recloser switch unit and single-phase type SDR controller. The connection on the control cable is protected against polarity mismatch.
2. Secure plugs to prevent them from loosening using the locking clip.
3. Connect voltage sensor cable (optional) to the recloser switch unit and single-phase type SDR controller. The connection on the sensor cable is protected against polarity mismatch.
4. Check plugs are inserted correctly and secured.

5. Fasten the control and sensor cable to the pole using appropriate means (for example, cable ties, Electrical Materials Company U-Guard™ and clamps). Cables must be clamped so that the weight of the cables does not hang from the connection housing or terminal plug.
6. Loop and fasten excess lengths of cable in the area below the pole-mounting frame at the highest position possible.
7. Cable ties or clamps should be no more than six feet apart on the pole.

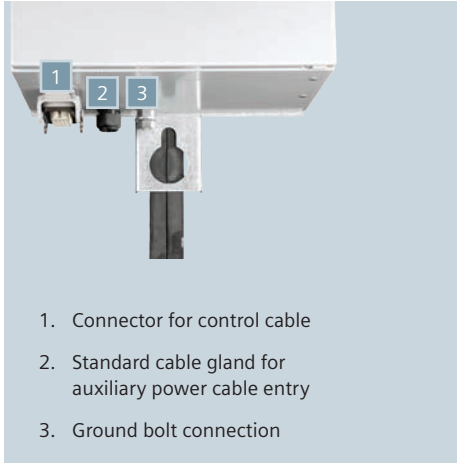

Figure 16: Single-phase type SDR controller standard connections



Figure 18: Cables

### Connecting the auxiliary voltage supply

The auxiliary voltage is supplied either by an external transformer or an external low-voltage power supply. In both cases, insert the connection cable through the cable gland (see Figure 16: Single-phase type SDR controller standard connections on page 19) into the single-phase type SDR controller and attach to the corresponding terminals at terminal block X1. Also refer to Figure 19: Typical terminal block arrangement on page 21.

Refer to the wiring diagrams supplied with the order specific drawings for terminal numbers and terminal block location.

Optional provision for connectorized power supply cables may be provided.

### Establishing high-voltage connection

The recloser switch unit is equipped with terminal connectors to fasten cables or with flat spade connectors, depending on the configuration specified by the purchaser.

### Commissioning

The equipment must be commissioned as follows. The installation and commissioning report (see page 32) serves as documentation and a checklist.

### Function and operational instructions

For functional test and operational instructions for use with the type SDR single-phase controller, refer to the vendor website information in Annex A on page 39.

Only the Siemens type 7SR11 control and protection relay option is illustrated in this instruction manual.

|   |   |
|---|---|
|  | <b>⚠ DANGER</b>   |
|   | <p><b>Hazardous voltages.</b><br/><b>Will cause death, serious injury and property damage.</b></p> <p>Do not contact energized conductors.</p> <p>De-energize and ground the equipment before working on or near high voltage conductors.</p> |

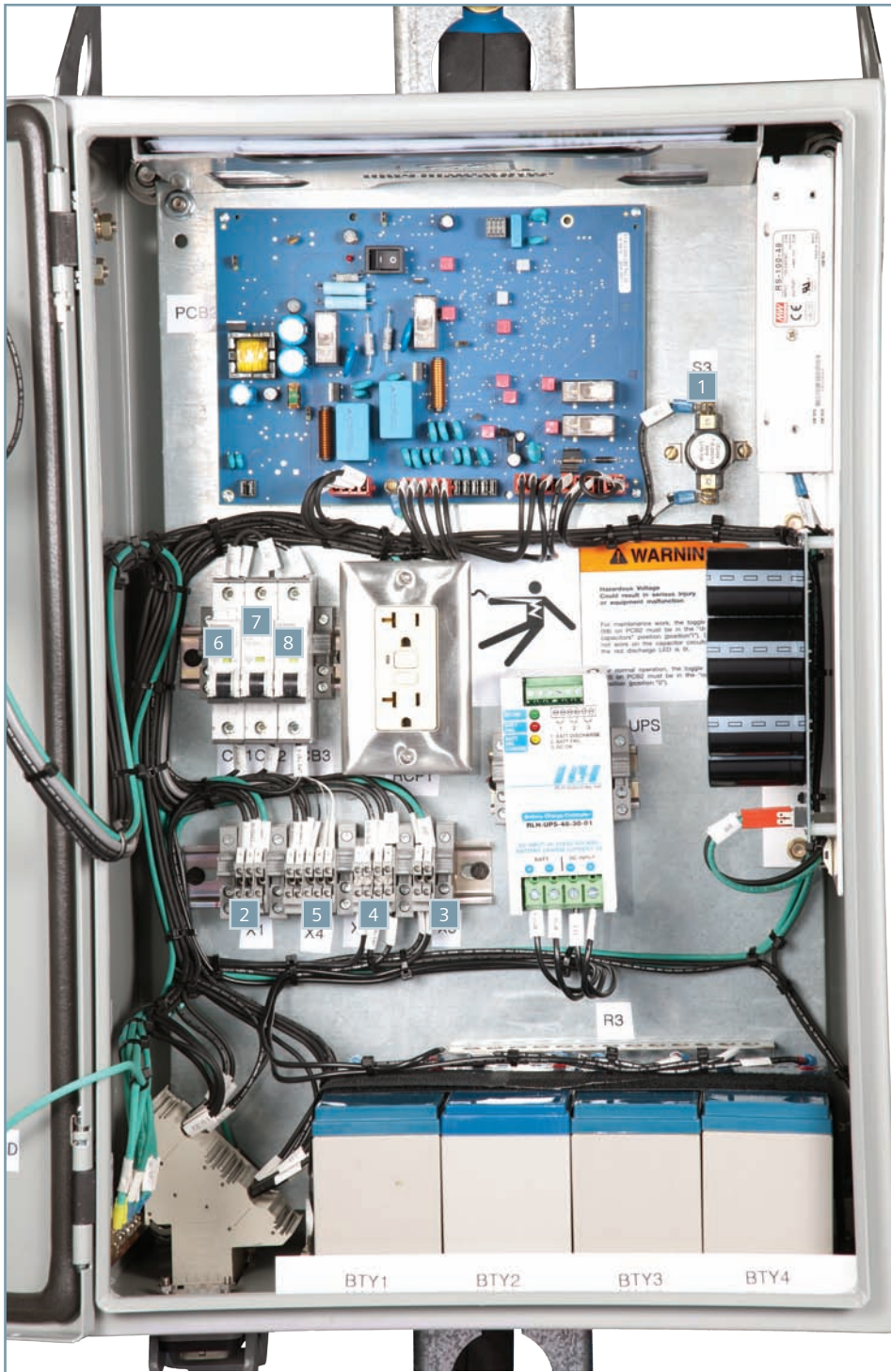
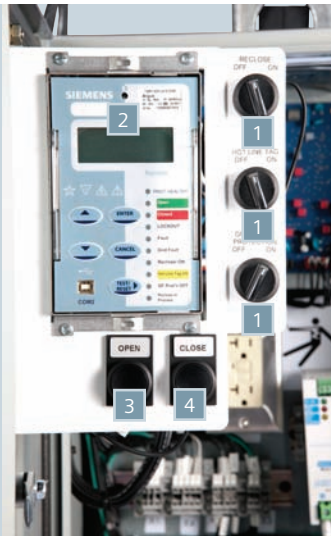

Figure 19: Typical terminal block arrangement

- |   |  |
|---|--|
| <ol style="list-style-type: none"> <li>1. Thermostat</li> <li>2. X1 (auxiliary power supply)</li> <li>3. X4 (customer connections)</li> <li>4. X2 (internal connections)</li> <li>5. X3 (internal connections)</li> </ol> | <ol style="list-style-type: none"> <li>6. CB1 - PS1 power supply and ground fault circuit interrupter (GFCI) duplex outlet</li> <li>7. CB2 - space heaters</li> <li>8. CB3 - 48 volt dc battery-powered control circuit</li> </ol> <p>Terminals for the type 7SR11 control and protection relay illustrated.</p> |
|---|--|

# Operation



1. Programmable, two-position switches
2. Control and protection relay
3. Open pushbutton
4. Close pushbutton

Figure 20: Single-phase type SDR controller with 7SR11 control and protection relay

## Operation

The recloser is just one device in a distribution system. The user of the recloser must set the controller protection and control parameters to suit the user's distribution system needs, and to provide reliable, safe and trouble-free operation of the recloser.

### Safety instructions for operation

In addition to the local safety rules and work practices, special precaution must be taken:

- The accessories required to operate the recloser must be stored in a clean location and must be checked regularly for completeness and good condition.
- All keys must be accessible only to the authorized operating personnel.
- No modifications should be made to the recloser. This includes, but is not limited to, removal of parts, opening the operating mechanism housing and any modification (including adjustment) of the drive system of the recloser.
- The control cable and the optional voltage sensor cable must not be removed during operation. Removing these cables would mean no further electrical operation could be performed and no measurement values or other signals could be sent from the recloser switch unit to the controller.

## Switching

Switching comprises electrical switching (remote and/or local operation) and mechanical switching (by means of the lockout handle).

Switching is carried out automatically by the controller to protect the network by remote control or manually on site.

### Local operation

Local operation describes the manual electrical switching of the recloser on site. Manual switching using the lockout handle is discussed in the lockout operation section of this instruction manual on page 23.

These switching actions can be carried out from the controller using the Close/Open pushbuttons or using the control mode on the control and protection relay. Refer to page 23 and Figure 20: Single-phase type SDR controller with 7SR11 control and protection relay for more information.



## ⚠ DANGER

### Hazardous voltages.

**Will cause death, serious injury or property damage.**

Always de-energize and ground the equipment and all terminals before performing any work near high-voltage conductors.

Work on the recloser switch unit or the control cubicle should be performed only by qualified personnel.

Do not open the inner panel of the control cubicle, as interior parts energized at voltages higher than 50 V are present.

Do not disconnect control or sensor cables while recloser is energized, as connectors contain energized parts.

### Lockout operation

Lockout operation combines the mechanical tripping/opening of the recloser and the interlocking to inhibit subsequent closing of the recloser.

The lockout can also be operated when under load.

### Open the recloser

1. Using a hot stick or suitable rod from the ground, pull down the lockout handle until it reaches the end (lower) position.
  - The recloser opens. By operating the lockout mechanism, the recloser is opened mechanically and locked in this position.
  - The mechanical position indicator on the bottom of the recloser switch unit shows green.
  - The green OPEN LED for the recloser on the protection and control relay indicates the switch unit pole has operated.
  - The switch action is completed.

As long as the lockout handle is pulled out, it is not possible to close the recloser electrically, whether locally or from a remote location.

### Closing the recloser electrically from the controller

1. Using a hot stick or suitable rod from the ground, push the lockout handle back in completely.
2. Follow the control and protection relay instructions to electrically close the recloser.
  - The recloser closes.
  - After switching, confirm that the red CLOSED LED on the control relay indicates the switch position has been reached.
  - Confirm the green OPEN LED is off.
  - The switch action is complete.
  - The mechanical position indicator on the bottom of the recloser switch unit shows red.

**Note:** The lockout handle needs to be pushed back completely. Otherwise, the interlocking still prevents closing.



Figure 21: Lockout handle with ring for manual operation (pushed in, normal operation)



Figure 22: Lockout handle with ring for manual operation (pulled out, recloser open and locked out)

Table 2: Troubleshooting

| Malfunction   | Remedy  |
|---|---|
| Failure of the auxiliary power supply (for example, "PS1 power supply" or "UPS charge controller" LED does not light up). | <p>The auxiliary power supply is protected by a miniature circuit breaker in the controller.</p> <ol style="list-style-type: none"> <li>1. Check miniature circuit breaker CB1 and switch on if necessary.</li> <li>2. Check the status of the external auxiliary power supply.</li> </ol>                  |
| Ground fault circuit interrupter (GFCI) duplex outlet does not work.  | <p>The ground fault circuit interrupter (GFCI) is protected by a miniature circuit breaker in the controller.</p> <ol style="list-style-type: none"> <li>1. Check miniature circuit breaker CB1 and switch on if necessary.</li> <li>2. Check the status of the external auxiliary power supply.</li> </ol> |
| Heating does not work   | <p>The heaters are protected by a miniature circuit breaker (in the controller).</p> <ol style="list-style-type: none"> <li>1. Check miniature circuit breaker CB2 and switch on if necessary.</li> </ol>   |
| Failure of batteries  | <p>The batteries are protected by a miniature circuit breaker (in the controller).</p> <ol style="list-style-type: none"> <li>1. Check miniature circuit breaker CB3 and switch on if necessary.</li> <li>2. Check the battery status or monitoring device and replace batteries if necessary.</li> </ol>   |
| Closing of the recloser is blocked  | <p>Manual lockout handle is not fully returned to (pushed in) starting position.</p> <ol style="list-style-type: none"> <li>1. Push manual lockout handle back in completely.</li> </ol>  |
| Controller does not start up  | <ol style="list-style-type: none"> <li>1. Check the auxiliary power supply to confirm it is turned on (connected and CB1 is switched on).</li> </ol>  |



# Maintenance

|   |   |
|---|---|
|  | <b>⚠ DANGER</b>   |
|   | <p><b>Hazardous voltages.</b></p> <p><b>Will cause death, serious injury or property damage.</b></p> <p>Always de-energize and ground the equipment and all terminals before performing any work near high-voltage conductors.</p> <p>Work on the recloser switch unit or the control cubicle should be performed only by qualified personnel.</p> <p>Do not open the inner panel of the control cubicle, as interior parts energized at voltages higher than 50 V are present.</p> <p>Do not disconnect control or sensor cables while recloser is energized, as connectors contain energized parts.</p> |

## General

The recloser switch unit of the SDR vacuum recloser is designed to require no maintenance for 10,000 operating cycles under ANSI/IEEE C37.60 "usual service conditions." Regular monitoring and, if need be, replacement of the batteries is necessary for the single-phase type SDR controller. Regular maintenance is required for components in the controller, primarily consisting of checks of cleanliness, tightness of connections, battery test and similar activities.

## Maintenance plan

The following work should be carried out as part of regular inspections reflected in Table 3.

### Spare parts

Parts must be replaced only by instructed and certified personnel. Refer to list in Table 4.

Table 3: Maintenance plan

| Work to be performed   | Recommended interval                                 |
|--|--|
| Visual inspections:<br>1. Terminals clean and undamaged<br>2. No visible corrosion or damage to metal parts and cables<br>3. No loose parts (for example, bolts or connections)<br>4. Ground (earth) connections secure and undamaged<br>5. Labeling clearly legible<br>6. Single-phase type SDR controller undamaged and correctly secured. | 12 months (adjust interval according to experience)  |
| Function tests:<br>1. Control and protection relay indicates fault-free operation of the auxiliary power supply, batteries and capacitors (monitoring LEDs)<br>2. Fault-free operation of communication modules<br>3. Perform battery test or check result of last battery tests at the control and protection relay.                        | 12 months (as part of visual inspection)             |
| Protection tests:<br>1. Protection test using secondary injection equipment, in conjunction with recloser function test (see the Installation and commissioning section of the control and protection relay instruction manual)<br>2. Function test of lockout handles.  | Four years (adjust interval according to experience) |
| Reset counter "Switching operations since last visit" (refer to control and protection relay instructions)   | Following every maintenance session                  |

Table 4: Spare parts

| Accessory/spare part  | Order number            |
|---|-------------------------|
| Surge arresters (3EK7)  | On request              |
| Auxiliary power supply (PS1)  | On request              |
| Switch unit driver (PCB2)   | On request              |
| Capacitor board (PCB3)  | On request              |
| External current transformer  | On request              |
| External voltage transformer  | On request              |
| Transformer for auxiliary voltage supply  | On request              |
| Current/voltage transformer pole-mount frame                                    | On request              |
| Control cable   | On request              |
| Voltage sensor cable  | On request              |
| Cover for position indicator  | On request              |
| Animal guards   | On request              |
| Set of terminal connectors (two pieces)   | On request              |
| Set of batteries (four batteries, 7 Ah, 12 V)                                   | On request              |
| Heaters   | On request              |
| Type SDR 15.5 kV to 27 kV single-phase distribution recloser instruction manual | E50001-F710-A461-X-XXXX |

# Technical data

| Characteristic   | Unit    | Voltage class |              |
|--|---------|---------------|--------------|
| Rated maximum voltage $U_r$  | kV      | 15.5          | 27.0         |
| Rated continuous current $I_r$   | A       | 630, 800      | 630, 800     |
| Rated lightning impulse withstand voltage $U_p$                                | kV      | 110           | 125          |
| Power frequency insulation level withstand test voltage (one minute dry) $U_d$ | kV      | 50            | 60           |
| Rated symmetrical interrupting current $I_{sc}$                                | kA      | 12.5, 16      | 12.5         |
| Rated asymmetrical making current (rms)  | kA      | 20, 25        | 20           |
| Rated peak making current  | kA      | 32.5, 41      | 32.5         |
| Mechanical life (operating cycles)   | OPS     | 10,000        | 10,000       |
| Permissible short-circuit operations   | OPS     | up to 250     | up to 250    |
| Ambient temperature range  | °C      | -40 to +55    | -40 to +55   |
| Flashover distance   | Unit    | Voltage class |              |
| Phase/ground (earth)   | in (mm) | 10.4 (265)    | 10.4 (265)   |
| Creepage distance  | Unit    | Voltage class |              |
| Phase/ground (earth)   | in (mm) | 31.9 (810)    | 31.9 (810)   |
| Between line-side and load-side terminal                                       | in (mm) | 46.1 (1,170)  | 46.1 (1,170) |

Table 5: Main characteristic data

| Protective function             | Unit | Minimum trip current |    |
|---------------------------------|------|----------------------|----|
| Phase faults                    | A    | 40                   | 40 |
| Ground (earth) faults           | A    | 4                    | 4  |
| Sensitive ground (earth) faults | A    | 4                    | 4  |

Table 6: Minimum trip currents

| Operation time    | Unit | Time |     |
|-------------------|------|------|-----|
| Closing time      | ms   | <60  | <60 |
| Opening time      | ms   | <35  | <35 |
| Arcing time       | ms   | <15  | <15 |
| Interrupting time | ms   | <50  | <50 |

Table 7: Operating times

| Dead time                             | Unit | Time range    |               |
|---------------------------------------|------|---------------|---------------|
| Dead time after first open            | s    | 0.2 to 14,400 | 0.2 to 14,400 |
| Dead time after second and third open | s    | 2 to 14,400   | 2 to 14,400   |
| Dead time after fourth open           | s    | 30 to 14,400  | 30 to 14,400  |

Table 8: Dead times for recloser cycle (reclosing interval)

### Current transformer data

The current transformer has a ratio of 800:1. The accuracy is 0.5 VA 5P20 to IEC 60044-1.

### Voltage sensor data (optional)

The ratio of the voltage sensors is adapted to operation with the control and protection relay and provides a  $110 \text{ V}/\sqrt{3}$  secondary signal when the recloser is energized at rated maximum voltage.

### Ambient conditions

The type SDR vacuum recloser is suitable for use under "usual service conditions" as given in IEEE standard C37.60/IEC 62271-111, as follows:

- Ambient temperature  $-40^\circ \text{C}$  to  $55^\circ \text{C}$
- Solar radiation  $<1,120 \text{ W/m}^2$
- Altitude  $<1,000 \text{ m}$  or less

### Altitude correction factor

The insulating capability of insulation in air decreases as the altitude increases due to the reduced air density. The rated lightning impulse withstand voltage values (see Table 5) are valid according to IEC 62271-1 and IEEE C37.60 up to an installation height of 1,000 m above sea level. Above a height of 1,000 m, the insulation level must be corrected in line with Figure 23: Altitude correction factor K.

**Example:** At 2,500 m altitude, a unit rated 110 kV BIL under "usual service conditions" will have a lightning impulse withstand capability of:

$$\frac{110}{K} = \frac{110}{e^{m(h-1000)/8150}} = \frac{110}{1.2} = 91.5 \text{ kV}$$

Table 9: Power consumption

| Auxiliary system  | Unit | Power consumption   |
|---|------|---|
| Auxiliary power requirement, controller                                       | W    | <15, typically <10  |
| Auxiliary power requirements, heating (controller and switch unit)            | W    | Controller = 37.5, switch unit = 50   |
| Auxiliary power requirement, communication (dependent on modem or radio used) | W    | <15 typical   |
| External requirements (external user, for instance, laptop)                   | A    | 2 (if supplied by auxiliary transformer); 10 (if connection to low-voltage network) |

Figure 23: Altitude correction factor K

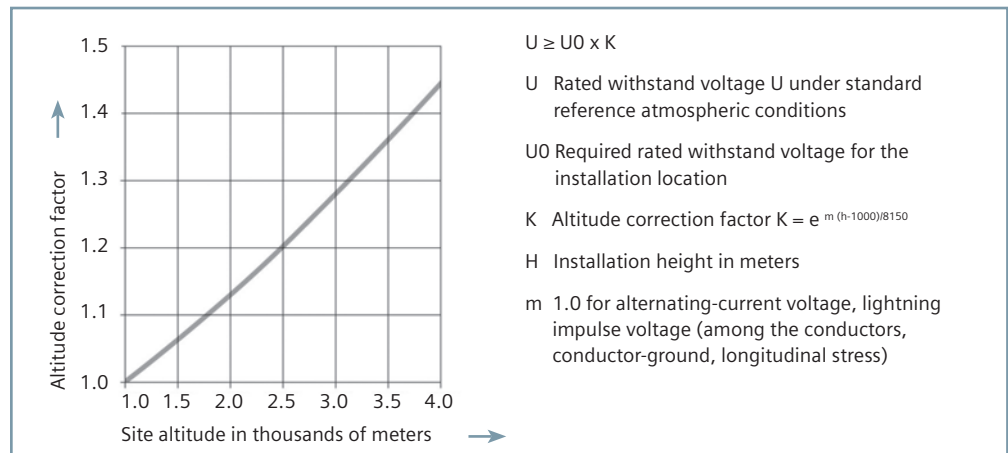

| Rated voltage U <sub>r</sub>        | Unit     | 15.5 kV and 27.0 kV                    |
|-------------------------------------|----------|--|
| Dimensions: length x width x height | in (mm)  | 14.5 (368) x 22.8 (579) x 42.8 (1,087) |
| Weight                              | lbs (kg) | 150 (68)                               |

Table 10: Switch unit dimensions and weights (without frame)

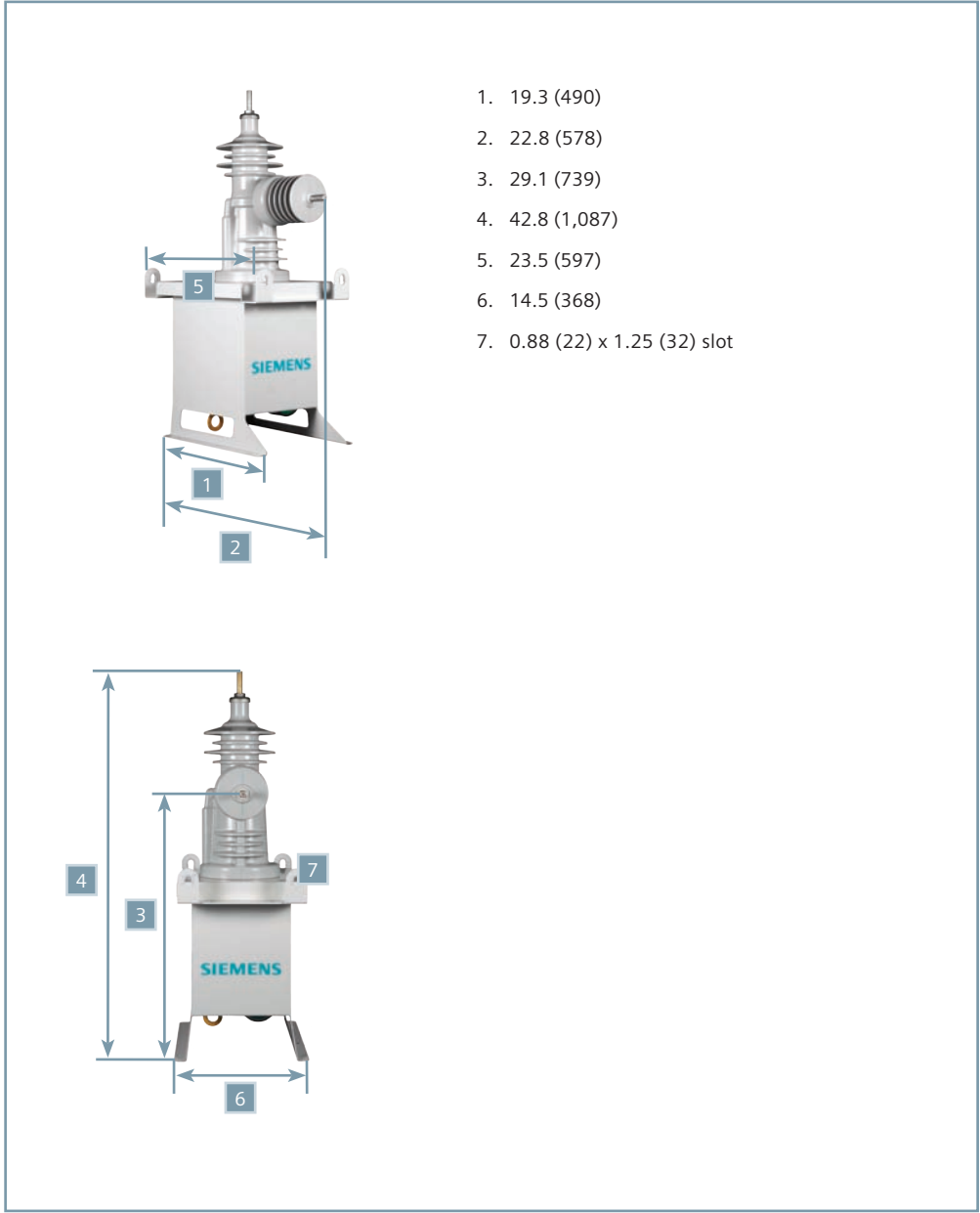

Figure 24: Recloser switch unit dimensions in (mm)

Table 11: Controller

| Rated voltage U <sub>r</sub>   |          | All voltages                         |
|--|----------|--------------------------------------|
| Dimensions: length x width x height<br>(without pole-mount brackets) | in (mm)  | 16.0 (406) x 10.0 (254) x 24.0 (610) |
| Weight (without batteries)   | lbs (kg) | 70 (32)                              |

Figure 25: Controller dimensions in (mm)

1. 16.0 (406)
2. 10.0 (254)
3. 24.0 (610)
4. 28.5 (724) center line pole-mounting bracket bolt holes



A stainless steel nameplate is located at the rear of the recloser switch unit. A corresponding rating label is located on the left wall inside the single-phase type SDR controller. This label identifies the serial number of the controller and switch unit that were tested as a complete assembly per IEEE C37.60.

Switch nameplate

|                         |                             |                        |                |
|-------------------------|-----------------------------|------------------------|----------------|
| <b>1</b> <b>SIEMENS</b> |                             | <b>7</b>               |                |
| Vacuum Recloser         |                             | <b>8</b> Design code   |                |
| <b>2</b>                | WOD Serial No. 3AD/00000000 | <b>9</b>               | Year of manuf. |
| <b>3</b>                | $U_r$ kV                    | <b>10</b>              | $I_r$ A        |
| <b>4</b>                | $U_p$ kV                    | <b>11</b>              | $I_{sc}$ kA    |
| <b>5</b>                | $U_d$ kV                    | <b>12</b>              | $m$ kg         |
| <b>6</b> Order Code     |                             | <b>13</b> ANSI C 37.60 |                |
| <b>MADE IN GERMANY</b>  |                             |                        |                |

Controller nameplate

|  |                              |
|--|------------------------------|
| <b>1</b> <b>SIEMENS</b>  |                              |
| <b>CONTROL CABINET tested with RECLOSER SWITCH</b>             |                              |
| Product Type/Style <b>14</b>                                   | Switch Manufacturer <b>1</b> |
| Sales Order No. <b>15</b>                                      | Switch Type <b>17</b>        |
| Sales Item No. <b>16</b>                                       | Switch A Serial No. <b>2</b> |
| Serial No. <b>2</b>  | Switch A Prod. Date <b>9</b> |
| Production Date <b>9</b>                                       | Switch B Serial No. <b>2</b> |
| Weight <b>12</b>   | Switch B Prod. Date <b>9</b> |
|  | Switch C Serial No. <b>2</b> |
|  | Switch C Prod. Date <b>9</b> |
|  | $U_r$ <b>3</b>               |
|  | $U_p$ <b>4</b>               |
|  | $U_d$ <b>5</b>               |
| <b>13</b> IEEE C37.60  | $I_r$ <b>10</b>              |
| <b>MADE IN USA</b>   | $I_{sc}$ <b>11</b>           |
| Order Code <b>6</b>  |                              |
| Instruction Manual No. <b>18</b>                               |                              |
| Siemens Industry, Inc.<br>7000 Siemens Road, Wendell, NC 27591 |                              |
| 18-762-111-050   |                              |

Figure 33: Nameplates

1. Manufacturer
2. Serial number
3. Rated maximum voltage  $U_r$
4. Rated lightning impulse withstand voltage  $U_p$
5. Rated short-time withstand voltage (60s)  $U_d$
6. Type designation/order number
7. Quality control stamp
8. Design code
9. Date of manufacture/production date
10. Rated continuous current  $I_r$
11. Rated symmetrical interrupting current  $I_{sc}$
12. Weight
13. Standard
14. Product type/style
15. Sales order number
16. Sales item number
17. Switch type
18. Instruction manual number

# Installation and commissioning report

## **Installation and commissioning report**

The installation and commissioning report on the following pages is intended for using and copying as a checklist.



# Installation and commissioning report

Type SDR distribution recloser

---

User

Siemens Type SDR

---

Location

---

Recloser type

---

Contract number

---

Serial number

---

Rated maximum voltage (kV)

---

Rated continuous current (A)

---

Auxiliary voltage

---

Rated short-circuit current (kA)

Table 12 is based on the Siemens type 7SR11 control and protection relay option for the single-phase type SDR controller.

Refer to page 22 for function test and operational instructions for other optional control and protection relays. Apply these instructions as applicable to complete the checklist.

Table 12: Preparatory tasks

| Item | Checklist   | Notes |
|------|---|-------|
| A.01 | Installation and commissioning personnel have received instruction and meet the conditions for "Qualified person" (see page 2): <ul style="list-style-type: none"> <li>■ Occupational safety</li> <li>■ Safety markings</li> <li>■ Transit damage.</li> </ul> |       |
| A.02 | The recloser (switch unit and controller) is visually in good condition and undamaged.  |       |
| A.03 | Any paint damage occurring during transport and installation has been repaired.   |       |
| A.04 | All accessories and special equipment ordered are available/ assembled at the installation site.  |       |
| A.05 | Pole or foundation is in suitable condition.  |       |
| A.06 | Grounding (earthing) is sufficient and in accordance with local regulations.  |       |
| A.07 | Compare the correct voltage of the recloser. (For example, compare the rated voltage of the recloser with the system voltage. Contact Siemens customer service if the voltage is incorrect at +1 (800) 347-6659 or +1 (919) 365-2200 outside the U.S.)        |       |

Table 13: Visual inspections after installation

| Item | Checklist   | Notes |
|------|---|-------|
| B.01 | All bolted connections and other assembly elements are tight.   |       |
| B.02 | Batteries are installed correctly: <ul style="list-style-type: none"> <li>■ All four are connected in series</li> <li>■ Contacts point to the rear of the battery tray.</li> <li>■ Polarity labeling on the supply wires correspond to actual connection of the batteries</li> <li>■ Hook and loop straps are over the batteries and fastened tightly.</li> </ul> |       |
| B.03 | Cross-sectional area of the ground (earth) connection is adequate or the required ground current and connection to the switch unit is secure.   |       |
| B.04 | Auxiliary voltage is connected correctly per order specific wiring diagram.   |       |
| B.05 | Capacitor discharge switch is in the operating position. Switch must be in position "O" (see Figure 11: PCB2 jumpers on page 12).   |       |

Table 14: Function checks

| Item | Checklist   | Notes |
|------|---|-------|
| C.01 | Switch on miniature circuit breakers: CB1 and CB3 (behind the panel): <ul style="list-style-type: none"> <li>■ Start-up of controller is shown on display.</li> <li>■ "Protection healthy" LED lights green after approximately 30 seconds</li> <li>■ Status LED "DC OK" lights up green on UPS charge controller</li> <li>■ LED next to the Open function buttons light up green</li> <li>■ Position indicator on the bottom of the recloser switch unit is green (open).</li> </ul>   |       |
| C.02 | Press the Close pushbutton: <ul style="list-style-type: none"> <li>■ Recloser closes.</li> <li>■ LED next to the Open function button is no longer lit</li> <li>■ LED next to the Close function button lights up red</li> <li>■ Position indicator on the bottom of the recloser switch unit is red.</li> </ul>  |       |
| C.03 | Press the Open pushbutton: <ul style="list-style-type: none"> <li>■ Recloser opens</li> <li>■ LED next to the Close function button is no longer lit</li> <li>■ LED next to the Open function button lights up green</li> <li>■ Position indicator on the bottom of the recloser switch unit is green (open).</li> </ul>  |       |
| C.04 | On the control and protection relay, press <Enter> to access the control mode. Then press the <V (down)> button once to access "CB: Close/Open" position screen. Press <Enter> and use the <Test/Reset> button to select Close. Press <Enter> to confirm the Close command: <ul style="list-style-type: none"> <li>■ Recloser closes</li> <li>■ LED next to the Open function button is no longer lit</li> <li>■ LED next to the Close function button lights up red</li> <li>■ Position indicator on the bottom of the recloser switch unit is red.</li> </ul>                               |       |
| C.05 | On the control and protection relay, press <Enter> to access the control mode. Then press the <V (down)> button once to access "CB: Close/Open" position screen. Press <Enter> and use the <Test/Reset> button to select Open. Press <Enter> to confirm the Open command: <ul style="list-style-type: none"> <li>■ Recloser opens</li> <li>■ LED next to the Close function button is no longer lit</li> <li>■ LED next to the Open function button lights up green</li> <li>■ Position indicator on the bottom of the recloser switch unit is green (open).</li> </ul>                       |       |
| C.06 | Press the Close pushbutton or on the control and protection relay, press <Enter> to access the control mode. Then press the <V (down)> button once to access "CB: Close/Open" position screen. Press <Enter> and use the <Test/Reset> button to select Close. Press <Enter> to confirm the Close command: <ul style="list-style-type: none"> <li>■ Recloser closes</li> <li>■ LED next to the Open function button is no longer lit</li> <li>■ LED next to the Close function button lights up red</li> <li>■ Position indicator on the bottom of the recloser switch unit is red.</li> </ul> |       |

Table 14: Function checks  
(continued)

| Item | Checklist   | Notes |
|------|---|-------|
| C.07 | <p>Mechanical operation of the recloser by pulling the lockout handle:</p> <ul style="list-style-type: none"> <li>■ Recloser opens</li> <li>■ LED next to the Close function button is no longer lit</li> <li>■ LED next to the Open function button lights up green</li> <li>■ Position indicator on the bottom of the recloser switch unit is green (open).</li> </ul>  |       |
| C.08 | <p>Press the Close pushbutton:</p> <ul style="list-style-type: none"> <li>■ No switching operation shall take place.</li> </ul>   |       |
| C.09 | <p>On the control and protection relay, press &lt;Enter&gt; to access the control mode. Then press the &lt;V (down)&gt; button once to access "CB: Close/Open" position screen. Press &lt;Enter&gt; and use the &lt;Test/Reset&gt; button to select Close. Press &lt;Enter&gt; to confirm the Close command:</p> <ul style="list-style-type: none"> <li>■ No switching operation shall take place.</li> </ul>   |       |
| C.10 | <p>Push lockout handle back in completely:</p> <ul style="list-style-type: none"> <li>■ Press Close pushbutton or on the control and protection relay, press &lt;Enter&gt; to access the control mode. Then press the &lt;V (down)&gt; button once to access "CB: Close/Open" position screen. Press &lt;Enter&gt; and use the &lt;Test/Reset&gt; button to select Close. Press &lt;Enter&gt; to confirm the Close command:</li> <li>■ Recloser closes</li> <li>■ LED next to the Open function button is no longer lit</li> <li>■ LED next to the Close function button lights up red</li> <li>■ Position indicator on the bottom of the recloser switch unit is red.</li> </ul> |       |
| C.11 | <p>Switch on miniature circuit breaker CB2:</p> <ul style="list-style-type: none"> <li>■ At external temperatures of &lt; 95 °F (35 °C) the heaters heat up after approximately one minute.</li> </ul>  |       |

| Item | Checklist  | Notes |
|------|--|-------|
| D.01 | Adjust the control and protection relay to the desired setting file:<br><ul style="list-style-type: none"> <li>■ The control and protection relay shows default set in - Group 1</li> <li>■ If necessary, select other group with user-specific parameter settings.</li> </ul> |       |
| D.02 | If applicable, check the voltage and current readings of the controller.   |       |
| D.03 | Check the date and the time on the controller and correct if necessary.  |       |
| D.04 | Set trip counter to zero (at initial installation only).   |       |
| D.05 | Delete event memory (at initial installation only):<br><ul style="list-style-type: none"> <li>■ If necessary, download events for further documentation.</li> </ul>  |       |
| D.06 | Install controller cover and fasten.   |       |
| D.07 | Close and secure single-phase type SDR controller door.  |       |

Table 15: Final tasks

| Item | Checklist   | Notes |
|------|---|-------|
| E.01 | Instruction manual available.                     |       |
| E.02 | Routine test records available.                   |       |
| E.03 | On-site instruction on recloser/controller.       |       |
| E.04 | Order specific drawings are available.            |       |
| E.05 | Type 7SR11/7SR12 quick reference guide available. |       |

Table 16 Other services



# Annex A

## Vendor website information:

- Siemens type 7SR11/7SR12 recloser control relay (standard control and protection relay option) <http://www.energy.siemens.com/us/en/power-distribution/reclosers/recloser-controller.htm>
- Schweitzer Engineering Laboratories, Inc. type SEL-351RS Kestrel recloser control relay (includes internal power module and capacitors which operate the switch unit magnetic actuator; type SDR switch unit driver electronics [PCB2] and capacitors [PCB3] are not utilized) [http://www.selinc.com/SEL-351RS\\_Kestrel/](http://www.selinc.com/SEL-351RS_Kestrel/)

The information provided in this document contains merely general descriptions or characteristics of performance which in case of actual use do not always apply as described or which may change as a result of further development of the products. An obligation to provide the respective characteristics shall only exist if expressly agreed in the terms of contract.

All product designations may be trademarks or product names of Siemens AG or supplier companies whose use by third parties for their own purposes could violate the rights of the owners..

Siemens Industry, Inc.  
7000 Siemens Road  
Wendell, NC 27591

For more information, contact:  
+1 (800) 347-6659  
[www.usa.siemens.com/reclosers](http://www.usa.siemens.com/reclosers)

Subject to change without  
prior notice.  
Order No.:  
E50001-F710-A461-X-4A00  
All rights reserved.  
Printed in USA  
© 2012 Siemens Industry, Inc.