



Level



Pressure



Flow



Temperature



Liquid
Analysis



Registration



Systems
Components



Services



Solutions

Operating Instructions

Proline Promass 83

Modbus RS485

Coriolis Mass Flow Measuring System

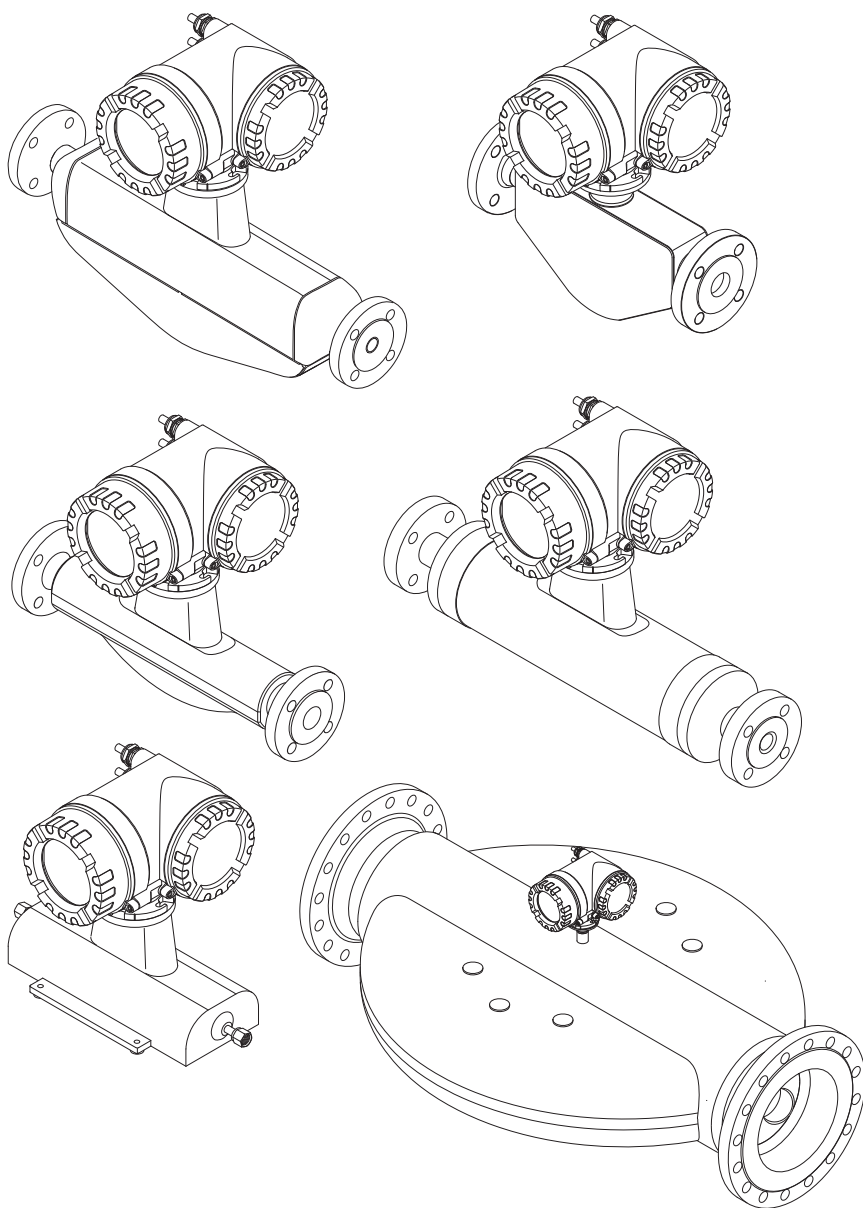

BA00107D/06/EN/14.12
71197490

Valid as of version
V 3.06.XX (device software)

Endress+Hauser

People for Process Automation

Table of contents

1	Safety instructions	5		
1.1	Designated use	5		
1.2	Installation, commissioning and operation	5		
1.3	Operational safety	6		
1.4	Return	6		
1.5	Notes on safety conventions and icons	6		
2	Identification	7		
2.1	Device designation	7		
2.1.1	Nameplate of the transmitter	8		
2.1.2	Nameplate of the sensor	9		
2.1.3	Nameplate for connections	10		
2.2	Certificates and approvals	11		
2.3	Registered trademarks	11		
3	Installation	12		
3.1	Incoming acceptance, transport and storage	12		
3.1.1	Incoming acceptance	12		
3.1.2	Transport	12		
3.1.3	Storage	13		
3.2	Installation conditions	14		
3.2.1	Dimensions	14		
3.2.2	Mounting location	14		
3.2.3	Orientation	16		
3.2.4	Special installation instructions	18		
3.2.5	Heating	20		
3.2.6	Thermal insulation	21		
3.2.7	Inlet and outlet runs	21		
3.2.8	Vibrations	21		
3.2.9	Limiting flow	21		
3.3	Installation	22		
3.3.1	Turning the transmitter housing	22		
3.3.2	Installing the wall-mount housing	23		
3.3.3	Turning the local display	25		
3.4	Post-installation check	25		
4	Wiring	26		
4.1	Modbus RS485 cable specifications	26		
4.1.1	Shielding and grounding	27		
4.2	Connecting the remote version	28		
4.2.1	Connecting connecting cable for sensor/ transmitter	28		
4.2.2	Cable specification for connecting cable	29		
4.3	Connecting the measuring unit	29		
4.3.1	Transmitter connection	29		
4.3.2	Terminal assignment	31		
4.4	Degree of protection	31		
4.5	Post-connection check	32		
5	Operation	33		
5.1	Quick operation guide	33		
5.2	Local display	34		
5.2.1	Display and operating elements	34		
5.2.2	Display (operation mode)	35		
5.2.3	Additional display functions	35		
5.2.4	Icons	36		
5.2.5	Controlling the batching processes using the local display	38		
5.3	Brief operating instructions to the function matrix	39		
5.3.1	General notes	40		
5.3.2	Enabling the programming mode	40		
5.3.3	Disabling the programming mode	40		
5.4	Error messages	41		
5.4.1	Type of error	41		
5.4.2	Error message type	41		
5.5	Modbus RS485 communication	42		
5.5.1	Modbus RS485 technology	42		
5.5.2	Modbus telegram	44		
5.5.3	Modbus function codes	45		
5.5.4	Maximum number of writes	45		
5.5.5	Modbus register addresses	46		
5.5.6	Modbus error messages	48		
5.5.7	Modbus auto-scan buffer	49		
5.6	Operating options	53		
5.6.1	FieldCare	53		
5.6.2	Current device description files	53		
5.7	Hardware settings	54		
5.7.1	Switching hardware write protection on/off	54		
5.7.2	Configuring the device address	55		
5.7.3	Configuring the terminating resistors	56		
5.7.4	Current output configuration	57		
5.7.5	Relay output configuration	58		
6	Commissioning	59		
6.1	Function check	59		
6.2	Switching on the measuring device	59		
6.3	Quick Setup	60		
6.3.1	Quick Setup "Commissioning"	60		
6.3.2	Quick Setup "Pulsating Flow"	62		
6.3.3	Quick Setup "Batching"	65		
6.3.4	Quick Setup "Gas Measurement"	69		
6.3.5	Quick Setup "Communication"	71		
6.3.6	Data backup/transmission	73		
6.4	Device configuration	74		
6.4.1	Concentration measurement	74		
6.4.2	Advanced diagnostic functions	79		
6.5	Adjustment	81		
6.5.1	Zero point adjustment	81		
6.5.2	Density adjustment	83		
6.6	Rupture disk	84		
6.7	Purge and pressure monitoring connections	85		
6.8	Data memory (HistoROM), F-CHIP	85		
6.8.1	HistoROM/S-DAT (sensor-DAT)	85		
6.8.2	HistoROM/T-DAT (transmitter-DAT)	85		
6.8.3	F-CHIP (Function-Chip)	85		

7	Maintenance	86
7.1	Exterior cleaning	86
7.2	Cleaning with pigs (Promass H, I, S, P)	86
7.3	Replacing seals	86
8	Accessories	87
8.1	Device-specific accessories	87
8.2	Measuring principle-specific accessories	87
8.3	Service-specific accessories:	88
9	Troubleshooting	89
9.1	Troubleshooting instructions	89
9.2	System error messages	90
9.3	Process error messages	96
9.4	Process errors without messages	99
9.5	Response of outputs to errors	100
9.6	Spare parts	101
9.6.1	Removing and installing printed circuit boards	102
9.6.2	Replacing the device fuse	106
9.7	Return	107
9.8	Disposal	107
9.9	Software history	107
10	Technical data	108
10.1	Technical data at a glance	108
10.1.1	Applications	108
10.1.2	Function and system design	108
10.1.3	Input	108
10.1.4	Output	111
10.1.5	Power supply	112
10.1.6	Performance characteristics	113
10.1.7	Operating conditions: Installation	133
10.1.8	Operating conditions: Environment	133
10.1.9	Operating conditions: Process	134
10.1.10	Mechanical construction	146
10.1.11	Operability	151
10.1.12	Certificates and approvals	152
10.1.13	Ordering information	153
10.1.14	Accessories	153
10.1.15	Supplementary Documentation	153
	Index	154

1 Safety instructions

1.1 Designated use

The measuring device described in these Operating Instructions is to be used only for measuring the mass flow rate of liquids and gases. At the same time, the system also measures fluid density and fluid temperature. These parameters are then used to calculate other variables such as volume flow. Fluids with widely differing properties can be measured.

Examples:

- Oils, fats
- Acids, alkalis, lacquers, paints, solvents and cleaning agents
- Pharmaceuticals, catalysts, inhibitors
- Suspensions
- Gases, liquefied gases, etc.
- Chocolate, condensed milk, liquid sugar

Resulting from incorrect use or from use other than that designated the operational safety of the measuring devices can be suspended. The manufacturer accepts no liability for damages being produced from this.



1.2 Installation, commissioning and operation

Note the following points:

- Installation, connection to the electricity supply, commissioning and maintenance of the device must be carried out by trained, qualified specialists authorized to perform such work by the facility's owner-operator. The specialist must have read and understood these Operating Instructions and must follow the instructions they contain.
- The device must be operated by persons authorized and trained by the facility's owner-operator. Strict compliance with the instructions in the Operating Instructions is mandatory.
- Endress+Hauser is willing to assist in clarifying the chemical resistance properties of parts wetted by special fluids, including fluids used for cleaning. However small changes in temperature, concentration or the degree of contamination in the process can result in changes of the chemical resistance properties. Therefore, Endress+Hauser can not guarantee or accept liability for the chemical resistance properties of the fluid wetted materials in a specific application. The user is responsible for the choice of fluid wetted materials in regards to their in-process resistance to corrosion.
- If carrying out welding work on the piping, the welding unit may not be grounded by means of the measuring device.
- The installer must ensure that the measuring system is correctly wired in accordance with the wiring diagrams. The transmitter must be earthed unless special protection measures have been taken e.g. galvanically isolated power supply SELV or PELV (SELV = Safe Extra Low Voltage; PELV = Protective Extra Low Voltage).
- Invariably, local regulations governing the opening and repair of electrical devices apply.

1.3 Operational safety

Note the following points:

- Measuring systems for use in hazardous environments are accompanied by separate "Ex documentation", which is an integral part of these Operating Instructions. Strict compliance with the installation instructions and ratings as stated in this supplementary documentation is mandatory. The symbol on the front of this supplementary Ex documentation indicates the approval and the certification body (e.g.  Europe,  USA,  Canada).
- The measuring device complies with the general safety requirements in accordance with EN 61010-1, the EMC requirements of IEC/EN 61326, and NAMUR Recommendation NE 21, NE 43 and NE 53.
- For measuring systems used in SIL 2 applications, the separate manual on functional safety must be observed.
- External surface temperature of the transmitter can increase by 10 K due to power consumption of internal electrical components. Hot process fluids passing through the measuring device will further increase the surface temperature of the measuring device. Especially the surface of the sensor can reach temperatures which are close to process temperature. Additionally safety precautions are required when increased process temperatures are present.
- The manufacturer reserves the right to modify technical data without prior notice. Your Endress+Hauser distributor will supply you with current information and updates to these Operating Instructions.

1.4 Return

- Do not return a measuring device if you are not absolutely certain that all traces of hazardous substances have been removed, e.g. substances which have penetrated crevices or diffused through plastic.
- Costs incurred for waste disposal and injury (burns, etc.) due to inadequate cleaning will be charged to the owner-operator.
- Please note the measures on →  107

1.5 Notes on safety conventions and icons

The devices are designed to meet state-of-the-art safety requirements, have been tested, and left the factory in a condition in which they are safe to operate. The devices comply with the applicable standards and regulations in accordance with EN 61010-1 "Protection Measures for Electrical Equipment for Measurement, Control, Regulation and Laboratory Procedures". The devices can, however, be a source of danger if used incorrectly or for other than the designated use. Consequently, always pay particular attention to the safety instructions indicated in these Operating Instructions by the following icons:



Warning!

"Warning" indicates an action or procedure which, if not performed correctly, can result in injury or a safety hazard. Comply strictly with the instructions and proceed with care.



Caution!

"Caution" indicates an action or procedure which, if not performed correctly, can result in incorrect operation or destruction of the device. Comply strictly with the instructions.



Note!

"Note" indicates an action or procedure which, if not performed correctly, can have an indirect effect on operation or trigger an unexpected response on the part of the device.

2 Identification

The following options are available for identification of the measuring device::

- Nameplate specifications
- Order code with breakdown of the device features on the delivery note
- Enter serial numbers from nameplates in *W@M Device Viewer* (www.endress.com/deviceviewer): All information about the measuring device is displayed.

For an overview of the scope of the Technical Documentation provided, refer to the following:

- The chapters "Supplementary Documentation" → 153
- Der *W@M Device Viewer*: Enter the serial number from the nameplate (www.endress.com/deviceviewer)

Reorder

The measuring device is reordered using the order code.

Extended order code:

- The device type (product root) and basic specifications (mandatory features) are always listed.
- Of the optional specifications (optional features), only the safety and approval-related specifications are listed (e.g. LA). If other optional specifications are also ordered, these are indicated collectively using the # placeholder symbol (e.g. #LA#).
- If the ordered optional specifications do not include any safety and approval-related specifications, they are indicated by the + placeholder symbol (e.g. 8E2B50-ABCDE+).

2.1 Device designation

The "Promass 83" flow measuring system consists of the following components:

- Promass 83 transmitter.
- Promass F, Promass E, Promass A, Promass H, Promass I, Promass S, Promass P, Promass O or Promass X sensor.

Two versions are available:

- Compact version: transmitter and sensor form a single mechanical unit.
- Remote version: transmitter and sensor are installed separately.

2.1.1 Nameplate of the transmitter

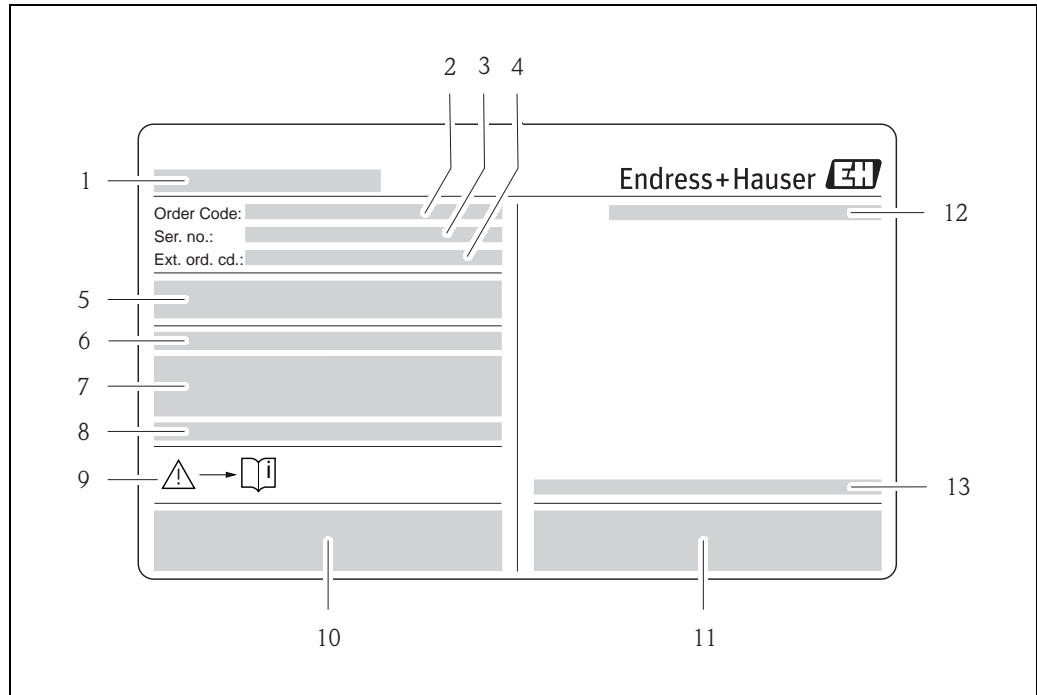

Fig. 1: Example of a transmitter nameplate

- 1 Name of the transmitter
- 2 Order code
- 3 Serial number (Ser. no.)
- 4 Extended order code (Ext. ord. cd.)
- 5 Power supply, frequency and power consumption
- 6 Additional function and software
- 7 Available inputs / outputs
- 8 Reserved for information on special products
- 9 Please refer to operating instructions / documentation
- 10 Reserved for certificates, approvals and for additional information on device version
- 11 Patents
- 12 Degree of protection
- 13 Ambient temperature range

2.1.2 Nameplate of the sensor

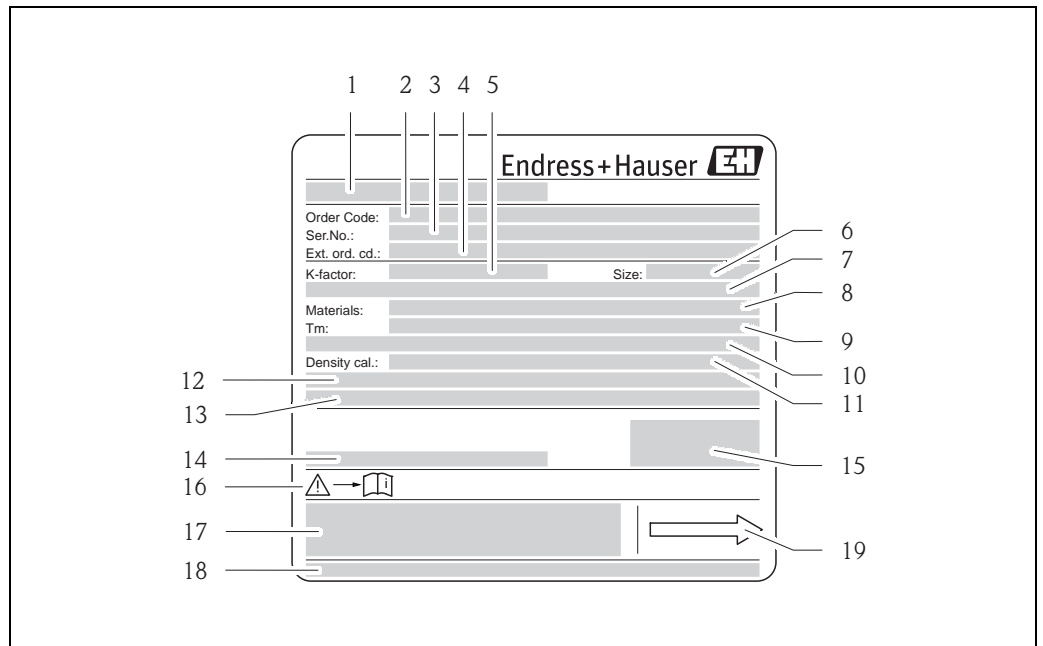
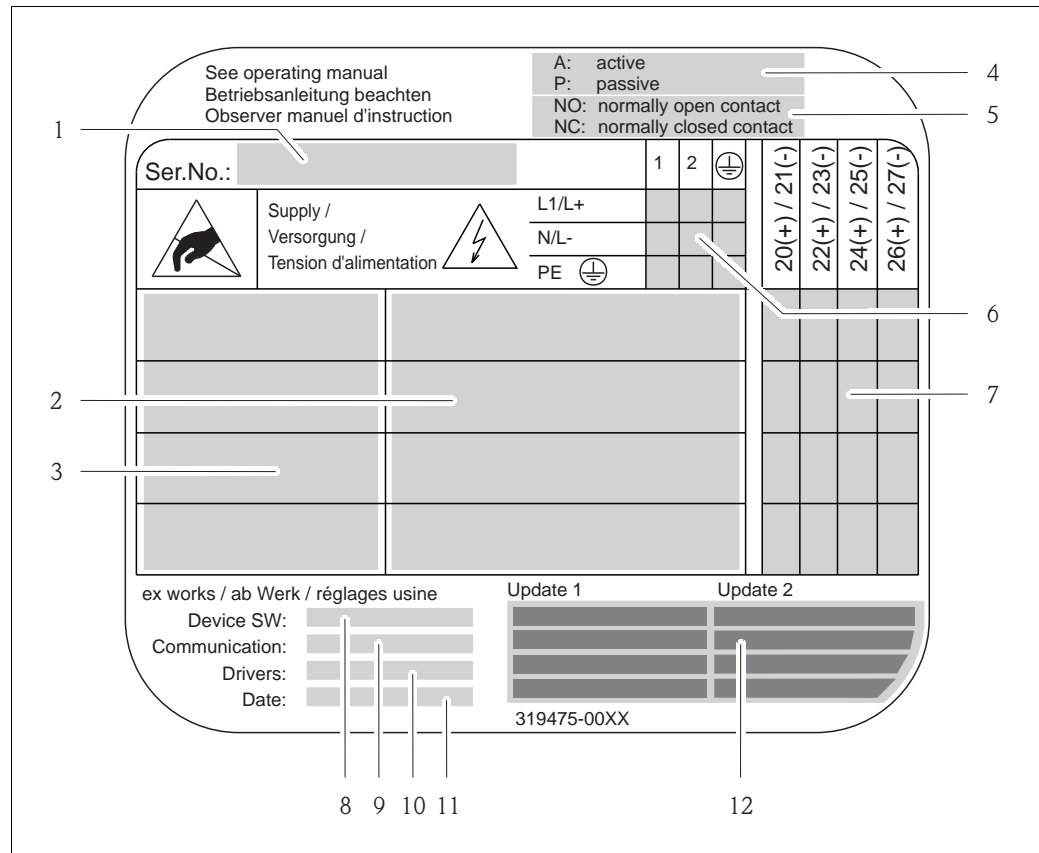

Fig. 2: Example of a sensor nameplate

- 1 Name of the sensor
- 2 Order code
- 3 Serial number (Ser. no.)
- 4 Extended order code (Ext. ord. cd.)
- 5 Calibration factor with zero point (K-factor)
- 6 Nominal diameter device (Size)
- 7 Flange nominal diameter/Nominal pressure
- 8 Material of measuring tubes (Materials)
- 9 Max. fluid temperature (Tm)
- 10 Pressure range of secondary containment
- 11 Accuracy of density measurement (Density cal.)
- 12 Additional information
- 13 Reserved for information on special products
- 14 Ambient temperature range
- 15 Degree of protection
- 16 Please refer to operating instructions / documentation
- 17 Reserved for additional information on device version (approvals, certificates)
- 18 Patents
- 19 Flow direction

2.1.3 Nameplate for connections



A0015931

Fig. 3: Example of a connection nameplate

- 1 Serial number (Ser. no.)
- 2 Possible inputs and outputs
- 3 Signals present at inputs and outputs
- 4 Possible configuration of current output
- 5 Possible configuration of relay contacts
- 6 Terminal assignment, cable for power supply
- 7 Terminal assignment and configuration (see point 4 and 5) of inputs and outputs
- 8 Version of device software currently installed (Device SW)
- 9 Installed communication type (Communication)
- 10 Information on current communication software (Drivers: Device Revision and Device Description),
- 11 Date of installation (Date)
- 12 Current updates to data specified in points 8 to 11 (Update1, Update 2)

2.2 Certificates and approvals

The devices are designed in accordance with good engineering practice to meet state-of-the-art safety requirements, have been tested, and left the factory in a condition in which they are safe to operate. See also "Certificates and approvals" →  152.

The devices comply with the applicable standards and regulations in accordance with EN 61010-1 "Protection Measures for Electrical Equipment for Measurement, Control, Regulation and Laboratory Procedures" and with the EMC requirements of IEC/EN 61326.

The measuring system described in these Operating Instructions thus complies with the statutory requirements of the EC Directives. Endress+Hauser confirms successful testing of the device by affixing to it the CE mark.

The measuring system complies with the EMC requirements of the "Australian Communications and Media Authority (ACMA)".

The measuring device meets all the requirements of the Modbus/TCP conformity test and holds the "Modbus/TCP Conformance Test Policy, Version 2.0". The measuring device has successfully passed all the test procedures carried out and is certified by the "Modbus/TCP Conformance Test Laboratory" of the University of Michigan.

2.3 Registered trademarks

KALREZ® and VITON®

Registered trademarks of E.I. Du Pont de Nemours & Co., Wilmington, USA

TRI-CLAMP®

Registered trademark of Ladish & Co., Inc., Kenosha, USA

SWAGELOK®

Registered trademark of Swagelok & Co., Solon, USA

HistoROM™, S-DAT®, T-DAT™, F-CHIP®, FieldCare®, Fieldcheck®, Applicator®

Registered or registration-pending trademarks of Endress+Hauser Flowtec AG, Reinach, CH

Modbus®

Registered trademark of the Modbus Organization

3 Installation

3.1 Incoming acceptance, transport and storage



3.1.1 Incoming acceptance

On receipt of the goods, check the following points:

- Check the packaging and the contents for damage.
- Check the shipment, make sure nothing is missing and that the scope of supply matches your order.

3.1.2 Transport

The following instructions apply to unpacking and to transporting the device to its final location:

- Transport the devices in the containers in which they are delivered.
- The covers or caps fitted to the process connections prevent mechanical damage to the sealing faces and the ingress of foreign matter to the measuring tube during transportation and storage. Consequently, do not remove these covers or caps until immediately before installation.
- Do not lift measuring devices of nominal diameters $> \text{DN } 40$ ($> 1\frac{1}{2}''$) by the transmitter housing or the connection housing in the case of the remote version (\rightarrow  4). - Use webbing slings slung round the two process connections. Do not use chains, as they could damage the housing.
- Promass X, Promass O sensor: see special instructions for transporting \rightarrow  13



Warning!

Risk of injury if the measuring device slips. The center of gravity of the assembled measuring device might be higher than the points around which the slings are slung.

At all times, therefore, make sure that the device does not unexpectedly turn around its axis or slip.

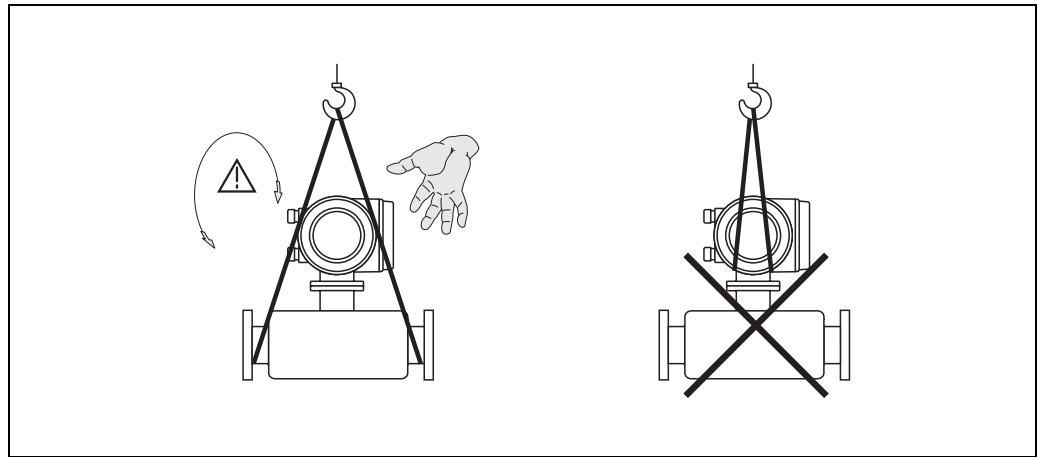

Fig. 4: Instructions for transporting sensors with $> \text{DN } 40$ ($> 1\frac{1}{2}''$)

40004294



Special instructions for transporting Promass X and O

Warning!

- For transporting use only the lifting eyes on the flanges to lift the assembly.
- The assembly must always be attached to at least two lifting eyes.

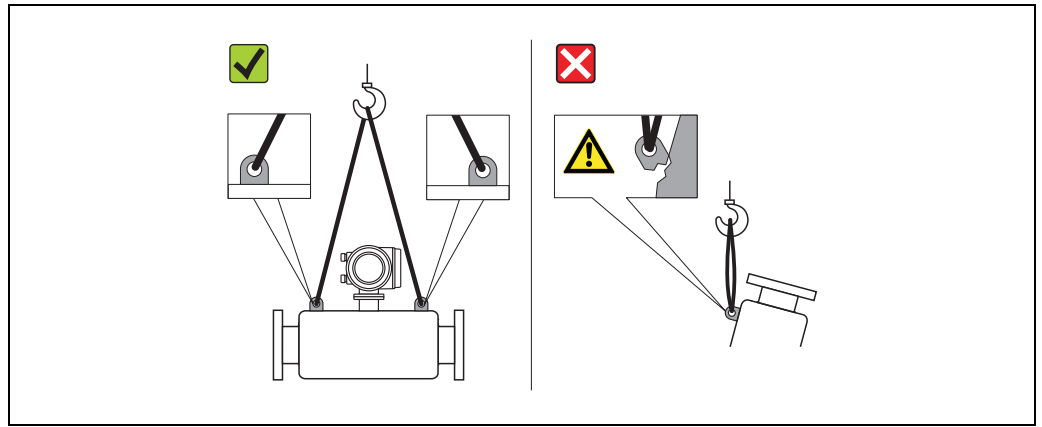

Fig. 5: Instructions for transporting Promass O

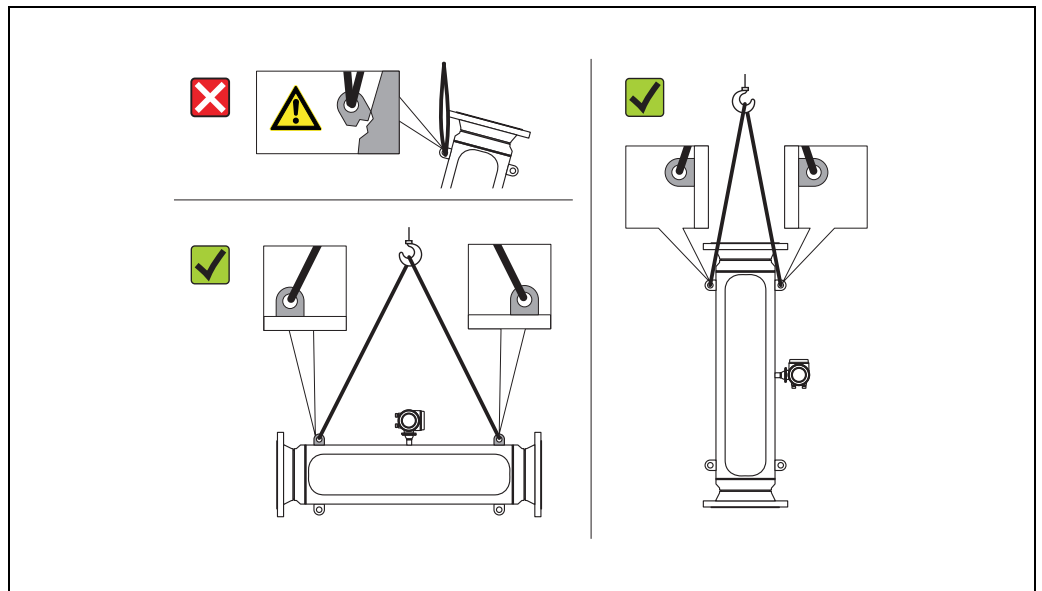

Fig. 6: Instructions for transporting Promass X

3.1.3 Storage

Note the following points:

- Pack the measuring device in such a way as to protect it reliably against impact for storage (and transportation). The original packaging provides optimum protection.
- The permissible storage temperature is -40 to $+80$ °C (-40 °F to $+176$ °F), preferably $+20$ °C ($+68$ °F).
- Do not remove the protective covers or caps on the process connections until you are ready to install the device.
- The measuring device must be protected against direct sunlight during storage in order to avoid unacceptably high surface temperatures.

3.2 Installation conditions

Note the following points:

- No special measures such as supports are necessary. External forces are absorbed by the construction of the instrument, for example the secondary containment.
- The high oscillation frequency of the measuring tubes ensures that the correct operation of the measuring system is not influenced by pipe vibrations.
- No special precautions need to be taken for fittings which create turbulence (valves, elbows, T-pieces, etc.), as long as no cavitation occurs.
- For mechanical reasons and in order to protect the pipe, it is advisable to support heavy sensors.

3.2.1 Dimensions

All the dimensions and lengths of the sensor and transmitter are provided in the separate documentation "Technical Information"

3.2.2 Mounting location

Entrained air or gas bubbles forming in the measuring tube can result in an increase in measuring errors.

Avoid the following locations in the pipe installation:

- Highest point of a pipeline. Risk of air accumulating.
- Directly upstream of a free pipe outlet in a vertical pipeline.

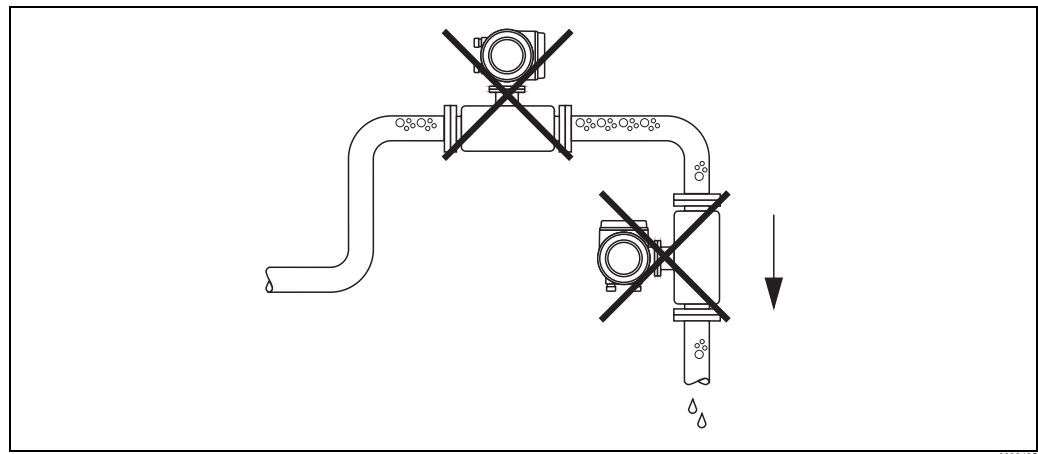

Fig. 7: Mounting location

Installation in a vertical pipe

The proposed configuration in the following diagram, however, permits installation in a vertical pipeline. Pipe restrictors or the use of an orifice plate with a smaller cross-section than the nominal diameter prevent the sensor from running empty during measurement.

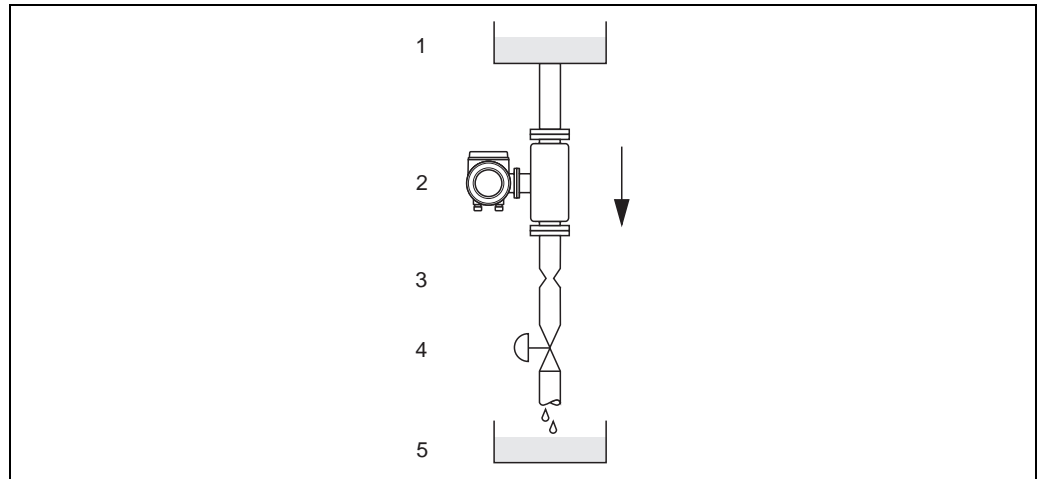

Fig. 8: Installation in a vertical pipe (e.g. for batching applications)

1 = Supply tank, 2 = Sensor, 3 = Orifice plate, pipe restrictors (see Table), 4 = Valve, 5 = Batching tank

DN		Ø Orifice plate, pipe restrictor	
		mm	inch
1	1/24"	0.8	0.03
2	1/12"	1.5	0.06
4	1/8"	3.0	0.12
8	3/8"	6	0.24
15	1/2"	10	0.40
15 FB	1/2"	15	0.60
25	1"	14	0.55
25 FB	1"	24	0.95
40	1 1/2"	22	0.87

FB = Full bore versions of Promass I

DN		Ø Orifice plate, pipe restrictor	
		mm	inch
40 FB	1 1/2"	35	1.38
50	2"	28	1.10
50 FB	2"	54	2.00
80	3"	50	2.00
100	4"	65	2.60
150	6"	90	3.54
250	10"	150	5.91
350	14"	210	8.27

System pressure

It is important to ensure that cavitation does not occur, because it would influence the oscillation of the measuring tube. No special measures need to be taken for fluids which have properties similar to water under normal conditions.

In the case of liquids with a low boiling point (hydrocarbons, solvents, liquefied gases) or in suction lines, it is important to ensure that pressure does not drop below the vapor pressure and that the liquid does not start to boil. It is also important to ensure that the gases that occur naturally in many liquids do not outgas. Such effects can be prevented when system pressure is sufficiently high.

For this reason, the following installation locations are preferred:

- Downstream from pumps (no danger of vacuum)
- At the lowest point in a vertical pipe.

3.2.3 Orientation

Make sure that the direction of the arrow on the nameplate of the sensor matches the direction of flow direction in which the fluid flows through the pipe.

Orientation Promass A

Vertical

Recommended orientation with direction of flow upwards. When fluid is not flowing, entrained solids will sink down and gases will rise away from the measuring tube. The measuring tubes can be completely drained and protected against solids build-up.

Horizontal

When installation is correct the transmitter housing is above or below the pipe. This means that no gas bubbles or solids deposits can form in the bent measuring tube (single-tube system).

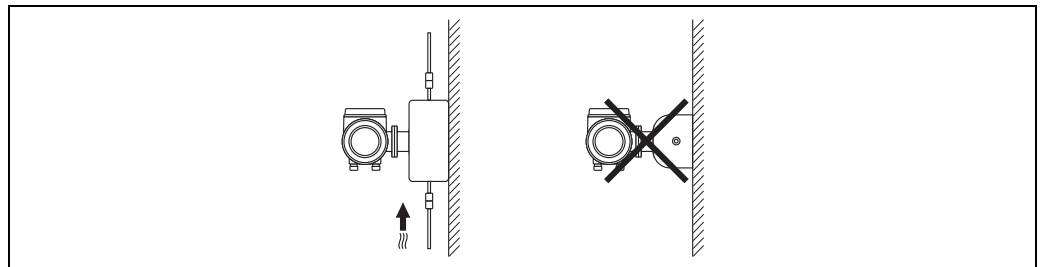

A0018978

Special installation instructions for Promass A



Caution!

Risk of measuring pipe fracture if sensor installed incorrectly!

The sensor may not be installed in a pipe as a freely suspended sensor:

- Using the base plate, mount the sensor directly on the floor, the wall or the ceiling.
- Support the sensor on a firmly mounted support base (e.g. angle bracket).

Vertical

We recommend two installation versions when mounting vertically:

- Mounted directly on a wall using the base plate
- Measuring device supported on an angle bracket mounted on the wall

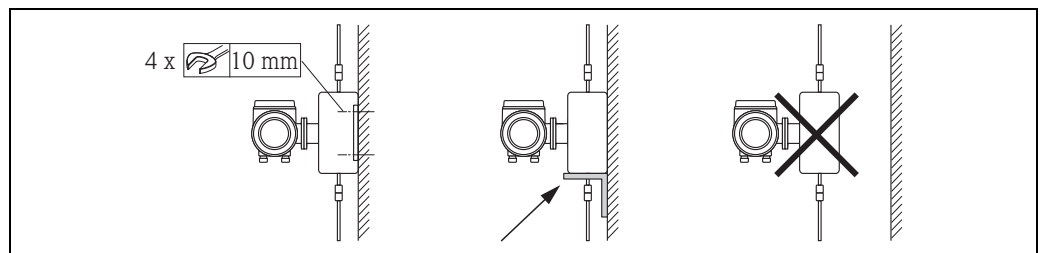

A0018980

Horizontal

We recommend the following installation version when mounting horizontally:

- Measuring device standing on a firm support base

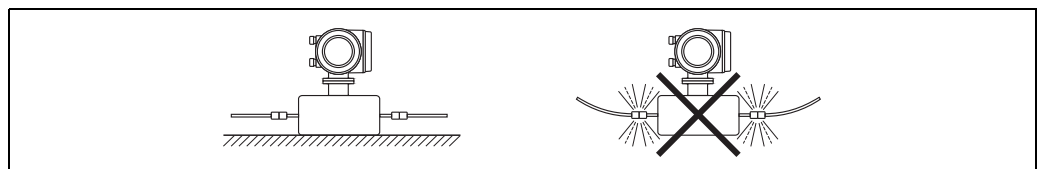

A0018979

Orientation Promass F, E, H, I, S, P, O, X

Make sure that the direction of the arrow on the nameplate of the sensor matches the direction of flow (direction in which the fluid flows through the pipe).

Vertical:

Recommended orientation with upward direction of flow (Fig. V). When fluid is not flowing, entrained solids will sink down and gases will rise away from the measuring tube.

The measuring tubes can be completely drained and protected against solids buildup.

Horizontal (Promass F, E, O):

The measuring tubes of Promass F, E and O must be horizontal and beside each other.

When installation is correct the transmitter housing is above or below the pipe (Fig. H1/H2).

Always avoid having the transmitter housing in the same horizontal plane as the pipe.

See next chapter - special installation instructions.

Horizontal (Promass H, I, S, P, X):

Promass H, I, S, P and X can be installed in any orientation in a horizontal pipe run.

Promass H, I, S, P: See next chapter - special installation instructions

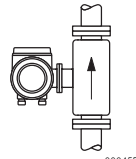
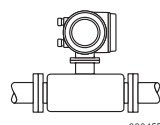
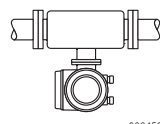
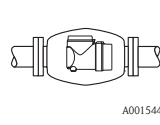
	Promass F, E, O Standard, compact	Promass F, E Standard, remote	Promass F High-temperature, compact	Promass F High-temperature, remote	Promass H, I, S, P	Promass X
Abb. V: Vertical orientation  a0004572	✓✓	✓✓	✓✓	✓✓	✓✓	✓✓
Abb. H1: Horizontal orientation Transmitter head up  a0004576	✓✓	✓✓	✗ TM > 200 °C (392 °F)	✓ TM > 200 °C (392 °F)	✓✓	✓✓
Abb. H2: Horizontal orientation Transmitter head down  a0004580	✓✓	✓✓	✓✓	✓✓	✓✓	✓✓
Abb. H3: Horizontal orientation Transmitter head to the side  A0015445	✗	✗	✗	✗	✓✓	✓①
✓✓ = Recommended orientation; ✓ = Orientation recommended in certain situations; ✗ = Impermissible orientation ① The measuring tubes are curved. Therefore the unit is installed horizontally, adapt the sensor position to the fluid properties: <ul style="list-style-type: none"> ■ Suitable to a limited extent for fluids with entrained solids. Risk of solids accumulating ■ Suitable to a limited extent for outgassing fluids. Risk of air accumulating 						

In order to ensure that the permissible ambient temperature range for the transmitter (→ 133) is not exceeded, we recommend the following orientations:

- For fluids with very high temperatures we recommend the horizontal orientation with the transmitter head pointing downwards (Fig. H2) or the vertical orientation (Fig. V).
- For fluids with very low temperatures, we recommend the horizontal orientation with the transmitter head pointing upwards (Fig. H1) or the vertical orientation (Fig. V).

3.2.4 Special installation instructions

Promass F, E, H, S, P and O



Caution!

If the measuring tube is curved and the unit is installed horizontally, adapt the sensor position to the fluid properties.

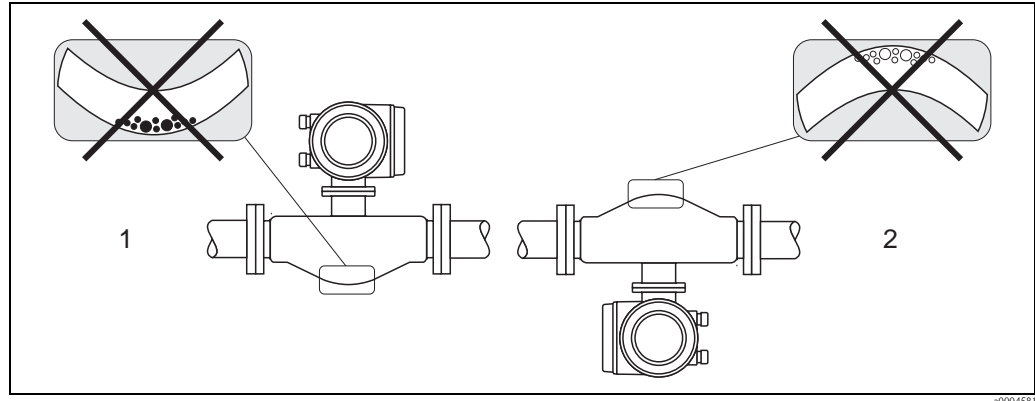

Fig. 9: Horizontal installation of sensors with curved measuring tube.

- 1 Not suitable for fluids with entrained solids. Risk of solids accumulating.
- 2 Not suitable for outgassing fluids. Risk of air accumulating.

Promass I and P with Eccentric Tri-clamps

Eccentric Tri-Clamps can be used to ensure complete drainability when the sensor is installed in a horizontal line. When lines are pitched in a specific direction and at a specific slope, gravity can be used to achieve complete drainability. The sensor must be installed in the correct position with the tube bend facing to the side, to ensure full drainability in the horizontal position. Markings on the sensor show the correct mounting position to optimize drainability.

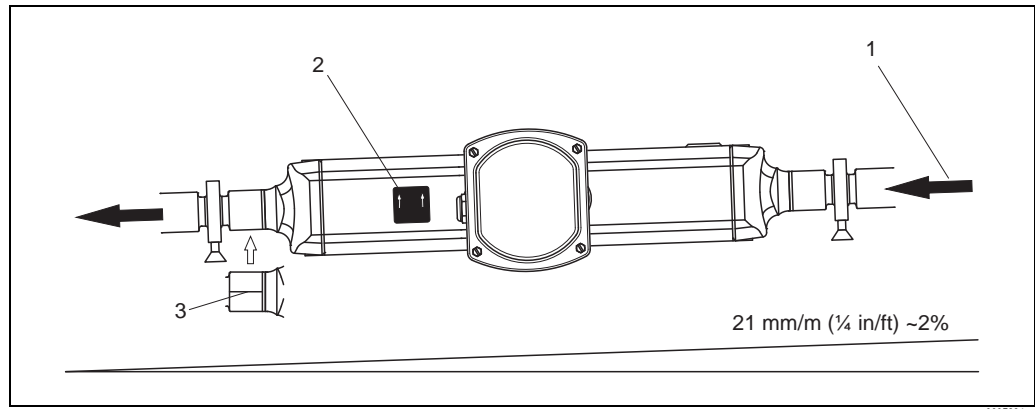

Fig. 10: Promass P: When lines are pitched in a specific direction and at a specific slope: as per hygienic guidelines (21 mm/m or approximately 2%). Gravity can be used to achieve complete drainability.

- 1 The arrow indicates the direction of flow (direction of fluid flow through the pipe).
- 2 The label shows the installation orientation for horizontal drainability.
- 3 The underside of the process connection is indicated by a scribed line. This line indicates the lowest point of the eccentric process connection.

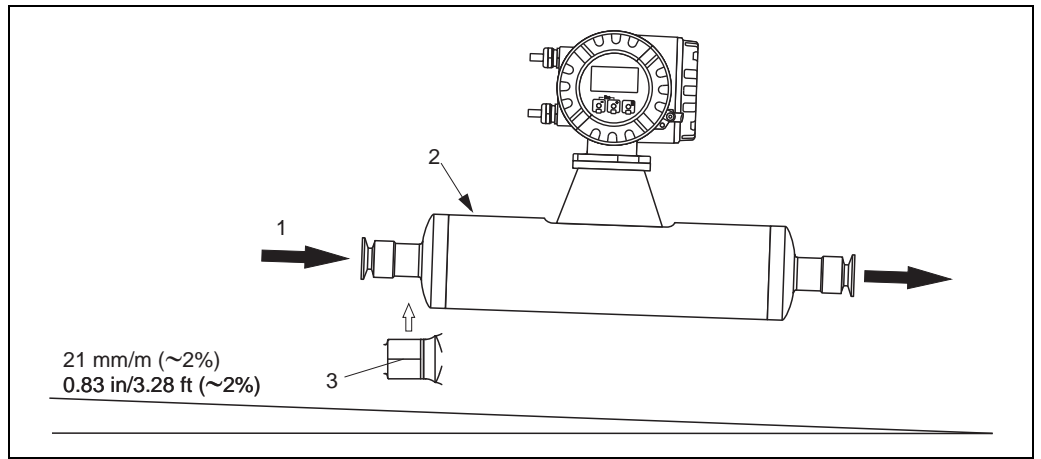

Fig. 11: Promass I: When lines are pitched in a specific direction and at a specific slope: as per hygienic guidelines (21 mm/m or approximately 2%). Gravity can be used to achieve complete drainability.

- 1 The arrow indicates the direction of flow (direction of fluid flow through the pipe).
- 2 The label shows the installation orientation for horizontal drainability.
- 3 The underside of the process connection is indicated by a scribed line. This line indicates the lowest point of the eccentric process connection.

**Promass I and P with hygienic connections
(mounting clamp with lining between clamp and instrument)**

It is not necessary to support the sensor under any circumstances for operational performance. If the requirement exists to support the sensor the following recommendation should be followed.

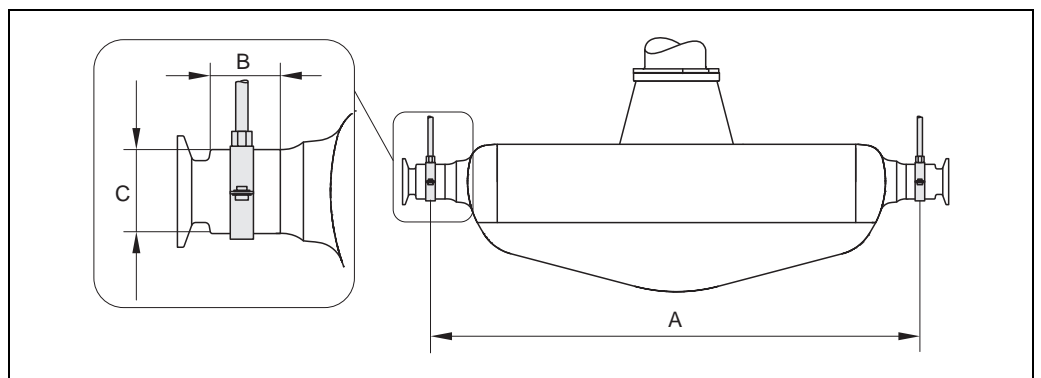

Fig. 12: Promass P, mounted with mounting clamp

DN	8	15	25	40	50
A	298	402	542	750	1019
B	33	33	33	36.5	44.1
C	28	28	38	56	75

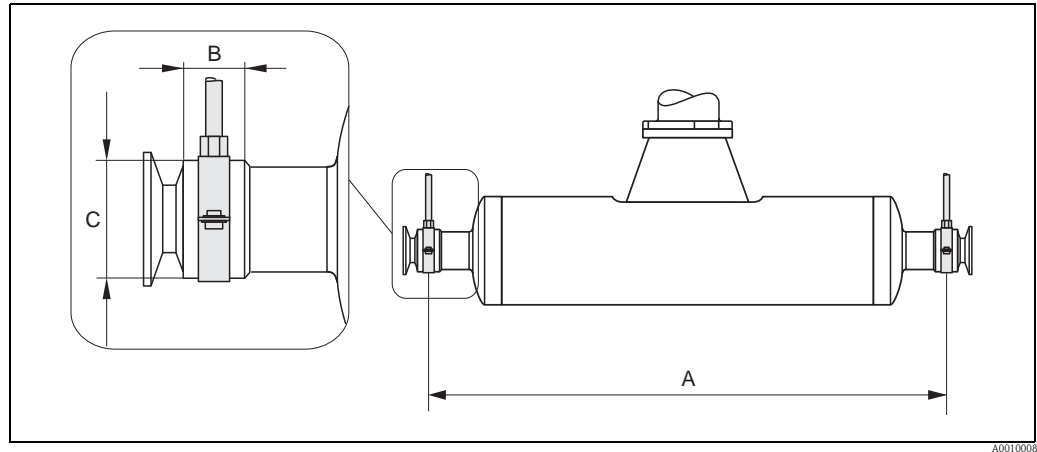

Fig. 13: Promass I, mounted with mounting clamp

DN	8	15	15FB	25	25FB	40	40FB	50	50FB	50FB	80	80
Tri-Clamp	½"	¾"	1"	1"	1 ½"	1 ½"	2"	2"	2 ½"	3"	2 ½"	3"
A	373	409	539	539	668	668	780	780	1152	1152	1152	1152
B	20	20	30	30	28	28	35	35	57	57	57	57
C	40	40	44.5	44.5	60	60	80	80	90	90	90	90

3.2.5 Heating

Some fluids require suitable measures to avoid loss of heat at the sensor. Heating can be electric, e.g. with heated elements, or by means of hot water or steam pipes made of copper or heating jackets.



Caution!

- Risk of electronics overheating! Make sure that the maximum permissible ambient temperature for the transmitter is not exceeded. Consequently, make sure that the adapter between sensor and transmitter and the connection housing of the remote version always remain free of insulating material. Note that a certain orientation might be required, depending on the fluid temperature → 16. For fluid temperature of 150°C (302°F) or above the usage of the remote version with separate connection housing is recommended.
- With a fluid temperature between 200 °C to 350 °C (392 to 662 °F) the remote version of the high-temperature version is preferable.
- When using electrical heat tracing whose heat is regulated using phase control or by pulse packs, it cannot be ruled out that the measured values are influenced by magnetic fields which may occur, (i.e. at values greater than those permitted by the EC standard (Sinus 30 A/m)). In such cases, the sensor must be magnetically shielded.
The secondary containment can be shielded with tin plates or electric sheets without privileged direction (e.g. V330-35A) with the following properties:
 - Relative magnetic permeability $\mu_r \geq 300$
 - Plate thickness $d \geq 0.35 \text{ mm (0.014")}$
- Information on permissible temperature ranges → 134
- Promass X: Especially under critical climatic conditions it has to be ensured that the temperature difference between environment and measured medium does not exceed 100 K. Suitable measures, such as heating or thermal insulation, are to be taken.

Special heating jackets which can be ordered as accessories from Endress+Hauser are available for the sensors.

3.2.6 Thermal insulation

Some fluids require suitable measures to avoid loss of heat at the sensor. A wide range of materials can be used to provide the required thermal insulation.

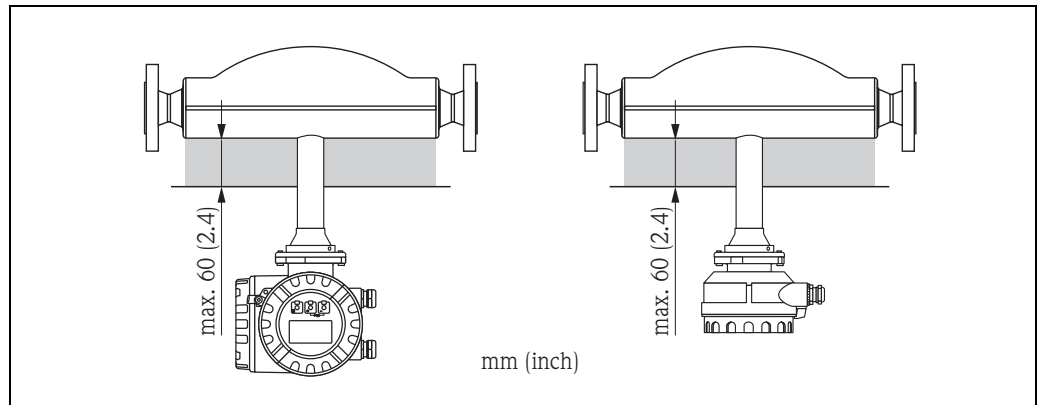

Fig. 14: In the case of the Promass F high-temperature version, a maximum insulation thickness of 60 mm (2.4") must be observed in the area of the electronics/neck.

If the Promass F high-temperature version is installed horizontally (with transmitter head pointing upwards), an insulation thickness of min. 10 mm (0.4") is recommended to reduce convection. The maximum insulation thickness of 60 mm (2.4") must be observed.

3.2.7 Inlet and outlet runs

There are no installation requirements regarding inlet and outlet runs. If possible, install the sensor well clear of fittings such as valves, T-pieces, elbows, etc.

3.2.8 Vibrations

The high oscillation frequency of the measuring tubes ensures that the correct operation of the measuring system is not influenced by pipe vibrations. Consequently, the sensors require no special measures for attachment.

3.2.9 Limiting flow

Relevant information can be found in the "Technical Data" section under "Measuring range" → 108 or "Limiting flow" → 136.

3.3 Installation

3.3.1 Turning the transmitter housing

Turning the aluminum field housing



Warning!

The turning mechanism in devices with EEx d/de or FM/CSA Cl. I Div. 1 classification is not the same as that described here. The procedure for turning these housings is described in the Ex-specific documentation.

1. Loosen the two securing screws.
2. Turn the bayonet catch as far as it will go.
3. Carefully lift the transmitter housing as far as it will go.
4. Turn the transmitter housing to the desired position (max. $2 \times 90^\circ$ in either direction).
5. Lower the housing into position and reengage the bayonet catch.
6. Retighten the two securing screws.

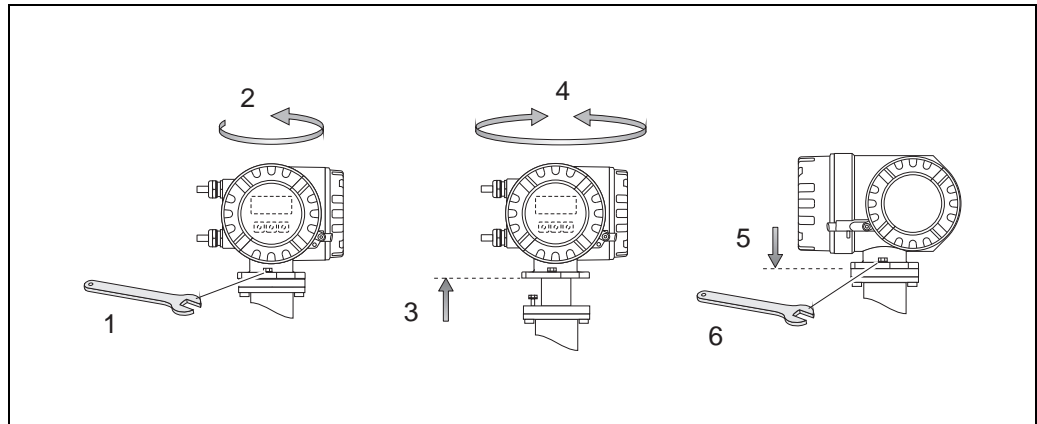

Fig. 15: Turning the transmitter housing (aluminum field housing)

Turning the stainless steel field housing

1. Loosen the two securing screws.
2. Carefully lift the transmitter housing as far as it will go.
3. Turn the transmitter housing to the desired position (max. $2 \times 90^\circ$ in either direction).
4. Lower the housing into position.
5. Retighten the two securing screws.

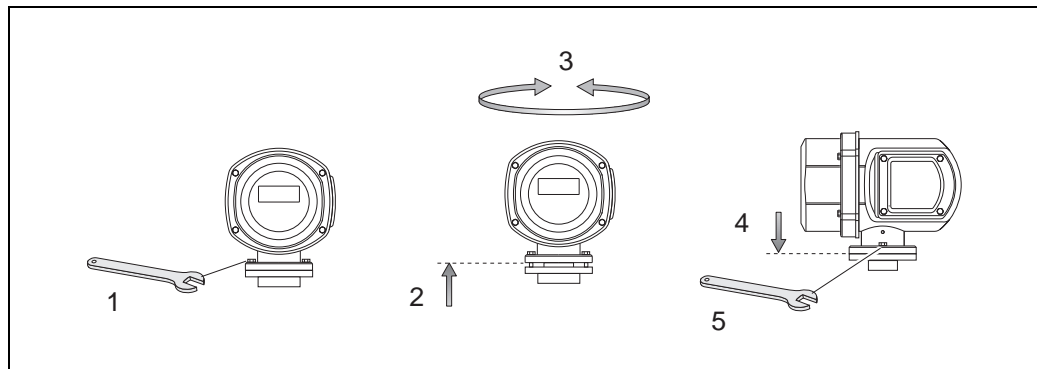

Fig. 16: Turning the transmitter housing (stainless steel field housing)

3.3.2 Installing the wall-mount housing

There are various ways of installing the wall-mount housing:

- Mounted directly on the wall
- Installation in control panel (separate mounting set, accessories) → 24
- Pipe mounting (separate mounting set, accessories) → 24



Caution!

- Make sure that ambient temperature does not go beyond the permissible range (– 20 to +60 °C (–4 to + 140 F), optional – 40 to +60 °C (–40 to +140 °F)). Install the device in a shady location. Avoid direct sunlight.
- Always install the wall-mount housing in such a way that the cable entries are pointing down.

Mounted directly on the wall

1. Drill the holes as illustrated in the diagram.
2. Remove the cover of the connection compartment (a).
3. Push the two securing screws (b) through the appropriate bores (c) in the housing.
 - Securing screws (M6): max. Ø 6.5 mm (0.26")
 - Screw head: max. Ø 10.5 mm (0.41")
4. Secure the transmitter housing to the wall as indicated.
5. Screw the cover of the connection compartment (a) firmly onto the housing.

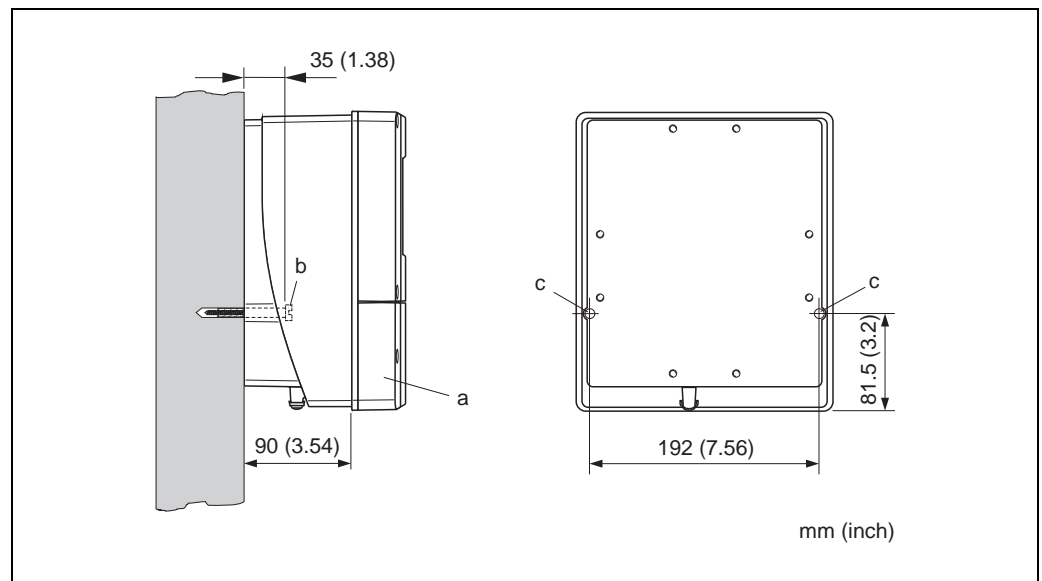

Fig. 17: Mounted directly on the wall

a0001130

Installation in control panel

1. Prepare the opening in the panel as illustrated in the diagram.
2. Slide the housing into the opening in the panel from the front.
3. Screw the fasteners onto the wall-mount housing.
4. Screw threaded rods into holders and tighten until the housing is solidly seated on the panel wall. Afterwards, tighten the locking nuts. Additional support is not necessary.

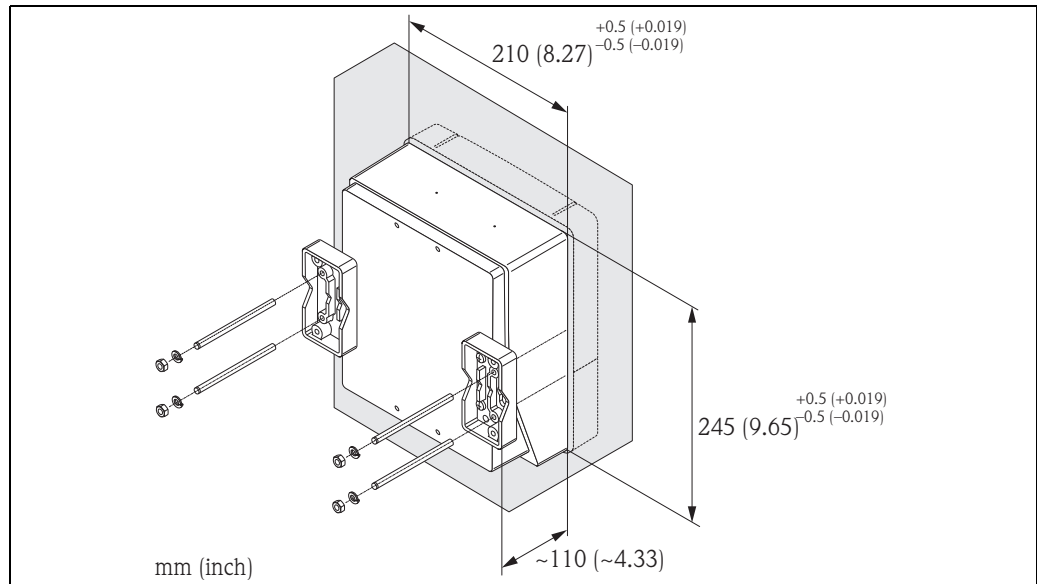

Fig. 18: Panel installation (wall-mount housing)

Pipe mounting

The assembly should be performed by following the instructions in the diagram.



Caution!

If a warm pipe is used for installation, make sure that the housing temperature does not exceed the max. permitted value of +60 °C (+140 °F).

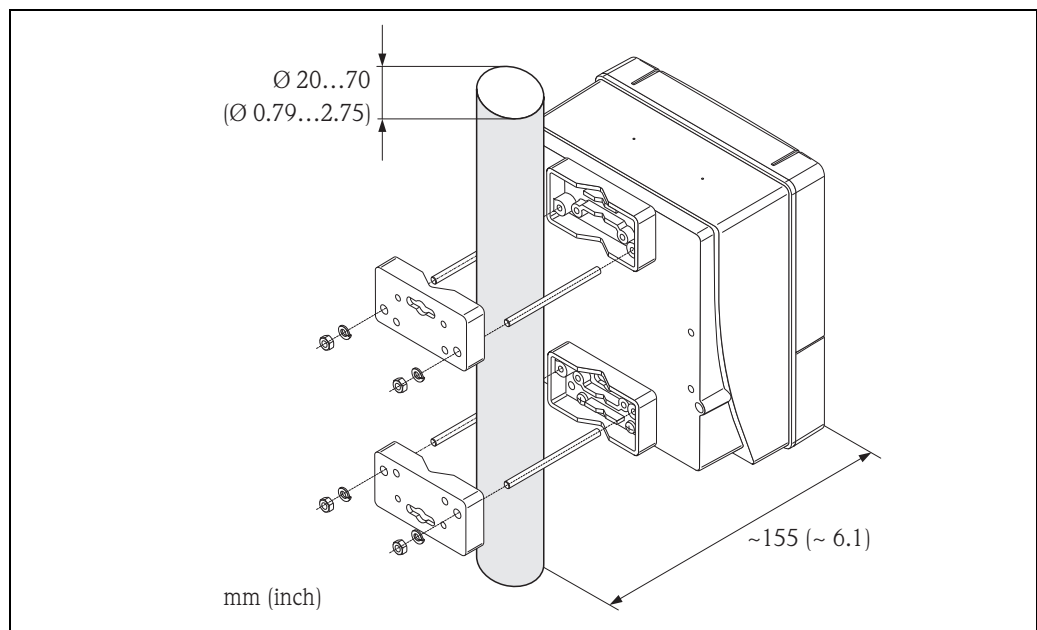

Fig. 19: Pipe mounting (wall-mount housing)

3.3.3 Turning the local display

1. Unscrew cover of the electronics compartment from the transmitter housing.
2. Press the side latches on the display module and remove the module from the electronics compartment cover plate.
3. Rotate the display to the desired position (max. $4 \times 45^\circ$ in both directions), and reset it onto the electronics compartment cover plate.
4. Screw the cover of the electronics compartment firmly back onto the transmitter housing.

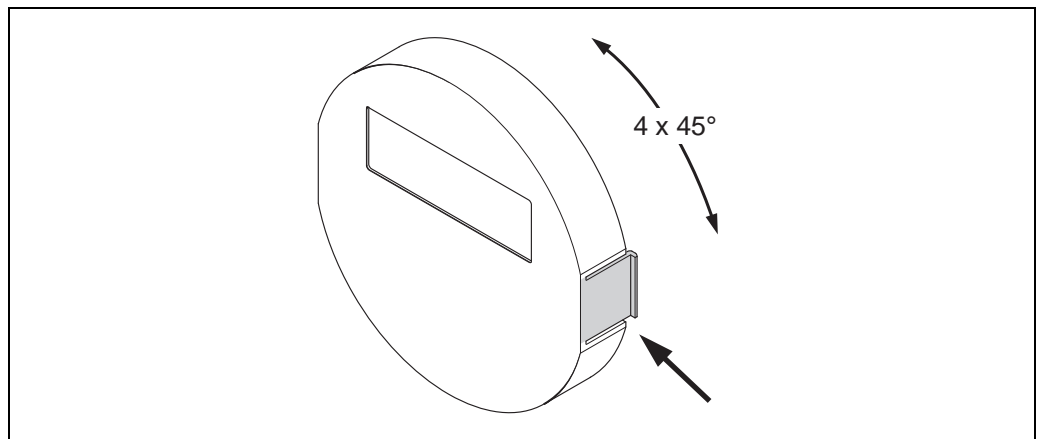

Fig. 20: Turning the local display (field housing)

3.4 Post-installation check

Perform the following checks after installing the measuring device in the pipe:

Device condition and specifications	Notes
Is the device damaged (visual inspection)?	-
Does the device correspond to specifications at the measuring point, including process temperature and pressure, ambient temperature, measuring range, etc.?	→ 5
Installation instructions	Notes
Does the arrow on the sensor nameplate match the direction of flow through the pipe?	-
Are the measuring point number and labeling correct (visual inspection)?	-
Is the orientation chosen for the sensor correct, in other words suitable for sensor type, fluid properties (outgassing, with entrained solids) and fluid temperature?	→ 14
Process environment / process conditions	Notes
Is the measuring device protected against moisture and direct sunlight?	-

4 Wiring



Warning!

When connecting Ex-certified devices, see the notes and diagrams in the Ex-specific supplement to these Operating Instructions. Please do not hesitate to contact your Endress+Hauser sales office if you have any questions.



Note!

The device does not have an internal power switch. For this reason, assign the device a switch or power-circuit breaker which can be used to disconnect the power supply line from the power grid.

4.1 Modbus RS485 cable specifications

In the EIA/TIA-485 standard, two versions (cable type A and B) are specified for the bus line and can be used for all transmission rates. However, we recommend you use cable type A. The cable specification for cable type A is provided in the following table:

Cable type A	
Characteristic impedance	135 to 165 Ω at a measuring frequency of 3 to 20 MHz
Cable capacitance	< 30 pF/m
Core cross-section	> 0.34 mm ² , corresponds to AWG 22
Cable type	Twisted pairs
Loop-resistance	\leq 110 Ω /km
Signal damping	Max. 9 dB over the entire length of the cable cross-section
Shielding	Copper braided shielding or braided shielding and foil shielding

Note the following points for the bus structure:

- All the measuring devices are connected in a bus structure (line).
- Using cable type A and with a transmission rate of 115200 Baud, the maximum line length (segment length) of the Modbus RS485 system is 1200 m (4000 ft). The total length of the spurs may not exceed a maximum of 6.6 m (21.7 ft) here.
- A maximum of 32 users are permitted per segment.
- Each segment is terminated at either end with a terminating resistor.
- The bus length or the number of users can be increased by introducing a repeater.

4.1.1 Shielding and grounding

When planning the shielding and grounding for a fieldbus system, there are three important points to consider:

- Electromagnetic compatibility (EMC)
- Explosion protection
- Safety of the personnel

To ensure the optimum electromagnetic compatibility of systems, it is important that the system components and above all the cables, which connect the components, are shielded and that no portion of the system is unshielded. Ideally, the cable shields are connected to the normally metal housings of the connected field devices. Since these are generally connected to the protective earth, the shield of the bus cable is grounded many times. Keep the stripped and twisted lengths of cable shield to the terminals as short as possible.

This approach, which provides the best electromagnetic compatibility and personnel safety, can be used without restriction in systems with good potential equalization.

In the case of systems without potential equalization, a power supply frequency (50 Hz) equalizing current can flow between two grounding points which, in unfavorable cases, e.g. when it exceeds the permissible shield current, may destroy the cable.

To suppress the low frequency equalizing currents on systems without potential equalization, it is therefore recommended to connect the cable shield directly to the building ground (or protective earth) at one end only and to use capacitive coupling to connect all other grounding points.



Caution!

The legal EMC requirements are fulfilled **only** when the cable shield is grounded on both sides!

4.2 Connecting the remote version

4.2.1 Connecting connecting cable for sensor/transmitter



Warning!

- Risk of electric shock. Switch off the power supply before opening the device.
Do not install or wire the device while it is connected to the power supply.
Failure to comply with this precaution can result in irreparable damage to the electronics.
- Risk of electric shock. Connect the protective earth to the ground terminal on the housing before the power supply is applied.
- You may only connect the sensor to the transmitter with the same serial number. Communication errors can occur if this is not observed when connecting the devices.

1. Remove the connection compartment cover (a) by loosening the fixing screws on the transmitter and sensor housing.
2. Feed the connecting cable (b) through the appropriate cable runs.
3. Establish the connections between sensor and transmitter in accordance with the wiring diagram:
– →  21
– See wiring diagram in screw cap
4. Screw the connection compartment cover (a) back onto the sensor and transmitter housing.

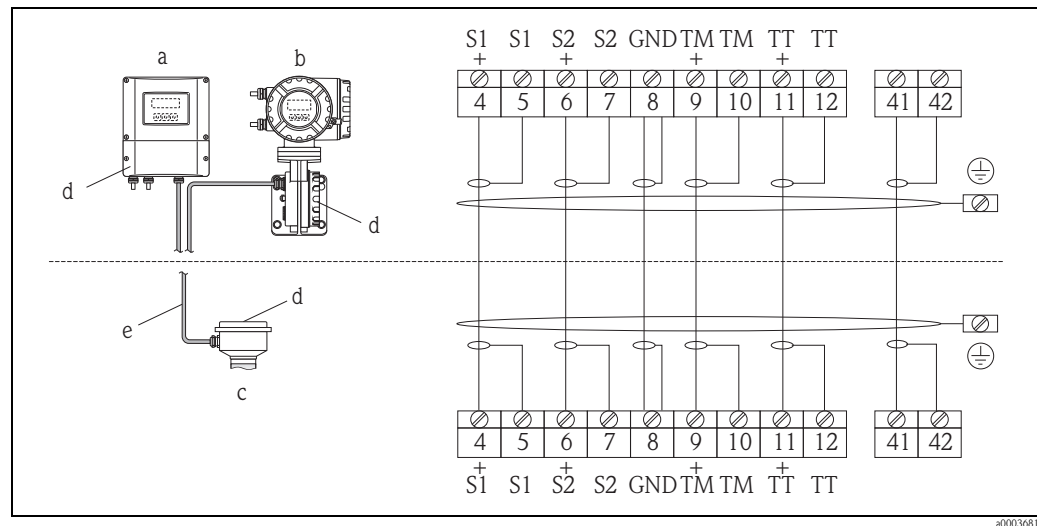

Fig. 21: Connecting the remote version

- a Wall-mount housing: non-hazardous area and ATEX II3G / Zone 2 → see separate Ex documentation
 b Wall-mount housing: ATEX II2G / Zone 1 / FM/CSA → see separate Ex documentation
 c Remote version, flanged version

Terminal No.: 4/5 = gray; 6/7 = green; 8 = yellow; 9/10 = pink; 11/12 = white; 41/42 = brown

4.2.2 Cable specification for connecting cable

The specifications of the cable connecting the transmitter and the sensor of the remote version are as follows:

- $6 \times 0.38 \text{ mm}^2$ PVC cable with common shield and individually shielded cores
- Conductor resistance: $\leq 50 \text{ } \Omega/\text{km}$
- Capacitance core/shield: $\leq 420 \text{ pF/m}$
- Cable length: max. 20 m (65 ft)
- Permanent operating temperature: max. $+105 \text{ } ^\circ\text{C}$ ($+221 \text{ } ^\circ\text{F}$)



Note!

The cable must be installed in a manner in which it is fixed securely.

4.3 Connecting the measuring unit

4.3.1 Transmitter connection



Warning!

- Risk of electric shock. Switch off the power supply before opening the device. Do not install or wire the device while it is connected to the power supply. Failure to comply with this precaution can result in irreparable damage to the electronics.
- Risk of electric shock. Connect the protective earth to the ground terminal on the housing before the power supply is applied (not required for galvanically isolated power supply).
- Compare the specifications on the nameplate with the local supply voltage and frequency. The national regulations governing the installation of electrical equipment also apply.

1. Unscrew the connection compartment cover (a) from the transmitter housing.
2. Feed the power supply cable (b), the signal cable (d) and the fieldbus cable (e) through the appropriate cable entries.
3. Perform wiring in accordance with the respective terminal assignment and the associated wiring diagram.



Caution!

- Risk of damage to the fieldbus cable!
Observe the information about shielding and grounding the fieldbus cable → 27.
 - We recommend that the fieldbus cable not be looped using conventional cable glands. If you later replace even just one measuring device, the bus communication will have to be interrupted.
4. Screw the cover of the connection compartment (a) back onto the transmitter housing.

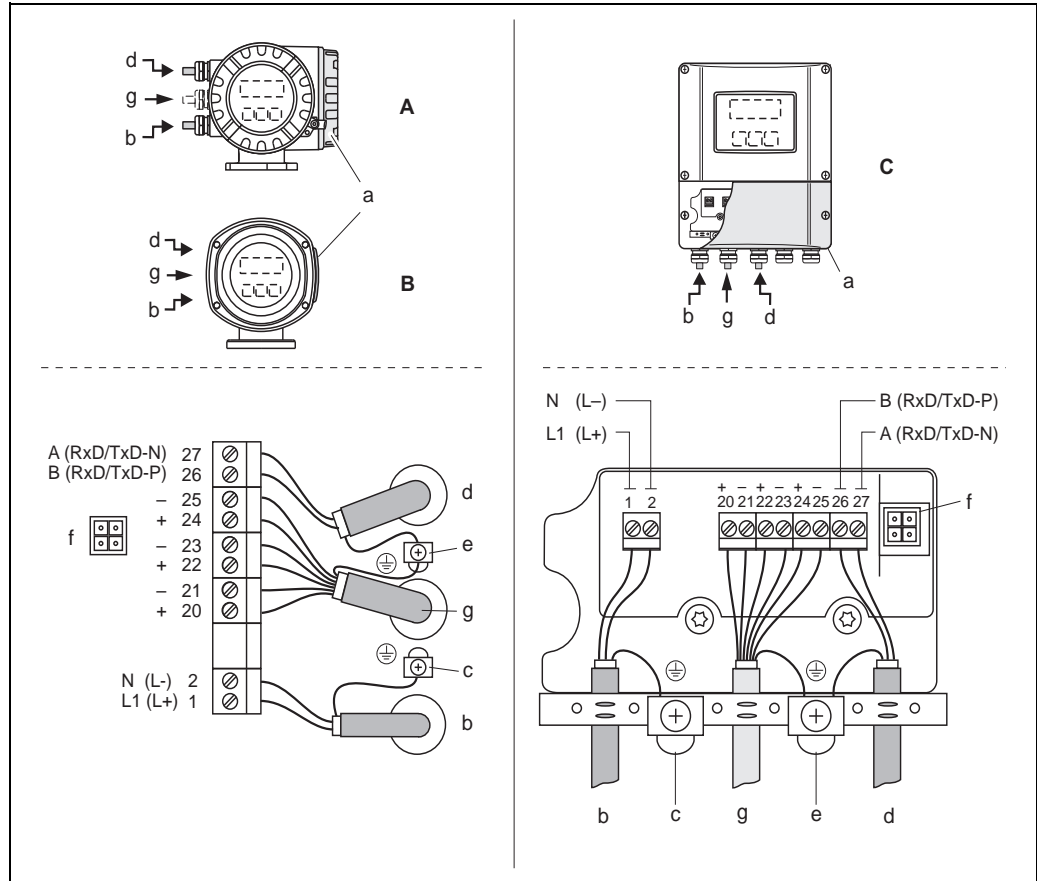

Fig. 22: Connecting the transmitter, Cable cross-section: max. 2.5 mm²

- A View A (field housing)
 B View B (stainless steel field housing)
 C View C (wall-mount housing)
- a Connection compartment cover
 b Cable for power supply: 85 to 260 V AC, 20 to 55 V AC, 16 to 62 V DC
 Terminal No. 1: L1 for AC, L+ for DC
 Terminal No. 2: N for AC, L- for DC
 c Ground terminal for protective ground
 d Fieldbus cable
 Terminal No. 26: B (Rx/D/TxD-P)
 Terminal No. 27: A (Rx/D/TxD-N)
 e Ground terminal for signal cable shield/fieldbus cable shield
 Observe the following:
 – the shielding and grounding of the fieldbus cable → 27
 – that the stripped and twisted lengths of cable shield to the ground terminal are as short as possible
 f Service adapter for connecting service interface FXA193 (Fieldcheck, FieldCare)
 g Signal cable: see terminal assignment → 31

4.3.2 Terminal assignment



Caution!

Only certain combinations of submodules (see Table) on the I/O board are permissible. The individual slots are marked and assigned to the following terminals in the connection compartment of the transmitter:

- Slot "INPUT / OUTPUT 3" = Terminals 22 / 23
- Slot "INPUT / OUTPUT 4" = Terminals 20 / 21

Order characteristic for "inputs/outputs"	Terminal No. (inputs/outputs)			
	20 (+) / 21 (-) Submodule on slot No. 4	22 (+) / 23 (-) Submodule on slot No. 3	24 (+) / 25 (-) Fixed on I/O board	26 = B (RxD/TxD-P) 27 = A (RxD/TxD-N) Fixed on I/O board
Q	–	–	Status input	Modbus RS485
7	Relay output 2	Relay output 1	Status input	Modbus RS485
N	Current output	Frequency output	Status input	Modbus RS485



Note!

The electrical values of the inputs and outputs can be found in the "Technical data" section.

4.4 Degree of protection

The measuring device fulfill all the requirements for IP 67.

Compliance with the following points is mandatory following installation in the field or servicing, in order to ensure that IP 67 protection is maintained:

- The housing seals must be clean and undamaged when inserted into their grooves. The seals must be dried, cleaned or replaced if necessary.
- The threaded fasteners and screw covers must be firmly tightened.
- The cables used for connection must be of the specified outside diameter → 112, cable entries.
- The cable entries must be firmly tighten (point **a** → 23).
- The cable must loop down in front of the cable entry ("water trap") (point **b** → 23). This arrangement prevents moisture penetrating the entry.



Note!

The cable entries may not be point up.

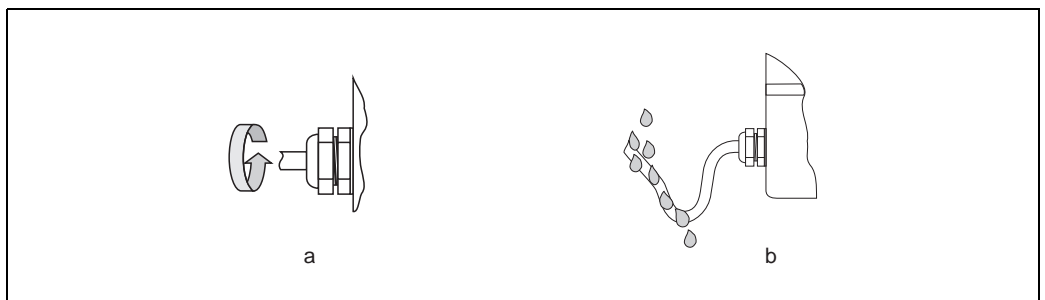

Fig. 23: Installation instructions, cable entries

- Remove all unused cable entries and insert plugs instead.
- Do not remove the grommet from the cable entry.



Caution!

Do not loosen the screws of the sensor housing, as otherwise the degree of protection guaranteed by Endress+Hauser no longer applies.

4.5 Post-connection check

Perform the following checks after completing electrical installation of the measuring device:

Device condition and specifications	Notes
Are cables or the device damaged (visual inspection)?	-
Electrical connection	Notes
Does the supply voltage match the specifications on the nameplate?	85 to 260 V AC (45 to 65 Hz) 20 to 55 V AC (45 to 65 Hz) 16 to 62 V DC
Do the cables comply with the specifications?	→ 26
Do the cables have adequate strain relief?	-
Cables correctly segregated by type? Without loops and crossovers?	-
Are the power-supply and signal cables correctly connected?	See the wiring diagram inside the cover of the terminal compartment
Are all screw terminals firmly tightened?	-
Are all cable entries installed, firmly tightened and correctly sealed? Cables looped as "water traps"?	See the "Degree of protection" section → 31
Are all housing covers installed and firmly tightened?	-
Fieldbus electrical connection	Notes
Has each fieldbus segment been terminated at both ends with a bus terminator?	→ 56
Has the max. length of the fieldbus cable been observed in accordance with the specifications?	→ 26
Has the max. length of the spurs been observed in accordance with the specifications?	→ 26
Is the fieldbus cable fully shielded and correctly grounded?	→ 27

5 Operation

5.1 Quick operation guide

You have a number of options for configuring and commissioning the device:

1. **Local display (option)** → 34
The local display enables you to read all important variables directly at the measuring point, configure bus-specific and device-specific parameters in the field and perform commissioning.
2. **Operating programs** → 53
Operation via:
 - FieldCare
 The Proline flowmeters are accessed via the service interface or via the service interface FXA193.
3. **Jumpers/miniature switches for hardware settings** → 53
You can make the following hardware settings using a jumper or miniature switches on the I/O board:
 - Address mode configuration (select software or hardware addressing)
 - Device bus address configuration (for hardware addressing)
 - Hardware write protection enabling/disabling



Note!

A description of the configuration of the current output (active/passive) and the relay output (NC contact/NO contact) can be found in the "Hardware settings" section → 54.

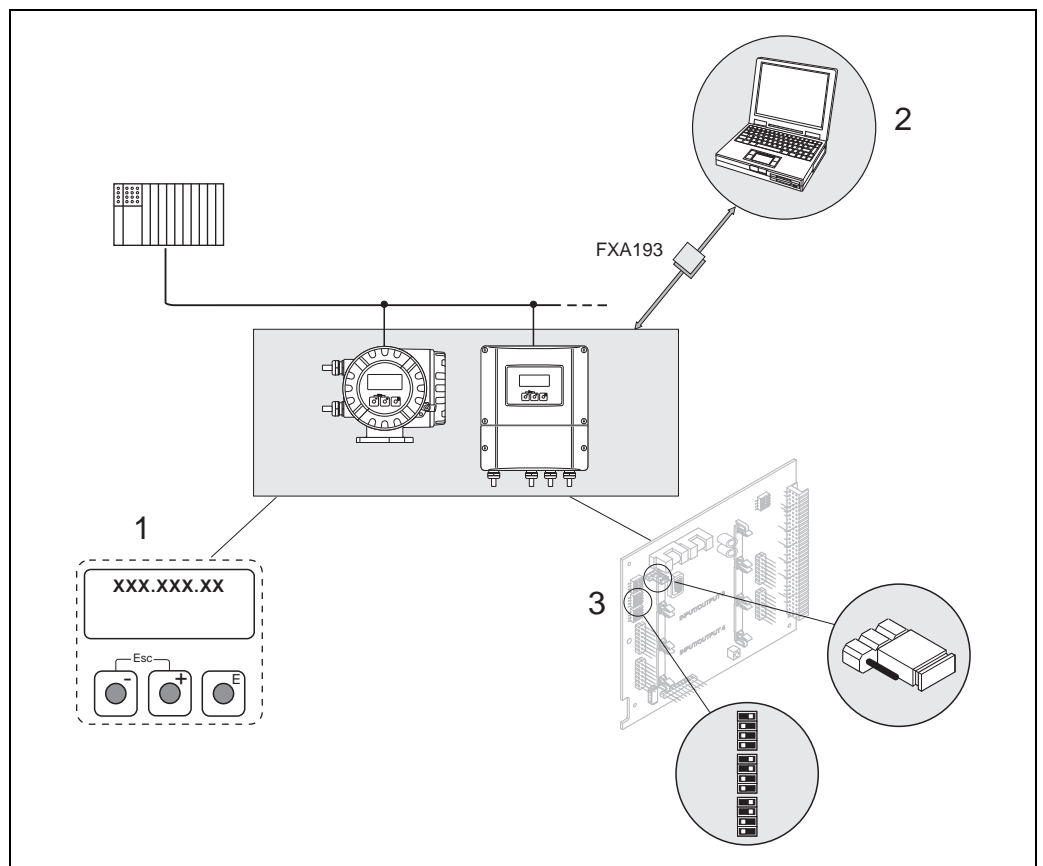

Fig. 24: Methods of operating Modbus RS485 devices

- 1 Local display for device operation in the field (option)
- 2 Configuration/operating program for operating via the service interface FXA193 (e.g. FieldCare)
- 3 Jumper/miniature switches for hardware settings (write protection, device address, address mode)

5.2 Local display

5.2.1 Display and operating elements

The local display enables you to read all important parameters directly at the measuring point and configure the device using the "Quick Setup" or the function matrix.

The display consists of four lines; this is where measured values and/or status variables (direction of flow, empty pipe, bar graph, etc.) are displayed. You can change the assignment of display lines to different variables to suit your needs and preferences (→ see the "Description of Device Functions" manual).

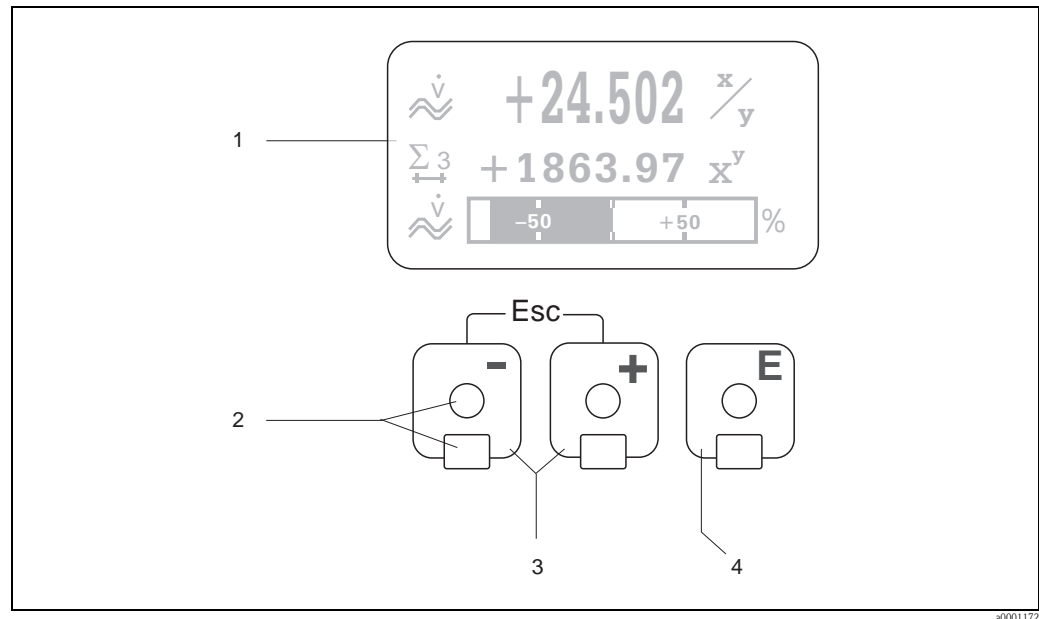

Fig. 25: Display and operating elements

- 1 **Liquid crystal display**
The backlit, four-line liquid crystal display shows measured values, dialog texts, fault messages and notice messages. The display as it appears when normal measuring is in progress is known as the HOME position (operating mode).
- 2 **Optical sensors for "Touch Control"**
- 3 **Plus/minus keys**
 - HOME position → Direct access to totalizer values and actual values of inputs/outputs
 - Enter numerical values, select parameters
 - Select different blocks, groups and function groups within the function matrix

Press the $\boxed{+}$ / $\boxed{-}$ keys ($\boxed{+/-}$) simultaneously to trigger the following functions:

 - Exit the function matrix step by step → HOME position
 - Press and hold down $\boxed{+}$ / $\boxed{-}$ keys for longer than 3 seconds → Return directly to HOME position
 - Cancel data entry
- 4 **Enter key**
 - HOME position → Entry into the function matrix
 - Save the numerical values you input or settings you change

5.2.2 Display (operation mode)

The display area consists of three lines in all; this is where measured values are displayed, and/or status variables (direction of flow, bar graph, etc.). You can change the assignment of display lines to different variables to suit your needs and preferences (→ see the "Description of Device Functions" manual).

Multiplex mode:

A maximum of two different display variables can be assigned to each line. Variables multiplexed in this way alternate every 10 seconds on the display.

Error messages:

Display and presentation of system/process errors → 41

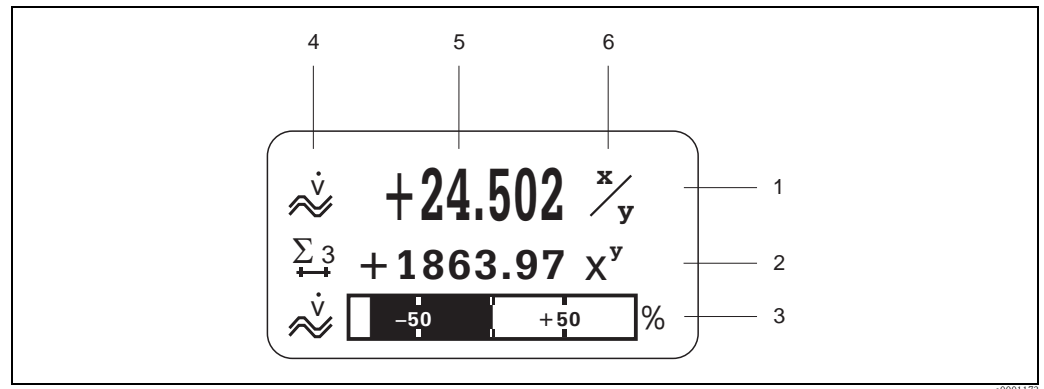

Fig. 26: Typical display for normal operating mode (HOME position)

- 1 Main line: shows the main measured values
- 2 Information line: shows additional measured variables and status variables
- 3 Information line: shows additional information on the measured variables and status variables, e.g. bar graph display
- 4 "Info icons" field: icons representing additional information on the measured values are shown in this field → 36.
- 5 "Measured values" field: the current measured values appear in this field
- 6 "Unit of measure" field: the units of measure and time defined for the current measured values appear in this field

5.2.3 Additional display functions

Depending on the order option, the local display has different display functions (F-CHIP → 85).

Device without batching software:

From HOME position, use the keys to open an "Info Menu" containing the following information:

- Totalizer (including overflow)
- Actual values or states of the configured inputs/outputs
- Device TAG number (user-definable)

→ Scan of individual values within the Info Menu



















(Esc key) → Return to HOME position









Device with batching software:

On measuring instruments with installed batching software (F-Chip*) and a suitably configured display line, you can carry out filling processes directly using the local display. For a detailed description → 38.

5.2.4 Icons

The icons which appear in the field on the left make it easier to read and recognize measured variables, device status, and error messages.

Icon	Meaning	Icon	Meaning
S	System error	P	Process error
⚡	Fault message (with effect on outputs)	!	Notice message (without effect on outputs)
I 1 to n	Current output 1 to n	P 1 to n	Pulse output 1 to n
F 1 to n	Frequency output	S 1 to n	Status output/relay output 1 to n (or status input)
Σ 1 to n	Totalizer 1 to n	 a0001187	Status input
 a0001181	Measuring mode: PULSATING FLOW	 a0001182	Measuring mode: SYMMETRY (bidirectional)
 a0001183	Measuring mode: STANDARD	 a0001184	Counting mode totalizer: BALANCE (forward and reverse flow)
 a0001185	Counting mode totalizer: forward	 a0001186	Counting mode totalizer: reverse
 a0001188	Volume flow	 a0001189	Target volume flow
 a0001190	Target corrected volume flow	 a0001191	Carrier volume flow
 a0001192	Carrier corrected volume flow	 a0001193	% Target volume flow
 a0001194	% Carrier volume flow	 a0001195	Mass flow
 a0001196	Target mass flow	 a0001197	% Target mass flow
 a0001198	Carrier mass flow	 a0001199	% Carrier mass flow

Icon	Meaning	Icon	Meaning
 a0001200	Fluid density	 a0001208	Reference density
 a0001207	Fluid temperature	 a0001206	Modbus communication active
 a0001201	Batching quantity upwards	 a0001202	Batching quantity downwards
 a0001203	Batching quantity	 a0001204	Batch sum
 a0001205	Batch counter (x times)		

5.2.5 Controlling the batching processes using the local display

Filling processes can be carried out directly by means of the local display with the aid of the optional "(Batching)" software package (F-CHIP, accessories → 87). Therefore, the device can be fully deployed in the field as a "batch controller".

Procedure:

1. Configure all the required batching functions and assign the lower display info line (= BATCHING KEYS) using the "Batch" Quick Setup menu (→ 65) or use the function matrix (→ 39).

The following "softkeys" then appear on the bottom line of the local display → 27:

- START = left display key (−)
- PRESET = middle display key (+)
- MATRIX = right display key (E)

2. Press the "PRESET (+)" key. Various batching process functions requiring configuration will now appear on the display:

"PRESET" → Initial settings for the batching process		
No.	Function	Settings
7200	BATCH SELECTOR	⊕ ⊖ → Selection of the batching liquid (BATCH #1 to 6)
7203	BATCH QUANTITY	If the "ACCESS CUSTOMER" option was selected for the "PRESET batch quantity" prompt in the "Batching" Quick Setup, the batching quantity can be altered via the local display. If the "LOCKED" option was selected, the batching quantity can only be read and cannot be altered until the private code has been entered.
7265	RESET TOTAL BATCH SUM/COUNTER	Resets the batching quantity counter or the total batching quantity to "0".

3. After exiting the PRESET menu, you can now start the batching process by pressing "START (−)". New softkeys (STOP / HOLD or GO ON) now appear on the display. You can use these to interrupt, continue or stop the batching process at any time. → 27

STOP (−) → Stops batching process

HOLD (+) → Interrupts batching process (softkey changes to "GO ON")

GO ON (+) → Continues batching process (softkey changes to "HOLD")

After the batch quantity is reached, the "START" or "PRESET" softkeys reappear on the display.

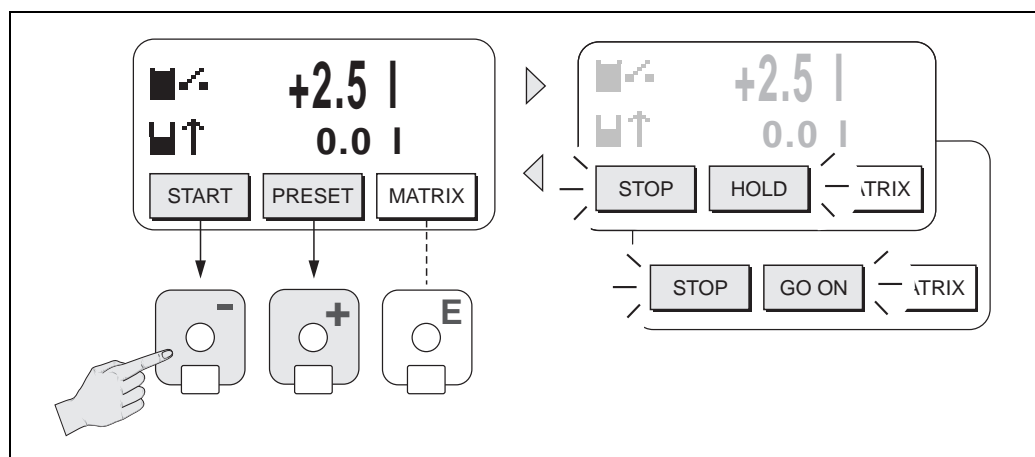

Fig. 27: Controlling batching processes using the local display (softkeys)

5.3 Brief operating instructions to the function matrix



Note!

- See the general notes → 40
 - Function descriptions → see the "Description of Device Functions" manual
1. HOME position → **E** → Entry into the function matrix
 2. Select a block (e.g. OUTPUTS)
 3. Select a group (e.g. CURRENT OUTPUT 1)
 4. Select a function group (e.g. SETTINGS)
 5. Select a function (e.g. TIME CONSTANT)
Change parameter / enter numerical values:
 - +** → Select or enter enable code, parameters, numerical values
 - E** → Save your entries
 6. Exit the function matrix:
 - Press and hold down Esc key (**Esc**) for longer than 3 seconds → HOME position
 - Repeatedly press Esc key (**Esc**) → Return step-by-step to HOME position

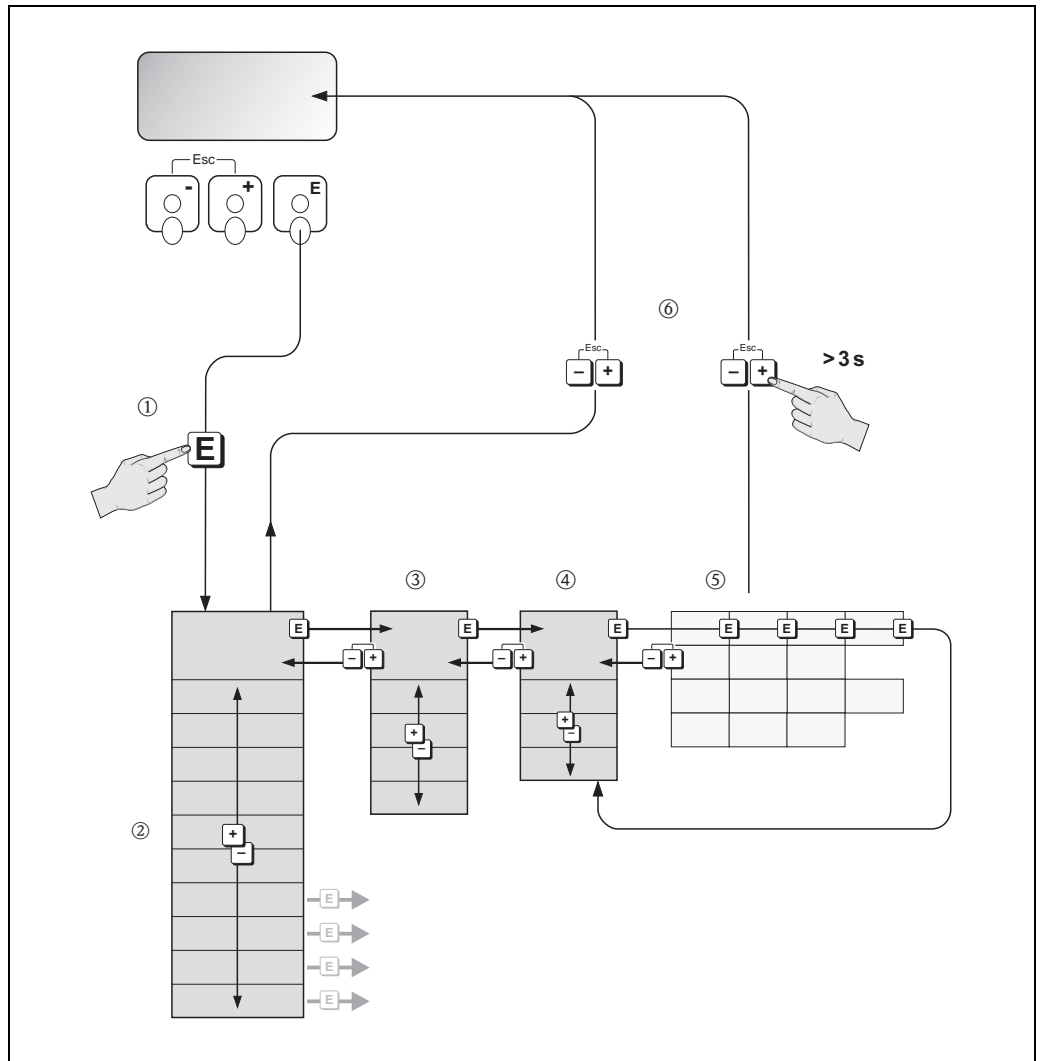





Fig. 28: Selecting functions and configuring parameters (function matrix)

5.3.1 General notes

The Quick Setup menu contains the default settings that are adequate for commissioning. Complex measuring operations on the other hand necessitate additional functions that you can configure as necessary and customize to suit your process parameters. The function matrix, therefore, comprises a multiplicity of additional functions which, for the sake of clarity, are arranged on a number of menu levels (blocks, groups, and function groups).

Comply with the following instructions when configuring functions:

- You select functions as described →  39.
 - Each cell in the function matrix is identified by a numerical or letter code on the display.
- You can switch off certain functions (OFF). If you do so, related functions in other function groups will no longer be displayed.
- Certain functions prompt you to confirm your data entries. Press  to select "SURE [YES]" and press  to confirm. This saves your setting or starts a function, as applicable.
- Return to the HOME position is automatic if no key is pressed for 5 minutes.
- Programming mode is disabled automatically if you do not press a key within 60 seconds following automatic return to the HOME position.



Caution!

All functions are described in detail, as is the function matrix itself, in the "Description of Device Functions" manual, which is a separate part of these Operating Instructions.



Note!

- The transmitter continues to measure while data entry is in progress, i.e. the current measured values are output via the signal outputs or the fieldbus communication in the normal way.
- If the supply voltage fails all preset and parameterized values remain safely stored in the EEPROM.

5.3.2 Enabling the programming mode

The function matrix can be disabled. Disabling the function matrix rules out the possibility of inadvertent changes to device functions, numerical values or factory settings. A numerical code (factory setting = 83) has to be entered before settings can be changed.

If you use a code number of your choice, you exclude the possibility of unauthorized persons accessing data (→ see the "Description of Device Functions" manual).

Comply with the following instructions when entering codes:

- If programming is disabled and the  operating elements are pressed in any function, a prompt for the code automatically appears on the display.
- If "0" is entered as the customer's code, programming is always enabled!
- The Endress+Hauser service organization can be of assistance if you mislay your personal code.



Caution!

Changing certain parameters such as all sensor characteristics, for example, influences numerous functions of the entire measuring system, particularly measuring accuracy.

There is no need to change these parameters under normal circumstances and consequently, they are protected by a special code known only to the Endress+Hauser service organization. Please contact Endress+Hauser if you have any questions.

5.3.3 Disabling the programming mode

Programming mode is disabled if you do not press a key within 60 seconds following automatic return to the HOME position.

You can also disable programming in the ACCESS CODE function by entering any number (other than the customer's code).

5.4 Error messages

5.4.1 Type of error

Errors which occur during commissioning or measuring operation are displayed immediately. If two or more system or process errors occur, the error with the highest priority is the one shown on the display.

The measuring system distinguishes between two types of error:

- **System error:** Includes all device errors, e.g. communication errors, hardware errors, etc. → 90
- **Process error:** Includes all application errors, e.g. fluid not homogeneous, etc. → 96

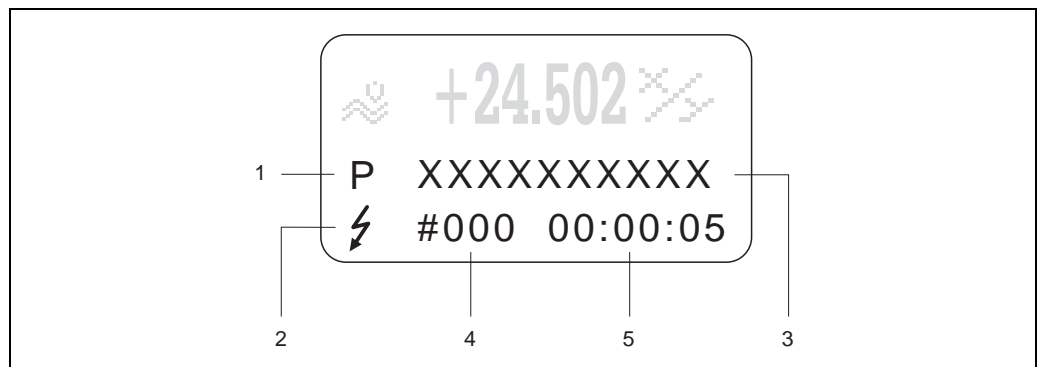

Fig. 29: Error messages on the display (example)

- 1 Error type: P = process error, S = system error
- 2 Error message type: ⚡ = fault message, ! = notice message
- 3 Error designation
- 4 Error number
- 5 Duration of most recent error occurrence (hours: minutes: seconds)

5.4.2 Error message type

The measuring device permanently assigns two types of error messages (**fault message** or **notice message**) to system errors and process errors, thereby giving them a different weighting → 89 ff. Serious system errors, e.g. module defects, are always identified and classed as "fault messages" by the measuring device.

Notice message (!)

- The error in question has no effect on the current measuring operation and the outputs of the measuring device.
- Displayed as → Exclamation mark (!), type of error (S: system error, P: process error)

Fault message (⚡)

- The error in question stops or interrupts running operation and has an immediate effect on the outputs. The response of the outputs (failsafe mode) can be defined by means of functions in the function matrix → 89.
- Displayed as → Lightning flash (⚡), type of error (S: system error, P: process error)



Note!

- Error conditions can be output via the relay outputs or the fieldbus communication.
- If an error message occurs, an upper or lower signal level for the breakdown information according to NAMUR NE 43 can be output via the current output.

5.5 Modbus RS485 communication

5.5.1 Modbus RS485 technology

The Modbus is an open, standardized fieldbus system which is deployed in the areas of manufacturing automation, process automation and building automation.

System architecture

The Modbus RS485 is used to specify the functional characteristics of a serial fieldbus system with which distributed, digital automation systems are networked together.

The Modbus RS485 distinguishes between master and slave devices.

■ Master devices

Master devices determine the data traffic on the fieldbus system. They can send data without an external request.

■ Slave devices

Slave devices, like this measuring device, are peripheral devices. They do not have their own access rights to the data traffic of the fieldbus system and only send their data due to an external request from a master.

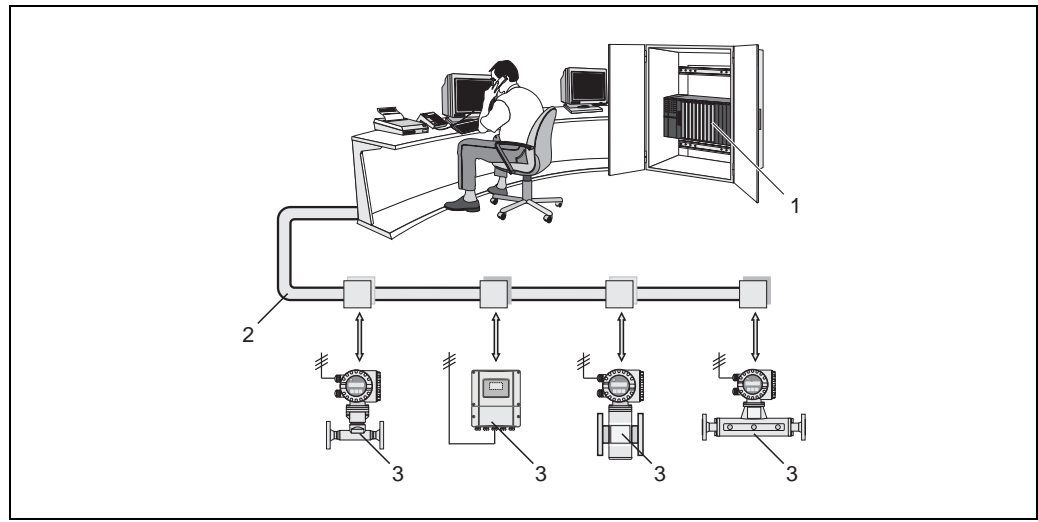

Fig. 30: Modbus RS485 system architecture

- 1 Modbus master (PLC, etc.)
- 2 Modbus RS485
- 3 Modbus slave (measuring devices, etc.)

Master/slave communication

A distinction is made between two methods of communication with regard to master/slave communication via Modbus RS485:

■ **Polling (request-response-transaction)**

The master sends a request telegram to **one** slave and waits for the slave's response telegram. Here, the slave is contacted directly due to its unique bus address (1 to 247).

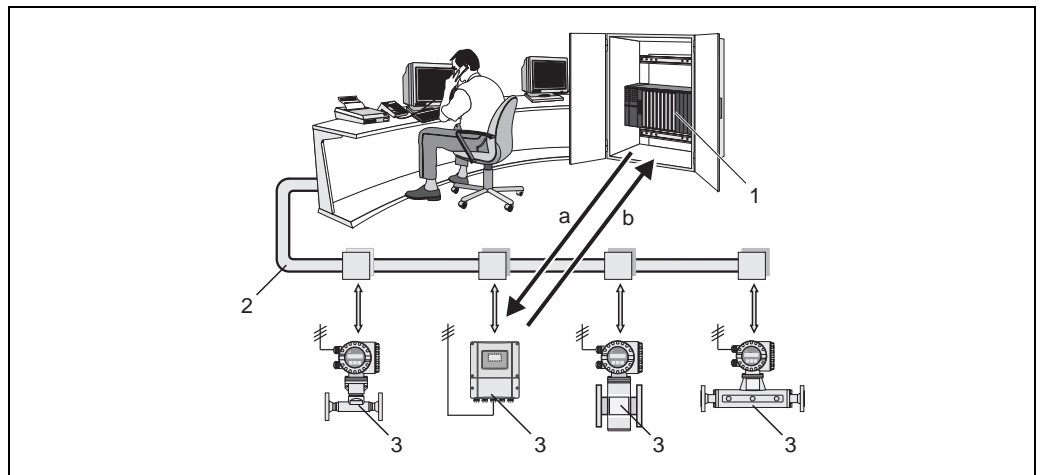

Fig. 31: Modbus RS485 polling data traffic

- 1 Modbus master (PLC, etc.)
- 2 Modbus RS485
- 3 Modbus slave (measuring devices, etc.)
- a Request telegram to this one specific Modbus slave
- b Response telegram to the Modbus master

■ **Broadcast message**

By means of the global address 0 (broadcast address), the master sends a command to all the slaves in the fieldbus system. The slaves execute the command without reporting back to the master. Broadcast messages are only permitted in conjunction with write function codes.

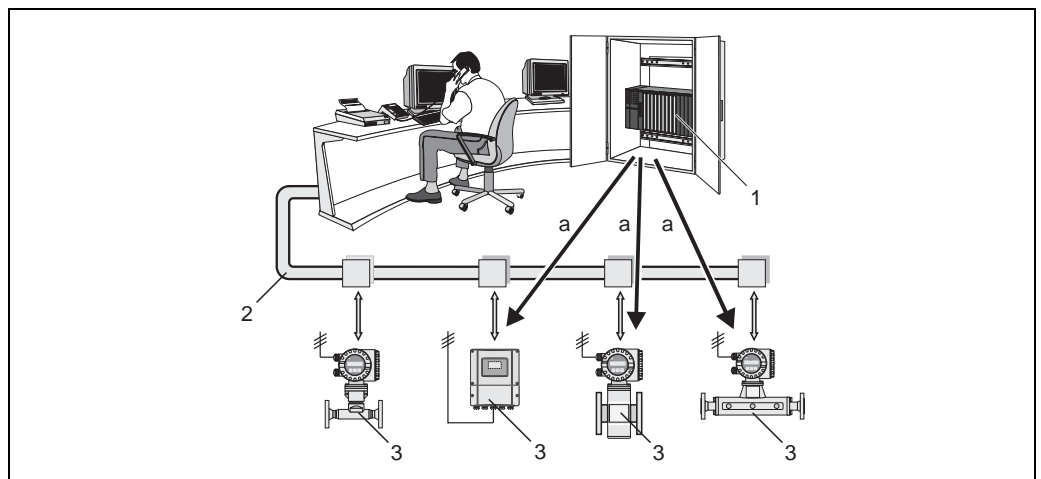

Fig. 32: Modbus RS485 polling data traffic

- 1 Modbus master (PLC, etc.)
- 2 Modbus RS485
- 3 Modbus slave (measuring devices, etc.)
- a Broadcast message - command to all Modbus slaves (request is executed without a response telegram to the master)

5.5.2 Modbus telegram

General

The master-slave process is used for data exchange. Only the master can initiate data transmission. Following the prompt, the slave sends the master the necessary data as a response telegram or executes the command requested by the master.

Telegram structure

The data is transferred between the master and slave by means of a telegram. A request telegram from the master contains the following telegram fields:

Telegram structure:

Slave address	Function code	Data	Check sum
---------------	---------------	------	-----------

- Slave address
 - The slave address can be in an address range from 1 to 247.
 - The master talks to all the slaves simultaneously by means of the slave address 0 (broadcast message).
- Function code
 - The function code determines which read, write and test operations should be executed by means of the Modbus protocol.
 - Function codes supported by the measuring device →  45
- Data
 - Depending on the function code, the following values are transmitted in this data field:
 - Register start address (from which the data are transmitted)
 - Number of registers
 - Write/read data
 - Data length
 - etc.
- Check sum (CRC or LRC check)
 - The telegram check sum forms the end of the telegram.

The master can send another telegram to the slave as soon as it has received an answer to the previous telegram or once the time-out period set at the master has expired. This time-out period can be specified or modified by the user and depends on the slave response time.

If an error occurs during data transfer or if the slave cannot execute the command from the master, the slave returns an error telegram (exception response) to the master.

The slave response telegram consists of telegram fields which contain the requested data or which confirm that the action requested by the master has been executed. It also contains a check sum.

5.5.3 Modbus function codes

The function code determines which read, write and test operations should be executed by means of the Modbus protocol. The measuring device supports the following function codes:

Function code	Name in accordance with Modbus specification	Description
03	READ HOLDING REGISTER	Reads one or more registers of the Modbus slave. 1 to a maximum of 125 consecutive registers (1 register = 2 byte) can be read with a telegram. Application: For reading measuring device parameters with read and write access, such as reading the batch quantity.
04	READ INPUT REGISTER	Reads one or more registers of the Modbus slave. 1 to a maximum of 125 consecutive registers (1 register = 2 byte) can be read with a telegram. Application: For reading measuring device parameters with read access, such as reading the measured values (mass flow, temperature, etc.).
06	WRITE SINGLE REGISTERS	Writes a single slave register with a new value. Application: For writing just one measuring device parameter, such as writing the batch quantity or resetting the totalizer.  Note! Function code 16 is used for writing several registers by means of just one telegram.
08	DIAGNOSTICS	Checks the communication connection between the master and slave. The following "diagnostics codes" are supported: <ul style="list-style-type: none"> ■ Sub-function 00 = Return query data (loopback test) ■ Sub-function 02 = Return diagnostics register
16	WRITE MULTIPLE REGISTERS	Writes several slave registers with a new value. A maximum of 120 consecutive registers can be written with a telegram. Application: For writing several measuring device parameters, such as writing the batch quantity and resetting the totalizer.
23	READ/WRITE MULTIPLE REGISTERS	Simultaneous reading and writing of 1 to max. 118 registers in a telegram. Write access is executed before read access. Application: For writing and reading several measuring device parameters, such as writing the batch quantity and the correction quantity and reading the totalizer value.



Note!

- Broadcast messages are only permitted with function codes 06, 16 and 23.
- The measuring device does not differentiate between function codes 03 and 04. These codes have the same result.

5.5.4 Maximum number of writes

If a nonvolatile device parameter is modified via the Modbus function codes 06, 16 or 23, this change is saved in the EEPROM of the measuring device.

The number of writes to the EEPROM is technically restricted to a maximum of 1 million. Attention must be paid to this limit since, if exceeded, it results in data loss and measuring device failure. For this reason, avoid constantly writing nonvolatile device parameters via the Modbus!

5.5.5 Modbus register addresses

Each device parameter has its own register address. The Modbus master uses this register address to talk to the individual device parameters and access the device data.

The register addresses of the individual device parameters can be found in the "Description of Device Functions" manual under the parameter description in question.

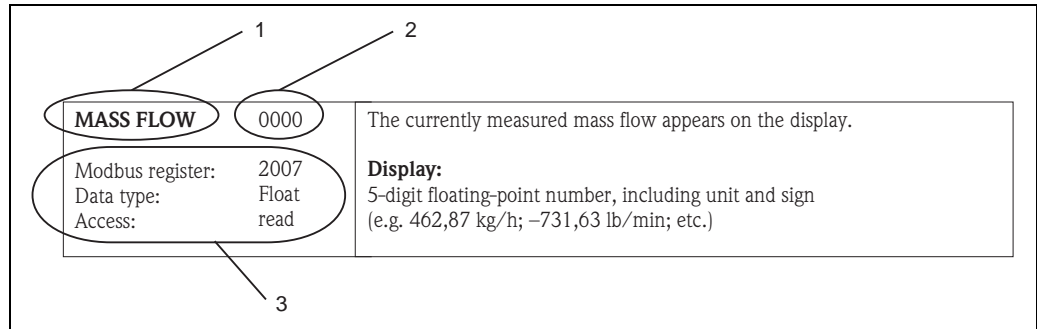

Fig. 33: Example of how a function description is illustrated in the "Description of Device Functions" manual

- 1 Name of the function
- 2 Number of the function (appears on the local display; is **not** identical to the Modbus register address)
- 3 Information on communication via Modbus RS485
 - Modbus register (information in decimal numerical format)
 - Data type: Float, Integer or String
 - Possible ways of accessing the function:
 - read = read access via function codes 03, 04 or 23
 - write = write access via function codes 06, 16 or 23

Modbus register address model

The Modbus RS485 register addresses of the measuring device are implemented in accordance with "Modbus Applications Protocol Specification V1.1".



Note!

In addition to the specification mentioned above, systems are also deployed which work with a register address model in accordance with the "Modicon Modbus Protocol Reference Guide (PI-MBUS-300 Rev. J)" specification. With this specification, the register address is extended, depending on the function code used. A "3" is put in front of the register address in the "read" access mode and a "4" in the "write" access mode.

Function code	Access type	Register in accordance with: "Modbus Applications Protocol Specification"	Register in accordance with: "Modicon Modbus Protocol Reference Guide"
03 04 23	Read	XXXX Example: mass flow = 2007	→ 3XXXX Example: mass flow = 32007
06 16 23	Write	XXXX Example: reset totalizer = 6401	→ 4XXXX Example: reset totalizer = 46401

Response times

The time it takes a measuring device to respond to a request telegram from the Modbus master is typically 25 to 50 ms. If faster response times are needed for time-critical applications (e.g. batching applications), the "auto-scan buffer" is to be used.



Note!

It may take longer for a command to be executed in the device. The data is not updated until the command has been executed. Especially write commands are affected by this!

Data types

The following data types are supported by the measuring device:

- **FLOAT** (floating-point numbers IEEE 754)
Data length = 4 bytes (2 registers)

Byte 3	Byte 2	Byte 1	Byte 0
SEEEEEEE	EMMMMMMM	MMMMMMMM	MMMMMMMM

S = sign
E = exponent
M = mantissa

- **INTEGER**
Data length = 2 bytes (1 register)

Byte 1	Byte 0
Most significant byte (MSB)	Least significant byte (LSB)

- **STRING**
Data length = depends on device parameter,
e.g. illustration of a device parameter with a data length = 18 bytes (9 registers):

Byte 17	Byte 16	...	Byte 1	Byte 0
Most significant byte (MSB)		...		Least significant byte (LSB)

Byte transmission sequence

Byte addressing, i.e. the transmission sequence of the bytes, is not specified in the Modbus specification. For this reason, it is important to coordinate the addressing method between the master and slave during commissioning. This can be configured in the measuring device by means of the "BYTE SEQUENCE" parameter (see "Description of Device Functions" manual).

The bytes are transmitted depending on the option selected in the "BYTE SEQUENCE" parameter:

FLOAT:

Selection	Sequence			
	1st	2nd	3rd	4th
1 - 0 - 3 - 2*	Byte 1 (MMMMMMMM)	Byte 0 (MMMMMMMM)	Byte 3 (SEEEEEEE)	Byte 2 (EMMMMMMM)
0 - 1 - 2 - 3	Byte 0 (MMMMMMMM)	Byte 1 (MMMMMMMM)	Byte 2 (EMMMMMMM)	Byte 3 (SEEEEEEE)
2 - 3 - 0 - 1	Byte 2 (EMMMMMMM)	Byte 3 (SEEEEEEE)	Byte 0 (MMMMMMMM)	Byte 1 (MMMMMMMM)
3 - 2 - 1 - 0	Byte 3 (SEEEEEEE)	Byte 2 (EMMMMMMM)	Byte 1 (MMMMMMMM)	Byte 0 (MMMMMMMM)

* = Factory setting
S = sign
E = exponent
M = mantissa

INTEGER:

Selection	Sequence	
	1st	2nd
1 - 0 - 3 - 2 * 3 - 2 - 1 - 0	Byte 1 (MSB)	Byte 0 (LSB)
0 - 1 - 2 - 3 2 - 3 - 0 - 1	Byte 0 (LSB)	Byte 1 (MSB)

* = Factory setting
 MSB = most significant byte
 LSB = least significant byte

STRING:

Illustration using the example of a device parameter with a data length of 18 bytes.

Selection	Sequence				
	1st	2nd	...	17th	18th
1 - 0 - 3 - 2 * 3 - 2 - 1 - 0	Byte 1	Byte 0 (LSB)	...	Byte 17 (MSB)	Byte 16
0 - 1 - 2 - 3 2 - 3 - 0 - 1	Byte 0 (LSB)	Byte 1	...	Byte 16	Byte 17 (MSB)

* = Factory setting
 MSB = most significant byte
 LSB = least significant byte

5.5.6 Modbus error messages

If the Modbus slave detects an error in the request telegram from the master, it sends a reply to the master in the form of an error message consisting of the slave address, function code, exception code and check sum. To indicate that this is an error message, the lead bit of the returned function code is used. The reason for the error is transmitted to the master by means of the exception code.

The following exception codes are supported by the measuring device:

Exception codes	Description
01	ILLEGAL_FUNCTION The function code sent by the master is not supported by the measuring device (slave).  Note! Description of the function codes supported by the measuring device → 45.
02	ILLEGAL_DATA_ADDRESS The register addressed by the master is not assigned (i.e. it does not exist) or the length of the requested data is too big.
03	ILLEGAL_DATA_VALUE <ul style="list-style-type: none"> ■ The master is attempting to write to a register which only allows read access. ■ The value that appears in the data field is not permitted: e.g. range limits overshoot or incorrect data format.
04	SLAVE_DEVICE_FAILURE The slave did not respond to the request telegram from the master or an error occurred when processing the request telegram.

5.5.7 Modbus auto-scan buffer

Function description

The Modbus master uses the request telegram to access the device parameters (data) of the measuring device. Depending on the function code, the master gains read or write access to a single device parameter or a group of consecutive device parameters. If the desired device parameters (registers) are not available as a group, the master has to send a request telegram to the slave for each parameter.

The measuring device has a special storage area, known as the auto-scan buffer, for grouping nonconsecutive device parameters. This can be used to flexibly group up to 16 device parameters (registers). The master can talk to this complete data block by means of just one request telegram.

Structure of the auto-scan buffer

The auto-scan buffer consists of two data records, the configuration area and the data area. In the configuration area, a list known as the scan list specifies which device parameters should be grouped. For this purpose, the corresponding register address, e.g. the register address 2007 for mass flow, is entered in the scan list. Up to 16 device parameters can be grouped.

The measuring device cyclically reads out the register addresses entered in the scan list and writes the associated device data to the data area (buffer). The request cycle runs automatically. The cycle starts again when the last entry in the scan list has been queried.

By means of Modbus, the grouped device parameters in the data area can be read or written by the master with just one request telegram (register address 5051 to 5081).

Configuration of the scan list

During configuration, the Modbus register addresses of the device parameters to be grouped must be entered in the scan list. The scan list can contain up to 16 entries. Float and Integer-type device parameters with read and write access are supported.

The scan list can be configured by means of:

1. The local display or a configuration program (e.g. FieldCare).
The scan list is configured here by means of the function matrix:
BASIC FUNCTION → Modbus RS485 → SCAN LIST REG. 1 to SCAN LIST REG. 16
2. The Modbus master.
Here, the scan list is configured via the register addresses 5001 to 5016.

Scan list		
No.	Modbus configuration Register address (data type = Integer)	Configuration via local operation / configuration program (BASIC FUNCTION → Modbus RS485 →)
1	5001	SCAN LIST REG. 1
2	5002	SCAN LIST REG. 2
3	5003	SCAN LIST REG. 3
4	5004	SCAN LIST REG. 4
5	5005	SCAN LIST REG. 5
6	5006	SCAN LIST REG. 6
7	5007	SCAN LIST REG. 7
8	5008	SCAN LIST REG. 8
9	5009	SCAN LIST REG. 9
10	5010	SCAN LIST REG. 10
11	5011	SCAN LIST REG. 11
12	5012	SCAN LIST REG. 12

Scan list		
No.	Modbus configuration Register address (data type = Integer)	Configuration via local operation / configuration program (BASIC FUNCTION → Modbus RS485 →)
13	5013	SCAN LIST REG. 13
14	5014	SCAN LIST REG. 14
15	5015	SCAN LIST REG. 15
16	5016	SCAN LIST REG. 16

Access to data via Modbus

The Modbus master uses the register addresses 5051 to 5081 to access the data area of the auto-scan buffer. This data area contains the values of the device parameters defined in the scan list. For example, if the register 2007 was entered for mass flow in the scan list by means of the SCAN LIST REG. 1 function, the master can read out the current measured value of the mass flow in register 5051.

Data area				
Parameter value/Measured values		Access via Modbus register address	Data type *	Access**
Value of scan list entry No. 1	→	5051	Integer / Float	Read / Write
Value of scan list entry No. 2	→	5053	Integer / Float	Read / Write
Value of scan list entry No. 3	→	5055	Integer / Float	Read / Write
Value of scan list entry No. 4	→	5057	Integer / Float	Read / Write
Value of scan list entry No. 5	→	5059	Integer / Float	Read / Write
Value of scan list entry No. 6	→	5061	Integer / Float	Read / Write
Value of scan list entry No. 7	→	5063	Integer / Float	Read / Write
Value of scan list entry No. 8	→	5065	Integer / Float	Read / Write
Value of scan list entry No. 9	→	5067	Integer / Float	Read / Write
Value of scan list entry No. 10	→	5069	Integer / Float	Read / Write
Value of scan list entry No. 11	→	5071	Integer / Float	Read / Write
Value of scan list entry No. 12	→	5073	Integer / Float	Read / Write
Value of scan list entry No. 13	→	5075	Integer / Float	Read / Write
Value of scan list entry No. 14	→	5077	Integer / Float	Read / Write
Value of scan list entry No. 15	→	5079	Integer / Float	Read / Write
Value of scan list entry No. 16	→	5081	Integer / Float	Read / Write
* The data type depends on the device parameter entered in the scan list				
** The data access depends on the device parameter entered in the scan list. If the device parameter entered supports read and write access, the parameter can also be accessed by means of the data area.				

Response time

The response time when accessing the data area (register addresses 5051 to 5081) is typically between 3 and 5 ms.



Note!

It may take longer for a command to be executed in the device. The data is not updated until the command has been executed. Especially write commands are affected by this!

Example

The following device parameters should be grouped via the auto-scan buffer and read out by the master with just one request telegram:

- Mass flow → Register address 2007
- Temperature → Register address 2017
- Totalizer 1 → Register address 2610
- Actual system condition → Register address 6859

1. Configuration of the scan list

- With the local operation or a configuration program (via the function matrix):
 BASIC FUNCTION block → Modbus RS485 function group → SCAN LIST REG. function
 → Entry of the address 2007 under SCAN LIST REG. 1
 → Entry of the address 2017 under SCAN LIST REG. 2
 → Entry of the address 2610 under SCAN LIST REG. 3
 → Entry of the address 6859 under SCAN LIST REG. 4
- Via the Modbus master (the register addresses of the device parameters are written to the registers 5001 to 5004 via Modbus):
 1. Write address 2007 (mass flow) to register 5001
 2. Write address 2017 (temperature) to register 5002
 3. Write address 2610 (totalizer 1) to register 5003
 4. Write address 6859 (actual system condition) to register 5004

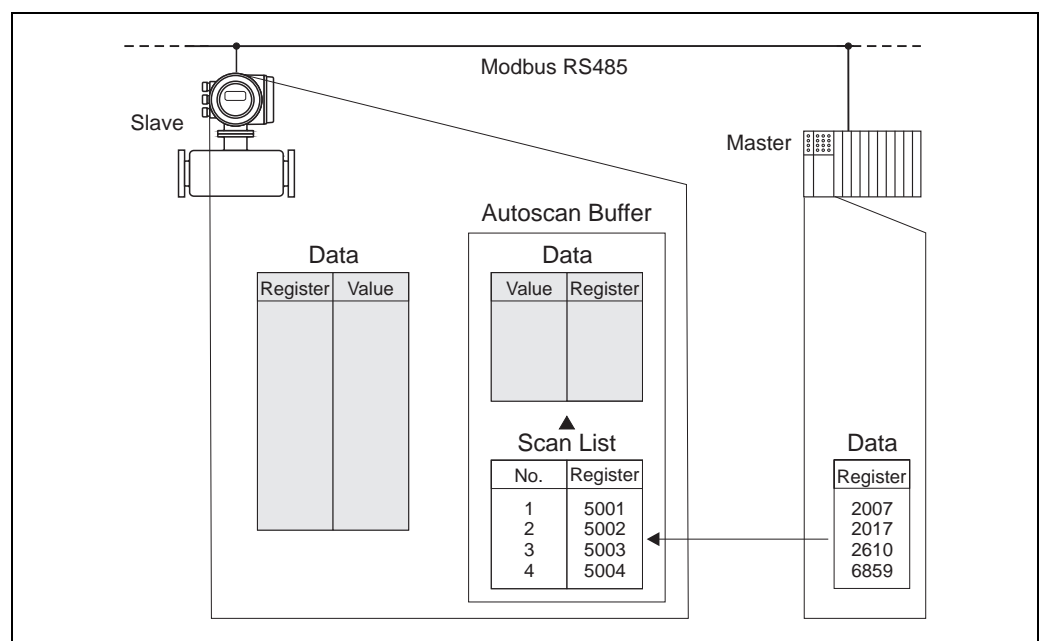

Fig. 34: Configuration of the scan list via the Modbus master

2. Access to data via Modbus

By specifying the register start address 5051 and the number of registers, the Modbus master can read out the measured values with just one request telegram.

Data area			
Access via Modbus register address	Measured values	Data type	Access
5051	Mass flow = 4567.67	Float	Read
5053	Temperature = 26.5	Float	Read
5055	Totalizer 1 = 56345.6	Float	Read
5057	Actual system condition = 1 (system ok)	Integer	Read

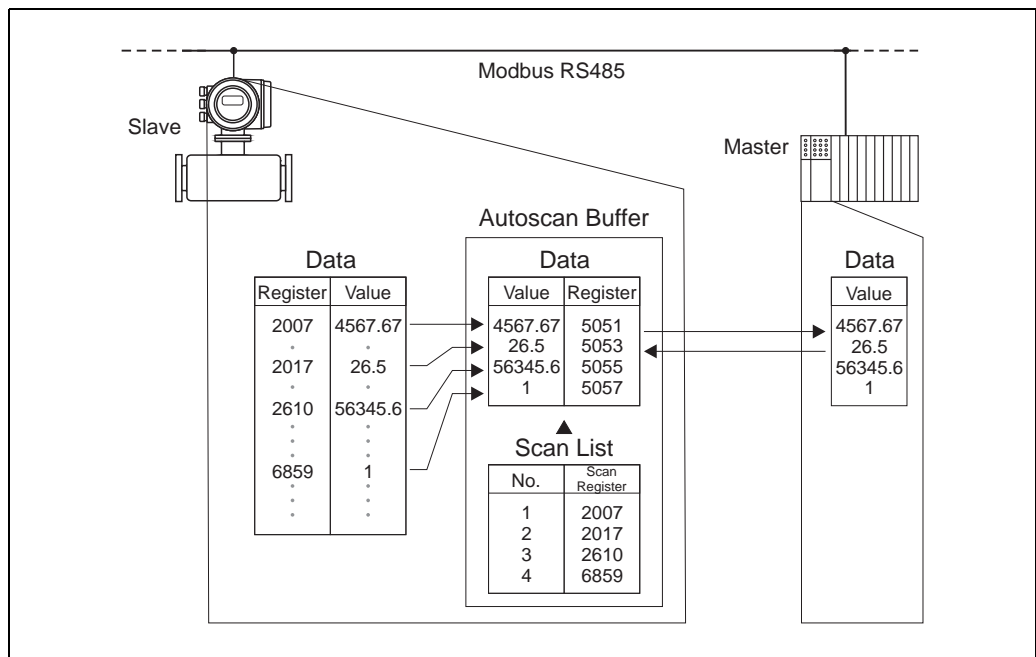

Fig. 35: With just one request telegram, the Modbus master reads out the measured values via the auto-scan buffer of the measuring device.

5.6 Operating options

5.6.1 FieldCare

FieldCare is Endress+Hauser's FDT-based plant asset management tool and allows the configuration and diagnosis of intelligent field devices. By using status information, you also have a simple but effective tool for monitoring devices. The Proline flowmeters are accessed via a service interface or via the service interface FXA193.

5.6.2 Current device description files

The following table illustrates the suitable device description file for the operating tool in question and then indicates where these can be obtained.

Operation via Service-Protokoll:

Valid for device software: 3.06.XX Software release: 06.2010		→ DEVICE SOFTWARE function (8100)
Operating program/Device driver:	How to acquire:	
FieldCare/DTM	<ul style="list-style-type: none"> ■ www.endress.com → Download ■ CD-ROM (Endress+Hauser order number: 56004088) ■ DVD (Endress+Hauser order number: 70100690) 	

Tester/simulator:	Sources for obtaining device descriptions:
Fieldcheck	<ul style="list-style-type: none"> ■ Update by means of FieldCare with the Flow Device FXA 193/291 DTM in the Fieldflash Module



Note!

The Fieldcheck tester/simulator is used for testing flowmeters in the field. When used in conjunction with the "FieldCare" software package, test results can be imported into a database, printed and used for official certification. Contact your Endress+Hauser representative for more information.

5.7 Hardware settings

5.7.1 Switching hardware write protection on/off

A jumper on the I/O board provides the means of switching hardware write protection on or off. When the write protection is switched on, it is **not** possible to write to the device parameters via Modbus RS485.



Warning!

Risk of electric shock. Exposed components carry dangerous voltages. Make sure that the power supply is switched off before you remove the cover of the electronics compartment.

1. Switch off power supply.
2. Remove the I/O board → 102
3. Configure the hardware write protection accordingly with the aid of the jumpers (see Figure).
4. Installation is the reverse of the removal procedure.

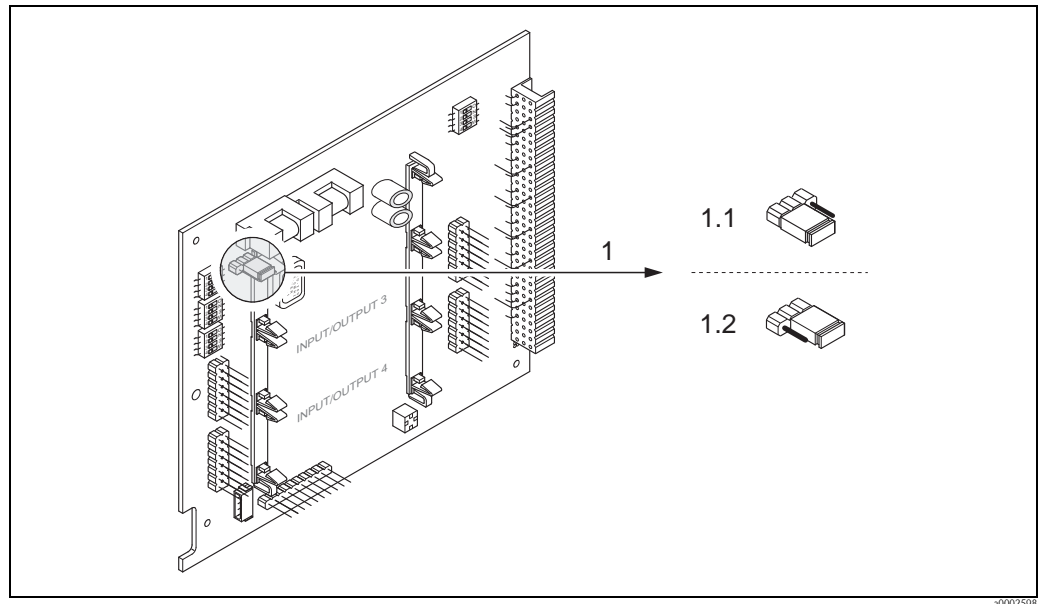

Fig. 36: Switching write protection on and off with the aid of a jumper on the I/O board

1 Jumper for switching write protection on and off

1.1 Write protection switched on = it is **not** possible to write to the device parameters via Modbus RS485

1.2 Write protection switched off (factory setting) = it is possible to write to the device parameters via Modbus RS485

5.7.2 Configuring the device address

The device address must always be configured for a Modbus slave. The valid device addresses are in a range from 1 to 247. In a Modbus RS485 network, each address can only be assigned once. If an address is not configured correctly, the device is not recognized by the Modbus master. All measuring devices are delivered from the factory with the device address 247 and with the "software addressing" address mode.

Addressing via local operation

More detailed explanations for addressing the measuring device via the local display → [71](#)

Addressing via miniature switches



Warning!

Risk of electric shock. Exposed components carry dangerous voltages. Make sure that the power supply is switched off before you remove the cover of the electronics compartment.

1. Loosen the Allen screw (3 mm) of the securing clamp.
2. Unscrew cover of the electronics compartment from the transmitter housing.
3. Remove the local display (if present) by loosening the set screws of the display module.
4. Set the position of the miniature switches on the I/O board using a sharp pointed object.
5. Installation is the reverse of the removal procedure.

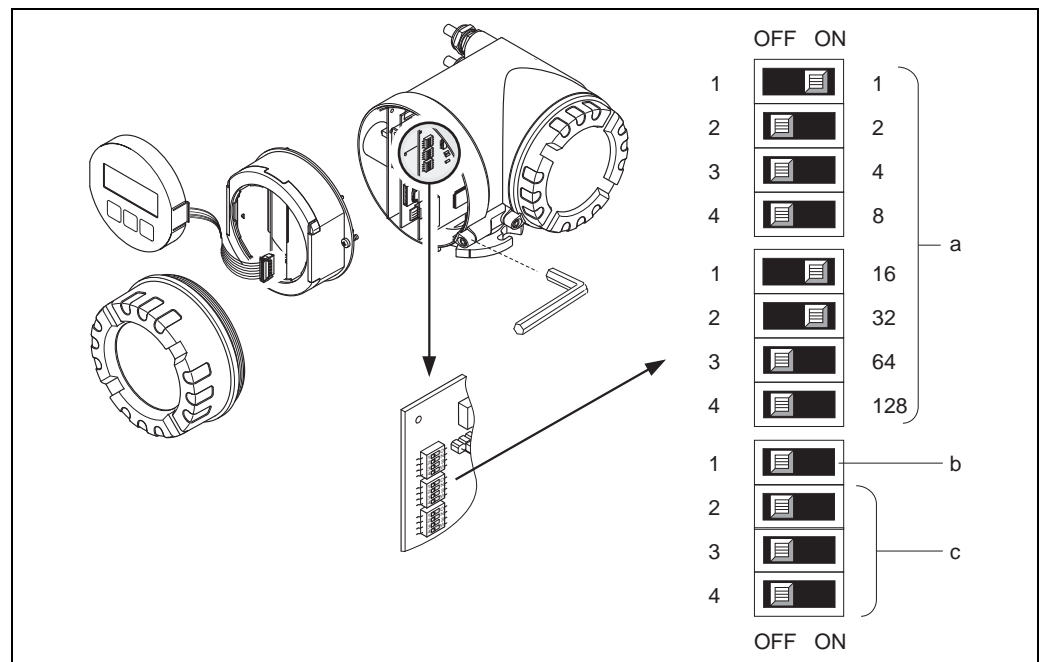

Fig. 37: Addressing with the aid of miniature switches on the I/O board

- a Miniature switches for setting the device address (illustrated: $1 + 16 + 32 =$ device address 49)
- b Miniature switches for the address mode (method of addressing)
- OFF = software addressing via local operation (factory setting)
 - ON = hardware addressing via miniature switches
- c Miniature switches not assigned

5.7.3 Configuring the terminating resistors

It is important to terminate the Modbus RS485 line correctly at the start and end of the bus segment since impedance mismatch results in reflections on the line which can cause faulty communication transmission.



Warning!

Risk of electric shock. Exposed components carry dangerous voltages.

Make sure that the power supply is switched off before you remove the cover of the electronics compartment.

The miniature switch for termination is located on the I/O board (see Figure):

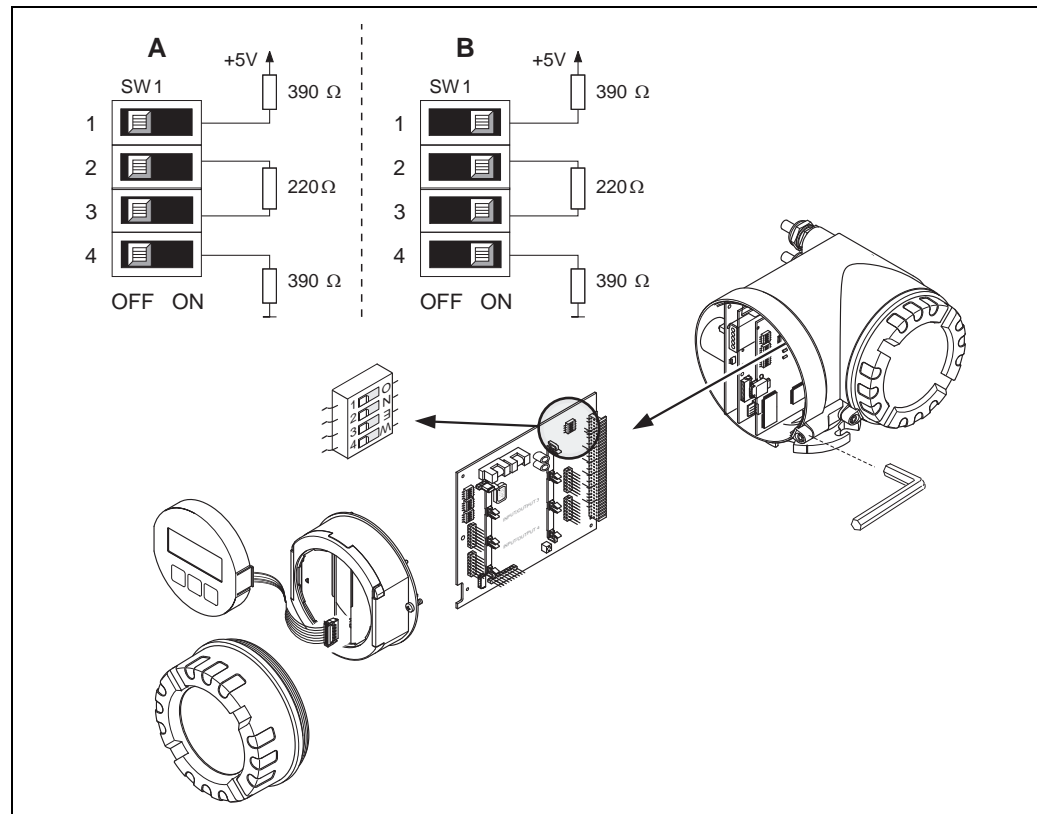

a0004392

Fig. 38: Configuring the terminating resistors

A = Factory setting

B = Setting at the last transmitter



Note!

It is generally recommended to use external termination since if a device that is terminated internally is defect, this can result in the failure of the entire segment.

5.7.4 Current output configuration

The current output is configured as "active" or "passive" by means of various jumpers on the current submodule.



Warning!

Risk of electric shock. Exposed components carry dangerous voltages.

Make sure that the power supply is switched off before you remove the cover of the electronics compartment.

1. Switch off power supply.
2. Remove the I/O board → 102.
3. Position the jumpers (see Figure).



Caution!

Risk of destroying the measuring device. Set the jumpers exactly as shown in the diagram.

Incorrectly set jumpers can cause overcurrents that would destroy either the measuring device or external devices connected to it.

4. Installation of the I/O board is the reverse of the removal procedure.

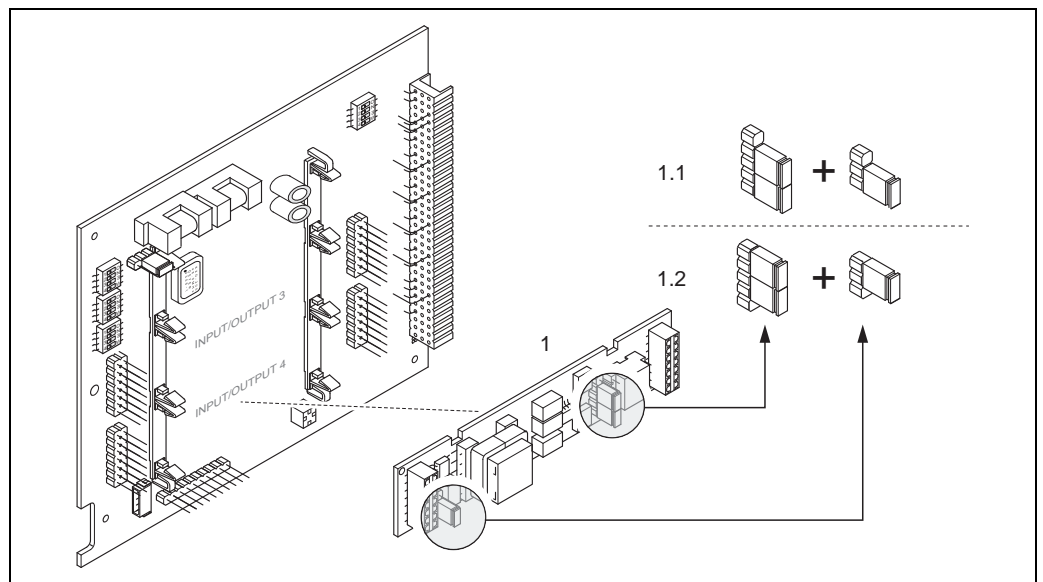

Fig. 39: Configuring the current input with the aid of jumpers (I/O board)

- 1 Current output
- 1.1 Active current output (default)
- 1.2 Passive current output

5.7.5 Relay output configuration

The relay contact can be configured as normally open (NO or make) or normally closed (NC or break) contacts by means of two jumpers on the pluggable submodule. This configuration can be called up at any time with the ACTUAL STATUS RELAY function (4740).



Warning!

Risk of electric shock. Exposed components carry dangerous voltages. Make sure that the power supply is switched off before you remove the cover of the electronics compartment.

1. Switch off power supply.
2. Remove the I/O board → 102.
3. Position the jumpers (see Figure).



Caution!

If you change the setting you must always change the positions of **both** jumpers! Note precisely the specified positions of the jumpers.

4. Installation of the I/O board is the reverse of the removal procedure.

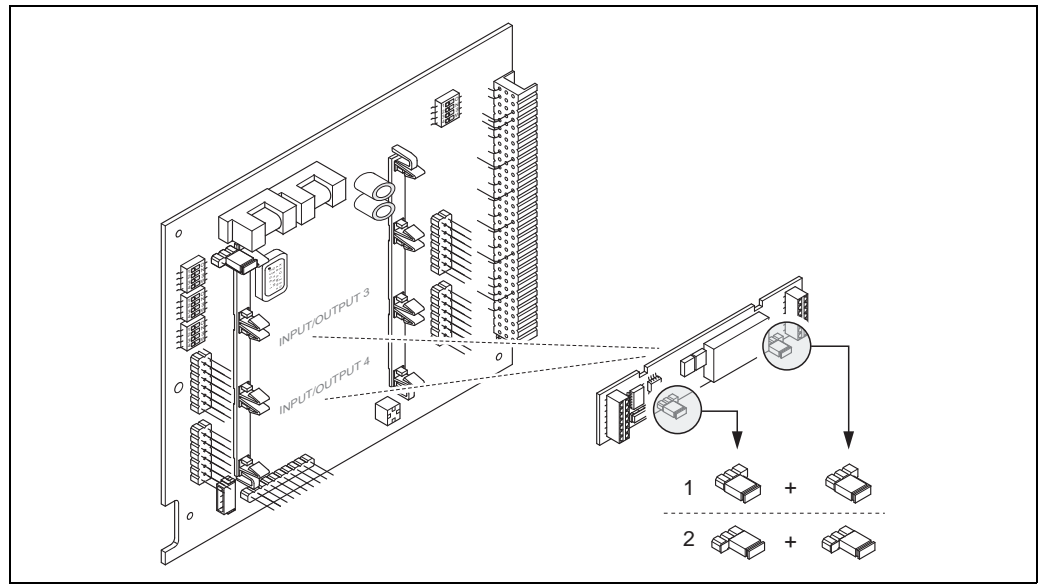

Fig. 40: Configuring relay contacts (NC / NO) on the convertible I/O board (submodule) with the help of jumpers.

- 1 Configured as NO contact (default, relay 1)
- 2 Configured as NC contact (default, relay 2)

6 Commissioning

6.1 Function check

Make sure that the following function checks have been performed successfully before switching on the supply voltage for the measuring device:

- Checklist for "Post-installation check" →  25
- Checklist for "Post-connection check" →  32

6.2 Switching on the measuring device

Once the function check has been performed successfully, the device is operational and can be switched on via the supply voltage. The device then performs internal test functions and the following messages are shown on the local display:

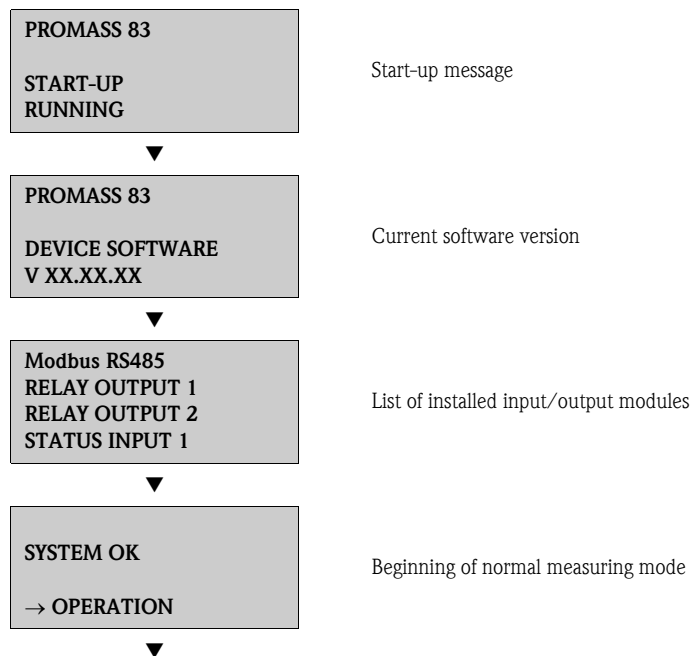

Normal measuring mode commences as soon as startup completes. Various measured-value and/or status variables (HOME position) appear on the display.



Note!

If startup fails, an error message indicating the cause is displayed.

6.3 Quick Setup

6.3.1 Quick Setup "Commissioning"

In the case of measuring devices without a local display, the individual parameters and functions must be configured via the operating program, e.g. FieldCare.

If the measuring device is equipped with a local display, all the important device parameters and additional functions for standard operation can be configured quickly and easily by means of the following Quick Setup menus.

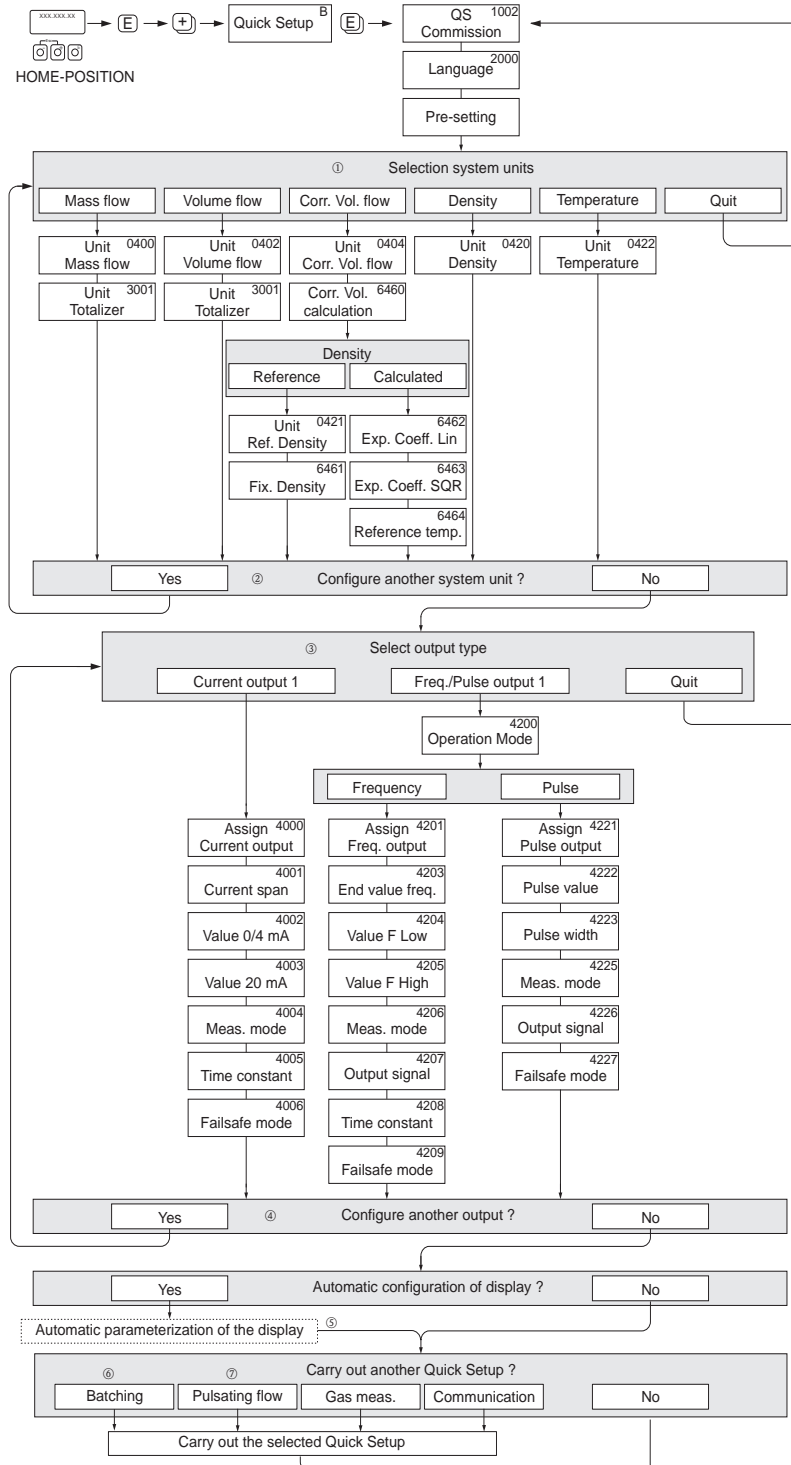

a0003255-en

Fig. 41: Quick Setup "Commissioning"

**Note!**

- The display returns to the cell SETUP COMMISSIONING (1002) if you press key combination during parameter interrogation. The stored parameters remain valid.
 - The "Commissioning" Quick Setup must be carried out before one of the Quick Setups explained below is run.
- ① The "DELIVERY SETTING" option sets every selected unit to the factory setting.
The "ACTUAL SETTING" accepts the units you configured beforehand.
 - ② Only units not yet configured in ① the current Setup are offered for selection in each cycle. The unit for mass, volume and corrected volume is derived from the corresponding flow unit.
 - ③ The "YES" option remains visible until all the units have been configured.
"NO" is the only option displayed when no further units are available.
 - ④ This prompt only appears if a current output and/or pulse/frequency output is available. Only the outputs not yet configured in the current Setup are offered for selection in each cycle.
 - ⑤ The "YES" option remains visible until all the outputs have been configured.
"NO" is the only option displayed when no further outputs are available.
 - ⑥ The "automatic parameterization of the display" option contains the following basic settings/factory settings
 - YES Main line = mass flow
 Additional line = totalizer 1
 Information line = operating/system condition
 - NO The existing (selected) settings remain.
 - ⑦ The execution of other Quick Setups is described in the following sections.

6.3.2 Quick Setup "Pulsating Flow"



Note!

The "Pulsating flow" Quick Setup is only available if the device has a current output or a pulse/frequency output.

Certain types of pump such as reciprocating, peristaltic and cam-type pumps, for example, create a flow characterized by severe periodic fluctuations. Negative flows can occur with pumps of these types on account of the closing volume of the valves or valve leaks.



Note!

Before carrying out the Quick Setup "Pulsating Flow" the Quick Setup "Commissioning" → 60 has to be executed.

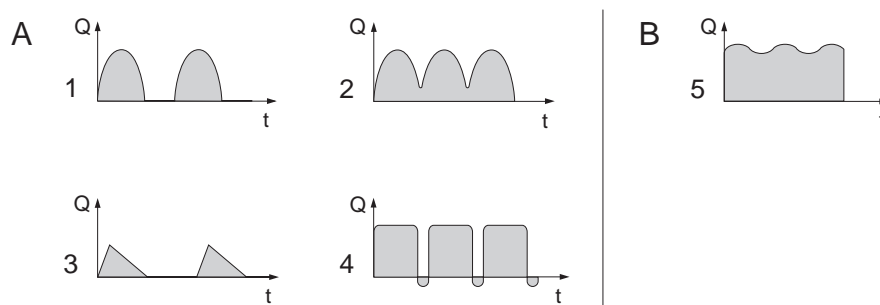

Fig. 42: Flow characteristics of various types of pump

- A With severely pulsating flow
B With low pulsating flow

- 1 1-cylinder cam pump
2 2-cylinder cam pump
3 Magnetic pump
4 Peristaltic pump, flexible connecting hose
5 Multi-cylinder reciprocating pump

a0001213

Severely pulsating flow

Once several device functions have been configured in the "Pulsating flow" Quick Setup menu, flow fluctuations of this nature can be compensated over the entire flow range and pulsating fluid flows measured correctly. Below you will find detailed instructions on how to use this Quick Setup menu.



Note!

It is always advisable to work through the "Pulsating flow" Quick Setup menu if there is any uncertainty about the exact flow characteristic.

Slightly pulsating flow

If flow fluctuations are no more than minor, as is the case, for example with gear-type, three-cylinder or multi-cylinder pumps, it is **not** absolutely necessary to work through the Quick Setup menu.

In cases of this nature, however, it is advisable to adapt the functions listed below in the function matrix (see the "Description of Device Functions" manual) to suit local process conditions in order to ensure a stable, unvarying output signal:

- Measuring system damping: FLOW DAMPING function → Increase value.
- Current output damping: TIME CONSTANT function → Increase value.

Performing the "Pulsating flow"

This Quick Setup menu guides you systematically through the setup procedure for all the device functions that have to be parameterized and configured for measuring pulsating flows. Note that this has no effect on values configured beforehand, such as measuring range, current range or full scale value!

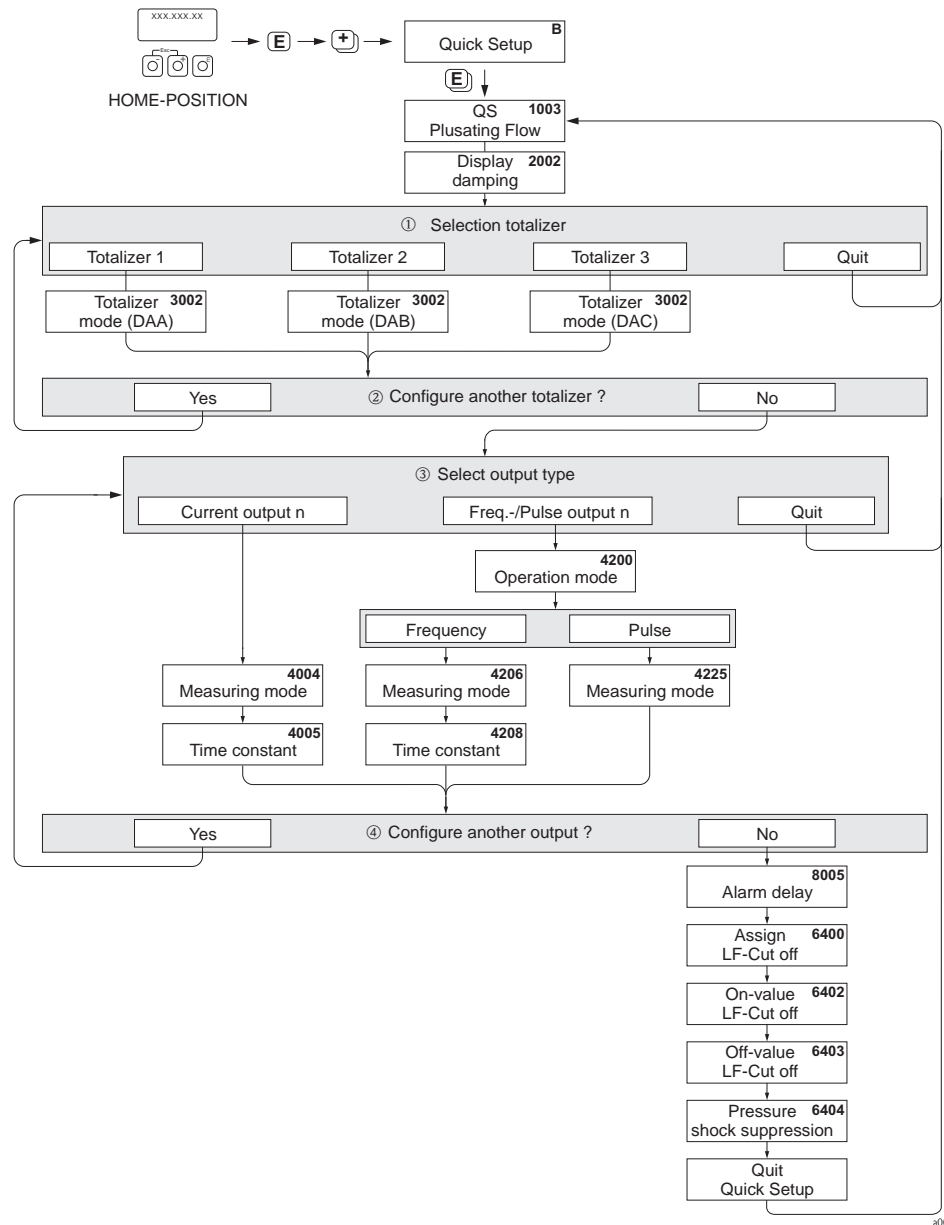

Fig. 43: Quick Setup for measuring severely pulsating flows.



Note!

- The display returns to the cell QUICK SETUP PULSATING FLOW (1003) if you press the key combination during parameter interrogation.
- The Setups can be called up either directly after the "COMMISSIONING" Quick Setup or manually by means of the QUICK SETUP PULSATING FLOW (1003) function.

- ① Only totalizers not yet configured in the current Setup are offered for selection in each cycle.
- ② The "YES" option remains visible until all the totalizers have been configured. "NO" is the only option displayed when no further totalizers are available.
- ③ Only the output not yet configured in the current Setup is offered for selection in the second cycle.
- ④ The "YES" option remains visible until both outputs have been parameterized. "NO" is the only option displayed when no further outputs are available.

Recommended settings

Quick Setup "Pulsating Flow"		
HOME position → <input type="button" value="E"/> → MEASURAND → <input type="button" value="F"/> → QUICK SETUP → <input type="button" value="E"/> → QS PULSATING FLOW (1003)		
Function No.	Function name	Selection with <input type="button" value="F"/> To next function with <input type="button" value="E"/>
1003	QS PULS. FLOW	YES After <input type="button" value="E"/> is pressed by way of confirmation, the Quick Setup menu calls up all the subsequent functions in succession.



Basic configuration		
2002	DISPLAY DAMPING	1 s
3002	TOTALIZER MODE (DAA)	BALANCE (Totalizer 1)
3002	TOTALIZER MODE (DAB)	BALANCE (Totalizer 2)
3002	TOTALIZER MODE (DAC)	BALANCE (Totalizer 3)
Signal type for "CURRENT OUTPUT 1"		
4004	MEASURING MODE	PULS. FLOW
4005	TIME CONSTANT	1 s
Signal type for "FREQ./PULSE OUTPUT 1" (for FREQUENCY operating mode)		
4206	MEASURING MODE	PULS. FLOW
4208	TIME CONSTANT	0 s
Signal type for "FREQ./PULSE OUTPUT 1" (for PULSE operating mode)		
4225	MEASURING MODE	PULS. FLOW
Other settings		
8005	ALARM DELAY	0 s
6400	ASSIGN LOW FLOW CUTOFF	MASS FLOW
6402	ON-VALUE LOW FLOW CUT OFF	Setting depends on diameter: DN 1 = 0.02 [kg/h] or [l/h] DN 2 = 0.10 [kg/h] or [l/h] DN 4 = 0.45 [kg/h] or [l/h] DN 8 = 2.0 [kg/h] or [l/h] DN 15 = 6.5 [kg/h] or [l/h] DN 15 FB = 18 [kg/h] resp. [l/h] DN 25 = 18 [kg/h] resp. [l/h] DN 25 FB = 45 [kg/h] resp. [l/h] DN 40 = 45 [kg/h] resp. [l/h] DN 40 FB = 70 [kg/h] resp. [l/h] DN 50 = 70 [kg/h] resp. [l/h] DN 50 FB = 180 [kg/h] resp. [l/h] DN 80 = 180 [kg/h] or [l/h] DN 100 = 350 [kg/h] or [l/h] DN 150 = 650 [kg/h] or [l/h] DN 250 = 1800 [kg/h] or [l/h] DN 350 = 3250 [kg/h] or [l/h] FB = Full bore versions of Promass I
6403	OFF-VALUE LOW FLOW CUTOFF	50%
6404	PRESSURE SHOCK SUPPRESSION	0 s



Back to the HOME position:

→ Press and hold down Esc key for longer than three seconds or

→ Repeatedly press and release Esc key → Exit the function matrix step by step

6.3.3 Quick Setup "Batching"



Note!

This function is only available when the additional "batching" software is installed in the measuring device (order option). You can order this software from Endress+Hauser as an accessory at a later date → [87](#).

This Quick Setup menu guides you systematically through the setup procedure for all the device functions that have to be parameterized and configured for batching operation. These basic settings allow simple (one step) batching processes.

Additional settings, e.g. for the calculation of after runs or for multi-stage batching procedures, must be made via the function matrix itself (see the "Description of Device Functions" manual).



Caution!

The "Batching" Quick Setup sets certain device parameters for discontinuous measurement operation.

If the measuring instrument is used for continuous flow measurement at a later time, we recommend that you rerun the "Commissioning" and/or "Pulsating Flow" Quick Setup.



Note!

- Before carrying out the Quick Setup "Batching" the Quick Setup "Commissioning" has to be executed → [60](#).
- You can find detailed information on the batching functions in the separate "Description of Device Functions" manual.
- You can also directly control filling process using the local display. During Quick Setup, an appropriate dialog appears concerning the automatic display configuration. Acknowledge this by clicking "YES".

This assigns special batching functions (START, PRESET, MATRIX) to the bottom line of the display. These can be directly executed onsite using the three operating keys ( /  / ).

Therefore, the measuring device can be fully deployed in the field as a "batch controller" → [38](#).



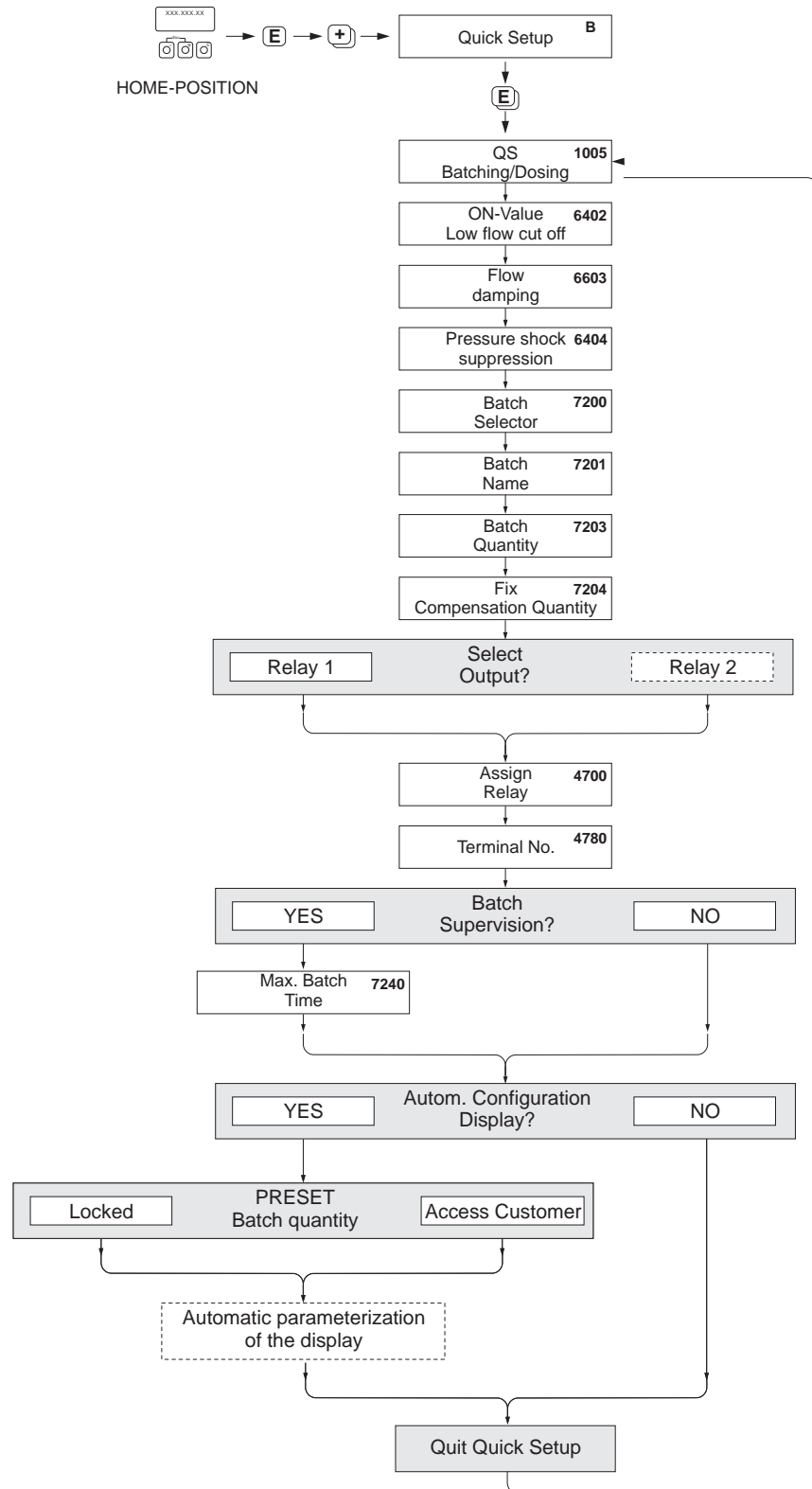





- You can also directly control the filling process using the fieldbus.
- The Quick Setup "Batching" is not available for Promass X.



a0004644-en

Fig. 44: Quick Setup "Batching"
 Recommended settings are found on the following page.

Recommended settings

Quick Setup "Batching"		
HOME position →  → MEASURED VARIABLE (A) MEASURED VARIABLE →  → QUICK SETUP (B) QUICK SETUP →  → QUICK SETUP BATCHING (1005)		
Function No.	Function name	Setting to be selected () (to next function with )
1005	QUICK SETUP BATCHING	YES After  is pressed by way of confirmation, the Quick Setup menu calls up all the subsequent functions in succession.
▼		
 Note! Functions with a gray background are configured automatically (by the measuring system itself)		
6400	ASSIGN LOW FLOW CUTOFF	MASS FLOW
6402	ON-VALUE LOW FLOW CUT OFF	see table on following page
6403	OFF-VALUE LOW FLOW CUTOFF	50%
6603	FLOW DAMPING	0 seconds
6404	PRESSURE SHOCK SUPPRESSION	0 seconds
7200	BATCH SELECTOR	BATCH #1
7201	BATCH NAME	BATCH #1
7202	ASSIGN BATCH VARIABLE	MASS
7203	BATCH QUANTITY	0
7204	FIX COMPENSATION QUANTITY	0
7205	CORRECTION MODE	OFF
7208	BATCH STAGES	1
7209	INPUT FORMAT	VALUE INPUT
4700	ASSIGN RELAY	BATCHING VALVE 1
4780	TERMINAL NUMBER	Output (display only)
7220	OPEN VALVE 1	0% or 0 [unit]
7240	MAXIMUM BATCHING TIME	0 seconds (= switched off)
7241	MINIMUM BATCHING QUANTITY	0
7242	MAXIMUM BATCHING QUANTITY	0
2200	ASSIGN (main line)	BATCH NAME
2220	ASSIGN (Multiplex main line)	OFF
2400	ASSIGN (additional line)	BATCH DOWNWARDS
2420	ASSIGN (Multiplex additional line)	OFF
2600	ASSIGN (information line)	BATCHING KEYS
2620	ASSIGN (Multiplex info line)	OFF
▼		
Back to the HOME position: → Press and hold down Esc key  for longer than three seconds or → Repeatedly press and release Esc key  → Exit the function matrix step by step		

DN		Low flow cut off / factory settings (v ~ 0.04 m/s (0.13 ft/s))	
		SI units [kg/h]	US units [lb/min]
1	1/24"	0.08	0.003
2	1/12"	0.4	0.015
4	1/8"	1.8	0.066
8	3/8"	8	0.3
15	1/2"	26	1.0
15 FB	1/2"	72	2.6
25	1"	72	2.6
25 FB	1"	180	6.6
40	1 1/2"	180	6.6
40 FB	1 1/2"	300	11
50	2"	300	11
50 FB	2"	720	26
80	3"	720	26
100	4"	1200	44
150	6"	2600	95
250	10"	7200	260

FB = Full bore versions of Promass I

6.3.4 Quick Setup "Gas Measurement"

The measuring device is not only suitable for measuring liquid flow. Direct mass measurement based on the Coriolis principle is also possible for measuring the flow rate of gases.



Note!

- Before carrying out the Quick Setup "Gas measurement" the Quick Setup "Commissioning" has to be executed → 60.
- Only mass and Corrected volume flow can be measured and output with the gas measurement mode. Note that direct density and/or volume measurement is not possible!
- The flow ranges and measuring accuracy that apply to gas measurement are not the same as those for liquids.
- If corrected volume flow (e.g. in Nm³/h) is to be measured and output instead of the mass flow (e.g. in kg/h), change the setting for the CORRECTED VOLUME CALCULATION function to "FIXED REFERENCE DENSITY" in the "Commissioning" Quick Setup menu.
Corrected volume flow can be assigned as follows:
 - to a display line
 - to the current output
 - to the pulse/frequency output.

Performing the "Gas Measurement" Quick Setup

This Quick Setup menu guides you systematically through the setup procedure for all the device functions that have to be parameterized and configured for gas measurement.

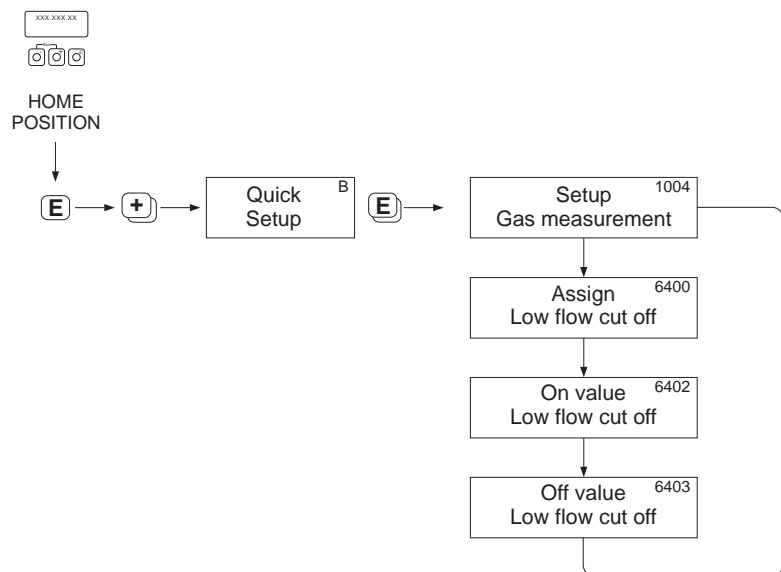









Fig. 45: Quick Setup "Gas Measurement"

Recommended settings are found on the following page.

a0002618 en

Recommended settings

Quick Setup "Gas Measurement"		
HOME position →  → MEASURED VARIABLE (A) MEASURED VARIABLE →  → QUICK SETUP (B) QUICK SETUP →  → QS GAS MEASUREMENT (1004)		
Function No.	Function name	Setting to be selected () (to next function with )
1004	QS GAS MEASUREMENT	YES After  is pressed by way of confirmation, the Quick Setup menu calls up all the subsequent functions in succession.
▼		
6400	ASSIGN LOW FLOW CUTOFF	On account of the low mass flow involved when gas flows are measured, it is advisable not to use a low flow cut off. Setting: OFF
6402	ON-VALUE LOW FLOW CUT OFF	If the ASSIGNMENT LOW FLOW CUTOFF function was not set to "OFF", the following applies: Setting: 0.0000 [unit] User input: Flow rates for gas measurements are low, so the value for the switch-on point (= low flow cut off) must be correspondingly low.
6403	OFF-VALUE LOW FLOW CUTOFF	If the ASSIGNMENT LOW FLOW CUTOFF function was not set to "OFF", the following applies: Setting: 50% User input: Enter the switch-off point as a positive hysteresis in %, referenced to the switch-on point.
▼		
Back to the HOME position: → Press and hold down Esc key  for longer than three seconds or → Repeatedly press and release Esc key  → Exit the function matrix step by step		

**Note!**

Quick Setup automatically deactivates the function EMPTY PIPE DETECTION (6420) so that the instrument can measure flow at low gas pressures.

6.3.5 Quick Setup "Communication"

To establish serial data transfer, various arrangements between the Modbus master and Modbus slave are required which have to be taken into consideration when configuring various functions. These functions can be configured quickly and easily by means of the "Communication" Quick Setup. The following table explains the parameter configuration options in more detail.

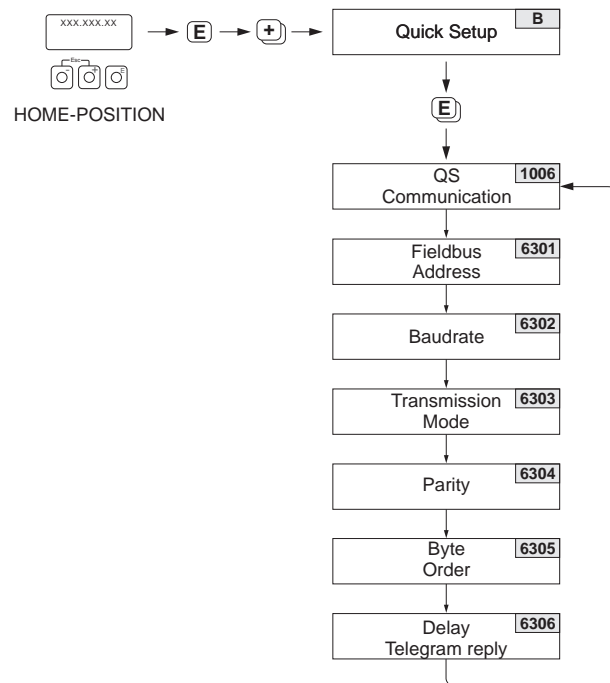











Fig. 46: Quick Setup communication

a0004430-en

"Communication" Quick Setup.		
HOME position →  → MEASURAND →  → QUICK SETUP →  → QUICK SETUP COMMUNICATION		
Function No.	Function name	Setting to be selected ( ) (to next function with )
1006	QUICK SETUP COMMUNICATION	YES → After  is pressed by way of confirmation, the Quick Setup menu calls up all the subsequent functions in succession.
6301	BUS ADDRESS	Enter the device address (permitted address range: 1 to 247) Factory setting: 247
6302	BAUDRATE	Supported baudrates [BAUD]: 1200/2400/4800/9600/19200/38400/57600/115200 Factory setting: 19200 BAUD
6303	MODE DATA TRANSFER	Select the data transfer mode: <ul style="list-style-type: none"> ■ ASCII → Data transmission in the form of readable ASCII characters. Error protection via LRC. ■ RTU → Data transmission in binary form. Error protection via CRC16. Factory setting: RTU
6304	PARITY	Selection depends on the "Data transfer mode" function: NONE; EVEN; UNEVEN <ul style="list-style-type: none"> ■ Available in the ASCII transfer mode → even or uneven parity bit (EVEN, UNEVEN). ■ Available in the RTU transfer mode → no parity bit (NONE) or even or uneven parity bit (EVEN, UNEVEN). Factory setting: EVEN
6305	BYTE SEQUENCE	Select the byte transmission sequence for the Integer, Float and String data types: 0 - 1 - 2 - 3 3 - 2 - 1 - 0 2 - 3 - 0 - 1 1 - 0 - 3 - 2 Factory setting: 1 - 0 - 3 - 2  Note! The transmission sequence must suit the Modbus master.
6306	RESPONSE TELEGRAM DELAY	For entering a delay time after which the measuring device replies to the request telegram of the Modbus master. This allows communication to be adapted to slow Modbus masters: 0 to 100 ms Factory setting: 10 ms
Back to the HOME position: → Press and hold down Esc keys  for longer than three seconds or → Repeatedly press and release Esc keys  = Exit the function matrix step by step		

**Note!**

The parameters described in the table can be found in the "Modbus RS485" group of the "BASIC FUNCTION" block in the function matrix (see separate "Description of Device Functions" manual).

6.3.6 Data backup/transmission

Using the T-DAT SAVE/LOAD function, you can transfer data (device parameters and settings) between the T-DAT (exchangeable memory) and the EEPROM (device storage unit).

This is required in the following instances:

- Creating a backup: current data are transferred from an EEPROM to the T-DAT.
- Replacing a transmitter: current data are copied from an EEPROM to the T-DAT and then transferred to the EEPROM of the new transmitter.
- Duplicating data: current data are copied from an EEPROM to the T-DAT and then transferred to EEPROMs of identical measuring points.



Note!

For information on installing and removing the T-DAT → 101.

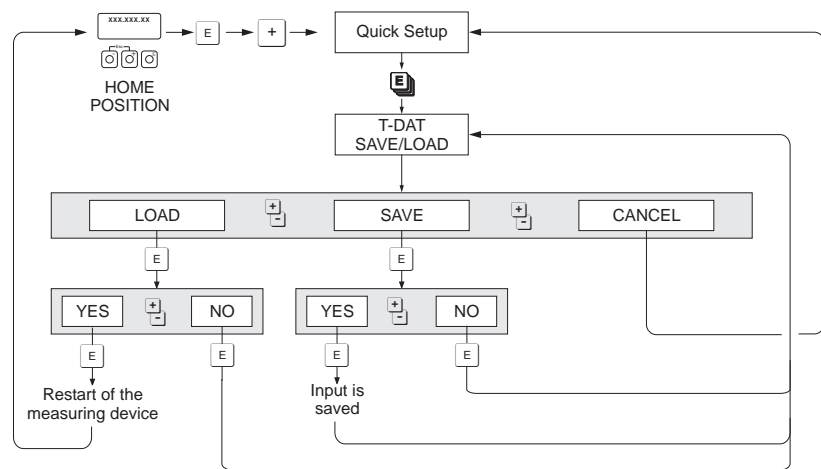

Fig. 47: Data backup/transmission with T-DAT SAVE/LOAD function

a0001221-en

Information on the LOAD and SAVE options available:

LOAD: Data are transferred from the T-DAT to the EEPROM.



Note!

- Any settings already saved on the EEPROM are deleted.
- This option is only available, if the T-DAT contains valid data.
- This option can only be executed if the software version of the T-DAT is the same or newer than that of the EEPROM. Otherwise, the error message "TRANSM. SW-DAT" appears after restarting and the LOAD function is then no longer available.

SAVE:

Data are transferred from the EEPROM to the T-DAT

6.4 Device configuration

6.4.1 Concentration measurement

The measuring device determines three primary variables simultaneously:

- Mass flow
- Fluid density
- Fluid temperature

As standard, these measured variables allow other process variables to be calculated, such as volume flow, reference density (density at reference temperature) and corrected volume flow.

The optional software package "Concentration measurement" (F-Chip, accessories) offers a multitude of additional density functions. Additional evaluation methods are available in this way, especially for special density calculations in all types of applications: → [87](#)

- Calculating percentage contents, mass and volume flow in two-phase media (carrier fluid and target fluid),
- Converting density of the fluid into special density units (°Brix, °Baumé, °API, etc.).

Concentration measurement with fixed calculation function

By means of the DENSITY FUNCTION (7000) function, you can select various density functions which use a fixed specified calculation mode for calculating concentration:

Density function	Remarks
%-MASS %-VOLUME	<p>By using the functions for two-phase-media, it is possible to calculate the percentage mass or volume contents of the carrier fluid or the target fluid. The basic equations (without temperature compensation) are:</p> $\text{Mass [\%]} = \frac{D2 \cdot (\rho - D1)}{\rho \cdot (D2 - D1)} \cdot 100\%$ $\text{Volume [\%]} = \frac{(\rho - D1)}{(D2 - D1)} \cdot 100\%$ <p>D1 = density of carrier fluid (transporting liquid, e.g. water) D2 = density of target fluid (material transported, e.g. lime powder or a second liquefied material to be measured) ρ = measured overall density</p>
°BRIX	<p>Density unit used for the Food & Beverage industry which deals with the saccharose content of aqueous solutions, e.g. for measuring solutions containing sugar such as fruit juice, etc. The following ICUMSA table for Brix units is the basis for calculations within the device.</p>
°BAUME	<p>This density unit or scale is mainly used for acidic solutions, e.g. ferric chloride solutions.</p> <p>Two Baumé scales are used in practice:</p> <ul style="list-style-type: none"> – BAUME > 1 kg/l : for solutions heavier than water – BAUME < 1 kg/l : for solutions lighter than water
°BALLING °PLATO	<p>Both units are a commonly used basis for calculating the fluid density in the brewery industry. A liquid with a value of 1° BALLING (Plato) has the same density as a water/cane sugar solution consisting of 1 kg cane sugar dissolved in 99 kg of water. 1° Balling (Plato) is thus 1% of the liquid weight.</p>
%-BLACK LIQUOR	<p>The units of concentration used in the paper industry for black liquor in % by mass. The formula used for the calculation is the same as for %-MASS.</p>
°API	<p>°API (= American Petroleum Institute) Density units specifically used in North America for liquefied oil products.</p>

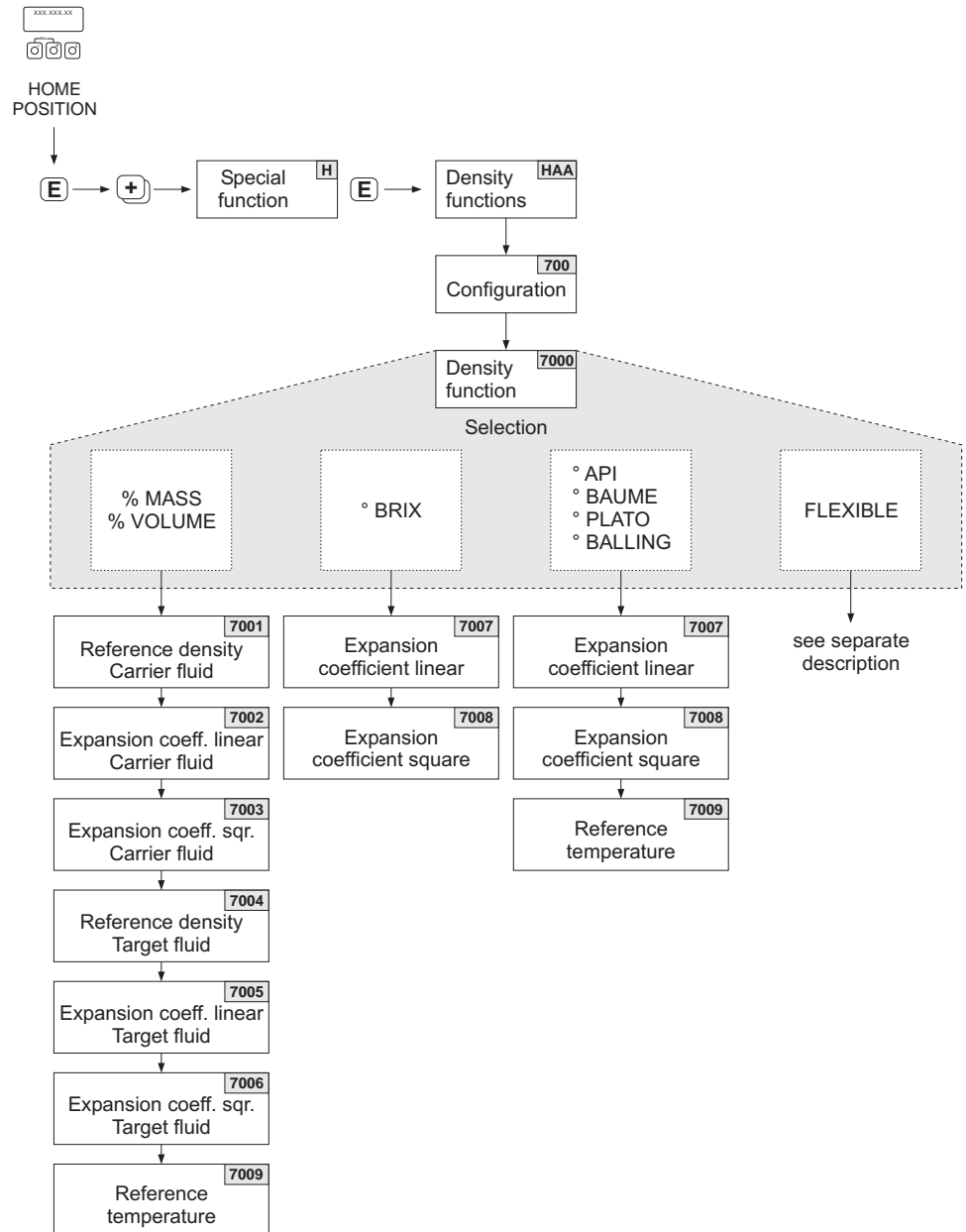

Fig. 48: Selecting and configuring different density functions in the function matrix

a0004598-en

Brixgrade (density of hydrous saccharose solution in kg/m ³)								
°Brix	10°C	20°C	30°C	40°C	50°C	60°C	70°C	80°C
0	999.70	998.20	995.64	992.21	988.03	983.19	977.76	971.78
5	1019.56	1017.79	1015.03	1011.44	1007.14	1002.20	996.70	989.65
10	1040.15	1038.10	1035.13	1031.38	1026.96	1021.93	1016.34	1010.23
15	1061.48	1059.15	1055.97	1052.08	1047.51	1042.39	1036.72	1030.55
20	1083.58	1080.97	1077.58	1073.50	1068.83	1063.60	1057.85	1051.63
25	1106.47	1103.59	1099.98	1095.74	1090.94	1085.61	1079.78	1073.50
30	1130.19	1127.03	1123.20	1118.80	1113.86	1108.44	1102.54	1096.21
35	1154.76	1151.33	1147.58	1142.71	1137.65	1132.13	1126.16	1119.79
40	1180.22	1176.51	1172.25	1167.52	1162.33	1156.71	1150.68	1144.27
45	1206.58	1202.61	1198.15	1193.25	1187.94	1182.23	1176.14	1169.70

Brixgrade (density of hydrous saccharose solution in kg/m ³)								
°Brix	10°C	20°C	30°C	40°C	50°C	60°C	70°C	80°C
50	1233.87	1229.64	1224.98	1219.93	1214.50	1208.70	1202.56	1196.11
55	1262.11	1257.64	1252.79	1247.59	1242.05	1236.18	1229.98	1223.53
60	1291.31	1286.61	1281.59	1276.25	1270.61	1264.67	1258.45	1251.88
65	1321.46	1316.56	1311.38	1305.93	1300.21	1294.21	1287.96	1281.52
70	1352.55	1347.49	1342.18	1336.63	1330.84	1324.80	1318.55	1312.13
75	1384.58	1379.38	1373.88	1368.36	1362.52	1356.46	1350.21	1343.83
80	1417.50	1412.20	1406.70	1401.10	1395.20	1389.20	1383.00	1376.60
85	1451.30	1445.90	1440.80	1434.80	1429.00	1422.90	1416.80	1410.50

Source: A. & L. Emmerich, Technical University of Brunswick; officially recommended by ICUMSA, 20th session 1990

Concentration measurement with flexible calculation function

Under certain application conditions, it may not be possible to use density functions with a fixed calculation function (% mass, °Brix, etc). However, user-specific or application-specific concentration calculations can be used with the "FLEXIBLE" setting in the function DENSITY FUNCTION (7000).

The following types of calculation can be selected in function MODE (7021):

- % MASS 3D
- % VOLUME 3D
- % MASS 2D
- % VOLUME 2D

Calculation type "% MASS 3D" or "% VOLUME 3D"

For this type of calculation, the relationship between the three variables – concentration, density and temperature must be known (3-dimensional), e.g. by a table. In this way, the concentration can be calculated from the measured density and temperature values by means of the following formula (the coefficients A0, A1, etc. have to be determined by the user):

$$K = A0 + A1 \cdot \rho + A2 \cdot \rho^2 + A3 \cdot \rho^3 + A4 \cdot \rho^4 + B1 \cdot T + B2 \cdot T^2 + B3 \cdot T^3$$

a0004620

<i>K</i>	<i>Concentration</i>
<i>ρ</i>	<i>Currently measured density</i>
<i>A0</i>	<i>Value from function (COEFFICIENT A0 (7032))</i>
<i>A1</i>	<i>Value from function (COEFFICIENT A1 (7033))</i>
<i>A2</i>	<i>Value from function (COEFFICIENT A2 (7034))</i>
<i>A3</i>	<i>Value from function (COEFFICIENT A3 (7035))</i>
<i>A4</i>	<i>Value from function (COEFFICIENT A4 (7036))</i>
<i>B1</i>	<i>Value from function (COEFFICIENT B1 (7037))</i>
<i>B2</i>	<i>Value from function (COEFFICIENT B2 (7038))</i>
<i>B3</i>	<i>Value from function (COEFFICIENT B3 (7039))</i>
<i>T</i>	<i>Currently measured temperature in °C</i>

Example:

The following is a concentration table from a reference source.

Temperature	10°C	15°C	20°C	25°C	30°C
Density					
825 kg/m ³	93.6%	92.5%	91.2%	90.0%	88.7%
840 kg/m ³	89.3%	88.0%	86.6%	85.2%	83.8%
855 kg/m ³	84.4%	83.0%	81.5%	80.0%	78.5%
870 kg/m ³	79.1%	77.6%	76.1%	74.5%	72.9%
885 kg/m ³	73.4%	71.8%	70.2%	68.6%	66.9%
900 kg/m ³	67.3%	65.7%	64.0%	62.3%	60.5%
915 kg/m ³	60.8%	59.1%	57.3%	55.5%	53.7%



Note!

The coefficients for the Promass 83 concentration algorithm should be determined with the density in units of kg/liter, temperature in °C and concentration in decimal form (0.50, not 50%). B1, B2 and B3 need to be entered into the matrix positions 7037, 7038 and 7039 in scientific notation as 10^{-3} , 10^{-6} or 10^{-9} .

Assume:

Density (ρ): 870 kg/m³ → 0.870 kg/l

Temperature (T): 20°C

Coefficients determined as per table above:

$$A0 = -2.6057$$

$$A1 = 11.642$$

$$A2 = -8.8571$$

$$A3 = 0$$

$$A4 = 0$$

$$B1 = -2.7747 \cdot 10^{-3}$$

$$B2 = -7.3469 \cdot 10^{-6}$$

$$B3 = 0$$

Calculation:

$$\begin{aligned}
 K &= A0 + A1 \cdot \rho + A2 \cdot \rho^2 + A3 \cdot \rho^3 + A4 \cdot \rho^4 + B1 \cdot T + B2 \cdot T^2 + B3 \cdot T^3 \\
 &= -2.6057 + 11.642 \cdot 0.870 + (-8.8571) \cdot 0.870^2 + 0 \cdot 0.870^3 + 0 \cdot 0.870^4 + (-2.7747) \cdot 10^{-3} \cdot 20 \\
 &\quad + (-7.3469) \cdot 10^{-6} \cdot 20^2 + 0 \cdot 20^3 \\
 &= 0.7604 \\
 &= \mathbf{76.04\%}
 \end{aligned}$$

a0004620

Calculation type "% MASS 2D" or "% VOLUME 2D"

For this type of calculation, the relationship between the two variables concentration and reference density must be known (2-dimensional), e.g. by a table. In this way, the concentration can be calculated from the measured density and temperature values by means of the following formula (the coefficients A0, A1, etc. have to be determined by the user):

$$K = A0 + A1 \cdot \rho_{ref} + A2 \cdot \rho_{ref}^2 + A3 \cdot \rho_{ref}^3 + A4 \cdot \rho_{ref}^4$$

a0004621

<i>K</i>	<i>Concentration</i>
<i>ρ_{ref}</i>	<i>Currently measured reference density</i>
<i>A0</i>	<i>Value from function (COEFFICIENT A0 (7032))</i>
<i>A1</i>	<i>Value from function (COEFFICIENT A1 (7033))</i>
<i>A2</i>	<i>Value from function (COEFFICIENT A2 (7034))</i>
<i>A3</i>	<i>Value from function (COEFFICIENT A3 (7035))</i>
<i>A4</i>	<i>Value from function (COEFFICIENT A4 (7036))</i>

**Note!**

Promass determines the reference density by means of the density and temperature currently measured. To do so, both the reference temperature (function REFERENCE TEMPERATURE) and the expansion coefficients (function EXPANSION COEFF) must be entered in the measuring system.

The parameters important for measuring the reference density can also be configured directly via the "Commissioning" Quick Setup menu.

6.4.2 Advanced diagnostic functions

Changes to the measuring system, e.g. coating buildup or corrosion and abrasion on the measuring tubes can be detected at an early stage by means of the optional software package "Advanced Diagnostics" (F-Chip, accessories → 87). Normally, these influences reduce the measuring accuracy of the system or may lead to serious system errors.

By means of the diagnostic functions it is now possible to record various process and device parameters during operation, e.g. mass flow, density/reference density, temperature values, measuring tube damping etc.

By analyzing the trend of these measured values, deviations of the measuring system from a "reference status" can be detected in good time and corrective measures can be taken.

Reference values as the basis for trend analysis

Reference values of the parameters in question must always be recorded for trend analysis. These reference values are determined under reproducible, constant conditions. Such reference values are initially recorded during calibration at the factory and saved in the measuring device.

Reference data can also be ascertained under customer-specific process conditions, e.g. during commissioning or at certain process stages (cleaning cycles, etc.).

Reference values are recorded and saved in the measuring system always by means of the device function REFERENCE CONDITION USER (7401).



Caution!

It is not possible to analyze the trend of process/device parameters without reference values! Reference values can only be determined under constant, non-changing process conditions.

Methods of ascertaining data

Process and device parameters can be recorded in two different ways which you can define in the function ACQUISITION MODE (7410):

- PERIODICAL option: Measuring device acquires data periodically. Enter the desired time interval by means of the function ACQUISITION PERIOD (7411).
- SINGLE SHOT option: The user himself acquires the data manually at different, free selectable periods.

Ensure that the process conditions always correspond to the reference status when data is being recorded. It is only in this way that deviations from the reference status can be clearly determined.



Note!

The last ten entries are retained in chronological order in the measuring system. The "history" of such values can be called up via various functions:

Diagnosis parameters	Data saved (per parameter)
Mass flow	Reference value → REFERENCE VALUE function
Density	Lowest measured value → MINIMUM VALUE function
Reference density	Highest measured value → MAXIMUM VALUE function
Temperature	List of the last ten measured values → HISTORY function
Measuring tube damping	Deviation measured/reference value → ACTUAL DEVIATION function
Sensor symmetry	
Operating frequency fluctuation	
Tube damping fluctuation	
More detailed information can be found in the "Description of Device Functions" Manual.	

Triggering warning messages

If required, a limit value can be assigned to all the process/device parameters relevant to the diagnostic functions. A warning message is triggered if this limit value is exceeded → function WARNING MODE (7403).

The limit value is entered into the measuring system as an absolute (+/-) or relative deviation from the reference value → function WARNING LEVEL (74...).

Deviations arising and recorded by the measuring system can also be output via the current or relay outputs or by means of the fieldbus.

Data interpretation

The way the data recorded by the measuring system is interpreted depends largely on the application in question. This means that users must have a very good knowledge of their specific process conditions and the related deviation tolerances in the process, which have to be determined by the users themselves in each individual case.

For example, when using the limit function it is especially important to know the minimum and maximum deviation tolerances allowed. Otherwise there is the danger that a warning message is triggered inadvertently during "normal" process fluctuations.

There can be various reasons for deviating from the reference status. The following table provides examples and pointers for each of the six diagnosis parameters recorded:

Diagnosis parameters	Possible reasons for deviation
Mass flow	A deviation from the reference status indicates possible zero point shift.
Density	A deviation from the reference status can be caused by a change in the measuring tube resonance frequency, e.g. from deposits in the measuring tube, corrosion or abrasion.
Reference density	The reference density values can be interpreted in the same way as the density values. If the fluid temperature cannot be kept completely constant, you can analyze the reference density (density at a constant temperature, e.g. at 20 °C) instead of the density. Ensure that the parameters required for calculating the reference density have been correctly configured (functions REFERENCE TEMPERATURE and EXPANSION COEFF.).
Temperature	Use this diagnosis parameter to check the functionality of the PT 1000 temperature sensor.
Measuring tube damping	A deviation from the reference status can be caused by a change in measuring tube damping, e.g. from mechanical changes (coating buildup, corrosion, abrasion).
Sensor symmetry	Use this diagnosis parameter to determine whether the sensor signals are symmetrical.
Operating frequency fluctuation	A deviation in the operating frequency fluctuation indicates possible gas content in the medium.
Tube damping fluctuation	A deviation in the tube damping fluctuation indicates possible gas content in the medium.

6.5 Adjustment

6.5.1 Zero point adjustment

All measuring devices are calibrated with state-of-the-art technology. The zero point obtained in this way is printed on the nameplate.

Calibration takes place under reference operating conditions → 113.

Consequently, the zero point adjustment is generally **not** necessary!

Experience shows that the zero point adjustment is advisable only in special cases:

- To achieve highest measuring accuracy also at very small flow rates.
- Under extreme process or operating conditions (e.g. very high process temperatures or very high viscosity fluids).

Preconditions for a zero point adjustment

Note the following before you perform a zero point adjustment:

- A zero point adjustment can be performed only with fluids that have no gas or solid contents.
- Zero point adjustment is performed with the measuring tubes completely filled and at zero flow ($v = 0 \text{ m/s}$). This can be achieved, for example, with shutoff valves upstream and/or downstream of the sensor or by using existing valves and gates.
 - Normal operation → valves 1 and 2 open
 - Zero point adjustment *with* pump pressure → Valve 1 open / valve 2 closed
 - Zero point adjustment *without* pump pressure → Valve 1 closed / valve 2 open

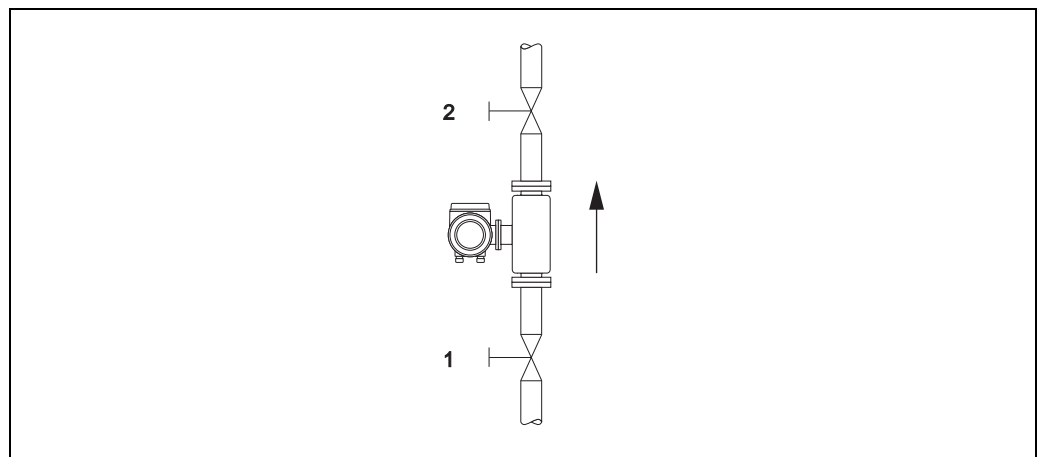

Fig. 49: Zero point adjustment and shutoff valves



















Caution!

- If the fluid is very difficult to measure (e.g. containing entrained solids or gas) it may prove impossible to obtain a stable zero point despite repeated zero point adjustments. In instances of this nature, please contact your E+H service center.
- You can view the currently valid zero point value using the ZERO POINT function (see the "Description of Device Functions" manual).

Performing a zero point adjustment

1. Operate the system until operating conditions have settled.
2. Stop the flow ($v = 0$ m/s).
3. Check the shutoff valves for leaks.
4. Check that operating pressure is correct.
5. Perform a zero point adjustment as follows:

Key	Procedure	Display text
	HOME position → Enter the function matrix	> GROUP SELECTION< MEASURED VARIABLES
	Select the BASIC FUNCTION block	> GROUP SELECTION< BASIC FUNCTION
	Select the PROCESS PARAMETER group	> GROUP SELECTION< PROCESS PARAMETER
	Select the ADJUSTMENT function group	> GROUP SELECTION< ADJUSTMENT
	Select the ZERO ADJUST. function	ZERO ADJUST. CANCEL
	After you press  , you are automatically prompted to enter the code if the function matrix is still disabled.	CODE ENTRY ***
	Enter the code (83 = default)	CODE ENTRY 83
	Confirm the code as entered. The ZERO ADJUST function reappears on the display.	PROGRAMMING ENABLED ZERO ADJUST. CANCEL
	Select START	ZERO ADJUST. START
	Confirm the entry by pressing the Enter key. The confirmation prompt appears on the display.	SURE? NO
	Select YES.	SURE? YES
	Confirm the entry by pressing the Enter key. Zero point adjustment now starts. While zero point adjustment is in progress, the display shown here is visible for 30 to 60 seconds. If the flow of fluid in the pipe exceeds 0.1 m/s, an error message appears on the display: ZERO ADJUST NOT POSSIBLE. When the zero point adjustment completes, the ZERO ADJUST. function reappears on the display.	ZERO ADJUST. RUNNING ZERO ADJUST. CANCEL
	After actuating the Enter key, the new zero point value is displayed.	ZERO POINT
	Simultaneously pressing  → HOME position	

6.5.2 Density adjustment

It is advisable to perform a density adjustment when optimum measuring accuracy is required for calculating density dependent values. The application may require a 1-point or 2-point density adjustment.

1-point density adjustment (with one fluid):

This type of density adjustment is necessary under the following circumstances:

- The sensor does not measure exactly the density value that the user expects on the basis of laboratory analyses.
- The fluid properties are outside the measuring points set at the factory, or the reference operating conditions used to calibrate the measuring device.
- The system is used exclusively to measure a fluid’s density which must be registered to a high degree of accuracy under constant conditions.

Example: Brix density measurement for apple juice.

2-point density adjustment (with two fluids):

This type of adjustment is always to be carried out if the measuring tubes have been mechanically altered by, e.g. material buildup, abrasion or corrosion. In such cases, the resonant frequency of the measuring tubes has been affected by these factors and is no longer compatible with the calibration data set at the factory. The 2-point density adjustment takes these mechanically-based changes into account and calculates new, adjusted calibration data.

Performing a 1-point or 2-point density adjustment





Caution!





- Onsite density adjustment can be performed only if the user has detailed knowledge of the fluid density, obtained for example from detailed laboratory analyses.
 - The target density value specified in this way must not deviate from the measured fluid density by more than ±10%.
 - An error in defining the target density affects all calculated density and volume functions.
 - The 2-point density adjustment is only possible if both target density values are different from each other by at least 0.2 kg/l. Otherwise the error message #731 (adjustment is not possible) appears in the "Diag. - Act. Sys. Condition" parameter.
 - Density adjustment changes the factory density calibration values or the calibration values set by the service technician.
 - The functions outlined in the following instructions are described in detail in the "Description of Device Functions" manual.
1. Fill the sensor with fluid. Make sure that the measuring tubes are completely filled and that liquids are free of gas bubbles.
 2. Wait until the temperature difference between fluid and measuring tube has equalized. The time you have to wait for equalization depends on the fluid and the temperature level.
 3. Using the local display, select the SETPOINT DENSITY function in the function matrix and perform density adjustment as follows:

Function No.	Function name	Setting to be selected (or) (to next function with)
6482	SETPOINT DENSITY	Use to select a 1- or 2-point adjustment. Note! When you press you are automatically prompted to enter the access code if the function matrix is still disabled. Enter the code.
6483	DENSITY SET VALUE 1	Use to enter the target density of the first fluid and press to save this value (input range = actual density value ±10%).
6484	MEASURE FLUID 1	Use to select START and press . The message "DENSITY MEASUREMENT RUNNING" appears on the display for approximately 10 seconds. During this time Promass measures the current density of the first fluid (measured density value).





Function No.	Function name	Setting to be selected ( or ) (to next function with )
--------------	---------------	---

For 2-point density adjustment only:

6485	DENSITY SET VALUE 2	Use  to enter the target density of the second fluid and press  to save this value (input range = actual density value $\pm 10\%$).
6486	MEASURE FLUID 2	Use  to select START and press  . The message "DENSITY MEASUREMENT RUNNING" appears on the display for approximately 10 seconds. During this time Promass measures the current density of the second fluid (measured density value).



6487	DENSITY ADJUSTMENT	Use  to select DENSITY ADJUSTMENT and press  . Promass compares the measured density value and the target density value and calculates the new density coefficient.
6488	RESTORE ORIGINAL	If the density adjustment does not complete correctly, you can select the RESTORE ORIGINAL function to reactivate the default density coefficient.



Back to the HOME position:

→ Press and hold down Esc key () for longer than three seconds or

→ Repeatedly press and release Esc key () → Exit the function matrix step by step

6.6 Rupture disk

Sensor housings with integrated rupture disks are optionally available.



Warning!

- Make sure that the function and operation of the rupture disk is not impeded through the installation. Triggering overpressure in the housing as stated on the indication label. Take adequate precautions to ensure that no damage occurs, and risk to human life is ruled out, if the rupture disk is triggered.

Rupture disk: Burst pressure 10 to 15 bar (145 to 218 psi)

(Promass X: 5,5 to 6,5 bar (80 to 94 psi))

- Please note that the housing can no longer assume a secondary containment function if a rupture disk is used.
- It is not permitted to open the connections or remove the rupture disk.



Caution!

- Rupture disks can not be combined with separately available heating jacket (except Promass A).
- The existing connection nozzles are not designed for a rinse or pressure monitoring function.



Note!

- Before commissioning, please remove the transport protection of the rupture disk.
- Please note the indication labels.

6.7 Purge and pressure monitoring connections

The sensor housing protects the inner electronics and mechanics and is filled with dry nitrogen. Beyond that, up to a specified measuring pressure it additionally serves as secondary containment.



Warning!

For a process pressure above the specified containment pressure, the housing does not serve as an additional secondary containment. In case a danger of measuring tube failure exists due to process characteristics, e.g. with corrosive process fluids, we recommend the use of sensors whose housing is equipped with special pressure monitoring connections (ordering option). With the help of these connections, fluid collected in the housing in the event of tube failure can be drained off. This diminishes the danger of mechanical overload of the housing, which could lead to a housing failure and accordingly is connected with an increased danger potential. These connections can also be used for gas purging (gas detection).

The following instructions apply to handling sensors with purge or pressure monitoring connections:

- Do not open the purge connections unless the containment can be filled immediately with a dry inert gas.
- Use only low gauge pressure to purge. Maximum pressure 5 bar (72,5 psi).

6.8 Data memory (HistoROM), F-CHIP

At Endress+Hauser, the term HistoROM refers to various types of data storage modules on which process and measuring device data is stored. By plugging and unplugging such modules, device configurations can be duplicated onto other measuring devices to cite just one example.

6.8.1 HistoROM/S-DAT (sensor-DAT)

The S-DAT is an exchangeable data memory in which all sensor-relevant parameters are stored, i.e., diameter, serial number, calibration factor, zero point.

6.8.2 HistoROM/T-DAT (transmitter-DAT)



The T-DAT is an exchangeable data storage device in which all transmitter parameters and settings are stored.

Storing of specific parameter settings from the EEPROM to the T-DAT and vice versa has to be carried out by the user (= manual save function). Detailed instructions regarding this can be found on →  73.

6.8.3 F-CHIP (Function-Chip)

The F-Chip is a microprocessor chip that contains additional software packages that extend the functionality and application possibilities of the transmitter.

In the case of a later upgrade, the F-CHIP can be ordered as an accessory and can simply be plugged on to the I/O board. After start up, the software is immediately made available to the transmitter.

- Accessories →  87
- Plugging on to the I/O board →  101



Caution!

To ensure an unambiguous assignment, the F-CHIP is coded with the transmitter serial number once it is plugged in. Thus, it can not be reused with other measuring devices.

7 Maintenance

No special maintenance work is required.

7.1 Exterior cleaning

When cleaning the exterior of measuring devices, always use cleaning agents that do not attack the surface of the housing and the seals.

7.2 Cleaning with pigs (Promass H, I, S, P)

If pigs are used for cleaning, it is essential to take the inside diameters of measuring tube and process connection into account. Technical Information →  108.

7.3 Replacing seals

Under normal circumstances, fluid wetted seals of the Promass A sensors do not require replacement. Replacement is necessary only in special circumstances, for example if aggressive or corrosive fluids are incompatible with the seal material.



Note!

- The period between changes depends on the fluid properties and on the frequency of cleaning cycles in the case of CIP/SIP cleaning.
- Replacement seals (accessories)

8 Accessories

Various accessories, which can be ordered separately from Endress+Hauser, are available for the transmitter and the sensor. The Endress+Hauser service organization can provide detailed information on the order code of your choice.

8.1 Device-specific accessories

Accessory	Description	Order code
Transmitter Proline Promass 83	Transmitter for replacement or for stock. Use the order code to define the following specifications: <ul style="list-style-type: none"> – Approvals – Degree of protection / version – Cable entries – Display / power supply / operation – Software – Outputs / inputs 	83XXX – XXXXX * * * * *
Inputs/outputs	Conversion kit with appropriate plug-in point modules for converting the input/output configuration in place to date to a new version.	DK8UI – * * * * *
Software packages for Proline Promass 83	Software add-ons on F-Chip, can be ordered individually: <ul style="list-style-type: none"> – Advanced diagnostics – Batching – Concentration measurement 	DK8SO – *

8.2 Measuring principle-specific accessories

Accessory	Description	Order code
Mounting set for transmitter	Mounting kit for wall-mount housing (remote version). Suitable for: <ul style="list-style-type: none"> – Wall mounting – Pipe mounting – Panel mounting Mounting set for aluminum field housing: Suitable for pipe mounting (3/4" to 3")	DK8WM – *
Post mounting set for the Promass A sensor	Post mounting set for the Promass A	DK8AS – * *
Mounting set for the Promass A sensor	Mounting set for Promass A, comprising: <ul style="list-style-type: none"> – 2 process connections – Seals 	DK8MS – * * * * *
Set of seals for sensor	For regular replacement of the seals of the Promass A sensors. Set consists of two seals.	DKS – * * *
Memograph M graphic display recorder	The Memograph M graphic display recorder provides information on all the relevant process variables. Measured values are recorded correctly, limit values are monitored and measuring points analyzed. The data are stored in the 256 MB internal memory and also on a DSD card or USB stick. Memograph M boasts a modular design, intuitive operation and a comprehensive security concept. The ReadWin® 2000 PC software is part of the standard package and is used for configuring, visualizing and archiving the data captured. The mathematics channels which are optionally available enable continuous monitoring of specific power consumption, boiler efficiency and other parameters which are important for efficient energy management.	RSG40 – * * * * * * * * *











8.3 Service-specific accessories:

Accessory	Description	Order code
Applicator	<p>Software for selecting and sizing Endress+Hauser measuring devices:</p> <ul style="list-style-type: none"> ■ Calculation of all the necessary data for identifying the optimum flowmeter: e.g. nominal diameter, pressure loss, accuracy or process connections ■ Graphic illustration of the calculation results <p>Administration, documentation and access to all project-related data and parameters over the entire life cycle of a project.</p> <p>Applicator is available:</p> <ul style="list-style-type: none"> ■ Via the Internet: https://wapps.endress.com/applicator ■ On CD-ROM for local PC installation. 	DXA80 – *
W@M	<p>Life cycle management for your plant</p> <p>W@M supports you with a wide range of software applications over the entire process: from planning and procurement, to the installation, commissioning and operation of the measuring devices. All the relevant device information, such as the device status, spare parts and device-specific documentation, is available for every device over the entire life cycle.</p> <p>The application already contains the data of your Endress+Hauser device. Endress+Hauser also takes care of maintaining and updating the data records.</p> <p>W@M is available:</p> <ul style="list-style-type: none"> ■ Via the Internet: www.endress.com/lifecyclemanagement ■ On CD-ROM for local PC installation. 	
Fieldcheck	<p>Tester/simulator for testing flowmeters in the field. When used in conjunction with the "FieldCare" software package, test results can be imported into a database, printed and used for official certification.</p> <p>Contact your Endress+Hauser representative for more information.</p>	50098801
FieldCare	<p>FieldCare is Endress+Hauser's FDT-based plant asset management tool. It can configure all intelligent field units in your system and helps you manage them. By using the status information, it is also a simple but effective way of checking their status and condition.</p>	See the product page on the Endress+Hauser website: www.endress.com
FXA193	<p>The FXA193 service interface connects the device to the PC for configuration via FieldCare.</p>	FXA193 – *

9 Troubleshooting

9.1 Troubleshooting instructions

Always start troubleshooting with the following checklist if faults occur after commissioning or during operation. The routine takes you directly to the cause of the problem and the appropriate remedial measures.

Check the display	
No display visible and no output signals present.	<ol style="list-style-type: none"> 1. Check the supply voltage → Terminals 1, 2 2. Check device fuse →  106 85 to 260 V AC: 0.8 A slow-blow / 250 V 20 to 55 V AC and 16 to 62 V DC: 2 A slow-blow / 250 V 3. Measuring electronics defective → order spare parts →  101
No display visible, but output signals are present.	<ol style="list-style-type: none"> 1. Check whether the ribbon-cable connector of the display module is correctly plugged into the amplifier board →  101 2. Display module defective → order spare parts →  101 3. Measuring electronics defective → order spare parts →  101
Display texts are in a foreign language.	Switch off power supply. Press and hold down both the  keys and switch on the measuring device. The display text will appear in English (default) and is displayed at maximum contrast.
Measured value indicated, but no signal at the current or pulse output	Measuring electronics defective → order spare parts →  101
▼	
Error messages on display	
<p>Errors which occur during commissioning or measuring operation are displayed immediately. Error messages consist of a variety of icons. The meanings of these icons are as follows (example):</p> <ul style="list-style-type: none"> – Error type: S = system error, P = process error – Error message type: ! = fault message, ! = notice message – MEDIUM INHOM. = error designation (e.g. fluid is not homogeneous) – 03:00:05 = duration of error occurrence (in hours, minutes and seconds) – #702 = error number <p> Caution! See the information →  41</p>	
▼	
Other error (without error message)	
Some other error has occurred.	Diagnosis and rectification →  99

9.2 System error messages

Serious system errors are **always** recognized by the instrument as "Fault message" and are shown as a lightning flash (⚡) on the display! Fault messages immediately affect the outputs.



Caution!

In the event of a serious fault, a flowmeter might have to be returned to the manufacturer for repair. Important procedures must be carried out before you return a flowmeter to Endress+Hauser → 107.

Always enclose a duly completed "Declaration of contamination" form. You will find a preprinted blank of this form at the back of this manual.



Note!

See the information → 41.

Modbus		No.	Device status message (local display)	Cause	Remedy (spare part → 101)
Register: 6859 Data type: Integer	Register: 6821 Data type: String (18 byte)				
Response to a fault message: The value "NaN" (not a number) is transmitted to the Modbus master instead of the current measured value.			Depicted on the local display: S = System error ⚡ = Fault message (with an effect on the outputs) ! = Notice message (without any effect on the outputs)		
1	SYSTEM OK	–	<i>There is no error present in the device</i>		
No. # 0xx → Hardware error					
2	CRITICAL FAIL.	001	S: CRITICAL FAILURE ⚡: # 001	Serious device error.	Replace amplifier board.
3	AMP HW-EEPROM	011	S: AMP HW-EEPROM ⚡: # 011	Amplifier: faulty EEPROM.	Replace amplifier board.
4	AMP SW-EEPROM	012	S: AMP SW-EEPROM ⚡: # 012	Amplifier: Error accessing EEPROM data.	The EEPROM data blocks in which an error has occurred are displayed in the TROUBLESHOOTING function. Press Enter to acknowledge the errors in question; default values are automatically inserted instead of the faulty parameter values. Note! The measuring device has to be restarted if an error has occurred in a totalizer block (see error No. 111/CHECKSUM TOTAL.).
11	SENSOR HW-DAT	031	S: SENSOR HW-DAT ⚡: # 031	1. S-DAT is not plugged into the amplifier board correctly (or is missing). 2. S-DAT is defective.	1. Check whether the S-DAT is correctly plugged into the amplifier board. 2. Replace the S-DAT if it is defective. Check that the new, replacement DAT is compatible with the measuring electronics. Check the: – Spare part set number – Hardware revision code 3. Replace measuring electronics boards if necessary. 4. Plug the S-DAT into the amplifier board.
12	SENSOR SW-DAT	032	S: SENSOR SW-DAT ⚡: # 032		

Modbus		No.	Device status message (local display)	Cause	Remedy (spare part → 101)
Register: 6859 Data type: Integer	Register: 6821 Data type: String (18 byte)				
13	TRANSM. HW-DAT	041	S: TRANSM. HW-DAT #: # 041	1. T-DAT is not plugged into the amplifier board correctly (or is missing). 2. T-DAT is defective.	1. Check whether the T-DAT is correctly plugged into the amplifier board. 2. Replace the T-DAT if it is defective. Check that the new, replacement DAT is compatible with the measuring electronics. Check the: - Spare part set number - Hardware revision code 3. Replace measuring electronics boards if necessary. 4. Plug the T-DAT into the amplifier board.
14	TRANSM. SW-DAT	042	S: TRANSM. SW-DAT #: # 042		
144	HW F-CHIP	061	S: HW F-CHIP #: # 061	Transmitter F-Chip: 1. F-Chip is defective. 2. F-Chip is not plugged into the I/O board or is missing.	1. Replace the F-CHIP. 2. Plug the F-Chip into the I/O board.
No. # 1xx → Software error					
143	A/C SW COMPATIB.	121	S: A / C COMPATIB. !: # 121	Due to different software versions, I/O board and amplifier board are only partially compatible (possibly restricted functionality).  Note! - This message is only listed in the error history. - Nothing is displayed on the display.	Module with lower software version has either to be actualized by FieldCare with the required software version or the module has to be replaced.
No. # 2xx → Error in DAT / no communication					
22	LOAD T-DAT	205	S: LOAD T-DAT !: # 205	Transmitter DAT: Data back-up (downloading) to T-DAT failed	1. Check whether the T-DAT is correctly plugged into the amplifier board.
23	SAVE T-DAT	206	S: SAVE T-DAT !: # 206	or Error when accessing (uploading) the values stored in the T-DAT.	2. Replace the T-DAT if it is defective. Before replacing the DAT, check that the new, replacement DAT is compatible with the measuring electronics. Check the: - Spare part set number - Hardware revision code 3. Replace measuring electronics boards if necessary.
27	COMMUNIC. SENS	251	S: COMMUNICATION I/ O #: # 251	Internal communication fault on the amplifier board.	Replace the amplifier board (see "Spare parts").
28	COMMUNIC. I/O	261	S: COMMUNICATION I/O #: # 261	No data reception between amplifier and I/O board or faulty internal data transfer.	Check the BUS contacts.

Modbus		No.	Device status message (local display)	Cause	Remedy (spare part → 101)
Register: 6859 Data type: Integer	Register: 6821 Data type: String (18 byte)				
No. # 3xx → System limits exceeded					
131 to 134	STACK CUR. OUT n	339 to 342	S: STACK CUR OUT n !: # 339 to 342	The temporarily buffered flow portions (measuring mode for pulsating flow) could not be cleared or output within 60 seconds.	1. Change the upper or lower limit setting, as applicable. 2. Increase or reduce flow, as applicable. Recommendation: – Configure the fault response of the output to "ACTUAL VALUE", so that the temporary buffer can be cleared. – Clear the temporary buffer by the measures described under Item 1.
135 to 138	STACK FREQ. OUT n	343 to 346	S: STACK FREQ. OUT n !: # 343 to 346		
139 to 142	STACK PULSE n	347 to 350	S: STACK PULSE OUT n !: # 347 to 350	The temporarily buffered flow portions (measuring mode for pulsating flow) could not be cleared or output within 60 seconds.	1. Increase the setting for pulse weighting. 2. Increase the max. pulse frequency, if the totalizer can handle a higher number of pulses. 3. Increase or reduce flow, as applicable. Recommendation: – Configure the fault response of the output to "ACTUAL VALUE", so that the temporary buffer can be cleared. – Clear the temporary buffer by the measures described under Item 1.
39 to 42	RANGE CUR. OUT n	351 to 354	S: CURRENT RANGE n !: # 351 to 354	Current output: The actual value for the flow lies outside the set limits.	1. Change the upper or lower limit setting, as applicable. 2. Increase or reduce flow, as applicable.
43 to 46	RANGE FREQ. OUT n	355 to 358	S: FREQ. RANGE n !: # 355 to 358	Frequency output: The actual value for the flow lies outside the set limits.	1. Change the upper or lower limit setting, as applicable. 2. Increase or reduce flow, as applicable.
47 to 50	RANGE PULSE n	359 to 362	S: PULSE RANGE !: # 359 to 362	Pulse output: Pulse output frequency is out of range.	1. Increase the setting for pulse weighting. 2. When selecting the pulse width, choose a value that can still be processed by a connected counter (e.g. mechanical counter, PLC, etc.). <i>Determine the pulse width:</i> – Version 1: Enter the minimum duration that a pulse must be present at the connected counter to ensure its registration. – Version 2: Enter the maximum (pulse) frequency as the half "reciprocal value" that a pulse must be present at the connected counter to ensure its registration. Example: The maximum input frequency of the connected counter is 10 Hz. The pulse width to be entered is: $\frac{1}{2 \cdot 10 \text{ Hz}} = 50 \text{ ms}$ 3. Reduce flow

a0004437

Modbus		No.	Device status message (local display)	Cause	Remedy (spare part → 101)
Register: 6859 Data type: Integer	Register: 6821 Data type: String (18 byte)				
52 to 53	LOW FREQ. LIM.	379	S: LOW FREQ. LIM !: # 379	The measuring tube oscillation frequency is outside the permitted range. Causes: – Change the upper or lower limit setting, as applicable. – Increase or reduce flow, as applicable.	Contact your Endress+Hauser service organization.
53	UPPER FREQ. LIM.	380	S: UPPER FREQ. LIM !: # 380		
54	FLUIDTEMP. MIN.	381	S: FLUIDTEMP.MIN. !: # 381	The temperature sensor on the measuring tube is likely defective.	Check the following electrical connections before you contact your Endress+Hauser service organization: – Verify that the sensor signal cable connector is correctly plugged into the amplifier board. – Remote version: Check sensor and transmitter terminal connections No. 9 and 10.
55	FLUIDTEMP. MAX.	382	S: FLUIDTEMP.MAX. !: # 382		
56	CARR.TEMP. MIN.	383	S: CARR.TEMP.MIN !: # 383	The temperature sensor on the carrier tube is likely defective.	Check the following electrical connections before you contact your Endress+Hauser service organization: – Verify that the sensor signal cable connector is correctly plugged into the amplifier board. – Remote version: Check sensor and transmitter terminal connections No. 11 and 12.
57	CARR.TEMP. MAX.	384	S: CARR.TEMP.MAX !: # 384		
58	INL. SENS DEF	385	S: INL.SENS.DEF. !: # 385	One of the measuring tube sensor coils (inlet) is likely defective.	Check the following electrical connections before you contact your Endress+Hauser service organization: – Verify that the sensor signal cable connector is correctly plugged into the amplifier board. – Remote version: Check sensor and transmitter terminal connections No. 4, 5, 6 and 7.
59	OUTL. SENS. DEF	386	S: OUTL.SENS.DEF. !: # 386	One of the measuring tube sensor coils (outlet) is likely defective.	
60	SEN. ASY. EXCEED	387	S: SEN.ASY.EXCEED !: # 387	Measuring tube sensor coil is probably faulty.	
61 to 62	AMP. FAULT CH2 AMP. FAULT CH3	388 to 390	S: AMP. FAULT !: # 388 to 390	Amplifier error	Contact your Endress+Hauser service organization.
No. # 5xx → Application error					
72	SW-DOWNLOAD	501	S: SW.-UPDATE ACT. !: # 501	New amplifier or communication (I/O module) software version is loaded. Currently no other functions are possible.	Wait until process is finished. The device will restart automatically.
73	DOWN-UPLOAD ACTIVE	502	S: UP-/DOWNLOAD ACT. !: # 502	Up- or downloading the device data via configuration program. Currently no other functions are possible.	Wait until process is finished.
129	BATCH RUNNING	571	S: BATCH RUNNING !: # 571	Batching is started and active (valves are open)	No measures needed (during the batching process some other functions may not be activated).
130	BATCH HOLD	572	S: BATCH HOLD !: # 572	Batching has been interrupted (valves are closed)	1. Continue batching with command "GO ON". 2. Interrupt batching with "STOP" command.

Modbus		No.	Device status message (local display)	Cause	Remedy (spare part → 101)
Register: 6859 Data type: Integer	Register: 6821 Data type: String (18 byte)				
76	OSC.AMP.LIM	586	S: OSC. AMP. LIMIT !: # 586	The fluid properties do not allow a continuation of the measurement. Causes: – Extremely high viscosity – Process fluid is very inhomogeneous (gas or solid content)	Change or improve process conditions.
77	TUBE NOT OSC.	587	S: TUBE NOT OSC !: # 587	Extreme process conditions exist. The measuring system can therefore not be started.	Change or improve process conditions.
78	GAIN RED.IMPOS	588	S: GAIN RED.IMPOS !: # 588	Overdriving of the internal analog to digital converter. Causes: – Cavitation – Extreme pressure pulses – High gas flow velocity A continuation of the measurement is no longer possible!	Change or improve process conditions, e.g. by reducing the flow velocity.
No. # 6xx → Simulation mode active					
79	POS.ZERO -RET.	601	S: POS. ZERO-RET. !: # 601	Positive zero return active.  Caution! This message has the highest display priority!	Switch off positive zero return.
80 to 83	SIM. CURR. OUT n	611 to 614	S: SIM. CURR. OUT. n !: # 611 to 614	Simulation current output active.	Switch off simulation.
84 to 87	SIM FREQ. OUT 1..4	621 to 624	S: SIM. FREQ. OUT. n !: # 621 to 624	Simulation frequency output active.	Switch off simulation.
88 to 91	SIM. PULSE n	631 to 634	S: SIM. PULSE n !: # 631 to 634	Simulation pulse output active.	Switch off simulation.
92 to 95	SIM. STAT. OUT n	641 to 644	S: SIM. STAT. OUT n !: # 641 to 644	Simulation status output active.	Switch off simulation.
96 to 99	SIM. STAT./REL. OUT n	651 to 654	S: SIM. RELAY n !: # 651 to 654	Simulation relay output active.	Switch off simulation.
104 to 107	SIM. STATUS IN n	671 to 674	S: SIM. STATUS IN n !: # 671 to 674	Simulation status input active.	Switch off simulation.
108	SIM. FAILSAFE	691	S: SIM. FAILSAFE !: # 691	Simulation of response to error (outputs) active.	Switch off simulation.
109	SIM MEASURAND	692	S: SIM. MEASURAND !: # 692	Simulation of measuring variables (e.g. mass flow).	Switch off simulation.
150	DEV. TEST ACT.	698	S: DEV. TEST ACT. !: # 698	The measuring device is being checked on site via the test and simulation device.	–



Modbus		No.	Device status message (local display)	Cause	Remedy (spare part → 101)
Register: 6859 Data type: Integer	Register: 6821 Data type: String (18 byte)				
No. # 8xx → Other error messages with software options (Coriolis flowmeter)					
117	M. FL. DEV. LIMIT	800	S: M. FL. DEV. LIMIT !: # 800	Advanced diagnostics: The mass flow is outside the limit value, set in the corresponding diagnosis functions.	–
118	DENS. DEV. LIM.	801	S: DENS. DEV. LIMIT !: # 801	Advanced diagnostics: The density is outside the limit value, set in the corresponding diagnosis functions.	–
119	REF. D. DEV. LIM.	802	S: REF. D. DEV. LIM. !: # 802	Advanced diagnostics: The reference density is outside the limit value, set in the corresponding diagnosis functions.	–
120	TEMP. DEV. LIMIT	803	S: TEMP. DEV. LIMIT !: # 803	Advanced diagnostics: The temperature is outside the limit value, set in the corresponding diagnosis functions.	–
121	T. DAMP. DEV. LIM	804	S: T. DAMP. DEV. LIM !: # 804	Advanced diagnostics: The tube damping is outside the limit value, set in the corresponding diagnosis functions.	–
122	EL. DYN. SENS. LIM.	805	S: E. D. SEN. DEV. LI !: # 805	Advanced diagnostics: The electrodynamic sensor is outside the limit value, set in the corresponding diagnosis functions.	–
123	F. FLUCT. DEV. LIM.	806	S: F. FLUCT. DEV. LIM !: # 806	Advanced Diagnostics: The fluctuation of the operating frequency is outside the limit value, set in the corresponding diagnosis functions.	–
124	TD FLUCT. DEV. LIM.	807	S: TD FLUCT. DEV. LIM !: # 807	Advanced Diagnostics: The fluctuation of the tube damping is outside the limit value, set in the corresponding diagnosis functions.	–

9.3 Process error messages







Note!
Further information → 41

Modbus		No.	Device status message (local display)	Cause	Remedy / spare part
Register: 6859 Data type: Integer	Register: 6821 Data type: String (18 byte)				
Response to a fault message: The value "NaN" (not a number) is transmitted to the Modbus master instead of the current measured value.			Depicted on the local display: S = System error † = Fault message (with an effect on the outputs) ! = Notice message (without any effect on the outputs)		
1	SYSTEM OK	–	<i>There is no error present in the device</i>		
126	> BATCH TIME	471	P: > BATCH TIME †: # 471	The maximum permitted batching time was exceeded.	1. Increase flow rate 2. Check valve (opening) 3. Adjust time setting to changed batch quantity Note! If the errors listed above occur, these are displayed in the Home position flashing continuously. <ul style="list-style-type: none"> ■ General: These error messages can be reset by configuring any batching parameter. It is sufficient to confirm with the key and then the key. ■ Batching via status input: The error message can be reset by means of a pulse. Another pulse then restarts the batching. ■ Batching via operating keys (soft keys) The error message is reset by pressing the START key. Pressing the START key a second time starts the batching process. ■ Batching via the BATCHING PROCESS function (7260): The error message can be reset by pressing the STOP, START, HOLD or GO ON keys. Pressing the START key a second time starts the batching process. ■ Batching via Modbus: The error message can be reset via Modbus by selecting 4 = RESET in the "BATCH PROCEDURE (7260)" parameter.

Modbus		No.	Device status message (local display)	Cause	Remedy / spare part
Register: 6859 Data type: Integer	Register: 6821 Data type: String (18 byte)				
127	>< BATCH QUANTITY	472	P: >< BATCH QUANTITY !: # 472	<ul style="list-style-type: none"> – Underbatching: The minimum quantity was not reached. – Overbatching: The maximum permitted batching quantity was exceeded. 	<p>Underbatching:</p> <ol style="list-style-type: none"> 1. Increase fixed correction quantity. 2. 2. Valve closes too quickly with active after run correction. Enter smaller after run as mean value. 3. If the batching quantity changes, the minimum batching quantity must be adjusted. <p>Overbatching:</p> <ol style="list-style-type: none"> 1. Reduce fixed correction quantity. 2. Valve closes too slowly with active after run correction. Enter larger after run as mean value. 3. If the batching quantity changes, the maximum batching quantity must be adjusted. <p> Note! Please observe Note in error message No. 471</p>
128	PROGRESS NOTE	473	P: PROGRESS NOTE !: # 473	End of filling process approaching. The running filling process has exceeded the predefined batch quantity point for the display warning message.	No measures required (if necessary prepare to replace container).
151	> MAX FLOW RATE	474	P: MAX. FLOW RATE !: # 474	Maximum flow value entered is overshoot.	Reduce the flow value.  Note! Please observe Note in error message No. 471
No. # 7xx → Other process errors					
111	EMPTY PIPE	700	P: EMPTY PIPE !: # 700	The process fluid density is outside the upper or lower limit values set in the "EPD" function Causes: <ul style="list-style-type: none"> – Air in the measuring tube – Partly filled measuring tube 	<ol style="list-style-type: none"> 1. Ensure that there is no gas content in the process liquid. 2. Adapt the values in the "EPD" function to the current process conditions.
112	EXC. CURR. LIM	701	P: EXC. CURR. LIM. !: # 701	The maximum current value for the measuring tube exciter coils has been reached, since certain process fluid characteristics are extreme, e.g. high gas or solid content. The instrument continues to work correctly.	In particular with outgassing fluids and/or increased gas content, the following measures are recommended to increase system pressure: <ol style="list-style-type: none"> 1. Install the instrument at the outlet side of a pump. 2. Install the instrument at the lowest point of an ascending pipeline. 3. Install a flow restriction, e.g. reducer or orifice plate, downstream from the instrument.
113	FLUID INHOM.	702	P: FLUID INHOM. !: # 702	Frequency control is not stable, due to inhomogeneous process fluid, e.g. gas or solid content.	

Modbus		No.	Device status message (local display)	Cause	Remedy / spare part
Register: 6859 Data type: Integer	Register: 6821 Data type: String (18 byte)				
114	NOISE LIM. CH0	703	P: NOISE LIM. CH0 !: # 703	Overdriving of the internal analog to digital converter.	Change or improve process conditions, e.g. by reducing the flow velocity.
115	NOISE LIM. CH1	704	P: NOISE LIM. CH1 !: # 704	Causes: – Cavitation – Extreme pressure pulses – High gas flow velocity A continuation of the measurement is still possible!	
116	FLOW LIMIT	705	P: FLOW LIMIT !: # 705	The mass flow is too high. The electronics' measuring range will be exceeded.	Reduce flow
124	ADJ. ZERO FAIL.	731	P: ADJ. ZERO FAIL !: # 731	The zero point adjustment is not possible or has been canceled.	Make sure that zero point adjustment is carried out at "zero flow" only (v = 0 m/s).

9.4 Process errors without messages

Symptoms	Rectification
<p>Comment: You may have to change or correct certain settings of the function matrix in order to rectify faults. The functions outlined below, such as DISPLAY DAMPING, for example, are described in detail in the "Description of Device Functions" manual.</p>	
<p>Measured-value reading fluctuates even though flow is steady.</p>	<ol style="list-style-type: none"> 1. Check the fluid for presence of gas bubbles. 2. TIME CONSTANT function → increase value (→ OUTPUTS / CURRENT OUTPUT / CONFIGURATION) 3. DISPLAY DAMPING function → increase value (→ USER INTERFACE / CONTROL / BASIC CONFIGURATION)
<p>Flow values are negative, even though the fluid is flowing forwards through the pipe.</p>	<p>Change the setting in the INSTALLATION DIRECTION SENSOR function accordingly</p>
<p>Measured-value reading or measured-value output pulsates or fluctuates, e.g. because of reciprocating pump, peristaltic pump, diaphragm pump or pump with similar delivery characteristic.</p>	<p>Run the "Pulsating Flow" Quick Setup →  62. If the problem persists despite these measures, a pulsation damper will have to be installed between pump and measuring device.</p>
<p>There are differences between the flowmeter's internal totalizer and the external metering device.</p>	<p>This symptom is due primarily to backflow in the piping, because the pulse output cannot subtract in the "STANDARD" or "SYMMETRY" measuring modes. The problem can be solved as follows: Allow for flow in both directions. Set the MEASURING MODE function to "Pulsating Flow" for the pulse output in question.</p>
<p>Measured value reading shown on display, even though the fluid is at a standstill and the measuring tube is full.</p>	<ol style="list-style-type: none"> 1. Check the fluid for presence of gas bubbles. 2. Activate the ON-VAL. LF-CUTOFF function, i.e. enter or increase the value for the low flow cut off (→ BASIC FUNCTION / PROCESS PARAMETER / CONFIGURATION).
<p>The fault cannot be rectified or some other fault not described above has arisen. In these instances, please contact your E+H service organization.</p>	<p>The following options are available for tackling problems of this nature:</p> <p>Request the services of an Endress+Hauser service technician If you contact our service organization to have a service technician sent out, please be ready to quote the following information: – Brief description of the fault – Nameplate specifications: order code, serial number →  7</p> <p>Returning devices to Endress+Hauser Carry out the measures listed before you return a flowmeter requiring repair or calibration to Endress+Hauser. →  107 Always enclose a duly completed "Declaration of contamination" form with the flowmeter. You will find a preprinted blank of the Dangerous Goods Sheet at the back of this manual.</p> <p>Replace transmitter electronics Components in the measuring electronics defective → order spare parts →  101</p>

9.5 Response of outputs to errors



Note!

The failsafe mode of totalizers, current, pulse and frequency outputs can be customized by means of various functions in the function matrix. You will find detailed information on these procedures in the "Description of Device Functions" manual.

You can use positive zero return to reset the signals of the current, pulse and frequency outputs to their fallback value, or reset measured value transmission via the fieldbus to '0'. This is used, for example, when measuring has to be interrupted while a pipe is being cleaned. This function takes priority over all other device functions. Simulations, for example, are suppressed.

Failsafe mode of outputs and totalizers		
	Process/system error is present	Positive zero return is activated
Caution! System or process errors defined as "Notice messages" have no effect whatsoever on the outputs. See the information on → 41		
Current output	MIN. CURRENT The current output will be set to the lower value of the signal on alarm level depending on the setting selected in the CURRENT SPAN (see the "Description of Device Functions" manual). MAX. CURRENT The current output will be set to the higher value of the signal on alarm level depending on the setting selected in the CURRENT SPAN (see the "Description of Device Functions" manual). HOLD VALUE Measured value display on the basis of the last saved value preceding occurrence of the fault. ACTUAL VALUE Measured value display on the basis of the current flow measurement. The fault is ignored.	Output signal corresponds to "zero flow"
Pulse output	FALLBACK VALUE Signal output → no pulses HOLD VALUE Last valid value (preceding occurrence of the fault) is output. ACTUAL VALUE Fault is ignored, i.e. normal measured-value output on the basis of ongoing flow measurement.	Output signal corresponds to "zero flow"
Frequency output	FALLBACK VALUE Signal output → 0 Hz FAILSAFE VALUE Output of the frequency specified in the FAILSAFE VALUE function. HOLD VALUE Last valid value (preceding occurrence of the fault) is output. ACTUAL VALUE Fault is ignored, i.e. normal measured-value output on the basis of ongoing flow measurement.	Output signal corresponds to "zero flow"
Totalizer	STOP The totalizers are paused until the error is rectified. ACTUAL VALUE The fault is ignored. The totalizer continues to count in accordance with the current flow value. HOLD VALUE The totalizers continue to count the flow in accordance with the last valid flow value (before the error occurred).	Totalizer stops
Modbus RS485	In the event of faults, the value "NaN" (not a number) is transmitted instead of the current measured value.	–

9.6 Spare parts

The previous sections contain a detailed troubleshooting guide → 89.

The measuring device, moreover, provides additional support in the form of continuous self-diagnosis and error messages.

Fault rectification can entail replacing defective components with tested spare parts. The illustration below shows the available scope of spare parts.



Note!

You can order spare parts directly from your Endress+Hauser service organization by providing the serial number printed on the transmitter's nameplate → 7.

Spare parts are shipped as sets comprising the following parts:

- Spare part
- Additional parts, small items (screws, etc.)
- Mounting instructions
- Packaging

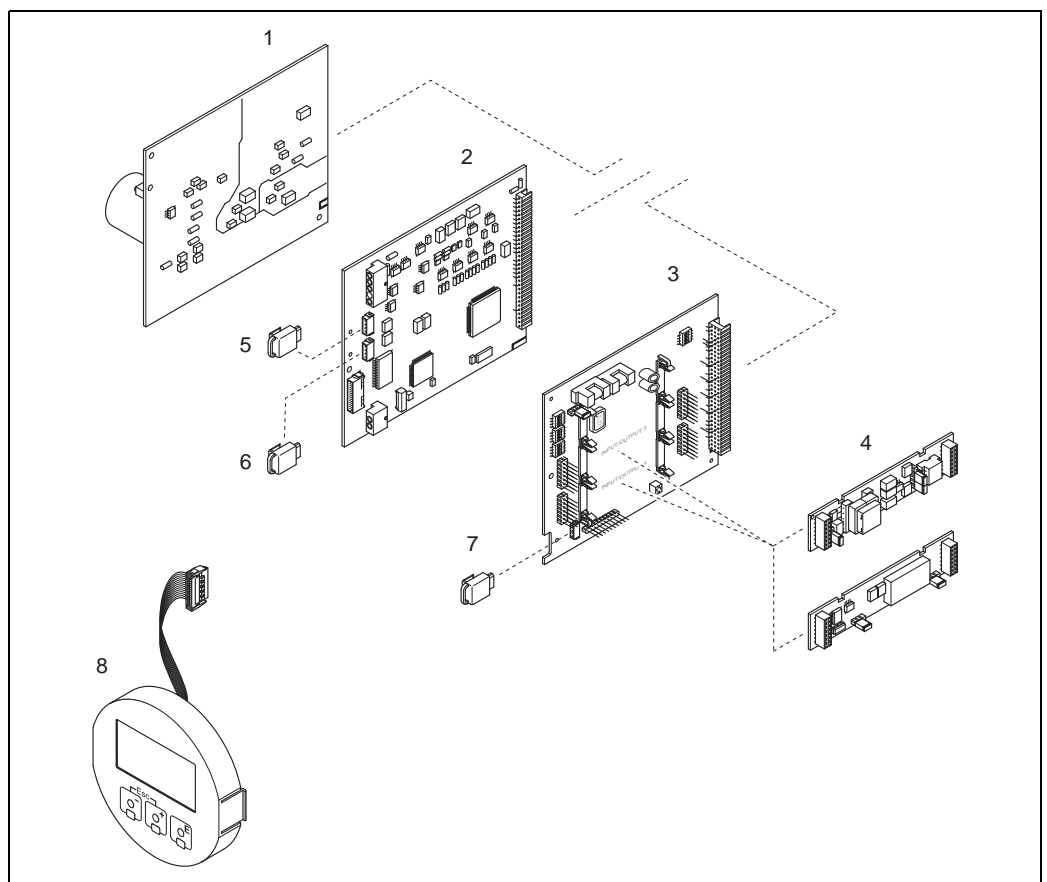

Fig. 50: Spare parts for transmitter (field and wall-mount housings)

- 1 Power unit board (85 to 260 V AC, 20 to 55 V AC, 16 to 62 V DC)
- 2 Amplifier board
- 3 I/O board (COM module), flexible assignment
- 4 Pluggable submodules (inputs/outputs); ordering structure → 87
- 5 S-DAT (sensor data memory)
- 6 T-DAT (transmitter data memory)
- 7 F-CHIP (function chip for optional software)
- 8 Display module

9.6.1 Removing and installing printed circuit boards

Field housing



Warning!

- Risk of electric shock. Exposed components carry dangerous voltages. Make sure that the power supply is switched off before you remove the cover of the electronics compartment.
- Risk of damaging electronic components (ESD protection). Static electricity can damage electronic components or impair their operability. Use a workplace with a grounded working surface purpose-built for electrostatically sensitive devices!
- If you cannot guarantee that the dielectric strength of the device is maintained in the following steps, then an appropriate inspection must be carried out in accordance with the manufacturer's specifications.



Caution!

Use only original Endress+Hauser parts.

Installing and removing printed circuit boards →  51:

1. Unscrew cover of the electronics compartment from the transmitter housing.
2. Remove the local display (1) as follows:
 - Press in the latches (1.1) at the side and remove the display module.
 - Disconnect the ribbon cable (1.2) of the display module from the amplifier board.
3. Remove the screws and remove the cover (2) from the electronics compartment.
4. Remove power unit board (4) and I/O board (6):
 - Insert a thin pin into the hole (3) provided for the purpose and pull the board clear of its holder.
5. Remove submodules (6.2) (optional):
 - No tools are required for removing the submodules (outputs) from the I/O board. Installation is also a no-tools operation.



Caution!

Only certain combinations of submodules on the I/O board are permissible →  31.

The individual slots are marked and correspond to certain terminals in the connection compartment of the transmitter:

- "INPUT / OUTPUT 3" slot = terminals 22/23
- "INPUT / OUTPUT 4" slot = terminals 20/21

6. Remove amplifier board (5):
 - Disconnect the plug of the sensor signal cable (5.1) including S-DAT (5.3) from the board.
 - Gently disconnect the plug of the exciting current cable (5.2) from the board, i.e. without moving it back and forth.
 - Insert a thin pin into the hole (3) provided for the purpose and pull the board clear of its holder.
7. Installation is the reverse of the removal procedure.

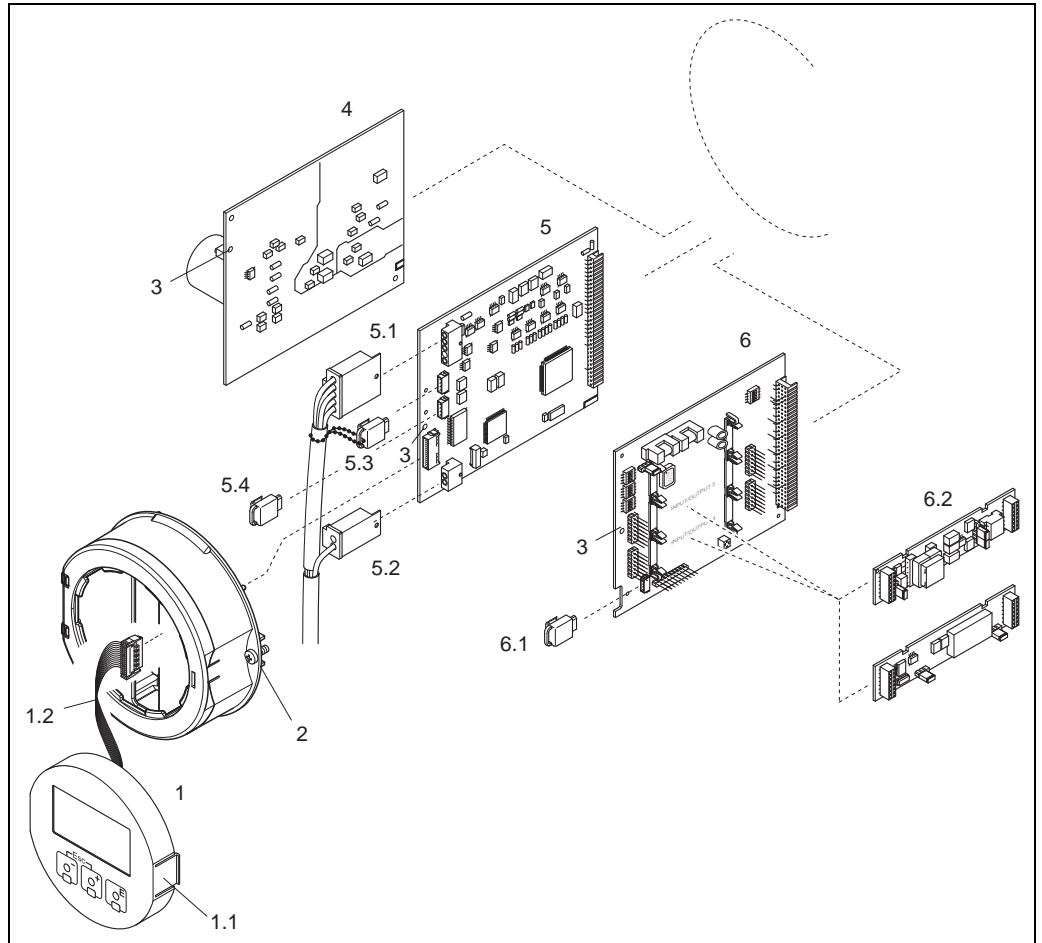

Fig. 51: Field housing: removing and installing printed circuit boards

- 1 Local display
- 1.1 Latch
- 1.2 Ribbon cable (display module)
- 2 Screws of electronics compartment cover
- 3 Aperture for installing/removing boards
- 4 Power unit board
- 5 Amplifier board
- 5.1 Signal cable (sensor)
- 5.2 Excitation current cable (sensor)
- 5.3 S-DAT (sensor data memory)
- 5.4 T-DAT (transmitter data memory)
- 6 I/O board (flexible assignment)
- 6.1 F-CHIP (function chip for optional software)
- 6.2 Optional: pluggable submodules (current output, pulse/frequency output and relay output)

Wall-mount housing**Warning!**

- Risk of electric shock. Exposed components carry dangerous voltages. Make sure that the power supply is switched off before you remove the cover of the electronics compartment.
- Risk of damaging electronic components (ESD protection). Static electricity can damage electronic components or impair their operability. Use a workplace with a grounded working surface purpose-built for electrostatically sensitive devices!
- If you cannot guarantee that the dielectric strength of the device is maintained in the following steps, then an appropriate inspection must be carried out in accordance with the manufacturer's specifications.

**Caution!**

Use only original Endress+Hauser parts.

Installing and removing printed circuit boards →  52:

1. Loosen the screws and open the hinged cover (1) of the housing.
2. Loosen the screws securing the electronics module (2). Then push up electronics module and pull it as far as possible out of the wall-mount housing.
3. Disconnect the following cable plugs from amplifier board (7):
 - Sensor signal cable plug (7.1) including S-DAT (7.3)
 - Connector of exciting current cable (7.2):
Gently disconnect the plug, i.e. without moving it back and forward.
 - Ribbon cable plug (3) of the display module
4. Remove the cover (4) from the electronics compartment by loosening the screws.
5. Remove the boards (6, 7, 8):
Insert a thin pin into the hole (5) provided for the purpose and pull the board clear of its holder.
6. Remove submodules (8.2) (optional):
No tools are required for removing the submodules (outputs) from the I/O board. Installation is also a no-tools operation.

**Caution!**

Only certain combinations of submodules on the I/O board are permissible →  31.
The individual slots are marked and correspond to certain terminals in the connection compartment of the transmitter:

"INPUT / OUTPUT 3" slot = terminals 22/23

"INPUT / OUTPUT 4" slot = terminals 20/21

7. Installation is the reverse of the removal procedure.

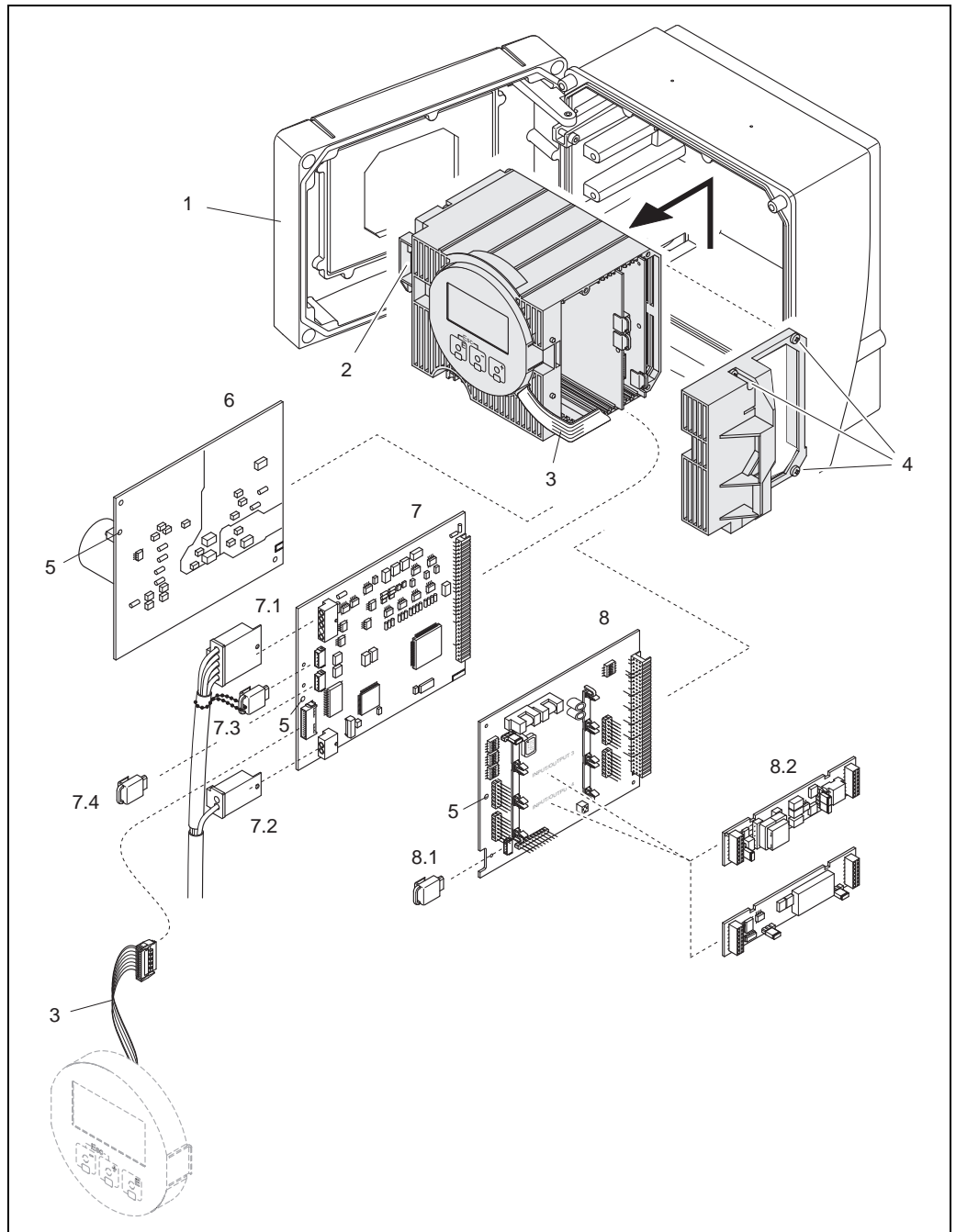

Fig. 52: Wall-mount housing: removing and installing printed circuit boards

- 1 Housing cover
- 2 Electronics module
- 3 Ribbon cable (display module)
- 4 Screws of electronics compartment cover
- 5 Aperture for installing/removing boards
- 6 Power unit board
- 7 Amplifier board
 - 7.1 Signal cable (sensor)
 - 7.2 Excitation current cable (sensor)
 - 7.3 S-DAT (sensor data memory)
 - 7.4 T-DAT (transmitter data memory)
- 8 I/O board (flexible assignment)
 - 8.1 F-CHIP (function chip for optional software)
 - 8.2 Optional: pluggable submodules (current output, pulse/frequency output and relay output)

9.6.2 Replacing the device fuse



Warning!

Risk of electric shock. Exposed components carry dangerous voltages. Make sure that the power supply is switched off before you remove the cover of the electronics compartment.

The main fuse is on the power unit board → 53.

The procedure for replacing the fuse is as follows:

1. Switch off power supply.
2. Remove the power unit board → 102
3. Remove the protection cap (1) and replace the device fuse (2).
 Only use the following fuse type:
 - 20 to 55 V AC / 16 to 62 V DC → 2.0 A slow-blow / 250 V; 5.2 × 20 mm
 - Power supply 85 to 260 V AC → 0.8 A slow-blow / 250 V; 5.2 × 20 mm
 - Ex-rated devices → see the Ex documentation
4. Installation is the reverse of the removal procedure.



Caution!

Use only original Endress+Hauser parts.

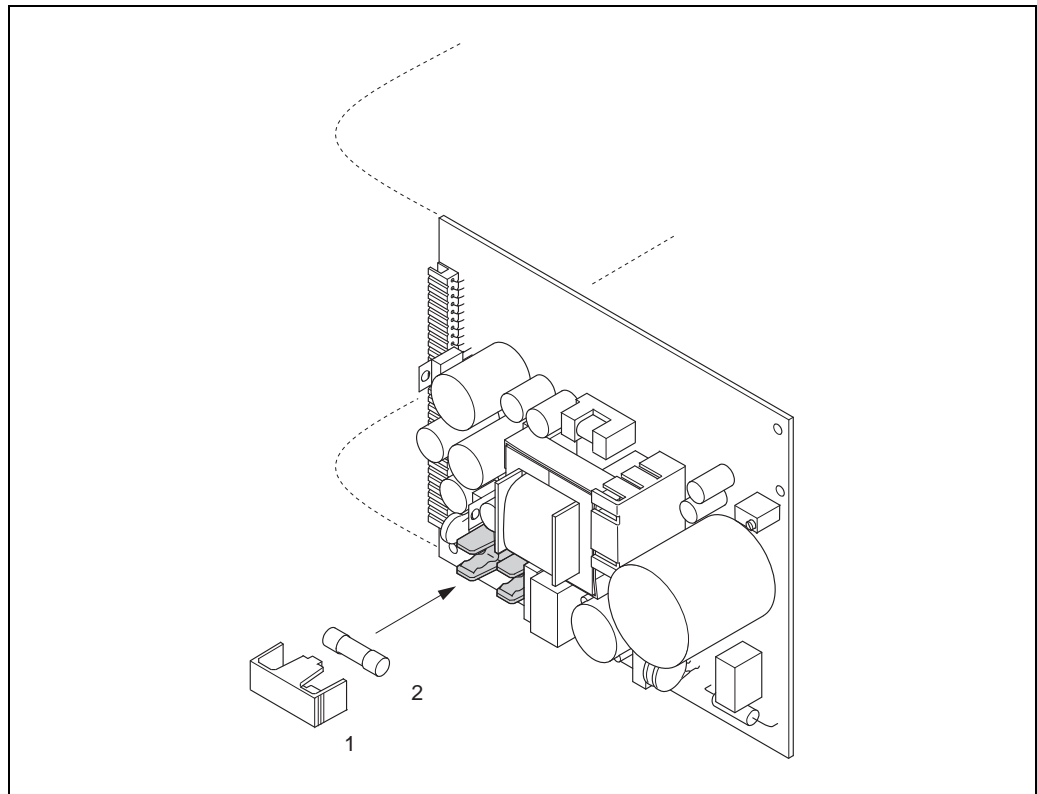

Fig. 53: Replacing the device fuse on the power unit board

- 1 Protective cap
- 2 Device fuse

9.7 Return



Caution!

Do not return a measuring device if you are not absolutely certain that all traces of hazardous substances have been removed, e.g. substances which have penetrated crevices or diffused through plastic.

Costs incurred for waste disposal and injury (burns, etc.) due to inadequate cleaning will be charged to the owner-operator.

The following steps must be taken before returning a flow measuring device to Endress+Hauser, e.g. for repair or calibration:

- Always enclose a duly completed "Declaration of contamination" form. Only then can Endress+Hauser transport, examine and repair a returned device.
- Enclose special handling instructions if necessary, for example a safety data sheet as per EC REACH Regulation No. 1907/2006.
- Remove all residues. Pay special attention to the grooves for seals and crevices which could contain residues. This is particularly important if the substance is hazardous to health, e.g. flammable, toxic, caustic, carcinogenic, etc.



Note!

You will find a preprinted "Declaration of contamination" form at the back of these Operating Instructions.

9.8 Disposal

Observe the regulations applicable in your country!

9.9 Software history

Date	Software version	Changes to software	Documentation
10.2012	3.06.XX	–	71197490/14.12
09.2011		New Sensor: Promass O and X	71141447/13.11
06.2010		Software adjustment	71116480/06.10
07.2007	3.04.XX	Software adjustment	71036012/12.06
12.2006	3.02.XX	New Sensor: Promass P and S	
12.2005		Software extension: – Support t-mass 65 Modbus RS485 – (No functional changes for Promass 83 Modbus RS485)	71008406/12.05
10.2005	3.01.XX	Software extension: – Promass I DN80, DN50FB – Additional functionalities for "Advanced Diagnostics" – Additional functionalities for "Batching" – General device functions	
11.2004	3.00.XX	–	50108189/11.04

10 Technical data

10.1 Technical data at a glance

10.1.1 Applications

→  5

10.1.2 Function and system design

Measuring principle Mass flow measurement by the Coriolis principle

Measuring system →  7

10.1.3 Input

Measured variable ■ Mass flow (proportional to the phase difference between two sensors mounted on the measuring tube to register a phase shift in the oscillation)
 ■ Fluid density (proportional to resonance frequency of the measuring tube)
 ■ Fluid temperature (measured with temperature sensors)

Measuring range *Measuring ranges for liquids*

DN		Range for full scale values (liquids) $\dot{m}_{\min(F)}$ to $\dot{m}_{\max(F)}$	
[mm]	[inch]		
1	1/24	0 to 20 kg/h	0 to 0.7 lb/min
2	1/12	0 to 100 kg/h	0 to 3.7 lb/min
4	1/8	0 to 450 kg/h	0 to 16.5 lb/min
8	3/8	0 to 2000 kg/h	0 to 73.5 lb/min
15	½	0 to 6500 kg/h	0 to 238 lb/min
15 FB	½ FB	0 to 18000 kg/h	0 to 660 lb/min
25	1	0 to 18000 kg/h	0 to 660 lb/min
25 FB	1 FB	0 to 45000 kg/h	0 to 1650 lb/min
40	1 ½	0 to 45000 kg/h	0 to 1650 lb/min
40 FB	1 ½ FB	0 to 70000 kg/h	0 to 2570 lb/min
50	2	0 to 70000 kg/h	0 to 2570 lb/min
50 FB	2 FB	0 to 180000 kg/h	0 to 6600 lb/min
80	3	0 to 180000 kg/h	0 to 6600 lb/min
100	4	0 to 350000 kg/h	0 to 12860 lb/min
150	6	0 to 800000 kg/h	0 to 29400 lb/min
250	10	0 to 2200000 kg/h	0 to 80860 lb/min
350	14	0 to 4100 t/h	0 to 4520 tn. sh./h

FB = Full bore versions of Promass I

Measuring ranges for gases, general, (except Promass H (Zr))

The full scale values depend on the density of the gas. Use the formula below to calculate the full scale values:

$$\dot{m}_{\max(G)} = \dot{m}_{\max(F)} \cdot \rho_{(G)} : x \text{ [kg/m}^3 \text{ (lb/ft}^3\text{)]}$$

$\dot{m}_{\max(G)}$ = Max. full scale value for gas [kg/h (lb/min)]

$\dot{m}_{\max(F)}$ = Max. full scale value for liquid [kg/h (lb/min)]

$\rho_{(G)}$ = Gas density in [kg/m³ (lb/ft³)] for process conditions

Here, $\dot{m}_{\max(G)}$ can never be greater than $\dot{m}_{\max(F)}$

Measuring ranges for gases (Promass F, O):

DN		x
[mm]	[inch]	
8	3/8	60
15	1/2	80
25	1	90
40	1 1/2	90
50	2	90
80	3	110
100	4	130
150	6	200
250	10	200

Measuring ranges for gases (Promass E)

DN		x
[mm]	[inch]	
8	3/8	85
15	1/2	110
25	1	125
40	1 1/2	125
50	2	125
80	3	155

Measuring ranges for gases (Promass P, S, H (Ta))

DN		x
[mm]	[inch]	
8	3/8	60
15	1/2	80
25	1	90
40 ¹⁾	1 1/2 ¹⁾	90
50 ¹⁾	2 ¹⁾	90

¹⁾ only Promass P, S

Measuring ranges for gases (Promass A)

DN		x
[mm]	[inch]	
1	1/24	32
2	1/12	32
4	1/8	32

Measuring ranges for gases (Promass I)

DN		x
[mm]	[inch]	
8	3/8	60
15	½	80
15 FB	½ FB	90
25	1	90
25 FB	1 FB	90
40	1 ½	90
40 FB	1 ½ FB	90
50	2	90
50 FB	2 FB	110
80	3	110

FB = Full bore versions of Promass I

Measuring ranges for gases (Promass X)

DN		x
[mm]	[inch]	
350	14	200

Calculation example for gas:

- Sensor type: Promass F, DN 50
- Gas: air with a density of 60.3 kg/m³ (at 20 °C and 50 bar)
- Measuring range (liquid): 70000 kg/h
- x = 90 (for Promass F DN 50)

Max. possible full scale value:

$$\dot{m}_{\max(G)} = \dot{m}_{\max(F)} \cdot \rho_{(G)} \div x \text{ [kg/m}^3\text{]} = 70000 \text{ kg/h} \cdot 60.3 \text{ kg/m}^3 \div 90 \text{ kg/m}^3 = 46900 \text{ kg/h}$$

Recommended full scale values

See → Page 127 ff. ("Limiting flow")

Operable flow range

Greater than 1000 : 1. Flows above the preset full scale value do not overload the amplifier, i.e. totalizer values are registered correctly.

Input signal	<p><i>Status input (auxiliary input):</i></p> <p>$U = 3$ to 30 V DC, $R_i = 3$ kΩ, galvanically isolated. Switch level: ± 3 to ± 30 VDC, independent of polarity</p> <p><i>Status input (auxiliary input):</i></p> <p>$U = 3$ to 30 V DC, $R_i = 3$ kΩ, galvanically isolated. Switch level: 3 to 30 V DC, independent of polarity. Configurable for: totalizer reset, positive zero return, error message reset, zero point adjustment start.</p>
--------------	--



10.1.4 Output

Output signal	<p><i>Current output</i></p> <p>Active/passive selectable, galvanically isolated, time constant selectable (0.05 to 100 s), full scale value selectable, temperature coefficient: typically 0.005% o.f.s/°C, resolution: 0.5 μA</p> <ul style="list-style-type: none"> ■ Active: 0/4 to 20 mA, $R_L < 700$ Ω ■ Passive: 4 to 20 mA; supply voltage U_S 18 to 30 V DC; $R_i \geq 150$ Ω <p><i>Pulse / frequency output:</i></p> <p>Active/passive selectable, galvanically isolated</p> <ul style="list-style-type: none"> ■ Active: 24 V DC, 25 mA (max. 250 mA during 20 ms), $R_L > 100$ Ω ■ Passive: open collector, 30 V DC, 250 mA ■ Frequency output: full scale frequency 2 to 10000 Hz ($f_{max} = 12500$ Hz), on/off ratio 1:1, pulse width max. 2 s ■ Pulse output: pulse value and pulse polarity selectable, pulse width configurable (0.05 to 2000 ms) <p><i>Modbus RS485:</i></p> <ul style="list-style-type: none"> ■ Modbus device type: slave ■ Address range: 1 to 247 ■ Functions codes supported: 03, 04, 06, 08, 16, 23 ■ Broadcast: supported with the function codes 06, 16, 23 ■ Physical interface: RS485 in accordance with standard EIA/TIA-485 ■ Baudrate supported: 1 200, 2400, 4800, 9600, 19200, 38400, 57600, 115200 Baud ■ Transmission mode: RTU or ASCII ■ Response time: <ul style="list-style-type: none"> Direct data access = typically 25 to 50 ms Auto-scan buffer (data area) = typically 3 to 5 ms ■ Possible output combinations → 31
---------------	--

Signal on alarm	<p><i>Current output</i></p> <p>Failsafe mode selectable (for example NAMUR recommendation NE 43)</p> <p><i>Pulse/frequency output</i></p> <p>Failsafe mode selectable</p> <p><i>Relay output</i></p> <p>De-energized by fault or power supply failure</p> <p><i>Modbus RS485</i></p> <p>If an error occurs, the value NaN (not a number) is output for the process variables.</p>
-----------------	--

Load	See "Output signal"
Relay output:	Normally closed (NC or break) or normally open (NO or make) contacts available (default: relay 1 = NO, relay 2 = NC), max. 30 V / 0.5 A AC; 60 V / 0.1 A DC, galvanically isolated.
Low flow cut off	Switch points for low flow cut off are selectable.
Galvanic isolation	All circuits for inputs, outputs, and power supply are galvanically isolated from each other.

10.1.5 Power supply

Electrical connections	→  26
Supply voltage	85 to 260 V AC, 45 to 65 Hz 20 to 55 V AC, 45 to 65 Hz 16 to 62 V DC
Cable entries	<p><i>Power supply and signal cables (inputs/outputs):</i></p> <ul style="list-style-type: none"> ■ Cable entry M20 × 1.5 (8 to 12 mm / 0.31 to 0.47 inch) ■ Threads for cable entries, 1/2" NPT, G 1/2" <p><i>Connecting cable for remote version:</i></p> <ul style="list-style-type: none"> ■ Cable entry M20 × 1.5 (8 to 12 mm / 0.31 to 0.47 inch) ■ Threads for cable entries, 1/2" NPT, G 1/2"
Cable specifications; remote version	→  29
Power consumption	<p>AC: <15 VA (including sensor) DC: <15 W (including sensor)</p> <p><i>Switch-on current:</i></p> <ul style="list-style-type: none"> ■ max. 13.5 A (< 50 ms) at 24 V DC ■ max. 3 A (< 5 ms) at 260 V AC
Power supply failure	<p>Lasting min. 1 power cycle:</p> <ul style="list-style-type: none"> ■ EEPROM and T-DAT save measuring system data if power supply fails ■ HistoROM/S-DAT: exchangeable data storage chip which stores the data of the sensor (nominal diameter, serial number, calibration factor, zero point, etc.)
Potential equalization	No measures necessary.

10.1.6 Performance characteristics

Reference operating conditions

- Error limits following ISO/DIN 11631
- Water, typically +15 to +45 °C (+59 to +113 °F); 2 to 6 bar (29 to 87 psi)
- Data according to calibration protocol ±5 °C (±9 °F) and ±2 bar (±29 psi)
- Accuracy based on accredited calibration rigs according to ISO 17025

Performance characteristic Promass A

o.r. = of reading; 1 g/cm³ = 1 kg/l; T = medium temperature

Maximum measured error

The following values refer to the pulse/frequency output.
 The additional measured error at the current output is typically ±5 µA.
 Design fundamentals → 114.

- Mass flow and volume flow (liquids): ±0.10% o.r.
- Mass flow (gases): ±0.50% o.r.
- Density (liquids)
 - Reference conditions: ±0.0005 g/cm³
 - Field density calibration: ±0.0005 g/cm³
 (valid after field density calibration under process conditions)
 - Standard density calibration: ±0.02 g/cm³
 (valid over the entire temperature range and density range → 134)
 - Special density calibration: ±0.002 g/cm³
 (optional, valid range: +5 to +80 °C (+41 to +176 °F) and 0.0 to 2.0 g/cm³)
- Temperature: ±0.5 °C ± 0.005 · T °C; ±1 °F ± 0.003 · (T - 32) °F

Zero point stability

DN		Max. full scale value		Zero point stability	
[mm]	[inch]	[kg/h] or [l/h]	[lb/min]	[kg/h] or [l/h]	[lb/min]
1	1/24	20	0.73	0.0010	0.000036
2	1/12	100	3.70	0.0050	0.00018
4	1/8	450	16.5	0.0225	0.0008

Example for max. measured error

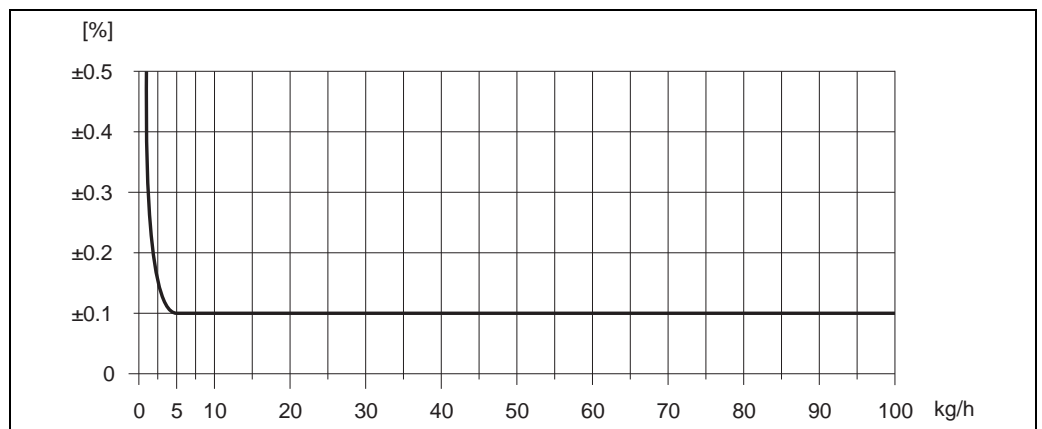

Fig. 54: Max. measured error in % o.r. (example: Promass A, DN 2)

Flow values (example)

Turn down	Flow		Max. measured error [% o.r.]
	[kg/h]	[lb/min.]	
250:1	0.4	0.0147	1.250
100:1	1.0	0.0368	0.500
25:1	4.0	0.1470	0.125
10:1	10	0.3675	0.100
2:1	50	1.8375	0.100

Design fundamentals → 114

Repeatability

Design fundamentals → 114

- Mass flow and volume flow (liquids): ±0.05% o.r.
- Mass flow (gases): ±0.25% o.r.
- Density (liquids): ±0.00025 g/cm³
- Temperature: ±0.25 °C ± 0.0025 · T °C; ±0.5 °F ± 0.0015 · (T - 32) °F

Influence of medium temperature

When there is a difference between the temperature for zero point adjustment and the process temperature, the typical measured error of the sensor is ±0.0002% of the full scale value / °C (±0.0001% of the full scale value/°F).

Influence of medium pressure

A difference in pressure between the calibration pressure and the process pressure does not have any effect on the accuracy.

Design fundamentals

Dependent on the flow:

- Flow ≥ Zero point stability ÷ (Base accuracy ÷ 100)
 - Max. measured error: ±Base accuracy in % o.r.
 - Repeatability: ± ½ · Base accuracy in % o.r.
- Flow < Zero point stability ÷ (Base accuracy ÷ 100)
 - Max. measured error: ± (Zero point stability ÷ measured value) · 100% o.r.
 - Repeatability: ± ½ · (Zero point stability ÷ measured value) · 100% o.r.

Base accuracy for	
Mass flow liquids	0.10
Volume flow liquids	0.10
Mass flow gases	0.50

Performance characteristic Promass E o.r. = of reading; $1 \text{ g/cm}^3 = 1 \text{ kg/l}$; T = medium temperature

Maximum measured error

The following values refer to the pulse/frequency output.
The additional measured error at the current output is typically $\pm 5 \mu\text{A}$.
Design fundamentals →  117.

- Mass flow and volume flow (liquids): $\pm 0.25\%$ o.r.
- Mass flow (gases): $\pm 0.75\%$ o.r.
- Density (liquids)
 - Reference conditions: $\pm 0.0005 \text{ g/cm}^3$
 - Field density calibration: $\pm 0.0005 \text{ g/cm}^3$
(valid after field density calibration under process conditions)
 - Standard density calibration: $\pm 0.02 \text{ g/cm}^3$
(valid over the entire temperature range and density range →  134)
- Temperature: $\pm 0.5 \text{ }^\circ\text{C} \pm 0.005 \cdot T \text{ }^\circ\text{C}$; $\pm 1 \text{ }^\circ\text{F} \pm 0.003 \cdot (T - 32) \text{ }^\circ\text{F}$

Zero point stability

DN		Zero point stability	
[mm]	[inch]	[kg/h] or [l/h]	[lb/min]
8	3/8	0.20	0.0074
15	1/2	0.65	0.0239
25	1	1.80	0.0662
40	1 1/2	4.50	0.1654
50	2	7.00	0.2573
80	3	18.00	0.6615

Example for max. measured error

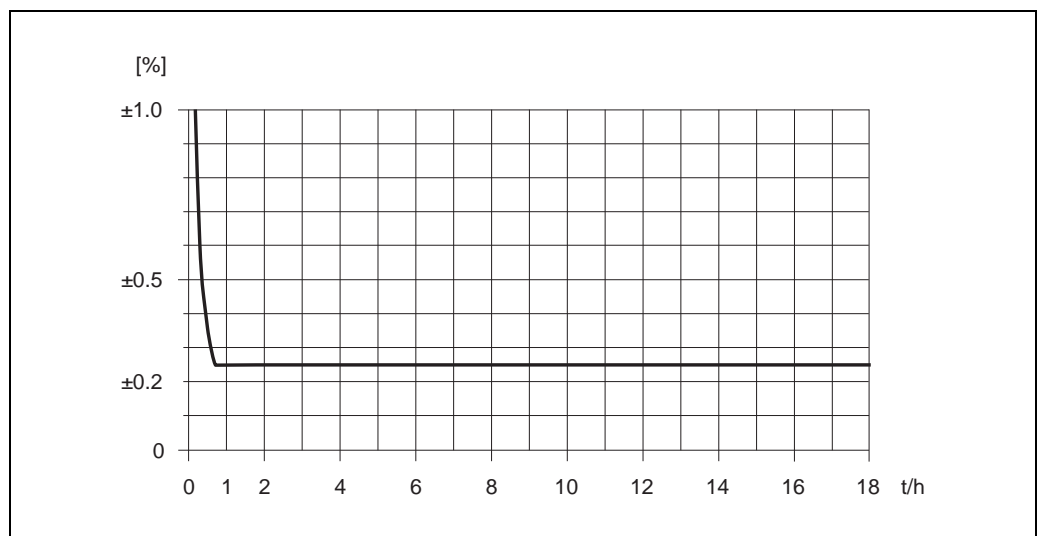

Fig. 55: Max. measured error in % o.r. (example: Promass E, DN 25)

Flow values (example)

Turn down	Flow		Maximum measured error [% o.r.]
	[kg/h]	[lb/min]	
250 : 1	72	2.646	2.50
100 : 1	180	6.615	1.00
25 : 1	720	26.46	0.25
10 : 1	1800	66.15	0.25
2 : 1	9000	330.75	0.25

Design fundamentals →  117

Repeatability

Design fundamentals →  117

- Mass flow and volume flow (liquids): ±0.10% o.r.
- Mass flow (gases): ±0.35% o.r.
- Density (liquids): ±0.00025 g/cm³
- Temperature: ±0.25 °C ± 0.0025 · T °C; ±0.5 °F ± 0.0015 · (T - 32) °F

Influence of medium temperature

When there is a difference between the temperature for zero point adjustment and the process temperature, the typical measured error of the sensor is ±0.0002% of the full scale value / °C (±0.0001% of the full scale value/°F).

Influence of medium pressure

The table below shows the effect on accuracy of mass flow due to a difference between calibration pressure and process pressure.

DN		[% o.r./bar]
[mm]	[inch]	
8	3/8	no influence
15	½	no influence
25	1	no influence
40	1½	no influence
50	2	-0.009
80	3	-0.020

Design fundamentals

Dependent on the flow:

- Flow \geq Zero point stability \div (Base accuracy \div 100)
 - Max. measured error: \pm Base accuracy in % o.r.
 - Repeatability: $\pm \frac{1}{2} \cdot$ Base accuracy in % o.r.
- Flow $<$ Zero point stability \div (Base accuracy \div 100)
 - Max. measured error: \pm (Zero point stability \div measured value) \cdot 100% o.r.
 - Repeatability: $\pm \frac{1}{2} \cdot$ (Zero point stability \div measured value) \cdot 100% o.r.

Base accuracy for	
Mass flow liquids	0.25
Volume flow liquids	0.25
Mass flow gases	0.75

Performance characteristic
Promass Fo.r. = of reading; $1 \text{ g/cm}^3 = 1 \text{ kg/l}$; T = medium temperature*Maximum measured error*

The following values refer to the pulse/frequency output.

The additional measured error at the current output is typically $\pm 5 \mu\text{A}$.Design fundamentals \rightarrow  119.

- Mass flow and volume flow (liquids):
 - $\pm 0.05\%$ o.r. (PremiumCal, for mass flow)
 - $\pm 0.10\%$ o.r.
- Mass flow (gases): $\pm 0.35\%$ o.r.
- Density (liquids)
 - Reference conditions: $\pm 0.0005 \text{ g/cm}^3$
 - Field density calibration: $\pm 0.0005 \text{ g/cm}^3$
(valid after field density calibration under process conditions)
 - Standard density calibration: $\pm 0.01 \text{ g/cm}^3$
(valid over the entire temperature range and density range \rightarrow  134)
 - Special density calibration: $\pm 0.001 \text{ g/cm}^3$
(optional, valid range: $+5$ to $+80 \text{ }^\circ\text{C}$ ($+41$ to $+176 \text{ }^\circ\text{F}$) and 0.0 to 2.0 g/cm^3)
- Temperature: $\pm 0.5 \text{ }^\circ\text{C} \pm 0.005 \cdot T \text{ }^\circ\text{C}$; $\pm 1 \text{ }^\circ\text{F} \pm 0.003 \cdot (T - 32) \text{ }^\circ\text{F}$

Zero point stability Promass F (standard)

DN		Zero point stability Promass F (Standard)	
[mm]	[inch]	[kg/h] or [l/h]	[lb/min]
8	3/8	0.030	0.001
15	1/2	0.200	0.007
25	1	0.540	0.019
40	1 1/2	2.25	0.083
50	2	3.50	0.129
80	3	9.00	0.330
100	4	14.00	0.514
150	6	32.00	1.17
250	10	88.00	3.23

Zero point stability Promass F (high-temperature version)

DN		Zero point stability Promass F (high-temperature version)	
[mm]	[inch]	[kg/h] or [l/h]	[lb/min]
25	1	1.80	0.0661
50	2	7.00	0.2572
80	3	18.0	0.6610

Example for max. measured error

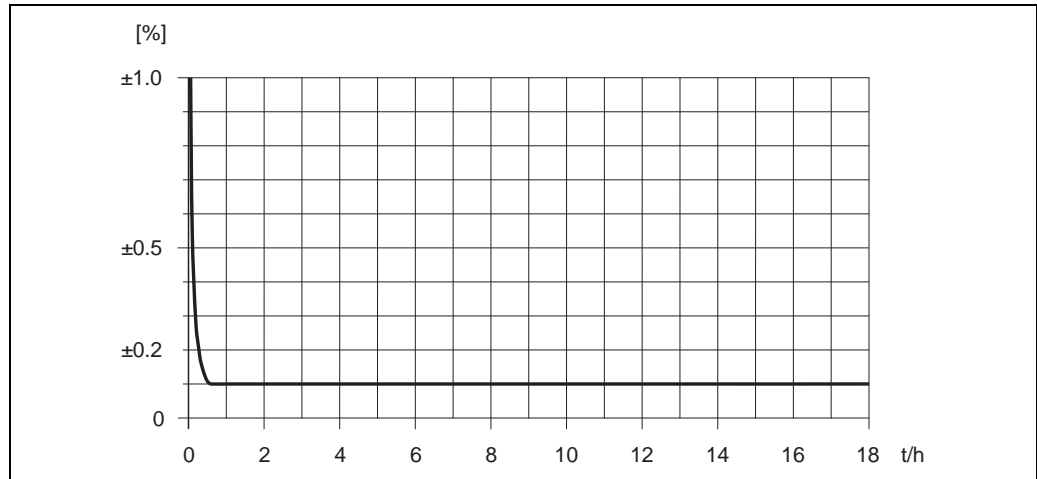

Fig. 56: Max. measured error in % o.r. (example: Promass F, DN 25)

Flow values (example)

Turn down	Flow		Maximum measured error [% o.r.]
	[kg/h]	[lb/min]	
500 : 1	36	1.323	1.5
100 : 1	180	6.615	0.3
25 : 1	720	26.46	0.1
10 : 1	1800	66.15	0.1
2 : 1	9000	330.75	0.1

Design fundamentals → 119

Repeatability

Design fundamentals → 119.

- Mass flow and volume flow (liquids):
 ±0.025% o.r. (PremiumCal, for mass flow)
 ±0.05% o.r.
- Mass flow (gases): ±0.25% o.r.
- Density (liquids): ±0.00025 g/cm³
- Temperature: ±0.25 °C ± 0.0025 · T °C; ±0.5 °F ± 0.0015 · (T - 32) °F

Influence of medium temperature

When there is a difference between the temperature for zero point adjustment and the process temperature, the typical measured error of the sensor is $\pm 0.0002\%$ of the full scale value / $^{\circ}\text{C}$ ($\pm 0.0001\%$ of the full scale value/ $^{\circ}\text{F}$).

Influence of medium pressure

The table below shows the effect on accuracy of mass flow due to a difference between calibration pressure and process pressure.

DN		Promass F (standard)	Promass F (high-temperature version)
[mm]	[inch]	[% o.r./bar]	[% o.r./bar]
8	3/8	no influence	–
15	1/2	no influence	–
25	1	no influence	no influence
40	1 1/2	–0.003	–
50	2	–0.008	–0.008
80	3	–0.009	–0.009
100	4	–0.007	–
150	6	–0.009	–
250	10	–0.009	–

Design fundamentals

Dependent on the flow:

- Flow \geq Zero point stability \div (Base accuracy \div 100)
 - Max. measured error: \pm Base accuracy in % o.r.
 - Repeatability: $\pm 1/2 \cdot$ Base accuracy in % o.r.
- Flow $<$ Zero point stability \div (Base accuracy \div 100)
 - Max. measured error: \pm (Zero point stability \div measured value) \cdot 100% o.r.
 - Repeatability: $\pm 1/2 \cdot$ (Zero point stability \div measured value) \cdot 100% o.r.

Base accuracy for	
Mass flow liquids, PremiumCal	0.05
Mass flow liquids	0.10
Volume flow liquids	0.10
Mass flow gases	0.35

Performance characteristic
Promass H

o.r. = of reading; $1 \text{ g/cm}^3 = 1 \text{ kg/l}$; T = medium temperature

Maximum measured error

The following values refer to the pulse/frequency output.
The additional measured error at the current output is typically $\pm 5 \mu\text{A}$.
Design fundamentals → 122.

- Mass flow and volume flow (liquids)
Zirconium 702/R 60702 and Tantalum 2.5W: $\pm 0.10\%$ o.r.
- Mass flow (gases)
Tantalum 2.5W: $\pm 0.50\%$ o.r.
- Density (liquids)
Zirconium 702/R 60702 and Tantalum 2.5W
 - Reference conditions: $\pm 0.0005 \text{ g/cm}^3$
 - Field density calibration: $\pm 0.0005 \text{ g/cm}^3$
(valid after field density calibration under process conditions)
 - Standard density calibration: $\pm 0.02 \text{ g/cm}^3$
(valid over the entire temperature range and density range → 134)
 - Special density calibration: $\pm 0.002 \text{ g/cm}^3$
(optional, valid range: $+10$ to $+80 \text{ }^\circ\text{C}$ ($+50$ to $+176 \text{ }^\circ\text{F}$) and 0.0 to 2.0 g/cm^3)
- Temperature: $\pm 0.5 \text{ }^\circ\text{C} \pm 0.005 \cdot T \text{ }^\circ\text{C}$; $\pm 1 \text{ }^\circ\text{F} \pm 0.003 \cdot (T - 32) \text{ }^\circ\text{F}$

Zero point stability

DN		Zero point stability	
[mm]	[inch]	[kg/h] or [l/h]	[lb/min]
8	3/8	0.20	0.007
15	1/2	0.65	0.024
25	1	1.80	0.066
40	1 1/2	4.50	0.165
50	2	7.00	0.257

Example for max. measured error

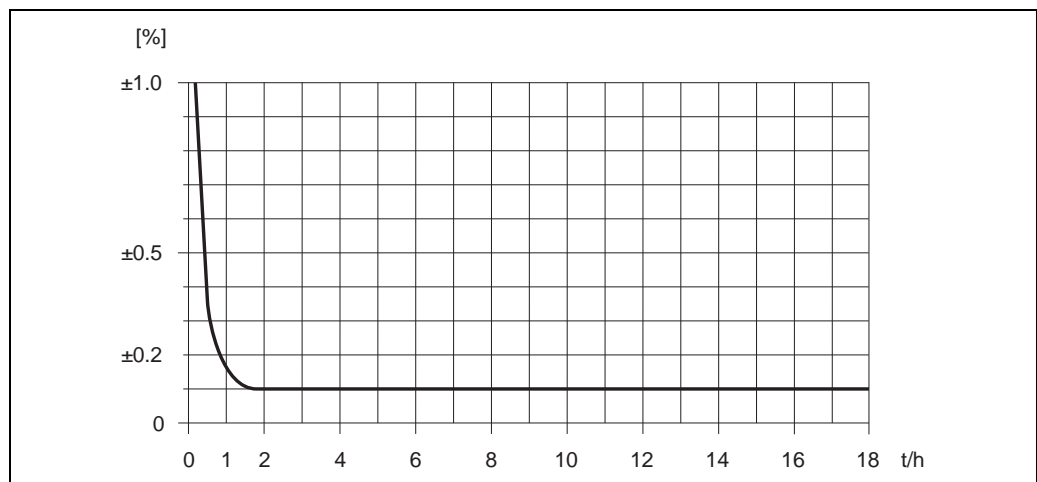

Fig. 57: Max. measured error in % o.r. (example: Promass H, DN 25)

Flow values (example)

Turn down	Flow		Maximum measured error [% o.r.]
	[kg/h]	[lb/min]	
250 : 1	72	2.646	2.50
100 : 1	180	6.615	1.00
25 : 1	720	26.46	0.25
10 : 1	1800	66.15	0.10
2 : 1	9000	330.75	0.10

Design fundamentals →  122*Repeatability*Design fundamentals →  122.*Material measuring tube: Zirconium 702/R 60702*

- Mass flow and volume flow (liquids): $\pm 0.05\%$ o.r.
- Density (liquids): ± 0.00025 g/cm³
- Temperature: ± 0.25 °C $\pm 0.0025 \cdot T$ °C; ± 0.5 °F $\pm 0.0015 \cdot (T - 32)$ °F

Material measuring tube: Tantalum 2.5W

- Mass flow and volume flow (liquids): $\pm 0.05\%$ o.r.
- Mass flow (gases): $\pm 0.25\%$ o.r.
- Density (liquids): ± 0.0005 g/cm³
- Temperature: ± 0.25 °C $\pm 0.0025 \cdot T$ °C; ± 0.5 °F $\pm 0.0015 \cdot (T - 32)$ °F

Influence of medium temperature

When there is a difference between the temperature for zero point adjustment and the process temperature, the typical measured error of the sensor is $\pm 0.0002\%$ of the full scale value / °C ($\pm 0.0001\%$ of the full scale value/°F).

Influence of medium pressure

The table below shows the effect on accuracy of mass flow due to a difference between calibration pressure and process pressure.

DN		Promass H Zirconium 702/R 60702	Promass H Tantalum 2.5W
[mm]	[inch]	[% o.r./bar]	[% o.r./bar]
8	3/8	-0.017	-0.010
15	1/2	-0.021	-0.010
25	1	-0.013	-0.012
40	1 1/2	-0.018	-
50	2	-0.020	-

Design fundamentals

Dependent on the flow:

- Flow \geq Zero point stability \div (Base accuracy \div 100)
 - Max. measured error: \pm Base accuracy in % o.r.
 - Repeatability: \pm $\frac{1}{2}$ · Base accuracy in % o.r.
- Flow $<$ Zero point stability \div (Base accuracy \div 100)
 - Max. measured error: \pm (Zero point stability \div measured value) · 100% o.r.
 - Repeatability: \pm $\frac{1}{2}$ · (Zero point stability \div measured value) · 100% o.r.

Base accuracy for	
Mass flow liquids	0.10
Volume flow liquids	0.10
Mass flow gases	0.50

Performance characteristic
Promass I

o.r. = of reading; 1 g/cm³ = 1 kg/l; T = medium temperature

Maximum measured error

The following values refer to the pulse/frequency output.
The additional measured error at the current output is typically $\pm 5 \mu\text{A}$.
Design fundamentals → 124.

- Mass flow and volume flow (liquids): $\pm 0.10\%$ o.r.
- Mass flow (gases): $\pm 0.50\%$ o.r.
- Density (liquids)
 - Reference conditions: $\pm 0.0005 \text{ g/cm}^3$
 - Field density calibration: $\pm 0.0005 \text{ g/cm}^3$
(valid after field density calibration under process conditions)
 - Standard density calibration: $\pm 0.02 \text{ g/cm}^3$
(valid over the entire temperature range and density range → 134)
 - Special density calibration: $\pm 0.004 \text{ g/cm}^3$
(optional, valid range: +10 to +80 °C (+50 to +176 °F) and 0.0 to 2.0 g/cm³)
- Temperature: $\pm 0.5 \text{ °C} \pm 0.005 \cdot T \text{ °C}$; $\pm 1 \text{ °F} \pm 0.003 \cdot (T - 32) \text{ °F}$

Zero point stability

DN		Zero point stability	
[mm]	[inch]	[kg/h] or [l/h]	[lb/min]
8	3/8	0.150	0.0055
15	1/2	0.488	0.0179
15 FB	1/2 FB	1.350	0.0496
25	1	1.350	0.0496
25 FB	1 FB	3.375	0.124
40	1 1/2	3.375	0.124
40 FB	1 1/2 FB	5.250	0.193
50	2	5.250	0.193
50 FB	2 FB	13.50	0.496
80	3	13.50	0.496

FB = Full bore

Example for max. measured error

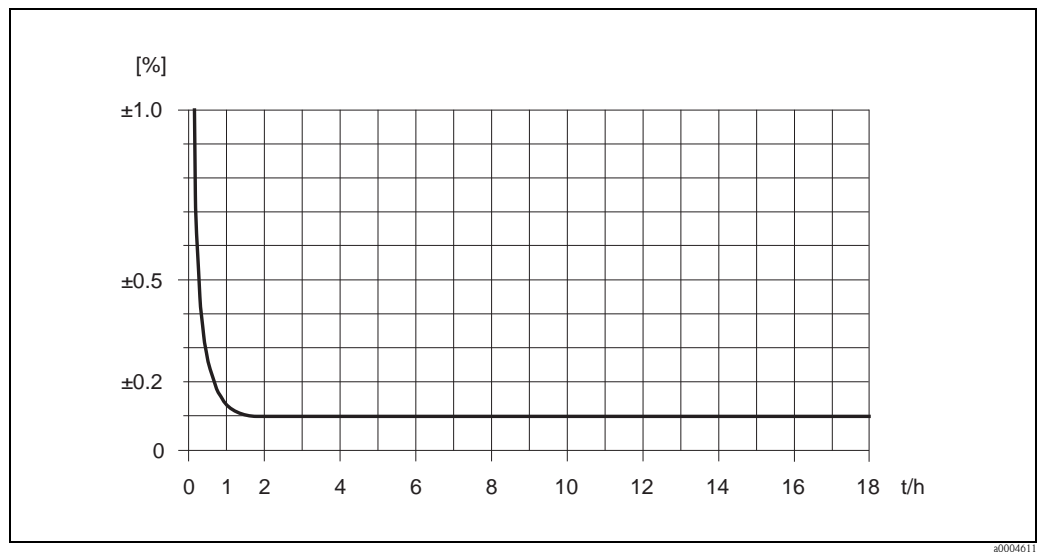

Fig. 58: Max. measured error in % o.r. (example: Promass I, DN 25)

Flow values (example)

Turn down	Flow		Maximum measured error [% o.r.]
	[kg/h]	[lb/min]	
250 : 1	72	2.646	1.875
100 : 1	180	6.615	0.750
25 : 1	720	26.46	0.188
10 : 1	1800	66.15	0.100
2 : 1	9000	330.75	0.100

Design fundamentals → 124

Repeatability

Design fundamentals → 124

- Mass flow and volume flow (liquids): ±0.05% o.r.
- Mass flow (gases): ±0.25% o.r.
- Density (liquids): ±0.00025 g/cm³
- Temperature: ±0.25 °C ± 0.0025 · T °C; ±0.5 °F ± 0.0015 · (T - 32) °F

Influence of medium temperature

When there is a difference between the temperature for zero point adjustment and the process temperature, the typical measured error of the sensor is ±0.0002% of the full scale value / °C (±0.0001% of the full scale value/°F).

Influence of medium pressure

The table below shows the effect on accuracy of mass flow due to a difference between calibration pressure and process pressure.

DN		[% o.r./bar]
[mm]	[inch]	
8	3/8	0.006
15	1/2	0.004
15 FB	1/2 FB	0.006
25	1	0.006
25 FB	1 FB	no influence
40	1 1/2	no influence
40 FB	1 1/2 FB	-0.003
50	2	-0.003
50 FB	2 FB	0.003
80	3	0.003

FB = Full bore

Design fundamentals

Dependent on the flow:

- Flow ≥ Zero point stability ÷ (Base accuracy ÷ 100)
 - Max. measured error: ±Base accuracy in % o.r.
 - Repeatability: ± 1/2 · Base accuracy in % o.r.
- Flow < Zero point stability ÷ (Base accuracy ÷ 100)
 - Max. measured error: ± (Zero point stability ÷ measured value) · 100% o.r.
 - Repeatability: ± 1/2 · (Zero point stability ÷ measured value) · 100% o.r.

Base accuracy for	
Mass flow liquids	0.10
Volume flow liquids	0.10
Mass flow gases	0.50

Performance characteristic
Promass O

o.r. = of reading; 1 g/cm³ = 1 kg/l; T = medium temperature

Maximum measured error

The following values refer to the pulse/frequency output.
The additional measured error at the current output is typically ±5 µA.
Design fundamentals → 126.

- Mass flow and volume flow (liquids):
 - ±0.05% o.r. (PremiumCal, for mass flow)
 - ±0.10% o.r.
- Mass flow (gases): ±0.35% o.r.
- Density (liquids)
 - Reference conditions: ±0.0005 g/cm³
 - Field density calibration: ±0.0005 g/cm³
(valid after field density calibration under process conditions)
 - Standard density calibration: ±0.01 g/cm³
(valid over the entire temperature range and density range → 134)

- Special density calibration: $\pm 0.001 \text{ g/cm}^3$
(optional, valid range: +5 to +80 °C (+41 to +176 °F) and 0.0 to 2.0 g/cm³)
- Temperature: $\pm 0.5 \text{ °C} \pm 0.005 \cdot T \text{ °C}$; $\pm 1 \text{ °F} \pm 0.003 \cdot (T - 32) \text{ °F}$

Zero point stability

DN		Zero point stability Promass F (Standard)	
[mm]	[inch]	[kg/h] or [l/h]	[lb/min]
80	3	9.00	0.330
100	4	14.00	0.514
150	6	32.00	1.17

Example for max. measured error

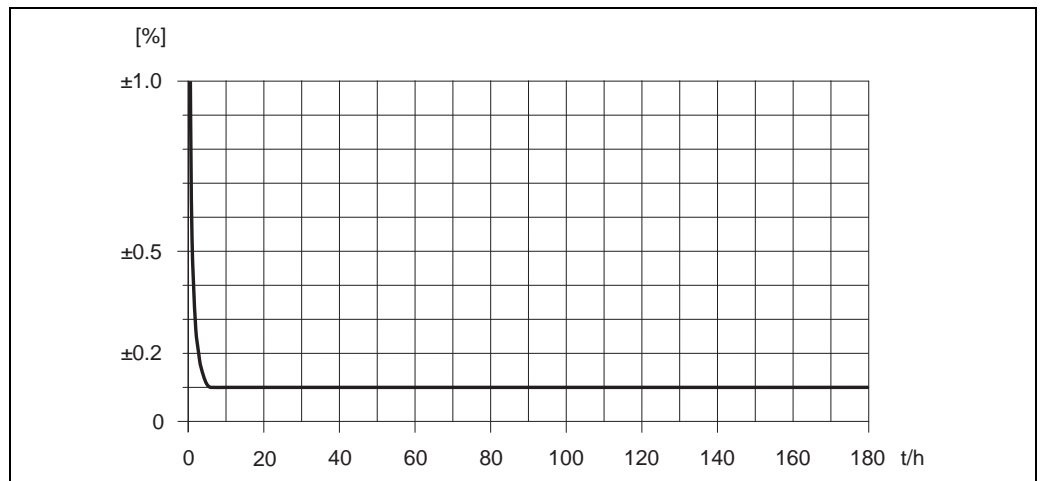

Fig. 59: Max. measured error in % o.r. (example DN 80)

Flow values (example DN 80)

Turn down	Flow		Maximum measured error [% o.r.]
	[kg/h]	[lb/min]	
500 : 1	360	13.23	1.5
100 : 1	1800	66.15	0.3
25 : 1	7200	264.6	0.1
10 : 1	18000	661.5	0.1
2 : 1	90000	3307.5	0.1

Design fundamentals → 126

Repeatability

Design fundamentals → 126.

- Mass flow and volume flow (liquids):
 ±0.025% o.r. (PremiumCal, for mass flow)
 ±0.05% o.r.
- Mass flow (gases): ±0.25% o.r.
- Density (liquids): ±0.00025 g/cm³
- Temperature: ±0.25 °C ± 0.0025 · T °C; ±0.5 °F ± 0.0015 · (T - 32) °F

Influence of medium temperature

When there is a difference between the temperature for zero point adjustment and the process temperature, the typical measured error of the sensor is ±0.0002% of the full scale value / °C (±0.0001% of the full scale value/°F).

Influence of medium pressure

The table below shows the effect on accuracy of mass flow due to a difference between calibration pressure and process pressure.

DN		Promass F (standard)
[mm]	[inch]	[% o.r./bar]
80	3	-0.0055
100	4	-0.0035
150	6	-0.002

Design fundamentals

Dependent on the flow:

- Flow ≥ Zero point stability ÷ (Base accuracy ÷ 100)
 - Max. measured error: ±Base accuracy in % o.r.
 - Repeatability: ± ½ · Base accuracy in % o.r.
- Flow < Zero point stability ÷ (Base accuracy ÷ 100)
 - Max. measured error: ± (Zero point stability ÷ measured value) · 100% o.r.
 - Repeatability: ± ½ · (Zero point stability ÷ measured value) · 100% o.r.

Base accuracy for	
Mass flow liquids, PremiumCal	0.05
Mass flow liquids	0.10
Volume flow liquids	0.10
Mass flow gases	0.35

Performance characteristic
Promass P

o.r. = of reading; $1 \text{ g/cm}^3 = 1 \text{ kg/l}$; T = medium temperature

Maximum measured error

The following values refer to the pulse/frequency output.
The additional measured error at the current output is typically $\pm 5 \mu\text{A}$.
Design fundamentals → 128.

- Mass flow and volume flow (liquids): $\pm 0.10\%$ o.r.
- Mass flow (gases): $\pm 0.50\%$ o.r.
- Density (liquids)
 - Reference conditions: $\pm 0.0005 \text{ g/cm}^3$
 - Field density calibration: $\pm 0.0005 \text{ g/cm}^3$
(valid after field density calibration under process conditions)
 - Standard density calibration: $\pm 0.01 \text{ g/cm}^3$
(valid over the entire temperature range and density range → 134)
 - Special density calibration: $\pm 0.002 \text{ g/cm}^3$
(optional, valid range: $+5$ to $+80 \text{ }^\circ\text{C}$ ($+41$ to $+176 \text{ }^\circ\text{F}$) and 0.0 to 2.0 g/cm^3)
- Temperature: $\pm 0.5 \text{ }^\circ\text{C} \pm 0.005 \cdot T \text{ }^\circ\text{C}$; $\pm 1 \text{ }^\circ\text{F} \pm 0.003 \cdot (T - 32) \text{ }^\circ\text{F}$

Zero point stability

DN		Zero point stability	
[mm]	[inch]	[kg/h] or [l/h]	[lb/min]
8	3/8	0.20	0.007
15	1/2	0.65	0.024
25	1	1.80	0.066
40	1 1/2	4.50	0.165
50	2	7.00	0.257

Example for max. measured error

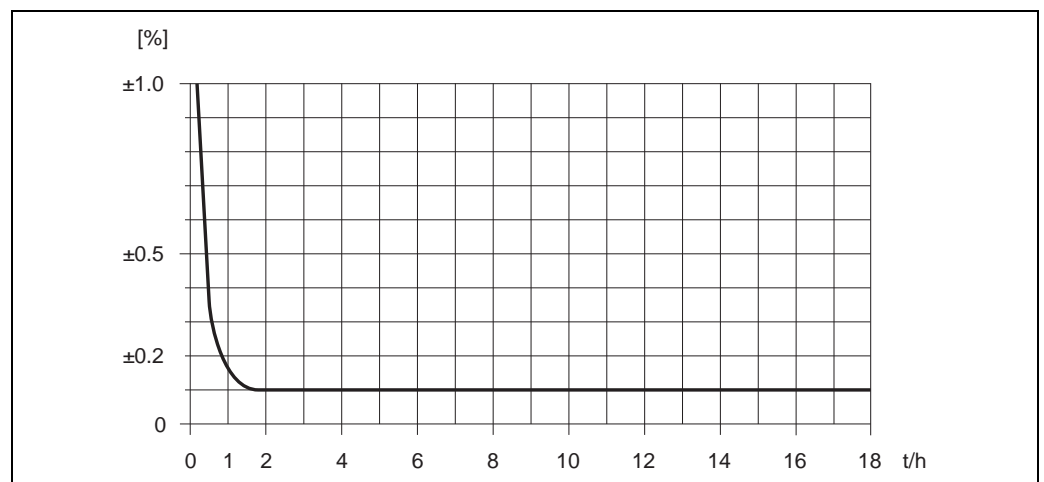

Fig. 60: Max. measured error in % o.r. (example: Promass P, DN 25)

Flow values (example)

Turn down	Flow		Maximum measured error [% o.r.]
	[kg/h]	[lb/min]	
250 : 1	72	2.646	2.50
100 : 1	180	6.615	1.00
25 : 1	720	26.46	0.25
10 : 1	1800	66.15	0.10
2 : 1	9000	330.75	0.10

Design fundamentals → 128

Repeatability

Design fundamentals → 128.

- Mass flow and volume flow (liquids): ±0.05% o.r.
- Mass flow (gases): ±0.25% o.r.
- Density (liquids): ±0.00025 g/cm³
- Temperature: ±0.25 °C ± 0.0025 · T °C; ±0.5 °F ± 0.0015 · (T - 32) °F

Influence of medium temperature

When there is a difference between the temperature for zero point adjustment and the process temperature, the typical measured error of the sensor is ±0.0002% of the full scale value / °C (±0.0001% of the full scale value/°F).

Influence of medium pressure

The table below shows the effect on accuracy of mass flow due to a difference between calibration pressure and process pressure.

DN		[% o.r./bar]
[mm]	[inch]	
8	3/8	-0.002
15	½	-0.006
25	1	-0.005
40	1½	-0.005
50	2	-0.005

Design fundamentals

Dependent on the flow:

- Flow ≥ Zero point stability ÷ (Base accuracy ÷ 100)
 - Max. measured error: ±Base accuracy in % o.r.
 - Repeatability: ± ½ · Base accuracy in % o.r.
- Flow < Zero point stability ÷ (Base accuracy ÷ 100)
 - Max. measured error: ± (Zero point stability ÷ measured value) · 100% o.r.
 - Repeatability: ± ½ · (Zero point stability ÷ measured value) · 100% o.r.

Base accuracy for	
Mass flow liquids	0.10
Volume flow liquids	0.10
Mass flow gases	0.50

Performance characteristic
Promass S

o.r. = of reading; $1 \text{ g/cm}^3 = 1 \text{ kg/l}$; T = medium temperature

Maximum measured error

The following values refer to the pulse/frequency output.
The additional measured error at the current output is typically $\pm 5 \mu\text{A}$.
Design fundamentals →  130.

- Mass flow and volume flow (liquids): $\pm 0.10\%$ o.r.
- Mass flow (gases): $\pm 0.50\%$ o.r.
- Density (liquids)
 - Reference conditions: $\pm 0.0005 \text{ g/cm}^3$
 - Field density calibration: $\pm 0.0005 \text{ g/cm}^3$
(valid after field density calibration under process conditions)
 - Standard density calibration: $\pm 0.01 \text{ g/cm}^3$
(valid over the entire temperature range and density range →  134)
 - Special density calibration: $\pm 0.002 \text{ g/cm}^3$
(optional, valid range: $+5$ to $+80 \text{ }^\circ\text{C}$ ($+41$ to $+176 \text{ }^\circ\text{F}$) and 0.0 to 2.0 g/cm^3)
- Temperature: $\pm 0.5 \text{ }^\circ\text{C} \pm 0.005 \cdot T \text{ }^\circ\text{C}$; $\pm 1 \text{ }^\circ\text{F} \pm 0.003 \cdot (T - 32) \text{ }^\circ\text{F}$

Zero point stability

DN		Zero point stability	
[mm]	[inch]	[kg/h] or [l/h]	[lb/min]
8	3/8	0.20	0.007
15	1/2	0.65	0.024
25	1	1.80	0.066
40	1 1/2	4.50	0.165
50	2	7.00	0.257

Example for max. measured error

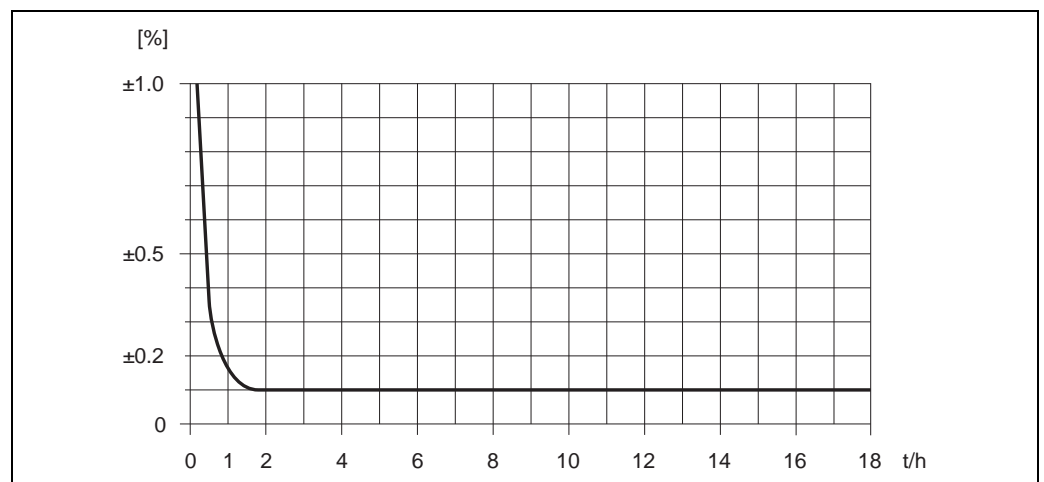

Fig. 61: Max. measured error in % o.r. (example: Promass S, DN 25)

Flow values (example)

Turn down	Flow		Maximum measured error [% o.r.]
	[kg/h]	[lb/min]	
250 : 1	72	2.646	2.50
100 : 1	180	6.615	1.00
25 : 1	720	26.46	0.25
10 : 1	1800	66.15	0.10
2 : 1	9000	330.75	0.10

Design fundamentals → 130

Repeatability

Design fundamentals → 130.

- Mass flow and volume flow (liquids): ±0.05% o.r.
- Mass flow (gases): ±0.25% o.r.
- Density (liquids): ±0.00025 g/cm³
- Temperature: ±0.25 °C ± 0.0025 · T °C; ±0.5 °F ± 0.0015 · (T - 32) °F

Influence of medium temperature

When there is a difference between the temperature for zero point adjustment and the process temperature, the typical measured error of the sensor is ±0.0002% of the full scale value / °C (±0.0001% of the full scale value/°F).

Influence of medium pressure

The table below shows the effect on accuracy of mass flow due to a difference between calibration pressure and process pressure.

DN		[% o.r./bar]
[mm]	[inch]	
8	3/8	-0.002
15	½	-0.006
25	1	-0.005
40	1½	-0.005
50	2	-0.005

Design fundamentals

Dependent on the flow:

- Flow ≥ Zero point stability ÷ (Base accuracy ÷ 100)
 - Max. measured error: ±Base accuracy in % o.r.
 - Repeatability: ± ½ · Base accuracy in % o.r.
- Flow < Zero point stability ÷ (Base accuracy ÷ 100)
 - Max. measured error: ± (Zero point stability ÷ measured value) · 100% o.r.
 - Repeatability: ± ½ · (Zero point stability ÷ measured value) · 100% o.r.

Base accuracy for	
Mass flow liquids	0.10
Volume flow liquids	0.10
Mass flow gases	0.50

Performance characteristic
Promass X

o.r. = of reading; $1 \text{ g/cm}^3 = 1 \text{ kg/l}$; T = medium temperature

Maximum measured error

The following values refer to the pulse/frequency output.
The additional measured error at the current output is typically $\pm 5 \mu\text{A}$.
Design fundamentals → 132.

- Mass flow and volume flow (liquids):
 - $\pm 0.05\%$ o.r. (PremiumCal, for mass flow)
 - $\pm 0.10\%$ o.r.
- Density (liquids)
 - Reference conditions: $\pm 0.0005 \text{ g/cm}^3$
 - Field density calibration: $\pm 0.0005 \text{ g/cm}^3$
(valid after field density calibration under process conditions)
 - Standard density calibration: $\pm 0.01 \text{ g/cm}^3$
(valid over the entire temperature range and density range → 134)
 - Special density calibration: $\pm 0.001 \text{ g/cm}^3$
(optional, valid range: $+5$ to $+80 \text{ }^\circ\text{C}$ ($+41$ to $+176 \text{ }^\circ\text{F}$) and 0.0 to 2.0 g/cm^3)
- Temperature: $\pm 0.5 \text{ }^\circ\text{C} \pm 0.005 \cdot T \text{ }^\circ\text{C}$; $\pm 1 \text{ }^\circ\text{F} \pm 0.003 \cdot (T - 32) \text{ }^\circ\text{F}$

Zero point stability

DN		Zero point stability Promass F (Standard)	
[mm]	[inch]	[kg/h] or [l/h]	[lb/min]
350	14	175	6.42

Example for max. measured error

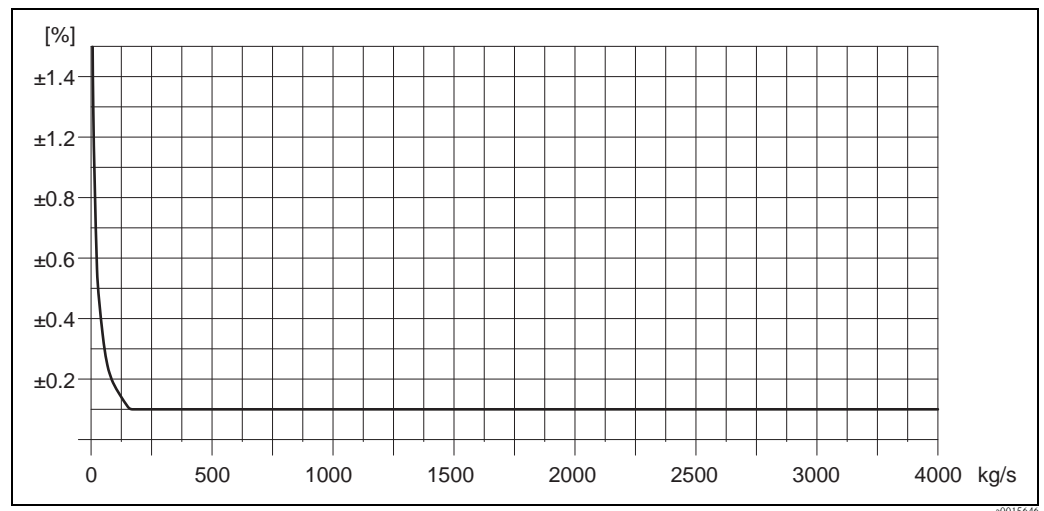

Fig. 62: Max. measured error in % o.r. (example: Promass 83X, DN 350)

Flow values (example)

Turn down	Flow		Maximum measured error [% o.r.]
	[kg/h]	[lb/min]	
500 : 1	8200	1.323	2.1
100 : 1	41 000	6.615	0.4
25 : 1	164 000	26.46	0.1
10 : 1	410 000	66.15	0.1
2 : 1	2 050 000	330.75	0.1

Design fundamentals → 132

Repeatability

Design fundamentals → 132.

- Mass flow and volume flow (liquids):
±0.025% o.r. (PremiumCal, for mass flow)
±0.05% o.r.
- Density (liquids): ±0.00025 g/cm³
- Temperature: ±0.25 °C ± 0.0025 · T °C; ±0.5 °F ± 0.0015 · (T - 32) °F

Influence of medium temperature

When there is a difference between the temperature for zero point adjustment and the process temperature, the typical measured error of the sensor is ±0.0002% of the full scale value / °C (±0.0001% of the full scale value/°F).

Influence of medium pressure

The table below shows the effect on accuracy of mass flow due to a difference between calibration pressure and process pressure.

DN		Promass F (standard) [% o.r./bar]
[mm]	[inch]	
350	14	-0.009



Design fundamentals

Dependent on the flow:

- Flow ≥ Zero point stability ÷ (Base accuracy ÷ 100)
 - Max. measured error: ±Base accuracy in % o.r.
 - Repeatability: ± ½ · Base accuracy in % o.r.
- Flow < Zero point stability ÷ (Base accuracy ÷ 100)
 - Max. measured error: ± (Zero point stability ÷ measured value) · 100% o.r.
 - Repeatability: ± ½ · (Zero point stability ÷ measured value) · 100% o.r.

Base accuracy for	
Mass flow liquids, PremiumCal	0.05
Mass flow liquids	0.10
Volume flow liquids	0.10

10.1.7 Operating conditions: Installation

Installation instructions	→  14
Inlet and outlet runs	There are no installation requirements regarding inlet and outlet runs.
Length of connecting cable; remote version	max. 20 m (65 ft)
System pressure	→  15

10.1.8 Operating conditions: Environment

Ambient temperature range	<p>Messaufnehmer und -umformer:</p> <ul style="list-style-type: none"> ■ Standard: -20 to +60 °C (-4 to +140°F) ■ Optional: -40 to +60 °C (-40 to +140°F) <p> Note!</p> <ul style="list-style-type: none"> ■ Install the device at a shady location. Avoid direct sunlight, particularly in warm climatic regions. ■ At ambient temperatures below -20 °C (-4 °F) the readability of the display may be impaired.
Storage temperature	-40 to +80 °C (-40 to +175 °F); preferably +20 °C (+68 °F)
Degree of protection	Standard: IP 67 (NEMA 4X) for transmitter and sensor
Shock resistance	According to IEC 68-2-31
Vibration resistance	Acceleration up to 1 g, 10 to 150 Hz, following IEC 68-2-6
CIP cleaning	Yes
SIP cleaning	Yes
Electromagnetic compatibility (EMC)	To IEC/EN 61326 and NAMUR Recommendation NE 21

10.1.9 Operating conditions: Process

Medium temperature range

Sensor:

Promass F, A, P:

–50 to +200 °C (–58 to +392 °F)

Promass F (high-temperature version):

–50 to +350 °C (–58 to +662 °F)

Promass H:

■ Zirconium 702/R 60702: –50 to +200 °C (–58 to +392 °F)

■ Tantalum 2.5W: –50 to +150 °C (–58 to +302 °F)

Promass I, S:

–50 to +150 °C (–58 to +302 °F)

Promass E:

–40 to +140 °C (–40 to +284 °F)

Promass O

–40 to +200 °C (–40 to +392 °F)

Promass X

–50 to +180 °C (–40 to +356 °F)

Seals:

Promass F, E, H, I, S, P, O, X:

No internal seals

Promass A

No seals inlying.

Only for mounting sets with threaded connections:

Viton: –15 to +200 °C (–5 to +392 °F)

EPDM: –40 to +160 °C (–40 to +320 °F)

Silicon: –60 to +200 °C (–76 to +392 °F)

Kalrez: –20 to +275 °C (–4 to +527 °F);

Fluid density range

0 to 5000 kg/m³ (0 to 312 lb/cf)

Limiting medium pressure range (rated pressure) The material load diagrams (pressure-temperature diagrams) for the process connections are provided in the separate "Technical Information" document on the device in question. This can be downloaded as a PDF file from www.endress.com. A list of the "Technical Information" documents available is provided in the "Documentation" section → [☰ 153](#).

Pressure ranges of secondary containment:

Promass A:

25 bar (362) psi

Promass E:

No secondary containment

Promass F:

DN 8 to 50 (3/8" to 2"): 40 bar (580 psi)

DN 80 (3"): 25 bar (362 psi)

DN 100 to 150 (4" to 6"): 16 bar (232 psi)

DN 250(10"): 10 bar (145 psi)

Promass H:

■ Zirconium 702/R 60702:

DN 8 to 15 (3/8" to 1/2"): 25 bar (362 psi)

DN 25 to 50 (1" to 2"): 16 bar (232 psi)

■ Tantalum 2.5W:

DN 8 to 25 (3/8" to 1"): 25 bar (362 psi)

DN 40 to 50 (1 1/2" to 2"): 16 bar (232 psi)

Promass I:

40 bar (580 psi)

Promass P:

DN 8 to 25 (3/8" to 1"): 25 bar (362 psi)

DN 40 (1 1/2"): 16 bar (232 psi)

DN 50 (2"): 10 bar (145 psi)

Promass S:

DN 8 to 40 (3/8" to 1 1/2"): 16 bar (232 psi)

DN 50 (2"): 10 bar (145 psi)

Promass O:

16 bar (232 psi)

Promass X:

Type approved, maximum allowable pressure according to ASME BPVC: 6 bar (87 psi)

Limiting flow

See the "Measuring range" section → Page 101 ff.

Select nominal diameter by optimizing between required flow range and permissible pressure loss. See the "Measuring range" section for a list of max. possible full scale values.

- The minimum recommended full scale value is approx. 1/20 of the max. full scale value.
- In most applications, 20 to 50% of the maximum full scale value can be considered ideal.
- Select a lower full scale value for abrasive substances such as liquids with entrained solids (flow velocity < 1 m/s (3 ft/s)).
- For gas measurement the following rules apply:
 - Flow velocity in the measuring tubes should not be more than half the sonic velocity (0.5 Mach).
 - The maximum mass flow depends on the density of the gas: formula → [109](#)

Pressure loss (SI units)

Pressure loss depends on the properties of the fluid and on its flow. The following formulas can be used to approximately calculate the pressure loss:

Pressure loss formulas for Promass F, E

Reynolds number	$Re = \frac{2 \cdot \dot{m}}{\pi \cdot d \cdot v \cdot \rho}$	a0004623
Re ≥ 2300 ¹⁾	$\Delta p = K \cdot v^{0.25} \cdot \dot{m}^{1.85} \cdot \rho^{-0.86}$	a0004626
	Promass F DN 250 $\Delta p = K \cdot \left[1 - a + \frac{a}{e^{b \cdot (v - 10^{-6})}} \right] \cdot v^{0.25} \cdot \dot{m}^{1.85} \cdot \rho^{-0.86}$	a0012135
Re < 2300	$\Delta p = K1 \cdot v \cdot \dot{m} + \frac{K2 \cdot v^{0.25} \cdot \dot{m}^2}{\rho}$	a0004628
Δp = pressure loss [mbar] v = kinematic viscosity [m ² /s] \dot{m} = mass flow [kg/s] ρ = fluid density [kg/m ³] d = inside diameter of measuring tubes [m] K to K2 = constants (depending on nominal diameter) a = 0.3 b = 91000 ¹⁾ To compute the pressure loss for gases, always use the formula for Re ≥ 2300.		

Pressure loss formulas for Promass H, I, S, P

Reynolds number	$Re = \frac{4 \cdot \dot{m}}{\pi \cdot d \cdot v \cdot \rho}$	a0003381
Re ≥ 2300 ¹⁾	$\Delta p = K \cdot v^{0.25} \cdot \dot{m}^{1.75} \cdot \rho^{-0.75} + \frac{K3 \cdot \dot{m}^2}{\rho}$	a0004631
Re < 2300	$\Delta p = K1 \cdot v \cdot \dot{m} + \frac{K3 \cdot \dot{m}^2}{\rho}$	a0004633
Δp = pressure loss [mbar] v = kinematic viscosity [m ² /s] \dot{m} = mass flow [kg/s] ρ = fluid density [kg/m ³] d = inside diameter of measuring tubes [m] K to K3 = constants (depending on nominal diameter) ¹⁾ To compute the pressure loss for gases, always use the formula for Re ≥ 2300.		

Pressure loss formulas for Promass A

Reynolds number	$Re = \frac{4 \cdot \dot{m}}{\pi \cdot d \cdot v \cdot \rho}$	A0003381
$Re \geq 2300^{1)}$	$\Delta p = K \cdot v^{0.25} \cdot \dot{m}^{1.75} \cdot \rho^{-0.75}$	A0003380
$Re < 2300$	$\Delta p = K1 \cdot v \cdot \dot{m}$	A0003379
<p>Δp = pressure loss [mbar] ρ = density [kg/m³] v = kinematic viscosity [m²/s] d = inside diameter of measuring tubes [m] \dot{m} = mass flow [kg/s] K to $K1$ = constants (depending on nominal diameter)</p> <p>¹⁾ To compute the pressure loss for gases, always use the formula for $Re \geq 2300$.</p>		

Pressure loss formulas for Promass O, X

Reynolds number	$Re = \frac{4 \cdot \dot{m}}{\pi \cdot d \cdot v \cdot \rho \cdot n}$	A0015582
Pressure loss	$\Delta p = (A_0 + A_1 \cdot Re^{A_2})^{1/A_3} \cdot \frac{1}{\rho} \cdot \left(\frac{2 \cdot \dot{m}}{5 \cdot \pi \cdot n \cdot d^2} \right)^2$	A0015583
<p>Δp = pressure loss [mbar] d = inside diameter of measuring tubes [m] v = kinematic viscosity [m²/s] A_0 to A_3 = constants (depending on nominal diameter) \dot{m} = mass flow [kg/s] n = number of tubes ρ = density [kg/m³]</p>		

Pressure loss coefficient for Promass F

DN	d[m]	K	K1	K2
8	$5.35 \cdot 10^{-3}$	$5.70 \cdot 10^7$	$9.60 \cdot 10^7$	$1.90 \cdot 10^7$
15	$8.30 \cdot 10^{-3}$	$5.80 \cdot 10^6$	$1.90 \cdot 10^7$	$10.60 \cdot 10^5$
25	$12.00 \cdot 10^{-3}$	$1.90 \cdot 10^6$	$6.40 \cdot 10^6$	$4.50 \cdot 10^5$
40	$17.60 \cdot 10^{-3}$	$3.50 \cdot 10^5$	$1.30 \cdot 10^6$	$1.30 \cdot 10^5$
50	$26.00 \cdot 10^{-3}$	$7.00 \cdot 10^4$	$5.00 \cdot 10^5$	$1.40 \cdot 10^4$
80	$40.50 \cdot 10^{-3}$	$1.10 \cdot 10^4$	$7.71 \cdot 10^4$	$1.42 \cdot 10^4$
100	$51.20 \cdot 10^{-3}$	$3.54 \cdot 10^3$	$3.54 \cdot 10^4$	$5.40 \cdot 10^3$
150	$68.90 \cdot 10^{-3}$	$1.36 \cdot 10^3$	$2.04 \cdot 10^4$	$6.46 \cdot 10^2$
250	$102.26 \cdot 10^{-3}$	$3.00 \cdot 10^2$	$6.10 \cdot 10^3$	$1.33 \cdot 10^2$

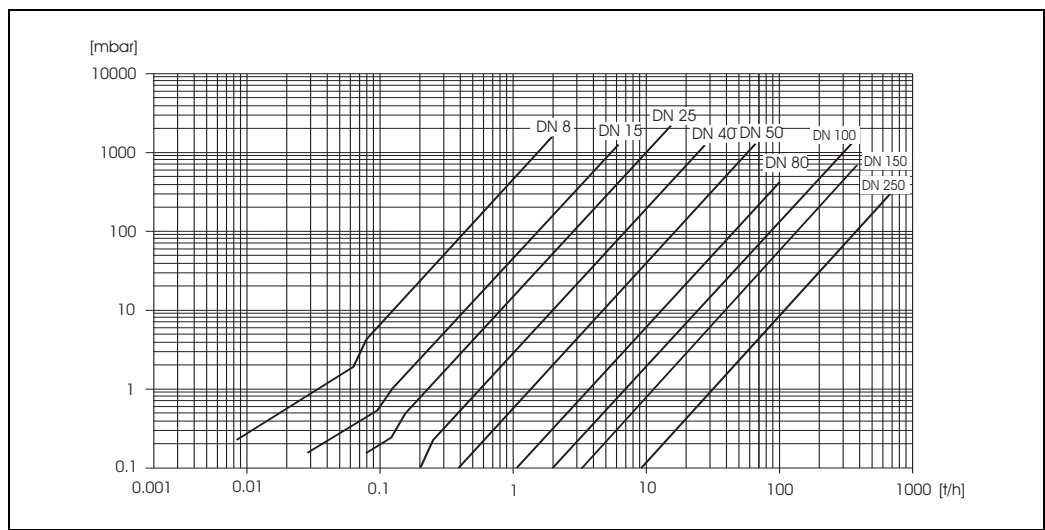

Fig. 63: *Pressure loss diagram for water*

Pressure loss coefficient for Promass E

DN	d[m]	K	K1	K2
8	$5.35 \cdot 10^{-3}$	$5.70 \cdot 10^7$	$7.91 \cdot 10^7$	$2.10 \cdot 10^7$
15	$8.30 \cdot 10^{-3}$	$7.62 \cdot 10^6$	$1.73 \cdot 10^7$	$2.13 \cdot 10^6$
25	$12.00 \cdot 10^{-3}$	$1.89 \cdot 10^6$	$4.66 \cdot 10^6$	$6.11 \cdot 10^5$
40	$17.60 \cdot 10^{-3}$	$4.42 \cdot 10^5$	$1.35 \cdot 10^6$	$1.38 \cdot 10^5$
50	$26.00 \cdot 10^{-3}$	$8.54 \cdot 10^4$	$4.02 \cdot 10^5$	$2.31 \cdot 10^4$
80	$40.50 \cdot 10^{-3}$	$1.44 \cdot 10^4$	$5.00 \cdot 10^4$	$2.30 \cdot 10^4$

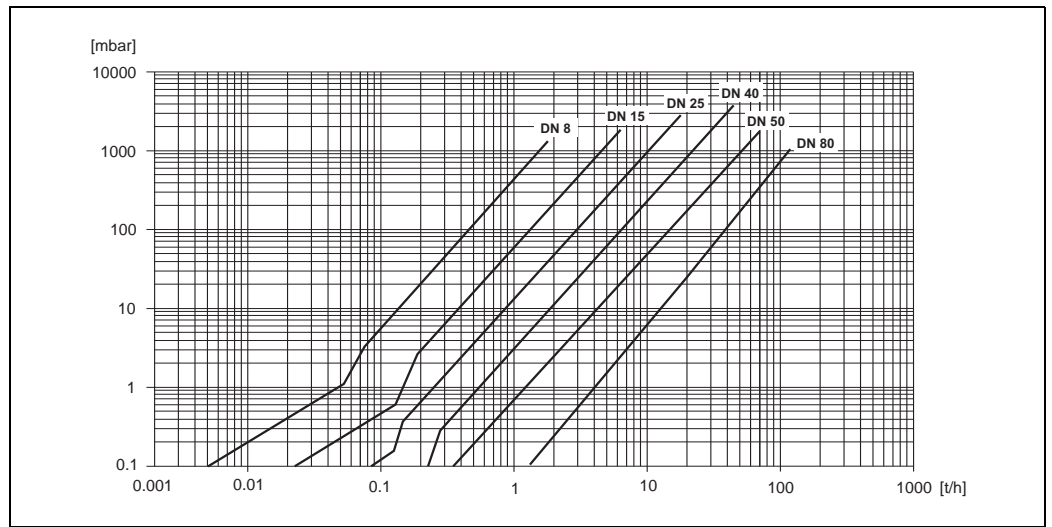

Fig. 64: Pressure loss diagram for water

Pressure loss coefficient for Promass A

DN	d[m]	K	K1
1	$1.1 \cdot 10^{-3}$	$1.2 \cdot 10^{11}$	$1.3 \cdot 10^{11}$
2	$1.8 \cdot 10^{-3}$	$1.6 \cdot 10^{10}$	$2.4 \cdot 10^{10}$
4	$3.5 \cdot 10^{-3}$	$9.4 \cdot 10^8$	$2.3 \cdot 10^9$
High pressure version			
2	$1.4 \cdot 10^{-3}$	$5.4 \cdot 10^{10}$	$6.6 \cdot 10^{10}$
4	$3.0 \cdot 10^{-3}$	$2.0 \cdot 10^9$	$4.3 \cdot 10^9$

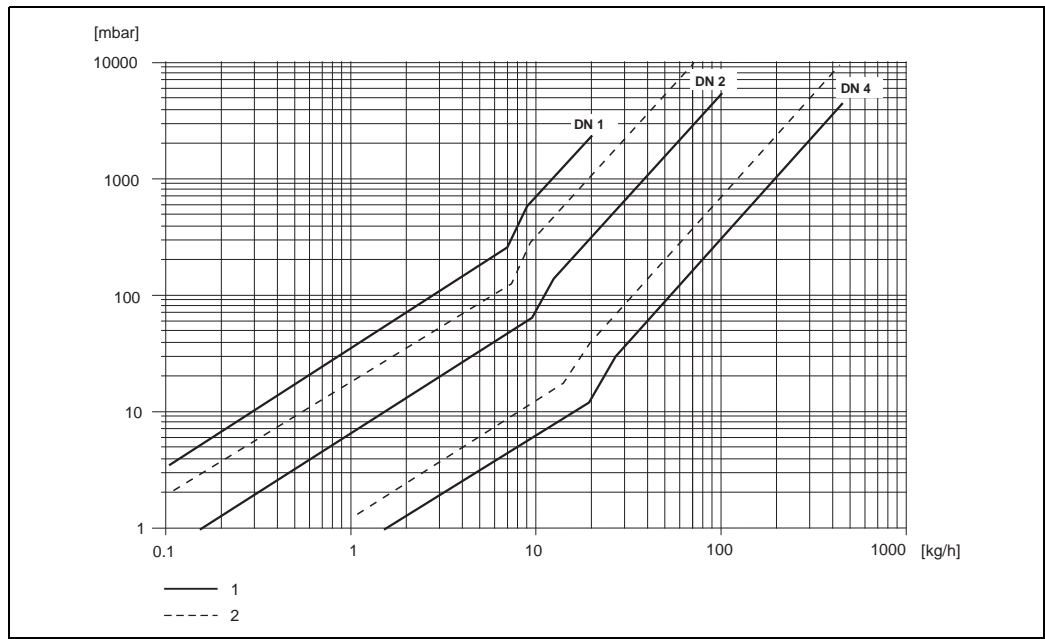

Fig. 65: *Pressure loss diagram for water*

- 1 *Standard version*
- 2 *High pressure version*

Pressure loss coefficient for Promass H

DN	d[m]	K	K1	K3
8	$8.51 \cdot 10^{-3}$	$8.04 \cdot 10^6$	$3.28 \cdot 10^7$	$1.15 \cdot 10^6$
15	$12.00 \cdot 10^{-3}$	$1.81 \cdot 10^6$	$9.99 \cdot 10^6$	$1.87 \cdot 10^5$
25	$17.60 \cdot 10^{-3}$	$3.67 \cdot 10^5$	$2.76 \cdot 10^6$	$4.99 \cdot 10^4$
40	$25.50 \cdot 10^{-3}$	$8.75 \cdot 10^4$	$8.67 \cdot 10^5$	$1.22 \cdot 10^4$
50	$40.5 \cdot 10^{-3}$	$1.35 \cdot 10^4$	$1.72 \cdot 10^5$	$1.20 \cdot 10^3$

Pressure loss data includes interface between measuring tube and piping

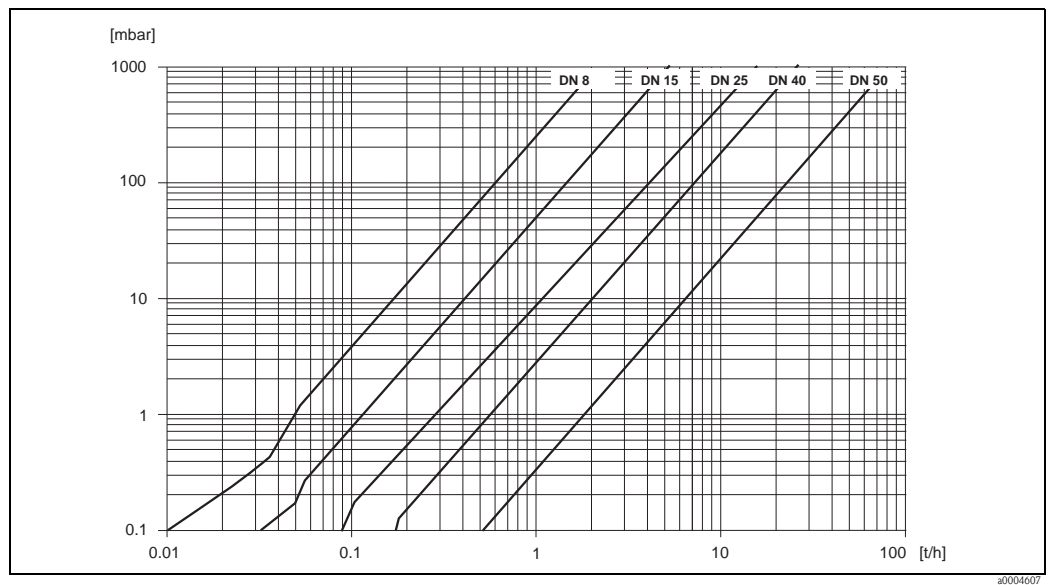

Fig. 66: Pressure loss diagram for water

Pressure loss coefficient for Promass I

DN	d[m]	K	K1	K3
8	$8.55 \cdot 10^{-3}$	$8.1 \cdot 10^6$	$3.9 \cdot 10^7$	$129.95 \cdot 10^4$
15	$11.38 \cdot 10^{-3}$	$2.3 \cdot 10^6$	$1.3 \cdot 10^7$	$23.33 \cdot 10^4$
15 ¹⁾	$17.07 \cdot 10^{-3}$	$4.1 \cdot 10^5$	$3.3 \cdot 10^6$	$0.01 \cdot 10^4$
25	$17.07 \cdot 10^{-3}$	$4.1 \cdot 10^5$	$3.3 \cdot 10^6$	$5.89 \cdot 10^4$
25 ¹⁾	$26.4 \cdot 10^{-3}$	$7.8 \cdot 10^4$	$8.5 \cdot 10^5$	$0.11 \cdot 10^4$
40	$26.4 \cdot 10^{-3}$	$7.8 \cdot 10^4$	$8.5 \cdot 10^5$	$1.19 \cdot 10^4$
40 ¹⁾	$35.62 \cdot 10^{-3}$	$1.3 \cdot 10^4$	$2.0 \cdot 10^5$	$0.08 \cdot 10^4$
50	$35.62 \cdot 10^{-3}$	$1.3 \cdot 10^4$	$2.0 \cdot 10^5$	$0.25 \cdot 10^4$
50 ¹⁾	$54.8 \cdot 10^{-3}$	$2.3 \cdot 10^3$	$5.5 \cdot 10^4$	$1.0 \cdot 10^2$
80	$54.8 \cdot 10^{-3}$	$2.3 \cdot 10^3$	$5.5 \cdot 10^4$	$3.5 \cdot 10^2$

Pressure loss data includes interface between measuring tube and piping

¹⁾ DN 15, 25, 40, 50 "FB" = Full bore versions of Promass I

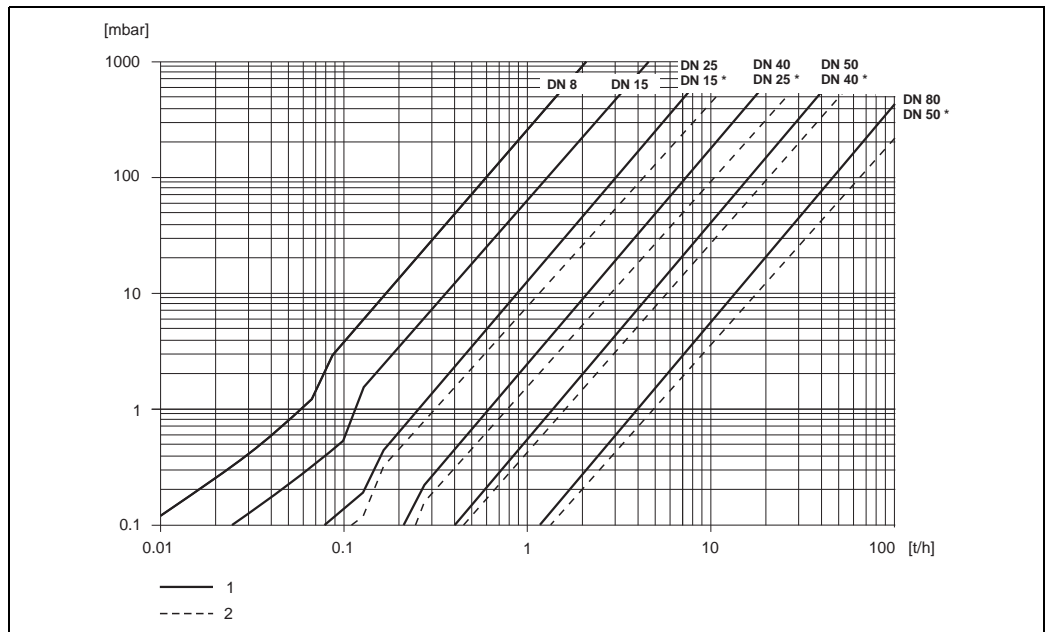

Fig. 67: Pressure loss diagram for water

- 1 Standard versions
- 2 Full bore versions (*)

Pressure loss coefficient for Promass S, P

DN	d[m]	K	K1	K3
8	$8.31 \cdot 10^{-3}$	$8.78 \cdot 10^6$	$3.53 \cdot 10^7$	$1.30 \cdot 10^6$
15	$12.00 \cdot 10^{-3}$	$1.81 \cdot 10^6$	$9.99 \cdot 10^6$	$1.87 \cdot 10^5$
25	$17.60 \cdot 10^{-3}$	$3.67 \cdot 10^5$	$2.76 \cdot 10^6$	$4.99 \cdot 10^4$
40	$26.00 \cdot 10^{-3}$	$8.00 \cdot 10^4$	$7.96 \cdot 10^5$	$1.09 \cdot 10^4$
50	$40.50 \cdot 10^{-3}$	$1.41 \cdot 10^4$	$1.85 \cdot 10^5$	$1.20 \cdot 10^3$

Pressure loss data includes interface between measuring tube and piping

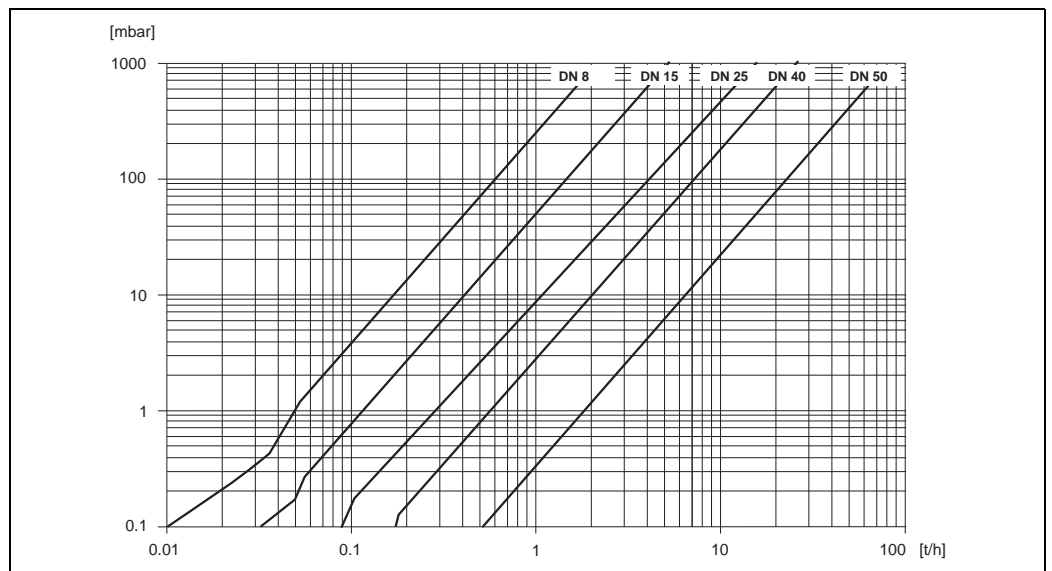

Fig. 68: Pressure loss diagram for water

80004607

Pressure loss coefficient for Promass O

DN		d[mm]	A ₀	A ₁	A ₂	A ₃
[mm]	[inch]					
80	3"	38.5	0.72	4.28	- 0.36	0.24
100	4"	49.0	0.70	3.75	- 0.35	0.22
150	6"	66.1	0.75	2.81	- 0.33	0.19

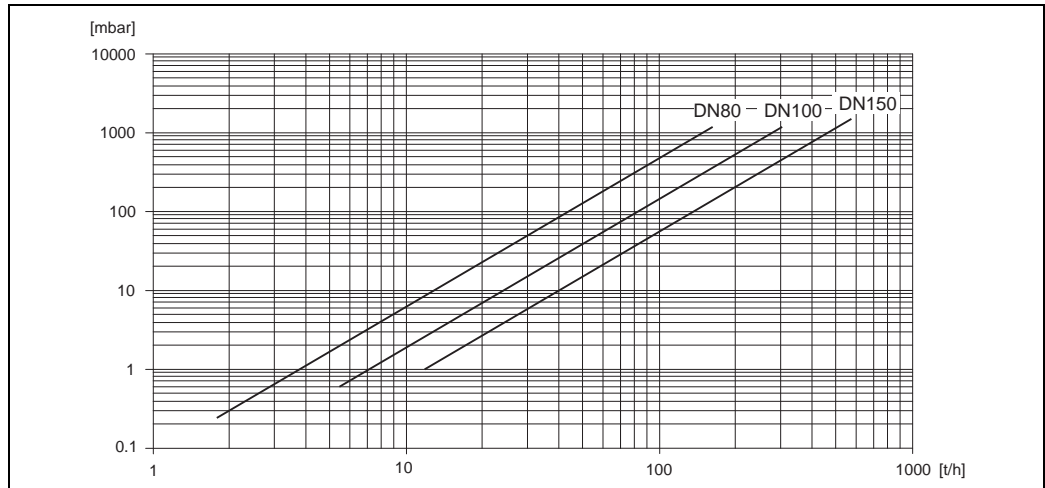

Fig. 69: Pressure loss diagram for water

Pressure loss coefficient for Promass X

DN		d[mm]	A ₀	A ₁	A ₂	A ₃
[mm]	[inch]					
350	14"	102.3	0.76	3.80	- 0.33	0.23

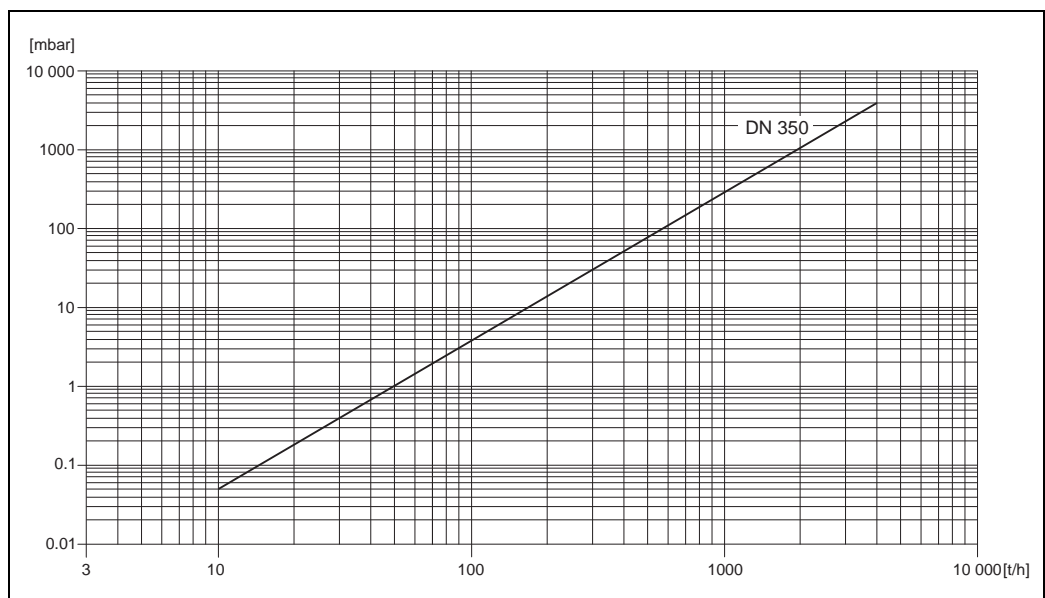

Fig. 70: Pressure loss diagram for water

Pressure loss (US units)

Pressure loss is dependent on fluid properties nominal diameter. Consult Endress+Hauser for Applicator PC software to determine pressure loss in US units. All important instrument data is contained in the Applicator software program in order to optimize the design of measuring system. The software is used for following calculations:

- Nominal diameter of the sensor with fluid characteristics such as viscosity, density, etc.
- Pressure loss downstream of the measuring point.
- Converting mass flow to volume flow, etc.
- Simultaneous display of various meter size.
- Determining measuring ranges.

The Applicator runs on any IBM compatible PC with windows.

10.1.10 Mechanical construction

Design / dimensions

The dimensions and lengths of the sensor and transmitter are provided in the separate "Technical Information" document on the device in question. This can be downloaded as a PDF file from www.endress.com. A list of the "Technical Information" documents available is provided in the "Documentation" section →  153.

Weight

- Compact version: see table below
- Remote version
 - Sensor: see table below
 - Wall-mount housing: 5 kg (11 lb)

Weight (SI units)

All values (weight) refer to devices with flanges according to EN/DIN PN 40. Weight data in [lb].

Promass F / DN	8	15	25	40	50	80	100	150	250*
Compact version	11	12	14	19	30	55	96	154	400
Compact version, high-temperature	–	–	14.7	–	30.7	55.7	–	–	–
Remote version	9	10	12	17	28	53	94	152	398
Remote version, high-temperature	–	–	13.5	–	29.5	54.5	–	–	–

* With 10" according to ASME B16.5 Cl 300 flanges

Promass E / DN	8	15	25	40	50	80
Compact version	8	8	10	15	22	31
Remote version	6	6	8	13	20	29

Promass A / DN	1	2	4
Compact version	10	11	15
Remote version	8	9	13

Promass H / DN	8	15	25	40	50
Compact version	12	13	19	36	69
Remote version	10	11	17	34	67

Promass I / DN	8	15	15FB	25	25FB	40	40FB	50	50FB	80
Compact version	13	15	21	22	41	42	67	69	120	124
Remote version	11	13	19	20	38	40	65	67	118	122

"FB" = Full bore versions of Promass I

Promass S / DN	8	15	25	40	50
Compact version	13	15	21	43	80
Remote version	11	13	19	41	78

Promass P / DN	8	15	25	40	50
Compact version	13	15	21	43	80
Remote version	11	13	19	41	78

Promass O / DN ¹⁾	80	100	150
Compact version	75	141	246
Remote version	73	139	244

¹⁾ with CI 900 flanges according to ASME

Promass X / DN ¹⁾	350
Compact version	555
Remote version	553

¹⁾ with 12" according to ASME B16.5 CI 150 flanges

Weight (US units)

All values (weight) refer to devices with EN/DIN PN 40 flanges.
Weight data in [lb].

Promass F / DN	3/8"	1/2"	1"	1 1/2"	2"	3"	4"	6"	10"*
Compact version	24	26	31	42	66	121	212	340	882
Compact version, high-temperature	–	–	32	–	68	123	–	–	–
Remote version	20	22	26	37	62	117	207	335	878
Remote version, high-temperature	–	–	30	–	65	120	–	–	–

* With 10" according to ASME B16.5 CI 300 flanges

Promass E / DN	3/8"	1/2"	1	1 1/2"	2"	3"
Compact version	18	18	22	33	49	69
Remote version	13	13	18	29	44	64

Promass A / DN	1/24"	1/12"	1/8"
Compact version	22	24	33
Remote version	18	20	29

Promass H / DN	3/8"	1/2"	1	1 1/2"	2"
Compact version	26	29	42	79	152
Remote version	22	24	37	75	148

Promass I / DN	3/8"	1/2"	1/2"FB	1 1/2"	1 1/2"FB	3/8"	3/8"FB	1	1FB	2"
Compact version	29	33	46	49	90	93	148	152	265	273
Remote version	24	29	42	44	86	88	143	148	260	269

"FB" = Full bore versions of Promass I

Promass S / DN	3/8"	1/2"	1	1 1/2"	2"
Compact version	29	33	46	95	176
Remote version	24	29	42	90	172

Promass P / DN	3/8"	1/2"	1	1 1/2"	2"
Compact version	29	33	46	95	176
Remote version	24	29	42	90	172

Promass O / DN ¹⁾	3"	4"	6"
Compact version	165	311	542
Remote version	161	306	538

¹⁾ with Cl 900 flanges according to ASME

Promass X / DN ¹⁾	350
Compact version	1224
Remote version	1219

¹⁾ with 12" according to ASME B16.5 Cl 150 flanges

Material

Transmitter housing:

- Compact version
 - Compact version: powder coated die-cast aluminum
 - Stainless steel housing: stainless steel 1.4404/CF3M
 - Window material: glass or polycarbonate
- Remote version
 - Remote field housing: powder coated die-cast aluminum
 - Wall-mount housing: powder coated die-cast aluminum
 - Window material: glass

Sensor housing / containment:

Promass F:

- Acid- and alkali-resistant outer surface
- Stainless steel 1.4301/1.4307/304L

Promass E, A, H, I, S, P:

- Acid- and alkali-resistant outer surface
- Stainless steel 1.4301/304

Promass X, O:

- Acid- and alkali-resistant outer surface
- Stainless steel 1.4404/316L

Connection housing, sensor (remote version):

- Stainless steel 1.4301/304 (standard, not Promass X)
- Powder coated die-cast aluminum
(high-temperature version and version for heating)

Process connections*Promass F:*

- Flanges according to EN 1092-1 (DIN 2501) / according to ASME B16.5 / JIS B2220
→ stainless steel 1.4404/316L
- Flanges according to EN 1092-1 (DIN 2501) / according to ASME B16.5 / JIS B2220
→ Alloy C-22 2.4602/N 06022
- DIN 11864-2 Form A (flat flange with groove) → stainless steel 1.4404/316L
- Threaded hygienic connections DIN 11851 / DIN 11864-1, Form A / ISO 2853 / SMS 1145
→ stainless steel 1.4404/316L
- Tri-Clamp (OD-tubes) → stainless steel 1.4404/316L
- VCO connection → stainless steel 1.4404/316L

Promass F (high-temperature version):

- Flanges according to EN 1092-1 (DIN 2501) / according to ASME B16.5 / JIS B2220
→ stainless steel 1.4404/316L
- Flanges according to EN 1092-1 (DIN 2501) / according to ASME B16.5 / JIS B2220
→ Alloy C-22 2.4602 (N 06022)

Promass E:

- Flanges according to EN 1092-1 (DIN 2501) / according to ASME B16.5 / JIS B2220
→ stainless steel 1.4404/316L
- DIN 11864-2 Form A (flat flange with groove) → stainless steel 1.4404/316L
- VCO connection → stainless steel 1.4404/316L
- Threaded hygienic connections DIN 11851 / DIN 11864-1, Form A / ISO 2853 / SMS 1145
→ stainless steel 1.4404/316L
- Tri-Clamp (OD-tubes) → stainless steel 1.4404/316L

Promass A:

- Mounting set for flanges EN 1092-1 (DIN 2501) / ASME B16.5 / JIS B2220
→ stainless steel 1.4539/904L, Alloy C-22 2.4602/N 06022.
Loose flanges → stainless steel 1.4404/316L
- VCO coupling → stainless steel 1.4539/904L, Alloy C-22 2.4602/N 06022
- Tri-Clamp (OD-tubes) (1/2") → stainless steel 1.4539/904L
- Mounting set for SWAGELOK (1/4", 1/8") → stainless steel 1.4401/316
- Mounting set for NPT-F (1/4") → stainless steel 1.4539/904L/1.4539/904L,
Alloy C-22 2.4602/N 06022

Promass H:

- Flanges EN 1092-1 (DIN 2501) / according to ASME B16.5 / JIS B2220
→ stainless steel 1.4301/304, parts in contact with medium: zirconium 702/R 60702 or
tantalum 2.5W

Promass I:

- Flanges EN 1092-1 (DIN 2501) / according to ASME B16.5 / JIS B2220
→ stainless steel 1.4301/304
- DIN 11864-2 Form A (flat flange with groove) → titanium grade 2
- Threaded hygienic connection DIN 11851 / SMS 1145 → titanium grade 2
- Threaded hygienic connection ISO 2853 / DIN 11864-1 → titanium grade 2
- Tri-Clamp (OD-tubes) → titanium grade 2

Promass S:

- Flanges EN 1092-1 (DIN 2501) / JIS B2220 → stainless steel 1.4404/316/316L
- Flanges according to ASME B16.5 → stainless steel 1.4404/316/316L
- DIN 11864-2 Form A (flat flange with groove) → stainless steel 1.4435/316L
- Threaded hygienic connections DIN 11851/ DIN 11864-1, Form A / ISO 2853 / SMS 1145 → stainless steel 1.4404/316L
- Tri-Clamp (OD-Tubes) → stainless steel 1.4435/316L
- Clamp aseptic connection DIN 11864-3, Form A → stainless steel 1.4435/316L
- Clamp pipe connection DIN 32676/ISO 2852 → stainless steel 1.4435/316L

Promass P:

- Flanges EN 1092-1 (DIN 2501) / JIS B2220 → stainless steel 1.4404/316/316L
- Flanges according to ASME B16.5 → stainless steel 1.4404/316/316L
- DIN 11864-2 Form A (flat flange with groove), BioConnect® → stainless steel 1.4435/316L
- Threaded hygienic connections DIN 11851/ DIN 11864-1, Form A / ISO 2853 / SMS 1145 → stainless steel 1.4435/316L
- Tri-Clamp (OD-Tubes) → stainless steel 1.4435/316L
- Clamp aseptic connection DIN 11864-3, Form A → stainless steel 1.4435/316L
- Clamp pipe connection DIN 32676/ISO 2852, BioConnect® → stainless steel 1.4435/316L

Promass O:

- Flanges according to EN 1092-1 (DIN 2501) / according to ASME B16.5 → stainless steel 25Cr duplex F53/EN 1.4410 (superduplex)

Promass X:

- Flanges according to EN 1092-1 (DIN 2501) / according to ASME B16.5 → stainless steel 1.4404/316/316L

Measuring tube(s):*Promass F:*

- DN 8 to 100 (3/8" to 4"): stainless steel 1.4539/904L; manifold: 1.4404/316L
- DN 150 (6"): stainless steel 1.4404/316L/1.4432
- DN 250 (10"): stainless steel 1.4404/316L/1.4432; manifold: CF3M
- DN 8 to 150 (3/8" to 6"): Alloy C-22 2.4602/N 06022

Promass F (high-temperature version):

- DN 25, 50, 80 (1", 2", 3"): Alloy C-22 2.4602/N 06022

Promass E, S:

- Stainless steel 1.4539/904L

Promass A:

- Stainless steel 1.4539/904L, Alloy C-22 2.4602/N 06022

Promass H:

- Zirconium 702/R 60702
- Tantalum 2.5W

Promass I:

- Titanium grade 9
- Titanium grade 2 (flange disks)

Promass P:

Stainless steel 1.4435/316L

Promass O:

- Stainless steel 25Cr Duplex EN 1.4410/UNS S32750 (superduplex)

Promass X:

- Stainless steel 1.4404/316/316L; manifold: 1.4404/316/316L

Seals:*Promass F, E, H, I, S, P, O, X:*

Welded process connections without internal seals

Promass A:

Welded process connections without internal seals.



Only for mounting sets with threaded connections: Viton, EPDM, Silikon, Kalrez

Material load diagram	The material load diagrams (pressure-temperature diagrams) for the process connections are provided in the separate "Technical Information" document on the device in question. This can be downloaded as a PDF file from www.endress.com . A list of the "Technical Information" documents available is provided in the "Documentation" section →  153.
-----------------------	---

Process connections	→ Page 138 ff.
---------------------	----------------

10.1.11 Operability

Display elements	<ul style="list-style-type: none"> ■ Liquid crystal display: illuminated, four lines with 16 characters per line ■ Selectable display of different measured values and status variables ■ At ambient temperatures below -20 °C (-4 °F) the readability of the display may be impaired.
------------------	---

Operating elements	<ul style="list-style-type: none"> ■ Local operation with three optical keys (//) ■ Application-specific Quick Setup menus for straightforward commissioning
--------------------	---

Language groups	<p>Language groups available for operation in different countries:</p> <ul style="list-style-type: none"> ■ Western Europe and America (WEA): English, German, Spanish, Italian, French, Dutch and Portuguese ■ Eastern Europe and Scandinavia (EES): English, Russian, Polish, Norwegian, Finnish, Swedish, Czech ■ South and East Asia (SEA): English, Japanese, Indonesian ■ China (CN): English, Chinese
-----------------	--



Note!

You can change the language group via the operating program "FieldCare".

10.1.12 Certificates and approvals

CE mark	The measuring system is in conformity with the statutory requirements of the EC Directives. Endress+Hauser confirms successful testing of the device by affixing to it the CE mark.
C-tick mark	The measuring system is in conformity with the EMC requirements of the "Australian Communications and Media Authority (ACMA)".
Ex approval	Information about currently available Ex versions (ATEX, FM, CSA, IECEx, NEPSI) can be supplied by your Endress+Hauser Sales Center on request. All information relevant to explosion protection is available in separate Ex documents that you can order as necessary.
Sanitary compatibility	<ul style="list-style-type: none"> ■ 3A authorization (all measuring systems, except Promass H, O and X) ■ EHEDG-tested (all measuring systems, except Promass E, H, O and X)
Modbus RS485	The measuring device meets all the requirements of the Modbus/TCP conformity and integration test and holds the "Modbus/TCP Conformance Test Policy, Version 2.0". The measuring device has successfully passed all the test procedures carried out and is certified by the "Modbus/TCP Conformance Test Laboratory" of the University of Michigan.
Pressure measuring device approval	<p>The measuring devices can be ordered with or without PED (Pressure Equipment Directive). If a device with PED is required, this must be ordered explicitly. For devices with nominal diameters less than or equal to DN 25 (1"), this is neither possible nor necessary.</p> <ul style="list-style-type: none"> ■ With the identification PED/G1/III on the sensor nameplate, Endress+Hauser confirms conformity with the "Basic safety requirements" of Appendix I of the Pressure Equipment Directive 97/23/EC. ■ Devices with this identification (with PED) are suitable for the following types of fluid: <ul style="list-style-type: none"> – Fluids of Group 1 and 2 with a steam pressure of greater or less than 0.5 bar (7.3 psi) – Unstable gases ■ Devices without this identification (without PED) are designed and manufactured according to good engineering practice. They correspond to the requirements of Art. 3, Section 3 of the Pressure Equipment Directive 97/23/EC. Their application is illustrated in Diagrams 6 to 9 in Appendix II of the Pressure Equipment Directive 97/23/EC.
Functional safety	SIL -2: In accordance with IEC 61508/IEC 61511-1 (FDIS)
Other standards and guidelines	<ul style="list-style-type: none"> ■ EN 60529 Degrees of protection by housing (IP code) ■ EN 61010-1 Protection Measures for Electrical Equipment for Measurement, Control, Regulation and Laboratory Procedures. ■ IEC/EN 61326 "Emission in accordance with requirements for Class A". Electromagnetic compatibility (EMC requirements) ■ NAMUR NE 21 Electromagnetic compatibility (EMC) of industrial process and laboratory control equipment. ■ NAMUR NE 43 Standardization of the signal level for the breakdown information of digital transmitters with analog output signal. ■ NAMUR NE 53 Software of field devices and signal-processing devices with digital electronics

10.1.13 Ordering information

The Endress+Hauser service organization can provide detailed ordering information and information on the order codes on request.

10.1.14 Accessories

Various accessories, which can be ordered separately from Endress+Hauser, are available for the transmitter and the sensor →  87.

10.1.15 Supplementary Documentation

- Flow measuring technology (FA00005D)
- Description of Device Functions Promass 83 (BA00108D)
- Supplementary documentation on Ex-ratings: ATEX, FM, CSA, IECEx NEPSI
- Special Documentation
 - Data transmission via EtherNet/IP (SD00138D)
- Technical Information
 - Promass 80A, 83A (TI00054D)
 - Promass 80E, 83E (TI00061D)
 - Promass 80F, 83F (TI00101D)
 - Promass 80H, 83H (TI00074D)
 - Promass 80I, 83I (TI00075D)
 - Promass 80P, 83P (TI00078D)
 - Promass 80S, 83S (TI00076D)
 - Promass 83O (TI00112D)
 - Promass 83X (TI00110D)

Index

A

Accessories	87
Ambient temperature range	133
Applications	5
Applicator (selection and configuration software)	88
Approvals	11
Auto-scan buffer	49

B

Batching/Dosing	38
Quick Setup	65
Blocks	39
Broadcast message	43
Byte transmission sequence	47

C

Cable entries	
Degree of protection	31
Technical data	112
Cable specifications	
Modbus RS485	26
Cable specifications (remote version)	29
CE mark (declaration of conformity)	11
Certificates	11
CIP cleaning	86
Cleaning	
CIP cleaning	86, 133
Exterior cleaning	86
SIP cleaning	86
Code entry (function matrix)	40
Commissioning	
Current output	57
Quick Setup	60
Relay output	58
Zero point adjustment	81
Commubox FXA193	53
Connection	
See Electrical connection	
C-Tick symbol	11
Current output	
Active/passive configuration	57
Technical data	111

D

Data back-up (of device data with T-DAT)	73
Data types	47
Declaration of conformity (CE mark)	11
Degree of protection	31, 133
Designated use	5
Device description files	53
Device designation	7
Device functions	
See "Description of Device Functions" manual	
Display	
Local display	34
Turning the display	25
Disposal	107

E

Electrical connection	
Cable specifications (remote version)	29
Degree of protection	31
Post-connection check	32
Electronics boards (installation/removal)	
Wall-mount housing	104
Error messages	
Confirming error messages	41
Process error (application error)	96
System error (device error)	90
Error messages (MODBUS)	48
Error messages (Modbus)	48
Error types (system and process errors)	41
European Pressure Equipment Directive	152
Ex approval	152
Exterior cleaning	86

F

F-Chip	85
FieldCare	53, 88
FieldCheck (tester and simulator)	88
Flow direction	16–17
Frequency output	
Technical data	111
Function check	59
Function code	45
Function descriptions	
See "Description of Device Functions" manual	
Function groups	39
Functions	39
Fuse, replacing	106
FXA193	88

G

Galvanic isolation	112
Grounding	27
Groups	39

H

Hardware write protection	54
Hazardous substances	107
HOME position (display operating mode)	34

I

Incoming acceptance	12
Inlet and outlet runs	133
Inlet runs	21
Input signal	111
Installation	133
See Installation conditions	
Installation conditions	
Dimensions	14
Inlet and outlet runs	21
Mounting location	14
Orientation (vertical, horizontal)	16
System pressure	15

- Vertical pipe 15
- Vibrations 21
- Installation instructions 133
 - Special instructions for Promass F, E, H, P and S..... 18
 - Special instructions for Promass I and P
with Eccentric Tri-clamps 18
 - Special instructions for Promass I and P
with hygienic connections 19
- Installing the wall-mount housing 23
- Insulation of sensors 21
- L**
- Language groups 151
- Length of connecting cable 133
- Life Cycle Management..... 88
- Limiting flow
 - See Measuring range
- Load 112
- Local display
 - See Display
- Low flow cut off 112
- M**
- Maintenance..... 86
- Master/slave communication 43
- Material 148
- Material load diagram 135, 151
- Measured variable 108
- Measuring principle..... 108
- Measuring range 108–110
- Measuring system 7
- Medium pressure range..... 135
- Medium temperature range 134
- Modbus RS485
 - Address model 46
 - Auto-scan buffer 49
 - Byte transmission sequence 47
 - Cable specification..... 26
 - Data types 47
 - Error messages..... 48
 - Function code 45
 - Master/slave devices 42
 - Max. writes 45
 - QS Communication 71
 - Register address 46
 - Response times 46
 - System architecture 42
 - Technical data 111
 - Technology 42
 - Telegram 44
- N**
- Nameplate
 - Connections 10
 - Sensor 9
- Nominal pressure
 - See Medium pressure range
- O**
- Operable flow range 110
- Operating conditions 133
- Operation
 - Device description files..... 53
 - FieldCare 53
 - Function matrix 39
- Operational safety 6
- Order code
 - Accessories 87
- Ordering information..... 153
- Outlet runs 21
- Output signal..... 111
- P**
- Performance characteristic
 - Promass A 113
 - Promass E 115
 - Promass F 117, 131
 - Promass H 120
 - Promass I..... 122
 - Promass O 124
 - Promass P 127
 - Promass S 129
- Polling..... 43
- Post-installation check (checklist)..... 25
- Power consumption..... 112
- Power supply (supply voltage) 112
- Power supply failure 112
- Pressure loss 145
- Pressure loss (formulas, pressure loss diagrams) 136
- Pressure measuring device approval 152
- Pressure monitoring connections 85
- Process connections..... 151
- Process error
 - Definition 41
- Process error messages..... 96
- Programming mode
 - Disabling 40
 - Enabling 40
- Pulsating flow
 - Quick Setup..... 62–63
- Pulse output
 - See Frequency output
- Pumps, mounting location, system pressure 15
- Purge connections..... 85
- Q**
- Quick Setup
 - Batching/Dosing 65
 - Commissioning 60
 - Communication..... 71
 - Data back-up (of device data with T-DAT) 73
 - Pulsating flow 62–63
- R**
- Reference operating conditions 113
- Register address..... 46
- Registered trademarks 11

Relay output 58, 112
 Repair 107
 Replacing
 Seals 86
 Returning devices 107

S

Safety icons 6
 Safety instructions 6
 Sanitary compatibility 152
 S-DAT (HistoROM) 85
 Seals
 Material 151
 Medium temperature range 134
 Replacing, replacement seals 86
 Secondary containment
 Gas purging, pressure monitoring connections 85
 Pressure range 135
 Sensor heating 20
 Sensor mounting
 See Sensor installation
 Service interface
 Commubox FXA193 53
 Serviceinterface
 Commubox FXA291 88
 Shielding 27
 SIL (functional safety) 6, 152
 SIP cleaning 86
 Software
 Amplifier display 59
 Spare parts 101
 Standards, guidelines 152
 Status input
 Technical data 111
 Storage 13
 Supplementary Ex documentation 6
 Supply voltage (power supply) 112
 Switching output
 See Relay output
 System error
 Definition 41
 System error messages 90

T

T-DAT (HistoROM) 85
 Save/load (data back-up, e.g. for replacing devices) ... 73
 Temperature ranges
 Ambient temperature range 133
 Medium temperature range 134
 Storage temperature 133
 Thermal insulation, general notes 21
 Transmitter
 Electrical connection 29
 Installing the wall-mount housing 23
 Turning the field housing (aluminum) 22
 Turning the field housing (stainless steel) 22
 Transporting the sensor 12
 Troubleshooting and remedy 89

V

Vertical pipe 15
 Vibration resistance 133
 Vibrations 21, 133

W

W@M 88
 Wall-mount housing, installing 23
 Weight 146
 Wiring
 See Electrical connection
 Writes (max.) 45

Z

Zero point adjustment 81

Declaration of Hazardous Material and De-Contamination *Erklärung zur Kontamination und Reinigung*

RA No.

Please reference the Return Authorization Number (RA#), obtained from Endress+Hauser, on all paperwork and mark the RA# clearly on the outside of the box. If this procedure is not followed, it may result in the refusal of the package at our facility.
Bitte geben Sie die von E+H mitgeteilte Rücklieferungsnummer (RA#) auf allen Lieferpapieren an und vermerken Sie diese auch außen auf der Verpackung. Nichtbeachtung dieser Anweisung führt zur Ablehnung ihrer Lieferung.

Because of legal regulations and for the safety of our employees and operating equipment, we need the "Declaration of Hazardous Material and De-Contamination", with your signature, before your order can be handled. Please make absolutely sure to attach it to the outside of the packaging.

Aufgrund der gesetzlichen Vorschriften und zum Schutz unserer Mitarbeiter und Betriebseinrichtungen, benötigen wir die unterschriebene "Erklärung zur Kontamination und Reinigung", bevor Ihr Auftrag bearbeitet werden kann. Bringen Sie diese unbedingt außen an der Verpackung an.

Type of instrument / sensor
Geräte-/Sensortyp _____

Serial number
Seriennummer _____

Used as SIL device in a Safety Instrumented System / Einsatz als SIL Gerät in Schutzeinrichtungen

Process data / Prozessdaten Temperature / *Temperatur* _____ [°F] _____ [°C] Pressure / *Druck* _____ [psi] _____ [Pa]
Conductivity / *Leitfähigkeit* _____ [µS/cm] Viscosity / *Viskosität* _____ [cp] _____ [mm²/s]

Medium and warnings
Warnhinweise zum Medium



	Medium /concentration <i>Medium /Konzentration</i>	Identification CAS No.	flammable <i>entzündlich</i>	toxic <i>giftig</i>	corrosive <i>ätzend</i>	harmful/ irritant <i>gesundheitsschädlich/ reizend</i>	other * <i>sonstiges*</i>	harmless <i>unbedenklich</i>
Process medium <i>Medium im Prozess</i>								
Medium for process cleaning <i>Medium zur Prozessreinigung</i>								
Returned part cleaned with <i>Medium zur Endreinigung</i>								

* explosive; oxidizing; dangerous for the environment; biological risk; radioactive

* *explosiv; brandfördernd; umweltgefährlich; biogefährlich; radioaktiv*

Please tick should one of the above be applicable, include safety data sheet and, if necessary, special handling instructions.

Zutreffendes ankreuzen; trifft einer der Warnhinweise zu, Sicherheitsdatenblatt und ggf. spezielle Handhabungsvorschriften beilegen.

Description of failure / Fehlerbeschreibung _____

Company data / Angaben zum Absender

Company / <i>Firma</i> _____	Phone number of contact person / <i>Telefon-Nr. Ansprechpartner:</i> _____
Address / <i>Adresse</i> _____	Fax / E-Mail _____
_____	Your order No. / <i>Ihre Auftragsnr.</i> _____

"We hereby certify that this declaration is filled out truthfully and completely to the best of our knowledge. We further certify that the returned parts have been carefully cleaned. To the best of our knowledge they are free of any residues in dangerous quantities."

"Wir bestätigen, die vorliegende Erklärung nach unserem besten Wissen wahrheitsgetreu und vollständig ausgefüllt zu haben. Wir bestätigen weiter, dass die zurückgesandten Teile sorgfältig gereinigt wurden und nach unserem besten Wissen frei von Rückständen in gefahrbringender Menge sind."

_____ (place, date / Ort, Datum)

_____ Name, dept./Abt. (please print / bitte Druckschrift)

_____ Signature / Unterschrift

www.endress.com/worldwide

Endress + Hauser 
People for Process Automation
