

---

2021 All Source RFP  
Bidders' Conference

July 29, 2021

---



## Safety moment: Preventing wildfires

**Wildfires are often preventable, because many originate from human error. Remember the following:**

- Check your forest district's wildfire danger rating before starting a campfire.
- Stay with your campfire until out, drown with water, cover with dirt, and repeat.
- Don't throw cigarettes, other smoking materials, or matches on the ground or out of vehicle windows.
- Never park vehicles, including recreational vehicles, on dry vegetation. The exhaust system can get hot enough to start a fire.
- Be sure to have a working approved spark arrester on your off-road vehicles.
- Speak up and alert authorities if you suspect someone is in danger of starting a wildfire.



## How to use Zoom

---

- Attendees will remain in listen-only mode
- The “chat” feature is disabled
- Enter questions anytime in the Q&A chat – organizers will read questions aloud during Q&A period of each presentation
- Call-in participants can still access the Q&A box if viewing the presentation online

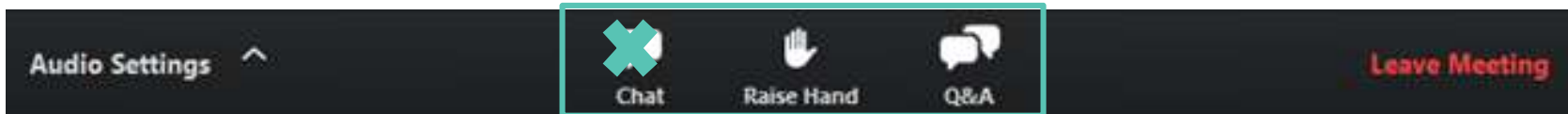

If you have a question,  
type it in the Q&A box!

# Introductions

---

## **Puget Sound Energy**

Resource Acquisitions, Colin Crowley (Manager)

Commercial team    Quantitative analytics

- Zac Yanez (Lead)
- Anthony O'Rourke
- Eric Kang
- Scott Williams
- Sheri Maynard
- Wei-min Dang (Lead)
- Cuong Nguyen
- David Meyer
- Rahul Venkatesh

Clean Energy Planning, Brian Tyson

Distributed Energy Resources, Jessica Raker

Demand Response, Jeff Tripp

Energy Delivery, Mahmoud Ghofrani, Laxman Subedi

## **PSE Transmission**

- Leslie Almond
- Pete Jones

## **Power System Consultants**

Energy Storage Location Study

- Tracy Rolstad

## **Bates White**

Independent Evaluator

- Frank Mossburg
- Vincent Musco

## **Maul Foster & Alongi**

Conference Facilitator

- Kathryn Murdock

# Agenda

---

1. Resource need
2. Eligible Resources
3. Minimum Requirements
4. PSE Assets Available for Bidder Use
- Q&A**
- Break----
5. Evaluation Process
6. CEIP and Customer Benefit Indicators
7. RFP Schedule
8. Targeted RFP and Schedule
9. Resources for Bidders
- Q&A**
- Break----
10. Bid Preparation and Submission Demonstrations
11. Energy Storage Location Study (Power System Consultants)
- Q&A**

## 2021 All Source RFP CETA need from 2021 IRP

**1,669 GWh of CETA-eligible clean energy resources by 2026** growing to 5,369 GWh by 2030

- Deliveries on or before **12/31/2025** for renewable resources
- Timing aligns with final year of PSE’s first four-year Clean Energy Implementation Plan (CEIP) 2022-2025
- Similar to prior RFPs, need is likely to be dynamic during the RFP evaluation and PSE will use the best available forecast information at each phase of the RFP evaluation

	A	B	C	D	E
<b>CETA Need in GWhs</b>	<b>2022</b>	<b>2023</b>	<b>2024</b>	<b>2025</b>	<b>2026</b>
1 CETA qualifying resources	7,398	9,045	9,087	8,963	9,016
2 2021 IRP Draft CETA Energy Target - Mid with Conservation	7,398	8,345	9,297	10,059	10,958
3 CETA Need/(Surplus)	0	-699	210	1,096	1,942
4 Net Hydro CETA energy additions	-499	-499	-442	-275	-273
5 Adjusted CETA Need/(Surplus)	-499	-1,198	-232	821	<b>1,669</b>
6 Need Assuming 36% Capacity Factor (WA Wind) (MW)				260	529
7 Need Assuming 24% Capacity Factor (East WA Solar) (MW)				391	794



*\* PSE’s draft 2021 load forecast indicates an increase in total load and peak load over the 2020 load forecast. PSE will update its renewable energy and capacity needs when the 2021 load forecast and analysis of the impact on resource needs is complete.*



## 2021 All Source RFP capacity and market reliance need from 2021 IRP

**527 MW incremental capacity need by 2027** growing to 735 MW by 2031

- Deliveries on or before **12/31/2026** for capacity resources
- Need driven by removal of Colstrip units 3&4 from PSE’s portfolio after 2025 and expiration of the Centralia Power Purchase Agreement
- IRP market risk assessment identified need to reduce market reliance on short-term Mid C market purchases by up to ~1,000 MW
- Similar to prior RFPs, need is likely to be dynamic during the RFP evaluation and PSE will use the best available forecast information at each phase of the RFP evaluation
- Actual glide path will be driven by resource opportunities and risk assessment

	A	B	C	D	E	F
<b>Need/(Surplus) and Additions in MW</b>	<b>2022</b>	<b>2023</b>	<b>2024</b>	<b>2025</b>	<b>2026</b>	<b>2027</b>
1 2021 Draft IRP Need/(Surplus)	-230	-350	-306	-257	369	<b>527</b>
2 Reduced Market Reliance Need		185	372	574	776	979
3 Total Resource Need/(Surplus)	-230	-165	66	317	1,145	1,506
4 Net Hydro Capacity Additions	-101	-106	-71	-71	-71	
5 Adjusted Total Resource Need/(Surplus)	-331	-271	-5	246	1,074	1,506
6 Estimated Glide Path of Incremental Resource additions		300	300	300	300	306

*\* PSE’s draft 2021 load forecast indicates an increase in total load and peak load over the 2020 load forecast. PSE will update its renewable energy and capacity needs when the 2021 load forecast and analysis of the impact on resource needs is complete.*



## Eligible resources: Any commercially-proven, CETA-compliant technology

Resource	Description (including but not limited to)	Structure
CETA-eligible energy	All commercially proven renewable resources	PPA, ownership
Baseload generation	Unit contingent, shaped, or blocked	PPA, ownership
Capacity products	Call options, dispatchable, storage	PPA, ownership
Temporal exchanges	Seasonal	PPA
Hybrid resources	Renewable + storage, etc.	PPA, ownership
Demand side resources	DR, DER, etc.	PPA
Other resources not specified above*	Any other commercially available resource	

### Power Purchase Agreements

- Resource-specific PPAs up to 20 years (or longer, if resource demonstrates longer useful life)
- Standalone system (e.g. non-resource specific) PPAs between 4 to 5 years
- Power bridging agreement up to 5 years, tied to long-lead resource with COD after 2025

### Ownership

- Only at or after COD (with consideration for tax and depreciation advantages)
- No PSE self-build development projects
- Co-ownership where PSE retains dispatchability and rights of control

\* The All Source RFP is open to all commercially-proven, CETA-compliant resources; Energy Efficiency resources traditionally acquired through PSE's Customer Energy Management (CEM) team which has separate RFI (<https://conduitnw.org/Pages/Article.aspx?rid=3715>) and RFP (<https://conduitnw.org/Pages/Article.aspx?rid=3741>) processes.



## Summary of key minimum proposal requirements

All Proposals
<ul style="list-style-type: none"> <li>• Commercially-proven technology</li> <li>• Proposal must be greater than 5 MW</li> <li>• Deliveries on or before <b>12/31/2026</b> for capacity resources</li> <li>• Deliveries on or before <b>12/31/2025</b> for renewable resources</li> <li>• Located on PSE’s system; delivery to PSE or eligible POD (Exhibit H)</li> <li>• Start interconnection process by September 1, 2021</li> <li>• Demonstrate site control</li> <li>• Include CETA Customer Benefit Plan</li> <li>• Provide all required data (Exhibit B)</li> <li>• Submit bid fee: one proposal with up to three (3) configurations</li> </ul>

Resource/Transaction Type
<ul style="list-style-type: none"> <li>• <b>Generation projects requiring fuel:</b> Firm fuel delivery and supply plan</li> <li>• <b>As-generated renewable energy:</b> Firm hourly schedule with all associated environmental attributes</li> <li>• <b>Stand-alone storage:</b> Interconnection and transmission service with ability to charge and discharge</li> <li>• <b>Wind proposals:</b> 1 year of verifiable wind data</li> <li>• <b>Solar proposals:</b> 1 year of verifiable irradiance data</li> <li>• <b>Ownership proposals:</b> At or after COD; no PSE self-build development projects</li> <li>• <b>Development projects:</b> Project detail to substantiate viable project, labor plan</li> <li>• <b>DER/DR projects:</b> Must include base configuration; may also provide two alternate configurations (see All-Source RFP, Section 2)</li> </ul>



## Bid completion and submission requirements

- Bidders must submit the following by **11:59 PST on September 1, 2021:**
  - Completed and validated Exhibit B forms
  - Signed Mutual Confidentiality Agreement
  - Prototype term sheets with redlines (if any)
  - Signed PSE Customer Consent Letter
  - Bid fee
- Submit bids electronically through newly developed web platform (<https://rfp.pse.com/>)
- More information about completing Exhibit B and submission of proposals through the web platform later in the presentation

### Review completeness of bid with the “Proposal Content Checklist” on Tab 1 of Exhibit B



1. Proposal Content Checklist			
Required for all RFP proposals. (Do not remove tab.)			
Proposal element	Required for	Section	Select response from drop-down list
<b>Required proposal contents</b>	<b>All proposals</b>	<b>Exhibit B</b>	
Proposal Content Checklist	All proposals	Tab 1	<input type="text"/>
Commercial Details	All proposals	Tab 2a	<input type="text"/>
Offer Details	All proposals	Tab 2b	<input type="text"/>
Facility	All proposals	Tab 3	<input type="text"/>
Variable Energy	Variable energy (also DERs, if applicable)	Tab 3a	<input type="text"/>
Flexible Capacity	Flexible capacity (also DERs, if applicable)	Tab 3b	<input type="text"/>
Energy Storage	Energy storage (also DERs, if applicable)	Tab 3c	<input type="text"/>
DR_DER_System	DRs, DERs, system resources	Tab 3d	<input type="text"/>
Energy Output (8760)	Variable resource proposals	Tab 4	<input type="text"/>
Integration and Transmission	All proposals	Tab 5	<input type="text"/>
Development - Projects Detail	Development or construction project proposals	Tab 6	<input type="text"/>
Ownership - Capital Costs	Proposals including asset sale offers	Tab 7	<input type="text"/>
Ownership - Operating Costs	Proposals including asset sale offers	Tab 8	<input type="text"/>
Bid Certification and contacts	All proposals	Tab 9	<input type="text"/>
<b>Mutual Confidentiality Agreement</b>	All proposals	Exhibit C	<input type="text"/>
Prototype Term Sheet (by offer structure)	All proposals (or specify Schedule C)	Exhibit E, F and G	<input type="text"/>
PSE Customer Consent Letter	Proposals for projects with a pending request for or agreement for PSE transmission or integration	Exhibit J	<input type="text"/>

Proposals must be substantially complete consistent with the requirements of this RFP.  
Proposals that do not provide sufficient information to substantiate a project or offer will not be considered in this RFP.



## Bid fee and success fee

**Bid fee** is assessed using a tiered fee structure based on nameplate capacity for equity considerations

The bid fee is designed to help offset costs of

- the independent evaluator,
- other third-party consultants,
- conducting studies, and/or
- legal services

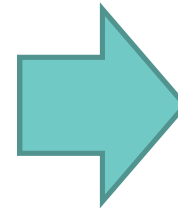

Proposal Size	Bid Fee
≥5 – 10 MW	\$2,500
>10 – 20 MW	\$5,000
>20 MW	\$10,000

Project size	\$/MW maximum	Success fee maximum
≥5 – 80 MW	\$650 / MW	\$50,000
>80 – 150 MW	\$800 / MW	\$105,200
>150 MW	\$1000/MW	\$ 250,000



**Success fee** cap based on tiered structure, however, assessed progressively.

- The success fee may be charged to all successful bidders at time of contract execution to help recover the incremental costs associated with due diligence work associated with negotiations
- Success fee would only be charged if the bid fee doesn't cover the costs



## PSE transmission assets available for bidder use

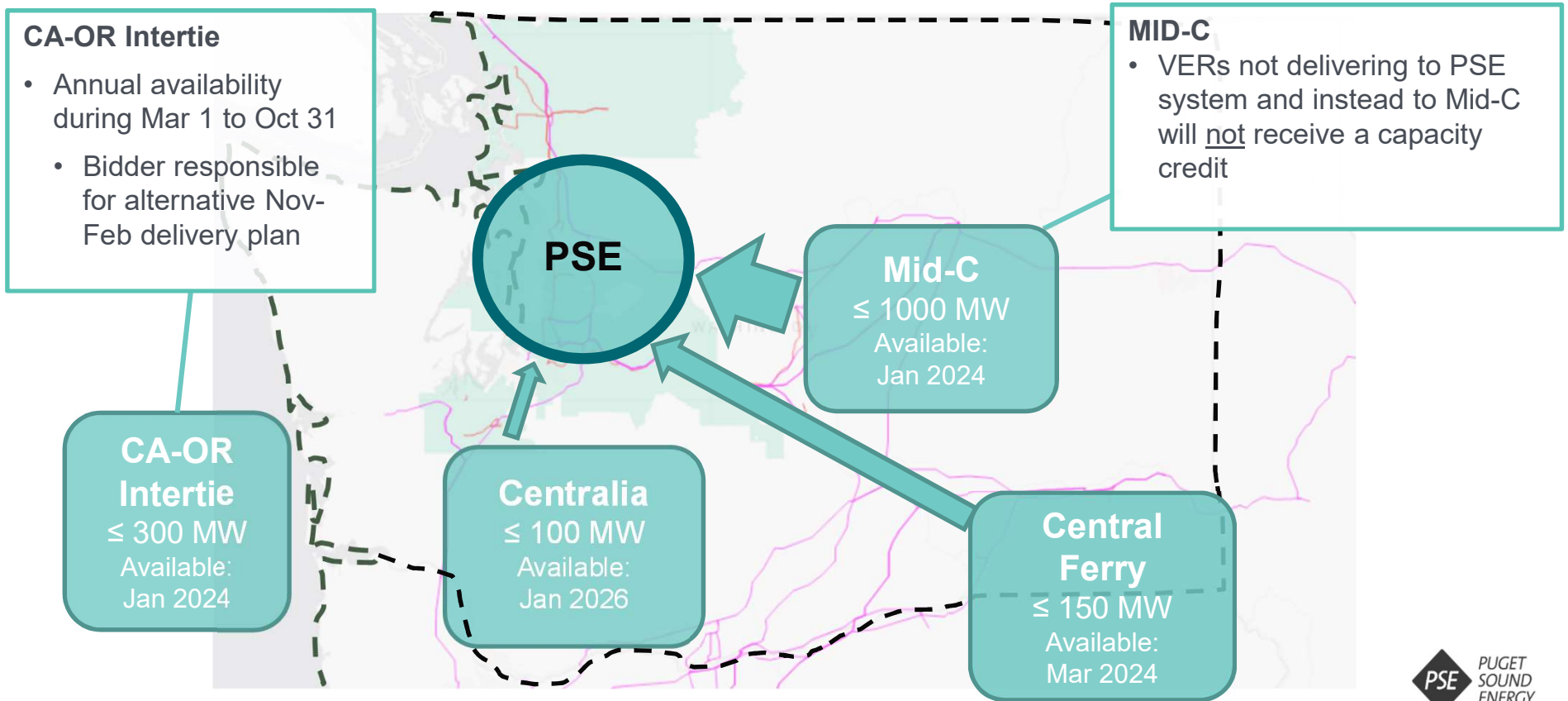

## Transmission assumptions for evaluation purposes

---

- All resources delivered at the CA-OR Intertie (summer only), Centralia, or Central Ferry will be assigned a capacity credit consistent with Exhibit H
  - VERS delivered at Mid-C will not be assigned a capacity credit (“ELCC”) due to Mid-C transmission being made available to help PSE meet its Market Reliance and Resource Adequacy needs.
- Updates to the Northwest Power Pool (“NWPP”) resource adequacy (“RA”) programs may be considered in Phase 2
- For resources delivering to the PODs in Exhibit H, a transmission adder will be applied consistent with the transmission provider’s OATT rate and PSE assumptions for future increases
  - Transmission adder only applied after current transmission contract assumed expiry date (5 years for Mid-C deliveries)
- Resources will only be assigned a transmission adder during months they are expected to deliver
  - VERS delivered to Mid-C will be given a half month per year transmission cost credit to reflect the assumption that transmission capacity will be utilized by firm capacity resources on peak days
- Resources with the ability to provide firm day-ahead schedule will receive capacity/RA credit
  - VER + storage, “block” PPA, dispatchable resources

## Lower Snake River wind development rights

- PSE is making ~140 MW of (LSR) development rights in the Oliphant North area available for bidders to propose a new development project
- Bidders will be competing for the 150 MW of transmission at Central Ferry (Exhibit H) and the transmission adder will be assessed in their proposals
  - Non-LSR bidders may also compete for the 150 MW Central Ferry transmission
- Bidders can view PSE’s development rights via a data room available as of 7/23
  - Final proposals are due 9/1/2021
- Documents provided include the LGIA, wind leases, EIS, Conditional Use Permit, wind data, cultural resource map, initial site map
- PSE currently prefers bidders to propose PPA or PPA + purchase option transactions
  - Details outlined in the RFP documentation
  - PSE has a limited ability to use tax incentives

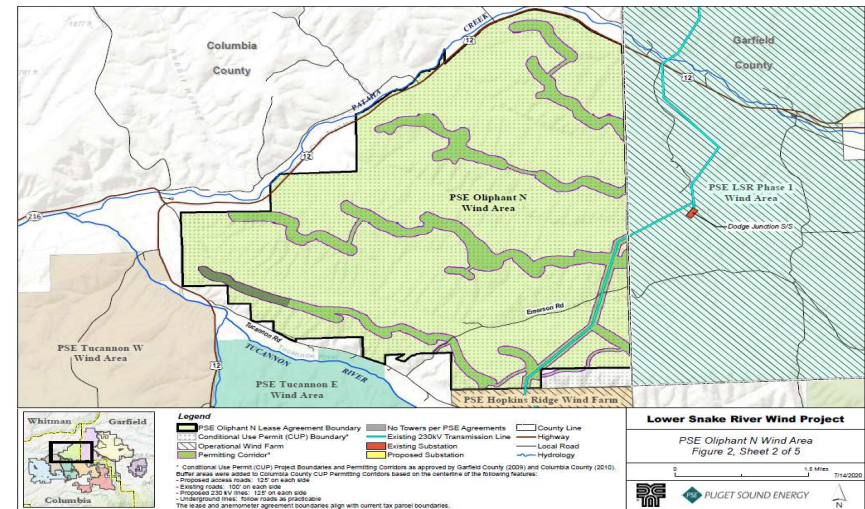

---

## Q&A

---

--- Break ---



## RFP evaluation process and estimated timeline

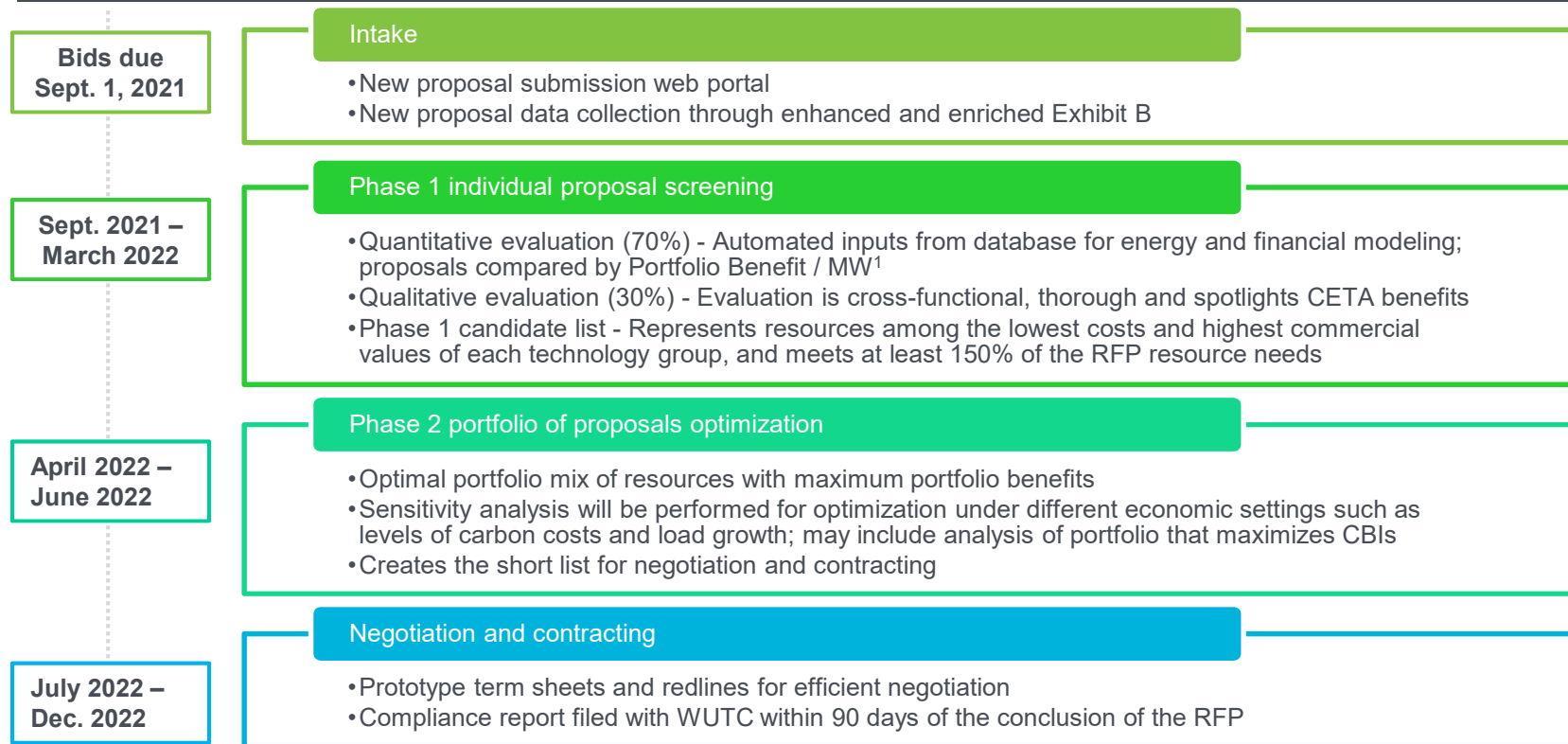

[1] Portfolio benefit includes social cost of carbon as a cost adder, consistent with PSE's 2021 Integrated Resource Plan and the requirements of RCW 19.280.030(3).



## Quantitative evaluation (70%): Screening metrics allow comparison and ranking of resources with different characteristics and capacities

- Phase 1 projects compared and ranked based on similar resource characteristics (e.g., technology, location, etc.)
- The project with the highest portfolio benefit/offer nameplate will receive the full score
- At the end of Phase 1, PSE will select a pool of resources that represents best-performing proposals from different resource types generally consistent with ELCC categories in 2021 IRP
- PSE may further refine resource categories based on proposals received and other factors, such as whether the resources deliver to PSE’s system or to Mid-C

Metric	Description	Value
<b>Portfolio benefit (\$)</b>	Difference between the net present value (“NPV”) portfolio revenue requirement with proposal replacing generic resource, and NPV portfolio revenue requirement of the all-generic portfolio.	<b>Higher is better.</b> Useful for comparing projects of similar size / technology type. Used to determine the least cost combination of resources that meets PSE’s resource needs.
<b>Portfolio benefit/ offered nameplate (\$/MW)</b>	NPV of a proposed project’s portfolio benefit divided by the net present value of the project’s offered nameplate capacity.	<b>Higher is better.</b> Useful for comparing different project sizes and technologies. Used along with qualitative metrics in establishing initial ranking of projects for inclusion in portfolio optimization.
<b>Levelized cost of energy (\$/MWh)</b>	NPV of a proposed project’s revenue requirement divided by the net present value of the project’s generation.	<b>Lower is better.</b> Useful for comparing projects that have the same or similar operating characteristics.

## Qualitative evaluation (30%): Non-price scoring rubric and due diligence

- Rubric designed to evaluate key areas applicable to all projects regardless of technology type
- Phase 1 rubric evaluation will occur on all conforming proposals:
  - Detailed information submitted by bidders (Exhibit B)
  - A “0” score on the rubric represents failure to meet RFP minimum criteria
  - Minimum criteria screening and fatal flaw review (3-day “cure period”)
  - Bidders required to submit a Customer Benefit Plan; opportunity to submit updated plan by 1/31/22 based on CBIs in final CEIP
- Additional due diligence in Phase 2 and term sheet review

Evaluation Categories	Measures	Weight
1. Counterparty Viability	<ul style="list-style-type: none"> <li>• Experience with similar projects</li> <li>• Counterparty stability</li> </ul>	10%
2. Project Viability	<ul style="list-style-type: none"> <li>• Financing plan</li> <li>• Supply chain</li> <li>• Program design (DR, DER)</li> <li>• Technology Risk</li> </ul>	10%
3. Site Control / Customer Acquisition	<ul style="list-style-type: none"> <li>• Land agreements status</li> <li>• Customer acquisition plan (DR, DER)</li> </ul>	10%
4. Permitting and Studies	<ul style="list-style-type: none"> <li>• Status of permitting and habitat studies</li> </ul>	10%
5. Energy Delivery	<ul style="list-style-type: none"> <li>• Interconnection and Transmission status (on/off PSE system)</li> <li>• Interconnection on Distribution (DR, DER)</li> </ul>	25%
6. CETA Customer Benefit Plan	<ul style="list-style-type: none"> <li>• Plan to address five CBIs:                             <ul style="list-style-type: none"> <li>◆Environment ◆Economic ◆Health</li> <li>◆Energy and Non-Energy Benefits</li> <li>◆Energy Security and Resiliency</li> </ul> </li> </ul>	35%

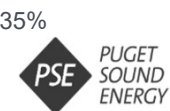

Consistent with IRP modeling and assumptions, **Aurora and Plexos** will be used to select the optimal resource portfolio to maximize portfolio benefit

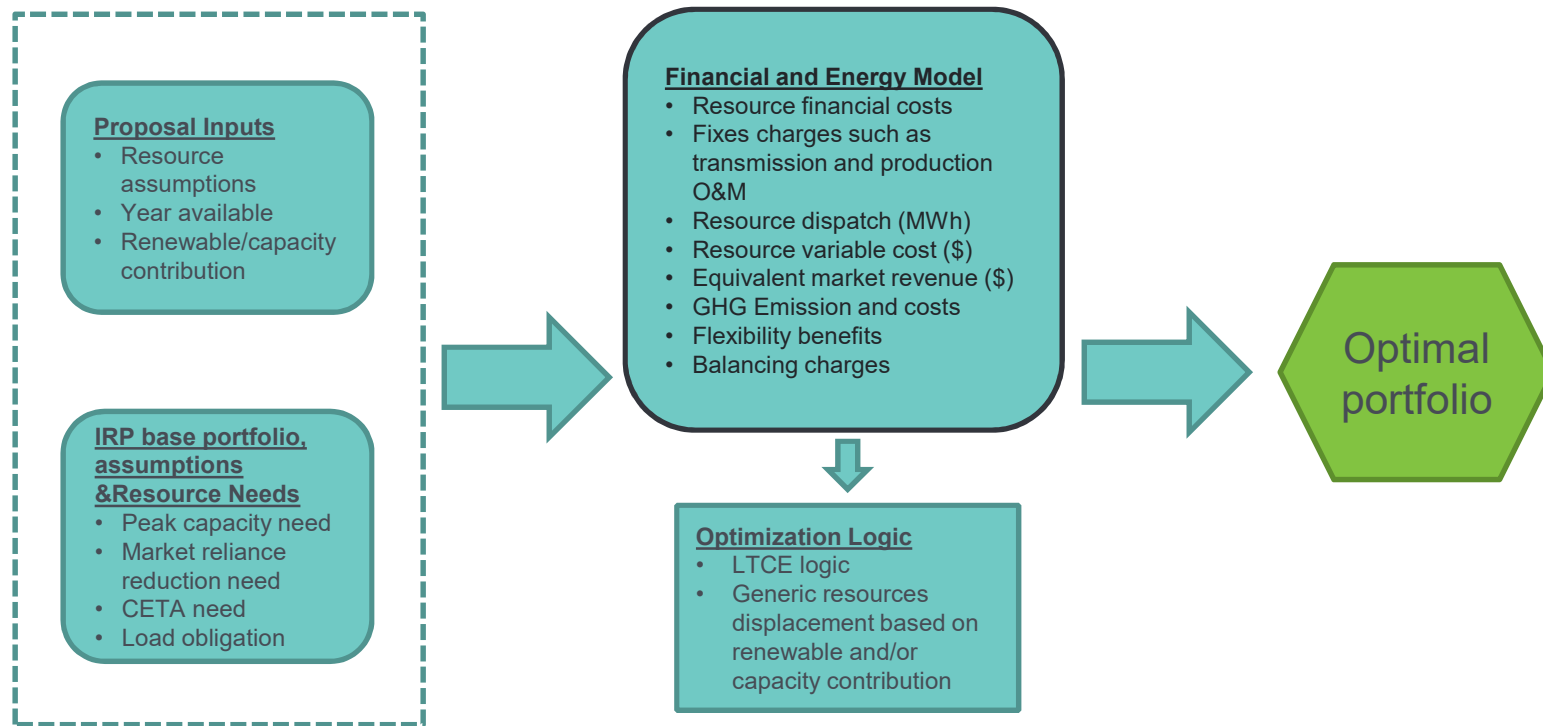

Aurora / Plexos



## About customer benefit indicators

---

**Customer benefit indicator (“CBI”) is an attribute, either quantitative or qualitative, of resources or related distribution investments associated with customer benefits described in RCW 19.405.040(8).**

### Customer benefit indicators are outcomes that improve customers lives

- Customer benefit indicators will:
  - Shape programs, actions and investment decisions
  - Help ensure all customers benefit from clean electricity transition
  - Be used through energy resource planning process (e.g., CEIP, Integrated Resource Plan, Clean Energy Action Plan)

## Draft customer benefit indicators

Updated 07/15/21

Highly impacted communities and vulnerable populations	All PSE customers (including highly impacted communities and vulnerable populations)	
<p><b>Energy benefits</b></p> <ul style="list-style-type: none"> <li>Improved participation from named communities</li> </ul>	<p><b>Public health</b></p> <ul style="list-style-type: none"> <li><b>Improved outdoor air quality</b></li> <li>Improved community health</li> </ul>	<p><b>Resiliency</b></p> <ul style="list-style-type: none"> <li><b>Decrease in frequency &amp; duration of outages</b></li> <li>Increased resiliency</li> </ul>
<p><b>Burden reduction</b></p> <ul style="list-style-type: none"> <li>Improved participation from named communities</li> <li><b>Reduced cost impacts</b></li> </ul>	<p><b>Environment</b></p> <ul style="list-style-type: none"> <li><b>Reduce GHG emissions</b></li> <li>Reduction of climate change impacts</li> </ul>	<p><b>Energy security</b></p> <ul style="list-style-type: none"> <li><b>Decrease in frequency &amp; duration of outages</b></li> <li>Increased resiliency</li> </ul>
<p><b>Non-energy benefits</b></p> <ul style="list-style-type: none"> <li>Improved participation from named communities</li> <li><b>Increase in clean energy jobs</b></li> <li>Improved home comfort</li> </ul>	<p><b>Risk reduction</b></p> <ul style="list-style-type: none"> <li>Reduction of climate change impacts</li> <li><b>Decrease in frequency &amp; duration of outages</b></li> <li>Increased resiliency</li> </ul>	<p><b>Cost reduction</b></p> <ul style="list-style-type: none"> <li><b>Affordability of clean energy</b></li> </ul>

\*Prioritized customer benefit indicator



## How customer benefit indicators will be used in the 2021 All-Source RFP

---

### Phase 1

- Five customer benefit indicator (“CBI”) categories based on CEIP rulemaking and 2021 IRP work

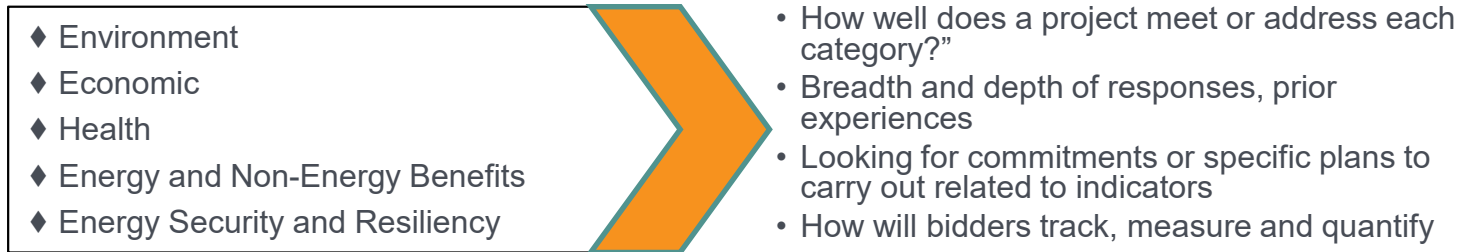

- Bidder opportunity to submit updated Customer Benefit Plan by January 31, 2022 based on CBIs in final CEIP

### Phase 2

- PSE may perform analyses aimed at producing a resource portfolio that meets the capacity and renewable need while maximizing customer benefit indicators
- Highlight prioritized indicators
- Help identify the resource mix that best aligns with CETA customer benefit and equity goals

# All-Source RFP Draft Schedule\*

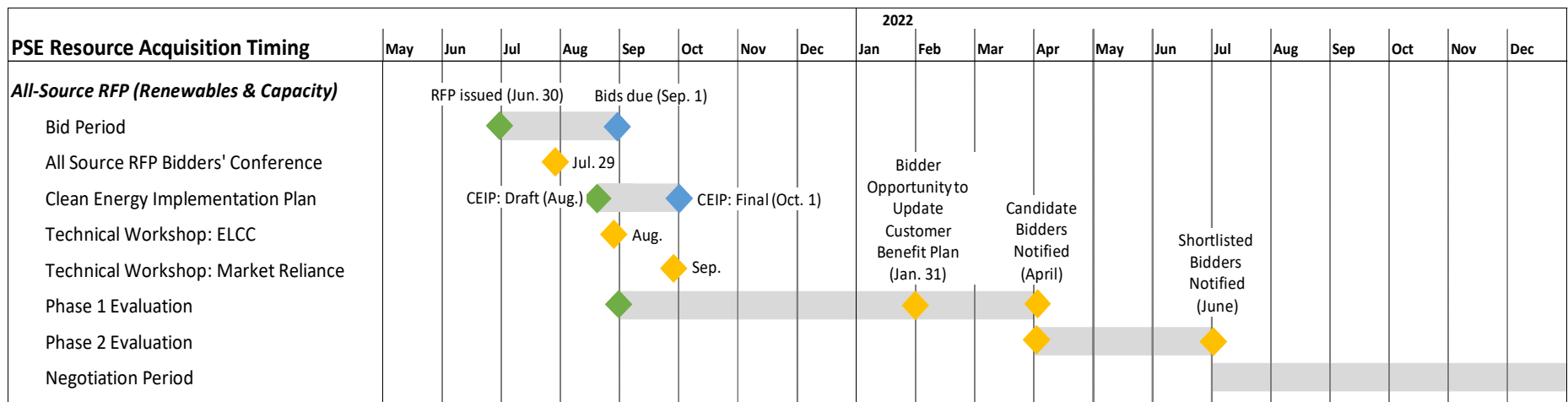

\* The All-Source RFP schedule is subject to adjustment based on Washington Utilities and Transportation Commission (“WUTC”) review and the actual pace of the evaluation process.





## Upcoming workshops

---

### **ELCC Workshop:** End of August, 2022

- Modeling approach and assumptions used to derive generic resource ELCC assumptions
- How the generic and resource-specific ELCC values will be used in the RFP analysis
- How the resource-specific ELCC values are different than the generic ELCC assumptions
- Reference material (“primer”) to be posted on the RFP website at least one week prior to the workshop

### **Market Reliance Reduction Workshop:** End of September, 2022

- Sharing of ongoing analysis of proposed market reliance reduction
- New information affecting planned reduction, glide path and timing of market reliance reduction
- Information to be posted to the RFP website at least one week prior to workshop

***Workshop dates will be shared with stakeholders and interested parties through the RFP mailbox and posted on PSE’s public RFP website  
[www.pse.com/rfp](http://www.pse.com/rfp)***

## PSE will file a targeted DER RFP in November 2021

### Targeted Distributed Energy Resources RFP

- Draft Targeted DER RFP will be filed by 11/15/21 and will include VPP specifications
- Process tailored for the unique benefits of smaller-scale DERs, including customer engagement and additional value streams from being located on the distribution system
- Solicited resources expected to be consistent with resource additions in 2021 IRP electric preferred portfolio:
  - DR: 29 MW
  - DER solar: 80 MW
  - DER battery: 25 MW
- Targets may be modified per CEIP to be filed in October 2021
- All-Source RFP acquisition targets may be revised based on final DER RFP targets

### Coordination and co-optimization of targeted DER RFP with All-Source RFP

- Each RFP separately evaluated through short list selection
- Short list from targeted DER RFP included in a combined portfolio analysis with short list from All-Source RFP to identify the best resources from both RFPs
- DERs have two opportunities to propose (All-Source RFP and Targeted DER RFP).
- Resources considered to meet both a) specific requirements identified in the CEIP and b) the broader electric portfolio need identified in the All-Source RFP regardless of the RFP into which they bid

## 2021 Targeted DER RFP Schedule and Estimated Timing of Combined Analysis

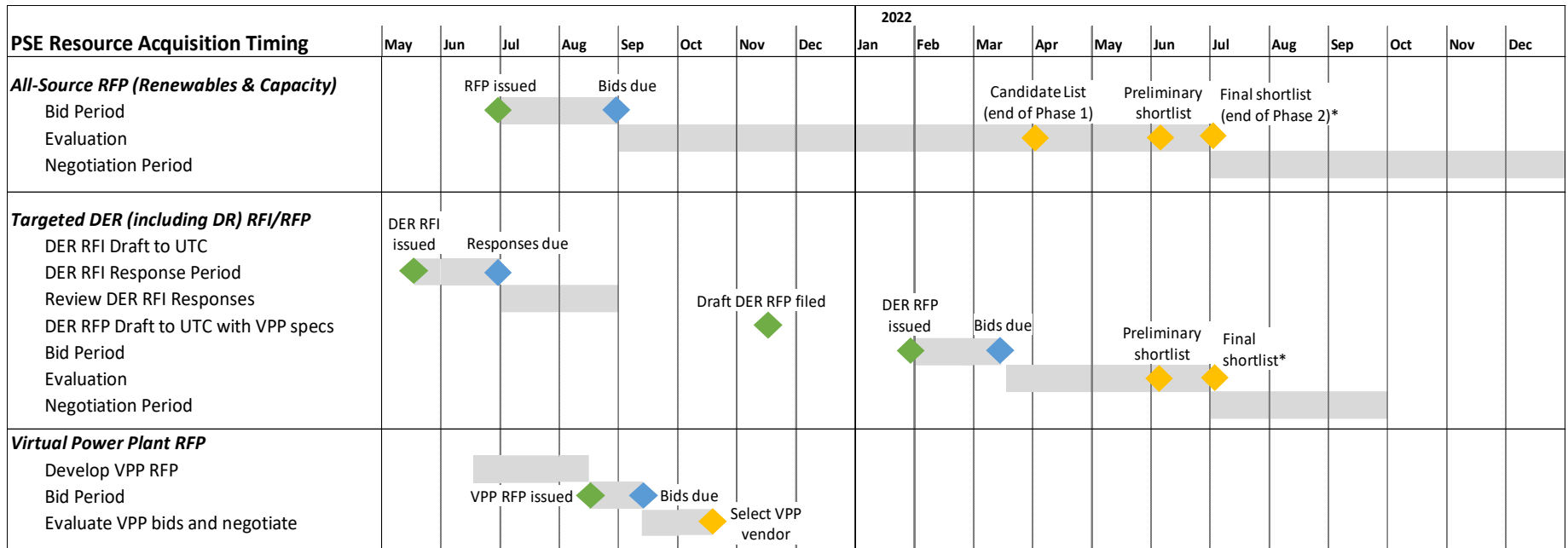

\*PSE will conduct a combined portfolio analysis of the All-Source RFP and Targeted DER RFP preliminary shortlists. Final shortlists would reflect adjustments, if any, resulting from combined analysis.



## New resources for bidders, stakeholders and other interested parties

### Public website ([www.pse.com/rfp](http://www.pse.com/rfp))

- All-Source RFP and Targeted DR/DER RFP schedules
- Updates and notifications
- Information about upcoming workshops
- Complete RFP documents for download

### RFP mailbox ([AllSourceRFPmailbox@pse.com](mailto:AllSourceRFPmailbox@pse.com))

- All questions related to the All Source RFP (periodic Q&A postings to website for benefit of all)
- Questions about the Targeted DER RFP may be sent to [DERRFPmailbox@pse.com](mailto:DERRFPmailbox@pse.com)

### New web portal for submittal of proposals (<https://www.rfp.pse.com>)

- Accessible through the public website ([www.pse.com/rfp](http://www.pse.com/rfp))
- Unlimited access to submit and resubmit proposals during RFP submission window
- Users manual and reference, with support through RFP inbox available to bidders
- More information on submission process later in presentation

### Bates White (Independent Evaluator)

- Frank Mossburg: [frank.mossburg@bateswhite.com](mailto:frank.mossburg@bateswhite.com)
- Vincent Musco: [vincent.musco@bateswhite.com](mailto:vincent.musco@bateswhite.com)

### PSE transmission and interconnection website (<http://www.oatioasis.com/psei/>)

- PSE transmission and interconnection contact information on home page of OASIS website (<http://www.oatioasis.com/psei/>)
- BPA transmission contacts: <https://www.bpa.gov/Contact/Pages/Contact-Information-Transmission.aspx>



---

## Q&A

---

--- Break ---

## Bid preparation and submission demonstrations

---

### Goals

- Allow bidders to successfully submit bids
- Minimize issues with automation effort

### Demonstrations

- Exhibit B - Clarify for bidders how to use the form
- RFP portal - Clarify for bidders how to use the portal
- RFP portal / Exhibit B – Troubleshooting data validation issues



## Puget BESS| July 2021| Presented by Tracy Rolstad



**Specialist Consultants  
to the Electricity Industry**



# PSC North America at a glance



**3**  
LOCAL OFFICES

**51**  
LOCAL SUBJECT  
MATTER EXPERTS

**14**  
YEARS OF SERVICE  
IN NORTH AMERICA



## Tracy Rolstad Education

---



- Diploma, Naval War College, College of Naval Command and Staff



- BSEE, University of Idaho



- Nuclear Navy
  - Nuclear Operational Prototype (S1C)
  - Nuclear Power School (Reactor Operator)
  - Electronics Technician School
    - Radar, Communications, etc.
- Professional Technical Education
  - Too numerous to list...

## Experience

---



- Power Systems Consultants

- Technical Director, Power Networks-North America
  - Presently WECC SRS Chair
    - Former WECC TSS Chair, Vice Chair, Secretary, DS Chair, JUG Chair, MSRATF Chair, PowerWorld User Group Chair



- Avista Corporation

- Senior Power System Consultant, System Planning



- Utility System Efficiencies

- Senior Power Systems Analyst/Principal Engineer



- The Bonneville Power Administration

- Senior Engineer, System Operations



- The Joint Warfare Analysis Center

- EP Senior Analyst, PACOM Chief of Targets



- Nuclear Navy (Attack Submarines)

- Chief Petty Officer (ETC/SS)
- Engineering Watch Supervisor/Reactor Operator



## Task: Determine Favorable Locations for BESS

---

- Identify favorable BESS sites in PSE system
  - Two methods
    - Qualitative
    - Quantitative
  - Qualitative
    - Over head imagery
    - Drawings
    - Power flow base case examination
    - Station configuration
    - Discussions with Puget staff
  - Quantitative
    - Builds off qualitative examination
      - Green, yellow, red station “grades”
        - Green=good, etc
    - Examine charge/discharge in 3 WECC cases
      - All Lines in Service
        - NERC TPL-001 P0
      - N-1 & N-2 contingencies (select ctgs based on PTDF/OTDF)
        - NERC TPL-001 P1 & P6

*Battery Energy Storage System (aka BESS)*



## Representative BESS System

- The study is technology neutral
  - Storage type is not important
    - Nor is equipment supplier
- Hornsdale example shows
  - Containerized nature of BESS
  - Size per MW/MW-hr
  - Typical Layout
  - Contextualizes conversation

*Hornsdale...once the worlds largest BESS*

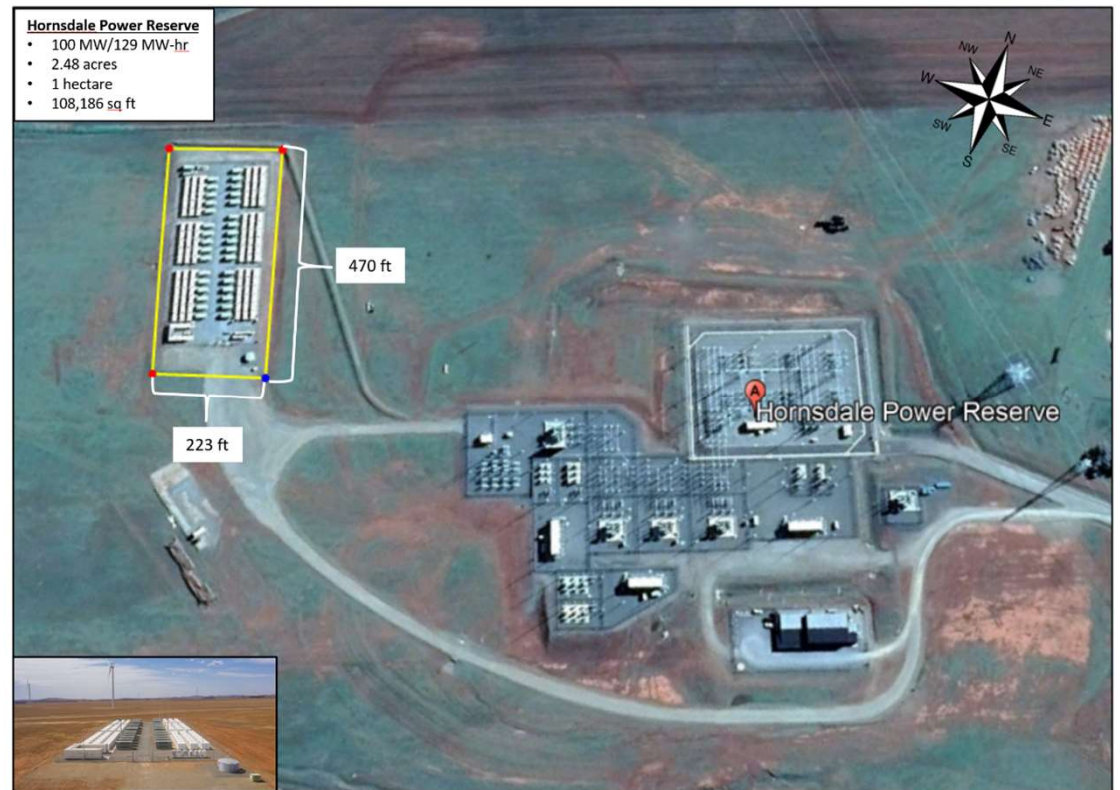

## Map and Extract PSE Stations for Screening

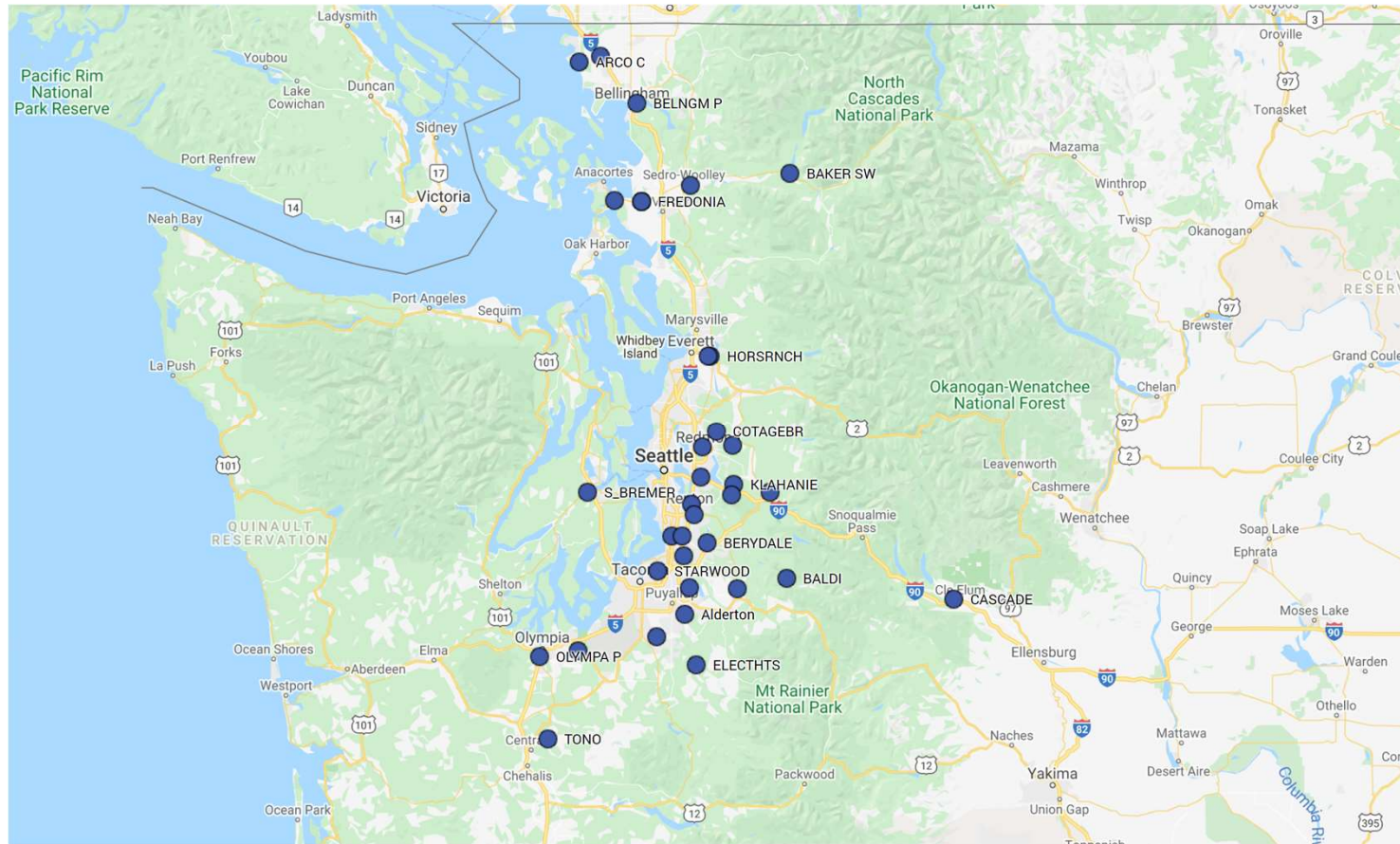

## Qualitative Example (Not Favorable)

- Qualitative
  - Over head imagery
    - Constrained footprint
  - Drawings
    - 2 transmission lines
  - Power flow base case examination
    - Ratings of lines, # of lines
  - Station configuration
  - Discussions with Puget staff
    - Fails Good Neighbor test!
      - Development potential is evident
      - Open space is desirable
      - Heavy residential presence is not desirable
      - The minimal number of landowners are impacted by a project
      - Land use should be reasonably consistent with its present use
      - See report for greater details

*Far too much impact from station development*

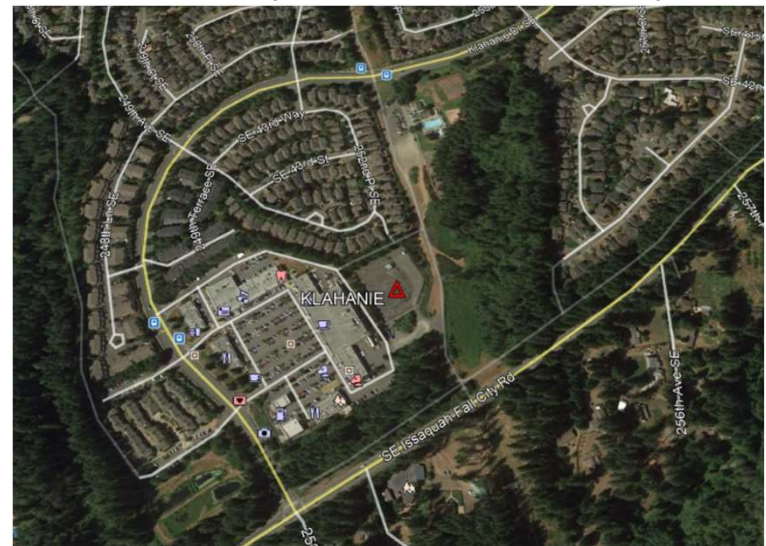

## Qualitative Results (High Risk in Red)

Sub Name	Nominal kV Range	# of Lines	Substation Type	Zone
ARCO C	115.0 (only)	4	Main Bus	WHATCOMI
BAKER SW	115.0 (only)	4	Main Bus	SKAGIT
BALDI	230.0 (only)	2	Tap	S.KING
CASCADE	34.5 to 230.0	3	Xfmr Term/Main Bus	KITTITAS
COTAGEBR	115.0 (only)	4	Main Bus	N.KING
ELECTHTS	57.5 to 115.0	5	Xfmr Term/Main Bus	PIERCE
HORSRNCH	230.0 (only)	3	Main Bus	N.KING
HRNCHTAP	230.0 (only)	2	Tap	N.KING
KLAHANIE	230.0 (only)	2	Tap	N.KING
LAKESIDE	115.0 (only)	7	Main Bus	N.KING
MINTFARM	13.8 to 230.0	1	Main (Gen Interconnection)	Portland Area
NOVELTYH	115.0 to 230.0	7	Main & Aux/Main Bus	N.KING
OLYMPA P	115.0 (only)	9	Main Bus	THURSTN
SHUFFLETON	115.0 (only)	4	Main & Aux	S.KING
SNOQ SW	2.0 to 115.0	5	Main Bus	N.KING
FREDONIA	13.8 to 115.0	4	Main Bus	SKAGIT



## Why Main Bus is less than desirable?

---

- Main bus
  - Provides basic service
  - Less reliable than other configurations
    - Breaker failure clears bus
  - Improved station types
    - Main & Transfer
    - Ring bus
    - Breaker & ½
    - Double bus/breaker
- Main bus results are removed
  - For final reporting

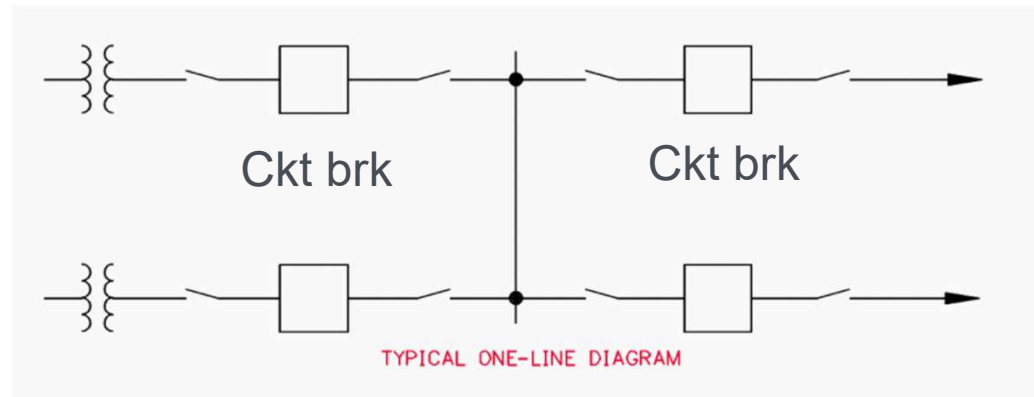

## Qualitative results (Low Risk and Medium Risk)

Sub Name	Nominal kV Range	# of Lines	Bus Configuration (low & high voltage)	Zone
Alderton	115.0 (only)	7	Main & Aux	PIERCE
Berrydale	115.0 to 230.0	7	Main & Aux / Brk & half	S.KING
Christopher	115.0 (only)	6	Main Bus	S.KING
Frederickson	13.8 to 115.0	4	Main Bus	PIERCE
Fredonia	13.8 to 230.0 (115kV)	2	Main Bus	SKAGIT
Lake Tradition	115.0 (only)	8	Main Bus	N.KING
March Point	115.0 to 230.0	12	Main & Aux / Xfrm Term	SKAGIT
Midway	115.0 (only)	6	Main & Aux	S.KING
Saint Clair	115.0 to 230.0	7	Main & Aux / DB-DB	THURSTN
Sammamish	115.0 to 230.0	11	Main & Aux / Main & Aux	N.KING
Talbot Hill	115.0 to 230.0	14	Main & Aux / DB-DB	S.KING
Tono	115.0 (only)	4	Main & Aux	THURSTN
Bellingham	115.0 (only)	11	Brk & half	WHATCOM
Krain Corner	57.5 to 115	6	Main Bus	PIERCE
O'Brien	115.0 to 230.0	11	Main & Aux / Xfrm Term	S.KING
Portal Way	115.0 (only)	5	Main & Aux	WHATCOM
S. Bremerton	115.0 to 230.0	6	Main & Aux / Xfrm Term	KITSAP
Sedro Woolley	115.0 to 230.0	12	Main & Aux / Brk & half	SKAGIT
Starwood	115.0 (only)	4	Main Bus	S.KING
White River	115.0 to 230.0	12	Main & Aux / DB-DB	PIERCE

# Quantitative Process (Simulation Based)

- Use of ATC tool in PowerWorld Simulator (version 21)
  - 3 WECC Base Cases
    - 2030: Heavy Summer, Heavy Winter, Light Spring
    - Charge and Discharge (generate)
  - Deliverability study with Puget gen fixed at case output
    - Sink/source was all other WECC gen
  - Purely physics, no contractual limits applied

ATC tool

- Efficient automation tool
- Examines multiple POI's
- Multiple contingencies
  - P0 (N-0)
  - P1 (N-1)
  - P6 (N-2)
- Charge/discharge (discovers maximums)
- Multiple cases

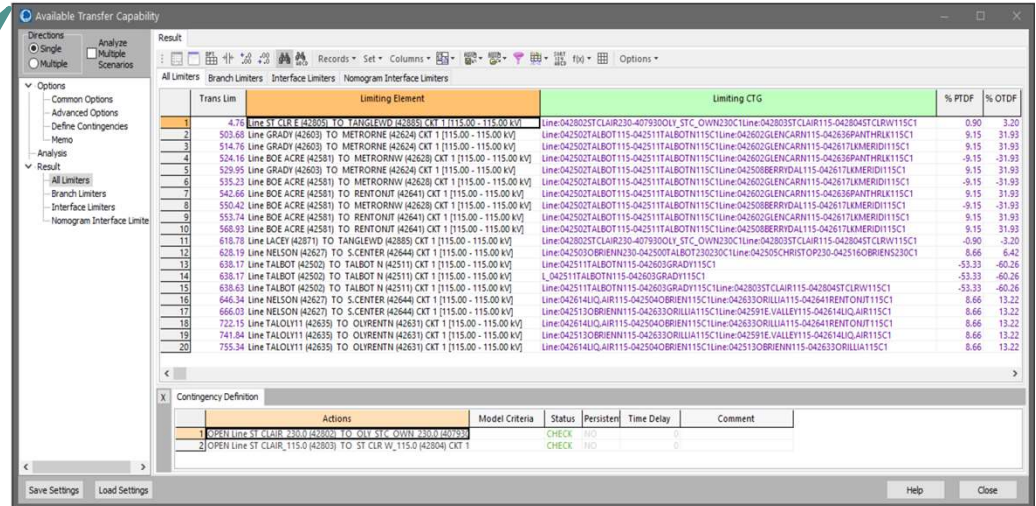

## “Raw” Quantitative Results (Culled to produce final results)

Remove Main bus for final

Substation	Substation Type	P0 Results		P1 Results		P6 Results		Maximum ESS		Total Maximum
		Generating	Charging	Generating	Charging	Generating	Charging	Generating	Charging	
Alderton	Main & Aux	725	(790)	96	(366)	134*	(76*)	96	(76*)	76*
Berrydale	Main & Aux	982	(248)	702	(167)	515*	(52*)	515*	(52*)	52*
Christopher	Main Bus	751	(419)	552	(217)	484*	(57*)	484*	(57*)	57*
Frederickson	Main Bus	404	(316)	135	(96)	99*	(86*)	99*	(86*)	86*
Fredonia	Main Bus	510	(803)	110	(532)	9*	(378)	9*	(378)	9*
Lake Tradition	Main Bus	725	(534)	518	(136)	521*	(44*)	518	(44*)	44*
March Point	Main & Aux	664	(367)	272	(189)	9*	(54)	9*	(54)	9*
Midway	Main & Aux	550	(263)	432	(164)	428*	(56*)	428*	(56*)	56*
Saint Clair	Main & Aux	520	(546)	45	(254)	39*	(412)	39*	(254)	39*
Sammamish	Main & Aux	409	(677)	323	(99)	323	(46*)	323	(46*)	46*
Talbot Hill	Main & Aux	754	(768)	552	(242)	450*	(48*)	450*	(48*)	48*
Tono	Main & Aux	548	(445)	275	(85)	267	(122*)	267	(85)	85
Bellingham	Brk & half	695	(578)	322	(109)	10*	(67)	10*	(67)	10*
Krain Corner	Main Bus	250	(222)	136	(34)	136*	(4*)	136*	(4*)	4*
O'Brien	Main & Aux	672	(554)	535	(258)	225	(54*)	225	(54*)	54*
Portal Way	Main & Aux	337	(565)	105	(446)	11*	(362)	11*	(362)	11*
S. Bremerton	Main & Aux	426	(328)	301	(27)	79	(23*)	79	(23*)	23*
Sedro Woolley	Main & Aux	779	(950)	287	(589)	48*	(590)	48*	(589)	48*
Starwood	Main Bus	573	(335)	373	(181)	240	(13*)	240	(13*)	13*
White River	Main & Aux	872	(802)	583	(379)	365*	(13*)	365*	(13)	13*

## Final Quantitative Results

Substation	Substation Type	Voltage (kV)	Location		Total Maximum ESS (MW)
			Latitude	Longitude	
Alderton	Main & Aux	115	47.15344	-122.2365	76
Berrydale	Main & Aux	115	47.37803	-122.1311	52
March Point	Main & Aux	115	48.45714	-122.5625	9
Midway	Main & Aux	115	47.40239	-122.2944	56
Saint Clair	Main & Aux	115	47.03511	-122.7356	39
Sammamish	Main & Aux	115	47.68558	-122.1499	46
Talbot Hill	Main & Aux	115	47.46864	-122.191	48
Tono	Main & Aux	115	46.75539	-122.8775	85
Bellingham	Brk & half	115	48.75939	-122.4604	10
O'Brien	Main & Aux	115	47.40317	-122.2432	54
Portal Way	Main & Aux	115	48.90361	-122.63	11
S. Bremerton	Main & Aux	115	47.53764	-122.6914	23
Sedro Woolley	Main & Aux	115	48.50458	-122.204	48
White River	Main & Aux	115	47.239	-122.2096	13

## Relative Size Graphic

- Generation Queue Not Modeled
  - These are screening results
    - Deliverability study
      - Not studied as Energy Resource
      - Not studied as Network Resource
        - Nuanced difference

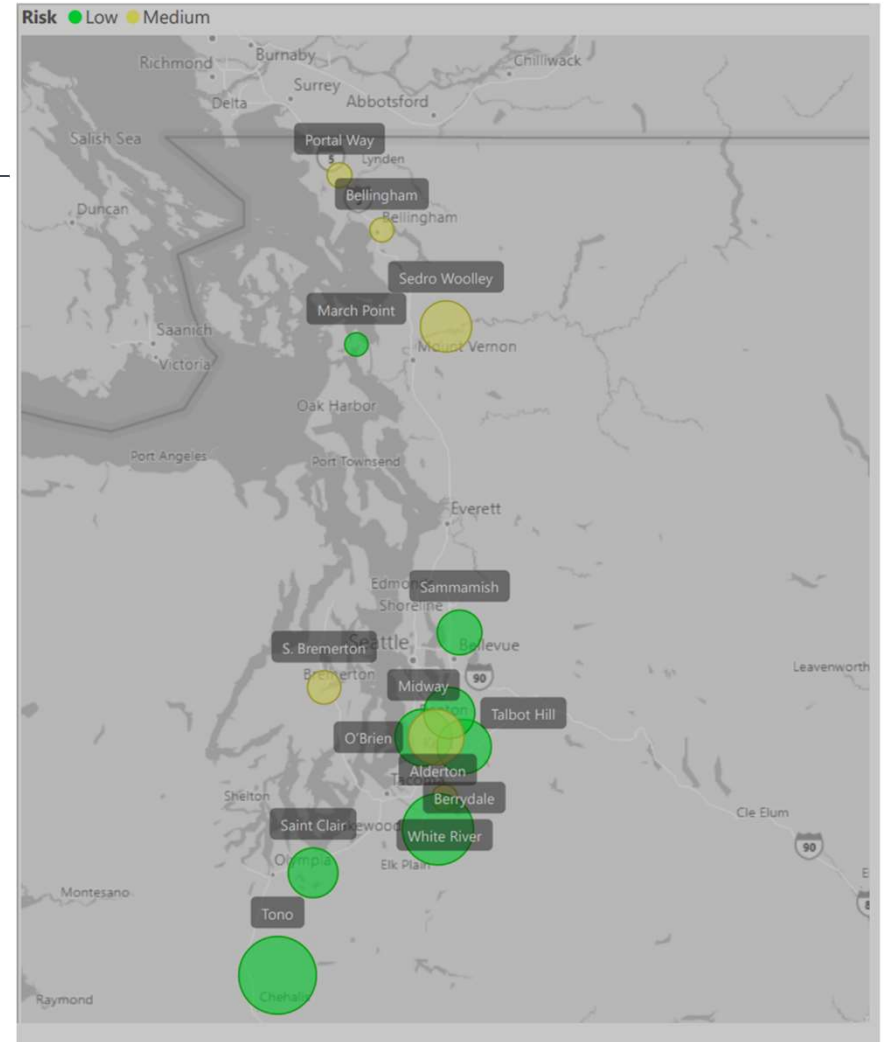

# Thank you!



Specialist Consultants  
to the Electricity Industry

**PSC Specialists Group, Inc.**  
[pscconsulting.com](http://pscconsulting.com)



## New resources for bidders, stakeholders and other interested parties

### Public website ([www.pse.com/rfp](http://www.pse.com/rfp))

- All-Source RFP and Targeted DR/DER RFP schedules
- Updates and notifications
- Information about upcoming workshops
- Complete RFP documents for download

### RFP mailbox ([AllSourceRFPmailbox@pse.com](mailto:AllSourceRFPmailbox@pse.com))

- All questions related to the All Source RFP (periodic Q&A postings to website for benefit of all)
- Questions about the Targeted DER RFP may be sent to [DERRFPmailbox@pse.com](mailto:DERRFPmailbox@pse.com)

### New web portal for submittal of proposals (<https://www.rfp.pse.com>)

- Accessible through the public website ([www.pse.com/rfp](http://www.pse.com/rfp))
- Unlimited access to submit and resubmit proposals during RFP submission window
- Users manual and reference, with support through RFP inbox available to bidders
- More information on submission process later in presentation

### Bates White (Independent Evaluator)

- Frank Mossburg: [frank.mossburg@bateswhite.com](mailto:frank.mossburg@bateswhite.com)
- Vincent Musco: [vincent.musco@bateswhite.com](mailto:vincent.musco@bateswhite.com)

### PSE transmission and interconnection website (<http://www.oatioasis.com/psei/>)

- PSE transmission and interconnection contact information on home page of OASIS website (<http://www.oatioasis.com/psei/>)
- BPA transmission contacts: <https://www.bpa.gov/Contact/Pages/Contact-Information-Transmission.aspx>





---

## Q&A