

Logic Panel

LP-S070

USER MANUAL



Preface

Thank you very much for selecting Autonics products.





Please familiarize yourself with the information contained in the **Safety Precautions** section before using this product.

This user manual contains information about the product and its proper use, and should be kept in a place where it will be easy to access.

User Manual Guide

- Please familiarize yourself with the information in this manual before using the product.
- This manual provides detailed information on the product's features. It does not offer any guarantee concerning matters beyond the scope of this manual.
- This manual may not be edited or reproduced in either part or whole without permission.
- A user manual is not provided as part of the product package. Please visit our home-page (www.autonics.com) to download a copy.
- The manual's content may vary depending on changes to the product's software and other unforeseen developments within Autonics, and is subject to change without prior notice. Upgrade notice is provided through our homepage.
- We contrived to describe this manual more easily and correctly. However, if there are any corrections or questions, please notify us these on our homepage.

User Manual Symbols

Symbol	Description
 Note	Supplementary information for a particular feature.
 Warning	Failure to follow instructions can result in serious injury or death.
 Caution	Failure to follow instructions can lead to a minor injury or product damage.
 Ex.	An example of the concerned feature's use.
※1	Annotation mark.

Safety Precautions

- Following these safety precautions will ensure the safe and proper use of the product and help prevent accidents and minimize hazards.
- Safety precautions are categorized as Warnings and Cautions, as defined below:

 Warning	Warning	Cases that may cause serious injury or fatal accident if instructions are not followed.
--	----------------	---

 Caution	Caution	Cases that may cause minor injury or product damage if instructions are not followed.
--	----------------	---



Warning

- In case of using this unit with machinery (Ex: nuclear power control, medical equipment, ship, vehicle, train, airplane, combustion apparatus, safety device, crime/disaster prevention equipment, etc) which may cause damages to human life or property, it is required to install fail-safe device.
It may cause a fire, human injury or property loss.
- Do not use the Logic Panel where serious physical damage or production halt can be caused.
It may cause a fire, human injury or property loss.
- In case using the Logic Panel touch switch for controlling, do not use the switch as an emergency switches or those related to safety that may cause physical injury or property damage in the event of a malfunction.
It may cause a fire, human injury or property loss.
- In the event of LP defect or malfunction in the Logic Panel, an alternative circuit must be constructed on the exterior.
It may cause a fire, human injury or property loss.
- Construct an emergency power-off circuit, safety circuit, or interlock circuit on the exterior of the Logic Panel.
It may cause a fire, human injury or property loss.
- If an error occurs on the watchdog timer of the Logic Panel, the logic program will shut down automatically, so an alternative circuit must be constructed on the exterior.
It may cause a fire, human injury or property loss.
- The overall system operation may malfunction due to an input error resulting from a failure in input signal detection; so an alternative circuit must be constructed on the exterior.
It may cause a fire, human injury or property loss.
- For output signals that may cause a serious accident if the output section is damaged, a detection circuit and alternative circuit must be constructed on the exterior.
It may cause a fire, human injury or property loss.
- In case controlling other devices through Logic Panel communication, and there is a possibility of malfunction due to communication error, an alternative circuit must be constructed.
It may cause a fire, human injury or property loss.

- When switching the mode to RUN mode, make sure that supply power to LP, I/O unit and load first. If not, output error or miss-operation may cause.
It may cause a fire, human injury or property loss.
- Do not use the product in an area or an environment not specified in the manual.
It may cause a fire, human injury or property loss.
- Do not connect, inspect or repair when power is on.
It may cause a fire or give an electric shock.
- Do not disassemble the product. Please contact us if it is required.
It may cause a fire or give an electric shock.
- Please use the rectified power with insulation trans.
It may cause a fire or give an electric shock.
- Do not use the power to the exceeded rated voltage.
It may cause a fire or give an electric shock.
- This product uses lithium battery, do not disassemble or burn up.
It may cause an explosion or a fire.
- Wire properly after checking power terminal polarity.
It may cause a fire or a malfunction.

**Caution**

- Please read all notes and cautions related to installation and wiring in the manual.
If this is not observed, electrical shock or malfunction may occur.
- Make sure the ground wire of Logic Panel is wired separately from the ground wires of other devices. Ground resistance must be less than 100Ω , and a lead wire of which sectional area is over 1.25mm^2 should be used.
If this is not observed, electrical shock or malfunction may occur.
- When connecting Logic Panel ports and constructing input/output, check the pin number and terminal block before connecting.
It may cause a fire or a malfunction.
- Please tighten bolt on terminal block with specified tightening torque.
It may cause a short circuit, fire or a malfunction.
- Do not press the surface of the touch panel with sharp or hard objects.
The touch panel may be damaged.
- Keep Logic Panel at the specified temperature.
If stored at a temperature beyond the specification, damage may occur.
- Do not inflow dust or wire dregs into the unit.
It may cause a fire or a malfunction.
- Do not use in an area with excessive humidity or temperature.
The Logic Panel may malfunction, or its useful life may be shortened.
- Do not close ventilating opening of this product.
Malfunction may occur due to temperature increase.
- Keep the product out of direct sunlight or excessive dust.
The Logic Panel may malfunction, or its useful life may be shortened.

- Do not use or store in a place with shock or vibration.
The Logic Panel may malfunction, or its useful life may be shortened.
- When liquid crystal from the broken LCD is smeared with skin, wash it for 15 minutes. If it is gotten in the eye, wash it for 15 minutes and contact with the medical specialist for more information.
- In cleaning unit, do not use water or an oil-based detergent and please use dry towels.
It may cause an electric shock or a fire.
- Please separate as an industrial waste when disuse this unit.
- To change the battery, contact the store or an authorized technician.
- The manufacturer is not liable for damages that occur due to causes for which the manufacturer is not responsible, damages that occur due to an extraordinary situation, secondary damages, compensation for accidents, damages occurring on other products, compensation for other processes, and damage and loss of opportunity to the user due a malfunction of the product, regardless of the predictability of the accident.
- Note that this device is KCC certified for commercial use. Make proper applications for the product.

※ **The specifications and dimensions of this manual are subject to change without any notice.**

Table of Contents

Preface	iii
User Manual Guide.....	iv
User Manual Symbols.....	v
Safety Precautions.....	vi
Table of Contents.....	ix
1 Overview	13
1.1 Logic Panel.....	13
1.2 Feature of LP.....	14
1.3 Ordering information.....	15
1.4 Specification.....	16
1.4.1 General specification.....	16
1.4.2 Performance specification.....	17
1.4.3 LP basic specification.....	18
1.5 Communication	19
1.5.1 Communication interface	21
1.6 Part description	23
1.7 Dimensions	24
2 Installation	25
2.1 LP installation	25
2.2 Power wiring	26
2.2.1 Ground wiring	27
2.2.2 Input wiring	28
2.2.3 Output wiring	29
2.3 Battery replacement.....	30
2.4 Caution for using.....	30
2.5 USB driver installation	31
2.5.1 Install with found new hardware wizard	31
2.5.2 Install with device manager	37
2.5.3 Install with control panel.....	39
2.5.4 Remove GP/LP USB driver.....	44
2.5.5 Update GP/LP USB driver.....	46
3 Device Construction	49
3.1 Device element.....	49
3.2 Device range.....	51
3.2.1 Bit device range	51
3.2.2 Word device range	52
3.3 Application of UW, UB corresponding.....	53
4 System Organization	55
4.1 Stand-alone	55
4.2 Connection with controller.....	56

4.2.1	1:1 organization	56
4.2.2	1:N organization	57
4.2.3	Heterogeneous organization	58
4.3	Universal organization	59
4.4	Connect with barcode, printer	60
4.5	Operation mode	61
4.6	Program processing procedure	62
4.7	Connect with GP Editor	63
4.7.1	GP Editor configuration	67
4.8	Connect with SmartStudio	68
4.8.1	LP configuration	68
4.8.2	SmartStudio configuration	68
5	Start up LP	69
5.1	Checking list before supplying power	69
5.2	Operation order	70
6	System Screen	71
6.1	Organization of system screen	71
6.2	Operation of system screen	72
6.3	Monitoring	73
6.3.1	Device monitor	73
6.3.2	I/O monitor	75
6.4	Environment	76
6.4.1	Serial communication	76
6.4.2	Serial details configuration	81
6.4.3	Language	83
6.4.4	Local Ethernet	84
6.4.5	Screen bright	85
6.4.6	Assistance setting	86
6.4.7	Clock	88
6.5	Functionality	89
6.5.1	Time switch	89
6.5.2	Data transfer	91
6.5.3	Data logger	92
6.5.4	Print out	112
6.6	Data	113
6.6.1	Data manager	113
6.6.2	Firmware update	118
6.6.3	System	120
6.6.4	User screen	122
6.7	Diagnostics	125
6.7.1	System initialization	125
6.7.2	Battery remaining	126
6.7.3	Screen diagnosis	127
6.7.4	Touch diagnosis	129
6.8	Parameter	131

6.8.1	Common.....	131
6.8.2	Action list.....	134
6.8.3	Pattern list	136
7	User Screen.....	137
7.1	Screen specification.....	137
7.2	Screen display object.....	138
7.3	Screen switching	140
7.4	Overlap window function.....	141
7.5	Device connection status display.....	143
8	System Window	145
8.1	Key pad type.....	145
8.2	Key pad organization.....	146
9	Troubleshooting.....	147
9.1	Error and troubleshooting.....	147
10	Firmware update	149
11	Repair and Check.....	151
11.1	Change repair component	151
11.1.1	Battery change	151
11.2	Check.....	152
11.2.1	General check	152
11.2.2	Periodic check	152
12	Appendix.....	155
12.1	Instruction	155
12.1.1	Basic instruction list.....	155
12.1.2	Application instruction list.....	157
12.2	Special device list	168
12.2.1	Bit special device list.....	168
12.2.2	Word special device list.....	171
12.3	Diagnosis code table	172
12.4	ASCII code table.....	173
12.5	UW correspondence table.....	174
12.6	Motion control I/O signal allotment	175

1 Overview

1.1 Logic Panel

Logic Panel (after referred to as LP) is the integrated device with HMI(Human Machine Interface) and PLC(Programmable Logic Controller) functions as one.

It is very effective to display visual interface about connected device's status and to control connected devices conveniently without additional device at limited space.

LP monitors control variables visually by LCD screen, switches the screen, sets the variable value by touching a touch screen, and controls the device directly by output port. The other controllers from LP are connected by serial communication and it is able to exchange mutual information.

The variable for controller is displayed by various methods as tag which is a graphic object. For example, if the physical variable for monitoring is temperature, LP displays temperature as numeral by numeral input tag, or as trend graph with changes by time. LP screen consists of these graphic objects combinations.

GP Editor which is dedicated software for user defined screen data and SmartStudio which is for user defined data help create program and draw or edit screen. After editing screen data such as tag form, arrangement, and attribution in GP Editor, download these to LP and LP starts to monitor by screen data. You can program PLC logic and monitor the operation in SmartStudio.

1.2 Feature of LP

- Compact structure
LP realizes as one with power, PLC, HMI, I/O modules.
- Logic specification
LP has 8000 step program capacity.
It supports 28 basic instructions and 233 application instructions.
- Wide device range
LP supports auxiliary device 10K Word, data device 10K Word and other several devices.
- Variable external I/O than equivalent product
LP supports input 16 points/ output 16 point basically. (Terminal block connector, ribbon cable connector)
- Space saving and simple wiring
Automation system with LP series saves install space and provides simple wiring.
- Cost saving for install and maintenance
Automation system with LP series saves cost and time for install and maintenance.
- Product upgrade by web site
We offer LP firmware, GP Editor, SmartStudio, protocol, language and font, various manuals at www.autonics.com to download conveniently.
- Monitoring function of other type controller
By PLC connection port, LP monitors and controls the variable of additionally connected controller (PLC, etc).
- Communication between heterogeneous controllers
You can connect other type controller to serial port separately.
LP monitors two different controllers simultaneously and relays communication between two controllers.
- Multi monitoring function
You can connect same type of several controllers.
- Supports multilingual
LP supports Korean, English and the other languages are available for the later.
- Supports several font
LP supports various bitmap font and vector font. You can select the desired font and use it.
- Multi communication port
LP supports several communication port such as RS232C / RS422 serial communication port, USB HOST USB DEVICE, and Ethernet.
Two serial ports of RS232C / RS422 are designated for the device connecting by software (PLC, computer, printer, barcode reader, etc). By supported communication type of connected device, select port to communication.
- Monitoring function for controller device
Without designed data, LP menu is available for monitoring connectable controller device.
- Printer and barcode reader connection
You can print alarm list by connecting printer.
It is able to read barcode by connecting barcode reader.

- Touch interface
It is able to input value in controller with touch switch on front screen.
- Slim size
It is easy to utilize space with slim size.
- Various display function
It is able to display data with various tags.
- Positioning function
It supports simultaneous output as max.100KHz pulse 2 points.

1.3 Ordering information

LP - S 070 - T 9 D 6 - C 5 R
 ① ② ③ ④ ⑤ ⑥ ⑦ ⑧ ⑨ ⑩

Item		Description
① Item	LP	Logic panel
② Series	S	S series
③ Screen size	070	7"
④ Display unit	T	TFT Color LCD
⑤ Color	9	16,777,216 color
⑥ Power supply	D	24VDC
⑦ Interface	6	RS232C, RS422, USB Device, USB Host, Ethernet
	7	RS232C, RS232, USB Device, USB Host, Ethernet
⑧ Module type	C	All-in-one type
⑨ I/O composition	5	IN: 16 point, OUT: 16 point
⑩ I/O connector	T	Terminal block connector
	R	Ribbon cable connector

1.4 Specification

1.4.1 General specification

Model	LP-S070-T9D6-C5T(R)	LP-S070-T9D7-C5T(R)
Power supply	24VDC	
Allowable voltage range	90 to 110% of power supply	
Power consumption	Max. 7.2W	
Serial interface	Asynchronous method: Each of RS232C, RS422	
	Each port of RS232C, RS422	Each port of RS232C, RS422
USB interface	Each of USB Host, USB Device (Version 1.1)	
Real-time controller	RTC embedded	
Battery life time	3 years at 25°C	
Insulated resistance	Min. 100M Ω (at 500VDC megger)	
Ground	3rd grounding(Max. 100 Ω)	
Noise immunity	The square wave noise (Pulse width 1 μ s) by the noise simulator with \pm 500V R/S phase and repetition frequency 60Hz	
Withstanding voltage	500VAC (50/60Hz) for a minute	
Vibration	Mechanical	0.75mm amplitude at frequency of 10 to 55Hz (for a minute) in each of X, Y, Z directions for an hour
	Malfunction	0.5mm amplitude at frequency of 10 to 55Hz (for a minute) in each of X, Y, Z directions for 10 minutes
Environment	Temperature	0 to 50°C, Storage: -20 to 60°C
	Humidity	35 to 85% RH, Storage: 35 to 85% RH
Protection	IP65F(for front panel)	
Accessory	Fixing bracket: 4pcs, Battery(included)	
Approval	CE 	
Unit weight	Approx. 540g	

※Environment resistance is rated at no freezing or condensation.

1.4.2 Performance specification

Display performance			
LCD type	TFT Color LCD		
Resolution	800 X 480 dot		
Display area	152.4mm X 94.44mm		
Color	16,777,216 color		
LCD view angle	Within each 50/60/65/65° of top/bottom/right/left		
Backlight	White LED		
Brightness	Adjustable by software		
Graphic drawing performance			
Language	Korean, English (You can add other supported languages.)		
Text	<ul style="list-style-type: none"> ▪Vector font ▪6X8, 8X8 ASCII character, high quality view of number ▪8X16 ASCII character, 16X16 regional characters(1 to 8 times bigger for width, 0.5 to 5 times for height) 		
Graphic drawing memory	16MB		
Number of user screen	500 pages		
Touch switch	Analog touch		
Control performance			
Instruction	Basic instruction: 28, Application instruction: 233		
Program capacity	8K step		
Processing time	Average: 2 μ s/basic instruction, application instruction		
I/O control type	Batch processing		
Operation control mode	Repeated-doubling method, interrupt processing		
Device range	Refer to '3.2 Device range'		
Special function	Positioning function		
Input/Output specification			
Input specification		Output specification	
Input point	16 points	Output point	16 points
Insulation method	Photo coupler insulation	Power supply	24VDC
Rated input voltage	24VDC	Insulation method	Photo coupler insulation
Voltage range	19.2 to 28.8VDC	Rated load voltage	19.2 to 28.8VDC
Input resistance	Contact X0 to X5: 2.2 k Ω Contact X6 to XF: 5.6 k Ω	Max. load current	0.1A/1point, 1.6A/1COM
Response time	1ms	Max. voltage falling when ON	Max. 0.2VDC
Common method	16 points/ 1COM	Common method	16 points/ 1COM
Acceptable wire	Wire 0.3 to 0.7	Acceptable wire	Wire 0.3 to 0.7

1.4.3 LP basic specification

Function		Description
Monitoring	Device monitor	Monitors connected PLC device and changes the status
	I/O monitor	Monitors I/O status of LP-S070
Environment	Language	Designates system language and character set
	Serial communication	Configures serial port for connecting between GP Editor and connected device, printer, barcode reader, or monitor
	Local Ethernet	Designates IP of LP-S070
	Clock	Designates current time and date
	Screen bright	Designates backlight brightness
	Assistance setting	Key of system setting menu: Designates the position for calling system setting menu
		Buzzer: Designates using buzzer or not
Screen open time: Set time for open screen when supplying power		
Off time of back light: Set off time for backlight		
Data	Data manager	Manages USB_DISK and GP/LP_DISK
	Base screen	Displays user-defined base screen title and number
	Window screen	Displays user-defined window screen title and number
	Comment	Displays downloaded comment list in LP
	Firmware update	Enables to update firmware
	System	System information: Displays current system information of LP
		Disk capacity: Checks total disk capacity and available disk capacity of LP
Functionality	Data transfer	Displays this menu during communicating (download/upload) between LP and GP Editor
	Time switch	Designates time switch
	Print out	Prints out alarm history with printer
	Data logger	Saves the specified device value by user-defined condition
Diagnostics	System initialization	Initializes every set value of system as default value
	Battery remaining	Displays battery remaining with percentage (%) and bar graph.
	Screen diagnosis	Checks LCD bad pixel and font by diagramming color and figures as pattern.
	Touch diagnosis	Diagnosis touch
Parameter	Common Setting	Check motion common setting values which are designated from SmartStudio
	Action/Pattern List	Check motion action/pattern list which is designated from SmartStudio

1.5 Communication

Depending on PLC model type, connections for PLC are different, therefore refer to 'GP, LP user manual for communication'.

Every device such as PLC is able to connect any RS232C or RS422 port. CH1, CH2 is designates in GP Editor.

(1) Connection of 1 PLC

Connect PLC to a port and one of PC, printer, barcode reader to the other port.

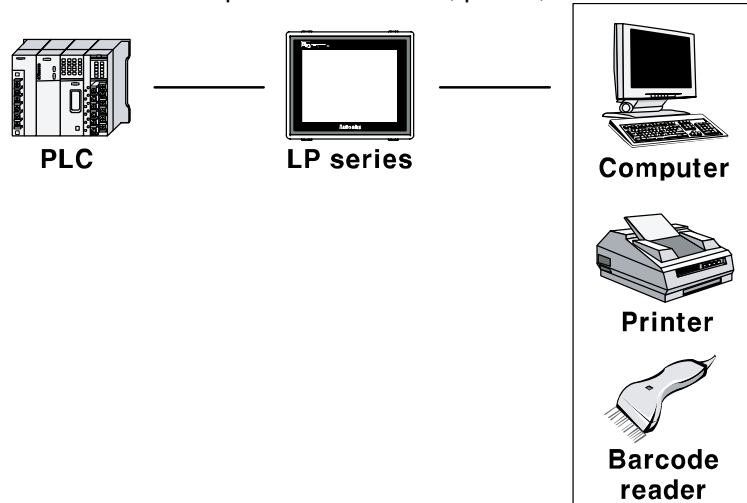

(2) Connection of CH1 and CH2

Connect PLC to LP-S070 ports.

It is able to connect even if CH and CH2 are not same type PLC, LP can relay data exchange between CH1 and CH2 according to configuration.

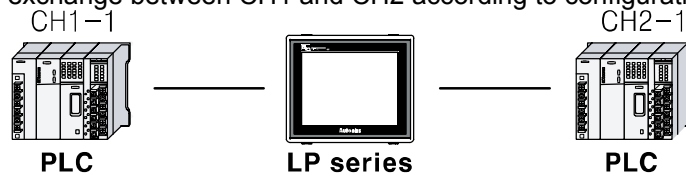

(3) Connection of plural PLCs

It is able to connect same device type to CH1 and CH2 as up to 32 by each.
In this case, LP can link data between CH1-1 to CH1-n and CH2-1 and CH2-n and it is able not to use CH1 or CH2.

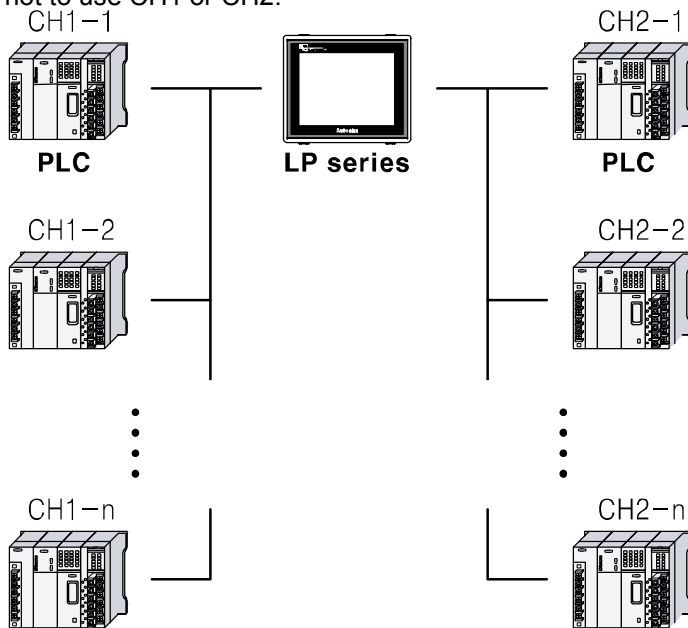

1.5.1 Communication interface

1.5.1.1 Serial interface

(1) Serial port

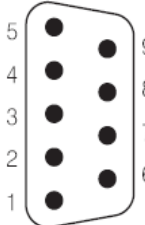
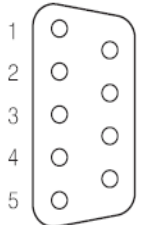
Port	Pin	Port	Pin		
RS232C-A RS232C-B  D-Sub 9Pin Male	1	Non-used	RS422  D-Sub 9Pin Female	1	TXD+
	2	RXD		2	RXD+
	3	TXD		3	Non-used
	4	DTR		4	Non-used
	5	SG		5	SG
	6	DSR		6	TXD-
	7	Non-used		7	RXD-
	8	Non-used		8	Non-used
	9	Non-used		9	Non-used

(2) Serial port setting

Designate the desired settings for below items at [Environment] - [Serial Communication]

Interface	RS232/RS422
Baud rate	300, 600, 1200, 2400, 4800, 9600, 19200, 38400, 57600, 115200bps
Data length	7, 8 Bit
Stop bit	1, 2 Bit
Parity	ODD, EVEN
Flow control	XON/XOFF, DSR/DTR, NONE

1.5.1.2 USB interface

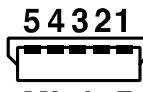
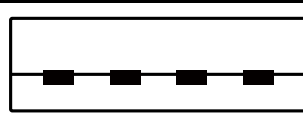
USB Device	Pin	USB HOST	Pin		
 Mini-B	1	 Type A	1	5V	
	2		D-	2	D-
	3		D+	3	D+
	4			4	GND
	5		GND		
You can download designed data of GP Editor and PLC program of SmartStudio by connecting USB Device PC.		You can update firmware by USB memory stick and install LP project file and SmartStudio project file.			

1.5.1.3 Ethernet Interface

IEEE802.3(U), 10/100 Base-T

You can download designed data of GP Editor and PLC program of SmartStudio by connecting PC.

- Crossover – Cable

PC1 Signal	Pin no.	Cable color		PC2 Signal	Pin no.
Tx+	1	White	Orange	3	Rx+
Tx-	2	Orange		Orange	Rx-
Rx+	3	White	Green	1	Tx+
	4	Blue		Blue	
	5	White	Green	5	
Rx-	6	Green		Green	Tx-
	7	White	Brown	7	
	8	Brown		Brown	

Tx: Transmit Data

Rx: Receive Data

For connecting line sharer, use direct cable.

- Straight(Direct) through – Cable

PC1 Signal	Pin no.	Cable color		PC2 Signal	Pin no.
Tx+	1	White	Orange	1	Rx+
Tx-	2	Orange		2	Rx-
Rx+	3	White	Green	3	Tx+
	4	Blue			
	5	White	Blue	5	
Rx-	6	Green			Tx-
	7	White	Brown	7	
	8	Brown			

Tx: Transmit Data

Rx: Receive Data

1.6 Part description

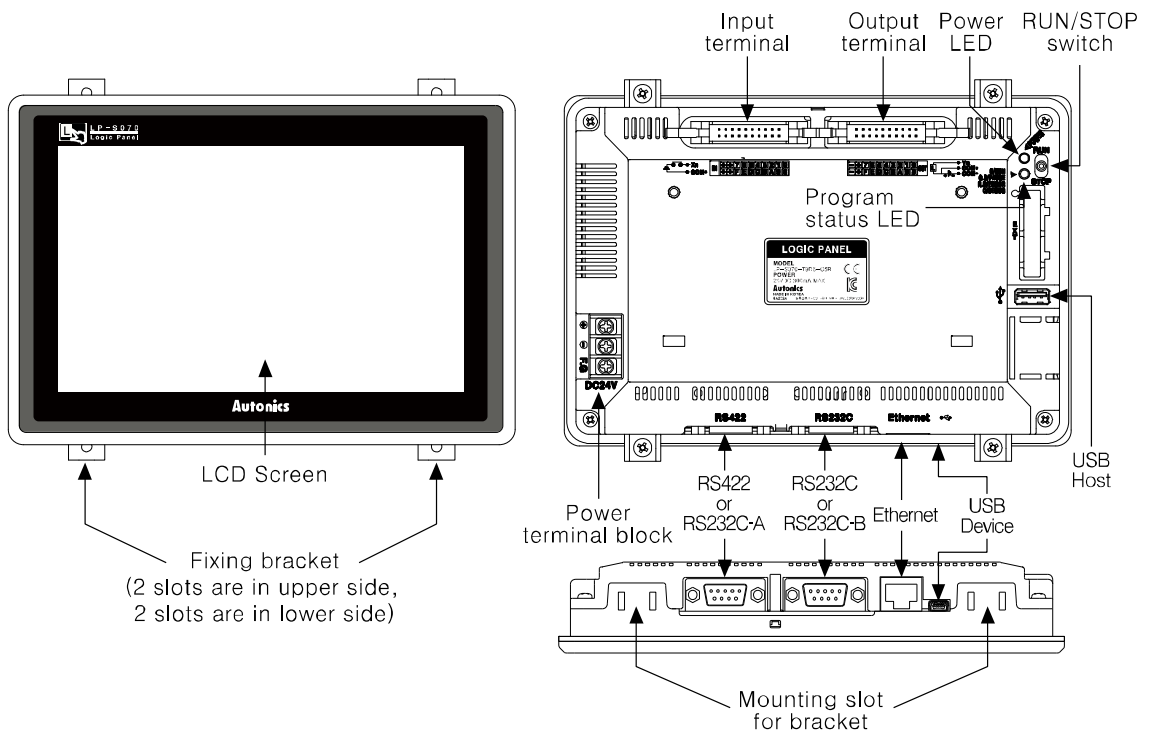

- Ethernet port
For connecting LAN cable and hub, use direct cable or for connecting PC directly, use cross cable.
- USB Device
USB device is available for project upload and download (to install USB driver to PC) and utilizes as general USB memory (recognized portable disk) when connecting PC.
- USB Host
Use USB host for data management, firmware update.

1.7 Dimensions

[Unit:mm]

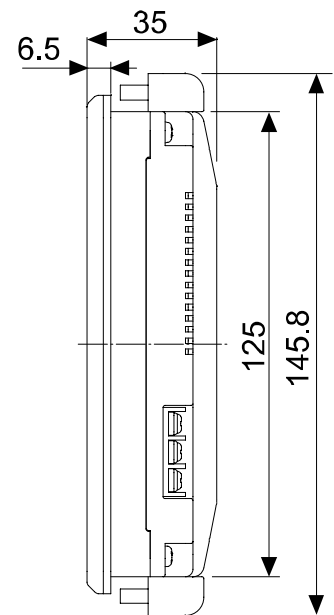
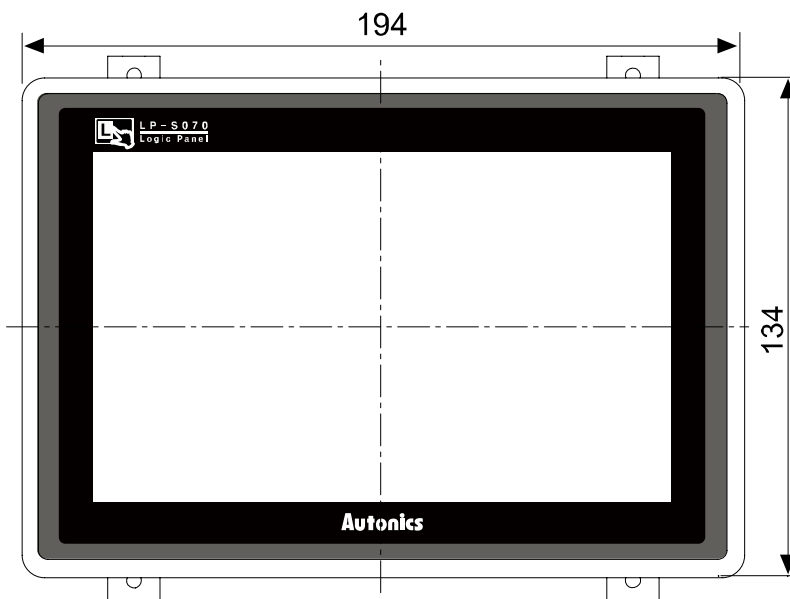
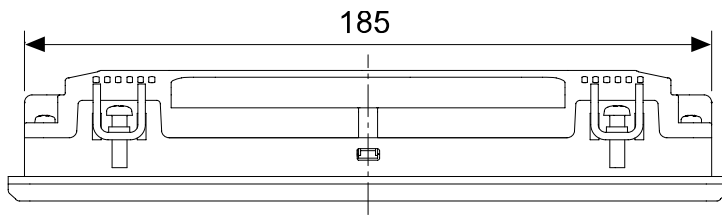

●Panel cut-out

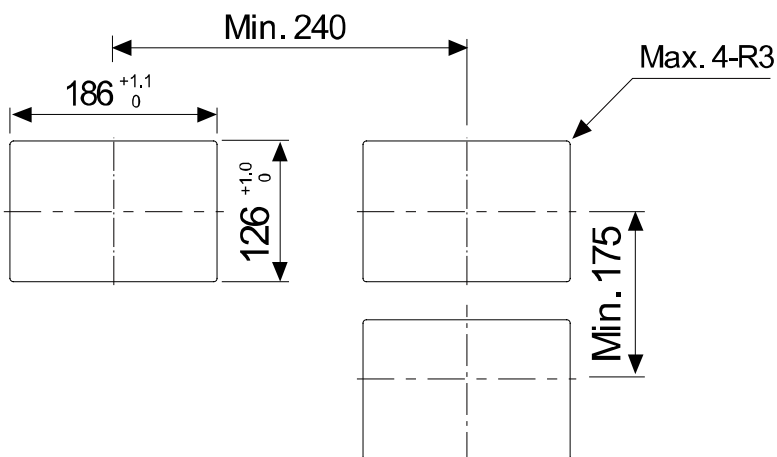

●Fixing bracket

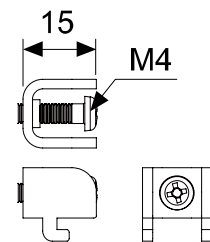

※Panel thickness : Max. 4mm

2 Installation

2.1 LP installation

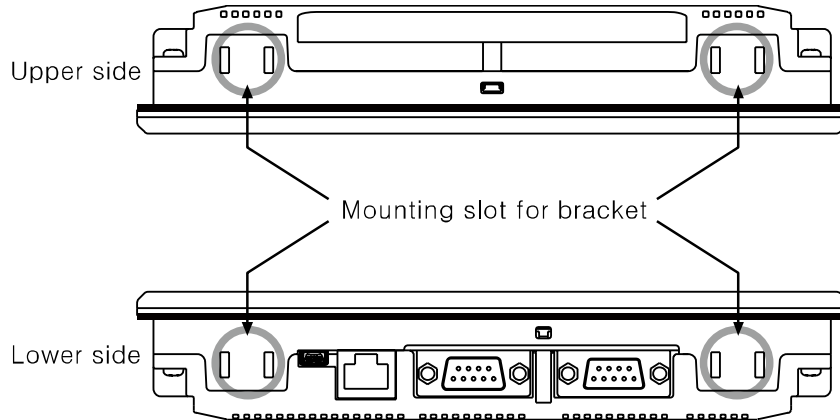

1st Set LP-S070 in panel which is cut for panel cut out dimension.

2nd Set fixing brackets in slots (2 slots are in upper side, 2 slots are in lower side).

3rd Tightening fixing bracket with M4 Screw driver and tightening torque is 0.3 to 0.5N·m.

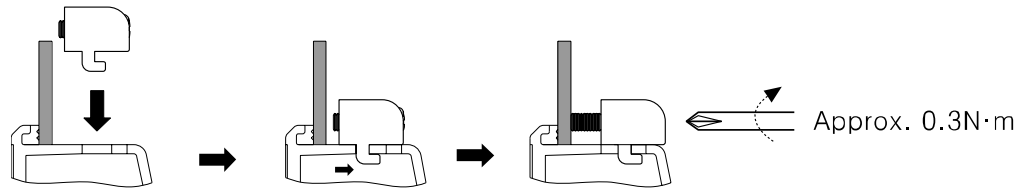

2.2 Power wiring

- For power supply, use the power line of which cross section is at least 0.75mm^2 and use the ground cable of which cross section is at least 1.25mm^2 .
- Use crimp-on type ring terminal with at least 3mm of internal diameter and less than 6mm of external diameter.
- Do not supply power before connecting power line.
- Check power polarity.
- Tighten the terminal screw with 0.5 to 0.8 N•m torque.
- Ground resistance should be less than 100Ω and ground it separately.

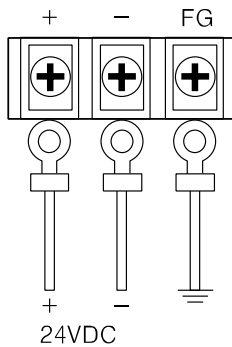

Caution

Caution for power wiring

- Before connecting power line, you must check power polarity.
- Do not connect power when power is supplied.
- Observe following allowable voltage change range of power voltage.

Power voltage	24VDC
Allowable voltage change range	21.6V to 26.4VDC

- When connecting power, supply power by power supply which has inner protection circuit. If the power supply which does not have inner protection circuit is used, you must install protection circuits such as fuse before using this. As following figure, LP must be separated power with motor or other I/O devices'.

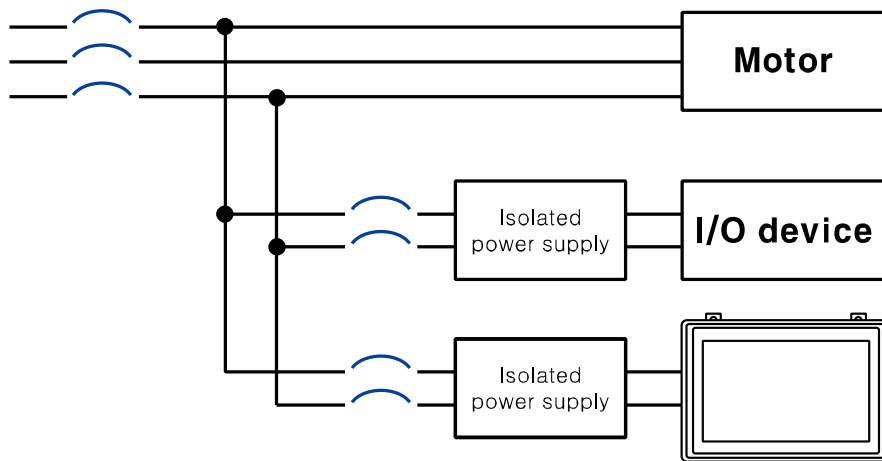

2.2.1 Ground wiring

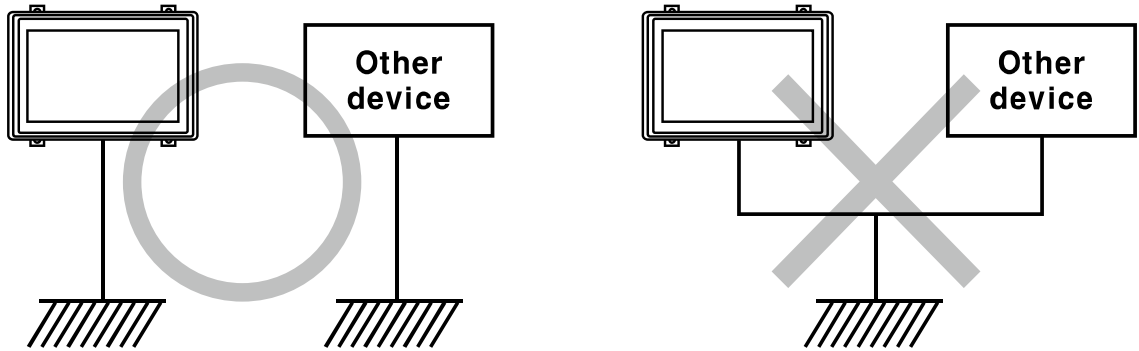

Caution

Caution for ground wiring

- Connect max. 100Ω of ground resistance.
- Diameter of cable for ground wiring connection should be over than 2 mm².
- As above figure, separate from other device's ground wire.

2.2.2 Input wiring

Consider required voltage for wiring I/O cable, and use optimal diameter cables.

(1) Input terminal wiring

Inner input module of LP-S070 series is NPN open collector (source type) type.

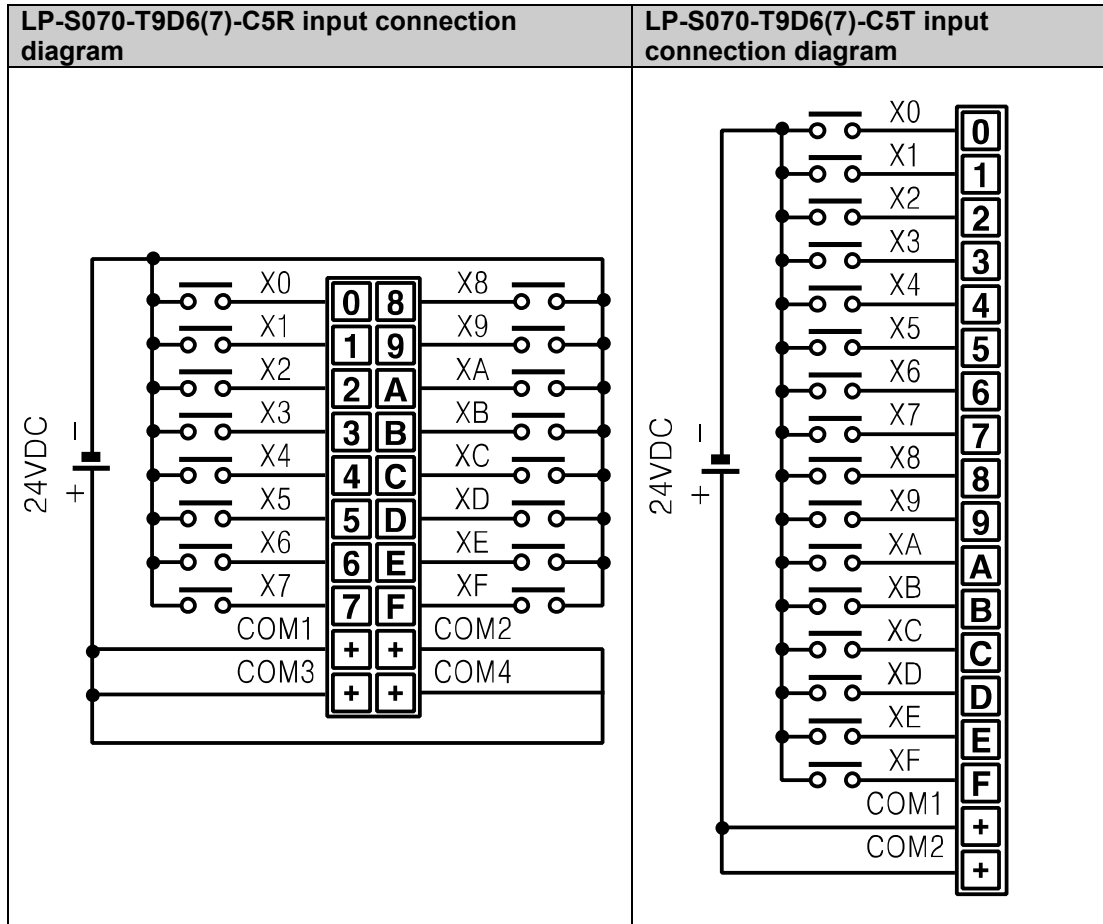

Caution

- Divide I/O cable by color. Do not wire I/O cables to same duct.
- Keep min.100mm distance from power line and other high voltage line to wire.

(2) Connection method by input device type

- Connect with relay output type

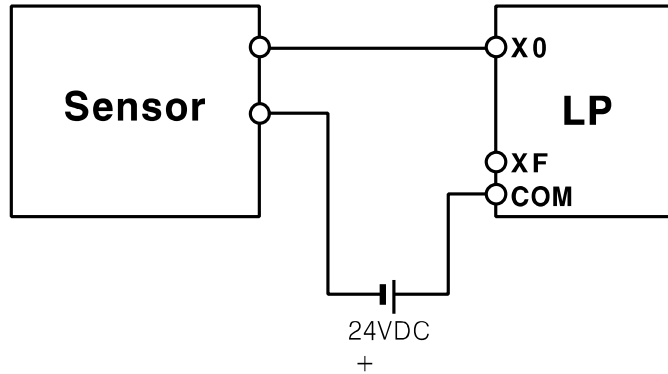

- Connect with NPN open collector output type

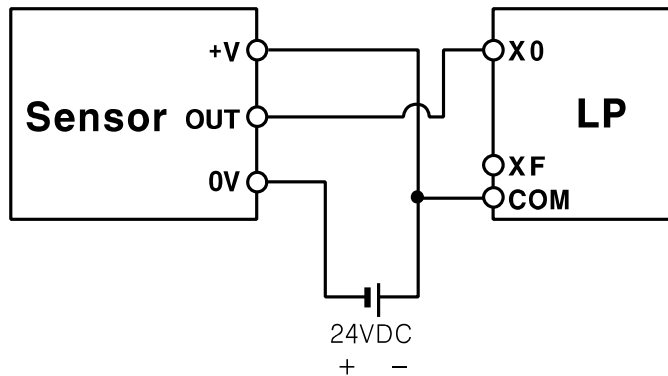

2.2.3 Output wiring

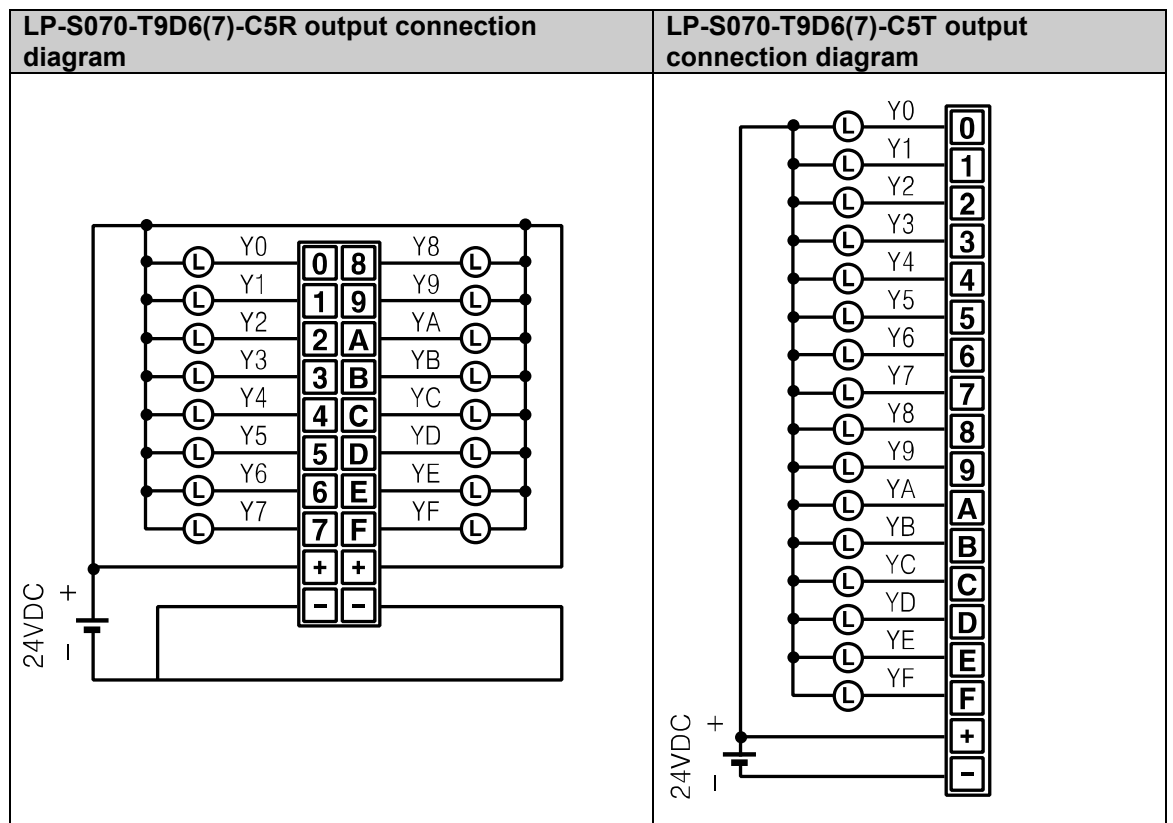

2.3 Battery replacement

Please contact our service center to replace LP-S070 battery.

It may cause an explosion or a fire when using improper battery.

2.4 Caution for using

- Use communication cable after checking whether there is break or short.
- Please install power switch or circuit-breaker in order to cut power supply off.
- Separate this unit from high voltage line, power line to avoid inductive noise.
- Do not use this product at below places where causes serious malfunction.
 - ① Place where there is severe vibration or impact.
 - ② Place where dust exists, or corrosion causing environments.
 - ③ Place where strong field or electric noise are generated.
 - ④ Place where temperature or humidity is beyond the specification.
 - ⑤ Place where strong alkalis or vibration or impact.
 - ⑥ Place where there are direct ray of sun.
- Installation environment
 - ① It shall be used indoor.
 - ② Altitude Max. 2,000m
 - ③ Pollution Degree 2
 - ④ Installation Category II

It may cause malfunction if above instructions are not followed.



Caution

Power and Usage Environment.

- A place where ambient temperature is outside the range of 0°C to 50°C.
- A place where ambient humidity is outside the range of 35% to 85% RH.
- A place where sudden temperature change occurs frequently (so dew may form on the product).
- A place where the product is not likely to be protected from direct sunlight and rain.
- A place exposed to dust or metallic fragments.
- A place exposed to corrosive or flammable gas.
- A place where continuous impact and vibration may occur.
- A place directly exposed to noise sources from high voltage transformers, current transformers, main power cables, power systems and frequency converters.

Pay attention to the following when installed:

- Do not let conductive substances from panel cut-out or wiring ducts enter into LP.
- Make sure to allow enough space to handle the LP.

Secure enough space to maintain inside temperature and humidity of the panel when you mount LP.

2.5 USB driver installation

GP/LP USB Driver' is driver for communication PC and LP-S070 by USB cable.

Before installing 'GP/LP USB Driver', visit our homepage(www.autonics.com) and download setup file.

Downloaded zip file name is as following.

GP_LP_Series.inf, GP_LP_Series.sys

2.5.1 Install with found new hardware wizard

1st Connect LP-S070 to PC with USB cable and 'Found New Hardware Wizard' operates.

Select 'No, not this time' and click 'Next'.



2nd Select 'Install from a list or specific location (Advanced)' and click 'Next'.

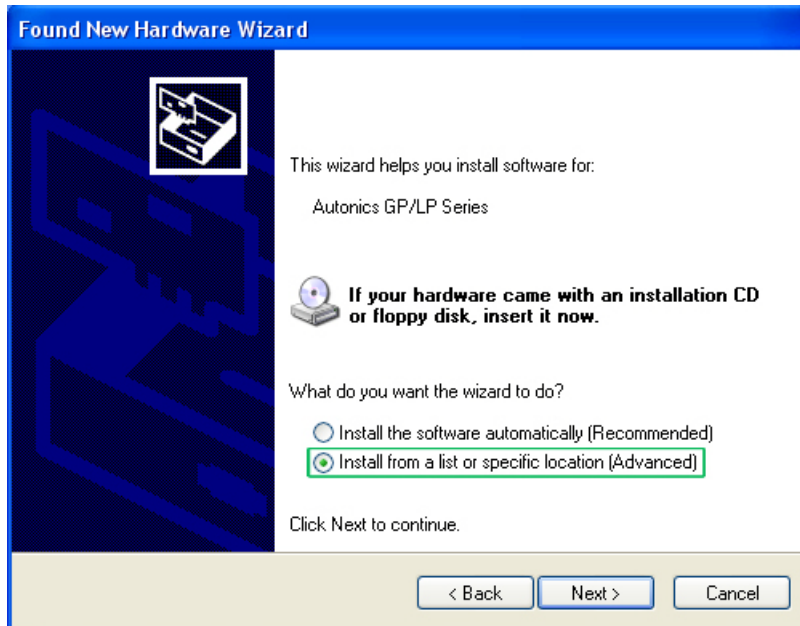

3rd Select 'Don't search. I will choose the driver to install.' and click 'Next'.

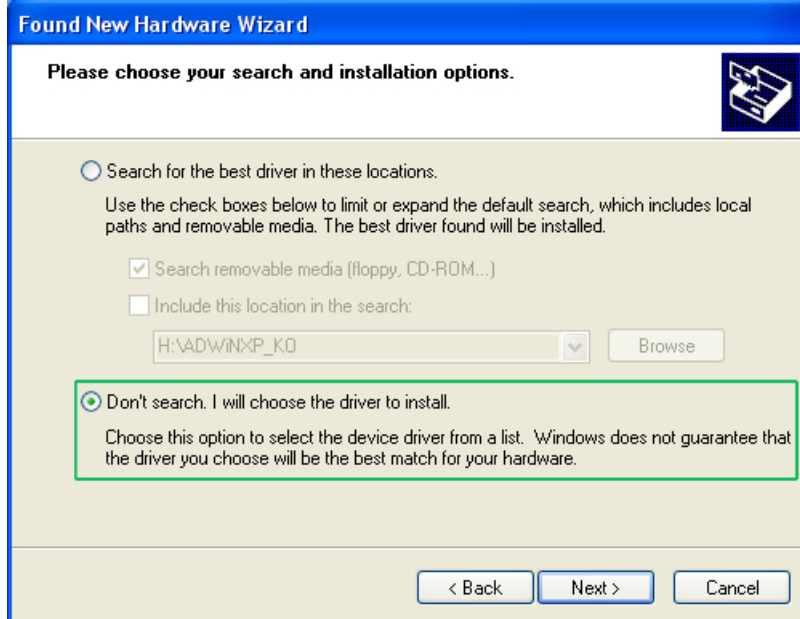

4th Select 'Show All Devices' for common hardware type and click 'Next'.

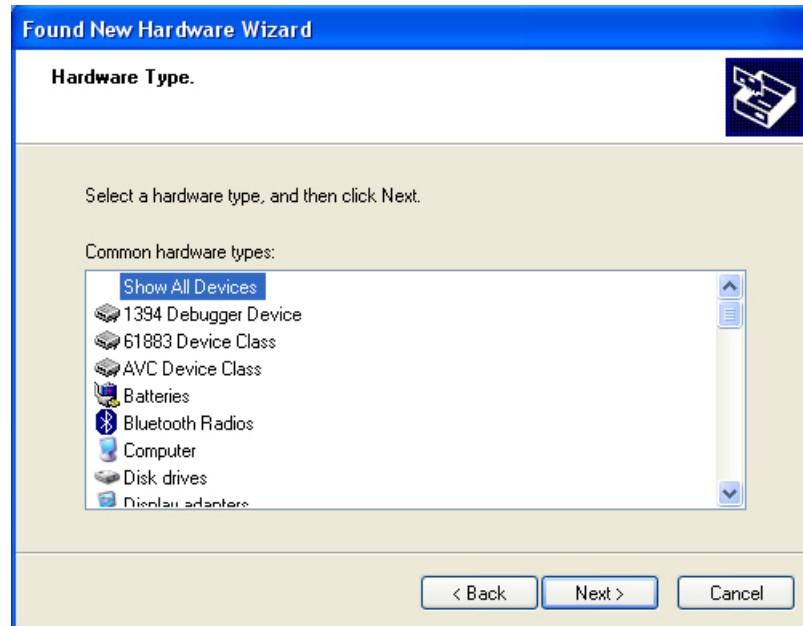

5th Select '(Standard system devices)' and 'HID-compliant game controller'.

6th Click 'Have Disk' and 'Install From Disk' dialog box appears.

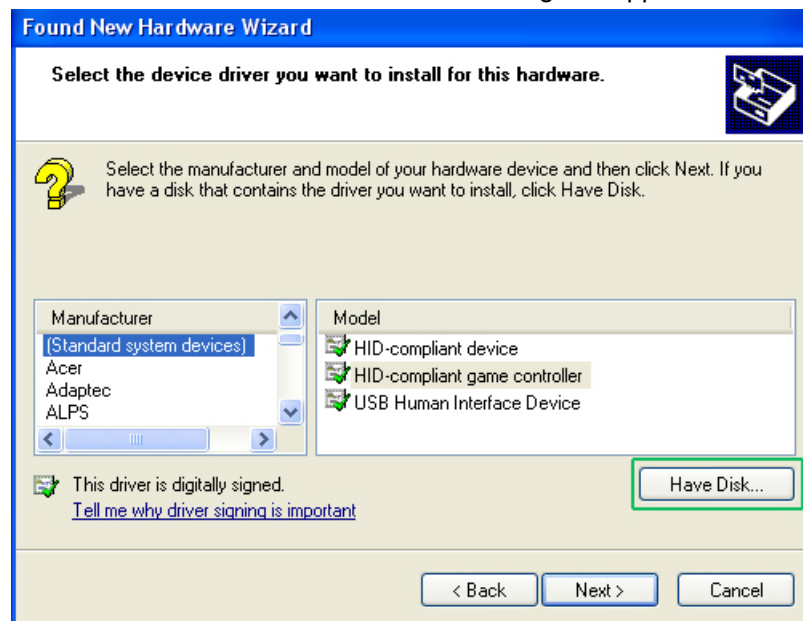

7th Click 'Browse', designate GP/LP USB Driver folder and click 'OK'.

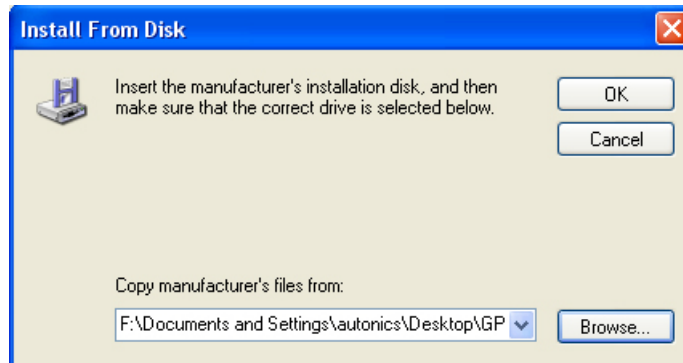

8th Select 'GP/LP Series' as below feature and click 'Next'.

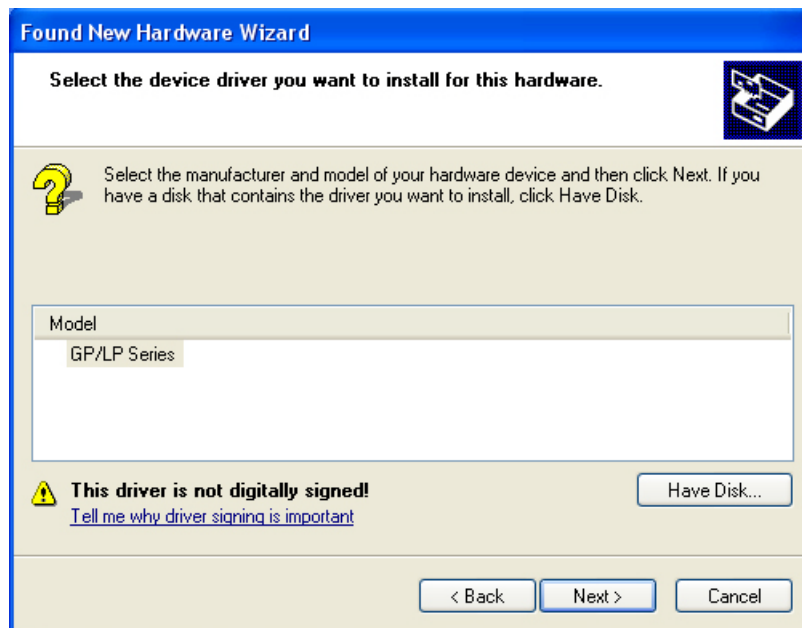

During installing driver, if following message appears, click 'Yes' and continues installing driver.

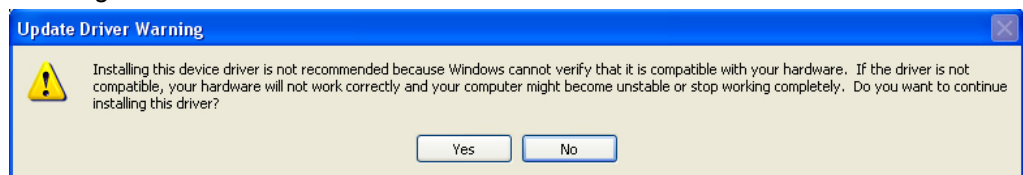

9th Processes installing GP/LP USB Driver.

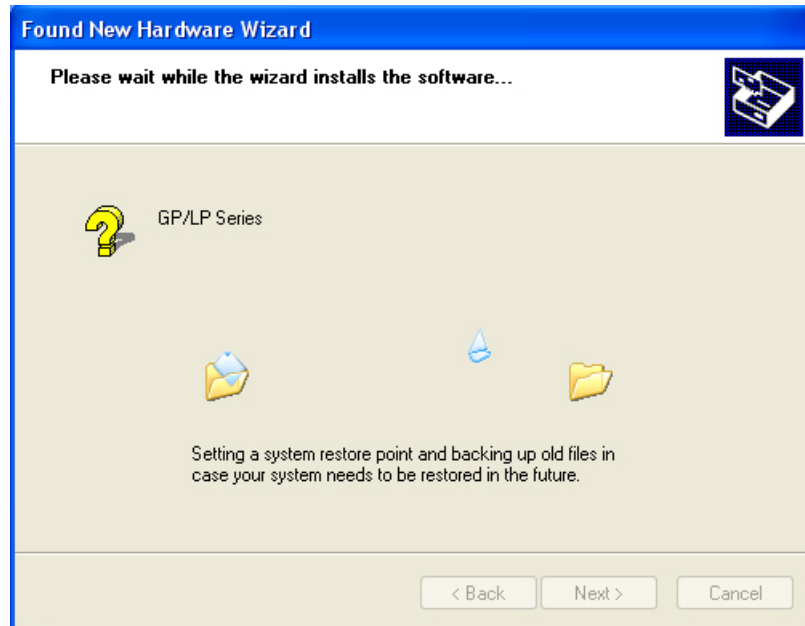

10th Click 'Finish' and completes installing driver.



11th You can check installed driver at [Start]-[Control Panel]-[System]-[Hardware]-[Device Manager].

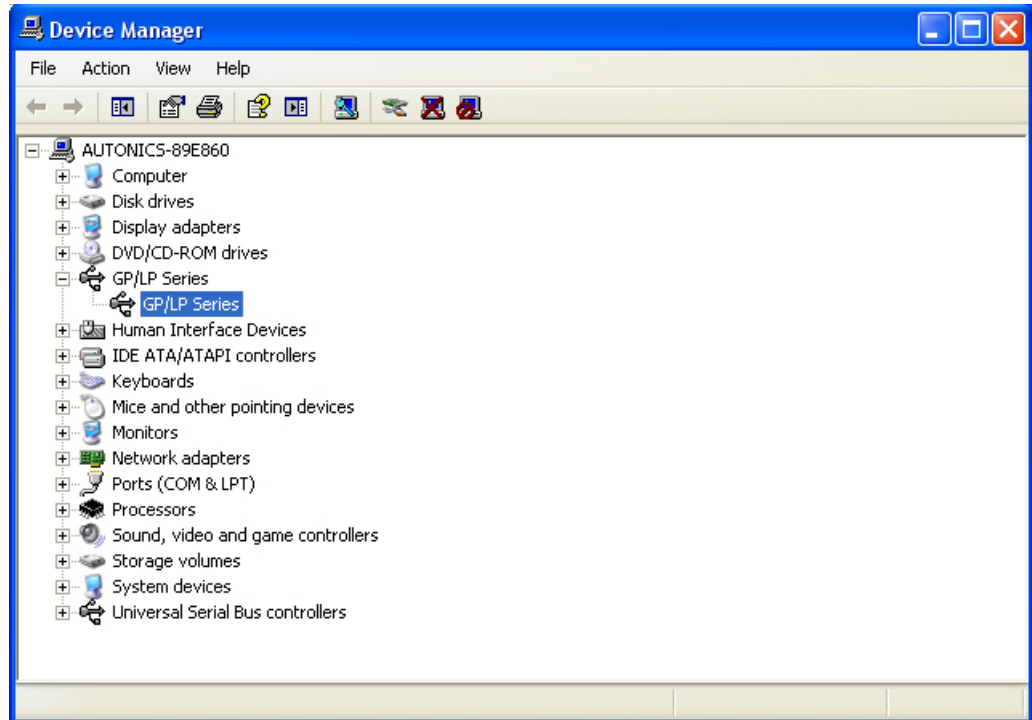

2.5.2 Install with device manager

1st If 'Found New Hardware Wizard' does not operate, you can install USB driver at [Start]-[Control Panel]-[System]-[Hardware]-[Device Manager].

Uninstalled driver displays '?' as following feature.

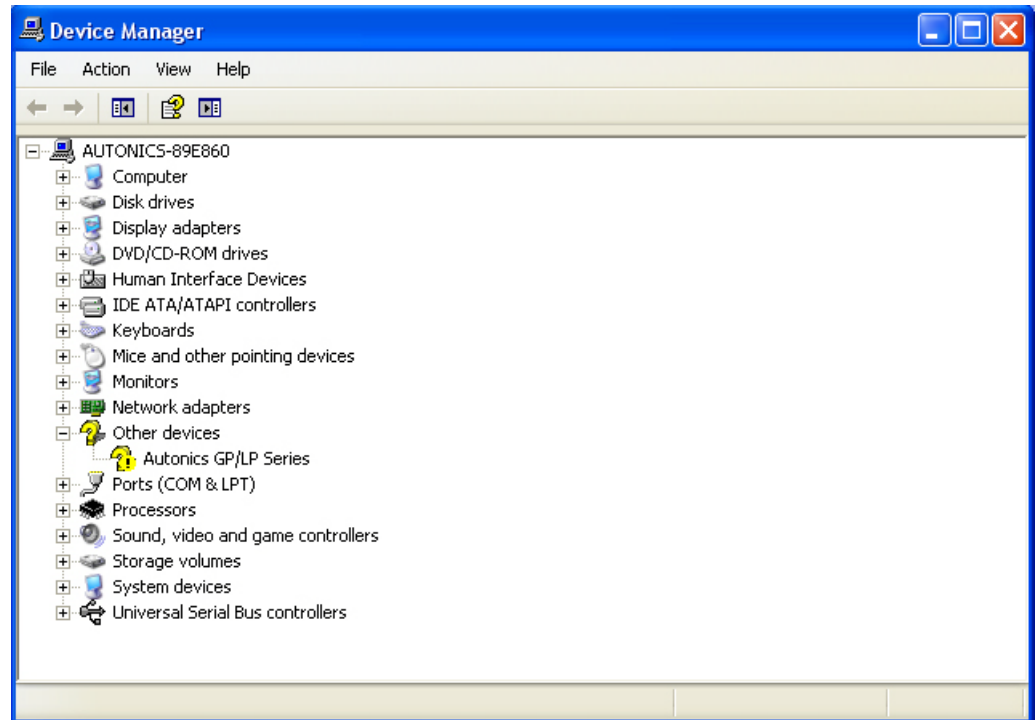

2nd Click 'Autonics GP/LP Series' with right mouse button and pop-up menu appears.

Select 'Properties'.

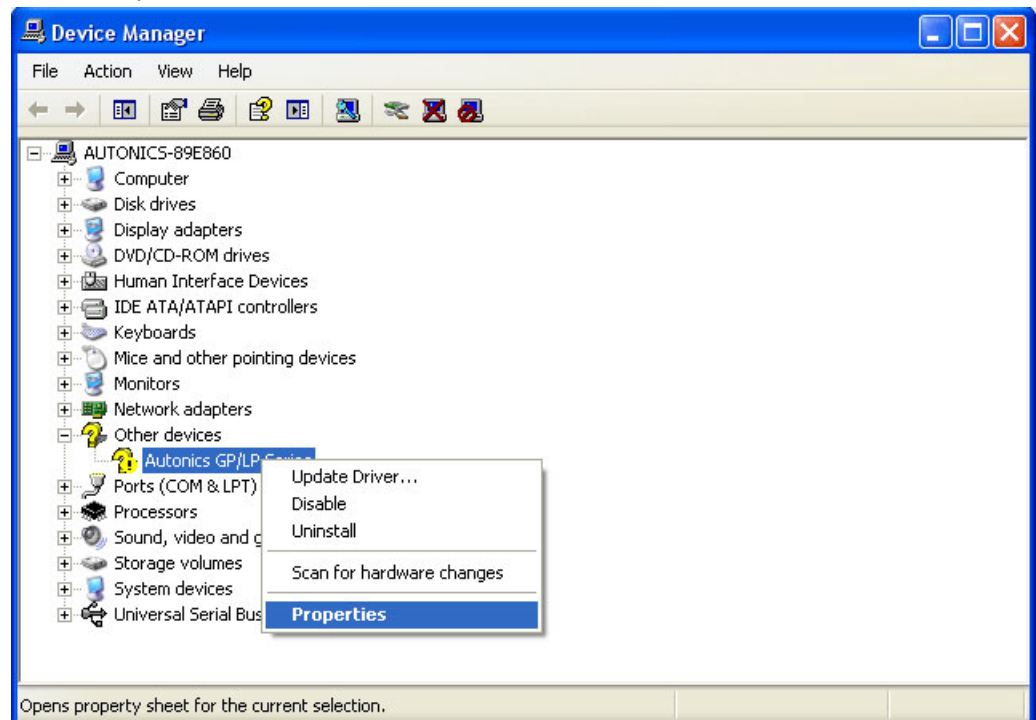

3rd 'Autonics GP/LP Series Properties' dialog box appears. Click 'Reinstall Driver'.

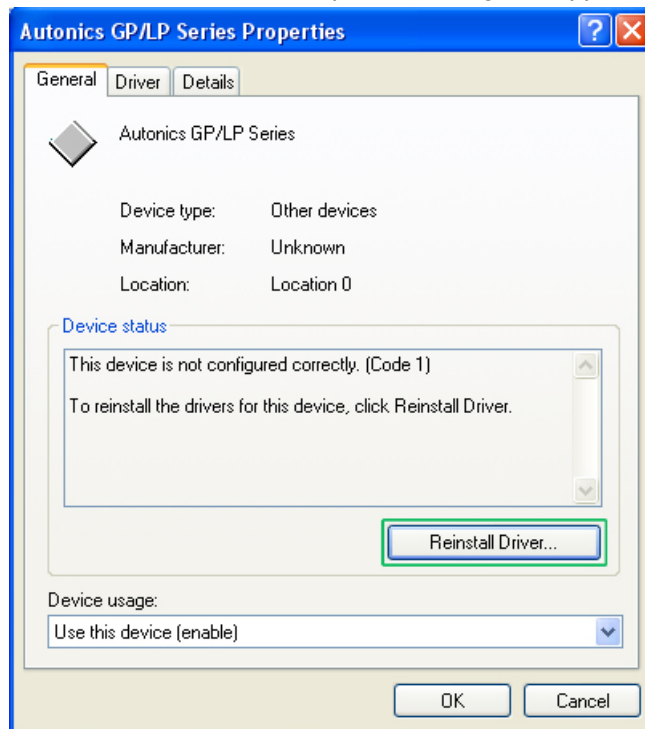

4th 'Found New Hardware Wizard' operates. Next steps are same as '2.5.1 Install with found new hardware wizard' and please refer this.

2.5.3 Install with control panel

1st Enter [Start]-[Settings]-[Control Panel] and click 'Add Hardware'.

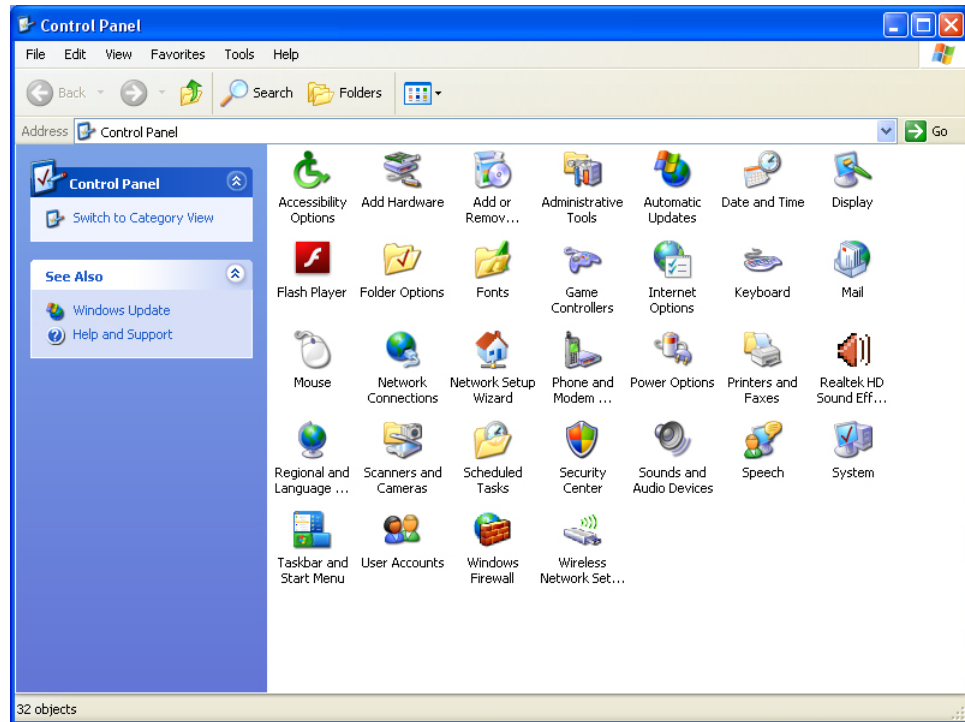

2nd 'Add Hardware Wizard' operates. Click 'Next'.



- 3rd Connect LP-S070 and PC with USB cable and select 'Yes, I have already connected the hardware' and click 'Next'.

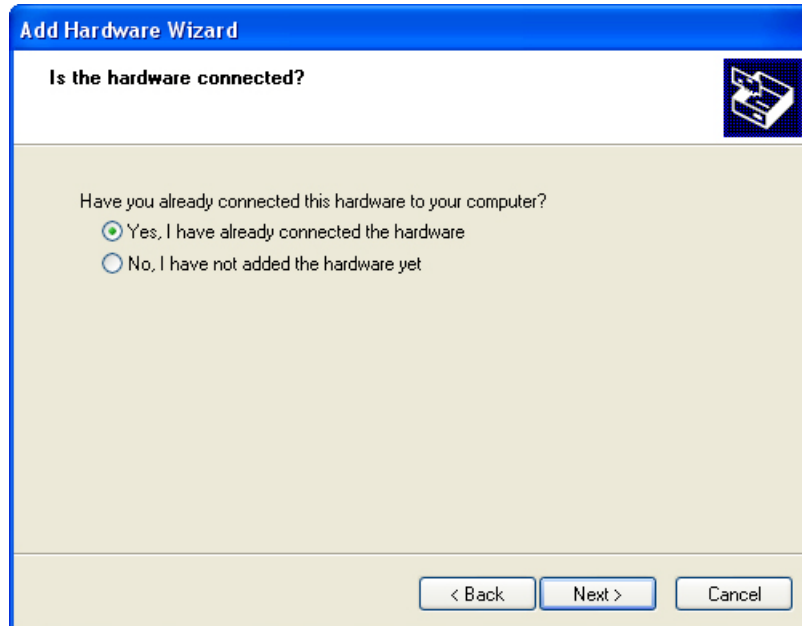

- 4th Select 'Add a new hardware device' and click 'Next'.

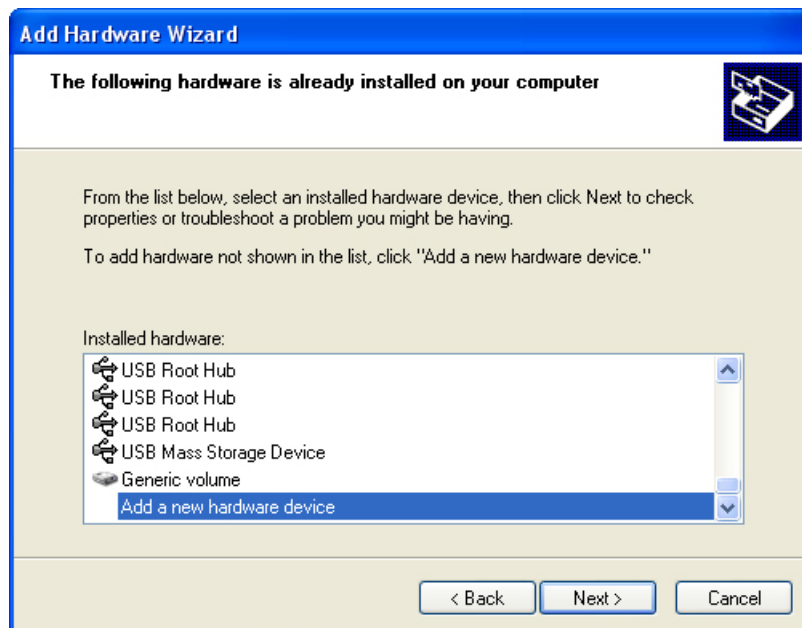

5th Select 'Install the hardware that I manually selected from a list' and click 'Next'.

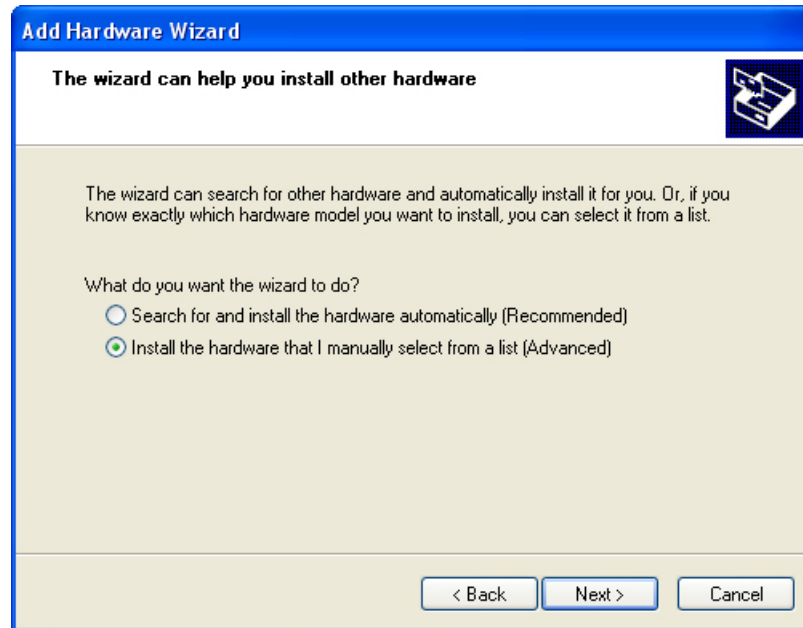

6th Select 'Show All Devices' for common hardware type and click 'Next'.

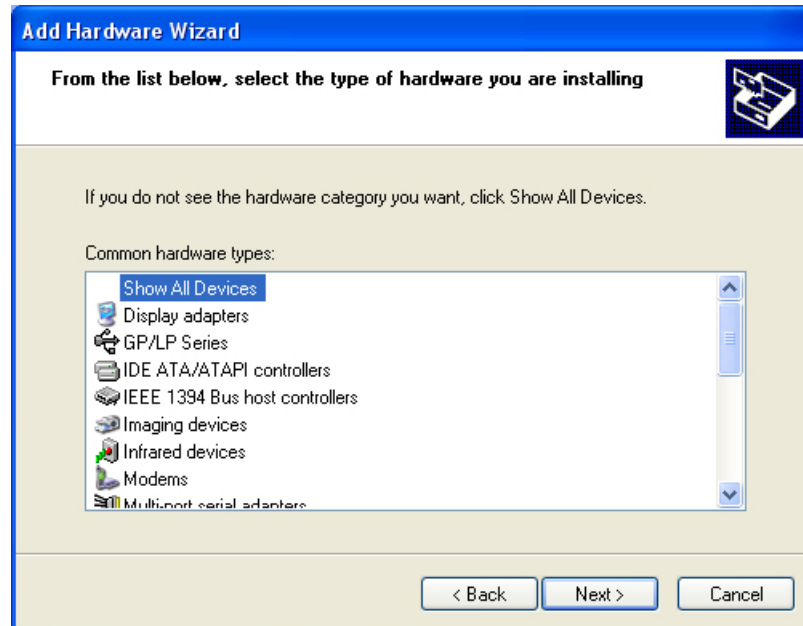

7th Click 'Have Disk' and 'Install From Disk' dialog box appears.

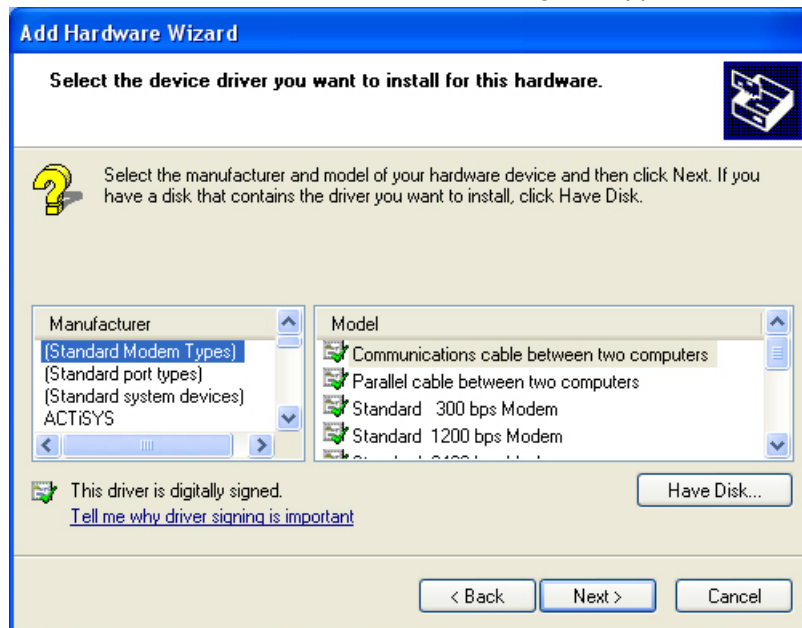

8th Click 'Browse', designate GP/LP USB Driver folder and click 'OK'.

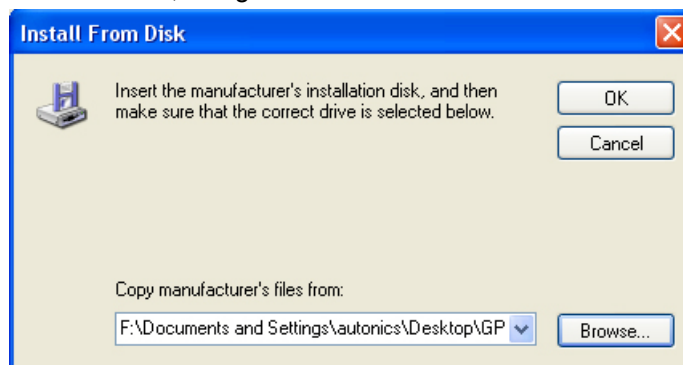

9th Select 'GP/LP Series' as below feature and click 'Next'.

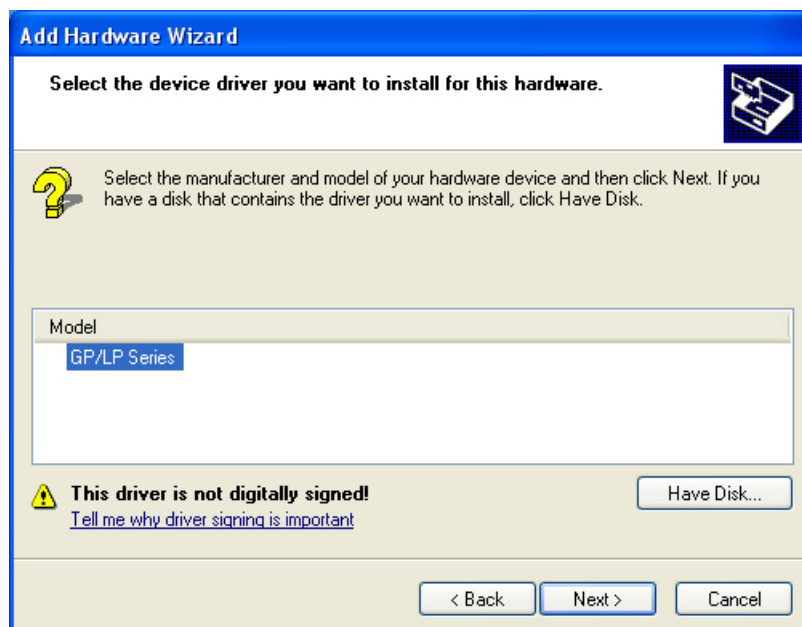

10th You can check installed driver at [Start]-[Control Panel]-[System]-[Hardware]-[Device Manager].

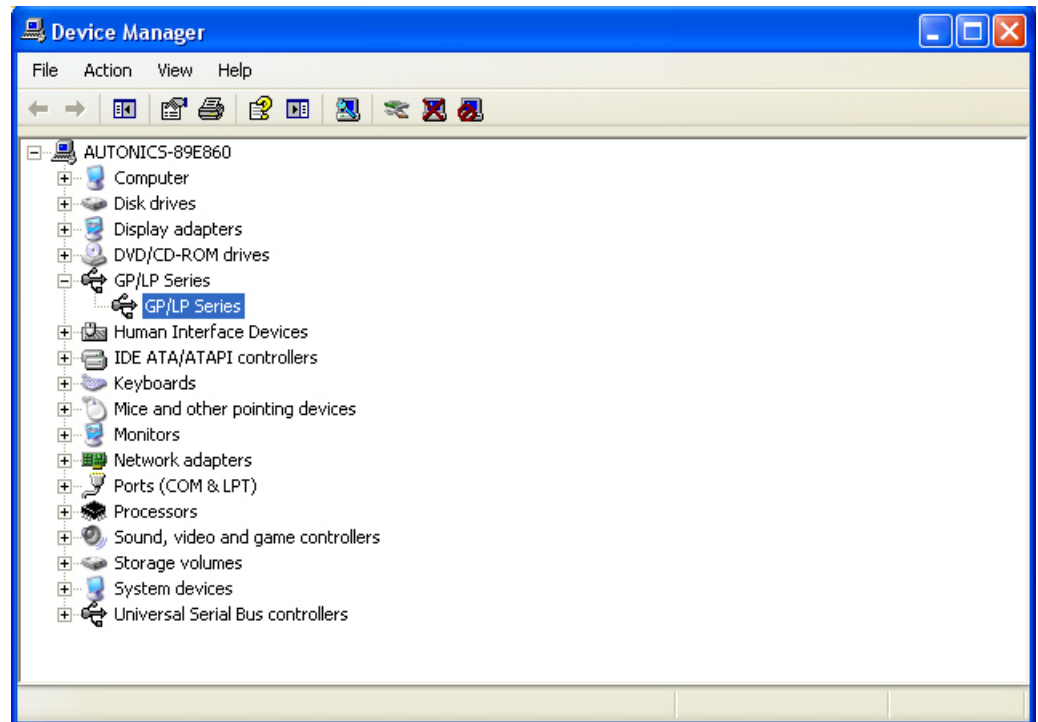

2.5.4 Remove GP/LP USB driver

- 1st Connect LP-S070 to PC with USB cable and enter [Start]-[Settings]-[Control Panel]-[System]-[Hardware]-[Device Manager].

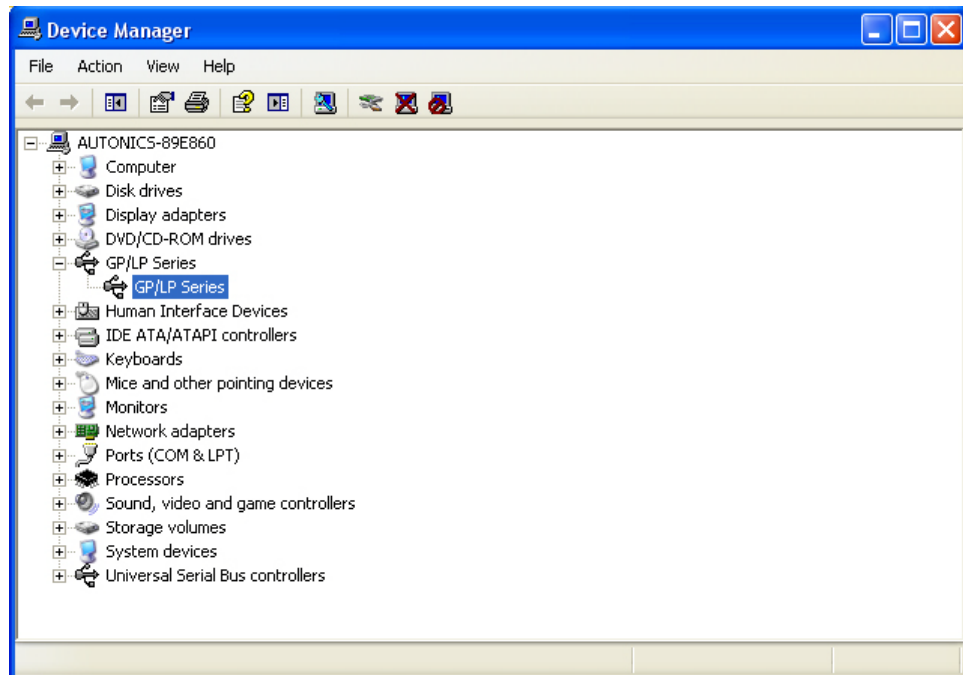

- 2nd Select GP/LP Series device and click with right mouse button and pop-up menu appears. Select 'Uninstall' menu.

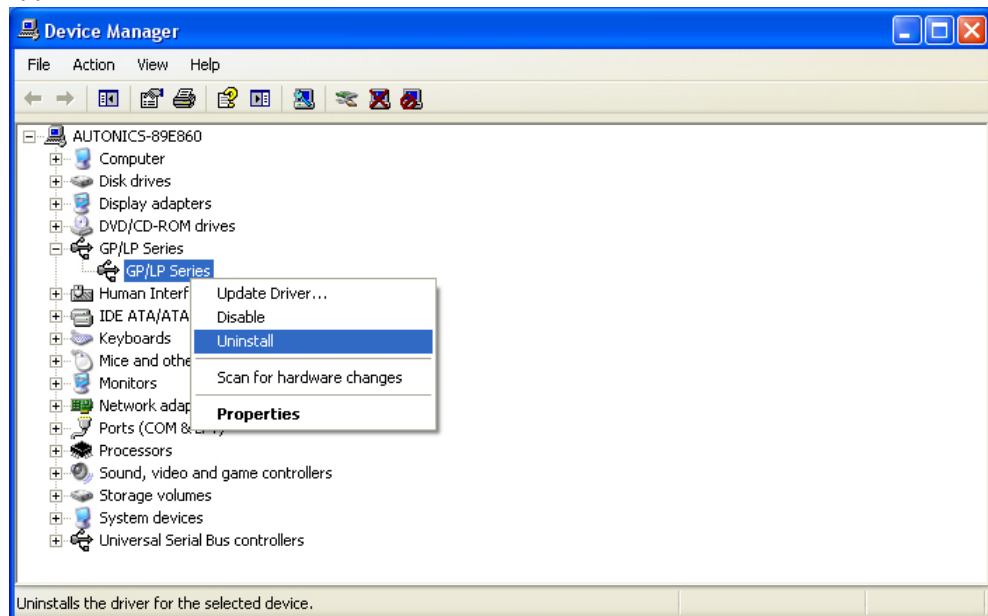

3rd 'Confirm Device Removal' dialog box appears. Click 'OK' to remove the driver.



2.5.5 Update GP/LP USB driver

- 1st Connect LP-S070 and PC with USB cable and enter [Start]-[Settings]-[Control Panel]-[System]-[Hardware]-[Device Manager].

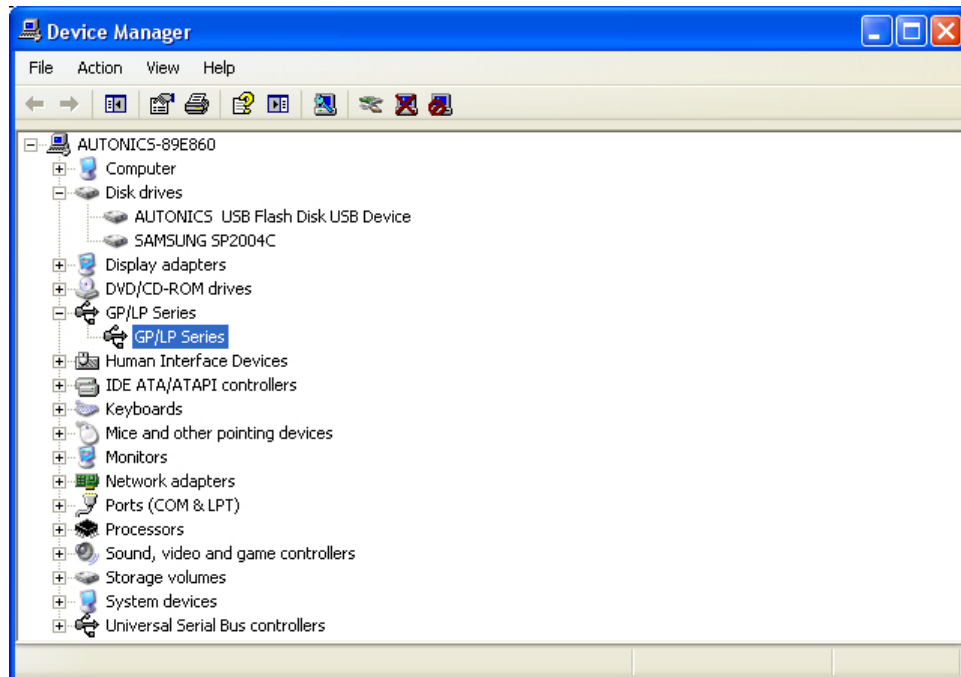

- 2nd Select GP/LP Series device and click with right mouse button and pop-up menu appears. Select 'Properties' menu.

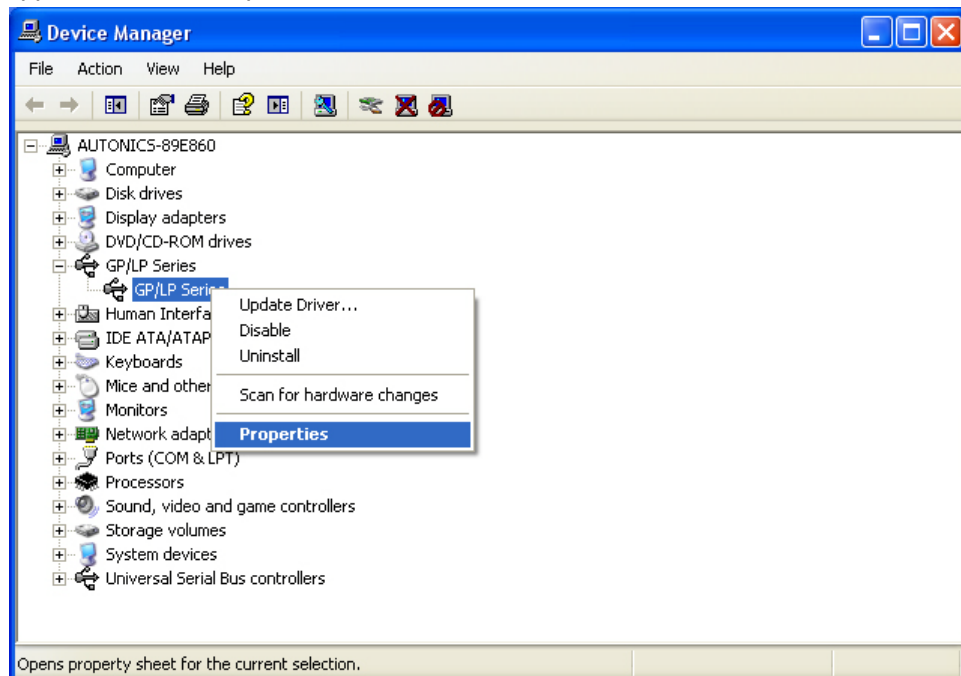

3rd 'GP/LP Series Properties' dialog box appears. Enter to 'Driver' tab and click 'Update Driver' to update driver.

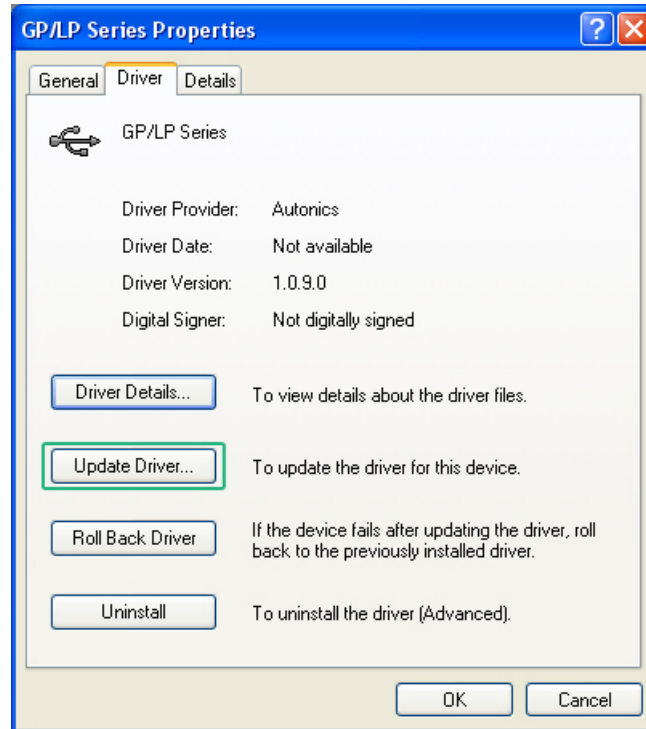

4th 'Driver Update Wizard' operates. Update method is same as '2.5.1 Install with found new hardware wizard'.

3 Device Construction

3.1 Device element

- GP read device [UW, UB]
This area is for controlling graphic panel function.
For further details, refer to 'GP Editor user manual'.
- GP write device [UW, UB]
This area is for displaying graphic panel state.
For further details, refer to 'GP Editor user manual'.
- GP user device [UW, UB]
This area is for using graphic panel function, general-purpose communication (universal communication) etc.
- Input device [X]
It reads all input port status before executing program scan.
This structure is for transmitting this to inner memory related X device area and utilizing this on the program.
- Output device [Y]
After executing program scan, it transfers all inner memory values related Y device area by output port.
- Recipe device [R]
It is a device used when using the recipe function of graphic panel.
- Virtual device [V]
It is the used area for matched automatically device area by system when using user defined function. User cannot use this device area.
For further details, refer to 'SmartStudio programming manual's '3.8 Usages of user defined functions'.
- Special device [F]
This area is for displaying and controlling several information and status about PLC functions.
For further details, refer to 'SmartStudio programming manual's 4. Special device'.
- Index device[Z]
It is a device that utilizes allotted device as index by indirect designation method.
The usage is as below.
In case of Z0 = 100, D10Z0 is as D110.
Therefore, if you use appropriate device address and index device [Z] as mixed, it is able to change appropriate device address to user defined address by indirect designation method.

**Ex.**

[Allots decimal 100 to Mov 100 Z0: Z0 device.]

Mov D10Z0 D101: D10Z0

Therefore, the current value of D110 device is changed with the current value of D101 device.

- Timer(coil)[T], Timer(current value)[T], Timer(set value)[TS]
When current value of timer is arrived at set value, it operates coil(timer).
It supports 100ms, 10ms timer.
For further details, refer to related timer instructions from 'SmartStudio user manual'.
- Counter(coil)[C], Counter(current value)[C], Counter(set value)[CS]
When current value of counter is arrived at set value, it operates coil.
For further details, refer to related counter instructions from 'SmartStudio user manual'.
- Inner auxiliary device [M]
This area is allotted only for inner operation which cannot control external I/O, for example, it receives external input and cannot execute external load.
- Step device[S]
This allotted area is for controlling step such as the progress which needs the order.
- Link device[L]
It is a device for linking external device, and data.
If this is not used as data link, it is available as data device or inner device.
- Data device[D]
It is an allotted device for saving numeral, ASCII, etc's data.
- Pointer[*]
Pointer[*] makes device use with special method.
You can use pointer (*) to every word device as following example.
The device with pointer (*) displays same type device as the value type of the device.

**Ex.**

In case of M100 = 123, M123 = 999, *M100 displays M123 which is M device related with M100 value as 123.

As following mnemonic, M0 has 999 value.

MOV M123 999

MOV *M100 M0

3.2 Device range

3.2.1 Bit device range

Mark	Name	Range	UB correspond address	Size
UB	Read area	UB000000 to UB00014F	UB000000 to UB00014F	00015F bit
UB	Write area	UB000015 to UB00029F	UB000015 to UB00029F	00015F bit
UB	User area	UB000030 to UB01999F	UB000030 to UB01999F	01969F bit
R	File device	R0 to R3999F	UB020000 to UB05999F	04000F bit
V	Virtual device	V0 to V255F	UB061000 to UB06355F	00256F bit
F	Special device	F0 to F255F	UB064000 to UB06655F	00256F bit
Z	Index device	Z0 to Z255F	UB067000 to UB06955F	00256F bit
X	Input device	X0 to X255F	UB070000 to UB07255F	00256F bit
Y	Output device	Y0 to Y255F	UB080000 to UB08255F	00256F bit
T	Timer contact	T0 to T255	UB100000 to UB10015F	00256 Bit
C	Counter contact	C0 to C255	UB150000 to UB15015F	00256 Bit
M	Auxiliary device	M0 to M9999F	UB200000 to UB29999F	10000F bit
S	Step device	S0.00 to S255.99	UB360000 to UB36255F	00256F bit
L	Link device	L0 to L255F	UB380000 to UB38999F	01000F bit

3.2.2 Word device range

Mark	Name	Range	UB correspond address	Size
UW	Read area	UW00000 to UW00014	UW00000 to UW00014	00015 Word
UW	Write area	UW00015 to UW00029	UW00015 to UW00029	00015 Word
UW	User area	UW00030 to UW01999	UW00030 to UW01999	01969 Word
R	File device	R0 to R3999F	UW02000 to UW05999	04000 Word
F	Special device	F0 to F255	UW06400 to UW06655	00256 Word
X	Input device	X0 to X255	UW07000 to UW07255	00256 Word
Y	Output device	Y0 to Y255	UW08000 to UW08255	00256 Word
T	Timer present value	T0 to T255	UW11000 to UW11255	00256 Word
C	Counter present value	C0 to C255	UW16000 to UW16255	00256 Word
M	Auxiliary device	M0 to M9999	UW20000 to UW29999	10000 Word
L	Link device	L0 to L255	UW38000 to UW38999	01000 Word
D	Data device	D0 to D9999	UW40000 to UW49999	10000 Word
V	Virtual device	V0 to V255	UW06100 to UW06355	00256 Word

3.3 Application of UW, UB corresponding

LP series is integrated with PLC and HMI device as one. You can monitor and control the device of the additionally connected devices (PLC, etc).

General PLCs usually have same device name regardless manufacture and model type. To monitor and control the device of the connected external device with LP series, it is needed to divide devices between PLC's and LP's.

To divide devices between PLC's and LP's during drawing the data in GP Editor, LP device should be as UW, UB device as following '13.5 UW correspondence table'. Additionally connected controllers is drawn with their characteristics device name.

4 System Organization

4.1 Stand-alone

As following organization, stand-alone system with LP-S070 monitors the program for controlling several type I/O and operation items (device, parameter) without additional device. You can also organize controlling organization for specific operation items with touching.

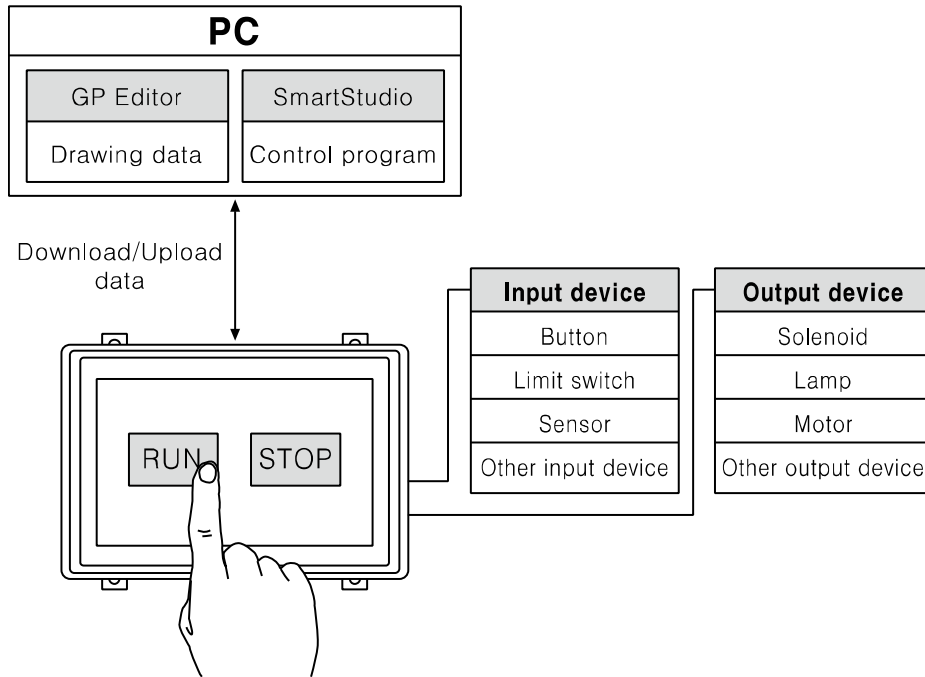

4.2 Connection with controller

4.2.1 1:1 organization

You can organize the system to monitor the action element (device, parameter, etc) status of the connected specified device during executing LP-S070 operation.

For monitoring inner device of LP-S070 and inner device of the connected controller at the same time, refer to '13.5 UW correspondence table'.

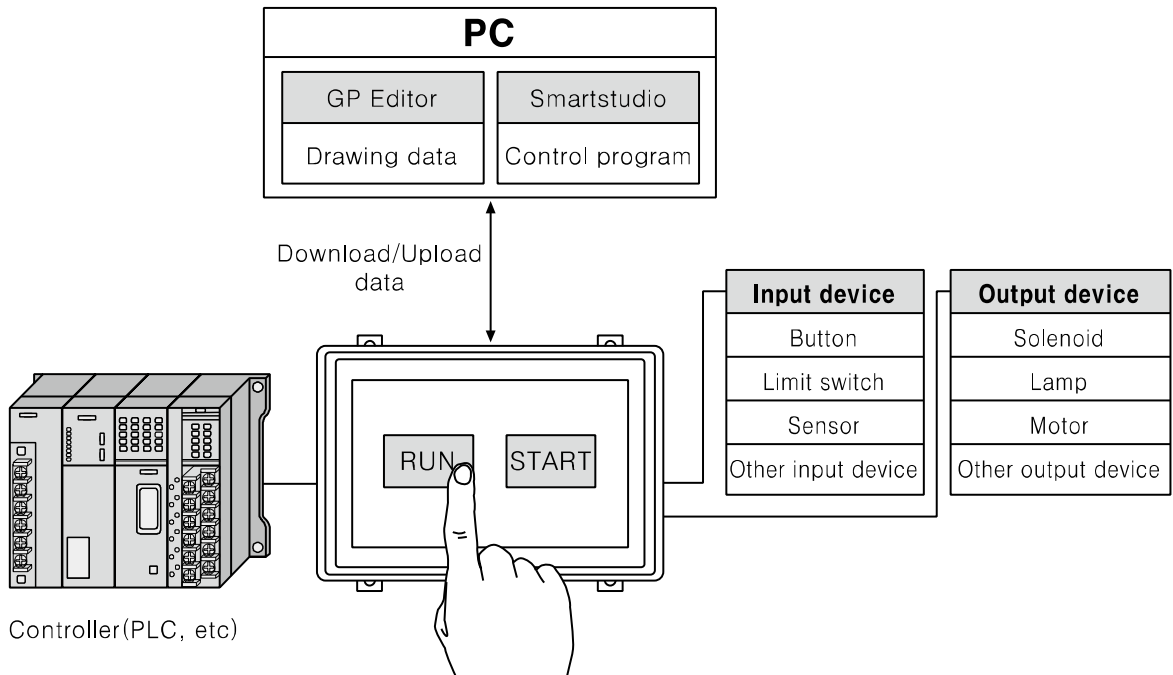

Note

If there are too much draw data, screen processing speed may be reduced. However, control program speed is not affected.

To monitor external connected devices, be sure that draw data properly not to cause problems for communication processing speed.

4.2.2 1:N organization

You can organize the system to monitor the action element (device, parameter, etc) status of the connected specified N devices which are same type controllers (PLC etc) during executing LP-S070 operation as following figure.

For monitoring inner device of LP-S070 and inner device of a connected controller at the same time, refer to '13.5 UW correspondence table'.

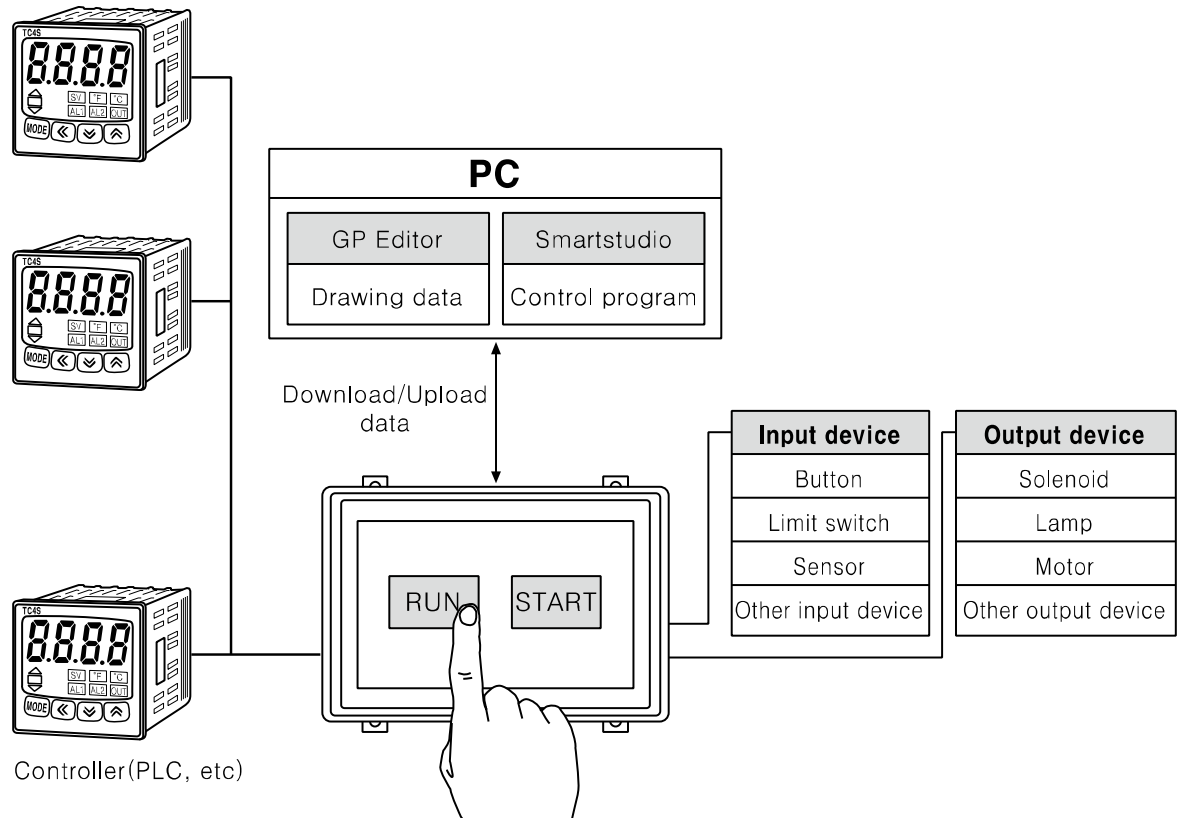

You can connect devices up to 32, it may be different by the product.
 Respond time is different by the connected devcie during communication, data renewal time may be longer.
 For further details, refer to 'GP, LP user manual for communication'.

4.2.3 Heterogeneous organization

You can organize the system to monitor the action element (device, parameter, etc) status of between two devices which are connected at each port as different type controller (PLC, etc) during executing LP-S070 operation as following figure.

For monitoring inner device of LP-S070 and inner device of a connected controller at the same time, refer to '13.5 UW correspondence table'.

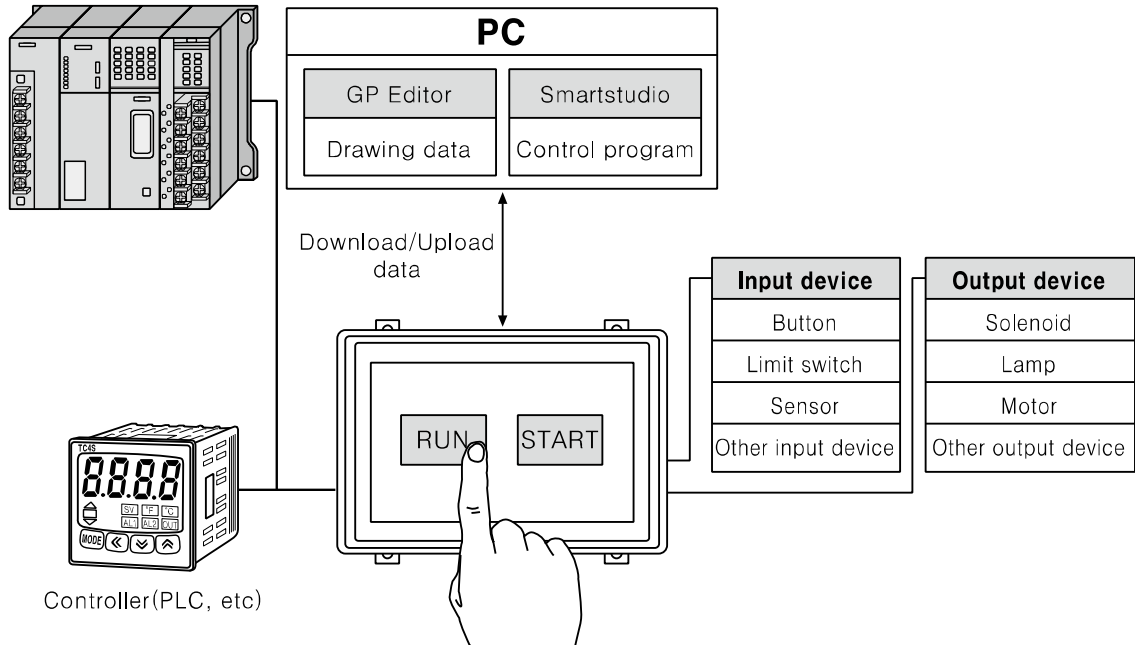

For further details, refer to 'GP, LP user manual for communication'.

4.3 Universal organization

As following figure, you can organize the system to monitor or control host unit data by universal communication during executing LP-S070 operation.

For monitoring inner device of LP and inner device of an additionally connected controller at the same time, refer to '13.5 UW correspondence table'.

For further details, refer to '5.4 Universal protocol' of 'GP,LP user manual for communication'.

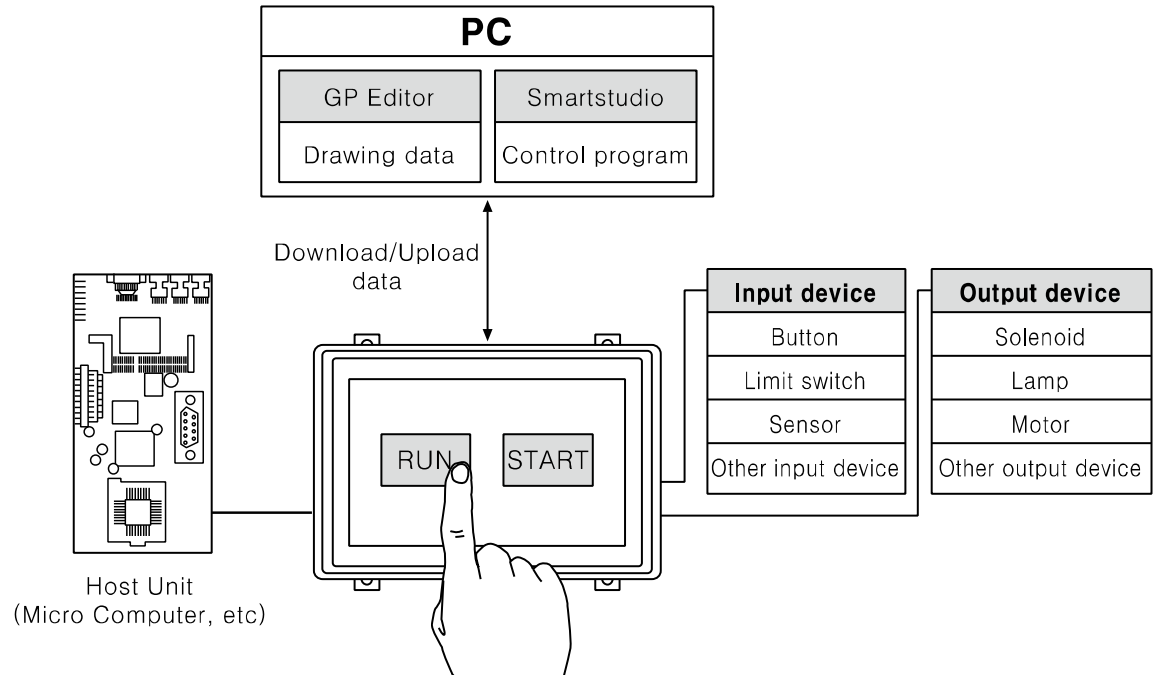

4.4 Connect with barcode, printer

As following figure, you can organize the system to read barcode data by connecting barcode reader, or to print alarm history by connecting serial print during executing LP-S070 operation.

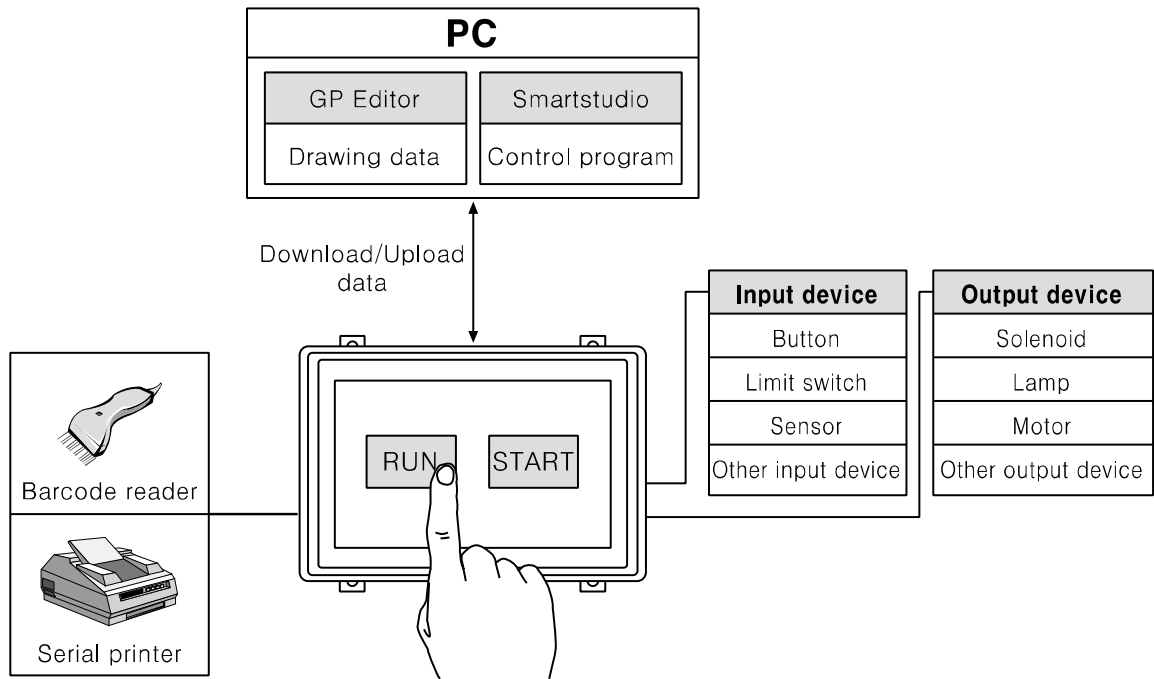

For further details, refer to 'GP, LP user manual for communication'.

4.5 Operation mode

Operation mode defines operation status, program execution of LP-S070.

You can change mode by switch of LP, or remote control in SmartStudio. Be sure that when mode is change, inner device and special device status are changed.

LP-S070 has four kinds of operation mode; RUN, STOP, PAUSE, and DEBUG mode.

- **RUN mode**
It saves external contact status to inner memory and executes the operations such as step order, branch instruction, or interrupt until END line. After this, it outputs repeatedly output device memory value as external output signal.
- **STOP mode**
It stops user defined program execution.
At the same time, it initializes inner memory data (except latch area, parts of special device) and makes every external output signal turn OFF to turn OFF external output signals by program.
- **PAUSE mode**
It stops only user defined program execution.
It maintains inner memory and external output signal.
- **DEBUG mode**
It is waiting status for executing debug instruction by stopping user defined program at 0 step. At the same time, it initializes inner memory data (except latch area, parts of special device) and makes every external output signal turn OFF.

(1) Change operation mode

MODE	RUN	STOP	PAUSE	DEBUG
Inner device(Latch area)	Maintain	Maintain	Maintain	Maintain
Inner device(Non latch area)	Delete	Delete	Maintain	Delete

(2) Change main special device status when entering operation mode

MODE	Special device
RUN mode	Deletes special device for error
STOP mode	Maintains special device for error, maintains special device operation for system clock
PAUSE mode	Maintains special device operation for system clock
DEBUG mode	Deletes special device for error

- ※1. For other special device operation, refer to 'SmartStudio programming manual's 4. Special device'.

(3) LP mode switch

LP mode switch is for changing mode RUN mode or STOP mode.

LP mode	Description
RUN	Enable to mode change from SmartStudio. Executes REMOTE function and when changing STOP → RUN, it executes mode changing function to RUN mode.
STOP	Disable to mode change from SmartStudio. Executes STOP function.

4.6 Program processing procedure

When power ON or LP mode switch is RUN, as following processing, it processes operation.

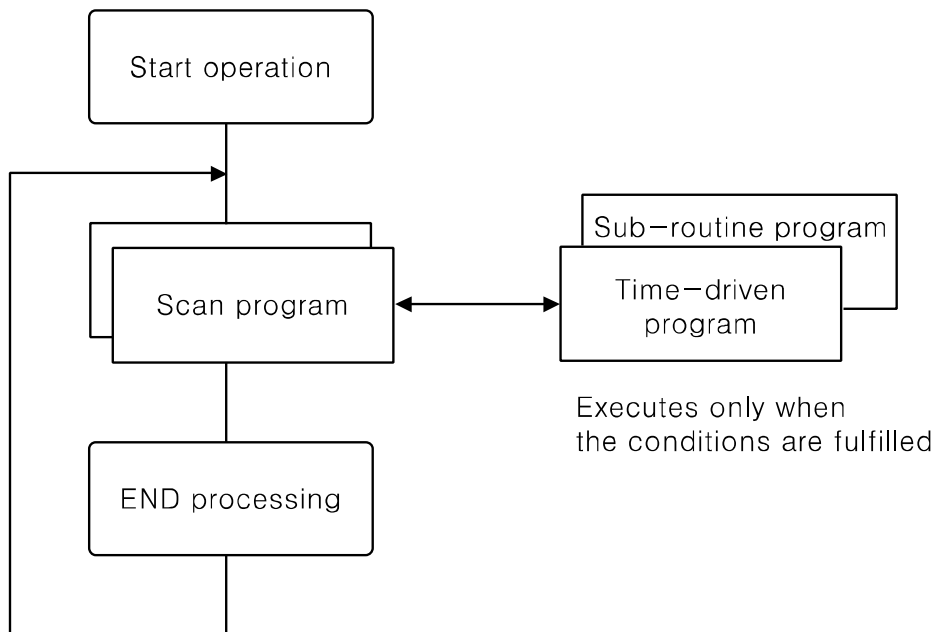

4.7 Connect with GP Editor

There are three ways to communicate between PC and LP-S070; serial communication, ethernet communication, USB.
Setting method is as below.

1st Enter system setting menu.

Touch left-upper point as default position of system setting menu.



2nd Select [Environment]-[Serial Communication].



3rd Designate communication method.

- ① Serial setting: Select [Serial Communication] menu, check that CH2 configuration is as 'EDITOR', and connected connection port with LP-S070 is as 'RS232C'.
If the configuration is not as 'EDITOR', touch (PROTOCOL) part and configure as 'EDITOR'.
Touch this, it rotates in order as EDITOR → PRINTER → BARCODE → MONITOR.

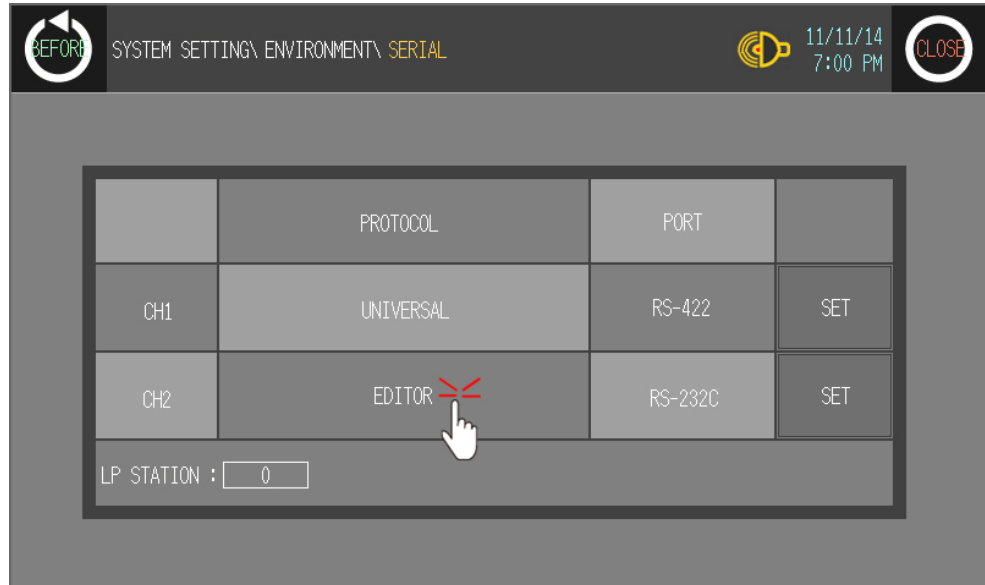

Touch (PORT) area to configure the connection port of LP-S070.

Touch this, it rotates in order as [RS422] and [RS232C].

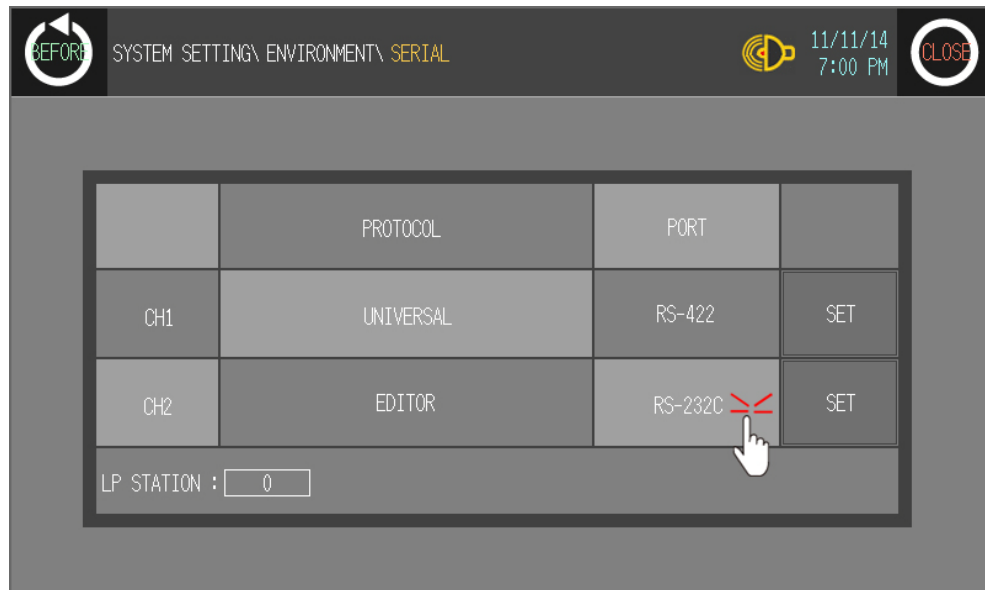

To check baud rate, data bit, stop bit, parity, etc, touch 'SET'.

It is able to download and upload GP Editor content to LP-S070 only when the baud rate between GP Editor and LP-S070 are configured as same.



- ② Ethernet setting: Select 'Local Ethernet' menu.

IP Address	192.168.100.10
Subnet Mask	123.255.255.0
Gateway	192.168.100.1
MAC Address	00 - 00 - 00 - 00 - 00 - 00

You can designate IP address, subnet mask, and gate way of LP-S070 and check MAC address.



Caution

IP setting of LP should not be duplicated with other communication devices. If IP address between other communication devices, communication is not able to operate by IP conflict.

- ③ USB setting: LP system menu does not have the setting of USB device. If there is Autonics USB driver in connected PC with LP, you can use it by PC.
- 4th Touch 'BEFORE', current setting values are saved and it returns to previous menu.
Touch 'CLOSE', current setting values are saved and it returns to user screen after exiting system setting menu.

4.7.1 GP Editor configuration

1st Select [Common]-[GP/PLC Type] of GP Editor menu.

Designate GP/LP type as the model name of 'LP-S070' by pull-down menu.

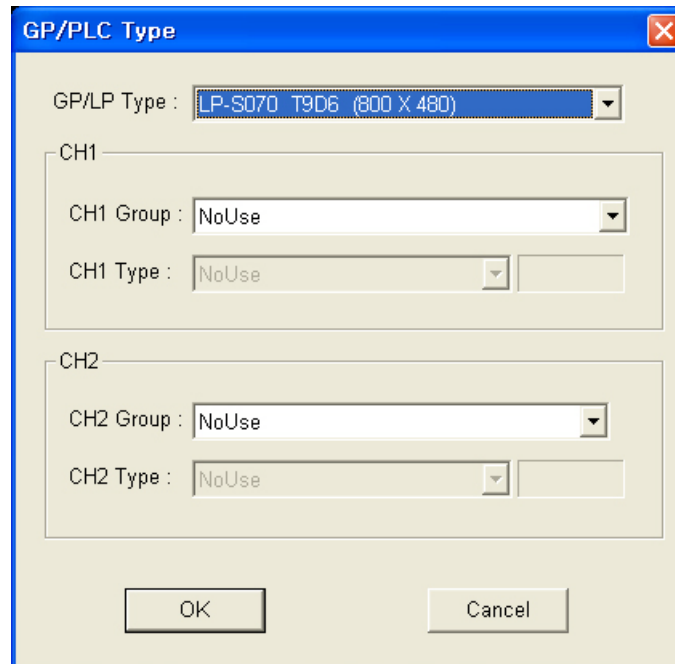

2nd Select [Communication]-[Option] and 'Option' dialog box appears.

Designate communication configuration as same as that of from LP-S070.

For further details of each option, refer to 'GP Editor user manual'.

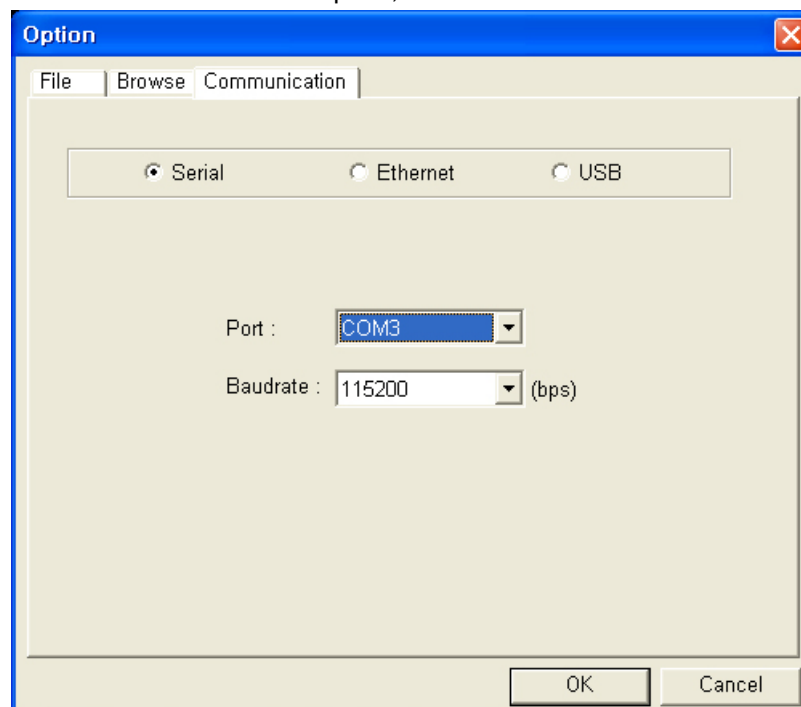

3rd After configuration, connect LP-S070 and PC by communication cable to download and upload drawn program from GP Editor.

4.8 Connect with SmartStudio

4.8.1 LP configuration

Refer to '5.7 Connect with GP Editor' and configurate LP as same these.

4.8.2 SmartStudio configuration

There are three ways to communicate between PC and LP-S070; serial communication, ethernet communication, USB. From SmartStudio, select [Online]-[Communication Option] and designate communication between LP-S070 and PC.

For configuration of each item, refer to 'SmartStudio user manual'.

5 Start up LP

This chapter describes start up procedure from supplying power to LP to switching user screen.

5.1 Checking list before supplying power

Before supplying power to LP-S070, please check the following list.

No	Check	Description
1	Install status	Check waterproof rubber ring is installed.
		Check all 4 fixing brackets are installed.
		Check fixing brackets are fixed with approved tightening torque.
2	Emergency stop circuit	Check individual emergency stop circuit at the external LP-S070 is placed.
		Check there is problem to emergency stop when error occurs.
3	Ground	Check ground cable is installed with separated other device ground cable.
		Check there is 3rd grounding.
4	Power cable	Check cable connection by polarity.
		Check the tightening status of screws on terminal.
5	I/O wiring	Check I/O wiring status.
		Check connector connection status.
6	Power	Check power voltage.
		Check this is installed as separated other device power.

5.2 Operation order

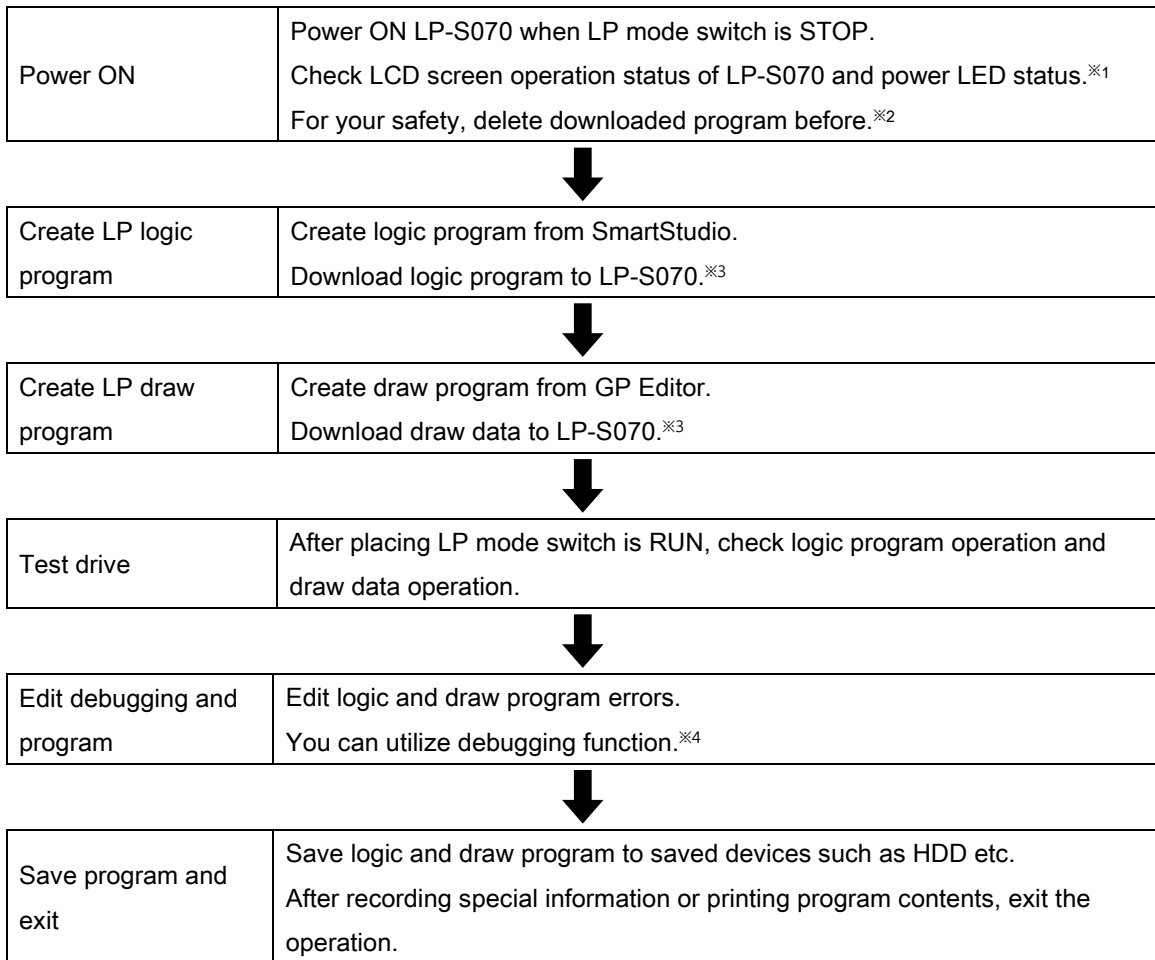

※1. If there are error for LCD screen operation of LP-S070 and power LED, refer to '10 Troubleshooting'.

※2. To delete program, [Diagnosis]-[System Initialization] of system setting menu or refer to 'SmartStudio user manual'.

※3. Connection with SmartStudio, GP Editor and LP-S070 is able to connect(download, upload, monitoring) by designated EDITOR port from [Environment]-[Serial Communication] of system setting menu. Therefore, you cannot connect SmartStudio and GP Editor at the same time.

For example, during monitoring logic program of LP-S070 in SmartStudio, you cannot download draw data of GP Editor to LP-S070. For downloading draw data, you should disconnect SmartStudio and connect GP Editor.

※4. SmartStudio supports several functions for debugging. For further details, refer to 'SmartStudio user manual's 7 Debug'.

6 System Screen

6.1 Organization of system screen

System setting screen appears for monitoring, environment, data, functionality, diagnostics and parameter settings by touching system screen calling. Select each menu and their sub-menu appears.

LP-S070 system setting menu	Monitoring	Device Monitor
		I/O Monitor
	Functionality	Time Switch
		Data Transfer
		Data Logger
		Print Out
	Data	Data Manager
		Firmware Update
		System
		User Screen
	Environment	Serial Communication
		Language
		Local Ethernet
		Screen Bright
		Assistance Setting
		Clock
	Diagnostics	System Initialization
		Battery Remaining
		Screen Diagnosis
		Touch Diagnosis
Parameter	Common Setting	
	Action/Pattern List	

6.2 Operation of system screen



No.	Function and operation
①	Moves to the prior menu.
②	Displays the menu title of current screen. Touch desired item and it moves it.
③	Set buzzer ON/OFF
④	Displays current time and date.
⑤	Exits system setting
⑥	Touch desired menu and sub menu is displayed.

6.3 Monitoring

6.3.1 Device monitor

Device monitor menu is for monitoring inner device of connected device or for designating the value to inner device of LP-S070.

It is able to monitor bit or word device of connected device, special function device, inner bit device of LP, or inner word device area.

Monitorable device is different depending on connected device. Confirm monitorable device by each device from 'GP, LP user manual for communication'.

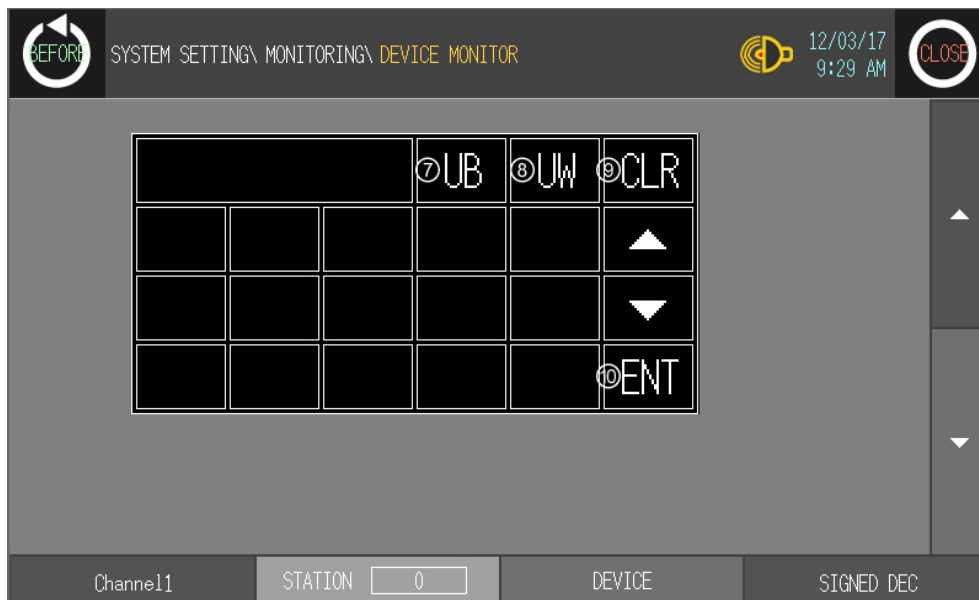

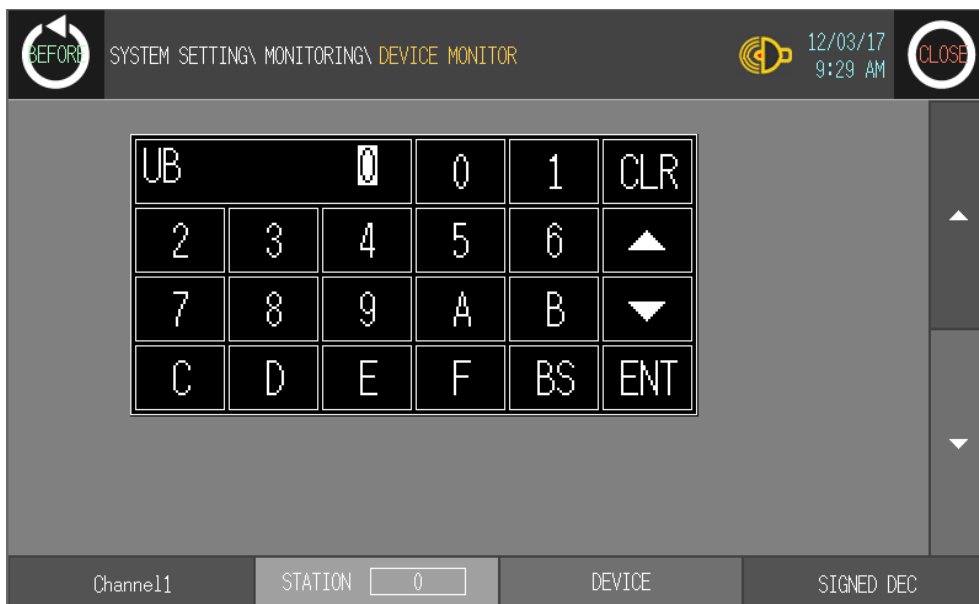

No.	Function and operation
①	Designate channel for connected device. Touch this it changes as Channel 1, Channel 2, Internal.
②	Designate station. (Range: 0 to 255) Touch this and decimal key pad appears.
③	Input key pad appears to select the device of selected device by channel (Channel 1, Channel 2, Internal).
④	Monitors the specified word device as decimal with sign, decimal without sign, or hexadecimal.
⑤	Moves lower device.
⑥	Moves upper device.
⑦	Select the specified bit device. Touch this and hexadecimal key pad appears.
⑧	Select the specified word device. Touch this and decimal key pad appears.
⑨	Cancels setting value input.
⑩	Enters setting value input. .

6.3.2 I/O monitor

This menu is able to monitor I/O status of LP-S070.

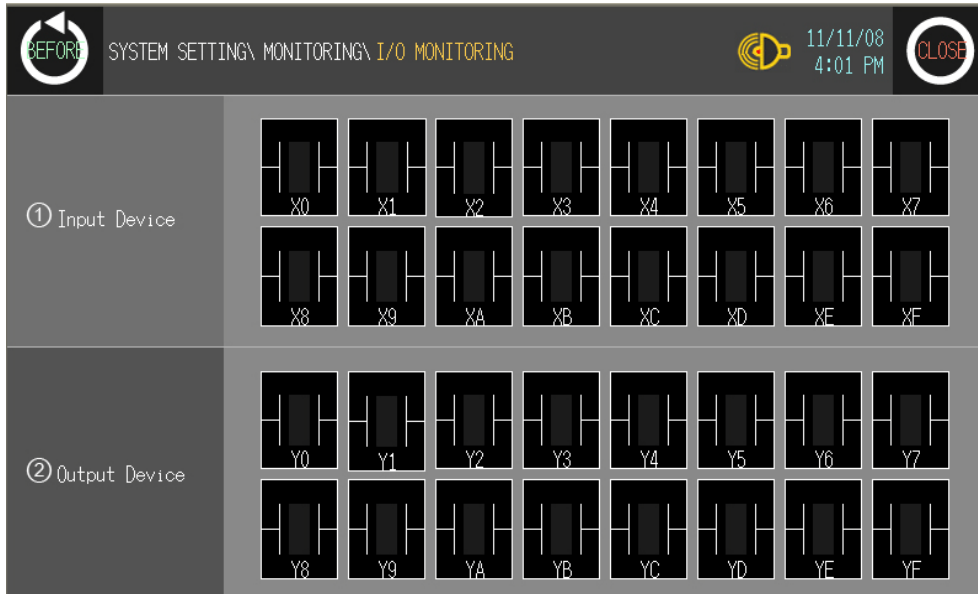

No.	Function and operation
①	Monitors input contact X0 to XF status.
②	Monitors output contact Y0 to YF status.

6.4 Environment

6.4.1 Serial communication

This menu displays connected device to RS232C, RS422 port of LP-S070. You can designate station and connected port by each channel.

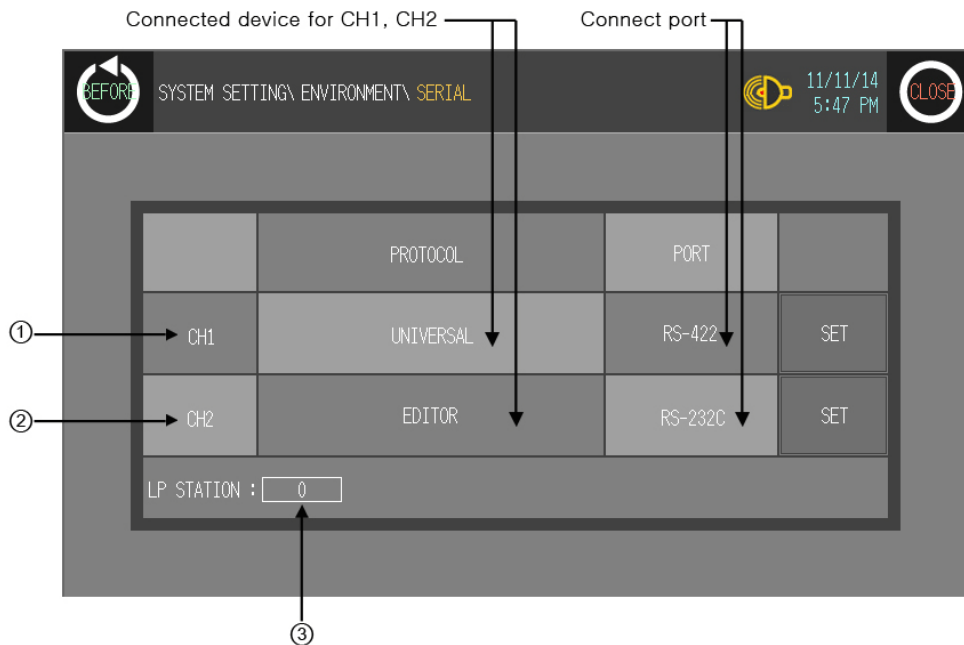

No.	Function and operation
① CH1 configuration line	<p>Displays connected device and connect port for CH1.</p> <p>Touch this to select one from downloaded protocol in GP Editor, EDITOR, PRINTER, BARCODE, UNIVERSAL, or DEFAULT protocol and designate connect port. (Select RS232C/RS422 or RS232C-A / RS232C-B).</p> <p>Depending on CH2 setting, CH1 may be changed as 'No Use'.</p>
② CH2 configuration line	<p>Displays connected device and connect port for CH2.</p> <p>Touch this to select one from downloaded protocol in GP Editor, EDITOR, PRINTER, BARCODE, UNIVERSAL, or DEFAULT protocol and designate connect port. (Select RS232C/RS422 or RS232C-A / RS232C-B or depending on CH1 setting, CH2 may be changed as 'No Use'.)</p> <p>If CH1 is SLAVE, MONITOR does not appear.</p>
③ LP station configuration touch key	<p>Touch this and input key pad for station appears.</p> <p>LP station set range: 0 to 31</p>
④ Configuration touch key by each channel	<p>Designate communication details of connected port for CH1 and CH2.</p> <p>You can designate baudrate, data bit, parity, stop bit, and flow control.</p>



Ex.

(1) In case of using only CH1 configured in GP Editor

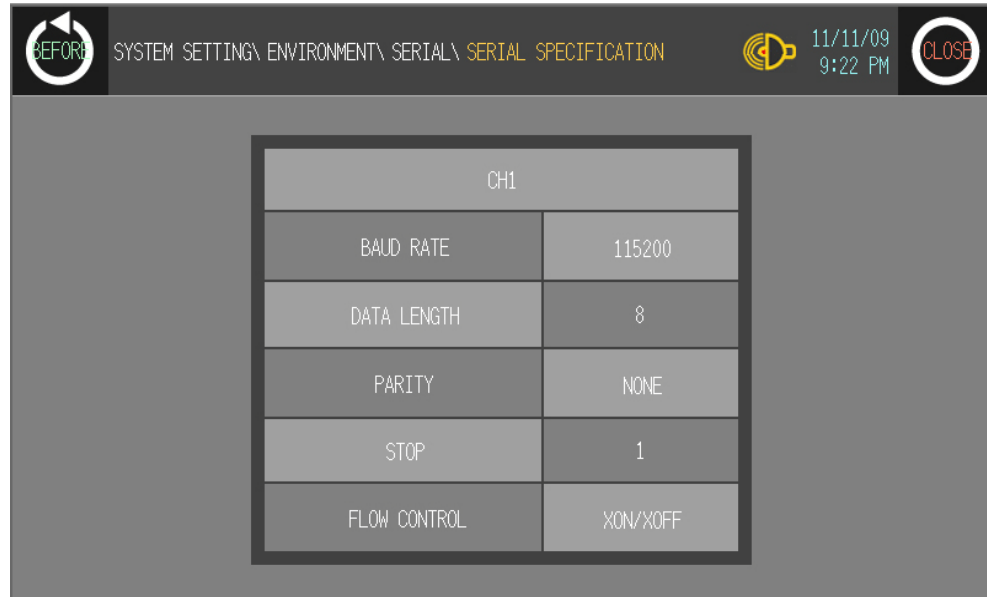
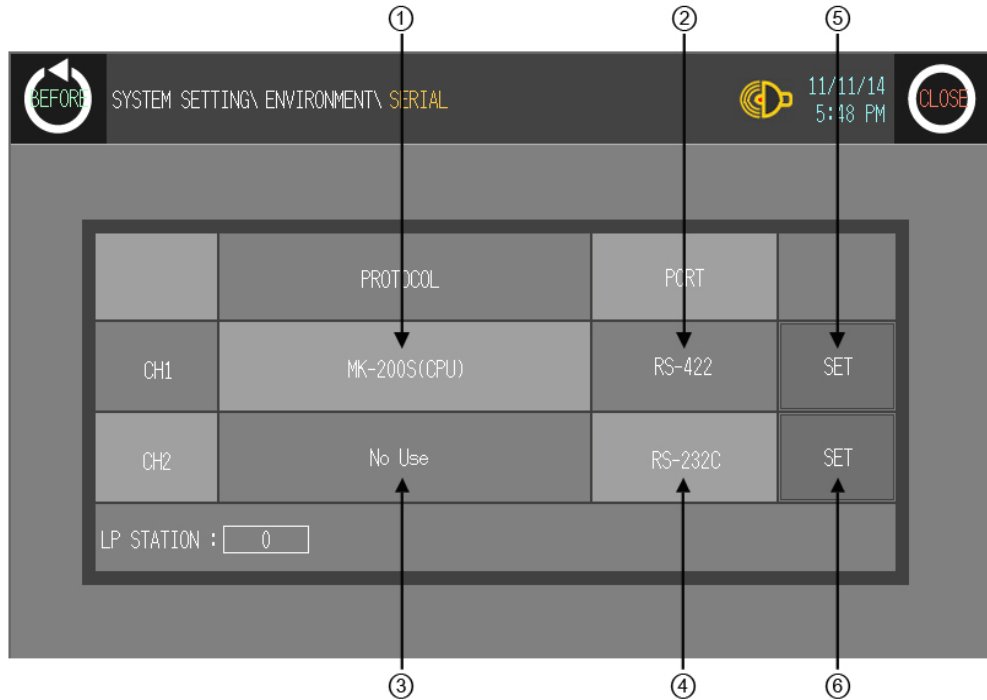

Item	Operation with touching
① Displays CH1 protocol	Rotates in order as downloaded protocol in GP Editor → EDITOR → PRINTER → BARCODE → UNIVERSAL → DEFAULT protocol (When CH2 is No Use.)

Item	Operation with touching
② Displays CH1 connect port (Designates automatically as non-using port in ④)	LP-S070-T9D6: RS422 PORT ↔ RS232C PORT
	LP-S070-T9D7: RS232C A PORT ↔ RS232C B PORT
③ Displays CH2 protocol (as EDITOR for default)	Rotates in order as EDITOR → PRINTER → BARCODE → MONITOR → UNIVERSAL → No Use If CH1 is SLAVE, MONITOR does not appear.
④ Displays CH2 connect port (Designates automatically as non-using port in ②)	LP-S070-T9D6: RS422 PORT ↔ RS232C PORT
	LP-S070-T9D7: RS232C A PORT ↔ RS232C B PORT
⑤ Communication configuration by each channel	Moves communication configuration setting window for selected connected device. You can designate baudrate, data bit, parity, stop bit, and flow control for each channel.

(2) In case of using only CH2 configured in GP Editor

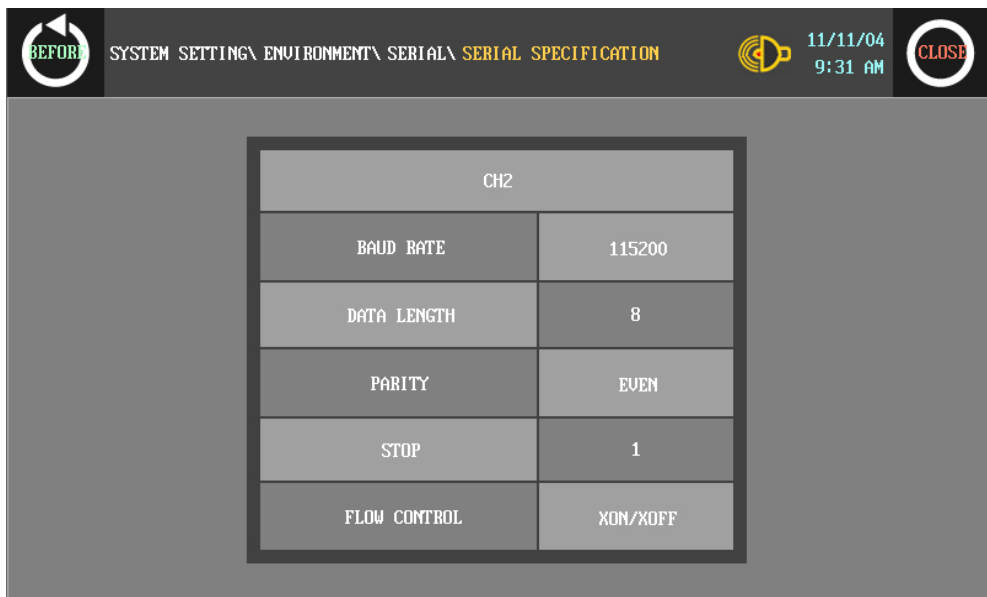
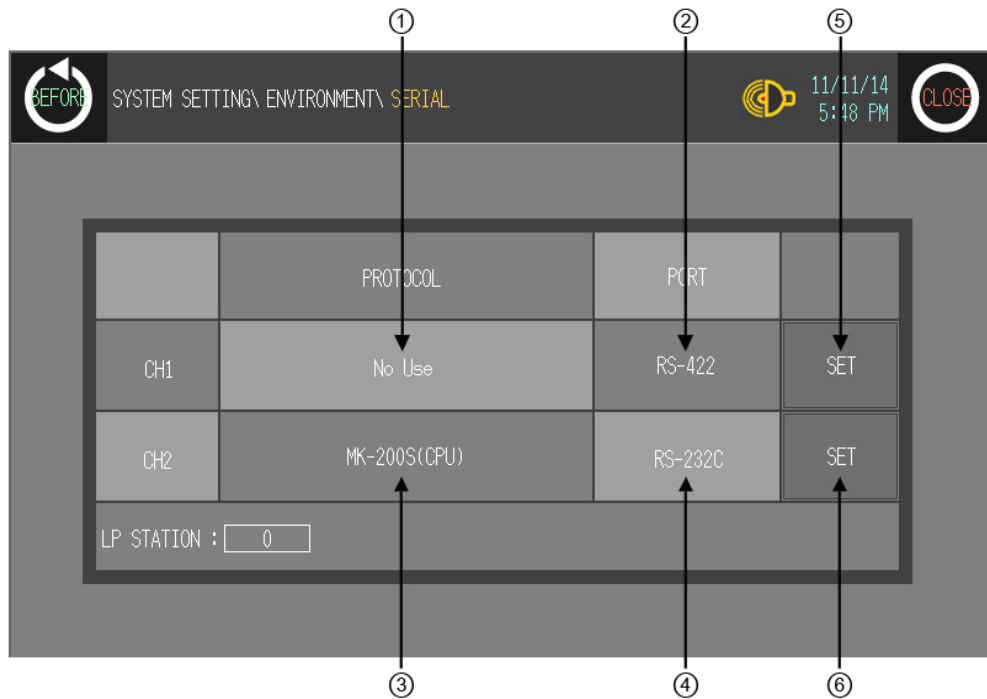

Item	Operation with touching
① Displays CH1 protocol	Rotates in order as NoUse → EDITOR → PRINTER → BARCODE → UNIVERSAL → DEFAULT protocol.
② Displays CH1 connect port (Designates automatically as non-using port in ④)	LP-S070-T9D6: RS422 PORT ↔ RS232C PORT LP-S070-T9D7: RS232C A PORT ↔ RS232C B PORT

Item	Operation with touching
③ Displays CH2 protocol (as downloaded protocol for default)	Rotates in order as downloaded protocol in GP Editor → EDITOR → PRINTER → BARCODE
④ Displays CH2 connect port (Designates automatically as non-using port in ②)	LP-S070-T9D6: RS422 PORT ↔ RS232C PORT
	LP-S070-T9D7: RS232C A PORT ↔ RS232C B PORT
⑤ Communication configuration by each channel	<p>Moves communication configuration setting window for selected connected device.</p> <p>You can designate baudrate, data bit, parity, stop bit, and flow control for each channel.</p> <p>If CH1 is as NoUse, it is not able to communication configuration.</p>

6.4.2 Serial details configuration

(1) CH1/ CH2 details configuration

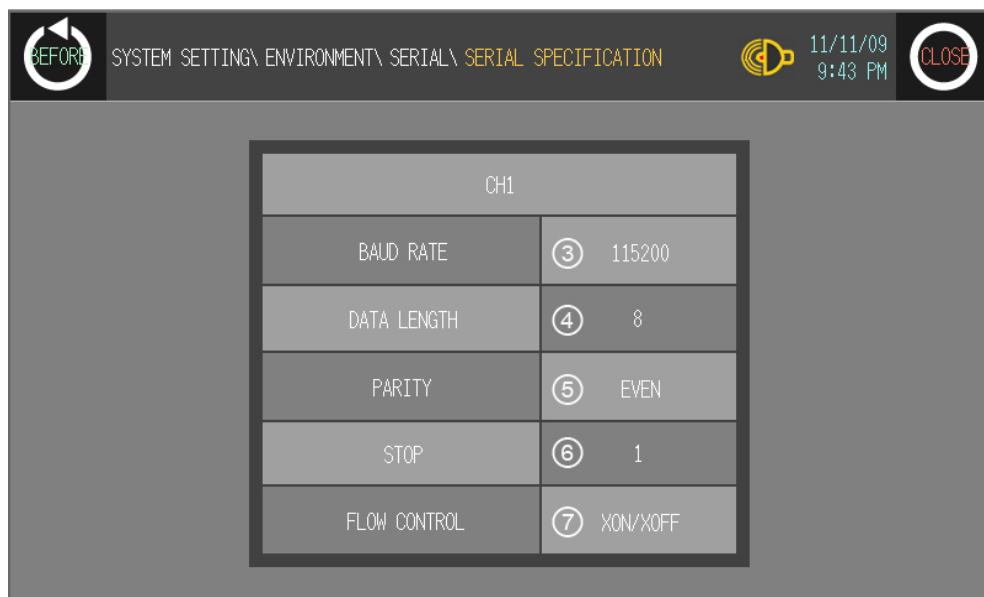
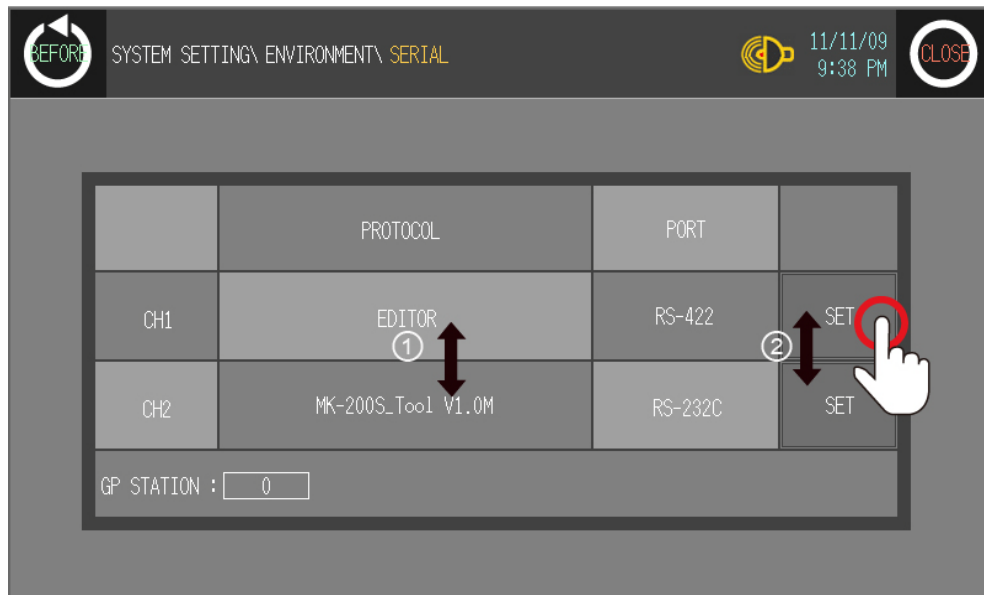

No.	Function and operation
①	<p>Designate operation mode.</p> <ul style="list-style-type: none"> • CH1, CH2 protocol: Communication mode for set PLC by LP and GP Editor by each port. • EDITOR: I/O mode for downloading user-designed data from GP Editor • PRINTER: Print mode for printing alarm history of LP • BARCODE: Input mode for reading data from barcode For further details, refer to Barcode description. • MONITOR: Available only in CH2. Monitoring mode for PLC which is connected to LP from PC directly. <p>LP is as transmitter by transmitting data from PC to PLC and data from PLC to PC. In case of MITSUBISHI FX-Series, editor mode is available for monitoring.</p>

No.	Function and operation
	<ul style="list-style-type: none"> • NoUse: Displayed only not using appropriate CH.
②	Touch this, detailed configuration screen for designated operation mode appears.
③ to ⑦	Designate detailed configuration for designated operation mode. <ul style="list-style-type: none"> • Baudrate: Designate baud rate. Supports 300, 600, 1200, 2400, 4800, 9600, 19200, 38400, 57600, or 115200 bps • Data: Designate data bit • Stop bit: Designate stop bit. Supports 1 bit, or 2 bit. • Parity: Designate parity type. Supports even, odd, or none parity. • Flow control: Designate data flow control. Supports XON/ XOFF, or DSR/DTR.

6.4.3 Language

User language for LP-S070 displays user language for displaying user-defined screen, international character font, English font, vector font. You can designate system language for LP-S070 inner system language.

- Supported language: It supports Korean, English at first and the other languages are supported later with upgrade.
- Font type: It supports various fonts by each language.

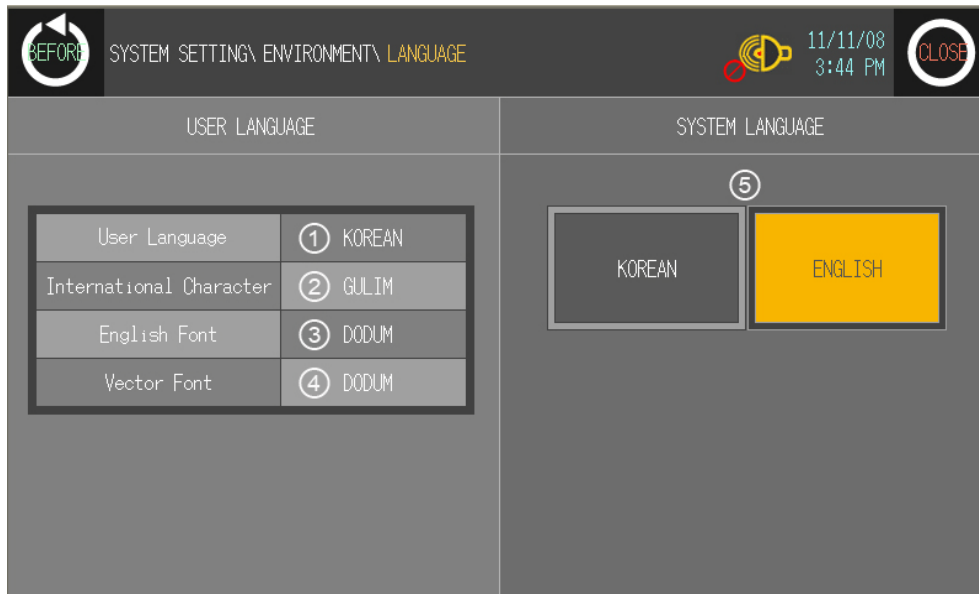

No.	Function and operation
①	Displays designated user language
②	Displays designated international character font
③	Displays designated English font (ASCII character) in LP-S070
④	Displays designated vector font in LP-S070
⑤	Touch the desired system language as displayed

To change system language, download new fonts from GP Editor.



Note

It prevent error at designing level with using the same font between designing font from GP Editor and used font in LP-S070.

6.4.4 Local Ethernet

By this local ethernet menu, between PC and LP-S070 communication is available.

No.	Function and operation
①	IP of LP-S070 for Ethernet communication
②	Subnet mask of LP-S070 for Ethernet communication
③	Gateway of LP-S070 for Ethernet communication
④	MAC address of LP-S070 for Ethernet communication



Caution

IP configuration of LP should not be duplicated with other network devices on same network. Duplicated IPs may cause IP conflict and communication cannot operate.

6.4.5 Screen bright

This menu is for designating screen brightness.

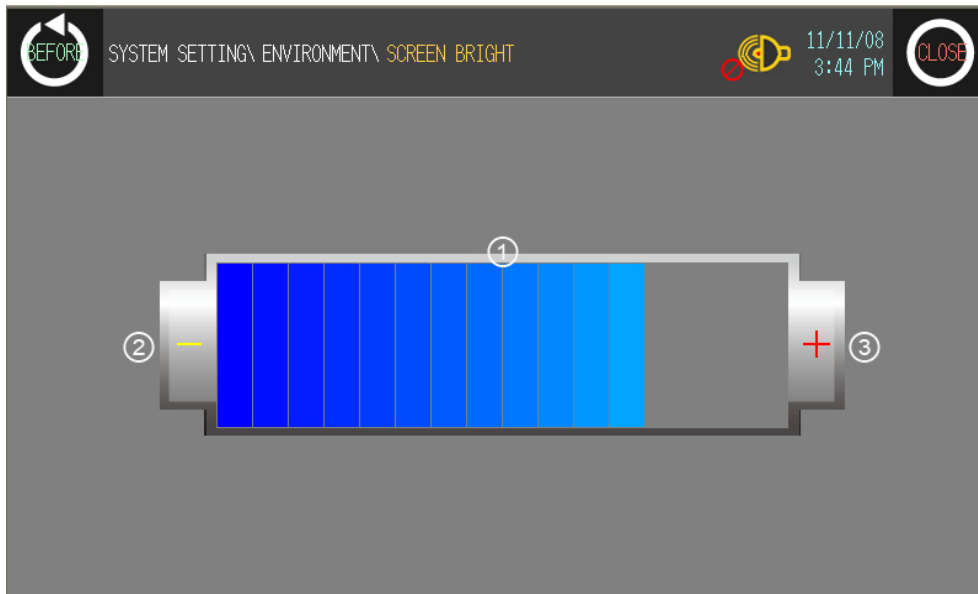

No.	Function and operation
①	Displays designated screen brightness as bar graph
②	Decreases one step of screen brightness with touching.
③	Increases one step of screen brightness with touching.

6.4.6 Assistance setting

This menu is for selecting the position of system setting menu key and designating UW device value LATCH function, buzzer on/off, screen open time, or off time of back light.

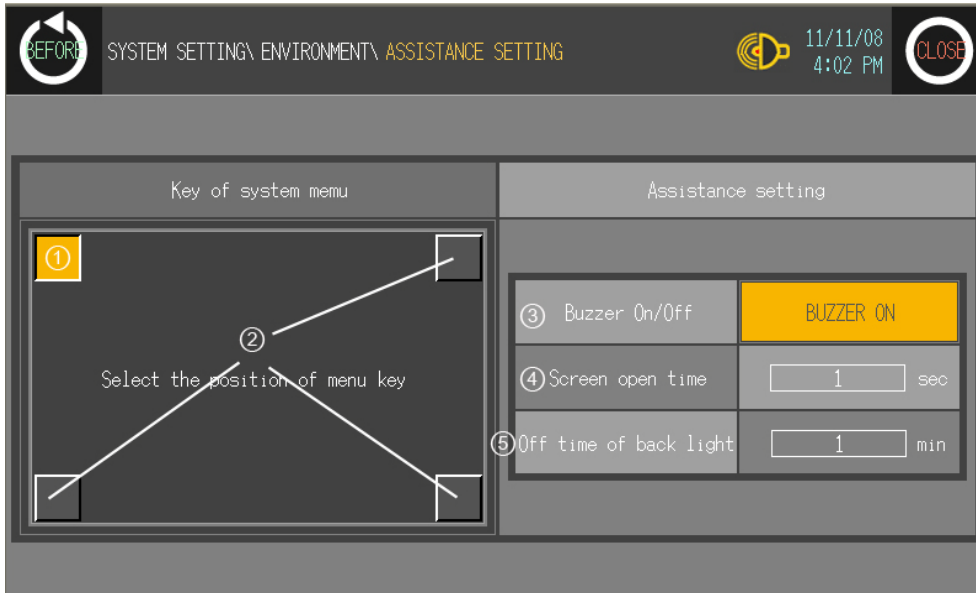

No.	Function and operation
①, ②	<p>Check or select the position of system setting menu key to enter from user screen.</p> <p>①: Displayed that this position is already designated for system setting menu key.</p> <p>②: Displayed that this position is not designated for system setting menu key.</p> <p>You can designate system setting menu key up to two keys. If two keys for system setting menu is set, you should touch both two keys simultaneously to enter system setting menu.※1</p>
③	<p>Designate buzzer on or off for touch key operation, numeral or ASCII input touch, system setting menu touch, communication start and complete, or alarm.</p> <p>Touch this, rotates Buzzer On or Buzzer Off.</p>
④	<p>Menu for set time of open screen when supplying power.</p> <p>Touch time displayed position and numeral input key pad appears to enter setting time.</p> <p>Setting time: 0 to 60 sec</p>
⑤	<p>Designate back light off time.</p> <p>If there is no touch on screen of GP/LP until off time of backlight, LCD backlight is OFF. Backlight is ON again when user touches it. In this case touching is only for backlight ON and the other operation is not valid.</p> <p>Touch time displayed position and numeral input key pad appears to enter setting time.</p> <p>Setting time: 0 to 60 min. (If 0 is set, backlight is not OFF.)</p> <p>Depending on the status from [System information device]–[Backlight control bit of read device] in LP–S070, controls the designated operation.</p> <p>Backlight setting and operation is available only when backlight control device is SET</p>

No.	Function and operation
	(ON). If backlight control device is RESET (OFF), it does not operate irrespectively menu setting. For further details, refer to 'GP Editor user manual'.

- ※1. In case screen direction is vertical (bottom side from front screen is placed at left status), default position of system setting menu key is placed at left-upper point.
Touch left-upper point as soon as re-supply power and it enters to system setting menu.
If there is numeral/ASCII input or touch key tag at system setting menu key position, it executes only tag operation and it does not enter system setting menu.

6.4.7 Clock

This menu is for setting or checking current time.



No.	Function and operation
①	Designate user designate time and data from current time. Touch the desired item to reset, numeral input key pad appears to input directly. Or touch +, - button to set.
②	Saves designated time. If this button is not touched and returns previous menu or exits menu after designating time, the designated time is not applied and is not saved. You should touch this button for saving desired time.



Caution

- Designated time is applied for clock, alarm history, or alarm list which is related with time.
- In case of connected external power, current time is maintained by external power. If external power is cut, current time is maintained by battery. If there is time error with connected external power, battery may be discharged. Please check battery status from [Diagnostics]-[Battery Remaining] of system setting menu.

6.5 Functionality

6.5.1 Time switch

When the designated time and day of the week, it turns bit device of connected device ON/OFF. Maximum 8 bit devices which have consecutive numbers operate as time switch. It is able to set operation time by each bit device.

Time switch function is also able to set at [Common]-[Time Action] menu of GP Editor.

① OP Num	② Operation	③ Start Time	④ End time	⑤ Day of The Week						
1	000000	0:00:00	0:00:00	SUN	MON	TUE	WED	THU	FRI	SAT
2	000000	0:00:00	0:00:00	SUN	MON	TUE	WED	THU	FRI	SAT
3	000000	0:00:00	0:00:00	SUN	MON	TUE	WED	THU	FRI	SAT
4	000000	0:00:00	0:00:00	SUN	MON	TUE	WED	THU	FRI	SAT
5	000000	0:00:00	0:00:00	SUN	MON	TUE	WED	THU	FRI	SAT
6	000000	0:00:00	0:00:00	SUN	MON	TUE	WED	THU	FRI	SAT
7	000000	0:00:00	0:00:00	SUN	MON	TUE	WED	THU	FRI	SAT
8	000000	0:00:00	0:00:00	SUN	MON	TUE	WED	THU	FRI	SAT

⑥ DELETE ALL ⑦ DELETE ⑧ DEVICE SET

No.	Function and operation
①, ②	① Touch each number and set bit device operation time individually. ② Bit devices as time switch operation which have consecutive number are able to display up to 8.
③, ④	Touch this, numeral input key pad appears to input start time and end time. Not designated time action is displayed as [0:00:00]. Time switch displays 24H and start time should be earlier value than end time. Default is 0:00:00, and end time should be input before inputting start time.
⑤	Touch desired day of the week. Set day is displayed with reversed color.
⑥	Deletes all of set time switch data.
⑦	Select the to be deleted OP Num (①) and touch this to delete time switch individually. DELETE is for deleting set time and day of the week items. For deleting set device item, touch 'DELETE ALL'.

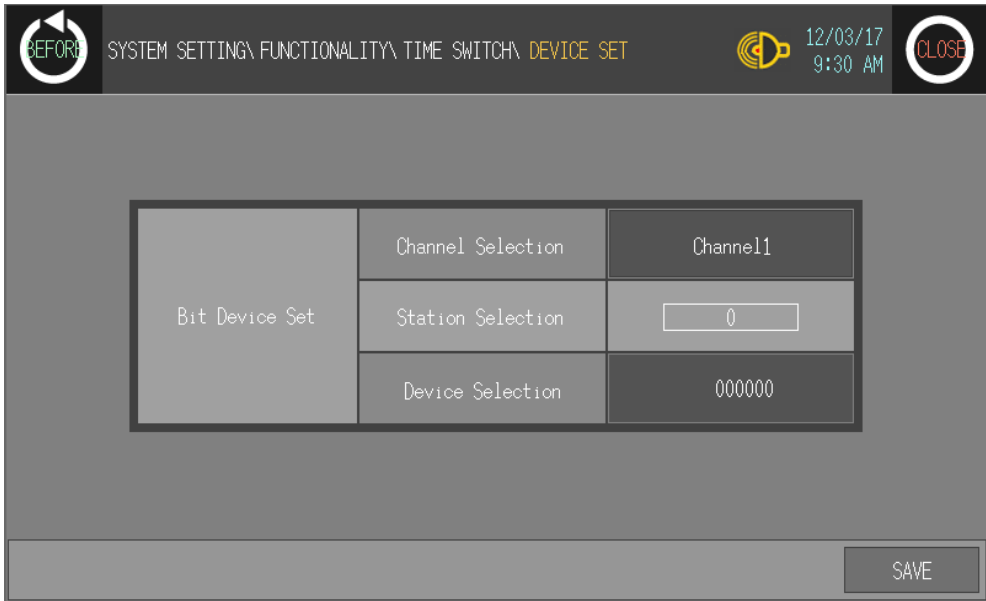
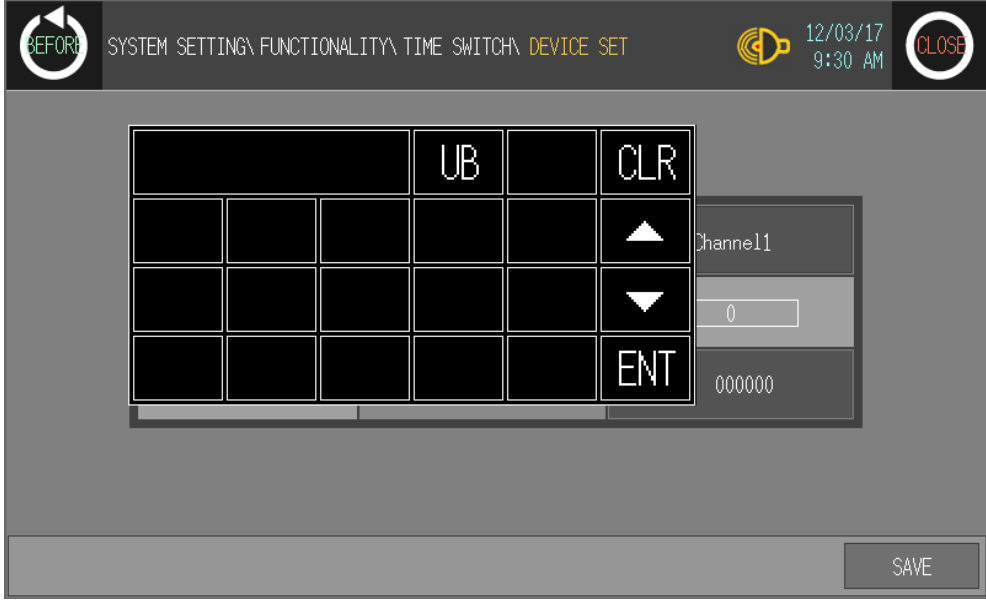
No.	Function and operation
	<p>Touch this, it moves to device set menu.</p> 
<p>⑧</p>	<p>Designate channel (Channel 1, Channel 2, Internal) and station (0 to 255). Touch the number (000000) and input key pad appears to set the appropriate bit device.</p> 

6.5.2 Data transfer

This menu screen is displayed during communicating (download/upload) between GP Editor of PC and LP.

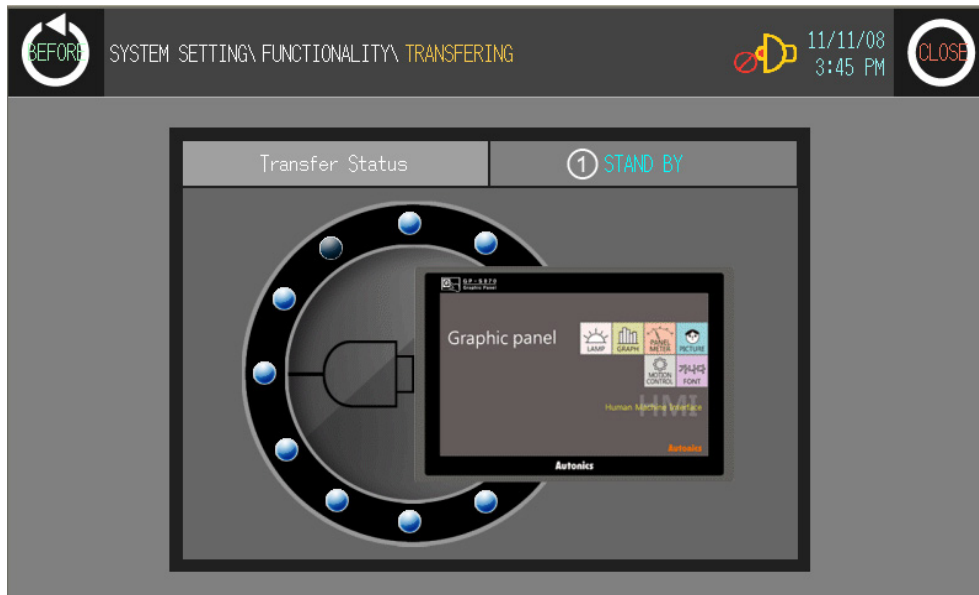

No.	Function and operation
①	You can check download or upload status of data.



Caution

If download stops during downloading due to power and cable connection problem, delete LP-S070 data and try download again.

6.5.3 Data logger

Data logger is for saving the specified device value by the user-defined conditions.

6.5.3.1 Log data file

Log data file is saved as DataLog[yyyymmddhhmm(year,month,date,hour,minute)].txt form. The capacity of GP/LP Disk saved log data is 32MByte, and max. log data file is max. 1MByte. (If 32 log data files are created, new log data file is overwritten on the oldest log data file.)



Ex.

If allotted save area for one file (max. 1MByte) is used all, log data file (up to 32) is created additionally. You can save max. 12,000 data to one file.

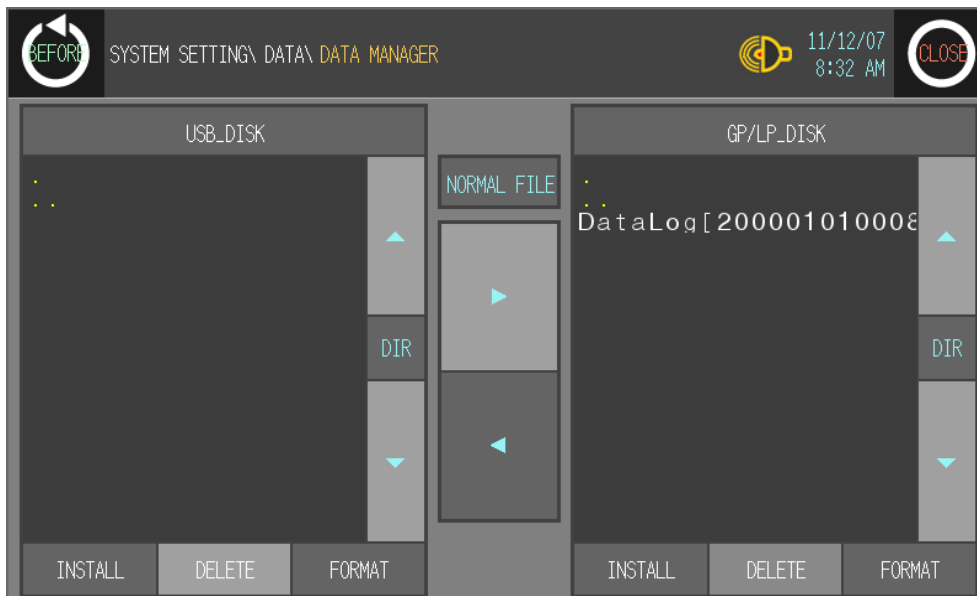

To save 8 log data hourly,

You can save log data as one file (1,500 hours) X 32 = 48,000 hours = 2,000 days = approx. 5.4 year.

You can check saved data file by copying to portable disk at [Data]-[Data Manager] of system setting menu.

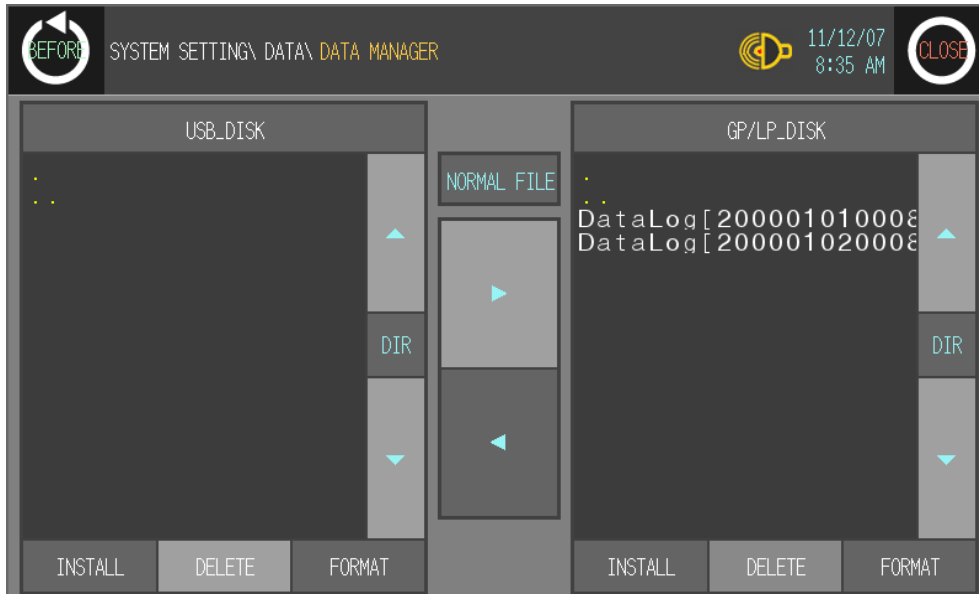

The below is the notepad to open saved data file.

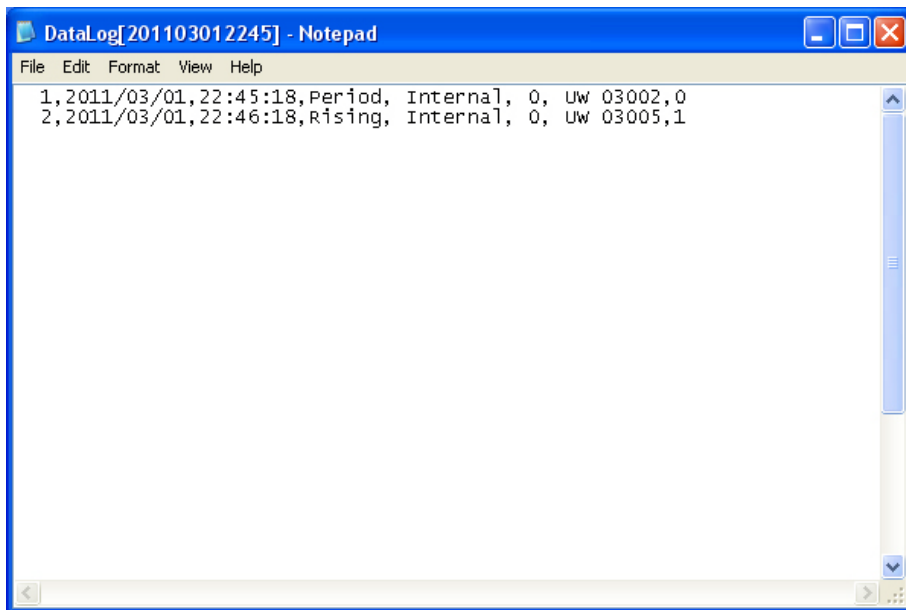

Each item is divided by comma (,), and item are as followings.

1	2012/09/12	22:45:18	Period	Internal	0	UW 03002	0
Order	Date	Time	Action conditions*1	Channel	Address	Save device	Device value

※1. In case of period logging, it displays “Period”. In case of conditional logging, “Rising” for rising edge, “Falling” for falling edge, “Change” for changing.

6.5.3.2 Logger conditions settings

BEFORE		SYSTEM SETTING \ FUNCTIONALITY \ DATA LOGGER					12/03/17 8:59 AM		CLOSE	
① Number	② Channel	③ Station	④ Device	⑤ Type	⑥ Consecutive Number	⑦ Repeat Count	⑧ Logger	⑨ Enable		
1	Channel1	0	000000	Bit	1	0	No Use	NO USE		
2	Channel1	0	000000	Bit	1	0	No Use	NO USE		
3	Channel1	0	000000	Bit	1	0	No Use	NO USE		
4	Channel1	0	000000	Bit	1	0	No Use	NO USE		
5	Channel1	0	000000	Bit	1	0	No Use	NO USE		
6	Channel1	0	000000	Bit	1	0	No Use	NO USE		
7	Channel1	0	000000	Bit	1	0	No Use	NO USE		
8	Channel1	0	000000	Bit	1	0	No Use	NO USE		

⑩ Delete All ⑪ Delete ⑫ Logger Set

No.	Function and operation
①	The serial number of data logger. Supports it up to 8. Touch each number and you can delete the saved data or set logger conditions.
②	Displays channel information (Channel 1, Channel 2, Internal).
③	Displays address.
④	Displays save device.
⑤	Displays save device type (BIT, WORD).
⑥	Displays the continuous number of the set logger condition's device In case of conditional logging, the continuous number of device is fixed as (1) by logger characteristics.
⑦	Displays the repeat number of set logger condition.
⑧	Displays the set logger condition (period logging, conditional logging).
⑨	Set the saved data logger function. Touch this, it switches 'USE' or 'NO USE'.
⑩	Delete all the saved data logger data.
⑪	Select to-be deleted series number (①) and touch to delete the selected logger data.
⑫	Select to-be set series number of data logger and touch the appropriate button to move logger condition setting menu.

6.5.3.3 Period logging

Period logging reads the set save device value at the designated time and saves it.

(1) Period logging setting

Number	Channel	Station	Device	Type	Consecutive Number	Repeat Count	Logger	Enable
1	Channel1	0	000000	Bit	1	0	No Use	NO USE
2	Channel1	0	000000	Bit	1	0	No Use	NO USE
3	Channel1	0	000000	Bit	1	0	No Use	NO USE
4	Channel1	0	000000	Bit	1	0	No Use	NO USE
5	Channel1	0	000000	Bit	1	0	No Use	NO USE
6	Channel1	0	000000	Bit	1	0	No Use	NO USE
7	Channel1	0	000000	Bit	1	0	No Use	NO USE
8	Channel1	0	000000	Bit	1	0	No Use	NO USE

Touch to-be set number as data logger and touch 'Logger Set' and 'PERIOD LOGGING' screen is displayed.

No.	Function and operation
①	Touch this, it moves to period logging setting screen, or conditional logging setting screen.
②	Logging operates by the set time type. <ul style="list-style-type: none"> • Random: Designate time interval to activate log function from the current time. • Every Hour: Designate minute and second to start logging. • Every Day: Designate hour, minute, second to start logging. • Every Week: Designate the day of week, hour, minute, second to start logging.

No.	Function and operation
	<ul style="list-style-type: none"> Every Month: Designate day, hour, minute, second to start logging. Touch to-be set time type and it moves to the relevant setting screen.
③	Displays time and day of repeat period by the set type.
④	Designate the repeat number of times to save after starting logging. Default is 0, if this is set as 0, repeat count is infinite.
⑤	<p>If the device is satisfied with the set condition, it saves logging device (save device) to the file.</p> <p>Select the device type (word or bit) and touch 'Device Set' and it moves to the device menu.</p>
⑥	Displays the set channel, address, device of the save device.
⑦	If it is word device, it displays the set data type (Signed Word: decimal with sign, Unsigned Word: decimal without sign) of the device.
⑧	<p>Displays the number of device to be read continuously from the start address of set save device.</p> <p>(Default is 1. In case of bit device, it is available to set up to 8. In case of word device, it is available to set up to 4.)</p>
⑨	Displays the number of logger setting screen.
⑩	Saves the set of logger data.

 Ex.

The following example is that logging starts at current time (09:00) by the 10 minutes period at 3 consecutive numbers of device with 3 repeats number of times.

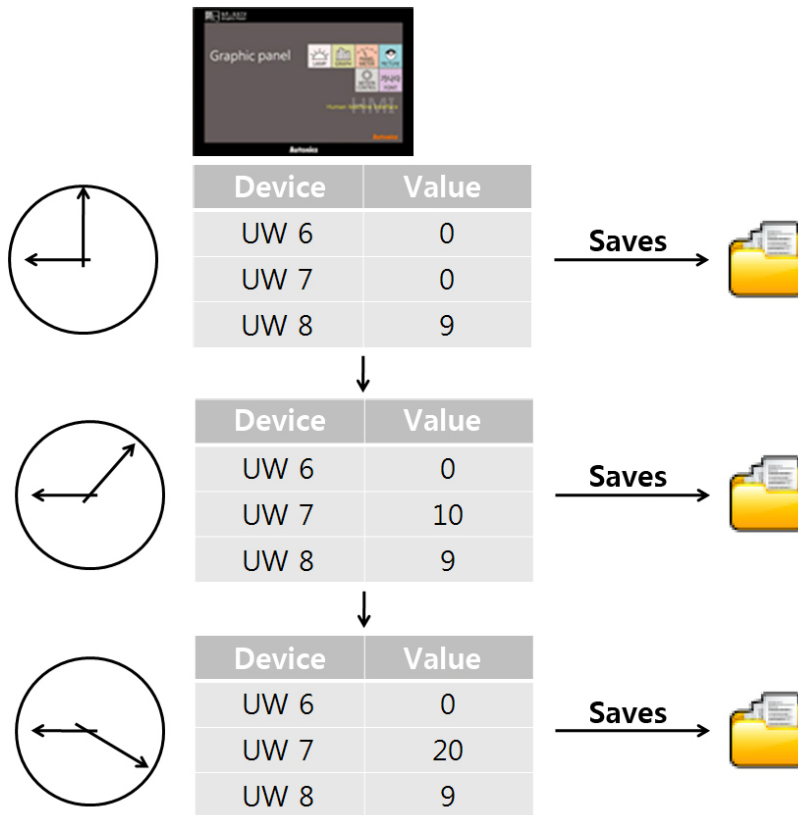

1st Touch 'PERIOD' and it moves to 'PERIOD LOGGING' set screen.

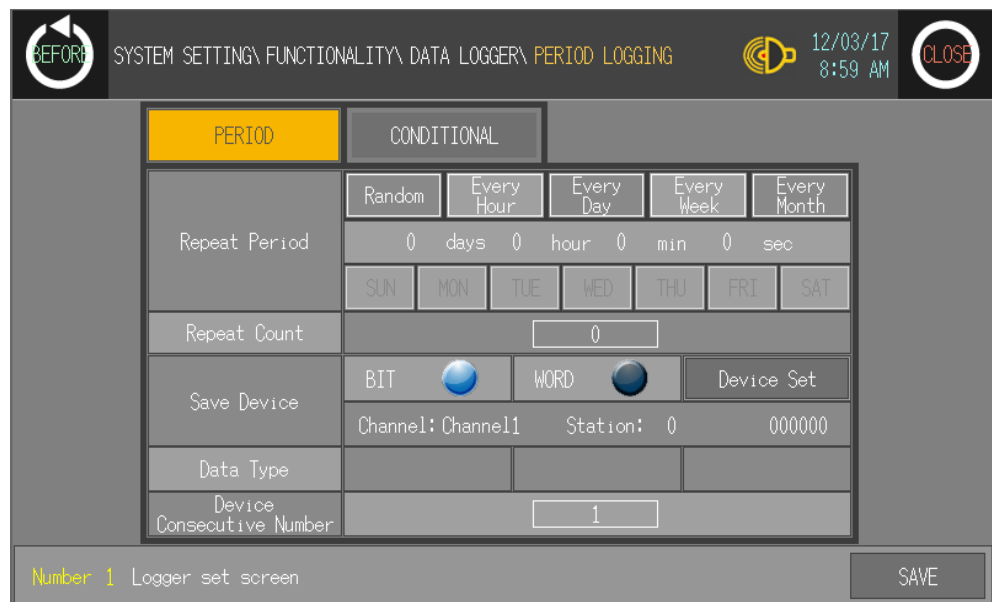

2nd Touch 'Repeat Period' and it moves to touch 'Random'.

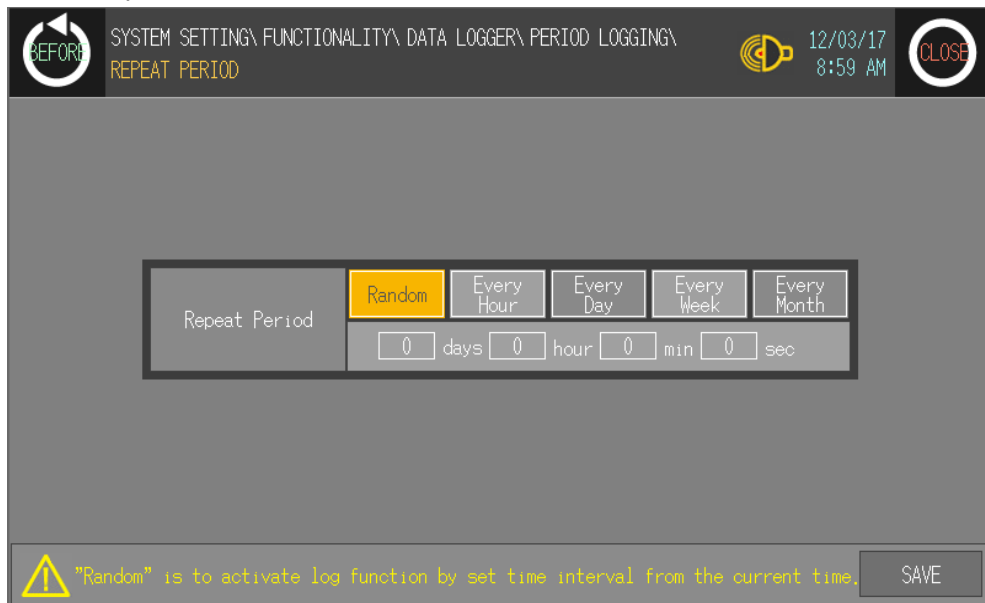

3rd It is 10 minute period, touch 'min' and input key pad appears. Enter '10'.

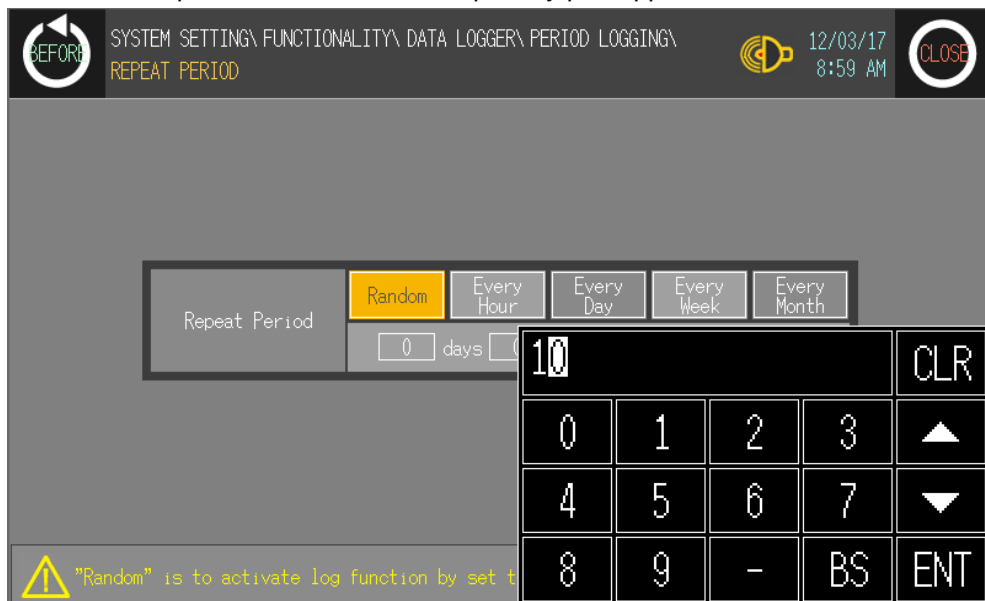

4th Touch 'SAVE' to save the setting.

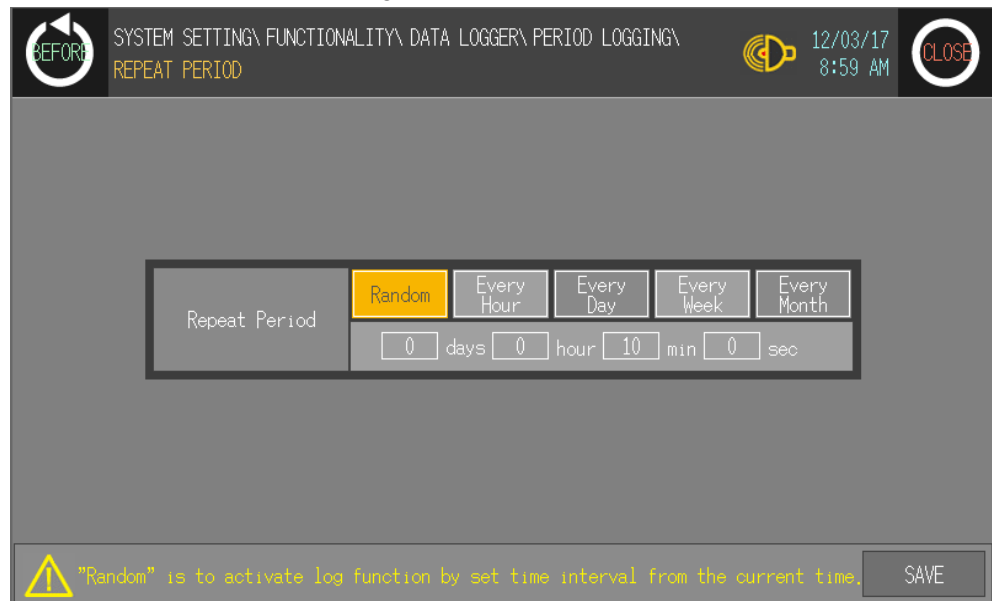

5th Designate 'Repeat Count'. Touch the number of repeat count and input key pad appears. Enter '3'. If this is set as 0, repeat count is infinite.

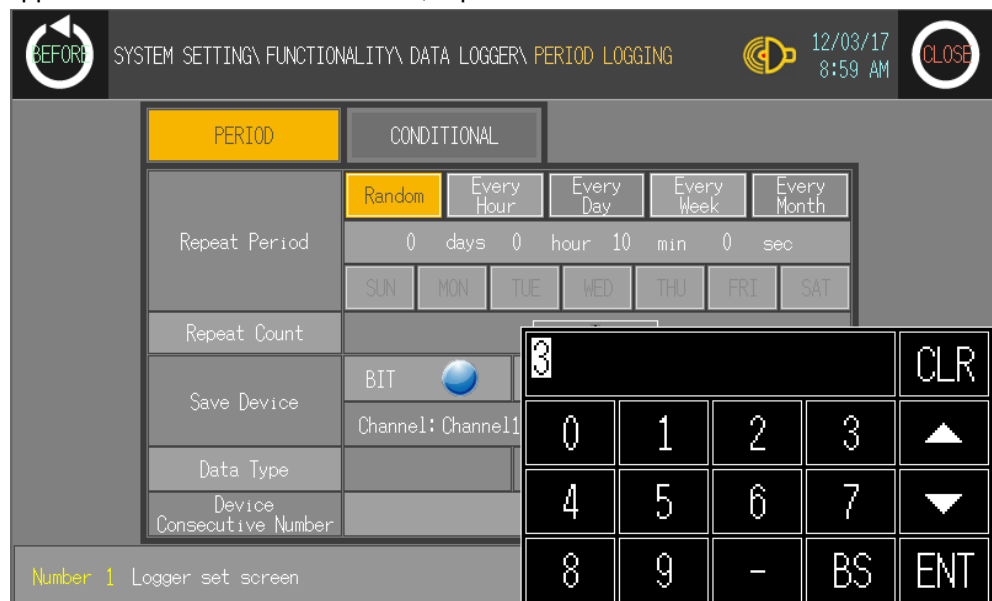

6th Designate save device. Select 'WORD' to set 'UW'.

SYSTEM SETTING\ FUNCTIONALITY\ DATA LOGGER\ PERIOD LOGGING		12/03/17 8:59 AM
PERIOD	CONDITIONAL	
Repeat Period	Random	Every Hour
	Every Day	Every Week
	Every Month	
	0 days 0 hour 10 min 0 sec	
	SUN	MON TUE WED THU FRI SAT
Repeat Count	3	
Save Device	BIT	WORD
	Device Set	
	Channel: Channel11	Station: 0 000000
Data Type		
Device Consecutive Number	1	
Number 1 Logger set screen		
SAVE		

7th Touch 'Device Set' and it moves to word device set menu.

You can set channel (Channel 1, Channel 2, Internal), station (0 to 255), device, and data type.

SYSTEM SETTING\ FUNCTIONALITY\ DATA LOGGER\ PERIOD LOGGING\ PERIOD SAVE WORD		12/03/17 8:59 AM
Word Device Set	Channel Selection	Channel11
	Station Selection	0
	Device Selection	000000
Data Type	<input checked="" type="radio"/> Signed Word	<input type="radio"/> Unsigned Word
SAVE		

8th Touch 'Device Selection' and input key pad appears to set appropriate device. Enter 'UW' 6.

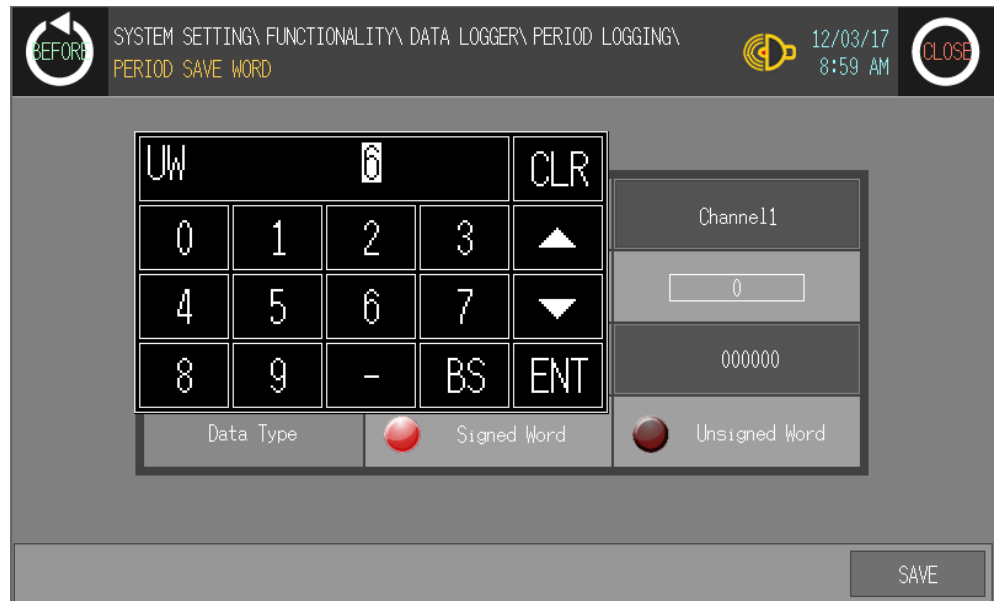

9th Check the set and touch 'SAVE'.

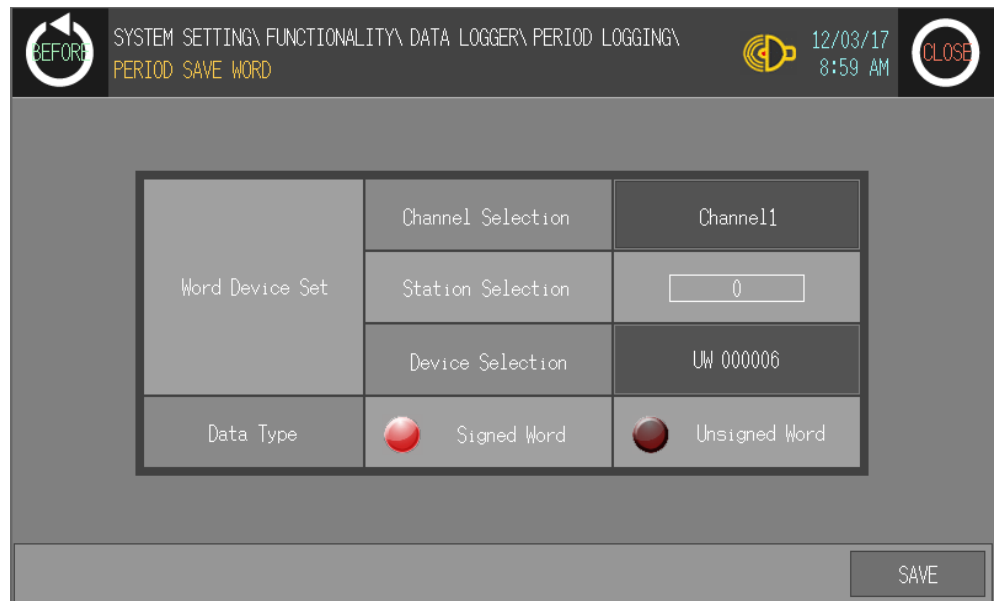

10th Designate 'Device Consecutive Number'.

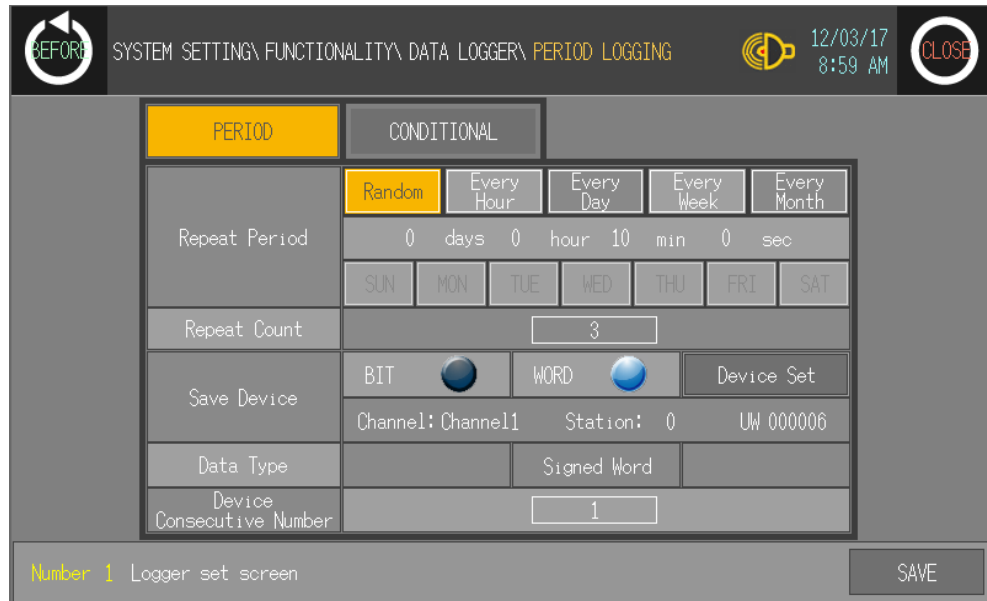

11th Touch 'Number (1)' of device consecutive number and input key pad appears.

Designate the number of device to be read continuously from the start address of set save device.

To read from UW6 to UW7, UW8 continue device, enter '3'.

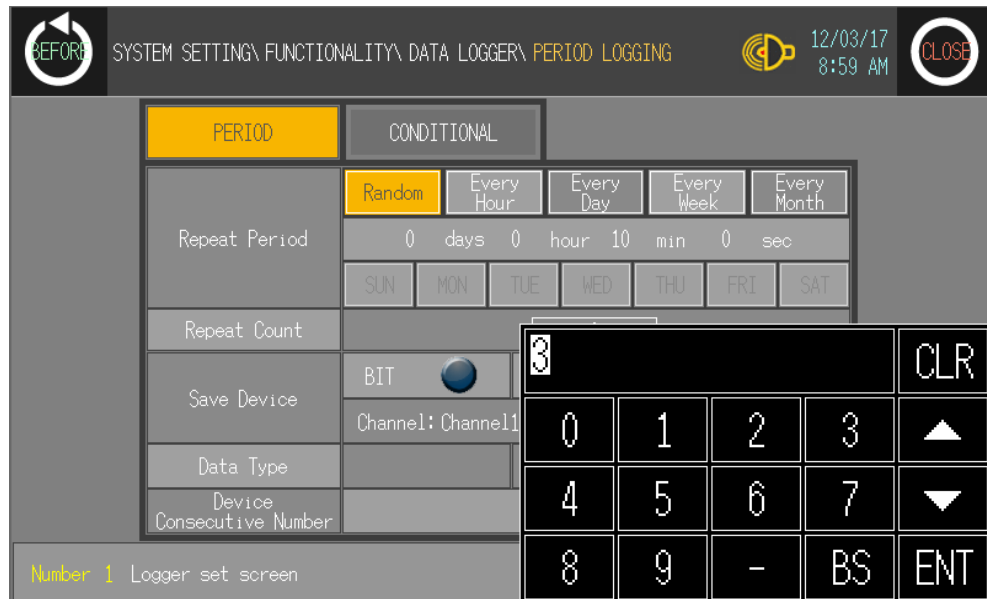

12th Check the set and touch 'SAVE'.

SYSTEM SETTING\FUNCTIONALITY\DATA LOGGER\PERIOD LOGGING

12/03/17 8:59 AM

PERIOD CONDITIONAL

Repeat Period: Random, Every Hour, Every Day, Every Week, Every Month

0 days 0 hour 10 min 0 sec

SUN MON TUE WED THU FRI SAT

Repeat Count: 3

Save Device: BIT, WORD, Device Set

Channel: Channel1 Station: 0 UW 000006

Data Type: Signed Word

Device Consecutive Number: 3

Number 1 Logger set screen

SAVE

13th Set 'USE' of Enable and data logger function operates.

SYSTEM SETTING\FUNCTIONALITY\DATA LOGGER

12/03/17 9:00 AM

Number	Channel	Station	Device	Type	Consecutive Number	Repeat Count	Logger	Enable
1	Channel1	0	UW 000006	Word	3	3	Period	USE
2	Channel1	0	000000	Bit	1	0	No Use	NO USE
3	Channel1	0	000000	Bit	1	0	No Use	NO USE
4	Channel1	0	000000	Bit	1	0	No Use	NO USE
5	Channel1	0	000000	Bit	1	0	No Use	NO USE
6	Channel1	0	000000	Bit	1	0	No Use	NO USE
7	Channel1	0	000000	Bit	1	0	No Use	NO USE
8	Channel1	0	000000	Bit	1	0	No Use	NO USE

Delete All Delete Logger Set

6.5.3.4 Conditional logging

Conditional logging starts logging when conditional device is satisfied with the set action condition (rising edge, falling edge, change).

- Action condition for Bit device
 - Rising edge: When the specified bit device is rising edge, it saves the set save device value.
 - Falling edge: When the specified bit device is falling edge, it saves the set save device value.
 - Change: When the specified bit device is changing (rising or falling) edge, it saves the set save device value.
- Action condition for Word device
 - Change: When the specified word device is changing, it saves the set save device value.

Touch the desired number to set logger condition and touch 'Logger Set'.

Touch 'CONDITIONAL' and it moves to 'CONDITONAL LOGGING' set screen.

PERIOD	CONDITIONAL		
Conditional Device	BIT <input checked="" type="radio"/>	WORD <input type="radio"/>	Device Set
	Channel: Channel1	Station: 0	000000
Action			
Save Device	BIT <input checked="" type="radio"/>	WORD <input type="radio"/>	Device Set
	Channel: Channel1	Station: 0	000000
Data Type			

Number: 1 Logger set screen

SAVE

(1) Conditional device setting

You can designate conditional device. Conditional device is bit or word unit.

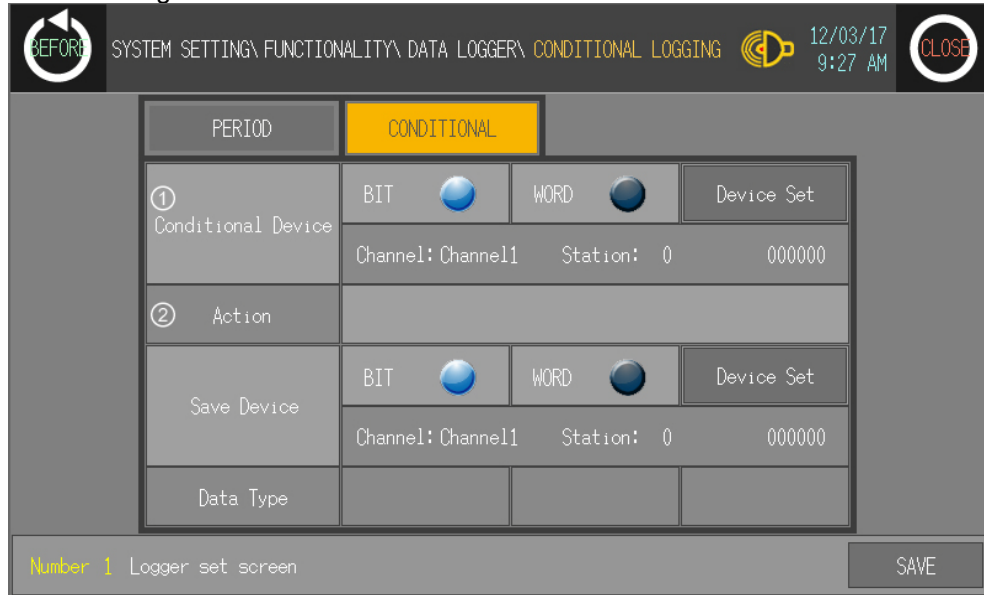

No.	Function and operation
①	Records save device value to file when conditional device is satisfied with set action (rising edge, falling edge, or change). Select the device type (bit or word) to set conditional device and touch 'SET', and it moves to the specified device menu.
②	Displays set action conditions of conditional device at the specified device menu. <ul style="list-style-type: none"> • Bit device action conditions: Rising edge, falling edge, or change • Word device action conditions: Change

(2) Save device setting

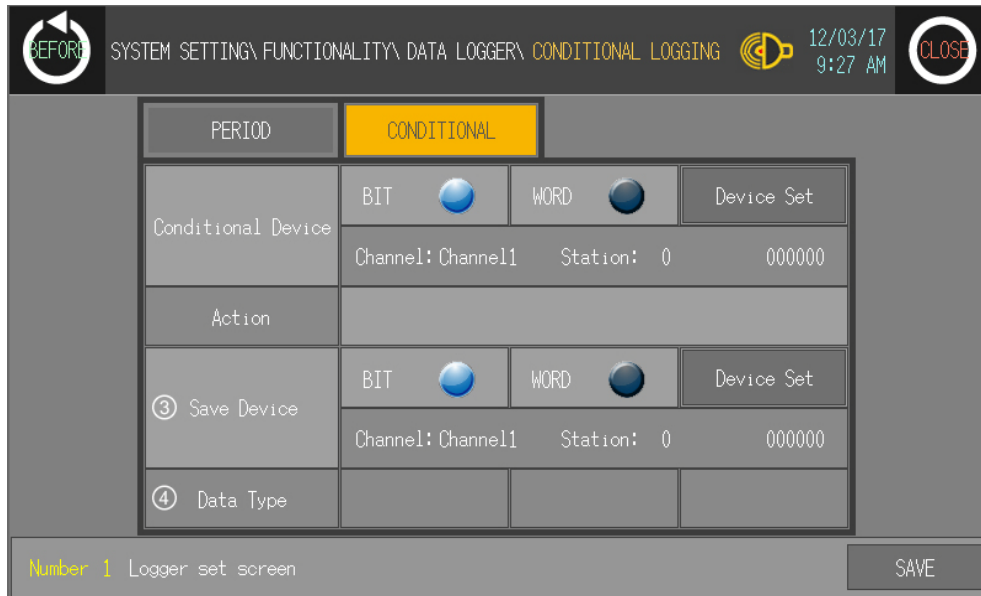

No.	Function and operation
③	Records save device value to file when conditional device is satisfied with set action conditions. Select the device type (bit or word) and touch 'SET', and it moves to the specified device menu.
④	Displays word device type (Signed Word: decimal with sign, Unsigned Word: decimal without sign) when the device type is selected as word.

Ex.

The following example is that conditional device is UB56 (Action conditions: Rising edge) and save device is UW6. When conditional device is On, the designated device value as save device is saved at file.

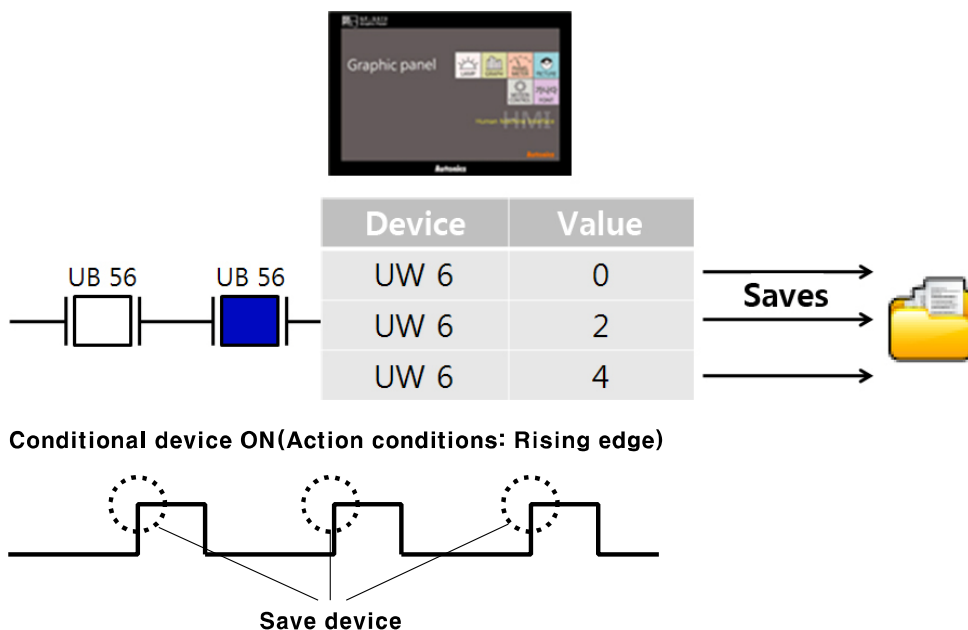

1st Touch 'CONDITIONAL' and moves to 'CONDITIONAL LOGGING' set screen.

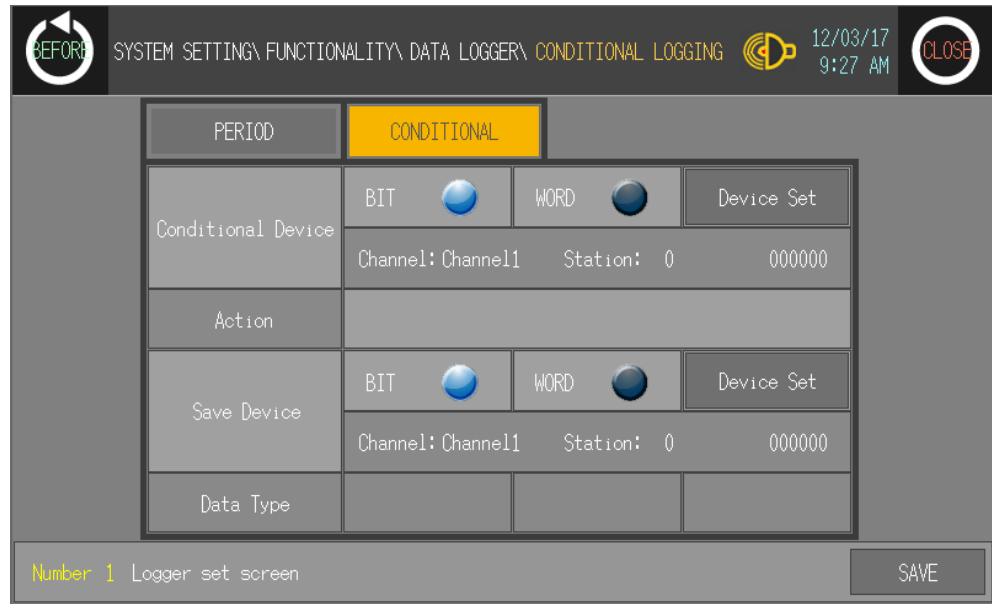

2nd Input conditional device. To set UB56 (action condition: rising edge), as example, select 'BIT' and touch 'Device Set'.

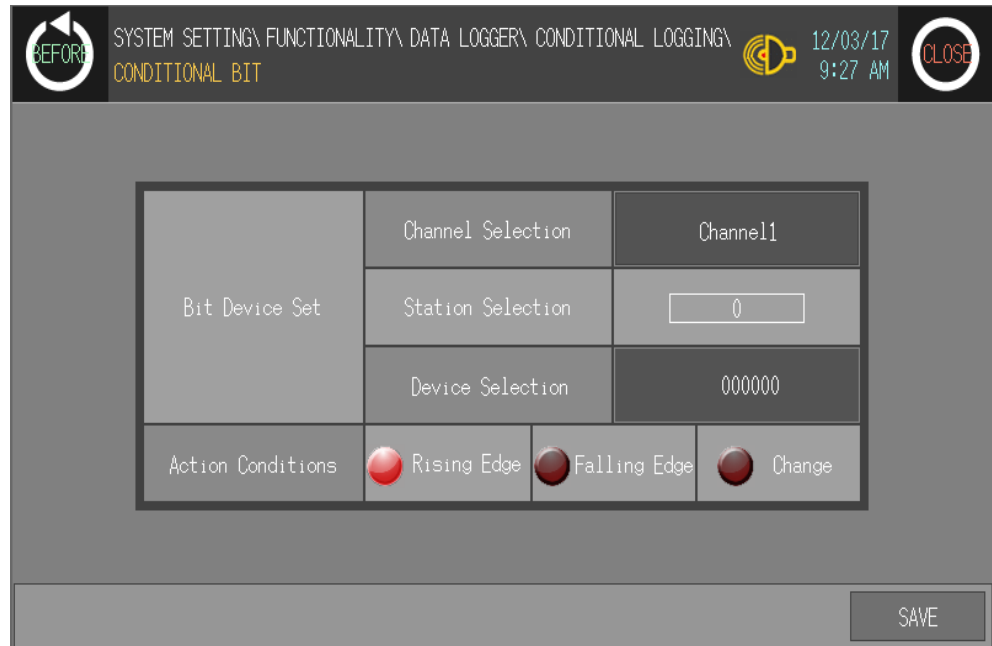

3rd Touch 'Number (000000)' to select device and input key pad appears. Enter 'UB56'.

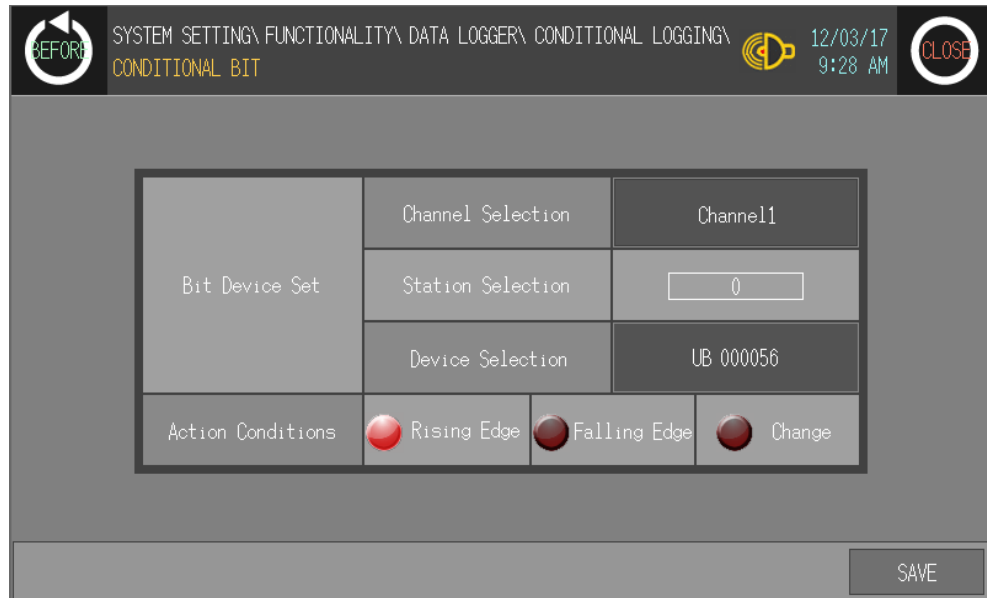
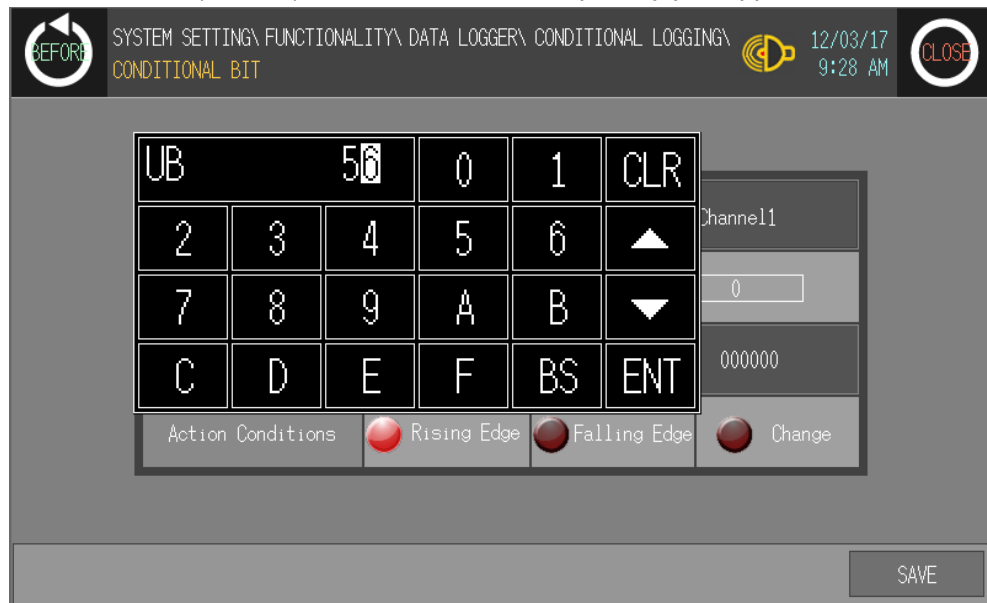

4th Designate save device. Select 'WORD' to set save device and touch 'Device Set'.

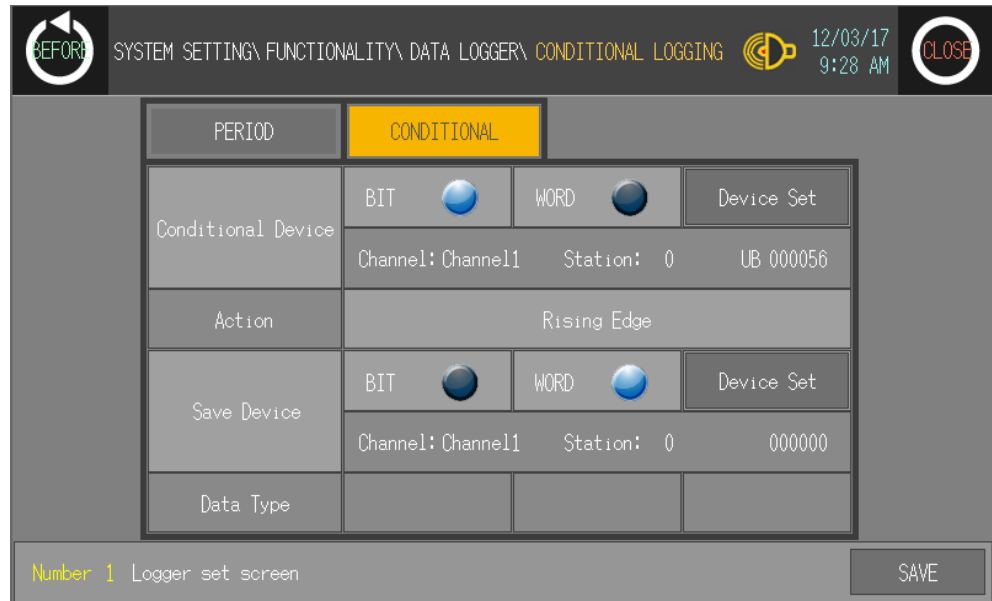

5th Touch 'Number (00000)' of Device Selection at Word Device Set for save device and input key pad appears.

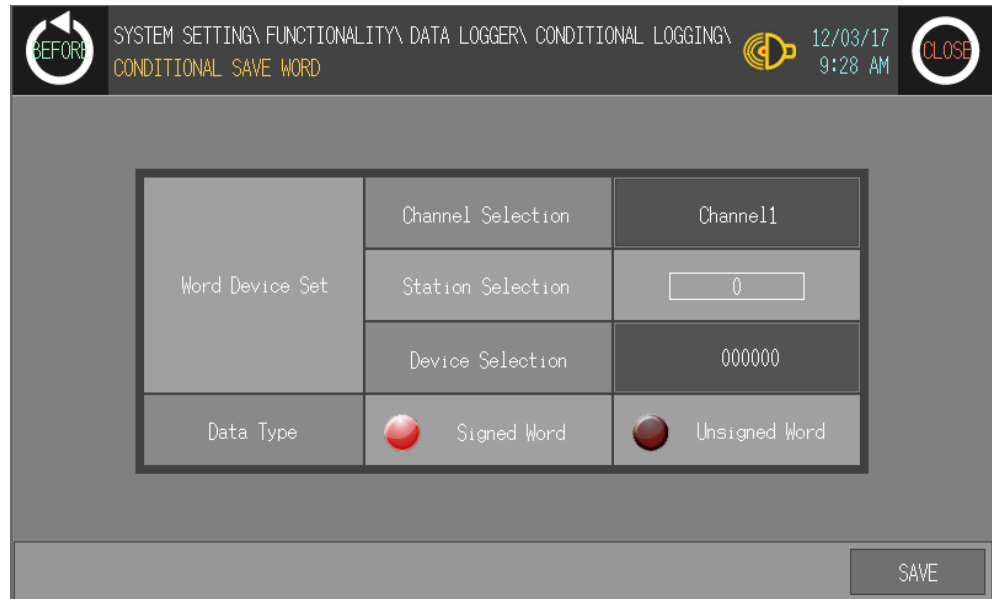

6th Enter 'UW6' and save this set.

BEFORE SYSTEM SETTING\ FUNCTIONALITY\ DATA LOGGER\ CONDITIONAL LOGGING 12/03/17 9:28 AM CLOSE

CONDITIONAL SAVE WORD

UW				6	CLR
0	1	2	3	▲	Channel1 0 000000 Signed Word Unsigned Word
4	5	6	7	▼	
8	9	-	BS	ENT	
Data Type		<input checked="" type="radio"/> Signed Word		<input type="radio"/> Unsigned Word	

SAVE

BEFORE SYSTEM SETTING\ FUNCTIONALITY\ DATA LOGGER\ CONDITIONAL LOGGING 12/03/17 9:28 AM CLOSE

PERIOD	CONDITIONAL		
Conditional Device	BIT <input checked="" type="radio"/>	WORD <input type="radio"/>	Device Set
	Channel: Channel1 Station: 0 UB 000056		
Action	Rising Edge		
Save Device	BIT <input type="radio"/>	WORD <input checked="" type="radio"/>	Device Set
	Channel: Channel1 Station: 0 UW 000006		
Data Type	Signed Word		

Number 1 Logger set screen

SAVE

7th Set 'USE' of Enable for logger condition, data logger function operates.

BEFORE
SYSTEM SETTINGS, FUNCTIONALITY, DATA LOGGER
12/03/17
9:28 AM
CLOSE

Number	Channel	Station	Device	Type	Consecutive Number	Repeat Count	Logger	Enable
1	Channel1	0	UW 000006	Word	1	0	Conditional	NO USE
2	Channel1	0	000000	Bit	1	0	No Use	NO USE
3	Channel1	0	000000	Bit	1	0	No Use	NO USE
4	Channel1	0	000000	Bit	1	0	No Use	NO USE
5	Channel1	0	000000	Bit	1	0	No Use	NO USE
6	Channel1	0	000000	Bit	1	0	No Use	NO USE
7	Channel1	0	000000	Bit	1	0	No Use	NO USE
8	Channel1	0	000000	Bit	1	0	No Use	NO USE

Delete All
Delete
Logger Set

6.5.4 Print out

This menu is for printing alarm history which is listed during LP operation by external printer.

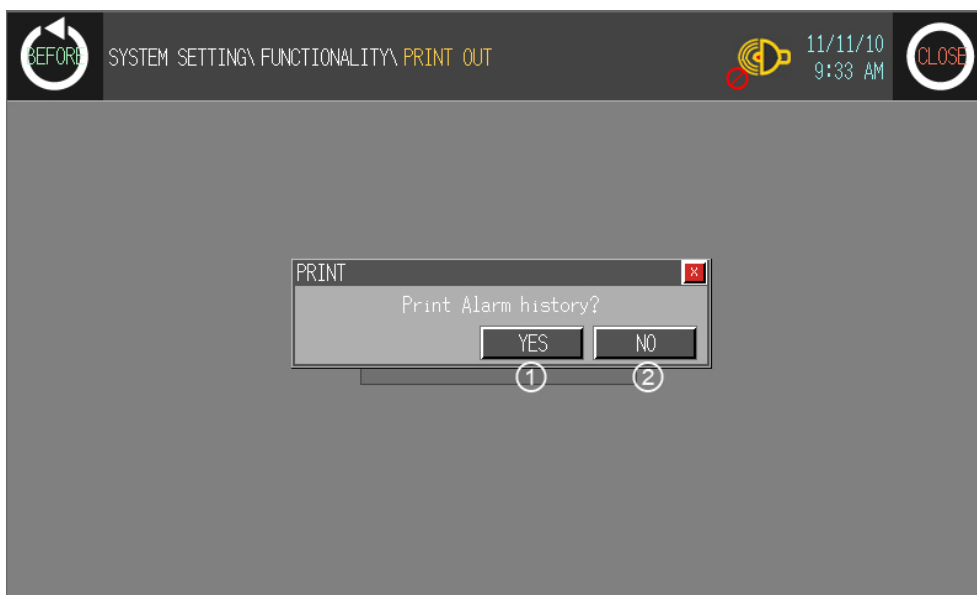
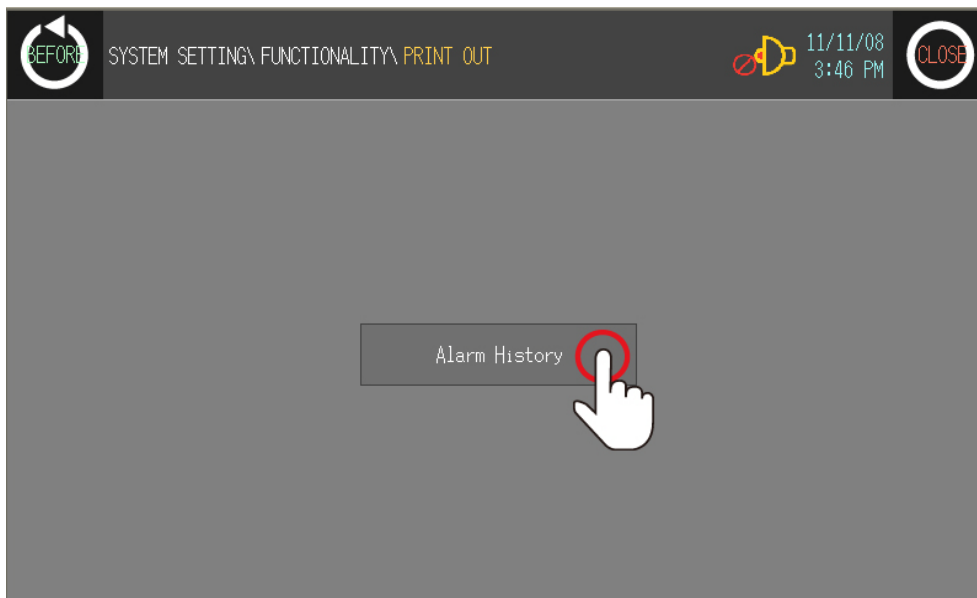

No.	Function and operation
①	Prints alarm history with touching. Printer port setting: From [Environment]-[Serial Communication] of system setting menu, set 'PRINTER'
②	Cancels printing alarm history.

6.6 Data

6.6.1 Data manager

You can check file list of GP/LP_DISK of USB_DISK connected LP-S070.
Selected file with touching is able to install, delete, or format.

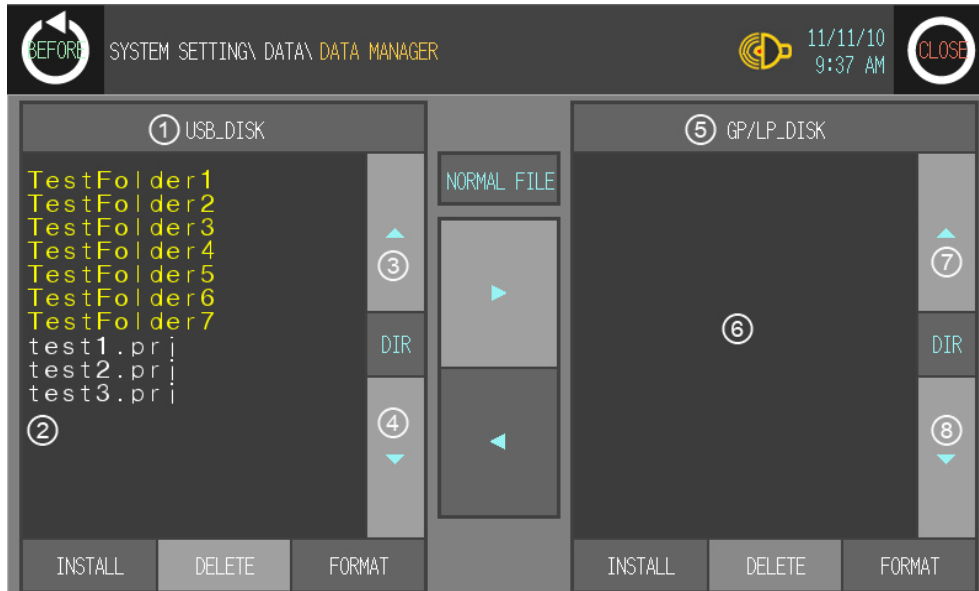

No.	Function and operation
①, ⑤	Select USB DISK or GP/LP DISK.
②, ⑥	Displays inner files of selected DISK.
③, ④ ⑦, ⑧	If inner files of selected DISK are out of list box, touch ▲, ▼ to move the list up and down.

6.6.1.1 INSTALL, DELETE, FORMAT

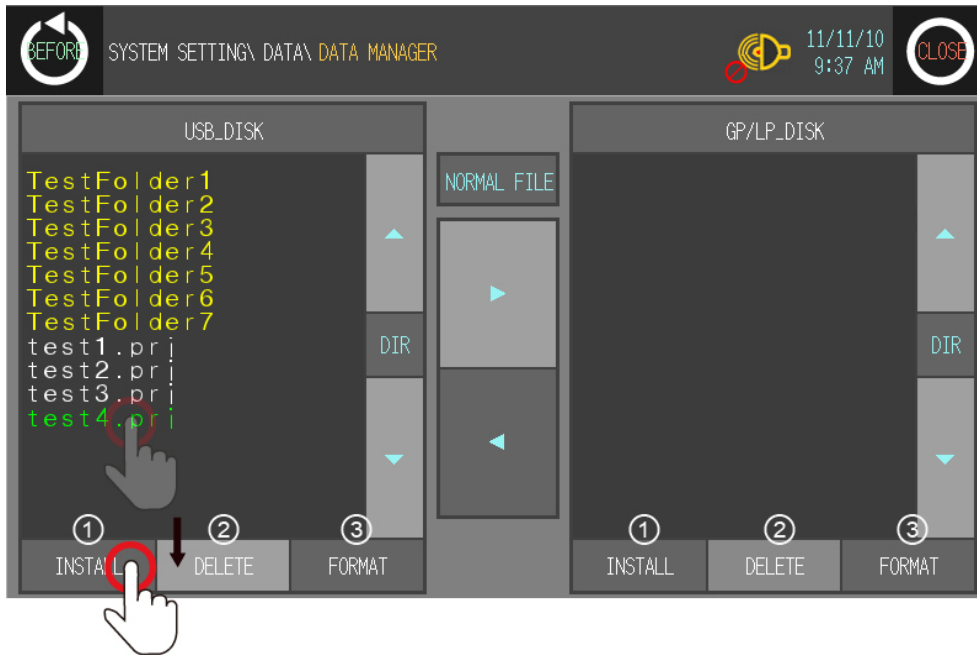

User screen

No.	Function and operation
①	Check the designed screen at user screen with touching 'INSTALL' when connecting USB memory stick which has project file designed from GP Editor.
②	Deletes selected data.
③	Formats selected DISK.

6.6.1.2 File copy

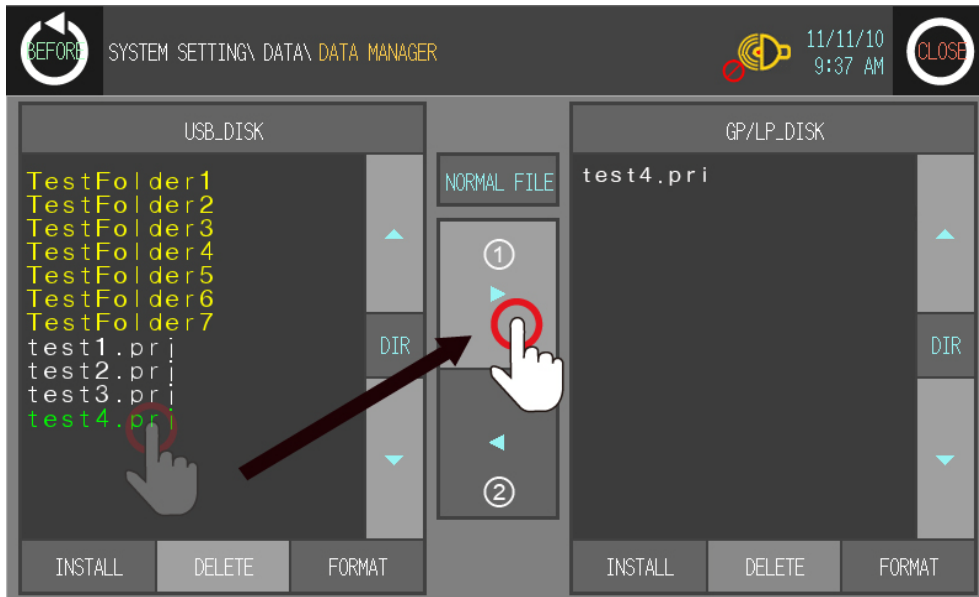

No.	Function and operation
①, ②	It is able to copy selected file to GP/LP_DISK or USB_DISK.

6.6.1.3 Directory movement

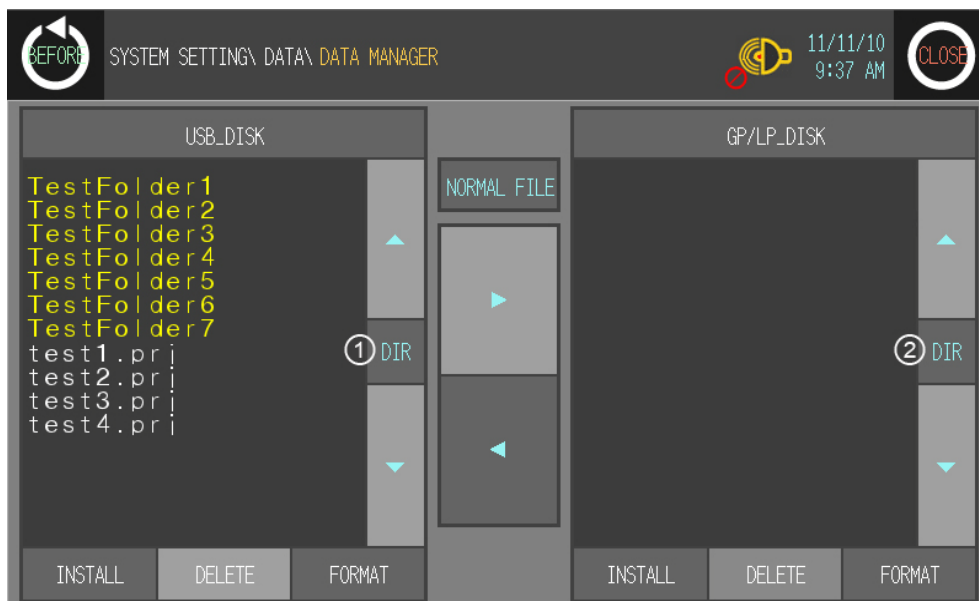

No.	Function and operation
①, ②	Moves top folder or sub folder of folder list in disk. (Moveable top folder is displayed as '..' with yellow, and sub folder is displayed as 'folder title' with yellow.) Touch the desired folder and touch 'DIR' button to move.



For moving sub directory, touch 'folder title' with yellow and touch 'DIR' button to move.

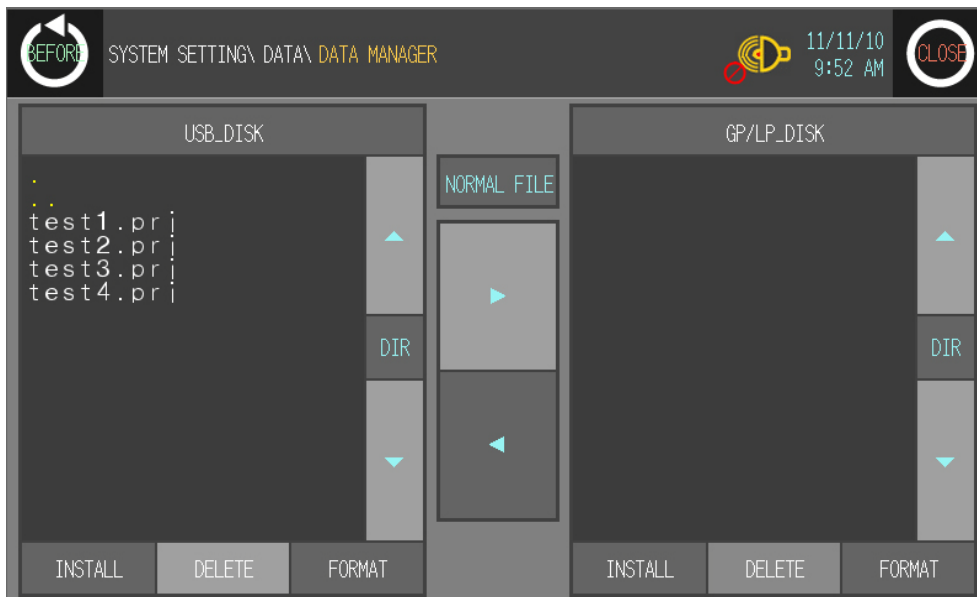
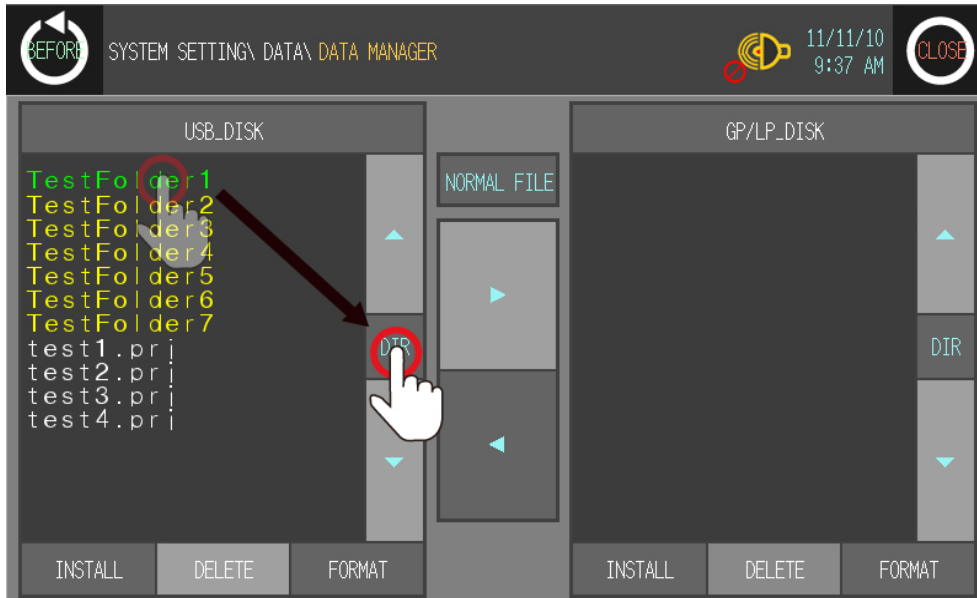

For moving top directory, touch '..' directory path with yellow and touch 'DIR' button to move.

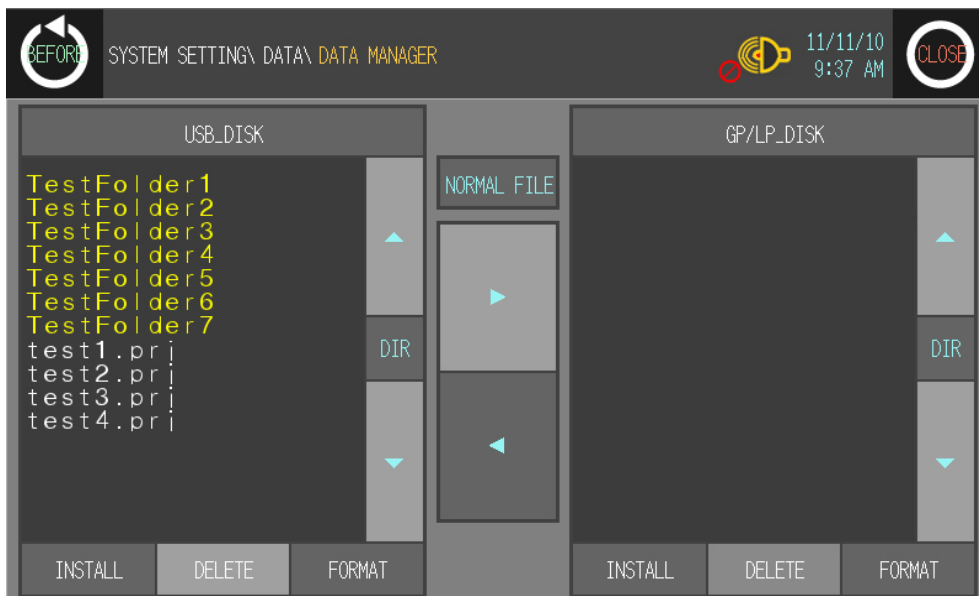
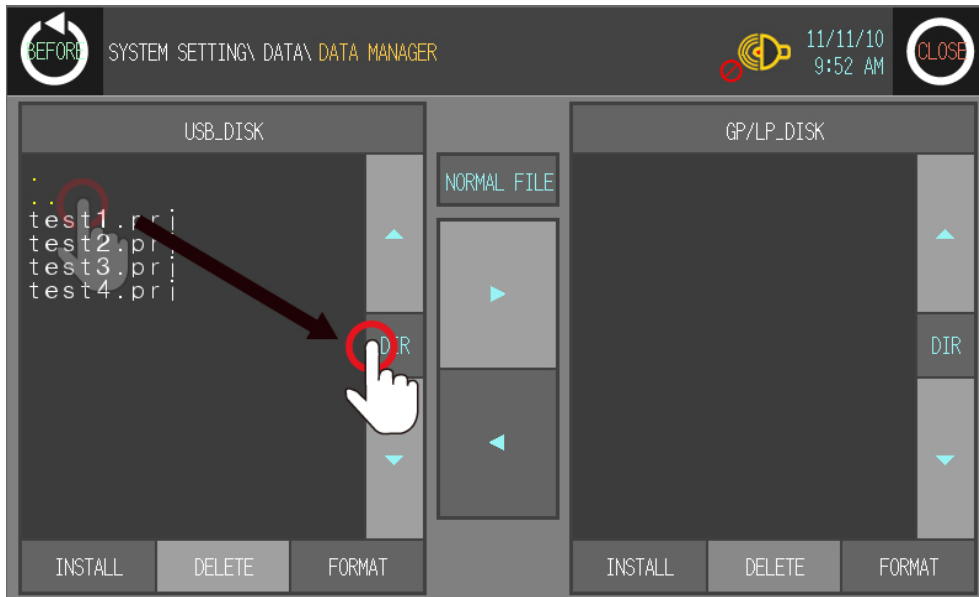

6.6.2 Firmware update

You can update firmware periodically if necessary.

- 1st For update firmware, visit our homepage (www.autonics.com) and download LP-S070 firmware file properly. Save this file to USB DISK.(Please format USB DISK before saving this file.)
- 2nd Connect LP-S070 and USB DISK and enter [Data]–[Firmware update] of system setting menu. Touch 'OK' to start firmware update.

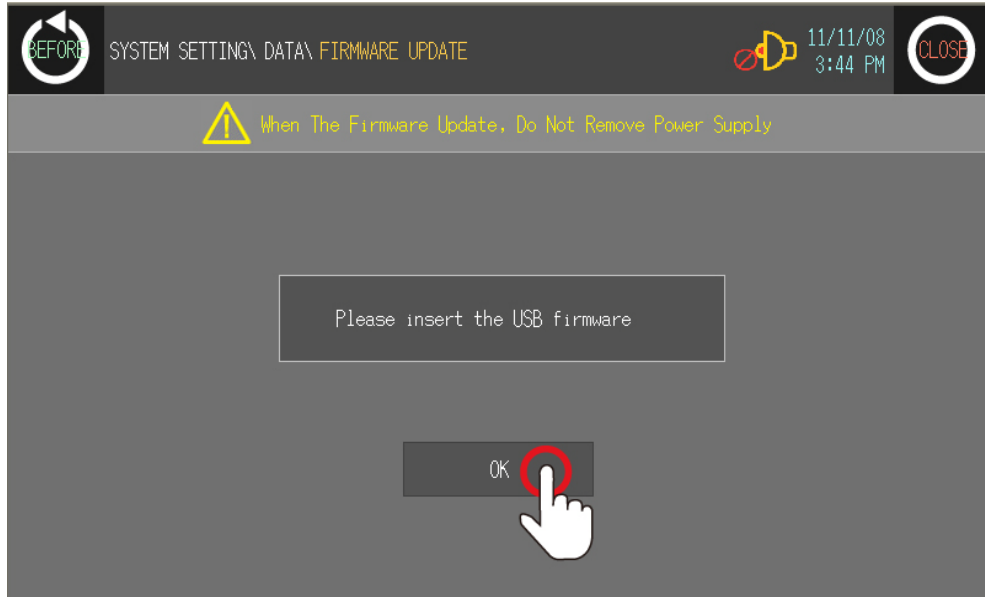

- 3rd Checking firmware update dialog box appears. Touch 'YES' to start firmware update.

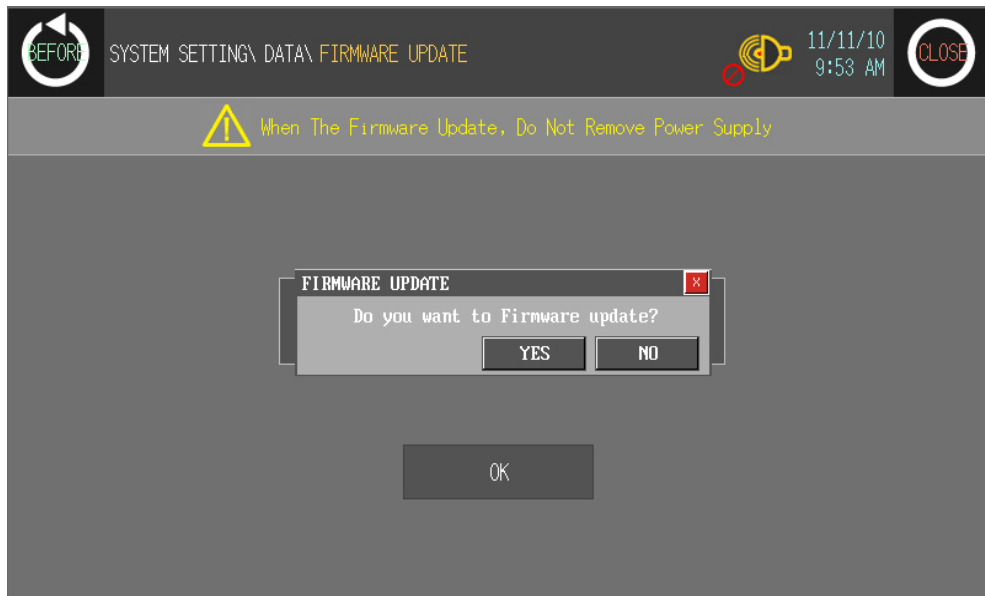

- 4th Firmware update progress is displayed as bar graph type.
If update completes, restart LP-S070.

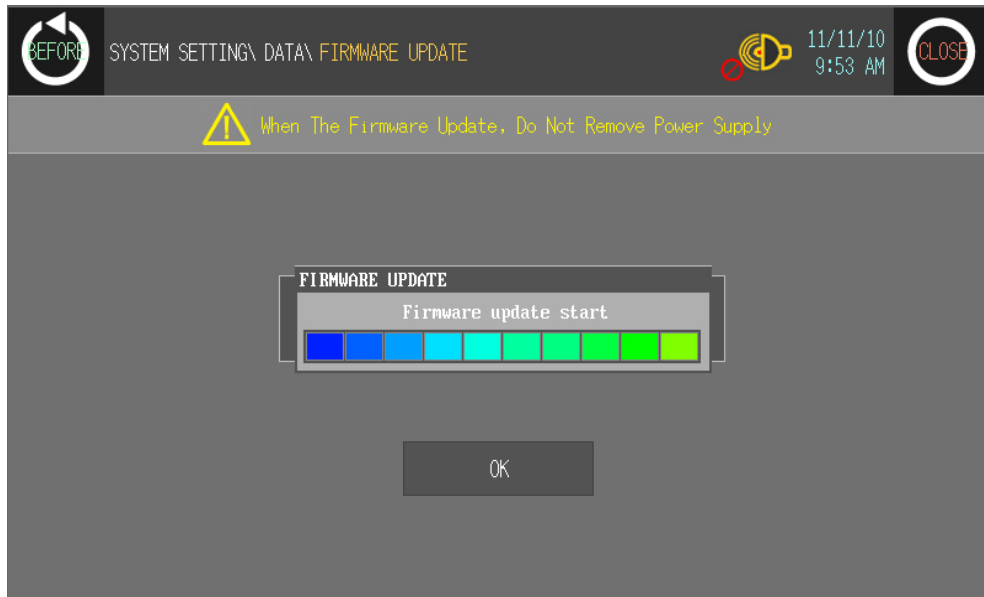

 **Caution**

Do not power OFF to LP-S070 during firmware update.

6.6.3 System

6.6.3.1 System information

This menu displays LP-S070 system information.

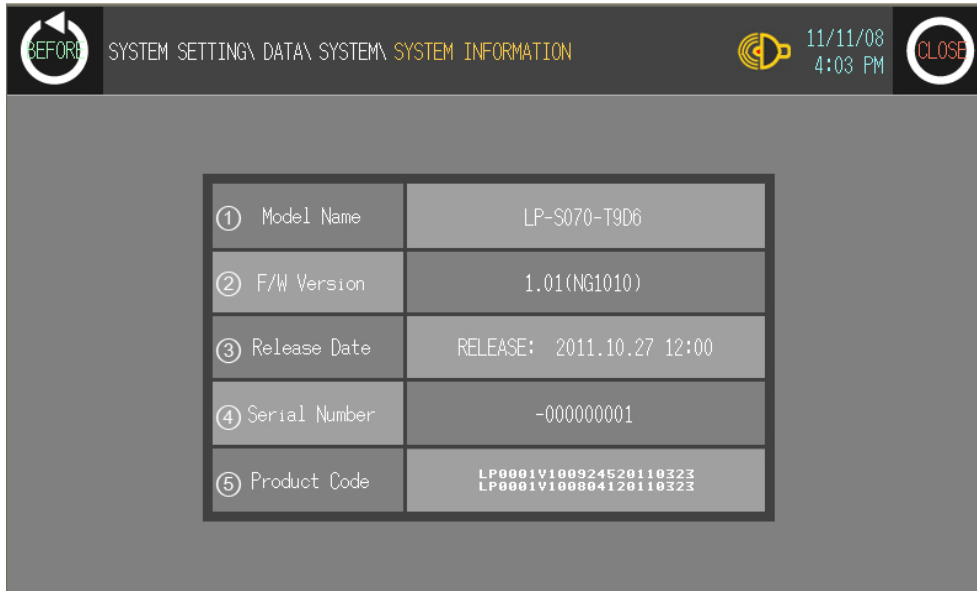

No.	Function and operation
①	Displays detail model name.
②	Displays firmware version
③	Displays update date of firmware version.
④	Displays serial number.
⑤	Product code for recognizing product information.

6.6.3.2 Disk capacity

This menu displays total disk capacity and available capacity of LP-S070.

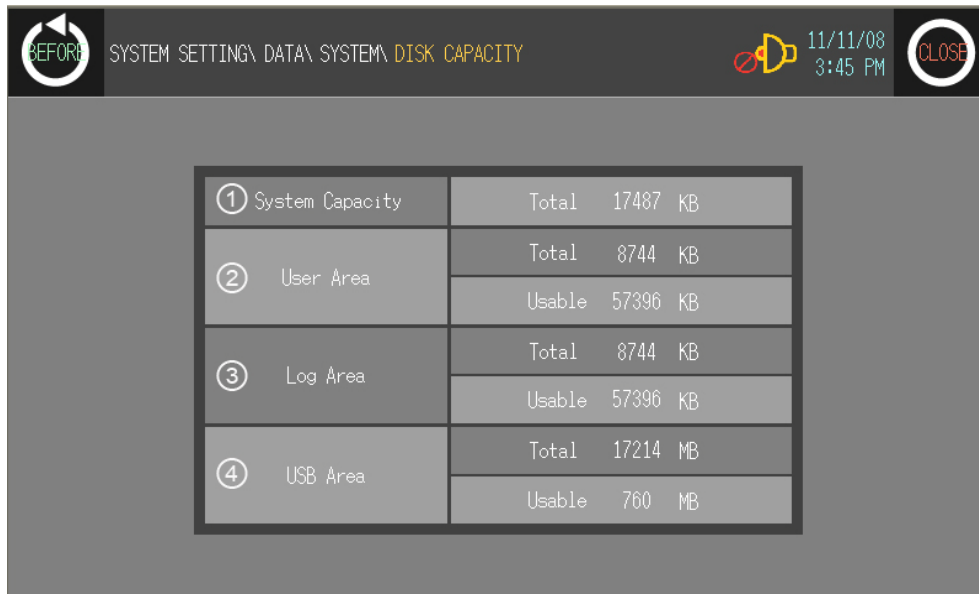

No.	Function and operation
①	Displays total system disk capacity.
②	Displays total and usable user disk area.
③	Displays total and usable log disk area.
④	Displays total and usable USB disk area connected LP-S070

6.6.4 User screen

6.6.4.1 Base screen

This menu displays screen number and screen title list for base screen. Touch the desired screen, you can check designed status of the screen.

Screen check and operation

- 1st Touch the desired screen line to check and it moves the selected screen to check.

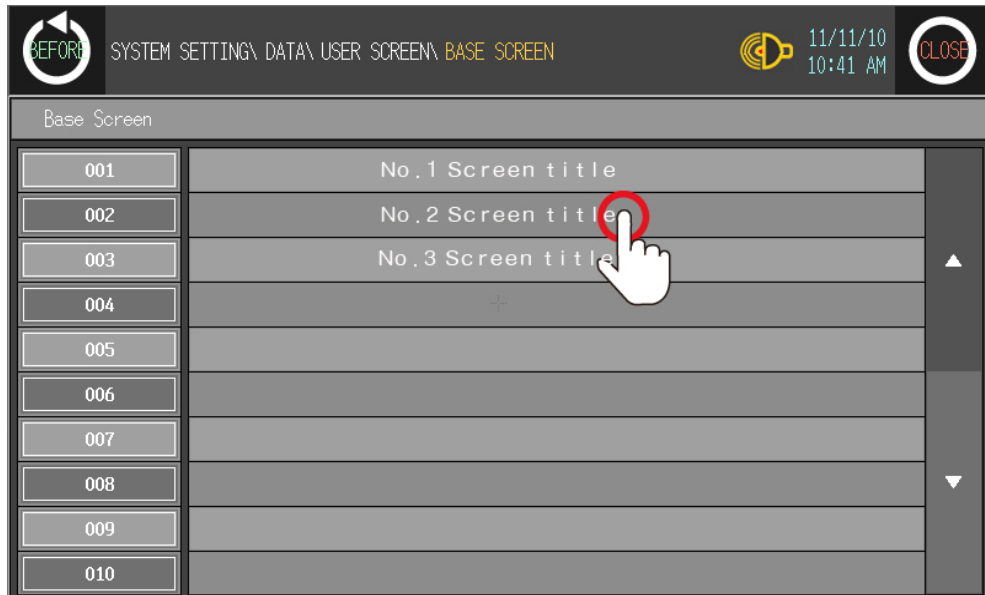

- 2nd At moved screen, touch any point to return to the previous.

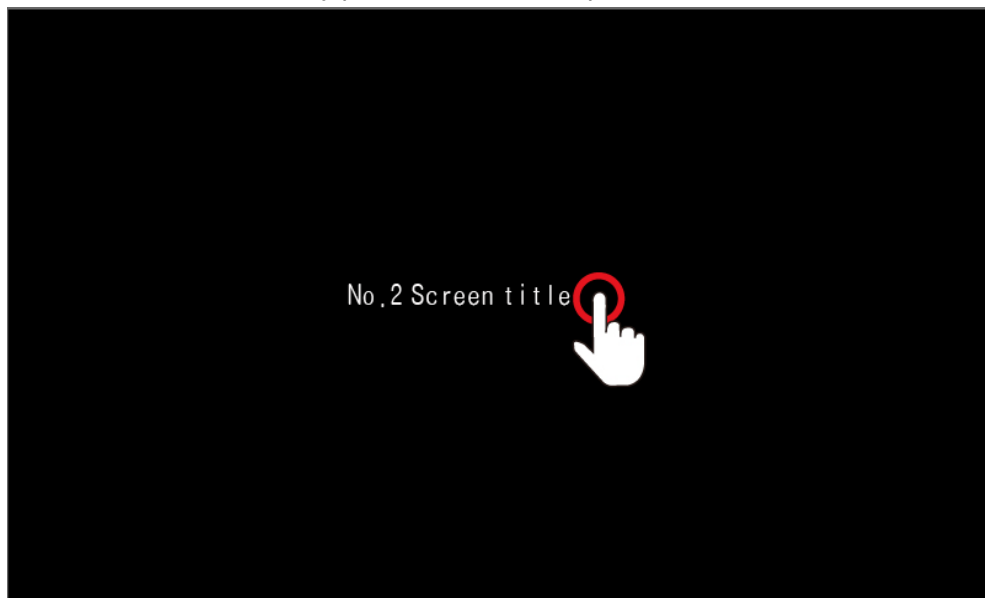

Caution

By checking base screen from the list, the display object of the selected base screen operates normally but the input object of the selected screen does not operate.

6.6.4.2 Window screen

This menu displays screen number and screen title list for window screen. Screen check method is same as base screen's.

1st Touch the desired screen line to check and it moves the selected screen to check.

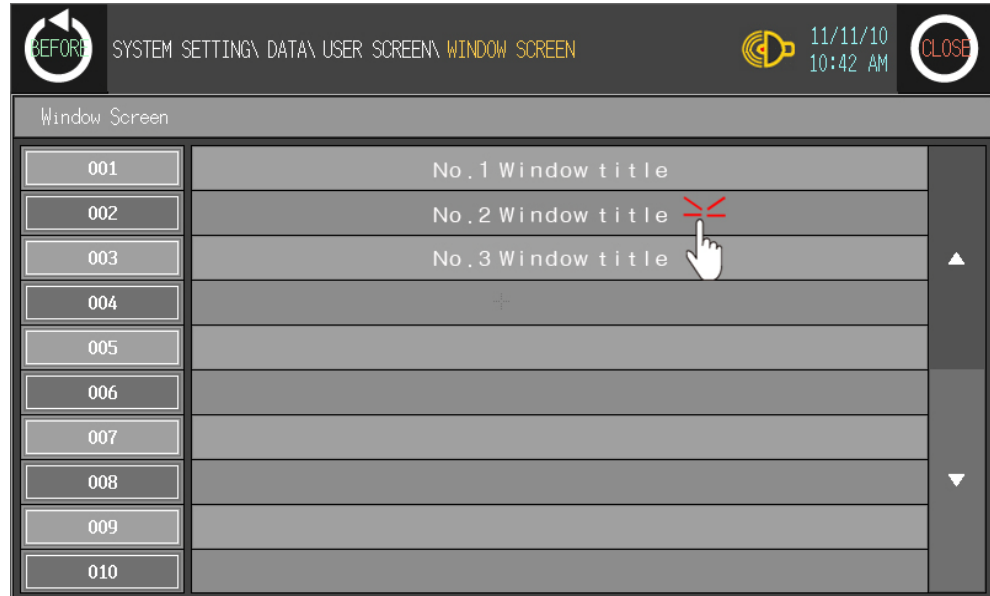

2nd At moved screen, touch any point to return to the previous.

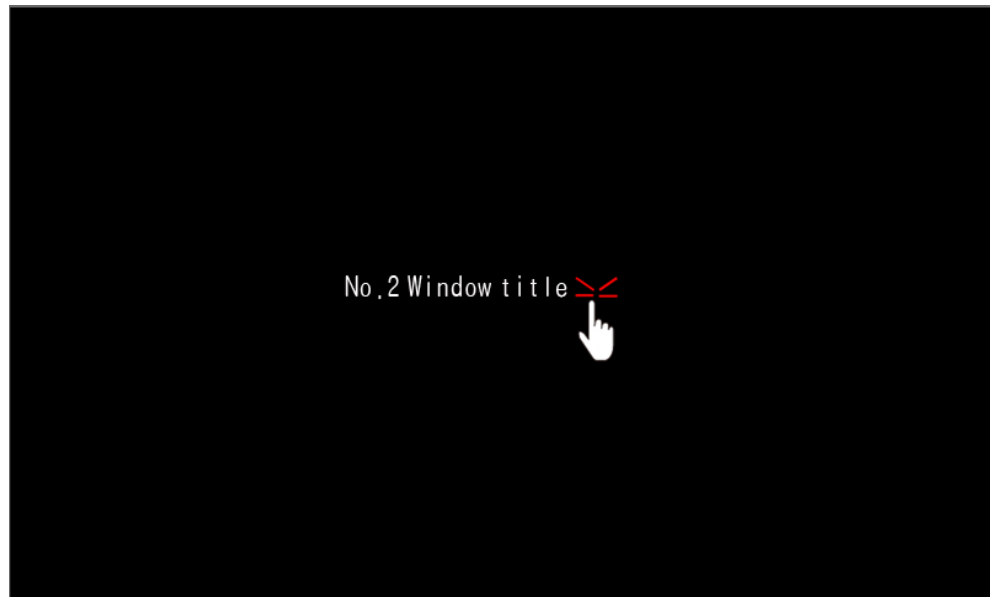

Caution

Window screen is designed up to 500 from GP Editor but actual downloadable window screens are up to 3 to LP-S070.

6.6.4.3 Comment

This menu displays downloaded user-defined comment.

Comment	
1	No. 1 comment
2	No. 2 comment
3	No. 3 comment
4	+
5	
6	
7	
8	
9	
10	

6.7 Diagnostics

6.7.1 System initialization

This menu is for initializing user data and setting values of LP-S070. Be sure that once deleted data cannot recover.

Especially for saving alarm history contents, by GP Editor upload alarm history and alarm frequency with checking 'Alarm History (Alarmhistory.txt)' and 'Alarm Frequency (Alarmfrequency.txt)' in tag box of 'Monitor Data Upload' dialog box from [Communication]–[Upload] menu to save txt files. If LP-S070 and serial printer is connected, you can print alarm history in [Functionality]–[Print Out] of system setting menu.

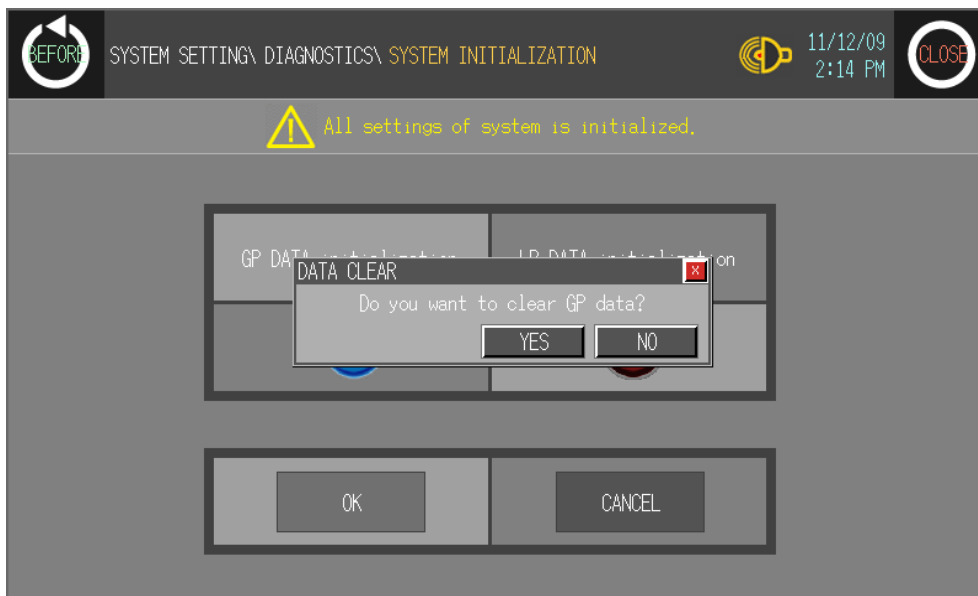
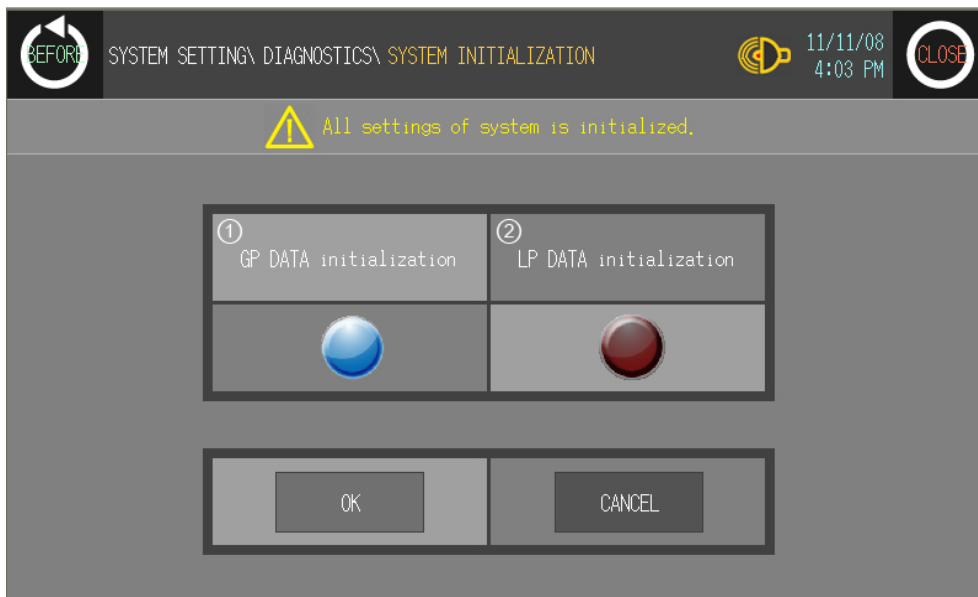

No.	Function and operation
①	Select 'GP DATA initialization' and touch 'OK'. Data, part, comment and common settings are initialized. After completing data initialization, 'USER SCREEN IS NOT FOUND' message appears.

No.	Function and operation
②	Select 'LP DATA initialization' and touch 'OK'. Ladder program, parameter, and device data are initialized.

6.7.2 Battery remaining

You can check battery remaining from [Diagnostics]-[Battery remaining] of system setting menu in LP-S070. Please replace battery if battery remaining is below 5%.

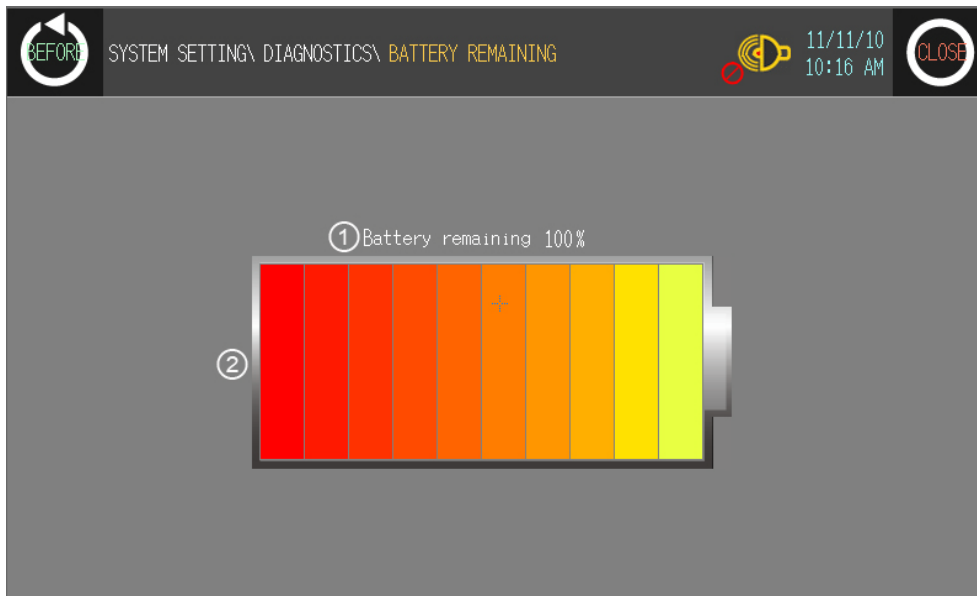

No.	Function and operation
①	Displays battery remaining with 0 to 100% as numerical percentage.
②	Displays battery remaining with bar graph



Caution

Please contact our service center to replace battery.
It may cause an explosion or a fire when using improper battery.

6.7.3 Screen diagnosis

This menu is for user to diagnose LCD screen and font of LP-S070.

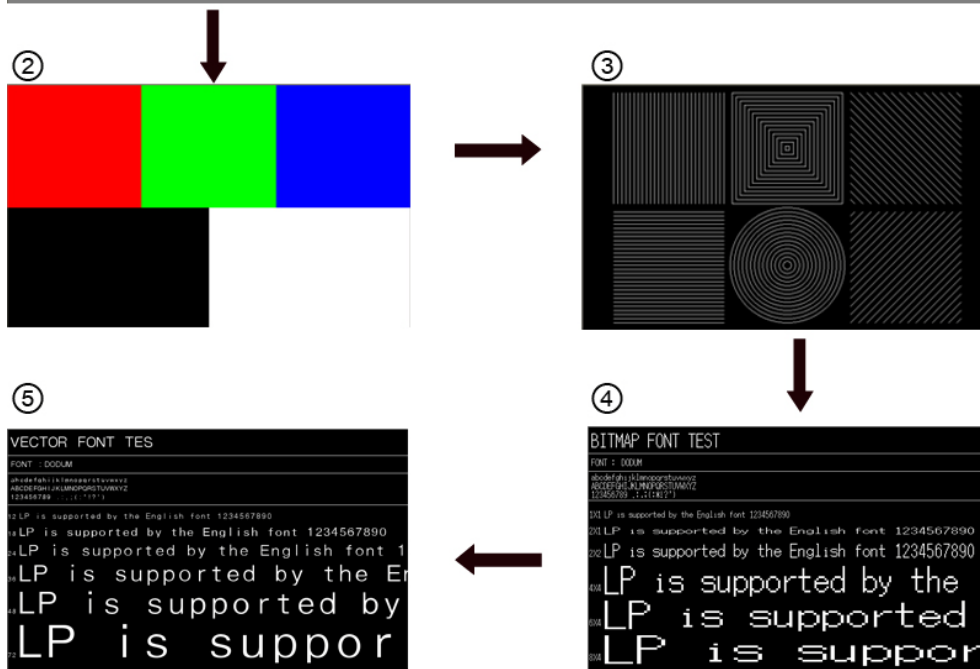
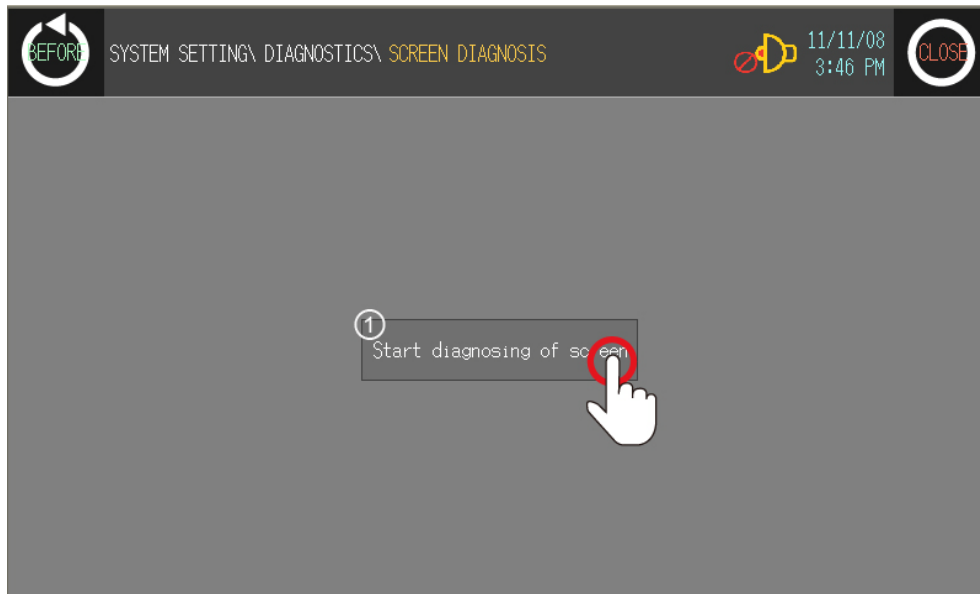

No.	Description	Operation with touching
①	Touch this for starting screen diagnosis	①Screen diagnosis menu → ②Check LCD color and bad pixel of LP
②	You can check LCD color and bad pixel of LP.	②LCD color and bad pixel of LP check → ③Displays LCD screen pattern of LP
③	You can check LCD screen pattern of LP.	③Displays LCD screen pattern of LP → ④Check the set bitmap font of LP

No.	Description	Operation with touching
④	You can check the set bitmap font of LP.	④ Check the set bitmap font of LP → ⑤ Check the set vector font of LP
⑤	You can check the set vector font of LP.	⑤ Check the set vector font of LP → ① Screen diagnosis menu

6.7.4 Touch diagnosis

This menu is for diagnosing touch and minimizing touch errors.

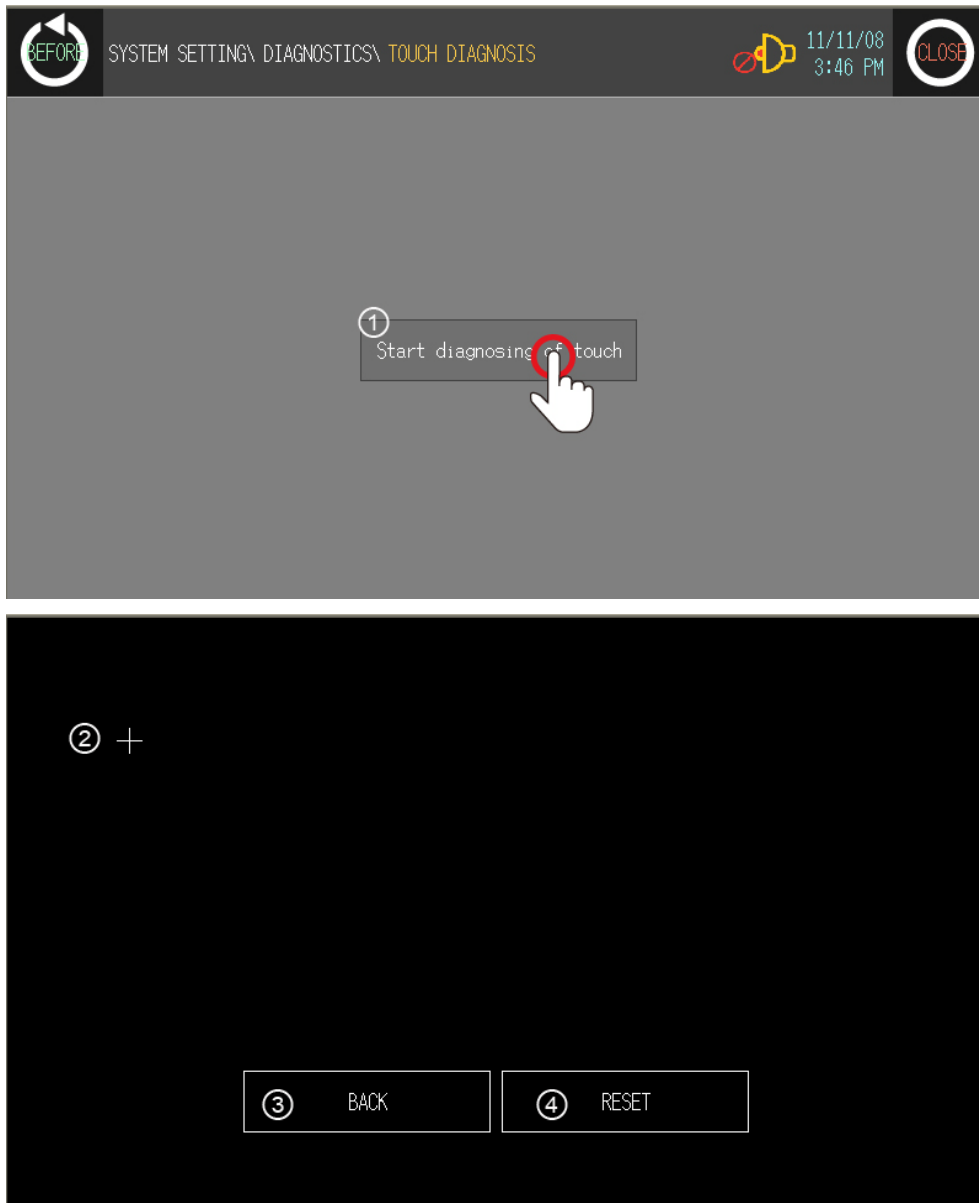



No.	Function and operation
①	Touch this, it moves diagnostics screen and starts diagnosing touch.
②	<p>First cross reference point of diagnosis is activated at left-upper based on the screen. Only when you touch within the diagnosis point, next touch diagnosis point is activated in order.</p> <p>Based on the screen, touch diagnosis points are activated in order as left-upper → left-lower → right-upper → right-left side.</p> <p>If you touch outside of the diagnosis point, error message appears. Touch 'RESET' and diagnose touch again.</p>
③	Returns to previous screen.
④	Re-starts touch diagnosis.
⑤	When touch diagnosis is completed, saving message for diagnosis value appears.

6.8 Parameter

6.8.1 Common

This menu is for designate motion control function.
For common setting information, refer to 'SmartStudio user manual'.

6.8.1.1 Common setting list

This menu is to designate CH1, CH2 operation for basic designation to use motion at LP-S070.

①

Item	Enable CH	S/W UpperLimit	S/W LowerLimit	StartSpeed(pps)	Origin Point	Home Search Dir
CH1	FALSE	0	0	0	0	Backward
CH2	TRUE	2147483647	-2147483647	500	1000	Forward

Item	AT1(ms)	AT2(ms)	AT3(ms)	AT4(ms)	AT5(ms)
CH1	0	0	0	0	0
CH2	500	1000	1500	2000	2500

AT = Acceleration Time

② Using Internal Device : USE M 000050

③ BACK NEXT

①

Item	DT1(ms)	DT2(ms)	DT3(ms)	DT4(ms)	DT5(ms)
CH1	0	0	0	0	0
CH2	500	1000	1500	2000	2500

Item	Jog Speed(pps)	Jog AT(ms)	Jog DT(ms)	AT to Origin (ms)	DT to Origin(ms)
CH1	0	0	0	0	0
CH2	1000	500	500	500	500

AT = Acceleration Time, DT = Deceleration Time

② Using Internal Device : USE M 000050

③ BACK NEXT

Item	Home Search Speed(pps)	Enable S/W Limit	Enable H/W Limit	Origin Back Kind
CH1	<input type="text" value="0"/>	FALSE	FALSE	H/W
CH2	<input type="text" value="2000"/>	FALSE	FALSE	S/W

Using Internal Device : USE

No.	Function and operation
①	Common setting items for using motion control from LP. After downloading the user defined data in SmartStudio, you can check common setting items of CH1, CH2.
②	After checking 'Using Internal Device' from [Parameter]-[MOTION] tab in SmartStudio and after downloading the program, you can edit directly the desired items at [Parameter]-[Action/Pattern list] of system menu in LP-S070.
③	Checks next or before common setting items.

6.8.1.2 Common setting item

Item	Data type	Description	Default
CH number	Unsigned word(2byte)	CH1, CH2	
Enable CH	Byte(1byte)	TRUE/FALSE	CH1 : FALSE CH2 : FALSE
S/W Upper Limit	Dword(4byte)	-2,147,483,648 to 2,147,483,647	2,147,483,647
S/W Lower Limit	Dword(4byte)	-2,147,483,648 to 2,147,483,647	-2,147,483,647
Start Speed	Unsigned dword(4byte)	0pps to 100,000pps	0pps
Origin Point	Unsigned dword(4byte)	-2,147,483,648 to 2,147,483,647	0
Home Search Direction	Byte(1byte)	Forward/Backward	Forward
Acceleration Time 1	Unsigned word(2byte)	0 to 65535ms	0 ms
Acceleration Time 2	Unsigned word(2byte)	0 to 65535ms	0 ms
Acceleration Time 3	Unsigned word(2byte)	0 to 65535ms	0 ms
Acceleration Time 4	Unsigned word(2byte)	0 to 65535ms	0 ms
Acceleration Time 5	Unsigned word(2byte)	0 to 65535ms	0 ms

Item	Data type	Description	Default
Deceleration Time 1	Unsigned word(2byte)	0 to 65535ms	0 ms
Deceleration Time 2	Unsigned word(2byte)	0 to 65535ms	0 ms
Deceleration Time 3	Unsigned word(2byte)	0 to 65535ms	0 ms
Deceleration Time 4	Unsigned word(2byte)	0 to 65535ms	0 ms
Deceleration Time 5	Unsigned word(2byte)	0 to 65535ms	0 ms
Jog Speed	Unsigned dword(4byte)	Unit: pps 0pps to 100,000pps	0 pps
Jog Acceleration Time	Unsigned word(2byte)	0 to 65535ms	0 ms
Jog Deceleration Time	Unsigned word(2byte)	0 to 65535ms	0 ms
Acceleration Time to Origin	Unsigned word(2byte)	0 to 65535ms	0 ms
Deceleration Time to Origin	Unsigned word(2byte)	0 to 65535ms	0 ms
Home Search Speed	Unsigned dword(4byte)	Unit: pps 0 to 100,000pps	0 pps
Enable S/W Limit	Byte(1byte)	TRUE / FALSE	FALSE
Enable H/W Limit	Byte(1byte)	TRUE / FALSE	FALSE
Origin Back Kind	Byte(1byte)	H/W , S/W	H/W

6.8.2 Action list

This menu is the saved list of unit action's setting value to use motion control easily.

For detail action list information, refer to 'SmartStudio user manual'.

You can edit and register basic action by one cycle with user defined common setting items.

NUM	Drv Type	CT	Dst Pos	Drv Dir	Drv Speed (pps)	AT	DT	Dwell Time (ms)
1	Speed	Absolute	0	Forward	20000	1	1	1000
2	Position	Absolute	0	Forward	10000	1	1	0
3	Position	Relative	10000	Forward	5000	1	1	1000
4	Position	Relative	20000	Forward	10000	2	2	1000
5	Position	Absolute	0	Forward	0	1	1	0

CT = Coordinate Type AT = Acceleration Time
DT = Deceleration Time

Using Internal Device : **USE** D 000100

BACK NEXT

No.	Function and operation
①	After checking 'Using Internal Device' from [Parameter]-[MOTION] tab in SmartStudio and after downloading the program, you can edit directly the desired items at [Parameter]-[Action list] of system menu in LP-S070.
②	Action list. You can check the user defined items, or edit these by 'Using Internal Device' function in 'SmartStudio'.
③	With scrollbar, you can check lower or upper user defined action list items.
④	Touch 'NEXT' or 'BACK' and moves to pattern list menu or returns to previous menu.

- Action list item

Item	Data type	Range	Default
Number	Unsigned word(2byte)	1 to 99	
Drive type	Byte(1byte)	Speed/Position drive	Position
Coordinate Type	Bool	Absolute/Relative position	Absolute
Destination Position	Dword(4byte)	-2,147,483,648 to 2,147,483,647	0
Drive Direction	Byte(1byte)	Forward/Backward	Forward
Drive Speed	Unsigned dword (4byte)	Unit: pps Max. speed: 100,000 pps Complete (single): After executing the specific step, it is complete. (After turning ON complete signal flag, it is complete.) Consecutive(successive): After executing the specific step and progressing dwell time, it executes the step of movement step.	0 pps
Acceleration Time	Unsigned word(2byte)	Select acceleration time (Select one of common setting item from 1 to 5)	1
Deceleration Time	Unsigned word(2byte)	Select deceleration time (Select one of common setting item from 1 to 5)	1
Dwell Time	Unsigned word(2byte)	After driving, dwell time 1 to 65535ms	0 ms

7 User Screen

User screen is a base or window screen designed with GP Editor.

7.1 Screen specification

(1) Base screen size

Base screen size is 800X480dots as entire area of the screen.

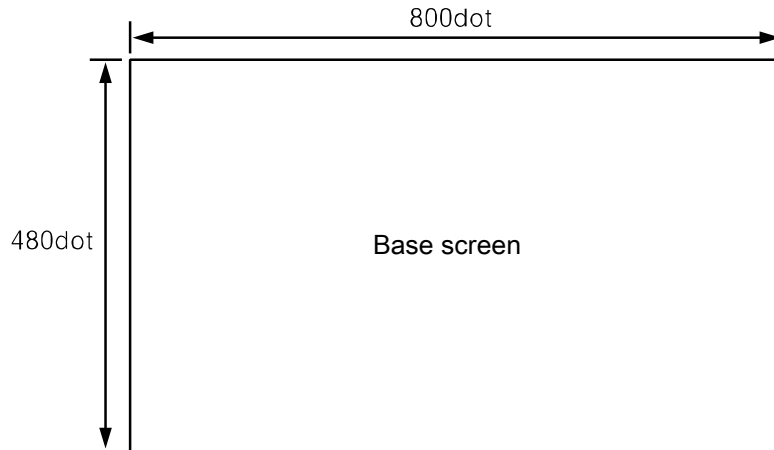

(2) Window screen size

Window screen size is min. 20X20dots to max. 800X480dots.

You can designate window screen size and its position in GP Editor, and also assign individual screen number for window screen as base screen number.

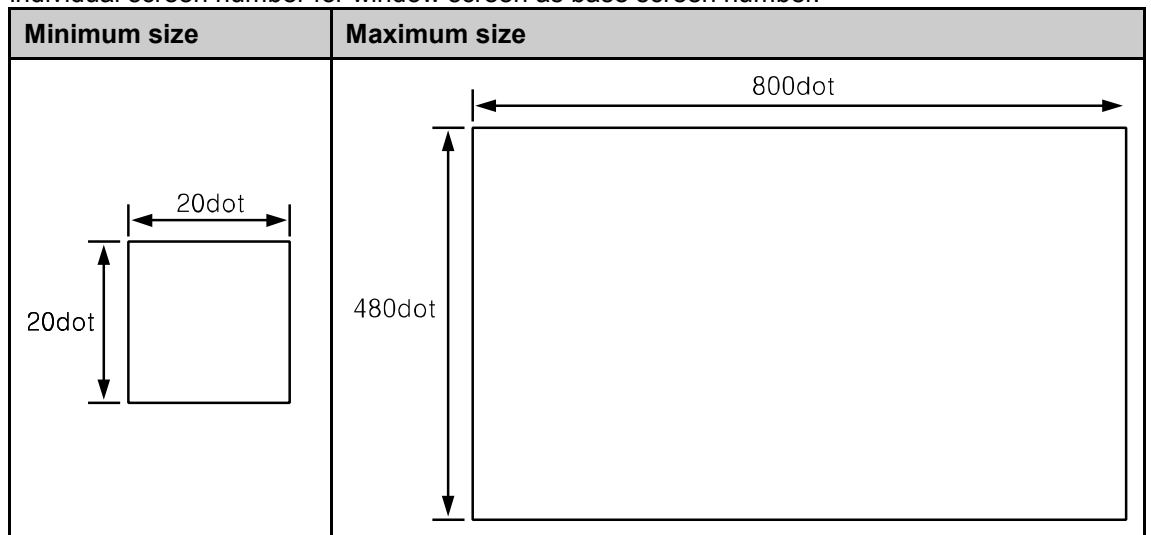

(3) Screen position

Content	Base screen	Window screen
Start position of screen (left-upper point)	(0, 0)	(0, 0) to (779, 459)
End position of screen (right-lower point)	(799, 479)	(19, 19) to (799, 479)
Position by screen type	Base screen size is not changeable and has fixed coordinate value.	If window screen is over maximum size, right-lower point moves automatically to the end point of screen. Therefore, it may different between user-defined position and window screen position.

(4) Screen number and the number of screen

Item	Base screen	Window screen
Screen number	Enable to designate from 1 to 500 range	
The number of designable screen	500	
The number of downloadable screen	500 ^{※1}	3 ^{※2}

※1. If designed base screen capacity is over user data area, data transmission does not operates normally. Please check designed data capacity and download it again.

※2. Designed window screen is for user-defined key pad. In this case, maximum number of downloadable screen to LP is 3.

7.2 Screen display object**(1) Available display object by screen type**

	Base screen	Window screen
Available display object	Line, rectangle, circle, text, bitmap, numeral display, ASCII display, numeral input^{※1} , ASCII input^{※1} , clock , comment list, alarm history^{※1} , alarm list^{※1} , part display, lamp display, line graph, trend graph, bar graph, statistic graph, panel meter, touch key	Line, rectangle, circle, text, bitmap, numeral display, ASCII display, clock, comment list, part display, lamp display, line graph, trend graph, bar graph, statistic graph, panel meter, touch key

※1. These are displayed only on base screen.

(2) Limit the number of display objects by screen type

Except below some objects, there is no limit the number of displaying for all tags on screen. However, too many objects on a screen may cause reducing monitor speed remarkably.

- Object which can exist only one on a screen
Alarm history, alarm list with scroll option, trend graph, and line graph
- Object which cannot exist on a screen
Alarm history, alarm list with scroll option, trend graph and line graph

(3) Limit the number of display objects by project

It is available to use objects with memory store function (trend graph, alarm list) on a project max.16.

7.3 Screen switching

(1) Screen switching device

The designed user screen in GP Editor has own number and it is downloaded to LP, LP-S070 monitors base screen switching device periodically and decides to be displayed base screen. Screen switching device is designated in GP Editor. It recognizes the current value of device assigned to switching device of base screen as screen number, it is displayed the screen.

In order to make same as the real screen number and device reference value for screen access, it is designed to display screen no.1 when the current value of device is '0'.

[Operation when D0 [Current value] device as base screen number device]

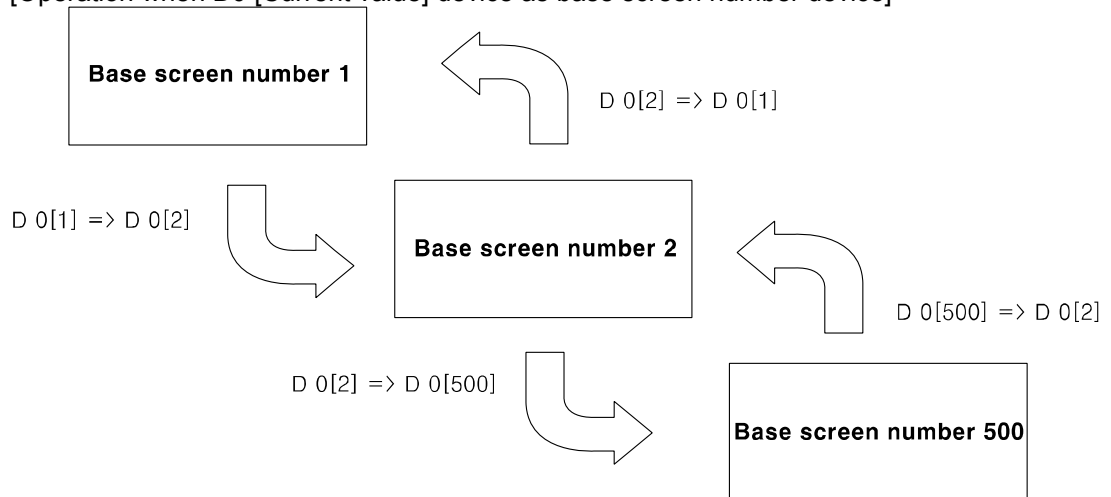

If there is no screen number corresponding the device value of screen data, error message appears as below screen.

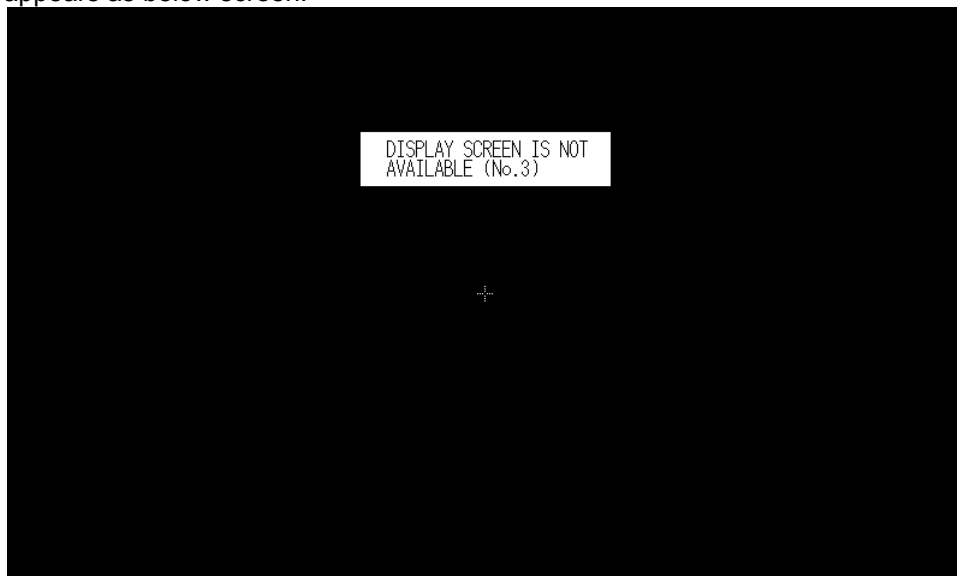

(2) Screen switching methods

It is switched to the appropriate screen when changing screen switching device value. It is changed as below methods.

- 1) Using touch key for switching screen
There are switching function of touch key operations as follows.
 - ◆ Switching to the fixed screen
 - ◆ Switching to the previous screen
 - ◆ Switching to the adjacent lower number of screen
 - ◆ Switching to the adjacent upper number of screen
- 2) Numeral input
It is switched to the appropriate screen inputting screen number in screen switching device using numeral input tag.
- 3) Device monitor
It is switched from device on device monitor of system screen to the appropriate screen inputting the value in screen switching.
- 4) Screen switching a screen by PLC program
When changing a screen switching device on PLC program, LP switches it into the appropriate screen.

7.4 Overlap window function

LP monitors user-defined of 2 screen overlap devices and overlaps the screen satisfying current value of the device on a base screen.

In order to use screen overlap function, designate the device for overlap window in GP Editor.

The overlap window is displayed in order of window 1, 2 on current screens as below. In case, the value of overlap window device is exceeded the range (1 to 500) or does not exist, the window is not displayed.

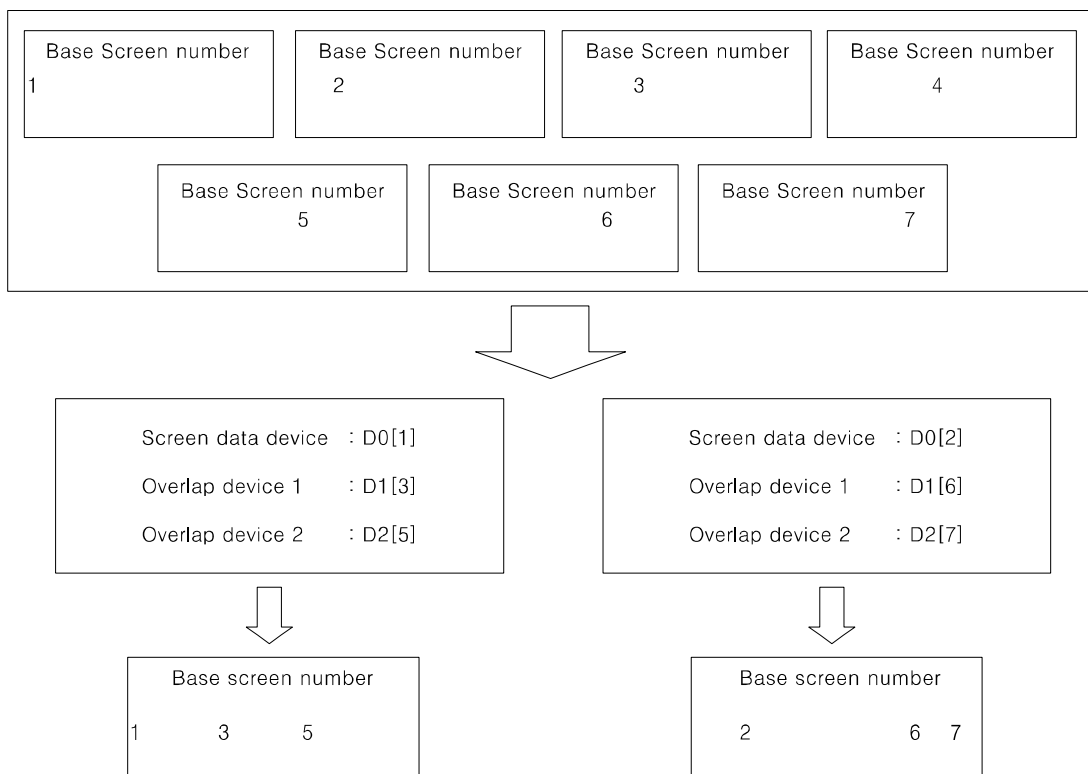

**Ex.**

It discibes when screen calling device is D 0, overlap window 1 device is D 1, overlap window 2 device is D 2.

All user-defined base screen numbers: 1, 2, 3, 4, 5, 6, 7, 8

- In case of D0=1, D1=3, D2=11,

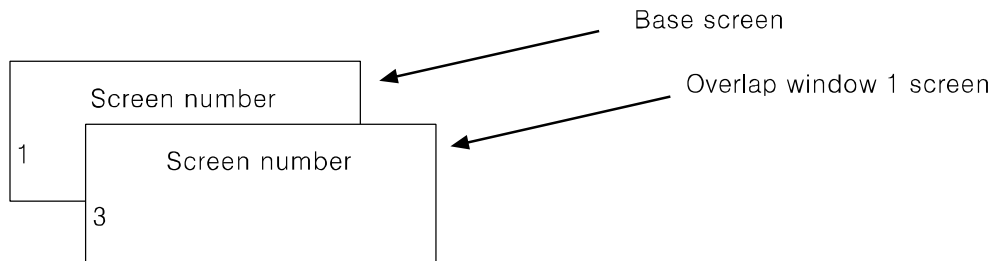

Overlap window 2 is not overlapped because the value of overlap window 2 device is not an existing base screen number.

- In case of D0=1, D1=3, D2=5,

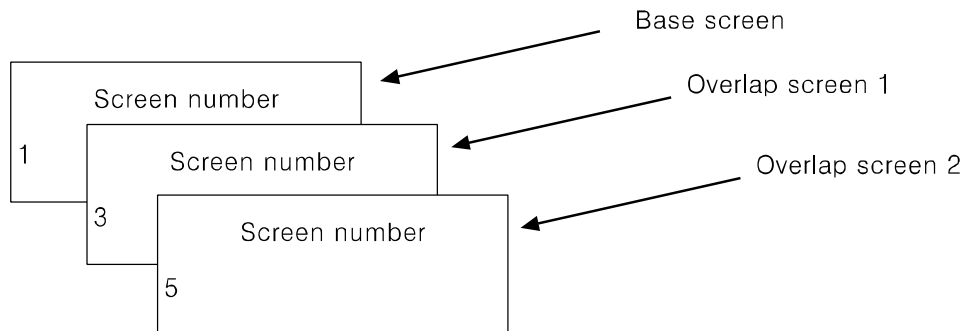
**Caution**

Various tags of overlap screen in the upper part can cover lower part of tags and they are not shown. If touch keys or input tags are overlapped, the upper one is only operated when it touched.

7.5 Device connection status display

If configured connect device is not connected or connection has error, at [SYSTEM SETTING] - [Environment] - [Serial Communication] menu displays error message as following screen.



Touch 'CLOSE' and error message dialog box disappears. If connection error is not resolved after 5 seconds, error message appears again on the screen.



Caution

Connection error message appears only on user screen.

When the third (CH1), fourth (CH2) bit of system signal 1 device in system information device are ON status, error message for specified connect device appears on the screen.

For further details, refer to 'GP Editor user manual'.

8 System Window

8.1 Key pad type

No.	Type	Key pad screen																																																																																																																																				
1	Binary	<table border="1"> <tr><td colspan="4"></td><td>CLR</td></tr> <tr><td colspan="4"></td><td>▲</td></tr> <tr><td colspan="4"></td><td>▼</td></tr> <tr><td>0</td><td>1</td><td>BS</td><td>ENT</td><td></td></tr> </table>					CLR					▲					▼	0	1	BS	ENT																																																																																																																	
				CLR																																																																																																																																		
				▲																																																																																																																																		
				▼																																																																																																																																		
0	1	BS	ENT																																																																																																																																			
2	Octal	<table border="1"> <tr><td colspan="4"></td><td>CLR</td></tr> <tr><td>0</td><td>1</td><td>2</td><td>▲</td><td></td></tr> <tr><td>3</td><td>4</td><td>5</td><td>▼</td><td></td></tr> <tr><td>6</td><td>7</td><td>BS</td><td>ENT</td><td></td></tr> </table>					CLR	0	1	2	▲		3	4	5	▼		6	7	BS	ENT																																																																																																																	
				CLR																																																																																																																																		
0	1	2	▲																																																																																																																																			
3	4	5	▼																																																																																																																																			
6	7	BS	ENT																																																																																																																																			
3	Decimal	<table border="1"> <tr><td colspan="5"></td><td>CLR</td></tr> <tr><td>0</td><td>1</td><td>2</td><td>3</td><td>▲</td><td></td></tr> <tr><td>4</td><td>5</td><td>6</td><td>7</td><td>▼</td><td></td></tr> <tr><td>8</td><td>9</td><td>-</td><td>BS</td><td>ENT</td><td></td></tr> </table>						CLR	0	1	2	3	▲		4	5	6	7	▼		8	9	-	BS	ENT																																																																																																													
					CLR																																																																																																																																	
0	1	2	3	▲																																																																																																																																		
4	5	6	7	▼																																																																																																																																		
8	9	-	BS	ENT																																																																																																																																		
4	Hexadecimal	<table border="1"> <tr><td colspan="5"></td><td>0</td><td>1</td><td>CLR</td></tr> <tr><td>2</td><td>3</td><td>4</td><td>5</td><td>6</td><td>▲</td><td></td></tr> <tr><td>7</td><td>8</td><td>9</td><td>A</td><td>B</td><td>▼</td><td></td></tr> <tr><td>C</td><td>D</td><td>E</td><td>F</td><td>BS</td><td>ENT</td><td></td></tr> </table>						0	1	CLR	2	3	4	5	6	▲		7	8	9	A	B	▼		C	D	E	F	BS	ENT																																																																																																								
					0	1	CLR																																																																																																																															
2	3	4	5	6	▲																																																																																																																																	
7	8	9	A	B	▼																																																																																																																																	
C	D	E	F	BS	ENT																																																																																																																																	
5	Real number	<table border="1"> <tr><td colspan="6"></td><td>CLR</td></tr> <tr><td>0</td><td>1</td><td>2</td><td>3</td><td>4</td><td>▲</td><td></td></tr> <tr><td>5</td><td>6</td><td>7</td><td>8</td><td>9</td><td>▼</td><td></td></tr> <tr><td>.</td><td>EXP</td><td>-</td><td></td><td>BS</td><td>ENT</td><td></td></tr> </table>							CLR	0	1	2	3	4	▲		5	6	7	8	9	▼		.	EXP	-		BS	ENT																																																																																																									
						CLR																																																																																																																																
0	1	2	3	4	▲																																																																																																																																	
5	6	7	8	9	▼																																																																																																																																	
.	EXP	-		BS	ENT																																																																																																																																	
6	ASCII	<table border="1"> <tr><td colspan="10"></td><td>CLR</td></tr> <tr><td>SP</td><td>!</td><td>"</td><td>#</td><td>\$</td><td>%</td><td>&</td><td>'</td><td>(</td><td>▲</td><td></td></tr> <tr><td>)</td><td>*</td><td>+</td><td>,</td><td>-</td><td>.</td><td>/</td><td>0</td><td>1</td><td>▼</td><td></td></tr> <tr><td>2</td><td>3</td><td>4</td><td>5</td><td>6</td><td>7</td><td>◀</td><td>▶</td><td>BS</td><td>ENT</td><td></td></tr> </table> <table border="1"> <tr><td colspan="10"></td><td>CLR</td></tr> <tr><td>8</td><td>9</td><td>:</td><td>;</td><td><</td><td>=</td><td>></td><td>?</td><td>@</td><td>▲</td><td></td></tr> <tr><td>A</td><td>B</td><td>C</td><td>D</td><td>E</td><td>F</td><td>G</td><td>H</td><td>I</td><td>▼</td><td></td></tr> <tr><td>J</td><td>K</td><td>L</td><td>M</td><td>N</td><td>O</td><td>◀</td><td>▶</td><td>BS</td><td>ENT</td><td></td></tr> </table> <table border="1"> <tr><td colspan="10"></td><td>CLR</td></tr> <tr><td>P</td><td>Q</td><td>R</td><td>S</td><td>T</td><td>U</td><td>V</td><td>W</td><td>X</td><td>▲</td><td></td></tr> <tr><td>Y</td><td>Z</td><td>[</td><td>¥</td><td>]</td><td>^</td><td>_</td><td>`</td><td>a</td><td>▼</td><td></td></tr> <tr><td>b</td><td>c</td><td>d</td><td>e</td><td>f</td><td>g</td><td>◀</td><td>▶</td><td>BS</td><td>ENT</td><td></td></tr> </table>											CLR	SP	!	"	#	\$	%	&	'	(▲)	*	+	,	-	.	/	0	1	▼		2	3	4	5	6	7	◀	▶	BS	ENT												CLR	8	9	:	;	<	=	>	?	@	▲		A	B	C	D	E	F	G	H	I	▼		J	K	L	M	N	O	◀	▶	BS	ENT												CLR	P	Q	R	S	T	U	V	W	X	▲		Y	Z	[¥]	^	_	`	a	▼		b	c	d	e	f	g	◀	▶	BS	ENT	
										CLR																																																																																																																												
SP	!	"	#	\$	%	&	'	(▲																																																																																																																													
)	*	+	,	-	.	/	0	1	▼																																																																																																																													
2	3	4	5	6	7	◀	▶	BS	ENT																																																																																																																													
										CLR																																																																																																																												
8	9	:	;	<	=	>	?	@	▲																																																																																																																													
A	B	C	D	E	F	G	H	I	▼																																																																																																																													
J	K	L	M	N	O	◀	▶	BS	ENT																																																																																																																													
										CLR																																																																																																																												
P	Q	R	S	T	U	V	W	X	▲																																																																																																																													
Y	Z	[¥]	^	_	`	a	▼																																																																																																																													
b	c	d	e	f	g	◀	▶	BS	ENT																																																																																																																													

No.	Type	Key pad screen																																								
		<table border="1"> <tr> <td colspan="9"></td> <td>CLR</td> </tr> <tr> <td>h</td><td>i</td><td>j</td><td>k</td><td>l</td><td>m</td><td>n</td><td>o</td><td>p</td><td>▲</td> </tr> <tr> <td>q</td><td>r</td><td>s</td><td>t</td><td>u</td><td>v</td><td>w</td><td>x</td><td>y</td><td>▼</td> </tr> <tr> <td>z</td><td>{</td><td> </td><td>}</td><td>~</td><td></td><td>◀</td><td>▶</td><td>BS</td><td>ENT</td> </tr> </table>										CLR	h	i	j	k	l	m	n	o	p	▲	q	r	s	t	u	v	w	x	y	▼	z	{		}	~		◀	▶	BS	ENT
									CLR																																	
h	i	j	k	l	m	n	o	p	▲																																	
q	r	s	t	u	v	w	x	y	▼																																	
z	{		}	~		◀	▶	BS	ENT																																	

8.2 Key pad organization

									CLR
SP	!	”	#	\$	%	&	'	(▲
)	*	+	,	-	.	/	0	1	▼
2	3	4	5	6	7	◀	▶	BS	ENT

KEY	Operation
ENT	Writes or inputs writing value on device.
CLR	Deletes all input value.
BS	Deletes latest input.
▲	Moves to the previous input field in accordance with configuration.
▼	Moves to the next input field in accordance with configuration.
◀※1	Moves to the previous page.
▶※1	Moves to the next page.

※1 Those keys are displayed only for ASCII input key pad.

ENT, CLR, ▲, ▼ key operation of user screen is according to 'Key Action' settings of 'Screen Auxiliary Configuration' dialog box.

Key operation	CLR	ENT	▲	▼
No movement	Holds keypad	Holds keypad	Not operated	Not operated
In order of user ID	Holds keypad	Holds keypad	Moves to previous input tag	Moves to next input tag
Hide cursor and key window	Closes keypad	Closes keypad	Moves to previous input tag	Moves to next input tag

9 Troubleshooting

This chapter is for possible errors in using LP-S070, for diagnosis method by several errors and for troubleshooting.

9.1 Error and troubleshooting

No	Error description	Troubleshooting (Further details, refer to additional description)
1	Power LED turns OFF.	Troubleshooting in power LED turning OFF.
2	Mode and status LED displays error.	Troubleshooting in error status.
3	External input value has error.	Troubleshooting in error for external input
4	External output value has error.	Troubleshooting in error for external output
5	There is error for writing, reading, or monitoring program.	Troubleshooting in communication connection error.

(1) Troubleshooting in power LED turning OFF

Check as following list by number. If error is not solved, please notify this to our service center.

No	Check item
1	Is power supplied?
2	Is supplied power within the allowable voltage range?
3	Is the polarity of power line wiring correct?
4	Is there a problem to tighten power terminal?

(2) Troubleshooting in error status

Check item	Error checking	Troubleshooting
Program grammar error	F0030, F0034 ON	Correct program grammar in SmartStudio and re-download the program.
Time-driven operation error	F0030, F0035 ON	Notify this to our service center.
Time setting error	F0030, F0036 ON	Reset time setting. (Refer to time setting and time compensation function.)
Communication error	F0030, F0038 ON	Refer to '(5) Troubleshooting in communication connection error' of next page.
I/O setting error	F0030, F0039 ON	Check extension module I/O setting.
WDT error	F0030, F003A ON	Restarts program.

(3) Troubleshooting in error for external input

Check as following list by number. If error is not solved, please notify this to our service center.

No	Check item
1	Is input wiring connection correct?
2	Is connection status of input connector fine?
3	In case of removing connected input device and connecting COM port of input terminal to input port, is input value entered correctly? (You can check input value in monitoring function of LP-S070 or in SmartStudio.)
4	Is there a problem to input device operation?

(4) Troubleshooting in error for external output

Check as following list by number. If error is not solved, please notify this to our service center.

Check item	Error
Is output wiring connection correct?	
Is connection status of output connector fine?	
Is connected power voltage to output within allowable voltage range?	
Is there problem to output device operation?	

(5) Troubleshooting in communication connection error

Check as following list by number. If error is not solved, please notify this to our service center.

Check item	Error
Do you designate communication configuration (baudrate, data bit, stop bit, and parity) correctly?	
Is the specification and wiring of communication cable rated at our specification? ^{※1}	

For connect LP-S070, external device and PC, you must use the provided cable (sold separately).

10 Firmware update

You can update firmware periodically if necessary.

- 1st For update firmware, visit our homepage (www.autonics.com) and download LP-S070 firmware file properly. Save this file to USB DISK.(Please format USB DISK before saving this file.)
- 2nd Connect LP-S070 and USB DISK and enter [Data]–[Firmware update] of system setting menu. Touch 'OK' to start firmware update.

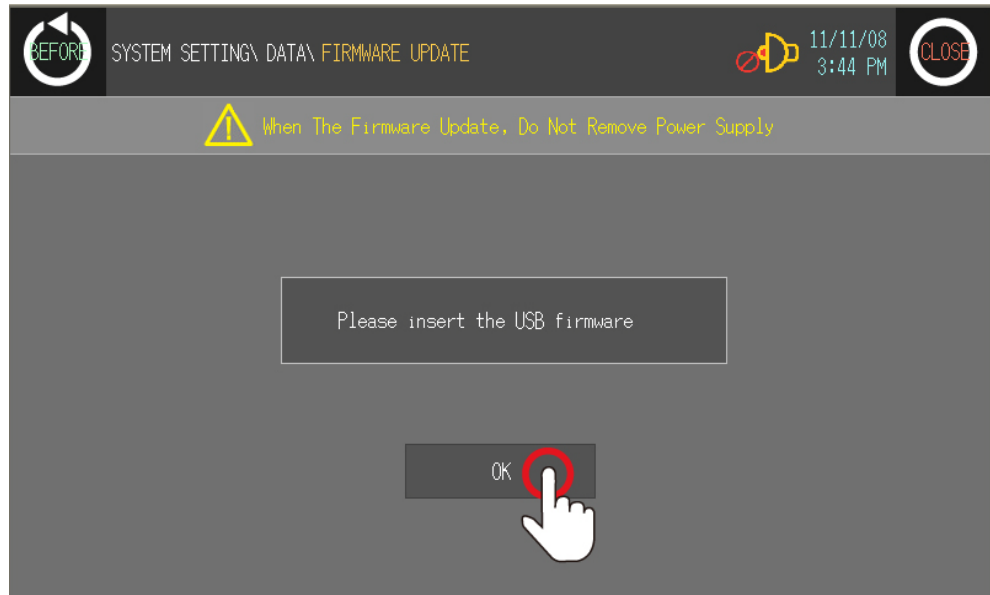

- 3rd Checking firmware update dialog box appears. Touch 'YES' to start firmware update.

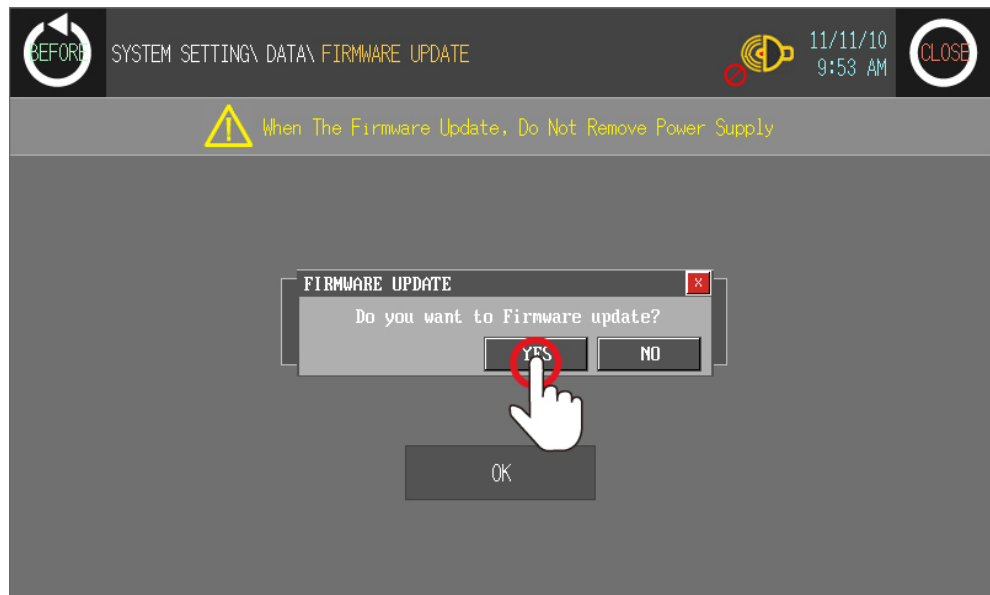

4th Firmware update progress is displayed as bar graph type.

If update completes, touch 'OK' and restart LP-S070.

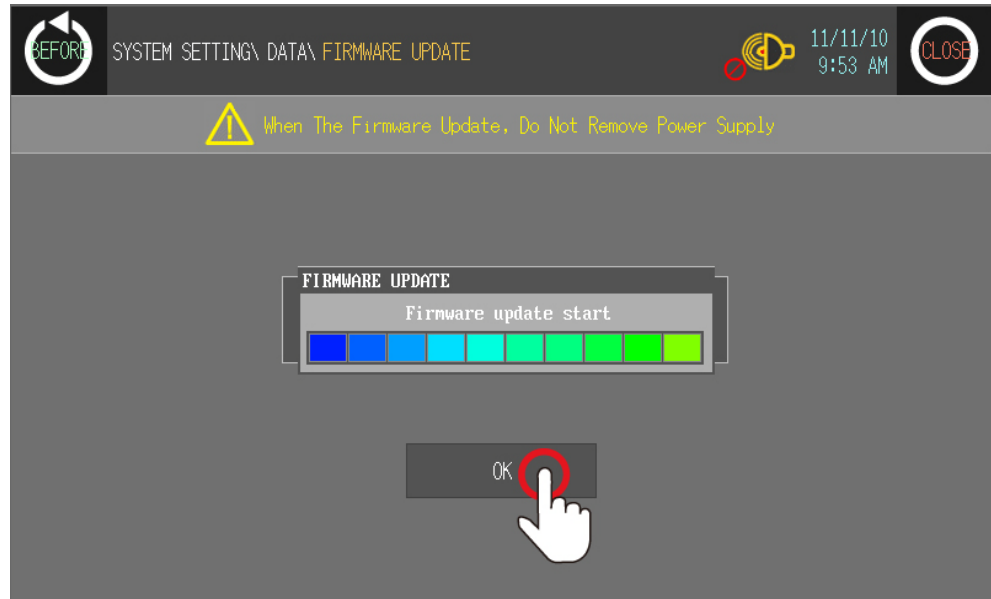

 **Caution**

Do not power OFF to LP-S070 during firmware update.

11 Repair and Check

11.1 Change repair component

11.1.1 Battery change

Battery of LP-S070 is available for maintain user-defined setting, data backup of latch area, and time if there is unexpected power failure or it is not able to supply power. You need to change battery regularly.

(1) The status with discharged battery

- When time is not correct.
- After power failure, time is reset.
- After power failure, data of latch area is reset.

(2) Battery residual quantity display

You can check battery remaining from [Diagnostics]-[Battery remaining] of system setting menu in LP-S070. Please replace battery if battery remaining is below 5%.

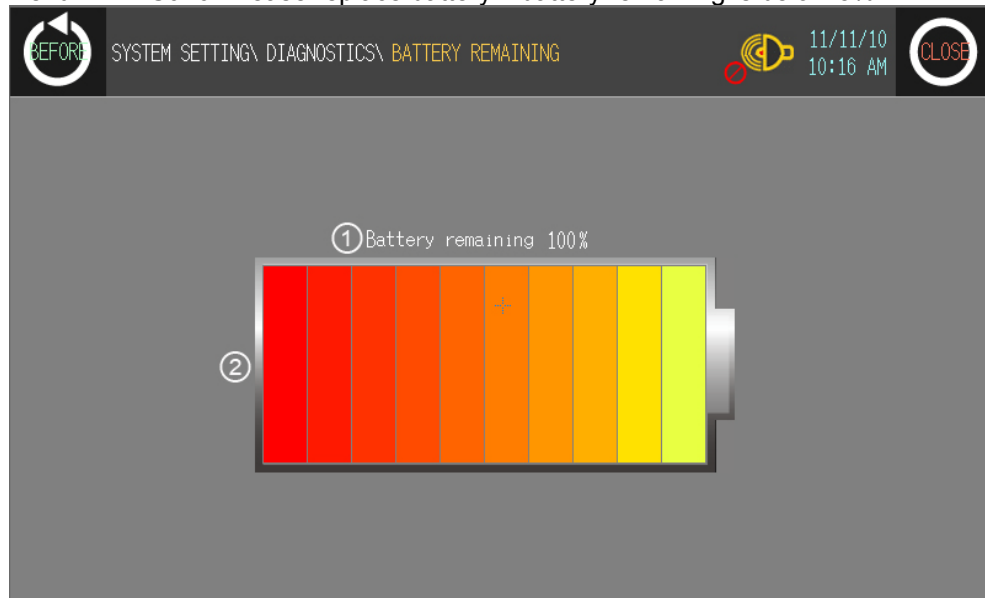

No.	Function and operation
①	Displays battery remaining with 0 to 100% as numerical percentage.
②	Displays battery remaining with bar graph

(3) Special register for battery

Current backup battery error [F0002C]	Turns ON when battery voltage is below than standard value
Maintain backup battery error [F0002D]	If current backup battery error turns ON at once, it maintains ON status before restarting LP-S070.

11.2 Check

11.2.1 General check

The following table is for checking by every day/week.

Item	Description	Standard	Troubleshooting
Environment	Temperature	0 to 50°C	Adjust the ambient temperature
	Humidity	35 to 85%RH	Adjust the ambient humidity
	Vibration	No vibration	Establish vibration protection
Mounting status of LP-S070	Check screw loosening for bracket	It should be mounted without a shaken.	Tight the screw.
Connection status of communication cable	Check screw loosening of connection cable	Cable connection part should be tightened.	Tight the screw. Use the standard cable
Connection status of I/O connector	Check whether connector locking or not, check connection of connector.	Connection part for connector should be connected tightly.	Secure locking part. Wire connect cable with duct, etc.

11.2.2 Periodic check

The following table is for checking by every month.

Item	Description	Standard	Troubleshooting
Power voltage	Measure power voltage	Within power voltage specification	Change supply power
Battery	Battery remaining status	Battery remaining 95%	Change battery
Waterproof rubber ring	Waterproof rubber ring status	Waterproof rubber ring should not be corroded.	Change waterproof rubber ring
Water leak and dusk proof	Water leak and dusk proof status	There is no water leaking, and no dust.	Establish water leak and dust protection
Inflammability gas	Leak inflammability gas	It should not be exposed at inflammability gas.	Establish leak inflammability gas protection

**Caution**

Caution for periodic check

- For checking power voltage, use the specified measuring device.
- If there are error elements, please write down the error and notify us with details.
- For changing the product, power must be turned OFF.
- For removing dust, foreign substance, use dry cloth without moist, or detergents.

12 Appendix

12.1 Instruction

12.1.1 Basic instruction list







12.1.1.1 Non processing instruction

Instruction	Ladder symbol	Step
NOP		1

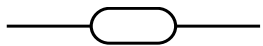

12.1.1.2 Contact instruction

Instruction	Ladder symbol	Step	Instruction	Ladder symbol	Step
LOAD		1	ANDF		2
LOADN		1	ANDL		1
LOADP		2	OR		1
LOADF		2	ORN		1
AND		1	ORP		2
ANDN		1	ORF		2
ANDP		2	ORL		1

12.1.1.3 Output instruction

Instruction	Ladder symbol	Step	Instruction	Ladder symbol	Step
OUT		1	SET		1
OUT Syyy.xx		1	SET Syyy.xx		1
OUTP		2	RST		1
OUTF		2			

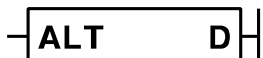
12.1.1.4 Reversal instruction

Instruction	Ladder symbol	Step	Instruction	Ladder symbol	Step
ALT		3	NOT		1

12.1.1.5 Stack instruction

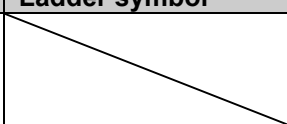
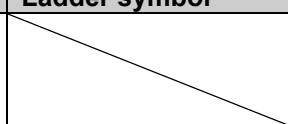
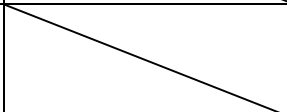

Instruction	Ladder symbol	Step	Instruction	Ladder symbol	Step
MPUSH		1	MPOP		1
MLOAD		1			

12.1.1.6 Exit instruction

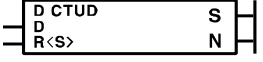

Instruction	Ladder symbol	Step
END		1

12.1.2 Application instruction list

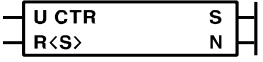

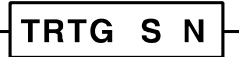
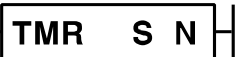

12.1.2.1 Counter instruction

Instruction	Ladder symbol	Step	Instruction	Ladder symbol	Step
CTU		5	CTUD		5
CTD		5	CTR		5



12.1.2.2 Timer instruction

Instruction	Ladder symbol	Step	Instruction	Ladder symbol	Step
TON		5	TMON		5
TOFF		5	TRTG		5
TMR		5			



12.1.2.3 Control instruction

Instruction	Ladder symbol	Step	Instruction	Ladder symbol	Step
JMP		3	FCALL		3
LABEL		3	FUNC		3

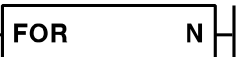

12.1.2.4 Branch instruction

Instruction	Ladder symbol	Step	Instruction	Ladder symbol	Step
CALL		3	RET		1
SUBRT		3			







12.1.2.5 Loop instruction

Instruction	Ladder symbol	Step	Instruction	Ladder symbol	Step
FOR		3	BREAK		1
NEXT		1			

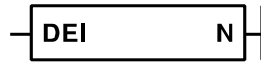
12.1.2.6 Master control instruction

Instruction	Ladder symbol	Step	Instruction	Ladder symbol	Step
MCS		2	MCR		2

12.1.2.7 Interrupt instruction

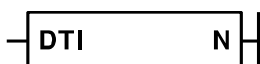



Instruction	Ladder symbol	Step	Instruction	Ladder symbol	Step
EI		1	DEI		1
DI		1	TINT		1
ETI		1	EINT		1
EEI		1	IRET		1
DTI		1			

12.1.2.8 Watchdog timer



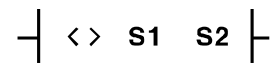
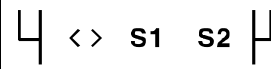

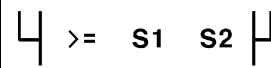
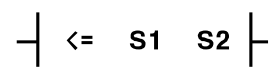
Instruction	Ladder symbol	Step
WDT		1

12.1.2.9 Input comparison instruction



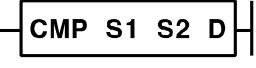

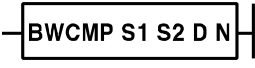
Instruction	Ladder symbol	Step	Instruction	Ladder symbol	Step
LOAD=		5	DAND=		5
LOAD>		5	DAND>		5
LOAD<		5	DAND<		5
LOAD<>		5	DAND<>		5
LOAD>=		5	DAND>=		5
LOAD<=		5	DAND<=		5
DLOAD=		5	OR=		5
DLOAD>		5	OR>		5
DLOAD<		5	OR<		5
DLOAD<>		5	OR<>		5
DLOAD>=		5	OR>=		5
DLOAD<=		5	OR<=		5
AND=		5	DOR=		5
AND>		5	DOR>		5
AND<		5	DOR<		5

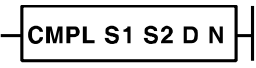
Instruction	Ladder symbol	Step	Instruction	Ladder symbol	Step
AND<>		5	DOR<>		5
AND>=		5	DOR>=		5
AND<=		5	DOR<=		5



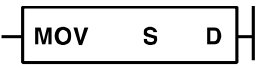

12.1.2.10 Comparison instruction

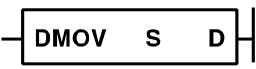
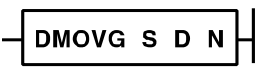
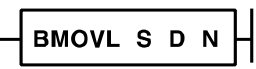
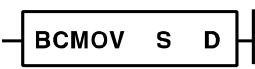
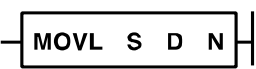
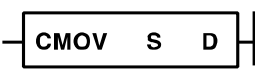
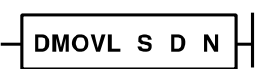
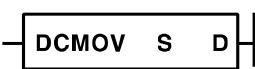
Instruction	Ladder symbol	Step	Instruction	Ladder symbol	Step
CMP		7	DCMPL		9
DCMP		7	BWCMP		9
ACMP		7	DBWCMP		9
CMPL		9			

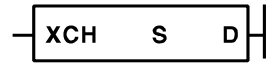

12.1.2.11 Transmission instruction

Instruction	Ladder symbol	Step	Instruction	Ladder symbol	Step
BMOV		5	BMOVG		7
MOV		5	MOVG		7
DMOV		5	DMOVG		7
BMOVL		7	BCMOV		5
MOVL		7	CMOV		5
DMOVL		7	DCMOV		5

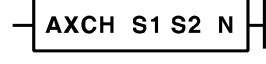



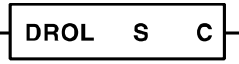

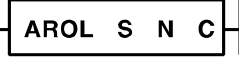
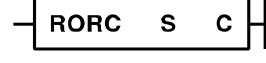
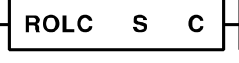
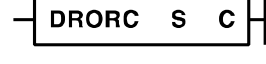
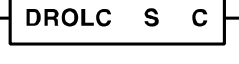
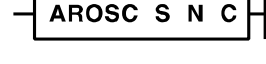
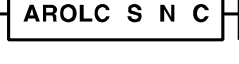
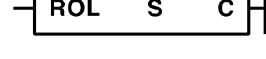
12.1.2.12 Exchange instruction

Instruction	Ladder symbol	Step	Instruction	Ladder symbol	Step
XCH		5	SWAP		3
DXCH		5	DSWAP		3
AXCH		7			

12.1.2.13 Rotation instruction

Instruction	Ladder symbol	Step	Instruction	Ladder symbol	Step
DROR		5	DROL		5
AROR		7	AROL		7
RORC		5	ROLC		5
DRORC		5	DROLC		5
ARORC		7	AROLC		7
ROL		5			

12.1.2.14 Movement instruction

Instruction	Ladder symbol	Step	Instruction	Ladder symbol	Step
SFTR		9	ASFTR		9
ASFTR		9	WSFTR		9
SFTL		9	WSFTL		9

12.1.2.15 Arithmetic operation instruction

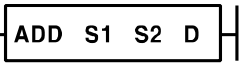
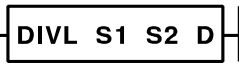
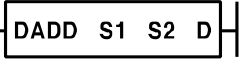
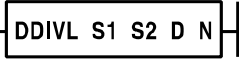
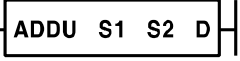
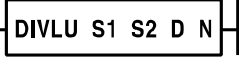
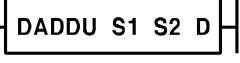
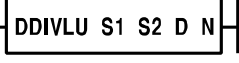
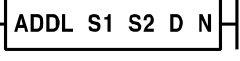
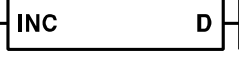
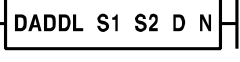
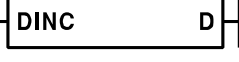
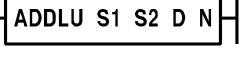
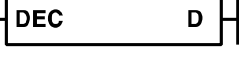
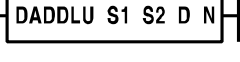
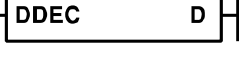
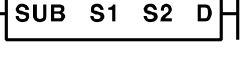
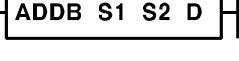
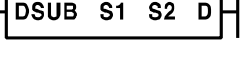
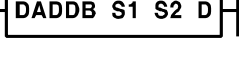
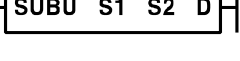
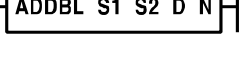
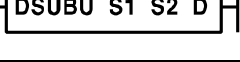
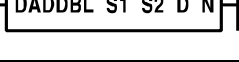
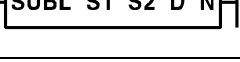
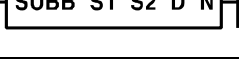
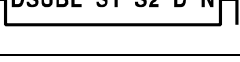
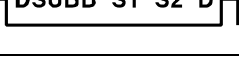
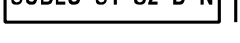
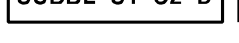
Instruction	Ladder symbol	Step	Instruction	Ladder symbol	Step
ADD		7	DIVL		9
DADD		7	DDIVL		9
ADDU		7	DIVLU		9
DADDU		7	DDIVLU		9
ADDL		9	INC		3
DADDL		9	DINC		3
ADDLU		9	DEC		3
DADDLU		9	DDEC		3
SUB		7	ADDB		7
DSUB		7	DADDB		7
SUBU		7	ADDBL		9
DSUBU		7	DADDBL		9
SUBL		9	SUBB		7
DSUBL		9	DSUBB		7
SUBLU		9	SUBBL		9

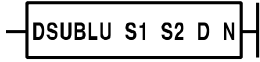
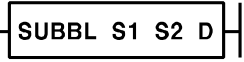
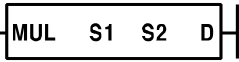
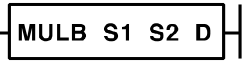
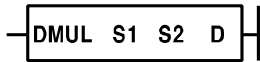
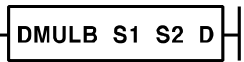
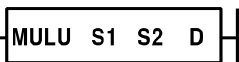
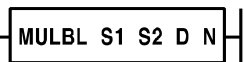
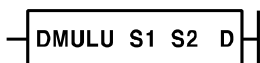
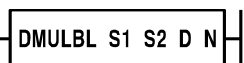
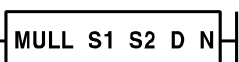
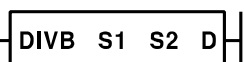
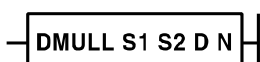
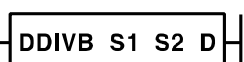
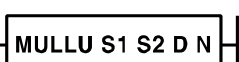
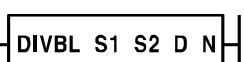
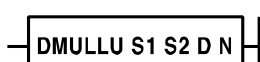
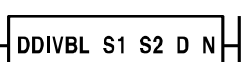
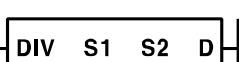
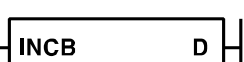
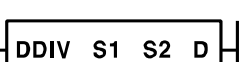
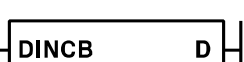
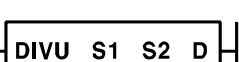
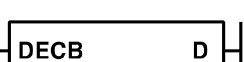
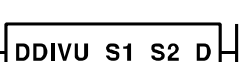
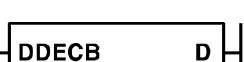
Instruction	Ladder symbol	Step	Instruction	Ladder symbol	Step
DSUBLU		9	DSUBBL		9
MUL		7	MULB		7
DMUL		7	DMULB		7
MULU		7	MULBL		9
DMULU		7	DMULBL		9
MULL		9	DIVB		7
DMULL		9	DDIVB		7
MULLU		9	DIVBL		9
DMULLU		9	DDIVBL		9
DIV		7	INCB		3
DDIV		7	DINCB		3
DIVU		7	DECB		3
DDIVU		7	DDECB		3



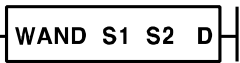
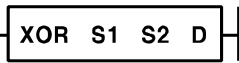
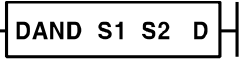
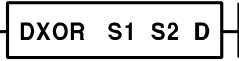
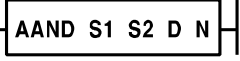
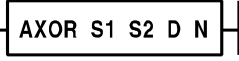
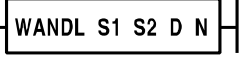
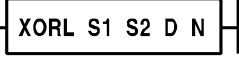
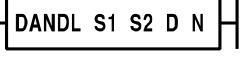
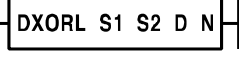
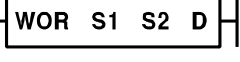
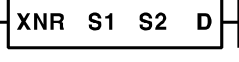
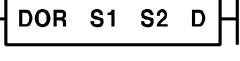
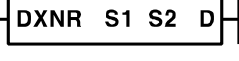
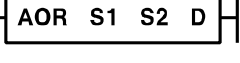
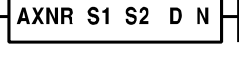
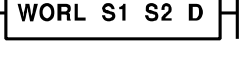
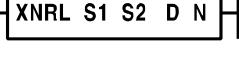
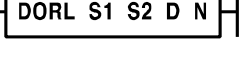
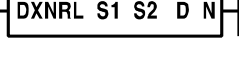

12.1.2.16 Logical operation instruction

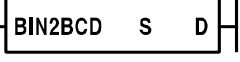
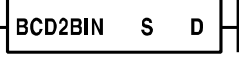
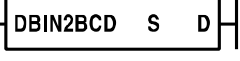
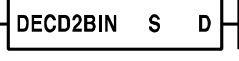
Instruction	Ladder symbol	Step	Instruction	Ladder symbol	Step
WAND		7	XOR		7
DAND		7	DXOR		7
AAND		9	AXOR		9
WANDL		9	XORL		9
DANDL		9	DXORL		9
WOR		7	XNR		7
DOR		7	DXNR		7
AOR		9	AXNR		9
WORL		9	XNRL		9
DORL		9	DXNRL		9



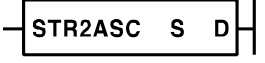
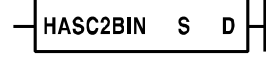
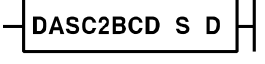
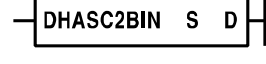
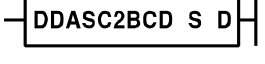
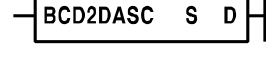
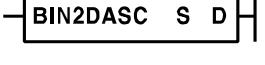
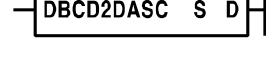

12.1.2.17 BIN/BCD instruction

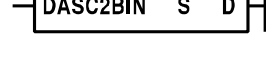
Instruction	Ladder symbol	Step	Instruction	Ladder symbol	Step
BIN2BCD		5	BCD2BIN		5
DBIN2BCD		5	DBC2BIN		5

12.1.2.18 String conversion instruction

Instruction	Ladder symbol	Step	Instruction	Ladder symbol	Step
BIN2HASC		5	DDASC2BIN		5
DBIN2HASC		5	STR2ASC		7
HASC2BIN		5	DASC2BCD		5
DHASC2BIN		5	DDASC2BCD		5
BCD2DASC		5	BIN2DASC		5
DBCD2DASC		5	DBIN2DASC		5
DASC2BIN		5			

12.1.2.19 Code conversion instruction

Instruction	Ladder symbol	Step	Instruction	Ladder symbol	Step
GRY2BIN		5	BIN2GRY		5
DGRY2BIN		5	DBIN2GRY		5

12.1.2.20 Sign reverse instruction

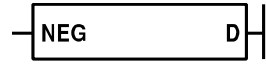
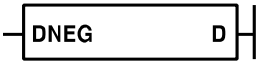
Instruction	Ladder symbol	Step	Instruction	Ladder symbol	Step
NEG		3	DNEG		3

12.1.2.21 Data conversion instruction

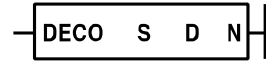
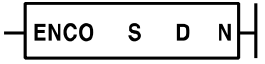
Instruction	Ladder symbol	Step	Instruction	Ladder symbol	Step
DECO		7	ENCO		7



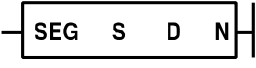

12.1.2.22 Refresh instruction

Instruction	Ladder symbol	Step
REF		5

12.1.2.23 Display instruction

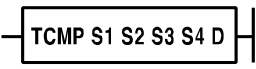
Instruction	Ladder symbol	Step
SEG		7

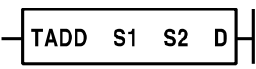
12.1.2.24 Clock instruction

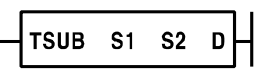
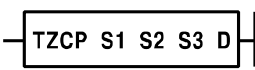
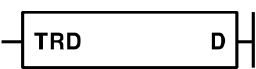
Instruction	Ladder symbol	Step	Instruction	Ladder symbol	Step
TCMP		7	TWR		3
TADD		7	HOUR		7
TSUB		7	TZCP		9
TRD		3			

12.1.2.25 Motion instruction

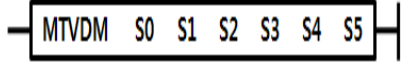
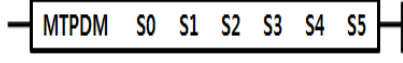
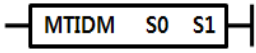
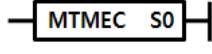
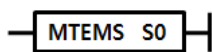
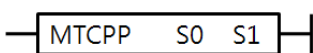
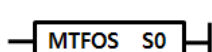
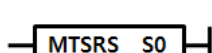
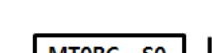
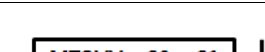
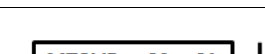
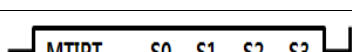
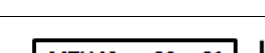
Instruction	Ladder symbol	Step
MTVDM		9
MTPDM		9
MTIDM		5
MTMEC		5
MTEMS		5
MTCPP		5
MTFOS		5
MTSRS		5
MTOBC		5
MTOVV		5
MTOVP		5
MTIPT		7
MTUAI		5

12.2 Special device list

12.2.1 Bit special device list

Name	GP device	LP device	Applied model	
			LP-S044	LP-070
Run mode	UB64000	F00000	●	●
Stop mode	UB64001	F00001	●	●
Pause mode	UB64002	F00002	●	●
Debug mode	UB64003	F00003	●	●
Normally ON	UB64010	F00010	●	●
Normally OFF	UB64011	F00011	●	●
1 scan ON	UB64012	F00012	●	●
1 scan OFF	UB64013	F00013	●	●
Scan pulse	UB64014	F00014	●	●
Time synchronous pulse	UB64015	F00015	●	●
While operating forced input	UB64020	F00020	●	●
While operating forced output	UB64021	F00021	●	●
While running time-driven	UB64024	F00024	●	●
Output allowance while debugging	UB64025	F00025	●	●
Back-up battery errors(At present)	UB6402C	F0002C	●	●
Back-up battery errors (Retaining)	UB6402D	F0002D	●	●
Error occurrence	UB64030	F00030	●	●
Errors related to PLC program	UB64034	F00034	●	●
Time-driven operation error	UB64035	F00035	●	●
Time setting error flag	UB64036	F00036	●	●
Communication errors	UB64038	F00038	●	●
I/O setting value errors	UB64039	F00039	●	●
Watchdog timer error flag	UB6403A	F0003A	●	●
Using inner device of SLOT 0	UB64040	F00040	●	●
Using inner device of SLOT 1	UB64041	F00041	●	●
Using inner device of SLOT 2	UB64042	F00042	●	●
Using inner device of SLOT 3	UB64043	F00043	●	●
Using inner device of SLOT 4	UB64044	F00044	●	●
Using inner device of SLOT 5	UB64045	F00045	●	●
Using inner device of SLOT 6	UB64046	F00046	●	●
Using inner device of SLOT 7	UB64047	F00047	●	●
Using inner device of SLOT 8	UB64048	F00048	●	●
Using inner device of SLOT 9	UB64049	F00049	●	●
Using inner device of SLOT 10	UB6404A	F0004A	●	●
Using inner device of SLOT 11	UB6404B	F0004B	●	●

Name	GP device	LP device	Applied model	
			LP-S044	LP-070
Using inner device of SLOT 12	UB6404C	F0004C	●	●
Using inner device of SLOT 13	UB6404D	F0004D	●	●
Using inner device of SLOT 14	UB6404E	F0004E	●	●
Using inner device of SLOT 15	UB6404F	F0004F	●	●
0.5ms clock(in reserve)	UB64050	F00050	●	●
1ms clock(in reserve)	UB64051	F00051	●	●
2ms clock(in reserve)	UB64052	F00052	●	●
5ms clock(in reserve)	UB64053	F00053	●	●
10ms clock	UB64054	F00054	●	●
20ms clock	UB64055	F00055	●	●
50ms clock	UB64056	F00056	●	●
100ms clock	UB64057	F00057	●	●
200ms clock	UB64058	F00058	●	●
500ms clock	UB64059	F00059	●	●
1s clock	UB6405A	F0005A	●	●
2s clock	UB6405B	F0005B	●	●
5s clock	UB6405C	F0005C	●	●
10s clock	UB6405D	F0005D	●	●
60s clock	UB6405E	F0005E	●	●
Zero flag	UB64060	F00060	●	●
Carry flag	UB64061	F00061	●	●
Borrow flag	UB64062	F00062	●	●
Operation error flag(At present)	UB64068	F00068	●	●
Operation error flag(Retaining)	UB64069	F00069	●	●
Settings for full output restriction	UB64070	F00070	●	●
Output reset restriction	UB64071	F00071	●	●
Start-up time-driven activity	UB64074	F00074	●	●
Change the time-driven run-time	UB64075	F00075	●	●
Change the time-driven interrupt time	UB64076	F00076	●	●
Retaining output status while stop	UB64077	F00077	●	●
Operating conditions for extended module function	UB64078	F00078	●	●
Default filter setting flag	UB64079	F00079	●	●
Filter setting change flag	UB6407A	F0007A	●	●
Time setting	UB64080	F00080	●	●
+/- 30 sec correction of time setting	UB64081	F00081	●	●
Settings for using inner device of SLOT0 module function	UB64090	F00090	●	●
Settings for using inner device of SLOT1 module function	UB64091	F00091	●	●
Settings for using inner device of SLOT2 module function	UB64092	F00092	●	●
Settings for using inner device of SLOT3 module	UB64093	F00093	●	●

Name	GP device	LP device	Applied model	
			LP-S044	LP-070
function				
Settings for using inner device of SLOT4 module function	UB64094	F00094	●	●
Settings for using inner device of SLOT5 module function	UB64095	F00095	●	●
Settings for using inner device of SLOT6 module function	UB64096	F00096	●	●
Settings for using inner device of SLOT7 module function	UB64097	F00097	●	●
Settings for using inner device of SLOT8 module function	UB64098	F00098	●	●
Settings for using inner device of SLOT9 module function	UB64099	F00099	●	●
Settings for using inner device of SLOT10 module function	UB6409A	F0009A	●	●
Settings for using inner device of SLOT11 module function	UB6409B	F0009B	●	●
Settings for using inner device of SLOT12 module function	UB6409C	F0009C	●	●
Settings for using inner device of SLOT13 module function	UB6409D	F0009D	●	●
Settings for using inner device of SLOT14 module function	UB6409E	F0009E	●	●
Settings for using inner device of SLOT15 module function	UB6409F	F0009F	●	●
Using Motion CH1	UB64100	F00100		●
Moving of Motion CH1	UB64101	F00101		●
Using acceleration of Motion CH1	UB64102	F00102		●
Driving with set speed of Motion CH1	UB64103	F00103		●
Decelerating of Motion CH1	UB64104	F00104		●
Dwelling of Motion CH1	UB64105	F00105		●
Finish driving of CH1	UB64106	F00106		●
Detecting S/W lower limit of Motion CH1	UB64107	F00107		●
Detecting S/W upper limit of Motion CH1	UB64108	F00108		●
Detecting H/W lower limit of Motion CH1	UB64109	F00109		●
Detecting H/W upper limit of Motion CH1	UB6410A	F0010A		●
Using Motion CH2	UB64120	F00120		●
Moving of Motion CH2	UB64121	F00121		●
Using acceleration of Motion CH2	UB64122	F00122		●
Driving with set speed of Motion CH2	UB64123	F00123		●
Decelerating of Motion CH2	UB64124	F00124		●
Dwelling of Motion CH2	UB64125	F00125		●
Finish driving of CH2	UB64126	F00126		●
Detecting S/W lower limit of Motion CH2	UB64127	F00127		●
Detecting S/W upper limit of Motion CH2	UB64128	F00128		●
Detecting H/W lower limit of Motion CH2	UB64129	F00129		●
Detecting H/W upper limit of Motion CH2	UB6412A	F0012A		●
Jog starting forward of Motion CH1	UB64501	F00501		●
Jog starting backward of Motion CH1	UB64502	F00502		●

Name	GP device	LP device	Applied model	
			LP-S044	LP-070
Jog starting forward of Motion CH2	UB64503	F00503		●
Jog starting backward of Motion CH2	UB64504	F00504		●
Channel error of Motion CH1	UB64110	F00110		●
Emergency stop error of Motion CH1	UB6411F	F0011F		●
Designation flag for MTSRS action (Finish action list)	UB64400	F00400		●
Designation flag for MTSRS action (Finish group)	UB64401	F00401		●
Channel error of Motion CH2	UB64130	F00130		●
Emergency stop error of Motion CH2	UB6413F	F0013F		●
Designation flag for MTSRS action (Finish action list)	UB64402	F00402		●
Designation flag for MTSRS action (Finish group)	UB64403	F00403		●

12.2.2 Word special device list

Name	GP device	LP device	Applied model	
			LP-S044	LP-S070
Error code check of Motion CH1	UW6420	F20		●
Error code check of Motion CH2	UW6421	F21		●
Current position of Motion CH1	UW6460	F60		●
Current speed of Motion CH1	UW6462	F62		●
Current action No. of Motion CH1	UW6464	F64		●
Current pattern No. of Motion CH1	UW6465	F65		●
Current home position of Motion CH1	UW6466	F66		●
Setting speed of Motion CH1	UW6468	F68		●
Current position of Motion CH2	UW6470	F70		●
Current speed of Motion CH2	UW6472	F72		●
Current action No. of Motion CH2	UW6474	F74		●
Current pattern No. of Motion CH2	UW6475	F75		●
Current home position of Motion CH2	UW6476	F76		●
Setting speed of Motion CH2	UW6478	F78		●
PLC series and model code	UW6500	F100	●	●
System version	UW6501	F101	●	●
Released date of the version(Year)	UW6506	F106	●	●
Released date of the version(Date)	UW6507	F107	●	●
Present scan time	UW6510	F110	●	●
Min. scan time	UW6511	F111	●	●
Max. scan time	UW6512	F112	●	●
Average scan time	UW6513	F113	●	●
Scan time count	UW6514	F114	●	●
Step operation generated error (At present)	UW6520	F120	●	●

Name	GP device	LP device	Applied model	
			LP-S044	LP-S070
Step operation generated error (Retaining)	UW6521	F121	●	●
Error step	UW6530	F130	●	●
Break step	UW6531	F131	●	●
Self-diagnosis error code	UW6540	F140	●	●
Time setting (Year)	UW6550	F150	●	●
Time setting (Month)	UW6551	F151	●	●
Time setting (Date)	UW6552	F152	●	●
Time setting (Hour)	UW6553	F153	●	●
Time setting (Min)	UW6554	F154	●	●
Time setting (Sec)	UW6555	F155	●	●
Time setting (Day)	UW6556	F156	●	●
Input filter settings	UW6560	F160	●	●
Time-driven run-time settings	UW6561	F161	●	●
Watchdog timer settings	UW6562	F162	●	●
Time-driven interrupt cycle settings 1	UW6570	F170	●	●
Time-driven interrupt cycle settings 2	UW6571	F171	●	●
Time-driven interrupt cycle settings 3	UW6572	F172	●	●
Time-driven interrupt cycle settings 4	UW6574	F174	●	●
Time-driven interrupt cycle settings 5	UW6575	F175	●	●
Time-driven interrupt cycle settings 6	UW6576	F176	●	●
Time-driven interrupt cycle settings 7	UW6577	F177	●	●
Time-driven interrupt cycle settings 8	UW6578	F178	●	●

12.3 Diagnosis code table

- Display self diagnosis error code: It saves error codes which correspond with error lamp flash and appropriate module code.
- Self diagnosis code: When operating PLC program, it executes 'refresh input-executing program-refresh output-self diagnosis' repeatedly. The latest detected error is displayed (UW6540) to self error code special device[F140] according to following error code during executing self-diagnosis.

UW6540(F140)	Type	Cause of error
0X0010	Watchdog error	Scan time excesses watchdog timer setting value
0X0020	Memory error	When a certain area of memory is the un-approached state.
0x0021	Battery error	When battery value is below the standard level
0x0022	RTC setting error	Disable to set RTC and RTC operation error
0X0030	Program instruction error	When the program contains instructions that are not able to read and inappropriate forms.
0X0031	Program sequence	When there is not the instructions required to

UW6540(F140)	Type	Cause of error
	error	process the program, such as user defined functions, label name, END, RET and IRET, etc.
0X0040	Parameter setting error	When there are some problems in settings for common and expansion parameters.
0X0041	Time-driven error	When it operates longer than the given time-driven run-time.
0X0050	Extended module setting error	In case the hardware constructions are different from previous parameter settings when applying power again and changing the mode.
0X0051	Extended module attaching and removing error	When the extended module is attached or removed in run mode.
0x0060	Communication fail error	When it is received NAK and data format not able to read.
0x0061	Communication format error	When there are some problems occurred in formats (excess of limited range etc.) and CHECK SUM while download and upload.

12.4 ASCII code table

Dec	Hx	Oct	Char	Dec	Hx	Oct	Html	Chr	Dec	Hx	Oct	Html	Chr	Dec	Hx	Oct	Html	Chr
0	0	000	NUL (null)	32	20	040	␣	Space	64	40	100	␣	␣	96	60	140	␣	␣
1	1	001	SOH (start of heading)	33	21	041	!	!	65	41	101	A	A	97	61	141	␣	␣
2	2	002	STX (start of text)	34	22	042	"	"	66	42	102	B	B	98	62	142	␣	␣
3	3	003	ETX (end of text)	35	23	043	#	#	67	43	103	C	C	99	63	143	␣	␣
4	4	004	EOT (end of transmission)	36	24	044	\$	\$	68	44	104	D	D	100	64	144	␣	␣
5	5	005	ENQ (enquiry)	37	25	045	%	%	69	45	105	E	E	101	65	145	␣	␣
6	6	006	ACK (acknowledge)	38	26	046	&	&	70	46	106	F	F	102	66	146	␣	␣
7	7	007	BEL (bell)	39	27	047	'	'	71	47	107	G	G	103	67	147	␣	␣
8	8	010	BS (backspace)	40	28	050	((72	48	110	H	H	104	68	150	␣	␣
9	9	011	TAB (horizontal tab)	41	29	051))	73	49	111	I	I	105	69	151	␣	␣
10	A	012	LF (NL line feed, new line)	42	2A	052	*	*	74	4A	112	J	J	106	6A	152	␣	␣
11	B	013	VT (vertical tab)	43	2B	053	+	+	75	4B	113	K	K	107	6B	153	␣	␣
12	C	014	FF (NF form feed, new page)	44	2C	054	,	,	76	4C	114	L	L	108	6C	154	␣	␣
13	D	015	CR (carriage return)	45	2D	055	-	-	77	4D	115	M	M	109	6D	155	␣	␣
14	E	016	SO (shift out)	46	2E	056	.	.	78	4E	116	N	N	110	6E	156	␣	␣
15	F	017	SI (shift in)	47	2F	057	/	/	79	4F	117	O	O	111	6F	157	␣	␣
16	10	020	DLE (data link escape)	48	30	060	0	0	80	50	120	P	P	112	70	160	␣	␣
17	11	021	DC1 (device control 1)	49	31	061	1	1	81	51	121	Q	Q	113	71	161	␣	␣
18	12	022	DC2 (device control 2)	50	32	062	2	2	82	52	122	R	R	114	72	162	␣	␣
19	13	023	DC3 (device control 3)	51	33	063	3	3	83	53	123	S	S	115	73	163	␣	␣
20	14	024	DC4 (device control 4)	52	34	064	4	4	84	54	124	T	T	116	74	164	␣	␣
21	15	025	NAK (negative acknowledge)	53	35	065	5	5	85	55	125	U	U	117	75	165	␣	␣
22	16	026	SYN (synchronous idle)	54	36	066	6	6	86	56	126	V	V	118	76	166	␣	␣
23	17	027	ETB (end of trans. block)	55	37	067	7	7	87	57	127	W	W	119	77	167	␣	␣
24	18	030	CAN (cancel)	56	38	070	8	8	88	58	130	X	X	120	78	170	␣	␣
25	19	031	EM (end of medium)	57	39	071	9	9	89	59	131	Y	Y	121	79	171	␣	␣
26	1A	032	SUB (substitute)	58	3A	072	:	:	90	5A	132	Z	Z	122	7A	172	␣	␣
27	1B	033	ESC (escape)	59	3B	073	;	;	91	5B	133	[[123	7B	173	␣	␣
28	1C	034	FS (file separator)	60	3C	074	<	<	92	5C	134	\	\	124	7C	174	␣	␣
29	1D	035	GS (group separator)	61	3D	075	=	=	93	5D	135]]	125	7D	175	␣	␣
30	1E	036	RS (record separator)	62	3E	076	>	>	94	5E	136	^	^	126	7E	176	␣	␣
31	1F	037	US (unit separator)	63	3F	077	?	?	95	5F	137	_	_	127	7F	177	␣	␣

12.5 UW correspondence table

	Description	Bit range	Word range	GP device(UB)	GP device (UW)
X	Input device	X0 to X255F	X0 to X255	UB70000 to UB7255F	UW7000 to UW7255
Y	Output device	Y0 to Y255F	Y0 to Y255	UB80000 to UB8255F	UW8000 to UW8255
M	Auxiliary device	M0 to M9999F	M0 to M9999	UB200000 to UB29999F	UW20000 to UW29999
S	Step device	S0.0 to S255.99			
D	Data device	D0 to D9999F	D0 to D9999		UW40000 to UW49999
T	Timer contact	T0 to T255		UB100000 to UB10015F	
T	Timer present value		T0 to T255		UW11000 to UW11255
T	Timer set value		T0 to T255		UW13000 to UW13255
C	Counter contact	C0 to C255		UB150000 to UB15015F	
C	Counter present value		C0 to C255		UW16000 to UW16255
C	Counter set value		C0 to C255		UW18000 to UW18255
Z	Index device	Z0 to Z255F	Z0 to Z255	UB067000 to UB06955F	UW6700 to UW6955
F	Special device	F0 to F255F	F0 to F255	UB64000 to UB6655F	UW6400 to UW6655
V	Virtual device	V0 to V255F	V0 to V255	UB061000 to UB06355F	UW06100 to UW06355
L	Link device	L0 to L999F	L0 to L999		UW38000 to UW38999
R	File device	R0 to R3999F	R0 to R3999	UB020000 to UB05999F	UW02000 to UW05999

12.6 Motion control I/O signal allotment

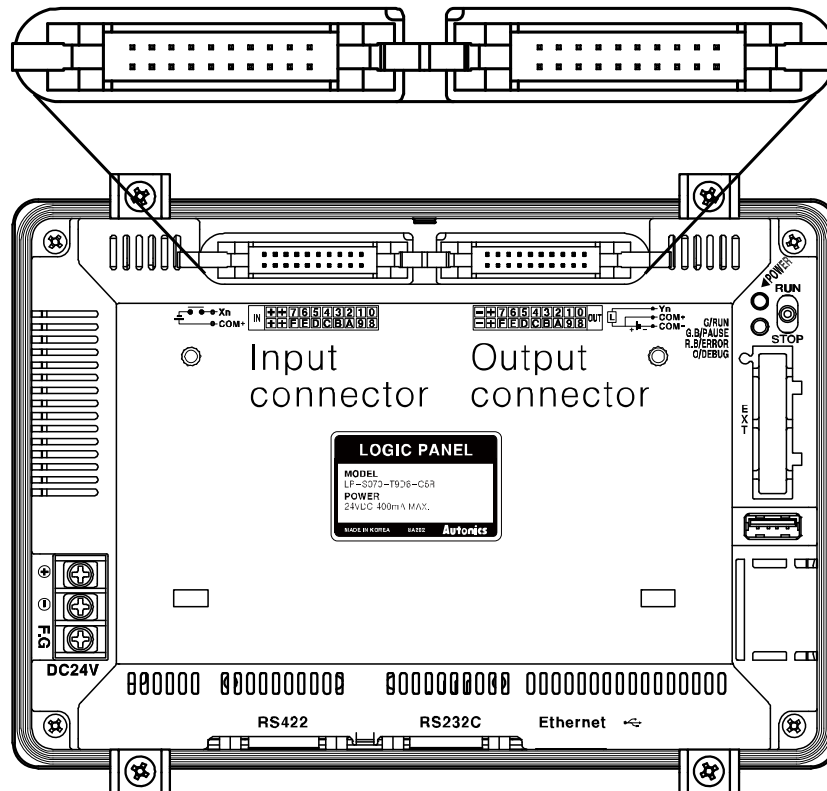
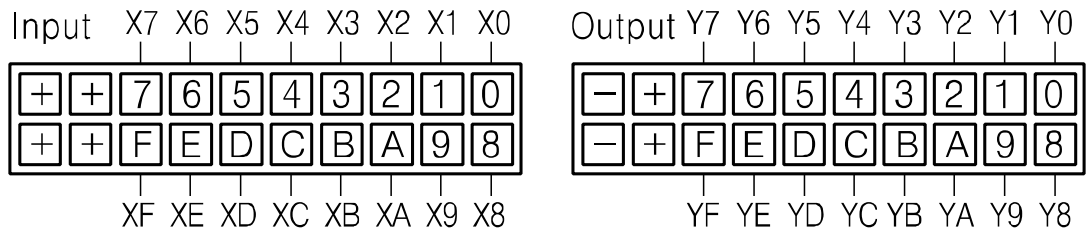

Signal name	Input contact number		Operation description
Lower limit signal	CH1	X0	When input contact has signal, it detects CH1 lower limit.
	CH2	X3	When input contact has signal, it detects CH2 lower limit.
Upper limit signal	CH1	X1	When input contact has signal, it detects CH1 upper limit.
	CH2	X4	When input contact has signal, it detects CH2 upper limit.
Origin point limit signal	CH1	X2	When input contact has signal, it detects CH1 origin point.
	CH2	X5	When input contact has signal, it detects CH2 origin point.
Direction selection signal	CH1	Y2	It outputs CH1 direction selection signal.
	CH2	Y3	It outputs CH2 direction selection signal.
PWM signal	CH1	Y0	It outputs CH1 PWM signal.
	CH2	Y1	It outputs CH2 PWM signal.

Input contact number is same number regardless ribbon type and terminal type.

LP-S070 uses 1Pulse input method. Be careful when you connect a motion controller.

Autonics

Sensors & Controllers

www.autonics.com

Distributor



Major products

Proximity sensors • Photoelectric sensors • Area sensors • Fiber optic sensors • Door/Door Side sensors • Pressure sensors • Rotary encoders • Sensor controllers • Switching power supply • Temp. controllers • Temperature/Humidity transducers • Power controllers • Recorders • Tachometer/Pulse(Rate) meters • Panel meters • Indicators • Signal convertors • Counters • Timers • Display units • Graphic panel • Stepping Motors & Drivers & Motion controllers

Any proposal for a product improvement and development: Product@autonics.com

Headquarters

41-5, Yongdang-dong, Yangsan-si, Gyeongnam, 626-847, Korea

Overseas Business Dept.

Bldg. 402 3rd Fl, Bucheon Techno Park, 193, Yakdae-dong, Wonmi-gu, Bucheon-si, Gyeonggi-do, 420-734, Korea

Tel: 82-32-610-2730 / Fax: 82-32-329-0728 / E-mail: sales@autonics.com

■ **Brazil** Autonics do Brasil Comercial Importadora Exportadora Ltda

Tel: 55-11-3055-1660 / Fax: 55-11-3055-1661 / E-mail: vendas@autonics.com.br

■ **China** Autonics electronic(Jiaxing) Corporation

Tel: 86-573-8216-1900 / Fax: 86-573-8216-1917 / E-mail: china@autonics.com

■ **India** Autonics Corporation - India Liaison Office

Tel: 91-22-2781-4305 / Fax: 91-22-2781-0538 / E-mail: india@autonics.com

■ **Indonesia** PT. Autonics Indonesia

Tel: 62-21-6586-6740 / Fax: 62-21-6586-6741 / E-mail: autonics@cbn.net.id

■ **Japan** Autonics Japan Corporation

Tel: 81-3-5730-0568 / Fax: 81-3-5730-0569 / E-mail: ja@autonicsjp.co.jp

■ **Malaysia** Mal-Autonics Sensor Sdn. Bhd.

Tel: 60-3-7805-7190(Hunting) / Fax: 60-3-7805-7193 / E-mail: malaysia@autonics.com

■ **Mexico** Autonics Mexico Sales Office

Tel: 52-55-5207-0019 / Fax: 52-55-5207-0099 / E-mail: ventas@autonics.com

■ **Russia** Autonics Corp. Russia Representative Office

Tel/Fax: 7-495-745-2343 E-mail: russia@autonics.com

■ **Turkey** Autonics Otomasyon Ticaret Ltd. Sti.

Tel: 90-212-222-0117 (PBX) / Fax: 90-212-222-0108 / E-mail: info@autonics.com.tr

■ **USA** Autonics USA, Inc.

Tel: 1-847-680-8160 / Fax: 1-847-680-8155 / E-mail: sales@autonicsusa.net

■ **Vietnam** Autonics Vietnam Representative Office

Tel: 84-8-3925-6563 / Fax: 84-8-3925-6564 / E-mail: vietnam@autonics.com