

MODEL

HT-SB603

SOUND BAR HOME THEATER SYSTEM

OPERATION MANUAL

Thank you for purchasing this SHARP product. To obtain the best performance from this product, please read this manual carefully. It will guide you in operating your SHARP product.

HT-SB603 consisting of Sound Bar Home Theater System (Sound Bar) and CP-SW603 (Active Subwoofer System).

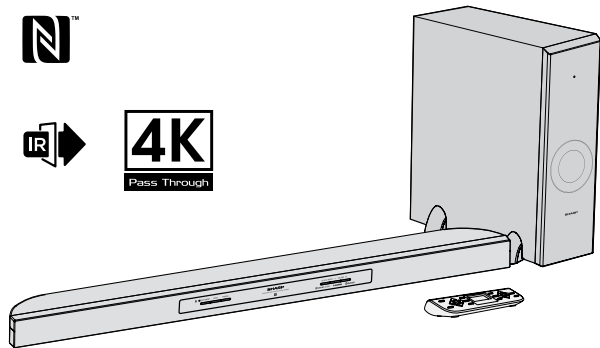

Note:

This product is recommended for 60" or larger flat panel TV (LED, LCD and Plasma).









- This audio system supports NFC-enabled devices with Android 4.1, Jelly Bean and higher.
- For device with a lower Android version, refer the operation manual of the device for recommended app (application).

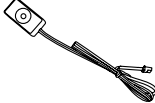

TINSE526AWZZ

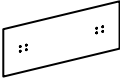
Accessories

The following accessories are included.

				
Remote Control x 1	Subwoofer Stand x 2	IR Transmitter x 1	HDMI Cable x 1	Wall Mount Angle x 2
				
Pattern Paper x 1	"AA" size battery (UM-3, R6, HP-7 or similar) x 2	NFC tag x 1	Velcro tape (hook type) x 1	Velcro tape (loop type) x 2

Special Notes

Manufactured under license from Dolby Laboratories. Dolby, Dolby Audio, and the double-D symbol are trademarks of Dolby Laboratories.

The terms HDMI and HDMI High-Definition Multimedia Interface, and the HDMI Logo are trademarks or registered trademarks of HDMI Licensing LLC in the United States and other countries.

The *Bluetooth*® word mark and logos are registered trademarks owned by the *Bluetooth* SIG, Inc. and any use of such marks by SHARP is under license. Other trademarks and trade names are those of their respective owners.

The N-Mark is a trademark or registered trademark of NFC Forum, Inc. in the United States and in other countries.

Warning:

- When the ON/STANDBY button is set at STANDBY position, mains voltage is still present inside the unit. When the ON/STANDBY button is set at STANDBY position, the unit may be brought into operation by the timer mode or remote control.
- This unit contains no user serviceable parts. Never remove covers unless qualified to do so. This unit contains dangerous voltages, always remove mains plug from the socket before any service operation and when not in use for a long period.
- To prevent fire or shock hazard, do not expose this appliance to dripping or splashing. No objects filled with liquids, such as vases, shall be placed on the apparatus.

Supply of this product does not convey a license nor imply any right to distribute content created with this product in revenue-generating broadcast systems (terrestrial, satellite, cable and/or other distribution channels), revenue-generating streaming applications (via Internet, intranets and/or other networks), other revenue-generating content distribution systems (pay-audio or audio-on-demand applications and the like) or on revenue-generating physical media (compact discs, digital versatile discs, semiconductor chips, hard drives, memory cards and the like). An independent license for such use is required. For details, please visit <http://mp3licensing.com>

MPEG Layer-3 audio coding technology licensed from Fraunhofer IIS and Thomson.

Precautions

■ General

- Please ensure that the equipment is positioned in a well ventilated area and ensure that there is a free space along the sides, top and back of the equipment as below.

Table/floor

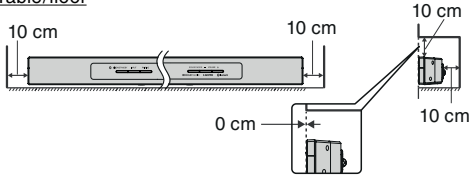

Wall mount

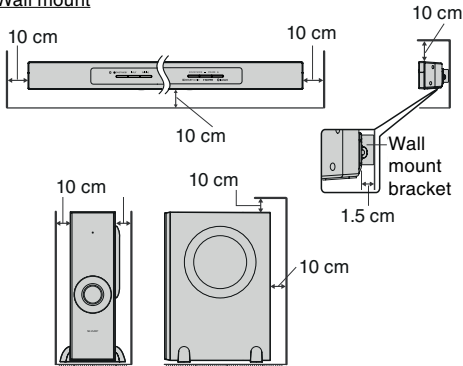

- Use the unit on a firm, level surface free from vibration.
- Keep the unit away from direct sunlight, strong magnetic fields, excessive dust, humidity and electronic/electrical equipment (home computers, facsimiles, etc.) which generate electrical noise.
- Do not place anything on top of the unit.

- Do not expose the unit to moisture, to temperatures higher than 60°C (140°F) or to extremely low temperatures.
- If the unit does not work properly, unplug and plug it in again. Then turn on the unit.
- In case of an electrical storm, unplug the unit for safety.
- Hold the AC power plug by the head when removing it from the wall socket, as pulling the lead can damage internal wires.
- The AC power plug is used as a disconnect device and shall always remain readily operable.
- **Do not remove the outer cover, as this may result in electric shock. Refer internal service to your local SHARP service facility.**
- This unit should only be used within the range of 5°C - 35°C (41°F - 95°F).
- SHARP are not responsible for damage due to improper use. Refer all servicing to a SHARP authorised service centre.

Warnings:

- The voltage used must be the same as that specified on this unit. Using a higher voltage is dangerous and may result in a fire or other type of accident causing damage. SHARP will not be held responsible for any damage resulting from such usage.
- In case of repairing, please bring the entire system set to the service centre.

■ Volume control

The sound level at a given volume setting depends on speaker efficiency, location and various other factors. It is advisable to avoid exposure to high volume levels, which occurs while turning the unit on with the volume control setting up high, or while continually listening at high volumes.

Controls and indicators

■ Sound Bar Front Panel

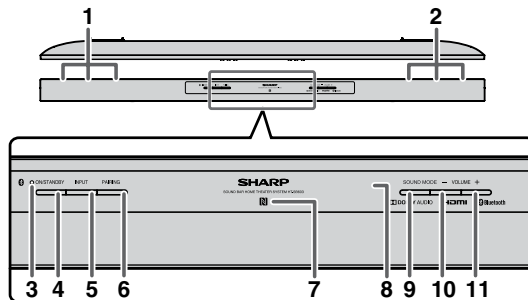

1. Left Channel Speakers
2. Right Channel Speakers
3. On/Standby/Pairing/Input indicator
4. On/Standby Button
5. INPUT Button
6. Pairing Button
7. NFC detection area
8. Remote Sensor
9. Sound Mode Button
10. Volume Down Button
11. Volume Up Button

Controls and indicators (continued)

■ Sound Bar Rear Panel

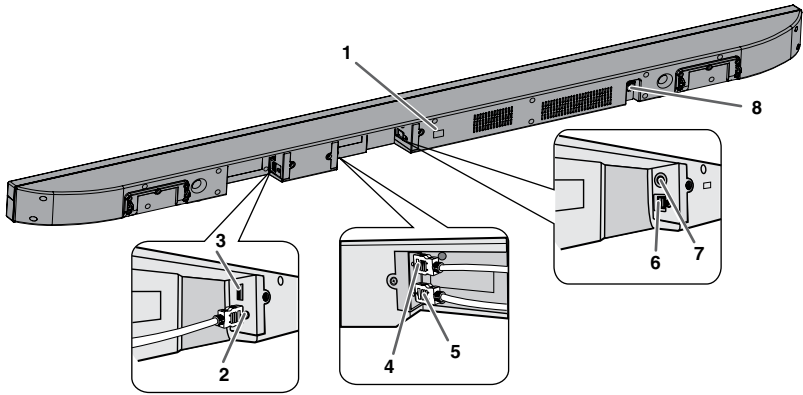

1. IR OUT Terminal
2. HDMI OUT (TV ARC) Socket
3. USB terminal
4. HDMI IN 1 Socket
5. HDMI IN 2 Socket
6. Optical IN Socket
7. Audio IN Terminal
8. AC Power Lead

■ Subwoofer

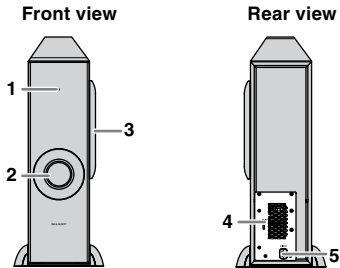

1. Power/Pairing Indicator
2. Bass Reflect Duct
3. Woofer
4. SW LINK (Subwoofer Link) button
5. AC Power Lead

Controls and indicators (continued)

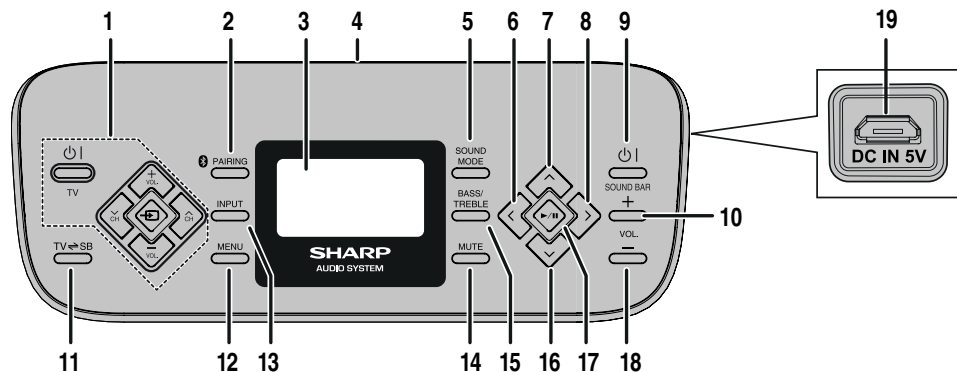

■ Remote Control

1. TV Operation Button
2. **Bluetooth®** Pairing Button
3. Display
4. Remote Control Transmitter
5. Sound Mode Button
6. Cursor Left/Fast Reverse/Skip Down button
7. Cursor Up/Play Mode Button
8. Cursor Right/Fast Forward/Skip Up Button
9. ON/STANDBY Button
10. Volume Up Button
11. TV \rightleftharpoons SB Speaker Select Button
12. Menu Button
13. Input Select Button
14. Mute Button
15. Bass/Treble Button
16. Cursor Down/Display Button
17. Play/Pause Button
18. Volume Down Button
19. DC IN Terminal

■ Display remote control

To control the sound bar

HT-SB603 comes with a wireless display remote control which uses *Bluetooth* to communicate instead of infra red which requires direct line of sight. You can control the sound bar from any direction or angle within 10 metres (32 feet).

To control SHARP TV

This remote control still uses infra red to control SHARP TV. Point the remote control at the TV remote sensor to operate the TV.

NOTE:

- In case the remote control is lost or needs repairing, bring the entire system set to the service centre.

■ Connecting the remote control

The remote control and sound bar will link automatically (wirelessly) as it is already pre-linked at the factory.

If the link cannot be established, please set the connection by the following method.

1. Bring the remote control near to the sound bar and select PAIRING from the remote control menu. (Refer '**To select a menu on the remote control**' on page 12)
2. Set the sound bar to standby mode (Eco mode off).
3. Press and hold the INPUT button on the sound bar until "CONNECTED!" appears on the display.





Note:

If the AC power lead of the sound bar is unplugged or if a power failure happened, the remote control will be disconnected. Press any key on the remote control to reactivate the connection.

■ TV code selection

The default TV code for the remote control is TV CODE 1. In case SHARP TV is not responding to TV operation button, change the code by selecting TV CODE from the remote control menu (Refer '**To select a menu on the remote control**' on page 12).

TV Operation Buttons (Only SHARP TV):

On/Standby Button  TV	Sets the TV power to "ON" or "STANDBY".	Input Select Button (TV) 	Press the button to switch the input source.
Channel Up and Down Buttons 	Switch up/down the TV channels.	Volume Up and Down Buttons  	Turn up/down the TV volume.

Note:

Some models of SHARP TV may not be operable.

Sound bar preparation

To mount the sound bar on the wall

Caution:

- Be very careful to prevent the sound bar [3.7 kg (7.9 lbs.)] from falling when mounting on the wall.
- Before mounting, check the wall strength. (Do not put on the veneer plaster or whitewashed wall. The sound bar may fall.) If unsure, consult a qualified service technician.
- Mounting screws are not supplied. Use appropriate ones.
- Check all wall mount angle screws for looseness.
- Select a good location. If not, accidents may occur or the sound bar may get damaged.
- **SHARP are not responsible for accidents resulting from improper installation.**

■ Driving screws

SHARP designed the sound bar so you may hang them on the wall. Use proper screws (not supplied). See below for size and type.

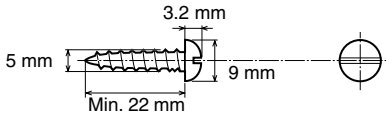

■ Fixing wall mount angle (Horizontal position)

- 1 Fix the pattern paper to the wall in horizontal position as below.

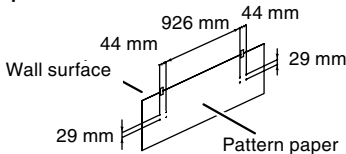

- 2 Make a hole on the wall following the screw point marks on the pattern paper by using a drill.

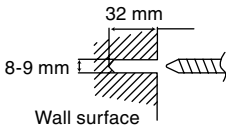

- 3 Fix a wall mount plug (not supplied) into the hole using a hammer, until it is flush with the wall surface.

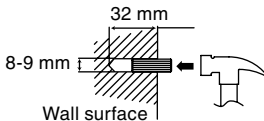

- 4 Screw the wall mount angle to the wall as shown in the illustration. (Total screw is 8 pieces)

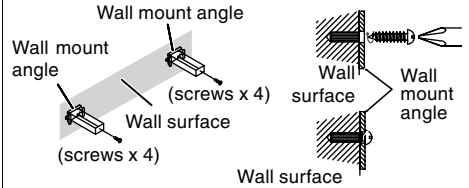

Note:

Make sure all screws are fully tightened. (screws are not supplied)

■ Installing the sound bar

- 1 Align the wall mount slot at the sound bar to the wall mount angle.
- 2 Slot the sound bar into the wall mount angle.
- 3 Fix them securely.

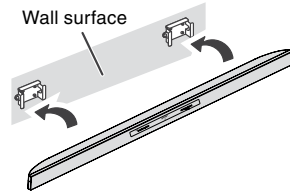

Falling prevention

- Safety wires (not supplied) are useful to prevent the sound bar from falling off.
- 2 persons are required to perform this procedure.

When mounting on the wall

- 1** Loop the safety wires (not supplied) into each hole of the wall mount angle as shown.

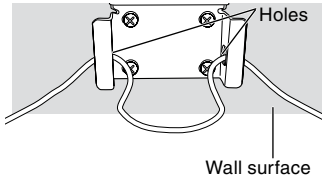

- 2** Loop the safety wires from wall mount angle into each hole of sound bar as shown.

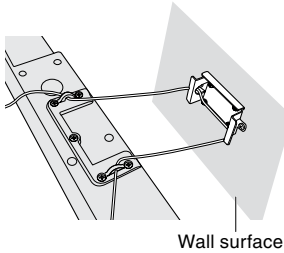

- 3** Align and fix the sound bar to wall mount angle.

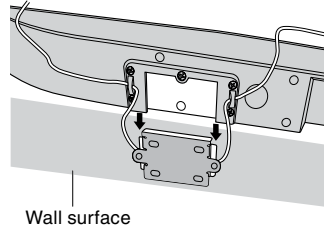

- 4** Tie the safety wires tightly.

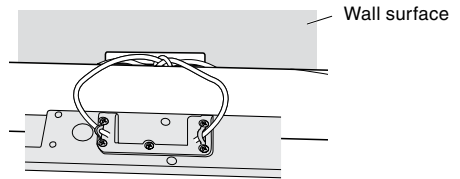

When placing on the shelf/table

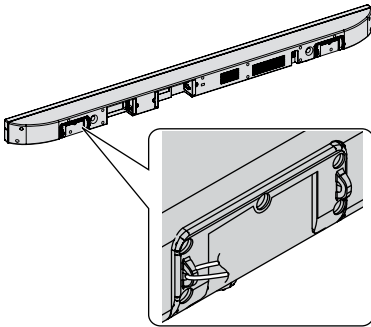

Loop the safety wires (not supplied) into each hole as shown and tie the safety wires to the TV stand.

Placing the system

Installation image:

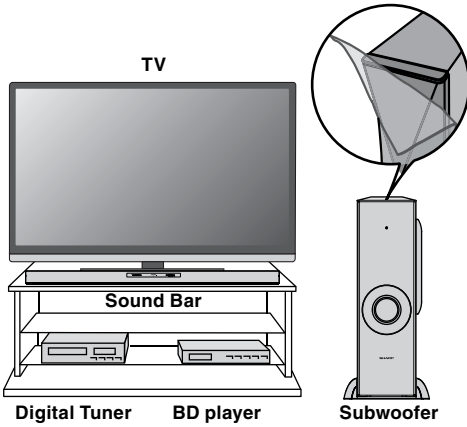

Place the system as shown.

Remove the protective film covering the subwoofer before turn on the system.

Notes:

- The front panel of the sound bar is not removable.
- The maximum transmission distance of the wireless signal between the subwoofer and sound bar is about 10 metres (32 feet), but may vary depending on your operating environment. If a steel-concrete or metallic wall is between the subwoofer and the sound bar, the system may not operate at all, because the wireless signal cannot penetrate metal.

Caution:

- Do not change the installation direction when the sound bar is turned on.
- Do not stand or sit on the sound bar and subwoofer as you may be injured.
- Do not allow any objects to fall into or to be placed in the bass reflex duct.

■ Placing the subwoofer stand

Place the stand as shown.

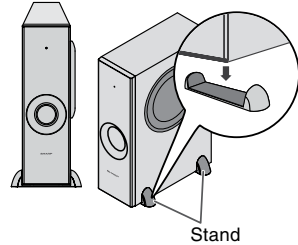

System connections

Make sure to unplug the AC power lead before making any connections.

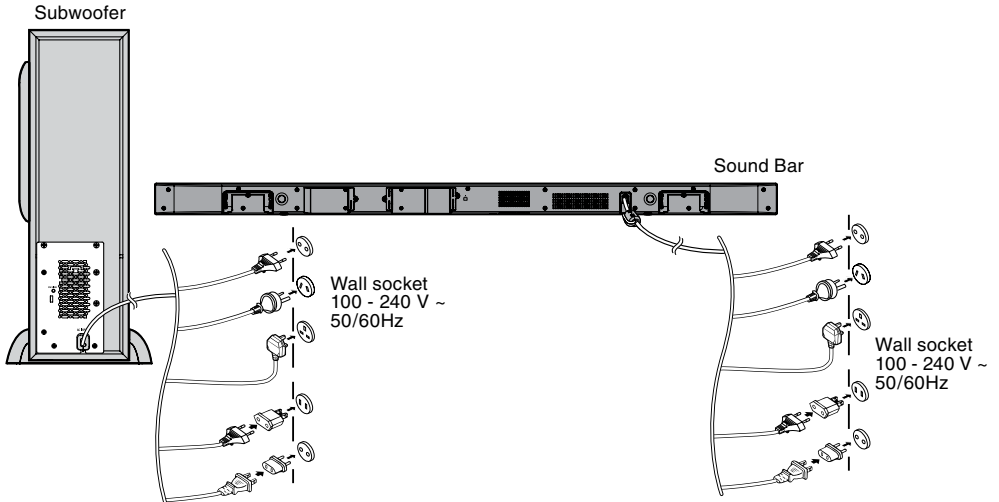

System connections (continued)

■ IR (Infrared) transmitter connection

If the TV's remote sensor is blocked by the sound bar, use the IR transmitter to relay the signal to the TV.

1. Connect the IR transmitter to IR out terminal to allow the TV's remote signal to pass through.
2. Place the infrared emitter near TV's remote sensor (refer the operation manual of the TV for the location of the sensor).
Point the TV's remote control at the sound bar remote sensor and operate the TV.
You may need to move the IR transmitter until the TV operates correctly.
Then secure the IR transmitter onto the sound bar using the double sided tape provided.

Note:

- Do not use the IR transmitter if the TV's remote control sensor is not blocked by the sound bar.

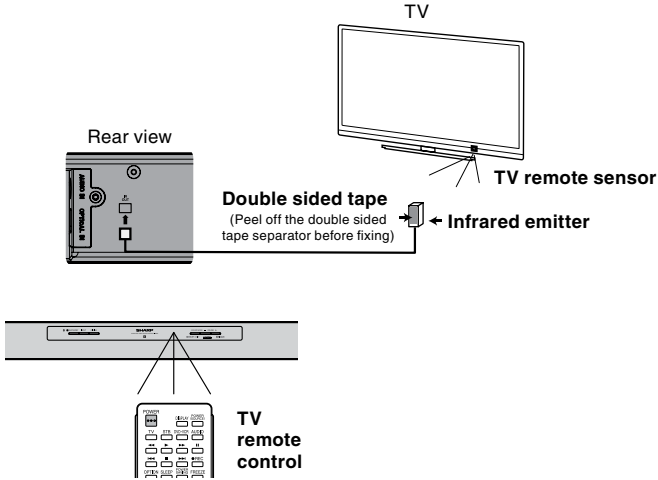

■ HDMI Connection

Caution:

Turn off all other equipment before making this connection.

The illustration below shows the flows of the signals.

Audio and Video signal



1. Method 1

This connection is for HDMI TV with ARC (Audio Return Channel).

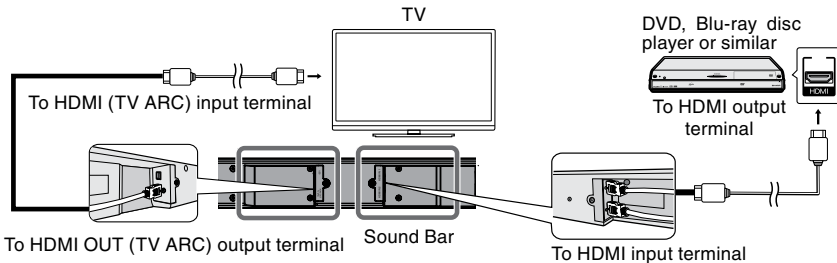

System connections (continued)

2. Method 2

This connection is for HDMI TV without ARC (Audio Return Channel).

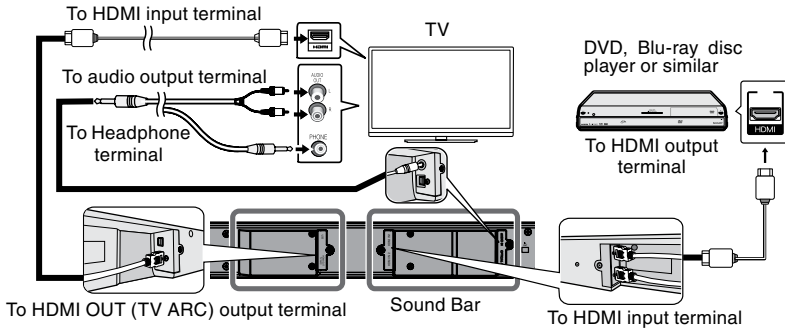

To select HDMI 1, 2 or TV ARC function (Source):

Press INPUT button repeatedly on the sound bar or remote control to select "HDMI 1", "HDMI 2" or "TV ARC".

Notes:

- This sound bar supports HDMI which enables ARC (Audio Return Channel).
- To enable ARC make sure to use High Speed HDMI™ cable (with ARC).
- This ARC feature requires TV that supports ARC. Refer the operation manual of the TV to determine which terminal supports ARC.
- To listen to the sound from a non-ARC-compatible TV, connect the audio output from TV to this system's. (refer figure above)
- This sound bar can be operated (power on/off or volume up/down) via a TV or similar component which supports HDMI CEC (Consumer Electronics Control). If this does not work, it does not mean this system is faulty. Refer to the operation manual of the respective component on how to activate the CEC.
Example: Go to the Menu of the component to search and enable the CEC. Different brands may have different naming for the CEC. For SHARP LCD TV, it is named as AQUOS LINK.
- **The system will automatically power off if TV or similar component which supports HDMI CEC, is turned off.**
- CEC is not available during Low power consumption mode (Eco mode on).
- **To listen to the sound from this system, you will need to select TV ⇌ SB menu (refer page 13) or adjust the speaker output settings within the TV menu.**
- For details, refer to the operation manual of the TV.
- **If you are unable to select external speaker setting from the TV menu (E.g. For SHARP LCD TV, it is named as AQUOS AUDIO SP), turn the CEC OFF and ON again.**
- To enjoy 3D images or 4K content, this system must be connected to a 3D or 4K-compatible TV and components (3D BD player, etc.) via High Speed HDMI cables. Put on the 3D glasses (for 3D-compatible TV and components), otherwise 3D images or 4K content may not be viewed properly.
- If you want to use HDMI IN 1 socket, please use the supplied HDMI cable.

Audio connections to TVs, DVD players, VCRs, etc.

■ Other connection (without HDMI)

The illustration below shows the flows of audio and video signals.

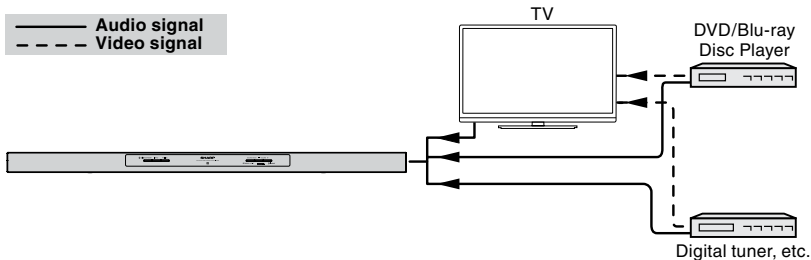

Notes:

- Refer to the operation manual of the equipment to be connected.
- Fully insert the plugs to avoid fuzzy pictures or noises.
- Connecting via this method may disable TV internal speakers.
- In some cases, a small background noise could emit from the sound bar, when you use the RCA audio output terminal connection from a TV-Set/DVD/Blu-ray Disc Player. In such case, please change the connection to the HDMI/ARC or headphone terminal connection. This effect depends on the used TV/DVD/Blu-ray Disc Player-Brand, model and age, and it is not a quality matter from the sound bar.

Audio connections to TVs, DVD players, VCRs, etc. (continued)

■ Connecting a TV, or DVD player, etc.

Connect to the TV using an optical digital cable or an audio cable.

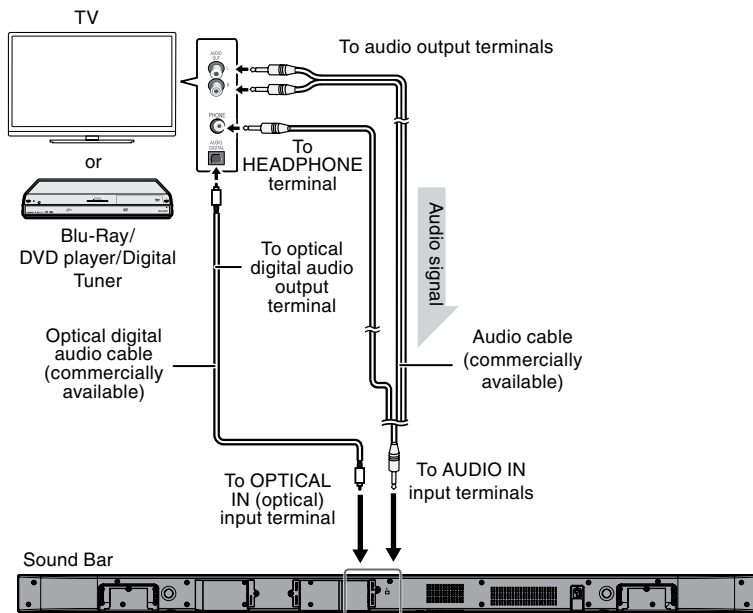

To select OPTICAL function:

Press the INPUT button repeatedly on the sound bar or remote control to select "OPTICAL".

To select AUDIO IN function:

Press the INPUT button repeatedly on the sound bar or remote control to select "AUDIO IN".

Remote control

- 1 Open the battery cover.
- 2 Insert the supplied batteries according to the direction indicated in the battery compartment.
When inserting or removing the batteries, push them towards the ⊖ battery terminals.
- 3 Close the battery cover.

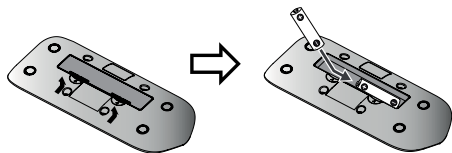

Note:

Battery life	Approx. 6 months (UM/SUM-3) Condition: Approx. 100 times key press per day.
---------------------	--

Battery life may vary depending on the temperature, battery types and usage condition.

Caution:

- Replace all old batteries with new ones at the same time.
- Do not mix old and new batteries.
- Remove the batteries if the sound bar will not be used for a long period of time. This will prevent battery deterioration and potential damage due to battery leakage.
- Do not use rechargeable battery (nickel-cadmium battery, etc.).
- Installing the batteries incorrectly may cause the sound bar to malfunction.
- Batteries (battery pack or battery installed) shall not be exposed to excessive heat such as sunshine, fire or the like.

Notes concerning use:

- Replace the batteries if the operating distance is reduced or if the operation becomes erratic. Purchase 2 "AA" size batteries (UM/SUM-3, R6, HP-7 or similar).
- Periodically clean the transmitter on the remote control with a soft cloth.
- Keep the remote control away from moisture, heat, shock, and vibrations.

Remote control (continued)

■ Checking the remaining amount of battery level

The battery level is shown by the battery indicator during operation.

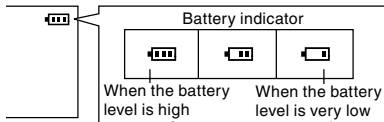

- When the battery level is very low, “Battery Low!” will appear on the display, then the remote control will be turned off automatically.
- Replace the batteries with new ones.

Notes:

- The battery indicator will not correctly display the remaining capacity for approximately 10 seconds after the power has been turned on.
- The number of bars shown in the battery indicator may increase or decrease, depending on the operation being performed. This is normal.
- The battery life and the operating time may be shortened by usage conditions, long periods of disuse, etc.

■ USB connection

To operate the remote control without battery power, connect a Micro USB cable (not supplied) to the remote control DC IN terminal.

- Connection of the USB cable to the remote control disconnects the batteries.

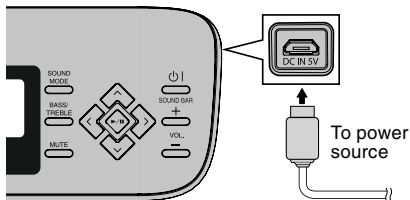

Caution:

The USB connection cannot be used to charge the remote control or as a media playback.

■ Test of the remote control (Sharp TV operation)

Point the remote control directly at the remote sensor on the TV.

The remote control can be used within the range shown below:

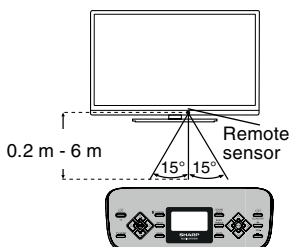

General control

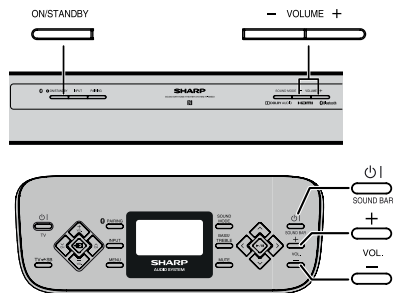

Make sure to enable the HDMI CEC when making HDMI connection. For details, refer to the operation manual of the TV.

■ To turn the power on

Press the ON/STANDBY button on the sound bar or the button on the remote control.

- The power turns on and the sound bar on/standby/pairing/input indicator lights up according to the input source. If the power does not turn on, check whether the AC power lead is plugged in properly.

Input source	Indicator
Bluetooth	Blue.
Others	Violet.

- The system will automatically power on if TV or similar component which supports HDMI CEC, is turned on.

To set the sound bar to standby mode:

Press the ON/STANDBY button on the sound bar or the button on the remote control. The sound bar on/standby/pairing/input indicator turns red.

Notes:

- A slight audio delay after TV is turned ON does not mean that the system is faulty. This is normal.
- “AQUOS speaker is enabled” message will be displayed if SHARP LCD TV does not detect HT-SB603 during power on. However the message “AQUOS audio with AQUOS LINK is enabled” will be displayed soon as HT-SB603 is detected. These messages may vary for other TV model.

■ Eco mode

- The first time the unit is plugged in, it will enter standby mode (ECO mode off). Sound bar indicator turns red.
- To cancel the standby mode, perform the following method.

Remote Control:

1. Select ECO MODE ON from remote control menu (Refer 'To select a menu on the remote control on page 12). The next time the unit is turned off it will enter the low power consumption mode (Sound bar indicator turns off).
2. To return to the standby mode, select ECO MODE OFF. The next time the unit is turned off it will enter standby mode.

General control (continued)

Sound Bar:

- Press and hold the ON/STANDBY button during power on until the sound bar is turned off.
 - The next time the unit is turned on and off again it will enter the low power consumption mode (Sound bar indicator turns off).
- To return to the standby mode, perform step 1 above.
 - The next time the unit is turned on and off again it will enter standby mode.
- During standby mode, NFC function is activated once your device touches the NFC detection area or the supplied NFC tag when there is no HDMI connection.

■ Pairing with the Subwoofer

The sound bar and subwoofer will link automatically (wirelessly) when turned on as it is already pre-linked at the factory.

Indication during power on

On Sound Bar	On Subwoofer
Indicator lights up in violet or blue (according to the input source)	Indicator lights up in blue

If the link cannot be established, please set the connection by the following method.

During sound bar standby and subwoofer power off mode (AC power lead unplugged):

- Press and hold the PAIRING button on the sound bar for more than 3 seconds.
- Within 3 minutes, plug in the AC power lead of the subwoofer and turn the power on.
 - In case the link is still not established (Sound bar and subwoofer indicator blink), press and hold the SW LINK button at the back of the subwoofer until sound bar and subwoofer indicator light up.

Indication during pairing process

Process	On Sound Bar	On Subwoofer
During pairing	Indicator will blink in violet	Indicator will blink in blue
Successful pairing	Indicator turns red	Indicator turns red

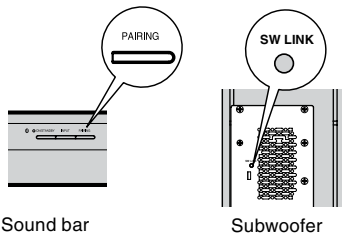

Sound bar

Subwoofer

Notes:

- If a device such as microwave oven, wireless LAN card, Bluetooth device or any other device that uses the same 2.4GHz frequency is placed near the system, some sound interruption may be heard due to interference.
- The maximum transmission distance of the wireless signal between the subwoofer and sound bar is about 10 metres (32 feet), but may vary depending on your operating environment. If a steel-concrete or metallic wall is between the subwoofer and the sound bar, the system may not operate at all, because the wireless signal cannot penetrate metal.

Caution:

- Keep the subwoofer away from water and moisture.
- To get the optimum listening performance, make sure the area around the sound bar and subwoofer is clear of any obstacles.

■ To select a menu on the remote control

- Press MENU button.
- To select a menu, press \wedge or \vee button, then press \triangleright button.
- Press \wedge or \vee button to select an option in the desired menu.
- To select another menu, press \triangleleft button and repeat steps 2 to 3 above.

Menu/Function	Level/Mode
3D AUDIO	3D AUDIO 0 \rightarrow 1 \rightarrow 2
AV SYNC	AV SYNC 0 \leftrightarrow 1 \leftrightarrow 2 \leftrightarrow 3
APC	05 MIN \leftrightarrow 10 MIN \leftrightarrow 15 MIN \leftrightarrow 20 MIN
SW LEVEL	-5 \leftrightarrow -4 0 \leftrightarrow +4 \leftrightarrow +5
ECO MODE	ECO MODE ON \leftrightarrow OFF
DISPLAY OFF	05 SEC \leftrightarrow 10 SEC \leftrightarrow 15 SEC
TV CODE	TV CODE 1 \leftrightarrow 2
PAIRING	To link the remote control and sound bar manually.
VERSION	Displays remote control and software version

Note:

Software version will be displayed if the remote control is connected with the sound bar.

■ Volume auto fade-in

When you turn on the sound bar, the volume starts at lower level and fades in to the last set level.

■ Volume control

Sound bar operation:

Press the VOLUME + button to increase the volume and the VOLUME - button for decreasing.

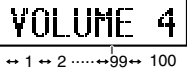

Remote control operation:

Press the VOL. + button to increase the volume and the VOL. - button to decrease the volume.

■ Sound Mode

To change to a different mode, press the SOUND MODE button repeatedly on the sound bar or remote control until the desired sound mode is displayed.

CINEMA	(for cinema sound effect)
MUSIC	(for standard sound effect)
GAME	(for game sound effect)
SPORT	(for sport broadcasting)
NEWS	(for news)
NIGHT	(for night)
BYPASS	(for flat sound effect)

■ Muting

The volume is muted temporarily when pressing the MUTE button on the remote control. Press again to restore the volume.

General control (continued)

Note:

When the sound bar is turned off and back on again, muting is cancelled.

■ Bass and Treble Control (remote control)

Bass Control

1. Press the BASS/TREBLE button to select bass.
2. Within 5 seconds, press the VOL. (+ or -) or ^ / v button to adjust the bass.

Treble Control

1. Press the BASS/TREBLE button repeatedly to select treble.
2. Within 5 seconds, press the VOL (+ or -) or ^ / v button to adjust the treble.

■ Subwoofer level control (remote control)

To increase or decrease the Subwoofer level, select SW LEVEL from the remote control menu.

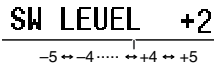

Notes:

- When sound from the speaker is distorted, decrease the subwoofer level.
- When changing the subwoofer level, the output level of the subwoofer is also changed.

■ AV SYNC level control (remote control)

AV Sync : Audio Video Synchronization. The audio output can be adjusted to minimise the time gap between the audio output and a visual display.

To increase or decrease the AV sync level, select AV SYNC from the remote control menu.

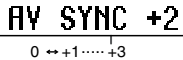

■ Speaker output selection (HDMI connection) (remote control)

Press TV ⇨ SB button on the remote control until "TV SPEAKER" or "SOUND BAR SPEAKER" appears on the display to toggle sound output between this sound bar or TV.

■ Function

HDMI 1 → HDMI 2 → TV ARC → OPTICAL
 ↑ BLUETOOTH ← USB ← AUDIO IN ↓

Press the INPUT button repeatedly on the sound bar or remote control to select the desired input source.

Note:

The backup function will protect the memorised function mode for a few hours should there be a power failure or the AC power lead becomes disconnected.

■ Auto power on

During the standby mode, the unit will automatically power on if it detects audio signal from AUDIO IN, OPTICAL IN or when the BLUETOOTH connection has been set up between the sound bar and your device.

Note:

This function is not applicable during low power consumption mode (Eco mode on).

■ APC (Auto Power Off Control) (remote control)

This sound bar can be set to turn off automatically if no signal or connection is detected. (During Audio In, HDMI, Optical In or USB function)

1. Select APC from the remote control menu to adjust the time.
2. The sound bar will enter the power standby mode automatically if no signal is detected after the preset time has elapsed.

■ Auto power off function

The unit will enter standby mode if:

Bluetooth:

- No connection for 1 minute.
- In the pause or stop mode and no incoming signal from device according to APC setting.

■ Audio Return Channel (ARC) (Audio Return Channel submenu)

The audio return channel (ARC) function enables an HDMI ARC-capable TV to send the audio stream to the HDMI OUT socket of the receiver. To use this function, you must select the TV ARC input and your TV must supports the ARC.

■ 3D sound mode

3D sound mode creates 3D sound through speakers regardless of the type of sound source, whether it is stereo or multichannel. It simulates sound transmission characteristics using digital signal processing to create a widening effect on the sound in the ambient space around the sound source.

By using this technology, multichannel surround sound can be produced from 2.1ch source.

Select the desired 3D sound from the menu

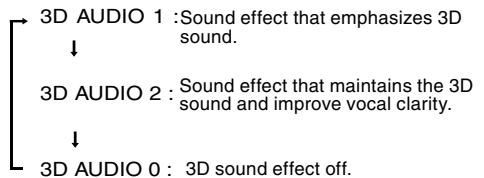

This product incorporates decoders supporting the Dolby Audio system.

Dolby Audio	One of the digital audio systems for theatrical use. You can also enjoy the stereophonic effect in the home theatre system. Dolby logo will be displayed on the remote control when detecting Dolby Audio signal.
PCM (Pulse Code Modulation)	This is a general term for digitally encoded audio signals on a CD or DVD. This sound bar lets you enjoy playback of digital signals from sources such as CD or DVD.

Bluetooth one touch connection via NFC

About NFC technology

Near Field Communication (NFC) is a set of standards for devices (smartphones/tablets) to establish radio communication with each other by touching/tapping them together or bringing them into close proximity.

Using NFC in this product simplifies the pairing method of Bluetooth connectivity.

- This audio system supports NFC-enabled device with Android 4.1, Jelly Bean and higher.
- For device with a lower Android version, refer the operation manual of the device for recommended app (application).

Unlike other wireless technology, NFC requires no discovery or pairing.

Simply tap the source device to the NFC detection area on the sound bar or the NFC tag to instantly enjoy seamless connectivity between your smart device and the audio system.

NFC detection area

NFC detection area location may vary depending on the device (smartphone / tablet). Refer operation manual of the device for detail.

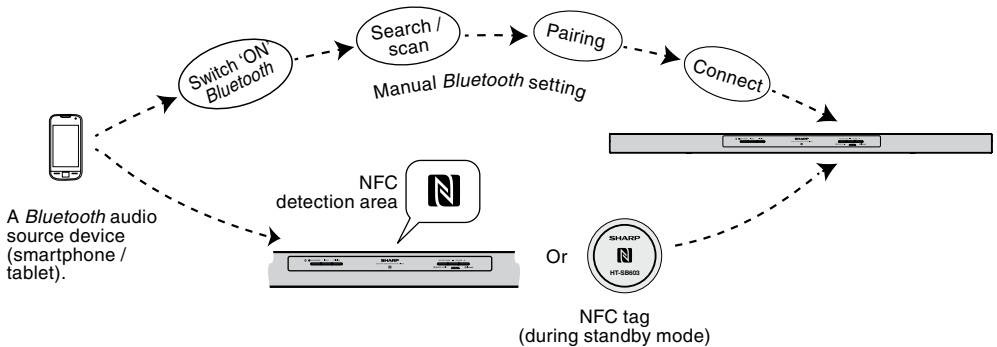

NFC tag set up

The NFC tag can be placed anywhere convenient to you. The velcro tapes supplied will help to secure the tag onto the desired location.

Caution :

- Make sure that the NFC tag is placed on a flat and level surface.
- If you choose not to use the velcro tape, do not place the NFC tag near metal surface to avoid connection interference during tagging.

Important:

- NFC tag provided has unique ID for each sound bar.
- SHARP will not be held liable for the damages caused by rewriting the tags.

Keep all small parts away from children as they may be accidentally swallowed.

- 2 Peel the separator off the velcro tape (hook type) and stick it to the rear of the NFC tag. Then place the tag onto the desired location.

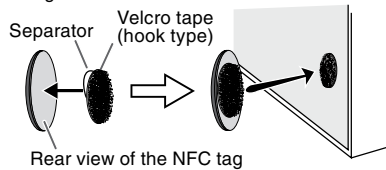

- 1 Peel the separator off the velcro tape (loop type) and stick it on a desired surface.

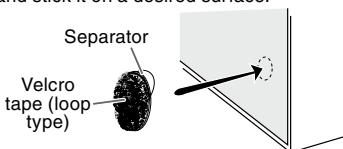

Bluetooth one touch connection via NFC (continued)

■ NFC connection for audio playback

Check that:

- Your device (smartphone / tablet) has an NFC function.
- NFC function on your device is enabled.
- Screen lock function of the device is off.
- This unit is not in low power consumption mode.

- 1 Touch your device to the NFC detection area on the sound bar or supplied NFC tag.

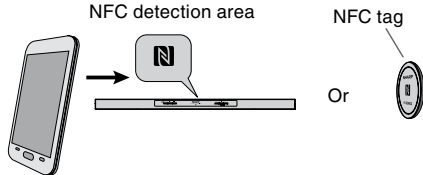

- 2 A pop-up window asking whether to proceed with the *Bluetooth* connection appears on the device. Select <YES>.

- The 'connected' message appears when the connection is complete.

- 3 Playback will start automatically. Otherwise, press play (on remote control or source device).

- Sound will be heard from the speakers of this unit via audio streaming.
- Your device must be within 10 metres (32 feet) from the sound bar.

Bluetooth operation buttons (remote control only)

	Press to play or pause.
	Press to skip up. Press and hold to fast forward.
	Press once to restart the current track. Press twice to skip down. Press and hold to fast reverse.

Notes:

- To disconnect, simply touch your device to the NFC detection area on the sound bar or NFC tag again.
- This product switches to *Bluetooth* function automatically when NFC tagging was done by your device.
- If your device does not support NFC, or if you wish to listen to audio via *Bluetooth* connectivity without NFC tag; refer "**Pairing with other Bluetooth source devices**" on the next page.
- Some *Bluetooth* devices will connect to this product automatically when the device or its *Bluetooth* mode was turned on. In such case, it will also change the function selection of this product. If you do not want it to connect automatically, please disable *Bluetooth* on your device.
- It takes about 6-8 seconds for a *Bluetooth* enabled device (eg. smartphone) to establish *Bluetooth* connection with this unit via NFC or manual connection.
- If "Empty tag" or similar message appears on your device, touch the device again to the NFC detection area on the main unit or supplied NFC tag.

Listening to Bluetooth enabled devices

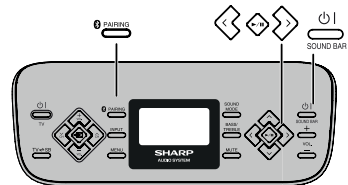

■ Bluetooth

Bluetooth wireless technology is a short-range radio technology that enables wireless communication between various types of digital devices, such as mobile phone or computer. It operates within a range of about 10 metres (32 feet) without the hassle of having to use cables to connect these devices.

This unit supports the following:

Communication System: *Bluetooth* Specification version 2.1 *Bluetooth* + Enhanced Data Rate (EDR).
Support Profile : A2DP (Advanced Audio Distribution Profile) and AVRCP (Audio/Video Remote Control Profile)

Notes when using unit with a mobile phone

- This unit cannot be used to talk over the telephone even when there is a *Bluetooth* connection made to a mobile phone.
- Please refer to the operating manual supplied with the mobile phone for details on operation of your mobile phone while transmitting the sound using a *Bluetooth* connection.

■ Pairing Bluetooth devices

Bluetooth devices need to be initially paired first before they can exchange data. Once paired, it is not necessary to pair them again unless:

- Pairing is made with more than 20 devices. Pairing can only be made one device at a time. This unit can be paired to a maximum of 20 devices. If subsequent device is paired, the oldest device paired, will be deleted and replaced with the new one.
- This unit is reset. All pairing information is deleted when unit is reset.
- Pairing information is deleted while re-pairing, etc.

Listening to *Bluetooth* enabled devices (continued)

Indicators on the sound bar:

Indicator (blue)	<i>Bluetooth</i> status
Blinks	In waiting or pairing mode
Lights up	Connected

However, the indication status is not appeared during standby mode or in other function.

■ Pairing with other *Bluetooth* source devices

- 1 Press the ON/STANDBY button on the sound bar or  SOUND BAR button on the remote control to turn the power on.
- 2 Select the *Bluetooth* function (on the sound bar or remote control). “*BLUETOOTH*” appears on the display.
- 3 Press and hold PAIRING button on the sound bar or remote control for 3 seconds or more. PAIRING indicator blinks quickly. The unit is now in pairing mode and is ready to be paired with other *Bluetooth* source device.

- 4 Within 1 minute, perform pairing procedure on the source device to detect this unit. “HT-SB603 SHARP” will appear in the detected devices list (if available) in the source device. (Refer the source device operating manual for details).

Notes:

- Place the devices to be paired within 1 metre (3 feet) of each other when pairing.
 - Some source devices are unable to display lists of detected devices. To pair this unit with the source device, refer to the source device operating manual for details.
- 5 Select “HT-SB603 SHARP” from the source device list. If Passcode* is required, enter “0000”.
* Passcode may be called PIN Code, Passkey, PIN number or Password.
 - 6 Pairing indicator will light up in blue once the unit is successfully paired with the source device. (Pairing information is now memorised in the unit.) Some audio source devices may connect with the unit automatically after pairing is completed, otherwise follow the instructions in the source device operating manual to start connection.
 - 7 Start *Bluetooth* streaming playback.

Notes:

- If a device such as microwave oven, wireless LAN card, *Bluetooth* device or any other device that uses the same 2.4 GHz frequency is placed near the system some sound interruption may be heard.
- The transmission distance of the wireless signal between the device and the sound bar is about 10 metres (32 feet), but may vary depending on your operating environment. If a steel concrete or metallic wall is between the device and the sound bar, the system may not operate at all, because the wireless signal cannot penetrate metal.
- If this unit or the source device is turned off before *Bluetooth* connection is completed, pairing will not be completed and the pairing information will not be memorised. Repeat step 1 onwards to start pairing again.

- To pair with other devices, repeat steps 1 - 5 for each device. This unit can be paired to a maximum of 20 devices. If subsequent device is paired, the oldest device paired, will be deleted and replaced with the new one.
- Once a device is ousted or deleted from the pairing list, the pairing information for the device is also deleted. To listen to the sound from the device again, it needs to be re-paired. Perform steps 1 - 5 to pair the device again.

■ Listening to the sound

Check that:

- The source device *Bluetooth* functionality is ON.
- Pairing of this unit and the source device is completed.
- Unit is in connected mode.

- 1 Press the ON/STANDBY button on the sound bar or the  SOUND BAR button on the remote control to turn the power on.
- 2 Select the *Bluetooth* function (on the sound bar or remote control).
- 3 Start the *Bluetooth* connection from the *Bluetooth* stereo audio source device.
- 4 Start *Bluetooth* streaming playback.

Notes:

- For various *Bluetooth* operations, refer “NFC connection for audio playback” on page 15.
- If the source device has an extra bass function or equalizer function, set them to off to avoid sound distortion.

Note:

- Make the *Bluetooth* connection again if the source device is not turned on, or its *Bluetooth* functionality is off or is in sleep mode.

■ To disconnect the *Bluetooth* device

Perform any of the followings.

- Disconnect the *Bluetooth* connection on the audio source device. Refer the operating manual supplied with the device.
- Turn off the *Bluetooth* stereo audio source device.
- Turn off this unit.

Note:

The volume of this unit may not be controlled as intended depending on the device.

Listening to USB mass storage device/MP3 player

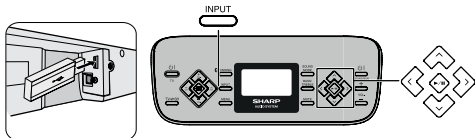

Note:

This product is not compatible with MTP and AAC file systems from USB mass storage device or MP3 player.

To play back USB/MP3 player

- 1 Select the USB function (on the sound bar or remote control). "USB" appears on the display. Connect the USB memory device containing MP3 files.
 - 2 Playback will start automatically. Otherwise press ►/II.
 - 3 Select desired file to be played back by pressing the < or > button.
- Title, Artist and Album name are displayed if they are recorded in the USB memory device.
 - Display content can be changed by pressing the ∨ button.

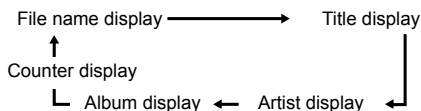

Note:

To pause playback:

Press the ►/II button.

Various USB functions

Function	Remote control	Operation
Track up/down		Press in the playback or pause mode.
Fast forward/reverse		Press and hold down in the playback mode. Release the button to resume playback.

Note:

Fast forward/reverse is invalid when playing back a variable bitrate file.

To remove USB memory device

- 1 Press the ►/II button to pause playback.
- 2 Unplug USB memory device from the USB terminal.

Notes:

- SHARP will not be held liable for the loss of data while the USB memory device is connected to the audio system.
- Files compressed in MP3 format can be played back when connected to the USB terminal.
- This USB memory's format supports FAT 16 or FAT 32.
- SHARP cannot guarantee that all USB memory devices will work on this audio system.

- USB cable is not recommended for use in this audio system to connect to USB memory device. Use of the USB cable will affect the performance of this audio system.
- This USB memory cannot be operated via USB hub.
- The USB terminal in this unit is not intended for a PC connection but is used for music streaming with a USB memory device.
- External HDD-storage cannot be played back via USB terminal.
- If the data inside the USB memory is large, it may take longer time for the data to be read.
- This product can play MP3 files. It will automatically detect the file type being played. If unplayable file is played on this product, the file will be automatically skipped. This will take a few seconds.
- This product relates to USB mass storage devices and MP3 players. It may however face some irregularities due to various unforeseen reasons from some devices. Should this happen, turn off the unit and then turn it on again.
- This unit only supports "MPEG-1 Audio Layer-3" format. (Sampling Frequency is 32, 44.1, 48kHz)
- Playback order for MP3 files may differ depending on the writing software used during file download.
- Bitrate which is supported by MP3 is 32-320 kbps.
- Please put ".MP3" extension. Files cannot be played back if there is no MP3 extension.
- Maximum total number supported for MP3 files is 999. However, it is advisable to playback a media with a small amount of MP3 files to maximise playability.

Repeat play

Repeat play can play one track or all tracks.

To repeat one track:

Press the ^ button repeatedly to select "REPEAT ONE".

To repeat all tracks:

Press the ^ button repeatedly to select "REPEAT ALL".

To cancel repeat play:

Press the ^ button repeatedly to select "NORMAL" and "c↵" disappears.

Caution:

After performing repeat play, be sure to press the ►/II button. Otherwise, the device will play continuously.

Random play

The tracks on the device can be played in random order automatically.

To random play all tracks:

Press the ^ button repeatedly to select "RANDOM".

To cancel random play:

Press the ^ button repeatedly to select "NORMAL".

Notes:

- If you press the > button during random play, you can move to the track selected next by the random operation. On the other hand, the < button does not allow you to move to the previous track. The beginning of the track being played will be located.
- In random play, the unit will select and play tracks automatically. (You cannot select the order of the tracks.).

Troubleshooting chart

Many potential problems can be resolved by the owner without calling a service technician.

If something is wrong with this product, check the following before calling your authorised dealer or service centre.

■ General

Symptom	Possible cause
<ul style="list-style-type: none"> No sound is heard. 	<ul style="list-style-type: none"> The input signal (selection) is not set properly. The volume level is set to "0". Muting is activated. The equipment used with this system is not HDMI compliance. The HDMI cable is not correctly connected. Connect the HDMI cable correctly and then perform the reset procedure. (refer page 19) Do not connect or disconnect an HDMI cable while power is on. This may lead to operation problems.
<ul style="list-style-type: none"> The sound from subwoofer is not well balanced. 	<ul style="list-style-type: none"> The subwoofer level is set to minimum or maximum level.
<ul style="list-style-type: none"> Power turns off suddenly. 	<ul style="list-style-type: none"> The HDMI cable is not correctly connected. Connect it correctly and then perform the reset procedure.
<ul style="list-style-type: none"> Noise is heard during playback. 	<ul style="list-style-type: none"> Move the speaker away from any computers or mobile phones.
<ul style="list-style-type: none"> When a button is pressed, the sound bar does not respond. 	<ul style="list-style-type: none"> Set the sound bar to the standby mode and then turn it back on.
<ul style="list-style-type: none"> The power is not turned on. 	<ul style="list-style-type: none"> The sound bar is unplugged. The protection circuit may be activated. Unplug and plug in the power lead again after 5 minutes or more.
<ul style="list-style-type: none"> 3D images and/ or 4K content not displayed on the TV. 	<ul style="list-style-type: none"> Depending on the TV and Video component, 3D images and 4K content may not be displayed. Check the operation manual of the respective component. HDMI cable not support 3D images and 4K content.
<ul style="list-style-type: none"> Background noise appears when connecting with RCA audio output terminal connection from a TV-set/ DVD/Blu-ray Disc Player. 	<ul style="list-style-type: none"> Please change to HDMI/ARC or headphone terminal from TV-Set/ DVD/Blu-ray Disc Player. This effect may occur depending on TV/DVD/Blu-ray Disc Player-Brand, model and age, and it is not the sound bar problem.
<ul style="list-style-type: none"> Wireless connection cannot be established. 	<ul style="list-style-type: none"> Check the distance between the sound bar and subwoofer (less than 10 metres (32 feet)). Make sure there is no other wireless devices near the unit.

Symptom	Possible cause
<ul style="list-style-type: none"> Wireless connection cannot be established. 	<ul style="list-style-type: none"> Make sure there is no obstacles (especially metal) blocking between the sound bar and subwoofer. Manually re-link the sound bar and subwoofer (refer page 12).

■ Remote control

Symptom	Possible cause
<ul style="list-style-type: none"> The remote control does not operate properly. 	<ul style="list-style-type: none"> The battery polarity is incorrect. The battery is dead. The distance or angle is incorrect. There are obstructions in front of the sound bar. There is a strong light shining on the remote sensor. The remote sensor for another equipment is used simultaneously. The remote control is not connected with the sound bar.
<ul style="list-style-type: none"> The sound bar cannot be turned on with the remote control. 	<ul style="list-style-type: none"> The AC power lead of the sound bar is not plugged in. Battery is not inserted. The remote control is not connected with the sound bar.

■ NFC / Bluetooth

Symptom	Possible cause
<ul style="list-style-type: none"> No sound is heard. 	<ul style="list-style-type: none"> The unit is too far from the <i>Bluetooth</i> stereo audio source device. The unit is not paired with the <i>Bluetooth</i> stereo audio source device.
<ul style="list-style-type: none"> <i>Bluetooth</i> sound is interrupted or distorted. 	<ul style="list-style-type: none"> The unit is too near to a device that generates electromagnetic radiation. There is an obstacle between the unit and the <i>Bluetooth</i> stereo audio source device.
<ul style="list-style-type: none"> NFC-enabled device cannot connect to <i>Bluetooth</i> via NFC. 	<ul style="list-style-type: none"> Sound bar is not in <i>Bluetooth</i> pairing mode. Perform "NFC connection for audio playback" on page 15 or "Pairing with other Bluetooth source devices" on page 16.

■ USB

Symptom	Possible cause
<ul style="list-style-type: none"> Device cannot be detected. Playback does not start. 	<ul style="list-style-type: none"> There is no MP3 file inside the device. The device is not properly plugged in. A MTP device is plugged in. The device contains AAC file only. A false MP3 file is being played back.

Troubleshooting chart (continued)

■ Condensation

Sudden temperature changes, storage or operation in an extremely humid environment may cause condensation inside the cabinet or on the transmitter on the remote control. Condensation can cause the sound bar to malfunction. If this happens, leave the power on until normal playback is possible (about 1 hour). Wipe off any condensation on the transmitter with a soft cloth before operating the sound bar.

■ If problem occurs during operation

When this product is subject to strong external interference (mechanical shock, excessive static electricity, abnormal supply voltage due to lightning, etc.) or if it is operated incorrectly, it may malfunction.

If such a problem occurs, do the following:

1. Set the sound bar to the standby mode and turn the power on again.
2. If the sound bar is not restored in the previous operation, unplug and plug in the sound bar again, and then turn the power on.

■ Factory reset, clearing all memory

Make sure to disconnect all output and input cables attached to the sound bar before performing the factory reset.

1. Press the ON/STANDBY button on the sound bar to enter the power standby mode.
2. While pressing the SOUND MODE button, press the ON/STANDBY button. ON/STANDBY indicator will blink.
3. Press the ON/STANDBY button again.
4. Unplug and plug in the sound bar again (ON/STANDBY indicator will turn red).

Caution:

This operation will erase all data stored in memory.

Maintenance

■ Cleaning the cabinet

Periodically wipe the cabinet with a soft cloth.

Caution:

- Do not use chemicals for cleaning (petrol, paint thinner, etc.). It may damage the cabinet finish.
- Do not apply oil to the inside of each component. It may cause malfunctions.

Error indicators and warnings

When you fail to perform operations properly, the following messages are displayed.

On remote control	Meaning
Reconnecting	● The sound bar is unplugged.

On sound bar	Meaning
 Error indicator (blinks red)	● When the protection circuit is activated.

Note:

Should the same message appear even if the sound bar is unplugged and plugged in, or is set to the standby mode and on again, contact your local dealer where you purchased the sound bar.

Specifications

As part of our policy of continuous improvement, SHARP reserves the right to make design and specification changes for product improvement without prior notice. The performance specification figures indicated are nominal values of production unit. There maybe some deviations from these values in individual unit.

■ Sound Bar

Power source	AC 100 - 240 V ~ 50/60Hz
Power consumption	36 W
Dimensions	Width: 1387 mm Height: 74 mm Depth: 68 mm
Weight	3.7 kg
Output power	MPO: 160 W (80 W + 80 W) (10% T.H.D.) RMS: Total 160 watts RMS: 160 W (80 W + 80 W) (10% T.H.D.) RMS: 120 W (60 W + 60 W) (1% T.H.D.)
Output terminal	HDMI™ output: (audio/video support up to 4K) x 1
Input terminal	500 mV / 47 kΩ (AUDIO IN) Optical digital input (OPTICAL): Square type x 1 HDMI input: (audio/video support up to 4K) x 2
Type	2-Way Speaker system 5.7 cm Woofer 2.5 cm Soft dome
Bluetooth Frequency band	2.400GHz - 2.480GHz
Compatible Bluetooth Profile	A2DP (Advanced Audio Distribution Profile), AVRCP (Audio/Video Remote Control Profile) Bluetooth 4.0 BLE (Remote Control) Bluetooth 2.1 +EDR
Impedance	6 Ω

■ USB (MP3)



USB host interface	<ul style="list-style-type: none"> ● Complies with USB 1.1 (Full Speed)/2.0 Mass Storage Class. ● Support Bulk only and CBI protocol.
---------------------------	---

Support file	● MPEG 1 Layer 3
Bitrate support	● MP3 (32 ~ 320 kbps)
Other	● Maximum total number of MP3 files is 999.
File system support	● Support USB devices with FAT 16/ FAT 32.

■ Subwoofer

Power source	AC 100 - 240 V ~ 50/60 Hz
Power consumption	31 W
Output power	MPO: 150 W (10% T.H.D.) RMS: 150 W (10% T.H.D.) RMS: 120 W (1% T.H.D.)
Type	Subwoofer system 16 cm woofer
Dimensions	Width: 144 mm Height: 432 mm Depth: 306 mm
Weight	6.1 kg

■ Remote Control

Power source	3 V  (AA, UM/SUM-3, R6, HP-7 or similar) x 2 DC IN 5 V  500 mA
---------------------	---