

Original manual | EN

# CB6273

Computerboard

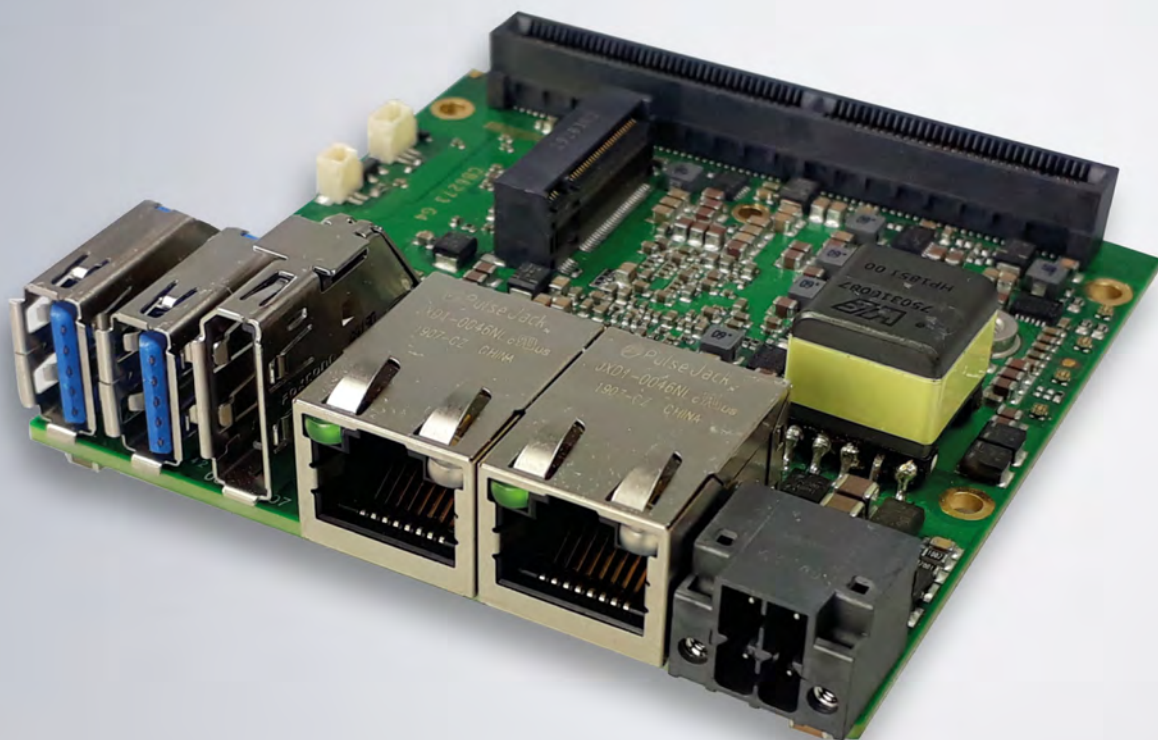



# Table of content

<b>1</b>	<b>Documentation issue status</b> .....	<b>5</b>
<b>2</b>	<b>Notes on the documentation</b> .....	<b>6</b>
<b>3</b>	<b>Safety instructions</b> .....	<b>7</b>
<b>4</b>	<b>Overview</b> .....	<b>9</b>
4.1	Properties .....	9
4.2	List of features .....	10
4.3	Specifications and documents.....	11
<b>5</b>	<b>Detailed description</b> .....	<b>12</b>
5.1	Power supply .....	12
5.2	CPU .....	12
5.3	Memory.....	12
5.4	M.2 socket .....	12
<b>6</b>	<b>Connections</b> .....	<b>13</b>
6.1	Note on the use of cables.....	13
6.2	Plug connections overview .....	13
6.3	List of plug connections .....	14
6.4	External connections .....	15
6.4.1	Front panel: Power supply (X101).....	15
6.4.2	Front panel: LAN (X102, X103).....	16
6.4.3	Front panel: DisplayPort / HDMI / DVI (X104).....	17
6.4.4	Front panel: USB 3.0 (X105, X106).....	18
6.5	Internal connections .....	19
6.5.1	Internal: BeaCon140.....	19
6.5.2	Internal: M.2 (Key B).....	22
6.5.3	Internal: FAN.....	24
6.5.4	Internal: RTC .....	25
<b>7</b>	<b>LEDs G4</b> .....	<b>26</b>
7.1	LED: Power control.....	26
7.2	LED: SATA .....	27
7.3	LED: TwinCAT.....	28
7.4	LED: UPS-OCT.....	29
<b>8</b>	<b>BIOS</b> .....	<b>30</b>
8.1	Using the setup.....	30
8.2	Main CB6273.....	31
8.3	Advanced CB6273.....	32
8.3.1	NIC Configuration .....	34
8.3.2	Driver Health.....	35
8.3.3	Trusted Computing .....	35
8.3.4	ACPI Settings .....	36
8.3.5	Hardware Monitor .....	36
8.3.6	CPU Configuration.....	37
8.3.7	AMI Graphic Output Protocol.....	39

8.3.8	PCI Subsystem Settings .....	40
8.3.9	Power Controller Options.....	42
8.3.10	USB Configuration .....	43
8.3.11	Security Configuration .....	44
8.3.12	SATA Configuration .....	45
8.3.13	Miscellaneous Configuration.....	47
8.3.14	Thermal.....	47
8.3.15	System Component .....	48
8.3.16	Serial Port Console Redirection.....	48
8.4	Chipset CB6273 .....	50
8.4.1	North Bridge.....	51
8.4.2	South Bridge .....	53
8.5	Security CB6273.....	59
8.5.1	Secure Boot.....	60
8.6	Boot CB6273 .....	62
8.6.1	Advanced Fixed Boot Order Parameters.....	64
8.7	Save&Exit CB6273 .....	65
8.8	Bios update.....	66
<b>9</b>	<b>Mechanical drawings.....</b>	<b>67</b>
9.1	PCB: Holes .....	67
9.2	PCB: Dimensions .....	68
<b>10</b>	<b>Technical data.....</b>	<b>69</b>
10.1	Electrical data .....	69
10.2	Environmental conditions .....	69
10.3	Thermal specifications .....	70
<b>11</b>	<b>Support and Service.....</b>	<b>71</b>
11.1	Beckhoff support.....	71
11.2	Beckhoff service .....	71
11.3	Beckhoff headquarters .....	71
<b>12</b>	<b>Appendix I: Post Codes .....</b>	<b>72</b>
<b>13</b>	<b>Appendix II: Resources.....</b>	<b>73</b>
13.1	Interrupt CB6273 .....	73
13.2	PCI Devices CB6273.....	73
13.3	SMB-Devices CB6273.....	73

# 1 Documentation issue status

Version	Changes
0.1	Preliminary version (draft)
0.2	Preliminary version, UPS-OCT, UPS-OCT-LED added, graphics for LEDs changed
0.3	Adaptation of interface designation
0.4	Insulated BAseCon plug connector added
1.0	Final version, new cover page, BeaCon140-plug connector

## 2 Notes on the documentation

This description is only intended for the use of trained specialists in control and automation engineering who are familiar with the applicable national standards.

It is essential that the documentation and the following notes and explanations are followed when installing and commissioning the components.

It is the duty of the technical personnel to use the documentation published at the respective time of each installation and commissioning.

The responsible staff must ensure that the application or use of the products described satisfy all the requirements for safety, including all the relevant laws, regulations, guidelines and standards.

### Disclaimer

The documentation has been prepared with care. The products described are, however, constantly under development.

We reserve the right to revise and change the documentation at any time and without prior announcement.

No claims for the modification of products that have already been supplied may be made on the basis of the data, diagrams and descriptions in this documentation.

### Trademarks

Beckhoff®, TwinCAT®, EtherCAT®, EtherCAT G®, EtherCAT G10®, EtherCAT P®, Safety over EtherCAT®, TwinSAFE®, XFC®, und XTS® and XPlanar®, are registered trademarks of and licensed by Beckhoff Automation GmbH.

Other designations used in this publication may be trademarks whose use by third parties for their own purposes could violate the rights of the owners.

### Patent Pending

The EtherCAT Technology is covered, including but not limited to the following patent applications and patents:

EP1590927, EP1789857, EP1456722, EP2137893, DE102015105702

with corresponding applications or registrations in various other countries.



EtherCAT® is registered trademark and patented technology, licensed by Beckhoff Automation GmbH, Germany

### Copyright

© Beckhoff Automation GmbH & Co. KG, Germany.

The reproduction, distribution and utilization of this document as well as the communication of its contents to others without express authorization are prohibited.

Offenders will be held liable for the payment of damages. All rights reserved in the event of the grant of a patent, utility model or design.

### 3 Safety instructions

#### Safety regulations

Please note the following safety instructions and explanations!  
 Product-specific safety instructions can be found on following pages or in the areas mounting, wiring, commissioning etc.

#### Exclusion of liability

All the components are supplied in particular hardware and software configurations appropriate for the application. Modifications to hardware or software configurations other than those described in the documentation are not permitted, and nullify the liability of Beckhoff Automation GmbH & Co. KG.

#### Personnel qualification

This description is only intended for trained specialists in control, automation and drive engineering who are familiar with the applicable national standards.

#### Description of symbols

In this documentation the following symbols are used with an accompanying safety instruction or note. The safety instructions must be read carefully and followed without fail!

<b>⚠ DANGER</b>
<p><b>Serious risk of injury!</b></p> <p>Failure to follow the safety instructions associated with this symbol directly endangers the life and health of persons.</p>

<b>⚠ WARNING</b>
<p><b>Risk of injury!</b></p> <p>Failure to follow the safety instructions associated with this symbol endangers the life and health of persons.</p>

<b>⚠ CAUTION</b>
<p><b>Personal injuries!</b></p> <p>Failure to follow the safety instructions associated with this symbol can lead to injuries to persons.</p>

<b>NOTE</b>
<p><b>Damage to the environment or devices</b></p> <p>Failure to follow the instructions associated with this symbol can lead to damage to the environment or equipment.</p>



**Tip or pointer**

This symbol indicates information that contributes to better understanding.

	<p><b>UL pointer</b></p> <p>This symbol indicates important information about the UL-certification.</p>
--	---

#### Intended use

The CB6273 Computer Board was designed and developed exclusively for configuration in automation processes. To that end the board is equipped with external interfaces in order to acquire or output digital or analog signals or forward them to higher-level components.

Any other use is regarded as inappropriate.

The specified limits for electrical and technical data must be adhered to.



# 4 Overview

## 4.1 Properties

The CB6273 is conceived as a compact PC. It offers basic functions, on-board RAM and a powerful CPU of the Intel® Processor N- and J-Series (formerly Apollo Lake) in the smallest space.

The CB6273 provides 1x Power, 1x DisplayPort/HDMI, 2x USB3.0, and 2x Gigabit-LAN as I/O interfaces on its front panel.

The BeaCon140 plug enables the flexible extension of the I/O functions of the CB6273. It provides 8 PCIe lanes, of which 4 can be multiplexed with SATA signals and 4 with USB 3.0 signals. The configuration of the I/O functions is taken care of by the PIC on the expansion card, which are communicated to the board upon connection and thus enable an uncomplicated and self-configuring extension of the I/O options.

Further, a Status LED shows the status of the power controller.

Despite its extremely small format, therefore, the CB6273 offers the full functionality of a motherboard.

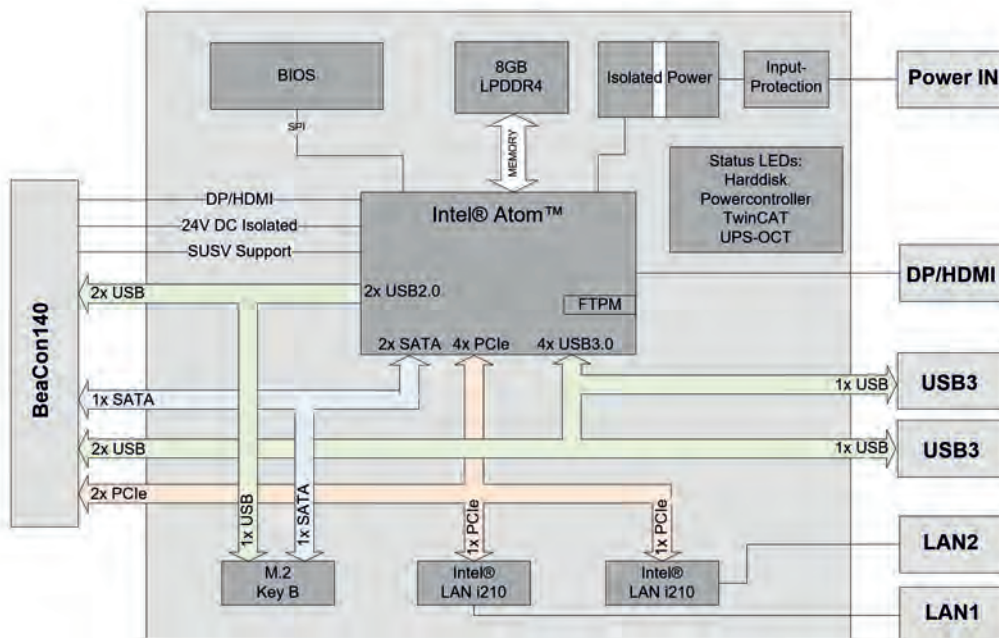

Fig. 1: CB6273 Block diagram-G4

## 4.2 List of features

### ● Availability of the processor



The list of features lists all processors that can be ordered. Their actual availability depends on the manufacturer.

List of features CB6273	
CB6273	75 x 75-Board
CPU	Intel® Atom™ x7-E3950 (QC, 2M, 1,6 GHz), TDP 12 W Intel® Atom™ x5-E3940 (QC, 2M, 1,6 GHz), TDP 9,5 W Intel® Atom™ x5-E3930 (DC, 2M, 1,3 GHz), TDP 6,5 W
Socket	BGA1296
Speicher	OnBoard DRAM-1.1V / LPDDR4 (depending on CPU up to 2400 MHz, up to 8 GB)
I/O Frontpanel	1x Power 1x DisplayPort (connection of HDMI-adapters for a HDMI-signal possible.) 2x LAN 10/100/1000 2x USB 3.0
I/O intern	1x BeaCon140, signals, see: <a href="#">Internal: BeaCon140 [► 19]</a> 1x M.2 (B) socket, signals dependent on chipset, see: <a href="#">Internal: M.2 (Key B) [► 22]</a>
Graphic resolution	HDMI 1.4b: 3840x2160 @ 30 Hz DisplayPort 1.2a/eDP 1.3: 4096x2160 @ 60 Hz MIPI-DSI: 2560x1600 @ 60 Hz
RTC	With external CMOS-Battery (via 2-pin contact strip or expansion card)
BIOS	AMI® Aptio V
Power supply	20 V - 30 V input voltage Overvoltage and undervoltage Reverse polarity protection, UPS-OCT possible
Format	Galvanically isolated

## 4.3 Specifications and documents

The following documents, specifications or webpages were used for the preparation of this manual or as further technical documentation respectively.

### **PCI-Spezifikation**

Version 2.3 bzw. 3.0

[www.pcisig.com](http://www.pcisig.com)

### **PCI Express® Base Specification**

Version 2.0

[www.pcisig.com](http://www.pcisig.com)

### **ACPI-Spezifikation**

Version 3.0

[www.acpi.info](http://www.acpi.info)

### **ATA/ATAPI-Spezifikation**

Version 7 Rev. 1

[www.t13.org](http://www.t13.org)

### **USB-Spezifikationen**

[www.usb.org](http://www.usb.org)

### **SM-Bus-Spezifikation**

Version 2.0

[www.smbus.org](http://www.smbus.org)

### **Intel®-Chipbeschreibungen**

Intel® Atom™ Processor E3900 Product Family datasheet

[www.intel.com](http://www.intel.com)

### **Intel®-Chipbeschreibung**

i210 Datasheet

[www.intel.com](http://www.intel.com)

### **SMSC®-Chipbeschreibung**

SCH3114 Datasheet (NDA erforderlich)

[www.smsc.com](http://www.smsc.com)

### **American Megatrends®**

Aptio™ Text Setup Environment (TSE) User Manual

[www.ami.com](http://www.ami.com)

### **American Megatrends®**

Aptio™ 4.x Status Codes

[www.ami.com](http://www.ami.com)

## 5 Detailed description

### 5.1 Power supply

The board is supplied with an isolated input voltage of nominally 24 V, which in reality may lie between 20 V and 30 V. In normal operation the DC/DC power rail is supplied with this voltage.

An UPS can also be implemented via an OCT signal (OCT = One Cable Technology).



#### UPS-OCT

The UPS-OCT can only be implemented with the Beckhoff CU81XX-xxxx UPS.

---

### 5.2 CPU

The processors employed are System-on-a-Chip models from Intel®. These SoCs are based on processors from the Atom™-E3900-Single-Core family, which are characterized by very low power consumption, but nevertheless offer a contemporary performance with clock rates of currently up to 2 GHz. Despite its extremely small size and low power consumption, the processor offers a second-level cache of 2 MB per and familiar standard features such as SSE4.1/4.2, loadable microcode, etc.

### 5.3 Memory

Four permanently installed DDR4-RAM memory modules are used on the CB6273 board.

Depending on the component variant, these are 2GByte or 4GByte LPDDR4 memory variants. A clock frequency of max. 2133 MHz for the CPUs x5-E39xx and max. 2400 MHz for the CPU x7-E3950 are supported.

### 5.4 M.2 socket

M.2 cards can easily and simply be inserted by plugging them into the slot and fixing them with a screw. Cards of different types have different recesses (keys). Depending on which types are supported, ports can accept expansion cards of one or more types. The M.2 socket of the CB6273 supports M.2 modules with Key B. SATA signals that allow an SSD to be connected are output via the interface.

## 6 Connections

### 6.1 Note on the use of cables

**NOTE**

**Requirement for the cabling!**

The cables used must meet certain requirements for most interfaces. For example, twisted and shielded cables are necessary for a reliable USB 2.0 connection. Limitations in the maximum cable length are also no rarity. All of these interface-specific requirements are to be taken from the respective specifications and observed accordingly.

**NOTE**

**Cable specification for power connector**

The cables for the power connector must be selected with regard to the current consumption, line-cross section, voltage drop, cable length and surrounding.

### 6.2 Plug connections overview

The plug connections of the CB6273 board are summarized in the illustration below. The function of the respective plug connection can be taken from the table below the illustration, as well as the page of the manual on which further information about this connection can be read.

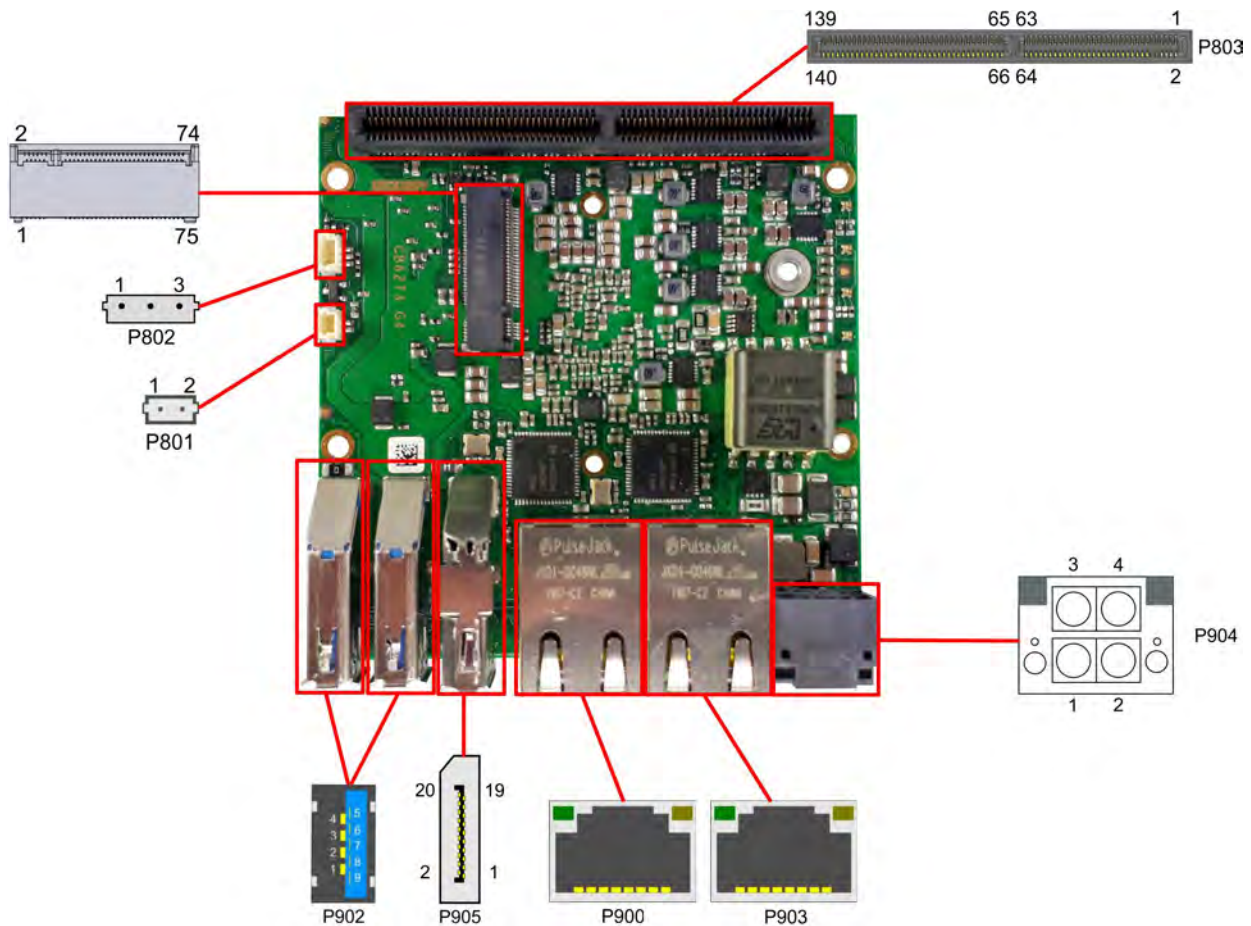

Fig. 2: CB6273 Plug connections overview

## 6.3 List of plug connections

Number	Function (designation)	Page
P904	Vin (X101)	Front panel: Power supply (X101) [ <a href="#">▶ 15</a> ]
P903	LAN 1 (X102)	Front panel: LAN (X102, X103) [ <a href="#">▶ 16</a> ]
P900	LAN 2 (X103)	Front panel: LAN (X102, X103) [ <a href="#">▶ 16</a> ]
P905	DisplayPort (X104)	Front panel: DisplayPort / HDMI / DVI (X104) [ <a href="#">▶ 17</a> ]
P902	USB3.0 (X105, X106)	Front panel: USB 3.0 (X105, X106) [ <a href="#">▶ 18</a> ]
P801	RealTimeClock RTC housing plug (two-pin)	Internal: RTC [ <a href="#">▶ 25</a> ]
P802	Fan connection housing plug (three-pole)	Internal: FAN [ <a href="#">▶ 24</a> ]
P800	M.2 socket	Internal: M.2 (Key B) [ <a href="#">▶ 22</a> ]
P803	BeaCon140	Internal: BeaCon140 [ <a href="#">▶ 19</a> ]



The numbers in brackets correspond to the labeling of the external interfaces on the housing on the front panel of the Industrial PC.



### Order of plugs

The plugs are listed clockwise, starting with the power connection P904.

---

## 6.4 External connections

### 6.4.1 Front panel: Power supply (X101)

The connection for the power supply is implemented as a 2x2-pin housing connector. The main power supply (24 V) for the module is on pin 3. This can also be implemented as UPS-OCT (One Cable Technology), i.e. the signal for the UPS is also transmitted to the board via this cable.



Fig. 3: CB6273 Frontpanel Power

Pin assignment of the power plug:					
Description	Signal	Pin		Signal	Description
PC_On: Input for starting and shutting down the PC. Low (0 V or open contact): PC starts. High (>3 V): PC shuts down.	PC_On	1	3	Vin	24 V supply voltage UPS-OCT is supported.
Power status: Output of the Power Status. The voltage corresponds to the positive supply voltage and can be loaded up to 500 mA. Low (0 V): PC is off. High (Vin): PC is on.	PC_ACTIVE	2	4	GND	Ground

#### ● **Function restrictions PC\_On switch**

**i** Please note that there are system states in which the activation of a connected PC\_On switch is ignored by the system, e.g. during booting of a Windows operating system.

In this case, repeat the operation of the switch after a few seconds.

The same applies to connected PC\_On buttons.

## 6.4.2 Front panel: LAN (X102, X103)

The board has two Gigabit-LAN connections. Network components compatible with 10BaseT, 100BaseT and 1000BaseT can be connected to all of them. The required speed is selected automatically. Auto-Cross and Auto-Negotiate are available as well as PXE and RPL functionality. Controller is Intel®'s i210.

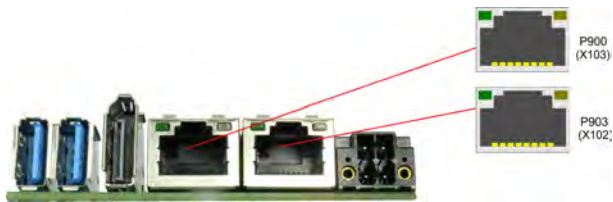

Fig. 4: CB6273 Frontpanel LAN

Pin assignment of LAN connector:		
Pin	Name	Description
1	LAN-0	LAN line 0 +
2	LAN-0#	LAN line 0 -
3	LAN-1	LAN line 1 +
4	LAN-2	LAN line 2 +
5	LAN-2#	LAN line 2 -
6	LAN-1#	LAN line 1 -
7	LAN-3	LAN line 3 +
8	LAN-3#	LAN line 3 -

The LEDs of the LAN interfaces indicate the activity and speed of the data transmission (Mbit/s). The left-hand LED lights up when there is a connection and activity, and the right-hand LED during data transmission:

Left LED Permanent with connection, Flashing during data transmission	Right LED Permanent during data transmission	Mbit/s
Green	Green	1000
Green	Orange	100
Green	None	10



### 6.4.3 Front panel: DisplayPort / HDMI / DVI (X104)

An appropriate standard plug is available for devices with a DisplayPort connection.

The interface additionally provides HDMI/DVI signals that can be used with aid of an adapter. Please consult your distributor with regard to a suitable adapter.

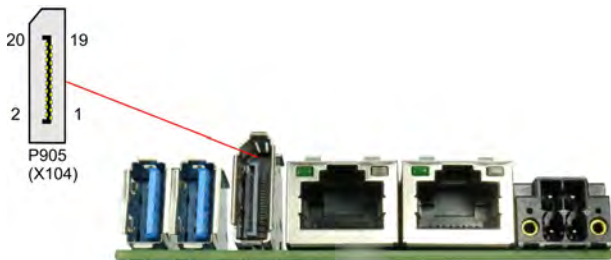

Fig. 5: CB6273 Frontpanel DP

Pin assignment of DisplayPort plug:					
Description	Signal	Pin		Signal	Description
DisplayPort Lane 0 +	L0	1	2	GND	Ground
DisplayPort Lane 0 -	L#0	3	4	L1	Line 1 plus
Ground	GND	5	6	L#1	Line 1 minus
Line 2 plus	L2	7	8	GND	Ground
Line 2 minus	L#2	9	10	L3	Line 3 plus
Ground	GND	11	12	L#3	Line 3 minus
DP / HDMI	HDMI#	13	14	GND	Ground
Auxiliary plus	AUX	15	16	GND	Ground
Auxiliary minus	AUX#	17	18	HPD	Hot Plug Detect
Ground	GND	19	20	3.3 V	3.3 V supply voltage

#### **i** Switching to HDMI

DisplayPort signals are led out via the interface by default. With the use of a level shifter cable the board switches the DisplayPort specification 1.1 automatically to HDMI signals.

### 6.4.4 Front panel: USB 3.0 (X105, X106)

The USB channels 1 and 2 are made available via a standard USB plug connector.

These USB channels support the USB 3.0 specification. Contrary to the specification, the USB 3.0 channel only supplies current up to 500 mA. Devices with their own current supply must be used for higher power demands. The USB interface is electronically fused.

All necessary settings for USB can be made in the BIOS. This applies to both USB interfaces. Note that the "USB mouse and keyboard" function in the BIOS setup is only required if the operating system does not offer USB support. This function should not be selected for settings in the setup and for booting Windows with a USB mouse and keyboard connected, because this would lead to considerable performance limitations.



Fig. 6: CB6273 Frontpanel USB

Pin assignment of USB 3.0 connector:		
Pin	Signal	Description
1	VCC	5 V supply voltage
2	D-	Data - (USB 2.0)
3	D+	Data + (USB 2.0)
4	GND	Ground
5	RX-	Receive line - (USB 3.0)
6	RX+	Receive line + (USB 3.0)
7	GND	Ground
8	TX-	Transmit line - (USB 3.0)
9	TX+	Transmit line + (USB 3.0)

## 6.5 Internal connections

### 6.5.1 Internal: BeaCon140

The BeaCon140 plug connector (Samtec HSEC-170-01-L-DV-A-K-TR) enables the flexible extension of the IO functions of the CB6273. It provides up to 8 PCIe lanes, of which 4 can be multiplexed with SATA2.0 (3G) signals and 4 with USB 3.0 signals. In addition, DisplayPort, HSIC, SMBus and 1Wire signals are fed out via the BeaCon plug connector. The extension board takes care of the configuration of the IO functions. A PIC on the expansion card contains the configuration data, which are communicated to the board upon connection and thus enable an uncomplicated and self-configuring extension of the I/O options.

**● Observe the current limits!**



In order to avoid damaging the device, it is essential to observe the following current limits:

A maximum load of 2.8 A per pin must not be exceeded. On account of the different current consumptions of the usable processors the actual current consumption may be lower. The respective maximum values can be obtained from your distributor on inquiry.

Irrespective of the CPU in use, a maximum total load of 100 W must not be exceeded.

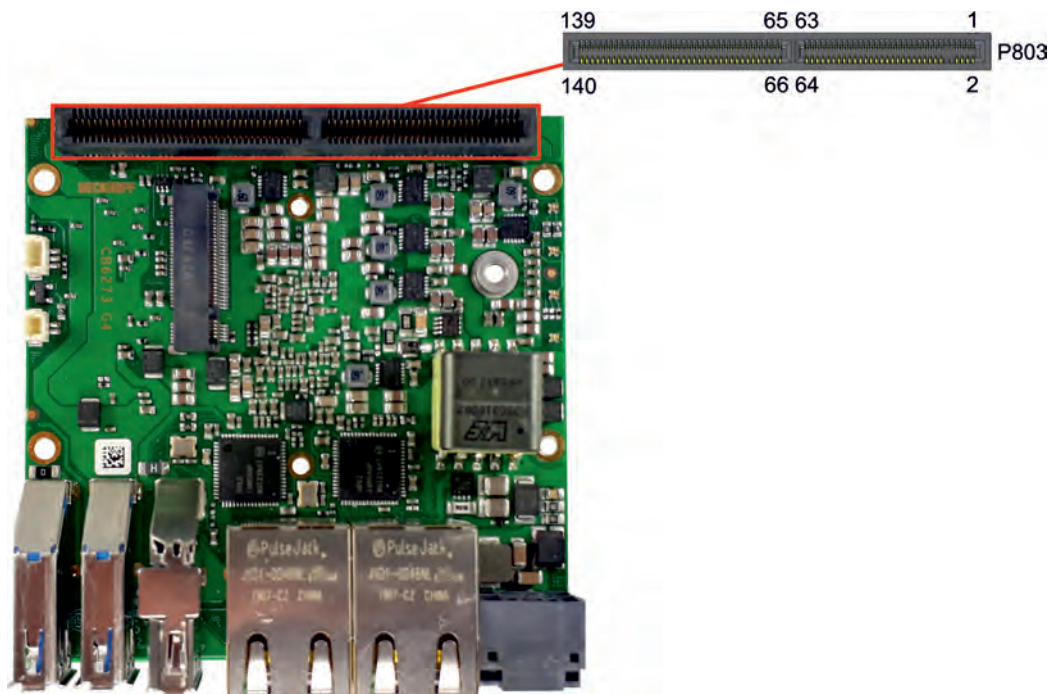

Fig. 7: CB6273 BeaCon140-G4

Pin assignment of BeaCon140 connector:					
Description	Signal	Pin		Signal	Description
P_VLoad 24 V S UPS output	VOLOAD/ P_VOLOAD1	1	2	P_VIN1/VIN1	V_IN S UPS input
P_VLoad 24 V S UPS output	VOLOAD/ P_VOLOAD2	3	4	P_VIN2/VIN2	P_VIN S UPS input
(not led out)	5V/NC	5	6	P_GND/GND	Ground
(not led out)	5V/NC	7	8	P_GND/GND	Ground
<b>INSULATION</b>					
Standby 5 Volt	S5V	13	14	S3.3 V	Standby 3.3 V
Ground	GND	15	16	GND	Ground
PCIe Lane 1 Transmit +	PE1/SATA4-TX	17	18	RX-SATA4/PE1	PCIe Lane 1 Receive +
PCIe Lane 1 Transmit -	PE1/SATA4-TX#	19	20	RX-SATA4/PE1#	PCIe Lane 1 Receive -
Ground	GND	21	22	GND	Ground
PCIe Clock Lane 1 +	PECLK1	23	24	PECLK2	PCIe Clock Lane 2 +
PCIe Clock Lane 1 -	PECLK1#	25	26	PECLK2#	PCIe Clock Lane 2 -
Ground	GND	27	28	GND	Ground
PCI Lane 2 Transmit +	PE2/SATA3-TX	29	30	RX-SATA3/PE2	PCIe Lane 2 Receive
PCI Lane 2 Transmit -	PE2/SATA3-TX#	31	32	RX-SATA3/PE2#	PCIe Lane 2 Receive -
Ground	GND	33	34	GND	Ground
PCIe Lane 3 Transmit +	PE3/SATA2-TX	35	36	RX-SATA2/PE3	PCIe Lane 3 Receive +
PCIe Lane 3 Transmit -	PE3/SATA2-TX#	37	38	RX-SATA2/PE3#	PCIe Lane 3 Receive -
Ground	GND	39	40	GND	Ground
PCIe Lane 3 Clock +	PECLK3	41	42	PECLK4	PCIe Clock 4 +
PCIe Lane 3 Clock 3 -	PECLK3#	43	44	PECLK4#	PCIe Clock 4 -
Ground	GND	45	46	GND	Ground
PCIe Lane 4 Transmit +	PE4/SATA1-TX	47	48	RX-SATA1/PE4	PCIe Lane 4 Receive +
PCIe Lane 4 Transmit -	PE4/SATA1-TX#	49	50	RX-SATA1/PE4#	PCIe Lane 4 Receive -
Ground	GND	51	52	GND	Ground
PCIe Clock Enable Lane 1 active low	PCKE1/DEVSLP4#	53	54	DEVSLP3/PCKE2#	PCIe Lane 2 Clock Enable active low
PCIe Clock Enable Lane 3 -	PCKE3/DEVSLP2#	55	56	DEVSLP1/PCKE4#	PCIe Lane 4 Clock Enable -
PCIe Reset active low	PERST#	57	58	PEWAKE#	PCIe Wake active low
SMBus Clock	SMBCLK	59	60	SMBDAT	SMBus Data
<b>KEY</b>					
SMBus Alert active low	SMB-Alert#	61	62	1Wire	1-Wire
PCIe Clock Enable Lane 5	PCKE5/OC4#	63	64	OC3/PCKE6#	PCIe Lane 6 Clock Enable 6 -
<b>KEY</b>					
PCIe Clock Enable Lane 7	PCKE7/OC2#	65	66	OC1/PCKE8#	USB Overcurrent active low
Ground	GND	67	68	GND	Ground
PCIe Lane 5 Transmit +	PE5/USB3-4/ USBC1-TX	69	70	RX-USBC1/ USB3-4/PE5	PCIe Lane 5 Receive +
PCIe Lane 5 Transmit -	PE5/USB3-4/ USBC1-TX#	71	72	RX-USBC1/ USB3-4/PE5#	PCIe Lane 5 Receive -

Pin assignment of BeaCon140 connector:					
Description	Signal	Pin		Signal	Description
USB 2.0 Channel 7 +	USB2-4#/(GND)	73	74	USB2-3/(GND)	USB 2.0 channel 8 Data +
PCIe Clock Lane 5 +	PECLK5/ USBC-SBU1/ (GND)	75	76	PECLK6/(GND)	PCIe Lane 6 Clock +
PCIe Clock 5 -	PECLK5/ USBC-SBU2#/ (GND)	77	78	PECLK6#/(GND)	PCIe Clock Lane 6 -
USB 2.0 Channel 7 -	USB2-4#/(GND)	79	80	USB2-3 D#/(GND)	USB 2.0 channel 8
(not led out)	PE6/USB3-3/ USBC2-TX	81	82	RX-USBC2/ USB3-3/PE6	(not led out)
(not led out)	PE6/USB3-3-TX/ USBC2-TX#	83	84	RX-USBC2/ USB3-3/PE6#	(not led out)
Ground	GND	85	86	GND	Ground
PCIe Lane 7 Transmit +	PE7/USB3-2-TX	87	88	RX-USB3-2/PE7	PCIe Lane 7 Receive +
PCIe Lane 7 Transmit -	PE7/USB3-2-TX#	89	90	RX-USB3-2/PE7#	PCIe Lane 7 Receive -
USB 2.0 Channel 9 +	USB2-2 (GND)	91	92	USB2-1/(GND)	USB 2.0 Channel 10 +
PCIe Lane 8 Transmit +	PECLK7/(GND)	93	94	PECLK8/(GND)	PCIe Lane 8 Clock +
PCIe Lane 8 Transmit -	PECLK7#/(GND)	95	96	PECLK8#/(GND)	PCIe Clock Lane 8 -
USB 2.0 Channel 9 -	USB2-2#/(GND)	97	98	USB2-1#/(GND)	USB 2.0 Channel 10 -
PCIe Lane 8 Transmit +	PE8/USB3-1-TX	99	100	RX-USB3-1/PE8	PCIe Lane 8 Receive +
PCIe Lane 8 Transmit -	PE8/USB3-1-TX#	101	102	RX-USB3-1/PE8#	PCIe Lane 8 Receive -
Ground	GND	103	104	GND	Ground
KEY					
SATA GP1	SATAGP1	105	106	SATAGP2	SATA GP 2
(not led out)	SATAGP3/ USBC-CC1	107	108	USB-CC2/ SATAGP4/	(not led out)
TwinCAT LED Red	TCLEDR	109	110	TCLEDG	TwinCAT LED Green
TwinCAT LED Blue	TCLEDB	111	112	RES	LAN-Sync
SATA LED active low	SATA-LED	113	114	USBPWREN	USB Power Enable
RTC Battery	BATT	115	116	PWRFAIL	SUSV
Power Management Event active low	PME#	117	118	PWRGOOD	Power good
Power button active low	PWRBTN#	119	120	MRST#	Reset button active low
PSON	PSON	121	122	ATXPWRGD	ATX Power good
Ground	GND	123	124	GND	Ground
DisplayPort -/ HDMI D	DP#/DVI	125	126	DDCC/ DPAUX	DDC Clock / DisplayPort Aux +
DisplayPort Hot Plug Detect	DPPHD	127	128	DDCD/ DPAUX#	DDC Data / DisplayPort Aux -
Ground	GND	129	130	GND	Ground
DisplayPort Lane 0 +	DPL0/TMDSD2	131	132	TMDSD1/DPL1	DisplayPort Lane 1+
DisplayPort Lane 0 -	DPL0/TMDSD2#	133	134	TMDSD1DPL1#	DisplayPort Lane 1 -
Ground	GND	135	136	GND	Ground
DisplayPort Lane 2+	DPL2/TMDS0	137	138	TMDSD3/DPL3	DisplayPort Lane 3 +
DisplayPort Lane 2 -	DPL2/FMDS0#	139	140	TMDSD3/DPL3#	DisplayPort Lane 3 -

## 6.5.2 Internal: M.2 (Key B)

The CB6273 is equipped with an M.2 socket, into which a M.2-2242 card (Key B) can be inserted. SATA signals (up to 3 GB/s), which enable the connection of an M.2-SSD card, are led out via this socket.

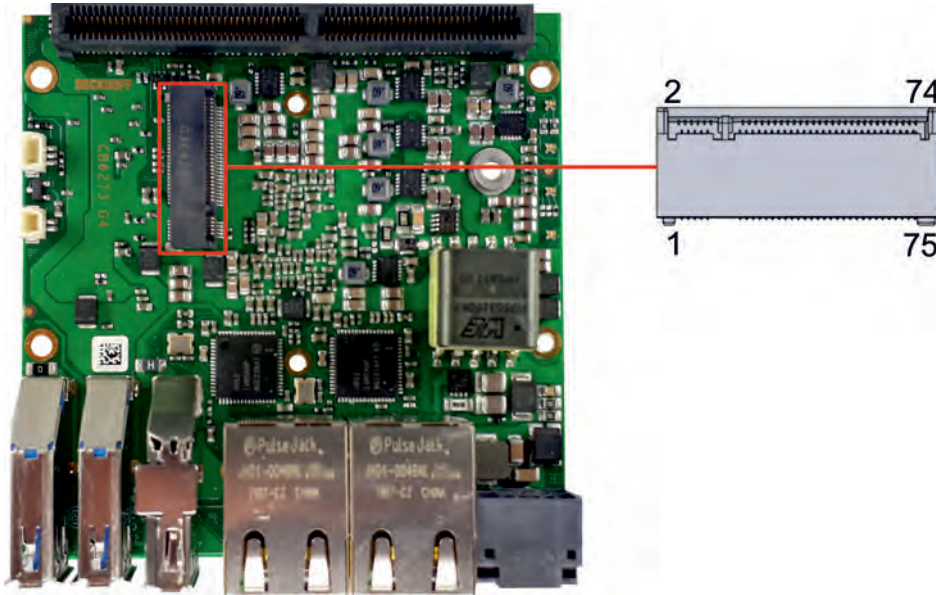

Fig. 8: CB6273 M.2 Key B

Pin assignment M.2 connector (Key B)					
Description	Signal	Pin		Signal	Description
Configuration pin	CONFIG_3	1	2	3.3 V1	Standby S3.3 Volt
Ground	GND	3	4	3.3 V2	Standby S3.3 Volt
Ground	GND	5	6	FCPWROFF#	Full Card Power OFF active low
USB data +	USB D+	7	8	WDISABLE#	(not led out)
USB data -	USB D-	9	10	GPIO9/DAS/DDS/LED1	(not led out)
Ground	GND	11	12	Connector Key	
Connector Key		13	14		
		15	16		
		17	18		
		19	20	GPIO5	(not led out)
Configuration pin	Config 0	21	22	GPIO6	(not led out)
(not led out)	GPIO11	23	24	GPIO7	(not led out)
(not led out)	DPR	25	26	GPIO10	(not led out)
Ground	GND	27	28	GPIO8	(not led out)
PCIe Lane 2 Receive -	PER1-USB3RX-SSICRX#	29	30	UIM RST	(not led out)
PCIe Lane 2 Receive +	PER1-USB3RX-SSICRX	31	32	UIM CLK	(not led out)
Ground	GND	33	34	UIM DATA	(not led out)
PCIe Lane 2 Transmit -	PET1-USB3TX-SSICTX#	35	36	UIM PWR	(not led out)
PCIe Lane 2 Transmit +	PET1-USB3TX-SSICTX	37	38	DEVSLP	DeviceSleep
Ground	GND	39	40	GPIO0	(not led out)
PCIe Lane 1 Receive +	PER0-SATAB	41	42	GPIO1	(not led out)
PCIe Lane 1 Receive -	PER0-SATAB#	43	44	GPIO2	(not led out)
Ground	GND	45	46	GPIO3	(not led out)
PCIe Lane 1 Transmit -	PET0-SATAA#	47	48	GPIO4	(not led out)
PCIe Lane 1 Transmit +	PET-SATAA	49	50	PRST#	PCIe Reset active low
Ground	GND	51	52	CLKREQ#	PCIe Clock Enable active low
PCIe Lane 1 Reference Clock -	REFCLK#	53	54	PEWAKE#	Link Reactivation active low
PCIe Lane 1 Reference Clock +	REFCLK	55	56	N/C	(not led out)
Ground	GND	57	58	N/C	(not led out)
(not led out)	ANTCTL0	59	60	COEX3	(not led out)
(not led out)	ANTCTL1	61	62	COEX2	(not led out)
(not led out)	ANTCTL2	63	64	COEX1	(not led out)
(not led out)	ANTCTL3	65	66	SIM DETECT	(not led out)
Power good	RESET#	67	68	SUSCLK	System clock
Configuration pin	CFG1	69	70	3.3 V	Standby S3.3 Volt
Ground	GND	71	72	3.3 V	Standby S3.3 Volt
Ground	GND	73	74	3.3 V	Standby S3.3 Volt
Configuration pin	CFG2	75			

### 6.5.3 Internal: FAN

The CB6273 has a 3-pin fan connection (JST BM03B-SRSS-TBT(LF)-(SN)). This enables a fan with a supply voltage of 5 V to be connected directly to the module. The connection has a speed monitoring function. The connected fan must supply a corresponding tachometer signal if this is to be used.

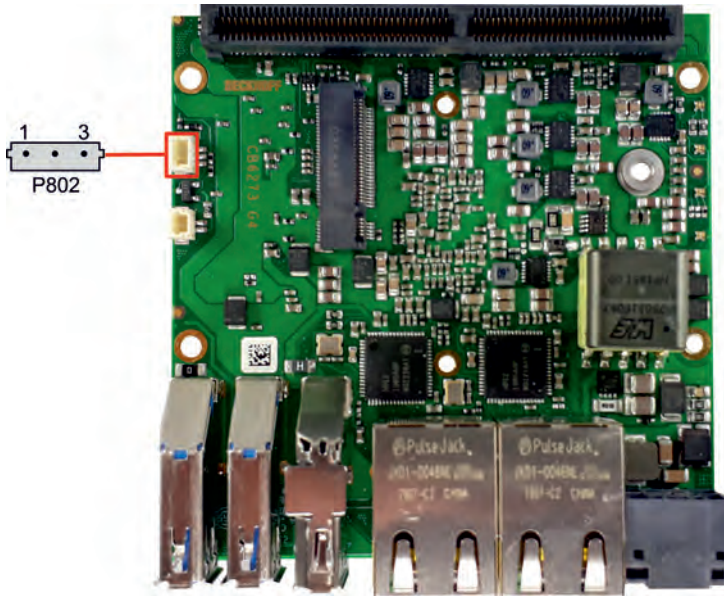



Fig. 9: CB6273 FAN-G4

Pin assignment of fan connector:		
Pin	Signal	Description
1	GND	Ground
2	5 V	Supply voltage 5 V regulated
3	TACHO	Speed monitoring



### 6.5.4 Internal: RTC

The CB6273 can be connected to an external RTC battery via a two-pin housing plug (JST BM02B-SRSS-TBT(LP)(SN) to provide power to the integrated clock even if there is no power supply. The battery voltage must not exceed 3.3 V.

	<p><b>UL conformity</b></p>
<p>All technical measures for UL conformity are already integrated on the board. Accordingly, no additional actions are necessary for the connection of an RTC battery. The battery must be connected directly.</p>	

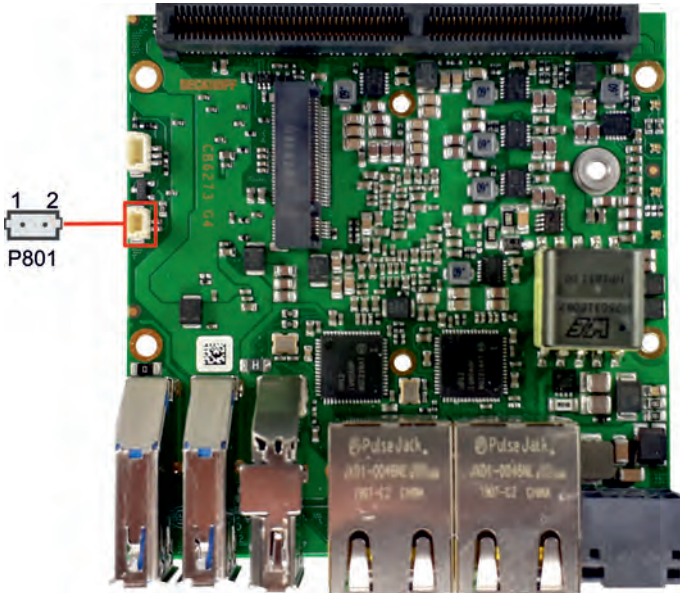

Fig. 10: CB6273 RTC-G4

● **Synchronism of the RTC**

**i** The quartz of the RTC reacts to temperature fluctuations. Therefore, correct synchronism of the RTC is possible only with suitable and sufficient cooling!

Pin assignment RTC battery plug:		
Pin	Name	Description
1	BATT	3.3 V battery voltage
2	GND	Ground

## 7 LEDs G4

### 7.1 LED: Power control

There is an RGB LED on the board with which status messages of the power controller are output by means of colors and flashing intervals.

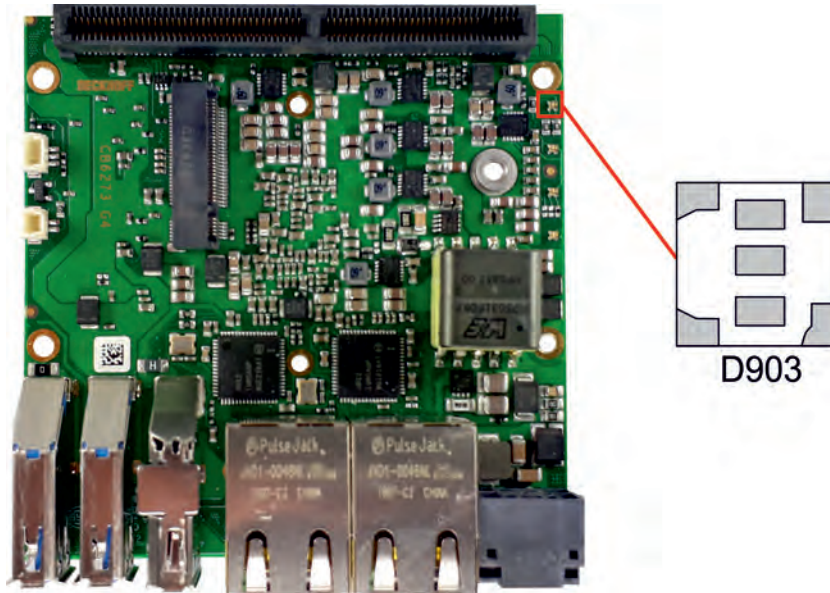

Fig. 11: CB6273 Powercontrol-LED

Color	Interval	Meaning
None	Steadily lit	System in error state
White	Steadily lit	Power fail
Cyan	Steadily lit	Reserved
Magenta	Steadily lit	S UPS active (if existent)
Blue	Steadily lit	Reserved
Yellow	Steadily lit	S5 state
Green	Steadily lit	S0 state
Red	Steadily lit	Reset/Start
Green/yellow	Flashing	Bootloader running without error
Red/yellow	Flashing	Bootloader is starting (start sequence is being run through)
Yellow	Flashing (6 s)	S4 state
Yellow	Flashing (3 s)	S3 state
Magenta	Flashing (0.5 s)	S UPS capacitance test (if S UPS exists)
Red/magenta	Flashing	Checksum error during I <sup>2</sup> C transmission in the boot loader

A steadily lit red LED can indicate a hardware error.

#### ● Adaptation of the status codes

**i** It is possible to adapt the status codes (e.g. as TwinCAT LED). To do this, the system colors can be changed with the aid of an SMB command. This change remains in force until the next restart or reset. A change of the default colors is indicated by the additional flashing of the white LED.

## 7.2 LED: SATA

A further RGB-LED indicates the hard disk activity.

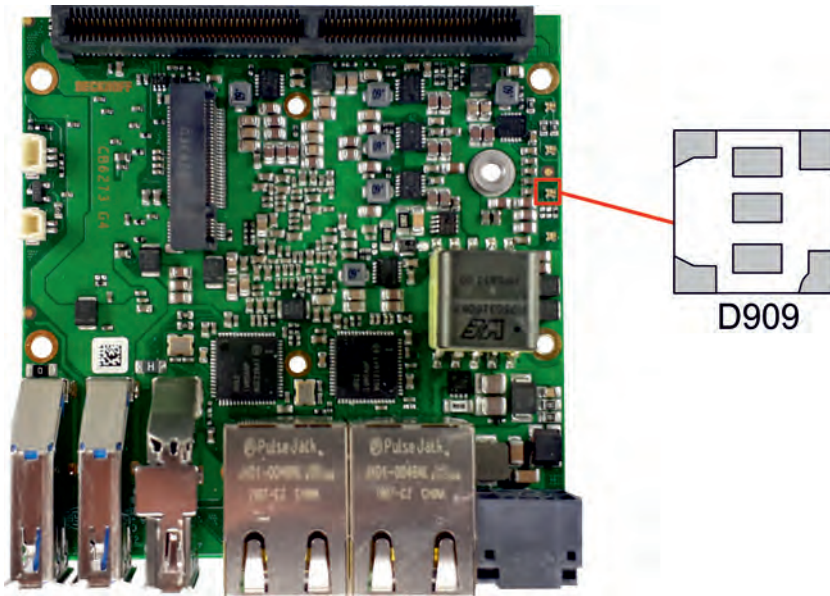

Fig. 12: CB6273 SATA-LED

Color	Interval	Meaning
Red	Flashing	Activity (access)

## 7.3 LED: TwinCAT

This RGB LED indicates the status of TwinCAT activity.

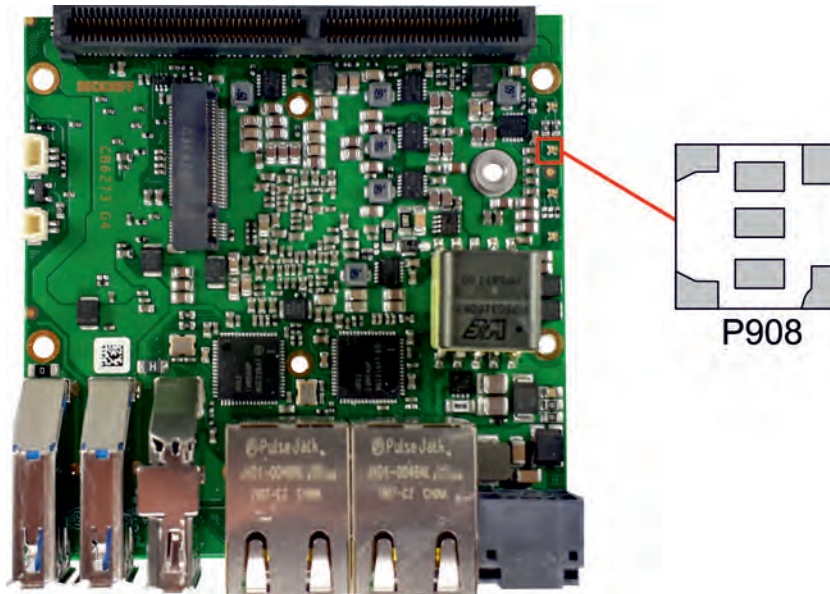

Fig. 13: CB6273 TwinCAT-LED

Color	Interval	Meaning
Green	Steadily lit	TwinCAT Run Mode
Blue	Steadily lit	TwinCAT Config Mode
Red	Steadily lit	TwinCAT Stop

## 7.4 LED: UPS-OCT

A RGB LED on the board indicates the status of the OCT interface via colors and flashing intervals.

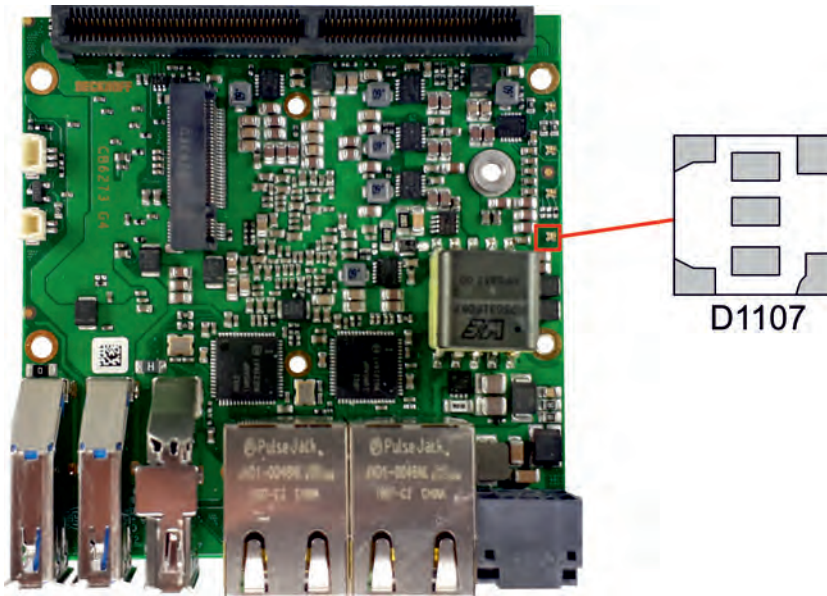

Fig. 14: CB6273 UPS-OCT-LED

Color	Interval	Meaning
None	Steadily lit	No UPS-OCT connected
Blue	Flashing	Boot loader active
Yellow	Flashing	Moderate signal quality
Green	Flashing	Good signal quality
Red	Flashing	Poor signal quality

If the LED is not lit, no UPS-OCT is connected.

### ● Adaptation of the status codes

**i** It is possible to adapt the status codes (e.g. as UPS-OCT-LED). To do this, the system colors can be changed with the aid of an SMB command. This change remains in force until the next restart or reset.

## 8 BIOS

### 8.1 Using the setup

Within the individual setup pages the last saved settings can be restored can at any time with F2 ("Previous Values"). Use F3 ("Optimized Defaults") to load the factory defaults. Use F2/F3 to load the complete set of settings and F4 to save them ("Save & Exit").

A "▶" sign in front of the menu item indicates that a submenu is available. Use the arrow keys to navigate between menu items. Use the Enter key to select menu items and call submenus or selection dialogs.

For each setup option a help text is displayed at the top right, which in many cases contains useful information about the option and permitted values, etc.

---

#### **Note on Setup Documentation**

**i** The BIOS is regularly updated so that the available setup options can change at any time without notice. This may result in differences between the options actually available and those described below. It should also be noted that the settings shown in the setup menus below are not necessarily the recommended or default settings. Which settings must be selected depends on the application scenario in which the board is operated.

---

## 8.2 Main CB6273

Aptio Setup Utility - Copyright (C) 2020 American Megatrends, Inc.

**Main** Advanced Chipset Security Boot Save & Exit

<pre> Board Information Board                      CB6273 Revision                   2 Bios Version               0.39  Platform Information Intel(R) Atom(TM) Processor E3930 @ 1.30GHz CPU Signature              506CA CPU Stepping               E0 Microcode Patch           8 MRC Version                0.56 PMC FW                     03.29 TXE FW                     3.1.50.2238 GOP                        10.0.1036  Memory Information Total Memory               8192 MB Memory Speed               2133 MHz  System Date                 [Sun 01/01/2012] System Time                 [03:03:08]                 </pre>	<p>Set the Date. Use Tab to switch between Date elements.                  Default Ranges:                  Year: 2005-2099                  Months: 1-12                  Days: dependent on month</p> <p>Set the Time. Use Tab to switch between Time elements.</p> <hr/> <p>←: Select Screen                  ↑↓: Select Item                  Enter: Select                  +/-: Change Opt.                  F1: General Help                  F2: Previous Values                  F3: Optimized Defaults                  F4: Save &amp; Reset                  ESC: Exit</p>
---	---

Version 2.18.1263. Copyright (C) 2020 American Megatrends, Inc.

Bios-Entry	Options
Board	None
Revision	None
Bios Version	None
Platform Information	
Intel(R) Atom(TM) Processor E3930 @ 1.30GHz	
CPU Signature	None
CPU Stepping	None
Microcode Patch	None
MRC Version	None
PMC FW	None
TXE FW	None
GOP	None
Memory Information	
Total Memory	None
Memory Speed	None
System Date	Set here the system date
System Time	Set here the system time

### 8.3 Advanced CB6273

Aptio Setup Utility - Copyright (C) 2020 American Megatrends, Inc.  
 Main **Advanced** Chipset Security Boot Save & Exit

<pre> Power-Supply Type                [ATX] SoftOff on Overheat              [Disabled] Show postcode on screen          [Disabled] ▶Intel(R) I210 Gigabit Network Connection - 00:01:05:3F:4B:C4: ▶Intel(R) I210 Gigabit Network Connection - 00:01:05:3F:4B:C3 ▶Intel(R) I210 Gigabit Network Connection - 00:01:05:3F:4B:C2 ▶Driver Health ▶Trusted Computing ▶ACPI Settings ▶Hardware Monitor ▶Serial Port Console Redirection ▶CPU Configuration ▶AMI Graphic Output Protocol Policy ▶PCI Subsystem Settings ▶Network Stack Configuration ▶Power Controller Options ▶NVMe Configuration ▶USB Configuration ▶Security Configuration ▶SATA Configuration ▶Miscellaneous Configuration ▶Thermal ▶System Component                 </pre>	<pre> Select the Type of the Power Supply: AT/ATX  -----: Select Screen ↑↓: Select Item Enter: Select +/-: Change Opt. F1: General Help F2: Previous Values F3: Optimized Defaults F4: Save &amp; Reset ESC: Exit                 </pre>
---	--

Version 2.18.1263. Copyright (C) 2020 American Megatrends, Inc.



Bios-Entry	Options
Advanced	
Power-Supply Type [ATX]	ATX / AT
SoftOff on Overheat [Disabled]	Disabled/Enabled
Show postcode on screen [Disabled]	Disabled/Enabled
▶ Intel(R) I210 Gigabit Network Connection - 00:01:05: 3F:4B:C4	Submenu: see <a href="#">NIC Configuration [▶ 34]</a>
▶ Intel(R) I210 Gigabit Network Connection - 00:01:05: 3F:4B:C3	Submenu: see <a href="#">NIC Configuration [▶ 34]</a>
▶ Intel(R) I210 Gigabit Network Connection - 00:01:05: 3F:4B:C2	Submenu: see <a href="#">NIC Configuration [▶ 34]</a>
▶ Driver Health	Submenu: see <a href="#">Driver Health [▶ 35]</a>
▶ Trusted Computing	Submenu: see <a href="#">Trusted Computing [▶ 35]</a>
▶ ACPI Settings	Enabled/Disabled
▶ Hardware Monitor	Submenu: see <a href="#">Hardware Monitor [▶ 36]</a>
▶ Serial Port Console Redirection	Submenu: see <a href="#">Serial Port Console Redirection [▶ 48]</a>
▶ CPU Configuration	Submenu: see <a href="#">CPU Configuration [▶ 37]</a>
▶ AMI Graphic Output Protocol Policy	Submenu: see <a href="#">AMI Graphic Output Protocol [▶ 39]</a>
▶ PCI Subsystem Settings	Submenu: see <a href="#">PCI Subsystem Settings [▶ 40]</a>
▶ Network Stack Configuration	Disabled/Enabled
▶ Power Controller Options	Submenu: see <a href="#">Power Controller Options [▶ 42]</a>
▶ NVMe Configuration	No NVME Device Found
▶ USB Configuration	Submenu: see <a href="#">USB Configuration [▶ 43]</a>
▶ Security Configuration	Submenu: see <a href="#">Security Configuration [▶ 44]</a>
▶ SATA Configuration	Submenu: see <a href="#">SATA Configuration [▶ 45]</a>
▶ Miscellaneous Configuration	Submenu: see <a href="#">Miscellaneous Configuration [▶ 47]</a>
▶ Thermal	Submenu: see <a href="#">Thermal [▶ 47]</a>
▶ System Component	Submenu: see <a href="#">System Component [▶ 48]</a>

### 8.3.1 NIC Configuration

Aptio Setup Utility - Copyright (C) 2020 American Megatrends, Inc.  
**Advanced**

<p>▶NIC Configuration</p> <p>Blink LEDs 0</p> <p>UEFI Driver Intel(R) PRO/1000 Ope...</p> <p>Device Name Intel(R) I210 Gigabit...</p> <p>Chip Type Intel i210</p> <p>PCI Device ID 1533</p> <p>PCI Address 01:00:00</p> <p>Link Status [Disconnected]</p> <p>MAC Address 00:01:05:3D:00:13</p> <p>Virtual MAC Address 00:00:00:00:00:00</p>	<p>Click to configure the network device port.</p> <hr/> <p>←: Select Screen ↑↓: Select Item Enter: Select +/-: Change Opt. F1: General Help F2: Previous Values F3: Optimized Defaults F4: Save &amp; Reset ESC: Exit</p>
---	--

Version 2.18.1263. Copyright (C) 2020 American Megatrends, Inc.

Bios-Entry	Options
▶NIC Configuration	Link Speed Input
Blink LEDs	None
UEFI Driver	None
Device Name	None
Chip Type	None
PCI Device ID	None
PCI Address	None
Link Status	None
MAC Address	None
Virtual MAC Address	None

### 8.3.2 Driver Health

Aptio Setup Utility - Copyright (C) 2020 American Megatrends, Inc.  
**Advanced**

Intel(R) PRO/1000 Open Source 8.3.10 PCI-E	Healthy	Provides Health Status for the Drivers/Controllers
		←: Select Screen ↑↓: Select Item Enter: Select +/ : Change Opt. F1: General Help F2: Previous Values F3: Optimized Defaults F4: Save & Reset ESC: Exit

Version 2.18.1263. Copyright (C) 2020 American Megatrends, Inc.

Bios-Entry	Options
Intel(R) PRO/1000 Open Source 8.3.10 PCI-E	None

### 8.3.3 Trusted Computing

Aptio Setup Utility - Copyright (C) 2020 American Megatrends, Inc.  
**Advanced**

Configuration Security Device Support [Disable] NO Security Device Found	Enables or Disables BIOS support for security device. O.S. will not show Security Device. TCG EFI protocol and INT1A interface will not be available.
↑↓: Select Screen ←: Select Item Enter: Select +/ : Change Opt. F1: General Help F2: Previous Values F3: Optimized Defaults F4: Save & Reset ESC: Exit	

Version 2.18.1263. Copyright (C) 2020 American Megatrends, Inc.

Bios-Entry	Options
Configuration	
Security Device Support	Enable / Disable
NO Security Device Found	None

### 8.3.4 ACPI Settings

Aptio Setup Utility - Copyright (C) 2020 American Megatrends, Inc.  
**Advanced**

ACPI Settings Enable ACPI Auto Configuration [Enabled]	Enables or Disables BIOS ACPI Auto Configuration.  ←: Select Screen ↑↓: Select Item Enter: Select +/-: Change Opt. F1: General Help F2: Previous Values F3: Optimized Defaults F4: Save & Reset ESC: Exit
---	---

Version 2.18.1263. Copyright (C) 2020 American Megatrends, Inc.

Bios-Entry	Options
ACPI Settings	
Enable ACPI Auto Configuration	Enabled / Disabled

### 8.3.5 Hardware Monitor

Aptio Setup Utility - Copyright (C) 2020 American Megatrends, Inc.  
**Advanced**

Pc Health Status  CPU dig. : +70 'C MB Temp : +60 'C 5V : +5.00 V FAN 1 : N/A	←: Select Screen ↑↓: Select Item Enter: Select +/-: Change Opt. F1: General Help F2: Previous Values F3: Optimized Defaults F4: Save & Reset ESC: Exit
--	--

Version 2.18.1263. Copyright (C) 2020 American Megatrends, Inc.

Bios-Entry	Options
Pc Health Status	
CPU dig.	None
MB Temp	None
5V	None
FAN 1	None

### 8.3.6 CPU Configuration

Aptio Setup Utility - Copyright (C) 2020 American Megatrends, Inc.

**Advanced**

<p>CPU Configuration</p> <p>▶Socket 0 CPU Information</p> <p>Speed 1300 MHz 64-bit Supported</p> <p>▶CPU Power Management</p> <p>Active Processor Cores [Disabled] Intel Virtualization Technology [Enabled] VT-d [Disabled] Bi-directional PROCHOT [Enabled] Thermal Monitor [Enabled] Monitor Mwait [Auto] DTS [Disabled]</p>	<p>Socket specific CPU Information</p>             <p>→: Select Screen ↑↓: Select Item Enter: Select +/-: Change Opt. F1: General Help F2: Previous Values F3: Optimized Defaults F4: Save &amp; Reset ESC: Exit</p>
---	---

Version 2.18.1263. Copyright (C) 2020 American Megatrends, Inc.

Bios-Entry	Options
<b>CPU Configuration</b>	
▶ Socket 0 CPU Information	Submenu: see <a href="#">Socket O CPU Information [▶_38]</a>
Speed	None
64-bit	None
▶ CPU Power Management	Submenu: see <a href="#">CPU Power Management [▶_39]</a>
Active Processor Cores	Disabled / Enabled
Intel Virtualization Technology	Enabled / Disabled
VT-d	Disabled / Enabled
Bi-directional PROCHOT	Enabled / Disabled
Thermal Monitor	Enabled / Disabled
Monitor Mwait	Auto / Enabled / Disabled
DTS	Disabled / Enabled

### 8.3.6.1 Socket O CPU Information

Aptio Setup Utility - Copyright (C) 2020 American Megatrends, Inc.  
**Advanced**

<p>Socket 0 CPU Information</p> <pre> Intel(R) Atom(TM) Processor E3930 @ 1.30GHz CPU Signature                506CA Microcode Patch              8 Max CPU Speed                1300 MHz Min CPU Speed                800 MHz Processor Cores              2 Intel HT Technology          Not Supported Intel VT-x Technology        Supported  L1 Data Cache                24 kB x 2 L1 Code Cache                32 kB x 2 L2 Cache                     1024 kB x 2 L3 Cache                     Not Present                     </pre>	<pre> ←: Select Screen ↑↓: Select Item Enter: Select +/-: Change Opt. F1: General Help F2: Previous Values F3: Optimized Defaults F4: Save &amp; Reset ESC: Exit                     </pre>
---	---

Version 2.18.1263. Copyright (C) 2020 American Megatrends, Inc.

Bios-Entry	Options
Socket O CPU Information	
Intel(R) Atom(TM) Processor E3930 @ 1.30GHz	
CPU Signature	None
Microcode Patch	None
Max CPU Speed	None
Min CPU Speed	None
Processor Cores	None
Intel HT Technology	None
Intel VT-x Technology	None
L1 Data Cache	Noine
L1 Code Cache	None
L2 Cache	None
L3 Cache	None

### 8.3.6.2 CPU Power Management

Aptio Setup Utility - Copyright (C) 2020 American Megatrends, Inc.  
**Advanced**

CPU Power Management Configuration EIST [Enabled] Turbo Mode [Enabled] Boot performance mode [Max Performance] C-States [Disabled]	Enable/Disable Intel SpeedStep  ←: Select Screen ↑↓: Select Item Enter: Select +/-: Change Opt. F1: General Help F2: Previous Values F3: Optimized Defaults F4: Save & Reset ESC: Exit
--	--

Version 2.18.1263. Copyright (C) 2020 American Megatrends, Inc.

Bios-Entry	Options
EIST	Enabled / Disabled
Turbo Mode	Enabled / Disabled
Boot performance mode	Max Performance / Max Battery
C-States	Disabled / Enabled

### 8.3.7 AMI Graphic Output Protocol

Aptio Setup Utility - Copyright (C) 2020 American Megatrends, Inc.  
**Advanced**

Intel(R) Graphics Controller Intel(R) GOP Driver [10.0.1036] Output Select [DVI1]	Output Interface  ←: Select Screen ↑↓: Select Item Enter: Select +/-: Change Opt. F1: General Help F2: Previous Values F3: Optimized Defaults F4: Save & Reset ESC: Exit
---	--

Version 2.18.1263. Copyright (C) 2020 American Megatrends, Inc.

Bios-Entry	Options
Intel(R) Graphics Controller Intel(R) GOP Driver [10.0.1036]	
Output Select	DVI1

### 8.3.8 PCI Subsystem Settings

Aptio Setup Utility - Copyright (C) 2020 American Megatrends, Inc.  
**Advanced**

<p>PCI Bus Driver Version                    A5.01.12</p> <p>PCI Devices Common Settings:</p> <p>PCI Latency Timer                        [32 PCI Bus Clocks]</p> <p>PCI-X Latency Timer                     [64 PCI Bus Clocks]</p> <p>VGA Palette Snoop                        [Disabled]</p> <p>PERR# Generation                        [Disabled]</p> <p>SERR# Generation                        [Disabled]</p> <p>Above 4G Decoding                       [Disabled]</p> <p>BME DMA Mitigation                      [Disabled]</p> <p>► PCI Hot-Plug Settings</p>	<p>Value to be programmed into PCI Latency Timer Register.</p>
<p>←: Select Screen ↑↓: Select Item Enter: Select +/-: Change Opt. F1: General Help F2: Previous Values F3: Optimized Defaults F4: Save &amp; Reset ESC: Exit</p>	

Version 2.18.1263. Copyright (C) 2020 American Megatrends, Inc.

Bios-Entry	Options
PCI Bus Driver Version A5.01.12	None
PCI Devices Common Settings:	
PCI Latency Timer	32 PCI Bus Clocks / (32 - 248)
PCI-X Latency Timer	64 PCI Bus Clocks / (32 - 248)
VGA Palette Snoop	Disabled / Enabled
PERR# Generation	Disabled / Enabled
SERR# Generation	Disabled / Enabled
Above 4G Decoding	Disabled / Enabled
BME DMA Mitigation	Disabled / Enabled
► PCI Hot-Plug Settings	Submenu: see <a href="#">PCI Hot-Plug Settings</a>   41



### 8.3.8.1 PCI Hot-Plug Settings

Aptio Setup Utility – Copyright (C) 2020 American Megatrends, Inc  
**Advanced**

<p>PCI Hot-Plug Settings</p> <p>BIOS Hot-Plug Support [Enabled]</p> <p>PCI Buses Padding [1]</p> <p>I/O Resources Padding [4 K]</p> <p>MMIO 32 bit Resources Padding [16 M]</p> <p>PFMMIO 32 bit Resources Padding [16 M]</p>	<p>If ENABLED allows BIOS build in Hot-Pug support. Use this feature if OS does not support PCI Express and SHPC hot-plug natively.</p> <hr/> <p>←: Select Screen                  ↑↓: Select Item                  Enter: Select                  +/-: Change Opt.                  F1: General Help                  F2: Previous Values                  F3: Optimized Defaults                  F4: Save &amp; Reset                  ESC: Exit</p>
---	---

Version 2.18.1263. Copyright (C) 2020 American Megatrends, Inc.

Bios-Entry	Options
PCI Hot-Plug Settings	
BIOS Hot-Plug Support	Enabled / Disabled
PCI Buses Padding	1 (Disabled, 1 - 5)
I/O Resources Padding	4K (Disabled, 4K, 8 K, 16 K, 32K)
MMIO 32 bit Resources Padding	16M (Disabled, 1 M, 2 M, 4 M ... 64 M, 128 M)
PFMMIO 32 bit Resources Padding	Disabled (Disabled, 1 M, 2 M, 4 M ... 64 M, 128 M)

### 8.3.9 Power Controller Options

Aptio Setup Utility – Copyright (C) 2020 American Megatrends, Inc.

**Advanced**

Bootloader Version                    2.00-02 Firmware Version                    2.00-02 Mainboard Serial No                0000000000000000 Mainboard Prod. Date (Week.Year)   -1.-1 Mainboard BootCount                1516 Mainboard Operation Time           183192min (3053h) Voltage (Min/Max)                    3.60V / 5.20V Temperature (Min/Max)              21'C /80'C  ext. USB-Port Voltage                [Off in S3-5] int. USB-Port Voltage                [Off in S3-5]  WDT OSBoot Timeout                 [Disabled]	Select Power line for external USB devices, if powered-down	
		←: Select Screen ↑↓: Select Item Enter: Select +/-: Change Opt. F1: General Help F2: Previous Values F3: Optimized Defaults F4: Save & Reset ESC: Exit

Version 2.18.1263. Copyright (C) 2020 American Megatrends, Inc.

Bios-Entry	Options
Bootloader Version	None
Firmware Version	None
Mainboard Serial No	None
Mainboard Prod. Date (Week.Year)	None
Mainboard BootCount	None
Mainboard Operation Time	None
Voltage (Min/Max)	None
Temperature (Min/Max)	None
ext. USB-Port Voltage	Off in S3 - 5 / by SVCC
int. USB-Port Voltage	Off in S3 - 5 / by SVCC
WDT OSBoot Timeout	Disabled / 45...255 Seconds (in steps +15)



### 8.3.11 Security Configuration

Aptio Setup Utility - Copyright (C) 2020 American Megatrends, Inc.

**Advanced**

TXE HMRFP0 [Disabled] TXE EOP Message [Enabled]	←: Select Screen ↑↓: Select Item Enter: Select +/-: Change Opt. F1: General Help F2: Previous Values F3: Optimized Defaults F4: Save & Reset ESC: Exit
--	--

Version 2.18.1263. Copyright (C) 2020 American Megatrends, Inc.

Bios-Entry	Options
TXE HMRFP0	Disabled / Enabled
TXE EOP Message	Enabled / Disabled



Bios-Enntry	Options
SATA Configuration	
Chipset-SATA Controller Configuration	
Chipset SATA	Enabled / Disabled
SATA Mode Selection	AHCI
SATA Test Mode	Disabled / Enabled
Aggressive LPM Support	Disabled / Enabled
SATA Controller Speed	Default / Gen1 / Gen2 / Gen3
SATA Port 0	Not Installed
Software Preserve	None
Port 0	Enabled / Disabled
SATA Port 0 Hot Plug Capability	Disabled / Enabled
Configured as eSATA	Hot Plug supported
Mechanical Presence Switch	Enabled / Disabled
Spin Up Device	Disabled / Enabled
SATA Device Type	Hard Disk Drive / Solid State Drive
SATA Port 0 DevSlp	Disabled / Enabled
DITO Configuration	Disabled / Enabled
SATA Port 1	Not Installed
Software Preserve	None
Port 1	Enabled / Disabled
SATA Port 1 Hot Plug Capability	Disabled / Enabled
Configured as eSATA	Hot Plug supported
Mechanical Presence Switch	Enabled / Disabled
Spin Up Device	Disabled / Enabled
SATA Device Type	Hard Disk Drive / Solid State Drive
SATA Port 1 DevSlp	Disabled / Enabled
DITO Configuration	Disabled / Enabled

### 8.3.13 Miscellaneous Configuration

Aptio Setup Utility - Copyright (C) 2020 American Megatrends, Inc.

**Advanced**

Miscellaneous Configuration 8254 Clock Gating [Enable] State After G3 [S0 State] Power Button Debounce Mode [Enable] Board Clock Spread Spectrum [Disable] UART Interface Selection [Internal UART]	Enable or Disable 8254 Clock Gating       ←: Select Screen ↑↓: Select Item Enter: Select +/-: Change Opt. F1: General Help F2: Previous Values F3: Optimized Defaults F4: Save & Reset ESC: Exit
--	---

Version 2.18.1263. Copyright (C) 2020 American Megatrends, Inc.

Bios-Entry	Options
Miscellaneous Configuration	
8254 Clock Gating	Enable / Disable
State After G3	S0 State / S5 State / Last State
Power Button Debounce Mode	Enable / Disable
UART Interface Selection	Internal UART / Super IO UART

### 8.3.14 Thermal

Aptio Setup Utility - Copyright (C) 2020 American Megatrends, Inc.

**Advanced**

Thermal Configuration Parameters Automatic Thermal Reporting [Disabled]  Dynamic Platform&Thermal Framework DPTF [Disable]	Configure _CRT, _PSV and _ACO automatically based on values recommended in BWG's Thermal Reporting for Thermal Management settings. Set to Disabled for manual configuration.       ←: Select Screen ↑↓: Select Item Enter: Select +/-: Change Opt. F1: General Help F2: Previous Values F3: Optimized Defaults F4: Save & Reset ESC: Exit
--	---

Version 2.18.1263. Copyright (C) 2020 American Megatrends, Inc.

Bios-Entry	Options
Thermal Configuration Parameters	
Automatic Thermal Reporting	Disabled / Enabled
Dynamic Platform&Thermal Framework	
DPTF	Disabled / Enabled

### 8.3.15 System Component

Aptio Setup Utility - Copyright (C) 2020 American Megatrends, Inc.  
**Advanced**

CRID Setting [CRID_0] PNP Setting [Power&Performance] OS Reset Select [Cold Reset] PS2 Keyboard and Mouse [Auto]	Select the Revision ID reflected in PCI config space	←: Select Screen ↑↓: Select Item Enter: Select +/-: Change Opt. F1: General Help F2: Previous Values F3: Optimized Defaults F4: Save & Reset ESC: Exit
---	--	--

Version 2.18.1263. Copyright (C) 2020 American Megatrends, Inc.

Bios-Entry	Options
CRID Setting	CRID_0 / CRID_1 / CRID_2 / Disable
PNP Setting	Power&Performance / Disable
OS Reset Select	Cold Reset / Warm Reset
PS2 Keyboard and Mouse	Auto / Enable / Disable

### 8.3.16 Serial Port Console Redirection

Aptio Setup Utility - Copyright (C) 2020 American Megatrends, Inc.  
**Advanced**

COM0(Pci Bus0,Dev21,Func0) Console Redirection [Enabled] ▶ Console Redirection Settings	Console Redirection Enable or Disable.
	←: Select Screen ↑↓: Select Item Enter: Select +/-: Change Opt. F1: General Help F2: Previous Values F3: Optimized Defaults F4: Save & Reset ESC: Exit

Version 2.18.1263. Copyright (C) 2020 American Megatrends, Inc.

Bios-Entry	Options
COM0(Pci Bus0,Dev21,Func0)	None
Console Redirection	Enabled / Disabled
▶ Console Redirection Settings	Submenu: see <a href="#">Console Redirection Settings [▶ 49]</a>



### 8.3.16.1 Console Redirection Settings

Aptio Setup Utility - Copyright (C) 2020 American Megatrends, Inc.

**Advanced**

COM0 (Pci Bus0,Dev21,Func0) Console Redirection Settings		Emulation: ANSI: Extended ASCII char set. VT100: ASCII char set. VT100+: Extends VT100 to support color, function keys, etc. VT-UTF8: Uses UTF8 encoding to map Unicode chars onto 1 or more bytes.
Terminal Type	[ANSI]	
Bits per second	[115200]	
Data Bits	[8]	
Parity	[None]	
Stop Bits	[1]	
Flow Control	[None]	
VT-UTF8 Combo Key Support	[Enabled]	
Recorder Mode	[Disabled]	
Resolution 100x31	[Enabled]	
Legacy OS Redirection Resolution	[80x24]	←: Select Screen ↑↓: Select Item Enter: Select +/-: Change Opt. F1: General Help F2: Previous Values F3: Optimized Defaults F4: Save & Reset ESC: Exit
Putty KeyPad	[VT100]	
Redirection After BIOS POST	[Always Enable]	

Version 2.18.1263. Copyright (C) 2020 American Megatrends, Inc.

Bios-Entry	Options
COM0 (Pci Bus0,Dev21,Func0) Console Redirection Settings	
Terminal Type	ANSI / VT100 / VT100+ / VT-UTF8
Bits per second	9600 / 19200 / 38400 / 57600 / 115200
Data Bit	7 / 8
Parity	None / Even / Odd / Mark / Space
Stop Bits	1 / 2
Flow Control	None / Hardware RTS / CTS
VT-UTF8 Combo Key Support	Enabled / Disabled
Recorder Mode	Disabled / Enabled
Resolution 100x31	Enabled / Disabled
Legacy OS Redirection Resolution	80x24 / 80x25
Putty KeyPad	VT100 / Intel Linux / XTERMR6 / SCO / ECSN / VT400
Redirection After BIOS POST	Always Enable / BootLoader

## 8.4 Chipset CB6273

Aptio Setup Utility - Copyright (C) 2020 American Megatrends, Inc.  
 Main Advanced **Chipset** Security Boot Save & Exit

▶North Bridge ▶South Bridge	North Bridge Parameters  ←: Select Screen ↑↓: Select Item Enter: Select +/-: Change Opt. F1: General Help F2: Previous Values F3: Optimized Defaults F4: Save & Reset ESC: Exit
--------------------------------	---

Version 2.18.1263. Copyright (C) 2020 American Megatrends, Inc.

Bios-Entry	Options
Chipset	
▶ North Bridge	Submenu: see <a href="#">North Bridge [▶ 51]</a>
▶ South Bridge	Submenu: see <a href="#">South Bridge [▶ 53]</a>

**8.4.1 North Bridge**

Aptio Setup Utility - Copyright (C) 2020 American Megatrends, Inc.  
**Chipset**

▶ Intel IGD Configuration	Intel IGD Configuration
Memory Information	
Total Memory	8192 MB (LPDDR4)
Memory Slot0	2048 MB (LPDDR4)
Memory Slot1	2048 MB (LPDDR4)
Memory Slot2	2048 MB (LPDDR4)
Memory Slot3	2048 MB (LPDDR4)
Max TOLUD	[2 GB]
	←: Select Screen ↑↓: Select Item Enter: Select +/-: Change Opt. F1: General Help F2: Previous Values F3: Optimized Defaults F4: Save & Reset ESC: Exit

Version 2.18.1263. Copyright (C) 2020 American Megatrends, Inc.

Bios-Entry	Options
▶ Intel IGD Configuration	Submenu: see <a href="#">GOP Configuration</a>   ▶ 52
Memory Information	
Total Memory	8192 MB (LPDDR4)
Memory Slot0	2048 MB (LPDDR4)
Memory Slot1	2048 MB (LPDDR4)
Memory Slot2	2048 MB (LPDDR4)
Memory Slot3	2048 MB (LPDDR4)
Max TOLUD	2 GB

### 8.4.1.1 GOP Configuration

Aptio Setup Utility - Copyright (C) 2020 American Megatrends, Inc.  
**Chipset**

GOP Configuration Force GT Frequency to [400 MHz]	Overrides SoC fuses GT frequency and force to specific frequency
IGD Configuration Integrated Graphics Device [Enable] Primary Display [IGD] RC6(Render Standby) [Disable] GTT Size [8MB] Aperture Size [256MB] DVMT Pre-Allocated [64M] DVMT Total Gfx Mem [256M] GT PM Support [Disable] PAVP Enable [Enable]	←: Select Screen ↑↓: Select Item Enter: Select +/-: Change Opt. F1: General Help F2: Previous Values F3: Optimized Defaults F4: Save & Reset ESC: Exit

Version 2.18.1263. Copyright (C) 2020 American Megatrends, Inc.

Bios-Entry	Options
<b>GOP Configuration</b>	
Force GT Frequency to	100...400 MHz
<b>IGD Configuration</b>	
Integrated Graphics Device	Enable/Disable
Primary Display	IGD / PCIe / HG
RC6(Render Standby)	Disable / Enable
GTT Size	2, 4, 8MB
Aperture Size	128, 256, 512MB
DVMT Pre-Allocated	64M / Various values
DVMT Total Gfx Mem	128, 256M/MAX
Cd Clock Frequency	144, 288, 384, 576, 624 MHz
GT PM Support	Disable / Enable
PAVP Enable	Enable / Disable

### 8.4.2 South Bridge

Aptio Setup Utility - Copyright (C) 2020 American Megatrends, Inc.  
**Chipset**

<ul style="list-style-type: none"> <li>▶HD-Audio Configuration</li> <li>▶PCI Express Configuration</li> <li>▶USB Configuration</li> </ul> <p>Serial IRQ Mode [Quiet]                  SMBus Support [Enabled]                  OS Selection [Windows]                  PCI CLOCK RUN [Enabled]                  Real Time Option [RT Enabled, Agent D...]</p> <p>M.2-Slot 0 Not Present                  M.2-Slot 1 Not Present</p>	<p>HD-Audio Configuration Settings</p> <hr/> <p>←: Select Screen                  ↑↓: Select Item                  Enter: Select                  +/-: Change Opt.                  F1: General Help                  F2: Previous Values                  F3: Optimized Defaults                  F4: Save &amp; Reset                  ESC: Exit</p>
---	--

Version 2.18.1263. Copyright (C) 2020 American Megatrends, Inc.

Bios-Entry	Options
▶ HD-Audio Configuration	Submenu: see <a href="#">HD-Audio Configuration [▶ 54]</a>
▶ PCI Express Configuration	Submenu: see <a href="#">PCI Express Configuration [▶ 55]</a>
▶ USB Configuration	Submenu: see <a href="#">USB Configuration [▶ 56]</a>
Serial IRQ Mode	Quiet / Continuous
SMBus Support	Enabled / Disabled
OS Selection	Windows / Android / Win7 / Intel Linux
PCI CLOCK RUN	Enabled / Disabled
Real Time Option	RT Enabled, Agent D...
M.2-Slot 0	None
M.2-Slot 1	None

### 8.4.2.1 HD-Audio Configuration

Aptio Setup Utility - Copyright (C) 2020 American Megatrends, Inc.  
**Chipset**

HD-Audio Configuration HD-Audio Support [Disable]	Enable/Disable HD-Audio Support  ←: Select Screen ↑↓: Select Item Enter: Select +/-: Change Opt. F1: General Help F2: Previous Values F3: Optimized Defaults F4: Save & Reset ESC: Exit
--	---

Version 2.18.1263. Copyright (C) 2020 American Megatrends, Inc.

Bios-Entry	Options
HD-Audio Configuration	
HD-Audio Support	Disable / Enable

### 8.4.2.2 PCI Express Configuration

Aptio Setup Utility - Copyright (C) 2020 American Megatrends, Inc.  
**Chipset**

<p>PCI Express Configuration</p> <p>PCI Express Port 1 is assigned to LAN 1                  PCI Express Port 2 is assigned to LAN 2                  PCI Express Port 3 is assigned to LAN 3</p> <p>PCI Express Clock Gating [Enabled]                  Port8xh Decode [Disabled]                  Peer Memory Write Enable [Disabled]                  Compliance Mode [Disabled]</p> <p>▶PCI Express Root Port 1                  ▶PCI Express Root Port 2                  ▶PCI Express Root Port 3                  ▶PCI Express Root Port 4</p>	<p>PCI Express Clock Gating                  Enable/Disable for each root port.</p>
←: Select Screen ↑↓: Select Item Enter: Select +/-: Change Opt. F1: General Help F2: Previous Values F3: Optimized Defaults F4: Save & Reset ESC: Exit	

Version 2.18.1263. Copyright (C) 2020 American Megatrends, Inc.

Bio-Entry	Options
PCI Express Configuration	
PCI Express Port 1 is assigned to LAN 1	
PCI Express Port 2 is assigned to LAN 2	
PCI Express Port 3 is assigned to LAN 3	
PCI Express Clock Gating	Enabled / Disabled
Port8xh Decode	Disabled / Enabled
Peer Memory Write Enable	Disabled / Enabled
Compliance Mode	Disabled / Enabled
▶PCI Express Root Port 1	None
▶PCI Express Root Port 2	Submenu: see PCI Express Root Port 2
▶PCI Express Root Port 3	Submenu: see PCI Express Root Port 3
▶PCI Express Root Port 4	Submenu: see PCI Express Root Port 4

### 8.4.2.2.1 USB Configuration

Aptio Setup Utility - Copyright (C) 2020 American Megatrends, Inc.  
**Chipset**

USB Port Disable Override [Disable] XHCI Support [Disable] USB HW MODE AFE Comparators [Disable]	Selectively Enable/Disable the corresponding USB port from reporting a Device Connection to the controller  ←: Select Screen ↑↓: Select Item Enter: Select +/-: Change Opt. F1: General Help F2: Previous Values F3: Optimized Defaults F4: Save & Reset ESC: Exit
--	--

Version 2.18.1263. Copyright (C) 2020 American Megatrends, Inc.

Bios-Entry	Options
USB Port Disable Override	Disable / Enable
XHCI Disable Compliance Mode	FALSE / TRUE
USB HW MODE AFE Comparators	Disable / Enable



### 8.4.2.2.2 PCI Express Root Port 2

Aptio Setup Utility - Copyright (C) 2020 American Megatrends, Inc.  
**Chipset**

PCI Express Root Port 2 [Enable] If DISABLED, goto ENABLE first the ASPM [Disable] L1 Substates [L1.1 & L1.2] ACS [Enabled] URR [Disable] FER [Disable] NFER [Disable] CER [Disable] CTO [Default Setting] SEFE [Disable] SENFEE [Disable] SECE [Disable] PME SCI [Enable] Hot Plug [Disable] PCIe Speed [Auto] Transmitter Half Swing [Disable] Extra Bus Reserved 0 Reserved Memory 10 Reserved I/O 4 PCH PCIe LTR Configuration PCH PCIe LTR [Enabled] Snoop Latency Override [Auto] Non Snoop Latency Override [Auto] PCIe LTR Lock [Disabled] PCIe selectable De-emphasis [Enabled]	Control the PCI Express Root Port. AUTO: To disable unused root port automatically for the most optimum power savings. Enable: Enable PCIe root port Disable: Disable PCIe root port  ←: Select Screen ↑↓: Select Item Enter: Select +/-: Change Opt. F1: General Help F2: Previous Values F3: Optimized Defaults F4: Save & Reset ESC: Exit
---	---

Version 2.18.1263. Copyright (C) 2020 American Megatrends, Inc.

Bios-Entry	Options
PCI Express Root Port 2	Auto / Disable / Enable
If DISABLED, goto ENABLE first the	
ASPM	Disable / Enable
L1 Substates	L1.1 & L1.2 / Disabled / L1.1 / L1.2
ACS	Enabled / Disabled
URR	Disabled / Enabled
FER	Disabled / Enabled
NFER	Disabled / Enabled
CER	Disabled / Enabled
CTO	Default Setting (various settings)
SEFE	Disabled / Enabled
SENF	Disabled / Enabled
SECE	Disabled / Enabled
PME SCI	Enabled / Disabled
Hot Plug	Disabled / Enabled
PCIe Speed	Auto / Gen1 / Gen2
Transmitter Half Swing	Disabled / Enabled
Extra Bus Reserved	0
Reserved Memory	10
Reserved I/O	4
PCH PCIe LTR Configuration	
PCH PCIE LTR	Enabled / Disabled
Snoop Latency Override	Auto / Manual / Disabled
Non Snoop Latency Override	Auto / Manual / Disabled
PCIE LTR Lock	Disabled / Enabled
PCIe selectable De-emphasis	Enabled / Disabled

### NOTE

#### PCIe Root settings port 2 - 4

The root settings at the ports 2 - 4 are identically. Port 2 is shown as example.

## 8.5 Security CB6273

```

Aptio Setup Utility - Copyright (C) 2020 American Megatrends, Inc.
Main Advanced Chipset Security Boot Save & Exit

Password Description
Minimum length             3
Maximum length            20

Setup Administrator Password

User Mode available
▶Secure Boot

Set Setup Administrator Password

←: Select Screen
↑↓: Select Item
Enter: Select
+/-: Change Opt.
F1: General Help
F2: Previous Values
F3: Optimized Defaults
F4: Save & Reset
ESC: Exit

Version 2.18.1263. Copyright (C) 2020 American Megatrends, Inc.
```

Bios-Entry	Options
Password Description	
Minimum length	None
Maximum length	None
Setup Administrator Password	
▶ Secure Boot	Submenu: see <a href="#">Secure Boot [▶ 60]</a>

## 8.5.1 Secure Boot

Aptio Setup Utility - Copyright (C) 2020 American Megatrends, Inc.  
**Security**

System Mode Vendor Keys  Secure Boot  Secure Boot Customization ▶Restore Factory Keys ▶Reset To Setup Mode  ▶Key Management	User Modified  [Disabled] Not Active  [Custom]	Secure Boot activated when: Secure Boot is enabled Platform Key(PK) is enrolled, System mode is User/Deployed, and CSM is disabled  ←: Select Screen ↑↓: Select Item Enter: Select +/-: Change Opt. F1: General Help F2: Previous Values F3: Optimized Defaults F4: Save & Reset ESC: Exit
--	--	--

Version 2.18.1263. Copyright (C) 2020 American Megatrends, Inc.

Bios-Entry	Options
System Mode	None
Vendor Keys	None
Secure Boot	Disabled Not Active
Secure Boot Customization	Custom/Standard
▶Restore Factory Keys	Install factory defaults (Yes or No)
▶Reset To Setup Mode	None
▶Key Management	Submenu: see <a href="#">Factory Key Provision [▶ 61]</a>

### 8.5.1.1 Factory Key Provision

Aptio Setup Utility - Copyright (C) 2020 American Megatrends, Inc.  
**Security**

<p>Factory Key Provision [Enabled]</p> <ul style="list-style-type: none"> <li>▶Restore Factory Keys</li> <li>▶Reset To Setup Mode</li> <li>▶Export Secure Boot variables</li> <li>▶Enroll Efi Image</li> </ul> <p>Device Guard Ready</p> <ul style="list-style-type: none"> <li>▶Remove 'UEFI CA' from DB</li> <li>▶Restore DB defaults</li> </ul> <table style="width: 100%; border-collapse: collapse; margin-top: 10px;"> <thead> <tr> <th style="text-align: left;">Secure Boot variable</th> <th style="text-align: center;">Size</th> <th style="text-align: center;">Keys</th> <th style="text-align: left;">Key Source</th> </tr> </thead> <tbody> <tr> <td>▶Platform Key(PK)</td> <td style="text-align: center;">0</td> <td style="text-align: center;">0</td> <td>No Keys</td> </tr> <tr> <td>▶Key Exchange Keys</td> <td style="text-align: center;">0</td> <td style="text-align: center;">0</td> <td>No Keys</td> </tr> <tr> <td>▶Authorized Signatures</td> <td style="text-align: center;">0</td> <td style="text-align: center;">0</td> <td>No Keys</td> </tr> <tr> <td>▶Forbidden Signatures</td> <td style="text-align: center;">0</td> <td style="text-align: center;">0</td> <td>No Keys</td> </tr> <tr> <td>▶Authorized TimeStamps</td> <td style="text-align: center;">0</td> <td style="text-align: center;">0</td> <td>No Keys</td> </tr> <tr> <td>▶OsRecovery Signatures</td> <td style="text-align: center;">0</td> <td style="text-align: center;">0</td> <td>No Keys</td> </tr> </tbody> </table>	Secure Boot variable	Size	Keys	Key Source	▶Platform Key(PK)	0	0	No Keys	▶Key Exchange Keys	0	0	No Keys	▶Authorized Signatures	0	0	No Keys	▶Forbidden Signatures	0	0	No Keys	▶Authorized TimeStamps	0	0	No Keys	▶OsRecovery Signatures	0	0	No Keys	<p>Provision factory default keys on next re-boot only when System in Setup Mode</p> <hr/> <p>←: Select Screen ↑↓: Select Item Enter: Select +/-: Change Opt. F1: General Help F2: Previous Values F3: Optimized Defaults F4: Save &amp; Reset ESC: Exit</p>
Secure Boot variable	Size	Keys	Key Source																										
▶Platform Key(PK)	0	0	No Keys																										
▶Key Exchange Keys	0	0	No Keys																										
▶Authorized Signatures	0	0	No Keys																										
▶Forbidden Signatures	0	0	No Keys																										
▶Authorized TimeStamps	0	0	No Keys																										
▶OsRecovery Signatures	0	0	No Keys																										

Version 2.18.1263. Copyright (C) 2020 American Megatrends, Inc.

Bios-Entry	Options
Factory Key Provision	Disabled / Enabled
▶ Restore Factory Keys	Press ,Yes' to proceed ,No' to cancel
▶ Reset To Setup Mode	Yes / No
▶ Export Secure Boot variables	File System
▶ Enroll Efi Image	File System
Device Guard Ready	
▶ Remove 'UEFI CA' from DB	Press ,Yes' to proceed ,No' to cancel
▶ Restore DB defaults	Press ,Yes' to proceed ,No' to cancel
Secure Boot variable	
▶ Platform Key(PK)	Push enter key
▶ Key Exchange Keys	Push enter key
▶ Authorized Signatures	Push enter key
▶ Forbidden Signature	Push enter key
▶ Authorized TimeStamp	Push enter key
▶ OsRecovery Signatures	Push enter key

## 8.6 Boot CB6273

Aptio Setup Utility - Copyright (C) 2020 American Megatrends, Inc.  
 Main Advanced Chipset Security **Boot** Save & Exit

<pre>                 Boot Configuration                 Setup Prompt Timeout          5                 Bootup NumLock State          [On]                  F7 Boot Menu                  [Enabled]                  Full Screen Logo              [Enabled]                 Fast Boot                     [Disable]                  Driver Option Priorities                 StartUpDelay for UEFI shell    5                  FIXED BOOT ORDER Priorities                 Boot Option #1                 [Service Stick]                 Boot Option #2                 [CFast]                 Boot Option #3                 [SSD]                 Boot Option #4                 [HDD]                 Boot Option #5                 [CD/DVD]                 Boot Option #6                 [USB Stick]                 Boot Option #7                 [USB Floppy]                 Boot Option #8                 [USB Hard Disk]                 Boot Option #9                 [USB CD/DVD]                 Boot Option #10                [Network]                 Boot Option #11                [USB Lan]                  ▶Advanced Fixed Boot Order Parameters             </pre>	<pre>                 Number of 1/10 sec. to wait                 for setup activation key. 0                 means no wait.                  ←: Select Screen                 ↑↓: Select Item                 Enter: Select                 +/-: Change Opt.                 F1: General Help                 F2: Previous Values                 F3: Optimized Defaults                 F4: Save &amp; Reset                  ESC: Exit             </pre>
---	--

Version 2.18.1263. Copyright (C) 2020 American Megatrends, Inc.

Bios-Entry	Options
Boot Configuration	
Setup Prompt Timeout	5
Bootup NumLock State	On/Off
F7 Boot Menu	Enabled / Disabled
Full Screen Logo	Enabled/Disabled
Fast Boot	Disable/Enable
Driver Option Priorities	
StartUpDelay for UEFI shell	5
FIXED BOOT ORDER Priorities	
Boot Option #1	Service Stick (Varoius options)
Boot Option #2	CFast (Varoius options)
Boot Option #3	HDD/SSD (Varoius options)
Boot Option #4	CD/DVD (Varoius options)
Boot Option #5	USB Stick (Varoius options)
Boot Option #6	USB Floppy (Varoius options)
Boot Option #7	USB Hard Disk (Varoius options)
Boot Option #8	USB CD/DVD (Varoius options)
Boot Option #9	Network (Varoius options)
Boot Option #10	USB Lan (Varoius options)
Boot Option #11	USB Lan (Varoius options)
► Advanced Fixed Boot Order Parameters	Submenu: see <a href="#">Advanced Fixed Boot Order Parameters</a> [► 64]

### 8.6.1 Advanced Fixed Boot Order Parameters

Aptio Setup Utility - Copyright (C) 2020 American Megatrends, Inc.  
**Boot**

Max. CFast capacity (GB)	62	Capacity limit for boot group CFast in GB
Max. USB Stick capacity (GB)	64	
UEFI BDS Boot Filter	[Enabled]	
		←: Select Screen ↑↓: Select Item Enter: Select +/-: Change Opt. F1: General Help F2: Previous Values F3: Optimized Defaults F4: Save & Reset ESC: Exit

Version 2.18.1263. Copyright (C) 2020 American Megatrends, Inc.

Bios-Entry	Options
Max. CFast capacity (GB)	61
Max. USB Stick capacity (GB)	64
UEFI BDS Boot Filter	Enabled / Disabled



## 8.7 Save&Exit CB6273

Aptio Setup Utility - Copyright (C) 2020 American Megatrends, Inc.  
 Main Advanced Chipset Security Boot **Save & Exit**

Save Changes and Reset Discard Changes and Reset  Restore Optimized Defaults  Boot Override Launch EFI Shell from filesystem device	Reset the system after saving the changes.       ←: Select Screen ↑↓: Select Item Enter: Select +/-: Change Opt. F1: General Help F2: Previous Values F3: Optimized Defaults F4: Save & Reset ESC: Exit
---	--

Version 2.18.1263. Copyright (C) 2020 American Megatrends, Inc.

Bios-Entry	Options
Save Changes and Reset	Yes / No
Discard Changes and Reset	Yes / No
Restore Optimized Defaults	Yes / No
Boot Override	Yes / No
Launch EFI Shell from filesystem device	Yes / No

## 8.8 Bios update

The "DecdFlash" program and a bootable medium with the latest BIOS version are used if the BIOS needs to be updated. When doing this it is important to start the program from a DOS environment without a virtual memory manager such as "EMM386.EXE". If such a memory manager is loaded, the program will abort with an error message or cause a crash.

DecdFlash is a program for the automatic updating of the BIOS on all boards with AMI-BIOS. All files contained in the zip file must be unpacked into a directory, from where

```
DecdFlash Bios-Dateiname
```

calling takes place. The name of the BIOS file and its length are checked. The BIOS will now be programmed. DecdFlash also exists as a UEFI tool for calling from the UEFI shell.

A running Flash procedure must never be interrupted, as otherwise the BIOS on the board will be destroyed. The Flash procedure takes about 75 seconds. The necessary firmware update takes place automatically.

### NOTE

#### **Avoid damage due to incorrect update execution!**

Folgen If the BIOS update is performed incorrectly, the board may become unusable. Therefore a BIOS update should only be done if the corrections / additions that the new BIOS version brings with it are really needed.

Before a planned BIOS update, it is essential to ensure that the BIOS file to be reloaded is really released for exactly this board and for exactly this board version. If an inappropriate file is used, the board will inevitably not boot afterwards.

# 9 Mechanical drawings



## Dimensional notation

All dimensions are in mil (1 mil = 0.0254 mm). Data in square brackets are in mm.

### 9.1 PCB: Holes

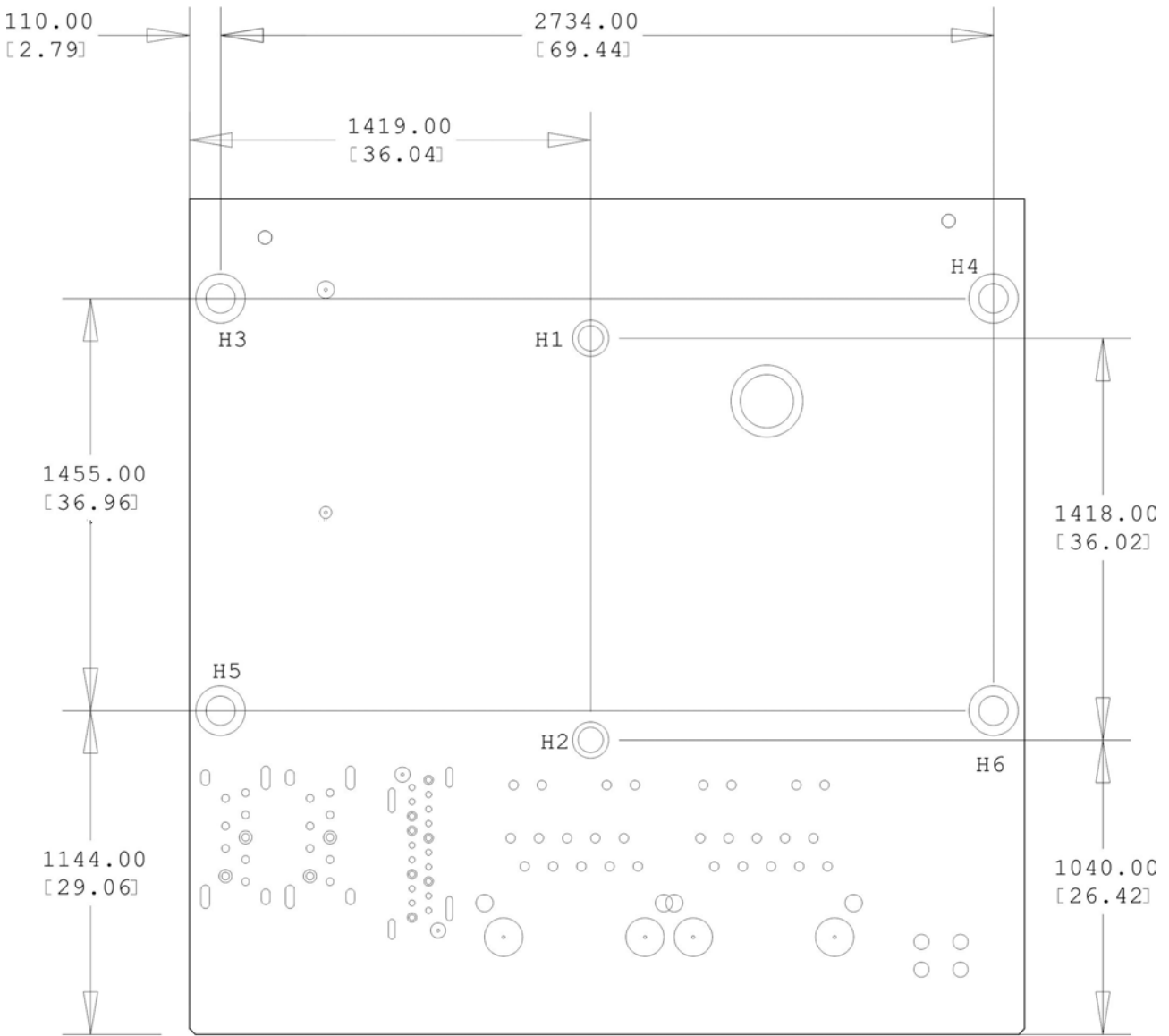

dimension mil [mm]

H1-H2: drill= 1.8mm  
outer diameter= 3mm

H3-H6: drill= 2.7mm  
outer diameter= 4.5mm

Fig. 15: CB6273 Holes

## 9.2 PCB: Dimensions

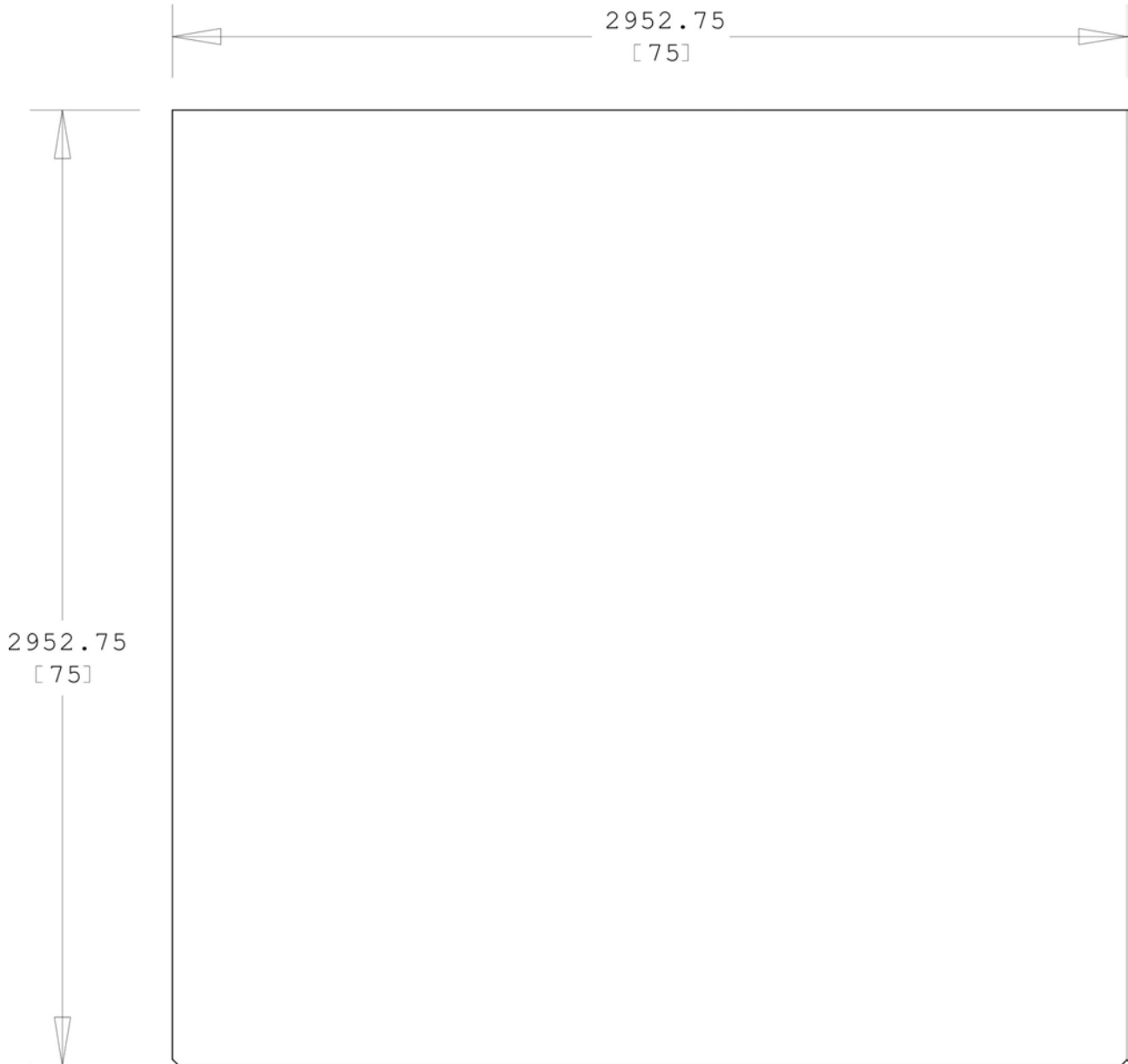

dimension = mil [mm]

Fig. 16: CB6273 Dimensions

## 10 Technical data

### 10.1 Electrical data

Power supply	
Board	24 V <sub>DC</sub> (+20 % / - 15 %)
RTC	≥ 3 A

Power	
Transformer	30 W continuous loadt 60 W peak load

Current consumption	
RTC	≤ 10 μA

### 10.2 Environmental conditions

Temperature range	
Operating	0 °C to +60 °C (extended temperature range on request)
Storage	-25 °C to +85 °C
Dispatch	-25 °C to +85 °C, for packed boards

Temperature changes	
Operating	0.5 °C per minute, 7.5 °C in 30 minutes
Storage	1.0 °C per minute
Dispatch	1.0 °C per minute, for packed boards

Relative humidity	
Operating	5% to 85% (non-condensing)
Storage	5% to 95% (non-condensing)
Dispatch	5% to 100% (non-condensing) for packed boards

Impact	
Operating	150 m/s <sup>2</sup> , 6 ms
Storage	400 m/s <sup>2</sup> , 6 ms
Dispatch	400 m/s <sup>2</sup> , 6 ms, for packed boards

Vibrations	
Operating	10 to 58 Hz, amplitude 0.075 mm 58 to 500 Hz, 10 m/s <sup>2</sup>
Storage	5 to 9 Hz, amplitude 3.5 mm 9 to 500 Hz, 10 m/s <sup>2</sup>
Dispatch	5 to 9 Hz, amplitude 3.5 mm 9 to 500 Hz, 10 m/s <sup>2</sup> , for packed boards

#### **i** Note on impact and vibration resistance

The specifications for impact and vibration resistance refer only to the motherboard itself without heat sink, memory module, cabling, etc.

## 10.3 Thermal specifications

The board is specified for an ambient temperature range of 0 °C to +60 °C (extended temperature range on request). In addition, care must be taken that the temperature of the processor die does not exceed 110 °C. To ensure this a suitable cooling concept must be implemented that is oriented to the maximum power consumption of the processor/chipset. It must also be ensured that any existing controllers are included in the cooling concept. The power consumption of these blocks may be of the same order of magnitude as the power consumption of the processor.

The board is prepared with suitable holes for the use of modern cooling solutions. We have a series of compatible cooling components in our range. Your distributor will be pleased to assist you in selecting suitable solutions.

### **NOTE**

#### **Prevent the maximum die temperature being exceeded!**

It is the end customer's responsibility to ensure that the die temperature of the processor does not exceed 100 °C! Continuous overheating can destroy the board!

If the temperature exceeds 100 °C, the ambient temperature needs to be reduced. Ensure sufficient air circulation if necessary.

# 11 Support and Service

## 11.1 Beckhoff support

Beckhoff Support offers you comprehensive technical assistance, helping you not only with the application of individual Beckhoff products, but also with other, wide-ranging services:

- world-wide support
- design, programming and commissioning of complex automation systems
- extensive training program for Beckhoff system components.

Hotline: +49(0)5246/963-157

Fax: +49(0)5246/963-9157

E-mail: [support@beckhoff.com](mailto:support@beckhoff.com)

## 11.2 Beckhoff service

The Beckhoff Service Center supports you in all matters of after-sales service:

- on-site service
- repair service
- spare parts service
- hotline service

Hotline: +49(0)5246/963-460

Fax: +49(0)5246/963-479

E-mail: [service@beckhoff.com](mailto:service@beckhoff.com)

## 11.3 Beckhoff headquarters

Beckhoff Automation GmbH & Co. KG

Hülshorstweg 20

33415 Verl

Germany

Phone: +49(0)5246/963-0

Fax: +49(0)5246/963-198

E-mail: [info@beckhoff.de](mailto:info@beckhoff.de)

Web: [www.beckhoff.de](http://www.beckhoff.de)

Further Support and Service addresses can be found on our website at <http://www.beckhoff.de>.

You will also find further documentation for Beckhoff components there.

## 12 Appendix I: Post Codes

During the boot phase, the BIOS generates a series of status messages (so-called "POST Codes"), which can be output with the help of a suitable reading device (POST Code card). The meanings of the POST Codes are explained in the document "Aptio™ 5.x Status Codes" from American Megatrends®, which is available from the website <http://www.ami.com>. In addition, the following OEM POST Codes are output:

Code	Description
87h	BIOS-API started
88h	PCA9535 started
89h	PWRCTRL firmware update started



# 13 Appendix II: Resources

## 13.1 Interrupt CB6273

The system BIOS determines the interrupt requests (IRQs) for all devices that request interrupts. In the operating system, interrupts can be dynamically forwarded to IRQs and can support a reassignment of IRQs if there is a conflict with the current use of the interrupt.

For further information please refer to the chipset manual.

**Also see about this**

 Specifications and documents [[▶ 11](#)]

## 13.2 PCI Devices CB6273

The PCI devices listed here all exist on the board, including those that are detected and configured by the BIOS. Due to the BIOS setup settings it may be the case that various PCI devices or functions of devices are not activated. If devices are deactivated, the bus numbers of other devices may change as a result.

INT	REQ	Bus	Dev.	Fkt.	Controller / Slot
-	-	0	0	0	Host Bridge ID 5AF0
A	-	0	2	0	VGA Controller ID 5A85
A	-	0	0E	0	Audio Device ID 5A98
A	-	0	0F	0	Communication Device ID 5A9A
A	-	0	12	0	AHCI Controller ID 5AE3
A	-	0	13	0	PCI-to-PCi Bridge ID 5AD8
B	-	0	13	1	PCI-to-PCi Bridge ID 5AD9
A	-	0	15	0	XHCI USB Controller ID 5AA8
-	-	0	1F	0	ISA Bridge ID 5AE8
A	-	0	1F	1	SMBus Controller ID 5AD4
A	-	2	0	0	Ethernet Controller ID 157B

## 13.3 SMB-Devices CB6273

The following table lists the reserved SM-Bus-Device-addresses in 8-Bit notation.

<b>NOTE</b>
These address ranges may not be used by external devices even if the component assigned in the table doesn't exist on the motherboard.

Address	Function
B0, B2, B8, BA	PWCTR3
70, 72	PostCode
34 (alt B4)	CA2000-0021/23 (power adapter)
40	PCA9535BS (16-bit I2C and SMBus, low power I/O port with interrupt)
C2	i210 (ARP) Ethernet Controller
..	SUSV



Beckhoff Automation GmbH & Co. KG  
Hülshorstweg 20  
33415 Verl  
Germany  
Phone: +49 5246 9630  
[info@beckhoff.com](mailto:info@beckhoff.com)  
[www.beckhoff.com](http://www.beckhoff.com)