



TVS 

TVS
RAIDER
— THE WICKED RIDE



OWNER'S MANUAL



ALWAYS USE TVS-M GENUINE PARTS

CONTACT(S) FOR SUPPORT	1
FOREWORD	5
SAFETY INFORMATION	6
NOTICE	7
RUNNING-IN INFORMATION	8
SAFE RIDING TIPS	9
KNOW YOUR TVS Raider 125	13
RIDING YOUR TVS Raider 125	43
MAINTENANCE	49
WARRANTY AND SERVICES	76
SERVICE INFORMATION	80
TECHNICAL SPECIFICATIONS	82
EXPRESS SERVICE	85
EXPERT ON WHEELS	86
PICKUP AND DROP	87
GENERAL INFORMATION	88

Incase you need any Clarification please contact

TVS Motor Company Authorised Main Dealer / Authorised Dealer

Or

TVS Motor Company's Area Offices (flip over for addresses)

Or

Toll Free Number : 1800-258-7111

Email : customercare@tvsmotor.com

Disclaimer : TVS Motor Company or any of its officials / Authorised Main Dealer / Authorised Dealer do not ask customers for bank / card / wallet details / authentication. In case you face any such claim, please report to the relevant local authorities immediately.

CONTACT AT OUR AREA OFFICES

TAMILNADU-1, 3 & 4

1. TVS Motor Company Limited

V Floor, Gee Gee Universal,
No. 2, MC Nichols Road,
Chetpet, Chennai - 600 031.
Phone : 044-28361651/28361654
Email : AO.Chennai@tvsmotor.com
AO.Madurai@tvsmotor.com

TAMILNADU-2

2. TVS Motor Company Limited

No. 10, 2nd floor,
Shree Shanmugapriya Towers,
Kannuswamy Street,
Behind Hotel Annapoorna,
R S Puram, Coimbatore - 641 002.
Phone : 0422-4350060/2541035
Email : AO.Coimbatore@tvsmotor.com

KERALA

3. TVS Motor Company Limited

Ambady Towers, Second Floor,
Door No. 27/631, A6,
Edappally-Pookkattupady Road,
Edappally PO., Cochin - 682 024.
Phone : 0484-2544578/2556938
Email : AO.Cochin@tvsmotor.com

KARNATAKA-1, 2 & GOA

4. TVS Motor Company Limited

No. 600, Anand Surya, 2nd Floor,
15th Cross, 6th Phase, JP Nagar,
Opp. BMTC Bus Stop,
Bangalore - 560 078.
Phone : 080-26653433
Email : AO.Bangalore@tvsmotor.com
AO.Hubli@tvsmotor.com

ANDHRAPRADESH -1 & 2

5. TVS Motor Company Limited

Rukumani Towers, First Floor,
No. 3-11-30, Plot No. 11,
Paigha Colony, Behind Anand Theater,
Secunderabad - 500 003.
Phone : 040-27840590/27844419
Email : AO.Hyderabad@tvsmotor.com
AO.Vijayawada@tvsmotor.com

MAHARASHTRA-1 & 2

6. TVS Motor Company Limited

No. 401, 4th Floor, The Chambers,
Plot No. 4/12/3, Near Ganapati Chowk,
Viman Nagar, Pune - 411 014.
Phone : 020-26632111/26632110
Email : Service.pune@tvsmotor.com

MAHARASHTRA-3 & CHATTISGARH

7. TVS Motor Company Limited

No. 502B, 6th Floor, B Wing,
Shriram Shyam Towers,
Near LIC Square, Sardar,
Nagpur - 440 001.
Phone : 0712-2569932
Email : Service.Nagpur@tvsmotor.com
AO.Raipur@tvsmotor.com

GUJARATH

8. TVS Motor Company Limited

109, Ayna Complex,
Opp. Suvarna Villa Bungalows,
100 ft Thaltej Hebbatpur Road,
Off : S.G. Highway, Thaltej,
Ahmedabad - 380 054.
Phone : 079-65443748
Email : AO.Ahmedabad@tvsmotor.com

MADHYA PRADESH-1 & 2

9. TVS Motor Company Limited

No. 211-212, 2nd Floor,
Chinar Incube Business Centre,
Chinar Fortune City,
Near Brindhavan Dhaba,
Hosangabad Road,
Bhopal - 462 026.
Phone : 0755-2499406/2499306
Email : AO.Bhopal@tvs motor.com
AO.Indore@tvs motor.com

RAJASTHAN-1 & 2

10. TVS Motor Company Limited

Plot No. 17-18,
2nd Floor of National Motors Building,
Jhotwara Industrial Area,
Jaipur - 302 012.
Phone : 0141-5150901/5150902
Email : AO.Jaipur@tvs motor.com
AO.Udaipur@tvs motor.com

DELHI & HARYANA

11. TVS Motor Company Limited

D-3 & D-4, 2nd Floor, Sector - 10,
Noida, Uttar Pradesh - 201 301.
Phone : 011-29834640/29834773
Email : AO.Delhi@tvs motor.com
AO.Haryana@tvs motor.com

PUNJAB & CHANDIGARH

12. TVS Motor Company Limited

4th Floor, Royal Business Park,
Chandigarh Ambala Highway,
Zirkapur - 140 603.
Phone : 01762-464777/465777
Email : AO.Chandigarh@tvs motor.com

UTTAR PRADESH WEST

13. TVS Motor Company Limited

D-3 & D-4, 2nd Floor,
Sector - 10, Noida,
Uttar Pradesh - 201 301.
Phone : 011-29834640/29834773
Email : AO.Upw@tvs motor.com

UTTAR PRADESH CENTRAL & EAST

14. TVS Motor Company Limited

1st Floor, Cyber Tower, TC-34/V-2,
Vibhuti Khand, Gomti Nagar,
Lucknow - 226 010.
Phone : 0522-4918300/4918301
Email : AO.Upe@tvs motor.com
AO.Upc@tvs motor.com

WEST BENGAL

15. TVS Motor Company Limited

Ground Floor & First Floor,
133 A. S. P. Mukherjee Road,
Opp. Tollygunge Police Station,
Kolkatta - 700 026.
Phone : 033-24617096/24617092
Email : AO.Kolkatta@tvs motor.com

BIHAR

16. TVS Motor Company Limited

N-Plaza, Jamal Road,
P.S. Kotwali,
Patna - 800 001.
Phone : 0612-2200068/2200069
Email : AO.BNJ@tvs motor.com

ORISSA & JHARKHAND

17. TVS Motor Company Limited

No. 303, 3rd Floor,
Creative Plaza, Rasulgarh,
Bhubaneswar - 751 010.
Phone : 0674-2580019
Email : AO.Bhubaneswar@tvsmotor.com

NORTH EAST STATES

18. TVS Motor Company Limited

147, Udayan, Ganesh Guri,
Opp. Punjab National Bank,
R G B. Road, Guwahati - 781 005.
Phone : 0361-2202030/2202031
Email : AO.Guwahati@tvsmotor.com

Dear Friend,

Thank you for choosing the all-new TVS Raider, the wicked ride.

As a proud owner of TVS Raider, you are now a part of a family of millions of satisfied TVS customers.

Your TVS Raider comes with animalistic LED headlamps and chunky tyres, the best-in-class pick up revved from its unique 3-valve engine, comfort of split seats, and mono-shock suspension and safety of disc brakes ensuring a wicked performance. What's more, the dual ride modes put the W in the Wicked, letting you switch from zipping through traffic to zooming ahead on a wide-open road, all at the touch of a button.

This manual explains the features and operations of your TVS Raider. Please read it carefully and follow the instructions to enjoy years of safe riding.

To ensure reliable performance, we urge you to get your TVS Raider serviced only at TVS Motor Company Authorised Main Dealers / Authorised Dealers at specified regular intervals.

Happy Riding!

TVS MOTOR COMPANY LIMITED

Operating this vehicle safely is an important responsibility of the rider. To help you make decisions on safety, we have provided necessary operating procedure and other information in this manual. This information alerts you on potential hazards that could hurt you or others. Since it is not possible to warn you about all the hazards associated with operating or maintaining the vehicle, you must use your own judgment.

You will find important safety information in following form in this manual. These words carry the following connotations:

Warning

*Disregarding this message might result in **injury to the rider or deadly accidents.***

Caution

*This message indicates special procedures or precautions to be followed to **avoid damage to the vehicle.***

Note

*This message provides further clarification for **clear understanding of any particular information.***

All information, illustrations, photographs and specifications contained in this owner's manual are based on the latest product information available at the time of this publication. TVS Motor Company Limited may, however, incorporate modifications or improvements on its vehicles at any time without notice, and therefore, in such events it is possible that the relevant part of the owner's manual does not apply to your vehicle.

Prior permission of TVS Motor Company Limited is required for quoting, copying or reproducing any part of this owner's manual.

Note

Accessories shown in the picture may not be part of the standard equipment.

Pictures shown in this manual are of TVS Raider 125 disc brake model unless specified.

Your motorcycle is provided with always glowing head lamp. The head lamp glows automatically once the engine is started.

Since your vehicle is fitted with side stand cut-off system ensure to retract the side stand before starting / moving the vehicle.

TVS Raider 125 comes with 'SYNCHRONIZED BRAKING TECHNOLOGY - SBT' which offers superior braking control. This new braking feature automatically activates front brake whenever the rear brake is used, thereby enhancing the braking performance of the vehicle. SBT assures more safety, reduces force required while braking and ensures lower chances of skidding.

SBT
SYNCHRONIZED BRAKING
TECHNOLOGY

The first 1000 km is a crucial part of your motorcycle. Proper running-in operation during this period helps in ensuring a **maximum life** and **smooth performance** of your motorcycle.

The reliability and performance of your motorcycle depends on the special care and restraint exercised during the running-in period. It is especially important that you avoid operating the engine in high speed (RPM), which could expose the engine parts to excessive stress. Recommended speed during the running-in is:

Maximum 50 kmph speed upto 1000 km (vary the engine speed for better mating of parts).

The first free service at 750 ~ 1000 km is most important. During running-in period all the engine components and other parts will have set in. All adjustments to be restored, all fasteners to be tightened. Engine cum transmission oil to be replaced. Timely performance of the first free service will ensure optimum service life and performance from the engine.



Caution

Replacing the engine cum transmission oil during first free service is most important for better life of engine. Always use TVS TRU4 PREMIUM oil (SAE 10W30 API-SL JASO MA2) for better performance and life.

*Since your motorcycle is fitted with Evaporative Emission Control System, **the motorcycle should not be laid on the floor during water wash.** Else it may lead to difficulty in starting and improper running of the motorcycle.*



SAFE RIDING RECOMMENDATIONS

Any two wheeler riding requires some precautions to be taken to ensure the safety of the rider, pillion and other road users. These precautions are:

Familiarise yourself with new TVS Raider 125

Riding skill and your mechanical knowledge form the foundation of safe riding practices. We suggest you to practice riding TVS RAIDER 125 in a low-traffic condition until you are thoroughly familiar with your vehicle and its controls. Remember practice makes you perfect.

Riding apparel

Loose, fancy clothing can be uncomfortable and unsafe when riding a two-wheeler. Choose good quality two wheeler riding apparel.

Know your limits

Ride within the boundaries of your own skill at all times. Knowing these limits and staying within them will help you to avoid accidents.

Warning

Two wheeler safety starts with wearing a good quality helmet. *One of the most serious injuries that can happen is a head injury. Always wear an ISI approved helmet that should fit your head comfortably and securely. You should also have good quality goggles to protect your eyes and help your vision.*

To prevent or minimize accident, never consume alcohol or drugs before or during the operation of your vehicle. Even minimal consumption of these will affect the rider's ability to control the vehicle.

Posture

Proper vehicle riding starts with proper posture.

1. Sit erect on the seat at the position which you feel most comfortable.
2. Keep your arms relaxed to give extra cushion for body on uneven road surfaces.
3. Keep right arm and foot close to the brake lever and pedal, so as to enable fast action during panic braking.
4. Look widely instead of gazing at one point.

Warning

One-hand riding is dangerous. *Keep both hands firmly on the handle bar and both feet securely on the foot rest. Under no circumstances should both the hands be removed from the handle bar, as it is very dangerous.*

Avoid use of mobile phones while riding as it could lead to fatal accident.

Slow down to a safe speed before negotiating a corner. If this is the first time that you are riding a vehicle of this type, we suggest that you practice on a safe, open area to become thoroughly familiar with the operation of the vehicle.

5. Alter your sitting location / posture slightly at intervals during long rides. This will reduce fatigue.

Cornering

When cornering, centrifugal force works in a direction perpendicular to the direction in which the vehicle is moving. Centrifugal force increases in proportion with speed and the radius of the corner.

During cornering, reduce speed so as to lessen the effects of centrifugal force. By all means, avoid abrupt application of brake or sudden steering.

Braking

For safe riding, it is very important to master the braking techniques.

1. Close / release the throttle.
2. Hold the vehicle upright as you apply the brake.
3. Progressive application of brake is safer.
4. Never depress the clutch lever while braking at higher speeds.
5. **Apply both the brakes. 'SBT' provides additional braking even when 'Only Rear brake' is applied, But applying 'Both the brakes' helps you use the full potential of the brakes.**

- Riding down hills, while cornering and wet roads, close the throttle and down shift the gear to take advantage of gearbox and engine which acts as an additional brake. This will avoid the loss of control over the vehicle due to over speed.

Causes for poor braking

- If the brake shoes / pads or drum / disc are worn out or if there is water or oil on them, sufficient friction does not develop and brakes do not work well.

Warning

As the vehicle speed increases, the stopping distance also increases progressively. Be sure that, you have sufficient distance between you and the vehicle or obstruction ahead of you.

*Using only the front or rear brake is dangerous and can cause skidding and loss of control. **Apply both the brakes together and with great care on a wet road or other slippery surfaces.***

Any abrupt braking on slippery or irregular roads can cause loss of rider control.

- Even when the brake works normally, if the road surface is wet or the tyre surface is worn-out, tyres do not take a firm hold on the surface, increasing the stopping distance.
- Approximately 60% braking effect is from front brake. **Non-usage of front brake causes poor braking.**

ACCESSORY INSTALLATION AND SAFETY TIPS

Use extreme caution while selecting and installing the accessories for your motorcycle.

The addition of **unsuitable accessories can lead to unsafe operating conditions.** Your friendly Dealer will assist you in selecting quality accessories and installing them correctly.

While selecting the accessories, make sure the accessories **should not obstruct lighting, steerability, suspension level and ground clearance.** Please ensure that, if the tank cover is used, it is not getting en-trapped between fuel tank and fuel tank cap.

Additional electrical equipment is not acceptable as it will void the warranty terms of the vehicle.

EMISSION CONTROL

All the TVS vehicles are tested in the factory for optimum fuel efficiency and CO levels. If the vehicle needs any adjustments, please consult nearest TVS Motor Company Authorised Main Dealer / Authorised Dealer.

While adequate care is exercised at the factory to ensure that the emissions are within the limits, it is essential for the owner to always maintain the motorcycle in good condition by getting it periodically checked and serviced by TVS Motor Company Authorised Main Dealer / Authorised Dealer so that the emission and fuel consumption levels are maintained as per norms.

Crankcase emission control system

The engine of TVS Raider 125 is equipped with a closed crankcase system to prevent discharging crankcase emissions into the atmosphere. Blow-by gas is returned to the combustion chamber through the air cleaner.

Evaporative Emission Control System

The TVS Raider 125 is equipped with an evaporative emission control system which consists of a canister and associated piping. This system prevents the escape of fuel vapors from the fuel tank.

Warning

If there is any abnormal jerk, startability issue are felt in the vehicle or noise due to sudden escape of gas during opening of fuel tank cap, immediately report to the TVS Motor Company Authorised Main Dealer / Authorised Dealer.

Note

Your vehicle is tested and certified for emission which meets BS VI emission norms and is valid for initial 12 months from the date of purchase. Get your vehicle certified by the Government authorised emission testing station after initial 12 months of usage. And ensure to get the vehicle certified on expiry of the certificate obtained.

LOCATION OF PARTS - HANDLE BAR

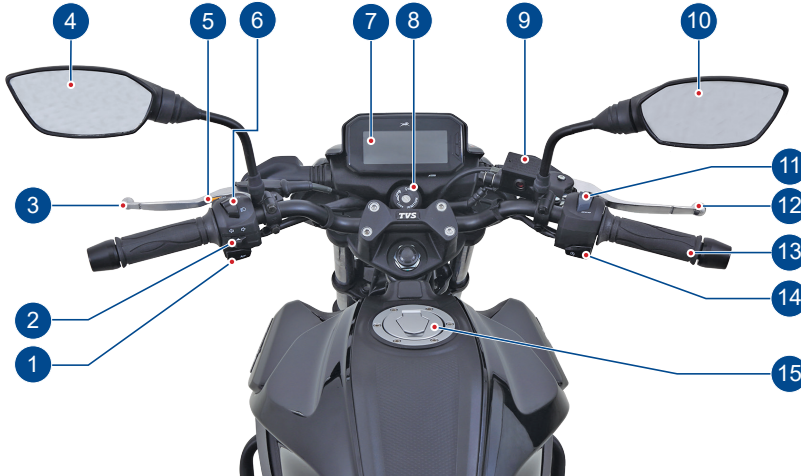

1. Horn switch
2. Turn signal lamp switch
3. Clutch lever
4. Rear view mirror L
5. Pass by switch
6. Beam control switch
7. Digital speedometer
8. Ignition cum steering lock
9. Master cylinder*
10. Rear view mirror R
11. Mode selection switch
12. Front brake lever
13. Throttle grip
14. Electric starter switch
15. Fuel tank cap

* Applicable only for Disc Brake version

LOCATION OF PARTS - VEHICLE LEFT SIDE



1. Front wheel axle
2. Gear shift lever
3. Centre stand
4. Side stand
5. Rider foot rest L
6. Pillion foot rest L
7. Rear wheel axle
8. Lady foot rest**
9. Saree guard**
10. Reflex reflector

** Mandatory and optional accessory will be charged extra

LOCATION OF PARTS - VEHICLE RIGHT SIDE



1. Disc plate front*
2. Front wheel axle nut
3. Caliper assembly front*
4. Spark plug
5. Gauge oil level
6. Rear brake pedal
7. Rider foot rest R
8. Rear shock absorber
9. Pillion foot rest R
10. Rear wheel axle nut
11. Rear brake adjuster
12. Muffler assembly
13. Pillion handle

* Applicable only for Disc Brake version

LOCATION OF PARTS - VEHICLE FRONT & REAR



FRONT

1. Turn signal lamp front L
2. LED head lamp assembly
3. Turn signal lamp front R

REAR

1. Tail lamp assembly
2. Turn signal lamp rear R
3. Reflex reflector
4. Turn signal lamp rear L

CONTROL KEY

TVS Raider 125 comes with a pair of identical control keys. These keys are to operate ignition cum steering lock, fuel tank cap and seat lock.

IGNITION CUM STEERING LOCK

There are three positions in the ignition cum steering lock. They are:

1. 'OFF' position

All the electrical circuits are turned 'OFF' in this position. Engine will not start. Key can be taken out.

2. 'ON' position

In this position, all the electrical circuits are turned 'ON' and the engine can be started. Key cannot be removed.



3. 'LOCK' position

TVS Raider 125's steering can be locked in both 'left' and 'right' directions. To lock the steering, turn the handle bar all the way to the 'left' or 'right' direction. Push the key 'IN' and turn it to the 'LOCK' position and take out. All the electrical circuits are turned 'OFF' in this position.

Insert the key into the lock and turn it to 'OFF' or 'ON' position to unlock the steering.

Warning

Never attempt to move the vehicle when the steering is locked, you may lose balance.

Caution

*Before turning the ignition key to 'ON' position, ensure the availability of adequate fuel in the tank **to avoid dry run of fuel pump. Fuel level always to be maintained above single bar.***

Never run the fuel pump dry to avoid failure of fuel pump.

Leaving the ignition cum steering lock in 'ON' position will drain the battery when the vehicle is not in use. Switch 'OFF' and take the key out when the vehicle is not in use.

Note

When you switch 'ON' the ignition, the pump priming noise may be heard, which is normal. Avoid frequent 'SWITCH - OFF & ON' of ignition to avoid unnecessary actuation of fuel pump.

Digital speedometer's back illumination, position lamp, tail lamp and number plate lamp glows automatically once the ignition is turned 'ON' without activating any other switches. The head lamp starts to glow along with above lamps once the engine is started.

When the ignition switch is turned 'ON', the speedometer performs self diagnostic cycle. A message 'HI' will be displayed on the speedometer's display. Wait till the '0 km/h' details appears on the display.

DIGITAL SPEEDOMETER

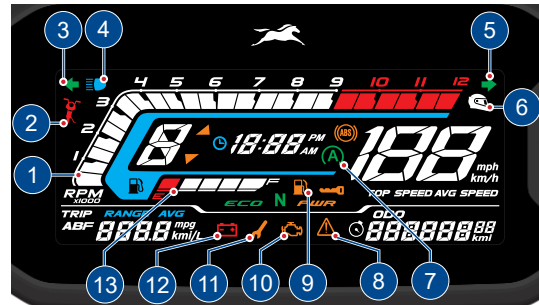

1. Tachometer

Tachometer indicates the engine speed in multiples of 1000 RPM (Revolutions Per Minute).

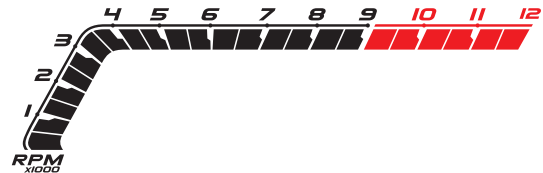

2. Side stand indicator

The side stand warning indicator turns 'ON' to alert you whenever the vehicle's side stand is deployed (vehicle in parked condition).

Note

In geared condition, if the side stand is deployed the vehicle will not start. In neutral condition, if the side stand is deployed the vehicle will start but as soon as the gear is engaged the vehicle will switch off.

If there is error in the side stand sensor the indication will blink and the vehicle will not start. In such a condition, please visit the nearest TVS Motor Company Authorised Main Dealer / Authorised Dealer.

3. Turn signal indicator lamp left

Flashes when the left side turn signal indication is activated.

4. High beam indicator lamp

Glowes when the head lamp high beam is activated.

5. Turn signal indicator lamp right

Flashes when the right side turn signal indication is activated.

6. Helmet icon

With every ignition 'ON', helmet icon  blinks for 10 seconds on the right side of the digital speedometer to remind the rider to wear a helmet.

7. 'TVS intelliGO'

Fuel is consumed unnecessarily when the engine is in idling (e.g. in traffic signals) as there is no useful output to the wheel. It contributes to emission and decreases mileage of the vehicle considerably.

To overcome this issue, 'TVS intelliGO' system is introduced in your motorcycle. This intelliGO system automatically shuts down the engine when the vehicle is kept idling.

The vehicle that is shut down by intelliGO system can be restarted easily at any time within 5 mins from stop just by applying throttle (open and close) when the vehicle is in neutral or by applying clutch and performing throttle operation (open and close) when the vehicle is in gear engaged condition.

We recommend to use this 'TVS intelliGO' system to improve fuel economy and to reduce the emission.

Activation of 'TVS intelliGO' system:

'TVS intelliGO' system gets activated when the following requirements are satisfied,

1. 'Mode' switch is in 'ECO' mode
2. Engine is warmed up and
3. When the vehicle speed has crossed 5 kmph

When the vehicle meets the above conditions, the 'TVS intelliGO' system gets enabled and the intelliGO indicator '  ' in the digital speedometer glows continuously and informs you that the vehicle has entered intelliGO loop and the engine will stop automatically at upcoming vehicle idling condition.

Once the vehicle enters the idling condition, the intelliGO indicator starts blinking instead of glowing and engine stops after predetermined time.



Note

'TVS intelliGO' system works only when the vehicle is in 'ECO' mode (refer page 24 for details). The vehicle, shut down by intelliGO system can be restarted easily just by applying throttle (open and close) when the vehicle is in neutral or by applying clutch and performing throttle operation (open and close) when the vehicle is in gear engaged condition.

Now, the intelliGO indicator again start to glow continually during the engine stop to indicate that the vehicle has stopped due to 'intelliGO' system.

Deactivation of 'intelliGO' system:

'TVS intelliGO' system will be deactivated if the 'MODE' switch is positioned at 'POWER' mode.

1. If the ISG malfunction indicator '  ' or engine malfunction indicator '  ' is 'ON', the intelliGO system will not get activated.
2. If there are 5 unsuccessful start of the vehicle either by electric start or by intelliGO restart method the intelliGO system will not get activated.
3. **If vehicle is not restarted within 5 mins from idle stop, then intelliGO system will be deactivated.**
4. During low battery condition the intelliGO system will be deactivated.

Prolonged idling:

When vehicle is in idling with the engine temperature high enough to maintain stable engine idling rpm and the 'Mode' switch is in 'ECO' mode, then the intelliGO system will be activated.

When 'TVS intelliGO' is enabled, the intelliGO lamp blinks for predetermined time and then the engine stops.

The intelliGO lamp will glow after the vehicle has stopped due to this feature. By applying throttle (open and close) the engine can be restarted again at any time within 5 mins from the stop of the vehicle.

Note

Ensure that the clutch free play is adjusted and it is within the limit for the proper working of 'TVS intelliGO' system.

Vehicle can be started at any point of time using electric start when the engine is in stall condition and the ignition key is in 'ON' condition.

'Mode' selection switch can be selected any point of time.

If vehicle is stopped by 'TVS intelliGO' system, and the 'Mode' switch is toggled from 'ECO' to 'PWR' and back to 'ECO', the intelliGO system will be initiated from beginning but the vehicle can be restarted by the electric start.

8. ISG malfunction indicator ()*

ISG malfunction indicator will be turned 'ON' when there is a fault in the ISG system.

If the ISG malfunction indicator is glowing continually after the self check cycle of the speedometer, immediately contact the nearest TVS Motor Company Authorised Dealer / Authorised Dealer.

Please remember that the 'TVS intelliGO' system will not work if the ISG malfunction indicator is 'ON'.

9. Low fuel indication ()

Low fuel indicator blinks when the fuel level is about to reach minimum safe fuel level. It glows continuously when the fuel comes below minimum safe level.

10. Malfunction indicator lamp - MIL ()

'MIL' will be turned 'ON' when the ECU detects a fault in the system.

If the malfunction indicator lamp '  ' is glowing continually even after the starting the engine, immediately contact the nearest TVS Motor Company Authorised Main Dealer / Authorised Dealer. Please remember that the 'TVS intelliGO' system will not work if the MIL indicator is 'ON'.

11. Service reminder ()

If the service is due, whenever the ignition switch is turned 'ON', an icon with spanner symbol blinks for 10 seconds after the self test cycle of speedometer and continues to glow till the vehicle is serviced and reset.

Get the vehicle serviced at TVS Motor Company Authorised Main Dealer / Authorised Dealer.

Note

Service reminder indicator lamp works only based on the distance (km) covered by the vehicle. This is only a reminder indicator. Customers are advised to keep track and follow the service schedule.

12. Low battery indicator

An icon with battery symbol '  ' glows when the battery charges is too low. Contact your nearest TVS Motor Company Authorised Main Dealer / Authorised Dealer.

13. Fuel gauge

Digital bars indicates the approximate fuel quantity available in fuel tank. There are five bars to indicate the quantity of fuel available in the fuel tank. All the five bars will be displayed when the fuel in the tank reaches above 8.5 liters approximately (full tank).



When the fuel reaches half tank (5.5 liters approx.) the fuel gauge displays only three bars as shown.



The fuel gauge shows only single bar when the fuel reaches reserve level (2.2 liters approx.). Refill the fuel immediately.



Once the fuel level reaches 1.2 liters approximately, no bar will be visible and low fuel indication (serial No. 9) glows continuously.



If all the fuel level bars in the cluster are starts blinking Contact nearest TVS Motor Company Authorised Main Dealer / Authorised Dealer.

Caution

Before turning the ignition key to 'ON' position, ensure the availability of adequate fuel in the tank. That is LOW FUEL INDICATION shall not come 'ON', before the start of the vehicle.

To avoid dry run of fuel pump, never run vehicle beyond 5 km, after LOW FUEL INDICATION.

14. Gear position indicator / 15. Gear shift indicator / 16. Economy and power indicators / 17. Neutral indicator / 18. Speedometer / Average speed / Top speed

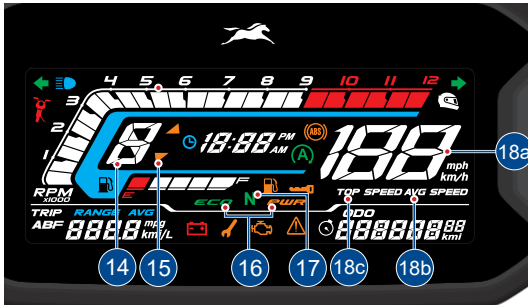

14. Gear position indicator

The gear position indicator in the digital display indicates the position of the gears.



15. Gear shift indicator

Gear shift indicator arrows alerts the user to up shift or down shift the gears when engine reaches the pre defined engine rpm.



16. Economy and power mode indicators

Economy indicator 'ECO' indicates that the vehicle is running in economy mode which will give you a better fuel economy. 'TVS IntelliGO' system will function only in 'ECO' Mode.

Power mode indicator '**PWR**' indicates that the vehicle is running in power mode which will result in higher acceleration and power compared to economy mode.

If mode change is done during vehicle riding condition, both 'ECO' and 'PWR' will blink at higher frequency to indicate that the throttle opening has to be reduced. If the throttle opening is below the predefined value, the blinking will stop or else the blinking will continue for 25 seconds and the vehicle will go into previous ride mode and the same will be displayed by the speedometer.

Note

If any error occurs in the EFI system of vehicle, during ignition key 'ON' condition, irrespective of 'Mode' switch position, the vehicle will shift to Power mode and both 'ECO' and 'PWR' indication will blink for 7 seconds followed by the display of Power mode continually. Take the vehicle to any of the TVS Motor Company Authorised Main Dealer / Authorised Dealer.

If any error occurs in the EFI system post ignition 'ON', during mode change the vehicle will remain in previous mode and both 'ECO' and 'PWR' indication will blink for 7 seconds followed by the display of the previous mode continually.

17. Neutral indicator lamp (N)

Glows when the vehicle is in neutral and goes 'OFF' if the gear is shifted from neutral.

18a. Speedometer

Indicates the vehicle speed in kilometer per hour.



18b. Average speed

Indicates the average speed in that the vehicle has been traveled in kilometer per hour.



18C. Top speed

Indicates the top speed so far that the vehicle has clocked in kilometer per hour.



19. Odometer / 20. Lap indicator / 21. Immobilizer indicator / 22. ABS indicator / 23. Digital clock / 24. Average mileage indication / 25. Range indication / 26. Trip meter A, B & F

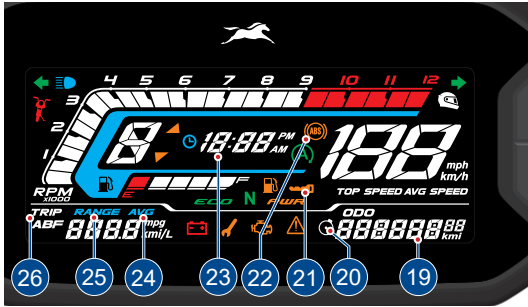

19. Odometer

Registers and displays the total distance covered by the vehicle in kilometers.

ODO
5306 km

20. Lap indicator

-NA-

21. Immobilizer indicator

-NA-

22. ABS indicator

-NA-

23. Digital clock

Indicates the time in 12 hour format (AM or PM).

 **11:30 AM**

Note

If the battery is disconnected and reconnected during service. You may need to reset the time as explained in page no. 31.

24. Average mileage indicator

Indicates the approximate average mileage that the vehicle has achieved so far from last reset.

Initial default value of average mileage will be 40 km/L for first 10 km and will get updated for every 2 km.

Refer page no. 29 for the resetting procedure of average mileage indicator.

AVG
56 km /L

When average mileage value is reset, then for the first 1 km, '- - km/L' will be displayed and then the calculated average mileage value will be updated for every 2 km.

In case of any error in the system the error message '- - km/L' will appear. Contact nearest TVS Motor Company Authorised Main Dealer / Authorised Dealer.

AVG
- - km /L

25. Range indicator

Indicates the approximate distance that can be covered by the vehicle with the available fuel in the tank. Range value will be updated for every 0.2 km.

RANGE
325 km

In case of any error in the system the message '- - km' will appear without range reset. Contact nearest TVS Motor Company Authorised Main Dealer / Authorised Dealer.

RANGE
- - km

When the range becomes 0 km, the indication '-- km' will be displayed until the fuel is refilled.

If the fuel is filled above 8.3L then the Range indication displays '- km'. Range will be displayed when the fuel left in tank is below 8.3L.

If either 'RANGE' or 'AVG' is reset the values of both the indicators will be reset and updation will happen after 1 km of reset.

Note

The average mileage and range value displayed are estimated values and the actual value may differ from the displayed one.

26a. Trip meter (A & B)

Trip meter indicates the trip distance traveled in kilometer. The digit after the dot mark denotes the one tenth of a kilometer.

Provision to measure two different distance 'TRIP A' or 'TRIP B' is provided for the users to use as per their convenience.



Refer page no. 29 for the resetting procedure of Trip meter.

26b. Trip F

'Trip F' function displays the distance travelled after the low fuel indicator '  ' starts blinking and the fuel indicator displays no bar or glows continuously with fuel gauge displaying no bar. The display switches automatically to the 'TRIP F' mode after 0.5 km run of the vehicle and the low fuel indicator starts counting from 0 km.

If the fuel level remains in minimum safe level, the reading is saved even after the ignition 'OFF'.

The count stops and clears automatically after a certain distance of run and when the fuel level rises above minimum safe level.

'TRIP F' meter cannot be activated or deactivated manually. At every ignition 'ON', 'TRIP F' meter will get enabled automatically until fuel level is reached above minimum safe level.



MODE AND SET BUTTONS

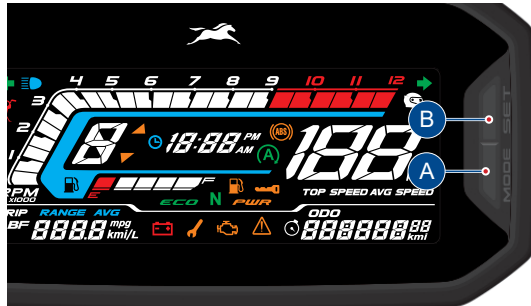

The 'Mode' (A) and 'Set' (B) buttons are provided to change between various modes and to set some of the digital display functions of the digital speedometer. The sequence of modes and their selections are explained in detail below.

Short press the 'Mode' button to access the following modes:

1. Trip A
2. Trip B
3. Range
4. Average mileage

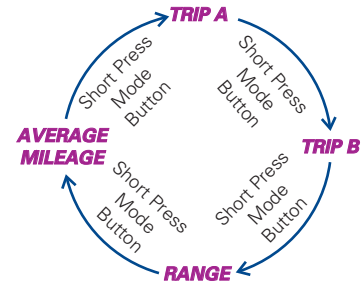

1. In 'Trip A' mode, press the 'Mode' button once to enter 'Trip B'.
 - To reset any of the trip meter while ensuring the display is in respective trip '^{TRIP} 603 km' or '^{TRIP} 573 km', press and hold the 'Set' button for a few seconds.

2. In 'Trip B' mode, press the Mode button once to enter 'RANGE' indicator mode '^{RANGE} 325 km'.
 - To reset the Range value while ensuring that the display in 'RANGE' mode '^{RANGE} 325 km'; press and hold the 'Set' button for a few seconds.
3. In 'RANGE' mode, press the 'Mode' button once to enter 'AVERAGE MILEAGE' indicator mode '^{AVG} 56 km/L'.
 - To reset the Average mileage indicator while ensuring that the display in 'AVERAGE MILEAGE' mode '^{AVG} 56 km/L', press and hold the 'Set' button for a few seconds.
4. Press the 'Mode' button once again to change the display to 'TRIP A' mode again.

Note

Above mode changes are possible only when the vehicle is in static condition for safety.

On long pressing the 'Mode' button, the following modes can be accessed.

1. SPEEDOMETER
2. TOP SPEED
3. AVERAGE SPEED
4. CLOCK SETTING

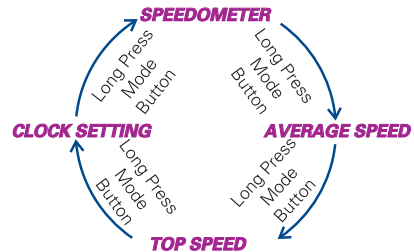

1. In 'Speedometer' mode, long press the 'Mode' button to enter 'Average speed'.
 - To reset the Average speed while ensuring the display is in 'Average Speed' mode '^{AVG} 60 km/L', press and hold the 'Set' button for a few seconds.

2. In 'Average speed' mode, long press the 'Mode' button to enter 'Top speed' mode.
 - To reset any of the Top speed while ensuring the display is in 'Top speed' mode, ' **95** ' press and hold the 'Set' button for a few seconds.
3. In 'Top speed' mode, long press the 'Mode' button to enter 'Clock setting'.

Clock setting

- On entering the clock setting mode, the digital clock starts blinking. Now, press the 'Set' button. On pressing the 'Set' button, the hour digits of the clock starts blinking and enables you to change the hours. Press the 'Mode' button to increase the hours while hour digits are blinking.
- On pressing the 'Set' button again the hours gets set and the minute digits starts blinking.
- Now, press the 'Mode' button to increase the minutes while minute digits are blinking.
- Once again press the 'Set' button so that the minutes of the clock is set and the hours format 'AM' or 'PM' starts blinking.
- Press the 'Mode' button to change the hour format either to 'AM' or 'PM'.

- Press the 'Set' button once again to set clock and long press 'Mode' button to come out of clock setting mode.
4. Press the 'Mode' button once to change the display to 'ODO' mode again.

Note

Above mode changes are possible only when the vehicle is in static condition for safety.

If no input is given for more than 20 secs during clock setting, the digital speedometer comes out of this setting mode automatically.

RAM AIR DUCT

TVS Raider 125 is designed with a ram air duct on the right side of the fuel tank. This ram air duct throws air exactly above the spark plug while the vehicle in move.

The air thrown above the spark plug cools the plug and maintains its temperature in optimum level. Which in-turn results in better heat management without any compromise on the engine performance and improves the engine's durability.

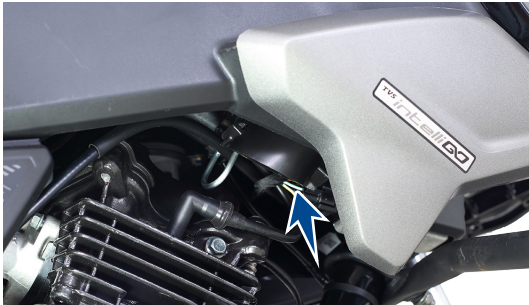

Caution

Care should be taken not to block the ram air duct air passage by cover or any other means. Else it will lead to over heating of engine or seizure.

LED HEAD LAMP

TVS Raider 125 comes with a LED head lamp which glows automatically once the engine is started. The head lamp beam (high / low) can be controlled by pressing the 'high / low' beam switch.



Note



Head lamp glows only when the engine is running.

HANDLE BAR LEFT SIDE

1. Horn switch

Press the switch '  ' to operate the horn.

2. Turn signal lamp switch

Slide the turn signal lamp switch to left '  ' or right side '  ' to operate the respective turn signal lamps (LH/RH). Press the switch to turn 'OFF'.

3. Clutch lever

Use the clutch lever to disengage the drive to the rear wheel while shifting the gears. Squeezing the lever towards grip disengages the drive.





4. Pass by switch

Press the switch to flash the head lamp high beam. It is used to give signal to the vehicles coming from opposite direction while overtaking other vehicles during day. If the switch is pressed while the head lamp is turned 'ON' and glowing in high beam, there will not be any change in the beam of head lamp.

5. Beam control switch

The head lamp beam (high/low) can be controlled by pressing the beam control switch.

Press the switch towards '  ' to turn-on the head lamp high beam or press the switch towards '  ' to turn-on the head lamp low beam.

Note

Head lamp glows only when the engine is in running.

Warning

Always use the appropriate turn signal lamps when you intend to change lanes or take turns. Be sure to switch it 'OFF' after negotiating the lanes or turns. Use appropriate head lamp beam 'high / low' as per the traffic and road conditions for your safety and to avoid inconvenience to other riders.

HANDLE BAR RIGHT SIDE

1. Mode setting switch*

To change the mode between 'ECO' or 'POWER' mode, mode selection switch is used. Keep the switch in respective mode to activate it.

Please remember that the 'TVS intelliGO' system will work only on selecting the 'ECO' mode.



2. Front brake lever

The front brake is applied while squeezing the front brake lever gently towards the throttle grip. The brake lamp glows on application of front brake.

3. Throttle grip

Engine speed is controlled by the rotation of the throttle grip. Twist it towards you to increase the engine speed and away from you or release it to decrease the engine speed.

4. Electric starter switch

Ensure the transmission is in neutral or else press the clutch lever and side stand is retracted before engaging the electric starter switch '  '.

Warning

Since your vehicle is fitted with SBT brake system it is essential to maintain the brake system in good condition. Adjust the brakes system at regular intervals for the proper working of SBT.

FUEL TANK** CAP

Flush type fuel tank cap (1) is provided in TVS Raider 125. To open the fuel tank cap, lift the protection lid (2), insert the control key into the lock and turn it in clockwise and lift the cap. Press the cap back to its original position, rotate the key in anti-clockwise direction and lock the cap. Close the lid at the end.

To avoid accumulation of water in the fuel tank, a small drain hole and a pipe is provided in the fuel tank lid cavity so that the water entering through the lid is drained out through a hose.



** The fuel tank is not a measuring instrument and the capacity of the fuel tank may slightly vary from the indicated capacity.

Warning

Avoid spilling of fuel on the hot engine.

Never refill fuel near open flame. Do not smoke while refueling.

Do not use cell phones while refueling.

EVAPORATIVE EMISSION CONTROL SYSTEM

This vehicle is fitted with Evaporative Emission Control System (EVAP). If there is any abnormal jerk, startability issue are felt in the vehicle or noise due to sudden escape of gas while opening the fuel tank cap, immediately report to the TVS Motor Company Authorised Main Dealer / Authorised Dealer.

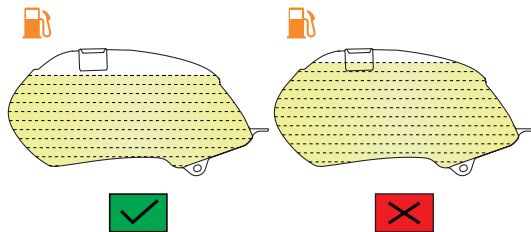

Caution

Do not clean the vehicle by laying down on floor, to avoid fuel entry into EVAP system.

Never fill fuel beyond the fuel tank inlet as shown.

Filling above the inlet may result in improper breathing of fuel tank which leads to difficulty in starting as well as improper running of the vehicle. Whenever refueling the bike fill only the recommended quantity of fuel.

GEAR SHIFT LEVER

TVS Raider 125 is equipped with a 5 speed constant mesh transmission. Neutral (N) position of the transmission is indicated by the warning light on the speedometer. To shift the transmission from neutral to first gear, press the gear shift lever down.

To change it to the second gear, lift the lever up. Lifting the lever up repeatedly engages all the gears in succession up to the fifth gear.

The gear position indicator on the speedometer dial indicates the current position of the gear and the gear shift indicator arrows guides you to up shift or down shift the gear at pre defined engine rpm.

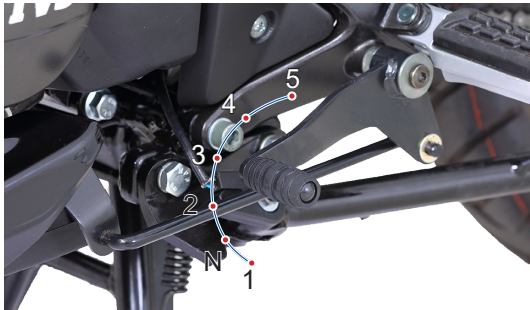

Caution

Never shift gears without disengaging the clutch and releasing the throttle. Failure to comply this will lead to rough shift or jerk while shifting the gears. Remember to return to neutral position before restarting the engine.

Note

Gear shift lever position can be set to your convenience. Contact your TVS Motor Company Authorised Main Dealer / Authorised Dealer for setting the gear shift lever position.

REAR BRAKE PEDAL

Rear brake pedal is located on the right side of the vehicle. Press the rear brake pedal with your right foot to apply the rear brake. The front brake also will be applied while applying the rear brake. The brake lamp glows on application of brake.

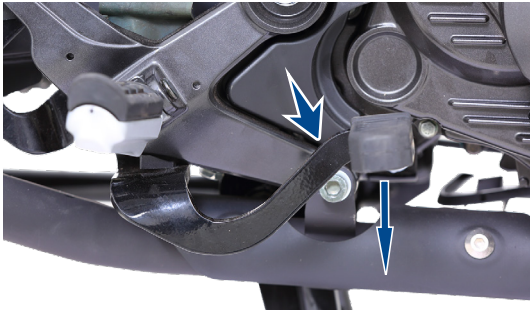

Warning

Brakes are items of personal safety and should always be maintained in proper condition.

CENTRE STAND AND SIDE STAND

TVS Raider 125 is equipped with a centre (1) and side stand (2). To place the vehicle on the centre stand, hold the handle bar left grip with left hand and pillion handle with right hand.

Place your foot firmly on the centre stand extension (1a) and press with adequate effort. Ensure both the legs of centre stand are touching the ground before placing the vehicle on the stand.

Side stand can be operated by sitting on the vehicle with your left foot by pushing it away from the vehicle till it stops.

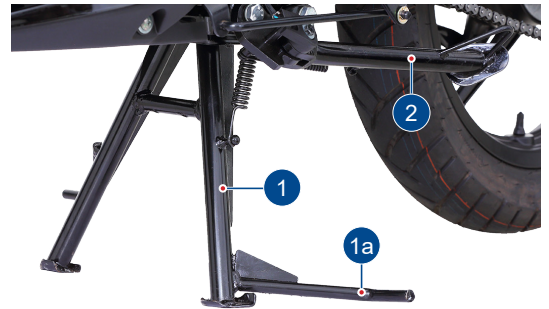

Warning

Park the motorcycle safely on a solid ground. On slopes, engage the first gear and park the vehicle in such a way that the front wheel faces uphill.

Always retract the side stand to its full up position before moving the vehicle. Else, the vehicle will get 'Switched OFF'.

Caution

Do not sit on the vehicle when it is parked on the side stand / centre stand, as your full weight would rest on the vehicle's only support.

SEAT

The seat lock is located at the rear end of the vehicle below the tail lamp assembly.

Rear seat (passenger seat)

To remove the rear seat, insert the ignition key into the seat lock and turn it in clockwise direction. Pull and take out the rear seat by lifting it from the rear end and gently tapping it on the front end and there by accessing the tool kit and first aid kit. To install the rear seat, reverse the removal procedure.



Note

Ensure the proper seating of seat assembly in the frame after reassembling.

TOOL KIT AND FIRST AID KIT

To assist you in performing certain aspects of periodic maintenance and emergency repairs, a tool kit is supplied along with the vehicle. A first aid kit is also available with the tool kit

Both tool kit and first aid kit are located in the utility box below the passenger seat. Remove the passenger seat as explained in the previous page to access them. Tool kit consists one number each of the following:

1. 12x14 mm open end spanner
2. Combination screw driver bit
3. Screw driver handle
4. Tool bag



Note

It is recommended to use the tool kit only in case of any emergency. It is always advisable to take your vehicle to TVS Motor Company Authorised Main Dealer / Authorised Dealer.

Warning

Do not remove the tool kit and first aid kit from the vehicle. Always ensure to keep them along with the vehicle. Ensure the first aid equipments are changed periodically based on the date of expiry.

COVER FRAME L

To access the battery assembly and the fuse, cover frame L need to be removed. Follow the procedure given below for removing and re-fixing cover frame.

For removing :

1. Remove the mounting screws (A & B) from the cover frame mounting.
2. Loosen the snap revet screws and pull out the snap rivets from the location (C,D & E).
3. Take out the cover frame by gently pulling it out at front top end and rear end of the cover frame.

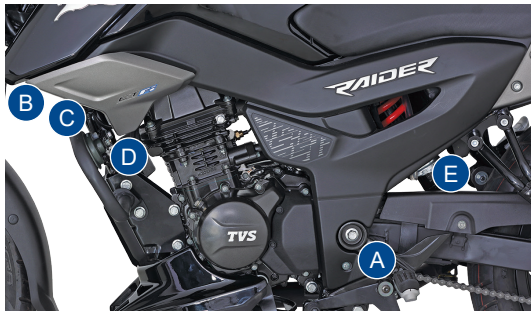

For reassembling:

1. Locate the lugs of the cover frame to the holes provided in the fuel tank assembly and the frame while ensuring the availability of the cushion in the holes.
2. Gently press the cover frame lugs into the holes.
3. Install the mounting screws (A & B) and the snap revets (C,D & E).
4. While ensuring the proper seating of cover.

Note

Care should be taken not to damage the cover frame and its lugs during removal and reassembly.

While re-fixing the cover frame, ensure the availability of rubber cushion in the fuel tank hole.

SMART PHONE CHARGER**

Location for fixing a smart phone charging USB socket is provided at the front end of the fuel tank bellow the handlebar near fuel tank cap. The smart phone charging socket supplied by the company can be fitted on your vehicle on chargeable basis. Ask your Dealer to fix the same if required. Please follow the guidelines mentioned below while using it.

DO's

1. Ensure that no water enters into the unit, by closing the USB flap properly.
2. Use the USB, only if approved standard USB cable is used for charging mobile.



3. Do make sure the flap is not damaged while opening / inserting the USB cable.

DON'TS

- Do not leave the USB charging flap open / partially closed.
 - Do not attempt to use / charge any other device, other than mobile phones. Only one mobile phone should be charged at a given time.
 - Do not try to force the USB connector in, check whether it is inserted in the appropriate direction, to prevent the damage to the charger.
- Do not charge your mobile when engine is off.

Caution

The charging time of the mobile may vary, depending on the mobile battery's state of charge.

*The rubber flap in the unit has been designed to prevent water entry and it is not replaceable. **No warranty for charger in case of rubber flap cut.***

** Optional accessory will be charged extra

PRE RIDE INSPECTION

Check the following items before riding

ITEM	WHAT TO CHECK FOR
Engine cum transmission oil	Availability of oil upto the level (page no. 58)
Fuel	Enough fuel for the planned distance of running
Tyres	Correct pressure (page no. 67) Adequate tread depth / No cracks or cuts
Battery	Proper working of digital speedometer, tail lamp, license plate lamp, brake lamp, turn signal lamps, horn and electric starter.
Digital speedometer	Performing self check
Lighting	Proper working of head lamp high beam / low beam and high beam indicator
Steering	Smooth movement / No play or looseness
Throttle	Correct free play of cable / smooth operation
Clutch	Correct free play of cable (page no. 59) Smooth and progressive action
Brakes	Availability of brake fluid and proper working of brake. Correct lever and pedal play (page no. 61, 63 and 65)
Wheels	Free rotation
Malfunction indicator	Turned 'OFF' after the engine starting (page no. 22)

Starting the engine

Ensure the availability of the fuel in the tank. Insert the control key into the ignition cum steering lock and turn it to the 'ON' position. After fuel pump priming (approx. few secs) keep the transmission in neutral and press the electric starter switch to start the engine. If the gear is engaged, press the clutch lever and retract the side stand before pressing the electric starter switch.

When the engine is cold

1. Start the engine with no opening / very less opening of throttle.
2. Once the engine is started and running stable ride the vehicle.



Caution

Once the vehicle is started, engine idling rpm will be high and will stabilize gradually. Do not open excessive throttle when engine is idling and the vehicle is parked. It leads to overheating of engine and damage to internal components.



Warning

Do not run the engine indoors where little or no ventilation available. Exhaust gases are extremely poisonous.

Setting the vehicle in motion

1. Depress the clutch lever and engage the first gear by pressing gear shift lever down.
2. Open the throttle slowly and simultaneously release the clutch lever gently and gradually. The vehicle starts moving forward.
3. As the vehicle picks up speed, shift to the next higher gear by closing the throttle, applying the clutch and lifting the gear shift lever.
4. Release the clutch lever and open the throttle smoothly. Select the required gear in similar manner.

Using the transmission

The transmission is provided to keep the engine to run smoothly in its normal operating speed range. The gear ratios have been carefully chosen to meet the characteristics of the engine.

The rider should always select the most suitable gear to achieve the necessary speed and pulling power smoothly.

Riding on hills / gradients

When climbing steep hills, the motorcycle may begin to slow down and show lack of power. At this point you should shift to a lower gear so that the engine will again be operating in its normal power range. Shift gears rapidly to prevent the motorcycle from losing momentum.

When riding down a hill, the engine may be used as braking by shifting to a lower gear.

Stopping and parking

1. Close the throttle completely and apply both the brakes simultaneously.
2. Down shift the gears as the road speed decreases. Bring the engine to neutral position just before the vehicle stops.
3. Turn the ignition 'OFF'.
4. Park the vehicle on a firm, flat surface.
5. Lock the steering.

Note

Ensure to maintain sufficient amount of fuel while riding the vehicle in up or down gradient.



Caution

It is not recommended to use the 'TVS IntelliGO' function for stopping the vehicle on a hill / gradient to ensure the controllability of the vehicle and safety



Warning

Reduce speed to a safe limit before turning / cornering. Do not apply brake while turning / cornering. Do not disengage clutch before braking.

FUEL RECOMMENDATION

Use only BS VI petrol with minimum RON 91. BS VI petrol containing upto 10% of ethanol by volume can be used.

Higher ethanol content in petrol can

- degrade plastic and rubber components of fuel system and vehicle parts
- cause corrosion damage to metal parts like fuel tank, etc
- result in startability & drivability issues
- decrease fuel economy

Ethanol absorbs water very easily, resulting fuel separation. Extra care shall be taken to prevent moisture entry into fuel tank while filling ethanol blended petrol and water washing of vehicle.

Painted parts (viz. panels, covers) shall not come in contact with ethanol blended fuels.

Manufacturer is not responsible for any warranty issues that results from using ethanol blend in excess of 10% by volume.

In case of any abnormalities observed due to use of ethanol blended fuels, customers are advised to use a different fuel station/brand for standard E10 fuel or contact authorised service centres.



Caution

Never mix oil in petrol in the fuel tank. Always fill fuel from the reputed and reliable fuel stations.

CHECKS AND TIPS FOR IMPROVING FUEL ECONOMY

Regular checks

Carry out the periodic maintenance checks as specified in this manual (page no. 50).

Regular maintenance checks will save fuel and ensure trouble-free, enjoyable and safe riding besides keeping environment clean.

Spark plug

A dirty or defective spark plug leads to wastage of fuel due to incomplete combustion. Inspect and clean the spark plug only if necessary. **Replace the spark plug every 12000 kms (1 year). Always use recommended spark plug only.**

Air cleaner element

A dirty air cleaner element restricts airflow and increases fuel consumption. **Replace the element every 12000 kms.**

Paper and foam type air cleaner element is used in your motorcycle. In case of any abnormalities (heavy dust clogging, damage), replace the filters earlier than the specified interval. Ensure to replace the filters as set.

Clutch

Increase in engine rpm during acceleration, without increase in road speed indicates the clutch slip. A slipping clutch will cause high fuel consumption and engine over heat.

If the condition persists even after adjusting the clutch lever play, immediately have the clutch checked by TVS Motor Company Authorised Main Dealer / Authorised Dealer.

Engine cum transmission oil

Dirty or less engine cum transmission oil increases the friction between various parts of the engine and reduces the engine life, thereby increases the fuel consumption.



Caution

Never drive the vehicle with half clutch. This will reduce the life of clutch and affects the performance of the vehicle and fuel economy.

Regularly inspect the engine cum transmission oil for correct level and top-up if necessary. Get it replaced at regular intervals as per the maintenance schedule.

Fuel leak

Check and arrest fuel leak if any, from tank, throttle body, injector and fuel lines. Loss of fuel due to leak may drain the fuel tank completely.

Tyres

Low tyre pressure has adverse effect on the vehicle. The **drag on the vehicle** increases resulting in decreased fuel economy. Further more, handling may be adversely affected.

Inspect the tyre pressure regularly (weekly) and inflate it to the recommended pressure (refer page no. 67). Never use tyres which are worn beyond the permissible limit.

Chain slackness

Check and ensure the drive chain slackness. Excess slackness leads to higher fuel consumption (refer page no. 70).

Wheel freeness

Inspect and ensure the wheel freeness by rotating the wheels at least once in a week to avoid wastage of fuel.

Fast starting from rest wastes fuel

A racing start from rest at full throttle can waste fuel and damage the engine. It also creates a potentially dangerous traffic situation.

Fast acceleration wastes fuel

Fuel is wasted whenever you suddenly accelerate or apply brake.

Avoid unnecessary idling

While waiting for someone or stopping in signals for long time, if the engine is kept running at idle speed, it causes unnecessary wastage of fuel. So, ensure to use the 'TVS intelliGO' system which automatically shuts down the engine when it is kept idling for long and there by avoiding unnecessary wastage of fuel.

Avoid frequent braking

Anticipate corners and slopes as well as the traffic conditions. **Unnecessary and frequent braking will reduce the fuel economy.**

Note

The on-road mileage of TVS Raider 125 is dependent on several factors like road condition, quality of fuel, riding speed, operation of clutch and brake, tyre inflation, maintenance / timely servicing of vehicle, load etc.. and hence will differ from the mileage given under standard test conditions such as made in recognised institutes.

MAINTENANCE SCHEDULE

The maintenance schedule indicates the intervals between periodic services. At the end of each interval, be sure to inspect, check, replace, adjust, lubricate and service as instructed. If the maintenance is not done periodically, it will result in rapid wear and severe damage to the vehicle. If the vehicle is used under high stress conditions such as continuous full throttle operation or if used / operated in dusty climate, certain jobs should be performed more often to ensure reliability of the vehicle. Cylinder head, steering components, suspension, chain and wheel components etc., are key items and require very special and careful servicing. TVS Motor Company Limited strongly recommends that the jobs as per the maintenance schedule be performed by your TVS Motor Company Authorised Main Dealer / Authorised Dealer.

Periodic inspections may reveal one or more parts that may need replacement. Whenever replacing parts on TVS Raider 125, it is recommended that you use only the **TVS Motor Company Genuine** parts.

Caution

Proper running-in and maintenance are mandatory for making certain that your vehicle is reliable and gives optimum performance at all times. Be sure that the periodic maintenance is performed thoroughly in accordance with the instructions given in this owner's manual.

In more dusty areas, the air filter element may required early replacement than the mentioned kilometers to avoid costly damages to the engine.

PERIODIC MAINTENANCE SCHEDULE (months or km whichever occurs earlier)

SERVICE km PERIOD FROM DATE OF SALE		FREE SERVICE			AFTER FREE SERVICE	REMARKS
		1st 750 ~ 1000 30 ~ 45 days	2nd 6000 6 months	3rd 12000 12 months	Every 6000 km / 6 months	
ITEMS	ACTIVITY					
Malfunction indicator lamp	Check with Diagnostic tool	I	I	I	I	Connect ride scan tool if MIL glows Check and clear DTCs
Engine cum transmission oil	Replace	R	R	R	R	
Centrifugal filter	Clean	-	-	C	-	Clean every 12000 Km
Spark plug	Replace	I	-	R	-	Inspect, clean if required. Replace every 12000 km
Air cleaner elements	Replace	-	-	R	-	Replace every 12000 km
Tappet clearance	Inspect and adjust	I	I & A	I & A	I & A	Inspect for any abnormal noise starting trouble and adjust if required
Fuel hose	Inspect and replace	-	-	-	-	Inspect at every 4 years and replace if required
Clutch and throttle play	Inspect and adjust	I & A	I & A	I & A	I & A	
Throttle grip	Lubricate	-	-	L	-	
Steering smooth operation / play	Inspect, adjust and lubricate	I	I	I	I	Adjust if required. Lubricate if issue persists
Front fork oil	Replace	-	-	-	-	Replace every 30000 km
Front and rear suspension	Inspect for proper functioning	I	I	I	I	

SERVICE km PERIOD FROM DATE OF SALE		FREE SERVICE			AFTER FREE SERVICE	REMARKS
		1st 750 ~ 1000 30 ~ 45 days	2nd 6000 6 months	3rd 12000 12 months	Every 6000 km / 6 months	
ITEMS	ACTIVITY					
All fasteners	Inspect and tighten	I & TI	I & TI	I & TI	I & TI	
Drive chain**	Clean, lubricate and adjust	C, L & A	C, L & A	C, L & A	C, L & A	
All bulbs, horn and switches	Inspect for proper functioning	I	I	I	I	
Head lamp beam	Inspect and adjust	I	I	I	I	Adjust if required
Battery voltage	Inspect and charge if necessary	I	I	I	I	Recharge if necessary
Brake effectiveness / play	Inspect and adjust	I & A	I & A	I & A	I & A	
Brake cams / SBT system parts	Clean	-	-	-	-	Inspect and clean if required
Brake fluid*	Inspect, topup and replace	-	-	-	-	Replace every 24000 km Top up if required
Master cylinder cups*	Replace	-	-	-	-	Replace every 24000 km
Wheels and tyres	Inspect and set	I	I	I	I	Inspect wheel for free rotation. Inspect tyre for wear and set pressure
Centre / side stand pivot	Lubricate	L	L	L	L	
Evaporative emission control system	Inspect	I	I	I	I	

R - Replace; I - Inspect; T - Top up; C - Clean; A - Adjust; L - Lubricate; TI - Tighten; S - Set

** Clean the drive chain with dry cloth and apply TRU SPRAY / TRU 4 oil as frequently as every 500 km for better chain life and smooth vehicle running. Check drive chain, rear sprocket and engine sprocket for wear. If any part is worn, replace the same. Always replace the engine sprocket, rear sprocket and chain together.

* Applicable only for Disc Brake version

RECOMMENDED LUBRICANTS

APPLICATION	QTY	MANUFACTURER	BRAND
Engine cum transmission oil	1000 ml	TVS Motor Company	TVS TRU4 PREMIUM oil (SAE 10W30 API-SL, JASO MA2)
Front fork oil	162 ± 3 ml / leg	Castrol / IOC	Teleshockab oil
Disc brake fluid*	-	TVS Girling	DOT 3 / DOT 4
Grease	-	Bharat petroleum IOC Bechem	MP Grease no. 3 Servo Gem no. 3 Bechem premium grade 3
Chain cleaner	--	TVS Motor Company	TRU SPRAY chain cleaner
Chain lubricant	--	TVS Motor Company	TRU SPRAY

* Applicable only for Disc Brake version

SELF - MAINTENANCE PROCEDURES

MAINTENANCE FREE (MF) BATTERY

Battery is located below the cover frame L. Follow the procedure given below for accessing the battery:

1. Place the vehicle on center stand on a flat surface and open the cover frame L as explained in page no. 41.
2. Check the battery voltage as per the schedule. If the voltage measured is less than 12.4 Volts, charge the battery using **recommended MF battery** charger at TVS Motor Company Authorised Main Dealer / Authorised Dealer.

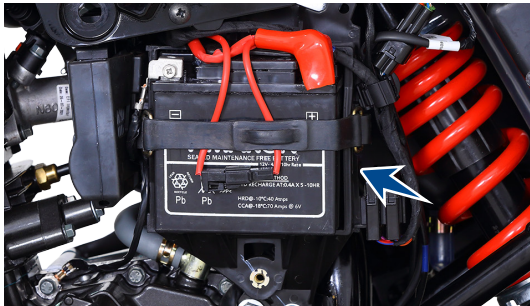

3. Adding any additional electrical accessories other than TVS Motor Company recommend ones, may lead to disqualification of warranty coverage.
4. While connecting the terminals, observe the correct polarity. Connect the red wire to the '+' terminal and black wire to the '-' terminal of battery

Incase of any abnormality or for removal of battery from the vehicle, contact TVS Motor Company Authorised Main Dealer / Authorised Dealer.

Caution

Never check the battery charge by shorting the terminals.

Always connect the positive terminal first (red wire) and then negative (black wire) to avoid sparking.

The inversion of the battery wires can damage the battery and the electrical system.

Recommendations to maintain battery health during prolonged parking conditions

While your vehicle is parked for prolonged duration, battery continues to discharge and if left unattended can get completely discharged. It is recommended to ride the vehicle for minimum 60 km every week to keep the battery in healthy condition. This could be at a stretch in one ride or several rides during the week. The vehicle speed will vary during the ride but an average speed of minimum 30 kmph will be helpful to ensure proper battery charging. Use kick-starting, if available, to conserve battery charge during such period. This is only a recommendation to maintain battery charge and regular service schedules must be followed to maintain your vehicle in good running condition.

The following is recommendations to users regarding battery maintenance before, during and after long storage of battery:

1. Before storage

- Store the battery only after fully charging it.
- Battery fuse to be disconnected and stored safely. This will reduce the sleep mode current and hence enhance storage life of battery.*

- Alternatively, battery connecting wires (positive and negative wires) can be disconnected and fasteners can be secured with battery terminals.*

2. During storage

- Store it at room temperature or lower.
- Store the vehicle in the shade and protected from rain and cover the vehicle to prevent rodents from entering and damaging the wires.

3. After storage

- Connect the wires and fuse, if disconnected earlier, with ignition switch in OFF position*
- Start the vehicle by kick starting (if available).

(Above recommendations do not consider storage effects on other systems such as induction and fuel systems and wheels).

Periodic maintenance of Batteries:

- Keep top of battery clean.
- Check cables, clamps, and case for obvious damage or loose connections.
- Clean terminals and connectors as necessary.

** To be done by skilled personnel*

- Recharge battery if voltage is below 12.4 Volts.
- Valve Regulate Lead Acid (VRLA) / Lead Acid batteries are prone to water damage. Any water entry, through vents or otherwise; will result in irreparable damage to the battery or the vehicle.

 **Warning**

Battery develop explosive gases. Keep it away from heat sources. If charging is required the battery must be charged in well ventilated area.

Unusable battery must be disposed in environment friendly manner. Do not discard it with household trash. Handover the battery to the battery dealers or to a recycle center that accept used battery.

 **Caution**

Never operate the vehicle with discharged battery as it may damage electrical components.

Do not push start the vehicle, use a good battery to start the vehicle.

FUSE

Non-working of electrical systems may be due to safety fuse failure. Short circuit or overload in the electrical system are the main causes for fuse failure. Follow the procedure given below for inspecting and replacing the fuse.

1. Open the cover frame L as explained earlier (refer page no. 41).
2. The fuse case fitted near the battery contains one 25A fuse, one 15A fuse and one 10A fuse. Each fuse is provided with a spare.
3. Take out the fuse case from the battery band and open its cover. Pull out the required fuse.

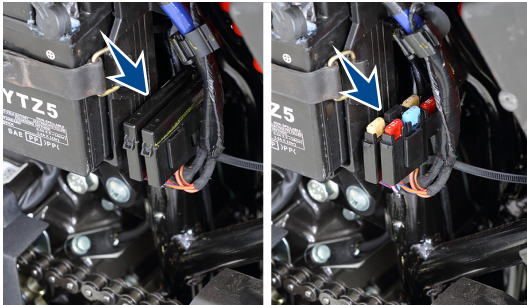

4. Inspect the fuse for failure. If found blown, replace it with new one with the same rating (additional fuses are provided inside the fuse case itself).
5. Close the fuse case and re-fix case into the battery band.
6. Turn 'ON' the ignition switch and check for proper functioning of electrical systems. In case the fuse fails again, consult the nearest TVS Motor Company Authorised Main Dealer / Authorised Dealer.

Caution

*Do not use vehicle by **shorting the wires without fuse**. This may result in overheating of electrical items / wiring and may result in fire.*

Do not use fuse of higher amperage than specified for the safety of electrical system.

SPARK PLUG

1. Clean the dust and mud around the spark plug mounting to avoid falling inside the cylinder.
2. Pullout the suppressor cap from the spark plug.
3. Using the spark plug spanner, remove the spark plug.

A spark plug with heavy carbon deposits will not produce strong sparks. Hence, only if necessary, clean the carbon deposits from the spark plug with a small wire brush or spark plug cleaning tool.

Inspect the spark plug electrodes (A) and (B) for any corrosion. If found any replace the spark plug with new.

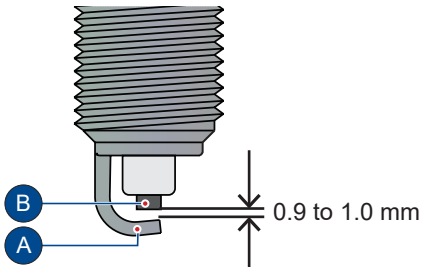

Inspect the spark plug gap visually (0.9 ~ 1.0 mm). If found more, replace the spark plug with a new one.

After cleaning and inspecting the gap, reinstall the spark plug and tighten by hand to avoid cross threading. Finally tighten using spark plug spanner. Do not over tight or cross thread the spark plug. After reassembling the plug fix back the suppressor cap and ensure its proper fitment.

Caution

*Always use only the recommended make and type of spark plug. **Replace the spark plug every 12000 km.***

Cover the spark plug hole with a clean cloth when the plug is removed to prevent dust / water entry.

It is advisable to tight the new spark plug by hand till the end and then loose. Again re-tight the spark plug by 1/8 of rotation after sealing by using only the hand tool.

Since the hook type spark plug is used, it is not advised to adjust the plug electrodes as it may damage the electrodes.

ENGINE CUM TRANSMISSION OIL LEVEL

Check the engine cum transmission oil level periodically.

1. Place the vehicle on centre stand on a flat surface. Wipe-off the surroundings of gauge oil level.
2. Remove the gauge oil level and wipe it clean.
3. Fix the gauge back to its mounting hole. Do not thread in.
4. Take out the gauge and check the oil level.
5. The oil level should be between minimum and maximum level marks of the gauge as shown in the figure.

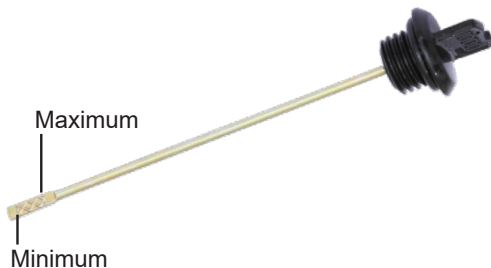

6. If the oil level is less than the minimum level, add TVS TRU4 PREMIUM oil ((SAE 10W30 API-SL JASO MA2) upto the maximum level mark.
7. Wipe out the oil traces with a clean cloth to prevent dust accumulation and assemble back the gauge oil level.

Caution

If the vehicle is driven with less engine cum transmission oil, the engine components will be severely damaged. Check the oil level as per the schedule to avoid costly damage.

Do not fill excess oil as it may cause the oil leak. Always use 'TVS TRU4 PREMIUM (SAE 10W30 API-SL JASO MA2)'.

CLUTCH ADJUSTMENT

Clutch lever free play is one of the most important adjustment which you may need to check in-between services for better life of the clutch plates. The free play of the clutch lever should be 8 ~ 15 mm as measured at the clutch lever end before the clutch begins to disengage.

Adjust the clutch lever free play periodically by means of clutch cable adjuster at arm clutch release if the free play is found more.

1. Ensure that the engine is cold.

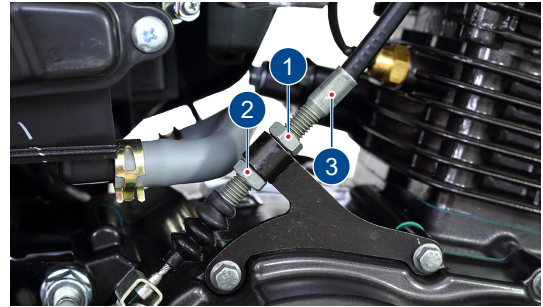

2. Loosen the lock nut (2) while holding the clutch cable adjuster (3). Adjust the clutch cable adjuster nut (1) 'in' or 'out' to give sufficient play in the clutch lever.
3. After adjusting the play, hold the adjuster nut (1) in the same position, tighten the lock nut (2).

Caution

*Too much or too less clutch lever free play will damage the clutch plates, thereby affecting the performance of the vehicle. **Adjust the clutch lever free play only when the engine is cold.***

REAR SHOCK ABSORBERS

TVS Raider 125 is provided with 5 step adjustable, gas charged, hydraulic shock absorbers to meet different road and load. There are 5 notches for adjusting spring load.

If the spring is adjusted to the minimum notch, then the shock absorber will be softer which is good for light loads. If the spring is adjusted to maximum notch, then it will be stiffer which is good for heavy loads.

Adjust the spring pre-load by shifting the adjuster to the required notch according to the different load conditions.

The more you compress the spring, the suspension becomes more stiff.

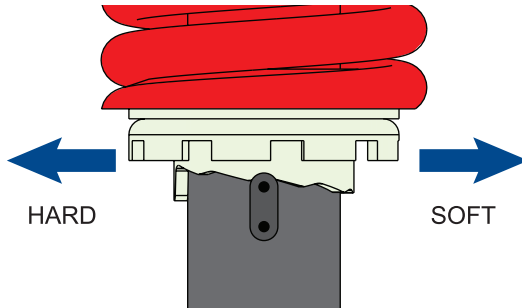
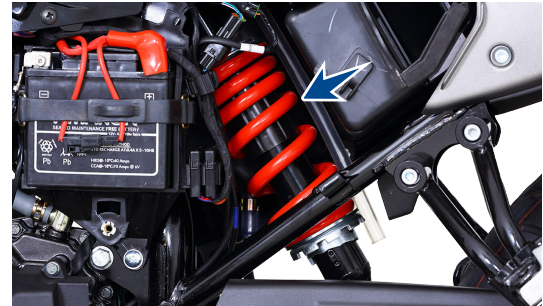

BRAKES

Front brake (Disc type)

You can observe a master cylinder (1) on the right side of the handle bar, a caliper assembly (2) fitted to the fork leg R, a disc (3) to the front wheel and a high pressure hose (4) connecting the master cylinder and the caliper assembly.

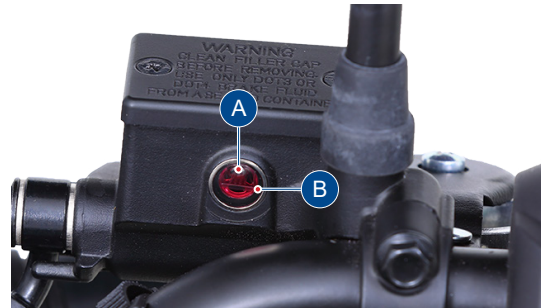
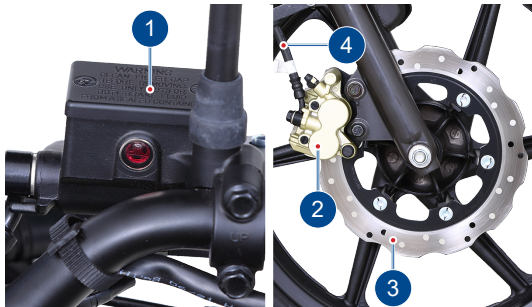

1. Check the master cylinder brake fluid level through the view piece glass (A).
2. Brake fluid level always should be above the 'MIN' mark (B) provided on the master cylinder view piece glass when the master cylinder is parallel to the ground.
3. If the brake fluid level is below the mark or while applying brake if you feel the brake is more spongy or ineffective due to air entry, contact TVS Motor Company Authorised Main Dealer / Authorised Dealer for topping-up the brake fluid, air bleeding and other brake related inspections.

Warning

Brakes are items of personal safety and should always be maintained in proper condition.

Warning

Since the vehicle is fitted with Synchronised Braking Technology (SBT) adjust the brakes with additional care. If not it may result in brakes not working properly.

Brake pad wear indicator

Visually check the brake pads wear. If the wear is found beyond the wear indicator groove as shown in the figure then, replace the brake pads.

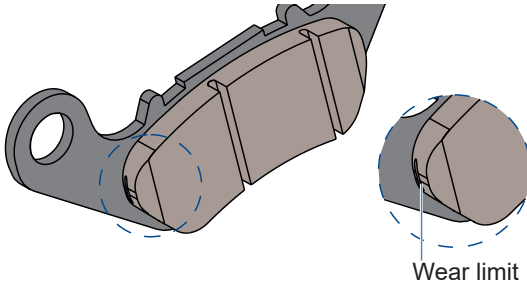
**Caution**

The brake pads must be replaced as a set if the brake pad wear limit indicator shows beyond the wear limit.

Front brake (Drum type)

1. Measure the free play of the front brake lever at the lever end as shown in the figure.
2. The free play of the brake lever before the engagement of brake should be between 15 ~ 20 mm.

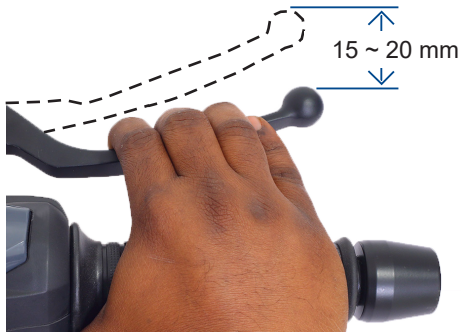

Warning

Brakes are items of personal safety and should always be maintained in proper condition.

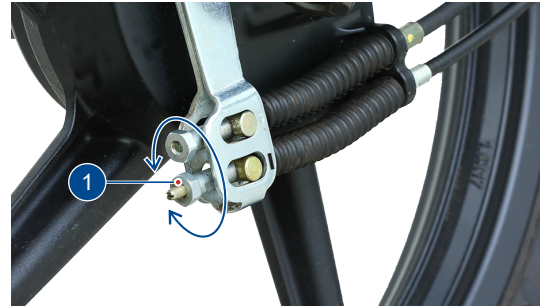

SBT
SYNCHRONIZED BRAKING
TECHNOLOGY

Warning

Since the vehicle is fitted with Synchronised Braking Technology (SBT) adjust the brakes with additional care. If not it may result in brakes not working properly.

Please contact TVS Motor Company Authorised Main Dealer / Authorised Dealer for any further assistance.

3. Turn the adjuster nut at bottom side (1) in the slot marked as "I" in clockwise direction for reducing the free play or in anti-clock wise direction for increasing the free play.
4. After obtaining the necessary free play at the lever end, inspect for the clearance between the bullet (3) and slot end (4) marked as "S" as shown in figure.
5. If any clearance is found then turn the top side adjuster nut (2) at slot marked as "S" in clockwise direction until there is no clearance between the bullet (3) and slot top (4).

6. After adjusting the nut top, If any clearance is observed in between the bullet bottom (5) and slot bottom (6) marked as "I" as shown, then turn the adjuster nut (2) in anti-clockwise until the clearance is closed.
7. Once again check and confirm the brake play at the lever end.

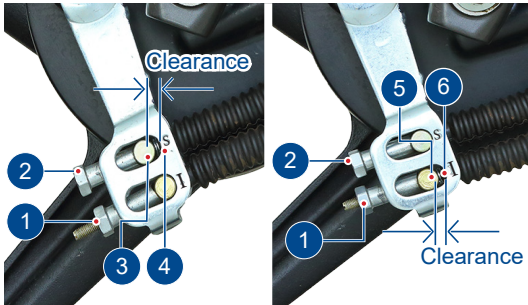

Rear brake

1. Measure the free play of the rear brake pedal at the pedal end as shown in the figure.
2. The free play of the brake pedal before the engagement of brake should be between 15 ~ 20 mm.
3. If the measured free play is more than the limit, adjust the nut provided at the rear wheel end to obtain the correct play.
4. Turn the adjuster nut clockwise to reduce the free play or turn it in anti-clockwise direction to increase the free play.



Warning

Please remember that the rear brake lever free play adjustment to be done only after adjusting the front brake lever play in case of front drum brake type vehicle.

Brake shoe wear indicator

When the brake is applied, wear limit index mark (A) on both front and rear brake cam should be within the range of wear limit indicator (B) on panel assembly. In case the index mark (A) is going beyond the wear limit (B), replace the brake shoes as a set, with the help of the nearest TVS Motor Company Authorised Main Dealer / Authorised Dealer.

However, if cam lever adjustment goes beyond certain range, then index the cam lever to next slot (serration tooth) with the help of the nearest TVS Motor Company Authorised Main Dealer / Authorised Dealer to utilize remaining shoe life until wear limit.

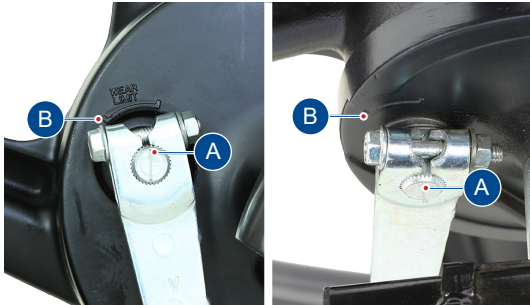

Caution

Replace the brake shoes as a set, if wear limit index mark (A) exceeds beyond the range of wear limit indicator (B) even after indexing the lever.

TYRES

Tyre pressure:

Check the tyre pressure atleast once in a week if not more frequently. Insufficient air pressure in the tyres not only hasten tyre wear, but also seriously affects the stability of the vehicle.

Under inflated tyres make smooth cornering difficult and over inflated tyres decreases the tyre contact with the ground which can lead to skidding and loss of control. **Lower tyre pressure consumes more fuel.** Be sure that the tyre pressure is within the specified limit at all times.

	Solo	Pillion
Front	1.75 kg/cm ² (25 PSI)	1.75 kg/cm ² (25 PSI)
Rear	1.97 kg/cm ² (28 PSI)	2.25 kg/cm ² (32 PSI)

Tyre tread condition

Operating the vehicle with excessively worn tyres will decrease riding stability and can lead to loss of control. It is recommended to replace the tyre when the tyre wears off to the tyre wear indicator level (indicated by TWI (A) on the tyre).

Tyre rotation direction

While reassembling the tyres, after removing from the wheel rim, ensure that the arrow mark on the tyre facing the direction of wheel rotation.



Warning

*The tyre inflation pressure in cold condition and the tyre tread condition are extremely important for the performance and safety of the rider. Check the tyres frequently for inflation pressure as well as the wear pattern on it. **Use of a tyre other than the standard may cause instability.***

Tyre puncture

Your motorcycle is fitted with a tubeless tyre on both front and rear wheel. In case of any puncture / tyre damage, it is advised to visit the nearest tyre manufacturer Dealer or the tyre repair shops who knows the repairing method of tubeless tyre.

It is not necessary to remove the tyre from wheel rim always to attend a puncture, Even though if there is need of tyre removal, it is strongly recommended to use a tyre removal / fitment machine. If at all, tyre levers needs to be used, the levers should be free from sharp edges. Care should be taken not to damage the tyres and rims.

Caution

The side walls of the tubeless tyre which in contact with the wheel rim are only seals the air inside the wheel assembly. Hence care should be taken not to damage the side walls of the tyres during removal / reassembly.

Inflation pressure check - Condition



Note

If vehicle is in hold condition for long time

- *Need movement of vehicle to avoid particular spot of tyre not to touch the ground for more than week time.*
- *Inflation pressure should check on cold condition maximum travel distance should not exceed more than 1 km.*
- *Weekly basis inflation pressure check helps to improve 10% of tread life and fuel efficiency.*

DRIVE CHAIN

Proper lubrication and adjustment of drive chain gives long service life of chain. Poor maintenance of chain causes premature wear or damage to the drive chain and sprockets. **Poor chain maintenance also affects mileage of the vehicle.** The drive chain must be cleaned, checked, lubricated and adjusted at specified intervals mentioned in the maintenance schedule.

If the vehicle is used under severe conditions and more dusty area, the drive chain must be attended more frequently.



Check, clean, lubricate and adjust the drive chain in the following manner:

1. Place the vehicle on centre stand with the transmission in neutral.
2. Inspect the drive chain slackness (vertical movement) using the finger as shown in the figure.
3. The slackness of the drive chain should not exceed the limit (maximum 20 ~ 30 mm). **Excess slackness consumes more fuel.**
4. If the slackness is found more, contact TVS Motor Company Authorised Main Dealer / Authorised Dealer for adjustment.
5. If the slackness found is within the limit, clean the chain with TRU SPRAY chain cleaner & dry cloth and lubricate using TRU SPRAY / TRU4 oil.

Warning

Riding with improperly adjusted chain / high slackness can cause the chain to come off the sprockets resulting in accident or serious damage to the motorcycle.

Misalignment of rear wheel or sprockets can cause abnormal wear of chain and sprockets and results in unsafe riding condition.

 **Caution**

Lubricate the drive chain after the motorcycle is washed with water or riding in rainy / wet condition.

The chain must be serviced more frequently when the vehicle is operated under severe conditions like dusty, muddy, wet, high speed or frequent starting / stopping.

FRONT WHEEL REMOVAL AND REASSEMBLY

1. Remove the axle nut (1) along with a washer.
2. Pull out the axle (2) from the front wheel.



3. In case of disc brake model, remove the spacers from both side of the wheel. In drum brake model remove a spacer from right side of the wheel.
4. Place a support below the frame to prevent the vehicle from falling and lift the vehicle up.
5. In case of drum brake model, dislocate the wheel assembly along with the brake panel. Separate the brake panel from the wheel and take out the wheel.
6. In case of disc brake model, carefully dislocate the disc from the caliper assembly and slide the wheel out.
7. Reverse the procedure for reassembling.

 **Warning**

Always make sure that whenever the wheel is removed, axle nut is properly re-tightened to the specified torque.

REAR WHEEL REMOVAL AND REASSEMBLY

1. Remove the rear brake adjuster nut (1) and disconnect the brake rod from the rear brake lever.
2. Remove the split pin (2) and the nut (3) from torque link mounting with the brake panel and disconnect the torque link.
3. Remove the axle nut (4) along with a washer.
4. Pull out the axle (5) along with a washer and take out the spacer bush from the rear wheel assembly.

5. Tilt the vehicle to the left and take out the wheel along with the brake panel. Separate the brake panel from the wheel.
6. For locating and reassembling the rear wheel easily, engage the gear. This will arrest the free movement of the drum sprocket.
7. Reverse the procedure for reassembly.

Caution

Once the split pins are removed, replace them with new ones.

Warning

Always make sure that whenever the wheel is removed, axle nut is properly re-tightened to the specified torque.

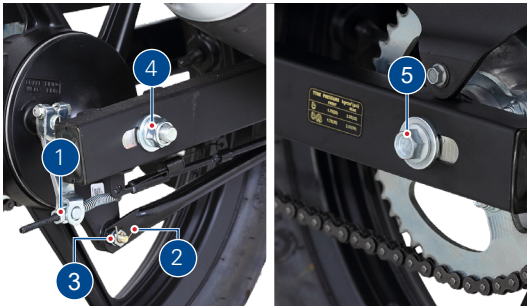

STORAGE PROCEDURES

For storage of your motorcycle for longer period of over a month and above, we recommend to carry out the following steps:

1. Clean the vehicle thoroughly. Park the vehicle on centre stand.
2. Warm up the engine and drain engine cum transmission oil. Store the oil, if new, in a dust free container.
3. Empty the fuel tank.
4. Remove the spark plug and feed in several drops of engine cum transmission oil through spark plug hole. Crank the engine few times and reinstall the spark plug.
5. Remove the battery, store it away from direct sunlight and freezing temperatures.
6. Place a suitable support at the bottom of the frame so that both the tyres are off the ground. This will ensure better tyre life.

Warning

The exhaust system becomes hot after a run. Park the vehicle in a place where pedestrians or children are not likely to touch the vehicle.

7. Cover up the vehicle completely with a clean tarpaulin or any other suitable cover. Store the vehicle inside a garage or similar area to avoid damage due to dust and rain. Make sure that the storage area is well ventilated and free from any source of flame or spark.

Caution

Do not park the vehicle on a slope or soft ground or else it may fall down.

During storage, the battery must be recharged on a TVS Motor Company recommended battery charger at least once in a month.

TAKING THE VEHICLE OUT OF STORAGE FOR REGULAR USE

1. Take the vehicle out of the garage and clean it thoroughly.
2. Remount the battery after bench charging if required.
3. Fill the engine cum transmission oil [TVS TRU4 PREMIUM oil (SAE 10W30 SLJASO MA2)] and check the oil level using gauge oil level.
4. Lubricate the parts as instructed in the periodic maintenance schedule.
5. Fill up fresh petrol in the fuel tank.
6. Check and inflate the tyres to the specified tyre pressure.
7. Check and correct the points mentioned in page no. 43.
8. Turn the ignition switch to 'ON' position. Retract the side stand if the vehicle is parked on side stand. Start the engine and allow it to idle for a few minutes and ride out.

Caution

Avoid using alkaline solution like detergent soaps for washing. This may damage head lamp and other lamp assemblies.

RECOMMENDED TIPS WHEN TAKING A LONG TRIP OF MORE THAN 500 KM:

- A) Please keep the following items for use in case of emergency:
1. Tool kit complete.
 2. Recommended spark plug one number.
 3. Turn signal lamp bulb one each.
 4. Throttle, clutch and front brake cable one each.
 5. First aid kit.
- B) Precautions to be taken for the journey:
1. Ensure engine cum transmission oil and brake oil* level are up to the level mark.
 2. Adequate fuel in fuel tank (refer page no. 23).

* Applicable only for Disc Brake version

- C) Check your motorcycle for the following:
1. Tightness of all bolts and nuts with correct torque value.
 2. Fitness of tyres / tyre pressure / tread depth.
 3. All bulbs, indicators and horn functioning.
 4. Smooth functioning of all cables and their free play.
 5. Smoothness of steering operation.
 6. Drive chain and sprocket condition. Chain adjustment.
 7. Front / rear brake functioning and rear brake lamp switch adjustment.
 8. Front fork for any abnormality.
 9. Spark plug gap and condition of spark plug.
 10. Air filter element cleanliness.
 11. Lubrication of all items mentioned in the periodic maintenance schedule.
 12. Intactness of EVAP system hoses and canister.
 13. Any other job as necessary.
 14. Have your vehicle checked at any TVS Motor Company Authorised Main Dealer / Authorised Dealer.

**Caution**

Long journey are to be taken only after the running-in period of 1000 km.

TVS Motor Company Limited ('the Company') give this warranty with respect to the TVS Raider 125 manufactured by the Company.

While the Company has taken every care to maintain quality in the manufacture of the TVS Raider 125, the above said warranty is subject to other terms of warranty:

During 5 Years from the date of purchase or during the first 60,000 km of run for the vehicle in the hands of original retail purchaser, whichever is earlier, the parts of the vehicle covered under warranty which prove to the satisfaction of the Company to have a manufacturing defect will be repaired or replaced free of cost.

The Company's obligation under this warranty is limited to repairing or replacing, free of cost, those parts of the vehicle which upon examination by the Company may prove to the Company's satisfaction to have a manufacturing defect, and in such cases the Company's decision either to repair or replace the affected parts will be final. In the event of replacement of parts, the Company also reserves the right to use parts of the same brand as the affected parts or any other brand which is used by the Company in the course of manufacture. All parts replaced under this warranty will become the property of the Company and must be returned to the company.

Limitations of Warranty:

This warranty shall not apply to following condition:

1. Any natural wear and tear, including without limitation, aging.
2. Warranty claims on proprietary items such as tyres, tubes and batteries etc., should be preferred by the user directly on the respective manufacturer, as per their warranty terms and the Company shall not be liable in any manner in respect to the same.
3. Parts repaired or replaced under this warranty are warranted only throughout the remainder of the original warranty period.
4. The Company is not liable for any delay in servicing due to reasons beyond the control of the Company or any of its Authorised Main Dealers / Authorised Dealers.
5. In any event, the Company is not liable for indirect, remote, incidental or consequential damages.



6. The Company may make any modification or improvement to vehicles in future production at any time without prior notice and without any obligation to install the same on vehicles previously dispatched for sale.
7. Any claim under this warranty will lie only when the customer:
 - takes his vehicle to an Authorised Main Dealer / Authorised Dealer of the Company and reports the problem he / she felt in the vehicle to enable the Authorised Main Dealer / Authorised Dealer to inspect the same and assess the cause for the reported problems.
 - produces to such Authorised Main Dealer / Authorised Dealer the Service handbook for the concerned vehicle for verification of relevant details.
8. This is the only warranty given by the Company for the TVS Raider 125. No employee, Dealer or other person is authorised to extend or enlarge this warranty.

 **Warning**

Modifications to this vehicle not approved by the TVS Motor Company may cause loss of performance and render it unsafe for use and disqualifies for warranty coverage also.

Following Toll Free numbers can be contacted for battery related queries if any

Incase of EXIDE battery, call :- 1800 103 5454

Incase of AMCO battery, call :- 1800 425 0096

Incase of TATA GREEN battery, call :- 1800 419 8888

Incase of AMARON battery, call :- 1800 425 5858

Following Toll Free numbers can be contacted for Tyre related queries if any

Incase of TVS Srichakra, call :- 04522443300

Incase of JK tyre, call :- 18002581100

Incase of Maxxis tyre, call :- 1800 532 2888

List of parts not covered under warranty

ITEM	WHAT TO CHECK FOR
Normal Maintenance operations	Engine tune-up, decarbonizing, fuel system cleaning, oil changes, head light focusing, fastener retightening, ignition timing, clutch and brakes as well as other normal adjustments.
Wear and tear items	Chain, sprockets, clutch and brake linings, fasteners, shims, washers, oil seals, gaskets, 'O' rings and spokes etc.
Electrical	Bulbs, fuse, AHO, DRL etc.
Service Maintenance Parts	Oil filters, spark plug, air filter, oil and brake fluid
Rubber, rexine and plastic items	All hoses , pipes and plastic aesthetics
Proprietary Items	Battery, tyres and tubes (the warranty terms are subject to our agreement with proprietary OEM)
Others Factors	Parts of the vehicle getting affected due to atmospheric effect / environmental factors (rusting, paint peel off etc.). However, depending on the vehicle usage condition, warranty would be accepted up to 2 years from the date of purchase.
	Parts of the vehicle which have been tampered with, altered, repaired or replaced by persons not authorised by the Company and which in the sole judgement of the Company affect the performance of the vehicle.
	Parts which are used in conjunction with parts not made or recommended by the Company.

List of parts not covered under warranty

ITEM	WHAT TO CHECK FOR
Others Factors	Parts suffering damage or resultant damage by accident, misuse, negligent treatment, use of bad quality lubricants or impure fuel or by omission to follow the guidance and instructions contained in this owner's manual.
	Vehicles on which engine number or chassis number is deleted, defaced or altered.
	Vehicles on which any warranty service including scheduled paid service is not availed when it falls due (at TVS Motor Company Authorised Main Dealer / Authorised Dealer).
	<p>Vehicles sold or transferred by original retail purchaser.</p> <p>Vehicles used for racing or any competition or used otherwise than for ordinary personal transportation.</p> <p>Vehicles attached with side cars etc.</p> <p>Vehicles which have been taken out of India.</p> <p>Vehicles affected by natural calamities like flood, earthquake, tsunami, storm etc.</p>
	If the vehicle has been used for commercial purpose like taxi or used for rental or hiring or any other purpose other than regular personal transportation.

SERVICE INFORMATION

There are eleven services for TVS Raider 125 during warranty period. Of these, the first three services are free services for which labour charges are free. In addition to these three free services, we have a scheme of eight pay services. For keeping maintenance track of your vehicle, free and pay service record sheets are attached in the Service Handbook given to you during the time of your vehicle purchase. Please have the relevant record sheet filled by the Dealer who is carrying out the maintenance service.

For availing any of the eleven warranty services, please take your vehicle and your Service Handbook to any of our Authorised Main Dealer or any of our Authorised Dealer. After effecting the service the Authorised Main Dealer or the Authorised Dealer will affix their stamp on the last column of the free or pay service record sheet of Service Handbook for your record and reference. An OTP would be sent to customer's registered mobile number. The same to be shared with the servicing Dealer on or before vehicle delivery.

Periodic maintenance always helps good performance of an automobile and our services are planned to keep your TVS Raider 125 performing good. **Please note that carrying out the service for your vehicle at scheduled intervals at any of the TVS Motor Company Authorised Main Dealer / Authorised Dealer is necessary for availing of warranty.** And please also remember that, after the services are over, periodic servicing of your vehicle at appropriate intervals, depending upon its extent of use, will keep your vehicle at its best level of performance.

In case you need any clarification or assistance, please feel free to write to us mentioning the frame number, engine number and the date of purchase of your vehicle also the name and place of the Authorised Main Dealer / Authorised Dealer from whom you bought the vehicle and getting it serviced.

Service Department

TVS MOTOR COMPANY LIMITED

P.O.Box No. 4, Harita, Hosur - 635 109,

TAMILNADU, INDIA.

Toll free no. :- 1800-258-7111



PLANNED SERVICE SCHEDULE (kms or month whichever of the two occurs early)*

Sl.No.	Service	Type	Kms	Months
1	1st Service	Free	750 ~ 1000	30 ~ 45 days
2	2nd Service	Free	5500 ~ 6000	6
3	3rd Service	Free	11500 ~ 12000	12
4	4th Service	Pay	17500 ~ 18000	18
5	5th Service	Pay	23500 ~ 24000	24
6	6th Service	Pay	29500 ~ 30000	30
7	7th Service	Pay	35500 ~ 36000	36
8	8th Service	Pay	41500 ~ 42000	42
9	9th Service	Pay	47500 ~ 48000	48
10	10th Service	Pay	53500 ~ 54000	54
11	11th Service	Pay	59500 ~ 60000	60

Note

Free service enables the customer to avail the service at free of labour charges. Charges for the pay service should be borne by the customer. Cost of engine oil, periodic maintenance parts, filter, brake fluids, all types of greases, petroleum jelly, distilled water, chain cleaner, lubricants, coolants, cleaning cloths for both free and paid services are chargeable to the customer.

* Please remember that, after the above schedule, periodic servicing of your vehicle at appropriate intervals, depending upon its extent of use, will keep your vehicle at its best level of performance.

MANUFACTURER : TVS MOTOR COMPANY LIMITED
P.B. No 4, Harita, Hosur - 635 109, India.

ENGINE

Type : Single cylinder, 4 stroke, fuel injection,
air cooled, spark ignition engine

Cylinder bore : 53.5 mm

Stroke : 55.5 mm

Piston displacement : 124.8 cc

Compression ratio : 10.3 : 1

Air filter : Foam + Paper filter element

Lubrication system : Wet sump lubrication

Maximum power in kW : 8.37 kW @ 7500 rpm

Maximum torque in Nm : 11.2 Nm @ 6000 rpm

Maximum speed : ISS disabled (Power mode) : 99 km/h
: ISS enabled (Eco mode) : 90 km/h

Engine idling rpm : 1400 ± 200 rpm (under warm condition)

Starting system : Electric starter

Emission norms : BS VI

TRANSMISSION

Clutch : Wet - Multi plate type

Transmission : 5 speed constant mesh

Gear shift pattern : 1 down and 4 up

Primary transmission : Spur gears

Secondary transmission : Chain and sprockets

GEAR RATIOS

I Gear : 2.917

II Gear : 1.857

III gear : 1.333

IV gear : 1.050

V gear : 0.880

Primary reduction : 3.250

Secondary reduction : 3.285

CHASSIS

Overall length	: 2070 mm
Overall width	: 785 mm
Overall height	: 1028 mm
Ground clearance	: 180 mm (unladen)
Wheel base	: 1326 mm
Kerb weight	: 122 kg (Drum brake version)
(with tool kit & 90% of fuel)	: 123 kg (Disc brake version)
Pay load	: 130 kg
Maximum laden weight	: 252 kg (Drum brake version)
	: 253 kg (Disc brake version)
Steering angle	: 80°
Caster angle	: 25.6°
Frame	: Single cradle tubular frame
Front suspension	: Telescopic oil damped
Rear suspension	: 5 step adjustable, gas charged hydraulic shock with swing arm
Trail length	: 85 mm

TYRE

Front tyre	: 80/100-17 M/C 46P Tubeless
Rear tyre	: 100/90-17 M/C 55P Tubeless

Tyre pressure

Front	: 1.75 kg/cm ² (25 PSI)
Rear - Solo	: 1.97 kg/cm ² (28 PSI)
Rear - Pillion	: 2.25 kg/cm ² (32 PSI)

BRAKES

Front	: Hand operated, 240 mm petal disc
	: Hand operated, 130 mm dia drum
Rear	: Foot operated, 130 mm dia drum

ELECTRICAL

Ignition system	: ECU - Electronic Control Unit
Spark plug	: BOSCH UR5KCW
Spark plug gap	: 0.9 ~ 1.0 mm
ISG magneto	: ISG Starter generator 12V, 160W
Battery	: 12V, 4 Ah MF
Head lamp	: 12V, LED, 10W Max
Tail / brake lamp	: 12V LED, 0.3W/2.5W
Turn signal lamps bulb	: 12V, 10W x 4
Number plate lamp bulb:	12V, 5W x 1

ELECTRICAL

Digital speedometer (instrument panel)	: LCD / LED indicators
Horn	: 12V, DC x 1
Fuse	: 12V 25 A x 1, 12V 15 A x 1 & 12V 10 A X 1 (mini blade type)

CAPACITIES

Fuel tank including reserve #	: 10 liters
Fuel	: BS VI petrol with minimum RON 91 (containing upto 10% of ethnlol by volume)
Engine cum transmission oil	: TVS TRU4 PREMIUM oil (SAE 10W30 API-SL, JASO MA2)
Engine cum transmission oil capacity	: 1000 ml
Front fork oil grade	: IOC / Castrol teleshockab oil
Front fork oil capacity	: 162 ± 3 ml / leg
Disc brake oil grade*	: TVS Girling DOT 3 / DOT 4

The fuel tank is not a measuring instrument and the capacity of fuel tank may slightly vary from the indicated capacity.



Caution

Using the bulb other than the specified rating can result in overloading of the electrical system or premature failure of the bulb.



Note

Specifications are subject to change without notice.

* Applicable only for Disc Brake version



Drive In.

Drive Out.



**Say bye-bye to waiting time
for servicing your bike.**

Get your vehicle serviced in 1 hour at no additional cost. Contact your nearest Dealership for details. †

† Facility available at selected Dealerships only. Terms and conditions apply



Busy Life? Easy Servicing!

Now, service your bike anywhere, anytime.

- ★ Service the vehicle at your door step.
- ★ Available for regular maintenance or breakdown service only.
- ★ Offered at nominal convenience charges.

Contact your nearest Dealership for details.[†]

[†]Facility available at selected Dealerships only. Terms and conditions apply





Busy Life? Easy Servicing!

Now, service your bike anywhere, anytime.

- ★ Service the vehicle at your door step.
- ★ Available for regular maintenance or breakdown service only.
- ★ Offered at nominal convenience charges.

Contact your nearest Dealership for details.[†]

[†]Facility available at selected Dealerships only. Terms and conditions apply

Dear Customer,

It is mandatory under the Motor Vehicles Act to insure all motor vehicles. No motor vehicle can be used in a public place without a valid policy of insurance issued by an authorised insurer. Driving a motor vehicle without any such insurance is an offense under Motor Vehicles Act.

To assist our Customers on their insurance requirements such as the prompt issue and renewal of policies as well as expeditious settlement of claims if any, our preferred insurers are:







TVS MOTOR COMPANY LIMITED. P.B. No.4, Harita, Hosur, 635109, Tamil Nadu, India.
Telephone: +91 (4344) 276780. Fax: +91 (4344) 276878 / 277311 www.tvsmotor.com