

VIZIO

 DOLBY ATMOS

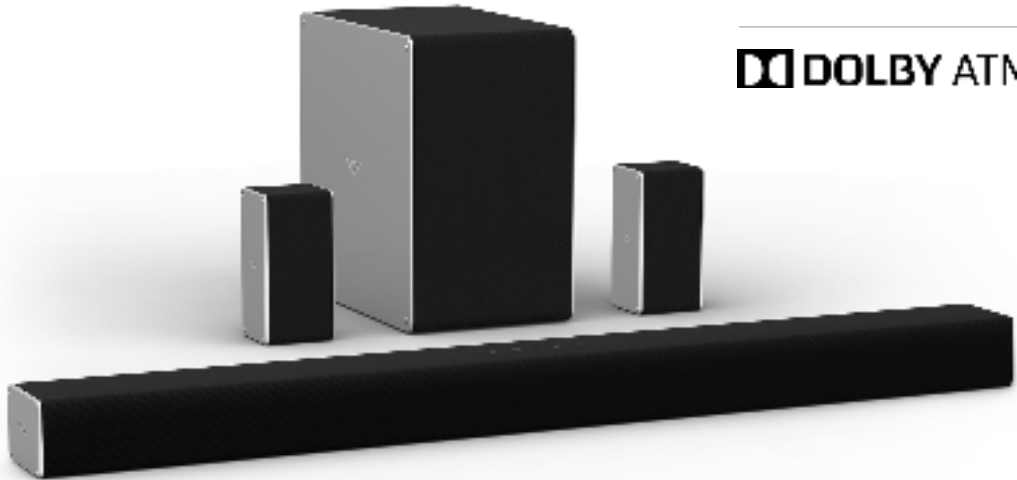

USER MANUAL

Model: SB36514-G6

VIZIO 36" 5.1.4 Channel Sound Bar Home Theater Sound System

Please read this guide before using the product.



IMPORTANT SAFETY INSTRUCTIONS

Your Unit is designed and manufactured to operate within defined design limits, and misuse may result in electric shock or fire. To prevent your Unit from being damaged, the following rules should be observed for its installation, use, and maintenance. Please read the following safety instructions before operating your Unit. Keep these instructions in a safe place for future reference.

- Read these instructions.
- Keep these instructions.
- Heed all warnings.
- Follow all instructions.
- Do not use this apparatus near water.
- Clean only with a dry cloth.
- Do not block any ventilation openings. Install in accordance with the manufacturer's instructions.
- Do not install near any heat sources such as radiators, heat registers, stoves, or other apparatus (including amplifiers) that produce heat.
- Do not defeat the safety purpose of the polarized or grounding-type plug. A polarized plug has two blades with one wider than the other. A grounding type plug has two blades and a third grounding prong. The wide blade or the third prong are provided for your safety. If the provided plug does not fit into your outlet, consult an electrician for replacement of the obsolete outlet.
- Protect the power cord from being walked on or pinched, particularly at plugs, convenience receptacles, and the point where they exit from the apparatus.
- Only use attachments/accessories specified by the manufacturer.
- Use only with the cart, stand, tripod, bracket, or table specified by the manufacturer, or sold with the apparatus. When a cart is used, use caution when moving the cart/apparatus combination to avoid injury from tip-over.
- Unplug this apparatus during lightning storms or when unused for long periods of time.
- Refer all servicing to qualified service personnel. Servicing is required when the apparatus has been damaged in any way, such as when the power supply cord or plug is damaged, liquid has been spilled or objects have fallen into the apparatus, the apparatus has been exposed to rain or moisture, does not operate normally, or has been dropped.
- To reduce the risk of electric shock or component damage, switch off the power before connecting other components to your Unit.
- Unplug the power cord before cleaning your Unit. A damp cloth is sufficient for cleaning. Do not use a liquid or a spray cleaner on your Unit. Do not use abrasive cleaners.
- Always use the accessories recommended by the manufacturer to insure compatibility.
- When moving your Unit from an area of low temperature to an area of high temperature, condensation may form in the housing. Wait before turning on your Unit to avoid causing fire, electric shock, or component damage.
- Slots and openings in the back and bottom of the cabinet are provided for ventilation. To ensure reliable operation of your Unit and to protect it from overheating, be sure these openings are not blocked or covered. Do not place your Unit in a bookcase or cabinet unless proper ventilation is provided.
- Never push any object into the slots and openings on your Unit enclosure. Do not place any objects on the top of your Unit. Doing so could short circuit parts causing a fire or electric shock. Never spill liquids on your Unit.
- Do not block the subwoofer ports. Allow for 1-2 inches of space around all sides for ventilation.
- **WARNING:** Exposure to loud sounds can damage your hearing causing hearing loss and tinnitus (ringing or buzzing in the ears). With continued exposure to loud noises, ears may become accustomed to the sound level, which may result in permanent damage to hearing without any noticeable discomfort.



- When connected to a power outlet, power is always flowing into your Unit. To totally disconnect power, unplug the power cord.
- Do not overload power strips and extension cords. Overloading can result in fire or electric shock.
- The wall socket should be located near your Unit and be easily accessible
- Keep your Unit away from moisture. Do not expose your Unit to rain or moisture. If water penetrates into your Unit, unplug the power cord and contact your dealer. Continuous use in this case may result in fire or electric shock.
- Do not use your Unit if any abnormality occurs. If any smoke or odor becomes apparent, unplug the power cord and contact your dealer immediately. Do not try to repair your unit yourself.
- Avoid using dropped or damaged appliances. If your Unit is dropped and the housing is damaged, the internal components may function abnormally. Unplug the power cord immediately and contact your dealer for repair. Continued use of your Unit may cause fire or electric shock.
- Do not install your Unit in an area with heavy dust or high humidity. Operating your Unit in environments with heavy dust or high humidity may cause fire or electric shock.
- Ensure that the power cord and any other cables are unplugged before moving your Unit.
- When unplugging your Unit, hold the power plug, not the cord. Pulling on the power cord may damage the wires inside the cord and cause fire or electric shock. When your Unit will not be used for an extended period of time, unplug the power cord.
- To reduce risk of electric shock, do not touch the connector with wet hands.
- Insert the remote control batteries in accordance with instructions. Incorrect polarity may cause the battery to leak which can damage the remote control or injure the operator.
- See the important note and rating located on the back of the unit.
- **WARNING** - This equipment is not waterproof. To prevent a fire or shock hazard, do not place any container filled with liquid near the equipment (such as a vase or flower pot) or expose it to dripping, splashing, rain, or moisture).
- **CAUTION** - Danger of explosion or fire if batteries are mistreated. Replace only with the same or specified type.
- Do not leave the batteries exposed to direct sunlight for a long period of time with doors and windows closed. Do not disassemble the batteries or dispose of it in fire.
- Where the MAINS plug or appliance coupler is used as the disconnect device, the disconnect device shall remain readily operable.

WARNING: To reduce the risk of fire or electric shock, do not expose this apparatus to rain or moisture.



The lightning flash with arrowhead symbol within an equilateral triangle is intended to alert the user to the presence of not isolated dangerous voltage within the product that may be sufficient magnitude to constitute a risk of shock to persons.



The exclamation point within an equilateral triangle is intended to alert the user to the presence of important operating and servicing instructions in the literature accompanying the appliance.



Warning: This equipment is a Class II or double insulated electrical appliance. It has been designed in such a way that it does not require a safety connection to electrical earth.

TABLE OF CONTENTS

Package Contents	5
Controls & Connections	6
First-Time Setup	10
Proper Placement	16
Using the Remote	17
Using your tablet or smartphone as a remote	18
LED Indicators	19
Using Button Combinations	24
Programming the Sound Bar	25
Bluetooth Audio Pairing	26
Using Bluetooth mode	27
Advanced Setup	28
Advanced Setup - HDMI ARC	29
Connecting with HDMI ARC	30
Connecting a Subwoofer	32
Wall-Mounting the Sound Bar	33
Wall-Mounting the Satellite Speakers	35
Help & Troubleshooting	38
Frequently Asked Questions	39
Limited Warranty	40
Specifications	43
Legal & Compliance	44

PACKAGE CONTENTS

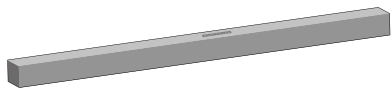

VIZIO
Sound Bar



Wireless Subwoofer



2 x Satellite
Speakers



Remote Control
with 2x AAA Batteries

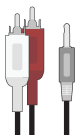

Stereo RCA to
3.5mm Audio Cable



3.5mm to 3.5mm
Audio Cable



HDMI Cable



Digital Optical
Cable

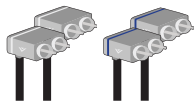

2 x Satellite Speaker
Audio Cables



2 x Power Cables

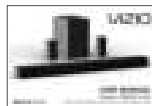

Quick Start Guide



4 x Cable Ties



2 x Wall
Mount Brackets
(Satellite Speakers)



2 x Wall
Mount Brackets
(Sound Bar)



Wall Mount Template



4 x Wall
Mount Screws

CONTROLS & CONNECTIONS

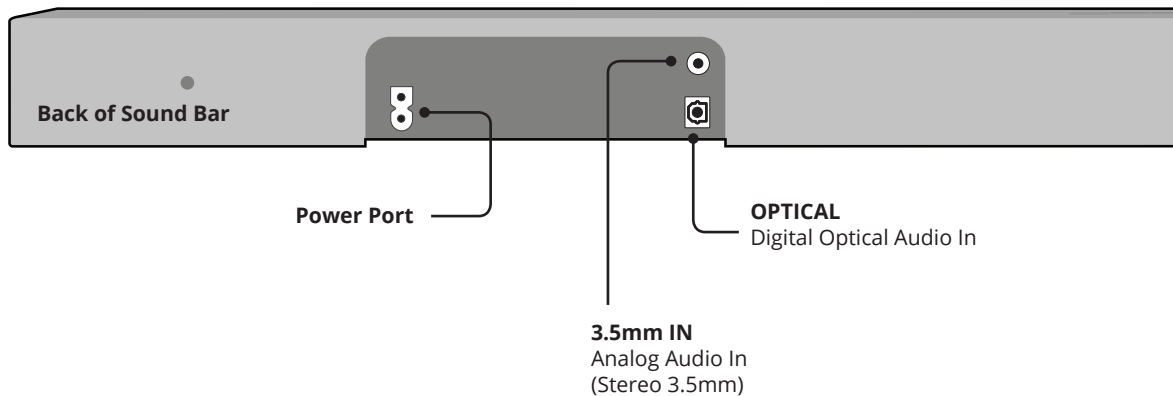

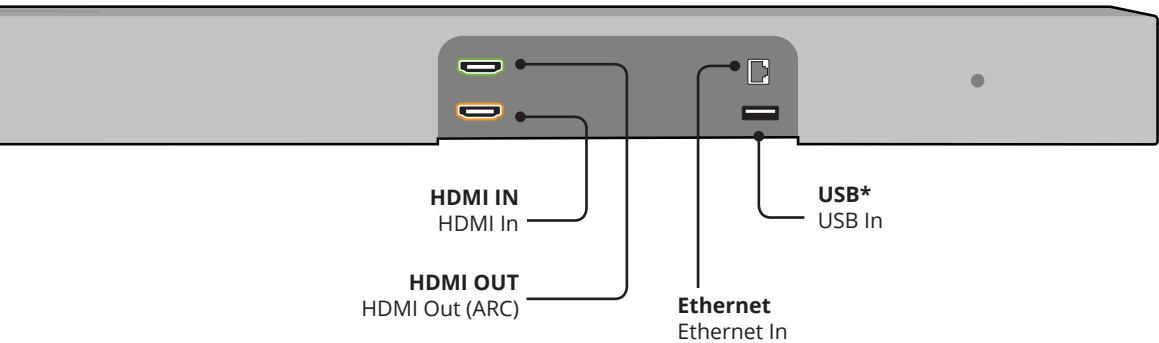

* Supports .WAV and .MP3 file format playback only.

Top of Sound Bar

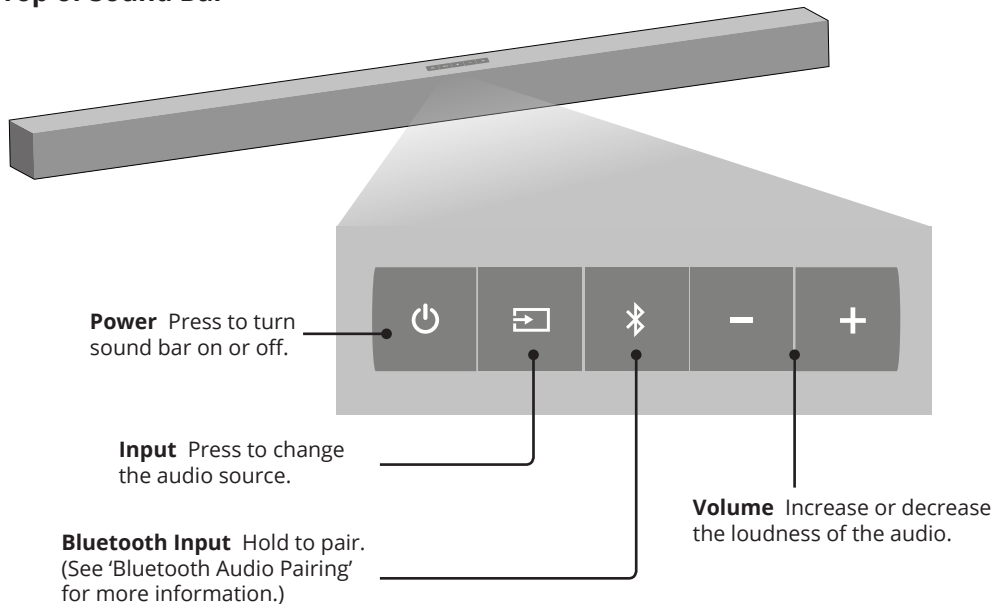

Back of Subwoofer

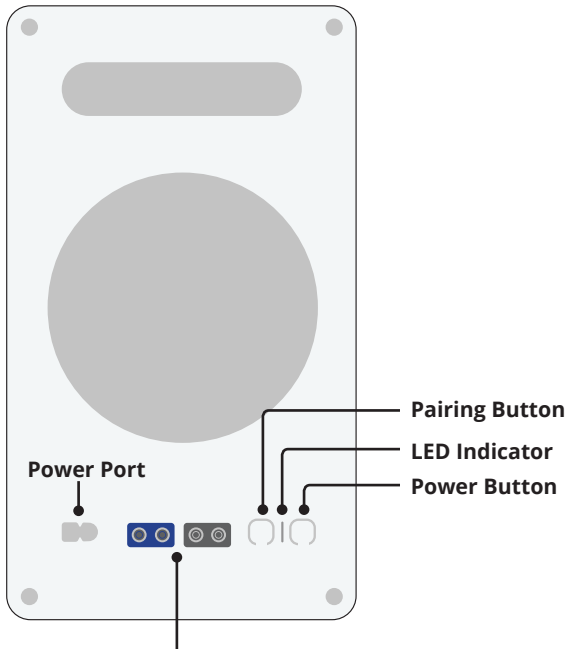

Connects to Left(blue cable)/Right (gray cable) Satellite Speakers

Back of Satellite Speaker

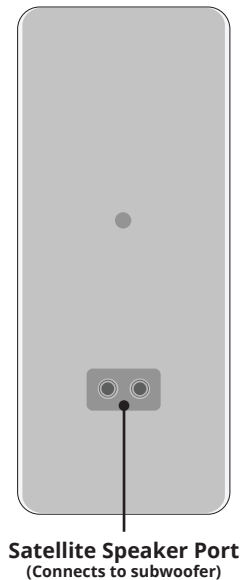

FIRST-TIME SETUP

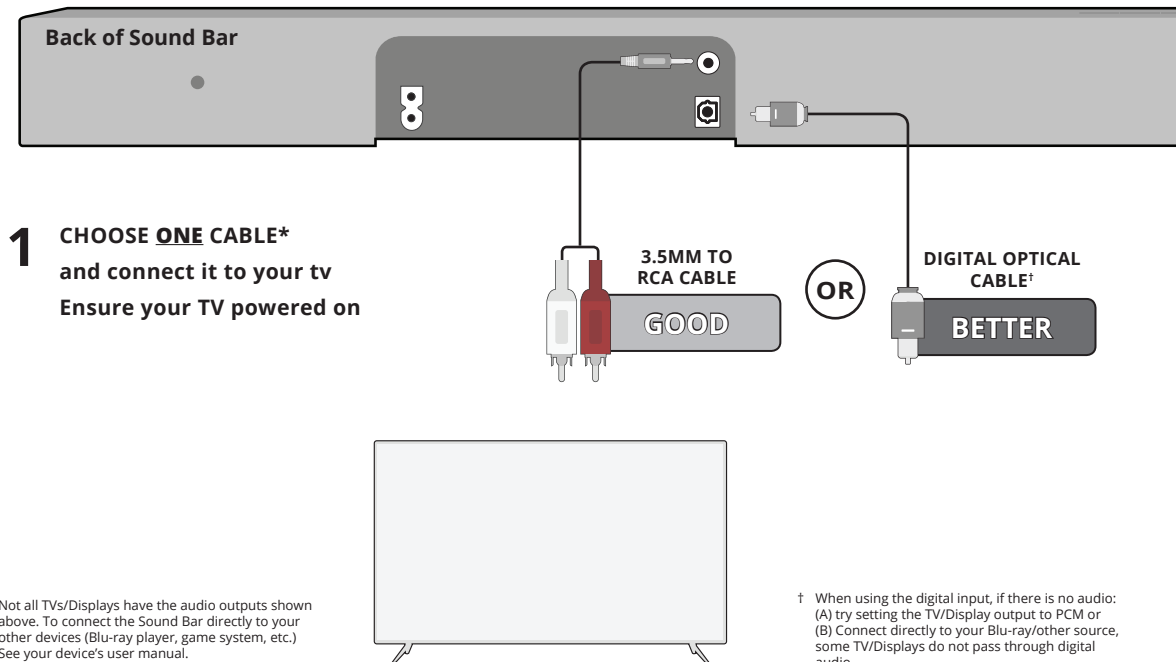

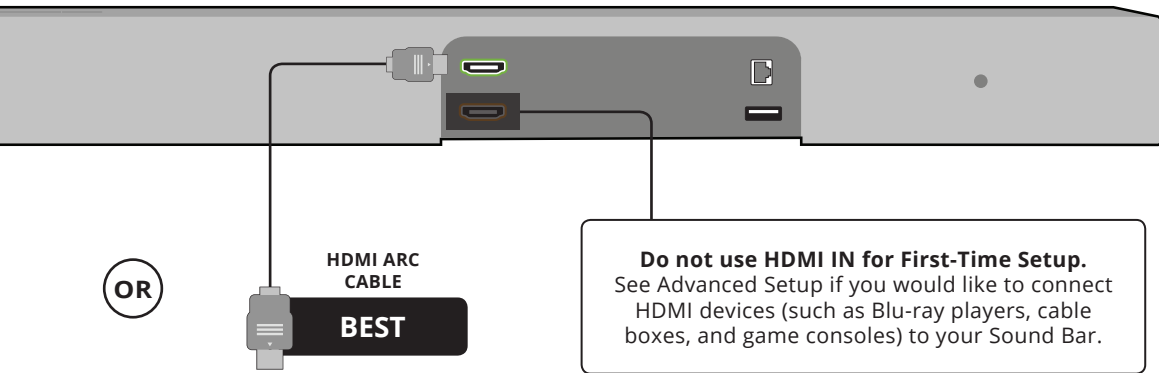

HDMI cables send Video (Out) and receive Audio from the TV/Display. See the *Connecting with HDMI* section for more information.

Connect the **sound bar** to your **TV/Display*** using **one** of the connection types to the left. Choose the best possible connection type. Be sure the TV/Display port is an audio output, not an audio input.

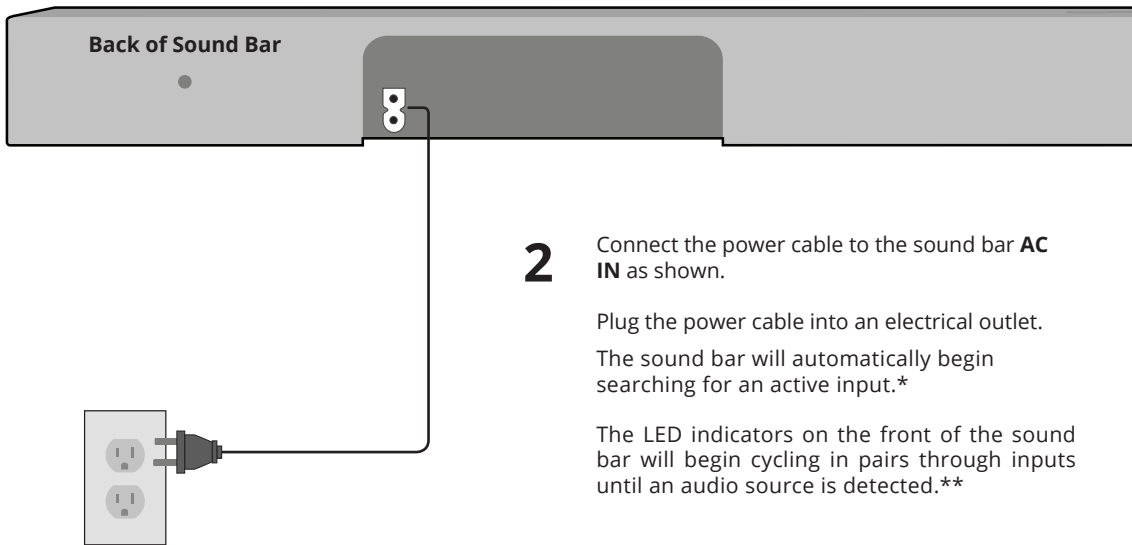

2 Connect the power cable to the sound bar **AC IN** as shown.

Plug the power cable into an electrical outlet.

The sound bar will automatically begin searching for an active input.*

The LED indicators on the front of the sound bar will begin cycling in pairs through inputs until an audio source is detected.**



Tip: Pressing the **INPUT** button will stop the auto detect function.

*Occurs only during first-time set up.

**Auto detect function only occurs once when the sound bar is first powered on. To enable this feature again, you must do a Factory Reset (see the Using Button Combinations section for more information) or press and hold the INPUT button for 3 seconds.

- 3** Connect the satellite speakers to the subwoofer using the included satellite speaker audio cables.



To properly connect the subwoofer and satellite speakers, ensure the notches on the cables and ports line up and that the cable is fully inserted.

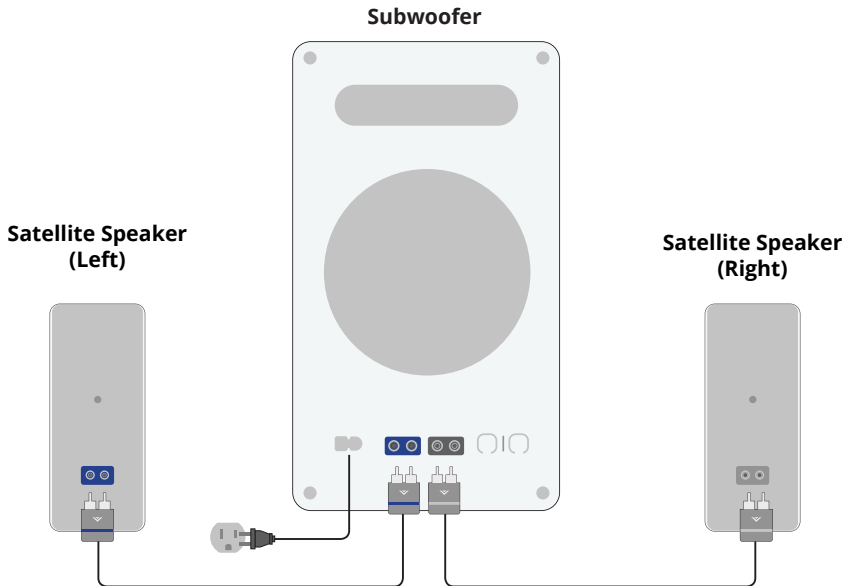

Match the color coded speaker cable to the matching speaker port color.
Blue for left surround and gray is for right surround.

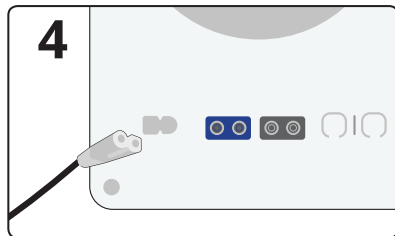
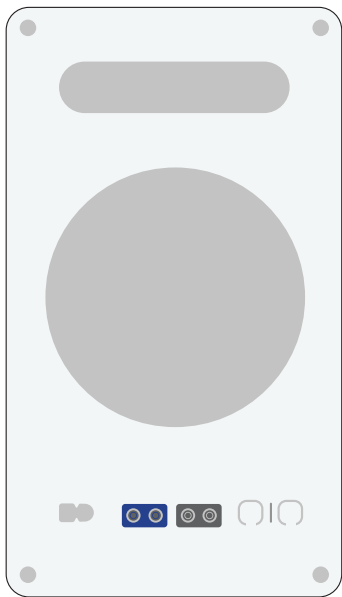

Connect a power cable to the subwoofer.

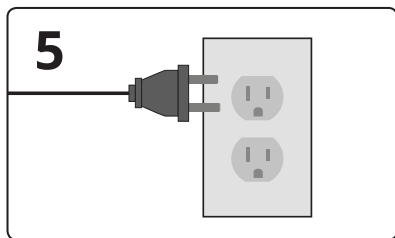

Plug the power cable into a power outlet.

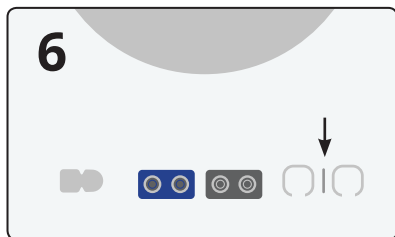

The subwoofer will automatically power on and link to the sound bar when plugged in. The LED will glow solid to confirm.

7

Top



Remove the battery cover by gently sliding it away from the remote.

8

Top



Insert the included batteries and gently slide the battery cover back into place.

9

You can press the **INPUT** button to switch between audio sources. For example, if you connected your TV to AUX, set the sound bar to AUX.

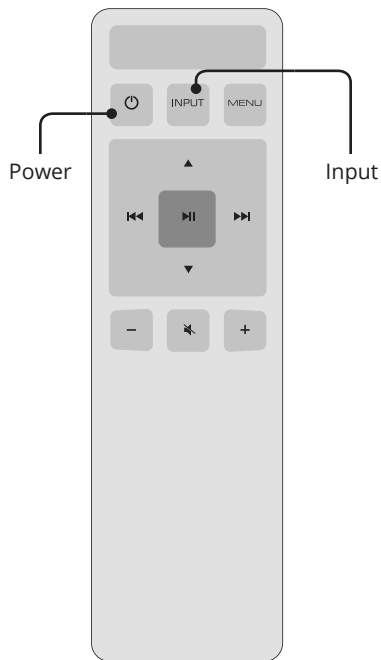

When needed, VIZIO recommends replacing the batteries that came with this remote with two, new Duracell 'AAA' alkaline batteries.

**POWER UP WITH
DURACELL**

PROPER PLACEMENT

For the best surround sound experience, position the sound bar, subwoofer, and satellite speakers as shown. The sound bar should be close to ear level.

You will get the best sound effect if your ceiling is flat and 7.5 ft to 12 ft high.

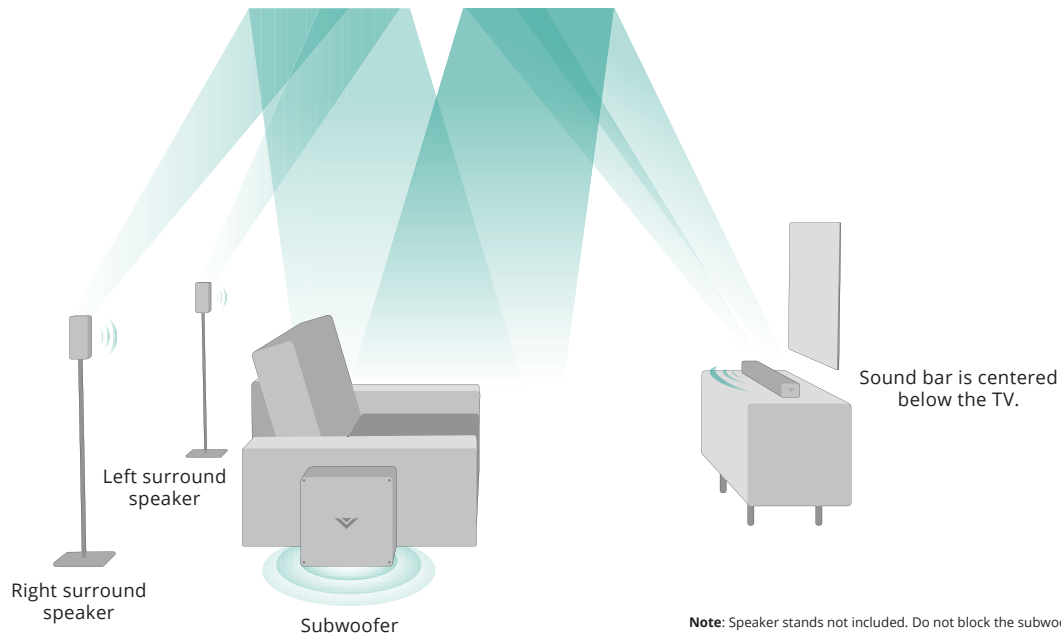

USING THE REMOTE

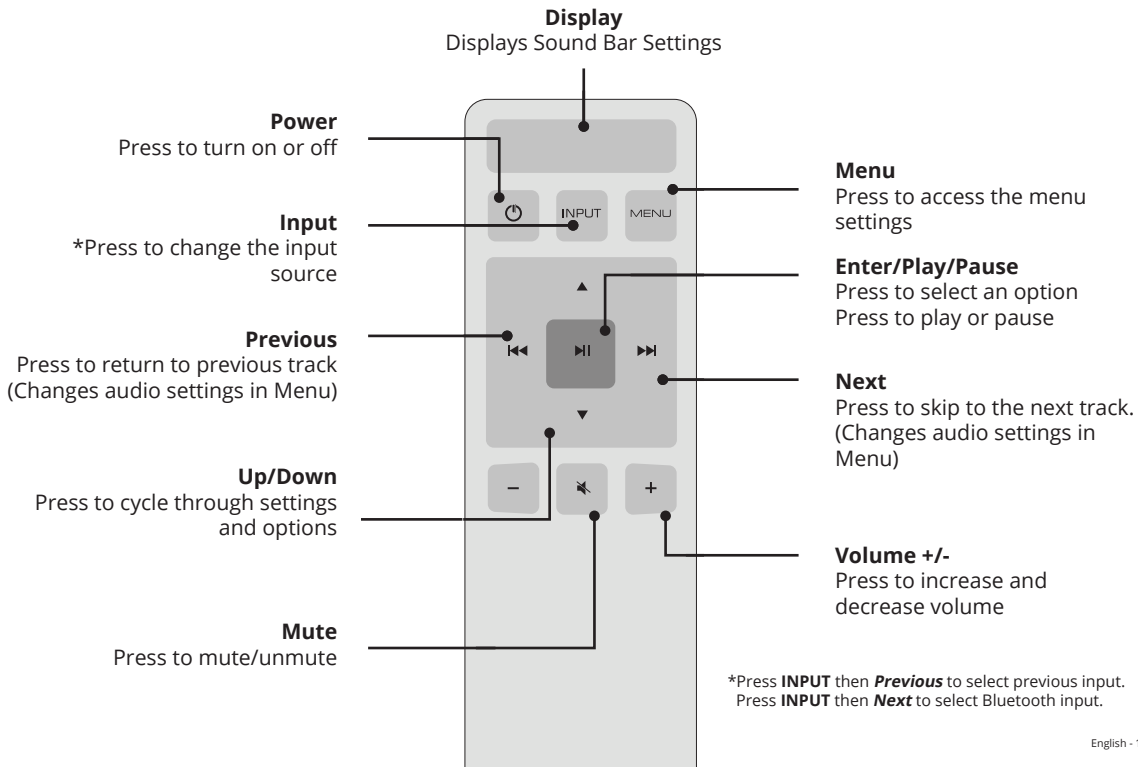

USING YOUR TABLET OR SMARTPHONE AS A REMOTE

Download the VIZIO SmartCast Mobile™ app and turn your smartphone or tablet into a remote to control your sound bar system.

- Visit www.vizio.com/smartcastapp on your device to download.
- Install the app and follow the on screen instructions to setup your device.



This will allow you to:

 Connect to Wi-Fi

 Cast your favorite audio applications

 Enable automatic updates and future enhancements

 Control your sound bar with your phone or tablet

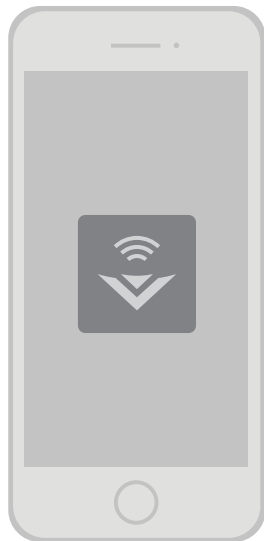





Visit www.vizio.com/smartcastapp for minimum requirements.





LED INDICATORS

Press the **Menu** button and use the **Up/Down Arrow** buttons on the remote to access the different functions and acoustic settings of the sound bar. Each function and setting will be displayed on the remote control's LCD display. The LED indicators will behave differently with each function.







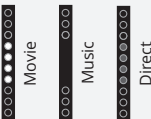

LED Indicators are located here.

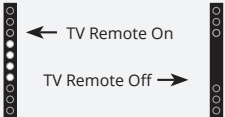
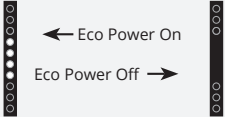
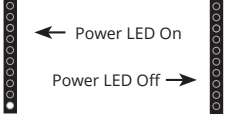
Function	LED Behavior	Description
Bluetooth Pairing BT Pair	 (When searching for device) Flash from Bottom to Top and back continuously.	Press the Enter button on the remote. The sound bar will be discoverable for 15 minutes. You can now search for the sound bar (VIZIO SB36514*) using your Bluetooth Device. The sound bar will power down if no device is found. Note: Set your Bluetooth device into pairing mode prior to the sound bar.
Bass Levels Bass	 Two center LEDs indicate Bass level 0.	Press the Next/Previous button to increase/decrease the bass level. The LED indicators will move to the top with increasing levels and to the bottom with decreasing levels.
Treble Levels Treble	 Two center LEDs indicate Treble level 0.	Press the Next/Previous button to increase/decrease the treble level. The LED indicators will move to the top with increasing levels and to the bottom with decreasing levels.
Center Levels Center	 Two center LEDs indicate Dialogue is centered.	Press the Next/Previous button to increase/decrease the presence of dialog in the center channel. The LED indicators will move to the top when the dialog presence is increased and to the bottom when the dialog presence is decreased.

Function	LED Behavior	Description
<p>Height Levels</p> <p>Height +</p>	 <p>Two center LEDs indicate height level 0.</p>	<p>Press the Next/Previous button to increase/decrease the level of the height speakers. Use this adjustment to accommodate various ceiling heights and seating distances.</p>
<p>Surround Levels</p> <p>Surround</p>	 <p>Two center LEDs indicate Surround level is centered.</p>	<p>Press the Next/Previous button to increase/decrease the surround sound level. The LED indicators will move to the top with increasing levels and to the bottom with decreasing levels.</p> <p>Note: Surnd setting on remote must be On to adjust the surround level.</p>
<p>Surround Balance</p> <p>Surr Bal</p>	 <p>Two center LEDs indicate Surround Balance is centered.</p>	<p>Press the Next/Previous button to increase/decrease the surround balance level on each side. The LED indicators will move to the top with balance levels to the right and down with balance levels to the left.</p>
<p>Subwoofer Levels</p> <p>Subwoofer</p>	 <p>Two center LEDs indicate subwoofer level 0.</p>	<p>Press the Next/Previous button to increase/decrease the level of the subwoofer. The LED indicators will move to the top with increasing levels and to the bottom with decreasing levels.</p> <p>Note: Decreasing the level to the minimum turns off the subwoofer.</p>
<p>Equalizer Mode</p> <p>EQ</p>	 <p>Movie</p> <p>Music</p> <p>Direct</p>	<p>Press the Next/Previous button to toggle between 3 preset equalizer settings, Music, Direct and Movie. Press the Play/Pause button to confirm.</p> <p>Note: Movie mode is on by default.</p>

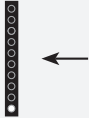
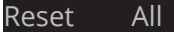
Function	LED Behavior	Description
Surround On/Off Surnd		Press the Next/Previous button to enable/disable surround sound. When disabled (Off), the satellite speakers and satellite height channels will be disabled.
Height Speakers Height VRT		Press the Next/Previous button to toggle between 3 preset height channels. When On is selected, the height speakers are turned on. When Virtual is selected, the system creates a virtual height speaker effect using the front firing speakers. When Off is selected, the height speakers are turned off without virtualising height. Note: Default is setting is On
Volume Leveling On/Off Vol Lv		Press the Next/Previous button to enable/disable Volume Leveling. When enabled (On), Volume Leveling provides a consistent and comfortable volume level for a more enjoyable listening experience. Note: Default is setting is Off.
Night Mode On/Off Night		Press the Next/Previous button to enable/disable Night Mode. When enabled (On), the sound bar will lower bass frequency levels to provide a more quiet environment (ideal for apartment living and homes with sleeping children). The setting will return to Off when the sound bar is powered off. Note: Default is setting is Off.
AV Delay AV Delay		Press the Next/Previous button to increase/decrease the amount of audio delay. The LED indicators will move to the top with increasing audio delay levels.

Function	LED Behavior	Description
TV Remote VZtv Rmt On		Press the Next/Previous button to enable/disable VIZIO TV Remotes. When enabled (On), you can use a VIZIO TV remote control to turn on the sound bar (using the TV Volume Up button) and control volume.
Program Remote Prg Remote	--	Press the Next/Previous and Play buttons to toggle and select and program your TV remote to control the Volume Down , Volume Up , and Mute functions on your sound bar. See the <i>Programming the Sound Bar</i> section for more information.
Eco Power On/Off Eco Pwr		Press the Next/Previous button to enable/disable Eco Power Mode. When enabled (On), the sound bar will go into standby after a period of inactivity. The sound bar will automatically turn off when no audio signal is detected. Off disables this feature. Note: If you would like to cast content without the need to manually turn on the sound bar, set this function to OFF.
Power LED Pwr LED		Press the Next/Previous and Play buttons to enable/disable the Power LED.
Speaker Test Spkr Test	—	Press the Play/Pause button to activate the speaker test function. A voice will begin calling out each speaker beginning with <i>left front</i> . (Left Front, Center, Right Front, Right Rear, Left Rear, Left Front Height, Right Front Height, Right Rear Height, and subwoofer-white noise) If any of these are missing, check the connection and run the speaker test function again.

Function	LED Behavior	Description
Wi-Fi Setup 	 <p>Single light with sound upon confirmation</p>	Press the Next/Previous and Play buttons to select and confirm enabling or disabling Wi-Fi Setup on your sound bar. Wi-Fi Setup allows the VIZIO SmartCast App to reconnect the sound bar to Wi-Fi or paired bluetooth devices in the event of a lost connection or if a new device is being paired.
Reset 	 <p>All 10 LEDs will flash 3 times once settings are reset</p>	Press the Next/Previous buttons to reset either Audio or All settings. Press the Play button to select. Audio - Only audio settings, such as bass and treble levels, will be reset. All - All paired Bluetooth devices will be unpaired and all network settings will be lost. All programmed IR remotes will also be removed. See the <i>Reset to Factory Default Settings</i> section for more information.
Info 	<p>--</p>	Press the Play button to have the sound bar verbally announce the current sound bar input and audio type being played with corresponding LED indicators.
When a Dolby Audio, Dolby Atmos or DTS audio format is detected.	 <p>Dolby Audio, Dolby Atmos or DTS audio format is detected Indicator LED</p>	Dolby Audio and DTS are available on the HDMI ARC, HDMI In, and Digital Optical Audio In inputs. Dolby Atmos is available on HDMI ARC and HDMI In when connected to supported devices and streaming services. When a Dolby or DTS signal is detected, the Dolby Atmos (Green) / Dolby Audio (White)/ DTS (Amber) indicator LED will light up for 5 seconds before fading away.
When the sound bar successfully connects to Wi-Fi.	 <p>Wi-Fi Indicator LED</p>	When Wi-Fi is successfully set up via the VIZIO SmartCast app or through an ethernet connection, the blue indicator LED will light up to confirm a successful connection.

USING BUTTON COMBINATIONS

There are 3 functions that are triggered by 3 different button combinations on the sound bar.



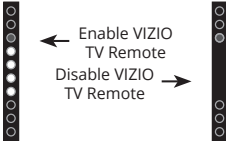
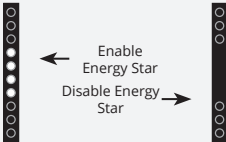

Buttons are located here.

Function	LED Behavior	Description
Factory Reset	 <p>All 10 LEDs will flash 3 times</p>	<p>Reset the sound bar to the factory default settings.</p> <p>To perform a Factory Reset, Press and Hold the Bluetooth (📶) and Volume Down (—) buttons for 5 seconds.</p> <p>Note: This will erase all settings and preferences that you have set.</p>
VIZIO TV Remote Control	 <p>← Enable VIZIO TV Remote Disable VIZIO TV Remote →</p>	<p>Enable/disable the use of a VIZIO TV remote control to power on and adjust the volume of the sound bar.</p> <p>To enable/disable this function, Press and Hold the Power (⏻) and Volume Up (+) buttons for 5 seconds.</p>
Energy Star/ EcoMode	 <p>← Enable Energy Star Disable Energy Star →</p>	<p>When the Energy Star setting is enabled, the sound bar will automatically power down after a period of inactivity. When disabled, the sound bar will remain powered on until you turn it off. To enable/disable this function, Press and Hold the Power (⏻) and Volume Down (—) buttons for 5 seconds.</p> <p>Note: Energy Star setting is enabled by default.</p>

PROGRAMMING THE SOUND BAR

You can program your sound bar to accept TV remote IR commands. Press the Menu button on the remote, then use the Up/Down buttons to navigate to Prg Remote. Use the Next/Previous buttons to toggle through Learn Vol -, Learn Vol +, and Learn Mute.

Function	LED Behavior	Description
Learn Volume Down Learn Vol-	 (Waiting to learn) Flash from bottom to top and back continuously.	Press the Play button to put the sound bar into learning mode. While the sound bar is in learning mode, press the Volume Down button on the TV remote control. All of the LED Indicators on the sound bar will flash two times indicating that it has successfully recognized the TV remote.
Learn Volume Up Learn Vol+		Press the Play button to put the sound bar into learning mode. While the sound bar is in learning mode, press the Volume Up button on the TV remote control. All of the LED Indicators on the sound bar will flash two times indicating that it has successfully recognized the TV remote.
Learn Mute Learn Mute	 All of the LEDs will blink twice to confirm.	Press the Play button to put the sound bar into learning mode. While the sound bar is in learning mode, press the Mute button on the TV remote control. All of the LED Indicators on the sound bar will flash two times indicating that it has successfully recognized the TV remote.



Turn off your TV speakers when programming your sound bar.



Point both the sound bar and TV remotes towards the front of the sound bar when programming.

BLUETOOTH AUDIO PAIRING

To pair the sound bar with a Bluetooth device:

1. Press and hold the **Bluetooth** button  on the sound bar for five seconds or select the BT Pair option from the display remote menu.

(When the sound bar is in Bluetooth Pairing Mode, the LED indicators on the front of the sound bar will light sequentially from bottom to top and back again. Once the device is paired, the LED Indicators will stop flashing.)

2. You can now search for the sound bar (VIZIO SB36514*) using your Bluetooth device. For more information, refer to the user manual that came with the other device.
3. You can now play audio from your Bluetooth device. Volume can be controlled on your source device and the sound bar.

*Sound bar name may be different if the sound bar was previously setup using the SmartCast Mobile app.

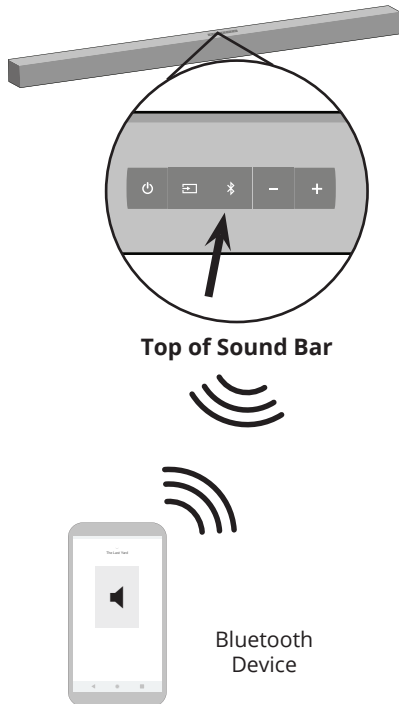

USING BLUETOOTH MODE

Your sound bar supports music streaming from smart phones, tablets, and computers with Bluetooth capability. Device compatibility will vary. Refer to your device's documentation for more information.

- Once you have paired your source device to the sound bar, as long as you stay within range of the sound bar, your device should remain paired.
- If the input is changed, the Bluetooth device will disconnect.
- If the source is changed back to Bluetooth, any paired Bluetooth device will reconnect automatically.



Your sound bar is not equipped with a microphone, so it cannot operate as a hands-free device for a smart phone.

Maximizing Signal

A Bluetooth signal has a range of up to 30 feet. Keep in mind that Bluetooth is a compressed audio format, so streamed music may lose some integrity when compared to a wired connection.

Try the following if your sound quality is less than optimal:

- If you hear any break-up or disconnect while streaming music from your device, move the source device closer to the sound bar.
- Be sure that there are no solid obstructions in the line-of-sight between the sound bar and the source device.
- Other wireless devices can affect Bluetooth range, including wireless security cameras, wireless video baby monitors, cordless phones, and microwave ovens. Turning off or moving these devices may improve Bluetooth range.



Reduce the volume levels on your device and on the sound bar before pressing Play. High volume levels can damage your hearing.

ADVANCED SETUP

Back of Sound Bar

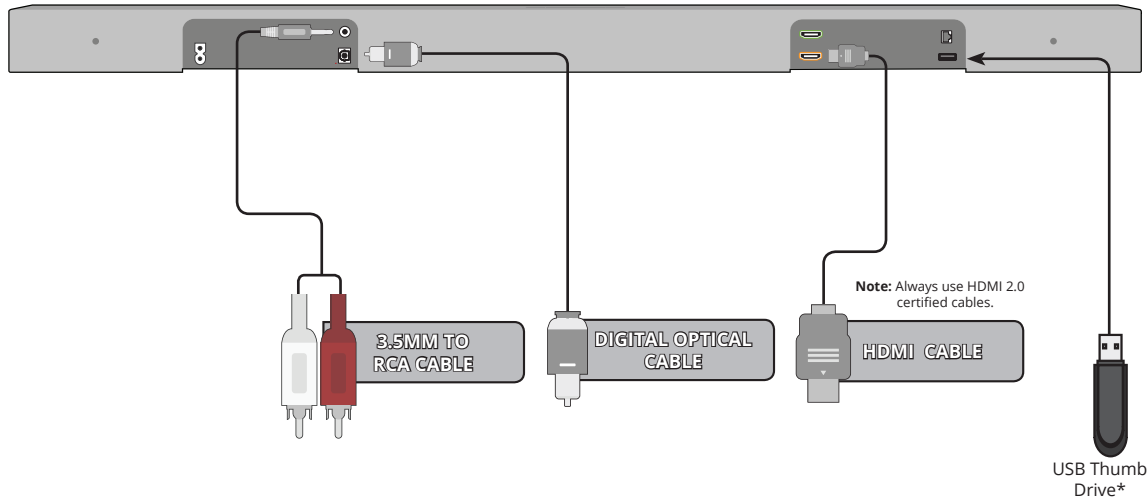

Tablet/MP3 Player/Laptop



Network Media Player



Game Console

* Supports .WAV and .MP3 file format playback only.

ADVANCED SETUP - HDMI ARC

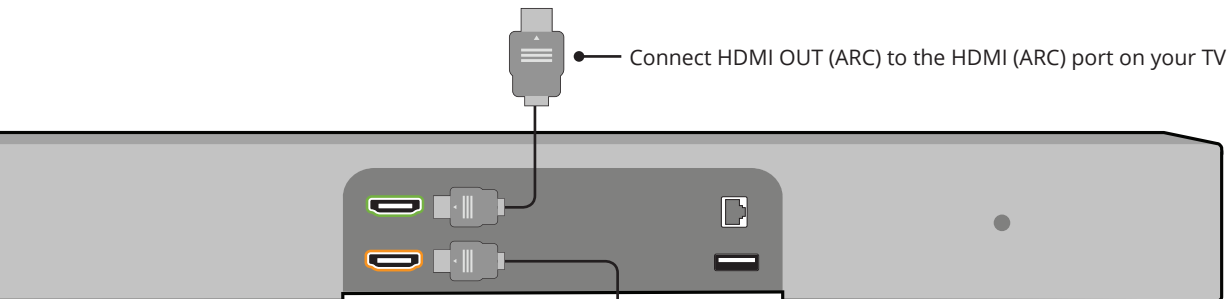

HDMI cables transmit both audio and video. To view video from these devices, turn the sound bar on, then set the sound bar input to HDMI In. Set your TV input to the HDMI port to which the sound bar is connected.



Note: Always use HDMI 2.0 certified cables.



Blu-ray Player

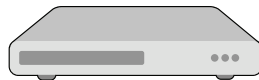

Cable/Satellite Box

CONNECTING WITH HDMI ARC

What is HDMI Audio Return Channel (ARC)?

Using HDMI (ARC), your TV can send audio to the sound bar using an HDMI cable.

You will need to connect your sound bar to your TV's HDMI (ARC) port using an HDMI cable that is ARC compatible.

To connect using HDMI*:

1. Connect one end of the HDMI cable to the **HDMI 1 (ARC)** port on the back of your TV.
2. Connect the other end to the **HDMI OUT (ARC)** port on your VIZIO sound bar.
3. From the AUDIO menu on your TV, change the Digital Audio Setting to **Dolby Digital** or **Bitstream**.
4. From the SYSTEM menu, enable CEC and ARC (SAC)[†] functions.
5. From the CEC menu, select **Device Discovery** to register the sound bar with the TV.



If you want to use the volume buttons on the TV remote control to control the sound bar, enable System Audio Control from the CEC menu.

* The following steps are for use with a VIZIO TV, steps may differ by TV manufacturer. See your TV's user manual for more information.

[†] CEC Function naming may differ by TV manufacturer. See your TV's user manual for more information.

Back of TV*

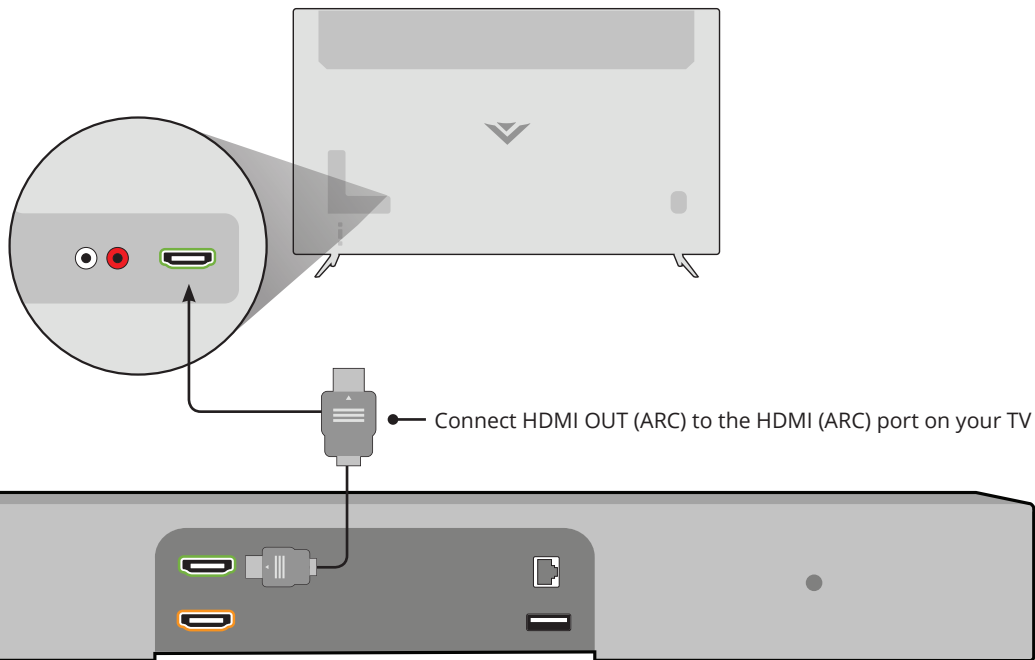

* HDMI ARC port location may differ by TV manufacturer. See your TV's user manual for more information.

CONNECTING A SUBWOOFER



The subwoofer has already been paired with the sound bar by VIZIO. However, the subwoofer may need to be re-linked to the sound bar if there is no sound coming from the subwoofer.



What does pairing mean?

Pairing means to wirelessly connect.

1

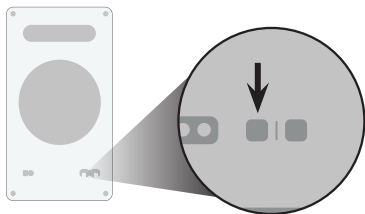

Back of Subwoofer

2

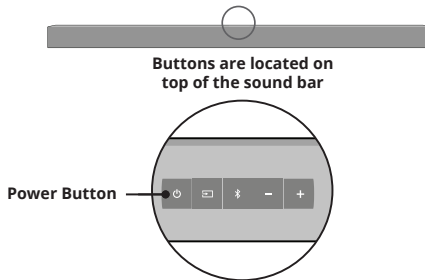

Buttons are located on top of the sound bar

Power Button

First confirm that the power LED is illuminated. Press and hold the **pairing** button on the back of the subwoofer for 5 seconds. The LED on the back of the subwoofer will begin to blink.

With the sound bar powered on, press and hold the **power** button on the top of the sound bar for 5 seconds. The LED indicators on the front will flash 3 times. The subwoofer is now linked with the sound bar.

WALL-MOUNTING THE SOUND BAR

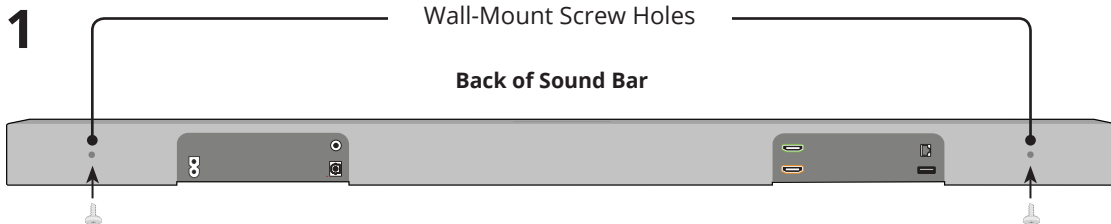

Insert the two wall-mount screws into the wall-mount screw holes, and then tighten them with a Phillips screwdriver.

2

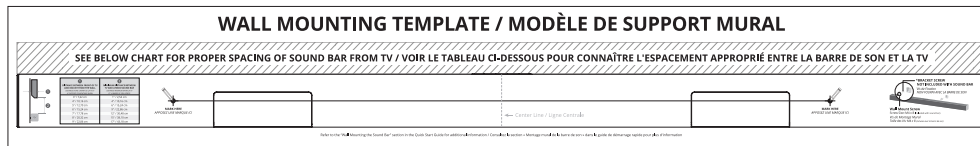

Place the included wall mounting template against the wall under your TV.
Mark the two bracket holes using a pencil.

3

Be sure your screws are attached to wood studs, drywall anchors (for drywall), or concrete anchors (for brick/concrete walls).

Screws for attaching the brackets to the wall are not included. Choose the screw type and length appropriate to your home's construction. If in doubt, consult a professional installer.

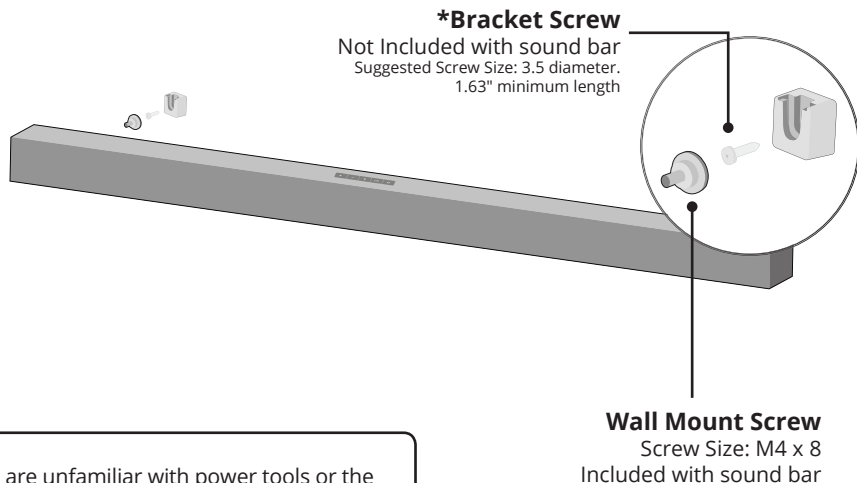

If you are unfamiliar with power tools or the layout of electrical wiring in the walls of your home, consult a professional installer.

* Do not use any of the included screws for the wall mount installation. These are not intended for mounting.

WALL-MOUNTING THE SATELLITE SPEAKERS

To wall-mount the satellite speakers:

1. Attach the wall mount screw to the back of the satellite speaker.
2. Secure the wall mount bracket to the wall. Bracket screw is not included.
3. Slide the speaker on to the wall bracket. Ensure the wall mount screw is secured within the bracket grooves.

Be sure your screws are attached to wood studs or drywall anchors (for drywall) or concrete anchors (for brick/concrete walls).

Wall mounting hardware is not included.

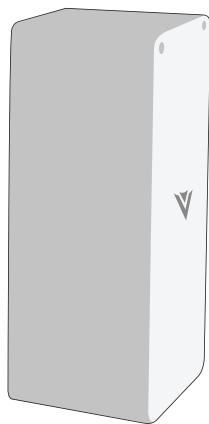

Wall Mount Screw
Screw Size: M4 x 8

***Bracket Screw**

Not Included with sound bar
Suggested Screw Size:
3.5" diameter,
1.63" minimum length



If you are unfamiliar with power tools or the layout of electrical wiring in the walls of your home, consult a professional installer.

* Do not use any of the included screws for the wall mount installation. These are not intended for mounting.

Take a moment to register your product

VIZIO.COM/PRODUCT-REGISTRATION

Why register?



Customized Support

Get assistance quickly with your information on hand.



News and Offers

Take advantage of the latest news and special offers from VIZIO.



Safety and Satisfaction

Stay up-to-date with important product updates and notifications.



NEED HELP?

Go to: support.vizio.com

Find help with:

- New product setup
- Connecting your devices
- Technical problems
- Product updates and more



Live chat
support available

You can also contact our support team at:

Phone: (844) 254-8087

Text Message: (205) 301-3729

Note: This number accepts SMS/MMS messages only. No voice calls are accepted.
Message and data rates may apply. (U.S. only).

Se habla Español • Nous parlons Français

HELP & TROUBLESHOOTING

There is no power.

- Press the **POWER** button on the remote control or on the top of your sound bar.
- Ensure the power cord is securely connected.
- Plug a different device into the electrical outlet to verify that the outlet is working correctly.

There is no sound.

- Increase the volume. Press **Volume Up** on the remote control or on the top of your sound bar.
- Press **MUTE** on the remote to ensure the sound bar is not muted.
- Press **INPUT** on the remote or on the top of your sound bar to select a different input source.
- When using the optical input, if there is no audio: (A) Try setting the TV output to PCM or (B) Connect directly to your Blu-ray/other source, some TVs do not pass through digital audio.
- Your TV may be set to variable audio output. Confirm that the audio output setting is set to **FIXED** or **STANDARD**, not **VARIABLE**. Consult your TV's user manual for more detailed information.
- If using Bluetooth, ensure that the volume on your source device is turned up and that the device is not muted.

I hear buzzing or humming.

- Ensure all cables and wires are securely connected. Satellite cables have notches that must line up with the ports.
- Connect a different source device (TV, Blu-ray player, etc) to see if the buzzing persists. If it does not, the problem may be with the original device.
- Connect your device to a different input on the sound bar.
- Connect your sound bar to a different power outlet.

The remote isn't working.

- Replace the remote batteries with new ones.
- Point the remote directly at the center of the sound bar when pressing a button.
- If using a Bluetooth connection, some of the buttons on the remote may not be supported by the streaming application (e.g., Pandora doesn't support the Back button).

FREQUENTLY ASKED QUESTIONS

How do I know if I'm playing Dolby Atmos content?

- You can verify content via the VIZIO SmartCast Mobile app. Download the VIZIO SmartCast Mobile app and sync your sound bar. Go to Settings > System Information to see what type of audio is being played. Visit vizio.com/smartcastapp for more on the SmartCast Mobile app.
- When Dolby Atmos content is detected the audio format LED on the bar will briefly appear green.
- From the remote control, choose the Info menu option and press the Play/Pause key. The sound bar will announce the current input and audio format being played.

Can I adjust each of the sound bar speaker channels individually?

- You cannot adjust each individual speaker. You can adjust the volume and presence of the Center channel and Surround speakers. You can also turn the height channels On or Off.

What sources play Dolby Atmos content?

- Dolby Atmos content can be found on select streaming apps, on 4K UHD Blu-Ray discs, and on some gaming systems and streaming sticks. To play Atmos content from these devices, connect the device directly to the HDMI in port of the sound bar.
- Dolby Atmos supported streaming apps built into connected TVs may also be played on the HDMI ARC port.
- SmartCast, Bluetooth, USB, Aux, Optical and Digital Coax inputs do not support Dolby Atmos.

The sound bar is in a room with a vaulted ceiling. Will I hear all the sounds properly?

- To clearly hear all Atmos has to offer, you will need a flat ceiling that is between 7.5 and 12 feet high. This allows the height speakers to reflect off the ceiling providing the sounds that would come from above.
- Vaulted ceilings or ceilings with acoustic treatments or tiles will diminish the effect. From the remote control select Height --> Virtual for a virtualized height experience. Dolby Atmos content will be played in Dolby Digital Plus format in this mode.

The system information says the audio type is Dolby Atmos-Dolby Digital Plus or Dolby Atmos-TrueHD. How do I get one or the other?

- Dolby Atmos-TrueHD typically comes from a UHD Blu-Ray player or console that is plugged into the sound bar's HDMI IN port. Dolby Atmos-Dolby Digital Plus is typically sent from supported apps being played from a smart TV that is plugged into the sound bar's HDMI ARC port.

LIMITED WARRANTY

UNITED STATES AND CANADA

BY USING YOUR VIZIO PRODUCT YOU AGREE TO BE BOUND BY ALL THE TERMS OF THIS WARRANTY. BEFORE USING YOUR VIZIO PRODUCT, PLEASE READ THIS WARRANTY CAREFULLY. IF YOU DO NOT AGREE TO THE TERMS OF THIS WARRANTY, DO NOT USE THE VIZIO PRODUCT AND, WITHIN THIRTY (30) DAYS OF THE DATE OF PURCHASE, RETURN IT FOR A REFUND TO THE AUTHORIZED RETAILER WHERE YOU PURCHASED IT.

This warranty contains a binding arbitration agreement and a class action waiver for United States residents. If you live in the United States, the binding arbitration agreement and class action waiver affect your rights under this warranty. Please read the text under the section titled "Binding Arbitration Agreement; Class Action Waiver (U.S. Residents Only)" carefully.

How Long This Warranty Lasts

For non-commercial use, VIZIO warrants the product on the terms set forth below for one (1) year from the date of original purchase. For commercial use, VIZIO warrants this product on the terms set forth below for ninety (90) days from the date of original purchase.

What This Warranty Covers

VIZIO warrants the product against defects in materials and workmanship when the product is used normally in accordance with VIZIO's user guides and manuals. Except where restricted by law, this warranty applies only to the original purchaser of a new product. The purchase must have been made from an authorized retailer in the United States (including Puerto Rico) or Canada. The product must also be located in the country where it was purchased at the time of warranty service.

How to Get Service

Before obtaining warranty service, you may visit www.vizio.com for additional help and troubleshooting. To obtain warranty service, contact VIZIO Technical Support via email at TechSupport@VIZIO.com or via phone at 877 MY VIZIO (877-698-4946).

Your Obligations Before Service

You must obtain pre-authorization before sending your product to a VIZIO service center. You may be required to supply a purchase receipt (or copy) to show that the product is within the warranty period.

When you return a product to a VIZIO service center, you must ship the product in its original packaging or in packaging that affords an equal degree of protection. VIZIO Technical Support will provide instructions for packing and shipping the product to the VIZIO service center.

ALL USER DATA AND DOWNLOADED APPLICATIONS STORED ON A PRODUCT WILL BE DELETED IN THE COURSE OF SOME IN-HOME AND ALL SHIP-IN WARRANTY SERVICE. If this occurs, your product will be restored to its original state. You will be responsible for restoring all applicable user data and downloaded applications. Recovery and reinstallation of user data and downloaded applications is not covered under this warranty. In order to protect your personal information, VIZIO recommends that you always clear all personal information from the product before it is serviced, regardless of the servicer.

VIZIO's Responsibilities

If VIZIO determines that a product is covered by this warranty, VIZIO will (at its option) repair or replace it, or refund the purchase price to you. There will be no charge for parts or labor during the warranty period. Replacement parts may be new or recertified at VIZIO's option and sole discretion. Replacement parts and VIZIO's labor are warranted for the remaining portion of the original warranty or for ninety (90) days from warranty service, whichever is longer.

Types of Service

Products must be sent to a VIZIO service center to obtain warranty service. VIZIO is not responsible for transportation costs to the service center, but VIZIO will cover return shipping to the customer.

What This Warranty Does Not Cover

This warranty does not cover: (a) cosmetic damage; (b) normal wear and tear; (c) improper operation; (d) improper voltage supply or power surges; (e) signal issues; (f) damage from shipping; (g) acts of God; (h) customer misuse, modifications or adjustments; (i) installation, set-up, or repairs attempted by anyone other than by a VIZIO authorized service center; (j) products with unreadable or removed serial numbers; (k) products requiring routine maintenance; or (l) products sold "AS IS", "CLEARANCE", "FACTORY RECERTIFIED", or by a non-authorized reseller.

What to Do If You Are Not Satisfied With Service

If you feel VIZIO has not met its obligations under this warranty, you may attempt to resolve the issue informally with VIZIO. If you are unable to resolve the issue informally and wish to file a formal claim against VIZIO, and if you are a resident of the United States, you must submit your claim to binding arbitration according to the procedures described below, unless an exception applies. Submitting a claim to binding arbitration means that you do not have the right to have your claim heard by a judge or jury. Instead your claim will be heard by a neutral arbitrator.

Binding Arbitration Agreement; Class Action Waiver (U.S. Residents Only)

UNLESS YOU HAVE BROUGHT AN ELIGIBLE CLAIM IN SMALL CLAIMS COURT OR HAVE OPTED OUT AS DESCRIBED BELOW, ANY CONTROVERSY OR CLAIM RELATING IN ANY WAY TO YOUR VIZIO PRODUCT, INCLUDING ANY CONTROVERSY OR CLAIM ARISING OUT OF OR RELATING TO THIS WARRANTY, A BREACH OF THIS WARRANTY, OR THE VIZIO PRODUCT'S SALE, CONDITION OR PERFORMANCE, WILL BE SETTLED BY BINDING ARBITRATION ADMINISTERED BY THE AMERICAN ARBITRATION ASSOCIATION AND CONDUCTED BY A SINGLE ARBITRATOR APPOINTED BY THE AMERICAN ARBITRATION ASSOCIATION, IN ACCORDANCE WITH ITS COMMERCIAL ARBITRATION RULES AND ITS SUPPLEMENTARY PROCEDURES FOR CONSUMER-RELATED DISPUTES. You may learn more about the American Arbitration Association and its rules for arbitration by visiting www.adr.org or by calling 800-778-7879. Since this warranty concerns a transaction in interstate or international commerce, the Federal Arbitration Act will apply.

The filing fees to begin and carry out arbitration will be shared between you and VIZIO, but in no event will your fees ever exceed the amount allowable by the American Arbitration Association, at which point VIZIO will cover all additional administrative fees and expenses. VIZIO waives its right to recover attorneys' fees in connection with any arbitration under this warranty. If you are the prevailing party in an arbitration to which the Supplementary Procedures for Consumer-Related Disputes applies, then you are entitled to recover attorneys' fees as the arbitrator may determine.

The dispute will be governed by the laws of the state or territory in which you resided at the time of your purchase (if in the United States). The place of arbitration will be Irvine, California, or your county of residence (if in the United States). The arbitrator will have no authority to award punitive or other damages not measured by the prevailing party's actual damages, except as may be required by statute. The arbitrator will not award consequential damages, and any award will be limited to monetary damages and will include no equitable relief, injunction, or direction to any party other than the direction to pay a monetary amount. Judgment on the award rendered by the arbitrator will be binding and final, except for any right of appeal provided by the Federal Arbitration Act, and may be entered in any court having jurisdiction. Except as may be required by law, neither you nor VIZIO nor an arbitrator may disclose the existence, content, or results of any arbitration under this warranty without the prior written consent of you and VIZIO.

ANY DISPUTE, WHETHER IN ARBITRATION, IN COURT, OR OTHERWISE, WILL BE CONDUCTED SOLELY ON AN INDIVIDUAL BASIS. VIZIO AND YOU AGREE THAT NO PARTY WILL HAVE THE RIGHT OR AUTHORITY FOR ANY DISPUTE TO BE ARBITRATED AS A CLASS ACTION, A PRIVATE ATTORNEY GENERAL ACTION, OR IN ANY OTHER PROCEEDING IN WHICH EITHER PARTY ACTS OR PROPOSES TO ACT IN A REPRESENTATIVE CAPACITY.

NO ARBITRATION OR PROCEEDING WILL BE JOINED, CONSOLIDATED, OR COMBINED WITH ANOTHER ARBITRATION OR PROCEEDING WITHOUT THE PRIOR

WRITTEN CONSENT OF ALL PARTIES TO ANY SUCH ARBITRATION OR PROCEEDING.

Exceptions to Binding Arbitration Agreement and Class Action Waiver

IF YOU DO NOT WISH TO BE BOUND BY THE BINDING ARBITRATION AGREEMENT AND CLASS ACTION WAIVER, THEN: (1) you must notify VIZIO in writing within sixty (60) days of the date that you purchased the product; (2) your written notification must be mailed to VIZIO at 39 Tesla, Irvine, CA 92618, Attn: Legal Department; and (3) your written notification must include (a) your name, (b) your address, (c) the date you purchased the product, and (d) a clear statement that you wish to opt out of the binding arbitration agreement and class action waiver.

In addition, you may pursue a claim in small claims court in your county of residence (if in the United States) or in Orange County, California. In such case the provisions of the section titled "Binding Arbitration Agreement; Class Action Waiver (U.S. Residents)" will not apply.

Exclusions and Limitations

TO THE GREATEST EXTENT PERMITTED BY APPLICABLE LAW, THERE ARE NO EXPRESS WARRANTIES OTHER THAN THOSE DESCRIBED ABOVE. ANY IMPLIED WARRANTIES, INCLUDING ANY IMPLIED WARRANTY OF MERCHANTABILITY AND FITNESS FOR A PARTICULAR PURPOSE, WILL BE LIMITED IN DURATION TO THE WARRANTY PERIOD SET FORTH ABOVE. SOME STATES AND PROVINCES DO NOT ALLOW LIMITATIONS ON HOW LONG AN IMPLIED WARRANTY LASTS, SO THE ABOVE LIMITATION MAY NOT APPLY TO YOU.

VIZIO WILL NOT BE RESPONSIBLE FOR LOSS OF USE, LOSS OF INFORMATION OR DATA, COMMERCIAL LOSS, LOST REVENUE OR LOST PROFITS, OR OTHER INDIRECT, SPECIAL, INCIDENTAL OR CONSEQUENTIAL DAMAGES, EVEN IF VIZIO HAS BEEN ADVISED OF THE POSSIBILITY OF SUCH DAMAGES, AND EVEN IF THE REMEDY FAILS OF ITS ESSENTIAL PURPOSE. SOME STATES AND PROVINCES DO NOT ALLOW THE EXCLUSION OR LIMITATION OF INCIDENTAL OR CONSEQUENTIAL DAMAGES, SO THE ABOVE LIMITATION OR EXCLUSION MAY NOT APPLY TO YOU.

IN LIEU OF ANY OTHER REMEDY FOR ANY AND ALL LOSSES AND DAMAGES RESULTING FROM ANY CAUSE WHATSOEVER (INCLUDING VIZIO'S NEGLIGENCE, ALLEGED DAMAGE, OR DEFECTIVE GOODS, NO MATTER WHETHER SUCH DEFECTS ARE DISCOVERABLE OR LATENT), VIZIO MAY, AT ITS SOLE AND EXCLUSIVE OPTION AND IN ITS DISCRETION, REPAIR OR REPLACE YOUR PRODUCT, OR REFUND ITS PURCHASE PRICE. AS NOTED, SOME STATES AND PROVINCES DO NOT ALLOW THE EXCLUSION OR LIMITATION OF INCIDENTAL OR CONSEQUENTIAL DAMAGES, SO THE ABOVE LIMITATION OR EXCLUSION MAY NOT APPLY TO YOU.

How the Law Applies

This warranty gives you specific legal rights, and you may also have other rights, which vary from state to state and province to province. This warranty applies to the greatest extent permitted by applicable law.

General

No employee or agent of VIZIO may modify this warranty. If any term of this warranty, other than the class action waiver, is found to be unenforceable, that term will be severed from this warranty and all other terms will remain in effect. If the class action waiver is found to be unenforceable, then the entire section titled "Binding Arbitration Agreement; Class Action Waiver (U.S. Residents Only)" will not apply. This warranty applies to the maximum extent not prohibited by law.

Changes to Warranty

This warranty may change without notice, but any change will not affect your original warranty. Check www.vizio.com for the most current version.

Specifications

Sound Bar: Forward Firing - Two 1.65" x 2.56" Full Range Driver for Each Channel (1 for left, 1 for right, 1 for center)
Upward Firing - Two 1.65" x 2.56" Full Range Driver for Each Channel (1 for left, 1 for right)

Satellite Speakers Forward Firing - Two 2.12" Full Range Driver for Each Channel (1 for left, 1 for right)
Upward Firing - Two 1.97" Full Range Driver for Each Channel (1 for left, 1 for right)

Subwoofer: One 6" Driver

Connections: One 3.5mm Stereo Audio
One Optical (Toslink)
One USB (Supports .WAV and .MP3 format only)
HDMI In
HDMI Out (Arc)
Bluetooth
802.11n (Wireless)
Ethernet (RJ45)

Power Output DC 5V,500mA

Sound Pressure Level (System): 103 dB

Frequency Response (System): 40 Hz - 16 KHz

Voltage: 120 VAC, 60 Hz

Compliances: cTUVus / FCC Class B / ICES-003 /CEC / Energy star

LEGAL & COMPLIANCE

FCC Class B Radio Interference Statement

NOTE: This equipment has been tested and found to comply with the limits for a Class B digital device, pursuant to Part 15 of the FCC Rules. These limits are designed to provide reasonable protection against harmful interference in a residential installation. This equipment generates, uses and can radiate radio frequency energy, and if not installed and used in accordance with the instructions, may cause harmful interference to radio communications. However, there is no guarantee that interference will not occur in a particular installation. If this equipment does cause harmful interference to radio or television reception, which can be determined by turning the equipment off and on, the user is encouraged to try to correct the interference by one or more of the following measures:

1. Reorient or relocate the receiving antenna.
2. Increase the separation between the equipment and receiver.
3. Connect the equipment into an outlet on a circuit different from that to which the receiver is connected.
4. Consult the dealer or an experienced radio/TV technician for help.

This device complies with Part 15 of the FCC Rules. Operation is subject to the following two conditions: (1) this device may not cause harmful interference, and (2) this device must accept any interference received, including interference that may cause undesired operation.

- (1) the device for operation in the band 5150-5250 MHz is only for indoor use to reduce the potential for harmful interference to co-channel mobile satellite systems;
- (2) the maximum antenna gain permitted for devices in the bands 5250-5350 MHz and 5470-5725 MHz shall comply with the e.i.r.p. limit; and
- (3) the maximum antenna gain permitted for devices in the band 5725-5825 MHz shall comply with the e.i.r.p. limits specified for point-to-point and non point-to-point operation as appropriate.
- (4) Users should also be advised that high-power radars are allocated as primary users (i.e. priority users) of the bands 5250-5350 MHz and 5650-5850 MHz and that these radars could cause interference and/or damage to LE-LAN devices.

Notice:

1. Any Changes or modifications not expressly approved by the party responsible for compliance could void the user's authority to operate the equipment.
2. Shielded interface cables and AC power cord, if any, must be used in order to comply with the emission limits.
3. The manufacturer is not responsible for any radio or TV interference caused by unauthorized modification to this equipment. It is the responsibilities of the user to correct such interference.

FCC RF Radiation Exposure Statement

1. This transmitter must not be collocated or operating in conjunction with any other antenna or transmitter.
2. This equipment complies with FCC radiation exposure limits set forth for an uncontrolled environment. This equipment should be installed and operated with minimum distance 20cm between the radiator & your body.
3. FCC RF Warning
This equipment must be installed and operated in accordance with provided instructions and the antenna(s) used for this transmitter must be installed to provide a separation distance of at least 20cm from all persons and must not be co-located or operating in conjunction with any other antenna or transmitter. End-users and installers must be provided with antenna installation instructions and transmitter operating conditions for satisfying RF exposure compliance.

IC Statement

1. This device complies with Industry Canada license-exempt RSS standard(s). Operation is subject to the following two conditions:
 - (1) this device may not cause interference, and
 - (2) this device must accept any interference, including interference that may cause undesired operation of the device.
2. Changes or modifications not expressly approved by the party responsible for compliance could void the user's authority to operate the equipment.

IC Radiation Exposure Statement

This equipment complies with IC RSS-102 radiation exposure limits set forth for an uncontrolled environment. This equipment should be installed and operated with minimum distance 20cm between the radiator & your body.

Battery Disposal and Recycling

You must dispose of this product properly, according to local laws and regulations. Because this product contains electronic components and/ or a battery, it must be disposed of separately from household waste. Contact local authorities to learn about disposal and recycling options. For more information, visit www.vizio.com/environment.

Software Licenses

All software is provided subject to software license agreements and you agree that you will be bound by such license agreements in addition to other applicable terms of use. By using the VIZIO products, you agree to the VIZIO Terms of Service and Privacy Policy, as well as Google's Terms of Service and Privacy Policy. The VIZIO Terms of Use and Privacy Policy may be updated from time to time and are available to view at <http://www.vizio.com/terms> and <http://www.vizio.com/privacy>, respectively.

Export Regulations

Customer acknowledges that the VIZIO products, which include technology and software, are subject to customs and export control laws in the United States ("US"). The products may also be subject to the customs and export control laws and regulations of the country in which the products are manufactured and/or received.

Internet Connectivity

Network conditions, environmental and other factors may negatively affect connectivity and the resulting audio quality, if any.

The applications and content of the applications pictured herein or described in accompanying documentation may only be available in certain countries or languages, may require additional fees or subscription charges, and may be subject to future updates, modifications or discontinuation without notice. VIZIO has no control over third party applications or content and assumes no responsibility for the availability or interruption of such applications or content. Additional third party terms, conditions and restrictions apply. A Google account is required to download applications from the Google Play store. A MyVIZIO account is required to access certain features of the VIZIO SmartCast app. Information in this Quick Start Guide is subject to change without notice. To review the most updated version of this Quick Start Guide and the associated User Manual, go to <http://www.vizio.com>.

© 2019 VIZIO, Inc. All Right Reserved.

Image(s) used under license from Shutterstock.com

This User Manual may not be copied in whole or in part without the written permission of VIZIO, Inc. VIZIO, Inc. has made reasonable efforts to ensure the accuracy of the information provided herein. All product specifications, functionality, features, configurations, performance, design and other product information described herein are subject to change without notice. VIZIO, Inc. is not responsible for typographical, technical, or descriptive errors.

VIZIO, the VIZIO logo, the V logo, and other terms and phrases are trademarks or registered trademarks of VIZIO, Inc.



HDMI, HDMI High-Definition Multimedia Interface, and the HDMI Logo are trademarks or registered trademarks of HDMI Licensing LLC.

The Bluetooth® word mark and logos are registered trademarks owned by the Bluetooth SIG, Inc. and any use of such marks by VIZIO, Inc. is under license. Other trademarks and trade names are those of their respective owners.

© 2019 Google Inc. All rights reserved. Android, Google Play, Chromecast and other marks are trademarks of Google inc.

Sound pressure level measured using pink noise at 1 meter, c-weighted.

Minimum requirements: Android 4.0 or later (to use the bluetooth functionality you must have Android™ 5.1 or later) iOS 9.0 or later. Subject to change. For a list of Android™ supported devices see <https://support.google.com/googleplay/answer/2844198?hl=en> Article. iOS devices supported: iPhone, iPad.



MANUFACTURED UNDER LICENSE FROM DOLBY LABORATORIES. DOLBY, DOLBY ATMOS, DOLBY AUDIO AND THE DOUBLE-D SYMBOL ARE TRADEMARKS OF DOLBY LABORATORIES.



MANUFACTURED UNDER LICENSE FROM DTS, INC. DTS, THE SYMBOL, DTS AND THE SYMBOL TOGETHER, DTS-HD MASTER AUDIO, VIRTUAL:X, THE DTS-HD MASTER AUDIO LOGO AND THE DTS VIRTUAL:X LOGO ARE REGISTERED TRADEMARKS OR TRADEMARKS OF DTS, INC. IN THE UNITED STATES AND/OR OTHER COUNTRIES. © DTS, INC. ALL RIGHTS RESERVED.



MANUFACTURED UNDER LICENSE FROM DTS, INC. DTS, THE SYMBOL, DTS AND THE SYMBOL TOGETHER, DTS-HD MASTER AUDIO, VIRTUAL:X, THE DTS-HD MASTER AUDIO LOGO AND THE DTS VIRTUAL:X LOGO ARE REGISTERED TRADEMARKS OR TRADEMARKS OF DTS, INC. IN THE UNITED STATES AND/OR OTHER COUNTRIES. © DTS, INC. ALL RIGHTS RESERVED.



THIS PRODUCT QUALIFIES FOR ENERGY STAR IN THE "FACTORY DEFAULT" SETTING AND THIS IS THE SETTING IN WHICH POWER SAVINGS WILL BE ACHIEVED. CHANGING THE FACTORY DEFAULT SETTINGS OR ENABLING OTHER FEATURES WILL INCREASE POWER CONSUMPTION THAT COULD EXCEED THE LIMITS NECESSARY TO QUALIFY FOR ENERGY STAR RATING. WE WANT TO HELP YOU SAVE ENERGY.



© 2019 VIZIO INC. ALL RIGHTS RESERVED.
190213SL