



G1003 HART to Modbus Gateway

User Manual



Microcyber Corporation



Caution

1. Please don't disassemble components by yourself.
2. Please check if the power meets the power request in the User Manual.

Version

V1.0

Disclaimer of Liability

We have reviewed the contents of this publication to ensure consistency with the hardware and software described. Since variance cannot be precluded entirely, we cannot guarantee full consistency. However, the information in this publication is reviewed regularly and any necessary corrections are included in subsequent editions.

Microcyber Corporation 2015

The technical data may change at any time.





Content

- CHAPTER 1 OVERVIEW.....1**

 - 1.1 OUTLINE STRUCTURE.....1

 - 1.1.1 Gateway Dimension Figure.....1
 - 1.1.2 Gateway Structure Figure.....2

- CHAPTER 2 INSTALLATION.....3**

 - 2.1 DIN RAIL INSTALLATION.....3
 - 2.2 GATEWAY HARDWARE INTERFACE.....3

 - 2.2.1 HART Interface.....4
 - 2.2.2 Gateway Power interface.....4
 - 2.2.3 Modbus-RS485/422Interface.....4
 - 2.2.4 Modbus-RS232 Interface.....4
 - 2.2.5 Gateway Mode Selection Switch.....4
 - 2.2.6 Internal /External Sampling Resistor Selection Switch (RS).....5

 - 2.2.7 LED 5

 - 2.3 TYPICAL TOPOLOGIC CONNECTION.....5

- CHAPTER 3 FUNCTION OVERVIEW.....8**

 - 3.1 WORKING MODES OF THE GATEWAY.....8

 - 3.1.1 Normal Working Mode.....8
 - 3.1.2 HART Modem Mode.....9
 - 3.1.3 Configuration Mode.....9
 - 3.1.4 Debugging Mode.....9

 - 3.2 SUMMARY OF HART CHANNEL.....9
 - 3.3 SUMMARY OF MODBUS CHANNEL.....10
 - 3.4 DATA AREA INSIDE THE GATEWAY.....11

 - 3.4.1 Internal Data Access.....11
 - 3.4.2 Partition of Internal Data Area.....12
 - 3.4.3 Default Auto-Polling Mode.....12
 - 3.4.4 Self-defined HART Command List.....14

- CHAPTER 4 GATEWAY CONFIGURATION.....16**

 - 4.1 INSTALL AND START CONFIGURATION SOFTWARE.....16



4.2	OVERVIEW OF CONFIGURATION SOFTWARE.....	16
4.3	SOFTWARE CONFIGURATION AND HARDWARE CONNECION.....	18
4.4	BASIC PARAMETER CONFIGURATION FOR MODBUS CHANNEL.....	20
4.5	BASIC PARAMETER CONFIGURATION OF HART CHANNEL.....	21
4.6	PARAMETER CONFIGURATION FOR CUSTOM HART COMMAND.....	22
4.6.1	<i>Address Automatic Mapping</i>	23
4.6.2	<i>Address Conflict Detection</i>	24
4.6.3	<i>Memory Data Display</i>	24
4.7	EXCEL SAVE CONFIGURATION PARAMETER.....	25
4.8	LIBRARY FILE SAVE CONFIGURATION PARAMETER.....	26
4.9	CONFIGURATION EXAMPLE AND VERIFICATION.....	26
4.9.1	<i>Example</i>	26
4.9.2	<i>Verificaion</i>	28
CHAPTER 5	GATEWAY STATUS.....	30
CHAPTER 6	GATEWAY MAINTENANCE.....	31
CHAPTER 7	TECHNICAL SPECIFICAIONS.....	32
7.1	PERFORMANCE.....	32
7.2	DEFAULT COMMUNICATION PARAMETER.....	33
APPENDIX A	GATEWAY MEMORY AND REGISTER DESCRIPTION.....	34
APPENDIX B	HART PROTOCL.....	36
APPENDIX C	MODBUS PROTOCL.....	47

Chapter 1 Overview

Product Name: HART to Modbus Gateway

Model No: G1003

The gateway realizes protocol converting from HART to Modbus RTU / ASCII. Supporting to connect multi HART slave devices into Modbus network. In the gateway, HART terminal is master station, Modbus terminal is slave station.



Figure 1 G1003 HART to Modbus Gateway Product Diagram

1.1 Outline Structure

1.1.1 Gateway Dimension Figure

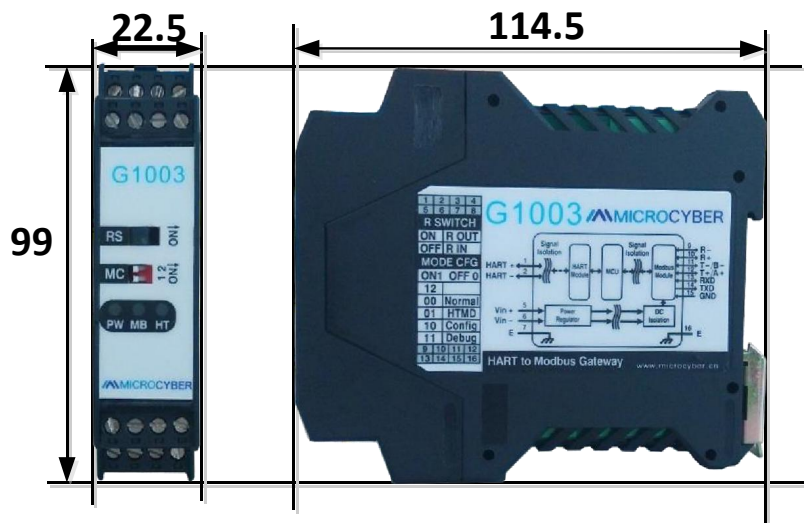

Figure 2 Gateway Dimension Figure (114.5x99x22.5, Unit: mm)

1.1.2 Gateway Structure Figure

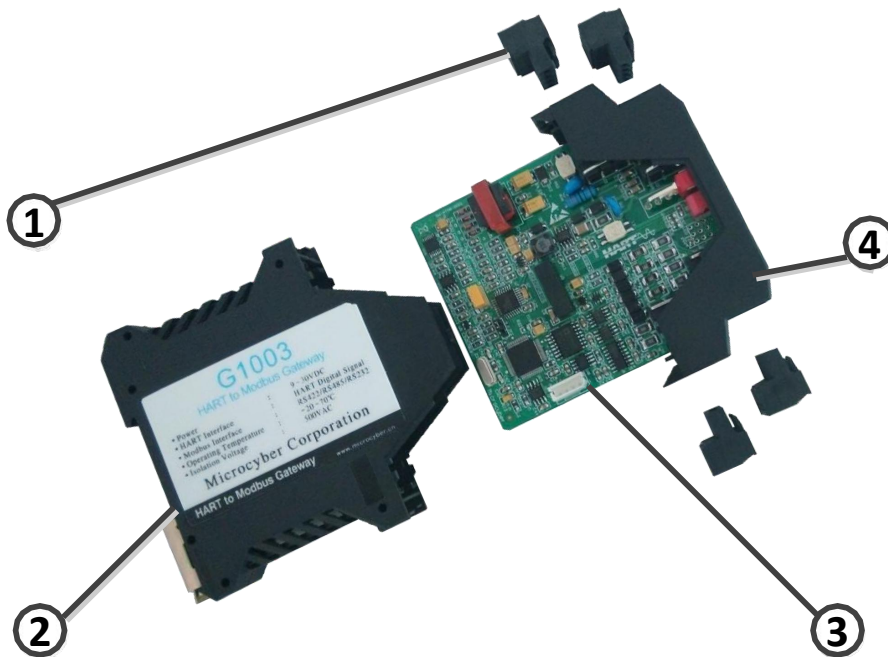

Figure 3 Gateway Structure Figure

1	Terminal	2	Bottom Housing	3	Main Board	4	Upside Housing
---	----------	---	----------------	---	------------	---	----------------

Chapter 2 Installation

2.1 Din Rail Installation

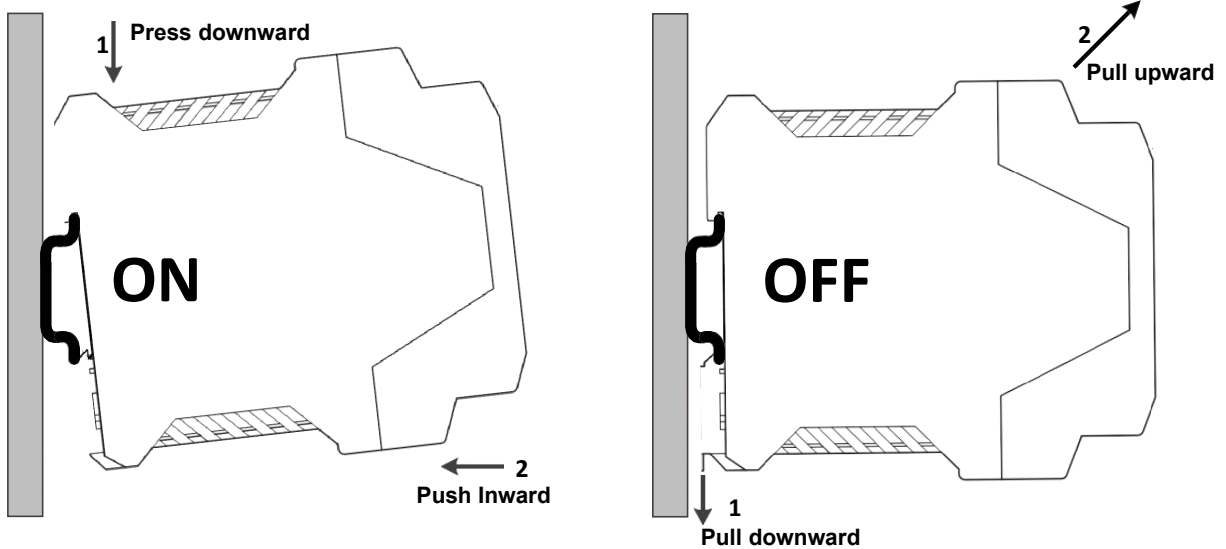

Figure 4 Din Rail Installation Figure

2.2 Gateway Hardware Interface

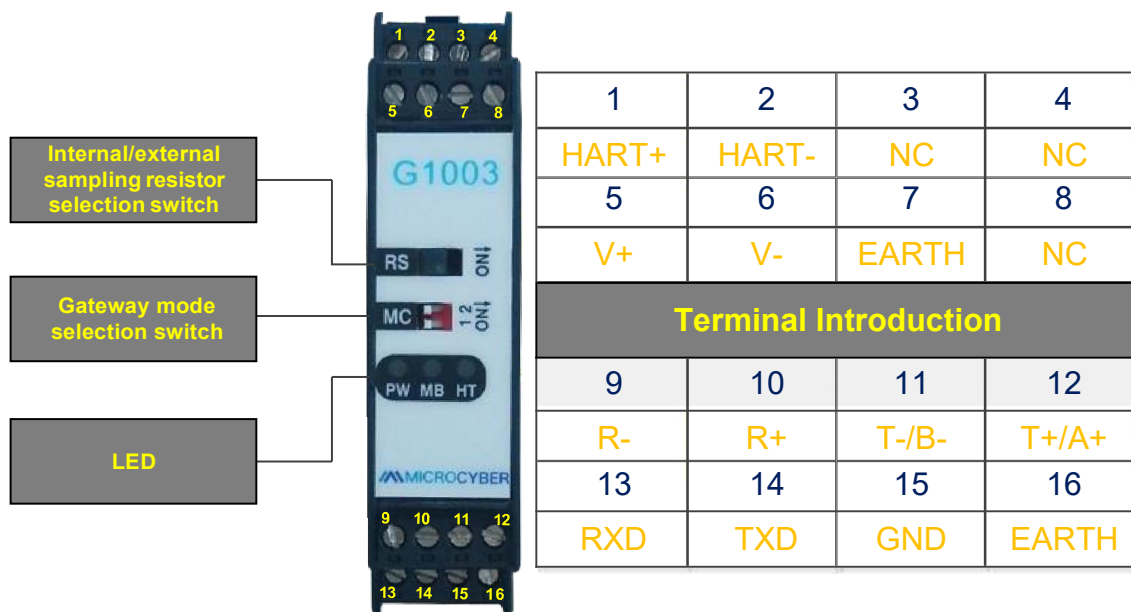

Figure 5 Gateway Hardware Interface Figure



2.2.1 HART Interface

Table 1 HART Interface Terminal Definition

No	Name	Usage
1	HART+	Connect HART sampling resistor
2	HART-	Connect HART sampling resistor
3	NC	Not Connected
4	NC	Not Connected

2.2.2 Gateway Power interface

Table 2 Power Interface Terminal Definition

No	Name	Usage
5	V+	Connect 9-30V DC power+
6	V-	Connect 9-30V DC power-
7	EARTH	Protective earth terminal
8	NC	Not Connected

2.2.3 Modbus-RS485/422Interface

Table 3 RS485/422 Interface Terminal Definition

No	Name	Usage
9	R-	RS-422 receiving -
10	R+	RS-422 receiving +
11	T-/B-	RS-422 sending - / RS-485 B-
12	T+/A+	RS-422 sending + / RS-485 A+

2.2.4 Modbus-RS232 Interface

Table 4 RS232 Interface Terminal Definition

No	Name	Usage
13	RXD	Connect TXD of Modbus master system
14	TXD	Connect RXD of Modbus master system
15	GND	Connect GND of Modbus master system
16	EARTH	Protective earth terminal

2.2.5 Gateway Mode Selection Switch

Table 5 Gateway Mode Selection Switch Definition

Code	Mode	DIP Switch 1	DIP Switch 2	Mode Description
00	Normal	OFF	OFF	Normal working mode(default)
01	HTMD	OFF	ON	HART modem mode
10	Config	ON	OFF	Configuration mode
11	Debug	ON	ON	Debugging mode

Notice: If switch mode, the gateway cannot enter the new mode before restarting power.

2.2.6 Internal /External Sampling Resistor Selection Switch (RS)

The HART to Modbus Gateway allows the user to select internal or external sampling resistor to obtain HART signals. The internal resistor is 250Ω, 1W. The user must use external resistor if the power of sampling resistor is more than 1W.

Table 6 Sample Resistor Selection Switch Definition

Name	Position	Description
RS	ON	Use external sampling resistor (R OUT)
	OFF	Use internal sampling resistor (R IN)

2.2.7 LED

Table 7 LED Definition

Name	Color	Description	
PW	Yellow	Device power indicator	
MB	Yellow-green	Yellow	Modbus sending indicator
		Green	Modbus receiving indicator
HT	Yellow-green	Yellow	HART sending indicator
		Green	HART receiving indicator

2.3 Typical Topologic Connection

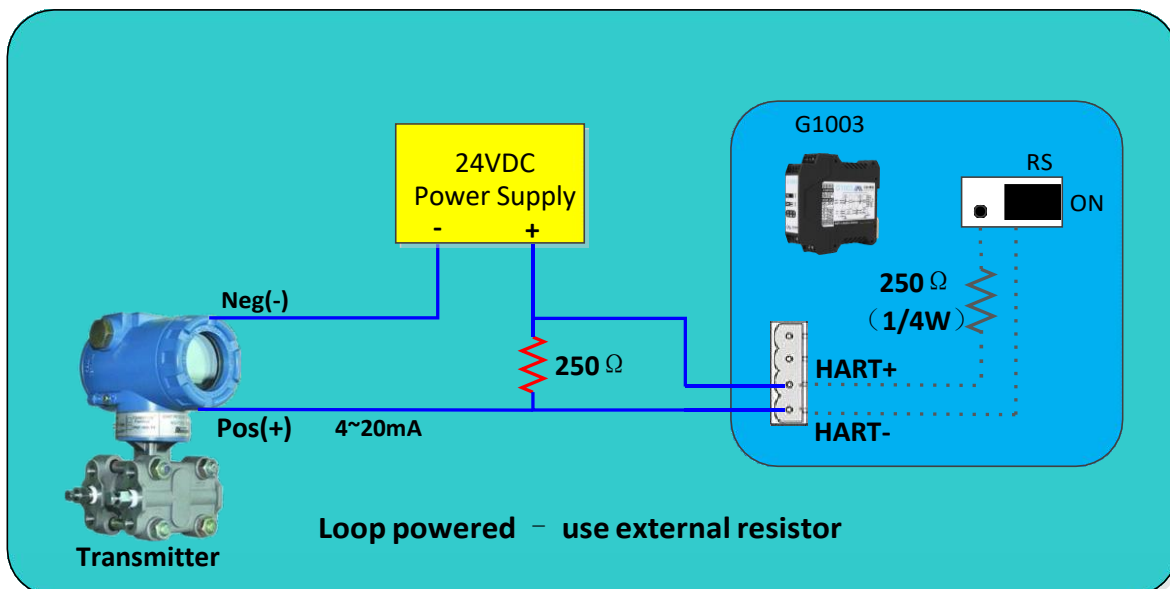

Figure 6 Loop Powered – Use External Resistor

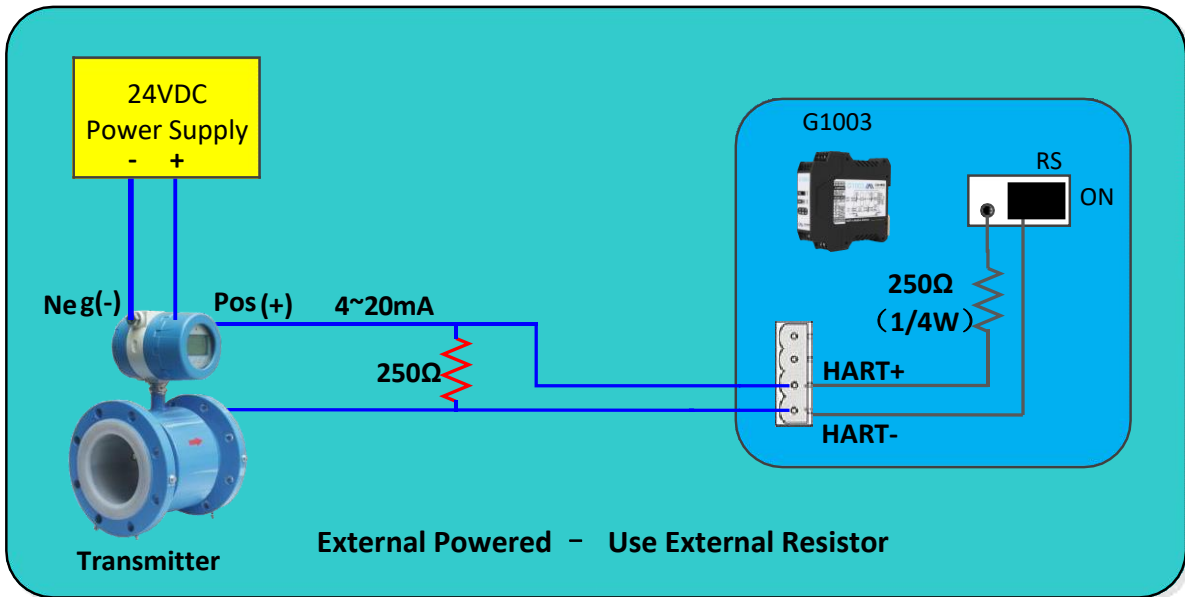

Figure 7 External Powered – Use External Resistor

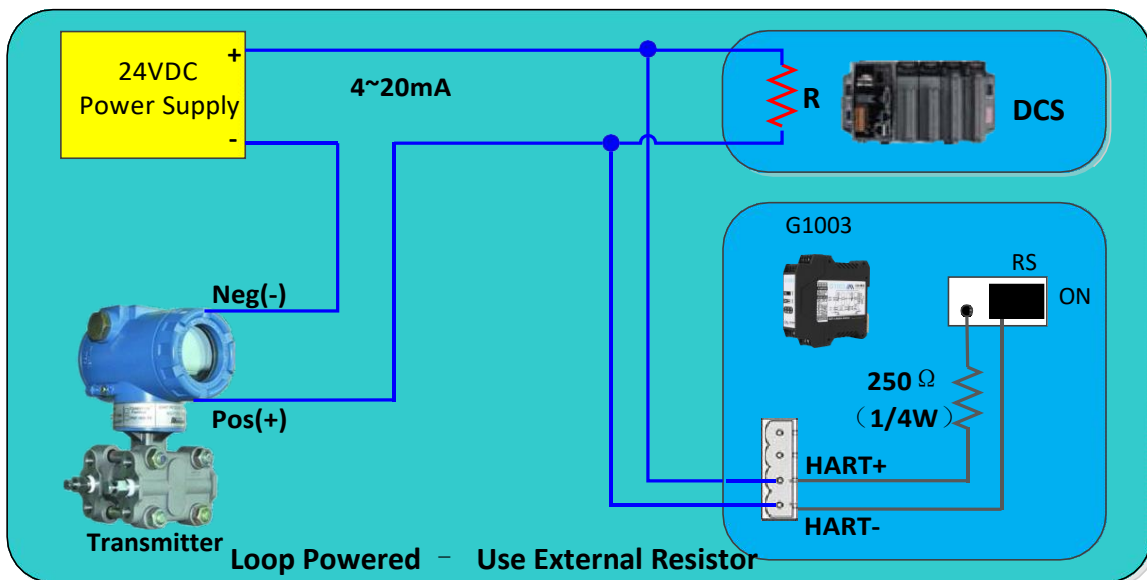

Figure 8 Loop Powered – Use External Resistor

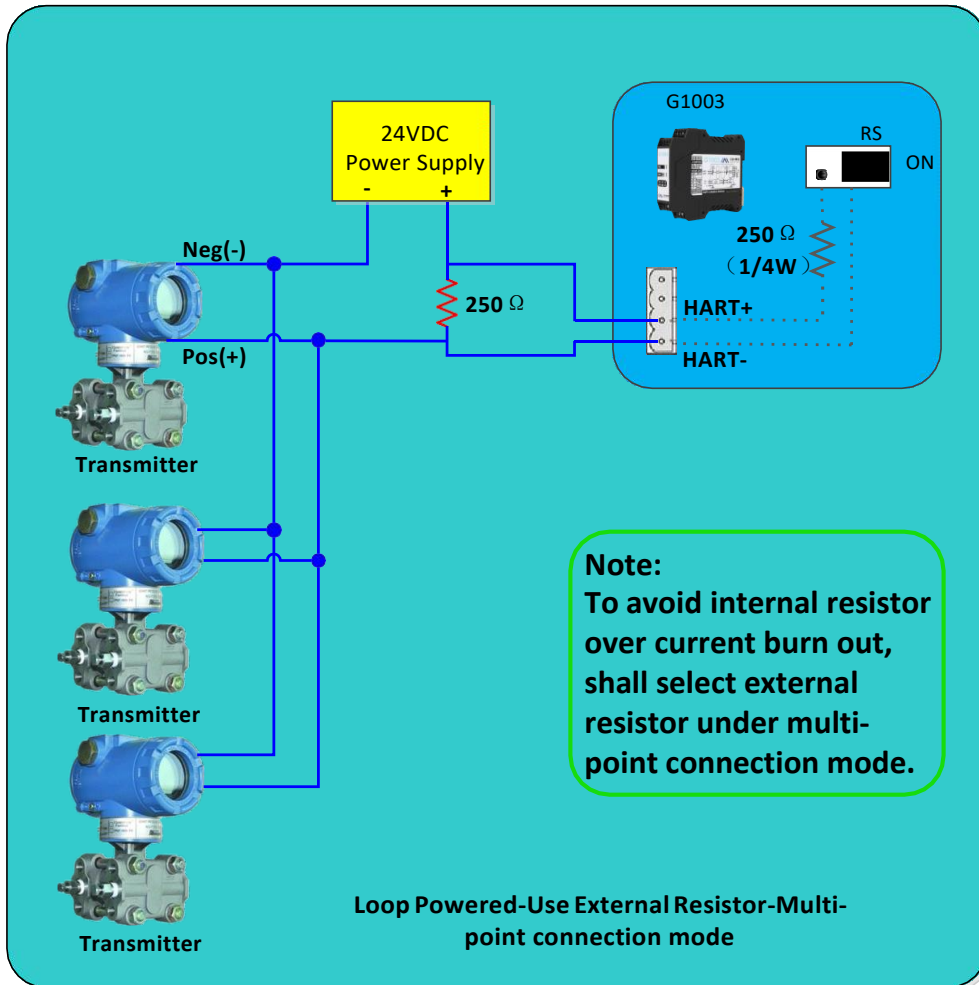

Figure 9 Loop Powered – Use External Resistor– Multi-point Connection Mode

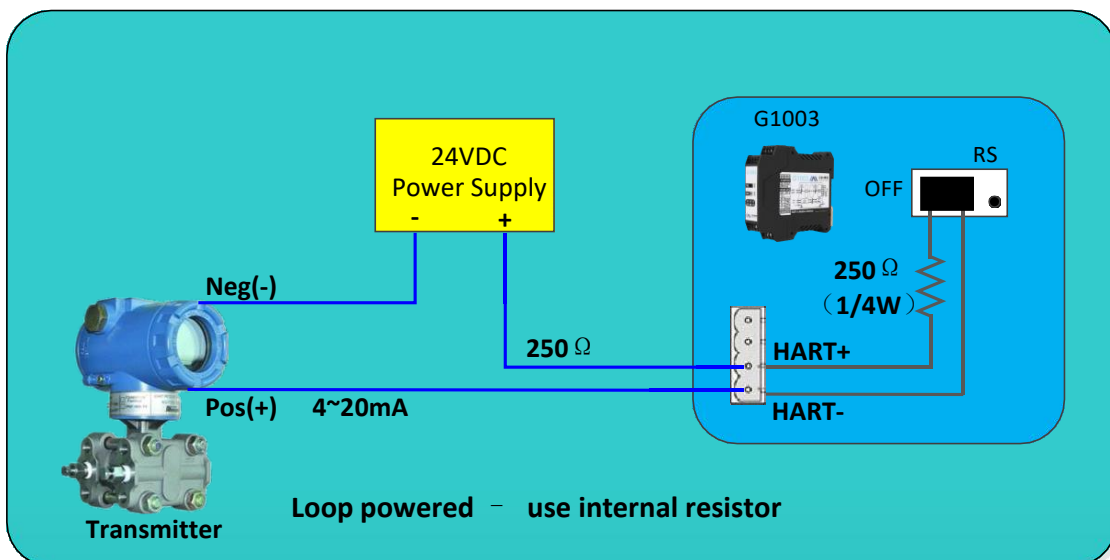

Figure 10 Loop Powered – Use Internal Resistor

Chapter 3 Function Overview

The HART to Modbus gateway contains a HART master channel and a Modbus slave channel. HART master channel is in charge of obtaining HART slave data in HART network, and write the obtained data into data area inside the gateway; Modbus slave channel is responsible for receiving request from Modbus master station, including requests during configuring gateway parameter and loop reading data area inside the gateway; By the HART to Modbus gateway, easily realize the function that Modbus master station accesses to HART network data.

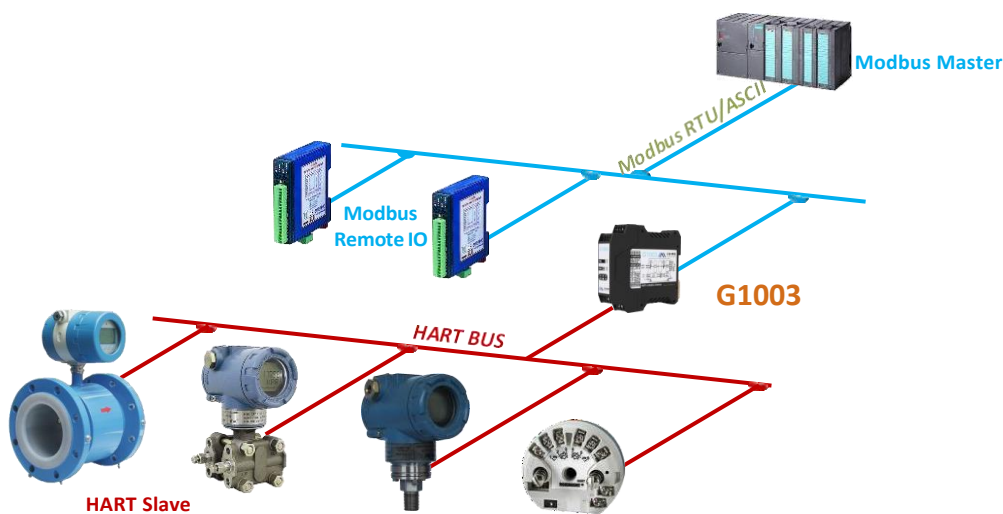

Figure 11 Topology Connection for Gateway Application

3.1 Working Modes of the Gateway

The HART to Modbus gateway has four working modes, respectively is normal working mode, HART modem mode, configuration mode and debugging mode. Gateway mode may be selected by two-bit DIP switch on the gateway. Please refer to 2.2.5 for detail setting.

3.1.1 Normal Working Mode

The Gateway runs based on the configured parameters, obtains slave device data in HART network and stores the data into data area inside the gateway. Simultaneously, Modbus channel is in a state of waiting for the request. It processes and responds if there's request. The Modbus channel communicates based on the communication parameters configured by user.



3.1.2 HART Modem Mode

The Gateway transfers all the data between HART master system and slave network by unvarnished transmission mode. The gateway may be completely used as HART modem. Modbus channel transmits data according to HART channel's communication parameters (baud rate: 1200bps, 8-bit data bit, odd parity, 1-bit stop bit).

3.1.3 Configuration Mode

With configuration software, all the parameters of the gateway can be configured. Under configuration mode, HART channel cannot work, only Modbus channel can receive request from the configuration software. Modbus channel communicates with the configuration software by the fixed communication parameters (address: 1, baud rate: 19200bps, 8-bit data bit, even parity, 1-bit stop bit, CRC low byte in the front).

3.1.4 Debugging Mode

HART channel and Modbus channel runs normally. Without available Modbus master system, the user can check all the parameters of the gateway by configuration software, simply debug the gateway. Modbus channel communicates with the configuration software by using the fixed communication parameters (address: 1, baud rate: 19200bps, 8-bit data bit, even parity, 1-bit stop bit, CRC low byte in the front).

3.2 Summary of HART Channel

The HART to Modbus gateway supports one HART channel, runs as the primary or the secondary master station, obtains (by sending HART command) all the configured HART slave device data from the HART network, and temporarily stores the data into data area inside the gateway, waiting for access request from Modbus master system.

Under normal working mode, the gateway will take the initiative to access HART slave device, namely send HART command 0, 3, 13, 14, 15 to obtain the specified HART slave device data in HART network, and store into basic data area of HART slave station.

In addition, the user can also configure required HART commands to perform specific functions. HART channel can be configured 100 HART commands. In view of the HART commands configured by the user, when the gateway receives response data from HART



slave device, the data will be temporarily stored into data input area inside the gateway; When the gateway needs to send a user configuration command to HART slave device, the data will be read from data output area inside the gateway.

After the HART to Modbus gateway is powered on, it will send HART command 0 to query if the configured device is online, and set whether online mark of the corresponding device by judging whether there's response from slave device. When sending other HART command, the gateway will only send command to the current online HART slave device. If there's no response from HART slave device after HART command is sent out, and exceeding number of retries, the gateway will take the current slave device as offline status, and update the device's status online or not only when the next command 0 is sent out to query offline device. The ability of the gateway can improve the communication throughput of HART network.

In one HART network, there may be two HART master stations at the same time, the primary or the secondary master station. The HART to Modbus gateway can be configured to work as any one, also supports there is another master, the primary or the secondary master in the network at the same time. When there are two masters communicating within the network at the same time, data throughput of the gateway will be decreased; And when there is only one HART maser communicating, data throughput of the gateway will increase significantly.

3.3 Summary of Modbus Channel

Modbus channel is taken as slave station. Its function is to receive the request from Modbus master system, including configuration request to gateway's parameters and request to read gateway's internal data. Modbus channel can be configured as Modbus RTU or Modbus ASCII, other communication parameters (Modbus slave address, baud rate, data bits, parity, stop, etc.) all may be easily configured by the configuration software.

Under different working mode, the communication parameters of Modbus channel are differrent. Under normal working mode, the communication parameter is set to that configured by the user; Under configuration and debugging modes, use fixed default communication parameters (address: 1, baud rate: 19200bps, 8-bit data bits, even parity, 1-bit stop bit); Under HART modem mode, to transmit HART data packet, the gateway must use HART communication mode, namely the communication parameters are set to (baud rate: 1200bps, 8-bit data, odd parity, 1-bit stop bit).

Modbus channel totally has three hardware interfaces, RS232, RS485 and RS422. And they

all occupy the Modbus channel, namely the three hardware interfaces can be connected at the same time, but cannot communicate at the same time.

3.4 Data Area inside the Gateway

Internal data area of the HART to Modbus gateway is shared by HART channel and Modbus channel. The gateway is like a pipe, and its function is to transmit device data in one network to the device in another network. Except the data from HART slave device and Modbus master device needs to be mapped into data area inside the gateway. Status and error information generated in the working process will also be mapped into specific data area inside the gateway

3.4.1 Internal Data Access

Figure 12 below describes direction of data flow inside and outside the gateway:

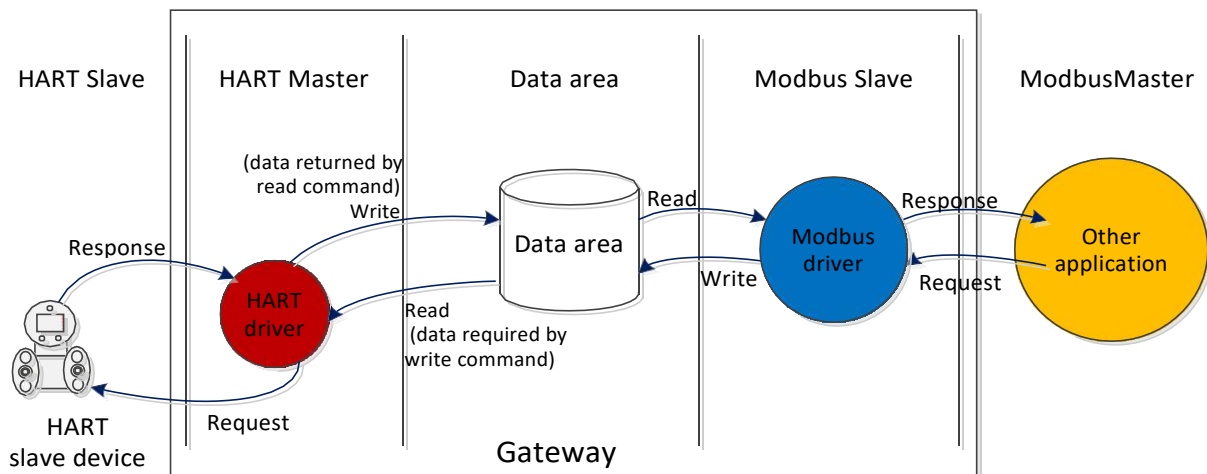

Figure 12 Gateway Data Access

(1) HART master drivers inside the gateway use data in two ways:

- Send HART read command to HART slave channel, returned response data will be written into data area inside the gateway;
- Send HART write command to HART slave device, then need to get data from data output area inside the gateway.

(2) Modbus drivers inside the gateway use data in two ways:

- Receive written request of Modbus master station, write data (configured parameters) into data area;
- Reply read request of Modbus master station, return data in the data area to Modbus master system.

3.4.2 Partition of Internal Data Area

Partition of data area inside the HART to Modbus gateway is shown in Figure13:

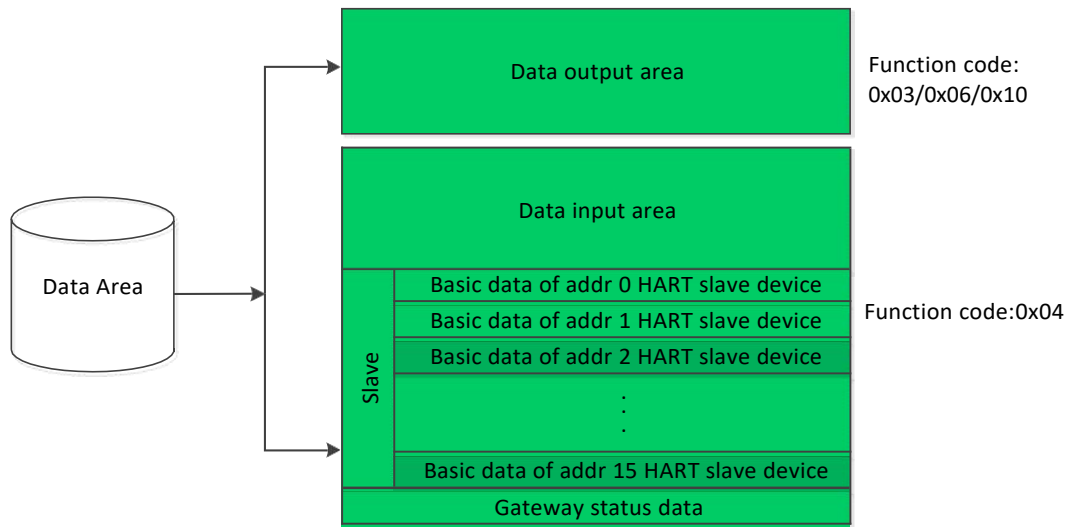

Figure 13 Partition of Data inside the Gateway

3.4.3 Default Auto-Polling Mode

Default auto-polling mode can be set by “Auto-polling mode enable switch” in HART configuration parameters. If the function is prohibited, HART channel will only perform the command in user self-defined HART command list; If the function is enabled, HART drivers inside the gateway will automatically obtain data of the configured HART slave device in HART network, and simultaneously perform the HART commands configured by user.

If auto-polling mode is enabled, the gateway will automatically perform the HART commands as the following table to the configured HART slave device, and automatically store response data into HART slave basic data area inside the gateway.

Table 8 Built-in HART Commands

Command No.	Description
0	Read unique identifier (long address, manufacturer ID, etc.)
3	Read dynamic variables and loop current
13	Read tag, descriptor and date
14	Read primary variable transducer information
15	Read device information

The gateway can obtain basic data information from 16 HART slave devices at most. Each HART slave device needs 102 bytes data area as buffer, and they are respectively stored with different short address, shown as Figure 13. The storage format of the 102-byte data is



in the table below:

Table 9 Basic Data Information of Each HART Slave Device

Data Area	Data Type	Description	Byte Number	Data Resource
0	Byte	Auto-polling mode command status	1	Produced by Gateway
1	Byte	Response Code (RC)	1	HART response frame
2	Byte	Device status (DS)	1	HART response frame
3	Byte	Minimum number of preambles required for the request message from the master to the slave	1	CMD0
4-5	Word	Manufacturer ID	2	CMD0
6-7	Word	Device Type	2	CMD0
8	Byte	Minimum number of preambles to be sent with the response message from the slave to the master	1	CMD0
9	Byte	HART protocol major revision number	1	CMD0
10	Byte	Device revision level	1	CMD0
11	Byte	Software revision level	1	CMD0
12	Byte	Hardware revision level	1	CMD0
13	Byte	Flags	1	CMD0
14-16	Byte	Device ID	3	CMD0
17	Byte	Maximum number of device variables	1	CMD0
18-19	Word	Configuration change counter	2	CMD0
20	Byte	Primary variable units code	1	CMD3
21	Byte	Secondary variable unit code	1	CMD3
22	Byte	Tertiary variable units code	1	CMD3
23	Byte	Quaternary variable units code	1	CMD3
24-31	Byte	Tag	8	CMD13
32-47	Byte	Descriptor	16	CMD13
48-50	Byte	Date	3	CMD13
51	Byte	Extended field device status	1	CMD0
52-54	Byte	Transducer serial No.	3	CMD14
55	Byte	Transducer limits and minimum span units code	1	CMD14
56	Byte	Option code for primary alarm	1	CMD15
57	Byte	Primary variable transfer function	1	CMD15
58	Byte	Primary range upper-lower unit	1	CMD15
59	Byte	Write protection code	1	CMD15



60-61	Word	Private label distributor code	2	CMD0/CMD15
62-65	Float	Primary variable (PV)	4	CMD3
66-69	Float	Secondary variable (SV)	4	CMD3
70-73	Float	Tertiary variable (TV)	4	CMD3
74-77	Float	Quaternary variable (QV)	4	CMD3
78-81	Float	Upper transducer limit	4	CMD14
82-85	Float	Lower transducer limit	4	CMD14
86-89	Float	Minimum span	4	CMD14
90-93	Float	PV upper range value	4	CMD15
94-97	Float	PV lower range value	4	CMD15
98-101	Float	PV damping value	4	CMD15
Total Byte Number			102	
Total Word Number			51	
Total register number per HART slave device			51	

Each “auto-polling mode command status” is defined in the following table:

Table 10 Execution State Definition of Built-in Commands

Position #	Description
0	Command 0 executed successfully
1	Command 3 executed successfully
2	Command 13 executed successfully
3	Command 14 executed successfully
4	Command 15 executed successfully
5	Reserved
6	Reserved
7	Reserved

Please refer to detail description in Annex A for register location of basic information for each HART slave device.

3.4.4 Self-defined HART Command List

Self-defined HART command list specifies user-configured HART commands. When sending this type command, the gateway will read parameters from data output area of the gateway’s internal data area, to make HART data packet, and send it to HART slave device; The gateway stores received response data into data input area of the gateway’s internal data area, used by Modbus channel.

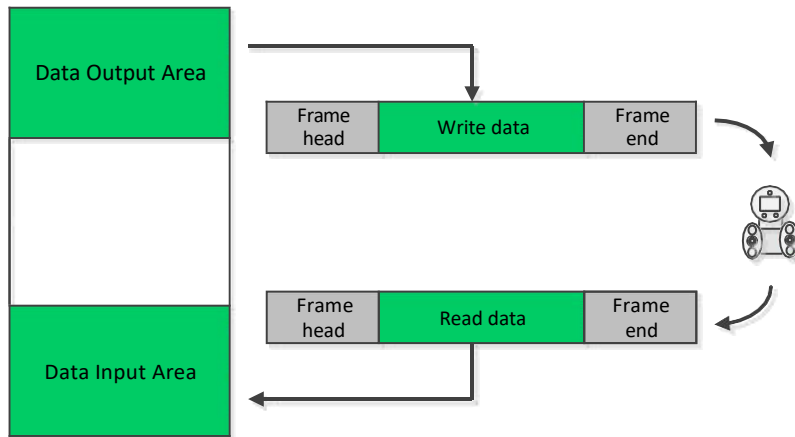

Figure 14 Data Input / Output Area Access

When sending self-defined HART command package, the data of data domain is written by the user in data output area, and the user shall ensure its correctness.



Chapter 4 Gateway Configuration

In this section, simply describe how to configure the HART to Modbus gateway, steps and quick configuration example with Modbus General Configuration tool (hereinafter referred to as “configuration software”). Please refer to user manual of configuration software for details.

4.1 Install and Start Configuration Software

Before configuring the HART to Modbus gateway, Modbus General Configuration tool must be installed (You can download the latest version from www.microcyber.cn/en). Then run file “Modbus General Configuration tool.exe”, following installation notes, you may install the software smoothly.

Three ways to start HART to Modbus configuration software:

- Start by double-clicking shortcut  in the PC desktop;
- Start by clicking shortcut  Modbus General Configuration tool in start menu;
- Start by double-clicking  Modbus General Configuration tool.exe in the install directory.

4.2 Overview of Configuration Software

After successful startup, configuration software interface is shown in Figure 15:

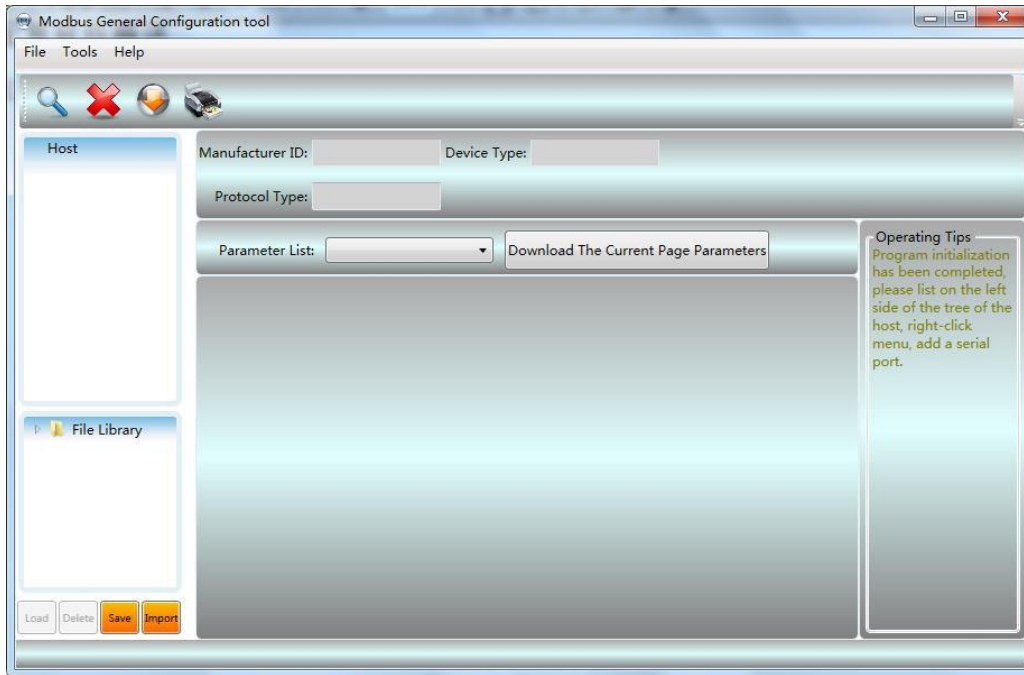



Figure 15 Main Interface of Configuration Software

① Menu Bar

- File, the user executes menu "File"- >"Exit" or click close button at top right corner of the window, the configuration software will exit;
- Tool, include "Language Setting" function, support Chinese and English
- Help, display basic information of the configuration software, such as software version number, release time, etc.

② Toolbar

 "Full search device" function, can full search online serial ports which are added into device list;

 "Cancel full search" function, cancel full search in progress;

 "Batch download" function, batch download the data in current parameter area;

 "Print" function, print the data in current parameter area.

③ Device List

Here in the form of a treeview, manage serial port and its subordinate device, maximum 16 serial ports, and manage one Modbus slave device under each port. In the treeview, the user can add serial port, search device, delete device, connect, disconnect, upload parameters, download online parameters, download offline parameters, etc.

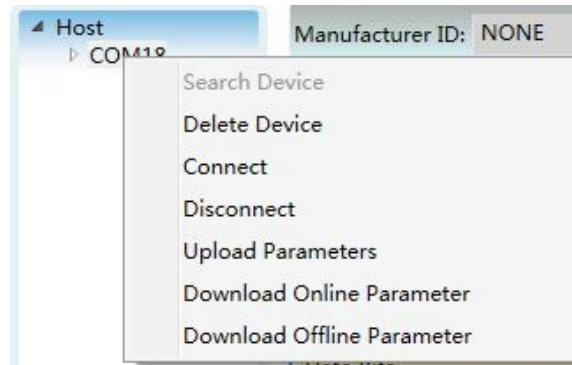

Figure 16 Device List Interface

④ Device Information

Display manufacturer information ID, device type ID and protocol type, etc.

⑤ Parameter Area

Display device configuration parameters by sort in the form of table, and can view and configure the gateway parameters through this parameter area.

⑥ Document Library

Manage files of the document library in the form of treeview. Library files are saved in XML format. Data content is parameter data with protocol type of slave device. The user can add, delete, save and import library files.

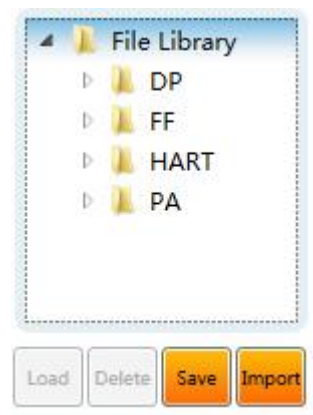

Figure 17 File Library Interface

⑦ Operation Tip

Here it displays some simple tips for user's operation, which helps user to check status and operation guidelines, etc.

4.3 Software Configuration and Hardware Connection

- (1) Before the user configures parameters of HART to Modbus gateway, the user shall make the MC,2-bit mode configuration in the front of gateway boards at configuration mode, that is:

Table 11 Definations of MC Position

MC	Bit 2	OFF
	Bit 1	ON

- (2) Use serial lines (or 485/422 serial line) to connect gateway's RS232 (or RS485/RS422) port and computer's port, and then t power on the gateway. And the gateway's power LED (PW) shall be on all the time.
- (3) Start the configuration software, click the device list "Host"with the right button, and click to "Add a serial port", the list intrface shall be shown as Figure 18. In the left side of "Port List"choose port connected with gateway, click  to move it into "Selected Ports" in the right side, and then click "Create", then the selcted serial port COMx shall be listed under the host in the device list.

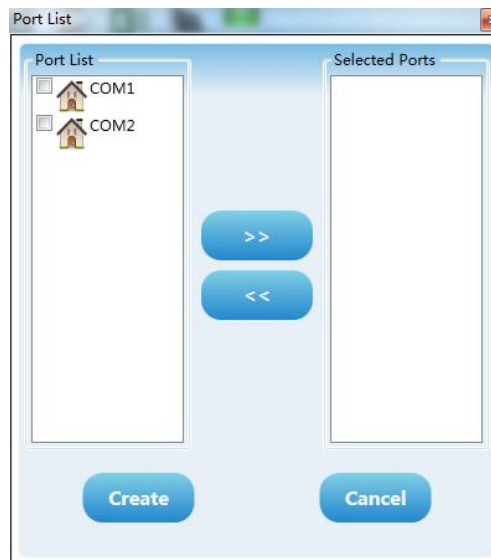
**Figure 18 Add Serial Port Interface**

- (4) Click serial port COMx in the device list with the right button, in the list, click "Search Device with the left button with the left button, or use "Search All Devices"  in the list to search devices with the left button.
- (5) Until now, G1003 shall be shown in the tree list of "Host->COMx" at the left side of configuration software. Click G1003 with the left button, the configuration software shall read out gateway's all the current configuration parameters, and show in the parameter zone of configuration software.

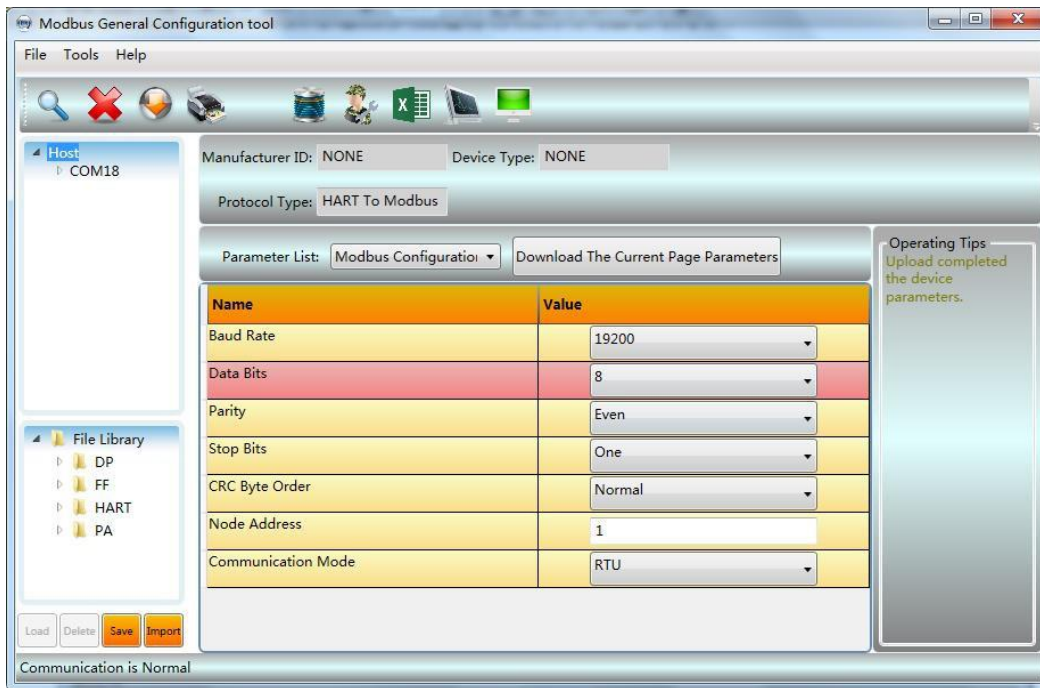

Figure 19 Interface for G1003 On-line

4.4 Basic Parameter Configuration for Modbus Channel

Here it describes basic parameter configuration for Modbus channel, and the parameters are effective when the gateway is working at normal mode. Choose “Modbus Configuration” in “Parameter List” in the parameter zone of configuration software, and it will show current configuration of Modbus channel, as Figure 20. The user can only modify part of parameters in this mode, after the configuration, click “Download The Current Page Parameters” to download the new configuration.

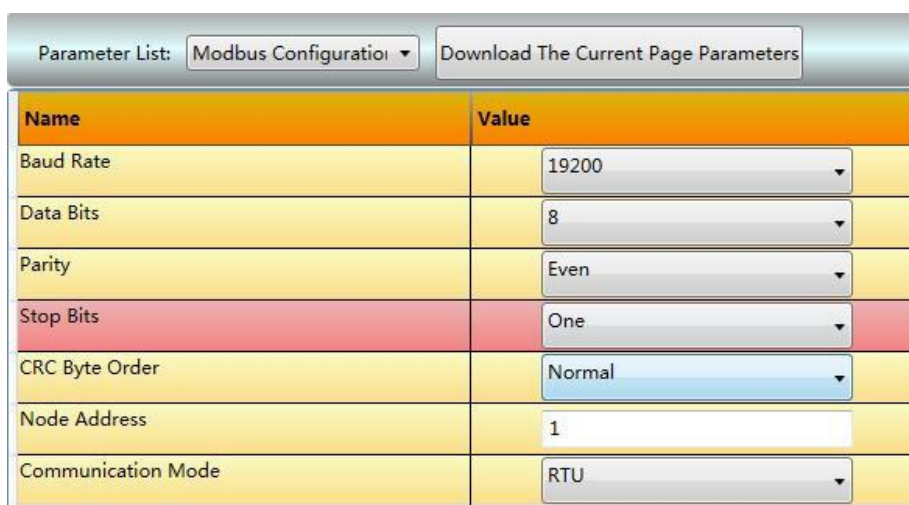

Figure 20 Modbus Channel Configuration Interface

Modbus configuration parameter’s description is shown as following:

Table 12 Modbus Configuration Parameter Description

Parameter Name	Parameter Description
Baud Rate	300,600,1200,2400,4800,9600,19200,38400,57600,115200bps, optional
Data Bits	7 bits or 8 bits, optional (When the communication mode is set as RTU, 7 bits is unmeaning.)
Parity	None, Even or Odd, optional.
Stop Bits	1 bit or 2 bits, optional
CRC Byte Order	Normal or exchange, optional (send high byte first or low one first)
Node Address	Set gateway's Modbus channel's slave address, 1~247
Communication Mode	RTU or ASCII, optional

4.5 Basic Parameter Configuration of HART Channel

Choose "HART configuration data" in the configuration software zone "Parameter List", and it will show the current parameter configuration of gateway's HART channel, shown as Figure 21. The user can only modify part of parameters in this mode, after the configuration, click "Download The Current Page Parameters" to download the new configuration.

Name	Value
Network Mode	Multidrop
Master Type	Primary Master
Short Addr List	0,1,2,3,4,5,6,7,8,9,10,11,12,13,1
Preambles	5
User Command Count	16
Retry Count	3
Auto-Polling	Enable
Poll Interval(ms)	300
Response Timeout(ms)	500

Figure 21 HART Channel Parameter Configuration Interface

HART configuration parameter's description is shown as following:

Table 13 HART Configuration Parameter Description

Parameter Name	Parameter Description
----------------	-----------------------



Network Mode	Choose HART network's topology connection is point to point or multi-drop mode. In point to point mode, gateway can only communicate with HART slave with address 0.
Master Type	Choose gateway to work as primary or secondary master.
Short Addr List	It is used to configure short address (polling address)of slave device in HART network, range is 0-15.And it has many options.
Preambles	Synchronization mark for sending HART frame time, range is 2-20. And it can set according to specific request of HART slave device.
User Command Count	The number of user's custom commands and it cannot be read. It shall increase automatically when the user is configuring commands.
Retry Count	After the gateway sends HART command, the number of retry times without receiving response, range 0-10.
Auto-Polling	It shall execute gateway's internal HART commands (CMD0/3/13/14/15).
Poll Interval (ms)	It is the time interval between sending a command and another command, range is 256-65535ms. If the polling time is shorter than response timeout, then the time for sending next command shall be delayed until the response time is over.
Response Timeout (ms)	The maximum time to set the gateway is waiting for the device response, range is 256-65535ms. The time shall be set according to maximum data frame length, and it is about frame length*9.16ms. If it is set too short, it may bring in data package lost.

4.6 Parameter Configuration for Custom HART Command

The user may use "Custom Command Configuration Data" in configuration software to add HART commands, to obtain more data information from device in the field. The user may configure 100 HART commands at most. After the configuration, click "Download The Current Page Parameters"to download the new configuration.

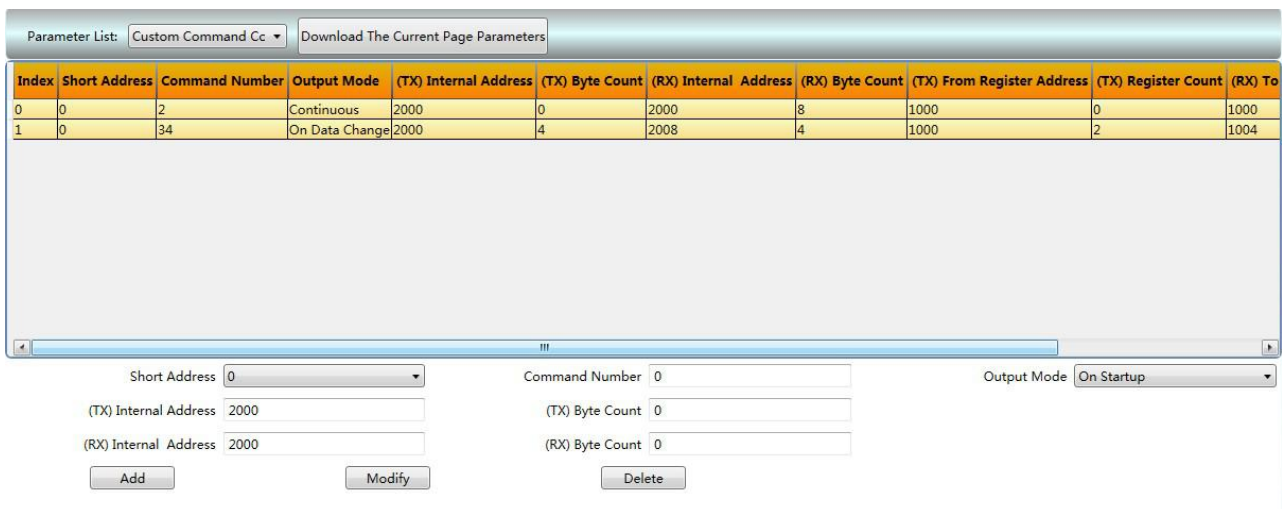

Figure 22 Custom Command Configuration Data Interface

Shown as Figure 22, after clicking "Add"to add one HART command, another line shall be added to the list above, and the left "Index"shall be increased from 0 automatically. After



choosing a command, the user may modify the command property and uses “Modify”to finish it. “Delete”shall delete the selected command. And each added command shall have the same property:

Custom HART command parameter’s description is shown as following:

Table 14 Custom HART Command Parameter Description

Parameter Name	Parameter Description
Index	Current command index, range is 0-99; The configuration software shall adjust without configuration.
Short Address	To configure the current command shall belong to which HART slave device, range is 0-15.
Command Number	HART Command No. range is 0-255.
Output Mode	It is used to chooser command execute way, including initialization output, polling output, alter output and no output. ① Initialization output: The commands shall be powered on gateway and related HART slave device shall send on-line once. ② Polling output: The commands shall output periodically. ③ Alter output: The command shall execute when the sending buffer zone alters. ④ No output: The commands don’t output automatically.
(TX) Internal Address	It is used to set memory starting address of command output data, and range is 2000-6999. More related HART information shall be referred in Appendix A.
(TX) Byte Count	It is used to set byte length of command output data.
(RX) Internal Address	It is used to set memory starting address of command input data, and receive the receive data range in buffer.The range is 2000-6999. More related HART information shall be referred in Appendix A.
(RX) Byte Count	It is used to set byte length of command input data.
(TX) From Register Address	It is used for the user to address easily via Modbus master setting parameter, range is 1000-3499. The configuration software shall adjust without configuration.
(TX) Register Count	The user shall adjust according to starting address and length without configuration.
(RX) To Register Address	It is used for the user to address easily via Modbus master setting parameter, range is 1000-3499. The configuration software shall adjust without configuration.
(RX) Register Count	The user shall adjust according to starting address and length without configuration.

4.6.1 Address Automatic Mapping

When the user has added HART commands, and configured all the parameters (except starting address of sending buffer zone and starting address of receiving buffer zone), the configuration software shall distribute starting address in input output zone automatically

without conflict, according to use's configuration type length in input output zone.

Click  to finish the automatic distribution.

4.6.2 Address Conflict Detection

Through conflict detection function The user may check distribution status for all the configured commands' input and output data in memory, to check if there is a conflict.

Click  to see Figure 23.

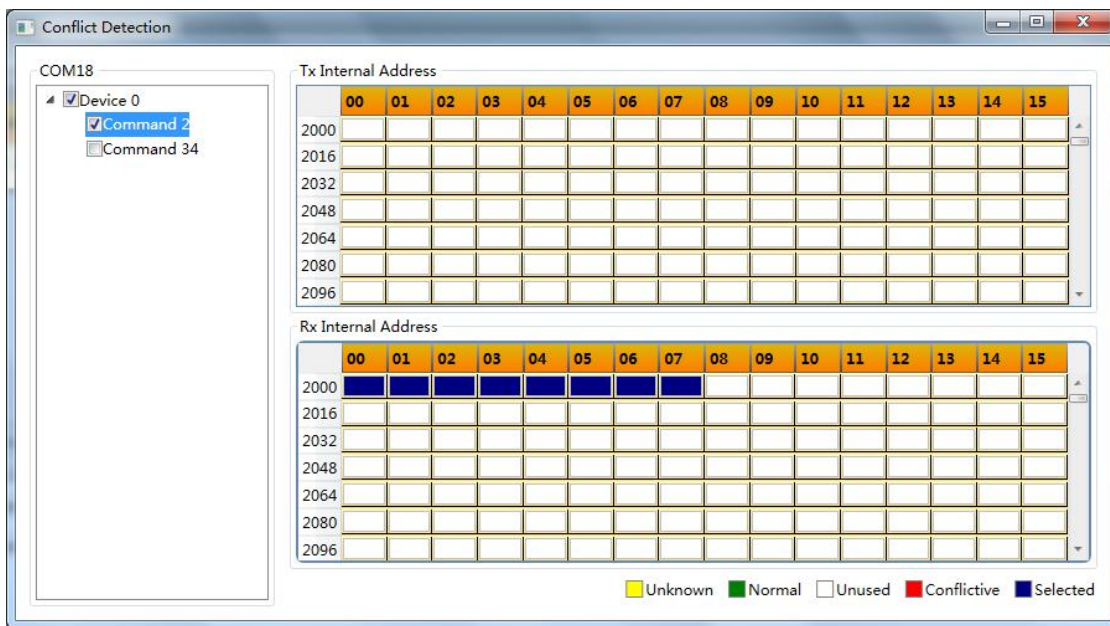

Figure 23 Address Conflict Detection

The tree list in the left shows the configured HART slave devices, and lists all the HART commands configured by the user. In the right it shows the memory distribution in current input and output zone. After clicking a command, memory distribution in the right shall display the storage position for input and output data of current commands in blue. And the conflict shall be marked in red.

4.6.3 Memory Data Display

Memory Data Display Function makes it easier for the user to check memory input and output data exchange status and modify the output data. When the gateway's Modbus channel is not connected with user's Modbus master system, the user may use configuration software to debug HART bus and HART slave device. The operations are as following:

- (1) Make MC at debugging mode:

Table 15 Definations of MC Position in Debugging Mode

MC	Bit 2	ON
	Bit 1	ON

- (2) Use a serial line (or 485/422 convert serial line)to connect gateway’s RS232 interface and PC serial port, and then power the gateway on, at this time, the gateway is under debugging mode.
- (3) Start configuration software, after G1003 is powered on, click  to see memory display shown as Figure 24.

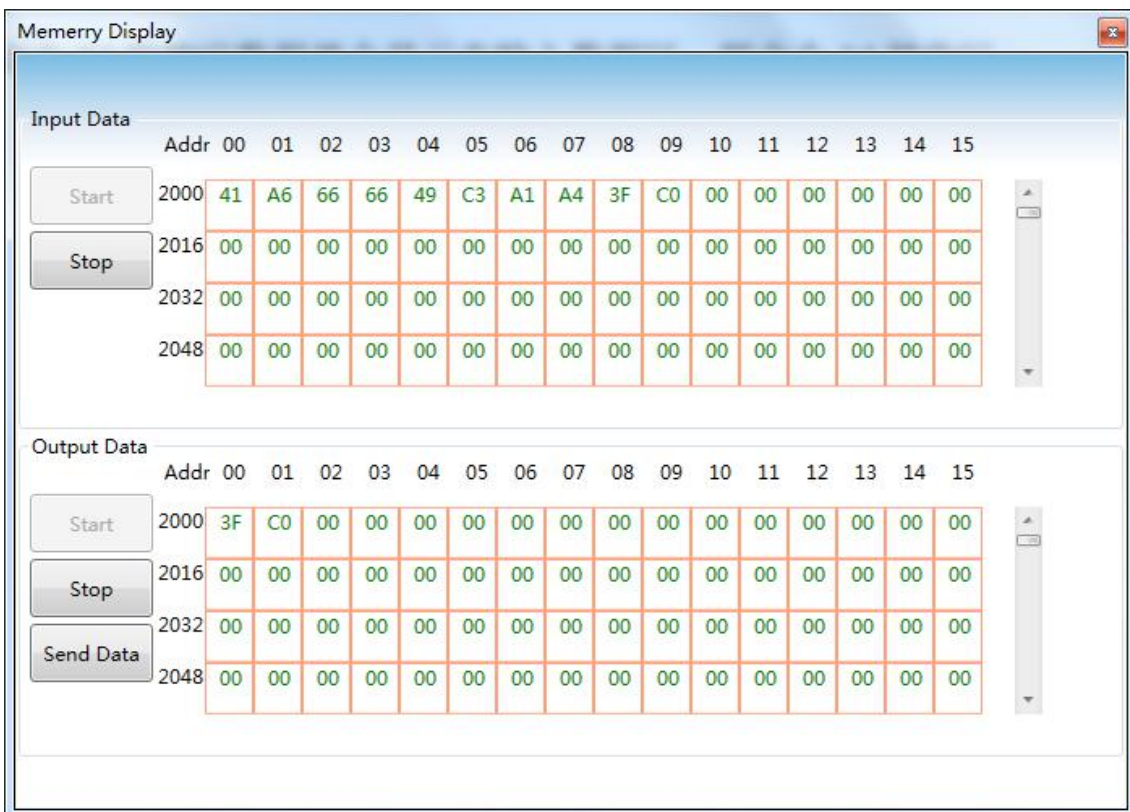



Figure 24 Memory Display

As Figure 24, input and output data shall display each memory’s current calue in tems of table. When the user is to modify output data, click “Stop”, modify the data, and click “Send Data”.

Note: In configuration mode, the user shall write HART command data in output data zone ahead of time for the configured HART command.

4.7 Excel Save Configuration Parameter

After configuration for gateway’s parameters, the user shall click , to save currentpage’s

Modbus configuration data, Modbus configuration data and custom command configuration data as .Excel file, for reference in the future.

4.8 Library File Save Configuration Parameter

After configuration for gateway's parameters, the user shall click "Save", to save current page's Modbus configuration data, Modbus configuration data and custom command configuration data as .xml file, shown as Figure 25.

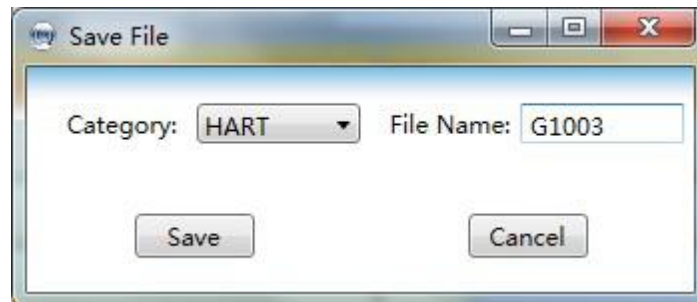

Figure 25 Library File Save

Choose "HART" in the library type, and input the name G1003, and click "Save", then G1003.xml file has been added to HART index under the tree list in the left.

If the user needs to configure another network, with the configuration parameter is as the same as the gateway. The user shall upload G1003.xml file and download the configured parameters.

4.9 Configuration Example and Verification

We shall take Modbus master simulation software to read HART slave device data information obtained from gateway with the polling address as an example, to introduce the operational steps for G1003.

4.9.1 Example

Please refer to 4.3 for hardware connection, configuration software start and G1003 on-line. And at this time, the gateway shall be under configuration mode.

Modbus configuration data is shown as Figure 26, and after the configuration, the user shall click "Download The Current Page Parameters".

Parameter List: Modbus Configuration | Download The Current Page Parameters

Name	Value
Baud Rate	19200
Data Bits	8
Parity	Even
Stop Bits	One
CRC Byte Order	Normal
Node Address	1
Communication Mode	RTU

Figure 26 Modbus Parameter Configuration Example

HART configuration data is shown as Figure 27, and after the configuration, the user shall click “Download the current page parameters”.

Parameter List: HART Configuration | Download The Current Page Parameters

Name	Value
Network Mode	Multidrop
Master Type	Primary Master
Short Addr List	0,1,2,3,4,5,6,7,8,9,10,11,12,13,14
Preambles	5
User Command Count	16
Retry Count	3
Auto-Polling	Enable
Poll Interval(ms)	300
Response Timeout(ms)	500

Figure 27 HART Parameter Configuration Example

To configure 2 HART custom commands, command 2 and command 34: Command 2 is to read loop current value and range percentage and command 34 is to write damping value. We shall configure command 2 as polling output and command 34 is alter output. Please refer to Figure 28 for more details and after the configuration, the user shall click “Download The Current Page Parameters”.

Parameter List: Custom Command Co Download The Current Page Parameters

Index	Short Address	Command Number	Output Mode	(TX) Internal Address	(TX) Byte Count	(RX) Internal Address	(RX) Byte Count	(TX) From Register Address	(TX) Register Count	(RX) To
0	0	2	Continuous	2000	0	2000	8	1000	0	1000
1	0	34	On Data Change	2000	4	2008	4	1000	2	1004

Short Address: 0 Command Number: 0 Output Mode: On Startup

(TX) Internal Address: 2000 (TX) Byte Count: 0

(RX) Internal Address: 2000 (RX) Byte Count: 0

Add Modify Delete

Figure 28 Custom Command Parameter Configuration Example

Switch the gateway mode to normal working mode and restart again. At this time the gateway shall execute configured HART commands and obtain device info with with slave address 0.

4.9.2 Verificaion

The user shall connect a HART pressure transmitter to G1003's HART interface, and connect RS232 (or RS485/RS422 via 485/422 to RS232 converter), shown as Figure 29.

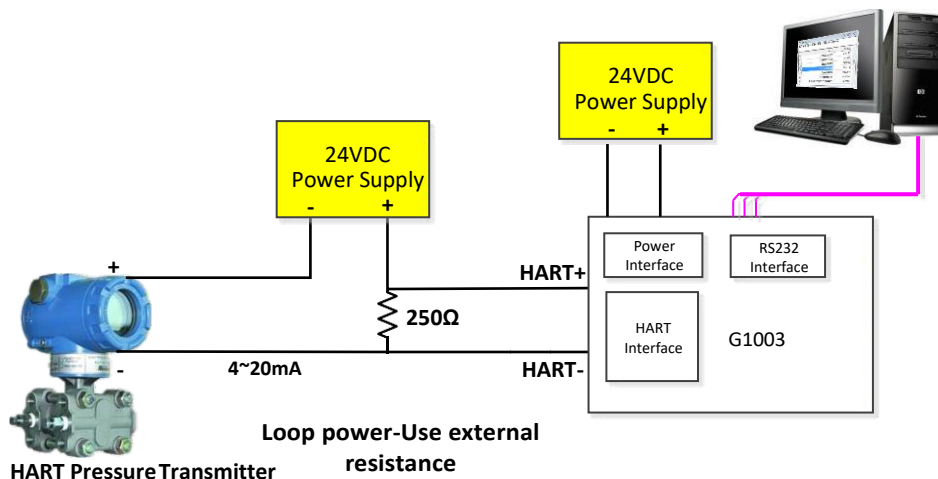

Figure 29 Connect G1003 to A Pressure Transmitter

The user man use to start memory display, shown as Figure 30.

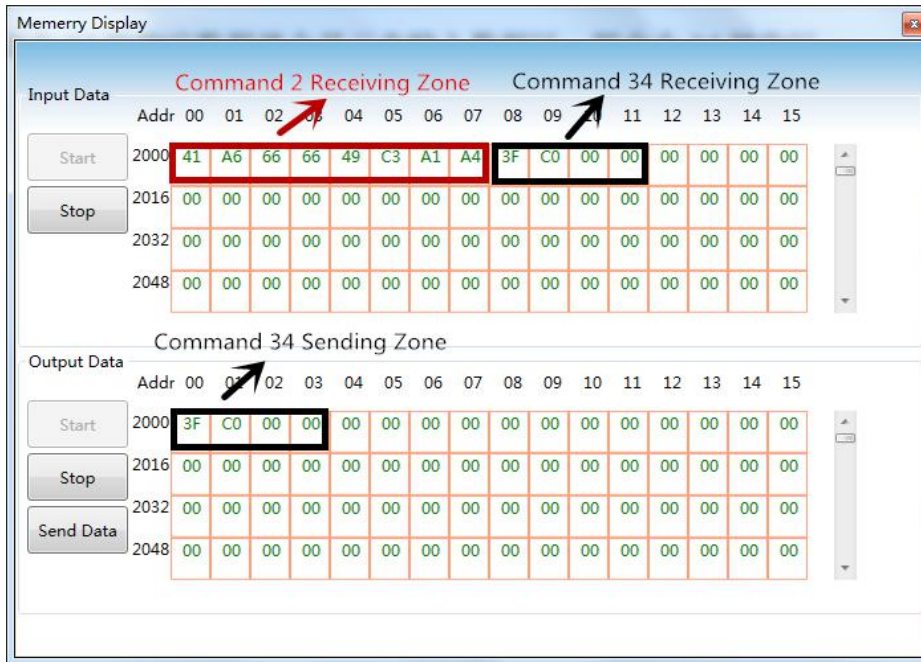



Figure 30 Memory Display

Command 2 is “Read loop current and percent of range”, and there is only response data and no request data. The first 4 byte groups make up the floating current value, and the last 4 byte groups make up the floating percentage.

Command 34 is “Write PV damping value” and the user shall write finished floating number in the command 34’s sending zone(e.g. 0x3FC00000), and “Send Data”. When the gateway has sent command 34 and received slave response successfully, the response data of command 34 shall be displayed in input zone, and that is receiving zone for command 34.

Chapter 5 Gateway Status

Shown as Figure 31, click the configuration software tool bar's gateway status monitor , the user may check gateway's current working status and if the slave device in HART network is on-line or not.

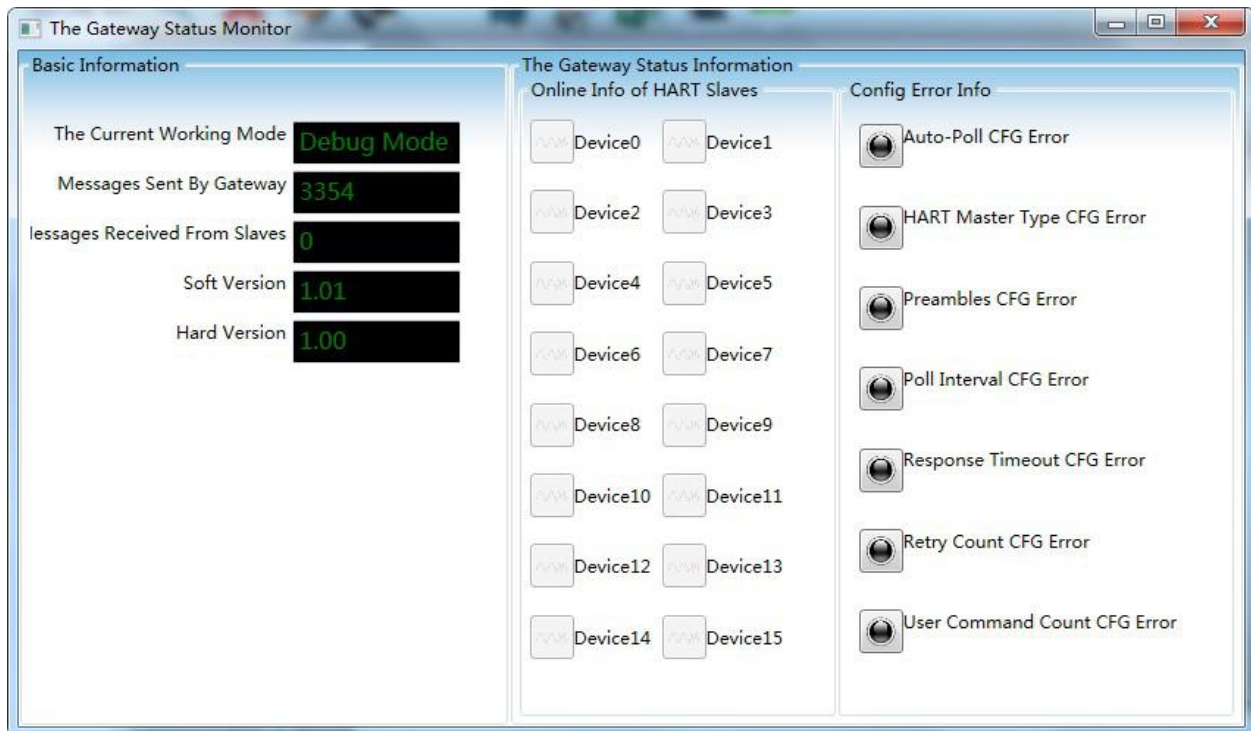

Figure 31 Gateway Status Monitor

The current working mode represents gateway's present working mode, and the user may judge if the MC is at the requested position.

Gateway status monitor represents numbers of gateway's sending HART command and receiving HART response. The 2 statuses shall only change when the gateway is working in debugging mode and normal working mode.

Device status lists 16 devices on-line or off-line information. When the related device logo is grey, it means the device is off-line (The gateway and the related device are not connected successfully). When the related device logo is green, it means HART slave device is on-line. Gateway error info indicates if the configuration parameters are wrong. When the related device logo is red, it means there is some error. When the related device logo is black, it means there no error.

Chapter 6 Gateway Maintenance

- Simple Maintenance

LED	Colour	Normal Status	Abnormal Status	Reasons	Solution
PW	Yellow	On	Off	Power failure	Check power and connection
				Internal failure	Contact technical support
HT	Yellow and Green	Flickering	Off	Wrong gateway configuration	Check configuration parameter, if there is HART command in the configuration
				Gateway is under configuration mode.	Check's gateway mode
				Power Failure	Check power and connection
				Internal failure	Contact technical support
MB	Yellow and Green	Flickering	Off	No Modbus device connection	Connect Modbus device correctly
				Wrong configuration	Check if the configuration module parameter is correct
				Power Failure	Check power and connection
				Internal failure	Contact technical support

No.	Abnomal Reason	Reason	Solution
1	Configuration software establishment serial port failure	a. The serial port to establish is occupied.	a. Turn off the occupied serial port or use other serial ports.
2	Configuration software search device fails	a. The gateway is not powered correctly. b. The connection between gateway and computer is wrong.	a. Check if gateway power meets the requirements. b. Check if the gateway connects with PO correctly via RS232, RS485 or RS485 interface.
3	Configuration software download paramter fails	a. The gateway is not powered correctly. b. The connection between gateway and computer is wrong. c. The gateway is not under configuration mode.	a. Check if gateway power meets the requirements. b. Check if the gateway connects with PO correctly via RS232, RS485 or RS485 interface. c. Check if MC is at configuration mode (1:ON, 2:OFF), after the gateway mode is switched, the user shall cut the electricity off to make it effective.
4	Patch download multiple gateway's parameter fails	a. Some gateway is not connected correctly. b. Some serial port is not connected with gateway. c. Check the gateway's power.	a. Check all the gateway's hardware connections. b. Check if the number of serial ports is related to the number of gateway. c. Check if gateway power meets the requirements.
5	Receiving negative response or no response for Modbus master read write gateway data	a. The gateway is not in the correct mode. b. Function code error.	a. Check if gateway power meets the requirements. b. Check the data to read is read only data (FC:4) or read and write data (FC:3,6,16).

- Daily maintenance means cleaning device only.
- Fault maintenance: Please return to the factory if there's fault.



Chapter 7 Technical Specifications

7.1 Performance

Name	Description
Gateway Power	9~30VDC
Modbus Interface	RS-232/RS-422/RS485
HART Interface	HART digital signal
Consumption	1W
Interface Input Impedance	≥5KΩ
HART Interface Voltage Insulation Value	50VDC
HART Output Amplitude	500mVpp (500Ω)
Humidity Range	(5~95)%RH
Working Temperature	-20°C~70°C
Storage Temperature	-20°C~70°C
Isolation Voltage	Modbus and HART interface, 500VAC
Protection Level	IP20
EMC	GB/T 18268.1-2010 GB/T 18268.23-2010
Weight	0.2kg
Construction material	Housing: ABS/PA66; Clip: POM; coating: Polyester epoxy resin
HART Master Type	The Primary or secondary master can be selected.
HART Network Topology	Support HART point to point or multi-drop working mode, and can connect 15 instruments at most
Burst Mode(Burst)	Support HART slave device burst mode
HART Customized Command	Support 100 HART customized commands at most, each 5000 bytes for HART input output zone and date buffer zone.
HART Modem Mode	Gateway can be set as HART modem mode.
HART Sampling Resistor	Optional for internal sampling resistor or external resistor
Modbus Baud Rate	300,600,1200,2400,4800,9600,19200,38400,57600,115200bps, optional



Modbus Communication Mode	Support Modbus slave RTU and ASCII communication mode
Modbus Function Code	0x03/0x04/0x06/0x10

7.2 Default Communication Parameter

Modbus Default Communication Parameter		
	Normal working mode / configuration mode / debug mode	HART Modem mode
Baud Rate	19200	1200
Date Bits	8	8
Rarity	Even	Odd
Stop Bits	1	1
CRC Byte Order	Normal	
Node Address	1	None
Communication Mode	RTU	
HART Default Communication Parameter		
Network Mode	Point to point	
Master Type	Master	
Short Addr List	0	
Preambles	5	
User Command Count	0	
Retry count	3	
Auto-Polling	Enable	
Poll interval (ms)	256ms	
Response timeout (ms)	500ms	



Appendix A Gateway Memory and Register Description

Function	Type	Gateway memory offset	Corresponding Modbus register address	Usage description	Register repair	
Read only register 【operated by function code 4】	InData	2000 ~ 6999	1000 ~ 3499	User defined HART command data input field, to cache response data from HART slave device		
	Slave station device data for HART short address 0 【each device has 102 byte, that is 51 registers】	7000		3500 H	State byte indicating if Command 0,3,13,14,15 is sent successfully	0000 H
		7001		3500 L	First byte of HART slave station response state	0000 L
		7002		3501 H	Second byte of HART slave station response state	0001 H
		7003		3501 L	Minimum number of preambles required for the request message from the master to the slave	0001 L
		7004 ~ 7005		3502	Manufacturer ID	0002
		7006 ~ 7007		3503	Device type	0003
		7008		3504 H	Minimum number of preambles to be sent with the response message from the slave to the master	0004 H
		7009		3504 L	HART protocol major revision number	0004 L
		7010		3505 H	HART slave station device revision level	0005 H
		7011		3505 L	HART slave station device software revision level	0005 L
		7012		3506 H	HART slave station device hardware revision level	0006 H
		7013		3506 L	Flags	0006 L
		7014 ~ 7016		3507 ~ 3508 H	Device ID	0007 ~ 0008 H
		7017		3508 L	Maximum number of device variables	0008 L
		7018 ~ 7019		3509	configuration change counter	0009
		7020		3510 H	Primary Variable Units Code	0010 H
		7021		3510 L	Secondary Variable Units Code	0010 L
		7022		3511 H	Tertiary Variable Units Code	0011 H
		7023		3511 L	Quaternary Variable Units Code	0011 L
7024 ~ 7031			3512 ~ 3515	Tag	0012 ~ 0015	
7032 ~ 7047		3516 ~ 3523	Descriptor	0016 ~ 0023		
7048 ~ 7050		3524 ~ 3525 H	Date	0024 ~ 0025 H		
7051		3525 L	Extended device status byte	0025 L		
7052 ~ 7054		3526 ~ 3527 H	Transducer serial no.	0026 ~ 0027 H		
7055		3527 L	Minimum span unit	0027 L		
7056		3528 H	Primary Variable Alarm option code	0028 H		
7057		3528 L	Primary Variable transfer function	0028 L		
7058		3529 H	Primary Variable range unit	0029 H		
7059		3529 L	Write protection code	0029 L		
7060 ~ 7061		3530	Private label distributor code	0030		
7062 ~ 7065		3531 ~ 3532	Primary Variable	0031 ~ 0032		
7066 ~ 7069		3533 ~ 3534	Secondary Variable	0033 ~ 0034		
7070 ~ 7073		3535 ~ 3536	Tertiary Variable	0035 ~ 0036		
7074 ~ 7077		3537 ~ 3538	Quaternary Variable	0037 ~ 0038		
7078 ~ 7081		3539 ~ 3540	Upper transducer limit	0039 ~ 0040		
7082 ~ 7085		3541 ~ 3542	Lower transducer limit	0041 ~ 0042		
7086 ~ 7089		3543 ~ 3544	Minimum SPAN	0043 ~ 0044		
7090 ~ 7093		3545 ~ 3546	PV upper range value	0045 ~ 0046		
7094 ~ 7097		3547 ~ 3548	PV lower range value	0047 ~ 0048		
7098 ~ 7101		3549 ~ 3550	PV damping value	0049 ~ 0050		
1	7102 ~ 7203	3551 ~ 3601	Slave station device data from HART short address 1			
2	7204 ~ 7305	3602 ~ 3652	Slave station device data from HART short address 2			
3	7306 ~ 7407	3653 ~ 3703	Slave station device data from HART short address 3			
4	7408 ~ 7509	3704 ~ 3754	Slave station device data from HART short address 4			
5	7510 ~ 7611	3755 ~ 3805	Slave station device data from HART short address 5			
6	7612 ~ 7713	3806 ~ 3856	Slave station device data from HART short address 6			
7	7714 ~ 7815	3857 ~ 3907	Slave station device data from HART short address 7			
8	7816 ~ 7917	3908 ~ 3958	Slave station device data from HART short address 8			
9	7918 ~ 8019	3959 ~ 4009	Slave station device data from HART short address 9			
10	8020 ~ 8121	4010 ~ 4060	Slave station device data from HART short address 10			
11	8122 ~ 8223	4061 ~ 4111	Slave station device data from HART short address 11			
12	8224 ~ 8325	4112 ~ 4162	Slave station device data from HART short address 12			
13	8326 ~ 8427	4163 ~ 4213	Slave station device data from HART short address 13			
14	8428 ~ 8529	4214 ~ 4264	Slave station device data from HART short address 14			
15	8530 ~ 8631	4265 ~ 4315	Slave station device data from HART short address 15			
Gateway status data	8632 ~ 8633		4316	Sending HART request frame's count		
	8634 ~ 8635		4317	Receiving HART request frame's count		
	8636 ~ 8637		4318	gateway configuration error message, 0 means no error		
	8638 ~ 8639		4319	HART slave station off-line info, 16bit,bit0~bit1 means device 0~15,1 means off-line		
	8640 ~ 8641		4320	Gateway software revision		
	8642 ~ 8643		4321	Gateway hardware revision		
	8644		4322 H	Gateway current mode(value 0:adjustment,1:HART modem,2:configuration,3:normal)		
	8645		4322 L	Reserved		
	Readable & writeable 3/6/16	OutData	2000 ~ 6999	1000 ~ 3499	User defined HART command data output zone, to save HART request frame required data	



Instructions:

Each HART slave station basic data registers address calculation method:

$=3500+51*Polling\ address+Register\ offsetting.$

Register byte order	Register N high byte	Register N low byte	Register N+1 high byte	Register N+1 low byte
8 bit integral data (88)	0x58	--	--	--
16 bit integral data (1616)	0x06	0x50	--	--
32 bit integral data (32323232)	0x01	0xED	0x36	0xA0
32 bit Floating point data (32.32)	0x42	0x01	0x47	0xAE

When a HART slave station device that connected with G1003's HART interface off-line (power down), G1003 will keep the latest HART slave station device information before power down.

Appendix B HART Protocol

HART protocol, proposed by Rosemount, is a kind of communication protocol used between intelligent instrument and control cabinet device. It's a transitional protocol from 4~20mA analogue signal to digital signal. To overlay a digital signal on 4~20mA analogue signal, the original analogue signal is still valid, and they two will not affect each other. HART protocol wired part refers to standard physical layer, data link layer and application layer from OSI seven layers models.

HART protocol wired part's physical layer regulates signal Transmission method and the transmission medium. It uses Bell 202 standard FSK to overlay digital signal to 4~20mA current circuit. It uses 1200Hz sine wave represents logic 1, and 2200Hz for logic 0, current peak is plus or minus 0.5mA.

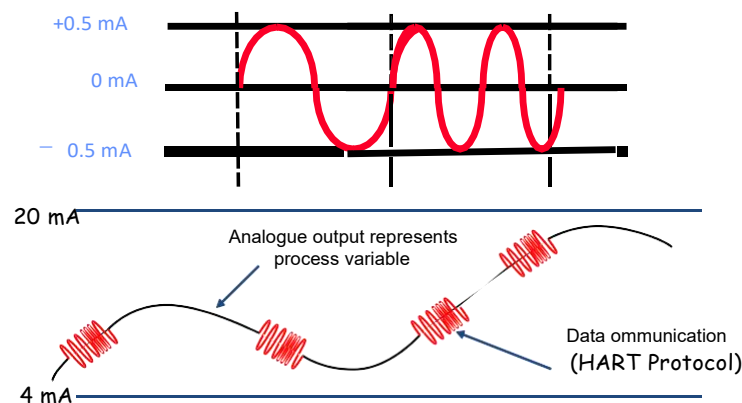

Figure 32 HART physical layer

HART wired part DDL defines HART wired frame format. The request and response frame format is showd as blow.



Figure 33 HART frame format

Name	Descriptions
Preamble	2~20 0xFF, synchronizing signal
Dlimiter	Indicate frame type and address type
Address	HART slave device address, short address (polling address) and long address
Command	Command number, 0~253
Byte count	Indicate the quantity of bytes in data field
Data	Send data or response data (output data or input data). When it is response frame, the first two bytes in data field is response code and device state.
Check byte	Exclusive OR check byte (all Exclusive OR operation from the leading delimiter to data



field end)

HART application layer includes three kinds of HART command. It's used to operate data, including universal command, common command and special command.

HART universal command is introduced as below:

➤ **Command 0: Read Unique Identifier**

Request Data Bytes

Byte	Format	Description
None		

Response Data Bytes

Byte	Format	Description
0	Unsigned-8	"254"
1-2	Enum	Expanded Device type
3	Unsigned-8	Minimum number of Preambles required for the request message from the Master to the Slave. This number includes the two preambles used in asynchronous Physical Layers (along with the Delimiter) to detect the start of message.
4	Unsigned-8	HART Protocol Major Revision Number implemented by this device. For HART Revision 7, this value must be the number 7.
5	Unsigned-8	Device Revision Level
6	Unsigned-8	Software Revision Level of this device. Levels 254 and 255 are reserved.
7	Unsigned-5	(Most Significant 5 Bits) Hardware Revision Level of the electronics in this particular device. Does Not Necessarily Trace Individual Component Changes. Level 31 is Reserved.
7	Enum	(Least Significant 3 Bits) Physical Signaling Code
8	Bits	Flags
9-11	Unsigned-24	Device ID. This number must be different for every device manufactured with a given Device Type.
12	Unsigned-8	Minimum number of preambles to be sent with the response message from the slave to the master.
13	Unsigned-8	Maximum Number of Device Variables.
14-15	Unsigned-16	Configuration Change Counter
16	Bits	Extended Field Device Status
17-18	Enum	Manufacturer Identification Code
19-20	Enum	Private Label Distributor
21	Enum	Device Profile



➤ **Command 1: Read Primary Variable**

Request Data Bytes

Byte	Format	Description
None		

Response Data Bytes

Byte	Format	Description
0	Enum	Primary Variable Units
1-4	Float	Primary Variable

➤ **Command 2: Read Loop Current and Percent of Range**

Request Data Bytes

Byte	Format	Description
None		

Response Data Bytes

Byte	Format	Description
0-3	Float	Primary Variable Loop Current (units of milli-amperes)
4-7	Float	Primary Variable Percent of Range (units of percent)

➤ **Command 3: Read Dynamic Variables and Loop Current**

Request Data Bytes

Byte	Format	Description
None		

Response Data Bytes

Byte	Format	Description
0-3	Float	Primary Variable Loop Current (units of milli-amperes)
4	Enum	Primary Variable Units Code
5-8	Float	Primary Variable
9	Enum	Secondary Variable Units
10-13	Float	Secondary Variable
14	Enum	Tertiary Variable Units Code
15-18	Float	Tertiary Variable



19	Enum	Quaternary Variable Units Code
20-23	Float	Quaternary Variable

➤ **Command 4: Reserved**

➤ **Command 5: Reserved**

➤ **Command 6: Write Polling Address, that is Device Short Address**

Request Data Bytes

Byte	Format	Description
0	Unsigned-8	Polling Address of Device
1	Enum	Loop Current Mode

Response Data Bytes

Byte	Format	Description
0	Unsigned-8	Polling Address of Device
1	Enum	Loop Current Mode

➤ **Command 7: Read Loop Configuration**

Request Data Bytes

Byte	Format	Description
None		

Response Data Bytes

Byte	Format	Description
0	Unsigned-8	Polling Address of Device
1	Enum	Loop Current Mode

➤ **Command 8: Read Dynamic Variable Classifications**

Request Data Bytes

Byte	Format	Description
None		

Response Data Bytes

Byte	Format	Description
0	Enum	Primary Variable Classification
1	Enum	Secondary Variable Classification



2	Enum	Tertiary Variable Classification
3	Enum	Quaternary Variable Classification

➤ **Command 9: Read Device Variables with Status**

Request Data Bytes

Byte	Format	Description
0	Unsigned-8	Slot 0: Device Variable Code
1	Unsigned-8	Slot 1: Device Variable Code
2	Unsigned-8	Slot 2: Device Variable Code
3	Unsigned-8	Slot 3: Device Variable Code
4	Unsigned-8	Slot 4: Device Variable Code
5	Unsigned-8	Slot 5: Device Variable Code
6	Unsigned-8	Slot 6: Device Variable Code
7	Unsigned-8	Slot 7: Device Variable Code

Response Data Bytes

Byte	Format	Description
0	Bits	Extended Field Device Status
1	Unsigned-8	Slot 0: Device Variable Code
2	Enum	Slot 0: Device Variable Classification
3	Enum	Slot 0: Units Code
4-7	Float	Slot 0: Device Variable Value
8	Bits	Slot 0: Device Variable Status
9	Unsigned-8	Slot 1: Device Variable Code
10	Enum	Slot 1: Device Variable Classification
11	Enum	Slot 1: Units Code
12-15	Float	Slot 1: Device Variable Value
16	Bits	Slot 1: Device Variable Status
17	Unsigned-8	Slot 2: Device Variable Code
18	Enum	Slot 2: Device Variable Classification
19	Enum	Slot 2: Units Code
20-23	Float	Slot 2: Device Variable Value
24	Bits	Slot 2: Device Variable Status
25	Unsigned-8	Slot 3: Device Variable Code
26	Enum	Slot 3: Device Variable Classification



27	Enum	Slot 3: Units Code
28-31	Float	Slot 3: Device Variable Value
32	Bits	Slot 3: Device Variable Status
33	Unsigned-8	Slot 4: Device Variable Code
34	Enum	Slot 4: Device Variable Classification
35	Enum	Slot 4: Units Code
36-39	Float	Slot 4: Device Variable Value
40	Bits	Slot 4: Device Variable Status
41	Unsigned-8	Slot 5: Device Variable Code
42	Enum	Slot 5: Device Variable Classification
43	Enum	Slot 5: Units Code
44-47	Float	Slot 5: Device Variable Value
48	Bits	Slot 5: Device Variable Status
49	Unsigned-8	Slot 6: Device Variable Code
50	Enum	Slot 6: Device Variable Classification
51	Enum	Slot 6: Units Code
52-55	Float	Slot 6: Device Variable Value
56	Bits	Slot 6: Device Variable Status
57	Unsigned-8	Slot 7: Device Variable Code
58	Enum	Slot 7: Device Variable Classification
59	Enum	Slot 7: Units Code
60-63	Float	Slot 7: Device Variable Value
64	Bits	Slot 7: Device Variable Status
65-68	Time	Slot 0 data time stamp

➤ **Command 11: Read Unique Identifier Associated With Tag**

Request Data Bytes

Byte	Format	Description
0-5	Packed	Tag

Response Data Bytes

Byte	Format	Description
Same as Command 0 Read Unique Identifier.		



➤ **Command 12: Read Message**

Request Data Bytes

Byte	Format	Description
None		

Response Data Bytes

Byte	Format	Description
0-23	Packed	Message

➤ **Command 13: Read Tag, Descriptor, Date**

Request Data Bytes

Byte	Format	Description
None		

Response Data Bytes

Byte	Format	Description
0-5	Packed	Tag
6-17	Packed	Descriptor
18-20	Date	Date code

➤ **Command 14: Read Primary Variable Transducer Information**

Request Data Bytes

Byte	Format	Description
None		

Response Data Bytes

Byte	Format	Description
0-2	Unsigned-24	Transducer Serial Number
3	Enum	Transducer Limits and Minimum Span Units Code
4-7	Float	Upper Transducer Limit (UTL)
8-11	Float	Lower Transducer Limit (LTL)
12-15	Float	Minimum Span



➤ **Command 15: Read Device Information**

Request Data Bytes

Byte	Format	Description
None		

Response Data Bytes

Byte	Format	Description
0	Enum	PV Alarm Selection Code
1	Enum	PV Transfer Function Code
2	Enum	PV Upper and Lower Range Values Units Code
3-6	Float	PV Upper Range Value (URV)
7-10	Float	PV Lower Range Value (LRV)
11-14	Float	PV Damping Value (units of seconds)
15	Enum	Write Protect Code
16	Enum	Reserved. Must be set to "250"
17	Bits	PV Analog Channel Flags (1 input, 0 output)

➤ **Command 16: Read Final Assembly Number**

Request Data Bytes

Byte	Format	Description
None		

Response Data Bytes

Byte	Format	Description
0-2	Unsigned-24	Final Assembly Number

➤ **Command 17: Write Message**

Request Data Bytes

Byte	Format	Description
0-23	Packed	Message String

Response Data Bytes

Byte	Format	Description
0-23	Packed	Message String



➤ **Command 18: Write Tag, Descriptor, Date**

Request Data Bytes

Byte	Format	Description
0-5	Packed	Tag
6-17	Packed	Descriptor
18-20	Date	Date code

Response Data Bytes

Byte	Format	Description
0-5	Packed	Tag
6-17	Packed	Descriptor
18-20	Date	Date code

➤ **Command 19: Write Final Assembly Number**

Request Data Bytes

Byte	Format	Description
0-2	Unsigned	Final Assembly Number

Response Data Bytes

Byte	Format	Description
0-2	Unsigned	Final Assembly Number

➤ **Command 20: Read Long Tag**

Request Data Bytes

Byte	Format	Description
None		

Response Data Bytes

Byte	Format	Description
0-31	Latin-1	Long Tag

➤ **Command 21: Read Unique Identifier Associated With Long Tag**

Request Data Bytes

Byte	Format	Description
0-31	Latin-1	Long Tag



Response Data Bytes

Byte	Format	Description
Same as Command 0 Read Unique Identifier.		

➤ **Command 22: Write Long Tag**

Request Data Bytes

Byte	Format	Description
0-31	Latin-1	Long Tag

Response Data Bytes

Byte	Format	Description
0-31	Latin-1	Long Tag

➤ **Command 38: Reset Configuration Changed Flag**

Request Data Bytes

Byte	Format	Description
0-1	Unsigned-16	Configuration Change Counter

Response Data Bytes

Byte	Format	Description
0-1	Unsigned-16	Configuration Change Counter

➤ **Command 48: Read Additional Device Status**

Request Data Bytes

Byte	Format	Description
0-5	Bits or Enum	Device-Specific Status
6	Bits	Extended Device Status
7	Bits	Device Operating Mode, 0x00
8	Bits	Standardized Status 0
9	Bits	Standardized Status 1
10	Bits	Analog Channel Saturated
11	Bits	Standardized Status 2
12	Bits	Standardized Status 3
13	Bits	Analog Channel Fixed
14-24	Bits or Enum	Device-Specific Status



Response Data Bytes

Byte	Format	Description
0-5	Bits or Enum	Device-Specific Status
6	Bits	Extended Device Status
7	Bits	Device Operating Mode, 0x00
8	Bits	Standardized Status 0
9	Bits	Standardized Status 1
10	Bits	Analog Channel Saturated
11	Bits	Standardized Status 2
12	Bits	Standardized Status 3
13	Bits	Analog Channel Fixed
14-24	Bits or Enum	Device-Specific Status

Appendix C Modbus Protocol

Statement: The objective of this document is only to present the MODBUS protocol to users.

- 1) Modbus protocol is mainly used between controllers. By Modbus, two controllers can communicate with each other or they can rely on network (e.g. Ethernet) to communicate with other devices. At present many devices use Modbus protocol.
- 2) According to ISO/OSI 7 layer network model, standard Modbus protocol defines Physical layer, Link layer and Application layer.

Physical layer: Define the asynchronous serial communication based on RS232 and RS485;

Link layer: Regulate the media access control based on station number identification method of master/slave;

Application layer : Regulate information standard (message format) and communication service function;

Layer	ISO/OSI Model	
7	Application	MODBUS Application Protocol
6	Presentation	Empty
5	Session	Empty
4	Transport	Empty
3	Network	Empty
2	Data Link	MODBUS Serial Line Protocol
1	Physical	EIA/TIA-485 (or EIA/TIA-232)

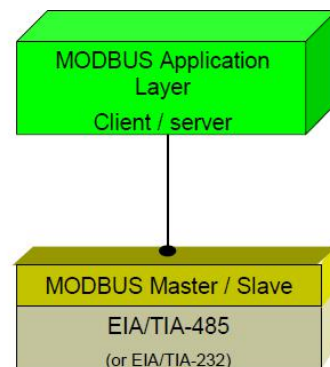

Figure 34 Modbus Protocol Model

- 3) Currently many Modbus devices are based on RS232/48 and also changed Modbus communication, with only Modbus application layer (information standard) and other communication protocols' bottom layer. For example, bottom layer uses Ethernet +TCP/IP and bottom layer uses radio extensive frequency communication etc.

Modbus Protocol main points

- 1) Modbus is master/slave communication protocol. Master station send message initiatively, and only the slave station which has the same calling address with master station will send response message.
- 2) Message is broadcast mode when sent by 0 address, not necessary for slave station's response.



3) Modbus defines two kinds of Character transfer mode: ASCII mode、RTU (binary system) mode, and they cannot be mix-up.This product is suitable for these two modes.

Features	RTU mode	ASCII mode
Coding	binary system	ASCII (Print character: 0-9, a-z, A-Z)
Each character bit	start bit: 1BIT	start bit: 1BIT
Data bits	data bit: 8BITS	data bit: 7BITS
Check bit	parity check bit (selectable): 1 bit	parity check bit (selectable): 1 bit
Stop bit	Stop bit: 1 or 2	Stop bit: 1 or 2
Message check	CRC	LRC

4) Transmission error check

- Transmission error check is inspected by odd-even check and redundancy check.
- When there's check error, message processing stops and meanwhile slave station stops communication and response to message.
- Once communication error happens, message is not reliable. Modbus master will response as "communication error has happened" if Modbus master station hasn't received response from slave station for some time.

5) Message level (character level) uses CRC-16.

6) Modbus message RTU format

No less than 3.5 characters'message interval time	Address	Function	Data	CRC check	No less than 3.5 characters'message interval time
	8 BITS	8 BITS	N ×8 BITS	16 BITS	

7) Modbus message ASCII format

Start	Address	Function	Data	LRC check	End
1 CHAR	2 CHARS	2 CHARS	n CHARS	2 CHARS	2 CHARS CRLF



MICROCYBER

YOUR FIELDBUS EXPERT

CONTACT INFORMATION

Address: 17-8 Wensu Street, Hunnan New District, Shenyang, China

Website: www.microcyber-fieldbus.com

Phone: +86-24-31217278/+86-24-31217280

Fax: +86-24-31217338

Email: fang.siqi@microcyber.cn