**User's
Manual**

YS1000TM Series

**YS1000 Series
Communication Interface
User's Manual**

**Functional
Enhancement**

IM 01B08J02-01EN

Introduction

Thank you for purchasing the YS1000 series single-loop controller (hereinafter referred to as "YS1000"). This manual describes how to use the YS1000's communication functions (Ethernet, serial and DCS-LCS communication). Read this manual thoroughly beforehand to ensure correct use of the YS1000.

Also, be sure to read the following manuals provided with the YS1000.

To use the YS1000, you must have a sufficient knowledge of the communication specifications of the host computer that the YS1000 is connected to, communication hardware, the program language used for communication, and other communication-related information.

Note that the manuals for the YS1000 comprises the following nine documents:

● Printed manuals

Name	Manual Number	Description
YS1500/YS1700 Operation Guide	IM 01B08B02-01EN	This manual describes the basic operation method.
YS1310 Operation Guide	IM 01B08D02-01EN	This manual describes the basic operation method.
YS1350/YS1360 Operation Guide	IM 01B08E02-01EN	This manual describes the basic operation method.

● Electronic manuals

Name	Manual Number	Description
YS1500/YS1700 Operation Guide	IM 01B08B02-01EN	This is identical to the printed manual.
YS1500/YS1700 User's Manual	IM 01B08B02-02EN	This manual describes the detailed functions and setting items. It does not contain user programs and communication functions.
YS1310 Operation Guide	IM 01B08D02-01EN	This is identical to the printed manual.
YS1310 User's Manual	IM 01B08D02-02EN	This manual describes the detailed functions and setting items. This manual does not describe the communication functions.
YS1350/YS1360 Operation Guide	IM 01B08E02-01EN	This is identical to the printed manual.
YS1350/YS1360 User's Manual	IM 01B08E02-02EN	This manual describes the detailed functions and setting items. This manual does not describe the communication functions.
YS1000 Series Communication Interface User's Manual	IM 01B08J02-01EN	This manual. It describes how to use Ethernet, serial and DCS-LCS communication. For communication wiring, see the Operation Guide.
YSS1000 Setting Software for YS1000 Series/YS1700 Programmable Function User's Manual	IM 01B08K02-02EN	This manual describes how to use the YSS1000 Setting Software for YS1000 Series and YS1700's programmable function.
YS1000 Series Replacement Manual	IM 01B08H02-01EN	This manual describes the compatibility of installation and wiring with YS100, YS80, EBS, I, EK, HOMAC, and 100 line.

User's manuals for YS1000 are available on the following web site: www.yokogawa.com/ns/ys/im/

You need Adobe Reader 7.0 or later (but the latest version is recommended) installed on the computer in order to open and read the manuals.

Notice

- The contents of this manual are subject to change without notice as a result of continuing improvements to the instrument's performance and functions.
- Every effort has been made to ensure accuracy in the preparation of this manual. Should any errors or omissions come to your attention, however, please inform YOKOGAWA Electric's sales office or sales representative.
- Under no circumstances may the contents of this manual, in part or in whole, be transcribed or copied without our permission.
- The document concerning TCP/IP software has been created by Yokogawa based on the BSD Networking Software, Release 1 that has been licensed from the University of California.

Trademarks

- Our product names or brand names mentioned in this manual are the trademarks or registered trademarks of YOKOGAWA Electric Corporation (hereinafter referred to as YOKOGAWA).
- Microsoft, MS-DOS, and Windows are either registered trademarks or trademarks of Microsoft Corporation in the United States and/or other countries.
- Adobe, Acrobat, and Postscript are either registered trademarks or trademarks of Adobe Systems Incorporated.
- We do not use the TM or ® mark to indicate these trademarks or registered trademarks in this user's manual.
- All other product names mentioned in this user's manual are trademarks or registered trademarks of their respective companies.

How to Use This Manual

Usage

First read through the [Operation Guide](#) to understand the basic operation and then read this manual.

This User's Manual is organized into Chapters 1 to 7 and an appendix as shown below.

Chapter	Title and Description
1	Overview Describes types of communication and communication specifications.
2	Setting Communication Functions Describes communication parameter setting items and operation modes.
3	Description of RS-485 Communication Describes how to use Modbus communication, PC link communication and YS protocol communication.
4	Description of Ethernet Communication (Modbus/TCP) Describes how to use Ethernet communication.
5	Description of DCS-LCS Communication Describes how to use DCS-LCS communication.
6	Functions and Application of YS1500/YS1700 D-registers Provides a map of the D registers.
7	Functions and Application of YS1310/YS1350/YS1360 D-registers Provides a map of the D registers.
Appendix	ASCII Code Table

Symbols Used in This Manual



This symbol is used on the instrument. It indicates the possibility of injury to the user or damage to the instrument, and signifies that the user must refer to the user's manual for special instructions. The same symbol is used in the user's manual on pages that the user needs to refer to, together with the term "WARNING" or "CAUTION."

WARNING

Calls attention to actions or conditions that could cause serious or fatal injury to the user, and indicates precautions that should be taken to prevent such occurrences.

CAUTION

Calls attention to actions or conditions that could cause injury to the user or damage to the instrument or property and indicates precautions that should be taken to prevent such occurrences.

Note

Identifies important information required to operate the instrument.



Indicates related operations or explanations for the user's reference.



Indicates a character string displayed on the display.

Setting Display

Indicates a setting display and describes the keystrokes required to display the relevant setting display.

Setting Details

Provides the descriptions of settings.

Description

Describes restrictions, etc. regarding a relevant operation.

Contents

Introduction	i
How to Use This Manual.....	ii
Chapter 1 Overview	
1.1 YS1000 Communication.....	1-1
1.2 Programmer Communication	1-3
1.3 RS-485 Communication (optional code /A31).....	1-4
1.3.1 Communication Specifications.....	1-4
1.4 Ethernet Communication (optional code /A34).....	1-7
1.4.1 Communication Specifications.....	1-7
1.5 DCS-LCS Communication (optional code /A32)	1-8
1.6 Peer-to-peer Communication (optional code /A31).....	1-9
Chapter 2 Setting Communication Functions	
2.1 Setting Communication Functions.....	2-1
2.2 Setting Parameters.....	2-2
2.2.1 Setting RS-485 Communication (optional code /A31).....	2-2
2.2.2 Setting the Terminating Resistor	2-5
2.2.3 Setting DCS-LCS Communication (optional code /A32)	2-7
2.2.4 Setting Ethernet Communication (optional code /A34)	2-8
2.3 Setting the Computer Mode	2-10
2.3.1 Setting the C Mode.....	2-10
2.3.2 Setting the Backup Mode	2-11
2.4 Operation Mode Transitions	2-12
2.4.1 YS1500/YS1700 Operation Mode Transitions (when RS-485 host communication is used).....	2-12
2.4.2 YS1500/YS1700 Operation Mode Transitions (when DCS-LCS communication is used).....	2-13
2.4.3 YS1350/YS1360 Operation Mode Transitions (when RS-485 host communication or DCS-LCS communication is used).....	2-14
Chapter 3 Description of RS-485 Communication (Optional Code: /A31)	
3.1 Modbus Communication.....	3-1
3.1.1 Overview	3-1
3.1.2 Configuration of Messages.....	3-3
3.1.3 Configuration of Responses (response from YS1000).....	3-7
3.1.4 Specifying Broadcast.....	3-8
3.1.5 Monitoring Discontinuation of Communication with Host Computer (description of CMWDT) ...	3-9
3.1.6 Messages and Responses.....	3-10
■ 03 Reading multiple D registers	3-10
■ 06 Writing D registers	3-11
■ 08 Loopback test	3-11
■ 16 Writing to multiple D registers.....	3-12
■ 66 Random reading.....	3-13
■ 67 Random writing.....	3-14
■ 68 Specify monitor.....	3-15
■ 69 Monitoring.....	3-15
3.2 PC Link Communication	3-16
3.2.1 Overview	3-16
3.2.2 Configuration of Commands.....	3-17
3.2.3 Configuration of Responses	3-18

3.2.4	Response Error Codes.....	3-19
3.2.5	Specifying Broadcast.....	3-20
3.2.6	Monitoring Discontinuation of Communication with Host Computer (description of CMWDT) ..	3-20
3.2.7	Commands and Responses.....	3-21
	■ WRD Read word units in D registers.....	3-21
	■ WWR Write word units in D registers	3-22
	■ WRR Random reading of word units in D registers.....	3-23
	■ WRW Random writing of word units in D registers.....	3-24
	■ WRS Specify D registers to be monitored in word units.....	3-25
	■ WRM Monitoring D registers in word units	3-26
	■ INF6 Read model name, suffix code and version.....	3-27
	■ INF7 Read CPU maximum value	3-28
3.2.8	Communication with FA-M3	3-29
3.3	YS Protocol	3-30
3.3.1	Overview	3-30
3.3.2	Communication Messages	3-30
3.3.3	Commands and Responses.....	3-31
	■ Data read command (DG)	3-31
	■ Data write command (DP)	3-32
	■ Timer setting command for monitoring discontinuation of communication with host computer in SPC or DDC mode (WDT)	3-32
3.3.4	List of Data Sent by Communication	3-33
3.3.5	Description of Communication Errors.....	3-47
3.3.6	List of Data Types on DCS Internal Devices When Connected to DCS.....	3-50

Chapter 4 Description of Ethernet Communication (Modbus/TCP) (Optional Code: /A34)

4.1	Overview	4-1
4.2	TCP/IP-based Communication.....	4-2
4.3	Configuration of Network Frames.....	4-3
	4.3.1 Configuration of MBAP Header.....	4-3
	4.3.2 Configuration of PDU	4-3
4.4	Communication with Host Computer.....	4-4
	4.4.1 List of Function Codes.....	4-4
	4.4.2 Specifying D Registers.....	4-4
	4.4.3 Requests and Responses	4-4
	■ 03 Reading multiple D registers	4-4
	■ 06 Writing D registers	4-5
	■ 08 Loopback test	4-5
	■ 16 Writing to multiple D registers.....	4-6
	■ 66 Random reading.....	4-6
	■ 67 Random writing.....	4-7
	■ 68 Specify monitor.....	4-7
	■ 69 Monitoring.....	4-8
4.4.4	Response Error Codes.....	4-9

Chapter 5 Description of DCS-LCS Communication (Optional Code: /A32)

5.1	List of Data Types on DCS Internal Devices on YS1000.....	5-1
	5.1.1 YS1500/YS1700 Controllers	5-1
	5.1.2 YS1350 Manual Setter for SV Setting	5-4
	5.1.3 YS1360 Manual Setter for MV Setting	5-5
5.2	YS1000 Operation Mode and Block Mode	5-6
	5.2.1 YS1500/YS1700 Operation Mode and Block Mode	5-6
	5.2.2 YS1350 Operation Mode and Block Mode	5-7
	5.2.3 YS1360 Operation Mode and Block Mode	5-7

Chapter 6 Functions and Application of YS1500/YS1700 D-registers

6.1	Overview	6-1
6.2	Conventions Used in D-Register Lists	6-2
6.3	Classification of D Registers	6-3
6.3.1	Writing Data to the Engineering Parameters 1	6-3
6.4	D Register Data	6-4
6.4.1	Setting D Registers as High Level or Low Level	6-4
6.5	Process Data (D0001 to D0400)	6-5
6.5.1	Process Data Area	6-9
6.5.2	Process Data, Analog Input/output, Status (D0001 to D0100)	6-9
6.5.3	Alarm/Event (D0101 to D0300)	6-14
6.5.4	Digital Input/output (D0301 to D0400)	6-15
6.6	Tuning Parameters (D0401 to D0900)	6-16
6.6.1	PID Parameters (D0401 to D0500)	6-20
6.6.2	STC Parameters (D0501 to D0600)	6-21
6.6.3	I/O Parameters (D0601 to D0700)	6-22
6.6.4	Special Parameters (D0701 to D0900)	6-22
6.7	Recognition Area/User Area (D0901 to D1000)	6-23
6.7.1	Recognition Area (D0901 to D0950)	6-23
6.7.2	User Area (D0951 to D1000)	6-23
6.8	Engineering Parameters (D1001 to D2000)	6-24
6.8.1	CONFIG (D1001 to D1100) 1/2	6-33
6.8.2	I/O Computation Setting, Alarm Setting (D1101 to D1200)	6-35
6.8.3	Display Setting, Contrast (D1201 to D1300) 1/2	6-36
6.8.4	Communication Setting (D1301 to D1400)	6-38
6.8.5	Preset PID, Sample and Batch (D1401 to D1500)	6-39
6.8.6	FX Table (D1501 to D1600)	6-39
6.8.7	GX Table (D1601 to D1700)	6-39
6.8.8	DI/DO Setting (D1701 to D1800)	6-40
6.8.9	Communication Access (D1801 to D1900)	6-42
6.9	User Program (D2001 to D4000)	6-43
6.9.1	Control Data, System Flag (D2001 to D2100)	6-47
6.9.2	Control Flag (D2101 to D2200)	6-48
6.9.3	Program Setpoint (D2201 to D2300)	6-49
6.9.4	P Registers (D2601 to D2700)	6-49

Chapter 7 Functions and Application of YS1310/YS1350/YS1360 D-registers

7.1	Overview	7-1
7.2	Conventions Used in D-Register Lists	7-2
7.3	Classification of D Registers	7-3
7.3.1	Writing Data to the Engineering Parameters 1	7-3
7.4	D Register Data	7-4
7.4.1	Setting D Registers as High Level or Low Level	7-4
7.5	Process Data (D0001 to D0400)	7-5
7.5.1	Process Data Area	7-9
7.5.2	Process Data, Analog Input/output, Status (D0001 to D0100)	7-9
7.5.3	Alarm/Event (D0101 to D0300)	7-12
7.5.4	Digital Input/output (D0301 to D0400)	7-12
7.6	Tuning Parameters (D0401 to D0900)	7-13
7.6.1	Setting Parameters (D0401 to D0500)	7-16
7.6.2	I/O Parameters (D0601 to D0700)	7-16
7.6.3	Special Parameters (D0701 to D0900)	7-16
7.7	Recognition Area/User Area (D0901 to D1000)	7-17
7.7.1	Recognition Area (D0901 to D0950)	7-17
7.7.2	User Area (D0951 to D1000)	7-17

7.8	Engineering Parameters (D1001 to D2000)	7-18
7.8.1	CONFIG (D1001 to D1100).....	7-24
7.8.2	I/O Computation Setting, Alarm Setting (D1101 to D1200)	7-25
7.8.3	Display Setting, Contrast (D1201 to D1300)	7-26
7.8.4	Communication Setting (D1301 to D1400).....	7-27
7.8.5	DI/DO Setting (D1701 to D1800)	7-28
7.8.6	Communication Access (D1801 to D1900)	7-29

Appendix ASCII Code Table

Revision Information

1.1 YS1000 Communication

The YS1000 supports three types of communication, RS-485 communication(*), DCS-LCS communication(*) and Ethernet communication.

It also supports programmer communication that uses the YSS1000 Setting Software for YS1000 Series to communicate with the YS1000.

Two types of RS-485 communication are provided: RS-485 host communication that enables centralized monitoring of the YS1000 by a host computer, and peer-to-peer communication that enables sharing of data with other YS1700s by reading and writing peer-to-peer communication registers in the user program.

*: RS-485 and DCS-LCS communication cannot be used simultaneously.

- ▶ [Programmer communication, peer-to-peer communication: "YSS1000 Setting Software/YS1700 Programmable Function User's Manual"](#)

YS1000 communications

Communication Function		Protocol	Terminal Position	Optional Code	Remarks
Programmer Communication		Modbus/RTU	• Exclusive terminal inside front swing-up built-in panel	None (standard)	Used by YSS1000 Setting Software (sold separately)
RS-485 Communication	RS-485 host Communication	YS protocol	Rear terminals	/A31 (Note 1)	Select protocol in parameters.
		PC link			
		PC link (with checksum)			
	Peer-to-peer Communication (Note 2)	Peer-to-peer Communication			
DCS-LCS communication (Note 3)		Exclusive protocol	Rear terminals	/A32 (Note 1)	
Ethernet communication		Modbus/TCP	Rear Ethernet terminal	/A34	

Note 1: Optional codes /A31 and /A32 cannot be used simultaneously.

Note 2: Can be used only in the programmable mode when optional code /A31 of YS1700 is selected.

Note 3: The YS1310 is not provided with DCS-LCS communication.

- ▶ [Terminal position: Operation Guide for respective YS1000](#)

1.1 YS1000 Communication

Model and Suffix Codes

Model	Suffix Code	Optional Code	Remarks
YS1700			Programmable indicating controller
YS1500			Indicating controller
YS1360			Manual setter for MV setting
YS1350			Manual setter for SV setting
YS1310			Indicator with alarm
Use	-1		With hard manual unit YS1310 and YS1350: Always "-1"
	-2		Without hard manual unit
Type	0		Basic type
	1		Basic type with expandable I/O (*1)
	2		Compatible type for YS100 (with YS100 case)
	3		Compatible type for YS80 internal unit/compatible type for EBS, I, EK, and HOMAC (*2)
	4		Compatible type for YS80 (compatible size for YS80 with YS100 terminal)
	5		Compatible type for pneumatic 100 line (with YS100 terminal) (*3)
Power supply	0		100 V AC, 24 V DC common power
	1		220 V AC power
Direct input (*4)	/A01		mV input
	/A02		Thermocouple input
	/A03		RTD input
	/A04		Potentiometer input
	/A05		Isolator
	/A06		Two-wire transmitter input (isolated)
	/A07		Two-wire transmitter input (non-isolated)
	/A08		Frequency input
	/DF		Direct input with Fahrenheit temperature function (*5)
Communication	/A31		RS-485 communication (PC-link, Modbus, YS protocol, and Peer-to-Peer) (*6)
	/A32		DCS-LCS communication (*7)
	/A34		Ethernet communication (Modbus/TCP) (*8)
Certification	/FM		FM nonincendive approved (FM Class I, Div 2) (*9) (To be approved)
	/CSA		CSA safety and nonincendive approved (Class I, DIV 2) (*10) (To be approved)

*1 Only YS1700 is compatible. The expandable I/O terminal (model YS010) and expandable I/O cable (model YS011) (cable length: 3 m) are provided.

*2 This type can be connected to the YS80 housing (model SHUP-000). (The EK/HOMAC-compatible housing (SHUP-420) and EBS/I series-compatible housing (SHUP-100) are sold separately.)

*3 The 100 line-compatible housing (model YS006) is sold separately.

*4 Direct input options can be combined only with suffix codes "-□2□," "-□4□," or "-□5□." Selection of multiple options is not possible.

*5 Optional code /DF can be combined only with optional code /A02 or /A03.

*6 A combination with suffix code "-□3□" is not possible. Optional codes /A31 and /A32 cannot be simultaneously specified. Please specify the communication options /A31 (RS-485 communication) to directly communicate with the CENTUM CS3000/VP.

*7 YS1310 cannot specify this optional code. Optional codes /A31 and /A32 cannot be simultaneously specified. Please specify the communication options /A32 (DCSLCS communication) to communicate with the CENTUM CS3000/VP through the SCIU.

*8 Optional code /A34 can be specified only for suffix codes "-□0□" or "-□1□."

*9 Optional code /FM can be combined only with suffix codes "-□0□" or "-□1□."

*10 Optional code /FM can be combined only with suffix codes "-□0□," "-□1□," or "-□2□."

1.2 Programmer Communication

In programmer communication, the YSS1000 Setting Software for YS1000 Series for communicating with the YS1000 is used.

Programmer communication enables all parameters held by the YS1000 and YS1700 user programs to be uploaded and downloaded.

To enable programmer communication, connect to the PC connector on the swing-up built-in panel.

For details on performing programmer communication, refer to "YSS1000 Setting Software/YS1700 Programmable Function User's Manual."

Example : When connecting by YS1000 dedicated USB cable

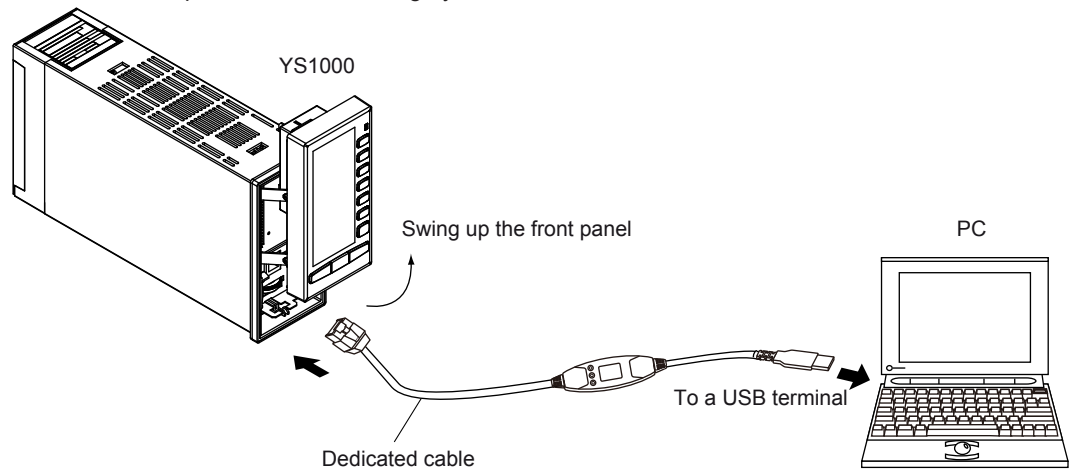

0101E.ai

1.3 RS-485 Communication (optional code /A31)

Four protocols are supported on the RS-485 interface: PC link communication protocol, Modbus/RTU communication protocol, Modbus/ASCII communication protocol, and YS protocol.

RS-485 communication allows data to be collected from the YS1000 and data to be set on the YS1000 easily from a host computer.

With RS-485 communication, responses are not returned in a FAIL status.

1.3.1 Communication Specifications

	Communication Specifications (PC link, Modbus, YS protocol)
Communication Interface	RS-485 5 terminals (4-wire type)/(2-wire type) The communication signal is isolated from the internal circuit.
Communication method	4-wire type half-duplex or 2-wire type half-duplex, asynchronous operation, non-procedural
Connection method	1:n multi-drop method
Connection distance	Max. 1200 m
Baud rate	1200, 2400, 4800, 9600, 19200, 38400 bps
Data length	YS protocol: Fixed at 8 bits Modbus communication (ASCII): Fixed at 7 bits Modbus communication (RTU): Fixed at 8 bits PC link communication: 7, 8 bits (with checksum / without checksum)
Parity bit	NONE (none), EVEN (even), ODD (odd)
Stop bit	1, 2 bits

Example:

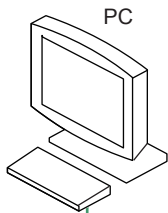

RS-485/
RS-232C
converter

Model ML2 manufactured by Yokogawa is recommended.

For details on wiring, refer to "Installation and Wiring" - "Wiring" - "Wiring for the Serial Communication Interface (Optional Code /A31)" in the respective YS1000 Operation Guide.

Max. 1200 m, number of connected slaves: 31

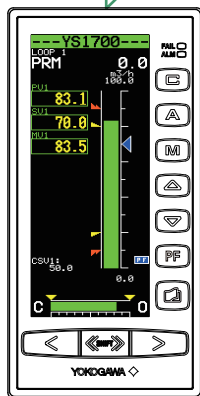

RS-485
communication address = 01

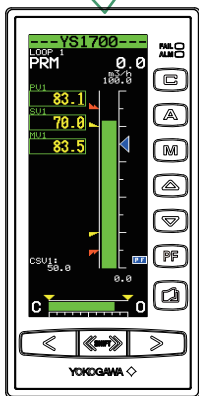

RS-485
communication address = 05

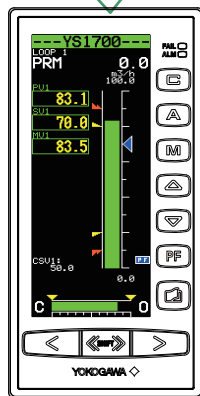

RS-485
communication address = 10

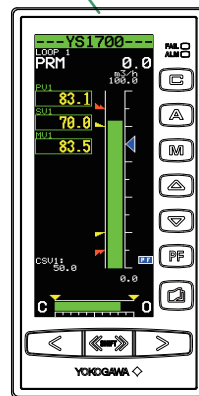

RS-485
communication address = 20

0102E.ai

1.3 RS-485 Communication (optional code /A31)

- **Example of communication with DCS**

For details on the number of connected controllers, performance and connection methods, refer to the DCS Sub-system Communications Manual.

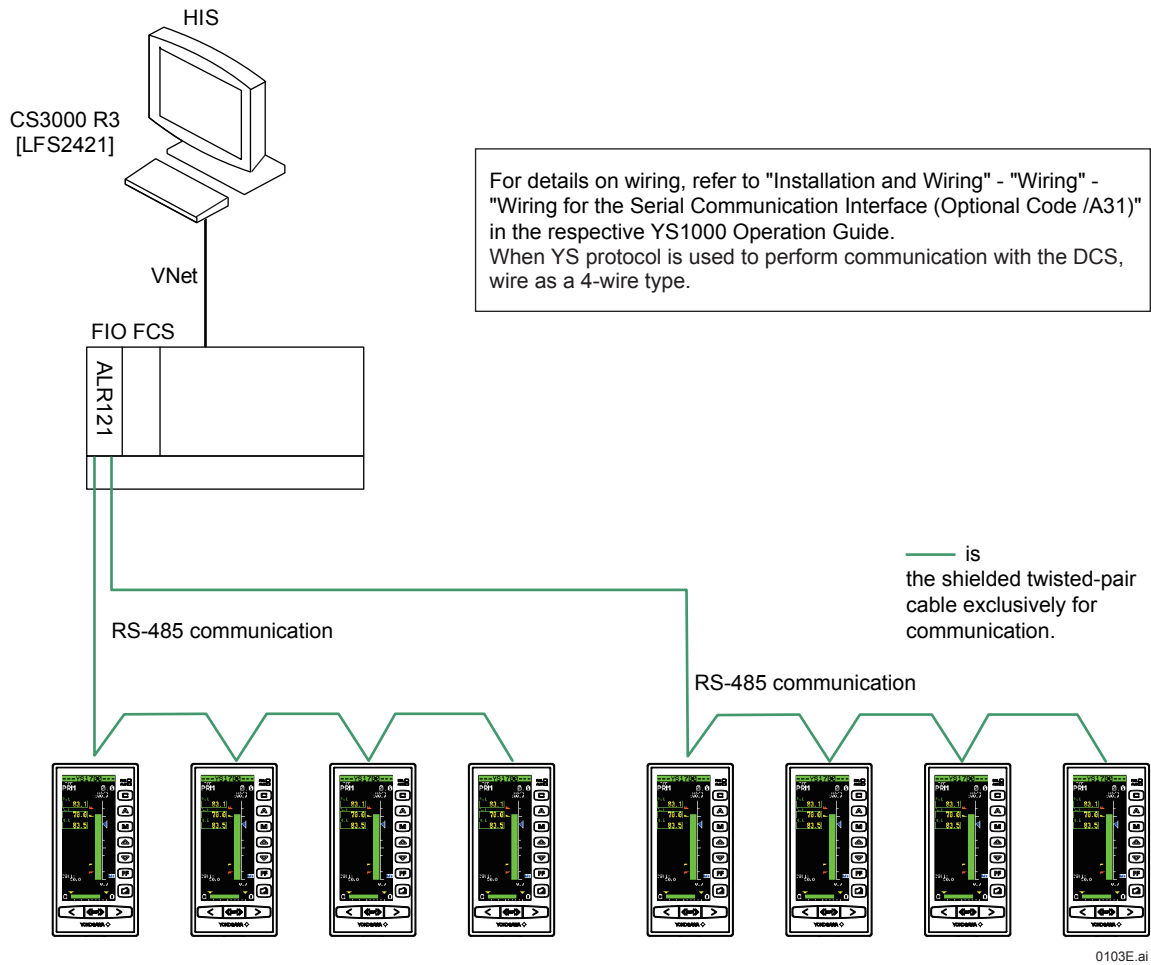

1.4 Ethernet Communication (optional code /A34)

By Ethernet communications, the YS1000 can be connected to an IEEE802.3-compliant network (10BASE-T/100BASE-TX) so that data can be collected from the YS1000 or set on the YS1000 by a host computer, such as a PC or a PLC.

With Ethernet communication, responses are not returned in a FAIL status.

Example:

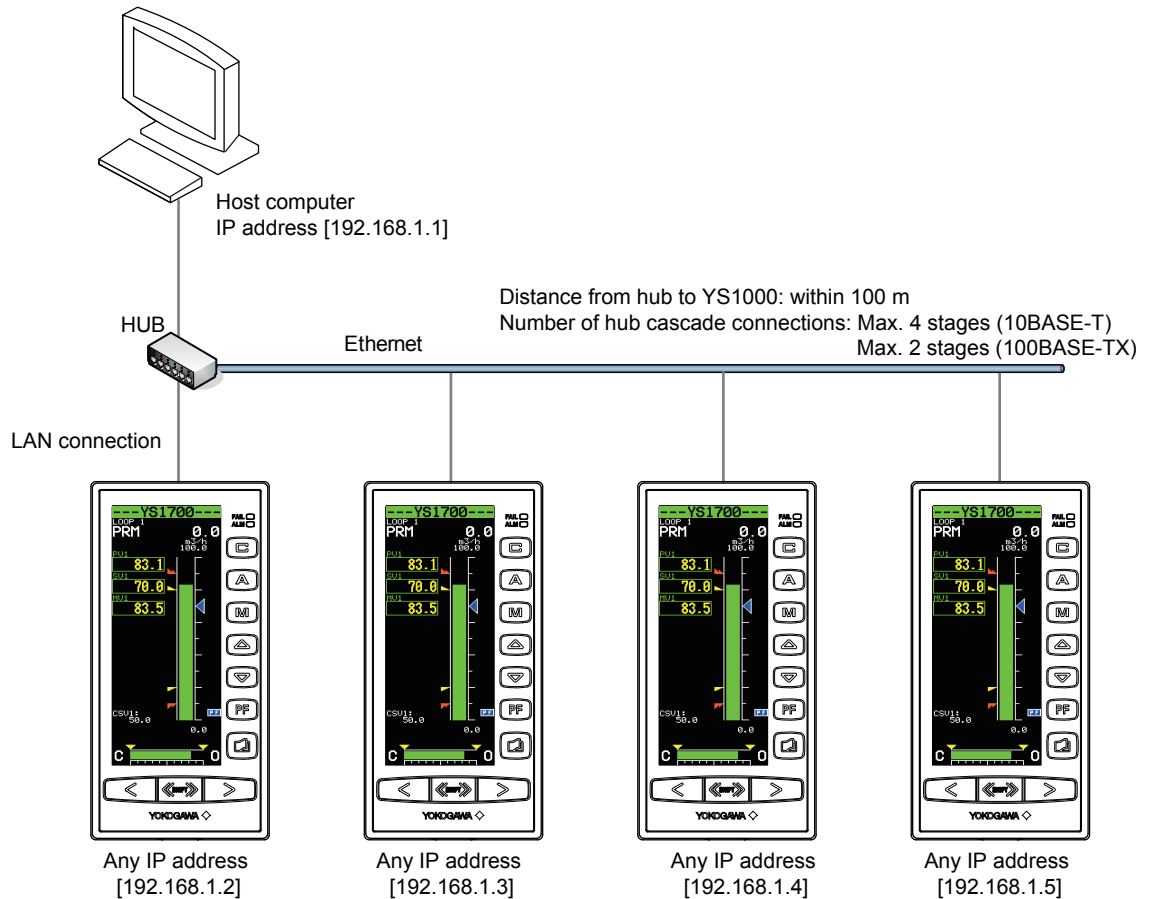

1.4.1 Communication Specifications

	Communication Specifications
Standard	Ethernet IEEE802.3-compliant
Interface	RJ45 (10BASE-T/100BASE-TX)
Access control	CSMA/CD
Transmission speed	10 Mbps/100 Mbps
Maximum segment length	100 m (Note 1)
Maximum connecting configuration	Cascade Max. 4 stages (10BASE-T) Max. 2 stages (100BASE-TX) (Note 2)
Communication method	Modbus/TCP
Data type	Binary
Maximum number of connections	2
Maximum number of transactions	1 (Note 3)
Port No.	502 (factory default), can be selected within range 1024 to 65535

Note 1: Distance from hub to YS1000

Note 2: Number of hub cascade connections

Note 3: Per a connection

1.5 DCS-LCS Communication (optional code /A32)

DCS-LCS communication enables the YS1000 to be monitored and operated without the aid of a program from the Human Interface Station (simply called "HIS" from here on) at Yokogawa Electric's Distributed Control System CENTUM CS (simply called "DCS" from here on) via the LCS Loop Communication Card (LCS card) or Communication Interface Unit (SCIU).

The YS1000 can be registered as a control function block in the Field Control Unit (simply called "FCS" from here on) of the DCS, and can be handled in the same way as other control function blocks.

For details on the number of connected controllers, performance and connection methods, refer to the "DCS Subsystem Communication Manual."

Note

The YS1310 indicator with alarm does not support a function for communicating with the DCS.

Example: YS communication (via SCIU)

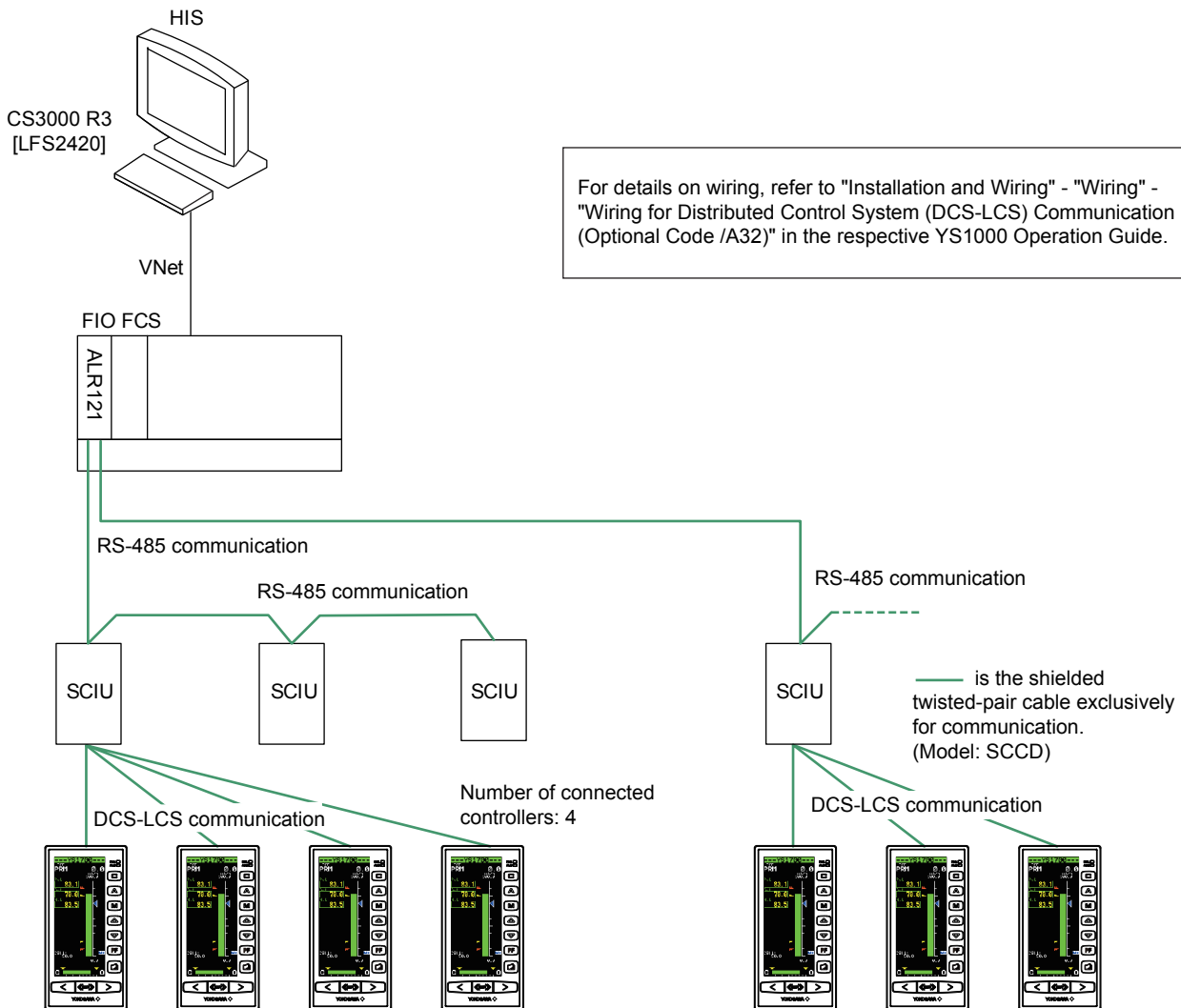

0105E.ai

1.6 Peer-to-peer Communication (optional code /A31)

Peer-to-peer communication enables up to 32 YS1700s to be connected. Of these 32 YS1700s, four units can send four analog data and 16 digital data, and receive 16 analog data and 64 digital data. The remaining 28 units can only receive 16 analog data and 64 digital data. The user can send and receive data simply by reading data from peer-to-peer communication registers (LD command) or writing data to peer-to-peer communication registers (ST command) by the user program on the YS1700 without being aware that communications is being performed.

- ▶ Peer-to-peer communication: refer to "Chapter 8 Performing Peer-to-peer Communication" of "YSS1000 Setting Software/YS1700 Programmable Function User's Manual."

Controller Nos.1 to 4 can transmit and receive data.

Controller Nos.5 to 32 can only receive data.

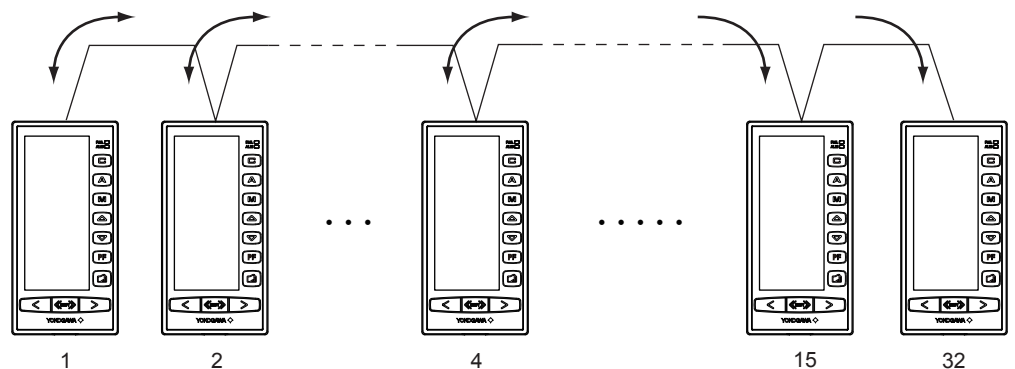

Max. 32 units

For details on wiring, refer to "Installation and Wiring" - "Wiring" - "Wiring for Peer-to-peer Communication (YS1700, Optional Code /A31)" in the respective YS1000 Operation Guide.

0106E.ai

2.1 Setting Communication Functions

This section describes the setup parameters and setting ranges of the YS1000 for using the communication functions.

Set the required parameters referring to "Operating the Engineering Displays" in the respective Operating Guide.

2.2 Setting Parameters

2.2.1 Setting RS-485 Communication (optional code /A31)

Setting Display

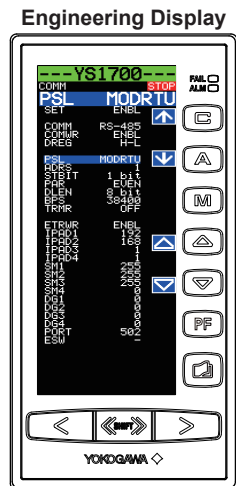

Operation Display > **[STOP]**+**[C]** keys (to the Tuning Menu Display) > **[STOP]**+**[C]** keys (to the Engineering Menu Display 1) > **[C]** key (to the Engineering Menu Display 2) > **[COMM]** software key (Communication Setting Display)

0201.ai

Setting Details

Parameter	Name	Setting Range		Factory Default
COMM	Terminal communication selection	RS-485 communication	Fixed at RS-485(1)	According to optional code specification
COMWR	Enable/Disable writing via RS-485 communication	Enable	ENBL (0)	ENBL (0)
		Disable	INHB (1)	
DREG1	RS-485 communication D register setting for High/Low level	High level-Low level	H-L (0)	H-L (0)
		Low level-High level	L-H (1)	
PSL	RS-485 protocol selection	PC link communication	PCL (0)	MODRTU (3)
		PC link communication (w/ checksum)	PCLSUM (1)	
		Modbus communication (ASCII)	MODASC (2)	
		Modbus communication (RTU)	MODRTU (3)	
		YS protocol	YS (4)	
	Peer-to-peer communication	P-to-P (5)		
ADRS	RS-485 communication address	1 to 99		1
STBIT	RS-485 stop bit	1bit (0)		1bit (0)
		2bit (1)		
PAR	RS-485 parity	None	None (0)	EVEN (2)
		Odd	ODD (1)	
		Even	EVEN (2)	
DLEN	RS-485 data length	PC link communication	7bit (0)	8bit (1)
			8bit (1)	
		Modbus communication (ASCII)	Fixed at 7bit (0)	
		Modbus communication (RTU)	Fixed at 8bit (1)	
	YS protocol	Fixed at 8bit (1)		
BPS	RS-485 baud rate	1200bps (0)		38400 (5)
		2400bps (1)		
		4800bps (2)		
		9600bps (3)		
		19200bps (4)		
		38400bps (5)		
TRMR	RS-485 communication terminating resistor ON/OFF	OFF (0)		OFF (0)
		ON (1)		

Note: Figures in parentheses "()" are values to be set when performing communication.

Description

- Terminal communications selection
This is fixed at "RS-485 communication" according to the optional code /A31 specification. Parameter COMM is read-only.
- Enable/Disable writing via RS-485 communication
Set "ENBL" to enable writing of data from the host computer, and "INHB" to disable writing.
- RS-485 communication D register setting for High/Low level
Two D registers are used to express one parameter data. Select which of the two registers is to be treated as the high-level register or low-level register.
- Protocol selection
Select the protocol to be used.
- RS-485 communication address
Any number within the range 1 to 99 can be set. (Numbers need not be consecutive and can be skipped. However, set only unique numbers within the same system. Do not set the same address twice.) The maximum connecting configuration is 31 controllers.
- RS-485 stop bit
Set the same stop bit as the host computer that the controller is to be connected to.
- RS-485 parity
Set the same parity bit as the host computer that the controller is to be connected to.
- RS-485 data length
Set the same data length as the host computer that the controller is to be connected to.
Modbus communication (ASCII) is fixed at 7 bits.
Modbus communication (RTU) and YS protocol are fixed at 8 bits.
- RS-485 baud rate
Set the same baud rate as the host computer that the controller is to be connected to. The baud rate unit is bps (bits per second).
- RS-485 communication terminating resistor ON/OFF
Set the RS-485 communication terminating resistor ON or OFF.

2.2.2 Setting the Terminating Resistor

With RS-485 communication (PC link, Modbus, YS protocol), a terminating resistor is required at both ends of the twisted-pair cable.

To use the terminating resistor, set the RS-485 communication terminating resistor ON/OFF parameter to ON. When the terminating resistor is not used, set this parameter to OFF.

For details on how to use the terminating resistor, see "Installation and Wiring" - "Wiring" - "Wiring for the Serial Communication Interface (Optional Code /A31) in the respective YS1000 Operation Guide.

Note

When the controller whose terminating resistor setting is ON (use terminating resistor) is power OFF, the terminating resistor setting is the same state as OFF (do not use terminating resistor). If necessary, install an external terminating resistor.

Setting Display

Engineering Display

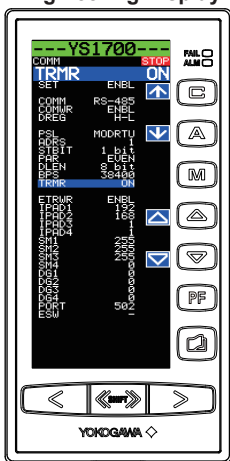

Operation Display > [←→]+[□] keys (to the Tuning Menu Display) > [←→]+[□] keys (to the Engineering Menu Display 1) > [□] key (to the Engineering Menu Display 2) > [COMM] software key (Communication Setting Display)

0202E.ai

Setting Details

Parameter	Name	Setting Range	Factory Default
TRMR	RS-485 communication terminating resistor ON/OFF	ON: Use terminating resistor (1) OFF: Do not use terminating resistor (0)	OFF (0)

Note: Figures in parentheses "()" are values to be set when performing communication.

2.2 Setting Parameters

Description

Connection example-1

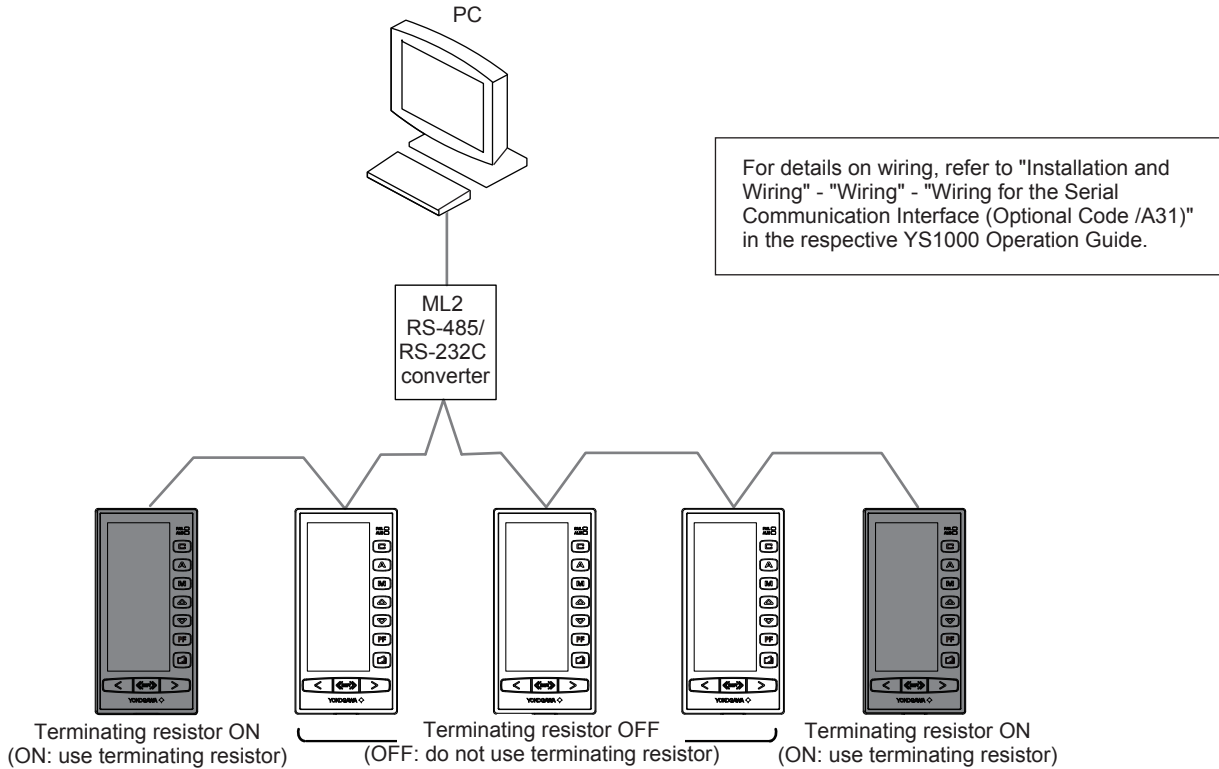

0203E.ai

Connection example-2

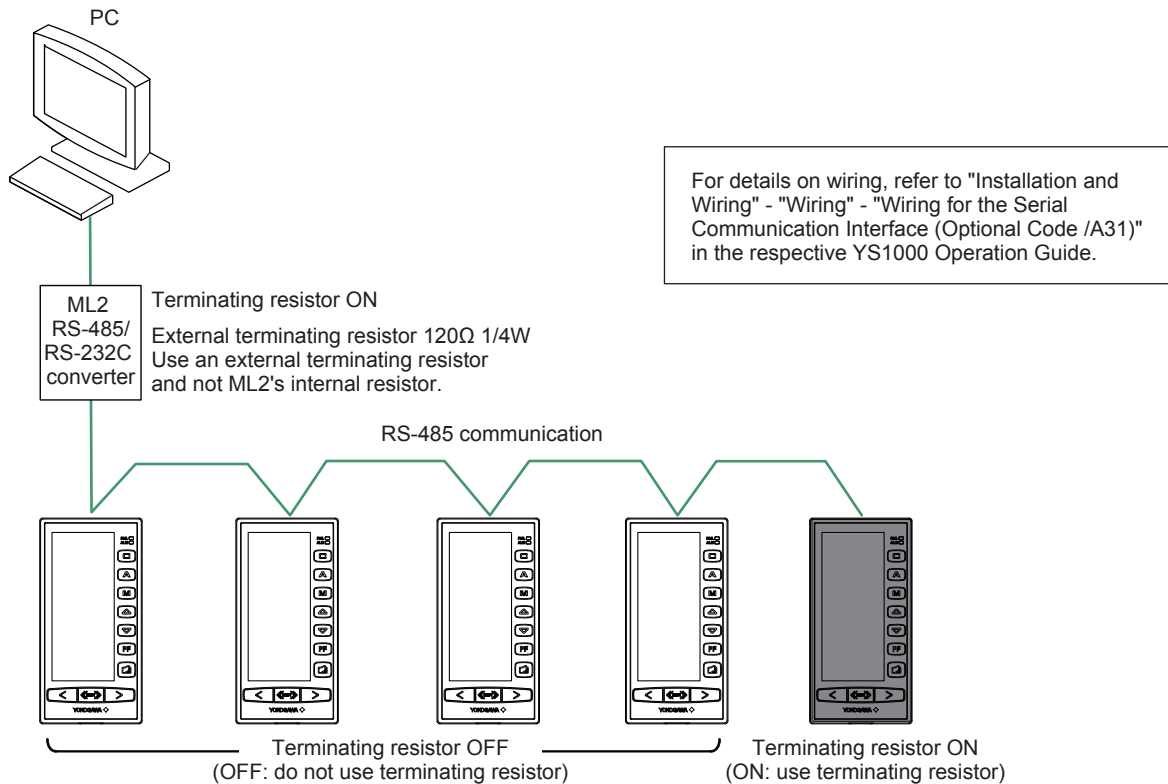

0204E.ai

2.2.3 Setting DCS-LCS Communication (optional code /A32)

Setting Display

Engineering Display

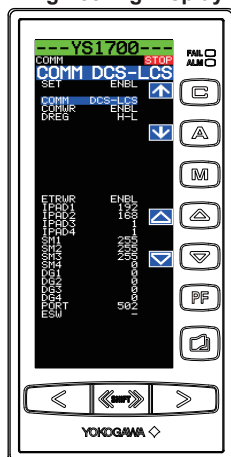

0206E.ai

Operation Display > + keys (to the Tuning Menu Display) > + keys (to the Engineering Menu Display 1) > key (to the Engineering Menu Display 2) > [COMM] software key (Communication Setting Display)

Setting Details

Parameter	Name	Setting Range		Factory Default
COMM	Communication selection	DCS-LCS communication	Fixed at DCS-LCS (0) option	According to the optional code specification
COMWR	Enable/Disable writing via DCS-LCS communication	Setting enabled	ENBL (0)	ENBL (0)
		Setting disabled	INHB (1)	

Note: Figures in parentheses "(") are values to be set when performing communication.

Description

- Terminal communication selection
This setting is fixed at "DCS-LCS communication" according to the optional code /A32 specification. Parameter COMM is read-only.
- Enable/Disable writing via DCS-LCS communication
Set "ENBL" to enable writing of data from the DCS, and "INHB" to disable writing.

2.2 Setting Parameters

2.2.4 Setting Ethernet Communication (optional code /A34)

Setting Display

Engineering Display

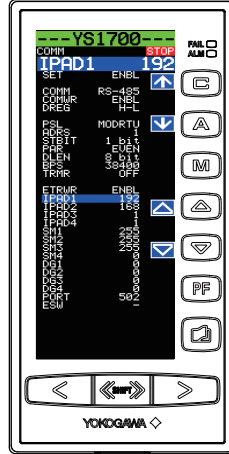

0207E.ai

Operation Display > [←] + [F] keys (to the Tuning Menu Display) > [←] + [F] keys (to the Engineering Menu Display 1) > [F] key (to the Engineering Menu Display 2) > [COMM] software key (Communication Setting Display)

Setting Details

Parameter	Name	Setting Range		Factory Default
		Setting enabled	ENBL (0)	
ETRWR	Enable/Disable writing via Ethernet communication	Setting enabled	ENBL (0)	ENBL (0)
		Setting disabled	INHB (1)	
DREG2	Ethernet communication D register setting for High/Low level	High level-Low level	H-L (0)	H-L (0)
		Low level-High level	L-H (0)	
ECTO	Ethernet communication timeout period	4 to 60 s		60
IPAD1	IP address 1	0 to 255		192
IPAD2	IP address 2			168
IPAD3	IP address 3			1
IPAD4	IP address 4			1
SM1	Subnet mask 1	0 to 255		255
SM2	Subnet mask 2			255
SM3	Subnet mask 3			255
SM4	Subnet mask 4			0
DG1	Default gateway 1	0 to 255		0
DG2	Default gateway 2			0
DG3	Default gateway 3			0
DG4	Default gateway 4			0
PORT	Port number	502, 1024 to 65535		502
ESW	Ethernet setting switch	- (0), ENTRY (1)		- (0)

Note: Figures in parentheses "()" are values to be set when performing communication.

Description

- Enable/Disable writing via Ethernet communication
Set "ENBL" to enable writing of data via Ethernet communication, and "INHB" to disable writing.
- Ethernet communication D register setting for High/Low level
Two D registers are used to express one parameter data. Select which of the two registers is to be treated as the high-level register or low-level register.

- IP address

Set the YS1000's IP address according to the following format:

IP address 0 to 255 0 to 255 0 to 255 0 to 255

. . .

0208E.ai

- Subnet mask

Set the YS1000's subnet mask according to the following format:

Subnet Mask 0 to 255 0 to 255 0 to 255 0 to 255

. . .

0209E.ai

- Default gateway

Set the YS1000's default gateway according to the following format:

Default Gateway 0 to 255 0 to 255 0 to 255 0 to 255

. . .

0210E.ai

- * Consult with the administrator of the network to which the YS1000 is to be connected before determining the IP address, subnet mask and default gateway settings.

- Port No.

Generally, use "502" as the port in the Modbus/TCP protocol. To use a different port No., set within the range 1024 to 65535.

- Ethernet setting switch

This switch is for enabling the Ethernet communications parameter settings. Setting this parameter to ENTRY "1" enables the parity, IP address, subnet mask, default gateway, and port No. settings. After this parameter is set to ENTRY "1" to enable the settings and Ethernet communication is enabled, it is automatically returned to "-0".

- * It takes about 20 seconds for the settings of Ethernet communication parameters to be enabled.

2.3 Setting the Computer Mode

The YS1000 has the following two computer modes, SPC and DDC, in addition to the regular mode in which the YS1000 is centrally monitored from the host computer or DCS. The computer modes are enabled in RS-485 communication (PC link, Modbus, YS protocol), Ethernet communication and DCS-LCS communication.

► [Computer mode in controller mode: "YS1500 Indicating Controller/YS1700 Programmable Indicating Controller User's Manual"](#)

SPC mode: In this mode, setpoints are assigned from the host system.

DDC mode: In this mode, the control operation result on the host system is output as the manipulated signal.

The following table summarizes the computer modes supported by each YS1000.

Computer modes supported by YS1000

Model	Computer Mode	
	SPC mode	DDC mode
YS1500 Indicating controller	✓	✓
YS1700 Programmable indicating controller	✓	✓
YS1310 Indicator with alarm	N/A	N/A
YS1350 Manual setter for SV setting	N/A	✓
YS1360 Manual setter for MV setting	N/A	✓

Legend ✓: Available, N/A: Not available

To use the computer mode, the settings in 2.2.1 and 2.2.2 are required.

2.3.1 Setting the C Mode

The state in which the C lamp of the operation mode key on the front panel of the YS1000 is lit is called the "C mode."

There are two "C modes," the "CAS mode" and "CMP mode."

Setting Display

Parameter	Name	Setting Range	Factory Default
CMOD1	C mode 1	-: None (0) CAS: Analog cascade setting mode (1) CMP: Computer cascade setting mode (2)	- (none) (0)
CMOD2	C mode 2	-: None (0) CAS: Analog cascade setting mode (1) CMP: Computer cascade setting mode (2)	- (none) (0)

Note: Figures in parentheses "(") are values to be set when performing communication.

Setting Details

The C mode is set in the CMODn (C mode selection n (n=1, 2*)) parameter (data selecting: -, CAS, CMP).

*: CMOD1 only is available on the YS1350/YS1360. CMOD2 is not available.

CAS mode: Analog cascade setting mode

External cascade input signals (1 to 5V) are treated as the following values:

YS1500/YS1700: Setpoint value

YS1350: Setting output value

YS1360: Manipulated output variable

CMP mode: Computer cascade setting mode

The setpoints and manipulated output variable of the YS1000 can be set in the SPC mode or DDC mode from the host computer by communications.

2.3.2 Setting the Backup Mode

When the YS1000 receives the FAIL signal from the host computer or DCS, or watchdog timer writing is discontinued during operation in the computer mode, the host system regards this as a communications failure.

Reception of FAIL signal: During DCS-LCS communication

Discontinuation of watchdog timer writing: During RS-485 host communication (PC link, Modbus, YS protocol)

(monitored by communication watchdog timer (CMWDT), see "3.1.5.")

The YS1000 continues operation even if it is made offline from the host system.

This operation status is called the "backup mode." There are two backup modes, the Automatic operation backup mode and the Manual operation backup mode.

When using the YS1500/YS1700 in the computer mode, set backup mode parameters BMOD1 or BMOD2 to either of the following settings:

BUM: Manual operation backup mode, output hold

BUA: Automatic operation backup mode

The YS1350/YS1360 are not provided with backup mode parameter settings, and are set to the BUM (Manual operation backup mode, output hold) at all times.

When the YS1000 enters the backup mode during operation in the "CMP mode," [BUM] or [BUA] are displayed on its display. When an error occurs on the host system during operation in the automatic control or manual control, the controller does not enter the backup mode.

In BUM mode: C lamp lit, M lamp blinking

In BUA mode: C lamp lit, A lamp blinking

2.4 Operation Mode Transitions

2.4.1 YS1500/YS1700 Operation Mode Transitions (when RS-485 host communication is used)

YS1500/YS1700 side: Display and Operation for Operation Modes

- Loop 1 (LS1) and Loop 2 (LS2) when BSC2 is used in the programmable mode
- Loop 2 (LS2) during cascade and selector control

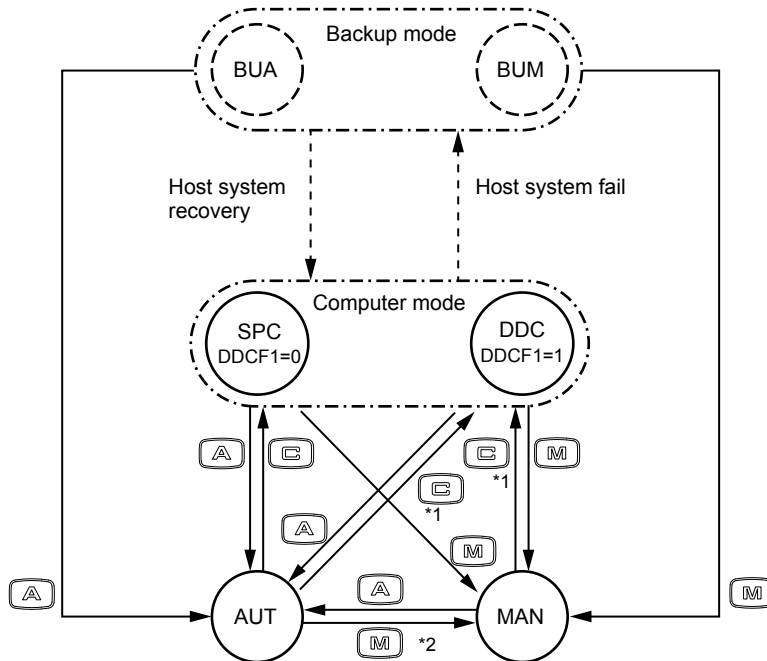

*1: In the MAN or AUT status when the DDC status is ON (DDCF1=1), move to the DDC status by operating the **C** key on the front panel of the YS1500/YS1700.

*2: The **M** key can be used by setting DDCF=1 in the communication command LS1 (DDC). However, when the power is turned OFF, DDCF=0.

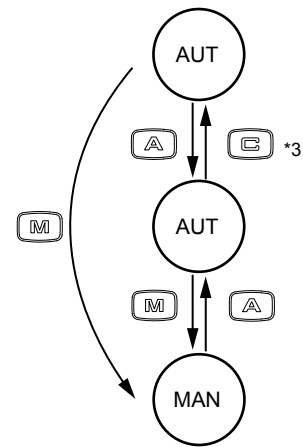

*3: During selector control, CMOD2 must be set to CAS.

- ← : Transitions to possible operation
- ← - - - : Transition to abnormal states and recovery
- : Operation on YS1000
- : Operation mode
- (dashed) : Operation mode in abnormal state
- (dotted) : Group in operation mode

0211E.ai

2.4.2 YS1500/YS1700 Operation Mode Transitions (when DCS-LCS communication is used)

YS1500/YS1700 side: Display and Operation for Operation Modes

- Loop 1 (LS1) and Loop 2 (LS2) when BSC2 is used in the programmable mode
- Loop 2 (LS2) during cascade and selector control

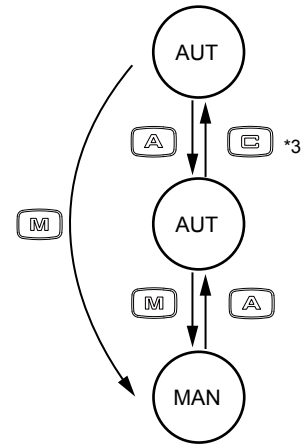
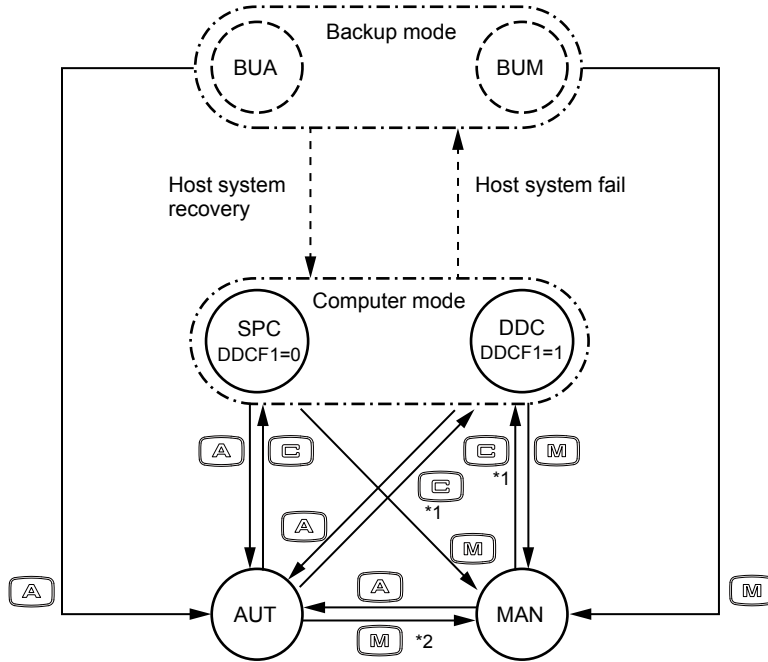

*3: During selector control, CMOD2 must be set to CAS.

*1: In the MAN or AUT status when the DDC status is ON (DDCF1=1), move to the DDC status by operating the **C** key on the front panel of the YS1500/YS1700.

*2: The **M** key can be used by setting DDCF=1 in the communication command LS1 (DDC). However, when the power is turned OFF, DDCF=0.

- ← : Transitions to possible operation
- ← - - - : Transition to abnormal states and recovery
- ◻ : Operation on YS1000
- : Operation mode
- ◌ (dashed) : Operation mode in abnormal state
- ◌ (dashed circle) : Group in operation mode

0212E.ai

2.4 Operation Mode Transitions

2.4.3 YS1350/YS1360 Operation Mode Transitions (when RS-485 host communication or DCS-LCS communication is used)

YS1350/YS1360 side: Display and Operation for Operation Modes

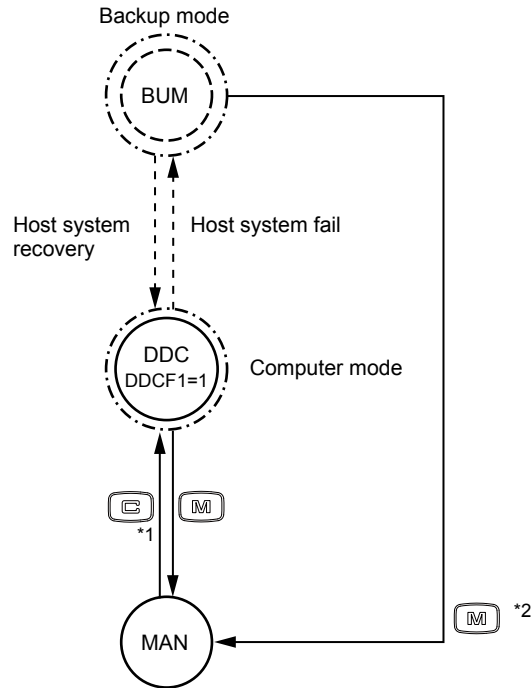

*1: In the MAN status when the DDC status is ON (DDCF1=1), move to the DDC status by operating the **C** key on the front panel of the YS1350/YS1360.

*2: The **M** key can be used by setting DDCF=1 in the communication command LS1 (DDC). However, when the power is turned OFF, DDCF=0.

- ← : Transitions to possible operation
- ← - - - : Transition to abnormal states and recovery
- C** : Operation on YS1000
- : Operation mode
- - - - : Operation mode in abnormal state
- - - - : Group in operation mode

0213E.ai

3.1 Modbus Communication

3.1.1 Overview

The YS1000 can communicate with PCs, PLCs(Sequencer), display devices, and other devices by using Modbus communication. With Modbus communication, the D registers (YS1000 internal registers) are read and written.

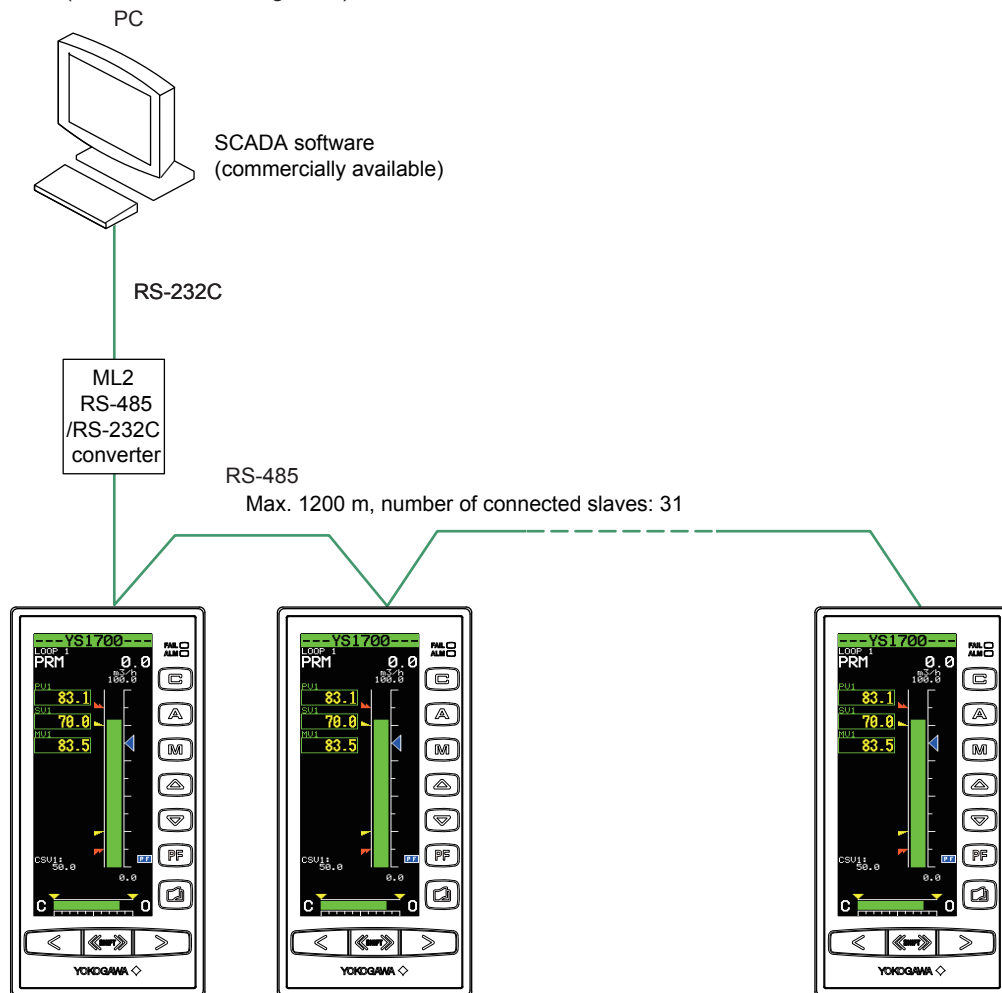

Figure 3.1 Overview of Modbus Communication Connection

0301E.ai

- ▶ D registers: "Chapter 6 Functions and Application of YS1500/YS1700 D-registers" or "Chapter 7 Functions and Application of YS1310/YS1350/YS1360 D-registers" in this manual

3.1 Modbus Communication

There are two transfer modes in Modbus communication, the ASCII mode and RTU mode (binary method).

When multiple controllers are connected on a single network, all of the controllers must be set to the same transfer mode.

The following table compares the RTU and ASCII modes.

Table 3.1 Comparison of RTU and ASCII Modes

Item	ASCII Mode	RTU Mode
Number of data bits	7bit (ASCII)	8bit (binary)
Detection of message start	Text: (colon)	Time Silent interval of 3.5 characters or more
Detection of message end	Text CR+LF	Time Silent interval of 3.5 characters or more
Message length (*1)	2N+1	N
Inter-character timer timeout	1 second	None
Error detection	Longitudinal redundancy check: LRC	Cyclic redundancy check: CRC-16

*1: The message length in the ASCII mode becomes "2N+1" when the message length in the RTU mode is set to "N".

Detection of message frame termination in RTU mode

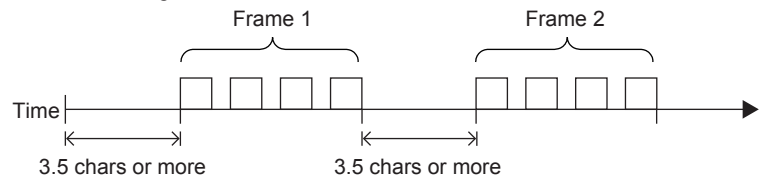

0302E.ai

Note

When the write data to D registers is outside the valid range, the response is returned as "normal." Cannot be written to D registers.

3.1.2 Configuration of Messages

The structure of messages sent to the YS1000 from the host computer is as follows:

	(1)	(2)	(3)	(4)	(5)	(6)
Element	Message start mark	Address No (ADRS)	Function code	Data	Error check	Message end mark
Number of bytes in RTU mode	None	1	1	2n (variable length)	2	None
Number of bytes in ASCII mode	1	2	2	4n (variable length)	2	2

- (1) Message start mark
This indicates the start of the message. A colon (:) is required only in the ASCII mode.
- (2) Address No. (01 to 99)
This No. is for enabling the host computer to identify the YS1000 at the communication destination.
(Individual YS1000 ID Nos. are expressed in messages in Hex.)
- (3) Function code (See "3.1.6 Messages and Responses.")
The instruction (function code) from the host computer is specified.
- (4) Data
The D register No. , number of D registers, and parameter values, etc. are specified according to the function code.
(These are expressed in Hex in messages.)
- (5) Error check
In the RTU mode, errors are checked by the cyclic redundancy check (CRC-16).
In the ASCII mode, errors are checked by the longitudinal redundancy check (LRC).
- (6) Message end mark
This indicates the end of the message. "CR" and "LF" are required only in the ASCII mode.

3.1 Modbus Communication

■ Specifying D registers

When specifying D registers, pay attention to each of the D register Nos. as the specified D registers for messages in the user communication program differ from the specified D registers when a commercially available SCADA, for example, is used.

In the case of a user communication program, specify the following as the D register No.:

D register No. = reference No. - 40001

Example:

When specifying "D0043 (reference No.: 40043)"

Specify the message in the user communication program as "002A". This number is the number "42" (number obtained by subtracting 40001 from the reference No.) expressed in Hex.

In SCADA, specify the reference number.

■ Error check

The error checking of the ASCII mode is different from the RTU mode.

● ASCII mode

In the ASCII mode, error checking is performed by the longitudinal redundancy check (LRC).

Each individual byte from the communication address up to the final data (excluding ":", "CR" and "LF") is added, and the 2's complement of the result becomes LRC.

Ignore the uppermost carry during addition.

Example:

How to calculate the LRC in the case of command [:]110300C80004[LRC][CR][LF] for reading values continuously from D register D0201 of the controller at communication address 17

(1) Communication address 17 is expressed as "0x11" in Hex.

D0201 is "0x00C8". This is the number "200" (number obtained by subtracting 40001 from reference No. 40201) expressed in Hex.

When this is converted to 1-byte Hex data, this becomes "11,03,00,C8,00,04".

(In Modbus/ASCII messages, "11" is ASCII code "H' 31, H' 31", which comprises two bytes.)

(2) This 1-byte Hex data is added one byte at a time as follows:

→ 11+03+00+C8+00+04 = E0

(3) 2's complement of the lowermost 1 byte of the result of addition is "20".

11100000 (0xE0)→ 00011111 (complement) +1=00100000 (20)

● RTU Mode

In the RTU mode, error checking is performed by the cyclic redundancy check (CRC-16). Of all message blocks (from communication address through to final data), eight bits (excluding start bit, stop bit and parity bit) are aligned serially, and the remainder (16 bits) when the result is divided by predetermined binary 17 bits becomes the CRC-16.

Example (CRC-16 calculation example)

When reading four data from D register D0043 by function code 03 (read status of multiple D registers) from the slave at communication address 11 (0Bh). "0B03002A0004" is sent as the send command.

- (1) Default is FFFF. This is XORed (exclusive ORed) with the 1st byte (= slave address 11).
- (2) The lower byte of the result is referenced, and the value corresponding to that value in the following table is obtained. In this case, the 244th value in the table is referenced to obtain 8701h as the result is F4h.
- (3) The upper byte of the result of the XOR in (1) is XORed with the result of (2).
- (4) The result (remainder) of (3) is taken as the next default, and the same operation is performed on the 2nd byte (=function code 03).

Default value	FF FF
Communication address	0B

XOR	FF F4
Reference to table	87 01

XOR	87 FE
Function code	03

XOR	87 FD
Reference to table	81 C1

XOR	81 46
.	.
.	.
.	.

XOR	E5 9E
Last character	04

XOR	E5 9A
Reference to table	6B 80

Resulting error	6B 65

Convert the hex value to a decimal value, find the corresponding number in Table 3.2, and substitute the number into the formula.
 In the example shown on the left, hex value "F4" is converted to decimal value 244. From Table 3.2, the number corresponding to 244 proves to be "8701". This number is substituted into the formula.

- (5) From here on, steps (1) to (4) are repeated to calculate up to the final "04".
- (6) The upper and lower bytes of the result of calculation "6B65" are inverted, and "656B" is appended to the final.
 0B03002A0004656B

3.1 Modbus Communication

Table 3.2 Table Showing Results of Error Checking (CRC) of Values 0 to 255 by A001h

Number	0	1	2	3	4	5	6	7
Result	0000	C0C1	C181	0140	C301	03C0	0280	C241
Number	8	9	10	11	12	13	14	15
Result	C601	06C0	0780	C741	0500	C5C1	C481	0440
Number	16	17	18	19	20	21	22	23
Result	CC01	0CC0	0D80	CD41	0F00	CFC1	CE81	0E40
Number	24	25	26	27	28	29	30	31
Result	0A00	CAC1	CB81	0B40	C901	09C0	0880	C841
Number	32	33	34	35	36	37	38	39
Result	D801	18C0	1980	D941	1B00	DBC1	DA81	1A40
Number	40	41	42	43	44	45	46	47
Result	1E00	DEC1	DF81	1F40	DD01	1DC0	1C80	DC41
Number	48	49	50	51	52	53	54	55
Result	1400	D4C1	D581	1540	D701	17C0	1680	D641
Number	56	57	58	59	60	61	62	63
Result	D201	12C0	1380	D341	1100	D1C1	D081	1040
Number	64	65	66	67	68	69	70	71
Result	F001	30C0	3180	F141	3300	F3C1	F281	3240
Number	72	73	74	75	76	77	78	79
Result	3600	F6C1	F781	3740	F501	35C0	3480	F441
Number	80	81	82	83	84	85	86	87
Result	3C00	FCC1	FD81	3D40	FF01	3FC0	3E80	FE41
Number	88	89	90	91	92	93	94	95
Result	FA01	3AC0	3B80	FB41	3900	F9C1	F881	3840
Number	96	97	98	99	100	101	102	103
Result	2800	E8C1	E981	2940	EB01	2BC0	2A80	EA41
Number	104	105	106	107	108	109	110	111
Result	EE01	2EC0	2F80	EF41	2D00	EDC1	EC81	2C40
Number	112	113	114	115	116	117	118	119
Result	E401	24C0	2580	E541	2700	E7C1	E681	2640
Number	120	121	122	123	124	125	126	127
Result	2200	E2C1	E381	2340	E101	21C0	2080	E041
Number	128	129	130	131	132	133	134	135
Result	A001	60C0	6180	A141	6300	A3C1	A281	6240
Number	136	137	138	139	140	141	142	143
Result	6600	A6C1	A781	6740	A501	65C0	6480	A441
Number	144	145	146	147	148	149	150	151
Result	6C00	ACC1	AD81	6D40	AF01	6FC0	6E80	AE41
Number	152	153	154	155	156	157	158	159
Result	AA01	6AC0	6B80	AB41	6900	A9C1	A881	6840
Number	160	161	162	163	164	165	166	167
Result	7800	B8C1	B981	7940	BB01	7BC0	7A80	BA41
Number	168	169	170	171	172	173	174	175
Result	BE01	7EC0	7F80	BF41	7D00	BDC1	BC81	7C40
Number	176	177	178	179	180	181	182	183
Result	B401	74C0	7580	B541	7700	B7C1	B681	7640
Number	184	185	186	187	188	189	190	191
Result	7200	B2C1	B381	7340	B101	71C0	7080	B041
Number	192	193	194	195	196	197	198	199
Result	5000	90C1	9181	5140	9301	53C0	5280	9241
Number	200	201	202	203	204	205	206	207
Result	9601	56C0	5780	9741	5500	95C1	9481	5440
Number	208	209	210	211	212	213	214	215
Result	9C01	5CC0	5D80	9D41	5F00	9FC1	9E81	5E40
Number	216	217	218	219	220	221	222	223
Result	5A00	9AC1	9B81	5B40	9901	59C0	5880	9841
Number	224	225	226	227	228	229	230	231
Result	8801	48C0	4980	8941	4B00	8BC1	8A81	4A40
Number	232	233	234	235	236	237	238	239
Result	4E00	8EC1	8F81	4F40	8D01	4DC0	4C80	8C41
Number	240	241	242	243	244	245	246	247
Result	4400	84C1	8581	4540	8701	47C0	4680	8641
Number	248	249	250	251	252	253	254	255
Result	8201	42C0	4380	8341	4100	81C1	8081	4040

0304E.ai

3.1.3 Configuration of Responses (response from YS1000)

If the instruction message from the host computer is normal and the address is for itself, the YS1000 moves to the process execution phase after it judges that the received content is normal. The YS1000 then parses the content of the instruction message and executes processing.

However, it does not execute processing if the content of the instruction message is in error. In this case, the YS1000 either ignores received content, or generates a response message to inform the host computer that the received content is in error.

After executing the requested processing when the received content is normal, the YS1000 generates a response message appended with an error check corresponding to the instruction function code, and sends this message to the host computer.

- Response in a normal state

In the case of the loopback function and write function on a single D register, the YS1000 returns the same response message as the instruction message.

In the case of a write function on multiple D registers, the YS1000 returns part of the instruction message as the response message.

In the case of the read function, the YS1000 appends the address No. and function code with the data that was read, and returns this as the response message.

- Response in an error state

"COMM" is displayed on the ALARM display as a communication error (framing error, parity error, inter-character timer timeout, receiving frame over-length). In this case, the YS1000 does not return a message.

When the message contains an inconsistency other than a communication error, the YS1000 does not perform any processing, and returns the following message.

Element	Message start mark	Address No (ADRS)	Function code (*1)	Error Code	Error check	Message end mark
Number of bytes in RTU mode	None	1	1	1	2	None
Number of bytes in ASCII mode	1	2	2	2	2	2

*1: The number "function code (Hex) + 0x80" is entered in the function code.

The following shows the details of the error code.

Error Code	Meaning	Cause
01	Function code error	The function code does not exist.
02	D register No. error	A No. outside the range has been specified.
03	Number of D registers error	A number of registers outside the range has been specified.
09	Monitor not specified	An attempt was made to read a monitor without specifying the monitor.

Even if continuous D registers specified by a read function include unused registers, no error is generated, and the YS1000 returns "0" as the value.

The YS1000 returns error code "02" or "03" when the start address of continuously specified addresses is in the range, and the continuously specified addresses become out of range as a result of the number of specified addresses. (according to function code)

- When there is no response even after a message is sent
 - When a transmission error (overrun, framing, parity, LRC or CRC-16 error) is detected
 - When the address in the instruction message is wrong
 - When there is a blank of at least one second in the data interval that comprises the message
However, it takes one second or more for response when the CTL (controller mode selection) of YS1500/YS1700 is changed.
 - When the communication address is "00" or "F8" (broadcast specification)
 - When a receive buffer overflow (buffer size: 512 bytes) has occurred

Note: *As a measure for the above, execute time-out processing by the communication function or communication program on the host computer.

3.1.4 Specifying Broadcast

This function allows multiple instruments specified by respective addresses to receive commands.

- (1) Broadcast specification is executed with the following addresses specified to the address No. in the command:
 "00": YS1000s on network
 "F8": YS1000 controllers (YS1500/YS1700) on network
- (2) This command functions regardless of communication address.
- (3) This address can be used only for writing.
- (4) When communication is performed with this address specified, the YS1000 that receives the command does not return a response.

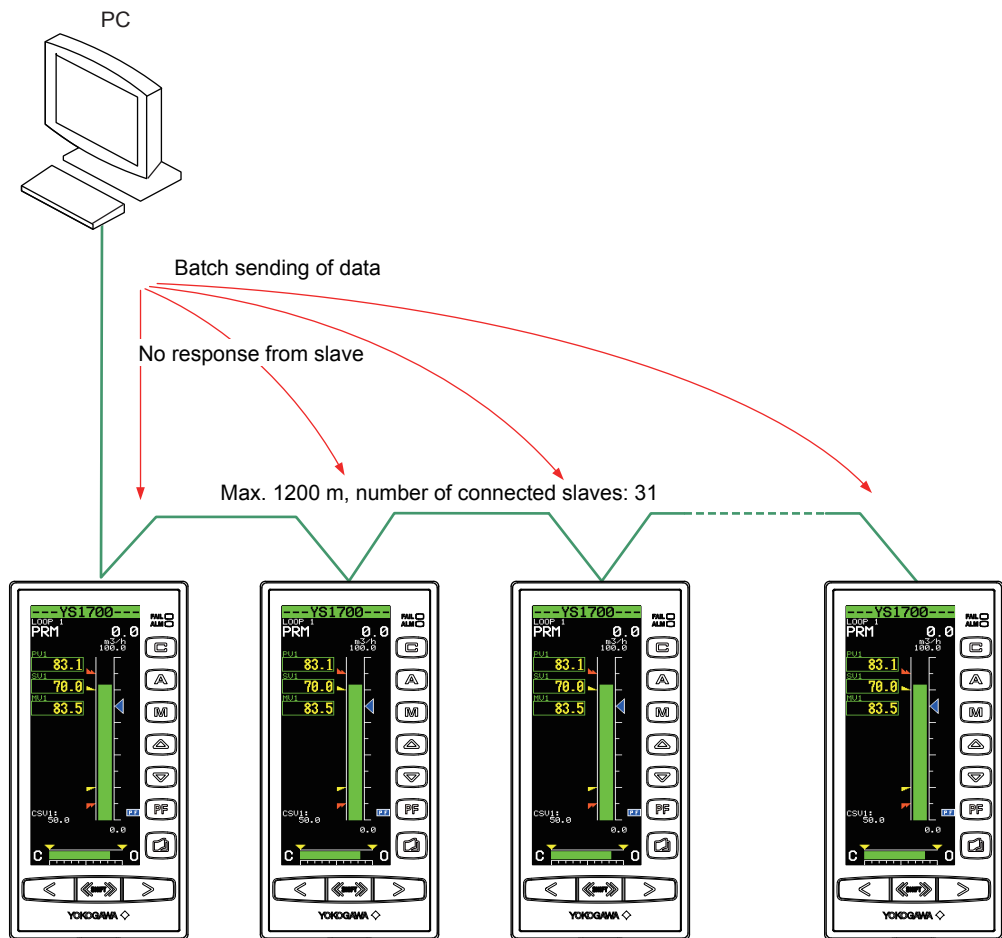

Figure 3.2 Broadcast Specification

0305E.ai

D registers are used for processing in communication on the YS1000.

[Example]

Write "1" to D0401 by the broadcast command.

[:]00100190000204000000158[CR][LF]

"00" broadcast specification, "10" function code 16, "0190" D register read No. 401, "0002" number of registers, "04" byte count, "00000001" data 0001, "58" error check

Note: Numbers enclosed by "" are Hex numbers.

No response is returned to the above messages.

3.1.5 Monitoring Discontinuation of Communication with Host Computer (description of CMWDT)

To detect a communication failure on the host computer with the YS1000 in the computer cascade mode (SPC mode or DDC mode), the host computer must send the reception timeout time at a fixed interval to the YS1000.

(This is done by writing the reception timeout value (1 to 9999 [seconds]) to the D register (CMWDT).)

When the reception timeout value is not written to CMWDT within this preset time, the YS1000 regards this as "operation suspended on the host computer" (communication failure), and immediately moves to the backup mode.

This function is disabled when the reception timeout value is set to "0" seconds.

The factory default or the value when the power is turned ON is "0 seconds (function disabled). The factory default or the value when the power is turned ON is "0 seconds (function disabled)."

3.1 Modbus Communication

3.1.6 Messages and Responses

These instruction words are used so that the host computer obtains the D register information of the YS1000.

For write commands, when the enable/disable writing from RS-485 communication (parameter: COMWR) setting is set to write-disabled, all write commands are disabled.

Table 3.3 List of Function Codes

Code No.	Function	Description
03	Reading of multiple D registers	Up to 100 D registers can be read continuously from D0001 to D4000.
06	Writing of D registers	Only one D register can be written from D0951 to D1000.
08	Loopback test	This is used to check the communication connection.
16	Writing of multiple D registers	Up to 50 D registers can be written continuously from D0001 to D4000.
66	Random reading	Up to 100 registers can be read at random from D0001 to D4000.
67	Random writing	Up to 50 registers can be read at random from D0001 to D4000.
68	Specify monitor	Up to 100 registers can be specified monitor at random from D0001 to D4000.
69	Reading of monitor	The register specified by "specify monitor" is read.

Function codes cannot be written to read-only or use-disabled registers.

■ 03 Reading multiple D registers

● Function

The content of D registers is read continuously for the number of registers specified from the specified D register No.

- The maximum number of registers that can be read in a single operation is 100.
- For details on the response format in an error, see "• Response in an error state" in "3.1.3 Configuration of Responses (response from YS1000)."

● Message (during normal operation)

Element	Message start mark (:)	Address No. (ADRS)	Function code (0x03)	Register start No.	Number of read registers	Error check	Message end mark (CR+LF)
Number of bytes in RTU mode	None	1	1	2	2	2	None
Number of bytes in ASCII mode	1	2	2	4	4	2	2

● Response (during normal operation)

Element	Message start mark (:)	Address No. (ADRS)	Function code (0x03)	Byte count (Note 1)	Register content	...
Number of bytes in RTU mode	None	1	1	1	2	...
Number of bytes in ASCII mode	1	2	2	2	4	...

Continuation of response

Register content	Error check	Message end mark (CR+LF)
2	2	None
4	2	2

Note 1: Byte count = 2 x number of read registers

■ 06 Writing D registers

- Function

Writes data to the specified register No.

- The number of registers that can be written in one write is 1.
- For details on the response format in an error, see "• Response in an error state" in "3.1.3 Configuration of Responses (response from YS1000)."
- When data outside the setting range of parameters is set, the response is a normal response, but the data is not written.
- Broadcasting can be specified.

- Message (during normal operation)

Element	Message start mark (:)	Address No. (ADRS)	Function code (0x06)	Register start No (Note 1)	Write data	Error check	Message end mark (CR+LF)
Number of bytes in RTU mode	None	1	1	2	2	2	None
Number of bytes in ASCII mode	1	2	2	4	4	2	2

- Response (during normal operation)

Element	Message start mark (:)	Address No. (ADRS)	Function code (0x06)	Register start No. (Note 1)	Write data	Error check	Message end mark (CR+LF)
Number of bytes in RTU mode	None	1	1	2	2	2	None
Number of bytes in ASCII mode	1	2	2	4	4	2	2

Note 1: Only the register numbers of D0951 to D1000 can be specified.

■ 08 Loopback test

- Function

This is used to check the communication connection.

- For details on the response format in an error, see "• Response in an error state" in "3.1.3 Configuration of Responses (response from YS1000)."
- The diagnostics code is fixed at "0000".
- Any data can be selected for the send data.

- Message (during normal operation)

Element	Message start mark (:)	Address No. (ADRS)	Function code (0x08)	Diagnostic code (0000)	Send data (arbitrary)	Error check	Message end mark (CR+LF)
Number of bytes in RTU mode	None	1	1	2	2	2	None
Number of bytes in ASCII mode	1	2	2	4	4	2	2

- Response (during normal operation)

Element	Message start mark (:)	Address No. (ADRS)	Function code (0x08)	Diagnostic code (0000)	Same as send data	Error check	Message end mark (CR+LF)
Number of bytes in RTU mode	None	1	1	2	2	2	None
Number of bytes in ASCII mode	1	2	2	4	4	2	2

3.1 Modbus Communication

■ 16 Writing to multiple D registers

● Function

Data is written to registers continuously for the number of registers specified from the specified register No.

- The maximum number of registers that can be written in a single operation is 50.
- For details on the response format in an error, see "• Response in an error state" in "3.1.3 Configuration of Responses (response from YS1000)."
- When data outside the setting range of parameters is set, the response is a normal response, but the data is not written.
- Broadcasting can be specified. No response is returned when broadcasting is specified.

● Message (during normal operation)

Element	Message start mark (:)	Address No. (ADRS)	Function code (0x10)	Register start No.	Number of registers	Byte count (Note 1)
Number of bytes in RTU mode	None	1	1	2	2	1
Number of bytes in ASCII mode	1	2	2	4	4	2

Continuation of message

Write data	• • •	Write data	Error check	Message end mark (CR+LF)
2	• • •	2	2	None
4	• • •	4	2	2

Note 1: Byte count = 2 × number of write registers

● Response (during normal operation)

Element	Message start mark (:)	Address No. (ADRS)	Function code (0x10)	Register start No.	Number of registers	Error check	Message end mark (CR+LF)
Number of bytes in RTU mode	None	1	1	2	2	2	None
Number of bytes in ASCII mode	1	2	2	4	4	2	2

■ 66 Random reading

- Function
Reads the register data of register Nos. specified at random.
- Register Nos. can be specified from all register areas.
- The maximum number of registers that can be set is 100.
- For details on the response format in an error, see "• Response in an error state" in "3.1.3 Configuration of Responses (response from YS1000)."

● Message (during normal operation)

Element	Message start mark (:)	Address No. (ADRS)	Function code (0x42)	Number of specified registers	Byte count (Note 1)
Number of bytes in RTU mode	None	1	1	2	1
Number of bytes in ASCII mode	1	2	2	4	2

Continuation of message

Specified Register No.	...	Specified Register No	Error check	Message end mark (CR+LF)
2	...	2	2	None
4	...	4	2	2

● Response (during normal operation)

Element	Message start mark (:)	Address No. (ADRS)	Function code (0x42)	Byte count (Note 1)	Register conten
Number of bytes in RTU mode	None	1	1	1	2
Number of bytes in ASCII mode	1	2	2	2	4

...
...
...

Continuation of response

Register content	Error check	Message end mark (CR+LF)
2	2	None
4	2	2

Note 1: Byte count = 2 x number of read registers

3.1 Modbus Communication

■ 67 Random writing

- Function

Writes the register No. and data of register Nos. specified at random.

- Register Nos. can be specified from all register areas.
- The maximum number of registers that can be written to in a single write is 50.
- For details on the response format in an error, see "• Response in an error state" in "3.1.3 Configuration of Responses (response from YS1000)."

- Message (during normal operation)

Element	Message start mark (:)	Address No. (ADRS)	Function code (0x43)	Number of specified registers	Byte count (Note 1)	Specified register No.1
Number of bytes in RTU mode	None	1	1	2	2	2
Number of bytes in ASCII mode	1	2	2	4	4	4

Continuation of message

Write data 1	...	Specified Register No.n	Write data n	Error check	Message end mark (CR+LF)
2	...	2	2	2	None
4	...	4	4	2	2

Note 1: Byte count = 4 × number of write registers

- Response (during normal operation)

Element	Message start mark (:)	Address No. (ADRS)	Function code (0x43)	Number of specified registers	Error check	Message end mark (CR+LF)
Number of bytes in RTU mode	None	1	1	2	2	None
Number of bytes in ASCII mode	1	2	2	4	2	2

■ 68 Specify monitor

● Function

Sets a register No. in the range D0001 to D4000 specified at random as specified for monitoring.

- The maximum number of registers that can be set for monitoring is 100.
- For details on the response format in an error, see "• Response in an error state" in "3.1.3 Configuration of Responses (response from YS1000)."

● Message (during normal operation)

Element	Message start mark (:)	Address No. (ADRS)	Functioncode (0x44)	Number of monitor-specified register	Byte count(Note 1)
Number of bytes in RTU mode	None	1	1	2	1
Number of bytes in ASCII mode	1	2	2	4	2

Continuation of message

Monitor-specified Register No.	...	Monitor-specified Register No.	Error check	Message end mark (CR+LF)
2	...	2	2	None
4	...	4	2	2

● Response (during normal operation)

Element	Message start mark (:)	Address No. (ADRS)	Function code (0x44)	Byte count (Note 1)	Error check	Message end mark (CR+LF)
Number of bytes in RTU mode	None	1	1	1	2	None
Number of bytes in ASCII mode	1	2	2	2	2	2

Note 1: Byte count = 2 × number of monitor-specified registers

■ 69 Monitoring

● Function

Reads the register content specified for monitoring specified by function code "68".

- For details on the response format in an error, see "• Response in an error state" in "3.1.3 Configuration of Responses (response from YS1000)."

● Message (during normal operation)

Element	Message start mark (:)	Address No. (ADRS)	Function code (0x45)	Error check	Message end mark (CR+LF)
Number of bytes in RTU mode	None	1	1	2	None
Number of bytes in ASCII mode	1	2	2	2	2

● Response (during normal operation)

Element	Message start mark (:)	Address No. (ADRS)	Function code (0x45)	Byte count (Note 1)	Register content	...
Number of bytes in RTU mode	None	1	1	1	2	...
Number of bytes in ASCII mode	1	2	2	2	4	...

Continuation of response

Register content	Error check	Message end mark (CR+LF)
2	2	None
4	2	2

Note 1: Byte count = 2 × number of read registers

3.2 PC Link Communication

3.2.1 Overview

PC link communication enables the YS1000 to communicate easily with PCs, touch panels, and FA-M3 (PLC) UT link modules. With PC link communication, the D registers (YS1000 internal registers) are read and written.

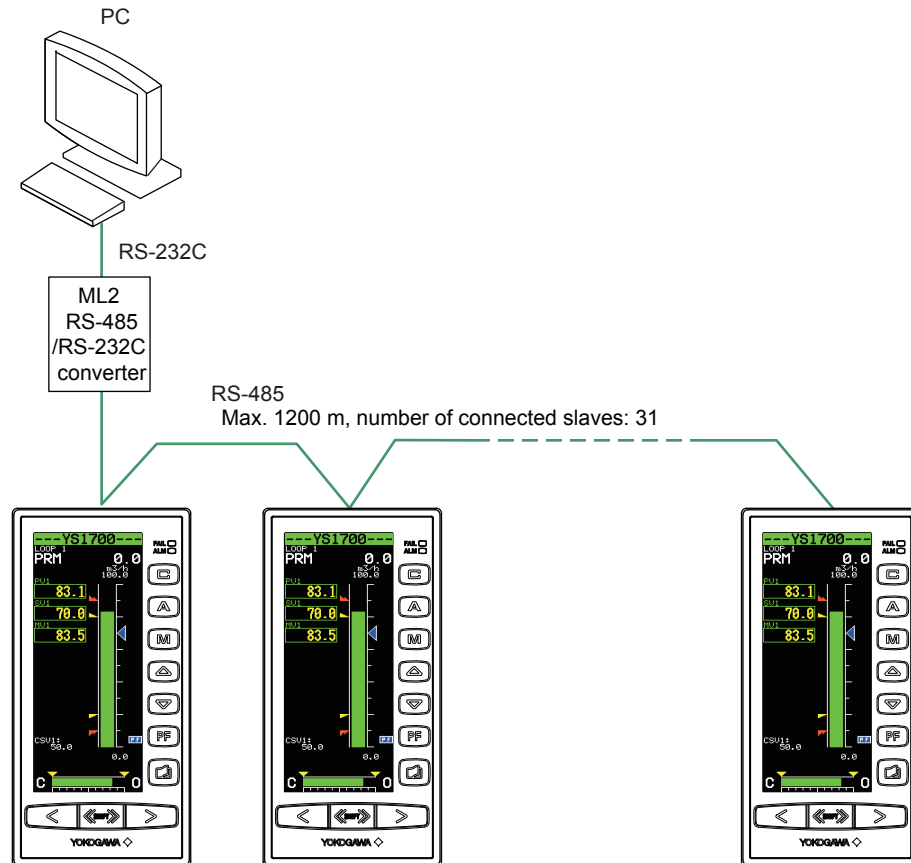

Figure 3.3 Overview of PC Link Communication Connection

0307E.ai

- ▶ D registers: "Chapter 6 Functions and Application of YS1500/YS1700 D-registers" or "Chapter 7 Functions and Application of YS1310/YS1350/YS1360 D-registers" in this manual

3.2.2 Configuration of Commands

The structure of commands sent to the YS1000 from the host computer is as follows:

	(1)	(2)	(3)	(4)	(5)	(6)	(7)	(8)	(9)
Number of bytes	1	2	2	1	3	Variable length	2	1	1
Element	STX	Address No. (ADR)	CPU No. (01)	Response waiting time	Command	Data to command corresponding	Checksum	ETX	CR

(1) STX (Start of Text)

This indicates the start of the command.

(2) Address No. (01 to 99)

This No. is for enabling the host computer to identify the YS1000 at the communication destination. (These are the ID Nos. of each YS1000.)

(3) CPU No.

Fixed at "01"

(4) Response waiting time

A waiting time (time delay) from transmission of a command up to reception of a response can be set.

Set the response waiting time within 0 to 600 ms using characters 0 to F. (The table below shows the correspondence between characters and waiting time.)

Character	Response Waiting Time (unit: ms)
0	0 (Note)
1	10
2	20
3	30
4	40
5	50
6	60
7	70
8	80
9	90
A	100
B	200
C	300
D	400
E	500
F	600

Note: Even if the response waiting time is set to "0", processing is delayed by the time taken to execute internal processing.

(5) Command (For a list of commands, see "3.2.7 Commands/Responses.")

The instruction (command) from the host computer is specified.

(6) Data corresponding to command

Internal register (D register), number of data points, etc. are specified.

D register data annotation methods are the same as in the Modbus protocol.

(For details, see "3.1.2 Configuration of Messages.")

(7) Checksum

The ASCII codes of text from the character following STX up to before the checksum are added one byte at a time. The lowermost byte of the addition result is removed, and an ASCII text string of two bytes expressed in Hex is taken to be the checksum. This column is required only when performing PC link communication with a checksum.

When performing PC link communication without a checksum, this ASCII code 2-byte area is not required.

3.2 PC Link Communication

- (8) ETX (End of Text)
This indicates the end of the command.
- (9) CR (Carriage Return)
This indicates the end of the command line.

Note

“STX”, “ETX” and “CR” are required for PC link communication commands. Communication cannot be performed normally if you forget to append these codes or make a mistake in their programmed order.

3.2.3 Configuration of Responses

YS1000 responses to commands sent from a host computer are configured as shown below according to whether execution of operation is normal or ends in error. When data outside the parameter setting range is set, the response is a normal response, but the data is not written.

- Response in a normal state

When communication is executed normally, the text string "OK" and data corresponding to the command are returned.

With write commands, parameter data area is not provided.

Number of bytes	1	2	2	2	Variable length	2	1	1
Element	STX	Address No. (ADRS)	CPU No. (01)	OK	Parameter data	Checksum	ETX	CR

- Response in an error state

When communication is not executed normally, the text string "ER" and an error code (EC1 or EC2) are returned. (See the next item, "3.2.4 Response Error Codes.

- There is no response (no reply) for address No. specification errors and CPU No. specification errors.
- Responses are sometimes not made (no reply) when the ETX in a command is not received.

Note: As a measure for the above, execute time-out processing by the communication function or in the communication program on the host computer.

Number of bytes	1	2	2	2	2	2	3	2	1	1
Element	STX	Address No. (ADRS)	CPU No. (01)	ER	EC1	EC2	Command	Checksum	ETX	CR

3.2.4 Response Error Codes

The error code (EC1) of the response and detailed error code (EC2) are as follows.

Table 3.4 List of Error Codes EC1

Error Code	Meaning	Cause
02	Command error	<ul style="list-style-type: none"> Command does not exist. Command cannot be executed.
03	Register specification error	<ul style="list-style-type: none"> Register name does not exist. Specification is incorrect when bits are used by words.
04	Setting value out of range (during a write)	<ul style="list-style-type: none"> A character other than 0 or 1 is used for the bit setting. Annotation other than Hex (0 to 9, A to F) is specified for the word setting. The start position exceeds the address range in a read/save instruction, etc.
05	Data number value out of range	<ul style="list-style-type: none"> The specification of the number of bits, number of words, etc. exceeds the specification range.
06	Monitor error	<ul style="list-style-type: none"> The monitor was executed without specifying the monitor (WRS).
08	Parameter error	<ul style="list-style-type: none"> The parameter is incorrect. (This occurs when there are no commas or spaces.)
42	Checksum error	<ul style="list-style-type: none"> Sum value mismatch
43	Internal buffer overflow	<ul style="list-style-type: none"> Data larger than the specified value (max. size of internal buffer: 512 [bytes]) was received.
44	Reception inter-character timer timeout	<ul style="list-style-type: none"> The end character or ETX is not received.

Table 3.5 List of Detailed Error Codes EC2

Error Code (EC1)	Meaning	Detailed Error Code (EC2)
03	Register specification error	Error parameter No. (Hex) Sequence No. of parameter where the error first occurred counting from the start of the parameter.
04	Setting value out of range	Example) Register name specification error ↓
05	Data number value out of range	[STX]01010WRW02 D0043,3F80.A0044,0000[ETX][CR] Parameter No. 1 2 3 4 5
08	Parameter error	[STX]0101ER0304WRW[ETX][CR] In this case, EC1=03 and EC2=04

In the case of errors other than EC1 above, EC2 is meaningless, and "00" is returned as the response.

○ Priority of error codes

Priority	Error Code EC1
High	44
↑	43
	42
	02
↓	
Low	03,04,05,06,08

When no response is returned

- (1) Transmission error (overrun, framing, parity)
- (2) When the communication address in the command is wrong (including broadcast specification)
- (3) When the CPU No. in the command is not "01"

3.2.5 Specifying Broadcast

This function allows multiple YS1000s specified by respective addresses to receive writing commands.

- (1) Broadcast is executed with "00" or "YS" specified as the address No. in the command.
 - 00: All YS1000s
 - YS: YS1000 controllers (YS1500/YS1700)
- (2) This address functions regardless of communication address.
- (3) This address can be used only for writing.
- (4) When communication is performed with this address specified, the YS1000 that receives the command does not return a response.

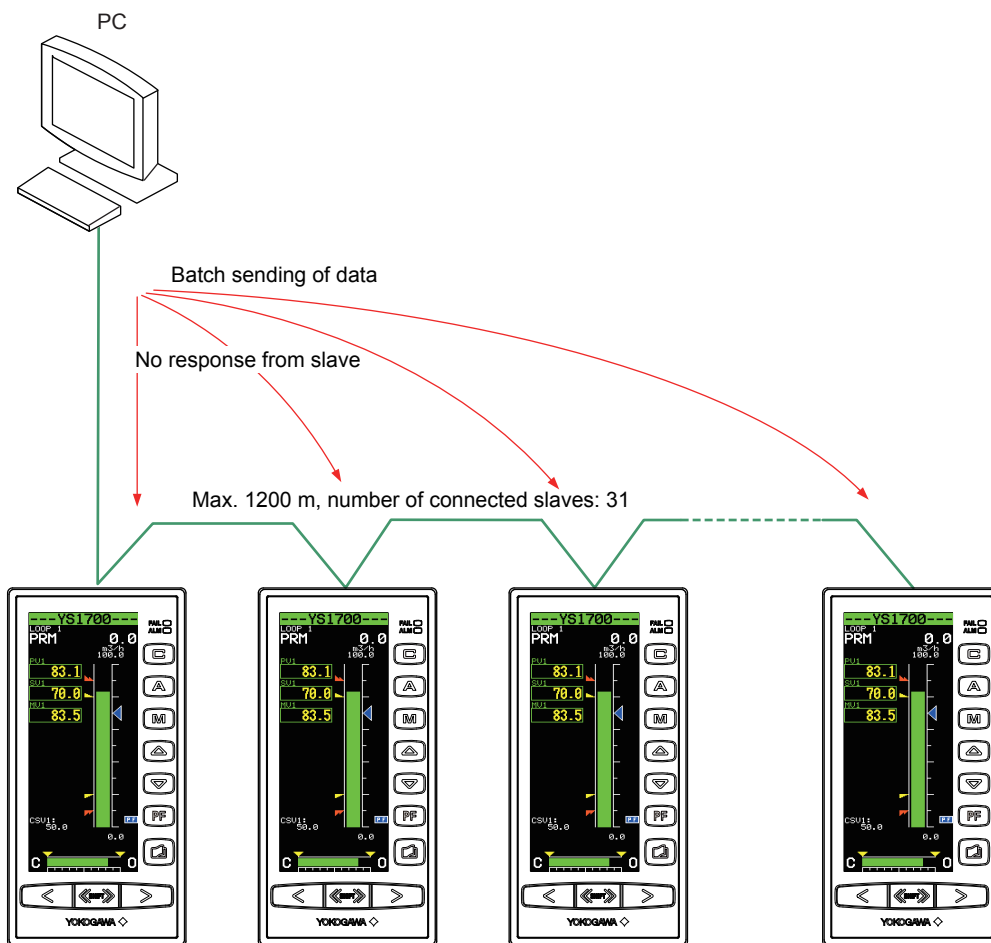

0308E.ai

3.2.6 Monitoring Discontinuation of Communication with Host Computer (description of CMWDT)

To detect a communication failure on the host computer with the YS1000 in the computer cascade mode (SPC mode or DDC mode), the host computer must send the reception timeout time at a fixed interval to the YS1000.

(This is done by writing the reception timeout value (1 to 9999 [seconds]) to the D register (CMWDT).)

When the reception timeout value is not written to CMWDT within this preset time, the YS1000 regards this as "operation suspended on the host computer" (communication failure), and immediately moves to the backup mode.

This function is disabled when the reception timeout value is set to "0" seconds.

The factory default or the value when the power is turned ON is "0 seconds (function disabled)."

3.2.7 Commands and Responses

This item shows lists of commands that can be used in PC link communication. Details are explained in the description for each command.

(1) Word-unit access commands

Command	Details of Processing	Number of Processing Points
WRD	Reading of word units	1 to 64 words
WWR	Writing of word units	1 to 64 words
WRR	Random reading of word units	1 to 32 words
WRW	Random writing of word units	1 to 32 words
WRS	Specification of D registers to be monitored in word units	1 to 32 words
WRM	Monitoring of word units	—

(2) Information commands

Command	Details of Processing	Number of Processing Points
INF6	Read type name, suffix code and version	1 unit
INF7	Read CPU maximum value	1 unit

■ WRD Read word units in D registers

● Function

Continuous register information for the number of specified words is read in word units from the specified register No.

- The number of words that can be read in a single read is 1 to 64 (decimal).
- For details on the response format at an error, see "3.2.4 Response Error Codes."
- The structure of the following commands/responses is the structure with a checksum. So, do not insert two bytes of checksum when performing communication without a checksum.

● Commands/responses (during normal operation)

Number of bytes	1	2	2	1	3	5	1	2	2	1	1
Command Element	STX	Address No. (ADRS)	CPU No. (01)	Response waiting time	WRD	Register No.*	, or space	Number of words(n)	Checksum	ETX	CR

*Register Nos. are described as D0013 (decimal).

Number of bytes	1	2	2	2	4	4	...	4	2	1	1
Response Element	STX	Address No. (ADRS)	CPU No. (01)	OK	dddd1	dddd2	...	ddddn	Checksum	ETX	CR

Responses are returned as a 4-digit text string in Hex (0000 to FFFF).

(ddddn: Read data of specified number of words
 ddddn is a Hex text string.
 n=1 to 64 words)

0309E.ai

3.2 PC Link Communication

■ WWR Write word units in D registers

● Function

Information is written to continuous registers for the number of specified words in word units from the specified register No.

- The number of words that can be written in a single write is 1 to 64 (decimal).
- For details on the response format at an error, see "3.2.4 Response Error Codes."
- The structure of the following commands/responses is the structure with a checksum. So, do not insert two bytes of checksum when performing communication without a checksum.

● Commands/responses (during normal operation)

Number of bytes	1	2	2	1	3	5	1	2	2	4
Command Element	STX	Address No. (ADRS)	CPU No. (01)	Response waiting time	WWR	Register No.*	, or space	Number of words(n)	, or space	ddd1

Continuation of command

4	• • •	4	2	1	1
ddd2	• • •	dddn	Checksum	ETX	CR

Write information is specified as a 4-digit text string in Hex (0000 to FFFF).

(dddd: Write data of specified number of words
 dddd is a Hex text string.
 n=1 to 64 words)

* Register Nos. are described as D0013 (decimal).

Number of bytes	1	2	2	2	2	1	1
Response Element	STX	Address No. (ADRS)	CPU No. (01)	OK	Checksum	ETX	CR

0310E.ai

■ WRR Random reading of word units in D registers

- Function

The state of registers specified at random is read in word units.

- The number of words that can be read in a single read is 1 to 32 (decimal).
- For details on the response format at an error, see "3.2.4 Response Error Codes."
- The structure of the following commands/responses is the structure with a checksum. So, do not insert two bytes of checksum when performing communication without a checksum.

- Commands/responses (during normal operation)

Number of bytes	1	2	2	1	3	2	5	1	5	1
Command Element	STX	Address No. (ADRS)	CPU No. (01)	Response waiting time	WRR	Number of words(n)	Register No.1*	, or space	Register No.2*	, or space

Continuation of command

...	5	2	1	1
...	Register No.n*	Checksum	ETX	CR

*Register Nos. are described as D0013 (decimal).

Number of bytes	1	2	2	2	4	4	...	4	2	1	1
Response Element	STX	Address No. (ADRS)	CPU No. (01)	OK	ddd1	ddd2	...	dddn	Checksum	ETX	CR

Responses are returned as a 4-digit text string in Hex (0000 to FFFF).

(ddddn: Read data of specified number of words
 ddddn is a Hex text string.
 n=1 to 32 words)

0311E.ai

3.2 PC Link Communication

■ WRW Random writing of word units in D registers

● Function

Register information specified to individual registers is written to registers for the number of words specified randomly.

- The number of words that can be written in a single write is 1 to 32 (decimal).
- For details on the response format at an error, see "3.2.4 Response Error Codes."
- The structure of the following commands/responses is the structure with a checksum. So, do not insert two bytes of checksum when performing communication without a checksum.

● Commands/responses (during normal operation)

Number of bytes	1	2	2	1	3	2	5	1	4	1
Command Element	STX	Address No. (ADRS)	CPUNo. (01)	Response waiting time	WRW	Number of words(n)	Register No.1*	, or space	dddd1	, or space

Continuation of command

5	1	4	• • •	5	1	4	2	1	1
Register No.2*	, or space	dddd2	• • •	Register No.n*	, or space	dddnn	Checksum	ETX	CR

Write information is specified as a 4-digit text string in Hex (0000 to FFFF).

Repeating of register No. and writing information for number of specified words.
 ddddn is a Hex text string.
 n=1 to 32 words

* Register Nos. are described as D0013 (decimal).

Number of bytes	1	2	2	2	2	1	1
Response Element	STX	Address No. (ADRS)	CPUNo. (01)	OK	Checksum	ETX	CR

0312E.ai

■ WRS Specify D registers to be monitored in word units

● Function

The register No. to be monitored in word units is specified. This command only specifies registers. Actual monitoring is performed by the WRM command after the register No. is specified by this command.

This command is effective, in particular, when there is a lot of data to communicate and you want to increase the communication speed by using the WRS and WRM commands rather than the WRR command.

When the YS1000 is turned OFF, the specified register Nos. are cleared from memory.

- The number of words that can be specified in a single operation is 1 to 32 (decimal).
- For details on the response format at an error, see "3.2.4 Response Error Codes."
- The structure of the following commands/responses is the structure with a checksum. So, do not insert two bytes of checksum when performing communication without a checksum.

● Commands/responses (during normal operation)

Number of bytes	1	2	2	1	3	2	5	1	5	1
Command Element	STX	Address No. (ADRS)	CPU No. (01)	Response waiting time	WRS	Number of words(n)	Register No.1*	, or space	Register No.2*	, or space

Continuation of command

• • •	5	2	1	1
• • •	Register No.n*	Checksum	ETX	CR

*Register Nos. are described as D0013 (decimal).

Number of bytes	1	2	2	2	2	1	1
Response Element	STX	Address No. (ADRS)	CPU No. (01)	OK	Checksum	ETX	CR

3.2 PC Link Communication

■ WRM Monitoring D registers in word units

- Function

The information of registers specified beforehand by the WRS command is read.

- Before this command is executed, the WRS command must be executed and the registers to monitor must be specified. If the registers are not specified, error code 06 occurs.
- For details on the response format at an error, see "3.2.4 Response Error Codes."
- The structure of the following commands/responses is the structure with a checksum. So, do not insert two bytes of checksum when performing communication without a checksum.

- Commands/responses (during normal operation)

Number of bytes	1	2	2	1	3	2	1	1
Command Element	STX	Address No. (ADRS)	CPU No. (01)	Response waiting time	WRM	Checksum	ETX	CR

Number of bytes	1	2	2	2	4	4	...	4	2	1	1
Response Element	STX	Address No. (ADRS)	CPU No. (01)	OK	dddd1	dddd2	...	ddddn	Checksum	ETX	CR

Responses are returned as a 4-digit text string in Hex (0000 to FFFF).

{

 ddddn: Read information of number of words specified by WRS
 ddddn is a Hex text string.
 n=1 to 32 words

}

0313E.ai

■ INF6 Read model name, suffix code and version

● Function

The model name, suffix code and version of the YS1000 are returned.

- For details on the response format at an error, see "3.2.4 Response Error Codes."

● Commands/responses (during normal operation)

Number of bytes	1	2	2	1	3	1	2	1	1
Command Element	STX	Address No. (ADRS)	CPU No. (01)	Response waiting time	INF	6	Checksum	ETX	CR

Number of bytes	1	2	2	2	11	5	4	4
Response Element	STX	Address No. (ADRS)	CPU No. (01)	OK	Suffix code Information (Note 1)	Version/revision (Note 2)	Specified start register for read refresh*	Specified number of registers for read refresh*

Continuation of response.

4	4	2	1	1
Specified start register for write refresh*	Specified number of registers for write refresh*	Checksum	ETX	CR

* indicates area that is referenced by the FA-M3 UT link module.

- Specified start register for read refresh (process data) = fixed at "0001"
- Specified number of registers for read refresh = fixed at "0024"
- Specified start register for write refresh (start of tuning data) = fixed at "0401"
- Specified number of registers for write refresh = fixed at "0000"

Note 1: Model name, suffix code information

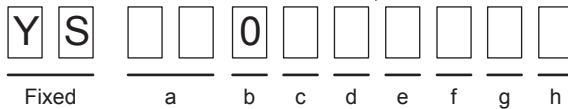

(a) Model Name

- 70: YS1700 Programmable Indicating Controller
- 50: YS1500 Indicating Controller
- 31: YS1310 Indicator with alarm
- 35: YS1350 Manual Setter for SV setting
- 36: YS1360 Manual Setter for MV setting

(b) Use

- 1: In cases of YS1700/YS1500/YS1360, It means "with hard manual."
In cases of YS1310/YS1350, Always "1"
- 0: In cases of YS1700/YS1500/YS1360, It means "without hard manual."

(c) Type

- 0: Basic type
- 1: Basic type (with expandable I/O) (YS1700 only)
- 2: Compatible type for YS100
- 3: Compatible type for YS80 internal unit / Compatible type for EBS, I, EK and HOMAC
- 4: Compatible type for YS80
- 5: Compatible type for Pneumatic 100 Line

(d) Power supply

- 1: 100V type (AC/DC common type)
- 2: 220V type (AC/DC common type)

*1: (C) type is enabled only in case of 2:YS1000 compatible type.

(e) Optional code, direct input

- 0: None
- 1: mV input
- 2: Thermocouple input
- 3: RTD input
- 4: Potentiometer input
- 5: Isolator
- 6: 2-wire transmitter input (isolated type)
- 7: 2-wire transmitter input (non-isolated type)
- 8: Frequency input

(f) Optional code, communication

- 0: None
- 1: RS-485 communication
- 2: DCS-LCS communication
- 3: Ethernet communication
- 4: RS-485 communication, Ethernet communication
- 5: DCS-LCS communication, Ethernet communication

(g) Optional code, construction*1

- 0: With case
- 1: Without case (for YS100 Replacement)

(h) Optional code

- Depends on (b) "Use" code.
- 0: With hard manual (suffix code -1xx)
- 1: Without hard manual (suffix code -2xx, YS1310, and YS1350)

Note 2: Version No. and revision No.

RO. □□

- : Version No.
- : Revision No.

3.2 PC Link Communication

■ INF7 Read CPU maximum value

- Function

The CPU maximum value per one corresponding PC link controller is returned.

- For details on the response format at an error, see "3.2.4 Response Error Codes."

- Commands/responses (during normal operation)

Number of bytes	1	2	2	1	3	1	2	1	1
Command Element	STX	Address No. (ADRS)	CPU No. (01)	Response waiting time	INF	7	Checksum	ETX	CR

Number of bytes	1	2	2	2	1	2	1	1
Response Element	STX	Address No. (ADRS)	CPU No. (01)	OK	CPU No. maximum value (Note 1)	Checksum	ETX	CR

Note 1: The maximum value of the CPU No. on the YS1000 is "1".

3.2.8 Communication with FA-M3

Host computers that can use PC link communication protocol can communicate with FA-M3.

■ Communication with FA-M3 (UT link module)

The YS1000 can communicate with FA-M3 simply by connecting to the UT link module by PC link communication protocol.

Set the communication conditions on the YS1000 to the same conditions as those on the UT link module.

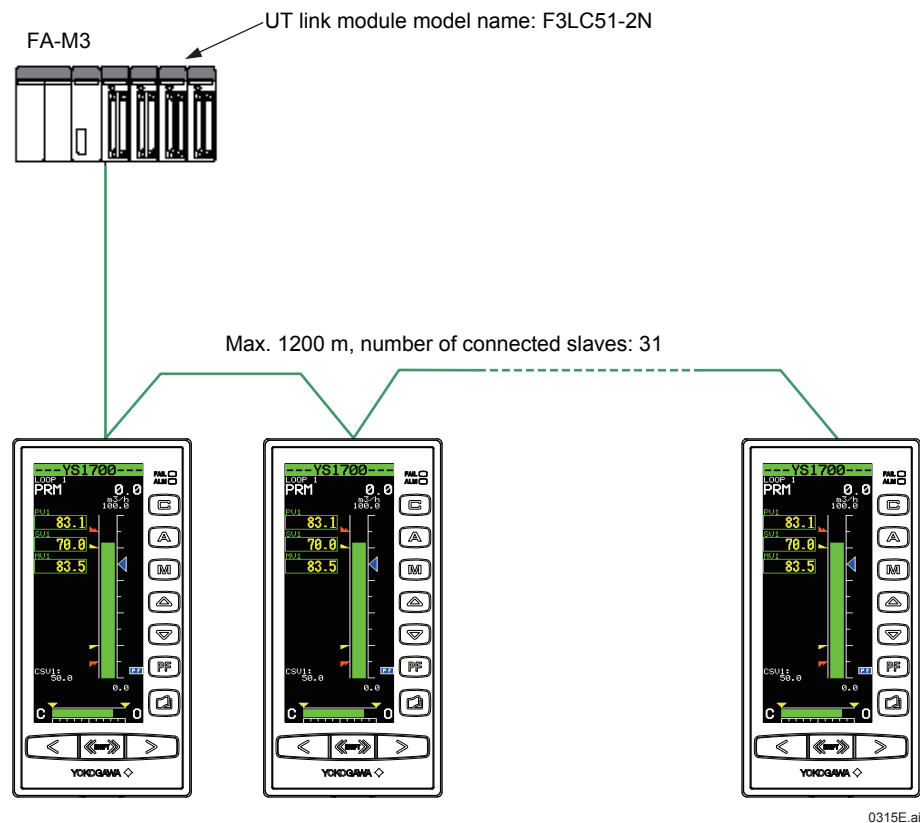

Figure 3.4 Communication with UT Link Module

The UT link module function is provided with three modes. So, data transactions are possible without being aware of communication. For details, refer to the "UT Link Module Instruction Manual (IM 34M6H25-01E)."

1. Automatic mode

In this mode, fixed devices on the controller (not user-specifiable) are read and refreshed.

Fixed devices are D registers D0001 to D0024. Fixed devices cannot be written as they are the read area on the YS1000.

2. Manual mode

In this mode, the devices (user-specifiable) on the YS1000 are read/written and refreshed manually.

▶ "Devices" here refers to D registers.

D registers: ["Chapter 6 Functions and Application of YS1500/YS1700 D-registers"](#) or ["Chapter 7 Functions and Application of YS1310/YS1350/YS1360 D-registers"](#) in this manual

3. Command operation

In this mode, the devices can be accessed whenever necessary.

3.3 YS Protocol

3.3.1 Overview

YS protocol communication enables centralized monitoring of the YS1000 by a host computer. The YS1000 communicates by replying with responses to instructions sent from the host computer. The host computer sends data acquisition and data setup instructions to the YS1000, and the YS1000 returns results in response to instructions. The contents of response data are compatible with those of the YS100 in order to connect with CENTUM CS3000.

3.3.2 Communication Messages

There are two types of communication messages, transmitted messages that the host computer uses to request data acquisition, etc. on the YS1000, and return messages from the YS1000 controller in response to these messages.

Format of communication message

Communication message

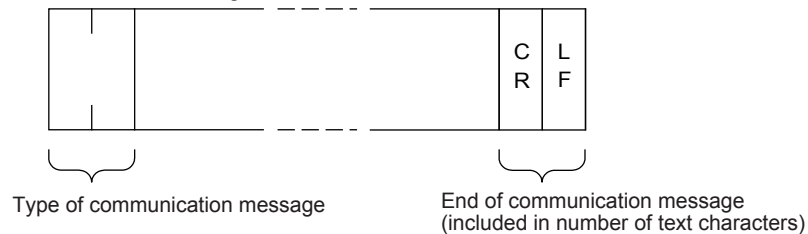

0316E.ai

The following shows the general format of each message. "_" indicates one space or more.

- **Transmitted message**
`<Command>_<RS-485 communication address>_<Number of data>_<Parameter>_<Data>[CR][LF]`
- **Response message**
`<Command>_<RS-485 communication address>_<Number of data>_<Data>[CR][LF]`

Command: 2-character alphabetic symbol that indicates the type of message

Example: DG

RS-485 communication address, number of data:

Parameters such as controller No. or number of data provided with the command

Some commands are not provided with these.

Parameters and data:

The body of the message text. Some commands are not provided with parameters and data.

Example: SV1_50.0

Data is expressed in ASCII format, and for the number of digits past the decimal point, the same decimal point position expressed in the data range is set. For details, see "3.3.4 List of Data Sent by Communication."

[General Rules for Communication Messages]

- (1) Communication messages are described in single-byte, uppercase alphabet characters. Lowercase characters or two-byte characters cannot be used.
- (2) Communication messages are limited to 512 characters including [CR][LF].
- (3) One or more spaces must be inserted between each of the command, RS-485 communication address, number of data, parameter, and data.
- (4) The end symbol for a message statement is [CR][LF].

Note

The inter-character interval for command text is 0.1 seconds. If text is configured using an interval exceeding this, the YS1000 regards the text at that session to be data for internal processing, and does not hand the data over, resulting in no response.

When a communication error such as above occurs, the YS1000 issues no response to transmission from the host computer.

On the host computer, avoid a communication hangup state by, for example, monitoring the reply time.

3.3.3 Commands and Responses

■ Data read command (DG)

This command is used when the host computer is to read data from the YS1000 controller. This indicates the format of the communication message.

- Host computer → YS1000 (transmitted message)
"DG_n_m_PARAM1_PARAM2 PARAMm[CR][LF]"
- YS1000 → Host computer (response message)
"DG_n_m_DATA1_DATA2 DATAm[CR][LF]"

n: YS1000 address ("01" to "99")

m: Number of data to read ("01" to "16")

PARAMm, DATAm: Name of the parameter to be read. The corresponding data is DATAm. For details on the names of parameters and data formats, see "3.3.4 List of Data Sent by Communication."

[Example of Use]

Example of communication message for reading process variable 1, setpoint value 1, and manipulated output variable 1 from the YS1000 at RS-485 communication address No.2

- Host computer → YS1000 (transmitted message)
"DG 02 03 PV1 SV1 MV1[CR][LF]"
- YS1000 → Host computer (response message)
"DG 02 03 50.0 30.0 65.5[CR][LF]"

■ Data write command (DP)

This command is used when the host computer is to set YS1000 parameters. This indicates the format of the communication message.

- Host computer → YS1000 (transmitted message)
"DP_n_m_PARAM1_DATA1_PARAM2_DATA2 PARAMm_DATAm[CR][LF]"
- YS1000 → Host computer (response message)
"DP_n_m_DATA1_DATA2 DATAm[CR][LF]"

n: YS1000 address ("01" to "99")* *: This is "01" to "16" on the YS100.

m: Number of data to write ("01" to "16")

PARAMm,DATAm: Name of parameter to write. The corresponding data is DATAm.

For details on the names of parameters and data formats, see "3.3.4 List of Data Sent by Communication."

[Example of Use]

Example of communication message for writing input alarm high limit setting value 1 (98.0%), low limit setting value (5.0%) and deviation alarm setting value (65.0%) to the YS1000 at RS-485 communication address No.2

- Host computer → YS1000 (transmitted message)
"DP 02 03 PH1 98.0 PL1 5.0 DL1 65.0[CR][LF]"
- YS1000 → Host computer (response message)
"DP 02 03 98.0 5.0 65.0[CR][LF]"

■ Timer setting command for monitoring discontinuation of communication with host computer in SPC or DDC mode (WDT)

To detect a communication failure on the host computer with the YS1000 in the computer cascade mode (SPC mode or DDC mode), the host computer must send this command at a fixed interval to the YS1000.

When this command does not arrive within the preset time, the YS1000 regards this as "operation suspended on the host computer" (communication failure), and immediately moves to the backup mode.

This function is disabled (0000 seconds) when the power is turned ON.

- Host computer → YS1000 (transmitted message)
"DC_n_WDT_xxxx[CR][LF]"
- YS1000 → Host computer (response message)
"DC_n_WDT_xxxx[CR][LF]"

n: YS1000 address ("01" to "99")

xxxx: Timer setting value (0000 to 9999 seconds) for monitoring discontinuation of communication on the host computer. Set this value in four digits.

This function is disabled if 0000 second is specified.

3.3.4 List of Data Sent by Communication

■ List of data sent by YS1500/YS1700 communication

This item shows the YS1500 and YS1700 data types and data ranges that can be used by the "data read command (DG)" and "data write command (DP)".

Though data types are completely compatible with the YS100, a part of data ranges differ.

Table 3.6 List of YS1500/YS1700 Communication Data

Type (PARAM)	Name	Write Viability	Unit	Display Setting Range	Description	Applicable Mode	
						Multi-function	Programmable
PV1, PV2	Process variable	-	%	-6.3 to 106.3		✓	✓
SV1, SV2	Setpoint value	Possible	%	-6.3 to 106.3	Settable when operation mode is MAN, AUT, SPC or DDC	✓	✓
CSV1, CSV2	Cascade setting value	-	%	-6.3 to 106.3		✓	✓
DV1, DV2	Deviation variable	-	%	-106.3 to 106.3		✓	✓
MV1, MV2	Manipulated output variable	Possible	%	-6.3 to 106.3	Settable when operation mode is MAN or DDC. MV2 is enabled only in dual-loop control. MV1 and MV2 are the same in cascade control and selector control.	✓	✓
PRCA	Process alarm	-	-	X1X2X3X4X5X6 X7X8 Xn=0 (normal) Xn=1 (error)	X1=PV1 high limit alarm X2=PV1 low limit alarm X3=PV1 deviation alarm X4=PV1 velocity alarm X5=PV2 high limit alarm X6=PV2 low limit alarm X7=PV2 deviation alarm X8=PV2 velocity alarm Example: When PV1 high limit alarm occurs 10000000	✓	✓
SYSA	System alarm	-	-	X1X2X3X4X5X6 X7X8 Xn=0 (normal) Xn=1 (error)	X1=input over range X2=current output open X3=invalid data X4=invalid data X5=computing overflow X6=invalid data (RAM content loss on YS100) Example: When current output open error occurs 01000000	✓	✓
LS1	Operation mode 1	Possible	-	MAN,AUT,CAS,SPC, DDC, BUA, or BUM	BUA and BUM not settable	✓	✓
LS2	Operation mode 2	Possible	-	See "Supplementary Explanation 1."		✓	✓
SLS1, SLS2	Auxiliary operation mode	-	-	X1X2X3X4X5X6 X7X8 Xn=0 (OFF) Xn=1 (ON)	X1=output tracking operation switch X2=preset output operation switch X3=X4=X5=X6=X7=X8= invalid data Example: When output tracking operation switch is ON 10000000	✓	✓
X01 to X05	Analog input	-	%	-25.0 to 125.0	X01 to X04 are enabled in the multi-function mode.	✓	✓
Y01	Analog output 1	-	%	-20.0 to 106.3	Y01 to Y04 are enabled in the multi-function mode. Display setting range on the YS100: -25.0 to 125.0	✓	✓

3.3 YS Protocol

Type (PARAM)	Name	Write Viability	Unit	Display Setting Range	Description	Applicable Mode	
						Multi-function	Programmable
Y02 to Y06	Analog output	-	%	-6.3 to 106.3	Y01 to Y04 are enabled in the multi-function mode. Display setting range on the YS100: -25.0 to 125.0	✓	✓
DI01 to DI06	Digital input	-	-	0,1(0=OFF,1=ON)		✓	✓
DO01 to DO16	Digital output	-	-	0,1(0=OFF,1=ON)		✓	✓
P01 to P30	Variable parameter	Possible	%	-800.0 to 800.0		-	✓
T01 to T30	Temporary memory register	-	%	-800.0 to 800.0		-	✓
K01 to K30	Constant register	-	%	-800.0 to 800.0		-	✓
PB1, PB2	Proportional band	Possible	%	0.1 to 999.9	Display setting range on the YS100: 2.0 to 999.9	✓	✓
TI1, TI2	Integral time	Possible	Seconds	1 to 9999		✓	✓
TD1, TD2	Derivative time	Possible	Seconds	0 to 9999	Operating range is 1 to 9999 seconds. (0=OFF)	✓	✓
SFA1, SFA2	Adjustable setpoint filter α	Possible	-	0.000 to 1.000		✓	✓
SFB1, SFB2	Adjustable setpoint filter β	Possible	-	0.000 to 1.000		✓	✓
AG1, AG2	Variable gain	-	-	-8.000 to 8.000		-	✓
GG1, GG2	Non-linear control gain	Possible	-	0.000 to 1.000		✓	✓
GW1, GW2	Non-linear control gap width	Possible	%	0.0 to 100.0		✓	✓
STM1, STM2	Sample PI sampled time	Possible	Seconds	0 to 9999		-	✓
SWD1, SWD2	Sample PI control time span	Possible	Seconds	0 to 9999		-	✓
BD1, BD2	Batch PID deviation setting value	Possible	%	0.0 to 100.0		-	✓
BB1, BB2	Batch PID bias	Possible	%	0.0 to 100.0		-	✓
BL1, BL2	Batch PID lock-up width	Possible	%	0.0 to 100.0		-	✓
MR1, MR2	Manual reset	Possible	%	-6.3 to 106.3		✓	✓
RB1, RB2	Reset bias	Possible	%	0.0 to 106.3		✓	✓
DM1, DM2	Input compensation	-	%	-100.0 to 100.0		-	✓
FF1, FF2	Feedforward input value	-	%	-100.0 to 200.0		✓	✓
TRK1, TRK2	Output tracking input value	-	%	-6.3 to 106.3		✓	✓
PMV1, PMV2	Preset output	Possible	%	-6.3 to 106.3		✓	✓
EXT	Selector external signal	-	%	-6.3 to 106.3		-	✓
SSW	Selector control switch	-	-	-8.000 to 8.000	See "Supplementary Explanation 2."	✓	✓
PH1, PH2	High limit alarm setpoint for PV	Possible	%	-6.3 to 106.3		✓	✓

Type (PARAM)	Name	Write Viability	Unit	Display Setting Range	Description	Applicable Mode	
						Multi-function	Programmable
PL1, PL2	Low limit alarm setpoint for PV	Possible	%	-6.3 to 106.3		✓	✓
DL1, DL2	Alarm setpoint for deviation variable	Possible	%	0.0 to 106.3		✓	✓
VL1, VL2	Velocity alarm setpoint for PV	Possible	%	0.0 to 106.3		✓	✓
VT1, VT2	Velocity alarm time setpoint for PV	Possible	Seconds	1 to 9999		✓	✓
MH1, MH2	High limit setpoint of MV	Possible	%	-6.3 to 106.3		✓	✓
ML1, ML2	Low limit setpoint of MV	Possible	%	-6.3 to 106.3		✓	✓
STC	STC mode	Possible	-	0, 1, 2, 3	0=OFF, 1=DISP, 2=ON, 3=ATSTUP	✓	✓
OD	On-demand tuning	Possible	-	0, 1	0=OFF, 1=ON	✓	✓
IP1,IP2	Process type	Possible	-	0, 1	0=STATIC, 1=DYNAM	✓	✓
TR1,TR2	Process response time	Possible	Seconds	4 to 9999		✓	✓
NB1, NB2	Noise band	Possible	%	0.0 to 20.0		✓	✓
OS1, OS2	Control target type	Possible	-	0, 1, 2, 3	0=ZERO, 1=MIN, 2=MED, 3=MAX	✓	✓
MI1, MI2	MV applied signal span	Possible	%	0.0 to 20.0		✓	✓
PMX1, PMX2	High limit setpoint of proportional band	Possible	%	2.0 to 999.9		✓	✓
PMN1, PMN2	Low limit setpoint of proportional band	Possible	%	2.0 to 999.9		✓	✓
IMX1, IMX2	High limit setpoint of integral time	Possible	Seconds	1 to 9999		✓	✓
IMN1, IMN2	Low limit setpoint of integral time	Possible	Seconds	1 to 9999		✓	✓
DMX1, DMX2	High limit setpoint of derivative time	Possible	Seconds	0 to 9999		✓	✓
PA1, PA2	Calculated proportional band	-	%	2.0 to 999.9		✓	✓
IA1, IA2	Calculated integral time	-	Seconds	1 to 9999		✓	✓
DA1, DA2	Calculated derivative time	-	Seconds	0 to 9999		✓	✓
CR1, CR2	Presumed accuracy error	-	%	0.00 to 99.99		✓	✓
RT1, RT2	Signal distribution ratio	-	-	0.000 to 9.999		✓	✓
LM1, LM2	Equivalent dead time	-	Seconds	0 to 9999		✓	✓
TM1, TM2	Equivalent lag time	-	Seconds	0 to 9999		✓	✓

3.3 YS Protocol

Type (PARAM)	Name	Write Viability	Unit	Display Setting Range	Description	Applicable Mode	
						Multi-function	Programmable
GM1, GM2	Equivalent process gain	-	-	0.000 to 9.999		✓	✓
STCA	STC alarm	-	-	X1X2X3X4X5X6X7 X8X9X10X11X12 X13X14X15X16 Xn=0(normal) Xn=1(error)	X1=X2=X3=X4=X5=X6=invalid data X7=SYSALM, X8=PVOVR, X9=MVLMT, X10=OPERR, X11=IDERR, X12=PWRDWN, X13=PBLMT, X14=TILMT, X15=TDLMT, X16=RTALM Example: When SYSALM error occurs 0000001000000000	✓	✓
FXO1n, FXO2n	0 to 100% setting of FX	Possible	%	0.0 to 100.0	n=01 to 11	✓	✓
GXI1n, GXI2n	Input setting for GX 1 to 10	Possible	%	-25.0 to 125.0	n=01 to 11	-	✓
GXO1n, GXO2n	Output setting for GX 1 to 10	Possible	%	-25.0 to 125.0	n=01 to 11	-	✓
PGT1n	Time setting for PGM1 1 to 10	Possible	Seconds	0 to 9999	n=01 to 10	-	✓
PGO1n	Output setting for PGM1 1 to 10	Possible	%	-25.0 to 125.0	n=01 to 10	-	✓
PPID1, PPID2	Preset PID switch registers	-	-	See "Supplementary Explanation 3."		-	✓
PPBm	Preset PID proportional band	Possible	%	0.1 to 999.9	m=01 to 08 (Display setting range on the YS100: 2.0 to 999.9)	-	✓
PTIm	Preset PID integral time	Possible	Seconds	1 to 9999	m=01 to 08	-	✓
PTDm	Preset PID derivative time	Possible	Seconds	0 to 9999	m=01 to 08, Operating range is 1 to 9999 seconds. ("0" is OFF.)	-	✓
PLC1, PLC2	Square root extraction low cutoff setpoint for PV	Possible	%	0.0 to 100.0			
PLG1, PLG2	First order lag time constant for PV	Possible	Seconds	0.0 to 800.0			
CLC1, CLC2	Square root extraction low cutoff setpoint for CSV	Possible	%	0.0 to 100.0		✓	-
CLG1, CLG2	First order lag time constant for CSV	Possible	Seconds	0.0 to 800.0		✓	-
CGN1, CGN2	Ratio gain for CSV	Possible	-	-8.000 to 8.000		✓	-
CBI1, CBI2	Ratio input bias for CSV	Possible	%	-106.3 to 106.3		✓	-
CBO1, CBO2	Ratio output bias for CSV	Possible	%	-800.0 to 800.0		✓	-
FLG	Feedforward lag time constant	Possible	Seconds	0.0 to 800.0		✓	-
FGN	Feedforward gain	Possible	-	-8.000 to 8.000		✓	-
FBI	Feedforward input bias	Possible	%	-106.3 to 106.3		✓	-
FBO	Feedforward output bias	Possible	%	-800.0 to 800.0		✓	-
TLG	Tracking input lag time constant	Possible	Seconds	0.0 to 800.0		✓	-

Type (PARAM)	Name	Write Viability	Unit	Display Setting Range	Description	Applicable Mode	
						Multi-function	Programmable
PSR1, PSR2	Square root extraction for PV	-	-	0, 1	0=OFF, 1=ON	✓	-
PFX1, PFX2	10-segment linearizer function for PV	-	-	0, 1	0=OFF, 1=ON	✓	-
CSR1, CSR2	Square root extraction for CSV	-	-	0, 1	0=OFF, 1=ON	✓	-
CSW1, CSW2	Ratio operation for CSV	-	-	0, 1	0=OFF, 1=ON	✓	-
FSW	Feedforward gain operation	-	-	0, 1	0=OFF, 1=ON	✓	-
FON	Addition of feedforward output	-	-	0, 1	0=OFF, 1=ON	✓	-
SCH1, SCH2	100% value of scale	-	-	-80000 to 80000	Display setting range on the YS100: -9999 to 9999	✓	✓
SCL1, SCL2	0% value of scale	-	-	-80000 to 80000	Display setting range on the YS100: -9999 to 9999	✓	✓
SCDP1, SCDP2	Decimal point position	-	-	0, 1, 2, 3, 4	0:##### 1:###.###, 2:###.##, 3:#####., 4:##### (Setting range on the YS100: 1, 2, 3, 4)	✓	✓
CNT1, CNT2	Control module setting information	-	-	See "Supplementary Explanation 4."		✓	✓
SYS1, SYS2	System setting information	-	-	See "Supplementary Explanation 5 and 6."		✓	✓
ID	Controller model name	-	-	YS150, YS170	16 digits in left justify (Fill up a blank in space). The ID becomes YS150 for the YS1500, and YS170 for the YS1700.	✓	✓

3.3 YS Protocol

Supplementary Explanation 1 Setting ranges of LS1 and LS2 for each control module

- Single-loop control
(when BSC1 is used in the single-loop mode or programmable mode)

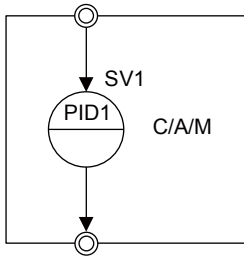

← LS1 setting range: MAN, AUT, CAS, SPC, DDC

*When BSC2 is not used, LS2 is disabled.
The setting range of LSC2 when BSC2 is used is the same as that for LS1.

- Cascade control
(when CSC is used in the cascade mode or programmable mode)

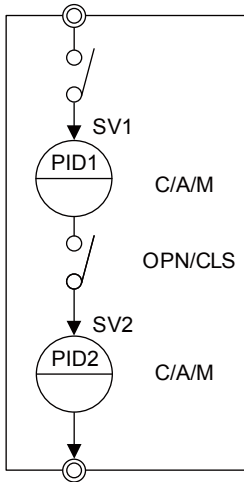

← LS1 setting range: MAN, AUT, CAS, SPC, DDC

← LS2 setting range: MAN, AUT, CAS

*When LS2 is set to CAS, the internal cascade closed (CLOSE) mode is entered.

*Both LS1 and LS2 are set to the MAN mode when either is changed to MAN.

- Selector control
(when SSC is used in the selector mode or programmable mode)

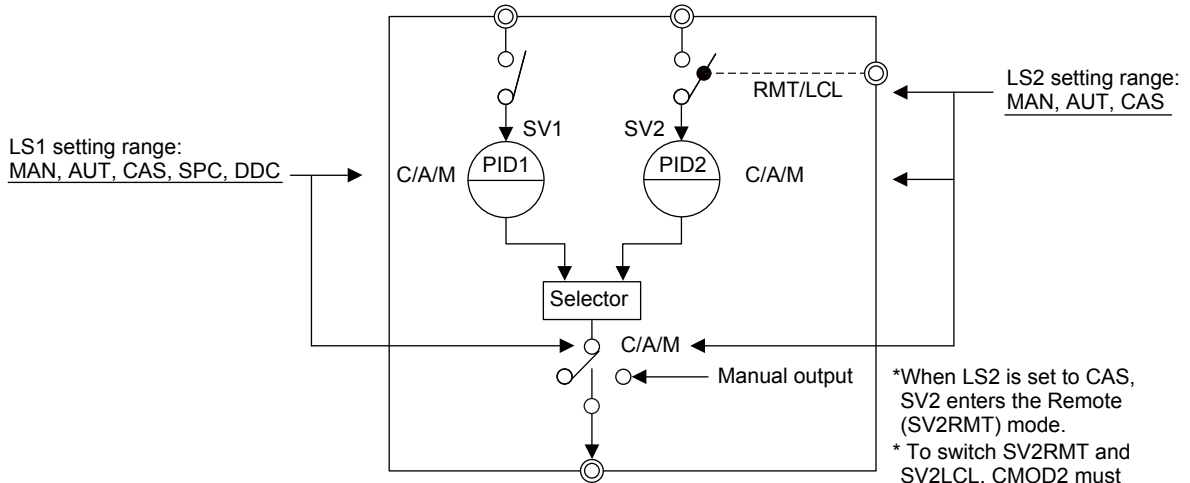

LS1 setting range: MAN, AUT, CAS, SPC, DDC

← LS2 setting range: MAN, AUT, CAS

*When LS2 is set to CAS, SV2 enters the Remote (SV2RMT) mode.

* To switch SV2RMT and SV2LCL, CMOD2 must be set to CAS.

* Both LS1 and LS2 are set to the MAN mode when either is changed to MAN.

0317E.ai

Supplementary Explanation 2 Selector control switch (SSW)

Data: -8.000 to 8.000

Value of SSW	Selector Function Operation
SSW<0.500	Autoselector
0.500≤SSW<1.500	Selection of Loop 1 output
1.500≤SSW<2.500	Selection of Loop 2 output
2.500≤SSW<3.500	External signal selected
3.500≤SSW	Slave signal selected

Supplementary Explanation 3 Preset PID switch register (PPID1, PPID2)

Data: -800.0% to 800.0%

Setting value to Registers	Preset PID to be Set
PPID<00.0	Current setting value is held.
00.0≤PPID<10.0	PID set 1 (PPB1, PTI1, PTD1)
10.0≤PPID<20.0	PID set 2 (PPB2, PTI2, PTD2)
20.0≤PPID<30.0	PID set 3 (PPB3, PTI3, PTD3)
30.0≤PPID<40.0	PID set 4 (PPB4, PTI4, PTD4)
40.0≤PPID<50.0	PID set 5 (PPB5, PTI5, PTD5)
50.0≤PPID<60.0	PID set 6 (PPB6, PTI6, PTD6)
60.0≤PPID<70.0	PID set 7 (PPB7, PTI7, PTD7)
70.0≤PPID	PID set 8 (PPB8, PTI8, PTD8)

Supplementary Explanation 4 Control module setting information (CNT1, CNT2)

Data format*: Y1, Y2, Y3, Y4, Y5, Y6, Y7, Y8

Data		0	1	2	3
Y1	Control type	Standard PID	Sample PI	Batch PID	Proportional (PD)
Y2	Control operation formula	PV proportional type	PV derivative type	Setpoint filter type	-
Y3	Control operation direction	Reverse action	Direct action	-	-
Y4	Valve direction	C-O	O-C	-	-
Y5	C mode	without C mode	Cascade	Computer	-
Y6	Backup mode	Manual operation backup mode	Automatic operation backup mode	-	-
Y7	Engineering units (Note 2)	6-digit alphanumeric			
Y8	Tag number	12-digit alphanumeric			

Note 1: "-" indicates invalid data.

Note 2: Though YS1000 internal parameter data is 7-digit alphanumeric, the value from which one character of the beginning was deleted is displayed.

*: About data format

The following shows the position of corresponding data in the response message.

Example: Reading of "CNT1"

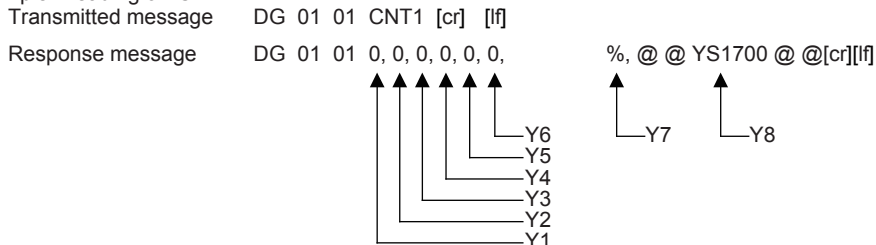

0320E.ai

3.3 YS Protocol

Supplementary Explanation 5 System setting information 1 (SYS1)

Data format*: Y1, Y2, Y3

Item		Data					
		0	1	2	3	4	5
Y1	Controller mode selection	Programmable	Single-loop	Cascade	Selector	-	-
Y2	Start mode	M-COLD	AUT	-	A-COLD	C-COLD	COLD
Y3	Enable/Disable writing	Settable	Setting disabled	-	-	-	-

Note 1: "-" indicates invalid data.

Supplementary Explanation 6 System setting information 2 (SYS2)

Data format*: Y1, Y2, Y3, Y4, Y5, Y6

Item		Data							
		0	1	2	3	4	5	6	7
Y1	Selection of PF key function (Note 2)	None	STC ON/OFF	-	-	-	-	-	-
Y2	DI1 function selection (Note 2) (Note 3)	None	A/M switching (E-MAN)	C/A switching (E-AUT)	Preset MV (E-PMV)	Tracking (E-TRK)	STC switching (E-STC)	Internal CAS switching (E-O/C)	Selector loop 2 C/A switching (E-L/R)
Y3	DI1 contact type (Note 2)	ON at open	ON at close	-	-	-	-	-	-
Y4	Alarm output contact status selection (Note 2) (Note 4)	NC	NO	-	-	-	-	-	-
Y5	Selection of tracking function (Note 2)	None	Setpoint value	Setpoint value	-	-	-	-	-
Y6	Autoselector function	Low selector	High selector	-	-	-	-	-	-

Note 1: "-" indicates invalid data.

Note 2: Y1, Y2, Y3, Y4, and Y5 return "0" in the programmable mode of YS1700.

Note 3: When the extended setup is set for YS1500/YS1700, Y2 returns "0" in the multi-function mode.

Note 4: Y4 always returns "0" because YS1500/YS1700 do not have the parameter concerned.

■ List of data sent by YS1310/YS1350/YS1360 communication

This item shows the YS1310/YS1350/YS1360 data types and data ranges that can be used by the "data read command (DG)" and "data write command (DP)."

Table 3.7 List of YS1310/YS1350/YS1360 Communication Data

Type (PARAM)	Name	Write Viability	Unit	Display Setting Range	Description	YS1310	YS1350	YS1360
PV1	Process variable 1	-	%	-6.3 to 106.3		✓	✓	✓
PV2	Process variable 2	-	%	-6.3 to 106.3		✓	-	-
SV1	Setpoint value 1	Possible	%	-6.3 to 106.3	Settable when operation mode is MAN, BUM or DDC	-	✓ (Note 1)	-
CIN1	Cascade input value 1	-	%	-6.3 to 106.3		-	✓	✓
MV1	Manipulated output variable 1	Possible	%	-6.3 to 106.3	Settable when operation mode is MAN, BUM or DDC output variable	-	-	✓ (Note 2)
PRCA	Process alarm	-	-	X1X2X3X4X5X6X7X8 Xn=0(normal) Xn=1(error)	X1=PV1 high limit alarm PH1 X2=PV1 low limit alarm PL1 X3=PV2 high limit alarm PH2 X4=PV2 low limit alarm PL2 X5=PV1 high high limit alarm HH1 X6=PV1 low low limit alarm LL1 X7=PV2 high high alarm HH2 X8=PV2 low low alarm LL2 Note: X3, X4, X7 and X8 are supported on YS1310 only. Example: When PV1 high limit alarm occurs 10000000	✓	✓	✓
SYSA	System alarm	-	-	X1X2X3X4X5X6X7X8 Xn=0(normal) Xn=1(error)	X1=input over range X2=current output open (YS1310 only) X3=invalid data X4=invalid data X5=invalid data X6=invalid data (RAM content loss on YS100) Example: When current output open error occurs, 01000000	✓	✓	✓
LS1	Operation mode 1	Possible	-	MAN, CAS, DDC, BUM	BUM not settable	-	✓	✓
X01	Analog input 1	-	%	-25.0 to 125.0	Measurement input 1	✓	✓	✓
X02	Analog input 2	-	%	-25.0 to 125.0	YS1310: Measurement input 2 YS1350: Cascade setting input YS1360: Cascade input	✓	✓	✓
Y01	Analog output 1	-	%	-20.0 to 106.3	Manipulated output variable 1	-	-(Note 3)	✓
Y02	Analog output 2	-	%	-6.3 to 106.3	YS1350: Cascade setting value output YS1360: Manipulated output variable 2	-	✓	✓
DI01	Digital input 1	-	-	0, 1(0=OFF, 1=ON)	Operation mode switching input	-	✓	✓
DO01	Digital output 1	-	-	0, 1(0=OFF, 1=ON)	YS1310: Alarm output 1 YS1350, YS1360: PV1 high limit alarm output	✓	✓	✓
DO02	Digital output 2	-	-	0, 1(0=OFF, 1=ON)	YS1310: Alarm output 2 YS1350, YS1360: PV1 low limit alarm output	✓	✓	✓
DO03	Digital output 3	-	-	0, 1(0=OFF, 1=ON)	Alarm output 3	✓	-(Note 3)	-(Note 3)
DO04	Digital output 4	-	-	0, 1(0=OFF, 1=ON)	YS1310: Alarm output 4 YS1350, YS1360: C/M status output	✓	✓	✓
DO05	Digital output 5	-	-	0, 1(0=OFF, 1=ON)	Alarm output 5	✓	-(Note 3)	-(Note 3)
DO06	Digital output 6	-	-	0, 1(0=OFF, 1=ON)	Alarm output 6	✓	-(Note 3)	-(Note 3)

3.3 YS Protocol

Type (PARAM)	Name	Write Viability	Unit	Display Setting Range	Description	YS1310	YS1350	YS1360
PH1	High limit alarm setpoint for PV1	Possible	%	-6.3 to 106.3		✓	✓	✓
PL1	Low limit alarm setpoint for PV1	Possible	%	-6.3 to 106.3		✓	✓	✓
HH1	High-high limit alarm setpoint for PV1	Possible	%	-6.3 to 106.3		✓	-	-
LL1	Low-low limit alarm setpoint for PV1	Possible	%	-6.3 to 106.3		✓	-	-
PH2	High limit alarm setpoint for PV2	Possible	%	-6.3 to 106.3		✓	-(Note 4)	-(Note 4)
PL2	Low limit alarm setpoint for PV2	Possible	%	-6.3 to 106.3		✓	-(Note 4)	-(Note 4)
HH2	High-high limit alarm setpoint for PV2	Possible	%	-6.3 to 106.3		✓	-	-
LL2	Low-low limit alarm setpoint for PV2	Possible	%	-6.3 to 106.3		✓	-	-
MH1	High limit setpoint of MV1	Possible	%	-6.3 to 106.3		-	-	✓
ML1	Low limit setpoint of MV1	Possible	%	-6.3 to 106.3		-	-	✓
PLC1	Square root extraction low cutoff setpoint for PV1	Possible	%	0.0 to 100.0		✓	✓	✓
PLC2	Square root extraction low cutoff setpoint for PV2	Possible	%	0.0 to 100.0		✓	-(Note 4)	-(Note 4)
PSR1	PV1 square root extraction	-	-	0, 1(0=OFF, 1=ON)		✓	✓	✓
PSR2	PV2 square root extraction	-	-	0, 1(0=OFF, 1=ON)		✓	-(Note 3)	-(Note 3)
PLG1, PLG2	First order lag time constant for PV	Possible	Seconds	0.0 to 800.0		✓	-	-
HYS1, HYS2	Alarm hysteresis	Possible	%	0.0 to 20.0	Display setting range on the YS100: 0.0 to 10.0	✓	-	-
ASW1 to ASW6	Alarm output connection	-	-	X1X2X3X4X5X6X7X8 Xn=0(not connected) Xn=1(connected)	X1=high limit alarm PH1 X2=low limit alarm PL1 X3=high high limit alarm HH1 X4=low low limit alarm LL1 X5=high limit alarm PH2 X6=low limit alarm PL2 X7=high high limit alarm HH2 X8=low low limit alarm LL2	✓	-	-
ANOR1 to ANOR6	Alarm AND/OR selection	-	-	0, 1	0(OR), 1(AND)	✓	-	-
AOUT1 to AOUT6	Alarm output contact status	-	-	0, 1	0(NC), 1(NO)	✓	-	-

Type (PARAM)	Name	Write Viability	Unit	Display Setting Range	Description	YS1310	YS1350	YS1360
SCH1	100% value of scale 1	-	-	-80000 to 80000	Display setting range on the YS100: -9999 to 9999	✓	✓	✓
SCH2	100% value of scale 2	-	-	-80000 to 80000	Display setting range on the YS100: -9999 to 9999	✓	-(Note 3)	-(Note 3)
SCL1	0% value of scale 1	-	-	-80000 to 80000	Display setting range on the YS100: -9999 to 9999	✓	✓	✓
SCL2	0% value of scale 2	-	-	-80000 to 80000	Display setting range on the YS100: -9999 to 9999	✓	-(Note 3)	-(Note 3)
SCDP1	Decimal point position 1	-	-	1, 2, 3, 4	0:##### 1:###.###, 2:###.##, 3:####.#, 4:##### (Display setting range on the YS100: 1, 2, 3, 4)	✓	✓	✓
SCDP2	Decimal point position 2	-	-	1, 2, 3, 4	0:##### 1:###.###, 2:###.##, 3:####.#, 4:##### (Display setting range on the YS100: 1, 2, 3, 4)	✓	-(Note 3)	-(Note 3)
CNT1	Computing module setting information 1	-	-	See "Supplementary Explanations 1, 3, 4."		✓	✓	✓
CNT2	Computing module setting information 2	-	-	See "Supplementary Explanation 2."		✓	-(Note 3)	-(Note 3)
SYS1	System setting information 1	-	-	See "Supplementary Explanation 5."		✓	✓	✓
SYS2	System setting information 2	-	-	See "Supplementary Explanation 6."		-(Note 3)	✓	✓
ID	Control model name	-	-	YS131, YS135, YS136	16 digits in left justify (Fill up a blank in space). Set YS131 for YS1310, YS135 for YS1350, and YS136 for YS1360.	✓	✓	✓

Note 1: SV1 can be written in the MAN, BUM and DDC modes.

Note 2: MV1 can be written in the MAN, BUM and DDC modes.

Note 3: Invalid data can be read. Error codes are not displayed, so do not access these parameters.

Note 4: Invalid data can be read and written. Error codes are not displayed, so do not access these parameters.

3.3 YS Protocol

Supplementary Explanation 1 Computing module setting information 1 of YS1310 (CNT1) Data format*: Y1, Y2, Y3, Y4, Y5, Y6, Y7, Y8

Item \ Data		0	1	2
Y1	Invalid item	(always "0")	-	-
Y2	Invalid item	(always "0")	-	-
Y3	Invalid item	(always "0")	-	-
Y4	Invalid item	(always "0")	-	-
Y5	Invalid item	(always "0")	-	-
Y6	Invalid item	(always "0")	-	-
Y7	Engineering unit 1 (Note 2)	6-digit alphanumeric		
Y8	Tag number 1	12-digit alphanumeric		

Note 1: "-" indicates invalid data.

Note 2: Though YS1000 internal parameter data is 7-digit alphanumeric, the value from which one character of the beginning was deleted is displayed.

*: About data format

The following shows the position of corresponding data in the response message.

Example:

Reading of "CNT1"

Transmitted message DG 01 01

Response message DG 01 01

CNT1[cr][lf]
0, 0, 0, 0, 0, 0,

%, @ @ YS1310 @ @ [cr][lf]

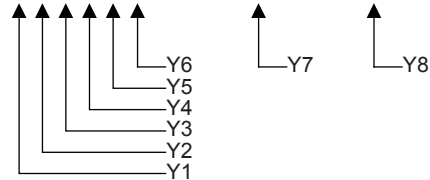

0321E.ai

Supplementary Explanation 2 Computing module setting information 2 of YS1310 (CNT2) Data format*: Y1, Y2, Y3, Y4, Y5, Y6, Y7, Y8

Item \ Data		0	1	2
Y1	Invalid item	(always "0")	-	-
Y2	Invalid item	(always "0")	-	-
Y3	Invalid item	(always "0")	-	-
Y4	Invalid item	(always "0")	-	-
Y5	Input specification of measurement input 2	without Input	with Input	-
Y6	Invalid item	(always "0")	-	-
Y7	Engineering units 2 (Note 2)	6-digit alphanumeric		
Y8	Tag number 2	12-digit alphanumeric		

Note 1: "-" indicates invalid data.

Note 2: Though YS1000 internal parameter data is 7-digit alphanumeric, the value from which one character of the beginning was deleted is displayed.

Supplementary Explanation 3 Computing module setting information 1 of YS1350 (CNT1)

Data format*: Y1, Y2, Y3, Y4, Y5, Y6, Y7, Y8

Item		Data	0	1	2
Y1	Invalid item		(always "0")	-	-
Y2	Invalid item		(always "0")	-	-
Y3	Invalid item		(always "0")	-	-
Y4	Invalid item		(always "0")	-	-
Y5	C mode selection		without C mode	Cascade	Computer
Y6	Backup mode		Fixed at Manual	-	-
Y7	Engineering units (Note 2)		6-digit alphanumeric		
Y8	Tag number		12-digit alphanumeric		

Note 1: "-" indicates invalid data.

Note 2: Though YS1000 internal parameter data is 7-digit alphanumeric, the value from which one character of the beginning was deleted is displayed.

Supplementary Explanation 4 Computing module setting information 1 of YS1360 (CNT1)

Data format*: Y1, Y2, Y3, Y4, Y5, Y6, Y7, Y8

Item		Data	0	1	2
Y1	Invalid item		(always "0")	-	-
Y2	Invalid item		(always "0")	-	-
Y3	Invalid item		(always "0")	-	-
Y4	Valve direction		C-O	O-C	-
Y5	C mode selection		without C mode	Cascade	Computer
Y6	Backup mode		Fixed at Manual	-	-
Y7	Engineering units (Note 2)		6-digit alphanumeric		
Y8	Tag number		12-digit alphanumeric		

Note 1: "-" indicates invalid data.

Note 2: Though YS1000 internal parameter data is 7-digit alphanumeric, the value from which one character of the beginning was deleted is displayed.

Supplementary Explanation 5 System setting information 1 of YS1310 (SYS1)

Data format*: Y1, Y2, Y3

Item		Data	0	1	2	3	4	5
Y1	Operation mode display		-	-	-	Indicator with alarm (YS1310)	-	-
Y2	Start mode		-	AUT	-	-	-	COLD
Y3	Enable/Disable writing via RS-485 communication		Settable	Setting disabled	-	-	-	-

Note 1: "-" indicates invalid data.

System setting information 1 of YS1350/YS1360 (SYS1)

Data format*: Y1, Y2, Y3

Item		Data	0	1	2	3	4	5
Y1	Operation mode display		-	Manual setter for MV setting (YS1360)	Manual setter for SV setting (YS1350)	-	-	-
Y2	Start mode		M-COLD	AUT	-	-	C-COLD	COLD
Y3	Enable/Disable writing via RS-485 communication		Settable	Setting disabled	-	-	-	-

Note 1: "-" indicates invalid data.

3.3 YS Protocol

Supplementary Explanation 6 System setting information 2 of YS1350/YS1360 (SYS2)
Data format*: Y1, Y2, Y3, Y4, Y5, Y6

Item		Data	0	1
Y1	Invalid item		(always "0")	-
Y2	DI1 function selection		None	C/M switching
Y3	DI1 contact type		ON at open	ON at close
Y4	Alarm output contact status selection (Note 2)		NC	NO
Y5	Invalid item		(always "0")	-
Y6	Invalid item		(always "0")	-

Note 1: "-" indicates invalid data.

Note 2: Y4 always returns "0" on the YS1350/YS1360 because they do not have the parameter concerned.

3.3.5 Description of Communication Errors

The following table summarizes probable causes for communication errors.
The table after this explains these communication errors and how to remedy them.

Table 3.8 Probable Causes and Phenomena in Communication Errors

Cause	Phenomenon
Communication condition (start bit, parity bit, baud rate, etc.) mismatch	The YS1000 does not return the response message. COMM is displayed in the ALARM Display.
Controller address mismatch (Also treated as inappropriate when 3 digit or more of address is specified).	The YS1000 does not return the response message.
Communication cable disconnection, communication card error, faulty contact, wrong terminator setting	The YS1000 does not return the response message or a reception error occurs on the host computer.
Command or parameter syntax error	The YS1000 returns an error code.
Transmission of too long command or parameter requesting a response message	The YS1000 returns an error code.
Setting to a parameter that cannot be set	The YS1000 returns the current value.
Setting of data outside the setting range of the parameter	The YS1000 writes the value after limiting it to the setting range.

3.3 YS Protocol

Table 3.9 Communication Errors and Remedies

Error Type	Processing Performed on YS1000	Remedy	Supplementary Explanation
Communication error in a transmitted message The YS1000 has detected a communication error in the transmitted message from the host computer.	The YS1000 does not return the response message to the host computer. COMM is displayed in the ALARM Display.	The host computer starts up the no response timer after sending the transmitted message. Then, when the timer reaches its preset time without the response message arriving from the YS1000, the host computer resends the transmitted message. The no response timer value must be set to at least 5 seconds.	Types of communication errors: Frame error, Parity error, Inter-character timer timeout (0.1 seconds), Receiving frame over-length (when 512 characters are exceeded by alphanumeric characters appended with [CR] and [LF])
Incorrect addressing error The address of the YS1000 in the transmitted message from the host computer is different. (No. does not match.)	The YS1000 does not return the response.	The host computer starts up the no response timer after sending the transmitted message. Then, when the timer reaches its preset time without the response message arriving from the YS1000, the host computer resends the transmitted message. The no response timer value must be set to at least 5 seconds.	
Communication error in a response message The host computer has detected a communication error in the response message from the YS1000.	The YS1000 cannot detect errors in sent response messages.	The host computer resends transmitted messages. At this time, the YS1000 re-executes the resent transmitted message.	
Overlength message The length of the message exceeds 512 bytes (512 characters appended with [CR] and [LF]).	The YS1000 returns the error code ("@100[CR][LF]").	The host computer program should be changed so that the YS1000 response message is within 512 bytes.	
Write-inhibit error An attempt was made to set to a parameter that cannot be set (i.e. in a non-settable status or read-only parameter).	The YS1000 does not write the data, and returns the current data. An error code is not returned.	The host computer must compare the data that was set with the data of the response message.	A "parameter in anon-settable status" refers to "read-only parameters" or a "status that cannot be set depending on the operation mode for SV or MV, for example."
Writing data over-range error An attempt was attempted to set data outside of the setting range of the parameter.	The YS1000 writes the value after limiting it to the setting range.	The host computer must compare the data that was set with the data of the response message.	
Syntax errors	The YS1000 returns an error code (@XXX[CR][LF]). ("XXX" stands for the error codes shown in Table 3.10.)	The user must check the communication program on the host computer.	When an error is detected midway through a statement in the case of data write command (DP) statements, that entire command is invalid.

Table 3.10 Syntax Errors and Corresponding Error Codes

Syntax Error	Error Code
Command name does not match. (YS1000 controller address matches.)	@011
Description format of number of parameters is inappropriate. (not a number, 3 digits or more)	@031
Specified number of parameters is out of range. (not in range 01 to 16)	@032
The specified number of parameters differs from the number of parameters in the command.	@033
The parameter name does not match.	@041
The description format of the setpoint value is inappropriate.	@051
The response message exceeds 512 bytes.	@100

[Examples of Syntax Errors]

The following shows examples of syntax errors in transmitted messages and response messages.

The "" symbol stands for a delimiter in the text, and is not included in the communication statement. "_" stands for a space.

- 1) The command "DD" does not exist:

```
"DD_05_01_PH1[CR][LF]"
```

```
"@011[CR][LF]"
```

- 2) The number of specified parameters is inappropriate:

```
"DP_08_02_PB1_200.0_TI1_55_TD1_0[CR][LF]"
```

```
"@033[CR][LF]"
```

- 3) The parameter "PS" does not exist:

```
"DG_01_1_PS1[CR][LF]"
```

```
"@041[CR][LF]"
```

- 4) 2-digit suffixes (e.g. Pn and Xn) that are to be programmed are programmed using only one digit:

```
"DG_02_2_P3_X1[CR][LF]"
```

```
"@041[CR][LF]"
```

- 5) The setpoint value is not a number:

```
"DG_04_1_SV1_ACG[CR][LF]"
```

```
"@051[CR][LF]"
```

[Syntax errors that are regarded as normal and command is executed]

- 1) There are multiple spaces between the parameter name and the setting data:

```
"DP_03_02_SV1_55.1_SV2_20.0[CR][LF]"
```

```
"DP_03_02_55.1_20.0[CR][LF]"
```

Note, however, that insertion of a space between the start of the statement or the end of the data and [CR][LF] is regarded as an error.

- a) "DP_03_02_SV1_55.1_[CR][LF]"

```
"@033[CR][LF]"
```

- b) "_DP_03_02_SV1_55.1[CR][LF]"

(no response)

- 2) The position of the decimal point in the setting data is different:

```
"DP_04_01_PB1_133.3333[CR][LF]"
```

```
"DP_04_01_133.3[CR][LF]"
```

(With PB, digits past the decimal point are discarded to one digit.)

```
"DP_01_01_TD1_555.6666[CR][LF]"
```

```
"DP_01_01_555[CR][LF]"
```

(With TD, all digits past the decimal point are discarded to become an integer.)

- 3) Zero prefixing the address and number of parameters is omitted:

```
"DG_1_1_SV1[CR][LF]"
```

```
"DG_01_01_100.0[CR][LF]"
```

3.3.6 List of Data Types on DCS Internal Devices When Connected to DCS

Each YS1000 operates as YS100 Series when connected to DCS. Set the DCS side setup referring to the table below.

Models of YS1000	Models of YS100
YS1700	YS170
YS1500	YS150
YS1360	YS136
YS1350	YS135

Lists of data types on DCS internal devices when YS1500/YS1700 are connected to DCS are shown below.

(The DCS internal device is different from the internal device when connected by DCS-LCS communication (optional code /A32).)

The internal device and data types when YS1350/YS1360 are connected to DCS are the same as those when connected by DCS-LCS communication (optional code /A32).

See "5.1 List of Data Types on DCS Internal Devices on YS1000."

For the operation mode and block mode, see "5.2 YS1000 Operation Mode and Block Mode."

(1)YS1500/YS1700 controllers (multi-function mode)

The table below shows the correspondence with data types when the YS1500/YS1700 (multi-function mode) is connected.

Table 3.11 Correspondence between CS3000 Internal Device Data Types and YS1500/YS1700 Controller Parameters
(In the table below, data types not having a corresponding parameter are information that is held uniquely by the CS3000.)

CS3000 Internal Device Data Types (internal device model name: SLCD)					YS1500/YS1700 Corresponding Parameters			Setting Viability
					YS1500/YS1700 Multi-function Mode			
Data Item	Data Name	Entry Viability	Range	Default	Single-loop Mode	Cascade Mode	Selector Mode	
MODE	Block mode	●	None	O/S (MAN)	LS1 (Note 1)	LS1 (Note 1)	LS1 (Note 1)	○
ALRM	Alarm status	–	None	NR				
AFLS	Alarm flashing status	–	None	0				
AF	Alarm detection specification	–	None	0				
AOFS	Alarm masking specification	–	None	0				
PV	Process variable	–	PV engineering unit data	SL	PV1 (PV) (Note 2)	PV1 (Note 2)	PV1 (Note 2)	×
SUM	Integrated value	○	Engineering unit data	0				
SV	Setpoint value	●	Same engineering unit data as PV	SL	SV1 (SV) (Note 2)	SV1 (Note 2)	SV1 (Note 2)	○
CSV	Cascade setting value	–	Same engineering unit data as PV	SL				
RSV	Remote setting value	–	Same engineering unit data as PV	SL				
DV	Deviation variable	–	Same engineering unit data as PV	0				
MV	Manipulated output variable	●	0.0 to 100.0%	0	MV1 (MV)	MV1 (MV) (Note 3)	MV1 (MV)	○
RMV	Remote manipulated output variable	–	0.0 to 100.0%	0				
PH	High limit alarm setpoint for PV	◆	SL to SH	SH				
PL	Low limit alarm setpoint for PV	◆	SL to SH	SL				
DL	Alarm setpoint for deviation variable	◆	±(SH - SL)	0				
MH	High limit setpoint of MV	●	0.0 to 100.0%	100	MH1	MH2	MH1	○
ML	Low limit setpoint of MV	●	0.0 to 100.0%	0	ML1	ML2	ML1	○

- Entry possible from both YS controllers and HIS
 - : Entry possible from HIS only
 - ◆: Data in YS blocks can be entered from HIS. Data in YS controllers can be entered from YS controllers.
 - : Entry not possible
- Note 1: Indicates the YS1500/YS1700 operation mode.
 Note 2: Engineering units that are set in YS1500/YS1700 scale parameters SCH1, SCL1 and SCDP1
 Note 3: This MV value is the output value of Loop 2.
 Note 4: Though parameters of the same name exist on the YS1500/YS1700, these parameters are set independently. (Set the same values to each parameter.)

3.3 YS Protocol

CS3000 Internal Device Data Types (internal device model name: SLCD)					YS1500/YS1700 Corresponding Parameters			Setting Viability
					YS1500/YS1700 Multi-function Mode			
Data Item	Data Name	Entry Viability	Range	Default	Single-loop Mode	Cascade Mode	Selector Mode	
SVH	Setpoint high limit setting value	○	SL to SH	SH				
SVL	Setpoint low limit setting value	○	SL to SH	SL				
P	Proportional band	●	6.3 to 999.9%	100	PB1	PB1	PB1	
I	Integral time	●	1 to 9999 sec.	20	TI1	TI1	TI1	
D	Derivative time	●	0 to 9999 sec.	0	TD1	TD1	TD1	
OPHI	Output high limit index	○	0.0 to 100.0%	100				
OPLO	Output low limit index	○	0.0 to 100.0%	0				
OPMK	Operation mark	○	0 to 255	0				
UAID	User application ID	○	None	0				
SH	PV scale high limit value	–	Same engineering unit data as PV	None				
SL	PV scale low limit value	–	Same engineering unit data as PV	None				
MSH	MV scale high limit value	–	Fixed at 100%	100				
MSL	MV scale low limit value	–	Fixed at 0%	0				
RAW	Unprocessed input data	–	0.0 to 100.0%	None				

- Entry possible from both YS controllers and HIS
 - : Entry possible from HIS only
 - ◆: Data in YS blocks can be entered from HIS. Data in YS controllers can be entered from YS controllers.
 - : Entry not possible
- Note: Though parameters of the same name exist on the YS1500/YS1700, these parameters are set independently. (Set the same values to each parameter.)

(2)YS1700 controller (programmable mode)

The table below shows the correspondence with data types when the YS1700 (programmable mode) is connected.

Table 3.12 Correspondence between CS3000 Internal Device Data Types and YS1700 Controller Parameters
(In the table below, data types not having a corresponding parameter are information that is held uniquely by the CS3000.)

CS3000 Internal Device Data Types (internal device model name: SLPC)					YS1700 Corresponding Parameters				Setting Viability
Data Item	Data Name	Entry Viability	Range	Default	YS1700 Programmable Mode				
					BSC1 Only	CSC	SSC	BSC1, BSC2	
MODE	Block mode	●	None	O/S (MAN)	LS1 (Note 1)	LS1 (Note 1)	LS1 (Note 1)	LS1 (Note 1)	○
ALRM	Alarm status	–	None	NR					
AFLS	Alarm flashing status	–	None	0					
AF	Alarm detection specification	–	None	0					
AOFS	Alarm masking specification	–	None	0					
PV	Process variable	–	PV engineering unit data	SL	PV1 (PV) (Note 2)	PV1 (Note 2)	PV1 (Note 2)	PV1 (Note 2)	×
SUM	Integrated value	○	Engineering unit data	0					
SV	Setpoint value	●	Same engineering unit data as PV	SL	SV1 (SV) (Note 2)	SV1 (Note 2)	SV1 (Note 2)	SV1 (Note 2)	○
CSV	Cascade setting value	–	Same engineering unit data as PV	SL					
RSV	Remote setting value	–	Same engineering unit data as PV	SL					
DV	Deviation variable	–	Same engineering unit data as PV	0					
MV	Manipulated output variable	●	0.0 to 100.0%	0	MV1 (MV)	MV1 (MV) (Note 3)	MV1 (MV)	MV1 (MV)	○
RMV	Remote manipulated output variable	–	0.0 to 100.0%	0					
PH	High limit alarm setpoint for PV	◆	SL to SH	SH					
PL	Low limit alarm setpoint for PV	◆	SL to SH	SL					
DL	Alarm setpoint for deviation variable	◆	±(SH - SL)	0					
MH	High limit setpoint of MV	●	0.0 to 100.0%	100	MH1	MH2	MH1	MH1	○
ML	Low limit setpoint of MV	●	0.0 to 100.0%	0	ML1	ML2	ML1	ML1	○

- Entry possible from both YS controllers and HIS
- : Entry possible from HIS only
- ◆: Data in YS blocks can be entered from HIS. Data in YS controllers can be entered from YS controllers.
- : Entry not possible

Note 1: Indicates the YS1700 operation mode.

Note 2: Engineering units that are set in YS1700 scale parameters SCH1, SCL1 and SCDP1

Note 3: This MV value is the output value of Loop 2.

Note 4: Though parameters of the same name exist on the YS1700, these parameters are set independently. (Set the same values to each parameter.)

3.3 YS Protocol

CS3000 Internal Device Data Types (internal device model name: SLCD)					YS1700 Corresponding Parameters				Setting Viability
					YS1700 Programmable Mode				
Data Item	Data Name	Entry Viability	Range	Default	BSC1 Only	CSC	SSC	BSC1, BSC2	
SVH	Setpoint high limit setting value	○	SL to SH	SH					
SVL	Setpoint low limit setting value	○	SL to SH	SL					
P	Proportional band	●	6.3 to 999.9%	100	PB1	PB1	PB1	PB1	○
I	Integral time	●	1 to 9999 sec.	20	TI1	TI1	TI1	TI1	○
D	Derivative time	●	0 to 9999 sec.	0	TD1	TD1	TD1	TD1	○
BS	Computation parameter 1	●	-8.000 to 8.000	0.0	P1 (Note 1)	P1 (Note 1)	P1 (Note 1)	P1 (Note 1)	○
CS	Computation parameter 2	●	-8.000 to 8.000	1.000	P2 (Note 1)	P2 (Note 1)	P2 (Note 1)	P2 (Note 1)	○
AUX1	Auxiliary input 1	-	0.0 to 100.0%	None	Y4	Y4	Y4	Y4	×
AUX2	Auxiliary input 2	-	0.0 to 100.0%	None	Y5	Y5	Y5	Y5	×
AUX3	Auxiliary input 3	-	0.0 to 100.0%	None	Y6	Y6	Y6	Y6	×
OPHI	Output high limit index	○	0.0 to 100.0%	100					
OPLO	Output low limit index	○	0.0 to 100.0%	0					
OPMK	Operation mark	○	0 to 255	0					
UAID	User application ID	○	None	0					
SH	PV scale high limit value	-	Same engineering unit data as PV	None					
SL	PV scale low limit value	-	Same engineering unit data as PV	None					
MSH	MV scale high limit value	-	Fixed at 100%	100					
MSL	MV scale low limit value	-	Fixed at 0%	0					
RAW	Unprocessed input data	-	0.0 to 100.0%	None					

- Entry possible from both YS controllers and HIS
 - : Entry possible from HIS only
 - ◆: Data in YS blocks can be entered from HIS. Data in YS controllers can be entered from YS controllers.
 - : Entry not possible
- Note 1: When the internal values of P1 and P2 are outside the range -8.000 to 8.000, BS and CS are limited to -8.000 to 8.000.
- Note 2: Though parameters of the same name exist on the YS1700, these parameters are set independently. (Set the same values to each parameter.)

4.1 Overview

The Modbus/TCP is a communication protocol used for performing communication with a general-purpose PC, programmable controller, touch panel, or other device using TCP/IP protocol via Ethernet or other network.

Internal registers on YS1000 Series controllers are read and written, and data transactions performed with connected devices via this communication protocol. The YS1000 Series can be connected to IEEE802.3-compliant networks (10BASE-T/100BASE-TX), and communication with the Modbus/TCP protocol is generally performed on port No. 502. (The port No. can be changed.)

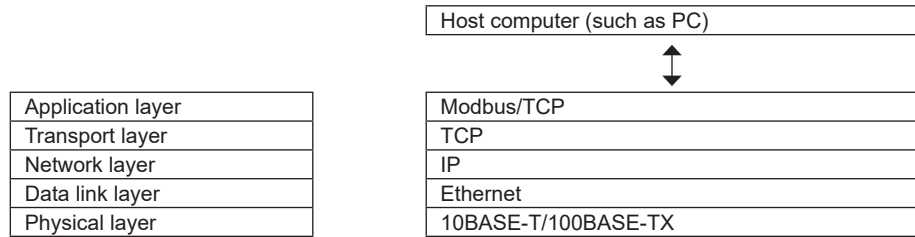

Figure 4.1 Network Layers

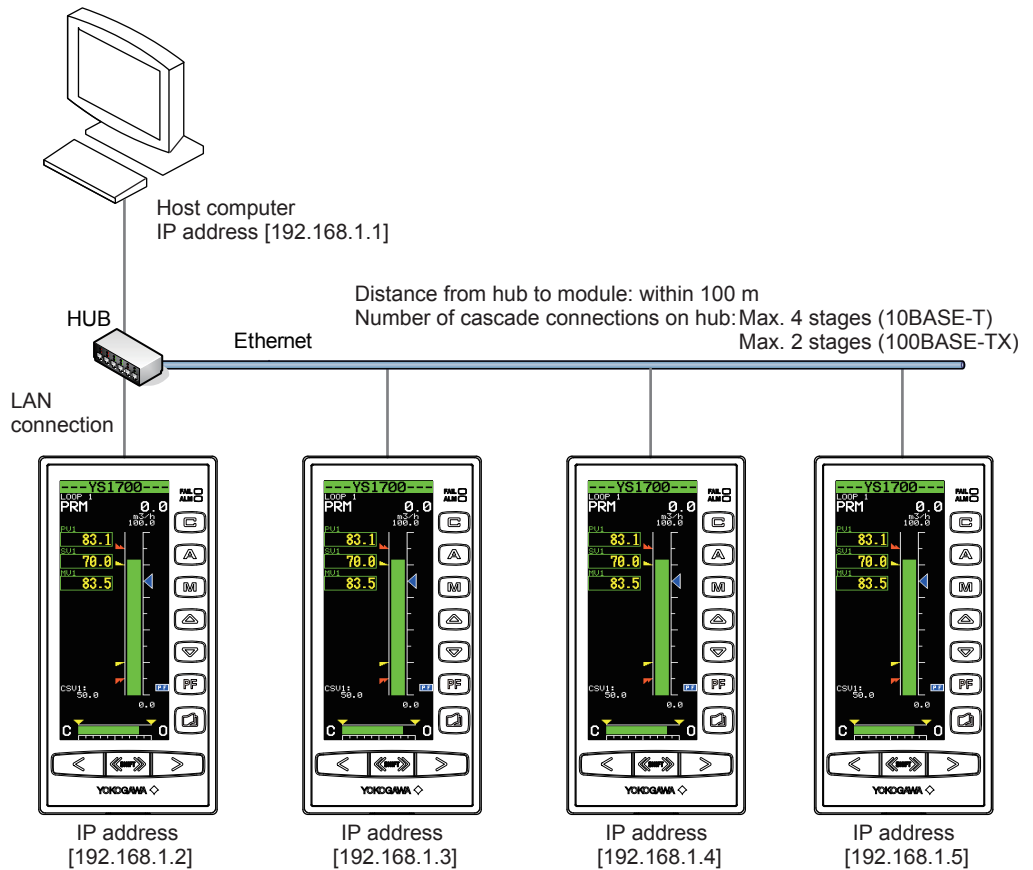

Figure 4.2 Overview of Ethernet Communication Connection

- ▶ D registers: "Chapter 6 Functions and Application of YS1500/YS1700 D-registers" or "Chapter 7 Functions and Application of YS1310/YS1350/YS1360 D-registers" in this manual

0401E.ai

4.2 TCP/IP-based Communication

Modbus/TCP performs transactions by the procedure in the figure below on the TCP/IP socket interface.

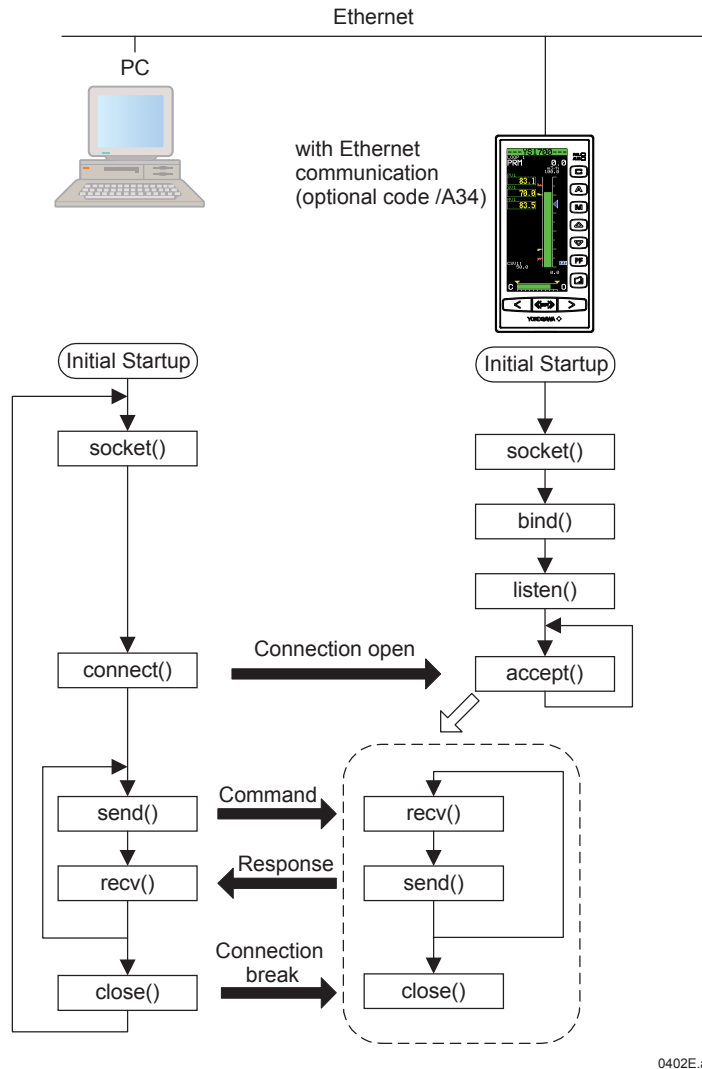

Note

If there is no request for at least Ethernet communication timeout period (Factory Default Value: 60 seconds) from the host computer after the connection is established, YS1000 breaks the connection.

The maximum number of transactions for YS1000 is "1".

When sending commands continuously, send the next command after confirming the response from YS1000. (Figure below)

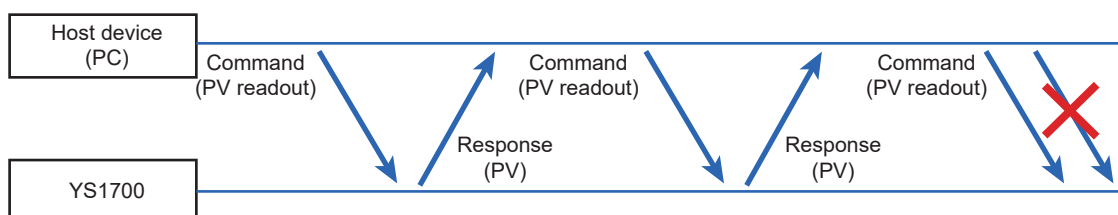

4.3 Configuration of Network Frames

Modbus/TCP frames are configured as follows:

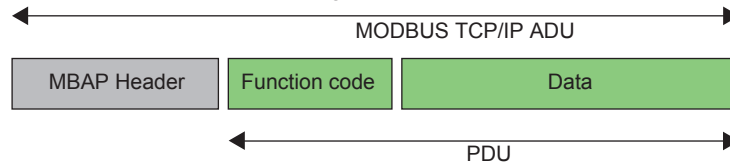

MBAP Header (Modbus Application Protocol Header): Header for identifying that the protocol is Modbus/TCP

PDU (Protocol Data Unit): Body of data communication

4.3.1 Configuration of MBAP Header

The MBAP header comprises seven bytes as follows:

Byte No	0	1	2	3	4	5	6
Content	Transfer ID		Protocol ID		Number of bytes		Unit ID

Transfer ID: The host computer specifies an arbitrary value for identifying transactions. The YS1000 returns the value received from the host computer as the response.

Protocol ID: "0" is specified in the case of the Modbus/TCP protocol.

Number of bytes: Number of bytes from the unit ID (byte No.6) onwards

Unit ID: The host computer specifies "1" and the YS1000 returns "1" as the response.

4.3.2 Configuration of PDU

The PDU (Protocol Data Unit) comprises n bytes as follows:

Byte No	0	1 onwards (n-1)
Content	Function code	Data

Function code: The instruction from the host computer is specified.

Data: The D register No. and number, parameter values, and the like of internal registers are specified according to the function code.

4.4 Communication with Host Computer

4.4.1 List of Function Codes

These instruction words are used so that the host computer obtains the D register information of the YS1000.

Table 4.1 List of Function Codes

Code No.	Function	Description
03	Reading of multiple D registers	Up to 100 registers can be read continuously from D0001 to D4000.
06	Writing of D registers	Only one register can be written from D0951 to D1000.
08	Loopback test	This is used to check the communication connection.
16	Writing of multiple D registers	Up to 50 registers can be written continuously from D0001 to D4000.
66	Random reading	Up to 100 registers can be read at random from D0001 to D4000.
67	Random writing	Up to 50 registers can be read at random from D0001 to D4000.
68	Specify monitor	Up to 100 registers can be monitored at random from D0001 to D4000.
69	Reading of monitor	The register specified by "specify monitor" is read.

Function codes cannot be written to read-only or use-disabled registers.

4.4.2 Specifying D Registers

Specify D registers from the host computer by the following procedure:

- (1) When using a commercially available SCADA or the equivalent, specify the Ref No. mentioned in "Chapter 6 Functions and Application of YS1500/YS1700 D-registers" or "Chapter 7 Functions and Application of YS1310/YS1350/YS1360 D-registers."
- (2) When using a communication program made by the user, specify the H-No. mentioned in "Chapter 6 Functions and Application of YS1500/YS1700 D-registers" or "Chapter 7 Functions and Application of YS1310/YS1350/YS1360 D-registers."

4.4.3 Requests and Responses

■ 03 Reading multiple D registers

● Function

The content of D registers is read continuously for the number of registers specified from the specified D register No.

- The maximum number of registers that can be read in a single operation is 100.
- For details on the response format at an error, see "4.4.4 Response Error Codes."

● Request (during normal operation) Read n number of data

Element	MBAP Header				PDU		
	2	2	2	1	1	2	2
Command element	Transfer ID	Protocol ID	Number of bytes	Unit ID	Function code	Register start No.	Number of registers
(Hex)	Optional value	0000	06	01	03		n

● Response (during normal operation)

Element	MBAP Header				PDU				
	2	2	2	1	1	1	2		2
Command element	Transfer ID	Protocol ID	Number of bytes	Unit ID	Function code	Byte count	Register content 1	• • •	Register content n
(Hex)	Optional value	0000	2n+3	01	03	2n			

■ 06 Writing D registers

- Function

Writes data to the specified register No.

- The number of registers that can be written in one operation is 1.
- For details on the response format at an error, see "4.4.4 Response Error Codes."

- Request (during normal operation)

Element	MBAP Header				PDU		
Number of bytes	2	2	2	1	1	2	2
Command element	Transfer ID	Protocol ID	Number of bytes	Unit ID	Function code	Register start No. (Note 1)	Write data
(Hex)	Optional value	0000	0006	01	06		

- Response (during normal operation)

Element	MBAP Header				PDU		
Number of bytes	2	2	2	1	1	2	2
Command element	Transfer ID	Protocol ID	Number of bytes	Unit ID	Function code	Register start No. (Note 1)	Write data
(Hex)	Optional value	0000	6	01	06		

Note 1: Only the register numbers of D0951 to D1000 can be specified.

■ 08 Loopback test

- Function

Use this function to check the communication connection.

- For details on the response format at an error, see "4.4.4 Response Error Codes."
- * below means that the value is fixed at "0000".
- An optional data can be selected for the send data.

- Message (during normal operation)

Element	MBAP Header				PDU		
Number of bytes	2	2	2	1	1	2	2
Command element	Transfer ID	Protocol ID	Number of bytes	Unit ID	Function code	0000*	Send data
(Hex)	Optional value	0000	0006	01	08	0000	Optional value

- Response (during normal operation)

Element	MBAP Header				PDU		
Number of bytes	2	2	2	1	1	2	2
Command element	Transfer ID	Protocol ID	Number of bytes	Unit ID	Function code	0000*	Send data
(Hex)	Optional value	0000	0006	01	08	0000	Optional value

4.4 Communication with Host Computer

■ 16 Writing to multiple D registers

- Function
Data is written to registers continuously for the number of registers specified from the specified register No.
 - The maximum number of registers that can be written in a single operation is 50.
 - For details on the response format at an error, see "4.4.4 Response Error Codes."
- Request (during normal operation) Write n number of data

Element	MBAP Header				PDU		
Number of bytes	2	2	2	1	1	2	2
Command element	Transfer ID	Protocol ID	Number of bytes	Unit ID	Function code	Register start No.	Number of registers
(Hex)	Optional value	0000	2n+7	01	10		n

Continuation of request

PDU			
1	2	• • •	2
Byte count	Data 1	• • •	Data n
2n			

- Response (during normal operation)

Element	MBAP Header				PDU		
Number of bytes	2	2	2	1	1	2	2
Command element	Transfer ID	Protocol ID	Number of bytes	Unit ID	Function code	Register start No.	Number of registers
(Hex)	Optional value	0000	0006	01	10		n

■ 66 Random reading

- Function
Reads the register data of register Nos. specified at random.
 - Register Nos. can be specified from all register areas.
 - The maximum number of registers that can be set is 100.
 - For details on the response format at an error, see "4.4.4 Response Error Codes."
- Request (during normal operation) Read n number of data

Element	MBAP Header				PDU		
Number of bytes	2	2	2	1	1	2	1
Command element	Transfer ID	Protocol ID	Number of bytes	Unit ID	Function code	Number of registers	Byte count
(Hex)	Optional value	0000	2n+5	01	42	n	2n

Continuation of request

PDU		
2	• • •	2
Specified register No.1	• • •	Specified register No.n

- Response (during normal operation)

Element	MBAP Header				PDU				
Number of bytes	2	2	2	1	1	1	2	• • •	2
Command element	Transfer ID	Protocol ID	Number of bytes	Unit ID	Function code	Byte count	Register content 1	• • •	Register content n
(Hex)	Optional value	0000	2n+3	01	42	2n			

■ 67 Random writing

- Function

Writes the register No. and data of register Nos. specified at random.

- Register Nos. can be specified from all register areas.
- The maximum number of registers that can be written to in a single write is 50.
- For details on the response format at an error, see "4.4.4 Response Error Codes."

- Message (during normal operation)

Element	MBAP Header				PDU		
Number of bytes	2	2	2	1	1	2	2
Command element	Transfer ID	Protocol ID	Number of bytes	Unit ID	Function code	Number of registers	Byte count
(Hex)	Optional value	0000	4n+6	01	43	n	4n

Continuation of request

PDU				
2	2	• • •	2	2
Specified register No.1	Data 1	• • •	Specified register No.n	Data n

- Response (during normal operation)

Element	MBAP Header				PDU	
Number of bytes	2	2	2	1	1	2
Command element	Transfer ID	Protocol ID	Number of bytes	Unit ID	Function code	Number of registers
(Hex)	Optional value	0000	4	01	43	n

■ 68 Specify monitor

- Function

Sets a register No. in the range D0001 to D4000 specified at random as specified for monitoring.

- The maximum number of registers that can be set for monitoring is 100.
- For details on the response format at an error, see "4.4.4 Response Error Codes."

- Message (during normal operation)

Element	MBAP Header				PDU		
Number of bytes	2	2	2	1	1	2	1
Command element	Transfer ID	Protocol ID	Number of bytes	Unit ID	Function code	Number of registers	Byte count
(Hex)	Optional value	0000	2n+5	01	44	n	2n

Continuation of request

PDU		
2	• • •	2
Specified register No.1	• • •	Specified register No.n

- Response (during normal operation)

Element	MBAP Header				PDU	
Number of bytes	2	2	2	1	1	1
Command element	Transfer ID	Protocol ID	Number of bytes	Unit ID	Function code	Byte count
(Hex)	Optional value	0000	3	01	44	2n

4.4 Communication with Host Computer

■ 69 Monitoring

- Function
Reads the register content specified for monitoring specified by function code "68."
 - For details on the response format at an error, see "4.4.4 Response Error Codes."
- Message (during normal operation)

Element	MBAP Header				PDU
Number of bytes	2	2	2	1	1
Command element	Transfer ID	Protocol ID	Number of bytes	Unit ID	Function code
(Hex)	Optional value	0000	2	01	45

- Response (during normal operation)

Element	MBAP Header				PDU				
Number of bytes	2	2	2	1	1	1	2		2
Command element	Transfer ID	Protocol ID	Number of bytes	Unit ID	Function code	Byte count	Register content 1	• • •	Register content n
(Hex)	Optional value	0000	2n+3	01	45	2n (Note 1)			

Note 1: The byte count specified by function code "68" is returned.

4.4.4 Response Error Codes

- When a response is returned to a request

When the PDU in the request contains an inconsistency, the YS1000 does not perform any processing, and returns the following request.

Element	MBAP Header				PDU	
Number of bytes	2	2	2	1	1	1
Command element	Transfer ID	Protocol ID	Number of bytes	Unit ID	Function code*	Error Code
(Hex)	Optional value	0000	03	01		

* The number "function code (Hex) + 80 (Hex)" is entered in the function code.

- Error code of response

Error Code	Meaning	Cause
01	Function code error	The function code does not exist.
02	D register No. error	A No. outside the range has been specified.
03	Number of D registers error	A number of registers outside the range has been specified.
09	Monitor not specified	An attempt was made to read a monitor without specifying the monitor.

- When a response is not returned to a request

In the following instances, the YS1000 does not perform any processing and does not return a response:

- When a connection has not been established on the TPC/IP socket interface
- When the MBAP Header in a request contains an inconsistency

* As a measure for the above, execute time-out processing by the communication function or communication program on the host computer.

5.1 List of Data Types on DCS Internal Devices on YS1000

This section describes the correspondence with data types of internal devices when respective YS1000 model are connected to the DCS. In the following descriptions, some data types of the internal devices have data that is not supported on the YS1000, while others are set independently.

Data types such as SUM (integrated value) and ALARM (alarm status) are held uniquely by DCS internal devices. PH (high limit alarm setpoint for PV), PL (low limit alarm setpoint for PV) and DL (alarm setpoint for deviation variable) are data types that are held independently by DCS internal devices and the YS1000.

5.1.1 YS1500/YS1700 Controllers

The table below shows the correspondence with data types when the YS1500/YS1700 is connected.

5.1 List of Data Types on DCS Internal Devices on YS1000

Table 5.1 Correspondence between CS3000 Internal Device Data Types and YS1500/YS1700 Controller Parameters
(In the table below, data types not having a corresponding parameter are information that is held uniquely by the CS3000.)

CS3000 Internal Device Data Types (internal device model name: SLPC)					YS1500/YS1700 Corresponding Parameters							Setting Viability
					YS1500/YS1700 Multi-function Mode			YS1700 Programmable Mode				
Data Item	Data Name	Entry Viability	Range	Default	Single-loop Mode	Cascade Mode	Selector Mode	BSC1 Only	CSC	SSC	BSC1, BSC2	
MODE	Block mode	●	None	O/S (MAN)	LS1 (Note 1)	LS1 (Note 1)	LS1 (Note 1)	LS1 (Note 1)	LS1 (Note 1)	LS1 (Note 1)	LS1 (Note 1)	○
ALRM	Alarm status	–	None	NR								
AFLS	Alarm flashing status	–	None	0								
AF	Alarm detection specification	–	None	0								
AOFS	Alarm masking specification	–	None	0								
PV	Process variable	–	PV engineering unit data	SL	PV1 (PV) (Note 2)	PV1 (Note 2)	PV1 (Note 2)	PV1 (PV) (Note 2)	PV1 (Note 2)	PV1 (Note 2)	PV1 (Note 2)	×
SUM	Integrated value	○	Engineering unit data	0								
SV	Setpoint value	●	Same engineering unit data as PV	SL	SV1 (SV) (Note 2)	SV1 (Note 2)	SV1 (Note 2)	SV1 (SV) (Note 2)	SV1 (Note 2)	SV1 (Note 2)	SV1 (Note 2)	○
CSV	Cascade setting value	–	Same engineering unit data as PV	SL								
RSV	Remote setting value	–	Same engineering unit data as PV	SL								
DV	Deviation variable	–	Same engineering unit data as PV	0								
MV	Manipulated output variable	●	0.0 to 100.0%	0	MV1 (MV)	MV1 (MV) (Note 3)	MV1 (MV)	MV1 (MV)	MV1 (MV) (Note 3)	MV1 (MV)	MV1 (MV)	○
RMV	Remote manipulated output variable	–	0.0 to 100.0%	0								
PH	High limit alarm setpoint for PV	◆	SL to SH	SH								
PL	Low limit alarm setpoint for PV	◆	SL to SH	SL								
DL	Alarm setpoint for deviation variable	◆	±(SH - SL)	0								

- Entry possible from both YS controllers and HIS
 - : Entry possible from HIS only
 - ◆: Data in YS blocks can be entered from HIS. Data in YS controllers can be entered from YS controllers.
 - : Entry not possible
- Note 1: Indicates the YS1500/YS1700 operation mode.
 Note 2: Engineering units that are set in YS1500/YS1700 scale parameters SCH1, SCL1 and SCDP1
 Note 3: This MV value is the output value of Loop 2.
 Note 4: Though parameters of the same name exist on the YS1500/YS1700, these parameters are set independently. (Set the same values to each parameter.)

5.1 List of Data Types on DCS Internal Devices on YS1000

CS3000 Internal Device Data Types (internal device model name: SLPC)					YS1500/YS1700 Corresponding Parameters							Setting Viability
					YS1500/YS1700 Multi-function Mode			YS1700 Programmable Mode				
Data Item	Data Name	Entry Viability	Range	Default	Single-loop Mode	Cascade Mode	Selector Mode	BSC1 Only	CSC	SSC	BSC1, BSC2	
MH	High limit setpoint of MV	●	0.0 to 100.0%	100	MH1	MH2	MH1	MH1	MH2	MH1	MH1	○
ML	Low limit setpoint of MV	●	0.0 to 100.0%	0	ML1	ML2	ML1	ML1	ML2	ML1	ML1	○
SVH	Setpoint high limit setting value	○	SL to SH	SH								
SVL	Setpoint low limit setting value	○	SL to SH	SL								
P	Proportional band	●	6.3 to 999.9%	100	PB1	PB1	PB1	PB1	PB1	PB1	PB1	○
I	Integral time	●	1 to 9999 sec.	20	TI1	TI1	TI1	TI1	TI1	TI1	TI1	○
D	Derivative time	●	0 to 9999 sec.	0	TD1	TD1	TD1	TD1	TD1	TD1	TD1	○
BS	Computation parameter 1	●	-8.000 to 8.000	0.0				P1 (Note 1)	P1 (Note 1)	P1 (Note 1)	P1 (Note 1)	○
CS	Computation parameter 2	●	-8.000 to 8.000	1.000				P2 (Note 1)	P2 (Note 1)	P2 (Note 1)	P2 (Note 1)	○
AUX1	Auxiliary input 1	-	0.0 to 100.0%	None				Y4	Y4	Y4	Y4	×
AUX2	Auxiliary input 2	-	0.0 to 100.0%	None				Y5	Y5	Y5	Y5	×
AUX3	Auxiliary input 3	-	0.0 to 100.0%	None				Y6	Y6	Y6	Y6	×
OPHI	Output high limit index	○	0.0 to 100.0%	100								
OPLO	Output low limit index	○	0.0 to 100.0%	0								
OPMK	Operation mark	○	0 to 255	0								
UAID	User application ID	○	None	0								
SH	PV scale high limit value	-	Same engineering unit data as PV	None								
SL	PV scale low limit value	-	Same engineering unit data as PV	None								
MSH	MV scale high limit value	-	Fixed at 100%	100								
MSL	MV scale low limit value	-	Fixed at 0%	0								
RAW	Unprocessed input data	-	0.0 to 100.0%	None								

- Entry possible from both YS controllers and HIS
 - : Entry possible from HIS only
 - ◆: Data in YS blocks can be entered from HIS. Data in YS controllers can be entered from YS controllers.
 - : Entry not possible
- Note 1: When the internal values of P1 and P2 are outside the range -8.000 to 8.000, BS and CS are limited to -8.000 to 8.000.
- Note 2: Though parameters of the same name exist on the YS1500/YS1700, these parameters are set independently. (Set the same values to each parameter.)

5.1 List of Data Types on DCS Internal Devices on YS1000

5.1.2 YS1350 Manual Setter for SV Setting

The table below shows the correspondence with data types when the YS1350 is connected.

CS3000 Internal Device Data Types (SMST-111)					YS1350 Parameters	
Data Alarm	Data Name	Entry Viability	Range	Default	Corresponding Parameter	Setting Viability
MODE	Block mode	●	None	O/S (MAN)	LS1 (Note 1)	○
ALRM	Alarm status	–	None	NR		
AFLS	Alarm flashing status	–	None	0		
AF	Alarm detection specification	–	None	0		
AOFS	Alarm masking specification	–	None	0		
PV	Process variable	–	PV engineering unit data	SL	PV1 (Note 2)	×
SUM	Integrated value	○	Engineering unit data	0		
SV	Setpoint value	●	Same engineering unit data as PV	SL	SV1 (Note 2)	○
CSV	Cascade setting value	–	Same engineering unit data as PV	SL		
RSV	Remote setting value	–	Same engineering unit data as PV	SL		
PH (Note 3)	High limit alarm setpoint for PV	◆	SL to SH	SH		
PL (Note 3)	Low limit alarm setpoint for PV	◆	SL to SH	SL		
SVH	Setpoint high limit setting value	○	SL to SH	SH		
SVL	Setpoint low limit setting value	○	SL to SH	SL		
OPMK	Operation mark	○	0 to 255	0		
UAID	User application ID	○	None	0		
SH	PV scale high limit value	–	Same engineering unit data as PV	None		
SL	PV scale low limit value	–	Same engineering unit data as PV	None		
RAW	Unprocessed input data	–	0.0 to 100.0%	None		

- Entry possible from both YS controllers and HIS
 - : Entry possible from HIS only
 - ◆: Data in YS blocks can be entered from HIS. Data in YS controllers can be entered from YS controllers.
 - : Entry not possible
- Note 1: Indicates the YS1350 operation mode.
 Note 2: Engineering units that are set in YS1350 scale parameters SCH1, SCL1 and SCDP1.
 Note 3: Though parameters of the same name exist on the YS1350, these parameters are set independently. (Set the same values to each parameter.)

5.1.3 YS1360 Manual Setter for MV Setting

The table below shows the correspondence with data types when the YS1360 is connected.

CS3000 Internal Device Data Types (SMST-121)					YS1360 Parameters	
Data Alarm	Data Name	Entry Viability	Range	Default	Corresponding Parameter	Setting Viability
MODE	Block mode	●	None	O/S (MAN)	LS1 (Note 1)	○
ALRM	Alarm status	–	None	NR		
AFLS	Alarm flashing status	–	None	0		
AF	Alarm detection specification	–	None	0		
AOFS	Alarm masking specification	–	None	0		
PV	Process variable	–	PV engineering unit data	SL	PV1 (Note 2)	×
SUM	Integrated value	○	Engineering unit data	0		
MV	Manipulated output variable	●	0.0 to 100.0%	0	MV1	○
RMV	Remote manipulated output variable	–	0.0 to 100.0%	0		
PH (Note 3)	High limit alarm setpoint for PV	◆	SL to SH	SH		
PL (Note 3)	Low limit alarm setpoint for PV	◆	SL to SH	SL		
MH	High limit setpoint of MV	●	0.0 to 100.0%	100	MH1	○
ML	Low limit setpoint of MV	●	0.0 to 100.0%	0	ML1	○
OPHI	Output high limit index	○	0.0 to 100.0%	100		
OPLO	Output low limit index	○	0.0 to 100.0%	0		
OPMK	Operation mark	○	0 to 255	0		
UAID	User application ID	○	None	0		
SH	PV scale high limit value	–	Same engineering unit data as PV	None		
SL	PV scale low limit value	–	Same engineering unit data as PV	None		
MSH	MV scale high limit value	–	Fixed at 100%	100		
MSL	MV scale low limit value	–	Fixed at 0%	0		
RAW	Unprocessed input data	–	0.0 to 100.0%	None		

- : Entry possible from both YS controllers and HIS
- : Entry possible from HIS only
- ◆: Data in YS blocks can be entered from HIS. Data in YS controllers can be entered from YS controllers.
- : Entry not possible

Note 1: Indicates the YS1360 operation mode.

Note 2: Engineering units that are set in YS1360 scale parameters SCH1, SCL1 and SCDP1.

Note 3: Though parameters of the same name exist on the YS1360, these parameters are set independently. (Set the same values to each parameter.)

5.2 YS1000 Operation Mode and Block Mode

The YS1000 has three operation modes, C, A and M modes. C mode has a further two modes, the cascade mode and the computer mode.

These operation modes are specified respectively on the YS1000 and DCS.

For details on operation mode transitions on the YS1000, see "2.4 Operation Mode Transitions."

5.2.1 YS1500/YS1700 Operation Mode and Block Mode

The relationship between the YS1500/YS1700 operation modes and the HIS Block mode display is as follows.

(1) Cascade mode

Operation Mode Display on YS1500/YS1700	Control Operation on YS1500/YS1700	Block Mode Display on HIS	Setting of SV and MV from HIS
C (CAS)	The YS1500/YS1700 performs operation by automatic control according to the setpoint value of CSV1 input.	CAS	Not possible
A	Automatic control	AUT	SV possible
M	Manual control	MAN	SV, MV possible

(2) Computer mode

Operation Mode Display on YS1500/YS1700	Control Operation on YS1500/YS1700	Block Mode Display on HIS	Setting of SV and MV from HIS
C	(DDC)	ROUT (DDC on CENTUM-XL and μ XL)	Not possible
	(SPC)	RCAS (SPC on CENTUM-XL and μ XL)	Not possible
	(SPC)	CAS	Not possible
A	Automatic control	AUT	SV possible
M	Manual control	MAN	SV, MV possible

5.2.2 YS1350 Operation Mode and Block Mode

The relationship between the YS1350 operation modes and the HIS Block mode display is as follows.

(1) Cascade mode

Operation Mode Display on YS1350	YS1350 Operation	Block Mode Display on HIS	Setting of SV from HIS
C (CAS)	YS1350 outputs the CIN1 input value as a setpoint value.	CAS	Not possible
M	The manual setpoint value is output.	MAN	Possible

(2) Computer mode

Operation Mode Display on YS1350	YS1350 Operation	Block Mode Display on HIS	Setting of SV from HIS
C (DDC)	The setpoint value assigned from DCS internal devices is output as the setting output signal.	CAS	Not possible
C (DDC)	The host computer sends the setpoint value to the DCS internal devices. The YS1350 outputs the above setpoint value as the setting output signal.	RCAS (DDC on CENTUM-XL and μ XL)	Not possible
M	The manual setpoint value is output.	MAN	Possible

Note: The YS1350 cannot be set to the computer mode from the HIS on DCS.

5.2.3 YS1360 Operation Mode and Block Mode

The relationship between the YS1360 operation modes and the HIS Block mode display is as follows.

(1) Cascade mode

Operation Mode Display on YS1360	YS1360 Operation	Block Mode Display on HIS	Setting of MV from HIS
C (CAS)	YS1360 outputs the CIN1 input value as the manipulated output variable signal.	CAS	Not possible
M	The manual output variable is output as the manipulated output variable signal.	MAN	Possible

(2) Computer mode

Operation Mode Display on YS1360	YS1360 Operation	Block Mode Display on HIS	Setting of MV from HIS
C (DDC)	The host computer sends output values to the DCS internal devices. YS1360 outputs the above output value as the manipulated output variable signal.	ROUT (DDC on CENTUM-XL and μ XL)	Not possible
M	The manual output variable is output as the manipulated output variable signal.	MAN	Possible

6.1 Overview

This chapter describes the functions and applications of the D registers.

D registers are used in Modbus, PC-link, or Ethernet communications, and are used for storing YS1000 parameter data, flag data, process data, and other data and values.

The host computer can utilize these data by reading from and writing to the D registers.

Use of the D registers enables the following:

- Centralized control by the host computer
- Reading and writing of data between the YS1500/YS1700 and the host computer

6.2 Conventions Used in D-Register Lists

This section describes the conventions used in the D-register map tables.

The numerical values arranged vertically in the leftmost column of the table represent (1) D register numbers. 5-digit numbers in the column next to it show (2) reference numbers for Modbus communication. The third column from the left provides (3) register numbers (hexadecimal) for Modbus communication.

Alphabet characters in the register map represent process data, operation parameters, setup parameters, and other flag register names. For details on operation parameters and setup parameters, refer to the respective YS1000 Operation Guide and User's Manual.

Register Map (Categories)							
Register Contents							
D-Reg No.	Ref. No.	H No.	Register Name	R/W			
				SINGLE	CAS	SELECT	PROG
D0001 to D0002	40001 to 40002	0000 to 0001	SYS_ALM_STS	R	R	R	R
D0003 to D0004	40003 to 40004	0002 to 0003	PRC_ALM_STS	R	R	R	R

(1) D-register numbers

(2) Reference numbers (for Modbus communication)
Reference number = D-Reg. No. + 40000

(3) Hexadecimal numbers
(for Modbus communication)

Read/write by communication
 R: Read enabled
 R/W: Read/write enabled
 ×: Read/write disabled
 (An attempt to read results in reading "0".)

Controller mode
 SINGLE: Single-loop mode
 CAS: Cascade mode
 SELECT: Selector mode
 PROG: Programmable mode

0601E.ai

6.3 Classification of D Registers

■ Classification of D Register Map Tables

The table below outlines how the D registers are classified by their numbers in the D Register Map tables.

Table 6.1 Classification of D Registers

Register No.	Area and data categories	Description	Reference
D0001 to D0400	Process data area	Process data, Analog input/output, Status, Alarm/Event, Digital input/output	Sections 6.5.2 to 6.5.4
D0401 to D0500	Tuning parameters (Note 1)	PID Parameter	Sections 6.6.1
D0501 to D0600		STC Parameter	Sections 6.6.2
D0601 to D0700		I/O Parameter	Sections 6.6.3
D0701 to D0800		Free area	
D0801 to D0900		Special Parameter	Sections 6.6.4
D0901 to D0950	Recognition area		Sections 6.7.1
D0951 to D1000	User area (Note 2)		Sections 6.7.2
D1001 to D1100	Engineering parameters 1 (Note 1)	CONFIG	Sections 6.8.1
D1101 to D1200		I/O computation setting, Alarm setting	Sections 6.8.2
D1201 to D1300		Display setting, Contrast	Sections 6.8.3
D1301 to D1400		Communication setting	Sections 6.8.4
D1401 to D1500	Engineering parameters 2 (Note 1)	Preset PID, Sample and batch	Sections 6.8.5
D1501 to D1600		FX table	Sections 6.8.6
D1601 to D1700		GX table	Sections 6.8.7
D1701 to D1800		DI/DO setting	Sections 6.8.8
D1801 to D2000		Communication access	Sections 6.8.9
D2001 to D2100	User program	Control data, System flag	Sections 6.9.1
D2101 to D2200		Control flag	Sections 6.9.2
D2201 to D2300		Program setpoint	Sections 6.9.3
D2301 to D2600		Free area	
D2601 to D2700		P registers	Sections 6.9.4
D2701 to D4000		Free area	

Note 1: Data in the tuning parameters and engineering parameters is stored in the format (data excluding the decimal point of engineering unit) described in "List of Parameters" in the YS1500/YS1700 Operation Guide.

The OFF status of data is indicated by "0" and the ON status is indicated by "1."

Note 2: The user area (D0951 to D1000) contains 16-bit register data used for the touch panel and other applications.

When using a touch panel, do not write data to or read it from this area as the user area for communication.

CAUTION

No data can be written to or read from blank parts of the data storage area by communication.

The YS1000 sometimes does not operate properly if an attempt is made to write to or read from blank parts of the data storage area.

6.3.1 Writing Data to the Engineering Parameters 1

When the operation status is STOP via communication (RSCOMM (D1811 to D1812) =1), data can be written to the parameters in the engineering parameters 1.

6.4 D Register Data

32 bits of data are allocated for parameter values. Since data handled by one D register is 16 bits, two D registers are used to express one parameter data.

Specify two D registers to write data except for the user area (D0951 to D1000) or text string data.

You can select which of the two D registers is to be treated as the high-level register or low-level register.

Example: D register data

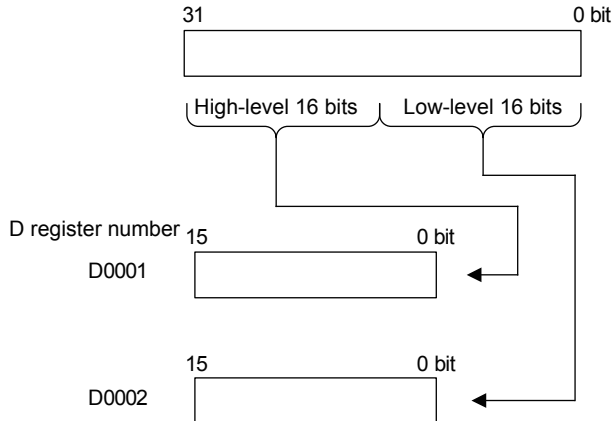

- D0001 set as the high-level register

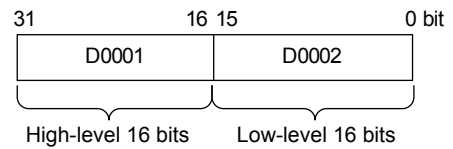

- D0001 set as the low-level register

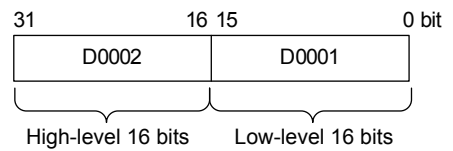

0602E.ai

6.4.1 Setting D Registers as High Level or Low Level

Parameter	Parameter Name	Setting	Default
DREG1	RS-485 communication D register setting for High/Low level	0: H-L 1: L-H	0
DREG2	Ethernet communication D register setting for High/Low level		

Example: When registers D0001 to D0002 are used

0: H-L (D0001: high level, D0002: low level)

1: L-H (D0001: low level, D0002: high level)

Note

The following sections (6.5 to 6.9) show the bit configurations when the D register setting for high/low level parameter (DREG1 or DREG2) is set to "0: H-L."

6.5 Process Data (D0001 to D0400)

Process data area							
Process data, Analog input/output, Status							
D-Reg No.	Ref. No.	H No.	Register name	R/W			
				SINGLE	CAS	SELECT	PROG
D0001 to D0002	40001 to 40002	0000 to 0001	SYS_ALM_STS	R	R	R	R
D0003 to D0004	40003 to 40004	0002 to 0003	PRC_ALM_STS	R	R	R	R
D0005 to D0006	40005 to 40006	0004 to 0005	STC_ALM_STS	R	R	R	R
D0007 to D0008	40007 to 40008	0006 to 0007	RSDISP	R	R	R	R
D0009 to D0010	40009 to 40010	0008 to 0009	LS1	R/W	R/W	R/W	R/W
D0011 to D0012	40011 to 40012	000A to 000B	PV1	R	R	R	R
D0013 to D0014	40013 to 40014	000C to 000D	SV1	R/W	R/W	R/W	R/W
D0015 to D0016	40015 to 40016	000E to 000F	MV1	R/W	R/W	R/W	R/W
D0017 to D0018	40017 to 40018	0010 to 0011	LS2	x	R/W	R/W	R/W
D0019 to D0020	40019 to 40020	0012 to 0013	PV2	x	R	R	R
D0021 to D0022	40021 to 40022	0014 to 0015	SV2	x	R/W	R/W	R/W
D0023 to D0024	40023 to 40024	0016 to 0017	MV2	x	R/W	R/W	R/W
D0025 to D0026	40025 to 40026	0018 to 0019					
D0027 to D0028	40027 to 40028	001A to 001B	CSV1	R	R	R	R
D0029 to D0030	40029 to 40030	001C to 001D	DV1	R	R	R	R
D0031 to D0032	40031 to 40032	001E to 001F	FF1	R	R	R	R
D0033 to D0034	40033 to 40034	0020 to 0021	TRK1	R	R	R	R
D0035 to D0036	40035 to 40036	0022 to 0023					
D0037 to D0038	40037 to 40038	0024 to 0025	CSV2	x	x	R/W	R/W
D0039 to D0040	40039 to 40040	0026 to 0027	DV2	x	R	R	R
D0041 to D0042	40041 to 40042	0028 to 0029	FF2	x	x	x	R
D0043 to D0044	40043 to 40044	002A to 002B	TRK2	x	x	x	R
D0045 to D0046	40045 to 40046	002C to 002D					
D0047 to D0048	40047 to 40048	002E to 002F	EVT_STS	R	R	R	R
D0049 to D0050	40049 to 40050	0030 to 0031					
D0051 to D0052	40051 to 40052	0032 to 0033	X1	R	R	R	R
D0053 to D0054	40053 to 40054	0034 to 0035	X2	R	R	R	R
D0055 to D0056	40055 to 40056	0036 to 0037	X3	R	R	R	R
D0057 to D0058	40057 to 40058	0038 to 0039	X4	R	R	R	R
D0059 to D0060	40059 to 40060	003A to 003B	X5	R	R	R	R
D0061 to D0062	40061 to 40062	003C to 003D	X6	R	R	R	R
D0063 to D0064	40063 to 40064	003E to 003F	X7	R	R	R	R
D0065 to D0066	40065 to 40066	0040 to 0041	X8	R	R	R	R
D0067 to D0068	40067 to 40068	0042 to 0043					
D0069 to D0070	40069 to 40070	0044 to 0045					
D0071 to D0072	40071 to 40072	0046 to 0047	Y1	R	R	R	R
D0073 to D0074	40073 to 40074	0048 to 0049	Y2	R	R	R	R
D0075 to D0076	40075 to 40076	004A to 004B	Y3	R	R	R	R
D0077 to D0078	40077 to 40078	004C to 004D	Y4	R	R	R	R
D0079 to D0080	40079 to 40080	004E to 004F	Y5	x	x	x	R
D0081 to D0082	40081 to 40082	0050 to 0051	Y6	x	x	x	R
D0083 to D0084	40083 to 40084	0052 to 0053					
D0085 to D0086	40085 to 40086	0054 to 0055					
D0087 to D0088	40087 to 40088	0056 to 0057	DISTATUS	R	R	R	R
D0089 to D0090	40089 to 40090	0058 to 0059	DOSTATUS	R	R	R	R
D0091 to D0092	40091 to 40092	005A to 005B	EXT_EXE	R	R	R	R
D0093 to D0094	40093 to 40094	005C to 005D					
D0095 to D0096	40095 to 40096	005E to 005F	MCUFAIL	R	R	R	R
D0097 to D0098	40097 to 40098	0060 to 0061	DCUFAIL	R	R	R	R
D0099 to D0100	40099 to 40100	0062 to 0063	ALMLAMP	R	R	R	R

6.5 Process Data (D0001 to D0400)

Process data area							
Alarm/Event							
D-Reg No.	Ref. No.	H No.	Register name	R/W			
				SINGLE	CAS	SELECT	PROG
D0101 to D0102	40101 to 40102	0064 to 0065	SYS_ALM_X1	R	R	R	R
D0103 to D0104	40103 to 40104	0066 to 0067	SYS_ALM_X2	R	R	R	R
D0105 to D0106	40105 to 40106	0068 to 0069	SYS_ALM_X3	R	R	R	R
D0107 to D0108	40107 to 40108	006A to 006B	SYS_ALM_X4	R	R	R	R
D0109 to D0110	40109 to 40110	006C to 006D	SYS_ALM_X5	R	R	R	R
D0111 to D0112	40111 to 40112	006E to 006F	SYS_ALM_X6	R	R	R	R
D0113 to D0114	40113 to 40114	0070 to 0071	SYS_ALM_X7	R	R	R	R
D0115 to D0116	40115 to 40116	0072 to 0073	SYS_ALM_X8	R	R	R	R
D0117 to D0118	40117 to 40118	0074 to 0075	SYS_ALM_Y1	R	R	R	R
D0119 to D0120	40119 to 40120	0076 to 0077	SYS_ALM_Y3	R	R	R	R
D0121 to D0122	40121 to 40122	0078 to 0079	SYS_ALM_CALC	x	x	x	R
D0123 to D0124	40123 to 40124	007A to 007B	SYS_ALM_OVER	x	x	x	R
D0125 to D0126	40125 to 40126	007C to 007D	SYS_ALM_COMM	R	R	R	R
D0127 to D0128	40127 to 40128	007E to 007F	SYS_ALM_ETHER	R	R	R	R
D0129 to D0130	40129 to 40130	0080 to 0081	SYS_ALM_PTOP	R	R	R	R
D0131 to D0132	40131 to 40132	0082 to 0083	SYS_ALM_USERPROG	x	x	x	R
D0133 to D0134	40133 to 40134	0084 to 0085	SYS_ALM_DATA	R	R	R	R
D0135 to D0136	40135 to 40136	0086 to 0087	SYS_ALM_CALR	R	R	R	R
D0137 to D0138	40137 to 40138	0088 to 0089					
D0139 to D0140	40139 to 40140	008A to 008B					
D0141 to D0142	40141 to 40142	008C to 008D					
D0143 to D0144	40143 to 40144	008E to 008F					
D0145 to D0146	40145 to 40146	0090 to 0091					
D0147 to D0148	40147 to 40148	0092 to 0093					
D0149 to D0150	40149 to 40150	0094 to 0095					
D0151 to D0152	40151 to 40152	0096 to 0097					
D0153 to D0154	40153 to 40154	0098 to 0099					
D0155 to D0156	40155 to 40156	009A to 009B					
D0157 to D0158	40157 to 40158	009C to 009D					
D0159 to D0160	40159 to 40160	009E to 009F					
D0161 to D0162	40161 to 40162	00A0 to 01A1					
D0163 to D0164	40163 to 40164	00A2 to 01A3					
D0165 to D0166	40165 to 40166	00A4 to 00A5	PRC_ALM_HH1	R	R	R	R
D0167 to D0168	40167 to 40168	00A6 to 00A7	PRC_ALM_LL1	R	R	R	R
D0169 to D0170	40169 to 40170	00A8 to 00A9	PRC_ALM_PH1	R	R	R	R
D0171 to D0172	40171 to 40172	00AA to 00AB	PRC_ALM_PL1	R	R	R	R
D0173 to D0174	40173 to 40174	00AC to 00AD	PRC_ALM_DL1	R	R	R	R
D0175 to D0176	40175 to 40176	00AE to 00AF	PRC_ALM_VL1	R	R	R	R
D0177 to D0178	40177 to 40178	00B0 to 00B1	PRC_ALM_HH2	x	R	R	R
D0179 to D0180	40179 to 40180	00B2 to 00B3	PRC_ALM_LL2	x	R	R	R
D0181 to D0182	40181 to 40182	00B4 to 00B5	PRC_ALM_PH2	x	R	R	R
D0183 to D0184	40183 to 40184	00B6 to 00B7	PRC_ALM_PL2	x	R	R	R
D0185 to D0186	40185 to 40186	00B8 to 00B9	PRC_ALM_DL2	x	R	R	R
D0187 to D0188	40187 to 40188	00BA to 00BB	PRC_ALM_VL2	x	R	R	R
D0189 to D0190	40189 to 40190	00BC to 00BD					
D0191 to D0192	40191 to 40192	00BE to 00BF					
D0193 to D0194	40193 to 40194	00C0 to 00C1					
D0195 to D0196	40195 to 40196	00C2 to 00C3					
D0197 to D0198	40197 to 40198	00C4 to 00C5					
D0199 to D0200	40199 to 40200	00C6 to 00C7					

Process data area							
Alarm/Event							
D-Reg No.	Ref. No.	H No.	Register name	R/W			
				SINGLE	CAS	SELECT	PROG
D0201 to D0202	40201 to 40202	00C8 to 00C9	STC_ALM_SYSALM	R	R	R	R
D0203 to D0204	40203 to 40204	00CA to 00CB	STC_ALM_PVOVR	R	R	R	R
D0205 to D0206	40205 to 40206	00CC to 00CD	STC_ALM_MVLMT	R	R	R	R
D0207 to D0208	40207 to 40208	00CE to 00CF	STC_ALM_OPERR	R	R	R	R
D0209 to D0210	40209 to 40210	00D0 to 00D1	STC_ALM_IDERR	R	R	R	R
D0211 to D0212	40211 to 40212	00D2 to 00D3	STC_ALM_PWRDWN	R	R	R	R
D0213 to D0214	40213 to 40214	00D4 to 00D5	STC_ALM_PBLMT	R	R	R	R
D0215 to D0216	40215 to 40216	00D6 to 00D7	STC_ALM_TILMT	R	R	R	R
D0217 to D0218	40217 to 40218	00D8 to 00D9	STC_ALM_TDLMT	R	R	R	R
D0219 to D0220	40219 to 40220	00DA to 00DB	STC_ALM_RTALM	R	R	R	R
D0221 to D0222	40221 to 40222	00DC to 00DD					
D0223 to D0224	40223 to 40224	00DE to 00DF					
D0225 to D0226	40225 to 40226	00E0 to 00E1					
D0227 to D0228	40227 to 40228	00E2 to 00E3					
D0229 to D0230	40229 to 40230	00E4 to 00E5					
D0231 to D0232	40231 to 40232	00E6 to 00E7					
D0233 to D0234	40233 to 40234	00E8 to 00E9	EVT_EVENT1	R	R	R	R
D0235 to D0236	40235 to 40236	00EA to 00EB	EVT_EVENT2	R	R	R	R
D0237 to D0238	40237 to 40238	00EC to 00ED	EVT_EVENT3	R	R	R	R
D0239 to D0240	40239 to 40240	00EE to 00EF	EVT_EVENT4	R	R	R	R
D0241 to D0242	40241 to 40242	00F0 to 00F1	EVT_EVENT5	R	R	R	R
D0243 to D0244	40243 to 40244	00F2 to 00F3					
D0245 to D0246	40245 to 40246	00F4 to 00F5					
D0247 to D0248	40247 to 40248	00F6 to 00F7	EXT_EXE_AUT	R	R	R	R
D0249 to D0250	40249 to 40250	00F8 to 00F9	EXT_EXE_MAN	R	R	R	R
D0251 to D0252	40251 to 40252	00FA to 00FB	EXT_EXE_PMV	R	R	R	R
D0253 to D0254	40253 to 40254	00FC to 00FD	EXT_EXE_TRK	R	R	R	R
D0255 to D0256	40255 to 40256	00FE to 00FF					
D0257 to D0258	40257 to 40258	0100 to 0101					
D0259 to D0260	40259 to 40260	0102 to 0103					
D0261 to D0262	40261 to 40262	0104 to 0105					
D0263 to D0264	40263 to 40264	0106 to 0107					
D0265 to D0266	40265 to 40266	0108 to 0109					
D0267 to D0268	40267 to 40268	010A to 010B					
D0269 to D0270	40269 to 40270	010C to 010D					
D0271 to D0272	40271 to 40272	010E to 010F					
D0273 to D0274	40273 to 40274	0110 to 0111					
D0275 to D0276	40275 to 40276	0112 to 0113					
D0277 to D0278	40277 to 40278	0114 to 0115					
D0279 to D0280	40279 to 40280	0116 to 0117					
D0281 to D0282	40281 to 40282	0118 to 0119					
D0283 to D0284	40283 to 40284	011A to 011B					
D0285 to D0286	40285 to 40286	011C to 011D					
D0287 to D0288	40287 to 40288	011E to 011F					
D0289 to D0290	40289 to 40290	0120 to 0121					
D0291 to D0292	40291 to 40292	0122 to 0123					
D0293 to D0294	40293 to 40294	0124 to 0125					
D0295 to D0296	40295 to 40296	0126 to 0127					
D0297 to D0298	40297 to 40298	0128 to 0129					
D0299 to D0300	40299 to 40300	012A to 012B					

6.5 Process Data (D0001 to D0400)

Process data area							
Digital input/output							
D-Reg No.	Ref. No.	H No.	Register name	R/W			
				SINGLE	CAS	SELECT	PROG
D0301 to D0302	40301 to 40302	012C to 012D	DISTATUS_DI01	R	R	R	R
D0303 to D0304	40303 to 40304	012E to 012F	DISTATUS_DI02	R	R	R	R
D0305 to D0306	40305 to 40306	0130 to 0131	DISTATUS_DI03	R	R	R	R
D0307 to D0308	40307 to 40308	0132 to 0133	DISTATUS_DI04	R	R	R	R
D0309 to D0310	40309 to 40310	0134 to 0135	DISTATUS_DI05	R	R	R	R
D0311 to D0312	40311 to 40312	0136 to 0137	DISTATUS_DI06	R	R	R	R
D0313 to D0314	40313 to 40314	0138 to 0139	DISTATUS_DI07	R	R	R	R
D0315 to D0316	40315 to 40316	013A to 013B	DISTATUS_DI08	R	R	R	R
D0317 to D0318	40317 to 40318	013C to 013D	DISTATUS_DI09	R	R	R	R
D0319 to D0320	40319 to 40320	013E to 013F	DISTATUS_DI10	R	R	R	R
D0321 to D0322	40321 to 40321	0140 to 0141					
D0323 to D0324	40323 to 40324	0142 to 0143					
D0325 to D0326	40325 to 40326	0144 to 0145					
D0327 to D0328	40327 to 40328	0146 to 0147					
D0329 to D0330	40329 to 40330	0148 to 0149					
D0331 to D0332	40331 to 40332	014A to 014B					
D0333 to D0334	40333 to 40334	014C to 014D	DOSTATUS_DO1	R	R	R	R
D0335 to D0336	40335 to 40336	014E to 014F	DOSTATUS_DO2	R	R	R	R
D0337 to D0338	40337 to 40338	0150 to 0151	DOSTATUS_DO3	R	R	R	R
D0339 to D0340	40339 to 40340	0152 to 0153	DOSTATUS_DO4	R	R	R	R
D0341 to D0342	40341 to 40342	0154 to 0155	DOSTATUS_DO5	R	R	R	R
D0343 to D0344	40343 to 40344	0156 to 0157	DOSTATUS_DO6	R	R	R	R
D0345 to D0346	40345 to 40346	0158 to 0159	DOSTATUS_DO7	R	R	R	R
D0347 to D0348	40347 to 40348	015A to 015B	DOSTATUS_DO8	R	R	R	R
D0349 to D0350	40349 to 40350	015C to 015D	DOSTATUS_DO9	R	R	R	R
D0351 to D0352	40351 to 40352	015E to 015F	DOSTATUS_DO10	R	R	R	R
D0353 to D0354	40353 to 40354	0160 to 0161	DOSTATUS_DO11	R	R	R	R
D0355 to D0356	40355 to 40356	0162 to 0163	DOSTATUS_DO12	R	R	R	R
D0357 to D0358	40357 to 40358	0164 to 0165	DOSTATUS_DO13	R	R	R	R
D0359 to D0360	40359 to 40360	0166 to 0167	DOSTATUS_DO14	R	R	R	R
D0361 to D0362	40361 to 40362	0168 to 0169	DOSTATUS_DO15	R	R	R	R
D0363 to D0364	40363 to 40364	016A to 016B	DOSTATUS_DO16	R	R	R	R
D0365 to D0366	40365 to 40366	016C to 016D	DOSTATUS_DO17	x	x	x	R
D0367 to D0368	40367 to 40368	016E to 016F	DOSTATUS_DO18	x	x	x	R
D0369 to D0370	40369 to 40370	0170 to 0171	DOSTATUS_DO19	x	x	x	R
D0371 to D0372	40371 to 40372	0172 to 0173	DOSTATUS_DO20	x	x	x	R
D0373 to D0374	40373 to 40374	0174 to 0175	DOSTATUS_DO21	x	x	x	R
D0375 to D0376	40375 to 40376	0176 to 0177	DOSTATUS_DO22	x	x	x	R
D0377 to D0378	40377 to 40378	0178 to 0179	DOSTATUS_DO23	x	x	x	R
D0379 to D0380	40379 to 40380	017A to 017B	DOSTATUS_DO24	x	x	x	R
D0381 to D0382	40381 to 40382	017C to 017D	DOSTATUS_DO25	x	x	x	R
D0383 to D0384	40383 to 40384	017E to 017F	DOSTATUS_DO26	x	x	x	R
D0385 to D0386	40385 to 40386	0180 to 0181	DOSTATUS_DO27	x	x	x	R
D0387 to D0388	40387 to 40388	0182 to 0183	DOSTATUS_DO28	x	x	x	R
D0389 to D0390	40389 to 40390	0184 to 0185	DOSTATUS_DO29	x	x	x	R
D0391 to D0392	40391 to 40392	0186 to 0187	DOSTATUS_DO30	x	x	x	R
D0393 to D0394	40393 to 40394	0188 to 0189	DOSTATUS_DO31	x	x	x	R
D0395 to D0396	40395 to 40396	018A to 018B	DOSTATUS_DO32	x	x	x	R
D0397 to D0398	40397 to 40398	018C to 018D					
D0399 to D0400	40399 to 40400	018E to 018F					

6.5.1 Process Data Area

Some of the D registers represent multiple events such as errors and status depending on combinations of bits in the register.

In the following tables, if an event indicated by a specific bit occurs, the state of that bit changes to "1." If no event occurs, the state of that bit is "0." Blank lines in each table indicate unused bits.

6.5.2 Process Data, Analog Input/output, Status (D0001 to D0100)

● Bit Configuration of D0001 to D0002: SYS_ALM_STS (System alarm)

High/low level (Note)	Bit	Code	Event
Low level	0	SYS_ALM_X1	Input 1 overrange (0: OFF 1: ON)
	1	SYS_ALM_X2	Input 2 overrange (0: OFF 1: ON)
	2	SYS_ALM_X3	Input 3 overrange (0: OFF 1: ON)
	3	SYS_ALM_X4	Input 4 overrange (0: OFF 1: ON)
	4	SYS_ALM_X5	Input 5 overrange (0: OFF 1: ON)
	5	SYS_ALM_X6	Input 6 overrange (0: OFF 1: ON)
	6	SYS_ALM_X7	Input 7 overrange (0: OFF 1: ON)
	7	SYS_ALM_X8	Input 8 overrange (0: OFF 1: ON)
	8	SYS_ALM_Y1	Current output 1 open (0: OFF 1: ON)
	9	SYS_ALM_Y3	Current output 3 open (0: OFF 1: ON)
	10	SYS_ALM_CALC	Computing overflow (0: OFF 1: ON)
	11	SYS_ALM_OVER	Control period overflow (0: OFF 1: ON)
	12	SYS_ALM_COMM	Communication error (0: OFF 1: ON)
	13	SYS_ALM_ETHER	Ethernet communication error (0: OFF 1: ON)
	14	SYS_ALM_PTOP	Peer-to-Peer communication data error (0: OFF 1: ON)
High level	15	SYS_ALM_USERPROG	User program error (0: OFF 1: ON)
	16	SYS_ALM_DATA	YSS writing not completed (0: OFF 1: ON)
	17	SYS_ALM_CALR	Factory adjustment inspection not completed (0: OFF 1: ON)
	18 to 31		

● Bit Configuration of D0003 to D0004: PRC_ALM_STS (Process alarm)

High/low level (Note)	Bit	Code	Event
Low level	0	PRC_ALM_HH1	PV1 high-high limit alarm flag (0: OFF 1: ON)
	1	PRC_ALM_LL1	PV1 low-low limit alarm flag (0: OFF 1: ON)
	2	PRC_ALM_PH1	PV1 high limit alarm flag (0: OFF 1: ON)
	3	PRC_ALM_PL1	PV1 low limit alarm flag (0: OFF 1: ON)
	4	PRC_ALM_DL1	Deviation variable 1 alarm flag (0: OFF 1: ON)
	5	PRC_ALM_VL1	PV1 velocity alarm flag (0: OFF 1: ON)
	6	PRC_ALM_HH2	PV2 high-high limit alarm flag (0: OFF 1: ON)
	7	PRC_ALM_LL2	PV2 low-low limit alarm flag (0: OFF 1: ON)
	8	PRC_ALM_PH2	PV2 high limit alarm flag (0: OFF 1: ON)
	9	PRC_ALM_PL2	PV2 low limit alarm flag (0: OFF 1: ON)
	10	PRC_ALM_DL2	Deviation variable 2 alarm flag (0: OFF 1: ON)
High level	11	PRC_ALM_VL2	PV2 velocity alarm flag (0: OFF 1: ON)
	12 to 15		
	16 to 31		

Note: In these bit configurations, the D register setting for high/low level parameter is set to "0: H-L" (i.e. the first register is high level).

6.5 Process Data (D0001 to D0400)

● Bit Configuration of D0005 to D0006: STC_ALM_STS (STC alarm)

High/low level (Note)	Bit	Code	Event
Low level	0	STC_ALM_SYSALM	STC system alarm (0: OFF 1: ON)
	1	STC_ALM_PVOVR	STC PV alarm (0: OFF 1: ON)
	2	STC_ALM_MVLMT	STC MV alarm (0: OFF 1: ON)
	3	STC_ALM_OPERR	STC operation error (0: OFF 1: ON)
	4	STC_ALM_IDERR	STC identification impossible (0: OFF 1: ON)
	5	STC_ALM_PWRDWN	STC power supply error (0: OFF 1: ON)
	6	STC_ALM_PBLMT	STC PB alarm (0: OFF 1: ON)
	7	STC_ALM_TILMT	STC TI alarm (0: OFF 1: ON)
	8	STC_ALM_TDLMT	STC TD alarm (0: OFF 1: ON)
	9	STC_ALM_RTALM	STC RT alarm (0: OFF 1: ON)
	10 to 15		
High level	16 to 31		

Note: In these bit configurations, the D register setting for high/low level parameter is set to "0: H-L" (i.e. the first register is high level).

● D0007 to D0046

Register No.	Description	Range and Meaning of Value
D0007 to D0008	RSDISP	Operation status display 0: RUN 1: STOP 2: TEST1 3: TEST2
D0009 to D0010	LS1	Operation mode 1 0: MAN 1: AUTO 2: CAS 3: SPC 4: DDC 5: BUA 6: BUM (Note 1)
D0011 to D0012	PV1	Process variable 1 Equivalent to -6.3 to 106.3% in the engineering unit (Note 2)
D0013 to D0014	SV1	Setpoint value 1
D0015 to D0016	MV1	Manipulated output variable 1 (Note 3) -6.3 to 106.3%
D0017 to D0018	LS2	Operation mode 2
D0019 to D0020	PV2	Process variable 2
D0021 to D0022	SV2	Setpoint value 2
D0023 to D0024	MV2	Manipulated output variable 2 (Note 3)
D0025 to D0026		
D0027 to D0028	CSV1	Cascade setting value 1 Equivalent to -6.3 to 106.3% in the engineering unit (Note 2)
D0029 to D0030	DV1	Deviation variable 1 PV1 - SV1
D0031 to D0032	FF1	Feedforward input value 1 -100.0 to 200.0%
D0033 to D0034	TRK1	Output tracking input value 1 -6.3 to 106.3%
D0035 to D0036		
D0037 to D0038	CSV2	Cascade setting value 2
D0039 to D0040	DV2	Deviation variable 2
D0041 to D0042	FF2	Feedforward input value 2
D0043 to D0044	TRK2	Output tracking input value 2
D0045 to D0046		

Note 1: "5: BUA" and "6: BUM" can not be set. Set them with the engineering parameter BMOD1.

Note 2: The engineering units set with the engineering parameters, SCH1, SCL1, and SCDP1.

Note 3: Settable when operation mode is MAN or DDC. MV2 is enabled only in dual-loop control. MV1 and MV2 are the same in cascade control and selector control.

● Bit Configuration of D0047 to D0048: EVT_STS (Event indicating flag)

High/low level (Note)	Bit	Code	Event
Low level	0	EVT_EVENT1	User setting event 1 (0: OFF 1: ON)
	1	EVT_EVENT2	User setting event 2 (0: OFF 1: ON)
	2	EVT_EVENT3	User setting event 3 (0: OFF 1: ON)
	3	EVT_EVENT4	User setting event 4 (0: OFF 1: ON)
	4	EVT_EVENT5	User setting event 5 (0: OFF 1: ON)
	5 to 15		
High level	16 to 31		

Note: In these bit configurations, the D register setting for high/low level parameter is set to "0: H-L" (i.e. the first register is high level).

● D0051 to D0082

Register No.	Description	Range and Meaning of Value
D0051 to D0066	X1 to X8 Analog input 1 to Analog input 8	-25.0 to 125.0%
D0071 to D0072	Y1 Analog output 1	-20.0 to 106.3%
D0073 to D0082	Y2 to Y6 Analog output 2 to Analog output 6	-6.3 to 106.3%

● Bit Configuration of D0087 to D0088: DISTATUS (Digital input status)

High/low level (Note)	Bit	Code	Event
Low level	0	DISTATUS_DI01	Digital input 1 (0: Contact inputs - open 1: Contact inputs - close)
	1	DISTATUS_DI02	Digital input 2 (0: Contact inputs - open 1: Contact inputs - close)
	2	DISTATUS_DI03	Digital input 3 (0: Contact inputs - open 1: Contact inputs - close)
	3	DISTATUS_DI04	Digital input 4 (0: Contact inputs - open 1: Contact inputs - close)
	4	DISTATUS_DI05	Digital input 5 (0: Contact inputs - open 1: Contact inputs - close)
	5	DISTATUS_DI06	Digital input 6 (0: Contact inputs - open 1: Contact inputs - close)
	6	DISTATUS_DI07	Digital input 7 (0: Contact inputs - open 1: Contact inputs - close)
	7	DISTATUS_DI08	Digital input 8 (0: Contact inputs - open 1: Contact inputs - close)
	8	DISTATUS_DI09	Digital input 9 (0: Contact inputs - open 1: Contact inputs - close)
	9	DISTATUS_DI10	Digital input 10 (0: Contact inputs - open 1: Contact inputs - close)
	10 to 15		
High level	16 to 31		

Note: In these bit configurations, the D register setting for high/low level parameter is set to "0: H-L" (i.e. the first register is high level).

6.5 Process Data (D0001 to D0400)

● Bit Configuration of D0089 to D0090: DOSTATUS (Digital output status)

High/low level (Note)	Bit	Code	Event
Low level	0	DOSTATUS_DO1	Digital output 1 (0: Contact outputs - open 1: Contact outputs - close)
	1	DOSTATUS_DO2	Digital output 2 (0: Contact outputs - open 1: Contact outputs - close)
	2	DOSTATUS_DO3	Digital output 3 (0: Contact outputs - open 1: Contact outputs - close)
	3	DOSTATUS_DO4	Digital output 4 (0: Contact outputs - open 1: Contact outputs - close)
	4	DOSTATUS_DO5	Digital output 5 (0: Contact outputs - open 1: Contact outputs - close)
	5	DOSTATUS_DO6	Digital output 6 (0: Contact outputs - open 1: Contact outputs - close)
	6	DOSTATUS_DO7	Digital output 7 (0: Contact outputs - open 1: Contact outputs - close)
	7	DOSTATUS_DO8	Digital output 8 (0: Contact outputs - open 1: Contact outputs - close)
	8	DOSTATUS_DO9	Digital output 9 (0: Contact outputs - open 1: Contact outputs - close)
	9	DOSTATUS_DO10	Digital output 10 (0: Contact outputs - open 1: Contact outputs - close)
	10	DOSTATUS_DO11	Digital output 11 (0: Contact outputs - open 1: Contact outputs - close)
	11	DOSTATUS_DO12	Digital output 12 (0: Contact outputs - open 1: Contact outputs - close)
	12	DOSTATUS_DO13	Digital output 13 (0: Contact outputs - open 1: Contact outputs - close)
	13	DOSTATUS_DO14	Digital output 14 (0: Contact outputs - open 1: Contact outputs - close)
	14	DOSTATUS_DO15	Digital output 15 (0: Contact outputs - open 1: Contact outputs - close)
High level	15	DOSTATUS_DO16	Digital output 16 (0: Contact outputs - open 1: Contact outputs - close)
	16	DOSTATUS_DO17	Digital output 17 (0: Contact outputs - open 1: Contact outputs - close)
	17	DOSTATUS_DO18	Digital output 18 (0: Contact outputs - open 1: Contact outputs - close)
	18	DOSTATUS_DO19	Digital output 19 (0: Contact outputs - open 1: Contact outputs - close)
	19	DOSTATUS_DO20	Digital output 20 (0: Contact outputs - open 1: Contact outputs - close)
	20	DOSTATUS_DO21	Digital output 21 (0: Contact outputs - open 1: Contact outputs - close)
	21	DOSTATUS_DO22	Digital output 22 (0: Contact outputs - open 1: Contact outputs - close)
	22	DOSTATUS_DO23	Digital output 23 (0: Contact outputs - open 1: Contact outputs - close)
	23	DOSTATUS_DO24	Digital output 24 (0: Contact outputs - open 1: Contact outputs - close)
	24	DOSTATUS_DO25	Digital output 25 (0: Contact outputs - open 1: Contact outputs - close)
	25	DOSTATUS_DO26	Digital output 26 (0: Contact outputs - open 1: Contact outputs - close)
	26	DOSTATUS_DO27	Digital output 27 (0: Contact outputs - open 1: Contact outputs - close)
	27	DOSTATUS_DO28	Digital output 28 (0: Contact outputs - open 1: Contact outputs - close)
	28	DOSTATUS_DO29	Digital output 29 (0: Contact outputs - open 1: Contact outputs - close)
	29	DOSTATUS_DO30	Digital output 30 (0: Contact outputs - open 1: Contact outputs - close)
	30	DOSTATUS_DO31	Digital output 31 (0: Contact outputs - open 1: Contact outputs - close)
	31	DOSTATUS_DO32	Digital output 32 (0: Contact outputs - open 1: Contact outputs - close)

● Bit Configuration of D0091 to D0092: EXT_EXE (External input function status)

High/low level (Note)	Bit	Code	Event
Low level	0	EXT_EXE_AUT	EXT-AUT function
	1	EXT_EXE_MAN	EXT-MAN function
	2	EXT_EXE_PMV	EXT-PMV function
	3	EXT_EXE_TRK	EXT-TRK function
	4 to 15		
High level	16 to 31		

Note: In these bit configurations, the D register setting for high/low level parameter is set to "0: H-L" (i.e. the first register is high level).

● **Bit Configuration of D0095 to D0096: MCUFAIL (MCU software FAIL)**

High/low level (Note)	Bit	Code	Event
Low level	0	MCU	Main microprocessor (MCU) abnormal
	1	AD	A/D converter faulty
	2	DA	D/A converter faulty
	3	ROM	MCU-ROM faulty
	4	RAM	MCU-RAM faulty
	5	FRAM	FRAM faulty
	6	SYS	System data abnormal
	7	FLASH	Flash memory faulty
	8	EMPFR	FRAM data non-initializaed, FRAM data lost
	9	EMPFL	Flash data non-initialized, Flash data lost
	10	OPT	Communication/expandable I/O abnormal
	11		
	12	SCLK	Sub-clock stopped
13 to 15			
High level	16 to 31		

● **Bit Configuration of D0097 to D0098: DCUFAIL (DCU FAIL detected by MCU)**

High/low level (Note)	Bit	Code	Event
Low level	0	DCU	DCU abnormal
	1 to 15		
High level	16 to 31		

Note: In these bit configurations, the D register setting for high/low level parameter is set to "0: H-L" (i.e. the first register is high level).

● **D0099 to D0100**

Register No.	Description	Range and Meaning of Value
D0099 to D0100	ALMLAMP ALM lamp status	0: OFF 1: ON

6.5 Process Data (D0001 to D0400)

6.5.3 Alarm/Event (D0101 to D0300)

Register No.	Description	Range and Meaning of Value
D0101 to D0116	SYS_ALM_X1 to SYS_ALM_X8 Input 1 overrange to Input 8 overrange	0: Normal 1: Overrange
D0117 to D0118	SYS_ALM_Y1 Current output 1 open	0: Close 1: Open
D0119 to D0120	SYS_ALM_Y3 Current output 3 open	
D0121 to D0122	SYS_ALM_CALC Computation overflow	0: Normal 1: Alarm generation
D0123 to D0124	SYS_ALM_OVER Control period overflow	
D0125 to D0126	SYS_ALM_COMM Communication error	
D0127 to D0128	SYS_ALM_ETHER Ethernet communication error	
D0129 to D0130	SYS_ALM_PTOP Peer-to-Peer communication data error	
D0131 to D0132	SYS_ALM_USERPROG User program error	
D0133 to D0134	SYS_ALM_DATA YSS writing not completed	
D0135 to D0136	SYS_ALM_CALR Factory adjustment inspection not completed	
D0137 to D0164		
D0165 to D0166	PRC_ALM_HH1 PV1 high-high limit alarm flag	0: Normal 1: Alarm
D0167 to D0168	PRC_ALM_LL1 PV1 low-low limit alarm flag	
D0169 to D0170	PRC_ALM_PH1 PV1 high limit alarm flag	
D0171 to D0172	PRC_ALM_PL1 PV1 low limit alarm flag	
D0173 to D0174	PRC_ALM_DL1 Deviation variable 1 alarm flag	
D0175 to D0176	PRC_ALM_VL1 PV1 velocity alarm flag	
D0177 to D0178	PRC_ALM_HH2 PV2 high-high limit alarm flag	
D0179 to D0180	PRC_ALM_LL2 PV2 low-low limit alarm flag	
D0181 to D0182	PRC_ALM_PH2 PV2 high limit alarm flag	
D0183 to D0184	PRC_ALM_PL2 PV2 low limit alarm flag	
D0185 to D0186	PRC_ALM_DL2 Deviation variable 2 alarm flag	
D0187 to D0188	PRC_ALM_VL2 PV2 velocity alarm flag	
D0189 to D0200		
D0201 to D0202	STC_ALM_SYSALM STC system alarm	0: Normal 1: Alarm
D0203 to D0204	STC_ALM_PVOVR STC PV alarm	
D0205 to D0206	STC_ALM_MVLMT STC MV alarm	
D0207 to D0208	STC_ALM_OPERR STC operation error	
D0209 to D0210	STC_ALM_IDERR STC identification impossible	
D0211 to D0212	STC_ALM_PWRDWN STC power supply error	
D0213 to D0214	STC_ALM_PBLMT STC PB alarm	
D0215 to D0216	STC_ALM_TILMT STC TI alarm	
D0217 to D0218	STC_ALM_TDLMT STC TD alarm	
D0219 to D0220	STC_ALM_RTALM STC RT alarm	
D0221 to D0232		
D0233 to D0242	EVT_EVENT1 to EVT_EVENT 5 User setting event 1 to User setting event 5	0: OFF 1: Event generation
D0243 to D0246		
D0247 to D0248	EXT_EXE_AUT EXT-AUT function	0: OFF 1: ON
D0249 to D0250	EXT_EXE_MAN EXT-MAN function	
D0251 to D0252	EXT_EXE_PMV EXT-PMV function	
D0253 to D0254	EXT_EXE_TRK EXT-TRK function	
D0255 to D0300		

6.5.4 Digital Input/output (D0301 to D0400)

Register No.	Description	Range and Meaning of Value
D0301 to D0320	DISTATUS_DI01 to DISTATUS_DI10 Digital input 1 to Digital input 10	0: Contact inputs - open 1: Contact inputs - close
D0321 to D0332		
D0333 to D0396	DOSTATUS_DO1 to DOSTATUS_DO32 Digital output 1 to Digital output 32	0: DO status OFF 1: DO status ON
D0397 to D0400		

6.6 Tuning Parameters (D0401 to D0900)

Tuning parameters area							
PID parameters							
D-Reg No.	Ref. No.	H No.	Register name	R/W			
				SINGLE	CAS	SELECT	PROG
D0401 to D0402	40401 to 40402	0190 to 0191	PB1	R/W	R/W	R/W	R/W
D0403 to D0404	40403 to 40404	0192 to 0193	TI1	R/W	R/W	R/W	R/W
D0405 to D0406	40405 to 40406	0194 to 0195	TD1	R/W	R/W	R/W	R/W
D0407 to D0408	40407 to 40408	0196 to 0197	SFA1	R/W	R/W	R/W	R/W
D0409 to D0410	40409 to 40410	0198 to 0199	SFB1	R/W	R/W	R/W	R/W
D0411 to D0412	40411 to 40412	019A to 019B	GW1	R/W	R/W	R/W	R/W
D0413 to D0414	40413 to 40414	019C to 019D	GG1	R/W	R/W	R/W	R/W
D0415 to D0416	40415 to 40416	019E to 019F	PH1	R/W	R/W	R/W	R/W
D0417 to D0418	40417 to 40418	01A0 to 01A1	PL1	R/W	R/W	R/W	R/W
D0419 to D0420	40419 to 40420	01A2 to 01A3	HH1	R/W	R/W	R/W	R/W
D0421 to D0422	40421 to 40422	01A4 to 01A5	LL1	R/W	R/W	R/W	R/W
D0423 to D0424	40423 to 40424	01A6 to 01A7	DL1	R/W	R/W	R/W	R/W
D0425 to D0426	40425 to 40426	01A8 to 01A9	HYS1	R/W	R/W	R/W	R/W
D0427 to D0428	40427 to 40428	01AA to 01AB	VL1	R/W	R/W	R/W	R/W
D0429 to D0430	40429 to 40430	01AC to 01AD	VT1	R/W	R/W	R/W	R/W
D0431 to D0432	40431 to 40432	01AE to 01AF	MH1	R/W	R/W	R/W	R/W
D0433 to D0434	40433 to 40434	01B0 to 01B1	ML1	R/W	R/W	R/W	R/W
D0435 to D0436	40435 to 40436	01B2 to 01B3	MR1	R/W	x	x	R/W
D0437 to D0438	40437 to 40438	01B4 to 01B5	RB1	R/W	R/W	R/W	R/W
D0439 to D0440	40439 to 40440	01B6 to 01B7	PMV1	R/W	R/W	R/W	R/W
D0441 to D0442	40441 to 40442	01B8 to 01B9					
D0443 to D0444	40443 to 40444	01BA to 01BB					
D0445 to D0446	40445 to 40446	01BC to 01BD					
D0447 to D0448	40447 to 40448	01BE to 01BF					
D0449 to D0450	40449 to 40450	01C0 to 01C1					
D0451 to D0452	40451 to 40452	01C2 to 01C3	PB2	x	R/W	R/W	R/W
D0453 to D0454	40453 to 40454	01C4 to 01C5	TI2	x	R/W	R/W	R/W
D0455 to D0456	40455 to 40456	01C6 to 01C7	TD2	x	R/W	R/W	R/W
D0457 to D0458	40457 to 40458	01C8 to 01C9	SFA2	x	R/W	R/W	R/W
D0459 to D0460	40459 to 40460	01CA to 01CB	SFB2	x	R/W	R/W	R/W
D0461 to D0462	40461 to 40462	01CC to 01CD	GW2	x	R/W	R/W	R/W
D0463 to D0464	40463 to 40464	01CE to 01CF	GG2	x	R/W	R/W	R/W
D0465 to D0466	40465 to 40466	01D0 to 01D1	PH2	x	R/W	R/W	R/W
D0467 to D0468	40467 to 40468	01D2 to 01D3	PL2	x	R/W	R/W	R/W
D0469 to D0470	40469 to 40470	01D4 to 01D5	HH2	x	R/W	R/W	R/W
D0471 to D0472	40471 to 40472	01D6 to 01D7	LL2	x	R/W	R/W	R/W
D0473 to D0474	40473 to 40474	01D8 to 01D9	DL2	x	R/W	R/W	R/W
D0475 to D0476	40475 to 40476	01DA to 01DB	HYS2	x	R/W	R/W	R/W
D0477 to D0478	40477 to 40478	01DC to 01DD	VL2	x	R/W	R/W	R/W
D0479 to D0480	40479 to 40480	01DE to 01DF	VT2	x	R/W	R/W	R/W
D0481 to D0482	40481 to 40482	01E0 to 01E1	MH2	x	R/W	R/W	R/W
D0483 to D0484	40483 to 40484	01E2 to 01E3	ML2	x	R/W	R/W	R/W
D0485 to D0486	40485 to 40486	01E4 to 01E5	MR2	x	x	x	R/W
D0487 to D0488	40487 to 40488	01E6 to 01E7	RB2	x	R/W	R/W	R/W
D0489 to D0490	40489 to 40490	01E8 to 01E9	PMV2	x	x	x	R/W
D0491 to D0492	40491 to 40492	01EA to 01EB					
D0493 to D0494	40493 to 40494	01EC to 01ED					
D0495 to D0496	40495 to 40496	01EE to 01EF					
D0497 to D0498	40497 to 40498	01F0 to 01F1					
D0499 to D0500	40499 to 40500	01F2 to 01F3					

6.6 Tuning Parameters (D0401 to D0900)

Tuning parameters area							
STC parameters							
D-Reg No.	Ref. No.	H No.	Register name	R/W			
				SINGLE	CAS	SELECT	PROG
D0501 to D0502	40501 to 40502	01F4 to 01F5	IP1	R/W	R/W	R/W	R/W
D0503 to D0504	40503 to 40504	01F6 to 01F7	TR1	R/W	R/W	R/W	R/W
D0505 to D0506	40505 to 40506	01F8 to 01F9	NB1	R/W	R/W	R/W	R/W
D0507 to D0508	40507 to 40508	01FA to 01FB	OS1	R/W	R/W	R/W	R/W
D0509 to D0510	40509 to 40510	01FC to 01FD	MI1	R/W	R/W	R/W	R/W
D0511 to D0512	40511 to 40512	01FE to 01FF	PMX1	R/W	R/W	R/W	R/W
D0513 to D0514	40513 to 40514	0200 to 0201	PMN1	R/W	R/W	R/W	R/W
D0515 to D0516	40515 to 40516	0202 to 0203	IMX1	R/W	R/W	R/W	R/W
D0517 to D0528	40517 to 40528	0204 to 0205	IMN1	R/W	R/W	R/W	R/W
D0519 to D0520	40519 to 40520	0206 to 0207	DMX1	R/W	R/W	R/W	R/W
D0521 to D0522	40521 to 40522	0208 to 0209	PA1	R	R	R	R
D0523 to D0524	40523 to 40524	020A to 020B	IA1	R	R	R	R
D0525 to D0526	40525 to 40526	020C to 020D	DA1	R	R	R	R
D0527 to D0528	40527 to 40528	020E to 020F	CR1	R	R	R	R
D0529 to D0530	40529 to 40530	0210 to 0211	RT1	R	R	R	R
D0531 to D0532	40531 to 40532	0212 to 0213	LM1	R	R	R	R
D0533 to D0534	40533 to 40534	0214 to 0215	TM1	R	R	R	R
D0535 to D0536	40535 to 40536	0216 to 0217	GM1	R	R	R	R
D0537 to D0538	40537 to 40538	0218 to 0219					
D0539 to D0540	40539 to 40540	021A to 021B					
D0541 to D0542	40541 to 40542	021C to 021D	STC	R/W	R/W	R/W	R/W
D0543 to D0544	40543 to 40544	021E to 021F	OD	R/W	R/W	R/W	R/W
D0545 to D0546	40545 to 40546	0220 to 0221					
D0547 to D0548	40547 to 40548	0222 to 0223					
D0549 to D0550	40549 to 40550	0224 to 0225					
D0551 to D0552	40551 to 40552	0226 to 0227	IP2	x	R/W	R/W	R/W
D0553 to D0554	40553 to 40554	0228 to 0229	TR2	x	R/W	R/W	R/W
D0555 to D0556	40555 to 40556	022A to 022B	NB2	x	R/W	R/W	R/W
D0557 to D0558	40557 to 40558	022C to 022D	OS2	x	R/W	R/W	R/W
D0559 to D0560	40559 to 40560	022E to 022F	MI2	x	R/W	R/W	R/W
D0561 to D0562	40561 to 40562	0230 to 0231	PMX2	x	R/W	R/W	R/W
D0563 to D0564	40563 to 40564	0232 to 0233	PMN2	x	R/W	R/W	R/W
D0565 to D0566	40565 to 40566	0234 to 0235	IMX2	x	R/W	R/W	R/W
D0567 to D0568	40567 to 40568	0236 to 0237	IMN2	x	R/W	R/W	R/W
D0569 to D0570	40569 to 40570	0238 to 0239	DMX2	x	R/W	R/W	R/W
D0571 to D0572	40571 to 40572	023A to 023B	PA2	x	R	R	R
D0573 to D0574	40573 to 40574	023C to 023D	IA2	x	R	R	R
D0575 to D0576	40575 to 40576	023E to 023F	DA2	x	R	R	R
D0577 to D0578	40577 to 40578	0240 to 0241	CR2	x	R	R	R
D0579 to D0580	40579 to 40580	0242 to 0243	RT2	x	R	R	R
D0581 to D0582	40581 to 40582	0244 to 0245	LM2	x	R	R	R
D0583 to D0584	40583 to 40584	0246 to 0247	TM2	x	R	R	R
D0585 to D0586	40585 to 40586	0248 to 0249	GM2	x	R	R	R
D0587 to D0588	40587 to 40588	024A to 024B					
D0589 to D0590	40589 to 40590	024C to 024D					
D0591 to D0592	40591 to 40592	024E to 024F					
D0593 to D0594	40593 to 40594	0250 to 0251					
D0595 to D0596	40595 to 40596	0252 to 0253					
D0597 to D0598	40597 to 40598	0254 to 0255					
D0599 to D0600	40599 to 40600	0256 to 0257					

6.6 Tuning Parameters (D0401 to D0900)

Tuning parameters area							
I/O parameters							
D-Reg No.	Ref. No.	H No.	Register name	R/W			
				SINGLE	CAS	SELECT	PROG
D0601 to D0602	40601 to 40602	0258 to 0259	PLC1	R/W	R/W	R/W	×
D0603 to D0604	40603 to 40604	025A to 025B	PLG1	R/W	R/W	R/W	×
D0605 to D0606	40605 to 40606	025C to 025D	CLC1	R/W	R/W	R/W	×
D0607 to D0608	40607 to 40608	025E to 025F	CLG1	R/W	R/W	R/W	×
D0609 to D0610	40609 to 40610	0260 to 0261	CGN1	R/W	R/W	R/W	×
D0611 to D0612	40611 to 40612	0262 to 0263	CBI1	R/W	R/W	R/W	×
D0613 to D0614	40613 to 40614	0264 to 0265	CBO1	R/W	R/W	R/W	×
D0615 to D0616	40615 to 40616	0266 to 0267					
D0617 to D0618	40617 to 40618	0268 to 0269					
D0619 to D0620	40619 to 40620	026A to 026B					
D0621 to D0622	40621 to 40622	026C to 026D					
D0623 to D0624	40623 to 40624	026E to 026F					
D0625 to D0626	40625 to 40626	0270 to 0271					
D0627 to D0628	40627 to 40628	0272 to 0273					
D0629 to D0630	40629 to 40630	0274 to 0275					
D0631 to D0632	40631 to 40632	0276 to 0277	FLG	R/W	R/W	×	×
D0633 to D0634	40633 to 40634	0278 to 0279	FGN	R/W	R/W	×	×
D0635 to D0636	40635 to 40636	027A to 027B	FBI	R/W	R/W	×	×
D0637 to D0638	40637 to 40638	027C to 027D	FBO	R/W	R/W	×	×
D0639 to D0640	40639 to 40640	027E to 027F	TLG	R/W	R/W	R/W	×
D0641 to D0642	40641 to 40642	0280 to 0281					
D0643 to D0644	40643 to 40644	0282 to 0283					
D0645 to D0646	40645 to 40646	0284 to 0285					
D0647 to D0648	40647 to 40648	0286 to 0287					
D0649 to D0650	40649 to 40650	0288 to 0289					
D0651 to D0652	40651 to 40652	028A to 028B	PLC2	×	R/W	R/W	×
D0653 to D0654	40653 to 40654	028C to 028D	PLG2	×	R/W	R/W	×
D0655 to D0656	40655 to 40656	028E to 028F	CLC2	×	×	R/W	×
D0657 to D0658	40657 to 40658	0290 to 0291	CLG2	×	×	R/W	×
D0659 to D0660	40659 to 40660	0292 to 0293	CGN2	×	×	R/W	×
D0661 to D0662	40661 to 40662	0294 to 0295	CBI2	×	×	R/W	×
D0663 to D0664	40663 to 40664	0296 to 0297	CBO2	×	×	R/W	×
D0665 to D0666	40665 to 40666	0298 to 0299					
D0667 to D0668	40667 to 40668	029A to 029B					
D0669 to D0670	40669 to 40670	029C to 029D					
D0671 to D0672	40671 to 40672	029E to 029F					
D0673 to D0674	40673 to 40674	02A0 to 02A1					
D0675 to D0676	40675 to 40676	02A2 to 02A3					
D0677 to D0678	40677 to 40678	02A4 to 02A5					
D0679 to D0680	40679 to 40680	02A6 to 02A7					
D0681 to D0682	40681 to 40682	02A8 to 02A9					
D0683 to D0684	40683 to 40684	02AA to 02AB					
D0685 to D0686	40685 to 40686	02AC to 02AD					
D0687 to D0688	40687 to 40688	02AE to 02AF					
D0689 to D0690	40689 to 40690	02B0 to 02B1					
D0691 to D0692	40691 to 40692	02B2 to 02B3					
D0693 to D0694	40693 to 40694	02B4 to 02B5					
D0695 to D0696	40695 to 40696	02B6 to 02B7					
D0697 to D0698	40697 to 40698	02B8 to 02B9					
D0699 to D0700	40699 to 40700	02BA to 02BB					

6.6 Tuning Parameters (D0401 to D0900)

Tuning parameters area							
Special parameters							
D-Reg No.	Ref. No.	H No.	Register name	R/W			
				SINGLE	CAS	SELECT	PROG
D0701 to D0896	40701 to 40702						
D0897 to D0898	40897 to 40898	0380 to 0381	EDSOA	R	R	R	R
D0899 to D0900	40899 to 40900	0382 to 0383	CEDA	W	W	W	W

6.6 Tuning Parameters (D0401 to D0900)

6.6.1 PID Parameters (D0401 to D0500)

Register No.	Description	Range and Meaning of Value
D0401 to D0402	PB1 Proportional band 1	0.1 to 999.9%
D0403 to D0404	TI1 Integral time 1	1 to 9999 s (second)
D0405 to D0406	TD1 Derivative time 1	0 to 9999 (0: OFF)
D0407 to D0408	SFA1 Adjustable setpoint filter α 1	0.000 to 1.000
D0409 to D0410	SFB1 Adjustable setpointing filter β 1	
D0411 to D0412	GW1 Non-linear control gap width 1	0.0 to 100.0%
D0413 to D0414	GG1 Non-linear control gain 1	0.000 to 1.000
D0415 to D0416	PH1 High limit alarm setpoint for PV1	Equivalent to -6.3 to 106.3% in the engineering unit (Note 1) (Note 2)
D0417 to D0418	PL1 Low limit alarm setpoint for PV1	
D0419 to D0420	HH1 High-high limit alarm setpoint for PV1	
D0421 to D0422	LL1 Low-low limit alarm setpoint for PV1	
D0423 to D0424	DL1 Alarm setpoint for deviation variable 1	Equivalent to 0.0 to 106.3% in the engineering unit (Note 1) (Note 2)
D0425 to D0426	HYS1 Alarm hysteresis 1	Equivalent to 0.0 to 20.0% in the engineering unit (Note 1)
D0427 to D0428	VL1 Velocity alarm setpoint for PV1	Equivalent to 0.0 to 106.3% in the engineering unit (Note 1) (Note 2)
D0429 to D0430	VT1 Velocity alarm time setpoint for PV1	1 to 9999 s (second)
D0431 to D0432	MH1 High limit setpoint of MV1	-6.3 to 106.3% (Note 3)
D0433 to D0434	ML1 Low limit setpoint of MV1	
D0435 to D0436	MR1 Manual reset 1	-6.3 to 106.3%
D0437 to D0438	RB1 Reset bias 1	0.0 to 106.3%
D0439 to D0440	PMV1 Preset output 1	-6.3 to 106.3% (Note 4)
D0441 to D0450		
D0451 to D0452	PB2 Proportional band 2	As same as D0401 to D0440
D0453 to D0454	TI2 Integral time 2	
D0455 to D0456	TD2 Derivative time 2	
D0457 to D0458	SFA2 Adjustable setpoint filter α 2	
D0459 to D0460	SFB2 Adjustable setpointing filter β 2	
D0461 to D0462	GW2 Non-linear control gap width 2	
D0463 to D0464	GG2 Non-linear control gain 2	
D0465 to D0466	PH2 High limit alarm setpoint for PV2	
D0467 to D0468	PL2 Low limit alarm setpoint for PV2	
D0469 to D0470	HH2 High-high limit alarm setpoint for PV2	
D0471 to D0472	LL2 Low-low limit alarm setpoint for PV2	
D0473 to D0474	DL2 Alarm setpoint for deviation variable 2	
D0475 to D0476	HYS2 Alarm hysteresis 2	
D0477 to D0478	VL2 Velocity alarm setpoint for PV2	
D0479 to D0480	VT2 Velocity alarm time setpoint for PV2	
D0481 to D0482	MH2 High limit setpoint of MV2	
D0483 to D0484	ML2 Low limit setpoint of MV2	
D0485 to D0486	MR2 Manual reset 2	
D0487 to D0488	RB2 Reset bias 2	
D0489 to D0490	PMV2 Preset output 2	

Note 1: The engineering units set with the engineering parameters, SCH1, SCL1, and SCDP1.

Note 2: If the high limit alarm setpoint for PV and the high-high limit alarm setpoint for PV are set to the maximum values, no alarm is generated.

If the low limit alarm setpoint for PV and the low-low limit alarm setpoint for PV are set to the minimum values, no alarm is generated.

Note 3: Be sure to set to MH1>ML1.

Note 4: When the controller mode is set to the cascade-selector mode, PMV will be displayed.

6.6.2 STC Parameters (D0501 to D0600)

Register No.	Description	Range and Meaning of Value
D0501 to D0502	IP1 Process type 1	0: STATIC (Static process) 1: DYNAM: (Astatic process (with integral characteristics))
D0503 to D0504	TR1 Process response time 1	4 to 9999 s (second)
D0505 to D0506	NB1 Noise band 1	Equivalent to 0.0 to 20.0% in the engineering unit (Note 1)
D0507 to D0508	OS1 Control target type 1	0: ZERO (Overshoot zero) 1: MIN (Overshoot: small (about 5%) Settling time: short) 2: MED (Overshoot: medium (about 10%) Rise time: Medium-fast) 3: MAX (Overshoot: large (about 15%) Rise time: Fast)
D0509 to D0510	MI1 MV applied signal span 1	0.0 to 20.0%
D0511 to D0512	PMX1 High limit setpoint of proportional band 1	2.0 to 999.9%
D0513 to D0514	PMN1 Low limit setpoint of proportional band 1	
D0515 to D0516	IMX1 High limit setpoint of integral time 1	1 to 9999 s (second)
D0517 to D0528	IMN1 Low limit setpoint of integral time 1	
D0519 to D0520	DMX1 High limit setpoint of derivative time 1	0 to 9999 s (second)
D0521 to D0522	PA1 Calculated proportional band 1	2.0 to 999.9%
D0523 to D0524	IA1 Calculated integral time 1	1 to 9999 s (second)
D0525 to D0526	DA1 Calculated derivative time 1	0 to 9999 s (second)
D0527 to D0528	CR1 Presumed accuracy error 1	0.00 to 99.99%
D0529 to D0530	RT1 Signal distribution ratio 1	0.000 to 9.999
D0531 to D0532	LM1 Equivalent dead time 1	0 to 9999 s (second)
D0533 to D0534	TM1 Equivalent lag time 1	0 to 9999 s (second)
D0535 to D0536	GM1 Equivalent process gain 1	0.000 to 9.999
D0537 to D0540		
D0541 to D0542	STC STC mode selection	0: OFF (STC is not operating) 1: DISP (STC values displayed only) 2: ON (STC is operating) 3: ATSTUP (STC automatic start-up) (Note 2)
D0543 to D0544	OD On-demand tuning start	0: OFF 1: ON
D0545 to D0550		
D0551 to D0552	IP2 Process type 2	As same as D0501 to D0508
D0553 to D0554	TR2 Process response time 2	
D0555 to D0556	NB2 Noise band 2	
D0557 to D0558	OS2 Control target type 2	
D0559 to D0560	MI2 MV applied signal span 2	As same as D0509 to D0536
D0561 to D0562	PMX2 High limit setpoint of proportional band 2	
D0563 to D0564	PMN2 Low limit setpoint of proportional band 2	
D0565 to D0566	IMX2 High limit setpoint of integral time 2	
D0567 to D0568	IMN2 Low limit setpoint of integral time 2	
D0569 to D0570	DMX2 High limit setpoint of derivative time 2	
D0571 to D0572	PA2 Calculated proportional band 2	
D0573 to D0574	IA2 Calculated integral time 2	
D0575 to D0576	DA2 Calculated derivative time 2	
D0577 to D0578	CR2 Presumed accuracy error 2	
D0579 to D0580	RT2 Signal distribution ratio 2	
D0581 to D0582	LM2 Equivalent dead time 2	
D0583 to D0584	TM2 Equivalent lag time 2	
D0585 to D0586	GM2 Equivalent process gain 2	
D0587 to D0600		

Note 1: The engineering units set with the engineering parameters, SCH1, SCL1, and SCDP1.

Note 2: ATSTUP can not be set if the controller mode is set to the selector or the selector control module is being used in the programmable mode.

6.6 Tuning Parameters (D0401 to D0900)

6.6.3 I/O Parameters (D0601 to D0700)

Register No.	Description	Range and Meaning of Value
D0601 to D0602	PLC1 Square root extraction low cutoff setpoint for PV1	0.0 to 100.0%
D0603 to D0604	PLG1 First order lag time constant for PV1	0.0 to 800.0 s (second)
D0605 to D0606	CLC1 Square root extraction low cutoff setpoint for CSV1	0.0 to 100.0%
D0607 to D0608	CLG1 First order lag time constant for CSV1	0.0 to 800.0 s (second)
D0609 to D0610	CGN1 Ratio gain for CSV1	-8.000 to 8.000
D0611 to D0612	CBI1 Ratio input bias for CSV1	-106.3 to 106.3%
D0613 to D0614	CBO1 Ratio output bias for CSV1	-800.0 to 800.0%
D0615 to D0630		
D0631 to D0632	FLG Feedforward lag time constant	0.0 to 800.0 s (second)
D0633 to D0634	FGN Feedforward gain	-8.000 to 8.000
D0635 to D0636	FBI Feedforward input bias	-106.3 to 106.3%
D0637 to D0638	FBO Feedforward output bias	-800.0 to 800.0%
D0639 to D0640	TLG Tracking input lag time constant	0.0 to 800.0 s (second)
D0641 to D0650		
D0651 to D0652	PLC2 Square root extraction low cutoff setpoint for PV2	As same as D0601 to D0614
D0653 to D0654	PLG2 First order lag time constant of PV2	
D0655 to D0656	CLC2 Square root extraction low cutoff setpoint for CSV2	
D0657 to D0658	CLG2 First order lag time constant for CSV2	
D0659 to D0660	CGN2 Ratio gain for CSV2	
D0661 to D0662	CBI2 Ratio input bias for CSV2	
D0663 to D0664	CBO2 Ratio output bias for CSV2	
D0665 to D0700		

6.6.4 Special Parameters (D0701 to D0900)

Register No.	Description	Range and Meaning of Value
D0701 to D0702		
D0897 to D0898	EDSOA Event display status	0: No 1 to 5: Display event 1 to 5
D0899 to D0900	CEDA Clear event display	1: Clear event display

6.7 Recognition Area/User Area (D0901 to D1000)

Recognition area/User area									
Recognition area					User area				
D-Reg No.	Ref. No.	H No.	Register name	R/W	D-Reg No.	Ref. No.	H No.	Register name	R/W
D0901 to D0902	40901 to 40902	0384 to 0385	PROG	R	D0951 to D0952	40951 to 40952	03B6 to 03B7	U1	R/W
D0903 to D0904	40903 to 40904	0386 to 0387	PROG	R	D0953 to D0954	40953 to 40954	03B8 to 03B9	U2	R/W
D0905 to D0906	40905 to 40906	0388 to 0389	REV	R	D0955 to D0956	40955 to 40956	03BA to 03BB	U3	R/W
D0907 to D0908	40907 to 40908	038A to 038B	REV	R	D0957 to D0958	40957 to 40958	03BC to 03BD	U4	R/W
D0909 to D0910	40909 to 40910	038C to 038D			D0959 to D0960	40959 to 40960	03BE to 03BF	U5	R/W
D0911 to D0912	40911 to 40912	038E to 038F			D0961 to D0962	40961 to 40962	03C0 to 03C1	U6	R/W
D0913 to D0914	40913 to 40914	0390 to 0391			D0963 to D0964	40963 to 40964	03C2 to 03C3	U7	R/W
D0915 to D0916	40915 to 40916	0392 to 0393			D0965 to D0966	40965 to 40966	03C4 to 03C5	U8	R/W
D0917 to D0918	40917 to 40918	0394 to 0395			D0967 to D0968	40967 to 40968	03C6 to 03C7	U9	R/W
D0919 to D0920	40919 to 40920	0396 to 0397			D0969 to D0970	40969 to 40970	03C8 to 03C9	U10	R/W
D0921 to D0922	40921 to 40922	0398 to 0399			D0971 to D0972	40971 to 40972	03CA to 03CB	U11	R/W
D0923 to D0924	40923 to 40924	039A to 039B			D0973 to D0974	40973 to 40974	03CC to 03CD	U12	R/W
D0925 to D0926	40925 to 40926	039C to 039D			D0975 to D0976	40975 to 40976	03CE to 03CF	U13	R/W
D0927 to D0928	40927 to 40928	039E to 039F			D0977 to D0978	40977 to 40978	03D0 to 03D1	U14	R/W
D0929 to D0930	40929 to 40930	03A0 to 03A1			D0979 to D0980	40979 to 40980	03D2 to 03D3	U15	R/W
D0931 to D0932	40931 to 40932	03A2 to 03A3			D0981 to D0982	40981 to 40982	03D4 to 03D5	U16	R/W
D0933 to D0934	40933 to 40934	03A4 to 03A5			D0983 to D0984	40983 to 40984	03D6 to 03D7	U17	R/W
D0935 to D0936	40935 to 40936	03A6 to 03A7			D0985 to D0986	40985 to 40986	03D8 to 03D9	U18	R/W
D0937 to D0938	40937 to 40938	03A8 to 03A9			D0987 to D0988	40987 to 40988	03DA to 03DB	U19	R/W
D0939 to D0940	40939 to 40940	03AA to 03AB			D0989 to D0990	40989 to 40990	03DC to 03DD	U20	R/W
D0941 to D0942	40941 to 40942	03AC to 03AD			D0991 to D0992	40991 to 40992	03DE to 03DF	U21	R/W
D0943 to D0944	40943 to 40944	03AE to 03AF			D0993 to D0994	40993 to 40994	03E0 to 03E1	U22	R/W
D0945 to D0946	40945 to 40946	03B0 to 03B1			D0995 to D0996	40995 to 40996	03E2 to 03E3	U23	R/W
D0947 to D0948	40947 to 40948	03B2 to 03B3			D0997 to D0998	40997 to 40998	03E4 to 03E5	U24	R/W
D0949 to D0950	40949 to 40950	03B4 to 03B5			D0999 to D1000	40999 to 41000	03E6 to 03E7	U25	R/W

6.7.1 Recognition Area (D0901 to D0950)

Register No.	Description	Range and Meaning of Value
D0901 to D0904	PROG User program name	8-digit alphanumeric (One D register expresses two ASCII characters.) D0901 to D0904
D0905 to D0908	REV System Rev.No.	8-digit of alphanumeric (One D register expresses two ASCII characters.) (Represent the product style number and revision number.) D0905 to D0908
D0909 to D0950		

6.7.2 User Area (D0951 to D1000)

Register No.	Description	Range and Meaning of Value
D0951 to D1000	U1 to U25	

6.8 Engineering Parameters (D1001 to D2000)

Engineering parameters 1 area							
CONFIG							
D-Reg No.	Ref. No.	H No.	Register name	R/W			
				SINGLE	CAS	SELECT	PROG
D1001 to D1002	41001 to 41002	03E8 to 03E9					
D1003 to D1004	41003 to 41004	03EA to 03EB	CTL	R/W	R/W	R/W	R/W
D1005 to D1006	41005 to 41006	03EC to 03ED	START	R/W	R/W	R/W	R/W
D1007 to D1008	41007 to 41008	03EE to 03EF	ATSEL	x	x	R/W	R/W
D1009 to D1010	41009 to 41010	03F0 to 03F1					
D1011 to D1012	41011 to 41012	03F2 to 03F3					
D1013 to D1014	41013 to 41014	03F4 to 03F5	DISP1	x	x	x	R/W
D1015 to D1016	41015 to 41016	03F6 to 03F7	NAME1	x	x	x	R/W
D1017 to D1018	41017 to 41018	03F8 to 03F9	DISP2	x	x	x	R/W
D1019 to D1020	41019 to 41020	03FA to 03FB	NAME2	x	x	x	R/W
D1021 to D1022	41021 to 41022	03FC to 03FD	CAMLK	R/W	R/W	R/W	R/W
D1023 to D1024	41023 to 41024	03FE to 03FF	SVLK	R/W	R/W	R/W	R/W
D1025 to D1026	41025 to 41026	0400 to 0401	MVLK	R/W	R/W	R/W	R/W
D1027 to D1028	41027 to 41028	0402 to 0403					
D1029 to D1030	41029 to 41030	0404 to 0405	Y3TP	x	x	x	R/W
D1031 to D1032	41031 to 41032	0406 to 0407	Y2S	R/W	R/W	R/W	x
D1033 to D1034	41033 to 41034	0408 to 0409	Y3S	R/W	R/W	R/W	x
D1035 to D1036	41035 to 41036	040A to 040B	Y4S	R/W	R/W	R/W	x
D1037 to D1038	41037 to 41038	040C to 040D					
D1039 to D1040	41039 to 41040	040E to 040F					
D1041 to D1042	41041 to 41042	0410 to 0411	CMOD1	R/W	R/W	R/W	R/W
D1043 to D1044	41043 to 41044	0412 to 0413	BMOD1	R/W	R/W	R/W	R/W
D1045 to D1046	41045 to 41046	0414 to 0415	CNT1	R/W	R/W	R/W	R/W
D1047 to D1048	41047 to 41048	0416 to 0417	ALG1	R/W	R/W	R/W	R/W
D1049 to D1050	41049 to 41050	0418 to 0419	ACT1	R/W	R/W	R/W	R/W
D1051 to D1052	41051 to 41052	041A to 041B					
D1053 to D1054	41053 to 41054	041C to 041D	UNIT1	R/W	R/W	R/W	R/W
D1055 to D1056	41055 to 41056	041E to 041F	UNIT1	R/W	R/W	R/W	R/W
D1057 to D1058	41057 to 41058	0420 to 0421	SCDP1	R/W	R/W	R/W	R/W
D1059 to D1060	41059 to 41060	0422 to 0423					
D1061 to D1062	41061 to 41062	0424 to 0425					
D1063 to D1064	41063 to 41064	0426 to 0427	VDIR1	R/W	R/W	R/W	R/W
D1065 to D1066	41065 to 41066	0428 to 0429	SCDV1	R/W	R/W	R/W	R/W
D1067 to D1068	41067 to 41068	042A to 042B	SCH1	R/W	R/W	R/W	R/W
D1069 to D1070	41069 to 41070	042C to 042D	SCL1	R/W	R/W	R/W	R/W
D1071 to D1072	41071 to 41072	042E to 042F	CMOD2	x	x	R/W	R/W
D1073 to D1074	41073 to 41074	0430 to 0431	BMOD2	x	x	x	R/W
D1075 to D1076	41075 to 41076	0432 to 0433	CNT2	x	R/W	R/W	R/W
D1077 to D1078	41077 to 41078	0434 to 0435	ALG2	x	R/W	R/W	R/W
D1079 to D1080	41079 to 41080	0436 to 0437	ACT2	x	R/W	R/W	R/W
D1081 to D1082	41081 to 41082	0438 to 0439					
D1083 to D1084	41083 to 41084	043A to 043B	UNIT2	x	R/W	R/W	R/W
D1085 to D1086	41085 to 41086	043C to 043D	UNIT2	x	R/W	R/W	R/W
D1087 to D1088	41087 to 41088	043E to 043F	SCDP2	x	R/W	R/W	R/W
D1089 to D1090	41089 to 41090	0440 to 0441	SCH2	x	R/W	R/W	R/W
D1091 to D1092	41091 to 41092	0442 to 0443	SCL2	x	R/W	R/W	R/W
D1093 to D1094	41093 to 41094	0444 to 0445	VDIR2	x	R/W	R/W	R/W
D1095 to D1096	41095 to 41096	0446 to 0447	SCDV2	x	R/W	R/W	R/W
D1097 to D1098	41097 to 41098	0448 to 0449	RSDISP	R	R	R	R
D1099 to D1100	41099 to 41100	044A to 044B					

Note: When the operation status is STOP via communication (RSCOMM=1), data can be written to all engineering parameters 1.

6.8 Engineering Parameters (D1001 to D2000)

Engineering parameters 1 area							
I/O computation setting, Alarm setting							
D-Reg No.	Ref. No.	H No.	Register name	R/W			
				SINGLE	CAS	SELECT	PROG
D1101 to D1102	41101 to 41102	044C to 044D	PFKEY	R/W	R/W	R/W	×
D1103 to D1104	41103 to 41104	044E to 044F	TRKSW	R/W	×	×	×
D1105 to D1106	41105 to 41106	0450 to 0451					
D1107 to D1108	41107 to 41108	0452 to 0453	FSW	R/W	R/W	×	×
D1109 to D1110	41109 to 41110	0454 to 0455	FON	R/W	R/W	×	×
D1111 to D1112	41111 to 41112	0456 to 0457					
D1113 to D1114	41113 to 41114	0458 to 0459					
D1115 to D1116	41115 to 41116	045A to 045B					
D1117 to D1118	41117 to 41118	045C to 045D					
D1119 to D1120	41119 to 41120	045E to 045F					
D1121 to D1122	41121 to 41122	0460 to 0461	PSR1	R/W	R/W	R/W	×
D1123 to D1124	41123 to 41124	0462 to 0463	FX1	R/W	R/W	R/W	×
D1125 to D1126	41125 to 41126	0464 to 0465	CSR1	R/W	R/W	R/W	×
D1127 to D1128	41127 to 41128	0466 to 0467	CSW1	R/W	R/W	R/W	×
D1129 to D1130	41129 to 41130	0468 to 0469					
D1131 to D1132	41131 to 41132	046A to 046B	PSR2	×	R/W	R/W	×
D1133 to D1134	41133 to 41134	046C to 046D	FX2	×	R/W	R/W	×
D1135 to D1136	41135 to 41136	046E to 046F	CSR2	×	×	R/W	×
D1137 to D1138	41137 to 41138	0470 to 0471	CSW2	×	×	R/W	×
D1139 to D1140	41139 to 41140	0472 to 0473					
D1141 to D1142	41141 to 41142	0474 to 0475					
D1143 to D1144	41143 to 41144	0476 to 0477					
D1145 to D1146	41145 to 41146	0478 to 0479					
D1147 to D1148	41147 to 41148	047A to 047B					
D1149 to D1150	41149 to 41150	047C to 047D					
D1151 to D1152	41151 to 41152	047E to 047F					
D1153 to D1154	41153 to 41154	0480 to 0481					
D1155 to D1156	41155 to 41156	0482 to 0483					
D1157 to D1158	41157 to 41158	0484 to 0485					
D1159 to D1160	41159 to 41160	0486 to 0487					
D1161 to D1162	41161 to 41162	0488 to 0489					
D1163 to D1164	41163 to 41164	048A to 048B					
D1165 to D1166	41165 to 41166	048C to 048D					
D1167 to D1168	41167 to 41168	048E to 048F					
D1169 to D1170	41169 to 41170	0490 to 0491					
D1171 to D1172	41171 to 41172	0492 to 0493					
D1173 to D1174	41173 to 41174	0494 to 0495					
D1175 to D1176	41175 to 41176	0496 to 0497					
D1177 to D1178	41177 to 41178	0498 to 0499					
D1179 to D1180	41179 to 41180	049A to 049B					
D1181 to D1182	41181 to 41182	049C to 049D	TAG1	R/W	R/W	R/W	R/W
D1183 to D1184	41183 to 41184	049E to 049F	TAG1	R/W	R/W	R/W	R/W
D1185 to D1186	41185 to 41186	04A0 to 04A1	TAG1	R/W	R/W	R/W	R/W
D1187 to D1188	41187 to 41188	04A2 to 04A3	TAG2	×	R/W	R/W	R/W
D1189 to D1190	41189 to 41190	04A4 to 04A5	TAG2	×	R/W	R/W	R/W
D1191 to D1192	41191 to 41192	04A6 to 04A7	TAG2	×	R/W	R/W	R/W
D1193 to D1194	41193 to 41194	04A8 to 04A9					
D1195 to D1196	41195 to 41196	04AA to 04AB					
D1197 to D1198	41197 to 41198	04AC to 04AD					
D1199 to D1200	41199 to 41200	04AE to 04AF					

Note: When the operation status is STOP via communication (RSCOMM=1), data can be written to all engineering parameters 1.

6.8 Engineering Parameters (D1001 to D2000)

Engineering parameters 1 area							
Display setting, Contrast							
D-Reg No.	Ref. No.	H No.	Register name	R/W			
				SINGLE	CAS	SELECT	PROG
D1201 to D1202	41201 to 41202	04B0 to 04B1	LOOP1	R/W	R/W	R/W	R/W
D1203 to D1204	41203 to 41204	04B2 to 04B3	LOOP2	R/W	R/W	R/W	R/W
D1205 to D1206	41205 to 41206	04B4 to 04B5	TRND1	R/W	R/W	R/W	R/W
D1207 to D1208	41207 to 41208	04B6 to 04B7	TRND2	R/W	R/W	R/W	R/W
D1209 to D1210	41209 to 41210	04B8 to 04B9	TRND3	R/W	R/W	R/W	R/W
D1211 to D1212	41211 to 41212	04BA to 04BB	ALARM	R/W	R/W	R/W	R/W
D1213 to D1214	41213 to 41214	04BC to 04BD					
D1215 to D1216	41215 to 41216	04BE to 04BF	DUAL1	R/W	R/W	R/W	R/W
D1217 to D1218	41217 to 41218	04C0 to 04C1	DUAL2	R/W	R/W	R/W	R/W
D1219 to D1220	41219 to 41220	04C2 to 04C3	MTR1	R/W	R/W	R/W	R/W
D1221 to D1222	41221 to 41222	04C4 to 04C5	MTR2	R/W	R/W	R/W	R/W
D1223 to D1224	41223 to 41224	04C6 to 04C7	FDSP	R/W	R/W	R/W	R/W
D1225 to D1226	41225 to 41226	04C8 to 04C9	MTMG1	R/W	R/W	R/W	R/W
D1227 to D1228	41227 to 41228	04CA to 04CB	MTMG2	R/W	R/W	R/W	R/W
D1229 to D1230	41229 to 41230	04CC to 04BD	TR1PV	R/W	R/W	R/W	R/W
D1231 to D1232	41231 to 41232	04CE to 04CF	TR1SV	R/W	R/W	R/W	R/W
D1233 to D1234	41233 to 41234	04D0 to 04D1	TR1MV	R/W	R/W	R/W	R/W
D1235 to D1236	41235 to 41236	04D2 to 04D3	TR2PV	×	R/W	R/W	R/W
D1237 to D1238	41237 to 41238	04D4 to 04D5	TR2SV	×	R/W	R/W	R/W
D1239 to D1240	41239 to 41240	04D6 to 04D7	TR2MV	×	R/W	R/W	R/W
D1241 to D1242	41241 to 41242	04D8 to 04D9	TRDS1	R/W	R/W	R/W	R/W
D1243 to D1244	41243 to 41244	04DA to 04DB	TRDS2	R/W	R/W	R/W	R/W
D1245 to D1246	41245 to 41246	04DC to 04DD	TRDS3	R/W	R/W	R/W	R/W
D1247 to D1248	41247 to 41248	04DE to 04DF	TRDS4	R/W	R/W	R/W	R/W
D1249 to D1250	41249 to 41250	04E0 to 04E1	TRDT1	R/W	R/W	R/W	R/W
D1251 to D1252	41251 to 41252	04E2 to 04E3	TRDT2	×	R/W	R/W	R/W
D1253 to D1254	41253 to 41254	04E4 to 04E5	TRDT3	R/W	R/W	R/W	R/W
D1255 to D1256	41255 to 41256	04E6 to 04E7	TR3DV	R/W	R/W	R/W	R/W
D1257 to D1258	41257 to 41258	04E8 to 04E9	ACTD1	R/W	R/W	R/W	R/W
D1259 to D1260	41259 to 41260	04EA to 04EB	ACTD2	R/W	R/W	R/W	R/W
D1261 to D1262	41261 to 41262	04EC to 04ED	TAGAL	R/W	R/W	R/W	R/W
D1263 to D1264	41263 to 41264	04EE to 04EF	LP1C	R/W	R/W	R/W	R/W
D1265 to D1266	41265 to 41266	04F0 to 04F1	LP2C	×	R/W	R/W	R/W
D1267 to D1268	41267 to 41268	04F2 to 04F3	BKCL	R/W	R/W	R/W	R/W
D1269 to D1270	41269 to 41270	04F4 to 04F5					
D1271 to D1272	41271 to 41272	04F6 to 04F7	ECO	R/W	R/W	R/W	R/W
D1273 to D1274	41273 to 41274	04F8 to 04F9	BRT	R/W	R/W	R/W	R/W
D1275 to D1276	41275 to 41276	04FA to 04FB					
D1277 to D1278	41277 to 41278	04FC to 04FD					
D1279 to D1280	41279 to 41280	04FE to 04FF					
D1281 to D1282	41281 to 41282	0500 to 0501					
D1283 to D1284	41283 to 41284	0502 to 0503					
D1285 to D1286	41285 to 41286	0504 to 0505					
D1287 to D1288	41287 to 41288	0506 to 0507					
D1289 to D1290	41289 to 41290	0508 to 0509					
D1291 to D1292	41291 to 41292	050A to 050B					
D1293 to D1294	41293 to 41294	050C to 050D					
D1295 to D1296	41295 to 41296	050E to 050F					
D1297 to D1298	41297 to 41298	0510 to 0511					
D1299 to D1300	41299 to 41300	0512 to 0513					

Note: When the operation status is STOP via communication (RSCOMM=1), data can be written to all engineering parameters 1. However, ECO and BRT parameters are excluded.

6.8 Engineering Parameters (D1001 to D2000)

Engineering parameters 1 area							
Communication setting							
D-Reg No.	Ref. No.	H No.	Register name	R/W			
				SINGLE	CAS	SELECT	PROG
D1301 to D1302	41301 to 41302	0514 to 0515	PSL	R/W	R/W	R/W	R/W
D1303 to D1304	41303 to 41304	0516 to 0517					
D1305 to D1306	41305 to 41306	0518 to 0519	ADRS	R/W	R/W	R/W	R/W
D1307 to D1308	41307 to 41308	051A to 051B	STBIT	R/W	R/W	R/W	R/W
D1309 to D1310	41309 to 41310	051C to 051D	PAR	R/W	R/W	R/W	R/W
D1311 to D1312	41311 to 41312	051E to 051F	DLEN	R/W	R/W	R/W	R/W
D1313 to D1314	41313 to 41314	0520 to 0521	BPS	R/W	R/W	R/W	R/W
D1315 to D1316	41315 to 41316	0522 to 0523					
D1317 to D1318	41317 to 41318	0524 to 0525	TRMR	R/W	R/W	R/W	R/W
D1319 to D1320	41319 to 41320	0526 to 0527	CMWDT	R/W	R/W	R/W	R/W
D1321 to D1322	41321 to 41322	0528 to 0529	ETRWR	R/W	R/W	R/W	R/W
D1323 to D1324	41323 to 41324	052A to 052B	IPAD1	R/W	R/W	R/W	R/W
D1325 to D1326	41325 to 41326	052C to 052D	IPAD2	R/W	R/W	R/W	R/W
D1327 to D1328	41327 to 41328	052E to 052F	IPAD3	R/W	R/W	R/W	R/W
D1329 to D1330	41329 to 41330	0530 to 0531	IPAD4	R/W	R/W	R/W	R/W
D1331 to D1332	41331 to 41332	0532 to 0533	SM1	R/W	R/W	R/W	R/W
D1333 to D1334	41333 to 41334	0534 to 0535	SM2	R/W	R/W	R/W	R/W
D1335 to D1336	41335 to 41336	0536 to 0537	SM3	R/W	R/W	R/W	R/W
D1337 to D1338	41337 to 41338	0538 to 0539	SM4	R/W	R/W	R/W	R/W
D1339 to D1340	41339 to 41340	053A to 053B	DG1	R/W	R/W	R/W	R/W
D1341 to D1342	41341 to 41342	053C to 053D	DG2	R/W	R/W	R/W	R/W
D1343 to D1344	41343 to 41344	053E to 053F	DG3	R/W	R/W	R/W	R/W
D1345 to D1346	41345 to 41346	0540 to 0541	DG4	R/W	R/W	R/W	R/W
D1347 to D1348	41347 to 41348	0542 to 0543	PORT	R/W	R/W	R/W	R/W
D1349 to D1350	41349 to 41350	0544 to 0545	ESW	R/W	R/W	R/W	R/W
D1351 to D1352	41351 to 41352	0546 to 0547	DREG1	R/W	R/W	R/W	R/W
D1353 to D1354	41353 to 41354	0548 to 0549	DREG2	R/W	R/W	R/W	R/W
D1355 to D1356	41355 to 41356	054A to 054B	COMM	R	R	R	R
D1357 to D1358	41357 to 41358	054C to 054D	ECTO	R/W	R/W	R/W	R/W
D1359 to D1360	41359 to 41360	054E to 054F					
D1361 to D1362	41361 to 41362	0550 to 0551					
D1363 to D1364	41363 to 41364	0552 to 0553					
D1365 to D1366	41365 to 41366	0554 to 0555					
D1367 to D1368	41367 to 41368	0556 to 0557					
D1369 to D1370	41369 to 41370	0558 to 0559					
D1371 to D1372	41371 to 41372	055A to 055B					
D1373 to D1374	41373 to 41374	055C to 055D					
D1375 to D1376	41375 to 41376	055E to 055F					
D1377 to D1378	41377 to 41378	0560 to 0561					
D1379 to D1380	41379 to 41380	0562 to 0563					
D1381 to D1382	41381 to 41382	0564 to 0565					
D1383 to D1384	41383 to 41384	0566 to 0567					
D1385 to D1386	41385 to 41386	0568 to 0569					
D1387 to D1388	41387 to 41388	056A to 056B					
D1389 to D1390	41389 to 41390	056C to 056D					
D1391 to D1392	41391 to 41392	056E to 056F					
D1393 to D1394	41393 to 41394	0570 to 0571					
D1395 to D1396	41395 to 41396	0572 to 0573					
D1397 to D1398	41397 to 41398	0574 to 0575					
D1399 to D1400	41399 to 41400	0576 to 0577					

Note: When the operation status is STOP via communication (RSCOMM=1), data can be written to all engineering parameters 1.

6.8 Engineering Parameters (D1001 to D2000)

Engineering parameters 2 area							
Preset PID, sample and batch							
D-Reg No.	Ref. No.	H No.	Register name	R/W			
				SINGLE	CAS	SELECT	PROG
D1401 to D1402	41401 to 41402	0578 to 0579	PPB1	x	x	x	R/W
D1403 to D1404	41403 to 41404	057A to 057B	PTI1	x	x	x	R/W
D1405 to D1406	41405 to 41406	057C to 057D	PTD1	x	x	x	R/W
D1407 to D1408	41407 to 41408	057E to 057F	PPB2	x	x	x	R/W
D1409 to D1410	41409 to 41410	0580 to 0581	PTI2	x	x	x	R/W
D1411 to D1412	41411 to 41412	0582 to 0583	PTD2	x	x	x	R/W
D1413 to D1414	41413 to 41414	0584 to 0585	PPB3	x	x	x	R/W
D1415 to D1416	41415 to 41416	0586 to 0587	PTI3	x	x	x	R/W
D1417 to D1418	41417 to 41418	0588 to 0589	PTD3	x	x	x	R/W
D1419 to D1420	41419 to 41420	058A to 058B	PPB4	x	x	x	R/W
D1421 to D1422	41421 to 41422	058C to 058D	PTI4	x	x	x	R/W
D1423 to D1424	41423 to 41424	058E to 058F	PTD4	x	x	x	R/W
D1425 to D1426	41425 to 41426	0590 to 0591	PPB5	x	x	x	R/W
D1427 to D1428	41427 to 41428	0592 to 0593	PTI5	x	x	x	R/W
D1429 to D1430	41429 to 41430	0594 to 0595	PTD5	x	x	x	R/W
D1431 to D1432	41431 to 41432	0596 to 0597	PPB6	x	x	x	R/W
D1433 to D1434	41433 to 41434	0598 to 0599	PTI6	x	x	x	R/W
D1435 to D1436	41435 to 41436	059A to 059B	PTD6	x	x	x	R/W
D1437 to D1438	41437 to 41438	059C to 059D	PPB7	x	x	x	R/W
D1439 to D1440	41439 to 41440	059E to 059F	PTI7	x	x	x	R/W
D1441 to D1442	41441 to 41442	05A0 to 05A1	PTD7	x	x	x	R/W
D1443 to D1444	41443 to 41444	05A2 to 05A3	PPB8	x	x	x	R/W
D1445 to D1446	41445 to 41446	05A4 to 05A5	PTI8	x	x	x	R/W
D1447 to D1448	41447 to 41448	05A6 to 05A7	PTD8	x	x	x	R/W
D1449 to D1450	41449 to 41450	05A8 to 05A9					
D1451 to D1452	41451 to 41452	05AA to 05AB	STM1	x	x	x	R/W
D1453 to D1454	41453 to 41454	05AC to 05AD	SWD1	x	x	x	R/W
D1455 to D1456	41455 to 41456	05AE to 05AF	BD1	x	x	x	R/W
D1457 to D1458	41457 to 41458	05B0 to 05B1	BB1	x	x	x	R/W
D1459 to D1460	41459 to 41460	05B2 to 05B3	BL1	x	x	x	R/W
D1461 to D1462	41461 to 41462	05B4 to 05B5					
D1463 to D1464	41463 to 41464	05B6 to 05B7					
D1465 to D1466	41465 to 41466	05B8 to 05B9					
D1467 to D1468	41467 to 41468	05BA to 05BB					
D1469 to D1470	41469 to 41470	05BC to 05BD					
D1471 to D1472	41471 to 41472	05BE to 05BF	STM2	x	x	x	R/W
D1473 to D1474	41473 to 41474	05C0 to 05C1	SWD2	x	x	x	R/W
D1475 to D1476	41475 to 41476	05C2 to 05C3	BD2	x	x	x	R/W
D1477 to D1478	41477 to 41478	05C4 to 05C5	BB2	x	x	x	R/W
D1479 to D1480	41479 to 41480	05C6 to 05C7	BL2	x	x	x	R/W
D1481 to D1482	41481 to 41482	05C8 to 05C9					
D1483 to D1484	41483 to 41484	05CA to 05CB					
D1485 to D1486	41485 to 41486	05CC to 05CD					
D1487 to D1488	41487 to 41488	05CE to 05CF					
D1489 to D1490	41489 to 41490	05D0 to 05D1					
D1491 to D1492	41491 to 41492	05D2 to 05D3					
D1493 to D1494	41493 to 41494	05D4 to 05D5					
D1495 to D1496	41495 to 41496	05D6 to 05D7					
D1497 to D1498	41497 to 41498	05D8 to 05D9					
D1499 to D1500	41499 to 41500	05DA to 05DB					

6.8 Engineering Parameters (D1001 to D2000)

Engineering parameters 2 area							
FX table							
D-Reg No.	Ref. No.	H No.	Register name	R/W			
				SINGLE	CAS	SELECT	PROG
D1501 to D1502	41501 to 41502	05DC to 05DD	FXO101	R/W	R/W	R/W	R/W
D1503 to D1504	41503 to 41504	05DE to 05DF	FXO102	R/W	R/W	R/W	R/W
D1505 to D1506	41505 to 41506	05E0 to 05E1	FXO103	R/W	R/W	R/W	R/W
D1507 to D1508	41507 to 41508	05E2 to 05E3	FXO104	R/W	R/W	R/W	R/W
D1509 to D1510	41509 to 41510	05E4 to 05E5	FXO105	R/W	R/W	R/W	R/W
D1511 to D1512	41511 to 41512	05E6 to 05E7	FXO106	R/W	R/W	R/W	R/W
D1513 to D1514	41513 to 41514	05E8 to 05E9	FXO107	R/W	R/W	R/W	R/W
D1515 to D1516	41515 to 41516	05EA to 05EB	FXO108	R/W	R/W	R/W	R/W
D1517 to D1518	41517 to 41518	05EC to 05ED	FXO109	R/W	R/W	R/W	R/W
D1519 to D1520	41519 to 41520	05EE to 05EF	FXO110	R/W	R/W	R/W	R/W
D1521 to D1522	41521 to 41522	05F0 to 05F1	FXO111	R/W	R/W	R/W	R/W
D1523 to D1524	41523 to 41524	05F2 to 05F3					
D1525 to D1526	41525 to 41526	05F4 to 05F5	FXO201	R/W	R/W	R/W	R/W
D1527 to D1528	41527 to 41528	05F6 to 05F7	FXO202	R/W	R/W	R/W	R/W
D1529 to D1530	41529 to 41530	05F8 to 05F9	FXO203	R/W	R/W	R/W	R/W
D1531 to D1532	41531 to 41532	05FA to 05FB	FXO204	R/W	R/W	R/W	R/W
D1533 to D1534	41533 to 41534	05FC to 05FD	FXO205	R/W	R/W	R/W	R/W
D1535 to D1536	41535 to 41536	05FE to 05FF	FXO206	R/W	R/W	R/W	R/W
D1537 to D1538	41537 to 41538	0600 to 0601	FXO207	R/W	R/W	R/W	R/W
D1539 to D1540	41539 to 41540	0602 to 0603	FXO208	R/W	R/W	R/W	R/W
D1541 to D1542	41541 to 41542	0604 to 0605	FXO209	R/W	R/W	R/W	R/W
D1543 to D1544	41543 to 41544	0606 to 0607	FXO210	R/W	R/W	R/W	R/W
D1545 to D1546	41545 to 41546	0608 to 0609	FXO211	R/W	R/W	R/W	R/W
D1547 to D1548	41547 to 41548	060A to 060B					
D1549 to D1550	41549 to 41550	060C to 060D					
D1551 to D1552	41551 to 41552	060E to 060F					
D1553 to D1554	41553 to 41554	0610 to 0611					
D1555 to D1556	41555 to 41556	0612 to 0613					
D1557 to D1558	41557 to 41558	0614 to 0615					
D1559 to D1560	41559 to 41560	0616 to 0617					
D1561 to D1562	41561 to 41562	0618 to 0619					
D1563 to D1564	41563 to 41564	061A to 061B					
D1565 to D1566	41565 to 41566	061C to 061D					
D1567 to D1568	41567 to 41568	061E to 061F					
D1569 to D1570	41569 to 41570	0620 to 0621					
D1571 to D1572	41571 to 41572	0622 to 0623					
D1573 to D1574	41573 to 41574	0624 to 0625					
D1575 to D1576	41575 to 41576	0626 to 0627					
D1577 to D1578	41577 to 41578	0628 to 0629					
D1579 to D1580	41579 to 41580	062A to 062B					
D1581 to D1582	41581 to 41582	062C to 062D					
D1583 to D1584	41583 to 41584	062E to 062F					
D1585 to D1586	41585 to 41586	0630 to 0631					
D1587 to D1588	41587 to 41588	0632 to 0633					
D1589 to D1590	41589 to 41590	0634 to 0635					
D1591 to D1592	41591 to 41592	0636 to 0637					
D1593 to D1594	41593 to 41594	0638 to 0639					
D1595 to D1596	41595 to 41596	063A to 063B					
D1597 to D1598	41597 to 41598	063C to 063D					
D1599 to D1600	41599 to 41600	063E to 063F					

6.8 Engineering Parameters (D1001 to D2000)

Engineering parameters 2 area				
GX table				
D-Reg No.	Ref. No.	H No.	Register name	R/W PROG
D1601 to D1602	41601 to 41602	0640 to 0641	GXI101	R/W
D1603 to D1604	41603 to 41604	0642 to 0643	GXI102	R/W
D1605 to D1606	41605 to 41606	0644 to 0645	GXI103	R/W
D1607 to D1608	41607 to 41608	0646 to 0647	GXI104	R/W
D1609 to D1610	41609 to 41610	0648 to 0649	GXI105	R/W
D1611 to D1612	41611 to 41612	064A to 064B	GXI106	R/W
D1613 to D1614	41613 to 41614	064C to 064D	GXI107	R/W
D1615 to D1616	41615 to 41616	064E to 064F	GXI108	R/W
D1617 to D1618	41617 to 41618	0650 to 0651	GXI109	R/W
D1619 to D1620	41619 to 41620	0652 to 0653	GXI110	R/W
D1621 to D1622	41621 to 41622	0654 to 0655	GXI111	R/W
D1623 to D1624	41623 to 41624	0656 to 0657		
D1625 to D1626	41625 to 41626	0658 to 0659	GXI201	R/W
D1627 to D1628	41627 to 41628	065A to 065B	GXI202	R/W
D1629 to D1630	41629 to 41630	065C to 065D	GXI203	R/W
D1631 to D1632	41631 to 41632	065E to 065F	GXI204	R/W
D1633 to D1634	41633 to 41634	0660 to 0661	GXI205	R/W
D1635 to D1636	41635 to 41636	0662 to 0663	GXI206	R/W
D1637 to D1638	41637 to 41638	0664 to 0665	GXI207	R/W
D1639 to D1640	41639 to 41640	0666 to 0667	GXI208	R/W
D1641 to D1642	41641 to 41642	0668 to 0669	GXI209	R/W
D1643 to D1644	41643 to 41644	066A to 066B	GXI210	R/W
D1645 to D1646	41645 to 41646	066C to 066D	GXI211	R/W
D1647 to D1648	41647 to 41648	066E to 066F		
D1649 to D1650	41649 to 41650	0670 to 0671		
D1651 to D1652	41651 to 41652	0672 to 0673	GXO101	R/W
D1653 to D1654	41653 to 41654	0674 to 0675	GXO102	R/W
D1655 to D1656	41655 to 41656	0676 to 0677	GXO103	R/W
D1657 to D1658	41657 to 41658	0678 to 0679	GXO104	R/W
D1659 to D1660	41659 to 41660	067A to 067B	GXO105	R/W
D1661 to D1662	41661 to 41662	067C to 067D	GXO106	R/W
D1663 to D1664	41663 to 41664	067E to 067F	GXO107	R/W
D1665 to D1666	41665 to 41666	0680 to 0681	GXO108	R/W
D1667 to D1668	41667 to 41668	0682 to 0683	GXO109	R/W
D1669 to D1670	41669 to 41670	0684 to 0685	GXO110	R/W
D1671 to D1672	41671 to 41672	0686 to 0687	GXO111	R/W
D1673 to D1674	41673 to 41674	0688 to 0689		
D1675 to D1676	41675 to 41676	068A to 068B	GXO201	R/W
D1677 to D1678	41677 to 41678	068C to 068D	GXO202	R/W
D1679 to D1680	41679 to 41680	068E to 068F	GXO203	R/W
D1681 to D1682	41681 to 41682	0690 to 0691	GXO204	R/W
D1683 to D1684	41683 to 41684	0692 to 0693	GXO205	R/W
D1685 to D1686	41685 to 41686	0694 to 0695	GXO206	R/W
D1687 to D1688	41687 to 41688	0696 to 0697	GXO207	R/W
D1689 to D1690	41689 to 41690	0698 to 0699	GXO208	R/W
D1691 to D1692	41691 to 41692	069A to 069B	GXO209	R/W
D1693 to D1694	41693 to 41694	069C to 069D	GXO210	R/W
D1695 to D1696	41695 to 41696	069E to 069F	GXO211	R/W
D1697 to D1698	41697 to 41698	06A0 to 06A1		
D1699 to D1700	41699 to 41700	06A2 to 06A3		

Note 1: GX table is available only in the programmable mode.

6.8 Engineering Parameters (D1001 to D2000)

Engineering parameters 2 area							
DI/DO setting							
D-Reg No.	Ref. No.	H No.	Register name	R/W			
				SINGLE	CAS	SELECT	PROG
D1701 to D1702	41701 to 41702	06A4 to 06A5	DIO16	R/W	R/W	R/W	R/W
D1703 to D1704	41703 to 41704	06A6 to 06A7	DIO25	R/W	R/W	R/W	R/W
D1705 to D1706	41705 to 41706	06A8 to 06A9	DIO34	R/W	R/W	R/W	R/W
D1707 to D1708	41707 to 41708	06AA to 06AB	DIO43	R/W	R/W	R/W	R/W
D1709 to D1710	41709 to 41710	06AC to 06AD	DIO52	R/W	R/W	R/W	R/W
D1711 to D1712	41711 to 41712	06AE to 06AF	DIO61	R/W	R/W	R/W	R/W
D1713 to D1714	41713 to 41714	06B0 to 06B1					
D1715 to D1716	41715 to 41716	06B2 to 06B3	DISELECT	R/W	R/W	R/W	×
D1717 to D1718	41717 to 41718	06B4 to 06B5	DI1D	R/W	R/W	R/W	×
D1719 to D1720	41719 to 41720	06B6 to 06B7	DI2D	R/W	R/W	R/W	×
D1721 to D1722	41721 to 41722	06B8 to 06B9	DI3D	R/W	R/W	R/W	×
D1723 to D1724	41723 to 41724	06BA to 06BB	DI4D	R/W	R/W	R/W	×
D1725 to D1726	41725 to 41726	06BC to 06BD	DI5D	R/W	R/W	R/W	×
D1727 to D1728	41727 to 41728	06BE to 06BF	DI6D	R/W	R/W	R/W	×
D1729 to D1730	41729 to 41730	06C0 to 06C1	DI7D	R/W	R/W	R/W	×
D1731 to D1732	41731 to 41732	06C2 to 06C3	DI8D	R/W	R/W	R/W	×
D1733 to D1734	41733 to 41734	06C4 to 06C5	DI9D	R/W	R/W	R/W	×
D1735 to D1736	41735 to 41736	06C6 to 06C7	DI10D	R/W	R/W	R/W	×
D1737 to D1738	41737 to 41738	06C8 to 06C9	DI1F	R/W	R/W	R/W	×
D1739 to D1740	41739 to 41740	06CA to 06CB	DI2F	R/W	R/W	R/W	×
D1741 to D1742	41741 to 41742	06CC to 06CD	DI3F	R/W	R/W	R/W	×
D1743 to D1744	41743 to 41744	06CE to 06CF	DI4F	R/W	R/W	R/W	×
D1745 to D1746	41745 to 41746	06D0 to 06D1	DI5F	R/W	R/W	R/W	×
D1747 to D1748	41747 to 41748	06D2 to 06D3	DI6F	R/W	R/W	R/W	×
D1749 to D1750	41749 to 41750	06D4 to 06D5	DI7F	R/W	R/W	R/W	×
D1751 to D1752	41751 to 41752	06D6 to 06D7	DI8F	R/W	R/W	R/W	×
D1753 to D1754	41753 to 41754	06D8 to 06D9	DI9F	R/W	R/W	R/W	×
D1755 to D1756	41755 to 41756	06DA to 06DB	DI10F	R/W	R/W	R/W	×
D1757 to D1758	41757 to 41758	06DC to 06DD					
D1759 to D1760	41759 to 41760	06DE to 06DF	DOSELECT	R/W	R/W	R/W	×
D1761 to D1762	41761 to 41762	06E0 to 06E1	DO1D	R/W	R/W	R/W	×
D1763 to D1764	41763 to 41764	06E2 to 06E3	DO2D	R/W	R/W	R/W	×
D1765 to D1766	41765 to 41766	06E4 to 06E5	DO3D	R/W	R/W	R/W	×
D1767 to D1768	41767 to 41768	06E6 to 06E7	DO4D	R/W	R/W	R/W	×
D1769 to D1770	41769 to 41770	06E8 to 06E9	DO5D	R/W	R/W	R/W	×
D1771 to D1772	41771 to 41772	06EA to 06EB	DO6D	R/W	R/W	R/W	×
D1773 to D1774	41773 to 41774	06EC to 06ED	DO7D	R/W	R/W	R/W	×
D1775 to D1776	41775 to 41776	06EE to 06EF	DO8D	R/W	R/W	R/W	×
D1777 to D1778	41777 to 41778	06F0 to 06F1	DO9D	R/W	R/W	R/W	×
D1779 to D1780	41779 to 41780	06F2 to 06F3	DO10D	R/W	R/W	R/W	×
D1781 to D1782	41781 to 41782	06F4 to 06F5	DO1F	R/W	R/W	R/W	×
D1783 to D1784	41783 to 41784	06F6 to 06F7	DO2F	R/W	R/W	R/W	×
D1785 to D1786	41785 to 41786	06F8 to 06F9	DO3F	R/W	R/W	R/W	×
D1787 to D1788	41787 to 41788	06FA to 06FB	DO4F	R/W	R/W	R/W	×
D1789 to D1790	41789 to 41790	06FC to 06FD	DO5F	R/W	R/W	R/W	×
D1791 to D1792	41791 to 41792	06FE to 06FF	DO6F	R/W	R/W	R/W	×
D1793 to D1794	41793 to 41794	0700 to 0701	DO7F	R/W	R/W	R/W	×
D1795 to D1796	41795 to 41796	0702 to 0703	DO8F	R/W	R/W	R/W	×
D1797 to D1798	41797 to 41798	0704 to 0705	DO9F	R/W	R/W	R/W	×
D1799 to D1800	41799 to 41800	0706 to 0707	DO10F	R/W	R/W	R/W	×

6.8 Engineering Parameters (D1001 to D2000)

Engineering parameters 2 area							
Communication access							
D-Reg No.	Ref. No.	H No.	Register name	R/W			
				SINGLE	CAS	SELECT	PROG
D1801 to D1802	41801 to 41802	0708 to 0709					
D1803 to D1804	41803 to 41804	070A to 070B					
D1805 to D1806	41805 to 41806	070C to 070D					
D1807 to D1808	41807 to 41808	070E to 070F					
D1809 to D1810	41809 to 41810	0710 to 0711					
D1811 to D1812	41811 to 41812	0712 to 0713	RSCOMM	R/W	R/W	R/W	R/W
D1813 to D1814	41813 to 41814	0714 to 0715					
D1815 to D1816	41815 to 41816	0716 to 0717					
D1817 to D1818	41817 to 41818	0718 to 0719					
D1819 to D1820	41819 to 41820	071A to 071B					
D1821 to D1822	41821 to 41822	071C to 071D	COMWR	R/W	R/W	R/W	R/W
D1823 to D1824	41823 to 41824	071E to 071F					
D1825 to D1826	41825 to 41826	0720 to 0721					
D1827 to D1828	41827 to 41828	0722 to 0723					
D1829 to D1830	41829 to 41830	0724 to 0725					
D1831 to D1832	41831 to 41832	0726 to 0727					
D1833 to D1834	41833 to 41834	0728 to 0729					
D1835 to D1836	41835 to 41836	072A to 072B					
D1837 to D1838	41837 to 41838	072C to 072D					
D1839 to D1840	41839 to 41840	072E to 072F					
D1841 to D1842	41841 to 41842	0730 to 0731					
D1843 to D1844	41843 to 41844	0732 to 0733					
D1845 to D1846	41845 to 41846	0734 to 0735					
D1847 to D1848	41847 to 41848	0736 to 0737					
D1849 to D1850	41849 to 41850	0738 to 0739					
D1851 to D1852	41851 to 41852	073A to 073B					
D1853 to D1854	41853 to 41854	073C to 073D					
D1855 to D1856	41855 to 41856	073E to 073F					
D1857 to D1858	41857 to 41858	0740 to 0741					
D1859 to D1860	41859 to 41860	0742 to 0743					
D1861 to D1862	41861 to 41862	0744 to 0745					
D1863 to D1864	41863 to 41864	0746 to 0747					
D1865 to D1866	41865 to 41866	0748 to 0749					
D1867 to D1868	41867 to 41868	074A to 074B					
D1869 to D1870	41869 to 41870	074C to 074D					
D1871 to D1872	41871 to 41872	074E to 074F					
D1873 to D1874	41873 to 41874	0750 to 0751					
D1875 to D1876	41875 to 41876	0752 to 0753					
D1877 to D1878	41877 to 41878	0754 to 0755					
D1879 to D1880	41879 to 41880	0756 to 0757					
D1881 to D1882	41881 to 41882	0758 to 0759					
D1883 to D1884	41883 to 41884	075A to 075B					
D1885 to D1886	41885 to 41886	075C to 075D					
D1887 to D1888	41887 to 41888	075E to 075F					
D1889 to D1890	41889 to 41890	0760 to 0761					
D1891 to D1892	41891 to 41892	0762 to 0763					
D1893 to D1894	41893 to 41894	0764 to 0765					
D1895 to D1896	41895 to 41896	0766 to 0767					
D1897 to D1898	41897 to 41898	0768 to 0769					
D1899 to D1900	41899 to 41900	076A to 076B					

6.8.1 CONFIG (D1001 to D1100) 1/2

Register No.	Description	Range and Meaning of Value
D1001 to D1002		
D1003 to D1004	CTL Controller mode selection (Note 1)	0: PROG (Programmable mode) (Note 2) 1: SINGLE (Single-loop mode) 2: CAS (Cascade mode) 3: SELECT (Selector mode)
D1005 to D1006	START Start mode	0: AUT (HOT start) 1: M-COLD (Power failure duration<2 sec.; HOT Start, Power failure duration≥2 sec.; M-COLD start) 2: A-COLD (Power failure duration<2 sec.; HOT Start, Power failure duration≥2 sec.; A-COLD start) 3: C-COLD (Power failure duration<2 sec.; HOT Start, Power failure duration≥2 sec.; C-COLD start) 4: COLD (Power failure duration<2 sec.; HOT Start, Power failure duration≥2 sec.; COLD start)
D1007 to D1008	ATSEL Autoselector selection	0: LOW (Lower output value) 1: HIGH (Higher output value)
D1009 to D1012		
D1013 to D1014	DISP1 Display register 1 selection	0: - 1: P01 2: P02 3: P03 4: P04 5: P05 6: P06 7: P07 8: P08 9: P09 10: P10 11: P11 12: P12 13: P13 14: P14 15: P15 16: P16 17: P17 18: P18 19: P19 20: P20 21: P21 22: P22 23: P23 24: P24 25: P25 26: P26 27: P27 28: P28 29: P29 30: P30
D1015 to D1016	NAME1 Name of display register 1	3-digit alphanumeric
D1017 to D1018	DISP2 Display register 2 selection	As same as D1013 to D1014
D1019 to D1020	NAME2 Name of display register 2	3-digit alphanumeric
D1021 to D1022	CAMLK Keylock for C/A/M mode change	0: UNLOCK 1: LOCK
D1023 to D1024	SVLK Keylock for SV change	
D1025 to D1026	MVLK Keylock for MV change	
D1027 to D1028		
D1029 to D1030	Y3TP Analog output 3 current/voltage switch	0: 4-20mA 1: 1-5V
D1031 to D1036	Y2S to Y4S Analog output 2 selection to Analog output 4 selection	0: OFF (None) 1: PV1 (Process variable 1) 2: SV1 (Setpoint value 1) 3: PV2 (Process variable 2) 4: SV2 (Setpoint value 2) 5: MV (Manipulated output variable) 6: X1 (Analog input 1) 7: X2 (Analog input 2) 8: X3 (Analog input 3) 9: X4 (Analog input 4) 10: X5 (Analog input 5) 11: X6 (Analog input 6) 12: X7 (Analog input 7) 13: X8 (Analog input 8)
D1037 to D1040		
D1041 to D1042	CMOD1 C-mode 1	0: - (None) 1: CAS (Analog cascade setting mode) 2: CMP (Computer cascade setting mode)
D1043 to D1044	BMOD1 Backup mode 1	0: BUM (Manual operation backup mode) 1: BUA (Automatic operation backup mode)
D1045 to D1046	CNT1 Control type 1 (Note 3)	0: PID (Standard PID) 1: S-PI (Sample-and-hold PI control) 2: BATCH (Batch PID control) 3: PD (Proportional (PD) control)
D1047 to D1048	ALG1 Control operation formula 1	0: I-PD (PV proportional type PID) 1: PI-D (PV derivative type PID) 2: SVF (Adjustable setpoint filter)
D1049 to D1050	ACT1 Control operation direction 1	0: RVS (Reverse action) 1: DIR (Direct action)
D1051 to D1052		

Note 1: When the controller mode is changed, it takes more time for response than when other registers are changed.

Note 2: "0: PROG" is displayed only on YS1700.

Note 3: In the single-loop mode, "0: PID", "1: S-PI" or "3: PD" is available for setting. In the cascade mode/selector mode, "0: PID" or "1: S-PI" is available for setting. "2: BATCH" is for the programmable mode.

Be sure to set the ALG1 and ALG2 (Control operation formula 1, 2) to "1: PI-D" to set "3: PD". The same settings should be done to each control module (basic/cascade/selector control) used in the programmable mode.

6.8 Engineering Parameters (D1001 to D2000)

6.8.1 CONFIG (D1001 to D1100) 2/2

Register No.	Description	Range and Meaning of Value
D1053 to D1056	UNIT1 Engineering unit 1	7-digit alphanumeric D1053 to D1056
D1057 to D1058	SCDP1 Decimal point position 1	0: ##### 1: #####.# 2: ###.## 3: ##.### 4: #.####
D1059 to D1062		
D1063 to D1064	VDIR1 Valve direction 1	0: C-O (MV 0%=Close, 100%=Open) 1: O-C (MV 0%=Open, 100%=Close)
D1065 to D1066	SCDV1 Scale division 1	0: 1 1: 2 2: 4 3: 5 4: 7 5: 10 6: 14 7: 20 divisions
D1067 to D1068	SCH1 100% value of scale 1	-80000 to 80000
D1069 to D1070	SCL1 0% value of scale 1	
D1071 to D1072	CMOD2 C-mode 2	As same as D1041 to D1056
D1073 to D1074	BMOD2 Backup mode 2	
D1075 to D1076	CNT2 Control type 2 (Note 1)	
D1077 to D1078	ALG2 Control operation formula 2	
D1079 to D1080	ACT2 Control operation direction 2	
D1081 to D1082		
D1083 to D1086	UNIT2 Engineering unit 2	As same as D1053 to D1070
D1087 to D1088	SCDP2 Decimal point position 2	
D1089 to D1090	SCH2 100% value of scale 2	
D1091 to D1092	SCL2 0% value of scale 2	
D1093 to D1094	VDIR2 Valve direction 2	
D1095 to D1096	SCDV2 Scale division 2	
D1097 to D1198	RSDISP Operation status display	0: RUN 1: STOP 2: TEST1 3: TEST2
D1099 to D1100		

Note 1: In the single-loop mode, "0: PID", "1: S-PI" or "3: PD" is available for setting. In the cascade mode/selector mode, "0: PID" or "1: S-PI" is available for setting. "2: BATCH" is for the programmable mode.

Be sure to set the ALG1 and ALG2 (Control operation formula 1, 2) to "1: PI-D" to set "3: PD". The same settings should be done to each control module (basic/cascade/selector control) used in the programmable mode.

6.8.2 I/O Computation Setting, Alarm Setting (D1101 to D1200)

Register No.	Description	Range and Meaning of Value
D1101 to D1102	PFKEY Selection of PF key function	0: - (None) 1: STC (Self tuning)
D1103 to D1104	TRKSW Selection of tracking function	0: - (None) 1: SVTRK (SV tracking) 2: PVTRK (PV tracking)
D1105 to D1106		
D1107 to D1108	FSW Feedforward gain operation	0: OFF 1: ON
D1109 to D1110	FON Addition of feedforward output	
D1111 to D1120		
D1121 to D1122	PSR1 Square root extraction for PV1	0: OFF 1: ON
D1123 to D1124	FX1 10-segment linearizer function for PV1	
D1125 to D1126	CSR1 Square root extraction for CSV1	
D1127 to D1128	CSW1 Ratio operation for CSV1	
D1129 to D1130		
D1131 to D1132	PSR2 Square root extraction for PV2	
D1133 to D1134	FX2 10-segment linearizer function for PV2	
D1135 to D1136	CSR2 Square root extraction for CSV2	
D1137 to D1138	CSW2 Ratio operation for CSV2	
D1139 to D1180		
D1181 to D1182	TAG1 Tag number 1	12-digit alphanumeric D1181 to D1186
D1183 to D1184		
D1185 to D1186		
D1187 to D1188	TAG2 Tag number 2	As same as D1181 to D1186
D1189 to D1190		
D1191 to D1192		
D1193 to D1200		

6.8 Engineering Parameters (D1001 to D2000)

6.8.3 Display Setting, Contrast (D1201 to D1300) 1/2

Register No.	Description	Range and Meaning of Value
D1201 to D1202	LOOP1 LOOP 1 Display ON/OFF	0: OFF 1: ON (Note 1)
D1203 to D1204	LOOP2 LOOP 2 Display ON/OFF	
D1205 to D1206	TRND1 TREND 1 Display ON/OFF	
D1207 to D1208	TRND2 TREND 2 Display ON/OFF	
D1209 to D1210	TRND3 TREND 3 Display ON/OFF (Note 2)	
D1211 to D1212	ALARM ALARM Display ON/OFF	
D1213 to D1214		
D1215 to D1216	DUAL1 DUAL 1 Display ON/OFF	
D1217 to D1218	DUAL2 DUAL 2 Display ON/OFF	
D1219 to D1220	MTR1 METER 1 Display ON/OFF	
D1221 to D1222	MTR2 METER 2 Display ON/OFF	
D1223 to D1224	FDSP Power-on initial display	0: LOOP1 (LOOP 1 Display) 1: LOOP2 (LOOP 2 Display) 2: MTR1 (METER 1 Display) 3: MTR2 (METER 2 Display) 4: TRND1 (TREND1 Display) 5: TRND2 (TREND2 Display) 6: TRND3 (TREND 3 Display) 7: ALARM (ALARM Display) 9: DUAL1 (DUAL 1 Display) 10: DUAL2 (DUAL 2 Display)
D1225 to D1226	MTMG1 10-exponential scale factor for METER 1 Display	0: AUTO 1: 10 ⁻⁵ 2: 10 ⁻⁴ 3: 10 ⁻³ 4: 10 ⁻² 5: 10 ⁻¹
D1227 to D1228	MTMG2 10-exponential scale factor for METER 2 Display	6: 10 ⁰ 7: 10 ¹ 8: 10 ² 9: 10 ³ 10: 10 ⁴ 11: 10 ⁵
D1229 to D1230	TR1PV PV1 trend ON/OFF for TREND 1 Display	0: OFF 1: ON
D1231 to D1232	TR1SV SV1 trend ON/OFF for TREND 1 Display	
D1233 to D1234	TR1MV MV1 trend ON/OFF for TREND 1 Display	
D1235 to D1236	TR2PV PV2 trend ON/OFF for TREND 2 Display	
D1237 to D1238	TR2SV SV2 trend ON/OFF for TREND 2 Display	
D1239 to D1240	TR2MV MV2 trend ON/OFF for TREND 2 Display	
D1241 to D1242	TRDS1 Data selection 1 for TREND 3 Display	0: OFF (None) 1: PV1 (Process variable 1) 2: SV1 (Setpoint value 1) 3: MV1 (Manipulated output variable 1) 4: PV2 (Process variable 2) 5: SV2 (Setpoint value 2) 6: MV2 (Manipulated output variable 2) 7: X1 (Analog input 1) 8: X2 (Analog input 2) 9: X3 (Analog input 3) 10: X4 (Analog input 4) 11: X5 (Analog input 5) 12: X6 (Analog input 6) (Note 3) 13: X7 (Analog input 7) (Note 3) 14: X8 (Analog input 8) (Note 3) 15: Y1 (Analog output 1) 16: Y2 (Analog output 2) 17: Y3 (Analog output 3) 18: Y4 (Analog output 4) (Note 3)
D1243 to D1244	TRDS2 Data selection 2 for TREND 3 Display	
D1245 to D1246	TRDS3 Data selection 3 for TREND 3 Display	
D1247 to D1248	TRDS4 Data selection 4 for TREND 3 Display	
D1249 to D1250	TRDT1 TREND 1 Display time span	
D1251 to D1252	TRDT2 TREND 2 Display time span	0: 1M (1min.) 1: 5M (5min.) 2: 10M (10min.) 3: 30M (30min.) 4: 1H (1hour) 5: 5H (5hours) 6: 10H (10hours) 7: 30H (30hours)
D1253 to D1254	TRDT3 TREND 3 Display time span	
D1255 to D1256	TR3DV Scale division for TREND 3 Display	0: 1 1: 2 2: 4 3: 5 4: 7 5: 10 6: 14 7: 20 divisions

Note 1: LOOP1 is always displayed even if you set "OFF" for all lines.

Note 2: When you do not use TRND3, set it to "OFF".

Note 3: This value is displayed only on YS1700 Basic type with expandable I/O.

6.8.3 Display Setting, Contrast (D1201 to D1300) 2/2

Register No.	Description	Range and Meaning of Value
D1257 to D1258	ACTD1 Active color display selection 1	0: OFF (None) 1: PH1 (High limit alarm setpoint for PV1) 2: PL1 (Low limit alarm setpoint for PV1) 3: HH1 (High-high limit alarm setpoint for PV1) 4: LL1 (Low-low limit alarm setpoint for PV1) 5: DL1 (Alarm setpoint for deviation variable 1) 6: VL1 (Velocity alarm setpoint for PV1) 7: DL1 VL1 (Alarm setpoint for deviation variable 1/Velocity alarm setpoint for PV1) 8: 1-ALM (OR for all alarms of the Loop 1)
D1259 to D1260	ACTD2 Active color display selection 2	0: OFF (None) 1: PH2 (High limit alarm setpoint for PV2) 2: PL2 (Low limit alarm setpoint for PV2) 3: HH2 (High-high limit alarm setpoint for PV2) 4: LL2 (Low-low limit alarm setpoint for PV2) 5: DL2 (Alarm setpoint for deviation variable 2) 6: VL2 (Velocity alarm setpoint for PV2) 7: DL2 VL2 (Alarm setpoint for deviation variable 2/Velocity alarm setpoint for PV2) 8: 2-ALM (OR for all alarms of the Loop 2)
D1261 to D1262	TAGAL Color inversion of tag number	0: OFF 1: ON
D1263 to D1224	LP1C LOOP 1 color selection	0: GREEN 1: AQUA 2: PINK 3: ORANGE
D1265 to D1266	LP2C LOOP 2 color selection	
D1267 to D1268	BKCL Background color selection	0: BLACK 1: WHITE 2: BLUE
D1269 to D1270		
D1271 to D1272	ECO LCD backlight auto-off timer	0: OFF 1: ON (Off timer: 30 min)
D1273 to D1274	BRT LCD brightness adjustment	0 to 5
D1275 to D1276		
D1277 to D1300		

6.8 Engineering Parameters (D1001 to D2000)

6.8.4 Communication Setting (D1301 to D1400)

Register No.	Description	Range and Meaning of Value
D1301 to D1302	PSL RS-485 protocol selection (Note 1)	0: PCL (PC-link communication) 1: PCLSUM (PC-link communication (with checksum)) 2: MODASC (Modbus communication (ASCII)) 3: MODRTU (Modbus communication (RTU)) 4: YS (YS protocol) 5: P-to-P (Peer-to-peer communication) (Note 3)
D1303 to D1304		
D1305 to D1306	ADRS RS-485 communication address (Note 1)	1 to 99
D1307 to D1308	STBIT RS-485 stop bit (Note 1)	0: 1 bit 1: 2 bit
D1309 to D1310	PAR RS-485 parity (Note 1)	0: NONE 1: ODD 2: EVEN
D1311 to D1312	DLEN RS-485 data length (Note 1)	0: 7 bit 1: 8 bit
D1313 to D1314	BPS RS-485 baud rate (Note 1)	0: 1200 1: 2400 2: 4800 3: 9600 4: 19200 5: 38400
D1315 to D1316		
D1317 to D1318	TRMR RS-485 communication terminating resistor ON/OFF (Note 1)	0: OFF 1: ON
D1319 to D1320	CMWDT Communication watchdog timer (Note 1)	0 to 9999 s (second)
D1321 to D1322	ETRWR Enable/Disable writing via Ethernet communication (Note 2)	0: ENBL (Setting possible) 1: INHB (Setting impossible)
D1323 to D1330	IPAD1 to IPAD4 IP address 1 to IP address 4 (Note 2)	0 to 255
D1331 to D1338	SM1 to SM4 Subnet mask 1 to Subnet mask 4 (Note 2)	
D1339 to D1346	DG1 to DG4 Default gateway 1 to Default gateway 4 (Note 2)	
D1347 to D1348	PORT Port number (Note 2)	502, 1024 to 65535
D1349 to D1350	ESW Ethernet setting switch (Note 2)	0: - 1: ENTRY
D1351 to D1352	DREG1 RS-485 communication D register setting for High/Low level (Note 1)	0: H-L 1: L-H
D1353 to D1354	DREG2 Ethernet communication D register setting for High/Low level (Note 2)	
D1355 to D1356	COMM Communication selection	0: - 1: RS-485 2: DCS-LCS
D1355 to D1357	ECTO Ethernet communication timeout period	4 to 60 s
D1359 to D1400		

Note 1: This parameter can be set when optional code /A31 is specified.

Note 2: This parameter can be set when optional code /A34 is specified.

Note 3: "5: P-to-P" can be set when the YS1700 is used.

6.8.5 Preset PID, Sample and Batch (D1401 to D1500)

Register No.	Description	Range and Meaning of Value
D1401 to D1448	PPB1 to PPB8 Preset PID proportional band 1 to Preset PID proportional band 8	0.1 to 999.9%
	PTI1 to PTI18 Preset PID integral time 1 to Preset PID integral time 8	1 to 9999 s (second)
	PTD1 to PTD 8 Preset PID derivative time 1 to Preset PID derivative time 8	0 to 9999 s (second)
D1449 to D1450		
D1451 to D1452	STM1 Sample PI sampled time 1	0 to 9999 s (second)
D1453 to D1454	SWD1 Sample PI control time span 1	
D1455 to D1456	BD1 Batch PID deviation setting value 1	0.0 to 100.0%
D1457 to D1458	BB1 Batch PID bias 1	
D1459 to D1460	BL1 Batch PID lock-up width 1	
D1461 to D1470		
D1471 to D1472	STM2 Sample PI sampled time 2	As same as D1451 to D1460
D1473 to D1474	SWD2 Sample PI control time span 2	
D1475 to D1476	BD2 Batch PID deviation setting value 2	
D1477 to D1478	BB2 Batch PID bias 2	
D1479 to D1480	BL2 Batch PID lock-up width 2	
D1481 to D1500		

6.8.6 FX Table (D1501 to D1600)

Register No.	Description	Range and Meaning of Value
D1501 to D1522	FXO101 to FXO111 0% setting of FX1 to 100% setting of FX1	0.000 to 100.0
D1523 to D1524		
D1525 to D1546	FXO201 to FXO211 0% setting of FX2 to 100% setting of FX2	0.000 to 100.0
D1547 to D1600		

6.8.7 GX Table (D1601 to D1700)

Register No.	Description	Range and Meaning of Value
D1601 to D1622	GXI101 to GXI111 Input 1 setting of GX1 to Input 11 setting of GX1	-0.250 to 1.250
D1623 to D1624		
D1625 to D1646	GXI201 to GXI211 Input 1 setting of GX2 to Input 11 setting of GX2	-0.250 to 1.250
D1647 to D1650		
D1651 to D1672	GXO101 to GXO111 Output 1 setting of GX1 to Output 11 setting of GX1	-0.250 to 1.250
D1673 to D1674		
D1675 to D1696	GXO201 to GXO211 Output 1 setting of GX2 to Output 11 setting of GX2	-0.250 to 1.250
D1697 to D1700		

6.8 Engineering Parameters (D1001 to D2000)

6.8.8 DI/DO Setting (D1701 to D1800)

● D1701 to D1712

Register No.	Description	Range and Meaning of Value
D1701 to D1702	DIO16 DI1/DO6 specification	0: DI (For digital input) 1: DO (For digital output)
D1703 to D1704	DIO25 DI2/DO5 specification	
D1705 to D1706	DIO34 DI3/DO4 specification	
D1707 to D1708	DIO43 DI4/DO3 specification	
D1709 to D1710	DIO52 DI5/DO2 specification	
D1711 to D1712	DIO61 DI6/DO1 specification	

● Bit Configuration of D1715 to D1716: DISELECT (DI contact direction)

High/low level (Note)	Bit	Code	Event
Low level	0	DI1D	DI1 contact type 0: OPN: Function is available when the contact is open 1: CLS: Function is available when the contact is closed
	1	DI2D	DI2 contact type 0: OPN: Function is available when the contact is open 1: CLS: Function is available when the contact is closed
	2	DI3D	DI3 contact type 0: OPN: Function is available when the contact is open 1: CLS: Function is available when the contact is closed
	3	DI4D	DI4 contact type 0: OPN: Function is available when the contact is open 1: CLS: Function is available when the contact is closed
	4	DI5D	DI5 contact type 0: OPN: Function is available when the contact is open 1: CLS: Function is available when the contact is closed
	5	DI6D	DI6 contact type 0: OPN: Function is available when the contact is open 1: CLS: Function is available when the contact is closed
	6	DI7D	DI7 contact type 0: OPN: Function is available when the contact is open 1: CLS: Function is available when the contact is closed
	7	DI8D	DI8 contact type 0: OPN: Function is available when the contact is open 1: CLS: Function is available when the contact is closed
	8	DI9D	DI9 contact type 0: OPN: Function is available when the contact is open 1: CLS: Function is available when the contact is closed
	9	DI10D	DI10 contact type 0: OPN: Function is available when the contact is open 1: CLS: Function is available when the contact is closed
	10 to 15		
High level	16 to 31		

Note: In these bit configurations, the D register setting for high/low level parameter is set to "0: H-L" (i.e. the first register is high level).

● D1717 to D1756

Register No.	Description	Range and Meaning of Value
D1717 to D1736	DI1D to DI10D DI1 contact type to DI10 contact type	0: OPN: Function is available when the contact is open 1: CLS: Function is available when the contact is closed
D1737 to D1756	DI1F to DI10F DI1 function selection to DI10 function selection	0: NONE (No function) 1: E-AUT (Switching to Automatic mode (status)) 2: E-MAN (Switching to Manual mode (status)) 3: E-O/C (Open/Close switching) (Note 1) 4: E-L/R (Local/Remote switching) (Note 2) 5: E-PMV (Preset MV switching) 6: E-STC (Self tuning switching) 7: E-SEL (Selector ON/OFF switching) (Note 2) 8: TR-MPMV (Manual and Preset MV switching) 9: TR-MAN (Switching to manual mode (trigger)) 10: TR-AUT (Switching to automatic mode (trigger)) 11: TR-CAS (Switching to cascade mode (trigger)) 12: LCD-OFF (Backlight auto-off) 13: E-TRK (Output tracking switching) 14: E-LPSEL (Output loop selection) (Note 2) 15: TR-EVT.C (All event elimination)

Note 1: This function can be selected when the controller mode is in the cascade mode. (Ex. DI_nD (n=1 to 10) = OPN: When the contact is closed, internal cascade is in close status. When the contact is open, internal cascade is in open status. The status of the contact can be changed by the contact type parameters.)

Note 2: This function can be selected when the controller mode is in the selector mode. (Ex. DI_nD (n=1 to 10) = OPN: E-L/R; When the contact is closed, SV2 is the local setpoint value. When the contact is open, SV2 is cascade setpoint value. E-SEL; When the contact is closed, MV of the loop 1 is selected. When the contact is opened, MV is selected automatically by ATSEL parameter) E-LPSEL: When the digital input signal (DI) is "Close", the computation results of Loop 1 are output. When the digital input signal (DI) is "Open", the computation results of Loop 2 are output.

● Bit Configuration of D1759 to D1760: DISELECT (DO contact direction)

High/low level (Note)	Bit	Code	Event
Low level	0	DO1D	DO1 contact type 0: OPN: When the event occurs, the contact is open 1: CLS: When the event occurs, the contact is closed
	1	DO2D	DO2 contact type 0: OPN: When the event occurs, the contact is open 1: CLS: When the event occurs, the contact is closed
	2	DO3D	DO3 contact type 0: OPN: When the event occurs, the contact is open 1: CLS: When the event occurs, the contact is closed
	3	DO4D	DO4 contact type 0: OPN: When the event occurs, the contact is open 1: CLS: When the event occurs, the contact is closed
	4	DO5D	DO5 contact type 0: OPN: When the event occurs, the contact is open 1: CLS: When the event occurs, the contact is closed
	5	DO6D	DO6 contact type 0: OPN: When the event occurs, the contact is open 1: CLS: When the event occurs, the contact is closed
	6	DO7D	DO7 contact type 0: OPN: When the event occurs, the contact is open 1: CLS: When the event occurs, the contact is closed
	7	DO8D	DO8 contact type 0: OPN: When the event occurs, the contact is open 1: CLS: When the event occurs, the contact is closed
	8	DO9D	DO9 contact type 0: OPN: When the event occurs, the contact is open 1: CLS: When the event occurs, the contact is closed
	9	DO10D	DO10 contact type 0: OPN: When the event occurs, the contact is open 1: CLS: When the event occurs, the contact is closed
		10 to 15	
High level	16 to 31		

Note: In these bit configurations, the D register setting for high/low level parameter is set to "0: H-L" (i.e. the first register is high level).

6.8 Engineering Parameters (D1001 to D2000)

● D1761 to D1800

Register No.	Description	Range and Meaning of Value
D1761 to D1778	DO1D to DO10D DO1 contact type to DO10 contact type	0: OPN (When the event occurs, the contact is opened) 1: CLS (When the event occurs, the contact is closed)
D1781 to D1800	DO1F to DO10F (Note 3) DO1 function selection to DO10 function selection	0: NONE (OFF) 1: PH1 (High limit alarm setpoint for PV1) 2: PL1 (Low limit alarm setpoint for PV1) 3: HH1 (High-high limit alarm setpoint for PV1) 4: LL1 (Low-low limit alarm setpoint for PV1) 5: DL1 (Alarm setpoint for deviation variable 1) 6: VL1 (Velocity alarm setpoint for PV1) 7: PH2 (High limit alarm setpoint for PV2) 8: PL2 (Low limit alarm setpoint for PV2) 9: HH2 (High-high limit alarm setpoint for PV2) 10: LL2 (Low-low limit alarm setpoint for PV2) 11: DL2 (Alarm setpoint for deviation variable 2) 12: VL2 (Velocity alarm setpoint for PV2) 13: DL1 VL1 (Alarm setpoint for deviation variable 1/ Velocity alarm setpoint for PV1) 14: DL2 VL2 (Alarm setpoint for deviation variable 2/ Velocity alarm setpoint for PV2) 15: 1-ALM (OR for all alarms of the loop 1) 16: 2-ALM (OR for all alarms of the loop 2) 17: CAS (Cascade mode) 18: CASAUT (Cascade or Automatic mode) 19: O/C (Open/Close) (Note 1) 20: L/R (Local/Remote) (Note 2) 21: OOP (Current output connection open)

Note 1: This function can be selected when the controller mode is in the cascade mode.

Note 2: This function can be selected when the controller mode is in the selector mode.

Note 3: Ex. When DInD (n=1 to 10) is OPN, and the DO function parameter is:

MAN: The contact is open when in the manual mode

O/C: The contact is closed when the internal cascade is in close status, the contact is open when the internal cascade is in open status.

L/R: The contact is closed when SV2 is local setpoint value, the contact is open when SV2 is cascade setpoint value.

All alarm related parameters: the contact is opened when the alarm occurs.

6.8.9 Communication Access (D1801 to D1900)

Register No.	Description	Range and Meaning of Value
D1801 to D1810		
D1811 to D1812	RSCOMM Operation status setting	0: RUN 1: STOP 2: TEST1 3: TEST2
D1813 to D1820		
D1821 to D1822	COMWR Enable/Disable writing via RS-485 communication & DCS-LCS communication (Note 1)	0: ENBL (Setting possible) 1: INHB (Setting impossible)
D1823 to D1900		

Note 1: This parameter can be set when optional code /A31 or /A32 is specified.

6.9 User Program (D2001 to D4000)

User program area							
Control data, System flag							
D-Reg No.	Ref. No.	H No.	Register name	R/W			
				SINGLE	CAS	SELECT	PROG
D2001 to D2002	42001 to 42002	07D0 to 07D1	LOAD	x	x	x	R
D2003 to D2004	42003 to 42004	07D2 to 07D3	LDMAX	x	x	x	R
D2005 to D2006	42005 to 42006	07D4 to 07D5					
D2007 to D2008	42007 to 42008	07D6 to 07D7					
D2009 to D2010	42009 to 42010	07D8 to 07D9					
D2011 to D2012	42011 to 42012	07DA to 07DB	SSW	x	x	R/W	x
D2013 to D2014	42013 to 42014	07DC to 07DD	EXT	x	x	x	R
D2015 to D2016	42015 to 42016	07DE to 07DF	SEL	x	x	R	R
D2017 to D2018	42017 to 42018	07E0 to 07E1					
D2019 to D2020	42019 to 42020	07E2 to 07E3					
D2021 to D2022	42021 to 42022	07E4 to 07E5					
D2023 to D2024	42023 to 42024	07E6 to 07E7					
D2025 to D2026	42025 to 42026	07E8 to 07E9					
D2027 to D2028	42027 to 42028	07EA to 07EB					
D2029 to D2030	42029 to 42030	07EC to 07ED					
D2031 to D2032	42031 to 42032	07EE to 07EF					
D2033 to D2034	42033 to 42034	07F0 to 07F1					
D2035 to D2036	42035 to 42036	07F2 to 07F3					
D2037 to D2038	42037 to 42038	07F4 to 07F5					
D2039 to D2040	42039 to 42040	07F6 to 07F7					
D2041 to D2042	42041 to 42042	07F8 to 07F9	AG1	x	x	x	R
D2043 to D2044	42043 to 42044	07FA to 07FB	DM1	x	x	x	R
D2045 to D2046	42045 to 42046	07FC to 07FD	FF1	R	R	R	R
D2047 to D2048	42047 to 42048	07FE to 07FF	TRK1	R	R	R	R
D2049 to D2050	42049 to 42050	0800 to 0801					
D2051 to D2052	42051 to 42052	0802 to 0803	AG2	x	x	x	R
D2053 to D2054	42053 to 42054	0804 to 0805	DM2	x	x	x	R
D2055 to D2056	42055 to 42056	0806 to 0807	FF2	x	x	x	R
D2057 to D2058	42057 to 42058	0808 to 0809	TRK2	x	x	x	R
D2059 to D2060	42059 to 42060	080A to 080B					
D2061 to D2062	42061 to 42062	080C to 080D	PVM1	R	R	R	R
D2063 to D2064	42063 to 42064	080E to 080F	SVM1	R	R	R	R
D2065 to D2066	42065 to 42066	0810 to 0811	MVM1	R	R	R	R
D2067 to D2068	42067 to 42068	0812 to 0813	PVM2	x	R	R	R
D2069 to D2070	42069 to 42070	0814 to 0815	SVM2	x	R	R	R
D2071 to D2072	42071 to 42072	0816 to 0817	MVM2	x	R	R	R
D2073 to D2074	42073 to 42074	0818 to 0819					
D2075 to D2076	42075 to 42076	081A to 081B	PPID	x	x	x	R
D2077 to D2078	42077 to 42078	081C to 081D	PPID2	x	x	x	R
D2079 to D2080	42079 to 42080	081E to 081F					
D2081 to D2082	42081 to 42082	0820 to 0821	IOP	x	x	x	R
D2083 to D2084	42083 to 42084	0822 to 0823	OOP	x	x	x	R
D2085 to D2086	42085 to 42086	0824 to 0825	COMS01	x	x	x	R
D2087 to D2088	42087 to 42088	0826 to 0827	COMS02	x	x	x	R
D2089 to D2090	42089 to 42090	0828 to 0829	CFL	R/W	R/W	R/W	R/W
D2091 to D2092	42091 to 42092	082A to 082B					
D2093 to D2094	42093 to 42094	082C to 082D					
D2095 to D2096	42095 to 42096	082E to 082F					
D2097 to D2098	42097 to 42098	0830 to 0831					
D2099 to D2100	42099 to 42100	0832 to 0833	KYL_PF	R	R	R	R

6.9 User Program (D2001 to D4000)

User program area							
Control flag							
D-Reg No.	Ref. No.	H No.	Register name	R/W			
				SINGLE	CAS	SELECT	PROG
D2101 to D2102	42101 to 42102	0834 to 0835	PRC_ALM_HH1	R	R	R	R
D2103 to D2104	42103 to 42104	0836 to 0837	PRC_ALM_LL1	R	R	R	R
D2105 to D2106	42105 to 42106	0838 to 0839	PRC_ALM_PH1	R	R	R	R
D2107 to D2108	42107 to 42108	083A to 083B	PRC_ALM_PL1	R	R	R	R
D2109 to D2110	42109 to 42110	083C to 083D	PRC_ALM_DL1	R	R	R	R
D2111 to D2112	42111 to 42112	083E to 083F	PRC_ALM_VL1	R	R	R	R
D2113 to D2114	42113 to 42114	0840 to 0841	TRKF1	x	x	x	R
D2115 to D2116	42115 to 42116	0842 to 0843	PMVF1	x	x	x	R
D2117 to D2118	42117 to 42118	0844 to 0845	CAF1	x	x	x	R
D2119 to D2120	42119 to 42120	0846 to 0847	CAMF1	x	x	x	R
D2121 to D2122	42121 to 42122	0848 to 0849	CCF1	x	x	x	R
D2123 to D2124	42123 to 42124	084A to 084B	DDCF1	x	x	x	R
D2125 to D2126	42125 to 42126	084C to 084D					R
D2127 to D2128	42127 to 42128	084E to 084F					R
D2129 to D2130	42129 to 42130	0850 to 0851					R
D2131 to D2132	42131 to 42132	0852 to 0853	PRC_ALM_HH2	x	R	R	R
D2133 to D2134	42133 to 42134	0854 to 0855	PRC_ALM_LL2	x	R	R	R
D2135 to D2136	42135 to 42136	0856 to 0857	PRC_ALM_PH2	x	R	R	R
D2137 to D2138	42137 to 42138	0858 to 0859	PRC_ALM_PL2	x	R	R	R
D2139 to D2140	42139 to 42140	085A to 085B	PRC_ALM_DL2	x	R	R	R
D2141 to D2142	42141 to 42142	085C to 085D	PRC_ALM_VL2	x	R	R	R
D2143 to D2144	42143 to 42144	085E to 085F	TRKF2	x	x	x	R
D2145 to D2146	42145 to 42146	0860 to 0861	PMVF2	x	x	x	R
D2147 to D2148	42147 to 42148	0862 to 0863	CAF2	x	x	x	R
D2149 to D2150	42149 to 42150	0864 to 0865	CAMF2	x	x	x	R
D2151 to D2152	42151 to 42152	0866 to 0867	CCF2	x	x	x	R
D2153 to D2154	42153 to 42154	0868 to 0869	DDCF2	x	x	x	R
D2155 to D2156	42155 to 42156	086A to 086B					
D2157 to D2158	42157 to 42158	086C to 086D					
D2159 to D2160	42159 to 42160	086E to 086F					
D2161 to D2162	42161 to 42162	0870 to 0871	STCSW	x	x	x	R
D2163 to D2164	42163 to 42164	0872 to 0873	STCM1	x	x	x	R
D2165 to D2166	42165 to 42166	0874 to 0875	STCM2	x	x	x	R
D2167 to D2168	42167 to 42168	0876 to 0877	STCLP	x	x	x	R
D2169 to D2170	42169 to 42170	0878 to 0879	STCOD	x	x	x	R
D2171 to D2172	42171 to 42172	087A to 087B	OCF	x	x	x	R
D2173 to D2174	42173 to 42174	087C to 087D	LRF	x	x	x	R
D2175 to D2176	42175 to 42176	087E to 087F	PRDF	x	x	x	R
D2177 to D2178	42177 to 42178	0880 to 0881					
D2179 to D2180	42179 to 42180	0882 to 0883					
D2181 to D2182	42181 to 42182	0884 to 0885					
D2183 to D2184	42183 to 42184	0886 to 0887					
D2185 to D2186	42185 to 42186	0888 to 0889					
D2187 to D2188	42187 to 42188	088A to 088B					
D2189 to D2190	42189 to 42190	088C to 088D					
D2191 to D2192	42191 to 42192	088E to 088F					
D2193 to D2194	42193 to 42194	0890 to 0891					
D2195 to D2196	42195 to 42196	0892 to 0893					
D2197 to D2198	42197 to 42198	0894 to 0895					
D2199 to D2200	42199 to 42200	0896 to 0897					

6.9 User Program (D2001 to D4000)

User program area									
Program setpoint					Free area				
D-Reg No.	Ref. No.	H No.	Register name	R/W PROG	D-Reg No.	Ref. No.	H No.	Register name	R/W
D2201 to D2202	42201 to 42202	0898 to 0899	PGT101	R/W	D2301 to D2302	42301 to 42302	08FC to 08FD		
D2203 to D2204	42203 to 42204	089A to 089B	PGT102	R/W	D2303 to D2304	42303 to 42304	08FE to 08FF		
D2205 to D2206	42205 to 42206	089C to 089D	PGT103	R/W	D2305 to D2306	42305 to 42306	0900 to 0901		
D2207 to D2208	42207 to 42208	089E to 089F	PGT104	R/W	D2307 to D2308	42307 to 42308	0902 to 0903		
D2209 to D2210	42209 to 42210	08A0 to 08A1	PGT105	R/W	D2309 to D2310	42309 to 42310	0904 to 0905		
D2211 to D2212	42211 to 42212	08A2 to 08A3	PGT106	R/W	D2311 to D2312	42311 to 42312	0906 to 0907		
D2213 to D2214	42213 to 42214	08A4 to 08A5	PGT107	R/W	D2313 to D2314	42313 to 42314	0908 to 0909		
D2215 to D2216	42215 to 42216	08A6 to 08A7	PGT108	R/W	D2315 to D2316	42315 to 42316	090A to 090B		
D2217 to D2218	42217 to 42218	08A8 to 08A9	PGT109	R/W	D2317 to D2318	42317 to 42318	090C to 090D		
D2219 to D2220	42219 to 42220	08AA to 08AB	PGT110	R/W	D2319 to D2320	42319 to 42320	090E to 090F		
D2221 to D2222	42221 to 42222	08AC to 08AD	PGT201	R/W	D2321 to D2322	42321 to 42322	0910 to 0911		
D2223 to D2224	42223 to 42224	08AE to 08AF	PGT202	R/W	D2323 to D2324	42323 to 42324	0912 to 0913		
D2225 to D2226	42225 to 42226	08B0 to 08B1	PGT203	R/W	D2325 to D2326	42325 to 42326	0914 to 0915		
D2227 to D2228	42227 to 42228	08B2 to 08B3	PGT204	R/W	D2327 to D2328	42327 to 42328	0916 to 0917		
D2229 to D2230	42229 to 42230	08B4 to 08B5	PGT205	R/W	D2329 to D2330	42329 to 42330	0918 to 0919		
D2231 to D2232	42231 to 42232	08B6 to 08B7	PGT206	R/W	D2331 to D2332	42331 to 42332	091A to 091B		
D2233 to D2234	42233 to 42234	08B8 to 08B9	PGT207	R/W	D2333 to D2334	42333 to 42334	091C to 091D		
D2235 to D2236	42235 to 42236	08BA to 08BB	PGT208	R/W	D2335 to D2336	42335 to 42336	091E to 091F		
D2237 to D2238	42237 to 42238	08BC to 08BD	PGT209	R/W	D2337 to D2338	42337 to 42338	0920 to 0921		
D2239 to D2240	42239 to 42240	08BE to 08BF	PGT210	R/W	D2339 to D2340	42339 to 42340	0922 to 0923		
D2241 to D2242	42241 to 42242	08C0 to 08C1			D2341 to D2342	42341 to 42342	0924 to 0925		
D2243 to D2244	42243 to 42244	08C2 to 08C3			D2343 to D2344	42343 to 42344	0926 to 0927		
D2245 to D2246	42245 to 42246	08C4 to 08C5			D2345 to D2346	42345 to 42346	0928 to 0929		
D2247 to D2248	42247 to 42248	08C6 to 08C7			D2347 to D2348	42347 to 42348	092A to 092B		
D2249 to D2250	42249 to 42250	08C8 to 08C9			D2349 to D2350	42349 to 42350	092C to 092D		
D2251 to D2252	42251 to 42252	08CA to 08CB	PGO101	R/W	D2351 to D2352	42351 to 42352	092E to 092F		
D2253 to D2254	42253 to 42254	08CC to 08CD	PGO102	R/W	D2353 to D2354	42353 to 42354	0930 to 0931		
D2255 to D2256	42255 to 42256	08CE to 08CF	PGO103	R/W	D2355 to D2356	42355 to 42356	0932 to 0933		
D2257 to D2258	42257 to 42258	08D0 to 08D1	PGO104	R/W	D2357 to D2358	42357 to 42358	0934 to 0935		
D2259 to D2260	42259 to 42260	08D2 to 08D3	PGO105	R/W	D2359 to D2360	42359 to 42360	0936 to 0937		
D2261 to D2262	42261 to 42262	08D4 to 08D5	PGO106	R/W	D2361 to D2362	42361 to 42362	0938 to 0939		
D2263 to D2264	42263 to 42264	08D6 to 08D7	PGO107	R/W	D2363 to D2364	42363 to 42364	093A to 093B		
D2265 to D2266	42265 to 42266	08D8 to 08D9	PGO108	R/W	D2365 to D2366	42365 to 42366	093C to 093D		
D2267 to D2268	42267 to 42268	08DA to 08DB	PGO109	R/W	D2367 to D2368	42367 to 42368	093E to 093F		
D2269 to D2270	42269 to 42270	08DC to 08DD	PGO110	R/W	D2369 to D2370	42369 to 42370	0940 to 0941		
D2271 to D2272	42271 to 42272	08DE to 08DF	PGO201	R/W	D2371 to D2372	42371 to 42372	0942 to 0943		
D2273 to D2274	42273 to 42274	08E0 to 08E1	PGO202	R/W	D2373 to D2374	42373 to 42374	0944 to 0945		
D2275 to D2276	42275 to 42276	08E2 to 08E3	PGO203	R/W	D2375 to D2376	42375 to 42376	0946 to 0947		
D2277 to D2278	42277 to 42278	08E4 to 08E5	PGO204	R/W	D2377 to D2378	42377 to 42378	0948 to 0949		
D2279 to D2280	42279 to 42280	08E6 to 08E7	PGO205	R/W	D2379 to D2380	42379 to 42380	094A to 094B		
D2281 to D2282	42281 to 42282	08E8 to 08E9	PGO206	R/W	D2381 to D2382	42381 to 42382	094C to 094D		
D2283 to D2284	42283 to 42284	08EA to 08EB	PGO207	R/W	D2383 to D2384	42383 to 42384	094E to 094F		
D2285 to D2286	42285 to 42286	08EC to 08ED	PGO208	R/W	D2385 to D2386	42385 to 42386	0950 to 0951		
D2287 to D2288	42287 to 42288	08EE to 08EF	PGO209	R/W	D2387 to D2388	42387 to 42388	0952 to 0953		
D2289 to D2290	42289 to 42290	08F0 to 08F1	PGO210	R/W	D2389 to D2390	42389 to 42390	0954 to 0955		
D2291 to D2292	42291 to 42292	08F2 to 08F3			D2391 to D2392	42391 to 42392	0956 to 0957		
D2293 to D2294	42293 to 42294	08F4 to 08F5			D2393 to D2394	42393 to 42394	0958 to 0959		
D2295 to D2296	42295 to 42296	08F6 to 08F7			D2395 to D2396	42395 to 42396	095A to 095B		
D2297 to D2298	42297 to 42298	08F8 to 08F9			D2397 to D2398	42397 to 42398	095C to 095D		
D2299 to D2300	42299 to 42300	08FA to 08FB			D2399 to D2400	42399 to 42400	095E to 095F		

Note: Program set value is available only in the programmable mode.

6.9 User Program (D2001 to D4000)

User program area									
P registers					Free area				
D-Reg No.	Ref. No.	H No.	Register name	R/W PROG	D-Reg No.	Ref. No.	H No.	Register name	R/W
D2601 to D2602	42601 to 42602	0A28 to 0A29	P01	R/W	D2701 to D2702	42701 to 42702	0A8C to 0A8D		
D2603 to D2604	42603 to 42604	0A2A to 0A2B	P02	R/W	D2703 to D2704	42703 to 42704	0A8E to 0A8F		
D2605 to D2606	42605 to 42606	0A2C to 0A2D	P03	R/W	D2705 to D2706	42705 to 42706	0A90 to 0A91		
D2607 to D2608	42607 to 42608	0A2E to 0A2F	P04	R/W	D2707 to D2708	42707 to 42708	0A92 to 0A93		
D2609 to D2610	42609 to 42610	0A30 to 0A31	P05	R/W	D2709 to D2710	42709 to 42710	0A94 to 0A95		
D2611 to D2612	42611 to 42612	0A32 to 0A33	P06	R/W	D2711 to D2712	42711 to 42712	0A96 to 0A97		
D2613 to D2614	42613 to 42614	0A34 to 0A35	P07	R/W	D2713 to D2714	42713 to 42714	0A98 to 0A99		
D2615 to D2616	42615 to 42616	0A36 to 0A37	P08	R/W	D2715 to D2716	42715 to 42716	0A9A to 0A9B		
D2617 to D2618	42617 to 42618	0A38 to 0A39	P09	R/W	D2717 to D2718	42717 to 42718	0A9C to 0A9D		
D2619 to D2620	42619 to 42620	0A3A to 0A3B	P10	R/W	D2719 to D2720	42719 to 42720	0A9E to 0A9F		
D2621 to D2622	42621 to 42622	0A3C to 0A3D	P11	R/W	D2721 to D2722	42721 to 42722	0AA0 to 0AA1		
D2623 to D2624	42623 to 42624	0A3E to 0A3F	P12	R/W	D2723 to D2724	42723 to 42724	0AA2 to 0AA3		
D2625 to D2626	42625 to 42626	0A40 to 0A41	P13	R/W	D2725 to D2726	42725 to 42726	0AA4 to 0AA5		
D2627 to D2628	42627 to 42628	0A42 to 0A43	P14	R/W	D2727 to D2728	42727 to 42728	0AA6 to 0AA7		
D2629 to D2630	42629 to 42630	0A44 to 0A45	P15	R/W	D2729 to D2730	42729 to 42730	0AA8 to 0AA9		
D2631 to D2632	42631 to 42632	0A46 to 0A47	P16	R/W	D2731 to D2732	42731 to 42732	0AAA to 0AAB		
D2633 to D2634	42633 to 42634	0A48 to 0A49	P17	R/W	D2733 to D2734	42733 to 42734	0AAC to 0AAD		
D2635 to D2636	42635 to 42636	0A4A to 0A4B	P18	R/W	D2735 to D2736	42735 to 42736	0AAE to 0AAF		
D2637 to D2638	42637 to 42638	0A4C to 0A4D	P19	R/W	D2737 to D2738	42737 to 42738	0AB0 to 0AB1		
D2639 to D2640	42639 to 42640	0A4E to 0A4F	P20	R/W	D2739 to D2740	42739 to 42740	0AB2 to 0AB3		
D2641 to D2642	42641 to 42642	0A50 to 0A51	P21	R/W	D2741 to D2742	42741 to 42742	0AB4 to 0AB5		
D2643 to D2644	42643 to 42644	0A52 to 0A53	P22	R/W	D2743 to D2744	42743 to 42744	0AB6 to 0AB7		
D2645 to D2646	42645 to 42646	0A54 to 0A55	P23	R/W	D2745 to D2746	42745 to 42746	0AB8 to 0AB9		
D2647 to D2648	42647 to 42648	0A56 to 0A57	P24	R/W	D2747 to D2748	42747 to 42748	0ABA to 0ABB		
D2649 to D2650	42649 to 42650	0A58 to 0A59	P25	R/W	D2749 to D2750	42749 to 42750	0ABC to 0ABD		
D2651 to D2652	42651 to 42652	0A5A to 0A5B	P26	R/W	D2751 to D2752	42751 to 42752	0ABE to 0ABF		
D2653 to D2654	42653 to 42654	0A5C to 0A5D	P27	R/W	D2753 to D2754	42753 to 42754	0AC0 to 0AC1		
D2655 to D2656	42655 to 42656	0A5E to 0A5F	P28	R/W	D2755 to D2756	42755 to 42756	0AC2 to 0AC3		
D2657 to D2658	42657 to 42658	0A60 to 0A61	P29	R/W	D2757 to D2758	42757 to 42758	0AC4 to 0AC5		
D2659 to D2660	42659 to 42660	0A62 to 0A63	P30	R/W	D2759 to D2760	42759 to 42760	0AC6 to 0AC7		
D2661 to D2662	42661 to 42662	0A64 to 0A65			D2761 to D2762	42761 to 42762	0AC8 to 0AC9		
D2663 to D2664	42663 to 42664	0A66 to 0A67			D2763 to D2764	42763 to 42764	0ACA to 0ACB		
D2665 to D2666	42665 to 42666	0A68 to 0A69			D2765 to D2766	42765 to 42766	0ACC to 0ACD		
D2667 to D2668	42667 to 42668	0A6A to 0A6B			D2767 to D2768	42767 to 42768	0ACE to 0ACF		
D2669 to D2670	42669 to 42670	0A6C to 0A6D			D2769 to D2770	42769 to 42770	0AD0 to 0AD1		
D2671 to D2672	42671 to 42672	0A6E to 0A6F			D2771 to D2772	42771 to 42772	0AD2 to 0AD3		
D2673 to D2674	42673 to 42674	0A70 to 0A71			D2773 to D2774	42773 to 42774	0AD4 to 0AD5		
D2675 to D2676	42675 to 42676	0A72 to 0A73			D2775 to D2776	42775 to 42776	0AD6 to 0AD7		
D2677 to D2678	42677 to 42678	0A74 to 0A75			D2777 to D2778	42777 to 42778	0AD8 to 0AD9		
D2679 to D2680	42679 to 42680	0A76 to 0A77			D2779 to D2780	42779 to 42780	0ADA to 0ADB		
D2681 to D2682	42681 to 42682	0A78 to 0A79			D2781 to D2782	42781 to 42782	0ADC to 0ADD		
D2683 to D2684	42683 to 42684	0A7A to 0A7B			D2783 to D2784	42783 to 42784	0ADE to 0ADF		
D2685 to D2686	42685 to 42686	0A7C to 0A7D			D2785 to D2786	42785 to 42786	0AE0 to 0AE1		
D2687 to D2688	42687 to 42688	0A7E to 0A7F			D2787 to D2788	42787 to 42788	0AE2 to 0AE3		
D2689 to D2690	42689 to 42690	0A80 to 0A81			D2789 to D2790	42789 to 42790	0AE4 to 0AE5		
D2691 to D2692	42691 to 42692	0A82 to 0A83			D2791 to D2792	42791 to 42792	0AE6 to 0AE7		
D2693 to D2694	42693 to 42694	0A84 to 0A85			D2793 to D2794	42793 to 42794	0AE8 to 0AE9		
D2695 to D2696	42695 to 42696	0A86 to 0A87			D2795 to D2796	42795 to 42796	0AEA to 0AEB		
D2697 to D2698	42697 to 42698	0A88 to 0A89			D2797 to D2798	42797 to 42798	0AEC to 0AED		
D2699 to D2700	42699 to 42700	0A8A to 0A8B			D2799 to D2800	42799 to 42800	0AEE to 0AEF		

Note: P register is available only in the programmable mode.

6.9.1 Control Data, System Flag (D2001 to D2100)

Register No.	Description	Range and Meaning of Value
D2001 to D2002	LOAD Current load factor for user program	0.0 to 2000.0%
D2003 to D2004	LDMAX Maximum load factor for user program	
D2005 to D2010		
D2011 to D2012	SSW Selector control switch	AUT: 0 (Automatic selection as in the setting of the engineering parameter "ATSEL") 1: 1 (Loop 1 output) 2: 2 (Loop 2 output)
D2013 to D2014	EXT Selector external signal	—
D2015 to D2016	SEL Selector selection loop	—
D2017 to D2040		
D2041 to D2042	AG1 Variable gain 1	—
D2043 to D2044	DM1 Input compensation 1	—
D2045 to D2046	FF1 Feedforward input value 1	-100.0 to 200.0%
D2047 to D2048	TRK1 Output tracking input value 1	-6.3 to 106.3%
D2049 to D2050		
D2051 to D2052	AG2 Variable gain 2	—
D2053 to D2054	DM2 Input compensation 2	—
D2055 to D2056	FF2 Feedforward input value 2	—
D2057 to D2058	TRK2 Output tracking input value 2	-6.3 to 106.3%
D2059 to D2060		
D2061 to D2062	PVM1 PV1 displayed on a bar-graph	-6.3 to 106.3%
D2063 to D2064	SVM1 SV1 displayed on a bar-graph	
D2065 to D2066	MVM1 MV1 displayed on a bar-graph	
D2067 to D2068	PVM2 PV2 displayed on a bar-graph	
D2069 to D2070	SVM2 SV2 displayed on a bar-graph	
D2071 to D2072	MVM2 MV2 displayed on a bar-graph	
D2073 to D2074		
D2075 to D2076	PPID1 Preset PID switch registers 1	-8000 ≤ PPID1 < 0 : Current setting value is held. 0 ≤ PPID1 < 100 : PID set 1 (PPB1, PTI1, PTD1) 100 ≤ PPID1 < 200 : PID set 2 (PPB2, PTI2, PTD2) 200 ≤ PPID1 < 300 : PID set 3 (PPB3, PTI3, PTD3) 300 ≤ PPID1 < 400 : PID set 4 (PPB4, PTI4, PTD4) 400 ≤ PPID1 < 500 : PID set 5 (PPB5, PTI5, PTD5) 500 ≤ PPID1 < 600 : PID set 6 (PPB6, PTI6, PTD6) 600 ≤ PPID1 < 700 : PID set 7 (PPB7, PTI7, PTD7) 700 ≤ PPID1 < 8000 : PID set 8 (PPB8, PTI8, PTD8)
D2077 to D2078	PPID2 Preset PID switch registers 2	-8000 ≤ PPID2 < 0 : Current setting value is held. 0 ≤ PPID2 < 100 : PID set 1 (PPB1, PTI1, PTD1) 100 ≤ PPID2 < 200 : PID set 2 (PPB2, PTI2, PTD2) 200 ≤ PPID2 < 300 : PID set 3 (PPB3, PTI3, PTD3) 300 ≤ PPID2 < 400 : PID set 4 (PPB4, PTI4, PTD4) 400 ≤ PPID2 < 500 : PID set 5 (PPB5, PTI5, PTD5) 500 ≤ PPID2 < 600 : PID set 6 (PPB6, PTI6, PTD6) 600 ≤ PPID2 < 700 : PID set 7 (PPB7, PTI7, PTD7) 700 ≤ PPID2 < 8000 : PID set 8 (PPB8, PTI8, PTD8)
D2079 to D2080		
D2081 to D2082	IOP Input overrange	0: Normal 1: Generation
D2083 to D2084	OOP Current output connection open	
D2085 to D2086	COMS01 Host system communication hardware abnormal	
D2087 to D2088	COMS02 Host system communication software abnormal	
D2089 to D2090	CFL Backlight ON/OFF flag	0: ON 1: OFF
D2091 to D2098		
D2099 to D2100	KYI_PF PF key input status	0: ON 1: OFF

6.9 User Program (D2001 to D4000)

6.9.2 Control Flag (D2101 to D2200)

Register No.	Description	Range and Meaning of Value
D2101 to D2102	PRC_ALM_HH1 PV1 high-high limit alarm flag	0: OFF 1: ON
D2103 to D2104	PRC_ALM_LL1 PV1 low-low limit alarm flag	
D2105 to D2106	PRC_ALM_PH1 PV1 high limit alarm flag	
D2107 to D2108	PRC_ALM_PL1 PV1 low limit alarm flag	
D2109 to D2110	PRC_ALM_DL1 Deviation variable 1 alarm flag	
D2111 to D2112	PRC_ALM_VL1 PV1 velocity alarm flag	
D2113 to D2114	TRKF1 Output tracking 1 flag	0: OFF 1: ON
D2115 to D2116	PMVF1 Preset output 1 flag	
D2117 to D2118	CAF1 C←→A mode change 1 flag	0: A 1: C
D2119 to D2120	CAMF1 C,A←→M mode change 1 flag	0: M 1: A/C
D2121 to D2122	CCF1 SV1 analog/computer flag	0: ANALOG 1: COMPUTER
D2123 to D2124	DDCF1 DDC output 1 flag	0: DDC_OTHER 1: DDC
D2125 to D2130		
D2131 to D2132	PRC_ALM_HH2 PV2 high-high limit alarm flag	As same as D2101 to D2124
D2133 to D2134	PRC_ALM_LL2 PV2 low-low limit alarm flag	
D2135 to D2136	PRC_ALM_PH2 PV2 high limit alarm flag	
D2137 to D2138	PRC_ALM_PL2 PV2 low limit alarm flag	
D2139 to D2140	PRC_ALM_DL2 Deviation variable 2 alarm flag	
D2141 to D2142	PRC_ALM_VL2 PV2 velocity alarm flag	
D2143 to D2144	TRKF2 Output tracking 2 flag	
D2145 to D2146	PMVF2 Preset output 2 flag	
D2147 to D2148	CAF2 C←→A mode change 2 flag	
D2149 to D2150	CAMF2 C,A←→M mode change 2 flag	
D2151 to D2152	CCF2 SV2 analog/computer flag	
D2153 to D2154	DDCF2 DDC output 2 flag	
D2155 to D2160		
D2161 to D2162	STCSW STC stop flag	0: STCSTART 1: STCSTOP
D2163 to D2164	STCM1 STC mode designation 1 flag	0: OFF 1: Specify it by combining the values STCM1 and STCM2.
D2165 to D2166	STCM2 STC mode designation 2 flag	0: OFF 1: Specify it by combining the values STCM1 and STCM2.
D2167 to D2168	STCLP STC loop flag	0: LOOP1 1: LOOP2
D2169 to D2170	STCOD On-demand designation flag	0: OFF 1: ON
D2171 to D2172	OCF Internal cascade switching flag	0: CLOSE (cascade) 1: OPEN (secondary control)
D2173 to D2174	LRF Secondary loop remote/local switching flag	0: REMOTE 1: LOCAL
D2175 to D2176	PRDF Primary direct flag	0: OFF 1: ON
D2177 to D2200		

6.9.3 Program Setpoint (D2201 to D2300)

Register No.	Description	Range and Meaning of Value
D2201 to D2220	PGT101 to PGT110 Time 1 setting for PGM1 to Time 10 setting for PGM1	0 to 9999
D2221 to D2240	PGT201 to PGT210 Time 1 setting for PGM2 to Time 10 setting for PGM2	
D2241 to D2250		
D2251 to D2270	PGO101 to PGO110 Output 1 setting for PGM1 to Output 10 setting for PGM1	-0.250 to 1.250
D2271 to D2290	PGO201 to PGO210 Output 1 setting for PGM2 to Output 10 setting for PGM2	
D2291 to D2300		

6.9.4 P Registers (D2601 to D2700)

Register No.	Description	Range and Meaning of Value
D2601 to D2660	P01 to P30 Variable parameter 1 to Variable parameter 30	Internal value (User program) = Maximum and Minimum value which can be expressed by floating point numbers. Setting and display range = -99999 to 99999 Communication setting = -2147483520 to 2147483520
D2661 to D2700		

7.1 Overview

This chapter describes the functions and applications of the D registers. D registers are used in Modbus, PC-link, or Ethernet communications, and are used for storing YS1000 parameter data, flag data, process data, and other data and values. The host computer can utilize these data by reading from and writing to the D registers.

Use of the D registers enables the following:

- Centralized control by the host computer
- Reading and writing of data between the YS1310/YS1350/YS1360 and the host computer

7.2 Conventions Used in D-Register Lists

This section describes the conventions used in the D-register map tables.

The numerical values arranged vertically in the leftmost column of the table represent (1) D register numbers. 5-digit numbers in the column next to it show (2) reference numbers for Modbus communication. The third column from the left provides (3) register numbers (hexadecimal) for Modbus communication.

Alphabet characters in the register map represent process data, operation parameters, setup parameters, and other flag register names. For details on operation parameters and setup parameters, refer to the respective YS1000 Operation Guide and User's Manual.

Register Map (Categories)						
Register Contents						
D-Reg No.	Ref. No.	H No.	Register Name	R/W		
				YS1310	YS1350	YS1360
D0001 to D0002	40001 to 40002	0000 to 0001	SYS_ALM_STS	R	R	R
D0003 to D0004	40003 to 40004	0002 to 0003	PRC_ALM_STS	R	R	R

(1) D-register numbers

(2) Reference numbers (for Modbus communication)
Reference number = D-Reg. No. + 40000

(3) Hexadecimal numbers
(for Modbus communication)

Read/write by communication
R: Read enabled
R/W: Read/write enabled
×: Read/write disabled
(An attempt to read results in reading "0".)

0701E.ai

7.3 Classification of D Registers

■ Classification of D Register Map Tables

The table below outlines how the D registers are classified by their numbers in the D Register Map tables.

Table 7.1 Classification of D Registers

Register No.	Area and data categories	Description	Reference
D0001 to D0400	Process data area	Process data, Analog input/output, Status, Alarm/Event, Digital input/output	Sections 7.5.2 to 7.5.4
D0401 to D0500	Tuning parameters (Note 1)	Setting Parameter	Sections 7.6.1
D0501 to D0600		(Not used)	
D0601 to D0700		I/O Parameter	Sections 7.6.2
D0701 to D0800		Free area	
D0801 to D0900		Special Parameter	Sections 7.6.3
D0901 to D0950	Recognition area		Sections 7.7.1
D0951 to D1000	User area (Note 2)		Sections 7.7.2
D1001 to D1100	Engineering Parameters 1 (Note 1)	CONFIG	Sections 7.8.1
D1101 to D1200		I/O computation setting, Alarm setting	Sections 7.8.2
D1201 to D1300		Display setting , Contrast	Sections 7.8.3
D1301 to D1400		Communication setting	Sections 7.8.4
D1401 to D1500	Engineering Parameters 2 (Note 1)	(Not used)	
D1501 to D1600		(Not used)	
D1601 to D1700		(Not used)	
D1701 to D1800		DI/DO setting	Sections 7.8.5
D1801 to D2000		Communication access	Sections 7.8.6

Note 1: Data in the tuning parameters and engineering parameters is stored in the format (data excluding the decimal point of engineering unit) described in "List of Parameters" in the YS1310/YS1350/YS1360 Operation Guide.

The OFF status of data is indicated by "0" and the ON status is indicated by "1."

Note 2: The user area (D0951 to D1000) contains 16-bit register data used for the touch panel and other applications.

When using a touch panel, do not write data to or read it from this area as the user area for communication.

CAUTION

No data can be written to or read from blank parts of the data storage area by communication.

The YS1000 sometimes does not operate properly if an attempt is made to write to or read from blank parts of the data storage area.

7.3.1 Writing Data to the Engineering Parameters 1

When the operation status is STOP via communication (RSCOMM (D1811 to D1812) =1), data can be written to the parameters in the engineering parameters 1. However, ECO and BRT parameters are excluded.

7.4 D Register Data

32 bits of data are allocated for parameter values. Since data handled by one D register is 16 bits, two D registers are used to express one parameter data.

Specify two D registers to write data except for the user area (D0951 to D1000) or text string data.

You can select which of the two D registers is to be treated as the high-level register or low-level register.

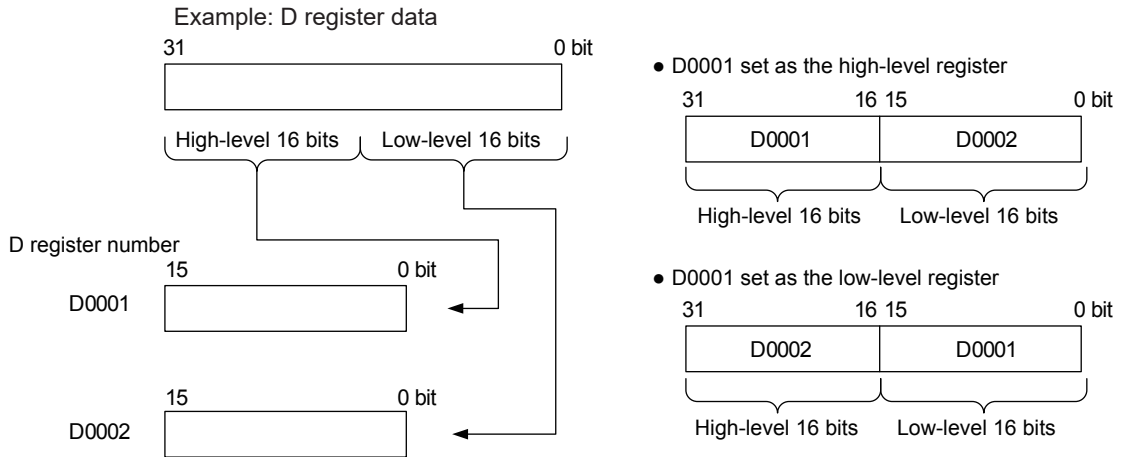

0702E.ai

7.4.1 Setting D Registers as High Level or Low Level

Parameter	Parameter Name	Setting	Default
DREG1	RS-485 communication D register setting for High/Low level	0: H-L 1: L-H	0
DREG2	Ethernet communication D register setting for High/Low level		

Example: When registers D0001 to D0002 are used

0: H-L (D0001: high level, D0002: low level)

1: L-H (D0001: low level, D0002: high level)

Note

The following sections (7.5 to 7.8) show the bit configurations when the D register setting for high/low level parameter (DREG1 or DREG2) is set to "0: H-L."

7.5 Process Data (D0001 to D0400)

Process data area						
Process data, Analog input/output, Status						
D-Reg No.	Ref. No.	H No.	Register name	R/W		
				YS1310	YS1350	YS1360
D0001 to D0002	40001 to 40002	0000 to 0001	SYS_ALM_STS	R	R	R
D0003 to D0004	40003 to 40004	0002 to 0003	PRC_ALM_STS	R	R	R
D0005 to D0006	40005 to 40006	0004 to 0005				
D0007 to D0008	40007 to 40008	0006 to 0007	RSDISP	R	R	R
D0009 to D0010	40009 to 40010	0008 to 0009	LS1	×	R/W	R/W
D0011 to D0012	40011 to 40012	000A to 000B	PV1	R	R	R
D0013 to D0014	40013 to 40014	000C to 000D	SV1	×	R/W	×
D0015 to D0016	40015 to 40016	000E to 000F	MV1	×	×	R/W
D0017 to D0018	40017 to 40018	0010 to 0011				
D0019 to D0020	40019 to 40020	0012 to 0013	PV2	R	×	×
D0021 to D0022	40021 to 40022	0014 to 0015				
D0023 to D0024	40023 to 40024	0016 to 0017				
D0025 to D0026	40025 to 40026	0018 to 0019				
D0027 to D0028	40027 to 40028	001A to 001B	CIN1	×	R	R
D0029 to D0030	40029 to 40030	001C to 001D				
D0031 to D0032	40031 to 40032	001E to 001F				
D0033 to D0034	40033 to 40034	0020 to 0021				
D0035 to D0036	40035 to 40036	0022 to 0023				
D0037 to D0038	40037 to 40038	0024 to 0025				
D0039 to D0040	40039 to 40040	0026 to 0027				
D0041 to D0042	40041 to 40042	0028 to 0029				
D0043 to D0044	40043 to 40044	002A to 002B				
D0045 to D0046	40045 to 40046	002C to 002D				
D0047 to D0048	40047 to 40048	002E to 002F	EVT_STS	R	R	R
D0049 to D0050	40049 to 40050	0030 to 0031				
D0051 to D0052	40051 to 40052	0032 to 0033	X1	R	R	R
D0053 to D0054	40053 to 40054	0034 to 0035	X2	R	R	R
D0055 to D0056	40055 to 40056	0036 to 0037				
D0057 to D0058	40057 to 40058	0038 to 0039				
D0059 to D0060	40059 to 40060	003A to 003B				
D0061 to D0062	40061 to 40062	003C to 003D				
D0063 to D0064	40063 to 40064	003E to 003F				
D0065 to D0066	40065 to 40066	0040 to 0041				
D0067 to D0068	40067 to 40068	0042 to 0043				
D0069 to D0070	40069 to 40070	0044 to 0045				
D0071 to D0072	40071 to 40072	0046 to 0047	Y1	×	R	R
D0073 to D0074	40073 to 40074	0048 to 0049	Y2	×	R	R
D0075 to D0076	40075 to 40076	004A to 004B				
D0077 to D0078	40077 to 40078	004C to 004D				
D0079 to D0080	40079 to 40080	004E to 004F				
D0081 to D0082	40081 to 40082	0050 to 0051				
D0083 to D0084	40083 to 40084	0052 to 0053				
D0085 to D0086	40085 to 40086	0054 to 0055				
D0087 to D0088	40087 to 40088	0056 to 0057	DISTATUS	R	R	R
D0089 to D0090	40089 to 40090	0058 to 0058	DOSTATUS	R	R	R
D0091 to D0092	40091 to 40092	005A to 005B	EXT_EXE	×	R	R
D0093 to D0094	40093 to 40094	005C to 005D				
D0095 to D0096	40095 to 40096	005E to 005F	MCUFAIL	R	R	R
D0097 to D0098	40097 to 40098	0060 to 0061	DCUFAIL	R	R	R
D0099 to D0100	40099 to 40100	0062 to 0063	ALMLAMP	R	R	R

7.5 Process Data (D0001 to D0400)

Process data area						
Alarm/Event						
D-Reg No.	Ref. No.	H No.	Register name	R/W		
				YS1310	YS1350	YS1360
D0101 to D0102	40101 to 40102	0064 to 0065	SYS_ALM_X1	R	R	R
D0103 to D0104	40103 to 40104	0066 to 0067	SYS_ALM_X2	R	R	R
D0105 to D0106	40105 to 40106	0068 to 0069				
D0107 to D0108	40107 to 40108	006A to 006B				
D0109 to D0110	40109 to 40110	006C to 006D				
D0111 to D0112	40111 to 40112	006E to 006F				
D0113 to D0114	40113 to 40114	0070 to 0071				
D0115 to D0116	40115 to 40116	0072 to 0073				
D0117 to D0118	40117 to 40118	0074 to 0075	SYS_ALM_Y1	×	×	R
D0119 to D0120	40119 to 40120	0076 to 0077				
D0121 to D0122	40121 to 40122	0078 to 0079				
D0123 to D0124	40123 to 40124	007A to 007B				
D0125 to D0126	40125 to 40126	007C to 007D	SYS_ALM_COMM	R	R	R
D0127 to D0128	40127 to 40128	007E to 007F	SYS_ALM_ETHER	R	R	R
D0129 to D0130	40129 to 40130	0080 to 0081				
D0131 to D0132	40131 to 40132	0082 to 0083				
D0133 to D0134	40133 to 40134	0084 to 0085	SYS_ALM_DATA	R	R	R
D0135 to D0136	40135 to 40136	0086 to 0087	SYS_ALM_CALR	R	R	R
D0137 to D0138	40137 to 40138	0088 to 0089				
D0139 to D0140	40139 to 40140	008A to 008B				
D0141 to D0142	40141 to 40142	008C to 008D				
D0143 to D0144	40143 to 40144	008E to 008F				
D0145 to D0146	40145 to 40146	0090 to 0091				
D0147 to D0148	40147 to 40148	0092 to 0093				
D0149 to D0150	40149 to 40150	0094 to 0095				
D0151 to D0152	40151 to 40152	0096 to 0097				
D0153 to D0154	40153 to 40154	0098 to 0099				
D0155 to D0156	40155 to 40156	009A to 009B				
D0157 to D0158	40157 to 40158	009C to 009D				
D0159 to D0160	40159 to 40160	009E to 009F				
D0161 to D0162	40161 to 40162	00A0 to 01A1				
D0163 to D0164	40163 to 40164	00A2 to 01A3				
D0165 to D0166	40165 to 40166	00A4 to 00A5	PRC_ALM_HH1	R	R	R
D0167 to D0168	40167 to 40168	00A6 to 00A7	PRC_ALM_LL1	R	R	R
D0169 to D0170	40169 to 40170	00A8 to 00A9	PRC_ALM_PH1	R	R	R
D0171 to D0172	40171 to 40172	00AA to 00AB	PRC_ALM_PL1	R	R	R
D0173 to D0174	40173 to 40174	00AC to 00AD				
D0175 to D0176	40175 to 40176	00AE to 00AF				
D0177 to D0178	40177 to 40178	00B0 to 00B1	PRC_ALM_HH2	R	×	×
D0179 to D0180	40179 to 40180	00B2 to 00B3	PRC_ALM_LL2	R	×	×
D0181 to D0182	40181 to 40182	00B4 to 00B5	PRC_ALM_PH2	R	×	×
D0183 to D0184	40183 to 40184	00B6 to 00B7	PRC_ALM_PL2	R	×	×
D0185 to D0186	40185 to 40186	00B8 to 00B9				
D0187 to D0188	40187 to 40188	00BA to 00BB				
D0189 to D0190	40189 to 40190	00BC to 00BD				
D0191 to D0192	40191 to 40192	00BE to 00BF				
D0193 to D0194	40193 to 40194	00C0 to 00C1				
D0195 to D0196	40195 to 40196	00C2 to 00C3				
D0197 to D0198	40197 to 40198	00C4 to 00C5				
D0199 to D0200	40199 to 40200	00C6 to 00C7				

Process data area						
Alarm/Event						
D-Reg No.	Ref. No.	H No.	Register name	R/W		
				YS1310	YS1350	YS1360
D0201 to D0202	40201 to 40202	00C8 to 00C9				
D0203 to D0204	40203 to 40204	00CA to 00CB				
D0205 to D0206	40205 to 40206	00CC to 00CD				
D0207 to D0208	40207 to 40208	00CE to 00CF				
D0209 to D0210	40209 to 40210	00D0 to 00D1				
D0211 to D0212	40211 to 40212	00D2 to 00D3				
D0213 to D0214	40213 to 40214	00D4 to 00D5				
D0215 to D0216	40215 to 40216	00D6 to 00D7				
D0217 to D0218	40217 to 40218	00D8 to 00D9				
D0219 to D0220	40219 to 40220	00DA to 00DB				
D0221 to D0222	40221 to 40222	00DC to 00DD				
D0223 to D0224	40223 to 40224	00DE to 00DF				
D0225 to D0226	40225 to 40226	00E0 to 00E1				
D0227 to D0228	40227 to 40228	00E2 to 00E3				
D0229 to D0230	40229 to 40230	00E4 to 00E5				
D0231 to D0232	40231 to 40232	00E6 to 00E7				
D0233 to D0234	40233 to 40234	00E8 to 00E9	EVT_EVENT1	R	R	R
D0235 to D0236	40235 to 40236	00EA to 00EB	EVT_EVENT2	R	R	R
D0237 to D0238	40237 to 40238	00EC to 00ED	EVT_EVENT3	R	R	R
D0239 to D0240	40239 to 40240	00EE to 00EF	EVT_EVENT4	R	R	R
D0241 to D0242	40241 to 40242	00F0 to 00F1	EVT_EVENT5	R	R	R
D0243 to D0244	40243 to 40244	00F2 to 00F3				
D0245 to D0246	40245 to 40246	00F4 to 00F5				
D0247 to D0248	40247 to 40248	00F6 to 00F7	EXT_EXE_AUT	×	R	R
D0249 to D0250	40249 to 40250	00F8 to 00F9	EXT_EXE_MAN	×	R	R
D0251 to D0252	40251 to 40252	00FA to 00FB	EXT_EXE_PMV	×	R	R
D0253 to D0254	40253 to 40254	00FC to 00FD	EXT_EXE_TRK	×	R	R
D0255 to D0256	40255 to 40256	00FE to 00FF				
D0257 to D0258	40257 to 40258	0100 to 0101				
D0259 to D0260	40259 to 40260	0102 to 0103				
D0261 to D0262	40261 to 40262	0104 to 0105				
D0263 to D0264	40263 to 40264	0106 to 0107				
D0265 to D0266	40265 to 40266	0108 to 0109				
D0267 to D0268	40267 to 40268	010A to 010B				
D0269 to D0270	40269 to 40270	010C to 010D				
D0271 to D0272	40271 to 40272	010E to 010F				
D0273 to D0274	40273 to 40274	0110 to 0111				
D0275 to D0276	40275 to 40276	0112 to 0113				
D0277 to D0278	40277 to 40278	0114 to 0115				
D0279 to D0280	40279 to 40280	0116 to 0117				
D0281 to D0282	40281 to 40282	0118 to 0119				
D0283 to D0284	40283 to 40284	011A to 011B				
D0285 to D0286	40285 to 40286	011C to 011D				
D0287 to D0288	40287 to 40288	011E to 011F				
D0289 to D0290	40289 to 40290	0120 to 0121				
D0291 to D0292	40291 to 40292	0122 to 0123				
D0293 to D0294	40293 to 40294	0124 to 0125				
D0295 to D0296	40295 to 40296	0126 to 0127				
D0297 to D0298	40297 to 40298	0128 to 0129				
D0299 to D0300	40299 to 40300	012A to 012B				

7.5 Process Data (D0001 to D0400)

Process data area						
Digital input/output						
D-Reg No.	Ref. No.	H No.	Register name	R/W		
				YS1310	YS1350	YS1360
D0301 to D0302	40301 to 40302	012C to 012D	DISTATUS_DI01	R	R	R
D0303 to D0304	40303 to 40304	012E to 012F	DISTATUS_DI02	R	R	R
D0305 to D0306	40305 to 40306	0130 to 0131				
D0307 to D0308	40307 to 40308	0132 to 0133				
D0309 to D0310	40309 to 40310	0134 to 0135				
D0311 to D0312	40311 to 40312	0136 to 0137				
D0313 to D0314	40313 to 40314	0138 to 0139				
D0315 to D0316	40315 to 40316	013A to 013B				
D0317 to D0318	40317 to 40318	013C to 013D				
D0319 to D0320	40319 to 40320	013E to 013F				
D0321 to D0322	40321 to 40321	0140 to 0141				
D0323 to D0324	40323 to 40324	0142 to 0143				
D0325 to D0326	40325 to 40326	0144 to 0145				
D0327 to D0328	40327 to 40328	0146 to 0147				
D0329 to D0330	40329 to 40330	0148 to 0149				
D0331 to D0332	40331 to 40332	014A to 014B				
D0333 to D0334	40333 to 40334	014C to 014D	DOSTATUS_DO1	R	R	R
D0335 to D0336	40335 to 40336	014E to 014F	DOSTATUS_DO2	R	R	R
D0337 to D0338	40337 to 40338	0150 to 0151	DOSTATUS_DO3	R	×	×
D0339 to D0340	40339 to 40340	0152 to 0153	DOSTATUS_DO4	R	R	R
D0341 to D0342	40341 to 40342	0154 to 0155	DOSTATUS_DO5	R	×	×
D0343 to D0344	40343 to 40344	0156 to 0157	DOSTATUS_DO6	R	×	×
D0345 to D0346	40345 to 40346	0158 to 0159				
D0347 to D0348	40347 to 40348	015A to 015B				
D0349 to D0350	40349 to 40350	015C to 015D				
D0351 to D0352	40351 to 40352	015E to 015F				
D0353 to D0354	40353 to 40354	0160 to 0161				
D0355 to D0356	40355 to 40356	0162 to 0163				
D0357 to D0358	40357 to 40358	0164 to 0165				
D0359 to D0360	40359 to 40360	0166 to 0167				
D0361 to D0362	40361 to 40362	0168 to 0169				
D0363 to D0364	40363 to 40364	016A to 016B				
D0365 to D0366	40365 to 40366	016C to 016D				
D0367 to D0368	40367 to 40368	016E to 016F				
D0369 to D0370	40369 to 40370	0170 to 0171				
D0371 to D0372	40371 to 40372	0172 to 0173				
D0373 to D0374	40373 to 40374	0174 to 0175				
D0375 to D0376	40375 to 40376	0176 to 0177				
D0377 to D0378	40377 to 40378	0178 to 0179				
D0379 to D0380	40379 to 40380	017A to 017B				
D0381 to D0382	40381 to 40382	017C to 017D				
D0383 to D0384	40383 to 40384	017E to 017F				
D0385 to D0386	40385 to 40386	0180 to 0181				
D0387 to D0388	40387 to 40388	0182 to 0183				
D0389 to D0390	40389 to 40390	0184 to 0185				
D0391 to D0392	40391 to 40392	0186 to 0187				
D0393 to D0394	40393 to 40394	0188 to 0189				
D0395 to D0396	40395 to 40396	018A to 018B				
D0397 to D0398	40397 to 40398	018C to 018D				
D0399 to D0400	40399 to 40400	018E to 018F				

7.5.1 Process Data Area

Some of the D registers represent multiple events such as errors and status depending on combinations of bits in the register.

In the following tables, if an event indicated by a specific bit occurs, the state of that bit changes to "1." If no event occurs, the state of that bit is "0." Blank lines in each table indicate unused bits.

7.5.2 Process Data, Analog Input/output, Status (D0001 to D0100)

● Bit Configuration of D0001 to D0002: SYS_ALM_STS (System alarm)

High/low level (Note)	Bit	Code	Event
Low level	0	SYS_ALM_X1	Input 1 overrange (0: OFF 1: ON)
	1	SYS_ALM_X2	Input 2 overrange (0: OFF 1: ON)
	2 to 7		
	8	SYS_ALM_Y1	Current output 1 open (0: OFF 1: ON)
	9 to 11		
	12	SYS_ALM_COMM	Communication error (0: OFF 1: ON)
	13	SYS_ALM_ETHER	Ethernet communication error (0: OFF 1: ON)
High level	14 to 15		
	16	SYS_ALM_DATA	YSS writing not completed (0: OFF 1: ON)
	17	SYS_ALM_CALR	Factory adjustment inspection not completed (0: OFF 1: ON)
	18 to 31		

● Bit Configuration of D0003 to D0004: PRC_ALM_STS (Process alarm)

High/low level (Note)	Bit	Code	Event
Low level	0	PRC_ALM_HH1	PV1 high-high limit alarm flag (0: OFF 1: ON)
	1	PRC_ALM_LL1	PV1 low-low limit alarm flag (0: OFF 1: ON)
	2	PRC_ALM_PH1	PV1 high limit alarm flag (0: OFF 1: ON)
	3	PRC_ALM_PL1	PV1 low limit alarm flag (0: OFF 1: ON)
	4 to 5		
	6	PRC_ALM_HH2	PV2 high-high limit alarm flag (0: OFF 1: ON)
	7	PRC_ALM_LL2	PV2 low-low limit alarm flag (0: OFF 1: ON)
	8	PRC_ALM_PH2	PV2 high limit alarm flag (0: OFF 1: ON)
	9	PRC_ALM_PL2	PV2 low limit alarm flag (0: OFF 1: ON)
	10 to 15		
High level	16 to 31		

Note: In these bit configurations, the D register setting for high/low level parameter is set to "0: H-L" (i.e. the first register is high level).

7.5 Process Data (D0001 to D0400)

● D0007 to D0046

Register No.	Description	Range and Meaning of Value
D0007 to D0008	RSDISP Operation status display	0: RUN 1: STOP
D0009 to D0010	LS1 Operation mode 1	0: MAN 2: CAS 3: SPC 4: DDC 5: BUA 6: BUM (Note 1)
D0011 to D0012	PV1 Process variable 1	Equivalent to -6.3 to 106.3% in the engineering unit (Note 2)
D0013 to D0014	SV1 Setpoint value 1	
D0015 to D0016	MV1 Manipulated output variable 1 (Note 3)	
D0017 to D0018		-6.3 to 106.3%
D0019 to D0020	PV2 Process variable 2	Equivalent to -6.3 to 106.3% in the engineering unit (Note 2)
D0021 to D0026		
D0027 to D0028	CIN1 Cascade input value 1	YS1350: Equivalent to -6.3 to 106.3% in the engineering unit (Note 2) YS1360: -6.3 to 106.3%
D0029 to D0046		

Note 1: "5: BUA" and "6: BUM" can not be set. Set them with the engineering parameter BMOD1.

Note 2: The engineering units set with the engineering parameters, SCH1, SCL1, and SCDP1.

Note 3: Settable when operation mode is MAN or DDC. MV2 is enabled only in dual-loop control. MV1 and MV2 are the same in cascade control and selector control.

● Bit Configuration of D0047 to D0048: EVT_STS (Event indicating flag)

High/low level (Note)	Bit	Code	Event
Low level	0	EVT_EVENT1	User setting event 1 (0: OFF 1: ON)
	1	EVT_EVENT2	User setting event 2 (0: OFF 1: ON)
	2	EVT_EVENT3	User setting event 3 (0: OFF 1: ON)
	3	EVT_EVENT4	User setting event 4 (0: OFF 1: ON)
	4	EVT_EVENT5	User setting event 5 (0: OFF 1: ON)
	5 to 15		
High level	16 to 31		

Note: In these bit configurations, the D register setting for high/low level parameter is set to "0: H-L" (i.e. the first register is high level)

● D0051 to D0074

Register No.	Description	Range and Meaning of Value
D0051 to D0054	X1 to X2 Analog input 1 to Analog input 2	-25.0 to 125.0%
D0055 to D0070		
D0071 to D0072	Y1 Analog output 1	-20.0 to 106.3%
D0073 to D0074	Y2 Analog output 2	-6.3 to 106.3%

● Bit Configuration of D0087 to D0088: DISTATUS (Digital input status)

High/low level (Note)	Bit	Code	Event
Low level	0	DISTATUS_DI01	Digital input 1 (0: Contact inputs - open 1: Contact inputs - close)
	1	DISTATUS_DI02	Digital input 2 (0: Contact inputs - open 1: Contact inputs - close)
	2 to 15		
High level	16 to 31		

Note: In these bit configurations, the D register setting for high/low level parameter is set to "0: H-L" (i.e. the first register is high level).

● **Bit Configuration of D0089 to D0090: DOSTATUS (Digital output status)**

High/low level (Note)	Bit	Code	Event
Low level	0	DOSTATUS_DO1	Digital output 1 (0: Contact outputs - open 1: Contact outputs - close)
	1	DOSTATUS_DO2	Digital output 2 (0: Contact outputs - open 1: Contact outputs - close)
	2	DOSTATUS_DO3	Digital output 3 (0: Contact outputs - open 1: Contact outputs - close)
	3	DOSTATUS_DO4	Digital output 4 (0: Contact outputs - open 1: Contact outputs - close)
	4	DOSTATUS_DO5	Digital output 5 (0: Contact outputs - open 1: Contact outputs - close)
	5	DOSTATUS_DO6	Digital output 6 (0: Contact outputs - open 1: Contact outputs - close)
	6 to 15		
High level	16 to 31		

● **Bit Configuration of D0091 to D0092: EXT_EXE (External input function status)**

High/low level (Note)	Bit	Code	Event
Low level	0	EXT_EXE_AUT	EXT-AUT function
	1	EXT_EXE_MAN	EXT-MAN function
	2	EXT_EXE_PMV	EXT-PMV function
	3	EXT_EXE_TRK	EXT-TRK function
	4 to 15		
High level	16 to 31		

● **Bit Configuration of D0095 to D0096: MCUFAIL (MCU software FAIL)**

High/low level (Note)	Bit	Code	Event
Low level	0	MCU	Main microprocessor (MCU) abnormal
	1	AD	A/D converter faulty
	2	DA	D/A converter faulty
	3	ROM	MCU-ROM faulty
	4	RAM	MCU-RAM faulty
	5	FRAM	FRAM faulty
	6	SYS	System data abnormal
	7	FLASH	Flash memory faulty
	8	EMPFR	FRAM data non-initialized, FRAM data lost
	9	EMPFL	Flash data non-initialized, Flash data lost
	10	OPT	Communication/expandable I/O abnormal
	11		
	12	SCLK	Sub-clock stopped
13 to 15			
High level	16 to 31		

● **Bit Configuration of D0097 to D0098: DCUFAIL (DCU FAIL detected by MCU)**

High/low level (Note)	Bit	Code	Event
Low level	0	DCU	DCU abnormal
	1 to 15		
High level	16 to 31		

Note: In these bit configurations, the D register setting for high/low level parameter is set to "0: H-L" (i.e. the first register is high level).

● **D0099 to D0100**

Register No.	Description	Range and Meaning of Value
D0099 to D0100	ALMLAMP ALM lamp status	0: OFF 1: ON

7.5 Process Data (D0001 to D0400)

7.5.3 Alarm/Event (D0101 to D0300)

Register No.	Description	Range and Meaning of Value
D0101 to D0104	SYS_ALM_X1 to SYS_ALM_X2 Input 1 overrange to Input 2 overrange	0: Normal 1: Overrange
D0105 to D0116		
D0117 to D0118	SYS_ALM_Y1 Current output 1 open	0: Close 1: Open
D0119 to D0124		
D0125 to D0126	SYS_ALM_COMM Communication error	0: Normal 1: Alarm generation
D0127 to D0128	SYS_ALM_ETHER Ethernet communication error	
D0129 to D0132		
D0133 to D0134	SYS_ALM_DATA YSS writing not completed	0: OFF 1: ON
D0135 to D0136	SYS_ALM_CALR Factory adjustment inspection not completed	
D0137 to D0164		
D0165 to D0166	PRC_ALM_HH1 PV1 high-high limit alarm flag	0: Normal 1: Alarm
D0167 to D0168	PRC_ALM_LL1 PV1 low-low limit alarm flag	
D0169 to D0170	PRC_ALM_PH1 PV1 high limit alarm flag	
D0171 to D0172	PRC_ALM_PL1 PV1 low limit alarm flag	
D0173 to D0176		
D0177 to D0178	PRC_ALM_HH2 PV2 high-high limit alarm flag	0: Normal 1: Alarm
D0179 to D0180	PRC_ALM_LL2 PV2 low-low limit alarm flag	
D0181 to D0182	PRC_ALM_PH2 PV2 high limit alarm flag	
D0183 to D0184	PRC_ALM_PL2 PV2 low limit alarm flag	
D0185 to D0232		
D0233 to D0242	EVT_EVENT1 to EVT_EVENT 5 User setting event 1 to User setting event 5	0: Normal 1: Event generation
D0243 to D0246		
D0247 to D0248	EXT_EXE_AUT EXT-AUT function	0: OFF 1: ON
D0249 to D0250	EXT_EXE_MAN EXT-MAN function	
D0251 to D0252	EXT_EXE_PMV EXT-PMV function	
D0253 to D0254	EXT_EXE_TRK EXT-TRK function	
D0255 to D0300		

7.5.4 Digital Input/output (D0301 to D0400)

Register No.	Description	Range and Meaning of Value
D0301 to D0304	DISTATUS_DI01 to DISTATUS_DI02 Digital input 1 to Digital input 2	0: Contact inputs - open 1: Contact inputs - close
D0305 to D0332		
D0333 to D0344	DOSTATUS_DO1 to DOSTATUS_DO6 Digital output 1 to Digital output 6	0: DO status OFF 1: DO status ON
D0345 to D0400		

7.6 Tuning Parameters (D0401 to D0900)

Tuning parameters area						
Setting parameters						
D-Reg No.	Ref. No.	H No.	Register name	R/W		
				YS1310	YS1350	YS1360
D0401 to D0402	40401 to 40402	0190 to 0191				
D0403 to D0404	40403 to 40404	0192 to 0193				
D0405 to D0406	40405 to 40406	0194 to 0195				
D0407 to D0408	40407 to 40408	0196 to 0197				
D0409 to D0410	40409 to 40410	0198 to 0199				
D0411 to D0412	40411 to 40412	019A to 019B				
D0413 to D0414	40413 to 40414	019C to 019D				
D0415 to D0416	40415 to 40416	019E to 019F	PH1	R/W	R/W	R/W
D0417 to D0418	40417 to 40418	01A0 to 01A1	PL1	R/W	R/W	R/W
D0419 to D0420	40419 to 40420	01A2 to 01A3	HH1	R/W	x	x
D0421 to D0422	40421 to 40422	01A4 to 01A5	LL1	R/W	x	x
D0423 to D0424	40423 to 40424	01A6 to 01A7				
D0425 to D0426	40425 to 40426	01A8 to 01A9	HYS1	R/W	R/W	R/W
D0427 to D0428	40427 to 40428	01AA to 01AB				
D0429 to D0430	40429 to 40430	01AC to 01AD				
D0431 to D0432	40431 to 40432	01AE to 01AF	MH1	x	x	R/W
D0433 to D0434	40433 to 40434	01B0 to 01B1	ML1	x	x	R/W
D0435 to D0436	40435 to 40436	01B2 to 01B3				
D0437 to D0438	40437 to 40438	01B4 to 01B5				
D0439 to D0440	40439 to 40440	01B6 to 01B7				
D0441 to D0442	40441 to 40442	01B8 to 01B9				
D0443 to D0444	40443 to 40444	01BA to 01BB				
D0445 to D0446	40445 to 40446	01BC to 01BD				
D0447 to D0448	40447 to 40448	01BE to 01BF				
D0449 to D0450	40449 to 40450	01C0 to 01C1				
D0451 to D0452	40451 to 40452	01C2 to 01C3				
D0453 to D0454	40453 to 40454	01C4 to 01C5				
D0455 to D0456	40455 to 40456	01C6 to 01C7				
D0457 to D0458	40457 to 40458	01C8 to 01C9				
D0459 to D0460	40459 to 40460	01CA to 01CB				
D0461 to D0462	40461 to 40462	01CC to 01CD				
D0463 to D0464	40463 to 40464	01CE to 01CF				
D0465 to D0466	40465 to 40466	01D0 to 01D1	PH2	R/W	x	x
D0467 to D0468	40467 to 40468	01D2 to 01D3	PL2	R/W	x	x
D0469 to D0470	40469 to 40470	01D4 to 01D5	HH2	R/W	x	x
D0471 to D0472	40471 to 40472	01D6 to 01D7	LL2	R/W	x	x
D0473 to D0474	40473 to 40474	01D8 to 01D9				
D0475 to D0476	40475 to 40476	01DA to 01DB	HYS2	R/W	x	x
D0477 to D0478	40477 to 40478	01DC to 01DD				
D0479 to D0480	40479 to 40480	01DE to 01DF				
D0481 to D0482	40481 to 40482	01E0 to 01E1				
D0483 to D0484	40483 to 40484	01E2 to 01E3				
D0485 to D0486	40485 to 40486	01E4 to 01E5				
D0487 to D0488	40487 to 40488	01E6 to 01E7				
D0489 to D0490	40489 to 40490	01E8 to 01E9				
D0491 to D0492	40491 to 40492	01EA to 01EB				
D0493 to D0494	40493 to 40494	01EC to 01ED				
D0495 to D0496	40495 to 40496	01EE to 01EF				
D0497 to D0498	40497 to 40498	01F0 to 01F1				
D0499 to D0500	40499 to 40500	01F2 to 01F3				

7.6 Tuning Parameters (D0401 to D0900)

Tuning parameters area						
I/O parameters						
D-Reg No.	Ref. No.	H No.	Register name	R/W		
				YS1310	YS1350	YS1360
D0601 to D0602	40601 to 40602	0258 to 0259	PLC1	R/W	R/W	R/W
D0603 to D0604	40603 to 40604	025A to 025B	PLG1	R/W	R/W	R/W
D0605 to D0606	40605 to 40606	025C to 025D				
D0607 to D0608	40607 to 40608	025E to 025F				
D0609 to D0610	40609 to 40610	0260 to 0261				
D0611 to D0612	40611 to 40612	0262 to 0263				
D0613 to D0614	40613 to 40614	0264 to 0265				
D0615 to D0616	40615 to 40616	0266 to 0267				
D0617 to D0618	40617 to 40618	0268 to 0269				
D0619 to D0620	40619 to 40620	026A to 026B				
D0621 to D0622	40621 to 40622	026C to 026D				
D0623 to D0624	40623 to 40624	026E to 026F				
D0625 to D0626	40625 to 40626	0270 to 0271				
D0627 to D0628	40627 to 40628	0272 to 0273				
D0629 to D0630	40629 to 40630	0274 to 0275				
D0631 to D0632	40631 to 40632	0276 to 0277				
D0633 to D0634	40633 to 40634	0278 to 0279				
D0635 to D0636	40635 to 40636	027A to 027B				
D0637 to D0638	40637 to 40638	027C to 027D				
D0639 to D0640	40639 to 40640	027E to 027F				
D0641 to D0642	40641 to 40642	0280 to 0281				
D0643 to D0644	40643 to 40644	0282 to 0283				
D0645 to D0646	40645 to 40646	0284 to 0285				
D0647 to D0648	40647 to 40648	0286 to 0287				
D0649 to D0650	40649 to 40650	0288 to 0289				
D0651 to D0652	40651 to 40652	028A to 028B	PLC2	R/W	×	×
D0653 to D0654	40653 to 40654	028C to 028D	PLG2	R/W	×	×
D0655 to D0656	40655 to 40656	028E to 028F				
D0657 to D0658	40657 to 40658	0290 to 0291				
D0659 to D0660	40659 to 40660	0292 to 0293				
D0661 to D0662	40661 to 40662	0294 to 0295				
D0663 to D0664	40663 to 40664	0296 to 0297				
D0665 to D0666	40665 to 40666	0298 to 0299				
D0667 to D0668	40667 to 40668	029A to 029B				
D0669 to D0670	40669 to 40670	029C to 029D				
D0671 to D0672	40671 to 40672	029E to 029F				
D0673 to D0674	40673 to 40674	02A0 to 02A1				
D0675 to D0676	40675 to 40676	02A2 to 02A3				
D0677 to D0678	40677 to 40678	02A4 to 02A5				
D0679 to D0680	40679 to 40680	02A6 to 02A7				
D0681 to D0682	40681 to 40682	02A8 to 02A9				
D0683 to D0684	40683 to 40684	02AA to 02AB				
D0685 to D0686	40685 to 40686	02AC to 02AD				
D0687 to D0688	40687 to 40688	02AE to 02AF				
D0689 to D0690	40689 to 40690	02B0 to 02B1				
D0691 to D0692	40691 to 40692	02B2 to 02B3				
D0693 to D0694	40693 to 40694	02B4 to 02B5				
D0695 to D0696	40695 to 40696	02B6 to 02B7				
D0697 to D0698	40697 to 40698	02B8 to 02B9				
D0699 to D0700	40699 to 40700	02BA to 02BB				

7.6 Tuning Parameters (D0401 to D0900)

Tuning parameters area						
Special parameters						
D-Reg No.	Ref. No.	H No.	Register name	R/W		
				YS1310	YS1350	YS1360
D0701 to D0896	40701 to 40896					
D0897 to D0898	40897 to 40898	0380 to 0381	EDSOA	R	R	R
D0899 to D0900	40899 to 40900	0382 to 0383	CEDA	W	W	W

7.6 Tuning Parameters (D0401 to D0900)

7.6.1 Setting Parameters (D0401 to D0500)

Register No.	Description	Range and Meaning of Value
D0401 to D0414		
D0415 to D0416	PH1 High limit alarm setpoint for PV1	Equivalent to -6.3 to 106.3% in the engineering unit (Note 1) (Note 2)
D0417 to D0418	PL1 Low limit alarm setpoint for PV1	
D0419 to D0420	HH1 High-high limit alarm setpoint for PV1	
D0421 to D0422	LL1 Low-low limit alarm setpoint for PV1	
D0423 to D0424		
D0425 to D0426	HYS1 Alarm hysteresis 1	Equivalent to 0.0 to 20.0% in the engineering unit (Note 1)
D0427 to D0430		
D0431 to D0432	MH1 High limit setpoint of MV1	-6.3 to 106.3% (Note 3)
D0433 to D0434	ML1 Low limit setpoint of MV1	
D0435 to D0464		
D0465 to D0466	PH2 High limit alarm setpoint for PV2	Equivalent to -6.3 to 106.3% in the engineering unit (Note 1) (Note 2)
D0467 to D0468	PL2 Low limit alarm setpoint for PV2	
D0469 to D0470	HH2 High-high limit alarm setpoint for PV2	
D0471 to D0472	LL2 Low-low limit alarm setpoint for PV2	
D0473 to D0474		
D0475 to D0476	HYS2 Alarm hysteresis 2	Equivalent to 0.0 to 20.0% in the engineering unit (Note 1)
D0477 to D0500		

Note 1: The engineering units set with the engineering parameters, SCH1, SCL1, and SCDP1.

Note 2: If the high limit alarm setpoint for PV and the high-high limit alarm setpoint for PV are set to the maximum values, no alarm is generated.

If the low limit alarm setpoint for PV and the low-low limit alarm setpoint for PV are set to the minimum values, no alarm is generated.

Note 3: Be sure to set to MH1>ML1.

7.6.2 I/O Parameters (D0601 to D0700)

Register No.	Description	Range and Meaning of Value
D0601 to D0602	PLC1 Square root extraction low cutoff setpoint for PV1	0.0 to 100.0%
D0603 to D0604	PLG1 First order lag time constant for PV1	0.0 to 800.0 s (second)
D0605 to D0650		
D0651 to D0652	PLC2 Square root extraction low cutoff setpoint for PV2	0.0 to 100.0%
D0653 to D0654	PLG2 First order lag time constant of PV2	0.0 to 800.0 s (second)
D0655 to D0700		

7.6.3 Special Parameters (D0701 to D0900)

Register No.	Description	Range and Meaning of Value
D0701 to D0702		
D0897 to D0898	EDSOA Event display status	0: No 1 to 5: Display event 1 to 5
D0899 to D0900	CEDA Clear event display	1: Clear event display

7.7 Recognition Area/User Area (D0901 to D1000)

Recognition area/User area									
Recognition area					User area				
D-Reg No.	Ref. No.	H No.	Register name	R/W	D-Reg No.	Ref. No.	H No.	Register name	R/W
D0901 to D0902	40901 to 40902	0384 to 0385			D0951 to D0952	40951 to 40952	03B6 to 03B7	U1	R/W
D0903 to D0904	40903 to 40904	0386 to 0387			D0953 to D0954	40953 to 40954	03B8 to 03B9	U2	R/W
D0905 to D0906	40905 to 40906	0388 to 0389	REV	R	D0955 to D0956	40955 to 40956	03BA to 03BB	U3	R/W
D0907 to D0908	40907 to 40908	038A to 038B	REV	R	D0957 to D0958	40957 to 40958	03BC to 03BD	U4	R/W
D0909 to D0910	40909 to 40910	038C to 038D			D0959 to D0960	40959 to 40960	03BE to 03BF	U5	R/W
D0911 to D0912	40911 to 40912	038E to 038F			D0961 to D0962	40961 to 40962	03C0 to 03C1	U6	R/W
D0913 to D0914	40913 to 40914	0390 to 0391			D0963 to D0964	40963 to 40964	03C2 to 03C3	U7	R/W
D0915 to D0916	40915 to 40916	0392 to 0393			D0965 to D0966	40965 to 40966	03C4 to 03C5	U8	R/W
D0917 to D0918	40917 to 40918	0394 to 0395			D0967 to D0968	40967 to 40968	03C6 to 03C7	U9	R/W
D0919 to D0920	40919 to 40920	0396 to 0397			D0969 to D0970	40969 to 40970	03C8 to 03C9	U10	R/W
D0921 to D0922	40921 to 40922	0398 to 0399			D0971 to D0972	40971 to 40972	03CA to 03CB	U11	R/W
D0923 to D0924	40923 to 40924	039A to 039B			D0973 to D0974	40973 to 40974	03CC to 03CD	U12	R/W
D0925 to D0926	40925 to 40926	039C to 039D			D0975 to D0976	40975 to 40976	03CE to 03CF	U13	R/W
D0927 to D0928	40927 to 40928	039E to 039F			D0977 to D0978	40977 to 40978	03D0 to 03D1	U14	R/W
D0929 to D0930	40929 to 40930	03A0 to 03A1			D0979 to D0980	40979 to 40980	03D2 to 03D3	U15	R/W
D0931 to D0932	40931 to 40932	03A2 to 03A3			D0981 to D0982	40981 to 40982	03D4 to 03D5	U16	R/W
D0933 to D0934	40933 to 40934	03A4 to 03A5			D0983 to D0984	40983 to 40984	03D6 to 03D7	U17	R/W
D0935 to D0936	40935 to 40936	03A6 to 03A7			D0985 to D0986	40985 to 40986	03D8 to 03D9	U18	R/W
D0937 to D0938	40937 to 40938	03A8 to 03A9			D0987 to D0988	40987 to 40988	03DA to 03DB	U19	R/W
D0939 to D0940	40939 to 40940	03AA to 03AB			D0989 to D0990	40989 to 40990	03DC to 03DD	U20	R/W
D0941 to D0942	40941 to 40942	03AC to 03AD			D0991 to D0992	40991 to 40992	03DE to 03DF	U21	R/W
D0943 to D0944	40943 to 40944	03AE to 03AF			D0993 to D0994	40993 to 40994	03E0 to 03E1	U22	R/W
D0945 to D0946	40945 to 40946	03B0 to 03B1			D0995 to D0996	40995 to 40996	03E2 to 03E3	U23	R/W
D0947 to D0948	40947 to 40948	03B2 to 03B3			D0997 to D0998	40997 to 40998	03E4 to 03E5	U24	R/W
D0949 to D0950	40949 to 40950	03B4 to 03B5			D0999 to D1000	40999 to 41000	03E6 to 03E7	U25	R/W

7.7.1 Recognition Area (D0901 to D0950)

Register No.	Description	Range and Meaning of Value
D0901 to D0904		
D0905 to D0908	REV System revision number	8-digit of alphanumeric (One D register expresses two ASCII characters.) (Represent the product style number and revision number.) D0905 to D0908
D0909 to D0950		

7.7.2 User Area (D0951 to D1000)

Register No.	Description	Range and Meaning of Value
D0951 to D1000	U1 to U25	

7.8 Engineering Parameters (D1001 to D2000)

Engineering parameters 1 area						
CONFIG						
D-Reg No.	Ref. No.	H No.	Register name	R/W		
				YS1310	YS1350	YS1360
D1001 to D1002	41001 to 41002	03E8 to 03E9				
D1003 to D1004	41003 to 41004	03EA to 03EB	CTL	R	R	R
D1005 to D1006	41005 to 41006	03EC to 03ED	START	R/W	R/W	R/W
D1007 to D1008	41007 to 41008	03EE to 03EF				
D1009 to D1010	41009 to 41010	03F0 to 03F1				
D1011 to D1012	41011 to 41012	03F2 to 03F3				
D1013 to D1014	41013 to 41014	03F4 to 03F5				
D1015 to D1016	41015 to 41016	03F6 to 03F7				
D1017 to D1018	41017 to 41018	03F8 to 03F9				
D1019 to D1020	41019 to 41020	03FA to 03FB				
D1021 to D1022	41021 to 41022	03FC to 03FD	CAMLK	x	R/W	R/W
D1023 to D1024	41023 to 41024	03FE to 03FF	SVLK	x	R/W	x
D1025 to D1026	41025 to 41026	0400 to 0401	MVLK	x	x	R/W
D1027 to D1028	41027 to 41028	0402 to 0403				
D1029 to D1030	41029 to 41030	0404 to 0405				
D1031 to D1032	41031 to 41032	0406 to 0407				
D1033 to D1034	41033 to 41034	0408 to 0409				
D1035 to D1036	41035 to 41036	040A to 040B				
D1037 to D1038	41037 to 41038	040C to 040D				
D1039 to D1040	41039 to 41040	040E to 040F				
D1041 to D1042	41041 to 41042	0410 to 0411	CMOD1	x	R/W	R/W
D1043 to D1044	41043 to 41044	0412 to 0413				
D1045 to D1046	41045 to 41046	0414 to 0415				
D1047 to D1048	41047 to 41048	0416 to 0417				
D1049 to D1050	41049 to 41050	0418 to 0419				
D1051 to D1052	41051 to 41052	041A to 041B	PV1IN	x	R/W	R/W
D1053 to D1054	41053 to 41054	041C to 041D	UNIT1	R/W	R/W	R/W
D1055 to D1056	41055 to 41056	041E to 041F	UNIT1	R/W	R/W	R/W
D1057 to D1058	41057 to 41058	0420 to 0421	SCDP1	R/W	R/W	R/W
D1059 to D1060	41059 to 41060	0422 to 0423				
D1061 to D1062	41061 to 41062	0424 to 0425				
D1063 to D1064	41063 to 41064	0426 to 0427	VDIR1	x	x	R/W
D1065 to D1066	41065 to 41066	0428 to 0429	SCDV1	R/W	R/W	R/W
D1067 to D1068	41067 to 41068	042A to 042B	SCH1	R/W	R/W	R/W
D1069 to D1070	41069 to 41070	042C to 042D	SCL1	R/W	R/W	R/W
D1071 to D1072	41071 to 41072	042E to 042F				
D1073 to D1074	41073 to 41074	0430 to 0431				
D1075 to D1076	41075 to 41076	0432 to 0433				
D1077 to D1078	41077 to 41078	0434 to 0435				
D1079 to D1080	41079 to 41080	0436 to 0437				
D1081 to D1082	41081 to 41082	0438 to 0439	PV2IN	R/W	x	x
D1083 to D1084	41083 to 41084	043A to 043B	UNIT2	R/W	x	x
D1085 to D1086	41085 to 41086	043C to 043D	UNIT2	R/W	x	x
D1087 to D1088	41087 to 41088	043E to 043F	SCDP2	R/W	x	x
D1089 to D1090	41089 to 41090	0440 to 0441	SCH2	R/W	x	x
D1091 to D1092	41091 to 41092	0442 to 0443	SCL2	R/W	x	x
D1093 to D1094	41093 to 41094	0444 to 0445				
D1095 to D1096	41095 to 41096	0446 to 0447	SCDV2	R/W	x	x
D1097 to D1098	41097 to 41098	0448 to 0449	RSDISP	R	R	R
D1099 to D1100	41099 to 41100	044A to 044B				

Note: When the operation status is STOP via communication (RSCOMM=1), data can be written to all engineering parameters 1.

7.8 Engineering Parameters (D1001 to D2000)

Engineering parameters 1 area						
I/O computation setting, Alarm setting						
D-Reg No.	Ref. No.	H No.	Register name	R/W		
				YS1310	YS1350	YS1360
D1101 to D1102	41101 to 41102	044C to 044D				
D1103 to D1104	41103 to 41104	044E to 044F				
D1105 to D1106	41105 to 41106	0450 to 0451				
D1107 to D1108	41107 to 41108	0452 to 0453				
D1109 to D1110	41109 to 41110	0454 to 0455				
D1111 to D1112	41111 to 41112	0456 to 0457				
D1113 to D1114	41113 to 41114	0458 to 0459				
D1115 to D1116	41115 to 41116	045A to 045B				
D1117 to D1118	41117 to 41118	045C to 045D				
D1119 to D1120	41119 to 41120	045E to 045F				
D1121 to D1122	41121 to 41122	0460 to 0461	PSR1	R/W	R/W	R/W
D1123 to D1124	41123 to 41124	0462 to 0463				
D1125 to D1126	41125 to 41126	0464 to 0465				
D1127 to D1128	41127 to 41128	0466 to 0467				
D1129 to D1130	41129 to 41130	0468 to 0469				
D1131 to D1132	41131 to 41132	046A to 046B	PSR2	R/W	×	×
D1133 to D1134	41133 to 41134	046C to 046D				
D1135 to D1136	41135 to 41136	046E to 046F				
D1137 to D1138	41137 to 41138	0470 to 0471				
D1139 to D1140	41139 to 41140	0472 to 0473				
D1141 to D1142	41141 to 41142	0474 to 0475	ASW1	R/W	×	×
D1143 to D1144	41143 to 41144	0476 to 0477	ASW2	R/W	×	×
D1145 to D1146	41145 to 41146	0478 to 0479	ASW3	R/W	×	×
D1147 to D1148	41147 to 41148	047A to 047B	ASW4	R/W	×	×
D1149 to D1150	41149 to 41150	047C to 047D	ASW5	R/W	×	×
D1151 to D1152	41151 to 41152	047E to 047F	ASW6	R/W	×	×
D1153 to D1154	41153 to 41154	0480 to 0481				
D1155 to D1156	41155 to 41156	0482 to 0483				
D1157 to D1158	41157 to 41158	0484 to 0485				
D1159 to D1160	41159 to 41160	0486 to 0487				
D1161 to D1162	41161 to 41162	0488 to 0489	ANOR1	R/W	×	×
D1163 to D1164	41163 to 41164	048A to 048B	ANOR2	R/W	×	×
D1165 to D1166	41165 to 41166	048C to 048D	ANOR3	R/W	×	×
D1167 to D1168	41167 to 41168	048E to 048F	ANOR4	R/W	×	×
D1169 to D1170	41169 to 41170	0490 to 0491	ANOR5	R/W	×	×
D1171 to D1172	41171 to 41172	0492 to 0493	ANOR6	R/W	×	×
D1173 to D1174	41173 to 41174	0494 to 0495				
D1175 to D1176	41175 to 41176	0496 to 0497				
D1177 to D1178	41177 to 41178	0498 to 0499				
D1179 to D1180	41179 to 41180	049A to 049B				
D1181 to D1182	41181 to 41182	049C to 049D	TAG1	R/W	R/W	R/W
D1183 to D1184	41183 to 41184	049E to 049F	TAG1	R/W	R/W	R/W
D1185 to D1186	41185 to 41186	04A0 to 04A1	TAG1	R/W	R/W	R/W
D1187 to D1188	41187 to 41188	04A2 to 04A3	TAG2	R/W	×	×
D1189 to D1190	41189 to 41190	04A4 to 04A5	TAG2	R/W	×	×
D1191 to D1192	41191 to 41192	04A6 to 04A7	TAG2	R/W	×	×
D1193 to D1194	41193 to 41194	04A8 to 04A9				
D1195 to D1196	41195 to 41196	04AA to 04AB				
D1197 to D1198	41197 to 41198	04AC to 04AD				
D1199 to D1200	41199 to 41200	04AE to 04AF				

Note: When the operation status is STOP via communication (RSCOMM=1), data can be written to all engineering parameters 1.

7.8 Engineering Parameters (D1001 to D2000)

Engineering parameters 1 area						
Display setting, Contrast						
D-Reg No.	Ref. No.	H No.	Register name	R/W		
				YS1310	YS1350	YS1360
D1201 to D1202	41201 to 41202	04B0 to 04B1	LOOP1	R/W	R/W	R/W
D1203 to D1204	41203 to 41204	04B2 to 04B3	LOOP2	R/W	×	×
D1205 to D1206	41205 to 41206	04B4 to 04B5	TRND1	R/W	R/W	R/W
D1207 to D1208	41207 to 41208	04B6 to 04B7	TRND2	R/W	R/W	R/W
D1209 to D1210	41209 to 41210	04B8 to 04B9	TRND3	R/W	×	×
D1211 to D1212	41211 to 41212	04BA to 04BB	ALARM	R/W	R/W	R/W
D1213 to D1214	41213 to 41214	04BC to 04BD	DUAL	R/W	×	×
D1215 to D1216	41215 to 41216	04BE to 04BF				
D1217 to D1218	41217 to 41218	04C0 to 04C1				
D1219 to D1220	41219 to 41220	04C2 to 04C3	MTR1	R/W	R/W	R/W
D1221 to D1222	41221 to 41222	04C4 to 04C5	MTR2	R/W	×	×
D1223 to D1224	41223 to 41224	04C6 to 04C7	FDSP	R/W	R/W	R/W
D1225 to D1226	41225 to 41226	04C8 to 04C9	MTMG1	R/W	R/W	R/W
D1227 to D1228	41227 to 41228	04CA to 04CB	MTMG2	R/W	×	×
D1229 to D1230	41229 to 41230	04CC to 04BD	TR1PV	R/W	R/W	R/W
D1231 to D1232	41231 to 41232	04CE to 04CF	TR1SV	×	R/W	×
D1233 to D1234	41233 to 41234	04D0 to 04D1	TR1MV	×	×	R/W
D1235 to D1236	41235 to 41236	04D2 to 04D3	TR2PV	R/W	×	×
D1237 to D1238	41237 to 41238	04D4 to 04D5				
D1239 to D1240	41239 to 41240	04D6 to 04D7				
D1241 to D1242	41241 to 41242	04D8 to 04D9	TRDS1	R/W	R/W	R/W
D1243 to D1244	41243 to 41244	04DA to 04DB	TRDS2	R/W	R/W	R/W
D1245 to D1246	41245 to 41246	04DC to 04DD	TRDS3	R/W	R/W	R/W
D1247 to D1248	41247 to 41248	04DE to 04DF	TRDS4	R/W	R/W	R/W
D1249 to D1250	41249 to 41250	04E0 to 04E1	TRDT1	R/W	R/W	R/W
D1251 to D1252	41251 to 41252	04E2 to 04E3	TRDT2	R/W	×	×
D1253 to D1254	41253 to 41254	04E4 to 04E5	TRDT3	R/W	R/W	R/W
D1255 to D1256	41255 to 41256	04E6 to 04E7	TR3DV	R/W	R/W	R/W
D1257 to D1258	41257 to 41258	04E8 to 04E9	ACTD1	R/W	R/W	R/W
D1259 to D1260	41259 to 41260	04EA to 04EB	ACTD2	R/W	×	×
D1261 to D1262	41261 to 41262	04EC to 04ED	TAGAL	R/W	R/W	R/W
D1263 to D1264	41263 to 41264	04EE to 04EF	LP1C	R/W	R/W	R/W
D1265 to D1266	41265 to 41266	04F0 to 04F1	LP2C	R/W	×	×
D1267 to D1268	41267 to 41268	04F2 to 04F3	BKCL	R/W	R/W	R/W
D1269 to D1270	41269 to 41270	04F4 to 04F5				
D1271 to D1272	41271 to 41272	04F6 to 04F7	ECO	R/W	R/W	R/W
D1273 to D1274	41273 to 41274	04F8 to 04F9	BRT	R/W	R/W	R/W
D1275 to D1276	41275 to 41276	04FA to 04FB				
D1277 to D1278	41277 to 41278	04FC to 04FD				
D1279 to D1280	41279 to 41280	04FE to 04FF				
D1281 to D1282	41281 to 41282	0500 to 0501				
D1283 to D1284	41283 to 41284	0502 to 0503				
D1285 to D1286	41285 to 41286	0504 to 0505				
D1287 to D1288	41287 to 41288	0506 to 0507				
D1289 to D1290	41289 to 41290	0508 to 0509				
D1291 to D1292	41291 to 41292	050A to 050B				
D1293 to D1294	41293 to 41294	050C to 050D				
D1295 to D1296	41295 to 41296	050E to 050F				
D1297 to D1298	41297 to 41298	0510 to 0511				
D1299 to D1300	41299 to 41300	0512 to 0513				

Note: When the operation status is STOP via communication (RSCOMM=1), data can be written to all engineering parameters 1. However, ECO and BRT parameters are excluded.

7.8 Engineering Parameters (D1001 to D2000)

Engineering parameters 1 area						
Communication setting						
D-Reg No.	Ref. No.	H No.	Register name	R/W		
				YS1310	YS1350	YS1360
D1301 to D1302	41301 to 41302	0514 to 0515	PSL	R/W	R/W	R/W
D1303 to D1304	41303 to 41304	0516 to 0517				
D1305 to D1306	41305 to 41306	0518 to 0519	ADRS	R/W	R/W	R/W
D1307 to D1308	41307 to 41308	051A to 051B	STBIT	R/W	R/W	R/W
D1309 to D1310	41309 to 41310	051C to 051D	PAR	R/W	R/W	R/W
D1311 to D1312	41311 to 41312	051E to 051F	DLEN	R/W	R/W	R/W
D1313 to D1314	41313 to 41314	0520 to 0521	BPS	R/W	R/W	R/W
D1315 to D1316	41315 to 41316	0522 to 0523				
D1317 to D1318	41317 to 41318	0524 to 0525	TRMR	R/W	R/W	R/W
D1319 to D1320	41319 to 41320	0526 to 0527	CMWDT	R/W	R/W	R/W
D1321 to D1322	41321 to 41322	0528 to 0529	ETRWR	R/W	R/W	R/W
D1323 to D1324	41323 to 41324	052A to 052B	IPAD1	R/W	R/W	R/W
D1325 to D1326	41325 to 41326	052C to 052D	IPAD2	R/W	R/W	R/W
D1327 to D1328	41327 to 41328	052E to 052F	IPAD3	R/W	R/W	R/W
D1329 to D1330	41329 to 41330	0530 to 0531	IPAD4	R/W	R/W	R/W
D1331 to D1332	41331 to 41332	0532 to 0533	SM1	R/W	R/W	R/W
D1333 to D1334	41333 to 41334	0534 to 0535	SM2	R/W	R/W	R/W
D1335 to D1336	41335 to 41336	0536 to 0537	SM3	R/W	R/W	R/W
D1337 to D1338	41337 to 41338	0538 to 0539	SM4	R/W	R/W	R/W
D1339 to D1340	41339 to 41340	053A to 053B	DG1	R/W	R/W	R/W
D1341 to D1342	41341 to 41342	053C to 053D	DG2	R/W	R/W	R/W
D1343 to D1344	41343 to 41344	053E to 053F	DG3	R/W	R/W	R/W
D1345 to D1346	41345 to 41346	0540 to 0541	DG4	R/W	R/W	R/W
D1347 to D1348	41347 to 41348	0542 to 0543	PORT	R/W	R/W	R/W
D1349 to D1350	41349 to 41350	0544 to 0545	ESW	R/W	R/W	R/W
D1351 to D1352	41351 to 41352	0546 to 0547	DREG1	R/W	R/W	R/W
D1353 to D1354	41353 to 41354	0548 to 0549	DREG2	R/W	R/W	R/W
D1355 to D1356	41355 to 41356	054A to 054B	COMM	R	R	R
D1357 to D1358	41357 to 41358	054C to 054D	ECTO	R/W	R/W	R/W
D1359 to D1360	41359 to 41360	054E to 054F				
D1361 to D1362	41361 to 41362	0550 to 0551				
D1363 to D1364	41363 to 41364	0552 to 0553				
D1365 to D1366	41365 to 41366	0554 to 0555				
D1367 to D1368	41367 to 41368	0556 to 0557				
D1369 to D1370	41369 to 41370	0558 to 0559				
D1371 to D1372	41371 to 41372	055A to 055B				
D1373 to D1374	41373 to 41374	055C to 055D				
D1375 to D1376	41375 to 41376	055E to 055F				
D1377 to D1378	41377 to 41378	0560 to 0561				
D1379 to D1380	41379 to 41380	0562 to 0563				
D1381 to D1382	41381 to 41382	0564 to 0565				
D1383 to D1384	41383 to 41384	0566 to 0567				
D1385 to D1386	41385 to 41386	0568 to 0569				
D1387 to D1388	41387 to 41388	056A to 056B				
D1389 to D1390	41389 to 41390	056C to 056D				
D1391 to D1392	41391 to 41392	056E to 056F				
D1393 to D1394	41393 to 41394	0570 to 0571				
D1395 to D1396	41395 to 41396	0572 to 0573				
D1397 to D1398	41397 to 41398	0574 to 0575				
D1399 to D1400	41399 to 41400	0576 to 0577				

Note: When the operation status is STOP via communication (RSCOMM=1), data can be written to all engineering parameters 1.

7.8 Engineering Parameters (D1001 to D2000)

Engineering parameters 2 area						
DI/DO setting						
D-Reg No.	Ref. No.	H No.	Register name	R/W		
				YS1310	YS1350	YS1360
D1701 to D1702	41701 to 41702	06A4 to 06A5	DIO16	R/W	x	x
D1703 to D1704	41703 to 41704	06A6 to 06A7				
D1705 to D1706	41705 to 41706	06A8 to 06A9				
D1707 to D1708	41707 to 41708	06AA to 06AB				
D1709 to D1710	41709 to 41710	06AC to 06AD				
D1711 to D1712	41711 to 41712	06AE to 06AF				
D1713 to D1714	41713 to 41714	06B0 to 06B1				
D1715 to D1716	41715 to 41716	06B2 to 06B3	DISELECT	x	R/W	R/W
D1717 to D1718	41717 to 41718	06B4 to 06B5	DI1D	R/W	R/W	R/W
D1719 to D1720	41719 to 41720	06B6 to 06B7	DI2D	x	R/W	R/W
D1721 to D1722	41721 to 41722	06B8 to 06B9				
D1723 to D1724	41723 to 41724	06BA to 06BB				
D1725 to D1726	41725 to 41726	06BC to 06BD				
D1727 to D1728	41727 to 41728	06BE to 06BF				
D1729 to D1730	41729 to 41730	06C0 to 06C1				
D1731 to D1732	41731 to 41732	06C2 to 06C3				
D1733 to D1734	41733 to 41734	06C4 to 06C5				
D1735 to D1736	41735 to 41736	06C6 to 06C7				
D1737 to D1738	41737 to 41738	06C8 to 06C9	DI1F	R/W	R/W	R/W
D1739 to D1740	41739 to 41740	06CA to 06CB	DI2F	x	R/W	R/W
D1741 to D1742	41741 to 41742	06CC to 06CD				
D1743 to D1744	41743 to 41744	06CE to 06CF				
D1745 to D1746	41745 to 41746	06D0 to 06D1				
D1747 to D1748	41747 to 41748	06D2 to 06D3				
D1749 to D1750	41749 to 41750	06D4 to 06D5				
D1751 to D1752	41751 to 41752	06D6 to 06D7				
D1753 to D1754	41753 to 41754	06D8 to 06D9				
D1755 to D1756	41755 to 41756	06DA to 06DB				
D1757 to D1758	41757 to 41758	06DC to 06DD				
D1759 to D1760	41759 to 41760	06DE to 06DF	DOSELECT	R/W	R/W	R/W
D1761 to D1762	41761 to 41762	06E0 to 06E1	DO1D	R/W	R/W	R/W
D1763 to D1764	41763 to 41764	06E2 to 06E3	DO2D	R/W	R/W	R/W
D1765 to D1766	41765 to 41766	06E4 to 06E5	DO3D	R/W	x	x
D1767 to D1768	41767 to 41768	06E6 to 06E7	DO4D	R/W	R/W	R/W
D1769 to D1770	41769 to 41770	06E8 to 06E9	DO5D	R/W	x	x
D1771 to D1772	41771 to 41772	06EA to 06EB	DO6D	R/W	x	x
D1773 to D1774	41773 to 41774	06EC to 06ED				
D1775 to D1776	41775 to 41776	06EE to 06EF				
D1777 to D1778	41777 to 41778	06F0 to 06F1				
D1779 to D1780	41779 to 41780	06F2 to 06F3				
D1781 to D1782	41781 to 41782	06F4 to 06F5	DO1F	x	x	R/W
D1783 to D1784	41783 to 41784	06F6 to 06F7	DO2F	x	x	R/W
D1785 to D1786	41785 to 41786	06F8 to 06F9				
D1787 to D1788	41787 to 41788	06FA to 06FB	DO4F	x	x	R/W
D1789 to D1790	41789 to 41790	06FC to 06FD				
D1791 to D1792	41791 to 41792	06FE to 06FF				
D1793 to D1794	41793 to 41794	0700 to 0701				
D1795 to D1796	41795 to 41796	0702 to 0703				
D1797 to D1798	41797 to 41798	0704 to 0705				
D1799 to D1800	41799 to 41800	0706 to 0707				

7.8 Engineering Parameters (D1001 to D2000)

Engineering parameters 2 area						
Communication access						
D-Reg No.	Ref. No.	H No.	Register name	R/W		
				YS1310	YS1350	YS1360
D1801 to D1802	41801 to 41802	0708 to 0709				
D1803 to D1804	41803 to 41804	070A to 070B				
D1805 to D1806	41805 to 41806	070C to 070D				
D1807 to D1808	41807 to 41808	070E to 070F				
D1809 to D1810	41809 to 41810	0710 to 0711				
D1811 to D1812	41811 to 41812	0712 to 0713	RSCOMM	R/W	R/W	R/W
D1813 to D1814	41813 to 41814	0714 to 0715				
D1815 to D1816	41815 to 41816	0716 to 0717				
D1817 to D1818	41817 to 41818	0718 to 0719				
D1819 to D1820	41819 to 41820	071A to 071B				
D1821 to D1822	41821 to 41822	071C to 071D	COMWR	R/W	R/W	R/W
D1823 to D1824	41823 to 41824	071E to 071F				
D1825 to D1826	41825 to 41826	0720 to 0721				
D1827 to D1828	41827 to 41828	0722 to 0723				
D1829 to D1830	41829 to 41830	0724 to 0725				
D1831 to D1832	41831 to 41832	0726 to 0727				
D1833 to D1834	41833 to 41834	0728 to 0729				
D1835 to D1836	41835 to 41836	072A to 072B				
D1837 to D1838	41837 to 41838	072C to 072D				
D1839 to D1840	41839 to 41840	072E to 072F				
D1841 to D1842	41841 to 41842	0730 to 0731				
D1843 to D1844	41843 to 41844	0732 to 0733				
D1845 to D1846	41845 to 41846	0734 to 0735				
D1847 to D1848	41847 to 41848	0736 to 0737				
D1849 to D1850	41849 to 41850	0738 to 0739				
D1851 to D1852	41851 to 41852	073A to 073B				
D1853 to D1854	41853 to 41854	073C to 073D				
D1855 to D1856	41855 to 41856	073E to 073F				
D1857 to D1858	41857 to 41858	0740 to 0741				
D1859 to D1860	41859 to 41860	0742 to 0743				
D1861 to D1862	41861 to 41862	0744 to 0745				
D1863 to D1864	41863 to 41864	0746 to 0747				
D1865 to D1866	41865 to 41866	0748 to 0749				
D1867 to D1868	41867 to 41868	074A to 074B				
D1869 to D1870	41869 to 41870	074C to 074D				
D1871 to D1872	41871 to 41872	074E to 074F				
D1873 to D1874	41873 to 41874	0750 to 0751				
D1875 to D1876	41875 to 41876	0752 to 0753				
D1877 to D1878	41877 to 41878	0754 to 0755				
D1879 to D1880	41879 to 41880	0756 to 0757				
D1881 to D1882	41881 to 41882	0758 to 0759				
D1883 to D1884	41883 to 41884	075A to 075B				
D1885 to D1886	41885 to 41886	075C to 075D				
D1887 to D1888	41887 to 41888	075E to 075F				
D1889 to D1890	41889 to 41890	0760 to 0761				
D1891 to D1892	41891 to 41892	0762 to 0763				
D1893 to D1894	41893 to 41894	0764 to 0765				
D1895 to D1896	41895 to 41896	0766 to 0767				
D1897 to D1898	41897 to 41898	0768 to 0769				
D1899 to D1900	41899 to 41900	076A to 076B				

7.8 Engineering Parameters (D1001 to D2000)

7.8.1 CONFIG (D1001 to D1100)

Register No.	Description	Range and Meaning of Value
D1001 to D1002		
D1003 to D1004	CTL Operation mode display	4: ALMSTN (YS1310 only) 5: SVSTN (YS1350 only) 6: MVSTN (YS1360 only)
D1005 to D1006	START Start mode (Note 1)	0: AUT (HOT start) 1: M-COLD (Power failure duration<2 sec.; HOT Start, Power failure duration≥2 sec.; M-COLD start) 3: C-COLD (Power failure duration<2 sec.; HOT Start, Power failure duration≥2 sec.; C-COLD start) 4: COLD (Power failure duration<2 sec.; HOT Start, Power failure duration≥2 sec.; COLD start)
D1007 to D1020		
D1021 to D1022	CAMLK Keylock for C/M mode change	0: UNLOCK 1: LOCK
D1023 to D1024	SVLK Keylock for SV change	
D1025 to D1026	MVLK Keylock for MV change	
D1027 to D1032		
D1033 to D1040		
D1041 to D1042	CMOD1 C-mode 1	0: - (None) 1: CAS (Analog cascade setting mode) 2: CMP (Computer cascade setting mode)
D1043 to D1050		
D1051 to D1052	PV1IN PV1 input specification	0: Not use, 1: Use PV1
D1053 to D1056	UNIT1 Engineering unit 1	7-digit alphanumeric D1053 to D1056
D1057 to D1058	SCDP1 Decimal point position 1	0: ##### 1: #####.# 2: ###.### 3: ##.### 4: #.#####
D1059 to D1062		
D1063 to D1064	VDIR1 Valve direction 1	0: C-O (MV 0%=Close, 100%=Open) 1: O-C (MV 0%=Open, 100%=Close)
D1065 to D1066	SCDV1 Scale division 1	0: 1 1: 2 2: 4 3: 5 4: 7 5: 10 6: 14 7: 20 divisions
D1067 to D1068	SCH1 100% value of scale 1	-80000 to 80000
D1069 to D1070	SCL1 0% value of scale 1	
D1071 to D1080		
D1081 to D1082	PV2IN PV2 input specification	0: - (None) 1: X2 (PV2 is used.)
D1083 to D1086	UNIT2 Engineering unit 2	As same as D1053 to D1070
D1087 to D1088	SCDP2 Decimal point position 2	
D1089 to D1090	SCH2 100% value of scale 2	
D1091 to D1092	SCL2 0% value of scale 2	
D1093 to D1094		
D1095 to D1096	SCVD2 Scale division 2	
D1097 to D1098	RSDISP Operation status display	0: RUN 1: STOP
D1099 to D1100		

Note 1: For YS1310, only [0: AUT] or [1: COLD] can be selected.

7.8.2 I/O Computation Setting, Alarm Setting (D1101 to D1200)

Register No.	Description	Range and Meaning of Value
D1101 to D1120		
D1121 to D1122	PSR1 Square root extraction for PV1	0: OFF 1: ON
D1123 to D1130		
D1131 to D1132	PSR2 Square root extraction for PV2	0: OFF 1: ON
D1133 to D1140		
D1141 to D1152	ASW1 to ASW5 Alarm 1 output connection to Alarm 6 output connection	0 to 255
D1153 to D1160		
D1161 to D1172	ANOR1 to ANOR6 Alarm 1 AND/OR selection to Alarm 6 AND/OR selection	0: OR 1: AND
D1173 to D1180		
D1181 to D1182		
D1183 to D1184	TAG1 Tag number 1	12-digit Alphanumeric D1181 to D1186
D1185 to D1186		
D1187 to D1188		
D1189 to D1190	TAG2 Tag number 2	As same as D1181 to D1186
D1191 to D1192		
D1193 to D1200		

7.8 Engineering Parameters (D1001 to D2000)

7.8.3 Display Setting, Contrast (D1201 to D1300)

Register No.	Description	Range and Meaning of Value
D1201 to D1202	LOOP1 LOOP 1 Display ON/OFF	0: OFF 1: ON (Note 1)
D1203 to D1204	LOOP2 LOOP 2 Display ON/OFF	
D1205 to D1206	TRND1 TREND 1 Display ON/OFF	
D1207 to D1208	TRND2 TREND 2 Display ON/OFF	
D1209 to D1210	TRND3 TREND 3 Display ON/OFF	
D1211 to D1212	ALARM ALARM Display ON/OFF	
D1213 to D1214	DUAL DUAL Display ON/OFF	
D1215 to D1218		
D1219 to D1220	MTR1 METER 1 Display ON/OFF	
D1221 to D1222	MTR2 METER 2 Display ON/OFF	
D1223 to D1224	FDSP Power-on initial display	0: LOOP1 (LOOP 1 Display) 1: LOOP2 (LOOP 2 Display) (Note 2) 2: MTR1 (METER 1 Display) 3: MTR2 (METER 2 Display) (Note 2) 4: TRND1 (TREND1 Display) 5: TRND2 (TREND2 Display) (Note 2) 6: TRND3 (TREND 3 Display) 7: ALARM (ALARM Display) 8: DUAL (DUAL Display) (Note 2)
D1225 to D1226	MTMG1 10-exponential scale factor for METER 1 Display	0: AUTO 1: 10 ⁻⁵ 2: 10 ⁻⁴ 3: 10 ⁻³ 4: 10 ⁻² 5: 10 ⁻¹
D1227 to D1228	MTMG2 10-exponential scale factor for METER 2 Display	6: 10 ⁰ 7: 10 ¹ 8: 10 ² 9: 10 ³ 10: 10 ⁴ 11: 10 ⁵
D1229 to D1230	TR1PV PV1 trend ON/OFF for TREND 1 Display	0: OFF 1: ON
D1231 to D1232	TR1SV SV1 trend ON/OFF for TREND 1 Display	
D1233 to D1234	TR1MV MV1 trend ON/OFF for TREND 1 Display	
D1235 to D1236	TR2PV PV2 trend ON/OFF for TREND 2 Display	
D1237 to D1240		
D1241 to D1242	TRDS1 Data selection 1 for TREND 3 Display	0: OFF (None) 1: PV1 (Process variable 1) 2: SV1 (Setpoint value 1) (Note 4) 3: MV1 (Manipulated output variable 1) (Note 5) 4: PV2 (Process variable 2) (Note 2) 7: X1 (Analog input 1) 8: X2 (Analog input 2) 15: Y1 (Analog output 1) (Note 5) 16: Y2 (Analog output 2) (Note 6)
D1243 to D1244	TRDS2 Data selection 2 for TREND 3 Display	
D1245 to D1246	TRDS3 Data selection 3 for TREND 3 Display	
D1247 to D1248	TRDS4 Data selection 4 for TREND 3 Display	
D1249 to D1250	TRDT1 TREND 1 Display time span	0: 1M (1min.) 1: 5M (5min.) 2: 10M (10min.) 3: 30M (30min.) 4: 1H (1hour) 5: 5H (5hours) 6: 10H (10hours) 7: 30H (30hours)
D1251 to D1252	TRDT2 TREND 2 Display time span	
D1253 to D1254	TRDT3 TREND 3 Display time span	
D1255 to D1256	TR3DV Scale division for TREND 3 Display	0: 1 1: 2 2: 4 3: 5 4: 7 5: 10 6: 14 7: 20 divisions
D1257 to D1258	ACTD1 Active color display selection 1	0: OFF (None) 1: PH1 (High limit alarm setpoint for PV1) 2: PL1 (Low limit alarm setpoint for PV1) 3: HH1 (High-high limit alarm setpoint for PV1) (Note 2) 4: LL1 (Low-low limit alarm setpoint for PV1) (Note 2) 8: 1-ALM (OR for all alarms of the Loop 1)
D1259 to D1260	ACTD2 Active color display selection 2	0: OFF (None) 1: PH2 (High limit alarm setpoint for PV2) 2: PL2 (Low limit alarm setpoint for PV2) 3: HH2 (High-high limit alarm setpoint for PV2) 4: LL2 (Low-low limit alarm setpoint for PV2) 8: 2-ALM (OR for all alarms of the Loop 2)
D1261 to D1262	TAGAL Color inversion of tag number	0: OFF 1: ON
D1263 to D1264	LP1C LOOP 1 color selection	0: GREEN 1: AQUA 2: PINK 3: ORANGE
D1265 to D1266	LP2C LOOP 2 color selection	
D1267 to D1268	BKCL Background color selection	
D1269 to D1270		0: BLACK 1: WHITE 2: BLUE
D1271 to D1272	ECO LCD backlight auto-off timer	0: OFF 1: ON (OFF timer: 30 min)
D1273 to D1274	BRT LCD brightness adjustment	0 to 5
D1275 to D1276		
D1277 to D1300		

Note 1: LOOP1 is always displayed even if you set "OFF" for all lines.

Note 2: YS1350 and YS1360 can not use the setting value.

Note 3: When you do not use TRND3, set it to "OFF".

Note 4: YS1310 and YS1360 can not use the setting value.

Note 5: YS1310 and YS1350 can not use the setting value.

Note 6: YS1310 can not use the setting value.

7.8.4 Communication Setting (D1301 to D1400)

Register No.	Description	Range and Meaning of Value
D1301 to D1302	PSL RS-485 Protocol selection (Note 1)	0: PCL (PC-link communication) 1: PCLSUM (PC-link communication (with checksum)) 2: MODASC (Modbus communication (ASCII)) 3: MODRTU (Modbus communication (RTU)) 4: YS (YS protocol)
D1303 to D1304		
D1305 to D1306	ADRS RS-485 communication address (Note 1)	1 to 99
D1307 to D1308	STBIT RS-485 stop bit (Note 1)	0: 1 bit 1: 2 bit
D1309 to D1310	PAR RS-485 parity (Note 1)	0: NONE 1: ODD 2: EVEN
D1311 to D1312	DLEN RS-485 data length (Note 1)	0: 7 bit 1: 8 bit
D1313 to D1314	BPS RS-485 baud rate (Note 1)	0: 1200 1: 2400 2: 4800 3: 9600 4: 19200 5: 38400
D1315 to D1316		
D1317 to D1318	TRMR RS-485 communication terminating resistor ON/OFF (Note 1)	0: OFF 1: ON
D1319 to D1320	CMWDT Communication watchdog timer (Note 1)	0 to 9999 s (second)
D1321 to D1322	ETRWR Enable/Disable writing via Ethernet communication (Note 2)	0: ENBL (Setting possible) 1: INHB (Setting impossible)
D1323 to D1330	IPAD1 to IPAD4 IP address 1 to IP address 4 (Note 2)	0 to 255
D1331 to D1338	SM1 to SM4 Subnet mask 1 to Subnet mask 4 (Note 2)	
D1339 to D1346	DG1 to DG4 Default gateway 1 to Default gateway 4 (Note 2)	
D1347 to D1348	PORT Port number (Note 2)	502, 1024 to 65535
D1349 to D1350	ESW Ethernet setting switch (Note 2)	0: - 1: ENTRY
D1351 to D1352	DREG1 RS-485 communication D register setting for High/Low level (Note 1)	0: H-L 1: L-H
D1353 to D1354	DREG2 Ethernet communication D register setting for High/Low level (Note 2)	
D1355 to D1356	COMM Communication selection	0: - 1: RS-485 2: DCS-LCS
D1357 to D1358	ECTO Ethernet communication timeout period	4 to 60 s
D1359 to D1400		

Note 1: This parameter can be set when optional code /A31 is specified.

Note 2: This parameter can be set when optional code /A34 is specified.

7.8 Engineering Parameters (D1001 to D2000)

7.8.5 DI/DO Setting (D1701 to D1800)

Register No.	Description	Range and Meaning of Value
D1701 to D1702	DIO16 DI1/DO6 specification	0: DI (For digital input) 1: DO (For digital output)
D1703 to D1712		

● Bit Configuration of D1715 to D1716: DISELECT (DI contact direction)

High/low level (Note)	Bit	Code	Event
Low level	0	DI1D	DI1 contact type 0: OPN: Function is available when the contact is open 1: CLS: Function is available when the contact is closed
	1	DI2D	DI2 contact type 0: OPN: Function is available when the contact is open 1: CLS: Function is available when the contact is closed
	2 to 15		
High level	16 to 31		

Note: In these bit configurations, the D register setting for high/low level parameter is set to "0: H-L" (i.e. the first register is high level)

● D1717 to D1758

Register No.	Description	Range and Meaning of Value
D1717 to D1720	DI1D to DI2D DI1 contact type to DI2 contact type	0: OPN: Function is available when the contact is open 1: CLS: Function is available when the contact is closed
D1721 to D1736		
D1737 to D1738	DI1F DI1 function selection	0: NONE (No function) 2: E-MAN (Switching to Manual mode (status)) (YS1350/YS1360 only) 9: TR-MAN (Switching to Manual mode) (YS1350/YS1360 only) 11: TR-CAS (Switching to Cascade mode) (YS1350/YS1360 only) 12: LCD-OFF (LCD backlight auto-off) (YS1310 only) 15: TR-EVT.C (All event elimination)
D1739 to D1740	DI2F DI2 function selection	0: NONE (No function) 9: TR-MAN (Switching to Manual mode) 11: TR-CAS (Switching to Cascade mode) 12: LCD-OFF (Backlight auto-off) 15: TR-EVT.C (All event elimination)
D1741 to D1758		

● Bit Configuration of D1759 to D1760: DISELECT (DO contact direction)

High/low level (Note)	Bit	Code	Event
Low level	0	DO1D	DO1 contact type 0: OPN: When the event occurs, the contact is open 1: CLS: When the event occurs, the contact is closed
	1	DO2D	DO2 contact type 0: OPN: When the event occurs, the contact is open 1: CLS: When the event occurs, the contact is closed
	2	DO3D	DO3 contact type 0: OPN: When the event occurs, the contact is open 1: CLS: When the event occurs, the contact is closed
	3	DO4D	DO4 contact type 0: OPN: When the event occurs, the contact is open 1: CLS: When the event occurs, the contact is closed
	4	DO5D	DO5 contact type 0: OPN: When the event occurs, the contact is open 1: CLS: When the event occurs, the contact is closed
	5	DO6D	DO6 contact type 0: OPN: When the event occurs, the contact is open 1: CLS: When the event occurs, the contact is closed
	6 to 15		
High level	16 to 31		

Note: In these bit configurations, the D register setting for high/low level parameter is set to "0: H-L" (i.e. the first register is high level)

● D1761 to D1800

Register No.	Description	Range and Meaning of Value
D1761 to D1772	DO1D to DO6D DO1 contact type to DO6 contact type	0: OPN (When the event occurs, the contact is opened) 1: CLS (When the event occurs, the contact is closed)
D1773 to D1780		
D1781 to D1782	DO1F DO1 function selection	0: NONE (No function) 1: High limit alarm for PV1 21: OOP (Current output open)
D1783 to D1784	DO2F DO2 function selection	0: NONE (No function) 2: Low limit alarm for PV1 21: OOP (Current output open)
D1773 to D1800		
D1787 to D1788	DO4F DO4 function selection	0: NONE (No function) 17: Cascade mode 21: OOP (Current output open)
D1789 to D1800		

7.8.6 Communication Access (D1801 to D1900)

Register No.	Description	Range and Meaning of Value
D1801 to D1810		
D1811 to D1812	RSCOMM Operation status setting	0: RUN 1: STOP
D1813 to D1820		
D1821 to D1822	COMWR Enable/Disable writing via RS-485 communication & DCS-LCS communication (Note 1)	0: ENBL (Setting possible) 1: INHB (Setting impossible)
D1823 to D1900		

Note 1: This parameter can be set when optional code /A31 or /A32 is specified.

Appendix ASCII Code Table

Hex.	Dec.	Symbol	Hex.	Dec.	Symbol	Hex.	Dec.	Symbol	Hex.	Dec.	Symbol
00	0	^@ NUL	20	32	SPC	40	64	@	60	96	`
01	1	^A SOH	21	33	!	41	65	A	61	97	a
02	2	^B STX	22	34	"	42	66	B	62	98	b
03	3	^C ETX	23	35	#	43	67	C	63	99	c
04	4	^D EOT	24	36	\$	44	68	D	64	100	d
05	5	^E ENQ	25	37	%	45	69	E	65	101	e
06	6	^F ACK	26	38	&	46	70	F	66	102	f
07	7	^G BEL	27	39	'	47	71	G	67	103	g
08	8	^H BS	28	40	(48	72	H	68	104	h
09	9	^I HT	29	41)	49	73	I	69	105	i
0A	10	^J LF	2A	42	*	4A	74	J	6A	106	j
0B	11	^K VT	2B	43	+	4B	75	K	6B	107	k
0C	12	^L FF	2C	44	,	4C	76	L	6C	108	l
0D	13	^M CR	2D	45	-	4D	77	M	6D	109	m
0E	14	^N SO	2E	46	.	4E	78	N	6E	110	n
0F	15	^O SI	2F	47	/	4F	79	O	6F	111	o
10	16	^P DLE	30	48	0	50	80	P	70	112	p
11	17	^Q DC1	31	49	1	51	81	Q	71	113	q
12	18	^R DC2	32	50	2	52	82	R	72	114	r
13	19	^S DC3	33	51	3	53	83	S	73	115	s
14	20	^T DC4	34	52	4	54	84	T	74	116	t
15	21	^U NAK	35	53	5	55	85	U	75	117	u
16	22	^V SYN	36	54	6	56	86	V	76	118	v
17	23	^W ETB	37	55	7	57	87	W	77	119	w
18	24	^X CAN	38	56	8	58	88	X	78	120	x
19	25	^Y EM	39	57	9	59	89	Y	79	121	y
1A	26	^Z SUB	3A	58	:	5A	90	Z	7A	122	z
1B	27	^[ESC	3B	59	;	5B	91	[7B	123	{
1C	28	^FS	3C	60	<	5C	92	\	7C	124	
1D	29	^] GS	3D	61	=	5D	93]	7D	125	}
1E	30	^^ RS	3E	62	>	5E	94	^	7E	126	~
1F	31	^_ US	3F	63	?	5F	95	_	7F	127	DEL

App01E.ai

App.

ASCII Code Table

Revision Information

- Title : YS1000 Series Communication Interface
User's Manual
- Manual No. : IM 01B08J02-01EN

June 2014/1st Edition

Newly published

March 2016/2nd Edition

Error correction

November 2019/3rd Edition

Addition of communication specifications (Maximum number of transactions)

-
- Written by Yokogawa Electric Corporation
 - Published by Yokogawa Electric Corporation
2-9-32 Nakacho, Musashino-shi, Tokyo 180-8750, JAPAN
-



YOKOGAWA ELECTRIC CORPORATION

Headquarters

9-32, Nakacho, 2-chome, Musashino-shi, Tokyo, 180-8750 JAPAN
Phone : 81-422-52-5555

Branch Sales Offices

Osaka, Nagoya, Kurashiki, Hiroshima, Fukuoka, Kitakyusyu

YOKOGAWA CORPORATION OF AMERICA

Head Office

12530 West Airport Blvd, Sugar Land, Texas 77478, USA
Phone : 1-281-340-3800 Fax : 1-281-340-3838

Georgia Office

2 Dart Road, Newnan, Georgia 30265, USA
Phone : 1-800-888-6400 Fax : 1-770-254-0928

YOKOGAWA AMERICA DO SUL LTDA.

Praca Acapulco, 31 - Santo Amaro, São Paulo/SP, BRAZIL, CEP-04675-190
Phone : 55-11-5681-2400 Fax : 55-11-5681-4434

YOKOGAWA EUROPE B. V.

Euroweg 2, 3825 HD Amersfoort, THE NETHERLANDS
Phone : 31-88-4641000 Fax : 31-88-4641111

YOKOGAWA ELECTRIC CIS LTD.

Grokholsky per 13 Building 2, 4th Floor 129090, Moscow, RUSSIA
Phone : 7-495-737-7868 Fax : 7-495-737-7869

YOKOGAWA CHINA CO., LTD.

3F Tower D Cartelo Crocodile Building, No.568 West Tianshan Road,
Shanghai 200335, CHINA
Phone : 86-21-62396262 Fax : 86-21-62387866

YOKOGAWA ELECTRIC KOREA CO., LTD.

(Yokogawa B/D, Yangpyeong-dong 4-Ga), 21, Seonyu-ro 45-gil, Yeongdeungpo-gu,
Seoul, 07209, KOREA
Phone : 82-2-2628-6000 Fax : 82-2-2628-6400

YOKOGAWA ENGINEERING ASIA PTE. LTD.

5 Bedok South Road, Singapore 469270, SINGAPORE
Phone : 65-6241-9933 Fax : 65-6241-2606

YOKOGAWA INDIA LTD.

Plot No.96, Electronic City Complex, Hosur Road, Bangalore - 560 100, INDIA
Phone : 91-80-4158-6000 Fax : 91-80-2852-0625

YOKOGAWA AUSTRALIA PTY. LTD.

Tower A, 112-118 Talavera Road, Macquarie Park NSW 2113, AUSTRALIA
Phone : 61-2-8870-1100 Fax : 61-2-8870-1111

YOKOGAWA MIDDLE EAST & AFRICA B.S.C.(C)

P.O. Box 10070, Manama, Building 577, Road 2516, Busaiteen 225, Muharraq,
BAHRAIN
Phone : 973-17-358100 Fax : 973-17-336100