



HP Elite x2 1012 G2 Tablet
HP Elite x2 1012 G2 Tablet with
Collaboration Keyboard

Maintenance and Service Guide

© Copyright 2017 HP Development Company, L.P.

AMD is a trademark of Advanced Micro Devices, Inc. Bluetooth is a trademark owned by its proprietor and used by HP Inc. under license. NVIDIA is a trademark and/or registered trademark of NVIDIA Corporation in the U.S. and other countries. Bluetooth is a trademark owned by its proprietor and used by HP Inc. under license. Intel and Core are trademarks of Intel Corporation in the U.S. and other countries. Windows is either a registered trademark or trademark of Microsoft Corporation in the United States and/or other countries.

The information contained herein is subject to change without notice. The only warranties for HP products and services are set forth in the express warranty statements accompanying such products and services. Nothing herein should be construed as constituting an additional warranty. HP shall not be liable for technical or editorial errors or omissions contained herein.

First Edition: June 2017

Document Part Number: 918953-001

Product notice

This user guide describes features that are common to most models. Some features may not be available on your computer.

Not all features are available in all editions of Windows. This computer may require upgraded and/or separately purchased hardware, drivers and/or software to take full advantage of Windows functionality. Go to <http://www.microsoft.com> for details.

In accordance with Microsoft's support policy, HP does not support the Windows 8 or Windows 7 operating system on this product or provide any Windows 8 or Windows 7 drivers on <http://support.hp.com>.

Software terms

By installing, copying, downloading, or otherwise using any software product preinstalled on this computer, you agree to be bound by the terms of the HP End User License Agreement (EULA). If you do not accept these license terms, your sole remedy is to return the entire unused product (hardware and software) within 14 days for a full refund subject to the refund policy of your seller.

For any further information or to request a full refund of the price of the computer, please contact your seller.

Safety warning notice

⚠ WARNING! To reduce the possibility of heat-related injuries or of overheating the device, do not place the device directly on your lap or obstruct the device air vents. Use the device only on a hard, flat surface. Do not allow another hard surface, such as an adjoining optional printer, or a soft surface, such as pillows or rugs or clothing, to block airflow. Also, do not allow the AC adapter to contact the skin or a soft surface, such as pillows or rugs or clothing, during operation. The device and the AC adapter comply with the user-accessible surface temperature limits defined by the International Standard for Safety of Information Technology Equipment (IEC 60950-1).

Table of contents

1 Product description	1
2 External component identification	6
Right	6
Left	7
Front	8
Top	9
Bottom	9
Rear	11
Using the kickstand	12
Keyboard components (select products only)	13
Connecting an optional keyboard	13
Removing the keyboard	14
Locating system information	14
3 Illustrated parts catalog	15
Computer major components	15
Miscellaneous parts	16
4 Removal and replacement procedures preliminary requirements	21
Tools required	21
Service considerations	21
Plastic parts	21
Cables and connectors	22
Drive handling	22
Grounding guidelines	23
Electrostatic discharge damage	23
Packaging and transporting guidelines	24
Workstation guidelines	24
Equipment guidelines	25
5 Removal and replacement procedures for Customer Self-Repair parts	26
Component replacement procedures	26
Kickstand	26

6 Removal and replacement procedures for Authorized Service Provider parts	28
Component replacement procedures	28
Back cover	29
Display panel	30
Battery	32
Hall sensor board	34
Kickstand hinges	35
Solid-state drive	36
WLAN module	38
WWAN or GPS module (select products only)	40
Webcam	42
Microphone board	43
Rear webcam	45
System board	47
POGO connector	48
Fan	49
Fingerprint reader board	51
Speakers	53
Antennas	54
7 Backing up, restoring, and recovering	57
Creating recovery media and backups	57
Creating HP Recovery media (select products only)	57
Using Windows tools	58
Restore and recovery	59
Recovering using HP Recovery Manager	59
What you need to know before you get started	59
Using the HP Recovery partition (select products only)	60
Using HP Recovery media to recover	60
Changing the computer boot order	61
Removing the HP Recovery partition (select products only)	61
8 Computer Setup (BIOS), TPM, and HP Sure Start	62
Using Computer Setup	62
Starting Computer Setup	62
Using a USB keyboard or USB mouse to start Computer Setup (BIOS)	62
Navigating and selecting in Computer Setup	62
Restoring factory settings in Computer Setup	63
Updating the BIOS	63
Determining the BIOS version	63

Downloading a BIOS update	64
Changing the boot order using the f9 prompt	65
TPM BIOS settings (select products only)	65
Using HP Sure Start (select products only)	65
9 Using HP PC Hardware Diagnostics (UEFI)	66
Downloading HP PC Hardware Diagnostics (UEFI) to a USB device	67
10 Specifications	68
Computer specifications	68
Display specifications	69
11 Power cord set requirements	70
Requirements for all countries	70
Requirements for specific countries and regions	71
12 Statement of memory volatility	73
Nonvolatile memory usage	75
Questions and answers	77
Using HP Sure Start (select models only)	78
13 Recycling	79
Index	80

1 Product description

Category	Description
Product Name	HP Elite x2 1012 G2 Tablet HP Elite x2 1012 G2 Tablet with Collaboration Keyboard
Processors	Intel® Kaby Lake U—NB ULX (Core i) Processor Intel Core i7-7600U Intel Core i5-7300U Intel Core i5-7200U Intel Core i3-7100U
Chipset	Intel Kaby Lake Premium PCH, integrated with CPU
Graphics	Intel UMA graphics: Intel (GT2) with shared video memory
Panel	12.3" 3:2 (LED backlight – Ultra-Slim) Wide Quad eXtended Graphics Array (WQXGA 72% 450 nits eDP Ultrastim (2736 x 1834) Corning Gorilla 4 Glass, GF2-MM, Direct Bonded
Memory	LPDDR3 1866 fine-pitch ball grid array (FBGA) package with 178 balls Supports dual channel memory, which is included in base units Supports up to 16GB Supports the following configurations: 4096 MB (8Gb 128Mx32x2, Qty 4) 8192 MB (16Gb 256Mx16x4, Qty 4) 16384 MB (32Gb 256Mx32x4, Qty 4)
Primary storage	Supports M.2 2280 Solid-State Drive (SSD) 128 GB M2 SATA-3 Value 128 GB M2 SATA-3 Triple Level Cell (TLC) 256 GB SATA-3 SED OPAL2 Triple Level Cell (TLC) 256 GB Turbo Drive G2 Triple Level Cell (TLC) 360 GB PCIe TLC 512 GB Turbo Drive G2 MLC 256GB PCIe NVMe Value 512 GB PCIe NVMe Value 1 TB Turbo Drive G2 Triple Level Cell (TLC)
Webcam and microphone	HP Bang & Olufsen Audio Audio Solution Codec "Neptune"

Category	Description
	<p>Audio controls</p> <p>Dual array microphone</p> <p>RGB Camera:</p> <p>Front facing webcam, 5 MP with LED indicator</p> <p>Rear webcam, 8 MP with flash LED</p> <p>Support "No RGB Camera" option</p> <p>IR Camera:</p> <p>Facing Camera IR</p> <p>Support "No IR Camera" option</p>
Audio	Two stereo speakers
Ethernet	<p>No direct Ethernet support - Ethernet via accessories.</p> <p>Supports HBMA (via UEFI PXE boot and Windows OS)</p> <p>Select dongles support S3 wake on LAN.</p>
Wireless	<p>WPAN Bluetooth</p> <ul style="list-style-type: none"> • Bluetooth® 4.2 only supported via combo card • Supports Bluetooth disabled <p>WLAN</p> <p>WLAN M.2:</p> <ul style="list-style-type: none"> • Intel Dual band wireless-AC 8265 802.11 AC 2x2 WiFi + BT 4.2 Combo Adapter (non-vPro) • Intel Dual band wireless-AC 8265 802.11 AC 2x2 WiFi + BT 4.2 Combo Adapter (VPro) • WLAN 2 antennas (2) • Bluetooth Disabled IOPT • Support for Wi-Fi Specific Absorption Rates (SAR) in BIOS (Intel Only) • Compatible with Miracast-certified devices • Support for HP Sure Connect <p>GPS</p> <ul style="list-style-type: none"> • U-Blox GPS EVA-M8M M.2/USB WW, not available with WWAN • Supports no GPS option <p>WWAN</p> <ul style="list-style-type: none"> • SIM Module (user-accessible on side (3FF/micro SIM). (SIM module is installed in the factory when a service provider is configured) • Huawei HP It4132, LTE/HSPA+ 4G with GPS M.2 • Foxconn HP It4120 LTE/EVDO/HSPA+ with GPS M.2 • Huawei HP It4225 LTE/EVDO (Japan only) • Huawei HP It4226 LTE/HSPA+ (Japan only) • Fibocom HP hs3210 WW HSPA+ without GPS • WWAN Antennas (2) (worldwide except Japan)

Category	Description
	<ul style="list-style-type: none"> • Supports non-WWAN option
External media cards	Micro SD media reader slot Supports SD/SDHC/SDXC Card tray
Ports	Slate: Audio-out (headphone)/Audio-in (microphone) combo jack USB-C 3.1 port with Thunderbolt (docking, power, USB) on unit: Micro SD Micro SIM USB 3.0a port Collaboration Travel Keyboard: Keyboard ClickPad
Sensors	Combo chip <ul style="list-style-type: none"> • Accelerometer • Magnetometer • Gyro Ambient light sensor (ALS) Proximity (SAR for WWAN) Dual accelerometers (in keyboard) Hall sensor
Docking	HP Advanced Wireless Dock HP Elite Thunderbolt 3 Dock HP Elite USB-C Docking Station
Keyboard/pointing devices	External Collaboration Travel Keyboard Backlit Function Keys: F1 – Display Switching F2 —Blank F3–Brightness Down F4–Brightness Up F5–Mute F6–Volume Down F7–Volume Up F8–Mic Mute F9–Backlight Toggle F10–Num Lock

Category	Description
	<p>F11–Wireless On/Off</p> <p>F12–Calendar</p> <p>Collaboration Keys:</p> <p>Call End</p> <p>Share/Present</p> <p>Call Answer</p> <p>Clickpad requirements:</p> <ul style="list-style-type: none"> • Supports 2-way scroll • Single and Double Taps enabled as default • Gestures enabled by default - 2 Finger Scrolling, 2 Finger Zoom (Pinch), 3 Finger tap (Cortana), 4 Finger tap (Action Center) <p>Supports no keyboard option</p>
Power requirements	<p>Battery</p> <p>4-cell Long Life Polymer 47 Whr (3055 mAh/cell)</p> <p>Supports HP Fast Charge</p> <p>AC adapter: (USB Type-C)</p> <p>1.8 M length power cord</p> <ul style="list-style-type: none"> • HP 65 W non-PFC USB Type-C AC adapter <p>Power cord:</p> <ul style="list-style-type: none"> • 1.0 M length power cord with duckhead • Duckhead
Security	<p>TPM 2.0</p> <p>Pad fingerprint reader (optional)</p> <p>No pad fingerprint reader</p> <p>Drive encryption pre-boot (password, fingerprint, select smart cards)</p> <p>Power-on authentication (password, fingerprint)</p>
Operating system	<p>Windows 10 Redstone 2</p> <p>Preinstalled:</p> <p>Windows 10 Pro 64</p> <p>Windows 10 Pro 64 StF MSNA, Plus (Available only with i7 processor AND more than 4GB RAM)</p> <p>Windows 10 Pro 64 StF MSNA Standard (Not available with i7 processor AND more than 4GB RAM)</p> <p>Windows 10 Pro 64 StF MSNA Strategic (Available only with i3 processor AND RAM equal to or less than 4GB AND Storage equal to or less than 128 GB SSD)</p> <p>Windows 10 Home 64 (Not available with i7 processor AND more than 4GB RAM)</p> <p>Windows 10 Home 64 Chinese Market CPPP (Available only for People's Republic of China locations)</p> <p>Windows 10 Home Single Language (Not available with i7 processor AND more than 4GB RAM)</p> <p>Windows 10 Home Plus 64 (Available only with i7 processor AND more than 4GB RAM)</p> <p>Windows 10 Home Plus 64 Single Language (Available only with i7 processor AND more than 4GB RAM)</p>



Category	Description
	<p data-bbox="501 222 1225 245">Restore Media: (available with any Windows 10 operating system for service only)</p> <p data-bbox="501 268 632 291">DR DVD Win10</p> <p data-bbox="501 315 632 338">OS DVD Win10</p> <p data-bbox="501 361 587 384">Certified:</p> <p data-bbox="501 407 644 430">Microsoft WHQL</p> <p data-bbox="501 453 1461 501">Win 10 Home 64 StF MSNA for Higher Education Strategic (Available only with i3 processor AND RAM equal to or less than 4GB AND Storage equal to or less than 128 GB SSD)</p> <p data-bbox="501 525 676 548">Web-only Support:</p> <p data-bbox="501 571 828 594">Windows 10 Enterprise 64 LTSB 1507</p>
Serviceability	<p data-bbox="501 617 751 640">End user replaceable parts:</p> <p data-bbox="501 663 700 686">AC adapter (Slate only)</p> <p data-bbox="501 709 587 732">Kickstand</p> <p data-bbox="501 756 536 779">Pen</p>

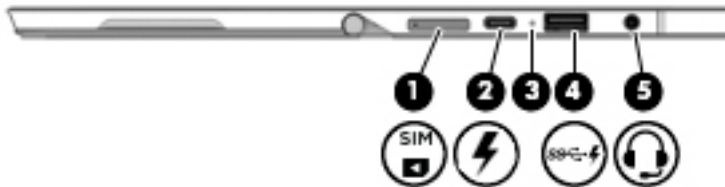

2 External component identification

Right

 **NOTE:** The port and connector icons are located on the protective cover.





Component	Description
(1) 	Micro SIM card slot (select products only) Supports a wireless subscriber identity module (SIM) card. .
(2) 	USB Type-C power connector and Thunderbolt port Connects an AC adapter that has a USB Type-C connector, supplying power to the computer and, if needed, charging the computer battery. – or – Connects and charges a USB device that has a Type-C connector, such as a cell phone, camera, activity tracker, or smartwatch, and provides high-speed data transfer. – or – Connects to various USB, video, HDMI, and LAN devices. NOTE: Cables and/or adapters (purchased separately) may be required. – or – Connects a display device that has a USB Type-C connector, providing display output. NOTE: Your computer may also support a Thunderbolt docking station.
(3) Battery light	When AC power is connected: <ul style="list-style-type: none">• White: The battery charge is greater than 90 percent.• Amber: The battery charge is from 0 to 90 percent.• Off: The battery is not charging. When AC power is disconnected (battery not charging): <ul style="list-style-type: none">• Blinking amber: The battery has reached a low battery level. When the battery has reached a critical battery level, the battery light begins blinking rapidly.• Off: The battery is not charging.



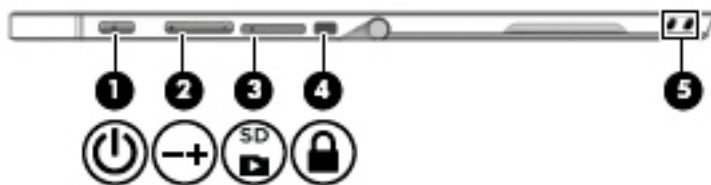

Component	Description
(4)  USB 3.x charging port	When the computer is on, connects and charges a USB device, such as a cell phone, camera, activity tracker, or smartwatch, and provides high-speed data transfer.
(5)  Audio-out (headphone)/Audio-in (microphone) combo jack	<p>Connects optional powered stereo speakers, headphones, earbuds, a headset, or a television audio cable. Also connects an optional headset microphone. This jack does not support optional standalone microphones.</p> <p>WARNING! To reduce the risk of personal injury, adjust the volume before putting on headphones, earbuds, or a headset. For additional safety information, refer to the <i>Regulatory, Safety, and Environmental Notices</i>.</p> <p>To access this document:</p> <ul style="list-style-type: none"> ▲ Select the Start button, select HP Help and Support, and then select HP Documentation. – or – ▲ Select the Start button, select HP, and then select HP Documentation. <p>NOTE: When a device is connected to the jack, the computer speakers are disabled.</p>

Left

 **NOTE:** The port and connector icons are located on the protective cover.



Component	Description
(1)  Power button	<ul style="list-style-type: none"> • When the computer is off, press the button to turn on the computer. • When the computer is on, press the button briefly to initiate Sleep. • When the computer is in the Sleep state, press the button briefly to exit Sleep. • When the computer is in Hibernation, press the button briefly to exit Hibernation. <p>CAUTION: Pressing and holding down the power button results in the loss of unsaved information.</p> <p>If the computer has stopped responding and shutdown procedures are ineffective, press and hold the power button for at least 5 seconds to turn off the computer.</p> <p>To learn more about your power settings, see your power options.</p>

Component	Description
	<p>▲ Type <code>power options</code> in the taskbar search box, and then select Power Options.</p> <p>– or –</p> <p>Right-click the Power icon , and then select Power Options.</p>
(2) 	<p>Volume button</p> <p>Increases or decreases speaker volume incrementally while you hold down the button.</p>
(3) 	<p>MicroSD memory card reader</p> <p>Reads optional memory cards that store, manage, share, or access information.</p>
(4) 	<p>Security cable slot</p> <p>Attaches an optional security cable to the computer.</p> <p>NOTE: The security cable is designed to act as a deterrent, but it may not prevent the computer from being mishandled or stolen.</p>
(5)	<p>Pen lanyard slots</p> <p>Allow you to connect the optional pen using the pen lanyard.</p>

Front

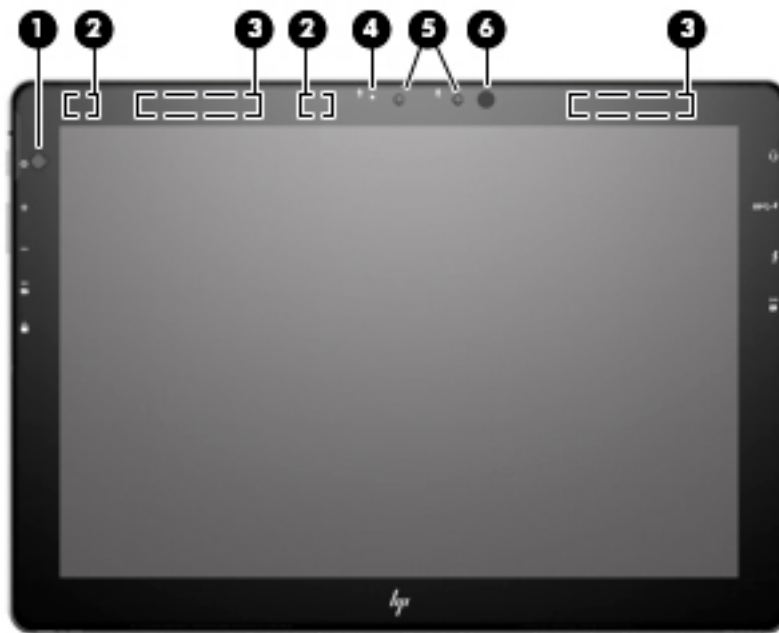

Component	Description
(1) Ambient light sensor	Automatically adjusts the display brightness based on the lighting conditions in your environment.
(2) WLAN antennas*	Send and receive wireless signals to communicate with wireless local area networks (WLANS).

Component	Description
(3) WWAN antennas* (select products only)	Send and receive wireless signals to communicate with wireless wide area networks (WWANs).
(4) Webcam light	On: The webcam is in use.
(5) Webcam	Records video and captures photographs. Some models allow you to video conference and chat online using streaming video. To use the webcam: ▲ Type <code>camera</code> in the taskbar search box, and then select Camera .
(6) Infrared camera	Allows a facial recognition logon to Windows, instead of a password logon.
(7) Infrared camera light	On: The infrared camera is in use.

*The antennas are not visible from the outside of the computer. For optimal transmission, keep the areas immediately around the antennas free from obstructions.

For wireless regulatory notices, see the section of the *Regulatory, Safety, and Environmental Notices* that applies to your country or region.

To access this document:

▲ Select the **Start** button, select **HP Help and Support**, and then select **HP Documentation**.

– or –

▲ Select the **Start** button, select **HP**, and then select **HP Documentation**.

Top

 **NOTE:** The microphone icons are located on the protective cover.



Component	Description
(1) Speakers (2)	Produce sound.
(2)  Internal microphones (2)	Record sound.

Bottom

 **NOTE:** The docking connector icon is located on the protective cover.



Component	Description
(1)	Alignment post connectors (2) Connect to the alignment posts on an optional keyboard.
(2) 	Docking connector Connects the tablet to an optional keyboard.

Rear

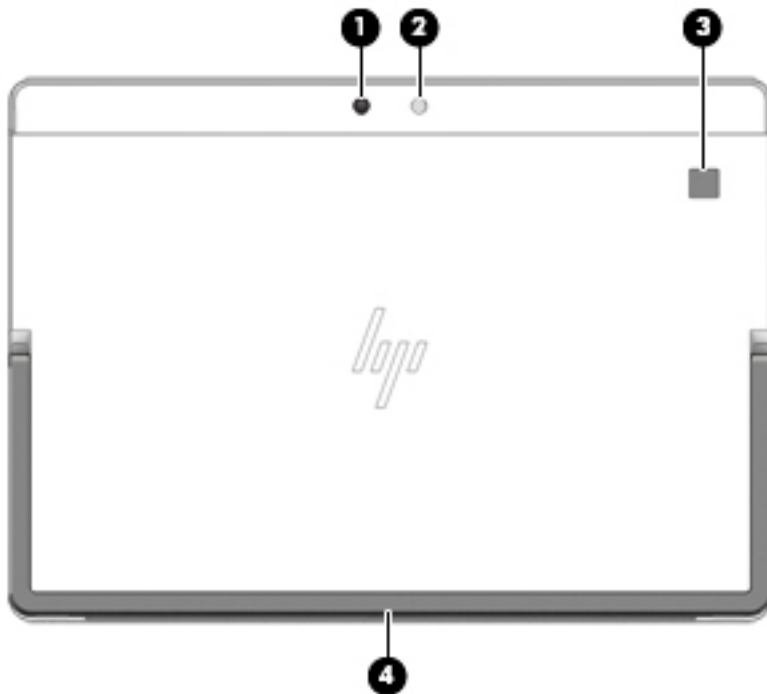

Component		Description
(1)	Webcam (rear)	Records video and captures photographs. Some products allow you to video conference and chat online using streaming video.
(2)	Camera flash	Provides a camera flash. You can control the flash using camera apps.
(3)	Fingerprint reader (select products only)	Allows a fingerprint logon to Windows®, instead of a password logon.
(4)	Kickstand	Provides stability and a variety of viewing angles.

Using the kickstand

To change the viewing angle, follow these steps:

1. Hold the computer with top edge up (the speakers are on top).
2. Use one of the kickstand tabs to lift the kickstand away from the computer, and then position the kickstand at the desired angle.



To close the kickstand, push the kickstand against the bottom of the computer until it is flush with the bottom.



Keyboard components (select products only)

Your computer supports an optional keyboard. This section provides information about the common features of the supported keyboards.

 **NOTE:** Keyboard appearance and features might vary. For additional details about using the keyboard, refer to the instructions included with the keyboard.

Connecting an optional keyboard

1. To connect an optional keyboard, lower the computer onto the alignment post connectors **(1)** on the keyboard until the connectors click into place.
2. Position the kickstand **(2)** at the desired angle.

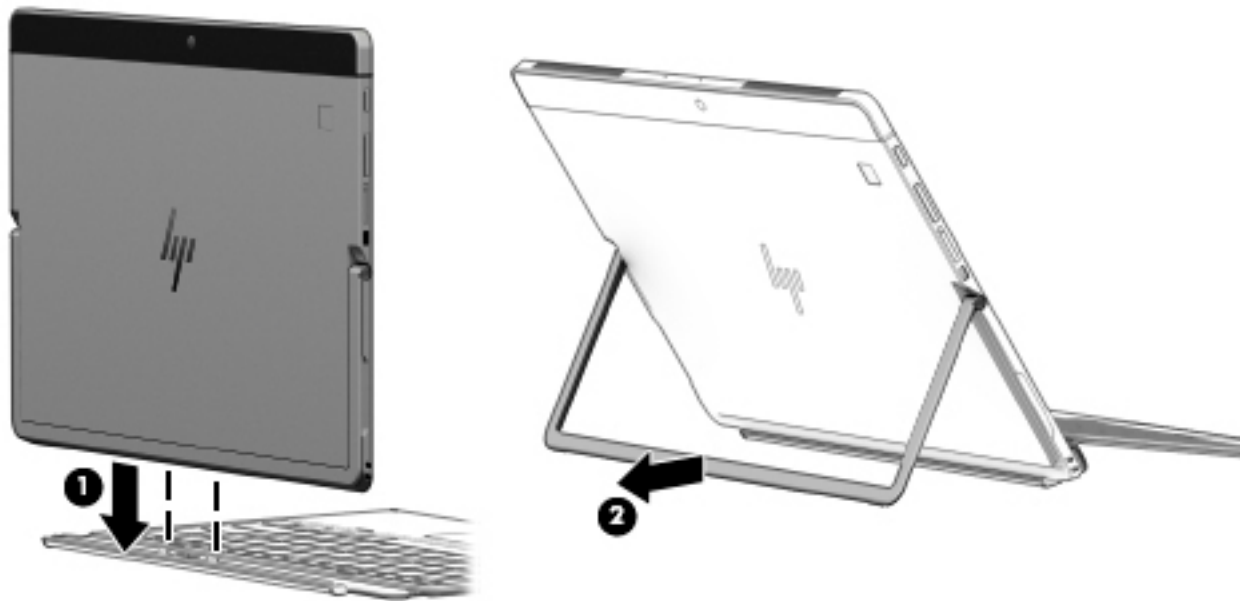

 **NOTE:** If you close the kickstand, you can leave the keyboard attached and rotate the keyboard behind the computer so that the back of the keyboard is against the back of the computer. The keyboard keys and TouchPad are locked to prevent you from accidentally typing while the keyboard is in this position.

Removing the keyboard

To remove the keyboard, pull the keyboard away from the computer.



Locating system information

Important system information is located on the bottom edge of the tablet or on the keyboard base. You may need the information when travelling internationally or when you contact support:

- (1):** Serial number
- (2):** Product number
- (3):** Model number
- (4):** Warranty period

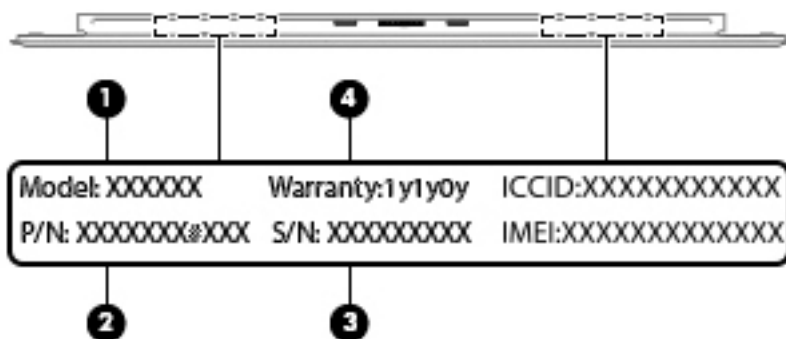

Using Windows, briefly press the **fn+esc** key combination to display the System Information screen, which provides the product name and serial number of your computer, as well as information about the memory, processor, BIOS, and keyboard.

3 Illustrated parts catalog

Computer major components

 **NOTE:** HP continually improves and changes product parts. For complete and current information on supported parts for your computer, go to <http://partsurfer.hp.com>, select your country or region, and then follow the on-screen instructions.

 **NOTE:** Details about your computer, including model, serial number, product key, and length of warranty, are on the service tag at the bottom of your computer. See [Locating system information on page 14](#) for details.

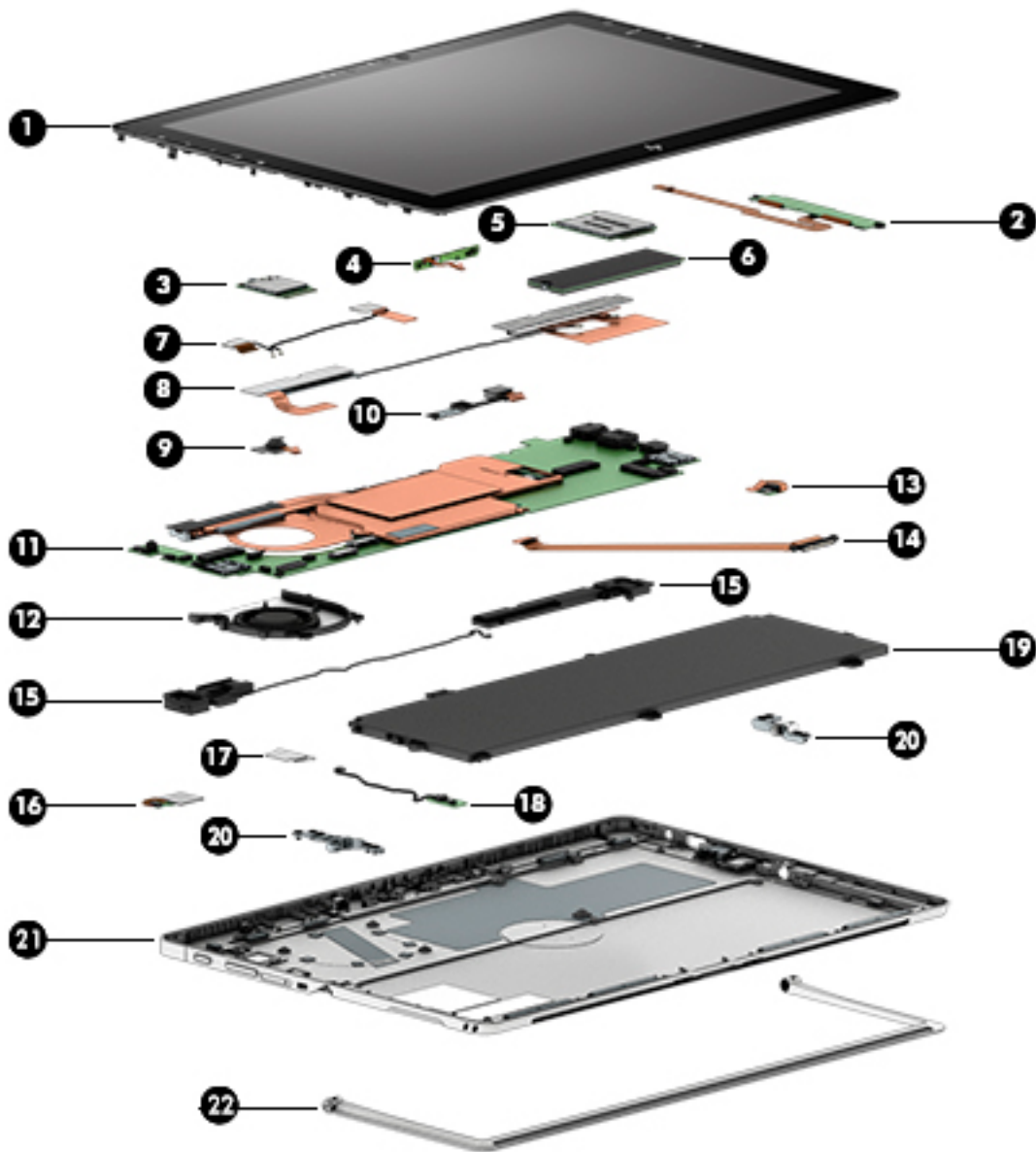

Item	Component	Spare part number
(1)	Display panel	
	LCD 12.3 WQXGA+BrightView UWVA with bezel, infrared camera, and touch board	924438-001
	LCD 12.3WQXGA+BrightView UWVA for non-IRA camera with bezel and touch board	925556-001
	LCD cable kit	924453-001
(2)	Touch board (included with display panel)	
(3)	WLAN module (includes cable) (see WLAN module on page 38)	
(4)	Microphone board	924449-001
(5)	WWAN module (see WWAN or GPS module (select products only) on page 40)	
(6)	Solid-state drive (see Solid-state drive on page 36)	
(7)	WLAN antenna	925446-001
(8)	WWAN antenna (includes cable) (see Antennas on page 54)	
(9)	Front-facing webcam (see Webcam on page 42)	
(10)	Rear webcam	900730-002
(11)	System board (see System board on page 47)	
(12)	Fan	924448-001
(13)	Fingerprint reader	924460-001
(14)	POGO board (includes cable)	938109-001
(15)	Speaker Kit	925445-001
(16)	Fingerprint reader	924460-001
(17)	Fingerprint reader bracket (included with fingerprint reader)	
(18)	Hall sensor board	938108-001
(19)	Battery, 4C 47Wh 3.05AH LI JI04047XL-PL	901247-855
(20)	Kickstand hinges (included with back cover)	L00122-001
(21)	Back cover	
	Includes back cover, stand, hinge, and infrared camera holder	924446-001
	Back cover for non-infrared camera	924447-001
(22)	Kickstand	L00121-001

Miscellaneous parts

Component	Spare part number
65 W nPFC S-3P 4.5MM AC adapter	710412-001
90W PFC S-3P 4.5MM AC adapter	710413-001
45 W nPFC SMART RC 4.5mm slim AC adapter	741727-001

Component	Spare part number
65 W nPFC RC USB-C 3 pin	860209-850
HP USB-C to 3 and 4.5mm Adapter	814813-001
HP USB-C to USB 3.0 Adapter	814618-001
HP USB to Gigabit RJ45 Adapter	829941-001
HP USB-C to VGA Adapter	831751-001
HP USB-C to HDMI Adapter	831752-001
HP USB-C to DisplayPort Adapter	831753-001
HP Elite USB-C Docking Station	844549-001
Dock with 90W adapter	923236-001
Wireless docking station	800866-001
HP Elite USB-C docking station	844549-001
HP Elite USB-C Desk Dock	920131-001
HP Elite USB-C Desk Dock TAA	931209-001
HP Nano Lock	919418-001
HP Active Pen with App Launch	846410-001
Keyboard:	
For use in Belgium	850487-A41
For use in Brazil	850487-201
For use in Bulgaria	850487-261
For use in Canada	850487-DB1
For use in the Czech Republic and Slovakia	850487-FL1
For use in Denmark	850487-081
For use in France	850487-051
For use in Germany	850487-041
For use in Greece	850487-151
For use in Hungary	850487-211
For use in Iceland	850487-DD1
For use in India	850487-D61
For use internationally	850487-B31
For use in Israel	850487-BB1
For use in Italy	850487-061
For use in Japan	850487-291
For use in Latin America	850487-161
For use in Northwest Africa	850487-FP1

Component	Spare part number
For use in Norway	850487-091
For use in Portugal	850487-131
For use in Romania	850487-271
For use in Russia	850487-251
For use in Saudi Arabia	850487-171
For use in Slovenia	850487-BA1
For use in South Korea	850487-AD1
For use in Spain	850487-071
For use in Sweden and Finland	850487-B71
For use in Switzerland	850487-BG1
For use in Taiwan	850487-AB1
For use in Thailand	850487-281
For use in Turkey	850487-141
For use in the United Kingdom and Singapore	850487-031
For use in the United States	850487-001
Backlit keyboard:	
For use in Belgium	922749-A41
For use in Brazil	922749-201
For use in Bulgaria	922749-261
For use in Canada	922749-DB1
For use in the Czech Republic and Slovakia	922749-FL1
For use in Denmark	922749-081
For use in France	922749-051
For use in Germany	922749-041
For use in Greece	922749-151
For use in Hungary	922749-211
For use in Iceland	922749-DD1
For use in India	922749-D61
For use internationally	922749-B31
For use in Israel	922749-BB1
For use in Italy	922749-061
For use in Japan	922749-291
For use in Latin America	922749-161
For use in Northwest Africa	922749-FP1

Component	Spare part number
For use in Norway	922749-091
For use in Portugal	922749-131
For use in Romania	922749-271
For use in Russia	922749-251
For use in Saudi Arabia	922749-171
For use in Slovenia	922749-BA1
For use in South Korea	922749-AD1
For use in Spain	922749-071
For use in Sweden and Finland	922749-B71
For use in Switzerland	922749-BG1
For use in Taiwan	922749-AB1
For use in Thailand	922749-281
For use in Turkey	922749-141
For use in the United Kingdom and Singapore	922749-031
For use in the United States	922749-001
Power cord for use in Europe	213350-001
Power cord 1.0 m for use in Europe	213350-014
Power cord for use in the United Kingdom and Singapore	213351-001
Power cord 1.0 m for use in the United Kingdom	213351-013
Power cord for use in Italy	213352-001
Power cord 1.0 m for use in Italy	213352-013
Power cord for use in Denmark	213353-001
Power cord 1.0 m for use in Denmark	213353-013
Power cord for use in Switzerland	213354-001
Power cord 1.0 m for use in Switzerland	213354-013
Power cord for use in Australia	213356-001
Power cord 1.0 m for use in Australia	213356-013
Power cord for use in Japan	226768-001
Power cord for use in South Korea	267836-001
Power cord for use in Thailand	285096-001
Power cord 1.0 m for use in Thailand	285096-012
Power cord for use in the People's Republic of China	286497-001
Power cord 1.0 m for use in the People's Republic of China	286497-013
Power cord Japan ground lead	349756-001

Component	Spare part number
Power cord OPT-917 3-COND 1.8-M-LG ROHS	361240-001
Power cord 1.0 m for use in South Africa	361240-007
Power cord 1.8 m for use in Taiwan	393313-001
Power cord 1.0 m for use in Taiwan	393313-007
Power cord 1.83 m for use in Israel	398063-001
Power cord 1.0 m for use in Israel	398063-008
Power cord 6 ft. for use in Argentina	401300-001
Power cord 1.0 m for use in Argentina	401300-011
Power cord 1.83 m for use in India	404827-001
Power cord 1.0 m for use in India	404827-008
Power cord 1.83 m for use in Brazil	438722-001
Power cord 1.0 m for use in Brazil	438722-008
Duck head for use in the United States	854702-001
Duck head for use in Europe and South Korea	854703-001
Rubber Kit	928645-001
Screw Kit	924456-001

4 Removal and replacement procedures preliminary requirements

Tools required

You will need the following tools to complete the removal and replacement procedures:

- Flat-bladed screwdriver
- Magnetic screwdriver
- Phillips P0 and P1 screwdrivers

Service considerations

The following sections include some of the considerations that you must keep in mind during disassembly and assembly procedures.

 **NOTE:** As you remove each subassembly from the computer, place the subassembly (and all accompanying screws) away from the work area to prevent damage.

Plastic parts

 **CAUTION:** Using excessive force during disassembly and reassembly can damage plastic parts. Use care when handling the plastic

Cables and connectors

⚠ CAUTION: When servicing the computer, be sure that cables are placed in their proper locations during the reassembly process. Improper cable placement can damage the computer.

Cables must be handled with extreme care to avoid damage. Apply only the tension required to unseat or seat the cables during removal and insertion. Handle cables by the connector whenever possible. In all cases, avoid bending, twisting, or tearing cables. Be sure that cables are routed in such a way that they cannot be caught or snagged by parts being removed or replaced. Handle flex cables with extreme care; these cables tear easily.

Drive handling

⚠ CAUTION: Drives are fragile components that must be handled with care. To prevent damage to the computer, damage to a drive, or loss of information, observe these precautions:

Before removing or inserting a hard drive, shut down the computer. If you are unsure whether the computer is off or in Hibernation, turn the computer on, and then shut it down through the operating system.

Before handling a drive, be sure that you are discharged of static electricity. While handling a drive, avoid touching the connector.

Before removing an optical drive, be sure that a disc is not in the drive and be sure that the optical drive tray is closed.

Handle drives on surfaces covered with at least one inch of shock-proof foam.

Avoid dropping drives from any height onto any surface.

After removing a hard drive or an optical drive, place it in a static-proof bag.

Avoid exposing an internal hard drive to products that have magnetic fields, such as monitors or speakers.

Avoid exposing a drive to temperature extremes or liquids.

If a drive must be mailed, place the drive in a bubble pack mailer or other suitable form of protective packaging and label the package “FRAGILE.”

Grounding guidelines

Electrostatic discharge damage

Electronic components are sensitive to electrostatic discharge (ESD). Circuitry design and structure determine the degree of sensitivity. Networks built into many integrated circuits provide some protection, but in many cases, ESD contains enough power to alter device parameters or melt silicon junctions.

A discharge of static electricity from a finger or other conductor can destroy static-sensitive devices or microcircuitry. Even if the spark is neither felt nor heard, damage may have occurred.

An electronic device exposed to ESD may not be affected at all and can work perfectly throughout a normal cycle. Or the device may function normally for a while, then degrade in the internal layers, reducing its life expectancy.

CAUTION: To prevent damage to the computer when you are removing or installing internal components, observe these precautions:

Keep components in their electrostatic-safe containers until you are ready to install them.

Before touching an electronic component, discharge static electricity by using the guidelines described in this section.

Avoid touching pins, leads, and circuitry. Handle electronic components as little as possible.

If you remove a component, place it in an electrostatic-safe container.

The following table shows how humidity affects the electrostatic voltage levels generated by different activities.

CAUTION: A product can be degraded by as little as 700 V.

Typical electrostatic voltage levels			
Event	Relative humidity		
	10%	40%	55%
Walking across carpet	35,000 V	15,000 V	7,500 V
Walking across vinyl floor	12,000 V	5,000 V	3,000 V
Motions of bench worker	6,000 V	800 V	400 V
Removing DIPS from plastic tube	2,000 V	700 V	400 V
Removing DIPS from vinyl tray	11,500 V	4,000 V	2,000 V
Removing DIPS from plastic foam	14,500 V	5,000 V	3,500 V
Removing bubble pack from PCB	26,500 V	20,000 V	7,000 V
Packing PCBs in foam-lined box	21,000 V	11,000 V	5,000 V

Packaging and transporting guidelines

Follow these grounding guidelines when packaging and transporting equipment:

- To avoid hand contact, transport products in static-safe tubes, bags, or boxes.
- Protect ESD-sensitive parts and assemblies with conductive or approved containers or packaging.
- Keep ESD-sensitive parts in their containers until the parts arrive at static-free workstations.
- Place items on a grounded surface before removing items from their containers.
- Always be properly grounded when touching a component or assembly.
- Store reusable ESD-sensitive parts from assemblies in protective packaging or nonconductive foam.
- Use transporters and conveyors made of antistatic belts and roller bushings. Be sure that mechanized equipment used for moving materials is wired to ground and that proper materials are selected to avoid static charging. When grounding is not possible, use an ionizer to dissipate electric charges.

Workstation guidelines

Follow these grounding workstation guidelines:

- Cover the workstation with approved static-shielding material.
- Use a wrist strap connected to a properly grounded work surface and use properly grounded tools and equipment.
- Use conductive field service tools, such as cutters, screwdrivers, and vacuums.
- When fixtures must directly contact dissipative surfaces, use fixtures made only of static safe materials.
- Keep the work area free of nonconductive materials, such as ordinary plastic assembly aids and plastic foam.
- Handle ESD-sensitive components, parts, and assemblies by the case or PCM laminate. Handle these items only at static-free workstations.
- Avoid contact with pins, leads, or circuitry.
- Turn off power and input signals before inserting or removing connectors or test equipment.

Equipment guidelines

Grounding equipment must include either a wrist strap or a foot strap at a grounded workstation.

- When seated, wear a wrist strap connected to a grounded system. Wrist straps are flexible straps with a minimum of one megohm $\pm 10\%$ resistance in the ground cords. To provide proper ground, wear a strap snugly against the skin at all times. On grounded mats with banana-plug connectors, use alligator clips to connect a wrist strap.
- When standing, use foot straps and a grounded floor mat. Foot straps (heel, toe, or boot straps) can be used at standing workstations and are compatible with most types of shoes or boots. On conductive floors or dissipative floor mats, use foot straps on both feet with a minimum of one megohm resistance between the operator and ground. To be effective, the conductive equipment must be worn in contact with the skin.

The following grounding equipment is recommended to prevent electrostatic damage:

- Antistatic tape
- Antistatic smocks, aprons, and sleeve protectors
- Conductive bins and other assembly or soldering aids
- Nonconductive foam
- Conductive tabletop workstations with ground cords of one megohm resistance
- Static-dissipative tables or floor mats with hard ties to the ground
- Field service kits
- Static awareness labels
- Material-handling packages
- Nonconductive plastic bags, tubes, or boxes
- Metal tote boxes
- Electrostatic voltage levels and protective materials

The following table lists the shielding protection provided by antistatic bags and floor mats.

Material	Use	Voltage protection level
Antistatic plastics	Bags	1,500 V
Carbon-loaded plastic	Floor mats	7,500 V
Metallized laminate	Floor mats	5,000 V

5 Removal and replacement procedures for Customer Self-Repair parts

 **NOTE:** The Customer Self-Repair program is not available in all locations. Installing a part not supported by the Customer Self-Repair program may void your warranty. Check your warranty to determine if Customer Self-Repair is supported in your location.

 **NOTE:** HP continually improves and changes product parts. For complete and current information on supported parts for your computer, go to <http://partsurfer.hp.com>, select your country or region, and then follow the on-screen instructions.

Component replacement procedures

 **NOTE:** Please read and follow the procedures described here to access and replace Customer Self-Repair parts successfully.

 **NOTE:** Details about your computer, including model, serial number, product key, and length of warranty, are on the service tag on the bottom of your computer. See [Locating system information on page 14](#) for details.

This chapter provides removal and replacement procedures for Customer Self-Repair parts.

There are as many as 30 screws that must be removed, replaced, and/or loosened when servicing Customer Self-Repair parts. Make special note of each screw size and location during removal and replacement.

Kickstand

Description	
Kickstand	L00121-001

 **IMPORTANT:** Make special note of each screw and screw lock size and location during removal and replacement.

Before removing the kickstand, follow these steps:

1. Turn off the computer. If you are unsure whether the computer is off or in Hibernation, turn the computer on, and then shut it down through the operating system.
2. Disconnect the power from the computer by unplugging the power cord from the computer.
3. Disconnect all external devices from the computer.

Remove the kickstand:

- ▲ Lift the kickstand **(1)**, remove 1 screw from each side of the kickstand**(2)**, and then remove the kickstand **(3)**.

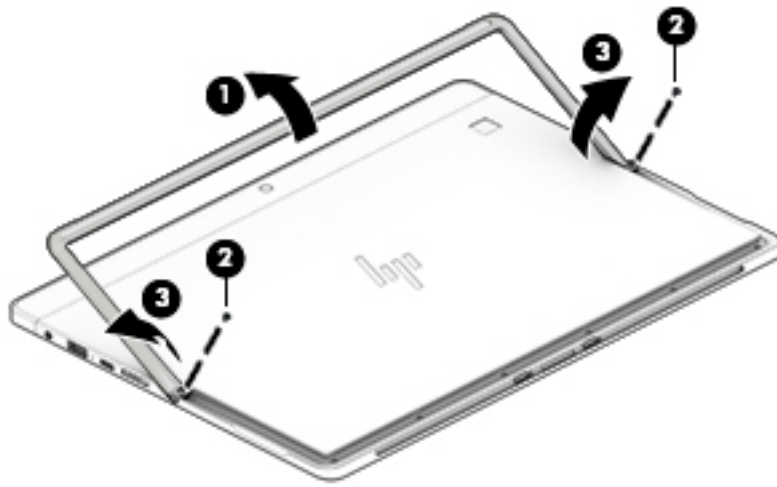

Reverse this procedure to replace the kickstand.

6 Removal and replacement procedures for Authorized Service Provider parts

This chapter provides removal and replacement procedures for Authorized Service Provider only parts.

 **CAUTION:** Components described in this chapter should only be accessed by an authorized service provider. Accessing these parts can damage the computer or void the warranty.

CAUTION: This computer does not have user-replaceable parts. Only HP authorized service providers should perform the removal and replacement procedures described here. Accessing the internal part could damage the computer or void the warranty.

Component replacement procedures

 **NOTE:** Details about your computer, including model, serial number, product key, and length of warranty, are on the service tag at the bottom of your computer. See [Locating system information on page 14](#) for details.

 **NOTE:** HP continually improves and changes product parts. For complete and current information on supported parts for your computer, go to <http://partsurfer.hp.com>, select your country or region, and then follow the on-screen instructions.

There are as many as 30 screws that must be removed, replaced, and/or loosened when servicing Authorized Service Provider only parts. Make special note of each screw size and location during removal and replacement.

Back cover

Back cover	
Includes back cover, stand, hinge, and infrared camera holder	924446-001
Back cover for non-infrared camera	924447-001

 **IMPORTANT:** Make special note of each screw and screw lock size and location during removal and replacement.

Before removing the back cover, follow these steps:

1. Turn off the computer. If you are unsure whether the computer is off or in Hibernation, turn the computer on, and then shut it down through the operating system.
2. Disconnect the power from the computer by unplugging the power cord from the computer.
3. Disconnect all external devices from the computer.
4. Remove the following components:
 - ▲ Kickstand (select products only) (see [Kickstand on page 26](#))

Remove the back cover:

- ▲ Lift the kickstand **(1)**, and then remove the 6 Torx T5 3 mm screws **(2)** securing the back cover.

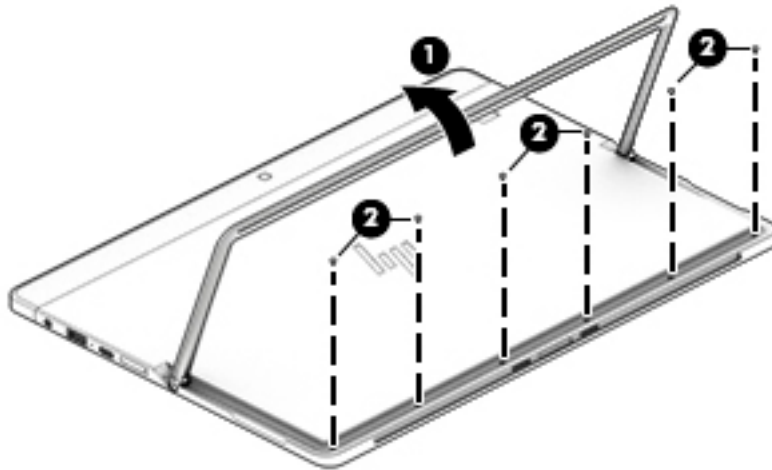

Reverse this procedure to replace the back cover.

Display panel

Display panel

LCD 12.3 WQXGA+BrightView UWVA with bezel, infrared camera, and touch screen	924438-001
LCD 12.3WQXGA+BrightView UWVA with bezel and touch screen	925556-001
LCD cable kit	924453-001



IMPORTANT: Make special note of each screw and screw lock size and location during removal and replacement.

Before removing the display panel, follow these steps:

1. Turn off the computer. If you are unsure whether the computer is off or in Hibernation, turn the computer on, and then shut it down through the operating system.
2. Disconnect the power from the computer by unplugging the power cord from the computer.
3. Disconnect all external devices from the computer.
4. Remove the following components:
 - a. Kickstand (see [Kickstand on page 26](#)).
 - b. Back cover (see [Back cover on page 29](#))

Remove the display panel:

1. Use a suction tool to loosen all 4 corners of the display panel (**1**), and then lift the panel carefully to remove it (**2**).

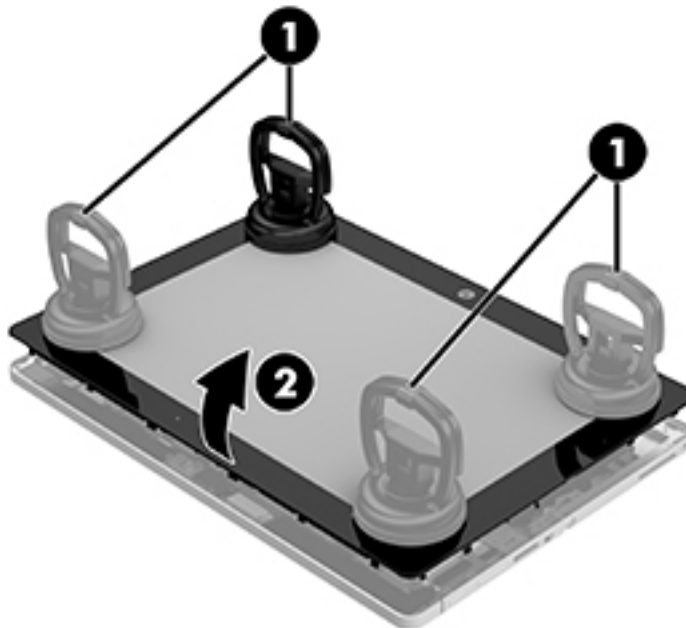

2. Lift the panel **(1)**, disconnect the display cable **(2)**, and then disconnect the touch cable **(3)**.

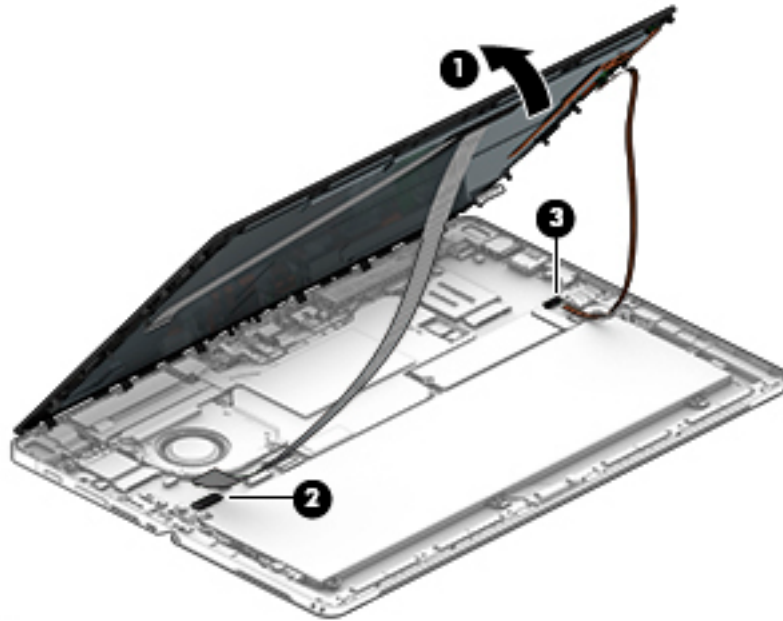

Reverse this procedure to replace the display panel.

Battery

Description	Spare part number
Battery, 4 C, 41 WH, 2.7 Ah, LI	860708-855

 **IMPORTANT:** Make special note of each screw and screw lock size and location during removal and replacement.

Before removing the battery, follow these steps:

1. Turn off the computer. If you are unsure whether the computer is off or in Hibernation, turn the computer on, and then shut it down through the operating system.
2. Disconnect the power from the computer by unplugging the power cord from the computer.
3. Disconnect all external devices from the computer.
4. Remove the following components:
 - a. Kickstand (select products only) (see [Kickstand on page 26](#))
 - b. Back cover (see [Back cover on page 29](#))
 - c. Display panel (see [Display panel on page 30](#))

Remove the battery:

1. Release the cable from the routing channels **(1)**, and then disconnect the battery **(2)**.

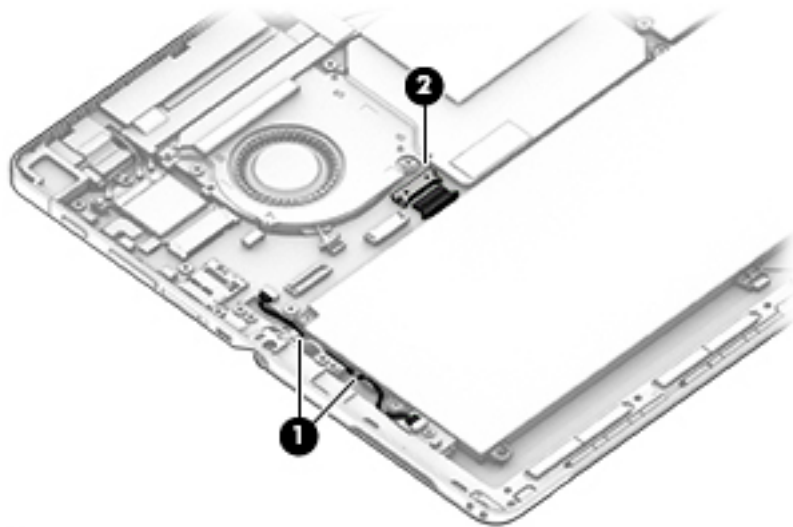

2. Remove 4 Phillips screws (1), and then carefully lift the battery (2) to remove it.

⚠ WARNING! To avoid personal injury and damage to the product, use extreme care not to puncture, twist, or crack the battery. A puncture or rupture of the battery internally can cause a short with the battery bursting into flames.

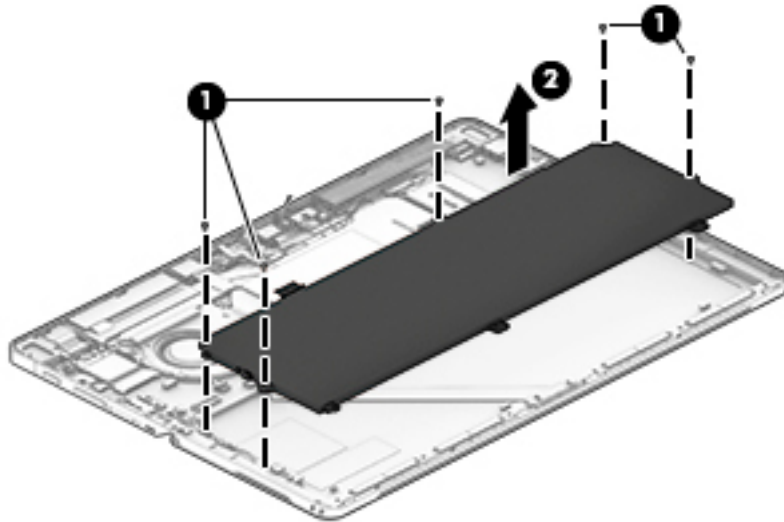

Reverse this procedure to replace the battery.

Hall sensor board

Description	Spare part number
Hall sensor board	938108-001

 **IMPORTANT:** Make special note of each screw and screw lock size and location during removal and replacement.

Before removing the Hall effects sensor board, follow these steps:

1. Turn off the computer. If you are unsure whether the computer is off or in Hibernation, turn the computer on, and then shut it down through the operating system.
2. Disconnect the power from the computer by unplugging the power cord from the computer.
3. Disconnect all external devices from the computer.
4. Remove the following components:
 - a. Kickstand (select products only) (see [Kickstand on page 26](#))
 - b. Back cover (see [Back cover on page 29](#))
 - c. Display panel (see [Display panel on page 30](#))
 - d. Battery (see [Battery on page 32](#))

Remove the Hall sensor board:

1. Disconnect the cable **(1)** from the Hall sensor board.
2. Release the cable from the routing channels**(2)** securing the cable.
3. Remove the Phillips screw **(3)** securing the board.
4. Lift the board **(4)** to remove it.

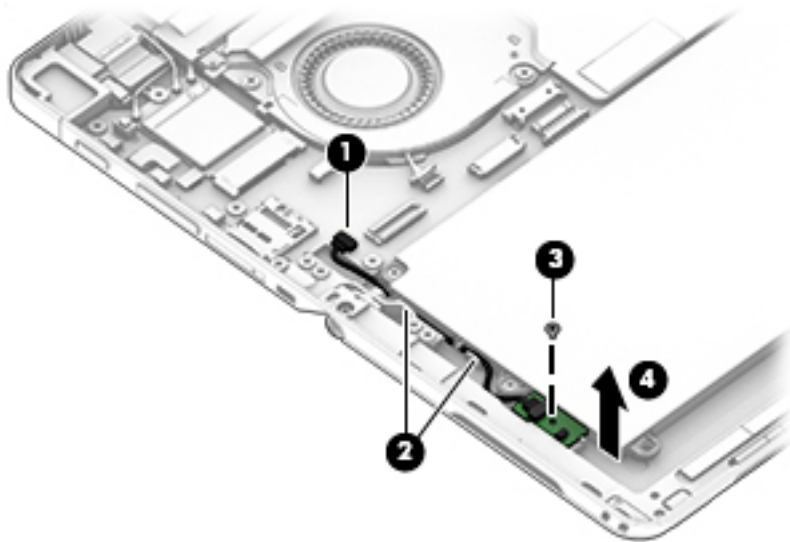

Reverse this procedure to replace the Hall sensor board.

Kickstand hinges

Description	
Kickstand hinges	L00122-001

 **IMPORTANT:** Make special note of each screw and screw lock size and location during removal and replacement.

Before removing the Hall effects sensor board, follow these steps:

1. Turn off the computer. If you are unsure whether the computer is off or in Hibernation, turn the computer on, and then shut it down through the operating system.
2. Disconnect the power from the computer by unplugging the power cord from the computer.
3. Disconnect all external devices from the computer.
4. Remove the following components:
 - a. Kickstand (select products only) (see [Kickstand on page 26](#))
 - b. Back cover (see [Back cover on page 29](#))
 - c. Display panel (see [Display panel on page 30](#))
 - d. Battery (see [Battery on page 32](#))
 - e. Hall sensor board (see [Hall sensor board on page 34](#))

Remove the kickstand hinges:

- ▲ Remove 5 screws from each kickstand hinge (1), and then remove the kickstand hinges (2).

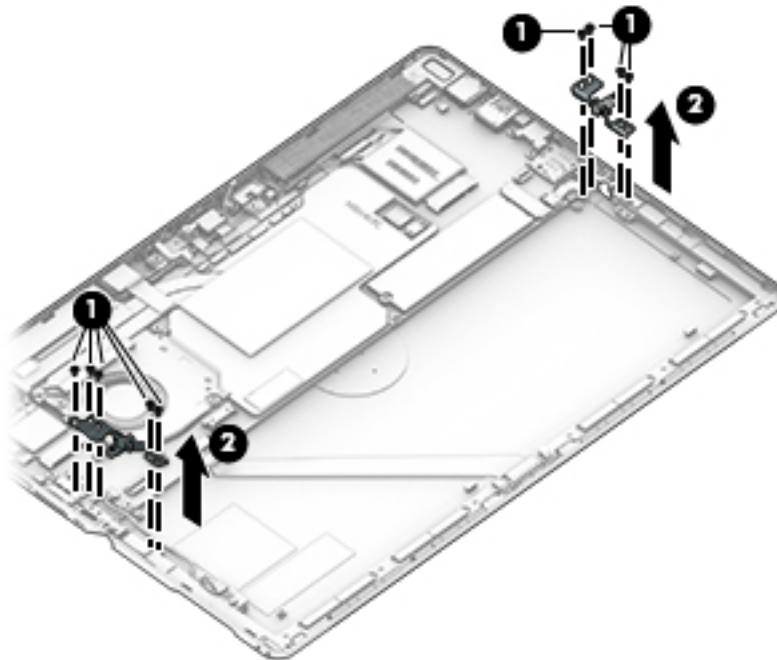

Reverse this procedure to replace the kickstand hinges.

Solid-state drive



IMPORTANT: Make special note of each screw and screw lock size and location during removal and replacement.

Description	Spare part number
Solid-state drive	
128 GB M2 SATA-3 Value	923773-001
1 TB Turbo Drive G2 TLC	923774-001
256 GB SATA-3 Self-encrypting drive OPAL2 TLC	923775-001
256 GB Turbo Drive G2 TLC	923776-001
512 GB Turbo Drive G2 MLC	923777-001
256 GB PCIe NVMe Value	926354-001
512 GB PCIe NVMe Value	926355-001
360 GB PCIe TLC	926356-001

Before removing the solid-state drive, follow these steps:

1. Turn off the computer. If you are unsure whether the computer is off or in Hibernation, turn the computer on, and then shut it down through the operating system.
2. Disconnect the power from the computer by unplugging the power cord from the computer.
3. Disconnect all external devices from the computer.
4. Remove the following components:
 - a. Kickstand (select products only) (see [Kickstand on page 26](#))
 - b. Back cover (see [Back cover on page 29](#))
 - c. Display panel (see [Display panel on page 30](#))
 - d. Battery (see [Battery on page 32](#))
 - e. Hall sensor board (see [Hall sensor board on page 34](#))
 - f. Kickstand hinges (see [Kickstand hinges on page 35](#))

Remove the solid-state drive:

- ▲ Remove 1 Phillips M2.0x2.0 screw **(1)**, and then remove the solid-state drive **(2)**.

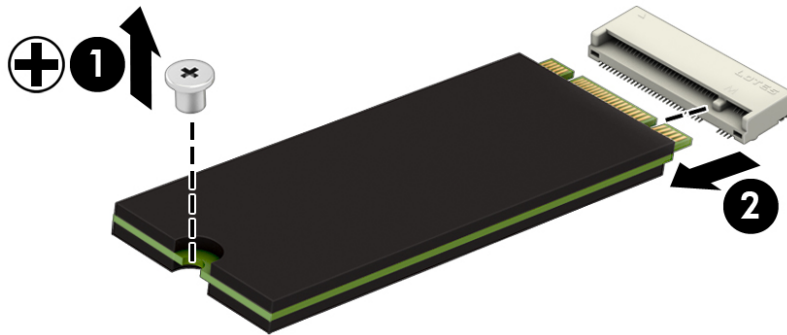

Reverse this procedure to replace the solid-state drive.

WLAN module



IMPORTANT: Make special note of each screw and screw lock size and location during removal and replacement.

Description	Spare part number
WLAN module (includes cable)	
11 AC 2x2 Intel 8265 NGW WdP	851592-001
11 AC 2X2 Intel 8265 NGW WDP NV	910264-855
11 AC Intel 18265.NGW OAK	924761-855

Before removing the WLAN or GPS module, follow these steps:

1. Turn off the computer. If you are unsure whether the computer is off or in Hibernation, turn the computer on, and then shut it down through the operating system.
2. Disconnect the power from the computer by unplugging the power cord from the computer.
3. Disconnect all external devices from the computer.
4. Remove the following components:
 - a. Remove the kickstand (see [Kickstand on page 26](#)).
 - b. Back cover (see [Back cover on page 29](#))
 - c. Display panel (see [Display panel on page 30](#))
 - d. Remove the battery (see [Battery on page 32](#))
 - e. Hall sensor board (see [Hall sensor board on page 34](#))
 - f. Kickstand hinges (see [Kickstand hinges on page 35](#))
 - g. Solid-state drive (see [Solid-state drive on page 36](#))

Remove the WLAN module:

- ▲ Disconnect the 3 antenna cables **(1)** and **(2)**, remove 1 Phillips M2.0x2.0 screw **(3)**, and then remove the module.

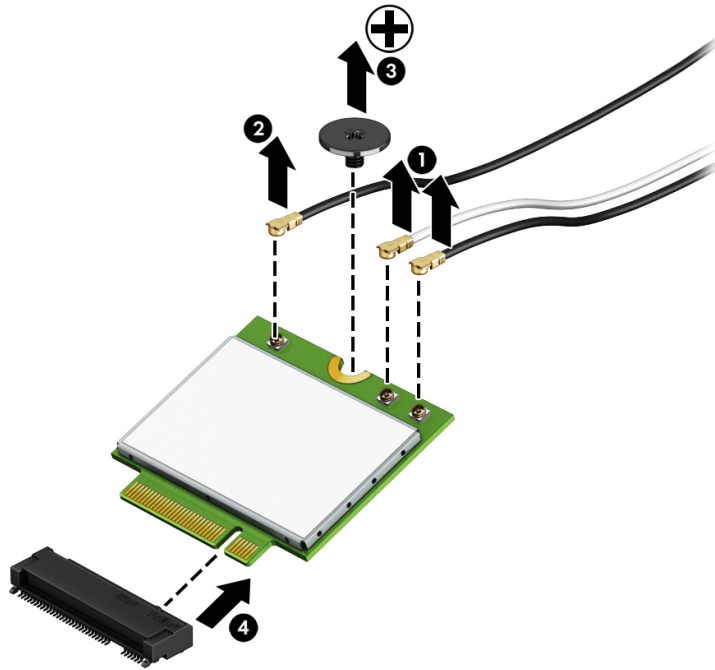

 **NOTE:** If the antenna cables are not connected to the terminals on the module, protective sleeves should be installed on the antenna connectors, as shown in the following illustration.

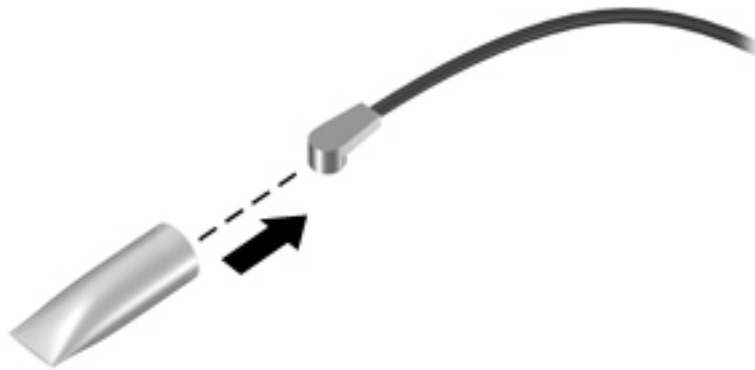

Reverse this procedure to replace the WLAN module (select products only).

WWAN or GPS module (select products only)



IMPORTANT: Make special note of each screw and screw lock size and location during removal and replacement.

Description	Spare part number
WWAN module (select products only)	
Wrangler 2 HSPA with antenna	923778-001
T77W595 with antenna	923779-001
ME906S with GPS with antenna	923780-001
Highlander ME906J with antenna	923781-001
GPS module with antenna	925647-001

Before removing the WWAN or GPS module, follow these steps:

1. Turn off the computer. If you are unsure whether the computer is off or in Hibernation, turn the computer on, and then shut it down through the operating system.
2. Disconnect the power from the computer by unplugging the power cord from the computer.
3. Disconnect all external devices from the computer.
4. Remove the following components:
 - a. Kickstand (select products only) (see [Kickstand on page 26](#))
 - b. Back cover (see [Back cover on page 29](#))
 - c. Display panel (see [Display panel on page 30](#))
 - d. Battery (see [Battery on page 32](#))
 - e. Hall sensor board (see [Hall sensor board on page 34](#))
 - f. Kickstand hinges (see [Kickstand hinges on page 35](#))
 - g. Solid-state drive (see [Solid-state drive on page 36](#))
 - h. WLAN module (see [WLAN module on page 38](#))

Remove the WWAN or GPS module:

- ▲ Disconnect the 2 antenna cables **(1)**, remove 1 Phillips M2.0x2.0 screw **(2)**, and then remove the module **(3)**.



NOTE: The GPS module will be connected to the WWAN AUX antenna cable only.

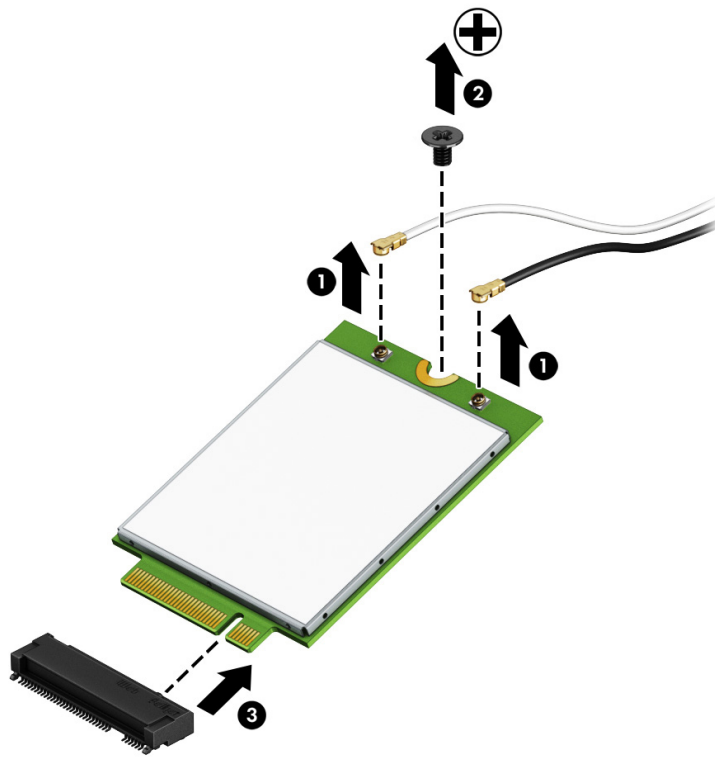

 **NOTE:** If the antenna cables are not connected to the terminals on the module, protective sleeves should be installed on the antenna connectors, as shown in the following illustration.

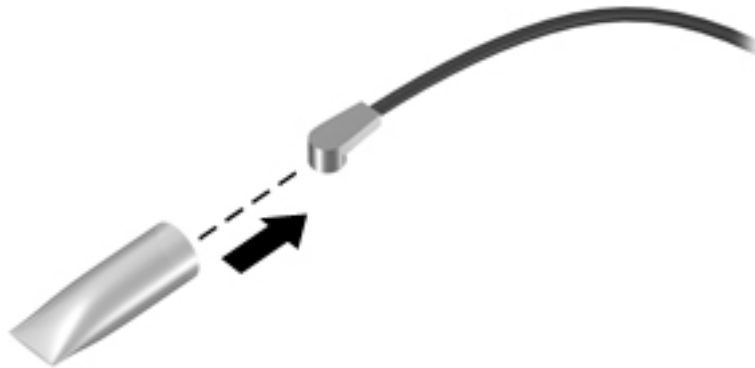

Reverse this procedure to replace the WWAN or GPS module (select products only).

Webcam

Description	Spare part number
Webcam	
1p MIPI-RAW 5MP	900731-002
1p MIPI-RAW VGA	907895-001



IMPORTANT: Make special note of each screw and screw lock size and location during removal and replacement.

Before removing the webcam, follow these steps:

1. Turn off the computer. If you are unsure whether the computer is off or in Hibernation, turn the computer on, and then shut it down through the operating system.
2. Disconnect the power from the computer by unplugging the power cord from the computer.
3. Disconnect all external devices from the computer.
4. Remove the following components:
 - a. Kickstand (select products only) (see [Kickstand on page 26](#))
 - b. Back cover (see [Back cover on page 29](#))
 - c. Display panel (see [Display panel on page 30](#))
 - d. Battery (see [Battery on page 32](#))
 - e. Hall sensor board (see [Hall sensor board on page 34](#))
 - f. Kickstand hinges (see [Kickstand hinges on page 35](#))
 - g. Solid-state drive (see [Solid-state drive on page 36](#))
 - h. WLAN module (see [WLAN module on page 38](#))
 - i. WWAN module (see [WWAN or GPS module \(select products only\) on page 40](#))

Remove the webcam:



CAUTION: Use care to prevent damaging the zero-insertion force (ZIF) connector and ribbon cable.

- ▲ Disconnect the ZIF connector and release the webcam cable **(1)** from the system board, and then lift the webcam **(2)** to remove it.

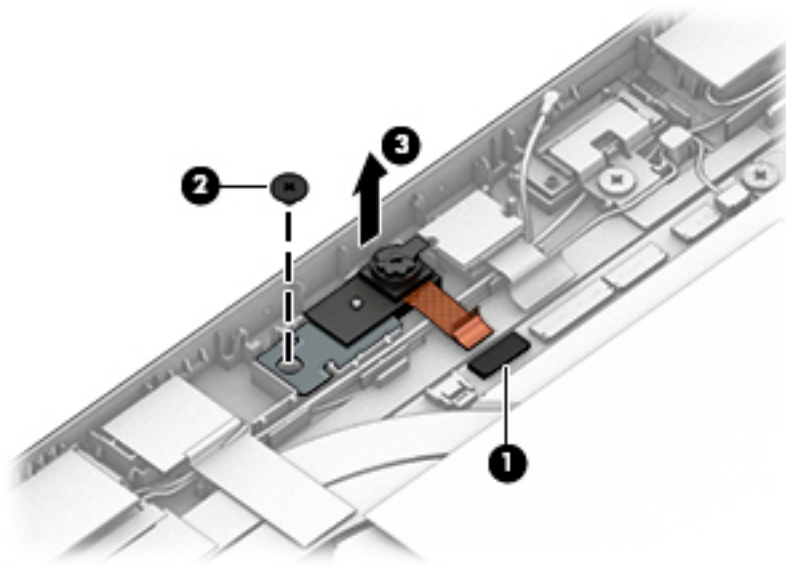

Reverse this procedure to replace the webcam and the rear webcam.

Microphone board

Description	Spare part number
Microphone board	924449-001

 **IMPORTANT:** Make special note of each screw and screw lock size and location during removal and replacement.

Before removing the webcam, follow these steps:

1. Turn off the computer. If you are unsure whether the computer is off or in Hibernation, turn the computer on, and then shut it down through the operating system.
2. Disconnect the power from the computer by unplugging the power cord from the computer.
3. Disconnect all external devices from the computer.
4. Remove the following components:
 - a. Kickstand (select products only) (see [Kickstand on page 26](#))
 - b. Back cover (see [Back cover on page 29](#))
 - c. Display panel (see [Display panel on page 30](#))
 - d. Battery (see [Battery on page 32](#))
 - e. Hall sensor board (see [Hall sensor board on page 34](#))
 - f. Kickstand hinges (see [Kickstand hinges on page 35](#))
 - g. Solid-state drive (see [Solid-state drive on page 36](#))
 - h. WLAN module (see [WLAN module on page 38](#))

- i. WWAN module (see [WWAN or GPS module \(select products only\) on page 40](#))
- j. Webcam (see [Webcam on page 42](#))

Remove the microphone board:

CAUTION: Use care to prevent damaging the zero-insertion force (ZIF) connector and ribbon cable.

- ▲ Disconnect the microphone cable from the system board **(1)**, remove the metal plate **(2)**, and then lift the microphone board to remove it **(3)**.

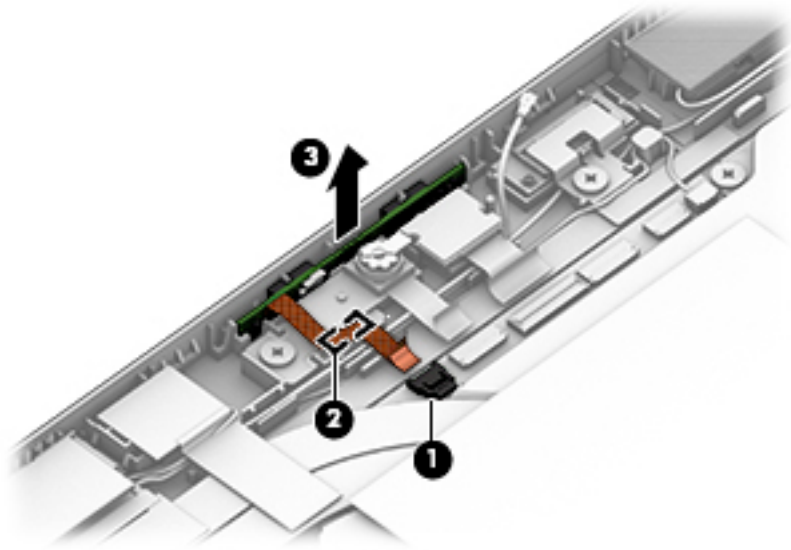

Reverse this procedures to replace the microphone board.

Rear webcam

Description	Spare part number
Rear webcam	
1p Auto NM MIPI-RAW 8MP	900730-002

 **IMPORTANT:** Make special note of each screw and screw lock size and location during removal and replacement.

Before removing the webcam, follow these steps:

1. Turn off the computer. If you are unsure whether the computer is off or in Hibernation, turn the computer on, and then shut it down through the operating system.
2. Disconnect the power from the computer by unplugging the power cord from the computer.
3. Disconnect all external devices from the computer.
4. Remove the following components:
 - a. Kickstand (select products only) (see [Kickstand on page 26](#))
 - b. Back cover (see [Back cover on page 29](#))
 - c. Display panel (see [Display panel on page 30](#))
 - d. Battery (see [Battery on page 32](#))
 - e. Hall sensor board (see [Hall sensor board on page 34](#))
 - f. Kickstand hinges (see [Kickstand hinges on page 35](#))
 - g. Solid-state drive (see [Solid-state drive on page 36](#))
 - h. WLAN module (see [WLAN module on page 38](#))
 - i. WWAN module (see [WWAN or GPS module \(select products only\) on page 40](#))
 - j. Webcam (see [Webcam on page 42](#))
 - k. Microphone board (see [Microphone board on page 43](#))

Remove the rear webcam:

 **CAUTION:** Use care to prevent damaging the zero-insertion force (ZIF) connector and ribbon cable.

- ▲ Disconnect the ZIF connector and release the rear webcam cable **(1)** from the system board, and then lift the rear webcam and flash **(2)** to remove it.

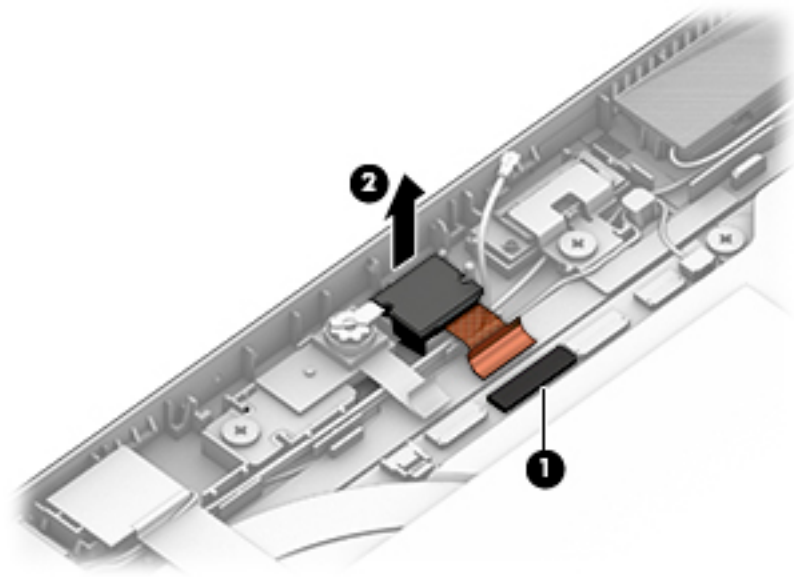

Reverse this procedure to replace the rear webcam.

System board

Description	Spare part number
System board	
i3-7100U 4 GB UMA graphics with thermal pads and Windows operating system	923765-601
i5-7200U 16 GB UMA graphics with thermal pads and Windows operating system	923766-601
i5-7200U 4GB UMA graphics with thermal pads and Windows operating system	923767-601
i5-7200U 8GB UMA graphics with thermal pads and Windows operating system	923768-601
i5-7300U 16 GB UMA graphics with thermal pads and Windows operating system	923769-601
i5-7300U 8GB UMA graphics with thermal pads and Windows operating system	923770-601
i7-7600U 16 GB UMA graphics with thermal pads and Windows operating system	923771-601
i7-7600U 8GB UMA graphics with thermal pads and Windows operating system	923772-601



IMPORTANT: Make special note of each screw and screw lock size and location during removal and replacement.

Before removing the system board, follow these steps:

1. Turn off the computer. If you are unsure whether the computer is off or in Hibernation, turn the computer on, and then shut it down through the operating system.
2. Disconnect the power from the computer by unplugging the power cord from the computer.
3. Disconnect all external devices from the computer.
4. Remove the following components:
 - a. Kickstand (select products only) (see [Kickstand on page 26](#))
 - b. Back cover (see [Back cover on page 29](#))
 - c. Display panel (see [Display panel on page 30](#))
 - d. Battery (see [Battery on page 32](#))
 - e. Hall sensor board (see [Hall sensor board on page 34](#))
 - f. Kickstand hinges (see [Kickstand hinges on page 35](#))
 - g. Solid-state drive (see [Solid-state drive on page 36](#))
 - h. WLAN module (see [WLAN module on page 38](#))
 - i. WWAN module (see [WWAN or GPS module \(select products only\) on page 40](#))
 - j. Webcam (see [Webcam on page 42](#))
 - k. Microphone board (see [Microphone board on page 43](#))
 - l. Rear webcam (see [Rear webcam on page 45](#))

Remove the system board:

1. Remove the 8 screws **(1)** securing the system board.

CAUTION: Use care to prevent damaging the ZIF connector and ribbon cable.

2. Remove the micro SD card tray and the micro SIM card tray.
3. Lift the top edge of the system board (3), and then remove it.

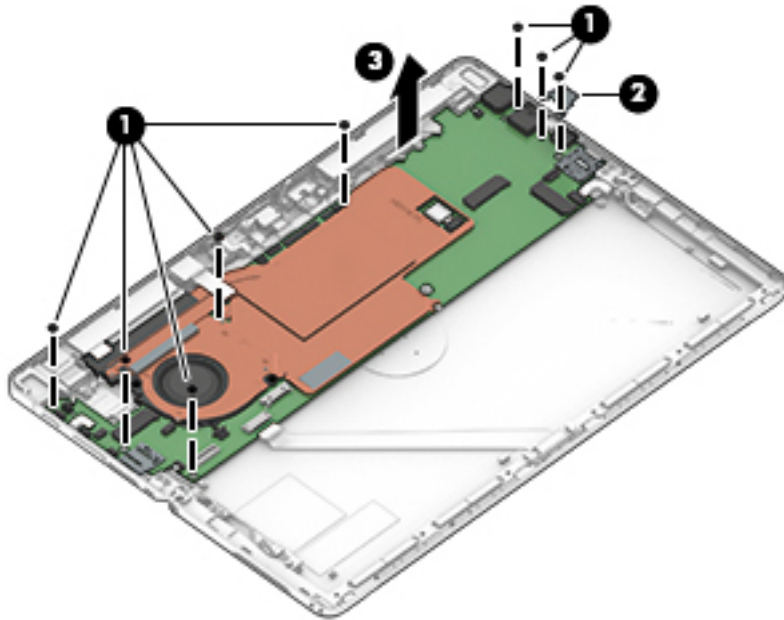

Reverse this procedure to replace the system board.

POGO connector

Description	Spare part number
POGO connector	938109-001

1. Turn off the computer. If you are unsure whether the computer is off or in Hibernation, turn the computer on, and then shut it down through the operating system.
2. Disconnect the power from the computer by unplugging the power cord from the computer.
3. Disconnect all external devices from the computer.
4. Remove the following components:
 - a. Kickstand (select products only) (see [Kickstand on page 26](#))
 - b. Back cover (see [Back cover on page 29](#))
 - c. Display panel (see [Display panel on page 30](#))
 - d. Battery (see [Battery on page 32](#))
 - e. Hall sensor board (see [Hall sensor board on page 34](#))
 - f. Kickstand hinges (see [Kickstand hinges on page 35](#))
 - g. Solid-state drive (see [Solid-state drive on page 36](#))
 - h. WLAN module (see [WLAN module on page 38](#))

- i. WWAN module (see [WWAN or GPS module \(select products only\) on page 40](#))
- j. Webcam (see [Webcam on page 42](#))
- k. Microphone board (see [Microphone board on page 43](#))
- l. Rear webcam (see [Rear webcam on page 45](#))
- m. System board (see [System board on page 47](#))

Remove the POGO connector:

- ▲ Disconnect the POGO cable from the system board **(1)**, peel the cable up from the back cover **(2)**, remove 2 screws from the POGO connector **(3)**, and then lift the connector to remove it **(4)**.

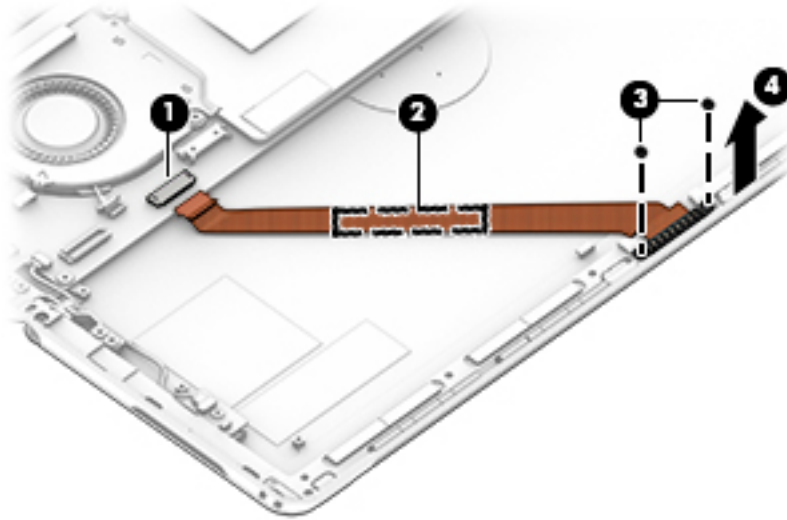

Reverse this procedure to replace the fan.

Fan

Description	Spare part number
Fan assembly	924448-001

1. Turn off the computer. If you are unsure whether the computer is off or in Hibernation, turn the computer on, and then shut it down through the operating system.
2. Disconnect the power from the computer by unplugging the power cord from the computer.
3. Disconnect all external devices from the computer.
4. Remove the following components:
 - a. Kickstand (select products only) (see [Kickstand on page 26](#))
 - b. Back cover (see [Back cover on page 29](#))
 - c. Display panel (see [Display panel on page 30](#))
 - d. Battery (see [Battery on page 32](#))
 - e. Hall sensor board (see [Hall sensor board on page 34](#))

- f. Solid-state drive (see [Solid-state drive on page 36](#))
- g. WLAN module (see [WLAN module on page 38](#))
- h. WWAN module (see [WWAN or GPS module \(select products only\) on page 40](#))
- i. Webcam (see [Webcam on page 42](#))
- j. Microphone board (see [Microphone board on page 43](#))
- k. Rear webcam (see [Rear webcam on page 45](#))
- l. System board (see [System board on page 47](#))
- m. POGO connector (see [POGO connector on page 48](#))

Remove the fan:

- ▲ Disconnect the fan cable from the system board **(1)**, remove 4 screws**(2)**, and then remove the fan from the system board.**(3)**.

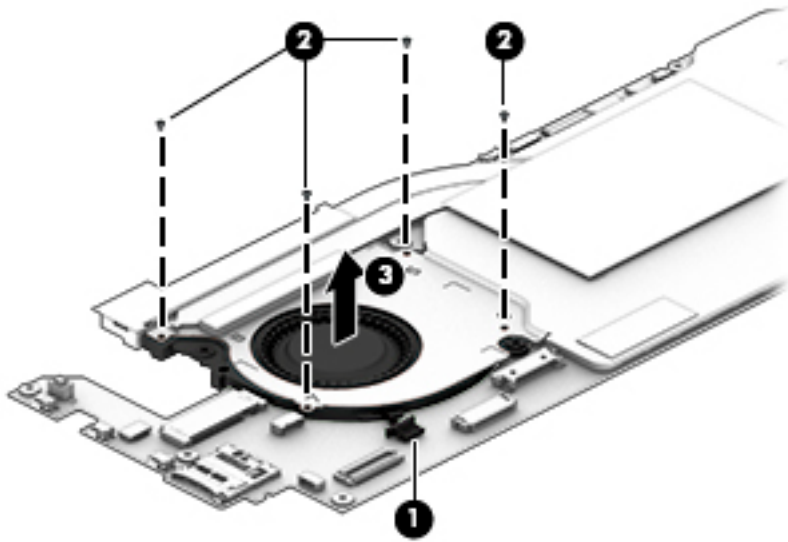

Reverse this procedure to replace the fan.

Fingerprint reader board

Description	Spare part number
Fingerprint reader board (includes bracket)	924460-001

 **IMPORTANT:** Make special note of each screw and screw lock size and location during removal and replacement.

Before removing the fingerprint reader board, follow these steps:

1. Turn off the computer. If you are unsure whether the computer is off or in Hibernation, turn the computer on, and then shut it down through the operating system.
2. Disconnect the power from the computer by unplugging the power cord from the computer.
3. Disconnect all external devices from the computer.
4. Remove the following components:
 - a. Kickstand (select products only) (see [Kickstand on page 26](#))
 - b. Back cover (see [Back cover on page 29](#))
 - c. Display panel (see [Display panel on page 30](#))
 - d. Battery (see [Battery on page 32](#))
 - e. Hall sensor board (see [Hall sensor board on page 34](#))
 - f. Kickstand hinges (see [Kickstand hinges on page 35](#))
 - g. Solid-state drive (see [Solid-state drive on page 36](#))
 - h. WLAN module (see [WLAN module on page 38](#))
 - i. WWAN module (see [WWAN or GPS module \(select products only\) on page 40](#))
 - j. Webcam (see [Webcam on page 42](#))
 - k. Microphone board (see [Microphone board on page 43](#))
 - l. Rear webcam (see [Rear webcam on page 45](#))
 - m. System board (see [System board on page 47](#))
 - n. POGO connector (see [POGO connector on page 48](#))
 - o. Fan (see [Fan on page 49](#))

Remove the fingerprint reader board:

 **CAUTION:** Use care to prevent damaging the ZIF connector and ribbon cable.

1. Remove the fingerprint reader bracket(1).

2. Lift the fingerprint reader board (2) to release it from the adhesive securing it, and then remove the fingerprint reader board.

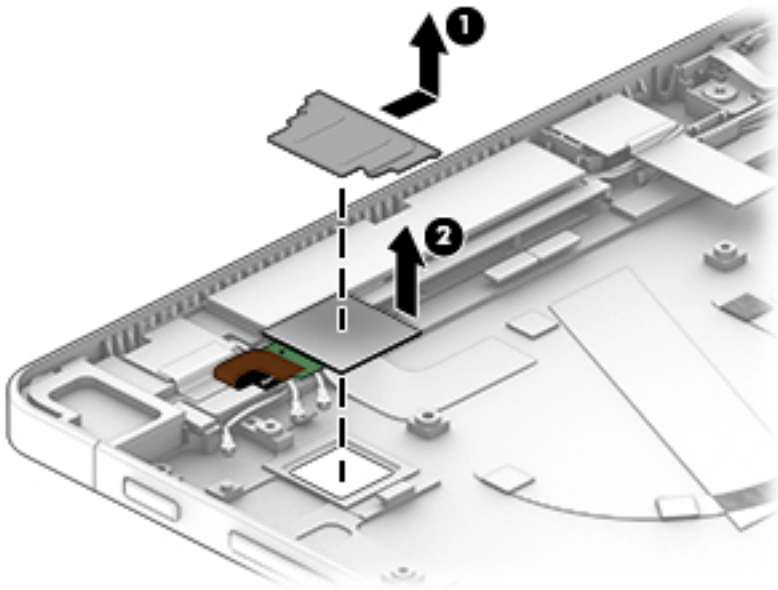

Reverse this procedure to replace the fingerprint reader board.

Speakers

Description	Spare part number
Speakers	925445-001

 **IMPORTANT:** Make special note of each screw and screw lock size and location during removal and replacement

Before removing the speakers, follow these steps:

1. Turn off the computer. If you are unsure whether the computer is off or in Hibernation, turn the computer on, and then shut it down through the operating system.
2. Disconnect the power from the computer by unplugging the power cord from the computer.
3. Disconnect all external devices from the computer.
4. Remove the following components:
 - a. Kickstand (select products only) (see [Kickstand on page 26](#))
 - b. Back cover (see [Back cover on page 29](#))
 - c. Display panel (see [Display panel on page 30](#))
 - d. Battery (see [Battery on page 32](#))
 - e. Hall sensor board (see [Hall sensor board on page 34](#))
 - f. Kickstand hinges (see [Kickstand hinges on page 35](#))
 - g. Solid-state drive (see [Solid-state drive on page 36](#))
 - h. WLAN module (see [WLAN module on page 38](#))
 - i. WWAN module (see [WWAN or GPS module \(select products only\) on page 40](#))
 - j. Webcam (see [Webcam on page 42](#))
 - k. Microphone board (see [Microphone board on page 43](#))
 - l. Rear webcam (see [Rear webcam on page 45](#))
 - m. System board (see [System board on page 47](#))
 - n. POGO connector (see [POGO connector on page 48](#))
 - o. Fan (see [Fan on page 49](#))
 - p. Fingerprint reader board (see [Fingerprint reader board on page 51](#))

Remove the speakers:

1. Lift the right speaker **(1)**, and then left the right speaker **(2)**.

2. Release the speaker wires from the routing, and then lift the speakers to remove them.

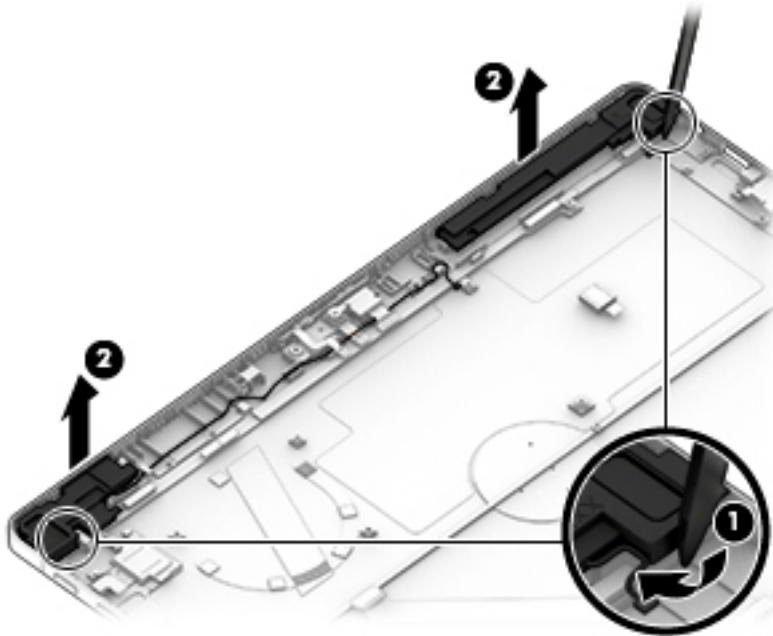

Reverse this procedure to replace the speakers.

Antennas

Description	Spare part number
Antennas, WLAN dual	925446-001

 **IMPORTANT:** Make special note of each screw and screw lock size and location during removal and replacement

Before removing the antennas, follow these steps:

1. Turn off the computer. If you are unsure whether the computer is off or in Hibernation, turn the computer on, and then shut it down through the operating system.
2. Disconnect the power from the computer by unplugging the power cord from the computer.
3. Disconnect all external devices from the computer.
4. Remove the following components:
 - a. Kickstand (select products only) (see [Kickstand on page 26](#))
 - b. Back cover (see [Back cover on page 29](#))
 - c. Display panel (see [Display panel on page 30](#))
 - d. Battery (see [Battery on page 32](#))
 - e. Hall sensor board (see [Hall sensor board on page 34](#))
 - f. Kickstand hinges (see [Kickstand hinges on page 35](#))
 - g. Solid-state drive (see [Solid-state drive on page 36](#))

- h.** WLAN module (see [WLAN module on page 38](#))
- i.** WWAN module (see [WWAN or GPS module \(select products only\) on page 40](#))
- j.** Webcam (see [Webcam on page 42](#))
- k.** Microphone board (see [Microphone board on page 43](#))
- l.** Rear webcam (see [Rear webcam on page 45](#))
- m.** System board (see [System board on page 47](#))
- n.** POGO connector (see [POGO connector on page 48](#))
- o.** Fan (see [Fan on page 49](#))
- p.** Fingerprint reader board (see [Fingerprint reader board on page 51](#))
- q.** Speakers (see [Speakers on page 53](#))

Remove the antennas:

- 1.** Remove the WLAN antennas.

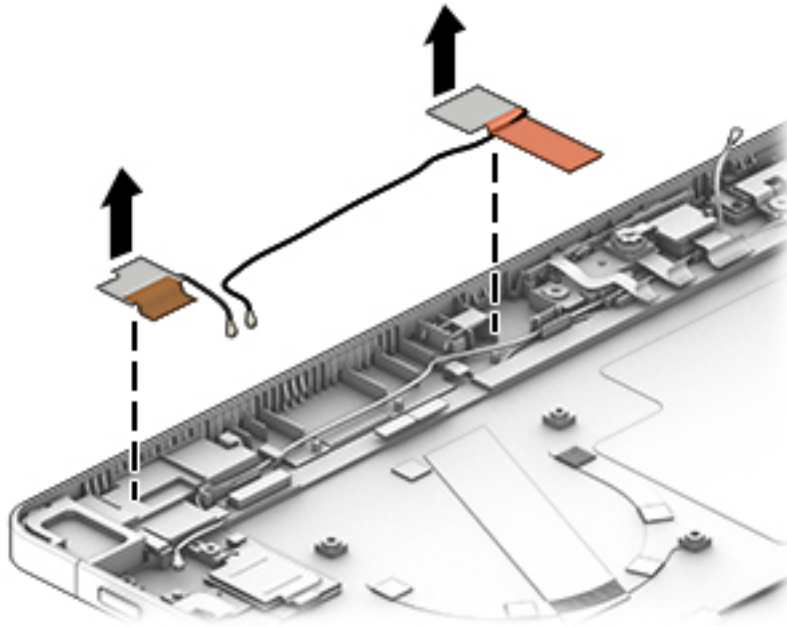

2. Remove the WWAN antennas.

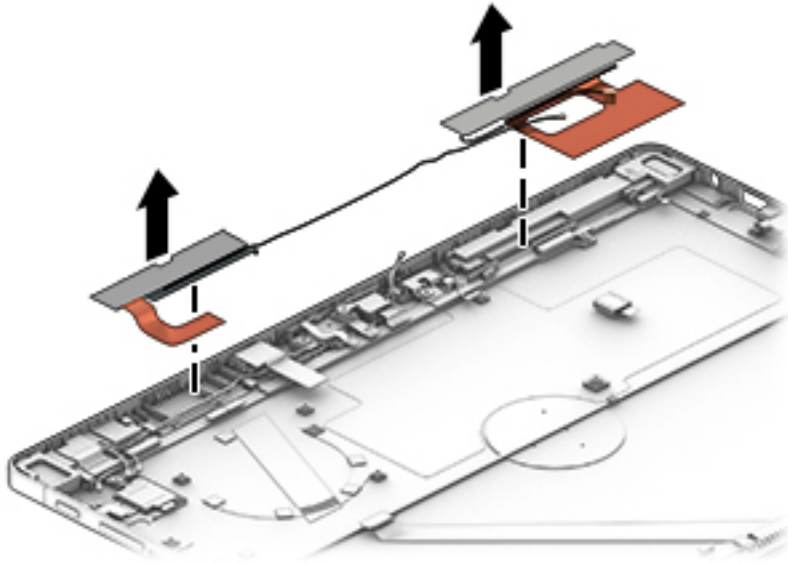

7 Backing up, restoring, and recovering

This chapter provides information about the following processes. The information in the chapter is standard procedure for most products.

- Creating recovery media and backups
- Restoring and recovering your system

For additional information, refer to the HP Support Assistant app.

- ▲ Type `support` in the taskbar search box, and then select the **HP Support Assistant** app.

– or –

Select the question mark icon in the taskbar.

 **IMPORTANT:** If you will be performing recovery procedures on a tablet, the tablet battery must be at least 70% charged before you start the recovery process.

IMPORTANT: For a tablet with a detachable keyboard, connect the tablet to the keyboard base before beginning any recovery process.

Creating recovery media and backups

The following methods of creating recovery media and backups are available on select products only. Choose the available method according to your computer model.

- Use HP Recovery Manager to create HP Recovery media after you successfully set up the computer. This step creates a backup of the HP Recovery partition on the computer. The backup can be used to reinstall the original operating system in cases where the hard drive is corrupted or has been replaced. For information on creating recovery media, see [Creating HP Recovery media \(select products only\) on page 57](#). For information on the recovery options that are available using the recovery media, see [Using Windows tools on page 58](#).

- Use Windows tools to create system restore points and create backups of personal information.

For more information, see [Recovering using HP Recovery Manager on page 59](#).

 **NOTE:** If storage is 32 GB or less, Microsoft System Restore is disabled by default.

- On select products, use the HP Cloud Recovery Download Tool to create a bootable USB drive for your HP recovery media. Go to <https://support.hp.com/us-en/document/c05115630?openCLC=true>, select your country or region, and follow the on-screen instructions.

Creating HP Recovery media (select products only)

If possible, check for the presence of the Recovery partition and the Windows partition. Right-click the **Start** menu, select **File Explorer**, and then select **This PC**.

- If your computer does not list the Windows partition and the Recovery partition, you can obtain recovery media for your system from support. You can find contact information on the HP website. Go to <http://www.hp.com/support>, select your country or region, and follow the on-screen instructions.

You can use Windows tools to create system restore points and create backups of personal information, see [Using Windows tools on page 58](#).

- If your computer does list the Recovery partition and the Windows partition, you can use HP Recovery Manager to create recovery media after you successfully set up the computer. HP Recovery media can be used to perform system recovery if the hard drive becomes corrupted. System recovery reinstalls the original operating system and software programs that were installed at the factory and then configures the settings for the programs. HP Recovery media can also be used to customize the system or restore the factory image if you replace the hard drive.
 - Only one set of recovery media can be created. Handle these recovery tools carefully, and keep them in a safe place.
 - HP Recovery Manager examines the computer and determines the required storage capacity for the media that will be required.
 - To create recovery discs, your computer must have an optical drive with DVD writer capability, and you must use only high-quality blank DVD-R, DVD+R, DVD-R DL, or DVD+R DL discs. Do not use rewritable discs such as CD±RW, DVD±RW, double-layer DVD±RW, or BD-RE (rewritable Blu-ray) discs; they are not compatible with HP Recovery Manager software. Or, instead, you can use a high-quality blank USB flash drive.
 - If your computer does not include an integrated optical drive with DVD writer capability, but you would like to create DVD recovery media, you can use an external optical drive (purchased separately) to create recovery discs. If you use an external optical drive, it must be connected directly to a USB port on the computer; the drive cannot be connected to a USB port on an external device, such as a USB hub. If you cannot create DVD media yourself, you can obtain recovery discs for your computer from HP. You can find contact information on the HP website. Go to <http://www.hp.com/support>, select your country or region, and follow the on-screen instructions.
 - Be sure that the computer is connected to AC power before you begin creating the recovery media.
 - The creation process can take an hour or more. Do not interrupt the creation process.
 - If necessary, you can exit the program before you have finished creating all of the recovery DVDs. HP Recovery Manager will finish burning the current DVD. The next time you start HP Recovery Manager, you will be prompted to continue.

To create HP Recovery media:



IMPORTANT: For a tablet with a detachable keyboard, connect the tablet to the keyboard base before beginning these steps.

1. Type `recovery` in the taskbar search box, and then select **HP Recovery Manager**.
2. Select **Create recovery media**, and then follow the on-screen instructions.

If you ever need to recover the system, see [Recovering using HP Recovery Manager on page 59](#).

Using Windows tools

You can create recovery media, system restore points, and backups of personal information using Windows tools.



NOTE: If storage is 32 GB or less, Microsoft System Restore is disabled by default.

For more information and steps, see the Get help app.

- ▲ Select the **Start** button, and then select the **Get Help** app.

 **NOTE:** You must be connected to the Internet to access the Get help app.

Restore and recovery

There are several options for recovering your system. Choose the method that best matches your situation and level of expertise:

 **IMPORTANT:** Not all methods are available on all products.

- Windows offers several options for restoring from backup, refreshing the computer, and resetting the computer to its original state. For more information see the Get help app.

▲ Select the **Start** button, and then select the **Get Help** app.

 **NOTE:** You must be connected to the Internet to access the Get help app.

- If you need to correct a problem with a preinstalled application or driver, use the Reinstall drivers and/or applications option (select products only) of HP Recovery Manager to reinstall the individual application or driver.

▲ Type `recovery` in the taskbar search box, select **HP Recovery Manager**, select **Reinstall drivers and/or applications**, and then follow the on-screen instructions.

- If you want to recover the Windows partition to original factory content, you can choose the System Recovery option from the HP Recovery partition (select products only) or use the HP Recovery media. For more information, see [Recovering using HP Recovery Manager on page 59](#). If you have not already created recovery media, see [Creating HP Recovery media \(select products only\) on page 57](#).
- On select products, if you want to recover the computer's original factory partition and content, or if you have replaced the hard drive, you can use the Factory Reset option of HP Recovery media. For more information, see [Recovering using HP Recovery Manager on page 59](#).
- On select products, if you want to remove the Recovery partition to reclaim hard drive space, HP Recovery Manager offers the Remove Recovery Partition option.

For more information, see [Removing the HP Recovery partition \(select products only\) on page 61](#).

Recovering using HP Recovery Manager

HP Recovery Manager software allows you to recover the computer to its original factory state by using the HP Recovery media that you either created or that you obtained from HP, or by using the HP Recovery partition (select products only). If you have not already created recovery media, see [Creating HP Recovery media \(select products only\) on page 57](#).

What you need to know before you get started

- HP Recovery Manager recovers only software that was installed at the factory. For software not provided with this computer, you must either download the software from the manufacturer's website or reinstall the software from the media provided by the manufacturer.

 **IMPORTANT:** Recovery through HP Recovery Manager should be used as a final attempt to correct computer issues.

- HP Recovery media must be used if the computer hard drive fails. If you have not already created recovery media, see [Creating HP Recovery media \(select products only\) on page 57](#).

- To use the Factory Reset option (select products only), you must use HP Recovery media. If you have not already created recovery media, see [Creating HP Recovery media \(select products only\) on page 57](#).
- If your computer does not allow the creation of HP Recovery media or if the HP Recovery media does not work, you can obtain recovery media for your system from support. You can find contact information from the HP website. Go to <http://www.hp.com/support>, select your country or region, and follow the on-screen instructions.

 **IMPORTANT:** HP Recovery Manager does not automatically provide backups of your personal data. Before beginning recovery, back up any personal data you want to retain.

Using HP Recovery media, you can choose from one of the following recovery options:

 **NOTE:** Only the options available for your computer display when you start the recovery process.

- System Recovery—Reinstalls the original operating system, and then configures the settings for the programs that were installed at the factory.
- Factory Reset—Restores the computer to its original factory state by deleting all information from the hard drive and re-creating the partitions. Then it reinstalls the operating system and the software that was installed at the factory.

The HP Recovery partition (select products only) allows System Recovery only.

Using the HP Recovery partition (select products only)

The HP Recovery partition allows you to perform a system recovery without the need for recovery discs or a recovery USB flash drive. This type of recovery can be used only if the hard drive is still working.

To start HP Recovery Manager from the HP Recovery partition:

 **IMPORTANT:** For a tablet with a detachable keyboard, connect the tablet to the keyboard base before beginning these steps (select products only).

1. Type `recovery` in the taskbar search box, select **HP Recovery Manager**, and then select **Windows Recovery Environment**.

– or –

For computers or tablets with keyboards attached, press **f11** while the computer boots, or press and hold **f11** as you press the power button.

For tablets without keyboards:

- Turn on or restart the tablet, and then quickly hold down the volume up button; then select **f11**.

– or –

- Turn on or restart the tablet, and then quickly hold down the volume down button; then select **f11**.

2. Select **Troubleshoot** from the boot options menu.
3. Select **Recovery Manager**, and then follow the on-screen instructions.

Using HP Recovery media to recover

You can use HP Recovery media to recover the original system. This method can be used if your system does not have an HP Recovery partition or if the hard drive is not working properly.

1. If possible, back up all personal files.
2. Insert the HP Recovery media, and then restart the computer.



NOTE: If the computer does not automatically restart in HP Recovery Manager, change the computer boot order. See [Changing the computer boot order on page 61](#).

3. Follow the on-screen instructions.

Changing the computer boot order

If your computer does not restart in HP Recovery Manager, you can change the computer boot order, which is the order of devices listed in BIOS where the computer looks for startup information. You can change the selection to an optical drive or a USB flash drive.

To change the boot order:



IMPORTANT: For a tablet with a detachable keyboard, connect the tablet to the keyboard base before beginning these steps.

1. Insert the HP Recovery media.
2. Access the system **Startup** menu.

For computers or tablets with keyboards attached:

- ▲ Turn on or restart the computer or tablet, quickly press **esc**, and then press **f9** for boot options.

For tablets without keyboards:

- ▲ Turn on or restart the tablet, and then quickly hold down the volume up button; then select **f9**.

– or –

Turn on or restart the tablet, and then quickly hold down the volume down button; then select **f9**.

3. Select the optical drive or USB flash drive from which you want to boot.
4. Follow the on-screen instructions.

Removing the HP Recovery partition (select products only)

HP Recovery Manager software allows you to remove the HP Recovery partition to free up hard drive space.



IMPORTANT: After you remove the HP Recovery partition, you will not be able to perform System Recovery or create HP Recovery media from the HP Recovery partition. So before you remove the Recovery partition, create HP Recovery media; see [Creating HP Recovery media \(select products only\) on page 57](#).



NOTE: The Remove Recovery Partition option is only available on products that support this function.

Follow these steps to remove the HP Recovery partition:

1. Type `recovery` in the taskbar search box, and then select **HP Recovery Manager**.
2. Select **Remove Recovery Partition**, and then follow the on-screen instructions.

8 Computer Setup (BIOS), TPM, and HP Sure Start

Using Computer Setup

Computer Setup, or Basic Input/Output System (BIOS), controls communication between all the input and output devices on the system (such as disk drives, display, keyboard, mouse, and printer). Computer Setup includes settings for the types of devices installed, the startup sequence of the computer, and the amount of system and extended memory.



NOTE: Use extreme care when making changes in Computer Setup. Errors can prevent the computer from operating properly.

Starting Computer Setup

- ▲ Turn on or restart the computer, and when the HP logo appears, press **f10** to enter Computer Setup.

Using a USB keyboard or USB mouse to start Computer Setup (BIOS)

You can start Computer Setup by using a keyboard or mouse connected to a USB port, but you must first disable FastBoot.

1. Turn on or restart the computer, and when the HP logo appears, press **f9** to enter the Boot Device Options menu.
2. Clear the check box for **Fast Boot**.
3. To save your changes and exit, select the **Save** icon in the lower-right corner of the screen, and then follow the on-screen instructions.

– or –

Select **Main**, select **Save Changes and Exit**, and then press **enter**.

Your changes go into effect when the computer restarts.

Navigating and selecting in Computer Setup

- To select a menu or a menu item, use the **tab** key and the keyboard arrow keys and then press **enter**, or use a pointing device to select the item.
- To scroll up and down, select the up arrow or the down arrow in the upper-right corner of the screen, or use the up arrow key or the down arrow key on the keyboard.
- To close open dialog boxes and return to the main Computer Setup screen, press **esc**, and then follow the on-screen instructions.

To exit Computer Setup menus, choose one of the following methods:

- To exit Computer Setup menus without saving your changes:
Select the **Exit** icon in the lower-right corner of the screen, and then follow the on-screen instructions.
– or –
Select **Main**, select **Ignore Changes and Exit**, and then press [enter](#).
- To save your changes and exit Computer Setup menus:
Select the **Save** icon in the lower-right corner of the screen, and then follow the on-screen instructions.
– or –
Select **Main**, select **Save Changes and Exit**, and then press [enter](#).

Your changes go into effect when the computer restarts.

Restoring factory settings in Computer Setup

 **NOTE:** Restoring defaults will not change the hard drive mode.

To return all settings in Computer Setup to the values that were set at the factory, follow these steps:

1. Start Computer Setup. See [Starting Computer Setup on page 62](#).
2. Select **Main**, and then select **Apply Factory Defaults and Exit**.

 **NOTE:** On select products, the selections may display **Restore Defaults** instead of **Apply Factory Defaults and Exit**.

3. Follow the on-screen instructions.
4. To save your changes and exit, select the **Save** icon in the lower-right corner of the screen, and then follow the on-screen instructions.
– or –
Select **Main**, select **Save Changes and Exit**, and then press [enter](#).

Your changes go into effect when the computer restarts.

 **NOTE:** Your password settings and security settings are not changed when you restore the factory settings.

Updating the BIOS

Updated versions of the BIOS may be available on the HP website.

Most BIOS updates on the HP website are packaged in compressed files called *SoftPaqs*.

Some download packages contain a file named *Readme.txt*, which contains information regarding installing and troubleshooting the file.

Determining the BIOS version

To decide whether you need to update Computer Setup (BIOS), first determine the BIOS version on your computer.

BIOS version information (also known as *ROM date* and *System BIOS*) can be accessed by pressing [fn+esc](#) (if you are already in Windows) or by using Computer Setup.

1. Start Computer Setup. See [Starting Computer Setup on page 62](#).
2. Select **Main**, and then select **System Information**.
3. To exit Computer Setup without saving your changes, select the **Exit** icon in the lower-right corner of the screen, and then follow the on-screen instructions.

– or –

Select **Main**, select **Ignore Changes and Exit**, and then press **enter**.

To check for later BIOS versions, see [Downloading a BIOS update on page 64](#).

Downloading a BIOS update

 **CAUTION:** To reduce the risk of damage to the computer or an unsuccessful installation, download and install a BIOS update only when the computer is connected to reliable external power using the AC adapter. Do not download or install a BIOS update while the computer is running on battery power, docked in an optional docking device, or connected to an optional power source. During the download and installation, follow these instructions:

Do not disconnect power on the computer by unplugging the power cord from the AC outlet.

Do not shut down the computer or initiate Sleep.

Do not insert, remove, connect, or disconnect any device, cable, or cord.

1. Type `support` in the taskbar search box, and then select the HP Support Assistant app.
– or –
Select the question mark icon in the taskbar.
2. Select **Updates**, and then select **Check for updates and messages**.
3. Follow the on-screen instructions.
4. At the download area, follow these steps:
 - a. Identify the most recent BIOS update and compare it to the BIOS version currently installed on your computer. Make a note of the date, name, or other identifier. You may need this information to locate the update later, after it has been downloaded to your hard drive.
 - b. Follow the on-screen instructions to download your selection to the hard drive.
Make a note of the path to the location on your hard drive where the BIOS update is downloaded. You will need to access this path when you are ready to install the update.

 **NOTE:** If you connect your computer to a network, consult the network administrator before installing any software updates, especially system BIOS updates.

BIOS installation procedures vary. Follow any instructions that are displayed on the screen after the download is complete. If no instructions are displayed, follow these steps:

1. Type `file` in the taskbar search box, and then select **File Explorer**.
2. Select your hard drive designation. The hard drive designation is typically Local Disk (C:).
3. Using the hard drive path you recorded earlier, open the folder that contains the update.
4. Double-click the file that has an `.exe` extension (for example, `filename.exe`).
The BIOS installation begins.
5. Complete the installation by following the on-screen instructions.



NOTE: After a message on the screen reports a successful installation, you can delete the downloaded file from your hard drive.

Changing the boot order using the f9 prompt

To dynamically choose a boot device for the current startup sequence, follow these steps:

1. Access the Boot Device Options menu:
 - Turn on or restart the computer, and when the HP logo appears, press **f9** to enter the Boot Device Options menu.
2. Select a boot device, press **enter**, and then follow the on-screen instructions.

TPM BIOS settings (select products only)



IMPORTANT: Before enabling Trusted Platform Module (TPM) functionality on this system, you must ensure that your intended use of TPM complies with relevant local laws, regulations and policies, and approvals or licenses must be obtained if applicable. For any compliance issues arising from your operation/usage of TPM which violates the above mentioned requirement, you shall bear all the liabilities wholly and solely. HP will not be responsible for any related liabilities.

TPM provides additional security for your computer. You can modify the TPM settings in Computer Setup (BIOS).



NOTE: If you change the TPM setting to Hidden, TPM is not visible in the operating system.

To access TPM settings in Computer Setup:

1. Start Computer Setup. See [Starting Computer Setup on page 62](#).
2. Select **Security**, select **TPM Embedded Security**, and then follow the on-screen instructions.

Using HP Sure Start (select products only)

Select computer models are configured with HP Sure Start, a technology that monitors the computer's BIOS for attacks or corruption. If the BIOS becomes corrupted or is attacked, HP Sure Start automatically restores the BIOS to its previously safe state, without user intervention.

HP Sure Start is configured and already enabled so that most users can use the HP Sure Start default configuration. The default configuration can be customized by advanced users.

To access the latest documentation on HP Sure Start, go to <http://www.hp.com/support>. Select **Find your product**, and then follow the on-screen instructions.

9 Using HP PC Hardware Diagnostics (UEFI)

HP PC Hardware Diagnostics is a Unified Extensible Firmware Interface (UEFI) that allows you to run diagnostic tests to determine whether the computer hardware is functioning properly. The tool runs outside the operating system so that it can isolate hardware failures from issues that are caused by the operating system or other software components.

When HP PC Hardware Diagnostics (UEFI) detects a failure that requires hardware replacement, a 24-digit Failure ID code is generated. This ID code can then be provided to support to help determine how to correct the problem.

 **NOTE:** To start diagnostics on a convertible computer, your computer must be in notebook mode and you must use the keyboard attached.

To start HP PC Hardware Diagnostics (UEFI), follow these steps:

1. Turn on or restart the computer, and quickly press *esc*.
2. Press *f2*.

The BIOS searches three places for the diagnostic tools, in the following order:

- a. Connected USB drive

 **NOTE:** To download the HP PC Hardware Diagnostics (UEFI) tool to a USB drive, see [Downloading HP PC Hardware Diagnostics \(UEFI\) to a USB device on page 67](#).

- b. Hard drive
- c. BIOS

3. When the diagnostic tool opens, select the type of diagnostic test you want to run, and then follow the on-screen instructions.

 **NOTE:** If you need to stop a diagnostic test, press *esc*.

Downloading HP PC Hardware Diagnostics (UEFI) to a USB device



NOTE: The HP PC Hardware Diagnostics (UEFI) download instructions are provided in English only, and you must use a Windows computer to download and create the HP UEFI support environment because only .exe files are offered.

There are two options to download HP PC Hardware Diagnostics to a USB device.

Download the latest UEFI version

1. Go to <http://www.hp.com/go/techcenter/pcdiags>. The HP PC Diagnostics home page is displayed.
2. In the HP PC Hardware Diagnostics section, select the **Download** link, and then select **Run**.

Download any version of UEFI for a specific product

1. Go to <http://www.hp.com/support>.
2. Select **Get software and drivers**.
3. Enter the product name or number.
4. Select your computer, and then select your operating system.
5. In the **Diagnostic** section, follow the on-screen instructions to select and download the UEFI version you want.

10 Specifications

Computer specifications

	Tablet	Keyboard	Tablet and Keyboard
Input power			
Dimensions			
Width	300.0 mm (11.81")	300.0 mm (11.81")	300.0 mm (11.81")
Depth	213.85 mm (8.42")	219.3 mm (8.65")	219.3 mm (8.65")
Height (front to back)	9.1 mm (0.36")	5.6 mm (0.22")	14.6 mm (0.57")
Weight	810 g (1.78 lb)	353 g (0.78 lb)	1163 g (2.56 lb)
Operating voltage and current	5 V dc @ 3 A / 9 V dc @ 3A / 10 V dc @ 5 A / 12 V dc @ 5 A / 15 V dc @ 4.33 A / 20 V dc @ 3.25 A - 65 W USB-C		
Temperature			
Operating	32° to 95° F (0° to 35° C) (not writing optical) 41° to 95° F (5° to 35° C) (writing optical)		
Nonoperating	-4° to 140° F (-20° to 60° C)		
Relative humidity (noncondensing)			
Operating	10% to 90%		
Nonoperating	5% to 95%		
Shock			
Operating	40 G, 2 ms, half-sine		
Nonoperating	240 G, 2 ms, half-sine		
Random Vibration			
Operating	1.043 grms		
Nonoperating	3.50 grms		
Maximum altitude (unpressurized)			
Operating	50 to 10,000 ft (-15.24 to 3,048 m)		
Nonoperating	-50 to 40,000 ft (-15.24 to 12,192 m)		
NOTE:	Applicable product safety standards specify thermal limits for plastic surfaces. The device operates well within this range of temperatures.		

Display specifications

Internal	
Touch screen	12.3" diagonal LED-backlit BV UWVA eDP 1.3 Ultra-slim (2736 x 1824 – Full HD*) Touch screen Chemically-strengthened Corning® Gorilla® Glass 4 top cover directly bonded to display
Brightness	450 nits
Pixel resolution	
Format	2736 x 1824 (WQXGA+)
Configuration	RGB stripe
Interface	eDP 1.3
LCD Mode	IPS/FFS/VA
PPI	192 ppi
Viewing angle	UWVA 85/85/85/85 (Left/Right/Down/Up)

11 Power cord set requirements

The wide-range input feature of the computer permits it to operate from any line voltage from 100 to 120 V ac, or from 220 to 240 V ac.

The 3-conductor power cord set included with the computer meets the requirements for use in the country or region where the equipment is purchased.

Power cord sets for use in other countries or regions must meet the requirements of the country and region where the computer is used.

Requirements for all countries

The following requirements are applicable to all countries and regions:

- The length of the power cord set must be at least **1.0 m** (3.3 ft) and no more than **2.0 m** (6.5 ft).
- All power cord sets must be approved by an acceptable accredited agency responsible for evaluation in the country or region where the power cord set will be used.
- The power cord sets must have a minimum current capacity of 10 A and a nominal voltage rating of 125 or 250 V ac, as required by the power system of each country or region.
- The appliance coupler must meet the mechanical configuration of an EN 60 320/IEC 320 Standard Sheet C13 connector for mating with the appliance inlet on the back of the computer.

Requirements for specific countries and regions

Country/region	Accredited agency	Applicable note number
Argentina	IRAM	1
Australia	SAA	1
Austria	OVE	1
Belgium	CEBEC	1
Brazil	ABNT	1
Canada	CSA	2
Chile	IMQ	1
Denmark	DEMKO	1
Finland	FIMKO	1
France	UTE	1
Germany	VDE	1
India	ISI	1
Israel	SII	1
Italy	IMQ	1
Japan	JIS	3
The Netherlands	KEMA	1
New Zealand	SANZ	1
Norway	NEMKO	1
The People's Republic of China	CCC	4
Saudi Arabia	SASO	7
Singapore	PSB	1
South Africa	SABS	1
South Korea	KTL	5
Sweden	SEMKO	1
Switzerland	SEV	1
Taiwan	BSMI	6
Thailand	TISI	1
The United Kingdom	ASTA	1
The United States	UL	2

1. The flexible cord must be Type H05VV-F, 3-conductor, 0.75 mm² conductor size. Power cord set fittings (appliance coupler and wall plug) must bear the certification mark of the agency responsible for evaluation in the country or region where it will be used.
2. The flexible cord must be Type SVT/SJT or equivalent, No. 18 AWG, 3-conductor. The wall plug must be a two-pole grounding type with a NEMA 5-15P (15 A, 125 V ac) or NEMA 6-15P (15 A, 250 V ac) configuration. CSA or C-UL mark. UL file number must be on each element.

Country/region	Accredited agency	Applicable note number
3.	The appliance coupler, flexible cord, and wall plug must bear a “T” mark and registration number in accordance with the Japanese Dentori Law. The flexible cord must be Type VCTF, 3-conductor, 0.75 mm ² or 1.25 mm ² conductor size. The wall plug must be a two-pole grounding type with a Japanese Industrial Standard C8303 (7 A, 125 V ac) configuration.	
4.	The flexible cord must be Type RVV, 3-conductor, 0.75 mm ² conductor size. Power cord set fittings (appliance coupler and wall plug) must bear the CCC certification mark.	
5.	The flexible cord must be Type H05VV-F 3-conductor, 0.75 mm ² conductor size. KTL logo and individual approval number must be on each element. Corset approval number and logo must be printed on a flag label.	
6.	The flexible cord must be Type HVCTF 3-conductor, 1.25 mm ² conductor size. Power cord set fittings (appliance coupler, cable, and wall plug) must bear the BSMI certification mark.	
7.	For 127 V ac, the flexible cord must be Type SVT or SJT 3-conductor, 18 AWG, with plug NEMA 5-15P (15 A, 125 V ac), with UL and CSA or C-UL marks. For 240 V ac, the flexible cord must be Type H05VV-F 3-conductor, 0.75 mm ² or 1.00 mm ² conductor size, with plug BS 1363/A with BSI or ASTA marks.	

12 Statement of memory volatility

The purpose of this chapter is to provide general information regarding nonvolatile memory in HP Business PCs. This chapter also provides general instructions for restoring nonvolatile memory that can contain personal data after the system has been powered off and the hard drive has been removed.

HP Business PC products that use Intel®-based or AMD®-based system boards contain volatile DDR memory. The amount of nonvolatile memory present in the system depends upon the system configuration. Intel-based and AMD-based system boards contain nonvolatile memory subcomponents as originally shipped from HP, assuming that no subsequent modifications have been made to the system and assuming that no applications, features, or functionality have been added to or installed on the system.

Following system shutdown and removal of all power sources from an HP Business PC system, personal data can remain on volatile system memory (DIMMs) for a finite period of time and will also remain in nonvolatile memory. Use the steps below to remove personal data from the PC, including the nonvolatile memory found in Intel-based and AMD-based system boards.

1. Follow steps (a) through (j) below to restore the nonvolatile memory that can contain personal data. Restoring or reprogramming nonvolatile memory that does not store personal data is neither necessary nor recommended.
 - a. Turn on or restart the computer, and then press **esc** while the “Press the ESC key for Startup Menu” message is displayed at the bottom of the screen.

A small icon of a notepad with a pencil, used to denote a note or important instruction.

NOTE: If the system has a BIOS administrator password, enter the password at the prompt.
 - b. Select **Main**, select **Restore Defaults**, and then select **Yes** to load defaults.
 - c. Select the **Security** menu, select **Restore Security Level Defaults**, and then select **Yes** to restore security level defaults.
 - d. If an asset or ownership tag is set, select the **Security** menu and scroll down to the **Utilities** menu. Select **System IDs**, and then select **Asset Tracking Number**. Clear the tag, and then make the selection to return to the prior menu.
 - e. If a DriveLock password is set, select the **Security** menu, and scroll down to **Hard Drive Tools** under the **Utilities** menu. Select **Hard Drive Tools**, select **DriveLock**, then clear the check box for **DriveLock password on restart**. Select **OK** to proceed.
 - f. If an Automatic DriveLock password is set, select the **Security** menu, scroll down to **Hard Drive Tools** under the **Utilities** menu. Select **Hard Drive Tools**, scroll down to **Automatic DriveLock**, then select the desired hard drive and disable protection. At the automatic drive lock warning screen, select **Yes** to continue. Repeat this procedure if more than one hard drive has an Automatic DriveLock password.
 - g. Select the **Main** menu, and then select **Reset BIOS Security to factory default**. Click **Yes** at the warning message.
 - h. Select the **Main** menu, select **Save Changes and Exit**, select **Yes** to save changes and exit, and then select **Shutdown**.

- i. Reboot the system. If the system has a Trusted Platform Module (TPM) and/or fingerprint reader, one or two prompts will appear—one to clear the TPM and the other to Reset Fingerprint Sensor; press or tap **F1** to accept or **F2** to reject.
 - j. Remove all power and system batteries for at least 24 hours.
2. Complete one of the following:
- Remove and retain the storage drive.
 - or –
 - Clear the drive contents by using a third-party utility designed to erase data from an SSD.
 - or –
 - Clear the contents of the drive by using the following BIOS Setup Secure Erase command option steps:



IMPORTANT: If you clear data using Secure Erase, it cannot be recovered.

- a. Turn on or restart the computer, and then press **esc** while the “Press the ESC key for Startup Menu” message is displayed at the bottom of the screen.
 - b. Select the **Security** menu and scroll down to the **Utilities** menu.
 - c. Select **Hard Drive Tools**.
 - d. Under **Utilities**, select **Secure Erase**, select the hard drive storing the data you want to clear, and then follow the on-screen instructions to continue.
- or –
- Clear the contents of the drive by using the following Disk Sanitizer command steps:



IMPORTANT: If you clear data using Disk Sanitizer, it cannot be recovered.



NOTE: The amount of time it takes for Disk Sanitizer to run can take several hours. Plug the computer into an AC outlet before starting.

- a. Turn on or restart the computer, and then press **esc** while the “Press the ESC key for Startup Menu” message is displayed at the bottom of the screen.
- b. Select the **Security** menu and scroll down to the **Utilities** menu.
- c. Select **Hard Drive Tools**.
- d. Under **Utilities**, select **Disk Sanitizer**, select the hard drive storing the data you want to clear, and then follow the on-screen instructions to continue.

Nonvolatile memory usage

Nonvolatile memory type	Amount (Size)	Does this memory store customer data?	Does this memory retain data when power is removed?	What is the purpose of this memory?	How is data input into this memory?	How is this memory write-protected?
HP Sure Start flash (select models only)	2 MBytes	No	Yes	Provides protected backup of critical System BIOS code, EC firmware, and critical PC configuration data for select platforms that support HP Sure Start. For more information, see Using HP Sure Start (select models only) on page 78.	Data cannot be written to this device via the host processor. The content is managed solely by the HP Sure Start Embedded Controller.	This memory is protected by the HP Sure Start Embedded Controller.
Real Time Clock (RTC) battery backed-up CMOS configuration memory	256 Bytes	No	Yes	Stores system date and time and noncritical data.	RTC battery backed-up CMOS is programmed using the Computer Setup (BIOS), or changing the Microsoft Windows date and time.	This memory is not write-protected.
Controller (NIC) EEPROM	64 KBytes (not customer accessible)	No	Yes	Stores NIC configuration and NIC firmware.	NIC EEPROM is programmed using a utility from the NIC vendor that can be run from DOS.	A utility is required to write data to this memory and is available from the NIC vendor. Writing data to this ROM in an inappropriate manner will render the NIC non-functional.
DIMM Serial Presence Detect (SPD) configuration data	256 Bytes per memory module, 128 Bytes programmable (not customer accessible)	No	Yes	Stores memory module information.	DIMM SPD is programmed by the memory vendor.	Data cannot be written to this memory when the module is installed in a PC. The specific write-protection method varies by memory vendor.
System BIOS	4 MBytes to 5 MBytes	Yes	Yes	Stores system BIOS code and PC configuration data.	System BIOS code is programmed at the factory. Code is updated when the system BIOS is updated. Configuration data and settings are input using the Computer Setup (BIOS) or a custom utility.	NOTE: Writing data to this ROM in an inappropriate manner can render the PC non-functional. A utility is required for writing data to this memory and is available on the HP website; go to http://www.hp.com/support , and select your country. Select Drivers &

Nonvolatile memory type	Amount (Size)	Does this memory store customer data?	Does this memory retain data when power is removed?	What is the purpose of this memory?	How is data input into this memory?	How is this memory write-protected?
Intel Management Engine Firmware (present in only specific ZBook and EliteBook models. For more information, go to http://www.hp.com/support , and select your country. Select Drivers & Downloads , and then follow the on-screen instructions.)	1.5 MBytes or 5 MBytes	Yes	Yes	Stores Management Engine Code, Settings, Provisioning Data and iAMT third-party data store.	Management Engine Code is programmed at the factory. Code is updated via Intel secure firmware update utility. Unique Provisioning Data can be entered at the factory or by an administrator using the Management Engine (MEBx) setup utility. The third-party data store contents can be populated by a remote management console or local applications that have been registered by an administrator to have access to the space.	Downloads , and then follow the on-screen instructions. The Intel chipset is configured to enforce hardware protection to block all direct read/write access to this area. An Intel utility is required for updating the firmware. Only firmware updates digitally signed by Intel can be applied using this utility.
Bluetooth flash	2 Mbit	No	Yes	Stores Bluetooth configuration and firmware.	Bluetooth flash is programmed at the factory. Tools for writing data to this memory are not publicly available but can be obtained from the silicon vendor.	A utility is required for writing data to this memory and is made available through newer versions of the driver whenever the flash requires an upgrade.
802.11 WLAN EEPROM	4 Kbit to 8 Kbit	No	Yes	Stores configuration and calibration data.	802.11 WLAN EEPROM is programmed at the factory. Tools for writing data to this memory are not made public.	A utility is required for writing data to this memory and is usually not made available to the public unless a firmware upgrade is necessary to address a unique issue.
Web camera	64 Kbit	No	Yes	Stores webcam configuration and firmware.	Webcam memory is programmed using a utility from the device manufacturer that can be run from Windows.	A utility is required for writing data to this memory and is usually not made available to the public unless a firmware upgrade is necessary to address a unique issue.
Fingerprint reader	512 KByte flash	Yes	Yes	Stores fingerprint templates.	Fingerprint reader memory is programmed by user enrollment in HP ProtectTools Security Manager.	Only a digitally signed application can make the call to write to the flash.

Questions and answers

1. How can the BIOS settings be restored (returned to factory settings)?



IMPORTANT: Restore defaults does not securely erase any data on your hard drive. See question and answer 6 for steps to securely erase data.

Restore defaults does not reset the Custom Secure Boot keys. See question and answer 7 for information about resetting the keys.

- a. Turn on or restart the computer, and then press **esc** while the “Press the ESC key for Startup Menu” message is displayed at the bottom of the screen.
- b. Select **Main**, and then select **Restore defaults**.
- c. Follow the on-screen instructions.
- d. Select **Main**, select **Save Changes and Exit**, and then follow the on-screen instructions.

2. What is a UEFI BIOS, and how is it different from a legacy BIOS?

The Unified Extensible Firmware Interface (UEFI) BIOS is an industry-standard software interface between the platform firmware and an operating system (OS). It is a replacement for the older BIOS architecture, but supports much of the legacy BIOS functionality.

Like the legacy BIOS, the UEFI BIOS provides an interface to display the system information and configuration settings and to change the configuration of your computer before an OS is loaded. BIOS provides a secure run-time environment that supports a Graphic User Interface (GUI). In this environment, you can use either a pointing device (Touchscreen, TouchPad, pointing stick, or USB mouse) or the keyboard to navigate and make menu and configuration selections. The UEFI BIOS also contains basic system diagnostics.

The UEFI BIOS provides functionality beyond that of the legacy BIOS. In addition, the UEFI BIOS works to initialize the computer’s hardware before loading and executing the OS; the run-time environment allows the loading and execution of software programs from storage devices to provide more functionality, such as advanced hardware diagnostics (with the ability to display more detailed system information) and advanced firmware management and recovery software.

HP has provided options in Computer Setup (BIOS) to allow you to run in legacy BIOS, if required by the operating system. Examples of this requirement would be if you upgrade or downgrade the OS.

3. Where does the UEFI BIOS reside?

The UEFI BIOS resides on a flash memory chip. A utility is required to write to the chip.

4. What kind of configuration data is stored on the DIMM Serial Presence Detect (SPD) memory module? How would this data be written?

The DIMM SPD memory contains information about the memory module, such as size, serial number, data width, speed/timing, voltage, and thermal information. This information is written by the module manufacturer and stored on an EEPROM. This EEPROM cannot be written to when the memory module is installed in a PC. Third-party tools do exist that can write to the EEPROM when the memory module is not installed in a PC. Various third-party tools are available to read SPD memory.

5. What is meant by “Restore the nonvolatile memory found in Intel-based system boards”?

This message relates to clearing the Real Time Clock (RTC) CMOS memory that contains PC configuration data.

6. How can the BIOS security be reset to factory defaults and data erased?

 **IMPORTANT:** Resetting will result in the loss of information.

These steps will not reset Custom Secure Boot Keys. See question and answer 7 for information about resetting the keys.

- a. Turn on or restart the computer, and then press **esc** while the “Press the ESC key for Startup Menu” message is displayed at the bottom of the screen.
- b. Select **Main**, and then select **Reset BIOS Security to Factory Default**.
- c. Follow the on-screen instructions.
- d. Select **Main**, select **Save Changes and Exit**, and then follow the on-screen instructions.

7. How can the Custom Secure Boot Keys be reset?

Secure Boot is a feature to ensure that only authenticated code can start on a platform. If you enabled Secure Boot and created Custom Secure Boot Keys, simply disabling Secure Boot will not clear the keys. You must also select to clear the Custom Secure Boot Keys. Use the same Secure Boot access procedure you used to create the Custom Secure Boot Keys, but make the selection to clear or delete all Secure Boot Keys.

- a. Turn on or restart the computer, and then press **esc** while the “Press the ESC key for Startup Menu” message is displayed at the bottom of the screen.
- b. Select the **Security** menu, select **Secure Boot Configuration**, and then follow the on-screen instructions.
- c. At the **Secure Boot Configuration** window, select **Secure Boot**, select **Clear Secure Boot Keys**, and then follow the on-screen instructions to continue.

Using HP Sure Start (select models only)

Select computer models are configured with HP Sure Start, a technology that continuously monitors your computer's BIOS for attacks or corruption. If the BIOS becomes corrupted or is attacked, HP Sure Start restores the BIOS to its previously safe state, without user intervention. Those select computer models ship with HP Sure Start configured and enabled. HP Sure Start is configured and already enabled so that most users can use the HP Sure Start default configuration. The default configuration can be customized by advanced users.

To access the latest documentation on HP Sure Start, go to <http://www.hp.com/support>, and select your country. Select **Drivers & Downloads**, and then follow the on-screen instructions.

13 Recycling

When a non-rechargeable or rechargeable battery has reached the end of its useful life, do not dispose of the battery in general household waste. Follow the local laws and regulations in your area for battery disposal.

HP encourages customers to recycle used electronic hardware, HP original print cartridges, and rechargeable batteries. For more information about recycling programs, see the HP Web site at <http://www.hp.com/recycle>.

Index

A

- AC adapter
 - spare part numbers 16
- AC adapter, spare part number 17
- AC adapter, spare part numbers 16
- adapter, spare part number 17
- ambient light sensor, identifying 8
- antenna
 - spare part number 16
- antennas 54
 - spare part numbers 54
- audio, product description 2
- audio-out (headphone)/audio-in (microphone) combo jack, identifying 7

B

- back cover 29
 - spare part number 16, 29
- backups 57
- battery 32
 - spare part number 16
 - spare part numbers 32
- battery light 6
- BIOS
 - determining version 63
 - downloading an update 64
 - updating 63
- boot order
 - changing 61
 - changing using the f9 prompt 65
- button
 - volume down 8
 - volume up 8
- buttons
 - power 7

C

- camera flash, identifying 11
- chipset, product description 1
- components
 - bottom 9
 - front 8
 - keyboard 13

- kickstand 12
 - left side 7
 - rear 11
 - right side 6
 - top 9
- computer major components 15
- Computer Setup
 - navigating and selecting 62
 - restoring factory settings 63
 - using a USB keyboard or USB mouse to start Computer Setup 62
- computer setup 62
- computer specifications 68
- connector, power 6

D

- display
 - specifications 69
- display panel 30
 - product description 1
 - spare part numbers 16
- docking
 - product description 3
- docking connector, identifying 10
- docking station, spare part number 17
- duck head, spare part number 20

E

- Ethernet, product description 2

F

- fan
 - spare part number 16
 - spare part numbers 49
- fingerprint board
 - spare part numbers 51
- fingerprint reader
 - spare part number 16
- fingerprint reader board 51
- fingerprint reader, identifying 11

G

- graphics, product description 1

H

- Hall effects sensor board 34
- Hall sensor board
 - spare part numbers 34
- hall sensor board
 - spare part number 16
- hard drive
 - product description 1
- HP PC Hardware Diagnostics (UEFI) using 66
- HP Recovery Manager
 - correcting boot problems 61
 - starting 60
- HP Recovery media
 - creating 57
 - recovery 60
- HP Recovery partition
 - recovery 60
 - removing 61
- HP Sure Start 78

I

- infrared camera
 - identifying 9
- infrared camera light, identifying 9
- integrated camera flash, identifying 11
- integrated camera light, identifying 9
- internal microphones, identifying 9

J

- jacks
 - audio-out (headphone)/audio-in (microphone) combo 7

K

- keyboard
 - components 13
 - connecting 13
 - product description 3
 - removing 14
- kickstand
 - spare part number 16

- kickstand bracket
 - spare part numbers 16
- kickstand, identifying 11
- L**
- labels
 - serial number 14
- lights
 - battery 6
 - webcam 9, 11
- lock, spare part number 17
- M**
- memory
 - nonvolatile 73
 - volatile 73
- memory card reader, identifying 8
- memory module
 - product description 1
- microphone board
 - spare part numbers 16, 43
- minimized image recovery 60
- minimized image, creating 59
- model name 1
- N**
- nonvolatile memory 73
- O**
- operating system, product description 4
- original system recovery 59
- P**
- pen lanyard slot, identifying 8
- pen, spare part number 17
- POGO
 - spare part number 16
- POGO connector
 - spare part numbers 48
- POGO pin connector, identifying 10
- pointing device, product description 3
- ports
 - product description 3
 - USB 3.x charging 7
 - USB Type-C power connector and Thunderbolt port 6
- power button, identifying 7
- power connector, identifying 6
- power cord
 - requirements for all countries 70
 - requirements for specific countries and regions 71
 - set requirements 70
- power cord, spare part number 19, 20
- power requirements, product description 4
- processor
 - product description 1
- product description
 - audio 2
 - camera 1
 - chipset 1
 - display panel 1
 - docking 3
 - Ethernet 2
 - external media cards 3
 - graphics 1
 - keyboard 3
 - memory module 1
 - microphone 1
 - operating system 4
 - pointing device 3
 - ports 3
 - power requirements 4
 - processors 1
 - product name 1
 - security 4
 - sensors 3
 - serviceability 5
 - storage 1
 - wireless 2
- product name 1
- product name and number, computer 14
- R**
- rear webcam
 - spare part number 16
 - spare part numbers 45
- recover
 - options 59
- recovery
 - discs 58, 60
 - HP Recovery Manager 59
 - media 60
 - starting 60
- supported discs 58
- system 59
- USB flash drive 60
- using HP Recovery media 58
- recovery media
 - creating 57
 - creating using HP Recovery Manager 58
- recovery partition
 - removing 61
- regulatory information 14
- removal/replacement
 - procedures 26, 28
- removing personal data from volatile system memory 73
- rubber kit, spare part number 20
- S**
- screw kit, spare part number 20
- security cable slot, identifying 8
- security, product description 4
- sensors
 - product description 3
- serial number 14
- serial number, computer 14
- serviceability, product description 5
- setup utility
 - navigating and selecting 62
 - restoring factory settings 63
- SIM card
 - inserting 6
 - removing 6
- SIM card slot, identifying 6
- slots
 - security cable 8
 - SIM card 6
- Solid-state drive 36
- solid-state drive
 - spare part number 16
 - spare part numbers 36
- speaker kit
 - spare part number 16
- speakers 53
- speakers, identifying 9
- speakers, spare part numbers 53
- speakers, identifying 9
- specifications
 - computer 68
 - display 69
- supported discs, recovery 58

- Sure Start
 - using 65
- system board 47
 - spare part number 16
 - spare part numbers 47
- system information
 - locating 14
- system memory, removing personal data from volatile 73
- system recovery 59
- system restore point
 - creating 58
- system restore point, creating 57

T

- Thunderbolt
 - identifying USB Type-C 6
- TPM settings 65

U

- USB 3.x charging port, identifying 7
- USB Type-C power connector and Thunderbolt port, identifying 6

V

- volume button, identifying 8

W

- warranty period 14
- webcam
 - identifying 11
 - rear 42, 45
 - spare part number 16
 - spare part numbers 42
- webcam light, identifying 9
- webcam, identifying 9
- Windows
 - system restore point 57, 58
- Windows tools
 - using 58
- wireless antennas, identifying 9
- wireless, product description 2
- WLAN antennas, identifying 8
- WLAN module 38
 - spare part numbers 16, 38
- WWAN
 - spare part number 16
- WWAN antennas, identifying 9
- WWAN module 40
 - spare part numbers 16, 40