

4 Easy Return

(Refer to return instructions in your kit)

- A.** Take original gateway to nearest The UPS Store (Bring your AT&T Account number located on your packing slip).
- B.** UPS will scan your equipment, provide a receipt, pack, and ship equipment to AT&T at no cost to you.

Please do not return other devices (e.g. backup battery, etc.)

Need more help?

No TV or Internet service:



Check your connections: Cables usually make an audible click when secure.

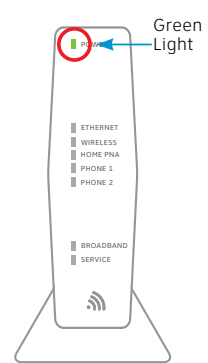

Check Power: Power light on the Wi-Fi Gateway should be green; if not, try another electrical outlet

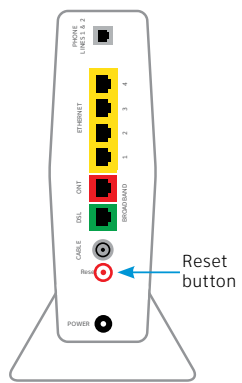

Check Service light on front of the Wi-Fi Gateway: If after 5 minutes, the light is red or off, power down the Wi-Fi Gateway by holding down red reset button for 15 seconds.



TV Receivers not responding: Confirm Service light is solid green on the Wi-Fi Gateway. If so, hold the TV receiver's power button down for 10 seconds and release, then wait five minutes.

Wi-Fi Gateway power light is amber: Don't worry. This is a normal part of the power up sequence.

No dial tone: Make sure your phone cable is plugged into the Phone Line port on the Wi-Fi Gateway.

Additional assistance: call 800.288.2020 and ask for "U-verse technical support"

Additional U-verse information

Manage your account:

Available 24/7, download the myAT&T app at att.com/myattapp from your mobile device.

¿Habla español?

Por favor visite att.com/uverseguias para ver la informacion en español. También pueden ver la siguiente guía: ATT121140818-3 (WIRELESS GATEWAY SWAP 3800 to 3801) para más detalles.

Support:

- For U-verse support, including live chat, go to att.com/uversesupport
- Visit att.com/userguides to find this guide (ATT121140818-3 Wireless Gateway Swap 3800 to 3801)

AT&T U-verse® Wi-Fi Gateway Replacement



For use with High Speed Internet, Voice, and TV



Get started

Total approximate installation time: 20 minutes

These instructions will guide you through the process of replacing your U-verse Wi-Fi Gateway.

In the box:

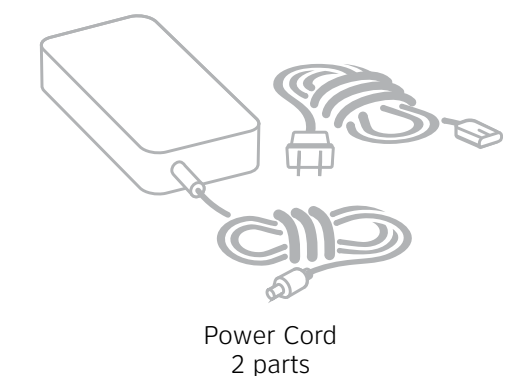
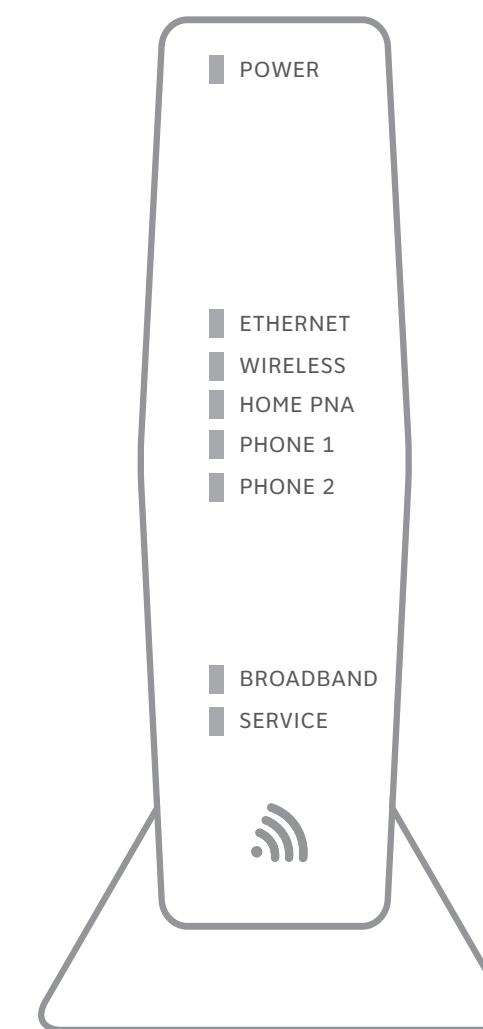

Reminder:

- Your new gateway does not contain a battery backup
- Battery backup is available for purchase from third party manufacturers and retailers to keep you connected in the event of a power failure. Visit att.com/batterybackup for more information



1 Set up Approximate time: 10 minutes

! Please note that your U-verse TV, internet, and voice services will not operate during this process. This includes recording TV shows.

- A.**
 - Unplug battery backup from existing Wi-Fi Gateway and set it aside
 - Stand new Wi-Fi Gateway side-by-side with existing Wi-Fi Gateway
- B.**
 - Transfer one connection at a time from the existing Wi-Fi Gateway to new Wi-Fi Gateway
- C.**
 - Connect new power cord to power port of new Wi-Fi Gateway and into electrical outlet

Below is a completed setup. Your connections may vary.

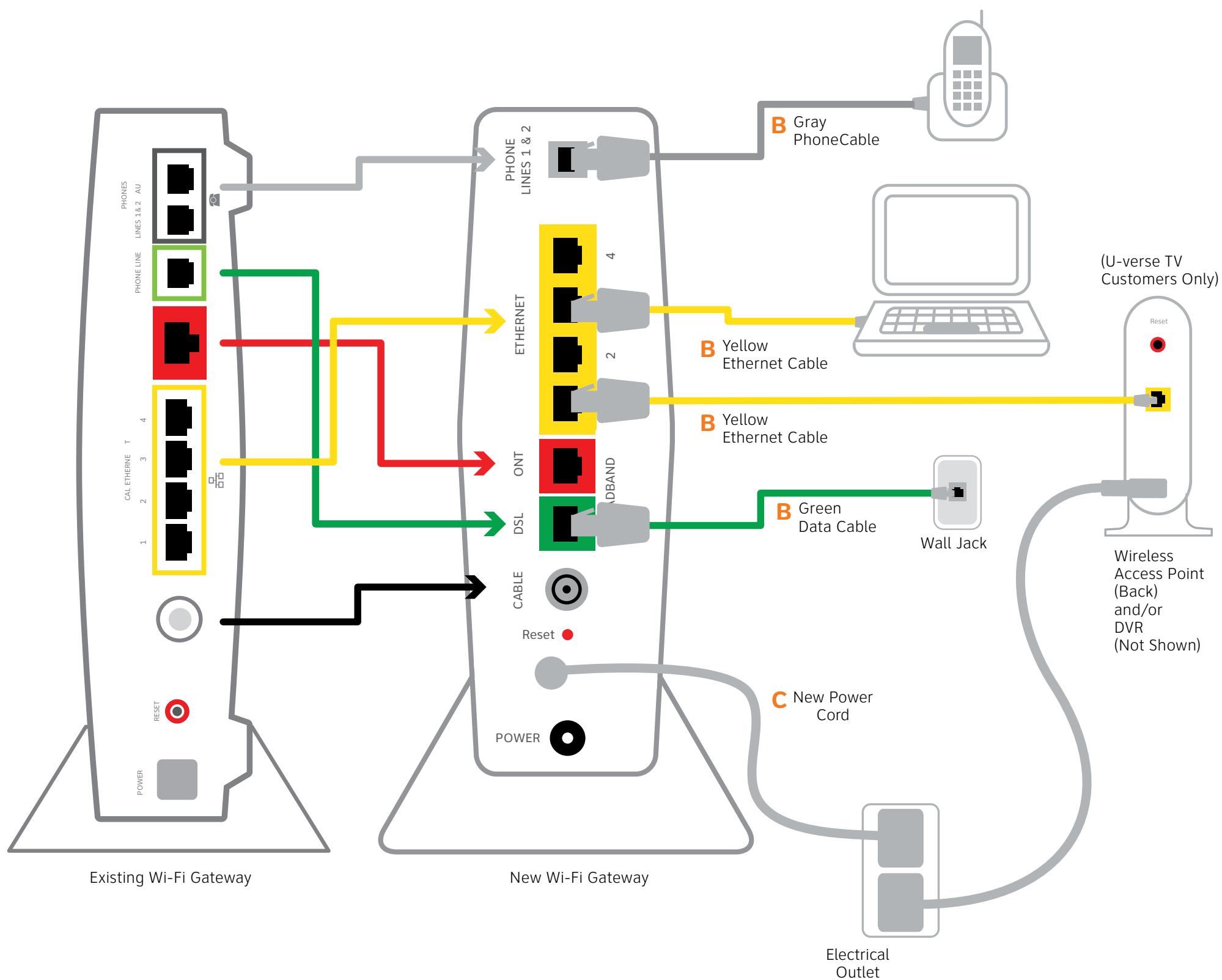

2 Power up Approximate time: 1-5 minutes

- A.** Your Wi-Fi Gateway is now powering up. During this time, the Broadband light will turn red and the Power light will turn solid green. Wait up to 5 minutes for the Service indicator light to turn solid green.

! During this time (up to 5 minutes), do not unplug the power cord or the green data cable, as this can permanently damage the Wi-Fi Gateway and significantly delay your service activation.

If the Service light does not turn solid green or continues to blink after 5 minutes, see the **Need more help?** section on the back of this guide.

- B.** For U-verse TV, restart your TV receivers after the Service light is solid green. Go to each TV and hold down the Power button on the U-verse receiver and DVR for ten seconds.

NOTE: Live TV may take a few minutes to display. If TV does not respond refer to **Need More Help?** on the back of this guide.

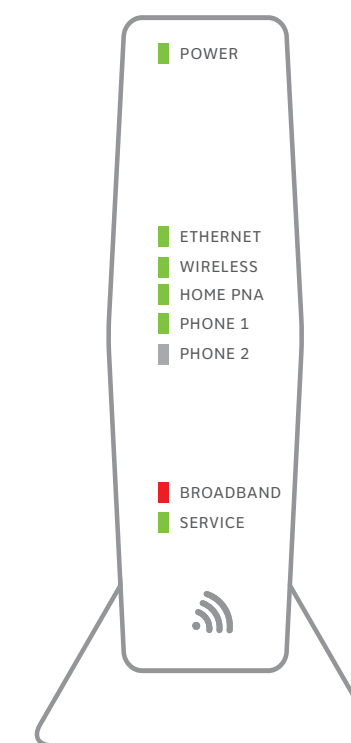

Lights may vary with setup.

3 Go Wi-Fi Approximate time: 1-5 minutes

New! Transfer Wi-Fi Settings (Network Name and Password) from existing Wi-Fi Gateway to your new Wi-Fi Gateway so that all your Wi-Fi connected laptops, tablets, and other devices still work.

- A.** Select only one option to begin the Wi-Fi Setup

Connect using PC (recommended)

- Connect laptop or PC with an Ethernet Cable to your Wi-Fi gateway
- Continue to **B**

or Connect using Tablet

- Establish a temporary connection using new Wi-Fi settings located on yellow sticker on new Wi-Fi Gateway
- Select your Wi-Fi network (SSID)
- Enter Wi-Fi Password (Wireless Network Key)
- Continue to **B**

or Connect using Smartphone

- Mobile internet access required
- Continue to **B**

- B.**

- Open a browser and go to <http://ufix.att.com/restore>
- Log into your U-verse account with your Member ID (primary AT&T email address) and Password
- Follow the on-screen instructions to transfer the existing Wi-Fi settings

Once Complete:

- Record existing Network Name and Wi-Fi Password on separate yellow sticker from kit
- Place new yellow sticker over your new Wi-Fi Gateway's yellow sticker

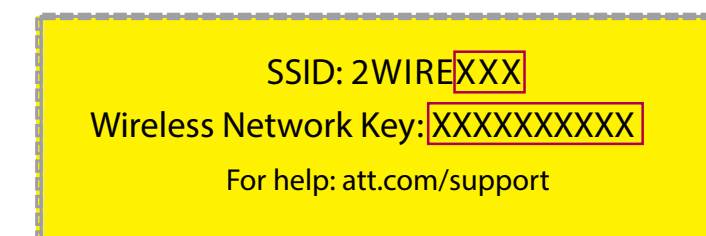

If existing Wi-Fi Settings did not transfer:

- Use settings from new Wi-Fi Gateway's yellow sticker
- Open your device's Wi-Fi connection settings and select your Wi-Fi Network Name
- Enter Wi-Fi Password to connect to your network
- Record and keep your Wi-Fi settings for future reference when connecting all your Wi-Fi devices

! **NOTE:** Any custom settings made for security cameras or game consoles, etc., on your original Wi-Fi Gateway will also need to be made to your new Wi-Fi Gateway.

Questions? Visit att.com/uversesupport

