

# RDX Series™ Two-Way Radios

*User Guide*



Models RDU2080d, RDV2080d, RDU4160d  
Radio models shown are RDU2080d & RDV2080d



# CONTENTS

<b>Contents</b> . . . . .	<b>1</b>	Front Buttons . . . . .	13
<b>Safety</b> . . . . .	<b>5</b>	Side Buttons . . . . .	14
<b>Batteries and Chargers</b>		The Lithium-Ion (Li-Ion) Battery . . . . .	14
<b>Safety Information</b> . . . . .	<b>6</b>	Battery Features . . . . .	16
Operational Safety Guidelines . . . . .	7	About the Li-Ion Battery . . . . .	16
<b>Introduction</b> . . . . .	<b>8</b>	Battery Recycling and Disposal . . . . .	17
Package Contents . . . . .	8	Installing the Lithium-Ion (Li-Ion) Battery . . . . .	18
<b>FCC Licensing Information</b> . . . . .	<b>10</b>	Removing the Lithium-Ion (Li-Ion) Battery . . . . .	18
Interference Information . . . . .	10	Alkaline Battery Pack (Optional Accessory) . . . . .	19
<b>Radio Overview</b> . . . . .	<b>12</b>	Installing Alkaline Batteries . . . . .	19
Parts of the Radio . . . . .	12	Removing Alkaline Batteries . . . . .	19
On/Off/Volume Knob . . . . .	13	Attaching and Removing Antenna . . . . .	20
Accessory Connector . . . . .	13	Attaching the Antenna . . . . .	20
Model Label . . . . .	13	Removing the Antenna . . . . .	20
Microphone . . . . .	13	Installing Spring Action Belt Clip . . . . .	21
Antenna . . . . .	13	Power Supply, Adaptor and Drop-in Tray Charger . . . . .	21
LED Indicator . . . . .	13	Battery Life Information . . . . .	22
		Alkaline Battery Life . . . . .	23
		Charging the Battery . . . . .	25

<b>Getting Started</b> .....	<b>32</b>	<b>Programming Features</b> .....	<b>42</b>
Turning radio ON/OFF .....	32	Entering Programming Mode .....	42
Adjusting volume .....	32	Programming RX (Reception) Frequencies .	43
Reading the Display .....	32	Programming RX (Reception) Codes	
Selecting a Channel .....	33	(CTCSS/DPL) .....	44
Talking and Monitoring .....	33	Programming Scramble  .....	44
Receiving a Call .....	33	Programming Maximum	
Signal Strength Indicator and		Number of Channels .....	45
Channel Busy Indicators .....	34	Programming Call Tones .....	46
Talk Range .....	34	Programming Microphone Gain Level .....	47
Radio LED Indicators .....	36	Programming Microphone	
Hands-Free Use/VOX .....	37	Accessory Gain Level .....	47
With Compatible VOX Accessories. . . . .	37	Other Programming Features .....	48
Hands Free without		Scan .....	48
Accessories (iVOX) .....	38	Programming Buttons .....	50
Battery Save .....	38	Editing Channel Alias Name .....	50
Reset to Factory Defaults .....	38	Nuisance Channel Delete .....	52
End of Transmission Tone		CPS (Computer Programming Software) . . .	52
(Roger Beep Tone) .....	39	Bandwidth Select .....	53
Keypad Beeps .....	39	Time-Out Timer .....	53
Keypad Lock/Unlock .....	39	Power Select .....	53
MENU Options .....	39	Battery Type Setting .....	54
Setting VOX / iVOX sensitivity .....	40	Call Tones .....	54

Scramble . . . . .	54	RDU2080d - UHF Default	
Reverse Burst . . . . .	54	Frequencies Chart . . . . .	73
Cloning Radios . . . . .	54	RDU4160d - UHF Default	
Cloning with a Multi-Unit		Frequencies Chart . . . . .	74
Charger (MUC) . . . . .	55	CTCSS and PL/DPL Codes . . . . .	76
Cloning Radios using the		Programming Customized Frequencies	
Radio to Radio (R2R) Cloning		on 4W/5W RDX models . . . . .	80
Cable (optional accessory) . . . . .	56	<b>Motorola Solutions Limited Warranty for</b>	
Cloning Radios using the CPS		<b>the United States and Canada . . . . .</b>	<b>81</b>
(Computer Programming Software) . . . . .	58	<b>Accessories . . . . .</b>	<b>85</b>
Repeater Capabilities . . . . .	58	Antennas . . . . .	85
<b>Troubleshooting . . . . .</b>	<b>61</b>	Audio Accessories . . . . .	85
<b>Use and Care . . . . .</b>	<b>65</b>	Battery . . . . .	85
<b>Frequency and Code Charts . . . . .</b>	<b>66</b>	Carry Accessories . . . . .	86
RDX VHF Frequencies Chart . . . . .	66	Power Supplies AC Pin Adaptors . . . . .	86
RDV2080d - VHF Default		Software Applications . . . . .	86
Frequencies Chart . . . . .	68	Cables . . . . .	86
RDX UHF Frequencies Chart . . . . .	69	Chargers . . . . .	86

Power Supplies . . . . .	.87
<b>RDX Series™ Features Summary . . . . .</b>	<b>.88</b>
<b>Programmable Buttons Chart . . . . .</b>	<b>.98</b>
<b>Icons Chart. . . . .</b>	<b>.99</b>

# SAFETY

## PRODUCT SAFETY AND RF EXPOSURE COMPLIANCE



Caution

Before using this product, read the operating instructions and RF energy awareness information contained in the Product Safety and RF Exposure booklet enclosed with your radio.

### ATTENTION!

This radio is restricted to occupational use only to satisfy FCC RF energy exposure requirements.

For a list of Motorola Solutions-approved antennas, batteries, and other accessories, visit the following website which lists approved accessories:

[www.motorolasolutions.com/RDX](http://www.motorolasolutions.com/RDX)

## BATTERIES AND CHARGERS SAFETY INFORMATION

This document contains important safety and operating instructions. Read these instructions carefully and save them for future reference.

Before using the battery charger, read all the instructions and cautionary markings on

- the charger,
  - the battery, and
  - the radio using the battery.
1. To reduce risk of injury, charge only the rechargeable Motorola Solutions-authorized batteries. Other batteries may explode, causing personal injury and damage.
  2. Use of accessories not recommended by Motorola Solutions may result in risk of fire, electric shock, or injury.

3. To reduce risk of damage to the electric plug and cord, pull by the plug rather than the cord when disconnecting the charger.
4. An extension cord should not be used unless absolutely necessary. Use of an improper extension cord could result in risk of fire and electric shock. If an extension cord must be used, make sure that the cord size is 18AWG for lengths up to 6.5 feet (2.0 m), and 16AWG for lengths up to 9.8 feet (3.0 m).
5. To reduce risk of fire, electric shock, or injury, do not operate the charger if it has been broken or damaged in any way. Take it to a qualified Motorola Solutions service representative.
6. Do not disassemble the charger; it is not repairable and replacement parts are not available. Disassembly of the charger may result in risk of electrical shock or fire.
7. To reduce risk of electric shock, unplug the charger from the AC outlet before attempting any maintenance or cleaning.



## OPERATIONAL SAFETY GUIDELINES

- Turn the radio OFF when charging battery.
- The charger is not suitable for outdoor use. Use only in dry locations/conditions.
- Connect charger only to an appropriately fused and wired supply of the correct voltage (as specified on the product).
- Disconnect charger from line voltage by removing main plug.
- The outlet to which this equipment is connected should be nearby and easily accessible.
- Maximum ambient temperature around the power supply equipment must not exceed 40°C (104°F).
- Power output from the power supply unit must not exceed the ratings stated on the product label located at the bottom of the charger.

## INTRODUCTION

Thank you for purchasing the Motorola Solutions RDX Series™ Radio. This radio is a product of Motorola Solutions' 75 plus years of experience as a world leader in the designing and manufacturing of communications equipment. The RDX Series™ radios provide cost-effective communications for businesses such as retail stores, restaurants, schools, construction sites, manufacturing, property and hotel management and more. Motorola Solutions Business two-way radios are the perfect communications solution for all of today's fast-paced industries.

**Note:** Read this user guide carefully to ensure you know how to properly operate the radio before use.

**Business Radios,  
RPSD 1C15, Motorola  
8000 West Sunrise Boulevard  
Plantation, Florida 33322**

### PACKAGE CONTENTS

- Radio
- Antenna (only for **RDU4160d**)
- Spring Action Belt-Clip
- Lithium-Ion Battery
- Power Supply
- User Guide
- Warranty Card
- Drop-in Tray Charger
- Product Safety & RF Exposure Booklet

For a copy of a large-print version of this user guide or for product-related questions, contact:

**1-800-448-6686 in the USA**

**1-800-461-4575 in Canada**

**1-866-522-5210 on your TTY (Text Telephone)**

For product information visit us at:  
**[www.motorolasolutions.com/RDX](http://www.motorolasolutions.com/RDX)**

# FCC LICENSING INFORMATION

## INTERFERENCE INFORMATION

This device complies with Part 15 of the FCC Rules. Operation is subject to the condition that this device does not cause harmful interference.

RDX Series™ Business two-way radios operate on radio frequencies that are regulated by the Federal Communications Commission

(FCC). To transmit on these frequencies, you are required to have a license issued by the FCC. Application is made available on FCC Form 601 and Schedules D, H, and Remittance Form 159.

To obtain these FCC forms, request document 000601 which includes all forms and instructions. If you wish to have the document faxed, mailed or have questions, use the following contact information.

**Faxed contact the Fax-On-Demand system at:**

1-202-418-0177

**Mailed call the FCC forms hotline at:**

1-800-418-FORM  
1-800-418-3676

**Questions regarding FCC license contact the FCC at:**

1-888-CALL-FCC  
1-888-225-5322  
Or: <http://www.fcc.gov>

Before filling out your application, you must decide which frequency(ies) you can operate on. See “Frequencies and Code Charts”. For questions on determining the radio frequency, call Motorola Solutions Product Services at:

**1-800-448-6686**

Changes or modifications not expressly approved by Motorola Solutions may void the user’s authority granted by the FCC to operate this radio and should not be made. To comply with FCC requirements, transmitter adjustments should be made only by or under the supervision of a person certified as technically qualified to perform transmitter maintenance and repairs in the private land mobile and fixed services as certified by an organization representative of the user of those services.

Replacement of any transmitter component (crystal, semiconductor, etc.) not authorized by the FCC equipment authorization for this radio could violate FCC rules.

Use of this radio outside the country where it was intended to be distributed is subject to government regulations and may be prohibited.

# RADIO OVERVIEW

## PARTS OF THE RADIO

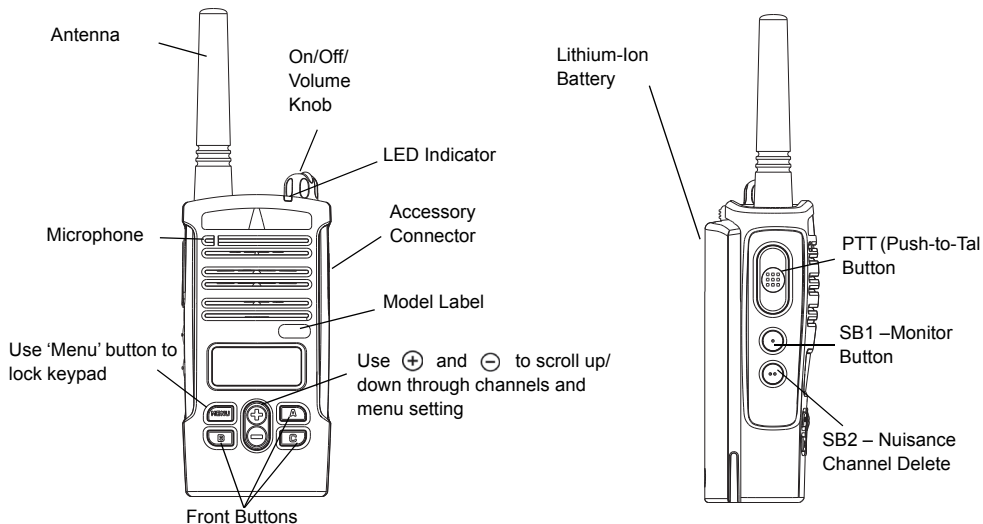

### On/Off/Volume Knob

Used to turn the radio ON or OFF and to adjust the radio's volume.

### Accessory Connector

Used to connect compatible audio accessories.

### Model Label

Indicates the model of the radio.

### Microphone

Speaks clearly into the microphone when sending a message.

### Antenna

For Models RDU2080d and RDV2080d, the antennas are non-removable antenna. For RDU4160d, the antenna is removable.

### LED Indicator

Used to give battery status, power-up status, radio call information and scan status.

### Front Buttons

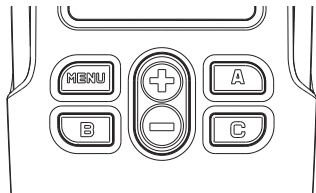

- **MENU Button**

This button give you access to set up features like VOX/ iVOX levels, battery type, etc. It also allows you to move through all the features while in Programming Mode.

- **+ - Toggle up / down buttons**

Allows you to change channels and to scroll up/ down menu options or set up programming values. These buttons are not programmable buttons.

- **A Programmable Button**

Configured as Preset Channel 1.

- **B Programmable Button**

Configured as Preset Channel 2.

- **C Programmable Button**

Configured as Tx Power Selection.

**Note:** A short press of either preset button (A or B) tunes the radio to the preset channel and the radio will play a good chirp. You can assign different functions to these buttons via the CPS. For example: Backlight Time Out, Reverse Burst, Power Select, Scan/Nuisance Channel Delete, Monitor and Call Tones. To learn more about how to program these buttons refer to “Entering Programming Mode” on page 42 and “CPS (Computer Programming Software)” on page 52.

## Side Buttons

### *Push-to-Talk (PTT) Button*

Press and hold down this button to talk, release it to listen.

### *Side Button 1 (SB1)*

The Side Button 1 is a general button that can be configured by the CPS. The default setting of the SB1 button is ‘Monitor’.

### *Side Button 2 (SB2)*

The Side Button 2 is a general button that can be configured by the CPS. The SB2 button default setting is ‘Scan/Nuisance Channel Delete’.

## The Lithium-Ion (Li-Ion) Battery

RDX Series™ provides different types of batteries. For more information, see “Battery Features” on page 16.



This User Guide covers multiple RDX Series™ models, and may detail some features your radio does not have. The radio's model is

shown on the front of the radio, underneath the speaker, and tells you the following information:

Model	Frequency Band	Transmit Power (Watts)	Number of Channels	Antenna
<b>RDV2080d</b>	VHF	2	8	Non-removable
<b>RDU2080d</b>	UHF	2	8	Non-removable
<b>RDU4160d</b>	UHF	4	16	Removable

## BATTERY FEATURES

RDX Series™ radios provide Lithium-Ion batteries that come in different capacities that will define the battery life. It also offers the option to use Alkaline batteries.

### About the Li-Ion Battery

The RDX Series™ radio comes equipped with a rechargeable Li-Ion battery. This battery should be charged before initial use to ensure optimum capacity and performance.

Battery life is determined by several factors. Among the more critical are the regular overcharge of batteries and the average depth of discharge with each cycle. Typically, the greater the overcharge and the deeper the average discharge, the fewer cycles a battery will last. For example, a battery which is overcharged and discharged 100% several times a day, lasts fewer cycles than a battery that receives less of an overcharge and is discharged to 50% per day. Further, a battery

which receives minimal overcharging and averages only 25% discharge, lasts even longer.

Motorola Solutions batteries are designed specifically to be used with a Motorola Solutions charger and vice versa. Charging in non-Motorola Solutions equipment may lead to battery damage and void the battery warranty. The battery should be at about 77°F (25°C) (room temperature), whenever possible. Charging a cold battery (below 50° F [10°C]) may result in leakage of electrolyte and ultimately in failure of the battery. Charging a hot battery (above 95°F [35°C]) results in reduced discharge capacity, affecting the performance of the radio. Motorola Solutions rapid-rate battery chargers contain a temperature-sensing circuit to ensure that batteries are charged within the temperature limits stated above.

## **Battery Recycling and Disposal**

Li-Ion rechargeable batteries can be recycled. However, recycling facilities may not be available in all areas. Under various U.S. state laws and the laws of several other countries, batteries must be recycled and cannot be disposed of in landfills or incinerators. Contact your local waste management agency for specific requirements and information in your area. Motorola Solutions fully endorses and encourages the recycling of Li-Ion batteries. In the U.S. and Canada, Motorola Solutions participates in the nationwide Rechargeable Battery Recycling Corporation (RBRC) program for Li-Ion battery collection and recycling.

Many retailers and dealers participate in this program. For the location of the drop-off facility closest to you, access RBRC's Internet web site at:

**[www.rbrc.com](http://www.rbrc.com)**

or call:

**1-800-8-BATTERY**

This internet site and telephone number also provides other useful information concerning recycling options for consumers, businesses and governmental agencies.

## Installing the Lithium-Ion (Li-Ion) Battery

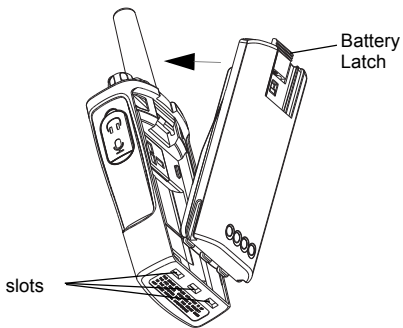

1. Turn OFF the radio.
2. With the Motorola Solutions logo side up on the battery pack, fit the tabs at the bottom of the battery into the slots at the bottom of the radio's body.
3. Press the top part of the battery towards the radio until a click is heard.

**Note:** To learn about the Li-Ion Battery Life features, refer to "About the Li-Ion Battery" on page 16.

## Removing the Lithium-Ion (Li-Ion) Battery

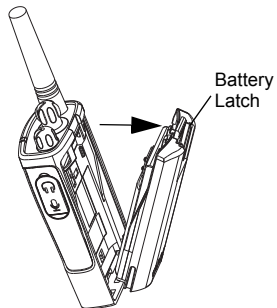

1. Turn OFF the radio.
2. Push down the battery latch and hold it depressed while removing the battery.
3. Pull the battery away from the radio.

## Alkaline Battery Pack (Optional Accessory)

### Installing Alkaline Batteries

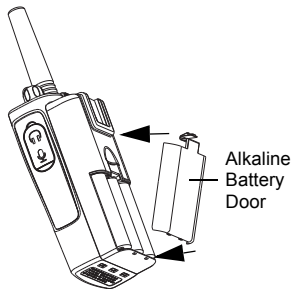

1. Turn OFF the radio, if it is turned ON.
2. Remove Li-Ion battery.
3. Assemble alkaline battery pack in the same steps as installing the Li-Ion battery pack.
4. Remove battery door from alkaline battery pack.
5. Slide the 5 AA alkaline batteries into the frame, matching the markings inside the compartment.

### Removing Alkaline Batteries

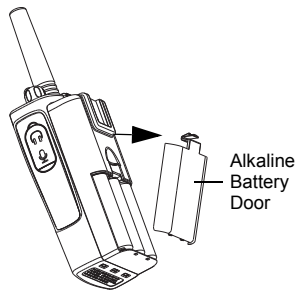

1. Turn OFF the radio, if it is turned ON.
2. Slide the battery latches, on both sides of the battery, downwards.
3. Pull the top of the battery away from the radio's body, and lift the battery from the radio's body.

## Attaching and Removing Antenna

These instructions apply **ONLY** for **RDU4160d** radio. Do not attempt to remove the antenna if your radio is not one of these models.

### Attaching the Antenna

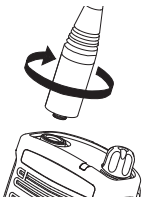

1. Align the threaded end of the antenna with the radio's antenna connector.
2. Turn the antenna clockwise to fasten it.

### Removing the Antenna

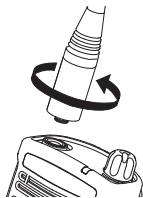

1. Turn the antenna counterclockwise until you can remove it.

## Installing Spring Action Belt Clip

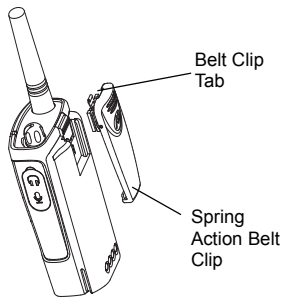

1. Slide the spring action belt clip rails into the belt clip grooves on the back of the battery pack and slide it down until the belt clip tab snaps into place.
2. To remove, pull back the metal release tab on the belt clip tab and push the spring action belt clip upward to remove.

## Power Supply, Adaptor and Drop-in Tray Charger

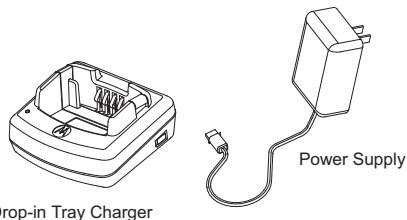

The radio is equipped with one Drop-in Tray Charger and one Power Supply with Adaptor. For details, see “Chargers” on page 86.

## Battery Life Information

When the Battery Save feature is ON (enabled by default) the battery life will be longer. The following chart summarizes battery life estimations:

Li-Ion Battery Life with Battery Save feature ON			
Battery Type	5 Watts	4 Watts	2 Watts
Standard	8.5 hours	8.5 hours	12 hours
High	17 hours	17 hours	24 hours
Ultra High	18.5 hours	18.5 hours	26 hours

**Note:** Battery life is estimated based on 5% transmit/ 5% receive/ 90% standby standard duty cycle.



## Alkaline Battery Life

The following chart estimates the Alkaline battery life:



Alkaline Battery Life			
Battery Save Feature	5 Watts	4 Watts	2 Watts
ON	26 hours*	26 hours*	26 hours

### Notes:

- Battery life are being estimated based on 5% transmit/ 5% receive/ 90% standby standard duty cycle.
- \* When using Alkaline battery, the radio is set to 2W by default.

## Battery Meter

The battery meter located in the upper left corner of the display indicates how much battery power you have remaining.

RDX Series™ Battery Meter			
Battery Type	3 Bars	2 Bars	1 Bar
			
Li-Ion	100%-70%	70%-30%	30%-0%
AA	100%-70%	70%-30%	30%-0%

## Charging the Battery

RDX Series™ offers two types of chargers :

- Standard Charger and,
- Rapid Charger.

The radio comes equipped with a Standard Charger.

To charge the battery (with the radio attached), place it in a Motorola-approved Drop-in Tray Single Unit Charger or Drop-in Tray Multi Unit Charger.

**Note:** When acquiring additional chargers or power supplies, make sure you have similar drop-in tray chargers and power supplies sets (all “rapid” or all “standard”). For part number details, refer to “Chargers” on page 86.

## Charging with the Drop-in Tray Single Unit Charger (SUC)

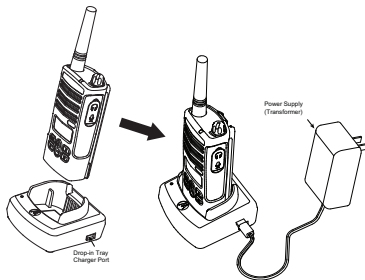

1. Place the drop-in tray charger on a flat surface.
2. Insert the connector of the power supply into the port on the side of the drop-in tray charger.
3. Plug the AC adaptor into a power outlet.
4. Insert the radio into the tray with the front of the radio facing the front of the charger, as shown.

**Note:** When charging a battery attached to a radio, turn the radio OFF to ensure a full charge. See “Operational Safety Guidelines” on page 7 for more information.

## Charging a Standalone Battery

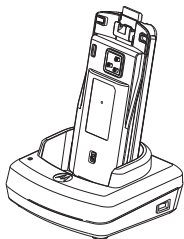

To charge only the battery – at step 4, insert the battery into the tray, with the inside surface of the battery facing the front of the charger, as shown. Ensure the slots in the battery correctly engage in the charger

**Note:** Ensure that the bracket in the charger is adjusted to the correct position for either Standard or High capacity battery. See “Charging a Standard Battery” on page 26

## Charging a Standard Battery

The drop-in tray charger has a removable bracket that is adjustable depending on the type of battery that needs to be charged. It is designed to charge either the battery (with the radio) or a standalone battery. The drop-in tray charger's default position will charge a standard battery. The following image shows the orientation for each battery:

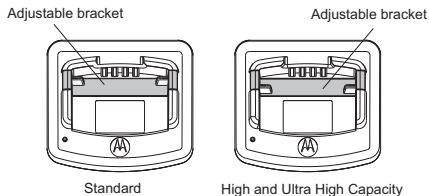

**Figure 1:** Identifying the Drop-In Charger's Position Before Charging the Battery

## Charging a High Capacity or Ultra High Capacity Battery

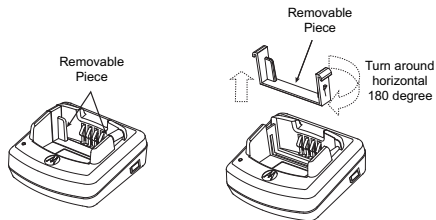

To convert the charger from the default setup to accommodate the High capacity or Ultra High capacity battery:

1. Squeeze both tabs on each side of the removable bracket in the drop-in charger tray and lift the bracket from the charger tray.
2. Rotate the removable bracket 180 degrees and replace it by fitting it in the charger slot until it snaps. The label on the removable bracket should show 'High & Ultra Capacity Battery' facing front of the charger.

3. Repeat same procedure to return to the charging a Standard Battery position. Label on the removable bracket should show 'Standard Battery' facing front.

**Note:** Make sure the bracket is assembled correctly for both standalone battery and battery (with radio).

## Drop-in Tray Charger LED Indicators

Standard Charger LED Indicator		
Status	LED Status	Comments
Power ON	Steady red indication for 3 seconds	The charger has powered up
Charging	Blinking red (slow)	The charger is currently charging
Charging Complete	Steady red indication	Battery is fully charged
Battery Fault(*)	Blinking red (fast)	Battery had a fault when battery was inserted

### Notes:

- (\*) Normally re-seating the battery pack will correct this issue.

### Rapid Charger LED Indicator

Status	LED Status	Comments
Power ON	Steady green indication for 3 seconds	The charger has powered up
Charging	Blinking green	The charger is currently charging
Top-off Charging	Blinking green (slow)	Battery is near fully charged
Charge Complete	Steady green indication	Battery is fully charged
Battery Fault (*)	Blinking red (fast)	Battery has a fault when battery was inserted
Waiting to Charge (**)	Double-blink yellow indications	Battery charging conditions not suitable

#### Notes:

- (\*) Normally re-seating the battery pack will correct this issue.
- (\*\*) Battery temperature is too warm or too cold or wrong power supply is being used.

## ***Estimated Charging Time***

The following table provides the estimated charging time of the battery. For further details, see “Battery” on page 85.

<b>Estimated Charging Time</b>			
<b>Charging Solution</b>	<b>Battery Type</b>		
	Standard	High Capacity	Ultra High Capacity
Standard Charging Solution	7 hours	12 hours	13 hours
Rapid Charging Solution	1.5 hours	3 hours	3.5 hours



## Charging a Radio and Battery using a Multi Unit Charger- MUC (Optional Accessory)

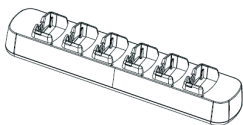

The Multi Unit Charger (MUC) allows drop-in charging of up to 6 radios or batteries. Batteries can be charged with the radios or removed and placed in the MUC separately. Each of the 6 charging pockets can hold a radio or battery, but not both.

1. Place the charger on a flat surface.
2. Insert the power cord plug into the MUC's jack.
3. Plug the cord into an AC outlet.
4. Turn the radio OFF.
5. Set removable bracket for battery type.
6. Insert the radio or battery into the charging pocket.

### Notes:

- This Multi Unit Charger also allows you to clone up to 3 radios (3 Source radios and 3 Target radios). Refer to page 55 for details.
- Further details on MUC's operation are explained in the Instructions Sheet provided with the MUC. For part number details, refer to the Accessories section.

### MUC LED Indicator

Status	LED Status	Comments
Charging	Steady Red Indication	The charger is currently charging
Charge Complete	Steady Green Indication	Battery is fully charged
Battery Fault (*)	Blinking red (fast)	Battery was faulty when inserted

**Note:** (\*) Normally re-seating the battery pack will correct this issue.

## GETTING STARTED

For the following explanations refer to "Parts of the radio" on page 12.

### TURNING RADIO ON/OFF

Turn the On/Off/Volume knob clockwise to turn ON the radio. The radio will chirp and the LED will briefly blink a red light.

To turn the radio OFF rotate the On/Off/Volume knob counterclockwise until you hear a 'click' and the radio LED indicator turn OFF.

### ADJUSTING VOLUME

Turn the On/Off/Volume knob clockwise to increase the volume, or counterclockwise to decrease the volume.

**Note:** Do not hold the radio too close to your ear when adjusting the volume or if it is at a high volume setting.

## READING THE DISPLAY

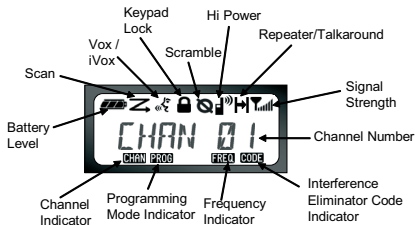

### Notes:

- The radio display shown here is for icon location only. Each radio display may appear different (channel and code) based on the preprogrammed radio defaults. Pressing any button, except the **PTT**, will turn on the backlight.
- Repeater/Talkaround capability is not available for all Radio Models.

## SELECTING A CHANNEL

Your radio offers different number of conventional channels depending on the model number. To select a channel, press the toggle  $\oplus$  /  $\ominus$  buttons until you reach the desired channel.

Program each channel separately. Each channel has its own Frequency, Interference Eliminator Code and Scan Settings.

## TALKING AND MONITORING

It is important to monitor traffic before transmitting to ensure that you do not 'talk over' someone who is already transmitting

For monitoring press and hold the SB1(\*) button to access channel traffic. If no activity is present, you will hear 'static'. Press again SB1 to release.

Once channel traffic has cleared, proceed with your call by pressing the **PTT** button.

When transmitting, the radio LED blinks red.

**Note:** To listen to all activity on a current channel, short press the SB1 to set the CTCSS/DPL code to 0. This feature is called 'CTCSS/DPL Defeat' (Squelch set to SILENT).

(\*) This assumes SB1 is not being programmed for a different mode.

## RECEIVING A CALL

1. Select a channel by pressing the toggle  $\oplus$  /  $\ominus$  buttons until you reach the desired channel.
2. Make sure the **PTT** button is released and listen for voice activity.
3. The LED indicator blinks RED while your radio is receiving.
4. To respond, hold the radio vertically 1 to 2 inches (2.5 to 5cm) from your mouth. Press the **PTT** button to talk; release it to listen.

## Signal Strength Indicator and Channel Busy Indicators

When there is activity on a frequency the radio displays the strength indicator icon  while radio LED blinks faster. When there is activity on the same frequency and code as your radio (your radio is receiving), the radio signal strength icon can change from 1 (weakest) to 6 (strongest) depending on the radio reception coverage. This can help determine when a radio is moving out of range.

**Note:** Obstacles that block the signal path may affect the strength of the incoming signal.



## TALK RANGE

TALK RANGE		
Model	Industrial	Multi-Level
	Inside steel/concrete Industrial buildings	Inside multi-level buildings
UHF 4W	Up to 350,000 Sq. Ft.	Up to 30 Floors
VHF 5W	Up to 300,000 Sq. Ft.	Up to 18 Floors
UHF 2W	Up to 250,000 Sq. Ft.	Up to 20 Floors
VHF 2W	Up to 220,000 Sq. Ft.	Up to 13 Floors

To talk with someone on your two-way radio, the channel, frequency, and interference eliminator code must be the same on both radios, which will depend on the stored profile that has been preprogrammed on the radio:

1. Channel: Current channel that the radio is using, depending upon radio model.

2. **Frequency:** The frequency your radio uses to transmit/receive.
3. **Interference Eliminator Code:** These codes help minimize interference by providing you with a choice of code combinations.
4. **Scramble Code:** Codes that make your transmissions sound garbled to anyone listening who is not set to that specific code.

For details of how to set up frequencies and CTCSS/DPL codes in your channels refer to the 'Programming Mode' Section.

## RADIO LED INDICATORS

RADIO STATUS	LED INDICATION
Channel Alias Edit	Red heartbeat
Channel Busy	Solid orange
Cloning Mode	Two orange heartbeats
Cloning In Progress	Solid orange
Fatal Error at Power up	One green blink, one orange blink, one green blink, then repeat for 4 seconds
Low Battery	Orange blink
Low Battery Shutdown	Orange heartbeat
Monitor	LED is OFF
Power-Up	Solid red for 2 seconds
'Idle' Programming Mode / Channel Mode	Green heartbeat
Scan Mode	Red heartbeat
Transmit (Tx)/Receive (RX)	Red heartbeat
Transmit in Low Power Select	Orange heartbeat

**Note:** Channel Alias Edit only applies to Display Models

## HANDS-FREE USE/VOX

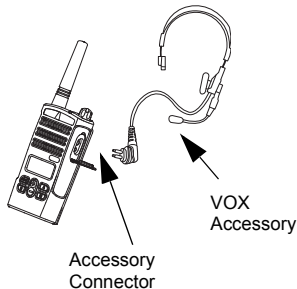

Motorola Solutions RDX™ radios can operate hands-free (VOX) when used with compatible VOX accessories.

### With Compatible VOX Accessories

The default factory setting for VOX sensitivity level is OFF (level '0'). Before using VOX, set the VOX level to a level different from '0' via the CPS. Then, perform the following steps:

1. Turn the radio OFF.

2. Open accessory cover.
3. Insert audio accessory's plug firmly into accessory port.
4. Turn the radio ON. Radio will beep and LED will blink double red. The display will show the VOX  icon.
5. Lower radio volume BEFORE placing accessory near ear.
6. To transmit, speak into accessory microphone and to receive, stop talking.
7. You can disable VOX operation by pressing the **PTT** button or removing the audio accessory.

**Note:** To order accessories, call 1 (800) 448-6686, or contact your Motorola Solutions point of purchase.

## Hands Free without Accessories (iVOX)

- Enable iVOX by pressing the **PTT** button while turning the radio ON and the  icon will blink.
- iVOX operation can be temporarily disabled by pressing the **PTT** button.

### Note:

- The iVOX feature is available only on display models RDU2080d, RDV2080d, and RDU4160d.
- To learn how to set VOX/iVOX sensitivity levels refer ahead to 'Menu Options' in this section.
- There is a short delay between when you start talking and when the radio transmits. To learn how to set VOX/iVOX sensitivity levels, refer to "MENU Options" on page 39.

## Battery Save

Battery Save feature extends battery life as your radio goes into 'Idle' state each time there is no radio activity. To enable/disable press SB1 and SB2 buttons simultaneously for 2 or 3 seconds while powering up the radio until you hear a quick series of beeps. To have a slightly better attack time, set Battery Save feature to OFF so that the radio is always ready to transmit or receive without any delays.

**Note:** Battery Save feature is set to ON by default

## Reset to Factory Defaults

Reset to Factory Defaults will set back all radio features to the original factory default settings. To do so press **PTT**, SB2 and SB1 simultaneously while turning ON the radio until you hear a high tone chirp.



## End of Transmission Tone (Roger Beep Tone)

Short press the SB1 button while turning ON the radio to enable/disable End of Transmission Tone.

**Note:** This setting is set to OFF by default

## Keypad Beeps

Keypad Beeps can be enabled/disabled by short pressing SB2 button (until radio 'chirps') while turning ON the radio.

## Keypad Lock/Unlock

You can lock the keypad to avoid accidentally changing your radio settings. Press and hold MENU for 4 seconds to lock the radio keypad. To unlock, press MENU for 4 seconds.

**Note:** The only buttons that cannot be locked using this feature are the **PTT** button and

Button A (if Call Tone feature has been assigned).



## MENU Options

To enter MENU, short press MENU button. The radio will take you to the next feature option. For each feature, you can navigate with the  $\oplus$  /  $\ominus$  buttons. After selecting your desired settings, you can:

- press MENU to save and go to the next option,
- long press the **PTT** button to save and exit or
- turn OFF the radio to exit without saving changes.

When there is no activity for more than ten seconds, MENU mode will time out.

## Setting VOX / iVOX sensitivity

The VOX/iVOX sensitivity can be adjusted via the MENU as well as the CPS. To modify via the MENU, first make sure you have enabled either VOX or iVOX (See “Hands-Free Use/VOX” on page 37.). Once VOX/iVOX has been enabled, short press MENU.

If you have iVOX enabled and press MENU, your radio will display the following:



If you have VOX enabled (with accessory connected) and press MENU, your radio will display the following:



To change the sensitivity level, use the  $\oplus$  /  $\ominus$  buttons:

0 = OFF (For VOX accessories only)

1 = Low sensitivity

2 = Medium sensitivity

3 = High sensitivity

Once you have selected the value you want, press MENU again to go to the next step or turn OFF radio to exit without saving changes.

Default value for VOX sensitivity is medium and for iVOX is high.

### **Battery Type Menu**

Only if the battery pack is not detected, the radio will allow changes to the battery type setting from either Lithium-Ion or Alkaline. To change the setting, press the MENU button as many times as needed until the radio blinks the current battery type (either 'LITHIUM' or 'ALKALINE'). A full battery icon will be shown as follows:



Use the ⊕ / ⊖ buttons to choose either 'LITHIUM' or 'ALKALINE'. Once you have selected the value you want, press MENU again to save and go to the next step or turn OFF radio to exit without saving changes. Battery Type can also be programmed using the CPS.

# PROGRAMMING FEATURES

## ENTERING PROGRAMMING MODE

To enter 'Programming Mode', press and hold both the **PTT** button and the SB1 button simultaneously for three seconds, while turning ON the radio. A unique tone will sound, indicating that the radio has entered 'Programming Mode' and the radio LED will signal a green heartbeat. Once the radio enters the 'Programming Mode', which defaults to 'Idle' Programming Mode, the LED will blink a green heartbeat.

Whenever you enter 'Programming Mode' the PROG icon will be displayed and the current channel aliasing name will be blinking to indicate that you can select the channel you want to program.

You can scroll up/down to select the different channels by pressing the  $\oplus$  /  $\ominus$  buttons.



In 'Programming Mode' your radio is capable of setting values for each channel by moving between the different programming modes available: Frequencies, CTCSS/DPL codes (Interference Eliminator Code), Scramble, Maximum Channels, Call Tone, Microphone Gain and Scan.

- To move along the different Programming Selection Modes without saving changes, short press the **PTT** button or MENU button.
- To save changes long press the **PTT** button. The radio will return to 'Idle' Programming Mode.

- If you're in 'Idle' Programming Mode and wish to exit the 'Programming Mode', long press the **PTT** button to return to normal radio operation.
- Whenever the radio wrap around to the beginning of the Programming Mode options the changes will be automatically saved, even if you turn OFF the radio.
- You can exit any Programming Mode without saving changes (as long as the radio has not return to the beginning) by turning the radio OFF.

## PROGRAMMING RX (RECEPTION) FREQUENCIES

Once you have chosen the channel you want to program, short press the **PTT** button or MENU to scroll through the options until you reach 'Frequency Programming Mode'.

The radio display will show the frequency code as follows:



To program the desired frequency, scroll up/down with the  $\oplus/\ominus$  buttons until you find the frequency code value you need. Long press the **PTT** button to exit and save, or short press the **PTT** button to move to the next programming feature without saving.

## PROGRAMMING RX (RECEPTION) CODES (CTCSS/DPL)

Once you have chosen the channel you want to program, short press the **PTT** button or MENU to scroll through the options until you reach the 'Code Programming Mode'.

The radio display will show the blinking CTCSS/DPL code as follows:



To program the desired code, scroll up/down with the  $\oplus/\ominus$  buttons until you get the CTCSS/DPL code value you want to set up. Long press the **PTT** button to exit and save.

## PROGRAMMING SCRAMBLE

The scramble feature makes your transmissions sound garbled to anyone listening without the same scramble code.

It does not guarantee confidentiality, but it adds an extra layer of privacy. Scramble default value is OFF.

Once you have entered 'Programming Mode' and selected the channel in which you want to enable Scramble () , scroll up/down through the programming options by short pressing the **PTT** button, until your radio reaches the 'Scramble Programming Mode':



The current scramble setting will blink. You can select the desired scramble value (0,1,2 or 3) by pressing the  $\oplus/\ominus$  buttons. Long press the **PTT** button to exit and save or short press the

**PTT** button to move to the next programming feature without saving.

**Note:** The values available for scrambling are dependent upon the values programmed via the CPS. When the scramble setting is '0' it means it is disabled.

## PROGRAMMING MAXIMUM NUMBER OF CHANNELS

You can configure the maximum number of channels for the radio. Once you have entered 'Programming Mode' scroll up/down by short pressing the **PTT** button until you reach the 'Max Channel Programming Mode':



The radio display will blink the current maximum number of channels programmed.

To program the maximum number of channels use the  $\oplus/\ominus$  buttons until you locate the desired setting. Long press the **PTT** button to save and exit.

**Note:** The value settings available are dependent upon the maximum number of channels the radio supports.

## PROGRAMMING CALL TONES

Call Tones will enable you to transmit to other radios in your group in such way that you can alert them that you are about to talk or alert them without speaking.

In 'Call Tone Selection Mode', you can configure the call tone type for the radio. The settings available will depend on the maximum number of call tones your radio supports.

To program Call Tones, enter 'Programming Mode' and scroll through the programming options until your display radio shows the Programming Call Tones selection:



The current call tone setting will be blinking. You can select the desired call tone value (0,1,2 or 3) by pressing the  $\oplus$ / $\ominus$  buttons. Each time you select a different setting your

radio will sound the call tone selected (except for setting '0'). Once you have selected the tone you want to program, long press the **PTT** button to exit and save or short press the **PTT** button to move to the next programming feature without saving

**Note:** The values available for Call Tones are dependent upon the values programmed via the CPS. When the call tone setting is '0' it means it is disabled.



## PROGRAMMING MICROPHONE GAIN LEVEL

To configure the microphone gain level, enter 'Programming Mode' and scroll through the programming options by short pressing the **PTT** button. When you reach the 'Microphone Gain Level Programming Mode' the display will read as follows:



The current microphone gain level setting will blink. You can select the desired microphone gain level by pressing the  $\oplus/\ominus$  buttons (1=low gain,2= Medium gain or 3= high gain).

Once you have selected the gain level you want to program, long press the **PTT** button to exit and save or short press the **PTT** button to move to the next programming feature without saving.

**Note:** The values available for microphone gain level are dependent upon maximum levels the radio supports.

## PROGRAMMING MICROPHONE ACCESSORY GAIN LEVEL

To configure the Accessory Microphone Gain Level, enter 'Programming Mode' and scroll through the programming options by short pressing the **PTT** button.

The current accessory microphone gain level setting will be blinking. You can select the desired gain level (1=Low gain,2= Medium gain or 3= High gain) by pressing the  $\oplus/\ominus$  buttons.



Once you have selected the gain level you want to program, long press the **PTT** button to

exit and save or short press the **PTT** button to move to the next programming feature without saving.

**Note:** The values available for accessory microphone gain level are dependent upon maximum levels the radio supports.

## OTHER PROGRAMMING FEATURES

### Scan

Scan allows you to monitor other channels to detect conversations.

When the radio detects a transmission, it will stop scanning and stays on the active channel. This allows you to listen and talk to the people on that channel without having to change the Channel Knob. If there is talking going on Channel 2 during this time, the radio will stay on Channel 1 and you will not hear Channel 2. After talking has stopped in Channel 1, the radio will wait for 5 seconds before resuming Scan again.

- To start scanning, press the SB2 button (\*). When the radio detects channel activity, it will stop on that channel until activity on the channel ends. You can talk to the person(s) transmitting without having to switch channels by pressing **PTT**.
- To stop scanning, short press the SB2 button again.
- If you press the **PTT** button while the radio is scanning, the radio will transmit on the channel which was selected before you activated Scan. If no transmission occurs within five seconds, scanning will resume.
- If you want to scan a channel without Interference Eliminator Codes (CTCSS/DPL), set the code settings for the channels to '0' in the CTCSS/DPL Programming Selection Mode.

Whenever the radio is set up in 'Scan Mode' the LED will signal a fast red blink.

**Note:** (\*) Assumes the SB2 button is not programmed to other function different from the default. If Auto-Scan has been enabled

for a particular channel, do not press SB2 button to start scanning, as the radio will do it automatically.

### **Programming Scan List**

You can enable/disable the Channel Scanning feature for each channel in your radio. To do so, enter 'Programming Mode' and select the channel you want to program. Scroll through the programming options by short pressing the **PTT** button until you reach the 'Scan Programming Mode'. The radio display will show the scan icon as follows:



Both the channel number and current scan setting (YES=ON or NO=OFF) will be blinking on the display, indicating that you can choose your setting. To set the channel number, press

the  $\oplus/\ominus$  buttons until you reach the desired channel number.

Once you have selected the channel, proceed to enable ('YES') or disable ('NO') the scan feature by toggling the SB2 (\*) button. Once you have set the values you need, long press the **PTT** button to save an exit.

#### **Notes:**

- (\*) This assumes the SB2 button is not being programmed for a different mode.
- If the MAX CHAN setting in the radio is set to 1, the Scan Programming option will not show (will be disabled).

## PROGRAMMING BUTTONS

You can map any channel to either button B or C as a preset channel. To enable, enter 'Programming Mode' and choose the channel you want to set as preset channel using the  $\oplus$ / $\ominus$  buttons. Once you have selected your channel, press and hold the B or C button for 2 – 3 seconds.

A short press of either preset button (B and C) will play a good key chirp.

When scanning, a short press of either preset button will change the home channel to the preset channel. The radio will display **FREQ/PL** and will continue to scan from the new home channel.

## EDITING CHANNEL ALIAS NAME

To edit a channel's alias, turn ON the radio and press and hold the **PTT** button and the  $\oplus$  button for 3 seconds. Upon entering the 'Channel Alias Mode', the radio will generate a special beep. You will see the current channel

alias name and channel number blinking as follows:



Choose the channel number you want to edit by pressing the  $\oplus$ / $\ominus$  buttons. Once you have selected the channel number, press the **PTT** button or **MENU** to start editing the channel name. If you want to exit the Channel Aliasing Mode long press the **PTT** button.



- A cursor will blink at the end of the channel name. Use button B to move the cursor to the left. If you're in the first character, the radio will give you a bonk tone. Whenever you press

button B and the cursor is positioned in a valid character, the button B will delete the current character and replace it with a blank space.

- Use the ⊕/⊖ buttons to change the current selected character to the next ASCII value in alphabetical order (from A to Z). The characters will be uppercase letters.
- To toggle character between uppercase and lower case, press the A button. Note that the supported lower case characters are: b, c, d, g, h, i, l, o, r, u.
- Pressing the C button will allow you to insert special characters and numbers in the following order: 0 - 9 \* {}? &% . + / - \_ ' ' \. Character ' ' is a space character.
- Long press the **PTT** button to save and go back to the 'Channel Aliasing Selection Mode' to choose other channel to edit the alias name or exit without saving changes by turning OFF the radio.

**Notes:**

- If the channel alias name is left blank, the radio will play a bad key chirp and will stay in the editing menu mode until the channel name is edited and saved.
- When editing the channel alias name, if the radio is left idle after 3 seconds, the radio will accept the existing character and advance the cursor one space to the right.

## NUISANCE CHANNEL DELETE

Nuisance Channel Delete allows you to temporarily remove channels from the 'Scan List'. This feature is useful when irrelevant conversations on a 'nuisance' channel tie up your radio's scanning features. To delete a channel from the scan list:

- Start 'Scan Mode' by short pressing the SB2 button (\*)
- Wait until the radio stops on the channel you wish to eliminate, then long press the SB2 button to delete it.
- The channel will be removed until you exit 'Scan Mode' by pressing the SB2 button again or if radio is turned OFF.

**Note:** (\*)Assumes the SB2 button is not programmed to another function different from the default.

## CPS (COMPUTER PROGRAMMING SOFTWARE)

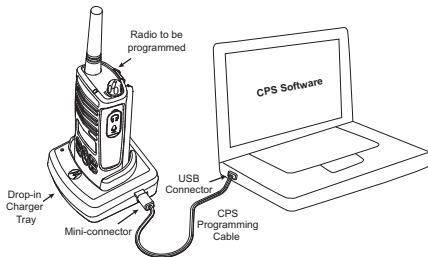

The easiest way to program or change features in your radio is by using the Computer Programming Software (CPS) and the CPS Programming Cable(\*). CPS Software is available for free as web based downloadable software at:

**[www.motorolasolutions.com/RDX](http://www.motorolasolutions.com/RDX)**

To program, connect the radio via the Drop-in Charger Tray and CPS Programming Cable as shown in the picture above.

The CPS allows the user to program frequencies, PL/DPL codes, as well as other features such as: Direct Frequency Input\*, Repeater/Talkaround\*, Time-out Timer, Power Select, Battery Type Select, Scan List, Call Tones, Scramble, Reverse Burst etc. CPS is a very useful tool as it can also lock the front-panel radio programming or restrict any specific radio feature to be changed (to avoid preset radio values from being accidentally erased). It also provides security by giving the option to set up a password for profile radio's management. Please refer to Features Summary Chart Section at the end of the user guide for details.

**Notes:**

- (\*) CPS Programming Cable (P/N RKN4155) is an accessory sold separately. Please contact your Motorola Solutions Point of Purchase for more information.

**Bandwidth Select**

Default setting for Bandwidth Select depends on the specific frequency and channel. For details refer to 'Frequencies and Codes Charts' Section. Some frequencies have selectable channel spacing, which must match other radios for optimum audio quality.

**Time-Out Timer**

When **PTT** button is pressed, transmissions can be terminated by setting up a 'time-out' timer.

**Power Select**

Power Select allows you to select the radio between high and low transmission power per frequency in each channel. The power levels for RDX™ series 2W toggle between 1W and 2W or 2W and 4W/5W depending on the radio model .

**Note:** Some frequencies may have FCC transmit power restrictions that don't allow them to be set at a higher power level. For details see the Frequencies and Code Chart Section.

### Battery Type Setting

The RDX™ series radio can be powered by either Alkaline, Lithium-Ion cells or battery pack. The battery pack can be detected at power-up and the corresponding battery level will be shown on the radio's display.

### Call Tones

See "Programming Call Tones" on page 46.

### Scramble

See "Programming Scramble 

### Reverse Burst

Reverse Burst eliminates unwanted noise (squelch tail) during loss of carrier detection. You can select values of either 180/240.

### Notes:

- The features described are just some of the features CPS has. There are many more capabilities that this software offers. For more information refer to the HELP file in the CPS
- Some of the features available with the CPS software may vary depending on the Radio Model.

### CLONING RADIOS

You can clone RDX™ Series radio profiles from one radio (the 'Source' radio) to a second radio (the 'Target' radio) by using any one of these 3 methods:

- One Multi Unit Charger (optional accessory)
- Two Single Unit Chargers and a Radio-to-Radio cloning cable (optional accessory)
- the CPS (free software download)



## Cloning with a Multi-Unit Charger (MUC)

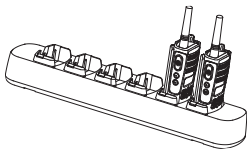

The MUC is capable of cloning radios. To do so, there must be at least two radios,

- a Source radio (radio which profiles will be cloned or copied from) and
- a Target radio (the radio which profile will be cloned from the source radio).

The Source radio has to be in Pocket 1, 3 or 5 while the Source radio to be cloned has to be in Pockets 2, 4 or 6, matching in the MUCs pockets by pairs as follows: 1 and 2 or 3 and 4 or 5 and 6 (\*).

When cloning, the MUC does not need to be plugged into a power source, but ALL radios require charged batteries.

1. Turn ON the Target radio and place it into one of the MUC Target Pockets
2. Power the Source radio following the sequence below:
  - Long press the **PTT** button and SB2 simultaneously while turning the radio ON.
  - Wait for 3 seconds before releasing the buttons until a distinctive audible tone is heard.
3. Place the Source radio in the source pocket that pairs with the target pocket you chose in step 1. Press and release SB1.
4. After cloning is completed, the Source radio will sound either a 'pass' tone (cloning was successful) or a 'fail' tone (cloning process has failed). The 'pass' tone sounds like a good key 'chirp' whereas the 'fail' tone sounds similar to a 'bonk' tone. If the Source radio is a display model, it will either show 'Pass' or 'Fail' on the display (a tone will be heard within 5 seconds).

- Once you have completed the cloning process, turn the radios OFF and ON to exit the 'cloning' mode.

**Note:** If cloning fails please refer to "What to do if cloning fails" on page 57.

Further details on how to clone units are explained in the instructions sheet provided with the MUC.

When ordering the MUC please refer to P/N RLN6309. See accessories details on "Chargers" on page 86.

**Notes:**

- Paired target radios and source radios must be of the same type in order for cloning to run successfully.
- (\*) MUC pockets numbers should be read from left to right with the Motorola Solutions logo facing front.

## Cloning Radios using the Radio to Radio (R2R) Cloning Cable (optional accessory)

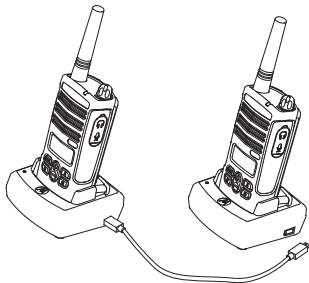

### Operating Instructions

Source Radio: Radio to be cloned.

Target Radio: Radio to which the configuration of the "Source Radio" will be copied (cloned).

- Before beginning the cloning process, make sure you have:
  - A fully charged battery on each one of the radios.
  - Two Single Unit Chargers (SUC).

- Both radios are turned OFF.
  - Both radios are of the same radio model.
2. Unplug any cables (power supply or USB cables) from the SUCs.
  3. Plug one side of the cloning cable mini connector to one SUC. Plug the other end to the second SUC.
- Note:** During the cloning process no power is being applied to the SUC. The batteries will not be charged. A data communication is being established between the two radios.
4. Turn ON the “Target Radio” and place it into one of the SUCs.
  5. On the “Source Radio”, power the radio following the sequence below:
    - Long press the Push-to-Talk (**PTT**) and Side Button 2 (SB2) simultaneously while turning the radio ON.
    - Wait for 3 seconds before releasing the buttons until a distinctive audible tone is heard.

6. Place the “Source Radio” in its SUC, press and release Side Button 1 (SB1).
7. After cloning is completed, the “Source Radio” will sound either a “pass” tone (cloning was successful) or a “fail” tone (cloning process has failed). The pass tone sounds like a good key “chirp” whereas the “fail” tone sounds similar to a “bonk” tone. If the “Source Radio” is a radio with a display, it will either show “Pass” or “Fail” on the display. (A tone will be heard in no more than 5 seconds).
8. Once you have completed the cloning process, you should turn the radios “OFF” and “ON” to bring them to normal user mode (exit “clone” mode).

### ***What to do if cloning fails***

The radio will emit an audible “bonk” indicating that the cloning process has failed. In the event that cloning fails, try performing each of the following before trying to start the cloning process again.

1. Make sure that the radio batteries on both radios are fully charged.
2. Verify the cloning cable connection on both SUCs.
3. Make sure that the battery is engaged properly on to the radio.
4. Make sure that there is no debris in the charging tray or on the radio contacts.
5. Verify that the source radio is in cloning mode.
6. Make sure that the radio to be cloned is turned ON.
7. Make sure that radios are both from the same type (same frequency band, same front panel (display/non display), same region and same transmission power).

**Note:** This cloning cable is designed to operate only with compatible Motorola Solutions RLN6175 (Standard) and RLN6304 (Rapid) Single Unit Chargers.

When ordering Cloning Cable please refer to P/N RLN6303. For details about accessories refer to Accessories section.

## Cloning Radios using the CPS (Computer Programming Software)

To clone RDX™ radios using the CPS software, you will need to have available the CPS, a Drop-in Charger Tray and the CPS Programming Cable. Information on how to clone using the CPS is available either in

- the CPS Help File --> Content and Index --> Cloning Radios or
- in the CPS Programming Cable Accessory Leaflet.

To order the CPS programming cable, please refer to P/N RKN4155. For details about accessories refer to the Accessories Section.

## Repeater Capabilities

### *Programming Repeater Capability*

You can only program Repeater Frequencies if your radio has been previously configured via the CPS. The repeater icon  will appear solid, and the MENU options for programming TX frequencies, TX CTCSS/DPL codes and TX

Bandwidth will be available. If the repeater feature is mapped (using CPS) to one of the radio buttons, then the repeater icon will blink. This indicates that you can use the repeater 'button' to toggle ON/OFF repeater. If repeater is not enabled in the radio this icon will not be displayed.



Once you have selected the channel you want to set up for repeater operation, you can move between the Programming options by short pressing the **PTT** or **MENU** button to program the frequency, code and bandwidth for the repeater channel.

To program the Frequency TX, scroll through the radio options until your display shows:



To program the desired frequency, scroll using the  $\oplus/\ominus$  buttons until you get the desired frequency code value. Long press the **PTT** button to exit and save or short press the **PTT** button to go to the next programming feature without saving.

**Note:** If your radio displays the  (Power Select) icon refer to note in 'Programming RX (Reception) Bandwidth' section for further explanation.

To program the CTCSS/DPL code, scroll through the programming options by short pressing the **PTT** button until your radio display shows:



To program the desired code, scroll using  $\oplus$  /  $\ominus$  buttons until you get the desired CTCSS/DPL code value. Long press the **PTT** button to exit and save or short press the **PTT** button to go to the next programming feature without saving.

To program the Bandwidth TX scroll down/up with the  $\oplus$  /  $\ominus$  buttons until you get the following screen:



To program the desired bandwidth (HI = 25 kHz, LOW = 12.5 kHz), toggle the  $\oplus$  /  $\ominus$  buttons to select the value. Long press the **PTT** button to exit and save or short press the **PTT** button to go to the next programming feature without saving.

**Note:** If the value of the bandwidth can not be changed, the setting will be displayed solidly

# TROUBLESHOOTING

<i>Symptom</i>	<i>Try This...</i>
No Power	Recharge or replace the Li-Ion battery. Reposition or replace AA batteries. Extreme operating temperatures may affect battery life. Refer to See "About the Li-Ion Battery" on page 16.
Hearing other noises or conversation on a channel	Confirm Interference Eliminator Code is set. Frequency or Interference Eliminator Code may be in use. Change settings: either change frequencies or codes on all radios. Make sure radio is at the right frequency and code when transmitting. Refer to "Talking and Monitoring" on page 33.
Message Scrambled	Scramble Code might be ON, and/or setting does not match the other radios' settings.
Audio quality not good enough	Radio settings might not be matching up correctly. Double check frequencies, codes and bandwidths to make sure they are identical in all radios.

<i>Symptom</i>	<i>Try This...</i>
Limited talk range	<p>Steel and/or concrete structures, heavy foliage, buildings or vehicles decrease range. Check for clear line of sight to improve transmission.</p> <p>Wearing radio close to body such as in a pocket or on a belt decreases range. Change location of radio. To increase range and coverage, you can either reduce obstructions, increase power, or use UHF radio instead of VHF radio. UHF radios provide greater coverage in industrial and commercial buildings. VHF is designed for outdoor or smaller or wood structures. Increasing power provides greater signal range and increased penetration through obstructions. Refer to Talking and Monitoring on page 33.</p>
Message not transmitted or received	<p>Make sure the <b>PTT</b> button is completely pressed when transmitting. Confirm that the radios have the same Channel, Frequency, Interference Eliminator Code and Scramble Code settings. Refer to “Talking and Monitoring” section on page 33 for further information.</p> <p>Recharge, replace and/or reposition batteries. Refer to “About your Li-Ion Battery” section on page 16.</p> <p>Obstructions and operating indoors, or in vehicles, may interfere. Change location. Refer to “Talking and Monitoring” Section on page 33.</p> <p>Verify that the radio is not in Scan. Refer to “Scan” on page 48 and “Nuisance Channel Delete” on page 52.</p>



<b>Symptom</b>	<b>Try This...</b>
Heavy static or interference	Radios are too close; they must be at least five feet apart. Radios are too far apart or obstacles are interfering with transmission. Refer to “Talking and Monitoring” on page 33.
Low batteries	Recharge or replace Li-Ion battery. Replace AA batteries. Extreme operating temperatures affect battery life. Refer to “About the Li-Ion Battery” on page 16.
Drop-in Charger LED light does not blink	Check that the radio/battery is properly inserted and check the battery/charger contacts to ensure that they are clean and charging pin is inserted correctly. Refer to “Charging the Battery” section on page 25, “Drop-in Tray Charger LED Indicators” section on page 28 and “Installing the Lithium-Ion Battery” section on page 18.
Low battery indicator is blinking although new batteries are inserted	Verify that the radio is set to the correct battery type. Refer to “Installing the Li-Ion Battery” section on page 18, “Installing Alkaline Batteries” section on page 19 and “About your Li-Ion Battery” section on page 16.

<i>Symptom</i>	<i>Try This...</i>
Cannot activate VOX	<p>VOX feature might be set to OFF.</p> <p>Use the CPS to ensure that the VOX Sensitivity level is not set to '0'.</p> <p>Accessory not working or not compatible.</p> <p>Refer to "Hands-Free Use/VOX" section on page 37.</p>
Battery does not charge although it has been placed in the drop-in charger for a while	<p>Check drop-in tray charger is properly connected and correspond to a compatible power supply.</p> <p>Ensure that you have the drop-in tray charger adjustable piece placed on the right position.</p> <p>Refer to "Charging with the Drop-In Tray Single Unit Charger" section on page 25 and "Charging a Standalone Battery" section on page 26.</p> <p>Check the charger's LEDs indicators to see if the battery has a problem. Refer to "Drop-in Tray Charger LED Indicators" section on page 28.</p>

**Note:** Whenever a feature in the radio seems to not correspond to the default or preprogrammed values, check to see if the radio has been programmed using the CPS with a customized profile.

## USE AND CARE



Use a soft damp cloth  
to clean the exterior



Do not immerse  
in water



Do not use alcohol or  
cleaning solutions

### If the radio is submerged in water...

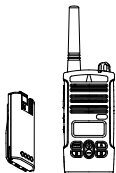

Turn radio OFF and  
remove batteries

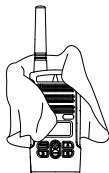

Dry with soft cloth



Do not use radio until  
completely dry

# FREQUENCY AND CODE CHARTS

## RDX VHF FREQUENCIES CHART

The charts in this section provide Frequency and Code information. These charts are useful when using Motorola Solutions RDX Series™ two-way radios with other business radios. Most of the frequency's positions are the same as Spirit M, GT, S, and XTN Series Frequencies.

### *RDX VHF Frequencies*

Frequency #	Frequency (MHz)	Bandwidth
1	151.6250	12.5 kHz
2	151.9550	12.5 kHz
3	152.8850	12.5 kHz
4	152.9150	12.5 kHz
5	151.7000	12.5 kHz
6	151.7600	12.5 kHz
*7	152.9450	12.5 kHz
*8	151.8350	12.5 kHz
*9	151.8050	12.5 kHz
10	151.5125	12.5 kHz
11	151.6550	12.5 kHz

Frequency #	Frequency (MHz)	Bandwidth
12	151.6850	12.5 kHz
13	151.7150	12.5 kHz
14	151.7450	12.5 kHz
15	151.7750	12.5 kHz
16	151.8650	12.5 kHz
17	151.8950	12.5 kHz
18	151.9250	12.5 kHz
19	152.9000	12.5 kHz
20	154.4900	12.5 kHz
21	154.5150	12.5 kHz
22	154.5275	12.5 kHz

### *RDX VHF Frequencies (continued)*

Frequency #	Frequency (MHz)	Bandwidth
23	154.5400	12.5 kHz
24	153.0050	12.5 kHz
25	154.5475	12.5 kHz

Frequency #	Frequency (MHz)	Bandwidth
26	158.4000	12.5 kHz
27	158.4075	12.5 kHz

#### **Notes:**

- (\*) Due to FCC regulations these frequencies (six in total) are different from the previous Motorola Solutions Legacy Series radios. This means that if you select the RDX radio in one of these frequencies the radio will not inter-operate with an XTN radio. In order for a RDX radio to inter-operate with an XTN radio, make sure you choose any of the frequencies (21 in total) that are common for both radios.

PLEASE NOTICE THAT THE FACTORY DEFAULT CONFIGURATION OF THE RDX RADIOS HAVE BEEN MODIFIED TO BE IN COMPLIANCE WITH THE 2013 FCC NARROWBAND MANDATE. THIS MANDATE REQUIRES RADIO OPERATORS TO SWITCH THE CONFIGURATION OF THEIR EQUIPMENT TO 12.5 KHZ CHANNEL BANDWIDTH BY JANUARY 1ST, 2013. THE RDX RADIO CHANNEL BANDWIDTH DEFAULT HAS BEEN SET AT 12.5 KHZ.

IF THIS NEW RADIO IS AN ADDITION OR REPLACEMENT TO AN EXISTING GROUP OF RADIOS WITH 25 KHZ SETTING (LEGACY FACTORY CONFIGURATION), ACTION MAY BE REQUIRED ON YOUR PART IN ORDER TO OPTIMIZE OPERATION OF YOUR FLEET AND BE IN COMPLIANCE WITH FCC RULES.

TO CHANGE THE CHANNEL BANDWITH OF YOUR OLDER RDX RADIO FROM 25 KHZ TO 12.5 KHZ YOU MAY USE THE CUSTOMER PROGRAMMING SOFTWARE AVAILABLE FOR FREE DOWNLOAD AT HYPERLINK "<http://www.motorola.com/RDX>" [WWW.MOTOROLASOLUTIONS.COM/RDX](http://www.motorolasolutions.com/RDX) (PROGRAMMING CABLE REQUIRED) OR YOU CAN FOLLOW DIRECTIONS IN THE USER GUIDE UNDER 'PROGRAMMING FEATURES'.

IF YOU HAVE QUESTIONS OR NEED FURTHER ASSISTANCE, PLEASE CONTACT OUR CUSTOMER CARE TEAM AT +800-448-6686.

FOR ADDITIONAL DETAILS ON THE NARROWBAND MANDATE PLEASE VISIT HYPERLINK [WWW.MOTOROLASOLUTIONS.COM/NARROWBANDING](http://WWW.MOTOROLASOLUTIONS.COM/NARROWBANDING)

## RDV2080d – VHF DEFAULT FREQUENCIES CHART

*RDV VHF 8CH Radios Default Frequencies – RDV2080d*

Channel	Frequency #	Frequency (MHz)	Code #	Code	Bandwidth
1	20	154.4900	1	67.0 Hz	12.5 kHz
2	21	154.5150	1	67.0 Hz	12.5 kHz
3	1	151.6250	1	67.0 Hz	12.5 kHz
4	2	151.9550	1	67.0 Hz	12.5 kHz
5	10	151.5125	1	67.0 Hz	12.5 kHz
6	12	151.6850	1	67.0 Hz	12.5 kHz
7	15	151.7750	1	67.0 Hz	12.5 kHz
8	26	158.4000	1	67.0 Hz	12.5 kHz

## RDX UHF FREQUENCIES CHART

### *RDX UHF Frequencies*

Frequency #	Frequency (MHz)	Bandwidth
1	464.5000	12.5 kHz
2	464.5500	12.5 kHz
*3	467.7625	12.5 kHz
*4	467.8125	12.5 kHz
*5	467.8500	12.5 kHz
*6	467.8750	12.5 kHz
*7	467.9000	12.5 kHz
*8	467.9250	12.5 kHz
9	461.0375	12.5 kHz
10	461.0625	12.5 kHz
11	461.0875	12.5 kHz
12	461.1125	12.5 kHz
13	461.1375	12.5 kHz

Frequency #	Frequency (MHz)	Bandwidth
14	461.1625	12.5 kHz
15	461.1875	12.5 kHz
16	461.2125	12.5 kHz
17	461.2375	12.5 kHz
18	461.2625	12.5 kHz
19	461.2875	12.5 kHz
20	461.3125	12.5 kHz
21	461.3375	12.5 kHz
22	461.3625	12.5 kHz
*23	462.7625	12.5 kHz
*24	462.7875	12.5 kHz
*25	462.8125	12.5 kHz
*26	462.8375	12.5 kHz

### *RDX UHF Frequencies (Continued)*

Frequency #	Frequency (MHz)	Bandwidth
*27	462.8625	12.5 kHz
*28	462.8875	12.5 kHz
*29	462.9125	12.5 kHz
30	464.4875	12.5 kHz
31	464.5125	12.5 kHz
32	464.5375	12.5 kHz
33	464.5625	12.5 kHz
34	466.0375	12.5 kHz
35	466.0625	12.5 kHz
36	466.0875	12.5 kHz
37	466.1125	12.5 kHz

Frequency #	Frequency (MHz)	Bandwidth
38	466.1375	12.5 kHz
39	466.1625	12.5 kHz
40	466.1875	12.5 kHz
41	466.2125	12.5 kHz
42	466.2375	12.5 kHz
43	466.2625	12.5 kHz
44	466.2875	12.5 kHz
45	466.3125	12.5 kHz
46	466.3375	12.5 kHz
47	466.3625	12.5 kHz
*48	467.7875	12.5 kHz



### *RDX UHF Frequencies (Continued)*

Frequency #	Frequency (MHz)	Bandwidth
*49	467.8375	12.5 kHz
*50	467.8625	12.5 kHz
*51	467.8875	12.5 kHz
*52	467.9125	12.5 kHz
53	469.4875	12.5 kHz
54	469.5125	12.5 kHz
55	469.5375	12.5 kHz
56	469.5625	12.5 kHz
57	462.1875	12.5 kHz
58	462.4625	12.5 kHz
59	462.4875	12.5 kHz
60	462.5125	12.5 kHz

Frequency #	Frequency (MHz)	Bandwidth
61	467.1875	12.5 kHz
62	467.4625	12.5 kHz
63	467.4875	12.5 kHz
64	467.5125	12.5 kHz
65	451.1875	12.5 kHz
66	451.2375	12.5 kHz
67	451.2875	12.5 kHz
68	451.3375	12.5 kHz
69	451.4375	12.5 kHz
70	451.5375	12.5 kHz
71	451.6375	12.5 kHz
72	452.3125	12.5 kHz

### *RDX UHF Frequencies (Continued)*

Frequency #	Frequency (MHz)	Bandwidth
73	452.5375	12.5 kHz
74	452.4125	12.5 kHz
75	452.5125	12.5 kHz
76	452.7625	12.5 kHz
77	452.8625	12.5 kHz
78	456.1875	12.5 kHz
79	456.2375	12.5 kHz
80	456.2875	12.5 kHz
81	456.3375	12.5 kHz

Frequency #	Frequency (MHz)	Bandwidth
82	456.4375	12.5 kHz
83	456.5375	12.5 kHz
84	456.6375	12.5 kHz
85	457.3125	12.5 kHz
86	457.4125	12.5 kHz
87	457.5125	12.5 kHz
88	457.7625	12.5 kHz
89	457.8625	12.5 kHz

**Notes:**

- (\*) Frequency limited to 2W maximum power output
- When referring to XTN radios, note that frequencies from # 57 to # 89 are 33 new additional frequencies

## RDU2080d – UHF DEFAULT FREQUENCIES CHART

### *RDX UHF 8 CH Radios Default Frequencies – RDU2080d*

Channel	Frequency #	Frequency (MHz)	Code #	Code	Bandwidth
1	2	464.5500	1	67.0 Hz	12.5 kHz
2	8	467.9250	1	67.0 Hz	12.5 kHz
3	5	467.8500	1	67.0 Hz	12.5 kHz
4	6	467.8750	1	67.0 Hz	12.5 kHz
5	10	461.0625	1	67.0 Hz	12.5 kHz
6	12	461.1125	1	67.0 Hz	12.5 kHz
7	14	461.1625	1	67.0 Hz	12.5 kHz
8	16	461.2125	1	67.0 Hz	12.5 kHz

## RDU4160d – UHF DEFAULT FREQUENCIES CHART

### *RDX UHF 16 CH Radios Default Frequencies – RDU4160d*

Channel	Frequency #	Frequency (MHz)	Code #	Code	Bandwidth
1	1	464.5000	1	67.0 Hz	12.5 kHz
2	1	464.5000	4	77.0 Hz	12.5 kHz
3	1	464.5000	8	88.5 Hz	12.5 kHz
4	1	464.5000	29	179.9 Hz	12.5 kHz
5	1	464.5000	0	–	12.5 kHz
6	2	464.5500	1	67.0 Hz	12.5 kHz
7	2	464.5500	6	82.5 Hz	12.5 kHz
8	2	464.5500	10	94.8 Hz	12.5 kHz
9	2	464.5500	29	179.9 Hz	12.5 kHz
10	2	464.5500	0	–	12.5 kHz

***RDX UHF 16 CH Radios Default Frequencies – RDU4160d (Continued)***

<b>Channel</b>	<b>Frequency #</b>	<b>Frequency (MHz)</b>	<b>Code #</b>	<b>Code</b>	<b>Bandwidth</b>
11	22	461.3625	3	74.4 Hz	12.5 kHz
12	30	462.4875	5	79.7 Hz	12.5 kHz
13	32	462.5375	7	85.4 Hz	12.5 kHz
14	34	462.0375	9	91.5 Hz	12.5 kHz
15	36	464.0875	11	97.4 Hz	12.5 kHz
16	38	464.1375	13	103.5 Hz	12.5 kHz

## CTCSS AND PL/DPL CODES

### CTCSS Codes

CTCSS	Hz		CTCSS	Hz		CTCSS	Hz
1	67.0		14	107.2		27	167.9
2	71.9		15	110.9		28	173.8
3	74.4		16	114.8		29	179.9
4	77.0		17	118.8		30	186.2
5	79.7		18	123		31	192.8
6	82.5		19	127.3		32	203.5
7	85.4		20	131.8		33	210.7
8	88.5		21	136.5		34	218.1
9	91.5		22	141.3		35	225.7
10	94.8		23	146.2		36	233.6
11	97.4		24	151.4		37	241.8
12	100.0		25	156.7		38	250.3
13	103.5		26	162.2		122 (*)	69.3

**Note:** (\*) New CTCSS code.

### *PL/DPL Codes*

<b>DPL</b>	<b>Code</b>		<b>DPL</b>	<b>Code</b>		<b>DPL</b>	<b>Code</b>
39	23		55	116		71	243
40	25		56	125		72	244
41	26		57	131		73	245
42	31		58	132		74	251
43	32		59	134		75	261
44	43		60	143		76	263
45	47		61	152		77	265
46	51		62	155		78	271
47	54		63	156		79	306
48	65		64	162		80	311
49	71		65	165		81	315
50	72		66	172		82	331
51	73		67	174		83	343
52	74		68	205		84	346
53	114		69	223		85	351
54	115		70	226		86	364

**PL/DPL Codes (Continued)**

<b>DPL</b>	<b>Code</b>		<b>DPL</b>	<b>Code</b>		<b>DPL</b>	<b>Code</b>
87	365		104	565		121	754
88	371		105	606		123	645
89	411		106	612		124	Customized PL
90	412		107	624		125	Customized PL
91	413		108	627		126	Customized PL
92	423		109	631		127	Customized PL
93	431		110	632		128	Customized PL
94	432		111	654		129	Customized PL
95	445		112	662		130	Inverted DPL 39
96	464		113	664		131	Inverted DPL 40
97	465		114	703		132	Inverted DPL 41
98	466		115	712		133	Inverted DPL 42
99	503		116	723		134	Inverted DPL 43
100	506		117	731		135	Inverted DPL 44
101	516		118	732		136	Inverted DPL 45
102	532		119	734		137	Inverted DPL 46
103	546		120	743		138	Inverted DPL 47



***PL/DPL Codes (Continued)***

<b>DPL</b>	<b>Code</b>		<b>DPL</b>	<b>Code</b>		<b>DPL</b>	<b>Code</b>
139	Inverted DPL 48		156	Inverted DPL 65		173	Inverted DPL 82
140	Inverted DPL 49		157	Inverted DPL 66		174	Inverted DPL 83
141	Inverted DPL 50		158	Inverted DPL 67		175	Inverted DPL 84
142	Inverted DPL 51		159	Inverted DPL 68		176	Inverted DPL 85
143	Inverted DPL 52		160	Inverted DPL 69		177	Inverted DPL 86
144	Inverted DPL 53		161	Inverted DPL 70		178	Inverted DPL 87
145	Inverted DPL 54		162	Inverted DPL 71		179	Inverted DPL 88
146	Inverted DPL 55		163	Inverted DPL 72		180	Inverted DPL 89
147	Inverted DPL 56		164	Inverted DPL 73		181	Inverted DPL 90
148	Inverted DPL 57		165	Inverted DPL 74		182	Inverted DPL 91
149	Inverted DPL 58		166	Inverted DPL 75		183	Inverted DPL 92
150	Inverted DPL 59		167	Inverted DPL 76		184	Inverted DPL 93
151	Inverted DPL 60		168	Inverted DPL 77		185	Inverted DPL 94
152	Inverted DPL 61		169	Inverted DPL 78		186	Inverted DPL 95
153	Inverted DPL 62		170	Inverted DPL 79		187	Inverted DPL 96
154	Inverted DPL 63		171	Inverted DPL 80		188	Inverted DPL 97
155	Inverted DPL 64		172	Inverted DPL 81		189	Inverted DPL 98

*PL/DPL Codes (Continued)*

DPL	Code		DPL	Code		DPL	Code
190	Inverted DPL 99		200	Inverted DPL 109		210	Inverted DPL 119
191	Inverted DPL 100		201	Inverted DPL 110		211	Inverted DPL 120
192	Inverted DPL 101		202	Inverted DPL 111		212	Inverted DPL 121
193	Inverted DPL 102		203	Inverted DPL 112		213	Inverted DPL 123
194	Inverted DPL 103		204	Inverted DPL 113		214	Customized DPL
195	Inverted DPL 104		205	Inverted DPL 114		215	Customized DPL
196	Inverted DPL 105		206	Inverted DPL 115		216	Customized DPL
197	Inverted DPL 106		207	Inverted DPL 116		217	Customized DPL
198	Inverted DPL 107		208	Inverted DPL 117		218	Customized DPL
199	Inverted DPL 108		209	Inverted DPL 118		219	Customized DPL

## PROGRAMMING CUSTOMIZED FREQUENCIES ON 4W/5W RDX MODELS

4W/5W Models can be programmed to have customized frequencies (different from the ones shown in the VHF and UHF charts in previous pages). VHF range is 146 –174 MHz and UHF 438 – 470 MHz.

4W/5W models can also be programmed to work with repeaters.

Please contact your Motorola Solutions point of purchase for details.

# MOTOROLA SOLUTIONS LIMITED WARRANTY FOR THE UNITED STATES AND CANADA

## What Does this Warranty Cover?

Subject to the exclusions contained below, Motorola Solutions, Inc. warrants its telephones, pagers, and consumer and business two-way radios (excluding commercial, government or industrial radios) that operate via Family Radio Service or General Mobile Radio Service, Motorola Solutions-branded or certified accessories sold for use with these Products (“Accessories”) and Motorola Solutions software contained on CD-ROMs or other tangible media and sold for use with these Products (“Software”) to be free from defects in materials and workmanship under normal consumer usage for the period(s) outlined below.

This limited warranty is a consumer’s exclusive remedy, and applies as follows to new Motorola Solutions Products, Accessories and Software

purchased by consumers in the United States, which are accompanied by this written warranty.

## Products and Accessories

Products Covered	Length of Coverage
<b>Products and Accessories</b> as defined above, unless otherwise provided for below.	<b>One (1) year</b> from the date of purchase by the first consumer purchaser of the product unless otherwise provided for below.
<b>Decorative Accessories and Cases.</b> Decorative covers, bezels, PhoneWrap™ covers and cases.	<b>Limited lifetime warranty</b> for the lifetime of ownership by the first consumer purchaser of the product.
<b>Business Two-way Radio Accessories</b>	<b>One (1) year</b> from the date of purchase by the first consumer purchaser of the product.
<b>Products and Accessories that are Repaired or Replaced.</b>	<b>The balance of the original warranty or for ninety (90) days</b> from the date returned to the consumer, whichever is longer.
<b>Two-way Radio</b>	<b>Two (2) years</b> from the date of purchase by the first consumer purchaser of the product.

## Exclusions

**Normal Wear and Tear.** Periodic maintenance, repair and replacement of parts due to normal wear and tear are excluded from coverage.

**Batteries.** Only batteries whose fully charged capacity falls below 80% of their rated capacity and batteries that leak are covered by this limited warranty.

**Abuse & Misuse.** Defects or damage that result from: (a) improper operation, storage, misuse or abuse, accident or neglect, such as physical damage (cracks, scratches, etc.) to the surface of the product resulting from misuse; (b) contact with liquid, water, rain, extreme humidity or heavy perspiration, sand, dirt or the like, extreme heat, or food; (c) use of the Products or Accessories for commercial purposes or subjecting the Product or Accessory to abnormal usage or conditions; or (d) other acts which are not the fault of Motorola, are excluded from coverage.

**Use of Non-Motorola Solutions Products and Accessories.** Defects or damage that result from the use of Non-Motorola Solutions branded or certified Products, Accessories, Software or other peripheral equipment are excluded from coverage.

**Unauthorized Service or Modification.** Defects or damages resulting from service, testing, adjustment, installation, maintenance, alteration, or modification in any way by someone other than Motorola, or its authorized service centers, are excluded from coverage.

**Altered Products.** Products or Accessories with (a) serial numbers or date tags that have been removed, altered or obliterated; (b) broken seals or that show evidence of tampering; (c) mismatched board serial numbers; or (d) nonconforming or non-Motorola Solutions housings, or parts, are excluded from coverage.

**Communication Services.** Defects, damages, or the failure of Products, Accessories or Software due to any communication service or signal you may subscribe to or use with the Products Accessories or Software is excluded from coverage.

## Software

Products Covered	Length of Coverage
<b>Software.</b> Applies only to physical defects in the media that embodies the copy of the software (e.g. CD-ROM, or floppy disk).	<b>Ninety (90) days</b> from the date of purchase.

## Exclusions

**Software Embodied in Physical Media.** No warranty is made that the software will meet your requirements or will work in combination with any hardware or software applications provided by third parties, that the operation of the software products will be uninterrupted or error free, or that all defects in the software products will be corrected.

## Software NOT Embodied in Physical Media.

Software that is not embodied in physical media (e.g. software that is downloaded from the internet), is provided “as is” and without warranty.

## WHO IS COVERED?

This warranty extends only to the first consumer purchaser, and is not transferable.

## HOW TO OBTAIN WARRANTY SERVICE OR OTHER INFORMATION?

Contact your Motorola Solutions point of purchase.

## SOFTWARE COPYRIGHT NOTICE

The Motorola Solutions products described in this manual may include copyrighted Motorola Solutions and third party software stored in semiconductor memories or other media. Laws in the United States and other countries preserve for Motorola Solutions and third party software providers certain exclusive rights for copyrighted software, such as the exclusive rights to distribute or reproduce the copyrighted software.

Accordingly, any copyrighted software contained in the Motorola Solutions products may not be modified, reverse-engineered, distributed, or

reproduced in any manner to the extent allowed by law.

Furthermore, the purchase of the Motorola Solutions products shall not be deemed to grant either directly or by implication, estoppel, or otherwise, any license under the copyrights, patents, or patent applications of Motorola Solutions or any third party software provider, except for the normal, non-exclusive, royalty-free license to use that arises by operation of law in the sale of a product.

#### **PATENT NOTICE**

This product is covered by one or more of the following United States patents.

5896277 5894292 5864752 5699006 5742484  
D408396 D399821 D387758 D389158 5894592  
5893027 5789098 5734975 5861850 D395882  
D383745 D389827 D389139 5929825 5926514  
5953640 6071640 D413022 D416252 D416893  
D433001

#### **EXPORT LAW ASSURANCES**

This product is controlled under the export regulations of the United States of America. The Governments of the United States of America may restrict the exportation or re-exportation of this product to certain destinations. For further information contact the U.S. Department of Commerce.

## ACCESSORIES

### ANTENNAS

Part No.	Description
RAN4033	UHF Stubby Antenna 450 – 470 MHz
RAN4041	VHF Helical Antenna 146 –174 MHz
RAN4031	UHF Whip Antenna 438 – 470 MHz

### AUDIO ACCESSORIES

Part No.	Description
53815	Headset w/Boom Mic BR
HMN9026	Remote Speaker Mic BR
HKLN4477	Surveillance Earpiece BR

Part No.	Description
53865	Headset w/Swivel Boom Mic
53866	Earbud w/Clip PTT Mic BR
56517	Earpiece w/Inline Mic
RLN6423	Swivel Earpiece BR

### BATTERY

Part No.	Description
RLN6306	Alkaline Battery Frame
RLN6351	Standard Li-Ion Battery
RLN6308	Ultra High Capacity Li-Ion Battery

**CARRY ACCESSORIES**

Part No.	Description
RLN6302	Hard Leather Carry Case
RLN6307	Spring Action Belt Clip

**POWER SUPPLIES AC PIN ADAPTORS**

Part No.	Description
RLN6349	North America AC Pin Adaptor

**SOFTWARE APPLICATIONS**

Part No.	Description
RVN5147	Computer Programming Software (CPS)

**CABLES**

Part No.	Description
RLN6303	Radio to Radio Cloning Cable
RKN4155	CPS Programming Cable

**CHARGERS**

Part No.	Description
RLN6304	Rapid ACCY Charging Kit – Americas (*)
RLN6309	Multi Unit Charger (MUC) Kit – North America
RLN6175	Standard Drop-in Tray Charger



## POWER SUPPLIES

Part No.	Description
RPN4054	Standard US Fixed Power Supply
RPN4058	Standard Exchg AC pin Pwr Supply
RLN6170	Rapid Exchg AC pin Pwr Supply

**Attention:** Certain accessories may be or may not be available at the time of purchase. For latest information on accessories, contact your Motorola Solutions point of purchase or visit: [www.motorolasolutions.com/RDX](http://www.motorolasolutions.com/RDX)

(\*) Americas Rapid Charging Kit includes Power Supply, Drop-in Tray Charger, and AC Pin adaptors.

Features	Programmable Via RADIO PANEL		Programmable via CPS		Default Value	Programming Tips
	Display	Non-Display	Display	Non-Display		
<b>Backlight</b>	No	N/A	Yes	N/A	5 Seconds	Choose the backlight's time out by using the CPS.
<b>Bandwidth Select</b>	Yes	No	Yes	Yes	Frequency Dependable	Front panel programming available only on display models by entering Programming Mode (1). Bandwidth is programmable according to FCC frequency regulations. Refer to the Frequencies and Code Charts Section for details.
<b>Battery Save (2)</b>	Yes	Yes	Yes	Yes	ON	To enable/disable Battery Save, press SB1 and SB2 simultaneously while turning ON the radio.
<b>Battery Type</b>	Yes	No	Yes	Yes	Li-Ion	Front panel radio programming is available in display models by pressing the MENU button and scrolling down/up with $\oplus$ and $\ominus$ buttons to set value. Long press <b>PTT</b> to save and exit.
<b>Buttons Reset</b>	No	No	Yes	Yes	ON	Available only via CPS. Allows to reset the radio buttons to factory default values. Refer to Radio Buttons Summary Table.

Features	Programmable Via RADIO PANEL		Programmable via CPS		Default Value	Programming Tips
	Display	Non-Display	Display	Non-Display		
Call Tones (4)	Yes	No	Yes	Yes	OFF / BUTTON A	Front panel radio programming available only for Display Models by going into Programming Mode(1). Values available are 0 (OFF),1, 2 and 3. To enable/disable Call Tones press Button A (default button).
Channel Aliasing	Yes	N/A	Yes	N/A	OFF	Only Display Models. To enter or exit Channel Aliasing mode press <b>PTT</b> and <b>+</b> buttons simultaneously while turning radio ON for 3 sec. After editing, to exit and save, long press <b>PTT</b> . <b>Note:</b> To edit, refer to Programming Features/ Editing Channels.
Channels	Yes	Yes	Yes	Yes	Model Dependant	You can select channels using the Channel Selector Knob (non-display models) or the MENU button (display models). You can also add or delete channels by using the CPS. <b>Note:</b> Enabling/disabling channels via CPS will automatically affect the Max Channels you are able to program via front panel.

Features	Programmable Via RADIO PANEL		Programmable via CPS		Default Value	Programming Tips
	Display	Non-Display	Display	Non-Display		
Cloning Mode	Yes	Yes	Yes	Yes	OFF	Enables radio to enter cloning mode in order to clone its profile settings into other radios (using Radio to Radio Cloning Cable or Multi-Unit Charger). Press <b>PTT</b> , SB2 while turning radio ON.  <b>Note:</b> <i>You can clone radios using the CPS.</i>
CPS Manager Lock	No	No	Yes	Yes	N/A	This feature is referred in the CPS software as “Codeplug Password”. It prevents unauthorized access to the CPS to the radio’s programmed configuration. Make sure you set up a 4 digits password that is easy to remember.
End of Tx Tone (or Roger Beep) (2)	Yes	Yes	Yes	Yes	OFF	To enable/disable press SB1 while powering up the radio.
Frequencies	Yes	Yes	Yes	Yes	Channel and Model Dependant	There are 27 VHF frequencies and 89 UHF frequencies available. Use Programming Mode (1) for front panel radio programming. Refer to Frequencies and Codes Charts Section for details.

Features	Programmable Via RADIO PANEL		Programmable via CPS		Default Value	Programming Tips
	Display	Non-Display	Display	Non-Display		
Frequencies, Direct Input (3)	No	No	Yes	Yes	Any value within radio frequency band	Allows you to customize frequencies in your radio. Available only for certain 4W/5W radio models.
Bandwidth Range	N/A	N/A	N/A	N/A	Model Dependant	Radios Bandwidth is fixed and non-programmable. Bandwidth Range for 2W radios: VHF 150.8 – 160 Mhz / UHF 450 – 470 Mhz Bandwidth Range for 4W/5W radios: VHF: 146 – 174 Mhz / UHF 438 – 470 Mhz.
Codes, Interference Eliminator Codes (CTCSS/DPL)	Yes	Yes	Yes	Yes	Channel and Model Dependant	Use Programming Mode for front panel radio programming. There are 122 codes available. For details refer to Frequencies and Codes Charts Section.
IVOX, enable/disable	Yes	N/A	N/A	N/A	OFF	Hands free without accessories, available for display models only. To enable IVOX long press the <b>PTT</b> button while turning radio ON and until the IVOX icon blinks.

Features	Programmable Via RADIO PANEL		Programmable via CPS		Default Value	Programming Tips
	Display	Non-Display	Display	Non-Display		
<b>IVOX, sensitivity Level</b>	Yes	N/A	Yes	N/A	HIGH (Level 3)	Available for Display models only. Allows user to specify IVOX sensitivity level. For front panel radio programming use the MENU button.
<b>Keypad Beep ( or Keypad Tone) (2)</b>	Yes	Yes	Yes	Yes	ON	Press SB2 while turning ON radio to enable/disable keypad beep.
<b>Keypad Lock (2)</b>	Yes	N/A	Yes	N/A	UNLOCKED	Press and hold MENU for 4 seconds to lock the radio keypad. To unlock, press MENU for 4 seconds.
<b>LEDs Enabled/ Disabled</b>	No	No	Yes	Yes	Enabled	Using CPS you can disable radio LEDs.
<b>Low Battery Alert – Shutdown</b>	N/A	N/A	N/A	N/A	ON	Gives a sequence of loud and high beep tones to alert battery level is low. LED will blink orange several times. This a non-programmable feature.
<b>Maximum Channels (2)</b>	Yes	No	Yes	Yes	Model and CPS programmable dependant	Front panel radio programming (only Display models): Set radio to Programming Mode(1) to get the Maximum Channels Menu option. <b>Note:</b> Default value is set to the maximum number of channels that the radio supports.

Features	Programmable Via RADIO PANEL		Programmable via CPS		Default Value	Programming Tips
	Display	Non- Display	Display	Non- Display		
Microphone Gain Level, ACCESSORY	Yes	No	Yes	Yes	Medium (Level 2)	For front panel programming enter Programming Mode (1).
Microphone Gain Level, RADIO	Yes	No	Yes	Yes	Medium (Level 2)	For front panel programming enter Programming Mode (1).
Monitor (4)	Yes	Yes	Yes	Yes	SB1 Button	Long Press SB1 to monitor and press SB1 again to release. <b>Note:</b> <i>PL/DPL defeat feature should be disabled in order to monitor.</i>
Nuisance Ch Delete (4)	Yes	Yes	Yes	Yes	SB2 Button	Press SB2 to start scanning and wait until the radio lands on the channel you want to delete. Long press SB2 to delete the channel. <b>Note:</b> <i>The nuisance deleted channel will be restored into the scan list when the radio is turned OFF or you exit SCAN.</i>

Features	Programmable Via RADIO PANEL		Programmable via CPS		Default Value	Programming Tips
	Display	Non-Display	Display	Non-Display		
PL Defeat	Yes	Yes	Yes	Yes	SB1 Button	Also known as 'Squelch defeat'. Short Press SB1 to enable PL/DPL defeat so you can listen or monitor any activity in the channel without noise. Press SB1 again to disable PL/DPL defeat.
Power Select (4)	No	No	Yes	Yes	High Power (Model dependant)	Use CPS for selecting the transmission power level you want for each channel. Power level default depends on maximum power the radio supports. <b>Note:</b> <i>There may be power restrictions depending on the frequency chosen in each channel.</i>
Power up Text	No	N/A	Yes	N/A	MOTOROLA	Text that shows up in the radio display when turned ON. Default text is MOTOROLA. Programmable via CPS.
Repeater/ Talkaround (3)	No	No	Yes	Yes	OFF	Available only for RDU4160d model.
Reset to Factory Defaults (2)	Yes	Yes	Yes	Yes	Enabled	Allows to restore radio's factory defaults. Press <b>PTT</b> , SB1, SB2 simultaneously for 3 seconds while turning ON radio.



Features	Programmable Via RADIO PANEL		Programmable via CPS		Default Value	Programming Tips
	Display	Non- Display	Display	Non- Display		
Reverse Burst	No	No	Yes	Yes	180	Reverse Burst eliminates unwanted noise (squelch tail) during loss of carrier detection. Use CPS to select values 180 or 240.

Features	Programmable Via RADIO PANEL		Programmable via CPS		Default Value	Programming Tips
	Display	Non-Display	Display	Non-Display		
Scan	Yes	Yes	N/A	N/A	SB2 Button	Short press SB2 to enable/disable scan.
Scan List	Yes	No	Yes	Yes	ON - All Channels	Use CPS for editing Scan List (adding/removing channels to be scanned). For display models only: you can add/delete channels in the scan list using front panel by going into Programming Mode(1).
Scan, Auto Scan	No	Yes	No	Yes	OFF	Feature available only for Non Display Models. For front programming using front panel radio enter Programming Mode(1).
Scramble (4)	Yes	No	Yes	Yes	OFF (level 0)	Display models only: you can program scramble using front panel by going into Programming Mode(1).
Time-Out Timer	No	No	Yes	Yes	60 seconds	Use CPS to program to program how long the <b>PTT</b> can be pressed before the transmission is automatically terminated. Values are 60, 120 and 180 seconds. (Pressing again <b>PTT</b> will start the transmission again).

Features	Programmable Via RADIO PANEL		Programmable via CPS		Default Value	Programming Tips
	Display	Non-Display	Display	Non-Display		
<b>VOX Sensitivity Level</b>	Yes	No	Yes	Yes	OFF (level 0)	Front panel radio programming available in display models by pressing <b>PTT</b> or <b>MENU</b> buttons and scrolling down/up with <b>+</b> and <b>-</b> buttons to set value. Long press <b>PTT</b> to save.
<b>VOX, enable/disable</b>	Yes	Yes	Yes	Yes	OFF	Allows to use 'hands-free' mode connecting microphone accessories. To enable connect external accessory and power up radio.  <b>Note:</b> The VOX sensitivity level default value is set to OFF in the CPS settings. Before using this feature, check VOX sensitivity level.

(1) To enter Programming Mode, press and hold both **PTT** and **SB1** simultaneously for 3-5 seconds while turning radio ON (LED will start to blink green). Short press **PTT** to get to the different programming options. For setting values, press **+** and **-** buttons.

(2) Using CPS you can prevent this feature to be programmed via front panel radio.

(3) Contact your Motorola Solutions Point of purchase for enabling this feature and/or for radio models details.

(4) For Non-Display Models, feature can be enabled for front panel programming by assigning feature to **SB1** or **SB2**. For Display models, feature can be enabled to any of the programmable buttons rather than the default ones. For more details refer to Programming Buttons Chart or CPS Menus.









## Programmable Buttons Chart





Button	Monitor	Scan / Nuisance Delete	Call Tone	Power Select	Scramble	Backlight	Channel Preset 1	Channel Preset 2	No Operation
SB1	Default	✓	✓	✓	✓	N/A	N/A	N/A	✓
SB2	✓	Default	✓	✓	✓	N/A	N/A	N/A	✓
BUTTON A (*)	✓	✓	Default	✓	✓	✓	✓	✓	✓
BUTTON B (*)	✓	✓	✓	✓	✓	✓	Default	✓	✓
BUTTON C (*)	✓	✓	✓	✓	✓	✓	✓	Default	✓

### Notes:

- Buttons come programmed to default functions. Using CPS you can assign one of the features shown in the chart, so the button can toggle values using radio front panel.
- (\*) Display models only.

## Icons Chart

Icon	Symbol	Comments
Battery Level		Displayed during normal radio mode operation, displays battery life remaining.
Channel		Displayed during normal radio operation and when programming channel features.
Code		Displayed during normal radio operation and when programming codes features.
Frequency		Displayed during normal radio operation and when programming frequency features.
Keypad lock		Displayed whenever the Keypad lock feature is enabled (keypad is locked).
Program		Displayed whenever the radio is set up to Programming Mode.
Scan		Displayed whenever the radio is set to SCAN mode.
Scramble		Displayed whenever scramble is enabled.

Icon	Symbol	Comments
<b>Power Select</b>		Displayed whenever the channel is transmitting or set to a high-power selection.
<b>Signal Strength</b>		RSSI Display Icon numbers of bars will indicate the strength of the received signal.
<b>Repeater(*)</b>		Displayed whenever the repeater feature is enabled.
<b>Vox/IVox</b>		Displayed when IVOX/VOX enabled or when programming MIC / MIC gain features.

*(\*) Available only for 4160d model. To enable, contact your Motorola Solutions point of purchase.*





NNTN8303A

MOTOROLA, MOTO, MOTOROLA SOLUTIONS and the Stylized M logo are trademarks or registered trademarks of Motorola Trademark Holdings, LLC and are used under license. All other trademarks are the property of their respective owners.

© 2007 and 2018 Motorola Solutions, Inc. All rights reserved.



6880309T01-CA