

MP-20x Telephone Adapter

Version 4.4.9 Build 111

Table of Contents

1	Introduction	11
2	Cabling the MP-20x Telephone Adapter	13
3	Setting up a Network Connection	15
3.1	Defining Your PC's Network Connection	15
3.1.1	Configuring your PC Running Windows 10	16
3.1.2	Configuring your PC Running Linux	18
3.2	Configuring the MP-20x's Network Connection.....	18
3.2.1	Logging in to MP-20x Web Interface	18
3.2.2	Configuring 'Quick Setup' Screen Parameters	19
3.2.2.1	Configuring Your Internet Connection.....	19
3.2.3	Configuring 3G/LTE USB Modem	24
4	Device Quick Setup.....	27
4.1	Preparing Initial Configuration	27
4.2	Configuring SIP Signaling Protocol.....	28
5	Getting Started with the Web Interface	31
5.1	Logging into the Web Interface.....	31
5.2	Menu Bar Description	32
5.3	Managing Tables.....	35
5.4	Configuring Users.....	36
5.4.1	Web User Permissions	39
5.4.1.1	Print Commands.....	39
5.5	Set Commands.....	48
5.6	Associated Elements	49
5.6.1	Configuring Scheduler Rules.....	49
5.6.2	Configuring Network Objects	51
5.6.3	Configuring Protocols	53
5.7	Logging out the Web Interface.....	54
6	Viewing a Graphical Display of the Device's Network	55
7	Configuring Computers for Connecting to Device's Network.....	57
7.1	Wired Computers	57
7.1.1	Configuring Computers Running on Windows 7	57
7.1.2	Configuring Computers Running on Linux.....	58
8	Setting up your Device	59
8.1	Setting up an Internet Connection using the Web Interface	59
8.1.1	WAN Ethernet.....	60
8.1.1.1	Manual IP Address Ethernet Connection	60
8.1.1.2	Automatic IP Address Ethernet Connection.....	61
8.1.1.3	PPPoE.....	61
8.1.1.4	PPTP	62
8.2	Using the Automatic Dialer for Internet Connection	63
8.2.1	Recommended Configuration.....	63
8.2.2	Setting up and Starting the Automatic Dialer.....	64
8.2.3	Quitting Automatic Dialer for Manual Configuration	64

9	Configuring VoIP Parameters	65
9.1	Configuring the SIP Signaling Protocol	66
9.1.1	Configuring Proxy Redundancy	71
9.1.2	Support for DNS Failover Mechanism	73
9.2	Support for Common Name/SubjectAltName Verification for SIP	74
9.3	Support for Advanced Alerting with Ring Splash	74
9.4	Configuring Dialing Parameters	74
9.4.1	Syntax for Digit Maps and Dial Plans	79
9.5	Configuring Media Streaming	81
9.5.1	SRTP	83
9.5.1.1	Support for Dynamic SRTP Policy	83
9.5.1.2	Changing Default Cipher Suites for SIP Over TLS	84
9.5.1.3	Support for RFC 3329 & MediaSec Extensions	84
9.5.1.4	Configuring Codecs	84
9.5.2	Supported Codecs	84
9.5.2.1	Packetization Time	84
9.6	Configuring Voice and Fax	85
9.7	Configuring Supplementary Services	90
9.7.1	Network-based Conferencing (RFC 4240)	93
9.8	Voice Menu Guidance	94
9.8.1	Configuring Voice Menu	94
9.8.1.1	Voice Menu Configuration Parameters	94
9.9	Configuring Micro PBX Line Settings	96
9.10	Configuring Line Extensions	99
9.11	Configuring Speed Dialing	101
9.12	Enabling Polarity Reversal	103
10	Making VoIP Calls with your Analog Telephones	105
10.1	Making a Call	105
10.2	Answering a Waiting Call	105
10.3	Putting a Call on Hold	106
10.4	Transferring a Call	106
10.5	Forwarding Calls to another Phone	107
10.6	Establishing a 3-Way Conference Call	108
11	Quality of Service	109
11.1	QoS Wizard	110
11.2	Configuring Traffic Shaping	111
11.2.1	Configuring Traffic Shaping	112
11.2.2	Configuring Shaping Classes	114
11.2.2.1	Class Rules	115
11.3	Configuring Traffic Priority	117
11.4	Configuring DSCP Mapping	121
11.5	Configuring 802.1p Mapping	123
11.6	Configuring Class Statistics	124
11.7	Configuring Basic VoIP QoS Example	125
12	Network Connections	127
12.1	Configuring a WAN Connection	127
12.1.1	WAN Ethernet Connections	129

12.1.1.1	External DSL Modem using PPPoE	129
12.1.1.2	External Cable Modem/Fiber Transceiver without Authentication	131
12.1.1.3	DHCP	133
12.1.1.4	Manual IP Address	134
12.2	LAN Connection	137
12.2.1	LAN Ethernet	137
12.2.1.1	General Tab	138
12.2.1.2	Settings Tab	138
12.2.1.3	Routing Tab	139
12.2.1.4	Advanced Tab	139
12.3	WAN Connection	141
12.3.1	General Tab	141
12.3.2	Settings Tab	142
12.3.2.1	Internet Protocol Settings	143
12.3.3	Routing Tab	146
12.3.4	PPP Tab	148
12.3.5	PPTP Tab	150
12.3.6	Advanced Tab	151
12.4	VLAN Settings	152
12.4.1	Settings Tab	155
12.4.1.1	IP Address Distribution	156
12.4.2	Routing Tab	158
12.4.3	Advanced Tab	159
12.5	LAN-WAN Bridge Settings	160
12.5.1	Editing LAN-WAN Bridging	162
13	Add-On Servers and Disk Management	165
13.1	External File Server	165
13.1.1	Automatic File Sharing	166
13.2	Print Server	168
13.2.1	Connecting and Setting up a Printer on Windows	169
13.2.2	Print Protocols	170
13.2.2.1	Internet Printing Protocol	171
13.2.2.2	Microsoft Shared Printing (Samba)	179
13.2.2.3	Line Printer Daemon (LPD)	182
13.2.3	Storing and Using Printer Drivers	190
14	Remote Device Management	191
14.1	Overview	191
14.1.1	Remote Configuration	191
14.1.2	Remote Management	193
14.1.2.1	Firmware Upgrade	193
14.1.2.2	Status and Performance Monitoring	194
14.1.2.3	Alarms, Notifications and Logging	195
14.2	Enabling Remote Management	196
14.2.1	Enabling Local or Remote Management using the SSH Protocol	199
14.3	Securing Remote Management with Certificates	200
14.4	Remote Configuration and Management Interfaces	204
14.4.1	Embedded Web Server	204
14.4.2	TR-069 and TR-104 CPE WAN Management Protocol	205
14.4.2.1	Configuring the Device via TR-069 and TR-104	206
14.4.2.2	Monitoring the Device Status via TR-069 and TR-104	214
14.4.2.3	Security Concerns and Measures	218
14.4.3	SNMP	218

14.4.3.1	Enabling SNMP in the Web Interface.....	219
14.4.3.2	Configuring the Device via SNMP.....	220
14.4.3.3	Status Monitoring of System and Network Interfaces via SNMP.....	220
14.4.3.4	Security Concerns and Measures.....	221
14.4.4	Syslog.....	222
14.4.5	Automatic File Download.....	222
14.4.5.1	Firmware File Download.....	222
14.4.5.2	Configuration File Download.....	222
14.4.5.3	Security Concerns and Measures.....	223
14.4.6	Telnet CLI.....	223
14.4.7	Redirect Server.....	223
14.4.8	BroadSoft BroadWorks DMS Provisioning.....	225
14.4.9	Provisioning using DHCP Options 66/67 and TFTP.....	225
14.4.9.1	Default Behavior.....	225
14.4.9.2	Disabling DHCP Options 66 and 67.....	226
14.4.10	Setting Provisioning Time of Day (TOD).....	226
14.4.10.1	Random TOD.....	226
14.4.10.2	Fixed TOD.....	227
14.4.10.3	No TOD Configured – Default Behavior.....	227
14.4.10.4	Changing Default Cipher Suits for Provisioning.....	227
15	Security.....	229
15.1	General Security Level Settings.....	230
15.2	Configuring Access Control.....	232
15.3	Configuring Port Forwarding.....	234
15.4	Configuring a DMZ Host.....	237
15.5	Configuring Port Triggering.....	238
15.6	Configuring Website Restrictions.....	241
15.7	Configuring NAT.....	244
15.8	Viewing Current Connections.....	247
15.9	Configuring Advanced Filtering.....	248
15.10	Viewing the Security Log.....	252
16	Advanced Networking Features.....	255
16.1	IP Address Distribution.....	255
16.1.1	Configuring the DHCP Server.....	257
16.1.2	Configuring DHCP Relay.....	258
16.1.3	Viewing DHCP Clients.....	259
16.1.4	Configuring Static DHCP Clients.....	260
16.2	Configuring a DNS Server.....	261
16.3	Configuring Dynamic DNS.....	263
16.4	Configuring Routing Rules.....	266
16.4.1	Managing Routing Table Rules.....	267
16.4.2	Configuring Routing Protocols.....	268
16.5	Enabling PPPoE Relay.....	269
16.6	Selecting Regional Settings for Analog Lines.....	270
16.7	Installation Wizard.....	271
17	Home Media.....	273
17.1	Universal Plug and Play.....	273
17.1.1	Enabling Universal Plug and Play on the Device.....	273
17.1.2	Adding UPnP-enabled PC to Home Network.....	274
17.1.3	Monitoring Connection Between the Device and Internet.....	275
17.1.4	Making Local Services available to PCs on Internet.....	276

18	Configuring the Device for PacketSmart.....	279
18.1	Configuring PacketSmart through the Web Interface	279
18.2	Configuring PacketSmart through the CLI	282
18.3	Upgrading PacketSmart on the Fly	283
18.4	Accessing the PacketSmart Web Portal	284
19	Media Sharing.....	287
19.1	Share Music, Pictures and Video on My Local Network.....	287
19.2	Automatically Share Media in All Folders.....	288
20	Maintenance	291
20.1	Enabling the Feature Key	291
20.2	Viewing the Device Software Version	293
20.3	Configuring Date and Time.....	294
20.4	Configuration File	297
20.4.1	Uploading Configuration File from PC on the Network.....	299
20.4.2	Uploading Configuration File from a Remote Server.....	301
20.4.3	Remote Configuration Provisioning Based on MD5 Checksum Comparison	304
20.4.4	Encrypting the Configuration File using CLI	305
20.4.5	Automatic Upload using SIP NOTIFY Message.....	306
20.5	Firmware Upgrade.....	307
20.5.1	Upgrading the Device from a Computer on the Network.....	308
20.5.2	Upgrading the Device from the Internet.....	311
20.6	Configuring System Settings	313
20.7	Rebooting the Device	316
20.8	Restoring Factory Settings	317
21	Diagnostics and Performance Monitoring	319
21.1	Running Diagnostics.....	319
21.1.1	Running the Ping Test.....	320
21.1.2	Running the ARP Test.....	320
21.1.3	Running a Traceroute	321
21.2	Running Debug	322
21.2.1	Running Packet Recording	323
21.2.2	Running SIP Debug Log	324
21.2.3	Running TCPDump.....	325
21.2.3.1	Updating Wireshark.....	325
21.2.3.2	Running TCPDump with Destination Port 7555	325
21.2.3.3	Defining a Different Destination Port (other than Port 7555)	326
21.2.4	Running Generic Commands	327
21.2.5	Commands Output and Report.....	328
21.3	System Monitoring.....	331
21.3.1	Viewing Network Connections Status.....	331
21.3.2	Viewing the System Log	332
21.3.3	Viewing CPU Statistics	333
21.3.4	Viewing VoIP Traffic Statistics.....	334
21.3.5	Viewing Internet Connection Utilization	335
21.3.6	Using Debugging Tools	336
21.4	Call Detail Records.....	337
21.4.1	CDR Field Descriptions	337
21.4.2	Release Reasons in CDR.....	339

21.4.3	Configuring CDR Reporting	339
21.4.4	CDR Log Local Storage	340
A	Technical Specifications	341
A.1	Device Gateway Specifications	341

Notice

Information contained in this document is believed to be accurate and reliable at the time of printing. However, due to ongoing product improvements and revisions, AudioCodes cannot guarantee accuracy of printed material after the Date Published nor can it accept responsibility for errors or omissions. Updates to this document can be downloaded from <https://www.audiocodes.com/library/technical-documents>.

This document is subject to change without notice.

Date Published: January-28-2020

WEEE EU Directive

Pursuant to the WEEE EU Directive, electronic and electrical waste must not be disposed of with unsorted waste. Please contact your local recycling authority for disposal of this product.

Customer Support

Customer technical support and services are provided by AudioCodes or by an authorized AudioCodes Service Partner. For more information on how to buy technical support for AudioCodes products and for contact information, please visit our website at <https://www.audiocodes.com/services-support/maintenance-and-support>.

Stay in the Loop with AudioCodes



Abbreviations and Terminology

Each abbreviation, unless widely used, is spelled out in full when first used.

General Notes, Warnings, and Safety Information



Note: OPEN SOURCE SOFTWARE. Portions of the software may be open source software and may be governed by and distributed under open source licenses, such as the terms of the GNU General Public License (GPL), the terms of the Lesser General Public License (LGPL), BSD and LDAP, which terms are located at <https://www.audiocodes.com/services-support/open-source/> and all are incorporated herein by reference. If any open source software is provided in object code, and its accompanying license requires that it be provided in source code as well, Buyer may receive such source code by contacting AudioCodes, by following the instructions available on AudioCodes website.

Document Revision Record

LTRT	Description
50610	Initial document release.
50611	Provisioning using DHCP Options 66 & 67 and TFTP Server sections were added.
50612	MP-204B features were added.
50613	The Remote Configuration and Management Interfaces section was updated.
50614	The PacketSmart Configuration section was updated.
50615	Introduction section was updated. Network Parameters section was removed. Support for CN/SANS and SRTP sections were added. T.38 Version and 3-Way Conference Mode parameters were added. The Max Rate parameter was updated. Screenshots were updated.
50616	New note in Introduction; Replaced Windows XP instructions with Windows 10 instructions, Restoring factory settings, Support for DNS Failover Mechanism; Support for Advanced Alerting with Ring Splash; Support for Dynamic SRTP Policy; Network-based Conferencing (RFC 4240); Configuring Date and Time; Automatic Upload using SIP NOTIFY Message; Restoring Factory Settings; Using Debugging Tools Deleted L2TP connection; External Cable Modem/Fiber Transceiver with L2TP; using the Internet Dialer for Automatic Connections.
50617	Added Call Detail Records.
50618	Added Changing Default Cipher Suites for SIP over TLS; Setting Provisioning Time of Day (and sub-sections)

Documentation Feedback

AudioCodes continually strives to produce high quality documentation. If you have any comments (suggestions or errors) regarding this document, please fill out the Documentation Feedback form on our Web site at <http://online.audiocodes.com/documentation-feedback>.

1 Introduction

AudioCodes MP-20x series of analog Telephone Adapters are cost-effective, feature-rich gateways, allowing the connection of ordinary POTS analog telephones or fax machines to a Voice-over-Broadband (VoBB) service provider.

The MP-20x series is designed for the rapidly growing residential and Small Office/Home Office (SOHO) voice-over-IP (VoIP) market. The MP-20x series typically connects to an existing Broadband Internet device (Cable and ADSL modem, - depending on model), and establishes a communications path with the service provider network through its IP uplink connection. Supporting a rich set of subscriber calling features such as caller ID, call forwarding, and call waiting, the MP-20x series maintains a uniform user experience when migrating to VoIP services. In addition, the MP-20x series serves as a router with capabilities such as DHCP, NAT, Firewall, PPPoE and PPTP, supporting connectivity of home PC networks.

The MP-20x VoIP Gateway is an all-in-one unit featuring (depending on model) a VoIP adapter, FXS lines, Ethernet LAN interfaces (with an internal Layer-2 switch), and Ethernet WAN interface.

Utilizing AudioCodes' VoIPerfect™ core architecture, and gaining from its accumulated experience in providing IP telephony solutions, the MP-20x series combines superior voice quality and cutting-edge features for end users, such as T.38 Fax Relay and G.168-2004 compliant Echo Cancellation. Low bit rate vocoders (voice coders) can be used simultaneously on all the telephony ports to save valuable bandwidth.

The MP-20x is available in the following models:

Table 1-1: MP-20x Models

Model	FXS	WAN	LAN	USB 2.0	Ethernet Relay
MP-202B/2S/SIP	2	1	1	-	-
MP-204B/4S/SIP	4	1	1	1	-
MP-202R/2S/SIP/CER/R	2	1	1	1	✓
MP-204R/4S/SIP/CER/R	4	1	1	1	✓



Note: MP-202R/MP-204R (128M RAM + Ethernet Relay Control) is now supported. The RAM memory has been increased and Ethernet Relay controlled by software now ensures minimal downtime if power is lost.

Figure 1-1: Rear Panel MP-20xB Models

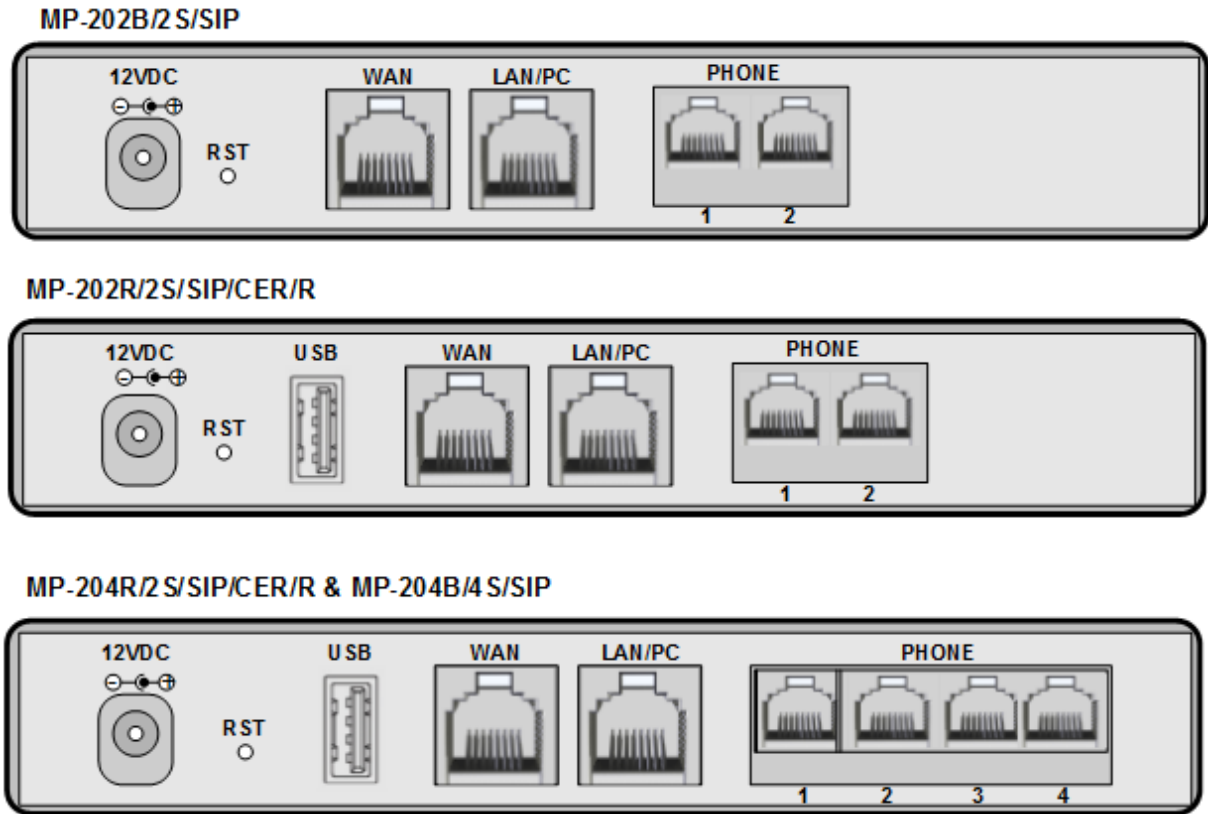

2 Cabling the MP-20x Telephone Adapter

The procedure below describes how to cable the MP-20x.

➤ **To cable the MP-20x:**

1. Connect the MP-20x's Ethernet connector labeled **WAN** to your cable or DSL modem, using the Ethernet cable.
2. Connect the MP-20x's Ethernet connector labeled **LAN/PC** to your PC, using the second Ethernet cable.
3. Connect the MP-20x's telephone ports labeled **PHONE** to analog telephones/faxes, using the RJ-11 telephone cables. (The number of telephone ports depends on your MP-20x model.)
4. Connect MP-20x to a standard 110/220 VAC electrical wall outlet, using the AC/DC power adapter; the **POWER** LED is lit (green) and when initialization completes (~ 1 minute), the **STATUS** LED changes from red to green.
5. The USB port can be used as a secondary WAN (with 3G/4G dongles) or to connect a disk-on-key, external hard disk drive or printer.

Figure 2-1: Cabling the Device (Example using MP-204R)

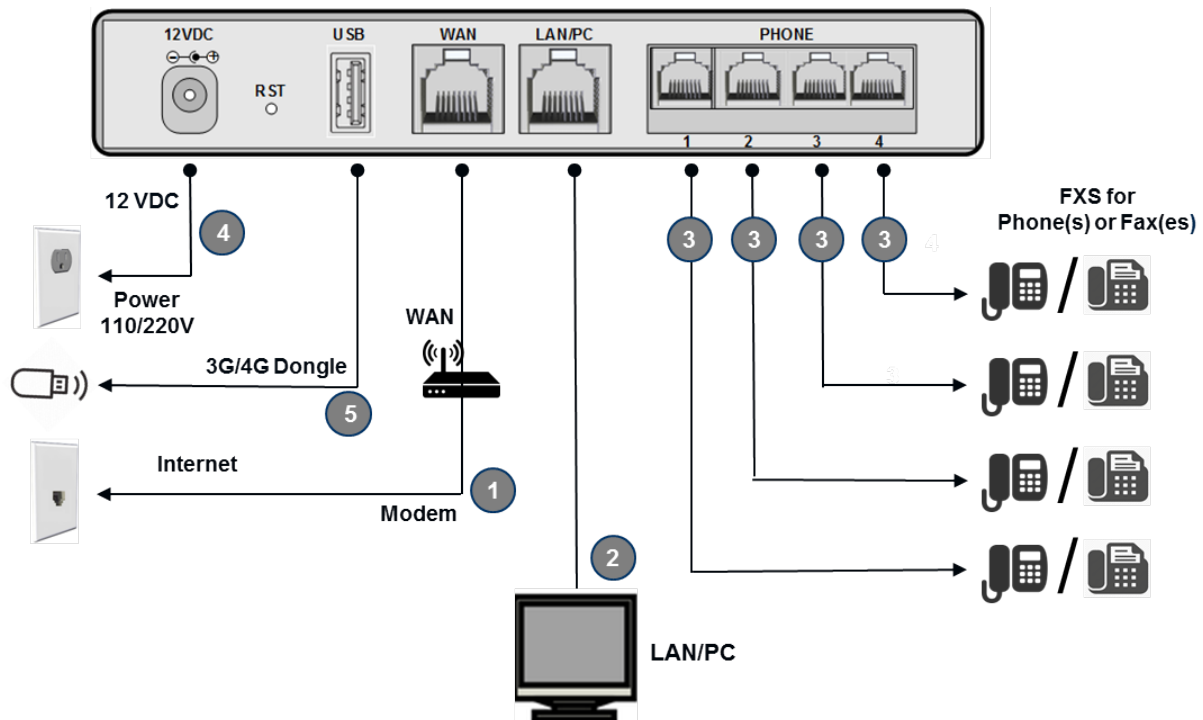

MP-20x provides LEDs on the front panel for indicating various operating status, as described in the table below:

Table 2-1: MP-204B LEDs Description

LED	Color	State	Description
POWER	Green	On	Power received by MP-20x
	-	Off	MP-20x has been powered off
STATUS	Green	On	System start-up successful
	Red	On	Reboot (automatic, by default)
PHONE 1- 4	Green	Type 1 Blinking	Idle Proxy register ok
		On	Off-hook
	Green	Type 2 Blinking	Phone ringing
		Type 3 Blinking	Upgrade in process (all LEDs including STATUS LED)
	Red	On	Idle Proxy register failed
	-	Off	On-hook and not ringing, not using Proxy
LAN / WAN	Yellow	Steady On	Connected at 10 Mbps
		Steady On	Connected at 100 Mbps
		Blinking	Activity - there is traffic on 10/100 Mbps
	Green	Steady On	Connected at 1000 Mbps
		Blinking	Activity - there is traffic on 1000 Mbps
	-	Off	Disconnected
USB	Green	On	USB device is connected
	-	Off	No USB device is connected

3 Setting up a Network Connection

The procedure below describes how to set up a network connection.

➤ **To set up a network connection:**

1. Define your PC's network connection (refer to 'Defining Your PC's Network Connection' on page 57).
2. Configure MP-20x's network connection (refer to 'Configuring the MP-20x's Network Connection' on page 59).

3.1 Defining Your PC's Network Connection

Refer to MP-20x Telephone Adapter Quick Installation Guide for instructions relating to installation on a Windows™ operating system.

Each network interface on the PC should either be configured with a statically defined IP address and DNS address, or should be instructed to automatically obtain an IP address using the Network DHCP server. MP-20x provides a DHCP server on its LAN and it is recommended to configure your PC to obtain its IP and DNS server IPs automatically. This configuration principle is identical but performed differently on each operating system.

- Refer to 'Configuring Computers Running on Windows 7' on page 57.
- Refer to 'Configuring Computers Running on Linux' on page 58.



Note: The setup procedure is in most cases unnecessary due to Windows' default network settings. For example, the default DHCP setting in Windows 10 is 'client', requiring no further modification. It is advisable however to follow the setup procedure to verify that all communication parameters are valid and that the physical cable connections are correct.

Figure 3-1: IP and DNS Configuration

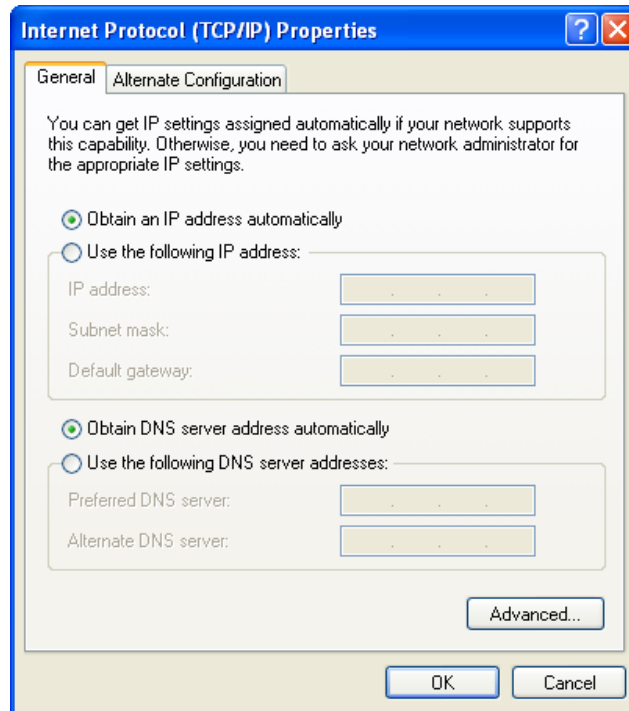

3.1.1 Configuring your PC Running Windows 10

➤ To configure your PC running Windows 10 for dynamic IP addressing:

1. Access 'Network Connections' from the Control Panel.

Figure 3-2: Ethernet Properties

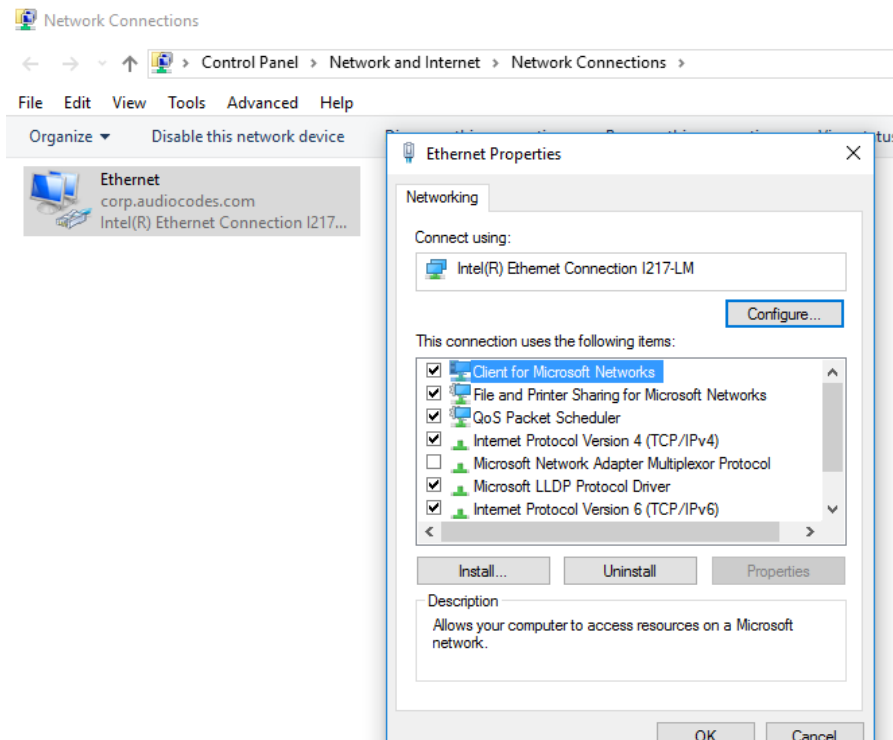

- Right-click the **Ethernet connection** icon, and then select 'Properties'.

Figure 3-3: IPv4 Properties

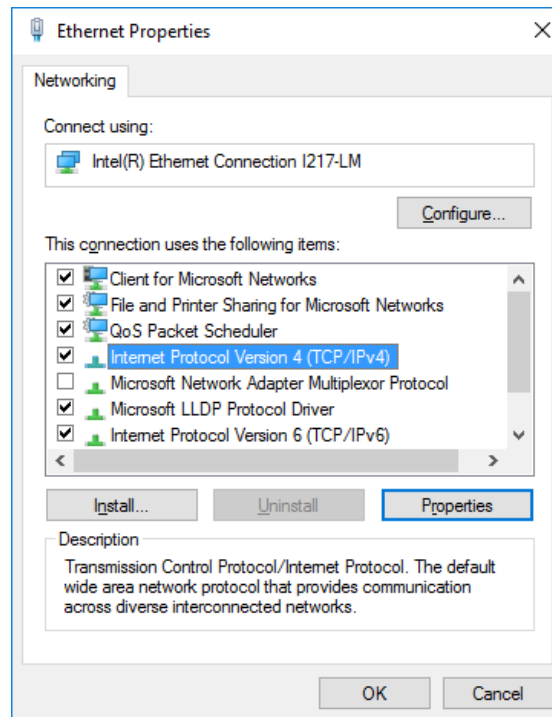

- Under the **General** tab, select the 'Internet Protocol (TCP/IP)' component, and click the **Properties** button.

Figure 3-4: Obtain an IP Address Automatically

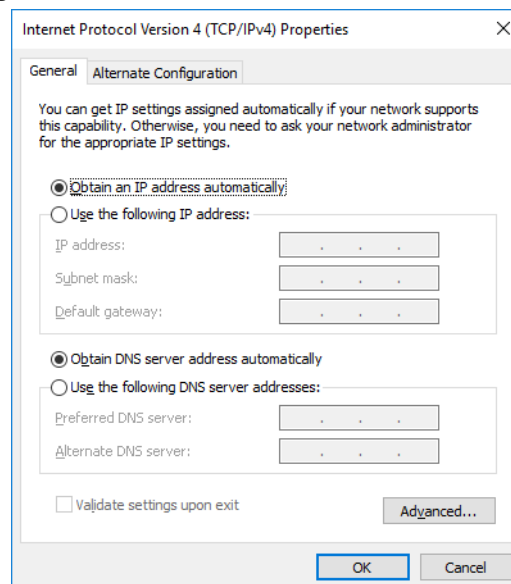

The 'Internet Protocol (TCP/IP)' properties window is displayed.

- Select the 'Obtain an IP address automatically' radio button.
- Select the 'Obtain DNS server address automatically' radio button.
- Click **OK** to save the settings.

3.1.2 Configuring your PC Running Linux

- **To configure your PC running Linux for dynamic IP addressing:**
 1. Log in into the system as a super-user, by entering `su` at the prompt.
 2. Type 'ifconfig' to display the network devices and allocated IP's.
 3. Type 'pump -i <dev>', where <dev> is the network device name.
 4. Type 'ifconfig' again to view the new allocated IP address.
 5. Make sure no firewall is active on device <dev>.

3.2 Configuring the MP-20x's Network Connection

The Web-based management interface of MP-20x allows you to control the device's system parameters. The interface is accessed through a Web browser. For detailed information on MP-20x's Web-management interface, refer to 'Using the MP-20x's Web Interface' on page 64.

3.2.1 Logging in to MP-20x Web Interface

The procedure below describes how to login to MP-20x's embedded Web interface.

- **To log in:**
 1. Launch a Web browser on your PC.
 2. With your PC connected directly to MP-20x, use URL *http://mp20x.home* to access the Web-based management interface; the 'Login' screen appears.

Figure 3-5: Logging In

3. In the 'User Name' field, enter your user name.
4. In the 'Password' field, enter your case-sensitive password.
5. Click **OK**; the 'Quick Setup' screen opens.



Notes:

- The default user name and password is "admin" (case-sensitive). However, it is recommended to define a new password after your first login session (refer to 'Configuring Users' on page 315).
- If there's inactivity after logging in, a new login becomes necessary after a lapse of 15 minutes.

3.2.2 Configuring 'Quick Setup' Screen Parameters

The 'Quick Setup' screen enables the speedy, precise, and accurate configuration of your Internet connection and other important parameters.

➤ **To access the 'Quick Setup' screen:**

1. From the sidebar menu, click the **Quick Setup** menu; the 'Quick Setup' screen appear.

Figure 3-6: Quick Setup Screen

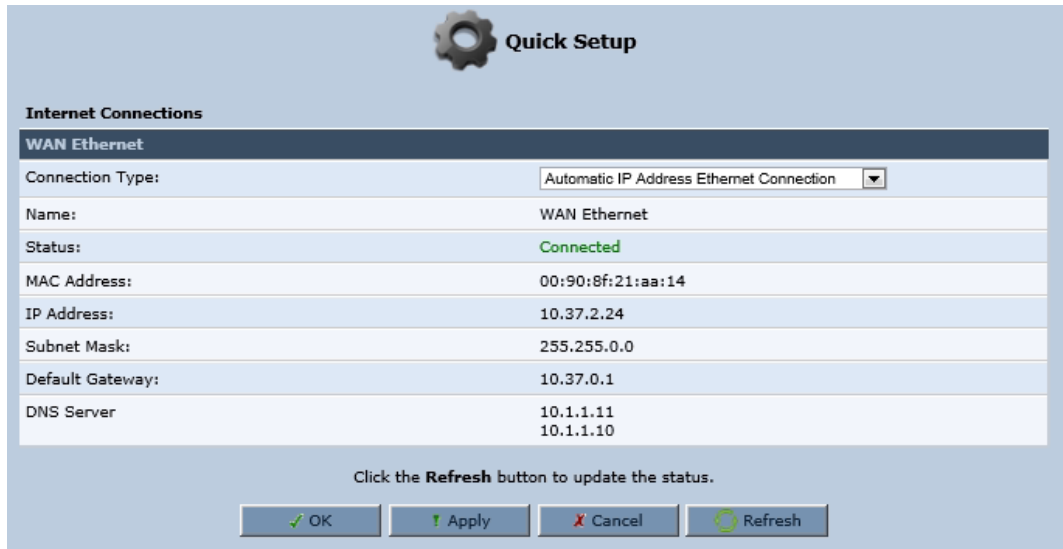

The screenshot shows the 'Quick Setup' screen with a gear icon and the title 'Quick Setup'. Under the 'Internet Connections' section, the 'WAN Ethernet' connection is displayed. The connection type is 'Automatic IP Address Ethernet Connection'. The status is 'Connected'. The IP address is 10.37.2.24, and the subnet mask is 255.255.0.0. The default gateway is 10.37.0.1, and the DNS server is 10.1.1.11. The MAC address is 00:90:8f:21:aa:14. At the bottom, there are buttons for 'OK', 'Apply', 'Cancel', and 'Refresh'. A note below the buttons says 'Click the Refresh button to update the status.'

Internet Connections	
WAN Ethernet	
Connection Type:	Automatic IP Address Ethernet Connection
Name:	WAN Ethernet
Status:	Connected
MAC Address:	00:90:8f:21:aa:14
IP Address:	10.37.2.24
Subnet Mask:	255.255.0.0
Default Gateway:	10.37.0.1
DNS Server:	10.1.1.11 10.1.1.10



Note: End users are advised not to modify the section 'Administrator'. The screen section applies to telephony carrier technicians.

2. In the 'Administrator' section of the 'Quick Setup' screen, specify the administrator's e-mail in the 'E-mail Address' field. System alerts and notifications are sent to this address.

3.2.2.1 Configuring Your Internet Connection

When subscribing to a broadband service, you should be aware of the method by which you are connected to the Internet. Technical information regarding the properties of your Internet connection should be provided by your Internet Service Provider (ISP). For example, your ISP should inform you whether you are connected to the Internet using a static or dynamic IP address, or what protocols, such as PPTP or PPPoE, you will be using to communicate over the Internet.

3.2.2.1.1 Automatic IP Address Ethernet Connection

'Automatic IP Address Ethernet Connection' is the default connection type in the 'Connection Type' drop-down list.

Figure 3-7: Internet Connection - Automatic IP Address Ethernet Connection

Quick Setup

Internet Connections

WAN Ethernet	
Connection Type:	Automatic IP Address Ethernet Connection <input type="button" value="v"/>
Name:	WAN Ethernet
Status:	Connected
MAC Address:	00:90:8f:21:aa:14
IP Address:	10.37.2.24
Subnet Mask:	255.255.0.0
Default Gateway:	10.37.0.1
DNS Server	10.1.1.11 10.1.1.10

Click the **Refresh** button to update the status.

If left at the default, MP-20x obtains the WAN IP and DNS IP addresses from a DHCP server on the WAN.

3.2.2.1.2 Manual IP Address Ethernet Connection

➤ **To configure manual IP address connection:**

1. From the 'Connection Type' drop-down list, select 'Manual IP Address Ethernet Connection'.

Figure 3-8: Internet Connection - Manual IP Address Ethernet Connection

Internet Connections				
WAN Ethernet				
Connection Type:	<input type="text" value="Manual IP Address Ethernet Connection"/>			
IP Address:	<input type="text" value="0"/>	<input type="text" value="0"/>	<input type="text" value="0"/>	<input type="text" value="0"/>
Subnet Mask:	<input type="text" value="0"/>	<input type="text" value="0"/>	<input type="text" value="0"/>	<input type="text" value="0"/>
Default Gateway:	<input type="text" value="0"/>	<input type="text" value="0"/>	<input type="text" value="0"/>	<input type="text" value="0"/>
Primary DNS Server:	<input type="text" value="0"/>	<input type="text" value="0"/>	<input type="text" value="0"/>	<input type="text" value="0"/>
Secondary DNS Server:	<input type="text" value="0"/>	<input type="text" value="0"/>	<input type="text" value="0"/>	<input type="text" value="0"/>
Click here for Advanced Settings				

2. According to your ISP's instructions, specify the following parameters:
 - IP address
 - Subnet mask
 - Default device
 - Primary DNS server
 - Secondary DNS server

3.2.2.1.3 Point-to-Point Protocol over Ethernet (PPPoE)

- **To configure PPPoE connection:**
- 1. From the 'Connection Type' drop-down list, select 'Point-to-point protocol over Ethernet (PPPoE)'.

Figure 3-9: Internet Connection - PPPoE

- 2. Your ISP should provide you with the following information:
 - Login user name
 - Login password

3.2.2.1.4 Point-to-Point Tunneling Protocol (PPTP)

- **To configure PPTP connection:**
- 1. From the 'Connection Type' drop-down list, select 'Point-to-Point Tunneling Protocol (PPTP)'.

Figure 3-10: Internet Connection - Point-to-Point Tunneling Protocol

- 2. Your ISP should provide you with the following information:
 - PPTP Server Host Name or IP Address
 - Login user name
 - Login password

3.2.2.1.5 No Internet Connection

This option is if you do not have an Internet connection, or if you want to disable all existing connections.

➤ **To configure no Internet connection:**

- From the 'Connection Type' drop-down list, select 'No Internet Connection'.

Figure 3-11: Internet Connection - No Internet Connection



3.2.3 Configuring 3G/LTE USB Modem



Note: This sub-section is only applicable MP-204B.

The procedure below describes how to configure a WAN connection using a 3G/LTE cellular modem. The 3G/LTE cellular modem is connected to the device's physical port.

➤ **To configure a WAN connection using a 3G/LTE cellular modem:**

1. On the Quick Setup page under the **WAN 3G USB Modem** group, from the 'Connection Type' drop-down list, select the required connection type. The device supports the following **WAN 3G USB Modem** connection types:
 - Point-to-Point Protocol over Serial (PPPoS)
 - Automatic IP Address over Serial

Figure 3-12: WAN 3G USB Modem

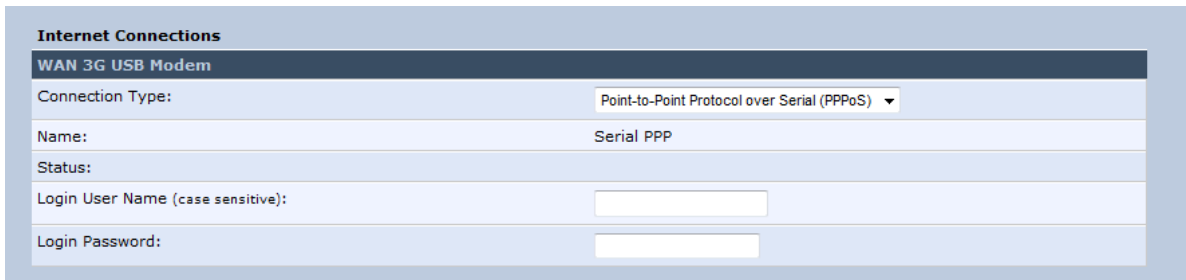

2. Enter your login user name and password.
3. Click **OK**.
4. On the 'Network Connections' screen, click the **WAN 3G USB Modem** hyperlink; the 'WAN 3G USB Modem Properties' screen appears.

Figure 3-13: WAN 3G USB Modem Properties

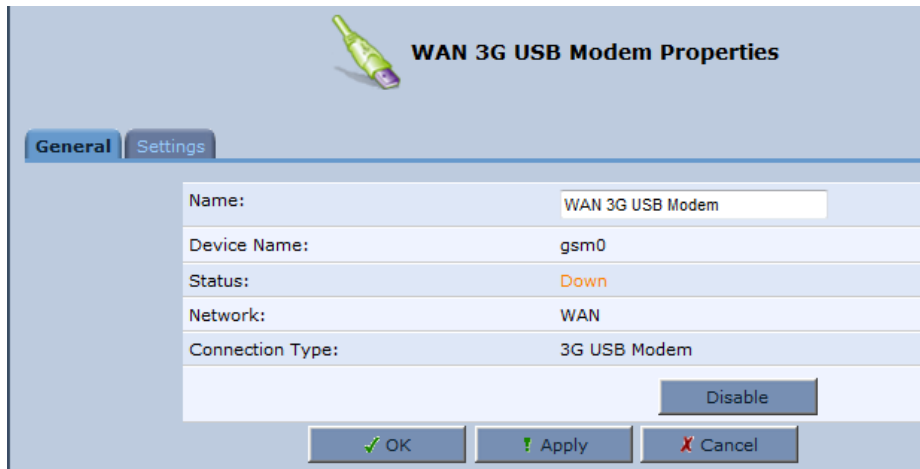

5. On the **General** tab, update the appropriate fields, and then click **Apply**.
6. Click the **Settings** tab; the following screen appears.

Figure 3-14: WAN 3G USB Modem Properties - Settings

WAN 3G USB Modem Properties

General Settings

Device Name: gsm0

Status: Down

Schedule: Always

Network: WAN

Connection Type: 3G USB Modem

3G Modem Settings

APN: DefaultAPN

Dial Number: *99

3G dongle access codes

Access Point PIN Code: 1234

Access Point PUK Code:

OK Apply Cancel

7. Configure the appropriate fields as necessary.
8. In the 'Access Point PIN Code' field, enter the modem's personal identification number (PIN), obtained from your Internet Service Provider.
9. In the 'Access Point PUK Code' field, enter the SIM's PIN Unlock Key obtained from your Internet Service Provider.
10. Click **OK**.

This page is intentionally left blank.

4 Device Quick Setup

The procedure below describes how to quickly configure your device for connecting it to the Internet (WAN).

4.1 Preparing Initial Configuration

The procedure below describes how to prepare the initial configuration.

➤ **To initially prepare for configuration:**

1. Connect the cables as shown in Section 2 on page 13.
2. Power on the device.
3. From your browser, enter the device's default IP address (**192.168.2.1**).
4. From the 'Language' drop-down list, select the desired language for the Web graphical user interface (GUI) display.
5. In the 'User Name' and 'Password' fields, define a login username and password, respectively and then click **Continue**.

Figure 4-1: Login Screen

Table 4-1: Login Parameters Description

Parameter	Description
User Name	Defines the username. The valid value is a string of up to 64 lower case characters. Note: The Web interface accepts upper case letters, but saves them in lower case.
Password	Defines the user's password. The valid value is a string of up to 64 characters. The Web interface accepts all characters.

4.2 Configuring SIP Signaling Protocol

The procedure below describes how to configure the SIP Signaling Protocol.

- **To configure the SIP Signaling Protocol:**
 1. Click the 'Voice Over IP' menu in the side menu bar; the 'Voice Over IP' screen appears.
 2. On the 'Signaling Protocol' page, enter the **Host Name or Address**.
 3. Under the **SIP Proxy and Registrar** group, select the 'Use SIP Proxy IP and Port for Registration' check box.
 4. Enter the **Host Name** as shown in the following screen:

Figure 4-2: Signaling Protocol

Voice Over IP

Signaling Protocol: SIP

SIP Proxy and Registrar

Use SIP Proxy

Host Name or Address: 10.37.5.8

Proxy Port: 5060

Maximum Number of Authentication Retries: 4

Use SIP Proxy IP and Port for Registration

Register Expires: 3600 Seconds

Register Failed Expires: 60 Seconds

OK Apply Cancel Advanced >>

5. Click the **Line Settings** tab; the following screen appears.

Figure 4-3: Line Settings

Voice Over IP

Line Settings

Line	User ID	Display Name	Action
1	100	Line 1	
2	0000000002	Line 2	

Line Phone1 Phone2

OK Apply Cancel

6. Select the **One Line Configuration**; the table lists the lines according to the selected line configuration mode.
7. Click the corresponding **Edit**  icon to configure the line; the following screen appears:

Figure 4-4: Line Settings

Line Settings

Line Number: 1

User ID: 000000001

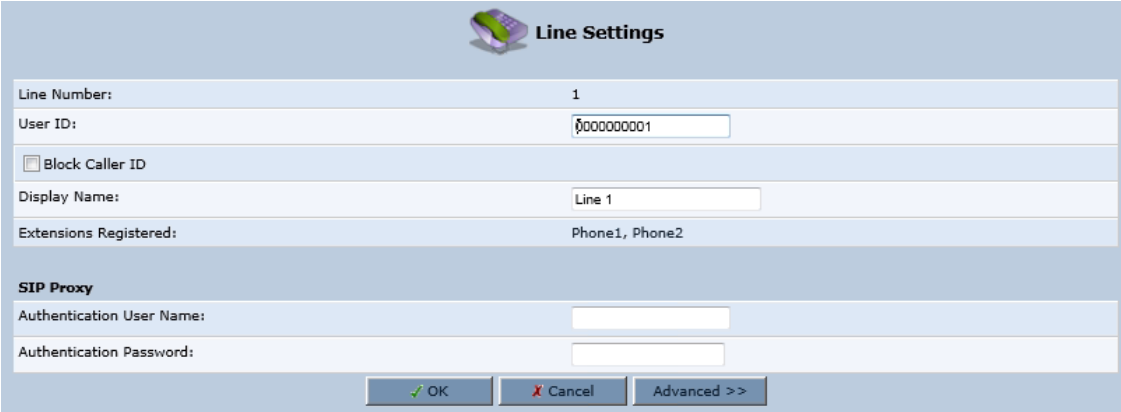
Block Caller ID

Display Name: Line 1

Extensions Registered: Phone1, Phone2

SIP Proxy

Authentication User Name:

Authentication Password:

8. In the 'User ID' field, enter the phone's VoIP user ID used for identification to initiate and accept calls.
9. In the 'Authentication User Name' field, enter the user name received from your VoIP service provider.
10. In the 'Authentication Password' field, enter the password received from your VoIP service provider.
11. Click **OK**.

This page is intentionally left blank.

5 Getting Started with the Web Interface

The device's embedded Web server (*Web interface*) provides a user-friendly Web-based management tool that allows you to configure and monitor the device. The procedures below describe how to access, navigate in, and configure parameters with the Web interface.

5.1 Logging into the Web Interface

The procedure below describes how to log in to the device's Web interface.

➤ **To log in to the device's Web interface:**

1. Connect a PC directly to the LAN port (labeled **LAN 1**) of the device.
2. On your PC, open a Web browser (e.g., Internet Explorer) and in the URL field, enter **http://mp202.home** (or 192.168.2.1). If your device is already connected to the network and you know its IP address, then enter its IP address instead. The 'Login' screen appears:

Figure 5-1: Login Screen



Language: EN English

User Name:

Password (case sensitive): Show password

3. From the 'Language' drop-down list, select the desired language for the Web graphical user interface (GUI) display.
4. In the 'User Name' and 'Password' fields, define a login username and password, respectively. This is applicable only if this is your first time that you are logging in to the Web interface. If you have logged in before, then enter the username and password that you defined previously.
5. Click **Continue**; the 'Quick Setup' screen appears, allowing you to quickly set up an Internet connection (as described in Chapter 6 on page 55).

Notes:













- The default username and password is "admin" (case-sensitive).
- If you wish to view the entered password (instead of asterisks), then select the 'Show password' check box.
- You can later change the username and password as described in Section 5.4 on page 315.
- If the Web interface is inactive for 15 minutes after logging in, the 'Login' screen appears again, prompting you to re-login.



























5.2 Menu Bar Description

The Web interface screens are conveniently grouped into related themes under specific menus. These menus are in the menu bar. The table below describes these menus.

Table 5-1: Menu Description

Menu	Description															
Home	Displays the Map View (refer to Chapter 6 on page 55).															
Quick Setup	Displays the 'Quick Setup' screen for quickly setting up an Internet connection with the device (see Section 8.1 on page 59).															
Network Connections	Displays the 'Network Connections' screen for configuring network connections: <ul style="list-style-type: none"> ▪ LAN (see Section 12.2 on page 137) ▪ WAN (see Chapter 12 on page 127) ▪ VLANs (see Section 12.4 on page 152) ▪ LAN-WAN bridging (see Section 12.5 on page 160) 															
Security	Displays the 'Security' screen for configuring security-related features such as Website restrictions (see Chapter 15 on page 229).															
Voice Over IP	Displays the 'Voice Over IP' screen for configuring the VoIP parameters to use the device's VoIP functionality to place and receive calls over the Internet using a standard telephone set.															
QoS	Displays the 'Quality of Service' screen for configuring Quality of Service (QoS) for the device (see Chapter 11 on page 109).															
Advanced	<p>Displays the 'Advanced' screen for configuring system parameters (e.g., DHCP server and DNS) and for administrative functions (e.g., changing password, setting date and time, and upgrading the system).</p> <table border="1"> <thead> <tr> <th>Icon</th> <th>Name</th> <th>Description</th> </tr> </thead> <tbody> <tr> <td></td> <td>3G USB</td> <td>Displays 3G dongle status and 3G dongle access codes (see Section 3.2.3 page 24).</td> </tr> <tr> <td></td> <td>About MP20x</td> <td>Displays technical information about the device, including version number (see Section 20.2 on page 293).</td> </tr> <tr> <td></td> <td>Certificates</td> <td>Manages digital certificates (see Section 14.3 on page 200).</td> </tr> <tr> <td></td> <td>Configuration File</td> <td> <p>Loads the Configuration File to the device (see Section 20.4 on page 297).</p> <p>Note: You can hide the Configuration File icon, by running the following CLI command in a Telnet session with the device:</p> <pre>conf_set rmt_config/hide_config_file_page 1.</pre> <p>This is useful, for example, in scenarios where you want to prevent a user accessing the Web interface to change the configuration file.</p> </td> </tr> </tbody> </table>	Icon	Name	Description		3G USB	Displays 3G dongle status and 3G dongle access codes (see Section 3.2.3 page 24).		About MP20x	Displays technical information about the device, including version number (see Section 20.2 on page 293).		Certificates	Manages digital certificates (see Section 14.3 on page 200).		Configuration File	<p>Loads the Configuration File to the device (see Section 20.4 on page 297).</p> <p>Note: You can hide the Configuration File icon, by running the following CLI command in a Telnet session with the device:</p> <pre>conf_set rmt_config/hide_config_file_page 1.</pre> <p>This is useful, for example, in scenarios where you want to prevent a user accessing the Web interface to change the configuration file.</p>
Icon	Name	Description														
	3G USB	Displays 3G dongle status and 3G dongle access codes (see Section 3.2.3 page 24).														
	About MP20x	Displays technical information about the device, including version number (see Section 20.2 on page 293).														
	Certificates	Manages digital certificates (see Section 14.3 on page 200).														
	Configuration File	<p>Loads the Configuration File to the device (see Section 20.4 on page 297).</p> <p>Note: You can hide the Configuration File icon, by running the following CLI command in a Telnet session with the device:</p> <pre>conf_set rmt_config/hide_config_file_page 1.</pre> <p>This is useful, for example, in scenarios where you want to prevent a user accessing the Web interface to change the configuration file.</p>														

Menu	Description	
	DNS Server	Alias a dynamic IP address to a static hostname (see Section 16.2 on page 261).
	Diagnostics	Performs networking diagnostics (see Section 21.1 on page 319).
	Feature Key	Enables new features on the Feature Key (see Section 20.1 on page 291).
	File Server	Creates a file server on the device (see Section 13.1 on page 165).
	Firmware Upgrade	Upgrades the device's firmware (see Section 20.5 on page 307).
	IP Address Distribution	Modifies the DHCP server for each LAN device and displays a list of DHCP clients in the local network (see Section 16.1 on page 255).
	Installation Wizard	Guides you through your Internet connection, to help you subscribe for services that are available to you as an MP-202B user (see Section 16.7 on page 271).
	Media Sharing	Enables media sharing on local networks and in all folders (see Section 19 on page 287).
	Network Objects	Defines groups of LAN devices for system rules (see Section 5.6.2 on page 51).
	PPPoE Relay	Enables PPPoE relay on the device (see Section 16.5 on page 269).
	PacketSmart Configuration	Enables PacketSmart Configuration (see Section 18 on page 279).
	Personal Domain Name (Dynamic DNS)	Displays and modifies the DNS hosts table (see Section 16.2 on page 261).
	Print Server	Shares a LAN printer (see Section 13.2 on page 168).
	Protocols	Manages protocols (see Section 5.6.3 on page 53).

Menu	Description	
		<p>Reboot Restarts MP-20x (see Section 20.7 on page 316).</p>
		<p>Regional Settings Modifies the regional settings (see Section 16.6 on page 270).</p>
		<p>Remote Administration Configures remote administration privileges (see Section 14.2 on page 196).</p>
		<p>Restore Factory Settings Restores default factory settings (see Section 20.8 on page 317).</p>
		<p>Routing Manages routing policies (see Section 16.4 on page 266).</p>
		<p>Scheduler Defines time segments for system rules (see Section 5.6.1 on page 49).</p>
		<p>Simple Network Management Protocol (SNMP) Configures the device's SNMP agent (see Section 14.2 on page 196).</p>
		<p>System Settings Modifies administrator settings, including the device's host name (see Section 16.5 on page 269).</p>
		<p>Time Settings Configures the local date and time (see Section 20.3 on page 294).</p>
		<p>Universal Plug and Play Configures Universal Plug-and-Play (UPnP) parameters (see Section 17.1 on page 273).</p>
		<p>Users Configures Users (see Section 5.4 on page 36).</p>
<p>System Monitoring</p>	<p>Displays the 'System Monitoring' screen for viewing various statuses such as network and traffic statistics (see Section 21.3 on page 331).</p>	
<p>Logout</p>	<p>Logs off the device's Web interface.</p>	

5.3 Managing Tables

Tables appear throughout the Web interface for configuring the device. This section describes the how to use these tables to configure the device.

The figure below displays a typical table in the Web interface:

Figure 5-2: Typical Table Structure

Network Connections		
Name	Status	Action
LAN Bridge	Connected	
LAN Wireless 802.11n Access Point	Disabled	
LAN Hardware Ethernet Switch	1 Ports Connected	
WAN 3G USB Modem	Down	
WAN DSL	Disabled	
WAN ATM over DSL	Down	
WAN PTM over DSL	Down	
WAN Ethernet	Connected	
Serial PPP	Waiting for Underlying Connection (WAN 3G USB Modem - Down)	
New Connection		

Each table row denotes an entry in the table. The table also provides 'Action' icons for performing various tasks. These icons are described in the table below.

Table 5-2: Table Action Icons Description

Action Icon	Name	Description
	New	Adds a new row to the table or opens another screen for adding an entry.
	Edit	Modifies a row entry in the table.
	Remove	Deletes a row entry in the table.
	Download	Downloads a file to a folder on your computer.

5.4 Configuring Users

The 'Users' screen allows you to add new users and assign login usernames and passwords. You may also group users according to your preferences. The default user is "Administrator" with "admin" (case-sensitive) as the username and password.



➤ **To configure users:**



1. On the 'Advanced' screen, click the **Users**  icon; the 'Users' screen appears.

Figure 5-3: Users Screen



Users

Users					
Full Name	User Name	Role	Access Permissions	Feature Permissions	Action
Administrator	admin	admin	Telnet Serial Console Wireless Permissions Microsoft File and Printer Sharing Access Internet Printer Access	Firewall Basic Permissions Qos Basic Permissions System Monitoring Permissions	
New User					

Groups			
Name	Description	Members	Action
Users		Home user	
New Group			

2. In the **Users** table, click the **New User**  icon; the 'Users Settings' screen appears.

Figure 5-4: Users Settings Screen

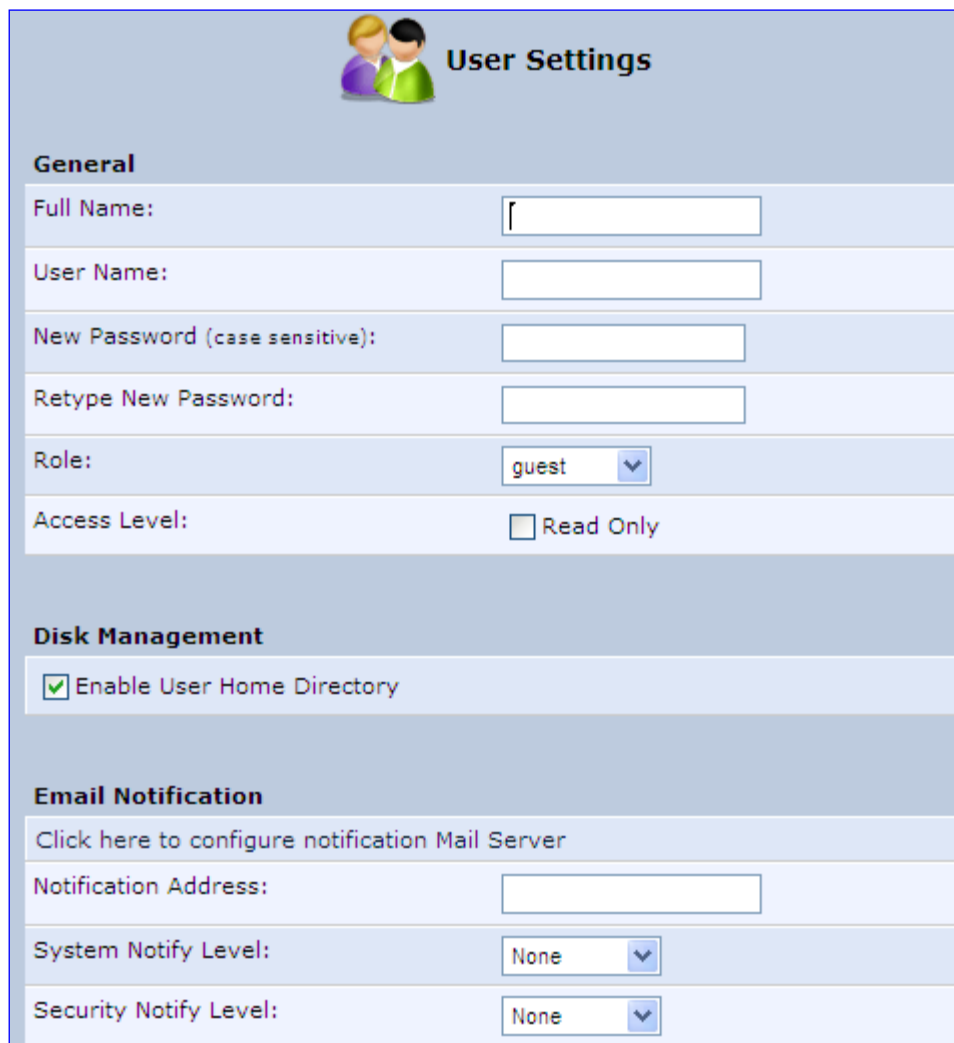

The screenshot shows the 'User Settings' web interface. At the top, there is a header with an icon of two people and the title 'User Settings'. Below this, the settings are organized into three main sections: 'General', 'Disk Management', and 'Email Notification'. The 'General' section includes fields for 'Full Name', 'User Name', 'New Password (case sensitive)', 'Retype New Password', 'Role' (a dropdown menu currently set to 'guest'), and 'Access Level' (a checkbox for 'Read Only'). The 'Disk Management' section has a checked checkbox for 'Enable User Home Directory'. The 'Email Notification' section includes a link to configure the mail server, a 'Notification Address' field, and two dropdown menus for 'System Notify Level' and 'Security Notify Level', both currently set to 'None'.

3. Add a new user by configuring the following fields:
 - a. **Full Name:** Enter a remote user's full name.
 - b. **User Name:** Enter a user name to access your home network.
 - c. **New Password:** Enter a new password for the remote user. If you do not want to change the remote user's password leave this field empty.
 - d. **Retype New Password:** If a new password was assigned, enter it again to verify correctness.
 - e. **Role:** User's role indicating privilege level, where "admin" possesses all privileges.
 - f. **Access Level – Read Only:** Select this check box if you want this user to have read-only privileges.
 - g. **Disk Management:** By default, this option is selected. When activated, it creates a directory for the user in the 'Home' directory of the system storage area. This directory is necessary when using various applications such as the mail server.

- h. **Email Notification:** You can use email notification to receive indications of system events for a predefined severity classification. The available types of events are 'System' or 'Security' events. The available severity of events is 'Error', 'Warning' and 'Information'. If the 'Information' level is selected, the user receives notification of the 'Information', 'Warning' and 'Error' events. If the 'Warning' level is selected, the user receives notification of the 'Warning' and 'Error' events etc.
 - ◆ **Click here to configure notification mail server:** This opens the 'System Settings' screen (see Section 16.5 on page 269) where you can define an outgoing mail server.
 - ◆ **Notification Address:** user's email address.
 - ◆ **System Notify Level:** By default, the 'None' option is selected, which means that the device does not send notifications to a remote host. To activate the feature, select one of the following notification types:
 - ✓ Error
 - ✓ Warning
 - ✓ Information
 - ◆ **Security Notify Level:** The remote security notification level can be one of the following:
 - ✓ None
 - ✓ Error
 - ✓ Warning
 - ✓ Information

4. Click **OK**.

The following is an example of the relevant Telnet parameters:

```
rg_conf/admin/user/0/enabled=1
rg_conf/admin/user/0/username=admin
rg_conf/admin/user/0/full_name=Administrator
rg_conf/admin/user/0/email=NULL
rg_conf/admin/user/0/notify_level/0=none
rg_conf/admin/user/0/notify_level/1=none
rg_conf/admin/user/0/directory=1
rg_conf/admin/user/0/role=admin

rg_conf/admin/user/1/enabled=1
rg_conf/admin/user/1/username=home
rg_conf/admin/user/1/password=&#x26;c&#x5c;&#x26;b5;
rg_conf/admin/user/1/full_name=Home user
rg_conf/admin/user/1/email=NULL
rg_conf/admin/user/1/notify_level/0=none
rg_conf/admin/user/1/notify_level/1=none
rg_conf/admin/user/1/directory=1
rg_conf/admin/user/1/role=home
```

➤ **To configure user groups:**

1. On the 'Users' screen, under the **Groups** group, click **New Group**  icon; the 'Group Settings' screen appears.

Figure 5-5: Group Settings Screen



2. In the 'Name' field enter a name for the group.
3. In the 'Description' field, enter a brief description of this group.
4. In the 'Group Members' list, select the users that you want to assign to this group.
5. Click **OK**.

The following is an example of the relevant Telnet parameter:

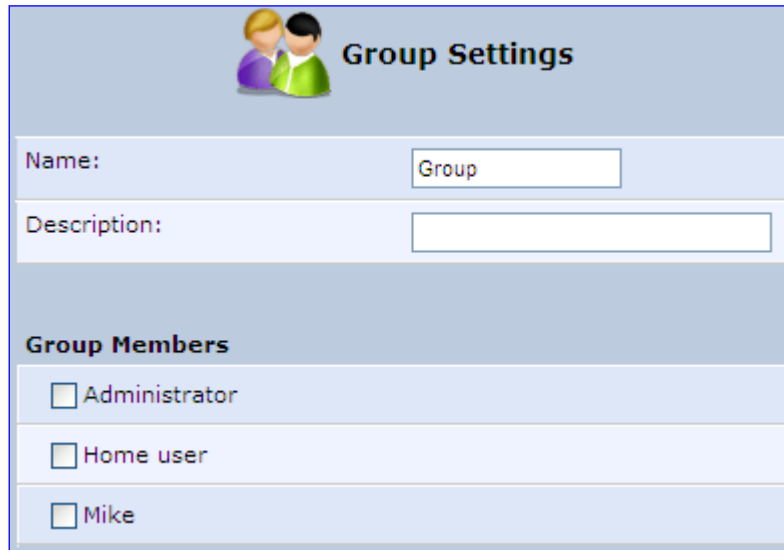
```
rg_conf/admin/group/0/name=Users
```

5.4.1 Web User Permissions

This sub-section describes the following commands for viewing and changing user permissions via Telnet:

- Print commands
- Set commands

5.4.1.1 Print Commands

This section describes the **Print** commands used for viewing and changing user's permissions.

5.4.1.1.1 Current User Roles

The example below shows the **Print** command for viewing current users. Note that each user's role is bolded.

```
MP264> conf
conf> print admin/user
(user
  (0
    (enabled(1))
    (username(admin))
    (full_name(Administrator))
```



```

        (basic(1))
        (advanced(1))
    )
)
(4
  (name(super))
  (permission(ffffffffffffffffffffffffffffffffffffffffffffffff00))
  (create_role
    (guest(1))
    (home(1))
    (admin(1))
    (super(1))
    (basic(1))
    (advanced(1))
  )
)
(5
  (name(basic))
  (permission(c0000003c0000000000000000000000000000000000000000000000000000000))
)
(6
  (name(advanced))
  (permission(c0000003c0000000000c00000000000000000000000000000000000000000000))
)
)
Returned 0
conf>

```

5.4.1.1.3 Permission Attributes per Role

The example below shows the **Print** command for viewing the permission attributes. In this example, the permission attributes for the **Advanced** role are displayed.

```

conf> print_permission admin/role/3/permission
(admin/role/3/permission
  (access_wbm(rw))
  (access_serial_cli(rw))
  (access_telnet(rw))
  (access_fs(rw))
  (access_ftp(rw))
  (access_mail(rw))
  (access_wlan(rw))
  (access_ssl_vpn(rw))
  (access_ssh(rw))
  (access_vpn(rw))
  (access_printer(rw))
  (access_rmt_mng(rw))
  (access_http_auth(rw))
  (access_ppp(rw))
  (access_rmt_upd_tftp(rw))
  (default(rw))
  (all(rw))
)

```

```

(reboot (rw))
(restore_factory (rw))
(firmware_upgrade (rw))
(upload_conf (rw))
(dump_conf (rw))
(ddns (rw))
(firewall_basic (rw))
(firewall_advanced (rw))
(firewall_nat (rw))
(date_time (rw))
(qos (rw))
(qos_advanced (rw))
(docsis_advanced (rw))
(system_monitor (rw))
(system_settings (rw))
(objects_rules (rw))
(remote_admin (rw))
(diagnostics (rw))
(mac_clone (--))
(radius_client (rw))
(radius_server (rw))
(internet_connection (rw))
(network_connections (rw))
(disk_mng (rw))
(file_server (rw))
(print_server (rw))
(ssl_vpn (rw))
(backup (rw))
(ssh (rw))
(routing (rw))
(voice_basic (rw))
(voice_admin (rw))
(groups (rw))
(page_about (rw))
(page_advanced (rw))
(advanced_sys_overview (rw))
(remote_admin_jrmp (--))
(virtual_ap (rw))
(dns (rw))
(new_connection (rw))
(block_ip_fragments (--))
(tab_local_network (rw))
(wbm_add_user (rw))
(website_restrictions (rw))
(entfy (--))
(clock_set (rw))
(wlan_inter_client (--))
(qos_stats (rw))
(conn_troubleshoot (rw))
(dhcps (rw))
(dlm (rw))
    
```

```
(nation_zone(rw))
(dhcp(rw))
(port_forwarding(rw))
(users(rw))
(upnp(rw))
(certificates(rw))
(page_map(rw))
(page_quick_setup_advanced(rw))
(dmz_host(rw))
(wireless_basic(rw))
(wireless_admin(rw))
(wireless_advanced(--))
(change_password(--))
(network_connections_common(rw))
(port_forwarding_advanced(rw))
(primus_advanced(rw))
(packetsmart(rw))
(ipsec(rw))
(installation_wizard(rw))
(media_sharing(rw))
(pptp_server(rw))
(parental_control(rw))
(watchdog(rw))
)

Returned 0
conf>

- Set Commands

conf> print_permission admin/role/3/permission
(admin/role/3/permission
  (access_wbm(rw))
  (access_serial_cli(rw))
  (access_telnet(rw))
  (access_fs(rw))
  (access_ftp(rw))
  (access_mail(rw))
  (access_wlan(rw))
  (access_ssl_vpn(rw))
  (access_ssh(rw))
  (access_vpn(rw))
  (access_printer(rw))
  (access_rmt_mng(rw))
  (access_http_auth(rw))
  (access_ppp(rw))
  (access_rmt_upd_tftp(rw))
  (default(rw))
  (all(rw))
  (reboot(rw))
```

```

(restore_factory(rw))
(firmware_upgrade(rw))
(upload_conf(rw))
(dump_conf(rw))
(ddns(rw))
(firewall_basic(rw))
(firewall_advanced(rw))
(firewall_nat(rw))
(date_time(rw))
(qos(rw))
(qos_advanced(rw))
(docsis_advanced(rw))
(system_monitor(rw))
(system_settings(rw))
(objects_rules(rw))
(remote_admin(rw))
(diagnostics(rw))
(mac_clone(--))
(radius_client(rw))
(radius_server(rw))
(internet_connection(rw))
(network_connections(rw))
(disk_mng(rw))
(file_server(rw))
(print_server(rw))
(ssl_vpn(rw))
(backup(rw))
(ssh(rw))
(routing(rw))
(voice_basic(rw))
(voice_admin(rw))
(groups(rw))
(page_about(rw))
(page_advanced(rw))
(advanced_sys_overview(rw))
(remote_admin_jrmp(--))
(virtual_ap(rw))
(dns(rw))
(new_connection(rw))
(block_ip_fragments(--))
(tab_local_network(rw))
(wbm_add_user(rw))
(website_restrictions(rw))
(entfy(--))
(clock_set(rw))
(wlan_inter_client(--))
(qos_stats(rw))
(conn_troubleshoot(rw))
(dhcps(rw))
(dlm(rw))
(nation_zone(rw))

```

```
(dhcp (rw))
(port_forwarding (rw))
(users (rw))
(upnp (rw))
(certificates (rw))
(page_map (rw))
(page_quick_setup_advanced (rw))
(dmz_host (rw))
(wireless_basic (rw))
(wireless_admin (rw))
(wireless_advanced (--))
(change_password (--))
(network_connections_common (rw))
(port_forwarding_advanced (rw))
(primus_advanced (rw))
(packetsmart (rw))
(ipsec (rw))
(installation_wizard (rw))
(media_sharing (rw))
(pptp_server (rw))
(parental_control (rw))
(watchdog (rw))
)

Returned 0
conf>
conf>
conf>
conf>
conf>
conf>
conf>
conf>
conf>
conf>
conf> set_permission admin/role/3/permission page_map --

Returned 0
conf> reconf 1

Returned 0
conf> print_permission admin/role/3/permission
(admin/role/3/permission
 (access_wbm (rw))
 (access_serial_cli (rw))
 (access_telnet (rw))
 (access_fs (rw))
 (access_ftp (rw))
 (access_mail (rw))
 (access_wlan (rw))
 (access_ssl_vpn (rw))
 (access_ssh (rw))
```

```

(access_vpn(rw))
(access_printer(rw))
(access_rmt_mng(rw))
(access_http_auth(rw))
(access_ppp(rw))
(access_rmt_upd_tftp(rw))
(default(rw))
(all(rw))
(reboot(rw))
(restore_factory(rw))
(firmware_upgrade(rw))
(upload_conf(rw))
(dump_conf(rw))
(ddns(rw))
(firewall_basic(rw))
(firewall_advanced(rw))
(firewall_nat(rw))
(date_time(rw))
(qos(rw))
(qos_advanced(rw))
(docsis_advanced(rw))
(system_monitor(rw))
(system_settings(rw))
(objects_rules(rw))
(remote_admin(rw))
(diagnostics(rw))
(mac_clone(--))
(radius_client(rw))
(radius_server(rw))
(internet_connection(rw))
(network_connections(rw))
(disk_mng(rw))
(file_server(rw))
(print_server(rw))
(ssl_vpn(rw))
(backup(rw))
(ssh(rw))
(routing(rw))
(voice_basic(rw))
(voice_admin(rw))
(groups(rw))
(page_about(rw))
(page_advanced(rw))
(advanced_sys_overview(rw))
(remote_admin_jrmp(--))
(virtual_ap(rw))
(dns(rw))
(new_connection(rw))
(block_ip_fragments(--))
(tab_local_network(rw))
(wbm_add_user(rw))

```

```
(website_restrictions(rw))
(entfy(--))
(clock_set(rw))
(wlan_inter_client(--))
(qos_stats(rw))
(conn_troubleshoot(rw))
(dhcps(rw))
(dlm(rw))
(nation_zone(rw))
(dhcp(rw))
(port_forwarding(rw))
(users(rw))
(upnp(rw))
(certificates(rw))
(page_map(--))
(page_quick_setup_advanced(rw))
(dmz_host(rw))
(wireless_basic(rw))
(wireless_admin(rw))
(wireless_advanced(--))
(change_password(--))
(network_connections_common(rw))
(port_forwarding_advanced(rw))
(primus_advanced(rw))
(packetsmart(rw))
(ipsec(rw))
(installation_wizard(rw))
(media_sharing(rw))
(pptp_server(rw))
(parental_control(rw))
(watchdog(rw))
)
Returned 0
conf>
```

5.5 Set Commands

This section describes the **Set** commands used for viewing and changing the user's permissions. The example below shows how to enable the 'Advanced' menu page and then to enable the **Reboot** option under the 'Advanced' page.

```
conf> set_permission admin/role/6/permission page_advanced 1

Returned 0
conf> reconf 1

Returned 0
conf> set_permission admin/role/6/permission reboot 1

Returned 0
conf> reconf 1

Returned 0
conf>
```



Note: In some cases, you need to enable specific pages prior to others. For example, enabling “reboot” will not be displayed, before “page_advanced” is enabled.

5.6 Associated Elements

You can define certain elements and then use them later when configuring various features throughout the Web interface. This is very convenient in that it eliminates the need to re-configure the same element, especially if used in multiple configuration areas. These elements include the following:

- Scheduler Rules – see Section 5.6.1 on page 49
- Network Objects – see Section 5.6.2 on page 51
- Protocols – see Section 5.6.3 on page 53

5.6.1 Configuring Scheduler Rules

Scheduler rules are used for limiting the activation of firewall rules to specific time periods, specified in days of the week, and hours.

➤ **To define a Rule:**

1. On the 'Advanced' screen, click the **Scheduler**  icon; the 'Scheduler Rules' screen appears.

Figure 5-6: Scheduler Rules Screen



2. Click the **New**  icon; the 'Edit Scheduler Rule' screen appears.

Figure 5-7: Edit Scheduler Rule Screen

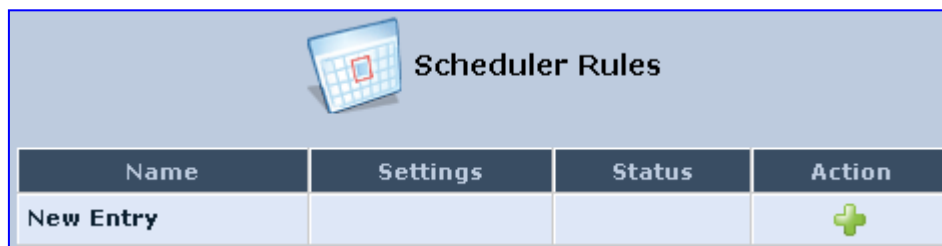
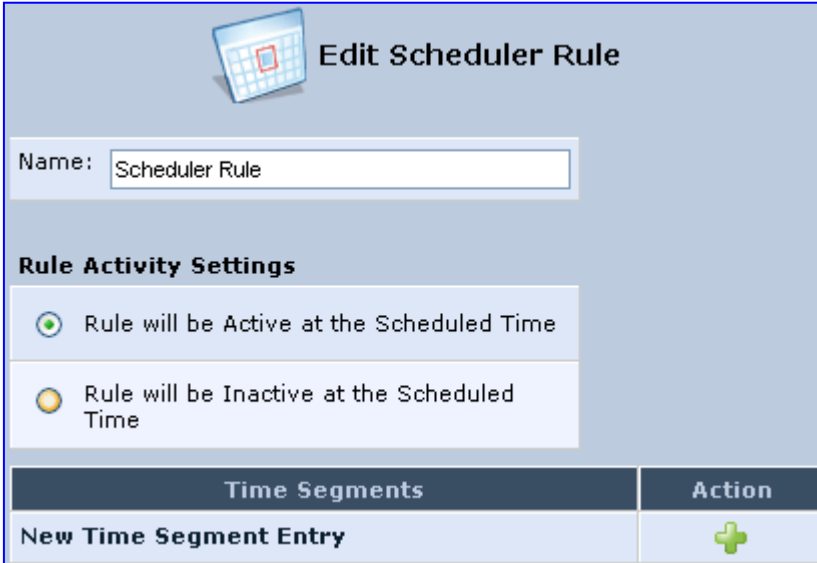

Name:

Rule Activity Settings

Rule will be Active at the Scheduled Time

Rule will be Inactive at the Scheduled Time

Time Segments	Action
New Time Segment Entry	

3. In the 'Name' field, specify a name for the scheduler rule.
4. Under the **Rule Activity Settings** group, specify if the rule is active or inactive during the designated time period, by selecting the appropriate check box.
5. Click the **New**  icon to define the time segment to which the rule applies; the 'Edit Time Segment' screen appears.

Figure 5-8: Edit Time Segment Screen

Days of Week

Monday

Tuesday

Wednesday

Thursday

Friday

Saturday

Sunday

Hours Range

Start Time	End Time	Action
New Hours Range Entry		+

- a. Under the **Days of Week** group, select the days of the week for which you want the rule to be active.
- b. In the **Hours Range** table, click the **New** + icon to define an active or inactive hourly range; the 'Edit Hour Range' screen appears.

Figure 5-9: Edit Hour Range Screen

Start Time: 00 : 00

End Time: 00 : 00

- c. In the 'Start Time' and 'End Time' field, enter the time interval in which the scheduler rule is active or inactive.
6. Click **OK** to save the settings.

5.6.2 Configuring Network Objects

Defining network objects is a method used to logically define a set of LAN hosts, according to one or more MAC address, IP address, and host name. Defining such a group can assist when configuring other system rules. For example, you can use network objects to apply security rules based on host names instead of IP addresses. This may be useful, since IP addresses change from time to time. Moreover, it is possible to define network objects according to MAC addresses, making rule application more persistent against network configuration settings.

➤ **To define a network object:**

1. On the 'Advanced' screen, click the **Network Objects**  icon; the 'Network Objects' screen appears.

Figure 5-10: Network Objects Screen

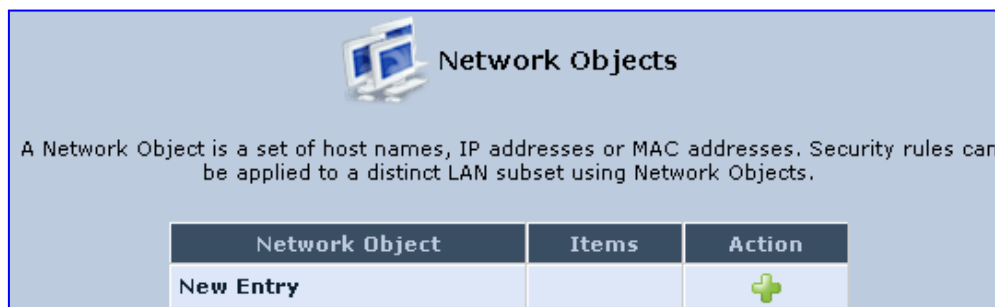

2. Click the **New**  icon; the 'Edit Network Object' screen appears.

Figure 5-11: Edit Network Objects Screen

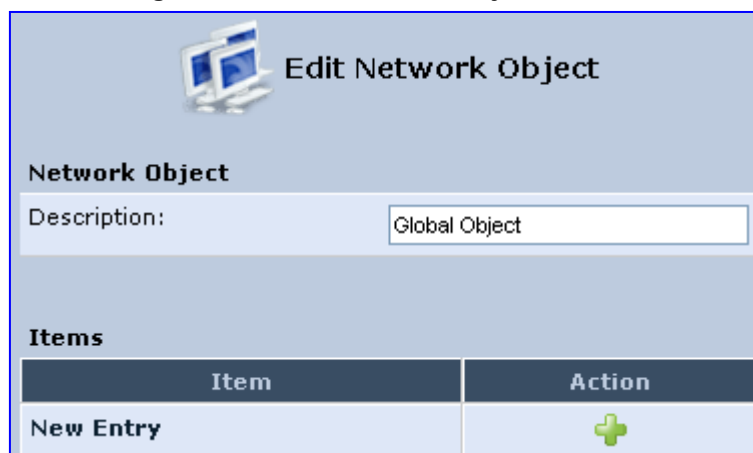

3. In the 'Description' field, enter a name for the network object, and then click the **New**  icon; the 'Edit Item' screen appears.

Figure 5-12: Edit Item Screen



4. From the 'Network Object Type' drop-down lists, select a source address type:

- IP Address
- IP Subnet
- IP Range
- MAC Address
- Host Name
- DHCP Option (supporting options 60, 61, and 77)
- All Private IP Addresses

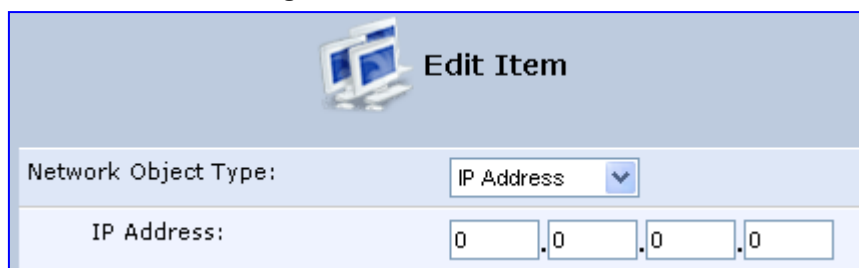
When selecting a method from the drop-down list, the screen refreshes, presenting the respective fields by which to enter the relevant information.

5. Click **OK** to save the settings.



























5.6.3 Configuring Protocols

The Protocols feature incorporates a list of preset and user-defined applications and common port settings. You can use protocols in various security features such as Access Control and Port Forwarding. You may add new protocols to support new applications or edit existing ones according to your needs.

➤ **To define a protocol:**

1. On the 'Advanced' screen, click the **Protocols**  icon; the 'Protocols' screen appears.

Figure 5-13: Advanced - Protocols

 Protocols		
Protocols	Ports	Action
FTP	TCP Any -> 21	 
HTTP	TCP Any -> 80	 
HTTPS	TCP Any -> 443	 
IMAP	TCP Any -> 143	 
L2TP	UDP Any -> 1701	 
Ping	ICMP Echo Request	 
POP3	TCP Any -> 110	 
SMTP	TCP Any -> 25	 
SNMP	UDP Any -> 161	 
Telnet	TCP Any -> 23	 
TFTP	UDP 1024-65535 -> 69	 
Traceroute	UDP 32769-65535 -> 33434-33523	 
<u>New Entry</u>		



2. Click the **New**  icon; the 'Edit Service' screen appears.

Figure 5-14: Advanced - Protocols - Edit Service

 **Edit Service**

Service Name:

Service Description:

Server Ports

Protocol	Server Ports	Action
New Server Ports		



- In the 'Service Name' field, enter the name of the service, and then click the **New**  icon; the 'Edit Service Server Ports' screen appears.

Figure 5-15: Advanced - Protocols - Edit Service - Server Ports

 **Edit Service Server Ports**

Protocol: ▼

Protocol Number:

- You may choose any of the protocols available in the drop-down list, or add a new one by selecting 'Other'. When selecting a protocol from the drop-down list, the screen refreshes, presenting the respective fields by which to enter the relevant information.
- Select a protocol and enter the relevant information.
- Click **OK** to save the settings.

5.7 Logging out the Web Interface

To log out of the device's Web interface, click the **Logout** menu in the menu bar. When you have logged out, the 'Login' screen is displayed, allowing you to re-login, if desired.

6 Viewing a Graphical Display of the Device's Network

The Web interface allows you to view a graphical display of the network elements connected to the device. This is displayed in the 'Map View' screen, accessed by clicking the **Home** menu in the menu bar.

You can click a displayed network element icon to access the relevant screen for configuring the element.





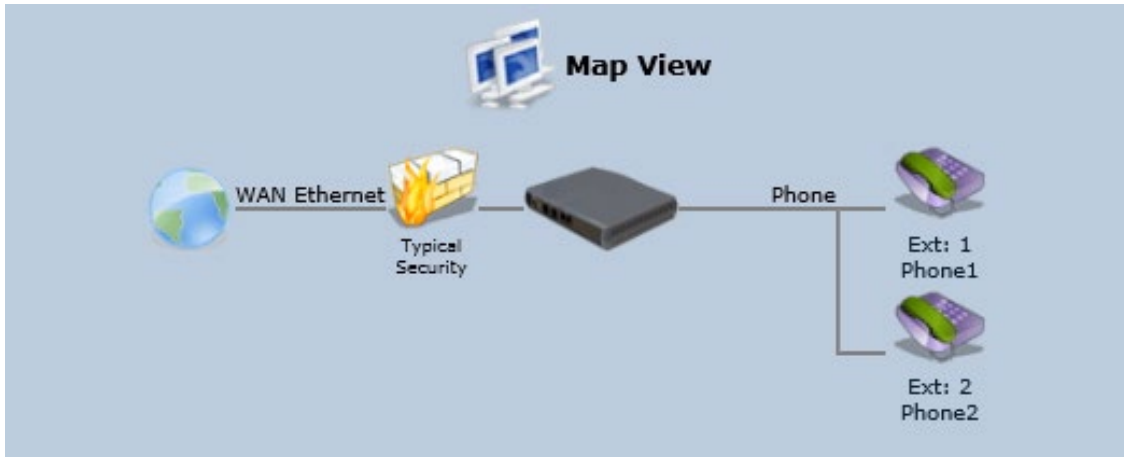

The figure below displays an example of a network map for a deployed device:

Figure 6-1: Map View Screen



The table below describes the possible icons that can be displayed in the 'Map View' screen:

Table 6-1: Map View Icon Description

Icon	Description
	<p>Depicts the Internet connection (e.g., WAN Ethernet). Click this icon to open the 'Quick Setup' screen (see Section 8.1 on page 59).</p>
	<p>Depicts the firewall. The height of the wall (yellow "bricks") corresponds to the security level (Minimum, Typical or Maximum). Click this icon to open the 'General Tab' screen (see Section 15.1 on page 230).</p>
	<p>Depicts the device and displays the currently software version. Click this icon to open the 'Quick Setup' screen (see Section 8.1 on page 59).</p>
	<p>Depicts an analog telephone connected to the device. Click this icon to open the 'Extension Settings' screen (see Section 9.10 on page 99).</p>
	<p>Depicts a file server (hard drive) that is connected to the device (typically through the USB port). Click this icon to view the file server configuration.</p>
	<p>Depicts a computer (host) in the device's network. Each computer connected to the network appears below the network symbol of the network through which it is connected. This host is either a DHCP client that has received an IP lease from the device, or a host with a static IP address, auto-detected by the device. Click this icon to open the 'Host Information' screen, displaying network information of the host. Note: The device recognizes a physically connected host and displays it in the Network Map only after network activity from that host has been detected (e.g., trying to browse to the Web management or to surf the Internet).</p>
	<p>Depicts a disconnected device.</p>

7 Configuring Computers for Connecting to Device's Network

The procedure below describes how to configure computers to connect to the device's network,

7.1 Wired Computers

This section describes how to configure computers that connect to the device's network through a LAN cable (i.e., wired).

You can configure the network interface of the computer using one of the following methods:

- Statically define an IP address and DNS address
- Automatically obtain an IP address using the device embedded DHCP server

This section describes how to configure the computers network for the following operating systems (OS):

- Windows 7 – see Section 7.1.1 on page 57
- Linux – see Section 7.1.2 on page 58



Note: It is recommended to set the computers to automatically obtain their IP addresses (from a DHCP server).

7.1.1 Configuring Computers Running on Windows 7

The procedure below describes how to configure a computer running on Windows 7 OS to automatically obtain its IP address (from a DHCP server, for example, MP-20x).



Note: For computers running Windows, the setup procedure is generally unnecessary as Windows' default network settings are to obtain an IP address automatically. However, it is recommended to follow the setup procedure to verify that all communication parameters are valid and that the physical cable connections are correct.

➤ **To configure a computer running Windows 7 for dynamic IP addressing:**

1. Click on your **Start** menu and select **Control Panel**.
2. Click Network and Internet.
3. Click Network and Sharing Center.
4. Click **Change adapter settings**, located on the left-side menu.
5. Right-click on the **Local Area Connection** icon and select **Properties**; the 'Internet Protocol (TCP/IP) Properties' dialog box is displayed.
6. Double-click on the appropriate Internet Protocol version.

Figure 7-1: Internet Protocol (TCP/IP) Properties Dialog Box

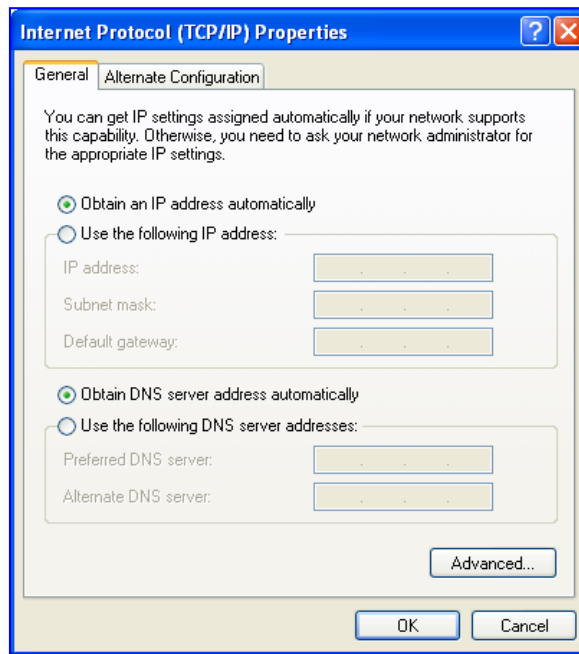

7. Select the Obtain an IP address automatically option.
8. Select the Obtain DNS server address automatically option.
9. Click **OK** to save the settings.

7.1.2 Configuring Computers Running on Linux

The procedure below describes how to configure a computer running on Linux operating system to automatically obtain its IP address from a DHCP server. The DHCP server can be the device's embedded DHCP server.

➤ **To configure a computer running Linux for dynamic IP addressing:**

1. Log in to the Linux computer as a super-user, by entering the following command:

```
su
```

2. View the network devices and allocated IP addresses, by typing the following command:

```
ifconfig
```

3. At the prompt, type the following command:

```
pump -i <dev>
```

Where *<dev>* is the network device name.

4. View the new allocated IP address, by typing the following command:

```
ifconfig
```

5. Make sure that no firewall is active on the device (*<dev>*).

8 Setting up your Device

The procedure below describes how to configure the device for connecting it to the Internet (WAN). You can connect the device to the Internet using one of the following methods:

- Configuring the device through the Web interface – see Section 8.1 on page 59
- Using the device's Automatic Internet Dialer Detection feature – see Section 8.1.1 on page 60



Note: If the Automatic Dialer feature is shipped preconfigured (i.e., enabled), then the device automatically detects the Internet dialer type and therefore, Internet connection configuration is unnecessary. However, it is recommended to manually configure the Internet connection after the Automatic Dialer process has completed (successfully or not). For more information on the Automatic Dialer feature, see Section 8.1.1 on page 60.

8.1 Setting up an Internet Connection using the Web Interface

You can quickly and easily set up a basic Internet connection using the Web interface's 'Quick Setup' screen (as shown in Figure 8-1). This screen is displayed when you log in to the Web interface (or you can click the **Quick Setup** menu from the menu bar).



Notes:

- Before configuring the device's Internet connection, ensure that you have obtained relevant technical information on the Internet connection type from your Internet Telephony Service Provider (ITSP). For example, whether you are connected to the Internet using a static or dynamic IP address, or PPPoE are used to communicate over the Internet.
- For advanced configuration of the WAN network, use the **Network Connections** menu, as described in Section 12.1 on page 127.

Figure 8-1: Internet Connection

 **Quick Setup**

Internet Connections

WAN Ethernet	
Connection Type:	Automatic IP Address Ethernet Connection ▾
Name:	WAN Ethernet
Status:	Connected
MAC Address:	00:90:8f:21:aa:14
IP Address:	10.37.2.24
Subnet Mask:	255.255.0.0
Default Gateway:	10.37.0.1
DNS Server	10.1.1.11 10.1.1.10

Click the **Refresh** button to update the status.

8.1.1 WAN Ethernet

The device supports the following WAN Ethernet connection types:

- Manual IP Address Ethernet Connection
- Automatic IP address
- Point-to-Point Protocol over Ethernet (PPPoE)
- Point-to-Point Tunneling Protocol (PPTP)



Notes:

- Automatic IP address is the default connection type.
- If you do not need an Internet (WAN Ethernet) connection, then in the 'Quick Setup' screen, from the 'Connection Type' drop-down list, select 'No Internet Connection'.

8.1.1.1 Manual IP Address Ethernet Connection

The procedure below describes how to connect to the Internet using a manually defined IP address.

➤ **To configure a manual IP address connection:**

1. From the 'Connection Type' drop-down list, select 'Manual IP Address Ethernet Connection'.

Figure 8-2: WAN Ethernet - Manual IP Address Ethernet Connection

WAN Ethernet	
Connection Type:	Manual IP Address Ethernet Connection
IP Address:	0 . 0 . 0 . 0
Subnet Mask:	0 . 0 . 0 . 0
Default Gateway:	0 . 0 . 0 . 0
Primary DNS Server:	0 . 0 . 0 . 0
Secondary DNS Server:	0 . 0 . 0 . 0

2. According to your ISP's instructions, specify the following parameters:
 - IP address
 - Subnet mask
 - Default Gateway
 - Primary DNS server
 - Secondary DNS server

8.1.1.2 Automatic IP Address Ethernet Connection

The procedure below describes how to connect to the Internet by automatically obtaining a WAN IP address and DNS IP address from a DHCP server on the WAN. This method is the default connection type.

- **To configure automatic IP address connection:**
 - From the 'Connection Type' drop-down list, select 'Automatic IP Address Ethernet Connection'.

Figure 8-3: Automatic IP Address WAN Ethernet Connection

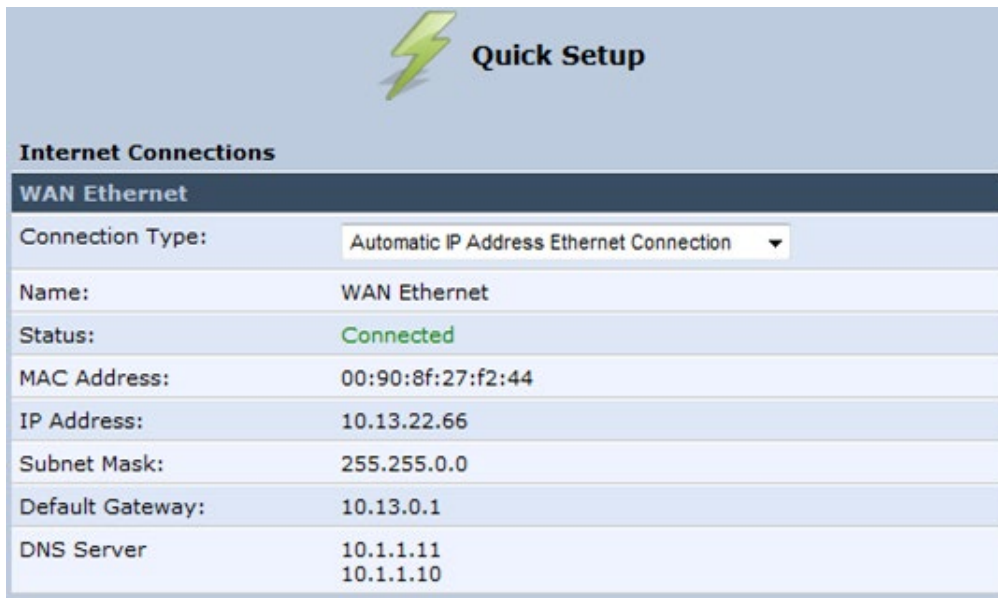

The screenshot shows the 'Quick Setup' interface for 'Internet Connections'. Under the 'WAN Ethernet' group, the 'Connection Type' is set to 'Automatic IP Address Ethernet Connection'. The configuration details are as follows:

WAN Ethernet	
Connection Type:	Automatic IP Address Ethernet Connection
Name:	WAN Ethernet
Status:	Connected
MAC Address:	00:90:8f:27:f2:44
IP Address:	10.13.22.66
Subnet Mask:	255.255.0.0
Default Gateway:	10.13.0.1
DNS Server:	10.1.1.11 10.1.1.10

8.1.1.3 PPPoE

The procedure below describes how to connect to the Internet by PPPoE

- **To configure PPPoE connection:**
 1. Under the **WAN Ethernet** group, from the 'Connection Type' drop-down list, select 'Point-to-Point Protocol over Ethernet (PPPoE)'.

Figure 8-4: PPPoE WAN Ethernet Connection

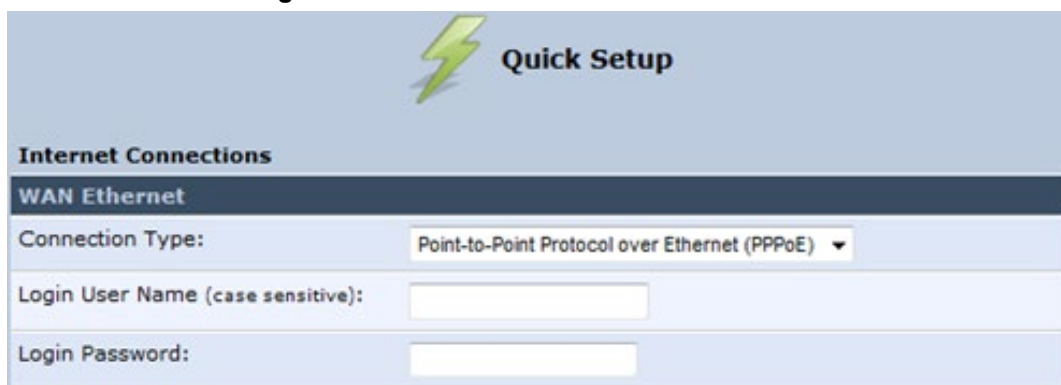

The screenshot shows the 'Quick Setup' interface for 'Internet Connections'. Under the 'WAN Ethernet' group, the 'Connection Type' is set to 'Point-to-Point Protocol over Ethernet (PPPoE)'. The configuration details are as follows:

WAN Ethernet	
Connection Type:	Point-to-Point Protocol over Ethernet (PPPoE)
Login User Name (case sensitive):	<input type="text"/>
Login Password:	<input type="password"/>

2. Configure the PPPoE login username and password (provided by your ITSP).

8.1.1.4 PPTP

The procedure below describes how to connect to the Internet by PPTP.

➤ **To configure PPTP connection:**

1. Under the **WAN Ethernet** group, from the 'Connection Type' drop-down list, select 'Point-to-Point Tunneling Protocol (PPTP)'.

Figure 8-5: PPTP WAN Ethernet Connection

The screenshot shows the 'Quick Setup' interface for 'WAN Ethernet'. The 'Connection Type' is set to 'Point-to-Point Tunneling Protocol (PPTP)'. There are input fields for 'PPTP Server Host Name or IP Address', 'Login User Name (case sensitive)', and 'Login Password'. The 'Internet Protocol' is set to 'Obtain an IP Address Automatically'.

Internet Connections	
WAN Ethernet	
Connection Type:	Point-to-Point Tunneling Protocol (PPTP) ▼
PPTP Server Host Name or IP Address:	<input type="text"/>
Login User Name (case sensitive):	<input type="text"/>
Login Password:	<input type="password"/>
Internet Protocol:	Obtain an IP Address Automatically ▼

2. Configure the following (provided by your ITSP):
 - PPTP Server Host Name or IP Address
 - Login user name
 - Login password
3. From the 'Internet Protocol' drop-down lists, select the method for assigning an IP address (provided by your ITSP).

8.2 Using the Automatic Dialer for Internet Connection

The Automatic Dialer feature allows the service provider to use one type of pre-configured devices for WAN Ethernet (DHCP, LT2P or PPPoE).

In the Private Labeling process, the factory setting is burned with the parameters of the different dialers.

This section describes the recommended process for using the Automatic Dialer.

8.2.1 Recommended Configuration

The recommended factory settings for the Automatic Dialer feature are shown below:

```
(auto_dialer_detect
  (enabled(1))
  (done(0))
  (connection_type
    (0
      (type(DHCP))
      (enabled(1))
      (max_dialer_conn_time(20))
    )
    (1
      (type(PPTP))
      (enabled(1))
      (server_ip(<Server Name or IP>))
      (username(<User Name>))
      (password(<Password>))
      (max_dialer_conn_time(120))
    )
    (2
      (type(PPPOE))
      (enabled(1))
      (username(<User Name>))
      (password(<Password>))
      (max_dialer_conn_time(120))
    )
  )
  (auto_detect_retries(15))
  (ping_retries(4))
  (ping_retries_timeout(2))
)
(system
  (network
```

```
(internet_url (<Address or Domain Name for Ping Test>))
)
)
```

8.2.2 Setting up and Starting the Automatic Dialer

The procedure below describes how to setup and start the Automatic Dialer feature.

➤ **To setup and start Automatic Dialer:**

1. Power off the device.
2. Connect the Ethernet cables.
3. Power on the device; the Automatic Dialer begins its operation and you can view the progress status by checking the device's LEDs.



Note: The connection is WAN Ethernet:

- For DHCP, the connection is fast.
- For PPPoE, the connection can take up to ~4 minutes.

8.2.3 Quitting Automatic Dialer for Manual Configuration

If, for any reason, you need to manually configure the Internet connection, you first need to stop the Automatic Dialer feature and then manually configure the connection, as described below,

➤ **To quit Automatic Dialer and manually configure the Internet connection:**

1. Power off the device.
2. Disconnect the Ethernet cable.
3. Power on the device.
4. Wait for the Automatic Dialer process to end (i.e., the **Broadband** LED stops blinking).
5. Log in to the device's Web interface.
6. Manually configure the Internet connection using the 'Quick Setup' screen (see Section 8.1 on page 59). This ensures that the Automatic Dialer feature does not re-activate itself after the device resets.

Once the device successfully connects to the Internet, it downloads its configuration file from the user-defined server on which the file is located.



Note: The configuration file must include the following parameter to indicate that Automatic Dialer is no longer needed: **auto_dialer_detect/done = 1**.

9 Configuring VoIP Parameters

The VoIP parameters are mainly configured in the 'Voice over IP' screen. This screen is accessed by clicking the **Voice over IP** menu in the side menu bar. The 'Voice over IP' screen provides tabs for configuring the following:

- Signaling protocol (i.e., Session Initiation Protocol / SIP) – see Section 9.1 on page 65
- Dialing – see Section 9.3 on page 72
- Media streaming – see Section 9.5 on page 81
- Voice and fax – see Section 9.6 on page 85
- Supplementary services – see Section 9.7 on page 90
- Line settings – see Section 9.8 on page 93
- Line extensions – see Section 9.10 on page 99
- Speed dials – see Section 9.11 on page 101
- Telephone interfaces – see Section 9.12 on page 103



Notes:

- By default, the 'Voice over IP' screens initially display only basic parameters. To view all the parameters, click the **Advanced** button in the required screen.
- Once you have configured the VoIP parameters, you can start using your analog telephones, as described in Chapter 10 on page 105.

9.1 Configuring the SIP Signaling Protocol

The procedure below describes how to configure the SIP parameters.

➤ **To configure SIP parameters:**

1. From the menu bar, click the **Voice Over IP** menu; the following screen appears:

Figure 9-1: Signaling Protocol Tab Screen



2. Configure the parameters, as required. For a description of the parameters displayed on this screen, see [Table 9-1](#).
3. Click **OK** to save your settings.

Table 9-1: Signaling Protocol Tab Parameters Description

Parameter	Description
Signaling Protocol Group	
Signaling Protocol protocol	(Read-only field.) Displays the signaling protocol running on the device. Note: Currently, only SIP is supported.
SIP Transport Protocol transport_protocol	Defines the SIP transport type - UDP (default), TCP, or TLS. Note: This parameter appears only in 'Advanced' mode.
Local SIP Port port	Defines the UDP / TCP port on which the SIP stack listens. The default port is 5060. Note: This parameter appears only in 'Advanced' mode.
Local SIP TLS Port tls_port	Defines the TLS port on which the SIP stack listens. The default port is 5060. Note: This parameter appears only if you select 'TLS' as the SIP transport protocol.

Parameter	Description
Gateway Name - User Domain proxy_gateway	Defines the device's domain name which is sent in the SIP From header of outgoing INVITE messages. Note: This parameter appears only in 'Advanced' mode.
user_agent	Defines the user agent parameter that is used in SIP packet headers.
configured_user_agent	Replaces the default user_agent with the following format: AudioCodes MP202B; <MAC>
Enable PRACK prack/enabled	When enabled, the device replies with a PRACK message upon receipt of a reliable provisional response. The device does not initiate reliable provisional responses. Note: This parameter appears only in 'Advanced' mode.
Include ptime in SDP sdp_include_ptime	When enabled, the device adds the ptime field to the SDP message body. Note: This parameter appears only in 'Advanced' mode.
advanced_dns	This parameter is automatically configured to: <ul style="list-style-type: none"> [DNS SRV] - If the SIP Proxy/Outbound Proxy port is configured to "65535" [NAPTR] – If the SIP Protocol is set to "UNDEFINED" Note: The default value is "Disabled".
Enable rport rport/enabled	When enabled, the device adds the rport parameter to the relevant SIP message fields. Note: This parameter appears only in 'Advanced' mode.
Connect media on 180 connectMediaOn180	When enabled, media is connected upon receipt of SIP 180, 183, or 200 messages. When this parameter is disabled, media is connected upon receipt of 183 and 200 messages only. Note: This parameter appears only in 'Advanced' mode.
Enable Keep Alive ka_options/enabled	When enabled, a keep-alive notification is sent every user-defined interval to the SIP registrar server. Note: This parameter appears only in 'Advanced' mode.
Keep-Alive Type ka_options/ka_type	The type of keep-alive mechanism sent to the SIP registrar: <ul style="list-style-type: none"> Using SIP OPTIONS: sends SIP OPTIONS messages Using an Empty UDP packet: sends empty UDP packets Note: This parameter is available only if the 'Enable Keep Alive' check box is selected.
Keep-Alive Period ka_options/timeout	Defines the periodic interval for keep-alive messages. Note: This parameter is available only if the 'Enable Keep Alive' check box is selected.
SIP Proxy and Registrar	
Use SIP Proxy use_proxy	When checked, outgoing calls are routed to the configured SIP proxy. If the 'Use SIP Proxy IP and Port for Registration' check box is also selected, the configured SIP proxy is also used as the registrar, allowing incoming calls.

Parameter	Description
Host Name or Address proxy_address	Defines the IP address or host name of the SIP proxy. Note: This parameter is available only if the 'Use SIP Proxy' check box is selected.
Proxy Port proxy_port	Defines the port (UDP, TCP, or TLS) of the SIP proxy. Note: This parameter is available only if the 'Use SIP Proxy' check box is selected.
Maximum Number of Authentication Retries auth_retries	Defines how many times authenticated register messages are re-sent if SIP 401 or 407 responses with a different "nonce" are received. Note: This parameter is available only if the 'Use SIP Proxy' check box is selected.
Use SIP Proxy IP and Port for Registration use_proxy_ip_port_for_registrar	When selected (default), the SIP proxy's IP address and port is also used for registration. When selected, there is no need to configure the address / port of the registrar (only the 'Register Expires' and 'Register Expires Failed' parameters – described later). Note: This parameter is available only if the 'Use SIP Proxy' check box is selected.
SIP Security signalling/sip/proxy_only	The device's firewall can be configured to block incoming packets that have the SIP signaling port as their destination. You can configure up to two SIP entities (for example, the SIP Proxy or an SBC), which are not blocked by the firewall. The default value is 'Allow all SIP traffic' [0]. [0] – 'Allow all SIP traffic' [1] – 'Allow SIP traffic from Proxy only' [2] – 'Allow SIP traffic from Proxy and additional SIP entity' Note: This parameter is available only if the 'Use SIP Proxy' check box is selected.
Address Type sip_entity_accept_in_type	Selects the address type of the additional SIP entity - IP address or host name. Note: This parameter is available only if the 'Sip Security' field is set to 'Allow SIP traffic from Proxy and Additional SIP Entity'.
SIP Entity Address sip_entity_accept_in	Defines the address or host name (depending on the settings of the 'Address Type' field) of the additional SIP entity. Note: This parameter is available only if the 'Sip Security' field is set to 'Allow SIP traffic from Proxy and Additional SIP Entity'.
Use Redundant Proxy redundancy_mode/mode=Redundant Proxy Mode	Enables the use of a redundant proxy.
Redundant Proxy Address redundant_proxy/addr	Defines the IP address of the redundant proxy. Note: This parameter is available only if the 'Use Redundant Proxy' check box is selected.

Parameter	Description
Redundant Proxy Port redundant_proxy/port	Defines the port of the redundant proxy. Note: This parameter is available only if the 'Use Redundant Proxy' check box is selected.
Redundant Proxy Keep Alive Period ka_options/period	Defines the interval between keep-alive packets (SIP OPTIONS) which are used by the proxy redundancy mechanism to check the connection status. Note: This parameter is available only if the 'Use Redundant Proxy' check box is selected.
Redundancy Mode redundancy_mode/mode	Defines a backup SIP proxy server. Enable this parameter if you want to operate with a Proxy server that serves as a backup.
Failback Period redundancy_mode/failback/period	Defines the time (in seconds) that must lapse before failback is performed. This applies only if you're operating with the DNS mode of failover, i.e., with DNS_SRV.
outgoing_request_no_response_timeout	Defines the timeout, in milliseconds, that lapses until the phone failovers to the secondary proxy.
Switch back to Primary SIP proxy when available	When selected, the device switches back to the primary proxy server when communication with it returns.
Use SIP Registrar sip_registrar/enabled	When selected, enables the use of a separate SIP registrar server.
Registrar Address sip_registrar/addr	Defines the IP address or host name of the registrar server. Note: This parameter is available only if the 'Use SIP Registrar' check box is selected.
Registrar Port sip_registrar/port	Defines the port (UDP or TCP) of the registrar server. Note: This parameter is available only if the 'Use SIP Registrar' check box is selected.
Register Expires proxy_timeout	Defines the registration timeout, in seconds. Note: This parameter is available only if the 'Use SIP Registrar' or 'Use SIP Proxy IP and Port for Registration' check box is selected.
Register Failed Expires registration_failed_timeout	Defines the timeout between registration attempts in case of a registration failure (e.g. due to a network problem). Note: This parameter is available only if the 'Use SIP Registrar' or 'Use SIP Proxy IP and Port for Registration' check box is selected.
Use SIP Outbound Proxy sip_outbound_proxy/enabled	When selected (default), an outbound SIP proxy is used (all SIP messages are sent to this server as the first hop). Note: This parameter appears only in 'Advanced' mode.
Outbound Proxy IP sip_outbound_proxy/addr	Defines the IP address of the outbound Proxy. If this parameter is set, all outgoing messages (including registration messages) are sent to this Proxy according to the Stack behavior. Note: This parameter is available only if 'Use SIP Outbound Proxy' is selected.

Parameter	Description
Outbound Proxy Port sip_outbound_proxy/port	Defines the port on which the outbound Proxy listens. Note: This parameter is available only if 'Use SIP Outbound Proxy' is selected.
SIP Timers Note: This group appears only in 'Advanced' mode.	
Retransmission Timer T1 sip_t1	Defines the SIP T1 retransmission timer according to RFC 3261.
Retransmission Timer T2 sip_t2	Defines the SIP T2 retransmission timer according to RFC 3261.
Retransmission Timer T4 sip_t4	Defines the SIP T4 retransmission timer according to RFC 3261.
INVITE Timer sip_invite_timer	Defines the SIP INVITE timer according to RFC 3261.
NAT Traversal	
Enable STUN stun/enabled	When selected, the SIP STUN Manager is enabled. The SIP STUN Manager resolves private addresses to public addresses. Note: This parameter appears only in 'Advanced' mode.
STUN Server Address stun/stun_server_ip	Defines the IP address of the STUN server used to resolve private addresses. Note: This parameter is available only if 'Enable STUN' is selected.
STUN Server Port stun/stun_server_por	Defines the port of the STUN server. Note: This parameter is available only if 'Enable STUN' is selected.
Subnet Mask stun/stun_need_mask	Defines the subnet mask address of the STUN server used to resolve private addresses. Note: This parameter is available only if 'Enable STUN' is selected.

■ **Transport Type and Port values in the 'Request-URI' SIP header can now be hidden.**

It may be required to hide the values listed below in the Nokia-Siemens IMS environment.

This can be done by running the following:

```
rg_conf/voip/signalling/sip/hide_uri_port={0 | 1}
rg_conf/voip/signalling/sip/hide_uri_transport={0 | 1}
```

Possible values:

0 = Transport Type and Port values appear in the Request-URI (default behavior for both values)

1 = Transport Type and Port values will not appear in the Request-URI

9.1.1 Configuring Proxy Redundancy

The Redundant Proxy feature allows the configuration of a backup SIP proxy server to increase Quality of Service (QoS). Once this feature is enabled, the device identifies cases where the primary proxy does not respond to SIP signaling messages. In these cases, the device registers to the redundant proxy and seamlessly continues normal functionality, without any noticeable connectivity failure or malfunction with the primary proxy.

The Redundant Proxy feature includes two operational modes:

- **Asymmetric mode:** This mode assigns the primary proxy a higher priority for registration over the redundant proxy. Once the device is registered to the primary proxy, it sends keep-alive messages (using SIP OPTIONS messages) to the primary proxy. If the primary proxy does not respond, the device registers to the redundant proxy, but continues sending keep-alive messages to the primary proxy. If the primary proxy responds to these keep-alive messages, the device re-registers to the primary proxy.
- **Symmetric mode:** In this mode, both proxies are assigned the same priority for registration. Once the device is registered to a proxy (primary or redundant), it sends keep-alive messages to this proxy. The device switches proxies only once the proxy to which it has registered, does not respond.

In both modes, the following applies:

- If the device is not registered (i.e., if the proxy server - redundant or primary - to which the device currently tries to register does not respond), the device attempts to register to an alternative proxy. These attempts continue until the device successfully registers.
- If this feature is enabled and you reboot the device, it registers to the last proxy to which it was trying to register (not necessarily to the primary proxy).

➤ **To configure proxy redundancy:**

1. From the menu bar, click the **Voice Over IP** menu; the **Signaling Protocol** tab screen appears.
2. Define a primary proxy server (under the **SIP Proxy and Registrar** group):
 - a. Select the 'Use SIP Proxy' check box.
 - b. In the 'Host Name or Address' field, enter the primary proxy's IP address.
 - c. In the 'Proxy Port' field, enter the primary proxy's port number.
3. Define a redundancy proxy server (under the **SIP Proxy and Registrar** group):
 - a. Select one of the following check boxes: 'Use SIP Registrar' or 'Use SIP Proxy IP and Port for Registration'.
 - b. Select the 'Use Redundant Proxy' check box.
 - c. In the 'Redundant Proxy Address' field, enter the redundant proxy's IP address or DNS name.
 - d. In the 'Redundant Proxy Port' field, enter the redundant proxy's port number.
 - e. In the 'Redundant Proxy Keep Alive Period' field, enter the rate (in seconds) of the keep-alive messages for sending to the proxy. The valid range is 10 to 86,400 seconds (i.e., 24 hours). The default value is 60 sec.
 - f. To toggle between Symmetric and Asymmetric modes, use the 'Switch back to Primary SIP proxy when available' check box.
 - ◆ **Asymmetric mode** - select the check box (i.e., mark it)
 - ◆ **Symmetric mode** - clear the check box

Figure 9-2: Configuring Proxy Redundancy

SIP Proxy and Registrar	
2-a →	<input checked="" type="checkbox"/> Use SIP Proxy
2-b →	Host Name or Address: <input type="text" value="10.33.2.36"/>
2-c →	Proxy Port: <input type="text" value="5060"/>
	Maximum Number of Authentication Retries: <input type="text" value="4"/>
3-a →	<input checked="" type="checkbox"/> Use SIP Proxy IP and Port for Registration
	Register Expires: <input type="text" value="3600"/> Seconds
	Register Failed Expires: <input type="text" value="60"/> Seconds
	Sip Security: <input type="text" value="Allow All SIP traffic"/>
3-a →	<input checked="" type="checkbox"/> Use Redundant Proxy
3-b →	Redundant Proxy Address: <input type="text" value="10.33.2.15"/>
3-c →	Redundant Proxy Port: <input type="text" value="5060"/>
3-d →	Redundant Proxy Keep Alive Period: <input type="text" value="60"/> Seconds
3-d →	<input checked="" type="checkbox"/> Switch back to Primary SIP proxy when available
3-e →	<input type="checkbox"/> Use SIP Outbound Proxy

4. Click **OK** to save your settings.

The following is an example of the relevant Telnet parameters:

```
rg_conf/voip/signalling/sip/sdp_include_ptime=1
rg_conf/voip/signalling/sip/transport_protocol=udp
rg_conf/voip/signalling/sip/port=5060
rg_conf/voip/signalling/sip/tls_port=5061
rg_conf/voip/signalling/sip/advanced_dns=DNS SRV
rg_conf/voip/signalling/sip/proxy_address=voip.proxy.com
rg_conf/voip/signalling/sip/proxy_port=5070
rg_conf/voip/signalling/sip/auth_retries=4
rg_conf/voip/signalling/sip/proxy_timeout=3600
rg_conf/voip/signalling/sip/registration_failed_timeout=60
rg_conf/voip/signalling/sip/intermediate_registrars_period=0
rg_conf/voip/signalling/sip/sip_registrar/enabled=0
rg_conf/voip/signalling/sip/sip_registrar/port=5060
rg_conf/voip/signalling/sip/sip_registrar/addr=0.0.0.0
rg_conf/voip/signalling/sip/redundancy_mode/mode=Failback Mode
rg_conf/voip/signalling/sip/redundancy_mode/ka_options/enabled=0
rg_conf/voip/signalling/sip/redundancy_mode/ka_options/ka_type=Using OPTIONS
rg_conf/voip/signalling/sip/redundancy_mode/ka_options/timeout=300
rg_conf/voip/signalling/sip/redundancy_mode/redundant_proxy/port=5060
rg_conf/voip/signalling/sip/redundancy_mode/redundant_proxy/addr=0.0.0.0
```



```

rg_conf/voip/signalling/sip/redundancy_mode/redundant_proxy/is_sym
metric=0
rg_conf/voip/signalling/sip/redundancy_mode/failback/period=120
rg_conf/voip/signalling/sip/sip_outbound_proxy/enabled=1
rg_conf/voip/signalling/sip/sip_outbound_proxy/port=65535
rg_conf/voip/signalling/sip/sip_outbound_proxy/addr=voip.outbandpr
oxy.com
rg_conf/voip/signalling/sip/sip_t1=500
rg_conf/voip/signalling/sip/sip_t2=4000
rg_conf/voip/signalling/sip/sip_t4=5000
rg_conf/voip/signalling/sip/sip_invite_timer=32000
rg_conf/voip/signalling/sip/proxy_gateway= voip.proxy.com
rg_conf/voip/signalling/sip/digit_map=NULL
rg_conf/voip/signalling/sip/number_rules=NULL
rg_conf/voip/signalling/sip/use_proxy_ip_port_for_registrar=1
rg_conf/voip/signalling/sip/proxy_only=0
rg_conf/voip/signalling/sip/prack/enabled=1
rg_conf/voip/signalling/sip/rport/enabled=1
rg_conf/voip/signalling/sip/connectMediaOn180=0
rg_conf/voip/signalling/sip/stun/enabled=0
rg_conf/voip/signalling/sip/stun/stun_server_ip=0.0.0.0
rg_conf/voip/signalling/sip/stun/stun_need_mask=0.0.0.0
rg_conf/voip/signalling/sip/stun/stun_server_port=3478
rg_conf/voip/signalling/sip/stun/stun_client_port=0
rg_conf/voip/signalling/sip/session_timer=0
rg_conf/voip/signalling/sip/min_session_interval=0
rg_conf/voip/signalling/sip/use_proxy=1
rg_conf/voip/signalling/sip/outgoing_request_no_response_timeout=1
1500
rg_conf/voip/signalling/protocol=sip

```

9.1.2 Support for DNS Failover Mechanism

AudioCodes now offers support for the DNS failover mechanism using TCP for truncated responses. MP-20x now sends a DNS query over TCP upon receiving a truncated DNS response in the UDP.

The following is an example of the DNS response with the 'TC' flag:

```

❏ Domain Name System (response)
  [Request In: 6063]
  [Time: 0.034340000 seconds]
  Transaction ID: 0xd865
  ❏ Flags: 0x8380 Standard query response, No error
    1... .. = Response: Message is a response
    .000 0... .. = Opcode: Standard query (0)
    .... .0... .. = Authoritative: Server is not an authority for domain
    .... ..1... .. = Truncated: Message is truncated
    .... ..1... .. = Recursion desired: Do query recursively
    .... ..1... .. = Recursion available: Server can do recursive queries
    .... ..0... .. = Z: reserved (0)
    .... ..0... .. = Answer authenticated: Answer/authority portion was not authenticated by the server
    .... ..0... .. = Non-authenticated data: Unacceptable
    .... ..0000 = Reply code: No error (0)

```

9.2 Support for Common Name/SubjectAltName Verification for SIP

If this feature is enabled, it checks that the Common Name/SubjectAltName (CN/SANS) fields from the certificate provided by the SIP server, are identical to the Outbound SIP Proxy / SIP Proxy FQDN.

If the certificate validation fails, then the TLS handshake is aborted and no SIP registration is performed.

To enable this functionality, the following parameters must be set:

```
rg_conf/voip/signalling/sip/check_tls_cert_san_and_cn=1
```

9.3 Support for Advanced Alerting with Ring Splash

1. AudioCodes now offers support for Advanced Alerting with Ring Splash for DND, CFA, CFS
2. This is a standard ring pattern that occurs only once (i.e., no recurring cadence) with a nominal duration of 500ms. The minimum on time should be 450ms with a maximum on time of 550ms (for BroadSoft).

9.4 Configuring Dialing Parameters

The procedure below describes how to configure the dialing parameters.

➤ **To configure dialing parameters:**

1. On the 'Voice Over IP' screen, click the **Dialing** tab; the following screen appears.

Figure 9-3: Dialing Tab Screen

Dialing Parameters	
Dialing Timeout:	5 Seconds
Interdigit Short Timeout:	5 Seconds
Phone Number Size:	15 Digits
<input checked="" type="checkbox"/> Enabled dialing complete key	
Complete dialing key:	#
Dial Tone Timeout:	30 Seconds
Reorder tone timeout:	40 Seconds
Unanswered call timeout:	60 Seconds
Howler tone timeout:	120 Seconds
Flash min:	100 milliseconds
Flash max:	1000 milliseconds
<input type="checkbox"/> Enable Re-Answer Timeout	
Send DTMF Out-Of-Band:	RFC2833
Digit Map:	
Dial Plan:	
Key Sequence	
Flash keys sequence style:	Flash + digits type 2

2. Configure the parameters, as required. For a description of the parameters displayed on this screen, see [Table 9-2](#).
3. Click **OK** to save your settings.

Table 9-2: Dialing Tab Parameters Description

Parameter	Description
Dialing Parameters	
Dialing Timeout dial_timeout	Defines the duration (in seconds) of allowed inactivity between dialed digits. When you work with a proxy, the number you have dialed before the dialing process has timed out is sent to the proxy as the user ID to be called. This is useful for calling remote parties without creating a speed dial entry (assuming the remote party is registered with the proxy).
Interdigit Short Timeout voip/interdigit_short_timer	Defines an additional timer can be used when configuring a dial plan or digit map rules.
Phone Number Size phone_number_max_size	Defines the maximum length of shortcut numbers that you can enter and the maximum number of digits that you can dial.
Enabled dialing complete key dial_complete_key/enabled	When selected (default), you can define a key that when pressed forces the device to make a call to the dialed digits even if there is no match in the dial plan or digit map. The key is defined in the 'Complete dialing key' field, which appears when this parameter is selected. Note: This parameter appears only in 'Advanced' mode.
Complete dialing key dial_complete_key/key	Defines the key that when pressed forces the device to make a call to the dialed digits even if there is no match in the dial plan or digit map. The default value is the pound (#) key. Note: This parameter is available only if the 'Enabled dialing complete key' is selected.
Dial Tone Timeout offhook_tone_timeout	Defines the duration of the dial tone (in seconds). If the limit is exceeded, the dial tone stops and you a reorder tone is played.
Reorder Tone Timeout warning_tone_timeout	Defines the duration (in seconds) of the reorder tone. The reorder tone is played, for example, when the device receives a SIP 486 response. If the limit is exceeded, the reorder tone stops and a howler tone is played. Note: This parameter appears only in 'Advanced' mode.
Unanswered call timeout unanswered_call_timeout	Defines the timeout before the device automatically sends a SIP CANCEL message. When the device makes a call and the other side doesn't answer, the device sends a CANCEL message after this timeout. Note: This parameter appears only in 'Advanced' mode.
Howler Tone Timeout warning_tone_timeout	Defines the duration (in seconds) of the howler tone. If the limit is exceeded, the howler tone stops playing. The howler tone informs a user that the user's phone has been left in an off-hook state. Note: This parameter appears only in 'Advanced' mode.
Flash min flash_min	Defines the duration (in ms) after which you can begin to perform a flash hook.
Flash max flash_max	Defines the maximum duration (in ms) that the flash hook button can be pressed, after which the call is disconnected.

Parameter	Description
Enable Re-Answer Timeout offhook_tone_timeout	When selected, the 'Re-Answer Timeout' field appears, allowing you to define the timeout after on-hooking an active call and then off-hooking it again. Once this time expires and the phone has not been off-hooked again, the call is disconnected.
Send DTMF Out-Of- Band out_of_band_dtmf	Defines how the DTMF tones are sent ('Inband', 'RFC2833', or 'Via SIP'). DTMFs are the tones generated by your telephone's keypad. Note: This parameter appears only in 'Advanced' mode.
Digit Map digit_map	Defines formats (or patterns) for the dialed number. A match to one of the defined patterns terminates the dialed number. For an explanation on digit map syntax, see Section 9.4.1 on page 79. Note: This parameter appears only in 'Advanced' mode.
Dial Plan number_rules	Defines patterns to translate to specific SIP destination addresses. For dial plan syntax rules for patterns entered to the left of the '=' sign, see Section 9.4.1 on page 79. Note: This parameter appears only in 'Advanced' mode.
Key Sequence	

Parameter	Description
<p>Flash keys sequence style key_sequence_style</p>	<p>Defines the key sequence with the flash button:</p> <ul style="list-style-type: none"> ▪ 'Flash only' (default) = uses only the phone's Flash button. There are three scenarios: <ul style="list-style-type: none"> ✓ During an existing call, if the user presses Flash, the call is put on hold, a dial tone is heard and the user is able to initiate a second call. Once the second call is established, on-hooking transfers the first (held) call to the second call. ✓ During an existing call, if the user presses Flash, the call is put on hold and a dial tone is heard. The user can initiate a second call and establish a 3-way conference by again pressing Flash after the second call is initiated. ✓ During an existing call, if a call comes in (call waiting), pressing Flash puts the active call on hold and answers the waiting call; pressing Flash again toggles between these two calls. ▪ 'Flash + digits sequence' = Flash button with a key sequence: <p>This feature has been updated and now includes three different types:</p> <p>Type 1:</p> <ul style="list-style-type: none"> ✓ Flash + 1 holds a call or toggles between two existing calls ✓ Flash + 2 makes a call transfer ✓ Flash + 3 establishes a 3-way conference <p>Type 2:</p> <ul style="list-style-type: none"> ✓ Flash – holds a call ✓ Flash + 2 toggles between two existing calls ✓ Flash + 3 establishes a 3-way conference ✓ Flash + 4 makes a call transfer <p>Type 3:</p> <ul style="list-style-type: none"> ✓ Flash + 1 toggles between two existing calls ✓ Flash + 2 holds a call ✓ Flash + 4 establishes a 3-way conference ▪ 'Send Flash Hook Via SIP' = you can modify the SIP INFO message that is sent upon Flash. You can change the Content Type header field and Message Body field. <p>Note: This parameter appears only in 'Advanced' mode.</p>
<p>SIP INFO Header sip_info_key_seq_header</p>	<p>When the key sequence is set to 'Send Flash Hook Via SIP', you can modify the Content Type header field of the SIP INFO message.</p> <p>For example: "application/broadsoft; version = 1.0"</p> <p>Note: This parameter appears only when the 'Flash keys sequence style' field is set to 'Send Flash Hook Via SIP'.</p>

Parameter	Description
SIP INFO Body sip_info_key_seq_body	When the key sequence is set to 'Send Flash Hook Via SIP', you can modify the Message Body field of the SIP INFO message. For example: " event flashhook" Note: This parameter appears only when the 'Flash keys sequence style' field is set to 'Send Flash Hook Via SIP'.

The following is an example of the relevant Telnet parameters:

```

rg_conf/voip/dial_timeout=5
rg_conf/voip/phone_number_max_size=15
rg_conf/voip/warning_tone_timeout=40
rg_conf/voip/offhook_tone_timeout=120
rg_conf/voip/pstn_line_access_code=-1
rg_conf/voip/fxs/polarity_reversal/enabled=0
rg_conf/voip/unanswered_call_timeout=60
rg_conf/voip/dial_complete_key/enabled=1
rg_conf/voip/dial_complete_key/key=#
rg_conf/voip/replace_number_sign_with_escape_char=0
rg_conf/voip/regret_call_enabled=0
rg_conf/voip/regret_call_timeout=60
rg_conf/voip/out_of_band_dtmf=rfc2833
rg_conf/voip/key_sequence_style=Flash only
rg_conf/voip/sip_info_key_seq/sip_info_key_seq_header=text/plain
rg_conf/voip/sip_info_key_seq/sip_info_key_seq_body=FLASH
rg_conf/voip/dialtone_timeout=30
rg_conf/voip/flash_min=100
rg_conf/voip/flash_max=1000
rg_conf/voip/secondary_dial_tone/enabled=0
rg_conf/voip/secondary_dial_tone/key_sequence=9
    
```

9.4.1 Syntax for Digit Maps and Dial Plans

Digit maps and dial plans are defined using special syntax rules, configured in the 'Dialing' screen (refer to 'Configuring Dialing Parameters' on page 72).

- **Digit Maps:** A phone's digit map allows MP-20x to know when an entered (dialed) telephone number is complete and therefore, when it should **immediately** initiate the call. If the phone digit map is defined incorrectly, MP-20x might start to dial before the telephone user has entered all the required digits. A digit map is defined either by a (case insensitive) "string" or by a list of strings. Each string in the list is an alternative numbering scheme, specified either as a set of digits or as an expression over which MP-20x attempts to find a shortest possible match. The syntax that can be used in each numbering scheme is described in the table below.
- **Dial Plans:** A dial plan translates specific patterns into specific SIP destination addresses. For example, dial plan rule "4xxx=Line_\\\@10.1.2.3" sends a dialed number consisting of the digit 4 followed by any three digits to IP address 10.1.2.3. The syntax of the pattern on the left of the equal (=) sign is described in the table below.

Table 9-3: Dial Plan (for Left of '=' Sign) and Digit Map Syntax

Type	Syntax
Digit	A digit from "0" to "9".
DTMF	A digit or one of the symbols "A", "B", "C", "D", "#", or "*".
Wildcard "x"	The symbol "x" denotes any digit from "0" through "9".
Range	Two digits separated by a hyphen ("-") and enclosed by square brackets. For example, the digit pattern "[2-5]" denotes any dialed digit that matches 2, 3, 4, or 5.
Separation of Patterns	The bar " " symbol is used to separate multiple digit patterns in your digit map.

An example of a digit map is shown below and described in the subsequent table:

[2-9]11|0|100|101|1[2-9]xxxxxxxxx|*xx|4xxx

Table 9-4: Digit Map Example

Digit Pattern	Description	Example
[2-9]11	Received dialed number that begins with any digit from 2 through 9, and ends with digits 11.	211, 311, 411, 511, 611, 711, 811, 911
0	Received dialed number of 0	0
100	Received dialed number of 100	100
101	Received dialed number of 101	101
1[2-9]xxxxxxxx	Received dialed number that begins with digit 1, followed by any digit from 2 through 9, and then followed by any nine digits.	19222244445
*xx	Received dialed number that begins with the star * sign (star key), followed by any two digits	*44
4xxx	Received dialed number that begins with digit 4 followed by any three digits	4162



Note: Digit patterns that are not included in the digit map are still allowed and will be dialed after the defined dialing timeout (5 seconds, by default). Therefore, this replaces the need to use the symbol "T" in the digit map.

9.5 Configuring Media Streaming

The procedure below describes how to configure the media streaming parameters.

➤ **To configure media streaming parameters:**

1. On the 'Voice Over IP' screen, click the **Media Streaming** tab; following screen appears.

Figure 9-4: Media Streaming Tab Screen

Codecs Priority	Supported Codecs	Packetization Time (milliseconds)
1st Codec	G.711, 64kbps, u-Law	20
2nd Codec	G.711, 64kbps, A-Law	20
3rd Codec	G.729, 8kbps	20
4th Codec	G.726, 16kbps	20
5th Codec	G.726-32, 32kbps	20

2. Select the 'Enabled' check box under "Wide-Band Restrictions", to restrict Wide-band codecs on FXS ports.
3. Configure the parameters, as required. For a description of the parameters displayed on this screen, see [Table 9-5](#).
4. Click **OK** to save your settings.

The following is an example of the relevant Telnet parameters:

```
rg_conf/voip/codec/0/enabled=1
rg_conf/voip/codec/0/name=PCMU
rg_conf/voip/codec/0/ptime=20
rg_conf/voip/codec/1/enabled=1
rg_conf/voip/codec/1/name=PCMA
rg_conf/voip/codec/1/ptime=20
rg_conf/voip/codec/2/enabled=1
rg_conf/voip/codec/2/name=G729
```

```

rg_conf/voip/codec/2/ptime=20
rg_conf/voip/codec/3/enabled=1
rg_conf/voip/codec/3/name=g726-16
rg_conf/voip/codec/3/ptime=20
rg_conf/voip/codec/4/enabled=1
rg_conf/voip/codec/4/name=g726-32
rg_conf/voip/codec/4/ptime=20

rg_conf/voip/media_port=5004
rg_conf/voip/dtmf_payload=101
rg_conf/voip/g726_payload=98
rg_conf/voip/media_tos=0xb8

rg_conf/voip/srtp/enabled=0
rg_conf/voip/srtp/method=aes_cm_128_hmac_sha1_80
    
```

Table 9-5: Media Streaming Tab Parameters Description

Parameter	Description
Media Streaming Parameters	
Local RTP Port Range - Contiguous Series of 8 Ports Starting From: media_port	Defines the port range for Real Time Protocol (RTP) voice transport.
DTMF Relay RFC 2833 Payload Type dtmf_payload	Defines the RTP payload type used for RFC 2833 DTMF relay packets. The range is 0-255. The default is 101.
G.726/16 Payload Type g726_payload	Defines the RTP payload type used for 16 kbps G.726 packets. The range is 0-255. The default is 98.
Quality of Service Parameters	
Type of Service (Hex) media_tos	This is a part of the IP header that defines the type of routing service to be used to tag outgoing voice packets originated from the device. It is used to inform routers along the way that this packet should get specific QoS. Leave this value as 0xb8 (default) if you are unfamiliar with the Differentiated Services IP protocol parameter.
Codecs	
1st - 6th Codec code/<1-6>/	Defines the voice codec. For more information, see 9.5.1 on page 83 .

9.5.1 SRTP

Secure Real-time Transport Protocol (SRTP) is a protocol that allows encryption for RTP data. Since the RTP encryption key is delivered using SIP, this feature is relevant only when SIP transport is secured, so when using this feature, you also need to use SIP over TLS. SRTP can be configured using the Web interface or configuration file.

To configure SRTP using the Web interface:

1. Access the Media Streaming page (**Configuration** tab > **Voice Over IP** menu > **Media Streaming**).

Figure 9-5: SRTP Enabled

2. Configure the SRTP settings according to the parameters in the table below, and then click **Apply**.

To configure SRTP using the configuration file:

Use the table below as reference.

Table 9-6: SRTP Parameters

Parameter	Description
Enabled voip/srtp/enabled	Enables secured RTP (SRTP). [0] Disable (default) [1] Enable
Method voip/srtp/method	The SRTP encryption method. [AES_CM_128_HMAC_SHA1_32] [AES_CM_128_HMAC_SHA1_80] (default) [AES_CM_128_ALL_METHODS]

9.5.1.1 Support for Dynamic SRTP Policy

VoIP media protocol can be configured automatically based on DNS NAPTR response for SIP Proxy / SIP outbound Proxy as follows:

- `_sip._tcp` = **TCP** for Signaling + **RTP** for Media
- `_sips._tcp` = **TLS** for Signaling + **SRTP** for Media

To enable the above functionality, the following parameters must be set:

```
rg_conf/voip/is_media_type_dynamic=1
```



Note: SIP Transport Protocol must be configured as – **Undefined**

Because DTAG allows access from both DTAG networks and from foreign networks (outside of DTAG) to the VoSIP network, the media protocol should be implemented dynamically based on the DNS NAPTR response as follows:

- DTAG access = TCP
- Foreign access = TLS

To enable the above functionality the following parameters must be set:

```
rg_conf/voip/is_media_type_dynamic=1
```

9.5.1.2 Changing Default Cipher Suites for SIP Over TLS

It is possible to change the default cipher suites to be used (or removed) for SIP over TLS. For example:

```
rg_conf/voip/cipher_list=
"EDH+CAMELLIA:EDH+aRSA:EECDH+aRSA+AESGCM:EECDH+aRSA+SHA384:EECDH+a
RSA+SHA256:EECDH:+CAMELLIA256:+AES256:+CAMELLIA128:+AES128:!SSLv3:
!aNULL:!eNULL:!LOW:!3DES:!MD5:!EXP:!PSK:!DSS:!RC4:!SEED:!ECDSA:CAM
ELLIA256-SHA:AES256-SHA:CAMELLIA128-SHA:AES128-SHA"
```

9.5.1.3 Support for RFC 3329 & MediaSec Extensions

Support an additional indication for secured media, used in combination with TLS/SRTP. This may be required in IMS-based core networks.

The following is an example of the relevant Telnet parameters:

```
rg_conf/voip/media_security/enabled=1
rg_conf/conf set voip/media_security/mechanism/0/name=sdes-srtp
```

9.5.1.4 Configuring Codecs

Codecs define the method of relaying voice data. Different codecs have different characteristics, such as data compression and voice quality. For example, G.723 is a codec that uses compression, so it is good for use where bandwidth is limited but its voice quality is not as good compared to other codecs such as the G.711.

9.5.2 Supported Codecs

To make a call, at least one codec must be enabled. Moreover, all codecs may be enabled for best performance. When you start a call to a remote party, your available codecs are compared against the remote party's to determine the codec used. The priority by which the codecs are compared is according to their order of appearance in the table (descending order). To change the priorities, rearrange the codecs in the required order.

If there is no codec that both parties have made available, the call attempt fails. Note that if more than one codec is common to both parties, you cannot force which of the common codecs that were found are used by the remote party's client. If you do wish to force the use of a specific codec, leave only that codec checked.

9.5.2.1 Packetization Time

The Packetization Time is the length of the digital voice segment that each packet holds. The default is 20 millisecond packets. Selecting 10 millisecond packets reduces the delay but increases the bandwidth consumption.

9.6 Configuring Voice and Fax

The procedure below describes how to configure the voice and fax parameters.

➤ **To configure voice and fax parameters:**

1. On the 'Voice Over IP' screen, click the **Voice and Fax** tab and then click **Advanced**; the following screen appears.

Figure 9-6: Voice and Fax Tab Screen

Gain Control	
<input type="checkbox"/> Enable Automatic Gain Control	
Jitter Buffer	
Minimum Delay (10 to 150 milliseconds):	<input type="text" value="35"/> milliseconds
Optimization Factor (1 to 13):	<input type="text" value="7"/>
Silence Compression	
<input type="checkbox"/> Enable Silence Compression	
Echo Cancellation	
<input checked="" type="checkbox"/> Enable Echo Cancellation	
Artificial Bandwidth Extension	
<input type="checkbox"/> Enable Artificial Bandwidth Extension	
Fax and Modem Settings	
Fax Transport Mode:	<input type="text" value="T.38 Relay"/> ▼
T38 Version:	<input type="text" value="Ver. 3"/> ▼
Max Rate:	<input type="text" value="33.6 Kbps"/> ▼
Max Buffer:	<input type="text" value="3000"/>
Max Datagram:	<input type="text" value="560"/>
<input checked="" type="checkbox"/> Error Correction Mode	
Image Data Redundancy Level:	<input type="text" value="1"/>
T30 Control Data Redundancy Level:	<input type="text" value="3"/>
Fax Relay Jitter Buffer Delay:	<input type="text" value="200"/>
Modem Transport Mode:	<input type="text" value="Voice Band Data"/> ▼
Fax/Modem Bypass Codec:	<input type="text" value="G.711, 64kbps, A-Law"/> ▼
CED Transfer Mode:	<input type="text" value="In Voice Or PCM Bypass"/> ▼
CNG Transfer Mode:	<input type="text" value="In Voice"/> ▼

2. Select the 'Enable Artificial Bandwidth Extension' check box to enable this setting.
3. Configure the parameters, as required. For a description of the parameters displayed on this screen, see [Table 9-7](#).
4. Click **OK** to save your settings.

Table 9-7: Voice and Fax Tab Parameters Description

Parameter	Description
Gain Control	
Enable Automatic Gain Control auto_gain_enabled	Enables the Automatic Gain Control (AGC) mechanism. The AGC mechanism adjusts the level of the received signal to maintain a steady (configurable) volume level.
Automatic Gain Control Direction auto_gain_location	Defines the AGC direction (local or remote user). Note: This parameter appears only if the 'Enable Automatic Gain Control' check box is selected.
Target Energy auto_gain_target_energy	Defines the signal energy value (in dBm) that the AGC attempts to attain. The range is 0 to -63 dBm. The default value is -19 dBm. Note: This parameter appears only if the 'Enable Automatic Gain Control' check box is selected.
Jitter Buffer	
Minimum Delay min_delay	Defines the initial and minimal delay of the adaptive jitter buffer mechanism, which compensates for network problems. The value should be set according to the expected average jitter in the network (in milliseconds). The default is 35 msec.
Optimization Factor optimization_factor	Defines the adaptation rate of the jitter buffer mechanism. Higher values cause the jitter buffer to respond faster to increased network jitter. The default is 7.
Silence Compression	
Enable Silence Compression silence_compression_enable	Enables silence compression, which reduces the network bandwidth consumption. The default is disabled.
Enable G.711/G.726 Comfort Noise g711_g726_comfort_noise_enable	Enables the Comfort Noise generation feature. When enabled and silence is detected, the device transmits a series of parameters called Silence Information Descriptor (SID), which are used to reproduce the local background noise at the remote (receiving) side. Note: This parameter appears only if the 'Enable Silence Compression' check box is selected.
Echo Cancellation	
Enable Echo Cancellation echo_cancellation/enabled	Enables (default) echo cancellation (disabling echo cancellation should be done for testing purposes only).
Fax and Modem Settings	
Fax Transport Mode fax_transport_mode	Selects the way fax calls are handled: <ul style="list-style-type: none"> ✓ Transparent = Fax is transferred in-band (like a voice call) - can be used if the codec is G.711 ✓ T.38 Relay = Fax is relayed to the remote side according to the T.38 standard ✓ Voice Band Data = Switch to G.711 via SIP messaging ✓ Bypass = An automatic switch to AudioCodes' proprietary payload type (102, 103).

Parameter	Description
T38 Version t38_version	Defines the T38 version, Versions: 0, 1, 2, 3 Note: Default is Ver.3 = V.34 (Super G3 Fax, max rate 33,600 Kbps).
Max Rate max_rate	Defines the maximum fax rate. 2.4 Kbps, 4.8 Kbps, 7.2 Kbps, 9.6 Kbps, 12 Kbps or 14.4 Kbps, 33.6Kbps (default). Note: This parameter appears only if 'Fax Transport Mode' is set to 'T.38 Relay'.
Max Buffer max_buffer	Defines the maximum amount of T.38 data stored on the devices. The valid range is 128 to 2048. The default is 1024. Note: This parameter appears only if 'Fax Transport Mode' is set to 'T.38 Relay'.
Max Datagram max_datagram	Defines the maximum total size of TCP/UDPTL packets that can be received at the remote gateway. The valid range is 160 to 1020. The default is 320. Note: This parameter appears only if 'Fax Transport Mode' is set to 'T.38 Relay'.
Image Data Redundancy Level ImageDataRedundancyLevel	Defines the level for output Image Data (2400...14400 bps). <ul style="list-style-type: none"> ▪ 0 = No redundancy ▪ 1 to 3 = Redundancy level Note: This parameter appears only if 'Fax Transport Mode' is set to 'T.38 Relay'.
T30 Control Data Redundancy Level T30ControlDataRedundancyLevel	Defines the redundancy level for output T.30 Control Data (300 bps). <ul style="list-style-type: none"> ▪ 0 = No redundancy ▪ 1 to 7 = Redundancy level Note: This parameter appears only if 'Fax Transport Mode' is set to 'T.38 Relay'.
Fax Relay Jitter Buffer Delay FaxModemJitter	Defines the Fax Relay Jitter Buffer. <ul style="list-style-type: none"> ▪ 0 = Adaptive Jitter Buffer. The device sets the Jitter Buffer size automatically and then adapts it according to network conditions. ▪ 1 to 511 = Fixed Jitter Buffer size (in msec). Note: This parameter appears only if 'Fax Transport Mode' is set to 'T.38 Relay'.
Error Correction Mode error_coerrection_enable	Enables (default) fax error correction mode (ECM). Note: This parameter appears only if 'Fax Transport Mode' is set to 'T.38 Relay'.
Fax Bypass Payload Type fax_bypass_payload	Defines the payload type for fax in Bypass mode. Note: This parameter appears only if 'Fax Transport Mode' is set to 'Bypass'.

Parameter	Description
Modem Transport Mode fax_transport_mode	Selects the way modem calls are handled: <ul style="list-style-type: none"> Transparent = Data is transferred in-band (like a voice call). This can be used if the codec is G.711. Voice Band Data = Switch to G.711 via SIP messaging. Bypass = An automatic switch to AudioCodes' proprietary payload type (102, 103). Note: If the Fax transport mode is Bypass or VBD, it must match the Modem transport mode.
Modem Bypass Payload Type data_bypass_payload	Defines the payload type for modems in Bypass mode. Note: This parameter appears only if 'Modem Transport Mode' is set 'Bypass'.
Fax/Modem Bypass Codec fax_bypass_payload	Defines the codec for the VBD and Bypass modes. PCMA (default) or PCMU. G.711 64 kbps A-Law -OR- G.711 64 kbps u-Law
CED Transfer Mode ced_transfer_mode	<ul style="list-style-type: none"> By Fax Relay: When the device is the receiver side, Switch to Fax relay is enabled upon CED. This allows a high reliable fax-over-IP call establishment at the beginning of CED tone. In Voice Or PCM Bypass: When the device is the receiver side, to avoid possible conflicts with low-speed modems, the CED (ANS) relay by FoIP protocol may be disabled by setting the CED transfer mode to 'In Voice Or PCM Bypass'. In this case, the device does not initiate the Fax Relay on detecting CED tone in absence of CNG, but switches to VBD or remains in voice mode (depends on the Modem Transport Mode). the device switches to FoIP later when it defines exactly that a monitored call is the fax call (CED and CND or V.21 Preamble).
Enable CNG Detection cng_detection_enabled	Enables detection of the fax CNG signal. When the local fax machine connected to the device receives a fax, the device switches to T.38 fax relay upon detection of the CED signal from the local fax. If the local fax machine sends a fax, the device switches to T.38 only after detecting the CNG signal from the local side and the CED signal from the remote side. If this check box is selected, the device switches to T.38 relay immediately upon detection of the CNG signal from the local side, without waiting for the CED signal from the remote side. The default is disabled.
Switch to Fax only by the Answering Side update_fax_to_transparent_enable	When setting this parameter to "Enable", the device, as the fax sender, will not send a T.38 Re-Invite and will wait for the answering side to initiate the T.38 session.

The following is an example of the relevant Telnet parameters:

```
rg_conf/voip/audio/jitter_buffer/min_delay=35
rg_conf/voip/audio/jitter_buffer/optimization_factor=7
rg_conf/voip/audio/echo_cancellation/enabled=1
rg_conf/voip/audio/automatic_gain_control/auto_gain_enabled=0
```



```
rg_conf/voip/audio/automatic_gain_control/auto_gain_location=For Remote User
rg_conf/voip/audio/automatic_gain_control/auto_gain_target_energy=-19
rg_conf/voip/audio/silence_compression_enable=0
rg_conf/voip/audio/g711_g726_comfort_noise_enable=1
rg_conf/voip/audio/fax/max_buffer=1024
rg_conf/voip/audio/fax/max_datagram=320
rg_conf/voip/audio/fax/ImageDataRedundancyLevel=0
rg_conf/voip/audio/fax/T30ControlDataRedundancyLevel=0
rg_conf/voip/audio/fax/FaxModemJitter=0
rg_conf/voip/audio/fax/bypass_coder=PCMA
rg_conf/voip/audio/fax/ced_transfer_mode=by_fax_relay
rg_conf/voip/audio/fax/cng_detection_enabled=1
rg_conf/voip/audio/fax/remote_side_reinvite=0
rg_conf/voip/audio/fax/max_rate=14.4 Kbps
rg_conf/voip/audio/fax/error_coercorrection_enable=0
rg_conf/voip/audio/fax/fax_bypass_payload=102
rg_conf/voip/audio/fax/data_bypass_payload=103
rg_conf/voip/audio/fax/audio_startup_enabled=0
rg_conf/voip/audio/fax/fax_audio_start_payload=120
rg_conf/voip/audio/fax/fax_end_report=0
rg_conf/voip/audio/fax/fax_transport_mode=T.38Relay
rg_conf/voip/audio/fax/data_transport_mode=Bypass
rg_conf/voip/audio/fax/update_fax_to_transparent_enable=1
rg_conf/voip/audio/cng_tone_detection_frequency=1275
rg_conf/voip/audio/output_volume_upon_cng_detection=-16
rg_conf/voip/rtp_mute_on_hold=0
rg_conf/voip/comfort_noise_payload=13
```

9.7 Configuring Supplementary Services

The procedure below describes how to configure the services parameters.

➤ **To configure supplementary services:**

1. On the 'Voice Over IP' screen, click the **Services** tab; the following screen appears.

Figure 9-7: Services Tab Screen

The screenshot displays the 'Voice Over IP' configuration interface with the 'Services' tab active. The top navigation bar includes tabs for Signaling Protocol, Dialing, Media Streaming, Voice and Fax, **Services**, Line Settings, Extension Settings, Speed Dial, and Telephone Interface. The main content area is divided into several sections:

- Call Waiting:** Includes a checked 'Enabled' checkbox, a 'Call Waiting SIP Reply' dropdown menu set to 'Queued', and a checked 'Enable Caller ID Type II' checkbox.
- Call Forward:** Includes an unchecked 'Enabled' checkbox.
- Do Not Disturb:** Includes an unchecked 'Enabled' checkbox.
- 3 Way Conference:** Includes a checked 'Enabled' checkbox and a '3 Way Conference Mode' dropdown menu set to 'Local'.
- Message Waiting Indication:** Includes a checked 'Enabled' checkbox and an unchecked 'Subscribe To MWI' checkbox.
- General Parameters:** Includes a 'Stutter Tone Duration' text input field with '500' and 'milliseconds' label, and an 'Out of Service Behavior' dropdown menu set to 'Reorder Tone'.

At the bottom of the screen are three buttons: 'OK', 'Apply', and 'Cancel'.

2. Configure the parameters, as required. For a description of the parameters displayed on this screen, see [Table 9-8](#).
3. Click **OK** to save your settings.

Table 9-8: Services Tab Parameters Description

Parameter	Description
Call Waiting	
Enabled call_waiting/enabled	Enables the Call Waiting feature.
Call Waiting SIP Reply call_waiting/sip_reply	Defines the SIP response (180 Ringing or 182 Queued - default) sent when another call arrives while a call is in progress. Note: This parameter appears only if Call Waiting is enabled.
Enable Caller ID Type II call_waiting/type2_enabled	Enables caller ID of a waiting call (Called Caller ID type 2). Note: This parameter appears only if Call Waiting is enabled.
Call Forward	
Enabled call_forward/enabled	Enables call forwarding. The Call Forward feature permits a user to redirect incoming calls addressed to another number. The user's ability to originate calls is unaffected by Call Forward. Note: The Call Forward feature is functional only when the device is registered to a proxy.
Call Forward Type call_forward/cfw_type	Defines the type of call forwarding: <ul style="list-style-type: none"> ▪ Unconditional: Incoming calls are forwarded independently of the status of the endpoint. ▪ Busy: Incoming calls are forwarded only if the endpoint is busy, i.e., if all lines are active. ▪ No Reply: Incoming calls are forwarded only if the endpoint does not answer before a user-defined timeout (see 'Time for No Reply Forward' parameter). Note: This parameter appears only if Call Forward is enabled.
Time for No Reply Forward call_forward/cfnr_timeout	Defines the timeout after which the call is forwarded if the endpoint does not answer. If you specify 5 seconds, for example, and 'No Reply' is selected for parameter 'Call Forward Type' (see above), incoming calls are forwarded only after 5 seconds lapse. Note: This parameter is available only when 'No Reply' is selected for the parameter 'Call Forward Type'.
Key Sequence call_forward/sequence	Defines the key sequence to activate call forwarding. The default is *72 but users can modify to any sequence of up to 2 digits, i.e., *n or *nm.
Do Not Disturb	
Enabled do_not_disturb/enabled	Enables the Do Not Disturb (DND) feature. This feature allows you to prevent incoming calls from ringing at your phone. When enabled, callers receive a busy signal or an announcement. The DND is activated using the phone keypad. The default is disabled.
Key Sequence do_not_disturb/sequence	Defines the key sequence to activate and deactivate the DND feature.

Parameter	Description
3 Way Conference	
Enabled conference/enabled	[0] - Disabled [1] - Enabled {default}
3 Way Conference Mode conference/conf_mode	Selects how three-way conference calls are handled: <ul style="list-style-type: none"> ▪ Local: locally by the device ▪ Remote: by a remote media server (RFC 4240)
Media Server Address conference/conf_id	The address of the remote media server that handles conference calls. Note: This parameter is available only when 'Remote' is selected for the parameter '3 Way Conference Mode'.
Message Waiting Indication	
Enabled msg_waiting_ind/enabled	If a user has an unheard voice mail message, a stutter dial tone is heard when the user picks up the phone. In addition, the device generates an FSK signal to the phone to indicate that a message is waiting. If the telephone connected to the device supports this feature, an MWI 'envelope icon' is displayed.
Subscribe to MWI msg_waiting_ind/subscribe	Select this check box if you must register with a MWI subscriber server. If so, configure the three parameters below.
MWI Server IP Address or Host Name msg_waiting_ind/subscribe_ip	Defines the IP address or host name of the MWI server. Note: This parameter is available only when the check box 'Subscribe to MWI' is selected.
MWI Server Port msg_waiting_ind/subscribe_port	Defines the port number of the MWI server. Note: This parameter is available only when the check box 'Subscribe to MWI' is selected.
MWI Subscribe Expiration Time msg_waiting_ind/expiration_timeout	Defines the interval between registrations. Note: This parameter is available only when the check box 'Subscribe to MWI' is selected.
Auto Attendant	
Enabled	Enables/Disables the Auto Attendant feature.
Line	Enables line numbers as they appear in the Line Settings tab.
Input Timeout	Enables the time in seconds, from the beginning of the Auto Attendant message, until the conversation disconnects, if the user hasn't received any input. This field should be set to the length of the Auto Attendant message itself, plus a few seconds to allow the user to press the required extension or to repeat the message.
Greeting File	Defines the filename of the Auto Attendant message (.pcm).
General Parameters	
Stutter Tone Duration stutter_tone_dur	When you enable message waiting and an unheard message exists, a stutter tone is played to the phone for the duration configured by this parameter and/or when you activate the call forwarding feature (see Section 10.5 on page 108).

Parameter	Description
Out of Service Behavior out_of_service_behavior	Defines the tone which is played instead of a dial tone if the user configured a registrar IP and the registration failed. When the Reorder tone is selected, a Reorder tone is played instead of a dial tone. If "No Tone" is selected, then no tone is played.

The following is an example of the relevant Telnet parameters:

```
rg_conf/voip/services/hold/enabled=1
rg_conf/voip/services/transfer/enabled=1
rg_conf/voip/services/call_waiting/enabled=1
rg_conf/voip/services/call_waiting/type2_enabled=1
rg_conf/voip/services/call_waiting/sip_reply=Queued
rg_conf/voip/services/conference/enabled=1
rg_conf/voip/services/conference/conf_mode=Local
rg_conf/voip/services/conference/conf_ms_addr=0.0.0.0
rg_conf/voip/services/call_forward/enabled=0
rg_conf/voip/services/call_forward/cfnr_timeout=5
rg_conf/voip/services/call_forward/cfw_type=Unconditional
rg_conf/voip/services/call_forward/sequence=72
rg_conf/voip/services/call_forward/cfw_notifier_enabled=0
rg_conf/voip/services/do_not_disturb/enabled=0
rg_conf/voip/services/do_not_disturb/sequence=68
rg_conf/voip/services/msg_waiting_ind/enabled=1
rg_conf/voip/services/msg_waiting_ind/subscribe=0
rg_conf/voip/services/msg_waiting_ind/subscribe_port=8933
rg_conf/voip/services/msg_waiting_ind/subscribe_ip=voiproxy5.adpt-
tech.com
rg_conf/voip/services/msg_waiting_ind/expiration_timeout=30
rg_conf/voip/services/stutter_tone_dur=2500
rg_conf/voip/services/out_of_service_behavior=Reorder Tone
rg_conf/voip/services/restore_defaults/sequence=3228679
rg_conf/voip/services/restore_defaults/enabled=0
rg_conf/voip/services/blind_transfer/enabled=0
rg_conf/voip/call_waiting_enabled=1
```

9.7.1 Network-based Conferencing (RFC 4240)

A SIP device establishes a dialog with a conference bridge. The device then refers existing dialogs to the conference bridge, which then automatically mixes the parties as they are added to the bridge

To enable this functionality, the following parameters must be set:

```
rg_conf/voip/services/conference/enabled=1
rg_conf/voip/services/conference/conf_mode=Remote
rg_conf/voip/services/conference/conf_ms_addr=<conf_ID@server_
addr>
```

9.8 Voice Menu Guidance

The FXS voice menu can be used to query a current firmware version and query or modify basic network configuration parameters, using a standard touch-tone telephone connected to one of the FXS ports.

9.8.1 Configuring Voice Menu

The Voice menu can be configured using the Web interface or the CLI.

➤ **To configure Voice menu using the Web Interface:**

1. In the 'Voice over IP' screen, click the **Services** tab.
2. Under the 'Voice Menu' section, select the 'Enabled' option to enable the Voice Menu feature.
3. Set Password allows you to modify the WAN Ethernet network settings using the Voice Menu (Administrator level).
4. Click **OK**.

Figure 1-1: Voice Menu Configuration



➤ **To configure Voice Menu using the CLI:**

1. Open a Telnet connection to the MP-20x device (Default: **telnet 192.168.2.1**)
2. Log in with administrator privileges (Default: **admin/admin**)
3. Run the following commands under the **MP20x>** prompt:

```
conf set /voip/services/voice_menu/enabled 1
conf set_obscure voip/services/voice_menu/password <password>
conf reconf 1
```

9.8.1.1 Voice Menu Configuration Parameters

Table 1-1: Voice Menu Configuration Parameters

The table below lists the configuration parameters that can be viewed and modified using the voice menu:

Item Number at Menu Prompt	Description
1	WAN IP address
2	Subnet Mask
3	Default Gateway IP address
4	Current firmware version

9.8.1.1.1 Playing current WAN IP address/Subnet Mask/GW and firmware:

1. Connect a telephone to one of the FXS ports.
2. Lift the handset and dial ******** (three stars).

3. Wait for the 'Configuration Menu' voice prompt to be played.
- **To play the IP address:**
 - a. Press **1** followed by the pound key (**#**); the current IP address of the device is played.
 - b. Press the **#** key to return to the main menu.
- **To play the Subnet Mask:**
 - a. Press **2** followed by the **#** key; the current subnet mask of the device is played.
 - b. Press the **#** key to return to the main menu.
- **To play the Default Gateway:**
 - a. Press **3** followed by the **#** key; the current default gateway of the device is played.
 - b. Press the **#** key to return to the main menu.
- **To play the firmware version:**
 - a. Press **4** followed by the **#** key; the current firmware version of the device is played.
 - b. Press the **#** key to return to the main menu.

9.8.1.1.2 Modifying WAN Ethernet IP settings

1. Connect a telephone to one of the FXS ports.
2. Lift the handset and dial *****<password>#** (three stars followed by admin password, and pound key, #).
3. Wait for the 'Configuration Menu' voice prompt to be played.
- **To change the IP address:**
 - a. Press **1** followed by the pound key (**#**); the current IP address of the device is played.
 - b. Press the pound key (**#**) to modify;
 - c. Dial the new IP address, using the star (*****) key instead of periods (**.**), e.g., 192*168*0*4, and then press **#** to finish.
 - d. Review the new IP address, and then press **1** to save.
- **To change the Subnet Mask:**
 - a. Press **2** followed by the **#** key; the current subnet mask of the device is played.
 - b. Press the pound key (**#**) to modify;
 - c. Dial the new subnet mask (e.g., 255*255*0*0), and then press **#** to finish.
 - d. Review the new subnet mask, and then press **1** to save.
- **To change the Default Gateway:**
 - a. Press **3** followed by the **#** key; the current default gateway of the device is played.
 - b. Press the pound key (**#**) to modify;
 - c. Dial the new default gateway (e.g., 192*168*1*1), and then press **#** to finish.
 - d. Review the new default gateway, and then press **1** to save.
 - e. Hang up (on-hook) the handset.

9.9 Configuring Micro PBX Line Settings

Before you can make phone calls, you need to configure lines. Lines are logical SIP ID numbers (i.e., telephone numbers) which are registered to a SIP proxy server and for which you are charged for calls you make on it.

With a micro PBX line setting configuration, you can associate any phone extension to any line.

- When you receive an incoming call, all the registered extensions on the line ring, and you can answer from any one of them. When you do answer, the other extensions stop ringing.
- If you receive another incoming call when you already have an established call on one extension, all the idle extensions ring, and the busy extension hears a call waiting tone.
- You can make outgoing calls from any of the extensions, using the first line of this extension.
- You can make multiple concurrent calls (i.e., each extension makes a call to a different destination and at the same time).



Notes:

- You can perform call hold, call transfer, and three-way conferencing between the internal extensions.
- Each SIP account (proxy) supports up to four concurrent calls.
- The device supports up to two concurrent HD VoIP conversations when using the G.722 or AMR-WB coders.

➤ **To configure lines:**

1. On the 'Voice Over IP' screen, click the **Line Settings** tab; the following screen appears.

Figure 9-8: Line Settings Tab Screen



2. For each line, click the corresponding **Edit**  icon to configure the line; the following screen appears:

Figure 9-9: Line Settings Screen for a New Line

Line Settings

Line Number:	2
User ID:	000000002
<input type="checkbox"/> Block Caller ID	
Display Name:	Line 2
Extensions Registered:	

SIP Proxy

Authentication User Name:	
Authentication Password:	

Advanced Line Parameters

<input checked="" type="checkbox"/> Enable Supplementary Services

The screen displays the following read-only information:

- **Line Number:** Line number
 - **Extensions Registered:** Extensions registered to this line
3. In the 'User ID' field, enter phone's VoIP user ID used for identification to initiate and accept calls.
 4. To hide the phone's ID from the remote party, select the 'Block Caller ID' check box.
 5. In the 'Display Name' field, enter a name to intuitively identify the line. This is also displayed to remote parties as your caller ID.
 6. Under the **SIP Proxy** group, define the SIP proxy server:
 - a. In the 'Authentication User Name' field, enter the user name received from your VoIP service provider. This is used when sending a response to Unauthorized or Proxy Authentication Requested (401/407).
 - b. In the 'Authentication Password' field, enter the password received from your VoIP service provider. This is used when sending a response to Unauthorized or Proxy Authentication Requested (401/407).
 7. In the 'Line Voice Volume' field, enter the voice volume of the line (i.e., the gain from the network toward the local phone). The default is 0 dB.
 8. To enable supplementary services on this line, select the 'Enable Supplementary Services' check box.
 9. To enable automatic dialing (which automatically dials a user-defined phone number when the line is off-hooked longer than a user-defined time), do the following:
 - a. Select the 'Enable Automatic Dialing' check box.
 - b. In the 'Automatic Dialing Timeout' field, enter the time after which automatic dialing is activated if the user has not started dialing before this timeout. When set to 0, automatic dialing is performed immediately.
 - c. In the 'Automatic Dialing Destination' field, enter the destination that is automatically dialed. This can be a phone number or a domain name (for example, user@101.10.13.2 or user@domain name).
 10. Click **OK** to save your settings.

Table 9-8: Services Tab Parameters Description

Parameter	Description
Enabled line/x/enabled	Enables the relevant line (x=0,1).
Line Number id	Defines the Line number.
CID snd_callerid	Sends the Caller ID (CID) to the remote side.
Line Name description	Describes the line name in words.
Relating physical ext. to SIP user line/0/extensions/ext_0	If Enabled, relates FXS1 to 1 st SIP user
Relating physical ext. to SIP user line/0/extensions/ext_1	If Enabled, relates FXS2 to 1 st SIP user
Relating physical ext. to SIP user line/1/extensions/ext_0	If Enabled, relates FXS1 to 2 nd SIP user
Relating physical ext. to SIP user line/1/extensions/ext_1	If Enabled, relates FXS2 to 2 nd SIP user
SIP User auth_name	Defines the SIP username.
SIP Password auth_password	Defines the SIP password.

The following is an example of the relevant Telnet parameters:

```
rg_conf/voip/line/0/enabled=1
rg_conf/voip/line/0/id=0000000001
rg_conf/voip/line/0/snd_callerid=1
rg_conf/voip/line/0/description=Line 1
rg_conf/voip/line/0/extensions/ext_0=1
rg_conf/voip/line/0/extensions/ext_1=0
rg_conf/voip/line/0/auth_name=0000000001
rg_conf/voip/line/0/auth_password=&97;iS&81;d&ec;&1f
rg_conf/voip/line/1/enabled=1
rg_conf/voip/line/1/id=0000000002
rg_conf/voip/line/1/snd_callerid=1
rg_conf/voip/line/1/description=Line 2
rg_conf/voip/line/1/extensions/ext_0=0
rg_conf/voip/line/1/extensions/ext_1=1
rg_conf/voip/line/1/auth_name=0000000002
rg_conf/voip/line/1/auth_password=&97;iS&81;d&ec;&1f
```

9.10 Configuring Line Extensions

Extensions are the physical telephony extensions on the device. These can be FXS ports (for analog POTS telephones). Once you have defined these lines, you can do the following:

- Define an arbitrary name for each extension (to help you identify the extension).
- Activate registration of the lines with the proxy server



Notes:

To verify successful registration with a SIP proxy server, you can check the following indications:

- The Phone LED is lit green
- On the Voice over IP tab screen (System Monitoring menu), the 'SIP Registration' field displays "Registered" for the configured lines (see Section 21.3.4 on page 334).

➤ To configure line extensions:

1. On the 'Voice Over IP' screen, click the **Extension Settings** tab; the following screen appears.

Figure 9-10: Extension Settings Tab Screen

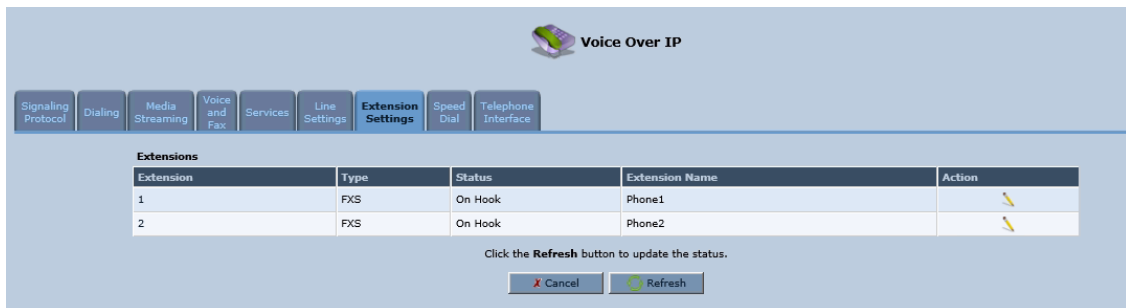

2. For each line extension, click the corresponding **Edit** icon to define a name for the extension; the following screen appears:

Figure 9-11: Extension Settings Screen

Extension Number:	1
Extensions Type:	FXS
Associated With Lines:	John
Extension Name:	<input type="text" value="FXS-1-John"/>

3. Click **OK** to save your settings.

The following is an example of the relevant Telnet parameters:

```

rg_conf/voip/extension/0/enabled=1
rg_conf/voip/extension/0/name=Phone1
rg_conf/voip/extension/0/type=FXS
rg_conf/voip/extension/0/supplementary_services=1
rg_conf/voip/extension/0/auto_dialing/enabled=0
rg_conf/voip/extension/0/auto_dialing/timeout=5
rg_conf/voip/extension/0/auto_dialing/destination=NULL
rg_conf/voip/extension/0/line_voice_volume=0
rg_conf/voip/extension/0/line_input_voice_volume=0
rg_conf/voip/extension/0/slic_gain/rx=0
rg_conf/voip/extension/0/slic_gain/tx=0
rg_conf/voip/extension/0/lines/line_0=1
rg_conf/voip/extension/0/lines/line_1=0
rg_conf/voip/extension/1/enabled=1
rg_conf/voip/extension/1/name=Phone2
rg_conf/voip/extension/1/type=FXS
rg_conf/voip/extension/1/supplementary_services=1
rg_conf/voip/extension/1/auto_dialing/enabled=0
rg_conf/voip/extension/1/auto_dialing/timeout=5
rg_conf/voip/extension/1/auto_dialing/destination=NULL
rg_conf/voip/extension/1/line_voice_volume=0
rg_conf/voip/extension/1/line_input_voice_volume=0
rg_conf/voip/extension/1/slic_gain/rx=0
rg_conf/voip/extension/1/slic_gain/tx=0
rg_conf/voip/extension/1/lines/line_0=0
rg_conf/voip/extension/1/lines/line_1=1
  
```

9.11 Configuring Speed Dialing

Use the 'Speed Dial Settings' screen to associate a called party's contact parameters (including the IP address of his/her ATA and Line ID) with a number that you'll dial to call the called part. The number of speed-dialing codes that can be defined is unlimited. Use the screen to define a destination type: Proxy, Local Line or Direct Call.



Note: When connecting the device to a World-Wide SIP Server, you don't need to configure 'Speed Dial Settings'.

➤ **To configure speed dialing:**

1. On the 'Voice Over IP' screen, click the **Speed Dial** tab; the following screen appears:

Figure 9-12: Speed Dial Tab Screen

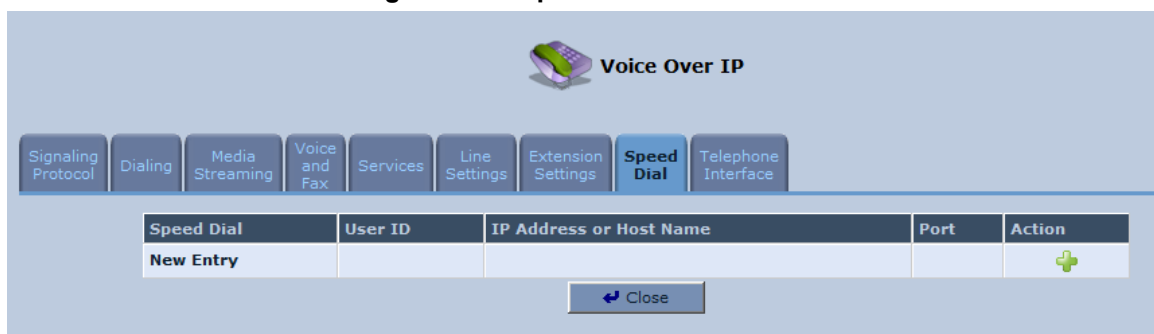

2. Click the **New**  icon; the 'Speed Dial Settings' screen appears.

Figure 9-13: Speed Dial Settings Screen (Proxy Destination)

3. In the 'Speed Dial' field, enter the shortcut number (i.e., speed dial) which you dial to call the party defined below.
4. From the 'Destination' drop-down list, select the destination type.
 - **Proxy:** If you select this option (as shown in the figure above), then in the 'User ID' field, enter the user ID to call.
 - **Local Line:** If you select this option, then from the 'Line' drop-down list, select the configured local line on your device.

Figure 9-14: Speed Dial Settings Screen (Local Line Destination)

The screenshot shows the 'Speed Dial Settings' interface for a local line destination. It features a header with a telephone icon and the title 'Speed Dial Settings'. Below the header are three rows of settings:

Speed Dial:	<input type="text"/>
Destination:	Local Line ▼
Line:	4001 (John) ▼

- **Direct Call:** if you select this option, then configure the following:
 - a. In the 'User ID' field, enter the user ID to call.
 - b. In the 'IP Address or Host Name' field, enter the remote party's IP address or host name.
 - c. In the 'Port' field, enter the SIP UDP or TCP port of the remote party.

Figure 9-15: Speed Dial Settings Screen (Direct Call Destination)

The screenshot shows the 'Speed Dial Settings' interface for a direct call destination. It features a header with a telephone icon and the title 'Speed Dial Settings'. Below the header are five rows of settings:

Speed Dial:	227 <input type="text"/>
Destination:	Direct Call ▼
User ID:	227 <input type="text"/>
IP Address or Host Name:	10.16.2.26 <input type="text"/>
Port:	5060 <input type="text"/>

5. Click **OK** to save your settings.

9.12 Enabling Polarity Reversal

The procedure below describes how to enable polarity reversal. When this feature is enabled, the analog port (FXS) interface polarity is reversed to indicate the start of a VoIP session, and is reversed back when the VoIP session ends.

➤ **To enable polarity reversal:**

1. On the 'Voice Over IP' screen, click the **Telephone Interface** tab; the following screen appears:

Figure 9-16: Telephone Interface Tab Screen

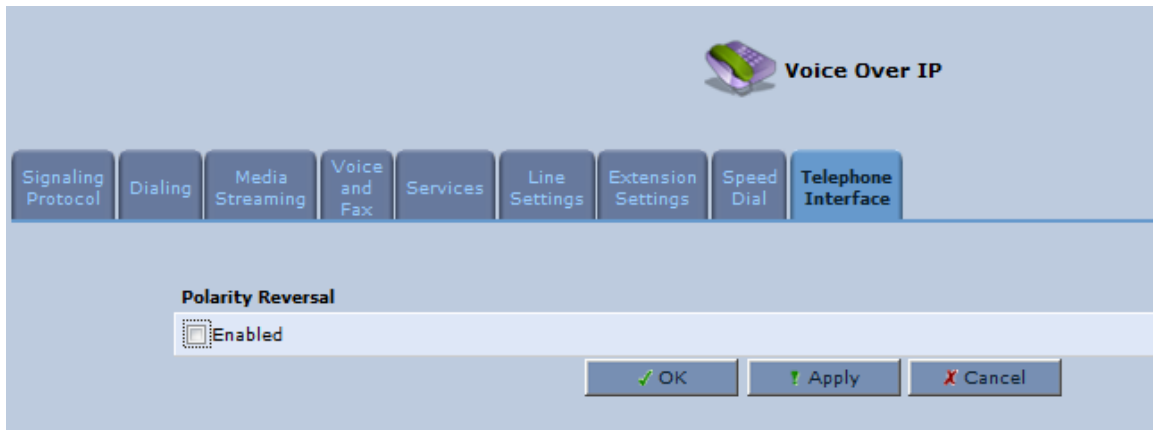

2. Select the 'Enabled' check box to enable the Polarity Reversal feature.
3. Click **OK** to apply your settings.

This page is intentionally left blank.

10 Making VoIP Calls with your Analog Telephones

Analog telephone users that are connected to the device can place calls, put calls on hold, transfer calls, and establish three-way conferences. The procedures below describe how to perform these operations.

10.1 Making a Call

The procedure below describes how to make a call.

➤ **To make a call:**

1. Pick up the phone.
2. Make sure that you can hear a dial tone.
3. Dial the remote party's number or the user-defined speed dial number (if configured in Section 9.11 on page 101).



Note: When calling another internal extension, dial “**0” for FXS1, “**1” for FXS2, “**2”.

10.2 Answering a Waiting Call

The procedure below describes how to answer a waiting call. This depends on how you configured the flash-hook functionality, using the 'Flash keys sequence style' parameter in Section 9.3 on page 74. To enable call waiting, see Section 9.7 on page 90.

➤ **To answer a waiting call when 'Flash only' is set:**

1. When you hear a call waiting tone (during a call), press the flash key button on your phone; the active call is put on hold and switches to the waiting call.
2. To return to the original call, press the flash button again. You can toggle from one party to another by pressing the flash button.

➤ **To answer a waiting call when 'Flash + digits sequence' is set:**

3. When you hear the call waiting tone (during a call), press the flash key button on your phone and then press the '1' key; the original call is put on hold and switches to the waiting call.
4. To return to the original call, press flash + 1 again. You can toggle from one party to another by pressing flash + 1.

10.3 Putting a Call on Hold

The procedure below describes how to put a call on hold. This depends on how you configured the flash-hook functionality, using the 'Flash keys sequence style' parameter in Section 9.3 on page 74.

➤ **To put the remote party on hold when 'Flash only' is set:**

- During a call, press the flash key button on your phone; a dial tone is heard. At this point you can initiate a second call by dialing another party's number.



Note: If you press the flash key button again before the second party answers, the call is established with the original call. If, however, the second party answers and you press the flash key button, a 3-way conference is established.

➤ **To put the remote party on hold when 'Flash + digits sequence' is set:**

1. Press the flash key button key and then press the '1' key on your phone; the phone plays a dial tone. At this point you can initiate a second call by dialing another party's number.
2. To cancel the hold state and resume the previous phone call, press the flash key button and then press '1'.

10.4 Transferring a Call

The procedure below describes how to transfer an established call to another destination. This depends on how you configured the flash-hook functionality, using the 'Flash keys sequence style' parameter in Section 9.3 on page 74.

➤ **To transfer a call when 'Flash only' is set:**

1. During a call with party B, press the flash key button on your phone; party B is placed on hold and a dial tone is heard.
2. Dial party C's number.
3. You can wait for C to answer or not.
4. On-hook your phone; party B is now transferred to party C.

➤ **To transfer a call when 'Flash + digits sequence' is set:**

1. During a call with party B, press the flash key button and then press the '1' key on the phone; party B is placed on hold and a dial tone is heard.
2. Dial party C's number.
3. You can wait for C to answer or not.
4. Press the flash key button key and then press '2'; party B is transferred to party C (and a warning tone is heard).

10.5 Forwarding Calls to another Phone

The procedure below describes how to automatically forward incoming (received) calls to another phone. Before you can forward calls, you need to enable and configure call forwarding as described in Section 9.7 on page 90.



Note: The Call Forward feature is functional only when the device is registered to a proxy.

➤ **To forward calls to another phone:**

1. Pick up the phone and make sure that you can hear a dial tone.
2. Dial the call forward key sequence (according to your configuration), for example, *32; a dial tone is heard.
3. Dial the number of the phone to where you want calls forwarded; a stutter tone is heard.
4. Replace the receiver; all incoming calls are forwarded. Every time you pick up the phone receiver, a stutter tone is played (for the length of time, as you configured for the 'Stutter Tone Duration' parameter).

➤ **To deactivate call forwarding:**

1. Pick up the phone; a stutter tone is heard.
2. Dial the call forward key sequence.
3. Replace the receiver.
4. To make sure that call forwarding has been de-activated, pick up the phone again; a regular dial tone should be heard (not the stutter tone).

10.6 Establishing a 3-Way Conference Call

The procedure below describes how to establish a 3-way conference call. The method for doing this depends on how you configured the flash-hook functionality, using the 'Flash keys sequence style' parameter in Section 9.3 on page 74. In addition, to configure 3-way conferencing, see Section 9.7 on page 90.

➤ **To establish a 3-way conference call when 'Flash only' is set:**

1. During a call with party B, press the flash key button on your phone; Party B is placed on hold and a dial tone is heard.
2. Dial party C's number and wait until the call is established.
3. Press the flash key button again to add parties B and C to a 3-way conference call.
4. To end the 3-way conference call, on-hook your phone (or alternatively, press the flash key button again).

➤ **To establish a 3-way conference call when 'Flash + digits sequence' is set:**

1. During a call with party B, press the flash key button on your phone and then press the '1' key; Party B is placed on hold and a dial tone is heard.
2. Dial party C's number and wait until the call is established.
3. Press the flash key button and then press the '3' key to add B and C to a 3-way conference call.
4. To end the 3-way conference call, on-hook your phone (or alternatively, press the flash key button and then press the '3' key).

11 Quality of Service

Network-based applications and traffic are growing at a high rate, producing an ever-increasing demand for bandwidth and network capacity. For obvious reasons, bandwidth and capacity cannot be expanded infinitely, requiring that bandwidth-demanding services be delivered over existing infrastructure, without incurring additional, expansive investments.

The next logical means of ensuring optimal use of existing resources are Quality of Service (QoS) mechanisms for congestion management and avoidance. QoS refers to the capability of a network device to provide better service to selected network traffic. This is achieved by shaping the traffic and processing higher priority traffic before lower priority traffic.

As QoS is dependent on the "weakest link in the chain", failure of but a single component along the data path to assure priority packet transmission can easily cause a VoIP call or a Video on Demand (VoD) broadcast to fail miserably. QoS must therefore obviously be addressed end-to-end.

The following are the potential bottleneck areas that need be taken into consideration when implementing an end-to-end QoS-enabled service.

- **The Local Area Network:** LANs have finite bandwidth, and are typically limited to 100 Mbps. When given the chance, some applications consume all available network bandwidth. In business networks, a large number of network-attached devices can lead to congestion.
- **The Broadband Router:** All network traffic passes through and is processed by the broadband router. It is therefore a natural focal point for QoS implementation. Lack of sufficient buffer space, memory or processing power, and poor integration among system components can result in highly undesirable real-time service performance. The only way to assure high QoS is the use of proper and tightly-integrated router operating system software and applications, which can effectively handle multiple real-time services simultaneously.
- **The Broadband Connection:** Typically, the most significant bottleneck of the network, this is where the high-speed LAN meets limited broadband bandwidth. Special QoS mechanisms must be built into routers to ensure that this sudden drop in connectivity speed is taken into account when prioritizing and transmitting real-time service-related data packets.
- **The Internet:** Internet routers typically have a limited amount of memory and bandwidth available to them, so that congestions may easily occur when links are over-utilized, and routers attempt to queue packets and schedule them for retransmission. One must also consider the fact that while Internet backbone routers take some prioritization into account when making routing decisions, all data packets are treated equally under congested conditions.



Note: For recommended QoS configuration see Section [11.7](#) on page [125](#).

11.1 QoS Wizard

The QoS wizard allows you to configure your QoS parameters according to predefined profiles, with just a few clicks. A chosen QoS profile automatically defines QoS rules, which you can view and edit in the rest of the QoS tab screens.

The QoS wizard also allows you to define the WAN bandwidth.

➤ **To use the QoS Wizard:**

1. From the menu bar, click the **QoS** menu link; the 'Quality of Service' screen appears with the **QoS Wizard** tab selected by default.

Figure 11-1: QoS Wizard Tab Screen



2. Define bandwidth limitation. From the 'WAN Devices Bandwidth (Rx/Tx)' drop-down list, select 'User Defined' if you want to define specific Rx and Tx bandwidth limitations, or select the Rx/Tx optional values provided in the drop-down list.
3. In the **QoS Profiles** group, select a QoS profile.
4. Click **OK**.



Note: Selecting a new QoS profile deletes all previous QoS settings

11.2 Configuring Traffic Shaping

Traffic Shaping is the solution for managing and avoiding congestion where a high speed LAN meets limited broadband bandwidth. A user may have, for example, a 100 Mbps Ethernet LAN with a 100 Mbps WAN interface router. The router may communicate with the ISP using a modem with a bandwidth of 2 Mbps. This typical setup makes the modem, having no QoS module, the bottleneck. The router sends traffic as fast as it is received, while its well-designed QoS algorithms are left unused. Traffic shaping limits the bandwidth of the router, artificially forcing the router to be the bottleneck.

A traffic shaper is essentially a regulated queue that accepts uneven and/or bursty flows of packets and transmits them in a steady, predictable stream so that the network is not overwhelmed with traffic.

While Traffic Priority allows basic prioritization of packets, Traffic Shaping provides more sophisticated definitions such as:

- Bandwidth limit for each device
- Bandwidth limit for classes of rules
- Prioritization policy
- TCP serialization on a device

You can also define QoS traffic shaping rules for a default device. These rules are used on a device that has no definitions of its own. This enables the definition of QoS rules on Default WAN, for example, and their maintenance even if the PPP or bridge device over the WAN is removed.

The device also supports dynamic traffic shaping during a call. Traffic shaping is critical in residential VoIP gateways because of the bottleneck created in Cable modem/fiber transceiver, mainly in the upload direction. Dynamic traffic shaping ensures a minimum bandwidth for VoIP calls. Without dynamic traffic shaping, traffic shaping limits the bandwidth at all times, even if the user is not making a VoIP call and therefore, the service provider needs to configure the QoS traffic shaping transmit (Tx) bandwidth according to the user's specific upload bandwidth. Configuring a lower value results in a lower upload bandwidth (not only during VoIP calls).

Dynamic traffic shaping enables the service provider to configure two upload traffic shaping bandwidth parameters:

- "Tx Bandwidth" - for all traffic
- "Tx Bandwidth during Call" - for VoIP calls

The device normally uses the "Tx Bandwidth" value. When the user makes a VoIP call (i.e. any phone/s connected to the device is ringing or off-hook), the device switches to use the "Tx Bandwidth during Call" value.

11.2.1 Configuring Traffic Shaping

The procedure below describes how to configure traffic shaping.

➤ **To add a traffic shaping device:**

1. From the menu bar, click the **QoS** menu, and then click the **Traffic Shaping** tab.

Figure 11-2: Quality of Service – Traffic Shaping Screen



2. Click the **New**  icon; the 'Add Device Traffic Shaping' screen appears.

Figure 11-3: Add Device Traffic Shaping Screen



3. From the 'Device' drop-down list, select the device for which you want to shape traffic. The list includes all interfaces (e.g., All LAN Devices, All WAN Devices) and VPNs such as PPOE or PPTP (if defined). For example, select 'WAN Ethernet', and then click **OK**; the 'Edit Device Traffic Shaping' screen appears.

Figure 11-4: Edit Device Traffic Shaping Screen



Edit Device Traffic Shaping



Device: WAN Ethernet

Tx Traffic Shaping

Tx Bandwidth: Specify Kbps

TCP Serialization: Disabled

Queue Policy: Class Based

Class ID	Name	Priority	Bandwidth		Status	Action
			Reserved	Maximum		
default	default	4	0 Kbps	Unlimited	Active	
New Entry 						

Enable Dynamic Traffic Shaping

Rx Traffic Policing

Rx Bandwidth: Specify Kbps

Queue Policy: Policer

Class ID	Name	Bandwidth		Status	Action
		Reserved	Maximum		
New Entry 					

4. Under the **Tx Traffic Shaping** group, from the 'Tx Bandwidth' drop-down list, select 'Specify' and define the device's maximum transmission bandwidth rate in the corresponding field. The purpose is to limit the bandwidth of the WAN interface to that of the weakest outbound link. This forces the device to be the network bottleneck, where sophisticated QoS prioritization can be performed. If the device's bandwidth is not limited correctly, the bottleneck is an unknown router or modem on the network path, rendering the device QoS useless. To configure unlimited bandwidth, select 'Unlimited'.
5. Under the **Rx Traffic Policing** group, from the 'Rx Bandwidth' drop-down list, select 'Specify' and define the device's maximum receive bandwidth rate in the corresponding field. This limits the device's bandwidth receipt rate to that of the Cable modem/fiber transceiver.
6. From the 'TCP Serialization' drop-down list, select whether to enable TCP serialization. The screen refreshes, displaying the 'Maximum Delay' field. This allows you to define the maximum allowed transmission time frame (in milliseconds) of a single packet. Any packet that requires a longer time to be transmitted is fragmented to smaller sections. This avoids transmission of large, bursty packets that may cause delay or jitter for real-time traffic such as VoIP.
7. Select the 'Enable Dynamic Traffic Shaping' check box if you want to configure traffic shaping specifically for VoIP calls (see Section 11.2 on page 111). When selected, the 'Tx Bandwidth During VoIP Call' field appears. Enter the bandwidth for VoIP calls. The device normally uses the "Tx Bandwidth" parameter value. When the user makes a VoIP call (i.e. any phone connected to the device is ringing or off-hook), the device switches to use the "Tx Bandwidth during Call" parameter value.

11.2.2 Configuring Shaping Classes

The bandwidth of a device can be divided to reserve constant portions of bandwidth to user-defined traffic types. Such a portion is known as a *Shaping Class*. When not used by its user-defined traffic type or owner (for example, VoIP), the class is then available to all other traffic. However, when needed, the entire class is reserved solely for its owner. Moreover, you can limit the maximum bandwidth that a class can use even if the entire bandwidth is available.

When a shaping class is defined for a specific traffic type, two shaping classes are created. The second class is the 'Default Class', responsible for all the packets that do not match the defined shaping class or any other classes that may be defined on the device. This can be viewed in the Class Statistics screen.

➤ **To add a shaping class:**



1. From the menu bar, click the **QoS** menu, and then click the **Traffic Shaping** tab.
2. Click the **Edit**  icon corresponding to the added Device (e.g., WAN); the 'Edit Device Traffic Shaping' screen appears.
3. Under the **Tx Traffic Shaping** group, click the **New**  icon; the 'Add Shaping Class' screen appears.

Figure 11-5: Add Shaping Class Screen



4. In the 'Name' field, enter a name for the class, and then click **OK**; the 'Edit Device Traffic Shaping' screen appears.
5. Edit the newly added shaping class, by clicking the corresponding **Edit**  icon; the 'Edit Shaping Class' screen appears.

Figure 11-6: Edit Shaping Class

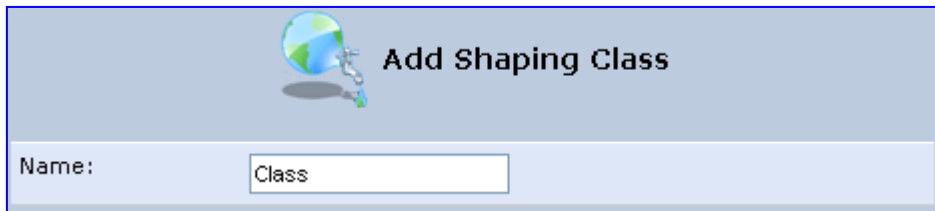

6. In the 'Name' field, modify the class name, if required.
7. From the 'Class Priority' drop-down list, select the priority level for the class, where zero is the highest and seven the lowest.

8. In the 'Bandwidth' field, define the bandwidth for the class:
 - **Reserved:** reserved (i.e., guaranteed) bandwidth (Committed Information Rate / CIR) in kbps.
 - **Maximum:** specify the maximum bandwidth
9. From the 'Policy' drop-down list, select the policy for routing packets within the class:
 - **Priority:** Priority queuing uses multiple queues so that traffic is distributed among queues based on priority. This priority is defined according to packet priority, which can be defined explicitly by a DSCP value or an 802.1p value.
 - **FIFO:** First In First Out. This priority queue ignores any previously-marked packet priority.
 - **Fairness:** The fairness algorithm ensures no starvation by granting all packets a certain level of priority.
 - **RED:** Random Early Detection. Utilizes statistical methods to drop packets in a 'probabilistic' way before queues overflow. Dropping packets in this way slows a source down enough to keep the queue steady and reduces the number of packets that would be lost when a queue overflows and a host is transmitting at a high rate.
10. From the 'Schedule' drop-down list, select the scheduler rule (defined in Section 5.6.1 on page 49) that defines the time segments during which the class can be active. By default, the class is always active.
11. Click **OK** to save your settings.

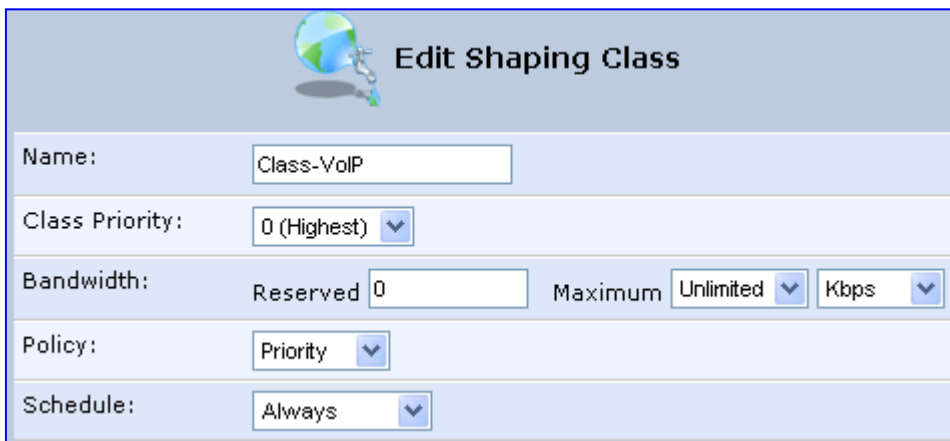
11.2.2.1 Class Rules

Class rules define which packets belong to the class. Without class rules, the shaping class has no effect. Each class can have outbound and inbound rules for outgoing and incoming traffic respectively. For example, you can define that all outgoing packets from computer A in your LAN belong to your VoIP class. These packets are limited to the class settings (bandwidth, schedule, etc.). In addition, you can define the traffic protocol and priority for each rule (this is not mandatory as in Traffic Priority rules).

11.2.2.1.1 Inbound and Outbound Data

The device can control outgoing data easily. It can queue packets, delay them, give precedence to other packets, or drop them. This helps in resolving upload (Tx) traffic bottlenecks and in most cases is sufficient. However, in the case of download (Rx) traffic bottlenecks, the ability to control the flow is much more limited. The device cannot queue packets, since in most cases the LAN is much faster than the WAN and when the device receives a packet from the WAN, it passes it immediately to the LAN.

QoS for ingress data has the following limitations, which do not exist for outgoing data:

- QoS can only be applied to TCP streams (UDP streams cannot be delayed)
- No borrowing mechanism
- When reserving Rx bandwidth, it is strictly taken from the bandwidth of all other classes

In addition, the device cannot control the behavior of its WAN (usually the ISP), which may not have proper QoS handling. Let's look at a scenario of downloading a large file and surfing the Internet at the same time. Downloading the file is distinguished by small requests, followed by very large responses. This may result in blocking HTML traffic at the ISP. A solution for such a scenario is limiting the bandwidth of low-priority TCP connections (such as file download).

To add outbound and inbound class rules, see [11.3](#) on page [117](#).



Note: The hierarchy of the class rules is determined by the order of their addition to the class. For example, if your first rule is match packets with any source address, any destination address, and any protocol to this class; then all packets traversing the device are associated with the specific class. Any rules defined later do not have any effect.

11.3 Configuring Traffic Priority

Traffic Priority allows you to manage and avoid traffic congestion by defining inbound and outbound priority rules for each device on your gateway. These rules determine the priority assigned to packets traveling through the device. QoS parameters (DSCP marking and packet priority) are set per packet, on an application basis.

You can set QoS parameters using flexible rules, according to the following parameters:

- Source/destination IP address, MAC address or host name
- Device
- Source/destination ports
- Limit the rule to specific days and hours

The device supports two priority marking methods for packet prioritization:

- DSCP
- 802.1p Priority

The matching of packets by rules is connection-based, known as Stateful Packet Inspection (SPI), using the same connection-tracking mechanism used by the firewall. Once a packet matches a rule, all subsequent packets with the same attributes receive the same QoS parameters, both inbound and outbound.

A packet can match more than one rule, and therefore:

- The first class rule has precedence over all other class rules (scanning is stopped once the first rule is reached).
- The first traffic-priority (classless) rule has precedence over all other traffic-priority rules.
- There is no prevention of a traffic-priority rule conflicting with a class rule. In this case, the priority and DSCP setting of the class rule (if given) takes precedence.

Connection-based QoS also allows inheriting QoS parameters by some of the applications that open subsequent connections. For instance, you can define QoS rules on SIP and the rules then apply to both control and data ports (even if the data ports are unknown). This feature applies to all applications that have ALG at firewall:

- Any
- User Defined (FTP, HTTP, HTTPS, TFTP, IMAP, PING, POP3, SMTP, Telnet, Traceroute or any other protocol)

- **To set traffic priority rules:**
- 1. From the menu bar, click the **QoS** menu, and then select the **Traffic Priority** tab; the 'Traffic Priority' screen appears.

Figure 11-7: Traffic Priority Screen

QoS Input Rules

Rule ID	Source Address	Destination Address	Match	Operation	Status	Action
All Devices						New Entry
WAN Ethernet Rules						New Entry
LAN Hardware Ethernet Switch Rules						New Entry
LAN Bridge Rules						New Entry
LAN Ethernet Rules						New Entry
LAN Wireless 802.11n Access Point Rules						New Entry
Serial PPP Rules						New Entry

QoS Output Rules

Rule ID	Source Address	Destination Address	Match	Operation	Status	Action
All Devices						New Entry
WAN Ethernet Rules						New Entry
LAN Hardware Ethernet Switch Rules						New Entry
LAN Bridge Rules						New Entry
LAN Ethernet Rules						New Entry
LAN Wireless 802.11n Access Point Rules						New Entry
Serial PPP Rules						New Entry

This screen is divided into two identical groups - 'QoS Input Rules' and 'QoS Output Rules' - for prioritizing inbound and outbound traffic respectively. Each group lists all the devices on which rules can be set. You can set rules on all devices at once by clicking the **New Entry** link corresponding to 'All Devices'

- 2. After clicking the appropriate **New Entry** link, the 'Add Traffic Priority Rule' screen appears.

Figure 11-8: Add Traffic Priority Rule Screen

Add Traffic Priority Rule

Matching

Source Address: Any

Destination Address: Any

Protocol: Any

DSCP

Priority

Device

Length

Connection Duration

Connection Size

Operation

Set DSCP

Set Priority

Set Rx Class Name: No RX class names available

Set Tx Class Name: No TX class names available

Apply QoS on: Connection

Logging

Log Packets Matched by This Rule

Schedule: Always

OK Cancel

3. Under the **Matching** group, configure the matching characteristics:
 - a. From the 'Source Address' drop-down list, select 'Any', 'User Defined' or the host as the source address of the packets sent to or received from the network object. If you have created network objects (see Section 5.6.2 on page 51), then these are also displayed in the list (or you can create one by selecting 'User Defined').
 - b. From the 'Destination Address' drop-down list, select the network object for the destination address of the packets sent to or received from the network object. See Step 3 above for a detailed explanation on the options.
 - c. From the 'Protocol' drop-down list, select the protocol. You can apply the rule to all protocols (i.e., 'Any') or select an already defined protocol. You can create a new protocol by selecting 'User Defined', and then following the procedure described in Section 5.6.3 on page 53.
 - d. To match DSCP, select the 'DSCP' check box, and then enter the DSCP markings.
 - e. To match priority, select the 'Priority' check box, and then select the priority of the packets.
 - f. To match the Device, select the 'Device' check box, and then select the Device interface.
 - g. To match packet or data length, select the 'Length' check box, and then enter the data or packet length.

11.4 Configuring DSCP Mapping

To understand Differentiated Services Code Point (DSCP), one must first be familiarized with the Differentiated Services (DiffServ) model. DiffServ is a Class of Service (CoS) model that enhances best-effort Internet services by differentiating traffic by users, service requirements and other criteria. Packets are specifically marked, allowing network nodes to provide different levels of service, as appropriate for voice calls, video playback or other delay-sensitive applications, via priority queuing or bandwidth allocation, or by choosing dedicated routes for specific traffic flows.

DiffServ defines a field in IP packet headers referred to as DSCP. Hosts or routers passing traffic to a DiffServ-enabled network typically mark each transmitted packet with an appropriate DSCP. The DSCP markings are used by DiffServ network routers to appropriately classify packets and to apply particular queue handling or scheduling behavior.

The device provides a table of predefined DSCP values, which are mapped to 802.1p priority marking method. You can edit or delete any of the existing DSCP setting, as well as add new entries.

➤ **To view and set DSCP rules:**

1. From the menu bar, click the **QoS** menu link, and then click the **DSCP Settings** tab; the following screen appears:

Figure 11-9: DSCP Settings Screen

DSCP Value (hex)	802.1p Priority	Action
0x0	0 (Queue 0 - Low)	
0x2	0 (Queue 0 - Low)	
0x4	4 (Queue 1 - Medium)	
0x6	4 (Queue 1 - Medium)	
0x8	2 (Queue 0 - Low)	
0xA	1 (Queue 0 - Low)	
0xC	3 (Queue 0 - Low)	
0xE	2 (Queue 0 - Low)	
0x10	7 (Queue 2 - High)	
0x12	6 (Queue 2 - High)	
0x14	7 (Queue 2 - High)	
0x16	6 (Queue 2 - High)	
0x18	5 (Queue 1 - Medium)	
0x1A	5 (Queue 1 - Medium)	
0x1C	5 (Queue 1 - Medium)	
0x1E	5 (Queue 1 - Medium)	
0x2E	7 (Queue 2 - High)	
New Entry		



- To edit an existing entry, click its corresponding **Edit**  icon. To add a new entry, click the **New**  icon. In both cases, the 'Edit DSCP Settings' screen appears:

Figure 11-10: Edit DSCP Settings



- In the 'DSCP Value (hex)' field, enter a hexadecimal number for the DSCP value.
- In the '802.1p Priority' drop-down list, select an 802.1p priority level (each priority level is mapped to low, medium, or high priority).
- Click **OK** to save your settings.

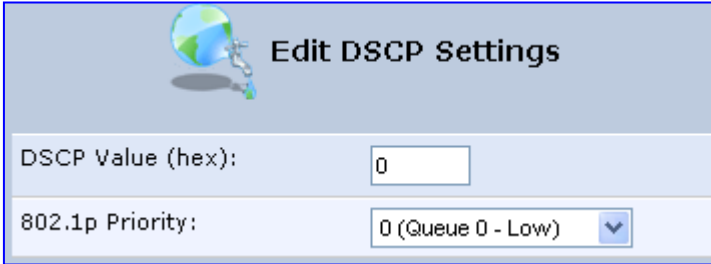

Note: The DSCP value overriding the priority of incoming packets with an unassigned value (priority 0, assumed to be a no-priority-set) is '0x0'. By default, this value is mapped to 802.1p priority level '0 -Low', which means that such packets receive the lowest priority.

11.5 Configuring 802.1p Mapping

The IEEE 802.1p priority marking method is a standard for prioritizing network traffic at the data link/MAC sub-layer. 802.1p traffic is simply classified and sent to the destination, with no bandwidth reservations established.

The 802.1p header includes a 3-bit prioritization field, which allows packets to be grouped into eight levels of priority. The device maps these eight levels to three main priorities: high, medium and low. By default, values six and seven are mapped to high priority, which may be assigned to network-critical traffic. Values four and five are mapped to medium priority, which may be applied to delay-sensitive applications, such as interactive video and voice. Values three to zero are mapped to low priority, which may range from controlled-load applications down to 'loss eligible' traffic. The zero value is normally used for best-effort traffic. It is the default value for traffic with unassigned priority.

➤ **To set 802.1p rules:**

1. From the menu bar, click the **QoS** menu link, and then click the **802.1p Settings** tab; the following screen appears:

Figure 11-11: 802.1p Settings Screen



802.1p Value	Queue
0	Queue 1 - Low
1	Queue 0 - Lowest
2	Queue 0 - Lowest
3	Queue 1 - Low
4	Queue 2 - High
5	Queue 2 - High
6	Queue 3 - Highest
7	Queue 3 - Highest

2. The eight 802.1p values are pre-configured with the three priority levels: high, medium and low. You can change these levels for each of the eight values in their respective drop-down list.
3. Click **OK** to save the settings.

11.6 Configuring Class Statistics

The device provides accurate, real-time information on the traffic passing through your defined device classes. For example, the amount of packets sent, dropped, or delayed are just a few of the parameters that you can monitor per each shaping class.



Note: Class statistics are available only if you have defined at least one class (otherwise no information is displayed).

➤ **To view your class statistics:**

- From the menu bar, click the **QoS** menu link, and then click the **Class Statistics** tab; the following screen appears:

Figure 11-12: Class Statistics Screen

Class	Packets Sent	Bytes Sent	Packets Dropped	Packets Delayed	Rate (bytes/s)	Packet Rate
default	365	233180	0	0	3620	5
Games	0	0	0	0	0	0

11.7 Configuring Basic VoIP QoS Example

The 'Traffic Shaping' feature only ensures priority to calls that originate from *inside* the device. When giving VoIP priority over data, the bottleneck is effectively moved from the Cable modem/fiber transceiver into the device. To give priority to calls from the LAN, you must define a traffic priority rule (for SIP and RTP from the device on the LAN).

This section recommends a minimal QoS configuration that ensures sufficient QoS for VoIP calls when the device is connected behind a broadband cable modem/fiber transceiver with limited uplink bandwidth and the user runs bandwidth-consuming applications on the PC.

Since most modems do not have any priority mechanisms, the Tx bandwidth of the device should be limited according to the modem's uplink bandwidth. Since the device automatically gives higher priority to VoIP packets (in its internal queues), it is not necessary to define traffic shaping classes.

➤ To configure basic QoS for VoIP:

1. From the menu bar, click the **QoS** menu link, and then click the **Traffic Shaping** tab; the 'Traffic Shaping' screen appears.
2. Click the **New**  icon; the screen 'Add Device Traffic Shaping' appears.
3. From the 'Device' drop-down list, select 'Default WAN Device' (or your PPTP/PPPoE connection you have created), and then click **OK**; the 'Edit Device Traffic Shaping' screen appears.
4. Limit the Tx bandwidth (in the 'Tx Bandwidth' field) according to your modem's uplink bandwidth.
5. To prevent jitter in outgoing RTP packets, from the 'TCP Serialization' drop-down list, select 'Enabled', and then in the 'Maximum Delay' field, define the maximum allowed delay (e.g. 20 milliseconds). This causes long TCP packets to be fragmented when there is an active voice call.

Figure 11-13: Edit Device Traffic Shaping



Edit Device Traffic Shaping

Device: Default WAN device

Tx Traffic Shaping

Tx Bandwidth: Specify 250 Kbps

TCP Serialization: Enabled

Maximum Delay: 20 ms

Devices: WAN Ethernet

Queue Policy: Class Based

Class ID	Name	Priority	Bandwidth		Status	Action
			Reserved	Maximum		
default	default	4	0 Kbps	Unlimited	Active	
New Entry 						

Enable Dynamic Traffic Shaping

Rx Traffic Policing

Rx Bandwidth: Unlimited

Devices: WAN Ethernet

Queue Policy: None

- Click **OK** to apply the new definition.

Figure 11-14: QoS - Edit Device Traffic Shaping - Submitting the Configuration

The screenshot shows the 'Quality of Service' configuration window. At the top, there is a navigation bar with tabs: 'QoS Wizard', 'Traffic Priority', 'Traffic Shaping' (which is selected), 'DSCP Settings', '802.1p Settings', and 'Class Statistics'. Below the tabs is a table with the following data:

Device	Tx Bandwidth (Kbps)	Rx Bandwidth (Kbps)	TCP Serialization	Action
<input checked="" type="checkbox"/> Default LAN device				
<input checked="" type="checkbox"/> Default WAN device	250	Unlimited	20 ms (640 bytes)	
New Entry				

- Click **OK** again.

12 Network Connections

The procedures below describe how to configure the following network connections:

- WAN – see Section 12.1 on page 127
- LAN – see Section 12.2 on page 137
- VLANs – see Section 12.4 on page 152
- LAN-WAN Bridging – see Section 12.5 on page 160

12.1 Configuring a WAN Connection

This section describes how to configure your WAN Ethernet connection.

The WAN connection is configured in the 'Network Connections' screen, which provides a connection wizard that guides you through the network configuration stages.



Notes:

- To quickly configure a basic WAN connection, use the 'Quick Setup' screen, as described in Section 8.1 on page 59.
- Before configuring the device Internet connection, ensure that you have obtained relevant technical information on the Internet connection type from your Internet Telephony Service Provider (ITSP). For example, whether you are connected to the Internet using a static or dynamic IP address, or what protocols such as PPTP or PPPoE are used to communicate over the Internet.
- If the Automatic Dialer feature is shipped preconfigured (i.e., enabled), then the device automatically detects the Internet dialer type and therefore, Internet connection configuration is unnecessary. However, it is recommended to manually configure the Internet connection **after** the Automatic Dialer process has completed (successfully or not). For more information on the Automatic Dialer feature, see Section 8.1.1 on page 60

- **To start the Connection Wizard:**
- 1. From the menu bar, click the **Network Connections** menu; the 'Network Connections' screen appears.

Figure 12-1: Network Connections Screen

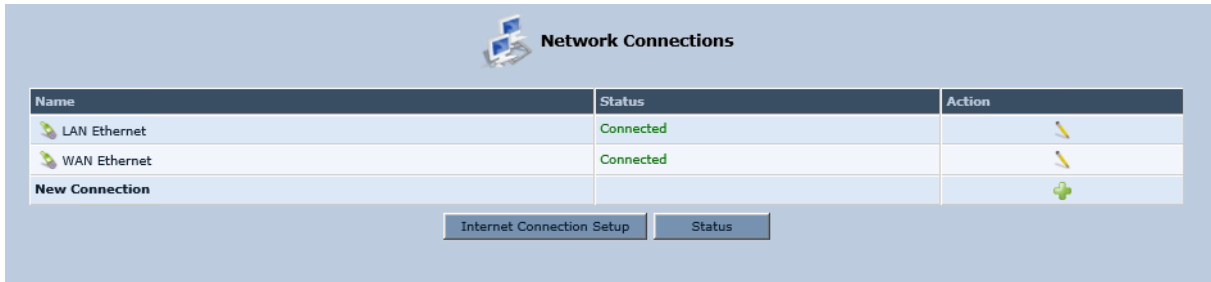

- 2. Click the **New** icon; the 'Connection Wizard' screen appears:

Figure 12-2: Connection Wizard Screen



- 3. Select the required network connection group:
 - **Internet Connection:** Configures an Internet connection when using an external DSL modem, Cable modem/fiber transceiver or Ethernet connection modem (see Section 12.1.1 on page 129)
 - **Advanced Connection:** Configures the WAN connection types as well as network bridging and VLANs.



Notes:

- For configuring VLANS, see Section 12.4 on page 152.
- For configuring network bridging, see Section 12.5 on page 160.

12.1.1 WAN Ethernet Connections

You can configure the following WAN Ethernet connection types:

- The device connected to an external DSL modem and using PPPoE – see Section 12.1.1.1 on page 129
- The device connected to an external Cable modem/fiber transceiver without authentication – see Section 12.1.1.2 on page 131
- The device connected to an external Cable modem/fiber transceiver using PPTP – see Section **Error! Reference source not found.** on page **Error! Bookmark not defined.**
- Automatic IP address using DHCP – see Section 12.1.1.3 on page 133
- Manual IP address – see Section 12.1.1.4 on page 134

12.1.1.1 External DSL Modem using PPPoE

The procedure below describes how to configure an Internet connection using PPPoE when the device is connected to an external DSL modem.

➤ **To create a PPPoE connection for external DSL modem:**

1. On the 'Network Connections' screen, click the **New**  icon; the 'Connection Wizard' screen appears.
2. Select the **Internet Connection** option, and then click **Next**.

Figure 12-3: Internet Connection



3. Select the **Internet Connection** option, and then click **Next**; the 'Internet Connection' screen appears.

Figure 12-4: Internet Connection – External DSL Modem

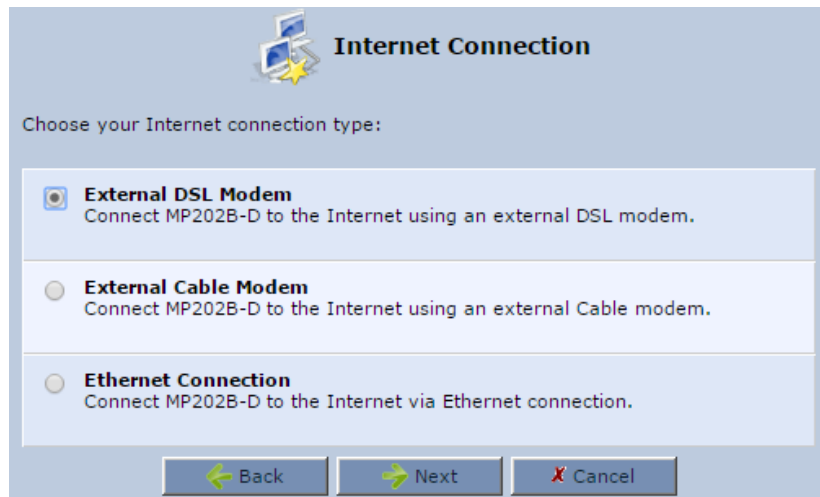

4. Select the **External DSL Modem** option, and then click **Next**; the 'Point-To-Point Protocol over Ethernet (PPPoE)' screen appears.

Figure 12-5: Point-to-Point Protocol over Ethernet (PPPoE) Screen

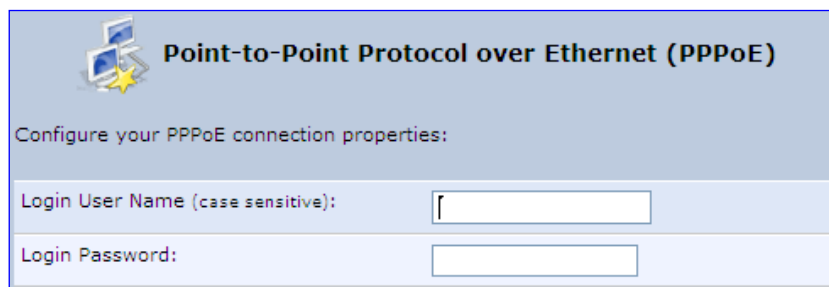

5. Enter the login PPPoE username and password.
6. Click **Next**; the screen 'Connection Summary' opens.

Figure 12-6: PPPoE Connection Summary

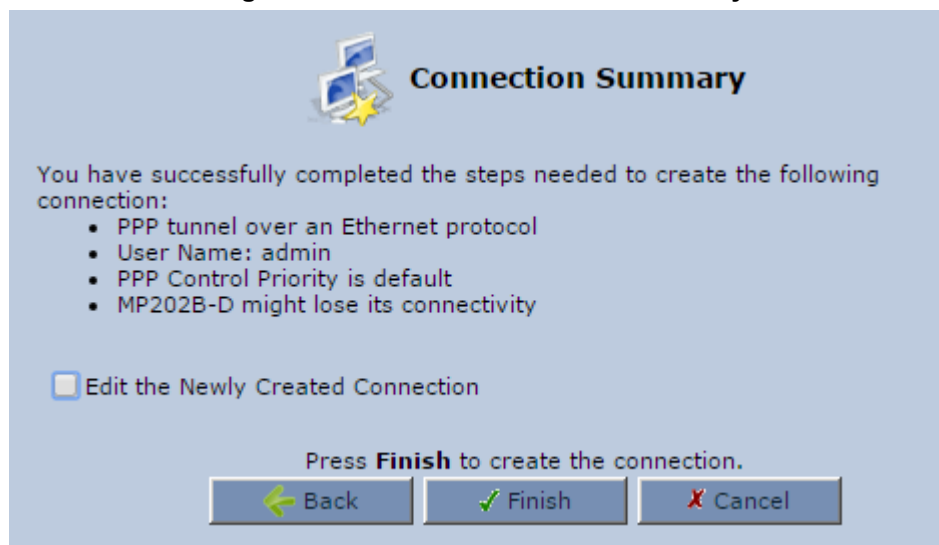

7. Select the 'Edit the Newly Created Connection' check box if you wish to be routed to the new connection's configuration screen after clicking **Finish**.
8. Click **Finish** to save the settings; the new PPPoE connection is added to the 'Network Connections' screen.

12.1.1.2 External Cable Modem/Fiber Transceiver without Authentication

The procedure below describes how to configure an Internet connection when the device is connected to an external Cable modem and the ITSP does not require a username or password to connect.

➤ **To create an Ethernet connection for external Cable modem/fiber transceiver:**

1. On the 'Network Connections' screen, click the **New**  icon; the 'Connection Wizard' screen appears.
2. Select the **Internet Connection** option, and then click **Next**.

Figure 12-7: Internet Connection



3. Select the **External Cable Modem** option, and then click **Next**.

Figure 12-8: Internet Connection – External Cable Modem

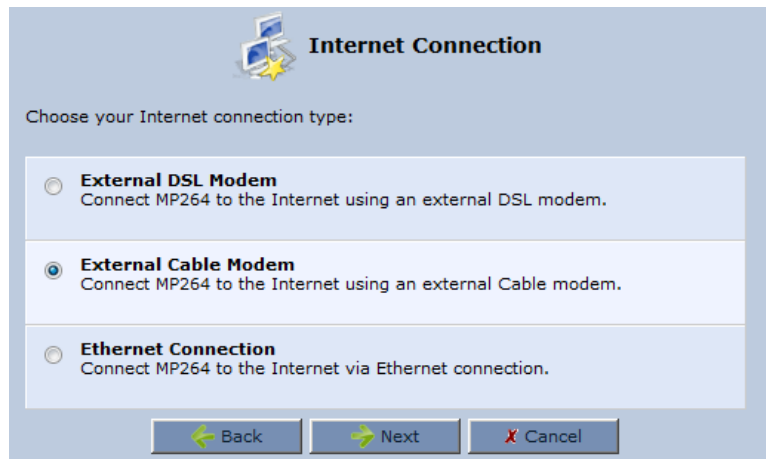

The 'Internet Cable Modem Connection' screen appears.

Figure 12-9: Internet Cable Modem Connection - Ethernet

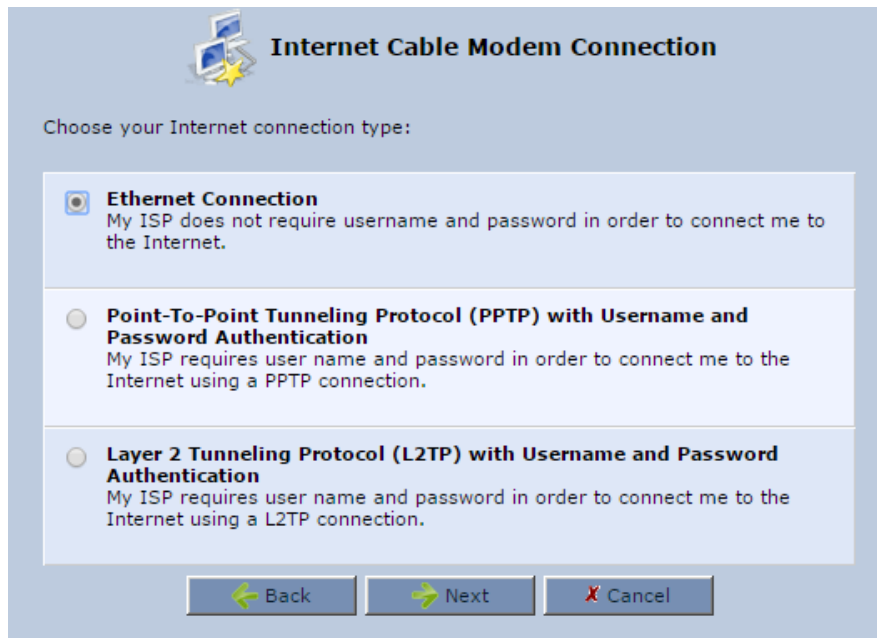

4. Select the **Ethernet Connection** option; the 'Connection Summary' screen appears.

Figure 12-10: Ethernet Connection Summary

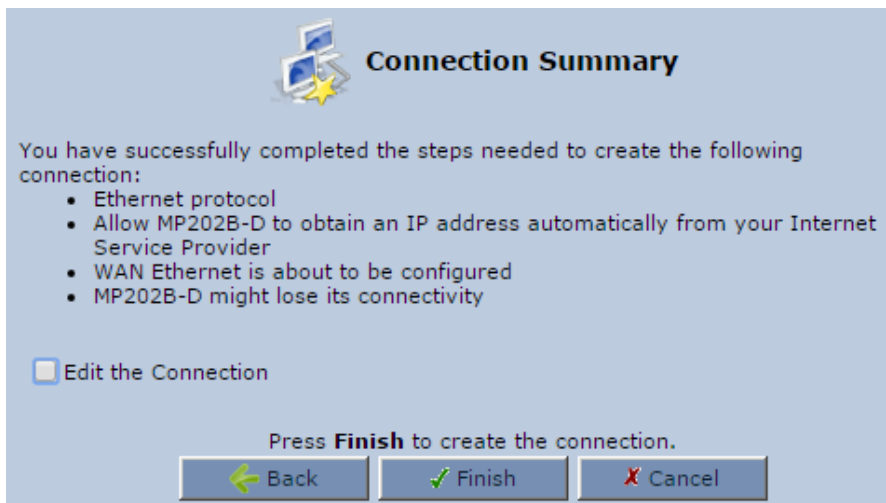

5. Select the 'Edit the Connection' check box if you wish to be routed to the new connection's configuration screen after clicking **Finish**.
6. Click **Finish** to save the settings; the new connection is added to the 'Network Connections' screen.

12.1.1.3 DHCP

The Dynamic Host Configuration Protocol (DHCP) connection for the physical WAN Ethernet, allows the device to obtain an IP address automatically from the service provider when connecting to the Internet.

➤ **To create a DHCP connection:**

1. On the 'Network Connections' screen, click the **New**  icon; the 'Connection Wizard' screen appears.
2. Select the **Internet Connection** option, and then click **Next**.
3. Select the **External Cable Modem** option, and then click **Next**;

Figure 12-11: Internet Connection – External Cable Modem



The 'Internet Cable Modem Connection' screen appears.

Figure 12-12: Internet Connection – External Cable Modem

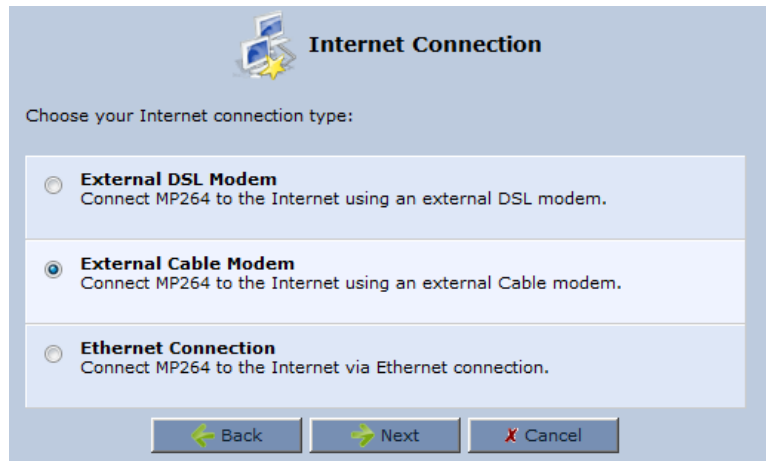
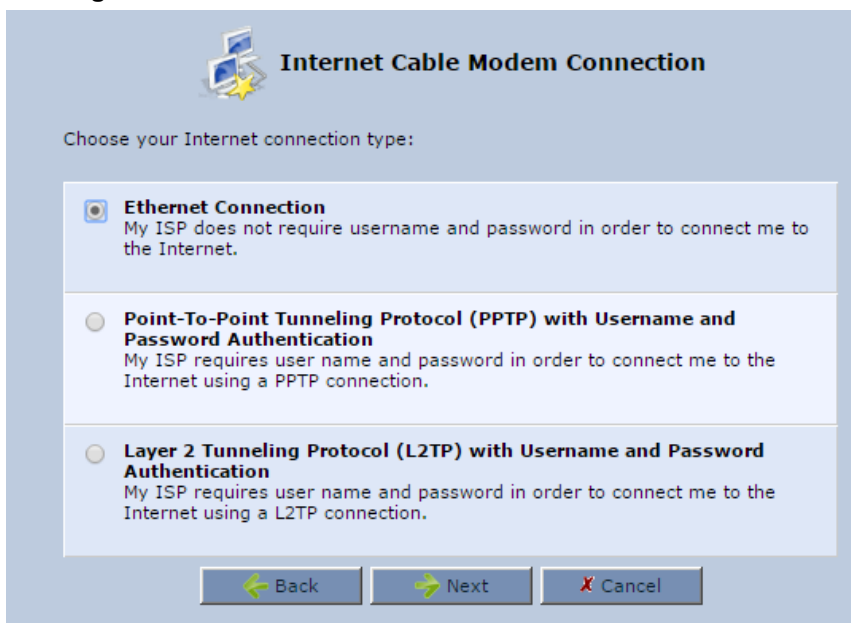

4. Select the **Ethernet Connection** option, and then click **Next**; the 'Connection Summary' screen appears.

Figure 12-13: DHCP Connection Summary

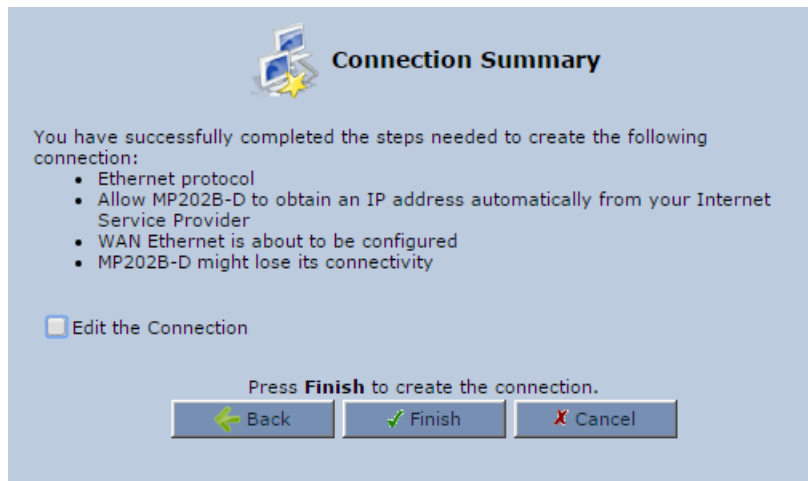

5. Select the 'Edit the Connection' check box if you wish to be routed to the new connection's configuration screen after clicking **Finish**.
6. Click **Finish** to save the settings; the new connection is added to the 'Network Connections' screen.

12.1.1.4 Manual IP Address

The Manual IP Address feature is used to manually configure the networking IP addresses when connecting to the Internet.

➤ **To manually configure the IP address:**

1. On the 'Network Connections' screen, click the **New**  icon; the 'Connection Wizard' screen appears.
2. Select the **Internet Connection** option, and then click **Next**.

Figure 12-14: Internet Connection



3. Select the **Ethernet Connection** option, and then click **Next**; the following screen appears.

Figure 12-15: Internet Connection – Ethernet Connection

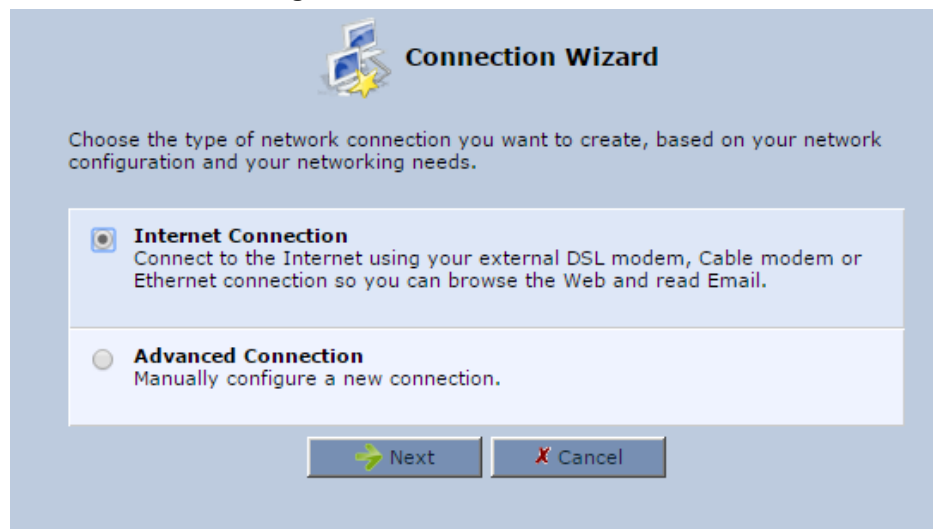
Internet Connection

Choose your Internet connection type:

External DSL Modem
Connect MP264 to the Internet using an external DSL modem.

External Cable Modem
Connect MP264 to the Internet using an external Cable modem.

Ethernet Connection
Connect MP264 to the Internet via Ethernet connection.

4. Select the **Ethernet Connection** option, and then click **Next**; the 'Ethernet Connection' screen appears.

Figure 12-16: Ethernet Connection Screen

Ethernet Connection

You can configure MP252's IP address manually, or let MP252 dynamically negotiate an IP with your Internet service provider.

Dynamic Negotiation (DHCP)
Obtain an IP address automatically from your Internet service provider.

Manual IP Address Configuration
Manually configure networking IP addresses.

5. Select the **Manual IP Address Configuration** option, and then click **Next**; the screen 'Manual IP Address Configuration' opens.

Figure 12-17: Manual IP Address Configuration Screen

Manual IP Address Configuration

Configure your IP and DNS properties:

IP Address:	10	37	2	24
Subnet Mask:	255	255	0	0
Default Gateway:	10	37	0	1
Primary DNS Server:	10	1	1	11
Secondary DNS Server:	10	1	1	10

6. Configure the IP address and other network parameters, and then click **Next**; Select the Manual IP Address Configuration option, and then click **Next**; the 'Connection Summary' screen appears.

Figure 12-18: Manual IP Connection Summary



7. Select the 'Edit the Connection' check box if you wish to be routed to the new connection's configuration screen after clicking **Finish**.
8. Click **Finish** to save the settings; the new connection is added to the 'Network Connections' screen.

12.2 LAN Connection

This section describes how to configure the LAN Ethernet.

12.2.1 LAN Ethernet

The LAN Ethernet interface represents the physical ports on the device.

➤ **To configure the LAN Ethernet:**

1. From the menu bar, click the **Network Connections** menu; the 'Network Connections' screen appears.

Figure 12-19: Network Connections Screen

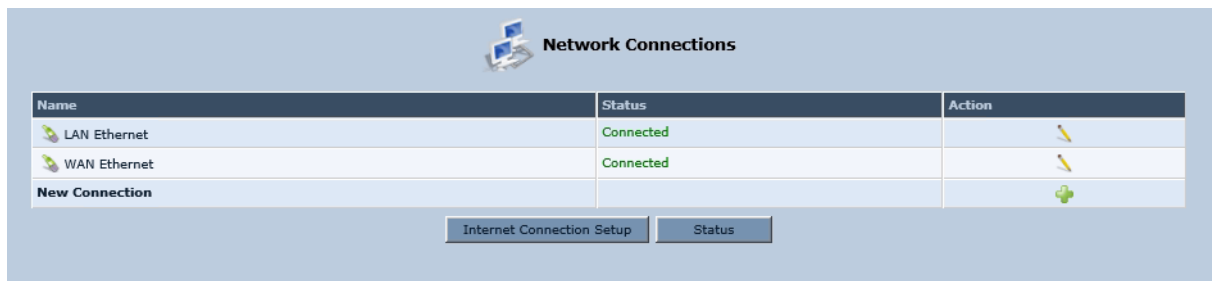

2. Click the **LAN Ethernet** link; the LAN Ethernet Properties screen appears:

Figure 12-20: LAN Ethernet Properties

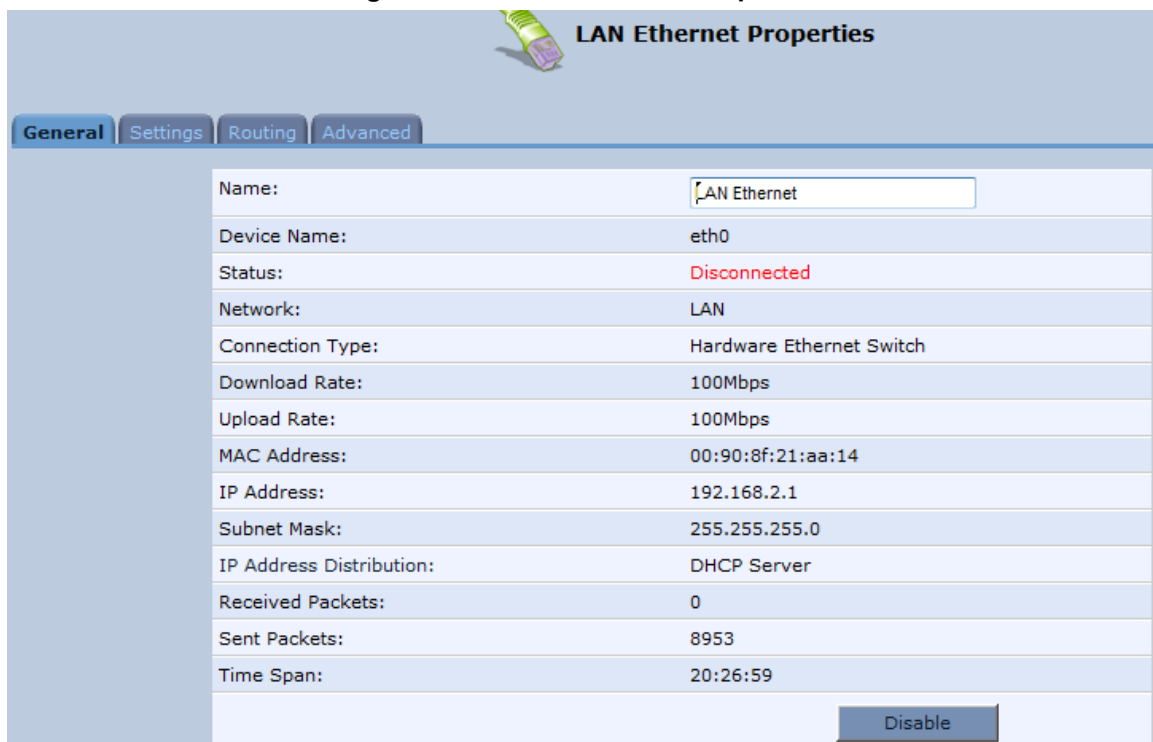

12.2.1.1 General Tab

- The General tab allows you to assign a name to this connection as well as disable or enable the connection, by clicking the **Enable** or **Disable** buttons respectively.

12.2.1.2 Settings Tab

The **Settings** tab screen is displayed below:

Figure 12-21: LAN Ethernet Properties – Settings Tab

The screenshot shows the 'LAN Ethernet Properties' window with the 'Settings' tab selected. The configuration includes:

- Device Name:** eth0
- Status:** Disconnected
- Schedule:** Always
- Network:** LAN
- Connection Type:** Hardware Ethernet Switch
- Physical Address:** 00:90:8f:21:aa:14
- MTU:** Automatic (1500)
- Internet Protocol:** Use the Following IP Address
- IP Address:** 192.168.2.1
- Subnet Mask:** 255.255.255.0
- DNS Server:** Use the Following DNS Server Addresses
- Primary DNS Server:** 0.0.0.0
- Secondary DNS Server:** 0.0.0.0
- IP Address Distribution:** DHCP Server
- Start IP Address:** 192.168.2.1
- End IP Address:** 192.168.2.254
- Subnet Mask:** 255.255.255.0
- WINS Server:** 0.0.0.0
- Lease Time in Minutes:** 60
- Station Name Given By (If Not Specified By Client):** Create New Name

DHCP Server Pools Table:

Description	Criteria	Dynamic IP Range	Netmask	Action
New IP Range				+

Buttons: OK, Apply, Cancel

The **Settings** tab provides you with the following parameters:

- **Schedule:** By default, the connection is always active. However, you can configure scheduler rules to define time segments during which the connection is active. Once a scheduler rule(s) is defined, the drop-down list allows you to choose between the available rules.
- **Network:** Select whether the parameters you are configuring relate to a WAN, LAN or DMZ connection.
- **Physical Address:** The physical address of the network card used for your network. Some cards allow you to change this address.
- **MTU:** Maximum Transmission Unit. It specifies the largest packet size permitted for Internet transmission. In the default setting, Automatic, the gateway selects the best MTU for your Internet connection. Select 'Automatic by DHCP' to have the DHCP determine the MTU. In case you select 'Manual' it is recommended to enter a value in the 1200 to 1500 range.

- **Internet Protocol:** Select one of the following Internet protocol options from the 'Internet Protocol' drop-down list:
 - **No IP Address** - Select 'No IP Address' if you require that your gateway have no IP address.
 - **Obtain an IP Address Automatically** – Use this to configure the connection to automatically obtain a DNS server address.
 - **Use the Following IP Address** – Use this option to manually configure DNS server addresses.
- **IP Address Distribution - DHCP Server:**
 - **Start IP Address** - The first IP address that may be assigned to a LAN host.
 - **End IP Address** - The last IP address in the range that can be used to automatically assign IP addresses to LAN hosts.
 - **Subnet Mask** - A mask used to determine to what subnet an IP address belongs.
 - **Lease Time In Minutes** - Each device will be assigned an IP address by the DHCP server for this amount of time, when it connects to the network.
 - **Provide Host Name If Not Specified by Client** - If the DHCP client does not have a host name, the gateway will automatically assign one.

12.2.1.3 Routing Tab

The **Routing** tab screen is displayed below:

Figure 12-22: LAN Ethernet Properties – Routing Tab

LAN Ethernet Properties

General Settings **Routing** Advanced

Routing Mode:

Device Metric:

Default Route

Multicast - IGMP Proxy Internal

IGMP Query Version:

Name	Destination	Gateway	Netmask	Metric	Status	Action
New Route						

OK Apply Cancel

12.2.1.4 Advanced Tab

The **Advanced** tab screen is displayed below:

Figure 12-23: LAN Hardware Ethernet Switch Screen – Advanced Tab

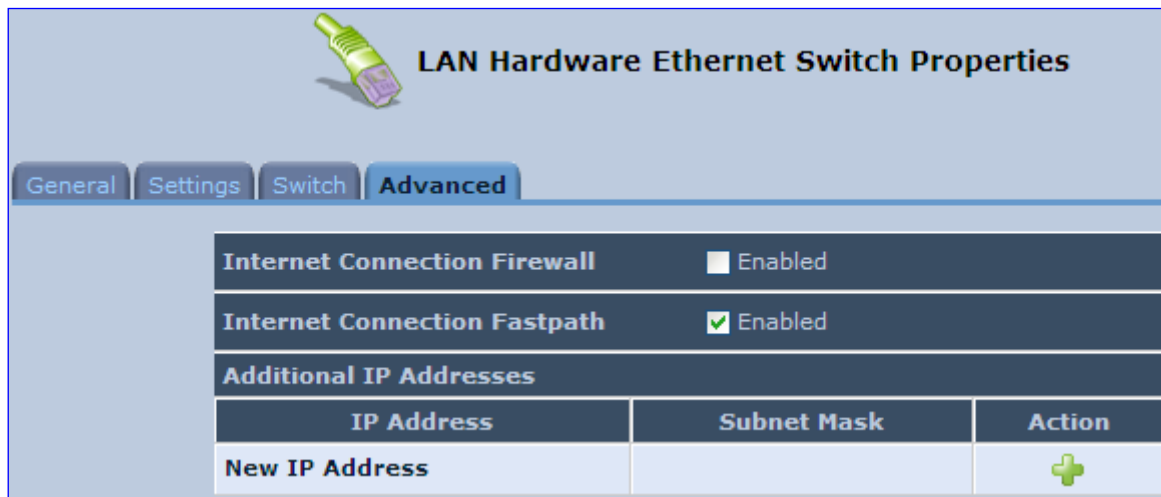

- Internet Connection Firewall: Your gateway's firewall helps protect your computer by preventing unauthorized users from gaining access to it through a network such as the Internet. The firewall can be activated per network connection. To enable the firewall on this network connection, select the 'Enabled' check box.
- Internet Connection Fastpath: Select this check box to utilize the Fastpath algorithm for enhancing packet flow, resulting in faster communication between the LAN and the WAN. By default, this feature is enabled.
- Additional IP Addresses: You can add alias names (additional IP addresses) to the gateway by clicking the 'New IP Address' link. This enables you to access the gateway using these aliases in addition to the IP address (e.g., 192.168.2.1) and the *http://mp202.home*.

12.3 WAN Connection

This section describes how to configure the WAN Ethernet.

12.3.1 General Tab

The **General** tab displays mainly read-only properties of the connection.

The main actions that can be done in this tab screen include the following:

- Modifying the connection name – in the 'Name' field
- Enabling and disabling the connection, by clicking the Enable or Disable button respectively

Below shows an example of a **General** tab screen, displaying the 'Name' field and the **Disable** button.

Figure 12-24: Editing Connection - General Tab (For Example, WAN Ethernet)



The screenshot shows a window titled "WAN Ethernet Properties" with a network cable icon. It has four tabs: "General", "Settings", "Routing", and "Advanced". The "General" tab is active and displays the following information:

Name:	WAN Ethernet
Device Name:	eth1
Status:	Connected
Network:	WAN
Underlying Device:	LAN Hardware Ethernet Switch
Connection Type:	Ethernet
Download Rate:	100.0 Mbps
Upload Rate:	100.0 Mbps
MAC Address:	00:90:8f:27:f2:44
IP Address:	10.13.22.32
Subnet Mask:	255.255.0.0
Default Gateway:	10.13.0.1
DNS Server:	10.1.1.11 10.1.1.10
IP Address Distribution:	Disabled
Received Packets:	13710
Sent Packets:	1167
Time Span:	0:40:40

At the bottom right of the dialog, there is a "Disable" button.

12.3.2 Settings Tab

The top part of the Settings tab screen displays general communication parameters. It is recommended not to change the default values in this screen unless you are familiar with the networking concepts they represent. Since your device is configured to operate with the default values, no parameter modification is necessary.

Figure 12-25: Editing Connection - Settings Tab (For Example, WAN Ethernet)

The screenshot shows the 'WAN Ethernet Properties' configuration window. At the top, there is a green Ethernet cable icon and the title 'WAN Ethernet Properties'. Below the title are four tabs: 'General', 'Settings' (which is selected), 'Routing', and 'Advanced'. The main content area is divided into several sections:

- Device Name:** eth1
- Status:** Connected
- Schedule:** Always (dropdown menu)
- Network:** WAN (dropdown menu)
- Connection Type:** Ethernet
- Physical Address:** A field with six segments containing the values: 00, 90, 8f, 27, 58, e4.
- MTU:** Automatic (dropdown menu) 1500
- Underlying Connection:** LAN Hardware Ethernet Switch
- Internet Protocol:** Obtain an IP Address Automatically (dropdown menu)
- Override Subnet Mask**
- DHCP Lease:** Renew (button) Release (button)
- Expires In:** 42980 minutes
- DNS Server:** Obtain DNS Server Address Automatically (dropdown menu)
- IP Address Distribution:** Disabled (dropdown menu)

The **Settings** tab screen allows you to configure the following:

Table 12-1: Settings Tab - Parameter Descriptions

Parameter	Description
Schedule	You can select a Scheduler rule that defines time segments during which the connection is active. To configure scheduler rules, see Section 5.6.1 on page 49.
Network	Select whether the connection relates to a LAN, WAN, or DMZ connection. Every network connection can be configured as one of these types. This provides flexibility and increased functionality. For example, you may define that a LAN Ethernet connection on the device operates as a WAN network. This means that all hosts in this LAN will be referred to as WAN computers, both by computers outside the device and by the device itself. WAN and firewall rules may be applied, such as on any other WAN network. Another example is that a network connection can be defined as a DMZ (Demilitarized) network. Although the network is physically inside the device, it will function as an unsecured, independent network, for which the device merely acts as a router.
Physical Address	The physical address of the network card used for your network.
MTU	Maximum Transmission Unit (MTU) species the largest packet size permitted for Internet transmission. In the default setting, 'Automatic', the device selects the best MTU for your Internet connection. Select 'Automatic by DHCP' to have the DHCP determine the MTU. If you change to 'Manual', you can enter the largest packet size; you should leave this value in the 1200 to 1500 range.
Internet Protocol	For more information, see Section 12.3.2.1 below.

12.3.2.1 Internet Protocol Settings

The 'Internet Protocol' group defines the Internet Protocol options. Select one of the following Internet Protocol options from the 'Internet Protocol' drop-down list:

- **No IP Address**
- **Obtain an IP Address Automatically:** Your WAN connection is configured by default to act as a DHCP client. You should keep this configuration in case your service provider supports DHCP, or if you are connecting using a dynamic IP address.

Figure 12-26: Automatically Obtaining an IP Address

The screenshot shows a configuration window for 'Internet Protocol'. At the top, a dropdown menu is set to 'Obtain an IP Address Automatically'. Below this, there is a checkbox labeled 'Override Subnet Mask' which is currently unchecked. Underneath, the 'DHCP Lease' section contains two buttons: 'Renew' and 'Release'. At the bottom, the 'Expires In' section displays '41959 minutes'.

The server that assigns the device with an IP address also assigns a subnet mask. You can override the dynamically assigned subnet mask by selecting the 'Override Subnet Mask' check box and specifying your own mask instead.

You can click the **Release** button to release the current leased IP address. Once the address has been released, the button text changes to 'Renew'. Use the **Renew** button to renew the leased IP address.

For defining DNS and DHCP servers, see sections 12.3.2.1.1 and 12.3.2.1.2 respectively.

- **Use the Following IP Address:** Your WAN connection can be configured using a permanent (static) IP address. Your service provider should provide you with this IP address, subnet mask and the default MP-202B IP address.

For defining DNS and DHCP servers, see sections 12.3.2.1.1 and 12.3.2.1.2 respectively.

12.3.2.1.1 DNS Server

Domain Name System (DNS) is the method by which websites or domain names are translated into IP addresses. You can configure the connection to automatically obtain a DNS server address, or specify such an address manually, according to the information provided by your ISP.

From the 'DNS Server' drop-down list, you can select one of the following methods:

- **Obtain DNS Server Address Automatically:** the connection automatically obtains a DNS server address.
- **Use the Following DNS Server Addresses:** manually configure DNS server - specify up to two different DNS server addresses - one primary, the other secondary:

Figure 12-27: Manually Defining DNS Server

- **No DNS Server:** select this if there is no DNS server.

12.3.2.1.2 IP Address Distribution

The 'IP Address Distribution' section allows you to configure the device's Dynamic Host Configuration Protocol (DHCP) server parameters. The DHCP automatically assigns IP addresses to network PCs. If you enable this feature, make sure that you also configure your network PCs as DHCP clients.

Select one of the following options from the 'IP Address Distribution' drop-down list:

- **Disabled:** Select this option to statically assign IP addresses to your network computers.
- **DHCP Server:** Enables DHCP server:

Figure 12-28: IP Address Distribution - DHCP Server

IP Address Distribution		DHCP Server	
Start IP Address:	0	0	0
End IP Address:	0	0	0
Subnet Mask:	0	0	0
Lease Time in Minutes:	0		
<input type="checkbox"/> Provide Host Name If Not Specified by Client			

- **Start IP Address:** The first IP address that may be assigned to a LAN host. Since the device's default IP address is 192.168.2.1, this address must be 192.168.2.2 or greater.
 - **End IP Address:** The last IP address in the range that can be used to automatically assign IP addresses to LAN hosts.
 - **Subnet Mask:** A mask used to determine to what subnet an IP address belongs.
 - **Lease Time In Minutes:** Each device is assigned an IP address by the DHCP server for this amount of time when it connects to the network. When the lease expires, the server determines if the computer has disconnected from the network. If it has, the server may reassign this IP address to a newly-connected computer. This feature ensures that IP addresses that are not in use become available for other computers on the network.
 - **Provide Host Name If Not Specified by Client:** If the DHCP client does not have a host name, the device automatically assigns one for him
- DHCP Relay: The device can act as a DHCP relay in case you would like to dynamically assign IP addresses from a DHCP server other than device's DHCP server.



Note: When selecting this option, you must also change the device's WAN to work in Routing mode.

Figure 12-29: IP Address Distribution - DHCP Relay

IP Address Distribution		DHCP Relay	
Address	Action		
<u>New IP Address</u>	+		

1. Click the **New**  icon; the 'DHCP Relay Server Address' screen appears:

Figure 12-30: DHCP Relay Server Address

DHCP Relay Server Address	
IP Address:	0 . 0 . 0 . 0

2. Specify the IP address of the DHCP server, and then click **OK** to save the settings.

12.3.3 Routing Tab

You can choose to setup your device to use static or dynamic routing. Dynamic routing automatically adjusts how packets travel on the network, whereas static routing specifies a fixed routing path to neighboring destinations.

Figure 12-31: Editing Connection - Routing Tab (For Example, WAN Ethernet)

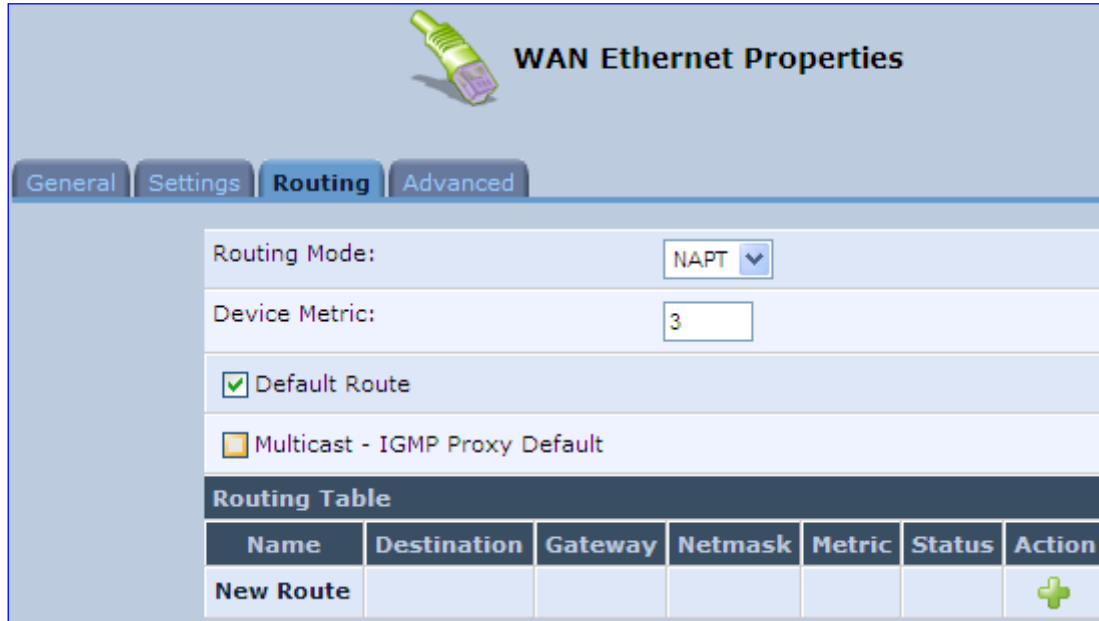
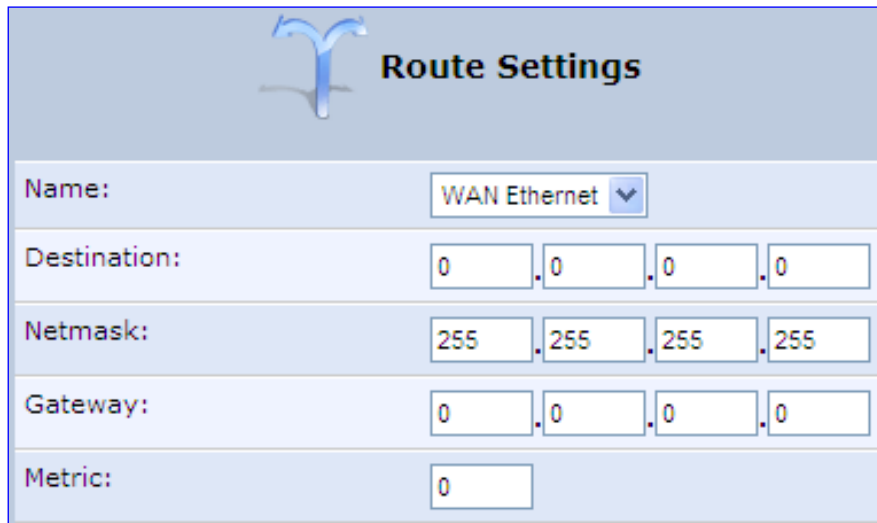

Table 12-2: Routing Parameters

Parameter	Description				
Routing Mode	Select one of the following Routing modes: <table border="1" style="width: 100%; border-collapse: collapse;"> <tr> <td style="width: 15%;">Route</td> <td>Use route mode if you want your device to function as a router between two networks.</td> </tr> <tr> <td>NAPT</td> <td>Network Address and Port Translation (NAPT) refers to network address translation involving the mapping of port numbers, allowing multiple machines to share a single IP address. Use NAPT if your LAN encompasses multiple devices, a topology that necessitates port translation in addition to address translation.</td> </tr> </table>	Route	Use route mode if you want your device to function as a router between two networks.	NAPT	Network Address and Port Translation (NAPT) refers to network address translation involving the mapping of port numbers, allowing multiple machines to share a single IP address. Use NAPT if your LAN encompasses multiple devices, a topology that necessitates port translation in addition to address translation.
Route	Use route mode if you want your device to function as a router between two networks.				
NAPT	Network Address and Port Translation (NAPT) refers to network address translation involving the mapping of port numbers, allowing multiple machines to share a single IP address. Use NAPT if your LAN encompasses multiple devices, a topology that necessitates port translation in addition to address translation.				
Device Metric	The device metric is a value used by the device to determine whether one route is superior to another, considering parameters such as bandwidth, delay, and more.				
Default Route	Select this check box to define this device as the default route.				
Multicast - IGMP Proxy Default	IGMP proxy enables the system to issue IGMP host messages on behalf of hosts that the system discovered through standard IGMP interfaces. IGMP proxy enables the routing of multicast packets according to the IGMP requests of LAN devices asking to join multicast groups.				
Routing Table	Allows you to add or modify routes when this device is active. Click the New icon to add a route (as shown in the figure below) or edit existing routes.				

Figure 12-32: Route Settings Screen



The screenshot shows a 'Route Settings' window with a blue header and a light blue background. At the top center is a blue logo of a stylized bird or 'Y' shape. Below the logo, the title 'Route Settings' is displayed in bold black text. The form contains five rows of input fields:

Name:	WAN Ethernet
Destination:	0 . 0 . 0 . 0
Netmask:	255 . 255 . 255 . 255
Gateway:	0 . 0 . 0 . 0
Metric:	0

- **Name:** Select the network device.
- **Destination:** destination host, subnet address, network address, or default route. The destination for a default route is 0.0.0.0.
- **Netmask:** This is used in conjunction with the destination to determine when a route is used.
- **Gateway:** Enter the device's IP address.
- **Metric:** A measurement of the preference of a route. Typically, the lowest metric is the most preferred route. If multiple routes exist to a given destination network, the route with the lowest metric is used.

12.3.4 PPP Tab

The **PPP** tab displays the PPP settings.



Note: This tab is applicable only to PPP connections.

Figure 12-33: Editing Connection - PPP Tab

WAN PPPoE Properties

General Settings Routing **PPP** Advanced

Service Name (should be filled only if specified by provider):

On Demand (will attempt to connect only when packets are sent)

Time Between Reconnect Attempts: Seconds

PPP Authentication

Login User Name (case sensitive):

Login Password:

Support Un-encrypted Password (PAP)

Support Challenge Handshake Authentication (CHAP)

Support Microsoft CHAP (MS-CHAP)

Support Microsoft CHAP Version 2 (MS-CHAP v2)

PPP Compression

BSD: ▾

Deflate: ▾

Table 12-3: PPP Tab Parameter Descriptions

Parameter	Description
On Demand	Use PPP on demand to initiate the PPP session only when packets are actually sent over the Internet.
Idle Time Before Hanging Up	Specify the amount of idle time (during which no data is sent or received) that should elapse before the gateway disconnects the PPP connection. Note: This parameter appears only if On Demand is selected.
Time Between Reconnect Attempts	Specify the duration between PPP reconnected attempts, as provided by your ISP.

Parameter	Description
PPP Authentication	<p>PPP supports four authentication protocols: Password Authentication Protocol (PAP), Challenge Handshake Authentication Protocol (CHAP), Microsoft CHAP version 1, and Microsoft CHAP version 2.</p> <p>This section allows you to select the authentication protocols your device may use when negotiating with a PPTP server. Select all the protocols if no information is available about the server's authentication protocols. Note that encryption is performed only if 'Microsoft CHAP', 'Microsoft CHAP version 2', or both are selected.</p> <ul style="list-style-type: none"> ▪ Login User Name: login username according to ISP ▪ Login Password: login password according to ISP ▪ Support Un-encrypted Password (PAP): PAP is a simple, plaintext authentication scheme. The username and password are requested by your networking peer in plain text. PAP, however, is not a secure authentication protocol. Man-in-the-middle attacks can easily determine the remote access client's password. PAP offers no protection against replay attacks, remote client impersonation, or remote server impersonation. ▪ Support Challenge Handshake Authentication (CHAP): CHAP is a challenge-response authentication protocol that uses MD5 to hash the response to a challenge. CHAP protects against replay attacks by using an arbitrary challenge string per authentication attempt. ▪ Support Microsoft CHAP: Select this check box if you are communicating with a peer that uses Microsoft CHAP authentication protocol. ▪ Support Microsoft CHAP Version 2: Select this check box if you are communicating with a peer that uses Microsoft CHAP Version 2 authentication protocol.
PPP Compression	<p>The PPP Compression Control Protocol (CCP) is responsible for configuring, enabling, and disabling data compression algorithms on both ends of the point-to-point link. It is also used to signal a failure of the compression/decompression mechanism in a reliable manner. For each compression algorithm, select one of the following from the drop down menu.</p> <ul style="list-style-type: none"> ▪ Reject: Reject PPP connections with peers that use the compression algorithm. ▪ Allow: Allow PPP connections with peers that use the compression algorithm. ▪ Require: Ensure a connection with a peer is using the compression algorithm.

12.3.5 PPTP Tab

The **PPTP** tab displays the PPTP settings.



Note: This tab is applicable only to PPTP connections.

Figure 12-34: Editing Connection - PPTP Tab

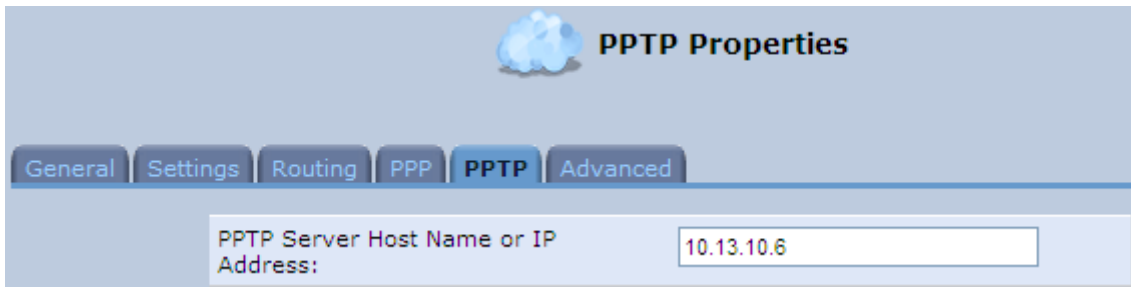

Table 12-4: PPTP Tab Parameter Descriptions

Parameter	Description
PPTP Server Host Name or IP Address	PPTP server host name or IP address provided by your ISP.

12.3.6 Advanced Tab

The **Advanced** tab provides various advanced configurations.

Figure 12-35: Editing Connection - Advanced Tab (For Example, WAN Ethernet)

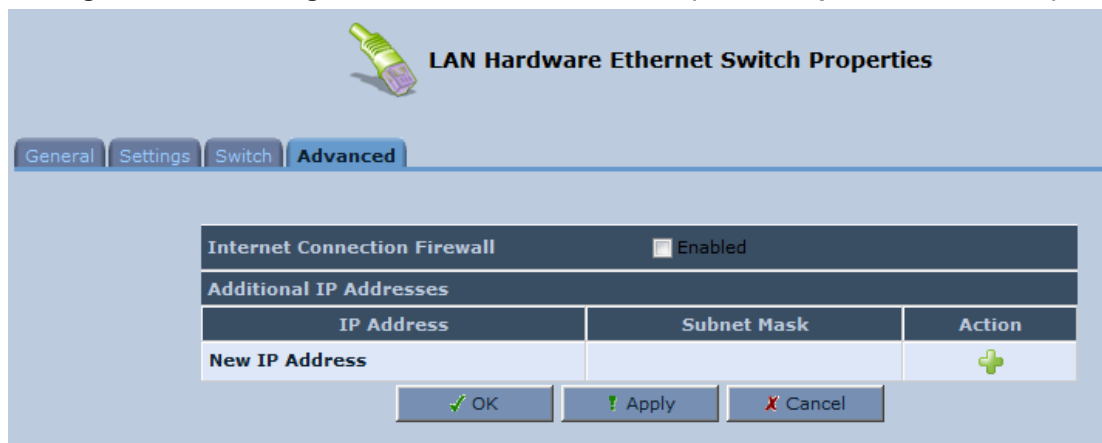

- **Internet Connection Firewall:** Your device's firewall helps protect your computer by preventing unauthorized users from gaining access to it through a network such as the Internet. The firewall can be activated per network connection. To enable the firewall on this network connection, select the 'Enabled' check box. You can click the Internet Connection Firewall link to access the 'Security' screen (see Section 15.1 on page 230).
- **Additional IP Addresses:** You can also add alias names (additional IP addresses) to the device, by clicking the **New**  icon. This enables you to access the device using these aliases in addition to the default IP addresses.

Figure 12-36: Additional IP Address Settings Screen

The screenshot shows the 'Additional IP Address Settings' dialog box. It has two main input sections. The first is labeled 'IP Address:' and contains a text box with the number '5' followed by four separate boxes, each containing the number '0', representing the IP address 5.0.0.0. The second is labeled 'Subnet Mask:' and contains four separate boxes, each containing the number '0', representing the subnet mask 0.0.0.0.

12.4 VLAN Settings

You can create VLANs for your LAN and WAN interfaces.

➤ **To create a new VLAN interface:**

1. From the menu bar, click the **Network Connections** menu, and then in the screen 'Network Connections' click the **New**  icon; the 'Connection Wizard' screen appears.

Figure 12-37: Connection Wizard Screen



2. Select the 'Advanced Connection' option, and then click **Next**; the 'Advanced Connection' screen appears.

Figure 12-38: Advanced Connection

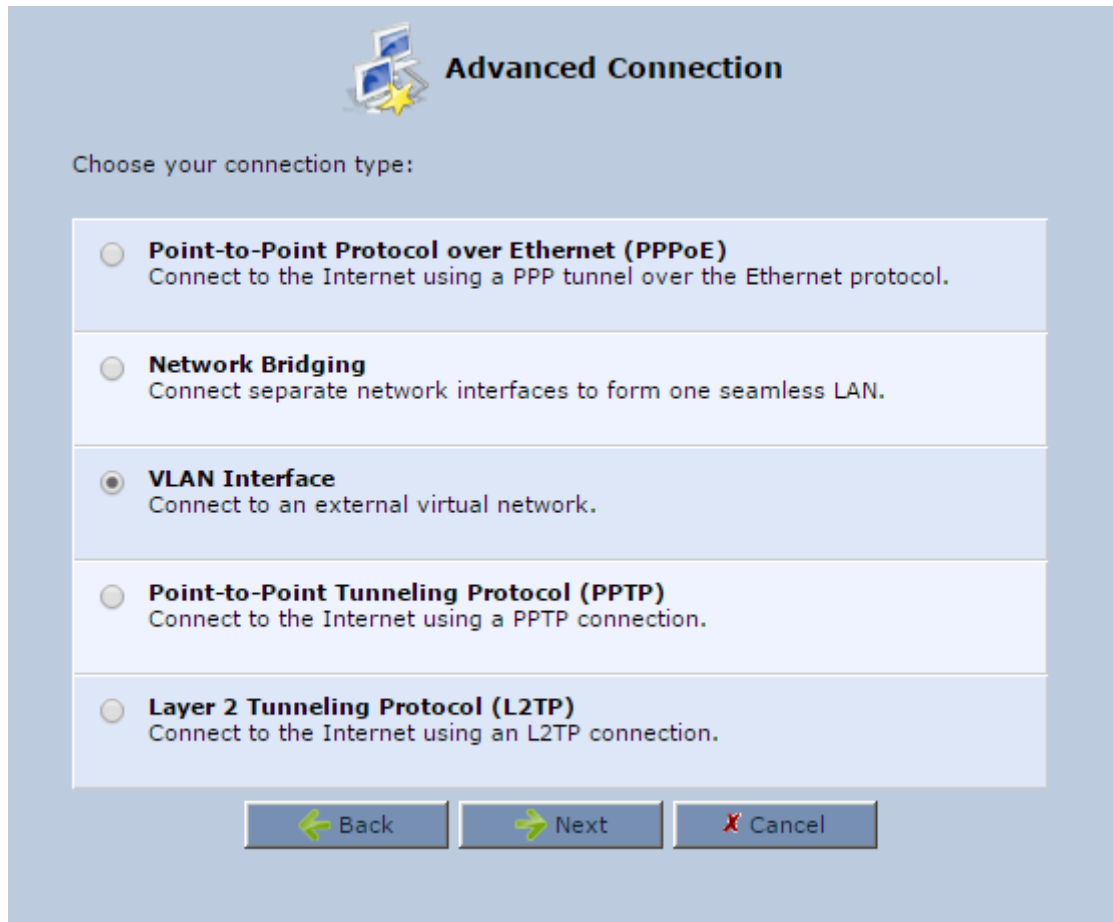

Advanced Connection

Choose your connection type:

- Point-to-Point Protocol over Ethernet (PPPoE)**
Connect to the Internet using a PPP tunnel over the Ethernet protocol.
- Network Bridging**
Connect separate network interfaces to form one seamless LAN.
- VLAN Interface**
Connect to an external virtual network.
- Point-to-Point Tunneling Protocol (PPTP)**
Connect to the Internet using a PPTP connection.
- Layer 2 Tunneling Protocol (L2TP)**
Connect to the Internet using an L2TP connection.

3. Select the 'VLAN Interface' option, and then click **Next**; the 'VLAN Interface' screen appears.

Figure 12-39: VLAN Interface

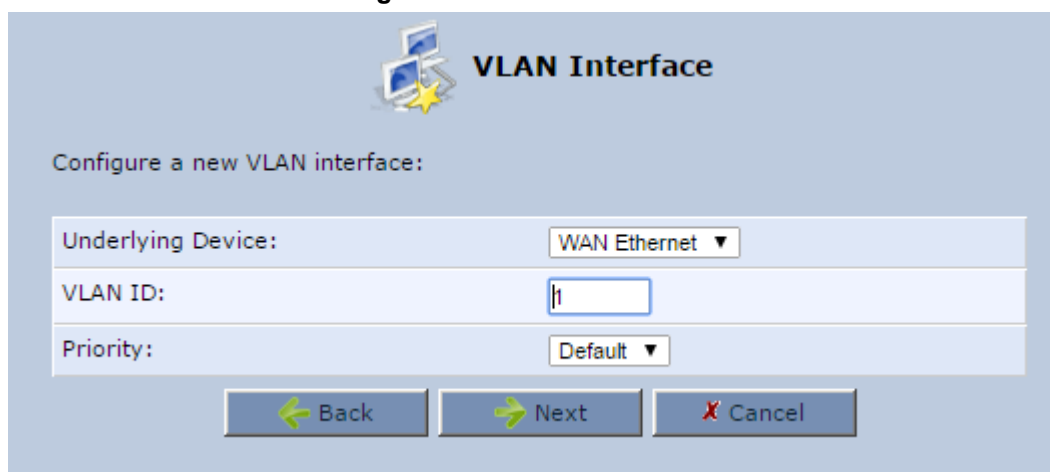

VLAN Interface

Configure a new VLAN interface:

Underlying Device:

VLAN ID:

Priority:

4. From the 'Underlying Device' drop-down list, select the underlying device (device's Ethernet connections) for this interface.
5. In the 'VLAN ID' field, enter a value to serve as the VLAN ID, and then click **Next**; the 'Connection Summary' screen appears.

Figure 12-40: Connection Summary

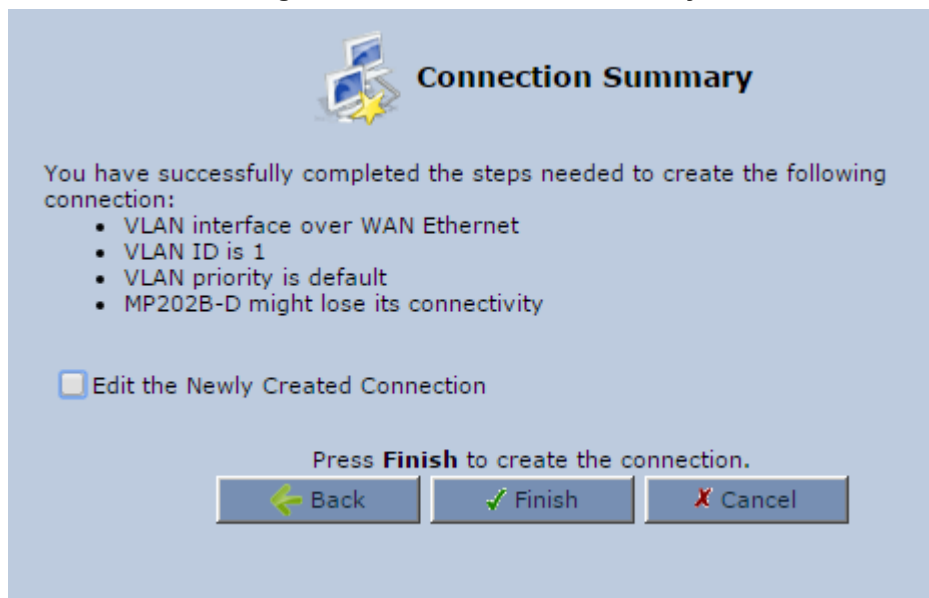

6. Check the 'Edit the Newly Created Connection' check box to be routed to the new connection's configuration screen after clicking **Finish**.
7. Click **Finish** to save the settings; the new VLAN interface is added to the network connections list; it's configurable like any other connection.

12.4.1 Settings Tab

The **Settings** tab of the 'VLAN Properties' displays general communication parameters. It's recommended to leave the values in this screen at their defaults unless you're familiar with the networking concepts they represent. Since your Telephone Adapter is configured to operate with the default values, no parameter modification is necessary. You can configure the following general connection settings:

Table 12-5: VLAN Interface - General Communication Parameters

Parameter	Description
Schedule	By default, the connection is always active. However, you can configure scheduler rules in order to define time segments during which the connection may be active. Once a scheduler rule(s) is defined (via Advanced>Scheduler Rules), this field changes to a drop-down list, allowing you to choose between the available rules. To configure scheduler rules, see Section 10.11.
Network	Select whether the parameters you are configuring relate to a WAN, LAN or DMZ connection, by selecting the connection type from the drop-down list. For detailed information, see Section 4.2.
Physical Address	The physical address of the network card used for your network.
MTU	MTU is the Maximum Transmission Unit. It specifies the largest packet size permitted for Internet transmission. In the default setting, Automatic, the Telephone Adapter selects the best MTU for your Internet connection. In case you change to manual, you can enter the largest packet size, you should leave this value in the 1200 to 1500 range.
Underlying Connection	The Ethernet device that the connection is implemented over.

Select one of the following Internet Protocol options from the 'Internet Protocol' drop down menu:

- No IP Address
- Obtain an IP Address Automatically
- Use the Following IP Address

Note that according to the selection you make in the 'Internet Protocol' drop down menu, the screen refreshes and displays relevant configuration settings.

- **No IP Address:** Select 'No IP Address' if you require that your Telephone Adapter has no IP address. This can be useful if you are working in an environment where you are not connected to other networks, such as the Internet.
- **Obtain an IP Address Automatically:** Your WAN connection is configured by default to act as a DHCP client. You should keep this configuration in case your service provider supports DHCP, or if you are connecting using a dynamic IP address. The server that assigns the Telephone Adapter with an IP address also assigns a subnet mask. You can override the dynamically assigned subnet mask by selecting the 'Override Subnet Mask' and specifying your own mask instead. You can click the **Release** button to release the current leased IP address. Once the address has been released, the button text changes to 'Renew'. Use the **Renew** button to renew the leased IP address.
- **Use the Following IP Address:** Your WAN connection can be configured using a permanent (static) IP address. Your service provider should provide you with this IP address, subnet mask and the default Telephone Adapter IP address.

12.4.1.1 IP Address Distribution

The 'IP Address Distribution' section allows you to configure the device's Dynamic Host Configuration Protocol (DHCP) server parameters. The DHCP automatically assigns IP addresses to network PCs. If you enable this feature, make sure that you also configure your network PCs as DHCP clients. For a comprehensive description of this feature, see Section 10.28.

Select one of the following options from the 'IP Address Distribution' drop-down list:

Table 12-6: IP Address Distribution Parameters

Parameter	Description
DHCP Server	Start IP Address The first IP address that may be assigned to a LAN host. Since the device's default IP address is 192.168.2.1, this address must be 192.168.2.2 or greater.
End IP Address	The last IP address in the range that can be used to automatically assign IP addresses to LAN hosts.
Subnet Mask	A mask used to determine to what subnet an IP address belongs. An example of a subnet mask value is 255.255.0.0.
Lease Time In Minutes	Each device is assigned an IP address by the DHCP server for this amount of time, when it connects to the network. When the lease expires the server determines if the computer has disconnected from the network. If it has, the server may reassign this IP address to a newly-connected computer. This feature ensures that IP addresses that are not in use become available for other computers on the network.
Provide Host Name If Not Specified by Client	If the DHCP client does not have a host name, the device automatically assigns one for him.

Figure 12-41: IP Address Distribution - DHCP Server

The screenshot shows a configuration window titled 'IP Address Distribution' with a dropdown menu set to 'DHCP Server'. Below the title are several input fields: 'Start IP Address' (0.0.0.0), 'End IP Address' (0.0.0.0), 'Subnet Mask' (0.0.0.0), and 'Lease Time in Minutes' (60). At the bottom, there is a checked checkbox labeled 'Provide Host Name If Not Specified by Client'.

Table 12-7: DHCP Relay

Parameter	Description
DHCP Relay	Your device can act as a DHCP relay in case you would like to dynamically assign IP addresses from a DHCP server other than your Telephone Adapter's DHCP server. Note: When selecting this option, you must also change the device's WAN to work in routing mode. For detailed information, see Section 10.28.2.

- After selecting 'DHCP Relay' from the drop-down list, a **New IP Address** link appears:

Figure 12-42: IP Address Distribution - DHCP Relay



- Click the **New IP Address** link; the 'DHCP Relay Server Address' screen appears:

Figure 12-43: DHCP Relay Server Address

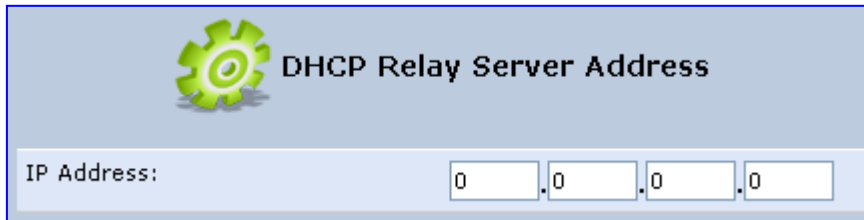

- Specify the IP address of the DHCP server.
- Click **OK** to save the settings.

Table 12-8: Assigning Static IP Addresses to Network Computers

Parameter	Description
Disabled	Select 'Disabled' from the drop-down list to statically assign IP addresses to your network computers.

Figure 12-44: IP Address Distribution - Disable DHCP



12.4.2 Routing Tab

You can choose to setup your Telephone Adapter to use static or dynamic routing. Dynamic routing automatically adjusts how packets travel on the network, whereas static routing specifies a fixed routing path to neighboring destinations.

Figure 12-45: Advanced Routing Properties

WAN Ethernet Properties

General Settings **Routing** Advanced

Routing Mode: NAPT

Device Metric: 3

Default Route

Multicast - IGMP Proxy Default

Routing Table						
Name	Destination	Gateway	Netmask	Metric	Status	Action
New Route						+

Table 12-9: Routing Parameters

Parameter	Description
Routing	Select 'Advanced' or 'Basic' routing.
Routing Mode	Select one of the following Routing modes: <ul style="list-style-type: none"> Route: Use route mode if you want your device to function as a router between two networks. NAT: Network Address Translation (NAT) translates IP addresses to a valid, public address on the Internet. This adds security since internal LAN addresses are not transmitted over the Internet. In addition, NAT allows many addresses to exist behind a single valid address. Use the NAT routing mode if your LAN consists of a single device, otherwise collisions may occur if more than one device attempts to communicate using the same port. NAPT: Network Address and Port Translation (NAPT) refers to network address translation involving the mapping of port numbers, allowing multiple machines to share a single IP address. Use NAPT if your LAN encompasses multiple devices, a topology that necessitates port translation in addition to address translation.
Device Metric	The device metric is a value used by the device to determine whether one route is superior to another, considering parameters such as bandwidth, delay, and more.
Default Route	Select this check box to define this device as the default route.

Parameter	Description
Multicast	IGMP Proxy Internal IGMP proxy enables the system to issue IGMP host messages on behalf of hosts that the system discovered through standard IGMP interfaces. IGMP proxy enables the routing of multicast packets according to the IGMP requests of LAN devices asking to join multicast groups. Select the 'Multicast IGMP Proxy Internal' check-box to enable this feature.
Routing Table	Allows you to add or modify routes when this device is active. Use the New Route button to add a route or edit existing routes.

12.4.3 Advanced Tab

Your Telephone Adapter's firewall helps protect your computer by preventing unauthorized users from gaining access to it through a network such as the Internet. The firewall can be activated per network connection. To enable the firewall on this network connection, select the 'Enabled' check box. For detailed information on your device's security features, see Section 5.

Figure 12-46: Internet Connection Firewall

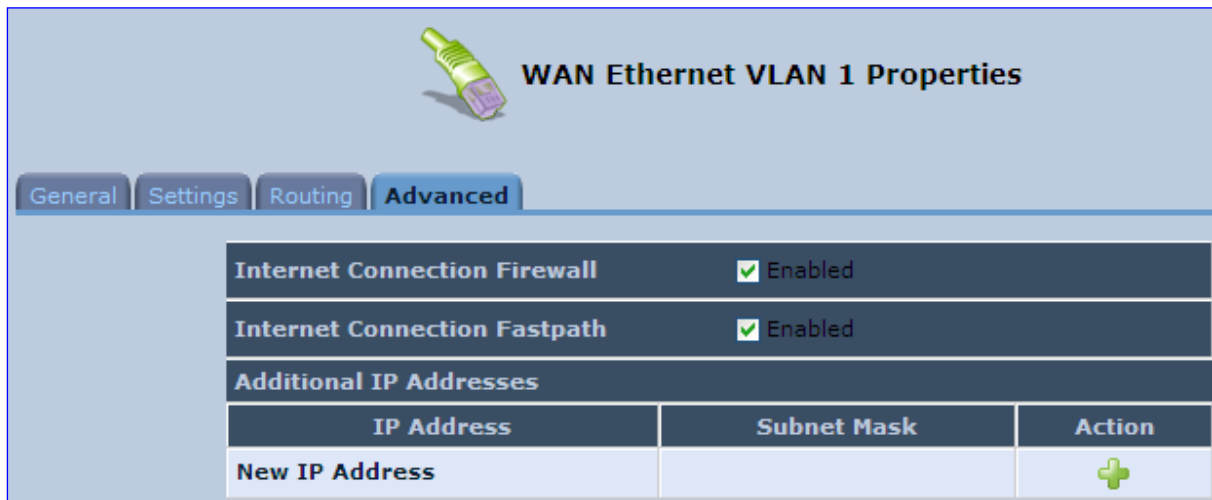

You can add alias names (additional IP addresses) to the device by clicking the 'New IP Address' link. This enables you to access the device using these aliases in addition to the IP address (e.g., 192.168.2.1) and *http://mp202.home*.

12.5 LAN-WAN Bridge Settings

A WAN-LAN bridge is a bridge over WAN and LAN devices. In such a setup, computers on the device LAN side can get IP addresses that are known on the WAN side.

➤ **To configure an existing bridge or create a new one:**

1. From the menu bar, click the **Network Connections** menu, and in the screen 'Network Connections' click the **New**  icon; the 'Connection Wizard' screen appears.
2. Select the 'Advanced Connection' option, and then click **Next**; the 'Advanced Connection' screen appears.
3. Select the 'Network Bridging' option, and then click **Next**; the screen 'Bridge Options' opens.

Figure 12-47: Bridge Options



4. Select whether to configure an existing bridge (this option only appears if a bridge exists) or to add a new one:
 - **Configure Existing Bridge:** Select this option and then click **Next**; the screen 'Network Bridging' opens, allowing you to add new connections or remove existing ones, by selecting or clearing their respective check boxes.

Figure 12-48: Network Bridging Screen

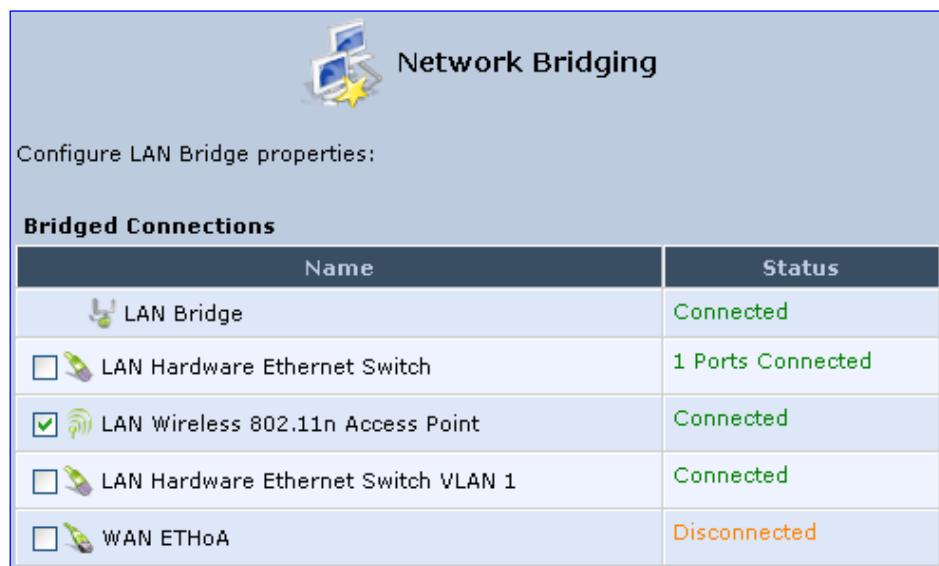

5. For example, checking the WAN check box creates a LAN-WAN bridge.
 - **Add a New Bridge:** Select this option and then click **Next**; a different 'Network Bridging' screen appears, allowing you to add a bridge over the unbridged connections, by selecting their respective check boxes.

Figure 12-49: Adding New Network Bridging

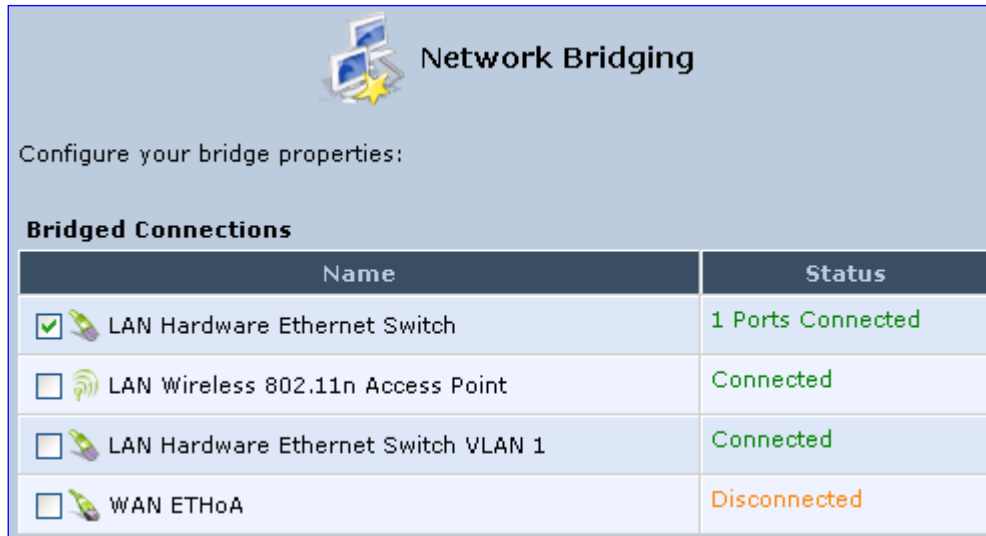

Important notes:

- The same connections cannot be shared by two bridges.
 - A bridge cannot be bridged.
 - Bridged connections lose their IP settings.
6. Click **Next**; the screen 'Connection Summary' opens, corresponding to your changes.

Figure 12-50: Connection Summary - Configure Existing Bridge



7. Select the check box 'Edit the Connection' to be routed to the new connection's configuration screen after clicking **Finish**.
8. Click **Finish** to save the settings; the new bridge is added to the network connections list; it's configurable like any other bridge.

12.5.1 Editing LAN-WAN Bridging

You can edit existing LAN-WAN bridges that are listed in the Connections list. This is done in the **Bridging** tab, which allows you to specify the LAN and WAN devices that you would like to join under the network bridge.

➤ **To edit LAN-WAN bridging:**

1. From the menu bar, click the **Network Connections** menu, and then in the screen 'Network Connections' click the **Edit** icon corresponding the bridged network; the 'Connection Wizard' screen appears.
2. Click the **Bridge** tab; the LAN Bridge Properties screen appears.

Figure 12-51: Bridging Tab

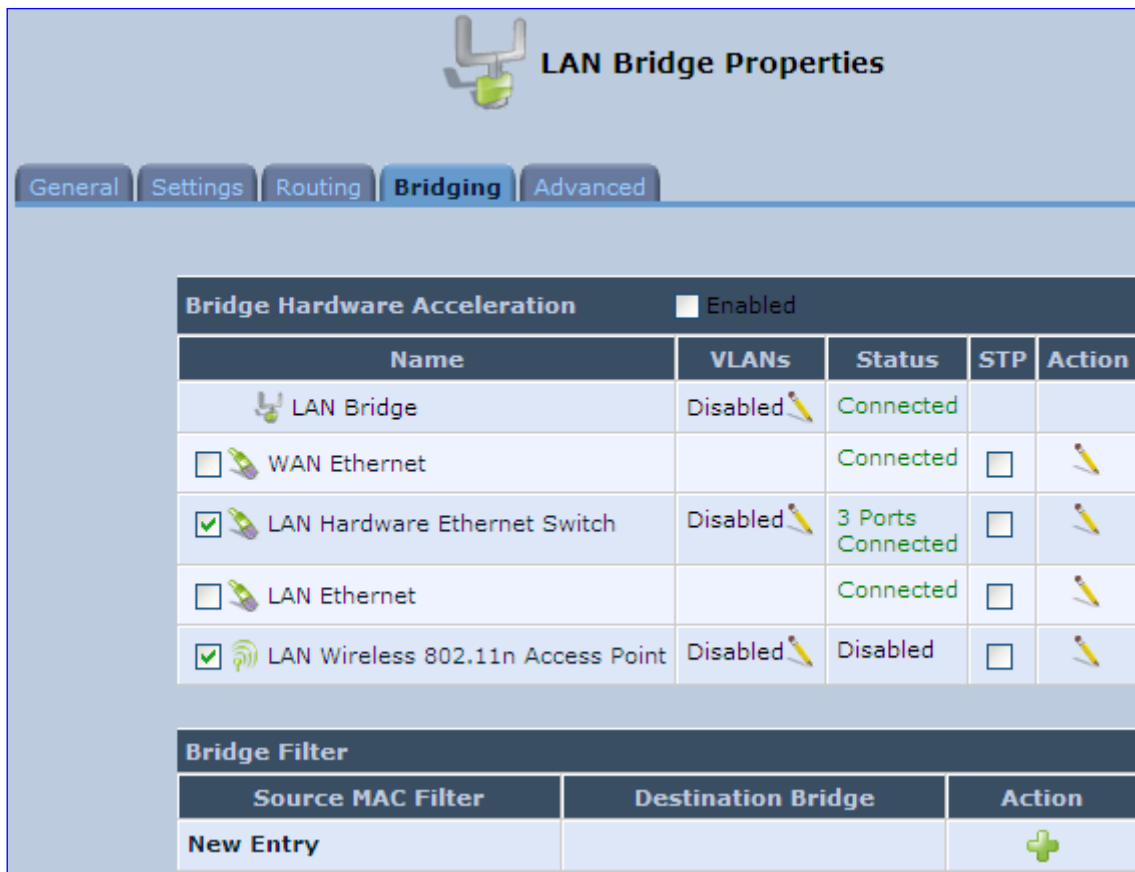

3. Select the check boxes corresponding to the connection names that you want to bridge, or clear the check boxes of connections that you do not want to bridge.
4. Select the 'Bridge Hardware Acceleration' check box to utilize the Fastpath algorithm, which enhances packet flow, resulting in faster communication between the LAN and the WAN.
5. Select the 'STP' check box to enable the Spanning Tree Protocol (STP) on the device. You should use this to ensure that there are no loops in your network configuration, and apply these settings if your network consists of multiple switches, or other bridges apart from those created by the device

6. To configure VLANs for each network connection in the bridge:
 - a. Click the **Edit**  icon in the 'VLANs' column corresponding to a network that you want to assign specific Virtual LANs; the 'VLAN Settings' screen appears.

Figure 12-52: VLAN Settings Screen



VLAN Settings

Enable VLAN

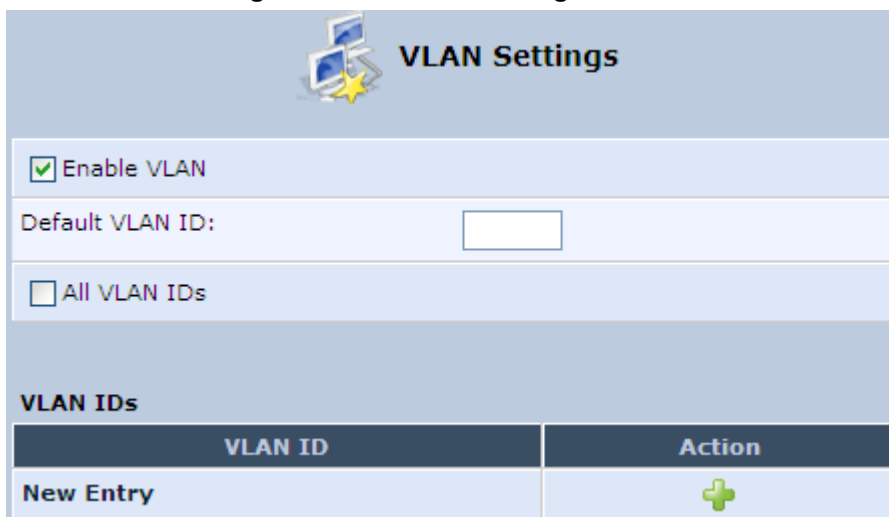
Default VLAN ID:

All VLAN IDs

VLAN ID	Action
New Entry	



- b. Select the 'Enable VLAN' check box to enable VLANs on this connection; the screen refreshes and additional parameters appear.
 - c. In the 'Default VLAN ID' field, enter a VLAN ID for this connection or add additional VLANs by clicking the **New**  icon, and then enter another VLAN ID.
7. To create a traffic filtering rule on the bridge to enable direct packet flow between the WAN and the LAN (i.e., Bridge Filtering):
 - a. In the 'Bridge Filter' table, click the **New**  icon; the 'Bridge Filter' screen appears.

Figure 12-53: Bridge Filter Screen



Bridge Filter

Matching

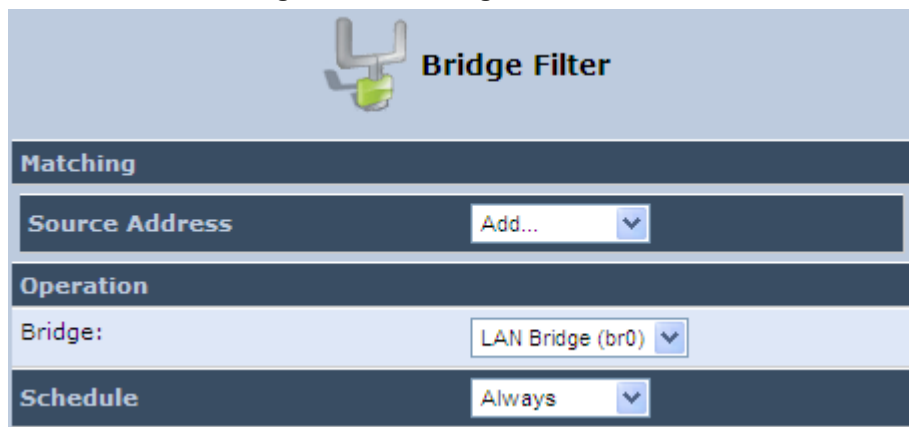
Source Address

Operation

Bridge:

Schedule

- b. From the 'Source Address' drop-down list, select a Network Object (defined in Section 5.6.2 on page 51) or create a new one by clicking 'User Defined'. You can define a traffic filtering rule that enables direct packet flow between the WAN and the LAN host that will be placed under the WAN-LAN bridge. This filtering rule can be based on either a LAN host's MAC address or one of its DHCP options.
 - c. From the 'Operation' drop-down list, select the bridge.
 - d. Click **OK**.

This page is intentionally left blank.

13 Add-On Servers and Disk Management

The procedures below describe how to configure additional servers and disk management.

13.1 External File Server

The device provides a file server utility, allowing you to perform various tasks on your files, such as manage file server shares and define access control lists. The file server utility complements the device's disk management.

➤ **To configure the file server:**

1. In the 'Advanced' screen, click the **File Server**  icon; the screen 'File Server' opens.

Figure 13-1: File Server Screen

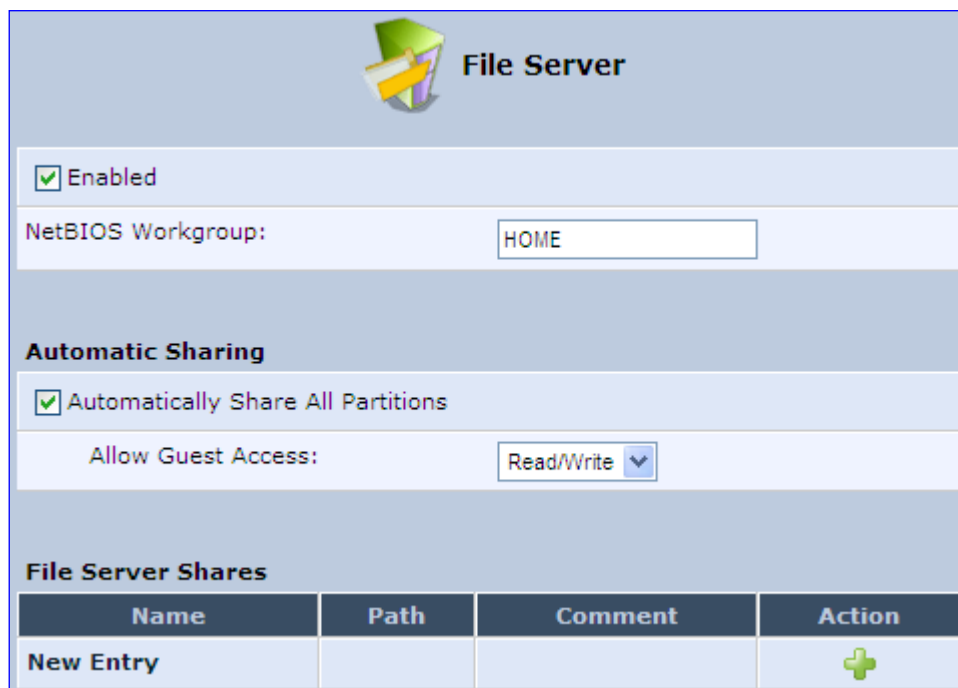

Name	Path	Comment	Action
New Entry			

2. Configure the following:
 - **Enabled:** Select or clear this check box to enable or disable this feature.
 - **NetBIOS Workgroup:** The device workgroup name that is displayed in the Windows network map of LAN hosts.
 - **Automatic Sharing:**
 - ◆ **Automatically Share All Partitions:** A partitioned storage device connected to the device is automatically displayed and shared by all LAN computers. This feature is enabled by default.

- ◆ **Allow Guest Access:** From the drop-down list, select a permission level, according to which the LAN users access the share:
 - ✓ **Read/Write:** Every LAN user can read and write the shared files without authentication.
 - ✓ **Read Only:** Every LAN user can only read the shared files.
 - ✓ **Disabled:** LAN users must authenticate themselves to access the share. They can use the share according to their permissions defined in the 'User Settings' screen.
- **File Server Shares:** Define file shares on your disk partitions, as described in the following sections.

13.1.1 Automatic File Sharing

By default, all partitions are automatically shared and displayed.

➤ **To share specific directories or partitions:**

1. Clear the 'Automatically Share All Partitions' check box, and then click **Apply**. The list of all automatically shared partitions disappears.
2. In the 'File Server Shares' table, click **New**  icon to define a new share; the 'File Server Share Settings' screen appears.

Figure 13-2: File Server Share Settings Screen



File Server Share Settings

Name:

Path:

Comment:

Users

Name	Access Level	Action
New User		

Groups

Name	Access Level	Action
New Group		

3. Enter the share's name (default is "share"), path, and (optionally) comment. The share's name is not case sensitive. Even if entered in upper-case letters, the name is displayed in lower case after saving the setting.
4. Associate a user or group of users with the share to grant them access to the shared files, by clicking the **New User** or **New Group** link in the Users or Groups table. Note that the user's settings must have the 'Microsoft File and Printer Sharing Access' check box selected under the 'Permissions' section (see 'Configuring Users' on page 36); the 'User' screen appears:

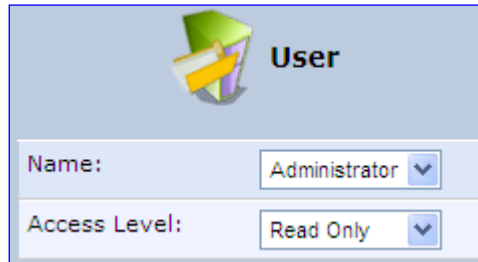

Figure 13-3: User Screen



The screenshot shows a window titled 'User' with a folder icon. Below the icon are two dropdown menus. The first is labeled 'Name:' and has 'Administrator' selected. The second is labeled 'Access Level:' and has 'Read Only' selected.

- a. From the 'Name' drop-down list, select the user name and the allowed access.
 - b. Click **OK**.
5. Click **OK** to save the settings. The 'File Server' screen appears, displaying the share.

Figure 13-4: File Server Screen with the Share

File Server Shares			
Name	Path	Comment	Action
share	A, B/my_documents		 
New Entry			

Click the share's name to view its content. The screen refreshes as the share is accessed. This screen enables you to modify and view the content of your file share. In the upper section of this screen, you can modify your file share by adding files or directories to it. Use the drop-down list to select an action:

- **Upload a File:** Uploads a file to the share. The screen refreshes - enter the location of the file to upload, or click the **Browse** button to browse for the file. Click the **Upload** button to upload the file.
- **Upload a Directory:** You can also upload an entire directory of files, by performing the following:
 - a. Create a tarball archive out of the target directory.
 - b. Enter the location of the archive, or click the **Browse** button to browse to its location.
 - c. Click the **Upload** button to upload the archive.
- **Create a new Directory:** You can create a new directory by simply typing its name and clicking **Go**.
- **Paste from Clipboard:** This option appears only after using the 'Copy to Clipboard' option to copy a directory or file from one directory to another.

The lower section of the screen displays your share's content. You can click the different directory names to access them or you can download, rename, copy or remove the directories using the standard action icons.

13.2 Print Server

The device includes a print server that allows printers attached to the device through the USB connection(s) to be shared by all computers on the LAN. Such a printer appears in the Network Map. You can access the printer settings directly, by clicking the printer icon in the Network Map or as described below.

➤ **To configure a print server:**

1. In the 'Advanced' screen, click the **Print Server**  icon; the 'Print Server' screen appears.

Figure 13-5: Advanced – Print Server Screen

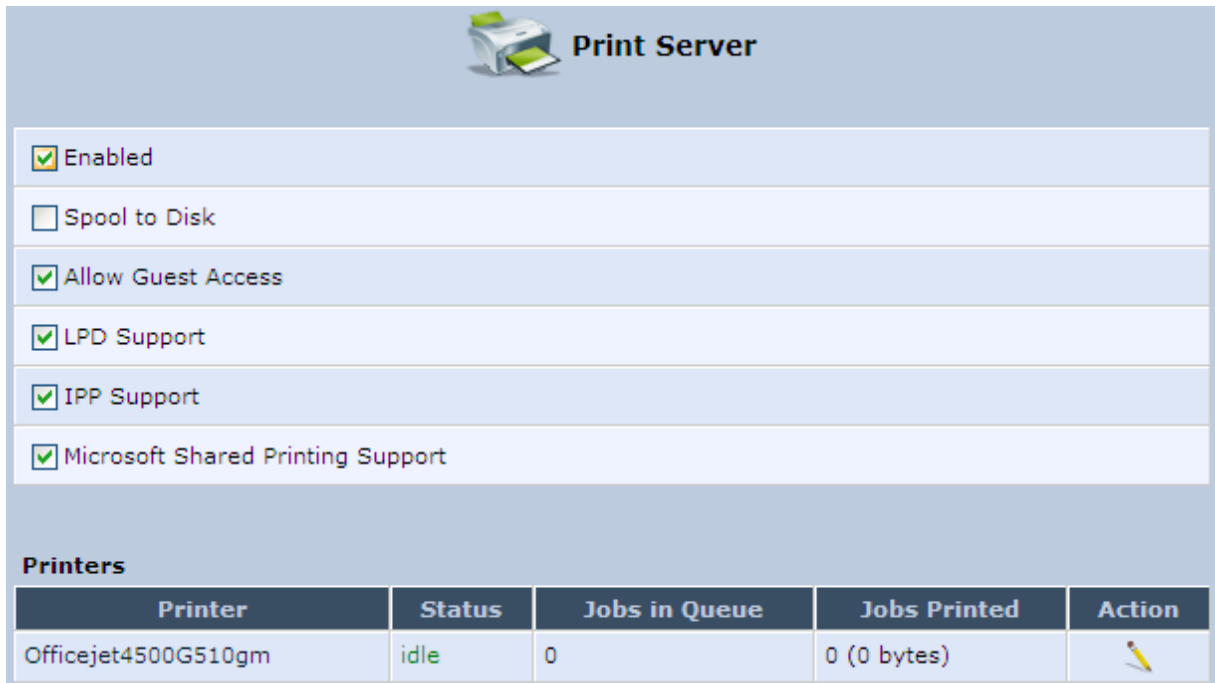

2. Select or clear (as required) the following check boxes:
 - **Enabled:** Enables or disables the print server feature.
 - **Spool to Disk:** Allows print jobs to be written to a disk before printing.
 - **Allow Guest Access:** Allows network users that have not logged in with a username and password to use the shared printer. If you want to restrict access to the network printer, you can clear this check box and grant user-specific permissions by creating a user set to 'Internet Printer Access' (see Section 5.4).
 - **LPD Support:** Enables the LPD protocol.
 - **IPP Support:** Enables the IPP protocol.
 - **Microsoft Shared Printing Support:** Enables the Samba protocol.
3. The **Printers** table lists the device printers, their status as well as their print job information. To view the printer's properties and optionally, to define a new name for the printer, click the **Edit**  icon corresponding to the printer; the 'Printer' screen appears.

Figure 13-6: Advanced – Printer Screen

Printer	
Name:	Officejet4500G510gm
IPP URL:	http://MP252.home:631/printers/Officejet4500G510gm
Model:	HP Officejet 4500 G510g-m
Status:	idle
Jobs Printed:	0 (0 bytes)
<input checked="" type="checkbox"/> Create Default Device Mode	

4. To change the displayed name of the printer, in the 'Name' field, enter a new name.
5. To set the printer as the default printer, select the 'Create Default Device Mode' check box.

13.2.1 Connecting and Setting up a Printer on Windows

The procedure below describes how to set up a network printer that is connected to the device USB port and shared by all LAN computers, running on the Windows operating system.



Note: The above configuration must be applied to each LAN PC individually in order to use the network printer.

➤ **To set up a printer running on Windows:**

1. Download the print driver to your computer.
2. Access the device LAN network where the disk and printer shares available on the device are displayed:

Figure 13-7: Disk and Printer Shares

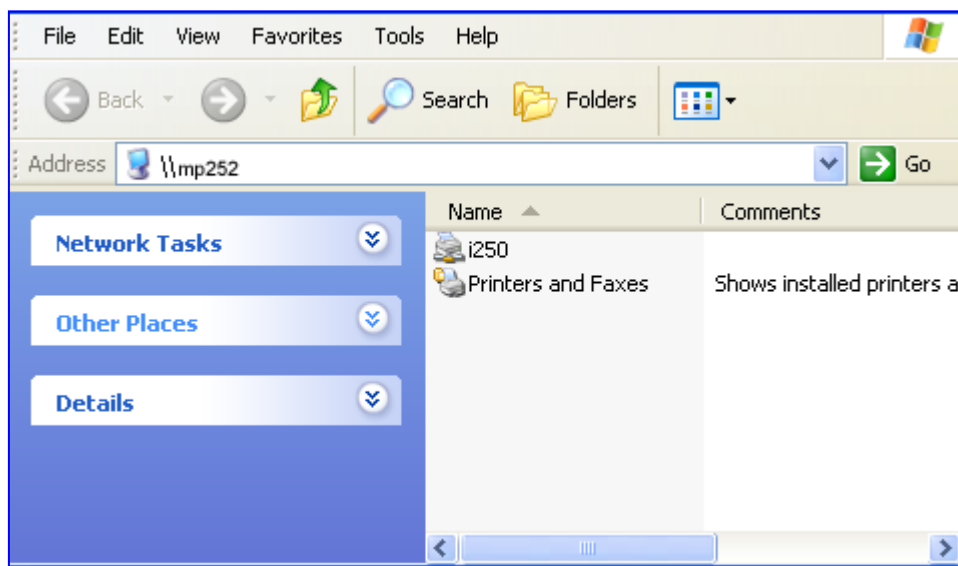

3. Select the printer icon that you want to designate as a LAN printer; a warning appears.
4. Click **Yes**; you are prompted to select a printer driver from a list. If unavailable, you can either browse to a location on your computer where you have stored the driver, or click **Have Disk** and insert the CD containing the driver (supplied with your printer). After a short upload and installation of the driver, the printer's print queue window appears, determining that the printer is ready for use. The new printer is added to your "Printers and Faxes" list as a network printer (to view this list press, in Windows Control Panel, select "Printers and Faxes"). As any printer, you can choose to make it your default printer, or specify its use when printing.
5. Print a test page by right-clicking the printer icon in the disk and printer shares window and selecting **Properties**; the 'Print Test Page' button is located at the bottom of the **General** tab.

13.2.2 Print Protocols

The Samba protocol with which you have created a network printer in the previous section, allows you to upload Windows print drivers to the device, enabling all Windows-based LAN hosts to connect to the network printer.

The device provides two additional protocols for computers to connect to its printers:

- Internet Printing Protocol (IPP) - the recommended protocol, offering fast installation and ease of use.
- Line Printer Daemon (LPD) - legacy network printing protocol, which should only be used for printing from computers that do not support IPP.

The following table compares the specifications of the three protocols:

Table 13-1: IPP, Samba, and LPD Specifications

Specification	IPP	Samba	LPD
Installation	Easy	Easy	Difficult
Driver upload	None	Supported	None
Supported clients	Windows, Unix, Mac	Windows, Mac	Windows, Unix, Mac
Job feedback and control	Print queue monitor and management console	Print queue monitor and management console	Management console only
Printer control	Print queue monitor	None	None
Access controls	Print and administrator	Print permission only	None



Note: For Mac Users: When connecting a print server to a MAC computer, you must verify that the printer connected to MP-264 is supported by Mac OS as a network printer. Supported printers are marked with an "X" at the following URL: <http://docs.info.apple.com/article.html?artnum=301175#hpdrivers>.

13.2.2.1 Internet Printing Protocol

This section describes how to connect computers to the device printers, using the IPP protocol.

13.2.2.1.1 Setting Up an IPP Printer on Windows

The procedure below describes how to set up an IPP printer on Windows 10.

➤ **To set up an IPP printer on Windows:**

1. In the 'Network Map' screen, click the printer icon to view the 'Printer' screen.

Figure 13-8: Printer Screen – IPP URL (Windows)

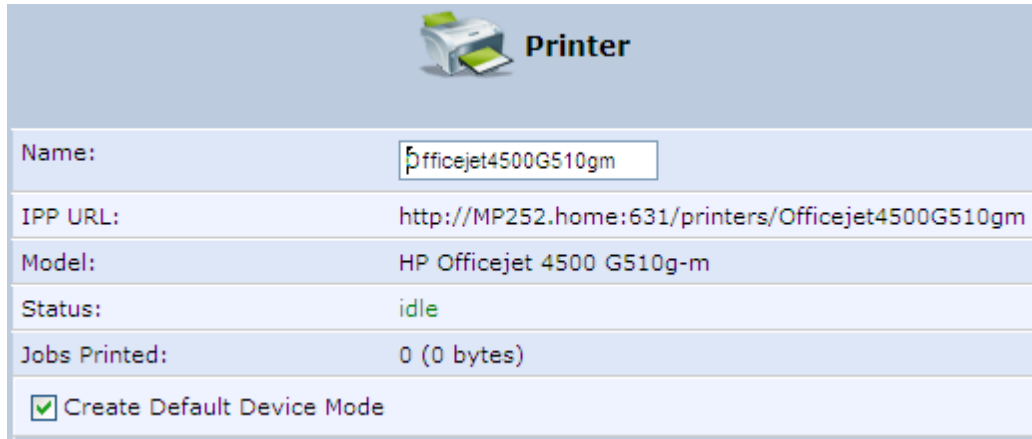

Name:	Officejet4500G510gm
IPP URL:	http://MP252.home:631/printers/Officejet4500G510gm
Model:	HP Officejet 4500 G510g-m
Status:	idle
Jobs Printed:	0 (0 bytes)
<input checked="" type="checkbox"/> Create Default Device Mode	

2. Copy the IPP URL to the clipboard.
3. On your Windows computer connected to the device, from the **Start** menu, point to **Settings**, then **Printers and Faxes**, and then click **Add Printer**; the Add Printer Wizard starts.
4. Click **Next** to proceed with the wizard sequence.
5. Select 'A network printer... ' and then click **Next**.

Figure 13-9: Local or Network Printer

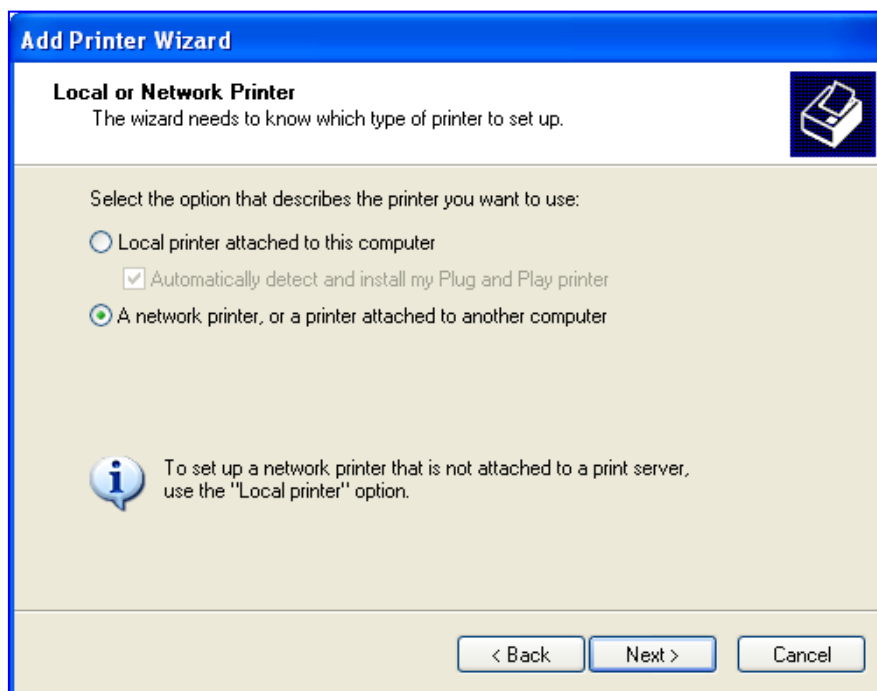

Add Printer Wizard

Local or Network Printer
The wizard needs to know which type of printer to set up.

Select the option that describes the printer you want to use:

Local printer attached to this computer
 Automatically detect and install my Plug and Play printer

A network printer, or a printer attached to another computer

i To set up a network printer that is not attached to a print server, use the "Local printer" option.

< Back Next > Cancel

6. Select 'Connect to a printer on the Internet...', and then paste the printer's IPP URL in the 'URL' field, and then click **Next**.

Figure 13-10: Specify a Printer

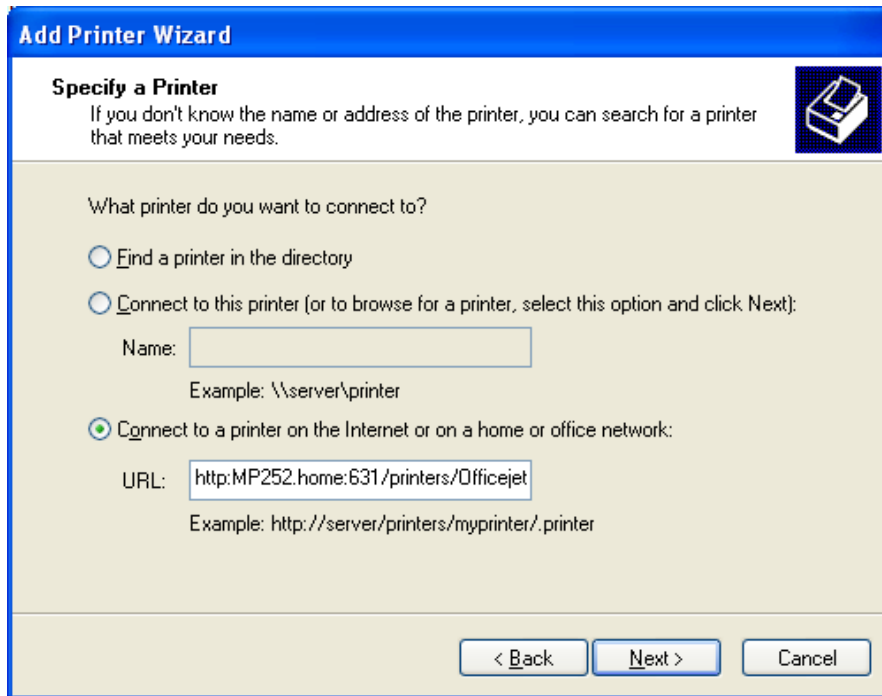

7. You may be asked to select the driver's make and model or its location. If so, provide the location on the device to where you have uploaded the driver (e.g. "\\MP264\A"), and click **Next**.
8. Click **Finish** to exit the wizard.

13.2.2.1.2 Setting Up an IPP Printer on Linux

The procedure below describes how to set up an IPP printer on Linux operating systems. You should use CUPS Daemon (CUPS D) when operating with Linux.

➤ **To set up an IPP printer on Linux:**

1. In the 'Network Map' screen, click the printer icon to view the 'Printer' screen.

Figure 13-11: Printer Screen – IPP URL (Linux)

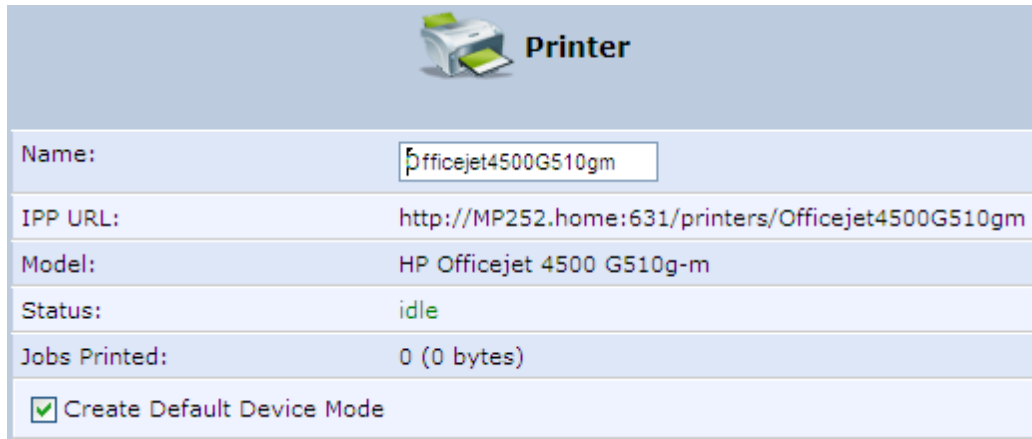

 Printer	
Name:	Officejet4500G510gm
IPP URL:	http://MP252.home:631/printers/Officejet4500G510gm
Model:	HP Officejet 4500 G510g-m
Status:	idle
Jobs Printed:	0 (0 bytes)
<input checked="" type="checkbox"/> Create Default Device Mode	

2. Copy the IPP URL to the clipboard.
3. On your Linux computer connected to the device, browse to <http://localhost:631>, and then choose **Manage Printers**.

Figure 13-12: Linux CUPS Management

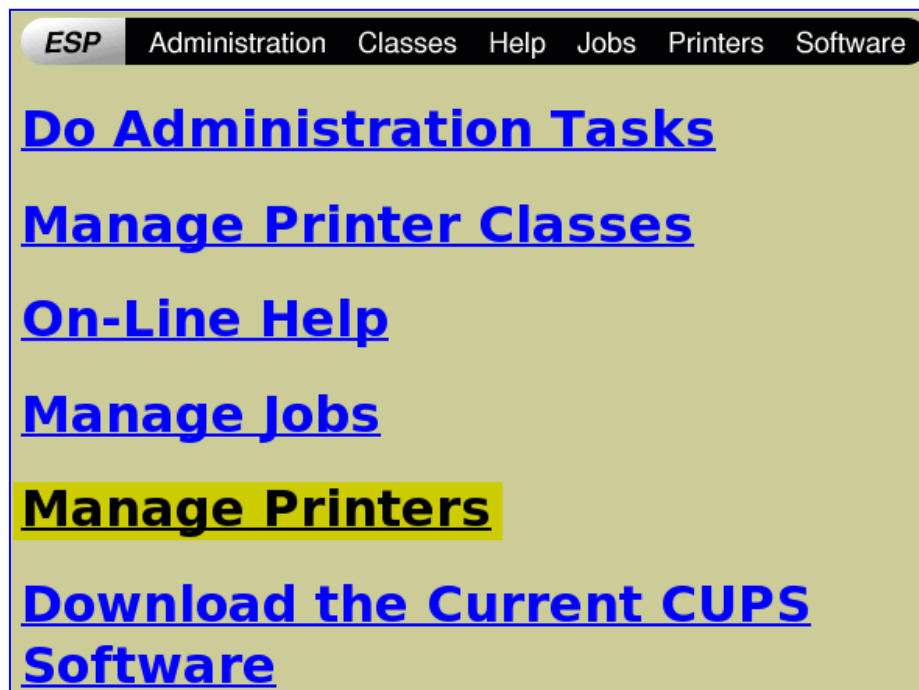

4. Click **Add Printer**.

Figure 13-13: Add Printer



5. In the 'Name' field, type the printer's name and then click **Continue**.

Figure 13-14: Printer Name

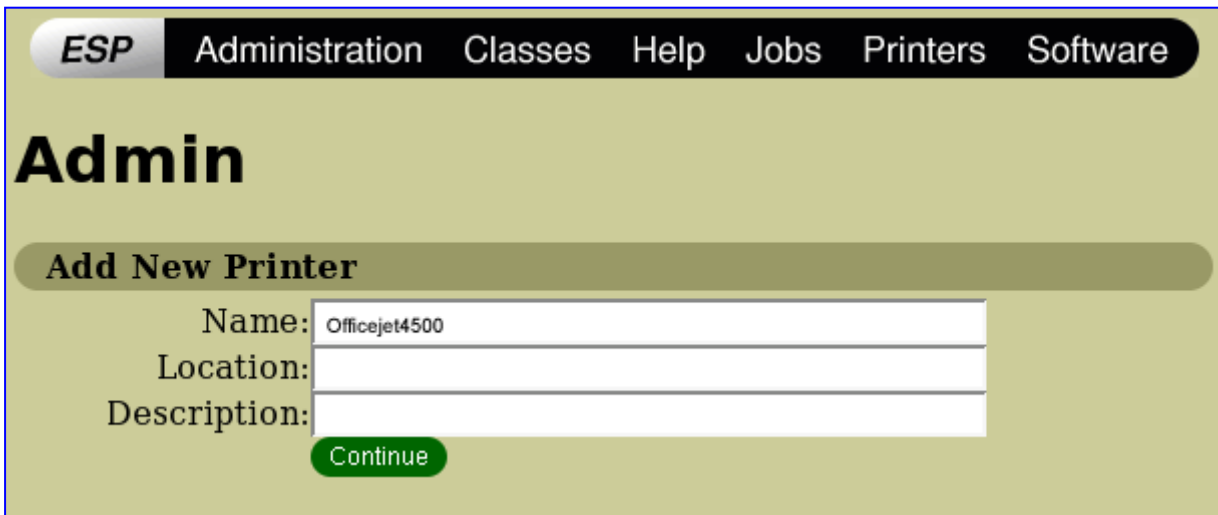

6. From the 'Device' drop-down list, select 'Internet Printing Protocol (http)' and then click **Continue**.

Figure 13-15: Printing Protocol

The screenshot shows the ESP Administration web interface. At the top, there is a navigation bar with the following items: ESP, Administration, Classes, Help, Jobs, Printers, and Software. Below the navigation bar, the word "Admin" is displayed in a large, bold font. Underneath, there is a section titled "Device for Canoni250". In this section, there is a label "Device:" followed by a dropdown menu that currently shows "Internet Printing Protocol (http)". Below the dropdown menu is a green button labeled "Continue".

7. Paste the printer's IPP URL in the 'Device URI' field, and then click **Continue**.

Figure 13-16: IPP URL

The screenshot shows the ESP Administration web interface. At the top, there is a navigation bar with the following items: ESP, Administration, Classes, Help, Jobs, Printers, and Software. Below the navigation bar, the word "Admin" is displayed in a large, bold font. Underneath, there is a section titled "Device URI for Canoni250". In this section, there is a label "Device URI:" followed by a text input field containing the URL "http://MP252.home:631/printers/Officejet4500G510gm". Below the input field, there is a section titled "Examples:" followed by a list of example URIs:

- file:/path/to/filename.prn
- http://hostname:631/ipp/
- http://hostname:631/ipp/port1
- ipp://hostname/ipp/
- ipp://hostname/ipp/port1
- lpd://hostname/queue
- socket://hostname
- socket://hostname:9100

 At the bottom of the section, there is a green button labeled "Continue".

8. The next window displays a manufacturer drop-down list. Select your printer's manufacturer and click **Continue**.
9. The next window displays a printer model drop-down list. Select your printer's model and click **Continue**.
10. The last window displays the following confirmation message: 'Printer has been added successfully'.
11. To test your printer's connection from a Linux PC, open a shell and enter the following command:

```
$ echo hello | lpr -P<Printer Name>
```

13.2.2.1.3 Setting Up an IPP Printer on Mac

The procedure below describes how to set up an IPP printer on Mac operating systems.

➤ **To set up an IPP printer on Mac:**

1. On your Mac computer connected to the device, open the 'Print & Fax' utility from 'System Preferences'; the 'Print & Fax' screen appears.

Figure 13-17: Print & Fax

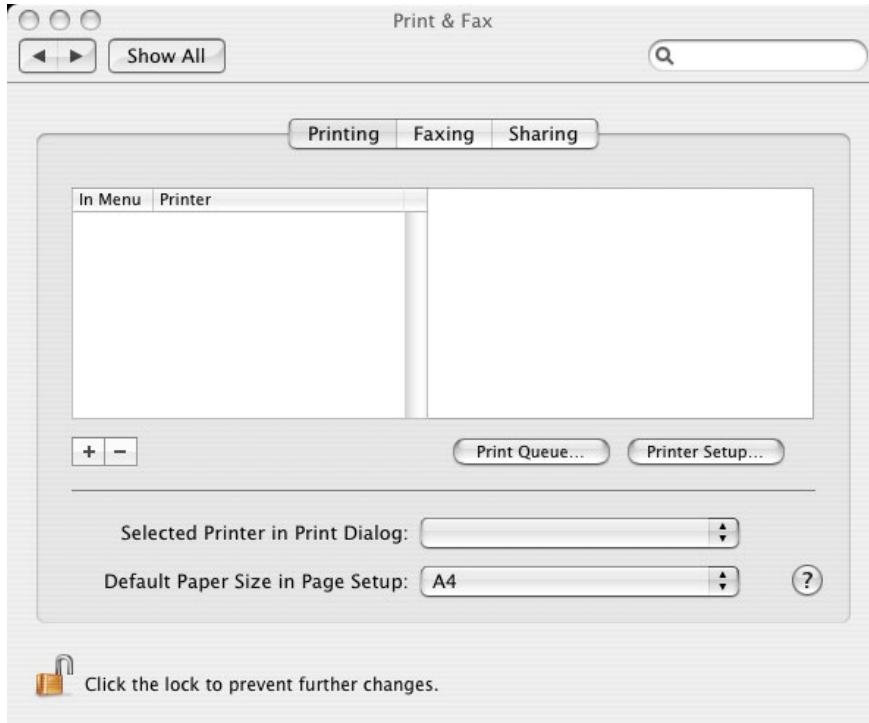

2. Click the + (add) button; the 'Printer Browser' screen appears.
3. Select the **IP Printer** tab.

Figure 13-18: Printer Browser – IP Printer

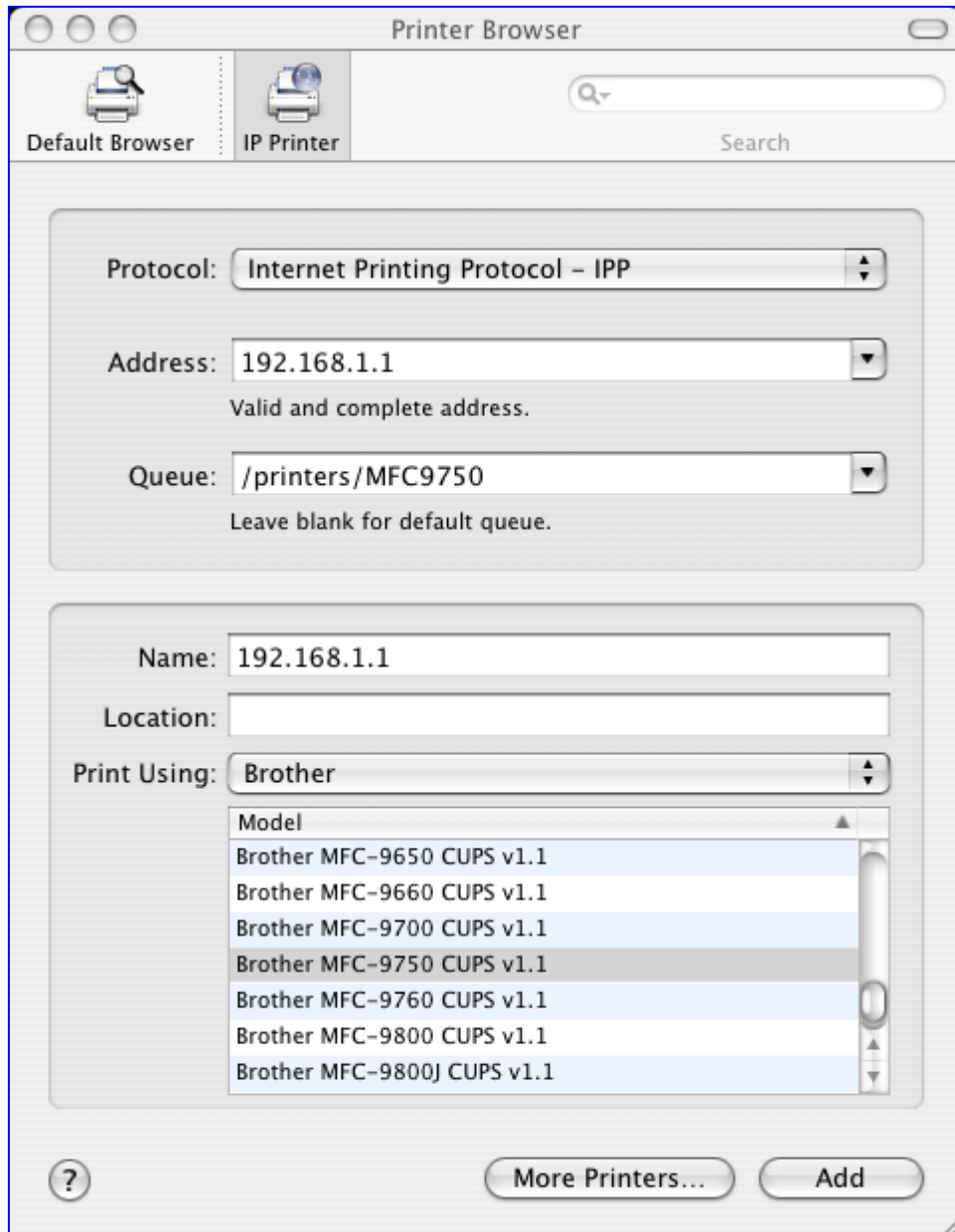

4. In this screen, configure the following:
 - a. From the 'Protocol' drop-down list, select IPP.
 - b. In the 'Address' field, enter the device's IP address (192.168.1.1).
 - c. In the 'Queue' field, enter the section of the path containing the folder and printer names, as it appears in the 'Printer' screen. For example, "/printers/MFC9750".
 - d. The 'Name' and 'Location' fields are optional; the default name is the gateway's IP address.
 - e. From the 'Print Using' drop-down list, select your printer's make and model.

5. Click the **Add** button; the new printer appears in the 'Print & Fax' screen.

Figure 13-19: Print & Fax – New IPP Printer

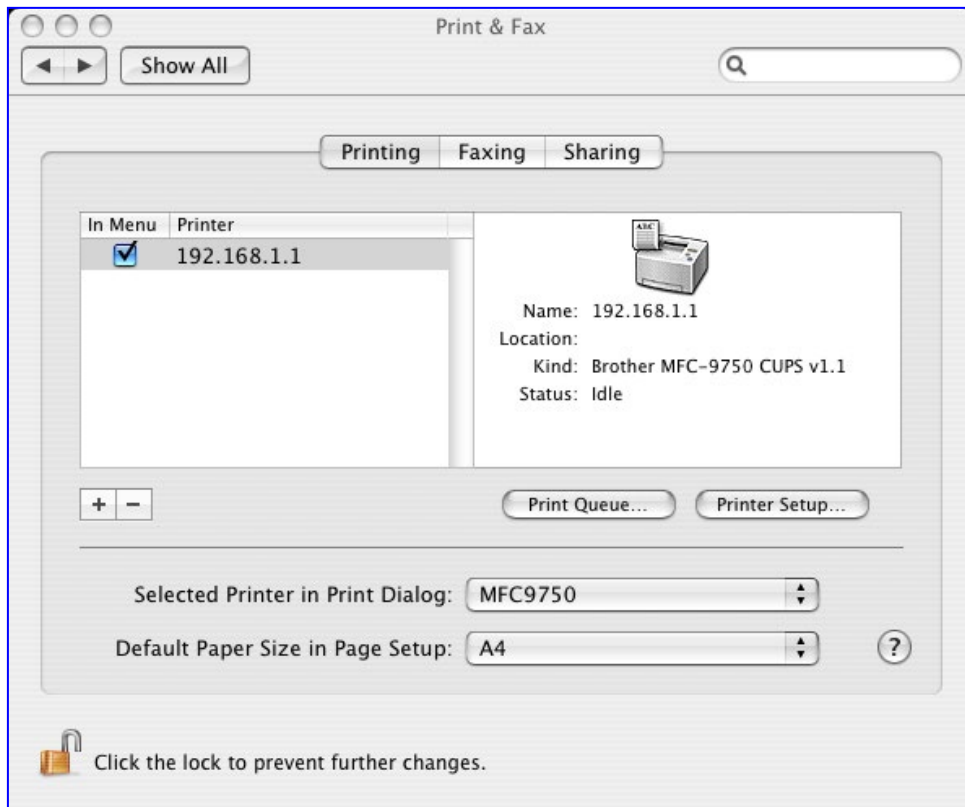

13.2.2.2 Microsoft Shared Printing (Samba)

The procedure below describes how to set up Microsoft Shared Printing (Samba).

- **To set up Microsoft shared printing (Samba):**
- 1. On your Mac computer connected to the device, open the 'Print & Fax' utility from 'System Preferences'; the 'Print & Fax' screen appears.

Figure 13-20: Print & Fax

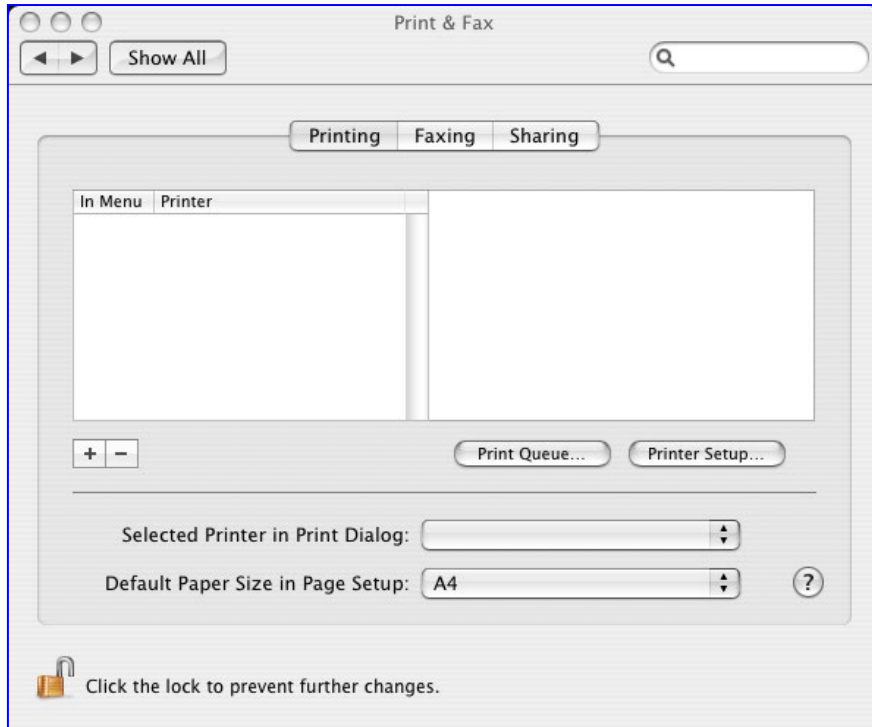

- Click the + (add) button; the 'Printer Browser' screen appears.

Figure 13-21: Printer Browser – Default Browser

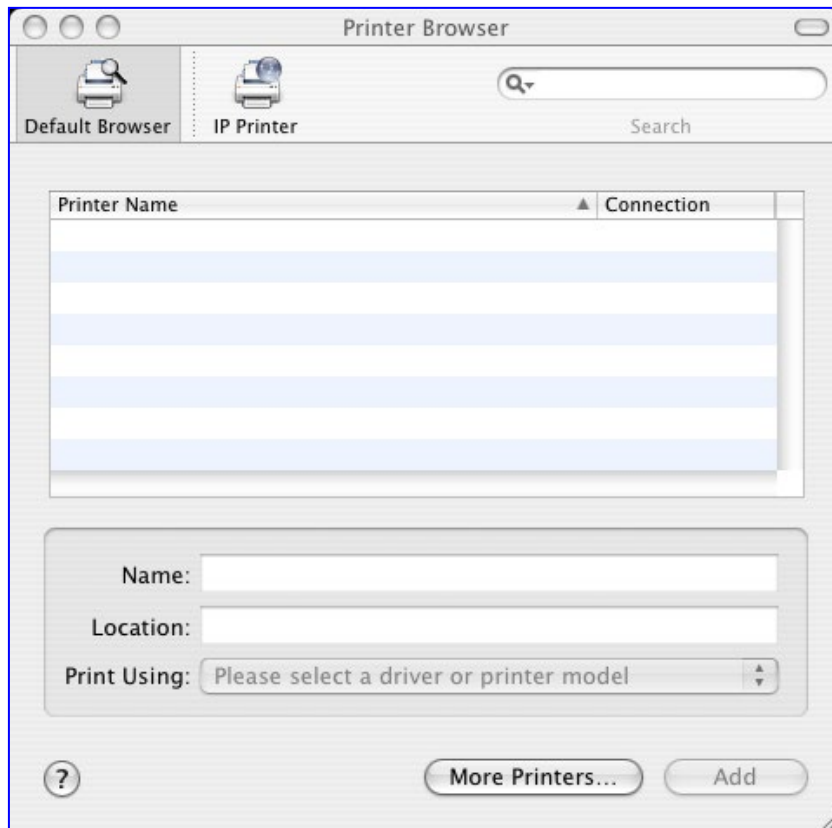

- Click the **More Printers** button; the following screen appears.

Figure 13-22: Printer Browser – More Printers

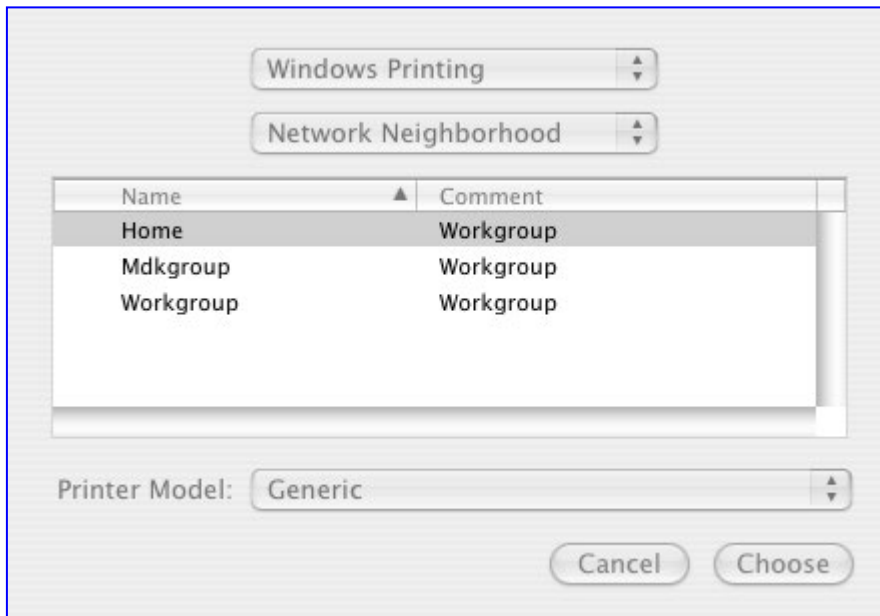

- From the second drop-down list, select 'Network Neighborhood'.

5. Select the 'Home' workgroup and then click **Choose**.

Figure 13-23: Printer Browser – MP264

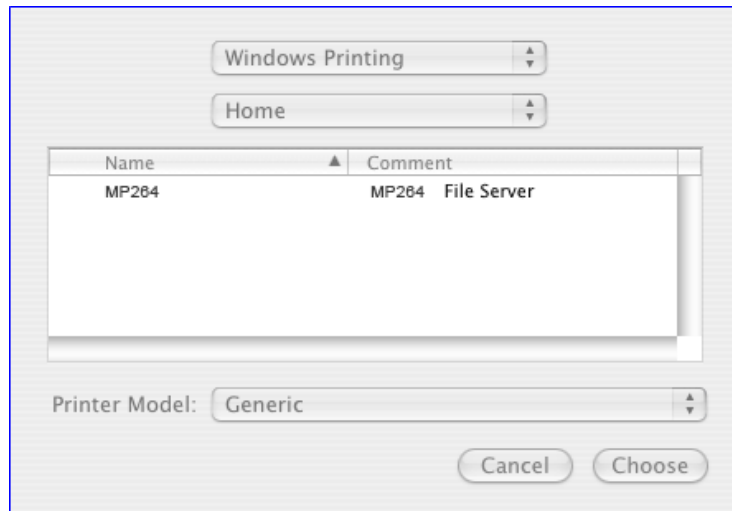

6. Select MP264, and then click **Choose**.
7. Select the printer, and from the 'Printer Model' drop-down list, select your printer's make and model.

Figure 13-24: Printer Browser – Printer Model (e.g., MP-264)

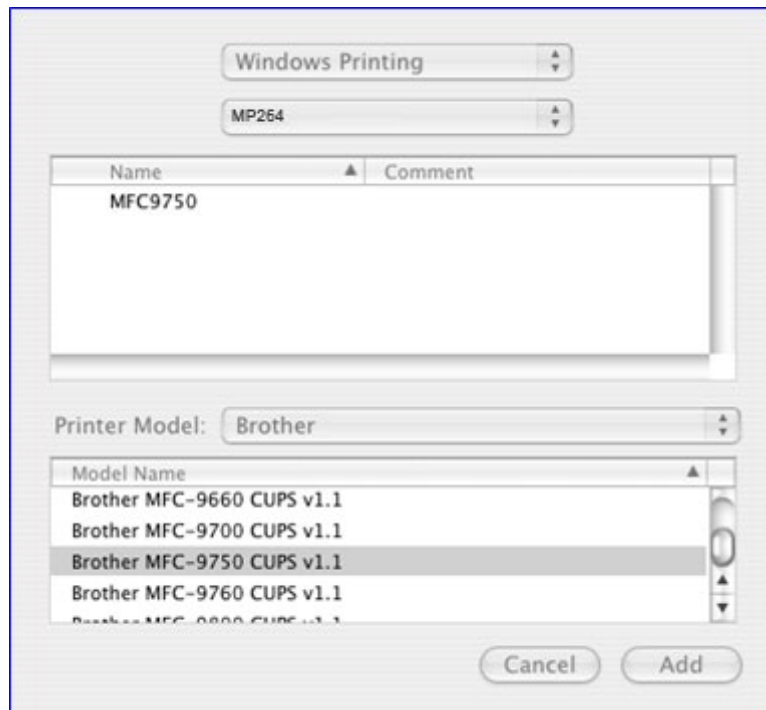

8. Click **Add**; the new printer appears in the 'Print & Fax' screen.

Figure 13-25: Print & Fax – New Samba Printer

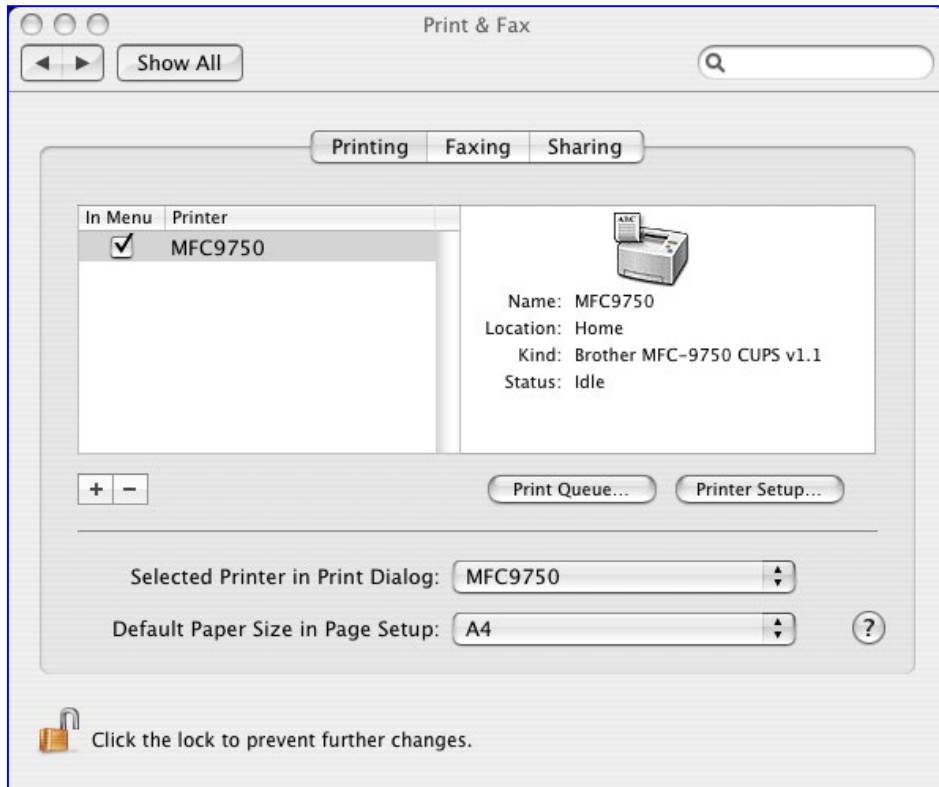

13.2.2.3 Line Printer Daemon (LPD)

This section describes how to connect computers to the device printers, using the LPD protocol.

13.2.2.3.1 Setting Up an LPD Printer on Windows

Before configuring the LPD protocol on a LAN PC, ensure that a print driver for the specific printer is installed.



Note: The following configuration must be applied to each LAN PC individually in order to use the network printer.

➤ **To set up an LPD printer on Windows:**

1. On your Windows computer connected to the device, from the **Start** menu, point to **Settings**, then **Printers and Faxes**, and then click **Add Printer**; the Add Printer Wizard starts.
2. Click **Next** to proceed with the wizard sequence.
3. Select 'Local printer attached to this computer' and then click **Next**.
4. Clear the 'Automatically detect and install my Plug and Play printer', and then click **Next**.

Figure 13-26: Local Printer

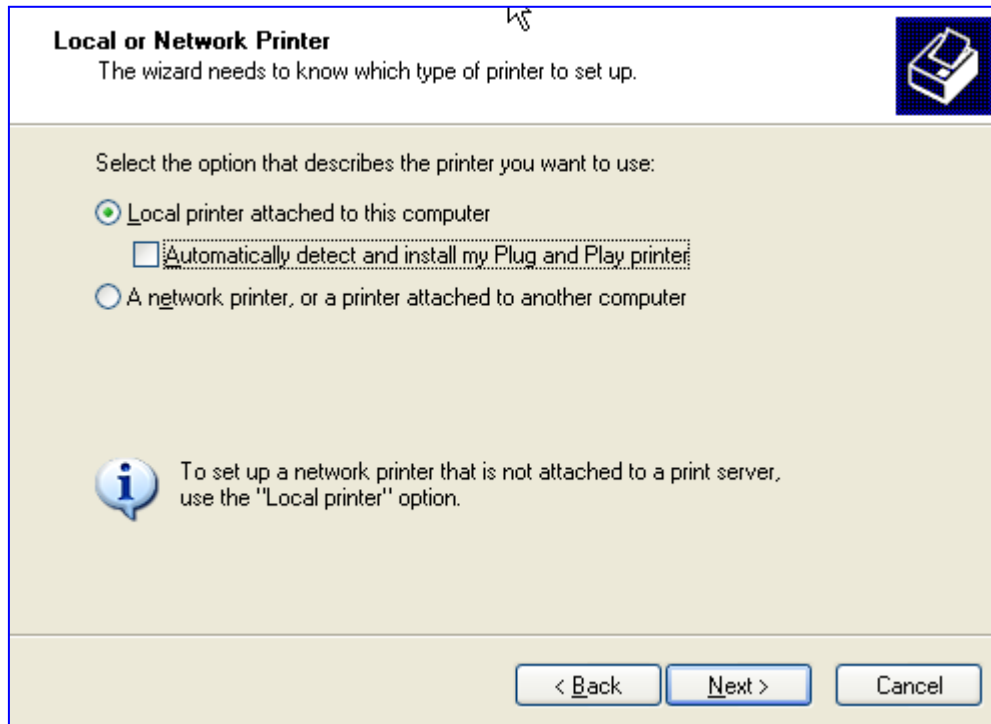

5. Select the 'Create a new port' option.
6. From the 'Type of port' drop-down list, select 'Standard TCP/IP Port'.

Figure 13-27: Select a Printer Port

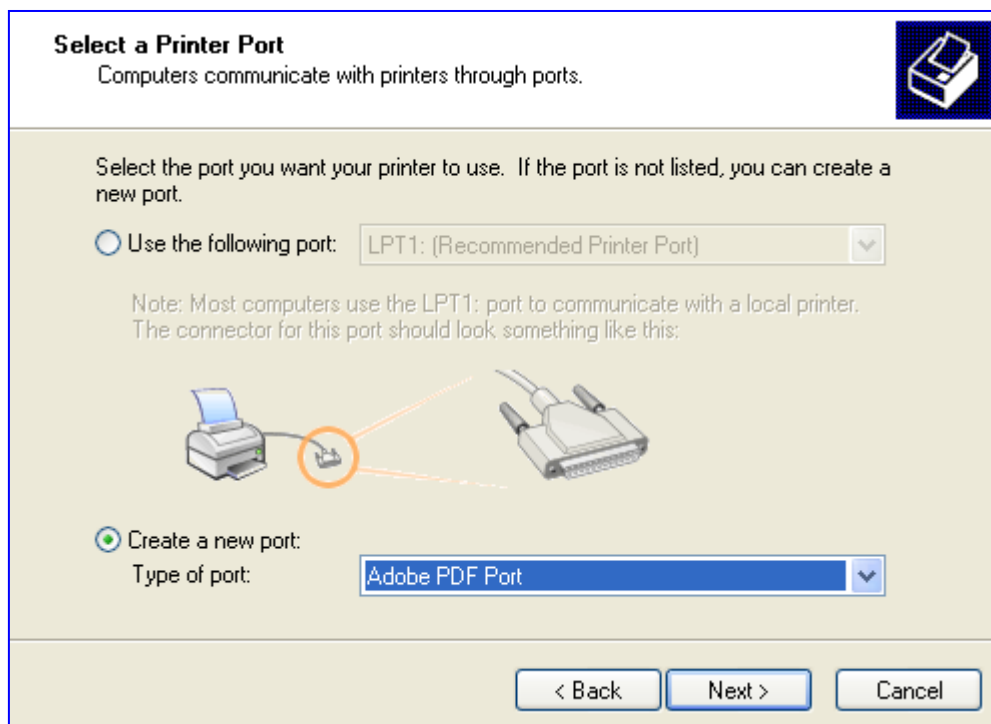

7. Click **Next** to activate the 'Add Standard TCP/IP Printer Port Wizard'.
8. Click **Next** to proceed with the new wizard.

- In the 'Printer Name or IP Address' field, specify 192.168.1.1, and then click **Next**.

Figure 13-28: Add Port

Add Port
For which device do you want to add a port?

Enter the Printer Name or IP address, and a port name for the desired device.

Printer Name or IP Address: 192.168.1.1

Port Name: IP_192.168.1.1

< Back Next > Cancel

- Select the 'Custom' option, and then click **Settings**.

Figure 13-29: Additional Port Information

Add Standard TCP/IP Printer Port Wizard

Additional Port Information Required
The device could not be identified.

The detected device is of unknown type. Be sure that:

- The device is properly configured.
- The address on the previous page is correct.

Either correct the address and perform another search on the network by returning to the previous wizard page or select the device type if you are sure the address is correct.

Device Type

Standard Fuji Xerox NIC

Custom Settings...

< Back Next > Cancel

11. In the 'Configure Standard TCP/IP Port Monitor' window, configure the following parameters:
 - a. Select the 'LPR' option.
 - b. In the device's Web interface, open the 'Print Server' screen.
 - c. Copy the printer's name (for example, "Officejet4000") and paste it in the 'Queue Name' field of the port monitor configuration window.

Figure 13-30: Printer Port Monitor Configuration

Configure Standard TCP/IP Port Monitor

Port Settings

Port Name: IP_192.168.1.1

Printer Name or IP Address: 192.168.1.1

Protocol

Raw LPR

Raw Settings

Port Number: 9100

LPR Settings

Queue Name: Officejet4000

LPR Byte Counting Enabled

SNMP Status Enabled

Community Name: public

SNMP Device Index: 1

OK Cancel

12. Click **OK**, and then click **Finish**; the 'Add Printer Software' wizard reappears.

Figure 13-31: Add Printer Wizard

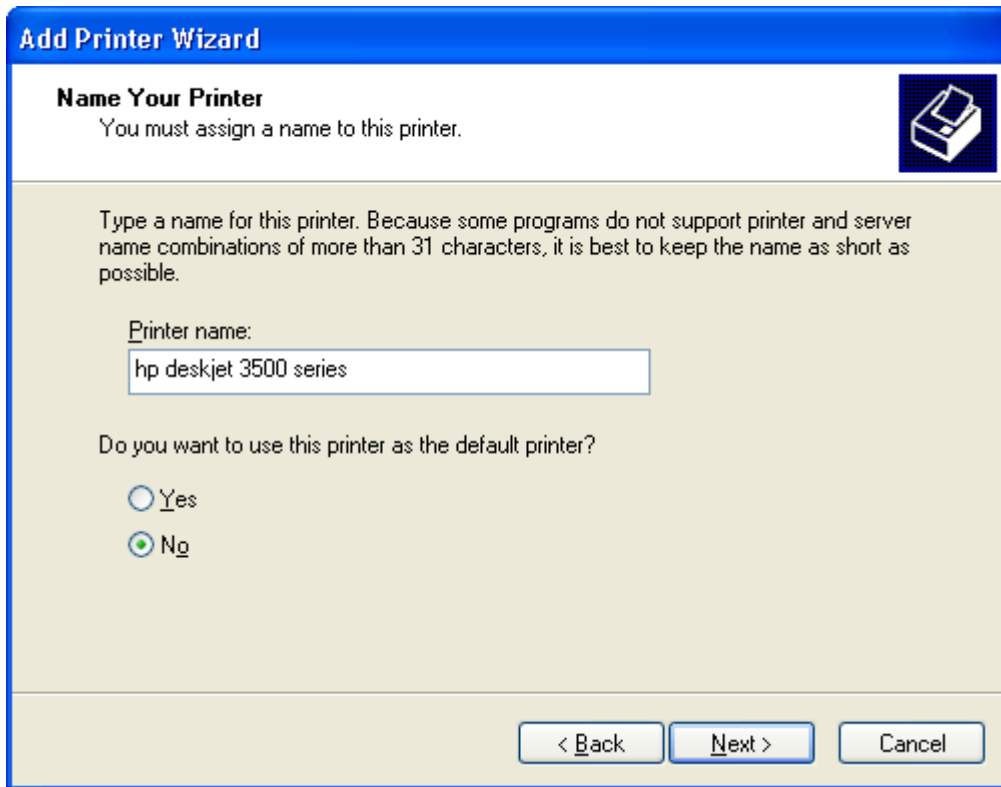

13. Select your printer manufacturer and model from the lists. If it does not appear in the lists, click **Have disk** to specify the driver location.
14. Specify the name you want to give the printer, and whether you want it to be the default printer. Click **Next**.
15. Click **Next** to proceed to the final wizard screen.
16. Select **Yes** to print a test page.
17. Click **Finish** to complete the setup procedure.

13.2.2.3.2 Setting Up an LPD Printer on Mac

The procedure below describes how to set up an LPD printer on Mac operating systems.

➤ **To set up an LPD printer on Mac:**

1. On your Mac computer connected to the device, open the 'Print & Fax' utility from 'System Preferences'; the 'Print & Fax' screen appears.

Figure 13-32: Print & Fax

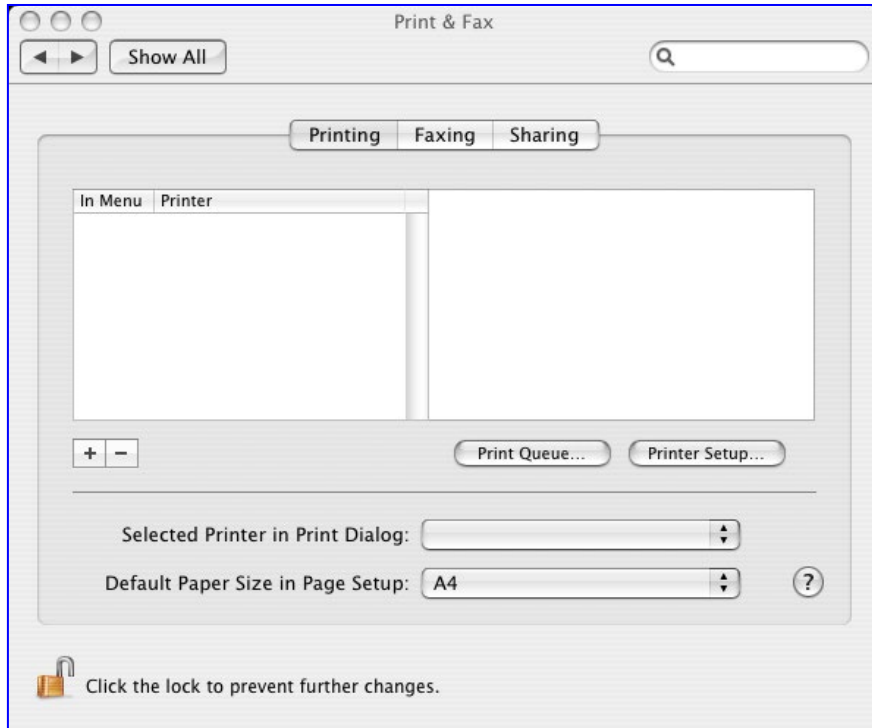

2. Click the + (add) button; the 'Printer Browser' screen appears.
3. Select the **IP Printer** tab and the configure the following:
 - a. From the 'Protocol' drop-down list, select LPD.
 - b. In the 'Address' field, enter the device's IP address (192.168.1.1).
 - c. In the 'Queue' field, enter the printer's name as it appears in the 'Printer' screen of the Web interface. For example, MFC9750.
 - d. The 'Name' and 'Location' fields are optional; the default name is the gateway's IP address.
 - e. From the 'Print Using' drop-down list, select your printer's make and model.

Figure 13-33: Printer Browser – LPD Printer

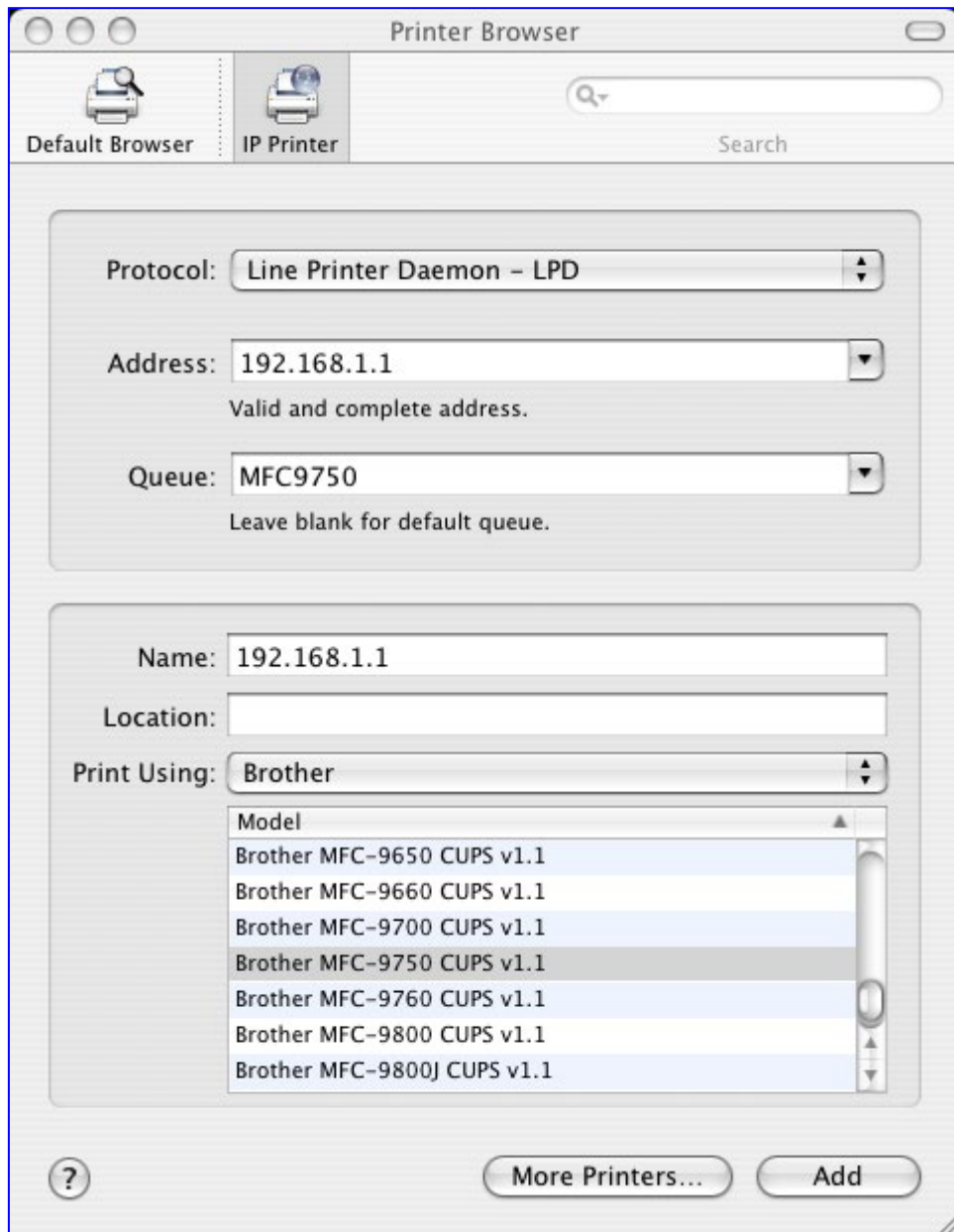

4. Click **Add**; the new printer appears in the 'Print & Fax' screen.

Figure 13-34: Print & Fax – New LPD Printer

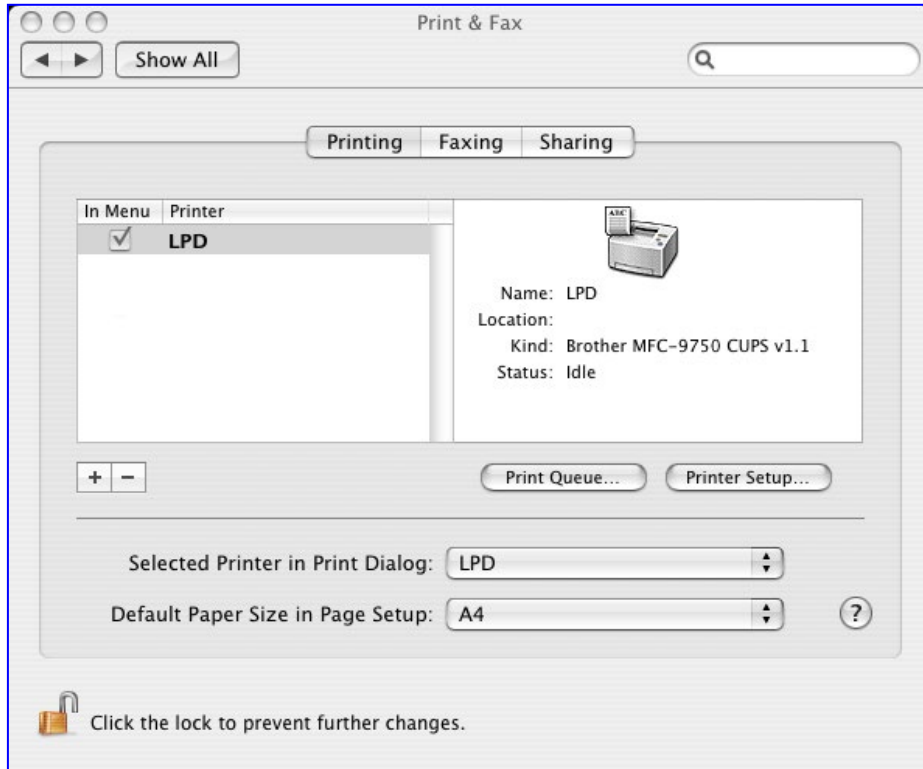

13.2.3 Storing and Using Printer Drivers

As explained earlier in this chapter, to use a shared printer connected to the device, a driver for the printer must be installed on the LAN computer from which the print job is to be sent. You can use the device file server to store printer drivers.

The drivers should be uploaded from a Windows computer and stored in the system storage area that you have created on one of the disk partitions. The printer can then be installed on other LAN computers using the driver stored on the device.

➤ **To upload the driver files to the device:**

1. From Window's **Start** menu, click **Run**, and then type "cmd" to open a command shell.
2. At the prompt, type **net use** to view the list of shares and their status.
3. Type **net use /del \\mp264\share-B** to delete the specific network mapping entry. Alternatively, you can use **net use /del *** to delete all network mapping entries.
4. Type **net use * \\openrg\print\$ [Admin's password] [/user:admin]**. This ensures that you are logged into the print server using the Admin user and have the permissions to upload files.
5. Browse to \\mp264 (use a Windows Explorer window if you are using a browser other than Internet Explorer). Should a Windows login dialog box appear, enter your Web username and password. The following window appears, displaying the disk and printer shares available on the device.

Figure 13-35: Disk and Printer Shares (e.g., MP-264)

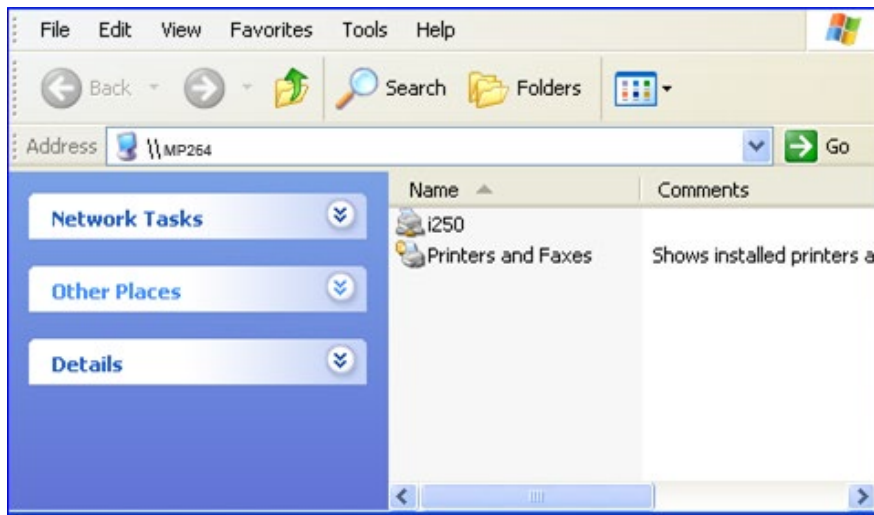

6. Click **Printers and Faxes**.
7. Right-click the printer icon and then select **Properties**.
8. If your operating system does not already have the driver, you will be asked if you want to install it now. Click **No**.
9. Select the **Advanced** tab, and then click **New driver**; the 'Add Printer Driver Wizard on the device starts. You are prompted to select a printer driver from a list. If unavailable, you can either browse to a location on your computer where you have stored the driver, or click **Have Disk** and insert the CD containing the driver (supplied with your printer).
10. Click **OK**; the driver is uploaded to the device's system storage directory (e.g. "\\mp264\A").

14 Remote Device Management

This chapter provides an overview of the device's remote configuration and management support. In addition, this chapter describes how to enable and secure remote management, as well configure the device through SNMP and TR-069.

14.1 Overview

The device is designed to be mass-deployed. One of the keys to guarantee end-user satisfaction and true toll-quality service in mass field deployment is comprehensive remote configuration and management capabilities:

- Automatic and remote configuration updates
- Automatic and remote firmware updates
- Remote diagnosis of problems reported by the user
- Remote collection of statistical information regarding the quality of the service
- Remote notifications of problems in the service

14.1.1 Remote Configuration

By default, the device is provided with factory default settings, which are common to all gateway devices (except for the MAC address). The factory settings allow the user to connect to the device's Web interface through the LAN.

By default, the WAN interface is configured for DHCP (i.e., automatically obtains its IP address from a DHCP server). The default configuration should not include any VoIP service provider settings (such as a SIP proxy).

In some cases, AudioCodes can ship devices that are pre-configured with some customer-specific parameters. This set of parameters is usually defined as the new "factory settings" for the specific customer.

The device's factory default settings and the current configuration running on the device are stored on the device's non-volatile flash memory. The current configuration can be remotely updated using several configuration interfaces:

- HTTP-based Web server
- SNMP
- TR-069
- Configuration file upload/download

Figure 14-1: Remote Management Interfaces

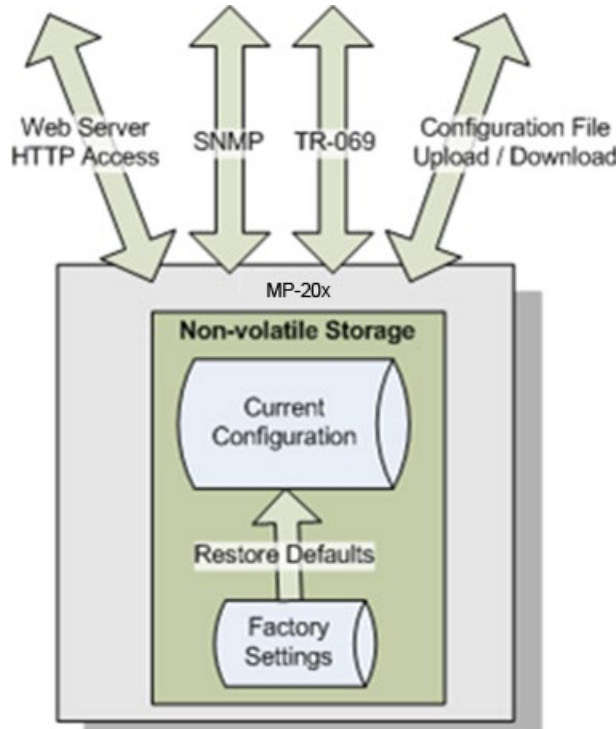

All configuration interfaces access the same internal configuration repository. The configuration file represents the complete set of the device configuration parameters. Specific configuration interfaces (e.g. TR-069) might support access only to a sub-set of these configuration parameters.

At any time, the factory settings can be restored using the Web interface or by pressing the **Reset** pin-hole button while the device is being powered up.

The table below lists the main device configuration parameter groups:

Table 14-1: Main Configuration Parameter Groups

Group	Description
VoIP	Parameters relating to the VoIP functionality (e.g. analog interface, SIP signaling, voice and fax, media streaming)
WAN Interface	The main WAN Internet connection (this group is also referred to as the "Quick Setup").
Network Connections	Configuration of all network connections (LAN and WAN), including advanced connections such as VLANs.
Security	Parameters relating to the internal firewall.
QoS	Configuration of Quality of Service parameters such as priorities and traffic shaping.
System / Advanced	Configuration of system parameters such as Remote Update and Remote Access and advanced parameters such as Dynamic DNS, UPnP.

A typical set of parameters that a service provider may want to configure include the following:

- Remote access and/or automatic firmware and configuration update parameters
- VoIP configuration: SIP proxy, line settings (User IP, Password)
- QoS parameters (e.g. traffic shaping)

14.1.2 Remote Management

Remote management includes the following:

- Firmware upgrade
- Status and performance monitoring
- Alarms, notifications, and logs

14.1.2.1 Firmware Upgrade

Service providers require the ability to update the device's firmware in the field (e.g. in case of maintenance releases or releases that support new required features). The process is required to be automatic, allowing mass update, which is robust and fail-safe.

The device's firmware is stored on the non-volatile flash memory. The device's flash memory is capable of storing a recovery firmware that ensures a fail-safe operation (even if the user unplugs the power during the firmware burning process).

The device's firmware can be upgraded using one of the following mechanisms:

- The new firmware can be "pushed" (uploaded) to the device, using the device's Web interface
- The new firmware can be "pulled" (downloaded) by the device from a remote HTTP, FTP, or TFTP server

The device has two areas in flash memory for storing the firmware image. One area is active, while the other is "burned" during the upgrade process.

If the upgrade process was successful, the new image is set as "active", while the other area will be used for the next upgrade. If upgrade is not successful, the one that is still active remains valid.

The remote firmware download process can be triggered by one of the following:

- The device checks for a new firmware upon device restart
- The device periodically checks for a new firmware
- Manual trigger using CLI, TR-069, SNMP or Web



Note: Unless forced, the device downloads and upgrades to the new firmware only if its version number is higher than the firmware version currently running on the device. The version number is not taken from the image file name, but from the header of the image file.

14.1.2.2 Status and Performance Monitoring

The ability to remotely monitor the status of the device is critical to the service provider, who wants to support users without having to send a technician on site (avoiding the "truck roll"). The service provider may want to know the current status of the device (e.g. is it registered to the SIP proxy, is the phone off-hook) or some statistical information (e.g. average packet loss during a call).

The device maintains a set of status and performance information internally. This information (or parts of it) can be retrieved via the different management interfaces (e.g. Web, or TR-069).

The table below describes the status and performance monitoring (statistical) information available in the device.

Table 14-2: Status and Performance Monitoring Parameters

Group	Description
VoIP	<ul style="list-style-type: none"> ▪ Current status information per line: <ul style="list-style-type: none"> ✓ Phone state ✓ Registration status ✓ Source, codec and type of current call ✓ Packet loss, jitter and delay of current call
Network Connections	<ul style="list-style-type: none"> ▪ Current status information per interface: <ul style="list-style-type: none"> ✓ Connection status ✓ Allocated IP address ✓ Received and transmitted packets
System	<ul style="list-style-type: none"> ▪ Software version information ▪ Hardware version information ▪ System Up time

14.1.2.3 Alarms, Notifications and Logging

Instead of periodically polling the device to obtain its current status, the service provider may want the device to notify abnormal events or to send regular reports to a logging server. Both options are supported by the device. The table below lists the relevant interfaces for alarms and notifications.

Table 14-3: Notifications and Logged Events

Group	Notifications and Logged Events
VoIP	<ul style="list-style-type: none"> ▪ Notifications: Registration error or timeout ▪ Logged Events: <ul style="list-style-type: none"> ✓ End of call (Call Detail Record logging) ✓ SIP messages logging (optional - for debugging)
Network Connections	<ul style="list-style-type: none"> ▪ Notifications: Connection up / down
Security	<ul style="list-style-type: none"> ▪ Logged Events: Security log (configurable)
System	<ul style="list-style-type: none"> ▪ Notifications: <ul style="list-style-type: none"> ✓ System restart ✓ Firmware / configuration update ▪ Logged Events: Debug-level logging (optional)

Note that the terms Alarm and Notification represent the same thing. The difference between alarm/notification and logging is that an alarm is normally used to represent an abnormal event (e.g. registration error), while logged events can represent either regular events (e.g. end of call) or abnormal events.

The table below lists the event severity levels defined in the device. Typically, events with severity of Error or Emergency are notified in addition to being logged.

Table 14-4: Severity of Logged Events

Severity	Description
Debug	Debug-level messages.
Notice	Normal but significant condition. Notices requiring attention at a later time. Non-error conditions that might require special handling.
Error	Recoverable / temporary error condition.
Emergency	System is unusable. The most severe messages that prevent continuation of operation, such as immediate system shutdown.

14.2 Enabling Remote Management

You can access and manage the device not only from within the home network, but also from the Internet. This allows you to view or change settings while travelling. It also enables you to allow your ISP to change settings or help you troubleshoot functionality or communication issues from a remote location.

Remote access to the device is blocked by default to ensure the security of your home network. However, remote access is supported by the following services, and you may use the 'Remote Access Configuration' screen to selectively enable these services if they are needed.



Notes:

- Telnet and Web-Management can be used to modify the settings of the firewall or to disable it. You can also change local IP addresses and other settings, making it difficult or impossible to access the device from the home network. Therefore, remote access to Telnet or HTTP services should be blocked and should only be permitted when absolutely necessary.
- Encrypted remote administration is done using a secure SSL connection that requires an SSL certificate. When accessing the device for the first time using encrypted remote administration, you are prompted by your browser with a warning regarding certificate authentication. This is because the device's SSL certificate is self-generated. When encountering this message under these circumstances, ignore it and continue. It should be noted that even though this message appears, the self-generated certificate is safe, and provides you with a secure SSL connection. You can also assign a user-defined certificate to the device.

➤ **To enable remote access to the device services:**

1. On the 'Advanced' screen, click the **Remote Administration**  icon; the 'Remote Administration' screen appears.

Figure 14-2: Remote Administration Screen



2. Select the services that you would like to make available to computers on the Internet.
 - **Allow Incoming WAN Access to Web-Management:** Allows access (from a Web browser) to the Web management interface and to all system settings and parameters. Both secure (HTTPS) and non-secure (HTTP) access is available.
 - **Allow Incoming WAN Access to the Telnet Server:** Allows access to the command-line session and to all system settings and parameters (using a text-based terminal).
 - **SNMP:** Allows Simple Network Management Protocol (SNMP) requests to remotely configure and monitor the device.
 - **Diagnostic Tools:** Allows remote access for ping and trace route (over UDP) troubleshooting.
 - **TR-069:** TR-069 is a WAN management protocol for communication between Customer Premise Equipment (CPE) and an Auto-Configuration Server (ACS). It defines a mechanism that encompasses secure auto-configuration of a CPE, and also incorporates other CPE management functions into a common framework.
3. Click **OK** to save your changes.
4. Select the services that you would like to make available to computers on the Internet.
 - **Allow Incoming WAN Access to Web-Management:** Allows access (from a Web browser) to the Web management interface and to all system settings and parameters. Both secure (HTTPS) and non-secure (HTTP) access is available.

Relevant Telnet Parameters:

```
rg_conf/admin/https/ports/0/port=80
rg_conf/admin/https/ports/0/ssl_mode=none
rg_conf/admin/https/ports/1/port=8080
rg_conf/admin/https/ports/1/ssl_mode=none
rg_conf/admin/https/ports/2/port=443
rg_conf/admin/https/ports/2/ssl_mode=no_verify
rg_conf/admin/https/ports/3/port=8443
rg_conf/admin/https/ports/3/ssl_mode=no_verify
```

- **Allow Incoming WAN Access to the Telnet Server:** Allows access to the command-line session and to all system settings and parameters (using a text-based terminal).

Relevant Telnet Parameters:

```
rg_conf/admin/telnets/ports/0/port=23
rg_conf/admin/telnets/ports/0/ssl_mode=none
rg_conf/admin/telnets/ports/0/remote_access=0
rg_conf/admin/telnets/ports/0/trusted_only=0
rg_conf/admin/telnets/ports/0/local_access=1
rg_conf/admin/telnets/ports/1/port=8023
rg_conf/admin/telnets/ports/1/ssl_mode=none
rg_conf/admin/telnets/ports/1/remote_access=0
rg_conf/admin/telnets/ports/1/trusted_only=0
rg_conf/admin/telnets/ports/1/local_access=1
rg_conf/admin/telnets/ports/2/port=992
rg_conf/admin/telnets/ports/2/ssl_mode=no_verify
rg_conf/admin/telnets/ports/2/remote_access=0
rg_conf/admin/telnets/ports/2/trusted_only=0
rg_conf/admin/telnets/ports/2/local_access=1
```

14.2.1 Enabling Local or Remote Management using the SSH Protocol

You can enable local or remote management using the SSH protocol, with the Web interface or CLI.

➤ **To enable local or remote management using the SSH protocol, with the Web interface:**

1. Open the SSH screen (**Advanced > SSH icon**).
2. Enter the appropriate values as needed.

Figure 14-3: SSH Screen

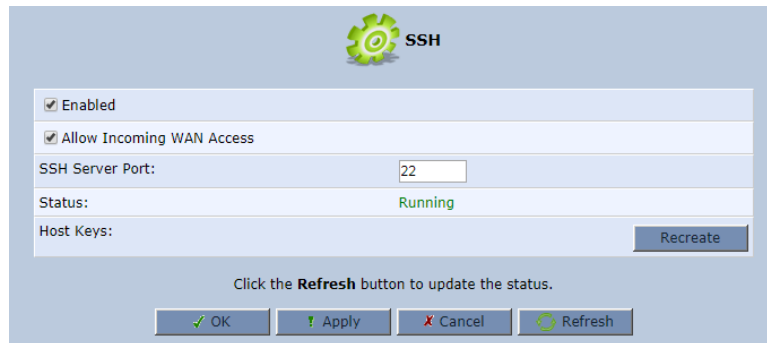

3. Select the 'Enabled' check box to allow local SSH access.
4. Select the 'Allow Incoming WAN Access' check box to allow remote SSH access.
5. The 'SSH Server Port' should be set to "22" by default. It can be modified to any other port.
6. The 'Status' field indicates the current SSH service status.
7. 'Host Keys' can be regenerated by clicking on the **Recreate** button.
8. Click **OK** or **Apply** to confirm your settings.

➤ **To enable local or remote management using the SSH protocol, with CLI:**

- Use the following:

```
rg_conf/ssh/enabled=1
rg_conf/ssh/remote_access=1
rg_conf/ssh/server_port=22
rg_conf/ssh/max_session=3
```

14.3 Securing Remote Management with Certificates

The **Certificates**  icon allows you to configure certificates. When a service provider implements remote provisioning in which a unique configuration file (per device) is placed on a server located on the WAN, the service provider can ensure that only its deployed device units are able to connect to the HTTP server via HTTPS. This is performed by using a certification validation process (client-server).

There are two types of certificates:

- Self-signed certificates
- Certificate Authority (CA) signed certificates

The procedure below describes how to operate with self-signed certificates.

➤ **To operate with self-signed certificates:**

1. On the 'Advanced' screen, click the  icon; the 'Certificates' screen appears.

Figure 14-4: New Certificates Screen

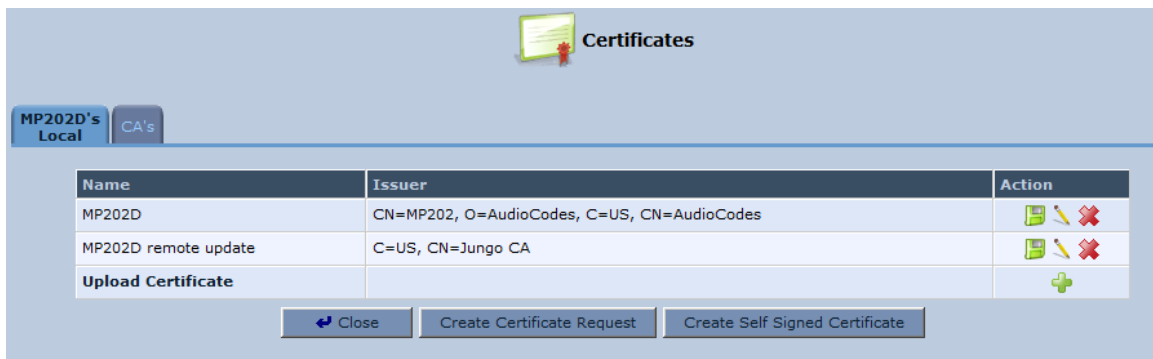

2. Create a self-signed certificate:



Note: You can also create a self-signed certificate using the free OpenSSL utility.

- a. Select the **MP202D's Local** tab.
- b. Click the **Create Self Signed Certificate** button; the 'Create Self Signed X509 Certificate' screen appears.

Figure 14-5: Create Self Signed X509 Certificate Screen

Create Self Signed X509 Certificate

Certificate Name:

Subject:

Organization:

State:

Country:

- c. Enter the fields as required, and then click **Generate**; a message appears notifying you that the device is generating the certificate.
- d. After a few moments, click **Refresh**; the 'New Self Signed X509 Certificate' screen appears.

Figure 14-6: New Self Signed X509 Certificate Screen

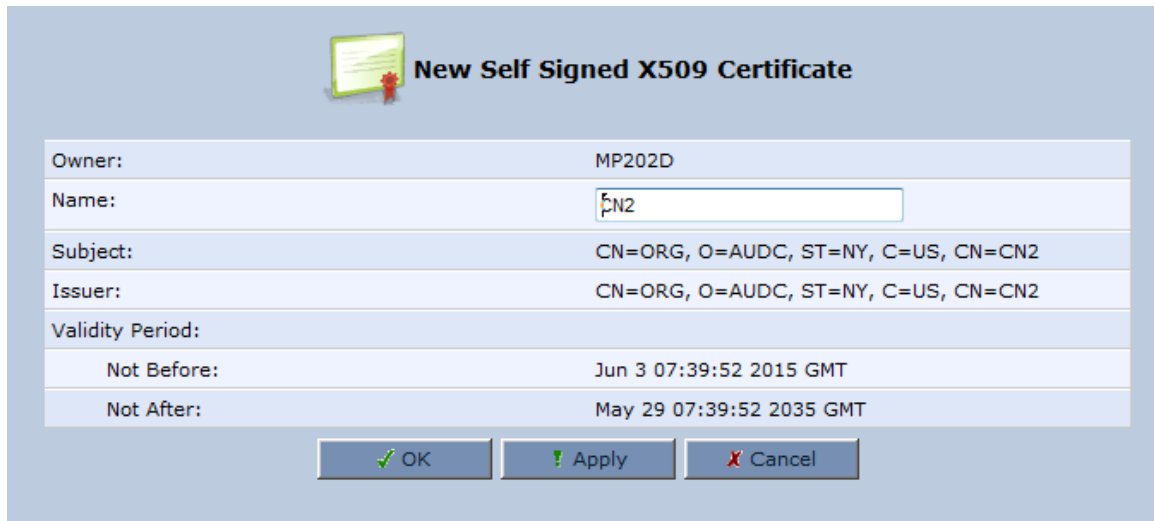

- e. Click **OK**; the new certificate appears listed in the 'Certificates' screen.

Figure 14-7: Newly Created Self-Signed Certificate

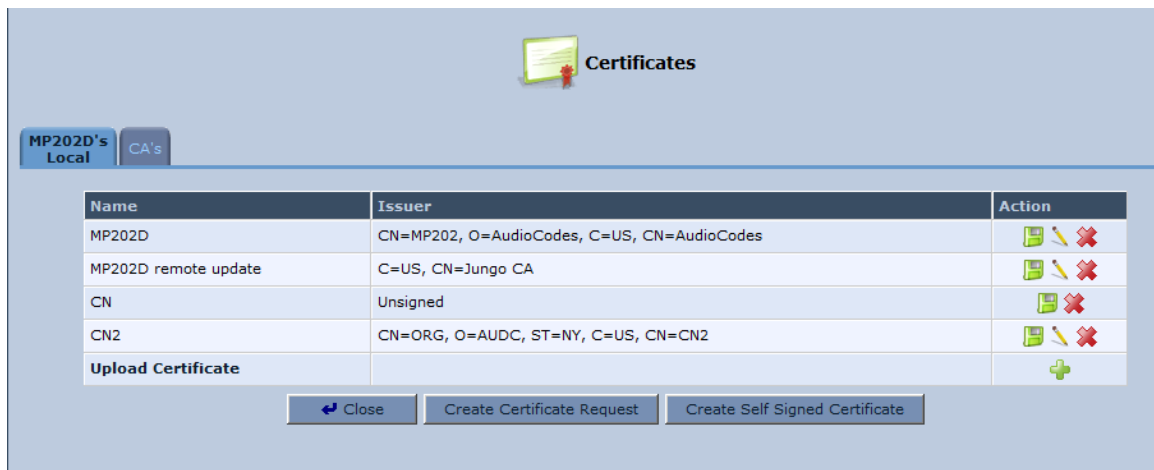

- f. On the 'Certificates' screen, click the **Download**  icon corresponding to the new self-signed certificate that you created; the 'File Download' window appears.

5. Load the CA's certificate to the device:
 - a. Select the **CA's** tab; the 'CA's' screen appears.

Figure 14-10: CA's Certificates Page

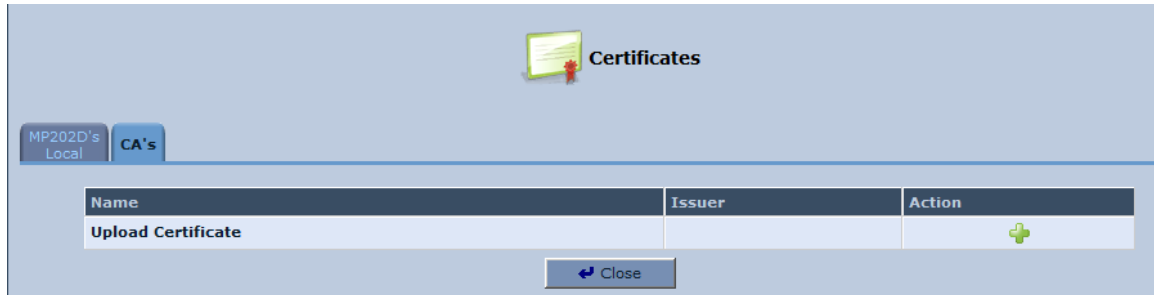

- b. Click the **New**  icon; the 'Load CA's Certificate' screen appears.

Figure 14-11: Load CA's Certificate Page



- c. Click **Browse**, locate the CA certification file that you created, and then click **Upload** to load the file.
6. Configure the Apache server, using the following parameters:
 - **SSLCACertificateFile**: Set the path to the CA's certificate.
 - **SSLCertificateFile**: Set the path to your signed certificate.
 - **SSLCertificateKeyFile**: Set the path to your private key.
7. Configure Certificate Protection on the device from being overwritten by the Configuration File.
 - By default, the 'rg_conf/rmt_config/override_cert_configuration' parameter doesn't exist. In this case, remote configuration update will not overwrite the certificates on the device. The same applies if the 'rg_conf/rmt_config/override_cert_configuration' parameter is set to Disabled (0).
 - To overwrite certificates on the device, set the 'rg_conf/rmt_config/override_cert_configuration' parameter to Enabled ('1').

14.4 Remote Configuration and Management Interfaces

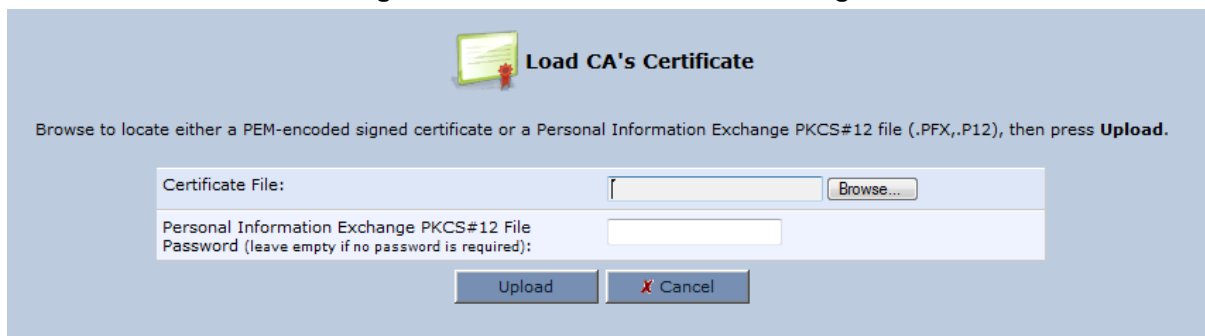
The device supports the following remote configuration and management interfaces:

- Web Server (GUI) over HTTP/HTTPS
- TR-069 and TR-104
- SNMP
- Syslog
- Firmware or configuration file download through HTTP/HTTPS and FTP/TFTP
- CLI over Telnet/SSH
- Redirect Server
- BroadSoft BroadWorks DMS Provisioning
- Provisioning using DHCP Options 66/67 and TFTP

The table below lists the possible operations over these different interfaces:

Table 14-5: Operations per Configuration/Management Interface

Operation	Web GUI	TR-069	SNMP	Syslog	File D/L	CLI
Configuration Update	Yes	Yes	Yes	No	Yes	Yes
Firmware Upgrade	Yes	Yes	Yes	No	Yes	Yes
Status Monitoring	Yes	Yes	Yes	No	No	Yes
Debugging and Diagnostics	Yes	No	No	Yes	No	Yes

Service providers can choose to combine several management interfaces.

14.4.1 Embedded Web Server

The device provides an embedded Web server with a rich Graphical User Interface (GUI). The Web server can be accessed from the local LAN interface (e.g. by the home user) or from the WAN interface (e.g. by the service provider support personnel). The Web GUI provides easy and intuitive configuration of all the device parameters (i.e., VoIP, network interfaces, security, QoS and advanced system settings). In addition, the Web GUI provides status monitoring pages, diagnostic pages and enabled firmware upgrade.

Typically, service providers do not want to configure each device manually and therefore, they do not use the Web server in live deployments. However, the Web server is still useful for:

- Trying different configurations in the lab during the integration phases
- Creating mass-configuration template files
- Debugging special customer problems (by accessing the Web server from the WAN interface)

Since the Web server allows all configuration and management operations, it is important to protect it. The following security measures are available:

- The Web server is user and password protected. Several users can be defined. A special user with limited-access (only to the 'Quick Setup' screen) can be defined.
- The access to the Web server can be blocked from the WAN and/or LAN interfaces.
- Access to the Web server can be limited to specific IP addresses.
- Secured HTTP (HTTPS) is supported. It is possible to enable HTTPS-only, if required.
- The HTTP and/or HTTPS port can be modified (from the default 80 and 8080).

14.4.2 TR-069 and TR-104 CPE WAN Management Protocol

TR-069 is a WAN management protocol intended for communication between Customer Premise Equipment (CPE) or residential devices (such as the device), and an Auto-Configuration Server (ACS), residing on the service provider's side. It defines a mechanism that encompasses secure auto configuration of CPE, and also incorporates other CPE management functions into a common framework. In simpler terms, TR-069 is a protocol that enables remote server management of the device. Such a protocol is useful, for example, for remotely and securely controlling the device by the CPE provider. The standard is published by the DSL Forum. TR-069 runs over SOAP/HTTP and enables device configuration, management (including firmware upgrade), and status monitoring. TR-104 is an extension of TR-069 for VoIP configuration and monitoring.

The TR standards are published by the DSL forum:

- **TR-069:** <http://www.broadband-forum.org/technical/download/TR-069.pdf>
- **TR-104:** <http://www.broadband-forum.org/technical/download/TR-104.pdf>

Figure 14-12: TR-069 CPE WAN Management Protocol

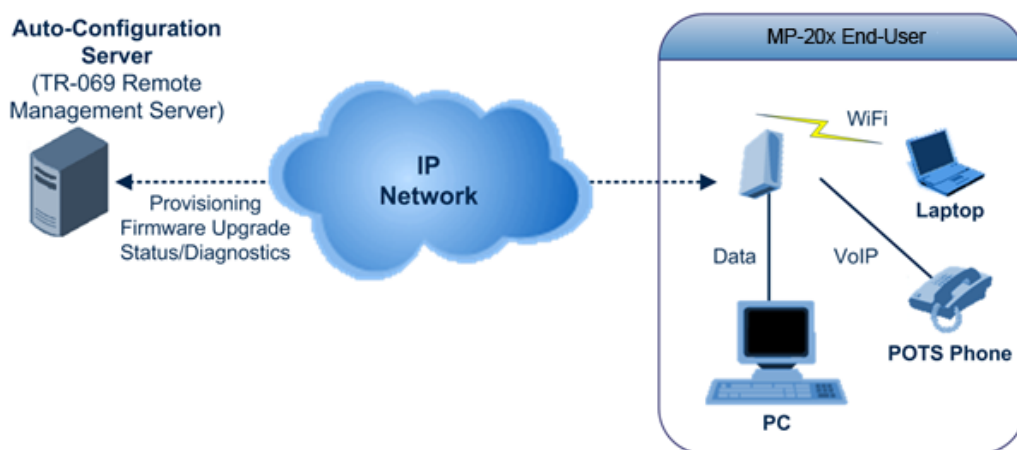

The TR-069 protocol allows an ACS to provision a CPE or collection of CPE based on a variety of criteria. The provisioning mechanism includes specific provisioning parameters and a general mechanism for adding vendor-specific provisioning capabilities as needed. The provisioning mechanism allows CPE provisioning at the time of initial connection to the broadband access network, and the ability to re-provision at any subsequent time. This includes support for asynchronous ACS-initiated re-provisioning of CPE. TR-069 defines several Remote Procedure Call (RPC) methods, as well as a large number of parameters, which may be set or read. Some of these methods and parameters are defined as mandatory.



Notes:

- The device was tested for interoperability with two ACS vendors – Motive and FriendlyTR69. Working with other ACS types may require specific interoperability effort.
- The parameter values in the subsequent tables are sample values only taken from an ACS.

14.4.2.1 Configuring the Device via TR-069 and TR-104

TR-069 allows basic configuration of the device. The configuration is defined in a hierarchical tree-like structure according to the TR-069 standard.

14.4.2.1.1 Configuring the WAN Interface

Table 14-6: InternetGatewayDevice.WANDevice.i.WANConnectionDevice.i.WANIPConnection.i

TR-069/TR-104 Parameter	Configuration File Parameter	Description
AddressingType	<code>mt_cwmp_param_wan_connection_ip_addressing_type_get/set</code>	The method used to assign an address to the WAN side interface of the CPE for this connection: <ul style="list-style-type: none"> ▪ “DHCP” ▪ “Static”
ConnectionStatus	<code>mt_cwmp_param_wan_connection_ip_status_get</code>	Current status of the connection: <ul style="list-style-type: none"> ▪ “Unconfigured” ▪ “Connecting” ▪ “Connected” ▪ “PendingDisconnect” ▪ “Disconnecting” ▪ “Disconnected”
ConnectionType	<code>mt_cwmp_param_wan_connection_ppp_type_get</code>	Specifies the connection type of the connection instance: <ul style="list-style-type: none"> ▪ “Unconfigured” ▪ “IP_Routed” ▪ “DHCP_Spoofed” ▪ “PPPoE_Bridged” ▪ “PPPoE_Relay” ▪ “PPTP_Relay”
DefaultGateway	<code>mt_cwmp_param_wan_connection_ip_default_gateway_get/set</code>	The IP address of the default gateway for this connection. This parameter is configurable only if the AddressingType is Static.
DNSEnabled	<code>mt_cwmp_param_wan_connection_ip_dns_enabled_get/set</code>	Whether or not the device should attempt to query a DNS server across this connection.
DNSOverrideAllowed	<code>mt_cwmp_param_wan_connection_ip_dnsoverrideallowed_get/set</code>	Whether or not a manually set, non-empty DNS address can be overridden by a DNS entry received from the WAN.
DNSServers	<code>mt_cwmp_param_wan_connection_ip_dns_servers_get/set(i)</code>	Comma-separated list of DNS server IP addresses for this connection. Support for more than three DNS Servers is optional.
Enable	<code>mt_cwmp_param_wan_connection_ip_enable_get/set(1)</code>	Enables or disables the connection instance. On creation of a WANIPConnection instance, it is initially disabled.
ExternalIPAddress	<code>mt_cwmp_param_wan_connection_ip_externalip_get(i)</code>	The external IP address used by NAT for this connection. This parameter is configurable only if the AddressingType is Static.

TR-069/TR-104 Parameter	Configuration File Parameter	Description
MaxMTUSize	<code>mt_cwmp_param_wan_connection_ip_max_mtu_size_get/set(i)</code>	The maximum allowed size of an Ethernet frame from LAN-side devices.
Name	<code>mt_cwmp_param_wan_connection_name_get/set(i)</code>	User-readable name of this connection.
NATEnabled	<code>mt_cwmp_param_wan_connection_nat_enabled_get/set(i)</code>	Indicates if NAT is enabled for this connection.
PortMappingNumberOfEntries	-	Total number of port mapping entries.
PossibleConnectionTypes	-	A comma-separated list indicating the types of connections possible for this connection instance. Each element of the list is an enumeration of: <ul style="list-style-type: none"> ▪ "Unconfigured" ▪ "IP_Routed" ▪ "IP_Bridged"
RouteProtocolRx	<code>mt_cwmp_param_wan_connection_route_protocol_rx_get/set</code>	Defines the Rx protocol to be used: <ul style="list-style-type: none"> ▪ "Off" ▪ "RIPv1" (Optional) ▪ "RIPv2" (Optional) ▪ "OSPF" (Optional)
RSIPAvailable	<code>mt_cwmp_param_wan_connection_rsip_available_get(i)</code>	Indicates if Realm-specific IP (RSIP) is available as a feature on the device.
ShapingRate	-	Rate to shape this connection's egress traffic to. If less than or equal to 100, in percentages of the rate of the highest rate-constrained layer over which the packet travels on egress. The rate is limited over the window period specified by ShapeWindow. If greater than 100, in bits per second. A value of -1 indicates no shaping.
SubnetMask	<code>lan_host_config_management_get/set rg_conf dhcps/ netmask</code>	Subnet mask of the WAN interface. This parameter is configurable only if the AddressingType is Static.
SpecVersion	""	Currently, 1.0 is the only available version.
Uptime	-	The time in seconds that this connection has been up.

14.4.2.1.2 Configuring the LAN Interface

Table 14-7: InternetGatewayDevice.LANDevice.i.LANEthernetInterfaceConfig

TR-069/TR-104 Parameter	Configuration File Parameter	Description
Enable	<code>device_eic_enable_get/set</code>	Enables or disables this interface.
MACAddress	<code>device_mac_address_get</code>	The physical address of the interface.
MaxBitRate	<code>device_max_bit_rate_get</code>	The maximum upstream and downstream bit rate available for this connection: <ul style="list-style-type: none"> ▪ “10” ▪ “100” ▪ “1000” ▪ “Auto”
Status	<code>device_status_get</code>	The status of the interface: <ul style="list-style-type: none"> ▪ “Up” ▪ “NoLink” ▪ “Error” ▪ “Disabled”

Table 14-8: InternetGatewayDevice.LANDevice.i.LANHostConfigManagement

TR-069/TR-104 Parameter	Configuration File Parameter	Description
AllowedMACAddresses	<code>allowed_mac_addresses_get/set</code>	Represents a comma-separated list of hardware addresses that are allowed to connect to this connection if <code>MACAddressControlEnabled</code> is 1 for a given interface.
DHCPLeaseTime	<code>dhcp_lease_time_get/set</code>	Specifies the lease time in seconds of client assigned addresses. A value of -1 indicates an infinite lease.
DHCPRelay	<code>dhcp_relay_get/set</code>	Determines if the DHCP server performs the role of a server (0) or a relay (1) on the LAN interface.
DHCPSEnable	<code>lan_host_config_management_get/set</code> <code>rg_conf dhcps/enable</code>	Enables or disables the DHCP server on the LAN interface.
DNSServers	<code>dhcps_dns_servers_get/set</code>	Comma-separated list of DNS servers offered to DHCP clients. Support for more than three DNS Servers is optional.
DomainName	<code>domain_name_get/set</code>	Sets the domain name for clients on the LAN interface.
IPRouters	<code>ip_routers_get/set</code>	Comma-separated list of IP addresses of routers on this subnet. Also known as default gateway. Support for more than one Router address is optional.

TR-069/TR-104 Parameter	Configuration File Parameter	Description
MaxAddress	<code>lan_host_config_management_get/set rg_conf dhcps/end_ip</code>	Specifies the last address in the pool to be assigned by the DHCP server on the LAN interface.
MinAddress	<code>lan_host_config_management_get/set rg_conf dhcps/start_ip</code>	Specifies the first address in the pool to be assigned by the DHCP server on the LAN interface.
SubnetMask	<code>lan_host_config_management_get/set rg_conf dhcps/netmask</code>	Specifies the client's network subnet mask.

14.4.2.1.3 Configuring VoIP via TR-104

Table 14-9: InternetGatewayDevice.Services.VoiceService.i.Capabilities

TR-069/TR-104 Parameter	Configuration File Parameter	Description
ButtonMap	-	Support for a configurable button map. A true value indicates support for a configurable button map via the <code>VoiceService.{i}.VoiceProfile.{i}.ButtonMap</code> object.
DSCPCoupled	-	A true value indicates that the CPE is constrained such that transmitted call control packets use the same DSCP marking as transmitted RTP packets. If the value is true, the CPE must not support the <code>DSCPMark</code> parameter for call control.
EthernetTagging Coupled	-	A true value indicates that the CPE is constrained such that transmitted call control packets use the same Ethernet tagging (VLAN ID Ethernet Priority) as transmitted RTP packets. If the value is true, the CPE must not support the <code>VLANIDMark</code> or <code>EthernetPriorityMark</code> parameters within a call control object (e.g., SIP, MGCP, or H323).
FaxPassThrough	-	Support for fax pass-through. A true value indicates support for the parameter <code>VoiceService.{i}.VoiceProfile.{i}.FaxPassThrough</code> . (True if <code>voip/audio/fax/fax_transport_mode</code> equals <code>Bypass</code>)
FaxT38	-	Support for T.38 fax. A true value indicates support for the object <code>VoiceService.{i}.VoiceProfile.{i}.FaxT38</code> .
MaxLineCount	<code>voip/num_of_fxs_lines</code>	Maximum number of lines supported across all profiles.

TR-069/TR-104 Parameter	Configuration File Parameter	Description
MaxProfileCount	-	Maximum number of distinct voice profiles supported.
MaxSessionCount	-	Maximum number of voice sessions supported across all lines and profiles. (This might differ from MaxLineCount if each line can support more than one session for CPE provided conference calling. This value can be less than the product of MaxLineCount and MaxSessionsPerLine.)
MaxSessionsPer Line	-	Maximum number of voice sessions supported for any given line across all profiles. A value greater than one indicates support for CPE provided conference calling.
ModemPassThrough	-	Support for modem pass-through. A true value indicates support for the parameter VoiceService.{i}.VoiceProfile.{j}.ModemPass Through.
NumberingPlan	-	Support for a configurable numbering plan. A true value indicates support for a configurable numbering plan via the VoiceService.{i}.VoiceProfile.{j}.NumberingPlan object.
PSTNSoftSwitch Over	-	A true value indicates the device is capable of supporting the PSO_Activate Facility Action, which allows a call to be switched to a PSTN FXO. Note: Currently, this parameter is not supported.
Regions	<code>pkg\mgt\lib\mgt_regional_settings.c slic_dsp_general_and _regional_settings_params_array</code>	Comma-separated list of geographic regions supported by the device. Each item in the list must be an alpha-2 (two-character alphabetic) country code as specified by ISO 3166. An empty list indicates that the device does not support region-based customization. Note: This format is currently not supported.
RingGeneration	-	Support for ring generation. A true value indicates support for control of ring generation via the VoiceService.{i}.VoiceProfile.{j}.Line.{i}.Ringer object. A true value also indicates that the RingDescriptionsEditable, PatternBasedRingGeneration and FileBasedRingGeneration parameters in this object are present.
RTCP	-	Support for RTCP.

TR-069/TR-104 Parameter	Configuration File Parameter	Description
RTPRedundancy	-	Support for RTP payload redundancy as defined in RFC 2198. A true value indicates support for <code>VoiceService.{i}.VoiceProfile.{i}.RTP.Redundancy</code> .
SignalingProtocols	<code>voip/signalling/protocol</code>	Signal protocol: <ul style="list-style-type: none"> ▪ "SIP" ▪ "MGCP" Each entry can be appended with a version indicator in the form "/X.Y". For example: "SIP/2.0". <p>Note: Only one protocol is supported at a time.</p>
SRTP	-	Support for SRTP. <p>Note: Currently, SRTP is not supported.</p>
ToneGeneration	-	Support for tone generation. A true value indicates support for the object <code>VoiceService.{i}.VoiceProfile.{i}.Tone</code> . A true value also indicates that the <code>ToneDescriptionsEditable</code> , <code>PatternBasedToneGeneration</code> and <code>FileBasedToneGeneration</code> parameters in this object are present.
VoicePortTests	-	Support for remotely accessible voice-port tests. A true value indicates support for the <code>VoiceService.{i}.PhyInterface.{i}.Tests</code> object.

Table 14-10: InternetGatewayDevice.Services.VoiceService.i.Capabilities.Codecs

TR-069/TR-104 Parameter	Configuration File Parameter	Description
Codec	voip/codec/i/name	Identifier of the type of codec.
EntryID	voip/codec/i/	Unique identifier for each entry in the table.
PacketizationPeriod	voip/codec/i/ptime	<p>Comma-separated list of supported packetization periods (in milliseconds), or continuous ranges of packetization periods. Ranges are indicated as a hyphen-separated pair of unsigned integers.</p> <p>For example:</p> <ul style="list-style-type: none"> ▪ “20” indicates a single discrete value. ▪ “10, 20, 30” indicates a set of discrete values. ▪ “5-40” indicates a continuous inclusive range. ▪ “5-10, 20, 30” indicates a continuous range in addition to a set of discrete values. <p>A range must only be indicated if all values within the range are supported.</p> <p>Note: Currently, only a single ptime per codec is supported.</p>

Table 14-11: InternetGatewayDevice.Services.VoiceService.i.VoiceProfile

TR-069/TR-104 Parameter	Configuration File Parameter	Description
DTMFMethod	voip/out_of_band_dtmf	<p>Method by which DTMF digits must be passed:</p> <ul style="list-style-type: none"> ▪ “InBand” ▪ “RFC2833” ▪ “SIPInfo”
Enable	-	<p>Enables or disables all lines in this profile, or places it into a quiescent state:</p> <ul style="list-style-type: none"> ▪ “Disabled” ▪ “Quiescent” ▪ “Enabled” <p>On creation, a profile must be in the Disabled state.</p> <p>In the Quiescent state, in-progress sessions remain intact, but no new sessions are allowed. Support for the Quiescent state in the device is optional. If this parameter is set to “Quiescent” in the device that does not support the Quiescent state, it must treat it the same as the Disabled state.</p>
Name	-	<p>String to easily identify the profile instance.</p> <p>Note: Currently, this is not supported.</p>

TR-069/TR-104 Parameter	Configuration File Parameter	Description
NumberOfLines	voip/num_of_fxs_lines	Number of instances of Line within this VoiceProfile.

Table 14-12: InternetGatewayDevice.Services.VoiceService.i.VoiceProfile.i.SIP

TR-069/TR-104 Parameter	Configuration File Parameter	Description
OutboundProxy	voip/signalling/sip/sip_outbound_proxy/addr	Host name or IP address of the outbound proxy. If a non-empty value is specified, the SIP endpoint must send all SIP traffic (requests and responses) to the host indicated by this parameter and the port indicated by the OutboundProxyPort parameter. This must be done regardless of the routes discovered using normal SIP operations, including use of Route headers initialized from Service-Route and Record-Route headers previously received. The OutboundProxy value is not used to generate the URI placed into the Route header of any requests.
OutboundProxyPort	voip/signalling/sip/sip_outbound_proxy/proxy	Destination port for connecting to the outbound proxy. This parameter must be ignored unless the value of the OutboundProxy parameter in this object is non-empty.
ProxyServer	voip/signalling/sip/proxy_address or voip/signalling/sip/sip_registrar/addr	Host name or IP address of the SIP proxy server.
ProxyServerPort	voip/signalling/sip/proxy_port or voip/signalling/sip/sip_registrar/port	Destination port for connecting to the SIP server.
ProxyServerTransport	voip/signalling/sip/transport_protocol	Transport protocol for connecting to the SIP server. Must be chosen from among the transports supported.
RegisterExpires	voip/signalling/sip/proxy_timeout	Register request Expires header value (in seconds).
RegistrarServerTransport	voip/signalling/sip/transport_protocol	Transport protocol for connecting to the SIP server. Must be chosen from among the transports supported.
UserAgentPort	voip/signalling/sip/port	Port for incoming call control signaling.
UserAgentTransport	voip/signalling/sip/transport_protocol	Transport protocol for incoming call control signaling.

14.4.2.1.4 Upgrading Firmware via TR-069

TR-069 contains a built-in mechanism for the device firmware upgrade.

14.4.2.2 Monitoring the Device Status via TR-069 and TR-104

The service provider can monitor the status of the device via TR-069 and TR-104.

14.4.2.2.1 Device Information

Table 14-13: InternetGatewayDevice.DeviceInfo

TR-069/TR-104 Parameter	Configuration File Parameter	Description
Description	manufacturer/description	A full description of the device (string).
DeviceLog	""	Vendor-specific log(s).
HardwareVersion	Manufacturer/hardware/version	A string identifying the particular device model and version.
Manufacturer	manufacturer/vendor_name	A string identifying the manufacturer of the device, i.e., AudioCodes.
ManufacturerOUI	manufacturer/vendor_oui	Organizationally unique identifier of the device manufacturer. Represented as a six hexadecimal-digit value using all upper-case letters and including any leading zeros.
ModelName	manufacturer/model_number	A string identifying the model name of the device.
ProductClass	manufacturer/product_class	Identifier of the class of product for which the serial number applies. That is, for a given manufacturer, this parameter is used to identify the product or class of product over which the SerialNumber parameter is unique.
ProvisioningCode	cwmp/provisioning_code	Identifier of the primary service provider and other provisioning information, which may be used by the Server to determine service provider-specific customization and provisioning parameters. If non-empty, this argument must be in the form of a hierarchical descriptor with one or more nodes specified. Each node in the hierarchy is represented as a 4-character sub-string, containing only numerals or upper-case letters. If there is more than one node indicated, each node is separated by a "." (dot). For example, "TLCO" and "TLCO.GRP2".
SerialNumber	Manufacturer/hardware/serial_num	Serial number of the device.

TR-069/TR-104 Parameter	Configuration File Parameter	Description
SoftwareVersion	system/external_version	A string identifying the software version currently installed in the device. To allow version comparisons, this element must be in the form of dot-delimited integers, where each successive integer represents a more minor category of variation. For example, 3.0.21 where the components mean Major.Minor.Build.
UpTime	-	Time in seconds since the device was last reset.

14.4.2.2 WAN Status

Table 14-14: InternetGatewayDevice.WANDevice.i.WANConnectionDevice.i.WANIPConnection.i.Stats

TR-069/TR-104 Parameter	Configuration File Parameter	Description
EthernetBytesReceived	mt_cwmp_param_wan_conn_ip_stats_get (STAT_RX_BYTES)	Total number of bytes received over all connections within the same WANConnectionDevice that share a common MAC address since the device was last reset.
EthernetBytesSent	mt_cwmp_param_wan_conn_ppp_stats_get (STAT_TX_BYTES)	Total number of bytes sent over all connections within the same WANConnectionDevice that share a common MAC address since the device was last reset.
EthernetPacketsReceived	mt_cwmp_param_wan_conn_ppp_stats_get (STAT_RX_PACKETS)	Total number of Ethernet packets received over all connections within the same WANConnectionDevice that share a common MAC address since the device was last reset.
EthernetPacketsSent	mt_cwmp_param_wan_conn_ppp_stats_get	Total number of Ethernet packets sent over all connections within the same WANConnectionDevice that share a common MAC address since the device was last reset.

14.4.2.2.3 LAN Status

Table 14-15: InternetGatewayDevice.LANDevice.i.LANEthernetInterfaceConfig.i.Stats

TR-069/TR-104 Parameter	Configuration File Parameter	Description
BytesReceived	mt_voip_get_state (line, state)	Total number of bytes received over the interface since the device was last reset.
BytesSent	mt_voip_get_state(line, state)	Total number of bytes sent over the interface since the device was last reset.
PacketsReceived	mt_voip_get_state(line, state)	Total number of packets received over the interface since the device was last reset.
PacketsSent	mt_voip_get_state(line, state)	Total number of packets sent over the interface since the device was last reset.

14.4.2.2.4 VoIP Status via TR-104

Table 14-16: InternetGatewayDevice.Services.VoiceService.i.VoiceProfile.i.Line.i.Stats

TR-069/TR-104 Parameter	Configuration File Parameter	Description
ResetStatistics	-	When set to one, it resets the statistics for this voice line. Always False when read.
PacketsSent	mt_voip_get_state(line, state)	Total number of RTP packets sent for this line.
PacketsReceived	mt_voip_get_state(line, state)	Total number of RTP packets received for this line.
BytesSent	mt_voip_get_state(line, state)	Total number of RTP payload bytes sent for this line.
BytesReceived	mt_voip_get_state(line, state)	Total number of RTP payload bytes received for this line.
PacketsLost	mt_voip_get_state(line, state)	Total number of RTP packets that have been lost for this line.
Overruns	-	Total number of times the receive jitter buffer has overrun for this line.
Underruns	-	Total number of times the receive jitter buffer has underrun for this line.
IncomingCalls Received	-	Total incoming calls received.
IncomingCalls Answered	-	Total incoming calls answered by the local user.
IncomingCalls Connected	-	Total incoming calls that successfully completed call setup signaling.
IncomingCallsFailed	-	Total incoming calls that failed to successfully complete call setup signaling.
OutgoingCalls Attempted	-	Total outgoing calls attempted.

TR-069/TR-104 Parameter	Configuration File Parameter	Description
OutgoingCalls Answered	-	Total outgoing calls answered by the called party.
OutgoingCalls Connected	-	Total outgoing calls that successfully completed call setup signaling.
OutgoingCallsFailed	-	Total outgoing calls that failed to successfully complete call setup signaling.
CallsDropped	-	Total calls that were successfully connected (incoming or outgoing), but dropped unexpectedly while in progress without explicit user termination.
TotalCallTime	-	Cumulative call duration (in seconds).
ServerDownTime	-	The number of seconds the device is unable to maintain a connection to the server. Applies only to SIP.
ReceivePacketLoss Rate	mt_voip_get_state(line, state)	Current receive packet loss rate (in percentage).
FarEndPacketLoss Rate	-	Current far-end receive packet lost rate (in percentage).
ReceiveInterarrival Jitter	-	Current receive interarrival jitter (in microseconds).
FarEndInterarrival Jitter	-	Current Interarrival jitter (in microseconds) as reported from the far-end device via RTCP.
RoundTripDelay	mt_voip_get_state	Current round-trip delay (in microseconds).
AverageReceive InterarrivalJitter	-	Average receive interarrival jitter (in microseconds) since the beginning of the current call.
AverageFarEnd InterarrivalJitter	-	Average far-end interarrival jitter (in microseconds) since the beginning of the current call.
AverageRoundTrip Delay	-	Average round-trip delay (in microseconds) since the beginning of the current call. This is the average of the RoundTripDelay statistics accumulated each time the delay is calculated.

14.4.2.3 Security Concerns and Measures

The CPE WAN Management Protocol is designed to allow a high degree of security in the interactions that use it. The CPE WAN Management Protocol is designed to prevent tampering with the transactions that take place between a CPE and ACS, provide confidentiality for these transactions, and allow various levels of authentication.

The following security mechanisms are incorporated in this protocol:

- The protocol supports the use of SSL/TLS for communications transport between CPE and ACS. This provides transaction confidentiality, data integrity, and allows certificate-based authentication between the CPE and ACS.
- The HTTP layer provides an alternative means of CPE authentication based on shared secrets.

14.4.3 SNMP

Simple Network Management Protocol (SNMP) is used in network management systems to configure and monitor network-attached devices. SNMP is an IETF standard defined by RFC 1157, 1441 and additional RFCs for specific Management Information Base (MIBs).

The device contains an embedded SNMP agent and supports SNMPv1, SNMPv2 and partially supports SNMPv3. For monitoring of the network interfaces, the standard SNMP MIB-II (RFC 1213) is supported. For more options, a proprietary MIB, AC-MP20X-MIB includes the following sections:

- **acMP20xConfig:** for changing the device's configuration
- **acMP20xStatus:** for monitoring the device's status

The figure below shows the SNMP network architecture:

Figure 14-13: SNMP Network Architecture



14.4.3.1 Enabling SNMP in the Web Interface

Simple Network Management Protocol (SNMP) enables Network Management Systems (NMSs) to remotely configure and monitor your device. Your ISP may use SNMP to identify and resolve technical problems. Technical information regarding the properties of the device's SNMP agent should be provided by your ISP.

The procedure below describes how to configure the SNMP agent embedded on the device.

➤ **To configure the device's SNMP agent:**

1. In the 'Advanced' screen, click the **Simple Network Management Protocol (SNMP)**

 icon; the 'Simple Network Management Protocol (SNMP)' screen appears.

Figure 14-14: Simple Network Management Protocol (SNMP) Screen



The screenshot shows the 'Simple Network Management Protocol (SNMP)' configuration page. At the top left is a small icon of a computer monitor displaying a green line graph. The title 'Simple Network Management Protocol (SNMP)' is centered at the top. Below the title are several configuration sections:

- Enabled:** A checked checkbox.
- Allow Incoming WAN Access to SNMP:** An unchecked checkbox.
- Read-Only Community Name:** A text input field containing 'public'.
- Read-Write Community Name:** A text input field containing 'private'.
- Trusted Peer:** A dark blue header with a dropdown menu below it showing 'Any Address'.
- SNMP Traps:** A dark blue header with an unchecked checkbox below it.

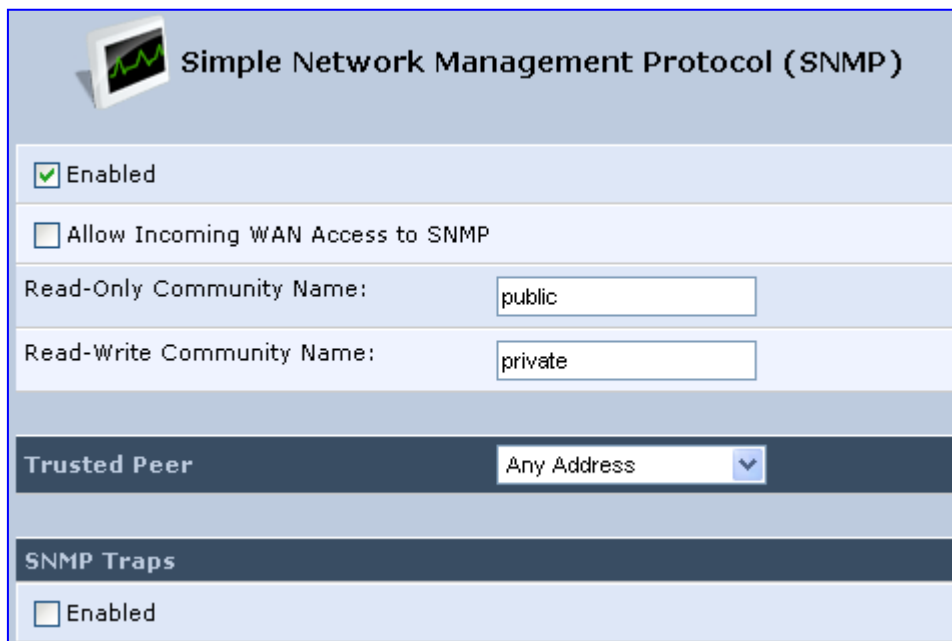
2. Select the 'Enabled' check box to enable SNMP.
3. Select the 'Allow Incoming WAN Access to SNMP' check box to allow access to the device's SNMP agent over the Internet.
4. In the 'Read-Only Community Names' and 'Read-Write Community Names' fields, enter the SNMP community strings. These strings are passwords used in SNMP messages between the management system and the device. A read-only community allows the manager to monitor the device. A read-write community allows the manager to monitor and configure the device.
5. From the 'Trusted Peer' drop-down list, enter the IP address, or subnet of addresses that identify which remote management stations are allowed to perform SNMP operations on the device.
6. Under the **SNMP Traps** group, select the 'Enabled' check box to allow the device to send messages (traps) to a remote management station to notify the manager about the occurrence of important events or serious conditions.
 - **Version:** SNMP version - SNMP v1 or SNMP v2c traps.
 - **Destination:** remote management station's IP address.
 - **Community:** community name that is associated with the trap messages.
7. Click **OK** to save your settings.

14.4.3.2 Configuring the Device via SNMP

The acMP20xConfig MIB section is structured in a similar hierarchy as the device's Web GUI. Each parameter in the MIB has a matching parameter in the Web GUI and a matching parameter in the gateway's configuration file. The MIB file defines the valid range and the default value for each parameter. Typically, the customer integrates the MP20x MIB into the customer's Network Management System (NMS) to automate the configuration process.



Note: A special MIB object is defined to allow the device firmware upgrade triggered by SNMP. The object acMP20xRemoteUpdate triggers a remote upgrade from the SNMP-configured URL.

14.4.3.3 Status Monitoring of System and Network Interfaces via SNMP

SNMP can be used to monitor the status of the device. Status monitoring of the system and network interfaces can be done via the standard MIB-II (iso(1).org(3).dod(6).internet(1).mgmt(2).mib-2(1)). The following table shows some of the information elements available via MIB-II:

Table 14-17: Table 3-13: Information Elements Available via MIB-II

Section	Available Information
system	<ul style="list-style-type: none"> ▪ Description ▪ Version Information ▪ Up-time
interfaces	<p>Information per network interface:</p> <ul style="list-style-type: none"> ▪ Description ▪ Type ▪ Speed ▪ MAC address ▪ Traffic statistics ▪ Errors
ip	Assigned IP addresses and IP-related parameters
icmp, udp, tcp	Transport-protocol specific statistical information
ifMIB	Information about network interfaces per RFC 2233

14.4.3.4 Security Concerns and Measures

Since SNMP allows write-access to configuration parameters, it is important to protect this interface. The following security measures are available:

- A community string (password) can be defined for read-only access and for read/write access.
- It is possible to limit access to SNMP to a trusted peer (single IP address or a range of addresses).
- SNMPv3 provides a significant security improvement over SNMPv1/2. Version 2.8.0 will support SNMPv3 and will allow the service provider to configure SNMPv3 security parameters.

14.4.4 Syslog

Syslog is a standard protocol for reporting and logging of messages over IP network and is defined by RFC 3164. The device enables the service provider to configure a Syslog server and a severity level above which errors are sent to the server. Typically, only error-level messages should be sent to the Syslog server (in order not to flood it with irrelevant debug-level information). For debugging, it is possible to temporarily allow logging for debug-level messages (e.g. for SIP messages).

Many free Syslog servers exist, including Kiwi Syslog Daemon (<http://www.kiwisyslog.com>).



Note: Since Syslog is used only to output messages from the device, it does not contain any security concerns.

14.4.5 Automatic File Download

A practical, straight-forward and easy to implement method for mass configuration and firmware update is automatic file download from a remote file server (via HTTP, FTP, or TFTP). This method is used by many service providers.

14.4.5.1 Firmware File Download

The device's firmware files contain information about the target product type and the firmware version information.

14.4.5.2 Configuration File Download

The device supports two configuration file formats, a ***.conf** file and an ***.ini** file. Both files define the same parameters, but in a different format; the ***.conf** file has a hierarchical tree-like structure and the ***.ini** file is "flat" (defining the full path for each parameter).

As with the firmware file, the configuration file can be "pushed" to the device via the Web server or "pulled" by the device from a remote server. This section refers only to the second option.

When the device downloads a file from a remote server, it performs the following actions:

- Decrypts the file, if it is encrypted.
- Checks that the file version is later than the current configuration file version (if it is not later, the new configuration is not used).
- Checks the software version with which the configuration file was created (if the file was created with a later software version, it is not used).

- Merges the configuration file with the current configuration:
 - Parameters that appear in the new file are modified or added
 - Parameters that do not appear in the new file remain in their existing value

**Notes:**

- It is recommended that the configuration file (that is downloaded from the network), contains only the small subset of parameters that the service provider needs to update remotely.
- To create the configuration file, it is recommended to use the device that is restored to factory settings, modify the required parameters using the Web GUI, and then upload the configuration file from the device with the option to get only the modified configuration fields enabled.

14.4.5.3 Security Concerns and Measures

The main security hazard in automatic file download is that a hacker can force the device to download a file from the hacker's server instead of the service provider's legitimate server. Another concern is exposing information such as the SIP proxy IP address and user and password information in the configuration file (if the hacker is sniffing the network).

The following security measures are available to prevent this:

- The configuration file can be encrypted using 3DES with pre-configured key. This prevents the user from learning the format of the file and obtaining information from it.
- HTTPS can be used to further encrypt the transport.
- HTTPS certificates can be used to allow the device to authenticate the server and also to prevent the user from acquiring the file from the server.

14.4.6 Telnet CLI

The device features a Command Line Interface (CLI) over Telnet. The CLI enables the service provider to manage the device (e.g. reboot, force a firmware upgrade), to obtain information about the status of the device (e.g. VoIP calls, network interfaces, version information), to change the configuration and to perform different debugging tasks (e.g. enable debug logging, enable packet recording).

Typically, the CLI interface is only used for debugging and diagnostics, since it does not allow mass configuration and monitoring.

Since the CLI allows all configuration and management operations, it is important to protect it. The following security measures are available:

- The CLI is user and password protected (same as the Web).
- Telnet access can be blocked from the WAN and/or LAN interfaces.
- It is possible to limit Telnet access to specific IP addresses.

14.4.7 Redirect Server

You can use the AudioCodes Redirect server to direct you to the appropriate Provisioning server URL to download the relevant configuration and firmware files.

Once the MP-20x is powered up and network connectivity is established, it automatically request for provisioning information. In case it does not obtain these files according to the regular provisioning hunt order methods, it sends a request to the AudioCodes Redirect server. The server responds to the MP-20x with an HTTP Redirect response containing the URL of the Provisioning server where the configuration file is located.

Once the MP-20x has successfully connected to the Provisioning server URL, the Automatic Update mechanism can commence.



Note:

- The MAC addresses of the MP-20x and the Provisioning server's URL are pre-configured on the Redirect server. For more information, contact AudioCodes support.
- The default URL of the Redirect server is:
`rmt_config/url=http://redirect.audiocodes.com/<mac>`
 This address can be reconfigured if required.

Figure 14-15: Redirect Server Configuration Process

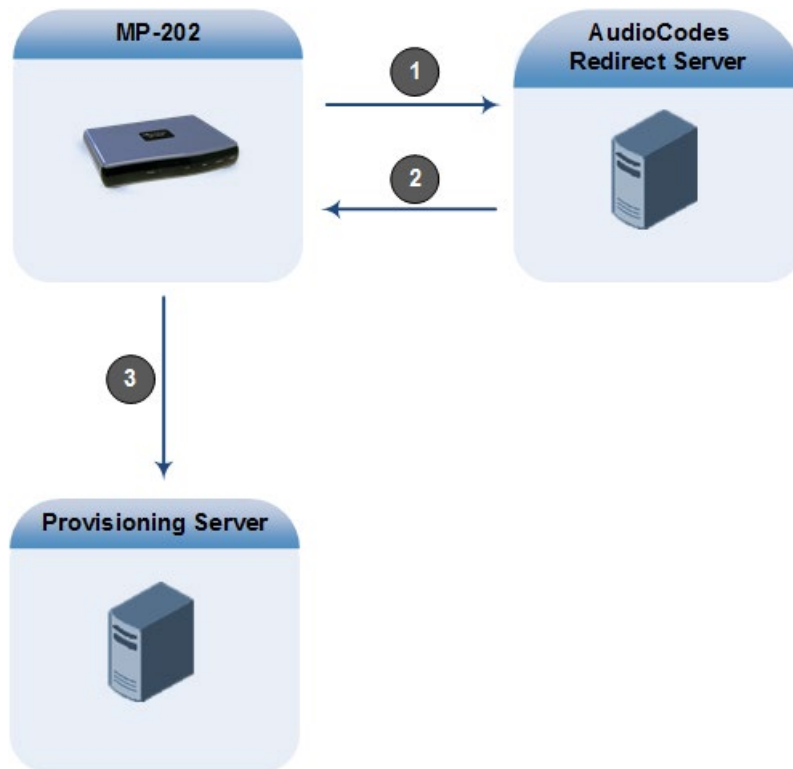

8. Device sends HTTP request to AudioCodes HTTP Redirect server.
9. Redirect server sends HTTP response with redirect URL of the Provisioning server.
10. MP-20x sends request to redirected URL (i.e., Provisioning server).



Note: The MP-20x repeats the redirect process whenever it undergoes a reset to factory defaults.

14.4.8 BroadSoft BroadWorks DMS Provisioning

1. You can now force the SIP and media to be encrypted using BroadSoft DMS (i.e., configuration file).

This is in addition to the current mechanism which is based on DNS NAPTR.

It gives additional control to the customer to force VoIP encryption by setting a specific custom tag from the BroadSoft Web portal. This tag `-%ENABLE_SIP_ENCRYPTION%` will reflect the relevant configuration parameter in MP-20x.

```
rg_conf/voip/signalling/enable_sip_rtp_encryption = {0,1} (0
by default)
```



Note: If `enable_sip_rtp_encryption=1` and the NAPTR record response does not contain any TLS option, the device stops the DNS query process and won't continue to the SIP Register phase.

For more information, refer to the *BroadSoft Partner Configuration Guide (PartnerConfigGuide_AudioCodes_MP-2xx.pdf)*.

14.4.9 Provisioning using DHCP Options 66/67 and TFTP

DHCP Options 66 and 67 together with the TFTP server allow mass provisioning of MP-20x devices. The following table describes these DHCP Options.

Table 14-18: DHCP Options 66/67 Descriptions

DHCP Option Number	DHCP Option Name	Description
66	TFTP Server Name	Defines the FQDN or IP address of the TFTP server that the device should use.
67	Filename	Defines the filename to be downloaded from the TFTP server specified in Option 66.

14.4.9.1 Default Behavior

During the DHCP process (DHCP Discover), the device declares the list of supported DHCP Options, including Options 66 and 67. If one or both of these Options are defined on the DHCP server, the DHCP server replies with defined values (i.e., IP address of the TFTP server and the file to download).

14.4.9.1.1 Option 66 Only

If the DHCP server replies to Option 66 only (i.e., sends the address of the TFTP server), the device sends a request to the TFTP server for the default firmware and configuration filenames:

- Firmware filename: MP202.rms
- Configuration filename: MP202_<MAC>.ini

If the firmware file exists, the device downloads the file, upgrades and reboots itself.

If the firmware file does not exist, the device downloads the configuration file, applies the settings and then reboots. The default firmware and configuration filenames can be changed through CLI, using the following:

```
rg_conf/system/dhccp/option_67_default_name=MP202_<MAC>.ini;MP202.rms
```

14.4.9.1.2 Options 66 and 67

If the DHCP server replies to both Options 66 and 67, the device sends a request to the TFTP server for a filename as specified in Option 67 (instead of the default filename).

14.4.9.2 Disabling DHCP Options 66 and 67

At every reboot, the device requests DHCP Options 66 and 67. If the DHCP server responds to the request, the device accesses the TFTP server and downloads the configuration. This process repeats itself until the device stops requesting these Options or the DHCP stops responding to these Options. To avoid this DHCP looping process upon each reboot, it is possible to disable the use of DHCP Options 66 and 67 on the WAN interface once the device downloads the file.

Add the relevant parameter (see below) on the device's WAN interface to the configuration file located in TFTP directory. The file is downloaded only once and after that, the device no longer declares Options 66 and 67.

The following needs to be added to the configuration to disable DHCP Options 66 and 67:

```
rg_conf/dev/eth1/dhcpc/options_66_67_disabled=1
```

To return to the default behavior, either remove this parameter or set the parameter to "0":

```
rg_conf/dev/eth1/dhcpc/options_66_67_disabled=0
```

14.4.10 Setting Provisioning Time of Day (TOD)

It is possible to configure the device to perform provisioning at random or fixed times using the configuration below.



Note: The device has to be rebooted for the configuration to take effect.

Table 14-19: Provisioning TOD Configuration

TOD Configuration	Type of TOD	Format (default)
rg_conf/rmt_config/random_tod/start	Random TOD	HH:MM (not configured)
rg_conf/rmt_config/random_tod/end	Random TOD	HH:MM (not configured)
rg_conf/rmt_config/random_tod/check_tod	Random TOD	HH:MM (not configured)
rg_conf/rmt_config/tod	Fixed TOD	HH:MM (not configured)
rg_conf/rmt_config/check_interval	No TOD	Seconds (86400)

14.4.10.1 Random TOD

You can configure a time range for when the provisioning can take place.

The range is configured between `rg_conf/rmt_config/random_tod/start` and `rg_conf/rmt_config/random_tod/end`.

The device calculates a new time each day in that range, for the provisioning.

The calculation time occurs every day at `rg_conf/rmt_config/random_tod/check_tod` (default is midnight), and is saved at `rg_conf/rmt_config/random_tod/calc_tod` for reference.

Example:

For the following configuration, at 10:00 AM every day, the device calculates a provisioning time between 22:00 and 02:00 the following day. There are 14,400 calculation possibilities (4 hours x 60 minutes x 60 seconds).

```
rg_conf/rmt_config/random_tod/start 22:00
rg_conf/rmt_config/random_tod/end 02:00
rg_conf/rmt_config/random_tod/check_tod 10:00
```

14.4.10.2 Fixed TOD

If Random TOD is not configured (i.e., no `rg_conf/rmt_config/random_tod` configuration is found), the device will perform provisioning every day at the time configured at `rg_conf/rmt_config/tod`.

14.4.10.3 No TOD Configured – Default Behavior

If no Random TOD or Fixed TOD is configured, the device tries to perform provisioning at fixed intervals since the start-up time of the device, configured with `rg_conf/rmt_config/check_interval` (configured in seconds – default is 24 hours).

14.4.10.4 Changing Default Cipher Suites for Provisioning

It is possible to change the default cipher suites to be used (or removed) for Provisioning. For example:

```
rg_conf/admin/cipher_list=
"EDH+CAMELLIA:EDH+aRSA:EECDH+aRSA+AESGCM:EECDH+aRSA+SHA384:EECDH+a
RSA+SHA256:EECDH:+CAMELLIA256:+AES256:+CAMELLIA128:+AES128:!SSLv3:
!aNULL:!eNULL:!LOW:!3DES:!MD5:!EXP:!PSK:!DSS:!RC4:!SEED:!ECDSA:CAM
ELLIA256-SHA:AES256-SHA:CAMELLIA128-SHA:AES128-SHA"
```

This page is intentionally left blank.

15 Security

The device's security suite includes comprehensive and robust security services: Stateful Packet Inspection Firewall, user authentication protocols and password protection mechanisms. These features together allow users to connect their computers to the Internet and simultaneously be protected from the security threats of the Internet.

The firewall, which is the cornerstone of your device's security suite, has been exclusively tailored to the needs of the residential/office user and has been pre-configured to provide optimum security.

Figure 15-1: Firewall in Action



The device firewall provides both the security and flexibility that home and office users seek. It provides a managed, professional level of network security while enabling the safe use of interactive applications, such as Internet gaming and video-conferencing.

Additional features, including surfing restrictions and access control, can also be easily configured locally by the user through a user-friendly Web-based interface, or remotely by a service provider.

The device firewall supports advanced filtering, designed to allow comprehensive control over the firewall's behavior. You can define specific input and output rules, control the order of logically similar sets of rules and make a distinction between rules that apply to WAN and LAN network devices.

The Web-based management screens in the Security section feature the following:

- The 'General' screen allows you to choose the security level for the firewall (see 'General Security Level Settings' on page 230).
- The 'Access Control' screen can be used to restrict access from the home network to the Internet (see 'Local Servers (Port Forwarding)' on page 234).
- The 'Port Forwarding' screen can be used to enable access from the Internet to specified services provided by computers in the home network and special Internet applications (see 'Port Forwarding' on page 234).
- The 'DMZ Host' screen allows you to configure a LAN host to receive all traffic arriving at the device, which does not belong to a known session (see 'Port Triggering' on page 238).
- The 'Port Triggering' screen allows you to define port triggering entries, to dynamically open the firewall for some protocols or ports. (see 'Remote Administration' on page 266).
- The 'Website Restrictions' allow you to block LAN access to a certain host or web site on the Internet (see 'Website Restrictions' on page 241).
- 'Advanced Filtering' allows you to implicitly control the firewall setting and rules (see 'Advanced Filtering' on page 247).
- 'Security Log' allows you to view and configure the firewall Log (see Security Log).

15.1 General Security Level Settings

Use the 'Security Settings' screen to configure the device's basic security settings.

Figure 15-2: General Security Level Settings



The firewall regulates the flow of data between the home network and the Internet. Both incoming and outgoing data are inspected and then either accepted (allowed to pass through the device) or rejected (barred from passing through the device) according to a flexible and configurable set of rules. These rules are designed to prevent unwanted intrusions from the outside, while allowing home users access to the Internet services that they require.

The firewall rules specify what types of services available on the Internet may be accessed from the home network and what types of services available in the home network may be accessed from the Internet. Each request for a service that the firewall receives, whether originating in the Internet or from a computer in the home network, is checked against the set of firewall rules to determine whether the request should be allowed to pass through the firewall. If the request is permitted to pass, then all subsequent data associated with this request (a "session") are also allowed to pass, regardless of its direction.

For example, when you point your Web browser to a Web page on the Internet, a request is sent out to the Internet for this page. When the request reaches the device, the firewall identifies the request type and origin--HTTP and a specific PC in your home network, in this case. Unless you have configured access control to block requests of this type from this computer, the firewall allows this request to pass out onto the Internet (see 'WAN PPPoE' on page 151 for more on setting access controls). When the Web page is returned from the Web server the firewall associates it with this session and allows it to pass, regardless of whether HTTP access from the Internet to the home network is blocked or permitted.

Note that it is the *origin of the request*, not subsequent responses to this request, that determines whether a session can be established or not.

You can choose from among three pre-defined security levels for the device: Minimum, Typical, and Maximum (the default setting). The table below summarizes the behavior of the device for each of the three security levels.

Table 15-1: Behavior for the Three Security Levels

Security Level	Requests Originating in the WAN (Incoming Traffic)	Requests Originating in the LAN (Outgoing Traffic)
Maximum Security (Default)	Blocked: No access to home network from Internet, except as configured in the Local Servers, DMZ host and Remote Access screens	Limited: Only commonly- used services, such as Web- browsing and e-mail, are permitted
Typical Security	Blocked: No access to home network from Internet, except as configured in the Local Servers, DMZ host and Remote Access screens	Unrestricted: All services are permitted, except as configured in the Access Control screen
Minimum Security	Unrestricted: Permits full access from Internet to home network; all connection attempts permitted.	Unrestricted: All services are permitted, except as configured in the Access Control screen

These services include Telnet, FTP, HTTP, HTTPS, DNS, IMAP, POP3 and SMTP.

The list of allowed services at 'Maximum Security' mode can be edited in the screen's 'Access Control on page 232'.

Some applications (such as some Internet messengers and Peer-To-Peer client applications) tend to use these ports if they cannot connect with their own default ports. When applying this behavior, these applications are not blocked outbound, even at Maximum Security Level.

➤ **To configure the device's security settings:**

(See the figure 'General Security Level Settings' on page 230.)

1. Choose from among the three predefined security levels described in the table above. 'Maximum Security' is the default setting.

Using the Minimum Security setting may expose the home network to significant security risks, and thus should only be used, when necessary, for short periods of time.

2. Check the 'Block IP Fragments' check box to protect your home network from a common type of hacker attack that could make use of fragmented data packets to sabotage your home network. Note that some UDP-based services make legitimate use of IP fragments. You need to allow IP fragments to pass into the home network to make use of these select services.
3. In the 'TCP Session timeout' field, enter the time-to-live (TTL) in units of seconds for TCP sessions. The valid range is 1 to 3600 hours (default is an hour).
4. Click **OK** to save the changes.

15.2 Configuring Access Control

You may want to block specific computers within the home network (or even the whole network) from accessing certain services on the Internet. For example, you may want to prohibit one computer from surfing the Web, another computer from transferring files using FTP, and the whole network from receiving incoming e-mail.

Access Control defines restrictions on the types of requests that may pass from the home network out to the Internet, and thus may block traffic flowing in both directions. In the e-mail example given above, you may prevent computers in the home network from receiving e-mail by blocking their *outgoing* requests to POP3 servers on the Internet.

There are services you should consider blocking, such as popular game and file sharing servers. For example, to ensure that your employees do not put your business at risk from illegally traded copyright files, you may want to block several popular P2P and file sharing applications.

➤ **To view and allow/restrict these services:**

1. From the menu bar, click the **Security** menu, and in the screen 'Security', click the **Access Control** tab; the screen 'Access Control' opens.

Figure 15-3: Access Control





2. Click the **New**  icon; the screen 'Add Access Control Rule' opens (see the figure below).

Figure 15-4: Add Access Control Rule

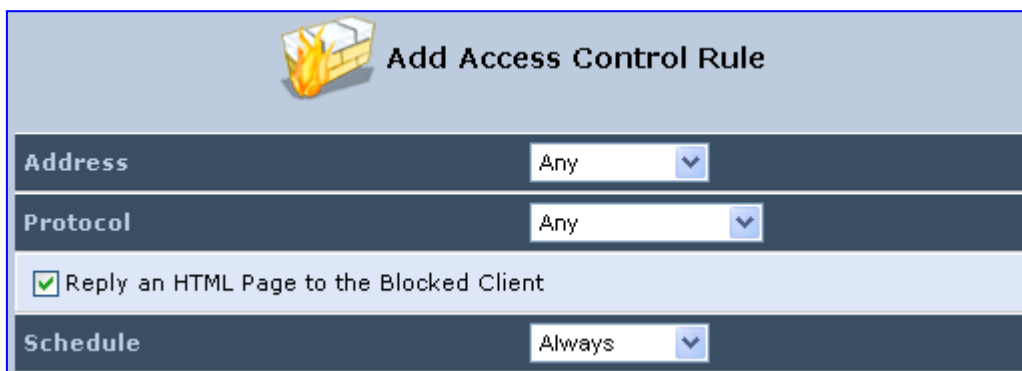

3. The parameter 'Address' enables you to specify the computer or group of computers for which you would like to apply the access control rule. You can select between any or a specific computer address in your LAN. If you choose the 'Specify Address' option, the screen refreshes, and an 'Add' link appears. Click it to specify a computer address. Specify an address by creating a 'Network Object'.
4. The parameter 'Protocol' lets you select or specify the type of protocol to be used. In addition to the list of popular protocols it provides, you may also choose any or a specific protocol. If you choose option 'Specify Protocol', the screen refreshes and an 'Add' link appears. Click it to specify a protocol address.

5. The parameter 'Schedule' allows you to define the time period during which this rule takes effect. You can select between 'Always' or a specific schedule. If you choose the option 'Specify Schedule', the screen refreshes and an 'Add' link appears. Click it to specify a schedule.
6. Click **OK** to save your settings; the 'Access Control' screen displays a summary of the rule that you just added. Click the **Edit**  icon to edit the access control rule for the service; the screen 'Edit Service' opens.
7. Select the network group to which you would like to apply the rule and the schedule during which the rule takes effect.
8. Click **OK** to save your changes and return to the 'Access Control' screen.

You can disable an access control rule and make the service available without having to remove the service from 'Access Control'. This can be useful when making the service only temporarily available and when expecting to reinstate the restriction in the future.

- To temporarily disable rule, clear the check box adjacent to the service name.
- To reinstate the restriction at a later time, recheck it.
- To remove a rule, click the Remove  icon for the service; the service is removed from 'Access Control'.



Note: When Web Filtering is enabled, HTTP services cannot be blocked by Access Control.

15.3 Configuring Port Forwarding

By default, the device blocks all external users from connecting to or communicating with your network. Therefore, the system is safe from hackers who may try to intrude on the network and damage it. However, you may want to expose your network to the Internet in certain limited and controlled ways to enable some applications to work from the LAN (game, voice and chat applications, for example) and to enable Internet access to servers in the home network. The Port Forwarding feature supports both of these functionalities.

The 'Port Forwarding' screen lets you define the applications that require special handling by the device. You must select the application's protocol and the local IP address of the computer using or providing the service. If required, you can add new protocols in addition to the most common ones provided by the device.

For example, to use an FTP application on one of your PCs, select 'FTP' from the list and enter the local IP address or host name of the designated computer; all FTP-related data arriving at the device from the Internet is then forwarded to the specified computer.

Similarly, to grant Internet users access to servers inside your home network, you must identify each service that you want to provide and the PC that provides it. For example, to host a Web server inside the home network you must select 'HTTP' from the list of protocols and enter the local IP address or host name of the computer that hosts the Web server. When an Internet user points her browser to the external IP address of the device, it forwards the incoming HTTP request to the computer that is hosting the Web server.

Additionally, port forwarding enables you to redirect traffic to a different port instead of the one to which it was designated. If for example you have a Web server running on your PC on port 8080 and you want to grant access to this server to anyone who accesses the device via HTTP, do the following:

- Define a port forwarding rule for the HTTP service, with the PC's IP or host name.
- Specify 8080 in the field 'Forward to Port'.

All incoming HTTP traffic is now forwarded to the PC running the Web server on port 8080.

When setting a port forwarding service, you must ensure that the port is not already in use by another application, which may stop functioning. A common example is when using SIP signaling in Voice over IP - the port used by the device's VoIP application (5060) is the same port on which port forwarding is set for LAN SIP agents.



Note: Some applications, such as FTP, TFTP, PPTP and H323, require the support of special specific Application Level Gateway (ALG) modules in order to work inside the home network. Data packets associated with these applications contain information that allows them to be routed correctly. An ALG is needed to handle these packets and ensure that they reach their intended destinations. The device is equipped with a robust list of ALG modules in order to enable maximum functionality in the home network. The ALG is automatically assigned based on the destination port.

- **To add a new port forwarding service:**
 1. From the menu bar, click the **Security** menu, and in the screen 'Security', click the **Port Forwarding** tab; the screen 'Port Forwarding' opens.

Figure 15-5: Port Forwarding Screen



2. Click the **New**  icon; the screen 'Add Port Forwarding Rule' opens.

Figure 15-6: Add Port Forwarding Rule

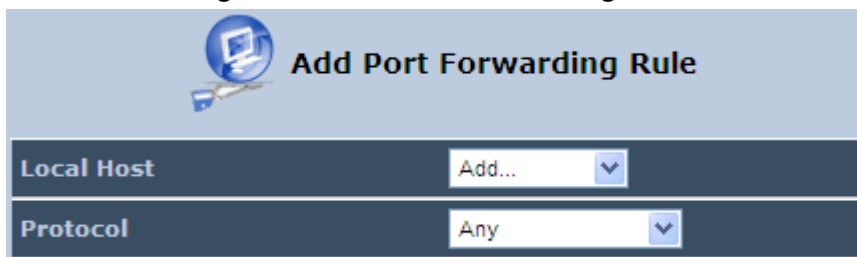

3. From the 'Local Host' drop-down list, select the network object (defined in Section 5.6.2 on page 51) or define one now by selecting the 'User Defined' option. This is the IP address or host name of the computer that provides the service (the 'server'). **Note:** Only one LAN computer can be assigned to provide a specific service or application.
4. From the 'Protocol' drop-down list, select the type of protocol (defined in Section 5.6.3 on page 53) or select 'User Defined' to define one now. You can select multiple protocols for this rule.

Figure 15-7: Selecting Protocol Type

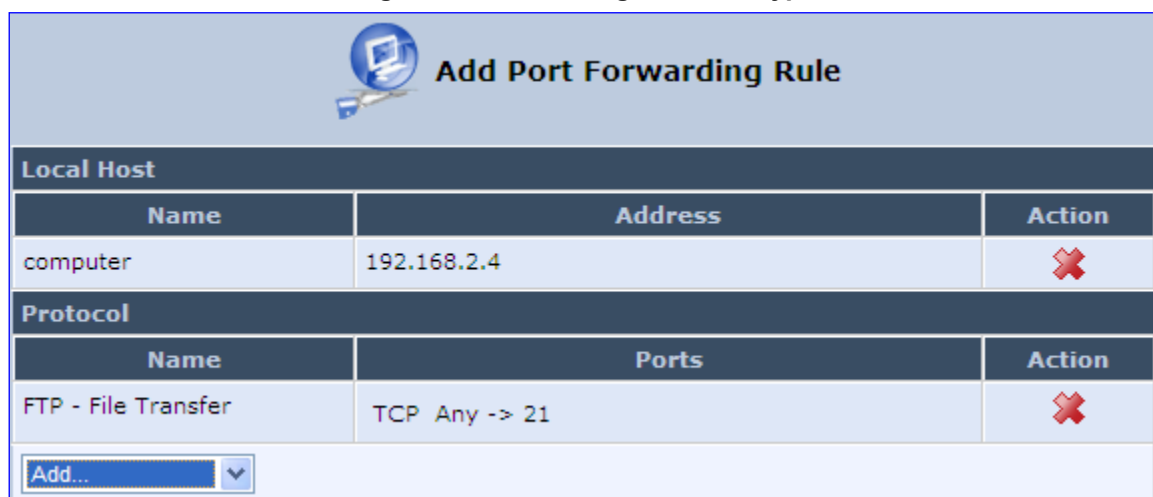

5. Click the **Advanced** button to configure advanced settings:
 - a. Select the 'Specify Public IP Address' check box if you want to apply this rule on the device's non-default IP address defined in the 'NAT' screen (see Section 15.7 on page 244). Enter the additional external IP address in the 'Public IP Address' field.

Figure 15-8: Specifying Public IP Address

- b. By default, the device forwards traffic to the same port as the incoming port. If you wish to redirect traffic to a different port, then from the 'Forward to Port' drop-down list, select the 'Specify', and then enter the port number in the field provided.
 - c. By default, the rule is always active. However, you can select a schedule rule that defines the time during which the rule may be active. From the 'Schedule' drop-down list, select a defined Schedule rule (defined in Section 5.6.1 on page 49) or define a new one quickly by selecting 'User Defined'.
6. Click **OK** to save changes.

You can disable a port forwarding rule to make a service unavailable without having to remove the rule from the screen 'Port Forwarding'. This can be useful when making the service temporarily unavailable and when expecting to reinstate it in the future.

Figure 15-9: Select Check Box of Port Forwarding Rule (Active)

Local Host	Local Address	Protocols	Status	Action
<input checked="" type="checkbox"/> 10.13.0.1	10.13.0.1	FTP - TCP Any -> 21	Active	
New Entry				

- To temporarily disable a rule, clear the check box next to the service name.
- To reinstate it at a later time, select the check box.
- To remove a rule, click the Remove icon for the service; the service is permanently removed.

15.4 Configuring a DMZ Host

The DMZ (Demilitarized) Host feature allows one local computer to be exposed to the Internet. Designate a DMZ host to:

- Use a special-purpose Internet service, such as an on-line game or video-conferencing program, that is not present in the Local Servers list and for which no port range information is available.
- To expose one computer to all services, without restriction, irrespective of security.

Warning: A DMZ host is not protected by the firewall and may be vulnerable to attack. Designating a DMZ host may also put other computers in the home network at risk. When designating a DMZ host, you must consider the security implications and protect it if necessary.

An incoming request for access to a service in the home network, such as a Web-server, is fielded by the device. The device forwards this request to the DMZ host (if one is designated) unless the service is being provided by another PC in the home network (assigned in Local Servers), in which case that PC receives the request instead.

➤ **To designate a local computer as a DMZ Host:**

1. From the menu bar, click the **Security** menu, and in the screen 'Security', click the **DMZ Host** tab; the screen 'DMZ Host' opens.

Figure 15-10: DMZ Host

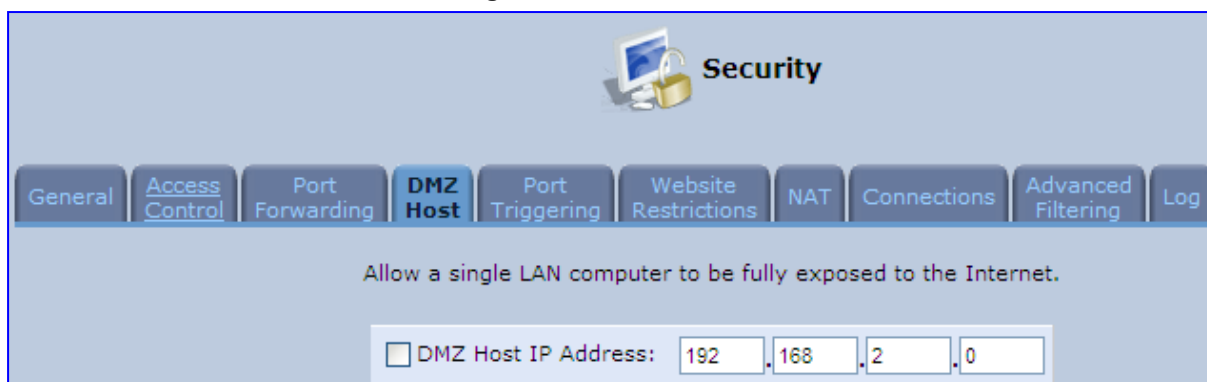

2. Enter the local IP address of the computer to be designated as a DMZ host. Note that only one LAN computer can be a DMZ host at any time.
3. Click **OK** to save your changes and return to the screen 'DMZ Host'.

You can disable the DMZ host so that it does not fully exposed to the Internet, but keep its IP address recorded on the 'DMZ Host' screen. This may be useful if you wish to disable the DMZ host but expect that you may want to enable it again in the future.

- To disable the DMZ host so that it is not fully exposed to the Internet, clear the check-box next to the DMZ IP designation and click **OK**.
- To re-enable the DMZ host later, recheck the check-box.

15.5 Configuring Port Triggering

Port triggering can be used for dynamic port forwarding configuration. By setting port triggering rules, you can allow inbound traffic to arrive at a specific LAN host, using ports different than those used for the outbound traffic. This is called port triggering since the outbound traffic triggers to which ports inbound traffic is directed.

For example, consider a gaming server that is accessed using UDP protocol on port 222. The gaming server responds by connecting the user using UDP on port 333 when starting gaming sessions. In such a case you must use port triggering, since this scenario conflicts with the following default firewall settings:

- The firewall blocks inbound traffic, by default.
- The server replies to the device's IP, and the connection is not sent back to your host, since it is not part of a session.

To solve this, you need to define a Port Triggering entry, which allows inbound traffic on UDP port 333, only after a LAN host generated traffic to UDP port 222. This results in accepting the inbound traffic from the gaming server and sending it back to the LAN Host which originated the outgoing traffic to UDP port 222.

- **To view port triggering settings:**
 1. From the menu bar, click the **Security** menu, and in the screen 'Security', click the **Port Triggering** tab; the screen 'Port Triggering' opens. The screen lists all port triggering entries.

Figure 15-11: Port Triggering

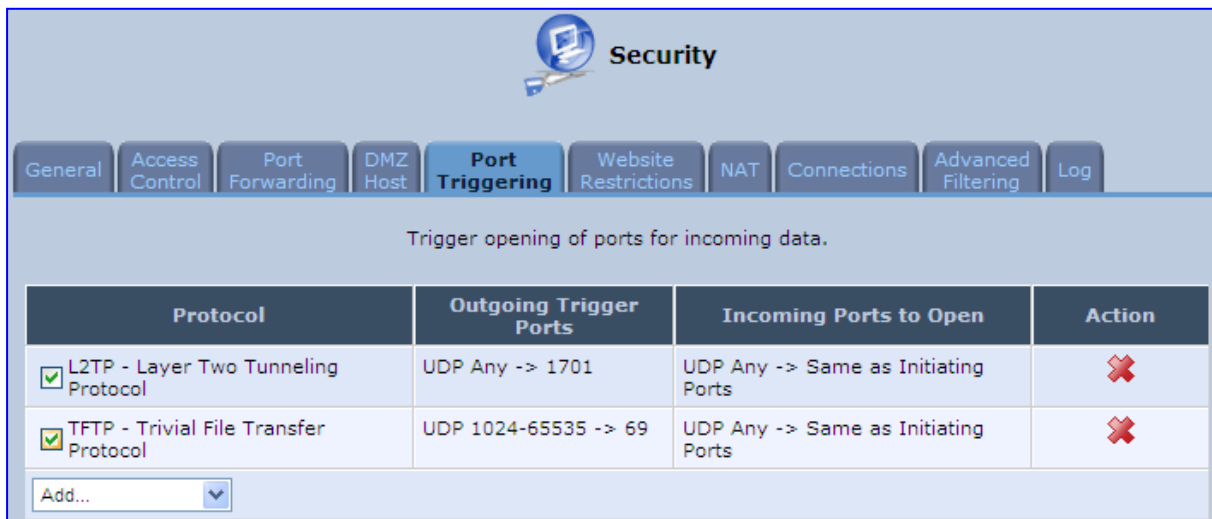

- **To add an entry for the gaming example above:**
- 1. From the drop-down list, select 'User Defined' to add an entry; the screen 'Edit Service' opens.

Figure 15-12: Adding Port Triggering Rules

- 2. Enter a name for the service (e.g., 'game_server'), and then click the link **New Trigger Ports**; the screen 'Edit Service Server Ports' opens.

Figure 15-13: Edit Service Server Ports

- 3. In the 'Protocol' drop-down list, select 'UDP'; the screen refreshes, providing source and destination port options.
- 4. Leave the 'Source Ports' drop-down list at its default 'Any'. In the 'Destination Ports' drop-down list, select 'Single'; the screen refreshes again, providing an additional field in which you should enter '222' as the destination port.

Figure 15-14: Edit Service Server Ports

- 5. Click **OK** to save the settings.
- 6. In the screen 'Edit Service', click the link **New Opened Ports**; the screen 'Edit Service Opened Ports' opens.

- Similar to the trigger ports screen, select UDP as the protocol, leave the source port at 'Any', and enter a 333 as the single destination port.

Figure 15-15: Edit Service Opened Ports

- Click **OK** to save the settings; the screen 'Edit Service' presents your entered information. Click **OK** again to save the port triggering rule; the screen 'Port Triggering' now includes the new port triggering entry.

Figure 15-16: New Port Triggering Rule

Protocol	Outgoing Trigger Ports	Incoming Ports to Open	Action
<input checked="" type="checkbox"/> L2TP - Layer Two Tunneling Protocol	UDP Any -> 1701	UDP Any -> Same as Initiating Ports	
<input checked="" type="checkbox"/> TFTP - Trivial File Transfer Protocol	UDP 1024-65535 -> 69	UDP Any -> Same as Initiating Ports	
<input checked="" type="checkbox"/> Game Server	UDP Any -> 222	UDP Any -> 333	

You can disable a port triggering rule without having to remove it from the screen 'Port Triggering':

- To temporarily disable a rule, clear the check box corresponding to the service name.
- To reinstate it later, simply reselect the check box.
- To remove a rule, click the **Remove** icon for the service; the service is permanently removed.

There may be a few default port triggering rules listed when you first access the port triggering screen. Note that disabling these rules may result in impaired device functionality.

15.6 Configuring Website Restrictions

You can configure the device to block specific Internet websites so that they cannot be accessed from computers in the home network. Moreover, restrictions can be applied to a comprehensive and automatically-updated table of sites to which access is not recommended.

➤ **To block access to a website:**

1. From the menu bar, click the **Security** menu, and in the screen 'Security', click the **Website Restrictions** tab; the screen 'Website Restrictions' opens.

Figure 15-17: Website Restrictions



2. Click the **New**  icon; the 'Restricted Website' screen appears.

Figure 15-18: Restricted Website

The screenshot shows the 'Restricted Website' configuration page. At the top, there is a 'Restricted Website' header with a flame icon. Below it is the instruction: 'Enter the website you wish to restrict:'. Below this is a form with the following fields:

- 'Restricted Website': A text input field.
- 'Local Host': A dropdown menu with 'Any' selected.
- 'Schedule': A dropdown menu with 'Always' selected.

3. Enter the website address (IP address or URL) that you would like to make inaccessible from your home network (all Web pages within the site are also blocked). If the website address has multiple IP addresses, the device resolves all additional addresses and automatically adds them to the restrictions table.
4. The 'Local Host' drop-down list provides you the ability to specify the computer or group of computers for which you would like to apply the website restriction. You can select between any or a specific computer address in your LAN. If you choose the option 'User Defined', the screen refreshes and the 'Edit Network Object' appears:

Figure 15-19: Add a Specific Host

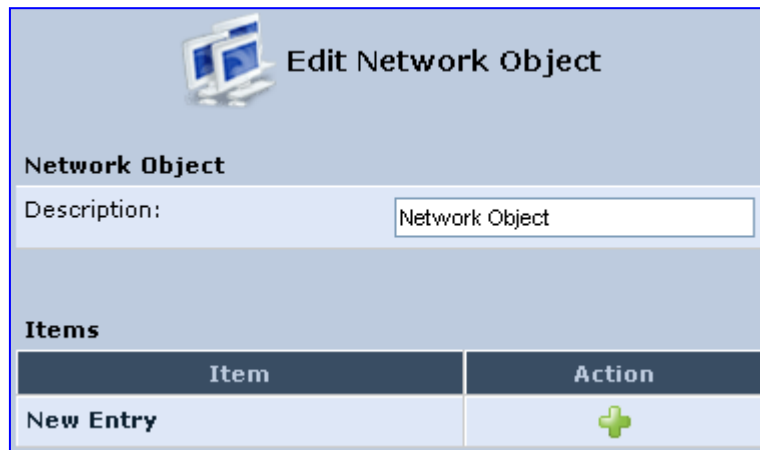



5. Click the **New**  icon to specify a computer address. Specify an address creating a 'Network Object'.
6. The parameter Schedule allows you to define the time period during which this rule takes effect. You can select between 'Always' or a specific schedule. If you choose the option 'User Defined', the screen 'Edit Scheduler Rule' appears:

Figure 15-20: Add a Specific Schedule

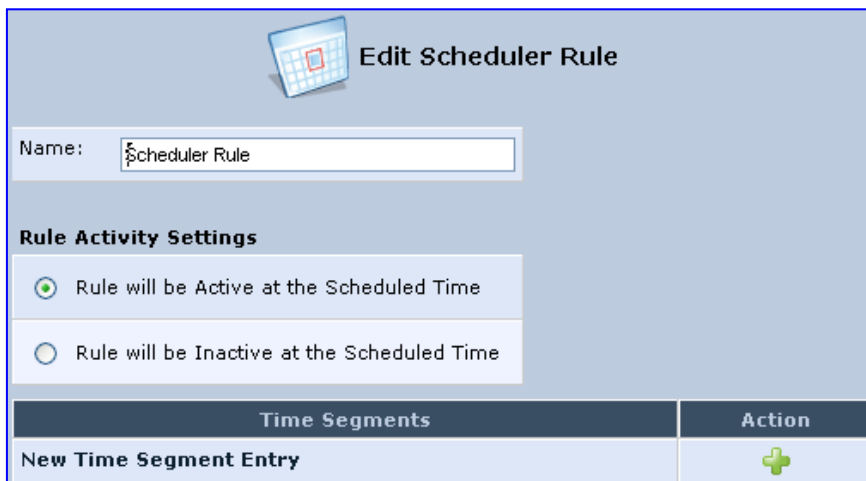

7. Click the **New**  icon to specify the time segment, and then click **OK**.
8. Click **OK** to save the settings; the device attempts to find the site. 'Resolving...' appears in the Status column while the site is being located (the URL is 'resolved' into one or more IP addresses).
9. Click the **Refresh** button to update the status if necessary. If the site is successfully located, 'Resolved' appears in the status bar; if not, 'Hostname Resolution Failed' appears.

➤ **If the device fails to locate the website:**

1. Use a Web browser to verify that the website is available. If it is, then you probably entered the website address incorrectly.
2. If the website is unavailable, return to the screen 'Website Restrictions' later and click the button **Resolve Now** to verify that the website can be found and blocked by the device.
3. You can edit the website restriction by modifying its entry under the column 'Local Host' in the screen 'Website Restrictions'.

➤ **To modify an entry:**

1. Click the icon **Edit** for the restriction; the screen 'Restricted Website' opens. Modify the website address, group or schedule as required.
2. Click **OK** to save your changes and return to the screen 'Website Restrictions'.

➤ **To ensure that all current IP addresses corresponding to the restricted websites are blocked:**

1. Click the button **Resolve Now**; the device checks each of the restricted website addresses and ensures that all IP addresses at which this website can be found are included in the IP addresses column.
2. You can disable a restriction to make a website available again without having to remove it from the screen 'Website Restrictions'. This can be useful when making the website temporarily available and when expecting to block it again in the future.
 - To temporarily disable a rule, clear the check box adjacent to the service name.
 - To reinstate it at a later time, recheck the check box.
 - To remove a rule, click the **Remove**  icon for the service; the service is permanently removed.

15.7 Configuring NAT

The device features a configurable Network Address Translation (NAT) and Network Address Port Translation (NAPT) mechanism, allowing you to control the network addresses and ports of packets routed through your gateway. When enabling multiple computers on your network to access the Internet using a fixed number of public IP addresses, you can statically define which LAN IP address will be translated to which NAT IP address and/or ports.

By default, the device operates in NAPT routing mode. However, you can control your network translation by defining static NAT/NAPT rules. Such rules map LAN computers to NAT IP addresses. The NAT/NAPT mechanism is useful for managing Internet usage in your LAN, or complying with various application demands. For example, you can assign your primary LAN computer with a single NAT IP address, in order to assure its permanent connection to the Internet. Another example is when an application server with which you wish to connect, such as a security server, requires that packets have a specific IP address – you can define a NAT rule for that address.

➤ **To define a NAT:**

1. From the menu bar, click the **Security** menu, and in the screen 'Security', click the **NAT** tab; the screen 'NAT' opens.

Figure 15-21: NAT Screen

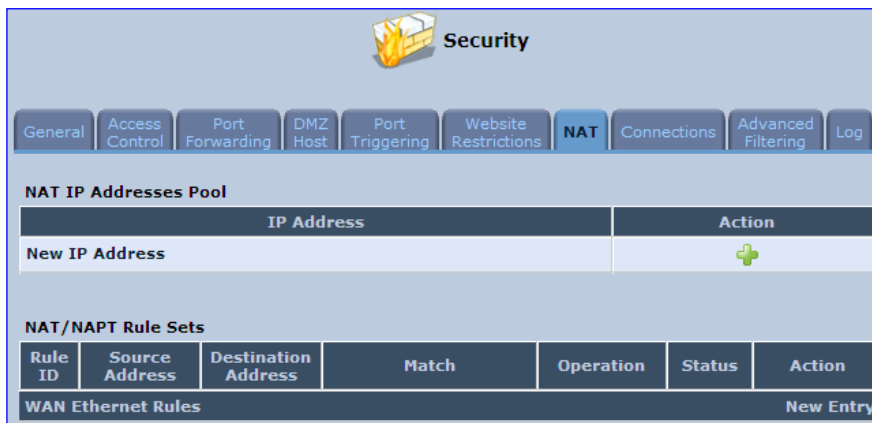

2. Before configuring NAT/NAPT rules, you must first enter the additional public IP addresses obtained from your ISP as your NAT IP addresses, in the 'NAT IP Addresses Pool' section. The primary IP address used by the WAN device for dynamic NAPT should not be added to this table.
 - a. To add a NAT IP address, click the **New**  icon; the 'Edit Item' screen appears.

Figure 15-22: Adding a NAT IP Address



- b. From the 'Network Object Type' drop-down list, select between IP address, subnet or range, and then enter the information respectively, and click **OK** to save the settings.

➤ **To add a new NAT/NAPT rule:**

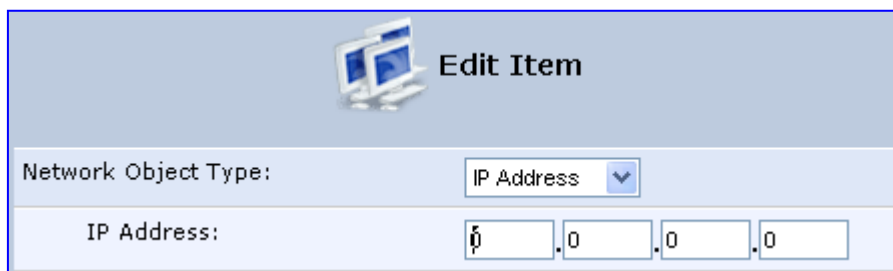
1. In the 'NAT/NAPT Rule Sets' section, click the **New Entry** link; the 'Add NAT/NAPT Rule' screen appears.

Figure 15-23: Adding NAT/NAPT Rule

 **Add NAT/NAPT Rule**

Matching	
Source Address	Any
Destination Address	Any
Protocol	Any
Operation	
NAT	Source IP translation rule
NAT Addresses	Add...
Logging	
<input type="checkbox"/> Log Packets Matched by This Rule	
Schedule	
Always	

This screen is divided into two main sections: 'Matching' and 'Operation'. The 'Matching' section defines the LAN addresses to be translated to the external addresses, which are defined in the 'Operation' section.

2. 'Matching' section (define characteristics of the packets matching the rule):
 - a. **Source Address:** source address of packets sent or received by the device. You can select the computer or group of computers on which you would like to apply the rule. To apply the rule on all the LAN hosts, select 'Any'. If you would like to add a new address, select the 'User Defined'. This commences a sequence to add a new Network Object, representing the new host.
 - b. **Destination Address:** destination address of packets sent or received by the device. This address can be configured in the same manner as the source address. This entry enables further filtration of the packets.
 - c. **Protocol:** specifies a traffic protocol. Selecting the 'Show All Services' option expands the list of available protocols. Select a protocol or add a new one using the 'User Defined' option. This commences a sequence that adds a new Service, representing the protocol. Using a protocol requires observing the relationship between a client and a server to distinguish between the source and destination ports.

3. Operation section (define the operation to apply on the IP addresses, matching the criteria defined above): NAT or NAPT.
 - **NAT Addresses:** NAT address into which the original IP address is translated. The drop-down list displays all of your available NAT addresses/ranges from which you can select an entry. If you would like to add a single address or a sub-range from the given pool/range, select the 'User Defined' option. This commences a sequence that adds a new Network Object, representing the new host.
 - **NAPT Address:** NAPT address into which the original IP address is translated. The drop-down list displays all of your available NAPT addresses/ranges from which you can select an entry. If you would like to add a single address or a sub-range from the given pool/range, select the 'User Defined' option. This commences a sequence that adds a new Network Object, representing the new host. . Note, that in this case the network object may only be an IP address, as NAPT is port-specific.
 - **NAPT Ports:** specify the port(s) of the IP address into which the original IP address is translated. Enter a single port or select 'Range' (the screen refreshes, enabling you to enter a range of ports).
4. Select the 'Log Packets Matched by This Rule' check box to log the first packet from a connection that was matched by this rule.
5. By default, the 'Schedule' rule is always active. However, you can configure scheduler rules to define time segments during which the rule may be active.
6. Click **OK** to save the settings.

15.8 Viewing Current Connections

The connection list displays all the connections that are currently open, as well as various details and statistics. You can use this list to close an undesired connection by clicking its corresponding action icon. The basic display includes the name of the protocol, the different ports it uses, and the direction in which the connection was initiated.

➤ **To view currently open connections:**

1. From the menu bar, click the **Security** menu, and on the 'Security' screen, click the **Connections** tab; the screen 'Connections' opens.
2. From the Connections Per Page drop-down list, select the number of connections that you want displayed per page. To browse to the next page, click the ➔ icon or the page number located at the bottom left of the page.

Figure 15-24: Connections Screen

The screenshot shows the 'Security' interface with the 'Connections' tab selected. It displays statistics for active connections and a table of connection details.

Active Connections: 11
Approximate Max. Connections: 181

Connection List Connections Per Page: 10

Number	Protocol	LAN IP:Port	MP252 IP:Port	WAN IP:Port	Direction	Action
1	TCP	10.13.22.32:80	10.13.22.32:80	10.13.22.25:1915	Incoming	✘
2	TCP	10.13.22.32:80	10.13.22.32:80	10.13.22.25:1914	Incoming	✘
3	UDP	239.255.255.250:1900	239.255.255.250:1900	10.13.22.13:63882	Incoming	✘
4	UDP	10.13.22.32:123	10.13.22.32:123	213.28.138.38:123	Outgoing	✘
5	UDP	239.255.255.250:1900	239.255.255.250:1900	10.13.2.17:53546	Incoming	✘
6	TCP	192.168.2.2:57061	10.13.22.32:57061	80.179.55.90:110	Outgoing	✘
7	TCP	192.168.2.2:57060	10.13.22.32:57060	80.179.55.90:110	Outgoing	✘
8	TCP	192.168.2.2:57059	10.13.22.32:57059	80.179.55.90:110	Outgoing	✘
9	TCP	192.168.2.2:57057	10.13.22.32:57057	17.149.34.67:5223	Outgoing	✘
10	TCP	192.168.2.2:57056	10.13.22.32:57056	17.149.36.195:5223	Outgoing	✘

1 2 ➔

To display additional details in the Connection list, click the **Advanced** button.

The 'Approximate Max. Connections' value displays the amount of additional concurrent connections possible.

15.9 Configuring Advanced Filtering

Advanced filtering is designed to allow comprehensive control over the firewall's behavior. You can define specific input and output rules, control the order of logically similar sets of rules and make a distinction between rules that apply to WAN and LAN devices.

- **To view the device's advanced filtering options:**
 - From the menu bar, click the **Security** menu, and in the screen 'Security', click the **Advanced Filtering** tab; the 'Advanced Filtering' opens.

Figure 15-25: Advanced Filtering

 **Security**

General
Access Control
Port Forwarding
DMZ Host
Port Triggering
Website Restrictions
NAT
Connections
Advanced Filtering
Log

Input Rule Sets

Rule ID	Source Address	Destination Address	Match	Operation	Status	Action
Initial Rules						New Entry
LAN Bridge Rules						New Entry
LAN Hardware Ethernet Switch Rules						New Entry
LAN Wireless 802.11n Access Point Rules						New Entry
WAN ETHoA Rules						New Entry
WAN PPPoE Rules						New Entry
Final Rules						New Entry

Output Rule Sets

Rule ID	Source Address	Destination Address	Match	Operation	Status	Action
Initial Rules						New Entry
LAN Bridge Rules						New Entry
LAN Hardware Ethernet Switch Rules						New Entry
LAN Wireless 802.11n Access Point Rules						New Entry
WAN ETHoA Rules						New Entry
WAN PPPoE Rules						New Entry
Final Rules						New Entry

ALG Rule Sets

Rule ID	Source Address	Destination Address	Match	Operation	Status	Action
Input						
<input checked="" type="checkbox"/> 0	Any	Any	FTP - TCP Any -> 21	ALG FTP	Active	✎ ✖ ⬇
<input checked="" type="checkbox"/> 1	Any	Any	SIP - UDP Any -> 5060	ALG SIP	Active	✎ ✖ ⬆ ⬇

This screen is divided into two identical sections, one for 'Input Rule Sets' and the other for 'Output Rule Sets', which are for configuring inbound and outbound traffic, respectively. Each section is comprised of subsets, which can be grouped into three main subjects:

- Initial rules - rules defined here are applied first, on all devices.
- Network devices rules - rules can be defined per the device.
- Final rules - rules defined here are applied last, on all devices.

Numerous rules are automatically inserted by the firewall to provide improved security and block harmful attacks.



Note: The order of appearance of the firewall rules determines the sequence by which they are applied.

➤ **To configure an advanced filtering rule:**

1. After choosing the traffic direction and the device on which to set the rule, click the corresponding link **New Entry**; the screen 'Add Advanced Filter' opens.

Figure 15-26: Add Advanced Filter

Add Advanced Filter

Matching

Source Address: Any

Destination Address: Any

Protocol: Any

Payload Content

DSCP

Priority

Length

Connection Duration

Connection Size

Operation

Drop: Drop packets

Logging

Log Packets Matched by This Rule

Schedule

Always

OK Cancel

2. In the 'Matching' section, define a match between IP addresses and a traffic protocol:
 - a. Configure the source address of the packets sent to or received from the network object. To add an address, select the option 'User Defined' from the drop-down list; the screen 'Edit Network Object' appears.

Figure 15-27: Add a Specific Host

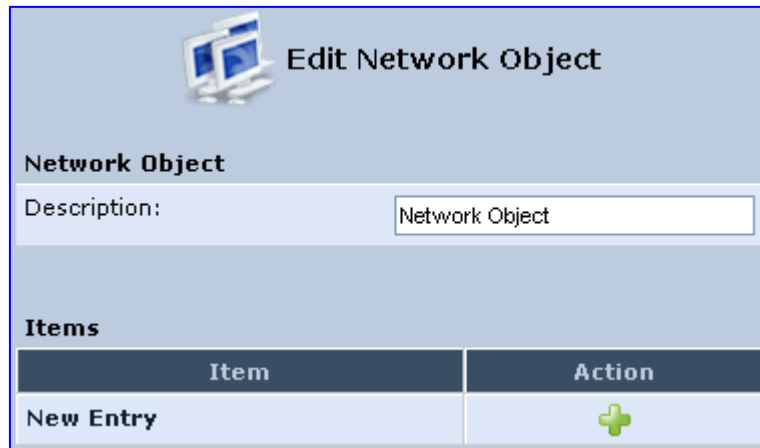

3. Click the **New**  icon; this commences a sequence that adds a new network object.
 - a. Configure the destination address of the packets sent to or received from the network object. This address can be configured in the same manner as the source address.
 - b. From the 'Protocol' drop-down list, select a specific traffic protocol or add a new one (by selecting 'User Defined'); the 'Edit Services' screen appears. Click the link **New Server Ports**; this commences a sequence that adds a new protocol.
4. Select the check box 'DSCP' to mark a DSCP value on packets matching this rule; the screen refreshes, allowing you to enter the hexadecimal value of the DSCP.
5. Select the check box 'Priority' to add a priority to the rule; the screen refreshes, allowing you to select between one of eight priority levels, zero being the lowest and seven the highest (each priority level is mapped to low/medium/high priority). This sets the priority of a packet on the connection matching the rule, while routing the packet.

Figure 15-28: Set Priority Rule



6. Select the check box 'Length' to specify the length of packets or the length of their data portion.
7. In the 'Operation' section, define the action of the rule:
 - **Drop:** Deny access to packets that match the source and destination IP addresses and service ports defined in 'Matching'.
 - **Reject:** Deny access to packets that match the source and destination IP addresses and service ports defined in 'Matching' and sends and sends an ICMP error or a TCP reset to the origination peer.
 - **Accept Connection:** Allow access to packets that match the source and destination IP addresses and service ports defined in 'Matching'. The data transfer session is handled using Stateful Packet Inspection (SPI).
 - **Accept Packet:** Allow access to packets that match the source and destination IP addresses and service ports defined in 'Matching'. The data transfer session is not handled using Stateful Packet Inspection (SPI), meaning that other packets that match this rule are not automatically allowed access. For example, this can be useful when creating rules that allow broadcasting.

8. Under the section 'Logging', select the parameter 'Log Packets Matched By This Rule' to log the first packet from a connection that was matched by this rule.
9. By default, the 'Schedule' rule is always active. However, you can configure scheduler rules to define time segments during which the rule may be active.
10. Click **OK** to save the settings.

15.10 Viewing the Security Log

The Security log displays a list of firewall-related events, including attempts to establish inbound and outbound connections, attempts to authenticate at an administrative interface (Web-based management or Telnet terminal), firewall configuration and system start-up.

➤ **To view the Security Log:**

1. From the menu bar, click the **Security** menu, and in the screen 'Security', click the **Log** tab; the screen 'Log' opens.

Figure 15-29: Security Log

The screenshot shows the 'Security' configuration page. At the top, there is a 'Security' header with a shield icon. Below it is a menu bar with tabs: General, Access Control, Port Forwarding, DMZ Host, Port Triggering, Website Restrictions, NAT, Connections, Advanced Filtering, and Log (which is highlighted). Below the menu bar are buttons for Close, Clear Log, Download Log, Settings, and Refresh. A message says 'Press the Refresh button to update the data.' Below this is a table with the following data:

Time	Event	Event-Type	Details
Jan 1 03:03:47 2003	WBM Login	User authentication success	Username: admin [repeated 5 times, last time on Jan 1 04:18:09 2003]
Jan 1 02:56:33 2003	Firewall Setup	Firewall internal	Firewall configuration succeeded
Jan 1 02:56:32 2003	Firewall Setup	Firewall internal	Starting firewall configuration
Jan 1 02:56:23 2003	WBM Login	User authentication success	Username: admin
Jan 1 02:43:42 2003	Firewall Setup	Firewall internal	Firewall configuration succeeded

2. The log table displays the following:
 - **Time:** to determine the time the event occurred.
 - **Event:** type of event. There are five types of events:
 - ◆ **Inbound Traffic:** The event is a result of an incoming packet.
 - ◆ **Outbound Traffic:** The event is a result of outgoing packet.
 - ◆ **Firewall Setup:** Configuration message.
 - ◆ **WBM Login:** Indicates that a user has logged in to WBM.
 - ◆ **CLI Login:** Indicates that a user has logged in to CLI (via Telnet).
 - **Event-Type:** textual description of the event:
 - ◆ **Blocked:** The packet was blocked. The message is color-coded red.
 - ◆ **Accepted:** The packet was accepted. The message is color-coded green.
 - **Details:** details of the packet or the event, such as protocol, IP addresses, ports, etc.
- **To change the security log settings:**
1. On the 'Log' screen, click **Settings**; the screen 'Log Settings' opens.

Figure 15-30: Security Log Settings



Log Settings

Accepted Events

Accepted Incoming Connections

Accepted Outgoing Connections

Blocked Events

All Blocked Connection Attempts

<input type="checkbox"/> Winnuke	<input type="checkbox"/> Multicast/Broadcast	<input type="checkbox"/> ICMP Replay
<input type="checkbox"/> Defragmentation Error	<input type="checkbox"/> Spoofed Connection	<input type="checkbox"/> ICMP Redirect
<input type="checkbox"/> Blocked Fragments	<input type="checkbox"/> Packet Illegal Options	<input type="checkbox"/> ICMP Multicast
<input type="checkbox"/> Syn Flood	<input type="checkbox"/> UDP Flood	<input type="checkbox"/> ICMP Flood
<input type="checkbox"/> Echo Chargen		

Other Events

Remote Administration Attempts

Connection States

Log Buffer

Prevent Log Overrun

2. Select the types of activities for which you would like to have a log message generated.
 - **Accepted Events:**
 - ◆ **Accepted Incoming Connections:** Write a log message for each successful attempt to establish an inbound connection to the home network.
 - ◆ **Accepted Outgoing Connections:** Write a log message for each successful attempt to establish an outgoing connection to the public network.
 - **Blocked Events:**
 - ◆ **All Blocked Connection Attempts:** Write a log message for each blocked attempt to establish an inbound connection to the home network or vice versa. You can enable logging of blocked packets of specific types by disabling this option, and enabling some of the more specific options below it.
 - ◆ **Specific Events:** Specify the blocked events that should be monitored. Use this to monitor specific event such as Syn Flood. A log message is generated if either the corresponding check-box is checked, or the check-box 'All Blocked Connection Attempts' is checked.
 - **Other Events:**
 - ◆ **Remote Administration Attempts:** Write a log message for each remote-administration connection attempt, whether successful or not.
 - ◆ **Connection States:** Provide extra information about every change in a connection opened by the firewall. Use this option to track connection handling by the firewall and Application Level Gateways (ALGs).
 - **Log Buffer:**
 - ◆ **Prevent Log Overrun:** Select this check box in order to stop logging firewall activities when the memory allocated for the log fills up.
3. Click **OK** to save the settings.

16 Advanced Networking Features

This chapter describes various advanced networking features such as DHCP.

16.1 IP Address Distribution

The device's Dynamic Host Configuration Protocol (DHCP) server makes it possible to easily add computers that are configured as DHCP clients to the home network. It provides a mechanism for allocating IP addresses and delivering network configuration parameters to such hosts. The device's default DHCP server is the LAN bridge.

A client (host) sends out a broadcast message on the LAN requesting an IP address for itself. The DHCP server then checks its list of available addresses and leases a local IP address to the host for a specific period of time and simultaneously designates this IP address as 'taken'. At this point, the host is configured with an IP address for the duration of the lease.

The host can choose to renew an expiring lease or let it expire. If it chooses to renew a lease then it also receives current information about network services, as it did with the original lease, allowing it to update its network configurations to reject any changes that may have occurred since it first connected to the network. If the host wishes to terminate a lease before its expiration it can send a release message to the DHCP server, which then makes the IP address available for use by others.

The device embedded DHCP server provides the following features:

- Displays a list of all DHCP host devices connected to the device
- Defines the range of IP addresses that can be allocated to the LAN
- Defines the length of time for which dynamic IP addresses are allocated
- Provides the above configurations for each LAN device and can be configured and enabled / disabled separately for each LAN device
- Can assign a static lease to a LAN PC so that it receives the same IP address each time it connects to the network even if this IP address is within the range of addresses that the DHCP server may assign to other computers
- Provides the DNS server with the host name and IP address of each PC that is connected to the LAN

In addition, the device can act as a DHCP relay, escalating DHCP responsibilities to a WAN DHCP server. In this case, the device acts merely as a router, while its LAN hosts receive their IP addresses from an external DHCP server on the WAN.

With the device's optional Zero Configuration Technology feature, the IP Auto Detection method detects statically-defined IP addresses in addition to the device's DHCP clients. It learns all the IP addresses on the LAN and integrates the collected information with the database of the DHCP server. This allows the DHCP server to issue valid leases, thus avoiding conflicting IP addresses used by other computers in the network.





- To view services currently provided by the DHCP server:
 - On the 'Advanced' screen, click the **IP Address Distribution**  icon; the 'IP Address Distribution' screen appears.

Figure 16-1: DHCP Server Summary

 IP Address Distribution				
Name	Service	Subnet Mask	Dynamic IP Range	Action
LAN Bridge	DHCP Server	255.255.255.0	192.168.2.1 - 192.168.2.254	
WAN Ethernet	Disabled			



Note: If the 'Service' column displays “Disabled”, then DHCP services are not being provided to hosts connected to the network through the device interface. This means that the device does not assign IP addresses to these computers, which is useful if you wish to work with static IP addresses only.

16.1.1 Configuring the DHCP Server

The procedure below describes how to edit a service provided by the DHCP server.

➤ **To edit the DHCP server settings for a device:**

1. On the 'IP Address Distribution' screen, click the **Edit**  icon corresponding to the entry that you want to edit; the DHCP Server settings for this device are displayed.

Figure 16-2: DHCP Settings Screen



DHCP Settings for WAN Ethernet	
IP Address Distribution	DHCP Server
Start IP Address:	0 . 0 . 0 . 0
End IP Address:	0 . 0 . 0 . 0
Subnet Mask:	0 . 0 . 0 . 0
Lease Time in Minutes:	0
<input type="checkbox"/> Provide Host Name If Not Specified by Client	

2. From the 'IP Address Distribution' drop-down list, select whether to disable the device DHCP server, or enable DHCP (the device serves as a DHCP server or DHCP relay).
3. In the 'Start IP Address' and 'End IP Address' fields, define the IP address range. This determines the number of hosts that may be connected to the network in this subnet. The 'Start IP Address' field specifies the first IP address that may be assigned in this subnet; the 'End IP Address' field specifies the last IP address in the range.
4. In the 'Subnet Mask' field, define the subnet to which an IP address belongs (e.g., 255.255.0.0).
5. In the 'Lease Time in Minutes' field, define the time for which each device is assigned an IP address by the DHCP server when it connects to the network. When the lease expires, the server determines if the computer has disconnected from the network. If it has, then the server may reassign this IP address to a newly-connected computer. This feature ensures that IP addresses that are not in use become available for other computers on the network.
6. Select the 'Provide Host Name If Not Specified by Client' check box to enable the device to assign clients a default name if they do not have a host name.
7. Click **OK**.

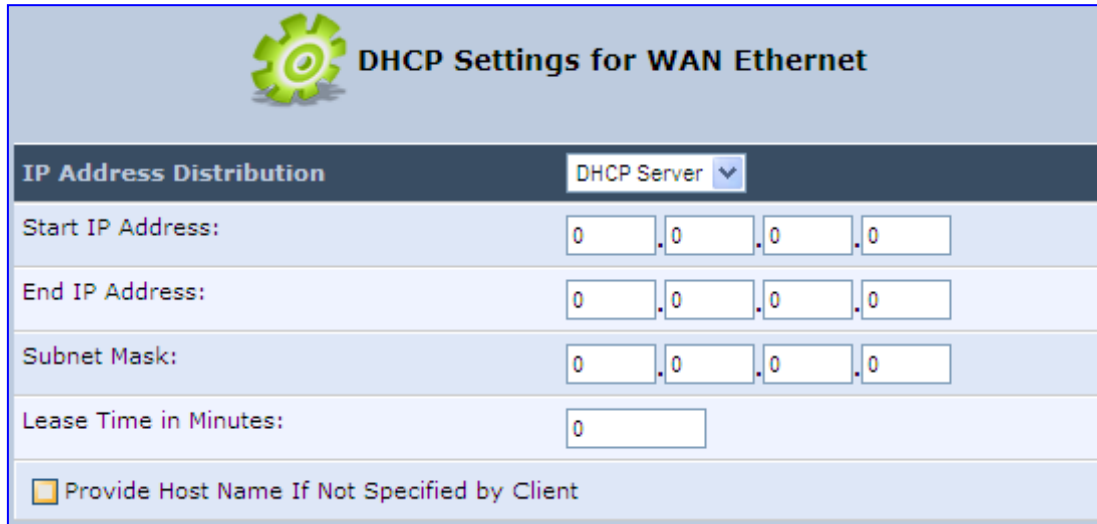
16.1.2 Configuring DHCP Relay

The device can act as a DHCP relay if you want to dynamically assign IP addresses from a DHCP server other than the device's DHCP server.



Note: When implementing DHCP relay, you must configure the WAN of the device to operate in routing mode.

➤ **To configure a device as a DHCP relay:**

1. On the 'IP Address Distribution' screen, click the **Edit**  icon corresponding to the entry that you want to edit; the DHCP Server settings for this device are displayed.
2. From the 'IP Address Distribution' drop-down list, select the 'DHCP Relay' option; the 'DHCP Settings' screen appears.

Figure 16-3: DHCP Settings



3. Click the **New**  icon; the 'DHCP Relay Server Address' screen appears.

Figure 16-4: DHCP Relay Server Address Screen

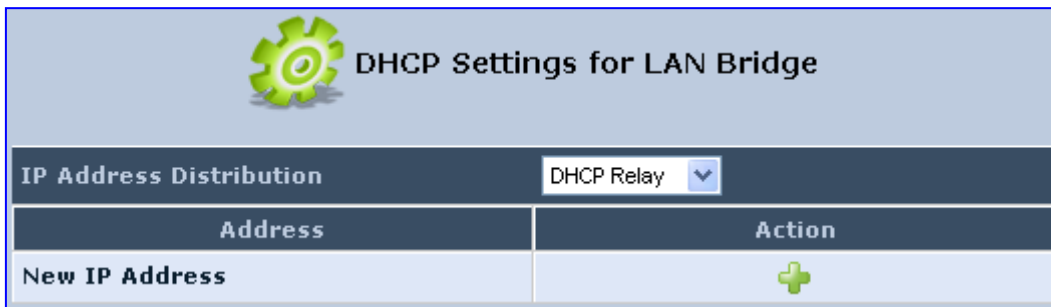
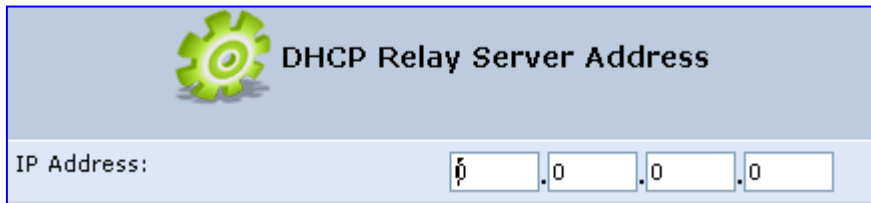





4. In the 'IP Address' field, enter the IP address of the DHCP server.
5. Click **OK** to save your changes.
6. Click **OK** once more in the 'DHCP Settings' screen.
7. Change the device's WAN to operate in routing mode:
 - a. On the menu bar, click the **Network Connections** menu; the 'Network Connections' screen appears.
 - b. Click the **Edit**  icon corresponding to the WAN Ethernet connection; the 'WAN Ethernet Properties' screen appears.
 - c. Click the **Routing** tab.
 - d. From the 'Routing Mode' drop-down list, select 'Route'.
 - e. Click **OK** to save the settings.

16.1.3 Viewing DHCP Clients

The procedure below describes how to view a list of hosts (computers) that are allocated IP addresses by the DHCP server.

- **To view a list of computers currently recognized by the DHCP server:**
- 1. On the 'IP Address Distribution' screen, click the **Connection List** button; the 'DHCP Connections' screen appears.

Figure 16-5: DHCP Connection Screen

 DHCP Connections							
Host Name	IP Address	Physical Address	Lease Type	Connection Name	Status	Expires In	Action
itaico-laptop	192.168.2.3	00:13:02:39:88:00	Dynamic	LAN Bridge	Active	36 Minutes	  
TW-Laptop	192.168.2.4	00:14:c2:e4:3d:f0	Dynamic	LAN Bridge	Active	49 Minutes	  
New Static Connection							

16.1.4 Configuring Static DHCP Clients

The procedure below describes how to define a static (fixed) IP address for a DHCP client.

➤ **To define a DHCP client with a fixed IP address:**

1. On the 'IP Address Distribution' screen, click the **Connection List** button; the 'DHCP Connections' screen appears.
2. Click the **New**  icon; the 'DHCP Connection Settings' screen appears.

Figure 16-6: DHCP Connection Settings Screen



DHCP Connection Settings	
Host Name:	<input type="text" value="new-host"/>
IP Address:	<input type="text" value="0"/> . <input type="text" value="0"/> . <input type="text" value="0"/> . <input type="text" value="0"/>
MAC Address:	<input type="text" value="00"/> : <input type="text" value="00"/> : <input type="text" value="00"/> : <input type="text" value="00"/> : <input type="text" value="00"/> : <input type="text" value="00"/>

3. In the 'Host Name' field, enter a host name for this connection.
4. In the 'IP Address' field, enter the fixed IP address to be assigned to the computer.
5. In the 'MAC Address' field, enter the MAC address of the computer's network card.

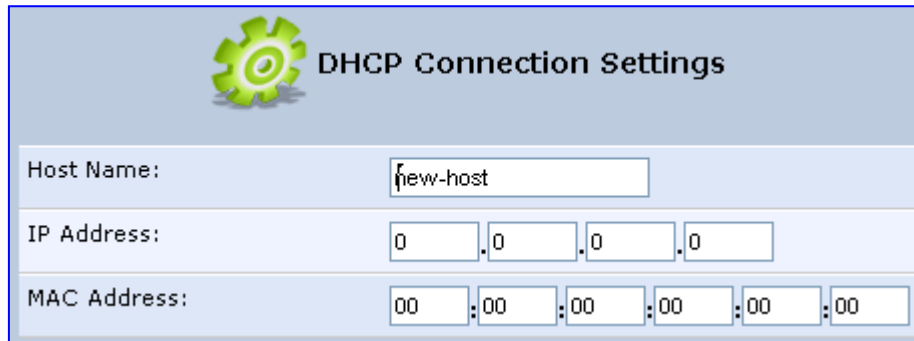

Note: The device's fixed IP address is actually assigned to the specific network card's (NIC) MAC address installed on the LAN computer. If you replace this network card then you must update the device's entry in the DHCP Connections list with the new network card's MAC address.

6. Click **OK** to save the settings; the 'DHCP Connections' screen reappears displaying the defined static connection. This connection can be edited or deleted.

16.2 Configuring a DNS Server

The **DNS Server**  icon allows you to manage the device's Domain Name System (DNS) server. The DNS server does not require configuration. However, you can view the list of computers known by the DNS, edit the host names or IP addresses of computers in the list, or manually add a new computer to the list.

DNS provides a service that translates domain names into IP addresses and vice versa. The device's DNS server is an auto-learning DNS, which means that when a new computer is connected to the network, the DNS server learns its name and automatically adds it to the DNS table. Other network users may immediately communicate with this computer using either its name or its IP address.

The device's DNS server also provides the following functionalities:



- Shares a common database of domain names and IP addresses with the DHCP server.
- Supports multiple subnets within the LAN simultaneously.
- Automatically appends a domain name to unqualified names.
- Allows new domain names to be added to the database using the device's Web interface.
- Permits a computer to have multiple host names.
- Permits a host name to have multiple IPs (needed if a host has multiple network cards).

➤ To add a new host computer to the DNS table:

1. On the 'Advanced' screen, click the  icon; the DNS table is displayed.

Figure 16-7: DNS Server



Host Name	IP Address	Source	Action
sue	10.13.2.1	User Defined	 
New DNS Entry			

2. Click the **New**  icon; the 'DNS Entry' screen appears.

Figure 16-8: DNS Entry

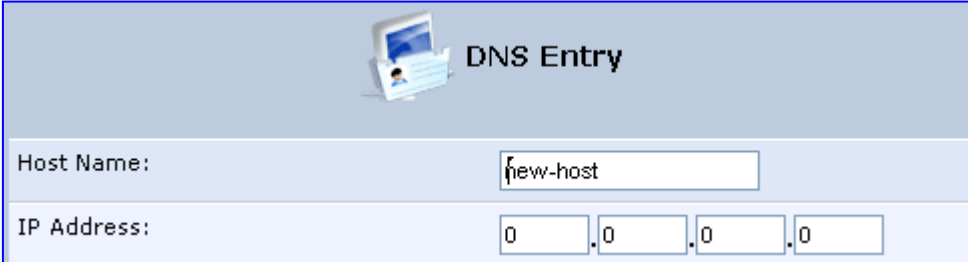

Host Name:

IP Address: . . .

3. Enter the computer's host name and IP address.
4. Click **OK** to save your changes.

➤ **To edit the host name or IP address of an entry:**

1. Click the **Edit**  icon corresponding to the host that you want to edit; the 'DNS Entry' screen appears.
2. If the host was manually added to the DNS Table, you can modify its host name and/or IP address. If it wasn't, you can only modify its host name.
3. Click **OK** to save your changes.

➤ **To remove a host from the DNS table:**

- Click the **Remove**  icon corresponding to the host that you want to delete; the entry is removed from the table.

16.3 Configuring Dynamic DNS

The Dynamic DNS (DDNS) feature allows you to alias a dynamic IP address to a static hostname, allowing your computer to be more easily accessible from various locations on the Internet. Typically, when you connect to the Internet, your ITSP assigns an unused IP address from a pool of IP addresses, and this address is used only for the duration of a specific connection. Dynamically assigning addresses extends the usable pool of available IP addresses, whilst maintaining a constant domain name.

When using the DDNS service, each time the IP address provided by your ITSP changes, the DNS database changes accordingly to reflect the change. In this way, even though your IP address changes often, your domain name remains constant and accessible.

To be able to use the Dynamic DNS (DDNS) feature, you must first open a free DDNS account at <http://www.dyndns.org/account/create.html>. When applying for an account, you need to specify a user name and password. Have them readily available when customizing the device's DDNS support. For detailed information on DDNS, see <http://www.dyndns.org>.

➤ **To open a dynamic DNS account:**



1. On the 'Advanced' screen, click the **Personal Domain Name (Dynamic DNS)**  icon; the 'Personal Domain Name (Dynamic DNS)' screen appears.

Figure 16-9: Personal Domain Name (Dynamic DNS) Screen

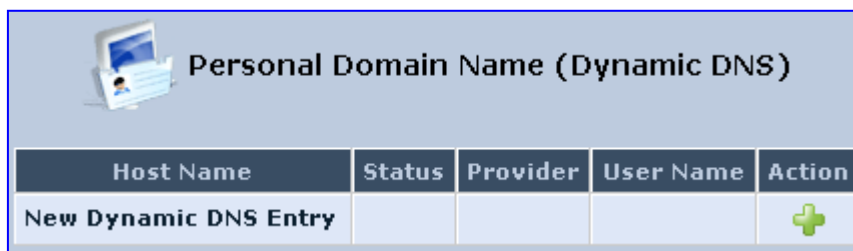

Host Name	Status	Provider	User Name	Action
New Dynamic DNS Entry				

2. Click the **New**  icon to add a new connection; the 'Personal Domain Name (Dynamic DNS)' screen appears.

Figure 16-10: Personal Domain Name (Dynamic DNS) - Adding

3. In the 'Host Name' field, enter your full DDNS domain name.
4. From the 'Connection' drop-down list, select the connection to which you want to couple the DDNS service. The DDNS service uses only the selected device, unless failover is enabled. In this case, the failed-to device is used instead (assuming its route rules consent), until the chosen device is up again. In a single WAN scenario, this field appears as static text (non-configurable). This is applicable if you have multiple WAN devices.
5. From the 'Provider' drop-down list, select your DDNS service provider and then click the link **Click here to initiate and manage your subscription** to open the selected provider's account creation Web page. For example, if you select 'dyndns.org', the following page opens: <http://www.dyndns.com/account>.
6. In the 'User Name' and 'Password' fields, enter your DDNS user name and password, respectively.
7. To enable use of special links (such as such as `www.<your host>.dyndns.org`), select the 'Wildcard' check box.
8. In the 'Mail Exchanger' field, enter your mail exchange server address to redirect all e-mails arriving at your DDNS address to your mail server.
9. To designate the mail exchange server as a backup server, select the 'Backup MX' check box.
10. To temporarily take your site offline (i.e., prevent traffic from reaching your DDNS domain name), select the 'Offline' check box. This redirects DNS requests to an alternative, predefined URL. The availability of this feature depends on your DDNS account's level of service. The redirection URL must be configured through the account as well.

11. From the 'SSL Mode' drop-down list, select the certificate validation method used by the device to validate the DDNS server's certificate upon secured connection to DDNS using HTTPS:
 - **None:** The server's certificate is not validated.
 - **Chain:** Validates the entire certificate chain. When selecting this option, the screen refreshes, displaying the 'Validate Time' drop-down list for selecting whether or not to validate the certificate's expiration time ('Ignore' or 'Check' respectively). If the certificate has expired, the connection terminates immediately.
 - **Direct:** Ensures that the server's certificate is directly signed by the root certificate. This option also provides the 'Validate Time' drop-down list for validation of the certificate's expiration time, as described above.
12. Click **OK**.

16.4 Configuring Routing Rules

This section describes how to configure routing rules and enable routing protocols. These are configured in the 'Routing' screen, as described below.

➤ **To access the Routing screen:**

- On the 'Advanced' screen, click the **Routing**  icon; the 'Routing' screen appears.

Figure 16-11: Routing Rules

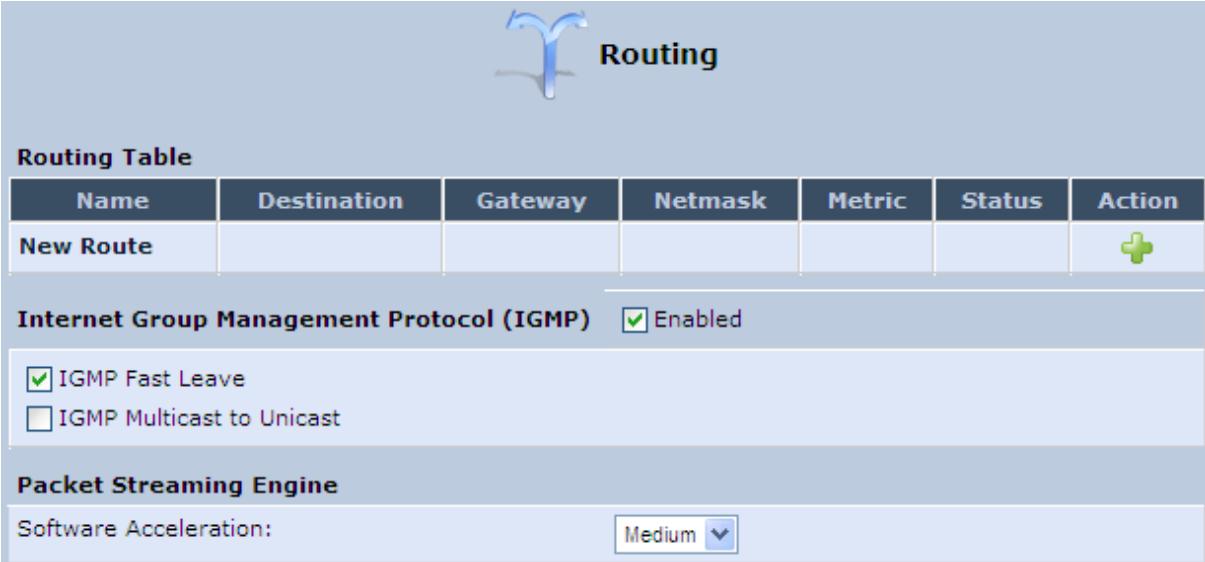

 **Routing**

Routing Table

Name	Destination	Gateway	Netmask	Metric	Status	Action
New Route						

Internet Group Management Protocol (IGMP) Enabled

IGMP Fast Leave

IGMP Multicast to Unicast

Packet Streaming Engine

Software Acceleration: Medium ▼

16.4.1 Managing Routing Table Rules

The procedure below describes how to add routing rules.

➤ **To add routing tables:**

1. On the 'Advanced' screen, click the **New**  icon in the **Routing Table**; the 'Route Settings' screen appears.

Figure 16-12: Route Settings Screen

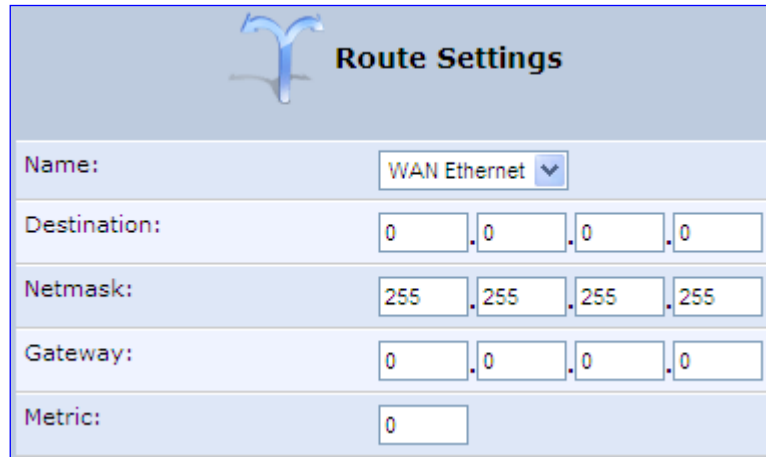

Name:	WAN Ethernet
Destination:	0 . 0 . 0 . 0
Netmask:	255 . 255 . 255 . 255
Gateway:	0 . 0 . 0 . 0
Metric:	0

2. From the 'Name' drop-down list, select the network device for which you want to add a routing rule.
3. In the 'Destination' field, enter the destination host, subnet address, network address, or default route. The destination for a default route is "0.0.0.0".
4. In the 'Netmask' field, enter the network mask that used in conjunction with the destination to determine when a route is used.
5. In the 'Gateway' field, enter the device's IP address.
6. In the 'Metric' field, enter the measurement of the preference of a route. Typically, the lowest metric is the most preferred route. If multiple routes exist to a given destination network, the route with the lowest metric is used.
7. Click **OK** to save your settings.

16.4.2 Configuring Routing Protocols

The device supports IGMP multicasting, which allows hosts connected to a network to be updated whenever an important change occurs in the network. A multicast is simply a message that is sent simultaneously to a pre-defined group of recipients. When you join a multicast group you receive all messages addressed to the group, similar to an e-mail message sent to a mailing list.

When an application running on a computer in the home network sends out a request to join a multicast group, the device intercepts and processes the request. If the device is set to 'Minimum Security', no further action is required. However, if the device is set to 'Typical Security' or 'Maximum Security', you must add the group's IP address to the device's 'Multicast Groups' screen. This allows incoming messages addressed to the group to pass through the device's firewall and on to the correct LAN computer.

➤ **To configure routing protocols:**

1. On the 'Advanced' screen, under the **Internet Group Management Protocol (IGMP) group**, do the following:
 - a. Select the 'Enabled' check box to enable IGMP multicasting.
 - b. Select the 'IGMP Fast Leave' check box if you want the device to stop forwarding traffic to a host that is the only subscriber, immediately upon request (without query delay).
 - c. Select the 'IGMP Multicast to Unicast' check box to enable the device to convert the incoming multicast data stream into unicast format to route it to the specific LAN host that requested the data. In this way, the device prevents flooding the rest of the LAN hosts with irrelevant multicast traffic.
2. Under the **Packet Streaming Engine group**, from the 'Software Acceleration' drop-down list, select the packet flow speed:
 - **None:** Packet Streaming Engine (PSE) is disabled
 - **Medium:** PSE is active (recommended)
 - **High:** PSE traffic is prioritized over other traffic
3. Click **OK**.

16.5 Enabling PPPoE Relay

PPPoE relay enables the device to relay packets on PPPoE connections while keeping its designated functionality for any additional connections.

➤ **To enable PPPoE relay:**

1. On the 'Advanced' screen, click the **PPPoE Relay**  icon; the 'PPPoE Relay' screen appears.

Figure 16-13: PPPoE Relay Screen

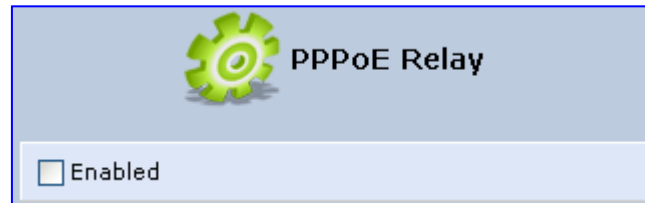

2. Select the 'Enabled' check box.
3. Click **OK**.

16.6 Selecting Regional Settings for Analog Lines

The behavior and parameters of analog telephones lines vary between countries. The set of Call Progress Tones, the protocol used for caller ID and the analog line impedance are all location-specific. The device enables users to select the country they reside in and the device automatically selects the correct regional settings.

➤ **To select your present location:**

1. On the 'Advanced' screen, click the **Regional Settings**  icon; the 'Regional Settings' screen appears.
2. Select the country from the drop-down list. If your current location is not listed, contact your service provider.

Figure 16-14: Regional Settings Screen



3. Click **OK**.
4. Reboot the device for your settings to take effect.

The following is an example of the relevant Telnet parameters:

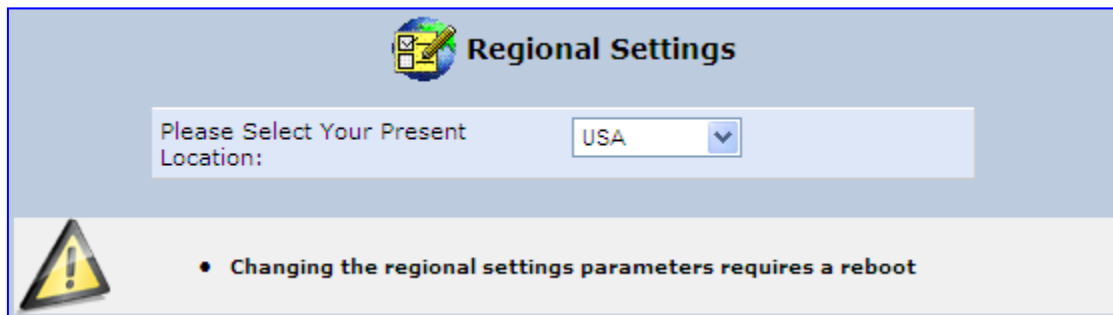
```
rg_conf/voip/regional_settings/selected_country=USA
rg_conf/voip/regional_settings/rg_conf_country=USA
rg_conf/voip/regional_settings/use_rg_conf_configuration=0
rg_conf/voip/regional_settings/caller_id_standard=0
rg_conf/voip/regional_settings/caller_id_timing=0
```

16.7 Installation Wizard

The procedure below describes how to run the Installation Wizard. It guides you through your Internet connection and helps you subscribe to services that are available to you as an MP-202B user. The wizard progress box, located at the right hand side of the screen, provides a monitoring tool for its steps during the installation process.

➤ **To run the Installation Wizard:**

1. On the 'Advanced' screen, click the **Installation wizard** ; the 'Installation Wizard' screen appears.

Figure 16-15: Installation Wizard



2. Click **Next**; the Installation Wizard progresses to analyze the Internet Connection type.
3. The Installation Wizard sets up an Internet Connection.
4. The Installation Wizard tests the connection to the Internet Service Provider.
5. Click **Finish**.

This page is intentionally left blank.

17 Home Media

The procedures below describe how to configure home media.

17.1 Universal Plug and Play

Universal Plug-and-Play (UPnP) is a networking architecture that provides compatibility among networking equipment, software, and peripherals. UPnP-enabled products can seamlessly connect and communicate with other UPnP-enabled devices without the need for user configuration, centralized servers, or product-specific device drivers. This technology leverages existing standards and technologies, including TCP/IP, HTTP 1.1 and XML, facilitating the incorporation of UPnP capabilities into a wide range of networked products for the home.

UPnP technologies are rapidly adopted and integrated into widely-used consumer products such as Windows 10. Therefore it is critical that today's Residential Gateways be UPnP-compliant. Your device is at the forefront of this development, offering a complete software platform for UPnP devices. This means that any UPnP-enabled control point (client) can dynamically join the network, obtain an IP address and exchange information about its capabilities and those of other computers on the network. They can subsequently communicate with each other directly, thereby further enabling peer-to-peer networking. And this all happens automatically, providing a truly zero-configuration network.

17.1.1 Enabling Universal Plug and Play on the Device

The procedure below describes how to enable the Universal Plug and Play (UPnP) feature on the device.

➤ **To enable UPnP:**

1. On the 'Advanced' screen, click the **Universal Plug and Play**  icon; the 'Universal Plug and Play' screen appears.

Figure 17-1: Advanced - Universal Plug n Play



2. Select the 'Allow Other Network Users to Control MP202D's Network Features' to enable the UPnP feature. This allows you to define UPnP services on any of the LAN hosts.
3. Select the 'Enable Automatic Cleanup of Old Unused UPnP Services' to enable automatic cleanup of invalid rules. This feature checks the validity of all UPnP services every five minutes, and removes old and obsolete services, unless a user-defined rule depends on them.
4. From the 'WAN Connection Publication' drop-down list, select which WAN information is published by the device. By default, the device publishes only its main WAN connection, which is controllable by UPnP entities. However, you may select the 'Publish All WAN Connections' option if you wish to grant UPnP control over all of the device's WAN connections.

17.1.2 Adding UPnP-enabled PC to Home Network

If your computer is running an operating system that supports UPnP such as Windows 10, you can add the computer to your home network and access the Web-based Management directly from Windows.

- **To add a UPnP-enabled computer to the home network:**
 - Connect the PC to the device; the PC automatically recognizes and adds to the home network. The device is added to 'My Network Places' as the Internet Gateway Device and allows configuration via a standard Windows interface. A message appears on the notification area of the taskbar notifying that the PC has been added to the network.
- **To access the Web-based management directly from Windows:**
 1. Open the 'My Network Places' window by double-clicking its desktop icon.

Figure 17-2: My Network Places

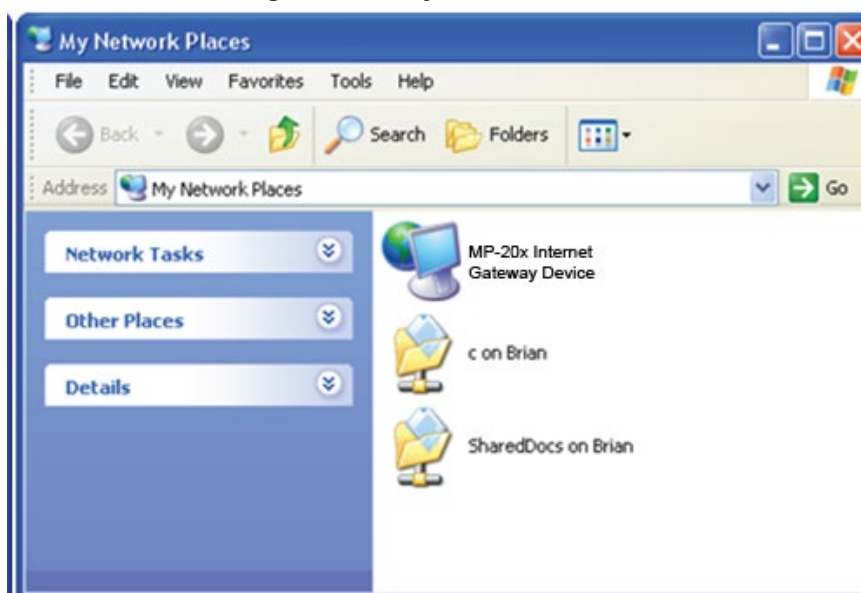

2. Double-click the **Internet Gateway Device** icon. The device Web interface 'Login' screen appears in a browser window. This method is similar to opening a browser window and typing in '192.168.1.1'.

17.1.3 Monitoring Connection Between the Device and Internet

The procedure below describes how to monitor the status of the connection between the device and the Internet.

➤ **To monitor the status of the connection between the device and the Internet:**

1. Open the 'Network Connections' control panel.
2. Double-click the **Internet Connection** icon. The 'Internet Connection Status' window appears:

Figure 17-3: Internet Connection Status

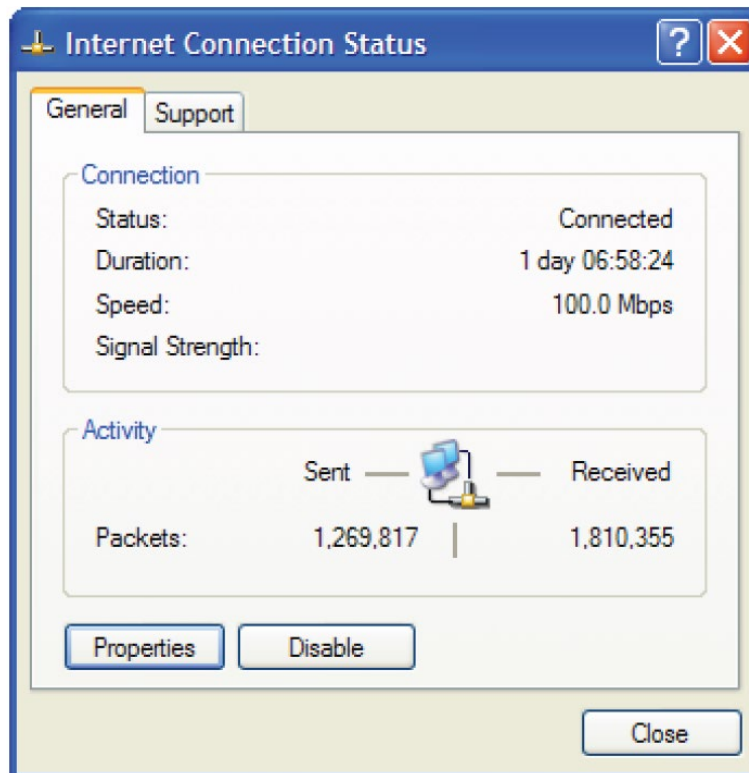

17.1.4 Making Local Services available to PCs on Internet

You can make services provided by computers in the home network available to computers on the Internet. For example, you may designate a PC in your home network to act as a Web server, allowing computers on the Internet to request pages from it. Or a game that you want to play over the Internet may require that specific ports be opened to allow communication between your PC and other players.

- **To make local services available to computers on the Internet:**
 1. Open the 'Network Connections' control panel.
 2. Right-click 'Internet Connection', and then choose **Properties**; the 'Internet Connection Properties' window appears.

Figure 17-4: Internet Connection Properties

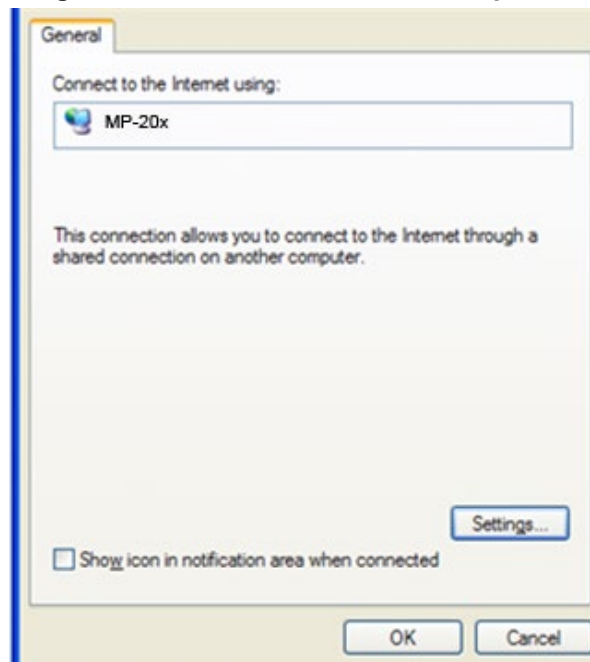

3. Click the **Settings** button; the 'Advanced Settings' window.

Figure 17-5: Advanced Settings

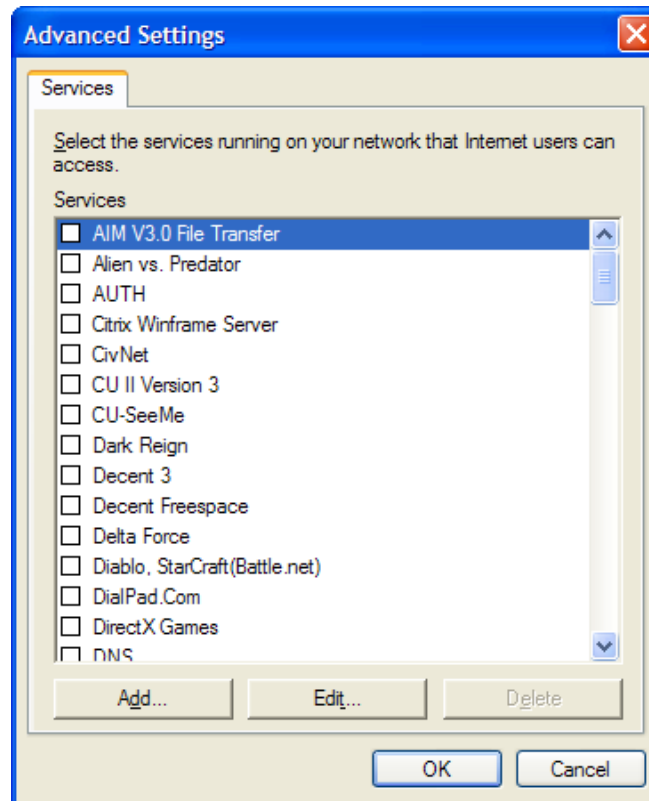

4. Select a local service that you would like to make available to computers on the Internet; the 'Service Settings' window automatically appears.

Figure 17-6: Service Settings

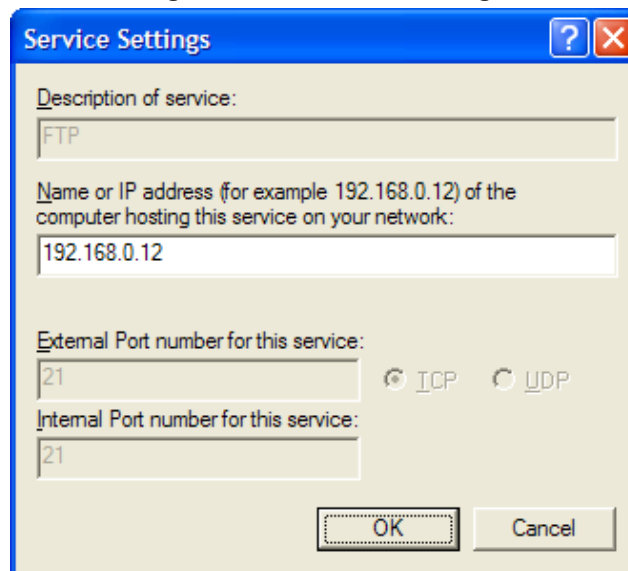

5. Enter the local IP address of the computer that provides this service and then click **OK**.
 6. Select other services as desired and repeat the previous step for each.
 7. Click **OK** to save the settings.
- **To add a local service that is not listed in the 'Advanced Settings' window:**
1. Follow steps 1-3 above.
 2. Click the **Add** button; the 'Service Settings' window appears.

Figure 17-7: Service Settings – Add Service

Service Settings

Description of service:
File Sharing

Name or IP address (for example 192.168.0.12) of the computer hosting this service on your network:
192.168.0.12

External Port number for this service:
1050 TCP UDP

Internal Port number for this service:
1050

OK Cancel

3. Complete the fields as indicated in the window.
4. Click **OK** to close the window and return to the 'Advanced Settings' window; the service is selected.
5. Click **OK** to save the settings.

18 Configuring the Device for PacketSmart

The device can be configured for PacketSmart through the Web interface or the CLI.



Note: PacketSmart is only applicable to **MP-202R** and **MP-204R** devices.

18.1 Configuring PacketSmart through the Web Interface

This section shows how to configure PacketSmart through the Web interface.

➤ **To configure PacketSmart through the Web interface:**

1. Open a Web browser on your PC.
2. Log in to the MP-20x's embedded Web interface: With your PC connected directly to the MP-20x, open a Web browser and enter "**192.168.2.1**" to access the Web-based management interface; the 'Login' screen is displayed.

Figure 18-1: Login

Language:

User Name:

Password (case sensitive): Show password

3. In the 'User Name' field, enter your user name (Default: **admin**)
4. In the 'Password' field, enter your case-sensitive password (Default: **admin**)
5. Click the **Continue >** button.
6. In the Advanced screen, click the **PacketSmart Configuration** icon ; the PacketSmart Configuration screen opens.

Figure 18-2: PacketSmart Configuration



7. Use the table below as reference when configuring PacketSmart.

Table 18-1: PacketSmart Configuration Parameters Description

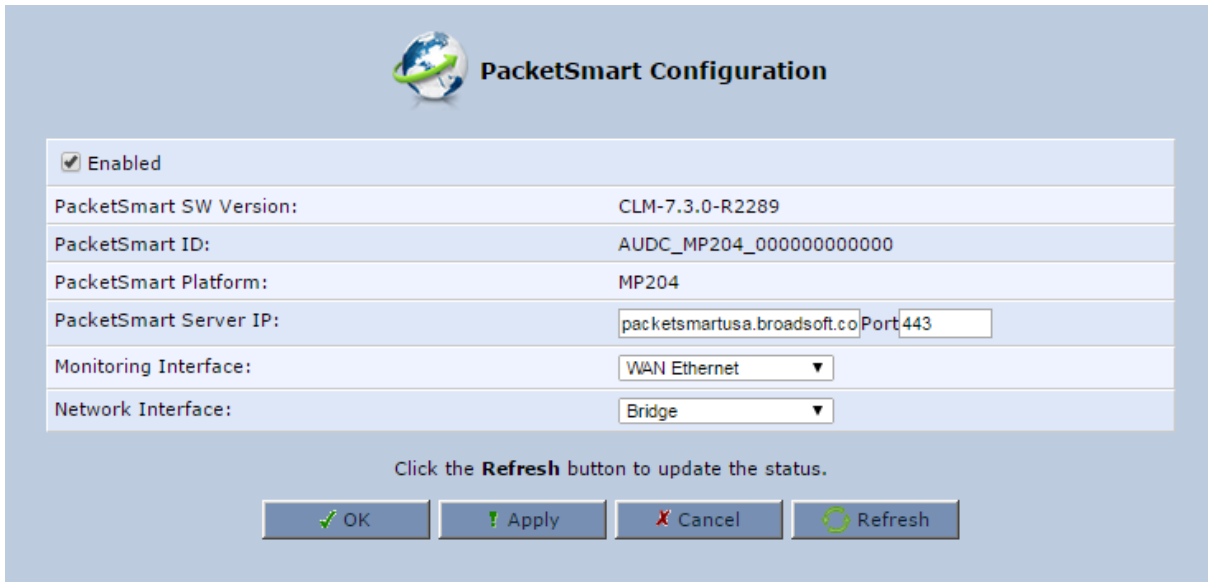
Parameter	Description
Enabled	Select this option to enable the embedded PacketSmart probe software. <ul style="list-style-type: none"> • Disabled (Default) • Enabled
PacketSmart SW Version	(Read-only) Displays the PacketSmart probe software version.
PacketSmart ID	(Read-only) Displays the PacketSmart probe software on the PacketSmart server in the following format: AUDC_<model_name>_<MAC_address> Example: AUDC_MP204_<MAC_address> where MP204 is the device Make sure the MAC address is correct.
PacketSmart Platform	(Read-only) Defines the device name.
PacketSmart Server IP	Defines the IP address of the PacketSmart server to which the PacketSmart probe software connects.
PacketSmart Port	Defines the TCP port of the PacketSmart server to which the PacketSmart probe software connects. <ul style="list-style-type: none"> ▪ Port 80 – for an HTTP connection ▪ Port 443 – for an HTTPS connection (secured)
Monitoring Interface	Defines the Interface to be monitored by PacketSmart probe software. Default: WAN Ethernet
Network Interface	Defines the interface through which the analyzed traffic is sent to the PacketSmart server. Default: WAN Ethernet

Parameter	Description
Configuration Server URL	Defines the address of the new PacketSmart firmware file. Note: This parameter does not appear in the Web interface. It can only be modified through the CLI. See Section 18.3 on page 283 for more information.
Upgrade Needed	This parameter is used to immediately upgrade PacketSmart. Possible values: <ul style="list-style-type: none">▪ 1 - Immediately upgrade▪ 0 – Do not upgrade Note: After PacketSmart has been upgraded, this parameter is automatically set to "0". *

8. Click **OK**.

18.2 Configuring PacketSmart through the CLI

You can alternatively configure PacketSmart through the device's Command Line Interface (CLI).

➤ **To configure PacketSmart through the CLI:**

1. Open a Telnet connection to the MP-20x device (Default: **telnet 192.168.2.1**)
2. Log in with administrator privileges (Default: **admin/admin**)
3. Run the following commands under the **MP20x>** prompt:

```
conf set "packetsmart/enabled" "1";
conf set "packetsmart/packetsmart_server_ip" "<URL>"
conf set "packetsmart/packetsmart_server_port" <Port>
conf set "packetsmart/configuration_upgrade_server_url"
"<URL>"
conf set "packetsmart/monitor_interface" "eth1"
conf set "packetsmart/network_interface" "br0"
conf reconf 1
```

18.3 Upgrading PacketSmart on the Fly

It is now possible to automatically upgrade PacketSmart by either:

- Changing the `configuration_upgrade_server_url` parameter in the configuration file on the Device Management server (DMS)
- Running CLI command.

➤ **To upgrade PacketSmart by changing the parameter:**

1. Change the `configuration_upgrade_server_url` parameter on DMS server. (e.g., change `configuration_upgrade_server_url=https://XX.XX.XX.XX/psmart.tar.gz` to `configuration_upgrade_server_url=https://XX.XX.XX.XX/newpsmart.tar.gz`).
2. The device will download a new configuration file during the next periodic check or after a manual reboot.
3. After downloading the configuration, the system checks if the PacketSmart `configuration_upgrade_server_url https://XX.XX.XX.XX/newpsmart.tar.gz` parameter has changed. If so, the device downloads an updated `tar.gz` file from the Configuration Upgrade Server URL to the device. The URL can either be **HTTP** or **HTTPS**. This check takes place during the boot process, after the `configuration_upgrade_server_url` parameter has changed.

➤ **To upgrade PacketSmart through the CLI:**

1. Open a Telnet connection to the MP-20x device (Default: Telnet 192.168.2.1).
2. Log in with administration privileges (Default: admin/admin).
3. Run the following commands under the **MP20x>** prompt:

```
conf set packetsmart/configuration_upgrade_server_url
http://xx.xx.xx.xx/newpacketsmart.tar.gz

conf set packetsmart/upgrade_needed 1
conf reconf 1
```

4. PacketSmart will be upgraded after 30 seconds.

18.4 Accessing the PacketSmart Web Portal

This section shows how to access BroadSoft's PacketSmart Web Portal and find analyzed information.

➤ **To access the PacketSmart Web Portal:**

1. Open a Web browser and in the URL field, enter <https://packetsmart.broadsoft.com/dashboard/>
2. In the PacketSmart Login screen that opens, enter the required fields and then click the **Login** button.

Figure 18-3: PacketSmart Login Screen

The screenshot shows the PacketSmart Login interface. At the top left is the BroadSoft logo and the text "broadsoft PacketSmart Login". Below this are five input fields: "Domain:" with a placeholder "Enter Domain (required)", "SME:" with a placeholder "Enter SME", "User:" with the value "am", "Password:" with a placeholder "Enter Password (required)", and "Psmart Server:" with a dropdown menu showing "psmart-USA (PST)". Below the fields are two buttons: a blue link "Forgot Password" and a green "Login" button. At the bottom, there are two lines of text with links: "To access our ticketing support system use the BroadCloud [click here](#)" and "To access our documentation, training and FAQs, Please refer to Broadworks [click here](#)". At the very bottom are two dropdown menus: "Language:" set to "English" and "Choose Theme:" set to "Blue".

➤ **To view records:**

1. In the main landing page, you'll view multiple window sections.
2. From the menu on the left, select the diagnosis type, e.g., Call Metrics, Signaling Records, Traffic Flows, etc.
3. Select PacketSmart **SME** and the associated device under **Display Name (Device)**; then define the time period and click **Show Data**.

Figure 18-4: PacketSmart Web Portal – Selecting the Device

Select SME and Device

SME:	<input type="text" value="_UNASSIGNED_"/>	<input type="text" value="07/11/2016 08:41"/>	<input type="button" value="Show Data"/>
Display Name (Device):	<input type="text" value="AUDC_MP204_00908F7F66E1"/>	<input type="text" value="07/12/2016 08:41"/>	<input type="button" value="Show Data"/>

Device Type:PACKETPRO, Last Contact Time:2016/7/12 08:41:41 America/Chicago, Version:CLM-7.2.0-R2221, IP:192.168.8.11, CIP:192.168.8.11, Mode:2, SIP PORT:5060



Note: Active devices are indicated with a green tick.

For more information, visit the PacketSmart Help website:
<https://packetsmart.broadsoft.com/help/>

This page is intentionally left blank.

19 Media Sharing

Media Sharing enables you to share and stream media files from a storage device connected to a media server. The procedure below shows how to enable media sharing on the device.

➤ **To enable media sharing:**

- In the 'Advanced' screen, click the Media Sharing  icon; the 'Media Sharing' screen appears.

Figure 19-1: Media Sharing Screen

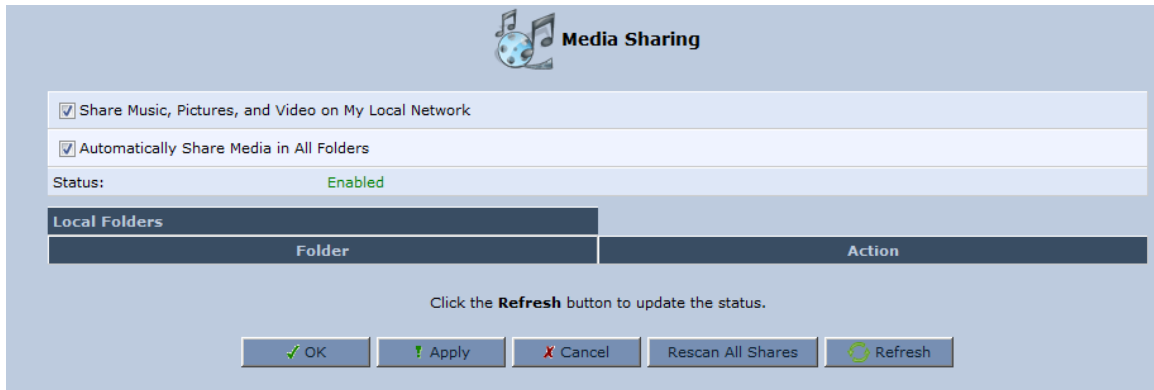

The following two options appear on the 'Media Sharing' screen:

- Share Music, Pictures, and Video on My Local Network
- Automatically Share Media in All Folders

19.1 Share Music, Pictures and Video on My Local Network

By default, this option is selected. To disable media sharing, deselect this option.

19.2 Automatically Share Media in All Folders

If this option is selected, all partitions and folders on the storage device are automatically shared.

➤ **To disable automatic sharing and manually share a specific folder:**

1. Deselect the 'Automatically Share Media in All Folders' check box and click **Apply**; the screen refreshes. A new section appears, enabling you to create and manage a list of manually shared partitions and their folders.

Figure 19-2: Media Sharing Screen - Expanded

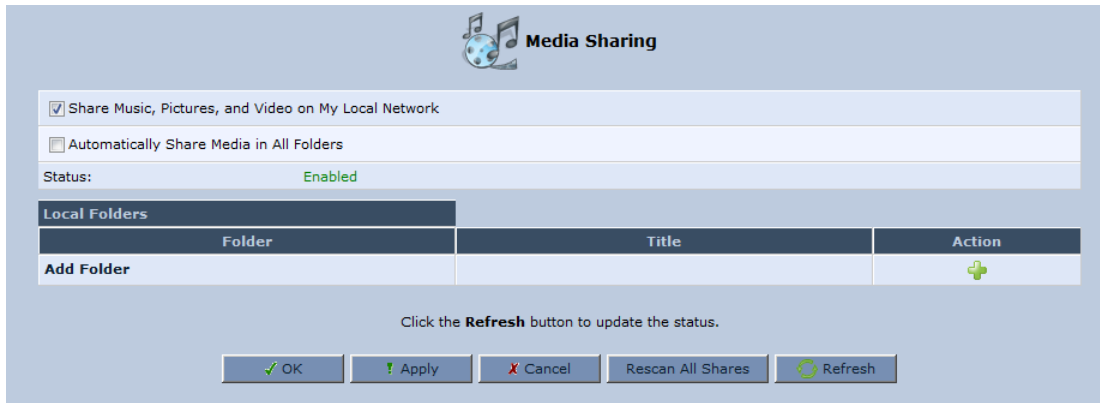

2. Click the 'Add Folder' link, or the Add Folder  icon; the 'Folder Settings' screen appears.

Figure 19-3: Folder Settings



3. In the 'Folder' field, enter the exact path (for example, A1/Music, where 'A1' is a partition's letter, and 'Music' is a folder on this partition).
4. In the 'Title' field, enter a descriptive title for the folder (for example, 'Jazz').





Note: 'Title' is a mandatory field.

5. Click **OK** to save the settings; the 'Media Sharing' screen appears, displaying the shared partition. If necessary, repeat the same procedure to share additional partitions and their folders.

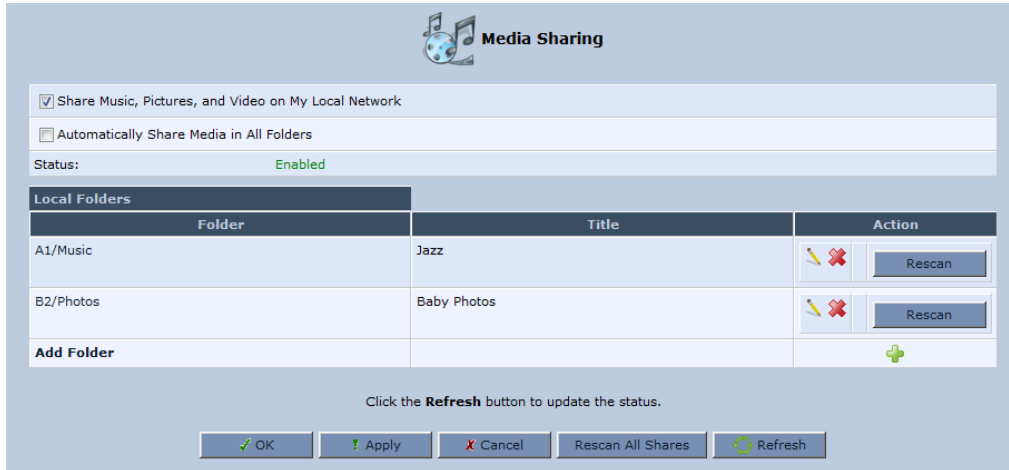
Figure 19-4: Shared Partitions



You can edit the partition or folder sharing settings by clicking the  Edit icon. You can also remove a partition or a folder from the shares list by clicking the  Remove icon.



Note: If you want to change the Sharing settings, click **Rescan** before trying to access the shared media remotely. Clicking **Rescan** updates the media database with the current shared media content and its path. The more disk space the media files occupy, the longer the scanning process may take.

This page is intentionally left blank.

20 Maintenance

The procedures below describe various maintenance procedures for the device.

20.1 Enabling the Feature Key

The Feature Key is a string stored in the device's non-volatile flash memory, defining the features and capabilities allowed by the specific license you purchased. The device only allows you to utilize those features allowed by the integral Feature Key.



Note: The Feature Key is an encrypted key provided by AudioCodes only.

The procedure below describes how to enable new features on the Feature Key.

➤ **To enable new features on the Feature Key:**

1. In the 'Advanced' screen, click the Feature Key  icon; the 'Feature Key' screen appears displaying the already enabled features on your device.

Figure 20-1: Feature Key Screen



Feature	Status
LST	Enabled
VoIP	Enabled
SIP Line Number	2
Parental Control	Enabled
BroadSoft PacketSmart	Enabled

Key

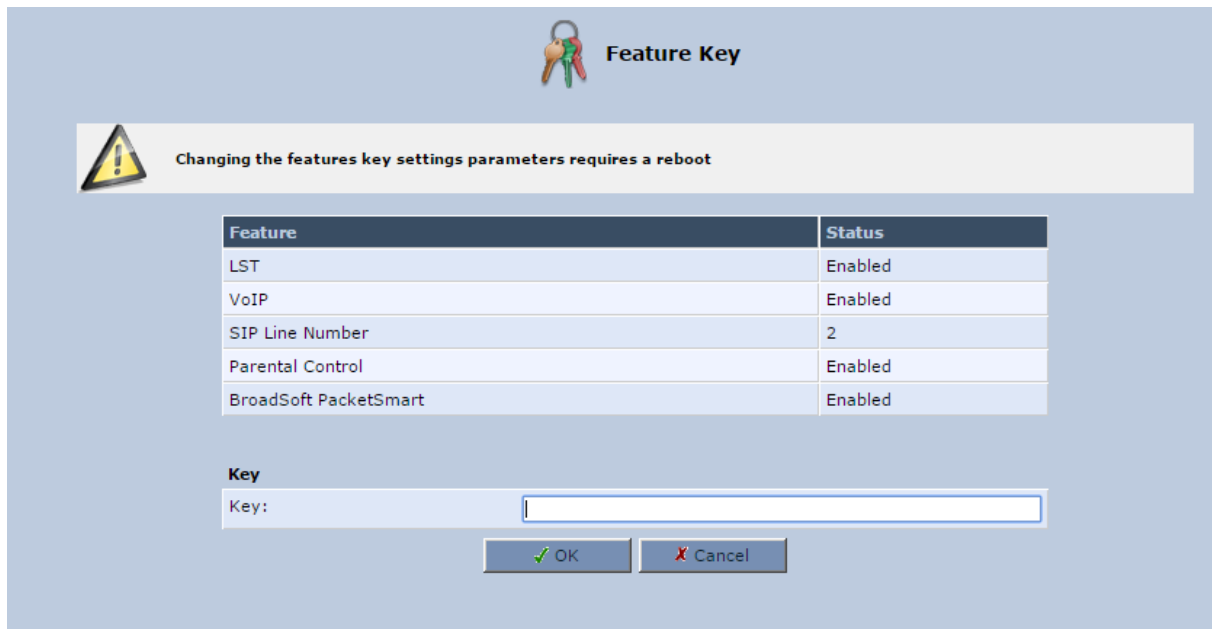
Key:

OK Cancel

2. Open the Feature Key file you received from AudioCodes, (it should open in Notepad), select and copy the key string and paste it into the Key field.
3. Click **OK**; the following screen appears:

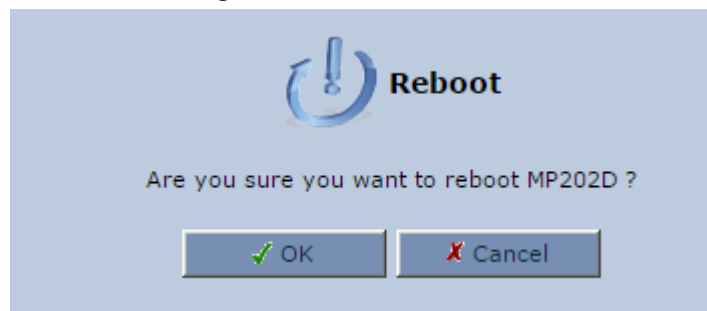
Figure 20-2: Reboot Screen

4. Click **OK** to reboot; the newly-enabled feature displays "Enabled" in the Status column.

20.2 Viewing the Device Software Version

The **About MP20x**  icon displays information about the device. This includes the software version, release date, and signaling protocol. You can also upgrade the software running on the device, by clicking the **Upgrade** link (for more information, see Section 20.5 on page 307).

➤ **To view information about the device:**

- On the 'Advanced' screen, click the  icon; in the example below, the 'About MP20x' screen appears.

Figure 20-3: About MP20x



Software Version:	4.4.3_build_03	Upgrade
Release Date:	13-May-15 08:04:39	
Signaling Protocol:	SIP	

Contact AudioCodes:
Web site: <http://www.audiocodes.com/>
E-mail: sales@audiocodes.com

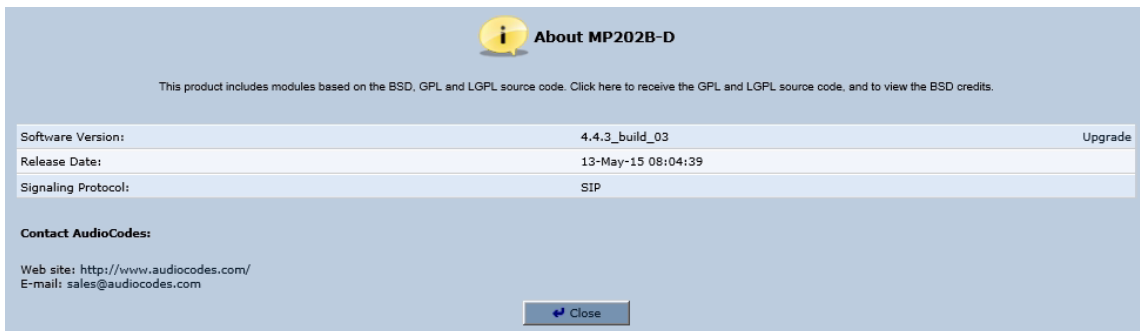

Note: The version upgrade percentage progress display updates when a screen refresh is done.

20.3 Configuring Date and Time

The procedure below describes how to set the date and time.

➤ **To configure date, time and daylight savings time settings:**

1. On the 'Advanced' screen, click the **Time Settings**  icon; the 'Date & Time' screen appears.

Figure 20-4: Date and Time Screen

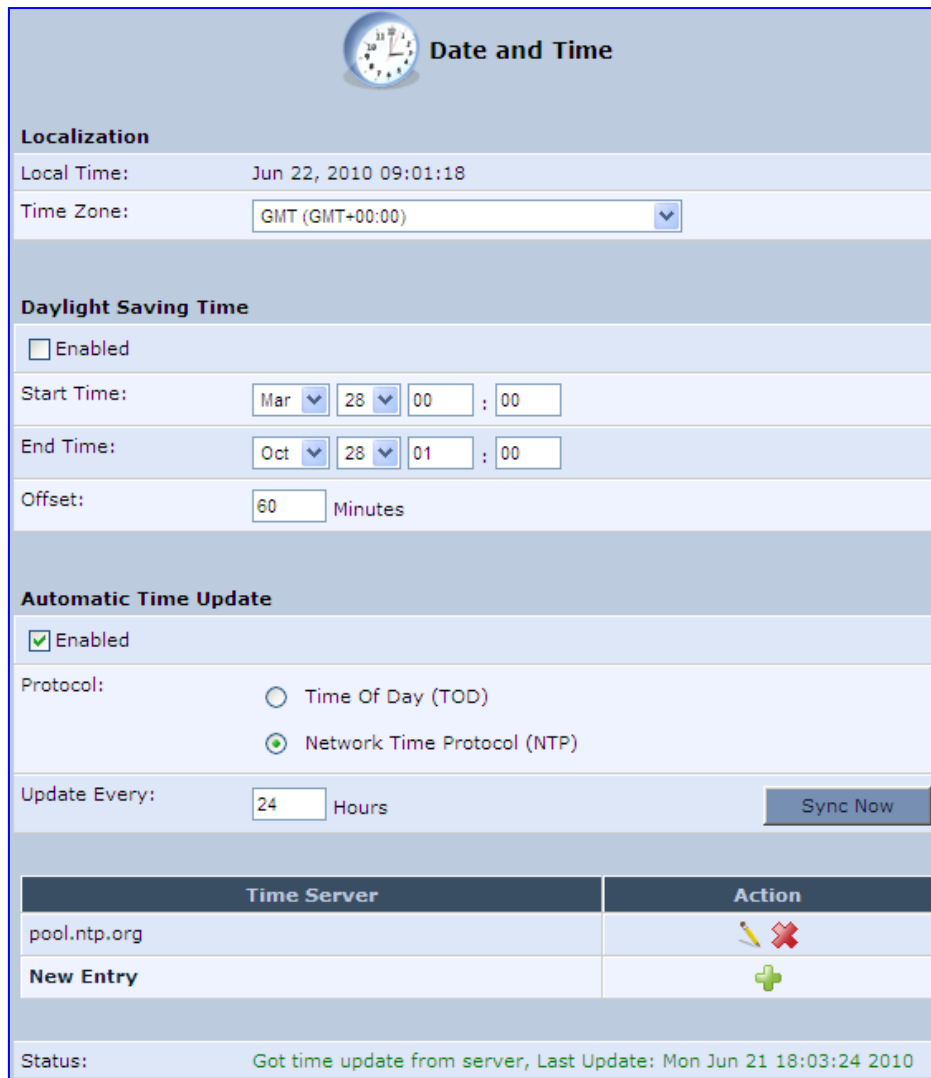

Date and Time

Localization

Local Time: Jun 22, 2010 09:01:18

Time Zone: GMT (GMT+00:00)

Daylight Saving Time

Enabled

Start Time: Mar 28 00 : 00

End Time: Oct 28 01 : 00



Offset: 60 Minutes

Automatic Time Update

Enabled

Protocol: Time Of Day (TOD) Network Time Protocol (NTP)

Update Every: 24 Hours Sync Now

Time Server	Action
pool.ntp.org	 
New Entry	

Status: Got time update from server, Last Update: Mon Jun 21 18:03:24 2010

2. From the 'Time Zone' drop-down list, select the local time zone. The device can automatically detect daylight saving setting for selected time zones.

3. Under the **Daylight Saving Time** group, configure the daylight saving settings for your time zone (if they are not automatically detected):
 - **Enabled:** Select this check box to enable daylight saving time.
 - **Mode:** Select either **Day of year** or **Day of month**.
 - **Start Time:** Date and time when daylight saving starts.
 - **End Time:** Date and time when daylight saving ends.
 - **Offset:** Daylight saving time offset.
 4. Daylight Saving Time can now be configured not only by fixed dates but also by a specific day of the month, or year, e.g., first Sunday in March.
- **To configure daylight saving to begin on a specific day of month, do the following:**
1. Select the 'Enabled' check box.
 2. From the 'Mode' drop-down list, select either **Day of year** or **Day of month**.
 3. From the 'day of the month Start Time' drop-down list, select **First** or **Last**.

CLI Figure 20-5: Daylight Saving Time

The screenshot shows the 'Date and Time' configuration page. It includes sections for Localization, Daylight Saving Time, and Automatic Time Update. The Daylight Saving Time section is highlighted, showing the 'Enabled' checkbox checked, 'Mode' set to 'Day of year', 'Start Time' set to 'Mar 28 00:00', 'End Time' set to 'Oct 28 01:00', and 'Offset' set to '60 Minutes'. The Automatic Time Update section shows 'Enabled' checked, 'Protocol' set to 'Network Time Protocol (NTP)', and 'Update Every' set to '24 Hours'. A table at the bottom lists the Time Server 'pool.ntp.org' with a 'New Entry' button.

From the 'day of the year' drop-down list, select the day of the year you wish to set the daylight saving Start Time.

Use the same approach to set 'day of the month'.

Set the Start Time and End Time 'hours' and 'minutes' fields appropriately.

Figure 20-6: Daylight Saving Time – Day Start

This close-up screenshot shows the 'Daylight Saving Time' section. The 'Mode' dropdown menu is open, showing options for 'Day of year' and 'Day of month'. The 'Day of month' option is selected. The 'Start Time' field is set to '00:00' and the 'End Time' field is set to '01:00'. The 'Offset' is set to '60 Minutes'.

4. For the device to perform an automatic time update, under the **Automatic Time Update** group, do the following:
 - a. Select the 'Enabled' check box.
 - b. Select the protocol to be used for time update, by selecting either the 'Time of Day' or 'Network Time Protocol' option.
 - c. In the 'Update Every' field, specify how often to perform the update.
 - d. You can define NTP servers, by clicking the **New**  icon; the 'Time Server Settings' screen appears.

Figure 20-7: Time Server Settings Screen



- e. In the 'Time Server' field, enter the IP address of the Time server (NTP), and then click **OK**.

The following is an example of the relevant Telnet parameters:

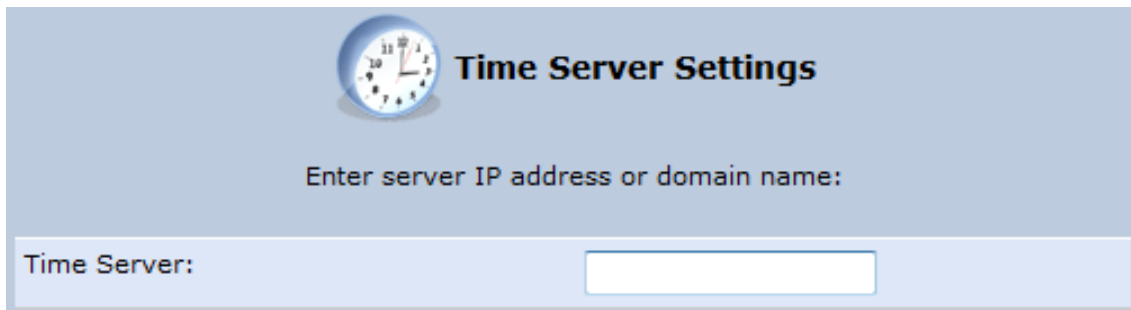
```
conf set "admin/daylight_saving/enabled" "1"
conf set "admin/daylight_saving/offset" "60"
conf set "admin/daylight_saving/start/hour" "0"
conf set "admin/daylight_saving/start/minute" "0"
conf set "admin/daylight_saving/start/month" "March"
conf set "admin/daylight_saving/start/day" "28"
conf set "admin/daylight_saving/start/weekday_type" "Last"
conf set "admin/daylight_saving/start/weekday" "Wednesday"
conf set "admin/daylight_saving/end/hour" "1"
conf set "admin/daylight_saving/end/minute" "0"
conf set "admin/daylight_saving/end/month" "October"
conf set "admin/daylight_saving/end/day" "28"
conf set "admin/daylight_saving/end/weekday_type" "Last"
conf set "admin/daylight_saving/end/weekday" "Sunday"
conf set "admin/daylight_saving/mode" "day_of_year" |
"day_of_month"
```

20.4 Configuration File

The **Configuration File**  icon allows you to view, save, and load the device configuration file. Therefore, you can backup and restore your current configuration.

The device also supports configuration file encryption, allowing you to load encrypted configuration files (using the file name extensions *.cfg or *.inx). For more information on encrypting a configuration file, see Section 20.4.4 on page 305.

The device allows you to use un-encrypted passwords in the configuration file (*.cfg or *.ini) that you want to load, and then encrypt the passwords before burning to flash. This is achieved by using the format {"<value>"} in the configuration file for password fields which are normally encrypted. Below are two examples of this feature:

- ini file: rg_conf/voip/line/1/auth_password={"foobaa"}
- cfg file: (auth_password({"foobaa"}))

➤ **To save and restore the configuration file:**

1. On the 'Advanced' screen, click the  icon; the 'Configuration File' screen appears, showing the entire contents of the configuration file.

Figure 20-8: Configuration File Screen



2. You can customize the displayed configuration file, by selecting the following check boxes:
 - **Display modified configuration fields only:** Displays only the configuration parameters that have values other than default values.
 - **Display configuration in flat ini-file format:** Displays the configuration file in flat INI-file format.
3. To back up your current configuration to a file on your PC, click **Download Configuration File**. The saved configuration file can be used as a backup for the specific the device's configuration for creating a configuration file for remote configuration update, and for debugging and diagnostics. When creating a configuration backup, disable the two display check boxes (i.e. save a full configuration file in the hierarchic **conf** format). This file can be loaded back to the same device, using the procedure described in Section 20.4.1 on page 299.



Note: The file is generated according to the selected display option (in Step 2).

4. To restore your configuration from a file saved on your PC, click **Upload Configuration File**.



Note: Do not load this file to a different device as it includes the MAC address, which is unique to the device from where it was saved.

When creating a file for remote configuration update, it is recommended to only select the 'Display modified configuration fields only'. This ensures that the file includes only parameters that were modified from their default value. You can choose the conf format or the flat ini-file format. In both cases, it is recommended to review the file and ensure that only the parameters that the user has intended to modify appear. This file can be placed on an FTP or HTTP server for mass configuration update, as described in Remote Configuration Download.



Note: When rebooting, the device restores the settings from its configuration file. However, if reboot attempts fail three times consecutively, the device resets the configuration file by restoring factory defaults before attempting to reboot.

20.4.1 Uploading Configuration File from PC on the Network

The procedure below describes how to upload a configuration file from a PC on the network to the device.

➤ **To upload a configuration file to the device from a PC on the network:**

1. Click the **Upload Configuration File**; the screen 'Upload Configuration File' opens.

Figure 20-9: Upload Configuration File

2. Under the 'Load the Configuration File From a PC on the Network' group, click **Upgrade Now**; the screen 'Upload Configuration File' opens.

Figure 20-10: Loading Configuration File from a PC on the Network

3. Enter the path of the configuration file or click **Browse** and navigate to the configuration file on your PC.
4. Click **OK**; the file starts loading from the PC to the device. When loading is complete, the screen 'Successful Configuration File Loading' opens, prompting you to confirm configuration file load.

Figure 20-11: Successful Configuration File Uploading

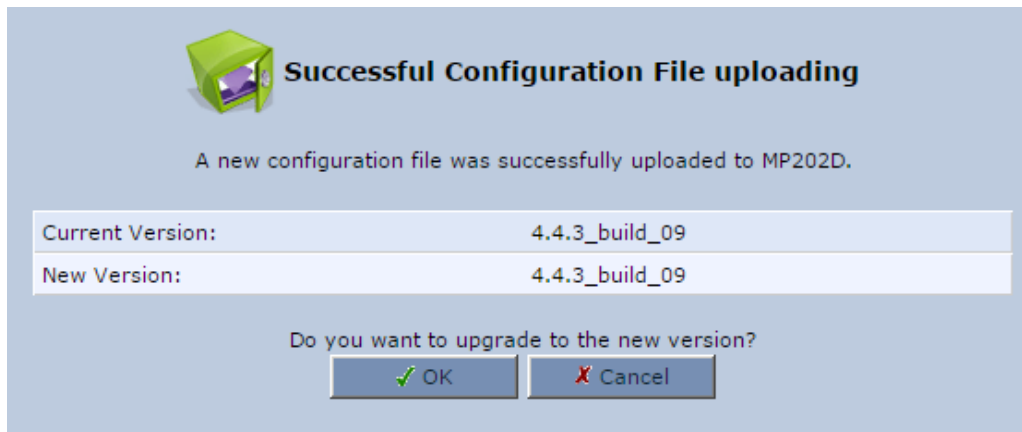

5. Click **OK** to confirm; the upgrade process commences and takes a couple of minutes to complete. At the conclusion of the file load process, the device automatically reboots. When the device completes the reboot, the new configuration file is applied and the 'Login' screen appears, prompting you to login again.
6. Login with your username and password.



Note: During the load process, it is recommended not to power down the device or stop the file load process to avoid damage to the main firmware. However, if you do, the device runs a recovery firmware image (also stored on its flash memory). Except for the analog or VoIP interfaces, the recovery image supports all interfaces and enables the device to reconnect to the Internet and then download the primary software.

20.4.2 Uploading Configuration File from a Remote Server

The procedure below describes how to upload a configuration file to the device from a remote server. This allows you to keep your configuration up-to-date, by performing daily checks for a newer configuration file each time the device restarts (i.e., automatic update), or manually checking for a newer configuration file.

➤ **To upload the device's configuration file from a remote server:**

1. Click the **Upload Configuration File**; the screen 'Upload Configuration File' opens.

Figure 20-12: Upload Configuration File

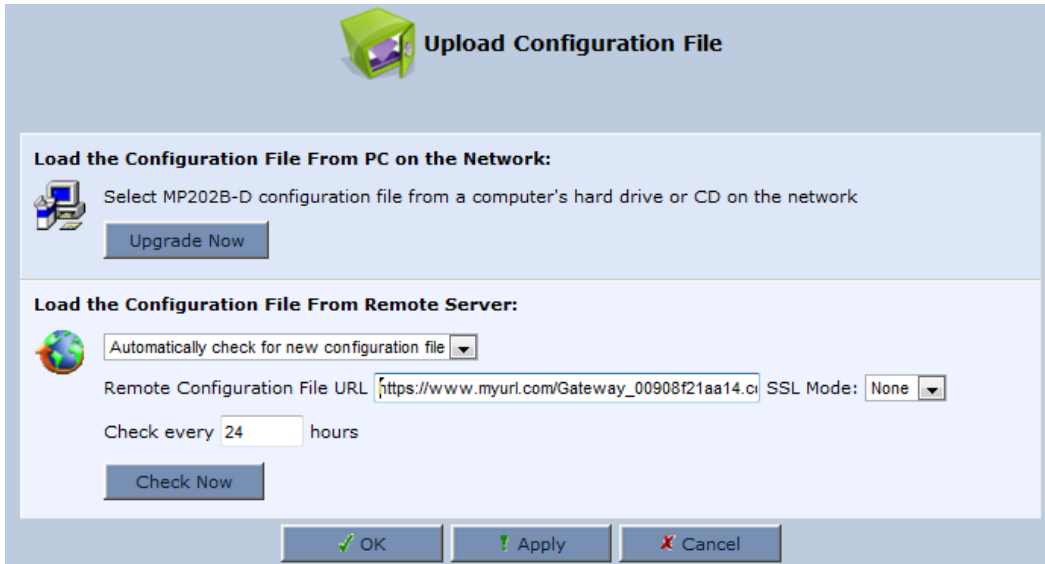

2. Under the 'Load the Configuration File From Remote Server' group, select the checking method and interval:
 - **Automatically check for new configuration file**
 - **Automatic configuration file check disabled**
3. In the 'Remote Configuration File URL' field, enter the URL address of the remote server where the configuration file is located. The URL format is as follows: **protocol://server/filename.<conf/ini>**, for example:
 - ftp://10.10.10.10/MP20x_<MAC>.conf
 - http://20.20.20.20/MP20x_<MAC>.ini

Where <MAC> is the MAC address of the device.
4. In the 'Check every' field, enter the interval (in hours) for which the device periodically checks for a new configuration file. If set to 0, the device checks only once for a new configuration file, and this occurs after it restarts.
5. Click the **Check Now** button to perform an immediate check (instead of waiting for the next scheduled one).
6. From the 'SSL Mode' drop-down list, select the type of Secure Socket Layer (SSL) certificate's validation method for accessing the remote server using HTTPS for the following purposes: downloading a new firmware file, downloading a new configuration file, and TR-069. Upon connection, the device validates the server's certificate using the selected method:
 - **None:** Do not validate the server's certificate (if you do not have a certificate).
 - **Chain:** Validate the entire certificate chain (if you have a certificate, but not necessarily signed by a root CA).
 - **Direct:** Ensure that the server's certificate is signed by the root certificate (CA).

7. Click **OK**; the download process begins. When downloading completes, a confirmation screen appears, prompting you to confirm loading the new version.
8. Click **OK** to confirm. The upgrade process begins and takes about one minute to complete. At the conclusion of the upgrade process, the device automatically reboots and the new software version runs.

If a new version is unavailable, click the **Check Now** button to perform an immediate check (instead of waiting for the next scheduled one). The screen displays a green "Check in progress..." message.

Parameter	Description
HTTP/S Access Authentication	
WGET Username system/wget_username	Username used for HTTP/S basic / digest access authentication
WGET Password system/wget_password	Password used for HTTP/S basic / digest access authentication

**Notes:**

- For additional security, the device can be configured to use HTTPS client-server certification when connecting to a remote server (see Section 14.3 on page 200).
- The configuration file can have one of the following two formats: a hierarchical conf file (indicated by file extension *.conf) or a flat ini file (indicated by file extension .ini).
- The parameter '/rmt_config/version' defines the version of the configuration file. The device uses the new configuration file only if the version that is defined in this file is later than the current version. By default, the 'version' is set to 0. This means that each time Service Providers' operations personnel require the device to download a new configuration file, they need to increment the 'version' parameter in the new file (in the .conf file, the 'version' parameter is under the section 'rmt_config'). To simplify the procedure, it is possible to use the current date in YYYYMMDD format as the version field.
- The remote configuration file must include only a subset of the complete MP20x.conf file. A recommended procedure is to start with the device restored to its factory settings, modify using the embedded Web server the parameters that should appear in the remote configuration file, and then upload (save) the configuration file. You must save only the modified parameters, as described in 'Remote Administration' on page 266.
- The string <MAC> enables the ISP to pre-configure all its deployed the devices with the same URL and file details (under rmt_config/url) and still have each device download its unique configuration file. Once the URL is configured with the string <MAC>, the device that is trying to update its configuration file automatically replaces <MAC> with its own unique MAC address. For example, if there's a device with a WAN MAC address 00:01:02:03:04:05, the ISP can configure the url to http://myserver.com/my_conf_file_<MAC>.conf - and place a file called 'my_conf_file_00_01_02_03_04_05.conf' on the server.
- Downloading a configuration file from a remote server can also be performed from the CLI:
 - 1) Using Telnet, access the device, and then enter the user name and password.
 - 2) Enter the command **rmt_config**, for example:
rmt_config -u http://myserver.com/my_conf_file.conf
 - 3) Enter **rmt_config** without any arguments for more help information.

20.4.3 Remote Configuration Provisioning Based on MD5 Checksum Comparison

By default, a new method for remote configuration provisioning based on MD5 checksum comparison has been added with the following steps:

1. The device downloads the configuration file and calculates its MD5-checksum.
2. The device compares the calculated value to the previous MD5-checksum ('rmt_config/checksum').
3. If the value is different, the device applies the downloaded configuration and saves the new MD5-checksum value.
4. If the value is the same, the downloaded file will be discarded.
5. To revert back to the methods used in previous versions, (e.g., "use_if_modified_since" or "version" counter), the following parameter needs to be added to the configuration: `rg_conf/rmt_config/default_prov_disabled=1`.

20.4.4 Encrypting the Configuration File using CLI

Encrypted files include the file name extension *.cfx (instead of *.cfg) or *.inx (instead of *.ini). After the device loads the encrypted file from the HTTP server, it automatically identifies the encrypted file by its file name extensions *.cfx or *.inx, and subsequently decrypts the file before saving it to flash memory.

The following procedure describes how to encrypt configuration files.

➤ **To encrypt a configuration file:**

- Run the following CLI shell command (on Linux or Windows PC with OpenSSL installed):

```
openssl des3 -in <original file> -out <encrypted file> -k  
<password> -S <salt value>
```

Where,

- <original file> is the original clear-text configuration file (*.cfg or *.ini file).
- <encrypted file> is the output file (an encrypted *.cfx or *.inx file).
- <password> is the password that is used to encrypt the file.
- <salt value> is the 8 bytes of a special key value that is combined with the password. The format is 16 hexadecimal digits [0-9,A-F].

An example of this command is shown below:

```
openssl des3 -in c:\temp\try_enc_conf.cfg -out  
c:\temp\try_enc_conf.cfx -k My_P@$w0rd! -S 0123456789ABCDEF
```



Notes:

- You can choose any <salt value> – the device does not have to know about it.
- A password can be pre-configured in the device, using the following CLI command:
`conf set_obscure/rmt_config/password <password>`
For example: `ftp://1.2.3.4/file`
- You can also define the password in a configuration file that you download from the server.
- If you don't define a password in the configuration file, a default password is used. Different default passwords are defined per customer, according to the config-file url hostname.

20.4.5 Automatic Upload using SIP NOTIFY Message

You can enable automatic configuration update for the device from a remote server, using the SIP NOTIFY message. The contents of the configuration file can initiate (“push”) the remote server to update the device to a desired configuration version.

➤ **To “push” a configuration file when a change of parameter is needed:**

1. Create a new configuration file with the required change.
2. Place the file on the HTTP server.
3. Send the SIP NOTIFY message to the device; the device integrates the contents of the new file and reboots.

➤ **To “push” a configuration file and initiate an upgrade or downgrade:**

1. Create a new configuration file that includes two important entries:
 - a. In `rg_conf/rmt_upd/chech_sync_version`, configure the details of the version to which you want the device to upgrade or downgrade, for example:

```
(rmt_upd
      (check_sync_version(4.4.8_build_86))
)
```
 - b. You may need to update the URL address from where the device is downloading the firmware (the path is configured in `rmt_upd/url`).



Note: In the case of a downgrade, the service provider **MUST** provide a configuration file based on a template that matches the version to which the device is downgrading.

2. Place the file on the HTTP server.
3. Send the SIP NOTIFY message to the device; the device integrates the contents of the new file and reboots. After rebooting, the device compares the currently running version with the version which is configured in `rmt_upd/chech_sync_version` and then determines whether to connect to the `rmt_upd/url` for downloading the new *.rmt file. Once the file is downloaded, its headers are parsed, and only if it represents the same version which was configured in the value of `rmt_upd/chech_sync_version`, does the upgrade/downgrade process begin.

In addition to the standard **Event: check-sync** format, AudioCodes now supports **o:check-sync**, in the compact format. The MP-20x’s behavior is similar for both formats.

20.5 Firmware Upgrade

The device provides a built-in mechanism for upgrading its software image. There are two methods for upgrading the software image:

- Upgrading from a Computer on the Network: This method uses a software image file that is pre-downloaded on a PC's disk drive or located on an accompanying CD. (See Section 20.5.1 on page 308.)
- Upgrading from the Internet: This method also referred to as 'Remote Update', upgrades your firmware by remotely downloading an updated software image file. (See Section 20.5.2 on page 310.)

The device provides a flash memory of 16 MB, which is capable of storing two firmware images. In addition to the primary firmware, the device also stores a recovery firmware, which is used only if the primary image is missing or damaged (e.g. if the user unplugs the power during firmware upgrade). Except for the analog or VoIP interfaces, the recovery image supports all interfaces and enables the device to reconnect to the Internet and download the primary firmware.



Note: During the upgrade process, do **NOT** power off the device.

20.5.1 Upgrading the Device from a Computer on the Network

The procedure below describes how to upgrade the device from a software image file located on a local computer or network.



Note: You can only use files with an *.rmt extension when performing the firmware upgrade procedure.

➤ To upgrade the device software image using a locally available .rmt file:

1. On the 'Advanced' screen, click the **Firmware Upgrade**  icon; the 'MP202D Firmware Upgrade' screen appears.

Figure 20-13: Firmware Upgrade Screen – New Versions

Firmware Upgrade

Visit www.audiocodes.com for upgrade support, upgrade options and information.

Current Version: 4.4.3_build_09

Upgrade From the Internet

Automatically Check for New Versions and Upgrade MP202B-D

Check every 24 hours at URL SSL Mode: None

first check will start 0 minutes after powerup

Next check scheduled in 6:50 hours

Status: OK

Internet Version: No new version available

Upgrade From a Computer in the Network

Select an updated MP202B-D firmware file from a computer's hard drive or a CD on the network

Click the **Refresh** button to update the status.

The following is an example of the relevant Telnets parameter:

```
rg_conf/rmt_upd/wan_upgrade_type=1
```

(Automatically check for New Versions)

Figure 20-14: Firmware Upgrade Screen – Check Disabled

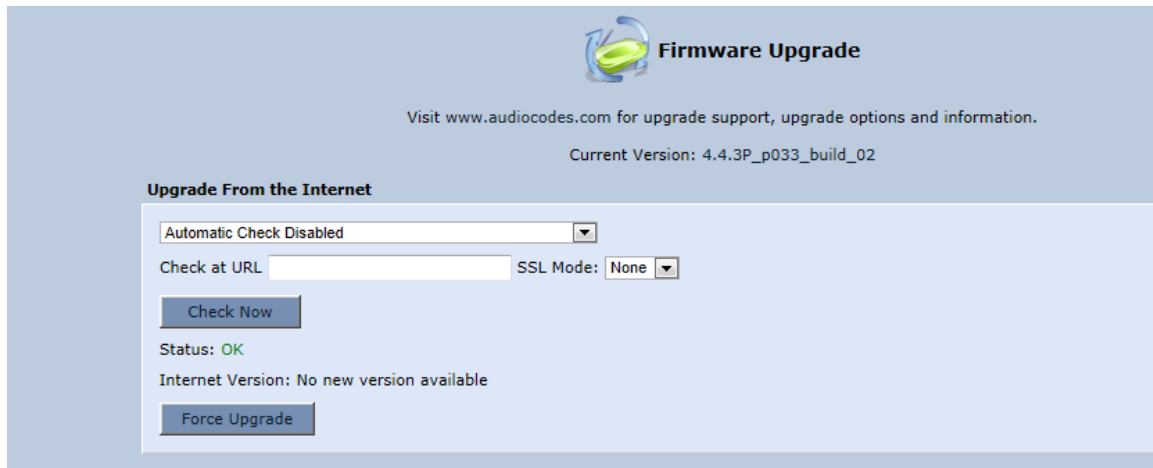

The following is an example of the relevant Telnet parameter:

```
rg_conf/rmt_upd/wan_upgrade_type=3
(Automatic Check Disabled)
```

2. Under the **Upgrade From a Computer in the Network** group, click the **Upgrade Now** button; the 'Upgrade From a Computer in the Network' screen appears.

Figure 20-15: Upgrade From a Computer in the Network Screen

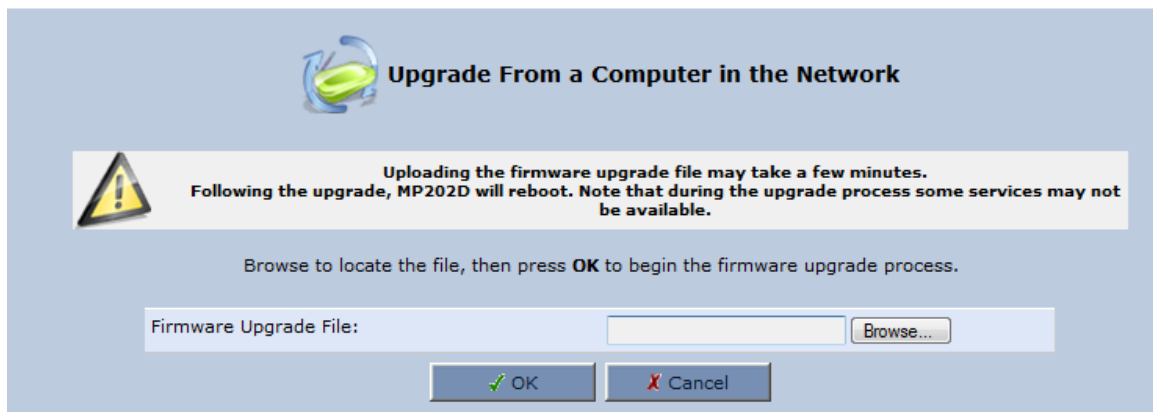

3. In the 'Firmware Upgrade File' field, enter the path to the software image file or click **Browse** and navigate to the *rmt* file on your PC.
4. Click **OK**; the device uploads the file from your PC. When loading is complete, you are prompted to confirm upgrade to the new version.

Figure 20-16: Confirming Firmware Upgrade Screen

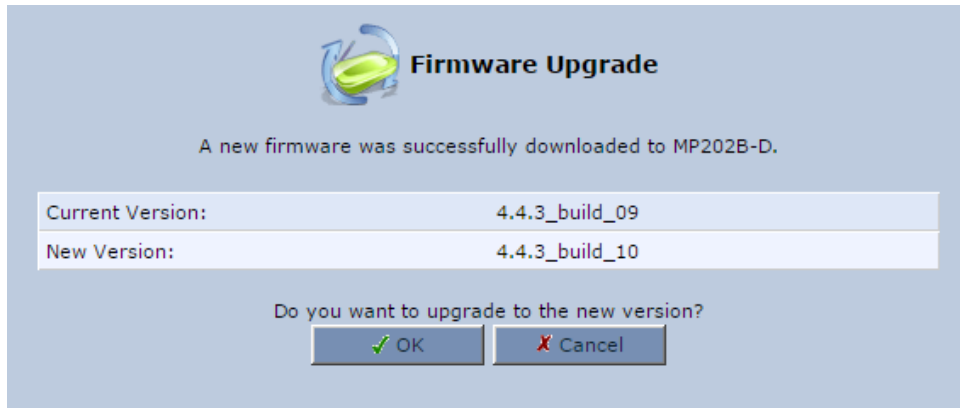

5. Click **OK** to confirm; the upgrade process commences (a few minutes).

Figure 20-17: Upgrading in Progress Screen

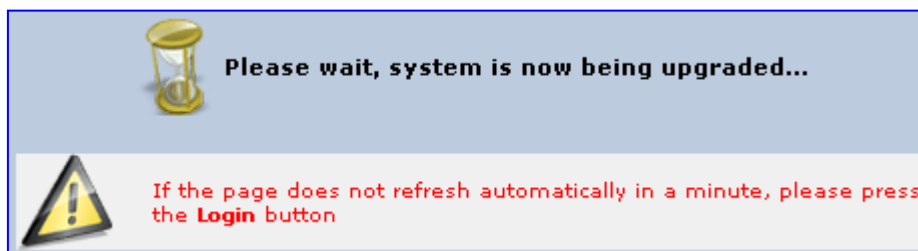

At the conclusion of the upgrade process, the device automatically reboots and the new software version now runs on the device, maintaining your configurations and settings.

20.5.2 Upgrading the Device from the Internet

The Remote Update mechanism helps you keep your software image up-to-date, by performing routine daily checks for newer software versions, as well as letting you perform manual checks. These updates are from a user-defined URL.

➤ **To upgrade the device's software image from the Internet:**

1. On the 'Advanced' screen, click the **Firmware Upgrade** icon; the 'MP64 Firmware Upgrade' screen appears.

Figure 20-18: Firmware Upgrade

Firmware Upgrade

Visit www.audiocodes.com for upgrade support, upgrade options and information.

Current Version: 4.4.3_build_09

Upgrade From the Internet

Automatically Check for New Versions and Upgrade MP202B-D ▼

Check every 24 hours at URL SSL Mode: None ▼

first check will start 0 minutes after powerup

Next check scheduled in 6:50 hours

Status: OK

Internet Version: No new version available

Upgrade From a Computer in the Network

Select an updated MP202B-D firmware file from a computer's hard drive or a CD on the network

Click the **Refresh** button to update the status.

2. Under the **Upgrade From the Internet** group, select the utility's checking method and interval:
 - **Automatically Check for New Versions and Upgrade device:** The device automatically checks for new versions every user-defined interval (defined in the 'Check every' field) at the URL address defined in the 'URL' field. You can define the time (in minutes) after which the first check commences after the device is reset.
 - **Automatically Check for New Versions and Notify via Email:** **Note:** Currently, this feature is not functional.
 - **Automatic Check Disable:** The device checks for a new version at the URL address defined in the 'URL' field, when you click the **Check Now** button.

The result of the last performed check is displayed between the **Check Now** and **Force Upgrade** buttons, indicating whether a new version is available or not.
3. If a new version is available:
 - a. Click the **Force Upgrade** button. A download process begins. When downloading is complete, you are prompted to confirm upgrade to the new version.

20.6 Configuring System Settings

The 'System Settings' screen allows you to configure various device System and Management parameters.

➤ **To configure device System and Management settings:**

1. On the 'Advanced' screen, click the **System Settings**  icon; the 'System Settings' screen appears.

Figure 20-19: Partial View System Settings Screen



System Settings

System

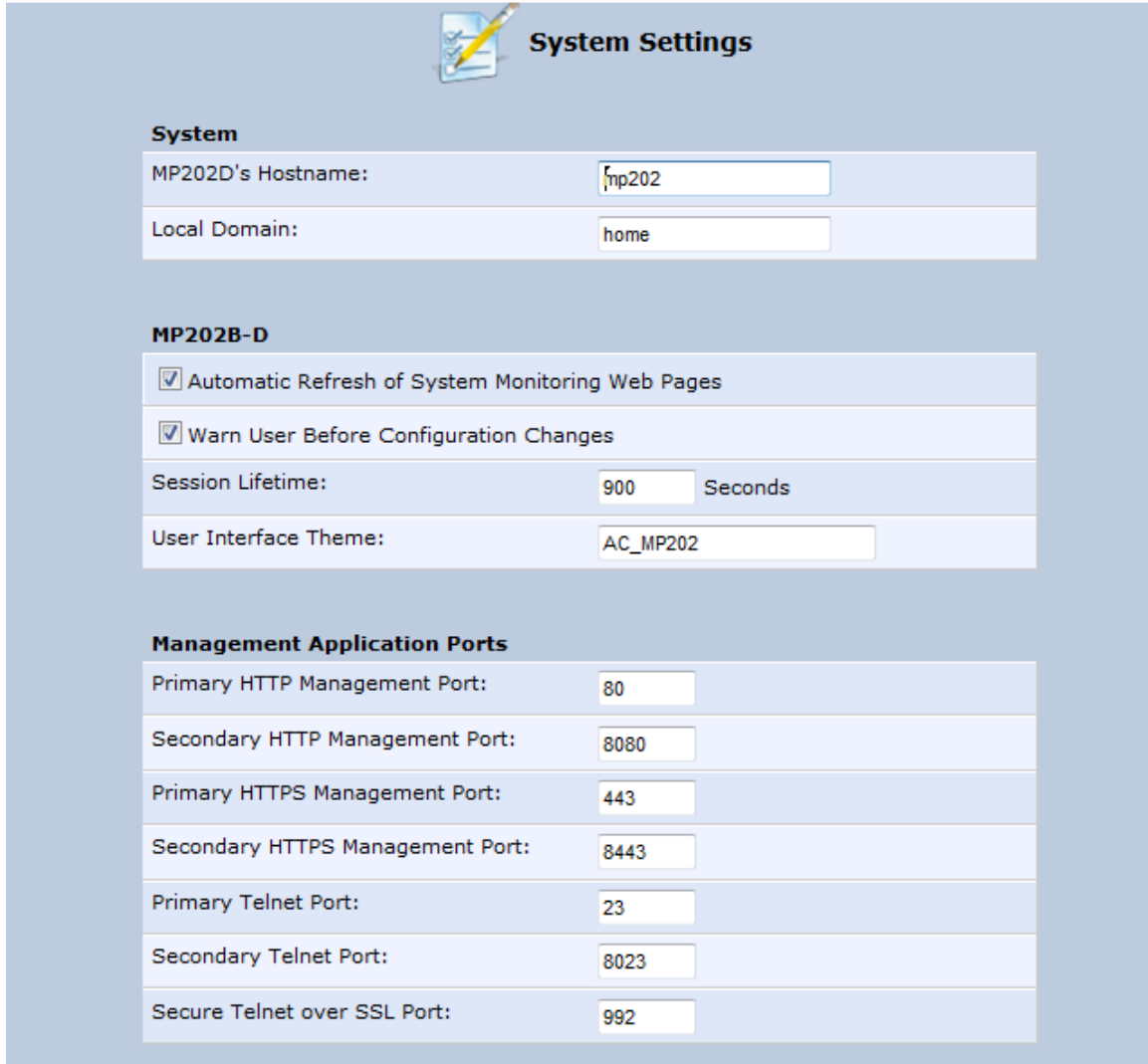
MP202D's Hostname:	<input type="text" value="mp202"/>
Local Domain:	<input type="text" value="home"/>

MP202B-D

<input checked="" type="checkbox"/> Automatic Refresh of System Monitoring Web Pages	
<input checked="" type="checkbox"/> Warn User Before Configuration Changes	
Session Lifetime:	<input type="text" value="900"/> Seconds
User Interface Theme:	<input type="text" value="AC_MP202"/>

Management Application Ports

Primary HTTP Management Port:	<input type="text" value="80"/>
Secondary HTTP Management Port:	<input type="text" value="8080"/>
Primary HTTPS Management Port:	<input type="text" value="443"/>
Secondary HTTPS Management Port:	<input type="text" value="8443"/>
Primary Telnet Port:	<input type="text" value="23"/>
Secondary Telnet Port:	<input type="text" value="8023"/>
Secure Telnet over SSL Port:	<input type="text" value="992"/>



Note: Due to the size of the 'System Settings' screen, the figure above provides only a partial display.

2. Under the **System Settings** group, configure the following:
 - In the 'MP202Ds Hostname' field, enter the device's host name. The host name is the device's URL address.
 - In the 'Local Domain' field, enter your network's local domain.
3. Under the **MP202b-D** group, do the following:
 - **Automatic Refresh of System Monitoring Web Pages:** select this check box to enable automatic refreshing of system monitoring Web interface pages.
 - **Warn User Before Network Configuration Changes:** select this check box to activate user warnings before network configuration changes take effect.
 - **Session Lifetime:** duration of idle time (in seconds) in which the Web session remains active. When this duration times out, you must re-login.
 - **User Interface Theme:** Defines a different GUI theme that affects the GUI design and available parameters. For more information, contact your AudioCodes distributor.
 - **Language:** select a language for the Web interface GUI.
4. Under the **Management Application Ports** group, define the following ports:
 - Primary/secondary HTTP management ports
 - Primary/secondary management HTTPS ports
 - Primary/secondary Telnet ports
 - Secure Telnet over SSL ports
5. Under the **Management Application SSL Authentication Options** group, configure whether the following is required:
 - Primary/Secondary HTTPS Management Client Authentication
 - Secure Telnet over SSL Client Authentication
6. Under the **System Logging** group, do the following:
 - **System Log Buffer Size:** size of the system log buffer in kilobytes.
 - **Remote System Notify Level:** The device sends notifications to a remote host (None, Error, Warning, Information)
 - **Persistent System Log:** saves the system log to the device flash memory. This prevents the system log from being erased when the device reboots.
7. Under the **Security Logging** group, do the following:
 - **Security Log Buffer Size:** size of the security log buffer in Kilobytes
 - **Remote Security Notify Level:** None, Error, Warning, Information
 - **Persistent Security Log:** saves the security log to the flash. This prevents the security log from being erased when the device reboots.



Note: Do not leave the persistent logging feature enabled permanently, as continuous writing of the log files to the flash memory reduces the device's performance.

8. Under the **Outgoing Mail Server** group, do the following:
 - **Server:** hostname of your outgoing (SMTP) server.
 - **From Email Address:** Each email requires a 'from' address and some outgoing servers refuse to forward mail without a valid 'from' address for anti-spam reasons.
 - **Port:** port used by your outgoing mail server.
 - **Server Requires Authentication:** If your outgoing mail server requires authentication, select this check box and enter your user name and password in the subsequent 'User Name' and 'Password' fields respectively.

To define email notifications per User to receive indications of system and security events, see Section 5.4 on page 36.
9. The **Swap** group configures the Swap feature that enables you to free a portion of the RAM by creating a swap file on the storage device connected to the device. This is especially useful for platforms with a small RAM. To activate this feature:
 - a. Verify that a storage device is connected to the device.
 - b. Select the 'Enabled' check box.
 - c. In the 'Swap Size' field, enter a swap file size in megabytes.
 - d. Click **Apply**; a swap file is created on the storage device and the read-only 'Status' field changes to "Ready".
10. Under the **Host Information** group, select the 'Enable Auto Detection of Host Services' check box to enable the device to auto-detect its LAN hosts' properties, available services, traffic statistics, and connections.
11. Under the **Installation Wizard** group, select the 'Use Installation Wizard Pre-configured Values' check box to have the wizard skip the steps for which parameters had been preconfigured and saved in the factory settings file (rg_factory).

20.7 Rebooting the Device

The procedure below describes how to reboot the device.

➤ **To reboot the device:**

1. On the 'Advanced' screen, click the **Reboot**  icon; the 'Reboot' screen appears.

Figure 20-20: Reboot Screen

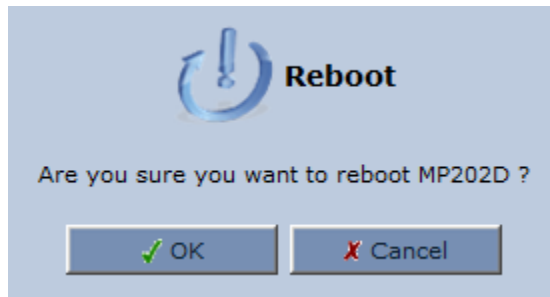

2. Click **OK** to reboot the device. This may take up to one minute.
3. To re-enter the Web interface after rebooting the device, refresh your Internet browser.

You can also reboot the device using a manual procedure, as described below:

➤ **To manually reboot the device:**

- Insert a paper clip (or any other similar pointed object) into the Reset pin-hole button located on the rear panel of the device, and keep the button pressed for at least 1 second (but no more than 5 seconds); the device reboots.

20.8 Restoring Factory Settings

You can restore the device to factory default settings. This is useful when, for example, you are initially creating a new network or when you cannot recall changes made to the network.



Notes:

- If you are accessing the device's Web interface from the WAN, restoring factory default settings causes the connection with the device to be lost, since access to the Web interface from the WAN is blocked by default.
- **All** Web-based management settings and parameters are restored to their default values. This includes the administrator username and password

➤ To restore the device to default settings:

1. On the 'Advanced' screen, click the **Restore Factory Settings**  icon; the 'Restore Factory Settings' screen appears.

Figure 20-21: Restore Factory Settings Screen



2. Click **OK** to restore the device's factory default settings.

If the device Web interface cannot be accessed (for example, if the password is unknown or if the LAN is disabled), you can restore default settings manually, as described below:

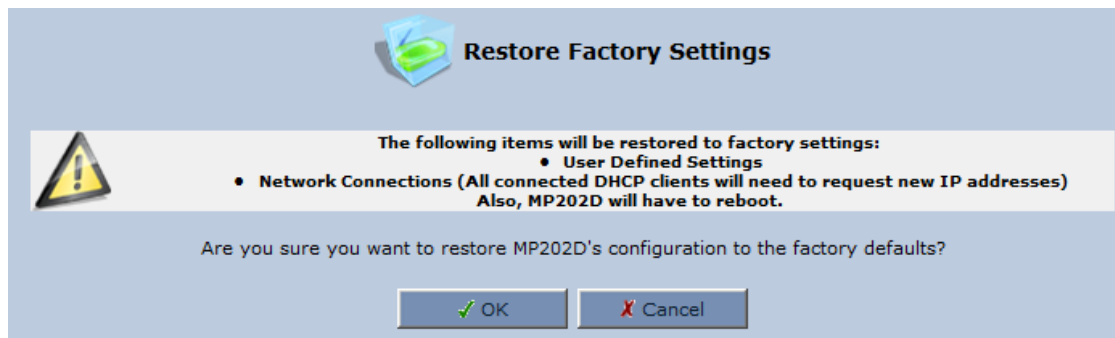
➤ To manually restore the device to default settings:

- Insert a paper clip (or any other similar pointed object) into the Reset pin-hole button located on the rear panel of the device, and keep the button pressed for at least seven seconds. While the device sets all its parameters to default, the Status, Broadband, and Phone LEDs blink red. After this, the Status LED is lit steady red while the device reboots.

■ Running configuration / default settings can now be updated using the USB dongle.

This can be done by running the following:

```
rg_conf/rmt_config/usb_key/conf/file_name=conf.ini
rg_conf/rmt_config/usb_key/conf/destination=/tmp/conf.ini

rg_conf/rmt_config/usb_key/factory/file_name=factory.conf
rg_conf/rmt_config/usb_key/factory/destination=/tmp/factory.conf
```

This page is intentionally left blank.

21 Diagnostics and Performance Monitoring

This chapter provides diagnostics and performance monitoring procedures.

21.1 Running Diagnostics

The **Diagnostics**  icon allows you to test network connectivity. In addition, it allows you to view statistics such as the number of packets transmitted and received, round-trip time, and success status. The test tools are platform-dependent and are not available simultaneously.

The **Diagnostics**  icon displays the 'Diagnostics' screen, as described below.

➤ **To access the 'Diagnostics' screen:**

1. On the 'Advanced' screen, click the  icon; the following screen appears.

Figure 21-1: Diagnostics Screen

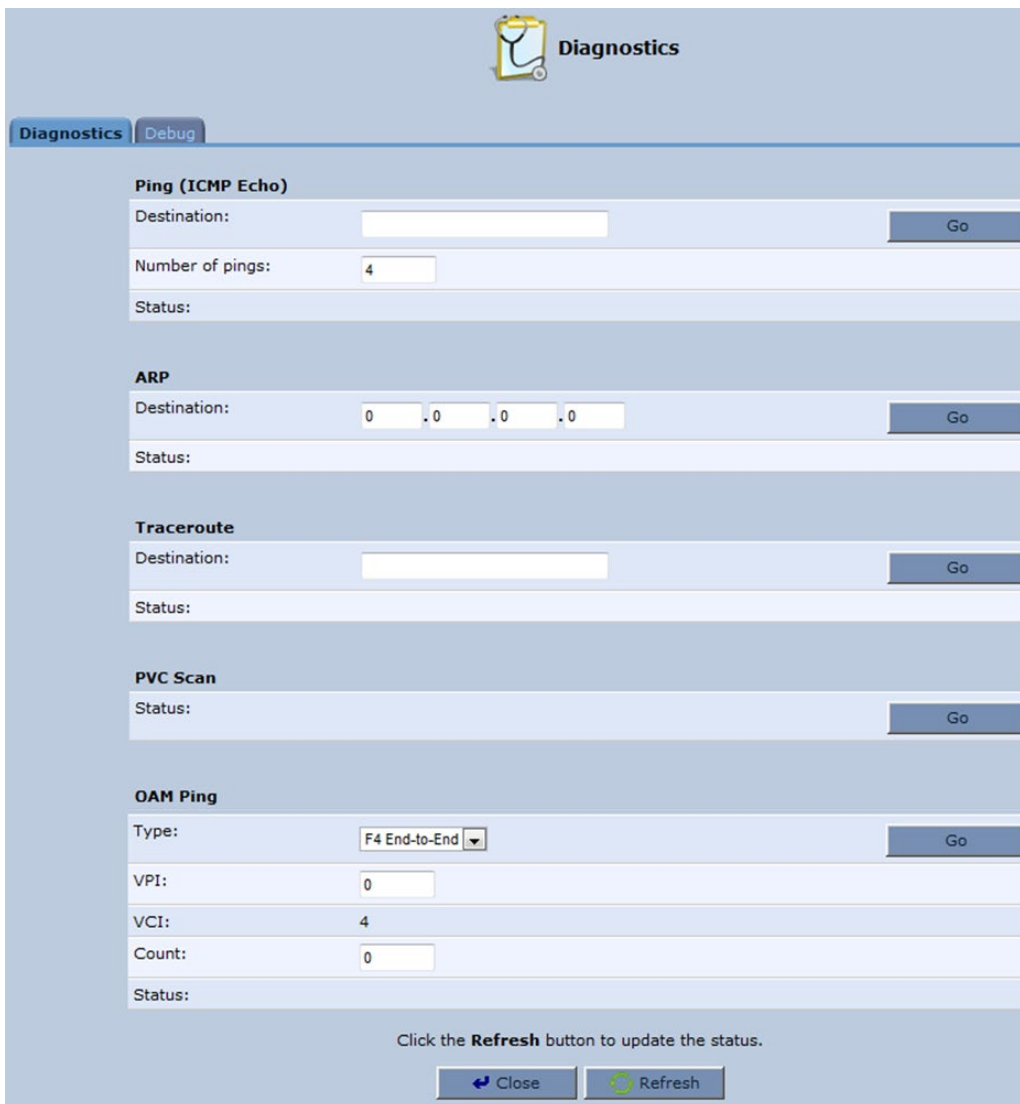

The screenshot shows the 'Diagnostics' screen with a light blue background. At the top, there is a 'Diagnostics' icon and the title 'Diagnostics'. Below the title, there are two tabs: 'Diagnostics' (selected) and 'Debug'. The screen is divided into several sections, each with a title and input fields:

- Ping (ICMP Echo)**: Destination: , Number of pings: , Status:
- ARP**: Destination: , Status:
- Traceroute**: Destination: , Status:
- PVC Scan**: Status:
- OAM Ping**: Type: , VPI: , VCI: , Count: , Status:

At the bottom, there is a message: 'Click the **Refresh** button to update the status.' Below this message are two buttons: 'Close' and 'Refresh'.

2. Click the **Diagnostics** tab.

21.1.1 Running the Ping Test

The procedure below describes how to run a ping (ICMP) test in the 'Diagnostics' screen. This test is done under the **Ping (ICMP Echo)** group.

➤ **To run a ping test:**

1. In the 'Destination' field, enter the IP address or URL to be tested.
2. In the 'Number of pings' field, enter the number of pings you want to perform.
3. Click **Go**; after a few seconds, diagnostic statistics are displayed. If no new information is displayed, click the **Refresh** button.

Figure 21-2: Running a Ping Test

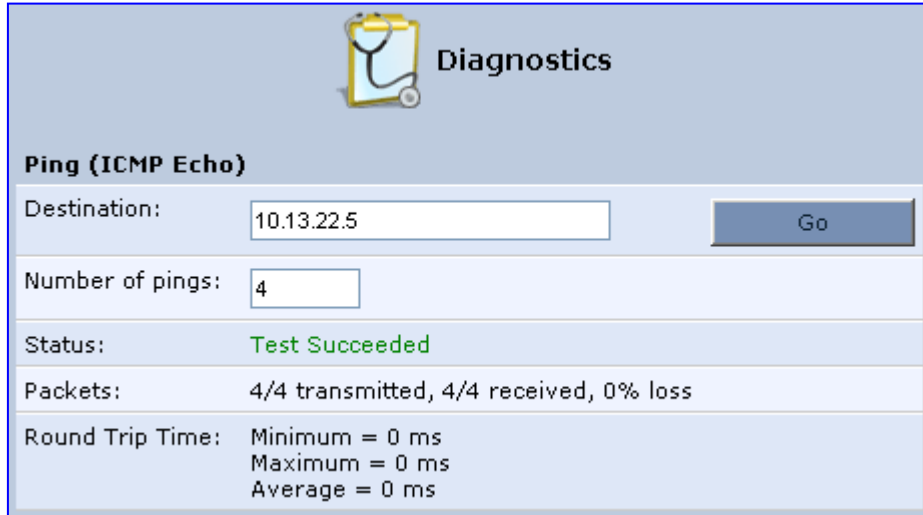

21.1.2 Running the ARP Test

The ARP test is used to query the physical address (i.e., MAC) of a host. The procedure below describes how to run an Address Resolution Protocol (ARP) test in the 'Diagnostics' screen. This test is done under the **ARP** group.

➤ **To run an ARP test:**

1. In the 'Destination' field, enter the IP address of the target host.
2. Click **Go**; after a few moments, diagnostic statistics is displayed. If no new information is displayed, click **Refresh**.

Figure 21-3: Running an ARP Test

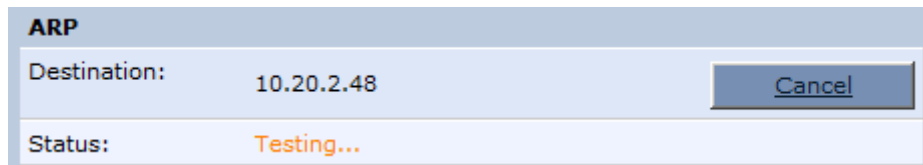

21.1.3 Running a Traceroute

The procedure below describes how to run a traceroute test in the 'Diagnostics' screen. This test is done under the **Traceroute** group.

➤ **To run a traceroute:**

1. In the 'Destination' field, enter the IP address or URL to be tested.
2. Click **Go**; a traceroute commences, constantly refreshing the screen.

Figure 21-4: Running a Traceroute

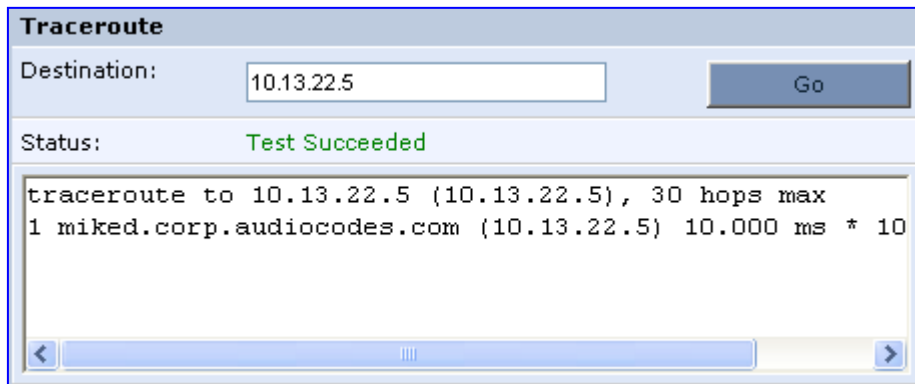

3. To stop the trace and view the results, click **Cancel**.

21.2 Running Debug

The **Diagnostics**  icon also allows you to run various Debug tests.

➤ To access the 'Debug' screen:

1. On the 'Advanced' screen, click the  icon
2. Click the **Debug** tab; the following screen appears.

Figure 21-5: Diagnostics – Debug Screen



Diagnostics

Debug

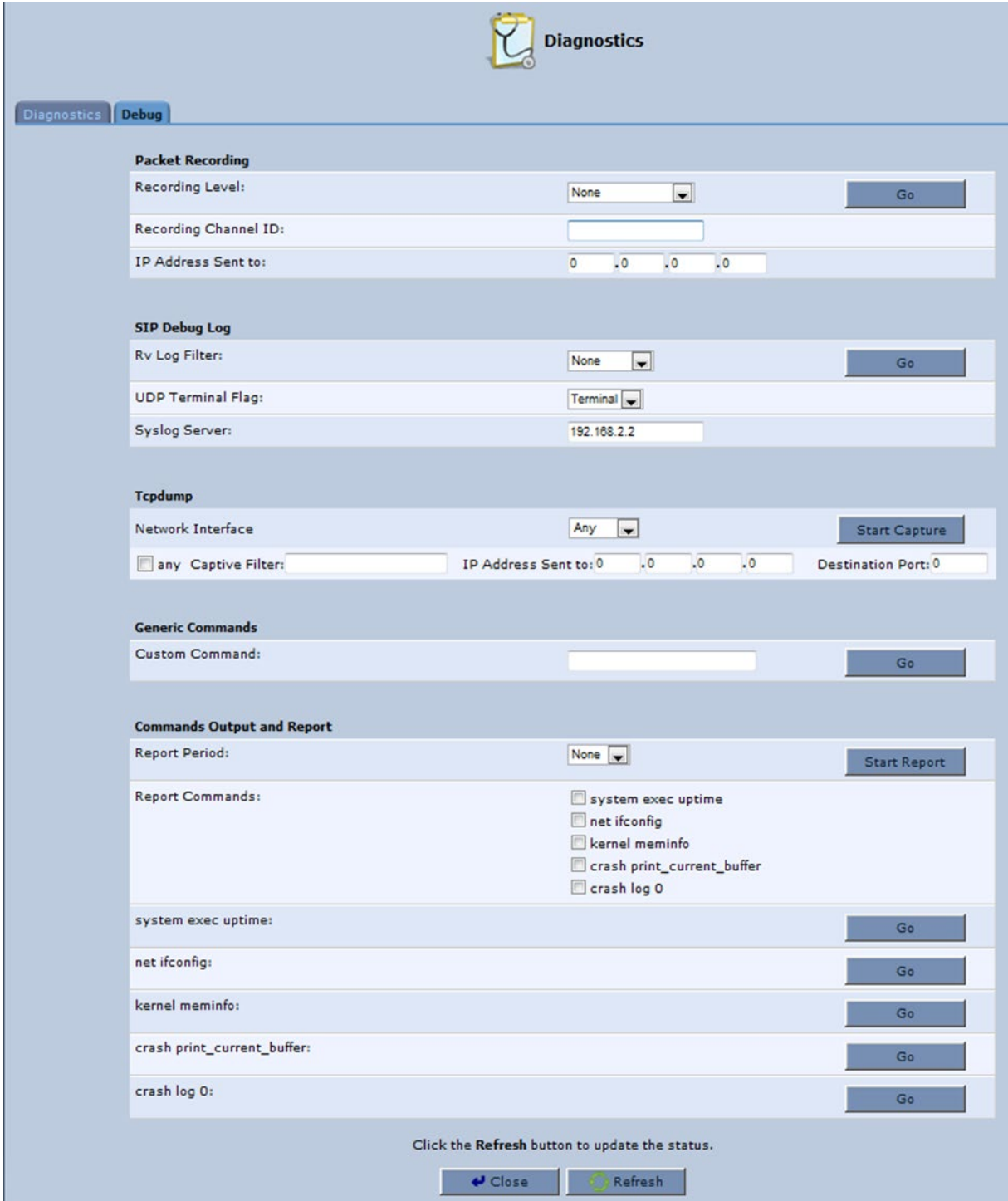
Packet Recording

Recording Level:

Recording Channel ID:

IP Address Sent to:

SIP Debug Log

Rv Log Filter:

UDP Terminal Flag:

Syslog Server:

Tcpdump

Network Interface:

any Captive Filter: IP Address Sent to: Destination Port:

Generic Commands

Custom Command:

Commands Output and Report

Report Period:

Report Commands:

- system exec uptime
- net ifconfig
- kernel meminfo
- crash print_current_buffer
- crash log 0

system exec uptime:

net ifconfig:

kernel meminfo:

crash print_current_buffer:

crash log 0:

Click the **Refresh** button to update the status.

21.2.1 Running Packet Recording

The procedure below describes how to run Packet Recording.



Note: For Packet Recording, connect a PC running Wireshark to any LAN port.

➤ **To run Packet Recording:**

1. Under the **Packet Recording** group, from the 'Recording Level' drop-down list, select the required Recording Level
 - **None:** Stop recording
 - **Packet Recording:** Command packets between DSP and CPU
 - **TDM:** Includes Packet Recording and V.Voice sample packets from the FXS to the DSP
 - **Network:** Includes TDM, Packet Recording, and Voice samples packets from the DSP to the FXS
 - **RTP:** Includes Network, TDM, Packet Recording, and encapsulated RTP packets between DSP and Network.
2. In 'Recording Channel ID' field, specify one or more channels to debug (use ',' or '-' to separate):
 - MP202
 - Channel ID **5** = FXS1
 - Channel ID **6** = FXS2
 - MP202R
 - Channel ID **3** = FXS1
 - Channel ID **4** = FXS2
 - MP204/MP204R
 - Channel ID **3** = FXS1
 - Channel ID **4** = FXS2
 - Channel ID **5** = FXS3
 - Channel ID **6** = FXS4
3. In the 'IP Address Sent to' field, enter the IP address of the PC running Wireshark.
4. Click **Go**.

Figure 21-6: Running Packet Recording

Packet Recording	
Recording Level:	Packet Recording <input type="button" value="Go"/>
Recording Channel ID:	0
IP Address Sent to:	192 . 168 . 2 . 2

21.2.2 Running SIP Debug Log

The procedure below describes how to run the SIP Debug log.



Note: To run the SIP Debug Log, connect a PC running Wireshark to LAN port or to any other accessible network, so the ATA could send the Syslog over WAN port.

➤ **To run the SIP Debug log:**

1. Under the SIP Debug Log section of the screen, in the 'Rv Log Filter' field, select **ALL**.
2. From the 'UDP Terminal Flag' drop-down list, select **UDP**.
3. From the 'Syslog Server' drop-down list, enter the IP of the PC running Wireshark.
4. Click **Go**.

Figure 21-7: Running SIP Debug Log

SIP Debug Log	
Rv Log Filter:	<div style="display: flex; justify-content: space-between; align-items: center;"> ALL ▼ </div>
UDP Terminal Flag:	<div style="display: flex; justify-content: space-between; align-items: center;"> UDP ▼ </div>
Syslog Server:	<input style="width: 100%;" type="text" value="192.168.2.2"/>
<input style="border: 2px solid blue;" type="button" value="Go"/>	

21.2.3 Running TCPDump

The procedure below describes debugging using the TCPDump packet analyzer. TCPDump captures and analyzes network behavior, performance and applications that send or receive network traffic. TCPDump lets you intercept and display TCP/IP and other packets transmitted or received over the network.



Notes: To run the TCPDump, connect a computer running Wireshark to any LAN port.

21.2.3.1 Updating Wireshark

To view ACP packets with Wireshark, update Wireshark by copying the following two files:

- acp.lua
- init.lua

from <ftp://vop-c5:audc76@ftp.audiocodes.com/tools/TCPdump>, to your Wireshark directory (C:\Program Files (x86)\Wireshark), replacing the current files in the directory. The .lua files define the ACP filter in Wireshark.

21.2.3.2 Running TCPDump with Destination Port 7555

The procedure below describes how to run TCPDump using Destination Port **7555**.

➤ **To run TCPDump:**

1. Under the **Tcpdump** group, from the 'Network Interface' drop-down list, select **Multiple**.
2. Select the relevant interface (e.g., ppp0).
3. In the 'IP Address Sent to' field, enter the IP address of the computer running Wireshark (e.g., 192.168.2.2).
4. In the 'Destination Port' field, enter "7555" (default port).
5. Click **Start Capture**.

Figure 21-8: Running TCPDump – Destination Port 7555

Network Interface	Captive Filter:	IP Address Sent to:	Destination Port:
<input type="checkbox"/> br0		0.0.0.0	0
<input type="checkbox"/> dsl0		0.0.0.0	0
<input type="checkbox"/> ptm0		0.0.0.0	0
<input type="checkbox"/> eth0		0.0.0.0	0
<input checked="" type="checkbox"/> ppp0		192.168.2.2	7555
<input type="checkbox"/> ipsec1		0.0.0.0	0



Note: If you configure TCPDump on the same device that you send the packets, you create a loop. This is not recommended. To trace **ppp0**, for example, don't send the TCPDump packets out through the device on which **ppp0** is located, but rather to a PC located in the LAN.

21.2.3.3 Defining a Different Destination Port (other than Port 7555)

The procedure below describes how to use a different destination port by decoding destination packets in Wireshark as "ACP". In the example shown in the figure below, Port 4321 is defined.

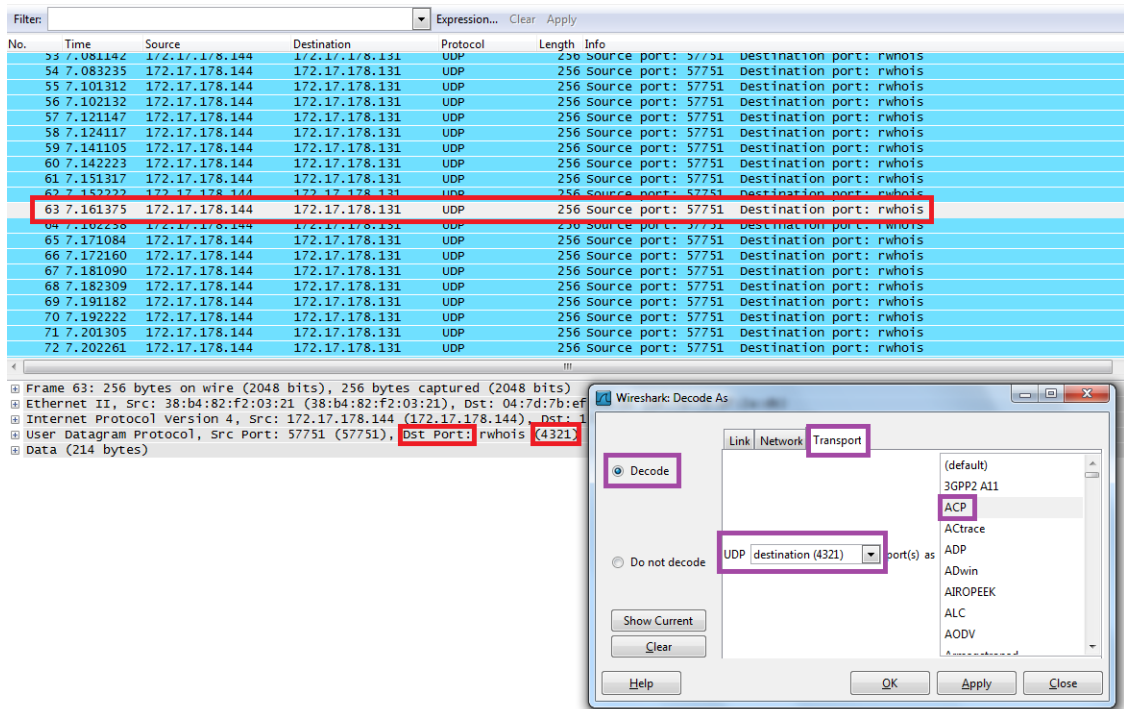

21.2.4 Running Generic Commands

The procedure below describes how to run generic commands in the debugging process.

➤ **To run a generic command:**

1. Under the **Generic Commands** group, in the 'Custom Command' field, enter a Telnet command.
2. Click **Go**; the command output is displayed on the screen.

Figure 21-9: General Commands Example

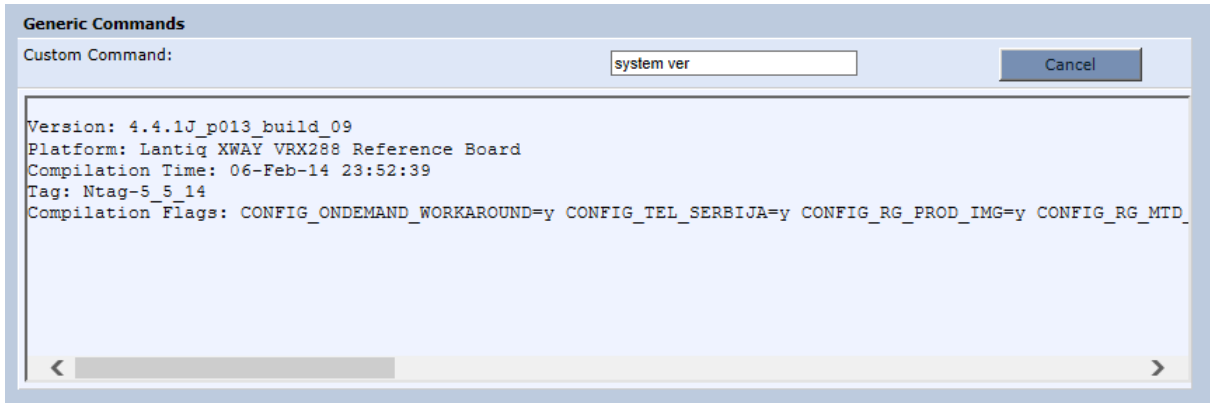

21.2.5 Commands Output and Report

The procedure below describes how to run specific debug commands and reports. Debug command reports can be run for specified periods at given intervals (e.g., run every 30 seconds) or can be run to view immediate results.

➤ **To run a debug report to run for a specified period:**

1. Under the **Commands Output and Report** group, from the 'Report Period' drop-down list, select the time frequency you want the report to be run. In this example, the report is run every minute.
2. In the 'Report Commands' field, select the specific reports you want to run.
3. Click **Start Report**; the report process begins.

Figure 21-10: Report Commands Example

Commands Output and Report

Report Period: None
15s
30s
1min
10min
1h Start Report Download

Report Commands:

system exec uptime
 net ifconfig
 kernel meminfo
 crash print_current_buffer
 crash log 0

system exec uptime: Go

net ifconfig: Go

kernel meminfo: Go

crash print_current_buffer: Go

crash log 0: Go

Click the **Refresh** button to update the status.

Close Refresh

4. Click **Stop Report** to stop the reporting process.

Figure 21-11: Report Commands Example – Stop Report

Commands Output and Report

Report Period: 1min Stop Report

Report Commands:

system exec uptime
 net ifconfig
 kernel meminfo
 crash print_current_buffer
 crash log 0

system exec uptime: Go

net ifconfig: Go

kernel meminfo: Go

crash print_current_buffer: Go

crash log 0: Go

Click the **Refresh** button to update the status.

Close Refresh

5. Click **Download**.

Figure 21-12: Report Commands Example - Download

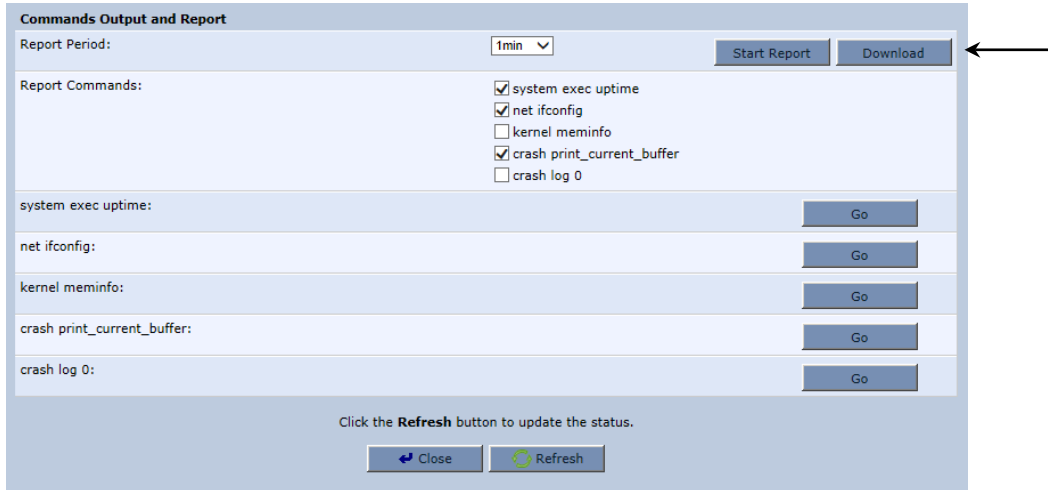

6. "Do you want to open or save....." message appears at the bottom of the screen.

Figure 21-13: Report Commands Example – Open or Save

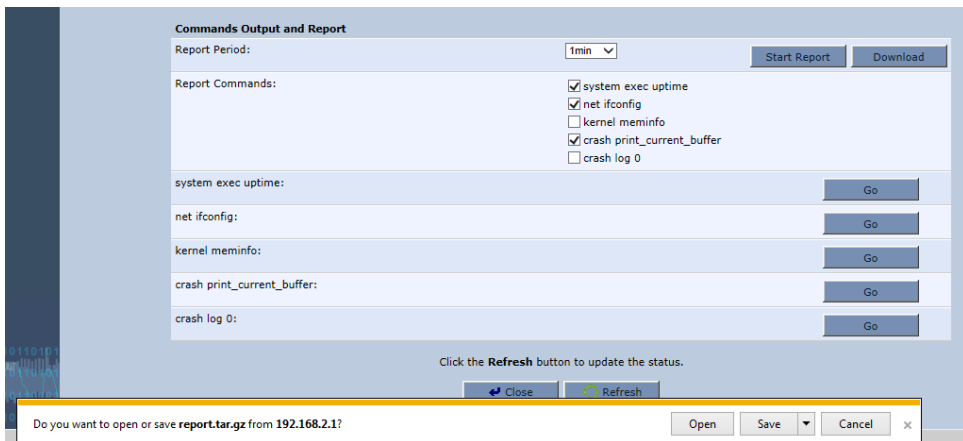

7. Click **Open**; a WinZip window appears.

Figure 21-14: Report Commands Example – WinZip Archive

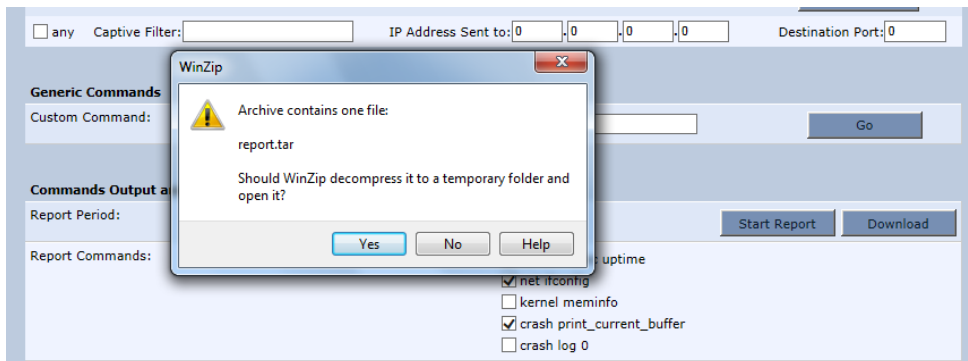

8. Click **Yes**; a WinZip window appears with the report files ready for viewing..

Figure 21-15: Report Commands Example – WinZip Report

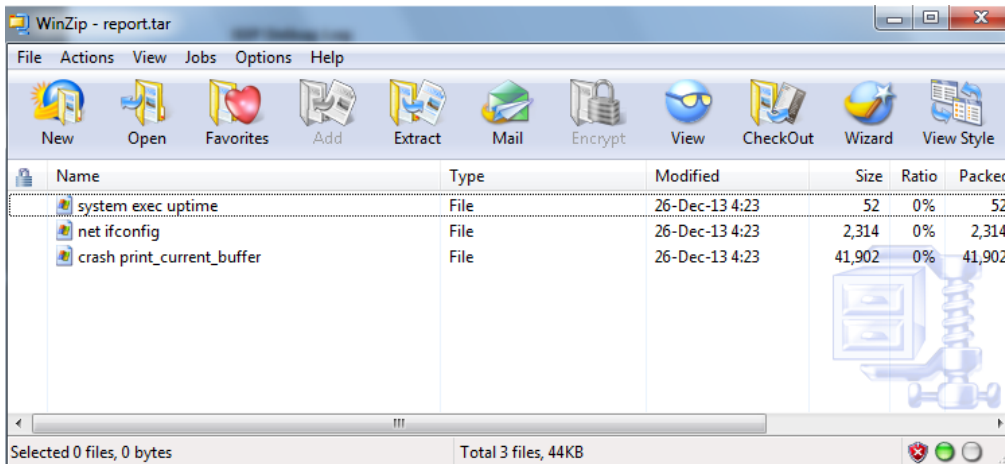

- **To run a debug report to run for immediate viewing:**
 1. Under the **Commands Output and Report** group, the following reports can be run for immediate viewing:
 - system exec uptime
 - net ifconfig
 - kernel meminfo
 - crash print_current_buffer
 - crash log 0
 2. For any of these reports, click **Go**; the appropriate report results appear in the screen.

Figure 21-16: Report Options with Go Button

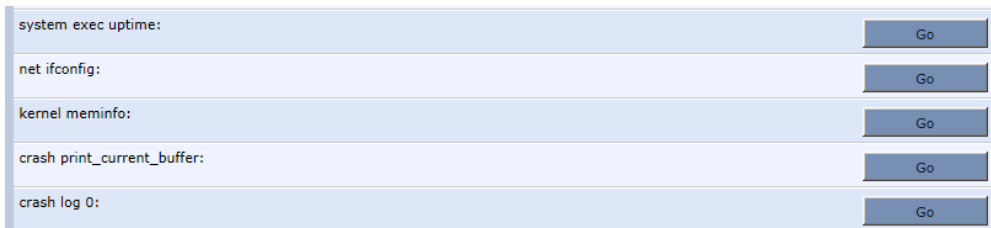

3. To run the 'system exec uptime' report, for example, click **Go** on the far-right of the same line; the results appear in the screen below.

Figure 21-17: System Exec Uptime Example

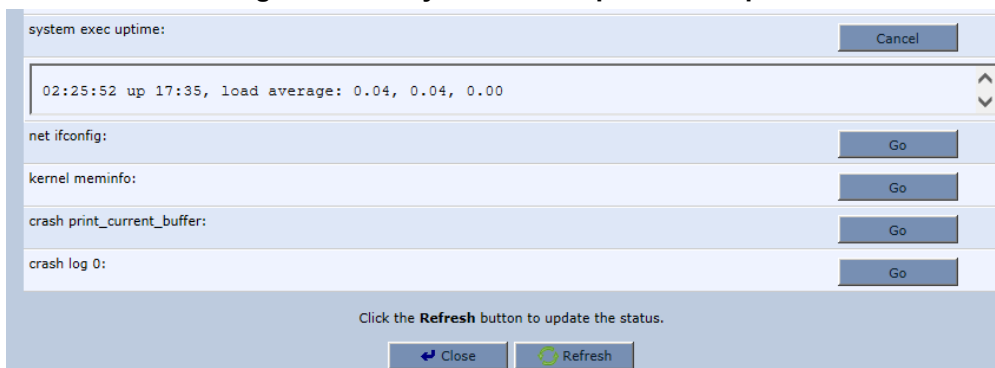

21.3 System Monitoring

This section describes how to view the device performance statistics.

21.3.1 Viewing Network Connections Status

The device constantly monitors traffic within the local network and between the local network and the Internet. You can view up-to-the-second statistical information about data received from and transmitted to the Internet (WAN) and about data received from and transmitted to computers in the local network (LAN).

➤ **To view network connections:**

1. From the menu bar, click the **System Monitoring** menu.
2. Select the Network **Connections** tab.

Figure 21-18: Network Connections Screen

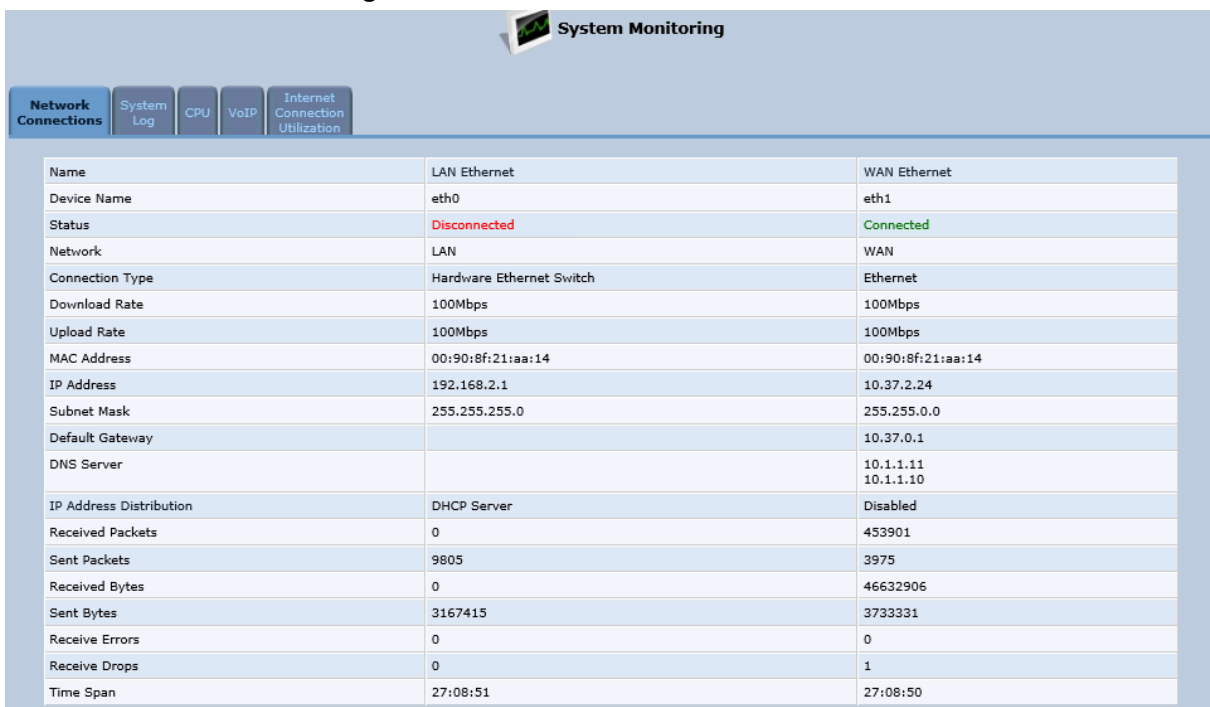

Name	LAN Ethernet	WAN Ethernet
Device Name	eth0	eth1
Status	Disconnected	Connected
Network	LAN	WAN
Connection Type	Hardware Ethernet Switch	Ethernet
Download Rate	100Mbps	100Mbps
Upload Rate	100Mbps	100Mbps
MAC Address	00:90:8f:21:aa:14	00:90:8f:21:aa:14
IP Address	192.168.2.1	10.37.2.24
Subnet Mask	255.255.255.0	255.255.0.0
Default Gateway		10.37.0.1
DNS Server		10.1.1.11 10.1.1.10
IP Address Distribution	DHCP Server	Disabled
Received Packets	0	453901
Sent Packets	9805	3975
Received Bytes	0	46632906
Sent Bytes	3167415	3733331
Receive Errors	0	0
Receive Drops	0	1
Time Span	27:08:51	27:08:50

3. Click the **Refresh** button to update the display or click the **Automatic Refresh On** button to automatically refresh the displayed parameters. To reset the counters, click the **Reset Statistics** button.

21.3.2 Viewing the System Log

The 'System Log' screen displays a list of the most recent activity that has occurred on the device.

- **To view the system log:**
 1. From the menu bar, click the **System Monitoring** menu.
 2. Select the **System Log** tab.

Figure 21-19: System Log Screen

Click the **Refresh** button to update the status.

Filters

Component	Severity	Action
All	Notice	
New Filter		+

Time	Component	Severity	Details
Jan 1 02:29:04 2003	Permissions	Warning	PERMISSION_CHECK USER[admin] ROLE[admin] PERMISSION [wireless_advanced] FAILED [repeated 3 times, last time on Jan 1 02:29:27 2003]
Jan 1 02:28:58 2003	LibJutil	Warning	sys_if_ioctl_mii_execute:433: Both tried MII ioctls 8947/89F0 failed: Operation not supported. [repeated 2 times, last time on Jan 1 02:28:58 2003]
Jan 1 02:28:57 2003	Permissions	Warning	PERMISSION_CHECK USER[admin] ROLE[admin] PERMISSION [wireless_advanced] FAILED
Jan 1 02:28:42 2003	LibJutil	Warning	sys_if_ioctl_mii_execute:433: Both tried MII ioctls 8947/89F0 failed: Operation not supported. [repeated 2 times, last time on Jan 1 02:28:42 2003]
Jan 1 02:28:42 2003	Permissions	Warning	PERMISSION_CHECK USER[admin] ROLE[admin] PERMISSION [wireless_advanced] FAILED
Jan 1 02:28:26 2003	LibJutil	Warning	sys_if_ioctl_mii_execute:433: Both tried MII ioctls 8947/89F0 failed: Operation not supported. [repeated 2 times, last time on Jan 1 02:28:26 2003]
Jan 1 02:28:26 2003	Permissions	Warning	PERMISSION_CHECK USER[admin] ROLE[admin] PERMISSION [wireless_advanced] FAILED

To update the display, click the **Refresh** button. To clear the list of logged events, click the **Clear Log** button. To save the logged events to a file (comma-separated values file) on your PC, click the **Download Log** button.

21.3.3 Viewing CPU Statistics

The 'CPU' screen displays the following system parameters:

- **Gateway ID:** Serial number of the device. This number also appears on the printed label located on the rear panel of the device.
- **System Has Been Up For:** Time that has passed since the device was last started.
- **Load Average:** Average number of processes that are either in a runnable or uninterruptible state. A process in the runnable state is either using the CPU or waiting to use the CPU. A process in the uninterruptible state is waiting for I/O access, e.g. waiting for the disk. The averages are taken over the three time intervals. The meaning of the load average value varies according to the number of CPUs in the system. This means for example, that a load average of 1 on a single-CPU system means that the CPU was loaded all the time, while on a 4-CPU system this means that the CPU was idle 75% of the time.
- **Processes:** Processes currently running on the device and their virtual memory usage. The amount of memory granted for each process is displayed as follows:
 - **Total Virtual Memory (VmData):** Amount of memory currently utilized by the running process.
 - **Heap size (VmSize):** Total amount of memory allocated for the running process.

➤ **To view the CPU statistics:**

1. From the menu bar, click the **System Monitoring** menu.
2. Select the **CPU** tab.

Figure 21-20: CPU Screen

System Monitoring

Network Connections | System Log | **CPU** | VoIP | Internet Connection Utilization

Gateway ID:	2206228
System Has Been Up For:	1 day, 3 hours
Load Average (1 / 5 / 15 mins.):	1.06 / 1.02 / 1.00

Processes

Process	Total Virtual Memory (VmData)	Heap size (VmSize)
init	148 kB	640 kB
openrg	2780 kB	9452 kB
l2tpd	212 kB	692 kB
voip_task	1768 kB	6708 kB
voip_task	1768 kB	6708 kB
voip_task	1768 kB	6708 kB

Click the **Refresh** button to update the status.

By default, the screen is automatically refreshed. To disable automatic refresh, click **Automatic Refresh Off**, and then click the **Refresh** button each time you want to update the display.

21.3.4 Viewing VoIP Traffic Statistics

The 'VoIP' screen displays information on VoIP traffic and settings.

➤ **To monitor VoIP traffic:**

1. From the menu bar, click the **System Monitoring** menu.
2. Select the **VoIP** tab.

Figure 21-21: VoIP Screen



By default, the screen is automatically refreshed. To disable automatic refresh, click **Automatic Refresh Off**, and then click the **Refresh** button each time you want to update the display.

21.3.5 Viewing Internet Connection Utilization

The 'Internet Connection Utilization' screen displays the Internet connection bandwidth usage information per computer and application.

➤ **To monitor Internet connection usage:**

1. From the menu bar, click the **System Monitoring** menu.
2. Select the **Internet Connection Utilization** tab. By default, the **By Computer** tab is selected.

Figure 21-22: Internet Connection Utilization – By Computer

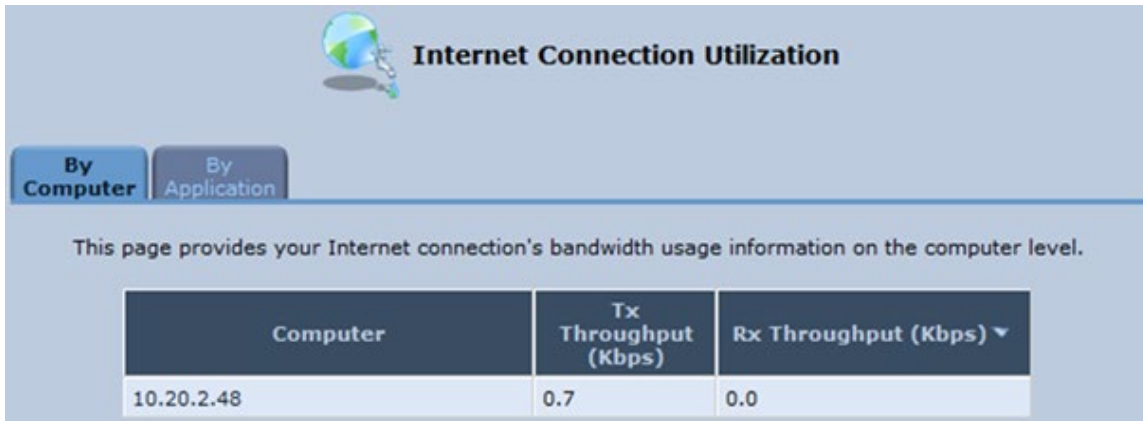

3. To view bandwidth utilization per application, click the **By Application** tab.

Figure 21-23: Internet Connection Utilization – By Application

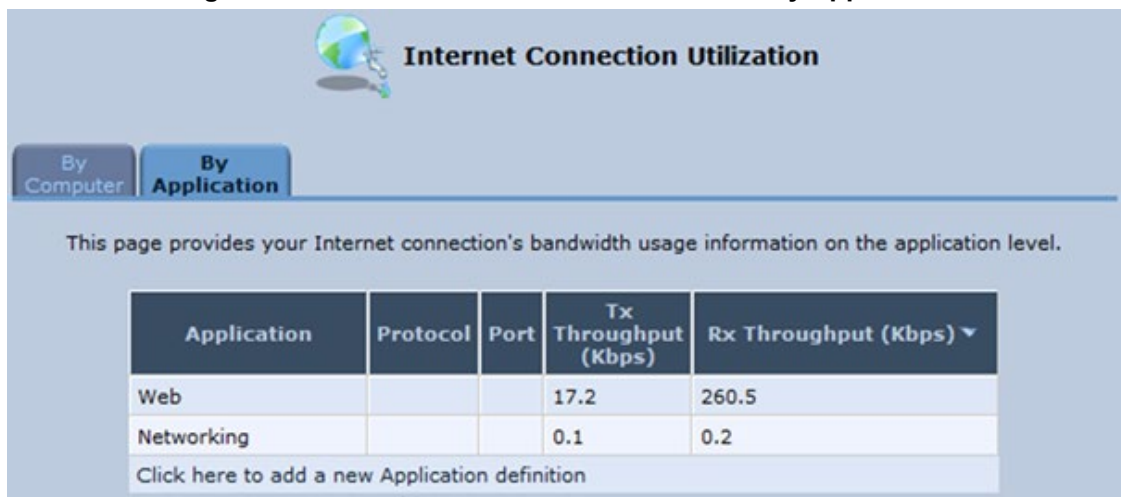

By default, the screen is automatically refreshed. To disable automatic refresh, click **Automatic Refresh Off**, and then click the **Refresh** button each time you want to update the display.

21.3.6 Using Debugging Tools

The following additional debug tools are now available:

- **MD5Sum**

Prints or checks MD5 checksums.

```
MP20x> system shell
/ # md5sum <filename>
```

- **WGET**

Retrieves files via HTTP or FTP.

```
MP20x> system shell
/ # wget http://<host>:<port>
```

- **Nslookup**

Useful CLI tool for troubleshooting DNS issues, such as host name resolution.

DNS query can be performed as follows:

```
NAPTR MP-20x> net naptr <name>
SRV   MP-20x> net srv <name>
A     MP-20x> net host <name>
```

- **GREP**

Searches for patterns in each file or standard input.

Options:

- H - Prefixes output lines with filename where match was found
- h - Suppresses the prefixing filename on output
- i - Ignores case distinctions
- l - Lists names of files that match
- n - Prints line numbers with output lines
- q - Be quiet. Returns 0 if result was found, 1 otherwise
- v - Selects non-matching lines
- s - Suppresses file open/read error messages

```
MP20x> system shell
/ # grep -[Hhilmnqvs] [pattern] [file]
```

- **Find**

Searches for files. The default PATH is the current directory, default EXPRESSION is '-print'.

```
MP20x> system shell
/ # find [PATH...] [EXPRESSION]
```

21.4 Call Detail Records

Call Detail Records (CDR) contain vital statistical information on calls made from the device. The device can be configured to generate and report CDRs for various stages of the call, for example, only at the end of the call or only at the start and end of the call. Once generated, the device sends the CDRs to a user-defined Syslog server.

The CDR Syslog message is identified by Facility 17 (Local1) and Severity 5 (Informational).

21.4.1 CDR Field Descriptions

The CDR fields generated by the MP-20x are listed in the table below.

Field Name	Description
CDRID	Identification number of the CDR message
ReportType	Report type: <ul style="list-style-type: none"> ▪ CALL_START ▪ CALL_CONNECT ▪ CALL_END
SIPCallId	Unique SIP Call ID
SessionID	SIP Session Identifier
SrcURI	Source URI (SrcPhoneNum@SourceIP)
DstURI	Destination URI (DstPhoneNum@DestIP)
Duration	Call duration
TrmSd	Initiator of call release (IP, Tel, or Unknown)
TrmReason	SIP call termination reason (see Section 21.4.2)
TrmReasonCategory	Termination reason category: <ul style="list-style-type: none"> ▪ Calls with duration = 0 (i.e., not connected): <ul style="list-style-type: none"> ✓ NO_ANSWER - GWAPP_NORMAL_CALL_CLEAR, GWAPP_NO_USER_RESPONDING, GWAPP_NO_ANSWER_FROM_USER_ALERTED ✓ BUSY - GWAPP_USER_BUSY ✓ NO_RESOURCES - GWAPP_RESOURCE_UNAVAILABLE_UNSPECIFIED, RELEASE_BECAUSE_NO_CONFERENCE_RESOURCES_LEFT, RESOURCE_BECAUSE_NO_TRANSCODING_RESOURCES_LEFT, RELEASE_BECAUSE_GW_LOCKED ✓ NO_MATCH - RELEASE_BECAUSE_UNMATCHED_CAPABILITIES ✓ FORWARDED - RELEASE_BECAUSE_FORWARD ✓ GENERAL_FAILED - any other reason ▪ Calls with duration: <ul style="list-style-type: none"> ✓ NORMAL_CALL_CLEAR - GWAPP_NORMAL_CALL_CLEAR ✓ ABNORMALLY_TERMINATED - Anything else ✓ N/A - Reasons not belonging to above categories
SetupTime	Call setup time
ConnectTime	Call connect time
ReleaseTime	Call release time

Field Name	Description
LegId	FXS port ID Note: This is only applicable when Report_Type = CALL_CONNECT or CALL_END.
Orig	Call originator: <ul style="list-style-type: none"> ▪ LCL (Tel side) ▪ RMT (IP side)

21.4.2 Release Reasons in CDR

The following is a list of possible reasons for call termination on the MP-20x, displayed in the TrmReason field:

- "RELEASE_BECAUSE_LOCAL_REJECT"
- "RELEASE_BECAUSE_REQUEST_FAILURE"
- "RELEASE_BECAUSE_SERVER_FAILURE"
- "RELEASE_BECAUSE_GLOBAL_FAILURE"
- "RELEASE_BECAUSE_LOCAL_DISCONNECTING"
- "RELEASE_BECAUSE_DISCONNECTED"
- "RELEASE_BECAUSE_REMOTE_DISCONNECTED"
- "RELEASE_BECAUSE_LOCAL_FAILURE"
- "RELEASE_BECAUSE_LOCAL_TIME_OUT"
- "RELEASE_BECAUSE_CALL_TERMINATED"
- "RELEASE_BECAUSE_AUTH_NEEDED"
- "RELEASE_BECAUSE_UNSUPPORTED_AUTH_PARAMS"
- "RELEASE_BECAUSE_LOCAL_CANCELING"
- "RELEASE_BECAUSE_REMOTE_CANCELED"
- "RELEASE_BECAUSE_REMOTE_DISCONNECT_REQUESTED"
- "RELEASE_BECAUSE_DISCONNECT_LOCAL_REJECT"
- "RELEASE_BECAUSE_DISCONNECT_REMOTE_REJECT"
- "RELEASE_BECAUSE_DISCONNECT_LOCAL_ACCEPT"
- "RELEASE_BECAUSE_NETWORK_ERROR"
- "RELEASE_BECAUSE_503_RECEIVED"
- "RELEASE_BECAUSE_GIVE_UP_DNS"
- "RELEASE_BECAUSE_CONTINUE_DNS"
- "RELEASE_BECAUSE_OUT_OF_RESOURCES"

21.4.3 Configuring CDR Reporting

The procedure below describes how to configure CDR reporting.

➤ **To configure CDR reporting:**

1. Open a browser, and then connect to the MP-20x Web interface.
2. In the Web interface, click the **Advanced** menu.
3. On the Diagnostics page, click **Debug** tab.
4. From the 'CDR Report Level' drop-down list, under the **CDR Log** group, select the required level.



Note: If the 'CDR Report Level' value is "None", the feature has been disabled.

5. In the 'CDR Server Address' field, enter the IP address of the Syslog server.
6. In the 'CDR Server Port' field, enter the port number of the Syslog server.
7. Click **Go**.

Figure 3-1: CDR Parameters in Advanced - Debug Parameters Page

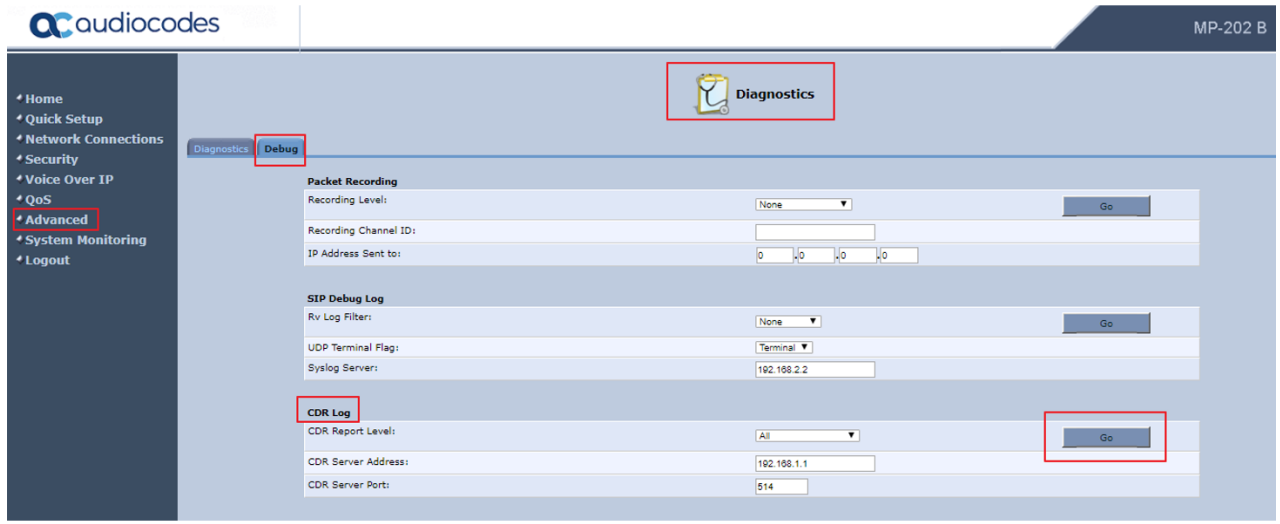

The following is an example of the relevant CDR parameters:

```
rg_conf/voip/cdr/cdr_server_addr=192.168.1.1
rg_conf/voip/cdr/cdr_server_port=514
rg_conf/voip/cdr/cdr_report_level=4
```

The possible 'cdr_report_level' values are shown in the table below:

Values	Description
0	Disables the CDR reporting feature
1	Ends the call
2	Starts and ends the call
3	Connects and ends the call
4	Starts, connects and ends the call

21.4.4 CDR Log Local Storage

You can obtain the CDR log from the device. The device saves the log in the */tmp/* folder in the *cdr_log.txt* file. The maximum size of the log file is 512 KB. When the size of the file reaches the maximum value, the device creates an additional *cdr_log_secondary.txt* file. All previous records are saved in this new file. The *cdr_log.txt* file continues to store the latest logs.



Note: All CDR files are deleted after a device reboot.

A Technical Specifications

The sub-sections below describe the specifications of AudioCodes' Device Gateway.



Note: For the list of features available in the current software version, refer to the latest *Release Notes*.

A.1 Device Gateway Specifications

The specifications for the router and VoIP functionality are listed in the table below:

Table A-1: MP-20x Telephone Adapter Software Specifications

Feature	Details
VoIP Signaling Protocols	<ul style="list-style-type: none"> ▪ SIP - RFC 3261, RFC 2327 (SDP)
Data Protocols	<ul style="list-style-type: none"> ▪ IPv4, TCP, UDP, ICMP, ARP, TLS (SIP over TLS) ▪ PPPoE (RFC 2516) ▪ PPTP (RFC 2637) ▪ DNS, Dynamic DNS ▪ WAN-to-LAN Layer-3 routing with: <ul style="list-style-type: none"> ✓ DHCP Client/Server (RFC 2132) ✓ NAT: RFC 3022, Application Layer Gateway (ALG) ✓ Stateful Packet Inspection Firewall ✓ QoS - Priority queues, VLAN 802.1p, Q tagging, traffic shaping ▪ STUN (RFC 3489)
Media Processing	<ul style="list-style-type: none"> ▪ Voice Coders: G.711, G.723.1, G.729A/B, G.726, G.772 ▪ Echo Cancellation: G.168-2004 compliant, 64-msec tail length ▪ Silence Compression ▪ Adaptive Jitter Buffer 300 msec ▪ Fax bypass, Voice-Band Data and T.38 fax relay ▪ Automatic Gain Control
Telephony Features	<ul style="list-style-type: none"> ▪ Call Hold and Transfer ▪ Call Waiting ▪ Message Waiting Indication ▪ Call Forward ▪ 3-Way Conferencing
Configuration/Management	<ul style="list-style-type: none"> ▪ Embedded Web Server for configuration and management ▪ TR-069 and TR-104 for remote configuration and management ▪ Remote firmware upgrade and configuration by HTTP, TFTP, FTP, and HTTPS ▪ Configuration file encryption (3DES) ▪ SIP-triggered remote firmware and configuration upgrade ▪ Command-Line Interface (CLI) over Telnet ▪ Dual image management ▪ SNMP

Feature	Details
	<ul style="list-style-type: none"> ▪ Local Support and Troubleshooting with Web interception and voice notification ▪ BroadSoft BroadCloud certification ▪ BroadCloud PacketSmart integration (applicable only to MP-204B) ▪ Optional 3G/4G dongle (applicable only to MP-204B) ▪ Link Layer Discovery Protocol (LLDP) support ▪ Faxback integration (Fax over HTTPS) – Optional ▪ File server ▪ Printer server ▪ DLNA Media server ▪ FXS Voice menu
Packetization	<ul style="list-style-type: none"> ▪ RTP/RTCP Packetization (RFC 3550, RFC 3551) ▪ DTMF Relay (RFC 2833)
Security	<ul style="list-style-type: none"> ▪ HTTPS for Web-based configuration ▪ Password protected Web pages (MD5)
Telephony Signaling	<ul style="list-style-type: none"> ▪ In-band: <ul style="list-style-type: none"> ✓ DTMF: Detection and Generation, TIA464B ✓ Caller ID: Telcordia, ETSI, NTT - Type I, Telcordia Type II ✓ Call Progress Tones ▪ Out-of-band: <ul style="list-style-type: none"> ✓ FXS Loop-start Signaling ✓ On/Off Hook, Flash Hook
Hardware	
Power	<ul style="list-style-type: none"> ▪ MP-202B – Power Supply 12VDC/1A ▪ MP-204B/MP-204R/MP202R – Power Supply 12VDC/2A
Interfaces	<ul style="list-style-type: none"> ▪ WAN 10/100Base-T (RJ-45) ▪ LAN 10/100Base-T (RJ-45) ▪ RJ-11 FXS ports for telephones (POTS) ▪ Network Interface WAN/LAN 10/100 Base-T(RJ-45) ▪ Ethernet ports are 10/100/1000Base-T (applicable to MP-204B) ▪ USB 2.0 (applicable to MP-204B)
LED Indications	<ul style="list-style-type: none"> ▪ FXS Phone lines (1 to 4, depending on MP-20x model) - Registered, In Use, Alert ▪ LAN activity on Ethernet Port ▪ WAN ▪ USB ▪ Status ▪ Power on
3G Backup (Optional)	<ul style="list-style-type: none"> ▪ Support for 3G USB dongles for primary WAN backup including: <ul style="list-style-type: none"> ✓ Alcatel 4G LTE (1bbb:f000->1bbb:0195) ✓ Alcatel AL720 ✓ Huawei E1550 ✓ Huawei E156 ✓ Huawei E156G ✓ Huawei E160 ✓ Huawei E169 ✓ Huawei E1750 ✓ Huawei E1756 ✓ Huawei E1756 Movistar

Feature	Details
	<ul style="list-style-type: none"> ✓ Huawei E303 ✓ Huawei E3131 ✓ Huawei E3272 ✓ Huawei E3276 ✓ Huawei E3372 ✓ Huawei E367 ✓ Huawei E392 ✓ Huawei E398 ✓ Huawei K3765 ✓ Huawei K3772 ✓ Sierra AC326U ✓ Vertex ✓ ZTE K3805-Z ✓ ZTE MF110 ✓ ZTE MF190 ✓ ZTE MF626 ✓ ZTE MF823
SLIC Characteristics	<ul style="list-style-type: none"> ▪ Maximum Ringer Load (REN) = 5 ▪ Short Haul ▪ Ringer Voltage - up to 65Vrms ▪ Configurable Terminating Impedance
Environmental	<ul style="list-style-type: none"> ▪ Operating Temperature: 0 to 40°C ▪ Storage Temperature: -25 to 70°C ▪ Operating Humidity: 10 to 90% non-condensing ▪ Storage Humidity: 10 to 90% non-condensing
Weight and Dimensions	<ul style="list-style-type: none"> ▪ MP-202B: 230 grams; 167 x 133 x 33 mm ▪ MP-204B/MP204R/MP202R: 280 grams; 167 x 133 x 33 mm

International Headquarters

1 Hayarden Street,
Airport City
Lod 7019900, Israel
Tel: +972-3-976-4000
Fax: +972-3-976-4040

AudioCodes Inc.

200 Cottontail Lane
Suite A101E
Somerset NJ 08873
Tel: +1-732-469-0880
Fax: +1-732-469-2298

Contact us: <https://www.audiocodes.com/corporate/offices-worldwide>

Website: <https://www.audiocodes.com/>

©2020 AudioCodes Ltd. All rights reserved. AudioCodes, AC, HD VoIP, HD VoIP Sounds Better, IPmedia, Mediant, MediaPack, What's Inside Matters, OSN, SmartTAP, User Management Pack, VMAS, VoIPerfect, VoIPerfectHD, Your Gateway To VoIP, 3GX, VocaNom, AudioCodes One Voice, AudioCodes Meeting Insights, AudioCodes Room Experience and CloudBond are trademarks or registered trademarks of AudioCodes Limited. All other products or trademarks are property of their respective owners. Product specifications are subject to change without notice.

Document #: LTRT-50618

