

A MCGRAW-HILL PUBLICATION

75 CENTS

JANUARY 24, 1964

electronics®

THIN-FILM ACTIVE DEVICES

What the
future holds

COMMUNICATIONS SATELLITES

New way to plot
coverage circles

SPACE TELEMETRY

Getting both control
and wide deviation



DISK ENCODER is photographically produced using a diamond-ruled master disk

MULTIMETER CONVENIENCE

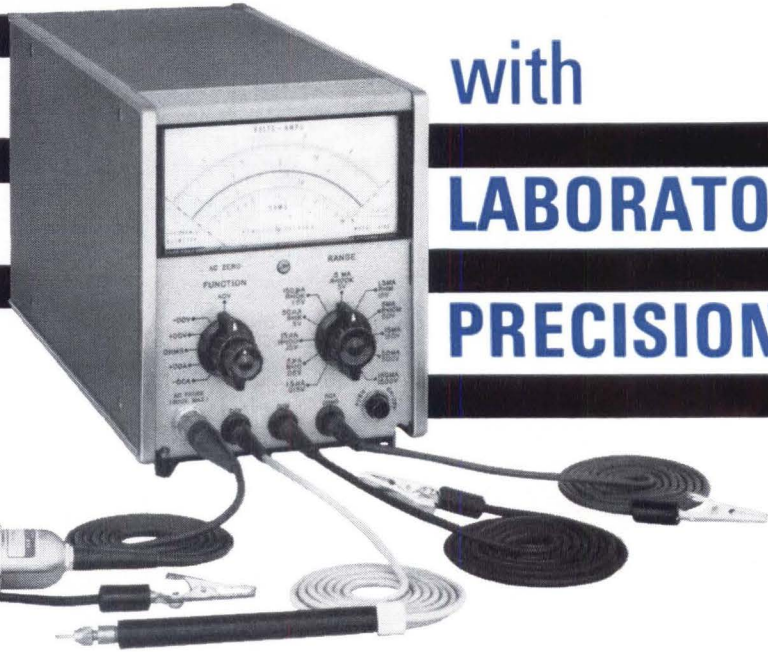

with LABORATORY PRECISION!

Look what you can measure with the hp 410C Electronic Voltmeter:

1. dc voltage, 1.5 mv to 1500 v; no zero set
2. dc current, 0.15 nanoamps to 150 ma; no zero set
3. ac voltage, 50 mv to 300 v; to 700 mc
4. resistance, 0.2 ohm to 500 megohms;
no zero or ∞ set

Never in electronic measurement has so small an instrument done so much so well! Ideal for use in the lab or service department or on the production line. A unique hybrid circuit eliminates drift (and the need for a zero set) and provides such features as 100 megohms dc voltmeter input impedance; low resistance recorder output, 1.5 v dc at full scale; dc voltage accuracy of $\pm 2\%$ of full scale, current accuracy of $\pm 3\%$ of full scale, floating input for measurement to 400 v above chassis ground. The 410C also incorporates a rugged individually calibrated taut band meter movement. Get all the facts from the specifications below. Then get a demonstration from your Hewlett-Packard field engineer.

Data subject to change without notice. Prices f.o.b. factory.

**HEWLETT
PACKARD
COMPANY**



1501 Page Mill Road, Palo Alto, Calif. 94304, (415) 326-7000. Sales and service in all principal areas. Europe, Hewlett-Packard S.A., 54 Route des Acacias, Geneva, Switzerland; Canada, Hewlett-Packard (Canada) Ltd., 8270 Mayrand St., Montreal, Que.

8690

DC VOLTMETER

Range: ± 15 mv to ± 1500 v full scale
Accuracy: $\pm 2\%$ of full scale, any range
Input resistance: 100 megohms $\pm 1\%$ on 500 mv range and above; 10 megohms $\pm 1\%$ on 15 mv, 50 mv and 150 mv ranges

DC AMMETER

Ranges: ± 1.5 μ a to ± 150 ma full scale
Accuracy: $\pm 3\%$ of full scale, any range
Input resistance: decreasing from 9 k ohms on 1.5 μ a scale to approx. 0.3 ohm on 150 ma scale
Special current ranges: ± 1.5 , ± 5 , and ± 15 nanoamps to $\pm 5\%$ on the 15, 50 and 150 mv ranges using voltmeter probe

OHMMETER

Range: 10 ohms to 10 megohms, center scale
Accuracy: $\pm 5\%$ of reading at mid-scale

AMPLIFIER

Voltage gain: 100 maximum
Output: proportional to meter indication; 1.5 v dc at full scale; maximum current 1 ma; impedance less than 3 ohms at dc

AC rejection: 3 db at $\frac{1}{2}$ cps; approx. 66 db at 50 cps and higher frequencies for signals less than 1600 v peak or 30 times full scale, whichever is smaller

Noise: less than 0.5% of full scale on any range (p-p)
DC drift: less than 0.5% of full scale/year at constant temperature; less than 0.02% of full scale/ $^{\circ}$ C
Recovery: recovers from 100:1 overload in less than 3 sec

AC VOLTMETER (hp 11036A AC Probe required)

Ranges: 0.5 v to 300 v full scale, 7 ranges
Accuracy: $\pm 3\%$ of full scale at 400 cps for sinusoidal voltages from 0.5 to 300 v rms; ac probe responds to the positive peak-above-average value of applied signal

Frequency response: $-3\% \pm 2\%$ at 100 mc; $\pm 10\%$ from 20 cps to 700 mc (400 cps reference); indications to 3000 mc

Frequency range: 20 cps to 700 mc
Input impedance: input capacity 1.5 pf, input resistance greater than 10 megohms at low frequencies; at high frequencies impedance drops because of dielectric loss
Meter: calibrated in rms volts for sine wave input

GENERAL

Maximum input: dc-100 v on 15, 50 and 150 mv ranges; 500 v on 0.5 to 15 v ranges; 1600 v on higher ranges; ac-100 times full scale or 450 v peak, whichever is less

Power: 115 or 230 volts $\pm 10\%$, 50 to 100 cps; 13 watts (20 watts with hp 11036A probe)

Dimensions: 6-17/32" high, 5-1/8" wide, 11" deep behind panel

Price: hp 410C, \$350 including 11036A ac probe

Option 02: hp 410C without ac probe, \$300

LEWIS H. YOUNG, Editor
Dial Direct: (971-2645)
Area Code 212

JANUARY 24, 1964

J. M. CARROLL, Managing Editor (2293)

SENIOR EDITORS
Samuel Weber (2371)
George W. Sideris (3444)

SENIOR ASSOCIATE EDITORS
Michael F. Wolff (2600)
John F. Mason (2666)

ASSOCIATE EDITORS
Michael F. Tomaino (2071)
William P. O'Brien (2297)
George J. Flynn (2188)
George V. Novotny (3151)
Leon H. Dulberger (3446)
Alexander A. McKenzie (2685)

ASSISTANT EDITORS
Stephen B. Gray (2245)
Barry A. Briskman (2306)
Dan Smith (2467)
Joel A. Strasser (2127)
Vincent S. Acunto (2592)
C. R. Whetstone (3495)
Eric Valentine (2710)
Louis S. Gomolak (2472)
G. G. Tirellis (2187)

REGIONAL EDITORS
Harold C. Hood,
1125 W. 6th St., Los Angeles 90017, Calif.
(213-482-5450)
Laurence D. Shergalis,
John Hancock Bldg., 255 California St.,
San Francisco 94111, Calif. (415-362-4600)
Thomas Maguire
McGraw-Hill Bldg., 607 Boylston St.,
Boston 02116, Mass. (617-262-1160)
Cletus M. Wiley,
Blair Bldg., 645 N. Michigan Ave.,
Chicago 60611, Ill. (312-664-5800)

ART DIRECTOR
Howard R. Berry (2430)

ASSISTANT ART DIRECTOR
John C. Wright, Jr. (3430)

EDITORIAL ASSISTANTS
Lorraine Rossi, Virginia T. Bastian,
Lynn Emery, Ann Mella, Lorraine Werner,
Alice M. Moyer, Sharon Parks,
Claire Benell, Kay Fontana,
Sandra A. Le Mond, Mary Jo Jadin

FOREIGN NEWS BUREAU
DIRECTOR, John Wilhelm, (2532);
Lawrence Mihlon (2997), Alyne Elias
(2998)
LONDON—John Shinn, Derek Barlow,
Nicholas Landon, 34 Dover St., London
W.1, England
BONN—Richard Mikton,
Silke McQueen, Mittelstrasse 39, Bad
Godesberg, Germany
BRUSSELS—Arthur Erikson, 27 Rue Ducarle,
Brussels, Belgium
PARIS—Robert Farrell, 17 Ave. Matignon,
3rd Fl., Paris 8, France
MILAN—Bruce Bendow, Via Manzoni
No. 12, Milan, Italy
MEXICO CITY—Wesley Perry, Jr.,
Lafraqua 4-314, Mexico 1 D.F. Mexico
RIO DE JANEIRO—Leslie Warren, Rua
Mexico 3-S/1507 1509, Rio de Janeiro,
Brazil
MOSCOW—Donald Winston,
Kutuzovskiy Prospekt 19, Apt. 28-29,
Moscow, USSR
TOKYO—Richard Halloran, Charles Cohen,
John Yamaguchi, Toranomon Sangyo
Bldg., 1 Kotohiracho Shiba, Minato-Ku,
Tokyo, Japan

CIRCULATION MANAGER
Hugh J. Quinn (2310)

C. C. RANDOLPH, Publisher (2016)

electronics

A MCGRAW-HILL PUBLICATION 75 CENTS

ENCODING DISKS with up to 32,768 lines (one line per 40 sec of arc) have been produced by the David W. Mann Co. A step-and-repeat instrument combines with a circular dividing engine to make the disks. A master plate with a diamond-ruled slit is placed on the step-and-repeat device while a sensitized disk is placed on the dividing engine. *As the disk moves beneath a projector, a light flashes through the slit opening to form the desired line image.* See p 56

COVER

DOD AND NASA BUDGETS: AUSTERE. Defense Department's \$51.1-billion budget for fiscal 1965 shows a drop of \$1.1 billion in spending. NASA's asking for \$5.3 billion, up \$200 million. *Both are tightening up on key programs*

10

TV FROM THE MOON. Next week, a Ranger space probe is scheduled to make another try at obtaining close-up tv transmission from the moon. This time, a battery of six tv cameras will be used. *A unique sequencing system and more powerful transmitters will, NASA hopes, send about 3,000 photos back to earth*

14

THIN-FILM ACTIVE DEVICES. This survey delineates the future of thin-film field-effect devices as amplifiers, varistors and current limiters. Most of the devices are made from cadmium sulfide. *One application contains an array of 81 devices per square centimeter.* By C. Feldman, Melpar, Inc.

23

SATELLITE COVERAGE CIRCLES. This graphical method will solve most circular-orbit cases to determine the possibility of communications by satellite. *Until now plotting the coverage circle of a satellite was tedious because of the extreme distortion of many map projections.*

By D. Levine and W. H. Welch, Lockheed

27

SQUARE-ROOT COMPUTER. Here is a simple way to find the square root of the sum of the squares of three variables. *The circuit represents still another application of the Hall-effect multiplier.* By H. H. Wieder, U. S. Naval Ordnance Lab, Corona

30

STABILITY IN SPACE TELEMETRY. Automatic-frequency-control loops are essential in design of satellite telemetry systems. A crystal discriminator in the afc loop gives a free-running voltage-controlled oscillator the stability of a crystal oscillator for slow changes. *But it permits a deviation of plus or minus 300 kc.*

By F. L. Carroll, Sylvania

32

Contents continued

Published weekly, with Electronics Buyers' Guide as part of the subscription, by McGraw-Hill, Inc. Founder: James H. McGraw (1860-1948).

SUBSCRIPTIONS: Available only by paid subscription. Publisher reserves the right to refuse non-qualified subscriptions. Subscriptions to Electronics solicited only from those actively engaged in the field of the publication. Position and company connection must be indicated on subscription orders forwarded to address shown below. Subscription rates for individuals in the field of the publication: U. S. and possessions and Canada \$6 one year, \$9 two years, \$12 three years (single copies 75¢). All other countries \$20 one year (single copies \$1.50).

EXECUTIVE, EDITORIAL, CIRCULATION and ADVERTISING OFFICES: McGraw-Hill Building, 330 West 42nd Street, New York, N. Y., 10036. Telephone Area Code 212-971-3333. Teletype TWX N. Y. 212-640-4646. Cable McGrawhill, N. Y. Printed in Albany, N. Y. Second class postage paid at Albany, N. Y. Title reg. ® in U. S. Patent Office. Copyright © 1964 by McGraw-Hill, Inc. All Rights Reserved. The contents of this publication may not be reproduced either in whole or in part without consent of copyright owner.

OFFICERS OF MCGRAW-HILL PUBLICATIONS: Shelton Fisher, President; Vice Presidents: Joseph H. Allen, Operations; John R. Callahan, Editorial; Ervin E. DeGraff, Circulation; Donald C. McGraw, Jr., Advertising Sales; Angelo R. Venezian, Marketing.

CORPORATION OFFICERS: Donald C. McGraw, President; L. Keith Goodrich, Hugh J. Kelly, Harry L. Waddell, Executive Vice Presidents; John J. Cooke, Vice President and Secretary; John L. McGraw, Treasurer.

UNCONDITIONAL GUARANTEE: The publisher, upon written request, agrees to refund the part of the subscription price applying to the remaining unfilled portion of the subscription if service is unsatisfactory.

SUBSCRIBERS: Please address all correspondence regarding subscriptions, change of address notices, and subscription orders to Fulfillment Manager, Electronics, P. O. Box 430 Hightstown, N. J., 08520. Change of address notices should be sent promptly; provide old as well as new address; include zip code or postal zone number if any. If possible, attach address label from recent issue. Please allow one month for change of address to become effective.

POSTMASTER: Please send Form 3579 to Fulfillment Manager, Electronics, P. O. Box 430, Hightstown, N. J., 08520.

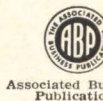
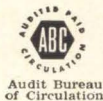

Contents continued

COMPRESSOR AMPLIFIER. Variable-gain amplifier accepts frequencies from 200 cps to 10 kc. It compresses a dynamic range of 1-to-30 to a variation of 1-to-15. *Can be used as a constant-voltage or current control and for constant transducer displacement.* By L. M. Hilles, Cohu Electronics 36

REFERENCE SHEET: DOUBLE-TUNED CIRCUITS. Use of double-tuned transformers in r-f stages reduces the number of tubes or transistors in a superheterodyne receiver's front end. *Graphs simplify the problem of designing tuned amplifiers in which coupled circuits are used.* By D. B. Hoisington, U. S. Naval Postgraduate School 39

MARINE ELECTRONICS. Pleasure boaters are buying more electronics, but it's a rough market. Faced by uncertain demand, manufacturers play down equipment development, step up efforts to raise their own quality and prestige. *Vhf and ssb, for example, are considered 5 to 10 years away* 42

DEPARTMENTS

Crosstalk. This Time, Let's Be Ready 5

Comment. Data. Crystal-Controlled Multivibrator 6

Electronics Newsletter 17

Meetings Ahead. ISA International Instrument-Automation Conference and Exhibit 18

Washington This Week. Senate To Review ICBM Reliability 20

Research and Development. On the Way: Microcircuit Doppler Radar 48

Components and Materials. Delay Line Has Infinite Resolution 52

Production Techniques. Harness Tester Detects and Remembers Intermittent Faults 57

New Products. Comparator Has Extended Range 58

Literature of the Week 63

People and Plants. UTP Plans New Plant 64

Index to Advertisers 68



Testing Integrated Circuits? reduce test time and cost

With TI's new Integrated Circuit Tester, the 659A, you can make 36 d-c or logic function tests on integral circuit packages in less than 2 seconds. Two-terminal (Kelvin) connections are made to 14 active leads. You can stack two units—operate them in series—for a 72 test sequence. You can program the 659A easily using printed circuit boards for bias conditions, tim-

ing, limits, and sorting logic. Integral circuit packages, no matter their size or shape, mount on device holders which plug into the test socket. To operate, simply press the start button. Four solid-state power supplies provide test bias voltages. Internal logic determines classification to 15 categories for use with a companion sorter. Failures are indicated on front

panel lights. The 659A is compact, yet designed for ease of maintenance. Test points are accessible on the front panel, printed circuit boards are easily removable . . . and the basic unit is priced at \$16,500 f.o.b. plant. Let a TI representative show you the advantages of 659A integrated circuit testing.

Write for complete information.

INDUSTRIAL
PRODUCTS
GROUP



TEXAS INSTRUMENTS
INCORPORATED
P. O. BOX 66027 HOUSTON 6, TEXAS

GOD

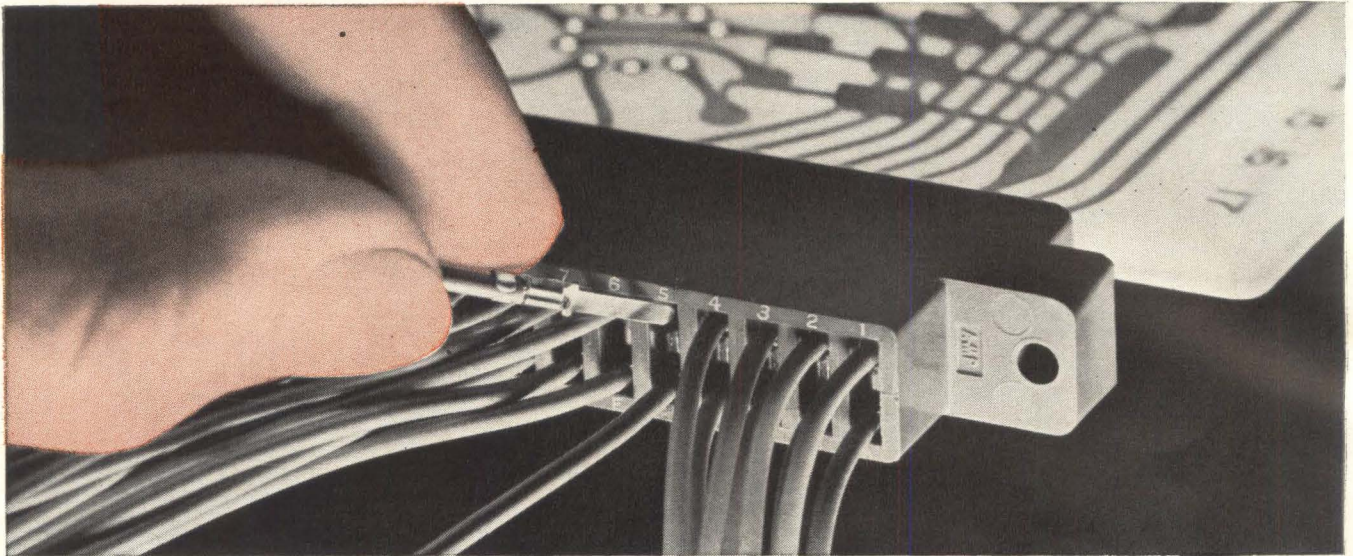

Home . . .

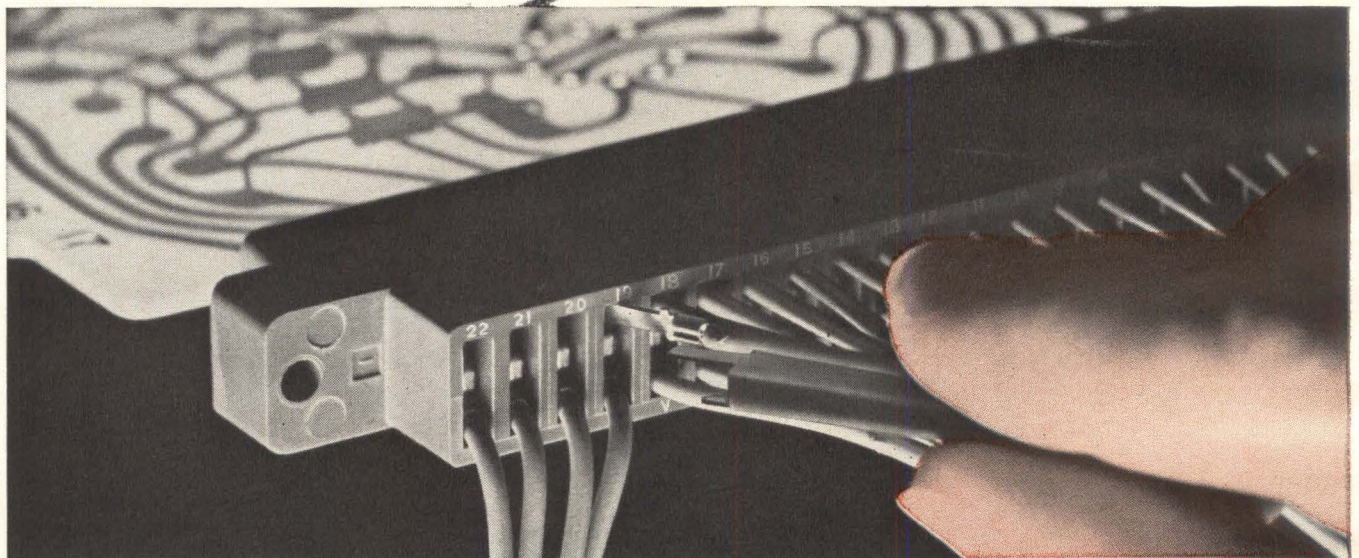

for quick change artists

Circuit changes, replacements or repairs . . . all these can be done faster with this new AMP-TAB★ Printed Circuit Connector and you need never take the connector off the board!

In this connector, easy hand insertion of tab terminals puts large-surface, formed tabs in touch with pre-inserted contacts. A metal to metal snap-lock device holds the tab securely in place, a simple extraction tool gets them out . . . just that quick! This means contacts last longer and blocks are not subjected to high insertion and extraction forces which may cause block damage.

You get other benefits too! Maximum density through design centers of .100, .125 and .156 inches. Commoning, built-in, for dual read-out and circuit redundancy. And spring values that maintain constant and uniform pressures on circuit paths.

All this is what's different but, you still get other premium AMP-line features. Contacts and tabs of phosphor-bronze base material with standard gold over nickel plating. Our reliable "F" crimp for maximum conductivity, near-wire tensile strength and built-in insulation support. And . . . automatic application of leads to tabs

at rates of up to 3,000 per hour for the lowest possible applied cost anywhere.

There's more!

- inter-contact keying plugs
- anti-flashover egg-crating insulates each terminal. Sleeving unnecessary
- dimensions and performance conform to MIL-C-21097
- available in 10, 15, 18, 22, 31, 41 and 43 positions for wire ranges—#18 AWG thru #26 AWG

And, there's still more! Just send today for the complete story on our new AMP-TAB Connector for Printed Circuits.

★Trademark of AMP INCORPORATED



AMP products and engineering assistance are available through subsidiary companies in: Australia • Canada • England • France • Holland • Italy • Japan • Mexico • West Germany

THIS TIME LET'S BE READY

DON'T GET COMPLACENT about all the blue-sky publicity that that has been associated with optoelectronics. It isn't that blue-sky any more.

Naturally, a designer toiling away on such well-established tasks as digital logic or industrial controls might assume that optoelectronics is a remote technology—particularly when optoelectronics makes headlines with such grandiose schemes as a laser space tracker with a 50-million-mile range, death rays, on-the-wall tv and the like.

The designer is lulled into feeling that all that is "ten years away" and of no direct concern to him. That's what some people said about transistors in 1950. And they had to scramble like the dickens to catch up.

Evidence is building up that we really are entering the new era of solid-state optoelectronics—and fast. All the clues indicate that optoelectronic technology (quick, somebody, an abbreviation!) has reached the same level the transistor reached in 1950.

Once again, the industry may be transformed.

One doesn't have to think big to see how light can do some things better, and do some things once considered impossible.

Even a brief skull session on the uses of light interaction in solid-state materials reveals a breathtaking number of attractive possibilities: using a light-emitting diode with a phototransistor in an amplifier with almost infinite input-output isolation; using light-sensitive devices to perform switching and other digital functions with almost instantaneous rise and fall times, etc., etc., etc.

The wide-bandwidth capabilities of optical communications are well known. But what about optical coupling instead of magnetic flux coupling in transformers and transducers? Or how about solving some of those knotty problems in microcircuit interconnection? Or why not replace those ordinary, but relatively complex, photoflash systems with a battery plus a light-emitting diode with a light spectrum tailored to the photographic problem at hand?

Our feelings are confirmed by a chat we had with RCA's E. O. Johnson, chairman of the upcoming International Solid State Circuits Conference. He is convinced, too, that optoelectronics is the next important art in electronics, and not very far away. The conference program reflects this in seven papers and two evening panel discussions.

Johnson believes that the potential efficiency of the devices emerging from the labs—lasers and light-emitting diodes, and the more familiar solar cells, optical fibers, photodetectors and phototransistors—and their inherent circuit compatibility are their chief attractions.

Better start cracking the books on optics. And we intend to do our part, by reporting this exciting new field until the concept of photons becomes as familiar and practical as the concept of electrons and holes.

New from Sprague!

GERMANIUM P-N-P 2N2962



**Extends High-Efficiency
ECDC Transistor
Performance to
VHF POWER RANGE**

- High Voltage—40 Volts
- High f_T —800 mc (typ.)
- Isolated Mounting Stud offers Design Freedom

TYPE	V_{CES}	$P_G @ 160 \text{ mc}$	$P_o @ 160 \text{ mc}$
2N2962	40 V	6 db	.5 W
2N2963	40 V	5 db	.5 W
2N2964	30 V	6 db	.5 W
2N2965	30 V	5 db	.5 W

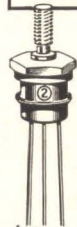

For application engineering assistance, write to Transistor Division, Sprague Electric Co., Concord, N. H. For technical data, write for Engineering Bulletins 30,452 and 30,454 to Technical Literature Service, Sprague Electric Co., 35 Marshall St., North Adams, Mass.



AST-165-63

COMMENT

DATA

I am disappointed by the manner in which you replied to Professor Varden regarding the word *data* in your *Comment* of Dec. 13, 1963 (p 6). Having based your defense on such vague statements as "we generally prefer the singular" and "*data* is not infrequently used as a singular," you dismissed the subject and Professor Varden with the flippant question, "... does anybody ever say, 'Our datum is . . . ?'". The answer to your question is a resounding YES—whenever the phrase is applicable.

It is interesting to note that Webster's Dictionary does not state that the use of the word *data* in the singular sense is correct, it merely records that the word is *not infrequently* used. This is the same authority which surrendered to pressure and included in a recent edition that horribly incorrect word *irregardless*, which action elicited an editorial in a national magazine. . . .

In this era of frequent complaints from senior business executives about the inferior ability of engineers in grammatical composition, it is the responsibility of such influential publications as yours to lead the way in this important aspect of engineering. . . .

J. L. COFFELL

Ottawa, Ontario
Canada

• About the time that such phrases as "if I was you" and "do like I say" become accepted usage, and they seem to be approaching it, *data* will be socially acceptable as the singular, whether we like it or not.

That dictionary, rather than having surrendered, has merely stopped trying to define that amorphous mass called "standard English," and now concerns itself with reporting current usage. For an interesting comment on dictionaries and usage, see Kim Boriskin's letter in the issue of March 15, 1963 (p 4).

CRYSTAL-CONTROLLED MULTIVIBRATOR

Approximately every three years someone discovers or reinvents the crystal-controlled multivibrator. Your issue of April 12, 1963 (p 60) contains the latest occurrence of this phenomenon. In this particular instance the multivibrator is transistorized, but in no other way is it essentially different from the previous "inventions of the wheel."

There is a general principle usable in oscillator design at work here. Any relaxation oscillator may be made into a sinusoidal oscillator by incorporating a resonator and adjusting the operating point. By overdrive so that limiting occurs at some point in the circuit, this oscillator will produce a squared-up output signal. The resonator will be a single frequency filter (within the limitations imposed by Q), producing a sinusoidal wave of current or voltage depending on the condition of resonance or antiresonance (respectively) of the resonator. . . .

JOHN H. SHERMAN, JR.
Quartz Crystal Engineer

Communications Products Department
General Electric Company
Lynchburg, Virginia

• The author replies:

I was not aware that a crystal controlled multivibrator has even been written up before and my patent search to date has not revealed one.

Mr. Sherman's [statement regarding overdrive] is quite true and well-known. It takes a vivid imagination, however, to compare this with a square wave usable for a computer application. In my circuit, the output waveforms had rise times in the order of less than 10 nanoseconds. By overdrive you would be very fortunate to get anywhere near this figure.

I would also like to point out that any amplifier can be made into an oscillator by using excessive regeneration, yet there are hundreds of patents on both these types of circuits. Also, the multivibrator circuit in the article could provide asymmetrical waveforms by using two different frequency crystals. I feel this is essentially different from previous "inventions of the wheel" (if they exist). . . .

HARRY R. NEWHOFF

Litton Systems, Inc.
Woodland Hills, California

COLOR TELEVISION

In your *Newsletter* item, Wide-Angle CRT Shrinks Japanese Color-Tv Set (p 18, Dec. 13, 1963), the price was misprinted as \$368 rather than the correct \$638 (domestic price in Japan).

W. OZAKI

Matsushita Electric Industrial Co., Ltd.
Osaka, Japan

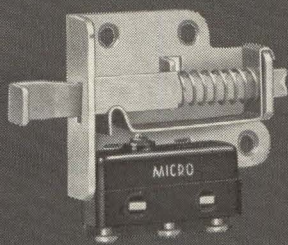

ACTUAL SIZE

"AC" INTERLOCK breaks circuit when door is opened... but allows CIRCUIT TESTING



MICRO SWITCH interlock switches automatically break the power circuit when doors or drawers are opened. However, the switch can be manually operated to energize the circuit for testing or checking. This eliminates the use of dangerous jumpers or tie-downs. When the door is closed, normal operation is resumed.

MICRO SWITCH interlock protection has been proved through the years on thousands of applications. MICRO SWITCH interlocks include sealed environment-proof and high temperature designs, subminiature and multi-circuit assemblies—your choice of more than 150 different interlock switches.

Send for Data Sheet 186 or see the Yellow Pages for the nearest MICRO SWITCH Branch Office.

OVER 150 INTERLOCK SWITCHES AVAILABLE

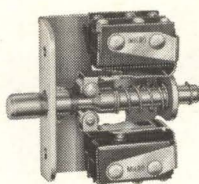

"8AC" Series

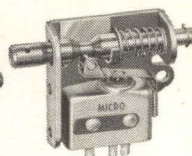

"9AC" Series

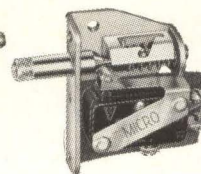

"13AC" Series

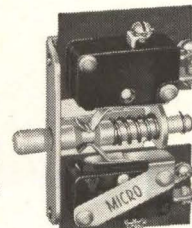

"24AC" Series



MICRO SWITCH

FREEPORT, ILLINOIS 61033

A DIVISION OF HONEYWELL

HONEYWELL PRESENTS



SCIENCE ALL STARS • SUNDAYS 4:30 E.S.T.
Beginning January 12

HONEYWELL INTERNATIONAL—SALES AND SERVICE OFFICES IN ALL PRINCIPAL CITIES OF THE WORLD. MANUFACTURING IN UNITED STATES, UNITED KINGDOM, CANADA, NETHERLANDS, GERMANY, FRANCE, JAPAN.



if your subminiature coaxial connector isn't here

Because there's a Subminax® coaxial connector that mates with or is interchangeable with every known subminiature connector on the market today. No matter which connector you are presently using, FXR's complete line of 117 different Subminax connectors includes its mate and its replacement—on the shelf.

Our series 5116 Subminax connectors are quick-crimp for fast assembly. Only three parts, including body assembly. 500 VRMS; impedances of 50, 75, or 90 ohms; with your choice of screw-on or push-on coupling. And

priced substantially below competitive "equivalents".

Our series 27 Subminax connectors are available in radial-crimp, braid and compression clamp, and hex-crimp. Same high-level electrical and mechanical performance as our series 5116.

For information, quotations and deliveries, contact Kent Buell, FXR, 33 East Franklin Street, Danbury, Connecticut, or your Amphenol-Borg distributor.

FXR™ THE RF PRODUCTS AND MICROWAVE DIVISION
OF AMPHENOL-BORG ELECTRONICS CORPORATION

it's nowhere

Defense and Space Money Tighter

PENTAGON PUTS BRAKES ON SPENDING

Spending requests for fiscal 1965 are \$1.1 billion lower than 1964
But carryovers will hold the decline to only \$100 million for now
Missile spending drops sharply, from \$3.7 billion to \$2.6 billion

NASA PLOWS ITS FUNDS INTO APOLLO

NASA wanted \$5.9 billion. This has been pared down to \$5.3 billion
More than 80 percent of the money is earmarked for the lunar landing
Tracking network will be expanded to meet Project Apollo's needs

By **SETH PAYNE**

HERBERT CHESHIRE
McGraw-Hill World News

Washington—Both the Defense Department and National Aeronautics and Space Administration will be operating under austere budgets for the fiscal year starting July 1, but the electronics industry will still find a whopping market in both.

Defense Spending Down—The military will spend \$51.1 billion during the year, about \$1.1 billion less than currently. But its request to Congress for new spending authority, which affects the size of defense outlays beyond the coming year, does not show so substantial a drop.

New appropriations requests, plus the carryover of past funds not yet obligated, would give the Defense Department total spending authority of \$52.4 billion, down only \$100 million from the current total.

Still a reduction of significance to the electronics industry—both in '65 outlays and in longer-range spending plans—is occurring in the procurement of strategic weapons. This means that the buildup in long-range ballistic missiles, strategic aircraft and nuclear submarines is "peaking out." Also new spending requests

for military research, development test and evaluation (RDT&E) are down slightly—from \$6.9 billion in the current year to \$6.7 billion.

NASA Up, But Tight—NASA is seeking \$5.3 billion from Congress, a peak budget but far below what the agency wanted. To keep on its time schedule for landing a team of astronauts on the moon this decade, more than 80 percent of NASA's budget must go into the lunar landing program. Even with this share of the money, the program has been pared back sharply. So NASA claims it must have every penny of its budget request or the moon program will slip beyond the 1970 target date.

Defense Budget Details — Electronics procurement is not specifically identified in the defense budget. But based on unofficial, though authoritative estimates, electronic equipment buying accounts for about 25 percent of aircraft procurement (see table), 35 percent of the missile dollar and 30 percent of research, development, test and evaluation.

The 1965 budget provides for 50 additional Minuteman missiles, bringing to 1,000 the number approved through the new year. The budget also continues procurement of the Bullpup, Sparrow and Shrike

missiles and provides for six new missile-firing submarines. Money also is sought for an extensive program to improve missiles in the existing arsenal, including modifications to earlier versions of Minuteman and Polaris to increase their range and versatility.

In the aircraft field, 889 new planes will be bought, compared with 840 this year. Most of these will be tactical and airlift aircraft. Also, modifications will be made to the B-52 to continue its effectiveness in future years.

Nike X Antimissile—Research and development money will provide for continued work on a priority basis of the Nike X antimissile system, as well as continued exploration of more advanced antimissile defense concepts. Other major outlays will be for work on the new mobile mid-range missile, the new F-111 tactical fighter for use by both the Navy and Air Force and a step-up in antisubmarine-warfare research.

As previously announced, the military budget reflects cancellation of the Dynasoar manned spacecraft project and its replacement by a manned orbital laboratory program.

The defense budget also includes money requests for electronics and communications equipment not associated directly with missiles and

aircraft. This "other procurement" category provides for increased buying by the Defense Communications Agency, but calls for decreases in Air Force procurement of electronics, telecommunications and automatic data processing equipment for communications and intelligence programs.

Apollo Program—NASA actually wanted some \$5.9 billion in new money for fiscal year 1965. The President, however, held the request to \$5.3 billion, but allowed a \$141-million supplemental request, all of which will go into the Apollo program.

In addition, NASA has been forced to channel another \$73 million in funds to the two-man Gemini project through reprogramming. Congress was notified of this action last week, as is required by law. Need for the additional money on Gemini stemmed from problems that arose in developing fuel-cell power for the craft and problems in perfection of the reaction-control system.

Electronics Research Center—Of particular interest to the electronics industry is provision to move ahead with a new electronics research center. Some \$10 million is provided for an administration building and laboratories with a staff of over 200 expected to be assembled during 1965. So far, NASA has not announced the site selected for the center. However, there is virtual assurance that it will be located in the Boston area just as NASA wanted to do more than a year ago. At that time, however, Congress ordered a new study made before finally okaying a location for the center. NASA is expected to notify Congress of its choice of a site this month. Then, the legislators have 45 days to protest the measure.

Tracking Stations—Maintaining and expanding the net of tracking stations needed for the lunar landing program as well as deep space probes will cost some \$267.9 million in 1965, up from the \$210 million in the current budget. The added money provides for three new Apollo tracking stations to be built. One will be located in the northwest Pacific and the other two are aug-

mentation of two Department of Defense stations downrange in the Atlantic Missile Range.

NASA won't pinpoint their locations at this time. Also included is a deep-space tracking station to be built in Spain. Final diplomatic agreements have not been reached as yet, however. It will be similar to the Goldstone station in California, and include an 85-ft antenna.

Computer Buying — Starting in 1965, NASA will begin buying more of its computer equipment instead of renting it. Some \$65 million is contained in the new budget for the purchase of this equipment. This is in conformance with a Bureau of the Budget directive of some years back allowing government agencies to buy equipment where it was more economical to do so in the long run.

DEFENSE BUDGETS, FISCAL YEARS 1964 AND 1965

	FY 1964 (Billions of Dollars)	FY 1965 (Billions of Dollars)
Total Defense Budget		
New Appropriations.....	50.9	50.8
Expenditures.....	52.2	51.1
Total Military Procurement		
New Appropriations.....	15.7	13.7
Expenditures (essentially deliveries).....	16.3	14.8
New Appropriations for Hardware.....	11.4	10.6
Missiles.....	3.7	2.6
Aircraft.....	5.7	5.9
Ships.....	2.1	1.9
Other Procurement		
Army Electronics & Communications.....	357	201
Navy Electronics & Communications.....	499	444
Air Force Electronics & Communications.....	485	435
Total Research, Development, Test and Evaluation		
New Appropriations.....	6.9	6.7
Expenditures.....	6.9	6.6

NASA'S PROPOSED BUDGET FOR SPACE PROGRAMS

	FY 1964 (Appropriated) (Millions of Dollars)	FY 1965 (Requested)
Total NASA Budget		
New Appropriations.....	\$5,100	\$5,304
Expenditures.....	4,300	5,000
Supplemental for FY 1964 for Project Apollo.....	141	...
Major Programs		
Manned Space Flight.....	2,790*	3,011
Geophysics and Astronomy.....	186	190
Lunar and Planetary Exploration.....	270	300
Launch Vehicle Development (other than manned flight).....	125	128
Bioscience.....	20	31
Meteorological Satellites.....	68	38
Communications Satellites.....	14	13
Advanced Technological Satellites.....	19	31
Basic Research.....	21	21
Space Vehicle Systems.....	49	39
Electronic Systems.....	29	28
Human Factor Systems.....	13	16
Nuclear-Electric Systems.....	45	48
Nuclear Rockets.....	83	58
Chemical Propulsion.....	46	60
Space Power.....	13	13
Aeronautics.....	22	37
Tracking and Data Acquisition.....	210	268
Construction.....	674	281
Other Programs.....	544	693
Total.....	5,241	5,304

* Includes supplemental.

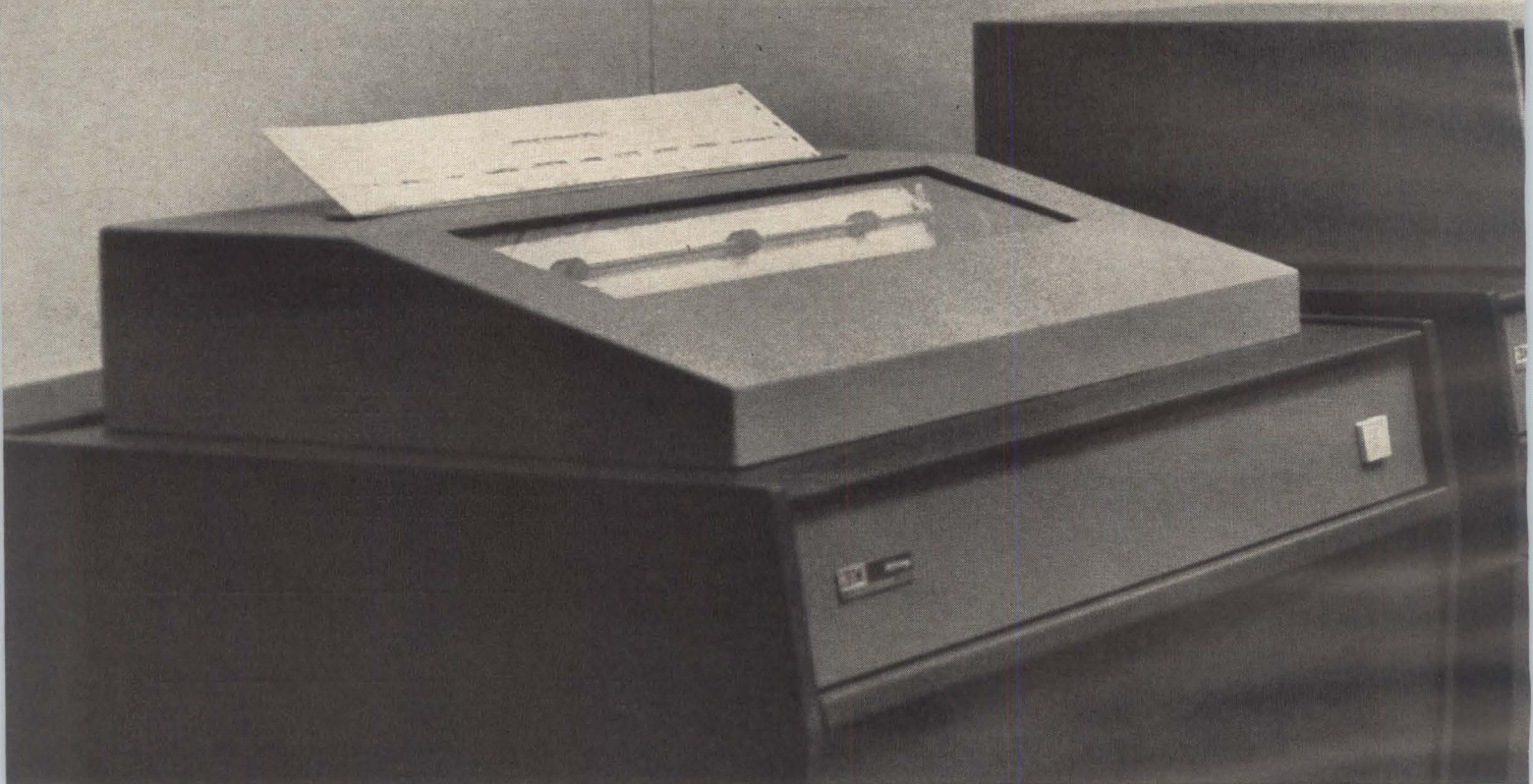

What's going on here – right this minute?

He's using IBM's new Data Collection System to report production information.

Installed throughout all your plant's operating areas, this new system provides the up-to-the-minute information you need to control your manufacturing operation.

IBM's new Data Collection System provides instant two-way communication between all your plant's operations and your central computer. Information can flow to and from fabrication, assembly, raw materials and parts. It's information for action.

With this kind of instant communication, you'll have all the information you need for on-the-spot decisions—the day-to-day decisions that affect the production cycle in your plant. And important information occurring in one area, can be communicated to all the other affected areas in seconds.

Find out how high-speed data collection and dissemination can improve your plant's operations. Call IBM.

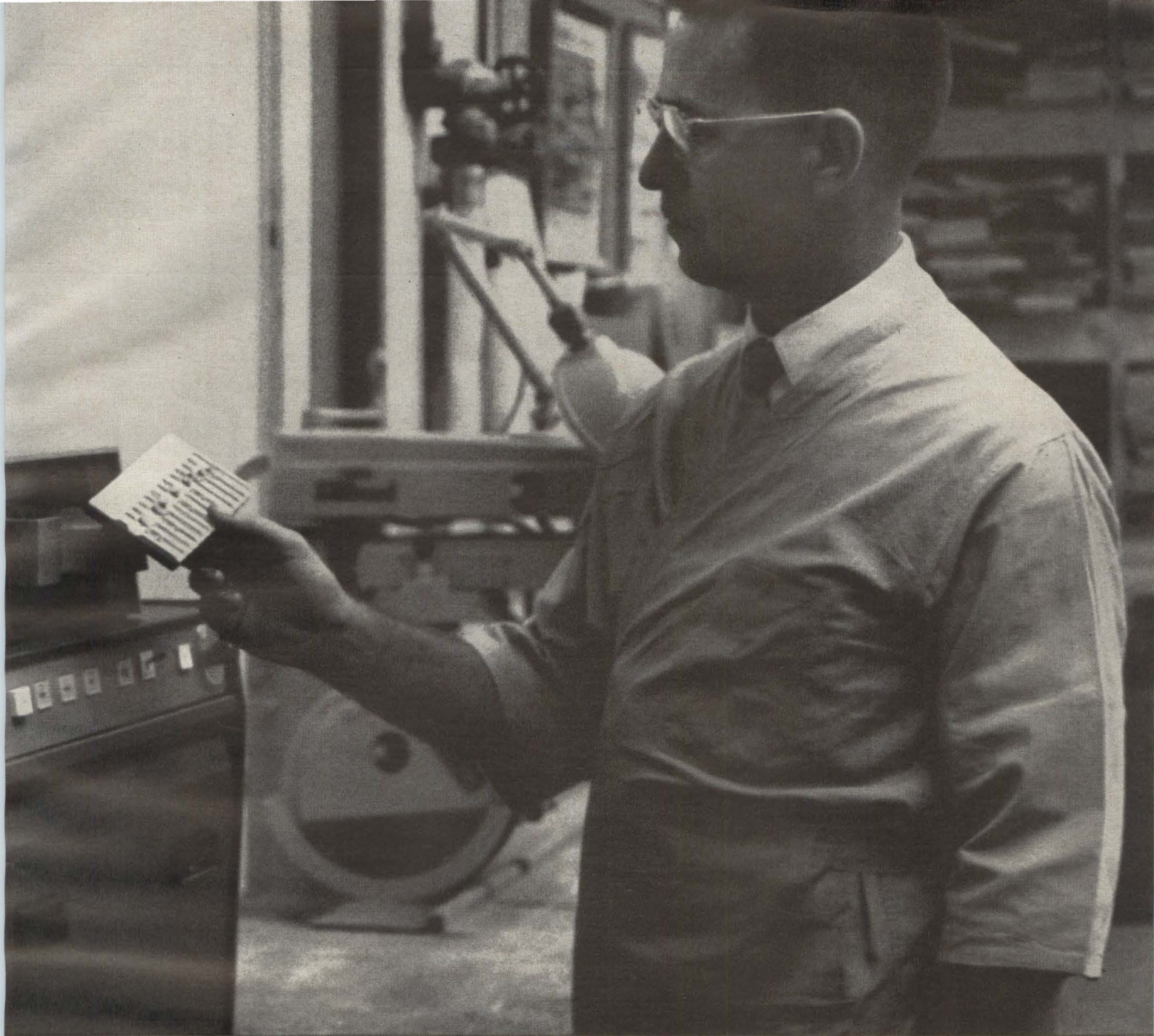

IBM 1030 Data Collection Units are installed anywhere you need them throughout your factory. Employee uses new IBM data cartridge to record information and transmit it to the central computer.

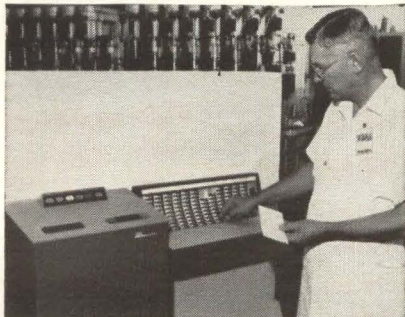

The IBM 357 Data Collection System records information, from any location in your plant, directly onto IBM punched cards. Input stations record data from badges, cards or manual keyboard.

IBM[®]
DATA PROCESSING

CIRCLE 13 ON READER SERVICE CARD

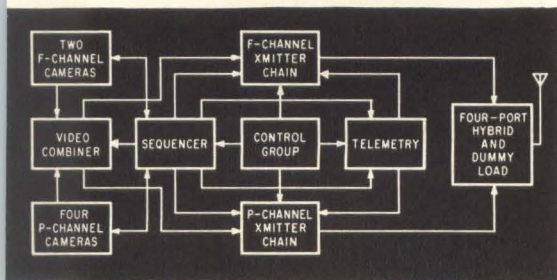

CAMERA CHAINS for the full-scan and partial-scan channels are independent. F-channel is transmitted at 959.52 Mc, P-channel at 960.58 Mc

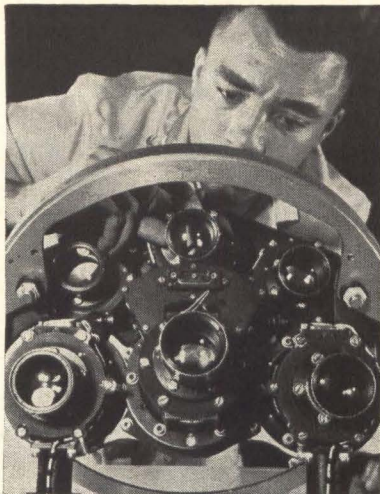

SIX TV CAMERAS—three wide-angle and three narrow-angle—will take the first close-up tv pictures of the moon

CAMERAS ARE ADJUSTED at RCA Space Center to peer out of port-hole in Ranger 6 spacecraft

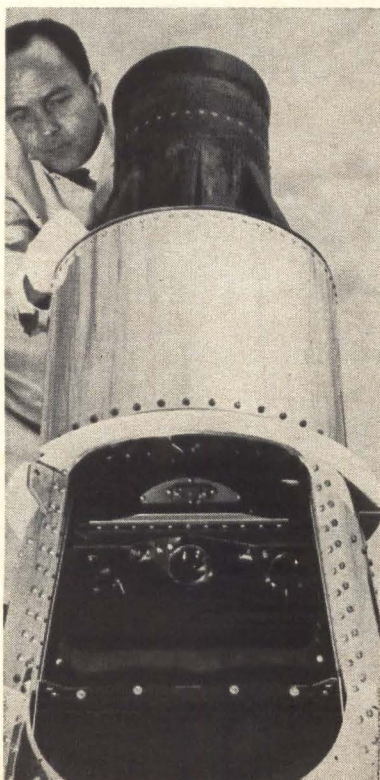

Close-up pictures from Ranger 6 will aid later Apollo flights

THE MOON: Before We

By JOEL A. STRASSER
Assistant Editor

HIGHSTOWN, N. J.—Next week, another Ranger space probe is scheduled to go on a one-way trip to the moon. If Ranger 6 succeeds in sending close-up tv pictures back to earth as it crash lands, it will have accomplished a job that three previous Rangers failed to do. And it will have set a new record for tv transmission—239,000 miles.

Ranger 6, scheduled for launch by NASA January 30 from Cape Kennedy, stands a better chance of achieving its goals. Bernard P. Miller, RCA's Ranger project manager, told *ELECTRONICS*. This confidence stems from the following improvements that have been built into the new Ranger:

- Number of tv cameras has been raised to six, to increase the number of detailed pictures transmitted in the 10 minutes before impact. A unique sequencing arrangement schedules their transmission.

- Transmitter output power has been raised to 60 w, the most power ever transmitted by a spacecraft. This compares with 3 w in previous Ranger one-camera systems.

- Completely redundant systems characterize spacecraft electronics. Ranger's six-camera tv subsystem has two independent channels.

- Reliability on both booster and tv subsystem has been tightened up through more rigorous testing and more careful component selection.

- Electronics are "right on the state of the art," according to Miller. Power amplifiers and the dummy load have been pressurized to counter the breakdown phenomena. These include both the partial pressure type of breakdown and "multipactor"—a-c or r-f breakdown that occurs only in hard vacuum as a result of secondary emission. Video combiner, previously a coaxial type, is now a solid-state device.

- Passive thermal control system, completely independent of JPL's, is built into the RCA portion of the electronics. The body of the tv sub-

system is used as a heat sink.

Ranger 6 is, however, "still a high risk type of shot" because of its difficult midcourse and terminal maneuvers, according to Miller. RCA built the tv subsystem for Ranger under contract to Jet Propulsion Laboratory. The systems are identical for Rangers 6 through 9.

Plans are to transmit a warm-up signal to the cameras 15 min before hard impact on the moon. The picture-taking sequence will start 10 min before Ranger impacts at 6,000 mph.

As Ranger falls toward the moon, area coverage is traded for increasing resolution. Some 3,000 pictures covering 101 nautical miles on a side from about 700 n miles from the surface down to pictures covering 123 ft on a side from about 2,000 to 3,000 feet up should result.

Television Subsystem—The six tv cameras (three are 1-inch wide-angle types and three 3-inch narrow-angle types) are mounted at slightly different angles.

Two cameras (one of each size) provide a full-scan of 800 resolution lines, and are in the F-channel (see diagram). Four cameras (two

BEFORE 6—1, 2, 3, 4, 5

RANGERS 1 and 2, launched in 1961, went into low earth orbits, rather than their programmed deep-space orbits, but achieved their primary objectives—testing the spacecraft.

In 1962, Ranger 3, the first to carry a tv camera, went into orbit around the sun after missing the moon. Ranger 4 (dubbed "Brainless I") impacted the moon but did not send back any data. And Ranger 5 lost power after launch and missed the moon by about 450 miles. Primary mission of these three was to obtain seismic data—tv was secondary.

On Ranger 6, tv is the primary mission

We Look Leap

of each size) provide partial-scan (P-channel) coverage of 200 resolution lines of the 800-line picture.

Each channel's transmitter chain provides 60-w output. Of the 120 w fed to a four-port hybrid, a directional antenna gets 60 w and the dummy load dissipates 60 w. Center frequency of the F-channel is 959.52 Mc, and of the P-channel, 960.58 Mc. Tv bandwidth is 200 kc.

Cameras are adjusted to a lighting range of 20 to 2,600 foot-lamberts—comparable to average lighting conditions on earth at 3 p.m. If the lunar surface is darker than expected, a low signal-to-noise ratio would result. If it's brighter than expected, some loss of the gray scale could occur from saturation.

Picture Sequencing—To squeeze as many pictures as possible into those valuable 10 min before impact, the pictures are sequenced for transmission.

Full-scan pictures will take 2.5 seconds to scan and 2.5 sec to prepare. With both cameras operating at the same frequency, one camera will be constantly preparing while the other is scanning.

On the P-channel, the scanning time is 0.2 sec and the preparation time is 0.6 sec. The first partial-scan camera will scan for 0.2 sec. When this is completed, the second will begin scanning, while the first begins its 0.6-sec preparation period. In short, when the fourth partial-scan camera completes scanning, the first has completed one 0.2-sec scan and one 0.6-sec preparation cycle; the second has completed one 0.2-sec scan and 0.4-sec of its preparation cycle; and the third has completed one 0.2-sec scan and 0.2 sec of its preparation cycle.

The use of different frequencies as well as different chains permit complete independence between F and P channels. Both operate simultaneously, but one can operate alone if the other malfunctions.

GUDEBROD CABLE-LACER SPEEDS AND IMPROVES WIRE HARNESS TYING—

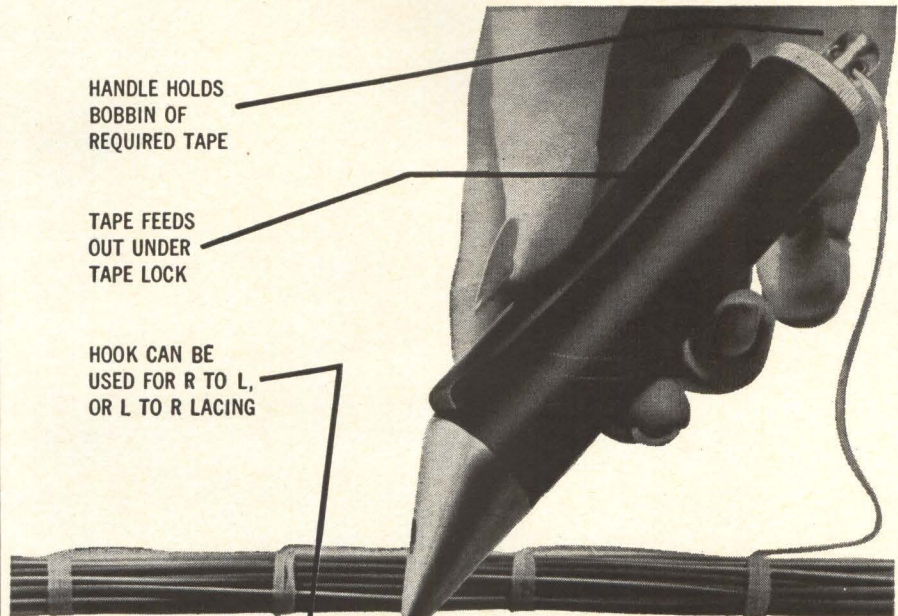

HANDLE HOLDS
BOBBIN OF
REQUIRED TAPE

TAPE FEEDS
OUT UNDER
TAPE LOCK

HOOK CAN BE
USED FOR R TO L,
OR L TO R LACING

GUDEBROD FLAT BRAIDED LACING TAPES FOR EVERY NEED

Specify Gudebrod Lacing Tapes for all your requirements. They meet or exceed all MIL-T specifications and commercial requirements. They will help increase your production because Gudebrod carefully tests, measures, and maintains close tolerances for slip resistance, fray resistance, breaking strength, wax content, fungistatic effectiveness. Standard, burn proof, high temperature tapes available in regular spools or in bobbins for the Cable-Lacer.

The Gudebrod Cable-Lacer is the first production tool specifically designed to speed, ease *and improve* the lacing of wire harnesses.

A bobbin of tape in the handle feeds tape as needed making the handling of long sections unnecessary. The number of splices are reduced too.

The hook (which can be arranged for left to right, or right to left hand lacing) facilitates the passing of the tape over or under the wiring.

The tape lock provides a firm hold on the tape augmenting the hand pull for up to 30% tighter knots. Hand contact in knot tying is eliminated.

The ease of handling the tape, the speeding of the knot tying, the elimination of hazard to hands are all appreciated by the harness section worker. Efficiency improvements of 20% and more have been proven. The Gudebrod line of lacing tapes is available in bobbins for use in the Cable-Lacer.

Gain these advantages for your harness tying operation—improved worker conditions—increased production—higher quality harness. For complete information get in touch with the Electronic Division.



GUDEBROD BROS. SILK CO., INC.

FOUNDED IN 1870

Electronic Division

12 SOUTH 12TH STREET, PHILADELPHIA 7, PENNSYLVANIA

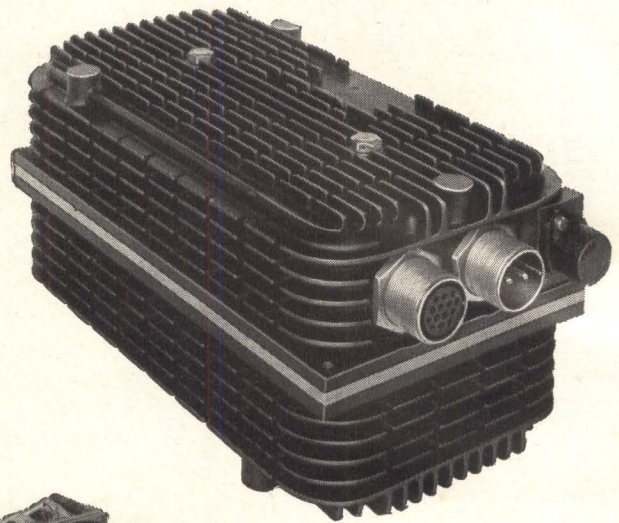

Designed...

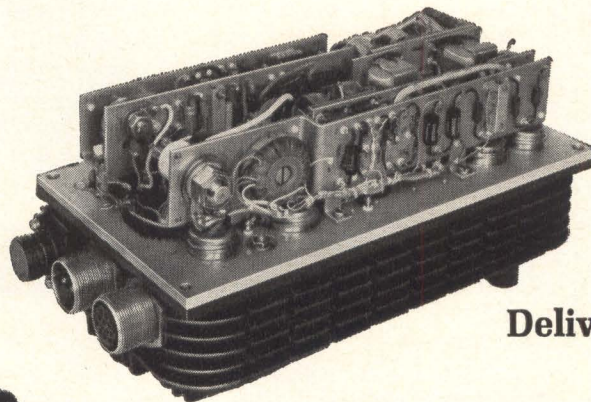

Delivered...

As ordered...

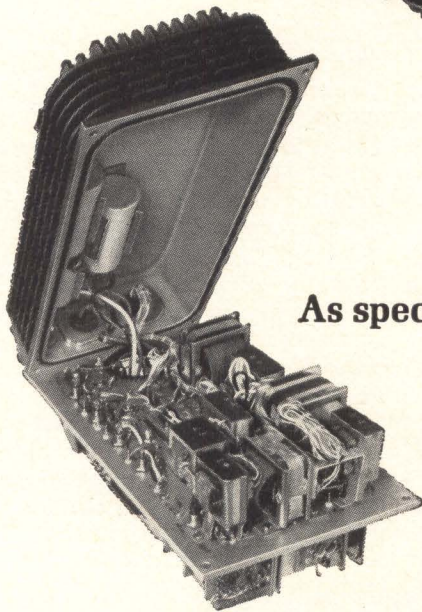

As specified...

As stated... That the unit pictured is a static inverter for a vehicle compass. That we designed it around the equipment in which it was to perform, not vice-versa. That it was delivered before the time stated in the bid. That it was delivered at the price stated. That it met all specifications—under operational conditions—as originally stated. That it embodied the extreme reliability stated, under the conditions of use, environment, shock, vibration and temperature originally specified, and always considered during development of the unit. □ This is the story; not only in this instance, but in that of all the specialized power supplies and associated electronic/magnetic equipment we produce. We deliver as stated. State your problem. SPERRY ELECTRO DEVICES LABORATORY, Sperry Gyroscope Co., Great Neck, N.Y.

SPERRY
DIVISION OF
SPERRY RAND
CORPORATION

R&D Shifting Away from Military

WASHINGTON—There's more money for research and development in the proposed federal budget for fiscal 1965—and there's also the anticipated shift away from military research.

Overall, the government's R&D requests for fiscal 1965 add up to \$15.3 billion, or 15.6 percent of the total budget of \$97.9 billion. This year, fiscal 1964, R&D got about \$14.8 billion, or 15.04 percent of the total. About 30 percent of government R&D is usually associated with electronics.

Of the 404-million rise in the R&D budget, \$152 million, would increase basic research.

About \$½ billion has been shifted from the Defense Department to NASA (for DOD and NASA budgets, see p 10). The overall space program, including DOD, AEC and other agencies, climbed by \$555 million, compared to the more than \$2 billion jump of a year ago.

Small, but significant increases in R&D are planned for virtually every agency. Samples: \$100 million to the Navy and other agencies for oceanographic research, instrumentation and facilities; \$9 million for a semiautomated oceanographic survey ship; and portions of a \$3.7 million hike in Weather Bureau R&D funds for meteorological sensing equipment.

Some \$100 million will be spent on R&D in technical information handling and data processing.

New specialized information and documentation centers are to be established and the National Bureau of Standards, already the home of the new National Standards Reference Data System, is expected to absorb and enhance the unclassified information handling functions of both the Office of Technical Services and the Defense Documentation Center. A \$6-million hike in the NBS budget over last year's \$28 million will go principally to NSRDS and information functions and improving Bureau standards work.

Green Laser May Find ASW Role

PALO ALTO, CALIF.—Gas laser that generates a green line at 5,225 Å—centered in the wavelength that provides maximum transmission path through sea water—was announced this week by Energy Systems, Inc. The company, formerly Radiation At Stanford, told ELECTRONICS that the device generates its green line directly, with no conversion or harmonic generation. The laser is a mercury-argon gas laser, but the resonant line is not that of mercury.

The laser is a 130-cm-long plasma tube pulsed at voltages from 15 to 30-kv with microsecond pulses. Output pulse length is 1 μsec or less. The laser has been operated at 3,000 pulses per second. Spot size is 1 to 2 mm with an angular divergence of less than 1 milliradian. Peak power output is estimated at 0.1 to 1 w.

Possible applications in antisubmarine warfare could lead to important weapon system developments

Chips Don't Touch Thin Films' Yield

HOBOKEN, N. J.—Overall yields of 20 percent for thin-film microcircuits were reported by R. H. Thun, of IBM Space Guidance Center, at the IREE Integrated Circuits Seminar last week. This figure was for a thin-film panel of 32 NAND gates containing a couple hundred components including attached glass passivated diodes and transistors. He estimated a single gate in a monolithic silicon chip might have an overall yield of 5 to 10 percent.

New Silicon Power Device Does Work of 2 SCR's

GATE-CONTROLLED a-c switch with three leads—a new type of silicon power semiconductor—could be used in circuits now requiring two silicon controlled rectifiers or an a-c diode with associated pulse transformer, says its developer, General Electric.

The firm's Triac permits two-way

current flow, unlike the scr, and needs less power to trigger into conduction than two-lead a-c semiconductor switches—less than 3 v and 50 ma compared to as much as 300 to 350 v for an a-c diode. Gating signal, applied between the control terminal and adjacent power terminal, may be positive or negative polarity, says GE, to control both directions of load-current conduction. Triggering is by unijunction transistors, neon lamps, and symmetrical trigger diode-type switches.

GE predicts its use will result in less costly circuits, improved performance, and fewer associated components.

Wide-Angle Color Tube Reaching Market in '64

CHICAGO — Rectangular, 25-inch RCA color tubes will reach the retail market before the end of the year, Raymond Saxon, president of RCA sales corporation, said last week. Limited quantities of the 90-degree tubes will appear first in the high end of the home enter-

tainment line, Saxon told ELEC-TRONICS. They will be more expensive than round color tubes.

Strapped-Down Guidance Investigated for NASA

HOUSTON—NASA Manned Spacecraft Center has awarded to Laboratory for Electronics, of Boston, a study contract on application of the digital operation technique in a "strapped-down" guidance system. Although not spelled out by NASA, it is believed the proposed technique would provide a backup for inertial-type systems in spacecraft.

In a strapped-down guidance system, accelerometers are fixed, gimbaling is eliminated, and the information from the strapped-down sensors is converted to another coordinate system, such as the ground or inertial space. The study will investigate application of D-O technique and the use of integrated cir-

cuits in the coordinate-conversion computer.

In essence, the technique involves a tradeoff of a mechanical function—gimbaling techniques—for a computation conversion. With integrated circuitry, this tradeoff becomes attractive—from the viewpoints of volume, weight and power. The LFE study will include estimates based on use of TI Solid Circuits and Fairchild Micrologic.

Earth Reentry Module Designed for Mars Flight

HOUSTON—Preliminary design for a spacecraft to return men from Mars in the 1970's was submitted to Manned Spacecraft Center by Lockheed following a six-month study. The craft would be used for about eight hours during the 13-month round-trip flight to Mars.

The spacecraft is designed to hold four to six astronauts who

could manually control the vehicle, although control would be primarily automatic. Navigation and guidance would be achieved with the aid of the earth, stars and radar. The module would contain communications and related electronics; thermal control and life support electronics, and room for about 800 lbs of scientific equipment.

CHAFED AT CHAFF

PHILADELPHIA—FCC monitors investigating complaints of interference to Ohio State University radiotelescope found that the annoying signals were arriving from a source well above the horizon. They finally determined that chaff, dropped in Air Force training missions to disrupt radar tracking, was picking up the radar signals but reflecting side-band frequencies back to earth. Air Force is now endeavoring to conduct its missions without chaffing the astronomers

MEETINGS AHEAD

ANTENNA RESEARCH APPLICATIONS FORUM, Midwest Electronics Research Center; University of Illinois, Urbana, Ill., Jan. 27-30.

ANNUAL MEETING-SEMINAR, Precision Potentiometer Manufacturers' Association, Hollywood Beach Hotel, Hollywood, Fla., Jan. 29-31.

INSTRUMENTATION SYMPOSIUM, ISA North Central Area; New Sheraton-Ritz Hotel, Minneapolis, Minn., Jan. 30-31.

ELECTRONIC SALES MARKETING ASSOCIATION MEETING, ESMA; Barbizon Plaza Hotel, New York, N. Y., Feb. 3-5.

MILITARY ELECTRONICS WINTER CONVENTION, IEEE-PTGMIL; Ambassador Hotel, Los Angeles, Calif., Feb. 5-7.

ELECTRONIC COMPONENTS INTERNATIONAL EXHIBITION, FNIE, SDSA; Paris Exhibition Park, Paris, France, Feb. 7-12.

INFORMATION STORAGE-RETRIEVAL INSTITUTE, American University; University, Washington, D. C., Feb. 17-21.

PHYSICAL METALLURGY OF SUPERCONDUCTORS MEETING, AIMPE Metallurgical Society; Hotel Astor, New York, N. Y., Feb. 18.

INTERNATIONAL SOLID STATE CIRCUITS CONFERENCE, IEEE, University of Pennsylvania; Sheraton Hotel and University of Pennsylvania, Philadelphia, Pa., Feb. 19-21.

NUMERICAL CONTROL PRESIDENTS' CONFERENCE, Numerical Control Society; Hotel Plaza, New York, N. Y., Feb. 20-21.

SOCIETY FOR INFORMATION DISPLAY NATIONAL SYMPOSIUM, SID; El Cortez Hotel, San Diego, Calif., Feb. 26-27.

WELDED ELECTRONIC PACKAGING SYMPOSIUM, WEPA; Miramar Hotel, Santa Monica, Calif., Feb. 26-27.

SCINTILLATION-SEMICONDUCTOR COUNTER SYMPOSIUM, IEEE, AEC, NBS; Hotel Shoreham, Washington, D. C., Feb. 26-28.

ADVANCE REPORT

ISA INTERNATIONAL INSTRUMENT-AUTOMATION CONFERENCE AND EXHIBIT, ISA; New York Coliseum, New York, N. Y., Oct. 12-15; March 31 is deadline for submitting abstracts to H. Tyler Marcy, Vice President-Development, General Products Division, International Business Machines Corporation, White Plains, N. Y. Topics cover all major areas of instrumentation, including measurement, information processing, and automatic control.

AF Pushes Development Of Low-Altitude Vehicle

DALLAS—A contract for continued "advance" development studies on the Air Force's Low Altitude Supersonic Vehicle program has been received by Ling-Temco-Vought. Amount of contract is believed to be approximately \$10 million. At one time since studies were initiated in 1956, the program was referred to as Slam (for Supersonic Low Altitude Missile).

New contract covers studies directed toward verifying feasibility investigations and leading toward the development of an airframe and related components. LTV's work has been directed toward a vehicle powered by a nuclear ramjet that would have practically unlimited range. The firm says much of the effort, however, would also have direct application to a shorter-range, chemically-powered vehicle.

FAA Spending Will Drop

WASHINGTON—Procurement and establishment of air-navigation and traffic-control facilities will decline under the Federal Aviation Agency's budget for fiscal 1965. FAA wants \$75 million in new funds compared to this year's \$100 million. The drop reflects completion of funding for the basic foundation of the improved traffic control system that FAA has been working on nearly three years.

Emphasis in 1965 will be on starting automation of the system, principally ground equipment for the beacon system. This system, using airborne transponders, will provide identification and altitude information printed electronically on the controller's radar scope. There are also funds for 13 improved computers compatible with the beacon system. FAA's R&D request of \$42 million—about the same as 1964—includes \$25 million for more automation and \$7.5 million for air navigation improvements, with continued emphasis on blind landing systems.

Lasers Aren't Ready For Bloodless Surgery

MADISON, WIS.—Lethal shock waves resulting from intense surface heating must first be eliminated before lasers can perform bloodless surgery, experiments by R. F. Heimberger, department of neurosurgery, Indiana University School of Medicine, indicate. Surgery will require additional instrumentation, it was reported at the Laser Institute here. In experiments on rat brains, surface heating resulted in explosive evaporation. When 250-joule pulses were used, impact drove skull fragments into the brain. A 150-joule pulse proved fatal when covering skin was removed from the skull.

Gravity-Stabilized Satellite Has Tumbling Problems

WASHINGTON — The gravity-stabilized satellite that was secretly launched Dec. 5 by the Navy (p 19,

Dec. 20, 1963) is reportedly encountering tumbling problems. The hysteresis rods that provide roll and yaw damping have become oversaturated, according to reliable sources.

This gravity-gradient, passive attitude-control system, was developed by Applied Physics Laboratory of Johns Hopkins University. It was first used successfully in a Navy satellite launched June 15, to keep one side of the spacecraft facing the earth at all times.

The gravity-gradient satellite launched in December was one of two satellites launched simultaneously and was powered by a Snap-9A nuclear generator. The 160-lb spacecraft uses waste heat from its nuclear generator to keep its interior instrumentation at about 70-deg constant temperature.

Side-Looking Sonar Maps Ocean Bottom

SONAR SYSTEM, using side-looking scanning techniques for producing three-dimensional maps of the ocean floor, has revealed this: The Westinghouse system, which was used in the *Thresher* search, paints a continuous picture of the ocean floor as it is towed behind a ship. It operates to depths down to 20,000 feet.

A pair of sonar transducers on each side of the towed vehicle scan the bottom from beneath the vehicle to 1,200 feet out on each side. Co-axial cable carries the information to display equipment in the towing ship, where the map is created. The final map picture is synthesized from a series of parallel lines in the manner that a tv picture is created. All hills and valleys, and shadows caused by protruding objects on the ocean bottom, are recorded.

IN BRIEF

JAPAN is developing a military night-vision system for use against tanks and possibly snipers. Work is also underway on a short-range missile for export to field armies.

CANADA'S Defence Research Board and NASA have agreed to a multi-satellite upper-atmosphere research program that would involve four more Canadian satellites, to be called Alouette B and Isis A, B and C.

LIGHTWEIGHT receiver-converter, for use with all hyperbolic navigation systems, has been developed by Lear Siegler. Pictorially or numerically, the 21-pound units displays geographic locations for planes, ships or ground vehicles.

CORNING GLASS reports invention of a glass that darkens when exposed to light and clears again when the light source is removed. Uses in self-erasing displays and as light valves are seen.

TELEFONOS de Mexico will buy electronics equipment from Europe using \$20 million in credits from commercial banks, mainly in Brussels and Paris. Credits are designed to divert to Europe some of Mexico's trade with Japan.

AEC has named Martin Marietta and Minnesota Mining and Manufacturing Co. to develop an advanced nuclear electric generator for undersea navigation beacons and deep-sea oceanographic research.

SOLID-STATE tropo scatter equipment, for use in AT&T telephone-telegraphic system, will be developed by Radio Engineering Laboratories. Equipment consists of two 10-w exciters, two klystron amplifiers, four low-noise diversity receivers, fault indicators and performance monitors.

AIR FORCE has awarded Northrop a \$9.5-million contract to design, build and install a Far East communications system. Gear includes submarine cable, microwave and tropo scatter units.

LASER ACTION at nine new wavelengths — including 57.355 microns, claimed to be the longest wavelength ever achieved by a gas laser — was announced at American Institute of Physics meeting this week by Bell Telephone scientists. They increased laser mirror reflectivity to 98.5 per cent by drilling 1/2-mm pinhole in mirror.

Goldwater Charge Prompts Senate Staff Review of ICBM Reliability

Staff of the Senate Preparedness Subcommittee is going to review and update its information about the reliability of intercontinental ballistic missiles. Chairman John Stennis (D-Miss.) ordered the review in the wake of Senator Barry Goldwater's (R-Ariz.) charge that the missiles are undependable. Goldwater specifically asserted that the ICBM's electronic guidance mechanisms could be knocked out of commission by a nuclear blast in space.

Goldwater called for hearings on his charge by the Stennis subcommittee. But no decision has been made about hearings. The subcommittee's staff keeps close tabs on the state of the nation's missile arsenal, including weapon reliability. In taking a new look at the dependability issue, it will balance Goldwater's charge against Defense Secretary Robert S. McNamara's claim that the senator's statements are "completely misleading, politically irresponsible and damaging to the national security."

Industry Execs Will Be Briefed On Military Needs

Defense Department is planning a series of classified briefings for top leaders of American industry on what the military will be buying over the next five years. Separate briefings—exact dates not yet set—will be held first for the electronics, missile and aircraft industries during the next six months, and then for shipbuilding, research and other firms. The briefings, which may include top-secret material, are to acquaint industry with the military's long-range development and procurement needs. Particular emphasis will be put on changing requirements.

Attendance at the briefings will be limited to three top executives who must be drawn from this group: chief executive officer; board chairman, president or general manager; and corporate planning director. Divisions of large, diversified corporations will be considered separate entities. Size of the organization and the holding of military R&D contracts will not be a factor in drawing up the invitation list. Ability to obtain suitable security clearance will be the controlling factor. If a company is not invited, it won't mean the company isn't eligible for future contracts.

FCC Plans Ban Of Radio 'Bugs'

Sweeping ban against eavesdropping with radio equipment is planned by the Federal Communications Commission. All seven commissioners have agreed to consider a rules change that would go beyond the present general rule that makes electronic eavesdropping illegal on unauthorized frequencies. The new rule would hit at eavesdropping involving licensed radio devices and authorized wireless microphones. (For review of types of "bugs" and their use, see *ELECTRONICS*, p 10, Oct. 25, 1963.)

National Academy Of Engineering Plans Firm Up

Engineering profession has begun a drive to obtain a larger voice in federal policy-making, more nearly comparable to the powerful influence that scientists have achieved. The first step will be establishment of a National Academy of Engineering. It will operate on the same principal as the old, respected National Academy of Sciences, and in all likelihood will absorb the NAS engineering section.

Congress will be asked to charter the new organization. The basic organization will be privately financed, but will then become the focal point for government-supported engineering research and development. One significant change is envisioned: membership in the NAS is by invitation based on a scientist's achievements throughout his career. Engineers would be invited on the basis of one singular achievement.

FOUR NEW HOT LITTLE NUMBERS

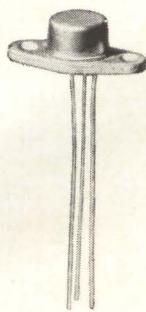

2N3212

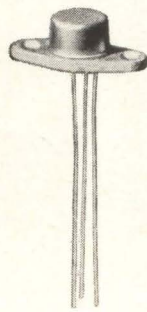

2N3213

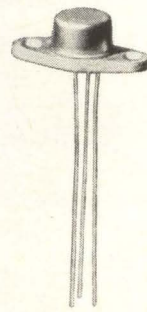

2N3214

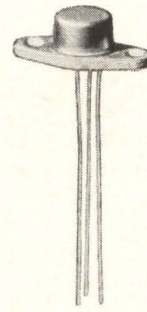

2N3215

FROM
DELCO

Now from Delco Radio come four remarkable new miniature Nu-Base† transistors for people who need high current, high voltage and fast switching in a very small package.

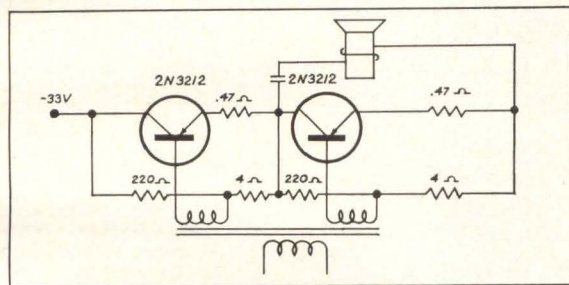

Miniature Class AB audio power amplifier:
Maximum RMS power output 18 watts at 200 cps

Each of these devices is rated at 5 amperes, maximum continuous collector current. Ranging from 30 to 80 volts, their VCEO ratings make them especially useful where high voltages and high currents are encountered. In addition, their relatively low saturation resistance and high speed give them excellent efficiency and reliability for switching applications.

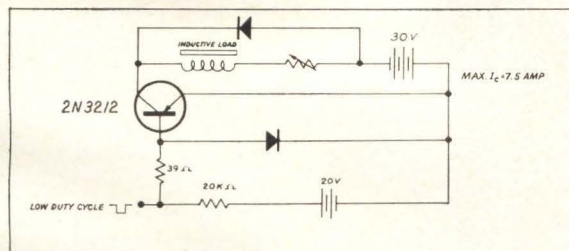

Miniature Solenoid Driver: Excellent high current gain of 2N3212 enables intermittent operation of solenoids at high currents such as 7.5 amperes. Duty cycles of 1 millisecond at 15 millisecond repetition rates are typical.

†Delco's name for drift field non-uniform diffused base construction.

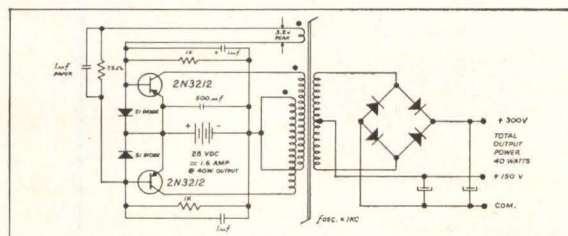

Miniature converter in which 2N3212 high gain, high current and fast switching speed characteristics provide a 40-watt output at an efficiency of over 87 percent.

The Delco Nu-Base construction features a husky element with built-in protection from current "hot spots" to assure freedom from secondary breakdown over the operating range.

These units will dissipate over 5 watts at 71°C case temperature, operate over a range of -65°C to 110°C and lend themselves easily to automatic insertion—all this in a TO-37 package.

The shortest distance between you and more detailed information is a call or letter to one of our sales offices or your Delco semiconductor distributor. Right now is as good a time as any.

TYPE	2N3212	2N3213	2N3214	2N3215
Vcbo	100	80	60	40
Vceo @ Ic=20ma	80	60	40	30
hFE @ 3A	30-90	30-90	30-90	25-100
Vce (sat) @ Ic=5A	0.5v	0.5v	0.5v	0.5v
Vce (sus.) @ Ic=3A	80	60	40	30
Conditions for Vce (sus.)	Pulse Width = 1.4ms Duty Cycle = 4% Inductance = 6mh			

Operating temperatures = 110°C max., -65°C min.; max. storage temperature = 125°C.

Union, New Jersey*
324 Chestnut Street
MURdock 7-3770
AREA CODE 201

Detroit, Michigan
57 Harper Avenue
TRinity 3-6560
AREA CODE 313

Palo Alto, California
201 Town & Country Village
DAvenport 6-0365
AREA CODE 415

Santa Monica, California*
726 Santa Monica Blvd.
UPlon 0-8807
AREA CODE 213

Syracuse, New York
1054 James Street
GRanite 2-2668
AREA CODE 315

Chicago, Illinois*
5151 N. Harlem Ave.
775-5411
AREA CODE 312

General Sales Office*: 700 E. Firmin, Kokomo, Ind., Gladstone 2-8211—Ext. 500 • Area Code 317

*Office includes field lab and resident engineer for applications assistance.

DELCO
DEPENDABILITY
RADIO
RELIABILITY
Division of General Motors, Kokomo, Indiana

most accessories, most versatility in x-y recording

Only Moseley offers so many analog, digital and special-purpose accessories to give you maximum usefulness from your x-y recorder. Just spot your problem... the solution is here... then call your Moseley/Hewlett-Packard field engineer for full details and a demonstration. You may be surprised at how much your x-y recorder can do for you with compatible accessories from Moseley.



Model 60D Logarithmic Converter, accepts ac or dc input, produces dc output proportional to the log of the positive peak amplitude of the input, \$575.



Type 101 Waveform Translator, converts high speed repetitive waveforms on an oscilloscope to accurately inked graphs with an x-y recorder, \$575.

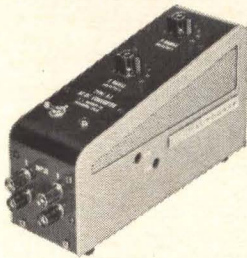

Type A-1 AC-to-DC Converter, dual-channel accessory for converting ac, 20 cps to 100 kc, to dc for input to x-y recorders, \$585.



Model 40D Keyboard, permits plotting of tabular data in point-graph form, plots points from zero to ± 1999 on each axis, \$975.

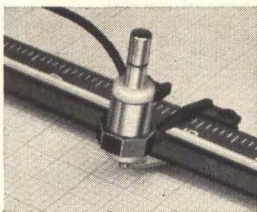

Types D-1B, D-2 Character Printers, for individually identifying plotted points; D-1B single character, \$160; D-2 a six-symbol character wheel, \$525.

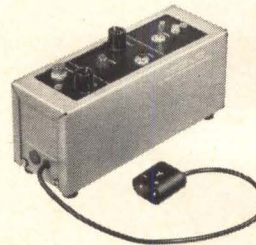

Type F-3 Line Follower, optically follows lines made with pencil or pigment type ink, permits regeneration of original data directly from previously recorded curves, \$795.

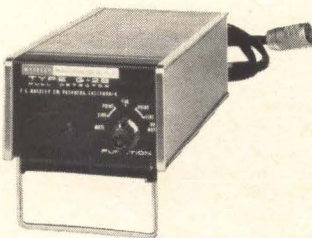

Type G-2 Null Detector, controls operating modes of x-y recorders during the plotting of continuous, discontinuous or point function data, \$175.

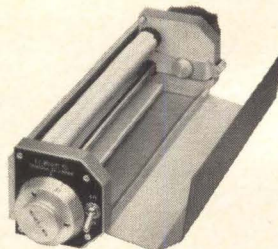

Roll Chart Accessories: Type Q-12 hand crank and pull-through-tear-off assembly, \$85; Type Q-3 (illustrated) variable speed motor drive, \$650; Type Q-4 automatic advance, \$1000.

The accessories above are useful with Model 2D series recorders (excepting 2D-4) and Model 7 (30" x 30") recorder. Model 60D, 101, F-3 and A-1 are also useful with the 135 and 2D-4 recorders. Roll chart accessories are for use with table- or rack-mounted instruments.

F. L. MOSELEY CO.
409 N. Fair Oaks Ave., Pasadena, Calif.
an affiliate of Hewlett-Packard



THE FUTURE OF THIN-FILM ACTIVE DEVICES

Survey of potential applications of thin-film field-effect devices as amplifiers, varistors and current limiters

By CHARLES FELDMAN, Melpar, Inc., Falls Church, Va.

FREQUENCY MODULATED oscillator, slightly less than an inch wide—Fig. 1

AT PRESENT, the principal value of thin-film electronics appears to lie where environment conditions preclude the use of conventional electronics. Recent radiation tests have indicated that thin-film active devices, as well as thin-film passive devices, offer considerably more resistance to gamma rays than conventional components.¹ There is little question that thin-film devices, which are composed of polycrystalline material and operate on majority-charge-carrier concepts, will be generally more radiation resistant than conventional single-crystal devices. It is becoming increasingly clear, however, that present thin-film devices represent merely a beginning of thin-film electronic technology.² Under study at various laboratories throughout the world are numerous types of physical effects, many of which will lead to practical film devices in the ensuing years. Some of these possible devices are listed in the table, which is by no means complete, but illustrates the large variety of materials and effects under various stages of development. The physical effects leading to the listed devices, of course, already exist. It is only a matter of time before all or most of

the devices in the list are developed into useful devices.

The transformation of the effects and materials under study into practical components must, however, be considered only a prelude to the thin-film electronics of the future. Materials listed in the table will be combined in various sophisticated geometries to produce complete electronic functions. The ability to form complete electronic functions through geometry may be consid-

AUTHOR'S PREDICTION

Systems containing the film device concepts discussed here will probably be in operation within three to five years. This in itself is remarkable, considering that a few years ago it was believed impossible to form useful thin-film active devices. This viewpoint has gradually changed through the efforts of numerous people in various laboratories. Many effects suitable for film devices are being explored. Effects such as tunneling and hot-electron emission hold promise, as well as other phenomena listed in the table. It thus appears that thin-film electronics will soon outgrow the laboratory and take its place in the electronics industry

ered as the key to advanced electronics. The use of this key in two thin-film devices, a field-effect transistor and a varistor, will be discussed.

Field-Effect Devices—Field effect, or the variation of current in a material by the application of a transverse electric field, may be used as a variable resistor, a variable capacitor or a purely amplifying device depending on the configuration of the layers. An excellent example of the use of a field-effect as a variable resistor is shown by the application of distributed parameter concepts in an f-m oscillator. The circuit was designed to use a commercial transistor as the amplifying device. The essential element in this circuit consisted of successive layers of germanium, silicon monoxide and aluminum forming a distributed capacitor. The germanium plate was shaped, in the plane of the substrate, in a logarithmic taper to achieve an impedance match to the amplifying transistor. The resistance of this germanium film could be modulated by an electric field applied between it and the top aluminum plate. Other semiconducting materials, such as CdS and CdSe,

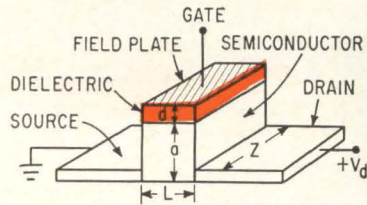

$$\text{TRANSCONDUCTANCE } g_m = \left(\frac{\partial I_d}{\partial V_g} \right)_{V_d} \approx \frac{k_1 Z}{d} \frac{\mu_D V_d}{L}$$

$$\text{DYNAMIC RESISTANCE } r_d = \left(\frac{\partial V_d}{\partial I_d} \right)_{V_g} \approx \frac{2L}{\sigma_z(2a+b) \left[1 - \left(\frac{b^2 + 4c V_d}{b^2 + 4c V_p} \right)^{1/2} \right]}$$

$$\text{PINCH OFF VOLTAGE } V_p = \frac{a(a+b)}{c}$$

$$\text{AMPLIFICATION FACTOR } \mu = \left(\frac{\partial V_d}{\partial V_g} \right)_{I_d} = g_m r_d$$

$$\text{GAIN BANDWIDTH PRODUCT } \text{GBW} = \frac{g_m}{2\pi C_q}$$

L	SOURCE-DRAIN SPACING
d	DIELECTRIC THICKNESS
a	SEMICONDUCTOR THICKNESS
Z	DEVICE WIDTH
k_1	DIELECTRIC CONST OF INSULATOR
k_2	DIELECTRIC CONST OF SEMICONDUCTOR
ϵ_0	PERMITTIVITY OF FREE SPACE
q	ELECTRONIC CHARGE
N	IMPURITY DENSITY
b =	$(k_2/k_1)d$
c =	$-2k_2\epsilon_0/qN$
μ_D	EFFECTIVE DRIFT MOBILITY
V_d	SOURCE-DRAIN POTENTIAL
I_d	SOURCE-DRAIN CURRENT
V_g	GATE VOLTAGE
σ	SEMICONDUCTOR CONDUCTIVITY
C_g	EFFECTIVE INPUT CAPACITANCE

DEFINITIONS of thin-film transistor parameters—Fig. 2

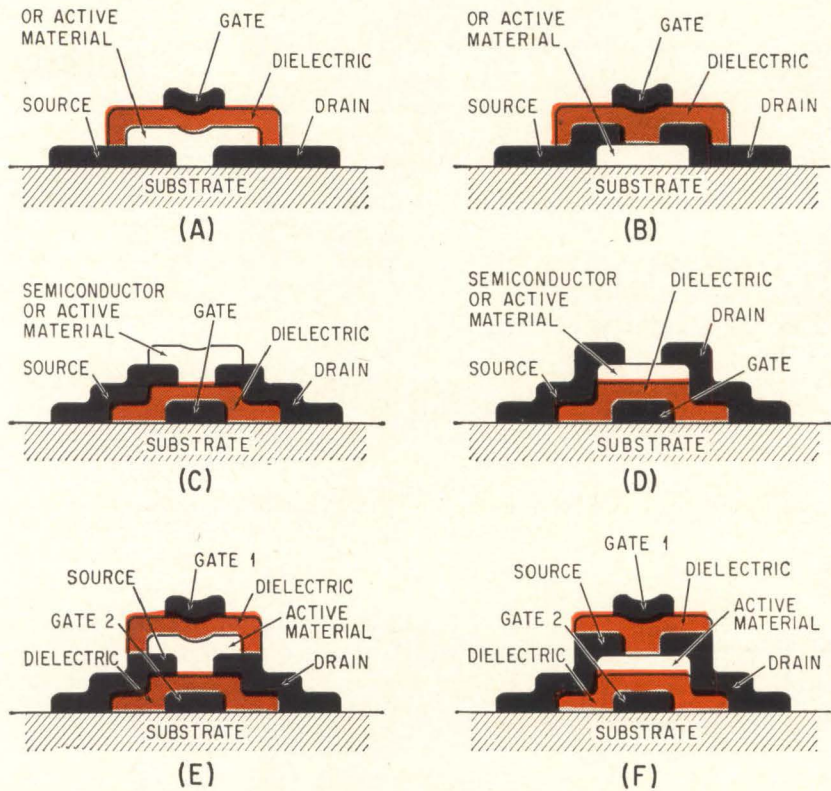

FIELD-EFFECT DEVICE structures: simplest structure for automatic deposition (A), most frequently used at Melpar; structure (B) is used when semiconductor layer is to be treated prior to device completion; (C), reverse deposition order of (A) with exception of source-drain electrodes, used as first step of structure (E); (D), exact reverse deposition order of (A), no particular advantage except when forming double gates as in (F); (E and F), same as structures (C) and (D) respectively, with addition of dielectric and second gate. The second gate increases the overall gain of the device, but is more difficult to fabricate—Fig. 3

may also be used in place of this germanium film. This circuit (Fig. 1) has been described in detail elsewhere.³ The use of active film layers combined with distributed

parameter networks will reduce the number of individual circuit components, thus resulting in greater circuit reliability.

The influence of geometry on an

amplifying field-effect element is shown in Fig. 2, and other variations of the device structure in Fig. 3. An enlarged photograph of the front and back view of an array with 81 devices per square inch is shown in Fig. 4. Note that the gate electrodes (small circles) as well as the source and drain electrodes may be connected by a straight line. Figure 2 shows how electrical parameters such as transconductance, dynamic resistance and gain-bandwidth are related to sample geometry. The behavior of input capacitance and resistance on the thickness of the dielectric layer is shown in Fig. 5A and 5B. The frequency response of the device is determined through the gain-bandwidth product. The ratio of channel spacing to charge carrier mobility (L/μ), which determines the transit time of the carriers, in addition to the total capacitance of the sample, limit the frequency response. It is believed that, with the presently attainable film mobilities and channel spaces, frequencies of over 100 Mc can be achieved.

Performance—As shown in Fig. 2, transconductance (g_m) is directly proportional to the width of the source-drain electrodes (Z) and inversely proportional to the channel spacing (L). The electron mobility (μ_0), which appears in the expression for g_m , is also dependent on the thickness of the semiconductor layer. Thus, any desired transconductance can be achieved with proper geometry and available space. Recently, tests have been made in this laboratory in which five similar devices were connected together simulating a width, Z , five times larger. The resulting characteristics are shown in Fig. 5C. The individual units had nearly identical characteristics. Transconductance values of each sample was in the vicinity of 1,500 μmhos , and the parallel arrangement, yielded a transconductance of 8,000 μmhos . Similar high transconductance values were also obtained by forming a single unit with a source-drain width of 500 μm , five times the single units described above, and a 0.013-mm channel spacing. Values of transconductance up to 20,000 μmhos were achieved in this manner; however, appreciable hysteresis was noted in the oscilloscope dis-

plays for devices with transconductance greater than $10,000 \mu\text{mhos}$.

The ability to choose the desired electrical properties through the choice of geometry enables one to simplify electronic circuits. One example of this simplification (Fig. 5D) illustrates the reduction in numbers of devices, components and connections in a resistance coupled amplifier, achieved by making the device width (Z) three times larger. Device characteristics can, of course, be altered in crystalline transistors as well as electron tubes; however, nowhere is the ability to alter easier than in vacuum-deposited film circuits where a change in masks during deposition will result in the required modified device parameters.

The amplifier in Fig. 5D was built, and had a flat response to 100 kc. The voltage gain was about 1,000; however, no degenerative feedback was used as is commonly done with direct-coupled amplifiers.

An attractive application of field-effect devices is their use as current limiters.⁴ In a current limiter, the source and gate are connected making the device into a two-terminal one as in Fig. 5E. The effect of connecting the source and gate together is to essentially reverse-bias the device, which causes a depletion layer to be created in the semiconductor film. As the applied voltage increases, the effective conducting path decreases (depletion layer increase) until "pinch-off" is reached and the constant-current condition is attained. The ultimate value of the current depends on the device with (Z).

It is easy to imagine many other variations in geometries that illustrate the versatility of field-effect phenomena in electronic circuitry. The examples given, however, illustrate the potentials of the device and the versatility of thin-film techniques. As fabrication techniques and material knowledge improves, device parameters will improve and applications will become more numerous. Device cost, even in laboratory quantities, looks extremely promising.

Thin-Film Varistors—Varistors or nonohmic, two-terminal, solid-state devices (diodes) have been under exploration for many years.⁵ Layered or film varistors, such as selenium and copper-oxide rectifiers,

were among the first solid-state components commercially available. As indicated in the table, both symmetrical and nonsymmetrical varistors are being studied in thin-film form. Research is being emphasized on phenomena such as tunnel effects, field effects and barrier effects. Thin-film varistors using each of these phenomena have been fabricated in this and other laboratories. There is no question that each effect and corresponding device will play its role in the thin-film electronics of the future.

Varistors can be tailored to meet specific electronic requirements in precisely the same manner as the field-effect devices described above. An example is easily found in a new type of symmetrical varistor being

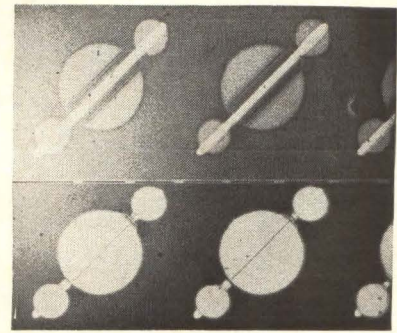

FRONT AND BACK views of array with 81 devices per sq cm—Fig. 4

explored in this laboratory. This varistor consists of deposited layers of metal, boron, and metal respectively. The metal-film electrodes are usually formed of aluminum; however, other metals such as gold

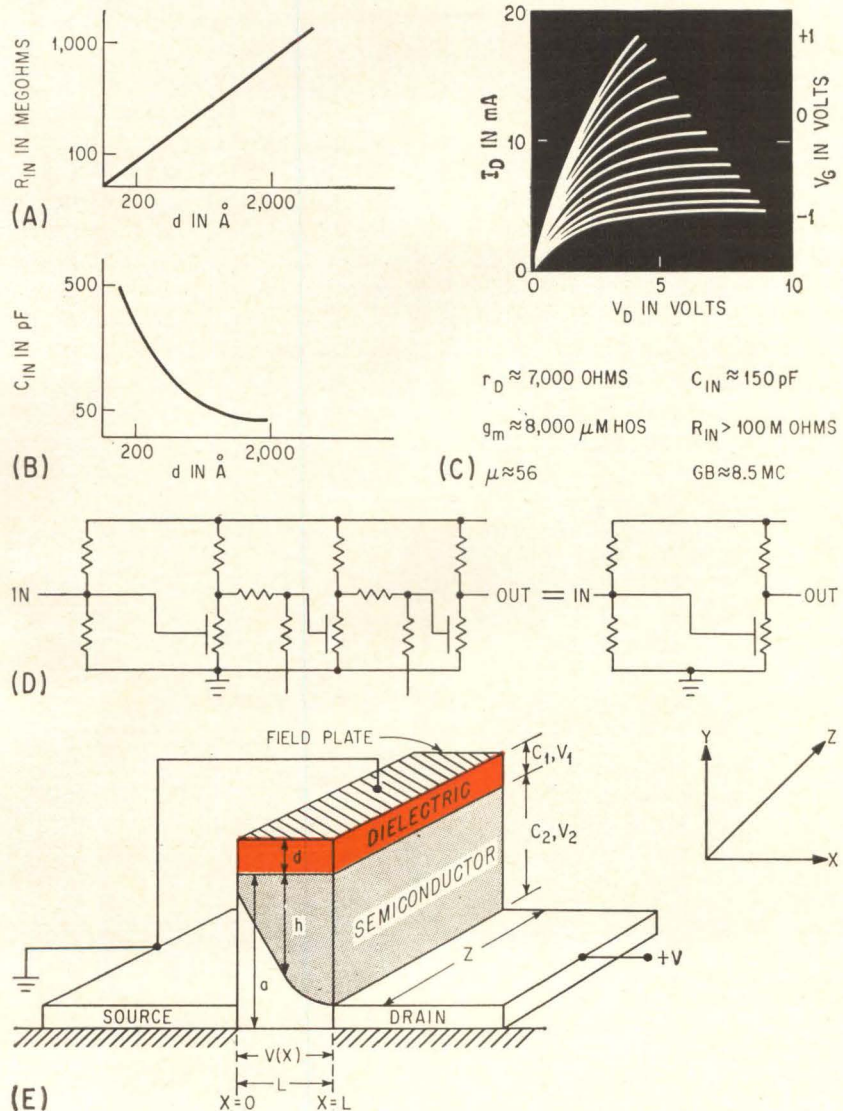

VARIATIONS of input resistance (A) and capacitance (B) of thin-film field-effect triodes with dielectric thickness; current-voltage characteristics (C) of five CdSe field-effect devices in parallel; resistance-coupled amplifier (D), reduced from three devices and nine resistors to one device and three resistors; self-biased field-effect device (E), a current limiter—Fig. 5

Thin-Film Devices—TABLE

TYPE	MATERIALS UNDER STUDY	APPROX. HIGHEST STATUS	TYPE	MATERIALS UNDER STUDY	APPROX. HIGHEST STATUS
VARISTORS (Diodes)			MEMORIES		
Symmetrical	B, SiC, Al ₂ O ₃ , TiO ₂ , Si	Research	Magnetic	Fe, Ni, alloys	Commercial
Unsymmetrical	Cu ₂ O, Se, TiO ₂ , CdS	Development & Commercial	Ferroelectric	BaTiO ₃	Research
Tunnel Diode	Si, Al ₂ O ₃ , Ge	Research	Fonic	PbCl, AgCl	Research
AMPLIFIERS (Triodes)			PHOTODEVICES		
Field Effect	CdS, CdSe, Ge, Si	Research & Development	Solar Cells	CdS, Si	Commercial
Hot Electron	Al ₂ O ₃ , TiO ₂	Research	Photoconductors	Se, CdS, PbS, Ge	Commercial
Minority Carrier	Ge, Si, CdS	Research			

appear to give equal results. The boron deposition is carried out by an electron beam. The properties of a typical sample are shown in Fig. 6A and 6B. The device has characteristics similar to silicon carbide bulk varistors and may consequently be used in similar fashions.⁶ The physical explanation of such nonlinear current-voltage curves is, at the moment, not clear. It appears from experimental work that an extremely pure, amorphous, boron film is necessary. Considerably more research in the physics involved will be required to completely explain the nonlinear characteristics of the device. Obviously, the electrical properties of this

varistor can be controlled by geometry. The area of the plates determines the total current flow, while the boron thickness controls the voltage operating point.

Distributed parameter techniques may be employed to advantage in thin-film varistors. If a resistive layer is substituted for one of the metal plates or electrodes, a three-terminal device is obtained. Such a device may be used as a clipping circuit, as in Fig. 6C to 6E. In this clipping network, the three-terminal device parameters are controlled by the thickness and area of the metal resistive layer as well as the area and thickness of the boron layer. A design engineer must thus specify,

length to width ratio, ohms per square, area and device thickness to obtain "clipping" at the required voltage.

Conclusions—Circuits using thin-film active devices are currently being evaluated in the laboratory. These circuits will be fabricated on automatic deposition equipment, which uses a phonograph record changer concept for mask and substrate pallets and an electron beam source for deposition. Initial tests with this equipment have proven the feasibility of automatically depositing complete circuits on a production basis.

The author acknowledges the efforts of all the members of the Physical Electronics Laboratory. The work of Herbert Wilson and William Gutierrez on active devices and Charles Gane on device circuits is particularly appreciated. The support of the Bureau of Naval Weapons on all phases of this work is gratefully acknowledged.

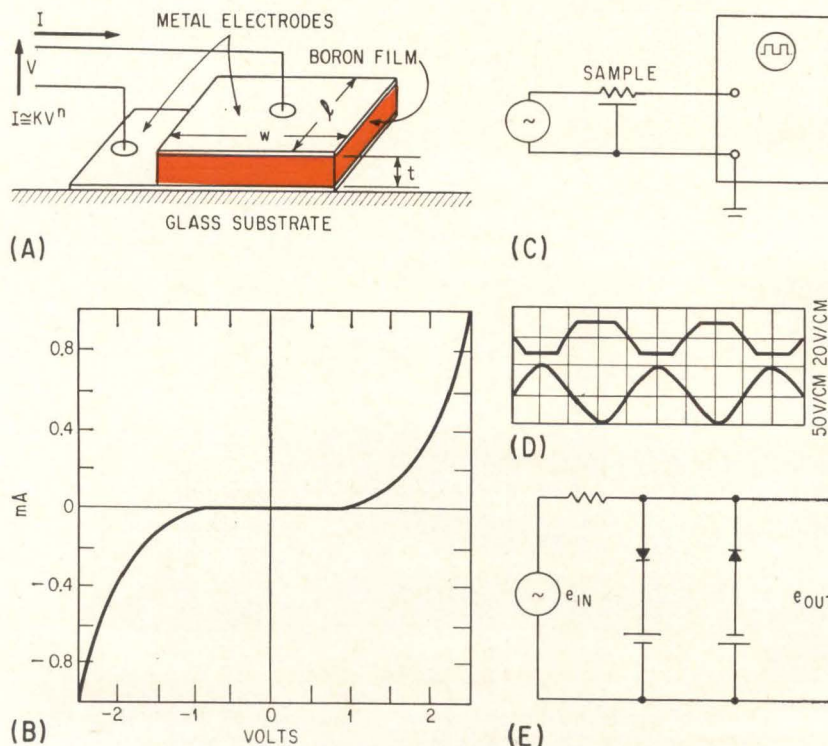

THIN-FILM VARISTOR (A) and current-voltage graph (B); thin-film clipping circuit (C), waveforms (D) and equivalent lumped-parameter clipping circuit (E)—Fig. 6

REFERENCES

- (1) R. W. Marshall, *Microelectronic Devices for Application in Application in Transient Nuclear Radiation Environments*, Proceedings of East Coast Conference on Aerospace & Navigational Electronics, IEEE, Baltimore, Oct. 22, 1963. See also: *Aviation Week and Space Technology*, p 93, Aug. 17, 1963.
- (2) For a state-of-the-art review see: "Integrated Circuits, Technical Review & Business Analysis," by Graduate Students of the Harvard Business School. Integrated Circuits Associates, P. O. Box 131, Cambridge, Mass., 1963.
- (3) H. E. Culver and C. E. Gane, *Proc IEEE*, 51, p 1,034, 1963. See also: *ELECTRONICS*, p 24, Oct. 12, 1962.
- (4) W. A. Gutierrez, H. L. Wilson, "An Analysis of the CdSe Thin-Film Triode as a Current Limiter," to be published.
- (5) F. R. Stansel, "The Characteristics and Some Applications of Varistors," *Proc IRE*, 39, p 342, 1951.
- (6) See for example, L. D. Kovack and W. Comley, *IRE Trans. on Electronic Computers*, EC-9, p 496, Dec. 1960.

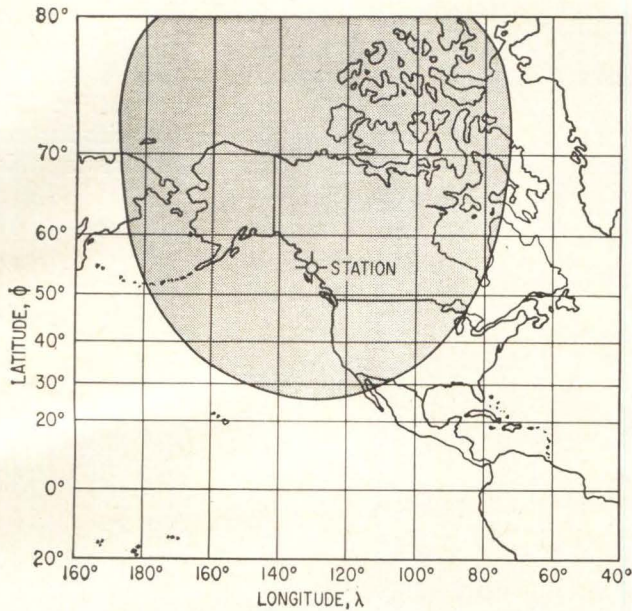

COVERAGE of a ground station located at 55 deg north latitude—Fig. 1

Plotting Coverage Circles For Satellite Communications

Graphical method solves most circular-orbit cases to determine possibility of communications

By **DANIEL LEVINE** and **WILLIAM H. WELCH**
Lockheed Missile and Space Co.
Sunnyvale, California

CIRCLE OF INFLUENCE

Continuing announcements of communication satellite plans give point to an article that shows how, with simple computation and available charts the planner, engineer and even the space hobbyist can determine the coverage circle of a ground station for a satellite in a nearly circular orbit

PLOTTING the coverage circle of a ground station that is in communication with a satellite is a tedious task because of the extreme distortion of many map projections, as illustrated in Fig. 1. A graphical technique has been developed that greatly facilitates this operation. It involves drawing the coverage circle as a semicircle on a work sheet and then transferring coordinate values to the map projection in use.

For this purpose, the surface station is taken to be located at 0 degrees longitude and ϕ_s degrees latitude. The radius of its coverage circle subtends the angle α at the center of the earth. The latitude and longitude, ϕ and λ , of points on the circumference of this circle satisfy the equation¹

$$\cos \lambda = (\cos \alpha - \sin \phi_s \sin \phi) / \cos \phi_s \cos \phi$$

Rather than solve this equation for specific pairs of coordinates, the engineer can use a compass to draw the coverage circle on the work sheet of Fig. 2A or 2B, depending upon the station coordinates. Figure 2A presents a polar stereographic projection of the

earth and Fig. 2B shows a meridional stereographic projection of the earth with the pole of the projection centered on the equator. A circle drawn on the earth about a point representing the station appears on the stereographic projection as a circle with its center displaced in latitude from the ground site.

The central angle of the coverage circle α can be determined from Fig. 3 for a particular elevation angle above the horizon for a satellite in a near-circular

orbit at an altitude of H nautical miles. For example, a central angle of 29 deg occurs for 0 deg elevation angle when the orbital altitude is approximately 490 nautical miles.

Example—The circle drawn on Fig. 2A is for a station latitude of 55 deg and circular coverage $\alpha = 29$ deg. The procedure for drawing this circle is as follows

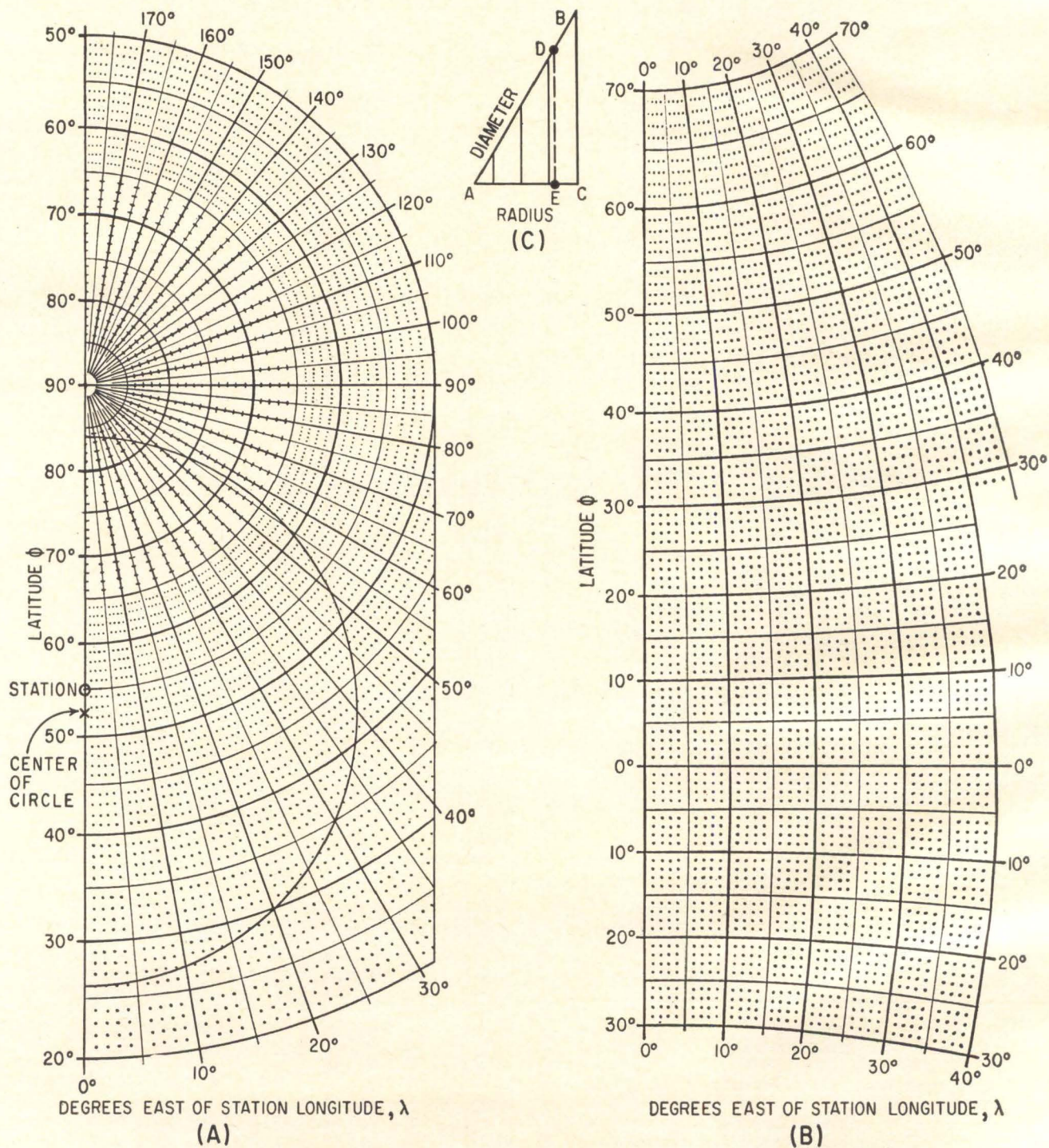

POLAR stereographic projection (A) stereographic meridional projection (B) and representative radius scale (C)—Fig. 2

1. Station latitude $\phi_s = 55$ deg N.
 2. $a = 29$ deg determines the northern and southern limits of the circle on the zeroth meridian as 55 deg + 29 deg = 84 deg N and 55 deg - 29 deg = 26 deg N.

3. A caliper is set at the diameter length between 84 deg N and 26 deg N on the zeroth meridian of Fig. 2A.

4. The caliper diameter AD is marked on scale AB of Fig. 2C and the corresponding circle radius AE is measured on the associated radius scale AC , as illustrated.

5. Measure the radius length AE from either the 84 deg N or the 26 deg N limit on the zeroth meridian of Fig. 2A to locate the center of the circle on the map.

6. The semicircle is drawn on Fig. 2A using the radius AE and the center location of step 5 above.

The coordinates of points on the circle read from Fig. 2A are shown in Table I. If the actual longitude of the station is 130 deg W, the table leads to the distorted coverage zone shown in Fig. 1 for a Mercator projection.

When the ground station is nearer the equator, the semicircle may extend beyond the limits of Fig. 2A. For this case, it should be drawn on the meridional stereographic projection of Fig. 2B, using the same sequence of steps outlined above. Both Fig. 2A and 2B are usable for stations in southern latitudes by reading all latitude values as south, rather than north. When the central angle exceeds 30 deg, a different graphical procedure may be employed.² Neither the technique described here, nor that of the footnote reference, applies for the coverage in a highly elliptic orbit, since the limits on the surface of the earth do not lie on a circle about the ground station.

Scaling Radius—Figure 2C provides a convenient means of dividing a length (the measured diameter of the circle) by two to obtain a direct measure of the radius. The figure comprises two lines that intersect at an angle of 60 deg. This can be redrawn enlarged with intermediate ticks to facilitate accuracy.

Alternatively, the latitude of the center of the circle may be computed by means of the relation

$$\phi_{\text{center}} = 90 \text{ deg} - 2 \tan^{-1} \frac{\cos \phi_s}{\sin \phi_s + \cos \alpha}$$

Thus, for the example presented, $\phi_s = 55$ deg, $\alpha = 29$ deg, and sliderule computation gives $\phi_{\text{center}} = 52.5$ deg, in agreement with the location on Fig. 2A.

Another simple means of locating the center of the circle is to measure the distance between the northern and southern limits on the zeroth meridian, established in step 2 of the example. Division of this distance by 2 then gives the linear measure of the separation of the center from either of the established limits.

REFERENCES

- (1) D. Levine, "Radargrammetry", p 300, McGraw-Hill Book Co., New York, N. Y., 1961.
- (2) "The Microwave Engineer's Handbook and Buyer's Guide," p 154, 1963.

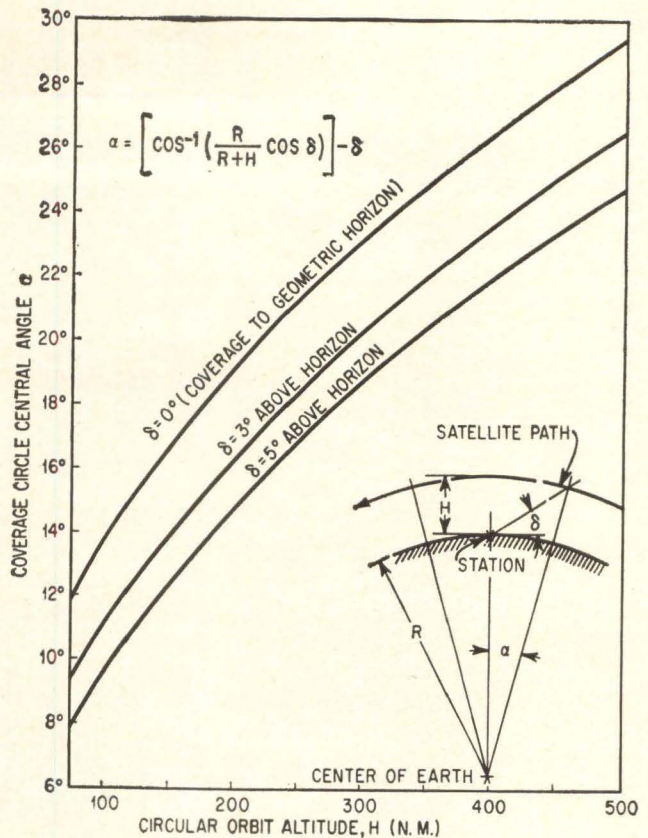

CENTRAL angle upon which coverage circle depends is determined from graph—Fig. 3

Coordinates for Example—TABLE I

Latitude ϕ in degrees	Longitude λ in degrees
84 N	0
80	± 46
70	± 57
60	± 54
50	± 47
40	± 37
30	± 20
26 N	0

Maps as Work Sheets—TABLE II

Since the Fig. 2A is a polar stereographic projection, the coverage circles may be drawn on any standard map that employs this projection. The following maps are listed in order of decreasing scale factor:

- (1) Scale 1:10,500,000, six-sheet wall map of the world, size 108 in. by 126 in., USAF Strategic Outline Charts, No. SO-17.
- (2) Scale 1:17,750,000, size 51 in. by 30 in., USAF Strategic Planning Charts, Northern hemisphere—No. SP-2; Southern hemisphere—No. SP-3.
- (3) Scale 1:24,000,000, size 38 in. by 36 in., Northern hemisphere USAF Strategic Outline Chart, No. SO-16.
- (4) Scale 1:48,000,000, size 19 in. by 18 in., Northern hemisphere, USAF Strategic Outline Chart, No. SO-16a.
- (5) Scale 1:63,000,000 at 60 deg. N. Lat., Weather Plotting Chart, Northern hemisphere, No. AWS-WPC-6-63-1. (Aeronautical Chart and Information Center).

The meridional stereographic projection, Fig. 2B, also corresponds to a standard projection, so the coverage circle may be drawn on any appropriate map. The choice now is more limited than for the first figure. For this purpose, there is available the National Geographic map of the Atlantic Ocean, scale 1:20,000,000, size 25 in. by 31.25 in. (Sept. 1941).

For this chart, the circle is centered on the 40th meridian, which corresponds to the vertical line on the left side of Fig. 2B. Continental outlines and other geographic features are ignored when using this map as a work sheet.

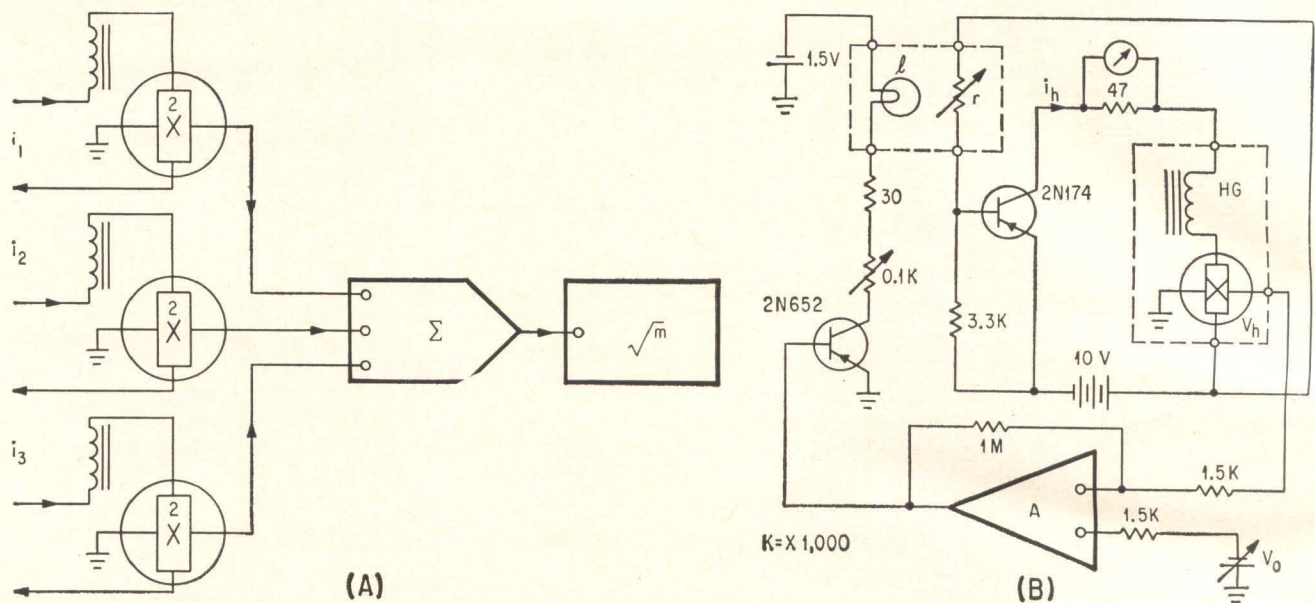

SQUARE-ROOT COMPUTER Uses

Simple analog device is the main component in a system designed to yield the square root of the sum of the squares of three variables that have been translated into electric currents

By H. H. WIEDER, U. S. Naval Ordnance Laboratory, Corona, California

MANY problems in physics or engineering require the solution of the square root of the sum of the squares of three independent variables. The simple analog computer described was designed and built specifically to solve such equations.

The main features of the computer are shown in Fig. 1A. Analog multipliers, based on the Hall effect, are used to advantage for performing most important computer functions. Linearity, speed of response and simplicity of Hall multipliers are particularly advantageous in this application.

The Hall-voltage output of a Hall generator v_h , is proportional to the product of the drive current i_h , and of the orthogonal magnetic induction B . The magnetic field applied across the Hall plate is produced in the gap of a magnetic circuit and the magnetomotive force is provided by a current i_m in an enclosed solenoid. In the gap $B = ai_m$, the parameter a is a function of the effective permeability of the gap, the geometry of the magnetic circuit, and the number of turns in the solenoid winding. For $i_h = i_m$ and with the Hall generator driven in series with the solenoid

$$v_h = \alpha \beta i_h^2 \quad (1)$$

The coefficient β is a material parameter of the Hall plate; it is also a function of its contour and thickness. Provided that thermal perturbations and magneto-resistive effects are negligible, β is a constant and v_h is directly proportional to i_h^2 .

Computer—The square-root computer operates on principles similar to those used in the design of an analog-ratio computer.¹ Figure 1B shows construction details. The output signal v_h of a Hall-effect squaring multiplier is fed to one of the input ports of the differential amplifier A , while the other port receives the arbitrary input signal v_o . The difference, $(v_o - v_h)$ amplified by the gain of the differential amplifier, drives a grounded-emitter power amplifier. The output current of the latter stage drives the lamp l whose light intensity determines the corresponding resistance of the photoresistor r .

The lamp and photoresistor represent an electro-optic assembly that provides isolation of the Hall-generator input from its output circuits, thus circumventing, severe loading of amplifier A . The 2N174 common-emitter power amplifier controls the Hall

◀ DIAGRAM of the computer shows the output from each Hall-effect squaring multiplier fed to the feedback summing amplifier and then to the square-root computer (A), and circuit of the square-root computer where one rectangle (HG) contains the Hall-effect multiplier and the other contains the electro-optic transducer (B)—Fig. 1

HALL current i_h , of the square-root computer is proportional to the square root of the input signal v_o . This plot of $\log i_h$ versus $\log v_o$ has a slope of $1/2$ —Fig. 2

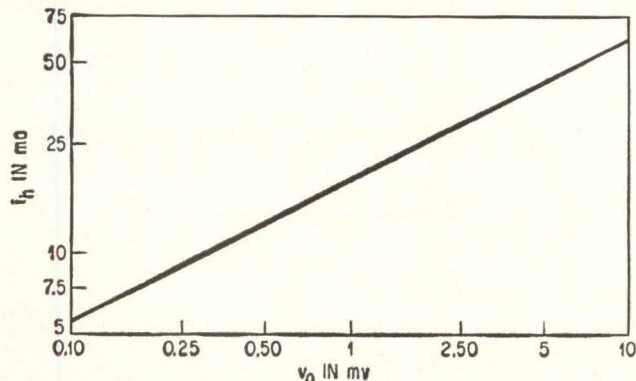

Hall Multiplier

current derived from a voltage source; this current is, therefore, controlled by the effective value of r . If an input signal $v_o > 0$ is applied to the amplifier A , the amplified signal at its output drives the base of the 2N652 transistor stage into conduction, causing a current to flow through l and, decreasing the resistance of r .

The resultant decrease in bias at the base of the 2N174 causes a current i_h to flow through the magnetizing solenoid in series with the Hall generator. In consequence, a Hall voltage v_h appears at the other input terminal of differential amplifier A .

The buildup of i_h and v_h continues until dynamic equilibrium is established and $v_h = v_o$. Hence from Eq. 1

$$i_h = \left(\frac{v_o}{\alpha\beta} \right)^{1/2} \quad (2)$$

In practice, there is a finite misalignment potential v_m' between the Hall electrodes and also a finite unbalance in the differential amplifier v_m'' causing an effective value of signal $v_m = v_m' + v_m''$ to appear at the input of A and hence a small Hall current i_{h0} to flow even if $v_o = 0$. Equation 2 should then be written

$$i_h = (v_o/\alpha\beta)^{1/2} [1 + v_m/v_o]^{1/2} \quad (3)$$

For $(v_m/v_o) \gg 1$, Eq. 2 is a good approximation and the Hall current is proportional to the square root of the input signal v_o .

Results—Some results obtained with the circuit illustrated in Fig. 1B are shown in Fig. 2. A plot of $\log i_h$ versus $\log v_o$ is shown to have a slope of $1/2$ over

two decades of v_o in agreement with Eq. 2. Within the range shown in Fig. 2, the accuracy of the square root computer is 2.8 percent of full scale. The complete circuit shown in Fig. 1A was assembled using three Hall-generator squaring multipliers. Commercially available indium arsenide Hall elements were mounted on the centerposts of ferrite cup-cores, each assembly having an 800-turn solenoid within it. The output of each multiplier was applied to a feedback summing amplifier²; a conventional operational amplifier (Philbrick P-2) was used and its output signal fed to a square-root computer built in accordance with Fig. 1B. For currents $0.2 \text{ ma} \leq i \leq 21 \text{ ma}$ applied to the squaring multipliers, the current i_h of the square-root computer is proportional to within 5 percent of full scale of the theoretically-calculated square root of the sum of the squares of the currents i_1 , i_2 and i_3 .

The accuracy of the computer is limited primarily by drift and thermal hysteresis in the electro-optic transducer and by magnetic hysteresis and nonlinearity in the ferromagnetic core. A considerable advantage in performance can be realized by the substitution or improvement in both of these devices.

REFERENCES

- (1) Wieder, H. H., "Analog Ratio Computer Uses Hall Multiplier," *ELECTRONICS*, Nov 8, p 46, 1963.
- (2) Wass, C. A. A., "Introduction to Electronic Analogue Computers," McGraw-Hill Book Co., Inc., 1955.

MORE USES FOR HALL MULTIPLIERS

In a previous article (*electronics*, p 46, Nov. 8, 1963) the author described a method by which a Hall multiplier could be applied to an analog ratio computer.

This article summarizes more extensive work with the Hall multiplier and describes its application to a square-root computer, where the square root of the sum of the squares of three variables is handled

How to Achieve Stability

Crystal discriminator in an afc loop gives a free-running voltage-controlled oscillator the stability of a crystal oscillator for slow changes but allows a deviation of ± 300 kc

By **FRANK L. CARROLL**, Sylvania Electronic Systems Division, Sylvania Electric Products Inc., Williamsville, New York

DATA COLLECTION by satellite has placed severe weight and reliability demands on the telemetry equipment orbited. Electronic gear being sent aloft today is becoming more precise and more complex, and is creating demands for greater telemetry bandwidth and greater frequency stability. At the same time, the gains made in miniaturization and reliability cannot be sacrificed but must in general be improved.

Thus, a requirement was recently established for an f-m telemetry oscillator operating at S-band, with a deviation of ± 300 kc, oscillation stability of ± 0.001 percent, and less than one-percent distortion for each 30-degree temperature band from -35 to 75 C. Crystal oscillator circuits were evaluated because of their simplicity but not enough deviation could be obtained. Next, mixing the output of a free-running f-m oscillator with a highly stable crystal was considered; stability specs could not be met without seriously degrading reliability. An automatic frequency control loop design was therefore begun and successfully completed.

AFC System—Of the several systems used for automatic frequency control, two of the more typical are shown in Fig. 1. In Fig. 1A the voltage controlled oscillator (VCO) operates at the center frequency of the discriminator. Deviation from center frequency produces a discriminator output voltage that is used to

control the frequency of the VCO. The same principle applies in Fig. 1B except that the discriminator is centered on some frequency lower than the VCO.

Design of the afc loop was begun by converting the circuit of Fig. 1A to its equivalent, Fig. 1C, where K_1 = a constant describing sensitivity of the modulator-oscillator combination (cycle/volt), K_2 = a constant describing sensitivity of the discriminator (volt/cycle) (K_2 is also a function of the peak voltages incident to the discriminator; in this application the drive is assumed to be a constant level), $G(S)$ = transfer function of lowpass filter, f_0 = output frequency of VCO, F_1 = initial frequency of VCO, F_2 = center frequency of discriminator, E_D = discriminator output voltage, and $F - F_2$ = deviation from discriminator center frequency.

Output frequency of the VCO is

$$f_0 = F_1 + K_1 E_{iN} \quad (1)$$

Discriminator output then is

$$E_D = -K_2(F - F_2) \quad (2)$$

where the minus sign refers to a negative slope on the discriminator curve. Neglecting an input signal

$$E_{iN} = E_D G(S) = -K_2(F - F_2) G(S) \quad (3)$$

Combining Eq. (1) and (3)

$$\begin{aligned} f_0 &= F_1 + (K_1)(-K_2)(F - F_2) G(S) \\ f_0 &= F_1 - K_1 K_2 F G(S) + K_1 K_2 F_2 G(S) \end{aligned} \quad (4)$$

SSB TELEMETRY receiver using afc loop is tuned by author



in Space Telemetry

BETTER DATA WITH AFC?

In 1963 the U. S. put 55 or more satellites of various types into orbit, trying to find out what's out there—or in some cases what's down here. The data collected is vital to our space program, but the data is only as good as the telemetry system. Good data plus good telemetry equals good data; good data plus poor telemetry equals poor data. If it's a problem of bandwidth and frequency stability, an afc loop can contribute a great deal

For $K = K_1 K_2$

$$f_0 = F_1 - K G(S) (F - F_2) \quad (5)$$

But $F = f_0$

$$f_0 = F_1 - K G(S) (f_0 - F_2)$$

$$f_0 = F_1 - K G(S) f_0 + K G(S) F_2$$

$$f_0 = \frac{F_1}{1 + K G(S)} + \frac{K G(S) F_2}{1 + K G(S)} \quad (6)$$

From Eq. 6, the larger the value of K , the more closely the output frequency approaches F_2 , which is the discriminator center frequency. Thus an increase in loop gain is a significant controlling factor because K is nothing more than loop gain, a product of volt/radian/second times radian/second/volt.

Therefore increases in loop gain can be accomplished by increasing K_1 , K_2 or both, by adding d-c amplifiers in the feedback loop for example. However, because of the problems with d-c amplifiers over wide temperature variation, a chopper, an a-c amplifier, and a rectifier circuit would be needed after the low-pass filter. Size and reliability, of course, are penalized as circuit complexity increases.

Therefore, loop or circuit gain was placed ahead of the discriminator, as shown in Fig. 2A. By employing a crystal discriminator, a small bandwidth is obtained at the crystal or VCO frequency. No mixing is required to achieve the bandwidth necessary for slight deviations from center frequency to produce an output voltage from the discriminator. As shown in Fig. 2B, the narrow bandwidth discriminator produces an output voltage E_{D2} that is greater than E_{D1} , the wide-bandwidth discriminator output. This voltage is really K_2 , in volt per radian per second.

Modulator—The modulator circuit receives an input signal voltage that changes modulator capacitance and therefore the capacitance of the VCO tank circuit. The VCO frequency, Fig. 3A, thus varies in accordance with the input signal voltage. Variable capacitance diodes were used because of the saving in parts and complexity when compared with a transistor modulator. Zener diodes, well bypassed to r-f, provide a constant bias to the variable capacitance diodes, thus preventing frequency modulation

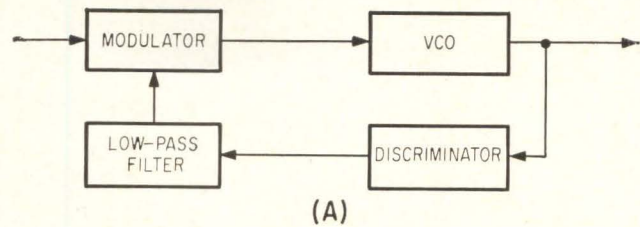

(A)

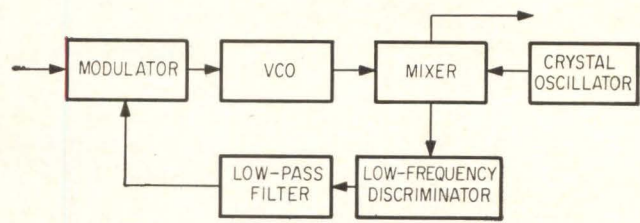

(B)

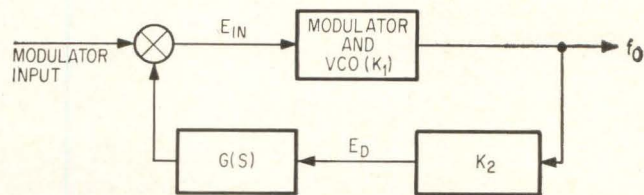

(C)

TWO TYPICAL afc systems (A) and (B), and equivalent control circuit (C) for top afc system, from which loop gain is determined—Fig. 1

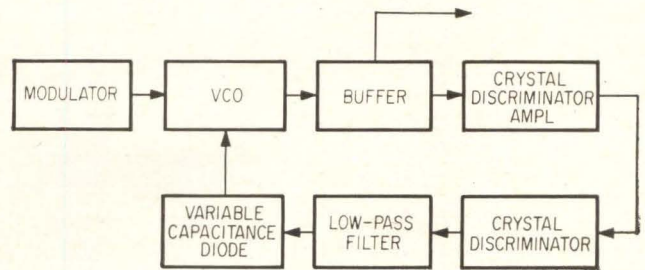

(A)

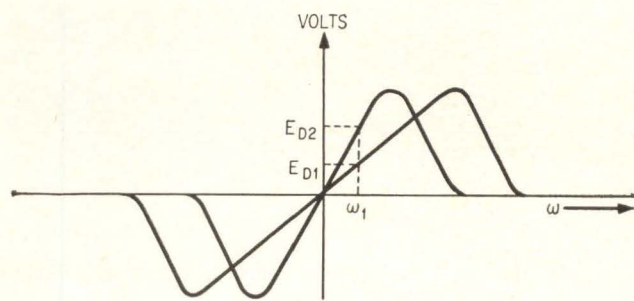

(B)

AFC LOOP (A) uses crystal discriminator as frequency reference to hold VCO to required stability. Low-pass filter keeps corrections developed by intelligence from feeding back. Crystal discriminator gain (B) is one factor in loop gain—Fig. 2

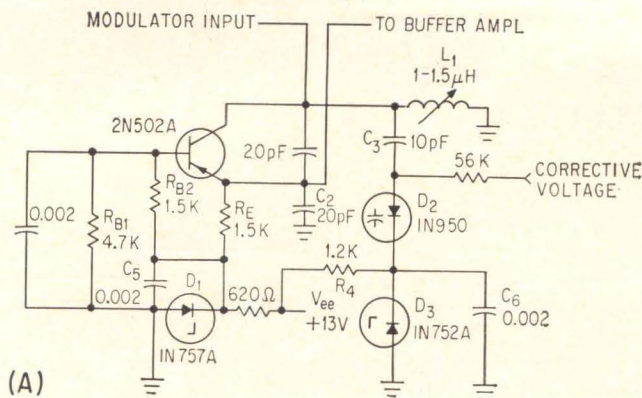

(A)

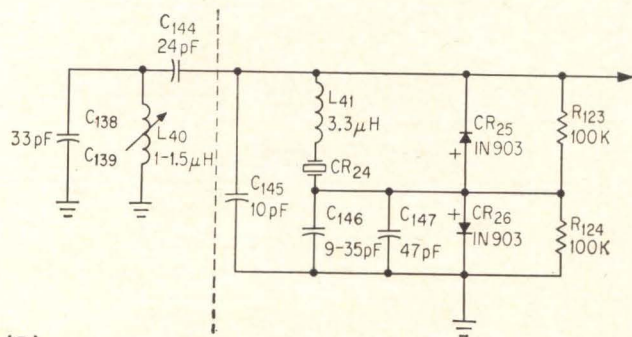

(B)

VOLTAGE-CONTROLLED oscillator and modulator (A) and crystal discriminator (B)—Fig. 3

from power-supply changes.

Bias voltage must be sufficient to prevent the peak a-c swing of the VCO collector from driving the diode into its forward conducting region. A capacitor, C_3 in Fig. 3A, between the collector and variable capacitance diode D_2 minimizes this effect by voltage-divider action of two capacitors in series. Usually C_3 should have a negative temperature coefficient to offset the positive coefficient of D_2 .

Bias voltage for D_2 is usually set for linear capacitance change versus voltage, preferably where maximum capacitance change is realized for a given voltage change. Variable capacitance diodes have different temperature characteristics at various bias levels, so this also affects the bias voltage.

VCO—Required VCO stability can be obtained by designing the free-running oscillator bias network for a stability factor (S_I) as close to unity as possible, where $S_I = \partial i_o / \partial i_{vo}$. First, the frequency shift of the oscillator over the desired temperature range was measured; silicon transistors were used to minimize collector leakage current. Then the oscillator was compensated with negative-temperature-coefficient capacitors to offset positive-coefficient inductances. Required loop gain was computed from $(K_1)(K_2) = (\text{Oscillator Open-Loop Drift}) / (\text{Desired Stability})$.

An important consideration was to make K_1 large (the afc modulator-oscillator constant). For a capacitive reactance modulator this is accomplished by keeping the fixed tank capacitance low; thus the full capacitance change of the modulator is reflected across the resonant tank circuit. To determine the value of K_1 present, various d-c levels were applied

to the modulator variable capacitor and the shift in frequency noted; the slope of the frequency versus voltage curve is a measure of K_1 . Oscillator stability was enhanced by decoupling to prevent loading. Further increases in stability were obtained by regulating the collector supply voltage with zener diodes. Low-output capacitance transistors were used to minimize collector to emitter capacitance changes with changes in collector voltage.

Crystal Discriminator—The crystal discriminator is the heart of the loop since it determines oscillator drift. However, a compromise must be made between maximum deviation and minimum drift. For 0.001 percent drift at 23 Mc, only 230 cps deviation is available as a restoring signal. Too wide a discriminator bandwidth results in small correction voltages for frequency changes; conversely, too narrow a bandwidth decreases the amount of allowable oscillator deviation.

A typical crystal discriminator response curve is shown in Fig. 4A and the equivalent circuit of a crystal is shown in Fig. 4B.

Because R_1 , Fig. 4B, is small in a series fundamental mode crystal (10 to 15 ohms), it can be neglected in analysis. With this assumption, the two resonant frequencies are

$$f_{\text{series}} = \frac{1}{2\pi \sqrt{L_1 C_1}} \quad f_{\text{parallel}} = 1 / 2\pi \sqrt{L_1 \left[\frac{C_1 C_0}{C_1 + C_0} \right]}$$

For the parallel mode, the equivalent discriminator configuration is shown in Fig. 4C.

The impedance, looking back from DF , is

$$Z_{DF} = \left[\frac{(j\omega L_{RQ})(1/j\omega C_0)}{j(\omega L_{RQ} + 1/\omega C_0)} \right] + \frac{1}{j\omega C}$$

$$Z_{DF} = \left[\frac{\omega L_{RQ}}{j(\omega^2 L_{RQ} C_0 - 1)} \right] + \frac{1}{j\omega C}$$

$$Z_{DF} = \left[\frac{\omega^2 L_{RQ} C + \omega^2 L_{RQ} C_0 - 1}{j\omega C (\omega^2 L C_0 - 1)} \right] \quad (7)$$

Equation 9 shows that, for practical values of crystal equivalent parameters at parallel resonance, $\omega^2 L C_0 \approx 1$. Thus the impedance approaches infinity and one point on the discriminator response curve is obtained.

A similar analysis can be applied to obtain Z_{DF} using the series equivalent circuit of the crystal. This, however, can be determined by inspection since a series resonant circuit has zero impedance. For the series circuit $Z_{DF} = 1/j\omega C$. A second point is thus obtained. More points can be obtained by choosing frequencies between f_s and f_p and plotting the equivalent impedance and therefore the voltage-versus-frequency response. By adding diodes for rectification and a d-c return, a d-c output proportional to the shift in frequency is obtained. To obtain a perfectly symmetrical S curve the diodes should be matched by capacitance rather than resistance.

Proper phasing of the crystal-discriminator diodes is necessary; proper polarity depends on the biasing applied to the variable capacitance diode. If the d-c from the discriminator is applied to the positive terminal of the variable capacitance diode, the diode polarity shown in Fig. 4C is required. This produces a

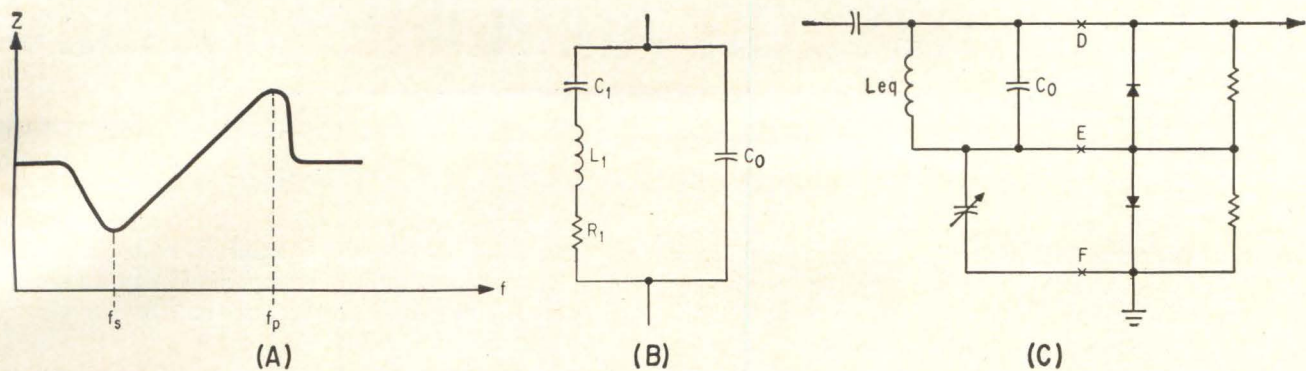

CRYSTAL IMPEDANCE near resonance (A) first falls, then rises as frequency increases. Crystal equivalent circuit (B) and crystal discriminator equivalent circuit at parallel resonant frequency (C)—Fig. 4

negative output voltage for frequencies below the discriminator center frequency and a positive voltage for frequencies above it. Thus, if the VCO frequency drifts lower, a negative voltage from the discriminator further back-biases the variable capacitance diode and its capacitance decreases sufficiently to return the VCO to its original frequency.

From a practical standpoint, an afc loop employing a crystal discriminator must be aligned with the loop closed. This results from the narrow bandwidth and the difficulty in maintaining the VCO free-running frequency somewhere within this bandwidth with the loop open. By tuning the VCO and monitoring its frequency and the discriminator's maximum positive and negative output voltage, the bandwidth of the discriminator can be determined with reasonable accuracy. The width of a marker, if used, while applying a sweep voltage usually causes appreciable error.

Improved discriminator response is obtained by adding an inductance in series with the crystal. This effectively lowers the resonant frequency of the crystal, improves the linearity and increases K_2 . The addition of a small resistance with the inductance provides an additional increase in K_2 .

A final point in crystal-discriminator design is the frequency of the crystal. Because the center frequency of the discriminator is desired and because it is somewhere between f_s and f_p , it is necessary to specify the desired discriminator response to the manufacturer. Once the requirements are known, the manufacturer can determine the value of L and C necessary to produce the desired response. In short, the design of crystal discriminator rests essentially with the manufacturer because the crystal cut is the controlling factor: a crystal for a discriminator will be cut differently than one for an oscillator.

Once the proper discriminator curve has been obtained, and since K_1 is known, the amount of drive to the discriminator necessary to produce the required K_2 can be determined.

Buffer Amplifier—A buffer amplifier follows the VCO to provide additional gain to drive the crystal discriminator and to isolate the oscillator from load changes. It also provides a convenient point for connections to other portions such as multiplier and power stages. Because of the bilateral effect of transistors,

it may be necessary to couple loosely to the buffer stage to obtain the desired isolation from the oscillator. Temperature compensation should be employed in the buffer if its tuning affects VCO frequency.

Driver Amplifier—Additional amplification to drive the crystal discriminator and provide impedance matching is provided by the driver amplifier. Also, isolation of the oscillator-to-buffer from the discriminator is provided, though this is only a secondary factor.

Because the driver amplifier provides the input to the discriminator, the amount of drive present determines the limit of the discriminator output voltages. Thus the limit of K_2 , the discriminator constant, is directly proportional to the applied voltage. The collector tank circuit provides some adjustment of the linearity of the discriminator response.

Low-Pass Filter—The signal from the VCO to the discriminator contains frequency modulation. If the correcting voltage developed by the discriminator is allowed to follow these frequency variations, the frequency modulation produced by the intelligence would be nullified. A low-pass filter following the discriminator permits only slow frequency drifts of the oscillator to be cancelled. Filter cut-off frequency is determined by the lowest modulation frequency to be transmitted, the pull-in range required, and noise immunity. If 20 cps is to be transmitted, a cut-off well below 20 cps is typically required. It can be shown that the pull-in range for small values of ω_N/K (where ω_N = resonant frequency of system and K = maximum frequency shift at output of system per radian shift at input) is proportional to the square root of the cut-off frequency ω_N and the gain constant K .¹

By using a double time constant afc system, the bandwidth can be adjusted independently of the gain constant, and the pull in range can therefore exceed the noise bandwidth by any desired amount.^{2, 3}

REFERENCES

- (1) Wolf J. Gruen, Theory of AFC Synchronization, *Proc IRE*, 41, Aug. 1953.
- (2) C. S. Weaver, Thresholds and Tracking Ranges in Phase-Locked Loops, *IRE Trans Space Electronics and Telemetry*, Sept. 1961.
- (3) A. K. Rue, and P. A. Lux, Transient Analysis of a Phase-Locked Loop Discriminator, *IRE Trans Space Electronics and Telemetry*, Dec. 1961.

COMPRESSOR AMPLIFIER Features

Instrument accepts frequencies from 200 cps to 10 kc. It compresses a dynamic range

VARIABLE-gain amplification has been achieved using the basic compressor amplifier, shown in Fig. 1A. It employs remote-cutoff variable μ tubes whose gain varies logarithmically with grid bias. The grid bias is supplied by the rectified and filtered output of the fixed-gain amplifier so that as the output tends to increase with increased input, the increase d-c bias reduces the gain, holding the output constant. This is similar in operation to conventional avc circuits. A signal input of 10 to 300 mv rms provides a corresponding output of 0.575 to 0.860 v rms. Transient response is: +10 db signal input, 25 ms; -10 db signal input, 75 ms.

The variable gain amplifier is unique because of its balanced push-pull type circuit that provides out-of-phase cancellation of the gain-controlling voltage at the output. The gain-controlling voltage acting on each grid in phase, produces in-phase voltages in the push-pull output transformers and regulates the gain of the tubes to the out-of-phase a-c voltages fed to the grids from the input. In this way the gain-controlling voltage variations are suppressed about 40 db, which means that the time constant of the smoothing filter can be made much faster without producing instability. This is advantageous when fast avc action at the lowest possible carrier frequency is required. Also, it is distinctly advantageous when this is used in another closed-loop feedback system.

Circuits—The high-pass filter provides additional attenuation of the low controlling frequencies and is necessary only because of imperfections in the balance parameters of the variable-gain amplifier. Since this device involves the processes of feedback control, it is subject to all the stability laws of closed-loop systems. The rectified output of the fixed-gain amplifier is filtered in a single R-C section filter which easily meets the stability requirement of 12 db/octave when the unit is used as a voltage compressor.

The rectifiers in the voltage delay rectifier are biased at a voltage level such that avc voltage is produced only when the peak output of the fixed-gain amplifier exceeds this bias. This results in a three-

hold input voltage at which the automatic gain operates and also provides tighter automatic control.

The smoothing filter is provided to remove a-c components from the unidirectional output current of the voltage delay rectifier.

A protective voltage clamping circuit is provided at the output which clips the peak output at about 1.2 v, thus assuring protection to other associated devices during fast high transient changes in input.

Applications—Other modes of operation are possible and can be provided for by selectable interconnections between the blocks. In applications such as constant-current control where the device being current controlled may have a high storage factor (high Q) the device's response to energy-level changes will be equivalent to additional attenuating and phase-shifting elements in the control loop. Therefore it is necessary to have a knowledge of the transfer function of the device being current controlled as its attenuation and phase shift must be added to that of the compressor to ascertain the loop-stability factor.

Figure 1 B is the block diagram for constant-current control. A current-sensing resistor produces a voltage proportional to the current in a variable load. This voltage is fed to the fixed-gain amplifier which produces a rectified and smoothed d-c control voltage that stabilizes the variable-gain amplifier to hold the current in the variable load constant. If the variable-gain amplifier derives its power from a constant-voltage source in the power amplifier, and the input to the variable-gain amplifier is held constant, the current in the load will vary 1 to 1.5 for a 1-to-30 change in load impedance. The input to the variable-gain amplifier may be held constant, by cascading another compressor amplifier between the current-control compressor and the frequency source.

Figure 1 C shows compressor amplifier connections required for holding the displacement of a transducer constant. A voltage proportional to transducer displacement is fed from the accelerometer to the input of the fixed-gain amplifier and produces a rectified and smoothed d-c control voltage which holds the

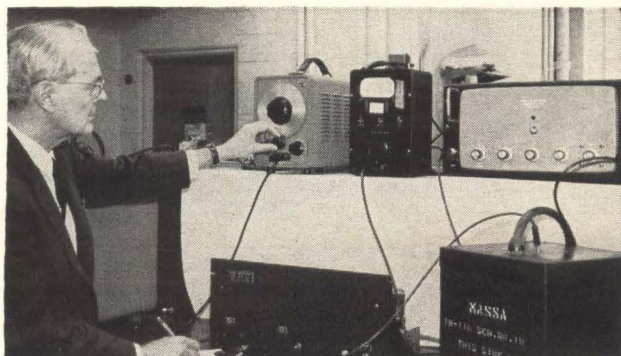

PRODUCT RESEARCH PAYS

Variable gain amplification has been achieved to tame a high-power shake table for low-level oscillating tests. The author has researched his product further to show that it has a wide variety of industrial and environmental testing applications depending on the manner in which it is connected

AUTHOR conducts a test for constant current control of a transducer

Balanced Push-Pull Circuit

of 1-to-30 to a variation from 1-to-1.5 at its output

By LEWIS M. HILLES

Project Engineer, Recorder Systems, Massa Division, Cohu Electronics, Inc., Hingham, Mass.

transducer displacement constant by stabilizing the variable-gain amplifier. If the input to the variable-gain amplifier is held constant, the displacement of the transducer will vary in the ratio of 1 to 1.5 for a 1-to-30 change in transduction. If it is desired to hold the input to the variable gain amplifier constant, another compressor amplifier, wired for constant voltage, may be cascaded between the variable gain amplifier and the frequency source.

Figure 1 D shows the compressor amplifier wired for constant voltage and inserted in a self-oscillating system where the frequency of oscillation is controlled by the high Q resonance of the transducer. Here the transfer function of every device in the closed loop must be known. The total transfer function is the product of all the loop transfer functions and must be of a characteristic that provides sustained oscillation only at the frequency of that part of the loop containing the transducer under test. Every device in the loop with the exception of the one under test should have a wide flat response. The balanced variable-gain amplifier in the signal compressor provides a wide flat response. Since the output signal does not pass through the low-frequency rejection filter, the response of the compressor is flat to the lowest possible frequency. The voltage input to the transducer varies in the ratio of 1 to 1.5 for a 1-to-30 variation in compressor input, if the gain of the power amplifier is constant.

Feedback—In a closed-loop oscillating system, the magnitude of the oscillation is governed by that part of the system having the lowest saturation level.

For example, in Fig. 1 D, the system oscillating magnitude builds up until several kw are delivered to the transducer—the saturation level of the power amplifier. In fact, even with the compressor included in the loop and the safety clamp excluded, the power level will tend to build up to the saturation level, but will be checked by the avc action in the compressor. If the time response of the avc action in the compressor is not faster than the time response of the transducer, a fluttering modulation of the power level will exist. This is why the safety clamp was employed. The safety clamp sets a saturation point and the following amplifier's gain controls the power level in the power amplifier for this saturation level.

Figure 1 E shows the compressor wired for constant-transducer displacement and inserted in a self-oscillating system oscillating at the resonant frequency of the transducer. Here the safety clamp sets the saturation level. The gain of the variable-gain amplifier controls the power level. Since the input to the fixed-gain amplifier is proportional to the accelerometer displacement, the d-c gain-control voltage is proportional to displacement. This regulates the gain of the variable gain amplifier to keep the displacement constant. The transduction can vary 1-to-30 with a resultant 1-to-1.5 variation in displacement.

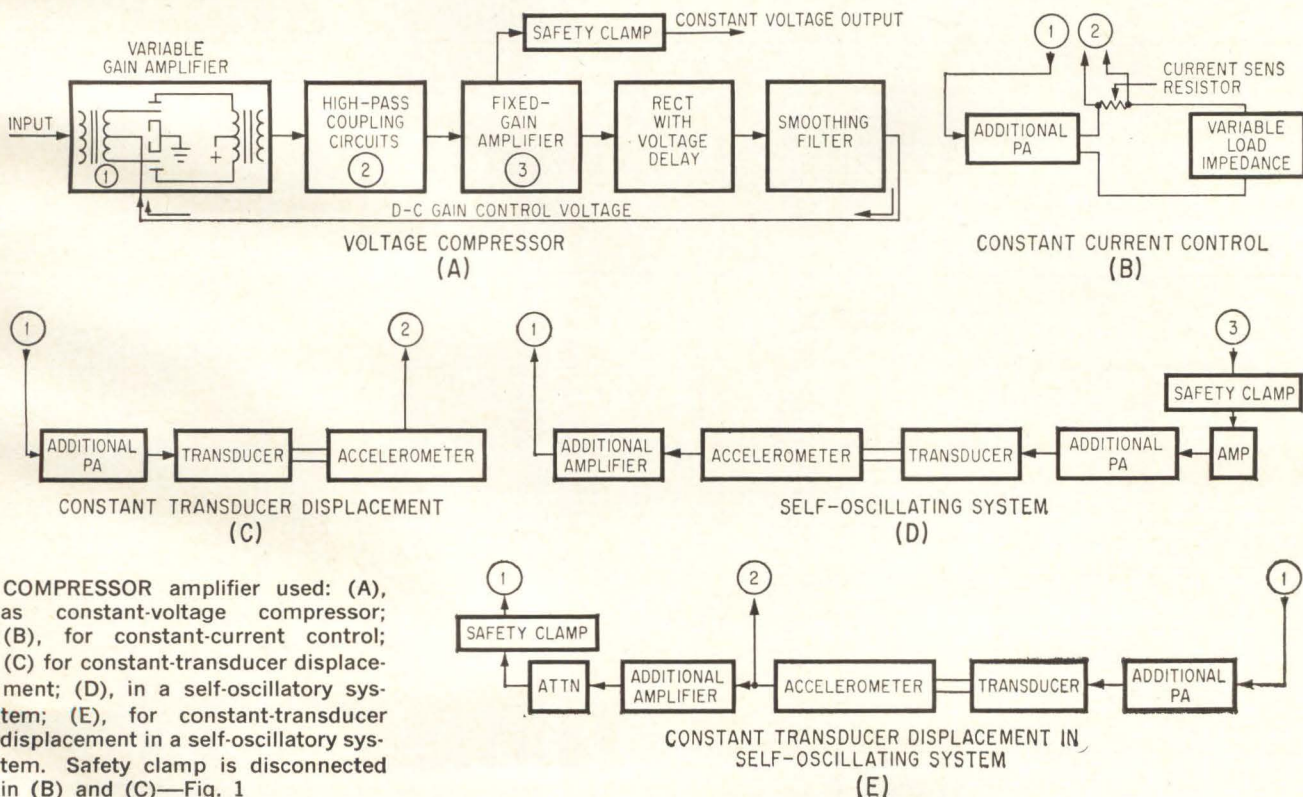

COMPRESSOR amplifier used: (A), as constant-voltage compressor; (B), for constant-current control; (C) for constant-transducer displacement; (D), in a self-oscillating system; (E), for constant-transducer displacement in a self-oscillating system. Safety clamp is disconnected in (B) and (C)—Fig. 1

we've charted a new dimension in

PNP PLANAR POWER

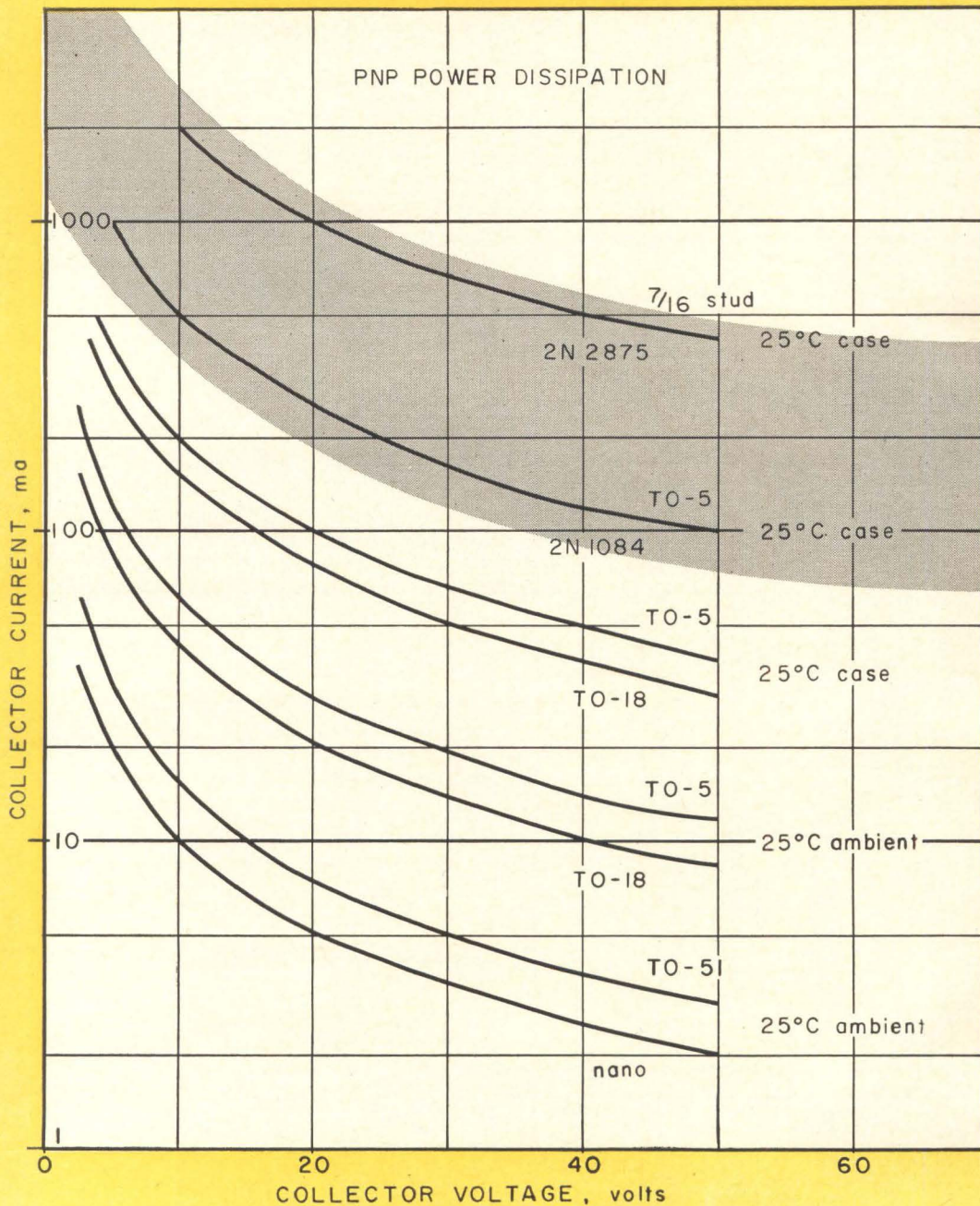

2N2875
MT-21 (7/16" stud)
(exclusive with Transistron)

2N1084
TO-5
(exclusive with Transistron)

2N721
2N722
2N978
TO-18

2N1131
2N1132
2N1991
TO-5

TMT-1131
TMT-1132
TO-51

TNT-1131
TNT-1132
Nano

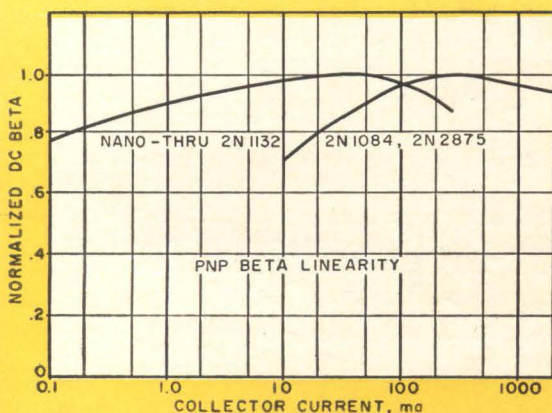

Our comprehensive line of silicon planar PNP transistors offers the broadest power range (100mW to 20W), the most versatile performance and the widest choice of packages ever available. Its many types include two important exclusive devices: the high power 2N2875 (20W) and the medium power 2N1084. All units offer planar dependability. All are available through your Transistron Distributor. For complete product information, write our Wakefield installation for our PNP Bulletin.

Transistron 
electronic corporation

wakefield, melrose, boston, mass.

SALES OFFICES IN PRINCIPAL CITIES THROUGHOUT THE U.S.A. AND EUROPE • CABLE ADDRESS: TRELCO

Double-Tuning Simplifies Superhets

By DAVID B. HOISINGTON, U. S. Naval Postgraduate School, Monterey, Calif.

MOST tunable superheterodyne receivers for frequencies below the uhf range use parallel resonant circuits in the r-f section to reduce spurious responses. Adjacent channel rejection is obtained in the intermediate-frequency amplifier. Use of a square-law or product mixer with the oscillator frequency above the signal frequency eliminates all spurious responses except signals at the intermediate and image frequencies. To suppress signals at these frequencies to the extent desired in a communications receiver may require several tuned circuits before the mixer. The most common practice is to use one tuned circuit per stage plus one in the antenna circuit, so that several stages of amplification are often necessary. High gain before the mixer is not desirable, because a high-gain amplifier may amplify unwanted signals in adjacent channels to the point where intermodulation may occur in the mixer or in an r-f stage. Consequently, r-f amplifiers are sometimes operated with stage gains an order of magnitude less than the devices used are capable of producing. If double-tuned transformers are employed in the r-f stages, the number of tubes, transistors, or other nonlinear amplifying devices can be reduced, and the remaining ones can be operated more nearly at the gains of which they are capable. This reduction in the number of nonlinear devices used may reduce the susceptibility to cross-modulation from signals in nearby channels, and by reducing the overall complexity, increase its reliability.

Design—In designing an r-f amplifier with double-tuned transformers, certain factors peculiar to this circuit must be considered. In receivers for frequencies above a few megacycles, a coefficient of coupling considerably less than critical is generally used. This is because the

bandwidth is increased as the coefficient of coupling is increased above zero, and while low coupling results in reduced gain, high gain is actually undesirable in these stages at frequencies below those at which thermal noise is a prime consideration. Moreover, if coefficients of coupling equal to or greater than critical are used as might be desirable at frequencies below a few megacycles, alignment and tracking become considerably more difficult. Tracking may be easier in the low-frequency range if a coefficient of coupling just under critical is used, since the amplification is more nearly constant near resonance under these conditions than when loosely coupled or isolated tuned circuits are employed.

Graphs—To simplify the problem of designing tuned amplifiers in which coupled circuits are used, a series of graphs are presented to

show the effect of the relative coefficient of coupling on the frequency response of the amplifier. Figure 1A gives response curves for a pair of circuits with critical coupling ($k/k_c = 1$) and for a pair of uncoupled circuits ($k/k_c = 0$). This latter curve applies for two stages of an amplifier with a single tuned circuit in each stage. The curves are normalized with respect to the gain at resonance and are exact only if primary and secondary have the same Q. In practice there is little error when primary and secondary have somewhat different Q's if the geometric mean Q is used. Note that, far from resonance, both curves have a slope of 40 db per decade, and the asymptotes pass through $Q\Delta f/f_r = 0.5$ and 0.707 for zero and critical coupling respectively. The curves may then be used beyond $Q\Delta f/f_r = 10$ by adding 40 db per decade to the asymptote. Far from resonance, 6.02 db less

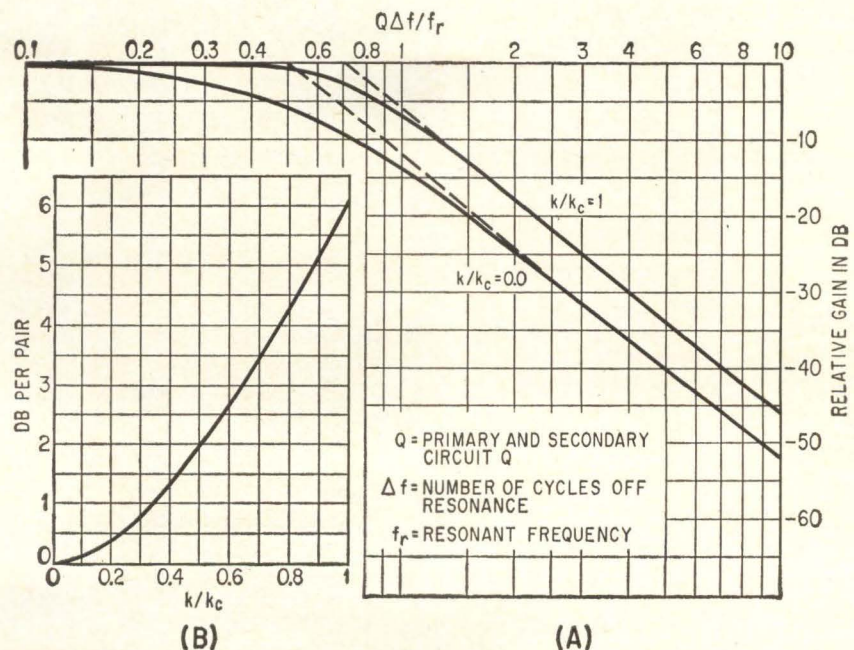

COUPLED CIRCUIT response (A); decreased skirt rejection due to coupling (B)—Fig. 1

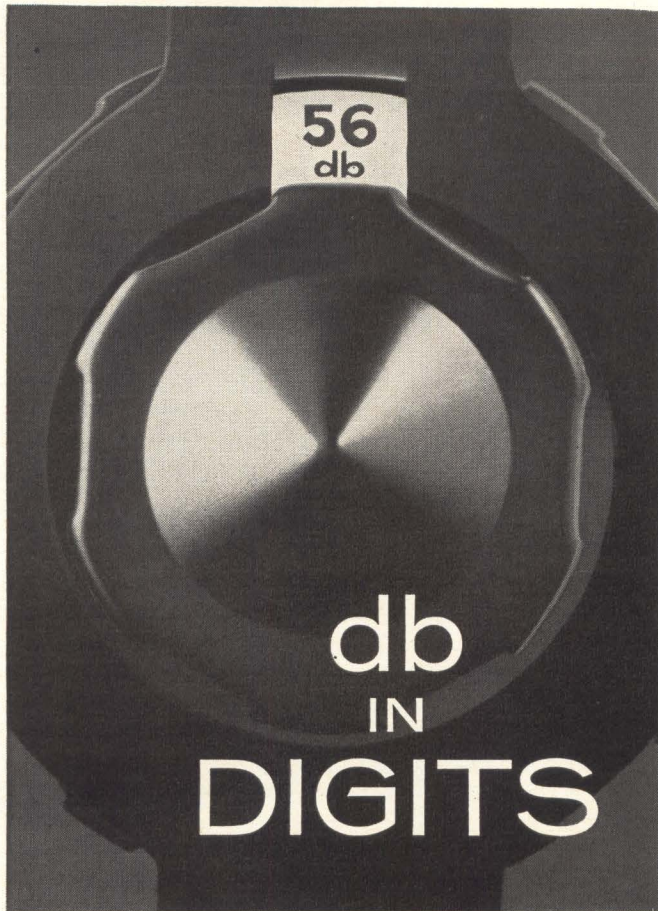

It attenuates any signal from DC to 1250 MC, has an operating range of 0 to 59 db, and provides error-free, digital indication of the db value. The Model No. is TAB-50. Its brand name is Telonic.

This turret attenuator is a unique Telonic design incorporating two concentric dial selectors with 10 db steps to 50 db, and 1 db steps to 10 db. Any db value from 1 to 59 can thus be selected and is indicated exactly by the digital readout. There is no approximation, no interpolation. Each decade and unit attenuation element is an individual pi-pad mounted to a precision machined rotor. Positioning is fast and exact, repetitive settings are always right on the mark.

Specifications are just as impressive: accuracy at 30 mc is $\pm 2\%$; VSWR to 300 MC is 1.2:1, and insertion loss is a low 0.1 db at 30 MC. And if extreme accuracy at high frequencies isn't mandatory, you may elect to use a Telonic Model TEB-50 identical to the TAB-50, but with relaxed specs above 30 MC — at a reduced price of course.

Both of these models are shipped ready for either bench use or panel mounting. Instructions and drilling template are furnished with each unit.

Telonic has, in fact, a wide selection of turret attenuators available for virtually any application. They range from 0 to 1 db in 0.1 db steps to 0 to 110 db in multiple mounts. A complete set of specification sheets on all models is available on request.



INDUSTRIES, INC.

60 NORTH FIRST AVENUE
BEECH GROVE, IND.
PHONE STATE 7-3231 AREA CODE 317
TWX 317-635 4748

Representatives in
Baltimore, Boston, Chicago, Cleveland, Dallas, Dayton, Denver, Huntsville, Indianapolis, Los Angeles, New York City, Orlando, Philadelphia, San Francisco, Seattle, St. Louis, Syracuse and principal cities throughout the world.

FOR OFHC COPPER COMPONENTS

Call **JANNEY**

Call **JANNEY** for Forgings,
Extrusions, High Energy Rate Forming

Benefit from JANNEY's extensive experience in forming OFHC* Copper and other high conductivity alloys for electronic applications. We offer:

1. Engineering know-how in this field
2. Flexibility of operation
3. Comprehensive quality controls
4. Machining facilities
5. Capacities: primarily parts weighing between 2 and 6 pounds each and billet sizes ranging between 2½" and 5" in diameter.

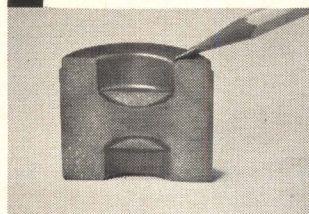

**OFHC COPPER
ELECTRONIC COMPONENT**
(HER Formed for smoother finish, better parts, less metal loss, simpler tooling)

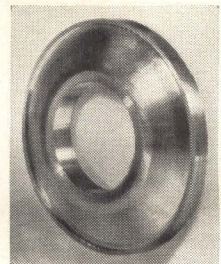

OFHC COPPER
(Ring Forging, Rough Machined)

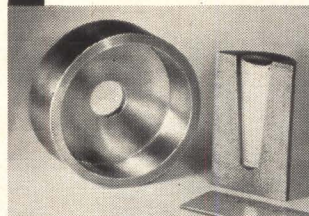

OFHC COPPER
Components for Electronic Applications



OFHC COPPER
A housing that has been backward extruded and machined. Note solid end.

Challenge us with your problem.
Write, wire or phone.

JANNEY CYLINDER COMPANY

7401 STATE ROAD, PHILADELPHIA 36, PA.

Phone: (215) MAYfair 4-6600

*Reg. Amer. Mtl. Climax, Inc.

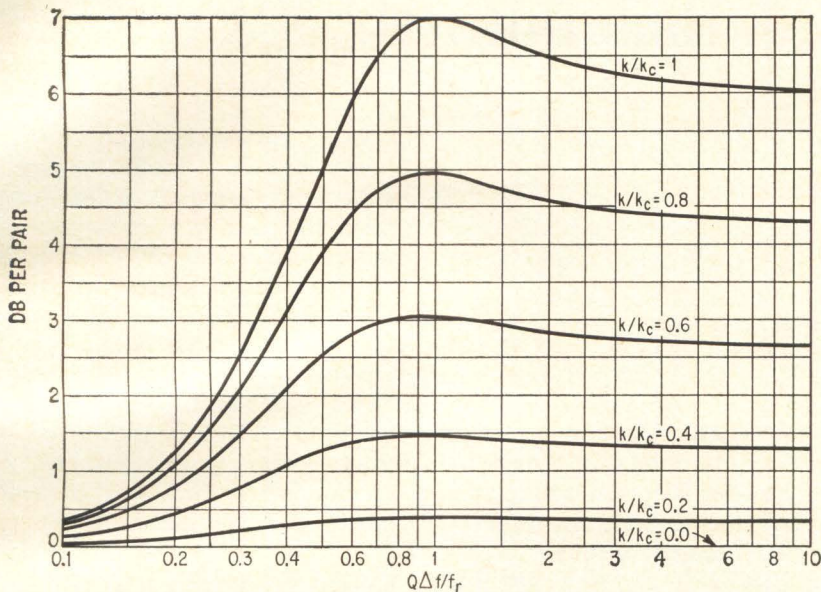

DECREASED REJECTION due to coupling—Fig. 2

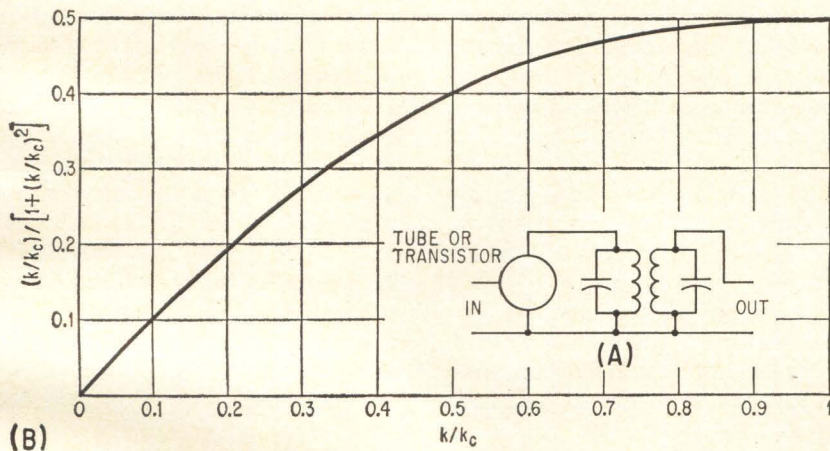

TUNED vacuum-tube or transistor amplifier (A); plot of $(k/k_c)/[1 + (k/k_c)^2]$ versus k/k_c (B)—Fig. 3

rejection is obtained at any frequency when the circuits are critically coupled than when they are uncoupled.

Figures 1B and 2 show, for various coefficients of coupling, how much rejection is sacrificed at various frequencies as compared with a pair of uncoupled tuned circuits. Figure 1B gives this information as a function of k/k_c on the skirts of the response curves. Inspection of Fig. 1A and Fig. 2 shows this curve

to be valid whenever $Q\Delta f/f_r$ is greater than three. The same information is given in Fig. 2 for frequencies closer to resonance for various coefficients of coupling. These curves are most useful when $Q\Delta f/f_r$ is less than three.

For a circuit in the form of Fig. 3A the gain of one stage at resonance may readily be obtained for $Q > 10$ from the formula

$$|A| \approx g_m \sqrt{Z_{01}Z_{02}} \frac{k/k_c}{1 + (k/k_c)^2} \quad (1)$$

where g_m = transconductance of tube or transistor, Z_{01} = resonant impedance of primary including effect of plate or collector resistance, Z_{02} = resonant impedance of secondary including effect of input resistance of following stage, and k/k_c = coefficient of coupling relative to critical coupling.

The factor $(k/k_c)/[1 + (k/k_c)^2]$ is plotted in Fig. 3B as a function of k/k_c .

Example—A vacuum-tube r-f amplifier is to be designed at a frequency of 30 Mc for a superheterodyne in which the intermediate frequency is 1.5 Mc. The tuning capacitance is 40 pf, the gain from the first grid to the mixer grid is to be 15 times for a tube transconductance of 5,300 μ mho, and the image rejection is to be at least 65 db. The net Q of each tuned circuit is 80, except that the input (antenna) tuned circuit has a Q that depends upon antenna impedance and may be as low as 40.

At the image frequency (33 Mc), $Q\Delta f/f_r$ is 4.0 in the antenna circuit under the worst circumstances, and is 8.0 in the other circuits. From Fig. 1A, the antenna circuit is seen to provide 18 db of image rejection, the rejection for a single tuned circuit being half that of a pair of tuned circuits for which $k/k_c = 0$. From this same figure, the image rejection for each coupled pair is seen to be 48 db for coupling approaching zero, or 42 db for critical coupling. One r-f stage with a double-tuned circuit in the plate will therefore give from 60 to 66 db image rejection. The value of k/k_c to obtain a stage gain of 15 is found from Eq. 1. $Z_{01} = Z_{02} = QX_c = 10,600$ ohms, so $(k/k_c)/[1 + (k/k_c)^2] = 15/(0.0053 \times 10,600) = 0.267$. From Fig. 3B k/k_c is 0.29. The actual image rejection can now be found with the help of Fig. 2, or in this case more conveniently from Fig. 1B since at the image frequency $Q\Delta f/f_r = 8$. The image rejection is found to be 0.7 db less than it would be for zero coupling between the circuits, or $(18 + 48 - 0.7) = 65$ db, meeting the specification.

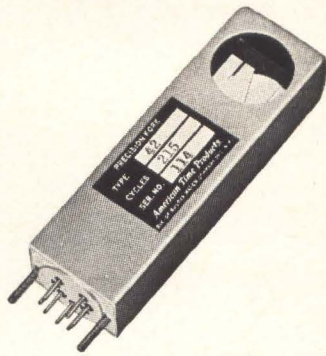

**AMERICAN
TIME
PRODUCTS**
10 to
1000 CPS
**LIGHT
CHOPPER**

NO LUBRICATION NEEDED

Unlike motor driven types, American Time optical choppers and modulators function without lubrication — no wear, with reliability multiplied several-fold. Based on the balanced, vibrating members of a tuning fork, the chopper also has the advantage of drastically reduced power requirements. These inherent benefits are obvious for space and other applications. IR, UV and other radiation are controllable.

Operated by an external 2 transistor circuit, signal voltage is available from the fork circuit as a reference. Accuracy of .05% in ranges from -55 to +85°C — higher accuracies can be obtained. Input power is 150 m.w. @ 28 volts into external circuit. Lower powers and lower voltages can be worked out. Operational altitude is up to space vacuum. And physical size is 1" x 3/4" x 3", with a 3/4" diameter window — the unit weighing a maximum of 3 oz.

Applications include spectrophotometers, mass spectrometers, radiometers, bolometers, IR detectors, star trackers, burglar alarm systems, intrusion systems, telemetry systems, colorimeters, and densitometers. Write Bulova, American Time Products, 61-20 Woodside Ave., Woodside 77, New York.

INDUSTRIAL/DEFENSE GROUP

BULOVA

AMERICAN TIME PRODUCTS

Marine Electronics Sail On A High But Rough Wave

Competition and whims make radio, navigation manufacturers headachy

By **ERIC VALENTINE**
Assistant Editor

NEW YORK—The business of supplying electronics to America's large, growing fleet of small pleasure craft is riding a swell of prosperity—but the headway is rough.

In 10 years the industry has tripled. Spokesmen placed marine electronics revenues last year at anywhere from \$10 million to more than \$25 million—with a more precise estimate made virtually impossible for lack of precise government figures.

But fierce competition, buyer whims, budgets too small to help firms shore up the future with in-house R&D, high overhead among big companies, high distribution costs for small ones—all make problems.

Questioned last week at the National Motor Boat Show here, small and big fish in the marine electronics pool saw the trend not toward new

types of equipment to do new jobs—at least not at the moment. Raytheon, Bendix, RCA—more proud of their new packages, new models but lacking new basic equipment—saw the R&D effort aimed more toward perfecting the quality of established main lines.

Why? The pleasure boatman, buying electronics, is a package of conflicts. He's conservative yet status-bound, price conscious yet careful. Most often, what he wants most—and will spend for—is fun.

Quality Control—"The explosion is in quality" at Bendix. They feel there that price, once paramount, is now secondary. To up-grade their product they've integrated quality control into the production line, boosting costs 5 percent but saving 10 percent in field servicing.

Quality, and the pursuit of it, led one RCA executive to state that the brand name—and the trust that goes with it—is a company's prime sales asset. With just so much business to get, getting it is tough. Half the 18 or 20 large and small firms now selling could fill all the orders, he said; and it's the "loft operators," who can't offer nationwide service but can quote lower prices, that

VHF, SSB IN PLEASURE-BOAT FUTURE

NEW YORK—Vhf and single-sideband radio, obstacle detectors, and computer-like course programmers are viewed for the future in small pleasure boating.

Clogged wavelengths, a headache on most of America's sounds, lakes and rivers, leads RCA to call vhf and single-sideband essential. But costs put them at least 5 to 10 years away.

Sonar-like systems to find submerged objects before the boat hits them, unlike present depth sounders, is another RCA project. They're studying telephone-dial radios as well.

Raytheon foresees an automatic course programmer and some type of automatic plotting radar. This would store radar data and keep track of not only where targets are, but where they've been. The Coast Guard's experimental RATAN, now servicing New York Harbor, could make pleasure boat radar unnecessary. In RATAN, high-definition radars feed information into a storage-tube scan converter. Changed from rotary to horizontal scan, it can be beamed to ordinary pleasure-boat tv receivers. The advantage: \$200 for a tv set, \$2,000 for radar

make life hard for the big firms. The problem: overhead.

Countered one small firm's representative: "Workmanship's standard, we all buy the same components." If the big companies can't square their profits with costs, that's simply free enterprise, he added.

One boat dealer, however, took issue. Quality does vary, sometimes surprisingly. He won't tell a buyer which firm to patronize, but he will make "suggestions" based on "experience." In one case, it led to a virtual blacklisting of one national supplier: "Experience shows the product just not reliable, regardless of the 'brand name.'"

The key to sales, said another boatseller, is service—and service means good national distribution. If it costs boatsellers too much for the requisite FCC-licensed installer, they'll buy from a dealer. He in turn buys either the "home product" or handles some nationwide franchise. Most choose the latter: he can promise repairs and deliver them wherever a boatman drops anchor. Theoretically, at least, the game should go to the big house—despite its high overhead.

Buying is Baffling—Who buys what gear and why is a mystery. Personal needs, say the companies, seems the first answer; but needs are not often rational and seldom predictable.

Women want the ship-to-shore telephone and want it to "look good," said Raytheon. Men buy the depth sounder. "For safety? That's what they'll tell you. Really, it's for prestige and fun."

The problem is best seen in the gas-fume detector. As a way to avoid one major hazard, it's vital; but both Bendix and Raytheon meet resistance. Said Raytheon: "If you could listen to a ball game on it, play music or keep the drinks cold, they might buy it. Otherwise it's a fight."

Or the ship-to-shore radio. Bendix packaged two models, one 35 watts, the other 70 watts, in the same case. The 70 watter raised problems. The two looked alike, the firm said, and people feared being chiseled.

Of all prestige items, radar comes first. It's not necessary, said Raytheon, for eight summer week-

continued p. 44



ELECTRONICS progress in semiconductors

When The Chips Are Down

... and the bets are being called, and you've gotta be right about the bet you're betting ... put your money on our "chip and wire" Active Functional Devices (AFD's). As we've told you before in these columns, AFD's are compatible with conventional circuit board or thin film techniques because the complete active portion of a flip flop or gate circuit is contained in one can, and the resistors or capacitors are contained on the circuit or thin film substrate. But what we want to emphasize now is that using this "chip and wire" approach WE CAN PUT ANY PELLET IN ANY PACKAGE used for chip and wire AFD's. The packages include 3 to 12 lead TO-5, 3 to 6 lead TO-18, 3 lead TO-46, TO-50, 6- and 12-lead flat packs, 6 lead network packs ... and throw in Kovar tabs for good measure. The pellets can be PEP (Planar Epitaxial Passivated) or Planar Passivated. In fact, we can offer you over 50 different pellet types and up to 6 pellets in a package.

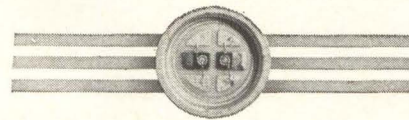
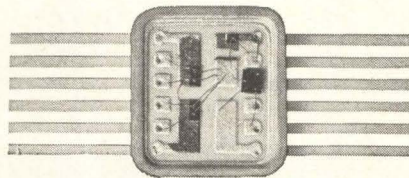

6- and 12-lead flat packs

We have over thirty "standard" circuits available, but an infinite variety can be tailored to your own circuit needs. Just as an example, we have seven basic transistor pellet types:

1. 11B pellet—2N1613, 1711, 1893, 2049, etc.
2. 11C pellet—2N2192-5, 2243, etc.
3. 10B pellet—2N914, 708, etc.
4. 10C pellet—2N915, 16, 759, 60, etc.
5. 10D pellet—2N918, etc.
6. 10H pellet—2N929, 30, etc.
7. 10J pellet—2N3082, 3083.

We also have three basic diode pellets—the SD150, SD600, and SD300 ... thin film resistors from 10 ohms to

100K ohms ... and thin film capacitors from 5 picofarads to 11,000 picofarads. The possible combinations are endless ... switches, amplifiers ... high speed ... low speed ... high frequency ... low frequency. When the chips are down, we've got it for you. But we can also simplify your circuit design problems too. Just write to "Application Engineering, Consulting Service", at the address listed below. You'll be glad you did.

While we're on the subject of "chip and wire", we've also got a couple of standard Differential Amplifiers (2N2060, 2N2652, etc.) in multi-lead TO-5 and TO-18 packages using ceramic disc construction. That means lower thermal impedance, better tracking with temperature because of more uniform thermal gradients, and the outstanding mechanical reliability we achieved for Minuteman. Write for complete details.

Now It Can Be Told

... the world's first 60¢ unijunction transistor is here! That's in 1,000 and up quantities, of course. This new 2N2646 not only simplifies circuits and eliminates the need for extra components the way all unijunctions do, it is ideal for use in firing circuits for Silicon Controlled Rectifiers and other applications where a guaranteed minimum pulse amplitude is required. At this price ... what a deal! Write and ask for the new spec sheet.

Any questions? Write Section 16A157, Semiconductor Products Department, General Electric Company, Electronics Park, Syracuse, New York. In Canada: Canadian General Electric, 189 Dufferin St., Toronto, Ont. Export: International General Electric, 159 Madison Ave., New York 16, N. Y.



**GENERAL
ELECTRIC**

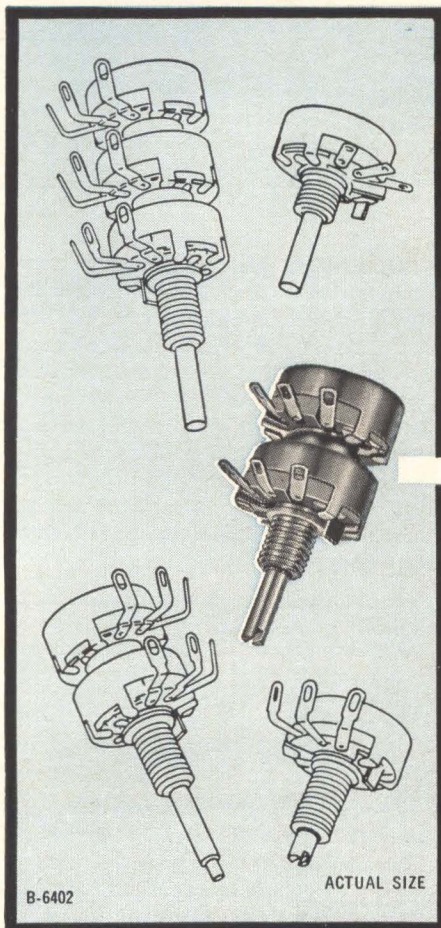

B-6402

ACTUAL SIZE

5/8" Potentiometers

MILITARY OR COMMERCIAL

CENTRALAB HAS 9 TYPES OF EACH

Composition or wirewound, in singles, twins, triples, dual concentrics or attenuators*... RV1 Style MIL-R-94B composition, or wirewounds to MIL-R-19A performance specifications, or their commercial equivalents, all available at realistic prices and delivery schedules.

Ratings: Composition, 1/4W at 70°C, zero at 120°C per MIL-R-94B
Wirewound, 2W at 70°C, zero at 135°C per proposed MIL-R-39002

Ranges: Composition, linear 200Ω to 5.0 meg, 10% log 5000Ω to 2.5 meg
Wirewound, 4 to 30,000Ω linear taper

For immediate delivery many types are stocked by Centralab Industrial Distributors as JMP, JML, JWP, JWJ series.

Write for detailed engineering data.

*not available as wirewounds

Centralab®

THE ELECTRONICS DIVISION OF GLOBE-UNION INC.
P.O. Box 591, Dept. 14A • Milwaukee, Wisconsin 53201
In Canada: Centralab Canada Ltd., P.O. Box 400, Ajax, Ont.

CIRCLE 44 ON READER SERVICE CARD

ends. "Yet if the guy in the ship next to his has one, a boatman may want it too." In fact, one bought an antenna cover—nothing else. He said he'd come back for the electronic insides later. He never did.

Breakthroughs Infrequent—Like so much of the industry, marine electronics suffers a developmental time lag. Radar and now the new loran-C cut their teeth commercially on large ocean vessels. It took about six years for them to appear on the pleasure boat's bridge.

The last major breakthrough was the transistor, yet only this year did one industry leader exhibit an all-transistor 45-watt radio.

Why? Manufacturing costs are prohibitive and before changes occur, RCA says there must be advances in mass need and production, besides state of the art.

For these reasons, new products come seldom. Marine electronics, compared with the overall industry, is a small part, said Bendix. "It can't afford its own R&D."

Optical Filter Reads Images

ANN ARBOR—An advance in optical spatial filtering is reported this month by B. Vander Lugt, of University of Michigan's Institute of Science and Technology.

Easy to Program—Vander Lugt told *ELECTRONICS* that his work provides the background theory for the construction of complex optical spatial filters that would facilitate automatic pattern recognition without a digital data processor. The system can be programmed to recognize a given pattern over a wide acceptance angle, without the use of scanning. Programming does not require experienced operator.

Such a system, capable of reading letters and numbers, would be useful in business and scientific applications, library indexing, data retrieval and automatic language translation.

With different programming they

could recognize camouflaged man-made features in aerial reconnaissance photographs.

Laser Light Source—Based on the recent discovery that a laser beam can be manipulated to store previously unrecordable phase information from the light distribution on photographic film (*ELECTRONICS*, p 44, Dec. 27, 1963), the new device includes a gas-laser light source as part of an interferometer optical processing system.

A modified Mach-Zehnder interferometer determines the phase of the spectrum under study, using a signal and a spherical lens inserted in one beam of the interferometer. The objective lens displays the Fourier transform of the signal outside the interferometer, at its back focal plane. Light from the collimated reference beam adds to this distribution.

Loudspeaker for Silent World

Underwater public address system developed for military, civilian divers

BENDIX has introduced an underwater public address system for divers that it hopes will find wide acceptance among military units and police and fire rescue teams across the nation.

Called the Watercom, the system enables a diver to talk to all others beneath the surface of the water within a range of 100 yards. Price is \$189, less batteries. A rechargeable battery is available at \$89 and a disposable battery at \$12.

The Navy, the largest potential user of the system, says it is interested in the Watercom but has made no definite plans to test it. Bendix expects to sell 1,500 of the systems

during their first year on the market.

Ear the Receiver—Since Watercom operates in the audio range, 300 to 2,000 cps, no receiving equipment other than the human ear is needed. Because of the difficulty of articulating underwater, intelligibility is limited to an estimated 75 percent. That is, one of every four words will not be understood by the hearer. For this reason, Bendix describes the device as a "working tool." Divers should find it adequate, Bendix says, for communicating about the business at hand. The subtleties of conversation are another matter.

Intelligibility varies however with the individual speaker and hearer, Bendix says. An upcoming boat version, selling for \$395 plus batteries, will have 100-percent intelli-



TRANSDUCER and battery unit is attached to air tank

gibility, according to Bendix. The biggest variation in the sound pattern is no more than 1½ db.

Other Components—The system, which weighs about 5 pounds under water, includes a transmitter that

Continued p. 46

for ceramic capacitors

YOUR BEST SOURCE IS CENTRALAB

Centralab provides the industry's most complete line of ceramic capacitors . . . disc, tubular, plate, trimmer, transmitting, feed thru, temperature stable, temperature compensating and custom designed units . . . both low and high voltage, for commercial and military applications.

For Immediate Delivery, over 900 part numbers are available from Centralab Industrial Distributors, in quantity, at factory prices.

Write for engineering catalogs describing over 65 standard lines.

Centralab®

THE ELECTRONICS DIVISION OF GLOBE-UNION INC.
P.O. Box 591, Dept. 14A • Milwaukee, Wisconsin 53201
In Canada: Centralab Canada Ltd., P.O. Box 400, Ajax, Ont.

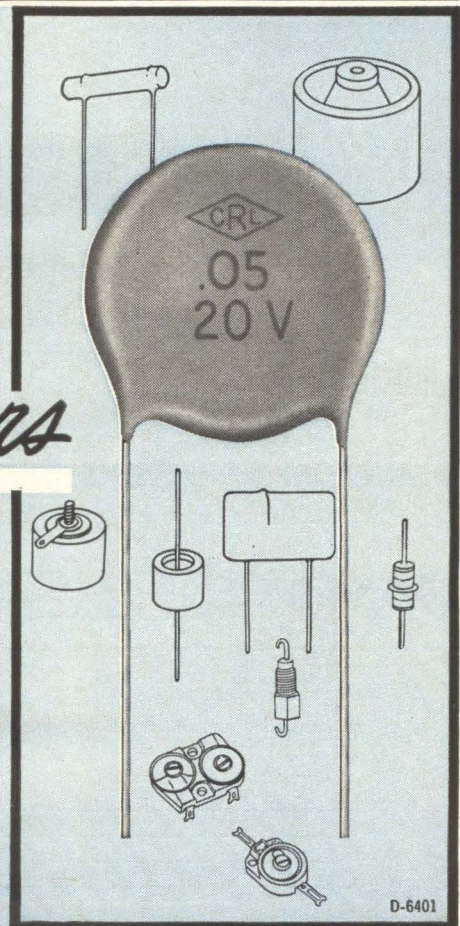

D-6401

this
Catalog is not for everybody...



It has been prepared for those who require technical information, mechanical and electrical specifications about precision-film potentiometers, pressure transducers, commutators and switches.

This sturdy loose leaf binder comes complete with 16 and 20 page catalogs, in separate categories for your convenience. Additional sections covering technical information, environment specs and applications, as well as newer products will be distributed as soon as they are ready. If you are one for whom this volume has been prepared — senior designer, engineer, technician or purchasing agent — just fill out the coupon below, please.

C.I.C. COMPUTER INSTRUMENTS CORPORATION
68 MADISON AVENUE, HEMPSTEAD, L.I., N.Y. / 516 IV 3-8200

COMPUTER INSTRUMENTS CORPORATION
68 Madison Avenue, Hempstead, N.Y.

Please send me, without obligation, the C.I.C. catalog, and include my name on your list for additional pages.

(All information must be filled in below.)

Name _____
Position _____
Company _____
Address _____

attaches to the diver's air tank, a throat microphone and a special mouth mask to which the diver's breathing hose is connected. The mask, making articulation possible, replaces the usual bit-like device which the diver must clench between his teeth. Watercom can be operated to any depth feasible for the diver because the pressure on the inside of the unit is automatically adjusted to equal outside pressure.

The transducer, which takes an input of 15 w, operates on a "voice coil principle" but Bendix spokesmen were reluctant to describe it in detail. Air pressure from the diver's storage tank is used to equalize pressure on the transducer face, leaving it free to vibrate.

Watercom is made by the Bendix-Pacific Marine Dept., of North Hollywood, Calif., which bought the patent and manufacturing rights from Celestronics, Inc., of Torrance, Calif. The system was developed by Mel Moore, president of Celestronics.

New 3-D Radar Folds Antenna Array

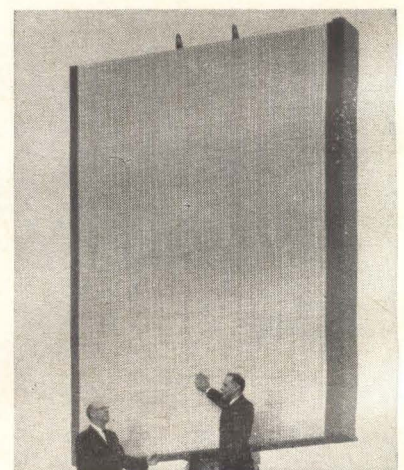

AIR-TRANSPORTABLE radar developed by Hughes includes plastic-faced, 9 x 12-foot antenna that folds in half. Three-ton radar system uses electronic frequency scanning to obtain 3-D data on large number of airborne targets. Hughes reported this month that it has demonstrated the system to U. S. and foreign military groups

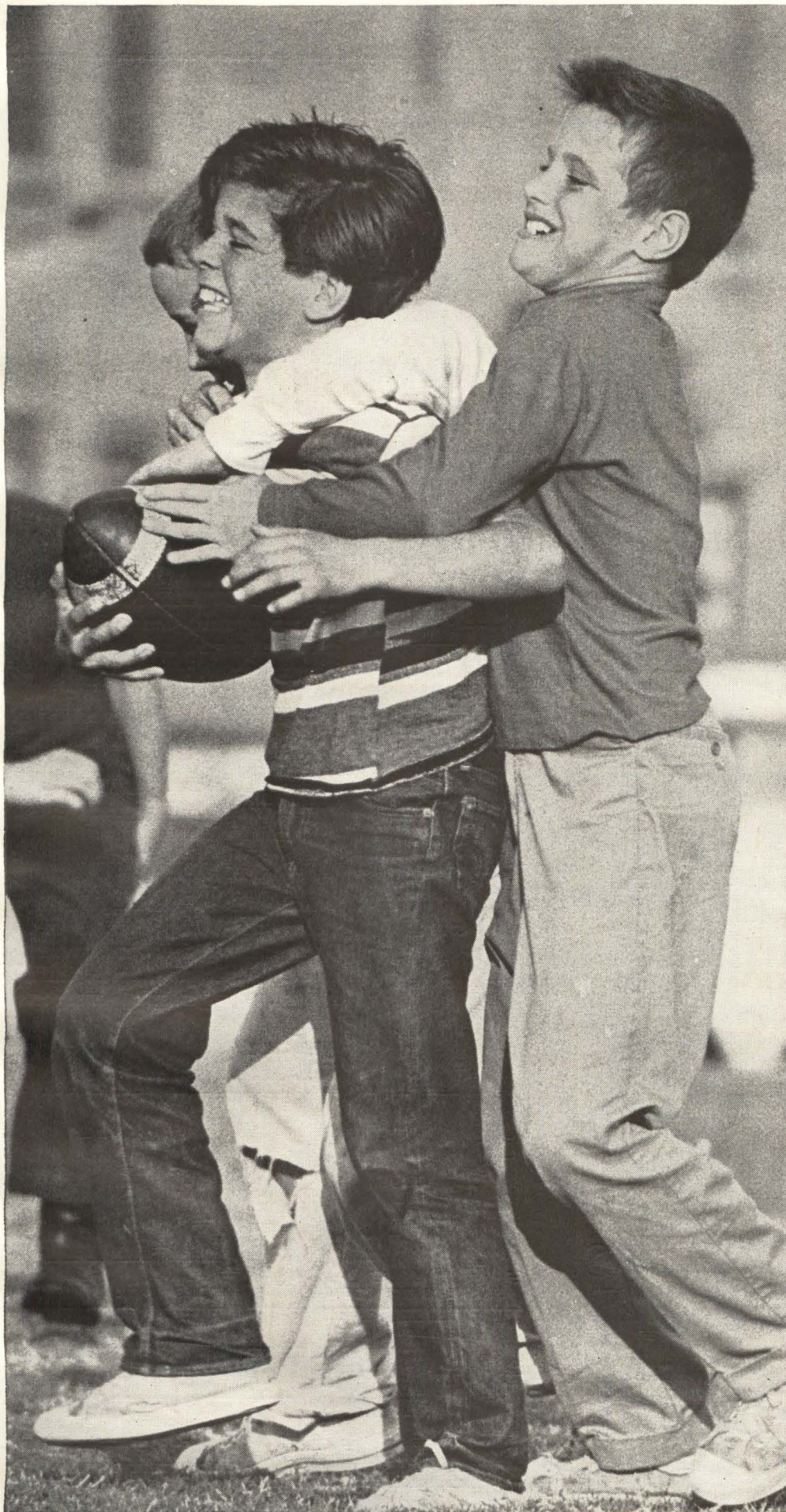

The men you hire tomorrow

are the kids you help today

Contributions made to United Funds or Community Chests are really an investment. An investment in *your* future. United Fund agencies take the edge off hunger and misery, sure, but they go way beyond that. They do an awful lot for youngsters—providing recreational facilities, finding homes for the homeless, steering puzzled teen-agers onto the right road. So it makes good sense to give the United Way. Your company can make a contribution, and you can make it convenient for your employees to join in through payroll payments. This once-a-year appeal cuts down on the confusion and duplication of separate drives, too. So give United. Could be, the kids you help today will be helping your business tomorrow.

**One gift works many
wonders/GIVE THE
UNITED WAY**

PHOTO BY PHIL BATH

Space contributed as a public service by this magazine.

ON THE WAY:

Microcircuit Doppler Radar

In-house facility to build smallest, most accurate and reliable system from standard integrated chips

By **SAMUEL WEBER**
Senior Editor

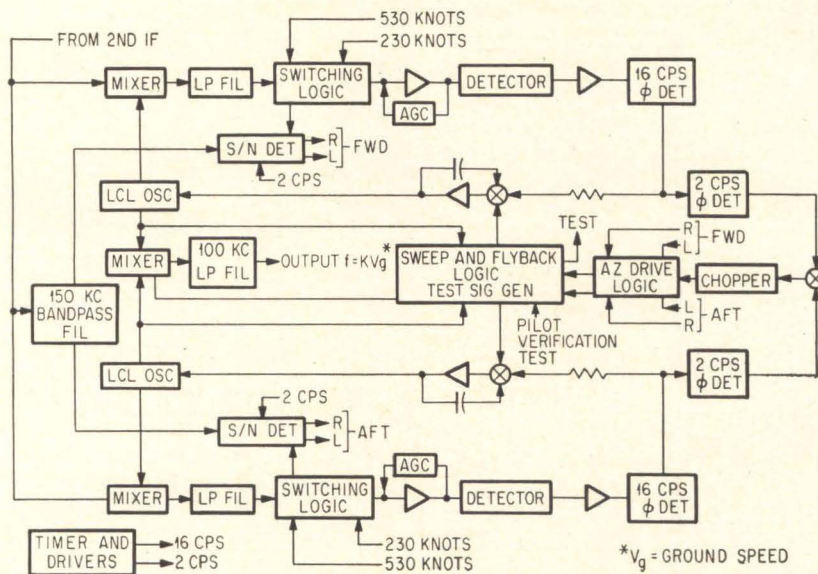

PLEASANTVILLE, N.Y. — Radical new systems designs based on integrated circuit techniques will be incorporated in a series of Doppler radar navigational equipments by General Precision Inc., resulting in systems with ten times the reliability of current in-production systems (about 1,000 hours MTBF), total weight less than 25 pounds, and a substantially lower cost.

According to J.C. Forrest, Director of Engineering at General Precision's GPL Division, the new molecularized Dopplers will make Doppler navigational radar practical for virtually any aircraft, including new supersonic transports,

MORE THAN 70 percent of the frequency tracker portion of the high-performance Doppler navigational radar shown here will be implemented with presently available standard integrated circuit packages—Fig. 1

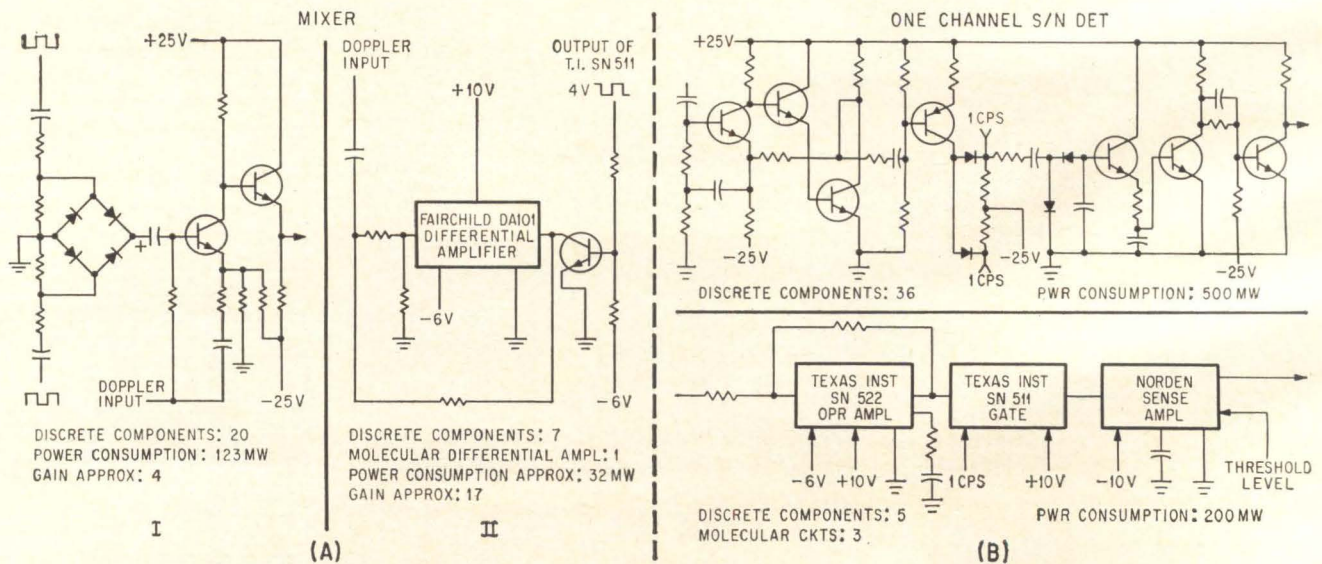

COMPARISON of discrete and integrated versions of mixer (A) and S/N detector (B) reveals distinct advantages in power dissipation, gain—Fig. 2



NEW!
MILLIVOLTMETER
\$195.

Model VM 77B is a versatile, general purpose instrument for laboratory and production work. It has twelve ranges between 0.001 volt and 300 volts AC full scale and a frequency range of 10 cps to 4.5 MC with measurements to 100 microvolts possible on the most sensitive range.

Input Impedance: 10M Ω 20 pF.

Amplifier output: Maximum output 1V r.m.s.

Voltmeter frequency range:

50c/s to 100kc/s: accuracy $\pm 3\%$ F.S.D.

15c/s to 2Mc/s: accuracy $\pm (3\% + 3\%$ F.S.D.)

2Mc/s to 4.5Mc/s: accuracy ± 2 dB.



houston instrument corporation

4950 Terminal Avenue / Belleire, Texas 77401 / MOhawk 7-7403

CIRCLE 201 ON READER SERVICE CARD

HOW TO USE YOUR ELECTRONICS BUYERS' GUIDE

Page Number References

For your convenience, advertisers in the ELECTRONICS BUYERS' GUIDE have the page numbers of their advertisements listed adjacent to their listings in the Product Listings (yellow paper) section of the book. Refer to these advertisements for full specifications on products. Keep your ELECTRONICS BUYERS' GUIDE at your work area at all times.

ELECTRONICS BUYERS' GUIDE
A MCGRAW-HILL PUBLICATION

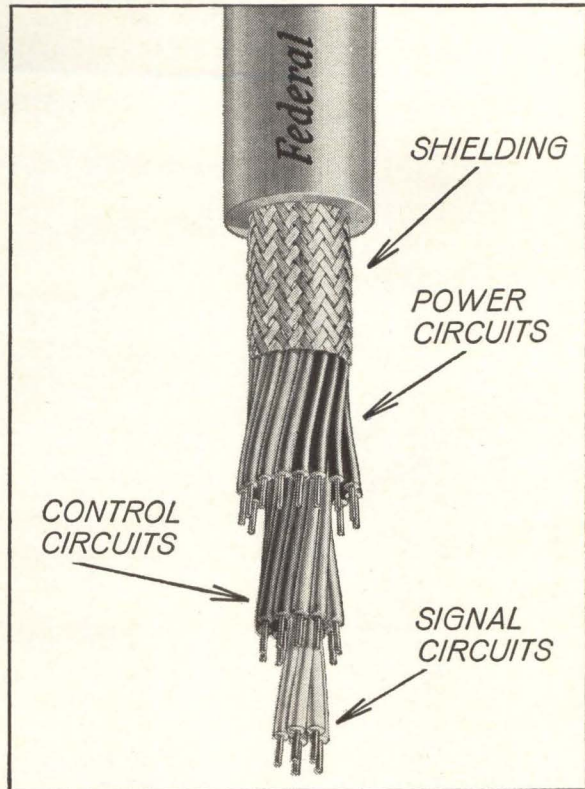

32 power, control & signal circuits in one Federal cable

This Federal multi-conductor cable will handle:

- 16 signal circuits
- 11 control circuits
- 5 power circuits

...all within one shielded jacket! This is a standard Federal cable available from stock.

Royal Electric has designed and built multi-conductor cables for a variety of applications ranging from office intercom systems to the vast BMEWS network.

For more information, contact your nearest Royal representative, or write Royal Electric Corporation, a subsidiary of International Telephone and Telegraph Corporation, Pawtucket, Rhode Island.

ITT ROYAL



THERE IS A JENNINGS VACUUM CAPACITOR FOR EVERY HIGH POWER RF APPLICATION

Jennings has been designing and building vacuum capacitors for 21 years. In this time we have designed vacuum capacitors for hundreds of standard and special applications. These designs are now production items—over 450 types. We can deliver from stock a vacuum capacitor to solve practically every specialized application.

But if a new design is necessary consider these resources ready to work for you at Jennings. • 21 years experience designing and building vacuum capacitors.

• Exclusive processing techniques that assure superior performance. • Qualified, experienced engineering staff. • The only complete rf laboratory in existence for proper testing of vacuum capacitors in high power rf circuits through 100 kw that duplicate actual operating conditions.

Jennings offers a complete line of vacuum capacitors for operating in the high frequency range at voltages up to 120 kv and capacities up to 5000 pf. We will be happy to send detailed catalog literature at your request.



UXCF 500

Capacity Range . . . 20-500 pf
Voltage Rating . . . 20 kv pk
RF Current Rating . 45 amps rms
Length 9⁷/₈ inches
Width 4³/₈ inches

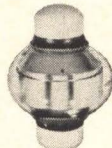

MMHC 1000

Capacity 1000 pf
Voltage Rating . . . 45 kv pk
Current Rating . . 150 amps rms
Length 13 inches
Width 9¹/₄ inches



CVHA 650

Capacity Range . . 30-650 pf
Voltage Rating . . . 55 kv pk
Current Rating . . 150 amps rms
Length 11¹¹/₃₂ inches
Width 7 inches

RELIABILITY MEANS VACUUM | VACUUM MEANS

Jennings[®]

JENNINGS RADIO MFG. CORP., 970 McLAUGHLIN AVE., SAN JOSE 8, CALIF., PHONE CYpress 2-4025

VSTOLS and advanced manned penetrators (AMP). One of the systems under development is a molecular version of a transistorized high performance equipment produced for use in an advanced Bomb/Nav system. GPL claims that when completed, the miniature pulsed coherent system will be the smallest, most reliable and—like its counterpart—the most accurate system available.

The company-funded microelectronics program also includes the development of a helicopter Doppler-Altitude (Helipath), using integrated circuits and solid state transmitter, which is well along in the breadboard stage.

Figure 1 shows a block diagram of the frequency tracker section of the high-performance Doppler navigator. The tracker configuration is essentially the same in the Helipath system. Both systems will be implemented by a combination of standard integrated circuit packages, GPL-modified standard chips and discrete components. With the present availability of integrated analog circuits, GPL engineers estimate that 70 percent of the frequency tracker, and more than 50 percent of the overall system can be integrated now, with a view to replacement of the discrete components as integrated equivalents become available.

Implementation of the mixer (Fig. 2A) and S/N detector (Fig. 2B) with standard circuits clearly shows the advantages obtained in terms of power consumption and component reduction. Though the numbers are totaled for discrete components used with the molecular circuits, the resistors and capacitors will be combined into thin-film packages for a compatible form factor. Other components, such as resistors and transistors for use in feedback loops, will be produced by modification of standard chips.

The new Doppler systems are the fruit of careful planning on the part of GPL to retain the organization's identity as a systems developer and manufacturer, and at the same time utilize the advantages inherent in integrated circuits. Thus, GPL has recently completed an in-house microelectronics facility capable of implementing non-standard circuitry with standard chips, using what is called an "adaptive interconnect

approach". Here's how it works:

Adaptive approach—The technique is based on securing from the major integrated circuit vendors, standard silicon wafers on which the resistors, capacitors, transistors or diodes have been placed in a particular pattern, but not interconnected to form a circuit. As GPL engineers design circuits of a non-standard nature for a system, they are guided toward the use of elements available on the uncommitted wafers.

In the microelectronics facility, which is established in the engineering department and not as an R&D function, the circuit requirement is analyzed and selection made of particular integrated circuit chips. The number and variety of circuit elements dictate the need for one, two or three chips each, with a maximum area of 0.01 sq. in. All chips for a particular circuit will be in a single case ranging from $\frac{1}{8} \times \frac{1}{4}$ to $\frac{3}{8} \times \frac{3}{8}$ by 0.06 in. thick, or a standard TO-5 case. Chips will be interconnected with 0.5 or 1-mil gold wire, and the circuit intraconnections on each of the chips are accomplished using an aluminum thin film technique applied directly to the silicon chip surface.

Thus the use of advanced semiconductor techniques and large equipment investment has been avoided through the purchase of standard circuit wafers from the major vendors. By performing the engineering function of committing the wafers to circuit patterns, GPL retains approximately 60 to 75 percent of the total direct labor involved in fabricating devices, yet can produce circuit designs based on industry-proven semiconductor technology. The majority of processing masks are standard vendor items permitting a low cost end product for ultimate production procurement.

According to Forrest, the alternative method of obtaining prototype non-standard integrated circuits from vendors would have been prohibitive from a cost or delivery point of view. "The need to take our turn at the vendor's facility would create an almost impossible scheduling problem during the relatively routine development phases, and a truly impossible and costly one during periods of development difficulty," he told ELECTRONICS.

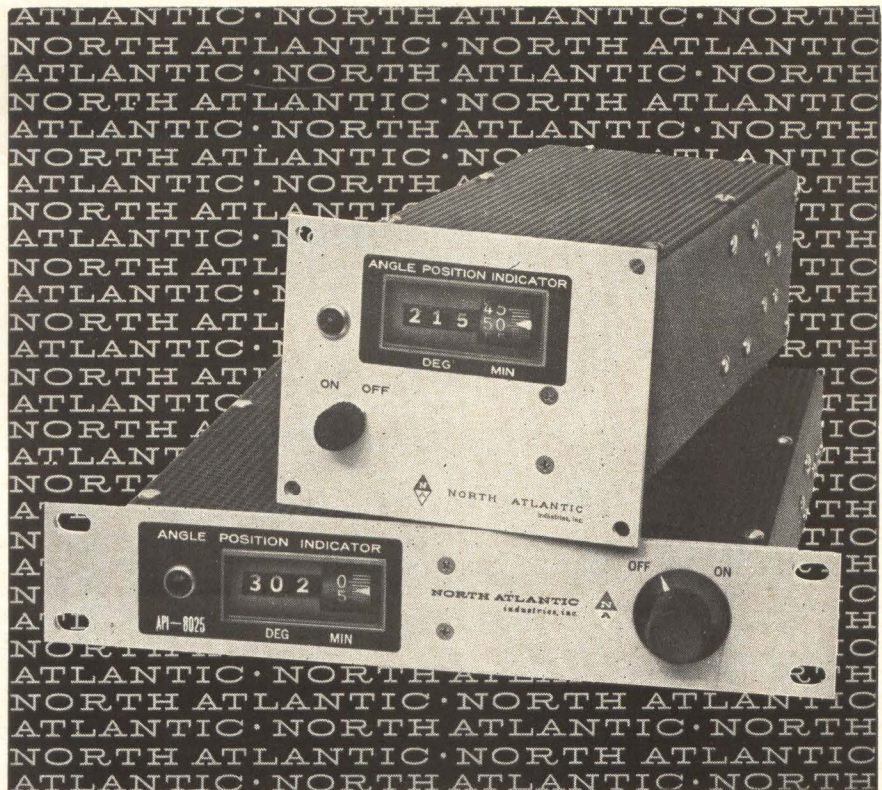

how to measure resolver or synchro position with 30 second repeatability

In both production test and ground checkout systems, North Atlantic's high performance Angle Position Indicators provide exceptional operator ease and precision in the measurement of synchro and resolver position. Features include digital readout in degrees and minutes, 30 second resolution, continuous rotation, plug-in solid-state amplifier and power supply modules. Due to the design flexibility of these units, they can be readily provided with a variety of features for specific requirements. Typical units in this line incorporate combinations of the following features:

- Single Synchro or Resolver Input
- Dual Synchro or Resolver Inputs
- Retransmit Synchro, Resolver, Potentiometer, or Encoder
- 2-Speed Synchro Input
- Multi-frequency Inputs
- DC Input
- 0-999 Counter

BASIC SPECIFICATIONS

Range	0°-360° continuous rotation
Accuracy	6 minutes (standard)
Repeatability	30 seconds
Slew Speed	25°/second
Power	115 volts, 400 cps
Size	API-8025 1 $\frac{3}{4}$ "h x 9 $\frac{1}{2}$ "w x 9"d
	API-8027 3 $\frac{1}{2}$ "h x 4 $\frac{7}{8}$ "w x 9 $\frac{3}{4}$ "d



Your local North Atlantic representative has complete data on the API line. Call him today or write direct for technical literature.

NORTH ATLANTIC industries, inc.
TERMINAL DRIVE, PLAINVIEW, L. I., NEW YORK • Overbrook 1-8600

Delay Line Has Infinite Resolution

New unit maintains constant impedance at all delay settings

By **E. S. WENDOLKOWSKI**
President, Computer Devices Corp.
Huntington Station, N. Y.

NEW APPROACH provides infinite resolution in a variable delay line; constant impedance is also maintained between input and output terminals at any delay setting.

Delay lines with infinite resolution, as contrasted with those having discrete tap settings, are especially useful in coordinating different waveforms. The new line has been used to correlate data coming from a multielement antenna and to adjust radar signals in time to feed a computer.

The length of this distributed-constant delay line is varied mechanically, eliminating mismatch problems associated with shorted turns in the usual distributor type delay line.

In effect, the new delay line acts as a multi-switch insertion-type delay line, wherein a series of switches disconnect unused portions of the delay line from the circuit. Both the new delay line and the multi-switch type maintain a constant impedance between input and output terminals.

The roller delay line uses the distributed constant principle wherein time delay is a function of inductance and capacitance: $T_d = \sqrt{LC}$. A silvered, then insulated, ceramic core is wrapped with a single-layer coil. The coil is inductive and capacitance is provided between the coil and the silver plating on the ceramic. Each increment of wire wound on the core provides an increment of inductance and capacitance, thereby providing an incre-

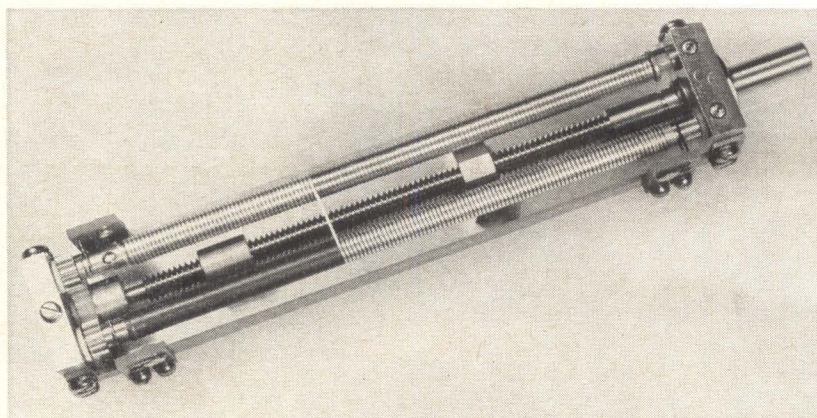

ROLLER-TYPE DELAY LINE varies delay by winding wire from delay-line mandrel (bottom) to shorting mandrel (top). Locknut (right center) provides positive, multi-turn stop to prevent damage to delay-line wire at either end —Fig. 1

ment of delay. Variation in delay is accomplished by winding and unwinding wire from the spool.

Mechanism—The delay line is composed of a delay-line mandrel, a shorting mandrel, and a drive system. The two mandrels are geared such that turning the drive shaft causes wire to wind from delay-line mandrel to shorting mandrel, or visa versa. The shorting mandrel is threaded to control the manner in which the wire is layered onto the delay-line mandrel.

A spring mechanism on the shorting mandrel maintains a constant tension on the wire.

Because the coil of wire is uninsulated, and the shorting mandrel is metal and also uninsulated, any inductance turns taken off the delay-line mandrel are shorted out. The removal of the slightest increment of wire removes a matched increment of capacitance and inductance, thus producing a corresponding change in delay. The delay adjustment is accomplished with infinite resolution at the impedance

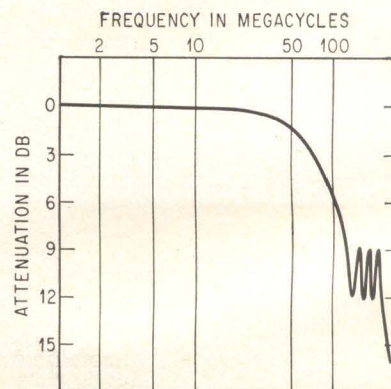

FREQUENCY RESPONSE of roller delay line is flat to 50 Mc. Vswr is less than 0.5 db to 45 Mc and less than 1 db from 45 Mc to 75 Mc. Beyond 75 Mc, vswr is still ± 3 db—Fig. 2

of the line.

Delay Line—The delay-line shown in Fig. 1 has a delay range of 0 to 50 nanoseconds, an impedance of 100 ohms, and a frequency response that is flat to 50 megacycles (Fig. 2). Full delay excursion is achieved in 60 turns of the control shaft. Delay lines with delays up to 100 nanoseconds have been produced in

The Hughes/NASA Syncom stands still at 6875 mph to talk to a billion people.

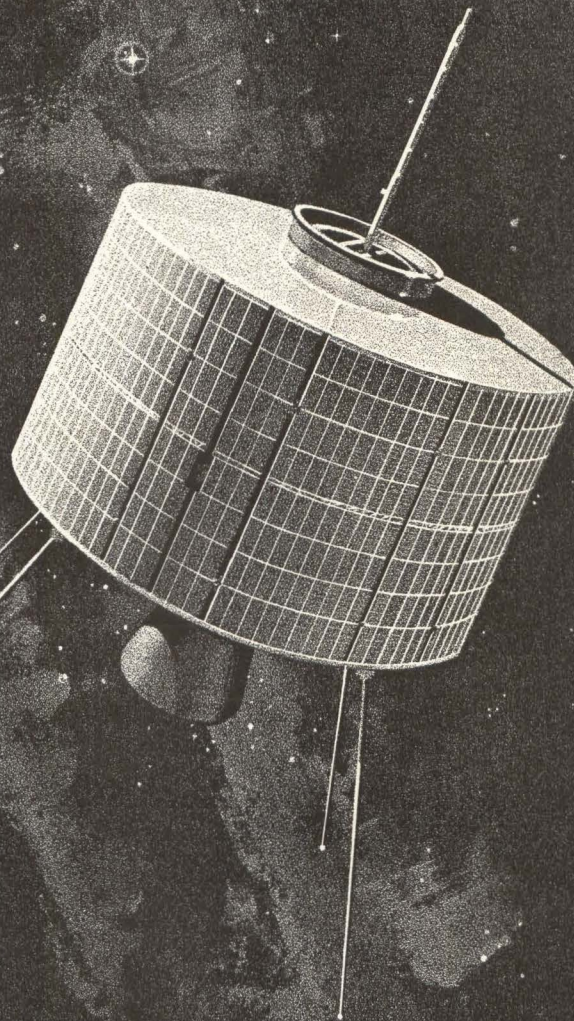

CIRCUIT DESIGNERS... is your appointment in space with Hughes?

Today, Hughes is one of the nation's most active aerospace/electronics firms. Projects include: F-111B PHOENIX Guided Missile System, TOW Anti-Tank Missile, SURVEYOR Lunar Spacecraft, SYNCOM, VATE, ARPAT, POLARIS, Hard Point Defense and others. This vigor will assist the qualified engineers and scientists towards more and better opportunities for both professional and personal growth.

Many immediate openings exist. The engineers selected for these positions will be assigned to the following design tasks: the development of high power airborne radar transmitters, the design of which involves use

of the most advanced components; the design of low noise radar receivers using parametric amplifiers; solid state masers and other advanced microwave components; radar data processing circuit design, including range and speed trackers, crystal filter circuitry and a variety of display circuits; high efficiency power supplies for airborne and space electronic systems; telemetering and command circuits for space vehicles, timing, control and display circuits for the Hughes COLIDAR (Coherent Light Detection and Ranging).

If you are interested and believe that you can contribute, make your appointment today.

For immediate consideration, please airmail your resume to:

Mr. Robert A. Martin
Head of Employment
Hughes Aerospace Divisions
11940 W. Jefferson Blvd.
Culver City 88, California

Creating a new world with electronics

HUGHES

HUGHES AIRCRAFT COMPANY
AEROSPACE DIVISIONS

An equal opportunity employer.

U. S. CITIZENSHIP REQUIRED

NEW 40 MC PULSE GENERATORS

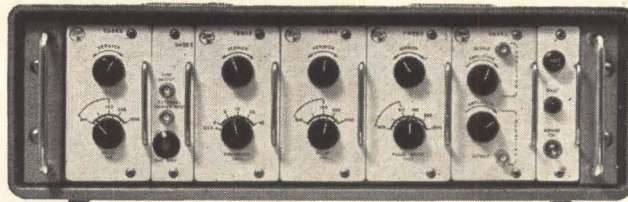

Feature Modular Expandability, Rise / Fall to 5 ns

The new SERVOPULSE® 9000 Series offers general-purpose pulse generators conveniently modularized to provide special capabilities. Among their outstanding features are very high clock rates, rise times to 5 ns and expandability which defies obsolescence. They deliver clean, sharp waveforms, and permit multi-pulse functions. Several Modules are available for each function of time delay, pulse width, frequency, and amplification. The units are packaged for either rack-mount or benchwork, with integral power supply. A wide spectrum of special functions is possible at prices you would expect for standard generators. Detailed information on request.

	MODEL 9350	MODEL 9450	MODEL 9455	MODEL 9550
Frequency Range	.2 cps - 5 kc	100 cps - 2 mc	100 cps - 10 mc	2 mc - 40 mc
Delay	.1 ms - 1 sec.	0 - 1 millisec.	0 - 1 microsec.	0 - 1 microsec.
Pulse Width	.1 ms - 1 sec.	.1 μ s - 1 ms.	25 ns - 1 μ s	25 ns - 1 μ s*
Simultaneous Pos & Neg Outputs	10V open circuit 7V into 93 ohms	10V open circuit 7V into 93 ohms	10V open circuit 7V into 93 ohms	10V open circuit 7V into 93 ohms
Rise & Fall Time	Under 5 nanosec.	Under 5 nanosec.	Under 5 nanosec.	Under 5 nanosec.
Max Duty Cycle At Full Amplitude	70%	70% - 40% at 2 mc	90%	90% - 60% at 40 mc
One Shot/Sync & External Trigger	Yes	Yes	Yes	Yes
Price	\$660.00	\$835.00	\$975.00	\$1,390.00

FLAT TOP FOR ALL INSTRUMENTS LESS THAN 2% AT MAX. PULSE WIDTH. * 15 ns at 40 mc



SERVO CORPORATION OF AMERICA SERVOPULSE® PRODUCTS
111 New South Road • Hicksville, L. I., New York • Wells 8-9700

CIRCLE 202 ON READER SERVICE CARD

the same 1 × 1¼ × 5½-inch package size. Different delays and impedances are achieved by adjusting the thickness of the dielectric, changing wire size, changing pitch, and by varying the diameter and length of the mandrels.

Application—The new units are most useful where a delay trim adjustment between units of an existing system are required.

The constant impedance feature permits the delay line to be directly inserted into the interconnecting coaxial cables of the system without system modification or degradation.

At vhf, the line provides a means for introducing a phase shift at any frequency up to 200 Mc.

Extremely accurate phase settings can be made due to the infinite resolution feature of the roller delay line.

Semimetals May Be Microwave Source

PALO ALTO—Investigations into the possibility of generating microwave and millimeter radiation by means of space charge interaction within an anisotropic material are under way at Microwave Electronics Corp. here. (ELECTRONICS, Oct. 25, 1963, p 19)

The most promising material to be studied is pyrolytic graphite, a material commonly used in nose cones (ELECTRONICS, Dec. 4, 1959, p. 124). Other suggested materials include bismuth and indium antimonide.

Anisotropic materials behave differently depending upon which way the material is oriented. They are electrically neutral in that they have an equal number of holes and electrons. Their energy bands just touch, and for these reasons they are characterized as semimetals.

Experiments will be based upon theoretical calculations by Pines and Schrieffer of the University of Illinois which indicate that two electron beams could be made to drift within a solid and the interaction of the two results in a growing space charge wave.

CEI TYPE 960
VHF RECEIVER

The 960 receiver is designed to operate from a 50-ohm source impedance. Separate inputs are provided permitting the use of optimum antenna for each frequency. Solid state devices and vacuum components are used for those functions for which they are best suited. This permits the design of an instrument with high performance and small size.

Frequency range.....30-300mc in 2 bands:
Band A: 30-90mc
Band B: 60-300mc
Noise figure.....Band A: 4.5 db max.
Band B: 6.5 db max.

Type of reception.....AM-FM-CW
IF bandwidths...2 operating simultaneously:
2mc, and either 200kc
or 20kc, selectable from
front panel.

Communication Electronics Incorporated

4908 HAMPDEN LANE, BETHESDA 14, MARYLAND

Frequency—There has been much study of this phenomenon within gaseous plasmas, but oscillation frequency is limited because of relatively low gas plasma density. Densities of the solids proposed in these studies are several orders of magnitude higher, thus it is expected that oscillations will be attained at wavelengths well into the submillimeter range. Frank Olson of MEC will conduct the investigation.

First problem, according to Olson is to get the two carriers going within the solid. Thus there is a quest for a material with holes and electrons with proper mobilities and velocities. So far, pyrolytic graphite appears most promising. The electrical conductivity properties of pyrolytic graphite are similar to its thermal conductivity properties. The material exhibits low conductivity in its C direction and high conductivity in its A plane.

In a thin sheet of graphite, the A plane may be considered the sheet itself, and the C direction perpendicular to the A plane. Since the graphite has a finite thickness, the A plane is parallel to the two large area surfaces. Oscillations could result if a double-stream instability is created when electrons and holes drift at different rates.

Mobility—It has been discovered that the mobility of pyrolytic graphite can be altered by heat treating.

Tentatively, it is planned to use a confocal resonator and dielectric transmission line to couple out the radiation above one-hundred gigacycles. Tests of the oscillation mechanism are planned as a function of temperature, so that the effect on the onset of the instability of various carrier mobilities can be determined.

After material studies, the next major effort will be to determine how to couple the space charge out of the solid to use the device as a millimeter or microwave generator. Amplifier applications are also possible. The effects of a magnetic field on the cross coupling of the solid plasma modes will also be investigated since efficiency of generation is affected by cross coupling.

MEC has been awarded \$80,420 from the U.S. Army Electronics Material Agency for the study.

NEW! BALLANTINE SENSITIVE TRUE-RMS RF MILLIVOLTMETER

Measures 300 μ V to 3 V
from 0.1 Mc to 1,000 Mc

Measures True-RMS regardless of Waveform and Voltage

High, Uniform Accuracy and Resolution over entire 5-inch scale

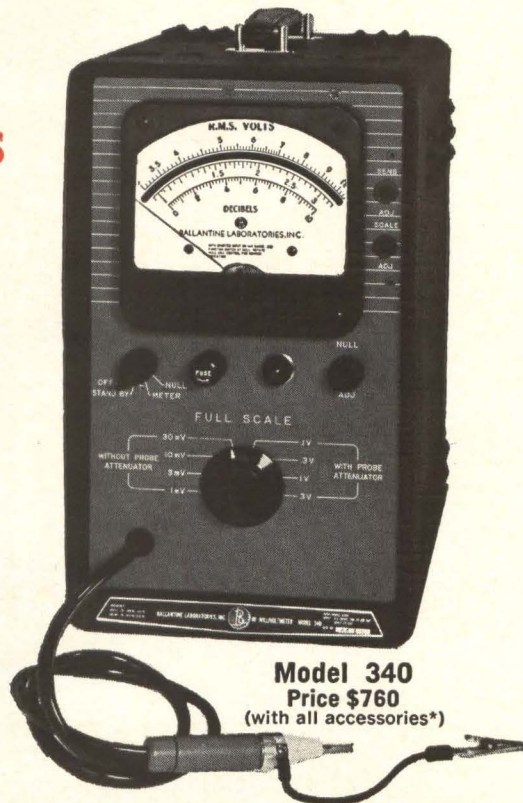

Model 340
Price \$760
(with all accessories*)

Ballantine's new Model 340 is an extremely sensitive RF millivoltmeter designed for accurate True-RMS measurements with high resolution. Its 5-inch voltage scale spreads out the readings logarithmically so that you can make measurements to the same high resolution and accuracy at the bottom as at full scale. This advantage means that you can not only measure voltages accurately, regardless of waveform, but also calibrate the 340 using a signal source that may be far from sinusoidal. The new 340 is now available in both portable and rack versions.

SPECIFICATIONS

Voltage Range.....	300 μ V to 3 V	Crest Factor.....	100 to 3 depending on voltage range
Frequency Range.....	0.1 Mc to >1,000 Mc; calibrated to 700 Mc	Scales.....	Two logarithmic voltage scales, 0.95 to 3.3 and 3.0 to 10.6. One decibel scale, 0 to 10
Indication.....	True-RMS on all ranges, all voltages	Mean Square DC Output...	0.1 V to 1.0 V dc. Internal resistance 20 kilohms. (For connection to recorder.)
Accuracy....% of Reading	0.1 Mc — 100 Mc, 4%; 100 Mc — 700 Mc, 10%; above 700 Mc as sensitive indicator		

*Accessories include a probe tip for in-circuit measurements, an adapter for connection to N or BNC, a T adapter for connection to a 50 ohm line, and a 40 db attenuator

Write for brochure giving many more details



— Since 1932 —
BALLANTINE LABORATORIES INC.

Boonton, New Jersey

CHECK WITH BALLANTINE FIRST FOR LABORATORY VACUUM TUBE VOLTMETERS, REGARDLESS OF YOUR REQUIREMENTS FOR AMPLITUDE, FREQUENCY, OR WAVEFORM. WE HAVE A LARGE LINE, WITH ADDITIONS EACH YEAR. ALSO AC/DC LINEAR CONVERTERS, CALIBRATORS, WIDE BAND AMPLIFIERS, DIRECT-READING CAPACITANCE METERS, AND A LINE OF LABORATORY VOLTAGE STANDARDS 0 TO 1,000 MC.

Harness Tester Detects and Indicates Intermittent Faults

Neon flip-flops remember faults during environmental testing

ENVIRONMENTAL SPECIFICATIONS for harnesses frequently require that wire continuity be checked while the harness is undergoing vibration or shock test. When the harness contains hundreds of wires, a considerable amount of electronic gear is required to monitor each wire individually and continuously. Some simplified test methods check for the existence of failure but do not indicate which wire has failed. Others rely on a sampling procedure, and will therefore overlook momentary failures.

A method developed by Eclipse-Pioneer Division, Bendix Corp., monitors each wire individually for momentary or continuous open circuits and includes a memory indication device. It is preferred as long as the total complexity is not excessive, says I. L. Fischer, senior engineer.

Each Wire Monitored—The difference between the firing voltage and the maintaining voltage of a neon glow lamp forms the basis of the method. This method avoids complexity by using a neon lamp flip-flop rather than conventional transistor or scr system to continuously monitor each individual wire in a cable harness.

The circuit illustrated performs the required flip-flop operation with two glow lamps and one resistor per conductor. One end of each conductor is grounded and the other end completes a circuit for the GO glow lamp. Initially, the momentary

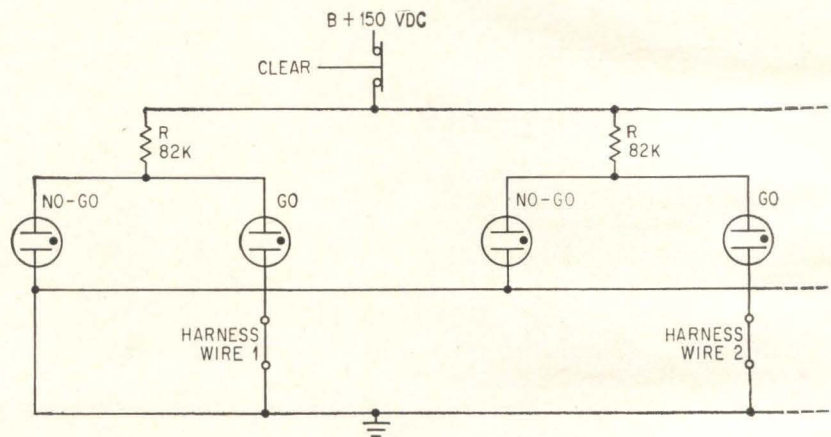

HARNES TESTER uses two neon lamps per conductor to indicate conditions during test. Momentary fault turns on NO-GO lamp until CLEAR switch is used

CLEAR button opens the circuit for the NO-GO lamps, extinguishing these lamps if they are on and causing the GO lamps to glow. Any discontinuity during the test opens the GO cathode to extinguish the lamp, decrease the voltage drop through resistor *R* and cause the NO-GO lamp to glow.

The choice of lamp and resistors depends on the power supply available. The lamp type T2-32-1 manufactured by Signalite Inc., Neptune, N. J., which breaks down between 72 and 70 volts d-c, can be used in the following combinations: if *B+* is 90 v d-c, and *R*'s are 33 k ½ w; if *B+* is 135 v d-c, and all *R*'s are 82 k ½ w; and if *B+* is 250 v d-c, and all *R*'s are 220 k ½ w.

Typical operation with this arrangement uses a *B+* voltage of 150 v and an 82-k resistor. Upon turning the *B+* on, all GO lamps fire and stay on if all wires are good. The maintaining voltages of the GO lamps are below the breakdown voltage of the NO-GO lamps. If there is an open circuit in a series wire, the voltage rises to 150 v and the NO-GO lamp

fires. After completion of test, the CLEAR switch restores the tester to original conditions.

Indicating Faults—During vibration tests, a momentary open circuit in any wire in the harness will extinguish its GO lamp. Voltage across the corresponding NO-GO lamp rises beyond its firing voltage so that this NO-GO lamp lights and will remain lit even after the momentary open circuit has vanished. At the end of the test, the operator can readily see which, if any, of the wires in the harness have open circuited.

Overall size and cost of this tester is practical for harnesses containing up to several hundred wires because of the small, inexpensive lamps used.

Dividing Engine Rules Lines 1 Micron Wide

PRODUCTION of disks used to preset or check out missile guidance equipment, digital shaft encoders and

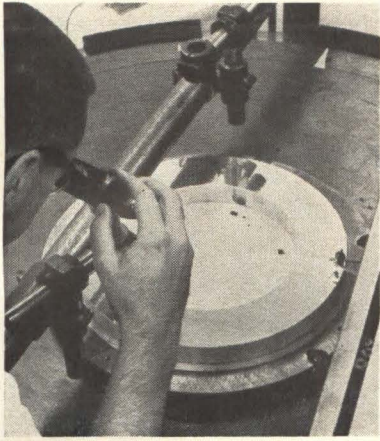

MICROMINIATURE lines are produced on glass-based disk. A slit on a master plate attached to a step and repeat instrument is projected on a sensitized disk mounted on a circular dividing engine

servo controls, with an accuracy of 1 second of arc on glass up to 30 inches in diameter is reported by the David W. Mann Company, Lincoln, Mass. One such disk is shown on the cover.

A step and repeat device on the dividing engine produces disks photographically or by diamond rule.

Photographically generated disks with up to 250 lines per millimeter are produced with the use of sensitized plates. Lines generated are as fine as 2 microns in width. A master plate with a diamond rule slit representing the line size desired is placed in a step-and-repeat device, and a sensitized disk is placed in the dividing engine. As the disk is moved at a set pace beneath the projector in the device, a light source flashes through the slit opening and forms the desired image on the disk.

Diamond-rule disks are similarly produced with up to 10,000 lines of only 1-micron width on a chemically deposited silver coating.

Wire Twisting at 300 TPM

A NEW, automatic wire twisting device is announced by Electro-Minatures Corp., Hackensack N. J. that twists two or more wires at the rate of 300 twists per minute. A counter is included to predetermine the number of twists from 1 to 9999. Attached to the twisting mechanism is a flexible shaft and chuck that accepts wire sizes from 16 to 42.

How to cut your handling time winding bobbin type coils

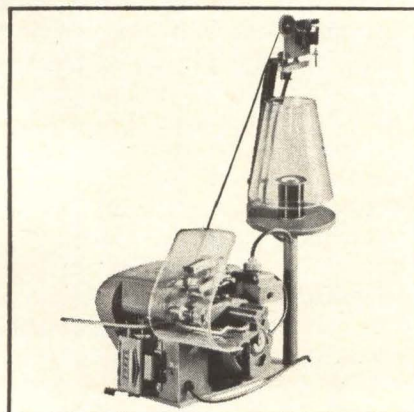

The Leesona No. 115 Bachi Bobbin Winder reduces coil handling time to a minimum for a single-head machine. All the operator has to do is load the bobbin on the arbor, close the tailstock, let the wire slip into the wire guide, and close the safety guard.

The No. 115 automatically:

- Starts
- Runs smoothly and quietly to 12,500 rpm
- Stops at ± 2 turns
- Re-indexes the wire guide
- Resets counter

Also available is the No. 115-B winder with bonding attachment to produce perfectly self-supporting coreless coils.

For full details write Leesona Corporation, Warwick, R. I. Or call Leesona at 5700 W. Diversey Avenue, Chicago 39, TUxedo 9-5735; 1500 Walnut St., Philadelphia 2, KIngsley 6-1720, or A. R. Campman & Co., 1762 Vernon Ave., Los Angeles, AXminister 3-6265.



23.3.27

Comparator Has Extended Range

Unit provides
high resolution and
rapid measurements

FREQUENCY COMPARATOR

model 102-10 processes signals and performs 1-second measurements with a resolution of 1 part in 10^{12} as referred to 1 Mc. Even greater resolution is available for extended observation times or from two frequency comparators connected in tandem. Periods as short as 0.0003 second can also be observed with correspondingly-high precision.

Two signals at 1, 2.5, 5 and/or 10 Mc, $\pm 1/2\%$ can be rapidly compared without offsetting either frequency. A simple test setup permits detailed examination of the frequency, phase and noise characteristics of the two frequency sources or of four-terminal networks driven by a

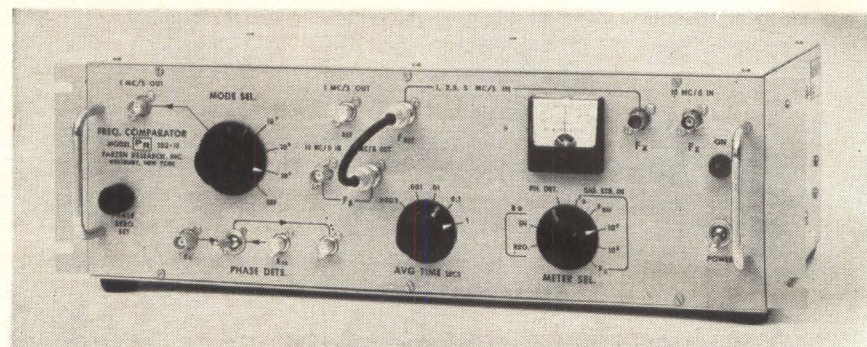

single source. Model 102-10 also permits calculation of the relative power spectrum of two similar oscillators or atomic standards.

Unit is constructed with low-noise silicon semiconductor modules. The instrument is self-checking and has a measured instability of less than 1 picosec per second. A number of presentations can be generated by the comparator including circular

clock-type displays, linear X-Y patterns, T-Y recordings and digital readouts. Two comparators in tandem are capable of effectively multiplying the input frequency error by 10^6 times, thus providing much higher resolution than available with a frequency counter. Price: \$5,450. Parzen Research, Inc., 48 Urban Ave., Westbury, N. Y.

CIRCLE 301, READER SERVICE CARD

C-Band TWT Produces High Power

GRIDDED, broad-band traveling wave tube type ZM-3174 is designed to operate between 5.0 Gc and 6.4 Gc with minimum saturation gain of 40 db.

Device will produce a minimum peak-power output of 1,000 watts at 10 percent duty. Moreover, it weighs only 6 pounds and features heat-sink cooling and severe environmental capabilities.

Type ZM-3174 is supplied as a complete assembly including the

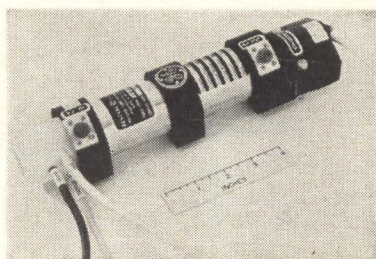

tube, ppm focusing and connectors. It can be mounted in any position and located near other tubes or magnetic materials without degradation in performance.

According to the manufacturer, the broad bandwidth, high gain and rugged construction make the tube particularly useful in military systems. Applications include pulse amplification in radar, electronic countermeasures and similar systems including phased-array radars.

The ZM-3174 has been operated at rated power with heat-sink temperatures ranging from -55 C to $+85\text{ C}$ and is capable of storage to $+125\text{ C}$. Other environmental capabilities confirmed by tests are: 15 g vibration to 3,000 cps, 35 g shock, 30 g acceleration and 120,000-ft altitude unpressurized. General Electric, Tube Div., Palo Alto, Calif. (302)

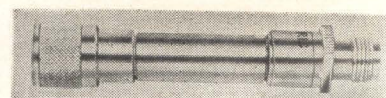

Coaxial Filters Achieve Small Size

SERIES of nine low-pass coaxial filters, called the smallest of their type by the manufacturer, have cutoff frequencies ranging from 100 Mc to 4.0 Gc. Units size ranges from $2\frac{1}{2}$ inches for the 4.0 Gc filter to $7\frac{1}{2}$ inches for the 100 Mc model. Pass-band insertion loss is 0.5 db maximum, and stopband rejection is a minimum of 60 db at 1.8 times cutoff frequency.

Filters have a pass-band vswr of 1.35 maximum, and an overall impedance of 50 ohms. They will handle 25 watts average power and are available with BNC, TNC or

JUST PUBLISHED!

IMPACT OF MICROELECTRONICS

Edited by George T. Jacobi,
IIT Research Institute
and Samuel Weber, **electronics**

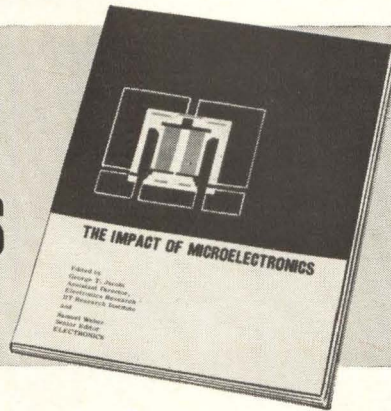

The Proceedings of the Conference on the Impact of Microelectronics, co-sponsored by the Armour Research Foundation (now IIT Research Institute) and **electronics**, a McGraw-Hill Publication, has just been published by **electronics**. The Conference, held last June 26-27 at the Illinois Institute of Technology, was acclaimed by the attendees and the industry at large. Now, in book form, all the invited papers and talks presented at the conference are available to you.

To whet your appetite, here are some of the contents:

The Electronics Components Industry and Microelectronics
by Robert C. Sprague, Chairman of the Board, Sprague Electric Company.

Profit and Loss in Microelectronics
by Robert W. Galvin, President, Motorola Inc.

Government Needs and Policies in the Age of Microelectronics
by James M. Bridges, Director of Communications and Electronics,
Department of Defense.

Management of Research and Engineering for Microelectronics Systems
by Dr. Peter B. Myers and Arthur P. Stern, Electronic Systems and
Products Division, Martin Company.

In House or Not: The Changing Buyer — Vendor Interface
by F. J. Van Poppelen, Jr., Vice President-Marketing, Signetics Corporation.

Current Technical Status and Problems in Microelectronics
by Jack S. Kilby, Integrated Circuits Dept., Texas Instruments, Inc.

Ultimate Limits of Microelectronics
by Dr. J. T. Wallmark, RCA Laboratories, David Sarnoff Research Center

Reliability in Microelectronics
by Ernest R. Jervis, ARINC Research Corporation.

Engineering Education in an Era of Changing Technology
by Dr. John Bardeen, University of Illinois.

IMPACT OF MICROELECTRONICS is must reading for men with a marketing and technical interest in this dynamic field of activity. Cramped with useful information, this neatly designed, 120 page volume keeps you up-to-date on this fast moving technology. Order today. Only \$3.50 per copy.

ORDER FORM

electronics Reprint Department
McGraw-Hill Publishing Co., Inc.
330 West 42nd Street
New York, N.Y. 10036

Dear Sirs:

Send me _____ copies of **IMPACT OF MICROELECTRONICS**
(\$3.50 per copy)

I am enclosing _____ (cash or check)

Bill me later _____ Bill my company _____

MY NAME _____ POSITION _____

COMPANY _____

ADDRESS _____

*measures
.002 microvolts!*



KEITHLEY MILLI-MICROVOLT METER

The Keithley Model 149 is the most sensitive electronic voltmeter available today, having a signal-to-noise ratio that approaches the theoretical limit. Recommended for use with thermocouples or thermopiles, the Model 149 is also ideal in cryogenics investigations and Hall Effect studies.

Zero suppression up to 100 times full scale adds versatility for the user. Line-operated, the Model 149 can accommodate either a floating or ground-referenced input. Output is 5 v or 5 ma on all ranges. Brief specifications:

- **range:** 0.1 microvolt to 100 millivolts in 13 overlapping 1x and 3x steps
- **noise:** less than 6×10^{-10} v rms with shorted input
- **input impedance:** 10K ohms on 0.1 μ v range rising to 10 megohms on 300 μ v scale
- **stability:** within 0.01 μ v per hour
- **speed of response:** to 90% fs in .5 seconds on most ranges
- **accuracy:** 2% fs on all ranges
- **price:** \$895.00

Other MICROVOLT METERS:

Model 150A 1 μ v sensitivity \$750.00
Model 151 100 μ v sensitivity \$420.00

full details in latest catalog . . .



**KEITHLEY
INSTRUMENTS**

12415 Euclid Avenue • Cleveland 6, Ohio

N-type coaxial connectors.

The nine standard models are available on an off-the-shelf basis. However, since the critical factors of low vswr, low pass-band insertion loss and high stop-band rejection are all inherent in the design, different cutoff frequencies and other options are minor design modifications. Price: \$40 each. RLC Electronics, Inc., 25 Martin Place, Portchester, N. Y.

CIRCLE 303, READER SERVICE CARD

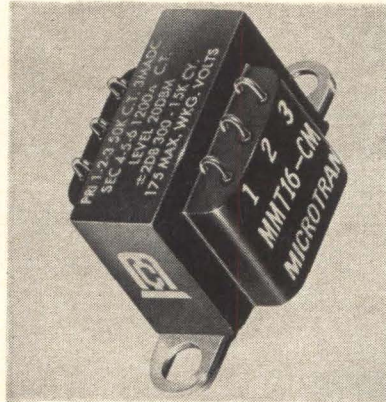

Tiny Transformers Are Contour Molded

A LINE of 31 microminiature contour molded transformers is announced. The MM-CM series was developed for use in miniaturized equipment and utilizes standard mounting channels with hooked terminals opposite the mounting surface. The transformers are epoxy molded to MIL-T-27A, Grade 5, Class S, Life X and are available as catalog items with 31 different electrical ratings to match latest transistor and tube circuitry. Size is $\frac{2}{8}$ in. by $\frac{7}{8}$ in. by $\frac{1}{4}$ in. high. Small quantity OEM cost is about \$5 to \$6. Microtran Co., Valley Stream, N. Y. (304)

Silicon Transistors Handle 70 Amperes

HIGH current capabilities are the key feature of 2N3149, 2N3150 and 2N3151 silicon power transistors. Units will deliver 70 amps of current for a total power capability of 300 watts. Supplied in a $1\frac{1}{16}$ inch, double-ended stud package, the units were designed specifically for military applications where space

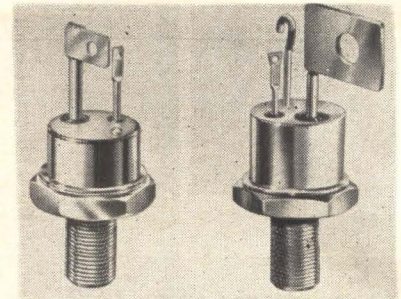

and weight limitations are critical.

Extremely-low saturation resistance of 0.03 ohms at $i_c = 50$ amps makes available new levels of high efficiency in power inverters with high-power regulated supplies. Equivalents of this series are also available in small-flag, two-lead versions and in types customized to specific requirements. Silicon Transistor Corp., Carle Place, N. Y. (305)

Parabolic Antennas Withstand High Winds

NOW AVAILABLE is a new series of parabolic antennas. A significant advantage is offered in that it is now possible to specify any focus-to-diameter ratio from 0.35 to 0.70 in the 12-ft to 22-ft diameter range without extra tooling costs. Either mesh or solid surface antennas can be supplied, as well as three types of standard feed supports with adjustments for three mutually perpendicular planes. The entire series is engineered to withstand 150 mph winds with less than 0.375 tip deflection. RF Systems, Inc., 356 South Ave., Whitman, Mass. (306)



Amplifier Features Wide Dynamic Range

ALL-SOLID-STATE amplifier, model 252, features 1,000-megohm input impedance, low noise, and wide dynamic range. It will accommodate input signals with an amplitude

IN A GREAT
MANY APPLI-
CATIONS, A
FLUKE
DIFFERENTIAL
VOLTMETER

- DOES THE WORK
OF A DIGITAL
VOLTMETER
COSTING SEVERAL
TIMES AS MUCH

For CATALOG DIGEST: Write
JOHN FLUKE MFG. CO., INC.,
Box 7428, Seattle, Wash. 98133



CIRCLE 203 ON READER SERVICE CARD

**WANT
TO DO
BUSINESS
WITH THE
GOVERNMENT**

??????????????

Then check the Military and Government Procurement Guide in the orange section of your ELECTRONICS BUYERS' GUIDE.

!!!!!!!!!!!!!!!!!!!!

range of more than 140 db, and has a typical noise level referred to the input of $5 \mu\text{v rms}$ over the amplifier bandwidth of 0.1 cps to 100 kc. Max output signal is 5 v rms with 0.5 percent max distortion. While standard gain accuracy is 5 percent, 1-percent accuracy is available. Ithaco, Inc., 413 Taughannock Blvd., Ithaca, N. Y. (307)

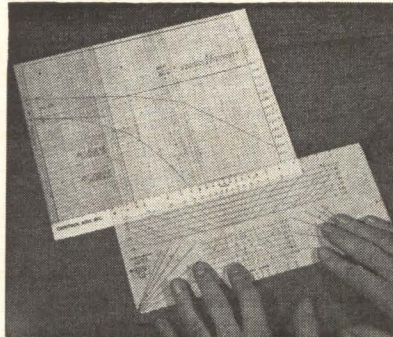

**Response Plotter for
Linear Networks**

NEW DEVICE plots the frequency and phase response of linear networks without tedious computations. It can be used to design filters, servos, power supplies, feedback amplifiers, and specialized networks with complex roots. The basic contribution is the speed with which the response can be plotted requiring only seconds to change the plot for a change in circuit components. Plotter plus 50 work sheets costs \$5. Control Aids Inc., P.O. Box 207, Woodmere, N. Y. (308)

**Wire Stripper Reaches
Confined Areas**

THE STRIPALL model TW-2 LN thermal wire stripper strips wire sizes No. 43 to No. 12 Awg. It cuts and removes wire coverings from Teflon and Kel-F as well as low

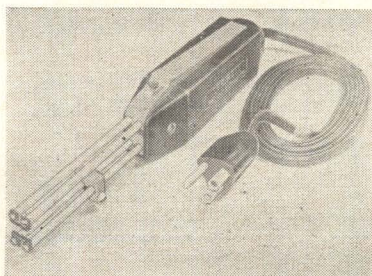

**WORLD'S
SMALLEST
DIGITAL
VOLT-
METER**

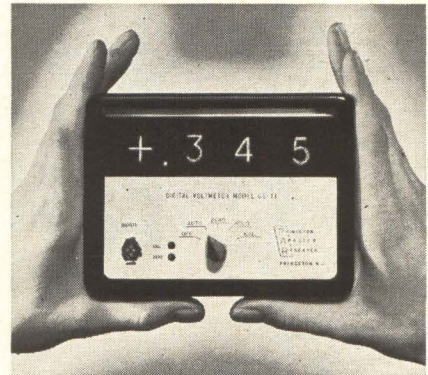

with all of these features:

- automatic ranging
 - automatic polarity
 - 10 meg input impedance
 - >100 db common mode rejection
 - truly floating differential input
 - 0.1% absolute accuracy
 - 1 millivolt sensitivity
 - solid state / reed relay design
 - rugged printed circuit construction
 - no stepping switches
 - price: \$995.00
 - measures only 6 1/2" wide, 5" high, 8" deep. Weighs 9 lbs.
- Model CS-3.1

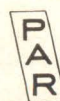

Write for Bulletin No. 107
PRINCETON APPLIED RESEARCH CORP.
Box 565, Princeton, New Jersey
Tel: 799-1222, area code 609

SPECIFY HANDSETS

by
Stromberg-Carlson



... for mobile radio, dictating systems, carrier, microwave and other applications.

Illustrated are lightweight models No. 33 and No. 35. Both incorporate push-to-talk switches and high-gain receivers and transmitters. These Stromberg-Carlson handsets meet a great variety of needs in a broad range of industrial applications.

No. 33 lightweight handset is furnished with a rocker bar switch.

No. 35 comes with a button switch, or with both the button and rocker bar switches.

Get technical data on these and other handsets from our Industrial Sales Department.

STROMBERG-CARLSON
A DIVISION OF **GENERAL DYNAMICS**
114 CARLSON ROAD • ROCHESTER 3, N. Y.

temperature wire coverings. Unit has extended electrodes for reaching into confined areas not ordinarily accessible. It is useful for stripping in nearly all hand stripping operations including installed wire harnesses and stripping or restripping of wires in computer wells and instruments. The extended electrodes also allow the unit to remove three inches or more of insulation in a single strip. Unit is completely hand-held and therefore extremely portable. Long life blades reach stripping temperature in less than 2 seconds. The nonoxidizing blades cool in less than 2 seconds when the heat button is released. M-K-S Data, Inc., 500 Cypress Lane, El Cajon, Calif.

CIRCLE 309, READER SERVICE CARD

Lint-Free Frocks for Laminar Air Flow Areas

STYLE No. 6427 frock in Dacura (Dacron polyester and rayon blend) is especially suited for use in the increasing number of laminar air flow work stations and work rooms. The frocks provide necessary product protection, and are full-cut to afford wearer comfort. They have adjustable snaps at the neck and wrist, providing a snug fit at the points which are primary sources of physical contamination. There are no belts, pockets, or other openings which could become lint traps. Angelica Uniform Co., 700 Rose-dale Ave., St. Louis 12, Mo. (310)

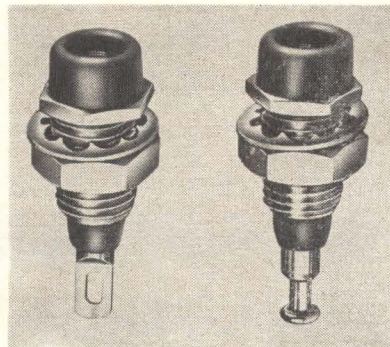

Tip Jacks Feature Closed Entry Contacts

LOW-VOLTAGE tip jacks with closed entry contacts comply with revised military specification MS16108 Re-

vision E. The closed entry feature prevents damage to the contact resulting from careless probe insertion. Separate spring contact assures even insertion and withdrawal forces for many cycles beyond conventional designs. Contact resistance is minimal with a drop in potential of less than 2 mv even after extensive environmental testing to comply with military specifications. Raytheon Co., 55 Chapel St., Newton 58, Mass. (311)

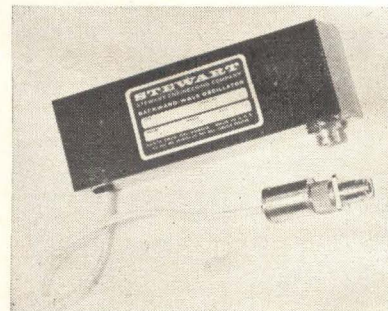

B-W Oscillator Designed for C-Band

A NEW p-m focused backward-wave oscillator in C-band has been announced. The SE-211A is a voltage tunable oscillator with a frequency range of 4 to 8 Gc. Power output is 20 mw minimum. Noise and spurious characteristics are excellent and no forced air cooling is required. The bwo operates with a cathode current of 9 ma and a helix voltage of 310 to 1825 v. Its handy package is 2½ in. square and 7½ in. long. Weight is less than 6 lb. Stewart Engineering Co., Santa Cruz, Calif. (312)

D-C Amplifier Encased in 1-In. Cube

TYPE 1-350 d-c amplifier with fixed zero and gain (preset at factory from 100 to 500) is announced. Encased in a 1-inch cube with no operating or adjustment controls, it has nickel wire leads designed for circuit-board mounting. Thermal zero shift and thermal gain shift are within 0.005 percent of full scale per deg F over a compensated temperature range of 0 to 200 F. Power input is 44 v at 10 ma maximum. Price is \$595. Consolidated Electrodynamics Corp., 360 Sierra Madre Villa, Pasadena, Calif. (313)

LITERATURE OF THE WEEK

- LOG PERIODIC ANTENNAS** Trylon, Inc., Elverson, Pa. 19520. Technical bulletin A1053 contains application advantages, electrical and structural characteristics and standard model specifications for the company's log periodic antennas. (360)
- TRANSISTOR CHOPPER DRIVER** Solid State Electronics Corp., 15321 Rayen St., Sepulveda, Calif. A catalog sheet describes the model TCD-101 silicon transistor chopper driver. (361)
- CARRYING CASES** Eugene Engineering Co., Inc., 50 Church St., Rockland, Mass. A four-page brochure illustrates carrying cases built to military specifications to transport and protect electronic components and instruments. (362)
- CONNECTORS** ITT Cannon Electric Inc., 3208 Humboldt St., Los Angeles, Calif. 90031, offers a catalog describing the DPYC rack/panel connectors. (363)
- DIGITAL COMPUTER** Advanced Scientific Instruments, 8001 Bloomington Freeway, Minneapolis, Minn., 55420. A 16-page descriptive manual covers the 2100 high-speed, general-purpose digital computer. (364)
- DESK COMPUTER** Comcor Inc., 430 South Navajo St., Denver, Colo. 80223. A 4-page brochure describes the Ci-150, a solid-state desk computer. (365)
- DIFFERENTIAL PRESSURE TRANSDUCER** Hagan Controls Corp., Box 11606, Pittsburgh, Pa. 15228. A 4-page booklet describes the operation and advantages of the PowrMag differential pressure transducer. (366)
- HAND EYELETER** Fastener Division, United Shoe Machinery Corp., Shelton, Conn. 06485. Bulletin E-110 describes model S-5 Hand Eyeleter, a hand-operated helical screw press for electronic prototype work. (367)
- CONSTANT-VOLTAGE TRANSFORMERS** Sola Electric Co., Elk Grove Village, Ill. Short-form catalog lists and describes the company's complete line of constant-voltage transformers. (368)
- MONITOR OSCILLOSCOPE** Consolidated Electroynamics Corp., 360 Sierra Madre Villa, Pasadena, Calif. A monitor oscilloscope that can be used with the most advanced high-performance magnetic-tape equipment is described in bulletin 12677. (369)
- VIBRATION MOUNT** Barry Controls, 700 Pleasant St., Watertown 72, Mass. Series 915 vibration isolator is described in bulletin 59-04.2. (370)
- VOLTMETER** General Radio Co., West Concord, Mass., has issued a mailing piece illustrating and describing type 1806-A, a d-c to 1500-Mc electronic voltmeter. (371)
- ELECTRONIC HARDWARE** Admiral Controls, Inc., 4250 Cutter St., Los Angeles 39, Calif. Catalog No. 10 presents complete data on a line of terminals, bushings, inserts, and lugs. (372)
- INSTRUMENTATION** Wayne Kerr Corp., 1633 Race St., Philadelphia 3, Pa. New 6-page describes over 50 precision instruments. (373)
- ULTRASONIC SEARCH UNITS** Sperry Products, Shelter Rock Road, Danbury, Conn., has published a revised catalog on ultrasonic nondestructive search units. (374)
- MODULE MOUNTING PANEL** Digital Equipment Corp. 146 Main St., Maynard, Mass. A 2-page technical bulletin (D-1935) describes a new, low-cost module mounting panel. (375)
- MULTIPOINT RECORDER APPLICATIONS** Barber-Colman Co., 1300 Rock St., Rockford, Ill. Bulletin F-11903 describes various applications of multipoint recorders on plastic extruder processes. (376)
- NUCLEAR POWER SOURCE** Leeson Moos Laboratories, Community Drive, Great Neck, N. Y. A technical data sheet gives detailed description and specifications on an extremely reliable power pack capable of providing pulse energies to 337,000 ergs. (377)
- VHF RECEIVERS** Regency Electronics, Inc., 7900 Pendleton Pike, Indianapolis 26, Ind. A 2-page technical information bulletin features two of the newest vhf aircraft receivers for the flight monitoring market. (378)
- ELECTROMETER AMPLIFIER** Washington Technological Associates, Inc., 979 Rollins Ave., Rockville, Md. Technical bulletin 311 announces development of an all-solid-state, direct-coupled electrometer amplifier designed to amplify currents as low as 5×10^{-12} amp. (379)
- PORTABLE POTENTIOMETERS** James G. Biddle Co., Township Line & Jolly Roads, Plymouth Meeting, Pa. Bulletin 60-35 covers portable potentiometers for plant and laboratory. (380)
- PRINTING TAPE PUNCH & READER** Navigation Computer Corp., Valley Forge Industrial Park, Norristown, Pa. An 8-page brochure provides specifications and illustrations of the series 1010 Tapewriter and Tapewriter-Reader systems. (381)
- STRAIN-GAGE MODULE** Leeds & Northrup Co., 4901 Stenton Ave., Philadelphia, Pa. 19144, has published a 2-page data sheet describing a strain-gage module used for adapting any fixed-span 0 to 10-mv indicator or recorder to mechanical measurements made by load cells. (382)
- MAGNETIC LATCHING RELAY** Executone Inc., 47-37 Austell Place, Long Island City 1, N. Y. A brochure illustrates and describes the low-cost, highly reliable series LS and LD Printact magnetic latching relay. (383)
- ELECTRICAL CONNECTORS** The Pyle-National Co., 1334 North Kostner Ave., Chicago 51, Ill. Bulletin 676 explains many of the fundamentals of electrical plugs and receptacles. (384)

NEW
emcee
precision
voltage
reference



replaces
equipment
costing many
times more!

- Ideally suited for routine calibration of DC amplifiers, recorders, indicators, oscilloscopes, etc.
 - Decade units permit step calibration across range of instrument.
 - Four models cover range of 10 microvolts to 1/10th of a volt:
 - Model 1118A 0.01-0.1 mv.
 - Model 1118B 0.1-1.0 mv.
 - Model 1118C 1-10 mv.
 - Model 1118D 10-100 mv.
 - Accurate within $\pm 0.5\%$ of stated voltage.
 - Completely self-contained with own power source; one year life expectancy.
 - Available for immediate shipment from stock.
- Priced at only \$39.50 Order Today!

emcee
electronics,

INCORPORATED
1202 ARNOLD AVENUE
GREATER WILMINGTON AIRPORT
NEW CASTLE, DELAWARE

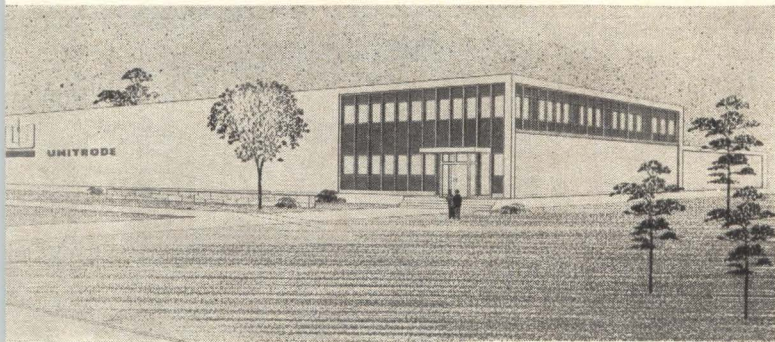

UTP Plans New Plant

UNITRODE TRANSISTOR PRODUCTS, Inc., has broken ground for a new building to be erected on a seven-acre site in Watertown, Mass.

The company, which was founded by president Malcolm Hecht, Jr., and vice president George Berman only 3½ years ago has 200 employees. When the new plant is completed, it is expected that pro-

duction schedules will require a work force of 500.

The new plant will have 18,000 square feet of prime production area on the first floor, while the second floor will have 12,000 square feet for administrative offices and a research and development area to assure future company growth. Unusual building methods will allow independent expansion of either floor as the company grows.

Master planning calls for two additional phases of construction at a later date. One whole side of the first 30,000-square-foot unit can be easily removed to lessen the cost of making additions.

Although it will not be visible from the outside, the entire building will be supported on concrete pilings and will stand 3 to 4 feet above ground level. The resultant space has been utilized by the designers to house vital piping and wiring. Easy accessibility to these services will allow flexibility of equipment arrangement, plus ease of maintenance.

Unitrode Transistor Products manufactures a glass diode used extensively in space probes and high-performance industrial equipment. Company officials say its products are represented on practically every missile, satellite and space program in the U. S. and Canada.



Bratton Accepts Ampex Post

WILLIAM E. BRATTON, formerly president of Librascope and president of The Information Systems Group of General Precision, Inc., Los Angeles, has been named vice president, general manager of the Ampex Corporation Computer Products division, Culver City, Calif.

In his new post, Bratton is responsible for the development and manufacture of Ampex electronic recording and data storage equipment for use in electronic computers and control systems.

Admiral To Move Palo Alto Operations

ADMIRAL CORPORATION's Palo Alto, Calif., production and research operations will be moved to Chicago by the end of February. The Palo Alto plant was operated primarily as a military electronics development laboratory, including radar beacons, laser modulation, delay lines, flight instrumentation, iff equipment, and photo reconnaissance stabilization equipment.

Thomas J. Lloyd, vice-president of Admiral's Government Electronics division, said this move consolidates all military production and engineering at the company's Chicago address.

General Dynamics Appoints Farrar

ASHLEY A. FARRAR has been named vice president-marketing for the Electronics division of General Dynamics, Rochester, N. Y. He was formerly vice president and general

manager of Pickard and Burns, Inc., electronics subsidiary of the Gorham Corp., in Waltham, Mass.



Taffet Electronics Names Cohen

APPOINTMENT of Nathaniel L. Cohen to the posts of vice president and director of engineering for Taffet Electronics, Inc., Woodside, N. Y., has been announced. Prior to joining the firm, Cohen was for nearly a decade on the staff of General Instrument Corp., Hicksville, N. Y., most recently as chief engineer of that company's Radio Re-

To Order Reprints

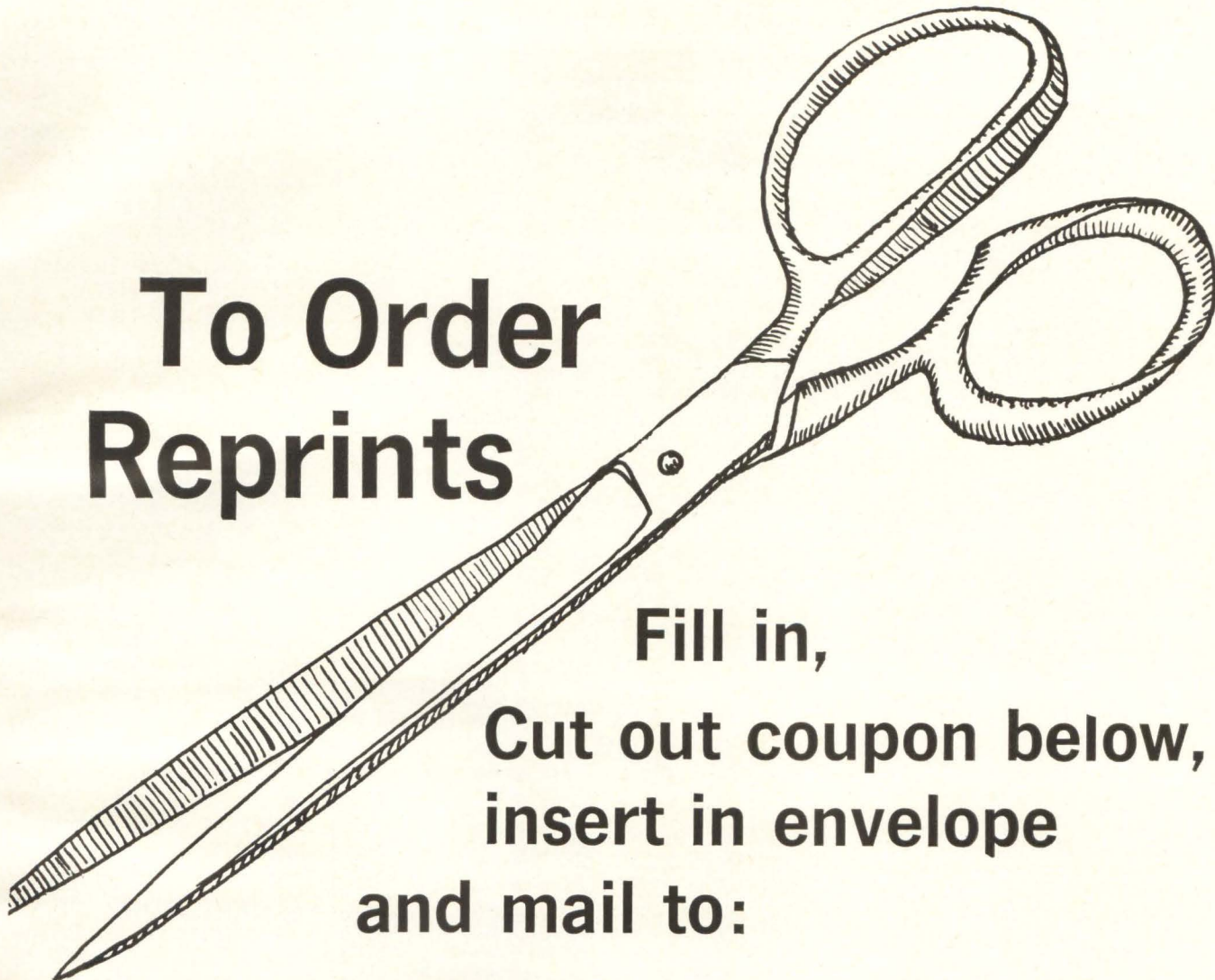

Fill in,
Cut out coupon below,
insert in envelope
and mail to:

electronics Reprint Dept.
330 West 42nd Street,
New York, N. Y.—10036

REPRINT ORDER FORM

For Listing of Reprints Available See Reader Service Card

(To help expedite mailing of your reprints please send cash, check or money order with your order.)

For Reprints of the latest Special Report:

Electronics Markets New Directions 1963-64-67

Send me Reprints of Key No. R-47 at 50¢ each.

For Reprints of previous **Special Reports** or **Feature Articles** fill in below:

Send me Reprints of Key No.(s) @ ¢ each. (For prices, see chart above.)

*For orders of Bulk Reprints of other editorial articles in **this issue** or **past issues**:

Send me Reprints of page (no.(s)) of issue

of article entitled

*Minimum bulk order 100 copies. You will be advised of costs by return mail.

Name

Number and Street

City, Zone No., State



LAYOUT SHEETS TWICE AS FAST

with
**New Di-Acro
Lokator Layout
Machine**

Here's a fast low cost method for laying out sheets and plates without individual use of squares, scribes, scales, punches and hammers. New sliding secondary scales on the primary transverse and longitudinal scales permit direct reading of all locations whether dimensioned from material edges or from each other.

Any bench mechanic can make layouts to $\pm .005$ " accuracy on the new Di-Acro Lokator Layout Machine—in half the time it takes by hand.

Permanent magnets hold work. Cast base is ribbed for rigidity. Sheets up to 36" wide by 1" thick by any length can be processed. Etched and plated satin finish steel scales read through magnifiers for maximum accuracy. Choose any of three models: calibrated in increments of $1/64$ " from 0 at base line on left side and bottom, $1/64$ " from 0 at center of sheet and $.001$ " from 0 at base line on left side and bottom.



mounting—removable cover.

For complete details see your nearest Di-Acro distributor or use coupon.

di-acro
PRECISION
METALWORKING
EQUIPMENT

**DI-ACRO
CORPORATION**

431 EIGHTH AVENUE LAKE CITY, MINNESOTA

Please send information on the following:

<input type="checkbox"/> Di-Acro Lokator Layout Machine	<input type="checkbox"/> Punch Presses
<input type="checkbox"/> Press Brakes	<input type="checkbox"/> Punches and Dies

Name _____

Address _____

City _____ State _____

ceptor division.

Taffet Electronics manufactures precision electronic equipment, specializing in communications and testing apparatus for military and defense agencies.

Name O'Donnell Vice President

CEDRIC F. O'DONNELL has been named vice president, research and development, at North American Aviation's Autonetics division. He had been acting director.

O'Donnell joined NAA in 1952, and has served in numerous key positions including data systems chief engineer and R&D assistant director.



Rotron Manufacturing Elects Hossack

ALEXANDER HOSSACK has been elected vice-president-engineering at Rotron Mfg. Co., Inc., Woodstock, N. Y. He was previously associated with Continental Aviation and Engineering Corp., Detroit, Mich.

TRG Incorporated Hires Kaplan

ROBERT KAPLAN has joined the Quantum Electronics department of TRG Incorporated, Melville, N. Y. In this department, which is concerned mainly with development and research on lasers and laser instrumentation, Kaplan will direct and coordinate all proposal efforts

and will review the fiscal and technical status of current projects; he will also provide technical liaison with the customer.

Kaplan was previously employed by Wheeler Laboratories, where he organized and directed their laser effort and specialized in the development of optical waveguides and research on modal characteristics of lasers.

PEOPLE IN BRIEF

Walter P. Siegmund moves up to mgr. of the Fiber Optics dept. at American Optical Co. **William A. Suiter** advances to president of Marbon Chemical div., Borg-Warner, replacing **Robert Shattuck** who will continue as board chairman. **Ernst Weber**, president of Polytech Inst. of Bklyn, appointed to the exec committee of the Defense Science Board. **Wesley M. Fujii** promoted to engineering mgr. of the audio operations dept. of Ampex Corp. He succeeds **Rein Narma** who was named engineering mgr. of the consumer and educational products div. **Edward D. Orenstein**, former v-p of Data Display, Inc., elected president of the corporation. **Daniel Kahn**, previously with Wheeler Electronics, joins Singer's Metrics div. as general foreman of electronic assembly operations. **George F. Towner** raised to mgr. of the space dept. at the Westinghouse Defense and Space Center. **William M. Shanhouse**, former president of International Systems Research Corp. and its S. S. Hunter div., elected v-p in charge of engineering of Renwell Industries, Inc. **John C. Day**, ex-Motorola, named chief device engineer at U. S. Semcor. **Albert W. Puttick** advances to project mgr. of cable communications for Minute-man at the central operation of Sylva Electronics Systems. **David Zekaria**, previously with Litton Industries, joins Navigation Computer Corp. as director of engineering. **Marcel J. E. Golay**, a consultant to Perkin-Elmer for the past 10 years, appointed senior scientist in the firm's Instrument Group.

HOW TO USE YOUR ELECTRONICS BUYERS' GUIDE

Advertising Product Sections

Advertisements in the **ELECTRONICS BUYERS' GUIDE** are grouped together according to the kind of product advertised. All Power Supply advertisements, for example, will be found in the same section of the book. Thus it is made convenient for you to "shop" through the specifications presented to you by advertisers, without having to flip pages back and forth constantly. Keep your **ELECTRONICS BUYERS' GUIDE** close to your work area at all times.

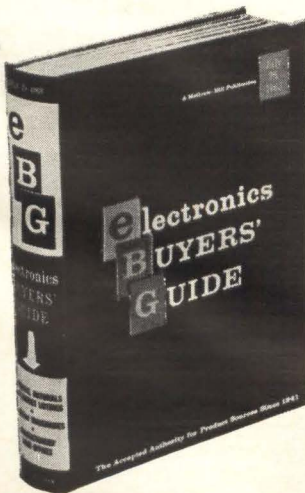

EMPLOYMENT OPPORTUNITIES



The advertisements in this section include all employment opportunities—executive, management, technical, selling, office, skilled, manual, etc. Look in the forward section of the magazine for additional Employment Opportunities advertising.

— RATES —

DISPLAYED: The advertising rate is \$52.00 per inch for all advertising appearing on other than a contract basis. Contract rates quoted on request. An advertising inch is measured $\frac{7}{8}$ " vertically on a column—3 columns—30 inches to a page.

Subject to Agency Commission.

UNDISPLAYED: \$2.70 per line, minimum 3 lines. To figure advance payment count 5 average words as a line.

Box numbers—count as 1 line.

Discount of 10% if full payment is made in advance for 4 consecutive insertions.

Not subject to Agency Commission.

INDUSTRIAL ELECTRON TUBES SALESMAN

DYNAMIC, WITH BROAD MARKET CONTACTS AND FOLLOWING. LIBERAL COMMISSION.

METROPOLITAN SUPPLY CORP.

443 PARK AVE. S., NEW YORK 16, N. Y.

(212) MU 6-2835

SEARCHLIGHT SECTION

(Classified Advertising)

BUSINESS OPPORTUNITIES

EQUIPMENT - USED or RESALE

DISPLAYED RATE

The advertising rate is \$27.25 per inch for all advertising appearing on other than a contract basis. Contract rates quoted on request. AN ADVERTISING INCH is measured $\frac{7}{8}$ inch vertically on one column, 3 columns—30 inches—to a page. EQUIPMENT WANTED or FOR SALE ADVERTISEMENTS acceptable only in Displayed Style.

UNDISPLAYED RATE

\$2.70 a line, minimum 3 lines. To figure advance payment count 5 average words as a line.

PROPOSALS, \$2.70 a line an insertion.

BOX NUMBERS count as one line additional in undisplayed ads.

DISCOUNT OF 10% if full payment is made in advance for four consecutive insertions of undisplayed ads (not including proposals).

Antique

TELEPHONES

As is complete, decorative purpose \$17.50. Working order, inter-comm. \$19.50 Ext. on dial \$24.50, talking circuit only. Write for complete list. All shipments FOB. Simpson, Pa.

TELEPHONE ENGINEERING CO.
Dept. 12464, Simpson Pa.



CIRCLE 951 ON READER SERVICE CARD

RADAR AUTO TRACK & TELEMETRY ANTENNA PEDESTALS 3 & 10 CM. SCR 584 AUTOTRACK RADARS. M-33 RADAR TPS-1D SEARCH. APS-45 TPS-10D HT. FINDERS. WX RADARS. FPN-32GCA. APS-10 APS-15B APS-27 (AMTI) SEARCH. ■ APN-102 DOPPLER. DOZENS MORE. CARCINOTRONS. PFN'S. 25-5-1-2-3-6 MEGAWATT PULSE MODULATORS. CAVITIES. PULSE TRANSFORMERS. IF STRIPS. WAVEGUIDE BENDS 200 MC. 1 KMC. 3 KMC. 6 KMC. 9 KMC. 24 KMC. RF PKGS.

RADIO RESEARCH INSTRUMENT CO.
550 5TH AVE., NEW YORK 36, N. Y. JU 6-4691

CIRCLE 952 ON READER SERVICE CARD

Somebody—Somewhere

needs your idle equipment! Reach that buyer quickly and economically thru the "SEARCHLIGHT SECTION"

The meeting place of
Used Equipment Buyers and Sellers



AUDIO SYSTEMS ENGINEERS

Can you design and engineer inter-communications systems for use at Cape Kennedy, Down Range Stations and Missile Tracking Ships? Systems with as many as 20 channels per station and up to hundreds of stations per system?

OR

Are you interested in developing unique Operations Control Consoles utilizing state-of-the-art communications and human engineering techniques? Consoles that will control this nation's future space exploration and missile development efforts?

OR

Can you create high-intelligibility Public Address Systems to be used under adverse noise and other extreme environmental conditions?

If you want to share the responsibility of Pan Am's Guided Missiles Range Division for advancing range technology at the Air Force Missile Test Center, have a BSEE degree and a minimum of three years experience in the audio field,

Write in confidence to:
Mr. R. Sorenson, Dept. 28A-4



GUIDED MISSILES RANGE DIVISION

PAN AMERICAN WORLD AIRWAYS, INC.
P. O. BOX 4465, PATRICK AIR FORCE BASE, FLORIDA
AN EQUAL OPPORTUNITY EMPLOYER

INDEX TO ADVERTISERS

• AMP Incorporated 4	IBM Data Processing 12, 13	• Telonic Industries Inc. 40
• American Time Products Div. of Bulova Watch Com- pany, Inc. 42	ITT Royal Electric Corp. 49	Texas Instrument Incorporated Industrial Products Group 3
		Transitron Electronic Corp. 38
• Ballantine Laboratories, Inc. 55	Janney Cylinder Co. 40	
	• Jennings Radio Manufacturing Corp. 50	
• Centralab The Electronics Div. of Globe- Union Inc. 44, 45	• Keithley Instruments, Inc. 60	
Communication Electronics Inc. 54	• Kepco, Inc. 4th cover	
• Computer Instruments Corp. 46		
	Leesona Corp. 57	
Delco Radio 21		
Di Acro Corp. 66	• Microswitch Division of Honeywell 7	
	• Moseley Co., F. L. 23	
EMCEE Electronics Inc. 63		
	• North Atlantic Industries, Inc. 51	
• FXR A Div. of Amphenol-Borg Electronics Corp. 8, 9	Princeton Applied Research Corp. 61	
Fluke Mfg. Co., Inc., John 61		
General Electric Co. Semiconductor Products Dept. 43	Servo Corporation of America 54	
Gudebrod Bros. Silk Co., Inc. 15	Silicon Transistor Corp. 3rd cover	
	Sperry Gyroscope Co. Div. of Sperry Rand Corp. 16	
• Hewlett-Packard Company 2nd cover	Sprague Electric Co. 6	
Houston Instrument Corp. 49	Stromberg-Carlson A Div. of General Dynamics 62	
Hughes Aircraft Co. Aerospace Divisions 53		

CLASSIFIED ADVERTISING
F. J. Eberle, Business Mgr. (2557)

EMPLOYMENT OPPORTUNITIES . . . 67

EQUIPMENT
(Used or Surplus New)
For Sale 67

CLASSIFIED ADVERTISERS INDEX
Metropolitan Supply Corp. 67
Pan American World Airways
Inc. 67
• Radio Research Instrument Co. 67
Telephone Engineering Co. 67

• See advertisement in the July 25, 1963 issue of electronics Buyers' Guide for complete line of products or services.

This Index and our Reader Service Numbers are published as a service. Every precaution is taken to make them accurate, but **electronics** assumes no responsibilities for errors or omissions.

electronics

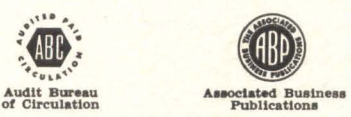

AUDITED PAID CIRCULATION

JAMES T. HAUPTLI (2210)
Advertising Sales Manager

HENRY M. SHAW (3485)
Market Research Manager

DAVID M. TEMPEST (3139)
Promotion Manager

electronics Buyers' Guide

R. S. QUINT (2335)
General Manager

RICHARD J. TOMLINSON (3191)
Business Manager

THEODORE R. GEIPEL (2044)
Production Manager

NEW YORK TELEPHONE: Dial Direct:
971 plus number in parenthesis,
Area Code 212

ADVERTISING REPRESENTATIVES

ATLANTA, GA. 30309
Michael H. Miller, Robert C. Johnson
1375 Peachtree St. N.E.,
Trinity 5-0523 (area code 404)

BOSTON, MASS. 02116
William S. Hodgkinson
McGraw-Hill Building, Copley Square,
Congress 2-1160 (area code 617)

CHICAGO, ILL. 60611
Harvey W. Wernecke,
Robert M. Denmead
645 North Michigan Avenue,
Mohawk 4-5800 (area code 312)

CLEVELAND, OHIO 44113
Paul T. Fegley
55 Public Square, Superior 1-7000
(area code 216)

DALLAS, TEXAS 75201
Frank Le Beau
The Vaughn Bldg.,
1712 Commerce St.
Riverside 7-9721 (area code 214)

DENVER, COLO. 80202
John W. Patten
Tower Bldg., 1700 Broadway,
Alpine 5-2981 (area code 303)

HOUSTON, TEXAS 77025
Kenneth George
Prudential Bldg., Halcombe Blvd.,
Riverside 8-1280 (area code 713)

LOS ANGELES, CALIF. 90017
Ashley P. Hartman, John G. Zisch,
1125 W. 6th St., Huntley 2-5450
(area code 213)

NEW YORK, N. Y. 10036
Donald H. Miller (212) 971 3615
George F. Werner (212) 971 3617
Donald R. Furth (212) 971 3616
500 Fifth Avenue

PHILADELPHIA, PA. 19103
Warren H. Gardner, William J. Boyle
6 Penn Center Plaza,
LOCust 8-6161 (area code 215)

SAN FRANCISCO, CALIF. 94111
Richard C. Alcorn
255 California Street,
Douglas 2-4600 (area code 415)

LONDON W1:
Edwin S. Murphy Jr.
34 Dover St.

FRANKFURT/Main:
Matthee Herfurth
85 Westendstrasse

GENEVA:
Michael R. Zeynel
2 Place du Port

TOKYO:
Shigeo Chiba,
1, Kotohiracho, Shiba, Minato-ku

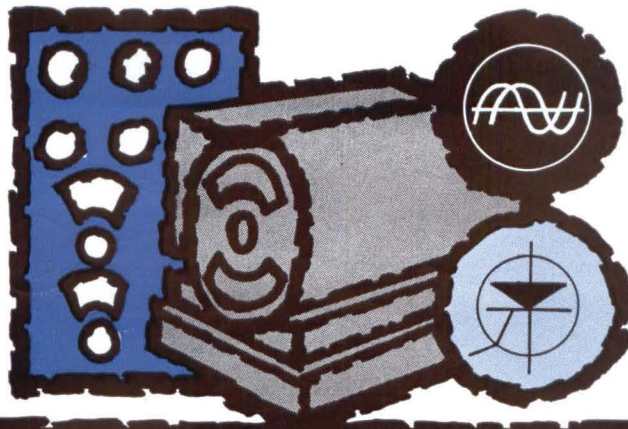

silicon controlled rectifiers

2N2573-2N2579 SERIES

TO-41



2N681-2N689 SERIES

TO-48



FROM THE LEADING MANUFACTURER OF SILICON POWER DEVICES

Backed by years of advanced research and successful new developments in the silicon power field, we are now producing these popular SCR series—2N681 through 2N689 series in the TO-48 package, and the 2N2573 through 2N2579 series in the TO-41 package. □ These all-diffused Silicon Controlled Rectifiers have the same rugged construction features that are built-in to our highly acclaimed transistor line. The rigid post and clip construction provides an element of rugged reliability and mechanical capability that is unequalled in the SCR field. The post is anchored at both ends and connects the terminals to the pellet.

In addition, these devices exhibit the desirable feature of having a positive temperature coefficient for the forward breakover voltage (V_{B0}) characteristic, with the minimum V_{B0} guaranteed at $T_c = -55^\circ\text{C}$. □ For regulated power supplies, power inverters, and motor control circuit design requirements, here are high reliability silicon controlled rectifiers at competitive commercial prices. □ If desired, they are also available in the familiar TO-3 package. □ For more information contact:

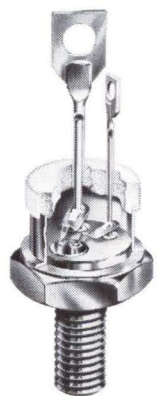

○  **SILICON TRANSISTOR CORPORATION**  ○

CARLE PLACE, LONG ISLAND, NEW YORK. 516-Pioneer 2-4100. TWX 516-248-9085

DISTRICT OFFICES: LONG BEACH 2, CALIF., 217 ELM AVE. (213) 437-2788. TWX 213-549-1972. DAYTON 19, OHIO, 49 PARK AVE. (513) 298-9913. TWX 513-944-0372. WALTHAM, MASS., 751 MAIN ST. (617) 899-3470. HUNTSVILLE, ALA., 1000 AIRPORT RD., SUITE NO. 2. (205) 881-4793

CIRCLE 901 ON READER SERVICE CARD

KEPCO

REGULATED **WR** DC SUPPLIES



POWER SUPPLIES WITH EXPERIENCE

Model 1520B



Model 605



Model 430D

The WR Group includes eleven time-proven models from Kepeco's current production of 230 standard models. Kepeco's representatives in your area can supply you with complete technical information, application ideas, and delivery.

APPLICATIONS:

- ELECTROPHORESIS ■ RADAR
- ELECTROCHEMICAL PROCESSES
- MICROWAVES ■ PHOTOMULTIPLIERS
- COMMUNICATIONS-TELEVISION
- TELEPHONE SYSTEMS
- ELECTRO-MECHANICAL DEVICES

GENERAL SPECIFICATIONS:

- **Input:** 105-125 VAC 50-65 cps single phase
- **Operating Temperature:** -20°C to +55°C
- **Temperature Coefficient:** < 0.01% per °C
- **Recovery Time:** 50 microseconds
- **Isolation:** 400 volts (except HB 2050)
- **Meters:** Voltmeter and Ammeter
- Convection Cooling
- For Relay Rack or Bench Use
- Multiple output and high voltages
- Plate, Grid and Heater Voltages
- Continuously Variable, Zero to full output

See our Complete Catalog in



MODEL	DC OUTPUT RANGE		REGULATION				RIPPLE RMS MV	AUX. OUTPUT 6.3VAC Unregulated	PRICE
	VOLTS	MA.	LOAD O-MAX %	LINE %	ΔV	ΔV			
2400 B - #1	0-150	0-5	*	*	*	*	1	\$540.00	
#2	0-400	0-150	0.025	0.1	0.1	0.4	3		
#3	0-400	0-150	0.025	0.1	0.1	0.4	3		
400 B	0-400 0-150	0-150 0-5	0.025 *	0.1 *	0.1 *	0.4 *	3 1	10 AMP	270.00
430 D - #1	0-450	0-300	0.025	0.1	0.1	0.4	3	10 AMP	675.00
#2	0-450	0-300	0.025	0.1	0.1	0.4	3	10 AMP	
800 B - #1	0-600	0-200	0.02	0.1	0.1	0.4	3	10 AMP	575.00
#2	0-600	0-200	0.02	0.1	0.1	0.4	3	10 AMP	
605	0-600 0-150	0-500 0-5	0.02 *	0.1 *	0.1 *	0.4 *	3 1	20 AMP	425.00
615B	0-600 0-150	0-300 0-5	0.02 *	0.1 *	0.1 *	0.4 *	3 1	10 AMP	355.00
1250 B	0-1000	0-500	0.01	0.1	0.05	0.4	3		650.00
1220 C	0-1200	0-50	0.01	0.1	0.05	0.4	3	10 AMP	465.00
1520 B	0-1500	0-200	0.01	0.1	0.05	0.4	3		695.00
HB 2050	0-2000	0-500	0.005	0.1	0.02	0.4	3		1565.00
HB 2500	0-2500	0-50	0.005	0.1	0.02	0.4	5		975.00

*0-150V bias - Regulation: 0.01% Line / 2% Load at 150V



For complete specifications on more than 230 standard model Power Supplies, send for NEW Catalog B-631.

131-38 SANFORD AVENUE, FLUSHING, N.Y. 11352 • Phone: (212) IN 1-7000 • TWX #212-539-6623 • Cable: KEPCOPOWER NEWYORK

CIRCLE 902 ON READER SERVICE CARD