



Ultra Low Temperature Freezers

Installation and Operation

315673H01

Rev. D

December 2014

Visit us online to register your warranty
www.thermoscientific.com/labwarranty

IMPORTANT Read this instruction manual. Failure to follow the instructions in this manual can result in damage to the unit, injury to operating personnel, and poor equipment performance.

CAUTION All internal adjustments and maintenance must be performed by qualified service personnel.

Material in this manual is for informational purposes only. The contents and the product it describes are subject to change without notice. Thermo Fisher Scientific makes no representations or warranties with respect to this manual. In no event shall Thermo be held liable for any damages, direct or incidental, arising from or related to the use of this manual.

© 2014 Thermo Fisher Scientific Inc. All rights reserved.

Table of Contents

Peek Models	1
Safety Precautions	2
Unpacking	4
Packing List	5
General Recommendations	6
Temperature Monitoring	6
General Usage	6
Initial Loading	6
Operating Standards	7
Electrical Specifications	7
Installation	9
Location	9
Wiring	9
Leveling	10
Backup System (Optional)	10
Superinsulated Cabinet Construction	10
Door Operation	10
Pressure Equalization Port	12
Installing the Remote Alarm Connector	13
Intended Use	13
Start Up	14
Initial Start Up	14
Unit Name (Optional)	15
Performance Mode	16
Security Mode	17
New User Entry	18
Operation	20
Operation Overview	20
Home Screen	20
Using the Main Toolbar	23
Setting Temperature Setpoints	24
Setting Preferences	26
Managing Users	27
Screen Calibration	30
Regional Settings	30
System Management	31
User Log On/Off	32
Health Status and Alarm Management	33
Health Status Overview	33

Table of Contents

Alarms	34
Temperature Sensor Screen	35
Event Log Screen	36
Power Systems Screen	37
Exporting Event and Temperature Data	38
Backup System (Optional)	40
CO ₂ and LN ₂ Precautions	40
Installation	41
Start Up	42
Operation	42
Chart Recorders (Optional)	43
Set Up and Operation	43
Changing Chart Paper	44
Calibration Adjustment	44
Maintenance and Troubleshooting.....	45
Cleaning the Condenser	45
Cleaning the Condenser Filter	45
Gasket Maintenance	46
Defrosting the Freezer	46
Alarm Battery Maintenance	46
Warranty	47
Warranty (International)	48

1 Peek Models

Brand - Model	Size (xxx)	Voltage (*)
Forma -88xxx*	300 / 400 / 500 / 600 / 700	A / D / V / G / J / K
TS -TSUxxx*	300 / 400 / 500 / 600 / 700	A / D / V
HF -HFUxxxT*	300 / 400 / 500 / 600 / 700	A / D / V
Revco -UxFxxx86*	300 / 400 / 500 / 600 / 700	A / D / V

Note *G, J and K nomenclature is for Japan models*

2 Safety Precautions

In this manual, the following symbols and conventions are used:



This symbol used alone indicates important operating instructions which reduce the risk of injury or poor performance of the unit.



CAUTION: This symbol, in the context of a CAUTION, indicates a potentially hazardous situation which if not avoided could result in minor to moderate injury or damage to the equipment.



WARNING: This symbol indicates potentially hazardous situations which, if not avoided, could result in serious injury or death.



WARNING: This symbol indicates situations where dangerous voltages exist and potential for electrical shock is present.



The snowflake symbol indicates extreme low temperatures and high risk of frostbite. Do not touch bare metal or samples with unprotected body parts.



This symbol indicates a need to use gloves during the indicated procedures. If performing decontamination procedures, use chemically resistant gloves. Use insulated gloves for handling samples and when using liquid nitrogen.



Before installing, using or maintaining this product, please be sure to read this manual and product warning labels carefully. Failure to follow these instructions may cause this product to malfunction, which could result in injury or damage.

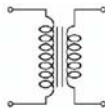

This symbol indicates transformer which is used additional with Japan models.

Below are important safety precautions that apply to this product:



Use this product only in the way described in the product literature and in this manual. Before using it, verify that this product is suitable for its intended use. If this equipment is used in a manner not specified by the manufacturer, the protection provided by the equipment may be impaired.



Do not modify system components, especially the controller. Use OEM exact replacement equipment or parts. Before use, confirm that the product has not been altered in any way.



WARNING: Your unit must be properly grounded in conformity with national and local electrical codes. Never connect the unit to overloaded power sources.



WARNING: Disconnect the unit from all power sources before cleaning, troubleshooting, or performing other maintenance on the product or its controls.

3 Unpacking

At delivery, examine the exterior for physical damage while the carrier's representative is present. If exterior damage is present, carefully unpack and inspect the unit and all accessories for damage.

If there is no exterior damage, unpack and inspect the equipment within five days of delivery. If you find any damage, keep the packing materials and immediately report the damage to the carrier. Do not return goods to the manufacturer without written authorization. When submitting a claim for shipping damage, request that the carrier inspect the shipping container and equipment.

4 Packing List

Inside the freezer cabinet is a bag containing:

- This manual
- A CD with user's manuals, including translated versions
- Certificates of conformance and calibration
- A remote alarm contact connector
- Posts for rear spacing
- A freezer key.

If you have ordered a field-installed chart recorder, the bag will also contain:

- Recorder installation instructions
- Extra inkless paper

If you have ordered a backup system, the cabinet will also contain:

- A hose assembly
- English and metric connectors

If specified on the order, the bag may also include:

- A QC temperature graph and test log
- Calibration information

If you have ordered the Proximity Access Card Option, the cards will be in a bag attached to the front of the freezer.

Note *For Japan, Models are,*

88300G

88400K, 88500K, 88600K

88400J, 88500J, 88600J.

* Transformer kit assembly is included.

* Transformer installation instructions is provided with transformer kit assembly.

Note *For 88300G no external boost transformer is required. The freezer is equipped with the power cord and locking plug (PN- 327197H02) designed to connect it to a power outlet which delivers the correct voltage.*

5 General Recommendations

5.1 Temperature Monitoring



IMPORTANT NOTE We recommend the use of a redundant and independent temperature monitoring system so that the freezer can be monitored continuously for performance commensurate with the value of product stored.

5.2 General Usage

This refrigeration system is designed to maintain ultra-low temperatures with safety in an ambient environment up to +32°C (90°F), only when the freezer is used for storage.



WARNING: This unit is not a “rapid-freeze” device. Freezing large quantities of liquid, or high-water content items, will temporarily increase the chamber temperature and will cause the compressors to operate for a prolonged time period.

Avoid opening the door for extended time periods since chamber temperature air will escape rapidly. Also, keep the inner doors closed as much as possible. When room air, which is higher in humidity, replaces chamber air, frost may develop in the chamber more rapidly.

5.3 Initial Loading

Allow the freezer to operate at the desired temperature for a minimum of 12 hours before loading.

Load the freezer one shelf at a time, beginning with the top shelf. After loading each shelf, allow the freezer to recover to the desired set point before loading the next shelf. Repeat this process until the freezer is fully loaded.



CAUTION: Failure to follow these procedures or overloading the unit may cause undue stress on the compressors or jeopardize user product safety.

6 Operating Standards

The freezers described in this manual are classified for use as stationary equipment in a Pollution Degree 2 and Overvoltage Category II environment.

These units are designed to operate under the following environmental conditions:

- Indoor use
- Altitude up to 2000m
- Maximum relative humidity 60% for temperatures up to 32°C (90°F)
- Main supply voltage fluctuations not to exceed 10% of the nominal voltage.

6.1 Electrical Specifications

The last character in the model number listed on the dataplate identifies the electrical specifications for your unit.

The voltage types are A, D, V, G, J and K as specified in the following table:

Table 1. Electrical Specifications

Model	Voltage	Frequency	Current
A	115V	60Hz	16A
D	208/230V	60Hz	9A
V	230V	50Hz	9.5A
G	100V	50Hz	16A
J	200V	50Hz	9.5A
K	200V	60Hz	9A

Note *G, J and K volt are Japan models with the voltage and frequency as mentioned in table 1. Contact your sales representative to assist with this selection.*

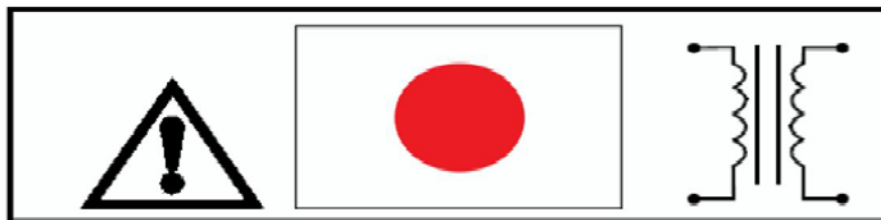

Figure 1. Transformer Reminder Sticker

Note *For proper operation of units in Japan, a kit that includes appropriate transformers, power cords and input voltage label is required. A transformer reminder sticker must be added to the Japan models as specified for proper installation of transformer with the unit. Please contact your sales representative to assist with this selection.*

Note *88300G Japan model is without external boost transformer, hence no transformer reminder sticker required on 88300G Japan model.*

7 Installation



WARNING: Do not exceed the electrical rating printed on the data plate located on the lower left side of the unit.

Note For Japan models, the data plate ratings are finalized with transformer connected in circuit with Freezer. Never remove transformer and run the unit by any other means.

Note Data plate ratings for 88300G Japan model is without external boost transformer.

7.1 Location

Install the unit in a level area free from vibration with a minimum of eight inches (20 cm) of space on the top and sides, six inches (15 cm) in back. (Refer to *Section 7.3* for further instructions on leveling cabinets.) Allow enough clearance so that door can swing open at least 85°.

The rear spacing posts provided with the freezer can be used to ensure proper clearance. To install the spacing posts, screw them into the back in the rear deck area.

Do not position the equipment in direct sunlight or near heating diffusers, radiators, or other sources of heat. The ambient temperature range at the location must be 59 to 90°F (15 to 32°C).

7.2 Wiring



CAUTION: Connect the equipment to the correct power source. Incorrect voltage can result in severe damage to the equipment.



CAUTION: For personal safety and trouble-free operation, this unit must be properly grounded before it is used. Failure to ground the equipment may cause personal injury or damage to the equipment. Always conform to the National Electrical Code and local codes. Do not connect the unit to overloaded power lines.



CAUTION: Do not position the unit in a way that impedes access to the disconnecting device or circuit breaker in the back of the unit.



CAUTION: Always connect the freezer to a dedicated (separate) circuit. Each freezer is equipped with a service cord and plug designed to connect it to a power outlet which delivers the correct voltage. Supply voltage must be within +10% or -10% of the freezer rated voltage.

Note *For Japan models, remove the service cord and discard. Keep the strain relief that fastens the service cord to the unit to be used with the transformer kit accessory. The service cord and plug comes with the transformer kit accessory will be used to connect the unit to power outlet which delivers the correct power.*

Note *88300G Japan model is without external boost transformer, freezer is equipped with a service cord (PN- 327197H02) and locking plug designed to connect it to a power outlet which delivers the correct voltage.*



CAUTION: Never cut the grounding prong from the service cord plug. If the prong is removed, the warranty is invalidated.

7.3 Leveling

Make sure that the floor is level. The unit must be level both front to back and side to side.

300 and 400 box capacity models are equipped with two leveling legs on the right hand side. These must be lowered to ensure stability of the unit.

Be sure to set the brakes for units equipped with casters.

7.4 Backup System (Optional)

If you are using a CO₂ or LN₂ backup system, refer to *Section 11* for installation and operation instructions.

7.5 Superinsulated Cabinet Construction

In all models, the cabinet walls have a vacuum insulation core encapsulated by a sealed film laminate.



CAUTION: Never drill holes in or near the cabinet walls. Drilling could damage the insulation and make the unit inoperable.

7.6 Door Operation

Upright freezer models are equipped with an advanced assembly specifically designed for ultra-low temperature freezers.

Features include:

- One-hand operation
- A front-accessible lock

- Hasps for a standard padlock to provide additional security
- Durable construction for reliable operation and safe product storage
- Optional controlled access to the freezer with Proximity Access cards



CAUTION: When moving the freezer, always grasp cabinet surfaces; never pull the freezer by the latch handle.

7.6.1 Opening the Door

For freezers with the Proximity Access Card option:

1. To unlock the door, pass the card in front of the freezer below the LCD display.
2. Grasp the latch handle and pull it toward yourself until the latch disengages from the cabinet strike.
3. Keep pulling by the latch handle to open the main door.

For freezers without the Access Card option:

1. Remove the padlock if installed.
2. Grasp the latch handle and pull it toward yourself until the latch disengages from the cabinet strike.
3. Keep pulling by the latch handle to open the main door.

7.6.2 Opening the Door During a Power Outage

In case of power outage, you may use a 9 volt battery to activate the proximity card access system. To access the 9 volt terminal, a piece of plastic trim must be removed near the user interface.

If the trim is gray, remove the left plastic trim by sliding it up and gently pulling it out.

If the trim is blue, slide the U-shaped trim piece down and gently pull it out.

Once the terminal is exposed, you can open the door by holding the 9 volt battery against the terminal and passing a valid proximity card below the display area.

Once the door is open, remove the battery.

7.6.3 Closing the Door

Note *The latch does not self-engage automatically when you close the door. You must rotate the latch into the open position first.*

1. Grasp the latch handle (preferably with your left hand) and pull it toward yourself, rotating the latch into the open position.
2. Move the freezer door into the closed position and gently push the handle away from you, making sure that the latch engages fully with the cabinet strike.
3. Keep applying gentle pressure to the latch handle until the latch is securely in closed position.
4. Insert the key and rotate counterclockwise to lock.
5. Replace the padlock as required.

7.7 Pressure Equalization Port

When an upright ultra-low temperature freezer door is opened, room temperature air rushes into the storage compartment. When the door is closed, the fixed volume of air is cooled rapidly. Pressure drops below atmospheric pressure, resulting in a substantial vacuum. Re-entry into the cabinet is impossible until internal pressures are returned to atmospheric pressure. Without a pressure equalization mechanism, it can take, in extreme cases, several hours before the door can easily be reopened.

All upright models feature a port that provides vacuum relief after door openings.

The pressure equalization port is located in the door behind the eye-level panel on the front of the freezer. Although the port is designed to self-defrost, excessive frost accumulation on the inner door could eventually restrict air flow. Therefore you should periodically inspect the inner door and brush away any loose frost using a stiff nylon brush.

7.8 Installing the Remote Alarm Connector

The remote alarm contacts are located on the back of the freezer above and to the left of the power switch. After installing the wiring from the remote alarm to the connector, install the connector to the freezer microboard.

The pin configuration is shown in Figure 1 below.

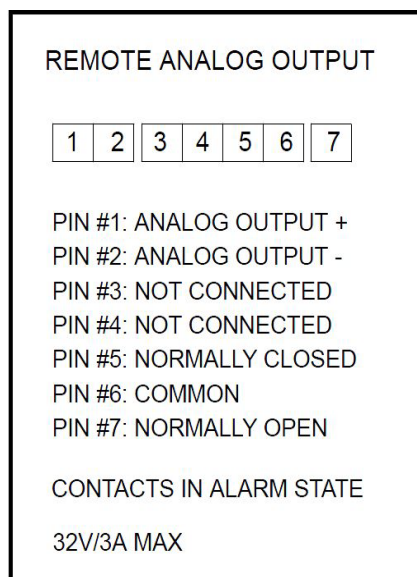

Figure 2. Remote Alarm Pin Configuration

The contacts will trip in the event of a power outage, high temperature alarm or low temperature alarm.

7.9 Intended Use

The -86°C freezer (refer to *Section 1* for the specific model series) described in this manual are high performance units for professional use. These products are intended for use as cold storage in research use and as a general purpose laboratory freezer, storing samples or inventory at operating temperatures between -50°C and -80°C.

It is not considered a medical device and has therefore not been registered with a medical device regulatory body (e.g. FDA): that is, it has not been evaluated for the storage of samples for diagnostic use or for samples to be re-introduced to the body.

This unit is not intended for use in classified hazardous locations, nor to be used for the storage of flammable inventory.

8 Start Up

8.1 Initial Start Up

To start up the freezer, complete the following steps:

1. Plug the freezer into the power outlet.
2. Turn the power switch in back of the freezer, on the bottom right, to the ON position.
3. When the freezer is powered up, you will see a logo displayed on the front screen for about 25 seconds, followed by a Regional Settings screen:



Figure 3. Regional Settings Screen

This screen allows you to specify the preferred display language along with date, time and temperature display preferences. If you prefer a display language other than English, press the correct radio button. Press the °F radio button if you want to change the display temperature from Celsius to Fahrenheit.

To set date, time, and 24hr/AM-PM display format, press each display you wish to change. Up and down arrows will then appear which you can use to change values.

On this and all other screens, a check mark icon will appear whenever you change values. Always be sure to press the check mark icon to confirm changes before navigating away from a screen.

Press the check mark icon to confirm changes. Press Next when ready.

4. A sequence of screens then asks you to verify that:
- The freezer is properly grounded and connected to a dedicated power source
 - The unit has sufficient clearance
 - The unit is level
 - Ambient conditions are within the acceptable range.

If you are in doubt about whether any of the above installation requirements have been met, refer to the details in *Section 7* and verify them before completing the startup procedure.

You will then be asked to specify unit name, performance mode, and security mode, as explained in the following sections.

8.2 Unit Name (Optional)

If desired, you can identify an individual freezer by specifying Unit Name on the screen below.

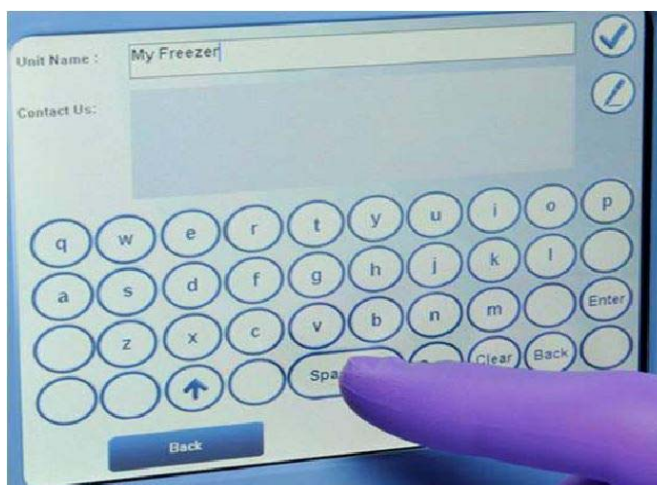

Figure 4. Unit Name Screen

The Contact Us information is pre-filled with Thermo Scientific information.

To enter unit name or contact information, press the field, then use the keyboard.

To edit unit name or contact information, press the pencil icon, then use the keyboard to edit.

The keyboard for this start up screen is English only.

- The **Sym** key switches to a symbol and numeric character set. To switch back to the alpha character set, press the up arrow (upper case).
- The Clear key clears edits.
- The Back key backs up one character.

Press the check mark to confirm entry, then press Next to continue.

8.3 Performance Mode

Specify Performance Mode on the screen below:

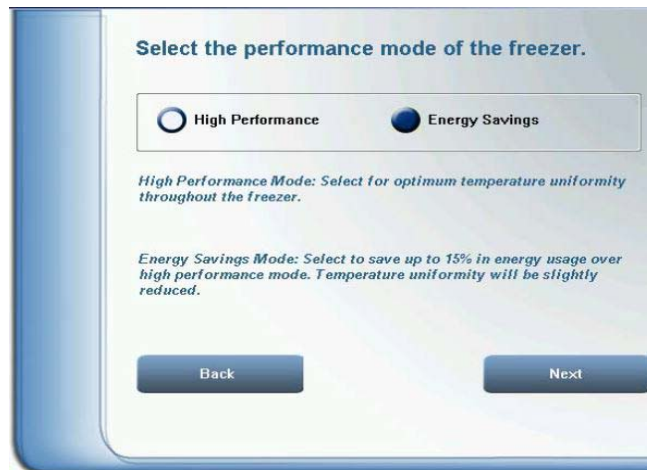

Figure 5. Performance Mode Screen

Use the radio button to change settings.

The default setting is High Performance Mode, which provides optimum temperature uniformity.

Energy Savings Mode is for customers who do not require maximum temperature uniformity. It can save up to 15% in energy usage.

If you change settings, press the check mark icon to confirm.

Press Next to continue.

8.4 Security Mode

The next startup screen determines whether the freezer will run in the set point security mode. Choices are Secured and Full Access.



Figure 6. Security Mode Screen

The default setting is Full Access Mode, in which all users have access to all functions, including changing freezer set points.

In Secured mode, administrators and users have access to functions according to the table below.

Table 2. Administrator and User Privileges

Function	Administrator	User
Acknowledge alarms	X	X
Change setpoints	X	
Add / delete users	X	
Download data	X	
Change freezer settings	X	

Note that if you choose to run in Full Access mode and if you have the Proximity Access Card option installed, you will need to activate the cards after start up. Refer to *Section 9.6* for details.

You can choose Secured mode to enable set point security. In Secured mode, only an administrator can change freezer settings.

Note This Selection can only be made during the start up procedure. After start up, you can only change security mode by restoring factory defaults and shutting down the freezer. Refer to Section 9.5.

If you wish to change the default, use the radio button to change to Secured. **Press the check mark icon to confirm.**

Press Next when ready.

8.5 New User Entry

If you have selected Secured mode, you will need to create at least one account with Administrator privileges and the following screen will be displayed:

Figure 7. New User Entry Screen

- **Name (required):** 4-10 characters, case sensitive. Any valid keyboard characters are permitted.
- **Given Name (optional):** 1-25 characters.
- **Password (required):** 4-10 characters, case sensitive. Any valid keyboard characters are permitted.
- **Type (required):** Select Admin. The first user must be an administrator.
- **E-mail (optional):** Maximum 30 characters.
- **Telephone (optional):** Maximum 20 characters, numeric only.
- **Access Card ID (optional):** Proximity Access Card ID number.

The Access Card field is active only if the Proximity Access Card option has been installed. To associate an access card with a user name, press the Access Card ID field and hold the card below the display. The card number will appear in the field and the card will be able to unlock the freezer door on subsequent card reads.

Press the corresponding X icon to delete a password or card ID.

Press the check mark icon to confirm entry, then Press Next to continue.

The start up wizard is now complete and the default Home Screen will be displayed. The start up screens shown in this section will not be displayed again unless the freezer has been turned off for 12 hours or the user has requested restoration of factory defaults.

9 Operation

9.1 Operation Overview

Once you have successfully completed the initial start up procedures, the freezer starts operating normally and the only actions required are:

- Setting the operating and alarm set points (refer to *Section 9.4*)
- Activating the CO₂ or LN₂ backup system if installed. For instructions on backup settings and activating the system, refer to *Section 11*.

9.2 Home Screen

The Home Screen below is the default screen.

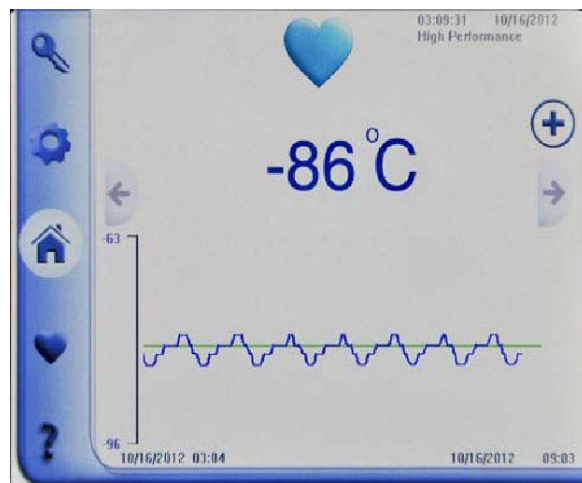

Figure 8. Home Screen

The color of the heart at the top indicates health of the freezer: red indicates a serious alarm condition, yellow indicates a noteworthy condition, and blue is normal. Refer to the appendices at the end of this manual for full details on the conditions that determine the color of the heart icon and alarm activation.

This screen displays the current cabinet temperature, the current temperature set point in green, and a graph showing recent readings.

According to the default setting, the screen will also automatically go blank to save power between the hours of 9PM and 6AM. For instructions on changing the default to continuous display, refer to *Section 9.5*. When a screen has gone blank, touch the screen anywhere to refresh the display.

9.2.1 Alarm and Error Conditions

A blinking heart indicates an active alarm or error condition.



IMPORTANT NOTE If the heart is red or yellow indicating an alarm or error condition, press the heart icon to bring up the health status screen (refer to *Section 10*) where you can view details on the alarm condition and mute audible alarms. Refer to *Appendix A* for details on alarms.

9.2.2 Event Icons

Icons will appear above the graph in the event of door opening, power failure, or multiple events:



Door opening



Power Failure



Multiple Events

For details on the time and duration of these events, press the heart to access the event log (refer to *Section 10.4*).

If more than one event occurs within ten minutes, the multiple events icon is displayed.

9.2.3 Reading the Graph

Use the right and left arrows to scroll to different time periods. The graph displays up to two weeks of temperature data.

The graphic display can be expanded by pressing the plus sign icon on the upper right side of the Home Screen (refer to *Figure 7*):



Figure 9. Expanded Graphic Display

Press an axis (temperature or Minutes) to adjust the scales.

Press the File Download icon at the lower left to download data to a USB flash drive. You can download both temperature and data. To create a .dat file, insert a USB flash drive in the USB port to the right of the display, then press the File Download icon. You will then be asked to specify date ranges of one to six months.

Press the thermometer icon to select thermocouples for graphing (for details on temperature sensors, refer to *Figure 22*).

If the (show data gap icon here) icon appears below the graph, that indicates a data gap, most likely caused by a power outage.

9.2.4 Compressor Staging

To optimize system performance, it may take up to six minutes for the first stage compressor to turn after initial power up, a power interruption, or a set point change. During this staging period, an hourglass icon will appear on the Home Screen as shown in the illustration below:

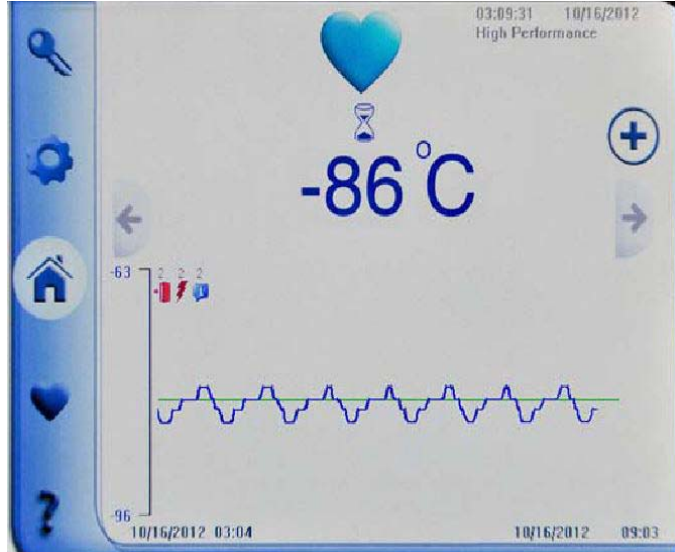

Figure 10. Home Screen During Compressor Staging

9.3 Using the Main Toolbar

The icons on the bluebar in the left side of the Home Screen provide access to all functions as shown below:

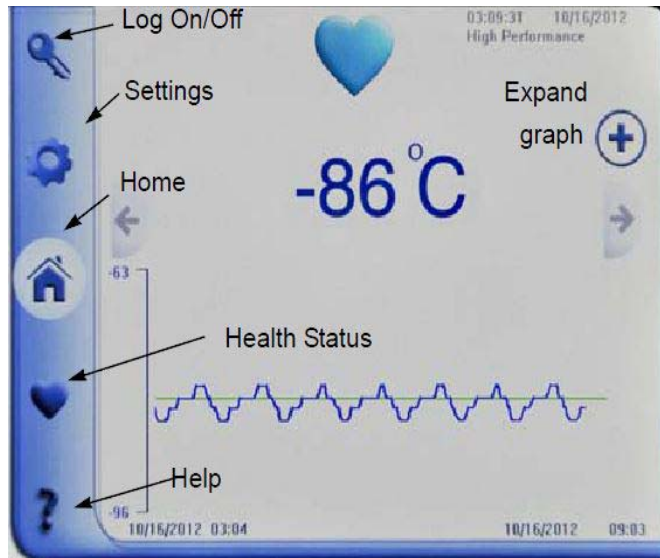

Figure 11. Main Toolbar

9.4 Setting Temperature Setpoints

To set temperature set points:

1. Press the Settings (gear) icon on the Main Toolbar shown in the figure below. The following screen will be displayed:



Figure 12. Settings Screen

2. Press the Freezer Settings icon (the freezer at the top of the circle) to display the following screen:



Figure 13. Freezer Settings

3. All parameters on this screen may be adjusted by pressing the value displayed. Left and right arrows will then appear when you press a field, as will a check mark icon to confirm changes. Use the arrows to increase or decrease the values.
4. **On this and all other screens, a check mark icon will appear whenever you change values. Always be sure to press the check mark icon to confirm changes before navigating away from a screen.**
5. Press the back arrow at the bottom right to return to the previous screen.

When secondary screens such as this one are displayed, the display will automatically return to the Home Screen if there is no user input within five minutes.

- **Primary Set Point:** Operating cabinet temperature. The minimum value is -50°C ; maximum is -86°C . Factory default is -80°C .
- **Primary Offset:** Used for calibration. Range is -10°C to $+7^{\circ}\text{C}$. Default is 0.

Note to calibrators: Customers performing on-site temperature calibration may observe as much as a 2°C variation when an external probe is placed next to the freezer control probe. This variation is due to optimization of the control system to ensure temperature uniformity throughout the chamber.

- **Life Guard:** Alarm setting for high internal (second sump) temperature. Range is 70°C to 98°C . Default is 94°C .
- **Extreme Ambient:** Alarm setting for high ambient temperature. Range is 32°C to 40°C . Default is 37°C .
- **Warm alarm:** -40°C to within 5°C of set point. Note that the warm alarm will be disabled for 12 hours from a warm start condition.
- **Cold alarm:** -99°C to within 5°C of set point.
- **Time Delay:** Specifies delay upon startup after power failure. Range is 0 to 20 minutes in steps of 6 seconds; default is 0.

9.5 Setting Preferences

Pressing the Preferences icon (refer to *Figure 11*) brings up the following screen:

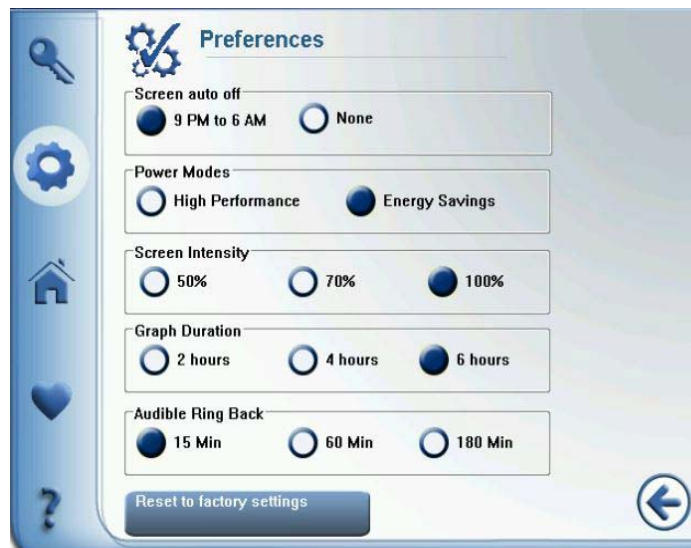

Figure 14. Preferences

Use the radio buttons to make selections, and confirm choices by pressing the check mark icon.

- **Screen Auto Off:** 9PM to 6AM darkens screens after hours. If you change to None, screen are constantly illuminated.
- **Power Mode:** The default setting is High Performance Mode, which provides optimum temperature uniformity. Energy Savings Mode is for customers who do not require maximum temperature uniformity.
- **Screen Intensity:** Controls the brightness of the screens.
- **Graph Duration:** Changes the x axis of the home screen graph. Choices are 2, 4, or 6 hour.
- **Reset Factory Settings:** Restores all freezer settings to factory default values.

Note *The Reset Factory Settings option has the effect of deleting ALL freezer settings and user databases. Be sure to save the configuration to preserve settings and users (refer to Section 9.9).*

- **Audible Ring Back:** Determines time to mute an active alarm. A muted alarm will sound again after the specified time elapses, 15, 60, or 180 minutes.

9.6 Managing Users

User management is used for two functions:

User Management: If running in Secured Mode, use the screens to manage users.

Access Card Assignment: If the freezer has the Access Card option installed, use the User Management screens to program access.

9.6.1 Secure Mode

Pressing the Users icon (refer to *Figure 11*) brings up the following screen:



Figure 15. User Management (Secure Mode)

To edit or delete a user, press the line and then press the appropriate icon on the right:

- **Pencil Icon:** Edit a user.
- **X:** Delete a user.

To add a user, press the star icon.

9.6.2 Managing Users

When logged on as an administrator while running in Secured Mode, the following screen appears:

Figure 16. Edit User Entry (Secure Mode)

Press a field to edit or create a new user entry.

Press the corresponding X icon to delete or change a password or card ID.

- **User Name (required):** 4-10 characters, case sensitive. Any valid keyboard characters are permitted.
- **Given Name (optional):** 1-25 characters.
- **Password (required):** 4-10 characters, case sensitive. Any valid keyboard characters are permitted.
- **Type (required):** Admin or User.
- **E-mail (optional):** Maximum 30 characters.
- **Telephone (optional):** Maximum 20 characters, numeric only.
- **Access Card ID (optional).** Proximity Access Card ID number.

This can be added or changed following the procedures described in the next section.

If you are adding multiple users, press the left arrow to return to the User Management Screen, press Star, and repeat the process.

Be sure to confirm changes by pressing the check mark icon.

9.6.3 Managing Access Cards

Press the Users icon (refer to *Figure 11*) to bring up the User Management screen. Then press the star icon to add a user, the pencil or X to edit or delete a user.

The following screen appears:

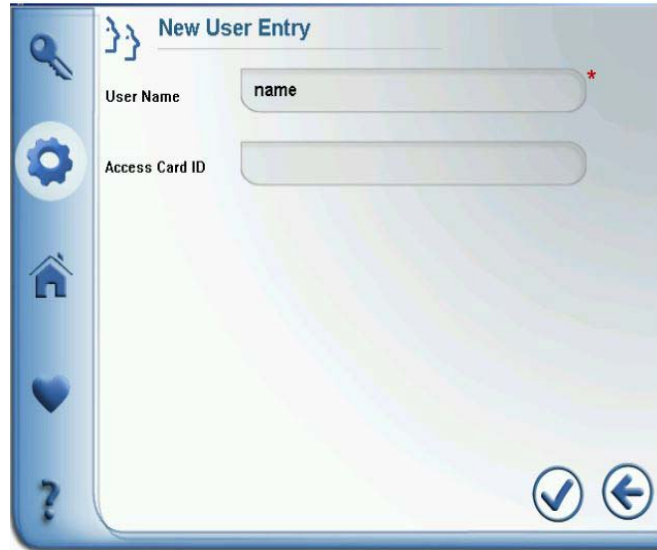

Figure 17. User Entry Screen (Full Access Mode)

Press the User Name field and enter the name using the keyboard. The name is 4-10 characters, case sensitive.

To associate an access card with a user name, press the Access Card ID field and hold the card below the display. The card number will appear in the field and the card will be able to unlock the freezer door on subsequent card reads.

If you are managing card access for multiple users, press the left arrow to return to the User Management Screen and repeat the process.

Note that access cards are not linked to set point security. They only unlock the door.

Be sure to confirm changes by pressing the check mark icon.

9.7 Screen Calibration

Pressing the Calibration icon (refer to *Figure 11*) brings up the following screen:

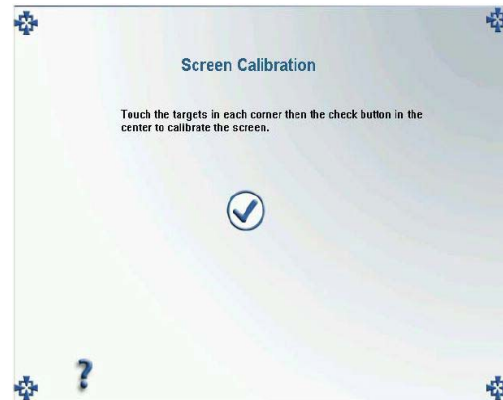

Figure 18. Screen Calibration

Touch the calibration points at each corner, one at a time, and press OK when you have touched all four corners.

9.8 Regional Settings

Pressing the System icon (refer to *Figure 11*) brings up the following screen, which displays the same parameters as the screen displayed at the beginning of the initial startup procedure:

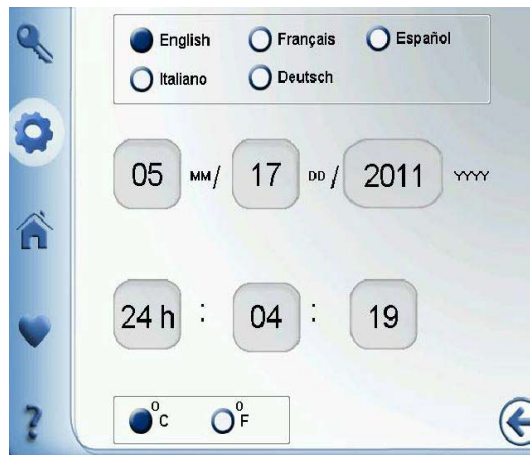

Figure 19. Regional Settings

If you prefer a display language other than English, press the correct radio button. Press the °F radio button if you want to change the display temperature from Celsius to Fahrenheit.

To set date, time, and 24hr/AM-PM display format, press each numeric display you wish to change. Up and down arrows will then appear which you can use to change values.

Click the check mark icon to confirm changes and press Next when ready.

9.9 System Management

Pressing the System Management icon (refer to *Figure 11*) brings up the following screen:

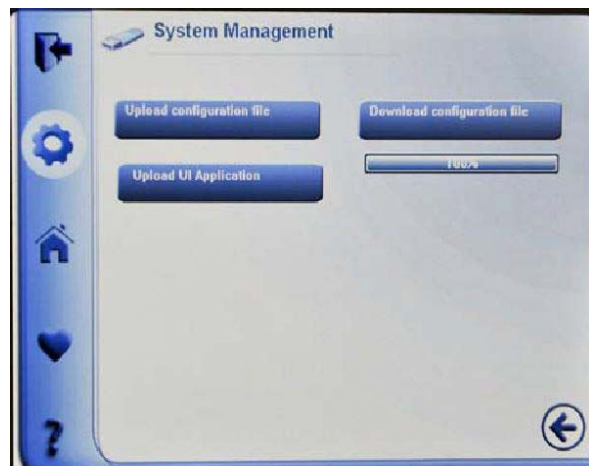

Figure 20. System Management Settings

Use this screen to upload and download configurations and user applications using a USB flash drive. The USB port is directly to the right of the display.

- Upload Configuration File: Insert USB drive to upload system settings
- Download Configuration File: Insert USB drive to download system settings
- Upload User Application: Insert USB drive to upload software updates.

Configuration files may be uploaded to other freezers.

Maximum power rating for USB flash drives is 500mA.

The Copy Files option is used to copy files to the SD card (user interface).

For information on exporting temperature and event data, refer to *Section 10.6*.

9.10 User Log On/Off

Use the key icon on the left bluebar to log on or log off.



Figure 21. User Log On

When the system is running in Secured mode, a password field will appear upon name entry.

Press the check mark icon to confirm entry, then Press Next to continue.

When the system is running in Full Access mode, this screen is used for service log on and log off functions.

10 Health Status and Alarm Management

10.1 Health Status Overview

Pressing the Health Status (heart) icon on the main toolbar displays the following screen:

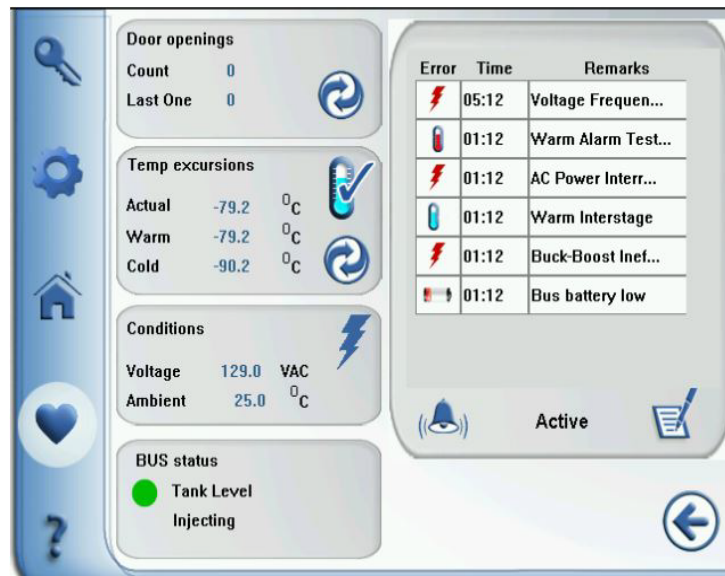

Figure 22. Health Status Screen

This screen reports door openings, temperature excursions, ambient conditions, BUS (backup system) status, and recent error and alarm conditions.

- **Door openings:** Number of door openings since last reset. Last One displays date and time of the last door opening. Press the Reset icon (the circle with arrows) to zero the door openings display.
- **Temp excursions:** Actual is current cabinet temperature. Warm and Cold are highest and lowest temperatures recorded since the last reset. Press the Reset icon (the circle with arrows) to clear the warm and cold values.
- **Conditions:** Current ambient temperature and line voltage.
- **BUS status:** Displayed only if backup system is installed. Red denotes low tank level; green is OK. Injecting/Not Injecting reports whether the backup is active.

Recent error and alarm conditions are listed on the right side.

You can press the temperature, lightning bolt, and pen-and-book icons to bring up secondary screens with more detailed health status information. These secondary screens are discussed below.

Press the left arrow to exit and return to the Home Screen.

10.2 Alarms

The Health Status Screen is the screen to use to manage alarm conditions. When an audible alarm is sounding, you can view the event log to see what is causing the alarm, and press the bell icon on the lower right to silence it.

Active alarms and unacknowledged past events are displayed in the alarm list at the lower right of the screen.

- Press the bell icon to silence an active alarm. Note that the alarm will resume ringing after a ring back interval settable by the user (refer to *Section 9.5*). The default ring back interval is 15 minutes.
- When (x) appears in place of the bell, press this icon to acknowledge a past event. The heart icon will then change color from yellow to blue.
- Press the notepad icon to access a complete list of freezer events and alarms.

The text field next to the bell icon indicates three possible conditions:

- **System OK:** No active or has-been alarm conditions
- **Active:** Alarm condition, press the bell icon to mute audible alarms
- **Past Event:** The bell icon is replaced by an X. Press the X to acknowledge that the past events have been recorded in the event log.

A red heart on the home screen indicates a serious alarm condition which must be corrected, such as a warm alarm or a power failure. A yellow heart indicates less serious warning conditions, such as open doors and “has-been” alarms.

For full details on alarm conditions, refer to *Appendix A: Alarm Summary*.

10.3 Temperature Sensor Screen

Pressing the Sensor icon displays:

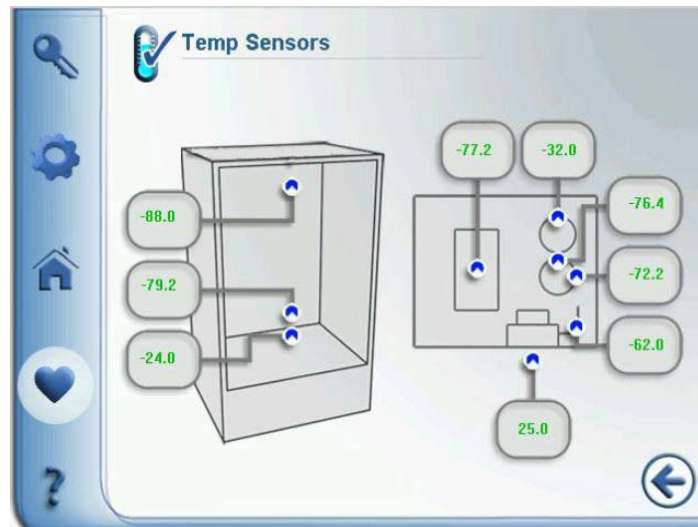

Figure 23. Temperature Sensor Screen

This screen displays the temperature readings at the sensors in the cabinet and on the compressor deck.

The cabinet sensors are (top to bottom):

TC 3: Evaporator inlet

RTD: Control sensor (main cabinet temperature)

TC 4: Evaporator outlet

The compressor deck sensors are (clockwise from the top):

TC 10: Heat exchanger

TC 1: First stage suction

TC 6: Second stage suction

TC 9: Second stage sump

TC 7: Liquid line (not used for water cooled units)

TC 2: Condenser air inlet

10.4 Event Log Screen

Pressing the book-and-pen icon displays:



Date	Time	Event
10/16/2012	03:09:04	System Battery Low
10/16/2012	03:08:09	Lost Communication With Main
10/16/2012	03:06:50	System Battery Low
10/16/2012	03:06:11	Cold Alarm has been RTD = -78.25
10/16/2012	03:05:07	Cold Alarm RTD = -125
10/16/2012	03:05:02	System Battery Low
10/16/2012	03:05:00	System Battery Low
10/16/2012	03:04:44	Cold Alarm has been RTD = -81

Figure 24. Event Log Screen

This screen displays up to two weeks of recent events, with date and time stamps for each event.

The Date and Type columns can be sorted ascending or descending by pressing on the column header.

You can also view details for an individual event by pressing on a single row.

The icons on the right side are filters:

- ALL displays all events.
- The bell icon displays only alarm conditions.
- The door icon displays only door opening events.
- The users icon displays only user events.
- The battery icon displays only battery events.
- The bottom icon displays only BUS (backup system) events.

Press the File Download icon at the lower left to download data to a USB flash drive. To create a .dat file, insert a USB flash drive in the USB port to the right of the display, then press the File Download icon. You will then be asked to specify file names and date ranges.

10.5 Power Systems Screen

Pressing the lightning bolt icon displays:

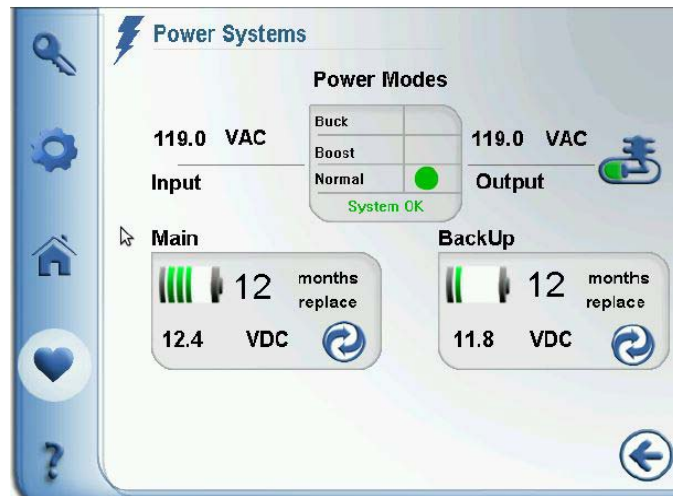

Figure 25. Power Systems Screen

The Power Modes area displays mode of operation (buck, boost or normal), input voltage, and output voltage.

In the Main and Backup battery areas, the “months” display shows the number of months remaining until the next recommended battery change. The bars to the left indicate voltage.

When changing a battery, press the Change Icon (the circle with arrows) in the lower right corner of the appropriate box. After a confirm dialog, the months to replace value is reset to 12.

10.6 Exporting Event and Temperature Data

The freezer records up to 15 years of temperature and event data. Data can easily be downloaded to a flash drive via the USB port.

10.6.1 Downloading Event Data

To download event log information:

1. Insert a USB flash drive in the USB port located to the right of the display.
2. Press the File Download icon at the lower left of the Event Log screen (refer to *Figure 23*). The following screen appears:



Figure 26. Export Event Log

3. Press the Year and Month fields to specify date ranges.
4. Press the icon to the right of the From fields when ready. You will get an error message if no USB flash drive is present.
5. If you wish to export another event log, press the File Download icon at the bottom of the screen and repeat the process.
6. Press the left arrow to exit.

10.6.2 Downloading Temperature Data

To download temperature data:

1. Insert a USB flash drive in the USB port located to the right of the display.
2. Press the File Download icon at the lower left of the Expanded Graph screen (refer to *Figure 8*). The following pop-up appears:



Figure 27. Export Temperature Log

3. Press the year and month fields to specify date ranges.
4. Press the icon to the right of the From fields when ready. You will get an error message if no USB flash drive is present.
5. Press the left arrow to exit.

11 Backup System (Optional)

When you purchase a built-in CO₂ or LN₂ optional backup system for the freezer, backup control is integrated into the main user interface.



Note Always purchase the cylinders which are equipped with siphon tubes for withdrawing liquid from the bottom of the cylinder. CO₂ cylinders must be kept at room temperature to function properly. LN₂ bottles are functional at any reasonable temperature.

11.1 CO₂ and LN₂ Precautions

The following are precautions for using liquid CO₂ and LN₂ backup systems.



WARNING: If a CO₂ or LN₂ cylinder falls and a valve is knocked off, the cylinder becomes a deadly and completely unguided missile. Transport the cylinders in a handtruck or cart with secure chain ties for the cylinder. After cylinders are connected to the equipment, securely attach them with chains to a solid, stationary object such as a building column.



WARNING: CO₂ and LN₂ liquids are non-poisonous but are very cold and will burn unprotected skin. Always wear protective eyewear and clothing when changing cylinders or working on the piping systems attached to an active source of liquid refrigerant.



WARNING: The gases produced by evaporation of CO₂ or LN₂ are non-poisonous but displace the oxygen in a confined space and can cause asphyxiation. Do not store the cylinders in subsurface or enclosed areas.



CAUTION: When closing the cylinder valve, make sure that the injection solenoid is energized to allow all the liquid to bleed off instead of being trapped in the supply hose. Failure to do this results in activation of the pressure relief device, which could damage the freezer and requires replacing if it is activated.



CAUTION: For models ordered with factory installed built-in backup systems, the flow of liquid CO₂ or LN₂ will be discontinued if the door is opened during operation of the backup system. For units operated with free-standing, field installed type backup system, the flow of liquid CO₂ or LN₂ will be discontinued upon door opening only if the switch provided with the free-standing package is installed on the freezer.

11.2 Installation

Field installed systems are supplied with complete installation and operating instructions. If your system is factory installed, the freezer is shipped with a coiled length of hose to connect the freezer to the bottles:

- 1/4" Flexible Hose with fittings for connection to the CO₂ supply.
- 1/2" Flexible Hose with fittings for connection to the LN₂ supply.

1. Straighten the coiled hose.
2. Connect one end to the labeled connection on the freezer.

- Tighten the nut two flats past finger tight, approximately 120 degrees.

Note For CO₂, remove the threaded fitting from the nut on the end of the copper tubing to access nut for connection to the freezer. Discard the threaded fitting.

3. Attach the other end to the supply bottle or building supply fitting.

- For CO₂:

- Remove Nipple from adapter (NPT Connection).
Remove cable tie to release alternative nut and washer.
Ensure the correct nut fitting is supplied over the nipple (US or European).
- Add 2 wraps of Teflon tape clockwise to the 1/4" NPT fitting (on the nipple) when viewed from the threads. Tighten the NPT fittings approximately 2 turns from finger tight (approximately 720 degrees).

Note The top of the nipple has a hex configuration, allowing for use of a wrench when the nut is pulled down.

- Add washer to nipple inside of nut (unless CO₂ supply has a built in washer).

Note Small raised area of washer fits into groove of nipple. The washer will feel snug when trying to shift side to side on nipple. The washers are designed for a limited number of attachments/disconnections from the supply and may wear over time. If washer appears worn and causes CO₂ leakage, replace washer. (Part Number 45705H03)

- Wrench tighten the supply nut to the supply.
- For LN₂:
 - Attach the fitting to the supply and wrench tighten.



Note Do not twist, torque, or subject the flexible hose to sharp bends. Doing so may shorten the life of the hose.

11.3 Start Up

To activate the backup system:

1. Follow the instructions in *Section 8* to power on the freezer and set temperature and alarm set points.
2. Enter the backup set point and backup type on the Backup Setting Screen below, which you can bring up by pressing the tank icon on the Freezer Settings Screen (refer to *Figure 12*):

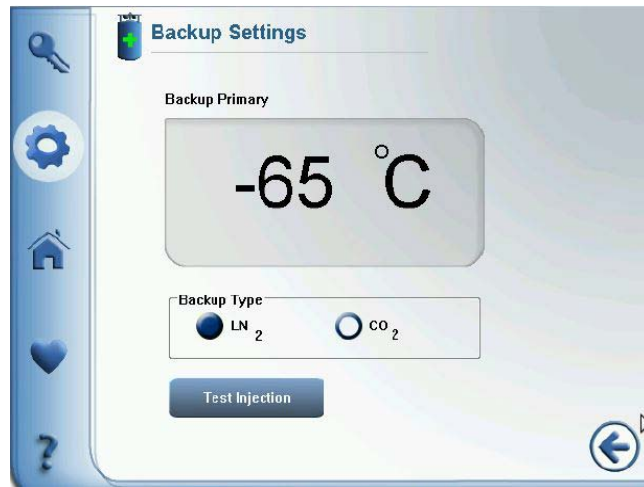

Figure 28. Backup Settings Screen

3. Press the check mark icon to confirm changes.
4. Turn on the CO₂ or LN₂ supply.

11.4 Operation

When the backup system is in operation, you can view and reset parameters on the settings screen).

Once the backup system has been activated, you can test it by pressing the Test Injection button. The system will inject as long as you keep pressing.

The backup system can run for a minimum of 24 hours on battery power.

On average, a backup system in operation uses 8 to 10 lbs. per hour of CO₂ or LN₂ at an ambient temperature of 25°C. This rate will vary depending on setpoint, load, ambient temperature and freezer size.

12 Chart Recorders (Optional)

Panel-mounted six-inch seven-day recorders are available as options for all freezer models except for the smallest (300 box capacity) models.

12.1 Set Up and Operation

To prepare the recorder to function properly, complete the following steps:

1. Open the recorder door to access the recorder.
2. Install clean chart paper (refer to *Section 12.2* below).
3. Remove the plastic cap from the pen stylus or ink pen and close the recorder door.

Recorder operation begins when the system is powered on. The recorder may not respond until the system reaches temperatures within the recorder's range.

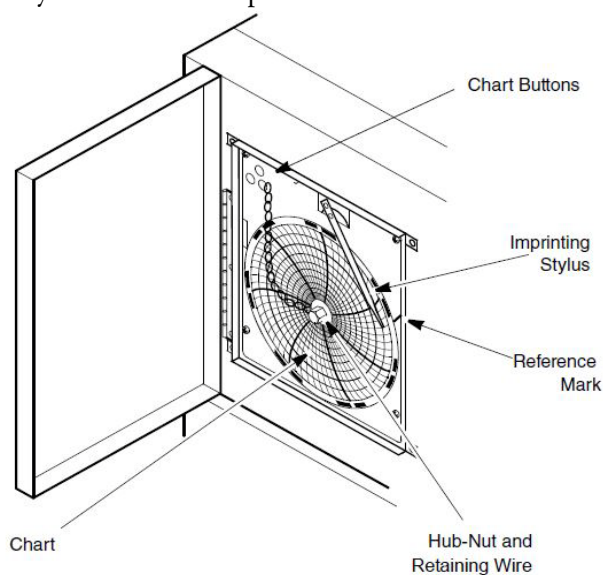

Figure 29. Chart Recorder

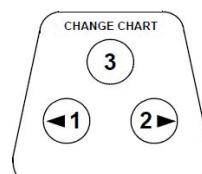

Figure 30. Chart Buttons



CAUTION: Do not use sharp or pointed objects to depress the chart buttons. This may cause permanent damage to the recorder.

12.2 Changing Chart Paper

To change the chart paper, complete the following steps:

1. Locate the pressure sensitive buttons at the front, upper left of the recorder panel.
2. Press and hold the Change Chart button (#3) for one second. The pen will move off the scale.
3. Unscrew the center nut, remove the old chart paper, and install new chart paper. Carefully align the day and time with the reference mark (a small groove on the left side of the recorder panel).
4. Replace the center nut and hand tighten. Press the Change Chart button again to resume temperature recording.

12.3 Calibration Adjustment

This recorder has been accurately calibrated at the factory and retains calibration even during power interruptions. If required, however, adjustments can be made as follows:

1. Run the unit continuously at the control set point temperature. Continue steady operation for at least two hours to provide adequate time for recorder response.
2. Measure cabinet center temperature with a calibrated temperature monitor.
3. Compare the recorder temperature to the measured cabinet temperature. If necessary, adjust recorder by pressing the left (#1) and right (#2) chart buttons.

Note *The stylus does not begin to move until the button is held for five seconds.*

13 Maintenance and Troubleshooting



WARNING: Unauthorized repair of your freezer will invalidate your warranty. Contact Technical Service at 1-800-438-4851 for additional information.



CAUTION: Maintenance should only be performed by trained personnel.

13.1 Cleaning the Condenser

Clean the condenser at least every six months; more often if the laboratory area is dusty.

There are two condenser filters: a main filter and a lower filter for extra air flow into the condenser.

To clean the condenser, complete the following steps:

1. Pull the grill open (300 and 400 box capacity models) or slide it to the right (larger models).
2. Remove both filters.
3. Vacuum the condenser.
4. Replace the filters and close the grill.

13.2 Cleaning the Condenser Filter

Clean the condenser filters every two or three months.

1. Pull the grill open (300 and 400 box capacity models) or slide it to the right (larger models).
2. Remove the filter.
3. Shake the filter to remove loose dust, rinse the filter in clean water, shake the excess water from the filter, and replace the filter.
4. Close the grill.

13.3 Gasket Maintenance

Periodically check the gaskets around the door for punctures or tears. Leaks are indicated by a streak of frost which forms at the point of gasket failure. Make sure that the cabinet is level (refer to *Section 7.3* for leveling information).

Keep the door gaskets clean and frost free by wiping gently with a soft cloth.

13.4 Defrosting the Freezer

Defrost the freezer once a year or whenever the ice buildup exceeds 3/8".

To defrost, complete the following steps:

1. Remove all products and place in another cabinet.
2. Turn off the freezer.
3. Open the outer door and all inner doors.
4. Let the freezer stand with doors open for at least 24 hours. This allows both the interior and foamed refrigerant system to warm to room temperature.
5. Dispose of the ice and wipe out any water standing in the bottom of the cabinet.
6. If there is freezer odor, wash the interior with a solution of baking soda and warm water. Clean the exterior with any common household cleaning wax.
7. Close the doors, restart the freezer and reload. Refer to *Section 5.3* to follow the instructions.

13.5 Alarm Battery Maintenance

Have a certified technician replace the alarm battery every twelve months at most, and check the condition of the battery frequently by viewing the Power Systems screen (refer to *Figure 16*). Be sure to reset the timer when the battery is replaced.

14 Warranty

Be sure to register your warranty online:

www.thermoscientific.com/labwarranty

THERMO FISHER SCIENTIFIC USA FREEZER WARRANTY

The Warranty Period starts two weeks from the date your equipment is shipped from our facility. This allows for shipping time so the warranty will go into effect at approximately the same time your equipment is delivered. The warranty protection extends to any subsequent owner during the warranty period.

During the first two years of the warranty period, component parts proven to be non-conforming in materials or workmanship will be repaired or replaced at Thermo's expense, labor included. The ULT Freezers include an additional three year warranty on the compressors, parts only, F.O.B. factory. Installation and calibration is not covered by this warranty agreement. The Technical Services Department must be contacted for warranty determination and direction prior to any work being performed. Expendable items, i.e., glass, filters, pilot lights, light bulbs and door gaskets are excluded from this warranty.

Replacement or repair of component parts or equipment under this warranty shall not extend the warranty to either the equipment or to the component part beyond the original two year warranty period. The Technical Services Department must give prior approval for the return of any components or equipment.

THIS WARRANTY IS EXCLUSIVE AND IN LIEU OF ALL OTHER WARRANTIES, WHETHER WRITTEN, ORAL, OR IMPLIED. NO WARRANTIES OF MERCHANTABILITY OR FITNESS FOR A PARTICULAR PURPOSE SHALL APPLY. Thermo shall not be liable for any indirect or consequential damages including, without limitation, damages relating to lost profits or loss of products.

Your local Thermo Scientific Sales Office is ready to help with comprehensive site preparation information before your equipment arrives. Printed instruction manuals carefully detail equipment installation, operation, and preventive maintenance.

If equipment service is required, please call your Technical Services Department at 1-800-438-4851 (USA and Canada). We're ready to answer your questions on equipment warranty, operation, maintenance, service, and special applications. Outside the USA, contact your local Thermo Scientific office or distributor for warranty information.

15 Warranty (International)

THERMO FISHER SCIENTIFIC FREEZER INTERNATIONAL WARRANTY

The Warranty Period starts two months from the date your equipment is shipped from our facility. This allows for shipping time so the warranty will go into effect at approximately the same time your equipment is delivered. The warranty protection extends to any subsequent owner during the warranty period. Dealers who stock our equipment are allowed an additional four months for delivery and installation, providing the warranty card is completed and returned to the Technical Services Department.

During the first two years of the warranty period, component parts proven to be non-conforming in materials or workmanship will be repaired or replaced at Thermo's expense, labor excluded. The ULT Freezers include an additional three year warranty on the compressors, parts only, F.O.B. factory. Installation and calibration is not covered by this warranty agreement. The Technical Services Department must be contacted for warranty determination and direction prior to any work being performed. Expendable items, i.e., glass, filters, pilot lights, light bulbs and door gaskets are excluded from this warranty.

Replacement or repair of component parts or equipment under this warranty shall not extend the warranty to either the equipment or to the component part beyond the original two year warranty period. The Technical Services Department must give prior approval for the return of any components or equipment.

THIS WARRANTY IS EXCLUSIVE AND IN LIEU OF ALL OTHER WARRANTIES, WHETHER WRITTEN, ORAL, OR IMPLIED. NO WARRANTIES OF MERCHANTABILITY OR FITNESS FOR A PARTICULAR PURPOSE SHALL APPLY. Thermo shall not be liable for any indirect or consequential damages including, without limitation, damages relating to lost profits or loss of products.

Your local Thermo Scientific Sales Office is ready to help with comprehensive site preparation information before your equipment arrives. Printed instruction manuals carefully detail equipment installation, operation, and preventive maintenance.

If equipment service is required, please contact your local Thermo Scientific office or local distributor.

We're ready to answer your questions on equipment warranty, operation, maintenance, service, and special applications. Outside the USA, contact your local Thermo Scientific office or distributor for warranty information.

Appendix A: Alarm Summary

Alarm Summary				
Alarms/Warnings	Audible (Tone)	Remote Alarm	Visual	Note (Summary of Alarm)
BPHX Persistent Temp Out			Yellow Heart	Active heat exchange temp out condition which has deactivated the 2nd stage
Buck/Boost Insufficient Correction			Yellow Heart	Input voltage out of range and cannot be corrected for.
BUS Battery Low			Yellow Heart	BUS battery low voltage condition.
BUS Battery PM Expired				A one time dialog reminds the user to change the battery. This message will appear for 24 hours or until acknowledged and does not impact control.
Clean Filter			Yellow Heart	Persistent $>10^{\circ}\text{C}$ persistent temperature delta (condenser air inlet and condenser out temperature)
Cold Alarm	Tone 1	X	Red Heart	Primary RTD $<$ set point (measured in 0.01C)
Cold Alarm Has-been			Yellow Heart	Must be acknowledged for yellow heart to clear
Door Ajar	Tone 2		Red Heart	Activates after 180 seconds of an open door condition (sensed by system door switch)
Extreme Ambient			Yellow Heart	Condenser air inlet temperature $>$ user programmed value (default 36.7°C)
Inability to Attain Set point			Yellow Heart	Activates after NDO $>12\text{hrs}$ without attaining cycle
Lifeguard			Yellow Heart	2nd stage sump temperature $>$ user programmed value (default 94°C)
Power Failure	Tone 1	X	Red Heart	Unit in power failure mode (running on battery).
Power Failure Has-been			Yellow Heart	Must be acknowledged for yellow heart to clear

Alarm Summary				
Alarms/Warnings	Audible (Tone)	Remote Alarm	Visual	Note (Summary of Alarm)
Stuck Button			Yellow Heart	Stuck button is detected on a continuous press from any screen and times out to the Home Screen.
System Battery Low			Yellow Heart	System battery low voltage condition.
System Battery PM Expired				A onetime dialog reminds the user to change the battery. This message will appear for 24 hours or until acknowledged and does not impact control.
UI/Main Lost Communications	Tone 3	X (from UI)	Yellow Heart	Primary RTD shows “----” Other Sensor outputs show blank Other settable parameters retain their value prior to lost communications
Warm Alarm Active	Tone 1	X	Red Heart	Primary RTD > Set point (measured in 0.01C)
Warm Alarm Has-been			Yellow Heart	Must be acknowledged for yellow heart to clear

Appendix B: Event Log Detail

Event Log Entry Detail		
Event Name	Event Log Type/Icon	Event Field-Intelligent Text Detail
Buck/Boost Insufficient Correction	Alarm	Input line voltage, compensated voltage and current Buck/Boost state.
BUS Battery Low	Alarm + BUS + Battery	Voltage of the backup system battery.
Clean Filter	Alarm	Condenser air temperature and the condenser liquid line out temperature.
Cold Alarm Active	Alarm	Primary RTD temperature that first caused the alarm as communicated via the Main when the alarm is first sensed, cabinet set point and the status of each compressor (on/off).
Cold Alarm Has-been	Alarm	Primary RTD temperature that first caused the has-been condition, cabinet set point and the status of each compressor (on/off).
Door Ajar	Alarm + Door	Primary RTD temperature, logged in user (if applicable) and HID user (if applicable)
Extreme Ambient	Alarm	Condenser air temperature.
Inability to Attain Set point	Alarm	Primary RTD temperature.
Lifeguard	Alarm	2 nd stage sump temperature.
Persistent Warm Heat Exchange	Alarm	Heat Exchange temperature.
Power Failure Active	Alarm	Current system voltage and time delay setting.
Power Failure Has-been	Alarm	Current system voltage and time delay setting.
System Battery Low	Alarm + Battery	Voltage of the system battery.
UI/Main Lost Communications	Alarm	Last valid RTD temperature.
Warm Alarm Active	Alarm	Primary RTD temperature that first caused the alarm as communicated via the Main when the alarm is first sensed, cabinet set point and the status of each compressor (on/off).
Warm Alarm Has-been	Alarm	Primary RTD temperature that first caused the has-been condition as communicated via the Main when the has-been is first sensed, cabinet set point and the status of each compressor (on/off).
Warm Pull Down Verification	Event	Records that the system pulled down successfully recording the 10°C slopes from 0°C to set point.
Access Card Database Full	Event	Access card user limit has been reached.

Event Log Entry Detail		
Event Name	Event Log Type/Icon	Event Field-Intelligent Text Detail
Access Card Event	Event	Access card read (date/time/card ID).
Access Card Write Error	Event	Access card not read.
Buck/Boost Stage Change	General	Non-compensated voltage at the time of performance mode change, the compensated voltage at the time of mode change and the state from/to.
BUS Battery PM Expired	Battery	Battery replacement period expired.
BUS Battery PM Reset	User + BUS + Battery	Value of the counter prior to reset and who performed the reset (secure mode)
BUS Communication Failure	Event	Freezer lost communication with the backup system
BUS Injection =ON, =OFF	Event	Backup system injection ON or OFF
BUS Pressure Switch =ON, =OFF	Event	Backup system pressure switch ON or OFF
BUS Set Point Setting Change	User + BUS	User who made the change (secure mode only) and the to/from BUS set point.
BUS Type Change	User + BUS	User who made the change (secure mode only) and the to/from BUS type.
Change/Set RTC (Time)	User	To/from time.
Cold Alarm Setting Change	User	User who made the change (secure mode only) and the to/from cold alarm set point.
Door Closed	Door	Open duration.
Door Count Reset	User	Door open count that was cleared.
Door Open	Door	Who opened (when the HID option is used). If no HID is user and there is a user logged in, that username is displayed.
Edit User Event	User	New user information.
Event Log Rollover	General	Earliest date remaining in the Event Log.
Firmware Upgrade (Main / UI)	User	To/from version information.
Offset Setting Change	User	User who made the change (secure mode only) and the to/from offset.
Performance Mode Change	Event	Mode changed from Energy Savings to High Performance or vice versa.
Power Up	Event	User and date/time of the power up.
Power Down	User	User and date/time of the power down.

Event Log Entry Detail		
Event Name	Event Log Type/Icon	Event Field-Intelligent Text Detail
Reset to Factory Settings	Event	All settings reset to factory defaults.
Remove User Event	User	User and user removed.
SD Card Not Found	Event	Failed to connect to SD card.
Sensor: Out of Range (OOR)	General	Which sensor(s) are currently out of range.
Set Point Setting Change	User	User who made the change (secure mode only) and the to/from set point.
Shut Down Unit	Event	Unit has been shut down (date/time).
Switch Mode Fully Accessible / Secure Mode	User	User who made the change (secure mode only) and the to/from operational mode.
System Battery PM Expired	Battery	Battery replacement period expired.
System Battery PM Reset	User + Battery	Value of the counter prior to reset and who performed the reset (secure mode)
Temperature Excursion Reset	User	User who reset and the value reset to.
Temperature Log Rollover	General	The earliest date remaining in the Temperature Log.
User Login/Off	User	Username and indicate if the logoff was a timeout.
Voltage/Frequency Mismatch	General	Measured voltage and frequency.
Warm Alarm Setting Change	User	User who made the change (secure mode only) and the to/from warm alarm set point.

WEEE Compliance

WEEE Compliance. This product is required to comply with the European Union's Waste Electrical & Electronic Equipment (WEEE) Directive 2002/96EC. It is marked with the following symbol. Thermo Fisher Scientific has contracted with one or more recycling/disposal companies in each EU Member State, and this product should be disposed of or recycled through them. Further information on our compliance with these Directives, the recyclers in your country, and information on Thermo Scientific products which may assist the detection of substances subject to the RoHS Directive are available at www.thermo.com/

Great Britain



WEEE Konformität. Dieses Produkt muss die EU Waste Electrical & Electronic Equipment (WEEE) Richtlinie 2002/96EC erfüllen. Das Produkt ist durch folgendes Symbol gekennzeichnet. Thermo Fisher Scientific hat Vereinbarungen getroffen mit Verwertungs-/Entsorgungsanlagen in allen EU-Mitgliederstaaten und dieses Produkt muss durch diese Firmen wiederverwertet oder entsorgt werden. Mehr Informationen über die Einhaltung dieser Anweisungen durch Thermo Scientific, die Verwerter und Hinweise die Ihnen nützlich sein können, die Thermo Fisher Scientific Produkte zu identifizieren, die unter diese RoHS-Anweisung fallen, finden Sie unter www.thermo.com/

Deutschland



Conformità WEEE. Questo prodotto deve rispondere alla direttiva dell'Unione Europea 2002/96EC in merito ai Rifiuti degli Apparecchi Elettrici ed Elettronici (WEEE).

È marcato col seguente simbolo. Thermo Fisher Scientific ha stipulato contratti con una o diverse società di riciclaggio/smaltimento in ognuno degli Stati Membri Europei. Questo prodotto verrà smaltito o riciclato tramite queste medesime. Ulteriori informazioni sulla conformità di Thermo Fisher Scientific con queste Direttive, l'elenco delle ditte di riciclaggio nel Vostro paese e informazioni sui prodotti Thermo Scientific che possono essere utili alla rilevazione di sostanze soggette alla Direttiva RoHS sono disponibili sul sito www.thermo.com/

Italia



Conformité WEEE. Ce produit doit être conforme à la directive euro-péenne (2002/96EC) des Déchets d'Equipements Electriques et Electroniques (DEEE). Il est marqué par le symbole suivant. Thermo Fisher Scientific s'est associé avec une ou plusieurs compagnies de recyclage dans chaque état membre de l'union européenne et ce produit devrait être collecté ou recyclé par celles-ci. Davantage d'informations sur la conformité de Thermo Fisher Scientific à ces directives, les recycleurs dans votre pays et les informations sur les produits Thermo Fisher Scientific qui peuvent aider la détection des substances sujettes à la directive RoHS sont disponibles sur www.thermo.com/

France



Important

For your future reference and when contacting the factory, please have the following information readily available:

Model Number: _____

Serial Number: _____

Date Purchased: _____

The above information can be found on the dataplate attached to the equipment. If available, please provide the date purchased, the source of purchase (manufacturer or specific agent/rep organization), and purchase order number.

IF YOU NEED ASSISTANCE:

Thermo Scientific products are backed by a global technical support team ready to support your applications. We also offer cold storage accessories, including remote alarms, temperature recorders and validation services. Visit www.thermoscientific.com or call:

USA/Canada	+1 866 984 3766	Germany international	+49 6184 90 6000
India toll free	1800 22 8374	Germany national toll free	0800 1 536 376
India	+91 22 6716 2200	Italy	+32 02 95059 552
China	+800 810 5118 (or) +400 650 5118	Netherlands	+31 76 579 55 55
Japan	+81 3 5826 1616	Nordic/Baltic/CIS countries	+358 9 329 10200
Australia	+61 39757 4300	Russia	+7 812 703 42 15
Austria	+43 1 801 40 0	Spain/Portugal	+34 93 223 09 18
Belgium	+32 53 73 42 41	Switzerland	+41 44 454 12 22
France	+33 2 2803 2180	UK/Ireland	+44 870 609 9203
New Zealand	+64 9 980 6700	Other Asian countries	+852 2885 4613
		Countries not listed	+49 6184 90 6000

Thermo Fisher Scientific Inc.

275 Aiken Road
Asheville, NC 28804
United States
www.thermofisher.com

Thermo
SCIENTIFIC

315673H01 Rev.D