

INTRODUCTION

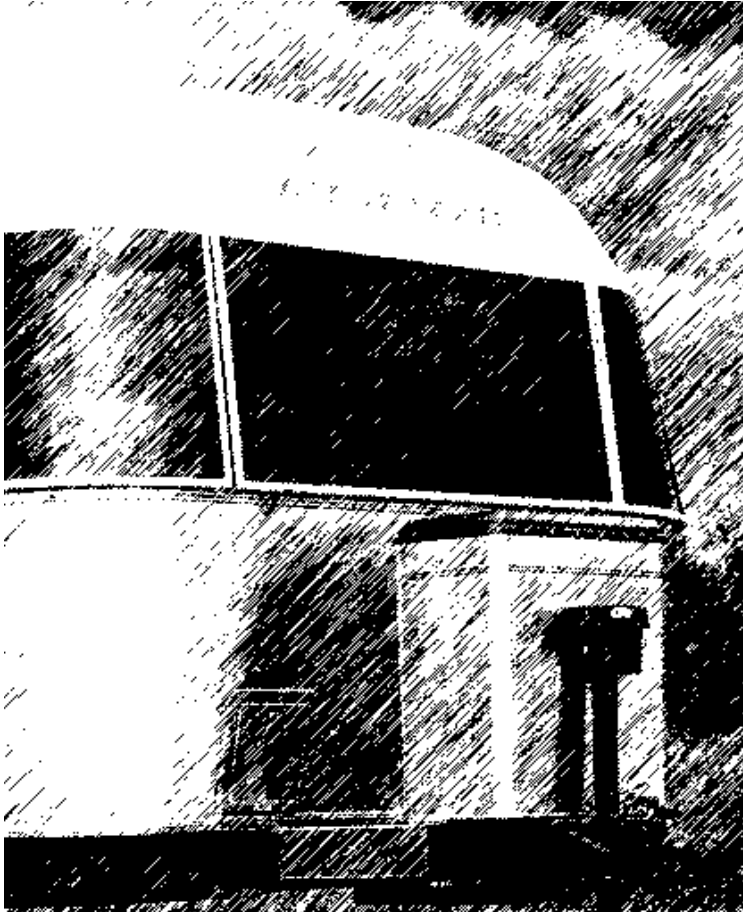

The **Owners Manual** for your new Airstream trailer is designed to respond to the most frequent inquiries regarding the operation, function and care of the many systems that make modern trailering a joy.

Airstream realizes our customers possess varying degrees of expertise in the area of repairing and maintaining the appliances in their trailer. For this reason, the service and trouble-shooting information found in this manual is directed toward those with average mechanical skills.

We also realize you may be more familiar in one area than you are in another. Only you know your capabilities and limitations. We want you to use this manual, and hope you will find the information contained in it useful, however, should you ever feel you may be “getting in over your head” please see your dealer to have the repairs made.

A brief explanation of the operation of the appliances such as refrigerator, furnace, water heater and others are explained in this manual. However, you will also find the manufacturer’s information supplied in a packet included with this manual more detailed.

All information, illustrations and specifications contained in this manual are based on the latest product information available at the time of publication approval. If and when new materials and production techniques are developed which can

improve the quality of its product, or material substitutions are necessary due to availability, Airstream reserves the right to make such changes.

We have provided many important safety messages in this manual. Always read and obey all safety messages.



WARNING indicates a potentially hazardous situation that, if not avoided, could result in death or serious injury.



CAUTION indicates a potentially hazardous situation that, if not avoided, could result in minor or moderate injury.

NOTICE: used without the safety alert symbol indicates a situation that could result in property damage if not avoided.

NOTE: Important information regarding the maintenance of your recreational vehicle.

(Optional)

This denotes items that may be an option on all or particular models. Additionally, some optional items can only be included during the manufacturing phase and

cannot be added.

The inclusion of optional items does not imply or suggest the availability, application suitability, or inclusion for any specific unit.

Important Safety Precautions

You'll find many safety recommendations on this page and throughout this manual. The following recommendations are the ones we consider to be the most important. Most are covered in depth in later sections of this manual.

Do Not Allow Passengers to Ride in the Trailer During Travel

The transport of people puts their lives at risk and may be illegal. The trailer does not have seat belts, therefore, it is not designed to carry passengers.

Reducing Fishtailing or Sway (See section B-12)

Sway or fishtailing is the sideways action of a trailer caused by external forces. Excessive sway of your travel trailer can lead to the rollover of the trailer and tow vehicle resulting in serious injury or death. Be sure to follow the instructions in this manual.

Mold (See page C-9)

There are mold and mold spores throughout the indoor and outdoor environment. There is no practical way to eliminate all mold and mold spores in the indoor environment; the way to control indoor mold growth is to control moisture.

Towing and Weight Distribution (See page B-1)

Weight distribution is an important factor when loading your travel trailer. A recreational vehicle with the cargo distributed properly will result in efficient, trouble-free towing. Be sure to follow the instructions in this manual.

Generator Safety

Do not operate the generator in an enclosed building or in a partly enclosed area such as a garage. Nor should the generator be operated while sleeping. Be sure to follow all instructions and warnings in this manual.

Lug Nut Torquing (See page D-16)

Being sure wheel mounting nuts (lug nuts) on trailer wheels are tight and properly torqued is an important responsibility that trailer owners and users need to be familiar with and practice. Inadequate and/or inappropriate wheel nut torque (tightness) is a major reason that lug nuts loosen in service. Loose

lug nuts can rapidly lead to a wheel separation with potentially serious safety consequences. Be sure to follow the instructions in this manual.

WHEEL SEPARATION CAN OCCUR

On first trip, tighten wheel nuts at start of first trip and at 10, 25, and 50 miles. Thereafter check wheel nut torque: Before each trip, Following winter storage, Following excessive braking, or whenever a wheel is removed and replaced.

See torque pattern on page D-16 for tightening sequence and follow torque specifications on page I-2.

Appliances and Equipment (See page H-1)

The appliances (stove, refrigerator, etc.) and equipment (hot water heater, furnace generator, etc.) typically operate on Propane gas. Propane gas is flammable and is contained under high pressure. Improper use may result in a fire and/or explosion. Be sure to follow all instructions and warnings in this manual as well as the specific owners' manuals of the appliances and equipment.

Tire Safety

Properly maintained tires improve the steering, stopping, traction, and load-carrying capability of your vehicle. Under inflated tires and overloaded vehicles are a major cause of tire failure. Be sure to read the Tire Safety Manual Addendum included with your owner's packet.

Chemical Sensitivity

After you first purchase your new recreational vehicle and sometimes after it has been closed up for an extended period of time you may notice a strong odor and chemical sensitivity. This is not a defect in your recreational vehicle. Like your home, there are many different products used in the construction of recreational vehicles such as carpet, linoleum, plywood, insulation, upholstery, etc. Formaldehyde is also the by-product of combustion and numerous household products, such as some paints, coatings and cosmetics. However, recreational vehicles are much smaller than your home and therefore the exchange of air inside a recreational vehicle is significantly less than a home. These products, when new or when exposed to elevated temperatures and/or humidity, may "off-gas" different chemicals, including formaldehyde. This off-gassing, in combination with the minimal air exchange, may cause you to experience irritation of the eyes, nose, and throat and sometimes headache, nausea, and a variety of asthma-like symptoms. Elderly persons and young

children, as well as anyone with a history of asthma, allergies, or lung problems, may be more susceptible to the effects of off-gassing.

Formaldehyde

Most of the attention regarding chemical off-gassing surrounds formaldehyde. Formaldehyde is a naturally occurring substance and is an important chemical used widely by industry to manufacture building materials and numerous household products. It is also a by-product of combustion and certain other natural processes. Thus, it may be present inside the trailer with some individuals being sensitive to it. Ventilation of the unit normally reduces the exposure to a comfortable level.

Trace levels of formaldehyde are released from smoking, cooking, use of soaps and detergents such as carpet shampoos, cosmetics, and many other household products. Some people are very sensitive to formaldehyde while others may not have any reaction to the same levels of formaldehyde. Amounts released decrease over time.

Your Airstream trailer was manufactured using low formaldehyde emitting (LFE) wood products, which is the typical usage in the recreation vehicle industry. Formaldehyde has an important role in the adhesives used to bind wood products used in recreation vehicles. The wood products in your trailer are

INTRODUCTION

designed to emit formaldehyde at or lower than industry guidelines and should not produce symptoms in most individuals.

While LFE wood products typically do not emit formaldehyde at a level that would cause symptoms in most individuals, it is possible, though not likely, for that to occur when the trailer is not properly ventilated. Ventilation is an essential requirement for trailer use, for many reasons. Any effects of formaldehyde can be greatly reduced by actions such as opening windows, opening roof vents, running the air conditioner, or some combination thereof. In addition, the emission of formaldehyde by these products naturally decreases rapidly over time.

Airstream strongly suggests that you take measures to properly ventilate your trailer on a regular basis. If you have any questions with respect to proper ventilation of your trailer, please do not hesitate to contact your dealer or Airstream.

Ventilation

To reduce or lessen exposure to chemicals from off-gassing it is of utmost importance that you ventilate your recreational vehicle. Ventilation should occur frequently after purchase and at times when the temperatures and humidity are elevated. Remember off-gassing is accelerated by heat and humidity. Open

windows, exhaust vents, and doors. Operate ceiling and/or other fans, roof air conditioners, and furnaces and use a fan to force stale air out and bring fresh air in. Decreasing the flow of air by sealing the recreational vehicle increases the formaldehyde level in the indoor air. Please also follow the recommendations contained in Chapter 2 regarding tips to avoid condensation problems. Many of the recommendations contained in Chapter 2 will assist in avoiding exposure to chemicals that off-gas.

Do Not Smoke

Finally, we recommend that you do not smoke inside your recreational vehicle. In addition to causing damage to your recreational vehicle, tobacco smoke releases formaldehyde and other toxic chemicals.

Medical Advice

If you have any questions regarding the health effects of formaldehyde, please consult your doctor or local health department.

Warranty Exclusion

Chemical gassing is not a “Defect” in your recreational vehicle and is not covered by the Limited Warranty. Please follow the recommendations in this manual to address this concern.

TABLE OF CONTENTS

A. WARRANTY AND SERVICE

Warranty

Warranty Explanation

Service

Reporting Safety Defects

Maintenance Schedule

Maintenance Parts & Supplies

B. TOWING

Tow Vehicles

Brakes

Loading

Weighing

Hitching Up

C. CAMPING

Pre-Travel Check List

Camping Safety

Overnight Stop/Extended Stay

Leveling & Stabilizing

Hook Ups

Winter Traveling

D. EXTERIOR

Cleaning

Chassis

Power Jack

Tires

Axle and Running Gear

Brakes

Tires

E. INTERIOR FURNISHINGS AND ACCESSORIES

Fabric Care

Lounges & Tables

Features & Fixtures

Storage Areas

Smoke Alarm

Gas Detector

Fire Extinguisher

Main Door

Exterior Windows Screens

F. PLUMBING

LP (Liquid Petroleum) Gas

Water

Drainage

Winterizing

Drain and Waste

Toilet

G. ELECTRICAL

Battery

Converter

12-Volt System & Components

TV Antenna

Satellite Antenna

Solar Panel

Bathroom Exhaust

Monitor Panel

110-Volt System & Components

F. APPLIANCES

Air Conditioner

Furnace

Range/Oven

Microwave

Refrigerator

Water Heater

Roof Vent, High Volume

I. SPECIFICATIONS

WARRANTY AND SERVICE

AIRSTREAM LIMITED WARRANTY

WARRANTY COVERAGE

Airstream Inc. (“Airstream”) warrants that it will repair or replace defects in material or workmanship in any components of a new Airstream trailer purchased from an authorized Airstream dealer in the United States or Canada for a period of twenty-four (24) months from the date the trailer is first delivered to the original retail purchaser. In order to obtain coverage under this Limited Warranty, you must notify an authorized Airstream dealership or Airstream of the warrantable defect no later than ten (10) days following expiration of this Limited Warranty. Airstream’s obligation to repair or replace defective materials or workmanship is the sole obligation of Airstream under this Limited Warranty. Airstream reserves the right to use new or remanufactured parts of similar quality to complete any warranty work.

LIMITATION OF IMPLIED WARRANTIES

IMPLIED WARRANTIES ARISING UNDER APPLICABLE LAW, IF ANY, INCLUDING BUT NOT LIMITED TO IMPLIED WARRANTIES OF MERCHANTABILITY OR FITNESS FOR A PARTICULAR PURPOSE, ARE HEREBY LIMITED IN DURATION TO THE TERM OF THIS LIMITED WARRANTY. ALL OTHER WARRANTIES, EXPRESS OR IMPLIED, ARE HEREBY DISCLAIMED BY AIRSTREAM. SOME STATES DO NOT ALLOW LIMITATIONS ON HOW LONG AN IMPLIED WARRANTY LASTS, SO THE

ABOVE LIMITATIONS MAY NOT APPLY TO YOU.

WHAT IS NOT COVERED BY THIS LIMITED WARRANTY

This Limited Warranty does not provide coverage for any of the following:

1. Tires, batteries, stereo, television, range/stove, furnace, refrigerator, water heater, microwave, generator, slide-out mechanisms, and other materials, parts and components warranted by persons or entities other than Airstream. Please refer to the warranties of component manufacturers for terms and conditions of coverage;
2. Any part or component of the trailer that was not manufactured or installed by Airstream;
3. Normal deterioration due to wear or exposure, including but not limited to rust, corrosion, oxidation, and cosmetic blemishes;
4. Normal maintenance and service items, including but not limited to light bulbs, fuses, lubricants, sealants and seals, slideout adjustments, door adjustments, and awning tension;
5. After-market equipment or accessories installed on the trailer after completion of manufacture by Airstream, or any defects or damage caused by such items;
6. Trailers not purchased through an authorized dealer of Airstream trailers, and trailers purchased directly or indirectly through auction, salvage, repossession, or other non-customary sale means;
7. Defects or damage caused by, in whole or in part, or in any way related to:



WARRANTY AND SERVICE

- 
- a. Accidents, misuse (including off-road use), or negligence.
 - b. Failure to comply with the instructions set forth in any owner's manual provided with the trailer.
 - c. Alteration or modification of the trailer except such alterations or modifications approved in writing by Airstream.
 - d. Acts of God or other environmental conditions, such as lightning, hail, salt, or other chemicals in the atmosphere.
 - e. De-icing agents or other chemicals applied to the trailer.
 - f. Failure to properly maintain or service the trailer, including but not limited to the maintenance of lubricants, sealants, and seals.
 - g. Condensation and the results of condensation including water damage and the growth of mold or mildew. Mold and mildew are natural growths given certain environmental conditions and are not covered by the terms of this Limited Warranty.
 - h. Use of the trailer other than for temporary recreation purposes, including but not limited to use of the trailer for residential, disaster relief, commercial, or rental purposes.
 - i. The addition of weight to the trailer that causes the trailer's total weight to exceed applicable trailer weight ratings, or addition of weight causing improper distribution of the weight of the trailer.
 - j. Selection, use, and operation of any hitch assembly.
 - k. Failure to seek and obtain repairs in a timely manner.
 - l. Failure to use reasonable efforts to mitigate damage caused by defects.

- m. Failure to properly ventilate the trailer.
- n. Improper electric power supply or improper vehicle hookup to other facilities.
- o. Acts or omissions of any person or entity other than Airstream.

DISCLAIMER OF INCIDENTAL AND CONSEQUENTIAL DAMAGES

Airstream hereby disclaims any and all incidental and consequential damages arising out of or relating to the trailer, including expenses such as transportation to and from vehicle dealerships and Airstream repair facilities, loss of time, loss of pay, loss of use, inconvenience, commercial loss (including lost profits), towing charges, bus fares, vehicle rental, service call charges, gasoline expenses, incidental charges such as telephone calls and facsimile transmissions, and expenses for lodging. This disclaimer is independent of any failure of the essential purpose of any warranties provided with a trailer, and shall survive any determination that a warranty failed of its essential purpose. Some states do not allow the exclusion or limitation of incidental or consequential damages, so the above limitation or exclusion may not apply to you.

OBTAINING WARRANTY SERVICE

In order to obtain warranty service under this Limited Warranty, the owner must do all of the following:

1. Owner and dealer representative must complete and return the Customer

WARRANTY AND SERVICE

- Performance Checkout within 10 days from delivery of the trailer;
2. Notify Airstream or one of its authorized, independent dealers, of any claimed defect within the warranty period or 10 days thereafter;
 3. Provide notification of a defect within 10 days of discovery of that defect;
 4. Promptly return the trailer to an authorized Airstream dealer or Airstream for repairs.

If you believe a defect covered by this Limited Warranty still exists after an attempted repair by an authorized Airstream dealer, you must contact Airstream at the following address, specifying:

1. The complete serial number of the trailer;
2. The date of original purchase and the date of original delivery;
3. The name of the selling dealer; and
4. The nature of the problem and the steps or service which have been performed.

AIRSTREAM, INC.
419 West Pike Street
P.O. Box 629
Jackson Center, Ohio 45334-0629
Attention: Owner Relations Department

Airstream may direct you to an authorized Airstream dealer, or may request

that you bring your trailer to the Airstream factory in Jackson Center, Ohio for repairs.

Airstream does not control the scheduling of repairs at its authorized Airstream dealers, and repairs at the Airstream factory may not be immediately available. Therefore, you may encounter delays in scheduling repairs and/or completion of repairs. All costs associated with transporting the trailer for any warranty service shall be the sole responsibility of the owner.

DEALER REPRESENTATIONS EXCLUDED

The entire Limited Warranty provided by Airstream is set forth herein. Airstream will not be responsible for any additional representations or warranties made by any person or entity other than Airstream, and Airstream's obligations are solely as set forth in the terms and conditions of this Limited Warranty.

WARRANTY TRANSFER

This Limited Warranty is transferable to subsequent owners for the remaining duration of the warranty period, upon approval from Airstream. Transfer of this Limited Warranty will only be approved by Airstream upon all of the following:

1. Airstream's receipt of a completed transfer application form;
2. The payment of a \$250.00 processing fee to Airstream; and
3. The completion of an inspection of the condition of the trailer, at the



WARRANTY AND SERVICE

owner's expense, by an authorized Airstream dealer in accordance with Airstream's required procedure and Airstream's receipt of a written report as to the results of such inspection.

Transfer application forms are available from your dealer or Airstream's Service Administration Department.

CHANGES IN DESIGN

Airstream reserves the right to make changes in design and improvements upon its products from time-to-time, without imposing upon itself any obligation to install additional features in your trailer.

STATUTE OF LIMITATIONS

No action may be brought against Airstream for breach of this Limited Warranty, any applicable implied warranty, or for any other claim arising out of or relating to an Airstream trailer, more than thirty (30) days after: (1) expiration of the twenty-four (24) month Limited Warranty period; or (2) expiration of the ten (10) day notice period that follows expiration of the Limited Warranty period, if such notice is given.

THIS WARRANTY GIVES YOU SPECIFIC LEGAL RIGHTS, AND YOU MAY ALSO HAVE OTHER RIGHTS WHICH VARY FROM STATE TO STATE.

AIRSTREAM, INC.
419 West Pike Street
P.O. Box 629
Jackson Center, OH 45334-0629
Tele: 937-596-6111
Fax: 937-596-6539

EXPLANATION OF AIRSTREAM LIMITED WARRANTY

The Airstream Limited Warranty is detailed on a Warranty Card. It is filled out by the dealer and presented to the owner during delivery of a new unit. The Limited Warranty must be presented to a dealer to obtain warranty service. It should be kept in the trailer during the warranty period.

EXCLUSIONS:

Normal Wear

Items such as tires, curtains, upholstery, floor coverings, window, door and vent seals will show wear or may even wear out within the one year warranty period depending upon the amount of usage, weather, and atmospheric conditions.

WARRANTY AND SERVICE

Accident

We strongly urge our dealers and customers to inspect the trailer upon receipt of delivery for any damage caused by accident while being delivered to the dealer, or while it is on the dealer's lot. Damage of this nature becomes the dealer or customer's responsibility upon acceptance of delivery, unless Airstream is notified and the person making the delivery verifies the damage. Glass breakage, whether obviously struck or mysterious, is always accidental and covered by most insurance policies.

Abuse

Lack of customer care and/or improper maintenance will result in early failure for which Airstream cannot be held responsible.

Exposure

Not unlike a car, the steel parts of a trailer can and will rust if subjected to prolonged exposure to moisture, salt air, or corrosive air-borne pollutants without repainting. Aluminum oxidizes when unprotected under similar conditions, and refinery chemicals of a sulfurous nature are harmful to finishes if not washed off periodically. Extremely hot or direct sunlight will deteriorate rubber and fade curtains and upholstery. Conditions of this nature, although they may be normal for the area, are beyond Airstream's control and become the

responsibility of the owner.

It is the responsibility of the owner to take such preventative measures as are necessary to maintain the exterior caulking and sealer of your unit. It is the responsibility of the owner to use reasonable, prudent care to prevent foreseeable secondary damage from rain, plumbing leaks, and the natural accumulation of moisture in your unit, such as a delaminated floor; stained upholstery, carpeting, or drapes; mold formation and growth; furniture damage, etc. Mold is a natural growth given certain environmental conditions and is not covered by the terms of the Limited Warranty.

Overload

Damage due to loading, either beyond capacity or to cause improper towing because of improper balance, is beyond Airstream's responsibility. The Airstream trailer is engineered to properly handle the gross vehicle load rating on the certification label. Load distribution has a definite effect upon the towing characteristics and attitudes of the trailer. Level hitch installations are a necessity, and very important on a tandem axle trailer. There are limits to the amount of load that can be safely transported depending upon speed and road conditions, and reasonable cause to believe these factors have been exceeded could void the Airstream warranty. For additional information on the loading of your trailer, consult your Owner's Manual or gross vehicle



WARRANTY AND SERVICE

weight rating plate.

 The axle is manufactured to a tolerance of 1-degree camber and 1/8" toe-in. These tolerances will only change if the trailer is subjected to abuse, such as dropping off a sharp berm, striking a curb, or hitting a deep hole in the road. Such damage could be considered as resulting from an accident which risks are not covered under the warranty. Abnormal tire wear and/or wheel alignment resulting from such damage is not covered under the terms of the warranty.

Chemical Gassing

Chemical gassing is not a "Defect" in your recreational vehicle and is not covered by the Limited Warranty. Please follow the recommendations in this manual to address this concern.

SERVICE:

Before leaving the factory, each and every vital part of the trailer is tested for performance. Each test is signed and certified by an inspector. After the trailer arrives on your dealer's lot all of these vital parts and systems are again tested. When you take delivery of your new trailer you will receive a complete check out.

At that time a specified list of performance checks on your trailer equipment will be conducted and any deficiencies you have experienced since taking delivery will be corrected.

Please contact your dealer if you need service. Major service under your Airstream Limited Warranty is available through our nationwide network of Airstream Dealer Service Centers. An up-to-date list of Dealer Service Centers will be sent with an Owner's Survey shortly after your trailer is delivered. WWW.Airstream.com web site also has a dealer locator on it. This list is current as of the date of this publication.

Occasionally dealerships change, or new dealers are added who may not appear on this list. For this reason, it is suggested that you contact your local dealer from time to time and bring your list up to date. He can also provide you with additional copies if you need them. **ALL CENTERS OPERATE ON AN APPOINTMENT BASIS FOR THE UTMOST EFFICIENCY.**

When you require service from the Airstream Factory Service Center, or a Certified Dealer Service Center, please contact the service manager for an appointment, and kindly inform him if you are unable to keep the appointment date or wish to change it. Service may be arranged at the Factory Service Center by contacting the Service Coordinator at: Airstream Factory Service Center, P.O. Box 629, 419 W. Pike Street, Jackson Center, Ohio 45334-0629

WARRANTY AND SERVICE

Phone: 937-596-6111

REPORTING SAFETY DEFECTS

If you believe that your vehicle has a defect which could cause a crash or could cause injury or death, you should immediately inform the National Highway Traffic Safety Administration (NHTSA) in addition to notifying Airstream Inc..

If NHTSA receives similar complaints, it may open an investigation, and if it finds that a safety defect exists in a group of vehicles, it may order a recall and remedy campaign. However, NHTSA cannot become involved in individual problems between you, your dealer, or Airstream Inc.

To contact NHTSA, you may either call the Vehicle Safety Hotline toll-free at 1-888-327-4236 (TTY: 1-800-424-9153); go to <http://www.safercar.gov>; or write to: Administrator, NHTSA, 1200 New Jersey Avenue S.E., Washington, DC 20590.

You can also obtain other information about motor vehicle safety from <http://www.safercar.gov>.

MAINTENANCE SCHEDULE



WARNING: FAILURE TO MAINTAIN YOUR COACH CAN CAUSE PREMATURE AND UNEXPECTED PARTS BREAKAGE AND/OR ERRATIC OPERATION THAT MAY BE HAZARDOUS.

Note: See appliance manufacturer's literature for further information.

SUGGESTED MAINTENANCE

EVERY 1,000 MILES OR 60 DAYS

Escape Window	Check operation of latches and upper hinge.
*Battery	Check water level
Smoke Alarm	Test and replace battery as required
Tires	Check tire pressure (See Specifications)
Hitch	Check for loose bolts or unusual wear.
GFI Circuit Breaker	Test and record.

WARRANTY AND SERVICE



WARNING: WHEEL SEPARATION CAN OCCUR

1. On first trip, tighten wheel nuts at start and at 10, 25, and 50 miles.
 2. Thereafter, check wheel nuts before each trip.
 3. Following winter storage, check before beginning a trip.
 4. Following excessive braking, inspect wheel nuts
- See Specification Section in this manual for wheel torque ratings.

EVERY 5,000 MILES OR 90 DAYS

Exterior Door locks	Lubricate with dry graphite
Exterior Hinges	Lubricate with light household oil
LPG Hold Down	Lubricate with light household oil
LPG Regulator	Check bottom vent for obstructions
Main Door Striker Pocket	Coat with paraffin.
Wheel Lug Nuts	See Specification Section in this manual for wheel torque ratings.

Break Away Switch	Pull pin and lubricate with household oil Replace pin immediately.
7-Way Plug	Spray with contact cleaner.
Hitch Ball Latch	Lubricate with non-detergent motor oil
Hitch Ball	Lubricate with hitch ball lube or wheel bearing grease.
Range Exhaust Hood	Clean fan blades and wash filter.
Roof Vent Elevator Screws	Lubricate with light household oil
Main Door Step	Lubricate moving parts and check.

* As a battery ages and becomes less efficient, the water level should be checked at more frequent levels.

WARRANTY AND SERVICE

EVERY 10, 000 MILES OR 6 MONTHS

EVERY YEAR

Brakes	Inspect, replace as necessary
Tires	Inspect and rotate
Spare Tire Carrier	Lubricate moving parts.
Seals, Windows & Door	Clean with mild detergent and coat with “Slipi cone”.
TV Antenna	Lubricate all moving parts with silicone lubricant.
Exterior	Wax
Escape Window	Lubricate latches with WD-40.
LP Bottles	Check tightness of center hold down rod where it fastens to A-Frame

Battery	Clean, neutralize and coat terminals with petroleum jelly.
A-Frame, Step	Wire brush and paint frame at front and rear.
LP Bottles	Have purged by LP supplier.
Seams	Check and reseal exterior seams, windows, lights and vents if necessary. Use Ten X or equivalent.
Hitch Coupler and Ball	Check for wear or damage. Assure all parts operate freely. Replace any component if worn or damaged.



WARRANTY AND SERVICE

PARTS AND LUBRICANTS

BULBS, EXTERIOR

Taillight	LED
Back Up	LED
License Plate	LED
Hitch Light	# 53, wedge base
Clearance Light	# 67
Door Light	# 1003
Hitch Light	# 193, wedge base
Compartment Light	#1141

BULBS, INTERIOR

Two-Bulb Pin Up Light	#1076
3 Arm Dinette Light	#921
Wall Light	#1076
Reading & Ceiling Light	#819
Pin Up Light	#1076



WARNING: Always replace the light bulb on an interior or exterior light fixture with the correct bulb for that light. Failure to heed this warning could cause fire, property damage, personal injury, or death.

FUSES

ATC 15 & 20 Amp

Battery Cable Fuses SLC 50 Amp (Canadian approved trailers only)

MISCELLANEOUS

Water Hose Gaskets

Wheel Bearing Grease (for hitch ball)

Extra Hair Pin Clips for Hitch

Dry Graphite

WD-40 or Equivalent Aerosol Lubricant

Oil Can with 30 Weight Non-Detergent Oil

Silicone Lubricant

Light Household Type Oil

Spray Contact Cleaner

Sealer

C & D-Cell Batteries

Flashlight

Rain Gear

Road Hazard Signals

WARRANTY AND SERVICE

MAINTENANCE RECORD

DATE	DEALER	SERVICE PERFORMED

DATE	DEALER	SERVICE PERFORMED



WARRANTY AND SERVICE

NOTES

A

TOWING YOUR AIRSTREAM

Tow Vehicle Equipment

If you plan to buy a new vehicle to tow your trailer we suggest that you include in your purchase the towing options offered by most vehicle manufacturers. These include such things a heavy-duty alternator and radiator, heavy-duty springs, (See Note:) shock absorbers, transmission cooler, heavy-duty fan and flasher unit and others, depending upon the make of the vehicle.

NOTICE: Be realistic when ordering heavy duty springs. Only springs heavy enough to support your loaded vehicle (not including trailer) are necessary. Too harsh of spring rate will only shorten the life of the tow vehicle and trailer, and will make your journeys less enjoyable.

Transmissions may be manual or automatic, but an automatic transmission may prolong your tow vehicle's life and generally does a better job of controlling engine loads than the average driver using a manual shift.

Having adequate power is very important when considering the purchase of a new vehicle or the trailer towing capability of your present one. American manufacturers realize more than 30% of the vehicles they sell will be used for towing some type of trailer. The dealers are provided with guidelines to use when helping a customer decide on a tow vehicle. The guidelines are not just determined by the power output of the engine. The gear ratio of the differential

is also a very part of the guideline.

Inspect vehicle's hitch regularly for loose bolts or nuts, cracked welds, loose ball mounts, worn parts, etc.

New trailerists often carry more food and other supplies than really needed. Remember that every item you take along is one more thing to stow and adds weight to the total load you must pull. Consolidate items in shelves, lockers, and in the refrigerator. It is better to have one full and one empty locker, than two half empty ones. Special care must be taken not to overload the front and rear ends of the trailer.

ELECTRIC BRAKES

Trailers are equipped with Dexter Nev-R-Adjust brakes. Please follow all maintenance procedure in the Dexter users manual provided in the owner's packet.

The brakes are operated by 12 volt current from your tow vehicle and **MUST BE HOOKED UP SO THAT YOU HAVE AN INTEGRAL SYSTEM WITH YOUR TOW VEHICLE BRAKES.** To prevent problems and insure satisfactory braking action, install an electronic controller in line with the brakes in your tow vehicle.

TOWING

An electronic controller installed in your tow vehicle will synchronize the trailer brakes with your tow vehicle brakes. It is designed to apply the trailer brakes with your tow vehicle brakes.

B Your brake controller should be adjusted to provide for a slight lead of the trailer brakes over the tow vehicle brakes. Follow the directions provided with your controller and keep the information for future reference. Don't be afraid to ask questions! If you don't understand the directions, have the installer explain the procedures.

Due to normal brake lining wear, the brakes and the controller setting should be checked and readjusted every six months or 10,000 miles whichever comes first.

Properly set adjustments will provide for safe comfortable stops. They will also help assure optimum brake and tire life for both the tow vehicle and the trailer.

Breakaway Protection

In **THE EVENT OF AN ACCIDENTAL SEPARATION** of the tow vehicle and trailer, the BREAKAWAY SWITCH will set and lock the trailer brakes for a sufficient length of time to stop the trailer. The switch is activated when the wire attached to it and to the tow vehicle pulls out the small pin in the front of the unit. **THIS PIN SHOULD BE PULLED OUT, LUBRICATED WITH LIGHT HOUSEHOLD OIL AND REPLACED EVERY 90 DAYS.**

To prevent corrosion within the breakaway switch, pull the switch's pin straight forward and spray the inside of the switch through the hole with an electric contact cleaner (such as Spra- Kleen) and reinsert pin. A drop of light household oil on the groove near the base of the pin will allow the pin to operate freely. **WHEN THE TRAILER IS CONNECTED TO THE TOW VEHICLE, THE BREAKAWAY SWITCH LOOP SHOULD BE ATTACHED TO THE PERMANENT FRAME OF YOUR HITCH.** When disconnecting the trailer from the tow vehicle remove wire loop from the frame. **DO NOT REMOVE THE PIN FROM THE SWITCH BECAUSE THIS WILL APPLY THE TRAILER BRAKES.**

NOTICE: Do not use breakaway switch for parking brake.



WARNING: Verify that your breakaway system functions properly before each trip!



WARNING: NEVER CRAWL UNDER YOUR TRAILER UNLESS IT IS RESTING ON PROPERLY PLACED JACK STANDS.

Settings and Use of Tow Vehicle Controllers

The settings of the tow vehicle controller are set by the driver. When properly set, the braking force of the trailer will provide sufficient braking so the brakes of the towing vehicle are not required to provide any braking force for the trailer. Variations in the controller settings may be required for different road conditions and for changes in trailer load. It is essential to maintain sufficient braking on the trailer on wet or slippery road surfaces. More braking with the trailer will help prevent the possibility of a jack-knife situation or prevent the trailer from swaying or pushing the towing vehicle. The tow vehicle brake controller also allows for manual activation of the trailer brakes independent of the tow vehicle, by using the manual override feature of the controller.



WARNING: It is essential that each driver read and fully understand the tow vehicle brake controller operating manual provided by the manufacturer of the tow vehicle brake controller. Failure to fully understand the use and operation of the tow vehicle brake controller by each driver may cause loss of vehicle control. This may result in physical

injury and/or property damage!

LOADING

When you tow a trailer, you are subject to new and different challenges on the highway than you may have previously encountered. Towing a trailer is no small responsibility and should be undertaken with great care and an eye toward safety first. An accident with a tow vehicle and trailer can have much greater consequences than carelessness with a small car. Like an airline pilot who is responsible for expensive equipment and many lives, you should take your responsibilities as a tow vehicle driver very seriously and learn all you can about doing the job safely and well. Balancing the load and preparing the trailer and tow vehicle are critical to safe handling.

One of the most critical aspects of safely operating a trailer is knowing the weights involved and where they are placed. The first thing to determine is how much is being towed and confirming that it is within the capacities of the equipment being used. Determining WHERE that load is placed is critical to the way your rig will handle on the road.

Do not try to guess what your recreational vehicle weighs loaded. Load your RV including water, propane, etc and take it to a public scales. Weigh each axle of your vehicle. Refer to your axle weight and tire limits to see if your

TOWING

within a safe range. Total all axle weights and make sure you are below the GVWR. If you are not overloaded make sure your load is balanced. Do not load too much on one side. A balanced load is much easier to tow or drive. Also, front to back balance is also important. Step back and look at your recreational vehicle. Make sure that there is not too much weight on the hitch or on the rear of the RV. Be sure to secure all items. Loose items can cause damage and be a safety issue if not properly secured.

The Cargo Carrying capacity tag shown below is installed on every trailer and can be found on the inside of the screen door on your vehicle.

RECREATIONAL VEHICLE TRAILER CARGO CARRYING CAPACITY
VIN #####
THE WEIGHT OF CARGO SHOULD NEVER EXCEED
XXX kg or XXX lbs
CAUTION
A full load of water equals XXX kg or XXX lbs of cargo @ 1 kg/L (8.3 lb/gal)

Airstream weighs the vehicle as finished to arrive at the Vehicle Weight. That number is subtracted from the Gross Vehicle Weight Rating (GVWR) of the trailer and listed under THE WEIGHT OF CARGO SHOULD NEVER EXCEED on the tag. The total weight of any and all cargo, including dealer modifications or additions, water, and propane should never exceed the number listed.

When loading the vehicle it is important to keep the Gross Vehicle Weight Rating, Gross Axle Weight Ratings, Tire Weight Ratings (listed on the vehicle Tire Information Placard), and Cargo in mind. These ratings should never be exceeded. Your safety depends on not overloading the trailer, its axles, and its tires. See the specification section for rating list.

When loading heavy objects such as tools, skillets, irons, and boxes of canned goods, etc. keep them as low as possible - preferably on the floor. Try to hold additional weight behind the axle to a minimum.



WARNING: Never add items such as generators, heavy toolboxes or motorcycle racks to the back of the trailer. Weight behind the axle will tend to magnify any sway that may occur when passing trucks or in gusty wind. If a heavy generator is mounted on the rear bumper what may have been an almost unnoticeable sway turns into a severe sway you may not be able to control.

NOTICE: Damage to your trailer caused by mounting heavy objects on the rear is considered abuse, and is not covered by warranty.

WEIGHING YOUR TRAILER

The diagram below shows how to weigh the trailer on scales.

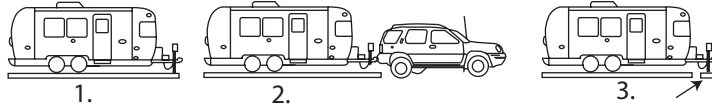

1. Trailer's total weight, cannot exceed GVWR
2. Trailer's weight on axles cannot exceed GVWR.
3. Weight on trailer tongue. The allowable personal cargo must be distributed in your trailer in such a manner that the Gross Axle Weight Rating is not exceeded.

To determine this, it is necessary to load all of your allowable personal cargo and variable weights. Then hitch the trailer to the tow vehicle with load equalizing hitch properly adjusted as shown on the following pages.

Place the trailer on a scale with both axles only on the scale (see illustration). If the weight on the axles exceeds the axle system GAWR then some of the personal cargo must be redistributed forward in order to place some of this weight on the tongue.

The tongue weight should be in between 10% - 15% of the trailer's total weight, and must not exceed the tow vehicle's or the hitch's maximum weight

rating. To determine tongue load, unhitch tow vehicle and place the tongue hitch post on a scale. The trailer must be properly loaded as determined above, with your allowable personal cargo and variable weights.

Use a scale, such as a bathroom scale, that has a lower weight limit than your tongue load, to check the tongue weight by using the following method (see illustration).

Place a piece of wood of approximately the same thickness as the bathroom scales on the ground in line with the trailer hitch jack as shown. It should be

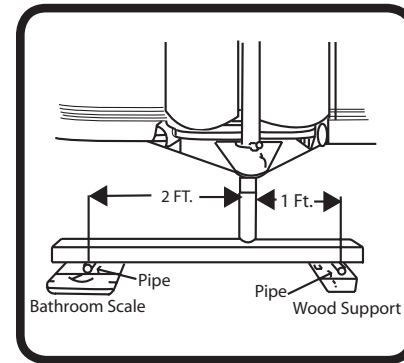

so spaced that a short piece of pipe or other round piece will lay exactly one foot from the centerline of the jack extension.

TOWING

Place the scales so that another round piece can be exactly two feet from the centerline of the jack extension in the other direction. Place a 4 x 4 on the two round pieces and screw the jack extension down on the top of the 4 x 4 until the tongue of the trailer is supported by it. Multiply the scale reading by three.

B This will be the tongue weight of your trailer. If you exceed the capacity of the bathroom scales, increase the two-foot dimension to three or four more feet, but always multiply the scale reading by the total number of feet between the wood and scales.

NOTE: Be sure trailer is level when you read scales.

HITCHING UP

Hitching up your trailer is something that will become almost second nature with practice. The following section includes proper hitch load distribution. Proper training on connecting your trailer to a tow vehicle is essential for safety. Please see your dealer or other qualified personnel for instruction on the proper hitching of your trailer. Safety chain use on the hitch are required in all states.

Equalizing Hitch Load Distribution

When a trailer is hitched up properly to a tow vehicle with a load equalizing hitch, approximately 1/3 of the trailer's tongue weight will be on the trailer's axles and 2/3 will be transferred to the tow vehicle, 1/3 of this weight transfer will be carried by the front wheels and 1/3 by the rear wheels of the tow vehicle (See diagram), Thus, the tire load of each wheel on the tow vehicle will be increased by 1/6 of the trailer's tongue weight. The tire air pressure of the tow vehicle should be increased to compensate for this additional weight. Refer to the vehicle's owner's manual for this information.

Percentage of Tongue Load distributed to car and or trailer wheels

Proper installation



Hitch Low

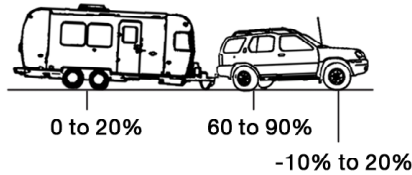

Hitch High

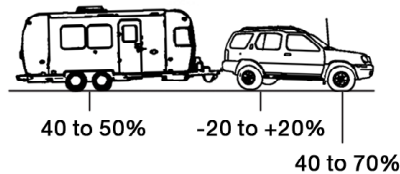

WARNING: The tongue weight should be approximately 10% of the trailer's total weight, but **MUST NOT EXCEED 1,000 lbs.** And, under no condition should it exceed the hitch rating. Your hitch installer should provide your hitch rating information.

Sway Control Device

Although Airstream has not intruded into the hitch manufacturers field of expertise and performed formal testing, we find the vast majority of Airstream owner's purchases sway-control devices.

When passed by large trucks or when exposed to sudden crosswinds the trailer will be "pushed" and this action will be felt in the tow vehicle. It's our understanding the sway control devices will reduce the amount of movement and make towing more comfortable and add some safety. Follow the directions of the sway control manufacturer when having it installed and using it.

TOWING

TOWING TIPS

We want every owner to be a safe and courteous driver. A few hours of towing practice in a large empty supermarket lot will make pulling your trailer over the road much easier. Line out two corners for left and right turns. You may also use these corners to practice backing and parking.

Tracking

OBSERVE THAT THE TRACKS MADE BY THE TRAILER WHEELS ARE DISTINCTLY DIFFERENT FROM THOSE MADE BY THE TOW VEHICLE. Studying this will make it easier for you to correct mistakes. Truck or trailer type fender or door grip rear view mirrors are a must for maximum visibility and in most states the law requires them.

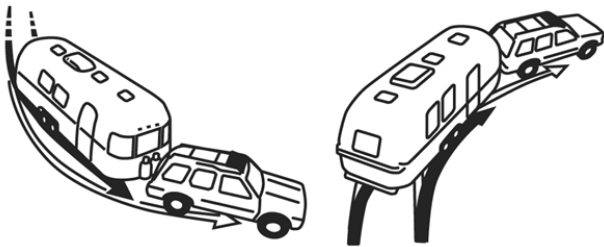

After thoroughly inspecting your hitch, brakes, and tires you should be ready

to tow. Check traffic, signal that you are about to pull away, and start slowly. Look often in your mirrors, and observe the action of the trailer, then carefully move into the proper lane of traffic. Remember that the trailer wheels will not follow the path of the tow vehicle wheels; therefore, **WIDER TURNS ARE NECESSARY WHEN TURNING TO THE LEFT OR TO THE RIGHT.**

The **BRAKE CONTROLLER** is activated when you apply the brakes of the tow vehicle. Your tow vehicle brakes will automatically apply the trailer brakes first when properly adjusted. This will help keep your tow vehicle and trailer in a straight line and make you stop as if you were driving the tow vehicle alone. If swaying or swerving should occur, briefly operating the controller separate from the vehicle brakes may help correct the situation. Practice this maneuver on a clear highway or deserted parking lot. Don't wait for an emergency then grope for the controller.

When trailering you might encounter a temporary cooling system overload during severe conditions, such as hot days when pulling on a long grade, when slowing down after higher speed driving, or driving long idle periods in traffic jams. If the hot indicator light comes on, or the temperature gauge indicates overheating and you have your air conditioner turned on, turn it off. Pull over in a safe place and put on your emergency brake. Don't turn off the engine. Increase the engine idle speed. Lift the engine hood and check for fluid leaks at the radiator overflow outlet. Check to see that all drive belts are

intact and the radiator fan is turning. If you have a problem have it fixed at the next opportunity. If there is no problem the light should go off or temperature should come down within one minute. Proceed on the highway a little slower. Ten minutes later resume normal driving.



DANGER: Never open a radiator cap when the tow vehicle is hot. Check the coolant level when the vehicle is cool.

When going downhill in dry weather, down shift so that engine compression will slow the whole rig down. Take dips and depressions in the road slowly and do not resume normal driving speeds until you are sure that the trailer wheels are clear of the dip.



WARNING: On slippery pavement do not use engine drag to help slow down as this may cause the rear wheels of the tow vehicle to skid. On icy pavement drive slowly and if you feel the tow vehicle skidding gently apply the trailer brakes only. This will bring the tow vehicle and trailer back into a single line. Chains do not help trailer wheels.

When driving in mud and sand let the momentum carry the rig through. Apply power gently and use as little as possible. Stay in the tracks of the vehicle ahead and keep the tow vehicle in the highest possible gear. If you get stuck it is best to tow out the entire rig together without unhitching.

Despite the best hitch you will notice that whenever a large bus or truck overtakes your rig the displaced air first pushes the trailer rear slightly to the right and then affects the front. It may be necessary to steer very slightly, momentarily, toward the bus or truck to help compensate for the sway induced by the passing-vehicle. Do not apply the vehicle brakes, as this can tend to exaggerate the situation. You may find, however, that briefly applying the trailer brakes with your manual control will help eliminate sway.



DANGER: CHOCK THE TRAILER WHEELS when stopping on a hill or slope. Leaving your tow vehicle in gear is not enough for standstill safety. Do not use trailer brakes as parking brakes.

On a two-lane road cars will be lining up behind you because you travel at a lower speed. It is both courteous and sensible to signal, pull onto the shoulder, and let them pass. Your trailer is designed to be towed easily at any legal speed, so if you are not careful you may be inclined to forget it is there.

TOWING

Passing

B ON FREEWAYS OR EXPRESSWAYS try to pick the lane you want and stay in it. Always maintain plenty of space between you and the car ahead, at least the length of the tow vehicle plus trailer for every ten miles per hour. Remember that in order to pass another vehicle you will need longer to accelerate. You must also allow for the length of the trailer when returning to the right hand lane.

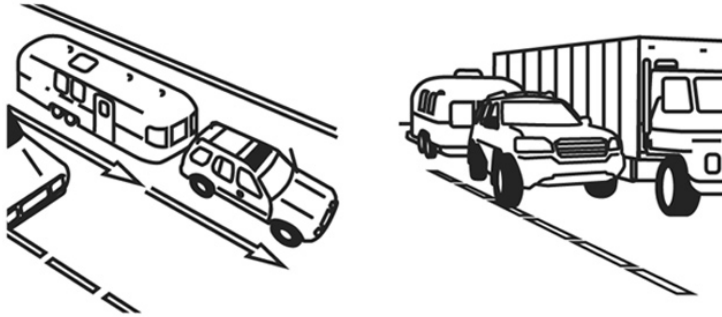

Backing Up

In BACKING UP the important thing to remember is to DO EVERYTHING SLOWLY and to correct immediately if you see the trailer turning the wrong way. Concentrate on the rear of the trailer. With your tow vehicle and trailer in a straight line back up slowly and turn the bottom of the steering wheel in the direction you want the trailer to go. Watch out the window or in the mirror until the rear of the trailer is pointing in the desired direction. Your tow vehicle will be following the trailer in an arc. Straighten the tow vehicle and trailer by turning the steering wheel more sharply, and then when they are in line, straighten the steering wheel.

ALWAYS TRY TO BACK TO YOUR LEFT BECAUSE THE VISIBILITY IS MUCH BETTER. (See Illustration) When you don't make it on the first try it is usually much easier to pull forward to your original position and start over or at least pull forward until the rig is straight and then start backing.

If your spouse or traveling companion normally directs you when backing they should position themselves forward of the tow vehicle so the driver can easily see them. Their directions should always indicate to the driver the direction the rear of the trailer should go. A little practice in a parking lot with the person giving directions can save a lot of frustration when backing into a campsite.

BACKING UP

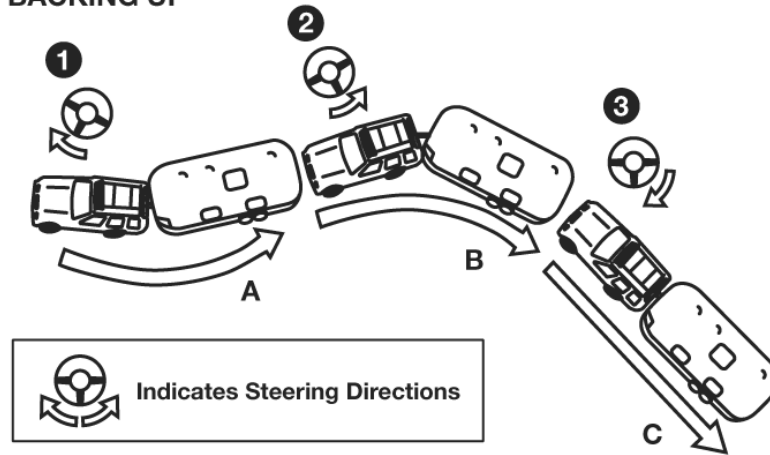

Position (A) start. Turn steering wheel as shown in (1) will put you in trailer Position (B). Turning steering wheel show in position (2) puts you in trailer position (C). Steering position (3) returns front wheels for straight backing.

TOWING

Controlling Sway or Fishtailing

Sway or fishtailing is the sideways action of a trailer caused by external forces. It is common for travel trailers to sway in response to strong winds, crosswinds, when passed by or passing a semi-tractor and trailer, or driving downhill.



WARNING: Excessive sway or fishtailing of your travel trailer can lead to the rollover of the trailer and tow vehicle. Serious injury or death can occur. It is important that you read and understand the information in this section.

Sway or fishtailing of your recreation vehicle can be controlled and is primarily impacted by four factors:

- Equipment
- Tongue weight
- Driving
- Corrective measures

Equipment – When hitched together, the trailer and the tow vehicle must be level. The tires of both the trailer and tow vehicle should be in good condition and inflated to the pressure recommended as noted on the exterior of the

trailer and in the owner's manuals of the trailer and tow vehicle.

Your trailer brakes should work in synchronization with your tow vehicle brakes. Never use your tow vehicle or trailer brakes alone to stop the combined load. Your brake controller must be set up according to the manufacturer's specifications to ensure proper synchronization between the tow vehicle and the trailer. Additionally, you may have to make small adjustments occasionally to accommodate changing loads and driving conditions.

Also, we recommend a friction sway damper or hitch with built-in sway control be provided for your unit. Please consult your dealer regarding this equipment.

Tongue weight – The tongue weight should be between 10% to 15% of the total travel trailer weight. See page B-5 of this manual regarding the proper weight distribution of your recreation vehicle.

Driving – This is the most important component. The tendency for the vehicle to sway increases with speed therefore, obey all speed limits and reduce speed during inclement weather or windy conditions.

Corrective measures – If sway occurs the following techniques should be used:

7-Way Diagram

1. Slow down immediately, remove your foot from the accelerator. Avoid using the tow vehicle brakes unless there is a danger of collision. Reduce speed gradually whenever possible. If you can do so safely, use the brake hand controller (independent of the tow vehicle brakes) to gently and progressively apply the trailer brakes. This will help to keep the vehicles aligned. Practice using the brake hand controller on a deserted parking lot. Don't wait until an emergency occurs before using it. Location of the brake hand controller is important and should be made easily accessible.

2. Steer as little as possible while maintaining control of the vehicle. Because of natural reaction lag time, quick steering movements to counter trailer sway will actually cause increased sway and loss of control. Keep both hands on the wheel. Hold the wheel as straight as possible until stability is regained.

3. Do not jam on the brakes or attempt to press on the accelerator to speed your way out of the fishtailing. Both actions make the situation worse and could cause severe injury or death.

4. Once the swaying is under control, stop as soon as possible. Check tire pressures, cargo weight distribution and look for any signs of mechanical failure. Travel at reduced speeds that permit full control until the problem can be identified and corrected.

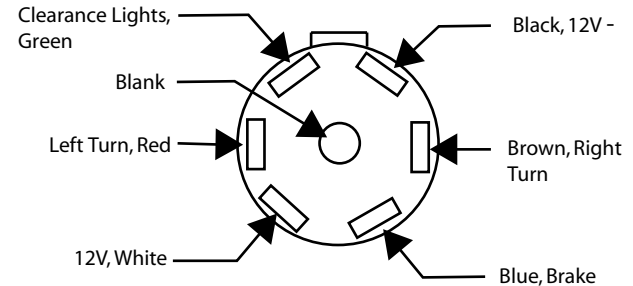

7 Way Plug-Tow Vehicle End

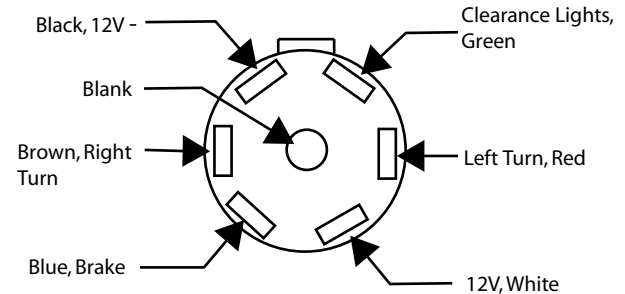

7 Way Plug-Trailer End

TOWING

NOTES

B

SUGGESTED PRE-TRAVEL CHECK LIST

Interior

1. Turn off water pump switch.
2. Close windows and vents.
3. Lock all interior cabinet doors.
4. Latch refrigerator door. (Seal containers first.)
5. Store and stack securely all loose, hard and sharp objects.
6. Fasten sliding and foldette doors.
7. Drain toilet bowl.
8. Turn off interior lights.
9. Set table in upright position.
10. Pull up or retract step.
11. Lower blinds.
12. Secure and lock the main door.

Exterior

1. Disconnect and slow the electrical hookup cord, the sewer hookup hose (flush out), and the water hookup hose.
2. Turn off gas at LP tanks.
3. Retract stabilizing jacks.

4. Check Hitch: It must be properly attached.
5. Check safety chains and breakaway switch cable.
6. Fully retract jack. Remove and stow jack stand or wood block.
7. Check clearance, turn, and stoplights.
8. Check lug nuts.
9. Check tires for correct pressure.
10. Check that TV antenna is properly stowed.
11. Adjust tow vehicle mirrors.
12. Pull forward some 50 ft., test brakes, and check site for forgotten objects and cleanliness.

Home

1. Leave house key with your neighbors.
2. Valuables and important papers should be stored in a safe place.
3. Newspaper and other deliveries should be discontinued.
4. Ask the Post Office to hold your mail for you.
5. Arrange with the telephone company for discontinued or "vacation service".
6. Arrange care for your pets.

7. Arrange care for your lawn, garden and houseplants.
8. Lock all windows and doors securely. Keep shades open for a lived in look.
9. Cover all food to keep out mice and insects
10. Eliminate all fire hazards. Place matches in a tin box or glass jar.
11. Store oil, gasoline and other flammables properly.
12. Destroy all newspapers, magazines and oily rags.
13. Notify police you will be out of town.

Trailer Equipment and Accessories

1. Water hose, 5/8 in. high pressure, tasteless, odorless, non-toxic, (2 -- 25 ft. sections).
2. "Y" connection -- water hose.
3. The sewer hose with clamp.
4. Drain cap with hose drain.
5. Holding tank cleaner and deodorizer.
6. Power cord adapter 30 --amp Capacity.
7. 50 ft. electric cord, 12-3 wire, 30-ampere capacity.

CAMPING

8. 25 ft. electric cord, 10-3, 30-ampere capacity.
9. Woodblocks for leveling.
10. Wheel chocks.
11. Hydraulic jacks.
12. Cross type lug wrench.
13. Torque Wrench
14. Quality tire gauge.
15. Emergency road warning triangle and flares.

Personal

1. Tow vehicle insurance to cover you and your family fully.
2. Avoid cash. Use Travelers Checks and credit cards.
3. Confirmed reservations.
4. Have sunglasses for everyone.
5. Pack camera and film.
6. Make a checklist of clothing and toilet articles for everyone.

Motoring Essentials

1. Display the tow vehicle and trailer registration properly.
2. Carry drivers license. In Canada, you'll need a non-residence liability insurance card, birth certificate and/or passport.
3. In Mexico, you must have special auto insurance and a passport.
4. Carry an extra set of the ignition and truck keys in a separate pocket, or in your wallet.
5. Keep an operating flashlight with fresh batteries in the glove compartment.
6. Pack the tow vehicle and trailer so that you can reach the tools and spare tires without completely unpacking.
7. Keep sharp or hard articles securely packed wherever they may be.
8. Do not packed things in the passenger seating area. You need the maximum space for comfort.
9. Wear easy wash, drip-dry traveling clothes.
10. Do not make your vacation trips a mileage marathon. Stop and relax frequently.
11. Carry a first-aid kit.

12. Carry your pets dish, food, leash, and health and registration papers.

SAFETY

As always, safety should be one of your top priorities. Make sure you, and everyone traveling with you, can operate the main door and emergency exit window rapidly without light. Contemplate other means of escape in case the designated exits are blocked.



WARNING: An escape window can be identified by its red release handles. Lifting up both latches, then turning the latches toward the center releases the escape window. Remove the screen. A loop is provided in the **SCREEN RETAINING SPLINE** so it can be rapidly removed. Push out and up on the glass and it will swing clear. The window operation should be checked each trip and the latches lubricated with **WD-40** or equivalent every six months.



WARNING: At each campsite make sure you have not parked in such a manner as to block the operation of the escape window by being too close to trees, fences or other impediments. Scenic views are one reason for traveling, but don't park so the beautiful lake or steep cliff is just outside your escape window.



WARNING: Read the directions carefully on the fire extinguisher. If there is any doubt on the operation, you and your family should practice,

then replace or recharge the extinguisher. You will find your local fire department will be happy to assist you and answer any questions.



WARNINGS:

Don't smoke in bed.

Keep matches out of reach of small children!

Don't clean with flammable material!

Keep flammable material away from open flame!

We have all heard these warnings many times, but they are still among the leading causes of fires.

Other safety information on the LPG system of your trailer is located in the plumbing section of this manual.

CAMPING

OVERNIGHT STOP-EXTENDED STAY

Airstream owners have parked virtually every place imaginable from filling stations to farmlands. In time you'll develop a knack for spying wonderful little roadside locations by turning off the main highway and exploring. There are many modern parks including State, County and Federal parks with good facilities where you might obtain hookups of electrical, water and sewer connections. Directories are published which described in detail these parks and tell what is available in the way of services and hookups.

On overnight or weekend trips chances are you will not use up the capacity of the sewage holding tank, deplete the water supply, or rundown the battery which supplies the 12 volt current.

On a longer trip, when you have stayed where sewer connections and utility hookups were not available, it will be necessary for you to stop from time to time to dispose of the waste in the holding tank and replenish the water supply. Many gas stations (chain and individually owned) have installed sanitary dumping stations for just this purpose. Booklets are available which lists these dumping stations.

When stopping for the night, your Airstream is built to be safely parked in any spot that is relatively level and where the ground is firm. Your facilities

are with you. You are self-contained. Unless the tow vehicle is needed for transportation, it is not necessary to unhitch.

All you need to do to enjoy the self-contained luxury of your Airstream is to turn on the LP gas and light any appliances with pilots.

Before moving on, check your campsite both for cleanliness and also to be sure you haven't left anything behind. Turn off the gas supply and make sure everything is properly stowed. Use your PRE-TRAVEL CHECK LIST and you are ready for more travel adventure.

Making a long trip in your Airstream is not very different from making a weekend excursion. Since everything you need is right at hand, you are at home wherever you go. When packing for an extended trip take everything you need, but only what you need.



WARNING: Do not park in a manner that would prevent the escape windows from opening.

Try to pick as level a parking spot as possible. Stabilizing jacks or blocks probably won't be required for an overnight stay. However, if you put the jack pad on the hitch jack and run the hitch jack down to take the weight off the cars springs it will provide some stability. If you must park on a slope, **PARK**

FACING DOWNHILL. It is easier to level the trailer this way.

NOTICE: Your trailer is not designed, nor intended, for permanent housing. Use of this product for long term or permanent occupancy may lead to premature deterioration of structure, interior finishes, fabrics, carpeting, and drapes. Damage or deterioration due to long-term occupancy may not be considered normal, and may under the terms of the warranty constitute misuse, abuse, or normal wear.

Leveling and Stabilizing

When you plan to stay in the same place for several days, weeks or months, you will want your trailer to be as level and steady as possible. Check the attitude with a small spirit level set on the inside work counter or the trailer hitch “A-Frame”. (See Diagram Below) If a correction is necessary then YOU MUST LEVEL FROM SIDE TO SIDE FIRST This can be done easily by backing the trailer up one or more 2” x 6” boards. (See Diagram) We do not recommend placing tires in a hole for leveling.

LEVEL FROM FRONT TO REAR by disconnecting the hitch from the tow vehicle, putting the jack pad under the hitch jack and adjusting the jack up or down until you are level. Block or chock the wheels to keep the trailer from rolling. Use STABILIZING JACKS at all four corners as shown in the diagram to eliminate the natural spring action of the axles.

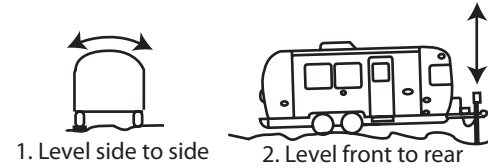

1. Level side to side

2. Level front to rear

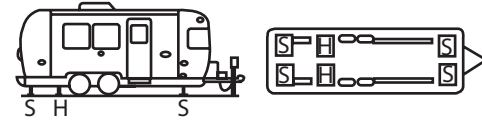

H-Hydraulic Jack Position

S-Stabilizing Jack Position

NOTICE: Optional STABILIZING JACKS, whether manual or power, should only be used to stabilize trailer.



WARNING: Whenever the trailer must be lifted with a jack, as when changing a tire or leveling on very rough terrain, ALWAYS PLACE THE LIFTING JACK UNDER THE MAIN FRAME RAIL. A label is provided to indicate the proper position for the jack. NEVER USE STABILIZING JACKS TO LIFT THE TRAILER.

CAMPING

HOOK UPS

HOOK UP TO CITY WATER by attaching a minimum 1/2" high-pressure water hose to the city water service.

The 110-volt shoreline cord is stored in the rear storage compartment. Remove the cord and plug the trailer end into the receptacle on the side of the trailer.

The other end of the shoreline is plugged into City Power Service.

Hook your WATER DRAIN HOSE in the SEWER DISPOSAL FACILITY and attach to the drain outlet in your trailer.

Turn on gas supply. Light the range and oven pilots. Turn on the water heater, refrigerator and furnace.

When you stay for an extended period where electric or water hookups are not available, you must make regular checks on the condition of your 12-volt battery.

Hooking up the tow vehicle/trailer electrical connector and running the tow

City Water Hookup

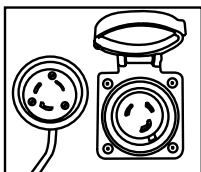
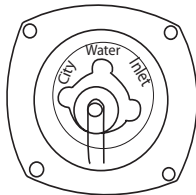

vehicle engine at a fast idle. 45 minutes per day should provide about 3-4 hours of power. Carry drinking water in a clean bucket to refill your tank. When your waste tank nears capacity move to a dumping location.

The exterior CABLE TV hookup is located in the power cord storage compartment.



Cable TV Hook Up

An exterior water service outlet is located in the power cord storage compartment also. It will work on the pump system or city water.

The TV-Outlet w/Antenna Booster must be on to receive antenna signals and off for cable TV operation.

The Cable TV/Telephone inlets are located in one of two locations on your trailer. Inside the rear roadside underbelly compartment or on the roadside sidesheet.

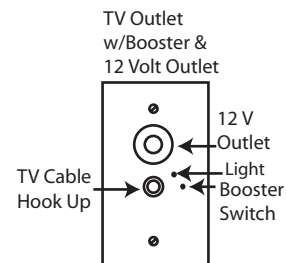

WINTER TRAVELING

Traveling in sub-freezing temperatures will require certain precautions to protect the plumbing system and your personal belongings from being damaged by freezing.

Whenever possible the heat should be kept on at a constant temperature. It is easier for the furnace to keep a constant room temperature than for the trailer temperature to be allowed to drop to 50 degrees Fahrenheit then attempt to raise it to room temperature.

NOTICE: If you have the optional air conditioners with heat pump they should not be used if ambient temperatures remain below 25 degrees F. for more than 12 hours.

Only the furnaces are ducted to provide heat to tanks and plumbing to prevent freezing.



WARNING: Always shut off the LP gas and be sure all flames are extinguished before gasoline is added to the tow vehicle.

Some states do not allow LPG to be turned on while moving. While traveling

in these states you must use your common sense. How cold is it? How long will it be before you can turn the heat back on? Is the temperature dropping or raising? Remember, when towing at 50 MPH the wind chill factor will cause the interior of the trailer to cool much faster than a trailer that is parked.

When parked in sub-freezing temperatures make sure you keep a full supply of LP gas and plug into a 110 volt power source whenever possible. A fully charged battery will not last more than 8 to 10 hours if the furnace is running almost constantly and 110-volt power is not available.

Leave cabinet doors, wardrobes and bed doors partially open to allow warm air to circulate around plumbing lines and fixtures. Insulate and/or wrap your exterior water lines with heat tape.

NOTICE: The exterior water service line to the utility compartment is in an unheated section of the trailer and must not be used in below freezing conditions.

A water valve is provided so the water can be turned off to the line. The exterior water service shut off valve is located in the lavatory cabinet. Close the shut off valve and open the water service for a few seconds to drain the line and prevent freeze damage.



CAMPING

EFFECTS OF PROLONGED OCCUPANCY

Your trailer was designed primarily for recreational use and short-term occupancy. If you expect to occupy the trailer for an extended period, be prepared to deal with condensation and the humid conditions that may be encountered. The relatively small volume and tight compact construction of modern recreation vehicles mean that the normal living activities of even a few occupants will lead to rapid moisture saturation of the air contained in the trailer and the appearance of visible moisture, especially in cold weather.

CONDENSATION

Just as moisture collects on the outside of a glass of cold water during humid weather, moisture can condense on the inside surfaces of the trailer during cold weather when relative humidity of the interior air is high. This condition is increased because the insulated walls of a recreation vehicle are much thinner than house walls.

Estimates indicate that a family of four can vaporize up to three gallons of water daily through breathing, cooking, bathing, and washing. Unless the water vapor is carried outside by ventilation, or condensed by a dehumidifier, it will condense on the inside of the windows and walls as moisture, or in cold weather as frost or ice. It may also condense out of sight within the walls or the

ceiling where it will manifest itself as warped or stained panels.

Appearance of these conditions may indicate a serious condensation problem. When you recognize the signs of excessive moisture and condensation in the trailer action should be taken to minimize their effects.

TIPS TO CONTROLLING CONDENSATION

To avoid condensation problems, try to follow these tips to help alleviate excess moisture.

- Allow excess moisture to escape to the outside when bathing, washing dishes, hair drying, laundering, and using appliances and non-vented gas burners. Always use the vent hood when cooking.
- Keep the bathroom door closed and the vent or window open when bathing and for a period of time after you have finished.
- Do not hang wet clothes in the trailer to dry.
- In hot weather, start the air conditioner early as it removes excess humidity from the air while lowering the temperature.
- Keep the temperature as reasonably cool during cold weather as possible. The warmer the vehicle, the more cold exterior temperatures and warm interior temperatures will collide on wall surfaces, thus creating condensation.
- Use a fan to keep air circulating inside the vehicle so condensation and mildew cannot form in dead air spaces. Allow air to circulate inside closets

and cabinets (leave doors partially open). Please keep in mind that a closed cabinet full of stored goods prevents circulation and allows the exterior temperature to cause condensation.

- The natural tendency would be to close the vehicle tightly during cold weather. This will actually compound the problem. Simply put, you need to remove some of the humid warm air, and allow some cool dry outside air to get inside the vehicle, so the furnace will not recycle the humid interior air.
- Use fluorescent ceiling lights and minimize prolonged use of incandescent lights, which produce heat and contribute to condensation in the roof above the ceiling lights.

ABOUT MOLDS

What are molds?

Molds are microscopic organisms that naturally occur in virtually every environment, indoors and out. Outdoors, mold growth is important in the decomposition of plants. Indoors, mold growth is unfavorable. Left unchecked, molds break down natural materials, such as wood products and fabrics. Knowing the potential risks is important for any type of homeowner to protect their investment.

What factors contribute to mold growth?

For mold growth to occur, temperatures, indoor or outdoors, must be between 40 degrees and 100 degrees Fahrenheit and also have a source of moisture, such as humidity, standing water, damp materials, etc. Indoors, the most rapid growth occurs with warm and humid conditions.

How can mold growth be inhibited?

By controlling relative humidity, the growth of mold and mildew can be inhibited. In warm climates, use of the air conditioner will reduce the relative humidity. Vents are located in the bathing and cooking areas and constant use is advised during food preparation and bathing, even during colder weather. Additionally, opening a window during these activities will assist in ventilation. In extremely humid conditions, the use of a dehumidifier can be helpful.*

Frequent use of your RV or cleaning regularly is an important preventive measure. Further, any spills should be wiped up quickly and dried as soon as possible. Avoid leaving damp items lying about. On safe surfaces, use mold or mildew killing cleaning products. Check sealants regularly, and reseal when necessary to avoid water leaks. Proper preventive maintenance to the RV and its accessories, as described both in this manual and in accompanying literature, will provide the best protection to the RV.

CAMPING

For more information of controlling moisture in the RV, please read, “Tips to Controlling Condensation,” located in this manual.

*If using a dehumidifier, please read and follow all manufacturer instructions and recommendations to the use and cleaning of the dehumidifier.



NOTICE: Your trailer is not designed, nor intended, for permanent housing. Use of this product for long term or permanent occupancy may lead to premature deterioration of structure, interior finishes, fabrics, carpeting, and drapes. Damage or deterioration due to long-term occupancy may not be considered normal, and may under the terms of the warranty constitute misuse, abuse, or normal wear.

EXTERIOR

Cleaning

As a general rule of thumb we recommend the trailer be washed about every four weeks and waxed in the spring and fall. In coastal and industrial areas cleaning and waxing should be done on a more frequent schedule. When traveling through winter weather all road treatment chemicals should be removed immediately.

NOTICE: ABRASIVE POLISHES OR CLEANING SOLVENTS SUCH AS AUTOMATIC DISHWASHER DETERGENTS OR ACID ETCH CLEANERS. ARE TOO STRONG AND SHOULD NEVER BE USED. RINSE ALL GRIT FROM SURFACE PRIOR TO WASHING. DO NOT USE WIRE BRUSHES, STEEL WOOL, ABRASIVES OR OTHER SIMILAR CLEANING TOOLS THAT WILL MECHANICALLY ABRASE THE COATING SURFACE. ALWAYS TEST A SMALL INCONSPICUOUS AREA FIRST.

ALWAYS CLEAN YOUR TRAILER IN THE SHADE OR ON A CLOUDY DAY WHEN THE ALUMINUM SKIN IS COOL. Use soft rags or wash mitts always moving lengthwise with the grain of the trailer. NEVER rub hard on the coating. Oil, grease, dust and dirt may be removed by washing with a 5% solution in water of commonly used commercial and industrial detergents. Cleaning

should be followed by a thorough clean water rinse. Drying the unit with a chamois or a soft cloth may prevent spots and streaks. WHEN WASHING OR WAXING YOUR TRAILER,

After cleaning and drying, a good grade of nonabrasive automotive paste or liquid wax will increase the life of the finish, especially in coastal areas where the finish is exposed to salt air or in polluted industrial areas. It will also protect the shell from minor scratches and make subsequent cleaning easier.

It is important to remove sap, gum, resin, asphalt, etc. as soon as possible after they appear by washing and waxing. Sunlight and time will bake-harden these materials making them almost impossible to remove without heavy buffing. If a substance is found on the coating that cannot be removed by normal washing procedures, Airstream recommends using DX 330 Acryli-Clean made by PPG Industries. Follow all directions and warnings on the product container. Acryli-Clean should be used by trained personnel only, using the proper equipment under controlled conditions. Use the Acryli-Clean as sparingly as possible to remove glue, tar, and other similar substance. Rinse with cool water immediately after use.

To keep your trailer looking new, paint the "A" frame, LPG tanks, and rear frame periodically.



EXTERIOR

The exterior includes plated medallions. Use mild soap and water on a soft cotton cloth to clean. The finish is soft metal and will scratch, if that does not work, use a mild metal polish such as PEAK METAL POLISH applying lightly with a clean soft cotton cloth.

It is recommended that the caulking and sealant used in external seams and joints such as end shell segments and around window frames, light bezels, beltline and rub rail molding, etc. be checked regularly. If this material has dried out and become cracked or checked, or if a portion has fallen out, it should be replaced with fresh material to prevent possible rain leaks. Caulking and sealing material is available from your Airstream dealer.

Precautions should be taken to prevent excessive sealant from getting on the coated surfaces. Remove excessive sealant before it cures using DX 330 Acryli-Clean made by PPG Industries as explained above.

NOTICE: It may be possible for solvents other than those recommended to extract materials from sealants that could stain the coated surface or could prove harmful to the sealants; therefore, these possible effects must be considered. Test a small area first.

Main Door

The main door of the trailer is manufactured with a built in keyed dead bolt and door lock. The door lock is engaged from the inside by a lever and the dead bolt is engaged by a turning the knob.

A main door hold back is mounted on the side sheet. The hold back secures the door to the side of the trailer. When opening the door, push it gently into the spring operated slide. To release the door, slide the hold back bolt back.

A little grease in the striker pockets and slight amount of household oil in the lock mechanisms will keep the locks operating smoothly.

Don't forget to lubricate the hinge pins periodically with household oil also. Use sparingly and remove any excess from exterior skin immediately.



CAUTION: When towing, all main door locks must be secured. If it they are not locked, the constant vibration of travel may cause the door to open with possible damage.

Screen Door

The screen door secures to the main door by means of a slide bolt type latch.

It can be operated independently by releasing the slide bolt and swinging the screen door away from the main door.

Step

To operate the step, lift up on the latch bar and the step will drop down. Unfold the lower step. To retract refold the double step and lift step assembly up until latch catches and the step is secured.



WARNING: Once the steps are lowered, press down on them to make sure they are secure in their notches. Never travel with step lowered or extended.

Exterior Windows

The windows in your trailer are safety glass. To open: release the two lever locks at the bottom, lift up on the two side operator handles until the window is in the desired position, and place the operators into one of the three positioning slots on the side of the frame. To lock the windows reverse this position. Some windows are designed as an emergency escape exits. The rubber Spline holding the screen in place is looped so it can be pulled out in one swift motion. You and all your family should practice escape procedures so they can be rapidly accomplished even in total darkness.



WARNING: Never park your trailer so the escape windows cannot be easily used for emergency exits.

Clean your trailer windows the same way you clean the windows in your home. Clean the seals with a damp cloth or mild detergent every three to six months, taking care not to use strong solvents, as they will damage the seals. A coat of natural silicone lubricant applied after the seal has dried will keep it flexible. Spread the lubricant evenly with a rag, brush, or finger, working it into the surface. This is a good practice for all rubber seals in your trailer. For replacement of a damaged window contact an Airstream Service Center.



CAUTION: Failure to properly clean and lubricate the windows could result in the window sticking to the jamb. Window seals that become stuck to the window jamb should be released by a qualified technician trained in the procedure.



DANGER: Do not force, pry, or apply great pressure to open the window. Failure to heed this warning may cause the window to shatter and/or cause personal injury.

NOTICE: Your PLASTIC SCREENS are easy to maintain. Clean occasionally with a damp cloth. Plastic screens will melt at the point of contact if touched by a cigarette.

EXTERIOR

Window Stoneguard

Stone guards may be provided for added protection on the front panoramic window option. To open the guard, unhook the two rubber T-handles on the bottom of the guard, raise the stoneguard to the desired height, and tighten the thumb screws on each support arm. Be sure to lower and fasten the guard when high winds may be approaching and before travel.

Awnings

Complete instructions have been provided with your awning. You should make sure your traveling companion is familiar with the operation of the awning.

We remind you that the awning is a sun protection, so please roll up your awning in case of heavy rain, wind or snow. To prevent water build up on the awning during a light rain, position one upper arm substantially lower than the other to create enough of a slope for adequate water run off.

There is a clear tape placed between the exterior skin and the awning fabric. This is to prevent the awning fabric from rubbing on the coating and wearing through it. Inspect the tape every year or after a long trip. Have it replaced if it begins to wear thin.

NOTE: IF WIND OR EXTENDED PERIODS OF RAIN ARE EXPECTED, ROLL UP THE AWNING AND SECURE AS FOR TRAVEL!



CAUTION: THE EFFECTS OF WIND AND RAIN ON ANY AWNING ARE UNPREDICTABLE. SEVERE DAMAGE TO THE VEHICLE AND OR THE AWNING MAY RESULT AND CANNOT BE COVERED BY WARRANTY!

CHASSIS

COUPLER

The standard RECOMMENDED HITCH BALL HEIGHT for an Airstream is 18" on all models. If you plan long trips with the trailer heavily loaded you should check your trailer, after loading, to determine the optimum height. To check, park the trailer on a level surface and crank the front jack up or down until the measurement from the frame to the ground is the same front and rear. Measure from the ground to the upper surface of the hitch ball coupler. Add one inch to this figure when setting the ball height on the tow vehicle to allow for the suspension settling under the added weight.

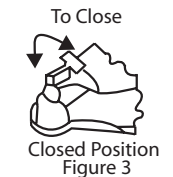
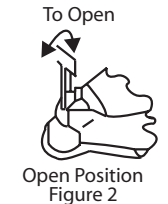
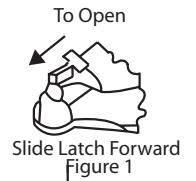



WARNING: ALWAYS OPEN LATCH HANDLE BEFORE INSERTING BALL.

OPERATION INSTRUCTIONS

1. To open - slide latch forward (Figure 1) and pull up to open latch (Figure 2) before inserting ball.
2. Lower coupler on ball of same diameter as coupler and of same or greater capacity.
3. When ball is completely nested in coupler socket, push top of latch handle rearward until handle snaps into closed position. (Figure 3).
4. Extend jack to ground and lift car/trailer combination 2-4" to insure coupler is securely attached to tow ball.
5. Retract jack before towing. Insert locking pin or padlock through hole in handle for safety and theft prevention.

POWER JACK

A switch located on the bottom of the housing operates the power jack. When the jack is fully extended or retracted internal limit switches automatically shut off the motor. Another switch operated the convenience light.

Should an electrical failure occur, remove the power head by loosening the two Allen set screws. The jack post may now be operated manually by inserting the emergency handle into the coupling on top of the post.

Replacing Power Head

It is essential that the following procedure be used before the power head is replaced on the post.

1. With 12 volts connected, ground the power head to trailer "A" frame. Operate main switch in "post retracting direction" until the motor stops automatically.
2. Using emergency handle, crank post clockwise by hand until fully retracted, then turn crank one turn counterclockwise.
3. Replace head on post and make sure that drive pin is engaged with post coupler. Tighten Allen set screws.

NOTICE: Leave tow vehicle transmission in neutral when lifting both units. Dolly wheels are not recommended. Always retract stabilizing jacks before using your Super Jack under load.

EXTERIOR

Maintenance

1. Every two years remove screws and cover and check grease condition. Use HMP grease similar to lubricate 630AA and spread on gear teeth, Grease is not required on the nylon timing gears. No internal lubrication of the post is required, but an occasional external application of a silicone or WD-40 spray lubricant on the inner tube of the post when extended is permissible.
2. Before replacing the cover ensure that the plate and limit switch unit are located correctly.
3. Apply a little sealing compound around the mating surface of the gear cover and replace screws tightening them diagonally. **Check synchronization if head has been removed from the post.**
3. A little penetrating oil on the Allen setscrews occasionally will help prevent corrosion and difficult removal.

Wrap Protectors

The front end of the trailer exterior shell is equipped with stainless steel protectors covering the lower corner wraps. The protectors provided added protection from road damage. The protectors can moved out of the way for cleaning the shell by unbolting and swinging the protectors forward on the hinge.

TIRES

Your trailer is equipped at the factory with name brand trailer tires. Airstream dealers cannot make adjustments to tires. A dealer who handles that particular brand must do this. If you ever have tire problems check the local telephone directory for the nearest dealer.

To get the maximum performance from your tires check the air pressure often, but only when the tires are cool. Never bleed out air immediately after driving. Recommended tire pressures vary with tire type and size. For pressures refer to the SPECIFICATION TABLE.



WARNING: WHEEL SEPARATION CAN OCCUR

1. On first trip, tighten wheel nuts at start and at 10, 25, and 50 miles.
2. Thereafter, check wheel nuts

Before each trip.

Following winter storage.

Following excessive braking

See Specification Section in this manual for inflation specifications and wheel torque ratings.

Try to park out of the sun whenever possible when in warm climates. In desert regions use tire covers to prevent ultra-violet deterioration to tires.

Tire Changing

To CHANGE A TIRE with a jack see the label affixed to the underbelly to the rear of the wheels. This label, says JACK with an arrow and points to a plate riveted to the mainframe rail where the jack head must be placed. A flat tire may also be changed without the aid of a jack. Drive the unit up on a ramp 8' wide, 6" high, and about 3 feet long at its base. Position the good tire on the ramp. This will raise the flat tire clear of the ground. All tire and wheel assemblies are balanced at the factory. Be sure to rebalance the wheel assemblies each time a tire is changed.



WARNING: Never attempt to change any tire without securely chocking remaining wheels. Never position yourself in a manner where a raised trailer can come down on you if it should become dislodged from a jack or ramp.



WARNING: When removing aluminum-forged wheels from spindle, it is very important to mark them to assure the wheel is placed in the same position of the drum when reinstalling. If the aluminum-forged wheel is to be mounted on a different drum it is important to clean all

loose corrosion from the mating surfaces.

In an emergency remove the flat tire. The independent suspension Of the Rubber Torsion Axle allows four or six wheel units to be safely towed on three or five wheels for a short distance (100 miles maximum) and only at a low speed (30 MPH). Be especially cautious in crossing holes or dips in the road. Under these circumstances it is good practice to set your rear view mirrors so that you can observe your tires along with the traffic.

SPARE TIRE CARRIER

The spare tire for Airstreams is stored under the front of the trailer. The front handle of the tire carrier is a one-inch tube protruding out from under the front A-frame on the curbside. It is secured by a bracket and bolt along the inside of the A frame rail. Removing the bolts allows the front on the tire carrier to be lowered and the spare tire removed. The lug nuts used on the aluminum rims can be used for a steel spare.



DANGER: The spare tire carrier is designed to carry an undamaged tire and rim assembly of the type and size specified for the trailer. Never place a severely damaged wheel assembly with a damaged partial tire, or a rim only in the carrier.



EXTERIOR

TIRE ROTATION (10,000-mile intervals)

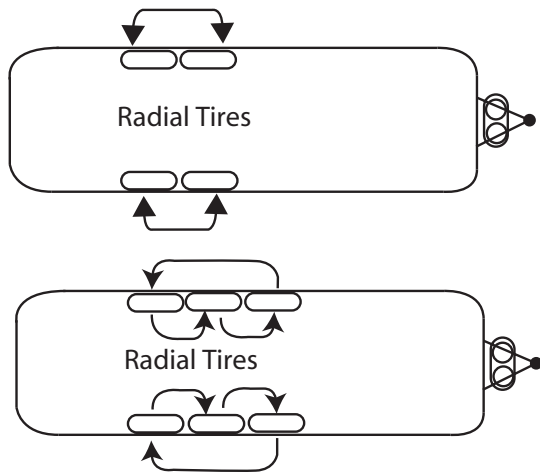

AXLE AND RUNNING GEAR ASSEMBLY

Each Airstream RUBBER TORSION axle is aligned during manufacturing, and double-checked on a random basis. Alignment after delivery is the customer's responsibility.

Hitting chuck holes or rough railroad tracks while going straight will only cause misalignment after the tire has been struck many repetitive times. Of course, a deep enough hole can affect the alignment immediately.

The worse culprit is a curb because they are normally struck at an angle. Surprisingly rear axles are occasionally damaged when people are attempting to park beside a curb and are backing up their trailer.

As you look under your trailer is it normal for the axle to be bent up in the middle. This bend is how the camber is obtained.

Toe-in is built into the axle by very slight bends in the axle tube on each end.

If tire wear ever indicate misalignment check with your dealer for the nearest location having the proper equipment.

Axle alignment specification are listed in the specification section of this manual.

NOTICE: Never allow heat to be applied to the axle tube since the rubber providing the spring torsion action will be severely damaged.

TIRES

Load/Inflation Information for Your Tires

Maintaining proper tire inflation pressure is essential for both tire safety and performance.

Proper Tire Inflation

The level of air in your tires affects your vehicle's overall performance. Not even the highest quality tire will perform well if it's not inflated properly. The correct pressure varies from vehicle to vehicle and depends in part upon driver preference. Each vehicle has a maximum inflation pressure, usually found on a metal tag riveted to the outside of the vehicle as well as on the original equipment tires.

Correct tire inflation is a key component in tire care. The recommended inflation pressures for your tires are indicated on the certification label or in your owner's manual. Since RVs can be loaded with many different configurations, the load on each tire will vary. For this reason, air pressure should be checked based on the load on each individual tire. Cold Inflation Pressure should be adjusted to handle the maximum tire load, and all tires on the axle should carry the same inflation pressure. **COLD TIRE INFLATION PRESSURE** is the tire pressure checked in the morning before you drive more than a few miles or before rising

ambient temperatures or the sun's radiant heat affects it. Check your tires' air pressures at least once a month, before each trip and each morning you drive during a trip. Tire pressure should be checked cold, as tire pressure ratings have been designed with typical running heat/pressure build-up in mind. Make sure the valves and caps are free of dirt and moisture.

Under Inflation

Under inflation brings a higher risk of damage due to road hazards, reduces casing durability, causes a loss in fuel economy, and uneven or irregular tire wear. Severe under inflation brings about an increased risk of tread separation, handling difficulties, and possibly tires failure, caused by overheating.

IMPORTANT: Lowering tire pressure in the search for a smoother ride is not only dangerous, it's relatively ineffective, and as the difference in the ride quality is not significant. When minimum inflation pressure requirements are not met, tire durability and optimum operating conditions are compromised. Tire inflation pressure should always meet the guidelines for vehicle weight.

- It may be necessary to inflate your tires at a truck stop or truck service center in order to achieve adequate air pressure for your coach's needs
- Only permanent air seal metal valve caps should be used.
- Be safe - if a tire has been run 20% under inflated, it must be dismantled and inspected by a trained professional. It should not be aired up without a



EXTERIOR

full inspection or without using a safety cage. Use a calibrated gauge. If your tire is rated for higher inflation pressures, a special gauge will be required designed for larger tires.

- Don't bleed air from warm tires to reduce pressure buildup
- Don't inflate tires to cold PSI rating beyond rim specifications

HOW OVERLOADING AFFECTS YOUR TIRES

Tire pressure is what enables your RV tire to support loads. Overloading your tires can have serious consequences for passengers and your RV. Too much weight can cause stress on your RV's suspension system, brake failure, shock absorber damage, handling and steering problems, irregular tire wear and possible tire failure. Excessive loads or under inflation can lead to an excessive amount of heat and tire failure. If you discover that your tires cannot handle the load, lighten the weight of the load on your tires.

Tire pressure should never be reduced below the vehicle manufacturer's recommended levels to support load conditions in order to improve the ride quality of a vehicle. The difference in ride quality is not significant. When inflation pressure requirements are not met, tire durability and optimum operation can be affected. **Recommended Tire Inflation Pressure**

The **recommended** inflation pressure is not to be confused with the **maximum**

inflation pressure that is shown on the side of the tire. At the recommended inflation pressure, tires will last longer and be less likely to fail, and the tow vehicle will use less fuel. Serious injury can result from tire failure because of under inflation or overloading.

Cold Tire inflation Pressure is the tire pressure checked in the morning before you drive more than a few miles or before rising ambient temperatures or the sun's radiant heat affects it. Check your tires' air pressures at least once a month, before each trip and each morning you drive during a trip. Tire pressure should be checked cold, as tire pressure ratings have been designed with typical running heat/pressure build-up in mind. Make sure the valves and caps are free of dirt and moisture.

Recommended Cold Tire Inflation Pressure

ST 225/75R-15 65 PSI



WARNING: The maximum speed rating on the tires installed on your trailer is 65 MPH. DO NOT EXCEED THIS RATING. Failure to heed this warning could cause catastrophic tire failure resulting in property damage, personal injury and/or death.

Nev-R-Lube Drums/Bearings

Dexter's Nev-R-Lube bearings are comprised of opposed tapered roller bearing cones sealed inside of a precision ground, one piece double cup arrangement. These bearings are designed with a small amount of axial end play. The end play is essential to the longevity of the bearings service life. Please read the Dexter Operation Maintenance Service manual provided in your owner's packet for complete maintenance procedures.

Bearing Inspection

Jack trailer at marked jack location pad behind axle on main frame.

1. Check for excessive wheel end clearance by pulling the tire assembly towards you and by pushing the assembly away from you. Slight end play is acceptable.
2. Rotate tire slowly forwards and backwards. The wheel assembly should turn freely and smoothly.
3. Excessive wheel end play, restriction to rotation, noise, or "bumpy" rotation should be remedied by replacing the bearing unit.
4. Bearing units should be inspected every year or 12,000 miles whichever comes first.

NOTE: A slight amount of grease weeping from the seal area is normal. Excessive leakage may indicate abnormal bearing operation.

Bearing end play inspection, drum removal/installation, and bearing replacement procedures are described in the Dexter Operation Maintenance Manual enclosed in your owner's packet. Airstream recommends that these procedures are performed by a qualified Dexter service technician due to the need of specialized tools and training.

WEIGHING YOUR TRAVEL TRAILER

Since a trailer or towed vehicle adds to the load on your tow vehicle's tires, it is crucial to properly weigh towed vehicles. A travel trailer should first be weighed with the tongue, while detached from the pulling vehicle. The actual weight of the trailer must be less than or equal to the GVWR for safe operation, otherwise contents must be removed until the weight is within maximum GVWR limitations. The weight of the complete, attached trailer, excluding the towing vehicle, must also be taken. Each wheel should be weighed while still attached to the towing vehicle, and the individual wheel positions on the towing vehicle should be weighed and checked for overload as well.

If you determine that the loading of your vehicle's tires are uneven, the actual weight of the trailer on each tire must be less than or equal to its maximum



EXTERIOR

load capacity for safe operation, otherwise contents must be removed until the weight is within maximum load limitations.

TIRE CARE

Tires are a very precisely engineered product designed for specific applications and use. The tire functions as the sole contact between the vehicle and the road. Therefore, it must provide several different functions in order for your recreational vehicle to handle properly. Most important are traction while moving, grip when steering or stopping, and a comfortable ride for you and your passengers. The Tires on your recreational vehicle are designed for highway use and must be properly maintained in order to maximize tire life, as well to provide a safe mode of transportation. Always keep your tires clean and properly inflated.

Correct tire inflation is a key component in tire care. The recommended inflation pressures for your tires are indicated on the certification label or in your owner's manual. Since RVs can be loaded with many different configurations, the load on each tire will vary. For this reason, air pressure should be checked based on the load on each individual tire. Cold Inflation Pressure should be adjusted to handle the maximum tire load, and all tires on the axle should carry the same inflation pressure.

Tips on Tire Care

Any tire, no matter how well constructed, may fail in use as a result of punctures, impact damage, improper inflation or other conditions resulting from use. Tire failures may create a risk of property damage or personal injury. To reduce the risk of tire failure we strongly recommend the following:

1. Check the pressure in your tires, including your spare, at least monthly when the tires are cool (after the vehicle has stopped three hours and then driven less than one mile.) Do not reduce pressure when tires are hot. Use a tire gauge to check pressure and maintain it at the recommended level.
2. Never overload your tires. The maximum load carrying capability of your tires is molded on the sidewall of the tire.
3. Check your tires frequently for scrapes, bulges, separations, cuts or snags resulting from use. See your tire dealer immediately if any such condition is discovered.
4. Never operate your vehicle in excess of lawful speeds or the maximum speeds justified by driving conditions, or in excess of speeds recommended for the tire you are using.
5. Make every effort to avoid running over objects that may damage the tire through impact or cutting, such as chuckholes, glass, metal, etc.
6. Never drive on smooth tires. Tires should be removed when 2/32nds inch of tread depth remains. In most states it is illegal to drive with less than 2/32nds inch remaining tread depth.

The Importance of Proper Air Pressure

The amount of air pressure in a tire determines the load that can be carried safely. Every tire will have the maximum load and inflation molded into the sidewall of the tire. This load and inflation ratio should never be exceeded since this can cause handling problems, irregular wear, and component failure. The proper amount of air pressure is always determined by the weight of your RV fully loaded. This weight takes into account all liquids, supplies, and passengers.

Tire pressure is what enables your RV tire to support loads. Overloading your tires can have serious consequences for passengers and your RV. Too much weight can cause stress on your RV's suspension system, brake failure, shock absorber damage, handling and steering problems, irregular tire wear and possible tire failure. Excessive loads or under inflation can lead to an excessive amount of heat and tire failure. If you discover that your tires cannot handle the load, lighten the weight of the load on your tires.

The level of air in your tires affects your vehicle's overall performance. Not even the highest quality tire will perform well if it's not inflated properly. The correct pressure varies from vehicle to vehicle and depends in part upon driver preference. Each vehicle has a recommended inflation pressure, usually found on a placard on the door section, doorpost, glove door, or fuel door.

Under Inflation

Under inflation brings a higher risk of susceptibility to damage due to road hazards, reduces casing durability, and causes a loss in fuel economy, plus uneven or irregular tire wear. Severe under inflation brings about an increased risk of tread separation, handling difficulties, and possibly tire failure, which is caused by overheating.

IMPORTANT: It's a common practice for RV owners to lower tire pressure in their search for a smoother ride. This is not only dangerous, it's relatively ineffective, and as the difference in ride quality is not significant. When minimum inflation pressure requirements are not met, tire durability and optimum operating conditions are compromised. Tire inflation pressure should always meet at least the minimum guidelines for vehicle weight.

- It may be necessary to inflate your tires at a truck stop or truck service center in order to achieve adequate air pressure for your coach's needs
- Only permanent air seal metal valve caps should be used.
- Be safe - if a tire has been run 20% under inflated, it must be dismantled and inspected by a trained professional. It should not be aired up without a full inspection or without using a safety cage. Use a calibrated gauge. If your tire is rated for higher inflation pressures, a



EXTERIOR

special gauge will be required designed for larger tires.

- Don't bleed air from warm tires to reduce pressure buildup

Don't inflate tires to cold PSI rating beyond rim specifications.

Tire pressure should never be reduced below the vehicle manufacturer's recommended levels to support load conditions in order to improve the ride quality of a vehicle. The difference in ride quality is not significant. When minimum inflation pressure requirements are not met, tire durability and optimum operation can be affected.

Always check air pressure with an accurate air gauge at a cold PSI. Never reduce pressure when a tire is hot and never exceed the maximum cold pressure molded on the sidewall.

Tires on RV applications are subject to a variety of more severe conditions when compared to automobiles or trucks. Because of many chassis and optional equipment differences, it is possible for an RV to be within its Gross Vehicle Weight Rating (GVWR), but overloaded when taking into consideration the weight of each wheel position.

The only way you can know the safe load and inflation pressure for the tires your RV is to know the actual weight of each wheel position under

actual loaded conditions.

Under inflation of a tire can cause poor handling, irregular wear, and decreased fuel economy. It also causes extreme heat build up within the components of the tire, which can lead to failure. Over inflation of the tire causes a deformation of the contact patch resulting in crowning of the center tread. This causes handling problems such as reduced traction, irregular wear, and an increased chance for impact damage.

Only after the individual loaded weight is known for each wheel position can a recommended air pressure be utilized using the load and inflation tables included in this web site.

If there is a difference between one side of the RV versus the other, the load must be redistributed so weights are as even as possible. As stated, you can be overloaded by specific wheel position, as well as one side compared to another. Such a situation can cause stresses on tires, wheels, and other components.

Always check air pressure with an accurate air gauge at a cold PSI. Never reduce pressure when a tire is hot and never exceed the maximum cold pressure molded on the sidewall.

The following work sheets are used for determining your loaded weight by

wheel position using a conventional platform scale.

Proper Inspection and Storage of Tires

Before taking your RV on a trip or when removing from an extended storage period, make it a practice to inspect the overall condition of your tires. Check for any type of condition or damage that might result in failure. A thorough check should include both inside and outside sidewalls, tread area and the condition of hardware such as valve stems, valve caps, and wheels. The tread should be checked for any unusual wear, cracking, penetrations and/or cuts. An uneven wear pattern can indicate misalignment or worn suspension parts.

Since many RVs are used seasonally and sometimes stored for extended times, it is possible that tires will take many years to wear out. Tires, as any rubber product, will age over time. If tires show cracking in the sidewall or tread surfaces that are more than 2/32nds deep, they should be replaced before your next trip or vacation. Store your RV in a cool dry area away from major heat sources and extreme cold. An enclosed area is best with no exposure to electromagnetic sources such as generators or transformers. If you must keep your RV outside, cover your tires from direct sunlight. Take your RV to your Tire dealer for service to check or correct any of these conditions.

Replacing Your Tires

It is possible to replace your tires with a different size in some instances to increase your load capacity with a different inflation pressure. If there is a reason to replace your tires with a different size, make sure the following checks are made before the purchase.

- Does the replacement tire have the load capacity that is needed for my RV and will it fit properly inside the wheel well?
- Will the overall diameter difference affect the speedometer or antilock braking system?
- Is the increase in air pressure compatible with the maximum rated pressure stamped on the rim?
- Is there enough dual spacing offset for the rear wheel positions?

Tires used on most RVs are driven at or near maximum loads during hot weather and then are left idle for months. In normal use oils in the tire come to the surface during flexing and protect the rubber from ultraviolet light. But when left idle natural aging may cause the rubber to crack prematurely, especially in the sidewall area.

Any tire on an RV that is over five years old should be inspected by a competent tire professional for cracking and replaced, even if it has no apparent tread wear. This is because a tire on a car or truck might last 80,000 to 120,000 miles

EXTERIOR

before it needs to be replaced, but an RV tire that only travels 5,000 miles per year will not approach that mileage for 20 years. It will need to be replaced much before that.

The first step is choosing a tire adequate for the load. The load rating printed on the sidewall will show the maximum load that can be carried at a defined pressure. As the inflation pressure drops, the load that can be carried is less. As speed increases, the amount of load that can be carried also drops. The load rating is also affected by how the tire is used, as a single or as a dual.

A Goodyear ST225/75 R15 tire inflated to 65 PSI has load capacity of 2540 Lbs.

Lug Nut Torquing

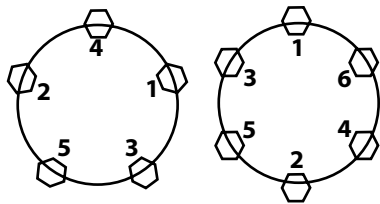

NOTICE: Use a torque wrench to tighten lug nuts. Tightening with an impact wrench is not recommended.

See Specification Section in this manual for wheel torque ratings.

Proper wheel nut torque is very important to safe and dependable towing of your vehicle. The wheel and axle systems used in travel trailers and fifth wheels are similar, yet different, in many ways to those used on cars and trucks. These differences are important and require special attention to wheel nut torque both while the trailer is new and throughout the trailer's life.

Trailer wheels must carry much higher loads per wheel than passenger car or truck wheels. Each wheel may carry 1000 pounds and higher. Furthermore, wheels on tandem axle trailers do not steer, and are subjected to very high side load stress whenever the trailer makes a tight turn. When you go around corners, especially slow, tight ones, the wheels on your trailer are subject to these strong side loads. This tends to flex the wheel and gradually loosen the wheel nuts. Although the materials and manufacturing methods are maximized for this kind of service, these extra loads can cause stress, which can result in flexing and loosening of wheel nuts.

Before each trip and any time a wheel is replaced, be sure to tighten the wheel nuts, following the sequence shown in the relevant lug pattern below. Set the torque specification as seen in the chart. If the wheel was replaced, check the torque every 10, 25, and 50 miles of travel.

If you notice wheel wobbling or hear a rattling sound coming from a wheel, especially at low speeds, a wheel lug nut may have come loose. This problem is usually caused by improper tightening or by faulty or damaged lug bolt threads. If you have a reason to believe a lug nut has come loose, safely stop the vehicle at the side of the road as soon as possible. Put up warning devices. Remove the lug caps and check the tightness of all the lug nuts. Tighten all lug nuts to the specified torque, using a torque wrench. If lug stud threads are damaged or faulty, get professional service help.



WARNING: WHEEL SEPARATION CAN OCCUR

1. On first trip, tighten wheel nuts at start and at 10, 25, and 50 miles.

2. Thereafter, check wheel nuts:

Before each trip.

Following winter storage.

Following excessive braking.

Axle systems are installed with hubs and drums that are compatible with many wheels used in the recreational vehicle industry that have matching bolt patterns. If the original manufacturer installed equipment is in need of replacement, the wheel manufacturer should be contacted for proof of compatibility prior to replacement and use.

Customers replacing original equipment that has not been tested for compatibility must ensure the replacements are compatible to the hub and drum assembly installed. Such elements of compatibility include, but are not limited to:

- Diameter of the hub-mounting surface.
- Stud length and diameter.
- Location and number of studs.
- Center hold diameter for the wheel.
- Wheel mounting offset from the rim center.
- Rated capacity of the wheel.
- Wheel fastener torque.
- Wheel nut size and shape.

Impact of any added wheel accessories (such as decorative center caps) that could affect proper seating of the wheel to the hub surface.



WARNING: Do not mismatch wheels and tires.



EXTERIOR

NOTES

D

INTERIOR

The interior of all Airstream trailers has been designed for comfort, convenience, durability and appearance. How you use it and how you take care of it naturally depends on you. However, if you learn to operate the interior components and take care of them and the trailer properly, this knowledge will add to your pleasure as well as the long life of your trailer.

All materials should be professionally dry cleaned to remove any overall soiled condition. However, these materials may be spot cleaned using the cleaning code instructions as listed. Sample swatches are furnished to our dealers. The dealer will be able to give you the name of the fabrics used in your particular trailer. Each swatch will show the cleaning code in parenthesis.

Upholstery

Upholstery-Cleaning Code S

All materials should be professionally dry cleaned to remove any overall soiled condition. Spot clean, using a mild water free solvent or dry cleaning product. DO NOT SATURATE THE FABRIC. Carefully follow instructions on such product. Clean only in a well-ventilated room. Avoid any product containing carbon tetrachloride, which is highly toxic. Pretest small area before proceed-

ing. Use professional furniture cleaner when an overall soiled condition is reached.

Leather

Clean leather fabrics with standard products used for that purpose. Follow instructions on the cleaning products container.

NOTICE: Never remove cushion cover for separate dry cleaning or washing. Any tumble cleaning method can destroy the backing, shrink or otherwise damage upholstery fabric.



WARNING: Keep your furniture and family safe from fires caused by careless smoking. Do not smoke when drowsy. Remove immediately any flowing ash or a lighted cigarette, which falls on furniture. Smoldering smoking material can cause upholstered furniture fires.

Interior Skin

Fabric covered interior skin can be cleaned with a vacuum cleaner. Spot clean, using the foam only from water based cleaning agent such as mild detergent or non-solvent upholstery shampoo product. Apply foam with a soft brush in a circular motion. Vacuum when dry. Pretest small area before pro-

INTERIOR

ceeding. Use professional furniture cleaner when an overall soiled condition is reached. The manufacturer of the fabric designed the above code.

For the vinyl Ceiling covering Damp wiping with mild detergent does routine cleaning. Using any of the automotive cleaners designed for vinyl car seats and dashes can perform more thorough cleaning.

The aluminum interior skin around the galley should be cleaned by following the same cleaning instructions detailed in the Exterior section of this manual for the exterior skin. Do not use abrasive cleaners or utensils on the aluminum skin as it is coated with a clear coat that could be damaged.

Draperies

NOTICE: All drapery materials and mattress covers must be professionally dry-cleaned.

Unsnapping from the wall, removing a screw or pop rivet from the end of the curtain track, and sliding them out remove draperies. The pop rivets are removed by drilling through the head with a 1/8" drill bit. To prevent damage to the draperies while traveling, the VENETIAN TYPE BLINDS should be lowered, secured at the bottom and the slats turned vertically.

Carpet

The carpet can be cleaned with any good commercial carpet cleaner, or with a detergent and water. BE CAREFUL NOT TO SOAK THE CARPET WITH WATER.

Vinyl Floor

The vinyl floor in your unit can be cleaned with liquid floor cleaning solutions recommended for vinyl floors and warm water.

Counter Area

The counter areas around the sink are of a high-pressure laminate or Corian and can be cleaned with soap and water, or you can use a common solvent on tough spots. Be sure no abrasive cleaner is used, as there is the possibility it could scratch the surface. A protective pad should always be placed under hot utensils. Sanding minor damaged areas can repair Corian counters. The color of the material is constant and not just a surface coat.

Vinyl Covering and Interior Ceiling

Damp wiping with mild detergent does routine cleaning. Using any of the

automotive cleaners designed for vinyl car seats and dashes can perform more thorough cleaning.

Sinks

The stainless steel galley sink can be cleaned with a commercial stainless steel cleaner available at most stores. The lavatory sink is a very dense material called KARRAN. In the unlikely event of it ever being stained powdered cleansers such as Ajax/Comet may be used or even Scotch-Brite pads. The color is constant through the thickness of the material,

Shower Stall

To clean your fiberglass shower stall unit use warm water and one of the stronger liquid detergents. Do not use abrasive cleaners, they may scratch and dull the surface of your fiberglass unit. Stubborn stains can be removed with solvents such as turpentine, paint thinner or acetone. Restore dulled areas by rubbing with an automotive type liquid cleaner then put the soft slow back into your fiberglass unit with a light application of liquid wax.

Lounges

To convert the front lounge to a bed first set the armrest cushions out of the

way, lift up on the front of the seat and pull it out. This will unhinge the sofa so it can be pushed flat into a bed.

Dinette

The dinette is made into a bed by rising up on the front of the table and folding the table leg up against the bottom of the leaf. As the table is raised it will unhook from the upper wall brackets. Once it is unhooked it can be pulled out and the wall hinge will let it be lowered on the supports of the dinette seats. The backrests of the seats are placed over the table to complete the conversion.

Table

To open the folding table, lift into a horizontal position and pull the table leg down toward the vertical position until it snaps into place, The leg is hinged at the front edge of the table and is held against the bottom of the table with Velcro. To extend into the double leaf position, lift the table slightly so the leg clears the carpet, and slide the leg and center support out toward the center of the trailer. The leaf then unfolds and rests against the leg support. Airstream recommends that during travel the table be folded up and stored. It has pressure catches to hold it in place during travel.

INTERIOR

Monitor Panel

The monitor panel allows you to check the amount of fluid in your fresh water tank, black tank (tank #1), and the gray tank (tank #2). The LP bottle gas levels and battery charge status are also shown. The panel operation is explained in detail later in this manual.

Battery Condition Tester

The battery condition tester, used when not plugged into 110-volt power, will indicate the trailer batteries condition. When they show weak or bad condition you should take every reasonable step to conserve power by using as few lights as possible and switching off appliances. The battery should be charged as soon as practical with the tow vehicle charging system, or by connecting to shoreline 110-volt power.

Water Pump Switch

Fresh water pump switches are located on the monitor panel and in the lavatory. Once the switch is turned on the pump will run until the water pressure reaches about 65 psi. At this point an internal pressure switch will shut it off. When a faucet is opened the water pressure will drop and the pump will start to run again. The water pump switch should be turned off when the trailer is

left unattended. Water pressure at some campgrounds may be low. The water pump can be turned on to assist the city water hookup pressure. Be sure there is some water in the fresh water tank. The pump will only use the water that is needed out of the tank to bring the pressure up to the usual standard.

Bathroom Exhaust Fan

The round bathroom exhaust fan is in the bathroom ceiling and is opened by pushing up on the handle running across the fan opening.

A power lift bathroom fan may be installed in your trailer. The switches for this fan will be located on the forward bath wall. One switch will open the dome for the fan and the other switch will activate the fan.

Telephone Shower Head

The telephone shower head is designed to give maximum flexibility in usage, and provides for water saving techniques when using your trailer on self-containment. It can be held in the hand and moved about the body. Normally the best water conservation procedure is to wet the entire body and then turn the water off. Apply soap, lather thoroughly, and then rinse the soap off. The telephone shower head is also used to fill the tub for taking a bath. When you have finished using the shower be sure to shut the water off at the faucet.

Bath Area Remote Switches

Two remote switches for appliances are located on the bathroom wall. One is for the water pump, and duplicates the pump switch on the monitor panel. Either pump switch may be used to turn the pump on or off at any time.

The second pair of switches, with a red indicator, is for lighting the water heater.

Incandescent Light Fixtures

The light fixture has a switch located on the end of the fixture. Gently squeezing in the middle and pulling down will remove the lens. During cold weather it is a good idea to leave the light on a few minutes prior to removing the lens.

Fluorescent Ceiling Lights & Light Bulbs

A wall switch just inside the door control lights in the forward section and a second wall switch in the bedroom will control the bedroom ceiling light. Each light also has its own individual switch. The wall must be turned on for the light switch to work.

Rotating one-quarter turn and bringing the bulb straight out of the fixture will

remove fluorescent light bulbs.

Fresh Air Vents

A control handle operates the fresh air vents. Turning clockwise will raise the vent and at the maximum extension, vents with fans will automatically turn on. For maximum air without fan, open until fan starts and back up just enough to turn fan off. Turning counterclockwise will close the vent. Screens should be removed for periodic cleaning.

Information on the optional high volume roof vent may be found in the appliance section of this book,

Bedroom/Patio Television, Optional

The optional bedroom television available only in the Thirty foot front bed model can be used as a exterior patio television also. The television will slide from its wall bracket by lifting it straight up. Remove the coax cable and unplug the power cord before removal.

A wall bracket is mounted on the exterior curbside wall just behind the front door. Slide the television onto the bracket and hook up the cable and power cord to the exterior outlets and enjoy.



INTERIOR

Storage

The kitchen cabinet should have the heaviest items on the bottom and lighter items overhead. After loading you should have the skillets and can goods on the floor or bottom shelf, and the cereals and crackers in the overhead roof locker. Use the unbreakable type plates and saucers, and consider storing your dish towels around them. Better yet, use paper plates. Who wants to wash dishes when on a trip or vacation?

E

A good place to store heavy items is in the front drawer assembly. It is rated for a 100 lb. capacity, plus adding weight to the front of the trailer may even improve towing slightly.

Clothes hung in wardrobes should be kept on hangers that snap over the clothes rods to keep them from “jumping” off on rough roads. Evening dresses should be kept in the plastic bags like dry cleaning businesses use. No matter how hard you try, if you travel a long dusty section of road the dust will work its way into the trailer and soil clothes. Try to avoid large bulky coats. Layers of lighter clothing will usually keep you warmer, are more versatile and easier to store.

Some additional storage is available under the shelf in the bottom of the wardrobe, but you must be sure it is loaded so the drain lines, water pump and

filter, and heat ducts can't be damaged.



WARNING: Keep flammable material away from the furnace.

Remember, heavy items should be stored low and toward the front, lighter items in the rear and overhead cabinets.

CARBON MONOXIDE ALARM

CAREFULLY READ AND UNDERSTAND THE CONTENTS OF THIS INSTRUCTION MANUAL BEFORE USING THE ALARM.

STORE THE MANUAL IN A SAFE PLACE FOR FUTURE REFERENCE. PAY PARTICULAR ATTENTION TO THE SAFETY WARNINGS. PASS THE MANUAL ONTO ANY SUBSEQUENT USERS OF THE ALARM

If you have not recieved the Owner's manual for the Carbon Monoxide Alarm please contact Airstream factory Customer Service or Quantum Group Inc. at 1.800.432.5599



WARNING: Activation of your CO alarm's audible horn indicates the presence of carbon monoxide (CO) which can KILL YOU.



WARNING: Alarm battery is shipped deactivated. Check your alarm for proper battery installation.



WARNING: THIS PRODUCT IS INTENDED FOR USE IN ORDINARY INDOOR LOCATIONS OF FAMILY LIVING UNITS. IT IS NOT DESIGNED TO MEASURE COMPLIANCE WITH OCCUPATIONAL SAFETY AND HEALTH ADMINISTRATION (OSHA) COMMERCIAL OR INDUSTRIAL STANDARDS.

INDIVIDUALS WHO ARE AT SPECIAL RISK FROM CARBON MONOXIDE EXPOSURE BY REASON OF AGE, PREGNANCY OR MEDICAL CONDITION MAY CONSIDER USING WARNING DEVICES WHICH PROVIDE AUDIBLE AND VISUAL SIGNALS FOR CARBON MONOXIDE CONCENTRATION UNDER 30 PPM. IF IN DOUBT CONSULT YOUR MEDICAL PRACTITIONER.

THIS CARBON MONOXIDE ALARM IS NOT

1. Designed to detect smoke, fire or any gas other than carbon monoxide.
2. To be seen as a substitute for the proper servicing of fuel-burning appliances.

3. To be used on an intermittent basis, or as a portable alarm for spillage of combustion products from fuel-burning appliances.



CAUTION: This carbon monoxide alarm is designed for indoor use only. Do not expose to rain or moisture. Do not knock or drop the alarm. Do not open or tamper with the alarm as this could cause malfunction. The alarm will not protect against the risk of carbon monoxide poisoning when the batteries are dead or missing. The alarm will only indicate the presence of carbon monoxide gas at the sensor. Carbon monoxide gas may be present in other areas.

IMPORTANT

Carbon monoxide is produced by the incomplete combustion of fuels such as wood, charcoal, coal, heating oil, paraffin, gasoline, natural gas, propane, butane, etc.

Ideally, it is recommended that a carbon monoxide alarm should be installed in or near every room that has a fuel burning appliance such as any room heaters, water heaters, cookers, grills, etc.

Ensure that the alarm horn can be heard by all those who are intended to hear it. Seek medical help if it is suspected that a user of the RV is suffering from carbon monoxide poisoning.

INTERIOR

If the alarm sounds, make sure to investigate the problem. Ignoring the alarm may result in sickness, injury or death. (CO may be present even if nothing is seen or smelled by the user).

Room spaces should be well ventilated when household cleaning supplies are used as these may cause a false alarm.

Alarm should be tested once per week.

This carbon monoxide alarm is designed to detect carbon monoxide gas from any source of combustion

WHAT IS CARBON MONOXIDE

Carbon monoxide (CO) is a highly poisonous gas which is released when fuels are burnt. It is invisible, has no smell and is therefore very difficult to detect with the human senses. Under normal conditions, in a room where fuel burning appliances are well maintained and correctly ventilated, the amount of carbon monoxide released into the room by appliances is not dangerous. These fuels include: Wood, coal, charcoal, oil, natural gas, gasoline, kerosene, and propane.

Common appliances are often sources of CO. If they are not properly main-

tained, are improperly ventilated, or malfunction, CO levels can rise quickly. CO is a real danger in “Air-tight” RVs with added insulation, sealed windows, and other weatherproofing can “trap” CO inside.

The following conditions can result in potentially dangerous CO situations.

1. Excessive spillage or reverse venting of fuel burning appliances caused by outdoor conditions, such as:
 - A. Wind direction and/or velocity: including high gusts of wind. Heavy air in the vent pipes (cold/humid air with extended periods between cycles).
 - B. Negative pressure differential resulting from sue of exhaust fans.
 - C. Simultaneous operation of several fuel burning appliances competing for limited internal air.
 - D. Vent pipe connections vibrating loose from clothes dryers, furnaces or water heaters.
 - E. Obstructions in or unconventional vent pipe designs which can amplify the above situations.
2. Extended use of unvented fuel burning devices.
3. Temperature increase that can trap exhaust gases near the ground.

SYMPTOMS OF CARBON MONOXIDE POISONING.

These symptoms are related to CO POISONING and should be discussed

with users of the RV.

1. Mild Exposure - Slight headache, nausea, vomiting, fatigue, (“flu-like” symptoms),
2. Medium Exposure - Throbbing headache, drowsiness, confusion, fast heart rate.
3. Extreme Exposure - Convulsions, unconsciousness, heart and lung failure,
4. Exposure to carbon monoxide can cause brain damage, death.



WARNING: Many causes of reported CARBON MONOXIDE POISONING indicate that while victims are aware that they are not well, they become so disoriented that they are unable to save themselves by either exiting the building or calling for assistance. Also young children and pets may be the first to be affected.



WARNING: Test units used in RVs after the vehicle has been in storage, before each trip and once a week while in use. Failure to test units used in RV's as described may remove your protection.



WARNING: Failure to replace this product by the “REPLACE BY DATE” printed on the alarm cover may result in death by Carbon Monoxide poisoning. Replace By Date is six (6) years from the date of manufacture.

SMOKE DETECTOR

A smoke detector is provided with your trailer. A manual pertaining to the detector is included in the paper work given to you at the dealership. Please read and follow all care, maintenance, and safety information contained in this manual.

The smoke alarm will “beep” once a minute for at least 30 days when the battery is weak. The battery must immediately be replaced with a fresh one.



WARNING: Alarm battery is shipped deactivated. Check your alarm for proper battery installation. To activate battery, new Airstream owner must install included battery to proper orientation.



WARNING: Smoke Alarms have a Limited Life. The unit should be replaced immediately if it is not operating properly. You should always replace a Smoke Alarm after 10 years from the date of purchase. Write the purchase date on the space provided on the back of unit.

SERVICE: If service is required or you have not received an smoke alarm users manual please contact the Consumer Affairs Division at 800.323.9005

INTERIOR

LP GAS DETECTOR

In the kitchen area of your unit, approximately six inches above the floor, is the LP gas detector. LP gas is a mixture of gases produced and sold commercially as a fuel for heating and cooking appliances. LP gas is highly flammable and, as a result, can be explosive if ignited under certain circumstances. LP gas is heavier than air and, if confined in a closed space, will accumulate close to the floor. When the LP gas concentration in your unit exceeds 2000 PPM the detector will provide a visual and audible alarm by sounding a buzzer and flashing the red LED two times per second.



WARNING: Activation of this detector indicates the presence of LP gas, which can cause an explosion and/or fire. This normally indicates a leak in the LP gas installation or a LP gas appliance. Extinguish all open flames, open your windows and door and evacuate the unit immediately. Do not activate any electrical switch. Turn off the LP at your gas bottle(s). DO NOT RE-ENTER YOUR UNIT UNTIL A QUALIFIED REPAIR TECHNICIAN HAS CORRECTED THE PROBLEM.

OPERATION

Your LP gas detector is wired directly to your vehicle battery and incorporates a 1-amp in-line fuse. When the device is operating normally the green LED will

be lit.



WARNING: It is not recommended that the detector be disconnected from the battery during periods of storage. There is a small heater on the sensor of the device, which “burns” away impurities in the air during periods of normal use. During periods when power is interrupted, impurities can build up on the sensor. When power is returned to the detector the detector alarm may activate until the impurities are “burned” off. This could take a number of hours, during which time the alarm will be constantly “on”.

DETECTOR TEST

Press the test button for 5 to 6 seconds until the alarm sounds then release the test button. The red LED should flash and the alarm sound for approximately 4 minutes. This test should be performed at least once a week during normal vehicle operation, and after periods of storage, and before each trip.



WARNING: Have a professional check your system if you have any doubts.

FIRE EXTINGUISHER

The fire extinguisher just inside your forward door should have the charge checked on a regular basis. Make sure your family, especially the cook, knows how to release the extinguisher storage bracket, and how to properly operate the extinguisher. If you find the directions on the extinguisher unclear, check with your local fire department for professional advice on its operation and use. We're sure they will be happy to assist you and your family.

EXTERIOR WINDOWS AND SCREENS

The windows in your trailer are safety glass. To open: release the two lever locks at the bottom, lift up on the two side operator handles until the window is in the desired position, and place the operators into one of three positioning slots on the side of the frames. To lock the windows, reverse this procedure.

Note: Some windows are designed as emergency escape exits. The rubber spline holding the screen in place is looped so it can be pulled out in one swift motion.

You and all your family should practice escape procedures so they can be rapidly accomplished even in total darkness.



WARNING: Never park your trailer so the escape windows cannot be easily used for emergency exits.

These windows are cleaned in the same manner that ordinary windows are. Clean the seals with a damp cloth or mild detergent every three to six months, taking care not to use a strong solvent, as it will damage the seals. A coat of natural silicone lubricant applied after the seal has dried will keep it flexible. Spread the lubricant evenly with a brush or finger, working it into the surface. This is a good practice for all rubber seals in your Airstream. For replacement of a damaged window contact an Airstream Service Center or the factory.

SCREENS

Your plastic screens are easy to maintain. Just clean them occasionally with a damp cloth.

NOTICE: Window and door screens will melt at the point of contact if touched by a cigarette.

RANGE EXHAUST

NOTICE: The range exhaust cover on the outside the trailer has a swinging door that can be latched during inclement weather and should be latched in travel. When operating the exhaust fan, the latches should be turned so the door swings open when the fan is on.



INTERIOR

NOTES



LIQUID PETROLEUM GAS (LPG)

FILL VALVE

Your trailer is equipped with LP tank fill valves called “RV Type I Acme” connection. The large, green, nylon swivel nut is a right hand thread and is designed for **hand operation only**.

The valve features an internal spring-loaded module that will not allow gas to flow from the cylinder until a positive seal has been made at the connection. The valve outlet has 1-5/16” Acme threads on the outlet exterior and female POL, left-handed threads on its interior. This feature allows for connection of the new wrenchless, right-handed, Acme RV connection and still accommodates the standard left-handed POL fittings used for filling propane cylinders.

The mating, green swivel nut and brass nipple also incorporates new features: the green nylon nut swivels on a black bushing that is heat sensitive. Between 240 degrees F. and 300 degrees F. the bushing will yield (melt) allowing the spring-loaded module in the valve to push the brass nipple back (approximately 1/4”) closing the module and stopping the flow of gas from the cylinder. Inside the brass nipple is a flow-limiting device designed to sense excessive gas flow. If an excessive flow is sensed, the flow-limiting device shuts the flow down to a maximum of 10 SCFH (Standard Cubic Feet per Hour) or less. This is also

referred to as the by-pass flow.

By-pass flow is extremely important in the proper operation of this connection. The flow-limiting device may activate if the cylinder valve is opened quickly. When all appliances are off, the by-pass flow allows the pressure downstream from the flow-limiting device to equalize. When pressure is equalized, the flow-limiting device will supply normal flow to the system. Equalization occurs in approximately 5 seconds and in most cases goes completely unnoticed. If, however, an appliance is left on or there is a leak or open flow in the system, the by-pass pressure will not be able to equalize and allow the flow-limiting device to re-open. Symptoms of this condition would be appliances that light but have lower than normal flame or starve out from lack of gas, a substantial reduction in the flame when another appliance is operating, or pilots that are difficult to light. If this should happen, the following steps should eliminate the condition:

1. Close LP cylinder valve.
2. Extinguish all flames and smoking materials
3. Be sure all gas appliances, including their pilot lights, are off.
4. Open LP cylinder valve slowly. **DO NOT SNAP OPEN.**
5. Wait at least 15 seconds before lighting appliances.

If operational difficulties continue, there may be a leak in the system.

Immediately close the LP cylinder valve and have the system inspected by a qualified RV service technician.

PLUMBING

Again, make sure all appliances are off before opening propane cylinder valves.

Exception: when reconnecting a full cylinder to an auto changeover regulator it is not necessary to shut off the appliances or close the valve of the cylinder already in service.



WARNING: LEAKING LP GAS MAY IGNITE CAUSING A FIRE OR EXPLOSION WHICH COULD RESULT IN SERIOUS BODILY INJURY, PROPERTY DAMAGE, OR DEATH.

How long a full tank of gas will last is dependent on usage. In cold weather, when you are using the furnace, large amounts of hot water, and are doing extensive cooking, you will naturally use more than you will in warm weather when you may do limited cooking. On the average, with normal cooking and other appliance use you can probably count on two to three weeks of service from each tank.

AUTOMATIC GAS REGULATOR

All models are equipped with a two stage automatic change over gas regulator that offers the convenience of automatic changeover from empty to full gas cylinders. Both tanks are connected to this regulator.

Make sure there is propane in both tanks before you start. Rotate the black lever on the top front side of the regulator toward the cylinder you want to use first. This will be the “service” cylinder and the other will be the “Reserve” cylinder. Slowly open both cylinders valves. Open both cylinder valves completely, then close about 1/4 turn. This will allow you to easily check to see if valves are open or closed. The indicator on top of the regulator will turn bright green. The indicator will stay bright green as long as there is fuel coming from the service cylinder. When the service cylinder empties, the regulator will draw fuel automatically from the reserve cylinder providing an uninterrupted fuel flow to the system. When it switches over, the indicator will change from green to red. This red color indicates the service cylinder is empty and needs to be filled.



WARNING: LP gas regulators must always be installed with the diaphragm vent facing downward. Regulators that are not in compartments have been equipped with a protective cover. Make sure that regulator vent faces downward and that cover is kept in place to minimize vent blockage, which could result in excessive gas pressure causing fire or explosion.



CAUTION: The LPG bottles are securely mounted on the front “A” frame of your trailer. If these bottles must be removed for service or replacement it is important that they be reinstalled correctly in order to prevent any possibility of their falling off or becoming dislodged during travel.

LPG BOTTLES

The following step-by-step procedure gives you the proper method of removing and installing these bottles:

1. Turn the knob on your automatic regulator so the arrow points to the tank opposite the one to be removed. Shut off the gas valve on the bottle to be removed.
2. Disconnect the rubber gas line at the bottle to be removed. (This fitting has a left hand thread and turns in the opposite direction to most threaded fittings.)
3. Turn the large clamping “T” handle counterclockwise until the hold down bracket is loose enough to remove the bottle. If your trailer is equipped with a gas bottle cover the “T” handle must be removed, and then remove the cover before removing the bottle.



WARNING: DO NOT REMOVE THE CENTER HOLD DOWN ROD.

To Install

1. Place the bottle in position on the “A” frame and bottle cross member so that it rests on the upper collar of both bottles with the collar rims engaged in

the grooves on the underside of the bracket. If your trailer is equipped with a gas bottle cover it should be positioned over the bottles next. Make sure the hold down rod projects up through the hole in the shroud center bracket.

2. Replace the “T” handle and tighten down until the bottles are held firmly in place.
3. Turn on gas shut off valves and test all fittings with a soap suds or detergent solution and watch for bubbles.

If you have allowed both tanks to run out, air may have gotten into the lines. In this event, the air must be forced out through the lines by gas pressure before you will be able to light the pilots. Hold a match to the pilot of the appliance closest to the tanks until it lights and stays lit. Then move to the next closest, etc.

Twice a year, or after a long storage period, we suggest you take your unit in for a checkup and cleaning of the gas operated appliances.

BASIC RULES FOR SAFETY

Many things can be construed as safety related, but the most important is your common sense. If you are careless with matches, cigarettes, flammable material or any other hazardous material, we are sure you realize your potential for accidents is greatly increased.

PLUMBING



WARNINGS:

Your LP tanks must be filled as directed by the tank manufacturer. Instructions are located on a decal near the fill valve. The decal must not be defaced.

Your LP tank must be, and can only be, placed in the proper position when remounting on the front of the trailer. In any other position the base of the tank will not fit into the recess.

Use only the gas bottles furnished with your trailer. If replacement is required it must be a bottle of the same size and design.

The vent at the bottom of the regulator must be kept free of any obstructions and must be pointed downward. A good habit is to check the vent each time a bottle is removed for filling. It is especially important to check the vent if the trailer has not been used regularly.

Do not store LP containers within a vehicle. LP containers are equipped with safety devices that vent gas should the pressure become excessive.

Do not use cooking appliances for comfort heating. Cooking appliances

need fresh air for safe operation. Before operation open an overhead vent or turn on an exhaust fan and open a window.

Portable fuel burning equipment, including wood and charcoal grills and stoves, shall not be used inside the recreational vehicle. The use of this equipment inside the recreational vehicle may cause fires or asphyxiation.

A warning label has been located near the LP gas container. This label reads: **DO NOT FILL CONTAINER(S) TO MORE THAN 80 PERCENT OF CAPACITY. Overfilling the LP gas container can result in uncontrolled gas flow, which can cause fire or explosion. A properly filled container will contain approximately 80 percent of its volume as liquid LP gas. Use only certified refill LP stations when filling an LP bottle**

Do not bring or store LP gas containers, gasoline or other flammable liquids inside the vehicle because a fire or explosion may result.

A warning label has been located in the cooking area to remind you to provide an adequate supply of fresh air for combustion. Unlike homes, the amount of oxygen supply is limited due to the size of the recreational vehicle; and, proper ventilation when using the cooking appliances will avoid dangers of asphyxiation. It is especially important that cooking appliances not be used for comfort heating as the danger of asphyxiation is greater when the appliance is

used for long periods of time.



WARNING: IF YOU SMELL GAS:

- 1. Extinguish any open flames, pilot lights and all smoking materials.
- 2. Do not touch electrical switches.
- 2. Shut off the gas supply at the tank valve(s) or gas supply connection.
- 3. Open doors and other ventilating openings.
- 4. Leave the area until odor clears.
- 5. Have the gas system checked and leakage source corrected before using again.

WATER SYSTEM-SELF CONTAINED

Fill the water tank by opening the exterior access door and remove screw cap. A garden hose can now be inserted. It's a good idea to let the water run through the hose for a short time to flush it out. Experienced RVers usually fill their tanks with "home" water to avoid strange water that may be distasteful to them.

The amount of water in the tank may be checked on the Monitor Panel, or you may fill the tank until water overflows out of the fill.

The water heater by-pass valve is located on the back the water heater and are accessed from inside the trailer. Access to the valve in most units is through the lavatory cabinet door; on others it will be necessary to remove a lavatory cabinet drawer.

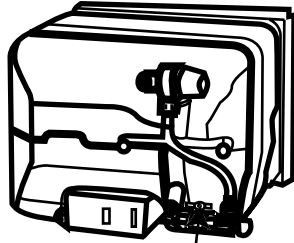

By Pass Valve

Open the hot side of the galley or lavatory faucet and turn on the water pump switch located on the monitor panel. For some time the

open faucet will only sputter. This is because the water heater is being filled and air is being pushed out through the lines. Once the water heater is full a steady stream of water will come from the faucet. Now open a cold faucet. It will sputter for a short time, but will soon expel a steady stream.

All other faucets can now be opened until all air is expelled.

Once the system is filled with water and the faucets closed, the water pump will shut off. When a faucet is opened the pump will come back on automatically. If the faucet is just barely open it is normal for the pump to cycle on and off

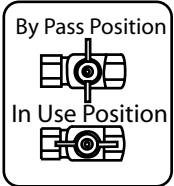

PLUMBING

rapidly.

Water pressure at some campgrounds may be low on city water. The water pump can be turned on to assist the city water hookup pressure. Be sure there is some water in the fresh water tank. The pump will only use the water that is needed out of the tank to bring the pressure up to the usual standard.

Reverse the valve to bypass water heater for winterizing.

F

WATER PUMP AND STRAINER

The water pump and strainer are located under the wardrobe on all models and is accessed by a hinged or removable bottom shelf or removable front panel.

To clean strainer screen, unscrew the clear plastic strainer cap, counter

clockwise, remove and clean the screen. After cleaning, place the screen back in the strainer cup and hand tighten the cap snugly. NOTE: DO NOT OVERTIGHTEN. The gasket ring inside the cap performs sealing and too much pressure will only break the strainer cap or ruin the gasket.

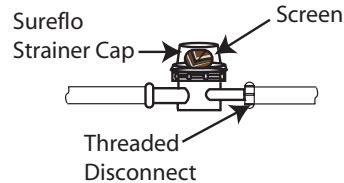

Start the pump and check for leaks. If a priming problem develops check all connection for air leaks. The complete strainer assembly can be removed by loosening the threaded disconnect nuts at the pump and strainer inlets.

SANITIZING

Potable water systems require periodic maintenance to deliver a consistent flow of fresh water. Depending on use and the environment the system is subject to, sanitizing is recommended prior to storing and before using the water system after a period of storage. Systems with new components, or ones that have been subjected to contamination, should also be disinfected as follows:

1. Use one of the following methods to determine the amount of common household bleach needed to sanitize the tank.
 - A) Multiply “gallons of tank capacity” by 0.13; the result is the ounces of bleach needed to sanitize the tank.
 - B) Multiply “Liters of tank capacity” by 1.0; the result is the milliliters of bleach needed to sanitize the tank.
2. Mix into solution the proper amount of bleach within a container of water.
3. Pour the solution (water/bleach) into the tank and fill the tank with potable water.
4. Open all faucets (Hot & Cold) allowing the water to run until the distinct odor of chlorine is detected.

5. The standard solution must have four (4) hours of contact time to disinfect completely. If you double the solution, this concentration allows for contact time of one (1) hour.
6. When the contact time is completed, drain the tank. Refill with potable water and purge the plumbing of all sanitizing solution.

NOTE: The sanitizing procedure outlined above is in conformance with the approved procedures of RVIA ANSI A119.2 and the U.S. Public Health Service.

NOTE: A petcock, visible between the tires, will drain the tank sufficiently for most purposes. Total drainage may be achieved by removing the large Allen Head Plug located on the bottom of the tank. An access plate must be removed from the tank pan to expose the plug.

CITY WATER HOOK-UP

The city water hook-up is found in the underbelly utility compartment on the trailer. A short piece of hose has been provided to extend the city water hookup.

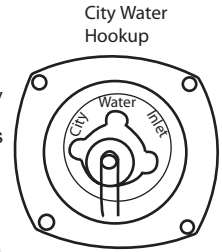

Use a high-pressure hose of at least 1/2" diameter. It should be one that is tasteless, odorless and non-toxic designed for RV use. The city water inlet is a standard garden hose thread. We suggest you carry two lengths of hose. This way you have the ability to reach hookups further away than normal, plus you have a spare hose should one fail or become damaged unexpectedly.

After hooking up the hose and turning on the city water valve provided in the park, slowly open a faucet. There will be a lot of spurts and sputtering until all the air is expelled from the trailer system. If the water heater is empty it will take some time before all the air is expelled and you get a steady flow of water at the faucet. Once a steady flow is achieved at one faucet the others should be opened long enough to expel the air in the lines going to them.

Water pressure at some campgrounds may be low. The water pump can be turned on to assist the city water hookup pressure. Be sure there is some water in the fresh water tank. The pump will only use the water that is needed out of

PLUMBING

the tank to bring the pressure up to the usual standard.

Your plumbing system has a built in pressure regulator to protect your lines and faucets from extremely high pressures on some city water systems.

EXTERIOR WATER SERVICE

Also in the underbelly utility compartment is a hose connection for the exterior water service. This is plumbed into the high-pressure water system of the trailer. This is an ideal place to rinse the sand off your feet after going to the beach, cleaning mud off your boots, and hundreds of other messy jobs that are better done outside. On all units except the 27' Front bed Model an exterior water service shut off valve is located inside the lavatory cabinet and can be accessed by either opening the cabinet doors or removing the cabinet drawers.

The front bed model shut off valve is accessed by removing a door on the wardrobe bottom shelf. The exterior water service is located beyond the heated area of the trailer and can be damaged if the water is not turned off in freezing temperatures. In freezing temperatures close the shut off the valve and open the exterior water service valve to drain the valve and line.

NOTE: On some units only the exterior water service shut off valve will be located inside the lavatory cabinet. On others there may be up to 3 valves located inside the cabinet. One of these are used as the water heater by-pass system as described in the winterizing section. Another may be for the toilet

shut off. The third valve is for the exterior water service. Always check to see if the water supply has been cut to the exterior service before using the rest of the water system in freezing weather.

GALLEY DRINKING WATER SPOUT W/ FILTRATION SYSTEM

Delta 211 Series

1-800-345-DELTA (3358) www-deltafaucet.com

This section is highlights of the manual provided by Delta and included in your owner's packet. Please read and follow all directions in that manual. Quality drinking water is important. The Delta Simply PUR water filtration system will provide filtered water while being easy to maintain.

Filter Replacement Instructions:

Use only PUR brand blue faucet mount filters -PUR filter cartridge #RF-4050 L or RF-9999 (same filters used in PUR faucet mount system). Replacement filters are available at most major retail stores, including: home improvement stores, discount stores, drug stores, hardware stores, and grocery stores. The filter life is up to 100 gallons or approximately 3 months. **NOTE:** You cannot clean a filter cartridge. Do not remove the filter unless you intend to replace it, the system will not operate without one.

Removing a filter resets the system.

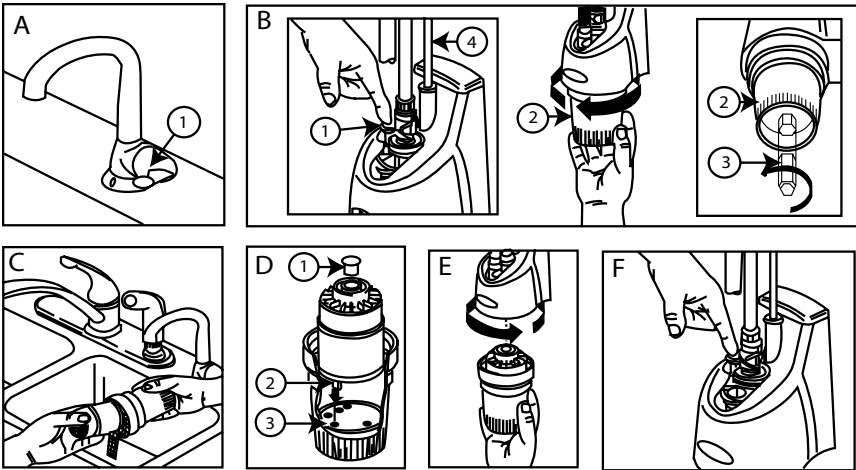

D. Remove freshness plug (1) from a new PUR filter and insert into lower housing. Ensure tab (cam) (2) and receptacle (3) are properly aligned before assembly.

E. Reattach the filter housing to the system by screwing into place. Do not over tighten.

F. Press air release valve, run the water for 5 minutes to flush the filter cartridge.

Battery Replacement Instructions:

2 AA Batteries -Battery life is approximately one year. Batteries are required to operate the light indicator.

A. The system cannot be in operation when changing the filter. Make sure the handle (1) is in the off (down) position. You DO NOT need to shut off the water supply line, however a shut valve has been provided .

B. Press air release valve (1) prior to unscrewing the filter lower housing (2). **Note: You can use the wrench (3) supplied with the unit to help loosen the housing.** If you encounter difficulty unthreading the lower housing, remove unit from wall mount bracket to replace filter cartridge. **NOTE: Be sure to remove the light pipe (4) before removing the filter unit.**

C. Bring the lower housing to the kitchen sink, remove the old filter and any water in the housing.

A. Remove the battery holder (1) from the top of the filter head (2).
 B. Replace the old batteries with 2 new AA batteries.
 C. Reinsert the battery holder into the top of the filter head. Make sure battery holder is pushed in all the way for full engagement. When battery holder is connected, the indicator light will flash red-green for 10 seconds.

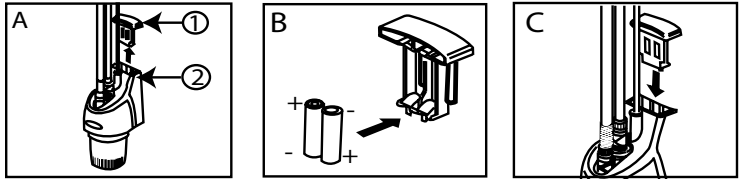

PLUMBING

USE AND CARE INSTRUCTIONS:

The Simply PUR Water Filtration System is designed for easy use and maintenance. Following these instructions will help maintain the life of the system.

Use:

Simply turn the handle in the on (up) position to dispense filtered water. Your kitchen faucet may be used at the same time as the filter system. If the filter system is not operational, your kitchen faucet will continue to operate normally, unless there is a plumbing issue affecting both units.

Light Indicators:

Green Light -Normal operation -Filter in use.

Amber Light - Approaching end of filter life.

Red Light - Replace filter - (Filter system will shut off at the end of filter life.)

Replace with PUR blue faucet mount filter RF-4050 L or RF-9999.

Flashing Amber Light - Batteries low (Replace -2-AA)

Flashing Green Light - Low or high water flow - system operational

When battery holder is connected, the red/green light will flash for 10

seconds.

The light indicator is operational when the system is in the on mode - handle is in the up position. Two AA batteries are required to operate the light indicator.

Cleaning and Care:

Care should be given to the cleaning of this product. Although its finish is extremely durable, it can be damaged by harsh abrasives or polish. To clean, simply wipe gently with a damp cloth and blot dry with a soft towel.

Simply PUR water filtration system is not intended to purify water. Do not use with water that is microbiologically unsafe or of unknown quality without adequate disinfection before or after the system.

Systems that are certified for cyst reduction may be used on disinfected water that may contain filterable cysts.

Do not use with water above 100°F/38°C as this may damage the filter. The Simply PUR water filtration system is intended for use with cold water only as hot water can reduce the quality of filtered water.

GALLEY FAUCET

Delta 473 Series

1-800-345-DELTA (3358)

www.deltafaucet.com

This section highlights of the manual provided by Delta and included in your owner's packet. Please read and follow all directions in that manual.

MAINTENANCE:

If faucet leaks from under handle - Remove handle and tighten adjusting Ring (1).

If leak persists - SHUT OFF CITY WATER SUPPLIES Replace cam and packing (2) and appropriate Ball Assembly.

If faucet leaks from spout outlet

SHUT OFF WATER SUPPLIES - Replace seals and springs (4).

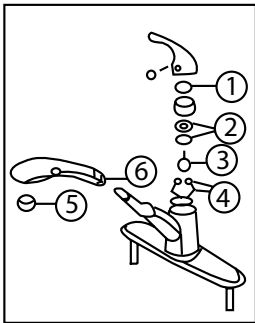
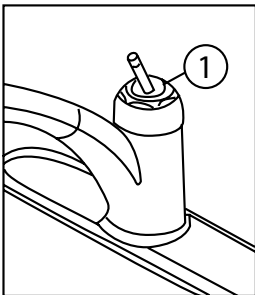

If leak persists

SHUT OFF WATER SUPPLIES. Replace appropriate Ball Assembly.

If faucet exhibits very low flow:

- A. Remove and clean aerator.
- B. Unscrew hose from wand and clean debris from screen (the screen is located just inside the wand)
- C. SHUT OFF WATER SUPPLIES
Clean seals and springs (4) of any debris.

CARE AND CLEANING

Care should be given to the care and cleaning of the galley faucet. Although the finish is extremely durable, it can be damaged by harsh abrasives or polish. To clean, simply wipe gently with a damp cloth and blot dry with a soft towel.

PLUMBING

LAVATORY FAUCET & SHOWER VALVE

Faucet - Delta 2555 Series

Shower Valve - Delta 1404 Series

Maintenance

If faucet leaks from spout outlet - Shut off water supplies - Replace Seats and Springs (1).*

If leak persists-Shut off water supplies-Replace Stem Unit Assembly (2): *Install stems (2) and 1/4 turn stops (3) correctly for proper handle rotation.

NOTICE: SCRUBBING BUBBLES BATHROOM CLEANER and LYSOL BASIN TUB AND TILE CLEANER must not be used on the clear knob handles and levers. Use of these cleaners can result in cracked or severely damaged handles If over spray gets onto the handles immediately wipe them dry with a soft cotton cloth.

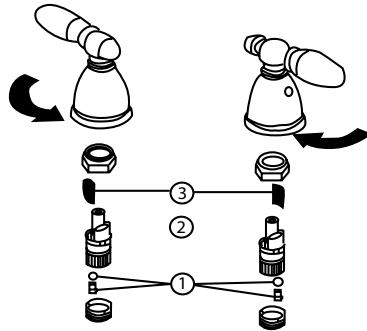

DRAIN VALVES

The fresh water line drain valves have been moved to the exterior of the coach for easier access. If you look between your tires you can see a galvanized “box” that is a few inches lower than the trailer frame. This “box” or pan supports the water tank.

The line drains will be the two brass petcocks extending from the end of the pan. The white plastic petcock you will see is to drain the water tank.

To Empty Fresh Water Tank

Pumping the water out with the self-contained water pump may empty the fresh water tank. Simply turn on the pump switch and open a couple of faucets until the water will no longer come out. On all models there is also a petcock type drain valve located in the wheel well and extended out through the tank support pan.

An additional drain plug is located on the bottom of the tank, accessible under the inspection plate close to the petcock that can be seen on the bottom of the tank support pan.

Note: For winterizing purposes, only the petcock behind the tires needs to be

opened to drain the tank.

Water Heater Draining

All models have a drain plug or petcock on the water heater. Access is from the exterior. The plug or valve is usually located in the lower left corner, viewed as you face the exterior of the water heater.

WATER VALVES

Your Airstream has 4 in-line water shut off valves. One is for the water purifier, two are for shutting off the cold water supply to the toilet and exterior water service, one is for bypassing the water heater when winterizing using the anti-freeze method as explained in the winterizing section of this manual.

The water heater by-pass valve is located on the water heater, accessed inside the lavatory cabinet by opening the cabinet door or removing the cabinet drawer, by opening the roadside exterior compartment door or removing the wardrobe shelf.

A toilet shut off valve is used to shut water off to the toilet in an emergency or service situation. On some units it is located inside the lavatory cabinet, on most units it is located just behind the toilet close to the floor.

A water purifier shut off valve is located under the galley top on the water feed line to the purifier cartridge.

On all units except the front bed models an exterior water service shut off valve is located inside the lavatory cabinet and can be accessed by either opening the cabinet doors or removing the cabinet drawers. The front bed models shut off valve is accessed by removing the access panel on the wardrobe bottom shelf. The exterior water service is located beyond the heated area of the trailer and can be damaged if the water is not turned off in freezing temperatures. In freezing temperatures close the shut off the valve and open the exterior water service valve to drain the valve and line.

There may be one, two, or three valves located inside the lavatory cabinet according to your model length. If there are more than one, one of valves is used as the water heater by-pass system as explained above and is easily recognizable as it will be located on the back of the water heater. Another may be for the toilet shut off. The third valve is for the exterior water service. Always check to see if the water supply has been cut to the exterior service before using the rest of the water system in freezing weather.

PLUMBING

WINTERIZING AND STORAGE

When storing your trailer for short or long periods use the same precautions as you would in your own home in regard to perishables, ventilation and rain protection. In addition, for prolonged storage periods flush out all the drain lines and the holding tanks. Also drain the entire water system including the water heater and the water storage tank. Instructions for draining the water system are explained in the following paragraphs on winterizing.

F THE MAIN CONSIDERATION IN WINTERIZING IS TO GUARD AGAINST FREEZING DAMAGE TO THE HOT AND COLD WATER SYSTEMS, THE WASTE DRAIN SYSTEM (INCLUDING THE TRAPS), AND THE WATER HOLDING TANKS, AND THE WATER HEATER AND THE BATTERY.

To completely winterize your trailer follow this procedure.

1. Level the trailer from side to side and front to rear. Open all faucets
2. Turn the water pump switch to the ON position to expel water from the storage tank
3. Open all drain valves including drain plug or valve on water heater and exterior water service valve. (See drain valves on previous page)
4. While the water is draining from the system, open and flush the toilet-flushing valve. Depress hand spray lever while holding the spray head down inside the bowl. Depress hand spray thumb button on the telephone shower head while

holding down inside the tub and drain all water from the flexible hose. Unscrew the heads on both spray units and store.

5. Turn the pump switch OFF after all water has been removed from the storage tank.
6. Remove exhaust hose from water pump.
7. Disconnect the water pump inlet connection and turn the pump on until all the water is expelled. This water, about 1/2 cup, can be caught in a towel or rag.
8. Lower the front of the trailer as far as the jack will allow until water ceases to drain, then crank the jack up as high as it will go and let any remaining water drain out.
9. After the water has stopped running from the drain lines, apply at least 60 lbs, of air pressure at the city water inlet. An air to city water adapter is available from your dealer's RV accessory store. Be sure the toilet valve and all drain valves and faucets are open and pump outlet hose is disconnected. This can be accomplished at a service station and will force any remaining water from the water heater and remove any water which may be trapped in low areas.
10. Pour a cup of non-toxic RV antifreeze which has been approved and listed by a recognized testing authority such as Underwriter Lab into the lavatory, sink and tub drains to prevent trap freeze-up.
11. Be sure to open the waste holding tank drain valves and drain and flush the tanks thoroughly (THIS IS VERY IMPORTANT AS THE SEWAGE IN THE

TANKS, IF FROZEN, COULD SERIOUSLY DAMAGE THE TANKS.)

12. Remove the cartridge of the water purifier and leave the purifier valve in the open position. (If so equipped.)
13. Remove the batteries from your trailer and store in a cool dry place where there is no danger of freezing. It is very important for optimum life of a battery to check it periodically and to keep it fully charged.
14. Remove any items (food, cosmetics, etc.) from trailer interior that might be damaged by freezing - or might damage the trailer if containers break.



CAUTION Remove all RV anti-freeze spillage from all drain and faucet parts after winterizing. Failure to do so could result in damage to the plumbing fixture's finish.

For additional winterizing protection add a non-toxic antifreeze (approved for drinking water system) to the water lines using the following procedure.

1. Reconnect all lines except the hose to the pump inlet port. Close all drain valves.
2. Turn the water heater by-pass valve to by-pass position as shown on page F-5.
3. Install a spare water purifier cartridge to be used specifically for winterizing. This cartridge will have RV anti-freeze in it when finished and will be removed

and the clean cartridge reinstalled for normal use. Keep the spare cartridge for future cold winterizing procedures.

4. Attach a length of hose to the pump inlet port. This piece of hose should be long enough for the free end to be inserted into and reach the bottom of the antifreeze container.
5. Dilute the antifreeze solution in accordance with the manufacturer's instructions
6. Open all water faucets.
7. Insert hose length into the antifreeze container, turn the pump switch on, and run the water pump until the antifreeze solution fills all water lines. Flush toilet. Work hand shower spray while holding down in tub.
8. Shut off the pump and close all faucets.
9. Disconnect the hose length from pump inlet fitting and reconnect water system inlet line.

PLUMBING

DRAIN AND WASTE SYSTEM

Your trailers drain and waste system includes waste-holding tanks made from molded plastic, free from corrosion problems, with trouble-free dump valves.

The MAIN HOLDING TANK enables you to use the toilet for several days away from disposal facilities. The wastewater from the sink, shower, bath and lavatory drains into the AUXILIARY HOLDING TANK. Each tank has its own dump valve, however, both tanks drain through a common outlet. Therefore, you need to make only one connection when hooking up in a trailer park with sewer facilities. The valves are labeled at the handles.

NOTICE: Never put wet strength paper towels or tissues in your holding tank since they won't dissolve and can "catch" in the mechanism of the dump valve. Colored toilet tissue is slower to dissolve than white. Most RV accessory stores offer tissue designed for RVs that will completely dissolve.

Typical Dump Valve System

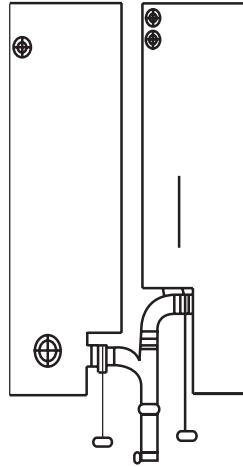

Dump Valve Handles

Check your monitor panel frequently. When the BLACK WATER HOLDING TANK is completely full, sewage cannot be emptied from the toilet bowl. If the GRAY WATER HOLDING TANK is overfilled, drain water will “backup” into the tub and cause an unpleasant cleaning job. Never drain the tanks at any place other than an approved dumping station.

Emptying Tanks

Almost all campgrounds will have dumping facilities. Park directories such as Woodalls and Rand McNally also list dumping stations.

To empty one or both tanks attach the sewer hose by pressing the bayonet fitting onto the dump valve outlet and rotate clockwise until it feels solid and secure. Attach the outlet end of the hose to the sewage outlet; making sure that the hose is placed so it will drain completely.

Pull the dump valve handle as far as it will go and wait until the tank is drained. When dumping, the main holding tank should be dumped first; then the auxiliary holding tank. This will help to rinse out the sewer line with auxiliary holding tank water.

The main holding tank must be flushed out until all paper and waste material is removed. Close the dump valve and refill the tank with clean water and repeat

until clean. Replace the cap prior to traveling.

The main and auxiliary tanks are heated by ducting from the furnace. Be sure to follow winterizing instructions for the tanks immediately in freezing temperatures if heat is not being supplied to the trailer.

Black Tank Flush

Inside the underbelly utility compartment is a water hose connector for the “black tank flush”. To use, hook up a hose and turn it on full force. Within the tank a head with multiple holes will spray the interior surface of the tank. A vacuum breaker and one-way valve is located inside the trailer above the exterior connection to prevent the black water from escaping to the hose connection. In most models this will place them under the lavatory.

The gate valve should be closed for the first couple of minutes, and then opened to let the water out in a rush. Close the gate valve and repeat as needed.

When Parked and Connected to Sewer Outlet

When you are in a park and connected to a sewer outlet keep the main holding tank dump valve closed, and empty the tank every few days or whenever it becomes almost full. ONLY BY SENDING A LARGE VOLUME OF LIQUID

THROUGH THE MAIN HOLDING TANK AT A TIME WILL TOILET PAPER AND OTHER SOLIDS COMPLETELY WASH AWAY.

This practice will avoid the accumulation of solids in the main holding tank, which could lead to an unpleasant cleaning job. Should solids accumulate, close the dump valve; fill the tank about half full with water, then tow the trailer for a few miles. The turbulence and surging of the water will usually dissolve the solids into suspension so the tank can be drained. Keep the auxiliary tank valve open when connected to a sewer outlet.

Draining the tanks as described will protect them from freezing during storage or when traveling in winter conditions. When traveling in sub-freezing temperatures and using the drain system use a winterizing solution designed for RV use. Follow the directions on the container.

All products should be marked approved for ABS drainage systems.

Drain Systems Cleaning

The only cleaning agents that can be used without causing harm to the system are household ammonia and tri-sodium phosphate in small quantities. Do not use any product that contains any portion of petroleum distillates. This attacks the rubber seats of your toilet and dump valve. Also, do not use any dish

PLUMBING

detergent or abrasive cleaners.

There are many deodorizers on the market in tablet, liquid and powder form. These not only combat odor, but also stimulate the bacteria that works to dissolve the solids in your tank.

TOILET

The RV toilet in your Airstream is a design that has been used for many years. There are two pedals. The large pedal opens and closes the slide mechanism, and the smaller pedal opens and closes a water valve.

In normal use, when you are hooked up to city water, both pedals are depressed together. This dumps the sewage and fresh water and flushes down the side of the bowl. Water will continue to run into the bowl for a short time after the pedals are released.

When you wish to conserve water hold the hand-spray head over the bowl and hold down the thumb-operated lever. Now when you depress the pedal all the water is routed through the hand-spray.

NOTICE: When you dump the bowl of the toilet make sure all paper and solids have cleared the slide mechanism before you allow it to close. Failure to do

so can cause the groove for the slide to become jammed and the slide will no longer close completely.

If the problem should occur a small nail or bent clothes hanger can be used to “pick” the material out of the groove.

Please see the toilet owner’s/user manual for warranty and user tips, and maintenance.

12-VOLT SYSTEM

The major portion of electrical power in your Airstream is 12-volt. The 12-volt current powers the fans, furnaces, water pump, and water heater ignition. The exception would be the air conditioner and microwave oven. All 12-volt current comes through the battery system in the front of your trailer. The battery or batteries are accessible from the exterior on the front of your trailer. Power from the battery first goes to a manual master or “kill” switch inside the trailer.

The manual kill switch, 12-volt distribution panel, and converter are located under the front sofa on most models. Open the drawer under the sofa seat and look on the roadside of the storage area. The kill switch and distribution panel are mounted on a hinged panel that lowers to access the converter. On trailers without a front sofa the 12-volt distribution panel and the kill switch is located under the computer table. The converter is located on the roadside front wall and can be accessed by removing cabinet drawers. The master switch should be left in the ON position except when storing, or a mechanic may use the switch when servicing the trailer.

Power from the main switch continues on to the 12-volt distribution panel, and then to the rest of the trailer. The 12-volt distribution panel has reset circuit breakers and does not require routine servicing. If a short should occur the breaker in that circuit will “click” off and you may notice some lights or

appliances losing power. If this should happen, immediately turn the lights and appliances off that are on the shorting circuit and reset the breaker by depressing the small button in the end. If the breaker continues to “click” turn the main power off until a qualified technician can service your trailer.

The charge in the 12-volt batteries is replenished when towing or when plugged into 110-volt city power.

The most common failure in the exterior electrical system is an open circuit. An open circuit is an interruption in the current flow, which may be in either the wire to the component or in the ground return.

Check the following areas for open circuits:

1. Loose or corroded connections at lighting device.
2. Loose or corroded connections at 7 way connector.
3. Improper grounding at the lighting device.

A continuity light or an ohmmeter will help you isolate the point of the “open” on the circuit. Another cause of failure is a short circuit usually resulting in a blown fuse or cycling circuit breaker at the power source. The wire coming in contact with a sharp edge usually causes a short. The sharp edge wears the wire’s insulation away until the “hot” wire short to ground.

ELECTRICAL

Only qualified service centers and technicians should troubleshoot and repair electrical systems.

Electronic Battery Disconnect Switch (Front Bed Model Only)

The disconnect switch is used to separate the battery from the 12-volt distribution panel and converter charging system. It is an electronic version of the manual “Kill” switch.

When the disconnect switch is turned to **“use”** (on) and the trailer is plugged into a 110-volt shoreline, the 12-volt distribution panel will receive power from the converter as the battery is charged through the converter charging system. If the trailer is not plugged into a 110-volt shoreline, the battery will supply 12-volts to the trailer and no charging to the battery is available since the converter is not receiving 110-volt power.

When the disconnect switch is turned to **“store”** (off) and the trailer is plugged into a 110-volt shoreline, the 12-volt distribution panel will still receive power from the converter, but the battery is disconnected from the system. The battery will not be drained with the switch in the **“store”** position. The converter will not charge the battery with the switch in the **“store”** position either.

The charge in the 12-volt batteries is replenished when towing from the tow

vehicle alternator through the 7-way cord. This charge will go to the battery no matter which position the Battery Disconnect Switch is in.

BATTERY

The battery (batteries) are located inside doors on the exterior front plate of the trailer or inside battery boxes in the trailer A-frame. A normal battery can discharge by itself in 30 to 40 days when not in use, therefore, IT IS NECESSARY TO PERIODICALLY CHECK THE BATTERY AND CHARGE IT AS IS NECESSARY.

When being towed, the 12-volt battery in your trailer is receiving a constant charge from the car’s generator or alternator through the seven-way connector. Your tow vehicle’s voltage regulator controls the charge rate. It is important to keep the seven-way connector clean. One method is to use “Spra-Kleen”.

Whenever possible use the automatic built in converter system for charging. The charging circuit automatically controls the current, reducing it as the battery increases in charge.

At service stations make certain they give your battery a slow charge because quick charges will drastically shorten the life of the battery, as will allowing repeated complete discharges.

Neglect is expensive. Care costs little. Check your batteries regularly. Follow these guidelines to extend the life of your low-maintenance battery:

1. Maintain Water Level. ADD DISTILLED WATER TO CELLS AS NECESSARY.

Check the electrolyte level at least once a month. When you are traveling steadily and for an extended period of time, or if you are in climates above 90 degrees F, check the electrolyte level about every two weeks. Your battery has removable vent caps, you should regularly check the water level and add distilled water when it is low. Do not add water to a battery in freezing temperatures unless the vehicle will be put to use at once, otherwise the added water may freeze. Do not fill battery above the split ring in filler opening. **DO NOT MEASURE SPECIFIC GRAVITY IMMEDIATELY** after adding water. The water must mix with the electrolyte by charging or by driving a few miles.

2. Keep Terminals Clean. Visually inspect the terminals and cables at least once a year, especially in hot temperatures, for signs of corrosion. If dirty or corroded, the battery terminals and the inside portion of the cable connector should be scraped or brushed until both of these surfaces are shiny bright. The cable connectors should then be reconnected to the battery and tightened. This will ensure a good connection and proper starting. **RECONNECT THE BATTERY CABLES TO THE CORRECT BATTERY POSTS.** The black cable should be connected to the negative (-) post and the red cable to the (+) post. The polarity of your tow vehicle must also be negative (-) ground since it must

always match the trailer. Most tow vehicles are negative grounded, but always check your vehicle owner's manual to be sure. The complete assembly, battery post and cable connector should be coated with heavy body mineral grease, petroleum grease or petroleum jell.

3) Keep Case Clean. Keep the top of the battery clean of heavy dirt and oil with a cloth dampened by ammonia or a 50/50 solution of baking soda and water. Then rinse with clear water and allow to thoroughly dry. Care must be used to make sure soda is not allowed to enter battery cells.

4) Keep Battery Charged. If your vehicle is not used regularly, it may be necessary to charge your battery before use. Lack of use is hard on a battery. Any unused battery, regardless of its chemistry, will self-discharge over time and, if allowed to remain discharged, will undergo severe positive grid corrosion and battery failure. The rate of discharge depends on the type of battery and the storage temperature. So, it's important to keep your battery charged by connecting you shoreline monthly. If you prefer that your mechanic take care of your battery, be sure to ask him (1) to maintain the water level and (2) to keep the connections and case clean of corrosion and dirt.

As batteries age, do their maintenance requirements change? Yes. Typically the specific gravity gets higher and gassing increases due to some battery deterioration and/or loss of reserve capacity. An older battery normally requires

ELECTRICAL

more charging.

Voltage	Freezing point
1.265	-71.3 F
1.250	-62 F
1.200	-16 F
1.100	+5 F
1.150	+19 F



WARNING: When checking or filling the electrolyte level in the batteries, do not allow battery electrolyte to contact skin, eyes, fabric, or painted surfaces. The electrolyte is a sulfuric acid solution, which could cause serious personal injury or damage to the trailer. Wear complete splash proof goggles and clothing protection when working with batteries. Avoid touching your eyes while working near batteries. The gases generated within a storage battery cell may be ignited by an open flame or spark in the vicinity of the battery. Do not use a match or flame to provide light for checking the level of the water.

We suggest checking the battery at least every two weeks in freezing weather. The temperature at which a battery will freeze depends on the condition of its charge. As an example: a fully charged battery with a specific gravity of 1.265 will not freeze until the electrolyte temperature drops to - 71.3 degrees F, while

a discharged battery will freeze at +19 degrees F. The following table shows the freezing points of batteries at various specific gravity readings, temperature corrected 80 degrees F.

During the winter or when your trailer is stored for a long period the battery should be removed from the trailer. To store your battery properly:

1. Slide the battery out onto the opened compartment door for service and removal or take it out of the battery box.
2. Clean the battery case and terminals with baking soda and water.
3. Check the water level and add water if needed.
4. Test your battery with a hydrometer and/or a voltmeter to ensure the battery is fully charged.
5. If needed, charge your battery. Batteries stored in a discharged state are susceptible to freezing, sulfation and an increased rate of discharge. A fully charged battery will not freeze unless the temperature reaches approximately 80°F below zero. But if discharged, it can freeze at 32°F.
6. Store your battery in a dry, cool, well-ventilated area—the cooler the better without going below 32°F—and out of the reach of children and pets
7. Check the water level and state of charge every 45-60 days. If needed, add distilled water and charge.

For battery service or replacement, go to any service station or dealer who sells

and services the make battery installed in your trailer.

CONVERTER

The converter system is the interior low voltage electrical system that enables you to use the interior lights, fans, pumps and 12-volt appliances whether operating on self-contained battery power or 120-volt city power. The converter provides power to charge the trailer battery and to operate the 12-volt interior electrical system.

On rear bed models it is located under the sofa and accessed by opening the sofa drawer.

Front bed models have the converter installed on the front lower portion of the pantry. Open the brown decorative door for access to 12-volt fuses and 110 volt breakers.

The converter provides power to the 12-volt distribution panel by transforming 120-volt alternating current (AC) from the shoreline into 12-volt direct current (DC). While providing power to the distribution panel, the converter also charges the 12-volt battery system.

The converter is energized only when the trailer is hooked up to 120-volt city

power through the shoreline.

Converter Testing

- A. Confirm 120 volt power is going into converter.
- B. Disconnect the 12+ wire from the master switch.
- C. Using a voltmeter check voltage output between heavy positive and negative wires coming out of converter.
- D. The voltage must be within 13.8 and 14.0 volts. (The meter of the tester should be calibrated periodically.)
- E. If converter is not within these voltages, replace it.

12V POWER CIRCUITS

The current in the converter system is 12 volts direct current (12VDC) negative grounded.

Power sources that supply 12VDC current to the system are as follows:

- A. Main charge line from tow vehicle
- B. Trailer Battery
- C. Converter

The power sources above are all electrically connected to the 12-volt

ELECTRICAL

distribution breaker panel that distributes current to interior branch circuits. The circuits provide power to operate all 12-volt DC lights, pumps, motors and appliances.

12-VOLT EXTERIOR

7-Way Harness and Plug

The diagram on this page matches the tow vehicle plug on an Airstream trailer. The 7-way wire is spliced to the main harness on the interior front wall of the trailer. The connection is accessed behind the furniture in the front of the trailer. One of these wires is not spliced onto a wire of the same color. It is the back up wire that is yellow in the cable and black in the harness.

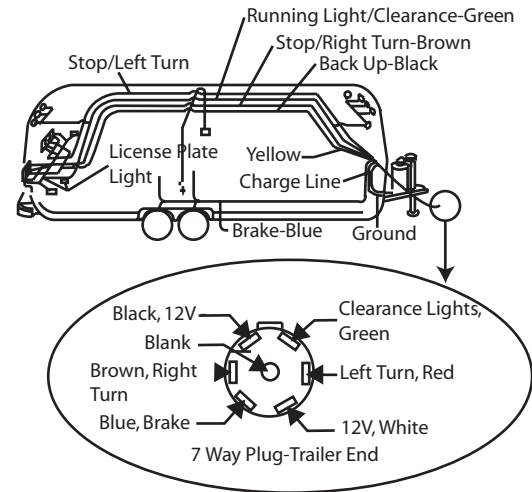

Wire Routing, 7-Way Plug , Battery Charge Line, Distribution Panel

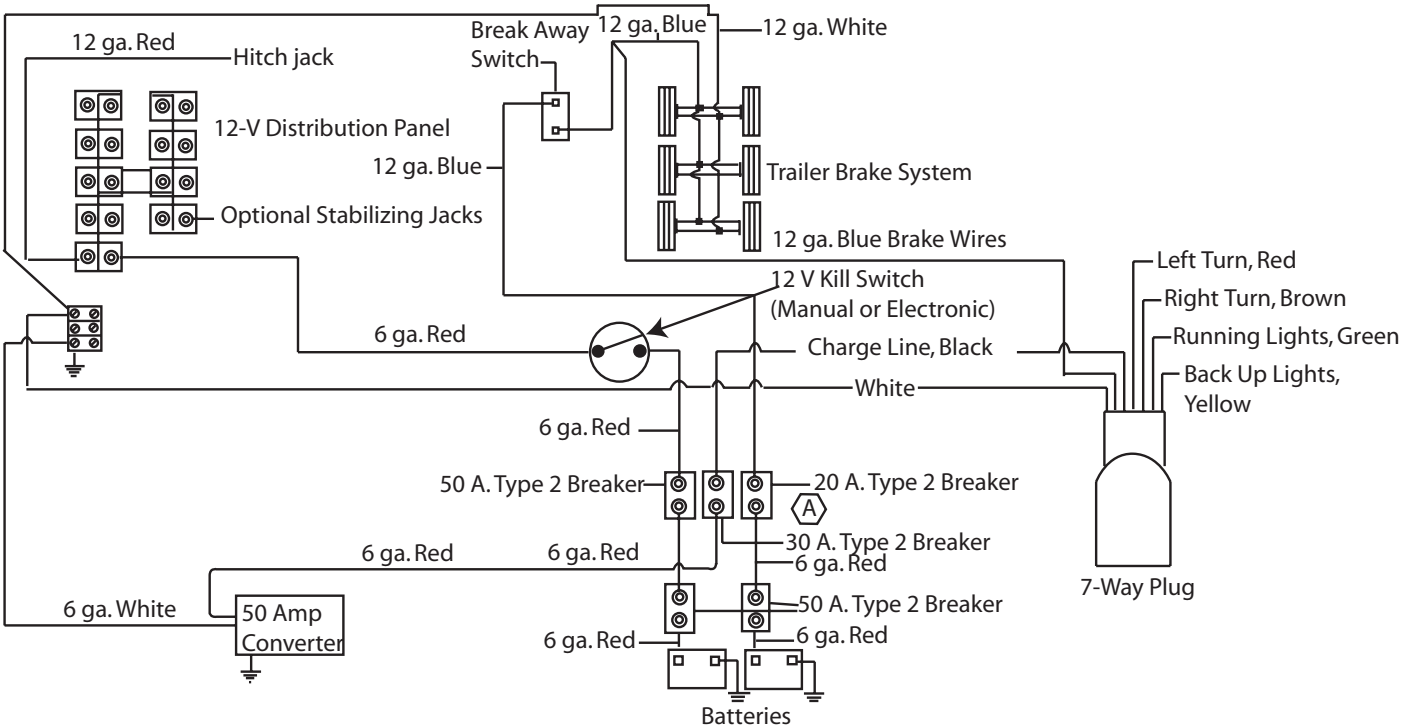

ELECTRICAL

12-VOLT INTERIOR

Distribution Panel, USA

The kill switch, 12-volt distribution panel, and converter are located under the front sofa on most rear bed models. Open the drawer under the sofa seat and look on the roadside of the storage area. The kill switch and distribution panel are mounted on a hinged panel that lowers to access the converter. On trailers without a front sofa the 12-volt distribution panel and the kill switch is located under the computer table. The converter is located on the roadside front wall and can be accessed by removing cabinet drawers.

G

On front bed models the electronic kill switch is located on the galley by the main door. The converter, is located on the front of the pantry cabinet. The 12-volt distribution panel and 110-volt breakers are accessed by opening the converter's brown decorative door.

Manual reset breakers protect all the 12-volt circuits. If a breaker trips, an audible click may be heard, and the 12-volt power supply to certain systems will be cut off. The protruding reset button can help identify the questionable breaker.

Reset the breaker by depressing the small rectangular button on the end of the breaker. If the breaker trips a second time, try shutting off an item on that circuit. If the breaker continues to trip the system affected should be checked by a qualified service center.

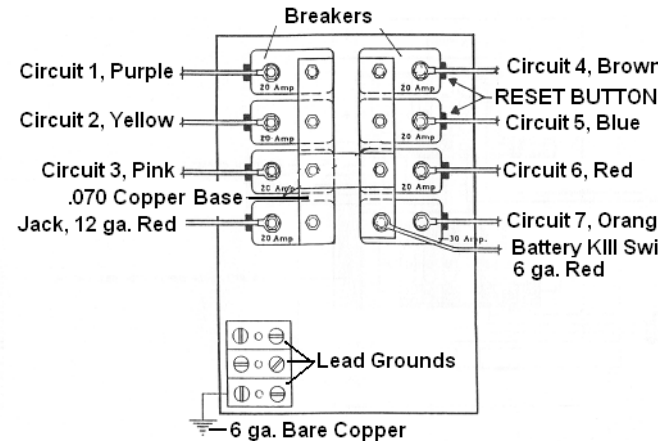

Canadian panels have automotive type fuses.

Canadian 12-Volt Distribution

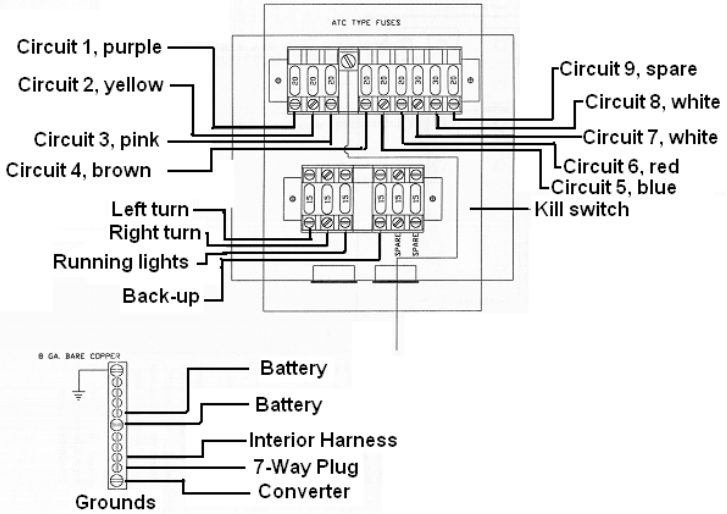

ELECTRICAL

110-VOLT SYSTEM

City Power

The Airstream converter system enables you to use the lights and appliances whether operating on self-contained battery power or hooked up to 110-volt city power. The 12-volt light bulbs give off the same light as regular household bulbs, so that when operating on self-contained battery power, everything works normally except the 110-volt convenience outlets and 110-volt appliances.

G When your trailer is hooked up to 110 volt AC the converter system automatically charges the trailer batteries and, if the 7-way connector is hooked up, your tow vehicle battery as well. The speed and degree of charge depends on how much power is used for lights and appliances, as only the surplus goes to charging the battery. If you are making an extended stay, then you should, if it is available, keep your trailer hooked up to a 110 volt current.

The converter system is designed to maintain constant output voltages regardless of the variances that occur in city power systems. The transformer design eliminates the need for complex electronic sensing systems to charge the battery, minimizing the possibility of failures and greatly increasing its overall reliability.

NOTICE: If your Airstream has a gas/electric water heater that has no water in it, make sure the 110-volt water heater switch is turned off before you plug your trailer in to city power. When operating with city power make very certain that the service is 110 volt and not 220 volt.

When the three-pronged plug on the shoreline cord can be used for shoreline power there will be no problems with proper polarity or grounding. In some older parks and other locations where three pronged outlets are not available, certain precautions to insure proper grounding and polarity must be taken.

These precautions are listed below:

- Attach the three-pronged plug to a two-pronged adapter. The third conductor line of this adapter has a short wire lead, which must be grounded.
- For proper grounding connect the short ground lead to a grounded outlet box or to a cold water pipe. When no water pipe is available drive a metal rod two feet into the ground and attach the ground lug to it, thus providing the unit with proper grounding. To operate self-contained, simply disconnect the power supply cable.

On rear bed models circuit breakers for the 110-volt system are located in the roadside rear corner of the trailer in the overhead cabinet.

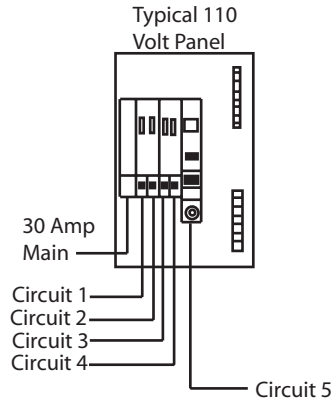

The breaker panel in your trailer has a label installed to designate circuit specific to the trailer.

30 amps Service

Circuit 1, 20 amps A/C
Circuit 2, 20 amps, Bedroom, converter
Circuit 3, 15 amps, Water Heater
Circuit 4, 20 amps, Microwave
Circuit 5, GFI, Galley, Lavatory, Exterior Outlet, Dinette, Lounge

50 Amp Service (Different Panel)

Circuit 1, 15 amps Water Heater
Circuit 2, 20 amps, Front A/C, Bedroom,
Circuit 3, 20 amps, Converter
Circuit 4, 20 amps, Microwave
Circuit 5, GFI, Galley, Lavatory, Exterior Outlet, Dinette, Lounge
Circuit 6, 20 Amps, Rear A/C
Circuit 7, 20 Amps, Bedroom TV

On front bed models 110-volt breakers are located inside the converter mounted on the pantry cabinet. they are accessed by opening the brown converter door.

While you are connected to the 110-volt receptacle the wiring is protected by circuit breakers in the breaker panel. **In the event of a failure of a 110-volt circuit check your circuit breakers first.** If a breaker continues to trip after you have reset it several times, your circuit may be overloaded with appliances or there may be a short in the circuit. The 110-volt switch on the water heater, with its 12 amp draw, would be one of the easiest places to reduce the load on 110-volt circuits. If lessening the load does not solve the problem consult an Airstream Service Center.

The 110-volt electrical system provides power to operate the air conditioner, converter and 110-volt receptacles for portable appliances. The power is carried through the 110-volt city power flexible cord to the 110-volt distribution panel, and then is distributed to each appliance or receptacle.

An exterior outlet for 110 volts service is located on the curbside exterior wall.

All wire, components, and wiring methods conform to federal and state requirements.

ELECTRICAL

Airstream installs a ground fault circuit interrupter to protect several outlets on the trailer.

When properly installed, the GFCI circuit breaker provides reliable overload and short circuit protection PLUS protection from Ground Faults that might result from contact with a “HOT” load wire and ground.

IMPORTANT NOTE: The GFCI circuit breaker will NOT reduce shock hazard if contact is made between a “HOT” load wire and a neutral wire or 2 “HOT” load wires.

G

Each GFCI circuit breaker is calibrated to trip with a ground current of 5 milliamperes or more. Since most persons can feel as little as 2 milliamperes, a distinct shock may be felt if the need for protection exists. However, the shock should be of such short duration that the effects would be reduced to less than the normally dangerous level. However, persons with acute heart problems or other conditions that can make a person particularly susceptible to electric shock may still be seriously injured.

While the GFCI circuit breaker affords a high degree of protection, there is no substitute for the knowledge that electricity can be dangerous when carelessly handled or used without reasonable caution.

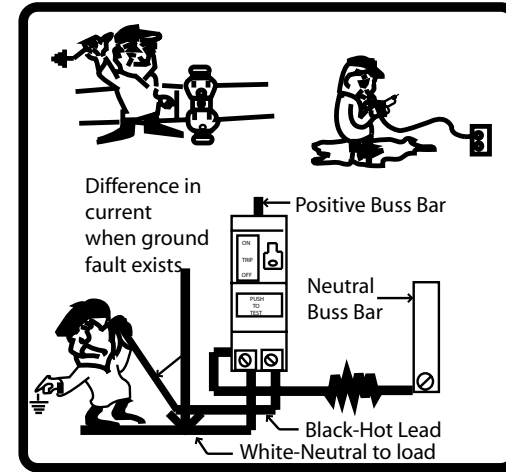

WARNING: The GFCI circuit breaker provides protection only to the circuit to which it is connected. It does NOT provide protection to any other circuit.

OCCUPANT:

GFCI s are proven lifesavers, however, consumers need to take a few minutes each month to do this simple test. By taking action, you can help protect your family from the risk of electric shock. Perform this test on the GFI Breaker each month and record the date on the chart.

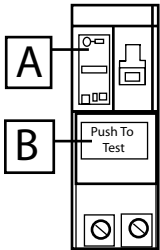

1. With handle B in “ON” position, press PUSH TO TEST button A.
2. Handle B should move to TRIP position, indicating that GFCI breaker has opened the circuit.
3. To restore power move handle B to “OFF” and the to “ON

	JAN	FEB	MAR	APR	MAY	JUN	JUL	AUG	SEP	OCT	NOV	DEC
2011												
2012												
2013												
2014												
2015												
2016												

Important: If handle B does not move to TRIP position when test button is pressed, the GFCI breaker protection is not complete. If this happens, replace GFCI breaker.

ELECTRICAL

Remote Generator Hook Up

The remote generator hook up will be located on the front plate of the trailer just behind the LPG bottles. A generator can be plugged into the 110-volt system using this plug and a power cord supplied with the unit.

The system includes a automatic transfer switch to prevent a power overload if a generator is started while the trailer's 110-volt shoreline is plugged into a 30 amp service. The transfer switch will automatically switch power from a shoreline source to a generator when it senses power entering the switch from the generator. When power is cut from the generator, the switch returns to the shoreline as its power source.

A minimum of 5.5 KW with a 30-amp breaker will be required to sufficiently power the 30 amp service.

INVERTOR (option)

The inverter converts 12 volt electricity from your batteries into 110 volt power. The switch for the inverter is located under the monitor panel.

The Inverter powers the TV and one additional labeled 110 volt receptacle.

On units 25' and over in length it also supplies power to the bedroom TV and/ or BlueRay Disc player when ordered as an option.

On units under 25' in length it also supplies power to the BlueRay Disc player when ordered as an option.

Overloading the inverter will cause a automatic shut off to activate. Removing the load will allow the inverter to reset.

DOOR BELL

The door bell module is located under the galley flip up shelf on all models except the 34 ', which is located under the dinette table. The module uses 4 "C" batteries. The batteries should be removed during long periods of storage.

ANTENNA/CABLE/SATELLITE ANTENNA WIRING

If you compare the two drawings you'll see wiring for a satellite dish antenna is relatively simple.

Units have a faceplate with two coax cable hook-ups. The faceplate has a small coax cable jumper running between the hook-ups to complete the cable TV circuit when in use. To install a satellite system use the following procedure:

Satellite Jumper Wire

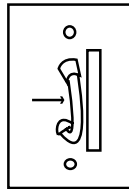

1. Remove the jumper wire from the coax faceplate.
2. Hook a portable dish into the Cable TV receptacle in the roadside rear underbelly compartment. This feeds the dish signal to the input side of the faceplate.
3. Install the satellite receiver input and output into the dual coax faceplate.

To return to a cable TV system, remove the satellite receiver from the faceplate and reinstall the jumper cable.

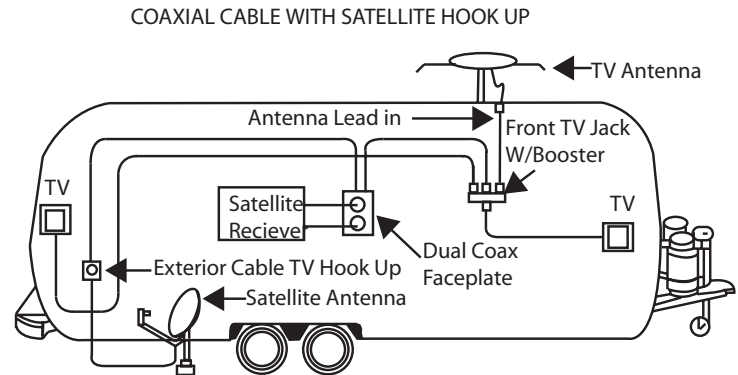
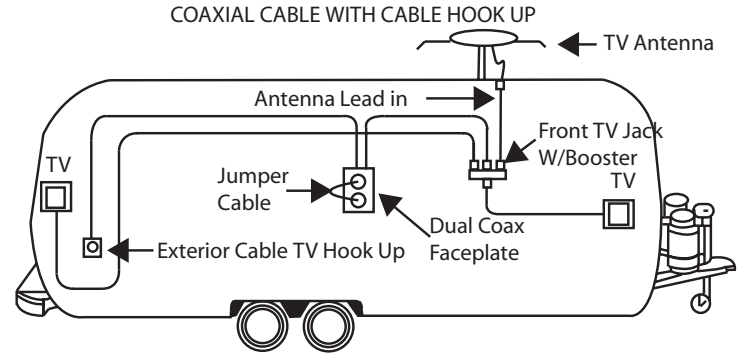

ELECTRICAL

SOLAR PANEL (option)

Airstream Travel Trailers use a Carmanah Technologies Corp. Solar Panel/Charger Controller/Display System. A manual on the use of the system is included with the Airstream Owner's Blue Delivery Case.

Carmanah Technologies Corp.
Building 4, 203 Harbour Road
Victoria, BC V9A 3S2
Tel: 800-667-6527
Fax: 866-607-6527
www.solarforrv.com

The following drawing is the way
Airstream wires the system on factory
installed units.

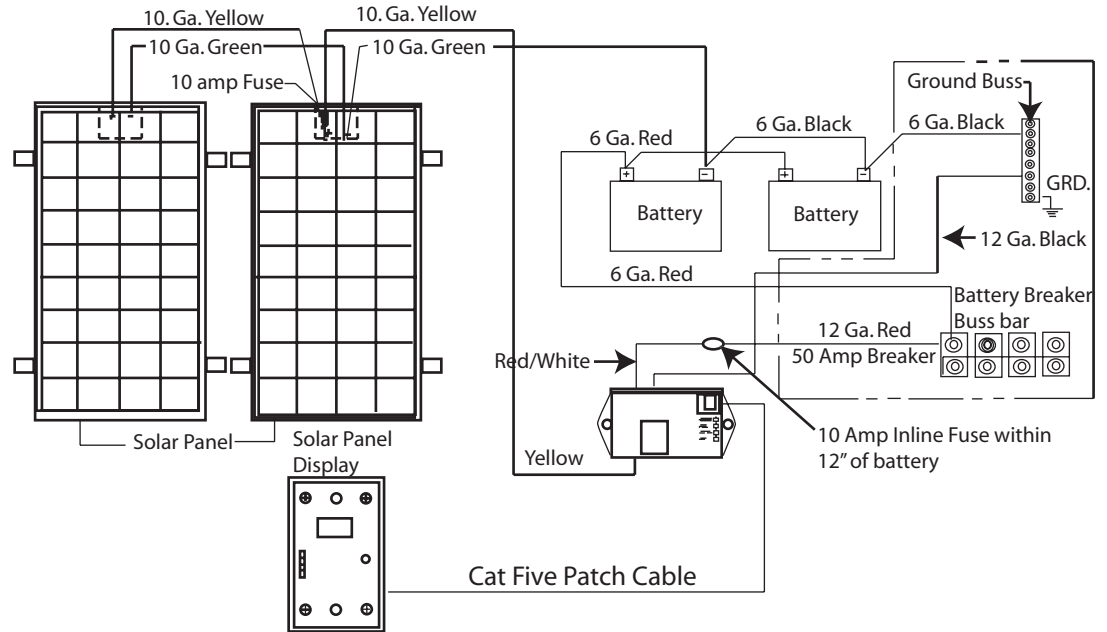

Solar Panel Pre-wire

Airstream pre-wires the trailers with yellow and green wires and a CAT 5 cable as explained in this section for the addition of an after market panel. All wires used for the prewire are identified with labels at all locations.

1. YELLOW (like the sun) positive and GREEN (like the earth) negative leads are coiled near the battery breaker buss bar area and again at a location in the roof. The battery buss bar is located behind the sofa on front lounge models, and next to the battery compartment. Battery cables will run to this bar. The roof location is marked with a label on the roof and a hole must be drilled to access them and pull them for an after market installation. The wires from the solar panel are connected to the positive and negative wires (yellow and green) of the pre-wire system.

2. A Cat 5 patch cord for the solar panel display runs from the battery buss bar to an area just below the CatCon monitor display. The Cat 5 wire is plugged into the display panel.

NOTICE: The Yellow wire is fused with a 10-amp in-line fuse at the 12-volt positive.

TV ANTENNA

Manufacturer: Winegard Company, 3000 Kirkwood Street, Burlington, Iowa 52601

Phone: 800-843-4741

MANUAL ANTENNA

Raising Antenna to Operating Position

Turn elevating crank in “UP” direction until some resistance to turning is noted. Antenna is now in operating position.

Raising Antenna



Rotating Antenna

Make sure antenna is in “UP” position. Pull down on directional handle with both hands until it disengages ceiling plate and rotate for best picture and sound on television set.

Rotating Antenna



Lowering Antenna to Travel Position

Rotate antenna until pointer on directional handle aligns with pointer on ceiling plate. Turn elevating crank in the “Down” direction until resistance is

Lowering Antenna



ELECTRICAL

noted. Antenna is now locked in travel position.



WARNING: Antenna must be in “down” position while traveling to prevent property damage.

Lubrication

To lubricate the elevating gear apply a liberal amount of silicone spray lubricant to the elevating gear with the lift in the down position, then run the lift up and down a few times to distribute lubricant over gears.

Lubricating Rotating Gear Housing

In the event that rotating the antenna becomes difficult, lubricating the bearing surface between the rotating gear housing and the base plate can restore normal operation. Any spray type silicone lubricant may be used.

Elevate antenna and remove setscrew from rotating gear housing as shown. Spray lubricant into hole and around edges of gear housing. Rotate gear housing until lubricant coats bearing surfaces and antenna rotates freely.

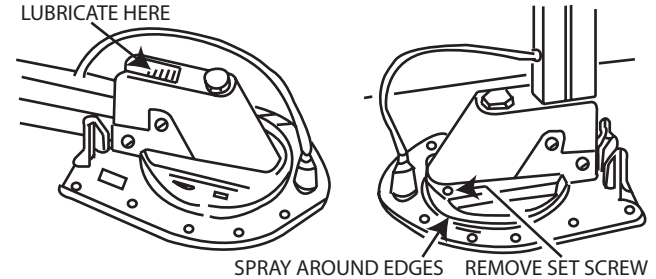

TV Booster/12 Volt Outlet

The TV booster amplifies the signal from the TV antenna. Pushing the small button activates and deactivates the booster. A green light comes on when the booster is activated. For viewing while hooked up to an exterior cable TV source, turn the booster off.

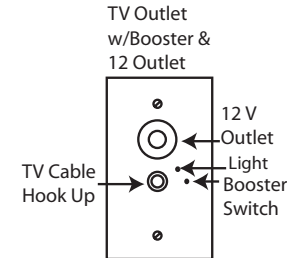

NOTE: The TV Booster must be on to receive antenna signals and off for cable TV operation.

Please review the antenna and booster manuals include in your owner’s packet before operating the system.

Rear TV Pre-Wire

Trailers have an HDMI cable pre-wired from the BlueRay player to the rear TV mounting location. The cable is coiled by the player and behind a wall plate located by the second TV mounting area. When adding an aftermarket TV, disconnect the HDMI cable to the standard TV from the player, add an HDMI splitter to the BlueRay player output, plug the standard TV HDMI back into the splitter, plug the coiled 2nd TV DMI into the splitter, pull the HDMI cable from behind the wall plate and plug into the aftermarket TV.

LAVATORY EXHAUST FAN W/POWER LIFT LID

The lavatory may have an exhaust fan that is operated by two wall switches. One switch will open the power lift lid and the other will operate the fan.

SHOWER FAN

The round bath exhaust is operated by pushing up on the handle to raise the fan lid. A push button switch will activate the fan.

HIGH VOLUME ROOF VENT

Manufacturer:

FAN-TASTIC VENT CORP. 2083 S. Almont Ave. Imlay City, MI 48444 1-313-742-0330 1-800-521-0298

Airstream installs two types of fans. One has the switch mounted on the fan, the other has the switch mounted on the wall. The optional High-volume roof vent system is designed to quickly exhaust stale, hot air and draw in fresh air. It's great to use when the outside temperature really doesn't call for air conditioning, but heat has built up in your coach.

OPERATING INSTRUCTIONS

(switch mounted on fan):

Open a window or door for airflow, source of airflow is determined by the window(s) or door(s) opened. For best results, close all roof vents and open 1 (one) window the greatest distance from your Fan-Tastic Vent ceiling fan,

- 1) Activate appliance by rotating SPEED CONTROL knob to desired performance lever (3-Low, 2-Medium, 1-High, O-Off)

- 2) Open dome approx. 3" or more with the DOME rocker switch (ceiling fan

ELECTRICAL

has a built in safety switch that will not allow motor to operate unless dome is partially open).

3) Select desired temperature or comfort level by rotating the THERMOSTAT knob. Fan motor will now start & stop automatically as interior temperature of coach exceeds or drops below selected level.

NOTE: Fan motor will not start if temperature selected is warmer than interior temperature of coach.

G 4) Turn the POWER rocker switch on.

NOTICE: Never place Lindeen™ or a like cover over ceiling fan. Greatly restricted airflow & increased sound levels will occur.

A built-in manual knob can be used to close the dome in an emergency, to adjust the dome to a desired partially open level or to override the rain sensor.

OPERATING INSTRUCTIONS (Wall Mounted switch)

Operating instructions are basically as above except Dome will lift automatically when appliance is turned on using the wall switch and the Thermostat is also located on the wall by the Power switch.

CLEANING INSTRUCTIONS:

- 1) Turn fan motor Off.
- 2) Remove 8 painted flat head Phillips screws around perimeter of screen insert only.
- 3) Clean screen with soap & water solution and reinstall.

SATELLITE RADIO (OPTION)

The travel trailer may be equipped with a satellite radio. This system is integrated with the entertainment system on the trailer. The system owner's manual is included with the packet from your dealer.

MONITOR PANEL

Micropulse Systems Monitor

CATCON PRODUCTS INC.

817-921-2188

techsupport@catconproducts.com



The MicroPulse System makes use of a single solid-state sensor per tank. The MicroPulse sensor measures the static (head) pressure at the bottom of the tank and transmits this information to the MicroPulse System Monitor. Knowing this pressure value, after a one-time calibration has been performed, the MicroPulse System will calculate and accurately display the tank level in 1/8 increment.

A single sensor is installed on the sidewall of each tank, near the bottom, via a 3/4" female NPT spin-in thread. The sensor is solid state, there are no moving parts to wear or maintain. Because the principle of operation does not involve any electrical current flow through the tanks contents (conducted or induced), the nature of the fluid in the tank is unimportant.

The monitor system has been calibrated at the factory and should never need another calibration. If you feel the system is not operating correctly, please contact CATCON Products or a local Airstream dealer. The following instructions are provided for qualified service technicians.

MICROPULSE SYSTEMS MONITOR OPERATION INSTRUCTIONS

This example shows the monitor reporting the following:

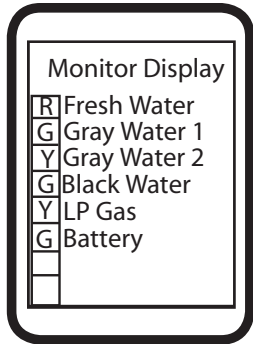

ELECTRICAL

Fresh Water = 1/8 to Empty

Gray Water 1 = Empty to 5/8

Gray Water 2 = 3/4

Black Water = Empty to 5/8

LP Gas = 1/4

Battery = Empty to 5/8

On all diagrams the Letters R=Red, Y=Yellow, G=Green, Blank=no LED lit.

NORMAL OPERATION

G

The MicroPulse Monitor will display the condition of each system at all times. The tricolor LED beside the system will indicate the condition of the system using the following color code.

Fresh Water, LP Gas, Battery are as follows:

Green LED = 3/8 to Full

Yellow LED = 1/4

Red LED = 1/8 to Empty

Gray Water, Black Water are as follows:

Green LED = Empty to 5/8

Yellow LED = 3/4

Red LED = 7/8 to Full

TO OBTAIN EXACT READING

To obtain an exact reading of all systems press and release the status button one time. The monitor will flash the LED beside the system it is about to report. It will then display the exact condition of that system by lighting the bar graph from Empty to Full. The monitor will display the exact condition of each system and then return to normal operation mode.

To obtain an exact reading of an individual system press and release the status button until the LED beside the system that you want the condition of is lit. Release the status button and the monitor will display the exact condition of that system by lighting the bar graph from Empty

APPLIANCES

All appliances are delivered to Airstream Inc. with in depth Owner's Manuals. Those manuals are included in the delivery case supplied by your dealer. The manuals may contain warnings, cautions, and operating instruction that should be read and followed before operating the appliances. The information contained in the appliances manuals supersedes any information contained in the Airstream Trailer Owner's Manual on appliances. If you believe contradictory information on appliances is contained in this manual, please contact the Airstream Customer Service Department at 937-596-6111 or write:

Airstream Factory Service Center,
P.O. Box 629
419 W. Pike Street
Jackson Center, Ohio 45334-0629

If any appliance manuals have not been provided with your trailer, contact your dealer, the respective appliance manufacturer, or Airstream Customer Service. A manual will be provided to you.

Maintenance: Follow the instructions and warnings noted in the appliances and equipment owner's manuals as well as the ones listed below:

- Annual maintenance should be conducted on propane gas appliances and equipment by an authorized dealer or repair facility.
- Insects can build nests in the burners of various appliances and equipment. The burner and burner orifice of the propane gas appliances and equipment should be cleaned out by an authorized dealer or repair facility anytime circumstances or conditions warrant., but no less than on an annual basis.

AIR CONDITIONER

Manufacturer:
Dometic Sales Corporation
2320 Industrial Parkway
P.O. Box 490
Elkhart, IN 46515
Phone: 219-295-5228

Note: Review the air conditioning literature supplied in your Owner's Packet before proceeding,

The roof air conditioner used on Airstream trailers is one of the most popular on the market today. In your Owner's Packet is a set of literature covering all operating and maintenance instructions. If the literature is misplaced

APPLIANCES

please contact the air conditioner manufacturer or your Airstream dealer for replacement.

The voltage to the air conditioner is critical. We commonly refer to 110 or 120 volts, but a check with a voltmeter may find voltage much lower. Your air conditioner will probably not function if the current drops below 105 volts. Low voltage is usually associated with older or poorly maintained trailer parks, but many people have found their homes, built only twenty or thirty years ago, may not be capable of operating the air conditioner on some receptacles, Parking your trailer so the power cord can be plugged into a receptacle close to the fuse or circuit breaker box can alleviate the problem. Avoid extension cords and adapters whenever possible. If an extension cord must be used it should be as short and heavy as possible to provide the most current to the air conditioner.

If high temperatures are expected, you should make an effort to park in a shaded area. Starting the air conditioner early in the morning also helps. It is much easier to hold a comfortable temperature than it is to lower the temperature after the interior of the trailer is already hot.

FURNACE

Manufacturer: Hydro Flame Corporation
1874 South Pioneer Road
Salt Lake City, UT 84104
Phone: 801-972-4621

The manufacturer of the furnace in your trailer is well known in the RV industry. The furnace burns LP gas, and is powered by 12 volt current from the battery or power converter when plugged into city power. Operating instructions are located in your Owners Packet. If they should become misplaced new literature can be ordered direct from the manufacturer or your Airstream dealer. The manufacturer also offers a detailed service guide for your furnace.



WARNING: Carefully read all the manufacturer's instructions prior to operating. NEVER store flammable material next to the furnace.

If warranty service is required use only a service location recommended by the furnace manufacturer or your Airstream dealer.

RANGE

Manufacturer: Magic Chef
28812 Phillips Street
Elkhart, Indiana 46514
219-264-9578

People using gas ranges in their home will find little difference in the operation of the range in the trailer. Other customers, used to electric ranges may be a little apprehensive at first; but will quickly gain confidence. The basic operation of the gas ranges have been the same for many years, but please be sure to read all the directions furnished by the manufacturer and located in the Owner's Packet. Excellent service and parts manuals are available from the manufacturer.

NOTICE: The range exhaust cover on the outside the trailer has a swinging door that can be latched during inclement weather and should be latched in travel. When operating the exhaust fan, the latches should be turned so the door swings open when the fan is on.



WARNING: The operation manual for the range is titled "Maytag RV Cooking Appliances". If this has not been provided with your trailer, contact the manufacturer listed at the top of the page to obtain. Their manual contains specialized warnings and cautions that should be reviewed prior to operating the appliance.

MICROWAVE OVENS

Review all Microwave Literature supplied in your Owner's Packet or stored in the microwave prior to operating.

Only federally certified technicians are permitted to service microwave ovens. For this reason the only service instructions contained in this manual are for removal of the complete oven. If you have a microwave oven problem please contact the appropriate manufacturer, an authorized Airstream dealer, or the Factory Customer Service Department.

Microwave ovens can be removed for service by removing the screws in the vented trim ring. The trim rings are fastened to microwave oven. After removing the screws, pull straight out on the oven until the 110-volt plug can be unplugged.

APPLIANCES

REFRIGERATOR

Manufacturer:

Dometic Sales Corporation 2320
Industrial Parkway P.O. Box 490
Elkhart, Indiana 46514
Phone: 219-295-5228

Review all Dometic Literature supplied in your Owner's Packet or stored in the refrigerator prior to operating.

 In an absorption refrigerant system ammonia is liquefied in the finned condenser coil at the top rear of the refrigerator. The liquid ammonia then flows into the evaporator (inside the freezer section) and is exposed to a circulating flow of hydrogen gas, which causes the ammonia to evaporate, creating a cold condition in the freezer.

The tubing in the evaporator section is specifically sloped to provide a continuous movement of liquid ammonia, flowing downward by gravity, through this section. If the refrigerator is operated out-of-level when the vehicle is not moving, liquid ammonia will accumulate in portions of the evaporator tubing. This will slow the circulation of hydrogen and ammonia gas, or in severe cases, completely block it, resulting in a loss of cooling.

Any time the vehicle is parked for several hours with the refrigerator operating the vehicle should be leveled to prevent this loss of cooling. The vehicle needs to be leveled only so it is **comfortable to live in** (no noticeable sloping of floor or walls).

When the vehicle is moving the leveling is not critical, as the rolling and pitching movement of the vehicle will pass to either side of level, keeping the liquid ammonia from accumulating in the evaporator tubing.

OPERATION

The refrigerator requires 12-volt current to operate even if running on LP or 110 volt modes. The 12-volt is used to power the circuit board that directs the refrigerator functions. When running in a mode such as LP, it means the heat source, by far the largest power requirement; to evaporate the ammonia is being provided by an LP Gas burner.



WARNING: Most LP gas appliances used in recreational vehicles are vented to the outside of the vehicle. When parked close to a gasoline pump, it is possible that gasoline fumes could enter this type of appliance and ignite the burner flame, CAUSING A FIRE OR AN EXPLOSION.

WATER HEATER

Manufacturer:

Atwood Mobile Products 4750
Hiawatha Drive P.O. Box 1205
Rockford, Illinois 61105
Phone: 815-877-7461

Note: Review the water heater literature supplied in your Owner's Packet before proceeding,

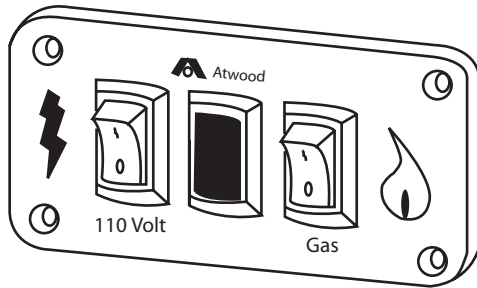

WARNING: Hydrogen gas can be produced in a hot water system served by this heater that has not been used for a long period of

time (generally two weeks or more). Hydrogen gas is extremely flammable. To reduce the risk of injury under these conditions, it is recommended that the hot water faucet be opened for several minutes at the kitchen sink before using any electrical appliance connected to the hot water system. If hydrogen is present there will probably be an unusual sound such as air escaping through the pipe as the water begins to flow. There should be no smoking or open flame near the faucet at the time it is open.

Electronic Ignition

The switches used to light your electronic ignition water heater are located in the bathroom above the lavatory top. When the gas switch is turned on, the red light will come on indicating the "try" mode is in effect. Normally the burner will ignite in just a few seconds, and the light will go out. If your LP system hasn't been used for some time, the system may go into safety lockout (about 20 seconds) before the air is all expelled from the lines. Turning the switch off for 30 seconds, then back on, reinstates the "try" mode.

A second switch for the water heater is also located on the panel. This provides power to the heating element. DO NOT use unless you are sure the water heater is full. (Open a faucet and see if there is a full stream of water on the hot side)

The 110-volt element may be operated at the same time as the gas burner. To

APPLIANCES

operate the 110-volt by itself simply turn the electronic gas igniter switch off.

The heating element is 1500 watts so if breakers start to kick out when the air conditioner cycles you may want to turn the switch off to the heating element.

SAFETY

If your water system is full and cold and the water heater is ignited the system can see pressures as high as 120 psi before the relief valve starts to open. Since the water system normally operates in the 40-psi range the water expanding does put unusual stress on the system. This normally does not cause any problems, but the stress is easily alleviated. As the water is heating just open any faucet and run as little as a cup of water. Just removing this small amount of water reduces the pressure build up significantly.

For fun, watch the sequence of events your family goes through when you park the trailer and ignite the water heater. More than likely someone will run water and relieve the pressure without even realizing it.

SPECIFICATIONS

Note: All weights listed in the Specification Chart are checked and updated throughout the model year. Your production trailer may vary from weights listed.

For precise cargo capacity read the Cargo Carrying Capacity tag on the inside of the screen door. The “WEIGHT OF CARGO SHOULD NEVER EXCEED” numbers shown on the Cargo Carrying Capacity tag in your vehicle is the maximum weight of cargo you can load and carry in your specific trailer as built with its options.

Two tags are located on the front roadside of your trailer.

The Tire & Loading information tag lists the Size and Cold Inflation Pressure of the tires on your vehicle, the weight of your trailer as manufactured, and the Gross Vehicular Weight Rating.

Vehicle Manufacturing Tag lists the Size of tires and wheel rims, Maximum Cold Inflation pressures, the Vehicle identification Number (VIN), and Gross Axle ratings (GAWR).

The UBW and NCC weights listed in the Specification Table are for the base unit with no options and fluids.

Gross Vehicular Weight Rating (GVWR): is the maximum permissible weight of this trailer when fully loaded. It includes all weight at the trailer axle (s) and tongue or pin.

Unit Base Weight (UBW): is the dry weight of the base unit without options.

Net Carrying Capacity (NCC): is equal to GVWR minus UBW

Gross Axle Weight Rating (GAWR): is the value specified as the load carrying capacity of a single axle system, as measured at the tire-ground interfaces.

SPECIFICATIONS

Axle Alignment:

Toe In 0 - 1/8" (All Models)

Camber 0 - 1 ° positive (All Models)

Tire Size

ST225/75R15 (All Models)

Tire Inflation (PSI) Cold

ST225/75R15 LRD 65 psi

Wheel Torque

Aluminum - 110 Ft. Lbs.

Steel - 100 Ft, Lbs.

Hitch Ball Height

The proper height will vary according to the weight you carry and the tires you use. However, checking the height on your trailer is relatively easy:

1. With trailer on fairly level ground measure from ground to bottom of frame, front and rear.
2. Adjust front jack until measurements are equal
3. Now measure from ground to the inside top of ball coupler. This figure is the hitch height. The hitch ball is then usually set 1/2" to 1" higher, according to the spring weight of your tow vehicle, to allow for it to settle when the trailer is hitched up.

SPECIFICATIONS

Note: All weights listed in the Specification Chart are checked and updated throughout the model year. Your production trailer may vary from weights listed.

MODEL	27' FB	30'	31' W/ DINETTE
EXTERIOR LENGTH	27' 9.5"	31'	31'
EXTERIOR WIDTH	8' 5½"	8' 5½"	8' 5½"
INTERIOR WIDTH	8' 1"	8' 1"	8' 1"
EXTERIOR HEIGHT W / AC	9' 7½"	9' 7½"	9' 7½"
INTERIOR HEIGHT W / AC	6' 3½"	6' 3½"	6' 3½"
HITCH BALL HEIGHT	18 ¾"	18 ¾"	18 ¾"
FRESH WATER (GAL.)	54	54	54
GRAY WATER (GAL.)	37	37	37
BLACK WATER (GAL)	39	39	39
HITCH WEIGHT (LBS.)	792	773	805
GVWR (LBS.)	9,000	10,000	10,000
UBW (LBS.)	6,592	7,085	7,174
NCC	2408	2,715	2,826
LPG BOTTLE CAPACITY (2 EA)	40 lbs	40 lbs	40 lbs

INDEX

Air ConditionerH-1
Alignment D-8, I-2
Antennas C-6, G-15, G-17
Appliances.....H-1
Axles.....D-8
Awning.....D-4

BackingB-10
Battery G-2
Bath Exhaust G-19
BearingD-11
Black Tank Flush F-17
Bottles, LP..... F-3
Brake ControllerB-2
BrakesB-1
Breakaway Switch.....B-2
Bulbs A-10, E-5

Camping.....C-1
Carpet.....E-2
Capacities..... I-3
Cargo.....B-3
Caution Introduction
Ceiling CoveringE-2

Chassis.....D-4
Check ListC-1
City Water Hook-Up C-6, F-7
CleaningD-1
Circuit Breakers..... G-10
Coaxial Cable Wiring..... G-15
CondensationC-8
Converter..... G-5, G-10

Connector
 7-WayB-13, G-6
 110-voltC-6
CouchE-3
CountertopE-2
Coupler.....D-4
CurtainsE-2
Control Panel..... E-4, F-16, G-21

Dimensions..... I-3
DinetteE-3
Doors
 Main.....D-2
 ScreenD-2
Door Bell..... G-14

Drain Valves F-12
Drainage F-17
DrapesE-2
Dump Valves..... F-16

Electrical..... G-1
 12 Volt..... G-1
 110 Volt..... G-10
 Circuit Breakers..... G-10
 Diagrams
 12 Volt..... G-6
 110 Volt..... G-11
 7-Way Cable.....B-13, G-6
 Cable TV..... G-15
Escape Window..... C-3, D-3, E-11
Exhaust Fans.....E-4, G-19
Extended StayC-4
Exterior MaintenanceD-1
Factory Service.....A-5
Fans.....E-4, G-19
Faucets..... F-8
Fill Valves, LPG..... F-1
Filter, Water..... F-9
Fire Extinguisher..... E-11

Flat Tire.....D-7	JacksC-5	ParkingB-10, C-4
FurnaceH-2	Stabilizing C-5	Passing.....B-10
Fuses.....A-10, C-11, G-5, G-9	Tire ChangingD-7	Plumbing F-1
Galley.....E-2	Lavatory.....E-3	Power Cord C-6, G-11
Gas, LP.....F-1	Length, Trailer I-3	Power Jack.....D-5
Gas Regulator F-2	Leveling C-5	Range H-3
Grey Tank (Aux)F-16, I-3	Lights.....E-5	Refrigerator..... H-4
Ground Fault Interrupter..... G-12	Loading.....B-10	Regulator, LP F-2
Grounding..... G-1, G-13	LoungeE-3	Roof VentsE-4, G-19
GVWR..... B-6, I-3	LP Bottles.....F-3	Rotation, TireD-8
GAWR..... B-5, I-3	LP Gas.....F-1	Sanitizing F-6
Generator, remote hook up G-14	LP Gas Detector.....E-10	Satellite Radio System G-22
Hitch B-6, D-4, I-2, I-3	Lug Nut Torquing.....D-16	Screens D-3, E-11
Hitching UpB-6	Maintenance PartsA-10	Service.....A-5
Hitch Weight B-5, I-3	Maintenance RecordA-11	7-Way Connector B-13, G-6
Holding Tanks.....F-16, I-3	Maintenance Schedule.....A-7	Sewer Hose F-16
Hitch Ball Height..... D-4, I-2, I-3	Microwave H-3	Shower E-3
HumidityC-8	Mold C-9	Sink.....E-3
InteriorE-1	Monitor Panel E-4, F-16, G-21	Smoke Alarm E-9
Inverter G-14	Oven H-3	Sofa E-3
	Overnight Stop C-4	Solar Panel G-16
		Specifications I-1

INDEX

Spare Tire	D-7	Waste System	F-16
Stabilizing	C-5	Water System	F-5
Step	D-3	Drainage	F-12
Storage	E-6, F-14	Filter, Faucet	F-9
Suspension	D-8	Inlet Connection	C-6
Sway, Controlling.....	B-12	Pump	E-5, F-6
Table	E-3	Strainer	F-6
Tires	D-6, I-1, I-2	Tank	F-5, F-12, I-3
Tongue Latch	D-4	Valves	F-5, F-12
Tongue Weight.....	B-6, I-3	Vinyl Floor.....	E-3
Toilet	F-18	Waxing.....	D-1
Towing	B-1	Weight	B-3
Tow Car	B-1	Weight Distribution	B-5
TV	C-6, G-15, G-17	Wheel	
TV Antenna.....	G-15, G-17	Torque.....	D-16
Upholstery	E-1	Alignment	D-8, I-2
Valves, Drain.....	F-12	Bearings	D-11
Vents.....	E-4, G-20	Windows.....	D-3, E-11
Warning	Introduction	Winter Traveling.....	C-7
Warranty	A-1	Winterizing.....	F-14
Washing.....	D-1	Wiring	See Electrical
Water Heater	E-5, F-5, F-13, H-5		