

ROOM FOLD SLIDING FOLDING INTERNAL DOORSET FINISHING & INSTALLATION GUIDELINES

IMPORTANT You can only assemble these door configurations by using the frame provided. Your warranty will be invalid if other alternatives are used.

All loads are taken by the top track to ensure smooth, light operation and long life. Prior to installing this doorset, inspect for damage and do not proceed to fit if any noticeable damage or defect is evident. This doorset should be stored in a dry flat location before installation.



CAUTION This product needs to be installed by a competent tradesperson with assistance. Two people are required to carry out the installation, as some components are heavy.

The outer frame requires fixing to the supporting structure above the opening.

The opening **MUST** be capable of carrying the load of the doorset in all conditions. Doors and frame must not be trimmed.

Operation

When operating a Room Fold you must always open by pulling the door closest to the frame first, and then fold the others away.

Pull first, then slide back

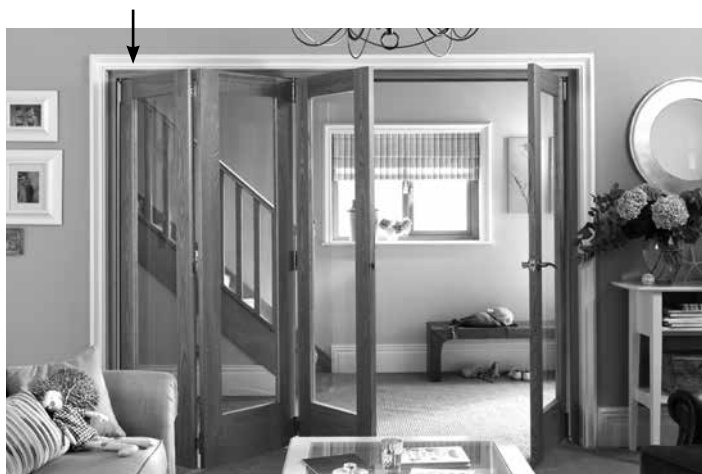

Tools required

- Spirit level
- Masonry drill
- 2mm, 3mm & 12mm wood drill bit
- Cordless screwdriver
- 5 metre measuring tape
- Mallet
- Hand router or wood chisels
- Hand timber saw
- Metal hacksaw



Materials required

- 90mm fixings for fixing the frame to your opening. These need to be appropriate for either brick or timber.
- 50mm wood screws for fixing the frame together.
- Packers if your frame is out of square.

Opening Information

The Room Fold is a heavy product and the weight load is all at the top, therefore you must ensure your opening has either a lintel or appropriate timber framing to fix to. Failure to do so will result in the product not performing correctly.

Finishing

It is essential that the doors are completely finished on the two faces and all FOUR edges plus any cut-outs for latches.

Prior to finishing or sealing, lightly sand any handling marks. Do not use wire wool or other sanding materials containing steel or iron on our doors.

Oak doors may be finished using a proprietary branded stain, paint, clear varnish or clear lacquer.

Primed doors may be finished using a proprietary branded paint. Usually three top coats are satisfactory but we strongly recommend you that you treat the doors in accordance with the manufacturer's instructions.

A light sanding between coats will provide the best finish. Adequate drying time must be allowed between each coat.

Our doors are NOT suitable for waxes, polishes, dyes or oils (e.g. Danish Oil) as they do not properly seal the door and can lead to delamination of the veneer.

Failure to seal the doors accordingly will invalidate any claims.

Contents

Installing the frame (all configurations) **4**

Installing the doors

Follow the guide below to find the installation guide for your chosen configuration:



Pg 6

2+0 Configuration



Pg 9

4+0 Configuration



Pg 13

6+0 Configuration



Pg 18

3+3 Configuration



Pg 21

3+0 Configuration



Pg 24

5+0 Configuration



Pg 28

3+1 Configuration



Pg 31

4+1 Configuration



Pg 35

5+1 Configuration

INSTALLING THE FRAME – ALL CONFIGURATIONS

1. Trimming the timber frame head and metal track

Depending on the width of the Room Fold you have ordered, you may need to trim the timber frame head and metal track. The table below shows the amount of trim you need to take off to get to the width required.

Important: Use appropriate tools for the job, when sawing metal take care and always use suitable eye protection.

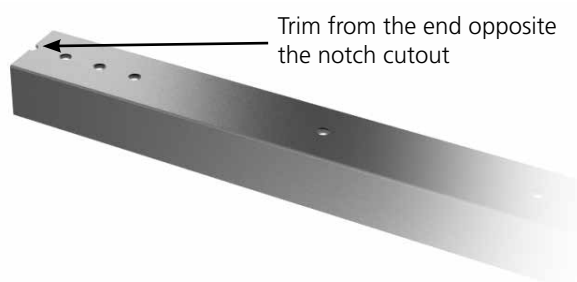

Configuration Trim Table

Configuration	Configuration Width	Trim Required
2+0	1319mm	N/A
2+0	1471mm	N/A
3+0	1929mm	N/A
3+0	2157mm	388mm
3+1	2545mm	N/A
3+1	2849mm	309mm
4+0	2545mm	N/A
4+0	2849mm	309mm
4+1	3158mm	N/A
4+1	3538mm	233mm
5+0	3158mm	N/A
5+0	3538mm	233mm
5+1	3771mm	N/A
5+1	4227mm	N/A
6+0	3771mm	N/A
6+0	4227mm	N/A
3+3	3771mm	N/A
3+3	4227mm	N/A

2. Frame assembly

Start by attaching the head and the two jambs together. Using a 3mm wood drill bit, drill pilot holes through the top of the head into each of the jambs. Using 50mm wood screws, attach the head and the jambs.

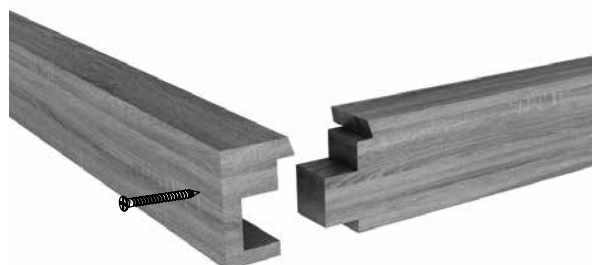

3. Fixing the frame to the opening

Offer the frame up to the opening, it should just slot in. If the frame is too tight it is important that you adjust your opening. Do not shave anything from the frame.

Pilot drill and fix the frame to the opening at the locations shown using appropriate 90mm fixings depending if you are fixing into timber or brick.

Use a spirit level to check the frame is accurately square and plumb.

Do not proceed with installation until you are sure the frame is accurately installed. Use packers if required to rectify any out of square openings.

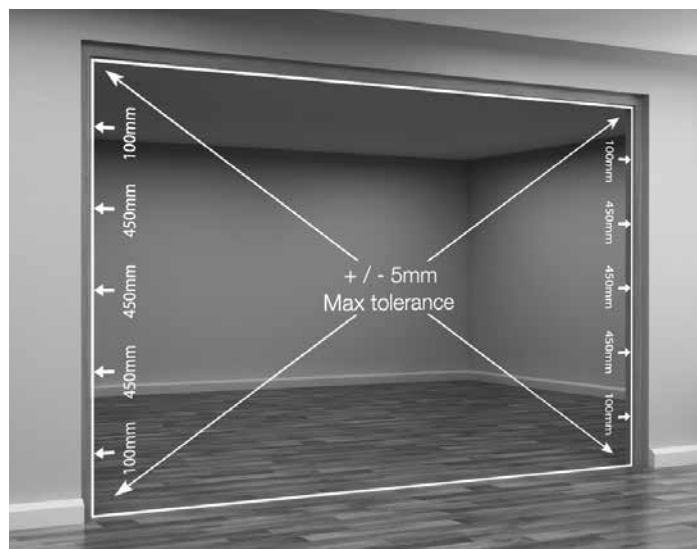

4. Inserting the ironmongery

It is important that the ironmongery used for this system is fitted in the correct order. See the table below which will guide you through this process.

The table shows ironmongery is left hand hung and ironmongery inserted from the right.

Please reverse this process for opposite handing.



Configuration	Ironmongery Order			
	1	2	3	4
2+0	●	★	N/A	N/A
3+0	●	■	N/A	N/A
3+1	●	■	●	N/A
4+0	●	■	★	N/A
4+1	●	■	★	●
5+0	●	■	■	N/A
5+1	●	■	■	●
6+0	●	■	■	★
3+3	●	■	■	●

IRONMONGERY KEY

- Top Fixed Pivot
- Intermediate Carrier
- ★ End Hanger

5. Locating and fixing the top track

The top metal track is designed to sit flush in the U channel in the timber frame as shown.

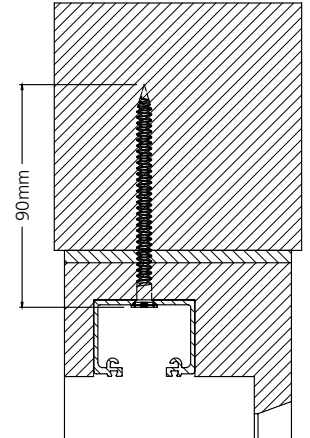

The top metal track is pre-drilled. Depending on your opening, brick or timber, fix through each pre-drilled hole using 90mm fixings to ensure the load is carried correctly.

Important: Do not over tighten the screws.

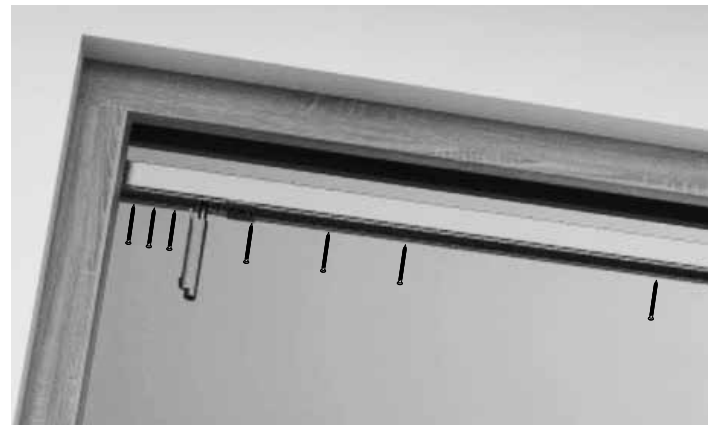

INSTALLING THE DOORS FOR A 2+0 CONFIGURATION



Detailed pack contents

Door Configuration		
Component	2+0 2047 x 1319mm	2+0 2047 x 1471mm
1. Timber Head	1 x 1319mm	1 x 1471mm
2. Timber Jambs	2 x 2032mm	2 x 2032mm
3. Metal Top Track	1 x 1253mm	1 x 1385mm
4. Pivot Set	1	1
5. Straight Handle Hinge Set	1	1
6. End Hanger Set	1	1
7. Flush Bolt	1	1
8. Latch Keep	1	1

Components

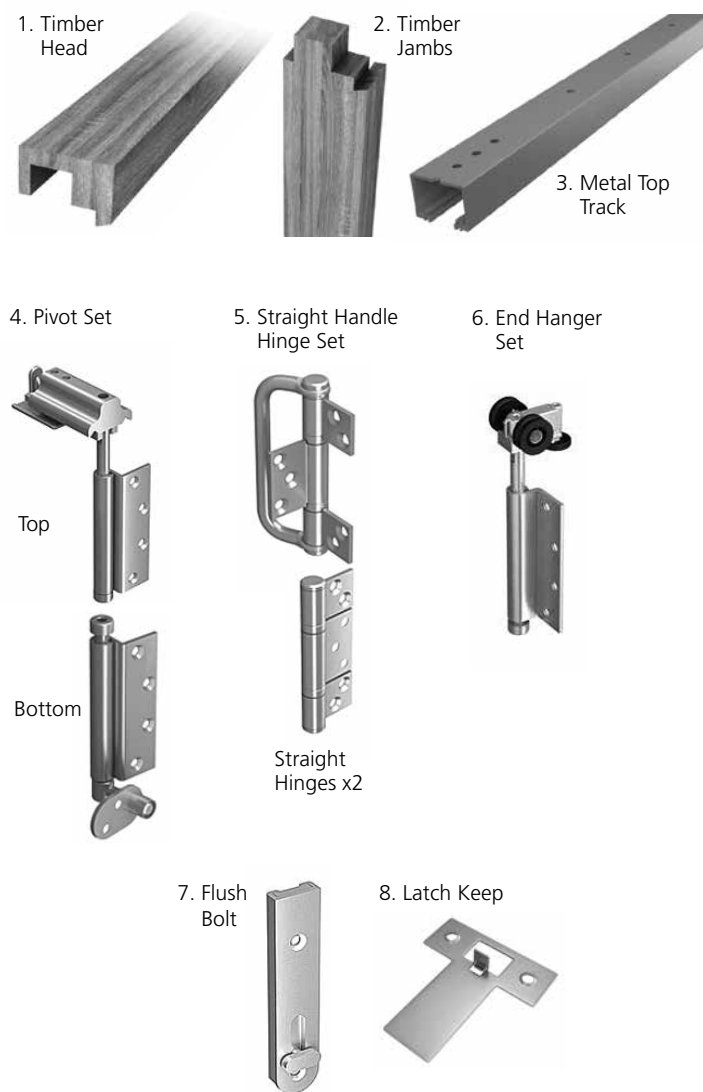

Ironmongery locations

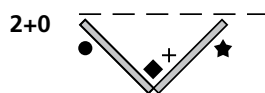

2 doors slide either to the left or to the right.

IRONMONGERY KEY

- Pivot Set
- ★ End Hanger Set
- ⊕ Flush Bolt Set
- ◆ Straight Hinge Set

Ironmongery position

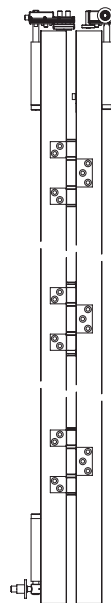

Flush bolt position

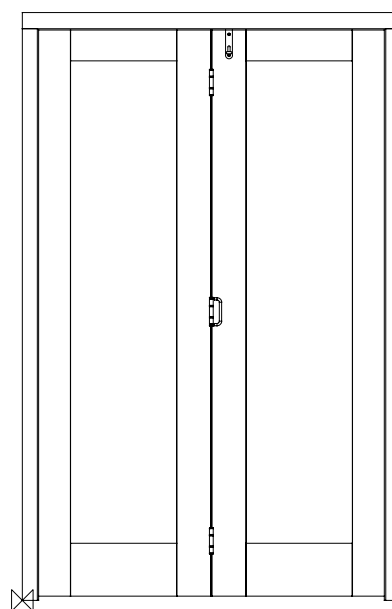

1. Hanging the first door

Using the hinges from the pivot set, measure and mark 15mm from the top edge of the door to the top edge of the hinge.

Using a 2mm wood drill bit, make pilot holes for each of the screw locations. Using 25mm screws from the pack, fix the hinge to the door.

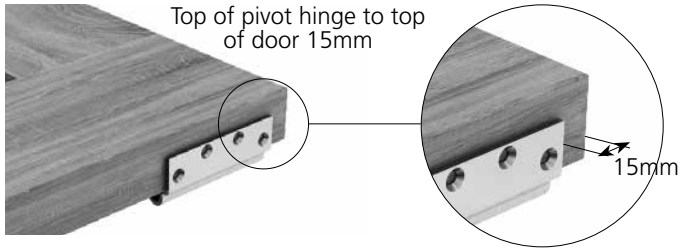

Measure and mark 30mm from the bottom edge of the door to the bottom of the hinge. Pilot drill and fix.

Important: Ensure you use the screwdriver bit included in your pack when fitting the ironmongery.

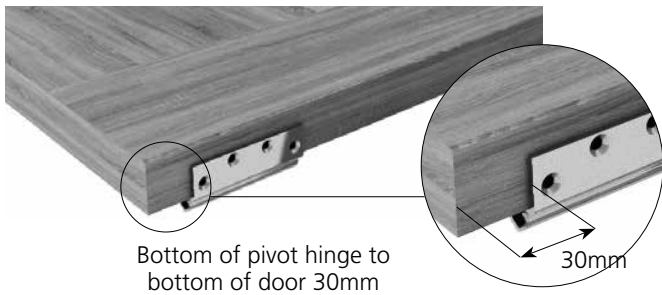

2. Setting the top pivot

A. Insert the top threaded hinge pin into the hinge barrel fixed to the door. Offer the door up to the top fixed pivot.

Press and hold the button to allow the hinge on the door to engage with the screw part of the top fixed pivot.

Using the Allen key provided, tighten until the door is set to the appropriate height for your floor covering.

Release the button to allow the top fixed pivot to lock into place.

B. The distance between the door frame edge and the edge of door one should be 6mm. Once in this position, using the Allen key once more, tighten the Allen bolts to keep the top fixed pivot in position in the metal top track.

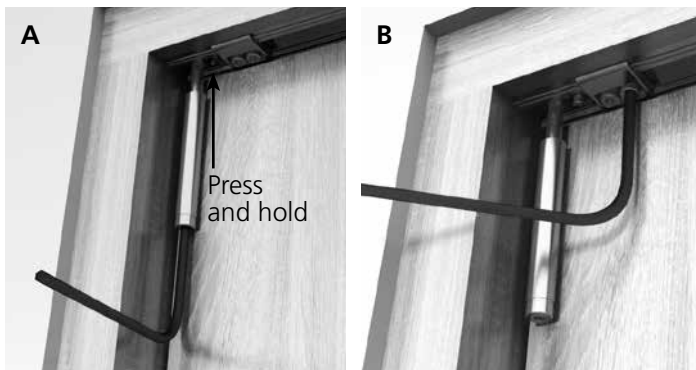

3. Fixing the bottom pivot

Insert the bottom pivot pin into the bottom fixed pivot hinge on the door. Using a pencil, mark the height of the pivot point.

Measure 32mm from the outer edge of the frame and mark with a pencil. Carefully hold the door away.

Using a 12mm wood drill bit make a pilot hole into the frame to allow pivot point to sit flush with the frame.

Screw the bottom fixed pivot into the timber frame using the 30mm screws provided from the pack.

Check the 6mm edge gap is equal at the top and the bottom.

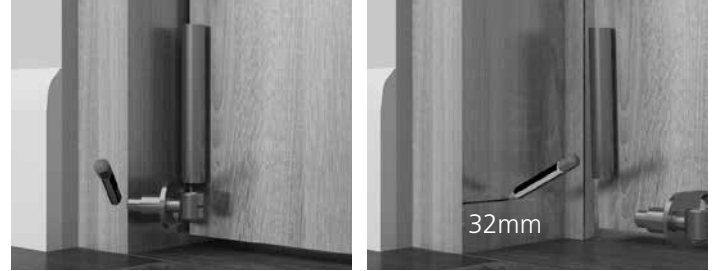

4. Preparing for the second door

A. Take a straight hinge from the handle hinge set and with the hinge closed as a guide, measure and mark **150mm** from the top of the door to the top of the hinge.

Mark the two screw positions on the top and bottom hinge flags and using a 2mm wood drill bit make pilot holes for each of the screw positions.

Using 25mm screws from the pack, fix the hinge to the door.

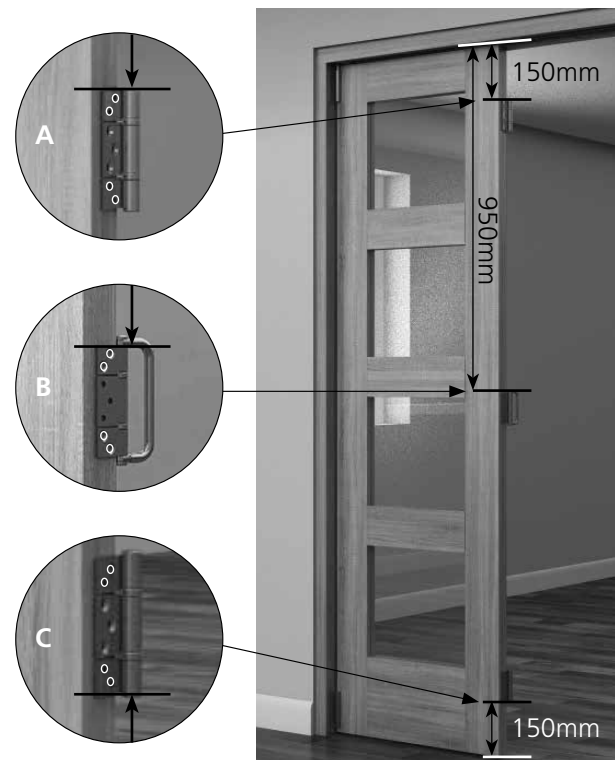

B. Take the handle hinge and measure and mark **950mm** from the top edge of the door to the top of the hinge. Pilot drill and fix the top and bottom hinge flags.

C. Fix the final hinge by measuring and marking **150mm** from the bottom of the door to the bottom of the hinge. Pilot drill and fix the top and bottom hinge flags.

5. Fitting the flush bolts

The position and quantity of the flush bolts varies by configuration, please refer to the ironmongery location diagram on page 6 to determine the correct position and amount required.

We recommend you use a hand router to form the necessary recesses to the top door edge. Alternatively hand tools can be used. Use the screws provided to fix.

Important: Router all flush bolt recesses on all applicable doors in one go.

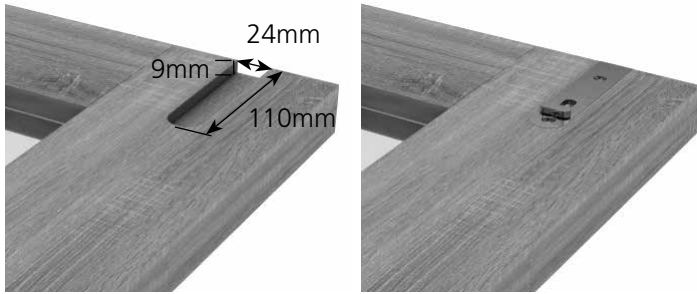

6. Fitting door two to door one

Using the hinges already fixed to door one as a guide, measure and mark down from the top edge of the door to the top of the middle hinge flag **173mm**. Pilot drill and fix.

Pilot drill and fix the centre and bottom hinges.

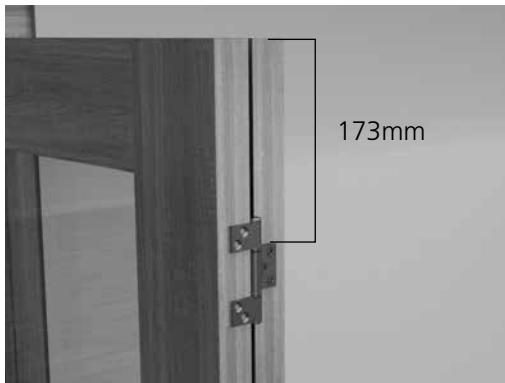

7. Fitting the end hanger

To fit the end hanger to door two, measure and mark **15mm** from the top edge of the door to the top of the hinge flag and pilot drill and fix.

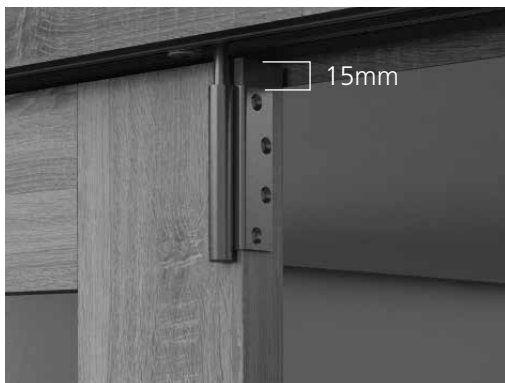

8. Fitting the latch keep

We have included a latch keep to be used with a standard 65mm latch (not provided) if you choose to fit handles to your configuration. Once you have fitted your latch, simply mark around the keep against the frame in the correct position.

Using a wood chisel, carefully cut around the mark going down by 1.5mm and remove the excess so the latch sits flush to the frame. Finally screw the latch keep to the frame.



DON'T FORGET

When operating a Room Fold you must always open by pulling the door closest to the frame first, and then fold the others away.

Pull first, then slide back



INSTALLING THE DOORS FOR A 4+0 CONFIGURATION



Detailed pack contents

Door Configuration		
Component	4+0 2047 x 2545mm	4+0 2047 x 2849mm
1. Timber Head	1 x 2545mm	1 x 3158mm
2. Timber Jambs	2 x 2032mm	2 x 2032mm
3. Metal Top Track	1 x 2460mm	1 x 3073mm
4. Pivot Set	1	1
5. Intermediate Carrier Set	1	1
6. Offset Handle Hinge Set	2	2
7. End Hanger Set	1	1
8. Flush Bolt	2	2
9. Latch Keep	1	1

Components

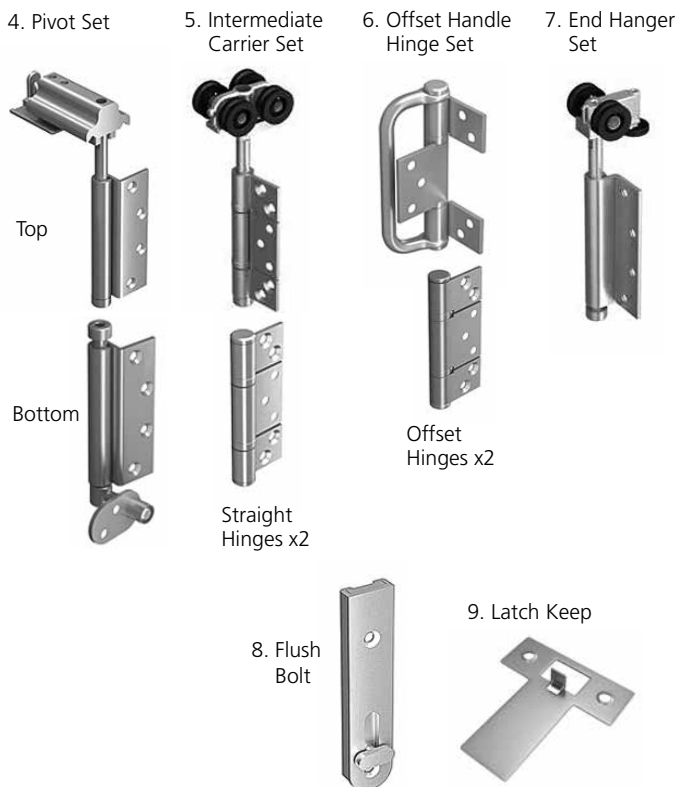
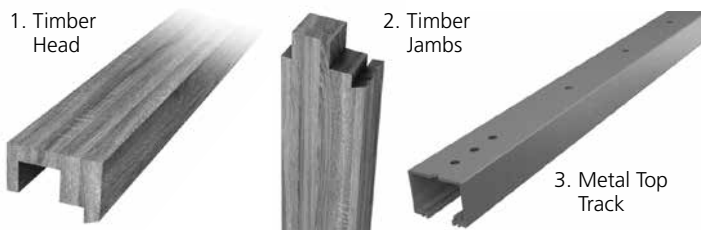

Ironmongery locations

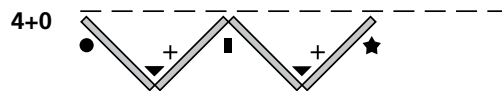

4 doors slide either to the left or to the right.

IRONMONGERY KEY

- ▼ Offset Hinge Set
- Pivot Set
- Intermediate Carrier Set
- + Flush Bolt Set
- ★ End Hanger Set

Ironmongery position

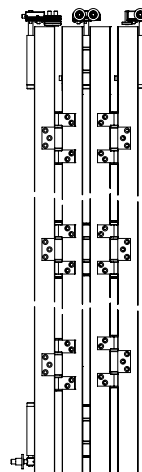

Flush bolt positions

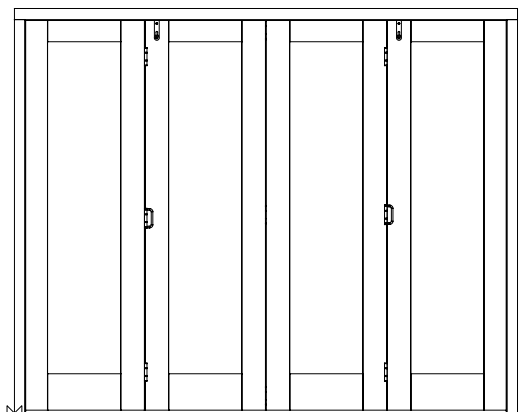

1. Hanging the first door

Using the hinges from the pivot set, measure and mark 15mm from the top edge of the door to the top edge of the hinge.

Using a 2mm wood drill bit, make pilot holes for each of the screw locations. Using 25mm screws from the pack, fix the hinge to the door.

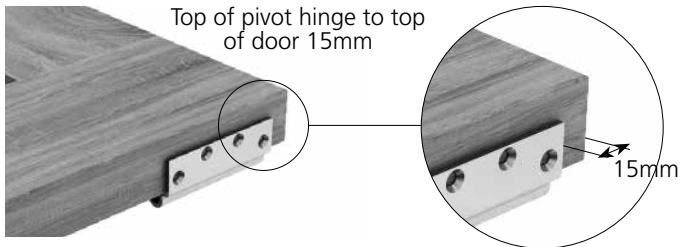

Measure and mark 30mm from the bottom edge of the door to the bottom of the hinge. Pilot drill and fix.

Important: Ensure you use the screwdriver bit included in your pack when fitting the ironmongery.



2. Setting the top pivot

A. Insert the top threaded hinge pin into the hinge barrel fixed to the door. Offer the door up to the top fixed pivot.

Press and hold the button to allow the hinge on the door to engage with the screw part of the top fixed pivot.

Using the Allen key provided, tighten until the door is set to the appropriate height for your floor covering.

Release the button to allow the top fixed pivot to lock into place.

B. The distance between the door frame edge and the edge of door one should be 6mm. Once in this position, using the Allen key once more, tighten the Allen bolts to keep the top fixed pivot in position in the metal top track.

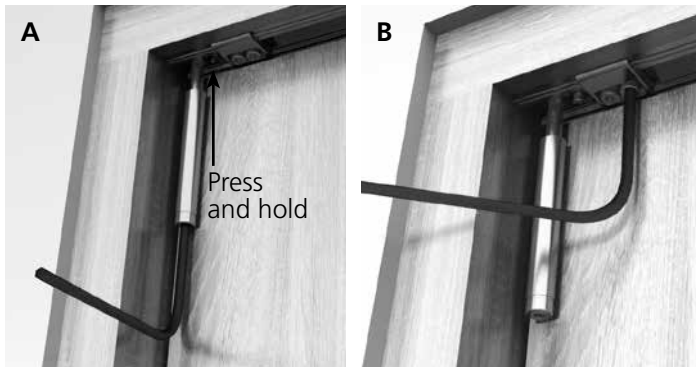

3. Fixing the bottom pivot

Insert the bottom pivot pin into the bottom fixed pivot hinge on the door. Using a pencil, mark the height of the pivot point.

Measure 32mm from the outer edge of the frame and mark with a pencil. Carefully hold the door away.

Using a 12mm wood drill bit make a pilot hole into the frame to allow pivot point to sit flush with the frame.

Screw the bottom fixed pivot into the timber frame using the 30mm screws provided from the pack.

Check the 6mm edge gap is equal at the top and the bottom.

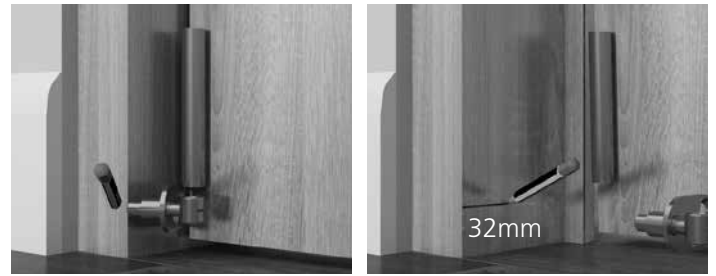

4. Preparing for the second door

A. Take an offset hinge from the handle hinge set and with the hinge closed as a guide, measure and mark **150mm** from the top of the door to the top of the hinge.

Mark the three screw positions on the middle hinge flag and using a 2mm wood drill bit make pilot holes for each of the screw positions.

Using 25mm screws from the pack, fix the hinge to the door.

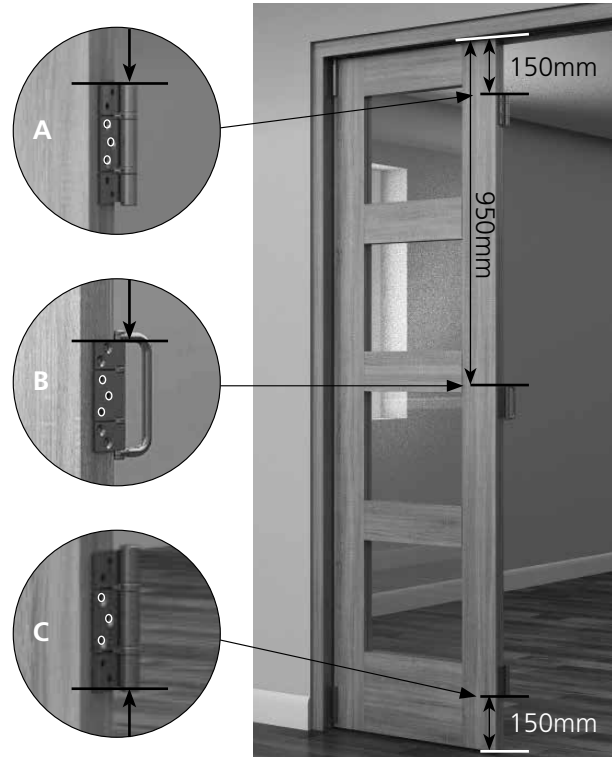

B. Take the handle hinge and measure and mark **950mm** from the top edge of the door to the top of the hinge. Pilot drill and fix the middle hinge flag.

C. Fix the final hinge by measuring and marking **150mm** from the bottom of the door to the bottom of the hinge. Pilot drill and fix the middle hinge flag.

5. Fitting the flush bolts

The position and quantity of the flush bolts varies by configuration, please refer to the ironmongery location diagram on page 9 to determine the correct position and amount required.

We recommend you use a hand router to form the necessary recesses to the top door edge. Alternatively hand tools can be used. Use the screws provided to fix.

Important: Router all flush bolt recesses on all applicable doors in one go.

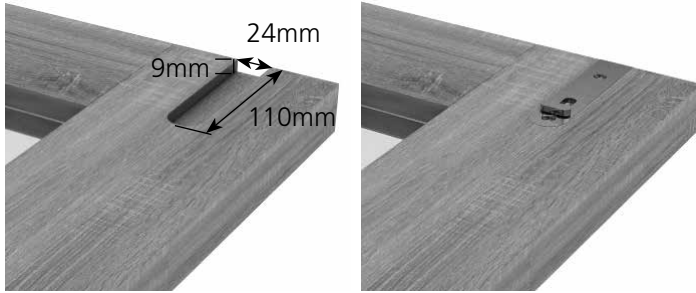

6. Fitting door two to door one

Using the hinges already fixed to door one as a guide, measure and mark down from the top edge of the door to the top of the hinge **150mm**. Pilot drill and fix.

Pilot drill and fix the centre and bottom hinges.



7. Preparing for the third door

Bring the intermediate carrier that is already in the top track to the edge of door two. Measure and mark **15mm** down from the top edge of the door to the top of the hinge. Pilot drill and fix the top and bottom hinge flags.

Take a straight hinge from the intermediate carrier set. Measure and mark **950mm** from the top edge of the door to the top of the hinge. Pilot drill and fix the top and bottom hinge flags.

Take another straight hinge and measure and mark **150mm** from the bottom of the door edge up to the bottom of the hinge. Pilot drill and fix the top and bottom hinge flags.

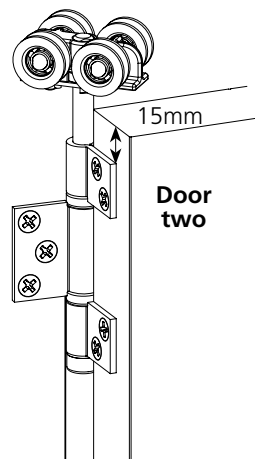

8. Fitting door three to door two

Pilot drill and fix the middle hinge flag on each hinge to door three.

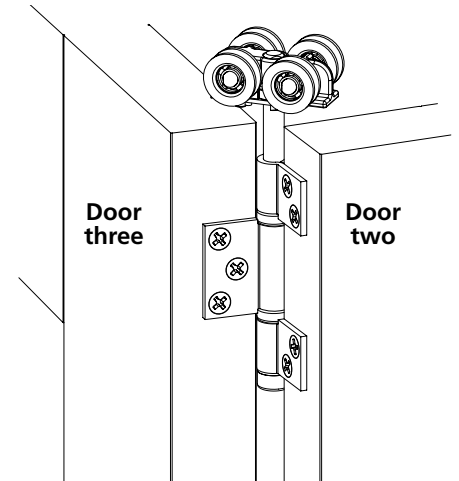

9. Preparing for the fourth door

A. Take an offset hinge from the handle hinge set and with the hinge closed as a guide, measure and mark **150mm** from the top of the door to the top of the hinge.

Mark the two screw positions on the top and bottom hinge flags and using a 2mm wood drill bit make pilot holes for each of the screw positions.

Using 25mm screws from the pack, fix the hinge to the door.

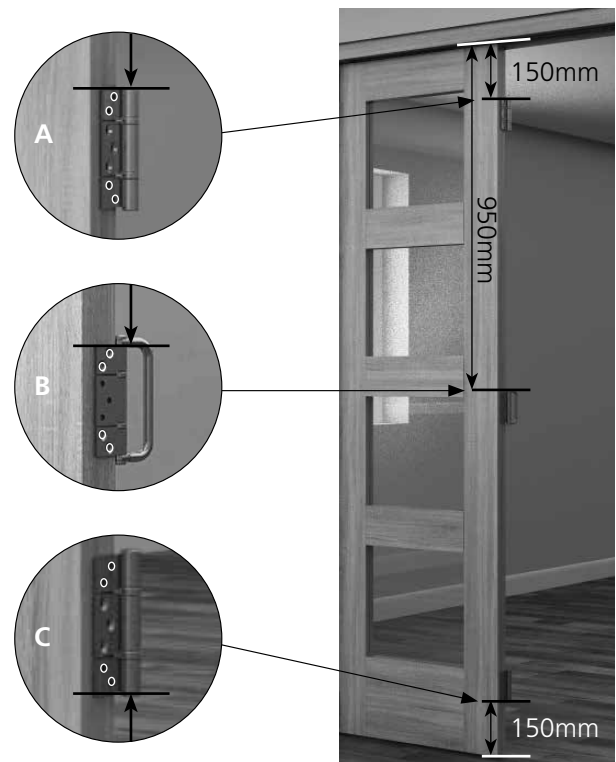

B. Take the handle hinge and measure and mark **950mm** from the top edge of the door to the top of the hinge. Pilot drill and fix the top and bottom hinge flags.

C. Fix the final hinge by measuring and marking **150mm** from the bottom of the door to the bottom of the hinge. Pilot drill and fix the top and bottom hinge flags.

10. Fitting door four to door three

Using the hinges already fixed to door three as a guide, measure and mark down from the top edge of the door to the top of the middle hinge flag **173mm**. Pilot drill and fix.

Pilot drill and fix the centre and bottom hinges.

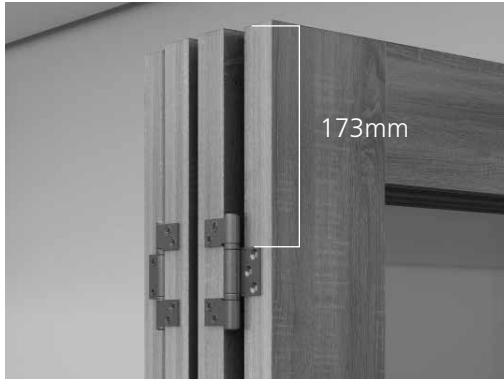

11. Fitting the end hanger

To fit the end hanger, measure and mark **15mm** from the top edge of the door to the top of the hinge flag and pilot drill and fix.

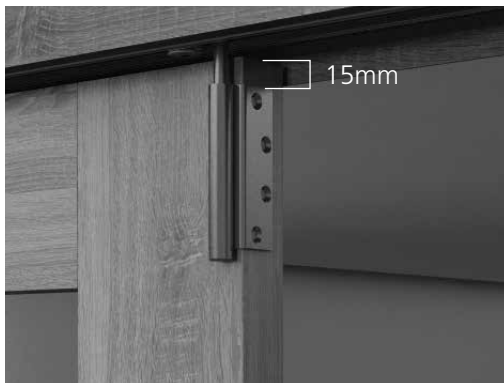

12. Fitting the latch keep

We have included a latch keep to be used with a standard 65mm latch (not provided) if you choose to fit handles to your configuration. Once you have fitted your latch, simply mark around the keep against the frame in the correct position.

Using a wood chisel, carefully cut around the mark going down by 1.5mm and remove the excess so the latch sits flush to the frame. Finally screw the latch keep to the frame.



DON'T FORGET

When operating a Room Fold you must always open by pulling the door closest to the frame first, and then fold the others away.

Pull first, then slide back



INSTALLING THE DOORS FOR A 6+0 CONFIGURATION



Components

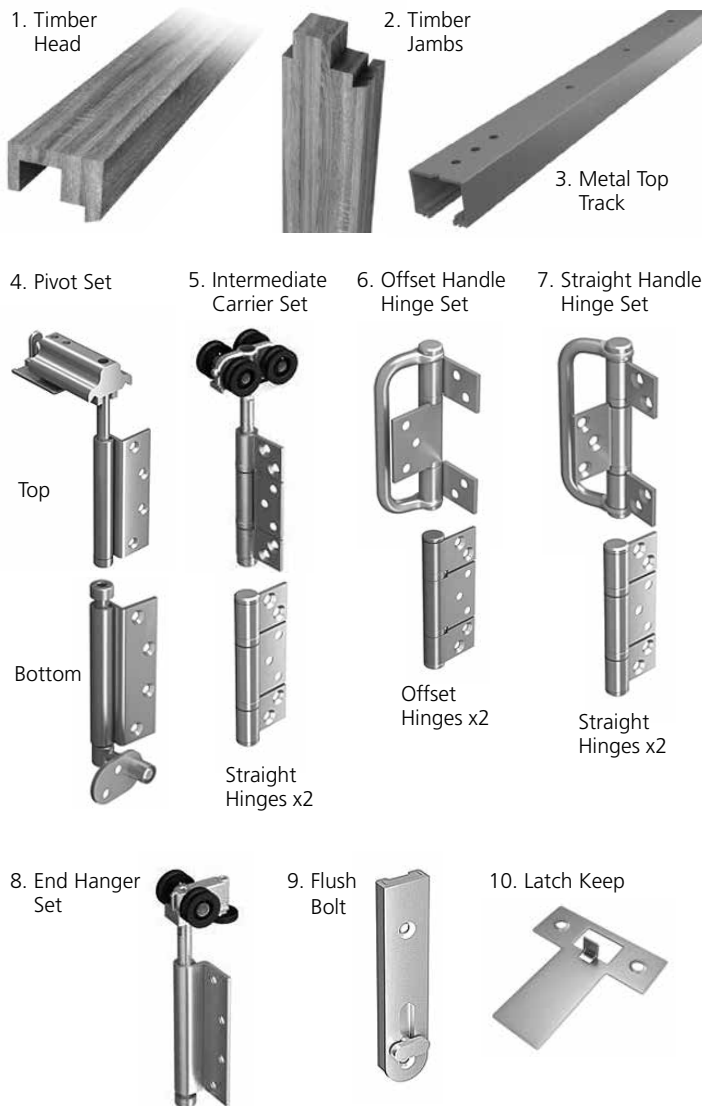

Detailed pack contents

Door Configuration		
Component	6+0 2047 x 3771mm	6+0 2047 x 4227mm
1. Timber Head	1 x 3771mm	1 x 4227mm
2. Timber Jamb	2 x 2032mm	2 x 2032mm
3. Metal Top Track	1 x 3686mm	1 x 4142mm
4. Pivot Set	1	1
5. Intermediate Carrier Set	2	2
6. Offset Handle Hinge Set	2	2
7. Straight Handle Hinge Set	1	1
8. End Hanger Set	1	1
9. Flush Bolt	3	3
10. Latch Keep	1	1

Ironmongery locations

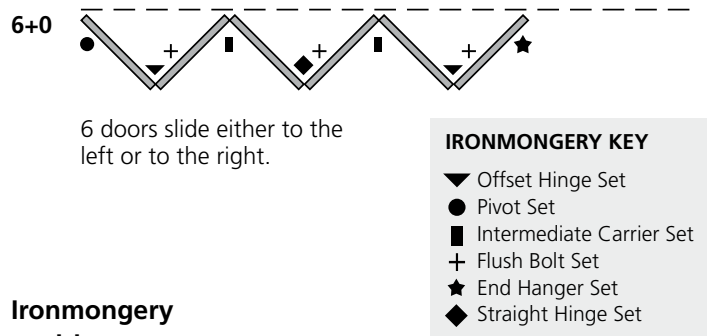

Ironmongery position

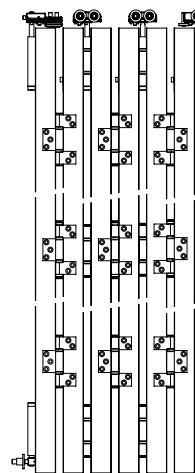

Flush bolt positions

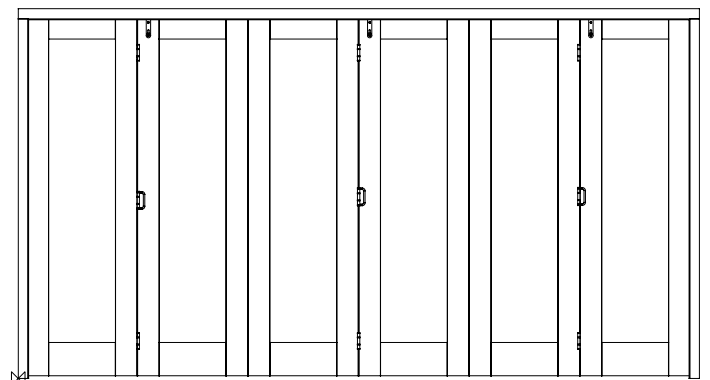

1. Hanging the first door

Using the hinges from the pivot set, measure and mark 15mm from the top edge of the door to the top edge of the hinge.

Using a 2mm wood drill bit, make pilot holes for each of the screw locations. Using 25mm screws from the pack, fix the hinge to the door.

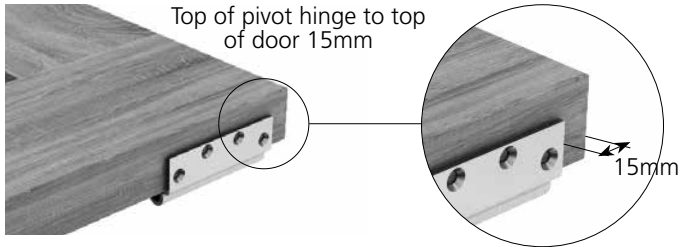

Measure and mark 30mm from the bottom edge of the door to the bottom of the hinge. Pilot drill and fix.

Important: Ensure you use the screwdriver bit included in your pack when fitting the ironmongery.

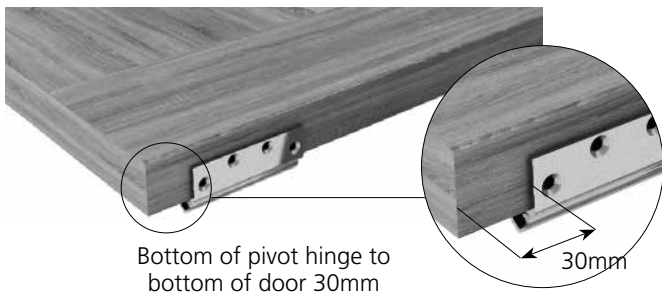

2. Setting the top pivot

A. Insert the top threaded hinge pin into the hinge barrel fixed to the door. Offer the door up to the top fixed pivot.

Press and hold the button to allow the hinge on the door to engage with the screw part of the top fixed pivot.

Using the Allen key provided, tighten until the door is set to the appropriate height for your floor covering.

Release the button to allow the top fixed pivot to lock into place.

B. The distance between the door frame edge and the edge of door one should be 6mm. Once in this position, using the Allen key once more, tighten the Allen bolts to keep the top fixed pivot in position in the metal top track.

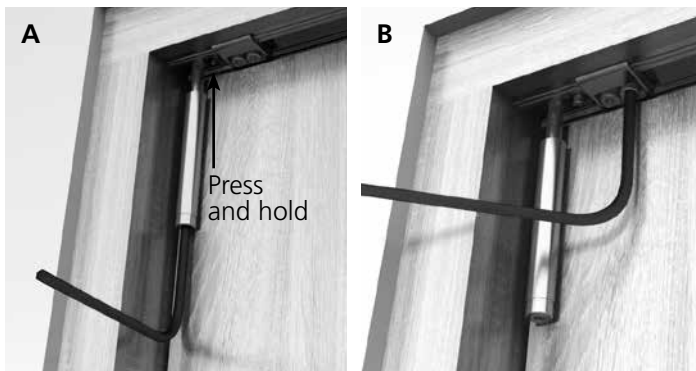

3. Fixing the bottom pivot

Insert the bottom pivot pin into the bottom fixed pivot hinge on the door. Using a pencil, mark the height of the pivot point.

Measure 32mm from the outer edge of the frame and mark with a pencil. Carefully hold the door away.

Using a 12mm wood drill bit make a pilot hole into the frame to allow pivot point to sit flush with the frame.

Screw the bottom fixed pivot into the timber frame using the 30mm screws provided from the pack.

Check the 6mm edge gap is equal at the top and the bottom.

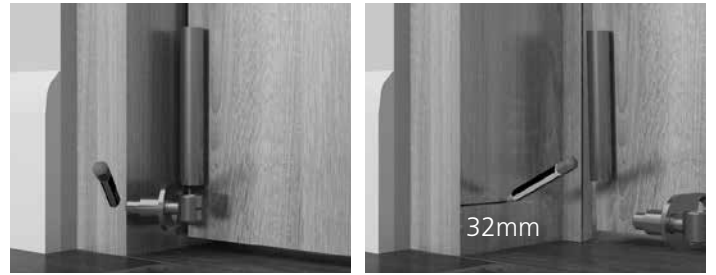

4. Preparing for the second door

A. Take an offset hinge from the handle hinge set and with the hinge closed as a guide, measure and mark **150mm** from the top of the door to the top of the hinge.

Mark the three screw positions on the middle hinge flag and using a 2mm wood drill bit make pilot holes for each of the screw positions. Using 25mm screws from the pack, fix the hinge to the door.

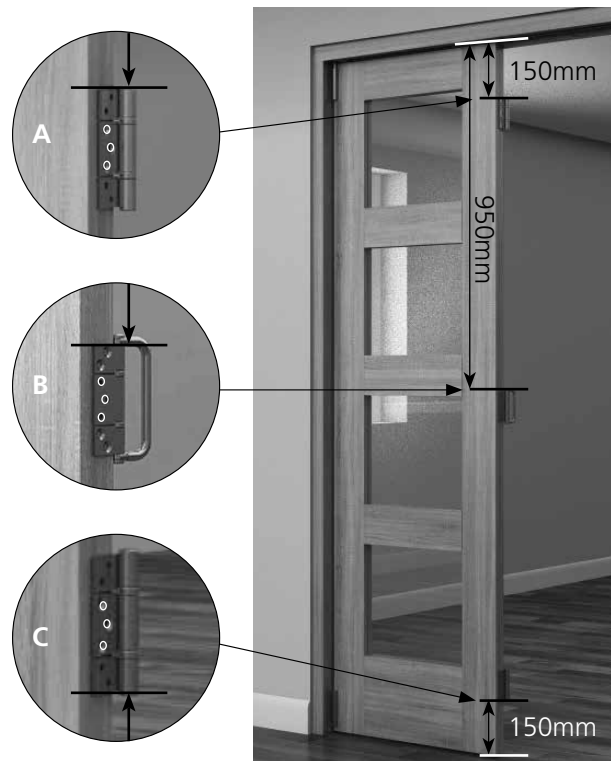

B. Take the handle hinge and measure and mark **950mm** from the top edge of the door to the top of the hinge. Pilot drill and fix the middle hinge flag.

C. Fix the final hinge by measuring and marking **150mm** from the bottom of the door to the bottom of the hinge. Pilot drill and fix the middle hinge flag.

5. Fitting the flush bolts

The position and quantity of the flush bolts varies by configuration, please refer to the ironmongery location diagram on page 13 to determine the correct position and amount required.

We recommend you use a hand router to form the necessary recesses to the top door edge. Alternatively hand tools can be used. Use the screws provided to fix.

Important: Router all flush bolt recesses on all applicable doors in one go.

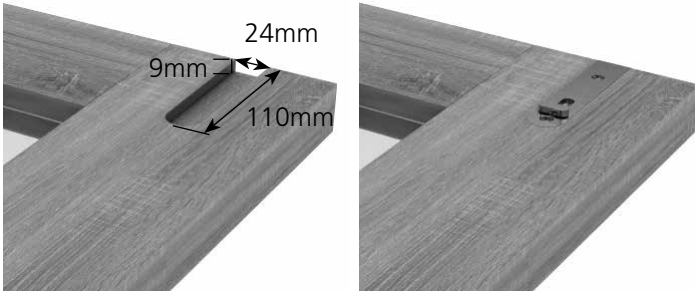

6. Fitting door two to door one

Using the hinges already fixed to door one as a guide, measure and mark down from the top edge of the door to the top of the hinge **150mm**. Pilot drill and fix.

Pilot drill and fix the centre and bottom hinges.



7. Preparing for the third door

Bring the intermediate carrier that is already in the top track to the edge of door two. Measure and mark **15mm** down from the top edge of the door to the top of the hinge. Pilot drill and fix the top and bottom hinge flags.

Take a straight hinge from the intermediate carrier set. Measure and mark **950mm** from the top edge of the door to the top of the hinge. Pilot drill and fix the top and bottom hinge flags.

Take another straight hinge and measure and mark **150mm** from the bottom of the door edge up to the bottom of the hinge. Pilot drill and fix the top and bottom hinge flags.

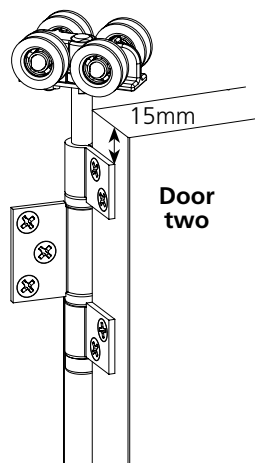

8. Fitting door three to door two

Pilot drill and fix the middle hinge flag on each hinge to door three.

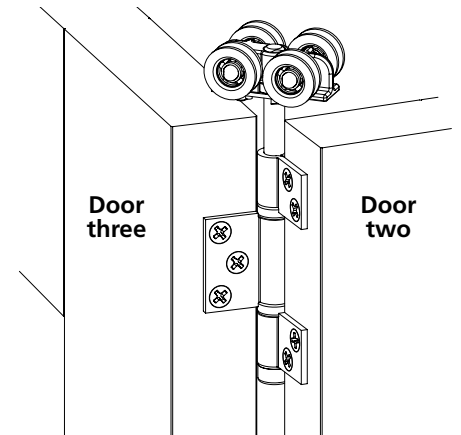

9. Preparing for the fourth door

A. Take a straight hinge from the handle hinge set and with the hinge closed as a guide, measure and mark **150mm** from the top of the door to the top of the hinge.

Mark the three screw positions on the middle hinge flag and using a 2mm wood drill bit make pilot holes for each of the screw positions.

Using 25mm screws from the pack, fix the hinge to the door.

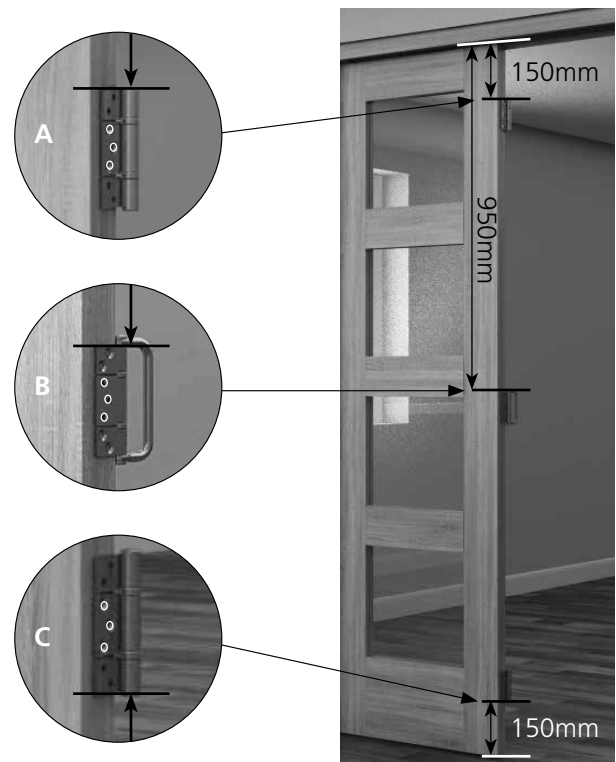

B. Take the handle hinge and measure and mark **950mm** from the top edge of the door to the top of the hinge. Pilot drill and fix the middle hinge flag.

C. Fix the final hinge by measuring and marking **150mm** from the bottom of the door to the bottom of the hinge. Pilot drill and fix the middle hinge flag.

10. Fitting door four to door three

Using the hinges already fixed to door one as a guide, measure and mark down from the top edge of the door to the top of the hinge **150mm**. Pilot drill and fix.

Pilot drill and fix the centre and bottom hinges.

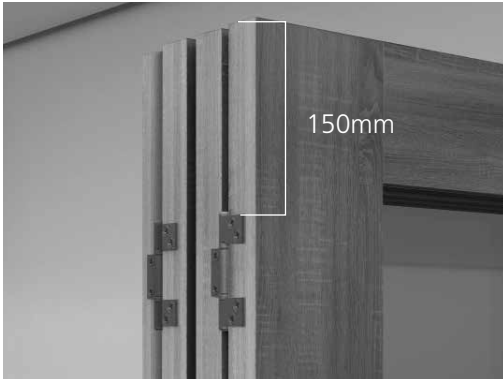

11. Preparing for the fifth door

Bring the intermediate carrier that is already in the top track to the edge of door four. Measure and mark **15mm** down from the top edge of the door to the top of the hinge. Pilot drill and fix the top and bottom hinge flags.

Take a straight hinge from the intermediate carrier set. Measure and mark **950mm** from the top edge of the door to the top edge of the hinge. Pilot drill and fix the top and bottom hinge flags.

Take another straight hinge and measure and mark **150mm** from the bottom of the door edge up to the bottom of the hinge. Pilot drill and fix the top and bottom hinge flags.

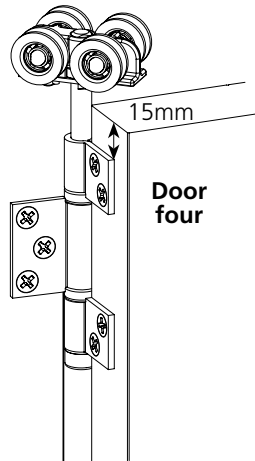

12. Fitting door five to door four

Pilot drill and fix the middle hinge flag on each hinge to door five.

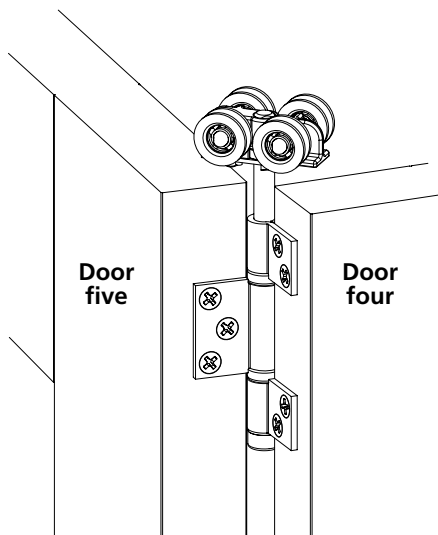

13. Preparing for the sixth door

A. Take an offset hinge from the handle hinge set and with the hinge closed as a guide, measure and mark **150mm** from the top of the door to the top of the hinge.

Mark the two screw positions on the top and bottom hinge flags and using a 2mm wood drill bit make pilot holes for each of the screw positions.

Using 25mm screws from the pack, fix the hinge to the door.

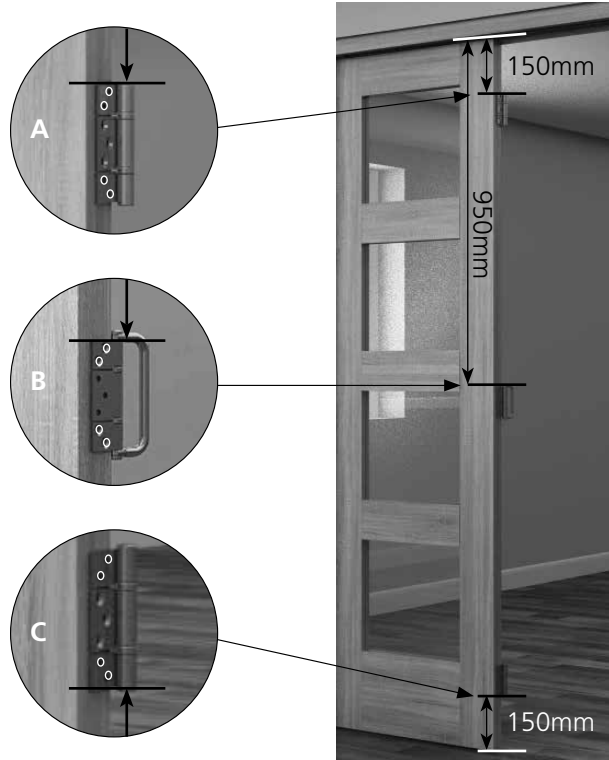

B. Take the handle hinge and measure and mark **950mm** from the top edge of the door to the top of the hinge. Pilot drill and fix the top and bottom hinge flags.

C. Fix the final hinge by measuring and marking **150mm** from the bottom of the door to the bottom of the hinge. Pilot drill and fix the top and bottom hinge flags.

14. Fitting door six to door five

Using the hinges already fixed to door five as a guide, measure and mark down from the top edge of the door to the top of the middle hinge flag **173mm**. Pilot drill and fix.

Pilot drill and fix the centre and bottom hinges.

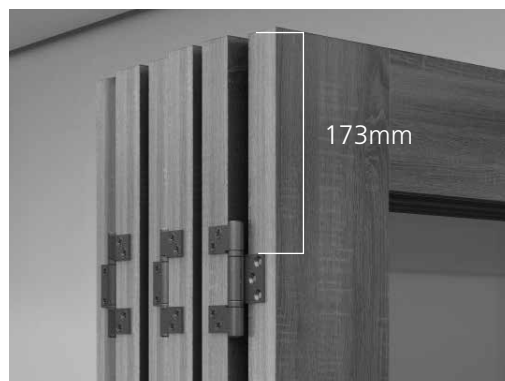

15. Fitting the end hanger

To fit the end hanger, measure and mark **15mm** from the top edge of the door to the top of the hinge flag and pilot drill and fix.

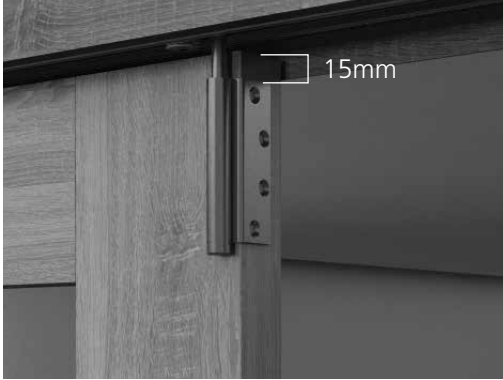

16. Fitting the latch keep

We have included an latch keep to be used with a standard 65mm latch (not provided) if you choose to fit handles to your configuration. Once you have fitted your latch, simply mark around the keep against the frame in the correct position.

Using a wood chisel, carefully cut around the mark going down by 1.5mm and remove the excess so the latch sits flush to the frame. Finally screw the latch keep to the frame.



DON'T FORGET

When operating a Room Fold you must always open by pulling the door closest to the frame first, and then fold the others away.

Pull first, then slide back

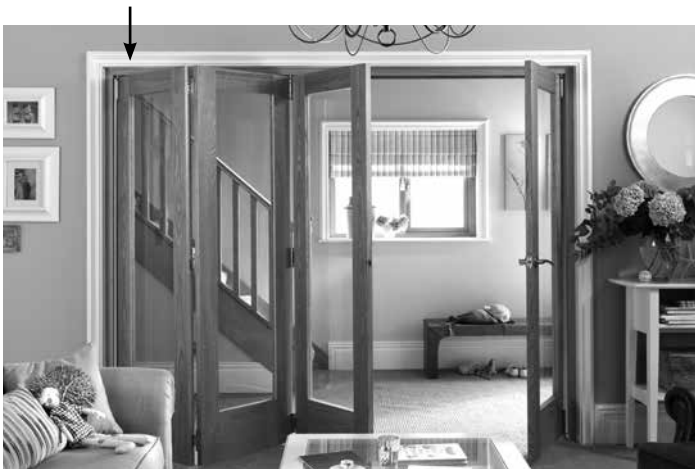

INSTALLING THE DOORS FOR A 3+3 CONFIGURATION



Components

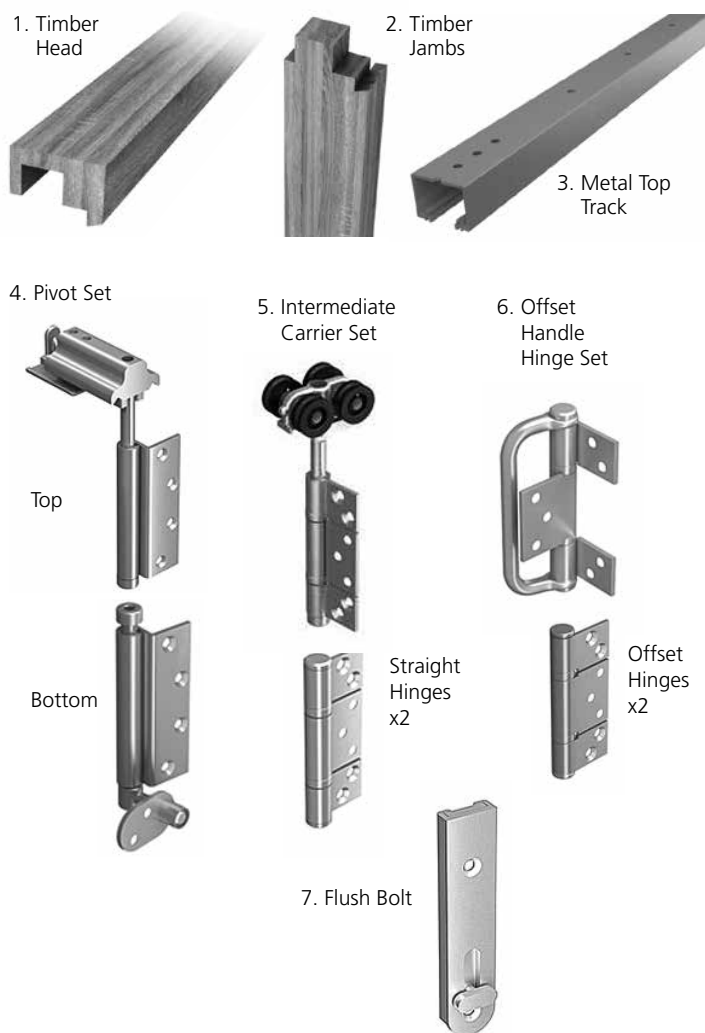

Detailed pack contents

Door Configuration		
Component	3+3 2047 x 3771mm	3+3 2047 x 4227mm
1. Timber Head	1 x 3771mm	1 x 4227mm
2. Timber Jamb	2 x 2032mm	2 x 2032mm
3. Metal Top Track	1 x 3686mm	1 x 4142mm
4. Pivot Set	2	2
5. Intermediate Carrier Set	2	2
6. Offset Handle Hinge Set	2	2
7. Flush Bolt	3	3

Ironmongery locations

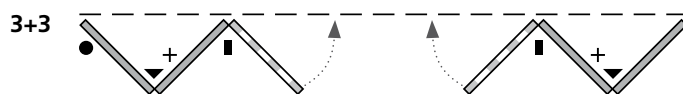

3 doors slide to the left 3 to the right with 2 doors hinged that opens independent to the others.

IRONMONGERY KEY

- ▼ Offset Hinge Set
- Pivot Set
- Intermediate Carrier Set
- + Flush Bolt Set

Ironmongery position

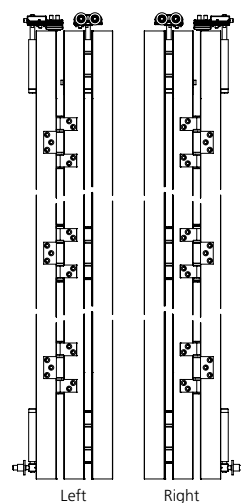

Flush bolt positions

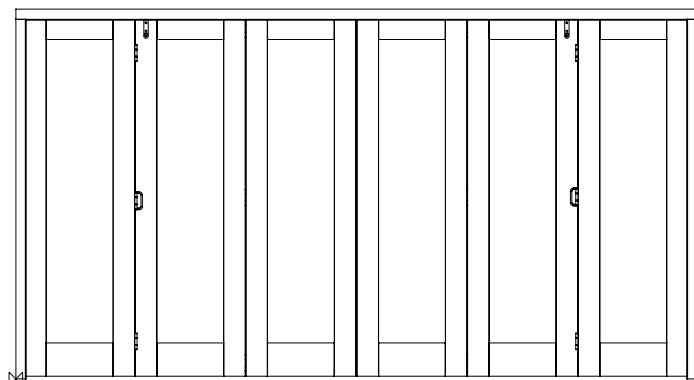

1. Hanging the first door on the on the left side

Using the hinges from the pivot set, measure and mark 15mm from the top edge of the door to the top edge of the hinge.

Using a 2mm wood drill bit, make pilot holes for each of the screw locations. Using 25mm screws from the pack, fix the hinge to the door.

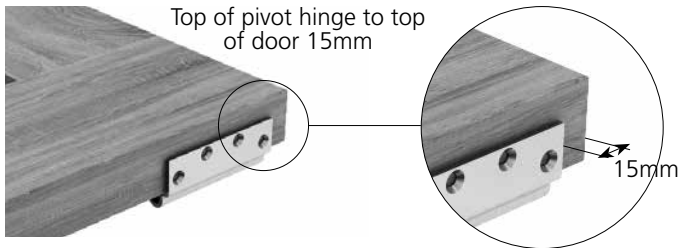

Measure and mark 30mm from the bottom edge of the door to the bottom of the hinge. Pilot drill and fix.

Important: Ensure you use the screwdriver bit included in your pack when fitting the ironmongery.

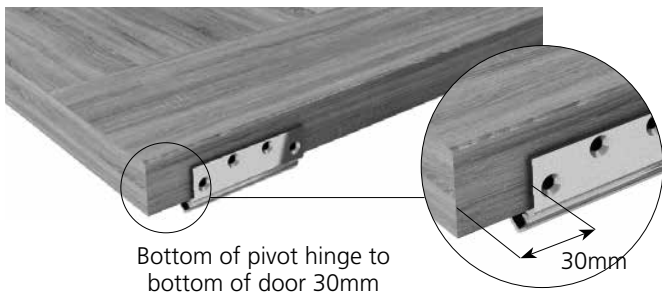

2. Setting the top pivot

A. Insert the top threaded hinge pin into the hinge barrel fixed to the door. Offer the door up to the top fixed pivot.

Press and hold the button to allow the hinge on the door to engage with the screw part of the top fixed pivot.

Using the Allen key provided, tighten until the door is set to the appropriate height for your floor covering.

Release the button to allow the top fixed pivot to lock into place.

B. The distance between the door frame edge and the edge of door one should be 6mm. Once in this position, using the Allen key once more, tighten the Allen bolts to keep the top fixed pivot in position in the metal top track.

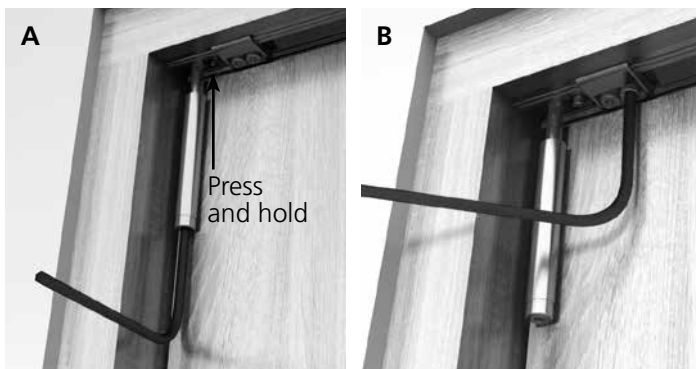

3. Fixing the bottom pivot

Insert the bottom pivot pin into the bottom fixed pivot hinge on the door. Using a pencil, mark the height of the pivot point.

Measure 32mm from the outer edge of the frame and mark with a pencil. Carefully hold the door away.

Using a 12mm wood drill bit make a pilot hole into the frame to allow pivot point to sit flush with the frame.

Screw the bottom fixed pivot into the timber frame using the 30mm screws provided from the pack.

Check the 6mm edge gap is equal at the top and the bottom.

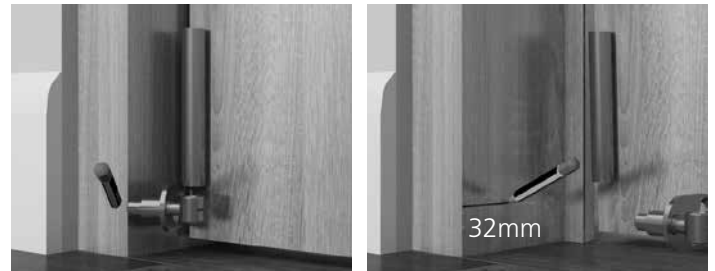

4. Preparing for the second door

A. Take an offset hinge from the handle hinge set and with the hinge closed as a guide, measure and mark **150mm** from the top of the door to the top of the hinge.

Mark the three screw positions on the middle hinge flag and using a 2mm wood drill bit make pilot holes for each of the screw positions.

Using 25mm screws from the pack, fix the hinge to the door.

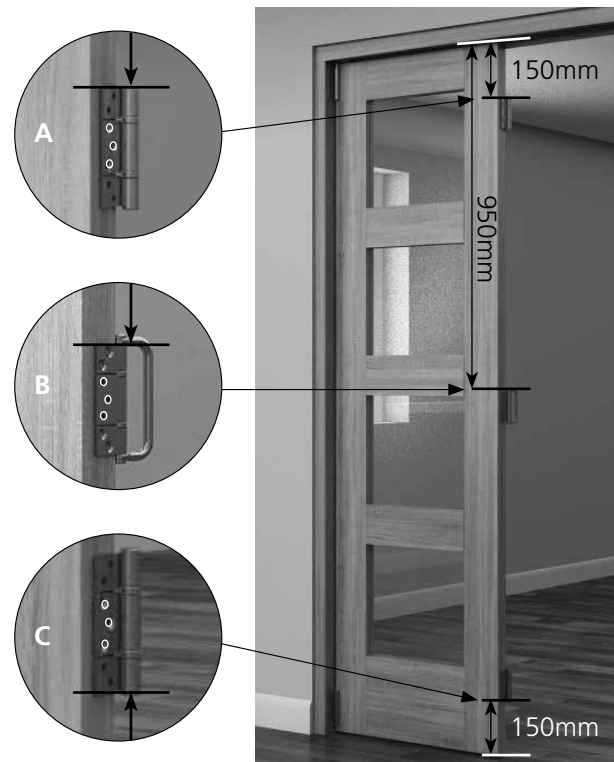

B. Take the handle hinge and measure and mark **950mm** from the top edge of the door to the top of the hinge. Pilot drill and fix the middle hinge flag.

C. Fix the final hinge by measuring and marking **150mm** from the bottom of the door to the bottom of the hinge. Pilot drill and fix the middle hinge flag.

5. Fitting the flush bolts

The position and quantity of the flush bolts varies by configuration, please refer to the ironmongery location diagram on page 18 to determine the correct position and amount required.

We recommend you use a hand router to form the necessary recesses to the top door edge. Alternatively hand tools can be used. Use the screws provided to fix.

Important: Router all flush bolt recesses on all applicable doors in one go.

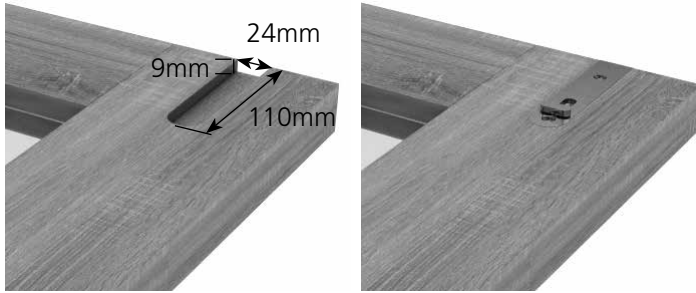

6. Fitting door two to door one

Using the hinges already fixed to door one as a guide, measure and mark down from the top edge of the door to the top of the hinge **150mm**. Pilot drill and fix.

Pilot drill and fix the centre and bottom hinges.



7. Preparing for the third door

Bring the intermediate carrier that is already in the top track to the edge of door two. Measure and mark **15mm** down from the top edge of the door to the top of the hinge. Pilot drill and fix the top and bottom hinge flags.

Take a straight hinge from the intermediate carrier set. Measure and mark **950mm** from the top edge of the door to the top of the hinge. Pilot drill and fix the top and bottom hinge flags.

Take another straight hinge and measure and mark **150mm** from the bottom of the door edge up to the bottom of the hinge. Pilot drill and fix the top and bottom hinge flags.

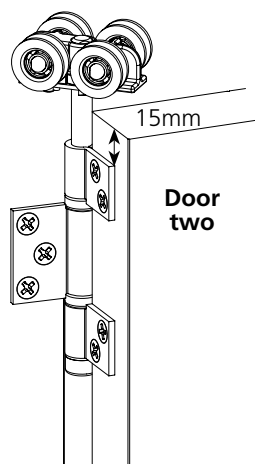

8. Fitting door three to door two

Pilot drill and fix the middle hinge flag on each hinge to door three.

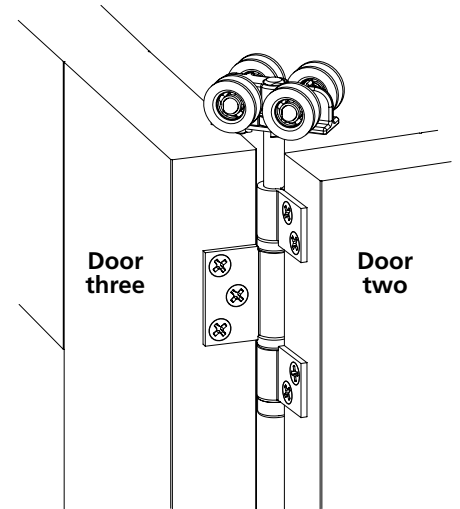

9. Hanging the doors on the right side

To hang the doors on the right side its simply a case of repeating steps 1 to 8.

DON'T FORGET

When operating a Room Fold you must always open by pulling the door closest to the frame first, and then fold the others away.

Pull first, then slide back

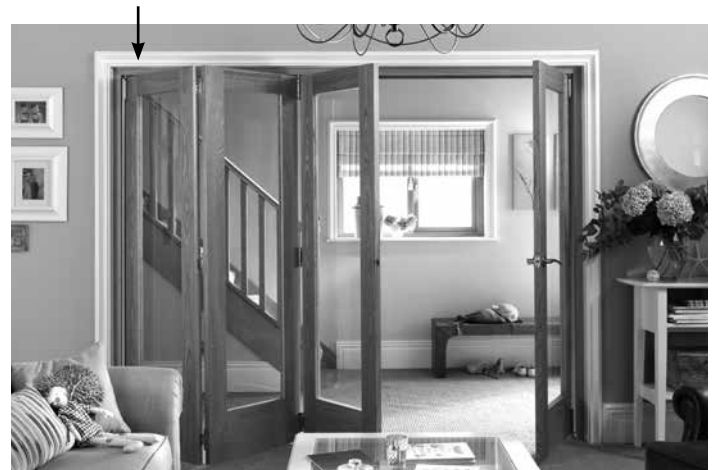

INSTALLING THE DOORS FOR A 3+0 CONFIGURATION



Detailed pack contents

Door Configuration		
Component	3+0 2047 x 1929mm	3+0 2047 x 2157mm
1. Timber Head	1 x 1929mm	1 x 2545mm
2. Timber Jambs	2 x 2032mm	2 x 2032mm
3. Metal Top Track	1 x 1844mm	1 x 2460mm
4. Pivot Set	1	1
5. Intermediate Carrier Set	1	1
6. Offset Handle Hinge Set	1	1
7. Flush Bolt	1	1
8. Latch Keep	1	1

Components

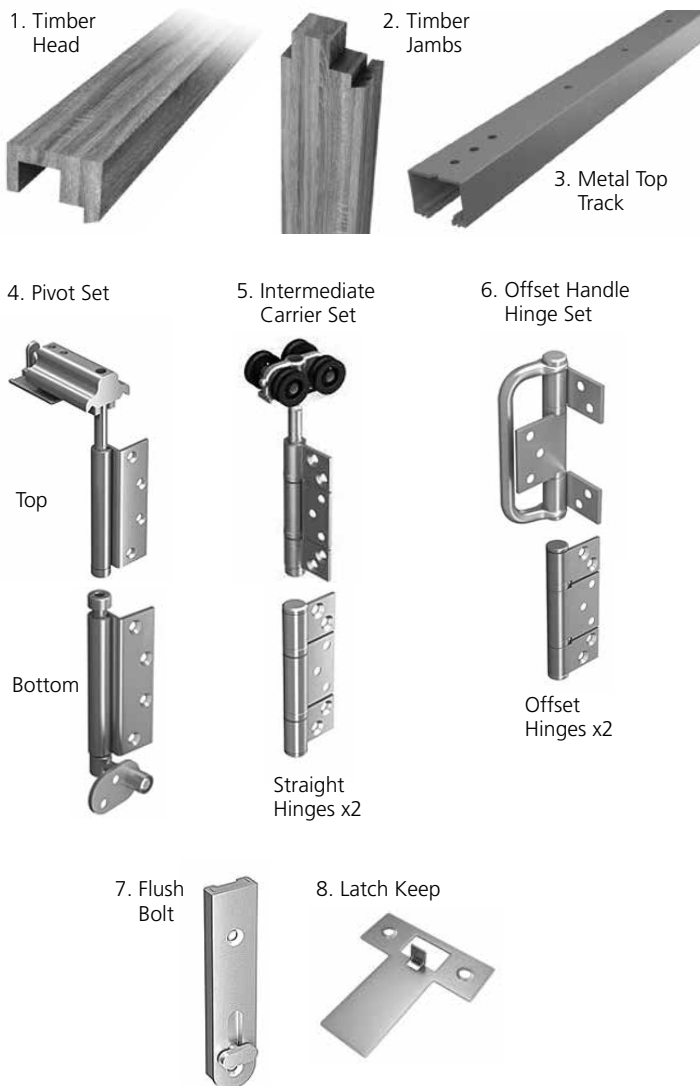

Ironmongery locations

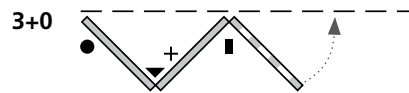

3 doors slide either to the left or to the right with 1 door hinged that opens independent to the others.

IRONMONGERY KEY

- ▼ Offset Hinge Set
- Pivot Set
- Intermediate Carrier Set
- + Flush Bolt Set

Ironmongery position

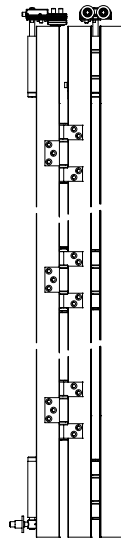

Flush bolt position

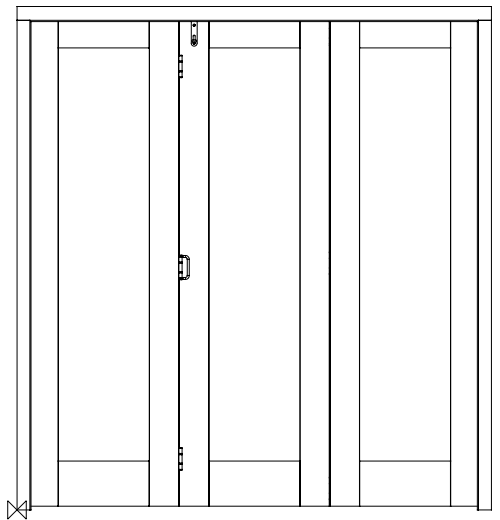

1. Hanging the first door

Using the hinges from the pivot set, measure and mark 15mm from the top edge of the door to the top edge of the hinge.

Using a 2mm wood drill bit, make pilot holes for each of the screw locations. Using 25mm screws from the pack, fix the hinge to the door.

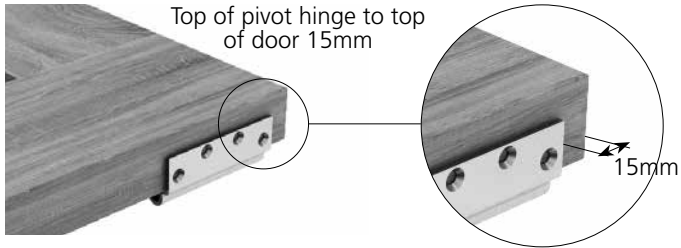

Measure and mark 30mm from the bottom edge of the door to the bottom of the hinge. Pilot drill and fix.

Important: Ensure you use the screwdriver bit included in your pack when fitting the ironmongery.

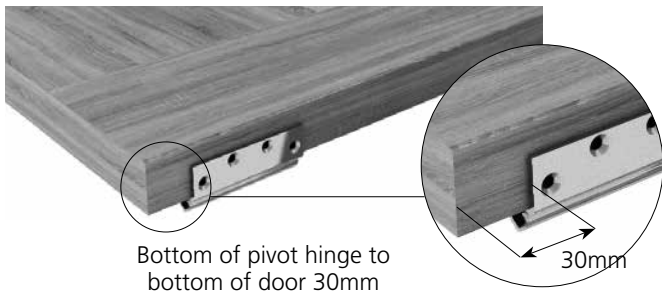

2. Setting the top pivot

A. Insert the top threaded hinge pin into the hinge barrel fixed to the door. Offer the door up to the top fixed pivot.

Press and hold the button to allow the hinge on the door to engage with the screw part of the top fixed pivot.

Using the Allen key provided, tighten until the door is set to the appropriate height for your floor covering.

Release the button to allow the top fixed pivot to lock into place.

B. The distance between the door frame edge and the edge of door one should be 6mm. Once in this position, using the Allen key once more, tighten the Allen bolts to keep the top fixed pivot in position in the metal top track.

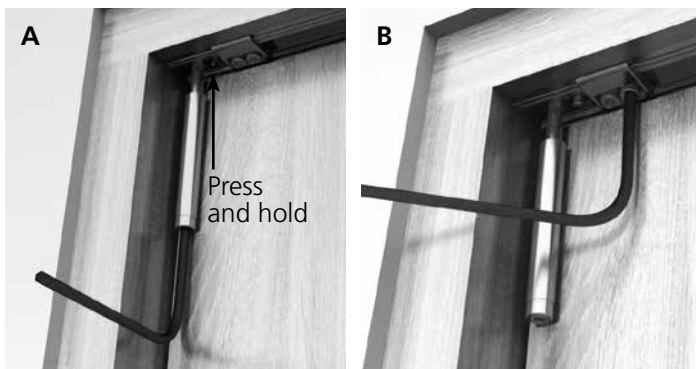

3. Fixing the bottom pivot

Insert the bottom pivot pin into the bottom fixed pivot hinge on the door. Using a pencil, mark the height of the pivot point.

Measure 32mm from the outer edge of the frame and mark with a pencil. Carefully hold the door away.

Using a 12mm wood drill bit make a pilot hole into the frame to allow pivot point to sit flush with the frame.

Screw the bottom fixed pivot into the timber frame using the 30mm screws provided from the pack.

Check the 6mm edge gap is equal at the top and the bottom.



4. Preparing for the second door

A. Take an offset hinge from the handle hinge set and with the hinge closed as a guide, measure and mark **150mm** from the top of the door to the top of the hinge.

Mark the three screw positions on the middle hinge flag and using a 2mm wood drill bit make pilot holes for each of the screw positions. Using 25mm screws from the pack, fix the hinge to the door.

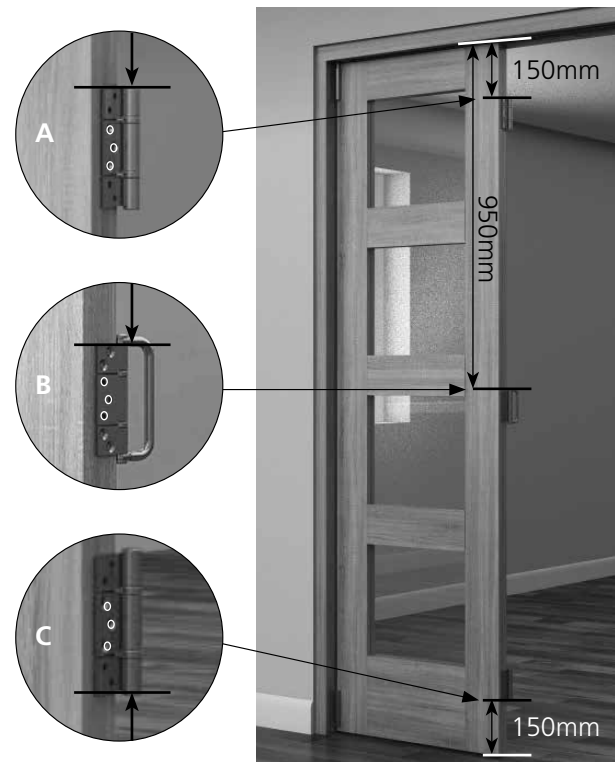

B. Take the handle hinge and measure and mark **950mm** from the top edge of the door to the top of the hinge. Pilot drill and fix the middle hinge flag.

C. Fix the final hinge by measuring and marking **150mm** from the bottom of the door to the bottom of the hinge. Pilot drill and fix the middle hinge flag.

5. Fitting the flush bolts

The position and quantity of the flush bolts varies by configuration, please refer to the ironmongery location diagram on page 21 to determine the correct position and amount required.

We recommend you use a hand router to form the necessary recesses to the top door edge. Alternatively hand tools can be used. Use the screws provided to fix.

Important: Router all flush bolt recesses on all applicable doors in one go.

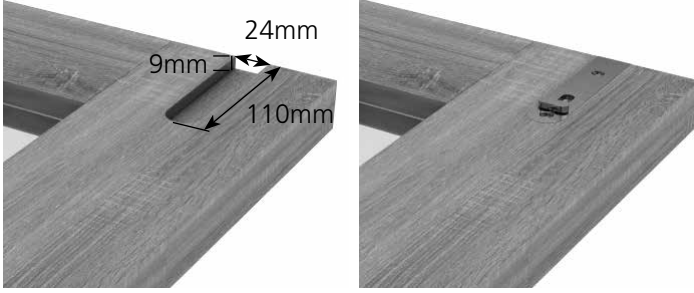

6. Fitting door two to door one

Using the hinges already fixed to door one as a guide, measure and mark down from the top edge of the door to the top of the hinge **150mm**. Pilot drill and fix.

Pilot drill and fix the centre and bottom hinges.



7. Preparing for the third door

Bring the intermediate carrier that is already in the top track to the edge of door two. Measure and mark **15mm** down from the top edge of the door to the top of the hinge. Pilot drill and fix the top and bottom hinge flags.

Take a straight hinge from the intermediate carrier set. Measure and mark **950mm** from the top edge of the door to the top of the hinge. Pilot drill and fix the top and bottom hinge flags.

Take another straight hinge and measure and mark **150mm** from the bottom of the door edge up to the bottom of the hinge. Pilot drill and fix the top and bottom hinge flags.

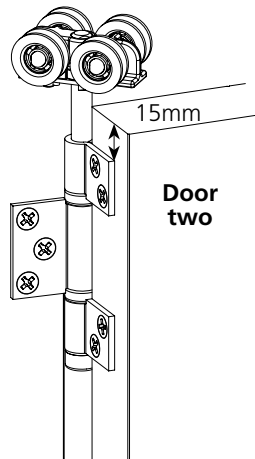

8. Fitting door three to door two

Pilot drill and fix the middle hinge flag on each hinge to door three.

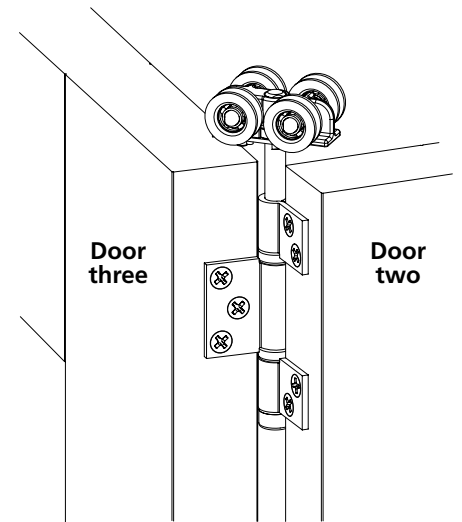

9. Fitting the latch keep

We have included a latch keep to be used with a standard 65mm latch (not provided) if you choose to fit handles to your configuration. Once you have fitted your latch, simply mark around the keep against the frame in the correct position.

Using a wood chisel, carefully cut around the mark going down by 1.5mm and remove the excess so the latch sits flush to the frame. Finally screw the latch keep to the frame.



DON'T FORGET

When operating a Room Fold you must always open by pulling the door closest to the frame first, and then fold the others away.

Pull first, then slide back

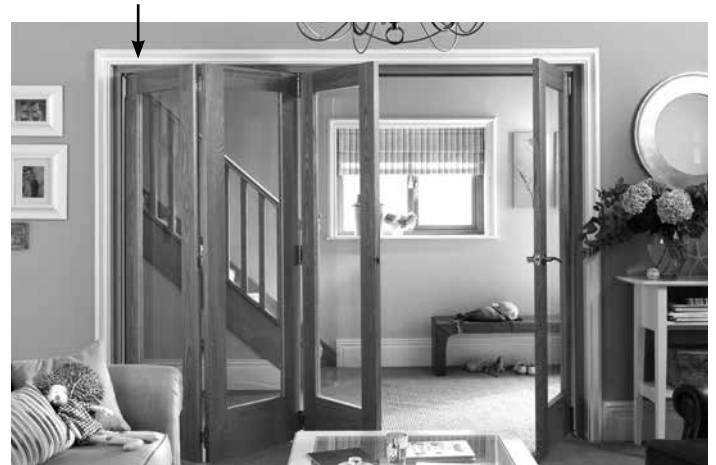

INSTALLING THE DOORS FOR A 5+0 CONFIGURATION



Components

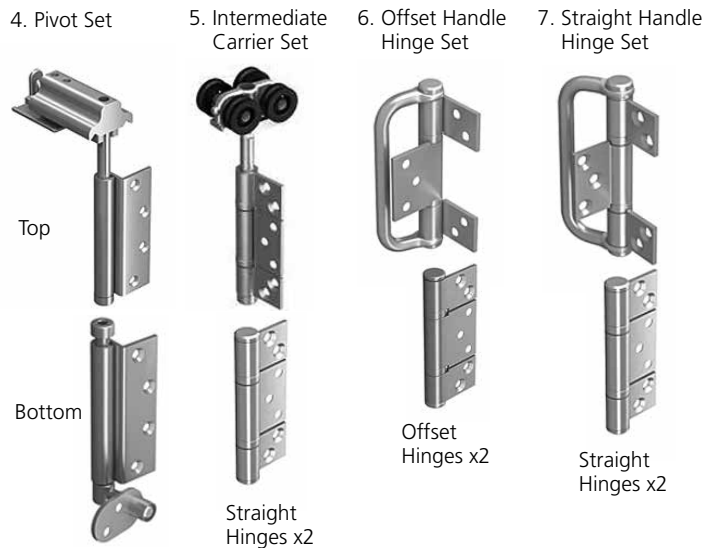
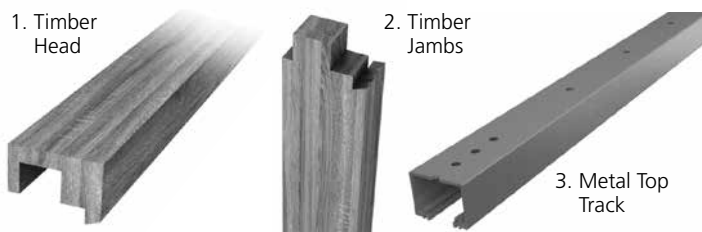

Detailed pack contents

Door Configuration		
Component	5+0 2047 x 3158mm	5+0 2047 x 3538mm
1. Timber Head	1 x 3158mm	1 x 3771mm
2. Timber Jambs	2 x 2032mm	2 x 2032mm
3. Metal Top Track	1 x 3073mm	1 x 3686mm
4. Pivot Set	1	1
5. Intermediate Carrier Set	2	2
6. Offset Handle Hinge Set	1	1
7. Straight Handle Hinge Set	1	1
8. Flush Bolt	2	2
9. Latch Keep	1	1

Ironmongery locations

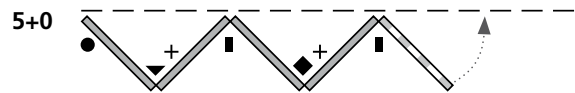

5 doors slide either to the left or to the right.

IRONMONGERY KEY

- ▼ Offset Hinge Set
- Pivot Set
- Intermediate Carrier Set
- + Flush Bolt Set
- ◆ Straight Hinge Set

Ironmongery position

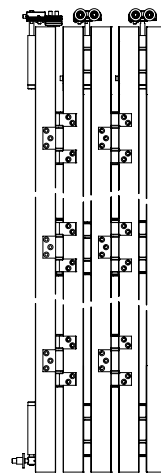

Flush bolt positions

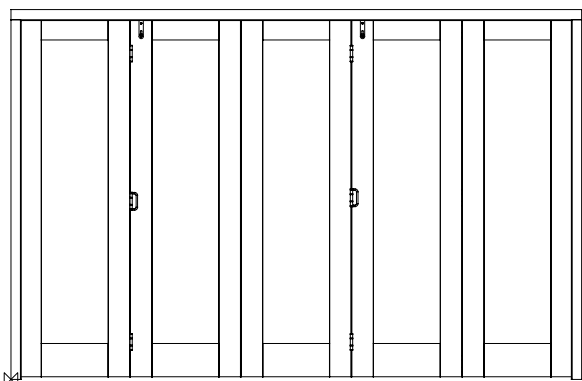

1. Hanging the first door

Using the hinges from the pivot set, measure and mark 15mm from the top edge of the door to the top edge of the hinge.

Using a 2mm wood drill bit, make pilot holes for each of the screw locations. Using 25mm screws from the pack, fix the hinge to the door.

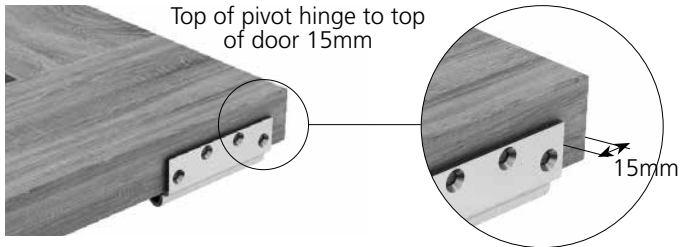

Measure and mark 30mm from the bottom edge of the door to the bottom of the hinge. Pilot drill and fix.

Important: Ensure you use the screwdriver bit included in your pack when fitting the ironmongery.

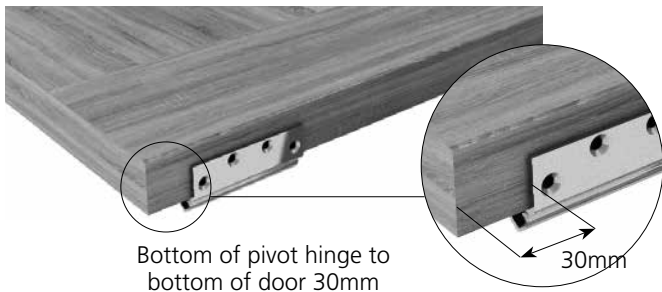

2. Setting the top pivot

A. Insert the top threaded hinge pin into the hinge barrel fixed to the door. Offer the door up to the top fixed pivot.

Press and hold the button to allow the hinge on the door to engage with the screw part of the top fixed pivot.

Using the Allen key provided, tighten until the door is set to the appropriate height for your floor covering.

Release the button to allow the top fixed pivot to lock into place.

B. The distance between the door frame edge and the edge of door one should be 6mm. Once in this position, using the Allen key once more, tighten the Allen bolts to keep the top fixed pivot in position in the metal top track.

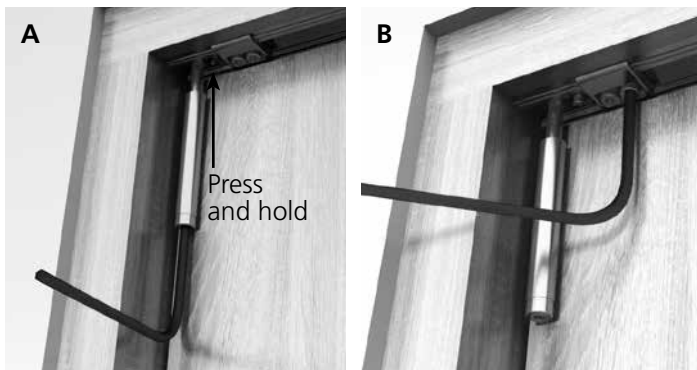

3. Fixing the bottom pivot

Insert the bottom pivot pin into the bottom fixed pivot hinge on the door. Using a pencil, mark the height of the pivot point.

Measure 32mm from the outer edge of the frame and mark with a pencil. Carefully hold the door away.

Using a 12mm wood drill bit make a pilot hole into the frame to allow pivot point to sit flush with the frame.

Screw the bottom fixed pivot into the timber frame using the 30mm screws provided from the pack.

Check the 6mm edge gap is equal at the top and the bottom.



4. Preparing for the second door

A. Take an offset hinge from the handle hinge set and with the hinge closed as a guide, measure and mark **150mm** from the top of the door to the top of the hinge.

Mark the three screw positions on the middle hinge flag and using a 2mm wood drill bit make pilot holes for each of the screw positions.

Using 25mm screws from the pack, fix the hinge to the door.

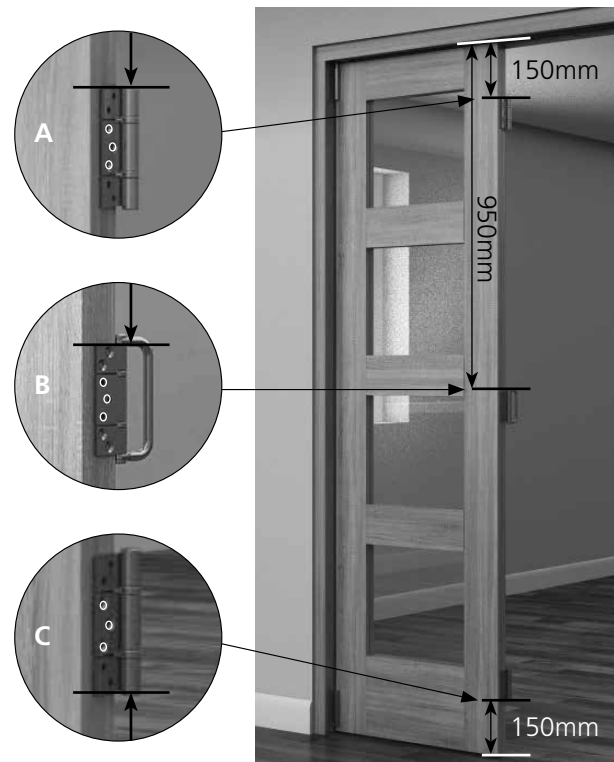

B. Take the handle hinge and measure and mark **950mm** from the top edge of the door to the top of the hinge. Pilot drill and fix the middle hinge flag.

C. Fix the final hinge by measuring and marking **150mm** from the bottom of the door to the bottom of the hinge. Pilot drill and fix the middle hinge flag.

5. Fitting the flush bolts

The position and quantity of the flush bolts varies by configuration, please refer to the ironmongery location diagram on page 24 to determine the correct position and amount required.

We recommend you use a hand router to form the necessary recesses to the top door edge. Alternatively hand tools can be used. Use the screws provided to fix.

Important: It is advised to router all flush bolt recesses on all applicable doors in one go.

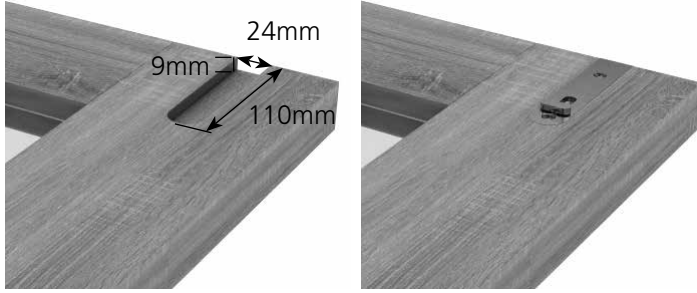

6. Fitting door two to door one

Using the hinges already fixed to door one as a guide, measure and mark down from the top edge of the door to the top of the hinge **150mm**. Pilot drill and fix.

Pilot drill and fix the centre and bottom hinges.



7. Preparing for the third door

Bring the intermediate carrier that is already in the top track to the edge of door two. Measure and mark **15mm** down from the top edge of the door to the top of the hinge. Pilot drill and fix the top and bottom hinge flags.

Take a straight hinge from the intermediate carrier set. Measure and mark **950mm** from the top edge of the door to the top of the hinge. Pilot drill and fix the top and bottom hinge flags.

Take another straight hinge and measure and mark **150mm** from the bottom of the door edge up to the bottom of the hinge. Pilot drill and fix the top and bottom hinge flags.

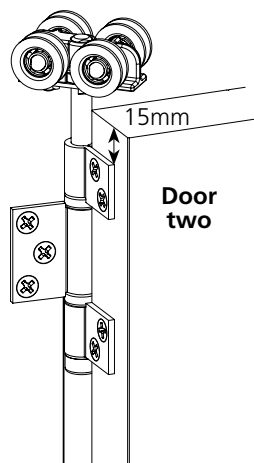

8. Fitting door three to door two

Pilot drill and fix the middle hinge flag on each hinge to door three.

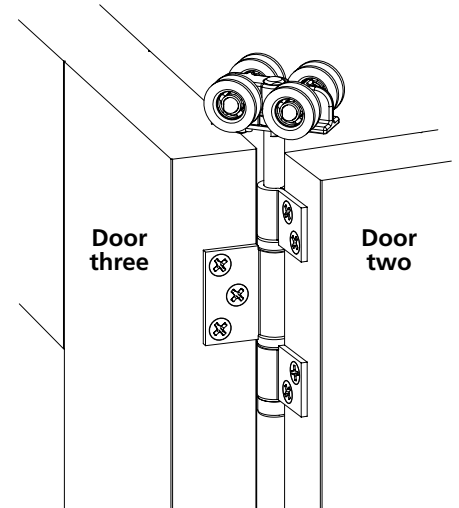

9. Preparing for the fourth door

A. Take a straight hinge from the handle hinge set and with the hinge closed as a guide, measure and mark **150mm** from the top of the door to the top of the hinge.

Mark the three screw positions on the middle hinge flag and using a 2mm wood drill bit make pilot holes for each of the screw positions.

Using 25mm screws from the pack, fix the hinge to the door.

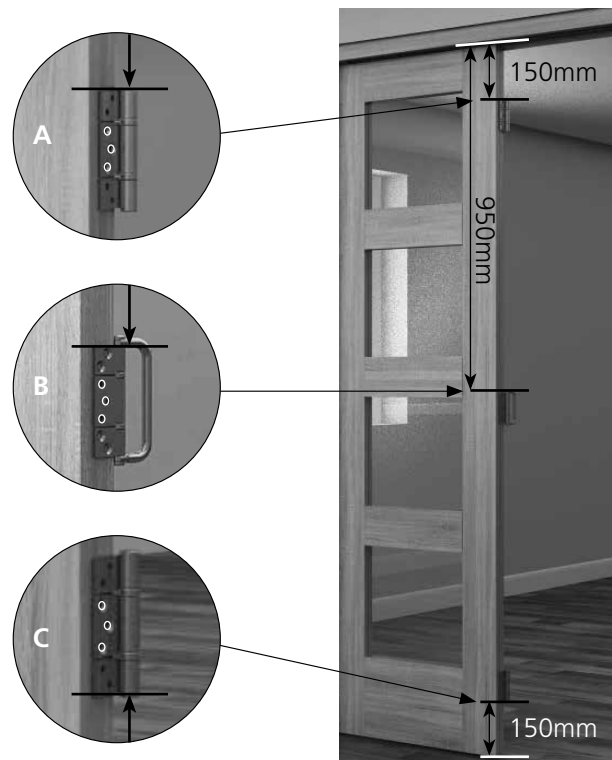

B. Take the handle hinge and measure and mark **950mm** from the top edge of the door to the top of the hinge. Pilot drill and fix the middle hinge flag.

C. Fix the final hinge by measuring and marking **150mm** from the bottom of the door to the bottom of the hinge. Pilot drill and fix the middle hinge flag.

10. Fitting door four to door three

Using the hinges already fixed to door three as a guide, measure and mark down from the top edge of the door to the top of the hinge **150mm**. Pilot drill and fix.

Pilot drill and fix the centre and bottom hinges.

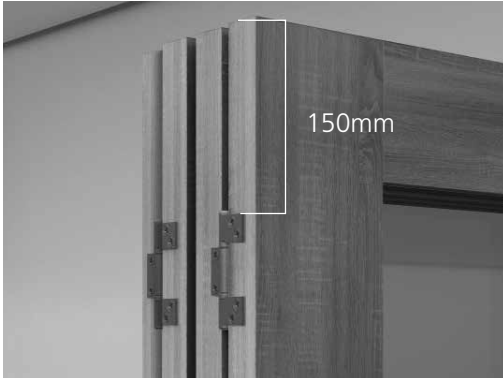

11. Preparing for the fifth door

Bring the intermediate carrier that is already in the top track to the edge of door four. Measure and mark **15mm** down from the top edge of the door to the top of the hinge. Pilot drill and fix the top and bottom hinge flags.

Take a straight hinge from the intermediate carrier set. Measure and mark **950mm** from the top edge of the door to the top of the hinge. Pilot drill and fix the top and bottom hinge flags.

Take another straight hinge and measure and mark **150mm** from the bottom of the door edge up to the bottom of the hinge. Pilot drill and fix the top and bottom hinge flags.

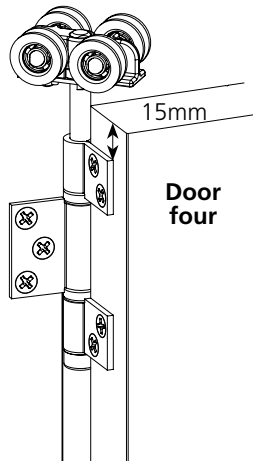

12. Fitting door five to door four

Pilot drill and fix the middle hinge flag on each hinge to door five.

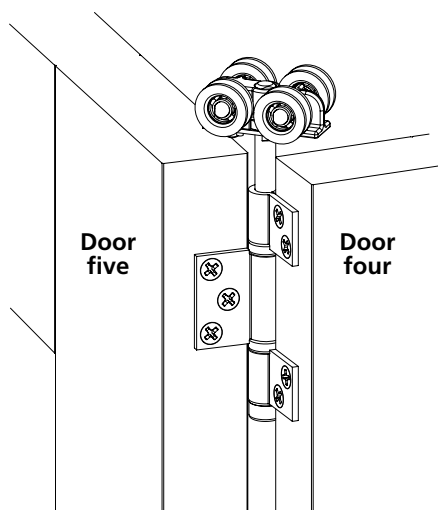

13. Fitting the latch keep

We have included a latch keep to be used with a standard 65mm latch (not provided) if you choose to fit handles to your configuration. Once you have fitted your latch, simply mark around the keep against the frame in the correct position.

Using a wood chisel, carefully cut around the mark going down by 1.5mm and remove the excess so the latch sits flush to the frame. Finally screw the latch keep to the frame.



DON'T FORGET

When operating a Room Fold you must always open by pulling the door closest to the frame first, and then fold the others away.

Pull first, then slide back

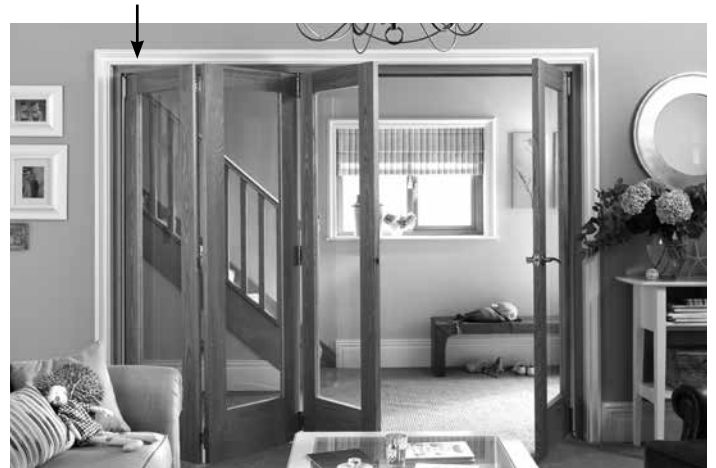

INSTALLING THE DOORS FOR A 3+1 CONFIGURATION



Detailed pack contents

Door Configuration		
Component	3+1 2047 x 2545mm	3+1 2047 x 2849mm
1. Timber Head	1 x 2545mm	1 x 3158mm
2. Timber Jambs	2 x 2032mm	2 x 2032mm
3. Metal Top Track	1 x 2460mm	1 x 3073mm
4. Pivot Set	2	2
5. Intermediate Carrier Set	1	1
6. Offset Handle Hinge Set	1	1
7. Flush Bolt	2	2

Components

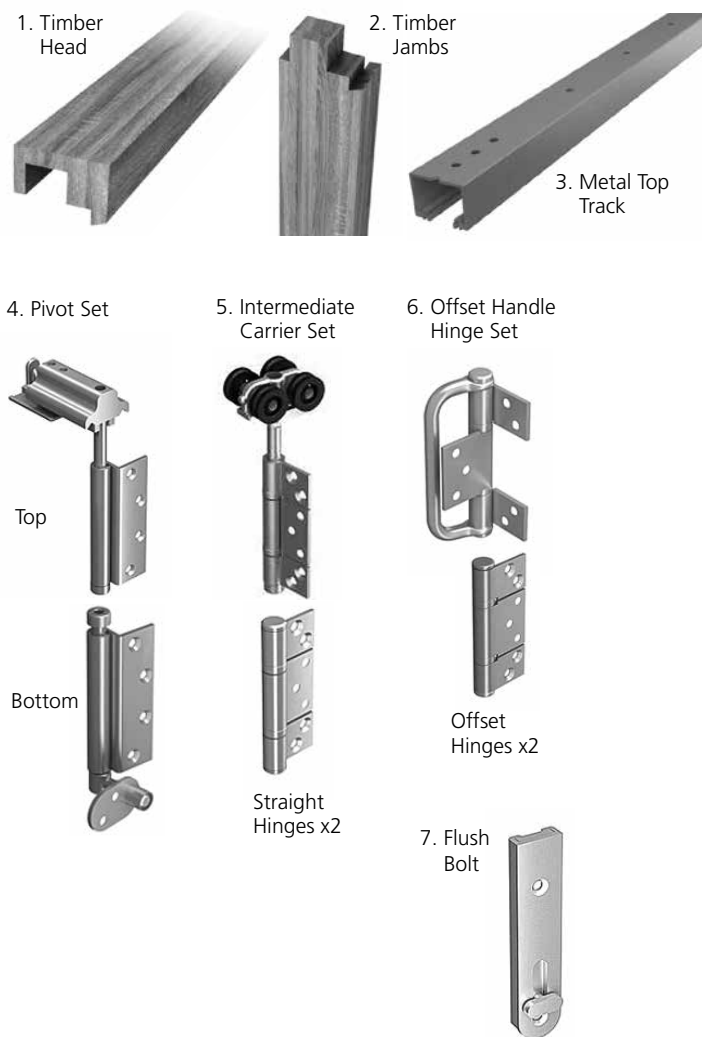

Ironmongery locations

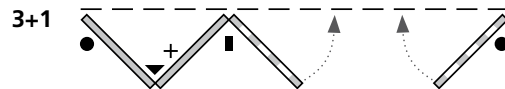

3 doors slide either to the left or to the right with 1 door hinged that opens independent to the others & 1 door hinged to the opposite side that also opens independent to the others.

IRONMONGERY KEY

- ▼ Offset Hinge Set
- Pivot Set
- Intermediate Carrier Set
- + Flush Bolt Set

Ironmongery position

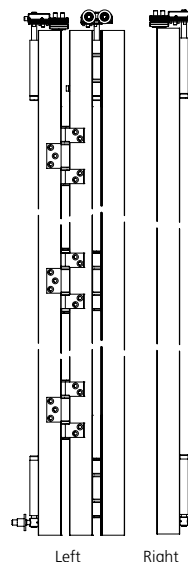

Flush bolt positions

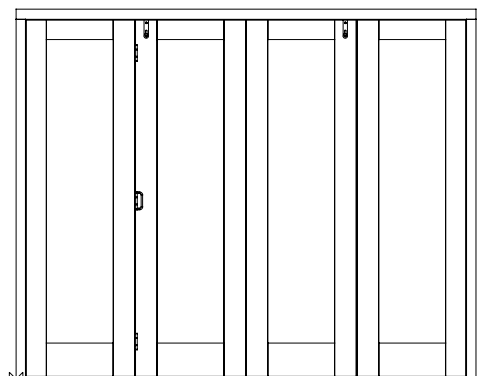

1. Hanging the first door to the left side

Using the hinges from the pivot set, measure and mark 15mm from the top edge of the door to the top edge of the hinge.

Using a 2mm wood drill bit, make pilot holes for each of the screw locations. Using 25mm screws from the pack, fix the hinge to the door.

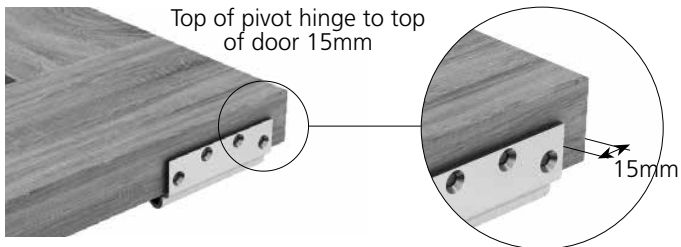

Measure and mark 30mm from the bottom edge of the door to the bottom of the hinge. Pilot drill and fix.

Important: Ensure you use the screwdriver bit included in your pack when fitting the ironmongery.

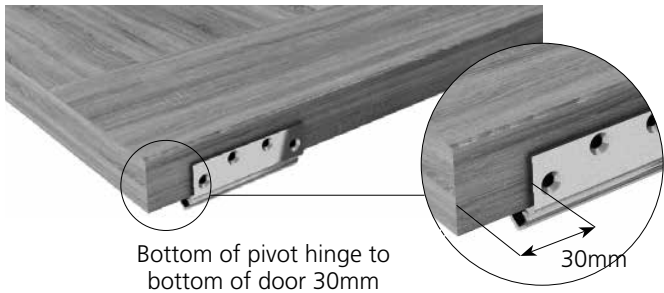

2. Setting the top pivot

A. Insert the top threaded hinge pin into the hinge barrel fixed to the door. Offer the door up to the top fixed pivot. Press and hold the button to allow the hinge on the door to engage with the screw part of the top fixed pivot.

Using the Allen key provided, tighten until the door is set to the appropriate height for your floor covering.

Release the button to allow the top fixed pivot to lock into place.

B. The distance between the door frame edge and the edge of door one should be 6mm. Once in this position, using the Allen key once more, tighten the Allen bolts to keep the top fixed pivot in position in the metal top track.

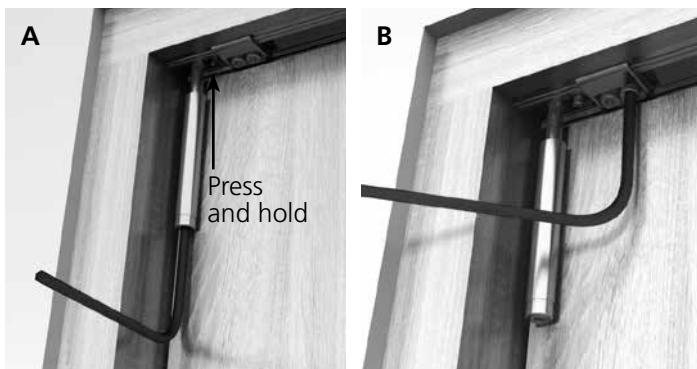

3. Fixing the bottom pivot

Insert the bottom pivot pin into the bottom fixed pivot hinge on the door. Using a pencil, mark the height of the pivot point.

Measure 32mm from the outer edge of the frame and mark with a pencil. Carefully hold the door away.

Using a 12mm wood drill bit make a pilot hole into the frame to allow pivot point to sit flush with the frame.

Screw the bottom fixed pivot into the timber frame using the 30mm screws provided from the pack.

Check the 6mm edge gap is equal at the top and the bottom.



4. Preparing for the second door

A. Take an offset hinge from the handle hinge set and with the hinge closed as a guide, measure and mark **150mm** from the top of the door to the top of the hinge.

Mark the three screw positions on the middle hinge flag and using a 2mm wood drill bit make pilot holes for each of the screw positions. Using 25mm screws from the pack, fix the hinge to the door.

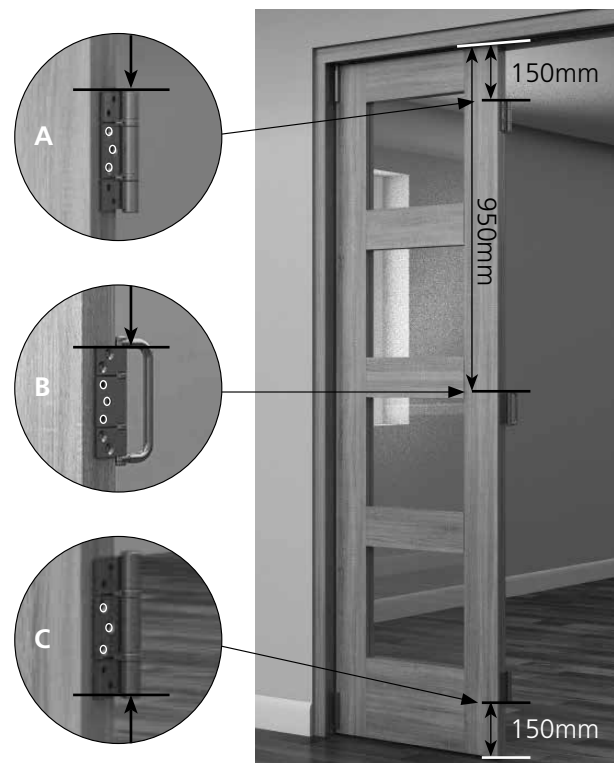

B. Take the handle hinge and measure and mark **950mm** from the top edge of the door to the top of the hinge. Pilot drill and fix the middle hinge flag.

C. Fix the final hinge by measuring and marking **150mm** from the bottom of the door to the bottom of the hinge. Pilot drill and fix the middle hinge flag.

5. Fitting the flush bolts

The position and quantity of the flush bolts varies by configuration, please refer to the ironmongery location diagram on page 28 to determine the correct position and amount required.

We recommend you use a hand router to form the necessary recesses to the top door edge. Alternatively hand tools can be used. Use the screws provided to fix.

Important: Router all flush bolt recesses on all applicable doors in one go.

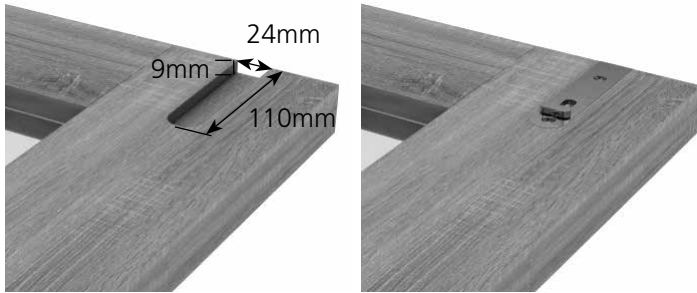

6. Fitting door two to door one

Using the hinges already fixed to door one as a guide, measure and mark down from the top edge of the door to the top of the hinge **150mm**. Pilot drill and fix.

Pilot drill and fix the centre and bottom hinges.



7. Preparing for the third door

Bring the intermediate carrier that is already in the top track to the edge of door two. Measure and mark **15mm** down from the top edge of the door to the top of the hinge. Pilot drill and fix the top and bottom hinge flags.

Take a straight hinge from the intermediate carrier set. Measure and mark **950mm** from the top edge of the door to the top of the hinge. Pilot drill and fix the top and bottom hinge flags.

Take another straight hinge and measure and mark **150mm** from the bottom of the door up to the bottom of the hinge. Pilot drill and fix the top and bottom hinge flags.

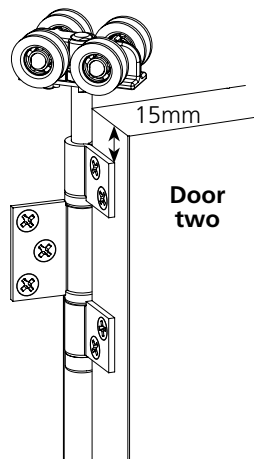

8. Fitting door three to door two

Pilot drill and fix the middle hinge flag on each hinge to door three.

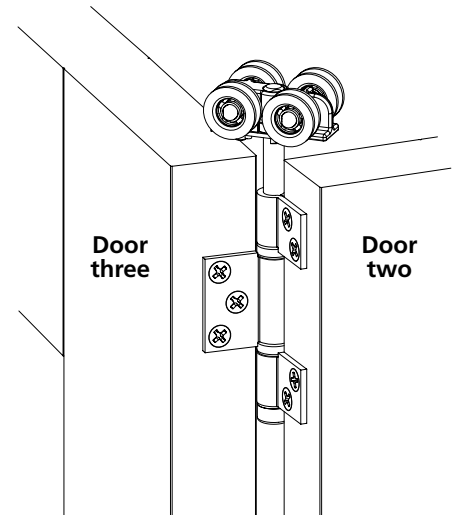

9. Hanging the single door on the right side

To hang the single door on the right hand side simply repeat steps 1, 2 and 3 on the right side.

DON'T FORGET

When operating a Room Fold you must always open by pulling the door closest to the frame first, and then fold the others away.

Pull first, then slide back

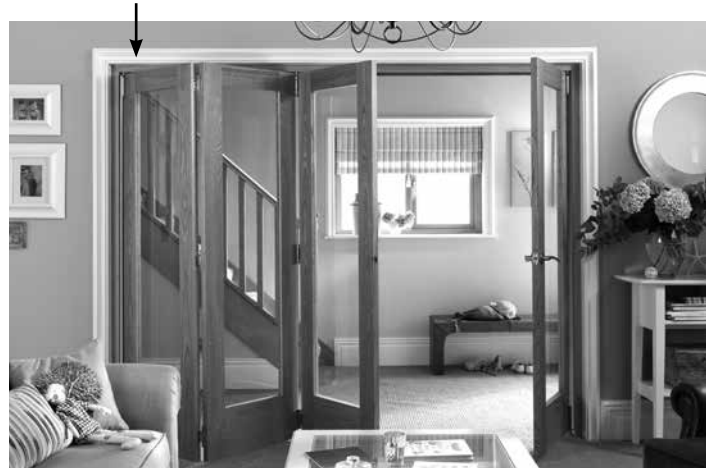

INSTALLING THE DOORS FOR A 4+1 CONFIGURATION



Detailed pack contents

Door Configuration		
Component	4+1 2047 x 3158mm	4+1 2047 x 3538mm
1. Timber Head	1 x 3158mm	1 x 3771mm
2. Timber Jambs	2 x 2032mm	2 x 2032mm
3. Metal Top Track	1 x 3073mm	1 x 3686mm
4. Pivot Set	2	2
5. Intermediate Carrier Set	1	1
6. Offset Handle Hinge Set	2	2
7. End Hanger Set	1	1
8. Flush Bolt	2	2

Components

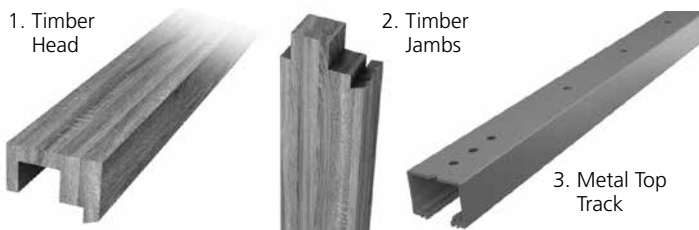

4. Pivot Set



5. Intermediate Carrier Set



Straight Hinges x2

6. Offset Handle Hinge Set



Offset Hinges x2

7. End Hanger Set



8. Flush Bolt

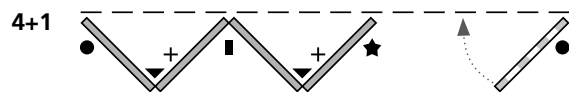

4 doors slide either to the left or to the right with 1 door hinged to the opposite side that opens independent to the others.

IRONMONGERY KEY

- ▼ Offset Hinge Set
- Pivot Set
- Intermediate Carrier Set
- + Flush Bolt Set
- ★ End Hanger Set

Ironmongery position

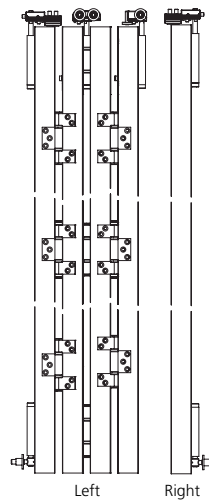

Flush bolt positions

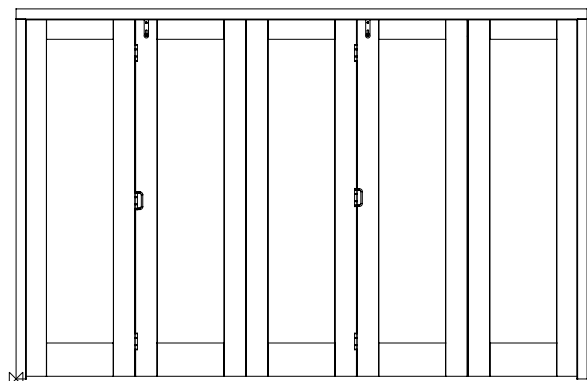

1. Hanging the first door on the left side

Using the hinges from the pivot set, measure and mark 15mm from the top edge of the door to the top edge of the hinge.

Using a 2mm wood drill bit, make pilot holes for each of the screw locations. Using 25mm screws from the pack, fix the hinge to the door.

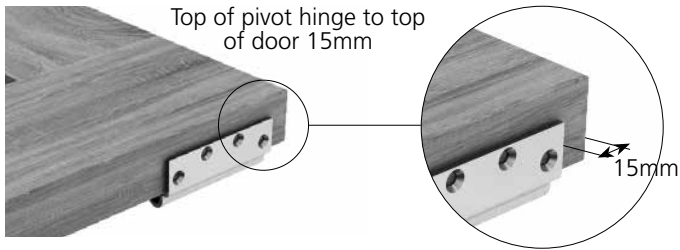

Measure and mark 30mm from the bottom edge of the door to the bottom of the hinge. Pilot drill and fix.

Important: Ensure you use the screwdriver bit included in your pack when fitting the ironmongery.

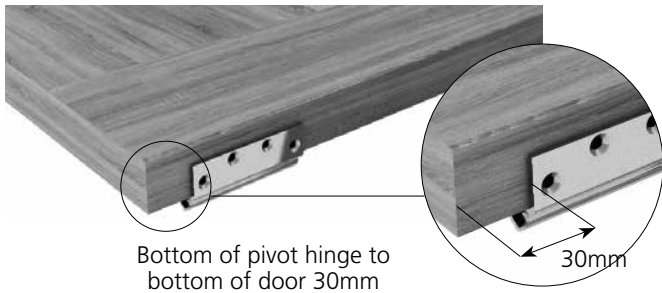

2. Setting the top pivot

A. Insert the top threaded hinge pin into the hinge barrel fixed to the door. Offer the door up to the top fixed pivot.

Press and hold the button to allow the hinge on the door to engage with the screw part of the top fixed pivot.

Using the Allen key provided, tighten until the door is set to the appropriate height for your floor covering.

Release the button to allow the top fixed pivot to lock into place.

B. The distance between the door frame edge and the edge of door one should be 6mm. Once in this position, using the Allen key once more, tighten the Allen bolts to keep the top fixed pivot in position in the metal top track.

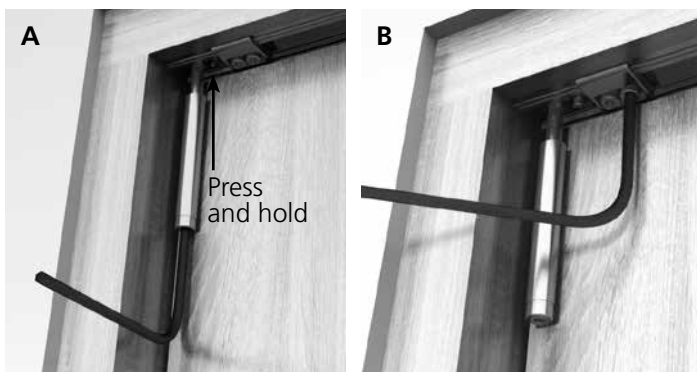

3. Fixing the bottom pivot

Insert the bottom pivot pin into the bottom fixed pivot hinge on the door. Using a pencil, mark the height of the pivot point.

Measure 32mm from the outer edge of the frame and mark with a pencil. Carefully hold the door away.

Using a 12mm wood drill bit make a pilot hole into the frame to allow pivot point to sit flush with the frame.

Screw the bottom fixed pivot into the timber frame using the 30mm screws provided from the pack.

Check the 6mm edge gap is equal at the top and the bottom.

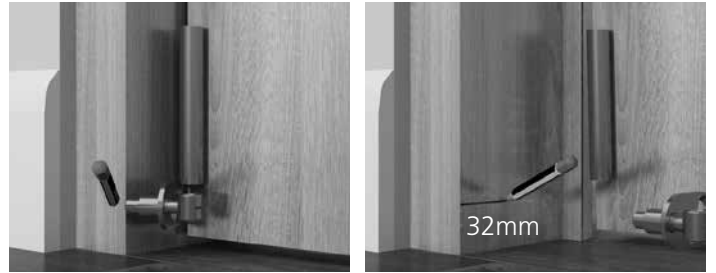

4. Preparing for the second door

A. Take an offset hinge from the handle hinge set and with the hinge closed as a guide, measure and mark **150mm** from the top of the door to the top of the hinge.

Mark the three screw positions on the middle hinge flag and using a 2mm wood drill bit make pilot holes for each of the screw positions.

Using 25mm screws from the pack, fix the hinge to the door.

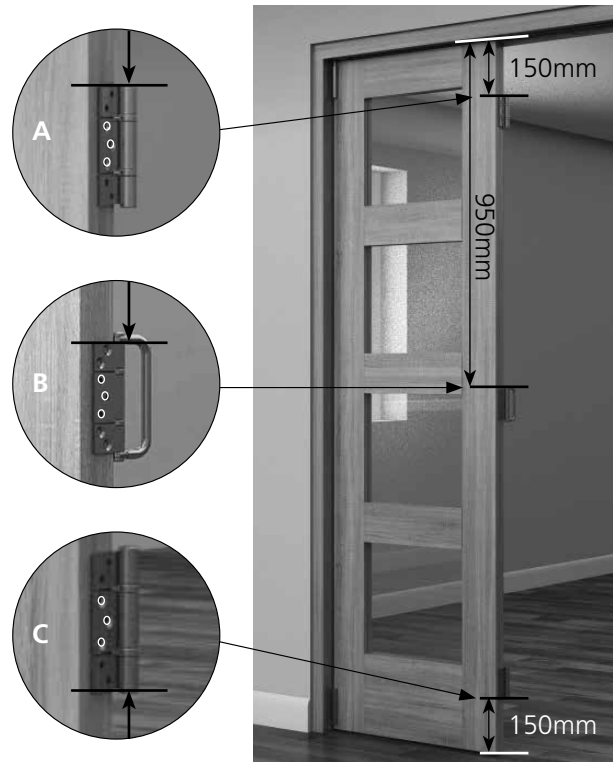

B. Take the handle hinge and measure and mark **950mm** from the top edge of the door to the top of the hinge. Pilot drill and fix the middle hinge flag.

C. Fix the final hinge by measuring and marking **150mm** from the bottom of the door to the bottom of the hinge. Pilot drill and fix the middle hinge flag.

5. Fitting the flush bolts

The position and quantity of the flush bolts varies by configuration, please refer to the ironmongery location diagram on page 31 to determine the correct position and amount required.

We recommend you use a hand router to form the necessary recesses to the top door edge. Alternatively hand tools can be used. Use the screws provided to fix.

Important: Router all flush bolt recesses on all applicable doors in one go.

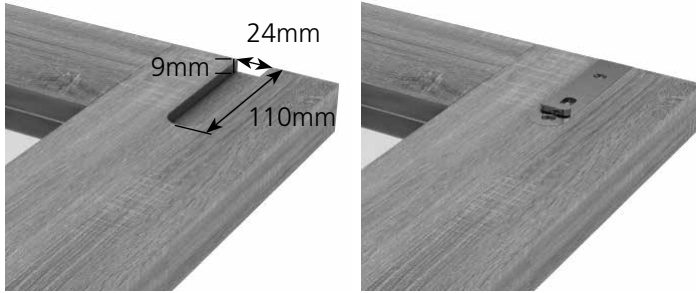

6. Fitting door two to door one

Using the hinges already fixed to door one as a guide, measure and mark down from the top edge of the door to the top of the hinge **150mm**. Pilot drill and fix.

Pilot drill and fix the centre and bottom hinges.



7. Preparing for the third door

Bring the intermediate carrier that is already in the top track to the edge of door two. Measure and mark **15mm** down from the top edge of the door to the top of the hinge. Pilot drill and fix the top and bottom hinge flags.

Take a straight hinge from the intermediate carrier set. Measure and mark **950mm** from the top edge of the door to the top of the hinge. Pilot drill and fix the top and bottom hinge flags.

Take another straight hinge and measure and mark **150mm** from the bottom of the door edge up to the bottom of the hinge. Pilot drill and fix the top and bottom hinge flags.

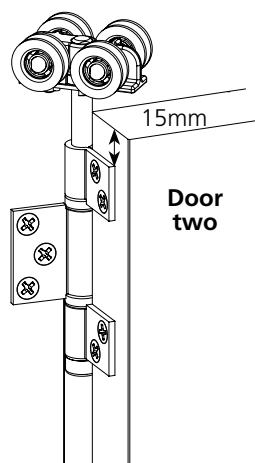

8. Fitting door three to door two

Pilot drill and fix the middle hinge flag on each hinge on door three.

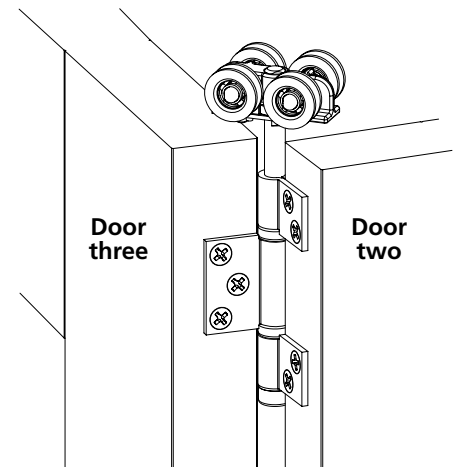

9. Preparing for the fourth door

A. Take an offset hinge from the handle hinge set and with the hinge closed as a guide, measure and mark **150mm** from the top of the door to the top of the hinge.

Mark the two screw positions on the top and bottom hinge flags and using a 2mm wood drill bit make pilot holes for each of the screw positions.

Using 25mm screws from the pack, fix the hinge to the door.

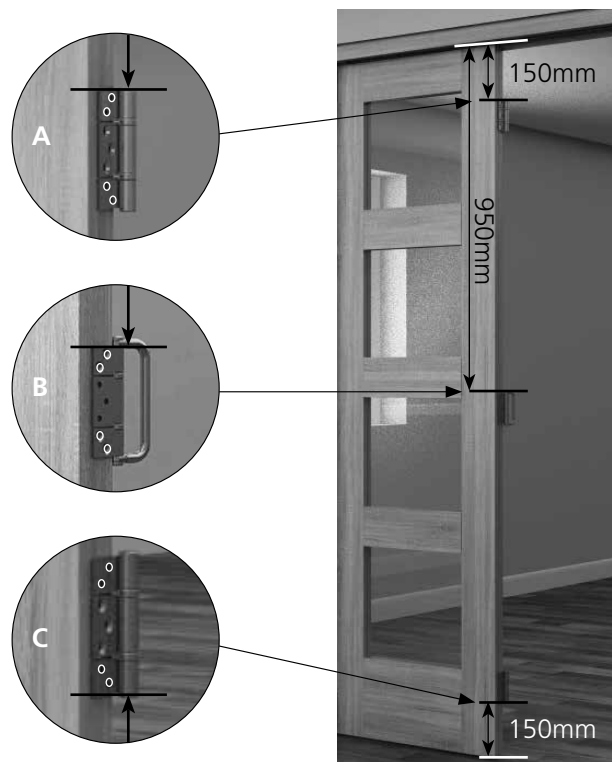

B. Take the handle hinge and measure and mark **950mm** from the top edge of the door to the top of the hinge. Pilot drill and fix the top and bottom hinge flags.

C. Fix the final hinge by measuring and marking **150mm** from the bottom of the door to the bottom of the hinge. Pilot drill and fix the top and bottom hinge flags.

10. Fitting door four to door three

Using the hinges already fixed to door three as a guide, measure and mark down from the top edge of the door to the top of the middle hinge flag **173mm**. Pilot drill and fix.

Pilot drill and fix the centre and bottom hinges.

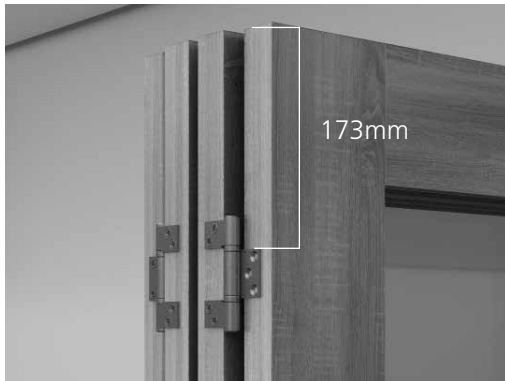

11. Fitting the end hanger

To fit the end hanger, measure and mark **15mm** from the top edge of the door to the top of the hinge flag and pilot drill and fix.

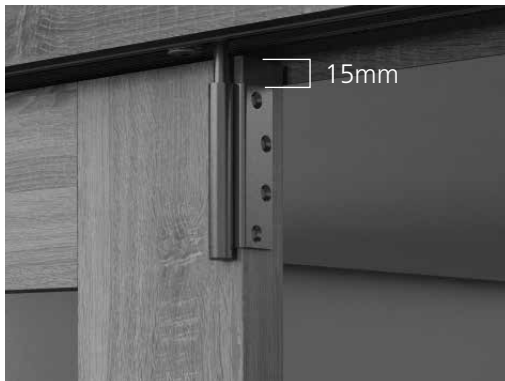

12. Hanging the single door to the right side

To hang the single door on the right side simply repeat steps 1, 2 and 3 on the right hand side.

DON'T FORGET

When operating a Room Fold you must always open by pulling the door closest to the frame first, and then fold the others away.

Pull first, then slide back



INSTALLING THE DOORS FOR A 5+1 CONFIGURATION



Components

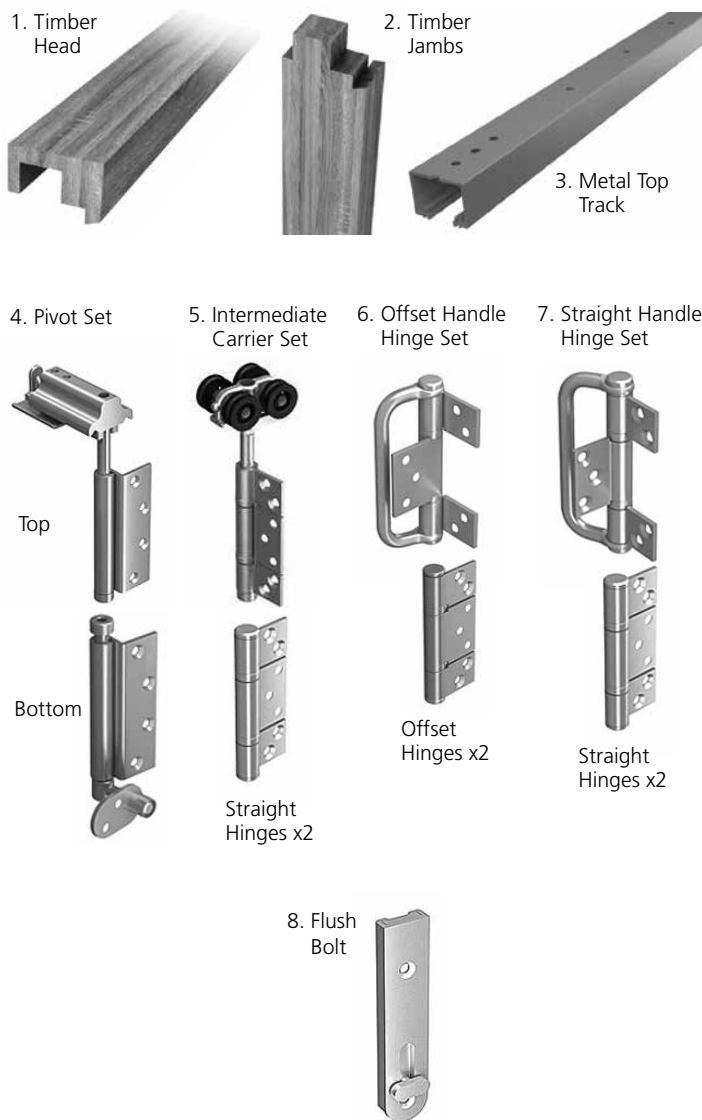

Detailed pack contents

Door Configuration		
Component	5+1 2047 x 3771mm	5+1 2047 x 4227mm
1. Timber Head	1 x 3771mm	1 x 4227mm
2. Timber Jambs	2 x 2032mm	2 x 2032mm
3. Metal Top Track	1 x 3686mm	1 x 4142mm
4. Pivot Set	2	2
5. Intermediate Carrier Set	2	2
6. Offset Handle Hinge Set	1	1
7. Straight Handle Hinge Set	1	1
8. Flush Bolt	3	3

Ironmongery locations

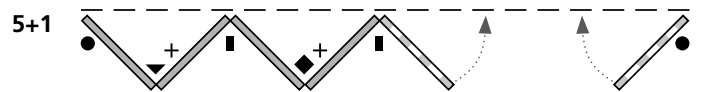

5 doors slide either to the left or to the right with 1 door hinged that opens independent to the others & 1 door hinged to the opposite side that also opens independent to the others.

IRONMONGERY KEY

- ▼ Offset Hinge Set
- Pivot Set
- Intermediate Carrier Set
- + Flush Bolt Set
- ◆ Straight Hinge Set

Ironmongery position

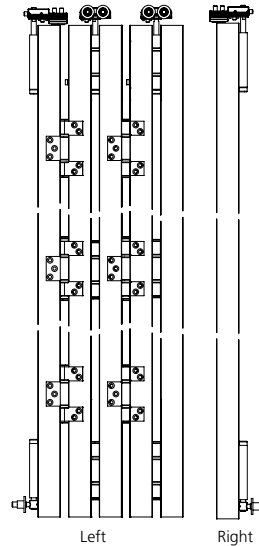

Flush bolt positions

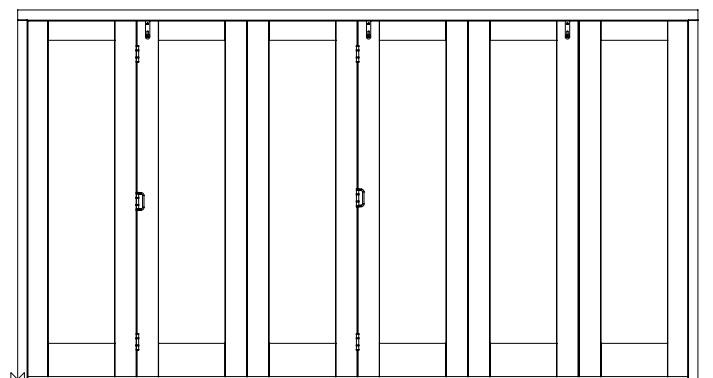

1. Hanging the first door on the left side

Using the hinges from the pivot set, measure and mark 15mm from the top edge of the door to the top edge of the hinge.

Using a 2mm wood drill bit, make pilot holes for each of the screw locations. Using 25mm screws from the pack, fix the hinge to the door.

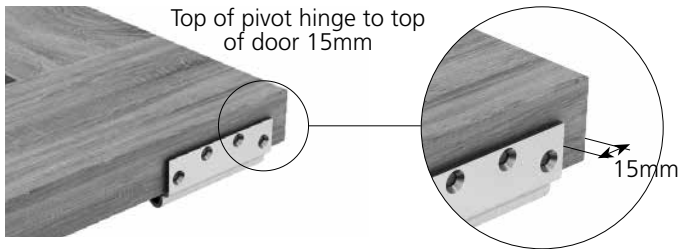

Measure and mark 30mm from the bottom edge of the door to the bottom of the hinge. Pilot drill and fix.

Important: Ensure you use the screwdriver bit included in your pack when fitting the ironmongery.

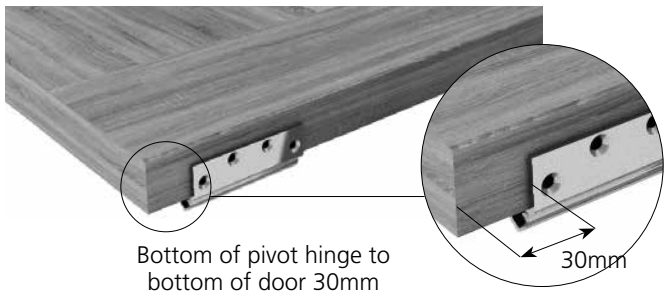

2. Setting the top pivot

A. Insert the top threaded hinge pin into the hinge barrel fixed to the door. Offer the door up to the top fixed pivot.

Press and hold the button to allow the hinge on the door to engage with the screw part of the top fixed pivot.

Using the Allen key provided, tighten until the door is set to the appropriate height for your floor covering.

Release the button to allow the top fixed pivot to lock into place.

B. The distance between the door frame edge and the edge of door one should be 6mm. Once in this position, using the Allen key once more, tighten the Allen bolts to keep the top fixed pivot in position in the metal top track.

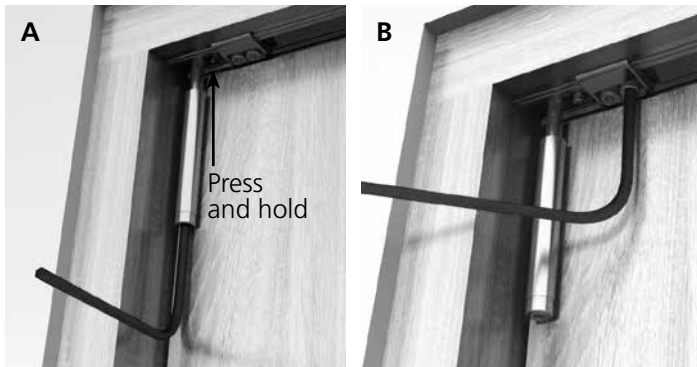

3. Fixing the bottom pivot

Insert the bottom pivot pin into the bottom fixed pivot hinge on the door. Using a pencil, mark the height of the pivot point.

Measure 32mm from the outer edge of the frame and mark with a pencil. Carefully hold the door away.

Using a 12mm wood drill bit make a pilot hole into the frame to allow pivot point to sit flush with the frame.

Screw the bottom fixed pivot into the timber frame using the 30mm screws provided from the pack.

Check the 6mm edge gap is equal at the top and the bottom.

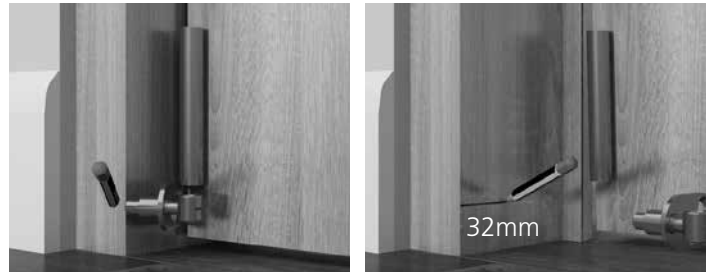

4. Preparing for the second door

A. Take an offset hinge from the handle hinge set and with the hinge closed as a guide, measure and mark **150mm** from the top of the door to the top of the hinge.

Mark the three screw positions on the middle hinge flag and using a 2mm wood drill bit make pilot holes for each of the screw positions.

Using 25mm screws from the pack, fix the hinge to the door.

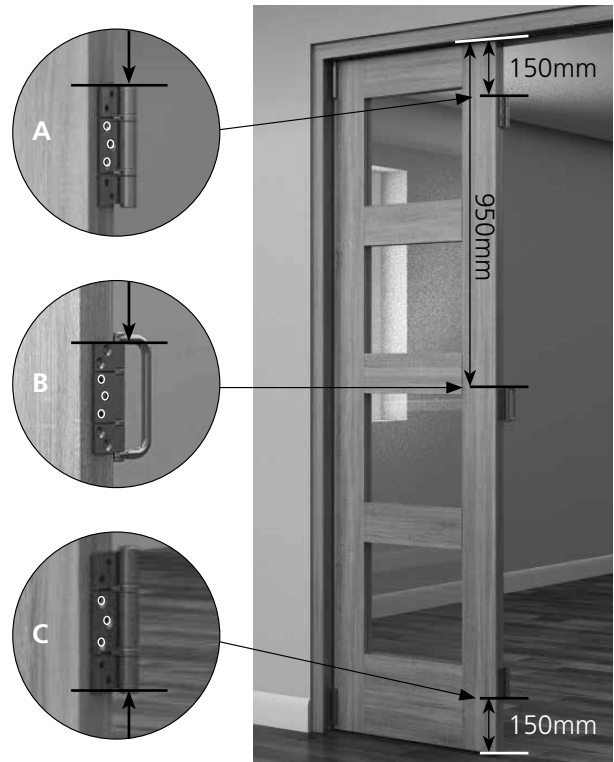

B. Take the handle hinge and measure and mark **950mm** from the top edge of the door to the top of the hinge. Pilot drill and fix the middle hinge flag.

C. Fix the final hinge by measuring and marking **150mm** from the bottom of the door to the bottom of the hinge. Pilot drill and fix the middle hinge flag.

5. Fitting the flush bolts

The position and quantity of the flush bolts varies by configuration, please refer to the ironmongery location diagram on page 35 to determine the correct position and amount required.

We recommend you use a hand router to form the necessary recesses to the top door edge. Alternatively hand tools can be used. Use the screws provided to fix.

Important: Router all flush bolt recesses on all applicable doors in one go.

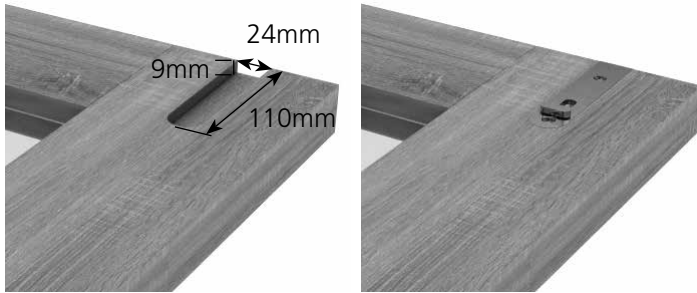

6. Fitting door two to door one

Using the hinges already fixed to door one as a guide, measure and mark down from the top edge of the door to the top of the hinge **150mm**. Pilot drill and fix.

Pilot drill and fix the centre and bottom hinges.



7. Preparing for the third door

Bring the intermediate carrier that is already in the top track to the edge of door two. Measure and mark **15mm** down from the top edge of the door to the top of the hinge. Pilot drill and fix the top and bottom hinge flags.

Take a straight hinge from the intermediate carrier set. Measure and mark **950mm** from the top edge of the door to the top of the hinge. Pilot drill and fix the top and bottom hinge flags.

Take another straight hinge and measure and mark **150mm** from the bottom of the door edge up to the bottom of the hinge. Pilot drill and fix the top and bottom hinge flags.

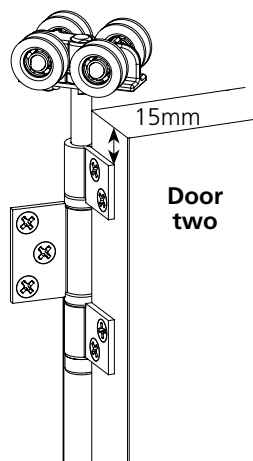

8. Fitting door three to door two

Pilot drill and fix the middle hinge flag on each hinge to door three.

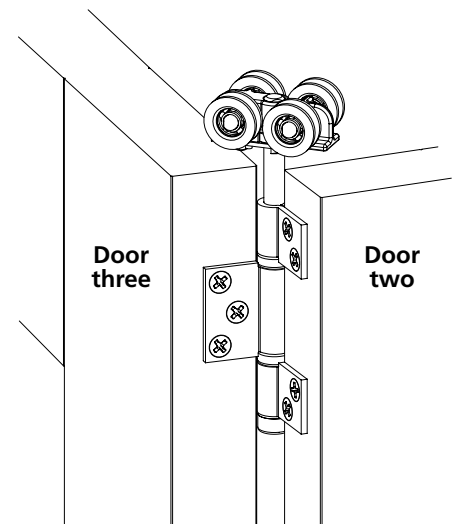

9. Preparing for the fourth door

A. Take a straight hinge from the handle hinge set and with the hinge closed as a guide, measure and mark **150mm** from the top of the door to the top of the hinge.

Mark the three screw positions on the middle hinge flag and using a 2mm wood drill bit make pilot holes for each of the screw positions. Using 25mm screws from the pack, fix the hinge to the door.

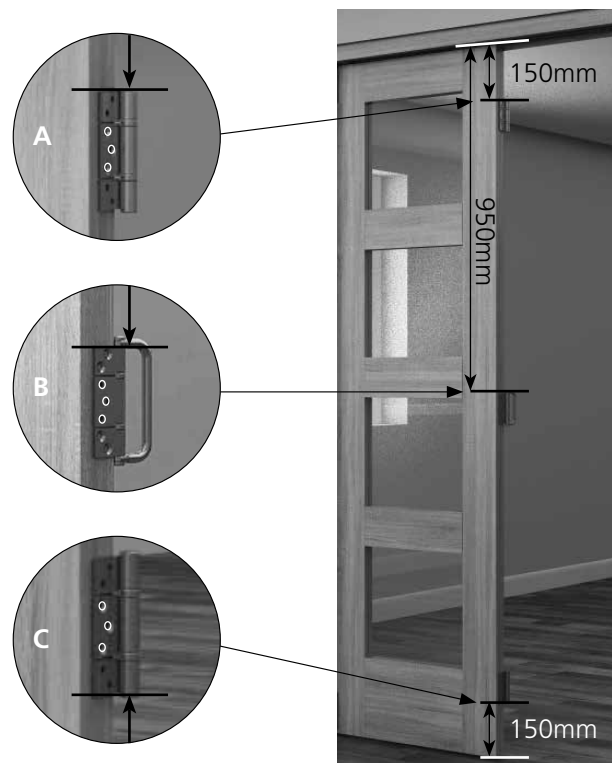

B. Take the handle hinge and measure and mark **950mm** from the top edge of the door to the top of the hinge. Pilot drill and fix the middle hinge flag.

C. Fix the final hinge by measuring and marking **150mm** from the bottom of the door to the bottom of the hinge. Pilot drill and fix the middle hinge flag.

10. Fitting door four to door three

Using the hinges already fixed to door three as a guide, measure and mark down from the top edge of the door to the top of the hinge **150mm**. Pilot drill and fix.

Pilot drill and fix the centre and bottom hinges.

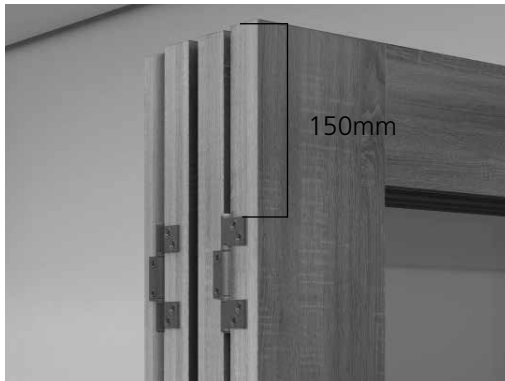

11. Preparing for the fifth door

Bring the intermediate carrier that is already in the top track to the edge of door four. Measure and mark **15mm** down from the top edge of the door to the top of the hinge. Pilot drill and fix the top and bottom hinge flags.

Take a straight hinge from the intermediate carrier set. Measure and mark **950mm** from the top edge of the door to the top of the hinge. Pilot drill and fix the top and bottom hinge flags.

Take another straight hinge and measure and mark **150mm** from the bottom of the door edge up to the bottom of the hinge. Pilot drill and fix the top and bottom hinge flags.

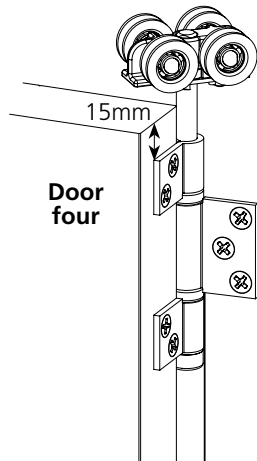

12. Fitting door five to door four

Pilot drill and fix the middle hinge flag on each hinge to door five.

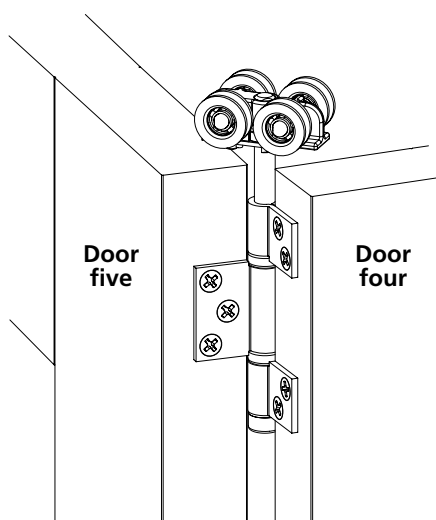

13. Hanging the single door to the right side

To hang the single door on the right side simply repeat steps 1, 2 and 3 on the right hand side.

DON'T FORGET

When operating a Room Fold you must always open by pulling the door closest to the frame first, and then fold the others away.

Pull first, then slide back



Adjustments

Doors can be adjusted in height.

To do this, press and hold the button and using the Allen key either wind up or down as required.

Once completed, release the button to allow the adjustment to lock into place.

Adjusting the pivot and intermediate ironmongery using the Allen key provided following the diagrams will increase or decrease any gaps between doors.

Remember to keep the Allen key safe as you will need this in the future if any adjustments are needed.

Pivot ironmongery

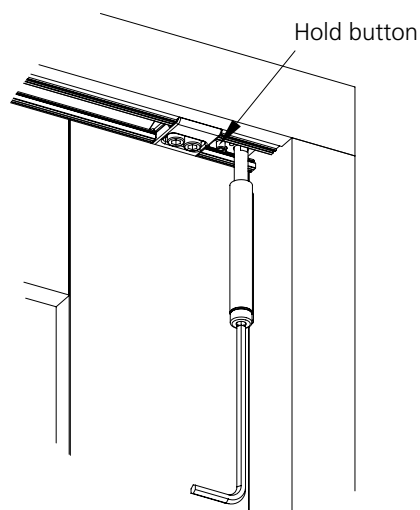

Intermediate ironmongery

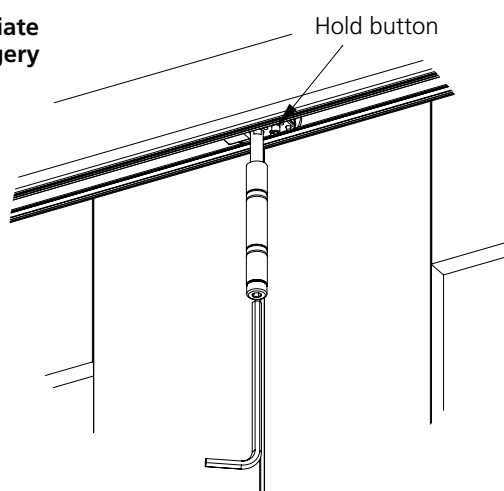

Troubleshooting guide

How do I adjust the door height?

Doors can be adjusted in height, please See adjustments.

My doors won't slide?

Please check for any obvious obstructions in the top metal track.

Make sure all screws are tightened up in the opening and not stopping any of the sliding ironmongery from moving past.

When operating you must always open the doors by pulling the door closest to the frame first, then fold away the others – see page 2 for illustration.

How often do I have to clean the ironmongery?

Moving parts should be checked, cleaned and lubricated annually.

