



BMW Motorrad

Rider's manual  
**S 1000 XR**

## Vehicle data/dealership details

### Vehicle data

---

Model

---

Vehicle Identification Number

---

Colour code

---

Date of first registration

---

Registration number

### Dealership details

---

Person to contact in Service department

---

Ms/Mr

---

Phone number

---

Dealership address/phone number (company stamp)

## **Welcome to BMW**

We congratulate you on your choice of a vehicle from BMW Motorrad and welcome you to the community of BMW riders. Familiarise yourself with your new vehicle so that you can ride it safely and confidently in all traffic situations.

### **About these operating instructions**

Read these operating instructions carefully before starting to use your new BMW. They contain important information on how to operate the controls and how to make the best possible use of all your BMW's technical features. In addition, they contain information on maintenance and care to help you maintain your vehicle's reliability and safety, as well as its value.

The record of the maintenance work you have had performed on your vehicle is a precondition for generous treatment of goodwill claims.

If the time comes to sell your BMW, please remember to hand over these operating instructions to the new owner. They are an important part of the vehicle.

### **Suggestions and criticism**

If you have questions concerning your vehicle, your authorised BMW Motorrad retailer will gladly provide advice and assistance.

We hope you will enjoy riding your BMW and that all your journeys will be pleasant and safe

BMW Motorrad.

01 40 5 A01 801



# Table of Contents

<b>1 General instructions .... 5</b>	Instrument cluster ..... 27	Turn indicators ..... 77
Overview ..... 6	<b>3 Status indicators ..... 29</b>	Dynamic Traction Control (DTC) ..... 78
Abbreviations and symbols ..... 6	Indicator and warning lights ..... 30	Electronic Suspension Adjustment (D-ESA) ..... 79
Equipment ..... 7	TFT display in Pure Ride view ..... 31	Riding mode ..... 82
Technical data ..... 7	TFT display in Menu view ..... 33	PRO riding mode ..... 83
Currency ..... 8	TFT display in Sport view ..... 35	Cruise-control system ..... 84
Additional sources of information ..... 8	Warning indicators ..... 36	Hill Start Control ..... 87
Certificates and operating licences ..... 8	<b>4 Operation ..... 63</b>	Shift light ..... 89
Data memory ..... 8	Ignition switch/steering lock ..... 64	Anti-theft alarm (DWA) ..... 90
Intelligent emergency call system ..... 13	Emergency off switch (kill switch) ..... 66	Tyre pressure monitoring (RDC) ..... 92
<b>2 General views ..... 17</b>	Ignition with Keyless Ride ..... 66	Heated handlebar grips ..... 92
General view, left side ..... 19	Intelligent emergency call ..... 70	On-board computer ..... 93
General view, right side ..... 21	Lights ..... 73	Seat ..... 94
Underneath the seat ..... 22	Daytime riding light ..... 75	Storage compartment ..... 95
Multifunction switch, left .... 23	Hazard warning lights ..... 76	<b>5 TFT display ..... 97</b>
Multifunction switch, right ..... 25		General notes ..... 98
Multifunction switch, right ..... 26		Principle ..... 99
		Pure Ride view ..... 106
		General settings ..... 107
		Bluetooth ..... 108
		My vehicle ..... 112

Navigation .....	115	Parking your motor-	
Media .....	117	cycle .....	135
Telephone .....	117	Refuelling .....	136
Display software		Securing motorcycle for	
version .....	118	transportation .....	140
Display licence informa-			
tion .....	118		
<b>6 Adjustment .....</b>	<b>119</b>	<b>8 Engineering</b>	
Mirrors .....	120	<b>details .....</b>	<b>143</b>
Headlight .....	120	General notes .....	144
Windscreen .....	121	Antilock Brake System	
Brakes .....	122	(ABS) .....	144
Adjusting clutch lever .....	122	Dynamic traction control	
		(DTC) .....	147
<b>7 Riding .....</b>	<b>125</b>	Dynamic engine brake con-	
Safety instructions .....	126	trol .....	148
Comply with checklist .....	128	Dynamic ESA .....	149
Always before riding		Riding mode .....	150
off: .....	128	Dynamic Brake Control .....	152
Every 3rd refuelling		Tyre pressure monitoring	
stop .....	128	(RDC) .....	153
Starting .....	128	Gear Shift Assistant .....	154
Running in .....	131	Hill Start Control .....	155
Shifting gear .....	132	Adaptive Headlight .....	157
Shift light .....	133		
Brakes .....	133		
		<b>9 Maintenance .....</b>	<b>159</b>
		General notes .....	160
		Toolkit .....	160
		Front-wheel stand .....	160
		Rear-wheel stand .....	161
		Engine oil .....	162
		Brake system .....	163
		Clutch .....	168
		Coolant .....	169
		Tyres .....	170
		Rims and tyres .....	171
		Wheels .....	171
		Lighting .....	179
		Jump-starting .....	180
		Battery .....	181
		Fuses .....	184
		Diagnostic connector .....	185
		Chain .....	186
		<b>10 Accessories .....</b>	<b>189</b>
		General notes .....	190
		Power socket .....	190
		Cases .....	191
		Topcase .....	193
		Navigation system .....	196

<b>11 Care .....</b>	<b>203</b>	Anti-theft alarm.....	224	Certificate for Keyless Ride .....	265
Care products .....	204	Dimensions .....	224	Declaration of conformity for tyre pressure control (RDC) .....	267
Washing the vehicle.....	204	Weights .....	225	Certificate for tyre pressure monitoring (Reifendruck-Control, RDC) .....	274
Cleaning easily damaged components.....	205	Performance figures.....	226	Declaration of conformity for TFT instrument cluster.....	275
Care of paintwork .....	206	<b>13 Service .....</b>	<b>227</b>	Certificate for TFT instrument cluster.....	281
Paintwork preservation ....	206	BMW Motorrad Service ...	228	Declaration of conformity for intelligent emergency call .....	284
Laying up the motorcycle .....	207	BMW Motorrad Service history .....	228	Declaration of conformity for anti-theft alarm system .....	290
Restoring motorcycle to use .....	207	BMW Motorrad mobility services .....	229	<b>15 Index .....</b>	<b>296</b>
<b>12 Technical data .....</b>	<b>209</b>	Maintenance work.....	229		
Troubleshooting chart .....	210	BMW Service .....	229		
Threaded fasteners .....	212	Maintenance schedule ....	233		
Fuel .....	214	Maintenance confirmations.....	234		
Engine oil .....	215	Service confirmations ....	248		
Engine .....	215	<b>14 Appendix.....</b>	<b>251</b>		
Clutch .....	216	Declaration of conformity for electronic immobiliser .....	252		
Transmission.....	217	Certificate for electronic immobiliser .....	258		
Final drive .....	217	Declaration of conformity for Keyless Ride.....	260		
Frame .....	218				
Suspension .....	218				
Brakes .....	219				
Wheels and tyres.....	220				
Electrical system .....	222				

## General instructions

Overview .....	6
Abbreviations and symbols .....	6
Equipment .....	7
Technical data .....	7
Currency .....	8
Additional sources of information ....	8
Certificates and operating licences .....	8
Data memory .....	8
Intelligent emergency call system .....	13

## Overview

Chapter 2 of this Rider's Manual will provide you with an initial overview of your motorcycle.

All maintenance and servicing work on the motorcycle is documented in the "Service" section. The record of the maintenance work you have had performed on your vehicle is a precondition for generous treatment of goodwill claims.

When the time comes to sell your BMW, please remember to hand over this Rider's Manual; it is an important part of the motorcycle.

## Abbreviations and symbols

 **CAUTION** Low-risk hazard. Non-avoidance can lead to slight or moderate injury.

 **WARNING** Medium-risk hazard. Non-avoidance can lead to fatal or severe injury.

 **DANGER** High-risk hazard. Non-avoidance leads to fatal or severe injury.

 **ATTENTION** Special notes and precautionary measures. Non-compliance can lead to damage to the vehicle or accessory and, consequently, to voiding of the warranty.

 **NOTICE** Specific instructions on how to operate, control, adjust or look after items of equipment on the vehicle.

◀ Indicates the end of an item of information.

• Instruction.

» Result of an activity.

➔ Reference to a page with more detailed information.

◁ Indicates the end of a passage relating to specific accessories or items of equipment.

 Tightening torque.

 Technical data.

NV National-market version.

OE Optional equipment. The vehicles are assembled complete with all the BMW Motorrad optional equipment originally ordered.



- OA Optional accessories.  
You can obtain BMW Motorrad optional accessories through your authorised BMW Motorrad dealer; optional accessories have to be retrofitted to the vehicle.
- EWS Electronic immobiliser.
- DWA Anti-theft alarm.
- ABS Anti-lock brake system.
- D-ESA Electronic chassis and suspension adjustment.
- DTC Dynamic Traction Control.
- RDC Tyre pressure monitoring.

## Equipment

When you purchased your BMW motorcycle, you chose a model with individual equipment. These operating instructions describe the optional equipment (OE) offered by BMW and selected optional accessories (OA).

This explains why the manual may also contain descriptions of equipment that you might not have selected. Please note, too, that on account of country-specific differences, your motorcycle might not be exactly as illustrated.

If your motorcycle contains equipment that has not been described, its description can be found in a separate manual.

## Technical data

All dimensions, weights and power ratings stated in the operating instructions are quoted to the standards and comply with the tolerance requirements of the Deutsches Institut für Normung e.V. (DIN).

Technical data and specifications in this rider's manual serve as reference points. The vehicle-specific data may deviate from these, for example as a result of selected optional equipment, the national-market version or country-specific measuring procedures. Detailed values can be taken from the vehicle registration documents and signs on the vehicle, or can be obtained from your authorised BMW Motorrad retailer or another qualified service partner or specialist workshop. The specifications in the vehicle documents always have priority

over the information provided in this rider's manual.

## Currency

The high safety and quality standards of BMW motorcycles are maintained by constant development work on designs, equipment and accessories. Because of this, your motorcycle may differ from the information supplied in the Rider's Manual. Nor can BMW Motorrad entirely rule out errors and omissions. We hope you will appreciate that no claims can be entertained on the basis of the data, illustrations or descriptions in these operating instructions.

## Additional sources of information

### Authorised BMW Motorrad retailer

Your BMW Motorrad retailer will be happy to answer any questions you may have.

### Internet

The operating instructions for your vehicle, operating and installation instructions for accessories and general information about BMW Motorrad, in relation to technology, for example, are available for download from **[www.bmw-motorrad.com/manuals](http://www.bmw-motorrad.com/manuals)**.

## Certificates and operating licences

The certificates for the vehicle and the official operating licences for any accessories are available at **[www.bmw-motorrad.com/certification](http://www.bmw-motorrad.com/certification)**.

## Data memory

### General

Control units are installed in the vehicle. Control units process data that they receive, for example, from vehicle sensors, or that they generate themselves or exchange between each other. Some control units are required for the vehicle to function safely or provide assistance during riding, for example assistance systems. In addition, control units enable comfort or infotainment functions.

Information on data that has been stored or exchanged can

be obtained from the manufacturer of the vehicle, for example via a separate booklet.

### **Personal reference**

Each vehicle is identified with a clear vehicle identification number. Depending on the country, the vehicle identification number, the number plate and the corresponding authorities can be referenced to ascertain the vehicle owner. There are also other ways to use data obtained from the vehicle to trace the rider or vehicle owner, for example using the ConnectedDrive user account.

### **Data protection rights**

In accordance with applicable data protection laws, vehicle users have certain rights in relation to the manufacturer of the vehicle or in relation to compan-

ies which collect or process personal data.

Vehicle users have the right to obtain full information at no cost from persons or entities storing personal data of the vehicle user.

These entities may include:

- Manufacturer of the vehicle
- Qualified service partners
- Specialist workshops
- Service providers

Vehicle users have the right to request information on what personal data has been stored, for what purpose the data is used, and where the data comes from.

To obtain this information, proof of ownership or use is required.

The right to information also includes information about data that has been shared with other companies or entities.

The website of the vehicle manufacturer contains the applicable data protection information. This

data protection information includes information on the right to have data deleted or corrected.

The manufacturer of the vehicle also provides their contact details and those of the data protection officer on their website.

The vehicle owner can also request that a BMW Motorrad retailer or another qualified service partner or specialist workshop read out the data that is stored in the vehicle for a charge.

The vehicle data is read out using the legally prescribed socket for on-board diagnosis (OBD) in the vehicle.

### **Legal requirements for the disclosure of data**

As part of its legal responsibilities, the manufacturer of the vehicle is obligated to make its stored data available to the relevant authorities. This data is provided in the required scope in

individual cases, for example to clarify a criminal offence.

In the context of applicable laws, public agencies are entitled in individual cases to read out data from the vehicle themselves.

### Operating data in the vehicle

Control units process data to operate the vehicle.

This includes, for example:

- Status reports of the vehicle and its individual components, for example wheel revolutions, wheel speed, deceleration
- Environmental conditions, for example temperature

The data is only processed in the vehicle itself and is generally non-permanent. The data is not stored beyond the operating period.

Electronic components, for example control units, contain components for storing technical in-

formation. Information can be temporarily or permanently stored on the vehicle condition, component loads, incidents or errors. This information is generally used to document the condition of a component, a module, a system or the surrounding area, for example:

- Operating conditions of system components, for example filling levels, tyre pressure
- Malfunctions and faults in important system components, for example light and brakes
- Response of the vehicle in special riding situations, for example engagement of the driving dynamics systems
- Information on incidents resulting in damage to the vehicle

The data is necessary for the provision of control unit functions. Furthermore, the data is used to detect and rectify malfunctions

and to enable the vehicle manufacturer to optimise vehicle functions.

The vast majority of this data is non-permanent and is only processed in the vehicle itself. Only a small amount of the data is stored in incident or fault memories as required by events.

If services are accessed, for example repairs, service processes, warranty cases and quality assurance measures, this technical information can be read out of the vehicle together with the vehicle identification number.

The information can be read out by a BMW Motorrad retailer or another qualified service partner or specialist workshop. The legally stipulated socket for on-board diagnosis (OBD) in the vehicle is used to read out the data.

The data is obtained, processed and used by the relevant parts of

the retailer network. The data is used to document the technical conditions of the vehicle, to help with error localization, to comply with warranty obligations and to improve quality.

In addition, the manufacturer has various product monitoring obligations arising from product liability legislation. To meet these obligations, the vehicle manufacturer requires technical data from the vehicle. The data from the vehicle can also be used to check warranty claims from the customer.

Error and incident memories in the vehicle can be reset during servicing or repair work by a BMW Motorrad retailer or another qualified service partner or specialist workshop.

## **Data input and data transfer in the vehicle**

### **General**

Depending on the equipment, comfort and customised settings can be stored in the vehicle and can be changed or reset at any time.

This includes, for example:

- Settings of the windscreen position
- Chassis and suspension settings

If required, data can be entered in the entertainment and communication system of the vehicle, for example using a smartphone.

Depending on the individual equipment, this includes:

- Multimedia data, such as music for playback
- Contacts data for use in connection with a communication system or an integrated navigation system

- Entered destinations
- Data on the use of internet services. This data can be stored locally in the vehicle or is located on a device that is connected to the vehicle, for example smartphone, USB stick, MP3 player. If this data is stored in the vehicle, the data can be deleted at any time.

This data is transferred to third parties only if personally requested within the context of using online services. This depends on the selected settings when using the services.

### **Incorporation of mobile devices**

Depending on the equipment, mobile devices connected to the vehicle, for example smartphones, can be controlled using the operating elements of the vehicle.

The image and sound of the mobile device can then be output via the multimedia system. At the same time, specific information is transferred to the mobile device. Depending on the type of integration, this includes, for example, position data and additional general vehicle information. This enables optimal use of the selected apps, for example navigation or music playback.

The type of additional data processing is determined by the provider of the respective app. The scope of the possible settings depends on the corresponding app and the operating system of the mobile device.

## Services

### General

If the vehicle has a wireless connection, this enables the exchange of data between the vehicle and other systems. The

wireless connection is enabled by the vehicle's own transmitter and receiver unit or using personally integrated mobile devices, for example smartphones. Online functions can be used using this wireless connection. These include online services and apps that are provided by the vehicle manufacturer or by other providers.

### Services of the vehicle manufacturer

For online services of the vehicle manufacturer, the individual functions are described at suitable points, for example rider's manual, website of the manufacturer. At the same time, information is also provided on the relevant data protection law. Personal data may be used to provide online services. Data is exchanged using a secure connection, for example with

the IT systems provided by the vehicle manufacturer.

Obtaining, processing and using personal data outside of the normal provision of services requires legal permission, contractual agreement or consent. It is also possible to have the entire data connection activated or deactivated. Statutory functions are excluded from this.

### Services from other providers

When using online services from other providers, these services are subject to the responsibility and the data protection and operating conditions of the individual provider. The vehicle manufacturer has no influence on the content that is exchanged in this instance. Information on the type, scope and purpose of the data capture and use of personal data as part of the services of third parties can be ascertained from the individual provider.

## Intelligent emergency call system

- with intelligent emergency call<sup>OE</sup>

### Principle

The intelligent emergency call system enables manual or automatic emergency calls, for example in the event of an accident.

The emergency calls are received by an emergency call centre that is commissioned by the vehicle manufacturer.

For information on operating the intelligent emergency call system and its functions, please refer to "Intelligent emergency call".

### Legal basis

Processing of personal data using the intelligent emergency call system is in line with the following regulations:

- Protection of personal data: Directive 95/46/EC of the European Parliament and of the Council.
- Protection of personal data: Directive 2002/58/EC of the European Parliament and of the Council.

The legal basis for the activation and function of the intelligent emergency call system is the concluded ConnectedRide contract for this function, as well as the corresponding laws, ordinances and directives of the European Parliament and of the European Council.

The relevant ordinances and directives regulate the protection of natural persons during the processing of personal data.

The processing of personal data by the intelligent emergency call system satisfies the European

directives for the protection of personal data.

The intelligent emergency call system processes personal data only with the agreement of the vehicle owner.

The intelligent emergency call system and other services with additional benefits can process personal data only with the express permission of the person affected by the data processing, for example the vehicle owner.

### SIM card

The intelligent emergency call system operates via the mobile phone network using the SIM card installed in the vehicle. The SIM card is permanently logged into the mobile phone network to enable rapid connection setup. Data is sent to the vehicle manufacturer in the event of an emergency.

## Improving quality

The data that is transferred in an emergency is also used by the manufacturer of the vehicle to improve product and service quality.

## Location determination

The position of the vehicle can be determined exclusively by the mobile phone network provider based on the mobile phone site locations. It is not possible for the provider to trace a connection between the vehicle's VIN and the phone number of the installed SIM card. Only the manufacturer of the vehicle can link a VIN and the phone number of the SIM card installed in a particular vehicle.

## Log data of emergency calls

The log data of emergency calls is stored in a memory of the vehicle. The oldest log data is

regularly deleted. The log data includes, for example, information on when and where an emergency call was made. In exceptional cases, the log data can be read out of the vehicle memory. As a rule, log data is only read out following a court order, and this is only possible if the corresponding devices are connected directly to the vehicle.

## Automatic emergency call

The system is designed so that, following a sufficiently serious accident, which is detected by sensors in the vehicle, an emergency call is automatically activated.

## Sent information

When making an emergency call using the intelligent emergency call system, the system forwards the same information to the designated emergency call centre as

is forwarded to the public emergency operations centre by the statutory emergency call system eCall.

In addition, the intelligent emergency call system sends the following additional information to an emergency call centre commissioned by the vehicle manufacturer and, if required, to the emergency services:

- Accident data, for example the direction of impact detected by the vehicle sensors, to assist the emergency services response.
- Contact details, for example the phone number of the installed SIM card and the phone number of the rider, if available, to enable rapid contact with those involved in the accident if required.



## **Data storage**

The data for an activated emergency call is stored in the vehicle. The data contains information on the emergency call, for example the location and time of the emergency call.

The voice recordings of the emergency call are stored at the emergency call centre.

The voice recordings of the customer are stored for 24 hours in case details of the emergency call need to be analysed. After this, the voice recordings are deleted. The voice recordings of the employee of the emergency call centre are stored for 24 hours for quality assurance purposes.

## **Information on personal data**

The data that is processed as part of the intelligent emergency call is processed exclusively to carry out the emergency call. As

part of its statutory obligation, the manufacturer of the vehicle provides information about the data that it has processed and any data that it still has stored.



## General views

General view, left side .....	19
General view, right side .....	21
Underneath the seat .....	22
Multifunction switch, left .....	23
Multifunction switch, right.....	25
Multifunction switch, right.....	26
Instrument cluster .....	27





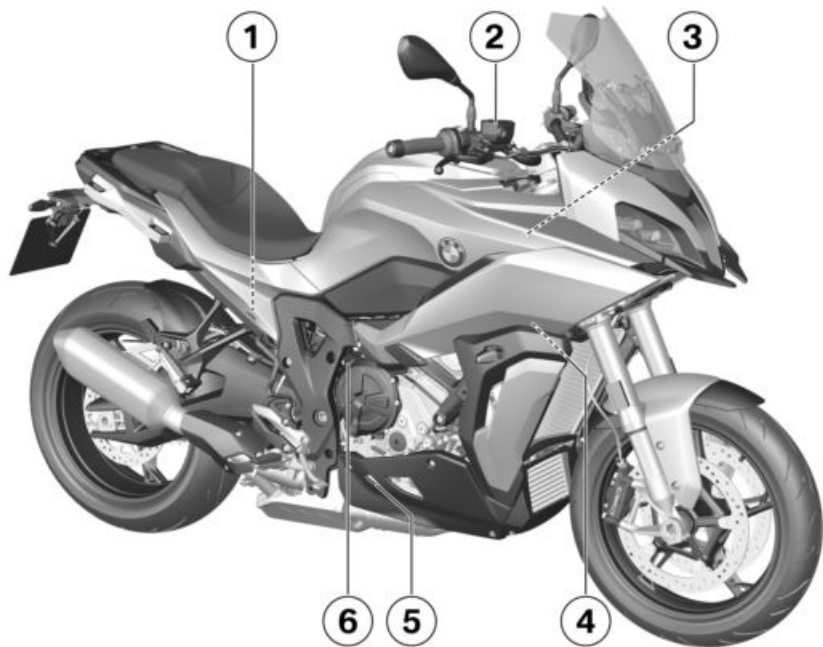

## General view, left side

- 1** Power socket (►►► 190)
- 2** Dynamic ESA spring strut, front  
Possibilities for adjustment, Dynamic ESA (►► 79)
- 3** Storage compartment  
Open and close the storage compartment (►►► 95).
- 4** Dynamic ESA spring strut, rear  
Possibilities for adjustment, Dynamic ESA (►► 79)
- 5** Seat lock  
Remove the seat (►►► 94).
- 6** Payload table
- 7** Tyre pressures table
- 8** Note on chain sag
- 9** Type plate (on the steering-head bearing)



## General view, right side

- 1 Brake-fluid reservoir, rear  
( 167)
- 2 Brake-fluid reservoir, front  
( 166)
- 3 Vehicle identification number (on the steering-head bearing)
- 4 Checking coolant level  
( 169)
- 5 Engine oil level indicator  
( 162)
- 6 Oil filler opening ( 163)

## Underneath the seat

- 1 Battery  
Maintenance instructions  
([►► 181](#))
- 2 Operating instructions
- 3 Toolkit ([►► 160](#))
- 4 Disengage the diagnostic  
socket ([►► 185](#)).
- 5 Replace the fuse ([►► 184](#)).

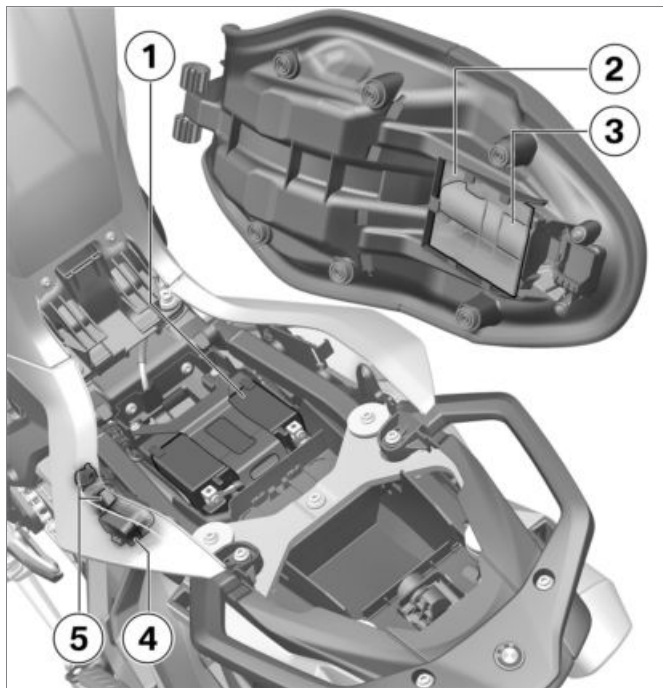



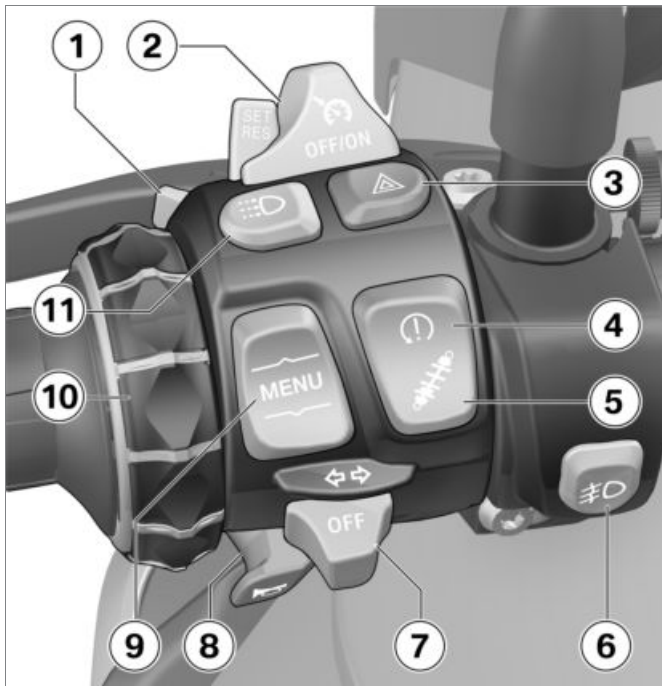

## Multifunction switch, left

- 1 High-beam headlight and headlight flasher (►► 73)
- 2 – with cruise control<sup>OE</sup>  
Switching on cruise control (►► 85).
- 3 Hazard warning lights (►► 76)
- 4 Dynamic Traction Control (DTC) (►► 78)
- 5 Possibilities for adjustment, Dynamic ESA (►► 79)
- 6 – with additional headlight<sup>OE</sup>  
Auxiliary headlights (►► 74).
- 7 Turn indicators (►► 77)
- 8 Horn
- 9 MENU rocker button (►► 99)
- 10 Multi-Controller Controls (►► 99)

- 11** – with daytime riding  
light<sup>OE</sup>

Manual daytime riding light  
( 75).

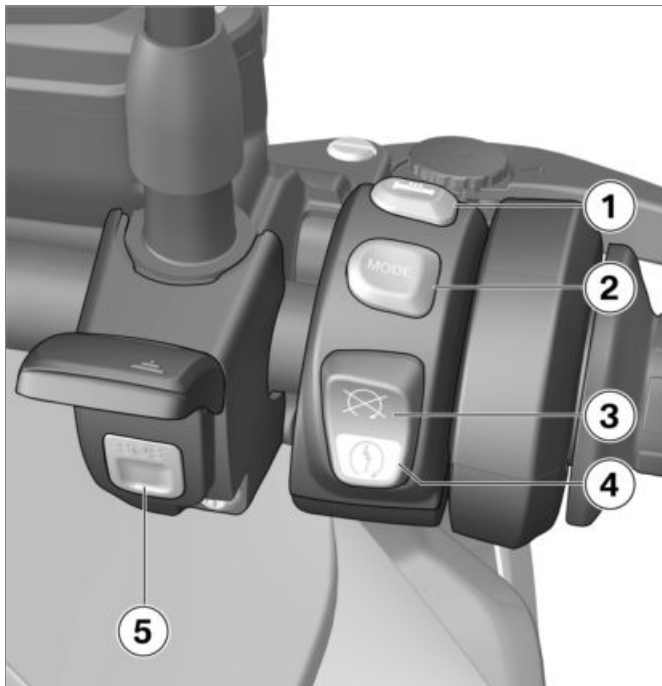

## Multifunction switch, right

– with intelligent emergency call<sup>OE</sup>

- 1 – with heated grips<sup>OE</sup>  
Heated handlebar grips (➡ 92).
- 2 Riding mode (➡ 82)
- 3 Emergency off switch (kill switch) (➡ 66)
- 4 Starter button  
Start the engine (➡ 128).
- 5 SOS button  
Intelligent emergency call (➡ 70)

## Multifunction switch, right

– without intelligent emergency call<sup>OE</sup>

- 1 – with heated grips<sup>OE</sup>  
Heated handlebar grips (➡ 92).
- 2 Riding mode (➡ 82)
- 3 Emergency off switch (kill switch) (➡ 66)
- 4 Starter button  
Start the engine (➡ 128).

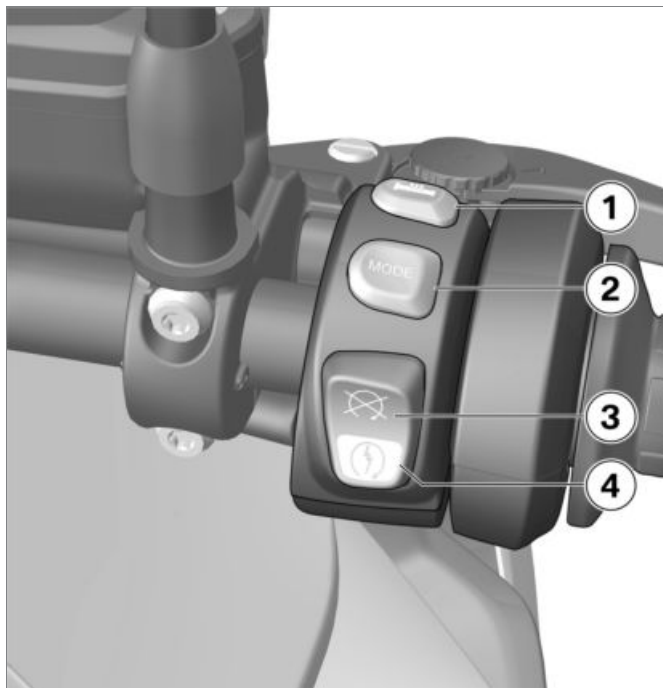

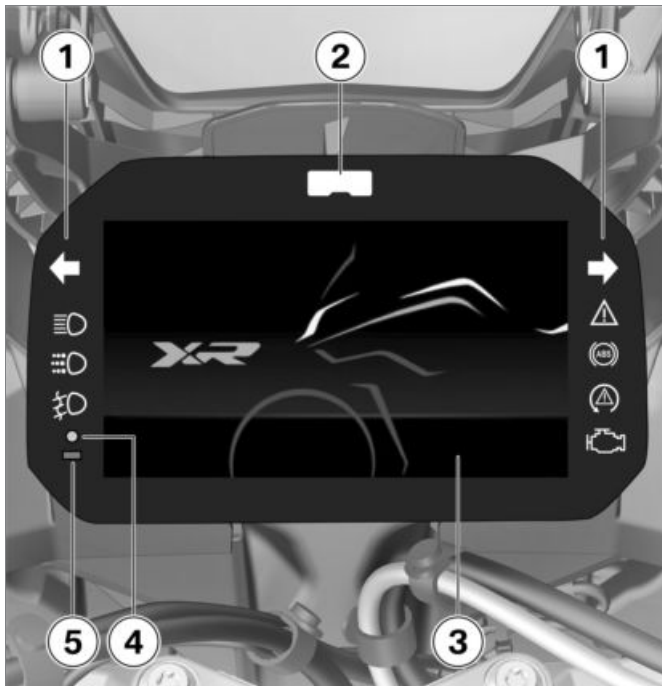

## Instrument cluster

- 1 Indicator and warning lights (➡ 30)
- 2 Shift light (➡ 133)
- 3 TFT display (➡ 31)  
(➡ 33)
- 4 Alarm system LED  
– with anti-theft alarm  
(DWA)<sup>OE</sup>  
Alarm signal (➡ 91)
- 5 Photosensor (for adapting  
the brightness of the in-  
strument lighting)



## Status indicators

Indicator and warning lights .....	30
TFT display in Pure Ride view .....	31
TFT display in Menu view .....	33
TFT display in Sport view .....	35
Warning indicators .....	36

## Indicator and warning lights

- 1 Turn indicators, left  
Operating the turn indicators (► 77).
- 2 High-beam headlight  
(► 73)
- 3 General warning light  
(► 36)
- 4 Turn indicators, right
- 5 - with EU markets export<sup>NV</sup>  
Malfunction indicator lamp  
Emissions warning (► 49)
- 6 DTC (► 57)
- 7 ABS
- 8 - with daytime riding light<sup>OE</sup>  
Manual daytime riding light  
(► 75).
- 9 - with additional headlight<sup>OE</sup>  
Auxiliary headlights  
(► 74).

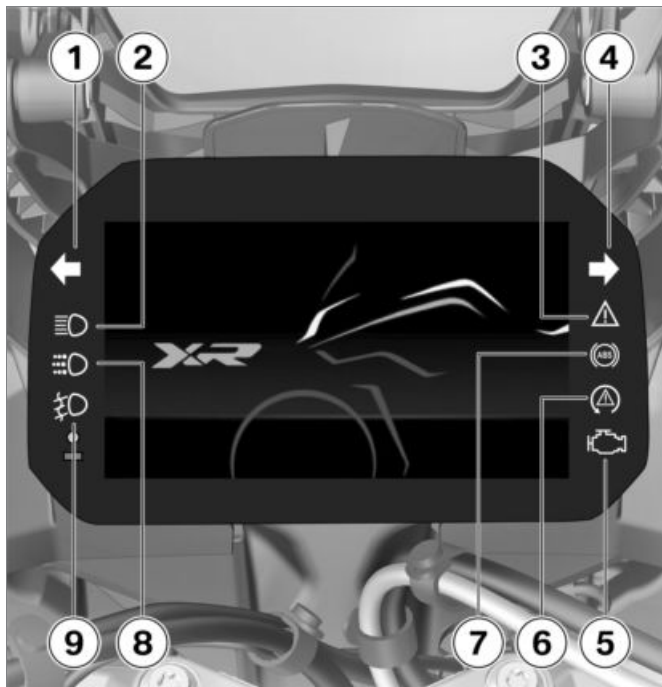



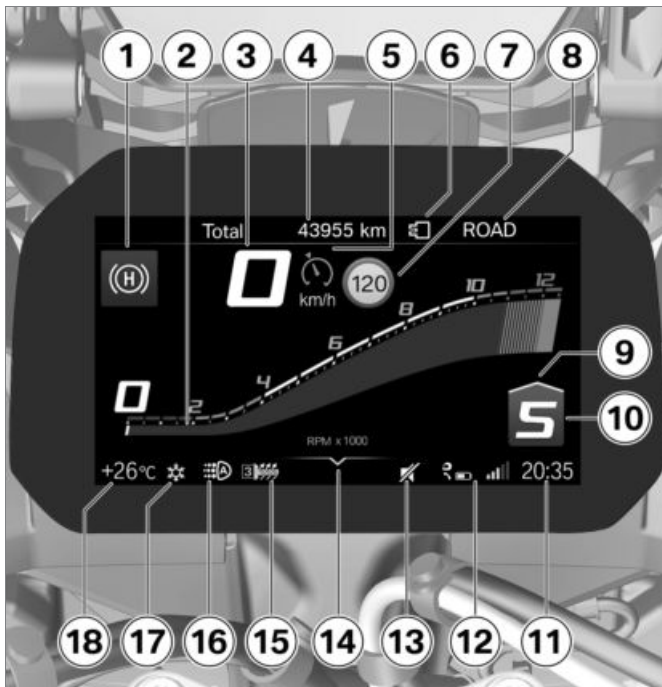

## TFT display in Pure Ride view

- 1 Hill Start Control (➡ 59)
- 2 Rev. counter (➡ 106)
- 3 Speedometer
- 4 Driver info. status line (➡ 104)
- 5 – with cruise control<sup>OE</sup>  
Switching on cruise control (➡ 85).
- 6 DYNAMIC PRO riding mode  
Setting up PRO riding mode (➡ 83).
- 7 Switch Speed Limit Info on or off (➡ 105).
- 8 Riding mode (➡ 82)
- 9 Recommendation to up-shift (➡ 107)
- 10 Gear indicator; "N" indicates neutral.
- 11 Clock (➡ 107)
- 12 Connection status (➡ 109)

- 13** Muting (▣▣▣▣ 107)
- 14** Operating help
- 15** Heating stages, handlebar grips (▣▣▣▣ 92)
- 16** – with daytime riding light<sup>OE</sup>  
Manual daytime riding light (▣▣▣▣ 75).
- 17** Outside temperature warning (▣▣▣▣ 45)
- 18** Ambient temperature

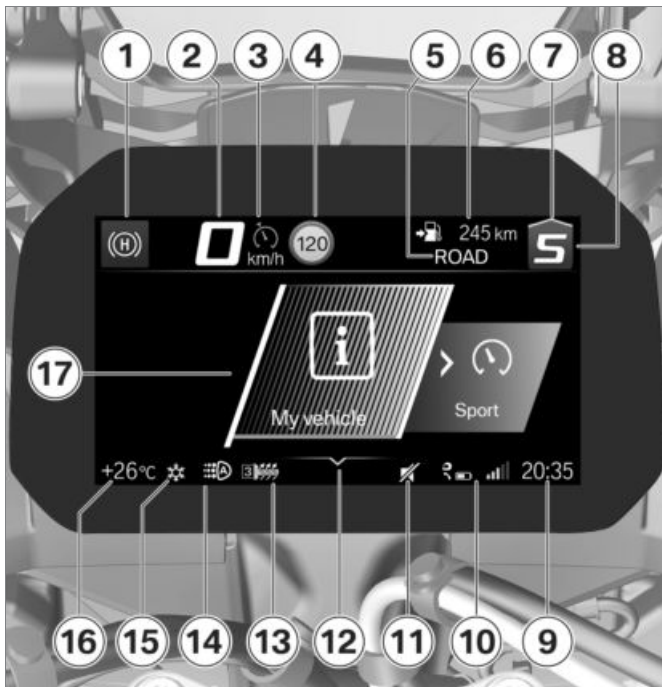

## TFT display in Menu view

- 1 Hill Start Control (➡ 59)
- 2 Speedometer
- 3 – with cruise control<sup>OE</sup>  
Switching on cruise control (➡ 85).
- 4 Switch Speed Limit Info on or off (➡ 105).
- 5 Riding mode (➡ 82)
- 6 Driver info. status line (➡ 104)
- 7 Recommendation to up-shift (➡ 107)
- 8 Gear indicator; "N" indicates neutral.
- 9 Clock
- 10 Connection status
- 11 Muting (➡ 107)
- 12 Operating help
- 13 Heating stages, handlebar grips (➡ 92)

- 14** – with daytime riding light<sup>OE</sup>  
Automatic daytime riding light (▣▣▣ 76).
- 15** Outside temperature warning (▣▣▣ 45)
- 16** Ambient temperature
- 17** Menu section



## TFT display in Sport view

- 1 Maximum DTC torque reduction
- 2 Current DTC torque reduction
- 3 Rev. counter
- 4 Maximum braking deceleration
- 5 Current braking deceleration
- 6 Current lean angle
- 7 Maximum lean angle
- 8 Unit for rpm display: 1,000 revolutions per minute

## Warning indicators

### Mode of presentation

Warnings are indicated by the corresponding warning lights. Warnings are indicated by 'General' warning light showing in combination with a dialogue in the TFT display. The 'General' warning light shows yellow or red, depending on the urgency of the warning.



The status of the 'General' warning light matches the most urgent warning. The possible warnings are listed on the next pages.



### Check Control display

The messages differ in how they show on the display. Different colours and symbols are used depending on priority:

- Green CHECK OK **1**: no message, optimum values.
- White circle with small "i" **2**: information.
- Yellow warning triangle **3**: warning, value not ideal.
- Red warning triangle **3**: warning, value critical

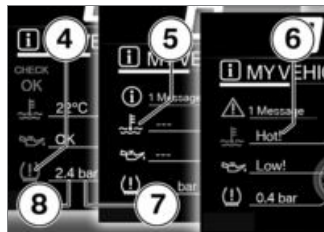

### Values display

Symbols **4** differ in how they show on the display. The colours used differ and reflect the urgency of the message. Along with numerical values **8** with units **7**, texts **6** are displayed as well:

#### Colour of the symbol

- Green: (OK) current value is ideal.
- Blue: (Cold!) current temperature is too low.
- Yellow: (Low! / High!) current value is too low or too high.

- Red: (Hot! / High!) current temperature or value is too high.
- White: (---) no valid value available. Dashes **5** are displayed instead of a numerical value.

## NOTICE

The assessment of some values is only possible from a certain journey duration or speed. If a measured value is still not being displayed because the conditions for measurement have not been met, dashes are displayed instead as a placeholder. If there are no valid measured values, there will be no assessment in the form of a coloured symbol. ◀



### Check Control dialogue

Messages are output as Check Control dialogues **1**.

- If there are two or more Check Control messages of equal priority, the messages keep changing in the order of their occurrence until they are acknowledged.
- If symbol **2** is actively displayed, it can be acknowledged by tilting the Multi-Controller to the left.
- Check Control messages are dynamically attached as additional tabs on the pages in the menu *My vehicle* (➡ 101).













You can go to the message again as long as the fault persists.

## Warnings, overview

### Indicator and warning lights

### Display text

### Meaning















		appears on the display.	Outside temperature warning (▶▶▶▶ 45)
 General warning light shows yellow.		Remote key not in range.	Radio-operated key out of range (▶▶▶▶ 45)
 General warning light shows yellow.		Remote key battery at 50%.	Replace battery of radio-operated key (▶▶▶▶ 46)
		Remote key battery weak.	
 General warning light shows yellow.		is displayed in yellow.	Voltage of the vehicle electrical system too low (▶▶▶▶ 46)
		Vehicle voltage low.	
 General warning light shows red.		is displayed in red.	Voltage of the vehicle electrical system critical (▶▶▶▶ 46)
		Vehicle voltage critical!	



## Indicator and warning lights

## Display text













## Meaning













 General warning light shows yellow.	 The faulty bulb is displayed.	Bulb faulty (➡ 47)
 General warning light flashes yellow.	 The faulty bulb is displayed.	
	 Alarm system batt. capacity weak.	Anti-theft alarm battery weak (➡ 48)
 General warning light shows yellow.	 Alarm system battery empty.	Anti-theft alarm battery flat (➡ 48)
 General warning light shows red.	 Coolant temperature too high!	Coolant temperature too high (➡ 49)
 The malfunction indicator lamp lights up.	 Engine!	Emissions warning (➡ 49)
 General warning light shows yellow.	 No communication with engine control.	Engine control failed (➡ 50)
 General warning light shows yellow.	 Fault in the engine control.	Engine in emergency-operation mode (➡ 50)

## Indicator and warning lights

## Display text

## Meaning

	General warning light flashes yellow.	 Serious fault in the engine control!	Severe fault in the engine control (➡ 50)
	General warning light shows yellow.	 is displayed in yellow.	Tyre pressure close to limit of permitted tolerance (➡ 52)
		 Tyre pressure does not match setpoint	
	General warning light flashes red.	 is displayed in red.	Tyre pressure outside permitted tolerance (➡ 53)
		 Tyre pressure does not match setpoint	
		 Tyre press. control. Loss of pressure.	
		 "----"	Transmission fault (➡ 53)
	General warning light shows yellow.	 "----"	Sensor faulty or system fault (➡ 54)

Indicator and warning lights	Display text	Meaning
 General warning light shows yellow.	 RDC sensor battery weak.	Battery for tyre pressure sensor weak (→ 55)
 General warning light shows yellow.	 Drop sensor faulty.	Drop sensor defective (→ 55)
	 Cannot start engine.	Motorcycle dropped (→ 55)
	 Emergency call failure.	Emergency call function restricted (→ 55)
	 Side stand monitoring faulty.	Side stand monitoring is faulty (→ 56)
 ABS indicator and warning light flashes.		ABS self-diagnosis not completed (→ 56)
 ABS indicator and warning light comes on.	 Limited ABS availability!	ABS fault (→ 56)
 ABS indicator and warning light comes on.	 ABS failure!	ABS failed (→ 56)

## Indicator and warning lights

## Display text

## Meaning



ABS indicator and warning light comes on.



ABS Pro failure!

ABS Pro failed (→ 57)



DTC indicator light quick-flashes.

DTC intervention (→ 57)



DTC indicator light slow-flashes.

DTC self-diagnosis not completed (→ 57)



DTC indicator and warning light comes on.



Off!

DTC switched off (→ 58)



Traction control deactivated.



DTC indicator and warning light comes on.



Traction control failure!

DTC fault (→ 58)











DTC indicator and warning light comes on.



Traction control limited!

DTC restricted (→ 58)

Indicator and warning lights	Display text	Meaning
 General warning light shows yellow.	 Spring strut adjustment faulty!	D-ESA fault (→ 59)
	 Fuel reserve reached. Go to a filling station soon	Fuel down to reserve (→ 59)
	 Green holding symbol is displayed.	Hill Start Control active (→ 59)
	 Yellow holding symbol flashes.	Hill Start Control automatically deactivated (→ 60)
	 Crossed-out holding symbol is displayed.	Hill Start Control cannot be activated (→ 60)
	 The gear indicator flashes.	Gear not taugth (→ 60)
 Turn signal indicator light flashes green.		Hazard warning lights system is switched on (→ 61)

## Indicator and warning lights

### Display text

### Meaning



Turn signal indicator light flashes green.

Hazard warning lights system is switched on (➡ 61)



is displayed in white.

Service due (➡ 61)

Service due!



General warning light shows yellow.



is displayed in yellow.

Service-due date has passed (➡ 61)

Service overdue!

## Ambient temperature

The ambient temperature is displayed status line of the TFT display.

When the vehicle is at a standstill, the heat of the engine can falsify the ambient-temperature reading. If the heat of the engine is affecting it too much, dashes are temporarily shown in place of the value.



There is a risk of black ice if the ambient temperature falls below the following limit value.



Limit value for the ambient temperature

approx. 3 °C

The first time the temperature drops below this value, the ambient-temperature reading and the ice crystal symbol flash in the status line of the TFT display.

## Outside temperature warning



appears on the display.

Possible cause:



The air temperature measured at the vehicle is lower than:

approx. 3 °C



**WARNING**

### Risk of black ice also applicable at over 3 °C

Risk of accident

- Always take extra care when temperatures are low; remember that there is particular danger of black ice forming on bridges and where the road is in shade.◀
- Ride carefully and think well ahead.

## Radio-operated key out of range

– with Keyless Ride<sup>OE</sup>



General warning light shows yellow.



Remote key not in range. Not possible to switch on ignition again.

Possible cause:

Communication between radio-operated key and engine electronics is disrupted.

- Check the battery in the radio-operated key.  
– with Keyless Ride<sup>OE</sup>
- Replace the battery of the radio-operated key (▶▶▶▶ 70).
- Use the spare key to continue your journey.  
– with Keyless Ride<sup>OE</sup>
- Loss of the radio-operated key (▶▶▶▶ 69).

- Remain calm if the Check Control dialogue appears on the display while you are riding. You can continue your journey, the engine will not switch off.
- Have the faulty radio-operated key replaced by an authorised BMW Motorrad retailer.

### Replace battery of radio-operated key

 General warning light shows yellow.

 Remote key battery at 50%. No functional impairment.

 Remote key battery weak. Limited central locking function. Change battery.

Possible cause:

- The integral battery in the radio-operated key has lost a significant proportion of its original capacity. There is no

assurance of how long the radio-operated key can remain operational.

– with Keyless Ride<sup>OE</sup>

- Replace the battery of the radio-operated key (►► 70).

### Voltage of the vehicle electrical system too low

 General warning light shows yellow.

 is displayed in yellow.

 Vehicle voltage low. Switch off unnecessary consumers.

### WARNING

#### Failure of the vehicle systems

Risk of accident

- Do not continue your journey. ◀

Battery is not being charged. If you continue to ride the motor-

cycle the on-board electronics will drain the battery.

### NOTICE

The fuse for the alternator regulator can blow if the 12 V battery is installed incorrectly or if the terminals are swapped (e.g. when using a starting aid). ◀

Possible cause:

The alternator or alternator drive is faulty, battery is faulty or the fuse for the alternator regulator has blown.

- Have the fault rectified as quickly as possible by a specialist workshop, preferably an authorised BMW Motorrad retailer.

### Voltage of the vehicle electrical system critical

 General warning light shows red.



 is displayed in red.

 Vehicle voltage critical! Consumers were switched off. Check battery condition.

## WARNING

### Failure of the vehicle systems

Risk of accident

• Do not continue your journey. ◀

Battery is not being charged. If you continue to ride the motorcycle the on-board electronics will drain the battery.

## NOTICE

The fuse for the alternator regulator can blow if the 12 V battery is installed incorrectly or if the terminals are swapped (e.g. when using a starting aid). ◀

Possible cause:

The alternator or alternator drive is faulty, battery is faulty or the fuse for the alternator regulator has blown.

- Have the fault rectified as quickly as possible by a specialist workshop, preferably an authorised BMW Motorrad retailer.

### Bulb faulty

 General warning light shows yellow.

 The faulty bulb is displayed:

 High beam faulty!

 Front left turn indicator faulty! or  
Front right turn indicator faulty!

 Low-beam headlight faulty!

 Front side light faulty!

– with daytime riding light<sup>OE</sup>

 Daytime riding light faulty! ◀

 Tail light faulty!

 Brake light faulty!

 Rear left turn indicator faulty! or  
Rear right turn indicator faulty!

 Number plate light faulty!

– Have it checked by a specialist workshop.



General warning light flashes yellow.



The faulty bulb is displayed:



Active headlight faulty. Have it checked by a specialist workshop.



## WARNING

### Vehicle overlooked in traffic due to failure of the lights on the vehicle

Safety risk

- Always replace a faulty bulb at the earliest possible opportunity. Consult a specialist workshop, preferably an authorised BMW Motorrad Retailer.◀

Possible cause:

One or more bulbs faulty.

- Identify faulty bulb or bulbs by visual check.
- Have LED light sources completely replaced; consult a specialist workshop, preferably an authorised BMW Motorrad retailer.

Possible cause:

Plug connection disconnected.

- Identify disconnected plug connection.
- Connect disconnected plug connection.

### Anti-theft alarm battery weak

– with anti-theft alarm (DWA)<sup>OE</sup>



Alarm system batt. capacity weak. No restrictions. Make an appointment at a specialist workshop.



## NOTICE

This error message shows briefly only after the Pre-Ride-Check completes.◀

Possible cause:

The integral battery in the anti-theft alarm has lost a significant proportion of its original capacity. There is no assurance of how long the anti-theft alarm can remain operational if the vehicle's battery is disconnected.

- Consult a specialist workshop, preferably an authorised BMW Motorrad retailer.

### Anti-theft alarm battery flat

– with anti-theft alarm (DWA)<sup>OE</sup>



General warning light shows yellow.

 Alarm system battery empty. No independent alarm. Make an appointment at a specialist workshop.

### NOTICE

This error message shows briefly only after the Pre-Ride-Check completes. ◀

Possible cause:

The integral battery in the anti-theft alarm has lost its entire original capacity. There is no assurance that the anti-theft alarm will be operational if the motorcycle's battery is disconnected.

- Consult a specialist workshop, preferably an authorised BMW Motorrad retailer.

## Coolant temperature too high



General warning light shows red.



Coolant temperature too high! Check coolant level. Continue driving in part-load to cool down.



### ATTENTION

## Riding with overheated engine

Engine damage

- Compliance with the information set out below is essential. ◀

Possible cause:

The coolant level is too low.

- Check the coolant level (➔ 169).

If the coolant level is too low:

- Allow the engine to cool down.

- Check the coolant level (➔ 169).
- Have the cooling system checked by a specialist workshop, preferably by a BMW Motorrad partner.

Possible cause:

The coolant temperature is too high.

- If possible, ride in the part-load range to cool down the engine.
- If the coolant temperature is frequently too high, have the fault rectified as soon as possible by a specialist workshop, preferably an authorised BMW Motorrad retailer.

## Emissions warning



The malfunction indicator lamp lights up.

 Engine! Have it checked by a specialist workshop.

Possible cause:

The engine control unit has diagnosed a fault which affects the pollutant emissions.

- Have the fault rectified by a specialist workshop, preferably an authorised BMW Motorrad retailer.
- » You can continue riding; pollutant emissions are higher than the threshold values.

### Engine control failed

 General warning light shows yellow.

 No communication with engine control. Multiple sys. affected. Ride carefully to the next specialist workshop.

### Engine in emergency-operation mode

 General warning light shows yellow.

 Fault in the engine control. Onward journey possible. Ride carefully to next specialist workshop.

### WARNING

#### Unusual ride characteristics when engine running in emergency-operation mode

Risk of accident

- Avoid accelerating sharply and overtaking. ◀

Possible cause:

The engine control unit has diagnosed a fault. In exceptional cases, the engine stops and refuses to start. Otherwise, the engine runs in emergency operating mode.

- You can continue to ride, but bear in mind that the usual engine power or the full range of engine rpm might not be available.
- Have the fault rectified as quickly as possible by a specialist workshop, preferably an authorised BMW Motorrad retailer.

### Severe fault in the engine control

 General warning light flashes yellow.

 Serious fault in the engine control! Riding at mod. speed pos. Damage possible. Have checked by workshop.

## WARNING

### Engine damage when running in emergency-operation mode

Risk of accident

- Ride slowly, avoid accelerating sharply and overtaking.
- If possible, have the vehicle picked up and have the fault rectified by a specialist workshop, preferably an authorised BMW Motorrad Retailer. ◀

Possible cause:

The engine control unit has diagnosed a fault which may cause severe secondary faults. The engine is in emergency-operation mode.

- It is possible to continue to ride but not recommended.
- Avoid high load and rpm ranges if possible.
- Have the fault rectified as quickly as possible by a

specialist workshop, preferably an authorised BMW Motorrad retailer.

### Tyre pressure

– with tyre pressure control (RDC)<sup>OE</sup>

In addition to the MY VEHICLE menu screen and the Check Control messages, there is also the TYRE PRESSURE screen for showing the tyre pressures:



The values on the left are for the front wheel; those on the right are for the rear wheel.

Actual and specified tyre pressures and the difference between them are displayed for each wheel.

Immediately after the ignition is switched on, only dashes are displayed. The sensors do not start transmitting tyre pressure signals until the first time the vehicle accelerates to more than the minimum speed stated below:



RDC sensor is not active

min 30 km/h (The RDC sensor does not transmit its signal to the vehicle until a certain minimum speed has been reached.)



The tyre pressures are shown in the TFT display as temperature compensated and always refer to the following tyre air temperature:

20 °C



If the tyre symbol appears as well, showing yellow or red, this is a warning. The pressure difference is highlighted with an exclamation mark in the same colour.



If the value in question is close to the limit of the permissible tolerance range, the reading is accompanied by the 'General' warning light showing yellow.



The 'General' warning light flashes red if the tyre pressure registered by the sensor is outside the permissible tolerance range.

For further information about the BMW Motorrad RDC, see the section entitled "Engineering details" from page (➡ 153) onward.

### Tyre pressure close to limit of permitted tolerance

– with tyre pressure control (RDC)<sup>OE</sup>



General warning light shows yellow.



is displayed in yellow.



Tyre pressure does not match setpoint Check tyre pressure.

Possible cause:

Measured tyre pressure is close to the limit of permitted tolerance.

- Correct tyre pressure.
- Before adjusting tyre pressure, read the information on temperature compensation and adjusting pressure in the section entitled "Engineering details":
  - » Temperature compensation (➡ 154)
  - » Pressure adaptation (➡ 154)
  - » Find the correct tyre pressures in the following places:
    - Back cover of the operating instructions
    - Instrument cluster in the TYRE PRESSURE view
    - Sign on the rear wheel swinging arm

## Tyre pressure outside permitted tolerance

– with tyre pressure control (RDC)<sup>OE</sup>



General warning light flashes red.



is displayed in red.



Tyre pressure does not match setpoint Stop immediately! Check tyre pressure.



Tyre press. control. Loss of pressure. Stop immediately! Check tyre pressure.



### WARNING

## Tyre pressure outside the permitted tolerance.

Risk of accident, degradation of the vehicle's driving characteristics.

- Adapt your style of riding accordingly. ◀

Possible cause:

Measured tyre pressure is outside permitted tolerance.

- Check the tyre for damage and to ascertain whether the vehicle can be ridden with the tyre in its present condition.

If the vehicle can be ridden with the tyre in its present condition:

- Correct the tyre pressure at the earliest possible opportunity.
- Before adjusting tyre pressure, read the information on temperature compensation and adjusting pressure in the section entitled "Engineering details":

- » Temperature compensation (▣▣▣ 154)
- » Pressure adaptation (▣▣▣ 154)
- » Find the correct tyre pressures in the following places:
- Back cover of the operating instructions

– Instrument cluster in the TYRE PRESSURE view

– Sign on the rear wheel swinging arm

- Have the tyre checked for damage by a specialist workshop, preferably an authorised BMW Motorrad retailer.

If you are unsure whether the vehicle can be ridden with the tyre in its present condition:

- Do not continue your journey.
- Notify the breakdown service.

## Transmission fault

– with tyre pressure control (RDC)<sup>OE</sup>



"---"

Possible cause:

The vehicle has not reached the minimum speed (▣▣▣ 153).



RDC sensor is not active

min 30 km/h (The RDC sensor does not transmit its signal to the vehicle until a certain minimum speed has been reached.)

- Increase speed above this threshold and observe the RDC readings.



Assume that a permanent fault has not occurred unless the 'General' warning light comes on to accompany the symptoms.

Under these circumstances:

- Have the fault rectified by a specialist workshop, preferably an authorised BMW Motorrad retailer.

Possible cause:

Wireless communication with the RDC sensors has been disrupted. Radio systems are located in the surrounding area which are interfering with the transmission between the RDC control unit and the sensors.

- Move to another location and observe the RDC readings.



Assume that a permanent fault has not occurred unless the 'General' warning light comes on to accompany the symptoms.

Under these circumstances:

- Have the fault rectified by a specialist workshop, preferably an authorised BMW Motorrad retailer.

## Sensor faulty or system fault

– with tyre pressure control (RDC)<sup>OE</sup>



General warning light shows yellow.



"---"

Possible cause:

Vehicle is fitted with wheels not equipped with RDC sensors.

- Fit wheels and tyres equipped with RDC sensors.

Possible cause:

1 or 2 RDC sensors have failed or there is a system fault.

- Have the fault rectified by a specialist workshop, preferably an authorised BMW Motorrad retailer.



## Battery for tyre pressure sensor weak

– with tyre pressure control (RDC)<sup>OE</sup>



General warning light shows yellow.



RDC sensor battery weak. Function limited. Have it checked by a specialist workshop.



### NOTICE

This error message shows briefly only after the Pre-Ride-Check completes. ◀

Possible cause:

The integral battery in the tyre-pressure sensor has lost a significant proportion of its original capacity. There is no assurance of how long the tyre pressure monitoring system can remain operational.

- Consult a specialist workshop, preferably an authorised BMW Motorrad retailer.

## Drop sensor defective



General warning light shows yellow.



Drop sensor faulty. Have it checked by a specialist workshop.

Possible cause:

The drop sensor is not available.

- Consult a specialist workshop, preferably an authorised BMW Motorrad retailer.

## Motorcycle dropped



Cannot start engine. Stand motorcycle upright. Switch ignition on/off. Start the engine.

Possible cause:

The drop sensor has detected a drop and has cut out the engine.

- Hold the vehicle upright and check it for damage.
- Switch the ignition off and then on again or switch the kill switch on and then off again.

## Emergency call function restricted

– with intelligent emergency call<sup>OE</sup>



Emergency call failure. Make an appointment at a specialist workshop.

Possible cause:

The emergency call cannot be made automatically or via BMW.

- Consult the information on operating the intelligent emergency call on page (▶▶ 70)ff.

- Consult a specialist workshop, preferably an authorised BMW Motorrad retailer.

## Side stand monitoring is faulty

 Side stand monitoring faulty. Onward journey possible. Engine stop, when stationary! Have checked by workshop.

Possible cause:

The side-stand switch or its wiring are damaged.

- Consult a specialist workshop, preferably an authorised BMW Motorrad retailer.

## ABS self-diagnosis not completed

 ABS indicator and warning light flashes.

Possible cause:



ABS self-diagnosis not completed

The ABS function is not available, because self-diagnosis did not complete. (The motorcycle has to reach a defined minimum speed for the wheel speed sensors to be checked: 5 km/h)

- Pull away slowly. Bear in mind that the ABS function is not available until self-diagnosis has completed.

## ABS fault



ABS indicator and warning light comes on.



Limited ABS availability! Onward journey possible. Ride carefully to next specialist workshop.

Possible cause:

The ABS control unit has detected a fault. The partially integral function and the Dynamic Brake Control function have failed. The ABS function is available, subject to restrictions.

- You can continue to ride. Bear in mind the more detailed information on certain situations that can lead to an ABS fault message (146).
- Have the fault rectified as quickly as possible by a specialist workshop, preferably an authorised BMW Motorrad retailer.

## ABS failed



ABS indicator and warning light comes on.



ABS failure! Onward journey possible. Ride carefully to next specialist workshop.

Possible cause:

The ABS control unit has detected a fault. The ABS function is not available.

- You can continue to ride. Bear in mind the more detailed information on certain situations that can lead to an ABS fault message (►► 146).
- Have the fault rectified as quickly as possible by a specialist workshop, preferably an authorised BMW Motorrad retailer.

### ABS Pro failed



ABS indicator and warning light comes on.



ABS Pro failure! Onward journey possible. Ride carefully to next specialist workshop.

Possible cause:

Monitoring of the ABS Pro function has detected a fault. The ABS Pro function is not available. The ABS function is still available. ABS provides support only for braking in straight-ahead driving.

- You can continue to ride. Bear in mind the more detailed information on certain situations that can lead to an ABS Pro fault message (►► 146).
- Have the fault rectified as quickly as possible by a specialist workshop, preferably an authorised BMW Motorrad retailer.

### DTC intervention



DTC indicator light quick-flashes.

The DTC has detected impending instability at the rear wheel and reduces the torque. The indicator light flashes for longer

than the DTC intervention lasts. This affords the rider visual feedback on control intervention even after the critical situation has been dealt with.

### DTC self-diagnosis not completed



DTC indicator light slow-flashes.

Possible cause:



DTC self-diagnosis not completed

The DTC function is not available, because self-diagnosis did not complete. (The motorcycle has to reach a defined minimum speed with the engine running for the wheel-speed sensors to be checked: min 5 km/h)

- Pull away slowly. Bear in mind that the DTC function is not

available until self-diagnosis has completed.

### DTC switched off



DTC indicator and warning light comes on.



Off!



Traction control de-activated.

Possible cause:

The rider has switched off the DTC system.

- Switch on DTC (➡ 78).

### DTC fault



DTC indicator and warning light comes on.



Traction control failure! Onward journey possible.

Ride carefully to next specialist workshop.

Possible cause:

The DTC control unit has detected a fault.



### ATTENTION

#### Damaged components

Damage to sensors, for example, which causes malfunctions

- Do not transport any objects underneath the driver or passenger seat.
- Secure the toolkit.◀
- Do not damage the angular rate sensor.
- Bear in mind that the DTC function and dynamic engine brake control are not available.
- You can continue to ride. Bear in mind the more detailed information on situations that can lead to a DTC fault (➡ 148).
- Have the fault rectified as quickly as possible by a specialist workshop, preferably

an authorised BMW Motorrad retailer.

### DTC restricted



DTC indicator and warning light comes on.



Traction control limited! Onward journey possible. Ride carefully to next specialist workshop.

Possible cause:

The DTC control unit has detected a fault.



### ATTENTION

#### Damaged components

Damage to sensors, for example, which causes malfunctions

- Do not transport any objects underneath the driver or passenger seat.
- Secure the toolkit.◀

- Do not damage the angular rate sensor.
- Bear in mind that the DTC function and dynamic engine brake control are restricted.
- You can continue to ride. Bear in mind the more detailed information on situations that can lead to a DTC fault (►► 148).
- Have the fault rectified as quickly as possible by a specialist workshop, preferably an authorised BMW Motorrad retailer.

## D-ESA fault



General warning light shows yellow.



Spring strut adjustment faulty! Onward journey possible. Ride carefully to next specialist workshop.

Possible cause:

The Dynamic ESA control unit has detected a fault. The damping and/or spring adjuster may be the cause. In Auto the cause may also be a fault in the riding position equaliser. In this condition, the motorcycle may have too much damping and is uncomfortable to drive, especially on roads in poor condition. Alternatively, the spring preload may be incorrectly adjusted.

- Have the fault rectified as quickly as possible by a specialist workshop, preferably an authorised BMW Motorrad retailer.

## Fuel down to reserve



Fuel reserve reached. Go to a filling station soon.



## WARNING

### Irregular engine operation or engine shutdown due to lack of fuel

Risk of accident, damage to catalytic converter

- Do not run the fuel tank dry. ◀

Possible cause:

The fuel tank contains no more than the reserve quantity of fuel.



Fuel reserve

approx. 4 l

- Refuel (►► 137).

## Hill Start Control active



Green holding symbol is displayed.

Possible cause:

Hill Start Control (155) has been activated by the rider.

- Switch off Hill Start Control.
- Operate Hill Start Control Pro (87).

### Hill Start Control automatically deactivated



Yellow holding symbol flashes.

Possible cause:

Hill Start Control has been automatically deactivated.

- Side stand has been extended.
  - » Hill Start Control is deactivated when the side stand is extended.
- Engine has been switched off.
  - » Hill Start Control is deactivated when the engine is switched off.
- Operate Hill Start Control Pro (87).

### Hill Start Control cannot be activated



Crossed-out holding symbol is displayed.

Possible cause:

Hill Start Control cannot be activated.

- Retract the side stand.
  - » Hill Start Control is operational only with the side stand retracted.
- Start the engine.
  - » Hill Start Control is operational only while the engine is running.

### Gear not taught

– with shift assistant Pro<sup>OE</sup>



The gear indicator flashes. The Pro shift assistant is not available.

Possible cause:

The gearbox sensor is not fully trained.

- Select neutral N and allow the engine to idle for at least 10 seconds to teach the neutral position.
- Use clutch control to engage each gear in turn and ride for a minimum of 10 seconds in each gear.
  - » The gear indicator stops flashing when the gearbox sensor has been trained successfully.
- When the gearbox sensor has been taught successfully, Gear Shift Assistant Pro works as described (154).
- If teaching is not successful, have the fault rectified by a specialist workshop, preferably an authorised BMW Motorrad retailer.

## Hazard warning lights system is switched on



Turn signal indicator light flashes green.



Turn signal indicator light flashes green.

Possible cause:

The driver has switched on the hazard warning lights system.

- Operating hazard warning flashers (→ 76).

## Service display



If service is overdue, the due date or the odometer reading at which service was due is accompanied by the 'General' warning light showing yellow.

If the service is overdue, a yellow CC message is displayed. Exclamation marks also draw your attention to the displays for service, service appointment and remaining distance in the

MY VEHICLE and SERVICE REQUIREMENTS menu screens.



### NOTICE

If the service-due indicator appears more than a month before the service date, the current date has to be corrected. This situation can occur if the battery was disconnected. ◀

## Service due



is displayed in white.

Service due! Have service performed by a specialist workshop.

Possible cause:

Service is due, because of either distance covered or time expired.

- Have your motorcycle serviced regularly by a specialist workshop, preferably by an authorised BMW Motorrad retailer.

- » The vehicle remains operationally reliable and roadworthy.
- » The vehicle retains its value.

## Service-due date has passed



General warning light shows yellow.



is displayed in yellow.

Service overdue! Have service performed by a specialist workshop.

Possible cause:

Service is overdue because of the driving performance or the date.

- Have your motorcycle serviced regularly by a specialist workshop, preferably by an authorised BMW Motorrad retailer.
- » The vehicle remains operationally reliable and roadworthy.
- » The vehicle retains its value.





## Operation

Ignition switch/steering lock .....	64	Shift light .....	89
Emergency off switch (kill switch) .....	66	Anti-theft alarm (DWA) .....	90
Ignition with Keyless Ride .....	66	Tyre pressure monitoring (RDC) ....	92
Intelligent emergency call .....	70	Heated handlebar grips .....	92
Lights .....	73	On-board computer .....	93
Daytime riding light .....	75	Seat .....	94
Hazard warning lights .....	76	Storage compartment .....	95
Turn indicators .....	77		
Dynamic Traction Control (DTC) ....	78		
Electronic Suspension Adjustment (D-ESA) .....	79		
Riding mode .....	82		
PRO riding mode .....	83		
Cruise-control system .....	84		
Hill Start Control .....	87		

## Ignition switch/steering lock

### Keys

You receive 2 vehicle keys.

If a key is lost or mislaid, consult the notes on the electronic immobiliser (EWS) (▮▮▮ 65).

Ignition switch/steering lock, fuel filler cap lock and seat lock are all operated with the same key.

### Engaging steering lock

- Turn the handlebars all the way to the left.

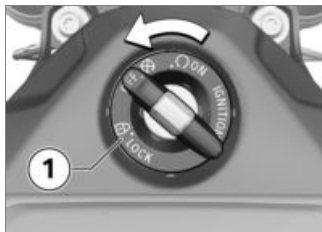

- Turn the ignition key to position **1**, while moving the handlebars slightly.
  - » Ignition, lights and all function circuits switched off.
  - » Steering lock engaged.
  - » Vehicle key can be removed.

## Switching on ignition

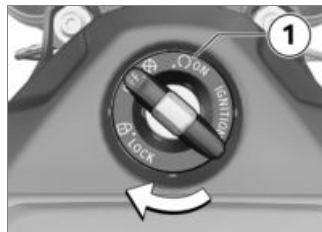

- Turn the ignition key to position **1**.
  - » Side lights and all function circuits switched on.
  - » Engine can be started.
  - » Pre-Ride-Check is performed. (▮▮▮ 129)
  - » ABS self-diagnosis is in progress. (▮▮▮ 130)
  - » DTC self-diagnosis is in progress. (▮▮▮ 130)

## Welcome lights

– with daytime riding light<sup>OE</sup>

- Switch on the ignition.
  - » The side lights briefly light up.
  - » The daytime riding lights briefly light up.
- with LED additional headlight<sup>OA</sup>
  - » The LED auxiliary headlights briefly light up.◀

## Switching off ignition

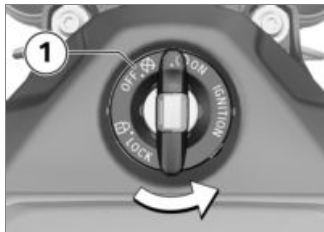

- Turn the ignition key to position **1**.
  - » Light switched off.

- » Handlebars not locked.
- » Vehicle key can be removed.

## Electronic immobiliser (EWS)

The on-board electronics access the data saved in the ignition key via a ring aerial in the ignition lock. The engine control unit will not permit the engine to be started unless the key is identified as “authorised”.

### NOTICE

A second ignition key attached to the same ring as the ignition key used to start the engine could “irritate” the electronics, in which case the enabling signal for starting is not issued.

Always keep the ignition keys separate from each other.◀

If you lose an ignition key, you can have it barred by your authorised BMW Motorrad retailer.

If you wish to do this, you will need to bring all other keys for the motorcycle with you. The engine cannot be started by a barred key, but a key that has been barred can subsequently be reactivated.

You can obtain spare keys only through an authorised BMW Motorrad retailer. The keys are part of an integrated security system, so the retailer is under an obligation to check the legitimacy of all applications for replacement/extra keys.

## Emergency off switch (kill switch)



- 1 Emergency off switch (kill switch)



### WARNING

#### Operation of the kill switch while riding

Risk of fall due to rear wheel locking

- Do not operate the kill switch when riding. ◀

The emergency off switch is a kill switch for switching off the engine quickly and easily.



- A Engine switched off  
B Normal operating position (run)

## Ignition with Keyless Ride

– with Keyless Ride<sup>OE</sup>

## radio-operated key



### NOTICE

The telltale light for the radio-operated key flashes while the search for the radio-operated key is in progress.

The light goes out as soon as the radio-operated key or the emergency key is found.

The light goes out briefly if the search times out without the radio-operated key or the emergency key being found. ◀

You receive one radio-operated key and one spare key. If a key is lost or mislaid, consult the notes on the electronic immobiliser (EWS) (➡ 65).

Ignition, fuel filler cap and anti-theft alarm system all work with the radio-operated key. Seat lock, topcase and cases can be locked and unlocked manually.



## NOTICE

The vehicle cannot be started if the radio control key is not within range (e.g. key inside one of the cases or the topcase).

If the radio-operated key remains out of range, the ignition is switched off after about 1.5 minutes to protect the battery. It is advisable to keep the radio-operated key on your person (e.g. in a jacket pocket) and to have the emergency key with you as an alternative.◀



Range of the Keyless Ride radio-operated key

– with Keyless Ride<sup>OE</sup>

approx. 1 m◀

## Locking the steering lock Requirement

Handlebars are turned to the left. Radio-operated key is within range.



- Press and hold down button **1**.
  - » The steering lock engages with an audible click.
  - » Ignition, lights and all function circuits switched off.
- To unlock the steering lock, briefly press button **1**.

## Switching on ignition Requirement

Radio-operated key is within range.



- The steering lock can be unlocked once the ignition is switched on.

### Steering lock is engaged:

- Press and hold down button **1**.
  - » The steering lock disengages.
  - » Side lights and all function circuits are switched on.
- with daytime riding light<sup>OE</sup>
  - » Daytime riding light is switched on.◀

- with LED additional headlight<sup>OA</sup>
- » LED auxiliary headlights are switched on.<
- » Pre-Ride-Check is performed. (▶▶▶ 129)
- » ABS self-diagnosis is in progress. (▶▶▶ 130)
- » DTC self-diagnosis is in progress. (▶▶▶ 130)

### The steering lock is disengaged:

- Briefly press button **1**.
- » Side lights and all function circuits are switched on.
- with daytime riding light<sup>OE</sup>
- » Daytime riding light is switched on.<
- with LED additional headlight<sup>OA</sup>
- » LED auxiliary headlights are switched on.<
- » Pre-Ride-Check is performed. (▶▶▶ 129)

- » ABS self-diagnosis is in progress. (▶▶▶ 130)
- » DTC self-diagnosis is in progress. (▶▶▶ 130)

### Switching off ignition Requirement

Radio-operated key is within range.



- The steering lock can be locked once the ignition is switched off.

### To switch off the ignition and engage the steering lock:

- Turn the handlebars all the way to the left.

- Press and hold down button **1**.
- » Light is switched off.
- » The steering lock engages.

### To switch off the ignition and do not engage the steering lock:

- Briefly press button **1**.
- » Light is switched off.
- » The steering lock does not engage.
- Locking the steering lock (▶▶▶ 67).

### Electronic immobiliser EWS

The on-board electronics access the data saved in the radio-operated key via a ring aerial in the R/C ignition lock. The ignition is not enabled for starting until the engine control unit has recognised the radio-operated key as "authorised" for your motorcycle.

## NOTICE

A second radio-operated key attached to the same ring as the radio-operated key used to start the engine could "irritate" the electronics, in which case the enabling signal for starting is not issued.

Always keep the radio-operated keys separate from each other. ◀

If you lose a radio-operated key, you can have it barred by your authorised BMW Motorrad retailer. In order to have a key barred you must bring along all the other keys belonging to the motorcycle.

The engine cannot be started by a barred radio-operated key, but a radio-operated key that has been barred can subsequently be reactivated.

You can obtain spare keys only through an authorised

BMW Motorrad retailer. The radio-operated keys are part of an integrated security system, so the retailer is under an obligation to check the legitimacy of all applications for replacement/extra keys.

## Loss of the radio-operated key

### NOTICE

Consult the information on the electronic immobiliser (EWS) if a key is lost or mislaid.

If the radio-operated key is lost or mislaid while you are on a journey, you can use the spare key to start the vehicle. ◀



- Hold spare key **1** close to the fuel tank with the spare key positioned above aerial **2**.

 Time during which the engine has to be started. The unlocking procedure has to be repeated if this time is allowed to expire.

30 s

- » Pre-Ride-Check is performed.
- Reserve key has been recognised.
- Engine can be started.
- Reserve key can be removed.
- Start the engine ( 128).

## Replacing battery of radio-operated key

If the radio-operated key does not react when you short-press or long-press a button:

- Battery of the radio-operated key is not at full capacity.

 Remote key battery weak. Limited central locking function. Change battery.

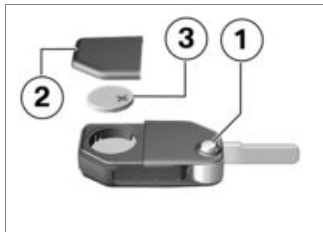

- Press button **1**.  
» Key bit flips out.
- Push battery cover **2** up.
- Remove battery **3**.

- Dispose of the old battery in accordance with all applicable laws and regulations; do not attempt to dispose of batteries as domestic waste.



### ATTENTION

#### Unsuitable or incorrectly inserted batteries

Component damage

- Use a battery compliant with the manufacturer's specifications.
- When inserting the battery, always make sure polarity is correct. ◀
- Insert the new battery with the positive terminal up.



Battery type

For Keyless Ride radio-operated key

CR 2032

- Install battery cover **2**.  
» Red LED in the instrument cluster flashes.  
» The radio-operated key is again ready for use.

## Intelligent emergency call

– with intelligent emergency call<sup>OE</sup>

### Emergency call via BMW

Press the SOS button in an emergency only.

Even if an emergency call using BMW is not possible, the system may make an emergency call to a public emergency call number. This depends on the respective mobile phone network and the national regulations.

The emergency call is not able to be ensured because of technical reasons due to unfavourable con-



ditions, e.g. in areas where there is no mobile phone reception.

## Language for emergency call

Each vehicle has a language assigned to it depending on the market for which it is intended. The BMW Call Center answers in this language.



### NOTICE

The language for the emergency call can only be changed by the BMW Motorrad partner. The language assigned to the vehicle differs from the display languages that can be selected by the rider in the TFT display. ◀

## Manual emergency call

### Requirement

An emergency call has occurred. The vehicle is at a standstill. The ignition is switched on.



- Open cover **1**.
- Briefly press SOS button **2**.

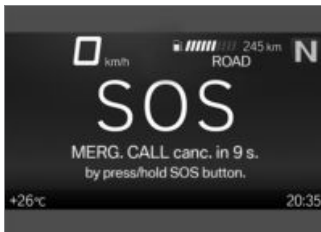

The time until transmission of the emergency call is displayed. During that time, it is possible to cancel the emergency call.

- Operate the emergency-off switch to stop the engine.
- Remove helmet.
  - » After expiry of the timer, a voice contact to the BMW Call Center is established.



The connection was established.



- Provide information to the emergency services using the microphone **3** and speaker **4**.

### Automatic emergency call

The intelligent emergency call is active after the ignition is switched on and reacts if a fall or crash occurs.

### Emergency call in the event of a light fall

- A minor fall or a crash is detected.
- » An acoustic signal is sounded.

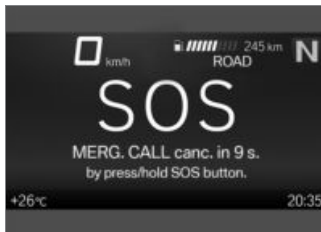

The time until transmission of the emergency call is displayed. During that time, it is possible to cancel the emergency call.

- If possible, remove helmet and stop engine.
- » A voice contact connection to the BMW Call Center is established.



The connection was established.

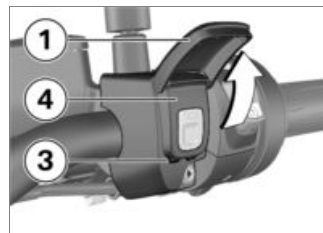

- Open cover **1**.
- Provide information to the emergency services using the microphone **3** and speaker **4**.

## Emergency call in the event of a severe fall

- A severe fall or a crash is detected.
- » The emergency call is placed automatically without delay.

## Lights

### Switching on low-beam headlight

- Switch on the ignition.
- Start the engine.



- Alternatively: pull switch **1** when ignition switched on.

## Side light

The side lights switch on automatically when the ignition is switched on.

### NOTICE

The side lights place a strain on the battery. Do not switch the ignition on for longer than absolutely necessary. ◀

### High-beam headlight and headlight flasher

- Switch on the ignition (➡ 64).

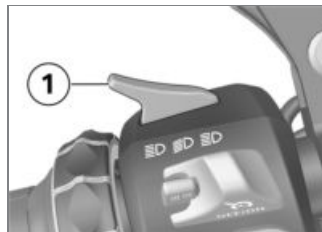

- Push switch **1** forward to switch on the high-beam headlight.
- Pull switch **1** back to operate the headlight flasher.

### Headlight courtesy delay feature

- Switch off the ignition.



- Immediately after switching off the ignition, pull switch **1** back and hold it in that position until the headlight courtesy delay feature comes on.
- » The vehicle's lights come on for one minute and then switch off automatically.
- This can be used to light up the path to the house door after the vehicle has been parked, for example.

### Parking lights

- Switch off the ignition (☞ 65).



- Immediately after switching off the ignition, push button **1** to the left and hold it in that position until the parking lights come on.
- Switch the ignition on and off again to switch off the parking lights.

### Auxiliary headlights

– with additional headlight<sup>OE</sup>

### Requirement

The low-beam headlight must be switched on.



### NOTICE

The auxiliary headlights have approval as fog lights and their use is permissible in bad weather conditions only. Always comply with the road traffic regulations in force in the country in which the vehicle is used.◀

- Start the engine (☞ 128).



- Press button **1** to switch on the additional headlight.



The indicator light for the additional headlight illuminates.

- Press button **1** again to switch off the additional headlight.

## Daytime riding light

– with daytime riding light<sup>OE</sup>

## Manual daytime riding light

### Requirement

Automatic daytime riding light is switched off.

### WARNING

### Switching on the daytime riding light in the dark.

Risk of accident

- Do not use the daytime riding light in the dark.◀

### NOTICE

By comparison with the low-beam headlight, the daytime running light makes the vehicle

more visible to oncoming traffic. This improves daytime visibility.◀

- Start the engine ( 128).
- Navigate to *Settings*, *Vehicle settings*, *Lights* and switch off the *Auto. daytime light* function.



- Press button **1** to switch on the daytime riding light.

 The indicator light for the daytime riding light lights up.

» The low-beam headlight and the front side lights are switched off.

- In the dark or in tunnels: Press button **1** again to switch off the daytime riding light and switch on the low-beam headlight and front side light.

### NOTICE

If the high-beam headlight is switched on while the daytime riding light is on, the daytime riding light is switched off after approx. 2 seconds and the high-beam headlight, low-beam headlight and front side light are switched on.

If the high beam headlight is switched off again, the daytime running light is not automatically reactivated, but must be switched on again if required.◀





- Press button **1** to switch on the hazard warning lights system.
- » Ignition can be switched off.
- To switch off the hazard warning lights system, switch on the ignition if necessary and press button **1** again.

## Turn indicators

### Operating the turn indicators

- Switch on the ignition (➡ 64).



- Push button **1** to the left to switch on the left turn indicators.
- Push button **1** to the right to switch on the right turn indicators.
- Centre button **1** to cancel the turn indicators.

## Comfort turn indicator



If button **1** has been pressed to the right or left, the turn indicators are automatically switched off under the following circumstances:

- Speed below 30 km/h: after 50 m distance covered.
- Speed between 30 km/h and 100 km/h: after a speed-dependent distance covered or in case of acceleration.
- Speed over 100 km/h: after five flashes.

If button **1** is pressed to the right or left slightly longer, the turn in-

dicators only switch off automatically once the speed-dependent distance covered is reached.

## Dynamic Traction Control (DTC)

### Switching off DTC

- Switch on the ignition.



#### NOTICE

Dynamic Traction Control (DTC) can also be switched off when the motorcycle is in motion. ◀



- Press and hold button **1** until the DTC indicator light changes its status. The new DTC system status **OFF!** is displayed.



DTC indicator and warning light comes on.

Possible DTC system status **OFF!** is displayed.

- Release button **1** once the status has changed. The new DTC system status **OFF!** is displayed.



DTC indicator and warning light remains on.

» The DTC function is switched off.

### Switching on DTC



- Press and hold down button **1** until the DTC indicator light changes status. The DTC system status **ON** is displayed immediately after pressing the button **1**.



DTC indicator and warning light goes out; if self-



diagnosis has not completed, it starts to flash.

Possible DTC system status ON is displayed.

- Release button **1** once the status has changed.

 DTC indicator and warning light remains off or continues to flash.

The new DTC system status ON appears briefly on the display.

- » The DTC function is switched on.
- In the RAIN, ROAD and DYNAMIC riding modes, you also have the option of switching the ignition off and then on again. In the DYNAMIC PRO riding mode, the most recently selected DTC status is retained when the ignition is switched on again.



A DTC fault has occurred if the DTC indicator light shows when the motorcycle accelerates to a speed in excess of the minimum stated below after the ignition was switched off and then on again.

min 5 km/h

- See the section entitled "Engineering details" for more information on Dynamic Traction Control:
  - » How does traction control work? (►► 147)

## Electronic Suspension Adjustment (D-ESA)

### Possibilities for adjustment, Dynamic ESA

Dynamic ESA is an electronic system that enables you to adjust your motorcycle's suspension quickly and easily

to suit the load the vehicle is carrying.

See the "Engineering details" section for more information on Dynamic ESA (►► 149).

## Viewing suspension settings

- Switch on the ignition (►► 64).



- Short-press button **1** to view the current setting.

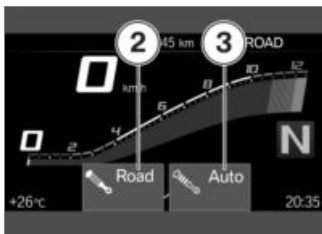
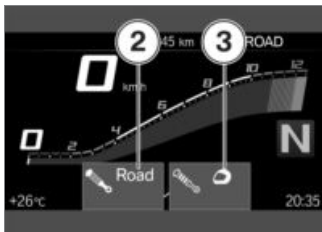

– with Dynamic ESA Pro<sup>OE</sup>  
◁

» Immediately after button **1** is pressed, the settings for damping **2** and spring preload **3** ap-

pear on the display. The setting shows briefly, then disappears automatically.

## Adjusting suspension damping

- Switch on the ignition (☛ 64).

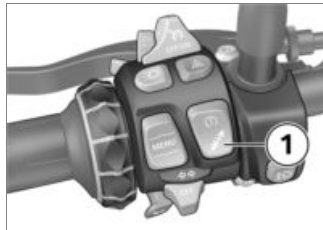

- Short-press button **1** to view the current setting.
- » When button **1** is pressed again, this message appears: D-ESA Pro required. Cannot adjust damping.

– with Dynamic ESA Pro<sup>OE</sup>  
To adjust damping:

- Repeatedly press button **1** briefly until the setting you want to use appears on the display.



## NOTICE

You can adjust the damping characteristic while the motorcycle is on the move. ◀

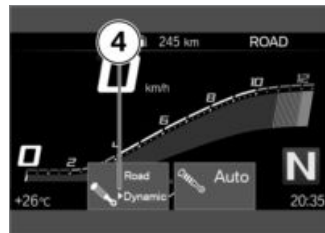

» Selection arrow **4** appears and subsequently disappears after the change of status.

The following settings are available:

- Road: Damping for comfortable on-road riding
  - Dynamic: Damping for dynamic on-road riding
- » The setting shown on the display is automatically accepted as the setting for suspension damping if you allow a certain length of time to pass without pressing button **1**.

## Adjusting spring preload



To adjust spring preload:

- Start the engine (118).
- Repeatedly press and hold button **1** until the setting you want to use appears on the display.

### NOTICE

You cannot adjust spring preload while the motorcycle is on the move. ◀

The following message is displayed if it is not possible to adjust a setting: Load adjustment only avail. stopped.

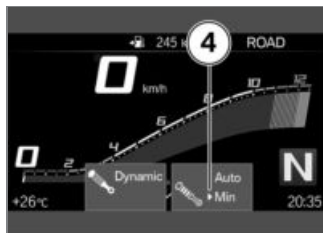
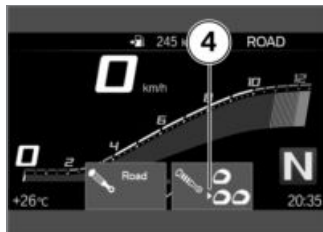



– with Dynamic ESA Pro<sup>OE</sup>  
◀

» Selection arrow **4** appears and subsequently disappears after the change of status.

» The following settings are available:

 One-up riding

 One-up with luggage

 Two-up (with luggage)

- with Dynamic ESA Pro<sup>OE</sup>
- **Min**: Minimum spring preload<
- with Dynamic ESA Pro<sup>OE</sup>
- **Auto**: Automatic adjustment of spring preload<

» The setting shown on the display is automatically accepted as spring preload if you allow a certain length of time to pass without pressing button **1**.

- If the temperature is very low, take the weight off the motorcycle before increasing spring

preload; if applicable, have your passenger dismount.

- with Dynamic ESA Pro<sup>OE</sup>
- » In **Auto** loading mode, the spring preload is adjusted only once the motorcycle is driven off.<

## Riding mode

### Using the riding modes

BMW Motorrad has developed operational scenarios for your motorcycle from which you can select the scenario suitable for your situation:

- **RAIN**: Riding on a rain-wet road surface.
- **ROAD**: Riding on a dry road surface.
- **DYNAMIC**: Dynamic riding on a dry road surface.
- **DYNAMIC PRO**: Dynamic riding with provision for the rider's custom settings.

The respective optimum interplay of engine characteristics, ABS control and DTC control is provided for each of these scenarios.

### Selecting riding mode

- Switch on the ignition (➡ 64).



- Press button **1**.



The riding mode currently active **2** is sent to the back and the first selectable riding mode **3** is displayed. The guide **4** displays how many riding modes are available.



- Repeatedly press button **1** until the riding mode you want appears on the display. The following steps must be taken to change the riding mode:
  - Close the throttle twistgrip.
  - Release the brake levers.
  - Deactivate the cruise control.

## PRO riding mode Adjustment option

The DYNAMIC PRO riding mode can be set up to suit the rider's preferences.

## Setting up PRO riding mode

- Switch on the ignition (➡ 64).
- Navigate to *Settings*, *Vehicle settings*.
- Select *Pro riding mode* and activate.

## Setting up Dynamic Pro

- Setting up PRO riding mode (➡ 83).
- Select *DYNAMIC PRO riding mode* and confirm.

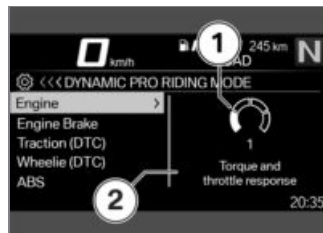

The *Engine* system has been selected. The current setting is displayed as a diagram **1** with

explanatory texts relating to the system **2**.

- Select system and confirm.



You can browse through the available settings **3** and the corresponding explanations **4**.

- Set up the system.
  - » The Engine Brake, Traction (DTC), Wheelie (DTC) and ABS systems can be set up in the same way. See the "Engineering details" section for more information on all these systems:
  - » Selection (▶▶▶ 150)

- The settings can be reset to the factory settings:
- Resetting riding mode settings (▶▶▶ 84).

### Resetting riding mode settings

- Setting up PRO riding mode (▶▶▶ 83).
- Select **Reset** and confirm.

### Cruise-control system

– with cruise control<sup>OE</sup>

### Display when adjusting settings (Speed Limit Info not active)



The symbol **1** for cruise control is displayed in the Pure Ride view and the top status line.

## Display when adjusting settings (Speed Limit Info active)



The symbol **1** for cruise control is displayed in the Pure Ride view and the top status line.

## Switching on cruise control

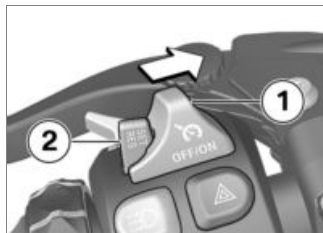

- Slide switch **1** to the right.  
» Button **2** is enabled for operation.

## Setting road speed



- Briefly push button **1** forward.

 Adjustment range for cruise control

20...210 km/h

 Indicator light for cruise control lights up.

- » The motorcycle maintains your current cruising speed and the setting is saved.

## Accelerating



- Briefly push button **1** forward.
  - » Speed is increased by approx. 1 km/h each time you push the button.
- Push button **1** forward and hold it in this position.
  - » The motorcycle accelerates smoothly.
  - » The current speed is maintained and saved if button **1** is not pushed again.

## Decelerating



- Briefly push button **1** back.
  - » Speed is reduced by 1 km/h each time you push the button.
- Push button **1** back and hold it in this position.
  - » The motorcycle decelerates smoothly.
  - » The current speed is maintained and saved if button **1** is not pushed again.

## Deactivating cruise control

- Brake, pull the clutch lever or turn the throttle grip (close the

throttle by turning the grip back past the idle position) to deactivate cruise control.

### NOTICE

Whenever the Pro shift assistant shifts down, cruise control is automatically disengaged for safety reasons.◀

### NOTICE

For safety reasons, cruise control is automatically deactivated with DTC interventions.◀

» Indicator light for cruise control goes out.



## Resuming former cruising speed



- Briefly push button **1** back to return to the speed saved beforehand.

### NOTICE

Opening the throttle does not deactivate the cruise-control system. If you release the twistgrip the motorcycle will decelerate only to the cruising speed saved in memory, even though you might have intended slowing to a lower speed.◀



Indicator light for cruise control lights up.

## Switching off cruise control

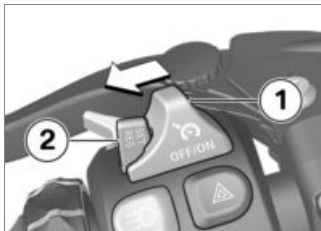

- Slide switch **1** to the left.
  - » The system is deactivated.
  - » Button **2** is disabled.

## Hill Start Control Reading

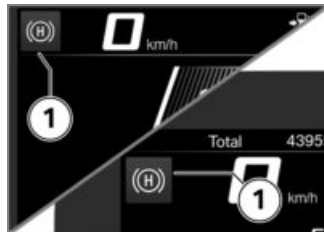

Symbol **1** for Hill Start Control appears in the Pure Ride view and the top status line.

### Operating Hill Start Control Pro Requirement

Vehicle stationary and upright, engine running.



### ATTENTION

**Failure of the drive-off assistant**

Risk of accident

- Secure the vehicle by braking manually.◀

#### NOTICE

The drive-off assistant Hill Start Control Pro is only a comfort system to enable easier riding off on gradients and should not be confused with an electromechanical holding brake.◀

#### NOTICE

The Hill Start Control Pro drive-off assistant should not be used on inclines of over 40 %.◀

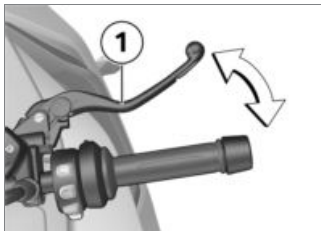

- Apply firm pressure to handbrake lever **1** or to the footbrake lever and then quickly release the lever.
- Alternatively, apply the brake for about one second beyond the vehicle reaching a standstill on an incline of at least 3 %.

 Green holding symbol is displayed.

- » Hill Start Control Pro is activated.
- To switch off the Hill Start Control Pro, operate the brake lever **1** or footbrake lever again.

#### NOTICE

If Hill Start Control Pro has been deactivated by means of the handbrake lever, automatic Hill Start Control is deactivated for the next 4 m.◀

 The holding symbol disappears.

- Alternatively, ride off in 1st or 2nd gear.

#### NOTICE

When riding off, Hill Start Control Pro is automatically deactivated.◀

 Once the brake has been fully released, the holding symbol disappears.

- » Hill Start Control Pro is deactivated.
- See the "Engineering details" section for more information on Hill Start Control Pro:

- » Hill Start Control function (➡ 155)

## Setting up Hill Start Control Pro

- Switch on the ignition (➡ 64).
- Navigate to **Settings**, **Vehicle settings**.
- Select **HSC Pro**.
- To switch off Hill Start Control Pro, select **Off**.
- » Hill Start Control Pro is deactivated.
- To switch on manual Hill Start Control Pro, select **Manual**.
- » Hill Start Control Pro can be activated by forcefully operating the handbrake or footbrake lever.
- To switch on automatic Hill Start Control Pro, select **Auto**.
- » Hill Start Control Pro can be activated by forcefully operating the handbrake or footbrake lever.

- » If the brake is actuated for approximately one second after the vehicle has come to a standstill and the motorcycle is on a gradient of at least 3%, Hill Start Control Pro is automatically activated.
- » The selected setting remains stored even after the ignition is switched off.

## Shift light

### Switching gearshift light on and off

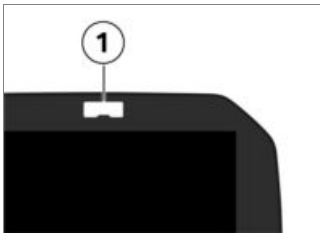

- Navigate to **Settings**, **Vehicle settings**.

- Switch **Shift light** on or off.

## Setting shift light

- Switch on the **Shift light** function.
- Navigate to **Settings**, **Vehicle settings**, **Configuration** (under **Shift light**).
- » The following settings are available:
  - **Start RPM**
  - **End RPM**
  - **Brightness**
  - **Frequency**. A flashing frequency of 0 Hz corresponds to steady light.
- » Changes to brightness and the flashing frequency are demonstrated by the shift light with it briefly lighting up or flashing.

## Anti-theft alarm (DWA)

– with anti-theft alarm (DWA)<sup>OE</sup>

### Activation

- Switch on the ignition (➡ 64).
- Customise the anti-theft alarm settings (➡ 91).
- Switch off the ignition.
  - » If the alarm system is activated, then the alarm system will be automatically activated when the ignition is switched off.
  - » Activation takes approximately 30 seconds to complete.
  - » Turn indicators flash twice.
  - » Confirmation tone sounds twice (if programmed).
  - » Anti-theft alarm is active.

– with Keyless Ride<sup>OE</sup>

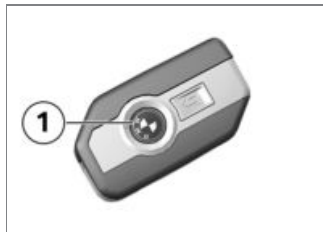

- Switch off the ignition.
- Press button **1** on the radio-operated key twice.
  - » Activation takes approximately 30 seconds to complete.
  - » Turn indicators flash twice.
  - » Confirmation tone sounds twice (if programmed).
  - » Anti-theft alarm is active.

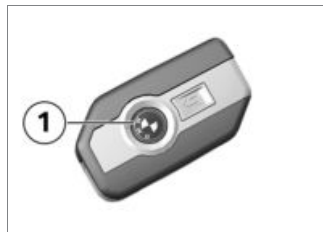

- To deactivate the motion sensor (for example if you are about to transport the motorcycle on a train and the swaying movement of the moving train could trip the alarm), press button **1** on the radio-operated key again during the activation phase.
  - » Turn indicators flash three times.
  - » Confirmation tone sounds three times (if programmed).
  - » Motion sensor has been deactivated.

## Alarm signal

A DWA alarm can be triggered by:

- Motion sensor
- Switch-on attempt with an unauthorised vehicle key.
- Disconnection of the DWA anti-theft alarm from the motorcycle's battery (DWA internal battery in the anti-theft alarm provides power - alarm tone only, the turn indicators do not flash)

All functions are sustained even if the internal battery of the DWA anti-theft alarm system is flat; the only difference is that an alarm cannot be triggered if the system is disconnected from the motorcycle's battery.

An alarm lasts for approximately 26 seconds. While an alarm is in progress an alarm tone sounds and the turn indicators flash. The

type of alarm tone can be set by an authorised BMW Motorrad retailer.

- with Keyless Ride<sup>OE</sup>

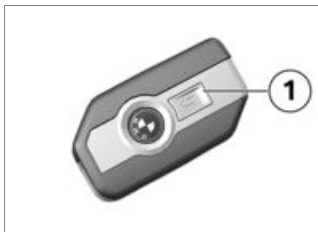

The activated alarm can be aborted at any time by pressing the **1** button on the radio-operated key, without deactivating the anti-theft alarm.

If an alarm was triggered while the motorcycle was unattended, the rider is notified accordingly by an alarm tone sounding once when the ignition is switched on. The DWA LED then indicates

the reason for the alarm for one minute.

### Light signals issued by the DWA LED:

- Flashes 1x: motion sensor 1
- Flashes 2x: motion sensor 2
- Flashes 3x: ignition switched on with unauthorised vehicle key
- Flashes 4x: disconnection of the anti-theft alarm from the motorcycle's battery
- Flashes 5x: motion sensor 3

### Deactivating DWA

- Switch on the ignition.
  - » Turn indicators flash once.
  - » Confirmation tone sounds once (if programmed).
  - » Anti-theft alarm (DWA) is deactivated.

### Customising anti-theft alarm settings

- Switch on the ignition (➡ 64).

- Navigate to Settings, Vehicle settings, Alarm system.
- » The following adaptation settings are available:
  - Adapt warning signal
  - Switch Tilt sensor on and off
  - Switch Arming tone on and off
  - Switch Arm automatically on and off

### Possibilities for adjustment

**Warning signal:** Set the increasing and decreasing or intermittent alarm tone.

**Tilt sensor:** Activate tilt sensor to monitor the inclination of the vehicle. The anti-theft alarm is tripped if any attempt is made to steal a wheel or lift the vehicle for towing, for example.



### NOTICE

Deactivate the tilt sensor when transporting the vehicle in order to prevent the DWA from tripping.◀

**Arming tone:** In addition to turn indicators flashing, alarm tone sounds as confirmation of activation/deactivation of the DWA.

**Arm automatically:** Automatic activation of the alarm function after the ignition is switched off.

### Tyre pressure monitoring (RDC)

- with tyre pressure control (RDC)<sup>OE</sup>

### Switching minimum pressure warning on or off

- The system can be set to issue a specified-pressure warn-

ing when tyre pressure drops to the defined minimum.

- Navigate to Settings, Vehicle settings, RDC.
- Switch Target pressure warn. on or off.

### Heated handlebar grips

- with heated grips<sup>OE</sup>

### Operating the heated handlebar grips



### NOTICE

The heating in the heated handlebar grips can be activated only when the engine is running.◀



### NOTICE

The increase in power consumption caused by having the heated handlebar grips switched on can drain the battery if you are riding at low engine speeds. If the

charge level is low, the heated handlebar grips are switched off to ensure the battery's starting capability. ◀

- Start the engine (▶▶ 128).

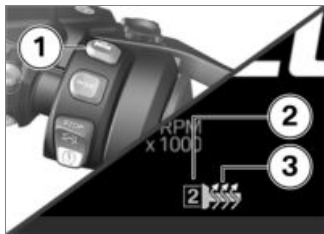

- Repeatedly press button **1** until the desired heating level **2** appears in front of the heated grip symbol **3**.

The handlebar grips have three-stage heating.



35% heating power



55% heating power



100% heating power

- » The 3rd stage is for heating the grips quickly: it is advisable to switch back to a lower stage as soon as the grips are warm.
- » The selected heating stage will be saved if you allow a certain length of time to pass without making further changes.
- To switch off the heated grips, repeatedly press button **1** until the heated grip **3** is hidden.

## On-board computer

### Operating on-board computer

Operating principle of the controls (▶▶ 99)

## Calling up on-board computer

- Call up the `My vehicle` menu.
- Scroll to the right until the `ON-BOARD COMPUTER` menu screen is displayed.

## Resetting on-board computer

- Call up the on-board computer (▶▶ 93).
- Press down the `MENU` rocker button.
- Select `Reset all values` or `Reset individual values` and confirm.

The following values can be reset:

- Break
- Journey
- Current (TRIP 1)
- Speed
- Consump.

## Calling up trip computer

- Call up the on-board computer (▣▣▣ 93).
- Scroll to the right until the TRIP COMPUTER menu screen is displayed.

## Resetting trip computer

- Call up the trip computer (▣▣▣ 94).
- Press down the MENU rocker button.
- Select *Autom. reset* or *Reset all values* and confirm.
  - » If *Autom. reset* is selected, the trip computer is automatically reset when a minimum of 6 hours have passed and the date has changed since the ignition was switched off.

## Seat

### Removing seat

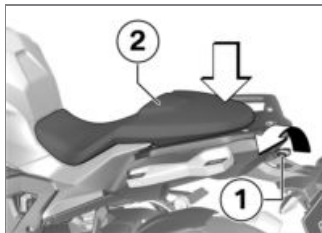

- Press down on the rear part of seat **2** to relieve the strain on the lock and at the same time unlock the seat lock by turning ignition key **1** counter-clockwise.
- Lift the seat at the rear and remove.
- Lay the seat on a clean surface.

### Installing seat

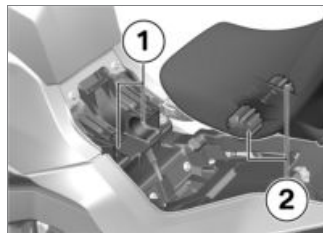

- Position the seat with mounts **1** in buffers **2** on left and right.
- Lower the rear of the seat and engage the seat in the latching mechanism.



## Storage compartment

### Opening and closing storage compartment

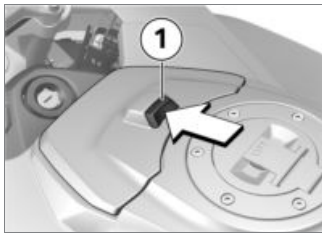

- To open the storage compartment, press button **1** and open the lid of the storage compartment.
- To close the storage compartment, push the lid closed.



## **TFT display**

General notes.....	98
Principle .....	99
Pure Ride view.....	106
General settings .....	107
Bluetooth .....	108
My vehicle .....	112
Navigation .....	115
Media.....	117
Telephone .....	117
Display software version .....	118
Display licence information.....	118

## General notes

### Warnings



#### WARNING

#### Using a smartphone during the journey or while the engine is running

Risk of accident

- Always observe the relevant road traffic regulations.
- Do not use the smartphone during the journey (apart from applications that do not require operation, e.g. making telephone calls with the hands-free system).◀



#### WARNING

#### Distraction from the road and loss of control

Operating the integrated information system and communication devices while driving results in a risk of accident

- Operate those systems or devices only when the traffic situation allows for it.
- If necessary, stop and operate the systems or devices when stationary.◀

### Connectivity functions

Connectivity functions include media, telephony and navigation. Connectivity functions can be used if the TFT display is connected to a mobile device and a helmet (📞➔ 109). For more information on the Connectivity functions go to **[bmw-motorrad.com/connectivity](http://bmw-motorrad.com/connectivity)**



#### NOTICE

If the fuel tank is between the mobile device and the TFT display, the Bluetooth connection may be restricted. BMW Motorrad recommends

storing the device above the fuel tank (e.g. in your jacket pocket).◀



#### NOTICE

Depending on the mobile device, the scope of the Connectivity functions may be restricted.◀

### BMW Motorrad Connected app

The BMW Motorrad Connected app contains usage and vehicle information. For some functions, such as navigation, the app must be installed on the mobile device and connected to the TFT display. The app is used to start route guidance and adjust the navigation.



#### NOTICE

On some mobile devices, e.g. those with iOS operating systems, the BMW Motorrad Con-

nected App must be opened before use. ◀

## Currency

The TFT display may be updated after the publication date. Because of this, your motorcycle may differ from the information supplied in the Rider's Manual. Up-to-date information is available at:

[bmw-motorrad.com/service](http://bmw-motorrad.com/service)

## Principle Controls

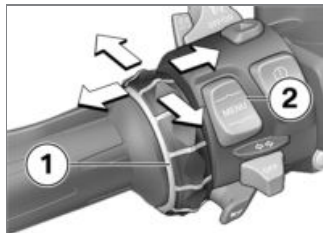

All contents of the display are operated using the multi-controller **1** and the MENU **2** rocker button.

Depending on the context, the following functions are possible.

### Multi-controller functions

#### Turn the multi-controller upwards:

- Move the cursor upwards in lists.
- Adjust settings.
- Increase volume.

#### Turn the multi-controller downwards:

- Move the cursor downwards in lists.
- Adjust settings.
- Decrease volume.

#### Tilt the multi-controller to the left:

- Activate the function in accordance with the operation feedback.
- Activate the function to the left or back.
- Go back to the Menu view after making the settings.
- In the Menu view, change up a level.
- In the My Vehicle menu: advance one menu screen.

#### Tilt the multi-controller to the right:

- Activate the function in accordance with the operation feedback.

- Confirm selection.
- Confirm settings.
- Advance a menu step.
- Scroll to the right in lists.
- In the My Vehicle menu: advance one menu screen.

### MENU rocker button functions

#### NOTICE

Instructions given by the navigation system are displayed in a dialogue box if the **Navigation** menu has not been called up. Operation of the MENU rocker button is temporarily restricted. ◀

#### Short press the top section of the MENU button:

- In the Menu view, change up a level.
- In the Pure Ride view: change the display for driver info status line.

#### Long-press the top section of the MENU button:

- In the Menu view: call up Pure Ride view.
- In the Pure Ride view: change operating focus to the Navigator.

#### Short-press the bottom section of the MENU button:

- Change down a level.
- No function if the lowest hierarchical level has been reached.

#### Long-press the bottom section of the MENU button:

- Change back to the last menu after a previous menu change effected by long-pressing the top section of the MENU button.

### Operating instructions in the main menu

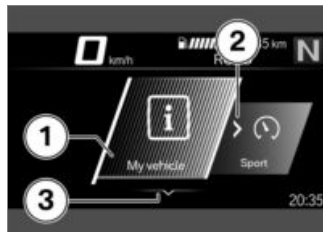

Operating instructions show whether interactions are possible, and which ones.

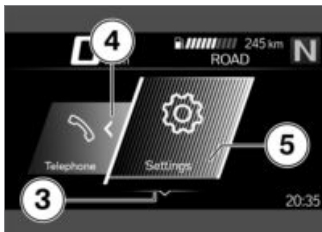

### Meaning of the operating instructions:

- Operating instruction **1**: the left end has been reached.
- Operating instruction **2**: it is possible to scroll to the right.
- Operating instruction **3**: it is possible to scroll down.
- Operating instruction **4**: it is possible to scroll to the left.
- Operating instruction **5**: the right end has been reached.

### Operating instructions in submenus

In addition to the operating instructions in the main menu, there are further operating instructions in submenus.

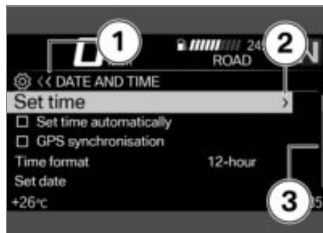

### Meaning of the operating instructions:

- Operating instruction **1**: The current display is in a hierarchical menu. One symbol represents one submenu level. Two symbols indicate two or more submenu levels. The colour of the symbol changes, depend-

ing on whether you can return to a higher level.

- Operating instruction **2**: One more submenu level can be accessed.
- Operating instruction **3**: There are more entries than can be displayed.

### Display Pure Ride view

- Long-press the top section of the MENU rocker button.

## Switching functions on and off



Some menu items have a check box in front of them. The check box shows whether the function is on or off. Action symbols after the menu items show what will be switched by tilting the multi-controller briefly to the right.

### Examples for switching on and off:

- Symbol **1** shows that the function is switched on.
- Symbol **2** shows that the function is switched off.

- Symbol **3** shows that the function can be switched off.
- Symbol **4** shows that the function can be switched on.

### Call up the menu

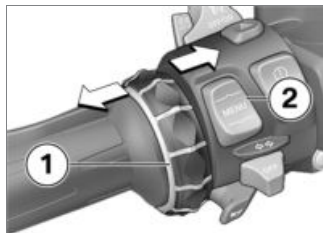

- Display Pure Ride view (101).
- Briefly push button **2** down.

The following menus can be called up:

- My vehicle
- Sport
- Navigation
- Media
- Telephone

– Settings

- Repeatedly press the multi-controller **1** briefly to the right until the desired menu item is highlighted.
- Briefly push button **2** down.

### NOTICE

The Settings menu can only be called up when the vehicle is stationary. ◀

### Move the cursor in lists

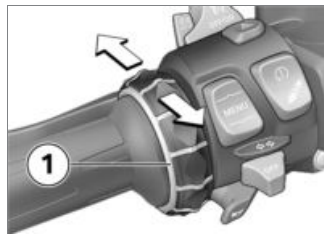

- Call up the menu (102).
- To move the cursor down in lists, turn the multi-controller **1**



down until the desired entry is highlighted.

- To move the cursor up in lists, turn the multi-controller **1** up until the desired entry is highlighted.

## Confirming selection

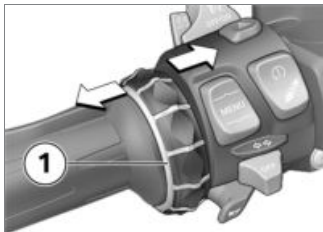

- Select the desired entry.
- Briefly press the multi-controller **1** to the right.

## Call up the last menu used

- In Pure Ride view: press and hold the MENU rocker button.

- » The last menu used is called up. The last entry highlighted is selected.

## Change of operating focus

- with preparation for navigation system<sup>OE</sup>

If the Navigator is connected, it is possible to switch between operation of the Navigator and the TFT display.

## Changing operating focus

- with preparation for navigation system<sup>OE</sup>
- with preparation for navigation system<sup>OA</sup>
- Secure the navigation system (►► 196).
- Display Pure Ride view (►► 101).
- Long-press the top section of the MENU rocker button.

- » Operating focus switches to the Navigator or the TFT display, as applicable. The active device is highlighted on the left in the top status line. Operator actions affect the currently active device until the operating focus is changed again.
- » Operating navigation system (►► 197)

## System status displays

The system status is displayed in the lower area of the menu if a function is switched on or off.



### Examples of what the system statuses mean:

- System status **1**: DTC function is switched on.

### Changing display for driver info. status line

#### Requirement

The vehicle is at a standstill. The Pure Ride view is displayed.

- Switch on the ignition (▶▶▶▶ 64).
- » All necessary information from the on-board computer for operation on public roads (e.g. TRIP **1**) and trip computer (e.g. TRIP **2**) are available in

the TFT display. The information can be displayed in the top status line.

- with tyre pressure control (RDC)<sup>OE</sup>
- » Information from the tyre pressure control can also be displayed.◀
- Select the content of the driver info. status line (▶▶▶▶ 105).



- Long-press button **1** to obtain the Pure Ride view.
- Briefly press button **1** to select the value in the top status line **2**.

The following values can be displayed:

- Odometer **Total**
- Trip distance 1 **TRIP 1**
- Trip distance 2 **TRIP 2**



Average consumption 1



Average consumption 2



Riding time 1



Riding time 2



Break time 1



Break time 2



Average speed 1



Average speed 2

 Tyre pressure

 Fuel gauge

 Range

## Selecting content of the driver info. status line

- Navigate to Settings, Display, Status line content.
- Switch on the desired displays.
  - » You can switch between the selected displays in the driver info. status line. If no displays are selected, only the range will be displayed.

## Adjust settings

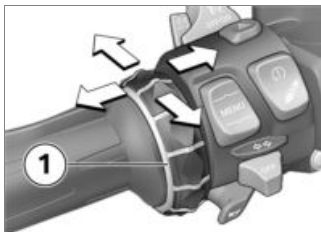

- Select and confirm the desired settings menu.
- Turn the multi-controller **1** downwards until the desired setting is highlighted.
- If there are operating instructions, tilt the multi-controller **1** to the right.
- If there are no operating instructions, tilt the multi-controller **1** to the left.
  - » The setting is saved.

## Switching Speed Limit Info on or off

### Requirement

Vehicle is connected with a compatible mobile device. The BMW Motorrad Connected app is installed on the mobile device.

- Speed Limit Info displays the maximum speed currently permitted.
- Call up the Settings, Display menu.
- Switch Speed Limit Info on or off.

## Pure Ride view

### Rev. counter

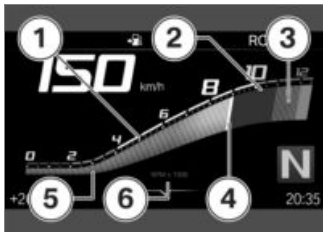

- 1 Scale
- 2 Low engine speed range
- 3 Upper/red engine speed range
- 4 Needle
- 5 Secondary indicator
- 6 Unit for engine speed display:  
1,000 revolutions per minute



### NOTICE

The red engine speed range changes depending on the coolant temperature:

The colder the engine, the lower the speed at which the red engine speed range starts.

The warmer the engine, the higher the speed at which the red engine speed range starts.

When the operating temperature is reached, the display of the red engine speed range no longer changes.

The upshift recommendation is dynamically adapted. ◀

## Range

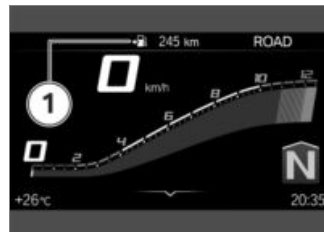

The range readout **1** indicates how far you can ride with the fuel remaining in the tank. This distance is calculated on the basis of average consumption and the quantity of fuel on board.

- When the motorcycle is propped on its side stand the slight angle of inclination means that the sensor cannot register the fuel level correctly. This is the reason why the range is recalculated only when the side stand is in the retracted position.



## Setting language

- Navigate to **Settings**, **System settings**, **Language**.

The following languages can be set:

- German
- English (UK)
- English (US)
- Spanish
- French
- Italian
- Dutch
- Polish
- Portuguese
- Turkish
- Russian
- Ukrainian
- Chinese

## Adjusting brightness

- Navigate to **Settings**, **Display**, **Brightness**.
- Adjust display brightness.
- » When ambient brightness drops below a defined

threshold, the display is dimmed to the brightness set here.

## Resetting all settings

- All the settings in the **Settings** menu can be reset to the factory settings.
- Call up the **Settings** menu.
- Select **Reset all** and confirm.

The settings in the following menus are reset:

- **Vehicle settings**
- **System settings**
- **Connections**
- **Display**
- **Information**

- » Existing Bluetooth connections are not deleted.

## Bluetooth

### Short-range wireless technology

The Bluetooth function might not be available in certain countries.

Bluetooth is a short-range wireless technology. Bluetooth devices are short-range devices transmitting on the license-free ISM band (Industrial, Scientific, Medical) between 2.402 GHz and 2.480 GHz. They can be operated anywhere in the world without a licence being required. Although Bluetooth is designed to establish and sustain robust connections over short distances, as with every other wireless technology disruptions are possible. Interference can affect connections or connections can sometimes fail. Particularly when multiple devices operate in a Bluetooth network, with wireless technology of this nature it is



- Select `Mobile device` and confirm.
- Select `Pair new mobile device` and confirm.

Mobile devices are being searched for.

 The Bluetooth symbol flashes in the bottom status line during pairing.

Mobile devices found are displayed.

- Select and confirm mobile device.
  - Follow the instructions on the mobile device.
  - Confirm that the code matches.
- » The connection is established and the connection status updated.
- » If the connection is not established, consult the troubleshooting chart in the

section entitled "Technical data". (►►► 210)

- » Depending on the mobile device, telephone data is transferred to the vehicle automatically.
- » Telephone data (►►► 118)
- » If the telephone book is not displayed, consult the troubleshooting chart in the section entitled "Technical data". (►►► 211)
- » If the Bluetooth connection is not working as expected, consult the troubleshooting chart in the section entitled "Technical data". (►►► 211)

### Connect rider's and passenger's helmet

- Pairing (►►► 109).
- Select `Rider's helmet` or `Passenger helm.` and confirm.
- Make the helmet's communication system visible.

- Select `Pair new rider's helmet` or `Pair new passenger helmet` and confirm. Helmets are searched for.

 The Bluetooth symbol flashes in the bottom status line during pairing.

Helmets found are displayed.

- Select and confirm helmet.
- » The connection is established and the connection status updated.
- » If the connection is not established, consult the troubleshooting chart in the section entitled "Technical data". (►►► 210)
- » If the Bluetooth connection is not working as expected, consult the troubleshooting chart in the section entitled "Technical data". (►►► 211)



## Deleting connections

- Call up the Settings, Connections menu.
- Select Delete connections.
- To delete an individual connection, select the connection and confirm.
- To delete all connections, select Delete all connections and confirm.

## My vehicle

### Start screen

- 1 Check Control display  
Mode of presentation (►►► 36)
- 2 Coolant temperature (►►► 49)
- 3 Range (►►► 106)
- 4 Total distance covered
- 5 Service display (►►► 61)
- 6 Tyre pressure, rear (►►► 51)
- 7 On-board voltage (►►► 181)
- 8 Tyre pressure, front (►►► 51)

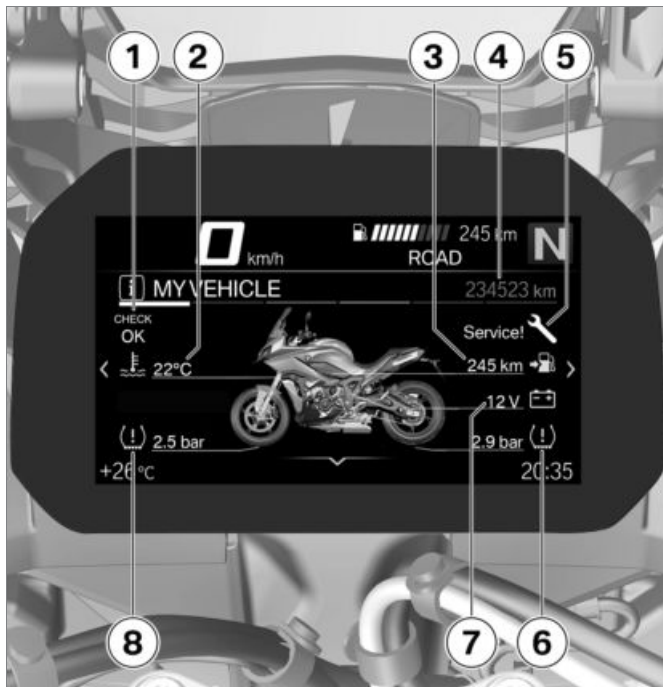

## Operating instructions

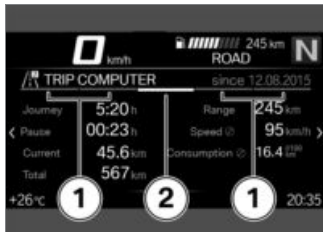

- Operating instruction **1**: tabs which show how far to the left or right can be scrolled.
- Operating instruction **2**: tab which shows the position of the current menu screen.

## Scrolling through menu screens

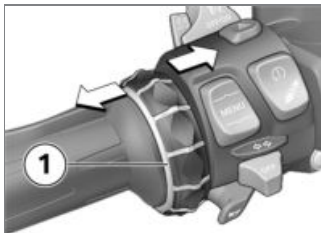

- Call up the *My vehicle* menu.
- To scroll to the right, short-press Multi-Controller **1** to the right.
- To scroll to the left, short press Multi-Controller **1** to the left.

The *My Vehicle* menu contains the following screens:

- MY VEHICLE
- Check Control messages (if any)
- ON-BOARD COMPUTER
- TRIP COMPUTER

- with tyre pressure control (RDC)<sup>OE</sup>
- TYRE PRESSURE ◀
- SERVICE REQUIREMENTS
- For more information on tyre pressures and Check Control messages, see the "Displays" section.



### NOTICE

Check control messages are attached dynamically to the *My Vehicle* menu screen as additional tabs. ◀

## On-board computer and trip computer

The ON-BOARD COMPUTER and TRIP COMPUTER menu screens display vehicle and trip data, such as average values.

## Service requirements

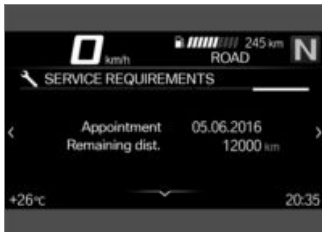

If the time remaining to the next service is less than a month or if the next service is due within 1000 km, a white Check Control message appears on the display.

## Navigation

### Warnings



#### Using a smartphone during the journey or while the engine is running

Risk of accident

- Always observe the relevant road traffic regulations.
- Do not use the smartphone during the journey (apart from applications that do not require operation, e.g. making telephone calls with the hands-free system). ◀



#### Distraction from the road and loss of control

Operating the integrated information system and communication devices while driving results in a risk of accident

- Operate those systems or devices only when the traffic situation allows for it.
- If necessary, stop and operate the systems or devices when stationary. ◀

### Precondition

The vehicle is connected to a compatible mobile device.

The BMW Motorrad Connected app is installed on the connected mobile device.



On some mobile devices, e.g. those with iOS operating systems, the BMW Motorrad Connected App must be opened before use. ◀

### Entering destination address

- Connect mobile device (➡ 109).
- Call up the BMW Motorrad Connected app and start the route guidance.
- Call up the **Navigation** menu in the TFT display.
  - » Active route guidance is displayed.
  - » If the active route guidance is not displayed, consult the troubleshooting chart in the section entitled "Technical data". (➡ 211)

### Selecting destination from recent destinations

- Call up the **Navigation, Recent destinations** menu.
- Select and confirm destination.
- Select **Start route guidance**.

## Selecting destination from favourites

- The FAVOURITES menu displays all destinations which have been saved as favourites in the BMW Motorrad Connected app. You cannot use the TFT display to add favourites to the list.
- Call up the Navigation, Favourites menu.
- Select and confirm destination.
- Select Start guidance.

## Entering special destinations

- Special destinations, such as points of interest, can be displayed on the map.
- Call up the Navigation, POIs menu.

The following locations can be selected:

- At current location
- At destination

- Along the route
  - Select where the special destinations should be looked for. e.g. the following special destination can be selected:
    - Filling station
    - Select and confirm the special destination.
    - Select Start route guidance and confirm.

## Setting route criteria

- Call up the Navigation, Route criteria menu. The following criteria can be selected:
  - Route type
  - Avoid
    - Select desired Route type.
    - Switch desired Avoid on or off.

The number of avoidances activated is displayed in brackets.

## Ending route guidance

- Call up the Navigation, Active route guidance menu.
- Select End route guidance and confirm.

## Switching spoken instructions on or off

- Connect rider's and passenger's helmet (☞ 110).
- The navigation can be read out by a computer voice. For this purpose, Spoken instruction must be switched on.
- Call up the Navigation, Active route guidance menu.
- Switch Spoken instruction on or off.

## Repeating last spoken instruction

- Call up the Navigation, Active route guidance menu.

- Select **Current instruction** and confirm.

## Media

### Precondition

The vehicle is connected to a compatible mobile device and helmet.

### Control music playback

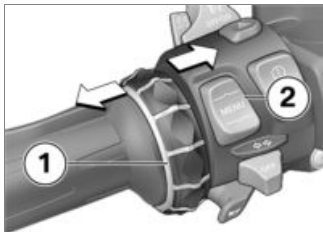

- Call up the **Media** menu.

#### **NOTICE**

BMW Motorrad recommends setting the volume on the mobile

end device for media and calls to maximum before setting off. ◀

- Adjust the volume (▮▶ 107).
- Next track: Short-tilt Multi-Controller **1** to the right.
- Last track or start of the current track: Short-tilt Multi-Controller **1** to the left.
- Fast forward: Long-tilt Multi-Controller **1** to the right.
- Rewind: Long-tilt Multi-Controller **1** to the left.
- Call up context menu: Press bottom part of button **2**.

#### **NOTICE**

Depending on the mobile device, the scope of the Connectivity functions may be restricted. ◀

- » The following functions can be used in the context menu:
  - Start playback Or Pause playback.
  - Select the **Now playing**, **All artists**, **All albums** Or **All**

**tracks** category for search and playback.

- Select **Playlists**.

You can make the following adjustments in the **Audio options** submenu:

- Switch **Shuffle** on or off.
- Select **Repeat**: **Off**, **One** (current track) or **All**.

## Telephone

### Precondition

The vehicle is connected to a compatible mobile device and helmet.

## Telephone calls

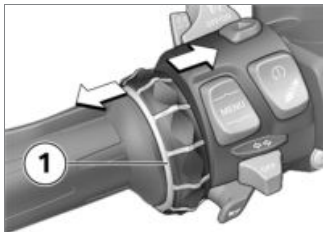

- Call up the Telephone menu.
- Accept call: Tilt Multi-Controller **1** to the right.
- Reject call: Tilt Multi-Controller **1** to the left.
- End call: Tilt Multi-Controller **1** to the left.

## Muting

During active phone calls, the microphone in the helmet can be muted.

## Phone calls with multiple participants

While a phone call is in progress, a second call can be accepted. The first phone call is put on hold. The number of active calls is shown in the Telephone menu. It is possible to switch between two phone calls.

## Telephone data

Depending on the mobile device, when pairing (☎➔ 109) completes telephone data are automatically sent to the vehicle.

**Phone book:** List of contacts saved on the mobile device

**Call list:** List of calls with the mobile device

**Favourites:** List of favourites saved on the mobile device

## Display software version

- Navigate to Settings, Information, Software version.

## Display licence information

- Navigate to Settings, Information, Licences.



## **Adjustment**

Mirrors .....	120
Headlight .....	120
Windscreen .....	121
Brakes .....	122
Adjusting clutch lever .....	122

## Mirrors

### Adjusting mirrors



- Turn the mirror to the desired position.

### Adjusting mirror arm

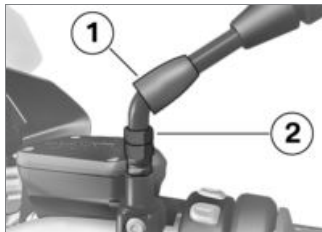

- Push protective cap **1** up the mirror arm to expose the threaded fastener.
- Loosen lock nut **2**.
- Turn the mirror arm to the appropriate position.
- Tighten the locknut to the specified tightening torque, while holding the mirror arm to ensure that it does not move out of position.



Mirror with lock nut to adapter

22 Nm (Left-hand thread)

- Push protective cap **1** over the threaded fastener.

## Headlight

### Headlight adjustment for right-hand or left-hand traffic

This motorcycle has a symmetric-beam low-beam headlight. If the motorcycle is ridden in a country where the opposite rule of the road applies, its symmetric low-beam headlight means that no measures are necessary to prevent the headlight beam from dazzling oncoming traffic.

### Headlight beam throw and spring preload

Headlight beam throw is generally kept constant when spring preload is adjusted to suit load. Headlight beam throw is set correctly ex-works.

## NOTICE

If there are doubts about the correct headlight beam throw, have the setting checked by a specialist workshop, preferably an authorised BMW Motorrad dealer. ◀

## Adjusting headlight beam throw



If, for a high load, the adjustment of the spring pre-load is no longer sufficient not to dazzle oncoming traffic:

- Use adjusting screws **1** on left and right to adjust beam throw for both headlights.

When the motorcycle is again ridden with a lower load:

- Return the headlight to its basic setting.

## Windscreen

### Adjusting windscreen

#### Requirement

The motorcycle is at a standstill.

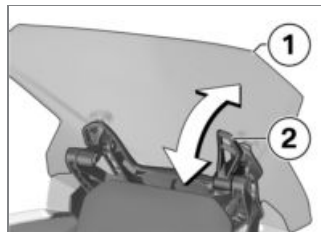

## WARNING

### Adjusting the windscreen while riding

Risk of falling

- Do not attempt to adjust the windscreen unless the motorcycle is at a standstill. ◀
- Pull lever **2** down to raise windscreen **1**.
- Push lever **2** up to lower windscreen **1**.

## Brakes

### Adjusting brake lever

**WARNING**

#### Relocated brake fluid tank

Air in the brake system

- Do not turn the handlebars or the handlebar fitting on the handlebar. ◀

**WARNING**

#### Adjusting the brake lever while riding

Risk of accident

- Do not attempt to adjust the brake lever unless the motorcycle is at a standstill. ◀

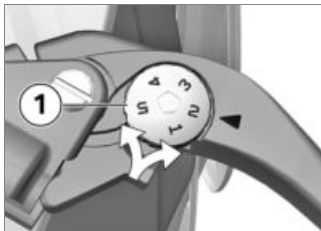

- Applying light pressure from behind, turn adjusting screw **1** to the desired position.

**NOTICE**

The adjusting screw is easier to turn if you push the brake lever forward. ◀

- » Adjustment options:
- from position 1: narrowest span between handlebar grip and brake lever
  - to position 5: widest span between handlebar grip and brake lever

## Adjusting clutch lever

### Adjusting clutch lever

**WARNING**

#### Adjusting the clutch lever while riding

Risk of accident

- Adjust the clutch lever only when the motorcycle is at a standstill. ◀

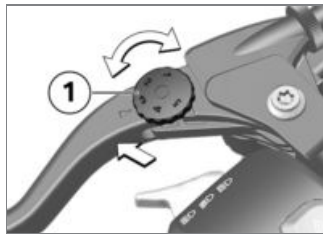

- Turn adjuster knob **1** to the desired position.



## NOTICE

The adjuster is easier to turn if you push the clutch lever forward.◀

- » Adjustment options:
  - Position 1: narrowest span between handlebar grip and clutch lever
  - Position 5: widest span between handlebar grip and clutch lever



## **Riding**

Safety instructions .....	126
Comply with checklist.....	128
Always before riding off: .....	128
Every 3rd refuelling stop .....	128
Starting .....	128
Running in .....	131
Shifting gear .....	132
Shift light .....	133
Brakes .....	133
Parking your motorcycle .....	135
Refuelling .....	136
Securing motorcycle for transportation .....	140

## Safety instructions

### Rider's equipment

Do not ride without the correct clothing! Always wear

- Helmet
- Suit
- Gloves
- Boots

This applies even to short journeys, and to every season of the year. Your authorised BMW Motorrad retailer will be glad to advise you on the correct clothing for every purpose.

### Restricted angle of heel

- with low-slung<sup>OE</sup>

A motorcycle with lowered suspension has less ground clearance and cannot corner at angles of heel as extreme as those achievable by a counterpart motorcycle with standard-height suspension (see

the section entitled "Technical data").



### WARNING

**When a motorcycle with lowered suspension is cornering, certain components can come into contact with the surface at a bank angle less than that to which the rider is accustomed.**

Risk of falling

- Carefully try out the limits of the motorcycle's bank angle and adapt your style of riding accordingly.◀

Test your motorcycle's angle of heel in situations that do not involve risk. When riding over kerbs and similar obstacles, bear in mind that your motorcycle's ground clearance is limited.

Lowering the motorcycle's suspension shortens suspension travel. Ride comfort might be restricted as a result. Be sure to adjust spring preload accordingly, particularly for riding two-up.

### Load



### WARNING

**Handling adversely affected by overloading and imbalanced loads**

Risk of falling

- Do not exceed the permissible gross weight and be sure to comply with the instructions on loading.◀

### Speed

If you ride at high speed, always bear in mind that various boundary conditions can adversely affect the handling of your motorcycle:



- Settings of the spring-strut and shock-absorber system
- Imbalanced load
- Loose clothing
- Insufficient tyre pressure
- Poor tyre tread
- Etc.

### Risk of poisoning

Exhaust fumes contain carbon monoxide, which is colourless and odourless but highly toxic.

#### WARNING

### Exhaust gases adversely affecting health

Risk of asphyxiation

- Do not inhale exhaust fumes.
- Do not run the engine in an enclosed space.◀

### Risk of burn injury

#### CAUTION

### Engine and exhaust system become very hot when the vehicle is in use

Risk of burn injury

- When you park the vehicle make sure that no-one and no objects can come into contact with the hot engine and exhaust system.◀

### Catalytic converter

If misfiring causes unburned fuel to enter the catalytic converter, there is a danger of overheating and damage.

The following guidelines must be observed:

- Do not run the fuel tank dry.
- Do not attempt to start or run the engine with a spark-plug cap disconnected.

- Stop the engine immediately if it misfires.
- Use only unleaded fuel.
- Comply with all specified maintenance intervals.

#### ATTENTION

### Unburned fuel in catalytic converter

Damage to catalytic converter

- Note the points listed for protection of the catalytic converter.◀

### Risk of overheating

#### ATTENTION

### Engine running for prolonged period with vehicle at stand-still

Overheating due to insufficient cooling; in extreme cases vehicle fire

- Do not allow the engine to idle unnecessarily.
- Ride away immediately after starting the engine.◀

## Tampering



### ATTENTION

#### **Tampering with the motorcycle (e.g. engine management ECU, throttle valves, clutch)**

Damage to the affected parts, failure of safety-relevant functions, voiding of warranty

- Do not tamper with the vehicle in any way that could result in tuned performance.◀

## Comply with checklist

- At regular intervals, use the checklist below to check your motorcycle.

## Always before riding off:

- Check operation of the brake system.
- Check operation of the lights and signalling equipment.
- Check operation of the clutch (▣▣▣ 168).
- Check the tyre tread depth (▣▣▣ 171).
- Check that bags and luggage are securely held in place.

## Every 3rd refuelling stop

- Check the engine oil level (▣▣▣ 162).
- Check the brake pad thickness, front brakes (▣▣▣ 164).
- Check the brake pad thickness, rear brakes (▣▣▣ 165).
- Check the brake-fluid level, front brakes (▣▣▣ 166).

- Check the brake-fluid level, rear brakes (▣▣▣ 167).
- Check the coolant level (▣▣▣ 169).
- Lubricate the chain (▣▣▣ 186).
- Check the chain tension (▣▣▣ 187).
- Check the chain wear (▣▣▣ 188).

## Starting

### Starting engine

- Switch on the ignition.
  - » Pre-Ride-Check is performed. (▣▣▣ 129)
  - » ABS self-diagnosis is in progress. (▣▣▣ 130)
  - » DTC self-diagnosis is in progress. (▣▣▣ 130)
- Select neutral or, if a gear is engaged, pull the clutch lever.



### NOTICE

You cannot start the motorcycle with the side stand extended and a gear engaged. The engine will

switch itself off if you start it with the gearbox in neutral and then engage a gear before retracting the side stand.◀

- For a cold engine start and low temperatures: pull clutch.
  - with M Lightweight battery<sup>OE</sup>
  - » Low temperatures can impact on the starting response. Repeated, brief application of load on the battery causes battery temperature to rise, so more battery power is available for starting the engine.◀



- Press the starter button **1**.

## NOTICE

The start attempt is automatically interrupted if battery voltage is too low. Recharge the battery before you start the engine, or use jump leads and a donor battery to start.

See the subsection on jump starting in "Maintenance" for more details.◀

- » The engine starts.
- » Consult the troubleshooting chart below if the engine refuses to start. (▶▶ 210)

## Pre-Ride-Check

The instrument cluster runs a test of the instruments and the indicator and warning lights when the ignition is switched on. This test is known as the Pre-Ride-Check. The check is aborted if you start the engine before it completes.

## Phase 1

All indicator and warning lights are switched on.

After a longer vehicle standstill period, an animation is displayed when the system starts up.

## Phase 2

The 'General' warning light changes from red to yellow.

## Phase 3

All the indicator and warning lights switched on in the initial phase are switched off in reverse sequence.

The malfunction indicator lamp only goes out after 15 seconds.

If one of the indicator and warning lights did not switch on:

- Have the fault rectified as quickly as possible by a specialist workshop, preferably an authorised BMW Motorrad retailer.

## ABS self-diagnosis

BMW Motorrad Integral ABS performs self-diagnosis to ensure its operability. Self-diagnosis starts automatically when you switch on the ignition.

### Phase 1

- » Test of the diagnosis-compatible system components with the vehicle at a standstill.



ABS indicator and warning light flashes.

### Phase 2

- » Test of the wheel-speed sensors as the vehicle pulls away from rest.



ABS indicator and warning light flashes.

## ABS self-diagnosis completed

- » The ABS indicator and warning light goes out.



ABS self-diagnosis not completed

The ABS function is not available, because self-diagnosis did not complete. (The motorcycle has to reach a defined minimum speed for the wheel speed sensors to be checked: 5 km/h)

If an indicator showing an ABS fault appears when ABS self-diagnosis completes:

- You can continue to ride. Bear in mind that neither the ABS function nor the integral braking function is available.
- Have the fault rectified as quickly as possible by a specialist workshop, preferably an authorised BMW Motorrad retailer.

## DTC self-diagnosis

BMW Motorrad DTC performs self-diagnosis to ensure its operability. Self-diagnosis is performed automatically when you switch on the ignition.

### Phase 1

- » Test of the diagnosis-compatible system components with the vehicle at a standstill.



DTC indicator light slow-flashes.

### Phase 2

- » Pullaway test of the system components with diagnostic capability.



DTC indicator light slow-flashes.

## DTC self-diagnosis completed

- » The DTC symbol no longer shows.

- Observe all the indicator and warning lights.

 DTC self-diagnosis not completed

The DTC function is not available, because self-diagnosis did not complete. (The motorcycle has to reach a defined minimum speed with the engine running for the wheel-speed sensors to be checked: min 5 km/h)

If an indicator showing a DTC fault appears when DTC self-diagnosis completes:

- You can continue to ride. Bear in mind that the DTC function is not available or the functionality might be subject to certain restrictions.
- Have the fault rectified as quickly as possible by a specialist workshop, preferably an authorised BMW Motorrad retailer.

## Running in Engine

- Until the running-in check, vary the throttle opening and engine-speed range frequently; avoid riding at constant engine rpm for prolonged periods.
- Try to do most of your riding during this initial period on twisting, fairly hilly roads.
- Comply with the running-in speeds.

 Running-in speed

<7000 min<sup>-1</sup> (Odometer reading 0...300 km)

<9000 min<sup>-1</sup> (Odometer reading 300...1000 km)

No full load (Odometer reading 0...1000 km)

- Note the mileage after which the running-in check should be carried out.

 Mileage until the running-in check

500...1200 km

## Brake pads

New brake pads have to bed down before they can achieve their optimum friction levels. You can compensate for this initial reduction in braking efficiency by exerting greater pressure on the levers.

 **WARNING**

### New brake pads

Longer stopping distance, risk of accident

- Apply the brakes in good time.◀

## Tyres

New tyres have a smooth surface. This must be roughened by riding in a restrained manner at various heel angles until the tyres are run in. This running in procedure is essential if the tyres are to achieve maximum grip.

### WARNING

#### **New tyres losing grip on wet roads and at extreme bank angles**

Risk of accident

- Ride carefully and avoid extremely sharp inclines.◀

## Shifting gear

– with shift assistant Pro<sup>OE</sup>

## Gear Shift Assistant Pro

### NOTICE

See the section entitled "Engineering details" for more information on the Pro shift assistant.◀

### NOTICE

Whenever the Pro shift assistant shifts gears, cruise control is automatically disengaged for safety reasons.◀

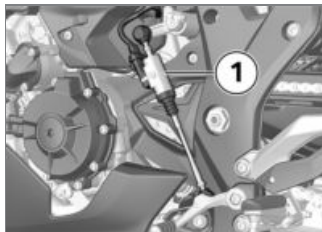

- You select the gear in the usual way by means of the foot-operated shift lever.

- » The sensor **1** on the gearshift rod registers the gearshift request and triggers shift assistance.
- » When riding at a steady speed in a low gear at high engine rpm, an attempt to shift gear without pulling the clutch can cause a severe load-change reaction. BMW Motorrad recommends disengaging the clutch for shifts in these circumstances. It is advisable to avoid using the shift assistant at engine speeds close to the limits at which the governor cuts in to limit engine rpm.
- » Shift assistance is not available in the following situations:
  - With clutch lever pulled
  - Shift lever not in its initial position
  - Upshifts with the throttle valve closed (engine overrun) and when slowing

- After a gearshift, the shift lever has to be fully released before another gearshift with the shift assistant can take place.

## Shift light Function

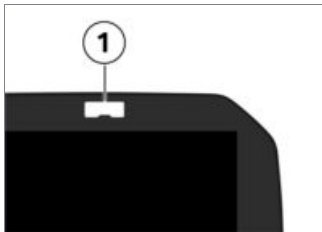

The gearshift light **1** indicates to the rider that the speed for shifting to the next higher gear is approaching.

- Shift light flashes at preset frequency: Approaching upshift rpm
- Shift light goes out: Engine revving at upshift rpm

The engine-speed thresholds and the way in which the shift light indicates the various states can be customised in the **Settings** menu, **Vehicle settings** (see the section headed "Operation").

## Brakes

### How can stopping distance be minimised?

Each time the brakes are applied, a load distribution shift takes place with the load shifting forward from the rear to the front wheel. The sharper the motorcycle decelerates, the more load is shifted to the front wheel. The higher the wheel load, the more braking force can be transmitted.

To optimise stopping distance, apply the front brakes rapidly and keep steadily increasing the force you apply to the brake lever.

This makes the best possible use of the dynamic increase in load

at the front wheel. Remember to pull the clutch at the same time. BMW Motorrad ABS prevents the front wheel from locking up. In the "emergency braking situations" that are trained so frequently, braking force is applied as rapidly as possible and with the rider's full force applied to the brake levers; under these circumstances the dynamic shift in load distribution cannot keep pace with the increase in deceleration and the tyres cannot transmit the full braking force to the surface of the road. In the absence of load on the wheel the ABS has to intervene to prevent the front wheel from locking even if the brakes are applied only very lightly. This leads to a reduced braking effect.

## Panic braking

If you brake sharply from a speed in excess of 50 km/h, the brake light flashes rapidly as a warning for road users behind you.

If you brake until your speed is less than 15 km/h, the hazard warning lights start to flash as well. The hazard warning lights switch off automatically as soon as you start to accelerate and vehicle speed reaches 20 km/h.

## Descending mountain passes



### Braking only with the rear brake on mountain descents

Brake fade, destruction of the brakes due to overheating

- Use both front and rear brakes, and make use of the engine's braking effect as well. ◀

## Wet and dirty brakes

Wetness and dirt on the brake discs and the brake pads diminish braking efficiency.

Delayed braking action or poor braking efficiency must be reckoned with in the following situations:

- Riding in the rain or through puddles of water.
- After the vehicle has been washed.
- Riding on salted or gritted roads.
- After work has been carried on the brakes, due to traces of oil or grease.
- Riding on dirt-covered surfaces or off-road.



### Wetness and dirt result in diminished braking efficiency

Risk of accident

- Apply the brakes lightly while riding to remove wetness and dirt, or dismount and clean the brakes.
- Think ahead and brake in good time until full braking efficiency is restored. ◀

## ABS Pro

### Physical limits applicable to motorcycling



### Braking when cornering

Risk of crash despite ABS Pro

- Invariably, it remains the rider's responsibility to adapt riding style to riding conditions.
- Do not take risks that would negate the additional safety offered by this system. ◀



ABS Pro is activated in the RAIN, ROAD and DYNAMIC riding



modes. In the Dynamic Pro riding mode, ABS Pro can be parametrised to suit the rider's individual needs and preferences.◀

### **Possibility of a fall not precluded**

Although ABS Pro and Dynamic Brake Control provide the rider with valuable assistance and constitutes a huge advance in safety for braking with the motorcycle banked for cornering, it cannot under any circumstances be considered as redefining the physical limits that apply to motorcycling. It is still possible for these limits to be overshoot due to misjudgement or rider error. In extreme cases this can result in a crash.

### **Use on public roads**

ABS Pro and Dynamic Brake Control help make the motorcycle even safer for riding on public roads. When the brakes are applied because of an unforeseen hazard when the motorcycle is banked for cornering, within the physical limits that apply to motorcycling the ABS Pro system prevents the wheels from locking and skidding away. In panic braking, Dynamic Brake Control increases the braking effect and intervenes if the throttle grip is accidentally turned during braking.

#### **NOTICE**

ABS Pro was not developed to enhance individual braking performance with the motorcycle banked into corners.◀

## **Parking your motorcycle**

### **Side stand**

- Switch off the engine.
- On a gradient, the motorcycle should always face uphill; select 1st gear.

#### **ATTENTION**

### **Poor ground underneath the stand**

Risk of damage to parts if vehicle topples

- Always check that the ground under the stand is level and firm.◀
- Extend the side stand and prop the motorcycle on the stand.

#### **ATTENTION**

### **Additional weight placing strain on the side stand**

Risk of damage to parts if vehicle topples

- Do not sit or lean on the vehicle while it is propped on the side stand. ◀
- If the camber of the roadway permits, turn the handlebars all the way to the left.

## Centre stand

– with centre stand<sup>OE</sup>

- Switch off the engine.



### ATTENTION

#### Poor ground underneath the stand

Risk of damage to parts if vehicle topples

- Always check that the ground under the stand is level and firm. ◀



### ATTENTION

#### Centre stand retracts due to severe movements

Risk of damage to parts if vehicle topples

- Do not lean or sit on the vehicle with the centre stand extended. ◀
- Extend the centre stand and lift the motorcycle on to the stand.

## Refuelling

### Fuel grade

#### Requirement

For optimum fuel consumption, fuel should be sulphur-free or as low-sulphur as possible.



### ATTENTION

#### Engine operation with leaded fuel

Damage to catalytic converter

- Do not attempt to run the vehicle on leaded fuel or fuel with metallic additives (e.g. manganese or iron). ◀

- Observe the maximum ethanol content of the fuel.



Recommended fuel grade



Premium Plus unleaded  
(max. 5 % ethanol, E5)



98 RON, 93 AKI



Alternative fuel grade



Super unleaded  
(limitations in terms of  
power and consumption)  
(max. 10 % ethanol, E10)  
95 ROZ/RON  
90 AKI



- » Pay attention to the following symbols in the fuel filler cap and on the fuel pump:



E10

## Refuelling

### WARNING

#### Fuel is highly flammable

Risk of fire and explosion

- Do not smoke. Never bring a naked flame near the fuel tank.◀

### WARNING

#### Escape of fuel due to heat-induced expansion if fuel tank is overfilled

Risk of falling

- Do not overfill the fuel tank.◀

### ATTENTION

#### Wetting of plastic surfaces by fuel

Damage to the surfaces (surfaces become unsightly or dull)

- Clean plastic surfaces immediately after contact with fuel.◀
- Make sure the ground is level and firm and place the motorcycle on its side stand.

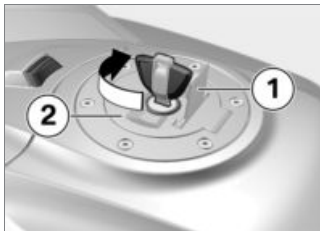

- Open protective flap **1**.
- Unlock fuel tank cap **2** by turning the ignition key clockwise and pop the cap open.



- Refuel with fuel of the grade stated above; do not fill the tank past the bottom edge of the filler neck.

### NOTICE

When refuelling after running on reserve, make sure that you top up the tank to a level above reserve, so that the new level is detected and the fuel reserve indicator light is switched off.◀

### NOTICE

The "usable fuel capacity" specified in the technical data is the

quantity that the fuel tank could hold if refilled after it had been run dry and the engine had cut out due to a lack of fuel.◀



Usable fuel capacity

approx. 20 l



Fuel reserve

approx. 4 l

- Press the fuel tank cap down firmly to close.
- Remove the ignition key and close the protective cap.

## Refuelling

– with Keyless Ride<sup>OE</sup>

## Requirement

The steering lock is disengaged.



## WARNING

### Fuel is highly flammable

Risk of fire and explosion

- Do not smoke. Never bring a naked flame near the fuel tank.◀



## WARNING

### Escape of fuel due to heat-induced expansion if fuel tank is overfilled

Risk of falling

- Do not overfill the fuel tank.◀



## ATTENTION

### Wetting of plastic surfaces by fuel

Damage to the surfaces (surfaces become unsightly or dull)

- Clean plastic surfaces immediately after contact with fuel.◀

- Make sure the ground is level and firm and place the motorcycle on its centre stand.
- with Keyless Ride<sup>OE</sup>
- Switch off the ignition (➡ 68).



## NOTICE

The fuel filler cap can be opened within the defined waiting time after the ignition has been switched off, without the radio-operated key being within range.◀



Waiting time for opening the fuel filler cap

2 min

- » There are **two variant ways** of opening the fuel filler cap:
- Within the waiting time.
  - After the waiting time has expired.

## Version 1

– with Keyless Ride<sup>OE</sup>

### Requirement

Within the waiting time

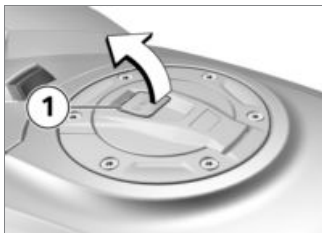

- Slowly pull tab **1** on the fuel filler cap up.
  - » Fuel filler cap unlocks.
- Fully open the fuel filler cap.

## Version 2

– with Keyless Ride<sup>OE</sup>

### Requirement

After the waiting time has expired

- Bring the radio-operated key into range.
- Slowly pull tab **1** up.
  - » The indicator light for the radio-operated key flashes while the search for the radio-operated key is in progress.
- Slowly pull tab **1** on the fuel filler cap up again.
  - » Fuel filler cap unlocks.
- Fully open the fuel filler cap.



- Refuel with fuel of the grade stated above; do not fill the tank past the bottom edge of the filler neck.

### NOTICE

When refuelling after running on reserve, make sure that you top up the tank to a level above reserve, so that the new level is detected and the fuel reserve indicator light is switched off.◀

### NOTICE

The "usable fuel capacity" specified in the technical data is the quantity that the fuel tank could hold if refilled after it had been run dry and the engine had cut out due to a lack of fuel.◀

 Usable fuel capacity

approx. 20 l

 Fuel reserve

approx. 4 l

- Press down firmly on the filler cap of the fuel tank.
- » The fuel filler cap engages with an audible click.
- » The fuel filler cap locks automatically when the waiting time expires.
- » The engaged fuel filler cap locks immediately when you secure the steering lock or switch on the ignition.

## Securing motorcycle for transportation

- Make sure that all components that might come into contact with straps used to secure the motorcycle are adequately protected against scratching. Use adhesive tape or soft cloths, for example, for this purpose.



### ATTENTION

#### Vehicle topples to side when being lifted on to stand

Risk of damage to parts if vehicle topples

- Secure the vehicle to prevent it toppling, preferably with the assistance of a second person.◀
- Push the motorcycle onto the transportation flat and hold it in position: do not place it on the side stand.

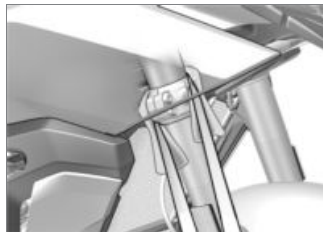

### ATTENTION

#### Trapping of components

Component damage

- Do not trap components such as brake lines or cable legs.◀
- At the front, loop a strap over the bottom fork bridge on each side.
- Pull the straps down and tight.

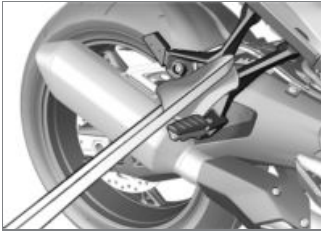

- At the rear, secure the straps to the rear frame on both sides and tighten the straps.
- Tighten all the straps uniformly; the vehicle's suspension should be compressed as tightly as possible front and rear.





## Engineering details

General notes.....	144
Antilock Brake System (ABS) .....	144
Dynamic traction control (DTC) ....	147
Dynamic engine brake control .....	148
Dynamic ESA.....	149
Riding mode .....	150
Dynamic Brake Control .....	152
Tyre pressure monitoring (RDC).....	153
Gear Shift Assistant.....	154
Hill Start Control .....	155
Adaptive Headlight.....	157

## General notes

To find out more about engineering go to:

**[bmw-motorrad.com/technology](http://bmw-motorrad.com/technology)**

## Antilock Brake System (ABS)

### Partially integral brakes

Your motorcycle is equipped with partially integral brakes. Both front and rear brakes are applied when you pull the handbrake lever. The footbrake lever acts only on the rear brake.

BMW Motorrad Integral ABS adapts braking force distribution between the front and rear brakes when braking with ABS intervention in progress, matching the shift of weight on the motorcycle to make the stopping distance as short as possible.



## ATTENTION

### Attempted burn-out despite Integral braking function

Damage to rear brake and clutch

- Burn-out must only occur from a vehicle standstill. Burn-out is not proper vehicle use and may therefore lead to fault messages. ◀

### How does ABS work?

The amount of braking force that can be transferred to the road depends on factors that include the coefficient of friction of the road surface. Loose stones, ice and snow or a wet road all have much lower coefficients of friction than a clean and dry asphalt surface. The lower the coefficient of friction, the longer the stopping distance.

If the rider increases braking pressure to the extent that braking force exceeds the maximum

transferable limit, the wheels start to lock and the motorcycle loses its directional stability; a fall is imminent. Before this situation can occur, ABS intervenes and adapts braking pressure to the maximum transferable braking force. The wheels continue to turn and the driving stability is retained irrespective of the road condition.

### What are the effects of surface irregularities?

Humps and surface irregularities can cause the wheels to lose contact temporarily with the road surface; if this happens the braking force that can be transmitted to the road can drop to zero. If the brakes are applied under these circumstances the ABS has to reduce braking force to ensure that directional stability is maintained when the wheels regain contact with the road sur-

face. At this instant the ABS must assume an extremely low coefficient of friction, so that the wheels will continue to rotate under all imaginable circumstances, because this is the precondition for ensuring directional stability. As soon as it registers the actual circumstances, the system reacts instantly and adjusts braking force accordingly to achieve optimum braking.

### **What feedback does the rider receive from the ABS?**

If the ABS has to reduce braking force on account of the circumstances described above, vibration is perceptible through the handbrake lever.

When the handbrake lever is pulled, brake pressure is also built up at the rear wheel by the integral function. If the brake pedal is depressed after

the handbrake lever is pulled, the brake pressure built up beforehand is perceptible as counter-pressure sooner than is the case when the brake pedal is depressed either before or at the same time as the brake lever is pulled.

### **Rear wheel lift**

Under very severe and sudden deceleration, however, under certain circumstances it is possible that the ABS will be unable to prevent the rear wheel from lifting clear of the ground. If this happens the outcome can be a highsiding situation in which the motorcycle can flip over.



### **WARNING**

#### **Rear wheel lift due to severe braking**

Risk of falling

- When you brake sharply, bear in mind that ABS control can-

not always be relied on to prevent the rear wheel from lifting clear of the ground.◀

### **What is the design baseline for ABS?**

Within the limits imposed by physics, the BMW Motorrad ABS ensures directional stability on any surface.

At speeds above 4 km/h, within the limits imposed by physics the BMW Motorrad ABS can ensure directional stability on any surface. Limitations inherent to the design principle mean that at lower speeds the BMW Motorrad ABS cannot provide optimum assistance on all surfaces.

The system is not optimised for special requirements that apply under extreme competitive situations off-road or on the track.

## Special situations

The speeds of the front and rear wheels are compared as one means of detecting a wheel's incipient tendency to lock. If the system registers implausible values for a lengthy period the ABS function is deactivated for safety reasons and an ABS fault message is issued. Self-diagnosis has to complete before fault messages can be issued. In addition to problems with the BMW Motorrad ABS, exceptional riding conditions can lead to a fault message being issued:

- Heating up with the motorcycle on the centre stand or an auxiliary stand, engine idling or with a gear engaged.
- Rear wheel locked by the engine brake for a lengthy period, for example while descending on a loose or slippery surface.

If a fault message is issued on account of exceptional riding conditions, you can reactivate the ABS function by switching the ignition off and on again.

## What significance devolves on regular servicing?



### WARNING

#### Brake system not regularly serviced.

Risk of accident

- In order to ensure that the ABS is always maintained in optimum condition, it is essential for you to comply strictly with the specified inspection intervals.◀

## Safety reserves

The potentially shorter braking distances which ABS permits must not be used as an excuse for careless riding. The system is primarily a means of ensuring a safety margin in genuine emergencies.



### WARNING

#### Braking when cornering

Risk of accident despite ABS

- Invariably, the rider bears responsibility for assessing road and traffic conditions and adopting his or her style of riding accordingly.
- Do not take risks that would negate the additional margin of safety offered by this system.◀

## ABS Pro

ABS Pro increases safety, particularly when braking in bends. ABS Pro prevents the wheels from locking even under sharp braking. ABS Pro reduces abrupt changes in steering force, particularly in shock-braking situations, counteracting the vehicle's otherwise natural but undesirable tendency to straighten up.

## ABS intervention

Technically speaking, depending on the riding situation ABS Pro adapts ABS intervention to the motorcycle's bank angle. Signals for rate of roll and rate of yaw and lateral acceleration are used to calculate bank angle. They come from the angular rate sensor, an integral component of Dynamic Traction Control DTC and Dynamic ESA. As the motorcycle is heeled over more and more as it banks into

a corner, an increasingly strict limit is imposed on the brake-pressure gradient for the start of brake application. This slows the build-up of brake pressure to a corresponding degree. Additionally, pressure modulation is more uniform across the range of ABS intervention.

## Advantages for the rider

The advantages of ABS Pro for the rider are sensitive response and high braking and directional stability combined with best-case deceleration of the motorcycle, even when cornering.



### NOTICE

ABS Pro is activated in the RAIN, ROAD and DYNAMIC riding modes. In the Dynamic Pro riding mode, ABS Pro can be parametrised to suit the rider's individual needs and preferences. ◀

## Dynamic traction control (DTC)

### How does traction control work?

Traction control compares the front and rear wheel circumferential velocities. The differential is used to compute slip as a measure of the reserves of stability available at the rear wheel. If slip exceeds a certain limit, the engine management system intervenes and adapts engine torque accordingly.

BMW Motorrad DTC is designed as an assistant system for the rider and for use on public roads. The extent to which the rider affects DTC control can be considerable (weight shifts when cornering, items of luggage loose on the motorcycle), especially when the style of riding takes rider and machine close to the limits imposed by physics.

The system is not optimised for special requirements that apply under extreme competitive situations off-road or on the track. The BMW Motorrad DTC can be deactivated in these cases.



## WARNING

### Risky riding

Risk of accident despite DTC

- Invariably, the rider bears responsibility for assessing road and traffic conditions and adopting his or her style of riding accordingly.
- Do not take risks that would negate the additional safety offered by this system. ◀

### Special situations

In accordance with the laws of physics, the ability to accelerate is restricted more and more as the angle of heel increases. Consequently, there can be a per-

ceptible reduction in acceleration out of very tight bends.

With DTC, the speeds of the front and rear wheels are compared and the angle of heel taken into account as one means of detecting the rear wheel's incipient tendency to spin or slip sideways.

If the lean angle values are identified as implausible over an extended period of time, a substitute value is used for the lean angle or the DTC is switched off. Under these circumstances the indicator for a DTC fault shows. Self-diagnosis has to complete before fault messages can be issued.

The BMW Motorrad traction control may switch off automatically under the exceptional riding conditions outlined below.

### Exceptional riding conditions:

- Riding for a lengthy period with the front wheel lifted off the ground (wheelie).
- Rear wheel rotating with the vehicle held stationary by applying the front brake (burn-out).
- Heating up with the motorcycle on an auxiliary stand, in neutral or with a gear engaged.

### Dynamic engine brake control

#### How does dynamic engine brake control work?

The purpose of dynamic engine brake control is to prevent the unstable riding states that can be produced by excessive engine braking moment acting on the rear wheel. Depending on the road condition and riding dynamic, excessive braking

torque can produce a sharp rise in rear-wheel slip and impair directional stability. Dynamic engine brake control limits this slip at the rear wheel to a safe mode-dependent and bank-angle-dependent regulated slip.

### **Causes for excessive slip at the rear wheel:**

- Riding with engine overrun on a surface with a low coefficient of friction (e.g. wet leaves).
- Rear-wheel hop when rider downshifts.
- Sharp braking during sporty riding.

In the same way as DTC traction control, dynamic engine brake control compares the wheel circumferential velocities of the front and rear wheels. Additional information on the bank angle enables dynamic engine brake control to calculate slip and the

reserve of stability at the rear wheel.

If slip overshoots the applicable limit, the throttle valves are opened very slightly to increase engine torque. Slip is reduced and the vehicle is stabilised.

### **Effect of dynamic engine brake control**

- In the RAIN and ROAD riding modes: Maximum stability.
- In the DYNAMIC and DYNAMIC PRO riding modes: High stability.
- In the DYNAMIC PRO riding mode additionally: Maximum performance. On a poor road surface or with unsuitable tyres, stability might be impaired.

## **Dynamic ESA**

– with Dynamic ESA Pro<sup>OE</sup>

### **Riding position equaliser**

The electronic chassis and suspension setting Dynamic ESA is able to adjust your motorcycle automatically to the load. If the spring setting is set to `Auto`, the rider does not have to change the load setting.



### **NOTICE**

BMW Motorrad recommends the `Auto` chassis and suspension setting. ◀

When driving off and when riding, the system monitors the suspension at the rear wheel and corrects the spring setting in order to set the correct riding position. The damping is also adjusted automatically to the load. By interpreting ride height sensor signals, Dynamic ESA detects

movements in the suspension and responds by adjusting the damper valves. This enables the suspension to adapt to the terrain.

Dynamic ESA calibrates itself at regular intervals to ensure the system functions correctly.

### **Possibilities for adjustment**

#### **Damping modes**

- Road: Damping for comfortable on-road riding
- Dynamic: Damping for dynamic on-road riding

#### **Load settings**

- One-up riding
- One-up with luggage
- Two-up (with luggage)
- Min: Minimum spring setting (only to make the motorcycle easier for the rider to mount)

- Auto: Active ride compensation with automatic adjustment of the spring setting and damping (recommended suspension setting)

## **Riding mode**

### **Selection**

To adjust the motorcycle to the road condition and the desired driving experience, the following riding modes can be selected:

- RAIN
- ROAD
- DYNAMIC
- DYNAMIC PRO

There are matched settings for the Engine, Engine Brake, Traction (DTC), Wheelie (DTC) and ABS systems in each riding mode.

In the DYNAMIC PRO riding mode, the settings for the Engine, Engine Brake, Traction (DTC), Wheelie (DTC) and ABS systems can be varied to suit the rider's individual needs and preferences.

### **Torque and throttle response**

- In the RAIN riding mode: Gentle throttle response, reduced torque in low gears.
- In the ROAD and DYNAMIC riding modes: Optimum throttle response, reduced torque in low gears.
- In the DYNAMIC PRO riding mode: Optimum throttle response, maximum torque.

In the DYNAMIC PRO riding mode additionally: Gentle throttle response.



## **Braking effect of the engine**

- In the RAIN and ROAD riding modes: Maximum braking effect of the engine and maximum stability.
- In the DYNAMIC and DYNAMIC PRO riding modes: Medium braking effect of the engine and high stability.
- In the DYNAMIC PRO riding mode additionally: Minimum braking effect of the engine and maximum performance.

## **Traction control (DTC)**

- In the RAIN riding mode: maximum stability on wet roads. There may be reduced acceleration on dry roads.
- In the ROAD riding mode: high stability on dry roads. There may be slightly reduced acceleration on dry roads.
- In the DYNAMIC riding mode: high performance on dry roads.

In the event of poor road conditions, optimum stability cannot be guaranteed.

- In DYNAMIC PRO riding mode: Maximum performance. On a poor road surface or with unsuitable tyres, stability might be impaired.

## **Wheelie (DTC) – lifting of the front wheel**

- In the RAIN riding mode: maximum stability. Efforts are made to suppress a Wheelie .
- In the ROAD and DYNAMIC riding modes: Shallow Wheelie possible, optimum forward acceleration.
- In the DYNAMIC PRO riding mode: System is deactivated.
- In the DYNAMIC PRO riding mode additionally: High Wheelie possible. The rider has to slow the rear wheel to keep the motorcycle from flip-

ping over backwards. The system only intervenes late.

## **ABS**

- The rear wheel lift-off assistant is active in the RAIN, ROAD and DYNAMIC riding modes.
- In RAIN, ROAD, DYNAMIC and DYNAMIC PRO riding modes, the ABS is set to on-road mode.
- In the DYNAMIC PRO riding mode additionally: ABS intervention can be tuned to suit rider preference.

## **DYNAMIC ESA**

- In the RAIN, ROAD, DYNAMIC and DYNAMIC PRO riding modes: Damper characteristic set up for comfortable riding.

- with Dynamic ESA Pro<sup>OE</sup>

## **DYNAMIC ESA PRO**

In the RAIN and ROAD riding modes additionally: Damper characteristic set up for dynamic riding.

In the DYNAMIC and DYNAMIC PRO riding modes additionally: Damper characteristic set up for comfortable riding.

## **Mode changes**

The riding mode can be changed while the vehicle is stationary with the ignition on. It is possible to change it while driving under the following conditions:

- No drive torque on the rear wheel.
- No brake pressure in the brake system.

The following steps must be taken to change the riding mode:

- Close the throttle twistgrip.
- Release the brake levers.
- Deactivate the cruise control.

The desired riding mode is initially preselected. The mode change does not take place until the systems in question are all in the appropriate state.

The selection menu does not disappear from the display until the mode change has taken place.

## **Dynamic Brake Control**

### **Dynamic Brake Control function**



#### **NOTICE**

The Dynamic Brake Control function is active in all riding modes. It can be deactivated in the DYNAMIC PRO riding mode only, by custom parametrisation of the ABS. ◀

The Dynamic Brake Control function assists the rider in emergency braking situations.

### **Detection of emergency braking**

- Sudden, sharp application of the front brake is interpreted as emergency braking.

### **Behaviour in emergency braking**

- If emergency braking occurs at a speed in excess of 10 km/h, the ABS function is further assisted by Dynamic Brake Control.
- If partial braking at high brake pressure gradients is initiated, the Dynamic Brake Control increases the integral brake pressure on the rear wheel. The stopping distance shortens and controlled braking is possible.

## Behaviour during accidental actuation of the throttle grip

- If the throttle is accidentally opened (throttle grip position > 5 %) during emergency braking, Dynamic Brake Control ensures the desired braking effect by ignoring actuation of the throttle grip. The effectiveness of emergency braking is ensured.
- If the throttle is closed (throttle grip position < 5 %) while Dynamic Brake Control is in action, the engine torque requested by the ABS brake system is restored.
- If emergency braking ceases and the rider still has not changed the position of the throttle grip, Dynamic Brake Control steadily ramps engine torque back to the rider's requested level.

## Tyre pressure monitoring (RDC)

- with tyre pressure control (RDC)<sup>OE</sup>

### Function

A sensor integrated into each tyre measures the air temperature and the air pressure inside the tyre and transmits this information to the control unit. Each sensor has a centrifugal-force tripswitch that does not enable transmission of the measured values until the motorcycle has accelerated to a defined minimum speed for the first time.

 Minimum speed for transmission of the RDC measured values:
min 30 km/h

The display shows -- for each tyre until the tyre-pressure signal is received for the first time. The

sensors continue to transmit the measured-value signals for some time after the vehicle comes to a stop.

 Time for transmission of measured values after vehicle comes to a stop:
min 15 min

An error message is issued if wheels without sensors are fitted to a vehicle equipped with an RDC control unit.

### Tyre pressure ranges

The RDC control unit distinguishes between three tyre pressure ranges matched to the vehicle:

- Filling pressure within the permissible tolerance
- Filling pressure in the limit range of the permissible tolerance
- Filling pressure outside permitted tolerance

## Temperature compensation

Tyre pressure is a temperature-sensitive variable: pressure increases as tyre-air temperature rises and decreases as tyre-air temperature drops. Tyre-air temperature depends on ambient temperature as well as on the style of riding and the duration of the ride.



The tyre pressures are shown in the TFT display as temperature compensated and always refer to the following tyre air temperature:

20 °C

The air lines available to the public in petrol stations and motorway service areas have gauges that do not compensate for temperature; the reading shown by a gauge of this nature is the temperature-dependent tyre-air

pressure. As a result, the values displayed there usually do not correspond to the values displayed in the TFT display.

## Pressure adaptation

Compare the RDC value on the TFT display with the value in the table on the back cover of the Rider's Manual. Then use the air-line gauge at a service station to compensate for the difference between the RDC reading and the value in the table.



Example

According to the operating instructions, the tyre pressure should be:

2.5 bar

The following display is shown in the TFT display:

2.3 bar



Example

So pressure is low by:

0.2 bar

The gauge on the air line shows:

2.4 bar

You must now increase tyre pressure until the value is:

2.6 bar

## Gear Shift Assistant

– with shift assistant Pro<sup>OE</sup>

### Gear Shift Assistant Pro

Your vehicle is equipped with a shift assistant, a system originally developed for racing and now adapted for riding on public roads. It permits upshifts and downshifts without declutching or closing the throttle in virtually all load and rpm ranges.

## Advantages

- 70-80 % of all gearshifts on a trip can be done without using the clutch.
- Less relative movement between rider and passenger because the shift pauses are shorter.
- It is not necessary to close the throttle valve when shifting under acceleration.
- When braking and downshifting (throttle valve closed), engine speed is adjusted by blipping the throttle.
- Shift time is shorter than a gearshift with clutch actuation.

In order for the system to identify a request for a gearshift, the rider has to move the shift lever from its idle position in the desired direction against the force of the spring through a certain "over-travel" at ordinary speed or rapidly and keep the shift lever in

this position until the gearshift is completed. It is not necessary to increase the force applied to the gearshift lever while shifting in progress. Once the gearshift has completed the shift lever has to be fully released before another gearshift with the Pro shift assistant can take place. When shifting gears with the Gear Shift Assistant Pro, the rider has to keep load state (throttle twistgrip position) constant before and during the gearshift. A change in the position of the throttle twistgrip during a gearshift can cause the function to abort and/or lead to a missed shift. Gear Shift Assistant Pro provides no assistance for the gearshift if the rider declutches.

## Downshifting

- Downshifting is assisted until maximum rpm for the target gear to be selected is reached. This prevents over-rewinding.

 Maximum engine speed
max 12000 min <sup>-1</sup>
– with power reduction <sup>OE</sup>
max 12000 min <sup>-1</sup> ◁

## Upshifting

- The shift assistant provides no assistance if engine speed drops below idle during an upshift.

 Idle speed
1270±50 min <sup>-1</sup> (Engine at regular operating temperature)

## Hill Start Control

### Hill Start Control function

Hill Start Control is a pullaway assistant that operates on the partially integrated ABS system to prevent the vehicle from rolling

back on a gradient, without the rider having to keep pressure applied to the brake lever. When Hill Start Control is activated, pressure is built up in the rear brake system to keep the machine at a standstill on a gradient. The brake pressure in the brake system is dependent on the gradient.

### **Effect of an incline on brake pressure and drive-off behaviour**

- If the motorcycle is stopped on a gentle incline, only low brake pressure is built up. In this case, the brakes are quickly released when driving off. The motorcycle can be moved off more gently. It is not necessary to turn the throttle grip again.
- If the motorcycle is stopped on a steep incline, high brake pressure is built up. In this case, the brakes take longer to release when driving off. More

torque is required for driving off which also requires the rider to turn the throttle grip again.

### **Behaviour when the motorcycle rolls or slips**

- If the motorcycle starts to roll while Hill Start Control is active, brake pressure is increased.
- If the rear wheel slips, the brake is released again after approx. 1 m. This prevents the vehicle slipping with a locked rear wheel, for example.

### **Releasing brake when stopping the engine or timeout**

Hill Start Control is deactivated when the engine is stopped using the emergency-off switch, when the side stand is folded out or after timeout (10 minutes). In addition to the indicator and warning lights, the rider should be made aware that Hill Start

Control has been deactivated by the following behaviour:

### **Brake warning jolt**

- The brake is released briefly and reactivated immediately.
- This creates a jolt which the rider feels.
- The ABS brake system with partially integral function sets a speed of approx. 1-2 km/h.
- The rider must brake the motorcycle manually.
- After two minutes, or when the brake is actuated, Hill Start Control is completely deactivated.



### **NOTICE**

The holding pressure is released immediately without a brake warning jolt as soon as the ignition is switched off. ◀

## Adaptive Headlight

– with adaptive head light<sup>OE</sup>

### Function

In addition to the bulbs for low beam, high beam and daytime riding light, or side light, the headlight has two separate reflectors. These reflectors are activated as a function of bank angle in addition to the low-beam headlight, enabling the headlight to illuminate the inside of the bend as the motorcycle banks for cornering. The adaptive cornering headlight is optimised for bank angles up to 25 °.

The adaptive cornering headlight is activated under the following conditions:

- Bank angle is more than 7 °.
- Speed is higher than 10 km/h.
- The low-beam headlight is switched on.





## Maintenance

General notes.....	160
Toolkit .....	160
Front-wheel stand .....	160
Rear-wheel stand .....	161
Engine oil .....	162
Brake system .....	163
Clutch .....	168
Coolant .....	169
Tyres .....	170
Rims and tyres.....	171
Wheels .....	171
Lighting.....	179
Jump-starting.....	180
Battery.....	181
Fuses .....	184

Diagnostic connector .....	185
Chain .....	186

## General notes

The "Maintenance" chapter describes straightforward procedures for checking and replacing certain wear parts.

Special tightening torques are listed as applicable. The tightening torques for the threaded fasteners on your motorcycle are listed in the section entitled "Technical data".

You will find information on more extensive maintenance and repair work in the repair manual on DVD for your vehicle, available from your authorised BMW Motorrad retailer.

Some of the work calls for special tools and a thorough knowledge of the technology involved. If you are in doubt, consult a specialist workshop, preferably your authorised BMW Motorrad retailer.

## Toolkit

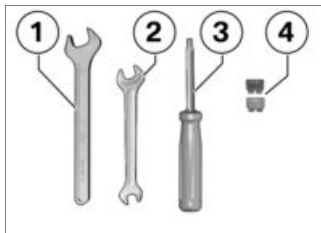

- 1 Open-ended spanner  
Width across flats 14  
– Adjust the mirror arm (►► 120).  
– Adjust the chain tension (►► 187).
- 2 Open-ended spanner  
Width across flats 8/10  
– Adjust the chain tension (►► 187).
- 3 Reversible screwdriver  
blade  
Phillips PH1 and Torx T25

- 4 Reserve fuses  
Miniature fuses, 7.5 A and 15 A

## Front-wheel stand Installing front-wheel stand



### ATTENTION

#### Use of the BMW Motorrad front-wheel stand without accompanying use of centre stand or auxiliary stand

Risk of damage to parts if vehicle topples

- Place the motorcycle on its centre stand or another auxiliary stand before lifting the front wheel with the BMW Motorrad front-wheel stand. ◀
- with centre stand<sup>OE</sup>
- Make sure the ground is level and firm and place the motorcycle on its centre stand.



## ATTENTION

### Centre stand retracts if the vehicle lifted too high

Risk of damage to parts if vehicle topples

- When raising the vehicle, make sure that the centre stand remains on the ground.
  - If necessary, adjust the height of the front-wheel stand.◀
  - Make sure the motorcycle is standing firmly.◀
- without centre stand<sup>OE</sup>
- Place the motorcycle on an auxiliary stand; BMW Motorrad recommends the BMW Motorrad rear-wheel stand.
  - Install the rear-wheel stand (▶▶ 161).◀



- See the instructions issued with the front-wheel stand for the details of the correct procedure for installation.
- BMW Motorrad offers an auxiliary stand suitable for every vehicle. Your BMW Motorrad retailer will be happy to help you with the selection of a suitable auxiliary stand.

## Rear-wheel stand Installing rear-wheel stand



- The description of how to fit the rear-wheel stand correctly will be found in the instructions for the stand.
- BMW Motorrad offers an auxiliary stand suitable for every vehicle. Your BMW Motorrad retailer will be happy to help you with the selection of a suitable auxiliary stand.

## Engine oil

### Checking engine oil level

#### ATTENTION

**Misinterpretation of oil level reading, because oil level is temperature-dependent (the higher the temperature, the higher the oil level)**

Engine damage

- Check the oil level only after a lengthy ride or when the engine is at operating temperature.◀
- Make sure the engine is at operating temperature and hold the motorcycle upright.
- Allow the engine to idle for one minute.
- Switch off the ignition.
- Wait five minutes for the oil to drain into the oil pan.



#### NOTICE

To protect the environment, BMW Motorrad recommends occasionally checking the engine oil after a journey of at least 50 km.◀

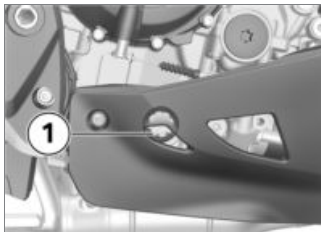

- Check the oil level in the display **1**.



Engine oil, specified level

Between **MIN** and **MAX** marks



## Engine oil, capacity

SAE 5W-40, API SJ / JASO MA2, Additives (e.g. molybdenum-based) are not permissible because they can attack coated components of the engine, BMW Motorrad recommends BMW Motorrad ADVANTEC Ultimate oil.

approx. 4.0 l (with filter change)

If the oil level is below the minimum mark:

- Top up the engine oil (➡ 163).

If the oil level is above the maximum mark:

- Have the oil level corrected by a specialist workshop, preferably an authorised BMW Motorrad retailer.

## Topping up the engine oil

- Make sure the ground is level and firm and place the motorcycle on its stand.
- Wipe the area around the oil filler opening clean.

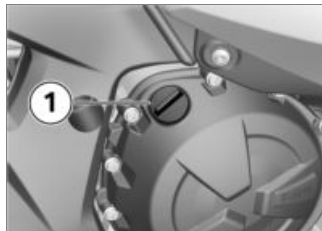

- Remove cap **1** of the oil filler opening.



### ATTENTION

#### Use of insufficient engine oil or too much engine oil

Engine damage

- Always make sure that the oil level is correct.◀

- Top up the engine oil to the specified level.
- Check the engine oil level (➡ 162).
- Install cap of oil filler opening **1**.

## Brake system

### Checking operation of the brakes

- Operate the brake lever.
  - » The pressure point must be clearly perceptible.
- Press the footbrake lever.
  - » The pressure point must be clearly perceptible.

If pressure points are not clearly perceptible:



### ATTENTION

#### Work on brake system not in compliance with correct procedure

Risk to operational reliability of the brake system

- Have all work on the brake system undertaken by trained and qualified specialists. ◀
- Have the brakes checked by a specialist workshop, preferably an authorised BMW Motorrad retailer.

### Checking brake pad thickness, front brakes

- Make sure the ground is level and firm and place the motorcycle on its stand.
- Turn the handlebars to the full-lock position.

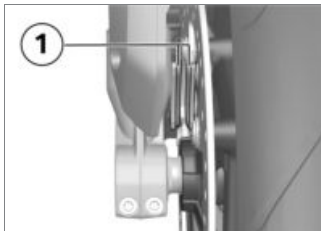

- Visually inspect the left and right brake pads to ascertain their thickness. Viewing direction: from the front toward brake pads **1**.

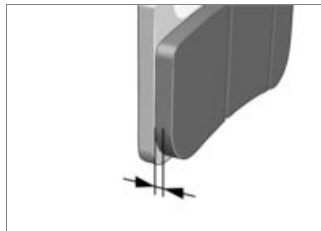

Brake-pad wear limit,  
front

min 1.0 mm (Friction pad only, without backing plate. The wear indicators (grooves) must be clearly visible.)

If the brake pads are worn:

## WARNING

### Brake-pad thickness less than permissible minimum

Diminished braking effect, damage to the brakes

- In order to ensure the dependability of the brake system, do not permit the brake pads to wear past the minimum permissible thickness.◀
- Have the brake pads replaced by a specialist workshop, preferably an authorised BMW Motorrad retailer.
- If the brake pads installed are not genuine BMW Motorrad brake pads, it is absolutely essential to measure the thickness of the brake-pad carrier plates.

## WARNING

### Use of unsuitable brake pads

Failure of the brake system due to loss of the brake pads

- Use only brake pads with brake pad carrier plates of adequate thickness.◀
- BMW Motorrad recommends installing only genuine BMW Motorrad brake pads.

### Checking brake pad thickness, rear brakes

- Make sure the ground is level and firm and place the motorcycle on its stand.

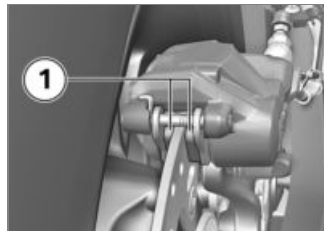

- Visually inspect the brake pads to ascertain their thickness. Viewing direction: from the rear toward brake pads **1**.

 Brake-pad wear limit, rear

min 1.0 mm (Friction pad only, without backing plate. The wear indicators (grooves) must be clearly visible.)

If the wear indicating mark is no longer visible:

## WARNING

### Brake-pad thickness less than permissible minimum

Diminished braking effect, damage to the brakes

- In order to ensure the dependability of the brake system, do not permit the brake pads to wear past the minimum permissible thickness.◀
- Have the brake pads replaced by a specialist workshop, preferably an authorised BMW Motorrad retailer.

### Checking brake-fluid level, front brakes

## WARNING

### Not enough brake fluid in brake fluid reservoir, or contaminants in brake fluid

Considerably reduced braking power due to presence of air,

contaminants or water in the brake system

- Cease operation of the vehicle immediately and do not ride it until the fault has been rectified.
  - Check the brake-fluid levels at regular intervals.
  - Always make sure that the lid of the brake fluid reservoir and the area around the lid are cleaned before opening.
  - Make sure that only fresh brake fluid from a sealed container is used.◀
- with centre stand<sup>OE</sup>
- Make sure the ground is level and firm and place the motorcycle on its centre stand.<
- without centre stand<sup>OE</sup>
- Make sure the ground is level and firm and hold the motorcycle upright.<

- Turn the handlebars to a position in which the brake fluid reservoir is horizontal.



- Check the brake fluid level in brake fluid reservoir for front wheel brake **1**.

## NOTICE

Wear of the brake pads causes the brake fluid level in the reservoir to sink.◀





Brake fluid level, front

Brake fluid, DOT4

The brake fluid level must not fall below the **MIN** mark. (Brake fluid reservoir horizontal)

If the brake fluid level drops below the permitted level:

- Have the fault rectified as quickly as possible by a specialist workshop, preferably an authorised BMW Motorrad retailer.

## Checking brake-fluid level, rear brakes

### WARNING

#### Not enough brake fluid in brake fluid reservoir, or contaminants in brake fluid

Considerably reduced braking power due to presence of air, contaminants or water in the brake system

- Cease operation of the vehicle immediately and do not ride it until the fault has been rectified.
- Check the brake-fluid levels at regular intervals.
- Always make sure that the lid of the brake fluid reservoir and the area around the lid are cleaned before opening.
- Make sure that only fresh brake fluid from a sealed container is used. ◀

- Make sure the ground is level and firm and hold the motorcycle upright.



- Check the brake fluid level in brake fluid reservoir for rear wheel brake **1**.

### NOTICE

Wear of the brake pads causes the brake fluid level in the reservoir to sink. ◀



Brake fluid level, rear

Brake fluid, DOT4

The brake fluid level must not fall below the **MIN** mark. (Brake fluid reservoir horizontal)

If the brake fluid level drops below the permitted level:

- Have the fault rectified as quickly as possible by a specialist workshop, preferably an authorised BMW Motorrad retailer.

## Clutch

### Checking operation of clutch

- Pull the clutch lever.
    - » The pressure point must be clearly perceptible.
- If the pressure point is not clearly perceptible:
- Have the clutch checked by a specialist workshop, preferably an authorised BMW Motorrad retailer.

### Checking clutch-lever play

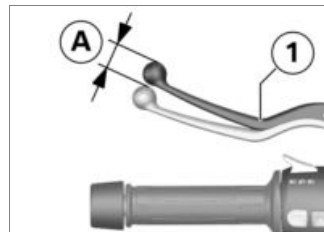

- Pull clutch lever **1** until resistance is perceptible.
- In this position, measure clutch play **A** between the handlebar fitting and the clutch lever.



Clutch-lever play

3...5 mm (measured at the outer end of the clutch lever, handlebars in straight-ahead position, engine cold)

Clutch play is out of tolerance:

- Adjust the clutch-lever play (►► 169).

## Adjusting clutch-lever play

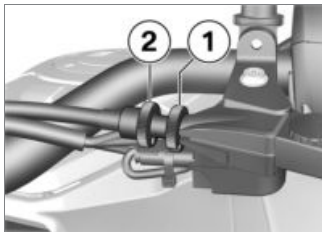

- Loosen lock nut **1**.
- To increase clutch play: Tighten screw **2** into the handlebar fitting.
- To reduce clutch play: Back off screw **2** in the handlebar fitting.
- Check the clutch-lever play (►► 168).

- Repeat the steps in this procedure until clutch play is set correctly.
- Tighten lock nut **1**.

## Coolant

### Checking coolant level

- Make sure the ground is level and firm and place the motorcycle on its stand.

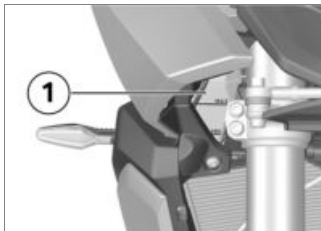

- Check the coolant level in expansion tank **1**. Viewing direction: From in front toward the inside of the right side panel.

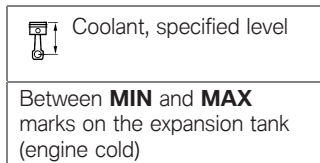

If the coolant drops below the permitted level:

- Top up the coolant.

## Topping up coolant



- Use a suitable container, such as a laboratory flask, for topping up the coolant.

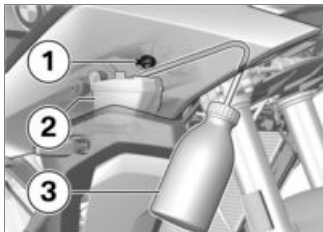

- Open cap **1** of expansion tank **2**.

- Using laboratory flask **3**, top up the coolant to the specified level.
- Check the coolant level (▮▮▮▮▶ 169).
- Close cap **1** of expansion tank **2**.

## Tyres

### Checking tyre pressures



**WARNING**

#### Incorrect tyre pressure

Impaired handling characteristics of the motorcycle, shorter useful tyre life

- Always check that the tyre pressures are correct.◀



**WARNING**

#### Tendency of valve inserts to open by themselves at high riding speeds

Sudden loss of tyre pressure

- Install valve caps fitted with rubber sealing rings and tighten firmly.◀
- Make sure the ground is level and firm and place the motorcycle on its stand.
- Check tyre pressures against the data below.



Tyre pressure, front

2.5 bar (One-up, tyre cold)

2.5 bar (Two-up mode with load, with cold tyres)



Tyre pressure, rear

2.9 bar (One-up, tyre cold)

2.9 bar (Two-up mode with load, with cold tyres)

If tyre pressure is too low:

- Correct tyre pressure.

## Rims and tyres

### Checking rims

- Make sure the ground is level and firm and place the motorcycle on its stand.
- Visually inspect the rims for defects.
- Have damaged rims checked and, if necessary, replaced by a specialist workshop, preferably an authorised BMW Motorrad retailer.

### Checking tyre tread depth



#### Riding with badly worn tyres

Risk of accident due to impaired handling

- If applicable, have the tyres changed in good time before they wear to the minimum tread depth permitted by law.◀

- Make sure the ground is level and firm and place the motorcycle on its stand.
- Measure the tyre tread depth in the main tread grooves with wear marks.



Wear indicators are built into the main profile grooves on each tyre. The tyre is worn out when the tyre tread has worn down to the level of the marks. The locations of the marks are indicated on the edge of the tyre, e.g. by the letters TI, TWI or by an arrow.◀

If the tyre tread is worn to minimum:

- Replace tyre or tyres, as applicable.

## Wheels

### Effect of wheel size on chassis and suspension control systems

Wheel size is very important as a parameter for the running-gear control systems such as DTC, for example. In particular, the diameter and the width of a vehicle's wheels are programmed into the control unit and are fundamental to all calculations. Any change in these influencing variables, caused for example by a switch to wheels other than those installed ex-works, can have serious effects on the performance of the control systems.

The sensor rings are essential for correct road-speed calculation, and they too must match the motorcycle's control systems and consequently cannot be changed.

If you decide that you would like to fit non-standard wheels to your motorcycle, it is very important to consult a specialist workshop beforehand, preferably an authorised BMW Motorrad retailer. In these cases, the data programmed into the control units has to be changed to suit the new wheel sizes.

## Removing front wheel

- Place the motorcycle on an auxiliary stand; BMW Motorrad recommends the BMW Motorrad rear-wheel stand.
- Install the rear-wheel stand (►► 161).
- Mask off the parts of the wheel rim that could be scratched in the process of removing the brake calipers.

- with centre stand<sup>OE</sup>
- Make sure the ground is level and firm and place the motorcycle on its centre stand.◀

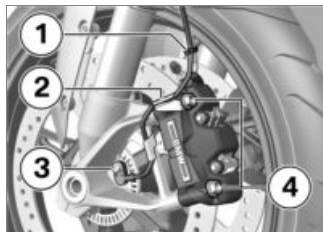

- Disengage the cable for the wheel speed sensor from holding clips **1** and **2**.
- Remove screw **3** and remove the wheel speed sensor from its bore.



### ATTENTION

#### Unwanted inward movement of the brake pads

Component damage on attempt to install the brake caliper or be-

cause brake pads have to be forced apart

- Do not operate the brakes with a brake caliper not correctly secured.◀
- Remove mounting bolts **4** of the left and right brake calipers.

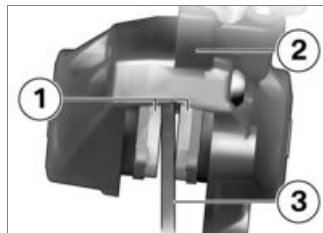

- Force the brake pads **1** slightly apart by rotational movement of the brake caliper **2** against brake disc **3**.
- Carefully pull the brake calipers back and out until clear of the brake discs.

- Lift the front of the motorcycle until the front wheel is clear of the ground, preferably using a BMW Motorrad front-wheel stand.
- Install the front-wheel stand (▶▶ 160).

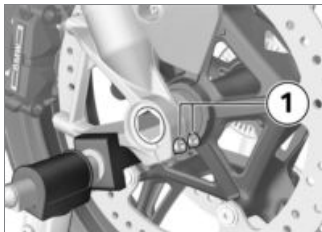

**CF** **ATTENTION**

**Incorrect gap between sensor ring and wheel speed sensor due to misaligned threaded bush in front suspension**

Damage to wheel speed sensor.  
ABS malfunction

- Left clamp locates the threaded bush; do not loosen or remove this clamp.◀
- Slacken axle clamping screws **1**.

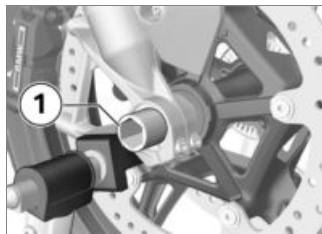

- Support the front wheel and remove quick-release axle **1**.
- Set down front wheel and roll forwards out of the front suspension.

## Installing front wheel

**!** **WARNING**

**Use of a non-standard wheel**  
Malfunctions in operation of ABS and DTC

- See the information on the effect of wheel size on the ABS and DTC systems at the start of this chapter.◀

**CF** **ATTENTION**

**Tightening threaded fasteners to incorrect tightening torque**

- Damage, or threaded fasteners work loose
- Always have the security of the fasteners checked by a specialist workshop, preferably an authorised BMW Motorrad dealer.◀



## ATTENTION

### Front wheel installed wrong way round

Risk of accident

- Note direction-of-rotation arrows on tyre or rim. ◀
- Roll the front wheel into position between the front forks.

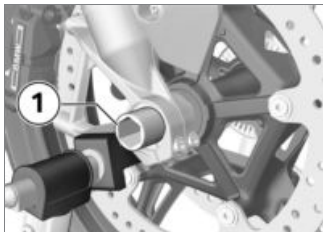

- Raise the front wheel, install quick-release axle **1** and tighten to specified torque.



Quick-release axle in threaded bush

50 Nm

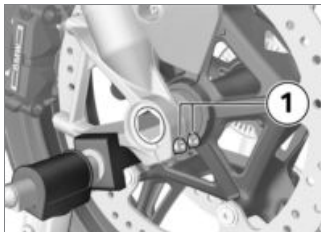

- Tighten axle clamping screws **1** to the specified torque.



Clamping screws in axle holder

Tightening sequence: Tighten screws six times in alternate sequence

19 Nm

- Position left and right brake calipers on the brake discs.



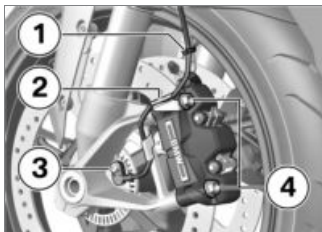

- Install securing screws **4** on left and right and tighten to specified tightening torque.

 Radial brake caliper to axle holder

38 Nm

- Remove the adhesive tape from the wheel rim.

### **WARNING**

#### **Brake pads not lying against the brake disc**

Risk of accident due to delayed braking effect.

- Before driving, check that the brakes respond without delay. ◀
- Operate the brake several times until the brake pads are bedded.
- Insert the cable for the wheel speed sensor into holding clips **1** and **2**.
- Insert the wheel speed sensor into the bore hole and install screw **3**.

 Wheel speed sensor to forkleg

Thread-locking compound: micro-encapsulated

8 Nm

- Remove the front-wheel stand and the auxiliary stand.

### **Removing rear wheel**

- Lift the motorcycle, preferably with a BMW Motorrad rear-wheel stand.

- Install the rear-wheel stand (►► 161).
- Slip wooden chocks or similar under the rear wheel to prevent it from dropping out after the quick-release axle has been removed.

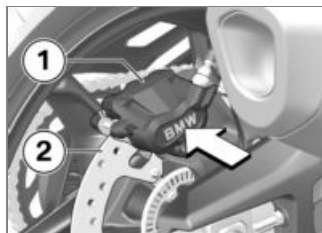

- Press the brake caliper **1** against the brake disc **2**.  
» Brake pistons are pushed back.

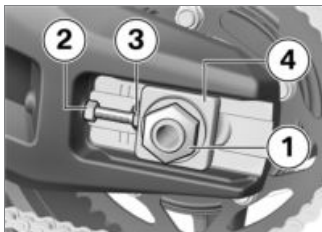

- Remove nut **1** with washer.
- Loosen lock nuts **2** on left and right.
- Loosen adjusting screws **3** on left and right.
- Remove adjusting plate **4** and push the axle in as far as it will go.



- Remove quick-release axle **2** and remove adjustment plate **1**.

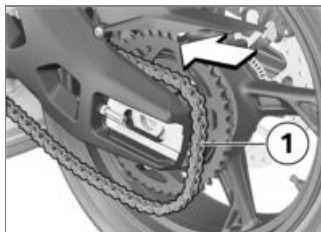

- Roll the rear wheel as far forward as possible and

disengage chain **1** from the sprocket.

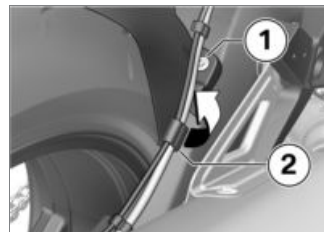

- Remove screw **1** and disengage the brake line from holder **2**.



- When rolling the rear wheel clear of the motorcycle, take care not to damage wheel-speed sensor **1**.



- Roll the rear wheel to the rear and clear of the swinging arm and at the same time pull

brake-caliper carrier **1** back far enough to allow the rear wheel to clear it.

#### **NOTICE**

The sprocket and the spacer bushes on left and right are loose fits in the wheel. Make sure that these parts are not damaged or get lost on removal.◀

### **Install the rear wheel**

#### **ATTENTION**

#### **Change in tyre size**

Effect on control systems

- Have the new parameters encoded by a specialist workshop, preferably by an authorised BMW Motorrad Retailer.◀

#### **ATTENTION**

#### **Tightening threaded fasteners to incorrect tightening torque**

Damage, or threaded fasteners work loose

- Always have the security of the fasteners checked by a specialist workshop, preferably an authorised BMW Motorrad dealer.◀
- Roll the rear wheel on the support into the swinging arm as far as necessary to permit the brake-caliper carrier to be inserted.

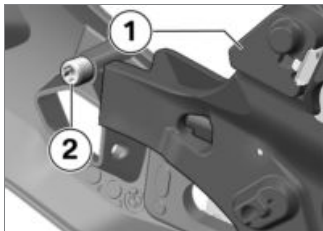

- Insert the brake-caliper carrier **1** into guide **2**.



- When rolling the rear wheel into position, take care not to damage wheel-speed sensor **1**.



- Roll the rear wheel further into the swinging arm, while pushing brake-caliper carrier **1** forward at the same time.

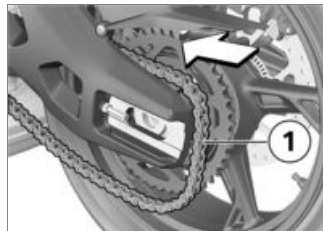

- Roll the rear wheel as far forward as possible and loop chain **1** over the sprocket.



- Install adjustment plate on the right **1** in the swinging arm.
- Lift the rear wheel and work quick-release axle **2** through

the adjustment plate and into the brake-caliper support and the rear wheel.

- Make sure that the quick-release axle fits into the recess for the flats.

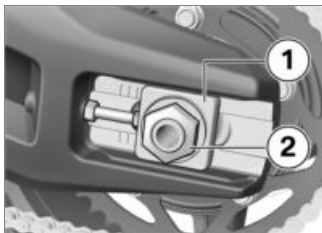

- Insert left adjustment plate **1**.
- Install nut **2** with its washer, but do not tighten the nut at this point.

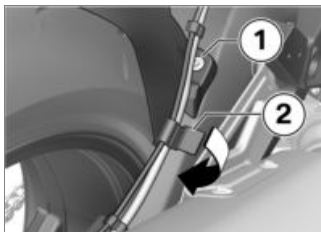

- Secure the brake line in holder **2** and install screw **1**.

### **WARNING**

#### **Brake pads not lying against the brake disc**

Risk of accident due to delayed braking effect.

- Before driving, check that the brakes respond without delay.◀
- Operate the brake several times until the brake pads are bedded.
- Adjust the chain tension (🔧 187).

## Lighting

### Replacing LED light sources

#### **WARNING**

#### **Vehicle overlooked in traffic due to failure of the lights on the vehicle**

Safety risk

- Always replace a faulty bulb at the earliest possible opportunity. Consult a specialist workshop, preferably an authorised BMW Motorrad Retailer.◀

All light sources of the vehicle are LED light sources. The service life of the LED light sources is longer than the presumed vehicle service life. If an LED light source is faulty, please contact a specialist workshop, preferably an authorised BMW Motorrad retailer.

## Jump-starting



### CAUTION

#### Touching live parts of the ignition system when the engine is running

Electric shock

- Do not touch parts of the ignition system when the engine is running. ◀



### ATTENTION

#### Excessive current flowing when the motorcycle is jump-started

Wiring smoulders/ignites or damage to the on-board electronics

- If the motorcycle has to be jump-started connect the leads to the battery terminals; never attempt to jump-start the engine by connecting leads to the on-board socket. ◀



### ATTENTION

#### Contact between crocodile clips of jump leads and vehicle

Risk of short-circuit

- Use jump leads fitted with fully insulated crocodile clips at both ends. ◀



### ATTENTION

#### Jump-starting with a voltage greater than 12 V

Damage to the on-board electronics

- Make sure that the battery of the donor vehicle does not exceed a voltage of 12 V. ◀
- When jump-starting the engine, do not disconnect the battery from the on-board electrical system.
- Remove the seat (▣ 94).

- Run the engine of the donor vehicle during jump-starting.
- Begin by connecting one end of the red jump lead to the positive terminal of the discharged battery and the other end to the positive terminal of the donor battery.
- Then connect one end of the black jump lead to the negative terminal of the donor battery, and the other end to the negative terminal of the discharged battery.
- Start the engine of the vehicle with the discharged battery in the usual way; if the engine does not start, wait a few minutes before repeating the attempt in order to protect the starter motor and the donor battery.
- Allow both engines to idle for a few minutes before disconnecting the jump leads.

- Disconnect the jump lead from the negative terminals first, then disconnect the second lead from the positive terminals.
- Install the seat (►► 94).

## Battery

### Maintenance instructions

Correct upkeep, recharging and storage will prolong the life of the battery and are essential if warranty claims are to be considered.

Compliance with the points below is important in order to maximise battery life:

- Keep the surface of the battery clean and dry.
- Do not open the battery.
- Do not top up with water.
- Be sure to read and comply with the instructions for charging the battery on the following pages.

- Do not turn the battery upside down.



### ATTENTION

#### On-board electronics (e.g. clock) draining connected battery

Battery is deep-discharged; this voids the guarantee

- Connect a float charger to the battery if the motorcycle is to remain out of use for more than four weeks.◀



### NOTICE

BMW Motorrad has developed a float charger specially designed for compatibility with the electronics of your motorcycle. Using this charger, you can keep the battery charged during long periods of disuse, without having to disconnect the battery from the motorcycle's on-board sys-

tems. You can obtain additional information from your authorised BMW Motorrad dealer.◀

### Charging battery when connected



### ATTENTION

#### Charging the battery that is connected to the vehicle via the battery terminals

Damage to the on-board electronics

- Disconnect the battery at the battery terminals before charging.◀



### ATTENTION

#### Recharging a fully discharged battery via the power socket or extra socket

Damage to the vehicle electronics

- If a battery has discharged to the extent that it is completely

flat (battery voltage less than 12 V, indicator lights and multifunction display remain off when the ignition is switched on) always charge the **disconnected** battery with the charger connected directly to the battery terminals.◀



### ATTENTION

#### Unsuitable chargers connected to a socket

Damage to charger and vehicle electronics

- Use suitable BMW chargers. The suitable charger is available from your authorised BMW Motorrad dealer.◀
- With the battery connected to the vehicle's on-board electrical system, charge via the power socket.



### NOTICE

The motorcycle's on-board electronics know when the battery is fully charged. The on-board socket is switched off when this happens.◀

- Comply with the operating instructions of the charger.



### NOTICE

If you are unable to charge the battery through the on-board socket, you may be using a charger that is not compatible with your motorcycle's electronics. In this case, directly charge the battery at the terminals of the battery that has been disconnected from the vehicle.◀

#### Charging the battery when disconnected

- Disconnecting battery from motorcycle (▣▣▣ 182).

- Charge the battery using a suitable charger.
- Comply with the operating instructions of the charger.
- Once the battery is fully charged, disconnect the charger's terminal clips from the battery terminals.



### NOTICE

The battery has to be recharged at regular intervals in the course of a lengthy period of disuse. See the instructions for caring for your battery. Always fully recharge the battery before restoring it to use.◀

- Connecting battery to motorcycle (▣▣▣ 183).

#### Disconnecting battery from motorcycle

- Make sure the ground is level and firm and place the motorcycle on its stand.



- Remove the seat (▣▣▣ 94).

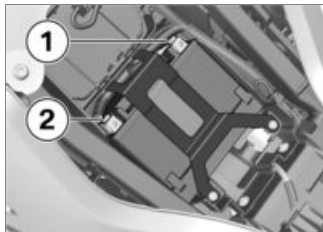

## ATTENTION

### Battery not disconnected in accordance with correct procedure

Risk of short-circuit

- Always proceed in compliance with the specified disconnection sequence.◀
- First disconnect negative battery cable **1**.
- Then disconnect positive battery cable **2**.

## Connecting battery to motorcycle

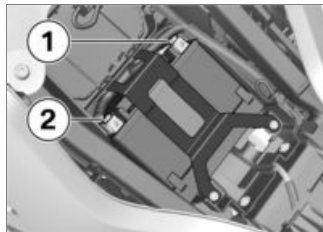

- First connect positive battery cable **2**.
- Then connect negative battery cable **1**.
- Install the seat (▣▣▣ 94).

## Removing battery

- Remove the seat (▣▣▣ 94).
- Disconnecting battery from motorcycle (▣▣▣ 182).

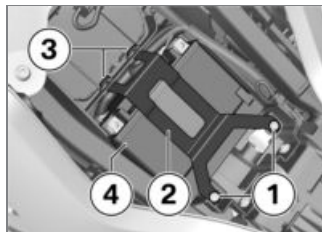

- Remove screws **1**.
- Disengage holder **2** from bracket **3** and remove.
- Lift battery **4** up and out; work it slightly back and forth if it is difficult to remove.

## Installing battery



## NOTICE

If the vehicle has been disconnected from the battery for a significant time, the current date will have to be entered in the instrument cluster to guarantee correct operation of the service display.◀

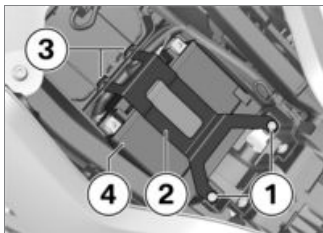

- Insert battery **4** into the battery compartment, positive terminal on the right in the forward direction of travel.
- Insert holder **2** into bracket **3** and install.
- Install screws **1**.
- Connecting battery to motorcycle (➡ 183).
- Install the seat (➡ 94).
- Set the clock (➡ 107).

## Fuses

### Replacing fuses



#### ATTENTION

#### Jumpering of blown fuses

Risk of short-circuit and fire

- Never attempt to jumper a blown fuse.
- Always replace a defective fuse with a new fuse of the same amperage.◀
- Switch off the ignition.
- Make sure the ground is level and firm and place the motorcycle on its stand.
- Remove the seat (➡ 94).

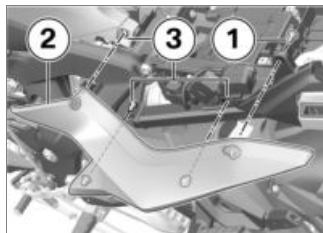

- Remove screw **1**.
- Carefully disengage side cover **2** from holding clips **3**.

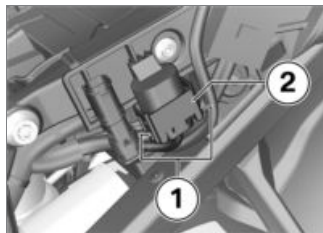

- Press locks **1** on both sides.
- Remove fuse box **2**.

- Consult the fuse assignment diagram and replace the defective fuse.



## NOTICE

If fuse defects recur frequently have the electric circuits checked by a specialist workshop, preferably an authorised BMW Motorrad dealer. ◀

- Reinsert fuse box **2**. Make sure that locks **1** engage on both sides.

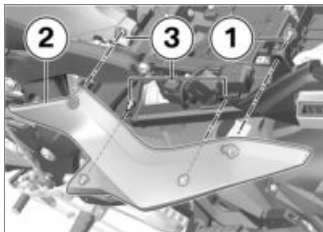

- Install side cover **2** in holding clips **3**.

- Install screw **1**.
- Install the seat (➡ 94).

## Fuse assignment

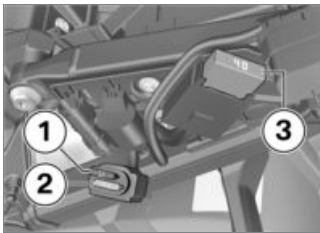

- |          |  |
|----------|--|
| <b>1</b> | 15 A<br>Instrument cluster<br>Anti-theft alarm (DWA)<br>Ignition switch<br>Diagnostic socket |
| <b>2</b> | 7.5 A<br>Multifunction switch, left<br>Tyre pressure monitoring (RDC)<br>Sensor box          |
| <b>3</b> | 40 A<br>Alternator regulator   |

## Diagnostic connector Disengaging diagnostic socket



## CAUTION

### Incorrect procedure followed when loosening the diagnostic connector for the on-board diagnosis

Motorcycle experiences malfunctions

- Only have the diagnostic connector loosened by a specialist workshop or other authorised persons during your next BMW Service appointment.
- Have the work performed by appropriately trained staff.
- Refer to the vehicle manufacturer specifications. ◀
- Remove the seat (➡ 94).

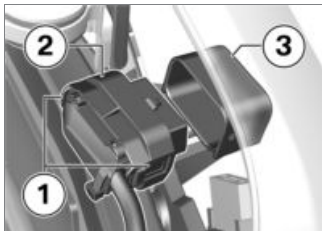

- Press locks **1**.
- Disengage diagnostic socket **2** from holder **3**.
- » The interface to the diagnosis and information system can be connected to the diagnostic connector **2**.

### Securing diagnostic socket

- Disconnect the interface for the diagnosis and information system.

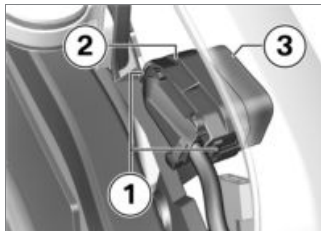

- Insert diagnostic socket **2** into holder **3**.
- » The locks **1** engage.
- Remove the seat (→ 94).

## Chain

### Lubricating chain



#### ATTENTION

### Inadequate cleaning and lubrication of the drive chain

Accelerated wear

- Clean and lubricate the drive chain at regular intervals.◀

- Lubricate the chain more frequently if the motorcycle is ridden in wet, dusty or dirty conditions.



Lubricate the drive chain at regular intervals.

min 800 km

- Switch the ignition off and select neutral.
- Clean the drive chain with a suitable cleaning product, dry it and apply chain lubricant.
- To prolong chain life, BMW Motorrad recommends the use of BMW Motorrad chain lubricant or:



Lubricant

Chain spray

- Wipe off excess lubricant.

## Checking chain tension

- Make sure the ground is level and firm and place the motorcycle on its stand.
- Turn the rear wheel until it reaches the position with the lowest amount of chain sag.

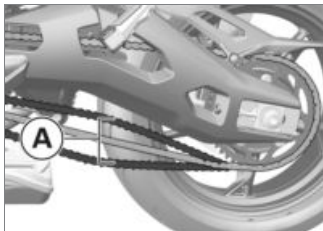

- Use a screwdriver to push the chain up and down at a point midway between the pinion and sprocket and measure chain sag **A**.



Chain deflection

45...50 mm (Motorcycle with no weight applied, supported on its side stand)

If chain deflection is outside permitted tolerance:

- Adjust the chain tension (►► 187).

## Adjusting chain tension

- Make sure the ground is level and firm and place the motorcycle on its stand.

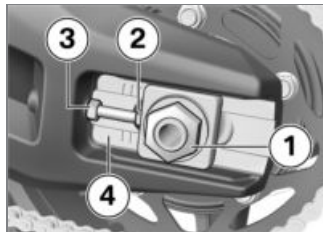

- Loosen nut **1**.
- Loosen lock nuts **3** on left and right.
- Use adjusting screws **2** on left and right to adjust chain tension.
- Check the chain tension (►► 187).
- Make sure that scale readings **4** are the same on left and right.
- Tighten lock nuts **3** on left and right to the specified tightening torque.



Locknut of the final-drive chain tensioning screw

19 Nm

- Tighten nut **1** to the specified tightening torque.



Rear quick-release axle in swinging arm

Thread-locking compound: mechanical

100 Nm

## Checking chain wear

- Engage 1st gear.
- Turn the rear wheel in the normal direction of travel until the chain is tensioned.
- Determine the length of the chain underneath the rear wheel swinging arm above the middle of 10 rivets in 3 different places.

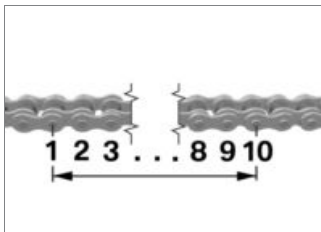

Permissible chain length

max 144 mm (measured from the **centre** of 10 rivets, chain pulled taut)

If the chain has stretched to the maximum permissible length:

- Consult a specialist workshop, preferably an authorised BMW Motorrad retailer.

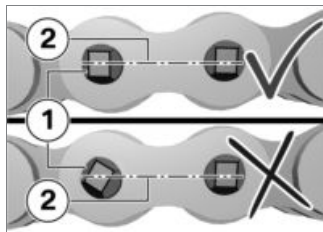

- Check whether a rivet head **1** has twisted out of line. Rivet heads are parallel to the chain centreline **2**.
- Chain riveting is OK.

If one or more rivet heads have twisted out of line:

- Consult a specialist workshop, preferably an authorised BMW Motorrad retailer.

## **Accessories**

General notes.....	190
Power socket .....	190
Cases.....	191
Topcase .....	193
Navigation system .....	196

## General notes

### CAUTION

#### Use of other-make products

Safety risk

- BMW Motorrad cannot examine or test each product of outside origin to ensure that it can be used on or in connection with BMW vehicles without constituting a safety hazard. Country-specific official authorisation does not suffice as assurance. Tests conducted by these instances cannot make provision for all operating conditions experienced by BMW vehicles and, consequently, they are not sufficient in some circumstances.
- Use only parts and accessories approved by BMW for your vehicle. ◀

BMW has conducted extensive testing of the parts and ac-

cessory products to establish that they are safe, functional and suitable. Consequently, BMW accepts responsibility for the products. BMW accepts no liability whatsoever for parts and accessories that it has not approved.

All modifications must be in compliance with legal requirements. Make sure that the vehicle does not infringe the national road-vehicle construction and use regulations applicable in your country.

Your BMW Motorrad retailer can offer expert advice on the choice of genuine BMW parts, accessories and other products. To find out more about accessories go to:

**[bmw-motorrad.com/equipment](http://bmw-motorrad.com/equipment)**

## Power socket

### Connection of electrical devices

- You can start using electrical devices connected to the motorcycle's sockets only when the ignition is switched on.

### Cable routing

- The cables from the power sockets to the auxiliary devices must be routed in such a way that they do not impede the rider.
- The cable routing should not restrict the steering angle or obstruct handling.
- The cables must not be trapped.

### Automatic shutdown

- The power supply to the socket is interrupted automatically during the start procedure.



- The power supply to the socket is switched off no more than 15 minutes after the ignition is switched off, in order to prevent overloading of the on-board electrics. Low-wattage electrical accessories might not be recognised by the vehicle's electronics. In these cases the power supply to the socket is switched off very shortly after the ignition is turned off.
- If the battery charge state is likely to drop too low to maintain the motorcycle's start capability, the power supply to the socket is switched off.
- The power supply to the socket is switched off if maximum load capability as stated in the technical data is exceeded.

## Cases

- with touring cases<sup>OA</sup>

### Opening cases



- Turn key **1** clockwise to the **RELEASE** position.
- Push key **1** down.
  - » Release lever **2** flips open.
- Pull release lever **2** up and open the case lid.

### Closing cases

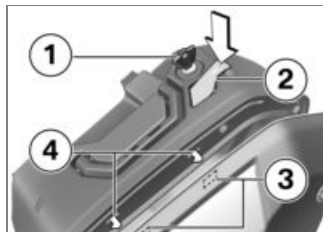

- Prepare the case for closing.
  - Key **1** is in the **RELEASE** position.
  - Release lever **2** is in the open position.
- Press catches **3** of the case lid into latches **4**. Check that nothing is trapped between the lid and the case.
- Close the case lid and push release lever **2** down.
  - » The lid engages with an audible click.

- Turn key **1** counter-clockwise to the LOCK position and remove the key.

## Removing cases

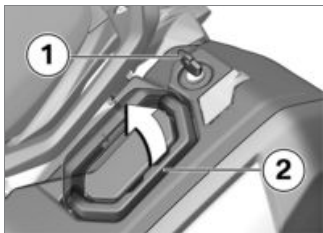

- Turn key **1** anticlockwise.
- » Release lever **2** flips open.
- Pull release lever **2** up.

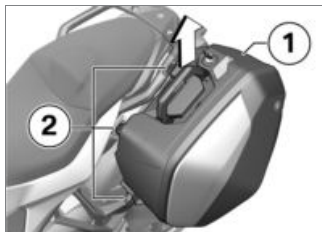

- Lift case **1** slightly and disengage it from holders **2**.

## Installing cases

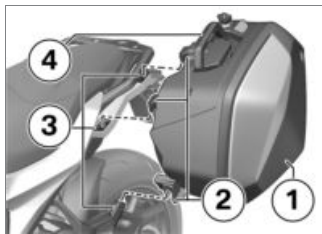

- Hold case **1** in position with release lever **4** open.

- Make sure that holders **2** are fully engaged in all retainers **3**.

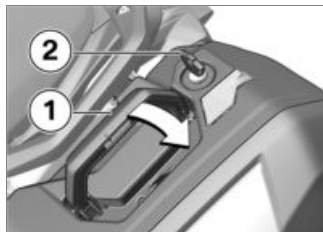

- Push release lever **1** down.
- » Lever **1** engages with an audible click.
- Turn key **2** to the LOCK position and remove the key.

## Maximum payload and maximum speed

Note the maximum payload and the maximum permissible speed. The values for the combination described here are as follows:

 Maximum permissible speed for riding with cases fitted to the motorcycle

max 180 km/h

 Payload per case

max 10 kg

## Topcase

### Opening topcase

- with topcase<sup>OA</sup>
- with luggage carrier<sup>OE</sup>



- Turn the key in the topcase lock to position **1**.



- Push lock barrel **1** forward.  
» Release lever **2** pops up.
- Pull the release lever all the way up.

» Topcase lid can be opened.

### Closing topcase

- with topcase<sup>OA</sup>
- with luggage carrier<sup>OE</sup>



- Pull release lever **1** up as far as it will go.
- Close the lid of the topcase and hold it down. Check that nothing is trapped between the lid and the case.



### NOTICE

The topcase can also be closed when the lock is in the **LOCK** position. In this case, make sure

that the key is not left inside the topcase.◀



- Push release lever **1** down until it engages.
- Turn the key in the topcase lock to the **LOCK** position and remove the key.

### Removing topcase

- with topcase<sup>OA</sup>
- with luggage carrier<sup>OE</sup>



- Turn the key in the topcase lock to position **1**.  
» The handle pops out.



- Pull carry handle **1** up as far as it will go.

- Lift the topcase at the rear and remove it from the luggage carrier.

### Installing topcase

- with topcase<sup>OA</sup>
- with luggage carrier<sup>OE</sup>



### WARNING

#### Topcase not properly secured

Driving safety is impaired

- The topcase must not wobble and must be secured free from play.◀
- Pull the handle up as far as it will go.

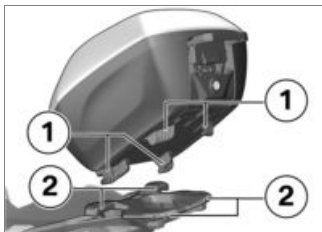

- Hook the topcase into position on the luggage carrier. Make sure that hooks **1** are securely seated in corresponding keepers **2**.



- Push carry handle **1** down until it engages.



- Turn the key in the topcase lock to the **1** position and remove the key.

## Maximum payload and maximum speed

- with topcase<sup>OA</sup>
- with luggage carrier<sup>OE</sup>

Note the maximum payload and the maximum permissible speed. The values for the combination described here are as follows:

	Maximum speed for riding with a loaded topcase
--	--

max 180 km/h
--------------

	Payload of topcase
--	--------------------

max 5 kg
----------

## Navigation system

### Securing navigation system

- with preparation for navigation system<sup>OE</sup>
- with navigation system<sup>OA</sup>



#### NOTICE

Navigation preparation is suitable from BMW Motorrad Navigator IV. ◀



#### NOTICE

The latching system of the Mount Cradle is not designed to protect against theft.

Always remove the navigation system and stow it away safely as soon as you finish your ride. ◀

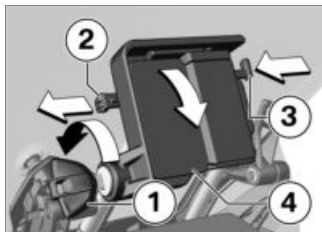

- Turn ignition key **1** anti-clockwise.
- Pull the lock retainer **2** to the **left**.
- Press the lock **3** in.
- » Mount Cradle is unlocked and cover **4** can be removed to the front in a swivelling motion.

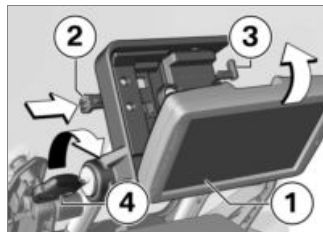

- Insert the navigation system **1** at the bottom and swing it towards the rear in one rotational movement.
- » The navigation system engages with an audible click.
- Push the lock retainer **2** all the way to the **right**.
- » Lock **3** is locked.
- Turn ignition key **4** clockwise.
- » The navigation system is secured and the ignition key can be removed.

## Removing navigation system and installing cover

- with preparation for navigation system<sup>OE</sup>
- with navigation system<sup>OA</sup>

### ATTENTION

#### Dust and dirt on the Mount Cradle contacts

Damaged contacts

- Always reinstall the cover as soon as you finish your ride.◀

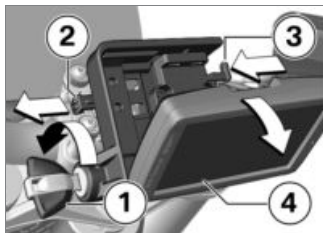

- Turn ignition key **1** anti-clockwise.

- Pull the lock retainer **2** all the way to the **left**.
  - » Lock **3** is unlocked.
- Push lock **3** all the way to the **left**.
  - » Navigation system **4** is unlocked.
- Tilt navigation system **4** and work it downward to remove.

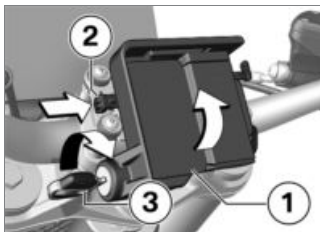

- Insert cover **1** in the lower section and swing to the top with a rotational movement.
  - » The cover engages with an audible click.

- Push lock retainer **2** to the **right**.
- Turn ignition key **3** clockwise.
  - » The cover **1** is secured.

## Operating navigation system

- with preparation for navigation system<sup>OE</sup>

### NOTICE

The description below is based on the BMW Motorrad Navigator V and the BMW Motorrad Navigator VI. The BMW Motorrad Navigator IV does not support all the options described here.◀

### NOTICE

Only the latest version of the BMW Motorrad communication system is supported. A software update of the BMW Motorrad communication system may

be necessary. If this is the case, consult your authorised BMW Motorrad dealer. ◀

If the BMW Motorrad Navigator is installed and the operating focus is switched to the Navigator (▶ 103), some of its functions can be operated without the rider removing a hand from the handlebars.

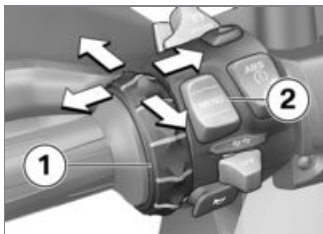

The navigation system is operated using Multi-Controller **1** and MENU rocker button **2**.

### Turning Multi-Controller 1 up and down

On the compass and Mediaplayer page: Increase or decrease the volume of a Bluetooth-connected BMW Motorrad communication system.

In the BMW special menu: Select menu item.

### Short-tilting Multi-Controller 1 to the left and right

Switch between the main pages of the Navigator:

- Map view
- Compass
- Mediaplayer
- BMW special menu
- My Motorcycle page

### Long-tilting Multi-Controller 1 to the left and right

Activate certain functions on the Navigator display. An arrow to the right or to the left above the corresponding button area on the display indicates a function that can be activated in this way.

 Long-push to the right to activate this function.

 Long-push to the left to activate this function.

### Pressing bottom section of MENU rocker button 2

Switch operating focus to Pure Ride view.

In detail, the following functions can be controlled:



## Map view

- Turn up: Zoom in.
- Turn down: Zoom out.

## Compass page

- Turning increases or decreases the volume of a BMW Motorrad communication system connected via Bluetooth.

## BMW special menu

- Speak: Repeat most recent navigation announcement.
- Waypoint: Save current location as a favourite.
- Home: Starts navigation to home address (greyed if no home address has been defined).
- Mute: Switch automatic navigation announcements off or on (off: a crossed-out lips symbol appears in the top line of the display). "Speak" will still activate navigation announcements.

All other acoustic outputs remain switched on.

- Switch off display: Deactivate the display.
- Dial home number: Dials the home phone number saved in the Navigator (not shown unless a communication system and a telephone are connected).
- Diversion: Activates the diversion function (not shown unless a route is active).
- Skip: Skips the next waypoint (not shown unless the route has waypoints).

## My Motorcycle

- Turn: Changes the number of data shown.
- Touch a data field on the display to open the menu for selecting data.
- The values available for selection depend on the optional extras installed on the vehicle.

## Mediaplayer

- Long-push to the left: Play preceding track.
- Long-push to the right: Play next track.
- Turning increases or decreases the volume of a BMW Motorrad communication system connected via Bluetooth.



## NOTICE

The Mediaplayer function is only available when a Bluetooth device complying with the A2DP standard is used, for example a BMW Motorrad communication system. ◀

## Warnings and status messages

- with navigation system<sup>OA</sup>



Warning and status messages from the motorcycle are indicated by a symbol **1** appearing at the top left in the map view.

#### NOTICE

If a BMW Motorrad communication system is connected, warnings are accompanied by an acoustic signal. ◀

If there are two or more active warnings the number appears below the warning triangle. Touching the warning triangle when more than one warning

is active opens a list of all the warnings. Additional information appears as soon as a message is selected.

#### NOTICE

Detailed information cannot be displayed for all warnings. ◀

#### Special functions

– with preparation for navigation system<sup>OE</sup>

Integration of the BMW Motorrad Navigator has produced a number of deviations from the descriptions in the operating instructions for the Navigator.

#### Reserve fuel level warning

The settings for the fuel gauge are not available, because the reserve warning is transmitted from the vehicle to the Navigator. Touch the message when it is

active to view the locations of the nearest filling stations.

#### Time and date

The Navigator sends the time and date to the motorcycle. To accept the time in the TFT display, navigate to **Settings**, **System settings**, **Date and time** and activate the **GPS synchronisation** function.

#### Security settings

The BMW Motorrad Navigator V and the BMW Motorrad Navigator VI can be secured against unauthorised use with a four-digit PIN (Garmin Lock). If this function is activated, while the Navigator is cradled on the motorcycle and the ignition is switched on you are prompted to add the motorcycle to the list of secured vehicles. If you answer "Yes" at this prompt, the Navigator saves

the VIN of this vehicle in its internal memory.

A maximum of five VINs can be saved in this way.

It is then no longer necessary to enter the PIN when the Navigator is switched on by ignition ON on any of these vehicles.

If the Navigator is removed from the vehicle while switched on, a security prompt is issued asking for the PIN to be entered.

### **Screen brightness**

Screen brightness is adjusted by the motorcycle while the unit is cradled. Manual input is not necessary.

Automatic setting can be switched off in the display settings for the Navigator if desired.



## Care

Care products .....	204
Washing the vehicle .....	204
Cleaning easily damaged components.....	205
Care of paintwork .....	206
Paintwork preservation.....	206
Laying up the motorcycle .....	207
Restoring motorcycle to use .....	207

## Care products

BMW Motorrad recommends that you use the cleaning and care products you can obtain from your authorised BMW Motorrad retailer. The substances in BMW Care Products have been tested in laboratories and in practice; they provide optimised care and protection for the materials used in your vehicle.



### ATTENTION

#### Use of unsuitable cleaning and care products

Damage to vehicle parts

- Do not use solvents such as cellulose thinners, cold cleaners, fuel or the like, and do not use cleaning products that contain alcohol. ◀



### ATTENTION

#### Use of strongly acidic or strongly alkaline cleaning agents

Damage to vehicle parts

- Dilute in accordance with the dilution ratio stated on the packaging of the cleaning agent.
- Do not use strongly acidic or strongly alkaline cleaning agents. ◀

#### Washing the vehicle

BMW Motorrad recommends that you use BMW insect remover to soften and wash off insects and stubborn dirt on painted parts prior to washing the vehicle.

To prevent stains, do not wash the motorcycle immediately after it has been exposed to strong

sunlight and do not wash it in the sun.

Remove dirt from the fork legs at regular intervals.

Make sure that the vehicle is washed frequently, especially during the winter months.

To remove road salt, clean the motorcycle with cold water immediately after every trip.



### WARNING

#### Wet brake discs and brake pads after vehicle wash, after riding through water and in rainy conditions

Diminished braking effect, risk of accident

- Apply the brakes in good time to allow the friction and heat to dry the brake discs and brake pads. ◀



## ATTENTION

### Effect of road salt intensified by warm water

Corrosion

- Use only cold water to wash off road salt. ◀



## ATTENTION

### Damage due to high water pressure from high pressure cleaners or steam cleaners

Corrosion or short circuit, damage to labels, seals, hydraulic brake system, electrical system and the motorcycle seat

- Exercise restraint when using a steam jet or high pressure cleaning equipment. ◀

## Cleaning easily damaged components

### Plastics



## ATTENTION

### Use of unsuitable cleaning agents

Damage to plastic surfaces

- Do not use cleaning agents that contain alcohol, solvents or abrasives.
- Do not use insect-remover pads or cleaning pads with hard, scouring surfaces. ◀

### Trim panel components

Clean trim panel components with water and BMW Motorrad solvent cleaner.

### Plastic windscreens and headlight lenses

Remove dirt and insects with a soft sponge and plenty of water.



## NOTICE

Soften stubborn dirt and insects by covering the affected areas with a wet cloth. ◀



Clean with water and sponge only.



Do not use any chemical cleaning agents.

### TFT display

Clean the TFT display with warm water and washing-up liquid. Then dry it with a clean cloth, e.g. a paper towel.

### Chrome

Carefully clean chrome parts with plenty of water and motorcycle cleaner from the BMW Motorrad Care Products range. This is particularly important to counter the effects of road salt.

For an additional treatment, use BMW Motorrad metal polish.

## Radiator

Clean the radiator regularly to prevent overheating of the engine due to inadequate cooling. For example, use a garden hose with low water pressure.



### ATTENTION

#### Bending of radiator fins

Damage to radiator fins

- Take care not to bend the radiator fins when cleaning.◀

## Rubber

Treat rubber components with water or BMW rubber-care products.



### ATTENTION

#### Application of silicone sprays to rubber seals

Damage to the rubber seals

- Do not use silicone sprays or care products that contain silicon.◀

## Care of paintwork

Washing the vehicle regularly will help counteract the long-term effects of substances that can damage the paint, especially if your vehicle is ridden in areas with high air pollution or natural sources of dirt, for example tree resin or pollen.

Remove particularly aggressive substances immediately, however, as otherwise the paint can be affected or become discoloured. Substances of this nature include spilt fuel, oil, grease, brake fluid and bird droppings. For this, we recommend BMW Motorrad solvent cleaner followed by BMW Motorrad gloss polish for preservation.

Marks on the paintwork are particularly easy to see after the motorcycle has been washed. Remove stains of this kind at the earliest possible opportunity, using benzine or petroleum spirit on a clean cloth or ball of cotton wool. BMW Motorrad recommends using BMW tar remover for removing specks of tar. Then apply preserving agent to the areas treated in this way.

## Paintwork preservation

If water no longer rolls off the paint, the paint must be preserved.

For paint preservation, BMW Motorrad recommends the use of BMW Motorrad gloss polish or agents containing carnauba wax or synthetic wax.



## Laying up the motorcycle

- Clean the motorcycle.
- Fill the motorcycle's fuel tank.
- Removing battery (▶▶▶ 183).
- Spray the brake and clutch lever pivots and the side-stand and centre-stand pivot mounts with a suitable lubricant.
- Coat bright metal and chrome-plated parts with an acid-free grease (e.g. Vaseline).
- Stand the motorcycle in a dry room in such a way that there is no load on either wheel (preferably using the front-wheel and rear-wheel stands from BMW Motorrad).

## Restoring motorcycle to use

- Remove the protective wax coating.
- Clean the motorcycle.
- Installing battery (▶▶▶ 183).
- Comply with checklist (▶▶▶ 128).



## Technical data

Troubleshooting chart .....	210
Threaded fasteners .....	212
Fuel.....	214
Engine oil .....	215
Engine .....	215
Clutch .....	216
Transmission .....	217
Final drive.....	217
Frame .....	218
Suspension .....	218
Brakes .....	219
Wheels and tyres .....	220
Electrical system.....	222
Anti-theft alarm .....	224
Dimensions .....	224

Weights.....	225
Performance figures .....	226

## Troubleshooting chart

Engine does not start or is difficult to start.

### Possible cause

### Rectification

Side stand extended and gear engaged

Retract the side stand.

Gear engaged and clutch not disengaged

Select neutral or pull the clutch lever.

No fuel in tank

Refuel (►► 137).

Battery flat

Charge the battery when disconnected (►► 182).

Starter motor overheating protection has tripped.  
The starter motor can be operated for a limited time only.

Allow the starter motor to cool down for approximately 1 minute before trying again.

The Bluetooth connection is not established.

### Possible cause

### Rectification

The steps required for pairing were not carried out.

Check the necessary steps for pairing in the operating instructions for the communication system.

The communication system was not connected automatically despite successful pairing.

Switch off the helmet's communication system and reconnect it after a minute or two.

Too many Bluetooth devices are saved on the helmet.

All pairing entries on the helmet are deleted (see the communication system operating instructions).

There are other vehicles with Bluetooth-capable devices in the vicinity.

Avoid simultaneously pairing with more vehicles.

Bluetooth connection is interrupted.

### Possible cause

### Rectification

The Bluetooth connection to the mobile device is interrupted.

Switch off energy saving mode.

The Bluetooth connection to the helmet is interrupted.

Switch off the helmet's communication system and reconnect it after a minute or two.

The volume in the helmet cannot be adjusted.

Switch off the helmet's communication system and reconnect it after a minute or two.

The telephone book is not displayed in the TFT display.

### Possible cause

### Rectification

The phone book was not transmitted to the vehicle.

Confirm transmission of the phone data (➡ 118) when pairing the mobile device.

Active route guidance is not displayed in the TFT display.

### Possible cause

### Rectification

Navigation from the BMW Motorrad Connected app was not transmitted.

The BMW Motorrad Connected app is opened on the connected mobile device prior to departure.

The route guidance cannot be started.





Secure the mobile device's data connection and check the map data on the mobile device.

## Threaded fasteners

Front wheel	Value	Valid
<b>Quick-release axle in threaded bush</b>		
M24 x 1.5	50 Nm	
<b>Clamping screws in axle holder</b>		
M8 x 35	<b>Tightening sequence: Tighten screws six times in alternate sequence</b>	
	19 Nm	
<b>Radial brake caliper to axle holder</b>		
M10 x 65	38 Nm	
Rear wheel	Value	Valid
<b>Locknut of the final-drive chain tensioning screw</b>		
M8	19 Nm	
<b>Nut on swinging arm axle</b>		
M18 x 1.5, Replace nut mechanical	100 Nm	

<b>Rear wheel</b>	<b>Value</b>	<b>Valid</b>
<b>Rear quick-release axle in swinging arm</b>		
M24 x 1.5 mechanical	100 Nm	
<b>Swinging-arm adapter to rear wheel swinging arm</b>		
M8 x 30	20 Nm	
<b>Spring strut at deflection lever</b>		
M12 x 1.5 x 75 - 10.9 micro-encapsulated	100 Nm	
<b>Mirrors</b>	<b>Value</b>	<b>Valid</b>
<b>Mirror with lock nut to adapter</b>		
M10 x 1.25	Left-hand thread, 22 Nm	

## Fuel

Recommended fuel grade	 Premium Plus unleaded (max. 5 % ethanol, E5) 98 RON, 93 AKI 
Alternative fuel grade	 Super unleaded (limitations in terms of power and consumption) (max. 10 % ethanol, E10)  95 ROZ/RON 90 AKI
Usable fuel capacity	approx. 20 l
Fuel reserve	approx. 4 l
Fuel consumption	6.2 l/100 km, according to WMTC
– with power reduction <sup>OE</sup>	6.2 l/100 km, according to WMTC
CO2 emission	144 g/km, according to WMTC
– with power reduction <sup>OE</sup>	144 g/km, according to WMTC
Exhaust emissions standard	EU 5



## Engine oil

Engine oil, capacity	approx. 4.0 l, with filter change
Specification	SAE 5W-40, API SJ / JASO MA2, Additives (e.g. molybdenum-based) are not permissible because they can attack coated components of the engine, BMW Motorrad recommends BMW Motorrad ADVANTEC Ultimate oil.
Engine oil, quantity for topping up	max 1.3 l, Difference between <b>MIN</b> and <b>MAX</b>

**BMW recommends** **ADVANTEC**  
ORIGINAL BMW ENGINE OIL

## Engine

Engine number location	Crankcase, bottom part, right
Engine type	A11A10A
Engine design	Oil/liquid-cooled 4-cylinder, 4-stroke in-line engine, four valves per cylinder
Displacement	999 cm <sup>3</sup>
Cylinder bore	80 mm
Piston stroke	49.7 mm
Compression ratio	12.5:1

Nominal capacity	121 kW, at engine speed: 11000 min <sup>-1</sup>
– with power reduction <sup>OE</sup>	79 kW, at engine speed: 7500 min <sup>-1</sup>
Torque	114 Nm, at engine speed: 9250 min <sup>-1</sup>
– with power reduction <sup>OE</sup>	104 Nm, at engine speed: 7000 min <sup>-1</sup>
Maximum engine speed	max 12000 min <sup>-1</sup>
– with power reduction <sup>OE</sup>	max 12000 min <sup>-1</sup>
Idle speed	1270 $\pm$ 50 min <sup>-1</sup> , Engine at regular operating temperature

## Clutch

Clutch type	Multi-plate oil-bath clutch, anti-hopping
-------------	---

## Transmission

Type of transmission	Claw-shift 6-speed gearbox, integrated into engine block
Gearbox transmission ratios	1.652 (76:46 teeth), Primary transmission ratio 2.647 (45:17 teeth), 1st gear 2.091 (46:22 teeth), 2nd gear 1.727 (38:22 teeth), 3rd gear 1.476 (31:21 teeth), 4th gear 1.304 (30:23 teeth), 5th gear 1.167 (28:24 teeth), 6th gear

## Final drive

Type of final drive	Chain drive
Final drive, number of teeth (Pinion / sprocket)	17/45
Secondary transmission ratio	2.647

## Frame

Frame type	Aluminium composite bridge frame, load-bearing engine
Type plate location	Frame, front left at steering head
Position of the vehicle identification number	Frame, front right on steering head

## Suspension

### Front wheel

Type of front suspension	Upside-down telescopic fork
Spring travel, front	150 mm, at front wheel
– with low-slung <sup>OE</sup>	120 mm, at front wheel

### Rear wheel

Type of rear suspension	Two-arm aluminium swinging arm
Type of final drive	Chain drive
Spring travel, rear	150 mm, at rear wheel
– with low-slung <sup>OE</sup>	120 mm, at rear wheel

## Brakes

### Front wheel

Type of front brake	Twin disc brake, diameter 320 mm, 4-piston fixed caliper
Brake-pad material, front	Sintered metal
Brake disc thickness, front	4.5 mm, When new min 4.0 mm, Wear limit
– with M forged wheels <sup>OE</sup>	min 5 mm, When new min 4.5 mm, Wear limit
Play of brake controls (Front brake)	0.7...1.7 mm, at piston

### Rear wheel

Type of rear brake	Single-disc brake, diameter 265 mm, 2-piston floating caliper
Brake-pad material, rear	Organic material
Brake disc thickness, rear	5 mm, When new min 4.5 mm, Wear limit
Blow-by clearance of the footbrake lever	2...3 mm, between the footbrake lever and footrest plate

## Wheels and tyres

Recommended tyre combinations	Your authorised BMW Motorrad retailer will be happy to supply an up-to-date list of the approved wheel/tyre combinations, or you can check the information posted on the <a href="http://bmw-motorrad.com">bmw-motorrad.com</a> website.
Speed category, front/rear tyres	W, required at least: 270 km/h
<b>Front wheel</b>	
Front-wheel type	Aluminium cast wheel
– with M forged wheels <sup>OE</sup>	Forged aluminium wheels
Front-wheel rim size	3.50" x 17"
Tyre designation, front	120/70 ZR 17
Load index, front tyre	min. 58
Permissible front-wheel imbalance	max 5 g

**Rear wheel**

Rear-wheel type	Aluminium cast wheel
– with M forged wheels <sup>OE</sup>	Forged aluminium wheels
Rear wheel rim size	6.0" x 17"
Tyre designation, rear	190/55 ZR 17
Load index, rear tyre	min. 75
Permissible rear-wheel imbalance	max 5 g

**Tyre pressure**

Tyre pressure, front	2.5 bar, One-up, tyre cold 2.5 bar, Two-up mode with load, with cold tyres
Tyre pressure, rear	2.9 bar, One-up, tyre cold 2.9 bar, Two-up mode with load, with cold tyres

## Electrical system

### Fuses

Fuse 1	15 A, Instrument cluster, anti-theft alarm, ignition lock, diagnostic socket, ignition coil isolating relay
Fuse 2	7.5 A, Multifunction switch left, RDC control unit, sensor box
Main fuse	40 A, Alternator regulator, isolating relay, BCL, BMS-O, antilock braking system, SAF, fuse box (slot 1 direct and slot 2 with isolating relay)
Electrical rating of on-board sockets	max 5 A, Total for all sockets

### Battery

Battery type	AGM
– with anti-theft alarm (DWA) <sup>OE</sup>	AGM
– with Keyless Ride <sup>OE</sup>	AGM
– with M Lightweight battery <sup>OE</sup>	Lithium-ion



Battery rated voltage	12 V
Battery rated capacity	9 Ah
– with anti-theft alarm (DWA) <sup>OE</sup> or – with Keyless Ride <sup>OE</sup>	12 Ah
– with M Lightweight battery <sup>OE</sup>	5 Ah

### Spark plugs

Spark plugs, manufacturer and designation	NGK LMAR9FI-10G
---	-----------------

### Lighting

Bulb for high-beam headlight	LED
Bulbs for the low-beam headlight	LED
Bulb for parking light	LED
Light source for the number plate light	LED
Bulb for tail light/brake light	LED

## Anti-theft alarm

Activation time on arming	approx. 30 s
Alarm duration	approx. 26 s
Battery type (For Keyless Ride radio-operated key)	CR 123 A

## Dimensions

Length of motorcycle	
– with topcase <sup>OA</sup>	2333 mm, over topcase
– with topcase <sup>OA</sup> – with low-slung <sup>OE</sup>	2328 mm, over topcase
Height of motorcycle	1411...1466 mm, over windscreen, at DIN unladen weight
– with low-slung <sup>OE</sup>	1384...1436 mm, over windscreen, at DIN unladen weight
– with windscreen, high <sup>OE</sup>	1445...1499 mm, over windscreen, at DIN unladen weight
Width of motorcycle	
– with touring cases <sup>OA</sup>	969 mm, with cases
– with hand protector <sup>OE</sup>	920 mm, with hand protector

Height of rider's seat	840 mm, without rider, at DIN unladen weight
– with rider's seat, low <sup>OE</sup>	820 mm, without rider, at DIN unladen weight
– with low-slung <sup>OE</sup>	790 mm, without rider, at DIN unladen weight
Rider's inside-leg arc, heel to heel	1880 mm, without rider, at DIN unladen weight
– with rider's seat, low <sup>OE</sup>	1867 mm, without rider, at DIN unladen weight
– with low-slung <sup>OE</sup>	1809 mm, without rider, at DIN unladen weight

## Weights

Vehicle kerb weight	226 kg, DIN unladen weight, ready for road, 90 % load of fuel, without optional equipment (OE)
Wheel load, front, at unladen weight	115 kg
Permissible wheel load, front	max 180 kg
Wheel load, rear, at unladen weight	111 kg
Permissible wheel load, rear	max 300 kg
Permissible gross vehicle weight	450 kg
Maximum payload	224 kg
Payload of topcase	max 5 kg
Payload per case	max 10 kg

## Performance figures

Top speed	>200 km/h
– with power reduction <sup>OE</sup>	>200 km/h
Maximum permissible speed for riding with cases fitted to the motorcycle	max 180 km/h
Maximum speed for riding with a loaded topcase	max 180 km/h

## Service

BMW Motorrad Service .....	228
BMW Motorrad Service history ....	228
BMW Motorrad mobility services .....	229
Maintenance work .....	229
BMW Service .....	229
Maintenance schedule .....	233
Maintenance confirmations .....	234
Service confirmations .....	248

## BMW Motorrad Service

BMW Motorrad has an extensive network of dealerships in place to look after you and your motorcycle in more than 100 countries. Authorised BMW Motorrad dealerships have the technical information and the technical know-how to carry out reliably all maintenance and repair work on your BMW.

You can locate the nearest authorised BMW Motorrad retailer by visiting our website:

**[bmw-motorrad.com](http://bmw-motorrad.com)**



### WARNING

#### **Maintenance and repair work not in compliance with correct procedure**

Risk of accident due to consequential damage

- BMW Motorrad recommends having work of this nature carried out on the vehicle by a

specialist workshop, preferably an authorised BMW Motorrad dealer. ◀

In order to help ensure that your BMW is always in optimum condition, BMW Motorrad recommends compliance with the maintenance intervals specified for your motorcycle. Have all maintenance and repair work carried out confirmed in the "Service" chapter in this manual. Evidence of regular maintenance is essential for generous treatment of claims submitted after the warranty period has expired.

Your authorised BMW Motorrad retailer can provide information on BMW services and the work undertaken as part of each service.

## BMW Motorrad Service history

### Entries

Maintenance work that has been carried out is entered in the proof of maintenance. The entries are like a Service Booklet and provide proof of regular maintenance.

When an entry is made in the electronic service booklet of the vehicle, service-relevant data is saved in the central IT systems of BMW AG, Munich, Germany. If there is a change in vehicle owner, the data saved in the electronic service booklet can also be viewed by the new vehicle owner. A BMW Motorrad retailer or a specialist workshop can also view data that is stored in the electronic service booklet.

## Objection

The vehicle owner can object to entries being made by the BMW Motorrad retailer or a specialist workshop in the electronic service booklet along with the corresponding storage of data in the vehicle and transfer of data to the vehicle manufacturer for the period of time that they are the vehicle owner. In this instance, no entry is made in the electronic service booklet of the vehicle.

## BMW Motorrad mobility services

As owner of a new BMW vehicle, in circumstances in which assistance is required you can benefit from the protection afforded by the various BMW Motorrad mobility services (e.g. Mobile Service, breakdown service, vehicle recovery service).

Find out from your authorised BMW Motorrad retailer which mobility services are offered.

## Maintenance work

### BMW pre-delivery check

Your authorised BMW Motorrad retailer conducts the BMW pre-delivery check before handing over the vehicle to you.

### BMW Running-in Check

The BMW running-in check has to be performed when the motorcycle has covered between 500 km and 1200 km.

## BMW Service

The BMW Service is carried out once a year; the extent of servicing can vary, depending on the age of the vehicle and the distance it has covered. Your authorised BMW Motorrad retailer confirms that the service work

has been carried out and enters the date when the next service will be due.

Riders who cover long distances in a year might have to bring in their vehicles for service before the next scheduled date. It is to allow for these cases that a maximum odometer reading is entered as well in the confirmation of service. Servicing has to be brought forward if this odometer reading is reached before the next scheduled date for the service.

The service display is a service-due indicator that appears on the TFT display to remind you about one month or 1000 km in advance when the time for a service is approaching, on the basis of the programmed values.

To find out more about service go to:

**[bmw-motorrad.com/service](http://bmw-motorrad.com/service)**

The maintenance tasks necessary for your vehicle are set out in the maintenance schedule below:







## Maintenance schedule

- 1** BMW running-in check (including oil change)
- 2** BMW Service, standard scope
- 3** Engine-oil change, with filter
- 4** Check valve clearances
- 5** Check timing
- 6** Replace all spark plugs
- 7** Replace air filter insert
- 8** Oil change in the telescopic forks
- 9** Change brake fluid, entire system
  - a** annually or every 10,000 km (whichever comes first)
  - b** for the first time after one year, then every two years

## Maintenance confirmations

### BMW Service standard scope

The repair tasks in the BMW Service standard scope are listed below. The actual scope of maintenance work applicable for your vehicle may vary.

- Setting service date and remaining distance with BMW Motorrad diagnosis system
- Performing vehicle test with BMW Motorrad diagnosis system
- Visual inspection of the brake lines, brake hoses and connections
- Checking front brake pads and brake discs for wear
- Checking brake-fluid level, front wheel brake
- Checking rear brake pads and brake disc for wear
- Checking brake-fluid level, rear wheel brake
- Checking steering-head bearing
- Checking coolant level
- Checking clutch cable and clutch-lever play
- Checking and lubricating the chain drive
- Checking inserts in case holder
- Checking tyre pressure and tread depth
- Check the side stand's ease of movement
- Lubricating side stand
- Check lighting and signalling system
- Function test, engine start suppression
- Final inspection and check for road safety
- Checking battery state of charge
- Confirming BMW service in on-board literature

## **BMW pre-delivery check**

carried out

at \_\_\_\_\_

\_\_\_\_\_  
Stamp, signature

## **BMW Running-in Check**

carried out

at \_\_\_\_\_

Odometer reading \_\_\_\_\_

Next service

at the latest

at \_\_\_\_\_

or, when reached earlier

Odometer reading \_\_\_\_\_

\_\_\_\_\_  
Stamp, signature

**BMW Service**

carried out

at \_\_\_\_\_

Odometer reading \_\_\_\_\_

Next service

at the latest

at \_\_\_\_\_

or, when reached earlier

Odometer reading \_\_\_\_\_

Work performed

BMW Service

Yes

No

Oil change, engine, with filter

Checking valve clearance

Checking valve timing (cylinder head cover removed)

Renewing all spark plugs

Renewing air cleaner insert

Oil change in telescopic front forks

Change brake fluid in entire system

Notes

-----

-----

-----

-----

-----

-----

-----

-----

\_\_\_\_\_

Stamp, signature

**BMW Service**

carried out

at \_\_\_\_\_

Odometer reading \_\_\_\_\_

Next service

at the latest

at \_\_\_\_\_

or, when reached earlier

Odometer reading \_\_\_\_\_

Work performed

BMW Service

Yes

No

Oil change, engine, with filter

Checking valve clearance

Checking valve timing (cylinder head  
cover removed)

Renewing all spark plugs

Renewing air cleaner insert

Oil change in telescopic front forks

Change brake fluid in entire system

Notes

-----

-----

-----

-----

-----

-----

-----

-----

\_\_\_\_\_  
Stamp, signature

**BMW Service**

carried out

at \_\_\_\_\_

Odometer reading \_\_\_\_\_

Next service

at the latest

at \_\_\_\_\_

or, when reached earlier

Odometer reading \_\_\_\_\_

Work performed

BMW Service

Yes

No

Oil change, engine, with filter

Checking valve clearance

Checking valve timing (cylinder head  
cover removed)

Renewing all spark plugs

Renewing air cleaner insert

Oil change in telescopic front forks

Change brake fluid in entire system

Notes

-----

-----

-----

-----

-----

-----

-----

-----

\_\_\_\_\_  
Stamp, signature





**BMW Service**

carried out

at \_\_\_\_\_

Odometer reading \_\_\_\_\_

Next service

at the latest

at \_\_\_\_\_

or, when reached earlier

Odometer reading \_\_\_\_\_

Work performed

BMW Service

Yes

No

Oil change, engine, with filter

Checking valve clearance

Checking valve timing (cylinder head  
cover removed)

Renewing all spark plugs

Renewing air cleaner insert

Oil change in telescopic front forks

Change brake fluid in entire system

Notes

-----

-----

-----

-----

-----

-----

-----

-----

 \_\_\_\_\_  
 Stamp, signature

**BMW Service**

carried out

at \_\_\_\_\_

Odometer reading \_\_\_\_\_

Next service

at the latest

at \_\_\_\_\_

or, when reached earlier

Odometer reading \_\_\_\_\_

\_\_\_\_\_  
Stamp, signature

Work performed

BMW Service

Oil change, engine, with filter

Checking valve clearance

Checking valve timing (cylinder head cover removed)

Renewing all spark plugs

Renewing air cleaner insert

Oil change in telescopic front forks

Change brake fluid in entire system

Yes

No

Notes

-----  
-----  
-----  
-----  
-----  
-----  
-----  
-----

**BMW Service**

carried out

at \_\_\_\_\_

Odometer reading \_\_\_\_\_

Next service

at the latest

at \_\_\_\_\_

or, when reached earlier

Odometer reading \_\_\_\_\_

Work performed

BMW Service

Yes

No

Oil change, engine, with filter

Checking valve clearance

Checking valve timing (cylinder head  
cover removed)

Renewing all spark plugs

Renewing air cleaner insert

Oil change in telescopic front forks

Change brake fluid in entire system

Notes

-----

-----

-----

-----

-----

-----

-----

-----

\_\_\_\_\_  
Stamp, signature

**BMW Service**

carried out

at \_\_\_\_\_

Odometer reading \_\_\_\_\_

Next service

at the latest

at \_\_\_\_\_

or, when reached earlier

Odometer reading \_\_\_\_\_

\_\_\_\_\_  
Stamp, signature

Work performed

BMW Service

Oil change, engine, with filter

Checking valve clearance

Checking valve timing (cylinder head cover removed)

Renewing all spark plugs

Renewing air cleaner insert

Oil change in telescopic front forks

Change brake fluid in entire system

Yes      No

Notes

-----  
-----  
-----  
-----  
-----  
-----  
-----  
-----  
-----

**BMW Service**

carried out

at \_\_\_\_\_

Odometer reading \_\_\_\_\_

Next service

at the latest

at \_\_\_\_\_

or, when reached earlier

Odometer reading \_\_\_\_\_

Work performed

BMW Service

Oil change, engine, with filter

Checking valve clearance

Checking valve timing (cylinder head  
cover removed)

Renewing all spark plugs

Renewing air cleaner insert

Oil change in telescopic front forks

Change brake fluid in entire system

Yes

No

Notes

-----

-----

-----

-----

-----

-----

-----

-----

\_\_\_\_\_  
Stamp, signature

**BMW Service**

carried out

at \_\_\_\_\_

Odometer reading \_\_\_\_\_

Next service

at the latest

at \_\_\_\_\_

or, when reached earlier

Odometer reading \_\_\_\_\_

Work performed

BMW Service

Yes

No

Oil change, engine, with filter

Checking valve clearance

Checking valve timing (cylinder head  
cover removed)

Renewing all spark plugs

Renewing air cleaner insert

Oil change in telescopic front forks

Change brake fluid in entire system

Notes

-----

-----

-----

-----

-----

-----

-----

-----

-----

\_\_\_\_\_  
Stamp, signature

**BMW Service**

carried out

at \_\_\_\_\_

Odometer reading \_\_\_\_\_

Next service

at the latest

at \_\_\_\_\_

or, when reached earlier

Odometer reading \_\_\_\_\_

Work performed

BMW Service

Oil change, engine, with filter

Checking valve clearance

Checking valve timing (cylinder head  
cover removed)

Renewing all spark plugs

Renewing air cleaner insert

Oil change in telescopic front forks

Change brake fluid in entire system

Yes

No

Notes

-----

-----

-----

-----

-----

-----

-----

-----

\_\_\_\_\_  
Stamp, signature



**BMW Service**

carried out

at \_\_\_\_\_

Odometer reading \_\_\_\_\_

Next service

at the latest

at \_\_\_\_\_

or, when reached earlier

Odometer reading \_\_\_\_\_

\_\_\_\_\_  
Stamp, signature

Work performed

BMW Service

Oil change, engine, with filter

Checking valve clearance

Checking valve timing (cylinder head cover removed)

Renewing all spark plugs

Renewing air cleaner insert

Oil change in telescopic front forks

Change brake fluid in entire system

Yes      No

Notes

-----  
-----  
-----  
-----  
-----  
-----  
-----  
-----  
-----

## Service confirmations

The table is used to verify maintenance and repair work as well as installed optional accessories and purchased special promotions.

Work performed	Odometer reading	Date

Work performed	Odometer reading	Date



## Appendix

Declaration of conformity for electronic immobiliser .....	252
Certificate for electronic immobiliser .....	258
Declaration of conformity for Keyless Ride .....	260
Certificate for Keyless Ride .....	265
Declaration of conformity for tyre pressure control (RDC) .....	267
Certificate for tyre pressure monitoring (Reifendruck-Control, RDC) .....	274
Declaration of conformity for TFT instrument cluster .....	275
Certificate for TFT instrument cluster .....	281
Declaration of conformity for intelligent emergency call .....	284

Declaration of conformity for anti-theft alarm system .....	290
---	-----

# Declaration of Conformity

## Radio equipment electronic immobiliser (EWS)

Simplified EU Declaration of Conformity acc. Radio Equipment Directive 2014/53/EU after 12.06.2016 and during transition period



### Technical information

Frequency Band: 134 kHz  
(Transponder: TMS37145 / TypeDST80,  
TMS3705 Transponder Base Station IC)  
Output Power : 50 dBµV/m

### Manufacturer and Address

Manufacturer: BECOM Electronics GmbH  
Adress: Technikerstraße 1, A-7442 Hochstraß

### Austria

Hiermit erklärt BECOM Electronics GmbH, dass der Funkanlagentyp EWS4 der Richtlinie 2014/53/EU entspricht.  
Der vollständige Text der EU-Konformitätserklärung ist unter der folgenden Internetadresse verfügbar:  
<http://www.becom.at/de/download/>

### Belgium

Le soussigné, BECOM Electronics GmbH, déclare que l'équipement radioélectrique du type EWS4 est conforme à la directive 2014/53/UE.  
Le texte complet de la déclaration UE de conformité est disponible à l'adresse internet suivante:  
<http://www.becom.at/de/download/>

### Bulgaria

С настоящото BECOM Electronics GmbH декларира, че този тип радиосъоръжение EWS4 е в съответствие с Директива 2014/53/ЕС.  
Цялостният текст на ЕС декларацията за съответствие може да се намери на следния интернет адрес:  
<http://www.becom.at/de/download/>

## **Cyprus**

Με την παρούσα ο/η BECOM Electronics GmbH, δηλώνει ότι ο ραδιοεξοπλισμός EWS4 πληροί την οδηγία 2014/53/EE.

Το πλήρες κείμενο της δήλωσης συμμόρφωσης EE διατίθεται στην ακόλουθη ιστοσελίδα στο διαδίκτυο: <http://www.becom.at/de/download/>

## **Czech Republic**

Tímto BECOM Electronics GmbH prohlašuje, že typ rádiového zařízení EWS4 je v souladu se směrnicí 2014/53/EU.

Úplné znění EU prohlášení o shodě je k dispozici na této internetové adrese:

<http://www.becom.at/de/download/>

## **Germany**

Hiermit erklärt BECOM Electronics GmbH, dass der Funkanlagentyp EWS4 der Richtlinie 2014/53/EU entspricht.

Der vollständige Text der EU-Konformitätserklärung ist unter der folgenden Internetadresse verfügbar:

<http://www.becom.at/de/download/>

## **Denmark**

Hermed erklærer BECOM Electronics GmbH, at radioudstyrstypen EWS4 er i overensstemmelse med direktiv 2014/53/EU.

EU-overensstemmelseserklæringens fulde tekst kan findes på følgende internetadresse:

<http://www.becom.at/de/download/>

## **Estonia**

Käesolevaga deklareerib BECOM Electronics GmbH, et käesolev raadioseadme tüüp EWS4 vastab direktiivi 2014/53/EL nõuetele.

ELi vastavusdeklaratsiooni täielik tekst on kättesaadav järgmisel internetiaadressil:

<http://www.becom.at/de/download/>

## **Spain**

Por la presente, BECOM Electronics GmbH declara que el tipo de equipo radioeléctrico EWS4 es conforme con la Directiva 2014/53/UE.

El texto completo de la declaración UE de conformidad está disponible en la dirección Internet siguiente:

<http://www.becom.at/de/download/>

## **Finland**

BECOM Electronics GmbH vakuuttaa, että radiolaitetyyppi EWS4 on direktiivin 2014/53/EU mukainen.

EU-vaatimustenmukaisuusvakuutuksen täysimittainen teksti on saatavilla seuraavassa internetosoitteessa:  
<http://www.becom.at/de/download/>

## **France**

Le soussigné, BECOM Electronics GmbH, déclare que l'équipement radioélectrique du type EWS4 est conforme à la directive 2014/53/UE. Le texte complet de la déclaration UE de conformité est disponible à l'adresse internet suivante: <http://www.becom.at/de/download/>

## **United Kingdom**

Hereby, BECOM Electronics GmbH declares that the radio equipment type EWS4 is in compliance with Directive 2014/53/EU. The full text of the EU declaration of conformity is available at the following internet address:  
<http://www.becom.at/de/download/>

## **Greece**

Με την παρούσα ο/η BECOM Electronics GmbH, δηλώνει ότι ο ραδιοεξοπλισμός EWS4 πληροί την οδηγία 2014/53/ΕΕ. Το πλήρες κείμενο της δήλωσης συμμόρφωσης ΕΕ διατίθεται στην ακόλουθη ιστοσελίδα στο διαδίκτυο: <http://www.becom.at/de/download/>

## **Croatia**

BECOM Electronics GmbH ovime izjavljuje da je radijska oprema tipa EWS4 u skladu s Direktivom 2014/53/EU. Cjeloviti tekst EU izjave o sukladnosti dostupan je na sljedećoj internetskoj adresi:  
<http://www.becom.at/de/download/>

## **Hungary**

BECOM Electronics GmbH igazolja, hogy a EWS4 típusú rádióberendezés megfelel a 2014/53/EU irányelvnek. Az EU-megfelelőségi nyilatkozat teljes szövege elérhető a következő internetes címen:  
<http://www.becom.at/de/download/>



## **Ireland**

Hereby, BECOM Electronics GmbH declares that the radio equipment type EWS4 is in compliance with Directive 2014/53/EU.

The full text of the EU declaration of conformity is available at the following internet address:

<http://www.becom.at/de/download/>

## **Italy**

Il fabbricante, BECOM Electronics GmbH, dichiara che il tipo di apparecchiatura radio EWS4 è conforme alla direttiva 2014/53/UE.

Il testo completo della dichiarazione di conformità UE è disponibile al seguente indirizzo Internet:

<http://www.becom.at/de/download/>

## **Lithuania**

Aš, BECOM Electronics GmbH, patvirtinu, kad radijo įrenginių tipas EWS4 atitinka Direktyvą 2014/53/ES.

Visas ES atitikties deklaracijos teksto prieinamas šiuo interneto adresu:

<http://www.becom.at/de/download/>

## **Luxembourg**

Le soussigné, BECOM Electronics GmbH, déclare que l'équipement radioélectrique du type EWS4 est conforme à la directive 2014/53/UE.

Le texte complet de la déclaration UE de conformité est disponible à l'adresse internet suivante:

<http://www.becom.at/de/download/>

## **Latvia**

Ar šo BECOM Electronics GmbH deklarē, ka radioiekārta EWS4 atbilst Direktīvai 2014/53/ES. Pilns ES atbilstības deklarācijas teksts ir pieejams šādā interneta vietnē:

<http://www.becom.at/de/download/>

## **Malta**

B'dan, BECOM Electronics GmbH, niddikjara li dan it-tip ta' tagħmir tar-radju EWS4 huwa konformi mad-Direttiva 2014/53/UE.

It-test kollu tad-dikjarazzjoni ta' konformità tal-UE huwa disponibbli f'dan l-indirizz tal-Internet li ġej:

<http://www.becom.at/de/download/>

## **Netherlands**

Hierbij verklaar ik, BECOM Electronics GmbH, dat het type radioapparatuur EWS4 conform is met Richtlijn 2014/53/EU.

De volledige tekst van de EU-conformiteitsverklaring kan worden geraadpleegd op het volgende internetadres:  
<http://www.becom.at/de/download/>

## **Poland**

BECOM Electronics GmbH niniejszym oświadcza, że typ urządzenia radiowego EWS4 jest zgodny z dyrektywą 2014/53/EU.

Pełny tekst deklaracji zgodności UE jest dostępny pod następującym adresem internetowym:  
<http://www.becom.at/de/download/>

## **Portugal**

O(a) abaixo assinado(a) BECOM Electronics GmbH declara que o presente tipo de equipamento de rádio EWS4 está em conformidade com a Diretiva 2014/53/EU.

O texto integral da declaração de conformidade está disponível no seguinte endereço de Internet:  
<http://www.becom.at/de/download/>

## **Romania**

Prin prezenta, BECOM Electronics GmbH declară că tipul de echipamente radio EWS4 este în conformitate cu Directiva 2014/53/UE.

Textul integral al declarației UE de conformitate este disponibil la următoarea adresă internet:  
<http://www.becom.at/de/download/>

## **Sweden**

Härmed försäkras BECOM Electronics GmbH att denna typ av radioutrustning EWS4 överensstämmer med direktiv 2014/53/EU. Den fullständiga texten till EU-försäkran om överensstämmelse finns på följande webbadress:  
<http://www.becom.at/de/download/>

## **Slovenia**

BECOM Electronics GmbH potrjuje, da je tip radijske opreme EWS4 skladen z Direktivo 2014/53/EU.

Celotno besedilo izjave EU o skladnosti je na voljo na naslednjem spletnem naslovu:  
<http://www.becom.at/de/download/>

**Slovakia**

BECOM Electronics GmbH týmto vyhlasuje, že rádiové zariadenie typu EWS4 je v súlade so smernicou 2014/53/EÚ.

Úplné EÚ vyhlásenie o zhode je k dispozícii na tejto internetovej adrese:

<http://www.becom.at/de/download/>

## FCC Approval

### Ring aerial in the ignition switch



To verify the authorization of the ignition key, the electronic immobilizer exchanges information with the ignition key via the ring aerial.

This device complies with Part 15 of the FCC rules. Operation is subject to the following two conditions:

- (1) This device may not cause harmful interference, and
- (2) this device must accept any interference received, including interference that may cause undesired operation.



Any changes or modifications not expressly approved by the party responsible for compliance could void the user's authority to operate the equipment. ◀

## Approbation de la FCC

### Antenne annulaire présente dans le commutateur d'allumage



Pour vérifier l'autorisation de la clé de contact, le système d'immobilisation électronique échange des

informations avec la clé de contact via l'antenne annulaire.

Le présent dispositif est conforme à la partie 15 des règles de la FCC. Son utilisation est soumise aux deux conditions suivantes :

- (1) Le dispositif ne doit pas produire d'interférences nuisibles, et
- (2) le dispositif doit pouvoir accepter toutes les interférences extérieures, y compris celles qui pourraient provoquer une activation inopportune.



Toute modification qui n'aurait pas été approuvée expressément par l'organisme responsable de l'homologation peut annuler l'autorisation accordée à l'utilisateur pour utiliser le dispositif. ◀

# Declaration of Conformity

## Radio equipment Keyless Ride

Simplified EU Declaration of Conformity acc.  
Radio Equipment Directive 2014/53/EU after  
12.06.2016 and during transition period



### Technical information

Frequency band: 434,42 MHz

Maximum Transmission Power: 10 mW

### Manufacturer and Address

Manufacturer:

Huf Hülsbeck & Fürst GmbH & Co. KG,  
Steeger Str. 17, 42551 Velbert, Germany

### Bŭlgarski

С настоящото Huf Hülsbeck & Fürst GmbH & Co. KG декларира, че този тип радиосъоръжение HUF5750 е в съответствие с Директива 2014/53/ЕС.

Цялостният текст на ЕС декларацията за съответствие може да се намери на следния интернет адрес: <http://www.huf-group.com/eudoc/>

### Česky

Tímto Huf Hülsbeck & Fürst GmbH & Co. KG prohlašuje, že typ rádiového zařízení HUF5750 je v souladu se směrnici 2014/53/EU.

Úplné znění EU prohlášení o shodě je k dispozici na této internetové adrese: [http://www.huf-group.com/eudoc](http://www.huf-group.com/eudoc/)

### Dansk

Hermed erklærer Huf Hülsbeck & Fürst GmbH & Co. KG, at radioudstyrstypen HUF5750 er i overensstemmelse med direktiv 2014/53/EU. EU-overensstemmelseserklæringens fulde tekst kan findes på følgende internetadresse: [http://www.huf-group.com/eudoc](http://www.huf-group.com/eudoc/)

## **Deutsch**

Hiermit erklärt Huf Hülsbeck & Fürst GmbH & Co. KG, dass der Funkanlagentyp HUF5750 der Richtlinie 2014/53/EU entspricht.

Der vollständige Text der EU-Konformitätserklärung ist unter der folgenden Internetadresse verfügbar: <http://www.huf-group.com/eudoc>

## **Eesti**

Käesolevaga deklareerib Huf Hülsbeck & Fürst GmbH & Co. KG, et käesolev raadioseadme tüüp HUF5750 vastab direktiivi 2014/53/EL nõuetele. ELi vastavusdeklaratsiooni täielik tekst on kättesaadav järgmisel internetiaadressil: <http://www.huf-group.com/eudoc>

## **English**

Hereby, Huf Hülsbeck & Fürst GmbH & Co. KG declares that the radio equipment type HUF5750 is in compliance with Directive 2014/53/EU. The full text of the EU declaration of conformity is available at the following internet address: <http://www.huf-group.com/eudoc>

## **Español**

Por la presente, Huf Hülsbeck & Fürst GmbH & Co. KG declara que el tipo de equipo radioeléctrico HUF5750 es conforme con la Directiva 2014/53/UE.

El texto completo de la declaración UE de conformidad está disponible en la dirección Internet siguiente: <http://www.huf-group.com/eudoc>

## **Français**

Le soussigné, Huf Hülsbeck & Fürst GmbH & Co. KG, déclare que l'équipement radioélectrique du type HUF5750 est conforme à la directive 2014/53/UE.

Le texte complet de la déclaration UE de conformité est disponible à l'adresse internet suivante: <http://www.huf-group.com/eudoc>

## **Hrvatski**

Huf Hülsbeck & Fürst GmbH & Co. KG ovime izjavljuje da je radijska oprema tipa HUF5750 u skladu s Direktivom 2014/53/EU.

Cjeloviti tekst EU izjave o sukladnosti dostupan je na sljedećoj internetskoj adresi: <http://www.huf-group.com/eudoc>

## **Íslenska**

Hér Hülsbeck & Fürst GmbH & Co. KG að radióbúnaður gerð HUF5750 tilskipunar 2014/53/EB samsvarandi.

The fullur texti af ESB-samræmisýfirlýsing er í boði á eftirfarandi veffang: <http://www.huf-group.com/eudoc>

## **Italiano**

Il fabbricante, Huf Hülsbeck & Fürst GmbH & Co. KG, dichiara che il tipo di apparecchiatura radio HUF5750 è conforme alla direttiva 2014/53/UE.

Il testo completo della dichiarazione di conformità UE è disponibile al seguente indirizzo Internet: <http://www.huf-group.com/eudoc>

## **Latviski**

Ar šo Huf Hülsbeck & Fürst GmbH & Co. KG deklarē, ka radioiekārta HUF5750 atbilst Direktīvai 2014/53/ES.

Pilns ES atbilstības deklarācijas teksts ir pieejams šādā interneta vietnē: <http://www.huf-group.com/eudoc>

## **Lietuvių**

Aš, Huf Hülsbeck & Fürst GmbH & Co. KG, patvirtinu, kad radijo įrenginių tipas HUF5750 atitinka Direktyvą 2014/53/ES.

Visas ES atitikties deklaracijos tekstas prieinamas šiuo interneto adresu: <http://www.huf-group.com/eudoc>

## **Magyar**

Huf Hülsbeck & Fürst GmbH & Co. KG igazolja, hogy a HUF5750 típusú rádióberendezés megfelel a 2014/53/EU irányelvnek.

Az EU-megfelelőségi nyilatkozat teljes szövege elérhető a következő internetes címen: <http://www.huf-group.com/eudoc>

## **Malti**

B'dan, Huf Hülsbeck & Fürst GmbH & Co. KG, niddikjara li dan it-tip ta' tagħmir tar-radju HUF5750 huwa konformi mad-Direttiva 2014/53/UE.

It-test kollu tad-dikjarazzjoni ta' konformità tal-UE huwa disponibbli f'dan l-indirizz tal-Internet li ġej: <http://www.huf-group.com/eudoc>



### **Nederlands**

Hierbij verklaar ik, Huf Hülsbeck & Fürst GmbH & Co. KG, dat het type radioapparatuur HUF5750 conform is met Richtlijn 2014/53/EU.

De volledige tekst van de EU-conformiteitsverklaring kan worden geraadpleegd op het volgende internetadres: <http://www.huf-group.com/eudoc>

### **Norsk**

Herved Huf Hülsbeck & Fürst GmbH & Co. KG at radioutstyrstype HUF5750 i direktiv 2014/53/EU tilsvarende.

Den fullstendige teksten i EU-erklæring er tilgjengelig på følgende internettadresse: <http://www.huf-group.com/eudoc>

### **Polski**

Huf Hülsbeck & Fürst GmbH & Co. KG niniejszym oświadcza, że typ urządzenia radiowego HUF5750 jest zgodny z dyrektywą 2014/53/UE. Pełny tekst deklaracji zgodności UE jest dostępny pod następującym adresem internetowym: <http://www.huf-group.com/eudoc>

### **Português**

O(a) abaixo assinado(a) Huf Hülsbeck & Fürst GmbH & Co. KG declara que o presente tipo de equipamento de rádio HUF5750 está em conformidade com a Diretiva 2014/53/UE. O texto integral da declaração de conformidade está disponível no seguinte endereço de Internet: <http://www.huf-group.com/eudoc>

### **Românesc**

Prin prezenta, Huf Hülsbeck & Fürst GmbH & Co. KG declară că tipul de echipamente radio HUF5750 este în conformitate cu Directiva 2014/53/UE.

Textul integral al declarației UE de conformitate este disponibil la următoarea adresă internet: <http://www.huf-group.com/eudoc>

### **Slovensko**

Huf Hülsbeck & Fürst GmbH & Co. KG potrjuje, da je tip radijske opreme HUF5750 skladen z Direktivo 2014/53/UE. Celotno besedilo izjave EU o skladnosti je na voljo na naslednjem spletnem naslovu: <http://www.huf-group.com/eudoc>

## **Slovensky**

Huf Hülsbeck & Fürst GmbH & Co. KG týmto vyhlasuje, že rádiové zariadenie typu HUF5750 je v súlade so smernicou 2014/53/EÚ.

Úplné EÚ vyhlásenie o zhode je k dispozícii na tejto internetovej adrese: <http://www.huf-group.com/eudoc>

## **Suomi**

Huf Hülsbeck & Fürst GmbH & Co. KG vakuuttaa, että radiolaitetyyppi HUF5750 on direktiivin 2014/53/EU mukainen.

EU-vaatimustenmukaisuusvakuutuksen täysimittainen teksti on saatavilla seuraavassa internetosoitteessa: <http://www.huf-group.com/eudoc>

## **Svenska**

Härmed försäkrar Huf Hülsbeck & Fürst GmbH & Co. KG att denna typ av radioutrustning HUF5750 överensstämmer med direktiv 2014/53/EU.

Den fullständiga texten till EU-försäkran om överensstämmelse finns på följande webbadress: <http://www.huf-group.com/eudoc>

## **Ελληνική**

Με την παρούσα ο/η Huf Hülsbeck & Fürst, δηλώνει ότι ο ραδιοεξοπλισμός HUF5750 πληροί την οδηγία 2014/53/ΕΕ.

Το πλήρες κείμενο της δήλωσης συμμόρφωσης ΕΕ διατίθεται στην ακόλουθη ιστοσελίδα στο διαδίκτυο: <http://www.huf-group.com/eudoc>

## Certifications

---

### BMW Keyless Ride ID Device



#### USA, Canada

Product name: BMW Keyless Ride ID Device  
FCC ID: YGOHUF5750  
IC: 4008C-HUF5750

#### Canada:

Operation is subject to the following two conditions:

- (1) This device may not cause harmful interference, and
- (2) this device must accept any interference received, including interference that may cause undesired operation.

#### USA:

This device complies with Part 15 of the FCC rules. Operation is subject to the following two conditions:

- (1) This device may not cause harmful interference, and
- (2) this device must accept any interference received, including interference that may cause undesired operation.



Any changes or modifications not expressly approved by the party responsible for compliance could void the user's authority to operate the equipment.

# Declaration Of Conformity

---

We declare under our responsibility that the product

## **BMW Keyless Ride ID Device (Model: HUF5750)**

complies with the appropriate essential requirements of the article 3 of the R&TIE and the other relevant provisions, when used for its intended purpose. Applied Standards:

1. Health and safety requirements contained in article 3 (1) a)
  - EN 60950-1:2006+A11:2009+A1:2010+A12:2011; Information technology equipment- Safety
2. Protection requirements with respect to electromagnetic compatibility article 3 (1) b)
  - EN 301 489-1 (V1.9.2, 09/2011), Electromagnetic compatibility and radio spectrum matters (ERM); Electromagnetic compatibility (EMC) standard for radio equipment and services; Part 1: Common technical requirements
  - EN 301 489-3 (V1.4.1, 08/2002) Electromagnetic compatibility and radio spectrum matters (ERM); Electromagnetic compatibility (EMC) standard for radio equipment and services; Part 3: Specific conditions for short range devices (SRD) operating on frequencies between 9 kHz and 40 GHz
3. Means of the efficient use of the radio frequency spectrum article 3 (2)
  - EN 300 220-1 & -2 (V2.4.1, 05/2012), electromagnetic compatibility and radio spectrum matters (ERM); Short range devices (SRD); Radio equipment to be used in the 25 MHz to 1000 MHz frequency range with power levels ranging up to 500 mW;  
Part 1: Technical characteristics and test methods.  
Part 2: Harmonized EN covering essential requirements under article 3.2 of the R&TIE directive

The product is labeled with the CE marking: **CE**

Velbert, October 15<sup>th</sup>, 2013

---

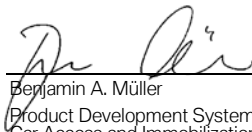

---

Benjamin A. Müller  
Product Development Systems  
Car Access and Immobilization – Electronics  
Huf Hüsbeck & Fürst GmbH & Co. KG  
Steeger Straße 17, D-42551 Velbert

# Declaration of Conformity

## Radio equipment tyre pressure control (RDC)

Simplified EU Declaration of Conformity acc. Radio Equipment Directive 2014/53/EU after 12.06.2016 and during transition period



### Technical information

Frequency Band: 433.895 - 433.945 MHz  
Output Power : <10 mW e.r.p.

### Manufacturer and Address

Manufacturer: Schrader Electronics Ltd.  
Adress: Technology Park, Antrim,  
N. Ireland BT41 1QS, United Kingdom

### Austria

Hiermit erklärt Schrader Electronics Ltd., dass der Funkanlagentyp BC5A4 der Richtlinie 2014/53/EU entspricht.  
Der vollständige Text der EU-Konformitätserklärung ist unter der folgenden Internetadresse verfügbar:  
[http://www.tpmseuroshop.com/documents/declaration\\_conformities](http://www.tpmseuroshop.com/documents/declaration_conformities)

### Belgium

Le soussigné, Schrader Electronics Ltd., déclare que l'équipement radioélectrique du type BC5A4 est conforme à la directive 2014/53/UE.  
Le texte complet de la déclaration UE de conformité est disponible à l'adresse internet suivante:  
[http://www.tpmseuroshop.com/documents/declaration\\_conformities](http://www.tpmseuroshop.com/documents/declaration_conformities)

## **Bulgaria**

С настоящото Schrader Electronics Ltd. декларира, че този тип радиосъоръжение BC5A4 е в съответствие с Директива 2014/53/ЕС.

Цялостният текст на ЕС декларацията за съответствие може да се намери на следния интернет адрес:

[http://www.tpmseuroshop.com/documents/declaration\\_conformities](http://www.tpmseuroshop.com/documents/declaration_conformities)

## **Cyprus**

Με την παρούσα ο/η Schrader Electronics Ltd., δηλώνει ότι ο ραδιοεξοπλισμός BC5A4 πληροί την οδηγία 2014/53/ΕΕ.

Το πλήρες κείμενο της δήλωσης συμμόρφωσης ΕΕ διατίθεται στην ακόλουθη ιστοσελίδα στο διαδίκτυο:

[http://www.tpmseuroshop.com/documents/declaration\\_conformities](http://www.tpmseuroshop.com/documents/declaration_conformities)

## **Czech Republic**

Tímto Schrader Electronics Ltd. prohlašuje, že typ rádiového zařízení BC5A4 je v souladu se směrnici 2014/53/EU.

Úplné znění EU prohlášení o shodě je k dispozici na této internetové adrese:  
[http://www.tpmseuroshop.com/documents/declaration\\_conformities](http://www.tpmseuroshop.com/documents/declaration_conformities)

## **Germany**

Hiermit erklärt Schrader Electronics Ltd., dass der Funkanlagentyp BC5A4 der Richtlinie 2014/53/EU entspricht.

Der vollständige Text der EU-Konformitätserklärung ist unter der folgenden Internetadresse verfügbar:

[http://www.tpmseuroshop.com/documents/declaration\\_conformities](http://www.tpmseuroshop.com/documents/declaration_conformities)

## **Denmark**

Hermed erklærer Schrader Electronics Ltd., at radioudstyrstypen BC5A4 er i overensstemmelse med direktiv 2014/53/EU.

EU-overensstemmelseserklæringens fulde tekst kan findes på følgende internetadresse:

[http://www.tpmseuroshop.com/documents/declaration\\_conformities](http://www.tpmseuroshop.com/documents/declaration_conformities)

**Estonia**

Käesolevaga deklareerib Schrader Electronics Ltd., et käesolev raadioseadme tüüp BC5A4 vastab direktiivi 2014/53/EL nõuetele.

ELi vastavusdeklaratsiooni täielik tekst on kättesaadav järgmisel internetiaadressil:

[http://www.tpmseuroshop.com/documents/declaration\\_conformities](http://www.tpmseuroshop.com/documents/declaration_conformities)

**Spain**

Por la presente, Schrader Electronics Ltd. declara que el tipo de equipo radioeléctrico BC5A4 es conforme con la Directiva 2014/53/UE.

El texto completo de la declaración UE de conformidad está disponible en la dirección Internet siguiente:

[http://www.tpmseuroshop.com/documents/declaration\\_conformities](http://www.tpmseuroshop.com/documents/declaration_conformities)

**Finland**

Schrader Electronics Ltd. vakuuttaa, että radiolaitetyyppi BC5A4 on direktiivin 2014/53/EU mukainen.

EU-vaatimusten mukaisuusvakuutuksen täysimittainen teksti on saatavilla seuraavassa internetosoitteessa:

[http://www.tpmseuroshop.com/documents/declaration\\_conformities](http://www.tpmseuroshop.com/documents/declaration_conformities)

**France**

Le soussigné, Schrader Electronics Ltd., déclare que l'équipement radioélectrique du type BC5A4 est conforme à la directive 2014/53/UE.

Le texte complet de la déclaration UE de conformité est disponible à l'adresse internet suivante:

[http://www.tpmseuroshop.com/documents/declaration\\_conformities](http://www.tpmseuroshop.com/documents/declaration_conformities)

## **United Kingdom**

Hereby, Schrader Electronics Ltd. declares that the radio equipment type BC5A4 is in compliance with Directive 2014/53/EU.

The full text of the EU declaration of conformity is available at the following internet address:

[http://www.tpmseuroshop.com/documents/declaration\\_conformities](http://www.tpmseuroshop.com/documents/declaration_conformities)

## **Greece**

Με την παρούσα ο/η Schrader Electronics Ltd., δηλώνει ότι ο ραδιοεξοπλισμός BC5A4 πληροί την οδηγία 2014/53/ΕΕ.

Το πλήρες κείμενο της δήλωσης συμμόρφωσης ΕΕ διατίθεται στην ακόλουθη ιστοσελίδα στο διαδίκτυο:

[http://www.tpmseuroshop.com/documents/declaration\\_conformities](http://www.tpmseuroshop.com/documents/declaration_conformities)

## **Croatia**

Schrader Electronics Ltd. ovime izjavljuje da je radijska oprema tipa BC5A4 u skladu s Direktivom 2014/53/EU.

Cjeloviti tekst EU izjave o sukladnosti dostupan je na sljedećoj internetskoj adresi:

[http://www.tpmseuroshop.com/documents/declaration\\_conformities](http://www.tpmseuroshop.com/documents/declaration_conformities)

## **Hungary**

Schrader Electronics Ltd. igazolja, hogy a BC5A4 típusú rádióberendezés megfelel a 2014/53/EU irányelvnek.

Az EU-megfelelőségi nyilatkozat teljes szövege elérhető a következő internetes címen:

[http://www.tpmseuroshop.com/documents/declaration\\_conformities](http://www.tpmseuroshop.com/documents/declaration_conformities)

## **Ireland**

Hereby, Schrader Electronics Ltd. declares that the radio equipment type BC5A4 is in compliance with Directive 2014/53/EU.

The full text of the EU declaration of conformity is available at the following internet address:

[http://www.tpmseuroshop.com/documents/declaration\\_conformities](http://www.tpmseuroshop.com/documents/declaration_conformities)



### **Italy**

Il fabbricante, Schrader Electronics Ltd., dichiara che il tipo di apparecchiatura radio BC5A4 è conforme alla direttiva 2014/53/UE.

Il testo completo della dichiarazione di conformità UE è disponibile al seguente indirizzo Internet:

[http://www.tpmseuroshop.com/documents/declaration\\_conformities](http://www.tpmseuroshop.com/documents/declaration_conformities)

### **Lithuania**

Aš, Schrader Electronics Ltd., patvirtinu, kad radijo įrenginių tipas BC5A4 atitinka Direktyvą 2014/53/ES.

Visas ES atitikties deklaracijos teksto prieinamas šiuo interneto adresu:

[http://www.tpmseuroshop.com/documents/declaration\\_conformities](http://www.tpmseuroshop.com/documents/declaration_conformities)

### **Luxembourg**

Le soussigné, Schrader Electronics Ltd., déclare que l'équipement radioélectrique du type BC5A4 est conforme à la directive 2014/53/UE.

Le texte complet de la déclaration UE de conformité est disponible à l'adresse internet suivante:

[http://www.tpmseuroshop.com/documents/declaration\\_conformities](http://www.tpmseuroshop.com/documents/declaration_conformities)

### **Latvia**

Ar šo Schrader Electronics Ltd. deklarē, ka radioiekārta BC5A4 atbilst Direktīvai 2014/53/ES. Pilns ES atbilstības deklarācijas teksts ir pieejams šādā interneta vietnē:

[http://www.tpmseuroshop.com/documents/declaration\\_conformities](http://www.tpmseuroshop.com/documents/declaration_conformities)

### **Malta**

B'dan, Schrader Electronics Ltd., niddikjara li dan it-tip ta' tagħmir tar-radju BC5A4 huwa konformi mad-Direttiva 2014/53/UE.

It-test kollu tad-dikjarazzjoni ta' konformità tal-UE huwa disponibbli f'dan l-indirizz tal-Internet li ġej: [http://www.tpmseuroshop.com/documents/declaration\\_conformities](http://www.tpmseuroshop.com/documents/declaration_conformities)

## **Netherlands**

Hierbij verklaar ik, Schrader Electronics Ltd., dat het type radioapparatuur BC5A4 conform is met Richtlijn 2014/53/EU.

De volledige tekst van de EU-conformiteitsverklaring kan worden geraadpleegd op het volgende internetadres:  
[http://www.tpmseuroshop.com/documents/declaration\\_conformities](http://www.tpmseuroshop.com/documents/declaration_conformities)

## **Poland**

Schrader Electronics Ltd. niniejszym oświadcza, że typ urządzenia radiowego BC5A4 jest zgodny z dyrektywą 2014/53/UE.

Pełny tekst deklaracji zgodności UE jest dostępny pod następującym adresem internetowym:  
[http://www.tpmseuroshop.com/documents/declaration\\_conformities](http://www.tpmseuroshop.com/documents/declaration_conformities)

## **Portugal**

O(a) abaixo assinado(a) Schrader Electronics Ltd. declara que o presente tipo de equipamento de rádio BC5A4 está em conformidade com a Diretiva 2014/53/UE.

O texto integral da declaração de conformidade está disponível no seguinte endereço de Internet:  
[http://www.tpmseuroshop.com/documents/declaration\\_conformities](http://www.tpmseuroshop.com/documents/declaration_conformities)

## **Romania**

Prin prezenta, Schrader Electronics Ltd. declară că tipul de echipamente radio BC5A4 este în conformitate cu Directiva 2014/53/UE.  
Textul integral al declarației UE de conformitate este disponibil la următoarea adresă internet:  
[http://www.tpmseuroshop.com/documents/declaration\\_conformities](http://www.tpmseuroshop.com/documents/declaration_conformities)

## **Sweden**

Härmed försäkrar Schrader Electronics Ltd. att denna typ av radioutrustning BC5A4 överensstämmer med direktiv 2014/53/EU.  
Den fullständiga texten till EU-försäkran om överensstämmelse finns på följande webbadress:  
[http://www.tpmseuroshop.com/documents/declaration\\_conformities](http://www.tpmseuroshop.com/documents/declaration_conformities)

## **Slovenia**

Schrader Electronics Ltd. potrjuje, da je tip radijske opreme BC5A4 skladen z Direktivo 2014/53/EU.

Celotno besedilo izjave EU o skladnosti je na voljo na naslednjem spletnem naslovu:

[http://www.tpmseuroshop.com/documents/declaration\\_conformities](http://www.tpmseuroshop.com/documents/declaration_conformities)

## **Slovakia**

Schrader Electronics Ltd. týmto vyhlasuje, že rádiové zariadenie typu BC5A4 je v súlade so smernicou 2014/53/EÚ.

Úplné EÚ vyhlásenie o zhode je k dispozícii na tejto internetovej adrese:

[http://www.tpmseuroshop.com/documents/declaration\\_conformities](http://www.tpmseuroshop.com/documents/declaration_conformities)

## Certification Tire Pressure Control (TPC)

---

FCC ID: MRXBC54MA4  
IC: 2546A-BC54MA4

FCC ID: MRXBC5A4  
IC: 2546A-BC5A4

This device complies with Part 15 of the FCC Rules and with Industry Canada license-exempt RSS standard(s).

Operation is subject to the following two conditions:

- (1) This device may not cause harmful interference, and
- (2) This device must accept any interference received, including interference that may cause undesired operation.

Le présent appareil est conforme aux CNR d'Industrie Canada applicables aux appareils radio exempts de licence. L'exploitation est autorisée aux deux conditions suivantes:

- (1) l'appareil ne doit pas produire de brouillage, et
- (2) l'utilisateur de l'appareil doit accepter tout brouillage radioélectrique subi, même si le brouillage est susceptible d'en compromettre le fonctionnement.

**WARNING:** Changes or modifications not expressly approved by the party responsible for compliance could void the user's authority to operate the equipment. The term "IC:" before the radio certification number only signifies that Industry Canada technical specifications were met.

# Declaration of Conformity

## Radio equipment TFT instrument cluster

Simplified EU Declaration of Conformity acc.  
Radio Equipment Directive 2014/53/EU after  
12.06.2016 and during transition period



### Technical information

BT operating frq. Range: 2402 – 2480 MHz  
BT version: 4.2 (no BTLE)  
BT output power: < 4 dBm  
WLAN operating frq. Range: 2412 – 2462 MHz  
WLAN standards: IEEE 802.11 b/g/n  
WLAN output power: < 20 dBm

### Manufacturer and Address

Manufacturer:  
Robert Bosch Car Multimedia GmbH  
Adress: Robert Bosch Str. 200,  
31139 Hildesheim, GERMANY

### Austria

Hiermit erklärt Robert Bosch Car Multimedia GmbH, dass der Funkanlagentyp ICC6.5in der Richtlinie 2014/53/EU entspricht.  
Der vollständige Text der EU-Konformitätserklärung ist unter der folgenden Internetadresse verfügbar: <http://cert.bosch-carmultimedia.net>

### Belgium

Le soussigné, Robert Bosch Car Multimedia GmbH, déclare que l'équipement radioélectrique du type ICC6.5in est conforme à la directive 2014/53/UE.  
Le texte complet de la déclaration UE de conformité est disponible à l'adresse internet suivante:<http://cert.bosch-carmultimedia.net>

## **Bulgaria**

С настоящото Robert Bosch Car Multimedia GmbH декларира, че този тип радиосъоръжение ICC6.5in е в съответствие с Директива 2014/53/ЕС. Цялостният текст на ЕС декларацията за съответствие може да се намери на следния интернет адрес: <http://cert.bosch-carmultimedia.net>

## **Cyprus**

Με την παρούσα ο/η Robert Bosch Car Multimedia GmbH, δηλώνει ότι ο ραδιοεξοπλισμός ICC6.5in πληροί την οδηγία 2014/53/ΕΕ. Το πλήρες κείμενο της δήλωσης συμμόρφωσης ΕΕ διατίθεται στην ακόλουθη ιστοσελίδα στο διαδίκτυο: <http://cert.bosch-carmultimedia.net>

## **Czech Republic**

Tímto Robert Bosch Car Multimedia GmbH prohlašuje, že typ rádiového zařízení ICC6.5in je v souladu se směrnici 2014/53/EU. Úplné znění EU prohlášení o shodě je k dispozici na této internetové adrese: <http://cert.bosch-carmultimedia.net>

## **Germany**

Hiermit erklärt Robert Bosch Car Multimedia GmbH, dass der Funkanlagentyp ICC6.5in der Richtlinie 2014/53/EU entspricht. Der vollständige Text der EU-Konformitätserklärung ist unter der folgenden Internetadresse verfügbar: <http://cert.bosch-carmultimedia.net/>

## **Denmark**

Hermed erklærer Robert Bosch Car Multimedia GmbH, at radioudstyrstypen ICC6.5in er i overensstemmelse med direktiv 2014/53/EU. EU-overensstemmelseserklæringens fulde tekst kan findes på følgende internetadresse: <http://cert.bosch-carmultimedia.net>

## **Estonia**

Käesolevaga deklareerib Robert Bosch Car Multimedia GmbH, et käesolev raadioseadme tüüp ICC6.5in vastab direktiivi 2014/53/EL nõuetele. ELi vastavusdeklaratsiooni täielik tekst on kättesaadav järgmisel internetiaadressil: <http://cert.bosch-carmultimedia.net>

## **Spain**

Por la presente, Robert Bosch Car Multimedia GmbH declara que el tipo de equipo radioeléctrico ICC6.5in es conforme con la Directiva 2014/53/UE.

El texto completo de la declaración UE de conformidad está disponible en la dirección Internet siguiente: <http://cert.bosch-carmultimedia.net>

## **Finland**

Robert Bosch Car Multimedia GmbH vakuuttaa, että radiolaitetyyppi ICC6.5in on direktiivin 2014/53/EU mukainen.

EU-vaatimustenmukaisuusvakuutuksen täysimittainen teksti on saatavilla seuraavassa internetosoitteessa: <http://cert.bosch-carmultimedia.net>

## **France**

Le soussigné, Robert Bosch Car Multimedia GmbH, déclare que l'équipement radioélectrique du type ICC6.5in est conforme à la directive 2014/53/UE.

Le texte complet de la déclaration UE de conformité est disponible à l'adresse internet suivante: <http://cert.bosch-carmultimedia.net>

## **United Kingdom**

Hereby, Robert Bosch Car Multimedia GmbH declares that the radio equipment type ICC6.5in is in compliance with Directive 2014/53/EU.

The full text of the EU declaration of conformity is available at the following internet address: <http://cert.bosch-carmultimedia.net>

## **Greece**

Με την παρούσα ο/η Robert Bosch Car Multimedia GmbH, δηλώνει ότι ο ραδιοεξοπλισμός ICC6.5in πληροί την οδηγία 2014/53/ΕΕ.

Το πλήρες κείμενο της δήλωσης συμμόρφωσης ΕΕ διατίθεται στην ακόλουθη ιστοσελίδα στο διαδίκτυο: <http://cert.bosch-carmultimedia.net>

## **Croatia**

Robert Bosch Car Multimedia GmbH ovime izjavljuje da je radijska oprema tipa ICC6.5in u skladu s Direktivom 2014/53/EU.

Cjeloviti tekst EU izjave o sukladnosti dostupan je na sljedećoj internetskoj adresi: <http://cert.bosch-carmultimedia.net>

## **Hungary**

Robert Bosch Car Multimedia GmbH igazolja, hogy a ICC6.5in típusú rádióberendezés megfelel a 2014/53/EU irányelvnek.

Az EU-megfelelőségi nyilatkozat teljes szövege elérhető a következő internetes címen: <http://cert.bosch-carmultimedia.net>

## **Ireland**

Hereby, Robert Bosch Car Multimedia GmbH declares that the radio equipment type ICC6.5in is in compliance with Directive 2014/53/EU. The full text of the EU declaration of conformity is available at the following internet address: <http://cert.bosch-carmultimedia.net>

## **Italy**

Il fabbricante, Robert Bosch Car Multimedia GmbH, dichiara che il tipo di apparecchiatura radio ICC6.5in è conforme alla direttiva 2014/53/UE.

Il testo completo della dichiarazione di conformità UE è disponibile al seguente indirizzo Internet: <http://cert.bosch-carmultimedia.net>

## **Lithuania**

Aš, Robert Bosch Car Multimedia GmbH, patvirtinu, kad radijo įrenginių tipas ICC6.5in atitinka Direktyvą 2014/53/ES.

Visas ES atitikties deklaracijos tekstas prieinamas šiuo interneto adresu: <http://cert.bosch-carmultimedia.net>

## **Luxembourg**

Le soussigné, Robert Bosch Car Multimedia GmbH, déclare que l'équipement radioélectrique du type ICC6.5in est conforme à la directive 2014/53/UE.

Le texte complet de la déclaration UE de conformité est disponible à l'adresse internet suivante: <http://cert.bosch-carmultimedia.net>



## **Latvia**

Ar šo Robert Bosch Car Multimedia GmbH deklarē, ka radioiekārta ICC6.5in atbilst Direktīvai 2014/53/ES.

Pilns ES atbilstības deklarācijas teksts ir pieejams šādā interneta vietnē: <http://cert.bosch-carmultimedia.net>

## **Malta**

B'dan, Robert Bosch Car Multimedia GmbH, niddikjara li dan it-tip ta' tagħmir tar-radju ICC6.5in huwa konformi mad-Direttiva 2014/53/UE.

It-test kollu tad-dikjarazzjoni ta' konformità tal-UE huwa disponibbli f'dan l-indirizz tal-Internet li ġej: <http://cert.bosch-carmultimedia.net>

## **Netherlands**

Hierbij verklaar ik, Robert Bosch Car Multimedia GmbH, dat het type radioapparatuur ICC6.5in conform is met Richtlijn 2014/53/EU.

De volledige tekst van de EU-conformiteitsverklaring kan worden geraadpleegd op het volgende internetadres: <http://cert.bosch-carmultimedia.net>

## **Poland**

Robert Bosch Car Multimedia GmbH niniejszym oświadcza, że typ urządzenia radiowego ICC6.5in jest zgodny z dyrektywą 2014/53/UE.

Pełny tekst deklaracji zgodności UE jest dostępny pod następującym adresem internetowym: <http://cert.bosch-carmultimedia.net>

## **Portugal**

O(a) abaixo assinado(a) Robert Bosch Car Multimedia GmbH declara que o presente tipo de equipamento de rádio ICC6.5in está em conformidade com a Diretiva 2014/53/UE.

O texto integral da declaração de conformidade está disponível no seguinte endereço de Internet: <http://cert.bosch-carmultimedia.net>

## **Romania**

Prin prezenta, Robert Bosch Car Multimedia GmbH declară că tipul de echipamente radio ICC6.5in este în conformitate cu Directiva 2014/53/UE.

Textul integral al declarației UE de conformitate este disponibil la următoarea adresă internet: <http://cert.bosch-carmultimedia.net>

## **Sweden**

Härmed försäkrar Robert Bosch Car Multimedia GmbH att denna typ av radioutrustning ICC6.5in överensstämmer med direktiv 2014/53/EU.

Den fullständiga texten till EU-försäkran om överensstämmelse finns på följande webbadress:  
<http://cert.bosch-carmultimedia.net>

## **Slovenia**

Robert Bosch Car Multimedia GmbH potrjuje, da je tip radijske opreme ICC6.5in skladen z Direktivo 2014/53/EU.

Celotno besedilo izjave EU o skladnosti je na voljo na naslednjem spletnem naslovu:  
<http://cert.bosch-carmultimedia.net>

## **Slovakia**

Robert Bosch Car Multimedia GmbH týmto vyhlasuje, že rádiové zariadenie typu ICC6.5in je v súlade so smernicou 2014/53/EU.

Úplné EÚ vyhlásenie o zhode je k dispozícii na tejto internetovej adrese: <http://cert.bosch-carmultimedia.net>

# Declaration of Conformity

## Radio equipment TFT instrument cluster

For all Countries without EU

### Technical information

BT operating frq. Range: 2402 – 2480 MHz

BT version: 4.2 (no BTLE)

BT output power: < 4 dBm

WLAN operating frq. Range: 2412 – 2462 MHz

WLAN standards: IEEE 802.11 b/g/n

WLAN output power: < 20 dBm

### Manufacturer and Address

Manufacturer:

Robert Bosch Car Multimedia GmbH

Adress: Robert Bosch Str. 200,

31139 Hildesheim, GERMANY

### Turkey

Robert Bosch Car Multimedia GmbH, ICC6.5in tipi telsiz sisteminin 2014/53/EU nolu yönetmeliğe uygun olduğunu beyan eder. AB Uygunluk Beyanı'nın tam metni, aşağıdaki internet adresinden görülebilir: <http://cert.bosch-carmultimedia.net>

### Brazil

Este equipamento opera em caráter secundário, isto é, não tem direito a proteção contra interferência prejudicial, mesmo de estações do mesmo tipo, e não pode causar interferência a sistemas operando em caráter primário.

## **Canada**

This device complies with Industry Canada's licence-exempt RSSs and part 15 of the FCC Rules. Operation is subject to the following two conditions:

(1) this device may not cause interference, and  
(2) this device must accept any interference, including interference that may cause undesired operation of the device.

Changes or modifications not expressly approved by the party responsible for compliance could void the user's authority to operate the equipment.

Le présent appareil est conforme aux CNR d'Industrie Canada applicables aux appareils radio exempts de licence. L'exploitation est autorisée aux deux conditions suivantes : (1) l'appareil ne doit pas produire de brouillage, et (2) l'appareil doit accepter tout brouillage radioélectrique subi, même si le brouillage est susceptible d'en compromettre le fonctionnement.

## **Mexico**

La operación de este equipo está sujeta a las siguientes dos condiciones:

(1) es posible que este equipo o dispositivo no cause interferencia perjudicial y  
(2) este equipo o dispositivo debe aceptar cualquier interferencia, incluyendo la que pueda causar su operación no deseada.

## **Taiwan, Republic of**

根據 NCC 低功率電波輻射性電機管理辦法 規定：  
第十二條

經型式認證合格之低功率射頻電機，非經許可，公司、商號或使用者均不得擅自變更頻率、加大功率或變更原設計之特性及功能。

### 第十四條

低功率射頻電機之使用不得影響飛航安全及干擾合法通信；經發現有干擾現象時，應立即停用，並改善至無干擾時方得繼續使用。

前項合法通信，

指依電信法規定作業之無線電通信。

低功率射頻電機須忍受合法通信或工業、科學及醫療用電波輻射性電機設備之干擾。

## Thailand

เครื่องโทรคมนาคมและอุปกรณ์นี้

มีความสอดคล้องตามข้อกำหนดของ กทช.

(This telecommunication equipments is in compliance with NTC requirements)

## United States (USA)

This device complies with Industry Canada's licence-exempt RSSs and part 15 of the FCC Rules. Operation is subject to the following two conditions:

(1) this device may not cause interference, and  
(2) this device must accept any interference, including interference that may cause undesired operation of the device.

Changes or modifications not expressly approved by the party responsible for compliance could void the user's authority to operate the equipment.

Le présent appareil est conforme aux CNR d'Industrie Canada applicables aux appareils radio exempts de licence. L'exploitation est autorisée aux deux conditions suivantes : (1) l'appareil ne doit pas produire de brouillage, et (2) l'appareil doit accepter tout brouillage radioélectrique subi, même si le brouillage est susceptible d'en compromettre le fonctionnement.

## Korea

적합성평가에 관한 고시

R-CMM-RBR-ICC651N

상호 : Robert Bosch Car Multimedia

GmbH 모델명 : ICC6.5in

기자재명칭 : 특정소출력 무선기기

(무선데이터통신시스템용 무선기기)

제조사 및 제조국가 : Robert Bosch Car  
Multimedia GmbH / 포르투갈

제조년월 : 제조년월로 표기

이 기기는 업무용 환경에서 사용할 목적으로 적합성평가를 받은 기기로서 가정용 환경에서 사용하는 경우 전파간섭의 우려가 있습니다.

# Declaration of Conformity

## Radio equipment intelligent emergency call

Simplified EU Declaration of Conformity acc.  
Radio Equipment Directive 2014/53/EU after  
12.06.2016 and during transition period



### Technical information

Antenna internal:

Frequency Band: 880 MHz - 915 MHz

Radiated Power [TRP]: < 22 dBm

Not accessible by user:

Frequency Band: 1710 MHz - 1785 MHz

Radiated Power [TRP]: < 26 dBm

Frequency Band: 1920 MHz - 1980 MHz

Radiated Power [TRP]: < 22 dBm

Frequency Band: 880 MHz - 915 MHz

Radiated Power [TRP]: < 23 dBm

### Manufacturer and Address

Manufacturer:

Robert Bosch Car Multimedia GmbH

Address: Robert Bosch Str. 200,  
31139 Hildesheim, GERMANY

### Austria

Hiermit erklärt Robert Bosch Car Multimedia GmbH, dass der Funkanlagentyp TPM E-CALL EU der Richtlinie 2014/53/EU entspricht.

Der vollständige Text der EU-Konformitätserklärung ist unter der folgenden Internetadresse verfügbar: <http://cert.bosch-carmultimedia.net/>

### Belgium

Le soussigné, Robert Bosch Car Multimedia GmbH, déclare que l'équipement radioélectrique du type TPM E-CALL EU est conforme à la directive 2014/53/UE.

Le texte complet de la déclaration UE de conformité est disponible à l'adresse internet suivante: <http://cert.bosch-carmultimedia.net>

## **Bulgaria**

С настоящото Robert Bosch Car Multimedia GmbH декларира, че този тип радиосъоръжение TPM E-CALL EU е в съответствие с Директива 2014/53/ЕС. Цялостният текст на ЕС декларацията за съответствие може да се намери на следния интернет адрес: <http://cert.bosch-carmultimedia.net/>

## **Cyprus**

Με την παρούσα ο/η Robert Bosch Car Multimedia GmbH, δηλώνει ότι ο ραδιοεξοπλισμός TPM E-CALL EU πληροί την οδηγία 2014/53/ΕΕ. Το πλήρες κείμενο της δήλωσης συμμόρφωσης ΕΕ διατίθεται στην ακόλουθη ιστοσελίδα στο διαδίκτυο: <http://cert.bosch-carmultimedia.net/>

## **Czech Republic**

Tímto Robert Bosch Car Multimedia GmbH prohlašuje, že typ rádiového zařízení TPM E-CALL EU je v souladu se směrnicí 2014/53/EU. Úplné znění EU prohlášení o shodě je k dispozici na této internetové adrese: <http://cert.bosch-carmultimedia.net>

## **Germany**

Hiermit erklärt Robert Bosch Car Multimedia GmbH, dass der Funkanlagentyp TPM E-CALL EU der Richtlinie 2014/53/EU entspricht. Der vollständige Text der EU-Konformitätserklärung ist unter der folgenden Internetadresse verfügbar: <http://cert.bosch-carmultimedia.net>

## **Denmark**

Hermed erklærer Robert Bosch Car Multimedia GmbH, at radioudstyrstypen TPM E-CALL EU er i overensstemmelse med direktiv 2014/53/EU. EU-overensstemmelseserklæringens fulde tekst kan findes på følgende internetadresse: <http://cert.bosch-carmultimedia.net>

## **Estonia**

Käesolevaga deklareerib Robert Bosch Car Multimedia GmbH, et käesolev raadioseadme tüüp TPM E-CALL EU vastab direktiivi 2014/53/EL nõuetele. ELi vastavusdeklaratsiooni täielik tekst on kättesaadav järgmisel internetiaadressil: <http://cert.bosch-carmultimedia.net>

## **Spain**

Por la presente, Robert Bosch Car Multimedia GmbH declara que el tipo de equipo radioeléctrico TPM E-CALL EU es conforme con la Directiva 2014/53/UE.

El texto completo de la declaración UE de conformidad está disponible en la dirección Internet siguiente: <http://cert.bosch-carmultimedia.net>

## **Finland**

Robert Bosch Car Multimedia GmbH vakuuttaa, että radiolaitetyyppi TPM E-CALL EU on direktiivin 2014/53/EU mukainen.

EU-vaatimustenmukaisuusvakuutuksen täysimittainen teksti on saatavilla seuraavassa internetosoitteessa: <http://cert.bosch-carmultimedia.net>

## **France**

Le soussigné, Robert Bosch Car Multimedia GmbH, déclare que l'équipement radioélectrique du type TPM E-CALL EU est conforme à la directive 2014/53/UE.

Le texte complet de la déclaration UE de conformité est disponible à l'adresse internet suivante: <http://cert.bosch-carmultimedia.net>

## **United Kingdom**

Hereby, Robert Bosch Car Multimedia GmbH declares that the radio equipment type TPM E-CALL EU is in compliance with Directive 2014/53/EU.

The full text of the EU declaration of conformity is available at the following internet address: <http://cert.bosch-carmultimedia.net>

## **Greece**

Με την παρούσα ο/η Robert Bosch Car Multimedia GmbH, δηλώνει ότι ο ραδιοεξοπλισμός TPM E-CALL EU πληροί την οδηγία 2014/53/ΕΕ.

Το πλήρες κείμενο της δήλωσης συμμόρφωσης ΕΕ διατίθεται στην ακόλουθη ιστοσελίδα στο διαδίκτυο: <http://cert.bosch-carmultimedia.net>



## **Croatia**

Robert Bosch Car Multimedia GmbH ovime izjavljuje da je radijska oprema tipa TPM E-CALL EU u skladu s Direktivom 2014/53/EU.

Cjeloviti tekst EU izjave o sukladnosti dostupan je na sljedećoj internetskoj adresi: <http://cert.bosch-carmultimedia.net>

## **Hungary**

Robert Bosch Car Multimedia GmbH igazolja, hogy a TPM E-CALL EU típusú rádióberendezés megfelel a 2014/53/EU irányelvnek.

Az EU-megfeleléségi nyilatkozat teljes szövege elérhető a következő internetes címen: <http://cert.bosch-carmultimedia.net>

## **Ireland**

Hereby, Robert Bosch Car Multimedia GmbH declares that the radio equipment type TPM E-CALL EU is in compliance with Directive 2014/53/EU.

The full text of the EU declaration of conformity is available at the following internet address: <http://cert.bosch-carmultimedia.net>

## **Italy**

Il fabbricante, Robert Bosch Car Multimedia GmbH, dichiara che il tipo di apparecchiatura radio TPM E-CALL EU è conforme alla direttiva 2014/53/UE.

Il testo completo della dichiarazione di conformità UE è disponibile al seguente indirizzo Internet: <http://cert.bosch-carmultimedia.net>

## **Lithuania**

Aš, Robert Bosch Car Multimedia GmbH, patvirtinu, kad radijo įrenginių tipas TPM E-CALL EU atitinka Direktyvą 2014/53/ES.

Visas ES atitikties deklaracijos tekstas prieinamas šiuo interneto adresu: <http://cert.bosch-carmultimedia.net>

## **Luxembourg**

Le soussigné, Robert Bosch Car Multimedia GmbH, déclare que l'équipement radioélectrique du type TPM E-CALL EU est conforme à la directive 2014/53/UE.

Le texte complet de la déclaration UE de conformité est disponible à l'adresse internet suivante: <http://cert.bosch-carmultimedia.net>

## **Latvia**

Ar šo Robert Bosch Car Multimedia GmbH deklarē, ka radioiekārta TPM E-CALL EU atbilst Direktīvai 2014/53/ES.

Pilns ES atbilstības deklarācijas teksts ir pieejams šādā interneta vietnē: <http://cert.bosch-carmultimedia.net>

## **Malta**

B'dan, Robert Bosch Car Multimedia GmbH, niddikjara li dan it-tip ta' tagħmir tar-radju TPM E-CALL EU huwa konformi mad-Direttiva 2014/53/UE.

It-test kollu tad-dikjarazzjoni ta' konformità tal-UE huwa disponibbli f'dan l-indirizz tal-Internet li ġej: <http://cert.bosch-carmultimedia.net>

## **Netherlands**

Hierbij verklaar ik, Robert Bosch Car Multimedia GmbH, dat het type radioapparatuur TPM E-CALL EU conform is met Richtlijn 2014/53/EU.

De volledige tekst van de EU-conformiteitsverklaring kan worden geraadpleegd op het volgende internetadres: <http://cert.bosch-carmultimedia.net>

## **Poland**

Robert Bosch Car Multimedia GmbH niniejszym oświadcza, że typ urządzenia radiowego TPM E-CALL EU jest zgodny z dyrektywą 2014/53/UE. Pełny tekst deklaracji zgodności UE jest dostępny pod następującym adresem internetowym: <http://cert.bosch-carmultimedia.net>

## **Portugal**

O(a) abaixo assinado(a) Robert Bosch Car Multimedia GmbH declara que o presente tipo de equipamento de rádio TPM E-CALL EU está em conformidade com a Diretiva 2014/53/UE. O texto integral da declaração de conformidade está disponível no seguinte endereço de Internet: <http://cert.bosch-carmultimedia.net>

## **Romania**

Prin prezenta, Robert Bosch Car Multimedia GmbH declară că tipul de echipamente radio TPM E-CALL EU este în conformitate cu Directiva 2014/53/UE.

Textul integral al declarației UE de conformitate este disponibil la următoarea adresă internet: <http://cert.bosch-carmultimedia.net>

## **Sweden**

Härmed försäkrar Robert Bosch Car Multimedia GmbH att denna typ av radioutrustning TPM E-CALL EU överensstämmer med direktiv 2014/53/EU.

Den fullständiga texten till EU-försäkran om överensstämmelse finns på följande webbadress: <http://cert.bosch-carmultimedia.net>

## **Slovenia**

Robert Bosch Car Multimedia GmbH potrjuje, da je tip radijske opreme TPM E-CALL EU skladen z Direktivo 2014/53/EU.

Celotno besedilo izjave EU o skladnosti je na voljo na naslednjem spletnem naslovu: <http://cert.bosch-carmultimedia.net>

## **Slovakia**

Robert Bosch Car Multimedia GmbH týmto vyhlasuje, že rádiové zariadenie typu TPM E-CALL EU je v súlade so smernicou 2014/53/EÚ.

Úplné EÚ vyhlásenie o zhode je k dispozícii na tejto internetovej adrese: <http://cert.bosch-carmultimedia.net>

# Declaration of Conformity

## Radio equipment anti-theft alarm (DWA)

Simplified EU Declaration of Conformity acc.  
Radio Equipment Directive 2014/53/EU after  
12.06.2016 and during transition period



### Technical information

Frequency Band: 433.05-434.79 MHz  
Output Power : 10 mW e.r.p.

### Manufacturer and Address

Manufacturer: Meta System S.p.A.  
Adress: Via Galimberti 5  
42124 Reggio Emilia - Italy –

### Austria

Hiermit erklärt Meta System S.p.A., dass der  
Funkanlagentyp TXBMWMMR der Richtlinie  
2014/53/EU entspricht.  
Der vollständige Text der EU-  
Konformitätserklärung ist unter der folgenden  
Internetadresse verfügbar:  
<https://docs.metasystem.it/>

### Belgium

Le soussigné, Meta System S.p.A., déclare que  
l'équipement radioélectrique du type TXBMWMMR  
est conforme à la directive 2014/53/UE.  
Le texte complet de la déclaration UE de  
conformité est disponible à l'adresse internet  
suivante:<https://docs.metasystem.it/>

### Bulgaria

С настоящото Meta System S.p.A. декларира, че  
този тип радиосъоръжение TXBMWMMR е в  
съответствие с Директива 2014/53/ЕС.  
Цялостният текст на ЕС декларацията за  
съответствие може да се намери на следния  
интернет адрес: <https://docs.metasystem.it/>

## **Cyprus**

Με την παρούσα ο/η Meta System S.p.A., δηλώνει ότι ο ραδιοεξοπλισμός TXBMWMMR πληροί την οδηγία 2014/53/EE.

Το πλήρες κείμενο της δήλωσης συμμόρφωσης EE διατίθεται στην ακόλουθη ιστοσελίδα στο διαδίκτυο: <https://docs.metasystem.it/>

## **Czech Republic**

Tímto Meta System S.p.A. prohlašuje, že typ rádiového zařízení TXBMWMMR je v souladu se směrnici 2014/53/EU.

Úplné znění EU prohlášení o shodě je k dispozici na této internetové adrese:

<https://docs.metasystem.it/>

## **Germany**

Hiermit erklärt Meta System S.p.A., dass der Funkanlagentyp TXBMWMMR der Richtlinie 2014/53/EU entspricht.

Der vollständige Text der EU-Konformitätserklärung ist unter der folgenden Internetadresse verfügbar:

<https://docs.metasystem.it/>

## **Denmark**

Hermed erklærer Meta System S.p.A., at radioudstyrstypen TXBMWMMR er i overensstemmelse med direktiv 2014/53/EU. EU-overensstemmelseserklæringens fulde tekst kan findes på følgende internetadresse:

<https://docs.metasystem.it/>

## **Estonia**

Käesolevaga deklareerib Meta System S.p.A., et käesolev raadioseadme tüüp TXBMWMMR vastab direktiivi 2014/53/EL nõuetele.

ELi vastavusdeklaratsiooni täielik tekst on kättesaadav järgmisel internetiaadressil:

<https://docs.metasystem.it/>

## **Spain**

Por la presente, Meta System S.p.A. declara que el tipo de equipo radioeléctrico TXBMWMMR es conforme con la Directiva 2014/53/UE.

El texto completo de la declaración UE de conformidad está disponible en la dirección Internet siguiente:

<https://docs.metasystem.it/>

## **Finland**

Meta System S.p.A. vakuuttaa, että radiolaitetyyppi TXBMWMMR on direktiivin 2014/53/EU mukainen.

EU-vaatimustenmukaisuusvakuutuksen täysimittainen teksti on saatavilla seuraavassa internetosoitteessa: <https://docs.metasystem.it/>

## **France**

Le soussigné, Meta System S.p.A., déclare que l'équipement radioélectrique du type TXBMWMMR est conforme à la directive 2014/53/UE.

Le texte complet de la déclaration UE de conformité est disponible à l'adresse internet suivante: <https://docs.metasystem.it/>

## **United Kingdom**

Hereby, Meta System S.p.A. declares that the radio equipment type TXBMWMMR is in compliance with Directive 2014/53/EU.

The full text of the EU declaration of conformity is available at the following internet address: <https://docs.metasystem.it/>

## **Greece**

Με την παρούσα ο/η Meta System S.p.A., δηλώνει ότι ο ραδιοεξοπλισμός TXBMWMMR πληροί την οδηγία 2014/53/ΕΕ.

Το πλήρες κείμενο της δήλωσης συμμόρφωσης ΕΕ διατίθεται στην ακόλουθη ιστοσελίδα στο διαδίκτυο: <https://docs.metasystem.it/>

## **Croatia**

Meta System S.p.A. ovime izjavljuje da je radijska oprema tipa TXBMWMMR u skladu s Direktivom 2014/53/EU.

Cjeloviti tekst EU izjave o sukladnosti dostupan je na sljedećoj internetskoj adresi: <https://docs.metasystem.it/>

## **Hungary**

Meta System S.p.A. igazolja, hogy a TXBMWMMR típusú rádióberendezés megfelel a 2014/53/EU irányelvnek.

Az EU-megfeleléségi nyilatkozat teljes szövege elérhető a következő internetes címen: <https://docs.metasystem.it/>

## **Ireland**

Hereby, Meta System S.p.A. declares that the radio equipment type TXBMWMR is in compliance with Directive 2014/53/EU. The full text of the EU declaration of conformity is available at the following internet address: <https://docs.metasystem.it/>

## **Italy**

Il fabbricante, Meta System S.p.A., dichiara che il tipo di apparecchiatura radio TXBMWMR è conforme alla direttiva 2014/53/UE. Il testo completo della dichiarazione di conformità UE è disponibile al seguente indirizzo Internet: <https://docs.metasystem.it/>

## **Lithuania**

Aš, Meta System S.p.A., patvirtinu, kad radijo įrenginių tipas TXBMWMR atitinka Direktyvą 2014/53/ES. Visas ES atitikties deklaracijos teksto prieinamas šiuo interneto adresu: <https://docs.metasystem.it/>

## **Luxembourg**

Le soussigné, Meta System S.p.A., déclare que l'équipement radioélectrique du type TXBMWMR est conforme à la directive 2014/53/UE. Le texte complet de la déclaration UE de conformité est disponible à l'adresse internet suivante: <https://docs.metasystem.it/>

## **Latvia**

Ar šo Meta System S.p.A. deklarē, ka radioiekārta TXBMWMR atbilst Direktīvai 2014/53/ES. Pilns ES atbilstības deklarācijas teksts ir pieejams šādā interneta vietnē: <https://docs.metasystem.it/>

## **Malta**

B'dan, Meta System S.p.A., niddikjara li dan it-tip ta' tagħmir tar-radju TXBMWMR huwa konformi mad-Direttiva 2014/53/UE. It-test kollu tad-dikjarazzjoni ta' konformità tal-UE huwa disponibbli f'dan l-indirizz tal-Internet li ġej: <https://docs.metasystem.it/>

## **Netherlands**

Hierbij verklaar ik, Meta System S.p.A., dat het type radioapparatuur TXBMWMR conform is met Richtlijn 2014/53/EU.

De volledige tekst van de EU-conformiteitsverklaring kan worden geraadpleegd op het volgende internetadres:  
<https://docs.metasystem.it/>

## **Poland**

Meta System S.p.A. niniejszym oświadcza, że typ urządzenia radiowego TXBMWMR jest zgodny z dyrektywą 2014/53/EU.

Pełny tekst deklaracji zgodności UE jest dostępny pod następującym adresem internetowym:  
<https://docs.metasystem.it/>

## **Portugal**

O(a) abaixo assinado(a) Meta System S.p.A. declara que o presente tipo de equipamento de rádio TXBMWMR está em conformidade com a Diretiva 2014/53/EU.

O texto integral da declaração de conformidade está disponível no seguinte endereço de Internet:  
<https://docs.metasystem.it/>

## **Romania**

Prin prezenta, Meta System S.p.A. declară că tipul de echipamente radio TXBMWMR este în conformitate cu Directiva 2014/53/UE.

Textul integral al declarației UE de conformitate este disponibil la următoarea adresă internet:  
<https://docs.metasystem.it/>

## **Sweden**

Härmed försäkras Meta System S.p.A. att denna typ av radioutrustning TXBMWMR överensstämmer med direktiv 2014/53/EU. Den fullständiga texten till EU-försäkran om överensstämmelse finns på följande webbadress:  
<https://docs.metasystem.it/>

## **Slovenia**

Meta System S.p.A. potrjuje, da je tip radijske opreme TXBMWMR skladen z Direktivo 2014/53/EU.

Celotno besedilo izjave EU o skladnosti je na voljo na naslednjem spletnem naslovu:  
<https://docs.metasystem.it/>



## **Slovakia**

Meta System S.p.A. týmto vyhlasuje, že rádiové zariadenie typu TXBMWMR je v súlade so smernicou 2014/53/EÚ.

Úplné EÚ vyhlásenie o zhode je k dispozícii na tejto internetovej adrese:

<https://docs.metasystem.it/>

- A**
- Abbreviations and symbols, 6
  - ABS
    - Engineering details, 144
    - Self-diagnosis, 130
    - Status indicators, 56
  - Accessories
    - general notes, 190
  - Adaptive Headlight, 157
    - Engineering details, 157
  - Air filter
    - Position on the motorcycle, 21
  - Ambient temperature
    - Outside temperature
      - warning, 45
    - Reading, 45
  - Anti-theft alarm
    - Indicator light, 27
    - operating, 90
    - Warning, 48
- B**
- Battery
    - charging battery when
      - connected, 181
    - charging the battery when
      - disconnected, 182
    - connecting to motorcycle, 183
    - disconnecting from
      - motorcycle, 182
    - Indicator light for vehicle
      - voltage, 46
    - installing, 183
    - Maintenance instructions, 181
    - Position on the vehicle, 22
    - removing, 183
    - Technical data, 222
  - Beam throw
    - adjusting, 121
  - Bluetooth, 108
    - Pairing, 109
  - Brake fluid
    - Checking fluid level, front, 166
    - Checking fluid level, rear, 167
    - Reservoir, front, 21
    - Reservoir, rear, 21
  - Brake pads
    - checking front, 164
    - checking rear, 165
    - Running in, 131
  - Brakes
    - ABS Pro, 147
    - ABS Pro depending on riding mode, 134
    - Adjusting handlebar levers, 122
    - Checking operation, 163
    - Dynamic Brake Control
      - depending on riding mode, 134
    - Safety instructions, 133
    - Technical data, 219
- C**
- Care
    - Chrome, 205
    - Paintwork preservation, 206
  - Cases, 191
  - Chain
    - Adjusting tension, 187
    - Checking tension, 187
    - Checking wear, 188
    - Lubricating, 186

Chassis and suspension  
Technical data, 218

Check control  
Dialogue, 36  
Display, 36

Checklist, 128

Clock  
adjusting, 107

Clutch, 122  
Adjusting play, 169  
Checking operation, 168  
Checking play, 168  
Technical data, 216

Coolant  
Checking fill level, 169  
Indicator light for  
overheating, 49

Cruise-control system, 23  
operating, 84

Currency, 8

## D

Damping, 80  
Adjuster, front, 19

Daytime riding lights  
automatic daytime riding  
light, 76  
manual daytime riding light, 75

Diagnostic connector  
disengaging, 185  
securing, 186

Dimensions  
Technical data, 224

Drop sensor  
Indicator light, 55

DTC, 23  
Engineering details, 147  
Indicator light, 57  
operating, 78  
Self-diagnosis, 130  
switching off, 78  
switching on, 78

DWA  
Technical data, 224

Dynamic Brake Control, 152  
Engineering details, 152

Dynamic engine brake  
control, 148

## E

Electrical system  
Technical data, 222

Emergency call  
Automatically in the event of a  
light fall, 72  
Automatically in the event of a  
severe fall, 73  
Language, 71  
manual, 71  
Notes, 13  
operating, 70

Emergency off switch (kill  
switch), 25, 26  
operating, 66

Engine  
Indicator light for engine  
control, 50  
Indicator light for engine  
electronics, 50  
Malfunction indicator lamp, 49  
parking, 65  
starting, 128  
Technical data, 215

Engine oil  
  Checking fill level, 162  
  Filler neck, 21  
  Fill-level indicator, 19, 21  
  Technical data, 215  
  topping up, 163

Equipment, 7

ESA  
  operating, 79

## F

Final drive  
  Technical data, 217

Frame  
  Technical data, 218

Front-wheel stand  
  installing, 160

Fuel  
  Fuel grade, 136  
  refuelling, 137  
  refuelling with Keyless  
  Ride, 138, 139  
  Technical data, 214

Fuel reserve  
  Range, 106  
  Warning, 59

Fuses  
  Position on the vehicle, 22  
  replacing, 184  
  Technical data, 222

## G

General views  
  Indicator and warning lights, 30  
  Instrument cluster, 27  
  Left multifunction switch, 23  
  left side of vehicle, 19  
  My vehicle, 112  
  Right multifunction switch, 25,  
  26  
  right side of vehicle, 21  
  TFT display, 31, 33  
  Underneath the seat, 22

## H

Hazard warning flashers  
  Control, 23, 25, 26  
  operating, 76

Headlight  
  Adjusting headlight beam  
  throw, 121  
  Adjustment for right-hand/left-  
  hand traffic, 120  
  Headlight beam throw and  
  spring preload, 120  
Headlight courtesy delay  
  feature, 73  
Heated handlebar grips  
  Control, 25, 26  
  operating, 92  
Hill Start Control, 87, 155  
  cannot be activated, 60  
  Engineering details, 155  
  Indicator and warning lights, 59,  
  60  
Hill Start Control Pro  
  adjusting, 89  
  Engineering details, 155  
  operating, 87  
Horn, 23

## I

### Ignition

- switching off, 65
- switching on, 64

### Immobiliser

- Reserve key, 65
- Spare key, 68

### Indicator lights, 27

- Overview, 30

### Instrument cluster

- Ambient-light brightness sensor, 27
- Overview, 27

## J

### Jump-starting, 180

## K

### Keyless Ride

- Electronic immobiliser EWS, 68
- Fuel filler cap, unlocking, 138, 139
- Locking the steering lock, 67
- Loss of the radio-operated key, 69
- Switching off ignition, 68

Switching on ignition, 67

Warning, 45, 46

Keys, 64, 66

## L

### Lighting

- Indicator light for faulty bulb, 47
- Replacing LED light sources, 179
- Technical data, 223

### Lights

- automatic daytime riding light, 76
- Control, 23
- Headlight courtesy delay feature, 73
- Headlight flasher, operating, 73
- High-beam headlight, operating, 73
- Low-beam headlight, 73
- manual daytime riding light, 75
- Operating auxiliary headlights, 74
- Parking lights, 74
- Side light, 73

Lowered suspension

Restrictions, 126

## M

### Maintenance

- Maintenance schedule, 233
- Maintenance confirmations, 234
- Maintenance intervals, 229

Malfunction indicator lamp, 49, 50

### Media

operating, 117

### Menu

Call up, 102

### Mirrors

adjusting, 120

Mobility services, 229

### Motorcycle

- care, 203
- cleaning, 203
- laying up, 207
- parking, 135
- securing, 140

Multi-Controller, 23

Multifunction display

Status indicators for racing, 35

- Multifunction switch
  - Overview, left side, 23
  - Overview, right side, 25, 26

**N**

- Navigation
  - operating, 115

**O**

- On-board computer, 93
- On-board voltage
  - Warning, 46
- Operating focus
  - change, 103

**P**

- Pairing, 109
- Parking, 135
- Parking light, 74
- Phone
  - operating, 117
- Power socket
  - Notes on use, 190
  - Position on the vehicle, 19
- Pre-Ride-Check, 129

- Pure Ride
  - Overview, 31

**R**

- RDC
  - Engineering details, 153
  - Warning indicators, 52
- Rear-wheel stand
  - installing, 161
- Refuelling, 137
  - Fuel grade, 136
  - with Keyless Ride, 138, 139
- Remote control
  - Replacing battery, 70
- Rev. counter, 27
  - Rev. counter, 106
- Rider info status line
  - adjusting, 104, 105
- Rider's Manual
  - Position on the vehicle, 22
- Riding mode, 82
  - Control, 25, 26
  - Engineering details, 150
  - Setting PRO riding mode, 83
- Running in, 131

**S**

- Safety instructions
  - for brakes, 133
  - for riding, 126
- Seat
  - installing, 94
  - Lock, 19
  - removing, 94
- Service, 228
  - Service history, 228
- Service-due indicator, 61
- Shift assistant, 132, 154
  - Engineering details, 154
  - Gear not taught, 60
  - Riding, 132
- Shift light, 89
  - adjusting, 89
  - switching on/off, 89
- Shifting gear
  - Recommendation to upshift, 107
  - Shift light, 133
- Spark plugs
  - Technical data, 223

- Speed Limit Info
  - Switching on or off, 105
- Speedometer, 27
- Spring preload, 81
  - Adjuster, front, 19
  - Adjuster, rear, 19, 21
- Starting, 128
  - Control, 25, 26
- Steering lock
  - Locking, 64

## T

- Technical data
  - Anti-theft alarm, 224
  - Battery, 222
  - Brakes, 219
  - Clutch, 216
  - Dimensions, 224
  - Electrical system, 222
  - Engine, 215
  - Engine oil, 215
  - Final drive, 217
  - Frame, 218
  - Fuel, 214
  - Fuses, 222

- General notes, 7
- Lighting, 223
- Performance figures, 226
- Spark plugs, 223
- Standards, 7
- Suspension, 218
- Transmission, 217
- Weights, 225
- Wheels and tyres, 220
- TFT display, 27
  - Control, 23
  - operating, 102, 103, 104
  - Overview, 31, 33
  - Selecting display, 99
- Toolkit
  - Contents, 160
  - Position on the vehicle, 22
- Topcase
  - operating, 193
- Torques, 212
- Traction control
  - DTC, 147
- Transmission
  - Technical data, 217
- Troubleshooting chart, 210

- Turn indicators
  - Control, 23
  - Control, right, 25, 26
  - operating, 77
- Type plate
  - Position on the vehicle, 21
- Tyre pressure monitoring RDC
  - Reading, 51
- Tyres
  - Checking tread depth, 171
  - Checking tyre pressure, 170
  - Pressures, 221
  - Running in, 132
  - Technical data, 220
  - Tyre pressures table, 19

## V

- Value
  - Display, 36
- Vehicle
  - restoring to use, 207
- Vehicle Identification Number
  - Position on the vehicle, 21

**W**

## Warning indicator lights

ABS, 56

Anti-theft alarm, 48

Bulb faulty, 47

Coolant temperature, 49

Drop sensor, 55

DTC, 57

Engine control unit, 50

Engine electronics, 50

Fuel reserve, 59

Gear not taught, 60

Hill Start Control, 59, 60

Malfunction indicator lamp, 49

Mode of presentation, 36

My vehicle, 112

On-board voltage, 46

Outside temperature  
warning, 45

RDC, 52

## Warning lights, 27

Overview, 30

## Warnings, overview, 38

## Weights

Payload table, 19

Technical data, 225

## Wheels

Change of size, 171

Checking rims, 171

Installing front wheel, 173

Installing rear wheel, 177

Removing front wheel, 172

Removing rear wheel, 175

Technical data, 220

## Windscreen

Adjuster, 21

adjusting, 121





Details described or illustrated in this booklet may differ from the vehicle's actual specification as purchased, the accessories fitted or the national-market specification. No claims will be entertained as a result of such discrepancies.

Dimensions, weights, fuel consumption and performance data are quoted to the customary tolerances.

The right to modify designs, equipment and accessories is reserved.

Errors and omissions excepted.

© 2019 Bayerische Motoren Werke Aktiengesellschaft  
80788 Munich, Germany  
Not to be reproduced by any means whatsoever, wholly or in part, without the written permission of BMW Motorrad, After Sales.

Original rider's manual, printed in Germany.

