

FUJIFILM

DIGITAL CAMERA

FinePix F50 fd

OWNER'S MANUAL

This manual will show you how to use your FUJIFILM DIGITAL CAMERA FinePix F50fd correctly. Please follow the instructions carefully.

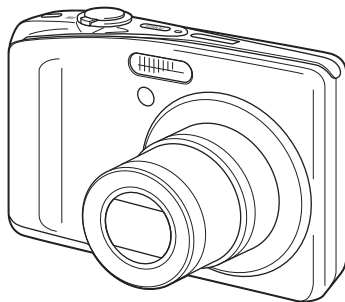

digital
Tools for the imagination.

Exif Print

xD
xD-Picture Card™

SD
HG

PictBridge



Getting Ready

Using the Camera

Advanced Features • Photography

• Playback

• Movie

Settings

Camera Connection

Software
Installation

Appendices

Troubleshooting

BL00629-200(1)



Warning

To prevent fire or shock hazard, do not expose the unit to rain or moisture.

For customers in the U.S.A.

*Tested To Comply
With FCC Standards
FOR HOME OR OFFICE USE*

FCC Statement

This device complies with Part 15 of the FCC Rules. Operation is subject to the following two conditions: (1) This device may not cause harmful interference, and (2) this device must accept any interference received, including interference that may cause undesired operation.

CAUTION

This equipment has been tested and found to comply with the limits for a Class B digital device, pursuant to Part 15 of the FCC Rules. These limits are designed to provide reasonable protection against harmful interference in a residential installation. This equipment generates, uses, and can radiate radio frequency energy and, if not installed and used in accordance with the instructions, may cause harmful interference to radio communications. However, there is no guarantee that interference will not occur in a particular installation. If this equipment does cause harmful interference to radio or television reception, which can be determined by turning the equipment off and on, the user is encouraged to try to correct the interference by one or more of the following measures:

- Reorient or relocate the receiving antenna.
- Increase the separation between the equipment and receiver.
- Connect the equipment into an outlet on a circuit different from that to which the receiver is connected.
- Consult the dealer or an experienced radio/TV technician for help.

You are cautioned that any changes or modifications not expressly approved in this manual could void the user's authority to operate the equipment.

Notes on the Grant:

To comply with Part 15 of the FCC Rules, this product must be used with a Fujifilm-specified ferrite-core A/V cable, USB cable, and DC supply cord.

For customers in Canada

CAUTION

This Class B digital apparatus complies with Canadian ICES-003.

Please read the Safety Notes (separate note "Notes and Cautions") and make sure you understand them before using the camera.

**Perchlorate Material-special handling may apply,
See <http://www.dtscc.gov/hazardouswaste/perchlorate>.**

NOTICE

BEFORE OPENING THE CD-ROM PROVIDED BY FUJIFILM CORPORATION, PLEASE READ THIS END USER LICENSE AGREEMENT CAREFULLY. ONLY IF YOU AGREE WITH THIS AGREEMENT, SHOULD YOU USE THE SOFTWARE RECORDED ON THE CD-ROM. BY OPENING THE PACKAGE, YOU ACCEPT AND AGREE TO BE BOUND BY THIS AGREEMENT.

End User License Agreement

This End User License Agreement ("Agreement") is an agreement between FUJIFILM Corporation ("FUJIFILM") and you, which sets forth the terms and conditions of the license granted for you to use the software provided by FUJIFILM.

The CD-ROM contains third party software. In case a separate agreement is provided by a third party supplier for its software, the provisions of such separate agreement shall apply to the use of such third party software, prevailing over those of this Agreement.

1. Definitions.

- (a) "Media" means the CD-ROM titled "Software for FinePix" - which is provided to you together with this Agreement.
- (b) "Software" means the software which is recorded on Media.
- (c) "Documentation" means the operation manuals of Software and other related written materials which are provided to you together with Media.
- (d) "Product" means Media (including Software) and Documentation collectively.

2. Use of Software.

FUJIFILM grants to you a nontransferable, nonexclusive license:

- (a) to install one copy of Software onto one computer in binary machine executable form;
- (b) to use Software on the computer onto which Software is installed; and
- (c) to make one backup copy of Software.

3. Restrictions.

- 3.1 You shall not distribute, rent, lease or otherwise transfer all or any part of Software, Media or Documentation to any third party without FUJIFILM's prior written consent. You also shall not sublicense, assign or otherwise transfer all or any part of the rights granted to you by FUJIFILM under this Agreement without FUJIFILM's prior written consent.
- 3.2 Except as expressly granted by FUJIFILM hereunder, you shall not copy or reproduce all or any part of Software or Documentation.
- 3.3 You shall not modify, adapt or translate Software or Documentation. You also shall not alter or remove copyright and other proprietary notices that appear on or in Software or Documentation.
- 3.4 You shall not, or shall not have any third party, reverse-engineer, decompile, or disassemble Software.

4. Ownership.

All copyrights and other proprietary rights to Software and Documentation are owned and retained by FUJIFILM or the third party suppliers as indicated on or in Software or Documentation. Nothing contained herein shall be construed, expressly or implicitly, as transferring or granting any right, license, or title to you other than those explicitly granted under this Agreement.

5. Limited Warranty.

FUJIFILM warrants to you that Media is free from any defect in material and workmanship under normal use for ninety (90) days from the date of your receipt of Media. Should Media not meet the foregoing warranty, FUJIFILM shall replace such defective Media with other Media bearing no defect. FUJIFILM's entire liability and your sole and exclusive remedy with regard to any defect in Media shall be expressly limited to such FUJIFILM's replacement of Media as provided herein

6. DISCLAIMER OF WARRANTY.

EXCEPT AS PROVIDED IN SECTION 5 HEREIN, FUJIFILM PROVIDES PRODUCT "AS IS" AND WITHOUT WARRANTIES OF ANY KIND, EXPRESS OR IMPLIED. FUJIFILM SHALL MAKE NO WARRANTY, EXPRESS, IMPLIED OR STATUTORY, AS TO ANY OTHER MATTERS, INCLUDING, BUT NOT LIMITED TO NON-INFRINGEMENT OF ANY COPYRIGHT, PATENT, TRADE SECRET, OR ANY OTHER PROPRIETARY RIGHTS OF ANY THIRD PARTY, MERCHANTABILITY, OR FITNESS FOR ANY PARTICULAR PURPOSE.

7. LIMITATION OF LIABILITY.

IN NO EVENT SHALL FUJIFILM HAVE ANY LIABILITY FOR ANY GENERAL, SPECIAL, DIRECT, INDIRECT, CONSEQUENTIAL, INCIDENTAL, OR OTHER DAMAGES (INCLUDING DAMAGES FOR LOSS OF PROFITS OR LOST SAVINGS) INCURRED FROM THE USE OF OR INABILITY TO USE PRODUCT EVEN IF FUJIFILM HAS BEEN ADVISED OF THE POSSIBILITY OF SUCH DAMAGES.

8. No export.

You acknowledge that neither Software nor any part thereof, will be transferred, or exported to any country or used in any manner in violation of any export control laws and regulations to which Software is subject.

9. Termination.

In case you breach any of the terms and conditions hereof, FUJIFILM may immediately terminate this Agreement without any notice.

10. Term.

This Agreement is effective until the date when you cease to use Software, unless earlier terminated in accordance with Section 9 hereof.

11. Obligation upon termination.

Upon termination or expiration of this Agreement, you shall, at your own responsibility and expense, delete or destroy immediately all Software (including its copies), Media and Documentation.

12. Governing Law.

This Agreement shall be governed by and construed in accordance with laws of Japan.

EC Declaration of Conformity

We

Name: FUJIFILM Europe GmbH
Address: Heesenstrasse 31
40549 Dusseldorf, Germany

declare that the product

Product Name: FUJIFILM DIGITAL CAMERA FinePix F50fd
Manufacturer's Name: FUJIFILM Corporation
Manufacturer's Address: 7-3, AKASAKA 9-CHOME, MINATO-KU, TOKYO 107-0052, JAPAN

conforms to the following Standards:

Safety: EN60065: 2002
EMC: EN55022: 2006 Classe B
EN55024: 1998 + A1: 2001 + A2: 2003
EN61000-3-2: 2000 + A2: 2003

following the provision of the EMC Directive (2004/108/EC) and Low Voltage Directive (2006/95/EC).



Dusseldorf, Germany

August 1, 2007

Place

Date

Signature/Managing Director



This product comes with batteries. When these are empty, you shouldn't throw them away but deliver them as domestic chemical refuse.

Disposal of Electric and Electronic Equipment in Private Households

Disposal of used Electrical & Electronic Equipment (Applicable in the European Union and other European countries with separate collection systems)



This symbol on the product, or in the manual and in the warranty, and/or on its packaging indicates that this product shall not be treated as household waste.

Instead it should be taken to an applicable collection point for the recycling of electrical and electronic equipment.

By ensuring this product is disposed of correctly, you will help prevent potential negative consequences to the environment and human health, which could otherwise be caused by inappropriate waste handling of this product.

If your equipment contains easy removable batteries or accumulators please dispose these separately according to your local requirements.

The recycling of materials will help to conserve natural resources. For more detailed information about recycling of this product, please contact your local city office, your household waste disposal service or the shop where you have purchased the product.

In Countries outside the EU:

If you wish to discard this product, please contact your local authorities and ask for the correct way of disposal.

Contents

Warning.....	2
IMPORTANT	3
EC Declaration of Conformity.....	4
Disposal of Electric and Electronic Equipment in Private Households	5
Contents.....	6
About this Manual	9
Accessories Included	10
Camera Parts and Features.....	11
Example of LCD Monitor Text Display	12

Getting Ready

Charging the Battery	13
Loading the Battery	15
Loading the Memory Card.....	17
Turning On and Off	20
Setting the language, date, and time	21
Correcting the Date and Time.....	24
Selecting the Language	25











Using the Camera

Taking Pictures (AUTO AUTO Mode).....	26
Using Intelligent Face Detection/ Red-eye Removal when taking pictures... 29	
Using the Dual Image Stabilizer function when taking pictures	31
Taking pictures with the focus and exposure locked	32
AF-assist illuminator.....	34
Adjusting the shot composition	35
Viewing the Images.....	36

Erasing the Images/Movies	42
---------------------------------	----











Advanced Features — Photography

Using the Photography Functions —	
Procedure of Setting	45
Setting the Shooting Mode	48
AUTO AUTO	48
📷 NATURAL LIGHT	48
📷🔌 NATURAL & 🔌	49
SP1/SP2 SCENE POSITION.....	49
[👤 PORTRAIT]	51
[👤 PORTRAIT ENHANCER]	51
[🏞️ LANDSCAPE].....	51
[🏃 SPORT].....	51
[🌃 NIGHT]	
([🌃📷 LONG EXPOSURE])	51
[🎆 FIREWORKS].....	51
[🌅 SUNSET]	51
[❄️ SNOW].....	51
[🏖️ BEACH].....	51
[🏊 UNDERWATER].....	52
[🏛️ MUSEUM].....	52
[🎉 PARTY]	52
[🌸 FLOWER].....	52
[TEXT].....	52
A/S APERTURE PRIORITY AE/ SHUTTER PRIORITY AE.....	54
📷 MANUAL.....	58
Adjusting the Image Brightness	
(📷 Exposure Compensation)	59
📷 Macro (Close-up).....	61

 Setting the Flash (Intelligent Flash).....	62
 Self-Timer	65
Using [F -MODE MENU] (Photography)/	
[SHOOTING MENU]	68
Setting the [F -MODE MENU]	
(Photography)	68
Setting the [SHOOTING MENU]	68
[F -MODE MENU] (Photography)	71
Setting the camera performance	
( POWER MANAGEMENT)	71
Changing the sensitivity setting	
( ISO)	72
Changing the quality setting	
( QUALITY)	73
Changing the FinePix COLOR setting	
( FinePix COLOR)	74
[SHOOTING MENU]	75
Selecting light metering method	
( PHOTOMETRY)	75
Adjusting color balance	
( WHITE BALANCE)	76
Taking pictures continuously	
( CONTINUOUS).....	77
Specifying focusing mode	
( AF MODE).....	80

Advanced Features — Playback

Using [F -MODE MENU] (Playback)/	
[PLAYBACK MENU]	82
Setting the [F -MODE MENU]	
(Playback)	82

Setting the [PLAYBACK MENU]	82
[F -MODE MENU] (Playback)	83
Sending and receiving images	
( IR COMMUNICATION)	83
Transmitting and saving blog images	
( TRIMMING FOR BLOG)	86
Setting automatic playback	
( SLIDE SHOW)	88
DPOF set frame	
( PRINT ORDER (DPOF))	88
[PLAYBACK MENU].....	92
Correcting red-eye effect in images	
( RED EYE REMOVAL).....	92
Rotating the images	
( IMAGE ROTATE).....	93
Protecting the images	
( PROTECT).....	94
Copying the images	
( COPY COPY)	95
Adding voice memos to the images	
( VOICE MEMO).....	97
Trimming the images	
( TRIMMING).....	100

Advanced Features — Movie

 Recording Movies	102
Changing movie size	104
 Playing Back Movies.....	105

Settings

[SET] SET-UP.....	107
Using the [SET-UP] menu.....	107
[SET-UP] menu option.....	108

Camera Connection

Connecting to a TV	116
Connecting Camera Directly to Printer — PictBridge Function	117

Software Installation

Installation on a Windows PC	121
Installation on a Mac OS X	123
Connecting to a PC	126
Using FinePixViewer.....	129

Appendices

System Expansion Option.....	131
Accessories Guide	132
Using Your Camera Correctly	134
Notes on the xD-Picture Card™ , the SD Memory Card and the Internal Memory	135
Warning Displays	136

Troubleshooting

Troubleshooting	141
-----------------------	-----

Specifications	149
Explanation of Terms	156
FUJIFILM Digital Camera Worldwide Network	157

Usable Memory Cards

You can use the **xD-Picture Card**, the SD Memory Card and the SDHC Memory Card with the FinePix F50fd. In this Owner's Manual, these cards are expressed as "Memory Card" and "SD Memory Card".

About this Manual

■ About marks

! **CAUTION:** This mark denotes issues that may affect the camera's operation.

✓ **CHECK:** This mark denotes points to notice in the camera's operation.

📄 **MEMO:** This mark denotes additional topics that complement the basic operating procedures.

■ Usable Memory Cards

You can use the **xD-Picture Card**, the SD Memory Card and the SDHC Memory Card with the FinePix F50fd. In this Owner's Manual, these cards are expressed as "Memory Card" and "SD Memory Card".

■ About illustration

Up, down, left, and right are indicated by black triangles in the Owner's Manual. Up or down is shown as ▲ or ▼, and left or right is shown as ◀ or ▶.

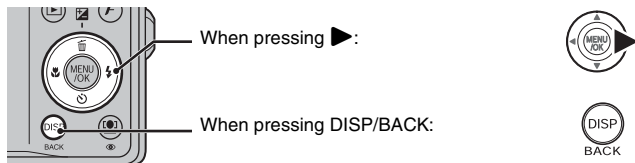

■ About cables

The cables used for FinePix F50fd are following:

- A/V cable for FinePix F50fd
- USB cable for FinePix F50fd

In this manual, these cables are expressed as "A/V cable" and "USB cable".

■ Note

In this manual, the menu names and messages displayed on the LCD monitor of the camera or PC screen appear in square brackets ([]).

Accessories Included

- Rechargeable Battery NP-50 (1)

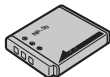

- Strap (1)



- Battery Charger BC-50 (1 set)

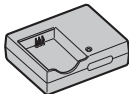

- A/V cable (1)

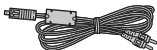

- USB cable (1)

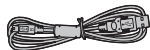

- CD-ROM (1)
Software for FinePix



- Owner's Manual (this manual) (1)

- Notes and Cautions (1)



Attaching the strap

Attach the strap as shown in 1 and 2.

When attaching the strap, move the fastener to adjust the length and slightly away from the end of the strap, as shown in figure 1.

1

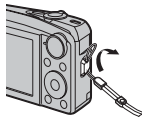



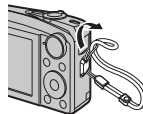



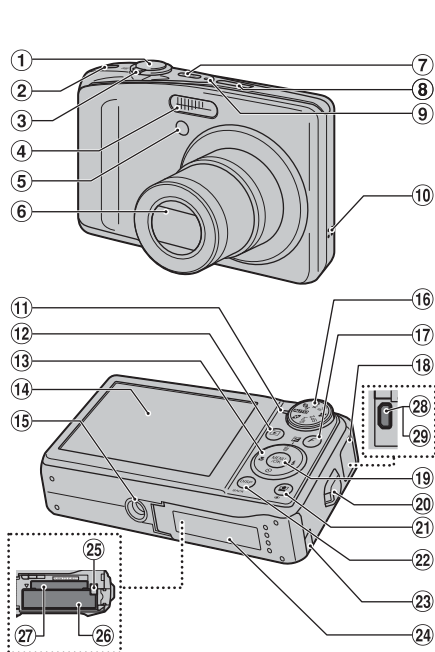

2



Camera Parts and Features

- Refer to the pages in parentheses for information on using the camera parts or features.



- 1 Shutter button
- 2 Dual IS button (p.31, 112)
- 3 Zoom switch (p.27, 37)
- 4 Flash (p.62)
- 5 AF-assist illuminator (p.34, 108)/Self-timer lamp (p.66)
- 6 Lens (lens cover)
- 7 POWER button
- 8 Infrared port (p.84)
- 9 Microphone
- 10 Speaker
- 11 Indicator lamp (p.29)
- 12  (Playback) button
- 13 4-direction (   ) button
- 14 LCD monitor
- 15 Tripod mount
- 16 Mode dial
- 17 Photo mode (*F*) button (p.68, 82)
- 18 Terminal cover
- 19 MENU/OK button
- 20 Strap mount
- 21  Intelligent Face Detection (p.29, 41)/
 Red-eye removal button (p.29)
- 22 DISP (Display)/BACK button (p.35, 36)
- 23 DC coupler cable cover
- 24 Battery cover (p.15)
- 25 Battery release catch (p.15)
- 26 Battery compartment (p.15)
- 27 Memory Card slot (p.17)
- 28 A/V OUT (Audio/Visual output) socket (p.116)
- 29 USB socket

Example of LCD Monitor Text Display

■ Photography mode

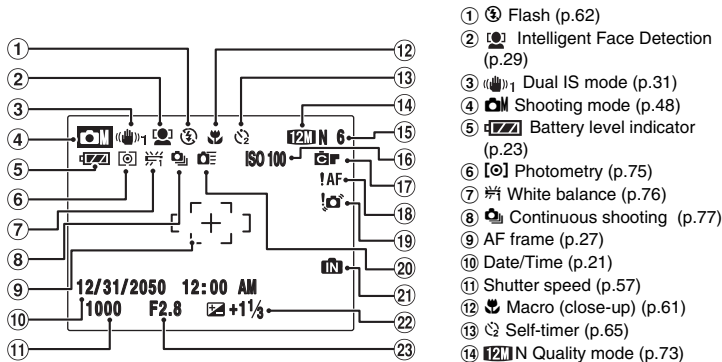

- 15 Number of available frames (p.154)
 16 ISO 100 Sensitivity (p.72)
 17 FinePix COLOR (p.74)
 18 !AF AF warning (p.27)
 19 Camera shake warning (p.28)
 20 Quick AF (p.71)
 21 Internal memory (p.19)
 22 Exposure compensation (p.59)
 23 Aperture (p.55)

■ Playback mode

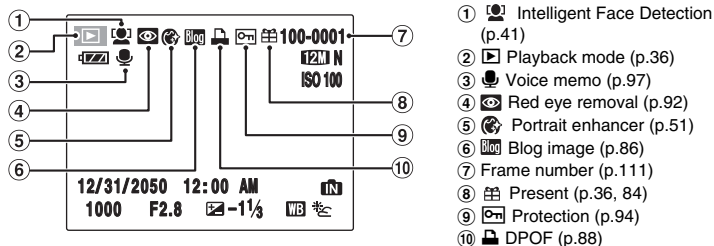

FinePix F50fd has internal memory that can store images without Memory Card. **IN** appears on the LCD monitor when the internal memory is active.

Charging the Battery

The battery is not fully charged at shipment and must be fully charged before being used.

Compatible battery

Rechargeable Battery NP-50 (1)



CAUTION

- The battery is not fully charged at shipment and must be fully charged before being used.
- Do not stick labels onto the battery as this could cause the battery to become jammed inside the camera.
- Any contact between the battery terminals could cause the battery to short circuit and overheat.
- See "Notes and Cautions" for information on the battery.
- Always use the Rechargeable Battery NP-50 (included). The use of other brands of rechargeable battery could cause faults or damage to the camera.
- Do not split or peel outer labels of the battery.
- Do not use the rechargeable battery NP-50 for the digital camera compatible with the rechargeable battery NP-40. The battery will be stuck inside of the camera and disassemble to be taken out.

1 Load the battery into the battery charger BC-50.

Set the battery correctly as indicated by the polarity icon.

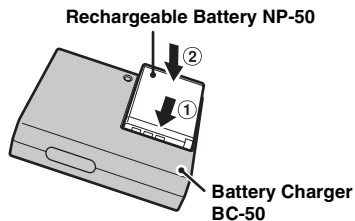

2 Plug the battery charger into a power outlet.

The charging indicator lights red and charging begins. When charging is completed, the indicator lights green. Charging completes after about 2.3 hours.

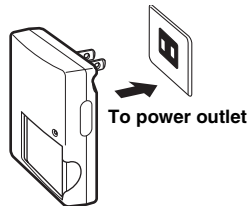

Continued ➔

<Charging Indicator and Statuses>

Charging Indicator	Status	Action
Off	Battery not loaded	Load the battery to be charged.
Lit green	Fully charged (charging complete)	Remove the battery from the battery charger.
Lit red	Charging	—
Blinking red	Battery fault during charging	Unplug the battery charger and remove the battery from the battery charger.

! CAUTION

- Unplug the battery charger from the power outlet when it is not in use.
- If the terminals of battery are soiled, it may not be possible to charge it. Clean the battery terminals and battery charger terminals with a clean, dry cloth.
- Charging times increase at low temperatures.
- The NP-50 gradually loses its charge even when not used. Charge a NP-50 just before taking pictures (in the last day or two).

Notes on Using the Battery Charger

Use with the following power supply cord set:
Cord: UL Listed, Type SPT-2, No.18 AWG, rated 300V, 10A, minimum 4 ft (1.2m), maximum 10 ft (3m) long. One end terminates in a molded-on, parallel-blade, (non-polarized) attachment plug with a 7A, 125V (NEMA 1-15P) configuration.

- The battery and battery charger themselves will become warm due to the power stored inside them. This is normal and does not indicate a fault. Wherever possible, use the battery charger in a well-ventilated location.
- There may be vibration noises from inside the battery charger during use. This is normal and does not indicate a fault.
- The battery charger could cause interference if placed close to a radio during charging. In this event, move the radio and charger further apart.
- Do not leave the battery charger in the following types of locations:
 - Extremely humidity or high temperatures, such as close to a heating appliance or in direct sunlight
 - Places with strong vibration
 - In very dusty places
- The battery charger accepts input voltages of 100-240 V AC at 50 or 60 Hz and can be used all over the world. However, the shape of the plug and socket-outlet depends on the country of use. Consult your travel agent for details.

Loading the Battery

Battery is required to operate the digital camera. At first, load the battery in the camera.

1 Open the battery cover.

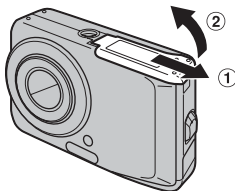

CHECK

Check that the camera is turned off before opening the battery cover.

CAUTION

- Do not open the battery cover while the camera is on. This could damage the Memory Card or ruin the image files on the Memory Card.
- Do not apply force to the battery cover.

2 Load the battery.

Make sure that the indicators are aligned. Push the battery release catch aside while loading the battery. Check that the battery is firmly held in place.

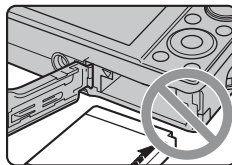
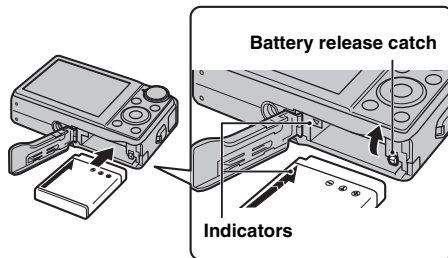

CAUTION

Load the battery in the correct direction.

Continued ➔

3 Close the battery cover.

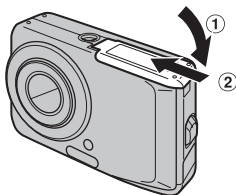

 **MEMO**

If you want to use the camera powered by AC, the AC power adapter, AC-5VX, and DC coupler, CP-50 (both sold separately), are necessary. Refer to the manual provided with the AC-5VX and CP-50 for instructions.

Loading the Memory Card

Although you can store pictures in the camera's internal memory, you can store many more images on the Memory Card (sold separately). You can use an **xD-Picture Card** and SD Memory Card with the FinePix F50fd. In this Owner's Manual, these cards are expressed as "Memory Card".

SD Memory Cards/SDHC Memory Cards

They are operation-checked at FUJIFILM Corporation.
Manufacturer: SanDisk

MEMO

- Compatible models will be updated in our web site:
http://www.fujifilm.com/products/digital_cameras/index.html
- Depending on the SD Memory Card, recording of movies may be interrupted. Use of above mentioned SD Memory Cards are recommended.
- The camera is not compatible with multimedia cards.

1 Open the battery cover.

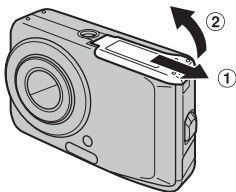

2 Insert an xD-Picture Card.

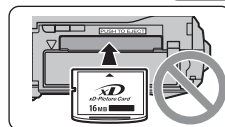
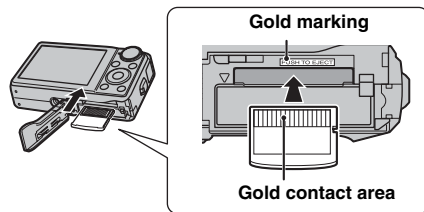

(SD Memory Card)

Align the gold marking with the gold contact area, then insert an **xD-Picture Card** completely.

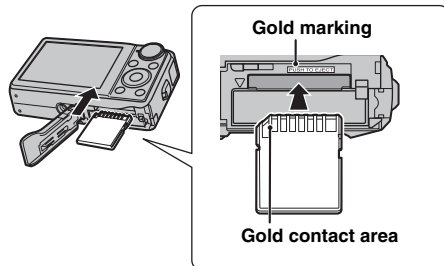

Align the gold marking with the gold contact area, then insert an SD Memory Card completely.

Continued ➔

! CAUTION

Be sure to unlock the protection of the SD Memory Card before inserting it. If it is locked, recording/deleting images, as well as formatting are not available. To unlock the protection, slide the switch back, and the SD Memory Card will work normally.

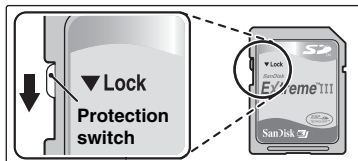

! CAUTION

- A new SD Memory Card or a card previously used on a PC or any device other than the camera should be formatted (→p.113) on the camera before use.
- Do not use a miniSD adaptor or a microSD adaptor which have exposed contact areas on the back. Use of these adaptors may cause a malfunction or damage due to the improper contacts.

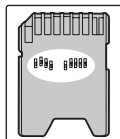

3 Close the battery cover.

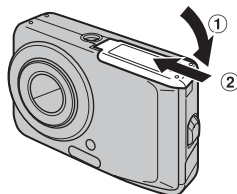

How to replace the Memory Card

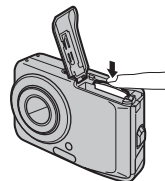

Push the Memory Card into the slot and then slowly remove your finger. The lock is released and the Memory Card is pushed out.

! CAUTION

- When storing Memory Cards, make sure that they are kept out of the reach of children. A Memory Card could be swallowed and cause suffocation. If a child swallows a Memory Card, seek medical attention or call emergency number right away.
- If the Memory Card is oriented incorrectly, it will not go all the way into the slot. Do not apply force when inserting a Memory Card.
- Note that the Memory Card may spring out if you release your finger quickly from the card immediately after the lock is released.
- Operation of this camera is only guaranteed when it is used with FUJIFILM **xD-Picture Card** and operation checked SD Memory Card (→p.17).
- See p.135 for information on the **xD-Picture Card**, SD Memory Card and the internal memory.

MEMO

- The size of an image file varies depending on the subject. For this reason, the number recorded may not represent the actual number of frames.
- See p.154 for information on the standard number of available frames.

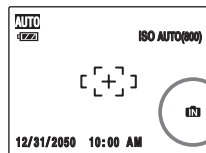
■ About internal memory

FinePix F50fd has internal memory that can store images without Memory Card. **iN** appears on the LCD monitor when internal memory is active.

When a Memory Card (sold separately) is inserted

Record images: Record images to a Memory Card.
 Playback images: Playback images in a Memory Card.

When a Memory Card (sold separately) is not inserted

Record images: Record images to internal memory.
 Playback images: Playback images in internal memory.

■ About images in the internal memory

Images held in the camera's internal memory may be corrupted or erased due to problems such as camera faults. Save your important data to another media (i.e., DVD-R, CD-R, CD-RW, hard disk, etc.). It is possible to transfer saved images on the internal memory to a Memory Card (→p.95).

! CAUTION

Erase the unnecessary images in the internal memory.
 (→p.42)

Turning On and Off

Turning the camera on in Photography mode

Press POWER down fully to turn the camera on. Press POWER again to turn the camera off.

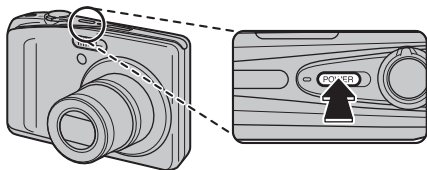

MEMO Changes between Photography mode and Playback mode

Press  during shooting to change to Playback mode. Press the shutter button down halfway to return to Photography mode.

CAUTION

- The lens moves and the lens cover opens when turning the camera on in Photography mode. Take care not to obstruct the lens.
- Take care not to get fingerprints on the camera lens as this will result in impaired image quality in your shots.

Turning the camera on in Playback mode

Press  for about 1 second to turn the camera on in Playback mode.

Press POWER to turn the camera off.

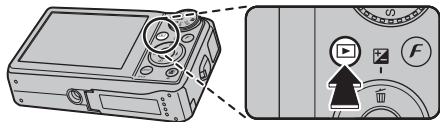

MEMO

To change to Photography mode, press the shutter button down halfway.

Setting the language, date, and time

When using the camera for the first time after purchasing, the language, date, and time are cleared. Set the language, date, and time.

1 [言語/LANG.] screen appears when turning the camera on.



① Press ▲, ▼, ◀, or ▶ to select the language.



② Press MENU/OK to confirm the setting.

2 Set the date and time.

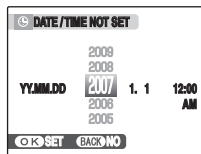

① Press ◀ or ▶ to select Year, Month, Day, Hour, or Minute.



② Press ▲ or ▼ to correct the setting.



MEMO

- Holding down ▲ or ▼ changes the numbers continuously.
- When the time displayed passes “12”, the AM/PM setting changes.

Continued ➔

3 Change the date format.



① Press ◀ or ▶ to select the date format.



② Press ▲ or ▼ to set the format.



③ Always press MENU/OK after the settings are completed.

Date format

ex. December 1, 2007

[YY.MM.DD]: [2007.12.1]

[MM/DD/YY]: [12/1/2007]

[DD.MM.YY]: [1.12.2007]

4 Set the [POWER MANAGEMENT] options.

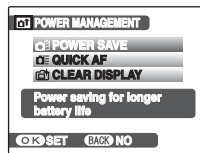

① Select an option from the menu.



② Press MENU/OK to confirm the setting.





MEMO

The confirmation screen appears when the battery is removed and the camera has been left unused for a long period. Keep the charged battery inside of the camera to retain the camera settings. Once a charged battery is installed for 4 days, the settings will be retained for roughly 7 days, even if the battery is removed.

Auto power off function

When the Auto power off function is active, if the camera is left unused for 2 or 5 minutes, this function turns the camera off (→p.114). To turn the camera back on, press POWER. To play back images, hold down  for about 1 second.

MEMO

When [POWER MANAGEMENT] is set to  QUICK AF] or  CLEAR DISPLAY], [AUTO POWER OFF] cannot be cancelled.





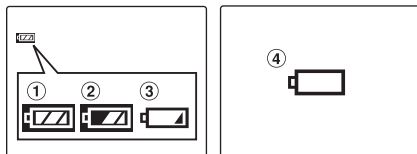

Checking the battery charge

Turn the camera on and check the battery level indicator on the LCD monitor.



- ① There is ample battery charge. (Lit white)
- ② The battery is almost half charged. (Lit white)
- ③ There is insufficient charge left in the battery. The battery will soon run out. Have a charged battery ready. (Lit red)
- ④ The battery is depleted. The display will shortly go blank and the camera will stop working. Replace the battery. (Blinking red)

CAUTION

- Due to the nature of the battery, the battery level indicator (, , or ) may appear early when the camera is used in cold locations. Try warming the battery in your pocket or a similar location before use.
- Battery with no remaining charge ( blinking red) may cause camera faults such as the camera turning itself off without retracting the lens. Always load a fully charged battery.
- Depending on the camera mode, the transition from  to  may occur more quickly.

Correcting the Date and Time

1 Open the [SET-UP] menu.

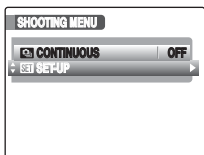

① Press MENU/OK to open the menu.



② Press ▲ or ▼ to select [SET] SET-UP.



③ Press ►.

2 Display the [DATE/TIME] screen.

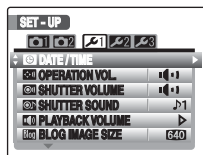

① Press ◀ or ▶ to select 1.



② Press ▼ to move to menu item.



③ Press ▲ or ▼ to select [DATE/TIME].



④ Press ►.

See "2 Set the date and time." (→p.21).

Selecting the Language

1 Open the [SET-UP] menu.

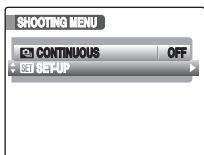

① Press MENU/OK to open the menu.



② Press ▲ or ▼ to select [SET-UP].



③ Press ►.

2 Display the [言語/LANG.] screen.

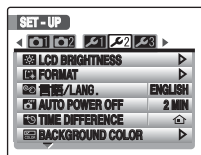

① Press ◀ or ▶ to select 2.



② Press ▼ to move to menu item.



③ Press ▲ or ▼ to select [言語/LANG.].



④ Press ►.

See "1 [言語/LANG.] screen appears when turning the camera on." (→p.21).

Taking Pictures (**AUTO** AUTO Mode)

This section describes the basic operations.

1 Turn the camera on.

- ① Press POWER to turn the camera on.

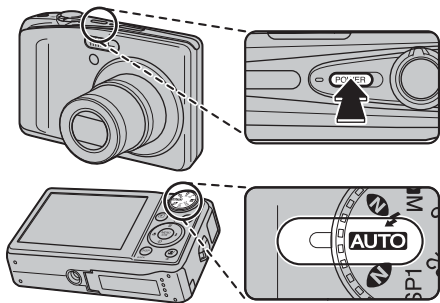

- ② Set the Mode dial to **AUTO**.

Holding the camera correctly

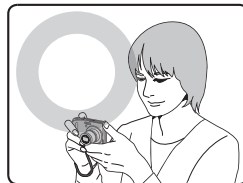

Brace your elbows against your sides and hold the camera with both hands.

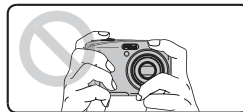

Do not cover the lens or flash with your fingers.

! CAUTION

- Moving the camera while shooting gives a blurred picture (camera shake). Hold the camera steadily with both hands.
- If the lens or flash is obscured by your fingers or the strap, subjects may be out of focus or the brightness (exposure) of your shot may be incorrect.

2 Check the composition on the LCD monitor. To adjust zoom scale using the Zoom lever:

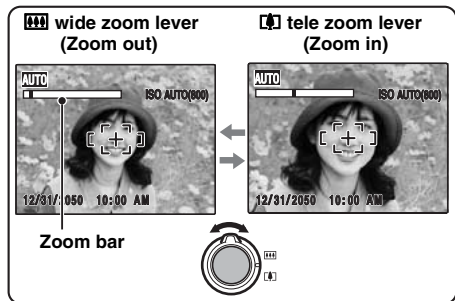

- **Focal range**
Wide-angle: approx. 45 cm (1.5 ft.) to infinity
Telephoto: approx. 60 cm (2.0 ft.) to infinity
- **Optical zoom focal length (35 mm camera equivalent)**
Approx. 35 mm to 105 mm
- **Max. zoom scale**
3x

MEMO

- Select Macro mode to take close-up shots (→p.61).
- Use digital zoom when you want to shoot the subject closer (→p.112).

3 Focus on the main subject in the AF frame and press the shutter button down halfway.

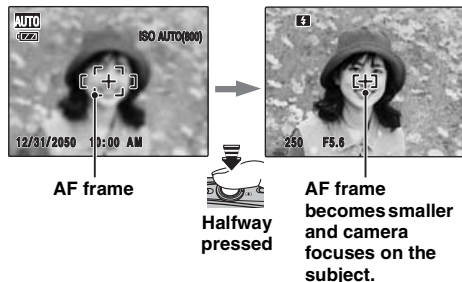

CHECK

- **Focus on the subject**
Double beep is heard
Indicator lamp lit green
- **Not focus on the subject**
No sound
AF frame lit red
!AF indicated
Indicator lamp blinking green

Continued →

 **MEMO**

- The shutter button has a halfway point at which focus and exposure are automatically optimized before taking the picture by pressing fully down.
- When pressing the shutter button halfway, a lens operation sound may be heard.

4 Press the shutter button fully.

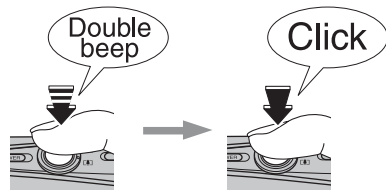

Halfway pressed

Fully pressed

 **CAUTION**

When taking a picture using the flash, the image may disappear and go dark briefly due to flash charging. The indicator lamp blinks orange during charging.

 **MEMO**

- When the subject is not in the AF frame, use AF/AE lock to take the picture (→p.33).
- When pressing the shutter button down fully in one motion, the camera takes the picture without the AF frame changing.

Flash



When pressing the shutter button down halfway,  appears on the LCD monitor before the flash fires.

Change the flash mode when you want to take pictures without flash. See p.62 for information on flash.

 **CAUTION**

- The image shown on the LCD monitor before the picture is taken may differ in brightness, color, etc. from the image actually recorded. Play back the recorded image to check it (→p.36).
- When selecting a slow shutter speed that will cause camera shake,  appears on the LCD monitor. Use flash or a tripod.
- See p.136-140 for information on warning displays. See "Troubleshooting" (→p.141-148) for more information.

Indicator lamp display

The indicator lamp lights or blinks when pressing the shutter button, etc. The indicator lamp shows the camera status.

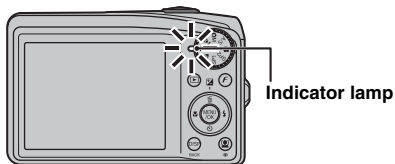

Display	Status
Lit green	Locking the focus, Setting the Mode dial
Blinking green	Camera shake warning, AF warning, or AE warning (ready to shoot)
Blinking green and orange alternately	Recording to Memory Card or internal memory (ready to shoot)
Lit orange	Recording to Memory Card or internal memory (not ready)
Blinking orange	Charging flash (flash will not fire)
Blinking red	<ul style="list-style-type: none"> Warnings for Memory Card and internal memory Card not formatted, incorrect format, memory full, Memory Card or internal memory error Lens operation error

MEMO

Detailed warning messages appear on the LCD monitor (→p.136-140).

Using Intelligent Face Detection/Red-eye Removal when taking pictures

Intelligent Face Detection allows you to focus on and adjust the brightness of people's faces. Intelligent Face Detection is effective with the camera held horizontally or vertically.

Available Photography modes: **AUTO**, **TV**, **AV**, **SP1/SP2** (☹, ☹*, ☹, ☹, ☹, ☹, OFF, ☹), **A/S**, **CM**

1 Set Intelligent Face Detection.

Press . Intelligent Face Detection setting changes each time you press .

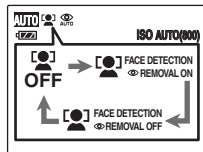
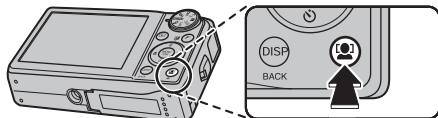

Red-eye effect, caused by the light of the flash reflecting off the inside of the eye, will be corrected automatically when a picture is taken with [] **FACE DETECTION** **REMOVAL ON**] set.

Continued ➔

! CAUTION

- If the camera is unable to detect faces in an image, it will not correct the red-eye effect sufficiently, or not at all. Also, the camera cannot correct the red-eye effect if the face is in profile.
- Correction results may differ depending on the scene.
- The processing may take more time if there are many faces in an image.

2 Check the composition on the LCD monitor.



Green frame

When there are multiple people in the frame, Intelligent Face Detection will set a green frame around the face nearest to the center of the picture. This face has focusing priority.

3 Press the shutter button down fully to take pictures.



✓ CHECK [[FACE] FACE DETECTION [REMOVAL ON]

When a picture is taken with [[FACE] FACE DETECTION [REMOVAL ON] set, the red-eye effect will be detected and corrected before the image is recorded.



① Red-eye effect in an image will be detected after the shooting.

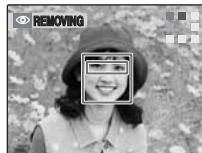

② Red-eye effect will be corrected before the image is recorded. When the red-eye effect is not detected, processing will end without the [REMOVING] screen displayed.

MEMO

The both of images with and without the red-eye effect corrected can be recorded when [REDA] SAVE ORG IMAGE] is set under the [SET] SET-UP] menu.

Subjects not suitable for Intelligent Face Detection

Intelligent Face Detection automatically focuses on a face(s). However, difficulties will occur with the Intelligent Face Detection mode in the following situations:

- The face is obscured by glasses, sunglasses, a hat or hair.
- The subject is too far away to recognize a face

Intelligent Face Detection will not work in cases where the subject is standing on his/her head, is not a person (pet or other animal), or if the camera is not held correctly.

Use AF/AE lock (→p.33) to guarantee best result when shooting a subject that is not suited for Intelligent Face Detection.



CAUTION

- If the camera or subject move as the picture is taken, the subject's face may move out of the Intelligent Face Detection frame.
- When the camera is detecting multiple faces, the green frame is set around the face near the center. If you want to focus on another subject, move the camera so that the new subject is in the center of the screen. If focus is still not achieved, press  (Intelligent Face Detection) to turn off the function, and take the picture using AF/AE lock (→p.33). Intelligent Face Detection can focus on a face in a white frame providing the subjects in the green and white frame are of the same focal length.
- Pressing the shutter button halfway with Intelligent Face Detection off, the focus will be on the center of the frame.



Using the Dual Image Stabilizer function when taking pictures

Camera shake and blurring (of moving subject) can be reduced by the optical image stabilizer function and a high sensitivity setting. Both camera shake and blurring are reduced when **AUTO** is selected for the shooting mode. Only camera shake will be reduced when any other shooting mode is selected.

Available Photography modes: All

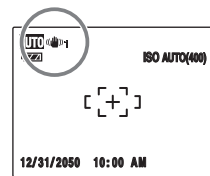
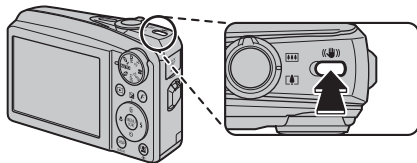
- 1 Press  to activate Dual IS (image stabilization) mode. Press  again to set Dual IS mode OFF.



₁ or ₂ will be displayed when Dual IS mode is activated.

Continued ➔



- ② Press the shutter button down fully to take pictures.

CAUTION

Camera shake and blurring may remain depending on scenes.

CHECK

The Dual IS mode can be set to [1 CONTINUOUS] or [2 SHOOTING ONLY] under [DUAL IS MODE] in the [SET-UP] menu (→p.108).

Taking pictures with the focus and exposure locked



In the above composition, the subjects (two people in this case) are not in the AF frame. Pressing the shutter button halfway at this point will result in the subjects being out of focus.

AF/AE lock is useful:

Use AF/AE lock to guarantee best result when shooting a subject that is not suited to autofocusing (→p.34). Use Intelligent Face Detection to focus on and adjust brightness of people's faces (→p.29).

CAUTION

When taking a picture in AF/AE lock, cancel Intelligent Face Detection.

Using AF/AE lock

- 1** Move the camera slightly so that one of the subjects is in the AF frame.



- 2** Press the shutter button halfway to focus on the subject.

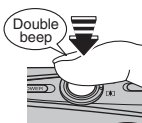

Halfway pressed



- 3** Continue to hold the shutter button down halfway. Move the camera back to the original image and press the shutter button fully.



MEMO

- AF/AE lock can be applied repeatedly before the shutter is released.
- Use AF/AE lock in all Photography modes to guarantee excellent results.
- On FinePix F50fd, pressing the shutter button down halfway locks the focus and exposure settings (AF and AE lock).

Continued ➔

Subjects not suitable for autofocus

FinePix F50fd uses a high-precision autofocus mechanism. However, it may have difficulty focusing on the following:



Very shiny subjects such as a mirror or car body

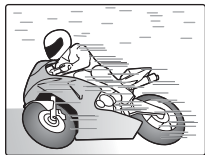

Fast moving subjects

- Subjects photographed through glass
- Subjects that do not reflect well, such as hair or fur
- Subjects with no substance, such as smoke or flames
- Dark subjects
- Subjects with little or no contrast between the subject and the background (such as subjects dressed in the same color as the background)
- Shots where another high-contrast object (not the subject) is close to the AF frame and is either closer or further away than your subject (such as a shot of someone against a background with strongly contrasting elements)

For such subjects use AF/AE lock (→p.33).





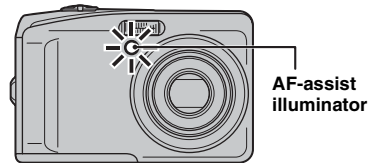

AF-assist illuminator

Use this illuminator to focus on the subject in dimly lit conditions.

When pressing the shutter button down halfway, the camera fires the AF-assist illuminator (white) while focusing on your subject.



MEMO

- Even when the AF-assist illuminator fires, the camera may have difficulty focusing in some conditions.
- Even though there is no danger to safety, do not expose it directly in someone's eyes.
- When using the AF-assist illuminator in Macro mode, the camera may have difficulty focusing to take close-up shots.
- See p.108 for information on turning the AF-assist illuminator off.
- AF-assist illuminator does not fire in , , , , , , or  mode.

Adjusting the shot composition

Select the LCD monitor display.

Press DISP/BACK to change the LCD monitor display.

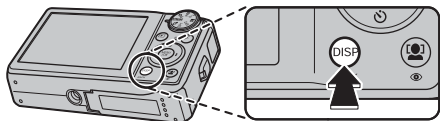

Text displayed



No text displayed



Framing guideline displayed

Best framing

Position the main subject at the intersection of two lines in this frame or align one of the horizontal lines with the horizon. Use this frame as a guide to the subject's size and the balance of the shot while composing a shot.



MEMO

Always use AF/AE lock when composing a shot. The image may be out of focus if AF/AE lock is not used.

Viewing the Images

Playback your images to check them. For important photographs, always take a test shot and view the image to make sure that the camera is working normally.

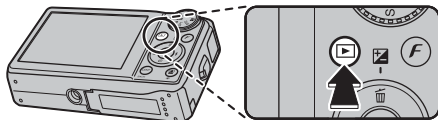

Setting the camera to Playback mode

Press  during shooting to change to Playback mode.



When the camera is off, press  for about 1 second to turn the camera on in Playback mode.

MEMO

- When pressing , the last image shot appears on the LCD monitor.
- When playing back images shot with a camera other than FinePix F50fd,  a present icon appears on the screen.

CAUTION Still images viewable on FinePix F50fd

This camera will display still images recorded on FinePix F50fd or still images (excluding some uncompressed images) recorded on any FUJIFILM digital camera that supports **xD-Picture Cards** or SD Memory Cards. Clear playback or playback zooming may not be possible for still images shot on cameras other than FinePix F50fd.

Select the LCD monitor display.

Press DISP/BACK during Playback mode to change the LCD monitor display.

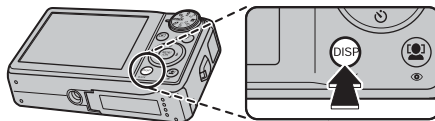

Sorting by date

Single-frame playback



To select the required image:

Press ◀: last image

Press ▶: next image

Selecting images



To select images on the thumbnail lists screen, hold down ◀ or ▶ for 1 second during playback. When releasing ◀ or ▶, camera returns to single-frame playback.

Playback zoom

1 Zoom in / Zoom out.

To zoom in an image during single-frame playback:

wide zoom lever
(Zoom out)

tele zoom lever
(Zoom in)

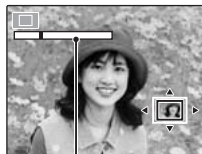

Zoom bar



Turn the zoom lever to or to zoom in or out an image.

Continued ➔

2 Display another part of the image.



Navigation screen
(Current displayed
image)



Press ▲, ▼, ◀, or ▶ to display another part of the image.



MEMO

Pressing DISP/BACK cancels playback zoom.

Zoom scales

Quality mode	Max. zoom scale
12M (4000 × 3000 pixels)	Approx. 6.3×
3:2 (4224 × 2816 pixels)	Approx. 6.6×
6M (2848 × 2136 pixels)	Approx. 4.5×
3M (2048 × 1536 pixels)	Approx. 3.2×
2M (1600 × 1200 pixels)	Approx. 2.5×

* Zoom cannot be performed when the images recorded by **03M** are played back.

Multi-frame playback

Use this function to display 2 frames, 9 frames or 100 frames. You can compare and select images using the Multi-frame display. Use the zoom lever to change the display.

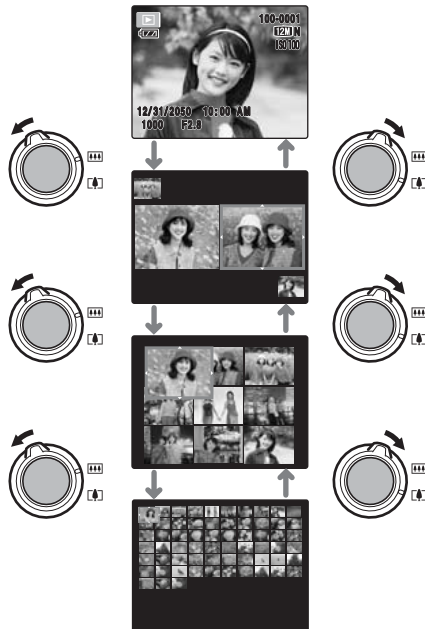

2 frames playback



- 1 Press ▲, ▼, ◀ or ▶ to select the image you want to compare, such as the image taken in NATURAL & mode.



- 2 Press MENU/OK to enlarge the image.

9 frames playback



- 1 Press ▲, ▼, ◀ or ▶ to change the colored frame and select an image. Press ▲ or ▼ repeatedly to jump to the next page.



- 2 Press MENU/OK to enlarge the image.

Micro thumbnails playback

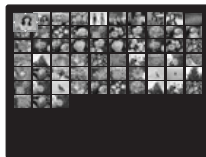

- 1 Press ▲, ▼, ◀ or ▶ to change the colored frame and select an image. Press ▲ or ▼ repeatedly to jump to the next page.



- 2 Press MENU/OK to enlarge the image.

Sorting by date

In sorting by date mode, you can view all images taken on the same day.



- ① Press ▲, ▼, ◀, or ▶ to move the cursor (colored frame) to select the image you want.



- ② Press MENU/OK to enlarge the image.

Selecting the date



- ① Press ▲, ▼, ◀, or ▶ to move the cursor (colored frame) to ◀ on the upper left frame.



- ② Press ◀ to display the selecting date.



- ③ Press ▲ or ▼ to move the cursor (colored frame) to select the date. Press ▲ or ▼ repeatedly to jump to the next page.



- ④ Press ▶.

Using Intelligent Face Detection when playing back pictures

You can display and enlarge the faces in images when playing back the images shot using the Intelligent Face Detection function ( is displayed) (→p.29).







- ① Press , then the frame(s) appears on the detected face(s) in pictures.



- ② The detected face(s) is enlarged each time you press .



- ③ Press , , , or  to display another part of the image (→p.37).

! CAUTION

The images recorded by  cannot be enlarged.



MEMO





- Press DISP/BACK to return to normal playback.
- If an image with red-eye effect was shot using Intelligent Face Detection, the red-eye effect, caused by the light of the flash reflecting off the inside of the eye, can be corrected (p.92).

Use this mode to erase unnecessary images or movies to have ample free space on the Memory Card or internal memory. Your camera calls images "frames".

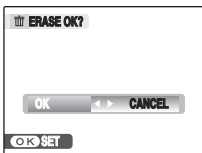
Using the erase button (/▲)





Pressing  (▲) erases images easily.

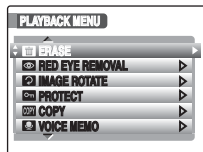

-  ① Press ◀ or ▶ to select the erasing image.
-  ② Press  (▲).
-  ③ Press ◀ or ▶ to select [OK].
-  ④ Press MENU/OK to erase the displayed image.

Erasing the images using [PLAYBACK MENU]



-  ① Press MENU/OK to open the [PLAYBACK MENU].
-  ② Press ▲ or ▼ to select [ ERASE].
-  ③ Press ▶.

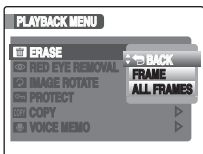

- ④ Press ▲ or ▼ to select [FRAME] or [ALL FRAMES].



- ⑤ Press MENU/OK to confirm the setting.

Erasing one frame at a time ([FRAME])

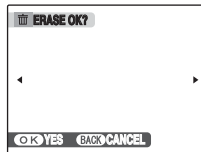

- ① Press ◀ or ▶ to select the erasing frame (file).



- ② Press MENU/OK to erase the currently displayed frame (file).



MEMO

To erase another frame (file), repeat above steps.
When erasing frames (files) is completed, press DISP/
BACK.



CAUTION

Pressing MENU/OK repeatedly erases consecutive frames (files). Take care not to erase a frame (file) by mistake.

Continued ➡

Erasing all frames ([ALL FRAMES])

① Press ◀ or ▶ to select [OK].

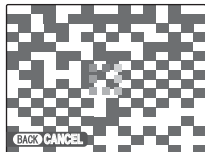

② Press MENU/OK to erase all the frames (files).

 **MEMO**

Press DISP/BACK to cancel erasing of all the frames (files). Some unprotected frames (files) will be left unerased.

 **MEMO**

- When using a Memory Card, the images in the Memory Card are erased. When not using a Memory Card, the images in the internal memory are erased.
- Protected frames (files) cannot be erased. Unprotect the frames (files) before erasing them (→p.94).
- [DPOF SPECIFIED. ERASE OK?] or [DPOF SPECIFIED. ERASE ALL OK?] appears, when erasing DPOF specified files is attempted.

 **CAUTION**

Erased frames (files) cannot be recovered. Back up important frames (files) onto your PC or another media.

Using the Photography Functions — Procedure of Setting

Specify the camera settings for taking pictures to get the best result. A general guide is given below.

1 Select the Photography mode.

Turn the Mode dial to select the Photography mode. The camera settings are tailored to the scene being shot.

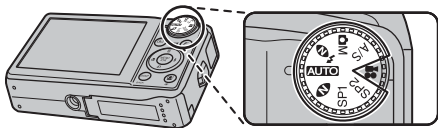

AUTO Auto	This is the easiest mode for taking pictures (→p.48).
N Natural Light	This mode produces beautiful images that retain the natural ambience when shots are taken in low-light conditions (→p.48).
NATURAL & ⚡	This mode shoots 2 images continuously without flash and with flash. Shooting with flash allows you to take a picture of a main subject brightly. This mode is useful for shooting 2 different types of pictures at the same time (→p.49).
SP1/SP2 Scene position	Select the best Shooting mode for the scene being shot (→p.49).
A/S Aperture priority AE/ Shutter priority AE	Used for changing the aperture or shutter speed setting so that the action is frozen, the flow of the motion is conveyed, or the background is out of focus (→ p.54).
Manual	This mode provides more detailed settings that are impossible to set in AUTO Auto mode (→ p.58).

Continued ➔

2 Specify the photography settings.

Pressing buttons or selecting menu allows you to specify photography functions. You can obtain the best result for shooting.

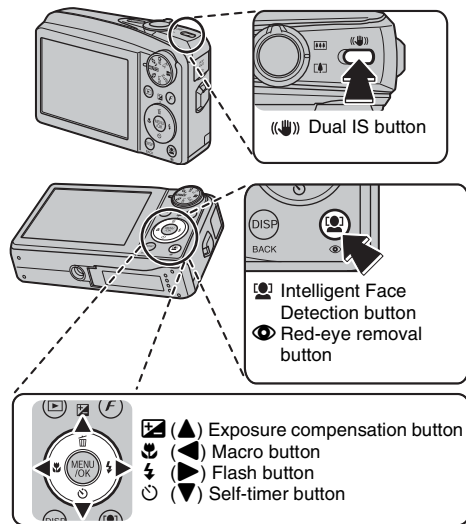

■ Specifying functions using buttons

Dual IS mode	Reduces camera shake and moving subject blurring (→p.31).
Intelligent Face Detection/ Red-eye removal	Pressing this button allows you to focus on people's faces. Also, red-eye effect, caused by the light of the flash reflecting off the inside of the eye, can be corrected before an image is recorded. (→p.29).
Exposure compensation	Used for changing the image brightness (→p.59), aperture (→p.55), or shutter speed (→p.57).
Macro	Used for close-up shots (→p.61).
Flash	Used for shots in dark locations or for backlit subjects, etc. (→p.62).
Self-timer	Used in situations such as group shots where the photographer is included in the shot (→p.65).

■ Specifying functions using [F-MODE MENU] (F button)

[] POWER MANAGEMENT	Use to set the camera performance (→p.71).
[] ISO	Use to specify required sensitivity setting (→p.72).
[] QUALITY	Use to specify required image size (→p.73).
[] FinePix COLOR	Use to specify required color tone (→p.74).

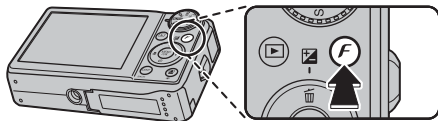

F-MODE MENU	
[] POWER MANAGEMENT	[]
[] ISO	AUTO
[] QUALITY	[] N
[] FinePix COLOR	STD

■ Specifying functions using [SHOOTING MENU] (MENU/OK button)

[] PHOTOMETRY	Use to select light metering method (only A/S,) (→p.75).
[] WHITE BALANCE	Use to adjust the color tone (only A/S,) (→p.76).
[] CONTINUOUS	Use to take pictures continuously (→p.77).
[] AF MODE	Use to specify focusing mode (only A/S,) (→p.80).

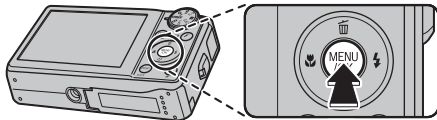

SHOOTING MENU	
[] PHOTOMETRY	[]
[] WHITE BALANCE	AUTO
[] CONTINUOUS	OFF
[] AF MODE	[]
[] SET - UP	[]

Setting the Shooting Mode

You can select the most suitable setting according to the subject by selecting one of the Shooting modes.

AUTO AUTO

This is the easiest mode for providing crisp and clear shots.

Use this mode for ordinary photography.

Camera specifies all settings other than **F**-MODE ([QUALITY] and [FinePix COLOR]) automatically.

Set the Mode dial to **AUTO**.

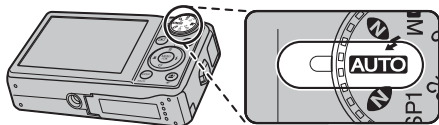

CHECK

- See p.63 for information on the available flash modes.
- Only [AUTO(1600)], [AUTO(800)], [AUTO(400)] can be selected for the [ISO ISO] (sensitivity) setting.

N NATURAL LIGHT

This mode produces beautiful images that retain the natural ambience when shots are taken in low-light conditions.

This mode is also ideal for shooting indoor or situations where the flash cannot be used.

Camera sets the high-sensitivity setting when selecting the Natural light mode. This mode is effective for reducing camera shake and moving-subject blurring when taking pictures in low-light conditions.

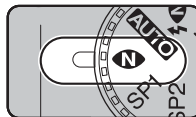

Set the Mode dial to **N**.

CHECK

- Flash cannot be used in the Natural light mode.
- Only [AUTO] can be selected for the [ISO ISO] (sensitivity) setting.

N **NATURAL & ⚡**

This mode shoots 2 images continuously without flash and with flash. Shooting with flash allows you to take a picture of a main subject brightly. Shooting without flash produces beautiful images that retain the natural ambience. This mode is useful for shooting 2 different types of pictures at the same time.

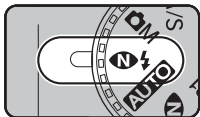

Set the Mode dial to .

When pressing the shutter button, first picture is taken without flash and next picture is taken with flash. Always 2 pictures are taken per 1 shot. Do not move the camera until the shooting ended.

MEMO

This mode helps to avoid failed shots that may occur when using other Shooting modes when taking a picture against the sun, etc.

CHECK

- Flash fires automatically. Do not use this mode at situations where the flash cannot be used.
- Only [AUTO] can be selected for the [ISO] ISO (sensitivity) setting.
- When there is insufficient space on the Memory Card or internal memory for 2 shots, a picture cannot be taken.
- Continuous shooting is disabled when setting .

SP1/SP2 SCENE POSITION

This mode provides the best Scene position setting for the scene being shot. Choose from 13 types of scene.

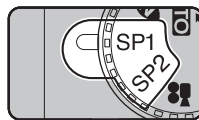

Select the Scene position setting in the [SCENE POSITION] menu.













Set the Mode dial to SP1/SP2.

About SP1 and SP2 of the Mode Dial

The camera enables to set the scene position for SP1 and SP2 separately.

For example, select  for SP1 and  for SP2 separately at traveling. The setting combination can be used for variety of shooting scene. The menu options of SP1 and SP2 are the same. However the options cannot be set for both SP1 and SP2.

MEMO

- SP1 and SP2 are set to  and  as factory default settings.
- See p.63 for information on the available flash modes.
- When anything other than  and  in the Shooting mode is selected, [CHROME] (→p.74) cannot be set.
- AF-assist illuminator does not fire in , , , , , and  mode.
- Only [AUTO] can be selected for the [ISO] ISO (sensitivity) setting.

■ Selecting Scene position setting



① Press MENU/OK to open the menu.



② Press ▲ or ▼ to select [SCENE POSITION].



③ Press ►.















④ Press ▲ or ▼ to select the setting.







⑤ Press MENU/OK button to confirm the setting.









■ Scene position list

Scene position	Functions
[ PORTRAIT]	Use this mode for photography to get beautiful skin tones and soft overall tone.
[ PORTRAIT ENHANCER]	Shoots face skin appear smooth. Whole image may be soft focused.
[ LANDSCAPE]	Use this mode for shooting scenery in daylight and provides crisp, clear shots of scenery such as buildings and mountains.
[ SPORT]	Use this mode to take pictures of a moving subject. It gives priority to faster shutter speeds.
[ NIGHT] ([ LONG EXPOSURE])	Use this mode for shooting evening and night scenes. A picture is taken with a slow shutter of up to 8 seconds. Refer to “Setting [ LONG EXPOSURE] in the [ NIGHT] mode” (→p.53).
[ FIREWORKS]	Use this mode to shoot fireworks. It is effective for taking more vivid shots of fireworks with a slow shutter. Refer to “Selecting the exposure time setting” (→p.54).
[ SUNSET]	Use this mode to shoot sunset, making the colors more vivid.
[ SNOW]	Use this mode to prevent darkening images and provide crisp, clear shots, when shooting at snowy scene where the whole screen appears white.
[ BEACH]	Use this mode to prevent darkening images and provide crisp, clear shots, when shooting at beach under strong sunlight.

Continued ➔

Scene position	Functions
[ UNDERWATER]	Use this mode for shooting with a waterproof case (sold separately). It is effective for taking more vivid shots of ocean blue.
[ MUSEUM]	Use this mode for taking pictures in places such as museum where the use of flash and making an operation sound and a shutter sound are restricted. Flash mode is forcibly set to Suppressed flash, and operation sound, shutter sound, and self-timer lamp are off.
[ PARTY]	Use this mode for shooting at indoor wedding and party. This mode produces beautiful images that retain the natural ambience when shots are taken in low-light conditions.
[ FLOWER]	Use this mode to take clear close-up shots when zooming up a flower. It is effective for taking more vivid shots of flower petal.
[ TEXT]	Use this mode to shoot documents and white board. It is effective for taking clearer shots.

CHECK

- When setting the [ SPORT] mode, the camera sets to [ QUICK AF] (→p.71) automatically.
- Use a tripod to prevent camera shake for [ NIGHT] ([ LONG EXPOSURE]) and [ FIREWORKS)], as a slow shutter speed is used.
- Shutter speed setting for [ FIREWORKS]: 1/2 sec. to 4 sec.
- Check whether photography is permitted before using the [ MUSEUM] mode.
- Focal range for [ FLOWER]:
Wide angle: Approx. 7 cm to 2 m (2.8 in. to 6.6 ft.)
Telephoto: Approx. 30 cm to 2 m (1.0 ft. to 6.6 ft.)
- Focal range for [ TEXT]:
Wide angle: Approx. 7 cm to 2 m (2.8 in. to 6.6 ft.)
Telephoto: Approx. 30 cm to 2 m (1.0 ft. to 6.6 ft.)

■ Setting [LONG EXPOSURE] in the [NIGHT] mode

Selecting the [LONG EXPOSURE] setting allows you to take a picture of a main subject in low-light condition. You can select shutter speeds from 1 to 8 seconds in this mode.

1 Select the [LONG EXPOSURE] setting.

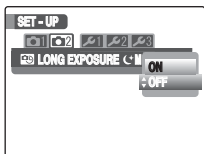

- ① Press ▲ or ▼ to select [LONG EXPOSURE] in the [SET SET-UP] menu.



- ② Press ►.



- ③ Press ▲ or ▼ to select ON.



- ④ Press MENU/OK to confirm the setting.

2 Select the exposure time.

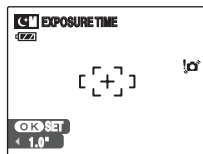

- ① Press [MENU/OK] (▲).



- ② Press ◀ or ▶ to select the exposure time.



- ③ Press MENU/OK to confirm the setting.

✓ CHECK

[LONG EXPOSURE] can be used in only the [NIGHT] mode.

Continued ➔

■ **Setting the exposure time in the [ FIREWORKS] mode.**

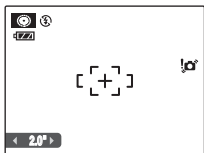

Press ◀ or ▶ to select the exposure time.



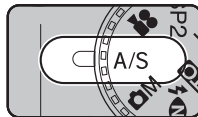

A/S APERTURE PRIORITY AE/ SHUTTER PRIORITY AE

Use this mode to change the aperture or shutter speed setting so that the action is frozen, the flow of the motion is conveyed, or the background is out of focus. Select APERTURE PRIORITY AE or SHUTTER PRIORITY AE in the Shooting mode.



Set the Mode dial to A/S.

Photography functions:

-  Exposure Compensation (→p.59)
-  PHOTOMETRY (→p.75)
-  WHITE BALANCE (→p.76)
-  AF MODE (→p.80)

 **CHECK**

See p.63 for information on the available flash modes.

■ Selecting the Shooting mode setting

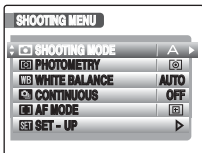

- ① Press MENU/OK to open the menu.
- ② Press ▲ or ▼ to select [CAMERA] SHOOTING MODE].
- ③ Press ►.
- ④ Press ▲ or ▼ to select the setting.
- ⑤ Press MENU/OK to confirm the setting.

A APERTURE PRIORITY AE

This is an automatic mode to set the aperture. Use this mode to have the area in front of and behind the subject out of focus (large aperture) or have both near and far subjects in focus (small aperture).

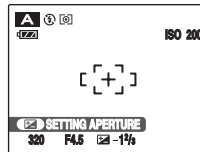

- ① Press [A] (▲) to display the aperture setting screen.
- ② Press ◀ or ▶ to select the aperture.
- ③ Press the shutter button to take pictures.

✓ CHECK

Aperture settings

Wide-angle: F2.8 to F8 in 1/3 EV increments

Telephoto: F5.1 to F8 in 1/3 EV increments

Continued ➔

! CAUTION

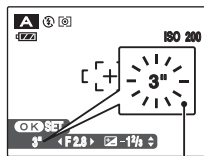

Lit red

When the correct exposure cannot be obtained with selected aperture setting, the shutter speed appears in red. When this occurs, adjust the aperture setting again.

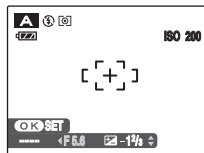

When the brightness of the subject is outside the camera's brightness metering range, [----] appears as the shutter speed. When this occurs, press the shutter button down halfway to measure the light level again.

Aperture

By adjusting the aperture, you can change the depth of focus (depth of field). Selecting a larger number of aperture (closed) obtains a larger depth of focus. Selecting a smaller number of aperture (open) has the area in front of and behind the subject out of focus.

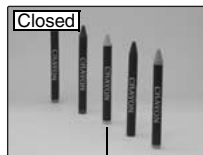

The area in front of and behind the subject is also in focus in the shot.

Main subject

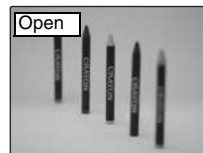

The area in front of and behind the subject is out of focus.

S SHUTTER PRIORITY AE

This is an automatic mode to set the shutter speed. Use this mode to freeze a moving subject (fast shutter speed) or convey the impression of movement (slow shutter speed).

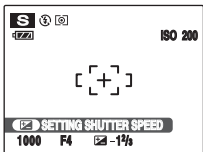

- ① Press  (▲) to display the shutter speed setting screen.



- ② Press ◀ or ▶ to select the shutter speed.



- ③ Press the shutter button to take pictures.

CHECK

Shutter speed setting

1 sec. to 1/1000 sec. in 1/3 EV increments

CAUTION

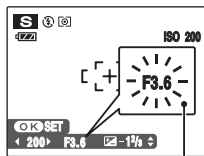

Lit red

When the correct exposure cannot be obtained with selected shutter speed, the aperture setting appears in red. When this occurs, adjust the shutter speed again.

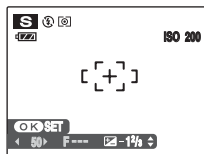

When the brightness of the subject is outside the camera's brightness metering range, [F---] appears as the aperture setting. When this occurs, press the shutter button down halfway to measure the light level again.

Continued ➔

Shutter speed

When shooting a moving subject, you can either “freeze the motion” or “capture the sense of movement” by adjusting the shutter speed.



Freezes the motion of the subject.



Photographs the traces left by the subject's movement.

MANUAL



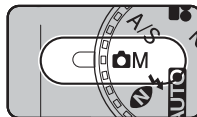

This is an automatic mode to specify the settings except for the shutter speed and aperture setting.

Set the Photography functions to manual to easily control yourself.



Set the Mode dial to .

Photography functions:

-  Exposure Compensation (→p.59)
-  [PHOTOMETRY] (→p.75)
-  [WB WHITE BALANCE] (→p.76)
-  [AF MODE] (→p.80)

CHECK

See p.63 for information on the available flash modes.

Adjusting the Image Brightness (☒ Exposure Compensation)

Use this menu for shots to get the correct brightness (exposure), such as shots with extremely high contrast between the subject and the background.

Available Photography modes: A/S, 

Adjusting exposure compensation

Press  (▲) to set the exposure compensation.

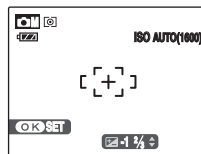
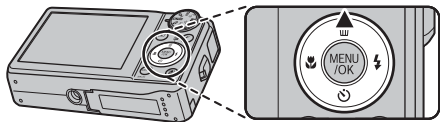

① Press ▲ or ▼ to adjust the exposure compensation.



② Press the shutter button to take pictures.

Continued ➔

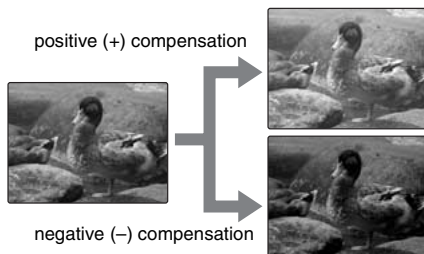

☑ CHECK

- Compensation range: -2 EV to +2 EV (13 steps in 1/3 EV increments)
- Explanation of Terms "EV" (→p.156)

Guide to compensation

- Backlit portraits: +2/3 EV to +1 2/3 EV



- Very bright scenes (such as snowfields) and highly reflective subjects: +1 EV





- Shots made up predominantly of sky: +1 EV
- Spotlight subjects, particularly against dark backgrounds: -2/3 EV
- Scenes with low reflectivity, such as shots of pine trees or dark foliage: -2/3 EV



MEMO

Any of the following disables exposure compensation:

- Using the flash in the [AUTO] or  mode
- Shooting dark scenes in  or  mode

Macro (Close-up)

Use this mode to take close-up shots.

Available Photography modes: **[AUTO]**, **[M]**, **[S]**, **[P]**, **[A/S]**, **[M]** (→p.48)

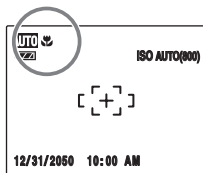
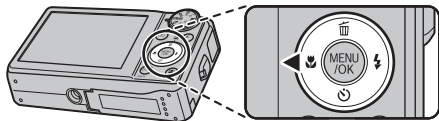

Press  (◀) to select Macro mode.

Press  (◀) again to cancel Macro mode.



 appears on the LCD monitor indicating that you can take close-up shots.

CHECK

- When setting  or **[M]** mode, the camera sets to Macro mode automatically.
- Focal range (except for  and **[M]**)
Wide angle:
Approx. 7 cm to 80 cm (2.8 in. to 2.6 ft.)
Telephoto:
Approx. 30 cm to 80 cm (1.0 ft. to 2.6 ft.)
- Focal range (, **[M]**)
Wide angle:
Approx. 7 cm to 2 m (2.8 in. to 6.6 ft.)
Telephoto:
Approx. 30 cm to 2 m (1.0 ft. to 6.6 ft.)
- Effective flash range
Approx. 30 cm to 80 cm (1.0 ft. to 2.6 ft.)
When taking a picture using the flash for a wide angle shot, the camera lens might cast a shadow in the frame. In such case, increase the distance from the subject a little and zoom in.

MEMO

- Use a tripod to prevent camera shake in Macro mode.
- Any of the following cancels Macro mode:
 - Changing the Shooting mode setting
 - Turning the camera off
- Even if **[P]** MULTI] (→p.81) in the **[AF MODE]** is set, the camera focuses near the center of the screen.
- AF-assist may not function correctly if the camera is up close to the subject, such as in macro-mode.

⚡ Setting the Flash (Intelligent Flash)

Flash photography is useful for taking pictures at night or indoor dark locations. Choose from 7 flash modes according to the type of shot. See p.63 for information on the available Photography modes.

MEMO

By calculating subject distance and brightness, the camera automatically adjusts the flash amount and sensitivity to suit shooting conditions. This maintains consistent balance of bright/dark areas across the image in low-light conditions (dimly-lit room, etc). The Intelligent Flash feature guarantees consistent results when using the flash.

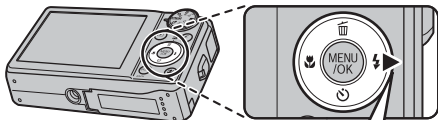

⚡ AUTO → ⚡ The flash setting changes each time you press ⚡ (▶).

⚡ AUTO → ⚡ When [FACE DETECTION REMOVAL ON] is set.

MEMO

When pressing the shutter button down halfway, **⚡** appears on the LCD monitor before the flash fires.

[AUTO AUTO FLASH] (not displayed)

Use this mode for ordinary photography. The flash fires as required by the shooting conditions.

[AUTO RED EYE REDUCTION]

This mode is suitable for shooting portraits in low-light conditions. Use this mode to minimize red-eye (eyes appear in red in the finished photo).



MEMO Red-eye effect

When using the flash to take a picture of people in low-light conditions, their eyes sometimes appear red in the picture. This is caused by the light of the flash reflecting off the inside of the eye.

[⚡ FORCED FLASH], [⚡ FORCED FLASH]



Use this mode in backlit scenes, or to get the correct colors when taking a picture under bright lighting. In this mode, the flash fires in bright as well as dark conditions. Using ⚡ synchronizes Red-eye reduction mode.

[SUPPRESSED FLASH]

This mode is suitable for situations where the flash cannot be used.

Use a tripod to prevent camera shake when shooting in Suppressed flash mode in the dark condition.
Any time, flash does not fire.

[SLOW SYNCHRO], [RED EYE & SLOW]

This mode allows you to take pictures of people at night that clearly show both your subjects and the night time backdrop. To prevent camera shake, always use a tripod. Using  synchronizes Red-eye reduction mode. Using  selects slow shutter speeds of up to 3 seconds.





























CAUTION

In bright scenes, overexposure may occur.

Available flash modes in Photography modes







Available flash modes in each Photography mode are listed below.

When [ FACE DETECTION  REMOVAL OFF] is set:

	AUTO			
 AUTO	✓	✓	✓	
 			✓	
		✓		
	✓	✓	✓	✓
	✓	✓	✓	✓
			✓	
	✓	✓	✓	
			✓	✓
		✓	✓	
			✓	
	✓	✓	✓	
	✓	✓	✓	
	✓	✓	✓	
			✓	
	✓			
			✓	
		✓	✓	
		✓	✓	✓
	✓	✓	✓	✓
			✓	
	✓			
			✓	
		✓	✓	
		✓	✓	
	✓	✓	✓	✓

⚡ Setting the Flash (Intelligent Flash)

When [ FACE DETECTION  REMOVAL ON] is set:

	 AUTO			 SLOW
 AUTO	✓	✓	✓	
			✓	
		✓		
	✓	✓	✓	✓
	✓	✓	✓	✓
			✓	
			✓	
			✓	✓
			✓	
			✓	
		✓	✓	
	✓	✓	✓	
	✓	✓	✓	
			✓	
	✓			
			✓	
			✓	
			✓	
			✓	
		✓	✓	✓
		✓	✓	
	✓	✓	✓	✓

CHECK

Effective flash range ( : [AUTO])

Wide-angle:

Approx. 60 cm to 4.4 m (2.0 ft. to 14.4 ft.)

Telephoto:

Approx. 60 cm to 2.4 m (2.0 ft. to 7.9 ft.)

If you take pictures outside of the effective flash range, the image may appear dark even if the flash is used.

CAUTION Notes on using flash

- If pressing the shutter button while the flash is charging (indicator lamp blinking orange), the picture will be taken without the flash (when using [AUTO] and ).
- The flash charging time may increase when the battery is low on charge.
- When taking a picture using the flash, the image may disappear and go dark briefly due to flash charging. The indicator lamp blinks orange during charging.
- The flash fires several times (pre-flashes and the main flash). Do not move the camera until the picture is taken.

Self-Timer

The self-timer is used in situations where the photographer is included in the shot.

Available Photography modes: All

Setting self-timer

The self-timer setting changes each time you press  (▼).

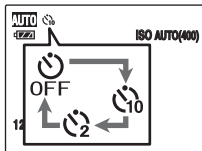
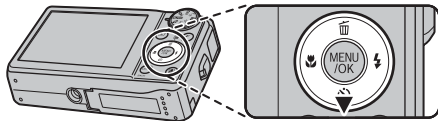

The last displayed setting is the selected mode.

: The picture is taken after 10 seconds.

: The picture is taken after 2 seconds.

Taking pictures using self-timer

- 1 Press the shutter button down halfway to focus on the subject and press the shutter button fully.

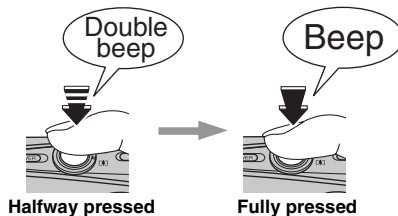

Pressing the shutter button down halfway that focuses on the subject.

Without releasing the shutter button, press the button all the way down (fully pressed) to start the self-timer.

Continued 

2 Take pictures in selected time.

A picture is taken after the self-timer lamp changes from lit to blinking (only blinks with the 2-second self-timer).

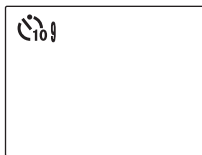
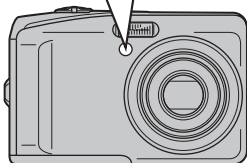
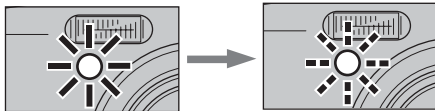

A countdown appears on the LCD monitor indicating the time remaining until the picture is taken.

Using the 2-second self-timer

This is useful when you worry about camera shake even if attaching the camera on a tripod.

MEMO

- To stop the self-timer, once it has started running, press DISP/BACK.
- Any of the following cancels the self-timer setting:
 - Completing the shooting
 - Changing the Photography mode setting
 - Setting the camera to Playback mode
 - Turning the camera off
- Take care not to stand in front of the lens when pressing the shutter button as this can prevent the correct focus or brightness (exposure) from being achieved.

Taking pictures with the self-timer and Intelligent Face Detection function

Available Photography modes: **AUTO**, , , SP1/SP2 (, , , , , , , A/S, 

Intelligent Face Detection

The Intelligent Face Detection function is especially useful when using the self timer since it ensures that faces will appear in focus automatically.

CHECK

See p.29 for Intelligent Face Detection.

CAUTION





Do not move, even after countdown has completed. Wait until the picture has been taken completely.

Using [*F*-MODE MENU] (Photography)/[SHOOTING MENU]

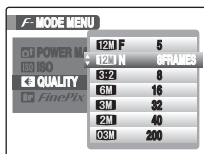
Use these menus to adjust image quality or focus. You can take pictures in a wide range of conditions.





Setting the [*F*-MODE MENU] (Photography)



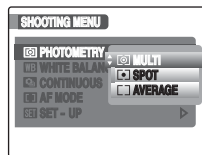







-  ① Press **F** to open the [*F*-MODE MENU].
-  ② Press ▲ or ▼ to select the menu.
-  ③ Press ►.
-  ④ Press ▲ or ▼ to change the setting.
-  ⑤ Press MENU/OK to confirm the setting.

Setting the [SHOOTING MENU]

























-  ① Press MENU/OK to open the [SHOOTING MENU].
-  ② Press ▲ or ▼ to select the menu.
-  ③ Press ►.
-  ④ Press ▲ or ▼ to change the setting.
-  ⑤ Press MENU/OK to confirm the setting.

■ List of [*F*-MODE MENU] options

Menu	Functions	Settings	Factory default
 POWER MANAGEMENT (→p.71)	Sets the camera performance. Use this setting to save power or to increase the focusing speed for shooting.		
 ISO (→p.72)	Specifies required sensitivity setting of the ambient light around the subject. The larger value of the sensitivity, the higher sensitivity is obtained. The higher sensitivity settings will allow you to take pictures in darker locations.	[AUTO]/ [AUTO(1600)]/ [AUTO(800)]/ [AUTO(400)]/[6400]/ [3200]/[1600]/[800]/ [400]/[200]/[100]	—
 QUALITY (→p.73)	Specifies the image size. The larger image size, the better image quality is obtained. The smaller image size, the larger number of images are recorded.		
 FinePix COLOR (→p.74)	Specifies required color tone. This mode is effective for taking more vivid shots or black and white shots.	[STD]/ 	[STD]

Continued ➔

■ List of [SHOOTING MENU] options

Menu	Functions	Settings	Factory default
 SHOOTING MODE] (→p.55)	This setting can be used when the Mode dial is set to A/S. Use this setting to provide the best aperture or shutter speed setting for the scene being shot.	A/S	A
 SCENE POSITION] (→p.49)	This setting can be used when the Mode dial is set to SP1/SP2. Use this setting to provide the best photography menu setting for the scene being shot.		SP1:  SP2: 
 PHOTOMETRY] (→p.75)	This setting can be used when the Mode dial is set to A/S and  . Use this setting to specify the light metering method.		
 WHITE BALANCE] (→p.76)	This setting can be used when the Mode dial is set to A/S and  . Use this setting to adjust the color balance to suit the color of the ambient light around the subject.	[AUTO]/ 	[AUTO]
 CONTINUOUS] (→p.77)	This setting can be used when the Mode dial is set to anything other than  and  . Use this setting to select the required Continuous shooting mode. [TOP12] and [FINAL 12] can be select when Photography mode is set to  AUTO,  A/S,  .	[OFF]/ 	[OFF]
 AF MODE] (→p.80)	This setting can be used when the Mode dial is set to A/S and  . Use this setting to specify the focusing mode.		

Setting the camera performance ([POWER MANAGEMENT])

Use this function to save power and increase the life of the battery, or to increase the focusing speed for shooting.



CAUTION

[POWER MANAGEMENT] cannot be set when shooting mode is set for .

POWER SAVE

The number of displayed frames per second will be minimized. Also, the LCD monitor display will automatically go dark when no operation is made for 10 seconds to save power.

CAUTION

- When Intelligent Face Detection function (→p.29) is ON,  POWER SAVE will be cancelled.
- Select  POWER SAVE when using continuously for long periods in a hot place. If using in other modes continuously for long periods in a hot place, vertical linear noise may appear in the image by the nature of CCD.

MEMO

Intelligent Face Detection function (→p.29) will automatically turn ON when using an optional AC power adapter and DC coupler.

QUICK AF

When the shutter button is pressed halfway, the focusing speed will be increased. This function allows you to shoot pictures quickly and is effective when you do not want to miss the chance to shoot. Be aware of the battery charge, since the camera consumes more power.

MEMO

- The focal range is approximately 1m (3.2 feet) to infinity.
- The LCD monitor display will go dark when no operation is made for 30 seconds, and will light up when any buttons are pressed.
- When [AUTO POWER OFF] is set to [OFF], the setting will be changed to [5 MIN].

CLEAR DISPLAY

The LCD monitor display will light up. The images will be displayed finely on the monitor. Be aware of the battery charge, since the camera consumes more power.

MEMO

- The LCD monitor display will go dark when no operation is made for 30 seconds, and will light up when any buttons are pressed.
- When [AUTO POWER OFF] is set to [OFF], the setting will be changed to [5 MIN].

Changing the sensitivity setting ([ISO ISO])

Use this menu to specify required sensitivity setting of the ambient light around the subject.

The larger value of the sensitivity, the higher sensitivity is obtained. The higher sensitivity settings will allow you to take pictures in darker locations.

✓ CHECK

• Settings

[AUTO]/[AUTO(1600)]/[AUTO(800)]/[AUTO(400)]/[6400]/[3200]/[1600]/[800]/[400]/[200]/[100]

Selecting [AUTO]/[AUTO(1600)]/[AUTO(800)]/[AUTO(400)] as the sensitivity setting, the camera selects the best sensitivity setting for the subject's brightness.

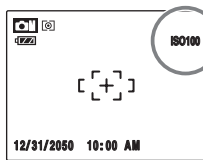

The selected sensitivity setting appears on the LCD monitor when the sensitivity setting is set to another setting excluding [AUTO].

• About [AUTO(1600)]/[AUTO(800)]/[AUTO(400)]

[AUTO(1600)]/[AUTO(800)]/[AUTO(400)] can be selected when the Mode dial is set to **AUTO**, A/S or **CM**. For [AUTO(1600)]/[AUTO(800)]/[AUTO(400)], sensitivity is automatically set in the same way as for [AUTO], but the highest sensitivity is limited. Select [AUTO(1600)]/[AUTO(800)]/[AUTO(400)] depending on the scene.

■ Correlation of sensitivity, quality and Photography modes

The image size (number of recorded pixels) depends on the sensitivity setting. Also, available sensitivity differs depending on the Photography modes.

ISO ISO	Quality			Photography mode		
	8M 2M 3M	6M	3:2 12M N 12M F	AUTO	A/S CM	N SP1 SP2
[100]	✓	✓	✓		✓	
[200]	✓	✓	✓		✓	
[400]	✓	✓	✓		✓	
[800]	✓	✓	✓		✓	
[1600]	✓	✓	✓		✓	
[3200]	✓	✓			✓	
[6400]	✓				✓	
[AUTO]	✓	✓	✓			✓
[AUTO(400)]	✓	✓	✓	✓	✓	
[AUTO(800)]	✓	✓	✓	✓	✓	
[AUTO(1600)]	✓	✓	✓	✓	✓	

! CAUTION

Although higher sensitivity settings will allow you to take pictures in darker locations, they will also increase the amount of speckling in your images. Choose the sensitivity setting that best suits the conditions.

**MEMO**

Sensitivity is retained even when the camera is turned off or the mode setting is changed.



Changing the quality setting ([QUALITY])

Use this menu to specify the image size (number of recorded pixels).

Select the quality setting for the scene being shot.

Quality settings in Photography mode

Quality mode	Sample uses
12M F (4000 × 3000)	Printing at up to 10R (25.4 × 30.5 cm/ 10 × 12 in.) / A3 size
12M N (4000 × 3000)	
8:2 (4224 × 2816)	
6M (2848 × 2136)	Printing at up to 10R (25.4 × 30.5 cm/ 10 × 12 in.) / A4 size
6M (2048 × 1536)	Printing at up to 6R (15.2 × 20.3 cm/6 × 8 in.) / A5 size
2M (1600 × 1200)	Printing at up to 4R (10.2 × 15.2 cm/4 × 6 in.) / A6 size
03M (640 × 480)	To use for e-mail or web site

Continued ➔

Area shot and quality setting

Area shot excluding 3:2



Area shot with 3:2



Normal shooting provides an aspect ratio of 4:3 and **3:2** shooting provides an aspect ratio of 3:2 (same aspect ratio as 35 mm film and post card).

MEMO



- The bigger the number of recorded pixels, the better the image quality becomes. As the number of recorded pixels becomes smaller, you will be able to record more frames to a Memory Card.
- The quality setting is retained even when the camera is turned off or the mode setting is changed.
- When changing the quality setting, the number of available frames also changes (→p.154). The numbers to the right of setting show the number of available frames.
- Available [ISO] setting changes depending on quality setting. Refer to "Correlation of sensitivity, quality and Photography modes" (→p.72).

Changing the FinePix COLOR setting ([F] FinePix COLOR)

Use this menu to specify required color tone. It is effective for taking vivid shots or black and white shots.

CHECK

FinePix COLOR settings

[STD] [F-STANDARD]	The contrast and color saturation are set to standard. Use this mode for normal photography.
 [F-CHROME]	The contrast and color saturation are set to high. This mode is effective for taking more vivid shots of subjects such as scenery (blue sky and greenery) and flowers.
 [F-B&W]	This mode converts the colors in the photographed image to black and white.

When setting [F-CHROME] or [F-B&W], the icon appears on the LCD monitor.

CAUTION

When the Mode dial is set to SP1 or SP2,  does not appear on the LCD monitor.

MEMO



- The [FinePix COLOR] setting is retained even when the camera is off or the mode setting is changed.
- [F-CHROME] may have little visible effect with some subjects or the scene being shot. You may not be able to see any difference on the LCD monitor.

Selecting light metering method ([] PHOTOMETRY)

Available Photography modes: A/S, 
(→p.54, 58)
(When Intelligent Face Detection is
turned OFF)

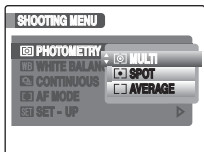
Use this setting when the correct exposure cannot be obtained by the shooting conditions.



- [] MULTI] (Pattern): Light metering where the camera assesses the scene and selects the correct exposure.
- [] SPOT] : Light metering where the exposure is optimized for the center of the image.
- [] AVERAGE] : Light metering where an average value for the entire image is used.

To use the photometry modes effectively

- [MULTI]
In this mode, the camera uses automatic scene recognition to analyze the subject and provide optimum exposure in a wide range of shooting conditions.
- [SPOT]
This mode is useful for subjects with strongly contrasting light and dark areas where you want to achieve the correct exposure for a particular feature.
- [AVERAGE]
The advantage of this mode is that the exposure tends not to change for different compositions or subjects. This mode is particularly effective for shots of people wearing black or white clothing and shots of scenery.

Adjusting color balance ([WB] WHITE BALANCE)

Available Photography modes: A/S, (→p.54, 58)

Adjust the color balance based on white to suit the color of the ambient light around the subject.

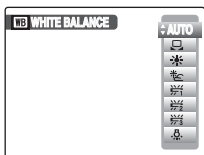

[AUTO]: Automatic adjustment

- : Select the white balance by using white paper to suit the shooting conditions.
- : Shooting outdoors in good weather
- : Shooting in shade
- : Shooting under Daylight fluorescent lamps
- : Shooting under Warm White fluorescent lamps
- : Shooting under Cool White fluorescent lamps
- : Shooting in incandescent light

Custom white balance

- ① Select custom white balance.
- ② Hold a piece of white paper under the light source for setting the white balance, so that it fills entire the LCD monitor. Then press the shutter button to set the white balance.

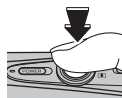
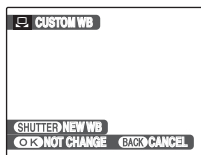

MEMO

- The white balance setting does not affect the image shown on the LCD monitor.
 - To use the white balance set previously, press the MENU/OK without pressing the shutter button.
- ③ When the correct exposure is measured, [COMPLETED!] appears. Press MENU/OK button to confirm the setting.

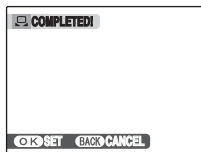

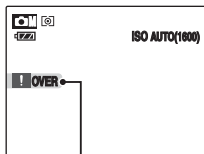

OVER or UNDER

Set the exposure compensation again, using a negative value (–) when [OVER] appears and a positive value (+) when [UNDER] appears (→p.59).

Example

You can change the white balance for a photographed image by using colored paper instead of white paper.

MEMO

- In [AUTO] mode, the correct white balance may not be achieved for subjects such as close-ups of people's faces and pictures taken under a special light source. Select the correct white balance for the light source.
- When the flash fires, the white balance (except for custom white balance) setting for the flash is used. Consequently, to achieve a particular effect, the flash mode should be set to [Ⓢ] SUPPRESSED FLASH] (→p.63).
- The specified custom white balance is retained until it is reset. This setting is retained even if the battery is removed.
- The color tones may vary depending on the shooting conditions (light source, etc.).
- After taking the picture, check the image color (white balance).
- Explanation of Terms "White Balance" (→p.156)

Taking pictures continuously ([CONTINUOUS])

Use this mode to take pictures of a moving subject.

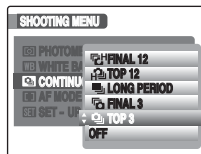

- Ⓜ : [FINAL 12] continuous shooting
- Ⓜ : [TOP 12] continuous shooting
- Ⓜ : [LONG PERIOD] continuous shooting
- Ⓜ : [FINAL 3] continuous shooting
- Ⓜ : [TOP 3] continuous shooting

Continued ➔

CAUTION

- Number of available frames is limited depending on the available space on the Memory Card or internal memory.
- In [TOP 3], [FINAL 3], [TOP 12] and [FINAL 12] continuous shooting mode, the focus and exposure is determined in the first frame and cannot be changed in mid-sequence ([LONG PERIOD] is the only exception.).
- The speed of continuous shooting varies depending on the shutter speed.
- The flash cannot be used as the flash mode is set to [Ⓞ SUPPRESSED FLASH] (→p.63). However, when the mode is changed back to normal photography, the flash setting specified before continuous shooting was selected is restored.
- For [TOP 3], [FINAL 3], [TOP 12] and [FINAL 12] continuous shooting, the results are always displayed after you shoot (Note that pictures taken using [LONG PERIOD] continuous shooting are recorded without displaying the results.).
- In [FINAL 3], [FINAL 12] and [LONG PERIOD] continuous shooting mode, only 1 frame can be shot when using the [FINAL 3]/[FINAL 12] / [LONG PERIOD] continuous shooting mode and Self-timer mode together.
- Continuous shooting cannot be selected in [Ⓜ NATURAL & Ⓜ].

[📷 TOP 3] continuous shooting

Available Photography modes: **AUTO**, **N**, SP1/SP2, A/S, **📷**



Shooting continues up to 3 frames as long as the shutter button is held down (max. 2 frames/sec.).

**MEMO**

The file recording time using the continuous shooting may increase when recording in the **xD-Picture Card** or internal memory.

[FINAL 3] continuous shooting

Available Photography modes: **AUTO**, **N**, SP1/SP2, A/S,

Shooting continues up to 40 frames as long as the shutter button is held down (max. 2 frames/sec.).

The last 3 frames are recorded after the shutter button is released.

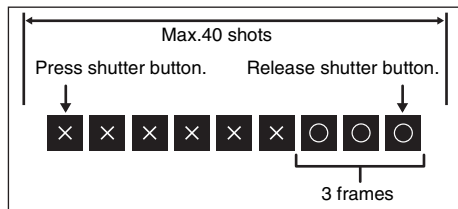

[LONG PERIOD] continuous shooting

Available Photography modes: **AUTO**, **N**, SP1/SP2, A/S,

Shooting continues as long as the shutter button is held down until the Memory Card or internal memory is full.

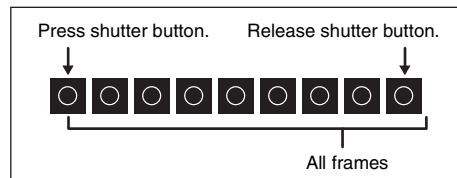

[TOP 12] continuous shooting

Available Photography modes: **AUTO**, , A/S,

Shooting continues up to 12 frames as long as the shutter button is held down (max. approx. 5 frames/sec.).

[FINAL 12] continuous shooting

Available Photography modes: **AUTO**, , A/S,

Shooting continues up to 40 frames as long as the shutter button is held down (max. approx. 5 frames/sec.).

The last 12 frames are recorded after the shutter button is released.

Continued ➔

About sensitivity and image size for the [H] TOP 12] and [F] FINAL 12]

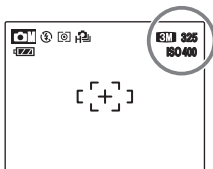

When [H] TOP 12] or [F] FINAL 12] is set, the sensitivity is restricted to over 400, and the image size is restricted to under **SM**. The changed sensitivity and image size will be displayed in yellow. When photography mode is set to other than **AUTO**, **A/S**, **CM**, the restriction is cleared.

Specifying focusing mode ([AF MODE])

Available Photography modes: A/S, **CM**
(→p.54, 58)

(When Intelligent Face Detection is turned OFF)

Use this mode to specify focusing mode that best suits the subject.

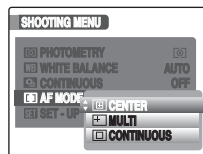

- [C] : [CENTER]
- [M] : [MULTI]
- [O] : [CONTINUOUS]

[C] CENTER]

The camera focuses on the center of the LCD monitor. Use this setting when taking pictures with AF/AE lock (→p.33).

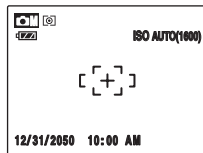

[+] MULTI]

When pressing the shutter button down halfway, the camera recognizes any strongly contrasting subject near the center of the LCD monitor and displays the AF frame over subject in focus.

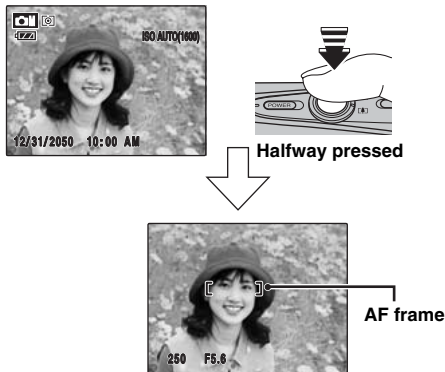
**! CAUTION**

When taking pictures in Macro mode, the camera focuses on the center of the screen.

MEMO

When the AF frame does not appear in the focusing position, select [□] CENTER in the [AF MODE] and use AF/AE lock (→p.33).

[□ CONTINUOUS]

Use this setting to take pictures of a moving subject. The camera continues to focus on the main subject in the AF frame.

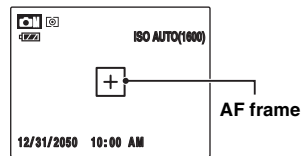
**! CAUTION**

When using [□ CONTINUOUS], attention must be given to the battery level.

The battery level (power consumption) increases when using [□ CONTINUOUS]. Because the camera focuses continuously without pressing the shutter button.

Using [*F*-MODE MENU] (Playback)/[PLAYBACK MENU]

Use these menus to play back photographed images.

Setting the [*F*-MODE MENU] (Playback)

- ① Set the camera to Playback mode (→p.36).

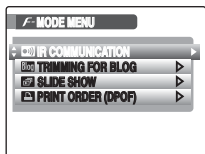

- ② Press *F* to open the [*F*-MODE MENU].



- ③ Press ▲ or ▼ to select the menu.



- ④ Press ►.



- ⑤ Press ▲ or ▼ to change the setting.



- ⑥ Press MENU/OK to confirm the setting.



Setting the [PLAYBACK MENU]

- ① Set the camera to Playback mode (→p.36).

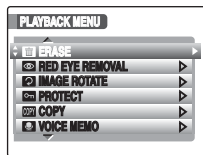

- ② Press MENU/OK to open the [PLAYBACK MENU].



- ③ Press ▲ or ▼ to select the menu.



- ④ Press ►.



- ⑤ Press ▲ or ▼ to change the setting.







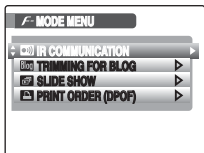

- ⑥ Press MENU/OK to confirm the setting.

Sending and receiving images **([IR] IR COMMUNICATION)**

You can send photographed images to another FUJIFILM digital camera (if it has IR Capability), other devices with high-speed infrared transmission capability, or any other mobile device with the IrSimple function. You can also receive photographed images from a FUJIFILM digital camera, another device with high-speed infrared transmission capability, or another mobile device with the IrSimpleShot™ (IrSS™) function.



- 
 ① Press  to set the camera to Playback mode (→p.36).
- 
 ② Press **F** to open the [F-MODE MENU].
- 
 ③ Press  or  to select [IR] IR COMMUNICATION.
- 
 ④ Press **F**.

MEMO

You can specify the infrared transmission setting in the [SET-UP] menu. See p.107, 109 for more information on specifying the infrared transmission setting.



CHECK

Refer to the manual provided with each device for more information.

Sending image data

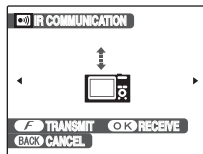
Sending image data to a FUJIFILM digital camera is shown as an example here. You can send the data to another device in the same way.



- ① Turn the camera on.
- 
 ② Press  or  to select the sending frame (file).

Continued 

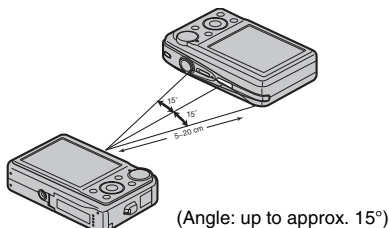

- ③ Point the camera's infrared port towards the front of the camera's infrared port (→p.11). Transmission distance is about 5 to 20 cm (2 to 7.9 in.) within approx. 15°.

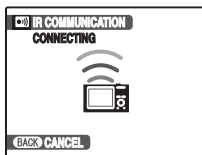

- ④ Press **F** to begin transmission. When transmission is completed, [TRANSMISSION COMPLETED] will appear on the LCD monitor.



! CAUTION

- Check that your camera is turned on when transmitting the image data.
- If the image is 3:2 ratio, white lines may appear at the top and bottom or right and left of the print, depending on the printer type.
- Movie images cannot be printed.
- Images photographed with a camera other than FinePix F50fd may not be printed or transmitted.
- If the [QUALITY] of sending image data is over **3M**, [QUALITY] of the image will be set to **3M**.

✓ CHECK

- You can send the image data by simply pressing **F** three times.
- Refer to the manual provided with the receiving device for more information.

Receiving the image data

Receiving the image data from a FUJIFILM digital camera is shown as an example here. You can receive data from another device in the same way.

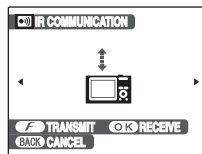

- ① Turn the camera on.



- ② Press ◀ or ▶ to select the sending frame (file).

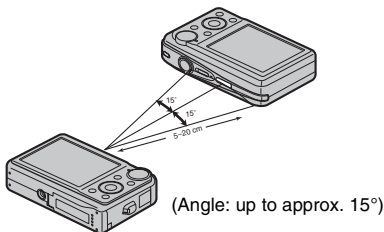

- ③ Point the camera's infrared port towards the front of the camera's infrared port (→p.11). Transmission distance is about 5 to 20 cm (2 to 7.9 in.) within approx. 15°.

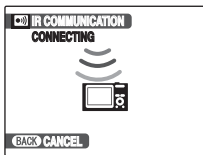

- ④ Press MENU/OK to begin transmission. When transmission is completed, [DATA RECEIVED] will appear on the LCD monitor.

✓ CHECK

You can receive image data by simply pressing buttons as the order below:

F → **F** → MENU/OK

! CAUTION

- Movie images cannot be transmitted.
- If [COMMUNICATION ERROR], [CANNOT BE TRANSMITTED], or [CANNOT BE RECEIVED] appears, press **F** or MENU/OK to retransmit the image data, or press DISP/BACK to cancel transmitting.
- Do not place anything between the transmitting and receiving device.
- Leaving the camera in direct sunlight or directly under fluorescent lighting may prevent successful data transfer.
- Successful transfer may not be possible when transmitting near infrared transmission devices (such as the remote controller of TV or VCR) or devices that generate electrical noise.
- Correctly aim the infrared port towards the front of the device or camera's infrared port during image data transmission.



MEMO

When playing back an image received from another camera,  will appear in the LCD monitor.

Transmitting and saving blog images

([Blog] TRIMMING FOR BLOG)

You can change the pictures you take to a smaller size and then transmit or save them. This function is perfect when you want to post your pictures on a blog or other online forum. It is also possible to trim images before transmitting or saving them.

MEMO

The sizes for blog images can be set to [640 STANDARD](640 × 480) or [320 SMALL](320 × 240) (→p.108). The size will be [640 STANDARD](768 × 512) or [320 SMALL](384 × 256) for images shot at 8:3.

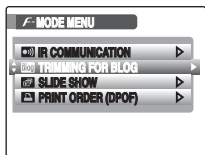

- 1 Press to set the camera to Playback mode (→p.36).



- 2 Press **F** to open the [F-MODE MENU].



- 3 Select [Blog] TRIMMING FOR BLOG.



- 4 The Transmit/Save screen appears.



MEMO Trimming Images

You can trim out the desired area of an image before transmitting or saving it.

- 1 Zoom in or out the image using the zoom lever (for zoom in and for zoom out).
- 2 Press to move the screen to the area you want to trim out.
- 3 Press MENU/OK to confirm the setting and return to the Transmit/Save screen.

Transmitting blog images

You can resize images to VGA and then transmit them to a device that supports the IrSimple function.

Saving blog images



① Select the frame (file) to save.



② Press MENU/OK to save the image.

CHECK

- Saved blog images have filenames that start with “BLOG” when they are imported to a PC or similar device.
- When saved blog images are played back,  appears on the screen and the images are surrounded by a black frame.

CAUTION

Saved blog images cannot be rotated or trimmed.

MEMO

Images rotated with  [IMAGE ROTATE] are transmitted or saved in their rotated state.

Setting automatic playback ([SLIDE SHOW])

Use this mode to play back photographed images continuously. You can select playback interval and type of image transition.

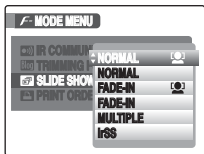

MEMO

- To interrupt automatic playback, press MENU/OK.
- Press ◀ or ▶ to advance or go back through the images when selecting [NORMAL] and [FADE-IN].
- The Auto power off function (→p.114) does not operate during slide show.
- Movie starts automatically. When the movie ends, the playback function moves it on.
- Press DISP/BACK once during playback to display on-screen help.
- The date is displayed on the Slide Show (except [MULTIPLE]) if the date is displayed on the Single-Frame Playback.
- You can watch a slide show without AV connection between camera and IR capable TV by selecting [IrSS]. For details on IR model, see our web site: http://www.fujifilm.com/products/digital_cameras/support/ir.html
- The camera plays back the image taken with Intelligent Face Detection (→p.29) zoomed in on the detected face when [NORMAL] or [FADE-IN] is selected.

DPOF set frame ([PRINT ORDER (DPOF)])

You can specify the image, number of prints, with or without date of printing with a DPOF-compatible printer.

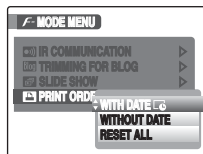

- [WITH DATE] : The date will be imprinted on your prints.
- [WITHOUT DATE] : The date will not be imprinted on your prints.
- [RESET ALL] : All DPOF settings will be canceled.

■ [PRINT ORDER (DPOF)]

DPOF stands for Digital Print Order Format and refers to a format that is used for recording printing specifications for images shot using a digital camera on media such as a Memory Card. The recorded specifications include information on which frames are to be printed.

This section gives a detailed description of how to order your prints with FinePix F50fd.

*Some printers do not support date and time imprinting or specification of the number of prints.

*The warnings shown below may appear while specifying the prints.

[DPOF SPECIFIED. ERASE OK ?]

[DPOF SPECIFIED. ERASE ALL OK ?]

When erasing the image, the DPOF setting for that image is deleted at the same time.

[RESET DPOF OK ?] (→p.91)



When inserting a Memory Card that contains images specified for printing by another camera, those print specifications are all reset and replaced by the new print specifications.

[DPOF FILE ERROR] (→p.138)

Up to 999 images can be specified on the same Memory Card.

Continued ➔

[WITH DATE] / [WITHOUT DATE]

Selecting [WITH DATE] ,  appears on the LCD monitor and the date will be imprinted on your prints.

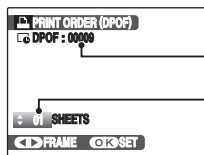

Total number of prints

Setting for that frame



- Press ◀ or ▶ to display the frame (file) for specifying DPOF setting.



- Press ▲ or ▼ to set a value.
Up to 99 sheets are printed.
For frames (files) that you do not want printed, set the number of prints to 0 (zero).

To specify more DPOF settings, repeat steps ① and ②.



- Always press MENU/OK after the settings are completed.
Pressing DISP/BACK cancels those settings.



- Press MENU/OK again. The total number of prints appears on the screen.

 **MEMO Canceling DPOF setting**

- Press **F** to open the [F-MODE MENU] and press ▲ or ▼ to select [PRINT ORDER (DPOF)].
- Press ▶.
- Press ▲ or ▼ to select [WITH DATE]  or [WITHOUT DATE] and press MENU/OK to display the print order screen.
- Press ◀ or ▶ to select the frame (file) with the DPOF setting you want to cancel.
- Press ▼ to set the number of prints to 0 (zero).

To cancel the DPOF setting for another frame (file), repeat steps ④ and ⑤.

Always press MENU/OK to complete the settings.

- [RESET ALL] (→p.91)

 **MEMO**

- When DPOF settings were specified on another camera.

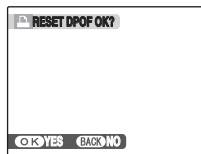





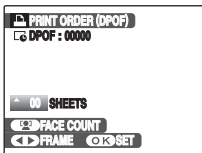

When the data includes a frame (file) with DPOF settings that were specified on another camera, [RESET DPOF OK?] appears. Pressing MENU/OK erases all of the DPOF settings already specified for each frame (file). Specify the DPOF setting for each frame (file) again.

- Prints of up to 999 frames (files) can be ordered on the same Memory Card.
- DPOF settings cannot be specified for movies.

CAUTION

- Pressing DISP/BACK while choosing settings will cancel all current settings. If there were previous DPOF settings, only the modifications are canceled.
- When selecting the [WITH DATE] setting, the date is imprinted on your shots using the Print Service or a DPOF-compatible printer (depending on the printer specifications, the date may not be printed in some cases).
- Images photographed with a camera  other than FinePix F50fd may not be specified DPOF settings.

Intelligent Face Detection

When DPOF settings are set to the images taking with the Intelligent Face Detection (→p.29) ( appears on the screen), press  (Intelligent Face Detection), the frame appears around the detected face, and then the number of the detected faces is set to print number. It is easy to set the number of prints for each person in the picture. Press  or  to set the print number. Press  (Intelligent Face Detection) again, the number of the detected faces is set to the print number. After setting, press MENU/OK.

[RESET ALL]

To cancel all DPOF settings:

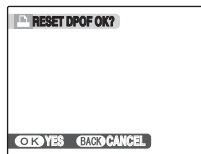

Select [RESET ALL] in the [**F**-MODE MENU] (→p.88).

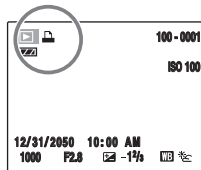

Press MENU/OK.

**MEMO**

 appears on the LCD monitor during playback when the image has specified DPOF settings.

Correcting red-eye effect in images

([REDA EYE REMOVAL])

You can correct the red-eye effect in images taken with the Intelligent Face Detection (→p.29) (appears on the screen).

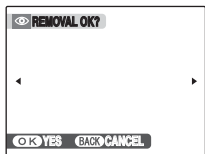

① Press ◀ or ▶ to select the frame taken with the Intelligent Face Detection.



② Press MENU/OK to open the [PLAYBACK MENU].



③ Press ▲ or ▼ to select [REDA EYE REMOVAL].



④ Press ▶.



⑤ Press MENU/OK to perform removal.

CAUTION

- If the camera is unable to detect faces in an image, it will not correct the red-eye effect sufficiently, or not at all. Also, the camera cannot correct the red-eye effect if the face is in profile.
- Correction results may differ depending on scene.
- The processing may take more time if there are many faces in the image.
- The camera cannot correct the red-eye effect in some images, such as those saved using [TRIMMING FOR BLOG] or black and white images.
- Images photographed with a camera other than FinePix F50fd cannot be red-eye corrected.
- The corrected image is added as a separate file in the final frame and is indicated in the image.
- A red-eye corrected image is shown with a . The image cannot be corrected again.

CHECK



① Red-eye effect in an image will be detected.



② Red-eye effect will be corrected before the image is recorded. When the red-eye effect is not detected, processing will end without the [REMOVING] screen displayed.

Rotating the images ([MENU/OK] IMAGE ROTATE)

When shooting in the vertical position, the image appears horizontal on the LCD monitor. Use this mode to rotate an image and to display correct direction. Your camera calls images "frames".

CAUTION

Protected frames (files) cannot be rotated. Unprotect the frames (files) before rotating them (→p.94).

MEMO

An image can be rotated only when playing back using FinePix F50fd. You may not be able to rotate images that were shot with a camera other than the FinePix F50fd.

- ① Press ◀ or ▶ to select the rotating frame (file).
- ② Press MENU/OK to open the [PLAYBACK MENU].
- ③ Press ▲ or ▼ to select [IMAGE ROTATE].
- ④ Press ▶.

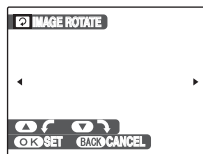

- ⑤ Press ▲ or ▼ to rotate the image.
▼: Rotates the image clockwise at a 90 degree angle.
▲: Rotates the image counterclockwise at a 90 degree angle.

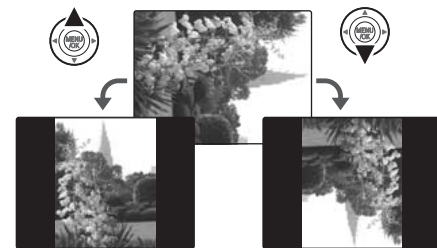

- ⑥ Press MENU/OK to confirm the setting. Next time the image is played back, it will be automatically rotated. Press DISP/BACK to cancel rotating the image.

Protecting the images ([PROTECT])

Use this mode to prevent frames (files) from being accidentally erased. Your camera calls images “frames”.

[FRAME] (set or reset a frame)

To protect or unprotect only the selected frame (file):

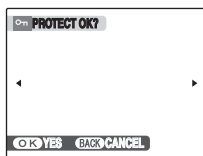

Unprotected

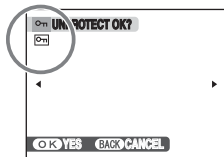

Protected ( appears)



① Press ◀ or ▶ to select the protecting/unprotecting frame (file).



② Press MENU/OK to protect/unprotect the currently displayed frame (file).
Unprotected: protecting frame (file)
Protected: reset frame (file)

To protect another frame (file), repeat steps ① and ②.
When protecting frames (files) is completed, press DISP/BACK.

[SET ALL]

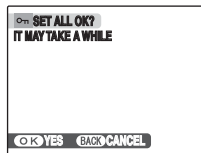

Press MENU/OK to protect all the frames (files).

[RESET ALL]

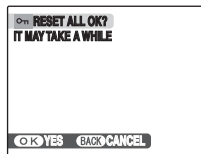

Press MENU/OK to unprotect all the frames (files).

 **MEMO** To stop the procedure midway

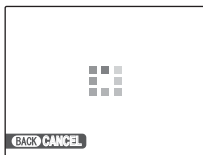

If the images are very large, protecting or unprotecting all the frames (files) may take some time.
If you want to take a picture or record a movie during the procedure, press DISP/BACK.

 **CAUTION**

The Format function erases all the frames (files), including protected frames (files) (→p.113).

Copying the images ([COPY] COPY)

It is possible to transfer saved images between the internal memory and a Memory Card. Your camera calls images "frames".

■ Selecting COPY

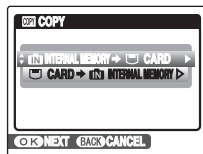

- ① Press ▲ or ▼ to select [INTERNAL MEMORY → CARD] or [CARD → INTERNAL MEMORY].



- ② Press ►.

Copying the images to another Memory Card

Copy images from the Memory Card inserted in your camera to the internal memory using the Copy Image function, then remove that Memory Card and insert another Memory Card into the camera. Then, copy the images to the Memory Card from the internal memory.

Continued →

Copying one frame at a time ([FRAME])

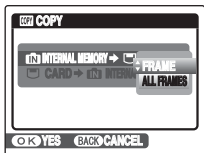

① Press ▲ or ▼ to select [FRAME].



② Press MENU/OK.



③ Press ◀ or ▶ to select the copying frame (file).



④ Press MENU/OK to copy the currently displayed frame (file).

MEMO

To copy another frame (file), repeat steps ③ and ④.
When copying frames (files) is completed, press DISP/
BACK.

Copying all frames ([ALL FRAMES])

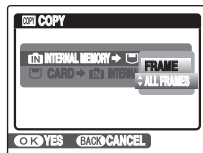

① Press ▲ or ▼ to select [ALL FRAMES].



② Press MENU/OK.



③ Press MENU/OK to copy all the frames (files).

CAUTION

- When [MEMORY FULL] or [MEMORY FULL] appears on the LCD monitor, copying the data stops on the way.
- When copying the image that has specified DPOF setting, the DPOF setting is not copied.

Adding voice memos to the images ([VOICE MEMO])

Voice memos of up to 30 seconds can be added to still images.

Recording voice memos

- ① Press ◀ or ▶ to select the image to add a voice memo.
- ② Press MENU/OK to open the [PLAYBACK MENU].
- ③ Press ▲ or ▼ to select [ VOICE MEMO].
- ④ Press ▶.



- ⑤ Press MENU/OK to start recording.

The remaining recording time appears during recording.

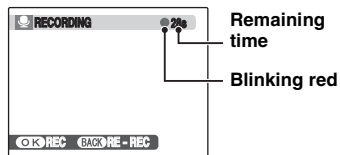

MEMO

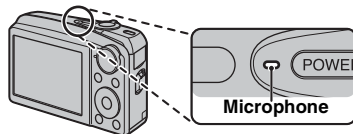

Hold the camera about 20 cm (7.9 in.) away for the best results.

Continued ➔

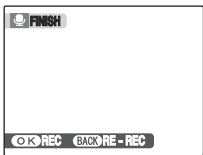

- ⑥ The voice memo ends when pressing MENU/OK midway or 30 seconds pass.

To record your comment: press MENU/OK.
To rerecord the comment: press DISP/BACK.

MEMO

- When the image already has a voice memo

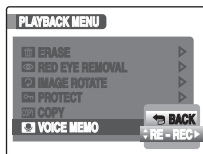

If you select an image that already has a voice memo, a screen appears in which you can select whether to rerecord the memo.

- When [PROTECTED FRAME] appears, unprotect the frame (→p.94).
- Voice memos cannot be added to movies.

Playing back voice memo



- ① Press ◀ or ▶ to select an image file with a voice memo.  appears on the LCD monitor.



- ② Press ▼ to start playing back the voice memo.

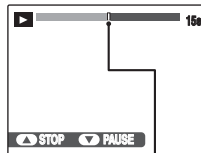

Progress bar



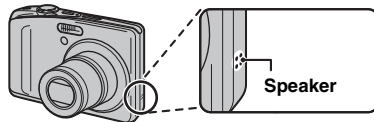

The playback time appears on the LCD monitor along with a progress bar.

CAUTION



Uncover the speaker.
The sound may be difficult to hear.

■ Playing back voice memos

	Control	Description
Playback		Playback begins. The voice memo stops when playback ends.
Pause / Resume		Pauses the voice memo during playback. Press ▼ again to resume playback.
Stop		Stops playback. Press ◀ or ▶ while voice memo playback is stopped to go back to the previous file or advance to the next file respectively.
Fast forward / Rewind		Press ◀ or ▶ during playback to skip forwards or backwards through the voice memo. These buttons do not function while playback is paused.

✓ CHECK

- Audio recording format:
WAVE (→p.156), PCM recording format
- Audio file size:
Approx. 330 KB (for a 30-second voice memo)

📎 MEMO Playing voice memo files

You may not be able to play back some voice memo files recorded on other cameras.

Adjusting volume of voice memos

Volume can be adjusted while playing back voice memos.

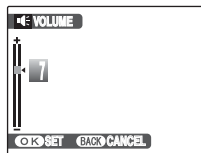

- 1 Press MENU/OK while playing back voice memo.
The voice memo is paused during playback.



- 2 Press ▲ or ▼ to adjust the volume.



- 3 Press MENU/OK to confirm your selection.
Camera starts to play back the voice memo.

Trimming the images ([TRIMMING])

Use this mode to trim the required part of the photographed image.

CHECK

Before selecting [TRIMMING], select the trimming frame (file).

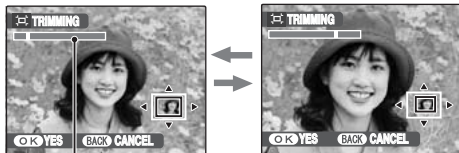

 **wide zoom lever**
(Zoom out)

 **Tele zoom lever**
(Zoom in)



Zoom bar







- Turn the zoom lever to  or  to zoom in or out an image.



Navigation screen
(Current displayed image)



- Press , , , or  to display another part of the image.



- Press MENU/OK.

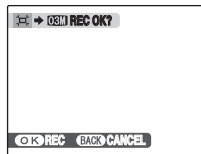

- Check the saved image size and press MENU/OK.
The trimmed image is added as a separate file in the final frame.



MEMO

- Pressing DISP/BACK in step ① or ② returns to single-frame playback.
- A saved image size varies depending on the zoom scale of step ①. For 0.3 M, **OK** YES option appears in yellow.
- Image sizes

6M	Printing at up to 10R (25.4 × 30.5 cm/10 × 12 in.) / A4 size
3M	Printing at up to 6R (15.2 × 20.3 cm/6 × 8 in.) / A5 size
2M	Printing at up to 4R (10.2 × 15.2 cm/4 × 6 in.) / A6 size
0.3M	To use for e-mail or web site



- When **3:2** quality setting is selected, the image is trimmed to normal size (4:3 aspect ratio).

CAUTION

You may not be able to trim images that were shot with a camera  other than FinePix F50fd.

Intelligent Face Detection



Images taken with the Intelligent Face Detection (→p.29) ( appears on the screen). Press  (Intelligent Face Detection), the face that is focused on is zoomed in to help crop the main subject. To specify a cropped part of the image according to preference, specify and adjust according to the procedure in [TRIMMING].

Recording Movies

Use this mode to record movies with sound.

1 Set the camera to Movie mode.

Set the Mode dial to .

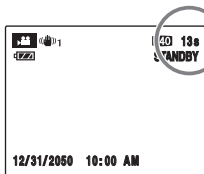
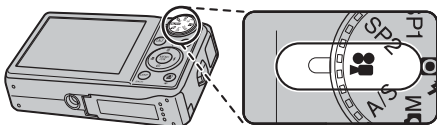



The available recording time appears on the LCD monitor.

Zooming the image

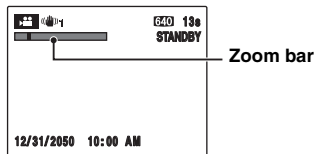
You must zoom beforehand as you cannot zoom during recording.



Turn the zoom lever to  or  to zoom in or out an image.

CHECK

Focal range

Wide-angle: Approx. 45 cm (1.5 ft) to infinity

Telephoto: Approx. 60 cm (2.0 ft) to infinity

2 Record movies.

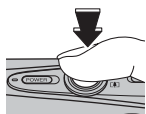

Fully pressed

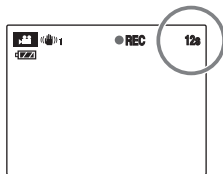

Press the shutter button down fully to start recording. During recording, [●REC] and a counter that shows the remaining time appear on the LCD monitor.



Halfway pressed

Recording ends when pressing the shutter button down halfway during recording or the remaining time runs out.

MEMO

- AF-assist illuminator will fire when the subject is poorly lit.
- See p.108 for information on turning the AF-assist illuminator off.
- There is no need to hold down the shutter button during recording.

CHECK Recording movies

- Specifications: Motion JPEG (→p.156), Monaural sound
- Quality selection method: **640** (640 × 480 pixels)
320 (320 × 240 pixels)
- Frame rate (→p.156): 25 frames per second (fixed)

MEMO

- The brightness and color of the LCD monitor shown during movie recording may differ from those shown before recording begins.
- Pressing the shutter button down fully fixes the focus, however the exposure and white balance are adjusted to the scene being shot.
- If recording is stopped immediately after it begins, 1 second of the movie is recorded onto the Memory Card or internal memory.

CAUTION

- Because a movie is recorded onto the Memory Card or internal memory as it is saved, it cannot be recorded correctly if the camera suddenly loses power (if the battery runs out, or the AC power adapter and DC coupler are disconnected).
- A movie file taken by FinePix F50fd may not be playable on other cameras.
- Because sound is recorded concurrently with the images, make sure that you do not cover the microphone with a finger, etc. (→p.11).
- Camera operation noises may be recorded during movie shooting.
- The size of a movie file can be up to 2GB.

Changing movie size

Press **F** to open the [**F**-MODE MENU].

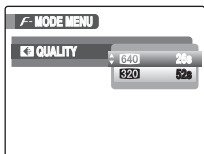

① Press **▶**.



② Press **▲** or **▼** to change the setting.



③ Press MENU/OK to confirm the setting.

Quality settings in Movie mode

640 (640 × 480 pixels): For better quality

320 (320 × 240 pixels): To record longer movies

MEMO

- The quality setting is retained even when the camera is turned off or the mode setting is changed.
- In **Movie** mode, you cannot set the [ISO] (sensitivity) setting and [FinePix COLOR] setting.
- See p.154 for information on recording times per Memory Card or internal memory.

CAUTION

If you shoot using the **xD-Picture Cards** with model numbers containing "M" such as DPC-M1GB, movie recording time may be reduced if you repeatedly record and erase (frame erase) image files.

In such a case, erase all frames or format the **xD-Picture Card** before use. Back up important frames (files) onto your PC or another media.

▶ Playing Back Movies

Setting the camera to ▶
Playback mode (→p.36)

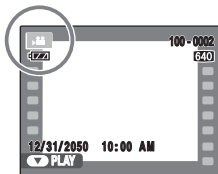

- ① Press ◀ or ▶ to select the movie file.
▶ appears on the LCD monitor.



- ② Press ▼ to begin playing back movie.

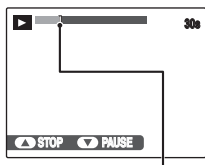

Progress bar

The playback time appears on the LCD monitor along with a progress bar.

■ Playing back movies

	Control	Description
Playback		Playback begins. Playback stops when the end of the movie is reached.
Pause / Resume		Pauses the movie during playback. Press ▼ again to resume playback.
Stop		Stops playback. Press ◀ or ▶ while playback is stopped to go back to the previous file or advance to the next file respectively.
Fast forward / Rewind		Press ◀ or ▶ during playback to skip forwards or backwards through the movie.
Skip playback		Press ◀ or ▶ when the movie is paused, the movie advances or goes back one frame. Hold down ◀ or ▶ to move through the frames quickly.

Continued ➔

 **MEMO**

If the subject of the shot is very bright, white vertical streaks or black horizontal streaks may appear in the image during playback. This is normal.

 **CAUTION**

- You may not be able to play back some movie files recorded on other cameras.
- To play back movie files on a PC, save the movie file on the Memory Card or internal memory to the PC's hard disk and then play back the saved file.
- Uncover the speaker. The sound is difficult to hear.

Adjusting volume of movies

Volume can be adjusted while playing back movies.

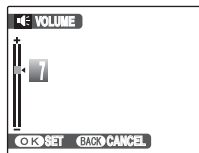

- ① Press MENU/OK while playing back movie.
The movie is paused during playback.



- ② Press ▲ or ▼ to adjust the volume.



- ③ Press MENU/OK to confirm the setting.
Camera starts to play back the movie.

Using the [SET-UP] menu

1 Open the [SET-UP] menu.



① Press MENU/OK to open the menu.



② Press ▲ or ▼ to select [SET] SET-UP.



③ Press ►.

2 Change the page.

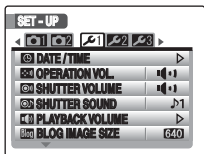

① Press ◀ or ▶ to select the page.



② Press ▼ to move to menu item.

3 Change the setting.

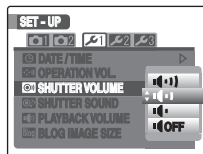

① Press ▲ or ▼ to select the menu.



② Press ►.
Different type of screen appears depending on selected item.

















③ Press ▲ or ▼ to change the setting.



④ Press MENU/OK to confirm the setting.

[SET-UP] menu option

	Setting	Display	Factory default	Explanation	Page
📷1	 IMAGE DISP.]	[3 SEC]/[1.5 SEC]/ [ZOOM (CONTINUOUS)]	[1.5 SEC]	Sets the way for displaying the check image screen (photograph result) after taking a picture. The color tones in images recorded may differ from actual color. Play back the recorded images to check them.	110
	 FRAME NO.]	[CONT.]/[RENEW]	[CONT.]	Specifies whether frame numbers are assigned consecutively from previous numbers or begin again.	111
	 DUAL IS MODE]	[👉]1 CONTINUOUS/ [👉]2 SHOOTING ONLY]	👉]1	Specifies whether the Dual Image Stabilization function is activated always at photography mode or it is activated only when shutter button is pressed down halfway.	112
	 SAVE ORG IMAGE]	[ON]/[OFF]	[OFF]	Specifies whether or not to record a shot image before red-eye correction is applied when using Intelligent Face Detection function with [👤] FACE DETECTION  REMOVAL ON].	29
	 AF ILLUMINATOR]	[ON]/[OFF]	[ON]	Specifies whether the AF-assist illuminator is ON or OFF.	34
	 DIGITAL ZOOM]	[ON]/[OFF]	[OFF]	Specifies whether digital zoom is used together.	112
📷2	 LONG EXPOSURE  NIGHT]	[ON]/[OFF]	[OFF]	Sets the long exposure setting when Photography mode is set to [🌃 NIGHT].	53
🔧1	 DATE/TIME]	-	-	Corrects the date or time.	24
	 OPERATION VOL.]	🔊OFF/🔊/🔊/🔊/🔊/🔊/🔊/🔊	🔊/🔊	Sets the volume of the tone emitted when the camera controls are used.	-
	 SHUTTER VOLUME]	🔊OFF/🔊/🔊/🔊/🔊/🔊/🔊/🔊	🔊/🔊	Sets the volume of the sound emitted when the shutter operates.	-
	 SHUTTER SOUND]	[🎵]1 SOUND1/ [🎵]2 SOUND2]	🎵]1	Sets the sound of the shutter emitted when the shutter operates.	-
	 PLAYBACK VOLUME]	-	[7]	Sets the volume of playing back movie and voice memo.	113
	 BLOG IMAGE SIZE]	[640] STANDARD]/ [320] SMALL]	640	Sets the size for blog image when the image is saved or transmitted.	86

	Setting	Display	Factory default	Explanation	Page
2	[☀️] LCD BRIGHTNESS]	–	[0]	Sets the LCD monitor brightness.	113
	[🗑️] FORMAT]	–	–	Initializes a Memory Card or internal memory. Select this menu to erase all the frames (files).	113
	[🗣️] 言語/LANG.]	[日本語]/[ENGLISH]/ [FRANCAIS]/[DEUTSCH]/ [ESPAÑOL]/[ITALIANO]/ [中文簡]/[繁體]/[한글]/ [РУССКИЙ]/[PORTUGUES]/ [NEDERLANDS]/[TURKÇE]/ [ČESKY]/[MAGYAR]/ [POLSKI]/[SVENSKA]	[ENGLISH]	Specifies the language used for LCD monitor display.	25
	[📷] AUTO POWER OFF]	[OFF]/[2 MIN]/[5 MIN]	[2 MIN]	Sets the time of turning camera off when camera is not used. [OFF] can be selected when [POWER MANAGEMENT] is set to [🔋] POWER SAVE.	114
	[🕒] TIME DIFFERENCE]	🏠 HOME/📶 LOCAL	🏠	Specifies the time difference settings.	114
	[🎨] BACKGROUND COLOR]	–	–	Specifies the colors of menu and background.	–
3	[i] GUIDANCE DISPLAY]	[ON]/[OFF]	[ON]	Specifies whether guidance for functions is displayed or not.	–
	[📺] VIDEO SYSTEM]	[NTSC]/[PAL]	–	Specifies whether video output is set to [NTSC] or [PAL].	–
	[📡] IR COMMUNICATION]	[STANDARD]/[IrSS]	[STD]	Specifies whether [📡] IR COMMUNICATION] is set to [STANDARD] or [IrSS]. Select [STANDARD] when communicating with a camera or printer, select [IrSS] when communicating with a TV.	–
	[🔄] RESET]	–	–	Resets all the camera settings (other than the [DATE/TIME], [TIME DIFFERENCE], [BACKGROUND COLOR], and [VIDEO SYSTEM]) to the factory default values set at shipment. A confirmation message appears when you press ▶. To reset the camera settings, press ◀ or ▶ to select [OK] and press MENU/OK.	–

[IMAGE DISP.]

Use this setting to set the way for displaying the check image screen (photograph result) after taking a picture.

[3 SEC]/[1.5 SEC]:

The image appears for about 3 or 1.5 seconds and is then recorded.

[ZOOM (CONTINUOUS)]:

The image appears enlarged. Use this mode to check details of image.

! CAUTION

- The color tones in images displayed when [3 SEC] or [1.5 SEC] is selected may differ slightly from those in the images actually recorded.
- [IMAGE DISP.] cannot be used when [LONG PERIOD] (→p.79) is set.

■ Enlarging images

Navigation screen
(Current displayed image)



- ① Turn the zoom lever to or to zoom in or out an image.



- ② Press , , , or to display another part of the image.



- ③ Press MENU/OK to take another picture.
The image is recorded automatically.

**MEMO**



- When quality setting is selected, the image cannot be enlarged.
- Pressing DISP/BACK cancels the zoom setting.
- This function is disabled when setting the continuous shooting.
- This function is disabled when selecting .

! Intelligent Face Detection

Images taken with the Intelligent Face Detection (→p.29). Press (Intelligent Face Detection) to alternate between the displayed faces. Turn the zoom lever to or to zoom in or out the selected face. Press , , or to display another part of the image.

[FRAME NO.]

Use this function to specify whether frame numbers are assigned consecutively from previous numbers or begin again.

	<CONT.>	<RENEW>
	0001 ⋮ 0005	0001 ⋮ 0005
↓		
	0006 ⋮ 0010	0001 ⋮ 0005

* Formatted Memory Card or internal memory used for both A and B.

[CONT.] : Pictures are stored beginning from the highest file number stored on the last Memory Card or internal memory used.

[RENEW] : Pictures are stored on each Memory Card beginning with a file number 0001. Each image will be numbered consecutively from the last number used. So when recorded images in the Memory Card are erased, the number of the erased frame will not be used again.

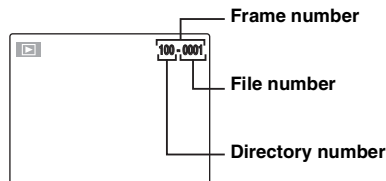
 **CHECK**

The last 4 digits of the 7-digit number in the top right corner of the LCD monitor are the file numbers, while the first 3 digits show the directory number.

 **MEMO**

- Setting this function to [CONT.] makes file management easier as it makes sure that file names are not duplicated when images are downloaded to a PC.
- When the camera settings are [RESET] (→p.109), the frame number setting ([CONT.] or [RENEW]) is changed to [CONT.] and the frame number itself does not return to 0001.
- In [CONT.] setting, images are stored beginning from the highest file number on the current Memory Card when the Memory Card already contains image files with file numbers higher than the highest file number on the last Memory Card.
- The displayed frame number may differ for images photographed on other cameras.

Continued ➔

[DUAL IS MODE]

Use this function to specify whether the Dual Image Stabilization function is always active in photography mode, or it is activated only when the shutter button is pressed down halfway.

[]1 CONTINUOUS]:

The Dual Image Stabilization function is activated always at photography mode.

[]2 SHOOTING ONLY]:

The Dual Image Stabilization is activated only when the shutter button is pressed down halfway.

[DIGITAL ZOOM]

Use this function to shoot enlarged images than maximum optical zoom scale.

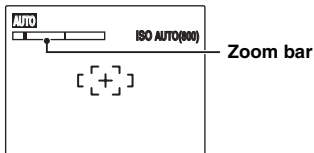
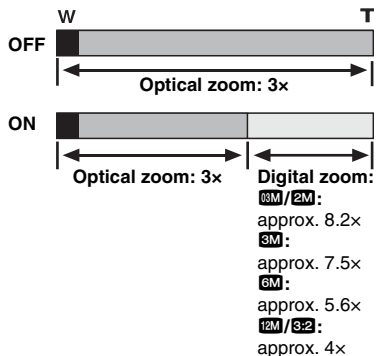
**Zoom bar display**** MEMO**

When zooming changes between optical and digital, the position of the “■” indicator stops. Press the same Zoom button again to start the “■” indicator moving again.

 CAUTION

Using the digital zoom allows you to enlarge your subject and shoot it. However, it will lower your image quality. Set the digital zoom when requiring it.

[PLAYBACK VOLUME]

Use this function to adjust volume while playing back movie and voice memo.

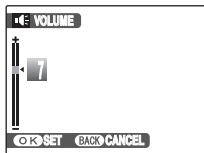

- ① Press ▲ or ▼ to adjust the volume.
The larger the number, the larger the volume is emitted. [0] (zero) indicates a sound deadening.



- ② Press MENU/OK to confirm the setting.

[LCD BRIGHTNESS]

Use this function to adjust the LCD monitor brightness.

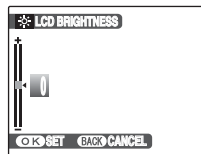

- ① Press ▲ or ▼ to adjust the LCD monitor brightness.
The indicator moves to the + to display the LCD monitor brightly or to the – to darken the LCD monitor.



- ② Press MENU/OK to confirm the setting.

[FORMAT]

Initialize (format) the Memory Card or internal memory for use with the camera.

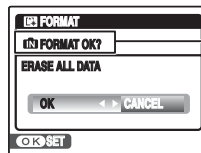

Place of initialize
[] FORMAT:
 Internal memory
[] FORMAT:
 Memory Card

Continued ➔



① Press ◀ or ▶ to select OK.



② Pressing MENU/OK initializes the Memory Card or internal memory.

! CAUTION

- The Format function erases all the frames (files), including protected frames (files). Back up important frames (files) onto your PC or another media.
- Do not open the battery cover or expose the camera to shock during formatting, as formatting will be interrupted.

[AUTO POWER OFF]

When this function is active and the camera remains unused for 2 or 5 minutes, it turns camera off. Use this function when you want to get the maximum possible running time from your battery.

! CAUTION

The Auto power off function is disabled during slide show (→p.88), and when a USB connection (→p.117, 126) is being used.



MEMO To restore power to the camera

Refer to "Turning On and Off" (→p.20).

[TIME DIFFERENCE]

Use this function when traveling to destinations in different time zones. This function sets a time difference relative to the date and time currently set. When this setting is enabled, the specified time difference is applied when pictures are taken.

1 Use Time difference function.

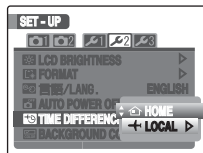

Press ▲ or ▼ to change between [HOME] and [LOCAL].

To set the time difference, select [LOCAL].

[HOME]: Your home time zone

[LOCAL]: Your destination time zone

2 Move to [TIME DIFFERENCE] screen.

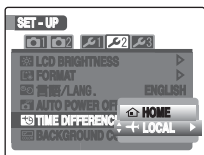

Press ►.

3 Set time difference.

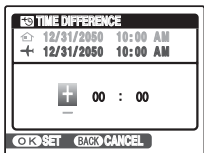

① Press ◀ or ▶ to select +/–, hour, and minute.



② Press ▲ or ▼ to change the setting.



③ Always press MENU/OK after the settings are completed.

✓ CHECK

Available time setting

–23:45 to +23:45 (in 15-minute increments)

📄 MEMO

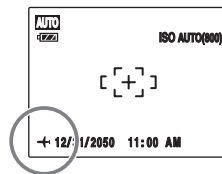

In the time difference setting, when you change to the Photography mode, + and the date is displayed for 3 seconds, the date display turns yellow.

✓ CHECK

Upon returning from a trip, always change the time difference setting back to [HOME] and then check the date and time again.

Connecting to a TV

When connecting to a TV, images can be displayed on wider screen. Using slide show function (→p.88) together, you can have fun with folks.

Plug the A/V cable (included) into the A/V OUT (Audio/Visual output) socket of the camera.

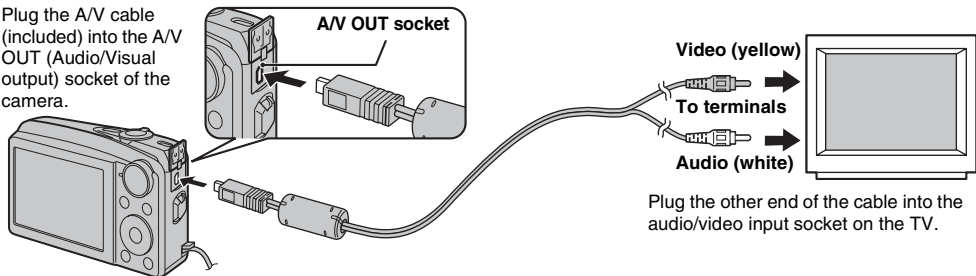

! CAUTION

- Plug the A/V cable (included) correctly in its terminal.
- See "Notes and Cautions" (included) for information on the AC power adapter.

📄 MEMO

- When connecting the A/V cable (included) to TV, the camera's LCD monitor is turned off.
- The image quality for movie playback is lower than for still images.
- When connecting to a TV, even if you adjust the volume from the [🔊] PLAYBACK VOLUME, the TV volume cannot be changed. Refer to the instructions provided with your TV for more information on audio/video input for your TV.
- Use the AC-5VX (sold separately) and CP-50 (sold separately) when FinePix F50fd is connected to a TV for long periods.

Connecting Camera Directly to Printer — PictBridge Function



When a printer that supports PictBridge is available, images can be printed by connecting the camera directly to the PictBridge-compatible printer without a PC.

Connecting to a printer

- 1 Connect the camera to your printer using the USB cable (included).

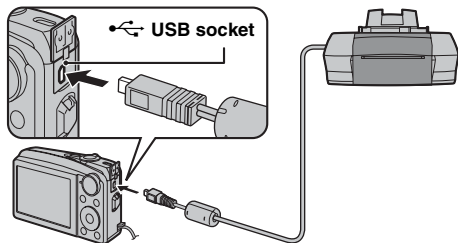

MEMO

Use the AC-5VX (sold separately) and CP-50 (sold separately) when FinePix F50fd is connected to a printer.

- 2 Connect the camera to a printer and turn the printer on.
Press POWER to turn the camera on.



[USB] appears on the LCD monitor.

- 3 The following screen appears on the LCD monitor after a moment.

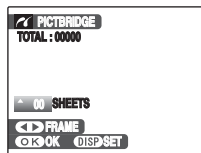

"Specifying images for printing"
→p.118
"Printing with DPOF setting"
→p.119

MEMO

Depending on the printer, some functions are disabled.

Specifying images for printing ([PRINT WITH DATE] / [PRINT WITHOUT DATE])

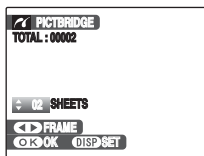

- ① Press ◀ or ▶ to display the frame (file) for specifying print setting.



- ② Press ▲ or ▼ to set a value.
Up to 99 sheets are printed.

To specify more print settings, repeat steps ① and ②.



- ③ Press MENU/OK to display the confirm setting.

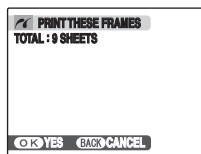

- ④ Press MENU/OK again to download the data to the printer and start printing the specified number of prints.



MEMO

Even if MENU/OK is pressed with total number of images set at 0 (zero), the screen printing once appears on the screen. Press MENU/OK again and printing starts.



MEMO Printing with date

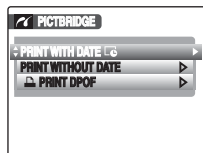

- ① Press DISP/BACK to display the setting display.
- ② Press ▲ or ▼ to select [PRINT WITH DATE] or [PRINT WITHOUT DATE].
- ③ Press MENU/OK.



CAUTION

[PRINT WITH DATE] is not available when the camera is connected to a printer that does not support date printing.

Printing with DPOF setting ([] PRINT DPOF)

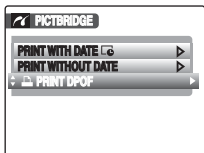

① Press DISP/BACK to open the menu.



② Press  or  to select [] PRINT DPOF.



③ Press MENU/OK to display the confirm setting.

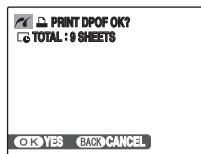

④ Press MENU/OK again to download the data to the printer and start printing the specified frames (files) continuously.

CHECK

To select [] PRINT DPOF, the DPOF settings must be specified on FinePix F50fd beforehand (→p.88).

CAUTION

Even when [WITH DATE ] is specified in the DPOF settings (→p.88), the date is not inserted on printers that do not support date printing.

Continued →

 **MEMO**

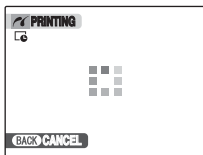

Press DISP/BACK to cancel the printing. Depending on the printer, the printing may not be canceled immediately or printing may stop midway through. When printing stops midway, briefly turn the camera off and then on again.

Disconnecting the printer

- ① Check that [PRINTING] is not displayed on the camera's LCD monitor.
 - ② Turn the camera off. Unplug the USB cable (included).
-

 **MEMO**

DPOF setting can be specified for images on internal memory.

 **CAUTION**

- In PictBridge function, images photographed on other than a camera may not be printed.
- The camera cannot be used to specify printer settings such as the paper size and print quality.
- Use internal memory or a Memory Card that was formatted on FinePix F50fd.
- Movies cannot be printed.
- Images photographed with a camera other than FinePix F50fd may not be printed.

Installation on a Windows PC

Pre-installation checklist

■ Hard ware (software) requirements and recommended system

To run this software, you must have the hardware and software described below. Check your system before you begin the installation.

Requirement		Recommendation	
Operating System*1	Windows 98 SE Windows Millennium Edition (Windows Me) Windows 2000 Professional*2 Windows XP Home Edition*2 Windows XP Professional*2 Windows Vista*2	Windows XP	Windows Vista
CPU	200 MHz Pentium minimum (Windows XP/Vista users: 800MHz Pentium 4 or better recommended)	2 GHz Pentium 4 or better	3 GHz Pentium 4 or better
RAM	128 MB minimum (512 MB minimum for Windows Vista)	512 MB or better	1 GB or better
Hard disk space	Amount required for installation: 450 MB minimum Amount required for operation: 600 MB minimum	2 GB or better	15 GB or better
Display	800 × 600 pixels or better, 16-bit color or better	1024 × 768 pixels or better, Highest (32 bit)	

*1 Models with one of the above operating systems pre-installed.

*2 When you install the software, login using a system administrator account (e.g. [Administrator]).

! CAUTION

- Additional USB interface board is not guaranteed.
- Windows 95, Windows 98 and Windows NT cannot be used.
- Operation is not guaranteed on home-built PCs or on PCs running updated operating system software.
- When you reinstall or remove FinePixViewer, the Internet menu and your user ID and password for the FinePix Internet Service are deleted from your PC. Click the [Register now] button, enter your registered user ID and password and download the menu again.

Continued ➔

Do not connect the camera to your PC until the software installation is completed.

1 Install FinePixViewer as instructed by the on-screen instructions.

Launching the installer manually

- 1 Double-click the [My Computer] icon.
* Windows XP users should click [My Computer] in the [Start] menu.
Windows Vista users should click [Computer] in the [Start] menu.
- 2 Right-click [FINEPIX] (CD-ROM drive) in the [My Computer] window (Windows Vista users: in the [Computer] window) and select [Open].
- 3 Double-click [SETUP] or [SETUP.exe] in the CD-ROM window.



- * The way file names are displayed differs as described below depending on your PC settings.
- File extensions (3-letter suffixes indicating the file type) may be shown or hidden. (e.g. Setup.exe or Setup)
 - Text may be shown normally or all in uppercase (e.g. Setup or SETUP).

For Windows Vista users:

When loading the bundled CD-ROM on your PC, the [AutoPlay] window may appear. In this case, click [SETUP.exe].

When [User Account Control] window appears, click [Allow].

2 Install DirectX as directed by the on-screen instructions and then restart your PC. If the latest version of DirectX is already installed on your PC, this installation is not performed.

! CAUTION

- If the latest version of DirectX or Windows Media Player has not been installed, each software will be installed, and then the PC will restart.
- Do not remove the CD-ROM during this procedure.

3 After restarting the PC, a message appears stating [Installation of the FinePixViewer has been completed]. Remove the CD-ROM from your PC.

Installation on a Mac OS X

Pre-installation checklist

Hardware and software requirements

To run this software, you must have the hardware and software described below. Check your system before you begin the installation.

Compatible Mac *1	Power Macintosh G3*2, PowerBook G3*2, Power Macintosh G4, iMac, iBook, Power Macintosh G4 Cube, PowerBook G4, Power Macintosh G5, MacBook, MacBook Pro, or Mac mini
Operating System	Mac OS X (compatible with version 10.3.9 to 10.4.9)
RAM	256 MB minimum
Hard disk space	Amount required for installation: 200 MB minimum Amount required for operation: 400 MB minimum
Display	800 × 600 pixels or better, at least 32,000 colors
Internet connection *3	<ul style="list-style-type: none">To use the FinePix Internet Service or mail attachment function: An Internet connection or e-mail transmission software is neededConnection speed: 56 k or better recommended

*1 PowerPC, Intel processor loaded

*2 Models with a USB port as a standard feature

*3 Required to use the FinePix Internet Service. The software can still be installed even if you do not have an Internet connection.

CAUTION

- Connect the camera directly to the Macintosh using the USB cable (included). The software may not operate correctly if you use an extension cable or connect the camera via a USB hub.
- Push the USB connector fully into the socket to ensure that it is securely connected. The software may not operate correctly if the connection is faulty.
- Additional USB interface board is not guaranteed.

Continued ➔

- 1 Turn your Macintosh on and start up Mac OS X. Do not launch any other applications.**
- 2 When the bundled CD-ROM is loaded into the CD-ROM drive, the [FinePix] icon appears. Double-click the [FinePix] icon to open the [FinePix] volume window.**
- 3 Double-click on [Installer for MacOSX].**
- 4 The Installer setup dialog appears. Click the [Installing FinePixViewer] button.**

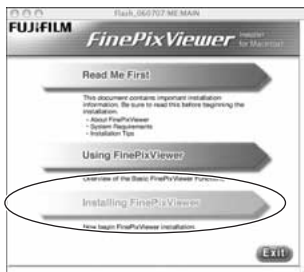

! CAUTION

For more information on what is installed, click the [Read Me First] button and [Using FinePixViewer] button.

- 5 The [Authenticate] dialog appears. Enter the name and password for the administrator account and then click the [OK] button.***

* The administrator account is the user account used for Mac OS X installation and you can confirm the user account in the Accounts dialog in the System Preferences.

- 6 Install FinePixViewer as directed by the on-screen instructions.**

7 The [FinePixViewer installation completed] message dialog appears. Then click exit button and close it.

! **CAUTION**

When Safari is used as the Web browser, a message may be displayed and the CD-ROM may not be removed. If this happens, click the Safari icon in the Dock to make Safari the active application and then select [Quit Safari] in the [Safari] menu to shut down Safari.

8 Launch [Image Capture] from the [Applications] folder.

9 Change the Image Capture settings. Select [Preferences...] from the [Image Capture] menu.



10 Select [Other...] from [When a camera is connected, open].

11 Select [FPVBridge] from [FinePixViewer] folder in the [Applications] folder and click the [Open] button.



12 Select [Quit Image Capture] menu in the [Image Capture] menu.

Connecting to a PC

By connecting the camera to a PC, your system can be expanded to fill a wide range of uses. Using "FinePixViewer" performs images saving, browsing and file management etc.

FinePixViewer Overview

Enables importing images, managing files and folders, and ordering prints using the internet (only Windows users).

! CAUTION

The Windows CD-ROM may also be required during installation. In this event, change CD-ROMs as directed by the on-screen instructions.

Refer to Software Installation (→p.121, 123) the first time you connect the camera to your PC.

Install the software first. Do not connect the camera to the PC before installing all the software.



CD-ROM
(Software for FinePix)

- 1 Insert the Memory Card with images into the camera (→p.17).

You can use the **xD-Picture Card** and the SD Memory Card with the FinePix F50fd.

In this Owner's Manual, these cards are expressed as "Memory Card".

! CAUTION

- Do not format the Memory Card in the camera on the PC.
- Use the Memory Card with images taken by a FUJIFILM Digital camera.

- 2 Connect the camera to your PC using the USB cable (included).

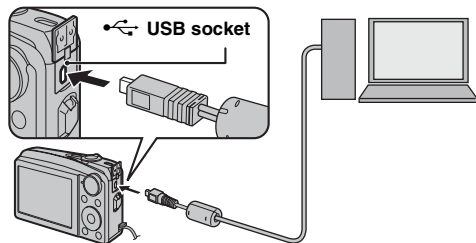

- 3 Press  for about 1 second to turn the camera on in Playback mode.

- 4 Set your PC



MEMO

In Windows, if FinePixViewer is already installed, the driver will be set automatically. No action is required.

! CAUTION

- FinePix F50fd is compatible with PTP (Picture Transfer Protocol)/MTP (Media Transfer Protocol). A PTP/MTP-compatible camera is a camera that can recognize the PC and printer automatically when connected.
- Do not disconnect the USB cable (included) when the camera is communicating with a PC. If the USB cable (included) is disconnected during communication, the files on the Memory Card or internal memory may be damaged.
- In Mac OS X, you must set automatic setup the first time you connect the camera to your PC.
- When the camera and PC are exchanging data, the indicator lamp blinks alternately green and orange.
- Auto power off is disabled during USB connection.
- Before replacing the Memory Card, always disconnect the camera from the PC.
- The camera and PC may be exchanging data even when [Copying] disappears from your PC screen. Before disconnecting the USB cable (included), always check that the indicator lamp is off.
- Always use FinePixViewer to transfer images with voice memos to a PC.
- The cost of an Internet provider for connecting to the internet is the user's responsibility.
- When using FinePixViewer to save images on a data server (network), FinePixViewer may not run as it would in a standalone PC environment.

! CAUTION

- Always use the FUJIFILM AC Power Adapter AC-5VX (sold separately) and DC coupler CP-50 (sold separately). If the camera suddenly loses power during data exchange, data exchange will not be performed correctly, and the Memory Card or internal memory could be damaged.
- Make sure that the USB cable (included) is connected correctly and securely.
- Connect the camera directly to the PC using the USB cable (included). The software may not operate correctly when you use an extension cable, or if you connect the camera via a USB hub.
- When your PC has more than one USB port, the camera can be connected to either port.
- When Windows 98 SE is used, the supplied software must be installed first before connecting the camera to a PC using the USB cable. The PC will not recognize the camera if it is connected before installation.
- A memory Card, the internal memory, data in a Memory Card or data in the internal memory could be damaged if any of the following are performed;
 - the USB cable is disconnected
 - power switch or buttons are pressed, or the lens cover is interfered with

Continued ➔

The following steps differ depending on the PC's operating system (Windows XP/Vista and Mac OS X case)

When your PC recognizes the camera automatically, FinePixViewer automatically starts up and the Save Image Wizard window (Save Image dialog box) appears. Follow the instructions provided on screen to save the images. To proceed without saving the images, click the [Cancel] button.

CAUTION

When there are many images stored on a Memory Card, it takes a while to display on the screen of your PC. Also, it may take a while to import images or you may be unable to save images. In this case, use an Image Memory Card Reader.

MEMO

- You can only see images saved on a PC. Save images on a PC.
- If you cancel saving by clicking the [Cancel] button, press POWER to turn off the camera and then disconnect it from the PC.
- When the camera is connected to your PC, FinePixViewer automatically starts up by the function of Exif Launcher, which is installed in FinePixViewer.

Proceed to "Using FinePixViewer" (→p.129).

CAUTION (Mac OS X)

If FinePixViewer does not start up automatically, the software may not be installed correctly. Set your PC again after disconnecting the camera and restart.

CAUTION (Mac OS X) Note on disconnecting the camera

- Close all files in the camera, and make sure the camera is not exchanging data.
- The camera and PC may be exchanging data even when [Copying] disappears from your PC screen, especially in the case of copying large data amounts. Do not disconnect the USB cable (included), immediately after this message has disappeared. Always check that the indicator lamp is off first before disconnecting.

Using FinePixViewer

Mastering FinePixViewer

For all information on FinePixViewer functions, refer to [How to Use FinePixViewer] in the Help menu for details.

• **What is explained in [How to Use FinePixViewer]...**
[How to Use FinePixViewer] covers a range of topics, including batch processing and ordering prints.

Example: Looking up slide shows

- 1 Click [How to Use FinePixViewer] in the FinePixViewer Help menu.
- 2 Click [Basic Operation] and then click [Slide Show] in the menu that appears.
- 3 The [Slide Show] information appears. Press the [<<<] key to view the previous page or the [>>>] key to view the next page.

Uninstalling the software

Only perform this operation when you no longer require the installed software or when the software was not installed correctly.

Windows

- 1 Check that the camera is not connected to the PC.
- 2 Quit all currently running applications.
- 3 The steps for uninstalling software differ depending on the operating system. Follow the steps for each operating system to uninstall the software listed below.

The following software is to be uninstalled:

- FinePixViewer
- FinePix Resource
- FinePix Studio*
- RAW FILE CONVERTER LE*

* May not have been installed depending on the operating system.

To remove FinePixViewer

FinePixViewer Ver.5.*

To remove the driver software

FUJIFILM USB Driver



Continued ➔

- ④ When the message appears, click the [OK] button. Check your selection carefully since the process cannot be canceled once you click the [OK] button.



Macintosh

Quit FinePixViewer. Then drag the installed FinePixViewer folder to the Trash and select [Empty Trash] in the [Finder] menu.

System Expansion Option

By using FinePix F50fd together with other optional FUJIFILM products, your system can be expanded to fill a wide range of uses.

Accessory availability may vary by country. Please check with your local Fujifilm representative to confirm product availability.

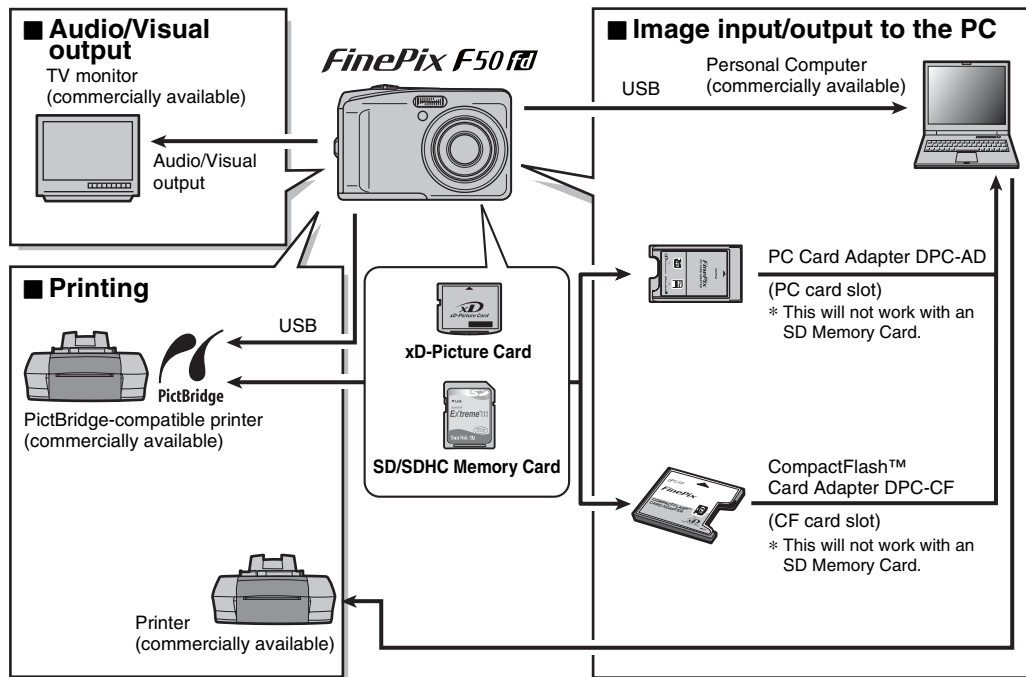

Accessories Guide

Visit the FUJIFILM web site for the latest information on camera accessories.

http://www.fujifilm.com/products/digital_cameras/index.html

Accessory availability may vary by country. Please check with your local Fujifilm representative to confirm product availability.

• **xD-Picture Card**

Use the following **xD-Picture Cards**:

256MB/512MB/1GB/2GB

There are two types of **xD-Picture Card**: standard type and Type M (containing "M" in the model number, such as DPC-M1GB).

FinePix F50fd is compatible with Type M, however they may not be compatible depending on the device used (Image Memory Card Reader, etc.).



• **Battery Charger BC-50**

Quickly charges the rechargeable battery. The BC-50 reduces charging time to approx. 140 minutes at +23°C.

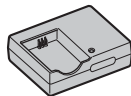

• **Rechargeable Battery NP-50 (1000 mAh)**

A Lithium-ion large capacity rechargeable battery.



• **AC Power Adapter AC-5VX**

Use the AC-5VX when taking pictures or play back images for long periods or when FinePix F50fd is connected to a PC.

Use AC-5VX AC adapter with CP-50 DC Coupler together for FinePix F50fd.

* The shape of the AC power adapter, the plug, and power outlet depend on the country.

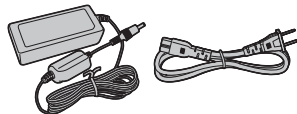

• **DC Coupler CP-50**

Use the CP-50 with AC-5VX when taking pictures or play back images for long periods or when FinePix F50fd is connected to a PC.



- **PC Card Adapter DPC-AD**

The PC Card Adapter allows the **xD-Picture Card** and SmartMedia to be used as a PC Card Standard ATA-compliant (PCMCIA 2.1) PC card (Type II).

-Compatible with **xD-Picture Card** of 16 MB to 512 MB, and SmartMedia of 3.3 V, 2 MB to 128 MB.
This is not compatible with the SD Memory Card.



- **CompactFlash™ Card Adapter DPC-CF**

Loading an **xD-Picture Card** into this adapter allows you to use the card as a CompactFlash card (Type I).

-This is not compatible with the SD Memory Card.



- **Waterproof Case WP-FXF50 (upcoming)**

This waterproof case protects your FinePix F50fd from water damage yet allows you to make camera adjustments and use the flash.

Dive up to 40 meters (131 feet) underwater with your FinePix F50fd digital camera.



Using Your Camera Correctly

Read this information and the “Safety Notes” (→“Notes and Cautions”), to make sure you use your camera correctly.

■ Places to Avoid

Do not store or use the camera in the following types of locations:

- In the rain or in very humid, dirty, or dusty places
- In direct sunlight or in places subject to extreme temperature rises, such as in a closed car in summer
- Extremely cold places
- Places with strong vibration
- Places with smoke or steam
- Places subject to strong electric magnetic fields (such as near broadcasting tower, power lines, radar, motors, transformers, magnets, etc.)
- In contact with chemicals such as pesticides
- Next to rubber or vinyl products

■ Damaged by Water or Sand

FinePix F50fd can be damaged on the inside and outside by water and sand. When you are at the beach or close to water, make sure that the camera is not damaged by water or sand. Take care not to place the camera on a wet surface.

■ Damaged by Condensation

If the camera is carried from a cold location into a warm place, water droplets (condensation) may form on the inside of the camera or on the lens. When this occurs, turn the camera off and wait an hour before using the camera. Condensation may also form on the Memory Card. In this event, remove the Memory Card and wait a short time.

■ When the Camera is Not Used or is stored Periods of Time

If you do not intend to use the camera for a long period of time, remove the battery and the Memory Card.

■ Cleaning Your Camera

- Use a blower brush to remove any dust on the lens or LCD monitor, and then gently wipe the camera with a soft, dry cloth. If any soil remains, apply a small amount of lens cleaning liquid to a piece of FUJIFILM lens cleaning paper and wipe gently.
- Do not scratch hard objects against the lens or LCD monitor.
- Clean the body of the camera with a soft, dry cloth. Do not use volatile substances or cleaning products these items can cause damage.

■ Using the Camera When Traveling

When traveling overseas, do not place your camera in the check-in baggage. Baggage can be subjected to violent shocks, and the camera may be damaged inside or outside.

Notes on the xD-Picture Card™, the SD Memory Card and the Internal Memory

■ Handling Memory Card

- When inserting the Memory Card into the camera, hold the Memory Card straight as you push it in.
- Never remove the Memory Card or turn the camera off during data recording or erasing (Memory Card formatting) as this could be damaged to the Memory Card.
- The use of **xD-Picture Cards** is recommended with FinePix F50fd.
The recording quality cannot be guaranteed when **xD-Picture Cards** other than those manufactured by FUJIFILM are used.
- The Memory Card may feel warm when it is removed from the camera after taking pictures. This is normal.
- Do not put labels on the Memory Card. Peeling labels can cause the camera not to work properly.



MEMO Type M and H of xD-Picture Card

- Type M
There are two types of Memory Card: standard type and Type M (containing "M" in the model number, such as DPC-M2GB).
FinePix F50fd is compatible with Type M.
- Type H
Type H and M share the same compatibility.
- Usable USB drive
Type H cannot be used with **xD-Picture Card** USB drive DPC-UD1, while Type M can.

■ Internal Memory





- Images held in the camera's internal memory may be corrupted or erased due to problems such as camera faults. Save your important data to another media (i.e., DVD-R, CD-R, CD-RW, hard disk, etc.).
- Data stored in the camera's internal memory cannot be guaranteed in the event that the camera is submitted for repairs.
- When the camera is repaired, any data stored in the camera's internal memory is subject to checking by the repairer.

■ Using Memory Card or Internal Memory with a PC

- When taking pictures using a Memory Card or internal memory that has been used on a PC, reformat the Memory Card using your camera.
- When formatting, a directory (folder) is created. Image data is then recorded in this directory.
- Do not change or delete the directory (folder) or file names on the Memory Card or internal memory because this will make it impossible to use the Memory Card or internal memory in your camera.
- Always use the camera to erase image data.
- To edit image data, copy or transfer the image data to the PC and edit the copied or transferred data.

Warning Displays

The table below lists the warnings that are displayed on the LCD monitor.

Warning Displayed	Explanation	Remedy
 (Lit red)  (Blinking red)	The battery is low or completely out of charge.	Load fully charged battery.
	There is a strong likelihood of camera shake because the shutter speed is slow.	Use flash photography. A tripod may be recommended, depending on the scene and mode.
 (Lit red) *The shape of the AF frame differs depending on the setting in the [SHOOTING MENU].	The AF (autofocus) cannot work effectively.	<ul style="list-style-type: none"> • If the image is too dark, take the picture at a distance of around 2 m (6.6 ft.) from the subject. • Use AF lock to take the picture (→p.33). • Select Macro mode when taking close-up shots (→p.61).
Aperture/ Shutter speed display (Lit red)	The camera cannot shoot the picture at the correct brightness due to too bright or dark shooting condition.	The picture can be taken, but the correct brightness (exposure) will not be obtained.
[FOCUS ERROR] [ZOOM ERROR] [LENS CONTROL ERROR]	Camera malfunction or fault.	<ul style="list-style-type: none"> • Turn the camera on again, taking care not to touch the lens. • Turn the camera off and on again. If the message still appears, contact your FUJIFILM dealer.
[NO CARD]	Memory Card is not inserted when transferring images.	Insert a Memory Card.
[CARD NOT INITIALIZED]	<ul style="list-style-type: none"> • The Memory Card or internal memory is not formatted. • The Memory Card was formatted on a PC. • The Memory Card contact area is soiled. <ul style="list-style-type: none"> • Camera fault. 	<ul style="list-style-type: none"> • Format the Memory Card or internal memory on the camera (→p.113). • Format the Memory Card on the camera. • Wipe the contact area on the Memory Card with a soft, dry cloth. It may be necessary to format the Memory Card (→p.113). If the message still appears, replace the Memory Card. • Contact your FUJIFILM dealer.

Warning Displayed	Explanation	Remedy
[CARD ERROR]	<ul style="list-style-type: none"> • The Memory Card contact area is soiled. • The Memory Card format is incorrect. • Camera fault. • The Memory Card is damaged. • Inserted Memory Card is not compatible with your camera. 	<ul style="list-style-type: none"> • Wipe the contact area on the Memory Card with a soft, dry cloth. It may be necessary to format the Memory Card (→p.113). If the message still appears, replace the Memory Card. • Contact your FUJIFILM dealer. • Insert a compatible Memory Card that is operationchecked at FUJIFILM Corporation.
[📷 CARD FULL] [📷 N CARD FULL]	The internal memory or Memory Card is full.	Erase some images in internal memory or Memory Card (→p.42), or use a Memory Card that has ample free space.
[WRITE ERROR]	<ul style="list-style-type: none"> • The data could not be recorded due to a Memory Card error or a connection error between the Memory Card and camera. • The image cannot be recorded as it is too large to fit in the available space on the Memory Card. • The Memory Card or internal memory is not formatted. 	<ul style="list-style-type: none"> • Re-insert the Memory Card or turn the camera off and then on again. If the message still appears, contact your FUJIFILM dealer. • Use a new Memory Card. • Format the Memory Card or internal memory on the camera (→p.113).
[PROTECTED CARD]	The SD Memory Card switch is slide to the "Lock" side.	Unlock the protection by sliding it back (→p.18).
[INTERNAL MEMORY IS FULL] [INSERT A NEW CARD]	The data could not be recorded or copied since the internal memory is full.	Erase some images from the internal memory (→p.42), or use a Memory Card that has ample free space.
[📷 BUSY]	The timing for recording was incorrect because the Memory Card was formatted on a PC.	Use an Memory Card that was formatted on the camera.
[FRAME NO. FULL]	The frame number has reached 999-9999.	① Insert a formatted Memory Card into the camera. ② Set [RENEW] as [FRAME NO.] setting in the [SET SET-UP] menu (→p.111). ③ Start taking pictures (The frame number starts from "100-0001"). ④ Set [CONT.] as [FRAME NO.] setting in the [SET SET-UP] menu.

Continued ➔

Warning Displayed	Explanation	Remedy
[READ ERROR]	<ul style="list-style-type: none"> The played back file was not recorded correctly. The Memory Card contact area is soiled. Camera fault. An attempt was made to play back the image or the movie that was not recorded on this camera. 	<ul style="list-style-type: none"> This file cannot be played back. Wipe the contact area on the Memory Card with a soft, dry cloth. It may be necessary to format the Memory Card (→p.113). If the message still appears, replace the Memory Card. Contact your FUJIFILM dealer. The movie and image cannot be played back.
[TOO MANY FRAMES]	An attempt was made to show 5,000 or more images by date sorting.	No more than 4,999 images can be shown by date sorting.
[PROTECTED FRAME]	<ul style="list-style-type: none"> An attempt was made to erase a protected file. An attempt was made to add a voice memo to protected file. An attempt was made to rotate a protected file. 	<ul style="list-style-type: none"> Protected files cannot be erased. Remove the protection (→p.94). Protected files cannot be added to voice memos. Remove the protection (→p.94). Protected files cannot be rotated. Remove the protection (→p.94).
[🔊 ERROR]	<ul style="list-style-type: none"> The voice memo file is faulty. Camera fault. 	<ul style="list-style-type: none"> The voice memo cannot be played back. Contact your FUJIFILM dealer.
[📷 NO IMAGE] [📷 IN NO IMAGE]	An attempt was made to transfer images from the Memory Card or internal memory that memory was empty.	It is impossible to copy.
[📷 CAN NOT TRIM]	An attempt was made to trim a 0.3M image.	The image cannot be trimmed.
[CAN NOT TRIM]	<ul style="list-style-type: none"> An attempt was made to trim an image shot using a camera  other than FinePix F50fd. The image is damaged. 	The image cannot be trimmed.
[DPOF FILE ERROR]	Prints were specified for 1000 or more frames in the DPOF frame settings.	The maximum number of frames for which prints can be specified on the same Memory Card is 999. Copy the images for which you want to order prints onto another Memory Card and then specify the DPOF settings.
[CAN NOT SET DPOF] [📷 CAN NOT SET DPOF]	An attempt was made to specify DPOF settings for an image that is not supported by DPOF.	DPOF printing cannot be used with this image format.

Warning Displayed	Explanation	Remedy
[CAN NOT ROTATE] [📷 CAN NOT ROTATE]	An attempt was made to rotate a movie or an image shot using a camera other than FinePix F50fd.	These images cannot be rotated by image formats.
[📷 CAN NOT EXECUTE] [📷 CAN NOT EXECUTE] [? CAN NOT EXECUTE]	An attempt was made to transmit or save an image or movie recorded with another device, or an image that cannot be played back, with [TRIMMING FOR BLOG].	Some image formats cannot be transmitted or saved with [TRIMMING FOR BLOG].
[📷 CAN NOT EXECUTE]	An attempt was made to resave an image that was saved with [TRIMMING FOR BLOG].	Images saved with [TRIMMING FOR BLOG] cannot be resaved.
[COMMUNICATION ERROR]	The camera is not connected to a PC or printer.	<ul style="list-style-type: none"> • Check that the USB cable (included) is connected correctly. • Check that your PC or printer is turned on. • When using infrared transmission function, transmit the image data within the camera's or another device's transmission range.
[CANNOT BE TRANSMITTED]	<ul style="list-style-type: none"> • An attempt was made to send a movie or an image shot by the camera other than FinePix F50fd (📷 is displayed). • Transmission was disconnected during IR communication. 	<ul style="list-style-type: none"> • The image format is not transmittable. • A movie can not be sent. • Do not move the camera out of the transmission distance. Do not place anything between the transmitting and receiving devices.

Continued ➔

Warning Displays

Warning Displayed	Explanation	Remedy
[CANNOT BE RECEIVED]	Transmission was disconnected during IR communication.	Do not move the camera out of the transmission distance. Do not place anything between the transmitting and receiving devices.
[PRINTER ERROR]	Displayed for PictBridge.	<ul style="list-style-type: none">• Check that the printer is not out of paper or out of ink.• Turn the printer off briefly and then turn it back on.• Refer to the user manual supplied with your printer.
[PRINTER ERROR RESUME?]	Displayed for PictBridge.	Check that the printer is not out of paper or out of ink. Printing automatically restarts when the error is cleared. If the message still appears after checking, press MENU/OK to restart printing.
[CANNOT BE PRINTED]	Displayed for PictBridge.	<ul style="list-style-type: none">• Refer to the user manual for the printer being used and check whether the printer supports the JFIF-JPEG or Exif-JPEG image format. If not, the printer cannot print the images.• Movie images cannot be printed.• Was the image data photographed using FinePix F50fd? You may not be able to print some images photographed on other cameras.

Troubleshooting

■ Getting ready

Matters	Problems	Possible causes	Solutions	Page
Battery and power supply	Nothing happens when pressing POWER.	The battery has run out.	Load fully charged battery.	13, 15
		The battery is loaded backward.	Load the battery in the corrected direction.	15
		The battery cover is not closed securely.	Close the battery cover securely.	15
		The AC power adapter and DC coupler are not connected correctly.	Connect the AC power adapter and DC coupler correctly.	–
	Battery runs out quickly.	Camera is used in extremely cold conditions.	Put the battery in your pocket or another warm place to heat it and then load it into the camera just before you take a picture.	13, 15
		The battery terminals are soiled.	Wipe the battery terminals with a clean, dry cloth.	–
		Same battery has been used for a long period.	The battery can no longer be recharged. Load a new battery.	13, 15
	Power cuts out during operation.	The battery has run out.	Load fully charged battery.	13, 15
		The AC power adapter and DC coupler are not connected correctly.	Connect the AC power adapter and DC coupler correctly.	–

Continued ➔

Matters	Problems	Possible causes	Solutions	Page
Charging a battery	Charging does not begin.	The battery is loaded backward.	Load the battery in the correct direction.	15
		The battery charger and connection cord are not connected correctly.	Connect the battery charger and connection cord correctly.	15
		The battery terminals are soiled.	Take the battery out briefly and wipe the battery terminals with a clean, dry cloth before reloading it.	–
		The battery can no longer be recharged.	Load a new battery. If the battery still fails to charge, contact your FUJIFILM dealer.	–



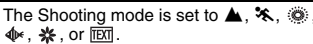
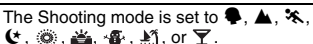

■ Setting menu etc.

Matters	Problems	Possible causes	Solutions	Page
LCD monitor display	Screens are not displayed in English.	A language other than English is selected in the [言語/LANG.] setting in the [SET-UP] menu.	Select [ENGLISH].	25

■ Shooting

Matters	Problems	Possible causes	Solutions	Page
Basic operations	No photograph is taken when pressing the shutter button.	The Memory Card or internal memory is full.	Insert a new Memory Card or erase some unnecessary frames.	17, 42
		The Memory Card or internal memory is not formatted.	Format the Memory Card or internal memory on the camera.	109, 113
		The Memory Card contact area is soiled.	Wipe the Memory Card contact area with a soft, dry cloth.	17
		The Memory Card is damaged.	Insert a new Memory Card.	17
		The battery has run out.	Load fully charged battery.	13, 15
		The Auto power off function has turned the camera off.	Turn the camera on.	20
	The LCD monitor darkens after taking a picture.	You took pictures with flash.	The LCD monitor may darken for charging flash. Wait a short time.	64
Focusing	Camera has difficulty in focusing on the subject.	You took a close-up shot without selecting Macro mode.	Select Macro mode.	61
		You photographed scenery with Macro mode selected.	Cancel Macro mode.	61
		You are shooting a subject that is not suited to autofocus (→p.34).	Use AF/AE lock to take the picture.	33
		You are trying to shoot a subject that is too close with [Q] QUICK AF function.	Select Macro mode.	61
Intelligent Face Detection	Cannot set Intelligent Face Detection.	The Shooting mode is set to  .	Change the Shooting mode.	48
Macro	Cannot set the camera to Macro (close-up) mode.	The Shooting mode is set to  .	Change the Shooting mode.	48

Continued →

Matters	Problems	Possible causes	Solutions	Page
Flash	Cannot use the flash.	The shutter button was pressed while the flash was charging.	Wait until the charging is completed before pressing the shutter button.	64
		The Shooting mode is set to  .	Change the Shooting mode.	48
		The battery has run out.	Load fully charged battery.	13, 15
		Continuous shooting is selected.	Set continuous shooting to [OFF].	77
		The flash is set to [Ⓢ SUPPRESSED FLASH] mode.	Set to another flash mode excluding the [Ⓢ SUPPRESSED FLASH] mode.	63
	The flash settings are restricted and cannot be selected.	The Shooting mode is set to anything other than  and  .	The flash settings are restricted because the camera settings are tailored to the scene being shot. Change the Shooting mode for a wider range of flash settings.	48
	The playback image is dark even though the flash was used.	The subject is too far away.	Move to within the effective flash range before taking the picture.	61, 64
Your finger was covering the flash.		Hold the camera correctly.	26	
Photographed images	The image is blurred.	The lens is dirty.	Clean the lens.	–
		AF frame (lit red) and !AF appeared when taking pictures.	Check the focus on the subject and take pictures.	27, 32, 136
		 appeared when taking pictures.	It may cause camera shake. Hold the camera steadily.	28, 136

Matters	Problems	Possible causes	Solutions	Page
Recording images	Photographed images or movies are not recorded.	AC power adapter and DC coupler are disconnected during turning the camera on.	Disconnect the AC power adapter and DC coupler only when the camera is off. Failing to turn the camera off first can result in damage to the Memory Card or malfunctions during PC connection.	-
	Vertical linear noise appears in the images.	Camera is used continuously in a hot place.	Turn the camera off for a while or select  [POWER SAVE] for [POWER MANAGEMENT].	71
Continuous shooting	Only 1 frame can be shot even though continuous shooting mode was set.	A picture is taken using self-timer when setting [FINAL 3], [LONG PERIOD], [TOP 12] or [FINAL 12] continuous shooting mode.	Only 1 frame can be shot when using [FINAL 3], [LONG PERIOD], [TOP 12] or [FINAL 12] continuous shooting mode and Self-timer mode together.	77

Continued ➔

■ **Playing back**

Matters	Problems	Possible causes	Solutions	Page
Playing back movie / voice memo	The camera does not emit any sound.	The camera volume is set too low.	Adjust the volume.	99, 106, 113
		The microphone was blocked during shooting/recording.	Take care not to block the microphone during shooting/recording.	11, 97, 103
		There is something covering the speaker during playback.	Make sure that the speaker is uncovered.	11, 98
Erasing	Erasing [FRAME] does not erase the frame.	Some frames may be protected.	Unprotect frames using the camera on which the protection was first applied.	94
	Erasing [ALL FRAMES] does not erase all the frames.			
Frame No.	[CONT.] in the frame number setting does not function.	You opened the battery cover without turning the camera off when replacing the battery or Memory Card.	Always turn the camera off when replacing the battery or Memory Card. Opening the battery cover without turning the camera off may cause the frame number memory to not function.	20

■ Connecting

Matters	Problems	Possible causes	Solutions	Page
Connecting to TV	There is no image or sound on the TV.	The camera is not connected to the TV correctly.	Connect the camera and TV correctly.	116
		The included A/V cable was connected during movie playback.	After the movie playback mode is stopped, connect the camera and TV correctly.	105, 116
		"TV" is selected as the TV input.	Set the TV input to "VIDEO".	–
		The video output setting is incorrect.	Change the setting to [NTSC] or [PAL].	107, 109
	The TV volume is turned down.	Adjust the volume.	–	
	The TV image is black and white.	The video output setting is incorrect.	Change the setting to [NTSC] or [PAL].	107, 109
Connecting to PC	PC does not recognize the camera.	The USB cable (included) is not correctly connected to the PC or camera.	Set up the camera, and connect the USB cable (included) correctly.	126
Connecting to printer	Cannot print with PictBridge.	The USB cable (included) is not correctly connected to the printer or camera.	Set up the camera, and connect the USB cable (included) correctly.	117
		The printer is not turned on.	Turn the printer on.	–

Continued ➔

■ Others

Matters	Problems	Possible causes	Solutions	Page
Camera operation etc.	Nothing happens when pressing the buttons on the camera.	Camera malfunction may be caused temporarily.	Briefly remove the battery / DC coupler, or disconnect the AC power adapter and DC coupler. Then reload the battery / DC coupler or reconnect the AC power adapter and DC coupler and try again.	13, 15
		The battery has run out.	Load fully charged battery.	13, 15
	The camera no longer works correctly.	Camera malfunction may be caused temporarily.	Briefly remove the battery / DC coupler, or disconnect the AC power adapter and DC coupler. Then reload the battery / DC coupler or reconnect the AC power adapter and DC coupler and try again. If you think the camera is faulty, contact your FUJIFILM dealer.	13, 15, 157

Specifications

System	
Model	Digital camera FinePix F50fd
Effective pixels	12 million pixels
CCD	1/1.6-inch Super CCD HR
Storage media	Internal memory (approx. 25 MB)/ xD-Picture Card (16/32/64/128/256/512 MB/1 GB/2 GB)/SD/SDHC Memory Card (FUJIFILM recommendation (→p.17))
File format	Still image: DCF-compliant Compressed: Exif ver.2.2 JPEG, DPOF-compatible *Design rule for Camera File System compliant/DPOF compatible Movie: AVI format, Motion JPEG Audio: WAVE format, Monaural sound
Number of recorded pixels	Still image: 4000 × 3000 pixels/4224 × 2816 pixels/2848 × 2136 pixels/2048 × 1536 pixels/1600 × 1200 pixels/640 × 480 pixels/(6M / 5.2M / 6M / 5M / 2M / 6M)
File size	See the table on the p.154
Lens	Fujinon 3× optical zoom lens F2.8-F5.1
Focal length	f=8 mm-24 mm (Equivalent to approx. 35 mm-105 mm on a 35 mm camera) (62 : Equivalent to approx. 36mm-108 mm on a 35 mm camera)
Digital zoom	Approx. 8.2× (3× optical zoom lens is used together: Max. zoom scale: approx. 24.6×)
Aperture (Wide-angle)	F2.8 to F8 (Up to 10 steps)
Focal range	Normal:wide-angle: approx. 45 cm (1.5 ft.) to infinity telephoto: approx. 60 cm (2.0 ft.) to infinity Macro: wide-angle: approx. 7 cm (2.8 in.) to 80 cm (2.6 ft.) telephoto: approx. 30 cm (1.0 ft.) to 80 cm (2.6 ft.)

Continued ➔

System	
Sensitivity	AUTO/AUTO(400)/AUTO(800)/AUTO(1600)/Equivalent to ISO 100/200/400/800/1600/3200 (max. number of recorded pixels: 6M)/6400 (max. number of recorded pixels: 8M) (Standard output sensitivity)
Photometry	TTL 256-zones metering Multi, Spot, Average
Exposure control	Program AE/Aperture priority AE/Shutter priority AE
Scene position	(NATURAL LIGHT), (NATURAL & LIGHT), (PORTRAIT), (PORTRAIT ENHANCER), (LANDSCAPE), (SPORT), (NIGHT), (FIREWORKS), (SUNSET), (SNOW), (BEACH), (UNDERWATER), (MUSEUM), (PARTY), (FLOWER), (TEXT)
Picture Stabilization	Optical Stabilization (CCD Shift)
Intelligent Face Detection	Available
Exposure compensation	-2 EV to +2 EV in 1/3 EV-step increments (A/S,)
Shutter speed	8 sec. to 1/2000 sec. (depend on Exposure mode) * The shutter speed can be set as follows, when the scene position is set to: FIREWORKS: 4 seconds or less, NIGHT (LONG EXPOSURE): 1 to 8 seconds.
Continuous shooting	<p>Top-3: Number of recorded frames: up to 3 frames (Max. 2 frames/sec.)</p> <p>Final-3: Number of recorded frames: Last 3 frames before releasing the shutter button (Max. 2 frames/sec.)</p> <p>Long-period: Number of recorded frames: Depend on memory size. 2.3 sec. interval at 12M N depending on quality level.</p> <p>Top-12: Number of recorded frames: up to 12 frames (Max. approx. 5 frames/sec.)</p> <p>Final-12: Number of recorded frames: Last 12 frames before releasing the shutter button (Max. approx. 5 frames/sec.)</p>
Focus	Mode: Single-AF, Continuous AF AF system: TTL contrast-type AF frame selection: AF (CENTER), AF (MULTI)

System	
White balance	Automatic scene recognition/Presets (Fine, Shade, Fluorescent (Daylight), Fluorescent (Warm White), Fluorescent (Cool White), Incandescent) /Custom
Self-timer	Approx. 2 sec./10 sec.
Flash type	Auto flash Effective range: (ISO: AUTO): Wide-angle: approx. 60 cm-4.4 m (2.0 ft.-14.4 ft.) Telephoto: approx. 60 cm-2.4 m (2.0 ft.-7.9 ft.) Macro: approx. 30 cm-80 cm (1.0 ft.-2.6 ft.)
Flash mode	Red-eye removal set to OFF: Auto, Forced Flash, Suppressed Flash, Slow Synchro Red-eye removal set to ON: Red-eye Reduction Auto, Red-eye Reduction & Forced Flash, Suppressed Flash, Red-eye Reduction & Slow Synchro
LCD monitor	2.7 inches, Aspect ratio: 4:3; 230,000 pixels Amorphous silicon TFT, Approx. 100% coverage
Movie	640 × 480 pixels/320 × 240 pixels (640/320) (25 frames per second with monaural sound) Images can be recorded depending on the available space on a Memory Card or internal memory. Zoom cannot be used during movie recording.
Photography functions	Intelligent face detection, Red-eye removal, Power management, Best framing, Frame No. memory
Playback functions	Intelligent face detection, Red-eye removal, Micro thumbnails playback, Trimming for blog, Trimming, Slide show, Multi-frame playback, Sorting by date, Image rotate, Voice memo, Infrared communication
Other functions	PictBridge, Exif print, Language (日本語, English, Français, Deutsch, Español, Italiano, 中文簡, 繁體, 한글, Русский, Português, Nederlands, Türkçe, Český, Magyar, Polski, Svenska), Time difference, FinePix photo mode(F-mode)

Continued ➔

Input/Output Terminal

A/V OUT (Audio/Visual output) NTSC/PAL-type (with monaural sound)

Digital input/output USB 2.0 High-Speed, PTP (Picture Transfer Protocol)/MTP (Media Transfer Protocol)

Power Supply and Others

Power supply Rechargeable Battery NP-50, DC coupler CP-50 (sold separately), AC power adapter AC-5VX (sold separately)

Guide to the number of available frames for battery operation

Battery Type	Number of frames
NP-50 (1000 mAh)	Approx. 230 frames

According to the CIPA (Camera & Imaging Products Association) standard procedure for measuring digital still camera battery consumption (extract):

When using a battery, use the battery supplied with the camera. The storage media should be **xD-Picture Card**.

Pictures should be taken at a temperature of +23°C (+73°F), with the LCD monitor turned on, the optical zoom moved from full wide-angle to full telephoto (or vice-versa) and back again to its original position every 30 seconds, the flash used at full power every second shot and the camera turned off and then on again once every 10 shots.

- Note: Because the number of available shots varies depending on the level of charge in the battery, the figures shown here for the number of available shots using the battery is not guaranteed. The number of available shots will also decline at low temperatures.

Camera dimensions (W/H/D) 92.5 mm × 59.2 mm × 22.9 mm/3.6 in. × 2.3 in. × 0.9 in. (not including accessories and attachments)

Camera mass (weight) Approx. 155 g/5.5 oz. (not including accessories, battery and Memory Card)

Weight for photography Approx. 175 g/6.2 oz. (including battery and Memory Card)

Operating Conditions Temperature: 0°C to +40°C (+32°F to +104°F)
80% humidity or less (no condensation)

Battery NP-50

Nominal voltage	DC 3.7V
Maximum voltage	DC 4.2V
Nominal capacity	1000 mAh
Operating temperature	0°C to +40°C (+32°F to +104°F)
Dimensions	35.4 mm × 40.0 mm × 6.6 mm(1.4 in. × 1.6 in. × 0.3 in.)(W × H × D)
Mass (Weight)	Approx. 18 g (0.6 oz.)

Battery Charger BC-50

Power supply	110-240 V AC, 50/60 Hz Rated input capacity: 4.2 W
Rated output	DC 4.20 V, 615 mA
Charging time	NP-50 (1000 mAh): 2.3 hrs.
Operating temperatures	0°C to + 40°C(+ 32°F to + 104°F)
Dimensions	60 mm × 86 mm × 20.5 mm(2.4 in. × 3.4 in. × 0.8 in.) (W × H × D)
Mass (Weight)	Approx. 65 g (2.3 oz.)

Continued ➔

■ Standard number of available frames/recording time per xD-Picture Card , SD Memory Card and internal memory

The number of available frames and recording time is approximate. The actual number of frames and recording time varies depending on the type of Memory Card or shooting conditions. Also, the number of frames and recording time displayed in the LCD monitor may not decrease regularly.

Quality setting	12M F	12M N	3:2	6M	3M	2M	3M	540 (25 fps)	320 (25 fps)	
Number of recorded pixels	4000 × 3000		4224 × 2816	2848 × 2136	2048 × 1536	1600 × 1200	640 × 480	640 × 480	320 × 240	
Image data size	4.7 MB	3.0 MB	3.0 MB	1.5 MB	780 KB	630 KB	130 KB	–	–	
Internal memory (approx.25 MB)	5	8	8	16	32	40	200	26 sec.	52 sec.	
xD-Picture Card	16 MB	3	5	5	10	19	25	122	16 sec.	32 sec.
	32 MB	6	10	10	20	40	50	247	33 sec.	65 sec.
	64 MB	13	21	21	42	81	101	497	66 sec.	131 sec.
	128 MB	26	43	43	84	162	204	997	134 sec.	264 sec.
	256 MB	54	86	87	169	325	409	1997	268 sec.	8.8 min.
	512 MB	108	173	174	339	651	818	3993	8.9 min.	17.7 min.
	1 GB	217	347	349	680	1305	1639	7995	17.9 min.	35.4 min.
2 GB	434	695	695	1360	2558	3198	15992	35.9 min.	70.8 min.	
SD Memory Card	512 MB	104	167	168	328	631	793	3867	8.7 min.	17.1 min.
	1 GB	210	336	338	658	1264	1588	7745	17.4 min.	34.3 min.
	2 GB	421	673	673	1319	2480	3100	15501	34.8 min.	68.6 min.
SDHC Memory Card	4GB	843	1348	1348	2640	4963	6204	31024	69.6 min*	137.3 min*
	8GB	1677	2681	2681	5248	9867	12334	61672	138.4 min*	272.9 min*

* A movie recording will stop automatically when a movie file becomes approx. 2GB. If you want to continue recording, press the shutter button again. The available recording time is displayed based on approx. 2GB.

If you shoot using the **xD-Picture Cards** with model numbers containing "M" such as DPC-M1GB, movie recording time may be reduced if you repeatedly record and erase (frame erase) image files. In such a case, erase all frames or format the **xD-Picture Card** before use. Back up important frames (files) onto your PC or another media.

- * These specifications are subject to change without notice. FUJIFILM shall not be held liable for damages resulting from errors in this Owner's Manual.
- * The LCD monitor on your digital camera is manufactured using advanced high-precision technology. Even so, small bright points and anomalous colors (particularly around text) may appear on the monitor. These are normal display characteristics and do not indicate a fault with the monitor. This phenomenon will not appear on the recorded image.
- * The operation error may be caused in a digital camera by the strong radio interference (i. e. electric fields, static electricity, line noise, etc.).
- * Due to the nature of the lens, the edges of images may appear distorted. This is normal.

Explanation of Terms

EV

A number denotes Exposure Value. The EV is determined by the brightness of the subject and sensitivity (speed) of the film or CCD. The number is larger for bright subjects and smaller for dark subjects. As the brightness of the subject changes, a digital camera maintains the amount of light hitting the CCD at a constant level by adjusting the aperture and shutter speed. When the amount of light striking the CCD doubles, the EV increases by 1. Likewise, when the light is halved, the EV decreases by 1.

Frame rate (fps)

The frame rate refers to the number of images (frames) that are photographed or played back per second. For example, when 10 frames are continuously photographed in a 1-second interval, the frame rate is expressed as 10 fps.

For reference, TV images are displayed at 30 fps (NTSC).

JPEG

Joint Photographic Experts Group

A file format used for compressing and saving color images. The higher the compression rate, the greater the loss of quality in the decompressed (restored) image.

Motion JPEG

A type of AVI (Audio Video Interleave) file format that handles images and sound as a single file. Images in the file are recorded in JPEG format. Motion JPEG can be played back by QuickTime 3.0 or later.

Smear

A phenomenon specific to CCDs whereby white streaks appear on the image when there is a very strong light source, such as the sun or reflected sunlight, in the photography screen.

WAVE

A standard format used on Windows systems for saving audio data. WAVE files have the ".WAV" file extension and the data can be saved in either compressed or uncompressed format. Uncompressed recording is used on this camera.

WAVE files can be played back on a personal computer using the following software:

Windows: MediaPlayer

Macintosh: QuickTime Player

* QuickTime 3.0 or later

White Balance

Whatever the kind of the light, the human eye adapts to it so that a white object still looks white. On the other hand, devices such as digital cameras see a white subject as white by first adjusting the color balance to suit the color of the ambient light around the subject. This adjustment is called matching the white balance.



Exif Print Format is a newly revised digital camera file format that contains a variety of shooting information for optimal printing.

FUJIFILM Digital Camera Worldwide Network

If you have technical questions or if you need repair service, ask the following local distributor. Please present the warranty card and your purchase receipt when you ask for repairs. Refer to the warranty card for conditions of the warranty. There is a case that repair and Technical support cannot be accepted for some models which your local distributor does not deal with. These lists are subject to change without notice.

NORTH AMERICA		
Canada	FUJIFILM Canada, Inc. Technical support Repair service	600 Suffolk Court Mississauga Ontario, L5R 4G4 TEL 1-866-818-FUJI (3854) http://www.fujihelp.ca 600 Suffolk Court Mississauga Ontario, L5R 4G4 TEL 1-800-263-5018 FAX 1-905-755-2993 http://www.fujihelp.ca
U.S.A.	FUJIFILM U.S.A., Inc. Technical support Repair service	1100 King George Post Rd., Edison, NJ 08837 TEL 800-800-3854 FAX 732-857-3487 digitalinfo@fujifilm.com 1100 King George Post Rd., Edison, NJ 08837 TEL 732-857-3000 FAX 732-857-3471 njcamerarepair@fujifilm.com
Hawaii	FUJIFILM Hawaii, Inc. Technical support & Repair service	94-468 Akoki Street, Waipahu, HI. 96797 TEL 1-808-677-3854, ext. 209 FAX 1-808-677-1443 kurt_kmett@fujifilmhawaii.com
CENTRAL & SOUTH AMERICA		
Argentina	Imagen e informacion S.A. Technical support & Repair service	Fondo de la Legua 936 San Isidro Pcia. de Buenos Aires TEL +54-11-4836-1000 FAX +54-11-4836-1144 servtec@imageneinformacion.com.ar
Bolivia	Reifschneider Bolivia Ltda. Technical support & Repair service	Calle H N.º 5 - Equipetrol Norte - Santa Cruz TEL +591 33 44 1129 FAX +591 33 45 2919 gciagral@bibosi.scz.entelnet.bo
Brazil	FUJIFILM do Brasil Ltda. Technical support & Repair service	Av. Vereador José Diniz, 3400 - Campo Belo, São Paulo/SP TEL 0800-12-8600 FAX +55 11 5091-4150 camarasdigitais@fujifilm.com.br
Chile	Reifschneider SA Technical support & Repair service	Av. El Conquistador del Monte 5024, Huechuraba, Santiago, Chile TEL 02-4431500 FAX 02-4431596 ceciliacalvo@reifschneider.cl
Colombia	Animex de Colombia Ltda. Technical support & Repair service	Calle 44 N.º 13-43 Piso 2 Apartado 18001 - Bogotá TEL +57 1 338-0299 FAX +57 1 288-2208 animex@etb.net.co
Ecuador	Espacri Cia Ltda Technical support & Repair service	Bolivar 5-69 y Hermano Miguel TEL 593-72-835526 FAX 593-72-833157

Continued ➔

FUJIFILM Digital Camera Worldwide Network

Ecuador	Importaciones Espacri Cia. Ltda. Technical support & Repair service	Simón Bolívar 5-69 y Hno. Miguel - Cuenca TEL +593 783 5526 FAX +593 783 3157 portiz@fujifilm.com.ec
Mexico	Fujifilm de Mexico, S.A. de C.V. Technical support Repair service	Av. Ejercito Nacional 351, Col. Granada 11520 Mexico, D.F. TEL (52-55) 5263-5566 / 68 FAX (52-55) 5254-1508 jlgiraud1@fujifilm.com.mx Av. Presidente Juarez 2007, Col. Tepetlalcálco, 54090 Tlalne-pantla, Edo. de Mexico TEL (52-55) 5263-5500 FAX (52-55) 5254-1508 jlgiraud1@fujifilm.com.mx
Paraguay	Errece S.R.L. Technical support & Repair service	Edificio Unitas 15 de Agosto 1035, Asunción TEL +595 21 444256 FAX +595 21 444651 jmarbulo@fujifilm.com.py
Peru	Procesos de Color S.A. Technical support & Repair service	Pablo Bermudez 111 Apartado 3794 - Esq. Arequipa - Lima 11 TEL +51 14 33 5563 FAX +51 14 33 7177 jalvarado@fujifilm.com.pe
Uruguay	Fotocámara S.R.L. Technical support & Repair service	Cuareim 1439, montevideo, Uruguay TEL +598-2-9002004 FAX +598-2-9008430 fotocam@adinet.com.uy
Uruguay	Kiel S.A. Technical support & Repair service	Maldonado 1787 Montevideo- Uruguay TEL (05982) 419 4542 FAX (05982) 412 0046 kiel@fujifilm.com.uy
Venezuela	C. Hellmund & Cia Sa Technical support & Repair service	Av. Ppal Diego Cisneros Caracas Venezuela Edf Oficentro TEL 0212-2022300 FAX 0212-2399796 hellmund@hellmund.com

EUROPE

Austria	Fuji Film Oesterreich Technical support & Repair service	Traviatagasse/Pfarrgasse, 1230 Vienna, Austria TEL 0043 1 6162606/51 or 52 FAX 0043 1 6162606/58 kamera.service@fujifilm.at
Belgium	Belgian Fuji Agency Technical support & Repair service	20, Avenue Lavoisier, Wavre, 1300, Belgium TEL 3210242090 FAX 3210238562 info@fuji.be
Croatia	I&I d.o.o. Technical support Repair service	Hondlova 2, Zagreb, Croatia TEL 38512319060 FAX 2310240 dsaravanja@fujifilm.hr Hondlova 2, Zagreb, Croatia TEL 38512316228 FAX 2310240 info@fujifilm.hr

Cyprus	PMS IMAGING LTD Technical support & Repair service	11, Dighenis Akritas Avenue, P.O.BOX 22315, 1586 Nicosia TEL 35722746746 FAX 35722438209 mariosashiotis@fujifilm.com.cy
Cyprus	Doros Neophytou CAMERA REPAIRS Technical support & Repair service	28B, Agiou Demetriou, Acropoli, Nicosia TEL 35722314719 FAX 35722515562 dorosn@logosnet.cy.net
Czech Republic	Fujifilm Cz., s.r.o. Technical support	U nakladoveho nadrazi 2/1949, 130 00 Praha 3 TEL 00420 234 703 411 FAX 00420 234 703 489 fricman@fujifilm.cz
Czech Republic	AWH servis Repair service	Milesovska 1, 130 00 Praha 3, Czech republic TEL 00420 222 721 525 FAX 00420 222 720 122 awh@awh.cz
Denmark	Fujifilm Denmark A/S Technical support & Repair service	Stubbeled 2, 2950 Vedbæk Denmark TEL 0045 45662244 FAX 0045 45662214 fujifilm@fujifilm.dk
Finland	Fuji Finland Oy Technical support & Repair service	Martinkyläntie 41, 01720 Vantaa, Finland TEL +358 9 825951 FAX +358 9 870 3818 fuji@fuji.fi
France	FUJIFILM France Technical support & Repair service	2, Avenue Franklin, 78186 Saint-Quentin en Yvelines, France FAX 33 1 01 30 58 58 65 direction.technique@fujifilm.fr
Germany	FUJIFILM (Europe) GmbH Technical support & Repair service	Heesenstr. 70, 40549 Düsseldorf International call TEL +49 211 50890 FAX +49 211 5089668 service@fujifilm.de National call* TEL 0180 5898980 FAX 0180 5898982 *12 Cent/Min aus dem deutschen Festnetz
Greece	FUJIFILM HELLAS S.A. Technical support & Repair service	1, Iliou & Ag. Anargiron str., 175 64 P.Phairo, Athens, Greece TEL 0030 210 9404100 FAX 0030 210 9404397 fujifilm@fujifilm.gr
Hungary	Fujifilm Hungary Ltd. Technical support	Váci ut 19. Budapest, 1134, Hungary TEL 3612389410 FAX 3612389401 fujifilm@fujifilm.hu
Iceland	Icephoto (Ljosmyndavörur) Technical support & Repair service	Skipholt 31, 105 Reykjavik, Iceland TEL 354 568 0450 FAX 354 568 0455 framkollun@fujifilm.is
Italy	FujiFilm Italia S.p.A. Technical support Repair service	Via Dell'Unione Europea, 4 - 20097 San Donato Milanese (MI), Italy TEL 039-02895821 FAX 039-0289582912 info@fujifilm.it Fujifilm On Line - Call center TEL 039-026695272 info@fujifilm.it

Continued ➔

FUJIFILM Digital Camera Worldwide Network

Lithuania	Fujifilm Lithuania Technical support & Repair service	Gerosios Vilties str. 38, LT-03143 Vilnius, Lithuania TEL 370-5-2130121 FAX 3705-5-2134066 info@fujifilm.lt
Malta	Ciancio (1913) Co.Ltd. Technical support & Repair service	Fuji Tech Centre, Ciancio House, Cannon Road, Qormi, QRM05 TEL 0356-21-480500 FAX 0356-21-488328 info@fujifilm.com.mt
Netherlands	Fujifilm Nederland BV Technical support Repair service	Hoogstraat 39, 3011 PE, Rotterdam, The Netherlands TEL 010-2812345 FAX 010-2812334 fuji@fujifilm.nl Hoevenseweg 43, 4877 LA, Etten-Leur, The Netherlands TEL 010-2812345 FAX 076-7502641 reparatie@fujifilm.nl
Norway	Fujifilm Norge AS Technical support Repair service	Lilleakerveien 10, 0283 Oslo, Norway TEL 0047-22736000 FAX 0047-22736020 http://www.fujifilm.no/ mailto:post@fujifilm.no Liaveien 1, 5132 Nyborg, Norway TEL 0047-55393880 FAX 0047-55195201 http://www.camera.no/ mailto:service@camera.no
Poland	Fujifilm Polska Distribution Sp. z o.o. Technical support Repair service	Poland Al..Jerozolimskie 178; 02-486 Warszawa TEL +48-22-517-66-00 FAX +48-22-517-66-02 fujifilm@fujifilm.pl Poland, Muszkieterow 15, 02-273 Warszawa TEL +48-22-886-94-40 FAX +48-22-886-94-42 serwis@fujifilm.pl
Portugal	Fujifilm Portugal, Lda Technical support Repair service	Av. Fontes Pereira de Melo, 342, 4100-259 Porto, Portugal TEL (351) 226194200 FAX (351) 226194213 finepix@fujifilm.pt Av. Fontes Pereira de Melo, 342, 4100-259 Porto, Portugal TEL (351) 226194200 FAX (351) 225194662 cameras@fujifilm.pt
Romania	CTS-Cardinal Top Systems Ltd Technical support & Repair service	112, Calea Dorobanti street, 4 flat, 1sector, Bucharest, Romania TEL 4021-230-09-82 FAX 4021-230-09-82 cts_tirla@hotmail.com
Russia	ZAO "Fujifilm RU" Technical support Repair service	Bld. 1, 10, Rozanova str., Moscow, 123007, Russia TEL +7-095-956-9858 FAX +7-095-230-6217 info@fujifilm.ru 18, Shelepikhinskaya Naberezhnaya str., Moscow, 123290, Russia TEL +7-095-797-3434 FAX +7-095-797-3434
Slovakia	Fujifilm Slovakia Technical support Repair service	Pribylinska 2, 831 04 Bratislava, Slovakia TEL 00421 2 44 888 077 FAX 00421 2 44 889 300 fujifilm@fujifilm.sk FIS Tatracentrum, Hodzovo nam. 4 - Tatracentrum, 811 06 Bratislava, Slovakia TEL 00421 2 54 647 347 fis.tatracentrum@stonline.sk

Spain	Fujifilm España S.A.	Aragón 180, 08011 Barcelona (España)
	Technical support	TEL 902012535 FAX 934515900 / 933230330 info@fujifilm.es
	Repair service	Aragón 180, 08011 Barcelona (España)
		TEL 934511515 FAX 934515900 / 933230330 tallersat@fujifilm.es
Sweden	Fujifilm Sverige AB	Sveavägen 167 104 35 Stockholm
	Technical support	TEL 46 8 506 141 70 FAX 46 8 506 142 09 kamera@fujifilm.se
	Repair service	Sveavägen 167 104 35 Stockholm
		TEL 46 8 506 513 54 FAX 46 8 506513 54 kameraverkstaden@fujifilm.se
Switzerland / Lichtenstein	Fujifilm (Switzerland) AG	Niederhaslistrasse 12, 8157 Dietlikon, Switzerland
	Technical support & Repair service	TEL +41 44 855 5154 FAX +41 44 855 5329 RepairCenter@fujifilm.ch
Turkey	Fujifilm Turkiye Sinfo A.S.	Fujifilm Plaza, Dereboyu Cad. 39 34660 Halkali, Istanbul, Turkey
	Technical support	TEL +90 212 696 5090 FAX +90 212 696 5009 csarp@fujifilm.com.tr
	Repair service	Fujifilm Plaza, Dereboyu Cad. 39 34660 Halkali, Istanbul, Turkey
		TEL +90 212 696 5090 FAX +90 212 696 5010 servis@fujifilm.com.tr
U.K.	FUJIFILM UK Ltd.	St Martins Way St Martins Business Centre Bedford MK42 0LF
	Technical support	TEL +44 (0)123 424 5383 FAX +44 (0)123 424 5285 fujitec@fuji.co.uk
	Repair service	St Martins Way St Martins Business Centre Bedford MK42 0LF
		TEL +44 (0)123 421 8388 FAX +44 (0)123 424 5285 fujitec@fuji.co.uk
Ukraine	Image Ukraine CJSC	12, Kontraktova ploshcha, Kyiv 04070, Ukraine
	Technical support & Repair service	TEL +380-44-4909075 FAX +380-44-4909076 d@fujifilm.ua
MIDDLE EAST		
Iran	Tehran Fuka Co.	229, "Fuji" Bldg., Mirdamad Blvd., Tehran 19189, Iran
	Technical support & Repair service	TEL (+98-21)2254810-19 FAX (+98-21)2221002 fuka@neda.net
Israel	Shimone Group Ltd.	Efal 33 keyriat Arie Petah Tikva 49130, Israel
	Technical support	TEL (+) 972 3 9250666 digital@fujifilm.co.il
	Repair service	Efal 33 keyriat Arie Petah Tikva 49130, Israel
		TEL (+) 972 3 9250666 FAX 972 3 9250699 khaim@shimone.com
Jordan	Grand Stores	Al- Abdali, Amman / Jordan
	Technical support & Repair service	TEL 009626-4646387 FAX 009626-4647542 gstores@go.com.jo
Qatar	Techno Blue	Blue Salon Bldg, 3rd Floor, Suhaim bin Hamad st, Al- Saad, Doha
	Technical support	TEL 00974 44 66 175 FAX 00974 44 79 053 prabu@techno-blue.com

Continued ➔

FUJIFILM Digital Camera Worldwide Network

Saudi Arabia	Emam Distribution Co. Ltd. Technical support	P.O. Box 1716, Jeddah 21441, Saudi Arabia TEL 96626978756 FAX 96626917036 service@fujifilm.com.sa
Syria	Film Trading Company Technical support Repair service	Al-Shahbandar P.O. Box:31180 Damascus SYRIA TEL + 963 11 2218049 FAX + 963 11 44673456 f.t.c@Net.SY Al-cheikh Taha P.O. Box: 6171 Aleppo SYRIA TEL + 963 21 4641903 FAX + 963 21 4641907 filmtradin@Net.SY
U.A.E.	Grand Stores Technical support & Repair service	P. O. Box 2144, Saleh Bin Lahej Building, Al Garhoud, Deira, Dubai TEL + 971-4-2823700 FAX + 971-4-2828382 photography@grandstores.ae
Yemen	Al-Haidary Trading Technical support Repair service	P.O.Box-2942 Haddah St. HTC, Sana'a, Yemen TEL 00967-1-503980 FAX 00967-1-503983 P.O.Box-2942 Haddah St. HTC, Sana'a, Yemen TEL 00967-1-503977 FAX 00967-1-503983

AFRICA

Egypt	Foto Express Egypt Technical support & Repair service	426 Pyramids St., Giza, Egypt TEL (202) 7762062 FAX (202) 7760169 fotoegypt@access.com.eg
Kenya	Fuji Kenya Ltd Repair service	P.O.Box 41669-00100, Fuji Plaza, Chiromo Road, Nairobi, Kenya. TEL (254-20)4446265-8 FAX (254-20)4448515 / 7 info@fujifilm.co.ke

OCEANIA

Australia	FUJIFILM Australia Pty Ltd Technical support Repair service	Locked Bag 5100, Brookvale NSW 2100 TEL 1800 226 355 FAX +61 (2) 9466 2854 digital@fujifilm.com.au
Fiji	Brijlal & Co. Ltd Technical support & Repair service	70-72 Cumming Street, Suva, Fiji TEL (679)3304133 FAX (679)3302777 kapadia@connect.com.fj
New Caledonia	Phocidis SARL Technical support & Repair service	58, rue Higginson - B.P.661 - 98845 TEL (00 687) 25-46-35 FAX (00 687) 28-66-70 phocidis@phocidis.nc
New Zealand	Fujifilm NZ Ltd Technical support & Repair service	Cnr William Pickering & Bush Road Albany, Auckland TEL +64-9-4140400 FAX +64-9-4140410 glenn.beaumont@fujifilm.co.nz
Papua New Guinea	Oceania PNG Limited Technical support	Section 15, Allotment 1, Reke St, Boroko NCD. PNG. Mail: PO Box 2167, Boroko NCD. PNG. TEL +675 3256411 FAX +675 3250311 oceania@daltron.com.pg

ASIA

Hong Kong	Fuji Photo Products Co., Ltd. Technical support & Repair service	8/F., TSUEN WAN IND. CENTRE, 220 TEXACO RD., TSUEN WAN, HONG KONG TEL (852)2406 3287 FAX (852)2408 3130 rsd@chinahkphoto.com.hk
Indonesia	PT Modern Photo Tbk Technical support & Repair service	Jl.Matraman Raya 12, Jakarta Timur 13150 TEL +62 021 2801000 FAX +62 021 8581620+62 021 2801012 assd_kmr@modernphoto.co.id
Malaysia	FUJIFILM (Malaysia) Sdn. Bhd. Technical support Repair service	Letter Box 1, Level 10, 11 & 12, Menara Axis, No 2, Jalan 51A/223, 46100 Petaling Jaya, Selangor Darul Ehsan, Malaysia TEL 603-79584700 FAX 603-79584110 digital@fujifilm.com.my Letter Box 1, Level 10, 11 & 12, Menara Axis, No 2, Jalan 51A/223, 46100 Petaling Jaya, Selangor Darul Ehsan, Malaysia TEL 603-79584700 FAX 603-79584110 technical@fujifilm.com.my
Philippines	YKL Development & Trdg. Corp. Technical support Repair service	24 Sto. Domingo St., Quezon City 1100, Philippines TEL 632-7436601~06 FAX 632-7324661 digital@yklcolor.com 24 Sto. Domingo St., Quezon City 1100, Philippines TEL 632-7436601~06 FAX 632-7324661 tech_services@yklcolor.com
Singapore	FUJIFILM (Singapore) Pte Ltd Technical support & Repair service	10 New Industrial Road Fujifilm Building Singapore 536201 TEL 65-6380 5557 FAX 65-6281 3594 service@fujifilm.com.sg
South Korea	Korea Fujifilm Co., Ltd. Technical support	30-1, Mukjeung-dong, Jung-gu, Seoul, Korea TEL +82-2-3282-7363 FAX +82-2-2269-7435 photo@fujifilm.co.kr
South Korea	Yonsan AS Center (Fujidigital) Repair service	#301, 3F, Jeonjaland, 16-9, Hangangro3-ga, Yongsan-gu, Seoul, Korea TEL +82-2-701-1472 FAX +82-2-718-1331 1bowl@hanmail.net
South Korea	Kangnam AS Center (Digitalgallery) Repair service	2F, Hyeongin Tower, 23-2, Bangyi-dong, Songpa-gu, Seoul, Korea TEL +82-2-2203-1472 FAX +82-2-418-5572 nurijili@hanmail.net
South Korea	Busan AS Center (Digital-Sewon) Repair service	241-4, Bujeon-dong, Busanjin-gu, Busan, Korea TEL +82-51-806-1472 FAX +82-51-817-0083 merahan@yahoo.co.kr
Taiwan	Hung Chong Corp. Technical support & Repair service	No. 38, Min-Chuan E. Rd. Sec. 6, Taipei (114), Taiwan, R.O.C. TEL 886-2-6602-8988 FAX 886-2-2791-8647 dah@mail.hungchong.com.tw
Thailand	FUJIFILM (Thailand) Ltd. Technical support Repair service	388 SP Building, 8th Floor, Phayathai, Bangkok 10400 TEL +662-2730029 ext. 755 FAX +662-2730239 supaleark@fujifilm.co.th 388 SP Building, 8th Floor, Phayathai, Bangkok 10400 TEL +662-2730029 ext.761,762 FAX +662-2730239 warin@fujifilm.co.th
Vietnam	International Minh Viet Co., Ltd. Technical support & Repair service	99-107 Bach Van street, Ward 5, District 5, Ho chi minh city TEL +84-8-8366807 ext.122 FAX +84-8-8380621 diep.phanthithanh@imv.com.vn

FUJIFILM

FUJIFILM Corporation

7-3, AKASAKA 9-CHOME, MINATO-KU, TOKYO 107-0052, JAPAN

http://www.fujifilm.com/products/digital_cameras/index.html

Printed in China