

50 Years
Limited
Warranty









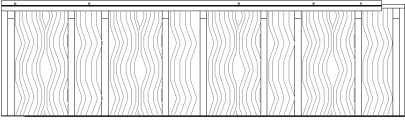
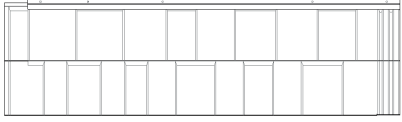

Terrabella®

Stone Coated
Steel Roof



Installation Manual

Terrabella Shake/Shingle Znap

<p>Terrabella Shake Znap Actual length = 52.6" Actual Width = 16.33" Coverage length = 49.7" Coverage width = 14"</p>	
<p>Terrabella Shingle Znap Actual Length = 52.375" Actual Width = 15.25" Coverage Length = 49.375" Coverage Width = 13.75"</p>	
<p>Shingle, Shake hip & ridge: Actual Length = 17.5" Actual Width = 6.06" Coverage Length = 15.6" Coverage Width = 6.06"</p>	
<p>End cap Terrabella Classic, Shingle and Shake</p>	
<p>Rake/Gable Channel Length = 50" Width = 4"</p>	
<p>Znap Valley: Length = 8" Width = 18"</p>	
<p>Znap Valley Cap: Length = 8" Width = 2"</p>	
<p>Channel: Length = 8' Width = 6"</p>	
<p>Starter Clip with Drip Edge Length= 8" Width = 3"</p>	
<p>Z-Bar Flashing Length=50" Width=3"</p>	
<p>Self tapping screw#9 Hex (1/4" diameter) x 1.5" (or length sufficient to penetrate roof deck 1/2")</p>	



TERRABELLA SHINGLE/SHAKE ZNAP SYSTEM

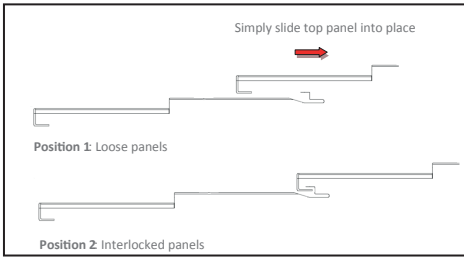
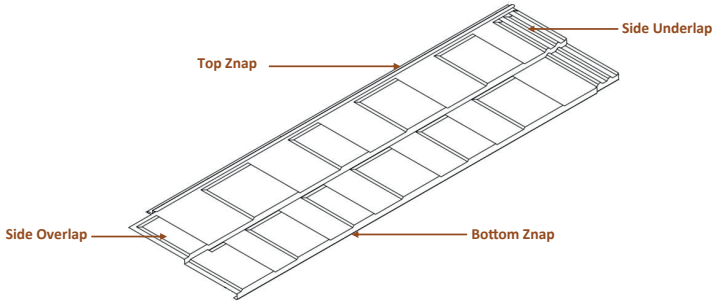

Figure 1. Znap Mechanism

In order to make sure every Terrabella® installation offers the best possible protection against wind and rain, the znap system has been developed.

Each Terrabella® panel is manufactured to be of equal dimensions to the rest. This fact combined with the interlock system allows the user to install straight lines and avoid any possibility of water leakage into the deck below.

Each panel is fastened to the panels around it, eliminating product tear-offs due to high velocity wind.

The znap system is installed by locking each panel onto the next, starting from the eave all the way to the ridge. Simply slide the upper panel into the top znap, as seen in **Figure 1**. Always make sure the bottom panel is securely fastened to the deck, or battens, before installing the one above it. Once the top and bottom znap are completely assembled on the entire length of the upper panel, screw the panel being installed and move on to the next one.

Always install shingle znap panels from left to right and shake znap panels from right to left. See the diagrams below:

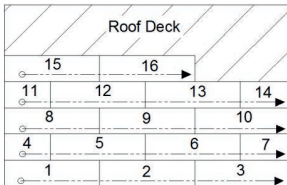

Figure 2. Shingle Znap

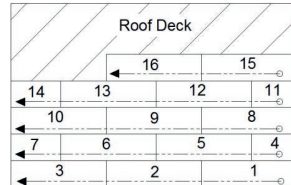

Figure 3. Shake Znap



ACCESSORY LOCATION AND DISTRIBUTION

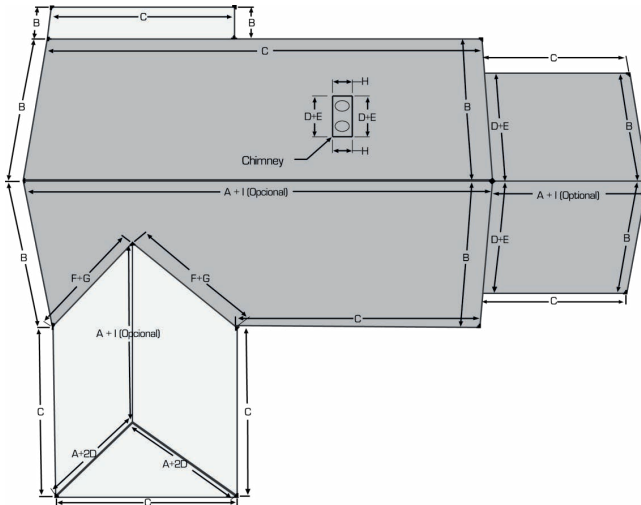

Figure 4. Accessory distribution

Terrabella Shingle Znap Panel (21ea per 100sq.ft.) plus 10-15% waste

Terrabella Shake Znap Panel (21ea per 100sq.ft.) plus 10-15% waste

Accessories

- A. Terrabella Shingle/Shake Hip and Ridge (1.32ft coverage each)
 - B. Terrabella Shake rake/Gable trim (4ft)
 - C. Terrabella Starter Clip with Drip Edge (8ft)
 - D. Terrabella Roof-to-wall Channel (8ft), step flashing and both sides of hips
 - E. Terrabella Z-Bar flashing (4ft), step and head wall
 - F. Terrabella Znap Valley (8ft)
 - G. Terrabella Znap Valley Cap (8ft)
 - H. Terrabella Flat Sheet 14"x50"
 - I. Ridge vents (Optional)
- Terrabella Shingle/Shake Hip and Ridge end cap (To close the ends of hips and ridges)

Installation Tools

- | | |
|--------------|--------------|
| Tin Snips | Circular Saw |
| Tape Measure | Screw Gun |
| Hand Benders | Hammer |
| Table saw | Chalk Line |

Other required items

Roofing underlayment (one layer required)
Spray Paint
High Grade Roofing Sealant
Galvanized Pipe Flashings
2x2 and 1x2 battens as needed for hips and ridges

Care and Recommendations

Installation Guidelines:

Products should be installed in accordance with the following guidelines established by Terrabella®:

- Do not use accessories that contain copper or lead with the steel roof system, as they are incompatible metals.
- A slope of 4/12 or more is required to install this product.
- When handling the product, be careful not to deform panels.
- Always wear gloves when working with metallic products.
- When installing Terrabella® roofing panels, care should be taken to avoid excessive friction between panels. This could damage the durability of the stone coating.
- Immediately after and/or during installation, remove any steel particles that may remain on the panels due to drilling and cutting. These particles will rust and might damage and stain the panels.
- It is recommended that those working on the roof use rubber soled shoes to avoid damaging the product.

Terrabella® Maintenance:

- Terrabella® is designed to withstand a most environment, but the product life can be extended with proper maintenance.
- Upon completing the installation, check that the roof surface is clean and free of objects that could damage the coating (metal burrs, screws, wire, sheet metal clippings, etc...)
- Avoid foot traffic on the roof whenever possible.
- It is recommended to clean the roof surface every six months when installed in a highly corrosive environment (use water and a soft brush, or have a professional do the job).
- Always carry out any work on the roof deck using all safety measures and wooden planks for weight distribution.

It is important to carefully read each of the recommendations in this installation manual before starting the installation process.

Terrabella® is not responsible for improper installation or misinterpretation of this manual.

For the most current and up-to-date installation instructions go to www.terrabellarooft.com

General recommendations for transportation, handling, and storage:

Storage Recommendations:

- Always store the product indoors.
- Store the product in a dry and ventilated area.
- Avoid stocking the product in direct contact with the floor over large periods of time.
- If stored outside: Locate product on a firm surface and protect from damage. Allow for water to drain off of the panels and protect it from being blown by wind.
- Packs of 5 panels can be stored on top of each other to a maximum height of 1 meter. Always make sure there is enough air circulation between packs.
- If using tarpaulins, leave enough space at the ends of the canvas to allow for air circulation.
- Do not use polyethylene or plastic to cover the packages.
- Do not store detergents, solvents, acidic materials, or alkali such as concrete or plaster with Terrabella® products.
- It is recommended to store products near the place where they will be installed to avoid damage from handling.

General recommendations for installation:

Structure: The roof structure should be inspected thoroughly. Any structural problems should be corrected prior to the installation of the roofing panels.

Decking: 15/32" minimum thickness; Grade B-C APA rate plywood or equal should be used.

Battens: Wood battens must be 2"x2" or 1"x2" standard grade Douglas fir or better, nominal thickness 1.5" x 1.5" and .75" x 1.5".

Underlayment: A minimum underlayment of #30 felt or synthetic underlayment is required on all new construction and tear-offs. Always check local building codes prior to installation.

Roof Saddles: Roof saddles are required behind any roof protrusion 48" in width and above. Panel diverters are easy to make and are a good way of diverting water from the back of the protrusion and should be used where necessary.

Sealants: A one-part polyurethane type sealant is recommended.

ROOFING PREPARATION

New roof: The shake and shingle znap system does not require battens to be installed on the deck. Prepare the wooden deck to be level and secure. Cut out decking in areas where you plan to install ridge vents and install #30 felt or equivalent synthetic underlayment on the decking. Always check local building codes for additional requirements.

Reroofing: Terrabella® roofing system may be installed over an existing asphalt shingle roof (maximum of 1 layer). Follow the steps below before installing Terrabella® panels and accessories on top of shingles:

Step 1: Remove all the old hips, ridges, gable material and any drip edge installed on eaves.

Step 2: Cut any existing overhang flush with the existing fascia. If necessary, build up the fascia at the eave using 1"x4"s and 2"x2"s until the fascia is flush with the rest of the roof.

Step 3: Install a new layer of underlayment over the entire roof area. #30 felt or equivalent synthetic underlayment is recommended. Always check local building codes, additional materials such as ice and water shield might be required for your area.

Step 4: Install Terrabella® roofing system following the installation procedure described in this manual. Be sure to use screws that are long enough to correctly fasten the panels and accessories on the deck or battens.

Tear-offs: If a complete tear-off is required, make sure to completely remove the entire old product in order to work on a leveled surface. Clean the deck thoroughly and install a layer of underlayment before installing the new product.

INSTALLATION OF STARTER CLIP

The Terrabella® starter clip with drip edge must be installed along all eaves and is the starting point for the panel installation. The starter clip with drip edge has two functions: It has the znaping system on the top and a drip edge on the bottom, which allows water to angle off of the roof.

The starter clip may be painted at the drip edge to match the fascia. Always paint the starter clip before the installation to avoid unwanted stains on walls and other surfaces.

Begin by installing the starter clip from the corners of the roof at a rake/gable and continue along the eave until it reaches the other end of the roof, screwing it on the deck every 8 inches. The starter clip with drip edge must always be overlapped **under** Terrabella® rake, valley or roof-to-wall channels.

To correctly overlap the starter clip beneath the rake, cut-off the znap clip from the top approximately 4 inches (10cm) or enough as to allow the rake to fit tightly above it. View **figure 5**.

When joining two pieces of starter clip together notch one of the clips 1 inch and overlap on the next one as shown in **Figure 6**.

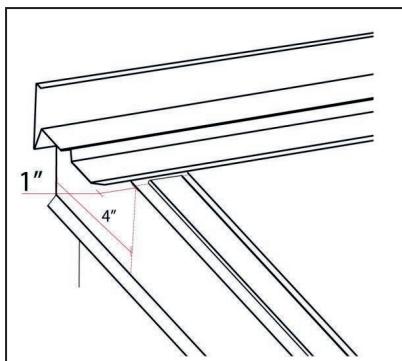

Figure 5. Installation of starter clip under rakes

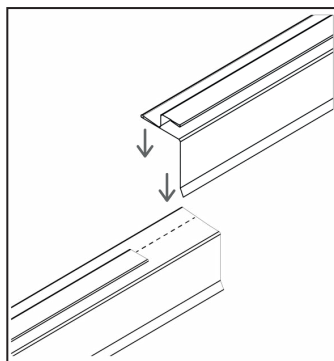

Figure 6. Starter Clip overlap

If installing at valleys and roof-to-wall channels, the recommended overlap is of 9" (23cm). In this case the top znap clip must be cut 9" so as to correctly overlap under the valley or roof-to-wall channel.

INSTALLATION OF RAKE/GABLE CHANNEL

The Terrabella® rake is a stone coated accessory which is installed along the roof's gables. Its main purpose is to collect all of the water that may run through the gables and redirect it towards the eaves. It also generates an aesthetic trim in this area.

Install the rake along gables using fasteners every 8" (20cm). To avoid water leakage, always install screws with EPDM washers as shown in the **figure** below:

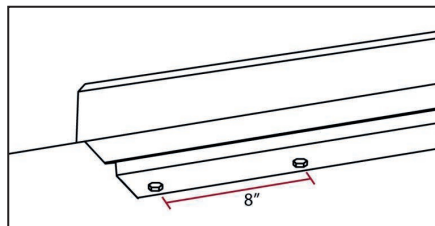

Figure 7. Screw Installation on Rake

Where the rake meets an eave, overlap it over the previously notched starter clip. Make sure the rake hangs 1 inch (2.54cm) past the eave, allowing the water that runs through the rake to exit the roof successfully. Additional drip edge may be installed beneath rake channel to further protect the structure. You may also pre-paint the exposed areas of the rake to match the color of the stone-coating.

To overlap two rakes simply notch the top of one of the pieces 1-1/2" (3.8cm) and slide it into the second one. Align all of the stone coated parts so as to keep a straight trim along the gable. Always install from the eaves towards the ridge, overlapping the top rake over the lower one. Avoid screwing over the overlapped areas.

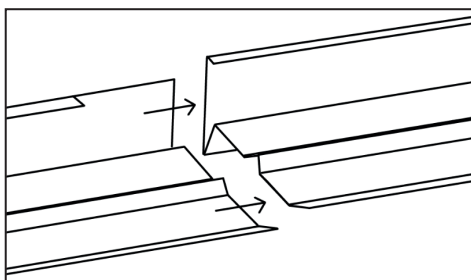

Figure 8. Rake overlap

INSTALLATION OF VALLEY

The Terrabella® valley channel is installed on each of the roof's valleys and is designed to capture and evacuate large amounts of water.

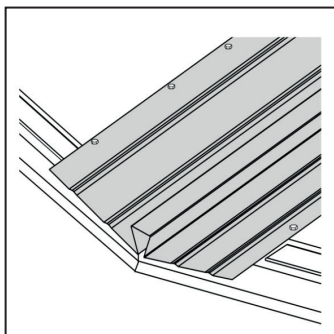

Figure 9. Valley Installation

The Valley must be installed along the center line of each valley. As with the rake, install so that a minimum 1" (2.54cm) hangs past the edge of the eave. A minimum of 6" (15cm) overlap is required when joining two valley pieces together. Install over previously notched starter clips at eaves. Always install screws with EPDM washer as far away from the center of the valley channel as possible. This will reduce any possibility of leakage through the screw holes.

Finally, snap or slide the stone-coated valley cap into place after the valley installation is complete. Stitch screws may be used to fix the valley caps in place. The exposed area of the valley may be painted to match the roof color.

INSTALLATION OF CHANNELS AT HIP

Roof-to-wall channels must be used at both sides of hips. Install two 2"x2" battens along the center of the hip and attach a roof-to-wall channel on each side as pictured in the **figure below**:

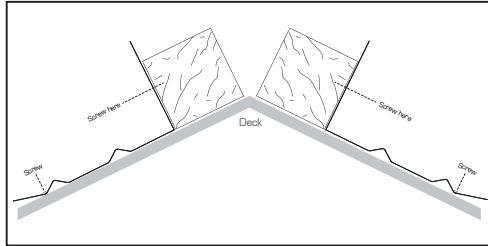

Figure 10. Roof-to-wall channel at hip

Install the channels using the recommended screws spaced every 6" (15cm) on the outside of each channel. When overlapping two roof-to-wall channels together, a 6" minimum overlap must be used. Install over starter clip at eaves in the same way as when installing rakes and valleys, leaving a 1" (2.54cm) overhang. Pre-paint all exposed areas with a color similar to the stone-coating on the panels and accessories. Always install from the ridge towards the ridge, overlapping over the lowest piece.

Bend the metal shingles up against the batten at the hip by at least 1 inch(2.54cm). This will act as a flashing below the ridge piece and will prevent water from entering the exposed hip area. If cuts must be made to the panel in order to bend it, be sure to seal these joints with the resin and stone chips from the touch-up kit.

INSTALLATION ROOF-TO-WALL CHANNEL

Whenever the roof meets a structure such as a wall or a chimney, a roof-to-wall channel must be installed in order to avoid leakage at these joints points.

Always start installing channels from the lowest point up towards the ridge. Remove any wall panels before installing the roof-to-wall channel so it can be installed over it later on. When a surface such as stucco is to be applied, do it after the channel installation to cover it up. Screw the channel every 8" (20cm) and apply a roofing grade sealant on the joint between the channel and the structure that meets the roof.

The installation of a flashing is also recommended wherever it might be necessary after the roof-to-wall channel is successfully installed. Stone-coated z-bars may be used over the channels to generate a consistent look on the roof. The Terrabella® roof-to-wall channel must have a 6" (15cm) minimum overlap and should run on top of a notched starter clip whenever it meets an eave (along with a 1" overhang). Paint any exposed areas of the channel to match the rest of the roof.

When installing panels that meet a roof-to-wall channel, make 2" notch at the top and bottom znap where the panel fits onto the Channel as shown in the **figure to the right**:

Figure 11. Roof to wall channel installation

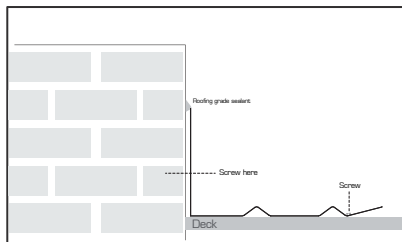

TERRABELLA® ZNAP PANEL INSTALLATION

Once all the starter clips, valleys, rakes and roof-to-wall channels are successfully installed, you may begin mounting the first course of Terrabella® panels. Make sure the roof is completely protected with the recommended underlayment and all of the accessories are installed following the guidelines set forth by this document.

The Initial point for panel installation will always be from the starter clips at the eave and advance toward the ridge in the order shown on the diagrams below:

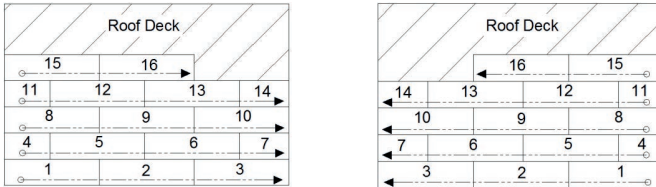

First Course: Beginning at the eave, place a full panel on position 1 (Figure 1 or figure 2). Be sure to always initiate the course from one end of the roof until it meets, and overlaps, a rake channel, valley channel or roof-to-wall channel. The bottom znap of the panels on the first course should be pulled back tightly over the znap system on the starter clip. Locking these two pieces too loosely can cause a rattling sound when high velocity winds are present.

Each full panel must be installed using 5 fasteners. When possible, use the pre-drilled holes on the top flange of each panel to screw down onto the deck. Angling the screws perpendicular to the surface of the deck can help pull the panels back.

⚠ Do not install the screw on the overlap until both panels are completely overlapped and second panel has at least one fastener.

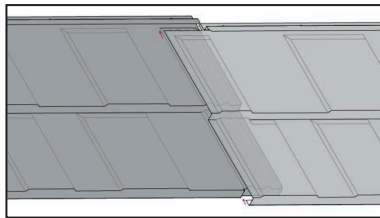

Figure 12. Panel Overlap

Second Course: If a full panel was used on the first course, a half-panel or piece must be used to start the second course; continue with a full panel. This must be done so that the overlap on all of the courses does not match, reducing any chance of water leakage and creating the uneven single/shake look.

Continue installing the next courses making sure the overlaps do not align with the course below. When fastening panels over at rakes, valleys and roof-to-wall channels, avoid using screws on the areas where water will flow. If there is no other way to securely fasten the panel other than installing a screw in these spots, use a roofing grade sealant around the installed screw.

It is strongly recommended to draw a chalk line every 3rd course to maintain straight, horizontal lines. There should be no space greater than 1/8" (3.2mm) between Shake or Shingle panels and they should fit flush with a minimum gap.

Panels at ridge: Before placing the last line of panels at the ridge, install two 2"x2" battens along the ridge. These battens must be spaced no further than 5" (12.7cm) measured from the outside face of both battens. Draw a chalk line to install the battens in a straight line, nail down as needed.

After the battens are nailed down, measure the length between top znap of the last panel installed, and the battens at the ridge. Mark a panel with the measurement obtained and add an additional 2" (5cm) to the measurement. Cut the panel using this new measurement and bend the additional 2 inches up so that it can be screwed into the battens when installed. See **figure 12**:

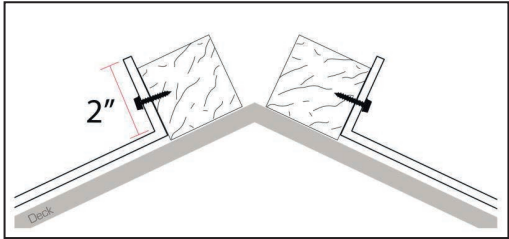

Figure 13. Panels at ridge

Keep measuring, cutting and bending panels at the ridge. Make sure the modified piece is interlocked tightly with the panel below and a correct overlap is maintained with the rest of the panels at the ridge.

Panels at rake/gable: Panels installed over Terrabella® rakes must be notched at the top and bottom znap. Simply cut a 2" (5cm) piece as shown in the **figure** below:

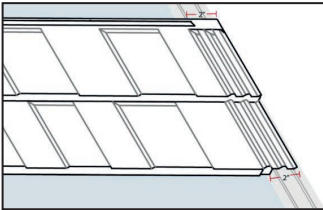

Figure 14. Panels at rake

This is done as an additional protection against leakage as it permits the water that is drained through the rake channel to exit onto the panels. This prevents the rake channel from ever overflowing and leaking water to the deck below. Avoid installing screws on the rake and always use caulk if you do.

Panels at hips and valleys: Where panels meet hips and valleys, cut the panels in a size and shape that tightly fit on the valley channels and roof-to-wall channels at hips. As with the panels at the rake, notch the top and bottom znap of each panel by 2" (5cm) at hips, and 4" (10cm) at valleys. Try to avoid using screws on top of the roof-to-wall channels and valley channels.

Panels at Head Wall: As with the panels at the ridge, measure the distance from the last panel installed to the wall. Add 1" (2.54cm) to the measurement and cut the panel. Bend the additional inch so it is parallel with the wall. Fasten the panel to the head wall and seal the joint with a roofing grade sealant and a flashing as needed. If there are wall panels or sidings, reinstall them over the bent portion of the Terrabella® panels.

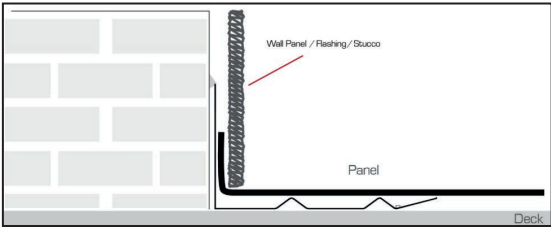
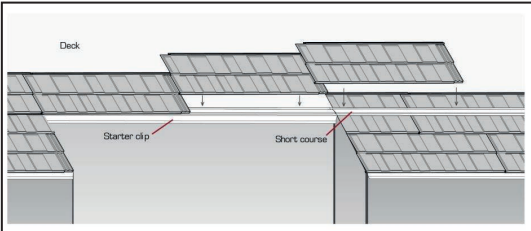

Figure 15. Panels at head wall

Panels at Uneven Fascia: In some roofs the fascia may be uneven throughout the eave. This will cause some difficulty when aligning panel courses. This issue can be fixed using a short course.

A short course is an accessory which allows panels to be installed in many positions and circumstances. It has the same znap system as the starter clip and as so, follows the same installation procedures and recommendations.

The short course may be used to resolve issues with panel alignment at uneven fascias. Simply install the short course over any surface, such as a Terrabella® panel, to start a new course. The figure below:



RIDGE AND HIP INSTALLATION

Once the panels at hips and ridges are installed as instructed above, the Terrabella® ridge and end caps may be installed. All panels and accessories should be installed at this point.

Ridge Installation: Make sure to begin installation from the end of the roof opposite to the direction of the wind. This will cause the overlap between each ridge piece to remain unaltered in the presence of strong winds. Fasten the ridge pieces on the battens at every overlap. Make sure to use pre-paint screws if you do not plan to stone coat each one with the touch-up kit. These are the only screws in the systems that remain exposed. Once all pieces are fastened cut-off the excess ridge piece and install the end cap on all ends.

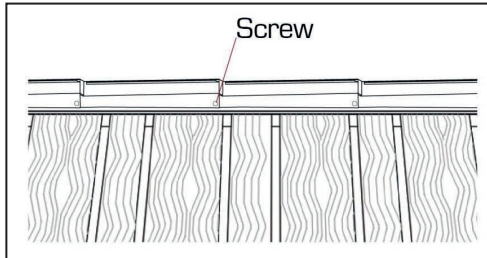

Figure 16. Ridge piece installation

If a ridge vent is to be installed, roll it out on top of the battens at the ridge and adjust into position. After the ridge vent has been set over the battens, install the ridge pieces as you normally would. Be sure to cover the entire ridge vent with the Terrabella® ridge pieces and end cap.

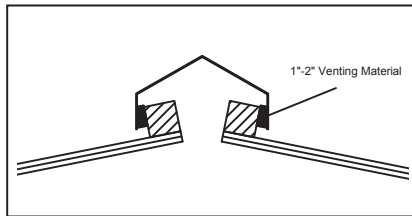

Figure 17. Venting the Ridge

Hip Installation: When installing ridge pieces on hips, always start from the eave upwards. Fasten on the battens installed on the hip using 2 screws for each piece. Use pre-painted screws or stone coat each one after installation with the touch-up kit. After placing the final hip piece, install the end caps where needed. Use sealant if there is a gap between the end cap and the hip piece.

At the intersection of the hip and ridge, modify the ridge pieces to connect them. Use tin snips to do ease this process. Cut the Ridge trim to fit the contour of the hip trims and install sealant at the overlap of the cut hip trims.

INSTALLATION AROUND PIPES

Whenever a pipe is present in a roof, the panels around it must be cut in the shape of the pipe. Install a pipe flashing around the pipe vent.

Cut the skirt on the top pipe flashing to fit height of the course, and fit it over the vent pipe. Mold the skirt of the flashing to fit the corrugations of the panel. Using a width of panel, that is wide enough to cover the entire pipe flashing skirt, carefully cut a hole to fit around the cone of the flashing. Install the "cover panel" and fasten. Be sure to seal and chip around the cone using the

Terrabella® Touch-up kit.

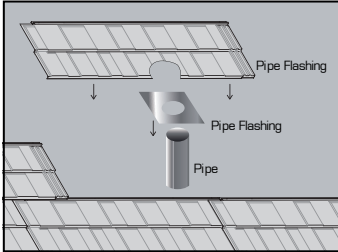

Figure 18. Pipe flashing layout

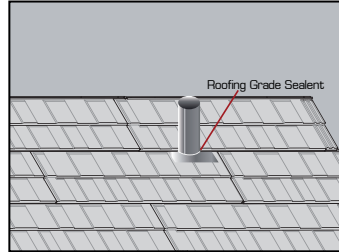

Figure 19. Installed pipe flashing

Chimneys, Skylights & Dormers

There will be times where panels must be installed around a chimney, skylight or dormers. Install full panels where possible and use cut panels cover the remaining areas. Start by measuring from the full panel below the chimney. Use the same procedure as with the installation of panels on a head wall.

Use roof-to-wall channels on the left and right faces of these structures. Install a z bar over the channel after installing panel pieces over it. The roof-to-wall channel should extend a minimum of 4" (20cm) past the chimney's edges. Proceed to install the cut panels over the channels notching the top and the bottom znap as done on other channels.

A chimney saddle may be used to cover the area above the chimney or dome. Avoid using lead or copper materials for this purpose as they must not be in prolonged contact with the rest of the system. After the flashings are installed, proceed to install the rest of the panels above the channels. Follow the **diagrams** below for a successful installation:

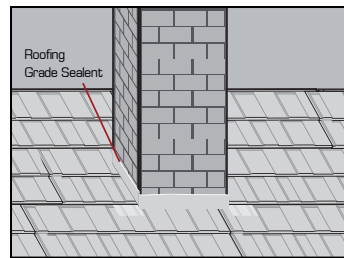
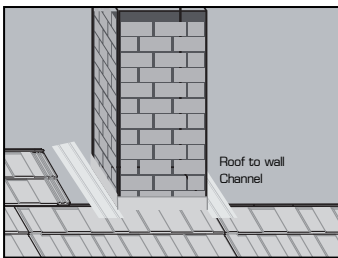

Figure 20. (1) Install roof-to-wall channel on both sides and at the back of the chimney; bend the front panel upwards as you would at a ridge. (2) Seal all around the chimney with roofing grade sealant. (3) Install Z bar around chimney.

USING THE TERRABELLA®TOUCH-UP KIT

The Terrabella® touch up kit is to be used to repair damaged areas, hiding screws, or stone-coating any surface. After completing the installation on the roof, begin identifying damaged or scratched panels as well as any visible screws.

Apply the resin on the required area and completely cover it with the stone granules. Let it harden for 24 hours before walking over these spots. Be careful not to spill any resin on the roof, these stains will not come off.

 **Keep the resin away from the eyes and mouth.**

 **Use safety glasses when handling the stone granules.**