

Effective: January 1992
 Supersedes I.L. 41-101T, Dated March 1968

Type CO Overcurrent Relay

(|) Denotes Change Since Previous Issue



Before putting relays into service, remove all blocking which may have been inserted for the purpose of securing the parts during shipment, make sure that all moving parts operate freely, inspect the contacts to see that they are clean and close properly, and operate the relay to check the settings and electrical connections.

1.0 APPLICATION

The CO relay is a single phase non-directional time ac overcurrent device. It is used to sense current level above the setting and normally is used to trip a circuit breaker to clear faults. A wide range of characteristics permit applications involving coordination with fuses, reclosers, cold load pickup, motor starting, or essentially fixed time applications. See Table 1 for typical applications.

**Table 1:
 TYPICAL APPLICATIONS OF THE CO RELAY**

RELAY TIME	TYPE CURVE	TYPICAL APPLICATIONS
CO-2	Short	1) Differential protection where saturation of current transformers is not expected, or where delayed tripping is permissible. 2) Overcurrent protection, phase or ground, where coordination with downstream devices is not involved and 2 to 60 cycle tripping is allowable.
CO-5	Long	Motor locked rotor protection where allowable locked rotor time is approximately between 10 and 70 seconds.
CO-6	Definite	Overcurrent protection where coordination with downstream devices is not involved and CO-2 is too fast. The operating time of this relay does not vary greatly as current level varies.
CO-7	Moderately Inverse	1) Overcurrent protection where coordination with other devices is required, and generation varies. 2) Backup protection for relays on other circuits.
CO-8	Inverse	
CO-9	Very Inverse	
CO-11	Extremely Inverse	1) Motor protection where allowable locked rotor time is less than 10 seconds. 2) Overcurrent protection where coordination with fuses and reclosers is involved, or where cold load pickup or transformer inrush are factors.

All possible contingencies which may arise during installation, operation or maintenance, and all details and variations of this equipment do not purport to be covered by these instructions. If further information is desired by purchaser regarding this particular installation, operation or maintenance of this equipment, the local ABB Inc. representative should be contacted.

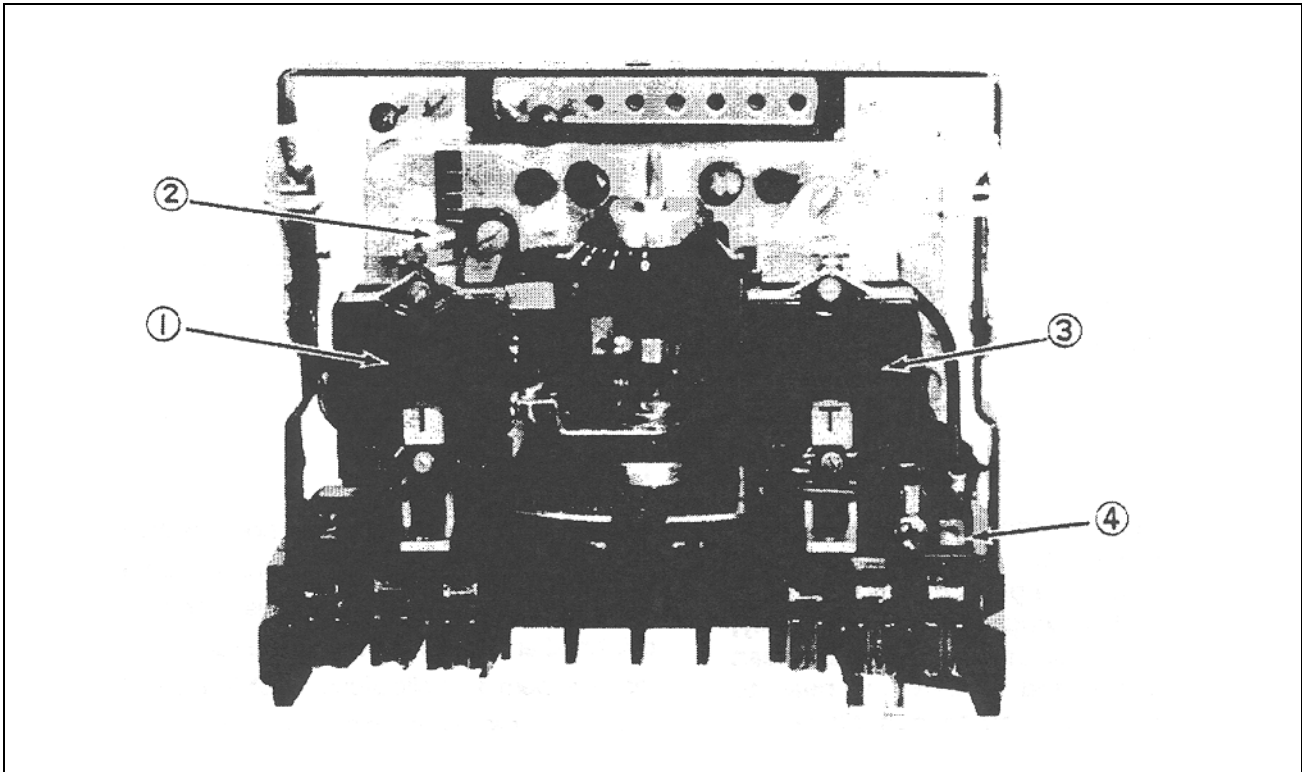

Figure 1: Type CO Relay Without Case. 1 = Indicating Instantaneous Trip (IIT). 2 = IIT Adjusting Screw. 3 = Indicating Contactor Switch (ICS). 4 = Indicating Contactor Switch Tap Block.

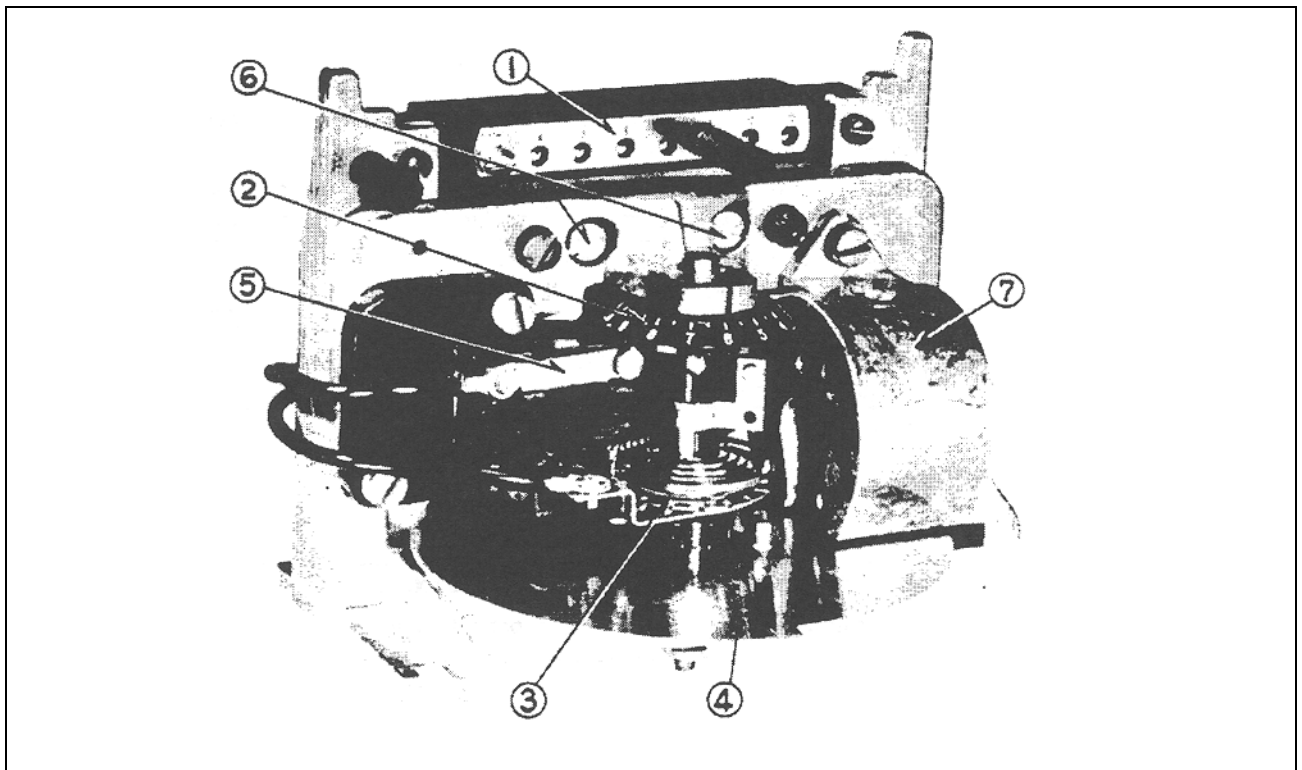

Figure 2: Time Overcurrent Unit (Front View). 1 = Tap block. 2 = Time Dial. 3 = Control Spring Assembly. 4 = Disc. 5 = Stationary Contact Assembly. 6 = Magnetic Plugs. 7 = Permanent Magnet.

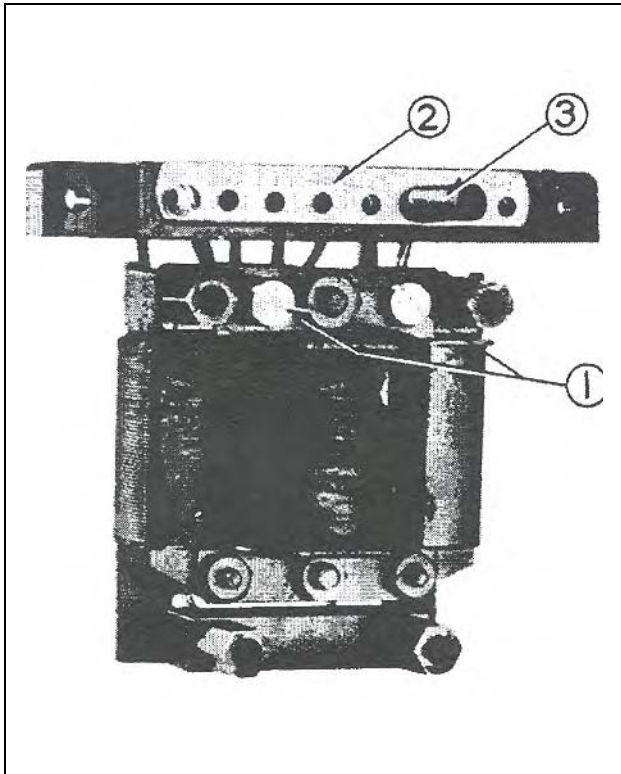

Figure 3: "E" Type Electromagnet.
1= Magnet Plugs.
2= Tap Block.
3= Tap Screw.

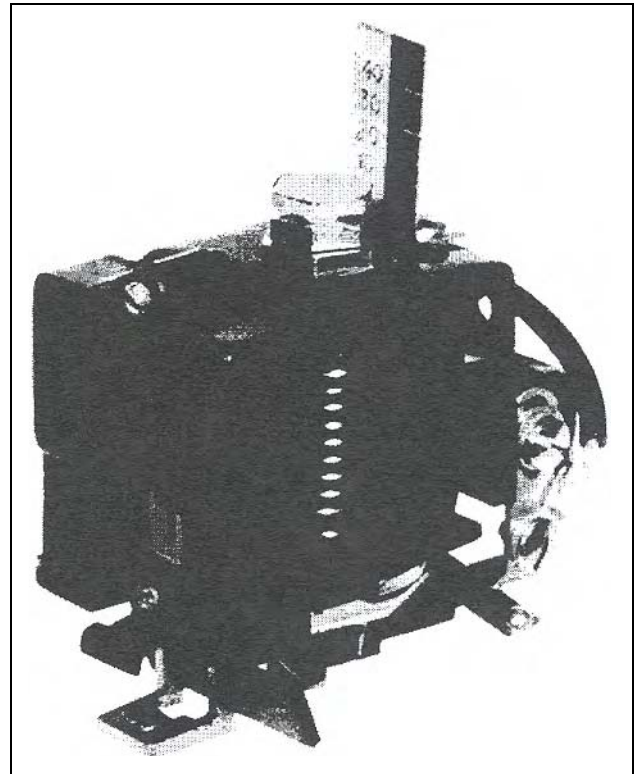

Figure 4: Indicating Instantaneous Trip Unit (IIT).

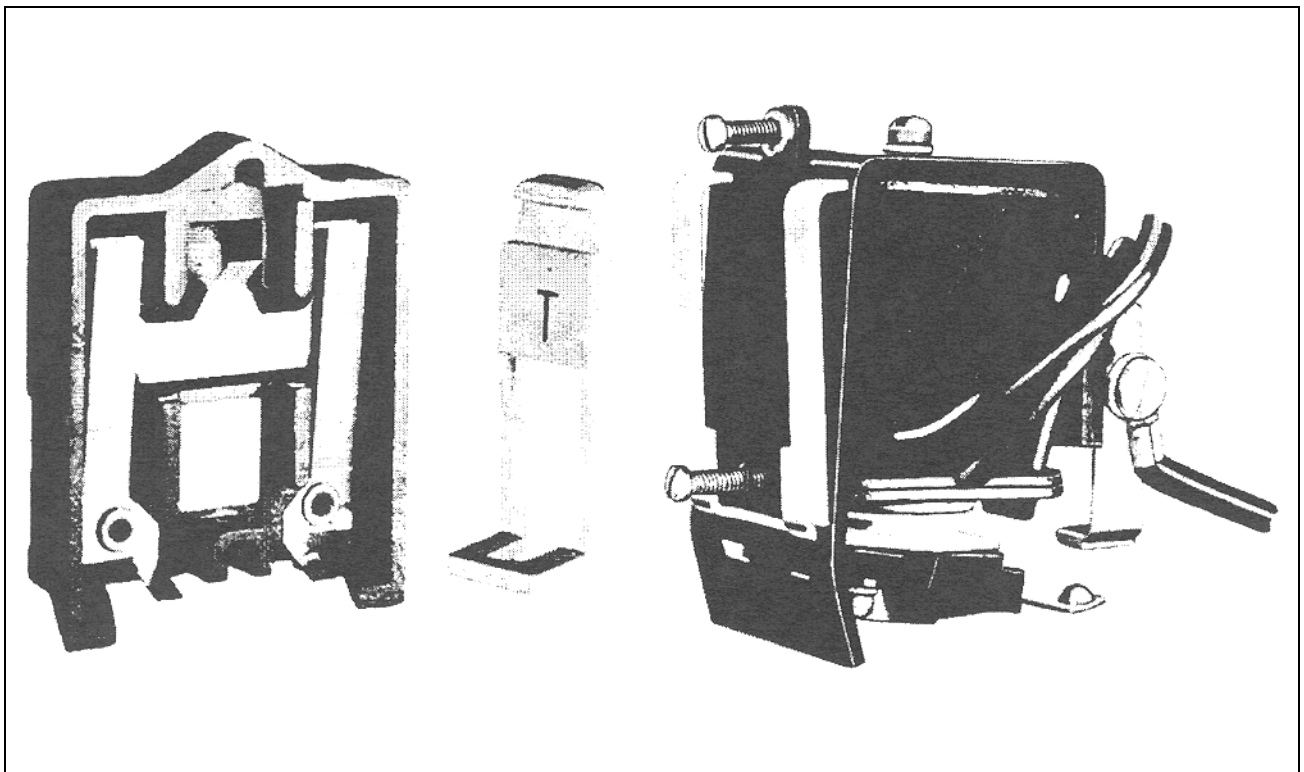

Figure 5: Indicating Contactor Switch (ICS).

2.0 CONSTRUCTION AND OPERATION

The type CO relays consist of an overcurrent unit (CO), an indicating contactor switch (ICS), and an indicating instantaneous trip unit (IIT) when required. The principal component parts of the relay and their location are shown in Figures 1 through 5.

2.1 ELECTROMAGNET

The electromagnets for the types CO-5, CO-6, CO-7, CO-8 and CO-9 relays have a main tapped coil located on the center leg of an "E" type laminated structure that produces a flux which divides and returns through the outer legs. A shading coil causes the flux through the left leg to lag the main pole flux. The out-of-phase fluxes thus produced in the air gap cause a contact closing torque. A torque controlled CO has the lag coil connections of the electromagnet brought out to separate terminals. This permits control of the closing torque such that only when these terminals are connected together will the unit operate.

The electromagnets for the types CO-2 and CO-11 relays have a main coil consisting of a tapped primary winding and a fixed secondary winding. Identical coils are on the outer legs of the lamination structure and are connected to the main coil fixed secondary in a manner so that the combination of all the fluxes produced by the electromagnet result in out-of-phase fluxes in the air gap. The out-of-phase air gap fluxes produced cause a contact closing torque.

2.2 INDICATING CONTACTOR SWITCH UNIT (ICS)

The dc indicating contactor switch is a small clapper type device. A magnetic armature, to which leaf-spring mounted contacts are attached, is attracted to the magnetic core upon energization of the switch. When the switch closes the moving contacts bridge two stationary contacts, completing the trip circuit. Also during this operation two fingers on the armature deflect a spring located on the front of the switch, which allows the operation indicator target to drop.

The front spring, in addition to holding the target, provides restraint for the armature and thus controls the pickup value of the switch.

2.3 INDICATING INSTANTANEOUS TRIP UNIT (IIT)

The instantaneous trip unit is a small ac operated clapper type device. A magnetic armature, to which leaf-spring mounted contacts are attached, is attracted to the magnetic core upon energization of the switch. When the switch closes, the moving contacts bridge two stationary contacts completing the trip circuit. Also, during the operation, two fingers on the armature deflect a spring located on the front of the switch which allows the operation indicator target to drop.

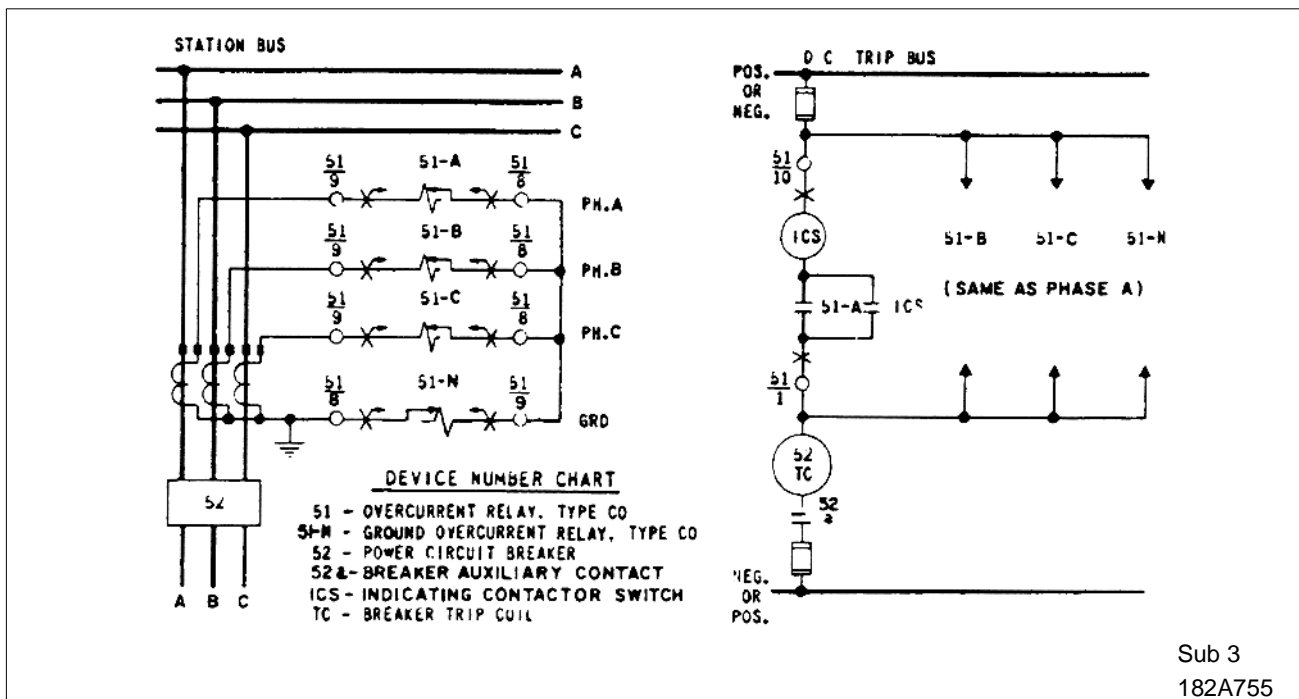

Figure 6: External Schematic of the Circuit-Closing Type CO Relay for Phase and Ground Overcurrent Protection on a Three-Phase System.

**ENERGY REQUIREMENTS
TYPE CO-2 RELAY**

Ampere Range	Tap	Continuous Rating (Amperes)	One Second Rating* (Amperes)	Power Factor Angle ϕ	VOLT AMPERES**			
					At Tap Value Current	At 3 Times Tap Value Current	At 10 Times Tap Value Current	At 20 Times Tap Value Current
0.5/2.5	0.5	0.91	28	58	4.8	39.6	256	790
	0.6	0.96	28	57	4.9	39.8	270	851
	0.8	1.18	28	53	5.0	42.7	308	1024
	1.0	1.37	28	50	5.3	45.4	348	1220
	1.5	1.95	28	40	6.2	54.4	435	1740
	2.0	2.24	28	36	7.2	65.4	580	2280
	2.5	2.50	28	29	7.9	73.6	700	2850
2/6	2.0	3.1	110	59	5.04	38.7	262	800
	2.5	4.0	110	55	5.13	39.8	280	920
	3.0	4.4	110	51	5.37	42.8	312	1008
	3.5	4.8	110	47	5.53	44.3	337	1120
	4.0	5.2	110	45	5.72	46.0	360	1256
	5.0	5.6	110	41	5.90	50.3	420	1500
	6.0	6.0	110	37	6.54	54.9	474	1800
4/12	4.0	7.3	230	64	4.92	39.1	268	848
	5.0	8.0	230	50	5.20	42.0	305	1020
	6.0	8.8	230	47	5.34	44.1	330	1128
	7.0	9.6	230	46	5.53	45.8	364	1260
	8.0	10.4	230	43	5.86	49.9	400	1408
	10.0	11.2	230	37	6.60	55.5	470	1720
	12.0	12.0	230	34	7.00	62.3	528	2064

CO-5 LONG TIME AND CO-6 DEFINITE MINIMUM TIME RELAYS

Ampere Range	Tap	Continuous Rating (Amperes)	One Second Rating* (Amperes)	Power Factor Angle ϕ	VOLT AMPERES**			
					At Tap Value Current	At 3 Times Tap Value Current	At 10 Times Tap Value Current	At 20 Times Tap Value Current
0.5/2.5	0.5	2.7	88	69	3.92	20.6	103	270
	0.6	3.1	88	68	3.96	20.7	106	288
	0.8	3.7	88	67	4.01	21.0	120	325
	1.0	4.1	88	66	4.07	22.3	130	400
	1.5	5.7	88	62	4.19	23.2	147	462
	2.0	6.8	88	60	4.30	24.9	168	548
	2.5	7.7	88	58	4.37	26.2	180	630
2/6	2	8.0	230	67	3.88	21.0	110	308
	2.5	8.8	230	66	3.90	21.6	118	342
	3	9.7	230	64	3.93	22.1	126	381
	3.5	10.4	230	63	4.09	23.1	136	417
	4	11.2	230	62	4.12	23.5	144	448
	5	12.5	230	59	4.20	24.8	162	540
	6	13.7	230	57	4.38	26.5	183	624
4/12	4	16.0	460	65	4.00	22.4	126	376
	5	18.8	460	63	4.15	23.7	143	450
	6	19.3	460	61	4.32	25.3	162	531
	7	20.8	460	59	4.35	26.4	183	611
	8	22.5	460	56	4.40	27.8	204	699
	10	25.0	460	53	4.60	30.1	247	880
	12	28.0	460	47	4.92	35.6	288	1056

* Thermal capacities for short times other than one second may be calculated on the basis of time being inversely proportional to the square of the current.

ϕ Degrees current lags voltage at tap value current.

** Voltages taken with Rectox type voltmeter.

**ENERGY REQUIREMENTS
CO-7 MODERATELY INVERSE TIME RELAY**

VOLT AMPERES**

Ampere Range	Tap	Continuous Rating (Amperes)	One Second Rating* (Amperes)	Power Factor Angle ϕ	VOLT AMPERES**			
					At Tap Value Current	At 3 Times Tap Value Current	At 10 Times Tap Value Current	At 20 Times Tap Value Current
0.5/2.5	0.5	2.7	88	68	3.88	20.7	103	278
	0.6	3.1	88	67	3.93	20.9	107	288
	0.8	3.7	88	66	3.97	21.1	114	320
	1.0	4.1	88	64	4.00	21.6	122	356
	1.5	5.7	88	61	4.08	22.9	148	459
	2.0	6.8	88	58	4.24	24.8	174	552
	2.5	7.7	88	56	4.38	25.9	185	640
2/6	2	8.0	230	66	4.06	21.3	111	306
	2.5	8.8	230	64	4.07	21.8	120	230
	3	9.7	230	63	4.14	22.5	129	366
	3.5	10.4	230	62	4.34	23.4	141	413
	4	11.2	230	61	4.34	23.8	149	448
	5	12.5	230	59	4.40	25.2	163	530
	6	13.7	230	58	4.62	27.0	183	624
4/12	4	16	460	64	4.24	22.8	129	392
	5	18.8	460	61	4.30	24.2	149	460
	6	19.3	460	60	4.62	25.9	168	540
	7	20.8	460	58	4.69	27.3	187	626
	8	22.5	460	55	4.80	29.8	211	688
	10	25	460	51	5.20	33.0	260	860
	12	28	460	46	5.40	37.6	308	1032

CO-8 LONG TIME AND CO-9 DEFINITE MINIMUM TIME RELAYS

VOLT AMPERES**

Ampere Range	Tap	Continuous Rating (Amperes)	One Second Rating* (Amperes)	Power Factor Angle ϕ	VOLT AMPERES**			
					At Tap Value Current	At 3 Times Tap Value Current	At 10 Times Tap Value Current	At 20 Times Tap Value Current
0.5/2.5	0.5	2.7	88	72	2.38	21.0	132	350
	0.6	3.1	88	71	2.38	21.0	134	365
	0.8	3.7	88	69	2.40	21.1	142	400
	1.0	4.1	88	67	2.42	21.2	150	440
	1.5	5.7	88	62	2.51	22.0	170	530
	2.0	6.8	88	57	2.65	23.5	200	675
	2.5	7.7	88	53	2.74	24.8	228	800
2/6	2	8.0	230	70	2.38	21.0	136	360
	2.5	8.8	230	66	2.40	21.1	142	395
	3	9.7	230	64	2.42	21.5	149	430
	3.5	10.4	230	62	2.48	22.0	157	470
	4	11.2	230	60	2.53	22.7	164	500
	5	12.5	230	58	2.64	24.0	180	580
	6	13.7	230	56	2.75	25.2	198	660
4/12	4	16.0	460	68	2.38	21.3	146	420
	5	18.8	460	63	2.46	21.8	158	480
	6	19.3	460	60	2.54	22.6	172	550
	7	20.8	460	57	2.62	23.6	190	620
	8	22.5	460	54	2.73	24.8	207	700
	10	25.0	460	48	3.00	27.8	248	850
	12	28.0	460	45	3.46	31.4	292	1020

* Thermal capacities for short times other than one second may be calculated on the basis of time being inversely proportional to the square of the current.

 ϕ Degrees current lags voltage at tap value current.

** Voltages taken with Rectox type voltmeter.

**ENERGY REQUIREMENTS
TYPE CO-11 RELAY**

Ampere Range	Tap	Continuous Rating (Amperes)	One Second Rating* (Amperes)	Power Factor Angle ϕ	VOLT AMPERES**			
					At Tap Value Current	At 3 Times Tap Value Current	At 10 Times Tap Value Current	At 20 Times Tap Value Current
0.1/0.5	0.1	0.04	11.5	34	0.64	6.5	70.3	240
	0.12	0.04	11.5	32	0.67	6.66	75.4	264
	0.16	0.04	11.5	30	0.76	7.3	82.4	297
	0.2	0.04	11.5	26	0.83	8.3	87.8	336
	0.3	0.04	11.5	22	1.01	10.3	117.6	420
	0.4	0.04	11.5	18	1.21	11.22	140.0	520
	0.5	0.04	11.5	16	1.38	13.8	168.0	630
0.5/2.5	0.5	1.7	56	36	0.72	6.54	71.8	250
	0.6	1.9	56	34	0.75	6.80	75.0	267
	0.8	2.2	56	30	0.81	7.46	84.0	298
	1.0	2.5	56	27	0.89	8.30	93.1	330
	1.5	3.0	56	22	1.13	10.04	115.5	411
	2.0	3.5	56	17	1.30	11.95	136.3	502
	2.5	3.8	56	16	1.48	13.95	160.0	610
2/6	2.0	7.0	230	32	0.73	6.30	74.0	264
	2.5	7.8	230	30	0.78	7.00	78.5	285
	3.0	8.3	230	27	0.83	7.74	84.0	309
	3.5	9.0	230	24	0.88	8.20	89.0	340
	4.0	10.0	230	23	0.96	9.12	102.0	372
	5.0	11.0	230	20	1.07	9.80	109.0	430
	6.0	12.0	230	20	1.23	11.34	129.0	504
4/12	4.0	14.0	460	29	0.79	7.08	78.4	296
	5.0	16.0	460	25	0.89	8.00	90.0	340
	6.0	17.0	460	22	1.02	9.18	101.4	378
	7.0	18.0	460	20	1.10	10.00	110.0	454
	8.0	20.0	460	18	1.23	11.1	124.8	480
	10.0	22.0	460	17	1.32	14.09	131.6	600
	12.0	26.0	460	16	1.8	16.3	180.0	720

* Thermal capacities for short times other than one second may be calculated on the basis of time being inversely proportional to the square of the current.

ϕ Degrees current lags voltage at tap value current.

** Voltages taken with Rectox type voltmeter.

INSTANTANEOUS TRIP UNIT (IIT)

RANGE IN AMPERES	BURDEN IN VOLT-AMPS AT	
	MINIMUM SETTING	MAXIMUM SETTING
2 - 8	4.5	32
4 - 16	4.5	32
10 - 40	4.5	40
10 - 80	6.5	70
40 - 160	9.0	144

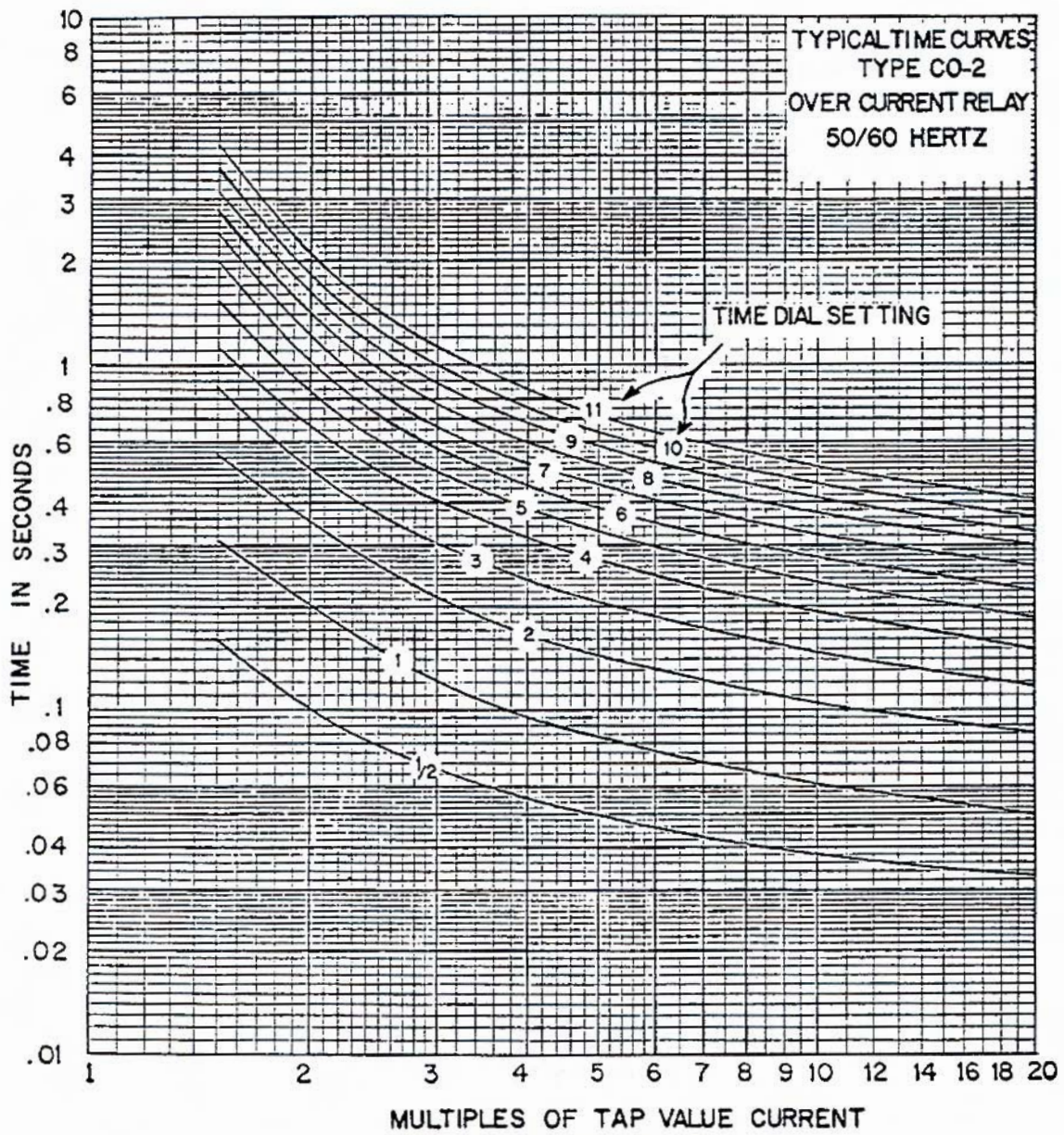

Sub 1
619584

Figure 7: Typical Time Curves of the Type CO-2 Relay

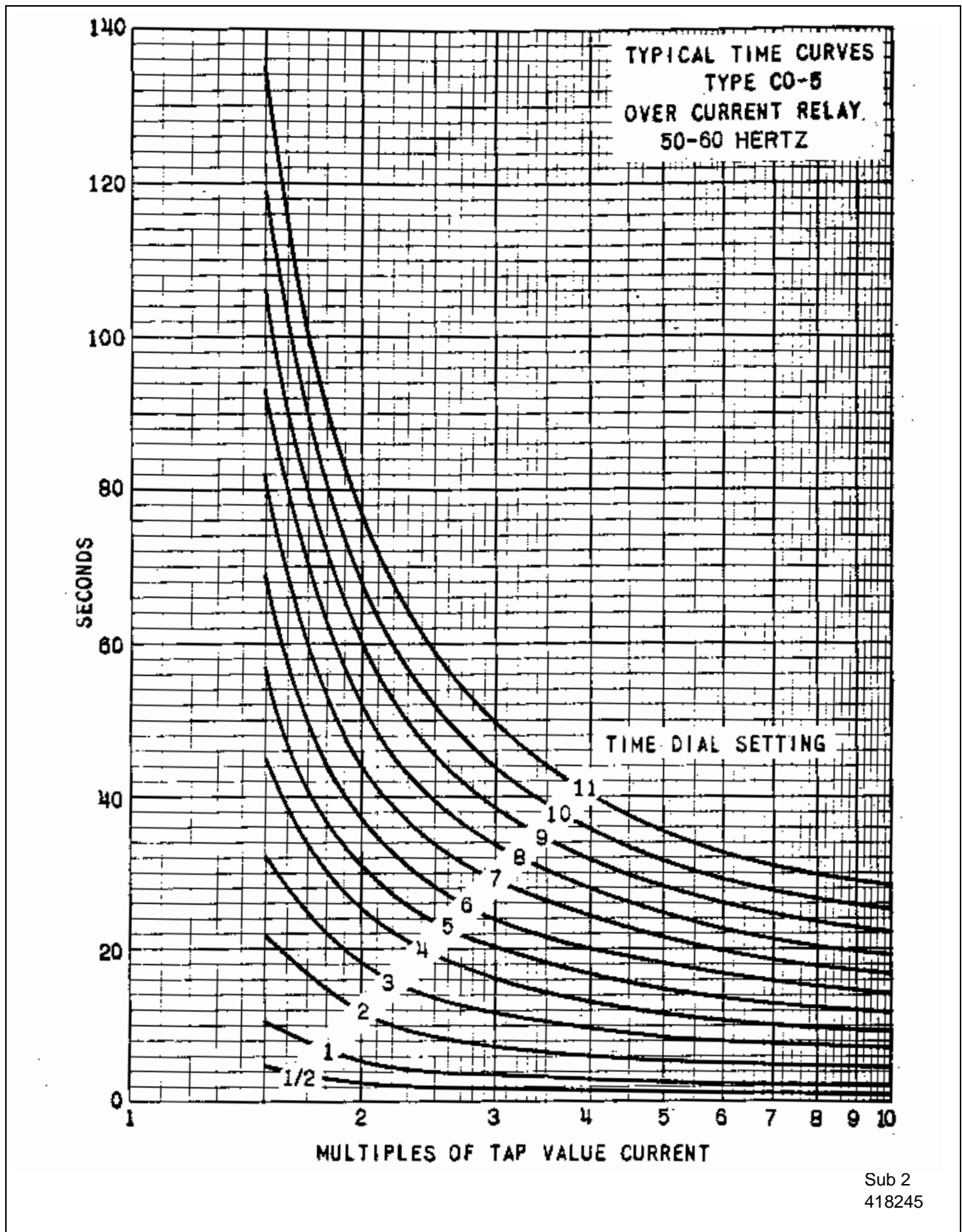

Figure 8: Typical Time Curves of the Type CO-5 Relay

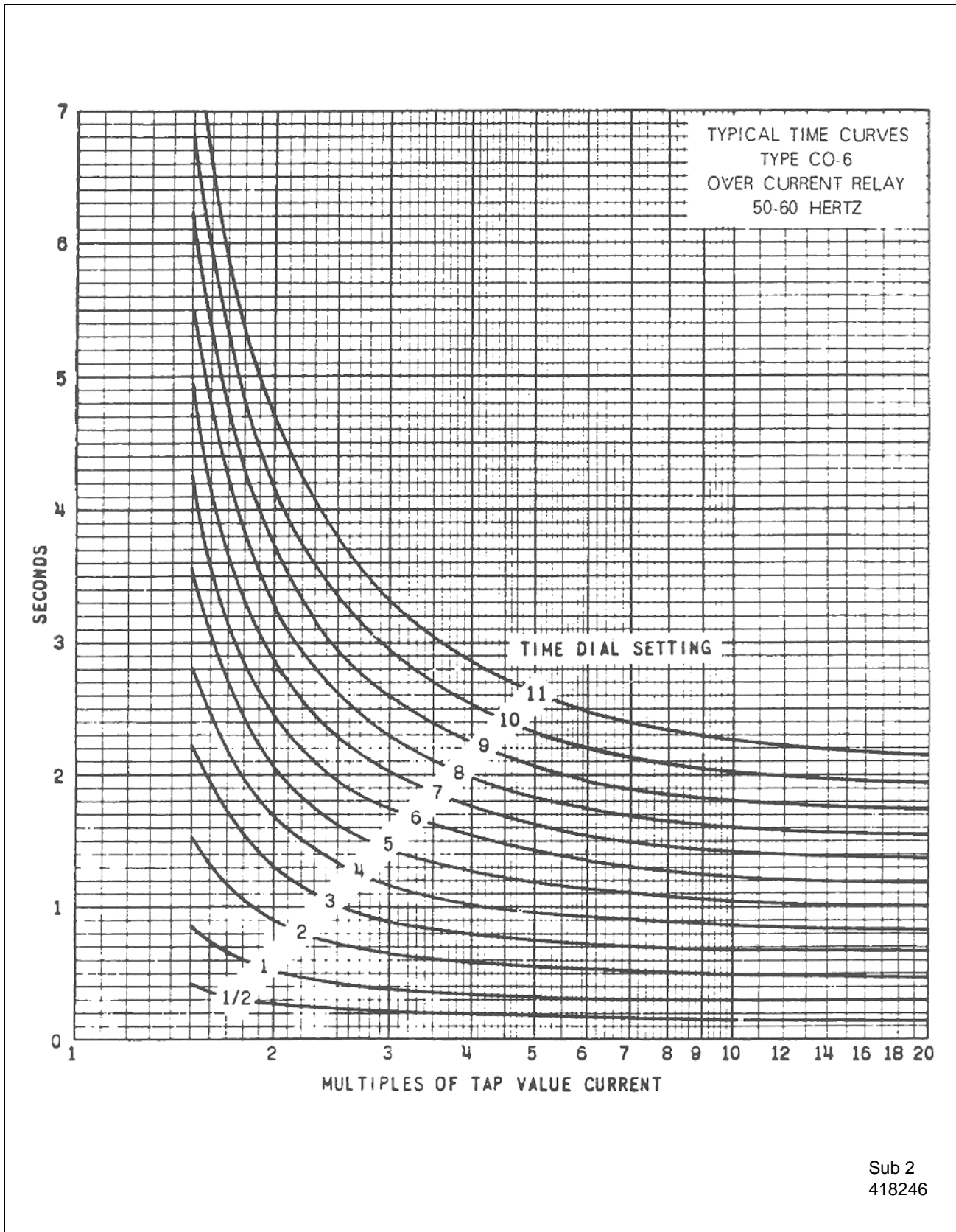
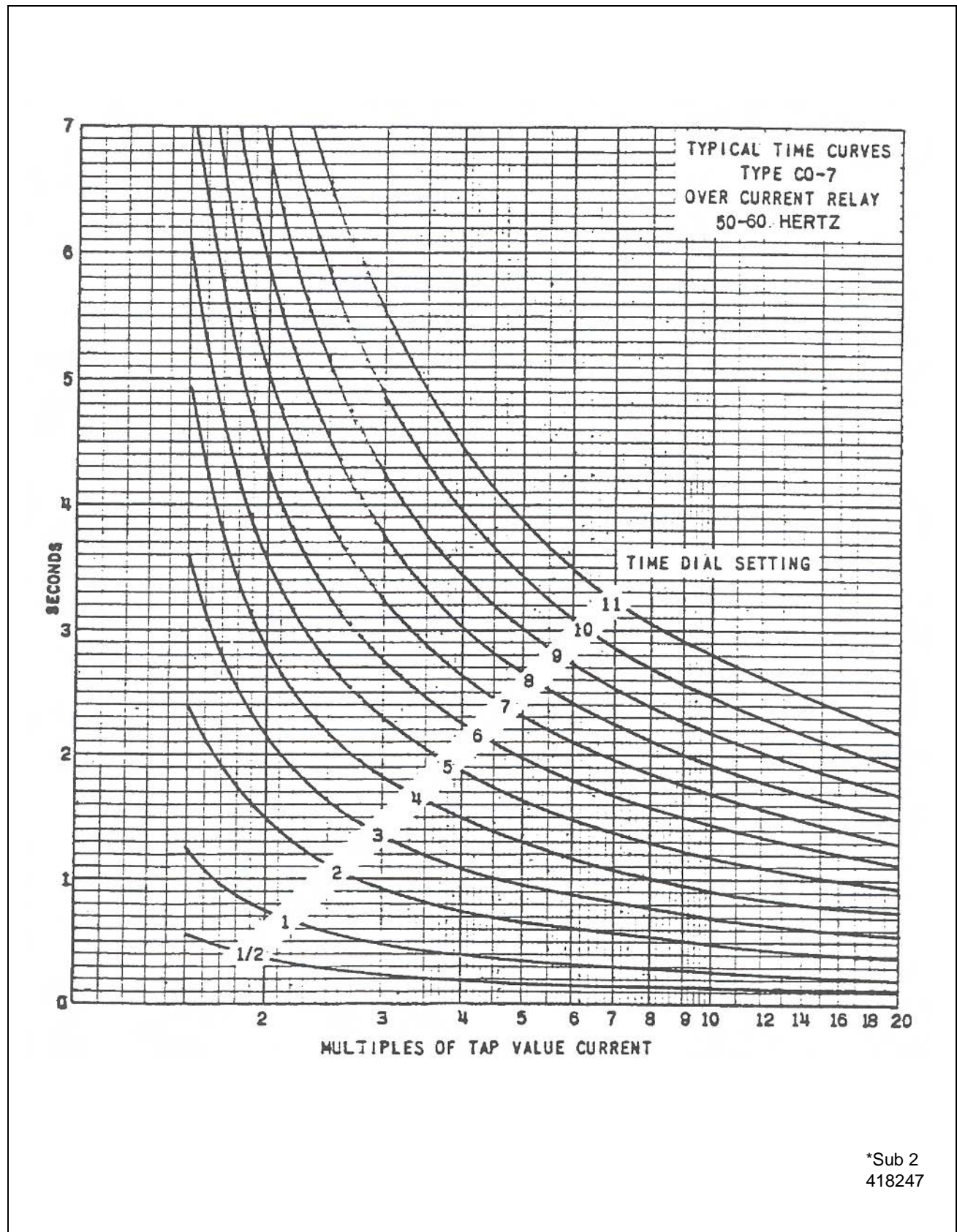

Figure 9: Typical Time Curves of the Type CO-6 Relay



*Sub 2
418247

Figure 10: Typical Time Curves of the Type CO-7 Relay

*Denotes Change

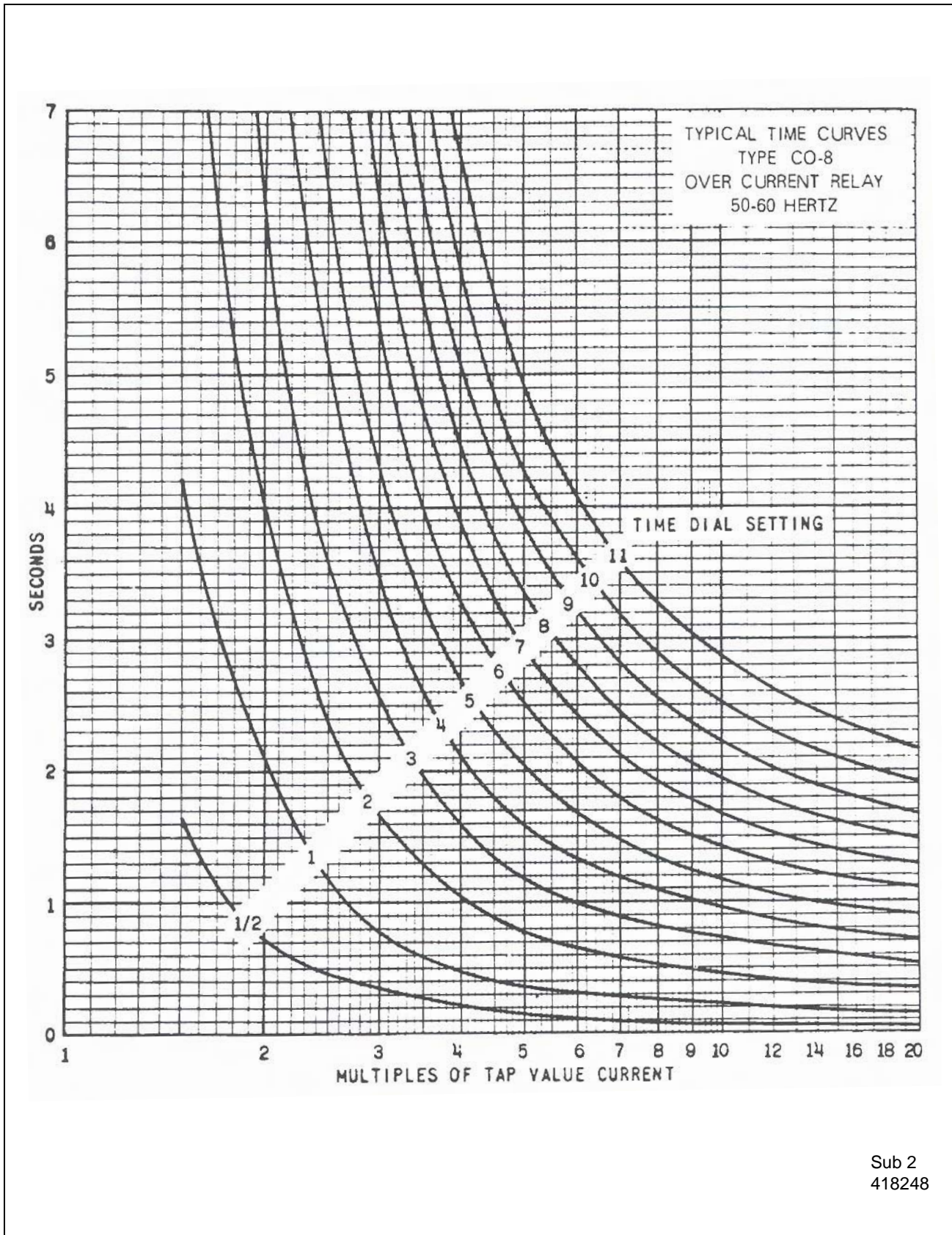

Sub 2
418248

Figure 11: Typical Time Curves of the Type CO-8 Relay

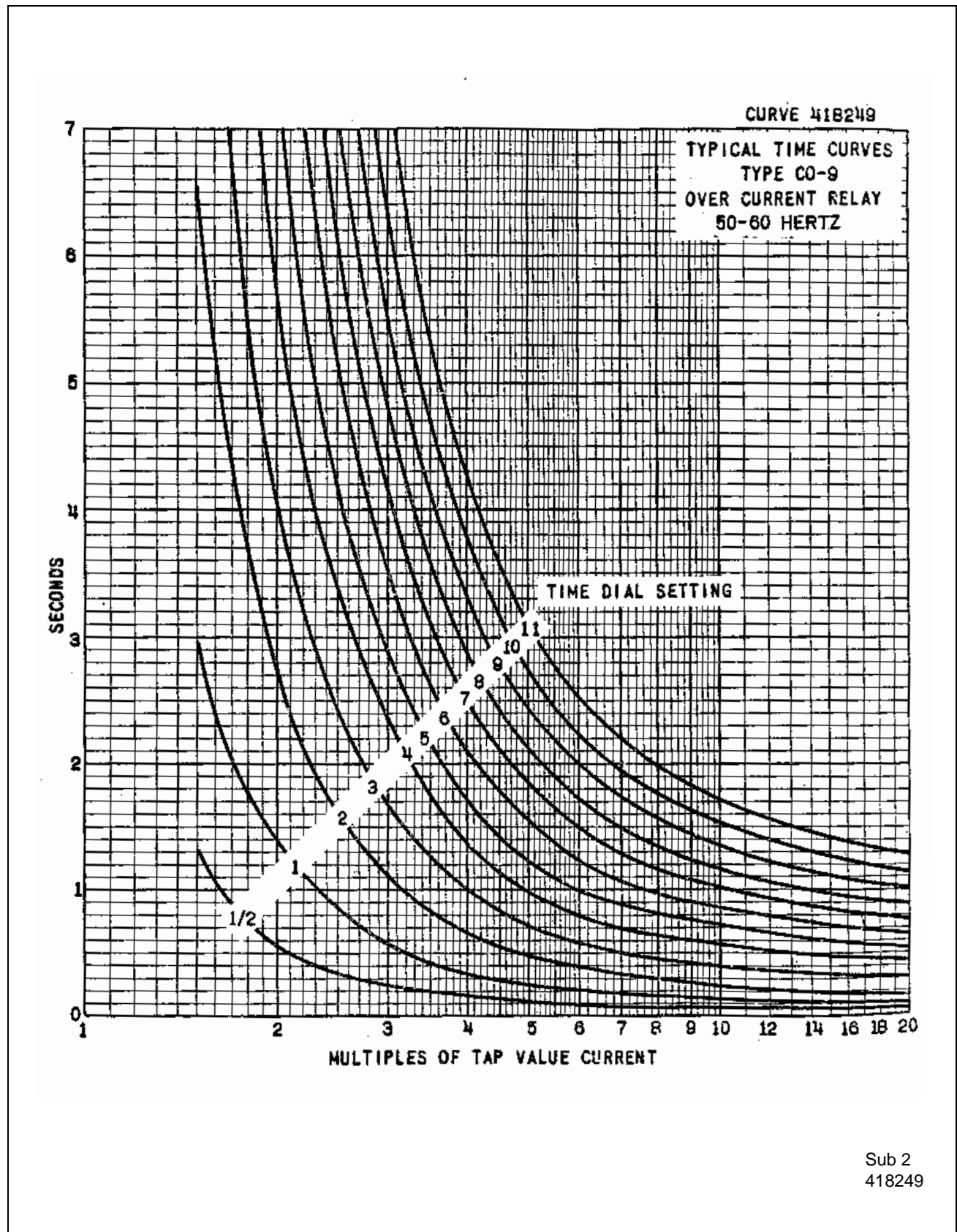
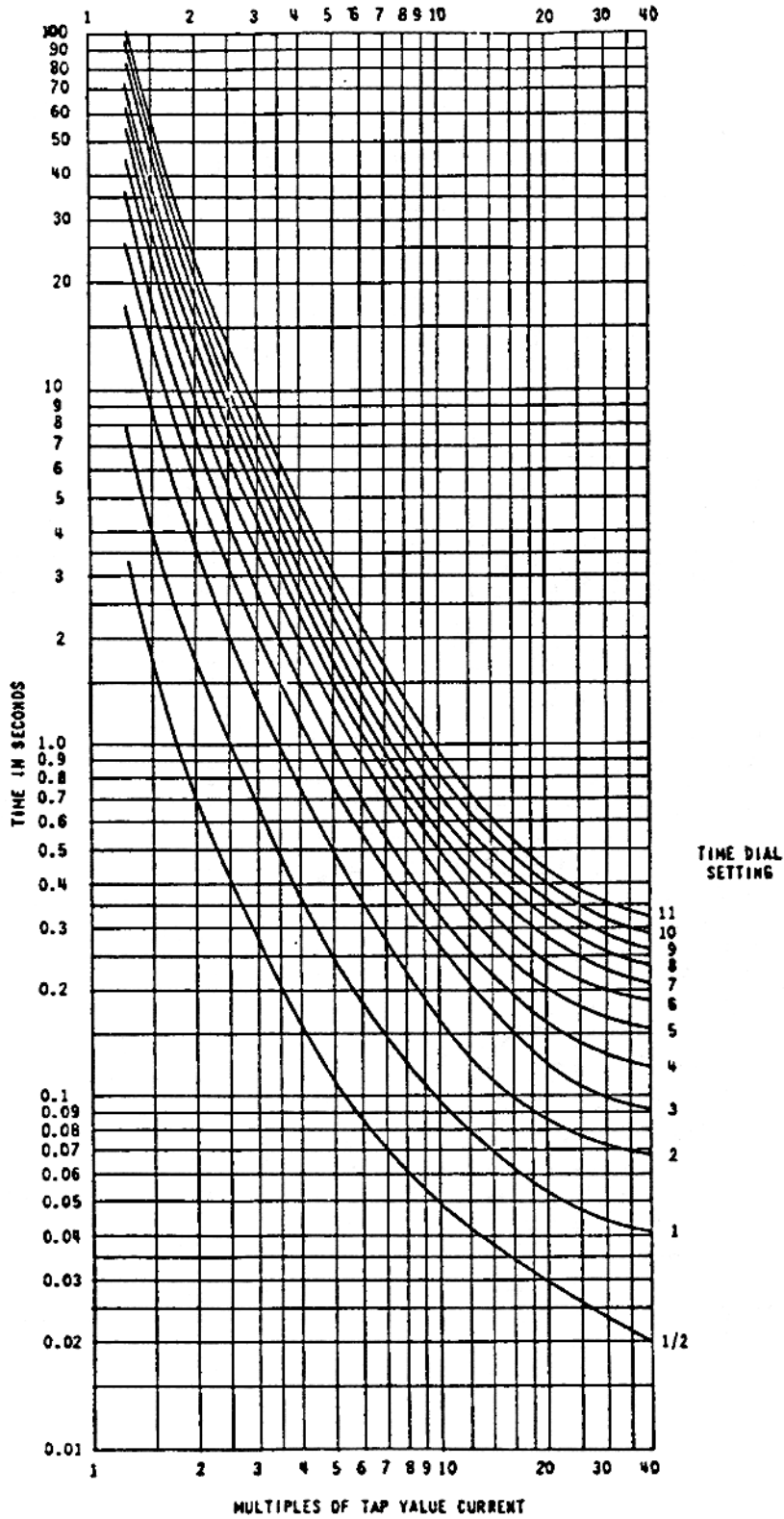

Figure 12: Typical Time Curves of the Type CO-9 Relay.



Sub 2
288B655

Figure 13: Typical Time Curves of the Type CO-11 Relay.

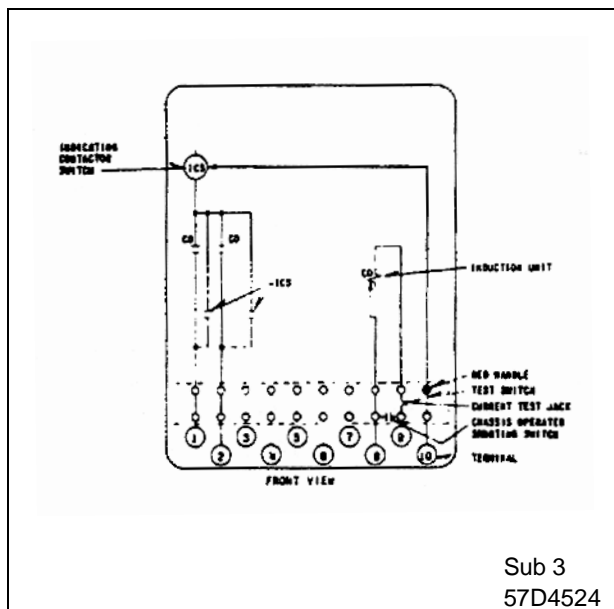

Figure 14: Internal Schematic of the Double Trip Circuit Closing Relay. For the Single Trip Relay the Circuits Associated with Terminal 2 are Omitted.

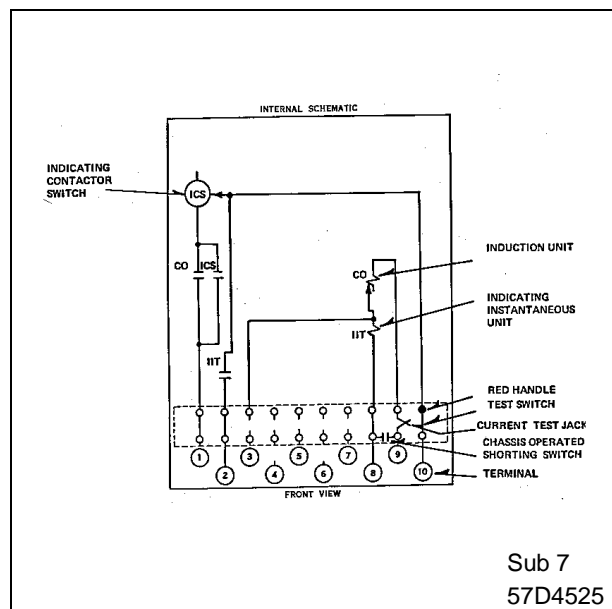

Figure 15: Internal Schematic of the Single Trip Circuit Closing Relay with Indicating Instantaneous Trip Unit.

A core screw accessible from the top of the switch provides the adjustable pickup range.

3.0 CHARACTERISTICS

The relays are generally available in the following current ranges.

Range	Taps						
† .1 - .5	0.1	0.12	0.16	0.2	0.3	0.4	0.5
.5 - 2.5	0.5	0.6	0.8	1.0	1.5	2.0	2.5
2.0 - 6.0	2.0	2.5	3.0	3.5	4.0	5.0	6.0
4.0 - 12.0	4.0	5.0	6.0	7.0	8.0	10.0	12.0

† Available for Type CO-11 Relay Only.

These relays may have either single or double circuit closing contacts for tripping either one or two circuit breakers.

The time vs. current characteristics are shown in Figures 7 to 13. These characteristics give the contact closing time for the various time dial settings when the indicated multiples of tap value current are applied to the relay.

3.1 TRIP CIRCUIT

The main contacts will close 30 amperes at 250 volts dc and the seal-in contacts of the indicating contactor switch will carry this current long enough to trip a circuit breaker.

The indicating instantaneous trip contacts will close 30 amperes at 250 volts dc, and will carry this current long enough to trip a breaker.

The indicating contactor switch has two taps that provide a pickup setting of 0.2 to 2 amperes. To change taps requires connecting the lead located in front of the tap block to the desired setting by means of a screw connection.

3.2 TRIP CIRCUIT CONSTANTS

Contactor Switch -

0.2 ampere tap = 6.5 ohms dc resistance

2.0 ampere tap = 0.15 ohms dc resistance

4.0 SETTINGS



Since the tap block screw on both the CO unit and IIT unit carries operating current, be sure that the screws are turned tight.

In order to avoid opening current transformer circuits when changing taps under load, the relay must be first removed from the case. Chassis operating shorting switches on the case will short the secondary of the current transformer. The taps should then be changed with the relay outside of the case and then re-inserted into the case.

4.1 CO UNIT

The overcurrent unit settings can be defined either by tap setting and time dial position or by tap setting and a specific time of operation at some multiple of the current tap setting (e.g., 4 tap setting, 2 time dial position or 4 tap setting, 0.6 seconds at 6 times tap value current).

To provide selective circuit breaker operation, a minimum coordinating time of 0.3 seconds plus circuit breaker time is recommended between the relay being set and the relays with which coordination is to be effected.

The screw on the terminal plate above the time dial makes connections to various turns on the operating coil. By placing this screw in the various terminal plate holes, the relay will respond to multiples of tap value currents in accordance with the various typical time-current curves.

4.2 INSTANTANEOUS RECLOSING

The factory adjustment of the CO unit contacts provides a contact follow. Where circuit breaker reclosing will be initiated immediately after a trip by the CO contact, the time of the opening of the contacts

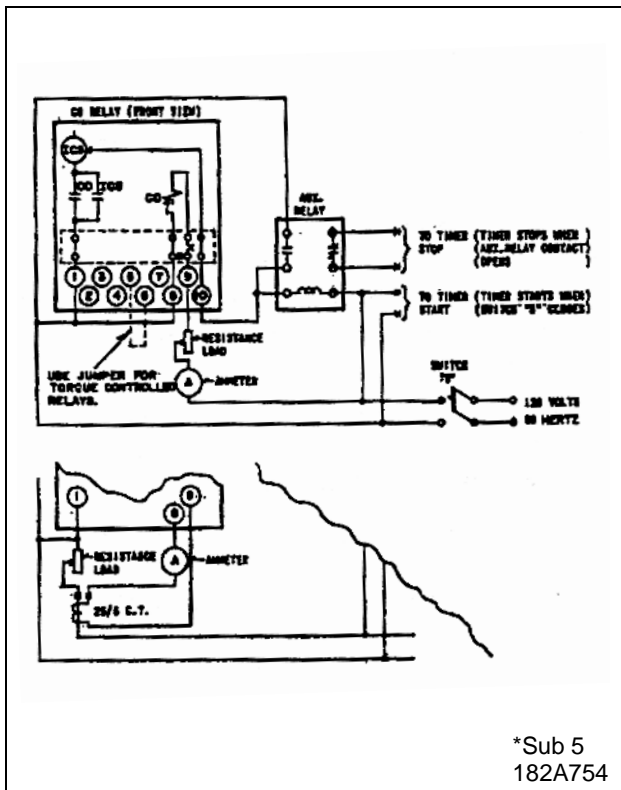

Figure 16: Internal Schematic of the Single Trip Circuit-Closing Relay with Indicating Instantaneous Trip Unit.

should be a minimum. This condition is obtained by loosening the stationary contact mounting screw, removing the contact plate and then replacing the plate with the bent end resting against the contact spring.

For double trip relays, the upper stationary contact is adjusted such that the contact spring rests solidly against the back stop. The lower stationary contact is then adjusted such that both stationary contacts make contact simultaneously with their respective moving contact.

4.3 INDICATING CONTACT SWITCH (ICS)

The only setting required on the ICS unit is the selection of the 0.2 or 2.0 ampere setting. This selection is made by connecting the lead located in front of the tap block to the desired setting by means of the connecting screw.

4.4 INDICATING INSTANTANEOUS TRIP (IIT)

The IIT setting is the level of ac current at which it will pickup. It should be set to coordinate with other devices so it will never operate for a fault in protective zone where tripping should be produced by other devices. The transient reach will not exceed 130% for an 80° circuit angle or 108% for a 60° circuit.

The proper tap must be selected and the core screw must be adjusted to the value of pick-up current desired.

5.0 INSTALLATION

The relays should be mounted on switchboard panels or their equivalent in a location free from dirt, moisture, excessive vibration and heat. Mount the relay vertically by means of the rear mounting stud or studs for the type FT projection case or by means of the four mounting holes on the flange for the semi-flush type FT case. Either the stud or the mounting screws may be utilized for grounding the relay. External toothed washers are provided for use in the locations shown on the outline and drilling plan to facilitate making a good electrical connection between the relay case, its mounting screws or studs, and the relay panel. Ground wires should be affixed to the mounting screws or studs as required for poorly grounded or insulating panels. Other electrical connections may be made directly to the terminals by means of screws for steel panel mounting or to the terminal stud furnished with the relay for thick panel mounting. The terminal stud may be easily removed or inserted by locking two nuts on the stud and then turning the proper nut with a wrench.

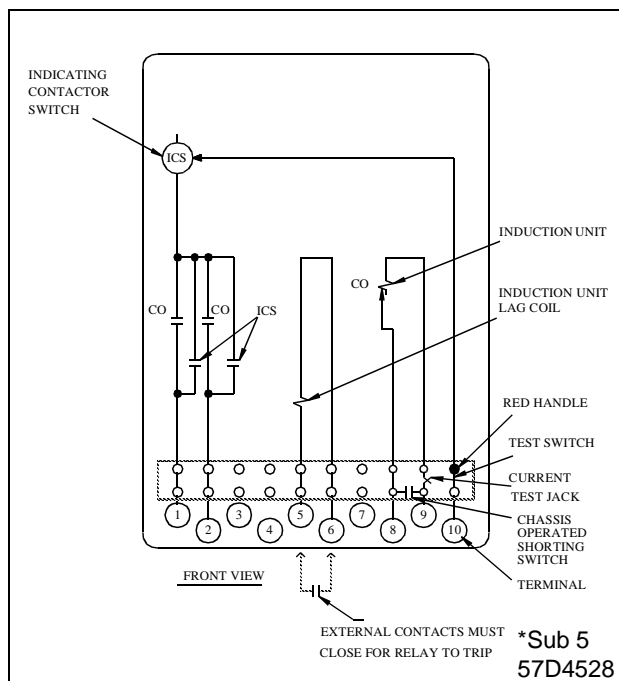

Figure 17: Internal Schematic of the Double Trip Circuit Closing Relay with Torque Control Terminals. For the Single Trip Relay, the Circuits Associated with Terminal 2 are Omitted.

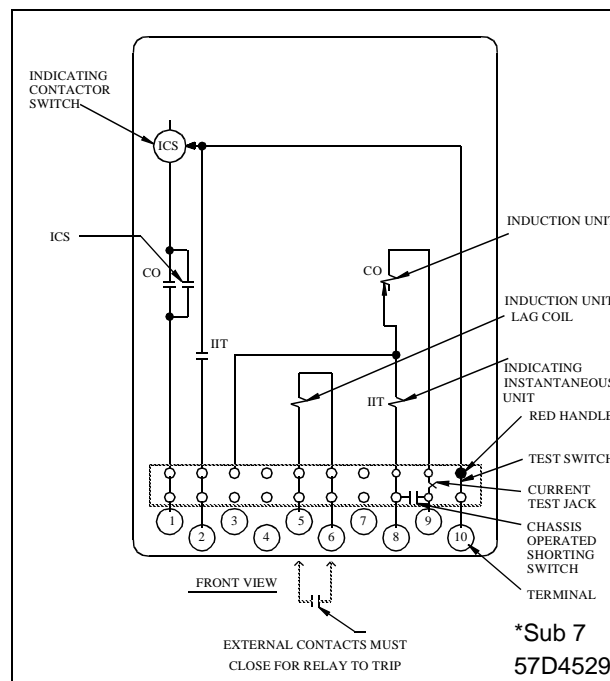

Figure 18: Internal Schematic of the Single Trip Circuit Closing Relay with Torque Control Terminals and Indicating Instantaneous Trip Unit.

For detail information on the FT case refer to Instruction Leaflet 41-076.

6.0 ADJUSTMENTS AND MAINTENANCE

Proper adjustments for correct operation of this relay have been made at the factory. Upon receipt of the relay no customer adjustments, other than those covered under Section 4 "Settings" should be required.

For relays which include an indicating instantaneous trip unit (IIT), the junction of the induction and indicating instantaneous trip coils is brought out to switch jaw #3. With this arrangement the overcurrent units can be tested separately.

6.1 PERFORMANCE CHECK

The following check is recommended to verify that the relay is in the proper working order:

6.1.1 Contact

- a. By turning the time dial, move the moving contacts until they deflect the stationary contact to a position where the stationary contact is resting against its backstop. The index mark located on

the movement frame should coincide with the "O" mark on the time dial. For double trip relays, the follow on the stationary contacts should be approximately 1/64".

- a. For relays identified with a "T", located at lower left of stationary contact block, the index mark on the movement frame will coincide with the "O" mark on the time dial when the stationary contact has moved through approximately one-half of its normal deflection. Therefore, with the stationary contact resting against the backstop, the index mark is offset to the right of the "O" mark by approximately .020". The placement of the various time dial positions in line with the index mark will give operating times as shown on the respective time-current curves. For double trip relays, the follow on the stationary contacts should be approximately 1/32".

6.1.2 Minimum Trip Current

Set the time dial to position 6 using the lowest tap setting, alternately apply tap value current plus 3% and tap value current minus 3%. The moving contact should leave the backstop at tap value current plus

3% and should return to the backstop at tap value current minus 3%.

6.1.3 Time Curve

For type CO-11 relay only, the 1.30 times tap value operating time from the number 6 time dial position is $53.5 \pm 5\%$ seconds and should be checked first. It is important that the 1.30 times tap value current be maintained accurately. The maintaining of this current accurately is necessary because of the steepness of the slope of the time-current characteristic (Figure 13). A slight variation, $\pm 1\%$, in the 1.3 times tap value current (including measuring instrument deviation) will change the timing tolerance to $\pm 10\%$ and the effects of different taps can make the total variations appear to be $\pm 15\%$.

Table 2 shows the time curve calibration points for the various types of relays. With the time dial set to the indicated position and the relay set on the lowest tap setting, apply the currents specified by Table 2, (e.g., for the CO-2, 3 and 20 times tap value current) and measure the operating time of the relay. The operating times should equal those of Table 2 plus or minus 5% (Use .5 tap for .1 to .5 range).

6.1.4 Indicating Instantaneous Trip Unit (IIT)

The core screw which is adjustable from the top of the trip unit determines the pickup value. The trip unit has a nominal ratio of adjustment of 1 to 4 and an accuracy within the limits of 10%.

The making of the contacts and target indication should occur at approximately the same instant. Position the stationary contact for a minimum of $1/32$ " wipe. The bridging moving contact should touch both stationary contacts simultaneously.

Apply sufficient current to operate the IIT. The operation indicator target should drop freely.

6.1.5 Indicating Contactor Switch (ICS)

Close the main relay contacts and pass sufficient dc current through the trip circuit to close the contacts of the ICS. This value of current should be not greater than the particular ICS tap setting being used. The operation indicator target should drop freely.

For proper contact adjustment, insert a $.030$ " feeler gauge between the core pin and the armature. Hold the armature closed against the core pin and gauge and adjust the stationary contacts such that they just make with the moving contact. Both stationary contacts should make at approximately the same time. The contact follow will be approximately $1/64$ " to $3/64$ ".

6.2 CALIBRATION

Use the following procedure for calibrating the relay if the relay has been taken apart for repairs or the adjustments disturbed. This procedure should not be used until it is apparent that the relay is not in proper working order. (See Section 6.1, Performance Check.)

6.2.1 Contact

- By turning the time dial, move the moving contacts until they deflect the stationary contact to a position where the stationary contact is resting against its backstop. The index mark located on the movement frame should coincide with the "O" mark on the time dial. For double trip relays, the follow on the stationary contacts should be approximately $1/64$ ".
- For relays identified with a "T", located at lower left of stationary contact block, the index mark on the movement frame will coincide with the "O" mark on the time dial when the stationary contact has moved through approximately one-half of its normal deflection. Therefore, with the stationary contact resting against the backstop, the index mark is offset to the right of the "O" mark by approximately $.020$ ". The placement of the various time dial positions in line with the index mark will give operating times as shown on the respective time-current curves. For double trip relays, the follow on the stationary contacts should be approximately $1/32$ ".

6.2.2 Minimum Trip Current

The adjustment of the spring tension in setting the minimum trip current value of the relay is most conveniently made with the damping magnet removed.

With the time dial set at "O", wind up the spiral spring by means of the spring adjuster until approximately $6 \frac{3}{4}$ convolutions show.

Set the relay on the minimum tap setting, the time dial to position 6.

Adjust the control spring tension so that the moving contact will leave the backstop at tap value current $+1.0\%$ and will return to the backstop at tap value current -1.0% .

6.2.3 Time Curve Calibration

Install the permanent magnet. Apply the indicated current per Table 2 for permanent magnet adjustment (e.g., CO-8, 2 times tap value) and measure

the operating time. Adjust the permanent magnet keeper until the operating time corresponds to the value of Table 2.

For type CO-11 relay only, the 1.30 times tap value operating time from the number 6 time dial position is $53.5 \pm 5\%$ seconds. It is important that the 1.30 times tap value current be maintained accurately. The maintaining of this current accurately is necessary because of the steepness of the slope of the time-current characteristic (Figure 13). A slight variation $\pm 1\%$, in the 1.3 times tap value current (including measuring instrument deviation) will change the timing tolerance to $\pm 10\%$ and the effect of different taps can make the total variations appear to be $\pm 15\%$. If the operating time at 1.3 times tap value is not within these limits, a minor adjustment of the control spring will give the correct operating time without any undue effect on the minimum pick-up of the relay. The check is to be made after the 2 times tap value adjustment has been completed.

Apply the indicated current per Table 2 for the electromagnet plug adjustment (e.g., CO-8, 20 times tap value) and measure the operating time. Adjust the proper plug until the operating time corresponds to the value in Table 2. (Withdrawing the left hand plug, front view, increases the operating time and withdrawing the right hand plug, front view, decreases the time.) In adjusting the plugs, one plug should be screwed in completely and the other plug run in or out until the proper operating time has been obtained.

Recheck the permanent magnet adjustment. If the operating time for this calibration point has changed, readjust the permanent magnet and then recheck the electromagnet plug adjustment.

6.2.4 Indicating Contactor Switch (ICS)

Close the main relay contacts and pass sufficient dc current through the trip circuit to close the contacts of the ICS. This value of current should be not greater than the particular ICS tap setting being used. The operation indicator target should drop freely.

6.2.5 Indicating Instantaneous Trip Unit (IIT)

The core screw must be adjusted to the value of pick-up current desired.

The nameplate data will furnish the actual current range that may be obtained from the IIT unit.

6.3 ROUTINE MAINTENANCE

All relays should be inspected and checked periodically to assure proper operation. Generally a visual inspection should call attention to any noticeable changes. A minimum suggested check on the relay system is to close the contacts manually to assure that the breaker trips and the target drops. Then release the contacts and observe that the reset is smooth and positive.

If an additional time check is desired, pass secondary current through the relay and check the time of operation. It is preferable to make this at several times pick-up current at an expected operating point for the particular application. For the .5 to 2.5 ampere range CO-5 and CO-6 induction unit use the alternative test circuit in Figure 16 as these relays are affected by a distorted wave form. With the connection the 25/5 ampere current transformers should be worked well below the knee of the saturation (i.e., use 10L50 or better).

All contacts should be periodically cleaned. A contact burnisher #182A836H01 is recommended for this purpose. The use of abrasive material for cleaning contacts is not recommended, because of the danger of embedding small particles in the face of the soft silver and thus impairing the contact.

7.0 RENEWAL PARTS

Repair work can be done most satisfactorily at the factory. However, interchangeable parts can be furnished to the customers who are equipped for doing repair work. When ordering parts, always give the complete nameplate data.

Table 2:

TIME CURVE CALIBRATION DATA - 50 & 60 HERTZ

RELAY TYPE	PERMANENT MAGNET ADJUSTMENT			ELECTROMAGNET PLUGS	
	TIME DIAL POSITION	CURRENT (MULTIPLES OF TAP VALUE)	OPERATING TIME SECONDS	CURRENT (MULTIPLES OF TAP VALUE)	OPERATING TIME SECONDS
CO - 2	6	3	0.57	20	0.22
CO - 5	6	2	37.80	10	14.30
CO - 6	6	2	2.46	20	1.19
CO - 7	6	2	4.27	20	1.11
CO - 8	6	2	13.35	20	1.11
CO - 9	6	2	8.87	20	0.65
CO -11	6	2	11.27	20	0.24 Δ

Δ For 50 Hertz CO-11 relay 20 times operating time limits are 0.24 + 10%, -5%.

RESERVED FOR NOTES

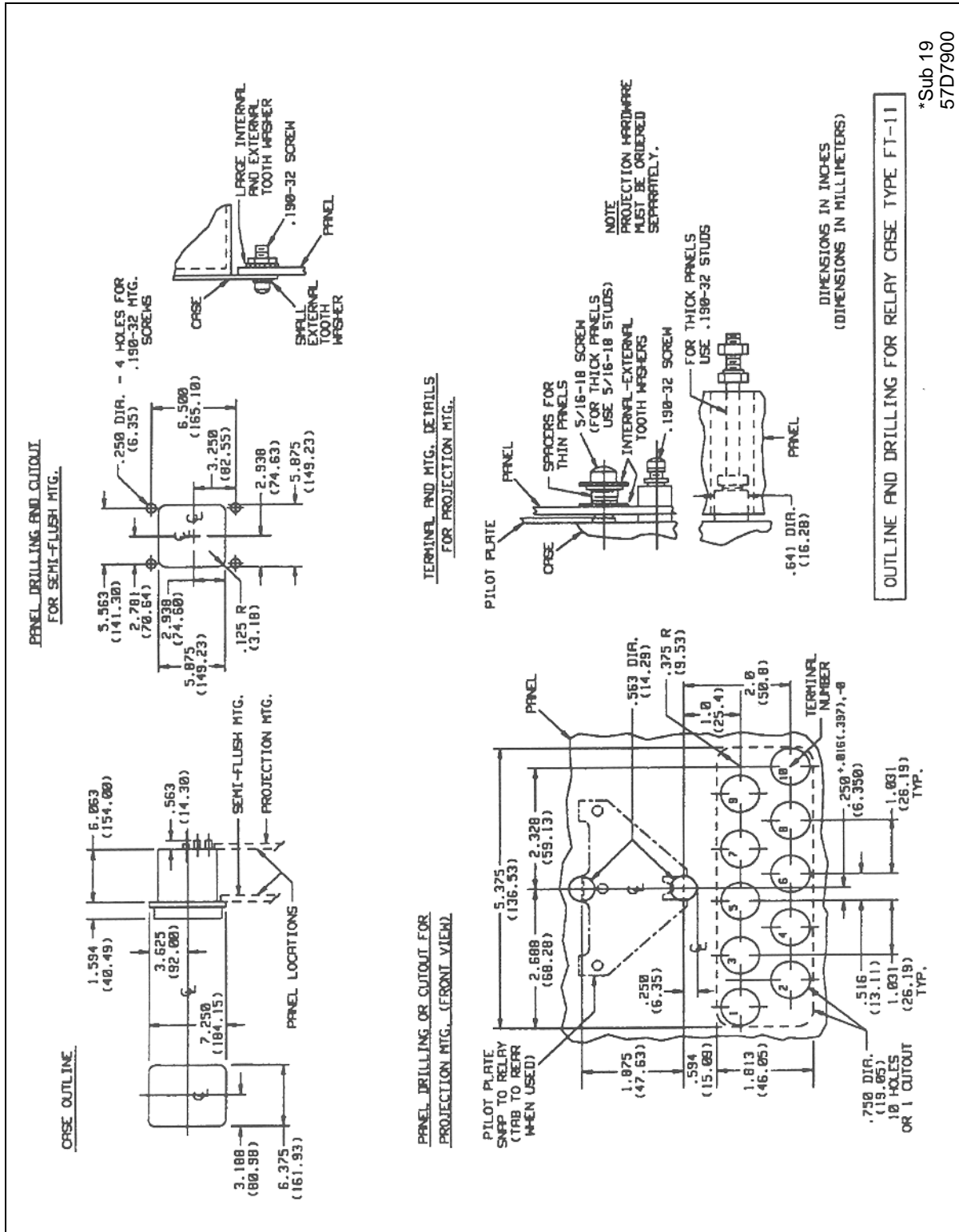

Figure 19: Outline and Drilling Plan for the Type CO Relay in the Type FT-11 Case

*Denotes Change

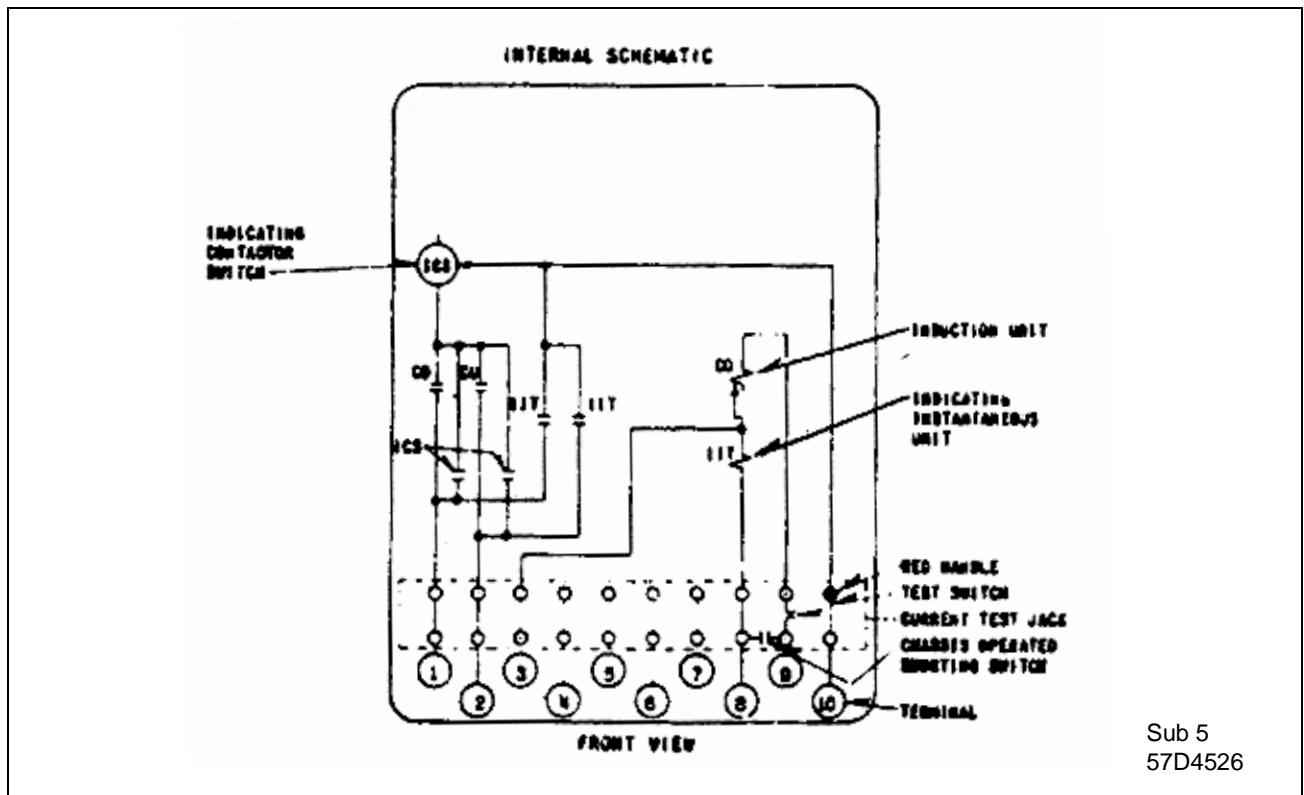

Figure 20: Internal Schematic of the Double Trip Circuit Closing Relay with Indicating Instantaneous Trip Unit.

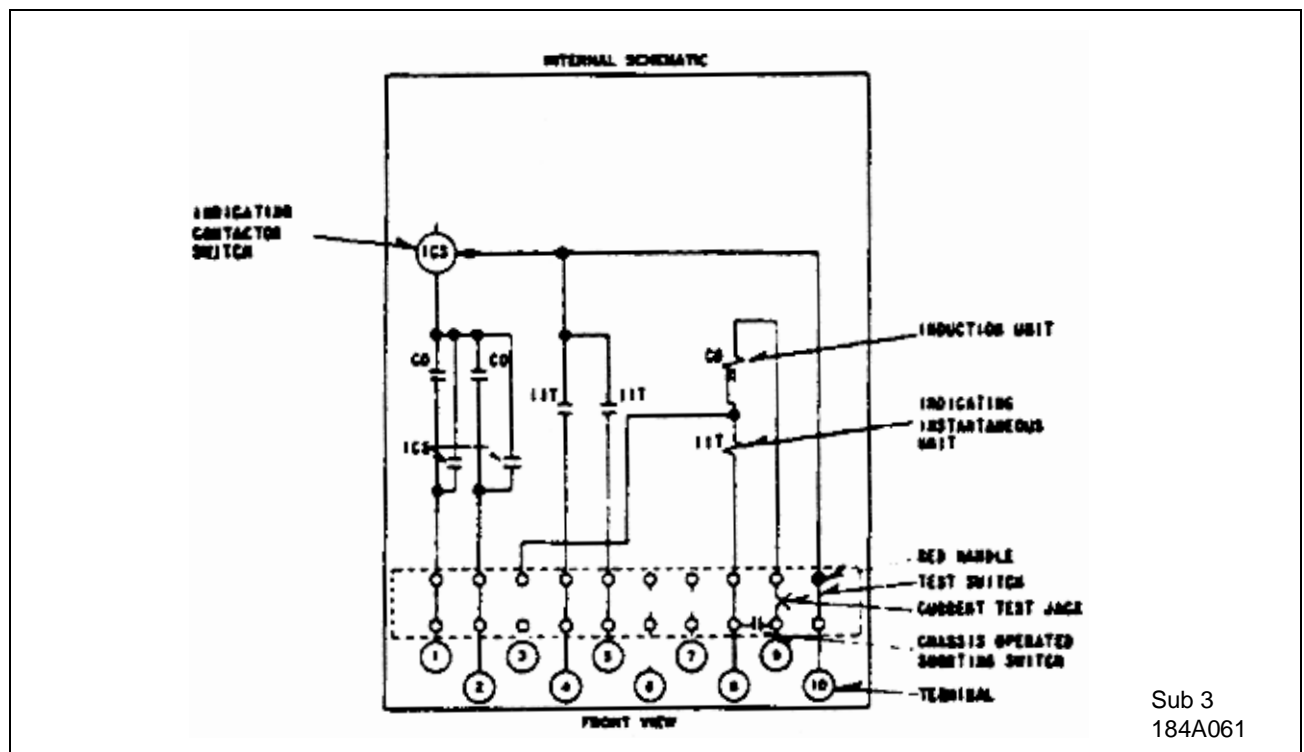

Figure 21: Internal Schematic of the Double Trip Circuit Closing Relay with Indicating Instantaneous Trip Unit to Separate Terminals.



ABB Inc.

4300 Coral Ridge Drive
Coral Springs, Florida 33065

Telephone: +1 954-752-6700

Fax: +1 954-345-5329

www.abb.com/substation_automation

IL 41-101 - Revision U