

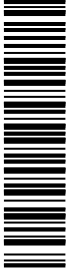

MERCURY
GO BOLDLY.™

8M0145515 418 eng



**Operation
Maintenance
and
Installation
Manual**

2.5/3.5 FourStroke

© 2018 Mercury Marine

Welcome

You have selected one of the finest marine power packages available. It incorporates numerous design features to ensure operating ease and durability.

With proper care and maintenance, you will enjoy using this product for many boating seasons. To ensure maximum performance and carefree use, we ask that you thoroughly read this manual.

The Operation and Maintenance Manual contains specific instructions for using and maintaining your product. We suggest that this manual remain with the product for ready reference whenever you are on the water.

Thank you for purchasing one of our products. We sincerely hope your boating will be pleasant!

Mercury Marine, Fond du Lac, Wisconsin, U.S.A.

Name / function:

John Pfeifer, President,
Mercury Marine



Read This Manual Thoroughly

IMPORTANT: If you do not understand any portion of this manual, contact your dealer. Your dealer can also provide a demonstration of actual starting and operating procedures.

Notice

Throughout this publication, and on your power package, warnings, cautions,

and notices, accompanied by the International Hazard Symbol , may be used to alert the installer and user to special instructions concerning a particular service or operation that may be hazardous if performed incorrectly or carelessly. Observe them carefully.

These safety alerts alone cannot eliminate the hazards that they signal. Strict compliance with these special instructions while performing the service, plus common sense operation, are major accident prevention measures.

WARNING

Indicates a hazardous situation which, if not avoided, could result in death or serious injury.

CAUTION

Indicates a hazardous situation which, if not avoided, could result in minor or moderate injury.

NOTICE

Indicates a situation which, if not avoided, could result in engine or major component failure.

IMPORTANT: Identifies information essential to the successful completion of the task.

NOTE: Indicates information that helps in the understanding of a particular step or action.

IMPORTANT: The operator (driver) is responsible for the correct and safe operation of the boat, the equipment aboard, and the safety of all occupants aboard. We strongly recommend that the operator read this Operation and Maintenance Manual and thoroughly understand the operational instructions for the power package and all related accessories before the boat is used.

California Proposition 65



WARNING: This product can expose you to chemicals including gasoline engine exhaust, which is known to the State of California to cause cancer and birth defects or other reproductive harm. For more information go to www.P65Warnings.ca.gov.

The serial numbers are the manufacturer's keys to numerous engineering details that apply to your Mercury Marine power package. When contacting Mercury Marine about service, **always specify model and serial numbers.**

Descriptions and specifications contained herein were in effect at the time this was approved for printing. Mercury Marine, whose policies are based on continuous improvement, reserves the right to discontinue models at any time or to change specifications or designs without notice and without incurring obligation.

Warranty Message

The product you have purchased comes with a **limited warranty** from Mercury Marine; the terms of the warranty are set forth in the Warranty Manual included with the product. The Warranty Manual contains a description of what is covered, what is not covered, the duration of coverage, how to best obtain warranty coverage, **important disclaimers and limitations of damages**, and other related information. Please review this important information.

Mercury Marine products are designed and manufactured to comply with our own high quality standards, applicable industry standards and regulations, as well as certain emissions regulations. At Mercury Marine every engine is operated and tested before it is boxed for shipment to make sure that the product is ready for use. In addition, certain Mercury Marine products are tested in a controlled and monitored environment, for up to 10 hours of engine run time, in order to verify and make a record of compliance with applicable standards and regulations. All Mercury Marine product, sold as new, receives the applicable limited warranty coverage, whether the engine participated in one of the test programs described above or not.

Copyright and Trademark Information

© MERCURY MARINE. All rights reserved. Reproduction in whole or in part without permission is prohibited.

Alpha, Axis, Bravo One, Bravo Two, Bravo Three, GO BOLDLY., Circle M with Waves Logo, K-planes, Mariner, MerCathode, MerCruiser, Mercury, Mercury with Waves Logo, Mercury Marine, Mercury Precision Parts, Mercury Propellers, Mercury Racing, MotorGuide, OptiMax, Quicksilver, SeaCore, Skyhook, SmartCraft, Sport-Jet, Verado, VesselView, Zero Effort, Zeus, #1 On the Water and We're Driven to Win are registered trademarks of Brunswick Corporation. Pro XS is a trademark of Brunswick Corporation. Mercury Product Protection is a registered service mark of Brunswick Corporation.

Identification Records

Please record the following applicable information:

Outboard		
Engine Model and Horsepower		
Engine Serial Number		
Gear Ratio		
Propeller Number	Pitch	Diameter
Watercraft Identification Number (WIN) or Hull Identification Number (HIN)		Purchase Date
Boat Manufacturer	Boat Model	Length
Exhaust Gas Emissions Certification Number (Europe Only)		

General Information

Boater's Responsibilities.....	1
Before Operating Your Outboard.....	1
Boat Horsepower Capacity.....	1
Lanyard Stop Switch.....	2
Protecting People in the Water.....	5
Exhaust Emissions.....	5
Selecting Accessories for Your Outboard.....	7
Safe Boating Recommendations.....	7
Recording Serial Number.....	10
Model Year Production Code.....	11
Specifications.....	11

Installation

Installing the Outboard.....	13
------------------------------	----

Transporting

Carrying, Storing, and Transporting the Outboard When Removed from Boat	14
Trailering the Boat.....	15

Fuel and Oil

Fuel Requirements.....	17
Special Features of the Fuel Tank.....	18
Filling the Fuel Tank.....	19
Engine Oil Recommendations.....	19
Checking Engine Oil.....	20

Features and Controls

Features and Controls.....	22
Tilting Outboard.....	24
Setting the Operating Angle of the Outboard	25

Operation

Prestating Check List.....	26
Operating in Freezing Temperatures.....	26
Operating in Saltwater or Polluted Water.....	26
Engine Break-in Procedure.....	27
Starting the Engine.....	27
Gear Shifting.....	31
Reversing Boat.....	31
Stopping the Engine.....	32

Maintenance

Outboard Care.....	33
EPA Emission Regulations.....	33
Inspection and Maintenance Schedule	34
Flushing the Cooling System.....	35
Top Cowl Removal and Installation.....	36
Corrosion Control Anode.....	37
Exterior Care.....	37
Propeller Replacement.....	38
Spark Plug Inspection and Replacement.....	40
Lubrication Points.....	41
Changing Engine Oil	42
Gearcase Lubrication.....	43
Submerged Outboard.....	44

Storage

Storage Preparation.....	45
Protecting External Outboard Components.....	45
Protecting Internal Engine Components.....	45
Gearcase.....	46
Positioning Outboard for Storage.....	46

Owner Service Assistance

Service Assistance.....	47
Ordering Literature.....	49

Maintenance Log

Maintenance Log.....	51
----------------------	----

GENERAL INFORMATION

Boater's Responsibilities

The operator (driver) is responsible for the correct and safe operation of the boat and the safety of its occupants and general public. It is strongly recommended that each operator read and understand this entire manual before operating the outboard.

Be sure that at least one additional person onboard is instructed in the basics of starting and operating the outboard and boat handling in case the driver is unable to operate the boat.

Before Operating Your Outboard

Read this manual carefully. Learn how to operate your outboard properly. If you have any questions, contact your dealer.

Safety and operating information that is practiced, along with using good common sense, can help prevent personal injury and product damage.

This manual as well as safety labels posted on the outboard use the following safety alerts to draw your attention to special safety instructions that should be followed.

WARNING

Indicates a hazardous situation which, if not avoided, could result in death or serious injury.

CAUTION

Indicates a hazardous situation which, if not avoided, could result in minor or moderate injury.

NOTICE

Indicates a situation which, if not avoided, could result in engine or major component failure.

Boat Horsepower Capacity

WARNING

Exceeding the boat's maximum horsepower rating can cause serious injury or death. Overpowering the boat can affect boat control and flotation characteristics or break the transom. Do not install an engine that exceeds the boat's maximum power rating.

GENERAL INFORMATION

Do not overpower or overload your boat. Most boats will carry a required capacity plate indicating the maximum acceptable power and load as determined by the manufacturer following certain federal guidelines. If in doubt, contact your dealer or the boat manufacturer.

U.S. COAST GUARD CAPACITY	
MAXIMUM HORSEPOWER	XXX
MAXIMUM PERSON CAPACITY (POUNDS)	XXX
MAXIMUM WEIGHT CAPACITY	XXX

26777

Lanyard Stop Switch

The purpose of a lanyard stop switch is to turn off the engine when the operator moves far enough away from the operator's position (as in accidental ejection from the operator's position) to activate the switch. Tiller handle outboards and some remote control units are equipped with a lanyard stop switch. A lanyard stop switch can be installed as an accessory - generally on the dashboard or side adjacent to the operator's position.

A decal near the lanyard stop switch is a visual reminder for the operator to attach the lanyard to their personal flotation device (PFD) or wrist.

GENERAL INFORMATION

The lanyard cord is usually 122–152 cm (4–5 feet) in length when stretched out, with an element on one end made to be inserted into the switch and a clip on the other end for attaching to the operator's PFD or wrist. The lanyard is coiled to make its at-rest condition as short as possible to minimize the likelihood of lanyard entanglement with nearby objects. Its stretched-out length is made to minimize the likelihood of accidental activation should the operator choose to move around in an area close to the normal operator's position. If it is desired to have a shorter lanyard, wrap the lanyard around the operator's wrist or leg, or tie a knot in the lanyard.

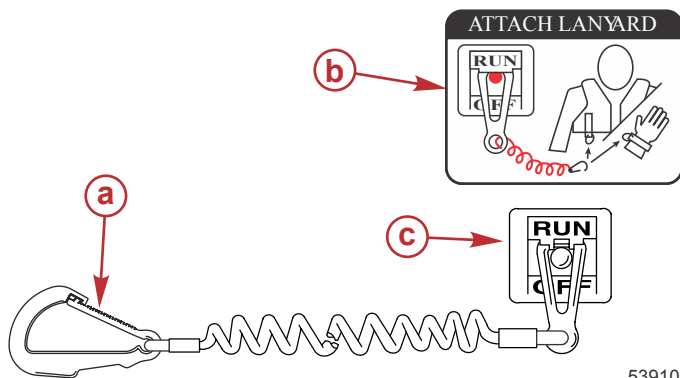

- a** - Lanyard cord clip
- b** - Lanyard decal
- c** - Lanyard stop switch

Read the following Safety Information before proceeding.

Important Safety Information: The purpose of a lanyard stop switch is to stop the engine when the operator moves far enough away from the operator's position to activate the switch. This would occur if the operator accidentally falls overboard or moves within the boat a sufficient distance from the operator's position. Falling overboard and accidental ejections are more likely to occur in certain types of boats such as low sided inflatables, bass boats, high performance boats, and light, sensitive handling fishing boats operated by a hand tiller. Falling overboard and accidental ejections are also likely to occur as a result of poor operating practices such as sitting on the back of the seat or gunwale at planing speeds, standing at planing speeds, sitting on elevated fishing boat decks, operating at planing speeds in shallow or obstacle infested waters, releasing your grip on a steering wheel or tiller handle that is pulling in one direction, drinking alcohol or consuming drugs, or daring high speed boat maneuvers.

GENERAL INFORMATION

While activation of the lanyard stop switch will stop the engine immediately, a boat will continue to coast for some distance depending upon the velocity and degree of any turn at shut down. However, the boat will not complete a full circle. While the boat is coasting, it can cause injury to anyone in the boat's path as seriously as the boat would when under power.

We strongly recommend that other occupants be instructed on proper starting and operating procedures should they be required to operate the engine in an emergency (if the operator is accidentally ejected).

▲ WARNING

If the operator falls out of the boat, stop the engine immediately to reduce the possibility of serious injury or death from being struck by the boat. Always properly connect the operator to the stop switch using a lanyard.

▲ WARNING

Avoid serious injury or death from deceleration forces resulting from accidental or unintended stop switch activation. The boat operator should never leave the operator's station without first disconnecting the stop switch lanyard from the operator.

Accidental or unintended activation of the switch during normal operation is also a possibility. This could cause any, or all, of the following potentially hazardous situations:

- Occupants could be thrown forward due to unexpected loss of forward motion - a particular concern for passengers in the front of the boat who could be ejected over the bow and possibly struck by the gearcase or propeller.
- Loss of power and directional control in heavy seas, strong current, or high winds.
- Loss of control when docking.

KEEP THE LANYARD STOP SWITCH AND LANYARD CORD IN GOOD OPERATING CONDITION

Before each use, check to ensure the lanyard stop switch works properly. Start the engine and stop it by pulling the lanyard cord. If the engine does not stop, have the switch repaired before operating the boat.

Before each use, visually inspect the lanyard cord to ensure it is in good working condition and that there are no breaks, cuts, or wear to the cord. Check that the clips on the ends of the cord are in good condition. Replace any damaged or worn lanyard cords.

GENERAL INFORMATION

Protecting People in the Water

WHILE YOU ARE CRUISING

It is very difficult for a person standing or floating in the water to take quick action to avoid a boat heading in his/her direction, even at slow speed.



Always slow down and exercise extreme caution any time you are boating in an area where there might be people in the water.

Whenever a boat is moving (coasting) and the outboard gear shift is in neutral position, there is sufficient force by the water on the propeller to cause the propeller to rotate. This neutral propeller rotation can cause serious injury.

WHILE THE BOAT IS STATIONARY

▲ WARNING

A spinning propeller, a moving boat, or any solid device attached to the boat can cause serious injury or death to swimmers. Stop the engine immediately whenever anyone in the water is near your boat.

Shift the outboard into neutral and shut off the engine before allowing people to swim or be in the water near your boat.

Exhaust Emissions

BE ALERT TO CARBON MONOXIDE POISONING

Carbon monoxide (CO) is a deadly gas that is present in the exhaust fumes of all internal combustion engines, including the engines that propel boats, and the generators that power boat accessories. By itself, CO is odorless, colorless, and tasteless, but if you can smell or taste engine exhaust, you are inhaling CO.

Early symptoms of carbon monoxide poisoning, which are similar to the symptoms of seasickness and intoxication, include headache, dizziness, drowsiness, and nausea.

GENERAL INFORMATION

⚠ WARNING

Inhaling engine exhaust gases can result in carbon monoxide poisoning, which can lead to unconsciousness, brain damage, or death. Avoid exposure to carbon monoxide.

Stay clear from exhaust areas when engine is running. Keep the boat well-ventilated while at rest or underway.

STAY CLEAR OF EXHAUST AREAS

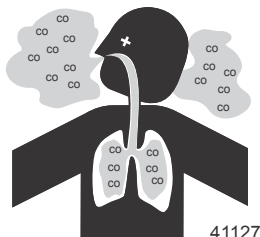

Engine exhaust gases contain harmful carbon monoxide. Avoid areas of concentrated engine exhaust gases. When engines are running, keep swimmers away from the boat, and do not sit, lie, or stand on swim platforms or boarding ladders. While underway, do not allow passengers to be positioned immediately behind the boat (platform dragging, teak/body surfing). This dangerous practice not only places a person in an area of high engine exhaust concentration, but also subjects them to the possibility of injury from the boat propeller.

GOOD VENTILATION

Ventilate the passenger area, open side curtains or forward hatches to remove fumes.

Example of desired air flow through the boat:



POOR VENTILATION

Under certain running and/or wind conditions, permanently enclosed or canvas enclosed cabins or cockpits with insufficient ventilation may draw in carbon monoxide. Install one or more carbon monoxide detectors in your boat.

Although the occurrence is rare, on a very calm day, swimmers and passengers in an open area of a stationary boat that contains, or is near, a running engine may be exposed to a hazardous level of carbon monoxide.

GENERAL INFORMATION

1. Examples of poor ventilation while the boat is stationary:

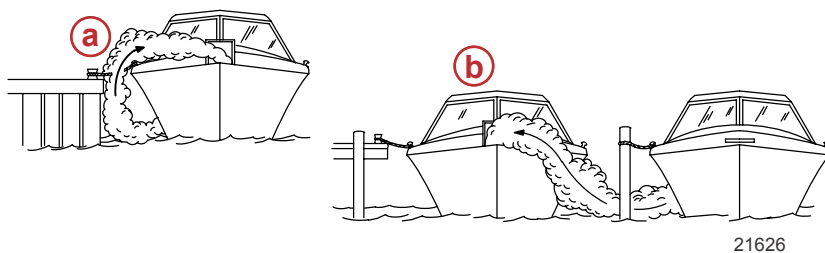

- a** - Operating the engine when the boat is moored in a confined space
- b** - Mooring close to another boat that has its engine operating

2. Examples of poor ventilation while the boat is moving:

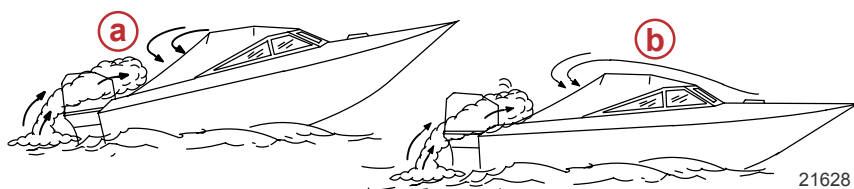

- a** - Operating the boat with the trim angle of the bow too high
- b** - Operating the boat with no forward hatches open (station wagon effect)

Selecting Accessories for Your Outboard

Genuine Mercury Precision or Quicksilver Accessories have been specifically designed and tested for your outboard. These accessories are available from Mercury Marine dealers.

IMPORTANT: Check with your dealer before installing accessories. The misuse of approved accessories or the use of nonapproved accessories can damage the product.

Some accessories not manufactured or sold by Mercury Marine are not designed to be safely used with your outboard or outboard operating system. Acquire and read the installation, operation and maintenance manuals for all your selected accessories.

Safe Boating Recommendations

To safely enjoy the waterways, familiarize yourself with local and all other governmental boating regulations and restrictions and consider the following suggestions.

Know and obey all nautical rules and laws of the waterways.

GENERAL INFORMATION

- We recommend that all powerboat operators complete a boating safety course. In the U.S., the U.S. Coast Guard Auxiliary, the Power Squadron, the Red Cross, and your state or provincial boating law enforcement agency provide courses. For more information in the U.S., call the Boat U.S. Foundation at 1-800-336-BOAT (2628).

Perform safety checks and required maintenance.

- Follow a regular schedule and ensure that all repairs are properly made.

Check safety equipment onboard.

- Here are some suggestions of the types of safety equipment to carry when boating:
 - Approved fire extinguishers
 - Signal devices: flashlight, rockets or flares, flag, and whistle or horn
 - Tools necessary for minor repairs
 - Anchor and extra anchor line
 - Manual bilge pump and extra drain plugs
 - Drinking water
 - Radio
 - Paddle or oar
 - Spare propeller, thrust hubs, and an appropriate wrench
 - First aid kit and instructions
 - Waterproof storage containers
 - Spare operating equipment, batteries, bulbs, and fuses
 - Compass and map or chart of the area
 - Personal flotation device (one per person onboard)

Watch for signs of weather change and avoid foul weather and rough-sea boating.

Tell someone where you are going and when you expect to return.

Passenger boarding.

- Stop the engine whenever passengers are boarding, unloading, or are near the back (stern) of the boat. Shifting the drive unit into neutral is not sufficient.

Use personal flotation devices.

- Federal law requires that there be a U.S. Coast Guard-approved life jacket (personal flotation device), correctly sized and readily accessible for every person onboard, plus a throwable cushion or ring. We strongly advise that everyone wear a life jacket at all times while in the boat.

Prepare other boat operators.

GENERAL INFORMATION

- Instruct at least one person onboard in the basics of starting and operating the engine and boat handling in case the driver becomes disabled or falls overboard.

Do not overload your boat.

- Most boats are rated and certified for maximum load (weight) capacities (refer to your boat's capacity plate). Know your boat's operating and loading limitations. Know if your boat will float if it is full of water. When in doubt, contact your authorized Mercury Marine dealer or the boat manufacturer.

Ensure that everyone in the boat is properly seated.

- Do not allow anyone to sit or ride on any part of the boat that was not intended for such use. This includes the backs of seats, gunwales, transom, bow, decks, raised fishing seats, and any rotating fishing seat. Passengers should not sit or ride anywhere that sudden unexpected acceleration, sudden stopping, unexpected loss of boat control, or sudden boat movement could cause a person to be thrown overboard or into the boat. Ensure that all passengers have a proper seat and are in it before any boat movement.

Never operate a boat while under the influence of alcohol or drugs. It is the law.

- Alcohol or drugs can impair your judgment and greatly reduce your ability to react quickly.

Know your boating area and avoid hazardous locations.

Be alert.

- The operator of the boat is responsible by law to maintain a proper lookout by sight and hearing. The operator must have an unobstructed view particularly to the front. No passengers, load, or fishing seats should block the operator's view when the boat is above idle or planing transition speed. Watch out for others, the water, and your wake.

Never drive your boat directly behind a water-skier.

- Your boat traveling at 40 km/h (25 mph) will overtake a fallen skier who is 61 m (200 ft) in front of you in five seconds.

Watch fallen skiers.

- When using your boat for waterskiing or similar activities, always keep a fallen or down skier on the operator's side of the boat while returning to attend to the skier. The operator should always have the down skier in sight and never back up to the skier or anyone in the water.

Report accidents.

GENERAL INFORMATION

- Boat operators are required by law to file a boating accident report with their state boating law enforcement agency when their boat is involved in certain boating accidents. A boating accident must be reported if 1) there is loss of life or probable loss of life, 2) there is personal injury requiring medical treatment beyond first aid, 3) there is damage to boats or other property where the damage value exceeds \$500.00, or 4) there is complete loss of the boat. Seek further assistance from local law enforcement.

Recording Serial Number

It is important to record this number for future reference. The serial number is located on the outboard as shown.

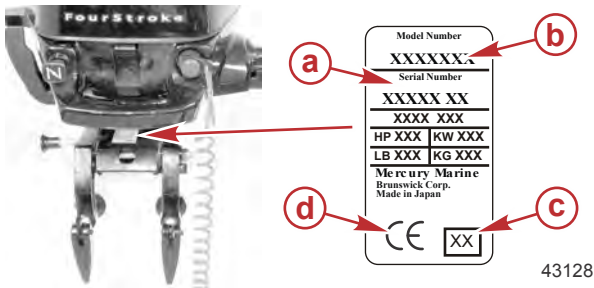

- a** - Serial number
- b** - Model designation
- c** - Year manufactured
- d** - Certified Europe Insignia (as applicable)

GENERAL INFORMATION

Model Year Production Code

The serial number decal lists the year of manufacture as an alpha code. This code can be deciphered into a corresponding number utilizing the following table.



Serial number decal alpha code

Model Year Manufactured Code										
Alpha Production Code	A	B	C	D	E	F	G	H	K	X
Corresponding Number	1	2	3	4	5	6	7	8	9	0

Examples:

- XX = 2000
- HK = 2089
- AG = 2017

Specifications

Models	2.5	3.5
Power	1.8 kw (2.5 hp)	2.6 kw (3.5 hp)
Full throttle RPM range	5000–6000	
Idle speed	1200 RPM in forward gear, 1300 RPM in neutral	
Number of cylinders	1	
Piston displacement	85.5 cc (5.21 cid)	
Cylinder bore	55 mm (2.16 in.)	
Piston stroke	36 mm (1.41 in.)	
Valve clearance (cold)		
Intake valve	0.06–0.14 mm (0.0024–0.0055 in.)	
Exhaust valve	0.11–0.19 mm (0.0043–0.0075 in.)	

GENERAL INFORMATION

Models	2.5	3.5
Engine oil capacity	300 ml (10 fl oz)	
Recommended spark plug	NGK DCPR6E	
Spark plug gap	0.9 mm (0.035 in.)	
Gearcase lubricant capacity	180 ml (6.0 fl oz)	
Gear ratio	2.15:1	
Recommended gasoline	Refer to Fuel and Oil	
Recommended oil	Refer to Fuel and Oil	
Emission control system	Engine modification (EM)	
Sound at drivers ear (ICOMIA 39-94) bBA	79.8	
Tiller handle vibration (ICOMIA 38-94) m/s ²	8.4	

INSTALLATION

Installing the Outboard

BOAT TRANSOM HEIGHT REQUIREMENT

Measure the transom height of the boat. The anti-ventilation plate should be 25–50 mm (1–2 in.) below the bottom of the boat.

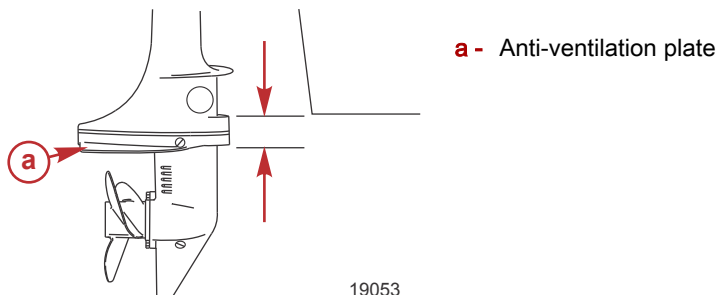

INSTALLING THE OUTBOARD ON THE TRANSOM

1. Place the outboard on the centerline of the transom.

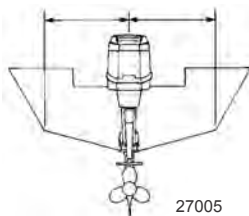

2. Tighten the transom clamp handles.

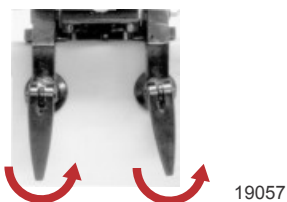

TRANSPORTING

Carrying, Storing, and Transporting the Outboard When Removed from Boat

With the outboard still in the water, close the fuel valve and run the engine until it stops. This will empty the fuel from the carburetor.

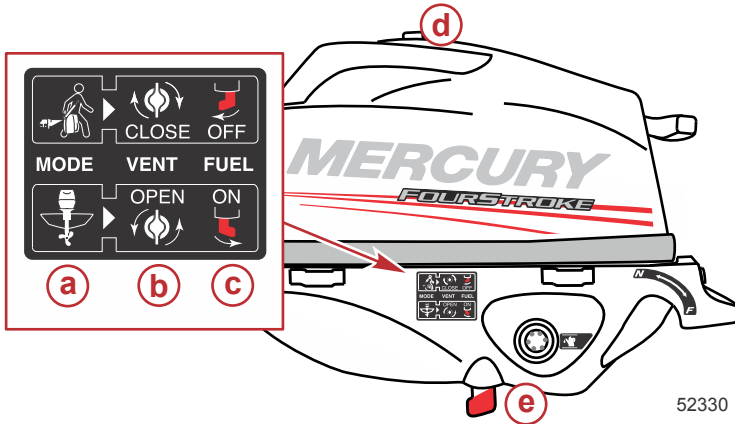

52330

- a** - Transport mode
- b** - Vent position
- c** - Fuel valve position
- d** - Vent screw
- e** - Fuel valve

Close the manual vent screw after the engine has stopped.

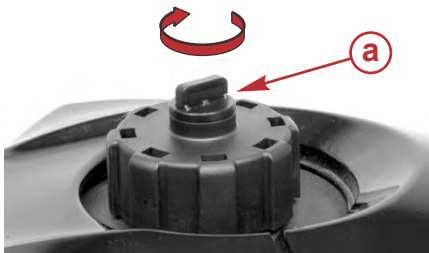

47362

- a** - Manual vent screw

Remove the outboard and hold it upright until the water is drained out. Keep the outboard in an upright position when carrying.

TRANSPORTING

Carry, transport, or store the outboard only in the upright position, or with the tiller handle (port) side facing up. These positions will prevent oil from draining out of the crankcase. A decal on the port side of the engine indicates which side should be up.

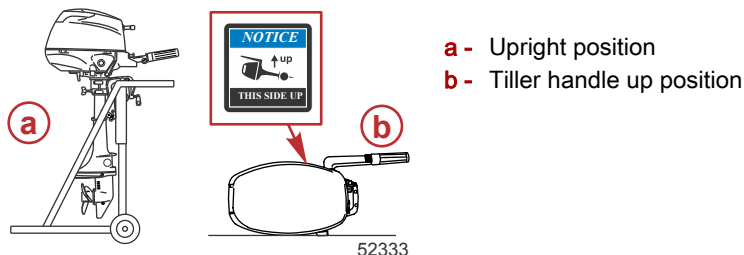

Never carry, store, or transport the outboard in these positions. Engine damage could result from oil draining out of the crankcase.

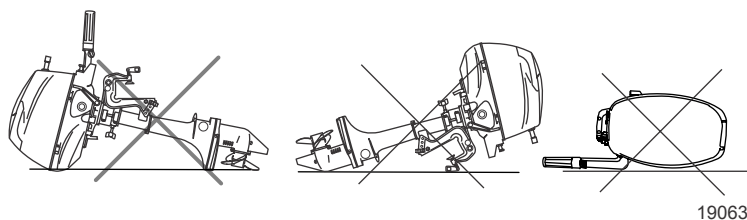

Trailing the Boat

IMPORTANT: The tilt lock mechanism is not intended to support the outboard in the tilted up position when trailing the boat. Use of the tilt lock mechanism could allow the outboard to bounce, and drop down causing damage to the outboard.

The boat should be trailed with the outboard tilted down (normal operating position).

If additional ground clearance is required, remove the outboard from the boat, and store securely. Additional clearance may be needed for railroad crossings, driveways, and trailer bouncing.

TRANSPORTING

Set the gear shift into forward gear. This prevents the propeller from spinning freely.

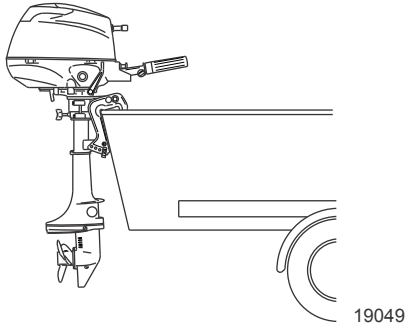

FUEL AND OIL

Fuel Requirements

IMPORTANT: Use of improper gasoline can damage your engine. Engine damage resulting from the use of improper gasoline is considered misuse of the engine and will not be covered under the limited warranty.

FUEL RATINGS

Mercury outboard engines will operate satisfactorily with any major brand of unleaded gasoline that meets the following specifications:

USA and Canada - A posted pump octane rating of 87 (R+M)/2, minimum, for most models. Premium gasoline 91 (R+M)/2 octane is also acceptable for most models. **Do not** use leaded gasoline.

Outside USA and Canada - A posted pump octane rating of 91 RON, minimum, for most models. Premium gasoline (95 RON) is also acceptable for all models. **Do not** use leaded gasoline.

USING REFORMULATED (OXYGENATED) GASOLINE (USA ONLY)

Reformulated gasoline is required in certain areas of the USA and is acceptable for use in your Mercury Marine engine. The only oxygenate currently in use in the USA is alcohol (ethanol, methanol, or butanol).

GASOLINE CONTAINING ALCOHOL

Bu16 Butanol Fuel Blends

Fuel blends of up to 16.1% butanol (Bu16) that meet the published Mercury Marine fuel rating requirements are an acceptable substitute for unleaded gasoline. Contact your boat manufacturer for specific recommendations on your boat's fuel system components (fuel tanks, fuel lines, and fittings).

Methanol and Ethanol Fuel Blends

IMPORTANT: The fuel system components on your Mercury Marine engine will withstand up to 10% alcohol (methanol or ethanol) content in the gasoline. Your boat's fuel system may not be capable of withstanding the same percentage of alcohol. Contact your boat manufacturer for specific recommendations on your boat's fuel system components (fuel tanks, fuel lines, and fittings).

Be aware that gasoline containing methanol or ethanol may cause increased:

- Corrosion of metal parts
- Deterioration of rubber or plastic parts
- Fuel permeation through the rubber fuel lines
- Likelihood of phase separation (water and alcohol separating from the gasoline in the fuel tank)

FUEL AND OIL

WARNING

Fuel leakage is a fire or explosion hazard, which can cause serious injury or death. Periodically inspect all fuel system components for leaks, softening, hardening, swelling, or corrosion, particularly after storage. Any sign of leakage or deterioration requires replacement before further engine operation.

IMPORTANT: If you use gasoline that contains or might contain methanol or ethanol, you must increase the frequency of inspection for leaks and abnormalities.

IMPORTANT: When operating a Mercury Marine engine on gasoline containing methanol or ethanol, do not store the gasoline in the fuel tank for long periods. Cars normally consume these blended fuels before they can absorb enough moisture to cause trouble; boats often sit idle long enough for phase separation to take place. Internal corrosion may occur during storage if alcohol has washed protective oil films from internal components.

Special Features of the Fuel Tank

The Environmental Protection Agency (EPA) will require the fuel tank on outboards produced after January 1, 2011 to remain fully sealed (pressurized) up to 24.1 kPa (3.5 psi).

The fuel cap has a two-way valve which allows air to enter the tank as the fuel is drawn to the engine, and also opens to vent to the atmosphere if internal pressure in the tank exceeds 24.1 kPa (3.5 psi). A hissing noise may be heard as the tank vents to the atmosphere. This is normal.

REMOVING THE FUEL CAP

IMPORTANT: Contents may be under pressure. Rotate the fuel cap 1/4 turn to relieve pressure before opening.

1. Open the manual vent screw on top of the fuel cap.
2. Rotate the fuel cap 1/4 turn to relieve pressure and slowly open the cap.

INSTALLING THE FUEL CAP

1. When installing the fuel cap, turn the cap to the right until you hear a click. This signals that the fuel cap is fully seated. A built-in device prevents overtightening.

FUEL AND OIL

2. Open the manual vent screw on top of the cap for operation and cap removal. Close the manual vent screw for transportation.

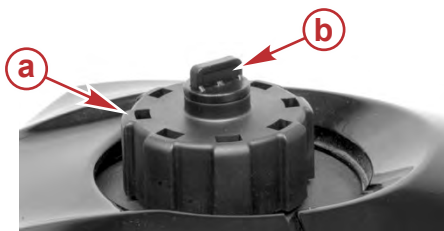

47368

- a - Fuel cap
- b - Manual vent screw

Filling the Fuel Tank

⚠ WARNING

Avoid serious injury or death from a gasoline fire or explosion. Use caution when filling fuel tanks. Always stop the engine and do not smoke or allow open flames or sparks in the area while filling fuel tanks.

Fill the fuel tank outdoors away from heat, sparks, and open flames.

Remove the portable fuel tanks from the boat to refill them.

Always stop the engine before refilling the fuel tank.

Do not completely fill the fuel tank. Leave approximately 10% of the tank volume unfilled. Fuel will expand in volume as its temperature rises, and can leak under pressure if the fuel tank is completely filled.

Engine Oil Recommendations

Mercury or Quicksilver NMMA FC-W certified SAE 10W-30 4-Stroke Marine Engine Oil is recommended for general, all-temperature use. If NMMA certified synthetic blend oil is preferred, use Mercury or Quicksilver SAE 25W-40 Synthetic Blend Marine 4-Stroke Engine Oil. If the recommended Mercury or Quicksilver NMMA FC-W certified outboard oils are not available, a major FC-W certified 4-stroke outboard oil may be used.

FUEL AND OIL

IMPORTANT: The use of nondetergent oils, multi-viscosity oils (other than Mercury or Quicksilver NMMA FC-W certified oil or a major brand NMMA FC-W certified oil), synthetic oils, low quality or oils that contain solid additives are not recommended.

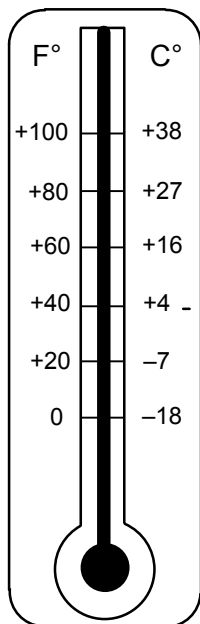

26795

Recommended SAE viscosity for engine oil

- a** - Mercury or Quicksilver SAE 25W-40 Synthetic Blend Marine 4-Stroke Engine Oil may be used at temperatures above 4 °C (40 °F)
- b** - Mercury or Quicksilver SAE 10W-30 4-Stroke Marine Engine Oil is recommended for use in all temperatures

Checking Engine Oil

IMPORTANT: Do not overfill. Be sure that the outboard is upright (not tilted) when checking oil.

1. Position the outboard so it is sitting level.
2. Verify the oil level through the oil level inspection window. If the oil level is down toward the lower level mark, remove the oil fill cap, and fill up to the upper level mark.

FUEL AND OIL

NOTE: If oil level is at the lower mark, add 100 ml (3 oz.) of oil.

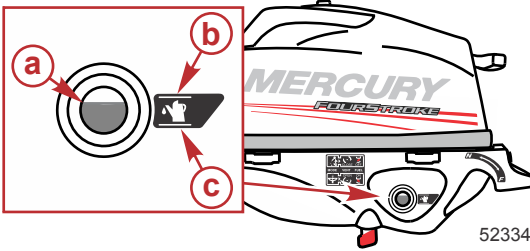

- a** - Oil level inspection window
- b** - Upper oil level
- c** - Lower oil level

3. Install the oil fill cap, and tighten securely.

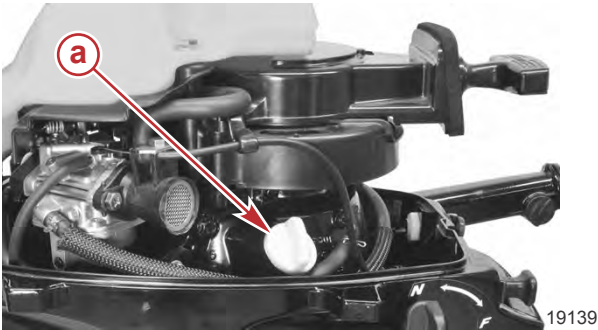

- a** - Oil fill cap

FEATURES AND CONTROLS

Features and Controls

Fuel shut off valve - Turn the valve to the closed (OFF) position to prevent fuel flow to the engine. Turn the valve to the open (ON) position when starting the engine.

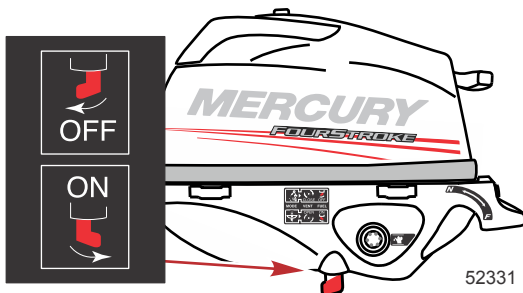

Choke knob - Pull completely out when starting a cold engine. Push halfway in as the engine is warming up. Push in completely after the engine is warmed up.

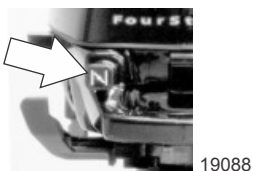

Throttle grip friction knob - Use the friction knob to set the throttle grip at a desired speed. Turn the knob clockwise to tighten friction or turn counterclockwise to loosen friction.



- a** - Direction to loosen friction
- b** - Direction to tighten friction

FEATURES AND CONTROLS

⚠ WARNING

Insufficient friction adjustment can cause serious injury or death due to loss of boat control. When setting the friction adjustment, maintain sufficient steering friction to prevent the outboard from steering into a full turn if the tiller handle or steering wheel is released.

Steering friction adjustment - Adjust this knob to achieve the desired steering friction (drag) on the tiller handle. Turn the knob clockwise to tighten friction and counterclockwise to loosen friction.

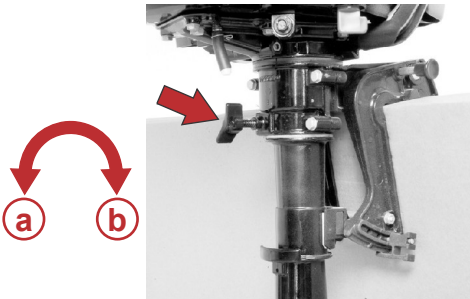

- a** - Direction to loosen friction
- b** - Direction to tighten friction

19100

Side handle gear shift - Controls gear shift. Place the gear shift into neutral position when starting the engine. F = forward gear, N = neutral position.

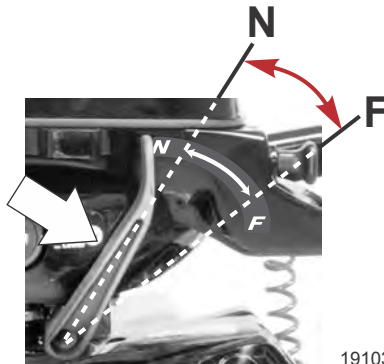

19103

FEATURES AND CONTROLS

Engine stop switch/lanyard stop switch - Push in or pull lanyard to stop the engine. The engine will not start unless the lanyard is engaged with the stop switch.

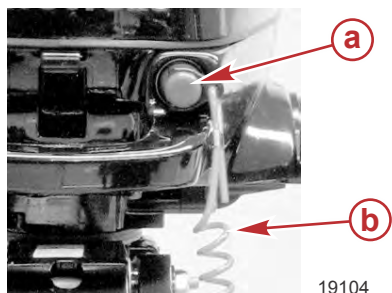

a - Engine stop switch/lanyard stop switch

b - Lanyard

Starter rope - Pulling the starter rope cranks the engine over for starting.

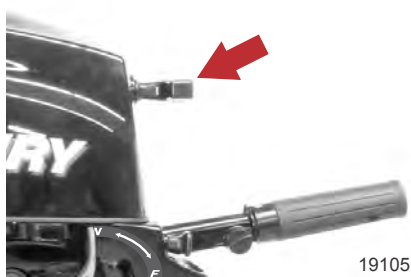

Tilting Outboard

TILTING TO FULL UP POSITION

1. Stop the engine.
2. Take hold of the top cowl grip, and raise outboard to the full up position.

FEATURES AND CONTROLS

3. Push in the tilt support pin. Lower the outboard to rest on the tilt support pin.

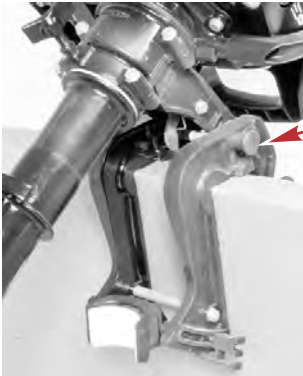

a - Tilt support pin

19051

LOWERING TO RUN POSITION

Lift the outboard and pull out the tilt support pin. Lower the outboard.

Setting the Operating Angle of the Outboard

The vertical operating angle of the outboard is adjusted by changing the position of the tilt pin in the adjustment holes provided. Proper adjustment allows the boat to achieve optimum performance, stability, and minimize steering effort.

The tilt pin should be adjusted so the outboard is positioned to run perpendicular to the water when the boat is running at full speed. This allows the boat to be driven parallel to the water.

Arrange passengers and load in the boat so the weight is distributed evenly.

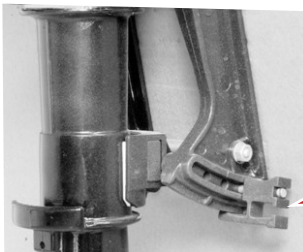

a - Tilt pin

19052

OPERATION

Prestarting Check List

- Operator knows safe navigation, boating, and operating procedures.
- An approved personal flotation device of suitable size for each person aboard and readily accessible (it is the law).
- A ring type life buoy or buoyant cushion designed to be thrown to a person in the water.
- Know your boats' maximum load capacity. Look at the boat capacity plate.
- Fuel supply OK.
- Arrange passengers and load in the boat so the weight is distributed evenly and everyone is seated in a proper seat.
- Tell someone where you are going and when you expect to return.
- It is illegal to operate a boat while under the influence of alcohol or drugs.
- Know the waters and area you will be boating; tides, currents, sand bars, rocks, and other hazards.
- Make inspection checks listed in **Maintenance - Inspection and Maintenance Schedule**.

Operating in Freezing Temperatures

When using your outboard or having your outboard moored in freezing or near freezing temperatures, keep the outboard tilted down at all times so the gearcase is submerged. This prevents the trapped water in the gearcase from freezing and causing possible damage to the water pump and other components.

If there is a chance of ice forming on the water, the outboard should be removed and drained completely of water. If ice should form at the water level inside the outboard driveshaft housing, it will block water flow to the engine causing possible damage.

Operating in Saltwater or Polluted Water

We recommend that you flush the internal water passages of your outboard with fresh water after each use in salt or polluted water. This will prevent a buildup of deposits from clogging the water passages. Refer to **Maintenance - Flushing the Cooling System**.

If you keep your boat moored in the water, always tilt the outboard so the gearcase is completely out of water (except in freezing temperatures) when not in use.

Wash the outboard exterior and flush out the exhaust outlet of the propeller and gearcase with fresh water after each use. Each month, spray Mercury Precision or Quicksilver Corrosion Guard on external metal surfaces. Do not spray on corrosion control anodes as this will reduce the effectiveness of the anodes.

OPERATION

Engine Break-in Procedure

IMPORTANT: Failure to follow the engine break-in procedures can result in poor performance throughout the life of the engine and can cause engine damage. Always follow break-in procedures.

1. For the first hour of operation, run the engine at varied throttle settings up to 2000 RPM or at approximately half throttle.
2. For the second hour of operation, run the engine at varied throttle settings up to 3000 RPM or at three-quarter throttle, and at full throttle for approximately one minute every ten minutes.
3. For the next eight hours of operation, avoid continuous operation at full throttle for more than five minutes at a time.

Starting the Engine

Before starting, read the **Prestarting Check List** and **Engine Break-in Procedure** in the **Operation** section.

NOTICE

Without sufficient cooling water, the engine, the water pump, and other components will overheat and suffer damage. Provide a sufficient supply of water to the water inlets during operation.

1. Check the engine oil level. Place the outboard in a level position and check that the engine oil level is within the operating range.

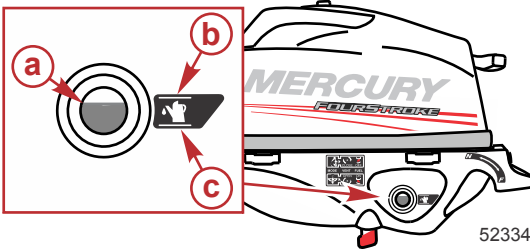

- a - Oil level inspection window
- b - Upper oil level
- c - Lower oil level

OPERATION

- Shift the outboard to the neutral (N) position.

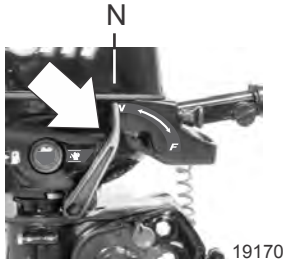

- Make sure the cooling water intake is submerged.

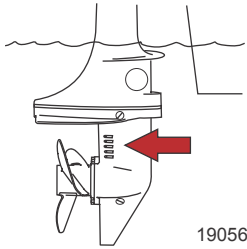

- Open the manual vent screw on the fuel tank.



- Move the fuel shut off valve to the open (ON) position.

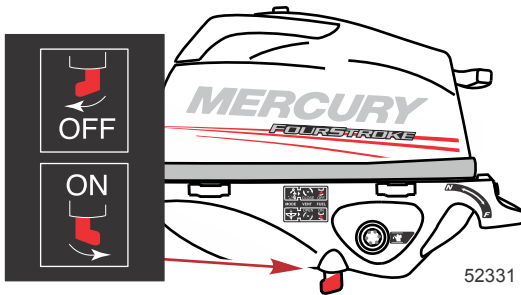

OPERATION

6. Attach the lanyard to the stop switch. Refer to **General Information - Lanyard Stop Switch**.

NOTE: The engine will not start unless the lanyard is engaged with the stop switch.

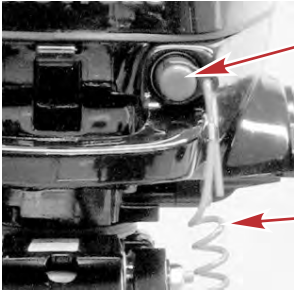

19104

- a - Stop switch
- b - Lanyard

7. If the engine is cold, set the throttle grip to the "START" position. If the engine is warm, set the throttle grip to the "RE-START" position.

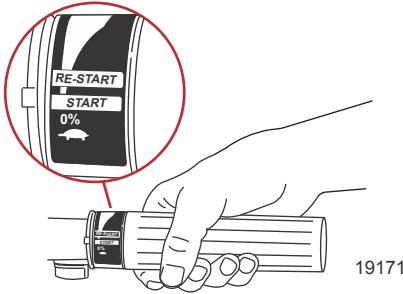

19171



OPERATION

8. If the engine is cold, completely pull out the choke. Push in the choke halfway as the engine is warming up. Push in completely after the engine is warmed up.

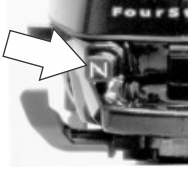

19088

NOTE: Starting flooded engine - Push in the choke knob. Wait 30 seconds, then continue to crank the engine for starting.

9. Pull the starter rope slowly until you feel the starter engage, then pull rapidly to crank the engine. Allow the rope to return slowly. Repeat until the engine starts.



19172

10. Check for a steady stream of water flowing out of the water pump indicator hole.

IMPORTANT: If no water is coming out of the water pump indicator hole, stop the engine and check cooling water intake for obstruction. No obstruction may indicate a water pump failure, or blockage in the cooling system. These conditions will cause the engine to overheat. Have the outboard checked by a dealer. Operating the engine while overheated may cause serious engine damage.

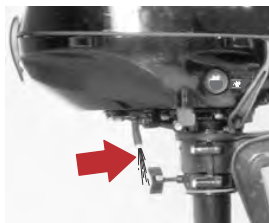

19246

OPERATION

Gear Shifting

The outboard has two gear shift positions to provide operation: Forward (F), and Neutral (N).

Reduce throttle speed to idle speed.

Always shift the outboard into gear with a quick motion.

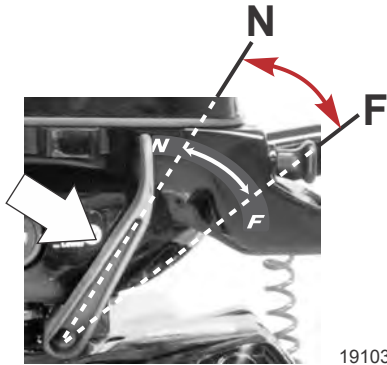

Reversing Boat

1. Move the throttle grip to the slow position.
2. To reverse direction, turn the outboard 180°. The tiller handle can be swung back for ease of operation.
3. Return the throttle grip to the slow position when turning the outboard back to forward direction.

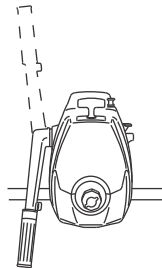

OPERATION

Stopping the Engine

Reduce engine speed and push in the stop switch or pull the lanyard.

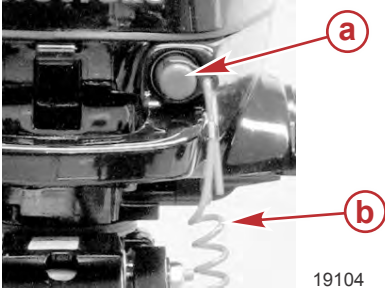

- a** - Stop switch
- b** - Lanyard

19104

MAINTENANCE

Outboard Care

To keep your outboard in the best operating condition, it is important that your outboard receive the periodic inspections and maintenance listed in the **Inspection and Maintenance Schedule**. We urge you to keep it maintained properly to ensure the safety of you and your passengers, and retain its dependability.

Record maintenance performed in the **Maintenance Log** at the back of this book. Save all maintenance work orders and receipts.

SELECTING REPLACEMENT PARTS FOR YOUR OUTBOARD

We recommend using original Mercury Precision or Quicksilver replacement parts and Genuine Lubricants.

EPA Emission Regulations

All new outboards manufactured by Mercury Marine are certified to the United States Environmental Protection Agency, as conforming to the requirements of the regulations for the control of air pollution from new outboard motors. This certification is contingent on certain adjustments set to factory standards. For this reason, the factory procedure for servicing the product must be strictly followed and, wherever practicable, returned to the original intent of the design.

Maintenance, replacement, or repair of the emission control devices and systems may be performed by any marine spark ignition (SI) engine repair establishment or individual.

MAINTENANCE

EMISSION CERTIFICATION LABEL

An emission certification label, showing emission levels and engine specifications directly related to emissions, is placed on the engine at time of manufacture.

The diagram shows a rectangular label titled "EMISSION CONTROL INFORMATION". At the top, it says "THIS ENGINE CONFORMS TO [] CALIFORNIA AND U.S. EPA EMISSION REGULATIONS FOR SPARK IGNITION MARINE ENGINES. REFER TO OWNER'S MANUAL FOR REQUIRED MAINTENANCE SPECIFICATIONS AND ADJUSTMENTS. PLEASE PERFORM THE ENGINE MAINTENANCE CORRECTLY." Below this, there are several fields for engine specifications: "DISPLACEMENT:", "FAMILY:", "FEL: HC+NOx=", "CO=", "HP:", "LOW-PERM/HIGH-PERM:", "MAXIMUM POWER:", "TIMING:", and "IDLE SPEED (IN GEAR):". The label also features a calendar grid on the left and right sides, with months from JAN to DEC. Callouts a through h point to specific fields: a to Displacement, b to FEL: HC+NOx, c to Low-Perm/High-Perm, d to Timing, e to Family, f to HP, g to Maximum Power, and h to Idle Speed. The brand name "MERCURY MARINE" is printed at the bottom of the label. The number "43058" is located at the bottom right of the page.

- a** - Piston displacement
- b** - Maximum emission output for the engine family
- c** - Percent of fuel line permeation
- d** - Timing specification
- e** - US EPA engine family name
- f** - Horsepower rating
- g** - Engine power - kilowatts
- h** - Idle speed (in gear)

OWNER RESPONSIBILITY

The owner/operator is required to have routine engine maintenance performed to maintain emission levels within prescribed certification standards.

The owner/operator is not to modify the engine in any manner that would alter the horsepower or allow emission levels to exceed their predetermined factory specifications.

Inspection and Maintenance Schedule

DAILY CHECKS

- Check the engine oil level
- Check the lanyard stop switch
- Inspect the fuel system for leaks
- Inspect the engine tightness on the transom
- Check the steering system for binding
- Check the propeller for damage
- Inspect the hydraulic steering fittings and hoses for leaks or signs of damage, if equipped

MAINTENANCE

- Check the hydraulic steering fluid level, if equipped

AFTER EACH USE

- Wash the power package exterior with fresh water
- Flush the outboard cooling system, saltwater or brackish water only

ANNUALLY OR 100 HOURS

- Grease the engine, if applicable
- Change the engine oil and filter, if equipped
- Inspect the thermostat, saltwater or brackish water only
- Add Quickleen to the fuel tank, once per year, per engine
- Apply antiseize to the spark plug threads
- Replace the gear lubricant
- Inspect the corrosion control anodes
- Lubricate the propeller shaft splines
- Replace all filters on the suction side of the fuel system—dealer item
- Lubricate the driveshaft splines—dealer item
- Check the tightness on all the fasteners—dealer item
- Check the torque of the outboard mounting hardware—dealer item
- Check the battery condition and tightness of the battery cable connection, if equipped—dealer item

THREE YEARS OR 300 HOURS

- Replace the spark plugs
- Replace the water pump impeller—dealer item
- Inspect the carbon fiber reeds, if equipped—dealer item
- Inspect the wire harness connectors—dealer item
- Check the remote control cable adjustment, if equipped—dealer item
- Replace the high-pressure fuel filter, if equipped—dealer item
- Replace the accessory drive belt, if equipped—dealer item
- Check the power trim fluid level, if equipped—dealer item
- Inspect the engine motor mounts—dealer item

Flushing the Cooling System

Flush the internal water passages of the outboard with fresh water after each use in salt, polluted, or muddy water. This will help prevent a buildup of deposits from clogging the internal water passages.

Use a Mercury Precision or Quicksilver accessory (or equivalent) flushing attachment.

NOTE: Do not run the engine while flushing the cooling system.

1. Remove the plug and gasket.

MAINTENANCE

2. Attach the hose coupling to the engine.
3. Attach a water hose to the hose coupling. Turn on the water gently and flush the cooling system for 3 to 5 minutes.
4. Turn the water off. Remove the hose coupling and install the plug and gasket.

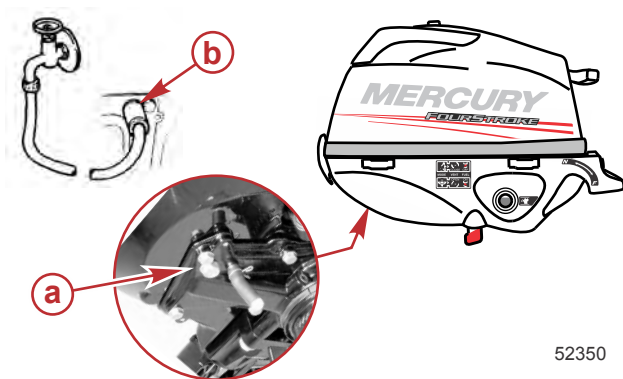

52350

- a** - Plug and gasket
- b** - Hose coupling

Top Cowl Removal and Installation

REMOVAL

1. Release the rear cowl latch.



47360

MAINTENANCE

2. Lift up the rear of the cowl and push it towards the front of the engine to clear the front hook.



19043

INSTALLATION

1. Engage the front hook and position the cowl over the engine.
2. Lock the rear cowl latch.

Corrosion Control Anode

Your outboard has a corrosion control anode installed on the gearcase. An anode helps protect the outboard against galvanic corrosion by sacrificing its metal to be slowly corroded instead of the outboard metals.

The anode requires periodic inspection especially in saltwater which will accelerate the erosion. To maintain this corrosion protection, always replace the anode before it is completely eroded. Never paint or apply a protective coating on the anode as this will reduce effectiveness of the anode.

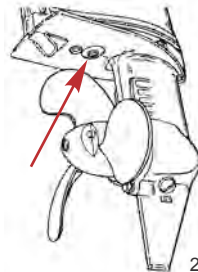

28709

Exterior Care

Your outboard is protected with a durable baked enamel finish. Clean and wax often using marine cleaners and waxes.

MAINTENANCE

Propeller Replacement

⚠ WARNING

Rotating propellers can cause serious injury or death. Never operate the boat out of the water with a propeller installed. Before installing or removing a propeller, place the drive unit in neutral and engage the lanyard stop switch to prevent the engine from starting. Place a block of wood between the propeller blade and the anti-ventilation plate.

1. Remove the spark plug lead to prevent the engine from starting.

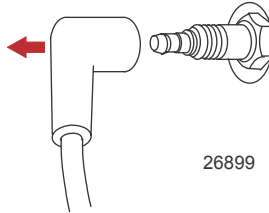

2. Move the gear shift lever into neutral.

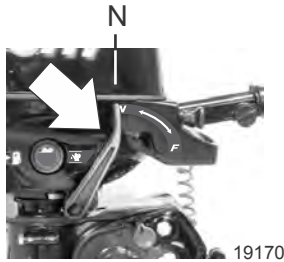

3. Straighten and remove the cotter pin.

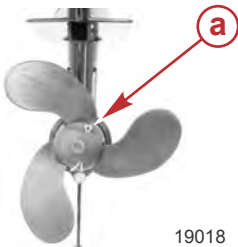

a - Cotter pin

MAINTENANCE

4. Pull the propeller straight off the shaft. Retain the drive pin. If the propeller is seized to the shaft and cannot be removed, have the propeller removed by an authorized dealer.

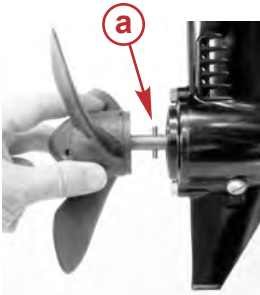

19022

a - Drive pin

5. Insert the drive pin into the propeller shaft.



19023

a - Drive pin

6. Slide the propeller onto the shaft, making sure the slot in the propeller engages with the drive pin.
7. Install the cotter pin through the hole in the propeller and bend the cotter pin ends.

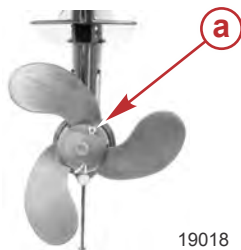

19018

a - Cotter pin

MAINTENANCE

Spark Plug Inspection and Replacement

⚠ WARNING

Damaged spark plug boots may emit sparks that can ignite fuel vapors under the engine cowl, resulting in serious injury or death from a fire or explosion. To avoid damaging the spark plug boots, do not use any sharp object or metal tool to remove the spark plug boots.

1. Remove the spark plug boot. Twist the rubber boot slightly and pull off.

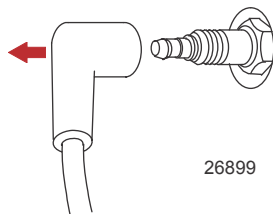

2. Remove the spark plug to inspect. Replace spark plug if electrode is worn or the insulator is rough, cracked, broken, blistered, or fouled.

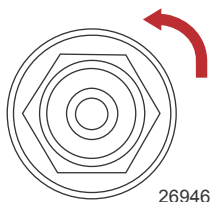

3. Set the spark plug gap to specification.

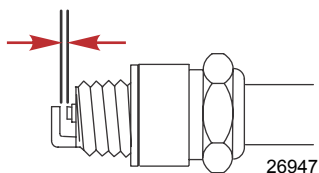

Spark Plug

Spark plug gap

0.9 mm (0.035 in.)



4. Before installing spark plug, clean off any dirt on the spark plug seat. Install plug finger-tight, and then tighten 1/4 turn or torque to specifications.

Description	Nm	lb-in.	lb-ft
Spark plug	27	-	20

MAINTENANCE

Lubrication Points

Lubricate the following with Quicksilver or Mercury Precision Lubricants 2-4-C with PTFE or Extreme Grease.

Tube Ref No.	Description	Where Used	Part No.
 95	2-4-C with PTFE	Steering friction knob threads, swivel bracket bushing, tilt support pin, transom clamp screws	92-802859A 1
	Extreme Grease	Steering friction knob threads, swivel bracket bushing, tilt support pin, transom clamp screws	8M0071842

- Steering friction knob - lubricate threads.



- Tilt support pin - lubricate pin
- Transom clamp screws - lubricate threads
- Tilt pivot point - lubricate with lightweight oil

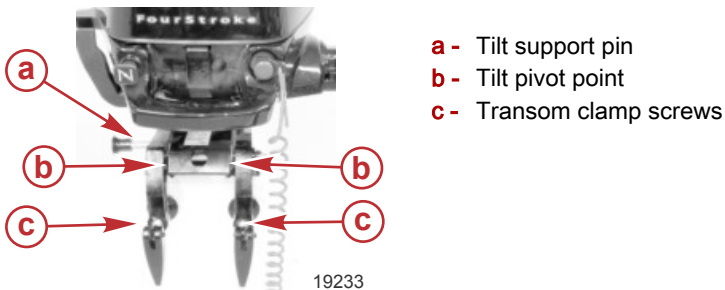

- Tiller handle rubber bushing - lubricate internal diameter with lightweight oil.

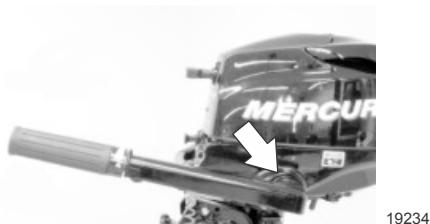

MAINTENANCE

- Swivel bracket - remove four bolts and rear cover and lubricate the inner nylon bushing.

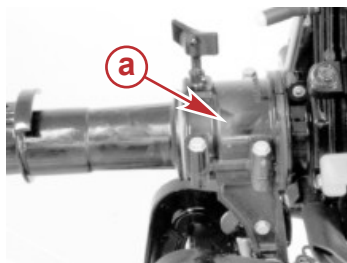

19240

a - Rear cover

Changing Engine Oil

ENGINE OIL CAPACITY

Engine oil capacity is approximately 300 ml (10 fl oz).

OIL CHANGING PROCEDURE

1. Place the outboard in an upright (not tilted) position.
2. Turn the outboard to gain access to the drain plug. Remove the drain plug and drain the engine oil into an appropriate container. Lubricate the seal on the drain plug with oil and reinstall.

IMPORTANT: Inspect oil for signs of contamination. Oil contaminated with water will have a milky color to it; oil contaminated with fuel will have a strong fuel smell. If contaminated oil is noticed, have the engine checked by your dealer.

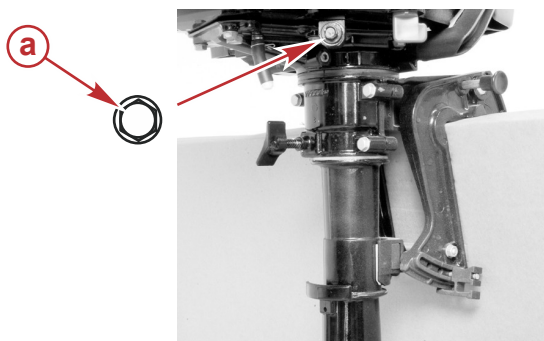

19128

a - Drain plug

OIL FILLING

IMPORTANT: Do not overfill. Be sure that the outboard is upright (not tilted) when checking oil.

MAINTENANCE

Remove the oil fill cap and refill with 300 ml (10 fl oz) of oil. Install the oil fill cap.

Idle engine for five minutes and check for leaks. Stop engine and check oil level. Add oil if necessary.

Gearcase Lubrication

When adding or changing gearcase lubricant, visually check for the presence of water in the lubricant. If water is present, it may have settled to the bottom and will drain out prior to the lubricant, or it may be mixed with the lubricant, giving it a milky colored appearance. If water is noticed, have the gearcase checked by your dealer. Water in the lubricant may result in premature bearing failure or, in freezing temperatures, will turn to ice and damage the gearcase.

Examine the drained gearcase lubricant for metal particles. A small amount of metal particles indicates normal gear wear. An excessive amount of metal filings or larger particles (chips) may indicate abnormal gear wear and should be checked by an authorized dealer.

DRAINING GEARCASE

1. Place the outboard in a vertical operating position.
2. Place the drain pan below outboard.
3. Remove the vent plug and fill/drain plug and drain lubricant.

NOTE: Replace the sealing washers with new washers.

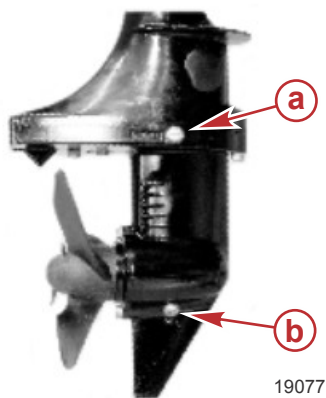

- a - Vent plug
- b - Fill/drain plug

GEARCASE LUBRICANT CAPACITY

Gearcase lubricant capacity is approximately 180 ml (6.0 fl oz).

CHECKING LUBRICANT LEVEL AND REFILLING GEARCASE

1. Place the outboard in a vertical operating position.
2. Remove the vent plug.

MAINTENANCE

- Remove fill/drain plug. Place lubricant tube into the fill hole and add lubricant until it appears at the vent hole.

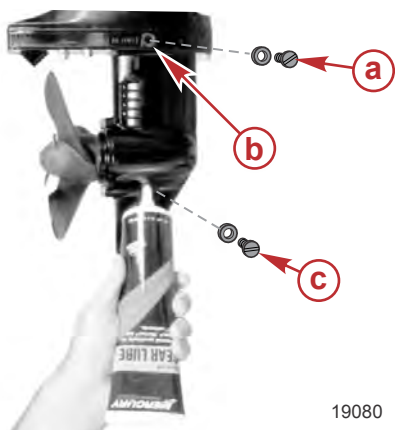

- a** - Vent plug and new sealing washer
- b** - Vent hole
- c** - Fill/drain plug and new sealing washer

19080

Tube Ref No.	Description	Where Used	Part No.
 82	Premium Gear Lubricant	Gearcase	92-858058K01

- Stop adding lubricant. Use new sealing washer and install the vent plug before removing the lubricant tube.
- Remove lubricant tube and install cleaned fill/drain plug and new sealing washer.

Submerged Outboard

A submerged outboard will require service within a few hours by an authorized dealer once the outboard is recovered from the water. This immediate attention by a servicing dealer is necessary once the engine is exposed to the atmosphere to minimize internal corrosion damage to the engine.

STORAGE

Storage Preparation

The major consideration in preparing your outboard for storage is to protect it from rust, corrosion, and damage caused by freezing of trapped water.

The following storage procedures should be followed to prepare your outboard for out of season storage or prolonged storage (two months or longer).

NOTICE

Without sufficient cooling water, the engine, the water pump, and other components will overheat and suffer damage. Provide a sufficient supply of water to the water inlets during operation.

FUEL SYSTEM

IMPORTANT: Gasoline containing alcohol (ethanol or methanol) can cause a formation of acid during storage and can damage the fuel system. If the gasoline being used contains alcohol, it is advisable to drain as much of the remaining gasoline as possible from the fuel tank, remote fuel line, and engine fuel system.

Fill the fuel tank and engine fuel system with treated (stabilized) fuel to help prevent formation of varnish and gum. Proceed with following instructions.

- Pour the required amount of gasoline stabilizer (follow instructions on container) into fuel tank. Tip fuel tank back and forth to mix stabilizer with the fuel.
- Place the outboard in water. Run the engine for five minutes to allow treated fuel to reach the carburetor.

Protecting External Outboard Components

- Lubricate all outboard components listed in **Maintenance - Inspection and Maintenance Schedule**.
- Touch up any paint nicks. See your dealer for touch-up paint.
- Spray Quicksilver or Mercury Precision Lubricants Corrosion Guard on external metal surfaces (except corrosion control anodes).

Tube Ref No.	Description	Where Used	Part No.
 120	Corrosion Guard	External metal surfaces	92-802878 55

Protecting Internal Engine Components

- Remove the spark plug and inject a small amount of engine oil inside the cylinder.
- Rotate the flywheel manually several times to distribute the oil in the cylinder. Install spark plug.
- Change the engine oil.

STORAGE

Gearcase

- Drain and refill the gearcase lubricant. Refer to **Gearcase Lubrication**.

Positioning Outboard for Storage

NOTICE

Storing the outboard in a tilted position can damage the outboard. Water trapped in the cooling passages or rain water collected in the propeller exhaust outlet in the gearcase can freeze. Store the outboard in the full down position.

1. Carry, transport, or store the outboard only in the following two positions. These positions will prevent oil from draining out of the crankcase.

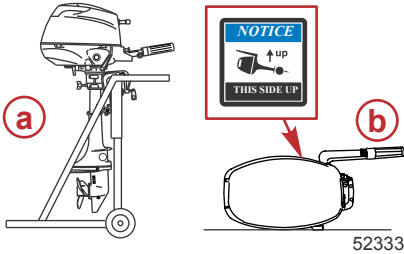

- a - Upright position
- b - Tiller handle up position

2. Never carry, store, or transport the outboard in the positions shown below. Engine damage could result from oil draining out of the crankcase.

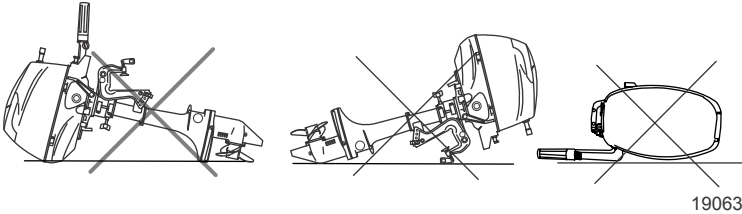

OWNER SERVICE ASSISTANCE

Service Assistance

LOCAL REPAIR SERVICE

If you need service for your Mercury-outboard-powered boat, take it to your authorized dealer. Only authorized dealers specialize in Mercury products and have factory-trained mechanics, special tools and equipment, and genuine Quicksilver parts and accessories to properly service your engine.

NOTE: *Quicksilver parts and accessories are engineered and built by Mercury Marine specifically for your power package.*

SERVICE AWAY FROM HOME

If you are away from your local dealer and the need arises for service, contact the nearest authorized dealer. If, for any reason, you cannot obtain service, contact the nearest Regional Service Center. Outside the United States and Canada, contact the nearest Marine Power International Service Center.

STOLEN POWER PACKAGE

If your power package is stolen, immediately advise the local authorities and Mercury Marine of the model and serial numbers and to whom the recovery is to be reported. This information is maintained in a database at Mercury Marine to aid authorities and dealers in the recovery of stolen power packages.

ATTENTION REQUIRED AFTER SUBMERSION

1. Before recovery, contact an authorized Mercury dealer.
2. After recovery, immediate service by an authorized Mercury dealer is required to reduce the possibility of serious engine damage.

REPLACEMENT SERVICE PARTS

WARNING

Avoid fire or explosion hazard. Electrical, ignition, and fuel system components on Mercury Marine products comply with federal and international standards to minimize risk of fire or explosion. Do not use replacement electrical or fuel system components that do not comply with these standards. When servicing the electrical and fuel systems, properly install and tighten all components.

Marine engines are expected to operate at or near full throttle for most of their lives. They are also expected to operate in both fresh and saltwater environments. These conditions require numerous special parts.

PARTS AND ACCESSORIES INQUIRIES

Direct any inquiries concerning genuine Mercury Precision Parts® or Quicksilver Marine Parts and Accessories® to a local authorized dealer. Dealers have the proper systems to order parts and accessories, if they are not in stock. **Engine model** and **serial number** are required to order correct parts.

OWNER SERVICE ASSISTANCE

RESOLVING A PROBLEM

Satisfaction with your Mercury product is important to your dealer and to us. If you ever have a problem, question or concern about your power package, contact your dealer or any authorized Mercury dealership. If you need additional assistance:

1. Talk with the dealership's sales manager or service manager.
2. If your question, concern, or problem cannot be resolved by your dealership, please contact the Mercury Marine Service Office for assistance. Mercury Marine will work with you and your dealership to resolve all problems.

The following information will be needed by the Customer Service:

- Your name and address
- Your daytime telephone number
- The model and serial numbers of your power package
- The name and address of your dealership
- The nature of the problem

CONTACT INFORMATION FOR MERCURY MARINE CUSTOMER SERVICE

For assistance, call, fax, or write to the geographic office in your area. Please include your daytime telephone number with mail and fax correspondence.

United States, Canada		
Telephone	English +1 920 929 5040 Français +1 905 636 4751	Mercury Marine W6250 Pioneer Road P.O. Box 1939 Fond du Lac, WI 54936-1939
Fax	English +1 920 929 5893 Français +1 905 636 1704	
Website	www.mercurymarine.com	

Australia, Pacific		
Telephone	+61 3 9791 5822	Brunswick Asia Pacific Group 41-71 Bessemer Drive Dandenong South, Victoria 3175 Australia
Fax	+61 3 9706 7228	

Europe, Middle East, Africa		
Telephone	+32 87 32 32 11	Brunswick Marine Europe Parc Industriel de Petit-Rechain B-4800 Verviers, Belgium
Fax	+32 87 31 19 65	

OWNER SERVICE ASSISTANCE

Mexico, Central America, South America, Caribbean		
Telephone	+1 954 744 3500	Mercury Marine 11650 Interchange Circle North Miramar, FL 33025 U.S.A.
Fax	+1 954 744 3535	

Japan		
Telephone	+072 233 8888	Kisaka Co., Ltd. 4-130 Kannabecho, Sakai-ku Sakai-shi, Osaka 590-0984, Japan
Fax	+072 233 8833	

Asia, Singapore		
Telephone	+65 65466160	Brunswick Asia Pacific Group T/A Mercury Marine Singapore Pte Ltd 29 Loyang Drive Singapore, 508944
Fax	+65 65467789	

Ordering Literature

Before ordering literature, have the following information about your power package available:

Model		Serial Number	
Horsepower		Year	

UNITED STATES AND CANADA

For additional literature for your Mercury Marine power package, contact your nearest Mercury Marine dealer or contact:

Mercury Marine		
Telephone	Fax	Mail
(920) 929-5110 (USA only)	(920) 929-4894 (USA only)	Mercury Marine Attn: Publications Department P.O. Box 1939 Fond du Lac, WI 54936-1939

OUTSIDE THE UNITED STATES AND CANADA

Contact your nearest Mercury Marine authorized service center to order additional literature that is available for your particular power package.

OWNER SERVICE ASSISTANCE

Submit the following order form with payment to:	Mercury Marine Attn: Publications Department W6250 Pioneer Road P.O. Box 1939 Fond du Lac, WI 54936-1939
--	--

Ship To: (Copy this form and print or type—This is your shipping label)	
Name	
Address	
City, State, Province	
ZIP or postal code	
Country	

Quantity	Item	Stock Number	Price	Total
			.	.
			.	.
			.	.
			.	.
			.	.
Total Due			.	.

MAINTENANCE LOG

Maintenance Log

Record all maintenance performed on your outboard here. Be sure to save all work orders and receipts.

Date	Maintenance Performed	Engine Hours