

AMERICAN WOODMARK CABINETRY COLLECTIONS

INSPIRING IDEAS

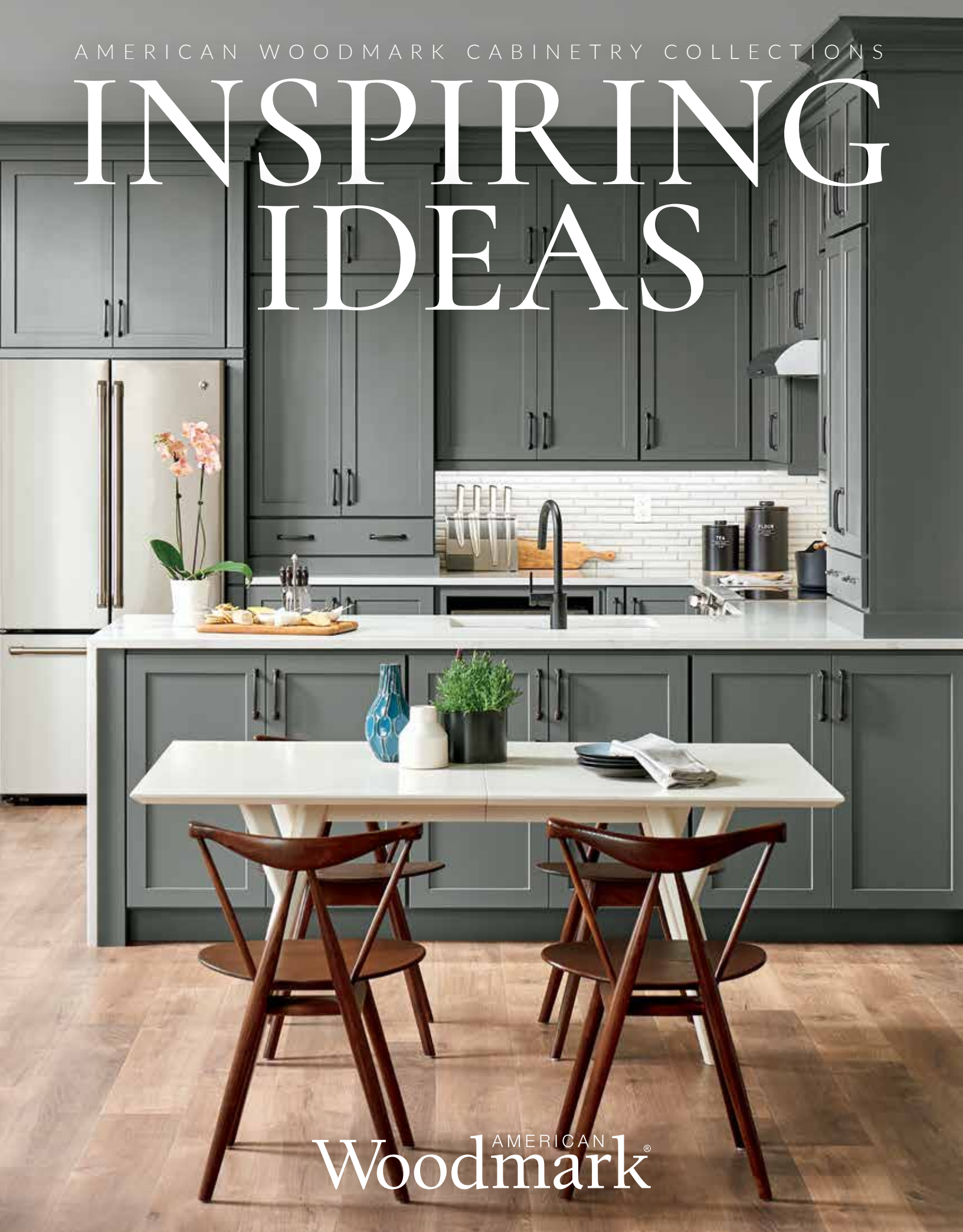

AMERICAN
Woodmark®

Make a space that's so *you.*

Give it your style. Your colors. Your personal touch. Add the people you love, and you've turned a house into a home. **Start here for inspiration.** And find just-right styles at just-right prices.



Define your style.

Discover endless options for creating and customizing your dream kitchen with American Woodmark products using your Pinterest app. (Be sure you have the latest version!) When you see a circular image like this one, use the camera inside the app to hover over the image. We're excited to bring you even more ways to make your space your very own.

Open  and tap  for ideas



AMERICAN
Woodmark[®]
Cabinetry Collections

Details make all the *difference*.

There are easy ways to take your kitchen from basic to beautiful. Eye-catching elements like moldings, corbels, legs and glass doors add interest and drama. So get inspired by what you can do with accessories. **And create a look you'll love for years to come.**



- 1 Molding Stack
- 2 Void Door Cabinets with Shaker Accent Molding
- 3 Flat Panel Arched Valance Range Hood
- 4 Shaker Valance
- 5 Light Rail Molding
- 6 Prairie Corbels
- 7 Parker Decorative Leg
- 8 Decorator Matching Doors
- 9 Open Frame Doors with Clear Glass

Get into the details.

Use your Pinterest camera to unlock an even wider selection of decorative details that can add a "wow" factor to your kitchen.



Open  and tap  for ideas



QUIET GRACE.

The **MacArthur** Collection

The MacArthur Collection



Maple Auburn Glaze

Cheers!

Build a **wine bar** with space for bottles, glassware and great times. Note the creative use of molding and shelves. Uncork. Unwind. And make cleaning up easy with a handy sink.



Painted Ember Glaze accented with Cherry Java



Sitting pretty.

This bench seat is so inviting—and so practical. **Pedestal drawers** offer plenty of storage. Add a pretty cushion and decorative pillows. Then sit back and relax.



Painted Ember Glaze accented with Cherry Java

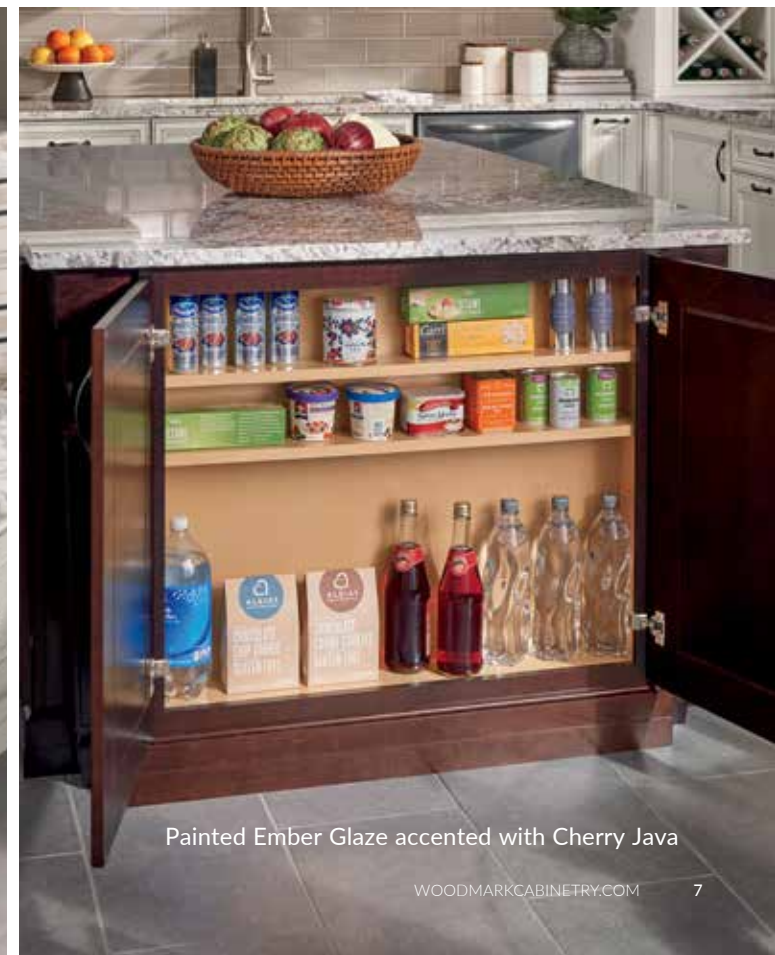

Painted Ember Glaze accented with Cherry Java

Painted Harbor accented with Maple Espresso



POLISHED CHARM.

The **Savannah**® Collection

AVAILABLE FINISHES: **PAINTED:** HARBOR · EMBER GLAZE · STONE · BOULDER · LINEN · PEWTER GLAZE · SILK · HAZELNUT GLAZE · CASHMERE **MAPLE:** NATURAL ·

RYE · SPICE · MOCHA GLAZE · COGNAC · AUBURN GLAZE · TRUFFLE · ESPRESSO **CHERRY:** AUTUMN · SPICE · BORDEAUX · JAVA · SLATE

The Savannah® Collection



Maple Mocha Glaze



Spice it up.

Sprinkle in nifty storage ideas throughout your kitchen. These handy **pull out cabinets** hold all your favorites, nice and neat.

Painted Harbor accented with Maple Espresso



Cherry Bordeaux

VANITY COLLECTION with Silstone®

woodmarkcabinetry.com/vanity



Painted Ember Glaze

Beautiful bathrooms.

Our cabinets are for more than just kitchens. Open your Pinterest app to find inspiration for all corners of your home.



Open  and tap  for ideas



Maple Espresso



SIMPLY ELEGANT.

The **Reading**® Collection



Clearly cool.

Decorative glass doors make any design shine. Check out this one in **Havana Glass**. Then up the wow factor with a unique frame, like these square **Vintage Iron Aluminum Frame Doors**.

Maple Truffle shown with 5-Piece Drawer Front



Coffee, anyone?

Imagine the perks of creating your very own **coffee bar**. This barista-worthy set-up could be in your future. For more inspiration, visit woodmarkcabinetry.com.

Painted Stone shown with 5-Piece Drawer Front



Painted Linen shown with Slab Drawer Front



Maple Cognac shown with 5-Piece Drawer Front

Maple Truffle Square accented with Painted Cashmere shown with 5-Piece Drawer Front

WARM ALLURE.

The **Portola**® Collection

AVAILABLE FINISHES: **PAINTED:** HARBOR · EMBER GLAZE · STONE · BOULDER · LINEN · PEWTER GLAZE · SILK · HAZELNUT GLAZE · CASHMERE **MAPLE:** NATURAL · RYE ·

SPICE · MOCHA GLAZE · COGNAC · AUBURN GLAZE · TRUFFLE · ESPRESSO **CHERRY:** AUTUMN · SPICE · BORDEAUX · JAVA · SLATE **OAK:** HONEY · TAWNY **THERMOFOIL:** LINEN



Go gray.

If calm was a color, it would be **Painted Harbor**. This light, warm gray is beautifully elegant. It also pairs well with warm stains and warm whites.

Painted Harbor Square shown with 5-Piece Drawer Front



Maple Truffle Square accented with Painted Cashmere shown with Slab Drawer Front

VANITY COLLECTION with Silestone™
woodmarkcabinetry.com/vanity



Cherry Slate Square shown with Slab Drawer Front



Painted Cashmere Square shown with 5-Piece Drawer Front



CLASSIC COOL.

The **Brookland**® Collection



Perfect endings.

Make your peninsula a work of art from all angles. Create a more finished look with **furniture ends** and **molding details**.

Painted Cashmere



Cherry Spice

VANITY COLLECTION with Silestone™
woodmarkcabinetry.com/vanity

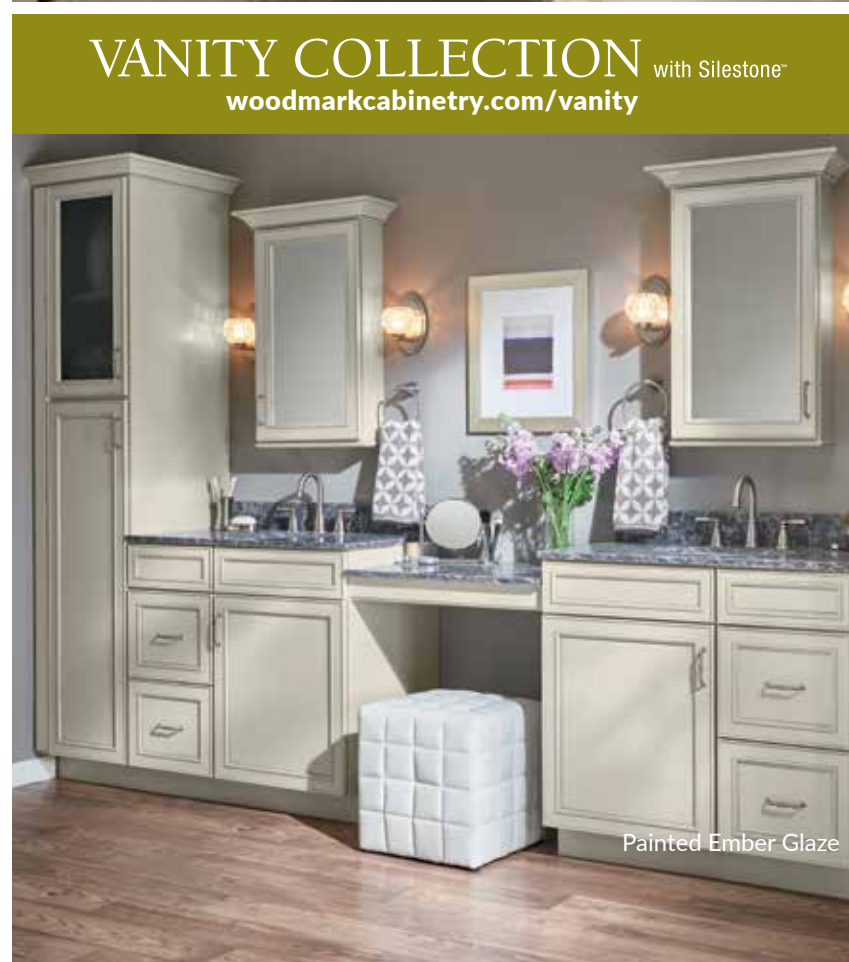

Painted Ember Glaze



Painted Pewter Glaze

URBAN CHIC.

The **Hanover**® Collection



Go modern.

Accentuate the clean lines of Hanover with **Satin Nickel T-Bar Pulls** and square-edged countertops. An angular **range hood** completes the look.



Cherry Spice



Cherry Autumn

VANITY COLLECTION with Silestone™
woodmarkcabinetry.com/vanity



Thermofoil Linen



Maple Espresso



Painted Linen



Painted Linen accented with Maple Truffle

VANITY COLLECTION with Silestone®
woodmarkcabinetry.com/vanity



Painted Hazelnut Glaze

Rock solid style.

Floating shelves can add understated, flexible storage that makes it easy to display favorite items, while **glass doors** can add a splash of interest and decorative style. Put them together, and you've created a unique space that allows you to show off your best pieces while keeping everything in order.



TRUE COMFORT.

The **Charlottesville**® Collection

AVAILABLE FINISHES: **PAINTED:** HARBOR · EMBER GLAZE · STONE · BOULDER · LINEN · PEWTER GLAZE · SILK ·

HAZELNUT GLAZE · CASHMERE **MAPLE:** NATURAL · RYE · SPICE · MOCHA GLAZE · COGNAC · AUBURN GLAZE · TRUFFLE · ESPRESSO

Painted Linen



COZY CASUAL.

The **Shorebrook**® Collection

AVAILABLE FINISHES: **PAINTED:** HARBOR · STONE · BOULDER · LINEN · SILK · CASHMERE **MAPLE:** NATURAL · RYE · SPICE · MOCHA GLAZE · COGNAC ·

AUBURN GLAZE · TRUFFLE **THERMOFOIL:** LINEN

The Shorebrook® Collection



Wall art.

Stack and stagger cabinets to create a unique, custom design. Top it off with **molding** for a fine furniture look. Make it even more functional with a bump-out bench and storage.

Maple Truffle



Painted Stone

VANITY COLLECTION with Silestone™

woodmarkcabinetry.com/vanity



Maple Mocha Glaze



Thermofoil Linen



CRAFTED BEAUTY.

The **Atherton** Collection



Tidy up.

Keep your mud room neat as a pin with **utility cabinets, open shelving,** and a **cabinet organizer.** A place for everything, and everything in its place.



Duraform Stone



Duraform Linen

Looking fine.

The furniture look is in. And it's easy to make. Create this classic hutch with cabinet drawers, a countertop, shelves and molding. **Decorative feet add the perfect touch.**

Duraform Linen accented with Duraform Stone island



STYLISH VIBES.

The **Glen Ellen** Collection

AVAILABLE FINISHES: **DURAFORM**®: STONE · LINEN · SILK



In this corner...

You'll find lots of storage. Make the most of your space with **cabinets on an angle**, including a handy drawer for linens.



Toy land.

A playroom should be playful. But also organized. This space has open cabinets and drawers galore. Plus **Floating Shelves** and a **cabinet bench** that offers extra storage.

Duraform Silk



Duraform Linen accented with Duraform Stone Island



Duraform Silk

Eye catchers.

Make your space special with options like **wine cubbies** and **glass doors**. Don't forget dramatic lighting and a splashy backsplash.

Painted Silk accented with Maple Espresso island



Maple Spice



Cherry Spice



Maple Espresso

RELAXED STYLE.

The **Del Ray** Collection



Maple Rye Square



Painted Silk Square



Cherry Autumn Square

Hot trends.

Built-in **oven cabinets** create a custom look. Choose from double oven, single oven and microwave configurations. Add drawers and doors to turn up the convenience factor.

Cherry Autumn Square accented with Painted Silk



DAPPER DÉCOR.

The **Olmsted** Collection

Painted Linen

Paradise islands.

Gorgeous places for eating. Great spaces for storage. And the **Decorative Doors** add a finished look.



Maple Truffle



Painted Hazelnut Glaze



Painted Stone

REFINED LINES.

The **Newport** Collection



CRISP SHAKER.

The **Leesburg**® Collection



Maple Cognac shown with 5-Piece Drawer Front



Painted Stone



Baker's delight.

If you're into baking, this center takes the cake. It has everything you need, from utensil bins to storage. **Shaker valances** and **furniture legs** add a charming touch.

Painted Linen shown with 5-Piece Drawer Front

Duraform Stone



MODERN LIFE.

The **San Mateo**® Collection

AVAILABLE FINISHES: DURAFORM®: STONE · LINEN · SILK

Duraform Stone



Let it slide.

Now you see it. Now you don't. Create a clever cover-up for **open shelves** with a sliding door.



Duraform Linen



Duraform Linen

WOODMARKCABINTRY.COM 53

Cherry Bordeaux



PERFECT LOOK.

The **Portland**® Collection



Maple Espresso



Oak Honey

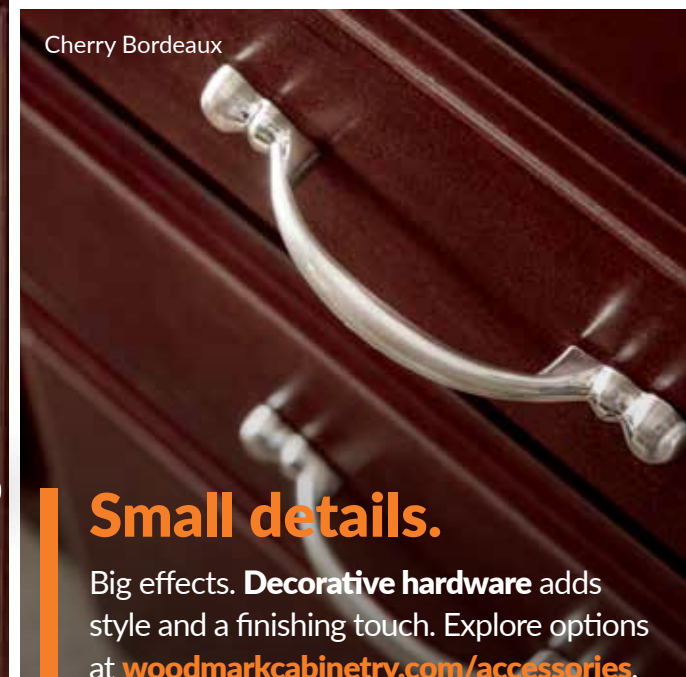

Cherry Bordeaux

Small details.

Big effects. **Decorative hardware** adds style and a finishing touch. Explore options at woodmarkcabinetry.com/accessories.

AVAILABLE FINISHES: **MAPLE:** NATURAL · RYE · SPICE · MOCHA GLAZE · COGNAC · AUBURN GLAZE · TRUFFLE · ESPRESSO **CHERRY:** AUTUMN · SPICE ·

BORDEAUX · JAVA · SLATE **OAK:** HONEY · TAWNY



Maple Cognac

VANITY COLLECTION with Silestone®
woodmarkcabinetry.com/vanity



Maple Spice



Cherry Spice

Painted Hazelnut Glaze



Flow with it.
This entertainment center creates a smooth transition from the kitchen to the living room with the same cabinetry in a custom configuration.

FINE DESIGN.

The **Ashland**® Collection

Simply Woodmark®

These stylish collections are our most affordable ever. Perfect for first-time homebuyers, property owners, and secondary spaces like basements and workshops, **Simply Woodmark** allows you to create the look you want at a price you'll love.



Espresso



Tawny



The Clearfield® Collection

- Partial overlay
- Flat veneer panel
- Decorative slab solid wood drawer front with engineered wood box
- Upgrade Option: 5/8-in Dovetail hardwood drawer box with laminated MDF bottom



The Sunbrook® Collection

- Partial overlay, with option for full overlay in white
- Raised veneer panel
- Decorative slab solid wood drawer front with engineered wood box
- Upgrade Option: 5/8-in Dovetail hardwood drawer box with laminated MDF bottom

Standard Construction

WALL CABINETS

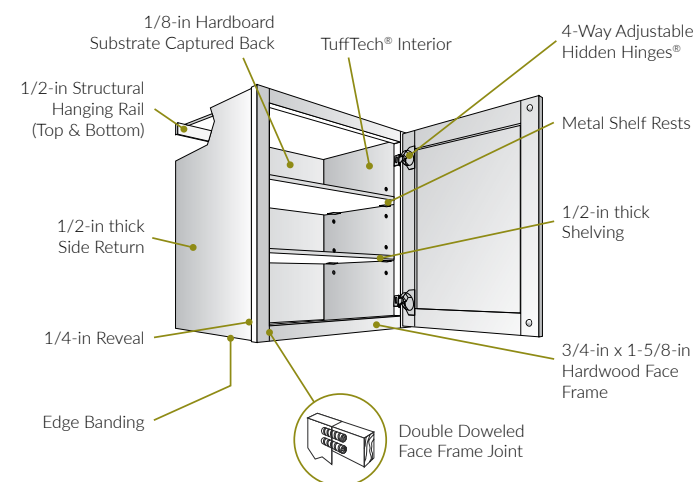

BASE CABINETS

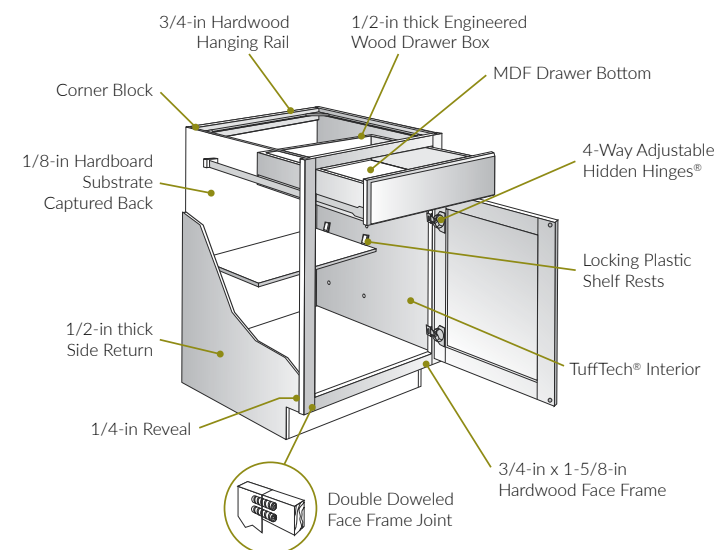

Face Frames: 3/4-in x 1-5/8-in solid hardwood. Joints are pressure fitted, glued, double doweled & stapled.

Sides: 1/2-in thick engineered wood with our TuffTech® finishing system.

Drawers: 1/2-in thick engineered wood with MDF bottoms, finished with our TuffTech® finishing system. Upgrade Option: 5/8-in Dovetail hardwood drawer box with laminated MDF bottom.

Drawer Glides: Side-mounted, epoxy coated & self-aligning.

Hinges: 4-way adjustable Hidden Hinges®.

Doors: Floating center panel with our BeautyGuard® finishing system used on wood doors.

Custom Options



Matching Interior



Hardwood Dovetail Drawer



Inverted Frame Cabinet



Recessed Toe Kick



Increased/Reduced Depth



Cabinet Front Only

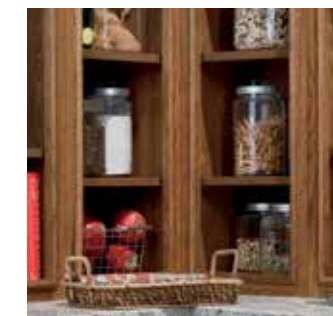

Void Door Option

FINISHES

HONEY

TAWNY

ESPRESSO

RYE

SPICE

NUTMEG

WHITE THERMOFOIL

Clearfield®



Sunbrook®



Accessories make all the difference.

Personalize your space with decorative details. Add functionality with organization options. **Here's a taste of what we offer. For more inspiration, visit woodmarkcabinetry.com/accessories.**

Hardware Selections

Accentuate your style with knobs and pulls in a wide variety of looks and finishes. Because they're grouped in three price tiers, you're sure to find the perfect piece at just the right price.

Classic Knobs & Pulls



Arched Pulls



Twisted Crescent Pull



Elliptical Knobs



T-Bar Knobs



Button Knob



Rope Knobs & Flat Contour Pulls



Craftsman Pull



Barrel Pulls



Antique Pewter Copper



Oak Leaf Knob & Pull



Beveled Knobs



Bow Pulls



T-Bar Pulls*



Slotted Pulls



Beaded Pulls*



Toggle Knobs



Turned Knobs



Stamped Knobs



Rectangular Knobs & Pulls*



Tab Pulls*



Cup Pulls*



Rounded Cup Pulls*



Sculpted Knobs & Pulls



Rustic Knob & Pull



Reeded Knob & Pull



Twist Knobs & Pulls



Vintage Pulls



Turned Pulls



Elegant Pulls



*Available in additional finishes or sizes

Moldings

Crown Moldings



Traditional Classic Crown (TCCM8) Crown (CM8) Angle Crown (ACM8)



Large Crown (LCM8) Small Cove (SCVM8) Decorative Small Cove Molding (DSCVM8)

Accent Moldings



CCM8 + CBE8 TCCM8 + RM8 SCVM8 + LBM8

Light Rail Moldings



SCLR8 ILR8 TLR8



OGLR8 SCLR8 STLR8

Molding Stacks



MS ACM8 100 MS ACM8 200 MS ACM8 300 MS LCM8 100 MS LCM8 200 MS LCM8 300



MS CCM8 100 MS CCM8 200 MS CCM8 300 MS LCV8 100 MS LCV8 200 MS LCV8 300



MS CM8 100 MS CM8 200 MS CM8 300 MS SCVM8 100 MS SCVM8 200 MS SCVM8 300

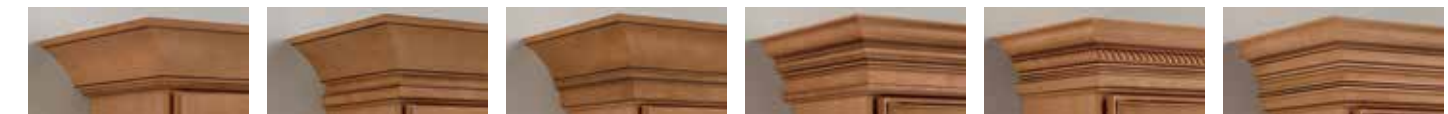

MS DLCVM8 100 MS DLCVM8 200 MS DLCVM8 300 MS TCCM8 100 MS TCCM8 200 MS TCCM8 300



MS DSCVM8 100 MS DSCVM8 200 MS DSCVM8 300 MS XLCM8 100 MS XLCM8 200 MS XLCM8 300

Create a Custom Build-up



Start with a crown molding.



Add a decorative insert.



Add molding below.

Accent Doors and Glass Inserts

Here are some excellent ways to add drama and achieve an open, airy look.



Open Frame Door

Mullion Frame Door

Horizontal Mullion Frame Door

Prairie Mullion Frame Door

Brushed Aluminum Frame Door shown with Woven Glass

Vintage Iron Aluminum Frame Door shown with Havana Glass

Matching Interior comes standard on all glass door cabinets.

Brushed Aluminum glass insert options include Frosted, Frosted Ash and Woven.

Vintage Iron glass insert options include Frosted, Frosted Umber and Havana.



Afton Glass*

Antiqued Afton Glass*

Clear Glass

Derbyshire Seeded Glass

Fincastle Glass*

Antiqued Fincastle Glass*



Frosted Glass

Frosted Ash Glass

Frosted Umber Glass

Havana Glass

Impression Glass

Lucent Glass



Meredith Glass

Mirrored Glass

Radiance Glass

Ribbed Glass

Twilight Glass

Woven Glass

*Fincastle and Afton Artisan Glasses are handmade in the USA

Decorative Accents

Beautiful details like these create a furniture look and add interest for years to come.

Legs and Feet



Chantilly Family

Parker Family

Orlean Family

Yates Family

Corbels



Cove

Narrow Cove

Finley

Prairie

Valencia

Laurel

Furniture Toe Kicks



Decorative

Classic

Floating Shelves



Stand Alone Flat Panel Arched Valance Range Hood with 390 CFM Blower
Choose a vented range hood exhaust fan in one of four blower types: 250 CFM, 390 CFM, 500 CFM or 960 CFM. Recirculating blowers and range hood liners are also available.



Stand Alone Raised Panel Arched Valance Range Hood



Captured Straight Valance Wall Range Hood

Range Hoods

Create an eye-catching focal point with one of our matching range hoods. They drop in easily and add a custom look above any stove or cooktop to make each kitchen unique. Choose a Tapered, Straight or Arched Valance style in a stand-alone or captured configuration.



Captured Tapered Range Hood

Organization Options

Make cooking and cleanup easier by organizing pots, pans, utensils and more. Plus, keep trash tidy and out of sight. Visit woodmarkcabinetry.com for more options.



Base Roll Out Trays



Base Pot and Pan Organizer



Pantry Roll Out Trays



Pantry Door and Swing Out Combination



Sink Base with Door Storage Units and Multi-Storage Shelf



Full Height Base Cabinet with Roll Out Trays



Base Cabinet with Wastebasket Pull Out



Wood Tiered Cutlery Divider



Spice Drawer Insert



Pedestal Drawers



Base Tray Divider Pull Out Cabinet



Base Pantry Pull Out Cabinet



Stackable Furniture Drawers

Get organized.

We've got a place for everything. Use Pinterest to find the custom storage your home needs.



Base Pantry Pull Out Utensil Storage Cabinet

Open and tap for ideas

Choose *your look.*

Selecting your door style is just the beginning. Here are options for paints, glazes and species—all choices that can affect your look in subtle or dramatic ways.

Characteristics of Species

Every material we offer has its own unique qualities and features. Choosing is just one more way you can get the exact performance and look you want.



OAK

Oak has a prominent grain. Light colored stains accentuate the color differences in its open and closed grain areas. Darker stains offer a more uniform appearance.



MAPLE

Maple has a fine grain. An exceptionally hard wood, its natural colors range from creamy white to light blonde to dark reddish brown. Darker stains reduce the natural color variations.



CHERRY

Cherry is closed-grained with occasional pin knots and variations. It ranges in color from pale yellow to deep reddish brown. Stains reveal its subtle variations, which tend to darken over time.



Duraform

Duraform® bonds a coating to composite wood for doors that are highly resistant to warping, heat, humidity and fading. Also durable and easy to clean. Cabinet interior is our standard, sturdy construction. Available in Linen, Silk and Stone.



THERMOFOIL

Thermofoil bonds a thick vinyl film to a warp-resistant engineered wood core for a surface that's durable, easy to clean and resistant to chips and cracks. Standard cabinet interior is a natural wood grain with TuffTech® finish.

Premium Finishes*

Painted and glazed finishes bring a deeper richness and luxury to your cabinetry. These hand-applied finishes vary by style. More intricate cuts will show more dramatic effect.



PAINTED PEWTER GLAZE



PAINTED BOULDER



MAPLE MOCHA GLAZE



PAINTED STONE

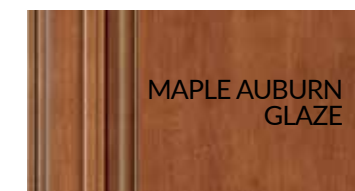

MAPLE AUBURN GLAZE

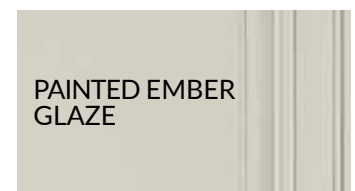

PAINTED EMBER GLAZE

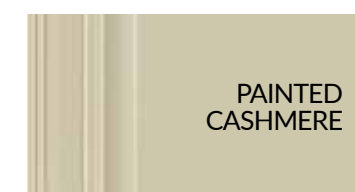

PAINTED CASHMERE

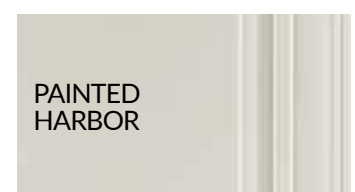

PAINTED HARBOR



PAINTED HAZELNUT GLAZE

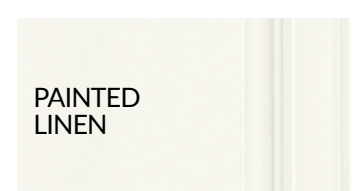

PAINTED LINEN

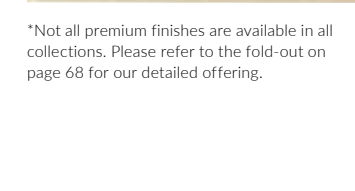

PAINTED SILK

*Not all premium finishes are available in all collections. Please refer to the fold-out on page 68 for our detailed offering.

Good to Know:

- While we try to match wood grains as closely as possible, the variations are part of what make our quality wood products so distinctive and beautiful.
- Over time, exposure to sunlight, smoke and chemicals may cause some finishes to fade or vary from their original color.
- Cabinets purchased at a later date may not exactly match cabinets installed now.
- A door sample may not represent the exact color of the cabinets you receive upon shipment.
- Read all cabinet cleaning agent instructions carefully before using them.

⚠ Warning: Drilling, sawing, sanding, or machining wood products can expose you to wood dust, a substance known to the State of California to cause cancer. Avoid inhaling wood dust or use a dust mask or other safeguards for personal protection. This product can expose you to chemicals, including methanol, which is known to the State of California to cause birth defects or other reproductive harm. For more information go to www.P65Warnings.ca.gov.

Find *your favorite.*

Choose the door that fits your style. Then customize it with paints or finishes to achieve a look that's truly your own. With a little imagination—and the right counters, flooring, lighting and accents—our collections can take on any look you want, from classic to casual to contemporary.



- MacArthur**
 - Full overlay mitered doors
 - Solid recessed panel*
 - 5-piece mitered solid wood drawer front*
- Savannah**
 - Full overlay mitered doors
 - Solid raised panel*
 - 5-piece mitered solid wood drawer front*
- Reading**
 - Full overlay, with 3" frame doors
 - Solid recessed shaker panel*
 - Matching solid wood drawer front*
 - Can be enhanced with optional 5-piece drawer front

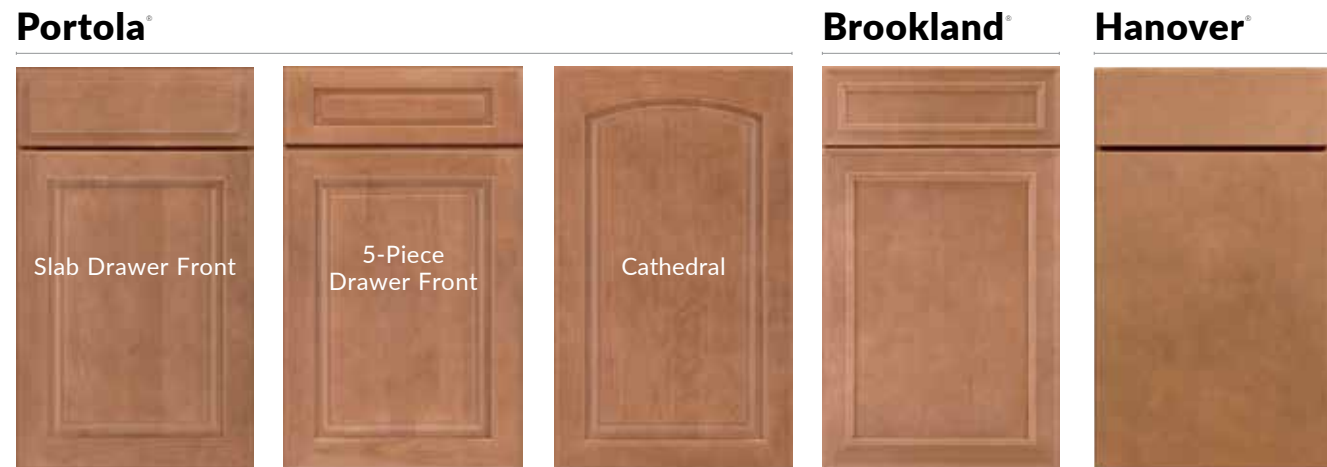

- Portola**
 - Full overlay Cathedral and Square doors
 - Solid raised panel*
 - Matching solid wood drawer front*
 - Can be enhanced with optional 5-piece drawer front**
- Brookland**
 - Full overlay mitered doors
 - Veneer recessed panel
 - Matching veneer drawer front*
- Hanover**
 - Full overlay doors
 - Slab veneer panel with solid wood edge banding
 - Matching veneer drawer front



- Charlottesville**
 - Full overlay doors
 - Solid raised panel*
 - Matching solid wood drawer front*
- Shorebrook**
 - Full overlay doors
 - Solid recessed beadboard panel*
 - Matching solid wood drawer front*
- Del Ray**
 - Full overlay, with 3" frame doors
 - Veneer recessed shaker panel*
 - Matching solid wood drawer front* Full overlay, with 3" frame doors
- Olmsted**
 - Partial overlay Cathedral and Square doors
 - Solid raised panel*
 - Matching solid wood drawer front*



- Newport**
 - Partial overlay doors
 - Solid raised panel*
 - Matching solid wood drawer front*
- Leesburg**
 - Full overlay, with 2-1/4" frame doors
 - Veneer recessed shaker panel*
 - Matching solid wood drawer front*
 - Can be enhanced with optional 5-piece drawer front
- Portland**
 - Partial overlay doors
 - Veneer raised panel
 - Matching solid wood drawer front



- Ashland**
 - Partial overlay doors
 - Veneer recessed panel*
 - Matching solid wood drawer front*
- Atherton**
 - Full overlay mitered doors
 - Recessed panel
 - Matching 5-piece drawer front
- Glen Ellen**
 - Partial overlay mitered doors
 - Recessed panel
 - Matching 5-Piece drawer fronts
- San Mateo**
 - Partial overlay doors
 - Recessed shaker panel
 - Slab drawer fronts

*Painted finishes may blend engineered and natural materials for a more consistent product.

**Not available in Thermofoil

	PAINTED						MAPLE								CHERRY						OAK		THERMOFOIL			DURAFORM®									
	HARBOR	EMBER GLAZE	STONE	BOULDER	LINEN	PEWTER GLAZE	SILK	HAZELNUT GLAZE	CASHMERE	NATURAL	RYE	SPICE	MOCHA GLAZE	COGNAC	AUBURN GLAZE	TRUFFLE	ESPRESSO	AUTUMN	SPICE	BORDEAUX	JAVA	SLATE	HONEY	TAWNY	ESPRESSO	STONE	LINEN	SILK	STONE	LINEN	SILK				
MacArthur®																																			
Savannah®																																			
Reading®																																			
Portola®																																			
Brookland®																																			
Hanover®																																			
Charlottesville®																																			
Shorebrook®																																			
Atherton®																																			
Glen Ellen®																																			
Del Ray®																																			
Olmsted®																																			
Newport®																																			
Leesburg®																																			
San Mateo®																																			
Portland®																																			
Ashland®																																			

Find great *inspiration* and *helpful tools*.

Visit woodmarkcabinetry.com.

See our full selection of accessories and options. Browse our inspiration gallery. View before and after photos. Check out detailed drawings, specifications and sizes. And use PROJECT — our fantastic new visualizer tool — to create your own 3D kitchen designs. It's all just a click away.

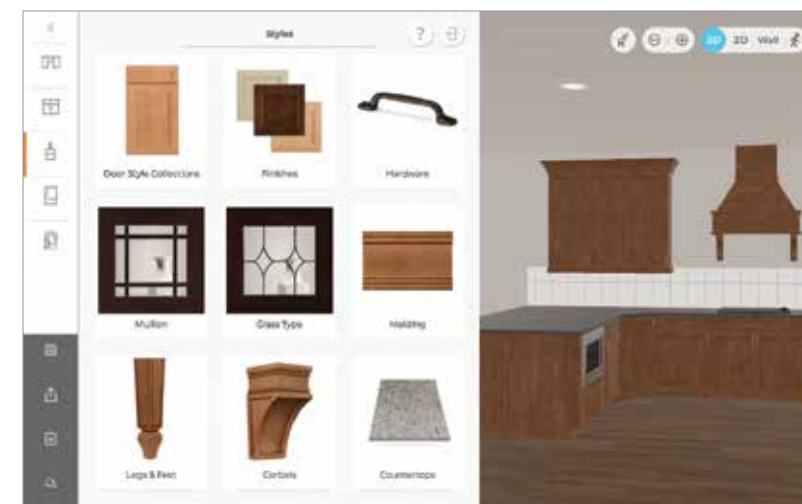
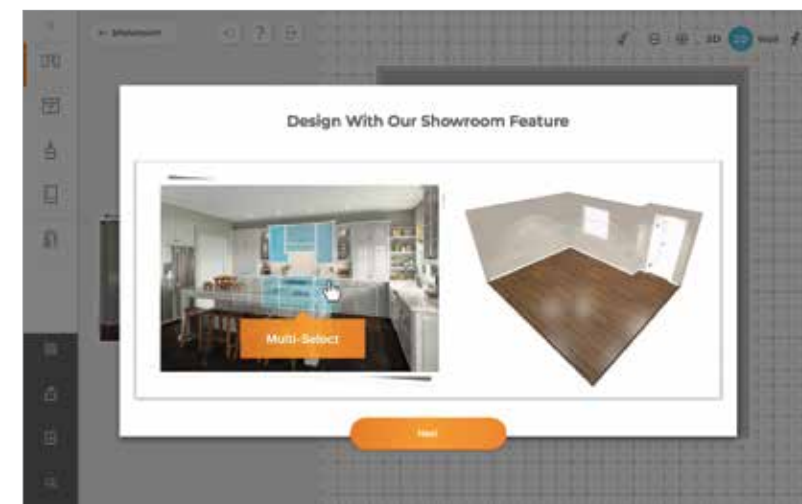
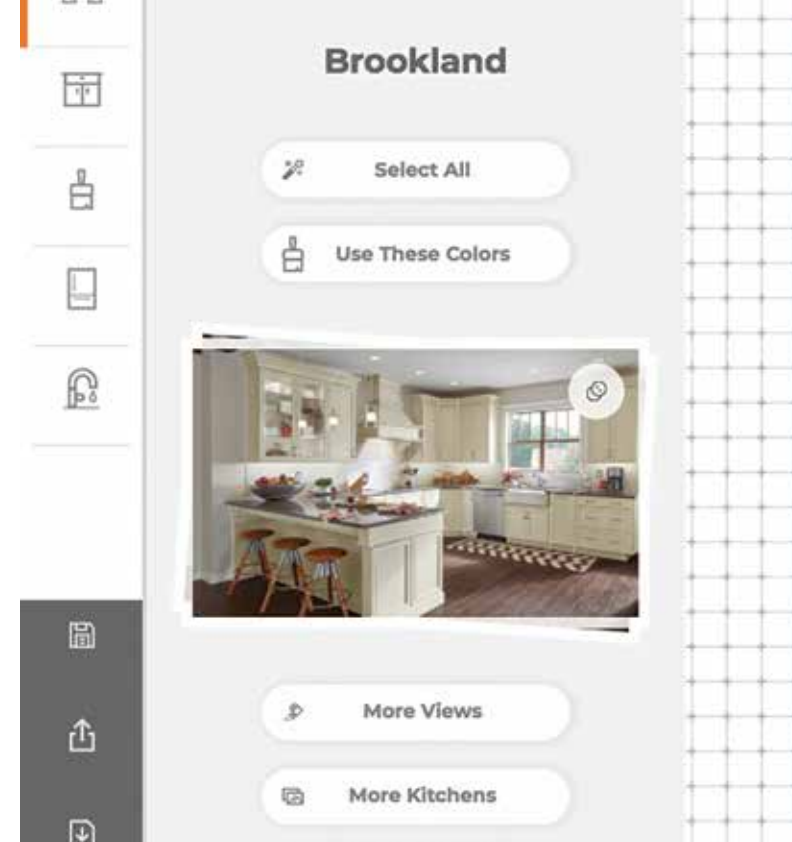

PROJECT by American Woodmark®

With our innovative, simple-to-use visualizer tool, you can:

- Start with our inspirational photos.
- Pick your cabinet style and finish.
- Select your appliances.
- Customize your backsplash, countertop, paint and more.

It's as simple as click and drag to create detailed, 3D kitchen designs. Make as many designs as you want. Save them. Then share them with your local Home Depot kitchen designer – and your friends and family! From your desktop or laptop, visit project.woodmarkcabinetry.com.

Order Samples

Be certain that your favorite cabinet style and color will work in your home. Order a sample and take the guesswork out of deciding. You're also welcome to order sample hardware pieces. For more details and to order, visit woodmarkcabinetry.com/order-samples.

Track Your Order

Check order details and status any time you want at woodmarkcabinetry.com. From the homepage, click "My Order." View order details, content, delivery information and more. And if you ever need to call us, you can reach a real person, 6 days a week during regular business hours.

Visit Us on Pinterest and Houzz!

See what everyone loves about American Woodmark cabinetry. Get great ideas and inspiration.

pinterest.woodmarkcabinetry.com

houzz.com/american-woodmark

Built to last—and to your preferences.

All of our cabinets feature quality construction, as well as options to fit your style and budget. Think about what's important to you. Then talk to a **Home Depot kitchen designer** about what options are best for you.

Keep it Quiet with CushionClose®

Enjoy the whisper-quiet luxury of a complete CushionClose kitchen. With smooth, self-closing performance, CushionClose reduces slams, noise and finger pinching. This unique technology comes automatically on all doors, drawers and roll outs, unless de-selected as an option.



Standard Construction

- 1/2" engineered wood sides with TuffTech® finish.
- Full Access Hidden Glides® System.
- 3/4" thick engineered wood shelving with edge banding.
- Adjustable drawer front with 5/8" dovetail box and plywood bottom.
- Double doweled 3/4" x 1 5/8" hardwood face frame joint.
- 1/2" engineered wood inset toe kick.

Quality Features

- Full Access Hidden Glides® System
- Hardwood drawers with dovetail construction
- 6-way adjustable hinges
- Solid, kiln-dried face frames

Plywood Ends Option

- 1/2" plywood sides.



All Plywood Construction Option

- 1/2" plywood sides, floors and cabinet tops.
- 3/4" thick plywood shelving with edge banding.
- 1/2" plywood inset toe kick.

All Plywood Construction refers to the cabinet box components and shelving as detailed in our specification guide (WoodmarkCabinetry.com/specguide.asp). Plywood components meet the Decorative Hardwoods Association's standards for hardwood and decorative plywood (www.decorativehardwoods.org).

Furniture Ends Option

These thicker plywood sides create a finished, furniture look on exposed cabinet ends and islands. They also make molding wraps easier and save installation time.

Partial vs. Full Overlay Doors

Different looks are achieved by using partial or full overlay. These terms refer to the size of the doors and drawer fronts, which determines how much of the cabinetry frame shows.

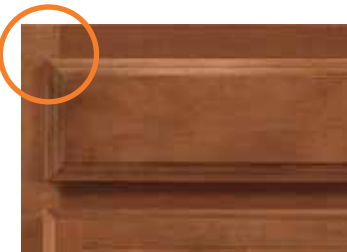

Partial Overlay

In partial overlay (also referred to as standard or traditional overlay), about an inch of the cabinetry frame is visible around the doors and drawers.



Full Overlay

In full overlay, the doors and drawer fronts are larger and cover nearly all of the cabinet framework.

Proud to be KCMA Certified for Quality and Sustainability

All American Woodmark cabinetry meets the rigorous strength, quality and performance standards set by the Kitchen Cabinet Manufacturers Association (KCMA).

We've also received certification by the KCMA Environmental Stewardship Program on all our products. This certification is awarded based on compliance across a broad range of activity, including air quality, product resource management, process resource management, environmental stewardship and community relations.

To find out more about our KCMA certifications, please visit WoodmarkCabinetry.com.



Lifetime Limited Warranty

We want you to be happy with your American Woodmark cabinets, so we stand behind every one with our warranty. Our warranty runs for as long as you own your home and begins upon the date of delivery to you. For details and disclaimers, please visit WoodmarkCabinetry.com and look for Warranty Info located in the About Us section.

Get Built-in Confidence from Our Partnership with The Home Depot®

For over 38 years, we've worked closely with The Home Depot to help remodel America's homes. We're one of their original partners, and our sales force is dedicated exclusively to the retailer.



Customer Care

Call us toll-free at **1-800-677-8182**, Monday through Friday, 8:00 a.m. – 8:00 p.m. or Saturday, 8:00 a.m. – 6:00 p.m. EST.

CustomerCare@AmericanWoodmark.com

Take it **1 step** at a time.

Remodeling is fun and exciting. It also takes time and planning. The best way to make sure things go smoothly is to understand what you're in for. Count on Home Depot as a partner you can rely on for help throughout the process. And check out this guide for approaching your project. While it gives you a good idea of what steps to expect, remember—everyone's project is different!

1 INSPIRATION & EXPLORATION AT YOUR OWN PACE

Dream Big. Live Better

Think about your current kitchen and what you wish you could change. How do you use the space? What improvements would you make? Begin to think about your style. Decide on features you definitely want to have.



Here's a list to get started.

- New Appliances
- More Storage Space
- More Counter Space
- A Baking Center
- A Place to Feed Pets
- A Coffee Bar
- An Eat-In Kitchen
- A Place to Entertain
- A Place to Do Crafts



Get Inspired

Go to woodmarkcabinetry.com to get ideas. Explore social media outlets like Pinterest and Houzz, and watch your favorite home improvement program. Keep a scrapbook and visit your local Home Depot store for inspiration.

Do Research

Have friends, family or neighbors who have remodeled? Ask about their experience. What do they love about their new kitchen? What is their biggest regret? Ask about their cabinets and contractor. And remember to check out Home Depot's Home Services for installation.



Shape Up

As you start your journey, consider your existing kitchen floor plan. Do you want to change it? Will you need to knock down walls, move appliances or windows? You should have your kitchen measured before meeting with a **Home Depot designer**.

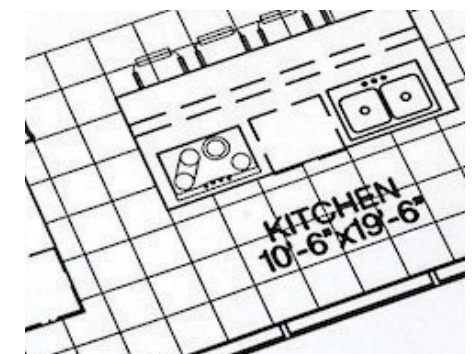

Get Into The Details

Don't forget kitchen must-haves like wastebasket cabinets, roll out trays and cutlery dividers. Decorative accessories add beauty and interest, so consider moldings, range hoods, hardware and glass doors.

2 PLANNING & DESIGN

- Have Your Space Measured
- Initial Design
- Final Design
- Order Cabinets

3 PREPARATION & DEMOLITION

- Product Receipt and Inspection
- Demolition
- Rough In Utilities
- Painting

4 INSTALLATION & FINISHING

- Install Flooring
- Install Cabinets
- Install Countertops
- Install Backsplash
- Install Appliances
- Install Lighting
- Finish Carpentry

Enjoy Your New Kitchen

Olmsted™ Cherry Autumn Square accented with Painted Silk



★★★★★ **“Love them!”**

This is our second house that we used American Woodmark. Both times customer service was great. They have soft close drawers and doors. The finish is perfect and the promos Home Depot offers makes them affordable. We can't recommend them enough. Very good quality. — **Kristine, Londonderry, NH**

★★★★★ **“Beautiful cabinets!”**

We wanted to renovate our kitchen but were concerned that it would be an exhausting process...wrong!! Our kitchen designer, Allie, from the local Home Depot was amazing! She helped me understand the process and I eventually chose the Savannah Maple mocha glaze cabinets for the kitchen. They were ready for delivery in only three weeks and we could not be more pleased!! The Home Depot installer did a great job and these cabinets are lovely!! We are so happy with our decision!! — **Ann, Wellington, FL**

Woodmark AMERICAN®

©2018 American Woodmark Corporation® All rights reserved.
The Home Depot® is a registered trademark of Home Depot, Inc.
09/18 350M Home Depot: AWH96841



KITCHEN CABINET
MANUFACTURERS ASSOCIATION®



American Woodmark has been certified by the Kitchen Cabinet Manufacturers Association (KCMA) for its use of environmentally responsible materials in its cabinetry.

Exclusively At

**Installation
Available**



D29K39483-131

woodmarkcabinetry.com