

# review

ABB Ability

03|2017 en

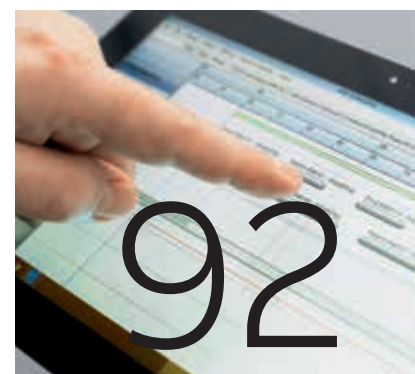

- 
- 06–13 ABB Voices
  - 14–37 ABB Ability
  - 38–67 Protection and safety
  - 68–81 Universal connections
  - 82–97 Control and productivity



84

Electric driven gas compressor control



Readership survey

Emax 2 all-in-one microgrid solution



60



Leading the way to wireless automation



Transforming acceleration: MFT for CERN





99



76

Shore-to-ship power

Emax 2 with Ekip Link  
in DP vessels



54

---

05 Editorial

---

## ABB Voices

08 Interview: ABB Ability™  
13 Cyber security from the ground up

---

## ABB Ability

16 Leading the way to wireless automation  
20 Predictive notification adds value  
26 Project execution in automation  
30 Automating engineering data exchange  
36 Data matters in mines

---

## Protection and safety

40 Circuit monitoring system  
47 Power protection with PCS120 MV UPS  
54 Protection at sea with Emax 2  
and Ekip Link  
60 Emax 2 microgrid breaker solution

---

## Universal connections

70 Transforming acceleration:  
MFT for CERN  
76 Shore-to-ship power

---

## Control and productivity

84 Electric driven gas compressor control  
92 A flexible and easy scheduling tool

---

## Buzzword demistifier

98 Blockchain

---

99 Imprint  
99 Readership survey

---

**The industrial world is at the cusp of transformative change, enabled by digitization and applied to every stage of the operations lifecycle. ABB is at the forefront of that innovation, with an installed base of 70 million digitally enabled devices, 70,000 digital control systems, and 6,000 enterprise-level software solutions. This issue of ABB Review explores how the company's collaboration with its customers gives them the ability to know more, do more, and do it better.**

**Also, please find on the last page the readership survey, which is your opportunity to tell ABB Review how we are doing, and how we can do it even better.**

---

EDITORIAL

# ABB Ability™



Dear Reader,

You will probably have noticed that the present issue of ABB Review is bulkier than usual. Our lead topic, ABB Ability™, is so vital that it merits an extended edition. ABB Ability enables significant gains in uptime, speed, yield, safety and security. The ecosystem includes an open-platform, solutions – both from ABB and third party partners, integrated with an increasing range of digitalized products from ABB and others. This issue of ABB Review has several tangible examples illustrating the platform.

At the beginning of this year, ABB Review was relaunched in a new format, with changes affecting design as well as content. Because your feedback is valuable to us, both in measuring our success and in guiding further development, we invite you to participate in a short survey. This is located on the inside back cover (you might even win a small prize).

Enjoy your reading!

A handwritten signature in red ink, appearing to read 'Bazmi Husain'.

Bazmi Husain  
Chief Technology Officer



# ABB Voices



**What will the future look like? Experts around the world are seeking to answer this question. Not only is ABB a prominent voice in many of these conversations, but it takes the lead by showing the way through real-world action. Digitization and cyber-security are two areas in which the company helps customers see the future right here, right now.**

- 08      ABB Ability™ is changing the way we do business
- 13      Cyber security from the ground up



## ABB VOICES

# ABB Ability™ is changing the way we do business



## Guido Jouret

ABB's Chief digital officer, Guido Jouret explains what the new ABB Ability platform is all about.

Guido Jouret discussed ABB's digital strategy in a previous interview (published in ABB Review 1/2017). In this second interview he talks about ABB Ability.

**AR ABB Review (AR):** In March of this year, the ABB Ability platform was launched at the ABB Customer World in Houston. What exactly is ABB Ability?

**GJ Guido Jouret (GJ):** ABB Ability is a set of industrial solutions that use digital technology. It is also the name of the platform to build such solution. ABB will digitalize its complete range of products and services and use a cloud-based platform built on technology from Microsoft Azure to offer a broad range of analytics and services.

**AR** In what way does ABB Ability go further than previous ABB automation and digitalization offerings?

**GJ** The Internet of Things is often described in terms of individual devices having embedded sensing and processing power, meaning they create data streams. Long before we launched ABB Ability, ABB was already speaking about the potential for leveraging productivity by not leaving data marooned in the field. Continuous progress in digitalization and communication meant this data could be shared to a higher hierarchical level where it was

01



01 ABB's Collaboration Table provides real time access to process data. This is just one example of the many ways in which ABB Ability makes data actionable.



aggregated and analyzed to be made available to managers, for example in the form of reports. What was often still missing was ABB Ability's means to take decisions based on that data in a direct manner. This is what in ABB we call "closing the loop" →1.

Control engineers know about control loops: Process data is fed back to influence actions with minimal latency. Sensor and actuator are in close proximity so that any adverse shift in output parameters can immediately be mitigated. This principle is at the heart of control theory. The loop we are closing with ABB Ability is conceptually similar, but concerns more over-arching decisions relating to operations and maintenance. It looks at higher-level patterns and correlations and has latency requirements that are more generous →2.

**AR** What sort of parameters would such higher-level control loops deal with?

**GJ** The type of control decisions being supported here can range from optimizing maintenance cycles to supporting higher-level management

—

**ABB will digitalize its complete range of products and services.**

decisions that take into account the bigger picture. This means opening the focus beyond the immediate process and looking at the broader situation within the plant and beyond. Management decisions can thus be based on actual real-time information rather than on data that has been collected beforehand – sometimes manually, and often limited in scope or potentially even containing transcription errors. By bridging this gap, the boardroom is increasingly meeting the control room →3.



This opening is occurring in both directions as not only do managers see current data, but decisions can flow back and be implemented immediately. This is the integration of IT (information technology) and OT (operational technology).

One example is the charging of an electric car. Obviously, the car and the charger need to talk to one another, for example for purposes of billing

—  
**Just as devices within the same system exchange information, clouds will exchange information regardless of manufacturer or architecture.**

the electricity, but also to ensure the battery is charged with the appropriate voltage and current and that the device disconnects when the battery is fully charged. This is the basic functionality of such a system. But moving beyond that, it also makes sense for the charger to talk to the grid. For example, the charging rate can be temporarily reduced if insufficient power is available and there are other consumers with higher priority.

Another example could be in discrete manufacturing: Managers might see that the delivery of a vital component has been disrupted upstream. Rather than running a downstream process at full force until a component unexpectedly runs out, this process be scheduled differently to mitigate the disturbance. The delay can be bridged by shifting production to a different product for example. Similarly, if a disturbance further downstream is detected, there may be more meaningful ways to use a given resource than manufacturing parts that cannot be consumed.

**AR** In the past, manufacturers sought to lock in customers and lock out competitors by creating proprietary standards. More recently, interoperability has become the prevalent policy. ABB supports standards such as IEC 61850 (for substation communication) assuring interoperability of devices from different manufacturers. The age of proprietary solutions on a system level is largely history. But what about the cloud level? Will we see history repeat itself with manufacturers attempting to lock out competition?

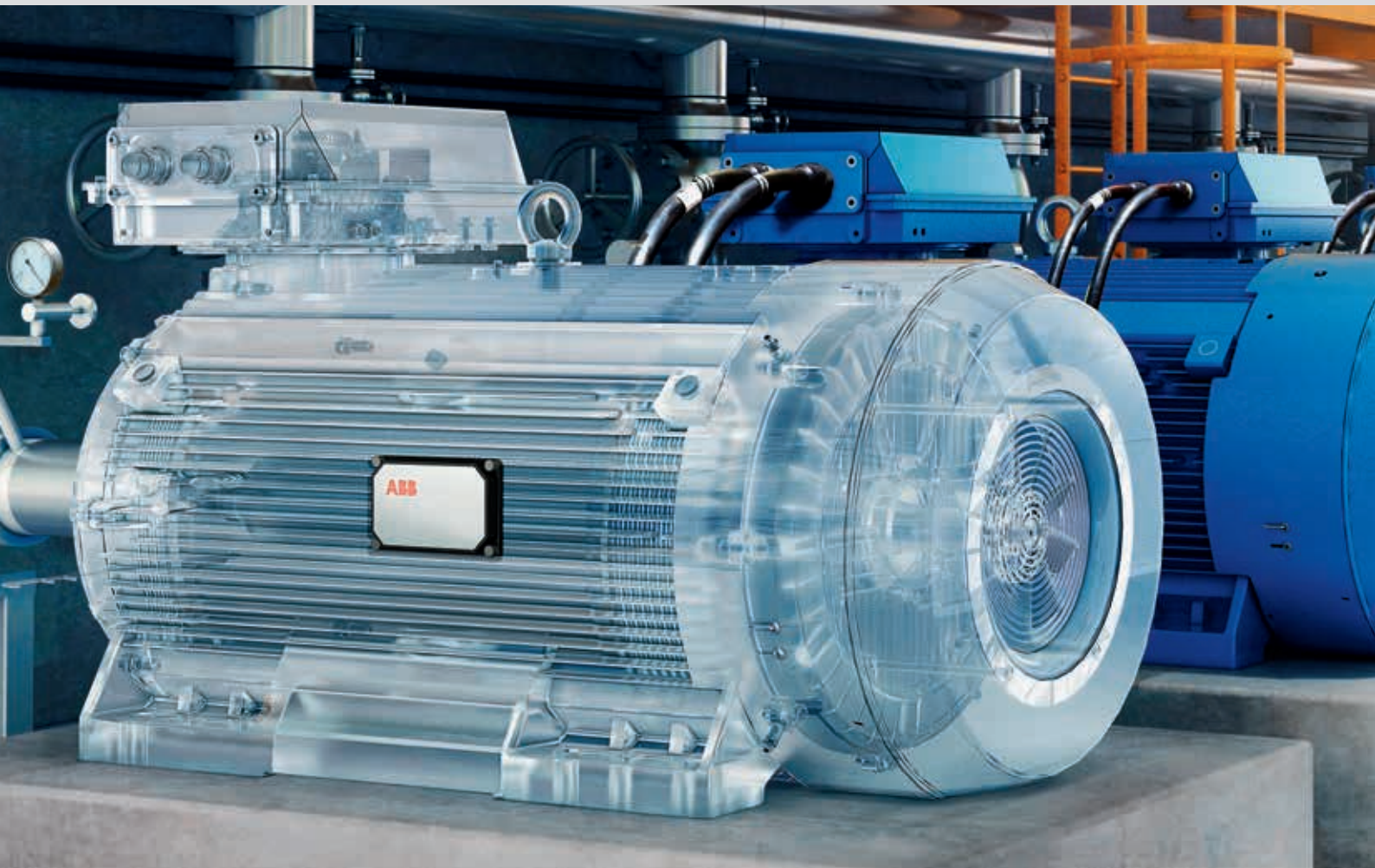

—  
02 Just as the closing of traditional control loops is about feeding back process data to influence ongoing decisions, ABB Ability is closing similar loops in operations and maintenance.

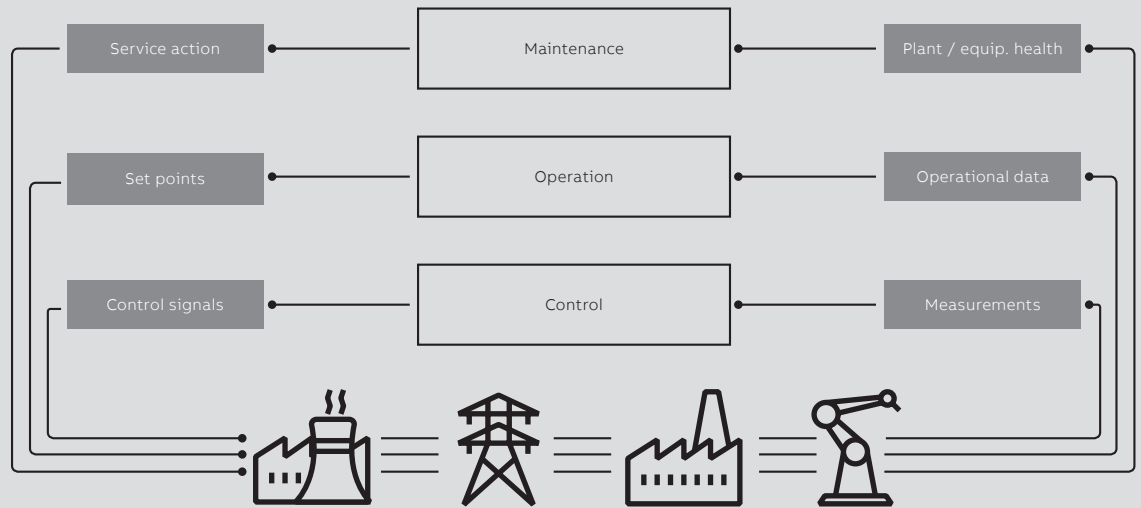

02

**GJ** On the contrary. Rather than chasing a bigger share of today's automation pie, we need to look at the vast potential there is for growing the pie.

Just as devices within the same system exchange information, clouds will exchange information regardless of manufacturer or architecture. We can thus talk of the "intercloud" in which entire clouds exchange information and collaborate →4.

**AR** The examples discussed previously pertain to data being shared within a customer organization. What about data being shared with ABB?

**GJ** ABB can analyze data and predict failure modes, advising customers about maintenance, or depending on the arrangement in place, taking action. In a way, it could be interpreted that ABB is hurting its own business by doing this. If better maintenance is extending the life of, for example, a motor, we may be missing out on the opportu-

—  
ABB's offering and market presence will shift away from selling equipment and towards selling services.

nity to replace it. But we need to see the bigger picture here. ABB's offering and market presence will shift away from selling equipment and towards selling services.

Besides maintenance, the customer is also benefiting by giving ABB a better understanding of its operations. For example if ABB understands how the customer is using a robot by looking at typical load cycles, ABB will be able to design the next generation of robots to better meet those needs.



—  
03 Smart sensors monitor the health of low voltage motors.

—  
04 Development of digitalization.

04a Traditional automation and digitalization relies on computing power that is located locally, often using proprietary hardware and software. This pre-cloud level of automation is sometimes called the “fog”.

04b Connecting these systems to the cloud can enable more advanced algorithms taking into account a broader base of data, leading to greater optimization and performance.

04c Different clouds from different manufacturers collaborate in the Intercloud.

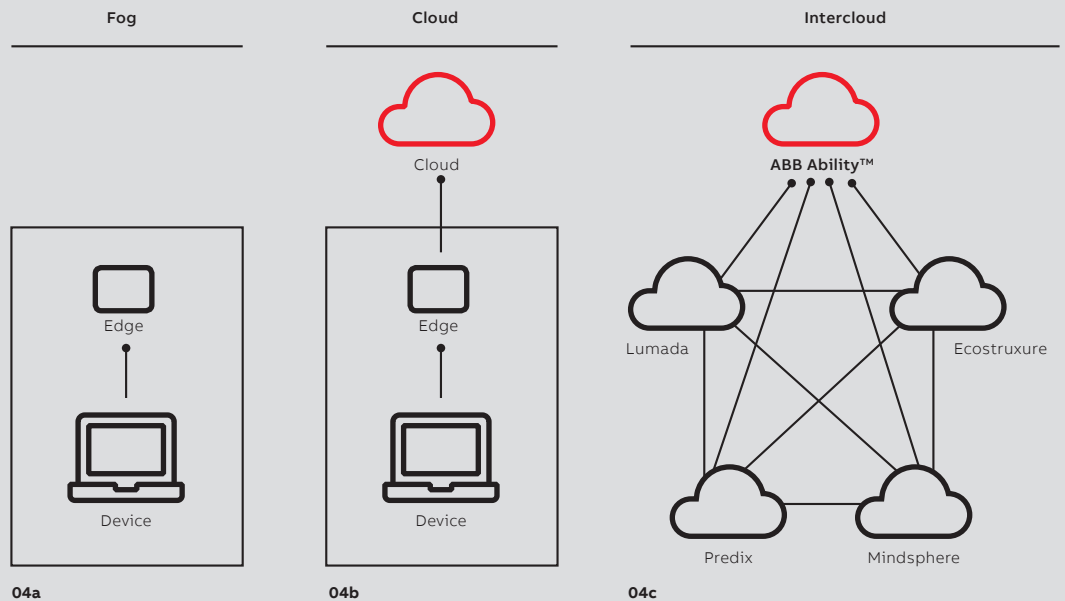

**AR** So the more data a customer chooses to share, the more the customer also stands to benefit. But won't the increased reliance on the cloud also make customers vulnerable?

**GJ** That is a very important question. We can already observe that more and more robots have cameras, for example Yumi. As a next step we will probably also see microphones becoming widespread, both to respond to human commands but also to

—  
**The IoT Data Bill of Rights will codify fundamental rights concerning data.**

increase the overall sensory awareness of robots. Access to these devices can pretty much provide eyes and ears into otherwise restricted areas of a factory. A customer might see trade secrets at risk, and also proprietary information such as production data. Let us take for example a manufacturer of high-end sports cars. A robot on that production line can provide an accurate measure of the number of any given model that has been produced. If such data should, whether through malice or by accident, fall into the hands of a competitor, they might gain an unfair market advantage.

**AR** So there is a conflict here between the advantages a customer can gain from sharing data, and the risks the customer is exposed to from sharing that data.

**GJ** What we need here is a sort of Bill of Rights. Just as the original Bill of Rights is about restricting a government's ability to take adverse actions against its citizens, the IoT Data Bill of Rights will codify fundamental rights concerning data.

ABB has already produced a first draft of such a document and is presently seeking input from customers on it. It is important to us that this document will not be drafted by lawyers but will remain in a form that is easy to understand by all. The bill will form a fundamental understanding between ABB and its customers, and will be at the heart of all dealings between ABB and its customers.

Important elements of this bill include:

- What data does ABB gather from its customers.
- Why does ABB need it.
- How does ABB secure it (via technology and policy).
- How do customers benefit from these practices.
- What ABB will do with somebody's data if they choose to stop being a customer.

In format and concept, the IoT Data Bill of Rights could draw inspiration from such things as the US government's highly effective Airline Passengers' Bill of Rights, which protects airline passengers from long waits on the tarmac, hidden fees, being kept in the dark about reasons for delays, no access to water or lavatories, and bag-check fees for luggage that ends up lost, among other guarantees.

We look forward to discussing this with customers.

**AR** Thank you for this interview ●

---

 ABB VOICES

# Cyber security from the ground up

ABB, being a large company spanning multiple continents, required one person overseeing the entire portfolio of security, product and information systems. To strengthen the existing cyber security teams ABB created the position of Chief Security Officer, which ensures the company has one view on security internally and externally.



**Satish Gannu**  
ABB Industrial Automation  
San Jose, US

cybersecurity@ch.abb.com

I recently joined ABB as the Chief Security Officer. In this role, I oversee the security of all products, services and information systems. My background is in computer programming and I'm pleased to be bringing nearly 30 years of security and analytics experience to ABB.

Through these last few months, I have noticed that the threat landscape is subject to greater fluctuation and it is becoming more vital to secure the industrial world. The three big reasons for these challenges have been the evolving nature of threat actors, increased exposure of security vulnerabilities and integration of information technology (IT) and operational technology (OT). In addition, historically, our industries haven't given great thought to securing the protocols. As an industry this is becoming more essential and efforts to achieve this must and are being made.

We all know the adage that security is only as strong as the weakest link and recent attacks prove this again and again. Hence, security has to be looked at holistically which also includes physical security.

When it comes to critical infrastructure, attackers work at it from all angles for many months or years. The recent attacks on the Ukrainian power network are a tangible reminder of both the priority and preemptive design that must be given to cyber security to prevent future attacks on industry.

---

## ABB is taking the defense-in-depth approach to security.

What is being learned from attacks is that security is no longer just about protecting the perimeter. Because that is no longer enough, at ABB we are taking the defense-in-depth approach to security. All products, services, cloud deployment and even our suppliers need to meet minimum cybersecurity requirements. Our Ability platform is built with security from the ground up.

Future ABB Review articles will be going into greater details on ABB's approach to cyber security. ●





# ABB



# Ability





The promise of industrial processes informed by big data is well known, yet integrating those information insights into direct action in the physical world – “closing the loop” – is an emergent opportunity, especially for mission-critical industries. ABB’s leading R&D identifies these possibilities, and the company’s decades’ worth of operational experience informs what it brings to them.



- 16 Leading the way to wireless automation
- 20 Value-based predictive notification improves production and performance
- 26 The future of project execution in automation
- 30 Collaboration Manager automates engineering data exchange
- 36 Data matters in mines



## ABB ABILITY

# Leading the way to wireless automation

Can wireless standards meet the performance requirements of fieldbuses, and thereby deliver the wireless automation future? An ABB research team set out to find the answer.

**Johan Åkerberg**  
Principal Scientist,  
Adj. Professor  
ABB Corporate Research  
Västerås, Sweden

johan.akerberg@  
se.abb.com

**Tilo Merlin**  
Manager New-Technologies  
ABB Germany

tilo.merlin@de.abb.com

**Stefan Bollmeyer**  
R&D Technology Manager  
ABB Germany

stefan.bollmeyer@  
de.abb.com

Factories around the world have been wired for automated controls since the 1970s (digital communication was introduced in 2000s), enabled in large part by standardized communication protocols, called “fieldbuses”, that allow for access to large scale production systems. Somehow, the promises of fieldbuses, such as easy and reliable deployment, use, maintenance, and issue diagnoses have not paid off, as still many installations run on analog 4..20 mA technology, even with smart sensors and actors.

Since wireless devices are around us everywhere, why not use radio communication technology to bypass shortcomings resulting of any wired installations, such as the effort of planning and installing cables, shielding and grounding issues to prevent EMC problems, the lack of flexibility in layout, and complexity in engineering?

01





—  
01 The Iggesund Mill  
(Image courtesy of  
Holmen, photo by Rolf  
Andersson, Bildbolaget)

Transitioning to that future will be a challenge, mostly because of the use of competing standards for wireless field devices that were introduced in the late 2000s (mainly for monitoring appli-

—  
Controlling large-scale industrial processes poses new requirements on the current wireless standards, which need to provide determinism and reliability on par with current fieldbus standards.

cations), and the simple fact that also a wireless fieldbus must operate reliably within explicit performance boundaries. For instance, the lag consumers are accustomed to tolerating in updating a smartphone screen could cost a manufacturer time, money, and even customers.

### The wired vs. wireless challenge

The ABB team tasked with the research project knew that the current wireless standards presented many performance characteristics that needed to be challenged when addressing control applications:

**Timeliness.** Controlling large-scale industrial processes poses new requirements on the current wireless standards, which need to provide determinism and reliability on par with current fieldbus standards (for example, qualify for use in sub-second closed loop control of safety-critical equipment). Timeliness also means that any extension of wired fieldbuses need to be commissioned, deployed, maintained and diagnosed in a simple and efficient manner.

**Visibility.** Since there are some installations where parts of a plant are controlled based on instrument readings using current wireless standards, it's vital that control engineers know how data have been gathered and delivered. This is especially true when control algorithms have been modified to compensate for the additional uncertainties and delays commensurate with existing wireless tools. Deployment of some kind of data identification is required in the control system in order to prevent using the wrong algorithm(s).



---

## THE DIVERSITY OF TODAY'S INDUSTRIAL WIRELESS PROTOCOLS

Industrial wireless sensor networks have been around for a number of years. Three standards dominate the automation market: Wireless HART, ISA 100.11a and WIA-PA. The Wireless HART standard, released in 2008, currently has the largest installed base, and all three are based on the same underlying 802.15.4 technology. The main applications for these standards are for process monitoring, but they can also be used to deliver sensor measurements for slow and non-critical process control.

There are many similarities among the three standards, but also some key differences. All three standards rely on the underlying physical layer of IEEE 802.15.4 that provides 250 kbit/s on 15 globally allowed channels in the ISM band, for instance.

One area of differentiation is in the standards for TDMA slot lengths (variable or fixed). Another is frequency hopping, as WirelessHART uses a fixed channel hopping table, but ISA 100.11a and WIA-PA have multiple channel hopping tables including the one used by WirelessHART.

From a topology perspective, they all use mesh networks, but WIA-PA uses distributed cluster heads that differentiate from the other two standards. When it comes to routing of packets, WirelessHART and ISA 100.11a use graph routing and source routing. WIA-PA uses a slightly different strategy due to the use of cluster heads, namely a mesh start routing approach since the field devices are organized in clusters. The real differences emerge in node addressing. ISA 100.11a uses IP addressing, and the others use their own proprietary solutions.

---

**Responsiveness.** Some of the most obvious limitations of the current standards are the lack of support for actuators and use of fail-safe states. For instance, having a TDMA layer instead of a CSMA doesn't guarantee predictable and consistent error detection on system level. In the same

—

**Any wireless network should self-heal without dropping packets, as the current redundant fieldbuses do.**

way, the self-healing properties of today's mesh networks are neither proactively nor reactively able to recover from link or network failures within the required deadlines for critical control applications. Any wireless network should self-heal without dropping packets, as the current redundant fieldbuses do.

**Delineation.** Another important characteristic that is missing in the current wireless standards is the ability to distinguish between real-time data and best-effort data. Device configuration data has to be end-to-end acknowledged before real-time communication can be used for control; otherwise, dangerous situations can occur since there are no guarantees that the information transmitted can be trusted or is properly scaled. On the other hand, real-time data for control loops may be outdated when queued together with best effort data. None of the current wireless standards provides real-time functionality as the fieldbuses do.

Based on the analysis of the current wireless fieldbus standards, ABB implemented improved stack layers on top of IEEE 802.15.4 in order to overcome the shortcomings. Tests in the lab showed such promising results that the idea was born to verify the approach in a running process plant. Iggesund Paperboard shared the innovative spirit and agreed to support such a field trial.

### From modeling to reality

Iggesund Paperboard makes two of the world's leading paperboard brands, Invercote and Incada. Its Iggesund Mill →1, located approximately 300 km north of Stockholm, Sweden, began operations in 1916, and is now one of the most advanced, fully integrated pulp and paper mills in the world.

The field trial phase was designed to be very short; it lasted little more than six weeks. ABB collaborated with its partner to design test criteria that helped ensure the accuracy of the results while minimizing interference with the plant's operation; for instance, operators were not noti-

—

**Also missing in the current wireless standards is the ability to distinguish between real-time data and best-effort data.**

fied when data were being transmitted wirelessly, so the data from the historian server provided an objective comparison between wired/wireless performance, instead of relying on the gut reactions of humans to the novel technology in their plant.

Specific technical details tracked in the test illustrate any trade-offs between TDMA slot length, transmission rate, and level of redundancy, along with an overall expression of availability (e.g. the number of communications failures) and end-to-end latency.

The setup involved three wireless control loops (temperature, flow, and pressure) utilizing three wireless instruments and actuators, connected to System 800xA via a Profinet IO-enabled gateway. The control loops are executed in ABB's AC800M Controller at a 250 ms period. The production system operated in batch/sequence mode, feeding information to ABB's system for full integration (thereby keeping the operator environment unchanged).

#### **The findings**

**Pressure control.** The performance of the pressure control loop quickly responded to process disturbances introduced by the sequence control in the batch process, and was stable in a fully wireless control loop.

**Flow control.** The flow controller was also stable but was subject to fewer process disturbances compared to the pressure controller. Only during the cleaning sequence at the end of a batch larger disturbances had to be controlled.

**Temperature control.** From a safety perspective, the most challenging control loop is the temperature controller since it injects high pressure steam into the boiler. From a control perspective it is the least challenging control loop.

**Latencies.** The average latencies for real-time and non real-time traffic showed that, when similar transmission and retransmission strategies as the wired fieldbuses were used, the latencies of the delivered real-time packets were small and had minimal variations.

**Packet loss.** During the measurements, only single occasional packet losses occurred, and the failsafe mechanisms were not triggered by three consecutive packet losses. Only three real-time packets were lost during an eight hour measurement period, which is comparable to current fieldbuses.

One final assessment from the feasibility study was to ask the operators if they could see any difference either in the control performance or the final quality of the material from the batch process. After carefully studying the data from the historian, they concluded that they couldn't.

#### **The transition to wireless**

The ABB feasibility study indicated that, with a carefully designed wireless protocol stack, it is possible to use a standard IEEE 802.15.4 radio transceiver, a real-time operating system and a stack designed for control applications to control a small part of a production plant. Perhaps more important is the finding that it is possible to achieve performance levels up to par with PROFIBUS or other modern fieldbuses.

ABB's research revealed important areas for future exploration, as it continues its work leading the way to wireless automation. ●

---

 ABB ABILITY

# Value-based predictive notification improves production and performance

ABB's technology-enabled services use predictive notification in a value-based service strategy for industrial producers. Predictive notification with the right people in the right place protects and enhances production, equipment availability, process performance and product quality.

**Dave Biros**

ABB Industrial Automation Service  
Westerville, United States

dave.biros@us.abb.com

**Kevin Starr**

ABB Oil, Gas and Chemicals  
Westerville, United States

Kevin.starr@us.abb.com

**Patrik Boo**

ABB Industrial Automation Service  
Houston, United States

patrik.boo@us.abb.com

Notifications are ubiquitous. Our smart phones receive notifications from “apps” informing us about appointments, software updates or even stock performances. We clearly think that notifications make our lives better. Why then are notifications not used routinely to improve industrial processes? The answer is because notifications tell us what has already happened. In an industrial setting, that could be a costly equipment failure. What if we could accurately predict what will happen, and send notification with enough time to act to avoid negative events, and exploit positive ones?

---

ABB has 137 expert service engineers utilizing advanced digital services to bring over \$60 million in value to its customers.

ABB has 137 expert service engineers utilizing advanced digital services to bring over \$60 million in value to its customers. ABB's experts evaluate predictive notification, identify problems and develop predictive maintenance programs based on value to deliver optimal advanced services in real-life industrial settings →1.

**Historical perspective on predictive strategies**

ABB recognizes that proactive service strategies with predictive notifications would be valuable to producers. Not only can failure be avoided and equipment maintenance improved, but the addition of a value-based predictive notification program also improves industrial processes. ABB experts have evaluated the problems with predictive strategies in the past.

Indicative strategies developed in the 1950s and 60s are still used today, such as when bolt-on machinery and software measure properties on-line to enable more and better products to be produced faster.

The earliest predictive control algorithms were developed during the 1970s and 1980s, setting the stage for software to eliminate the need for physical measurements. The resulting capabilities translate to a level of sophistication and sensitivity impractical for use beyond academia.

A practical, yet expensive, predictive method, condition monitoring, developed in the 1980s and 90s, detects impending equipment failures and notifies personnel to act. This is, however, expensive to deploy.



01

—  
01 The right people receive and act on predictive notification.

—  
02 Criticality ranking.

Nowadays, industrial producers contract with companies to regularly come on-site, make measurements and ensure that mechanics operate within set ranges. Although cost-effective, this strategy does not eliminate catastrophic failures, which occur between service visits.

Another problem faced by suppliers is a loss of talent. Cost pressures lead producers to reduce process-engineering staff. In advanced economies, many experts are approaching retirement.

Level	Effects (any of the following)
A	Loss of life, body part or lost time accident. Unit shutdown, immediate penalty cost. Regulatory non-compliance. Equipment damage over \$ 100,000.
B	Personal injury. Definite loss of production. Probable penalty cost or personnel injury. Equipment damage > \$ 10,000 and < \$ 100,000.
C	Could lead to personnel injury. Possible loss of production. Could lead to penalty cost. Possible equipment damage < \$ 100,000.
D	No risk of personnel injury. No effect on production. No regulatory non-compliance. Equipment damage < \$ 10,000.
Minimal	No effect on production. Repair costs < \$ 1,000.

02

For service strategies to be successful, expertise must be maintained.

A final roadblock to predictive notification is the reluctance to use remote-enabled technologies in industrial settings. Producers, fearing that

—  
**ABB developed a stepwise approach to achieve effective application of predictive notification with challenges in mind.**

someone could induce failure, are hesitant to allow remote connection to process control systems. Improvements in secure communications and cyber security safeguards reduce apprehension, yet industrial producers remain reluctant.

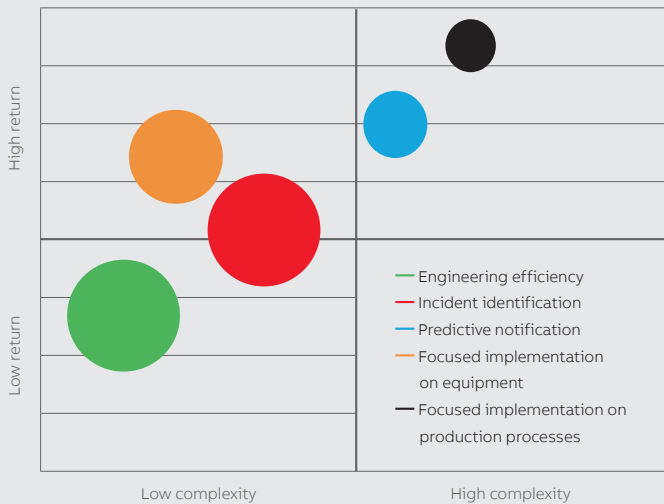

Note: Circle size is proportional to sample population surveyed

03

### The path to predictive notification

ABB developed a stepwise approach to achieve effective application of predictive notification with challenges in mind. First, choose the equipment or processes for which conditions should be predicted. Second, expedite expertise through identification, sorting and prioritizing of problems to provide guidance. Third, assess the value of digital services, which maximizes ease and value of improving equipment services and processes.

- Choose what to predict: A producer must select the specific facility's equipment and processes for which predictive notifications are to be received. A criticality analysis of equipment and processes will determine what could happen if something were to go wrong, and how that would adversely affect plant performance. A criticality ranking is applied to equipment or processes, ranging from the biggest safety production or cost impact, to the smallest →2.
- Expedite expertise: Many producers contract for condition monitoring, which means expertise depends on the person providing the service. Knowing how to capture an expert's knowledge, and deploy it in easy, repeatable ways leads to effective completion of time-consuming elements of the job.
- Assess the value: Primary value areas were identified in a sample of 111 industrial producers located in North America, South America, Europe, Asia, the Middle East, and Australia and comprising a variety of processes (cement, chemicals, mining, metals, oil and gas). ABB identified and measured the value delivered by digital services, including predictive notification →3:

### Digital services values

**Engineering efficiency:** The goal is to reduce diagnostic troubleshooting time by gathering and processing high volumes of production data. Value is reached by performing diagnostics faster. Producers easily understand the value, yet returns are lower than those of other values.

**Incident identification:** Rapid identification of incidents, such as equipment failures, is made through automatic analysis of high volumes of

—  
A criticality ranking is applied to equipment or processes, ranging from the biggest safety impact, production or cost, to those with the least.

data. Producers easily recognize the value of this service, characterized by a moderate return, and yet it is more difficult to achieve than other values. ABB collects and categorizes the data into key performance indicators (KPIs) →4. The KPIs are tracked using main indicator bars that increase as the subset bars increase, representing prioritized collections of discrete events that need attention.

— 03 Digital services are represented according to value and relevance to the sample population as indicated by the size of the plot points.

— 04 Pareto charts of KPIs from an operator interface.

Focused implementation on equipment: Values are obtained from improved equipment performance to identify an improvement opportunity. An enhancement is then performed quickly and efficiently, resulting in a high return. Delivery of this value can be complex, but original equipment manufacturers (OEMs) can usually achieve this value relatively easily.

Predictive notification: The goal is to expeditiously analyze, identify and categorize discrete events to produce patterns that predict failures, then alert personnel to take action rapidly. This value has moderate complexity, and yields a high return.

Focused implementation on equipment and focused implementation on processes rely on information delivered through predictive notification. These three service strategies address the overall equipment or process design, or maintenance path, to avoid repetition of negative events, making equipment and process availability optimal.

— **Predictive notification: The goal is to expeditiously analyze, identify and categorize discrete events to produce patterns that predict failures.**

ABB's assessment shows that providing a predictive notification to personnel, with a recommended action, results in an action taken. The beauty of implementing these service strategies together is that the response will likely produce a high value.

Focused implementation on the process: The aim is to optimize production, quality, or cost to produce results. The value derives from using services to identify improvement opportunities, and assigning the right skill to deliver services to improve performance. The value can be complex to deliver, yet has a high return. This is the hardest value to achieve, and is realized by a smaller population of producers.

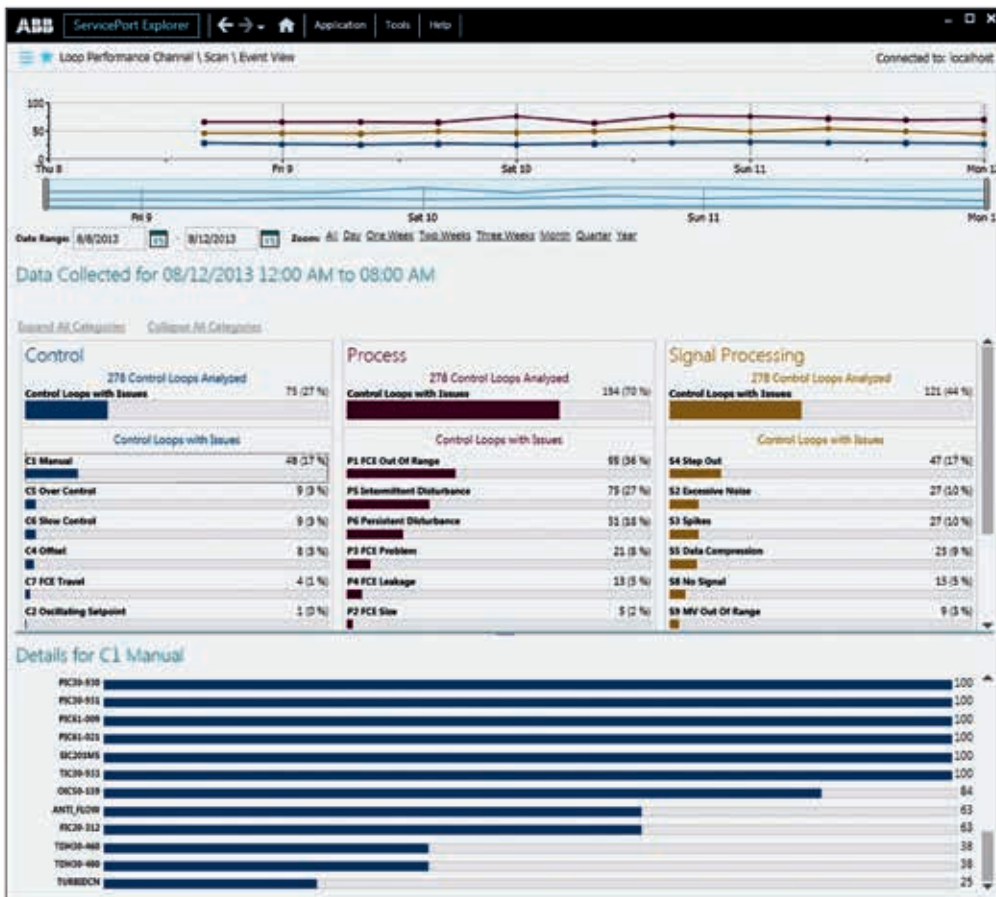

**Case study**

A plant in the United States manufactures products for food and beverage consumption, relying on quality. The plant uses quality control systems (QCSs) to operate machines and advanced digital services for early detection of potential QCS issues. Predictive notifications are provided to help the plant identify and mitigate problems that could cost millions of dollars in lost production.

**Application**

The digital services utilized by this plant automatically gather and analyze data from the QCS, present views of KPIs that help identify variables that impede productivity, and provide recommendations for action. These services identify, categorize and prioritize opportunities to improve equipment availability, process performance and product quality through visualization and analysis of instrument stability, control utilization and process variability. Service engineers address problems on-site and remotely.

Users view, analyze and scan data to produce a summary of KPIs ranked by severity; events are tracked, by setting parameters for KPIs that create customized displays of occurrences that fall outside parameters. KPIs that track outside predetermined parameters trigger predictive notifications →5.



05

**Notification**

Service engineers track KPIs by setting predictive notification parameters that notify if an instrument reading exceeds parameters. An engineer at this site received a predictive notification before arriving at work on a particular day, alerting him that the threshold for an instrument had been exceeded.

Once at the plant, the engineer investigated the issue using data views. A large bar in a Pareto chart on the display confirmed that an instrument's limits have been exceeded. The engineer studied the raw data view and the severity levels to verify the extent of the problem, and determined the necessary action to avoid downtime. The replacement of an instrument was scheduled during a planned outage.

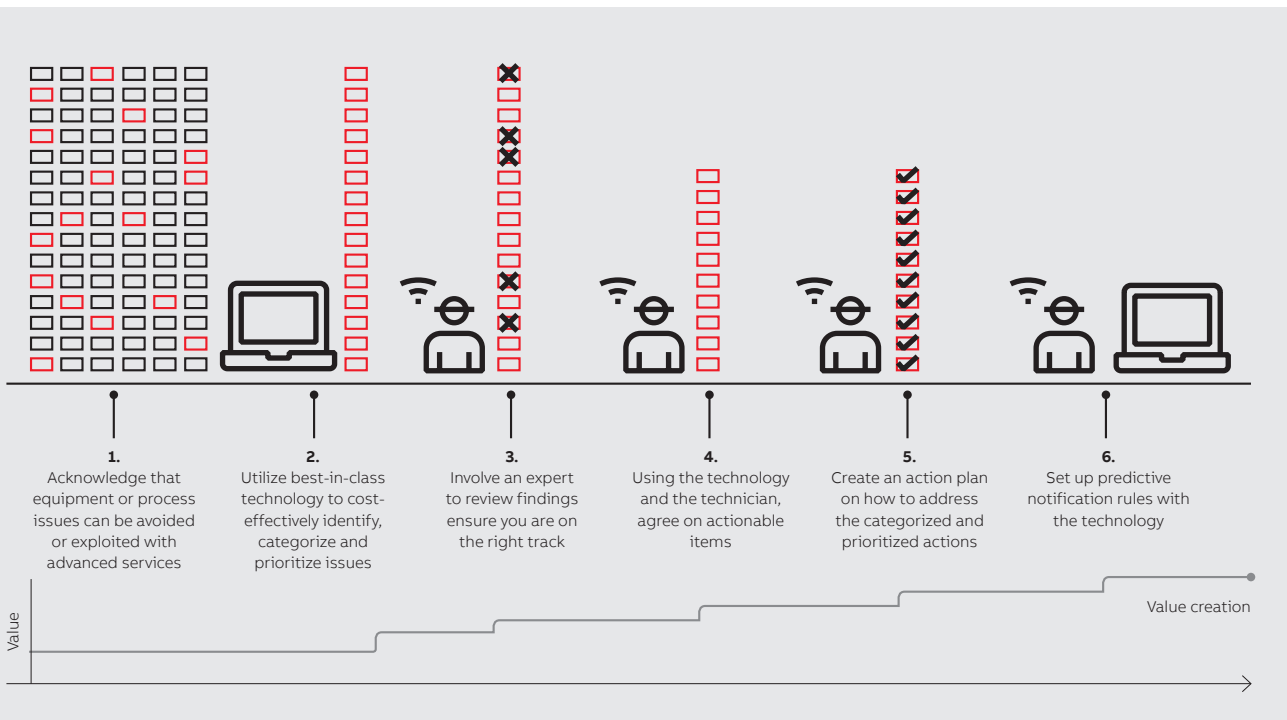



—  
05 A predictive notification sent as an email that prompted an ABB engineer to act and avoid unplanned downtime.

—  
06 A well-designed predictive notification program that focuses on high-value actions.

—  
07 Rules established for the predictive notification program.

—  
**Reference**  
[1] Biros, D., "Are you on track? How Predictive Notification keeps production on track," ABB White Paper, p. 18, 2015.

**Mitigation**

An emergency instrument replacement would have led to lost production, a costly event. The action taken by the engineer after receiving the predictive notification mitigated quality losses and unscheduled downtime of more than \$100,000. The plant continued to have high equipment availability, stable processes and good quality.

Digital services that use predictive notification are the most effective form of delivering advanced expertise in today's production environments.

**Preparing a predictive program**

ABB established a technology-enabled predictive notification stepwise program to successfully deliver advanced services that improve equipment availability, plant performance and product quality →6:

- Agree that equipment or process issues can be avoided or exploited accurately and cost-effectively with digital services. No value can be achieved if a producer does not believe problems can be mitigated through digital services.
- Use best-in-class technology to effectively identify, categorize and prioritize issues. Suppliers have different capabilities and specializations such as equipment areas, production or business processes, and industry equipment. Producers must identify suppliers who can provide the best technology and applications for the plant's equipment and business processes.

- Involve an expert to review findings to ensure that preparation is on track. Producers should have access to experts who are knowledgeable and experienced. They ensure that value-added KPIs are used to develop effective predictive notifications. For many, this knowledge can be found among OEMs.
- Agree on actionable items using the technology and technician. Once the best available technology and the most value-added KPIs are chosen, agree on actions to take when parameters are exceeded. Producers should collaborate with those who will take actions to ensure commonalities.
- Create an action plan to ensure the agreed-upon actions can be taken quickly and efficiently when parameters are exceeded and a predictive notification has been sent. Determine who will act; what will be done; where will it be done; where are the tools and/or parts; when will the action occur. The action will be taken.
- Set up predictive notification rules. Use the analyses, issues and processes, and KPIs, and establish thresholds that will drive the action →7.

Digital services are the most effective form of delivering advanced expertise in today's production environments. Predictive notification of impending issues provides producers with the primary value opportunity to improve equipment availability, process performance and product quality. Nonetheless, even the best digital services and predictive notification are only meaningful if the right people in the right place receive the notifications and act. Only then can digital services and predictive notifications truly make lives better. ●





ABB ABILITY

# The future of project execution in automation

Automation projects have employed controller-centric distributed control system (DCS) architectures for decades. This approach creates dependencies between project tasks that complicate late changes. ABB's new I/O solution will make late and overbudget automation projects a thing of the past.

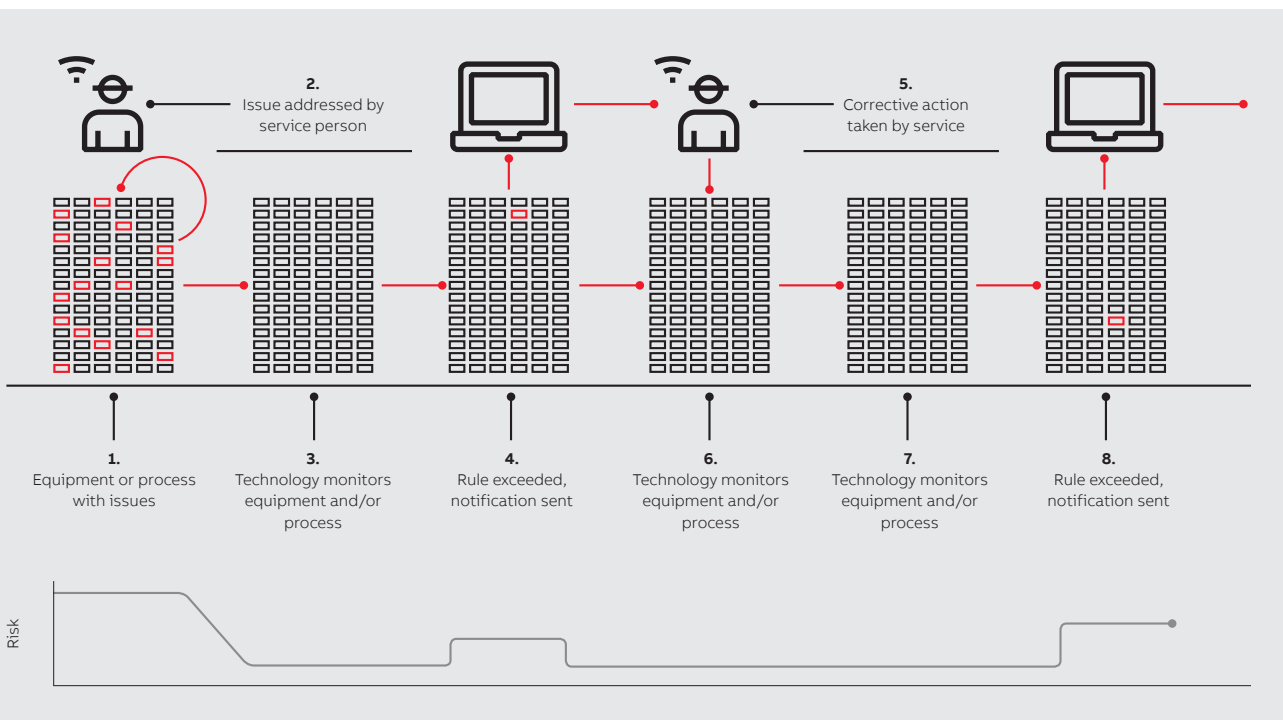

**Alicia Dubay**  
ABB Industrial Automation,  
Control Technologies  
Austin, United States

[Alicia.Dubay@us.abb.com](mailto:Alicia.Dubay@us.abb.com)



—  
01 ABB's Select IO solution fundamentally changes the way automation projects are executed.

—  
02 Project flow – old and new.

02a Traditional serial project flow.

02b Project flow with Select IO: tasks can be carried out in parallel.

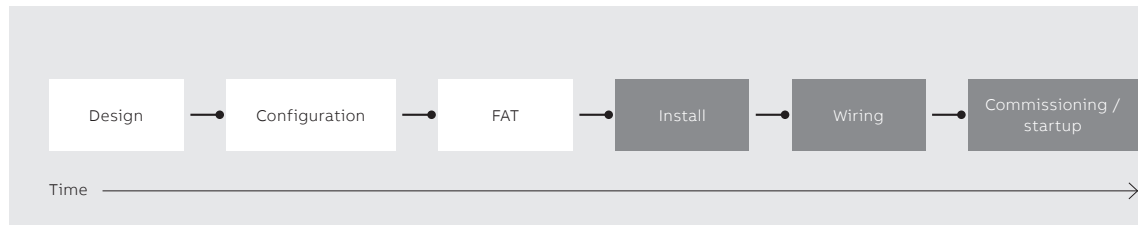

02a

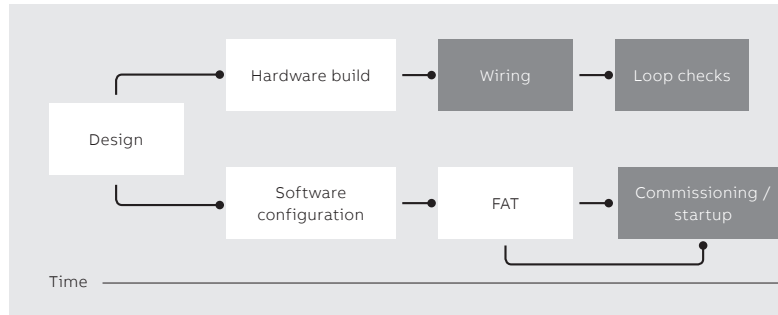

02b

For many years, controller-centric DCS architectures have been used in automation projects. However, a controller-centric approach ties the multichannel I/O modules to a particular process controller, thus creating dependencies between project tasks, which complicates late changes. This aspect is known to be a primary cause of project cost overrun and schedule delay and is the reason why automation tasks are on the critical path in many capital projects.

—  
**Select IO is a single-channel I/O system for both process and safety applications that communicates with the system via a redundant industrial Ethernet I/O network.**

ABB's new I/O solution and corresponding engineering software for the ABB Ability™ System 800xA platform will make overbudget or late automation projects a thing of the past →1.

#### Freeze over

Traditionally, most industrial technical projects feature a design freeze at a relatively early stage. After this point, automation engineers can finalize their design, order the required hardware – such as controllers, I/O, etc. – and start application programming. Changes made after the design freeze often result in rework and the later the changes are made, the higher is the rework cost and the higher is the chance of a schedule delay.

For companies that run many concurrent, large capital investment projects – each of which may involve dozens of subcontractors and vendors – the cumulative cost of overruns and schedule delays can be significant. For this reason, these companies have long partnered with automation providers to combine information stored in databases and spreadsheets with smart instrumentation and devices, digital fieldbus technologies and Ethernet-based I/O solutions to enable control systems to self-configure and validate, test, and provide documentation automatically. Adopting such an approach promotes the decoupling of project inter-dependencies and thus facilitates parallel execution. Parallel execution with multiple work streams provides a more flexible environment that better handles change. In particular, I/O commissioning can be done in parallel with the application engineering →2.

#### System 800xA's Select IO to the rescue

To expedite the commissioning of I/O in parallel with other project engineering tasks and thus reduce the impact of hardwired signal changes, ABB developed an extension to the System 800xA family of I/O solutions called Select IO. Select IO is a single-channel I/O system for both process and safety applications that communicates with the system via a redundant industrial Ethernet I/O network →3. A redundant network has the characteristic that it is not tied to one particular controller.

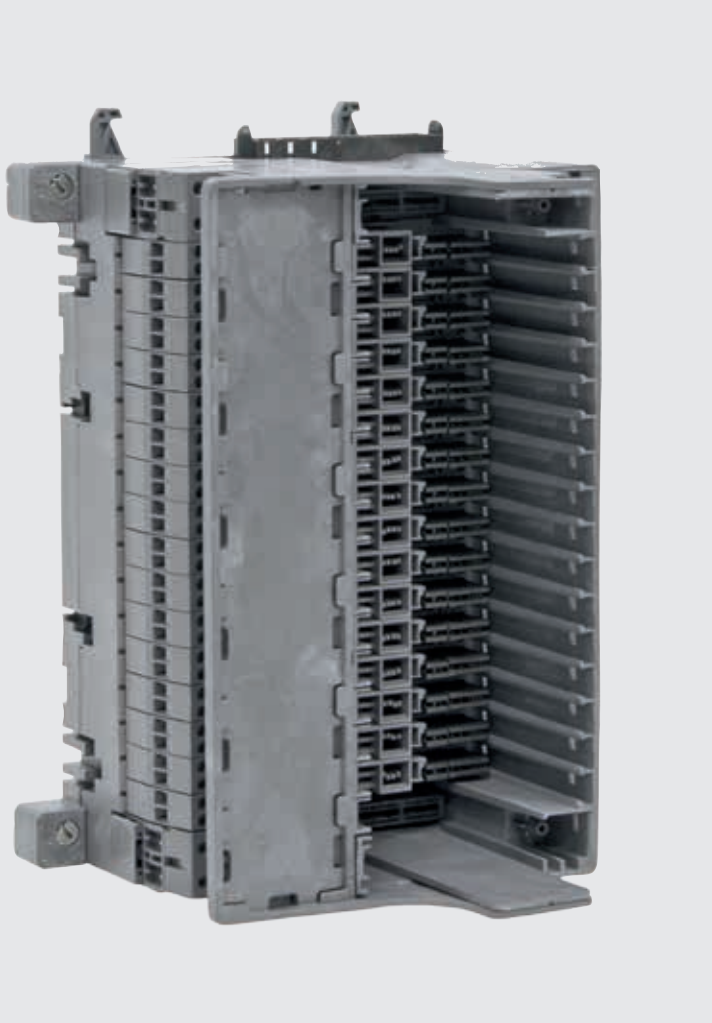

03

Select IO has many benefits:

- Terminations can be installed and wired in the field early on in the project, thus negating the need for bulky marshalling cabinets.
- Many aspects of Select IO are standardized. This reduces testing overhead.
- The hardware, I/O and the application can all be simulated in software.

Further, in the traditional approach to automation projects, multichannel I/O modules were usually ordered from the supplier just after design freeze so that panel shops could start the assembly process. Any late changes would cause rework. With Select IO, the signal types (AI, AO, DI, DO – representing analog and digital inputs and outputs) can be defined much later by adding individual signal conditioning modules (SCMs), thus reducing the importance of the design freeze and the financial impact of any late changes →4.

These factors allow standardized and compact Select IO cabinets to be built, pre-engineered, pretested and sent to site, where they can be installed and wired much earlier in the project than a traditional cabinet would be.

#### **A new marshal in town**

When I/O is made available on an Ethernet network, all the controllers can access it. Therefore, the I/O can be marshalled digitally, instead of physically with marshalling cabinets or cross-wiring. If a control application that requires connectivity to certain I/O signals is moved from one controller to another, no rework will be required as the I/O connectivity is marshalled automatically when the controller “compiles” its application software. This scheme minimizes the need for change orders to the end user or engineering contractor.

#### **xStream Engineering – configure, check, connect**

The xStream Engineering concept encompasses the idea that, by using System 800xA, multiple (or “x”) work streams can occur simultaneously and autonomously (or decoupled) from each other. By reducing the dependencies of various project tasks and providing a means for them to converge later in the project, the risk of project delay is greatly reduced and the probability of on-time, or early, project completion is greatly increased. At the heart of this concept is the Ethernet I/O Wizard, which is part of System 800xA’s engineering software. This can be used in any project execution methodology but is best used to configure and functionally check Select IO in the field prior to, and separate from, the delivery of the application.

—

**ABB’s Select IO solution and corresponding engineering software will make overbudget or late automation projects a thing of the past.**

To illustrate how xStream engineering functions, consider two simple work streams. One stream comprises the tasks that can be performed in the field while the other is the application work done in another location (often at the offices of ABB or the system integrator). In the field, the I/O cabinets can be delivered early in the project and then later, just before commissioning occurs, the following steps are carried out:

—  
03 ABB Select IO module base.

—  
04 Select IO signal conditioning module

—  
05 Select IO speeds and simplifies automation projects, leading to successful project outcomes.

1. **Configure:** On a particular cluster of Select IO, the Select IO module base is populated with the SCM that matches the I/O type. Then a field kit – comprising a controller and laptop with System 800xA engineering tools – is connected to the Ethernet I/O field communications interface (FCI). The Select IO is automatically scanned and configured using data from the I/O list, including signal name, and supplemented with HART configuration data that resides within the field instrument. A test configuration is also automatically created – based on the I/O type detected – to help with functional

2. **Check:** With the I/O configured and a test configuration downloaded to the controller, smart and non-smart field equipment can be functionally checked in the field in parallel with the application engineering being done back at one of ABB's project centers. Using System 800xA's documentation manager loop check templates, field testing and verification documentation is created and stored.

3. **Connect:** Once functionally checked, the I/O structure can be imported into the product application, which was engineered using the same signal names as the I/O configuration. Upon bringing the I/O configuration into the product system, the signals are "soft marshalled" automatically – no mapping is required. Any conflicts or missing I/O allocations are reported via the signal overview display and/or the Ethernet I/O Wizard and quickly corrected. The system is now ready for commissioning.

—  
When I/O is made available on an Ethernet network, all the controllers can access it. Therefore, the I/O can be marshalled digitally, instead of physically.

loop checks. For example, if there is an AI-type SCM connected to a HART transmitter, then the I/O wizard will automatically detect this, configure the I/O structure and create a temporary AI control module for testing purposes.

The steps above are performed in the field while the application code is being configured and checked by simulating hardware at ABB's or the system integrator's premises. Select IO and System 800xA's engineering tools promote the decoupling of tasks and allow two independent teams to work in parallel and bound together with precision and efficiency. The impact of changes during the project and commissioning time can thus be significantly reduced. Overall, Select IO, aided by System 800xA's engineering tools, helps meet the ultimate objective, which is to remove automation from the critical path of capital projects. With this solution, there are fewer surprises, fewer change orders, earlier commissioning of projects and happier owner-operators →5. ●



04



05

---

 ABB ABILITY

# Collaboration Manager automates engineering data exchange

ABB's Collaboration Manager (CM) automates engineering data exchange between tools from different vendors. In addition, CM provides change calculation, history tracking, versioning, consistency calculations, consistency visualization and a project manager cockpit.



**Prerna Bihani**  
ABB Power Grids,  
Grid Integration  
Ludvika, Sweden

prerna.bihani@se.abb.com

Engineering is teamwork and a fundamental aspect of teamwork is information exchange. However, whereas engineers can exchange ideas perfectly well, when it comes to data exchange between engineering tools, things can become tricky. Tool suites with a common database sound promising but bind customers to one vendor. And the best engineering tools are from different vendors. Further, each engineering tool is locally optimized according to its individual purpose but is not designed to interact with other tools.

In short, the handover of engineering data from tool to tool is a tedious, time-consuming and error-prone task, with a large manual element to it – commonly involving printed diagrams, hand-written papers or, in the best case, Excel or PDF files. In every data exchange scenario, the project progress stalls during data exchange and in many cases, already-engineered data is lost or has to be recreated. A seamless data exchange remains elusive and often inadequate, homemade solutions are created to fill the vacuum.



**Rainer Drath**  
Former ABB senior  
principal scientist

rainer.drath@  
hs-pforzheim.de

This lack of a systematic and guided data exchange – including difference handling and consistency checks – motivated ABB to invent Collaboration Manager (CM). ABB's high-voltage DC (HVDC) business in Sweden has introduced CM into workflows and is thereby creating significant cost savings and quality improvements.

---

The handover of engineering data from tool to tool today is a tedious, time-consuming and error-prone task, with a large manual element to it.

#### The idea of CM

ABB developed the CM concept to provide engineers with a guided data exchange between tools from different vendors [1-5]. CM provides functionality that an Excel file simply cannot: Change calculation, history tracking, versioning, consistency calculation, consistency visualization and a project manager cockpit.

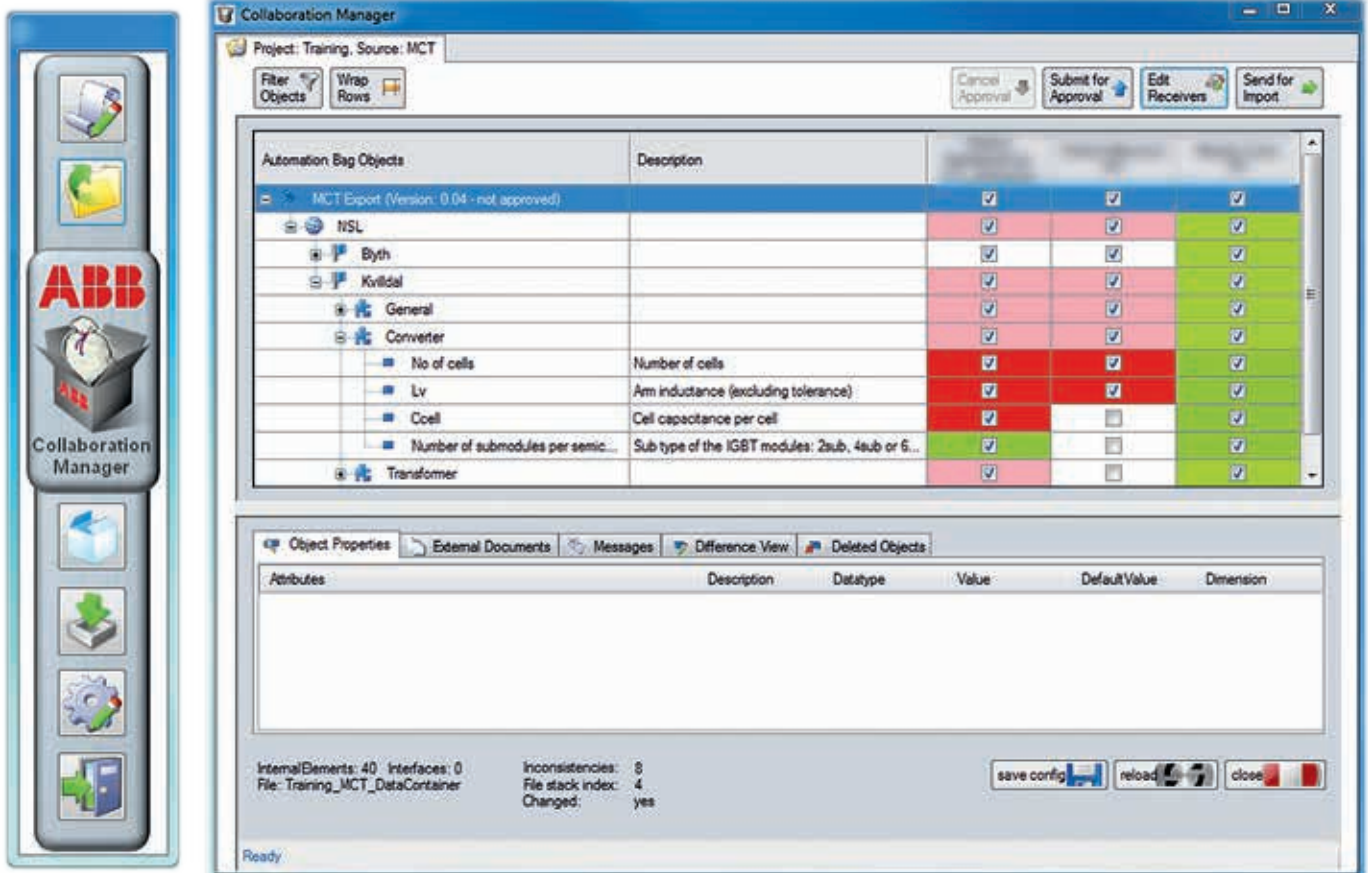

01

—  
01 CM: Example of data owner's view with three receivers.

An important property of CM is its simplicity: The data exchange is based on files stored on shared folders located either on a common network or in the cloud. CM acts as intermediate software on top of the data exchange file →1–2. CM is explicitly designed for iterative data exchange between an arbitrary number of independent engineering tool pairs.

—  
ABB developed the CM concept to provide engineers with a guided data exchange between tools from different vendors.

→3 illustrates a typical CM workflow: Emily is the owner of PLC (programmable logic controller) engineering data and she sends a subset of this data to Lisa, a robot engineer, who acts as a data receiver. CM knows which data has been consumed by Lisa and it can check and visualize at any time whether both data sets are synchronized or not. The power of CM comes into play in the second iteration: Emily performs changes and sends a new version of the data to Lisa. CM can compare data sets and visualize differences and inconsistencies via color codes to both Emily and Lisa.

Technically, CM is characterized by a simple software architecture without databases, client-servers or a service-oriented architecture (SOA). It is a simple file-based approach that just requires access to a common file server or a cloud-based storage system such as SharePoint. As a file format, CM uses the AutomationML standard according to IEC62714 [6]. AutomationML files are sent by simply transferring them into a defined folder. Even offline data exchange is supported via email or USB stick.

CM automatically archives all exchanged files and provides comparison functionality to observe and visualize all changes over time. It supports data exchange with change and version management between independent tools that do not need to know one another. CM also systematically avoids data ownership conflicts and achieves data consistency across engineering tools. CM provides benefits for different groups:

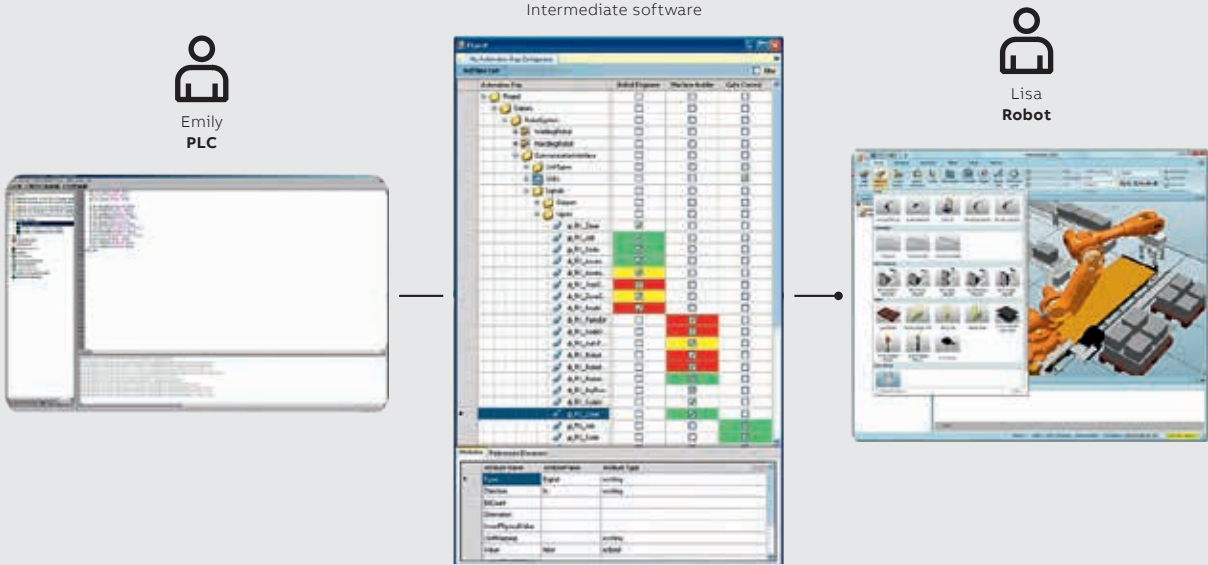

02

- For the engineer, CM delivers a transparent way to exchange data with other engineers while offering continuous information about the state of inconsistency between their engineering tool data and the receivers'. The data exchange is initiated by the engineers themselves, which emphasizes the responsibility of the engineers and allows spontaneous data exchange between arbitrary pairs of engineering tools.
- For the project manager, CM conceptually provides all information about the current state of data inconsistency across the overall project, highlighting points for attention.
- For the software developer and hosting organization, CM delivers a means to minimize effort in importer/exporter development.

**CM and HVDC – business meets innovation**

Since 1954, ABB has pioneered HVDC technology that provides reliable and efficient electrical power transmission over long distances with minimum losses. ABB has since been awarded over 110 HVDC projects with a total capacity of more than 120,000 MW – around half the global installed base.

—  
 An important property of CM is its simplicity: The data exchange is based on files stored on shared folders on a common network or in the cloud.

Currently, HVDC projects require around 40 engineering tools on 20 engineering tool platforms. In a typical year, approximately 30 parallel workflows will be in operation, with about 400 data exchange interaction points between different engineering studies in the System Design department alone. Every interaction, in turn, involves one or more data transfers between a sender and a receiver. Assuming two data exchanges per interaction point per year, this sums up to 24,000 data exchanges annually. If 20 parameters are exchanged across the workflow in a year, around 480,000 parameters will then need to be exchanged.



- 02 Early CM prototype illustrating the basic concept.
- 03 CM workflow.

The vast majority of these data transfers is currently performed on paper – an error-prone process that requires several man-years of effort each year. Combined with multiple iterations, lack of change management, lead-time delays and essentially duplicate scenarios across other engineering departments, costs can quickly rise.

Several improvement efforts were initiated including a project on dataflows to understand the complexity of data transfers in engineering studies. The need for automatic data exchange with change management became increasingly apparent, and a number of desired functionalities were identified for a data exchange software. Partial attempts were made with an internal Excel-based data exchange tool. However, use of Excel precluded proper change management and data could only be exchanged between Excel workbooks.

CM is the perfect solution to this HVDC project data exchange conundrum. With CM and its basis in AutomationML – a neutral XML-based data format designed specifically for exchanging

ABB’s HVDC business has introduced CM into workflows and is thereby creating significant cost savings and quality improvements.

engineering data – simple and effective automatic data transfer between the heterogeneous engineering tools and effective change management is made possible.

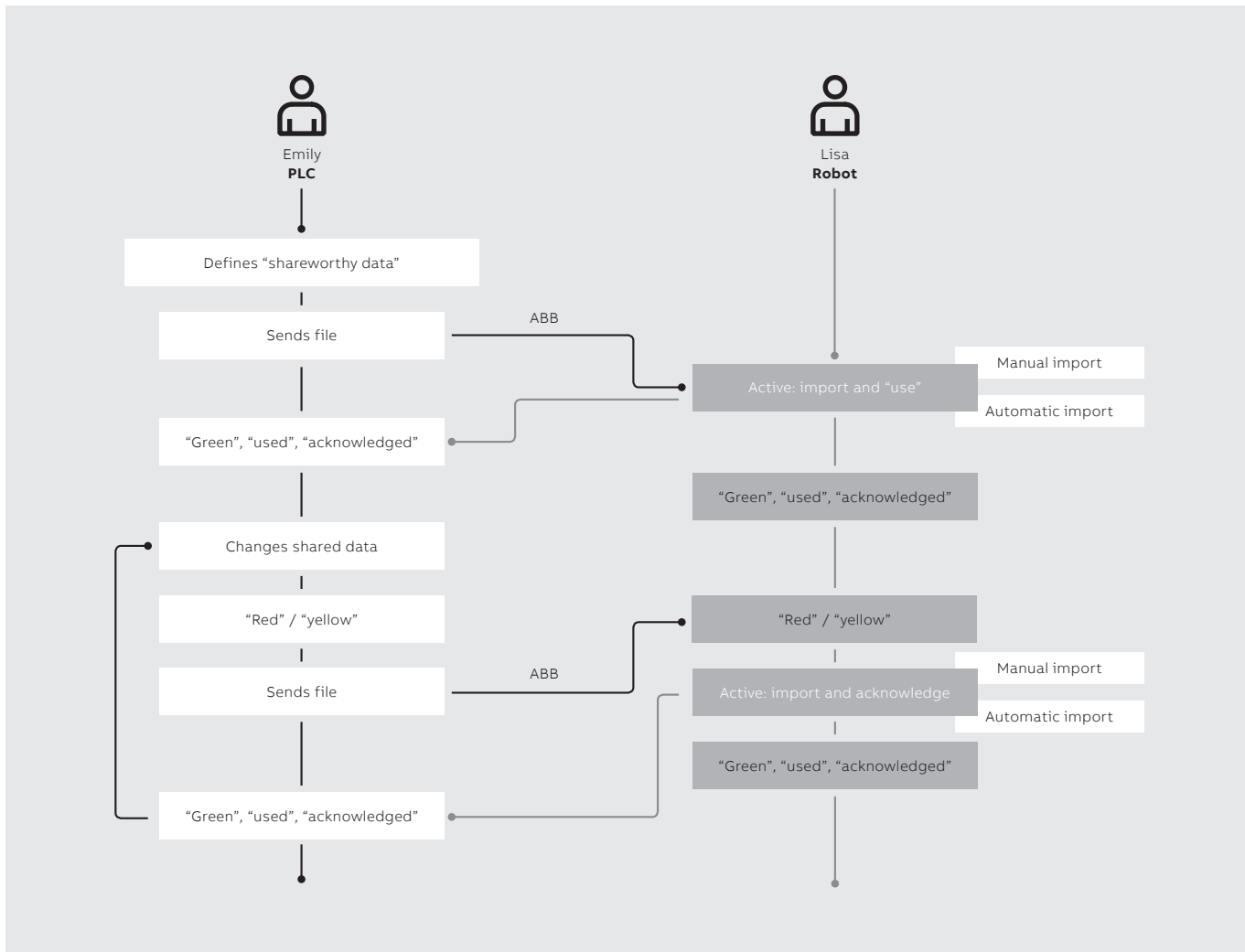

—  
04 The Project Cockpit  
— example of status over-  
view with nine project  
engineers, six tools.

—  
05 Receiver's view in the  
CM after one-click data  
import.

**CM for HVDC: Digitalizing data exchange for improved quality and efficiency**

New features were added to the CM research prototype as part of its customization for ABB HVDC projects:

CM is characterized by a simple software architecture without databases, client-servers or SOA.

- The Project Cockpit presents an overview of the current status of data transfers across an entire project. It includes a consistency status snapshot in a color-coded, sender-receiver matrix. Individual cells flag a receiver's synchronization status with regard to corresponding sender data →4. The Project Cockpit allows project managers to view status updates and easily identify potential problem areas for resolution.

- A new digital data approval process enables an “Approver” to confirm data quality. Multiple Approvers can be assigned to a particular data set, which is subsequently marked “approved” if confirmed by all Approvers, otherwise it is “rejected.” Furthermore, versioning is linked to approval status for easy identification of data quality.
- Mapping technology via AutomationML allows for source tool parameters to be mapped to corresponding destination tool parameters via pre-defined tool classes that are read by exporters and importers during operation. The benefits are twofold: Only data relevant to each receiver is selected for transfer at the sender's end and receivers can import data with a single click and without manually performing the mapping →5. This works without having a common semantic standard, a key property of AutomationML.

CM automatically archives all exchanged files and provides comparison functionality to observe and visualize all changes over time.

- User administration via AutomationML allows user profiles to be set up in a few minutes.
- Automatic email notifications are generated in Outlook as additional notice of data version updates available in CM.

		Receiver Tool Folders								
Used data % (version #)		MCT2	PSCAD2	RS2	CTI_Harmonics	MCT	RS1	ISO	PSCAD	HAP
Sender Tool Folders	MCT2		0.00 % (v.1.0)	99.99 % (v.1.0)	90.48 % (v.1.0)					
	PSCAD2									
	RS2									
	CTI_Harmonics									
	MCT		65.98 % (v.2.0)	99.99 % (v.2.0)	85.71 % (v.2.0)		99.99 % (v.2.0)	100.00 % (v.1.0)		
	RS1									
	ISO			100.00 % (v.3.0)			99.99 % (v.3.0)		85.71 % (v.3.0)	
	PSCAD									
	HAP			7.01 % (v.3.0)				99.99 % (v.3.0)		

—

**References**

[1] R. Drath, M. Barth, "Beherrschung von Semantikvielfalt mit AutomationML." In atp 12/2012, Oldenbourg Verlag, 2012.

[2] R. Drath, M. Barth, "Concept for managing multiple semantics with AutomationML." Accepted paper for the Proceedings of the IEEE Conference on Emerging Technologies and Factory Automation (ETFA), 2012, Krakow.

[3] R. Drath, M. Barth, "Concept for interoperability between independent engineering tools of heterogeneous disciplines." In Proceedings of the IEEE International Conference on Emerging Technologies and Factory Automation (ETFA), Toulouse, September 2011.

[4] R. Drath, "Let's talk AutomationML – What is the effort of AutomationML programming?" In Proceedings of the IEEE Conference on Emerging Technologies and Factory Automation (ETFA), September 2012.

[5] M. Barth, et al., "Evaluation of the openness of automation tools for interoperability in engineering tool chains." In Proceedings of the IEEE Conference on Emerging Technologies and Factory Automation (ETFA), September 2012.

[6] IEC 62714: Engineering data exchange format for use in industrial automation systems engineering (AutomationML), September 2012.

CM has hitherto been used to develop plugins for six core HVDC engineering tools across multiple platforms: Main Circuit Toolbox, Harmonic Analysis Program, the insulation coordination program ISO Light, the harmonic voltage sources calculation tool CTL Harmonics, transient simulation software PSCAD and an Excel requirements specification tool. With minimum effort required

## The Project Cockpit presents an overview of the current status of data transfers across an entire project.

for AutomationML programming [4], the bulk of the development effort was spent on preparing the engineering tools to meet basic data exchange requirements. For each tool integration, an average of five weeks was spent on tool preparation and one week on plugin development. These six tools exchange thousands of parameter values and comprise a major portion of data transfers in the System Design department. Extensions to other ABB HVDC activities are planned.

Data can now be exchanged automatically between senders and receivers with a few simple mouse clicks and without waiting for paper reports to be issued. CM promises significant cost savings and quality improvements for HVDC workflows.

CM provides automatic data transfers across multiple tool platforms – it tracks changes and defines data responsibilities, introduces a digital data approval process, provides versioning of data including history and introduces messaging for data objects. The Project Cockpit provides a comprehensive overview of the project-wide state of data inconsistency across all participating tools. The end result is shorter lead times, early cross-checks and data reports that are ready earlier for submission to customers.

Especially interesting is that data exchange between tools happens without semantic standardization. Nevertheless, CM paves the way towards a gradual standardization of data via an evolutionary framework. ●

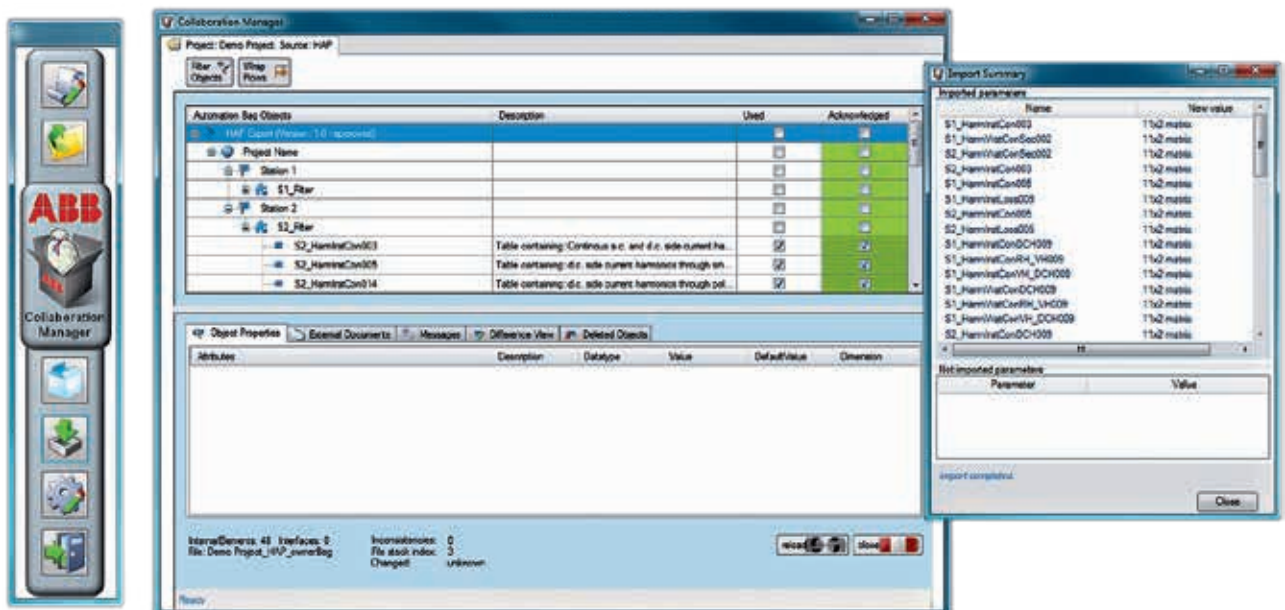

---

 ABB ABILITY

# Data matters in mines

ABB's mining customers are benefitting from improved processes and operations thanks to ABB Ability™.



Mine operators are facing difficult trade-offs. They are having to balance the diminished sales prices of their products with having to access remote and low quality ore bodies, while at the same time facing higher energy costs and tighter environmental regulations. These challenges can only be met by thorough optimization of process performance and increasing availability of equipment.



**Eduardo Galleste**  
**Venkat Nadipuram**  
ABB Process Automation  
Dättwil, Switzerland

eduardo.galleste@  
ch.abb.com  
venkat.nadipuram@  
ch.abb.com

---

**ABB has launched a program to improve reliability and performance of mining applications using the ABB Ability™ Platform.**

ABB is a key player in the electrification and automation of the minerals industry. The company's portfolio includes products and services for grinding, and for hoist and material handling, including components such as cyclo-converters, variable speed drives, motors, gearboxes and application-specific software.



---

Refurbished ASEA mine hoist in Sudbury, Ontario, Canada.



ABB has launched a program to improve reliability and performance of mining applications using the ABB Ability™ Platform. The program will furthermore enable improved remote operations and the support and deployment of advanced process control to help operators push their assets to their limits.

To achieve this, the company will use big-data related analytical methods to develop models that can predict system failures and improve performance utilizing data such as:

- high frequency electrical data
- process data from mineral processes in the context of reliability, performance and quality, typically from grinding, conveyors and hoist applications

An integral part of the concept is the creation of collaboration centers from which ABB will serve customers using specialists, ensuring the fastest possible response and access to the company's global expertise.

The expected results are

- lower OPEX
- increased productivity and energy efficiency at affordable costs
- improved ROI by extending equipment lifetime and reducing life cycle costs ●



47

# Protectio and safet



60



n



y

54

Keeping industrial operations and electrical distribution safe goes far beyond backups, fail-safes, and redundancies, and requires a deep understanding of how systems operate, and thereby how their functions can be protected. ABB designs its equipment on the basis of this expertise and supports a sea of applications ranging from ships to microgrids.

- 40      Circuit monitoring system
- 47      Multi-megawatt power protection at medium voltage
- 54      Ekip Link logiczone discrimination protection system
- 60      ABB's Emax 2 protects, monitors and manages microgrids



## PROTECTION AND SAFETY

# Circuit monitoring system

ABB's new ultracompact and high-performance multichannel circuit monitoring system (CMS) enables the operators of large and complex power installations to monitor, visualize, log and report electrical parameters such as current, power, energy and distortion in every branch.

**Paweł Ludowski**  
**Piotr Ryba**  
**Jerzy Wasacz**  
 ABB Corporate Research  
 Krakow, Poland

pawel.ludowski@pl.abb.com  
 piotr.ryba@pl.abb.com  
 jerzy.wasacz@pl.abb.com

**Harm deRoo**  
**Nico Ninov**  
**Fabian Maier**  
 ABB Low Voltage Products  
 Schaffhausen, Switzerland

harm.deroo@ch.abb.com  
 nico.ninov@ch.abb.com  
 fabian.maier@ch.abb.com

With energy costs and awareness of carbon footprint both rising, operators of installations with large and complex power infrastructures – such as data centers, airports, hospitals and banks – need a fine-grained knowledge of how power is being used in every branch of their network. This goal can be achieved with ABB's new CMS – a family of ultracompact and high-performance multichannel measurement devices →1.

The CMS consists of a control unit and sensors. The individual components of the system are easy to install in control and distribution cabinets and can be retrofitted to existing installations. During

previous CMS-600 product with the new CMS-700 control unit and new sensor types that allow monitoring not only of current but also of other electrical parameters such as power, energy, or total harmonic distortion (THD), both on the three-phase mains input as well as on each branch. New key features include visualization via a Web user interface, data logging, automatic reporting and Ethernet communication.

The CMS-700 has been developed specifically to meet the requirements of critical power applications, such as data centers. However, the CMS is eminently suited to other energy monitoring applications – for example, identification of savings potentials in structures like office buildings.

The CMS-700 has been developed specifically to meet the requirements of critical power applications, such as data centers.

the system's development, particular attention was paid to user-friendliness, a large measurement range (up to 160 A) and scalable solutions for every application. The CMS expands on the



—  
01 Circuit monitoring system.

### CMS hardware

The heart of the CMS-700 control unit is a Texas Instruments AM3352 ARM Cortex-A8 application processor →2. This processor is equipped with 256 MB DDR3 RAM memory and 4 GB eMMC flash

—  
The CMS is eminently suited to other energy monitoring applications – for example, identification of savings potentials in structures like office buildings.

memory. The device communicates with the external world over TCP/IP, Modbus RTU, Modbus TCP/IP or SNMP v1, v2c or v3. An Ethernet link provides access to a user Web interface via an HTTP application protocol and access to measurement data via Modbus TCP/IP or SNMP protocols. Three MODBUS connectors for CMS current sensors allow connection of up to 96 sensors (32 per channel).

Additionally, an isolated external Modbus port provides an industrial standard communication interface and backward compatibility with the previous version of the control unit – the CMS-600. A mains monitoring circuit has been included. This monitor measures electrical parameters such as the root mean square of the voltage (VRMS) and current (IRMS), power factor, energy, active power, passive power and apparent power. THD for voltages and currents is also calculated. Data is provided to the main processor via an I2C bus. The whole system is powered directly from the L1 phase and the flyback topology of the AC/DC converter provides isolation and low voltage to supply power to the entire device and to external sensors via CMM (communication media module) ports. The CMS-700 has three separate PCBs: One PCB, with a CPU, RAM, flash memory and Ethernet capability, provides the computational power →3.

01

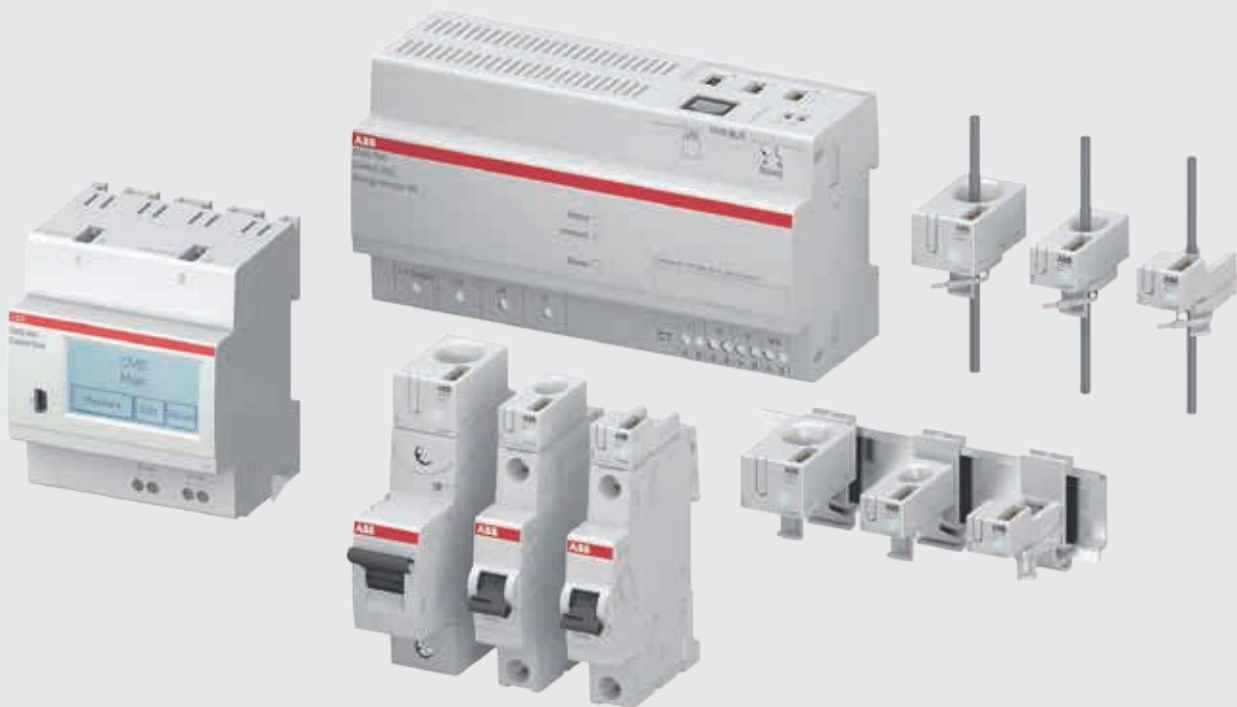

A second PCB includes AC/DC converters, the energy monitoring circuit and the external Modbus interface as well as ports for voltage inputs and

Three MODBUS connectors for CMS current sensors allow connection of up to 96 sensors.

current inputs. The third, and smallest, PCB contains connectors and a protection circuit that provides interconnection between the processor board and external CMM sensors. An exploded view of the entire device is shown in →4.

Hardware design simulation

The electronic design was supported by computational fluid dynamics (CFD) simulations prepared in ANSYS/Fluent software. The CAD (computer-aided design) models were exported from Altium Designer to STEP CAD format and then imported into and simplified in SolidWorks.

Models of the PCBs were placed in the model of the enclosure and were then loaded into ANSYS software where the finite volume mesh was created and the simulation physics defined →5.

The key point in this type of simulation is the proper modeling of multilayer PCBs. The CMS-700 PCBs contain up to six, 35 μm layers of copper with FR4 laminate between them. To handle meshing of thin copper layers, the shell conduction model was used, in which the virtual thickness and thermal conductivity of each layer were defined.

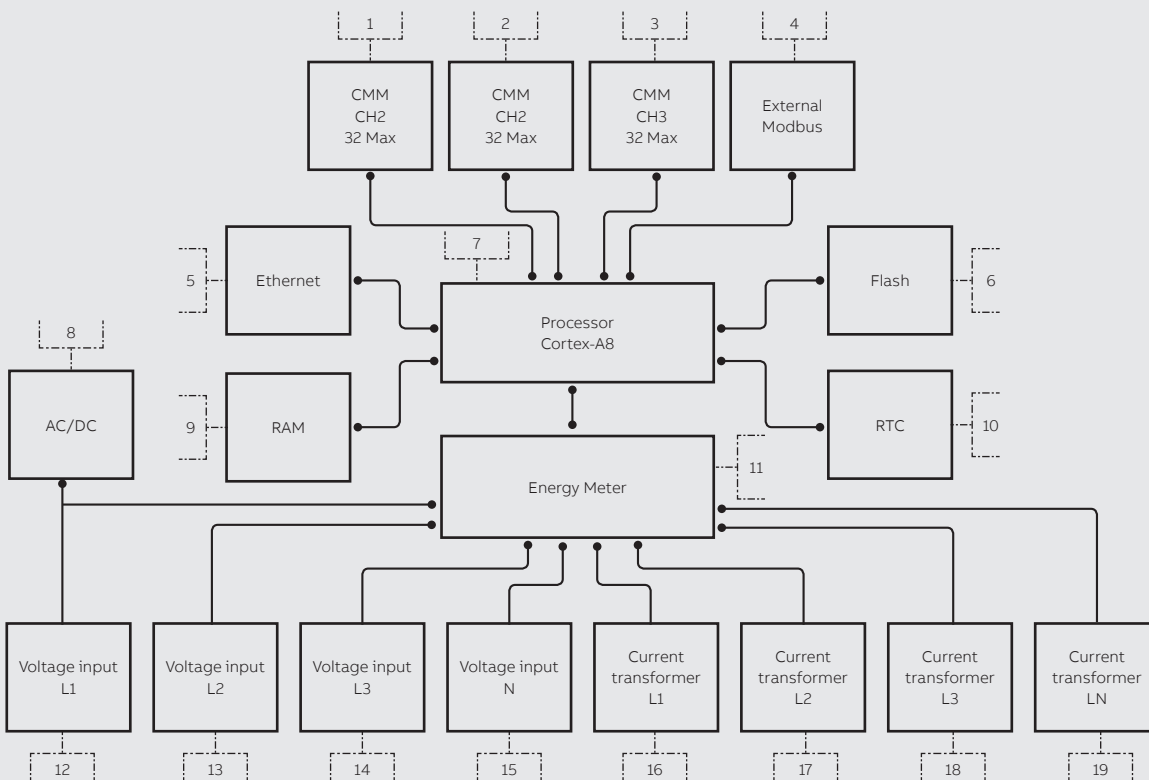

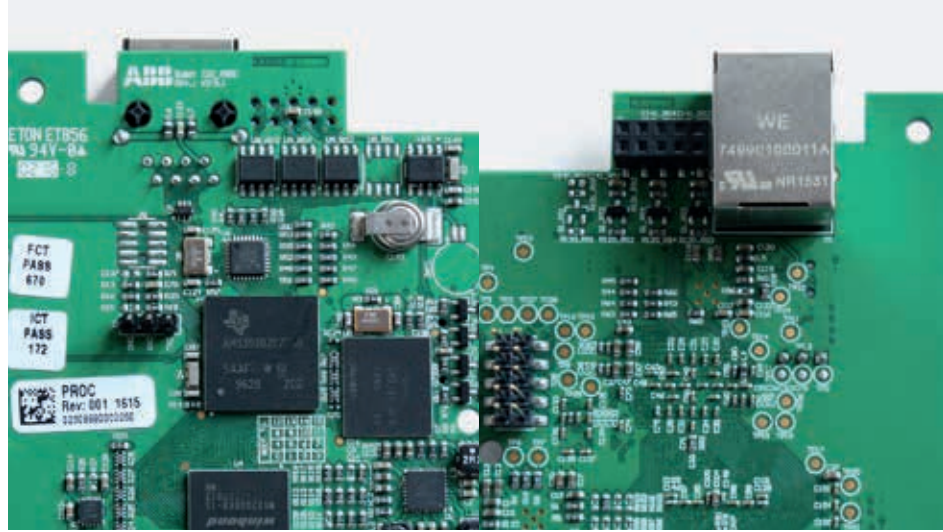

03

- 02 Hardware block schematic.
- 03 Processor board.
- 04 Exploded view of CMS-700 control unit.

The CFD simulations allowed the identification of hot spots and the assessment of enclosure design – taking heat dissipation into account →6. The simulations also supported the selection of the best ohmic value for the shunt resistors used for current measurements: Ideally, resistors should have a low resistance (to generate as little heat as possible), but lower resistance results in higher component cost. CFD modeling found the best compromise between generated heat and cost.

After preparation of the first prototypes, the CFD simulations were verified by temperature measurements. Hot spots were located using an infrared camera and exact temperature profiles were taken using PT100 resistance temperature detectors (RTDs). These measurements confirmed the accuracy of the CFD simulations →7.

The robustness of the hardware design was also confirmed by EMC tests performed according to International Electrotechnical Commission (IEC) standards.

#### Software

The CMS-700 is controlled by embedded software running on a custom Linux system. The embedded operating system contains a bootloader,

The robustness of the hardware design was also confirmed by EMC tests performed according to IEC standards.

a Linux kernel and the root file system. All the system components have been compiled for ARM architecture using the Linaro GCC toolchain. The bootloader and Linux kernel were prepared using a TI Linux software development kit. The root file system was built using the Buildroot tool and an open-source universal bootloader was selected.

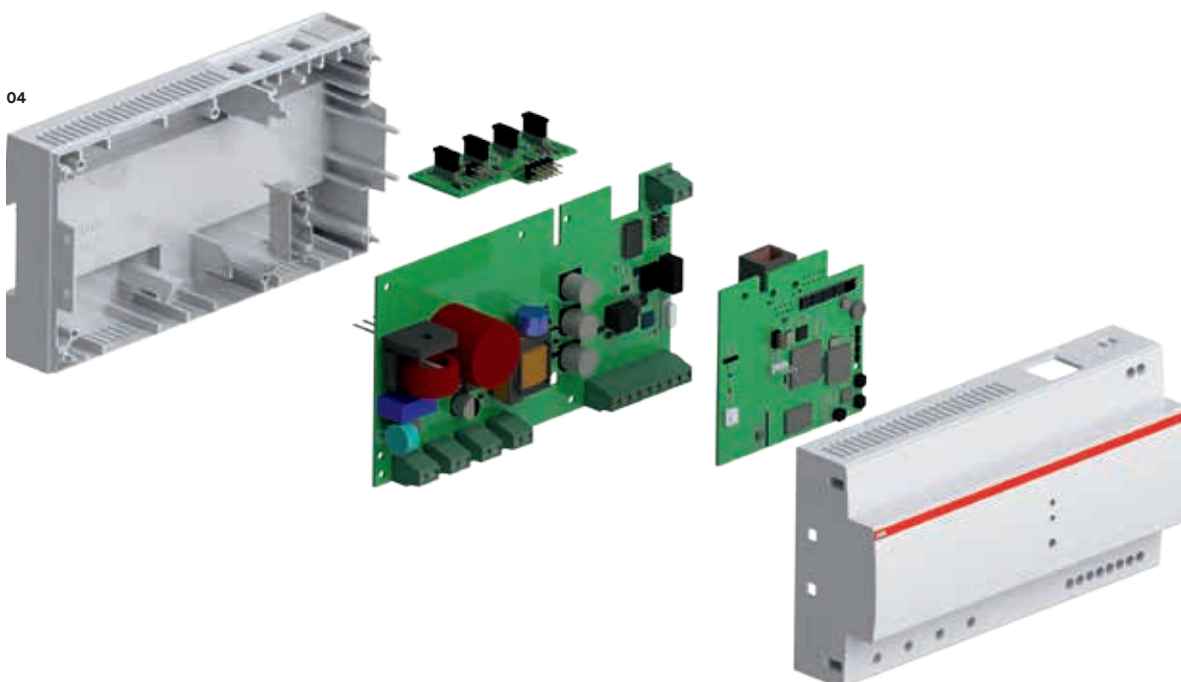

04

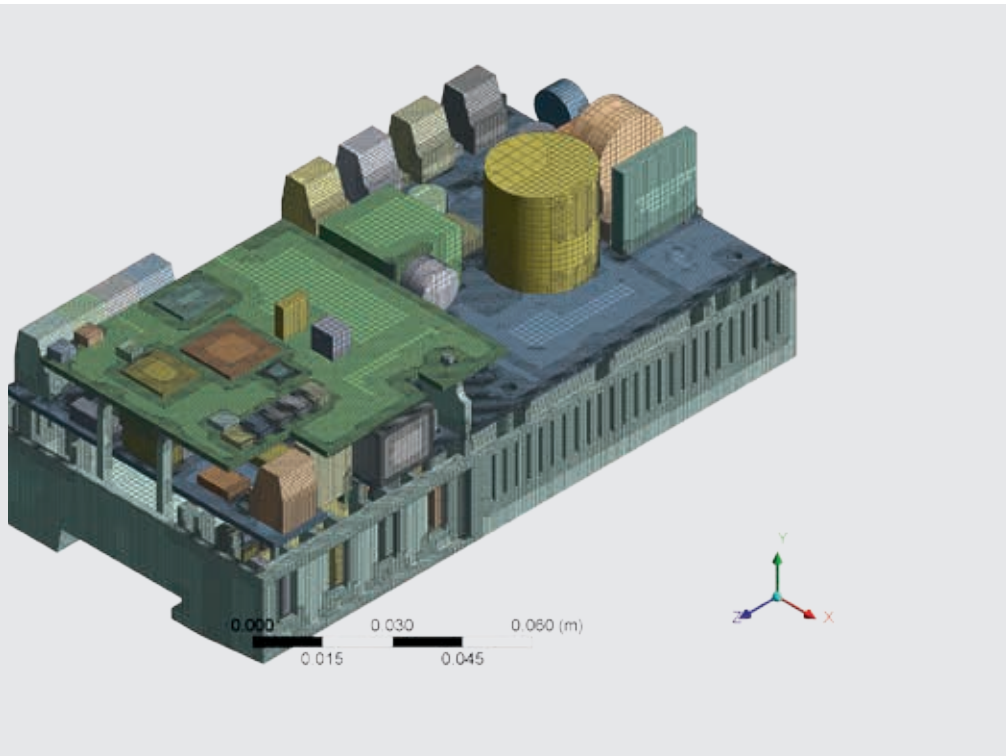

05

**Firewall**

The CMS-700 device is protected by an internal firewall based on the nftables network packet filter, which is a subsystem of the Linux kernel. Firewall rules allow only connections to HTTP, SNMP and Modbus services. Additionally, the firewall supports connection tracking, which allows the state firewall to be implemented and packet limiters to be configured. This type of firewall can be configured to accept all incoming packets belonging to the connection initiated by the CMS-700 (state: established) and all incoming packets belonging to the connections related to the connections initiated by CMS-700 (state: related). This feature is used, for example, to allow

for a response from the network time protocol (NTP) server when the connection is initiated by the CMS-700.

The firewall protects the device not only from unauthorized access but also from Denial of Service (DoS) attacks including ARP, ICMP, IP, TCP, and UDP packet storming. The strength of the device protection was verified in the ABB Device Security Assurance Center where the CMS-700 passed cyber security tests according to ABB directives.

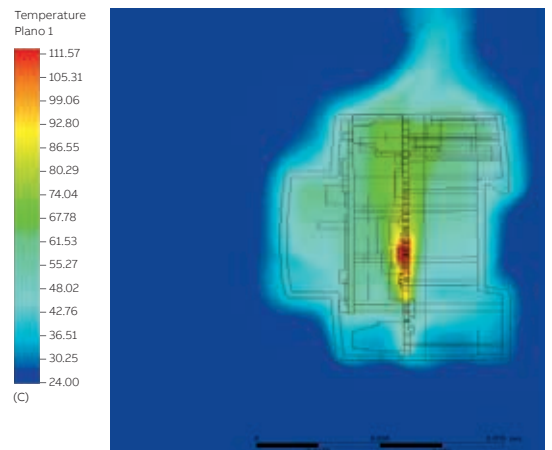
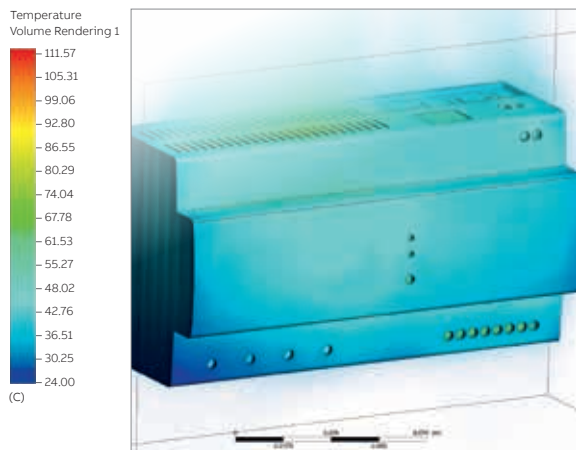

06

—  
05 Finite volume mesh on the CAD model.

—  
06 Results from the CFD simulations – temperature distribution outside and inside enclosure.

—  
07 Comparison of results from CFD simulations with PT100 temperature measurements.

07a CFD simulation predicts hot spots on the undersides of the eight surface-mounted components on the PCB with the AC/DC converter, energy monitoring circuit and external Modbus.

07b PT100 measurement along line 1 reflects the temperature profile seen in the simulation (left-most component).

### Back-end and front-end code

The code responsible for measurements, data transfer, configuration and visualization can be separated into back-end code and front-end code. The back-end code is the middle layer between the Web user interface and the hardware. It allows for device configuration, measurements, data acqui-

—  
**Measurements from CMM sensors are displayed as a short history chart with online values that can be read from a table.**

sition and transmission of the data by SNMP and Modbus protocols. The front-end software is the Web user interface, which is written in JavaScript using an Angular.js framework. The entire HTTP transmission between the CMS-700 and the Web browser is encrypted by Secure Sockets Layer (SSL) technology.

### Configuration

The device's website displays measurements and provides multilanguage configuration.

Measurements from CMM sensors are displayed as a short history chart with online values that can be read from a table. The device stores all measured data. Hence, there is an interface to read out historical data (which can be exported as .csv files). The same features are available for mains energy quality measurements (voltage, current, THD, power factor, and active, reactive and apparent power). The CMS-700 calculates energy consumption on the mains and on branches monitored by CMM sensors. These can be displayed in separate views.

The configuration section allows parameters to be edited – for example, for the mains, the current transformers ratios. CMM sensors can be elaborately configured – for instance, data binding parameters (branch name, group assignment, phase assignment and power factor correction) can be added, removed, displayed, identified and edited. Report delivery choice – e-mail or FTP server – is also configurable via the Web interface, as are communication protocols, language, time, passwords, software update and factory reset.

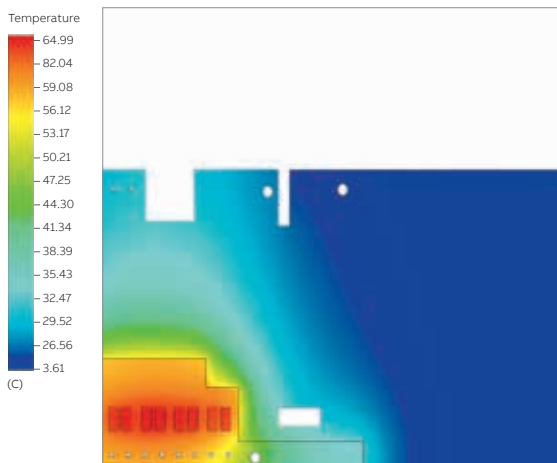

07a

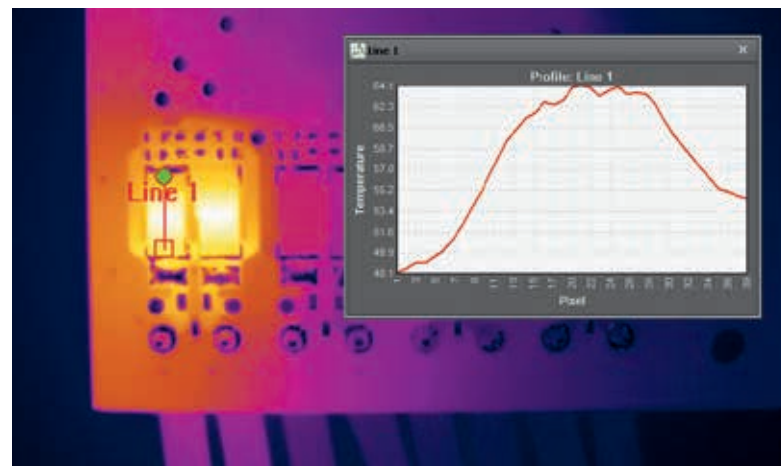

07b

- 08 Open-core sensor.
- 09 Solid-core sensor.

**New sensors**

Sensors are standardized into 18 or 25 mm widths and can measure harmonics as well as AC, DC or true RMS (TRMS) currents up to 160 A (TRMS).

As each sensor is equipped with its own microprocessor for processing the signal, the measurement data is transmitted digitally to the control unit via the bus interface. This minimizes the cabling required in the distribution cabinet and maximizes measured-value transmission reliability. Disturbances of the type experienced by analog data are eliminated.

As each sensor is equipped with its own microprocessor for processing the signal, the measurement data is transmitted digitally to the control unit via the bus interface.

ABB’s CMS sensors are available in an open-core or solid-core design →8–9. The solid-core units feature an enclosed structure and AC measurement accuracy of  $\leq \pm 0.5$  percent, and are, therefore, suitable for all applications in which maximum-precision measurement is crucial. Thanks to their U-shape, the open-core sensors can easily be retrofitted to existing installations without having to disconnect cabling or shut down equipment. With an AC accuracy of  $\leq \pm 1.0$  percent, they can be used in a multitude of applications.

**Applications and first customers**

The CMS-700 was developed specifically for critical power applications, as found in, for example, a data center. In a data center in Ireland, 20 control units were installed to monitor the current and energy in each phase and 730 branches. The customer can see the total energy consumption and that of each branch or server. The CMS also highlights any power irregularities. Other critical power users are, for example, airports, hospitals, the telecoms industry and banks. Recently, a bank in Brazil installed 90 control units and 8,000 sensors to monitor and visualize their energy consumption.

But the control unit is not only used for critical power – it can also be used for visualizing the energy usage of each consumer: One of ABB’s customers integrated the CMS-700 into a production line to help analyze the costs of each product. ●



08



09

## PROTECTION AND SAFETY

# Multi-megawatt power protection at medium voltage

2017 marks the introduction of ABB's revolutionary ZISC technology – a next generation of medium voltage (MV) uninterruptible power supply (UPS) based on the PCS120 converter platform →1. The high-performance, flexible system expands ABB's MV UPS Portfolio, supplying critical load industries with high-quality power, reliability and efficiency.



**Eduardo Soares**  
ABB Electrification  
Products, Power  
Conditioning  
Napier, New Zealand

eduardo.soares@  
nz.abb.com

The rapid rise of digital data and digital-based device use in the technology sector over the last decade is transforming modern business and society. The need for real-time, reliable data and digital device penetration is unprecedented. The

expansion ranges from customer-driven technologies such as the internet of things and personal smart devices to big data driven analytics, and data-dependent businesses such as financial institutions and governmental security agencies.

01



Propelling this drive for transformation is the development of extensive infrastructure and ever-increasing investments in electronics manufacturing facilities and enormous data centers. These facilities have been highly impacted by economies of scale, pushing single locations to grow even larger such as hyper-scale data centers with a correspondingly higher power demand – often well into the tens of megawatts.

Data centers have been highly impacted by economies of scale, pushing single locations to grow even larger with a correspondingly higher power demand – often well into the tens of megawatts.

These large-scale facilities rely on a power supply quality much greater than a utility can provide, as dollar losses for downtime in these critical facilities are simply not tolerable. This is valid not only for data centers and semi-conductor factories, but also other critical load industries such as pharmaceutical, chemical, and the food & beverage sectors.

Data centers strive to lower costs and pass on savings to their customers. Benchmarking standards such as PUE (power usage effectiveness) and operating costs analyses are the primary tools used by clients to determine which data center should receive contracts [1]. Because these high tech facilities are characterized by enormous power demands placed on a single location, the absolute requirement of maximum reliability and optimum efficiency is paramount to keep these critical load industries competitive.

Data gathered from data center research [2], for example, specify that the overall downtime cost for a power supply interruption is around \$5,600 per minute. With power interruptions lasting on average 90 minutes, the cost of a single downtime event can be well over half a million dollars. Clearly, financial losses of this magnitude are undesirable. To mitigate the possibility of such incidents, critical load industries require extremely reliable power supply as well as robust power distribution and power protection designs.

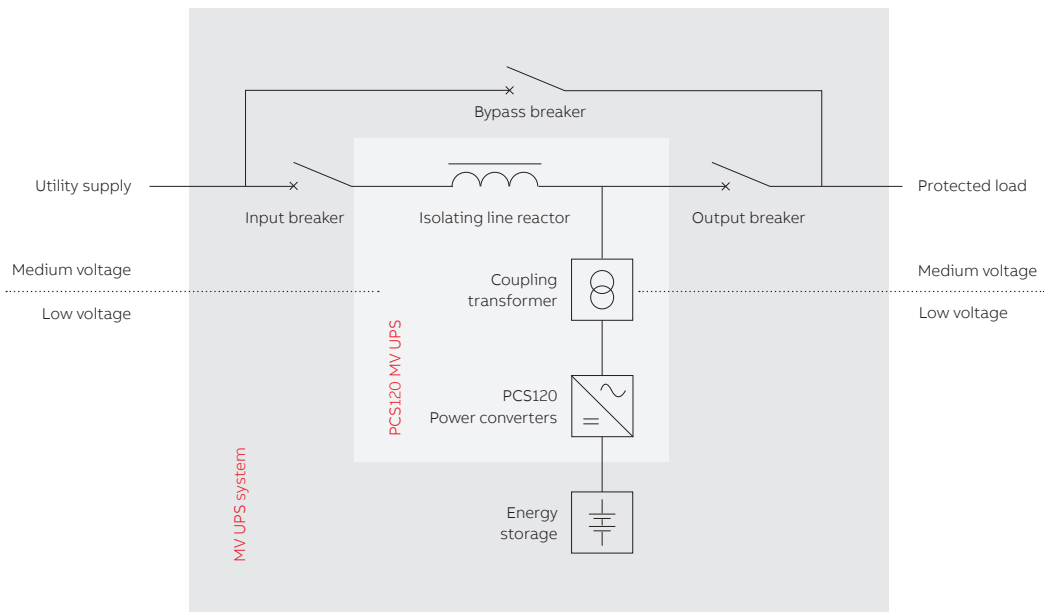



—  
01 ABB's PCS120 MV UPS.

—  
02 Single line diagram of ABB's ZISC architecture.

—  
03 PCS120 MV UPS in power conditioning mode resulting in clean continuous power.

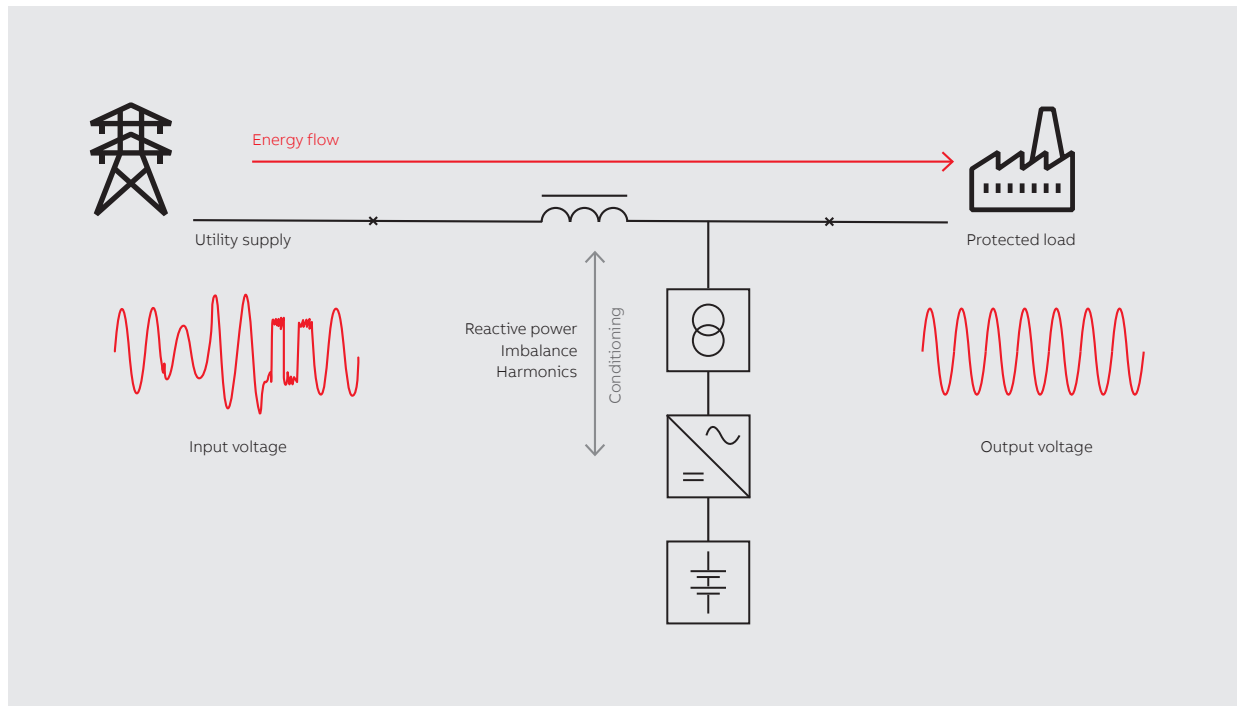

03

An additional technical challenge is to provide a flexible solution which reconciles the above mentioned needs for an ultra-reliable system design with the cost cutting requirements for enhanced

—  
By creating the PCS120 MV UPS, which is compatible with a variety of configurations especially the tested fault-tolerant ring bus configuration, ABB has found the optimal product solution.

efficiency and minimal operating costs. For these reasons, a medium-voltage power protection and power distribution solution combined with power conversion and storage at low voltage would be the ultimate solution for data centers and other critical load industries.

ABB prides itself on being able to find optimal product solutions for its customers' power needs. By creating the PCS120 MV UPS, which is compatible with a variety of configurations especially the tested fault-tolerant ring bus configuration, ABB does just that.

ABB's PCS120 MV adds needed flexibility by providing a static alternative to fit the ring bus arrangement resulting in a highly reliable and efficient solution.

#### Power protection at medium voltage

Providing power protection at medium voltage yields multiple advantages. Topping the list is the ability to simplify the design of power distribution, in which lower switchgear, transformer and cable counts are needed. Thereby making the system much easier to maintain, manage and supervise. The lower current requirements at medium voltage with an equivalent power demand make this configuration the most efficient system possible. In addition, heating losses are reduced and capital expenditures can be minimized.

Because the typical constraining factor of large low voltage facilities is the current limit of LV switchgear and bus bars, the MV design solves this constraint by allowing larger blocks of power to be provided from a single location. It also enables smarter use of whitespace, since a MV UPS can be placed on less expensive real estate located further away from the loads, such as electric rooms and substations.

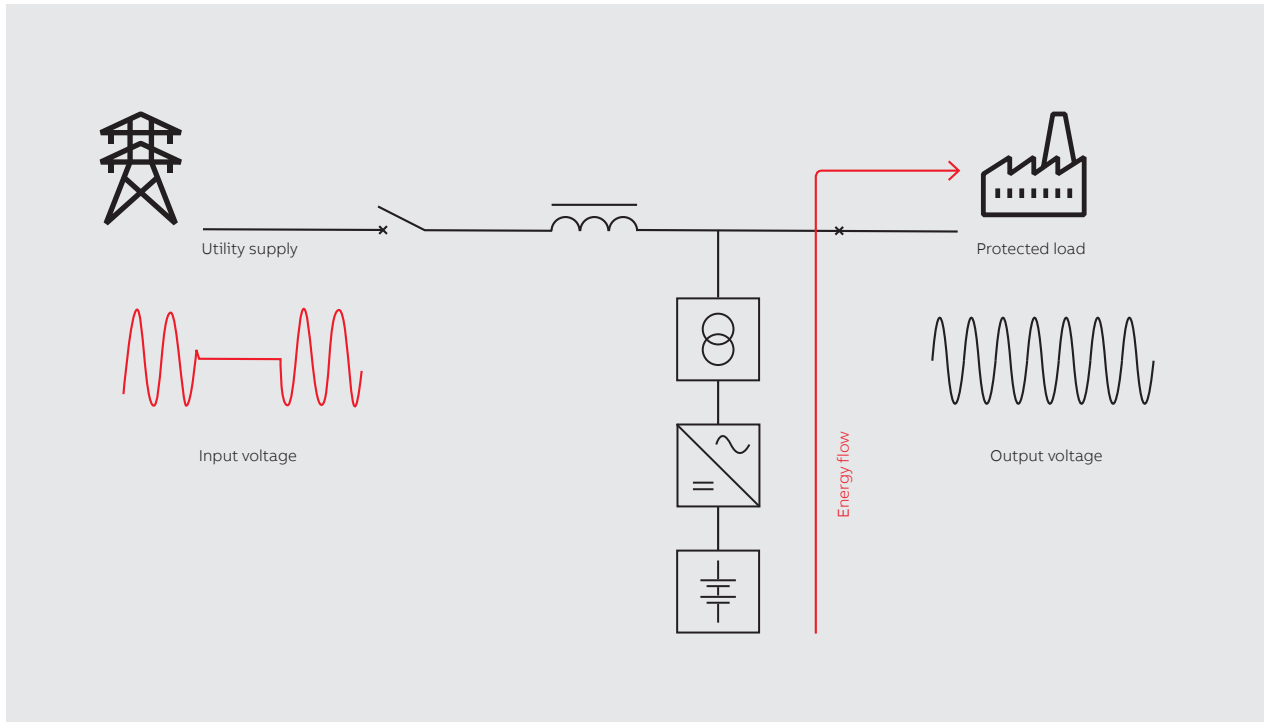

04

The power distribution system's overall reliability benefits greatly from being operated at medium voltage because less infrastructure equipment such as switchgears are required. Studies also show that the individual reliability of medium voltage devices are significantly greater than the reliability of their LV counterparts [3].

—

**ABB's ZISC topology backed by the PCS120 converter technology achieves efficiencies of up to 98 percent, significantly better than the segment incumbent rotary UPS system.**

#### **ABB's MV Power Protection portfolio**

To address the need for MV power protection, ABB introduced the PCS100 MV UPS in 2014. This product solution with a single conversion topology is scalable up to 6 MVA and voltages up to 6.6 kV. As a result of its efficiency the product has been quickly established in the market.

Following the successful operation of the first units, ABB was immediately challenged by customer demand to provide other possible MV power protection solutions. ABB took up the gauntlet to meet customers' needs. This meant developing an approach to include multiple voltage levels – for even larger amounts of power – and the ability of continuous power conditioning in lieu of the industry standard standby topology.

ABB's 134-year history of innovation at the forefront of technology development, provided the framework for ABB engineers to react rapidly. ABB's answer was to create a new ground-breaking medium voltage UPS design, the ZISC (Impedance Isolated Static Conversion) architecture, to satisfy clients' requirements.

#### **PCS120 MV UPS and the ZISC architecture**

The ZISC architecture introduced in 2017 is a new topology for the static medium voltage power protection market. The ZISC architecture is based on an isolating line reactor coupled with the new high performance ABB PCS120 power converters →2. By continuously controlling the voltage angle across the reactor, the inverters are able to control the real and reactive power from the utility to the load, without cycling the energy storage.

—  
04 PCS120 MV UPS in independent mode with seamless transition of the load from the utility to the energy storage supply.

—  
05 The PCS120 converter platform with 6 power modules per cabinet and built-in system redundancies.

At the same time the PCS120 converters are continuously conditioning and filtering any utility disturbances like harmonics and voltage imbalances

—  
From a hardware perspective, the PCS 120 MV converter platform modular approach allows unparalleled serviceability and redundancy, while maximizing uptime.

thereby providing reactive current support to the critical loads. →3 This operating mode is known as power conditioning mode. In case the utility power is no longer available, the PCS120 MV UPS opens its input breaker and seamlessly transfers the load to the energy storage, operating now in independent mode.

→4 This robust design concept thereby results in reliable power protection as well as continuous voltage conditioning, thus providing the load with prime power supply at all times.

ABB's ZISC topology backed by the PCS120 converter technology achieves efficiencies of up to 98 percent, significantly better than the segment incumbent rotary UPS system.

**“Everything should be made as simple as possible, but not simpler.” – Albert Einstein**

The beauty of the ZISC design lies in its duet of simplicity and robustness. The only equipment kept at medium voltage are the isolating line reactor and the coupling transformer. This enables the ZISC technology to be easily adapted to multiple voltage levels and power requirements. Paralleling is also easily performed, achieving power ratings in the range of over 40 MVA under different configurations.



By having the power conversion and energy storage at low voltage ABB customers maintain the familiar LV experience characterized by functionality, maintainability and, most significantly, the modularity of a low voltage system like the PCS120 converter platform.

**The PCS120 converter platform**

The PCS120 converter platform, was one of the major facilitators of the ZISC technology. Defined by double the power density of its predecessor, the PCS100, the PCS120 relies on the same modular approach. The PCS120 converter platform is ABB’s answer to innovative design in power electronics. →5

From a hardware perspective, the modular approach of the design allows unparalleled serviceability and redundancy, while maximizing uptime. For instance, in the unlikely event of a module failure, the system isolates the module and continues to run with marginally reduced output power capability. At the same time, the smart control delivers a notification of the event to the supervisory system so that maintenance technicians can schedule the next site visit at their convenience. Automatic smart firmware management tools and a new slide-in modular design ensure customers that the product has excellent maintainability as well as painless spare part management.

—  
With its many years on the forefront of technology development, that drove ABB’s insight towards a new ground-breaking medium voltage UPS design, the ZISC architecture.

At the heart of the UPS system, the PCS120 converter platform is not only a new concept in terms of product robustness and reliability but is novel in its connectivity potential. The brandnew ABB-engineered interface is integral in terms of the analysis of power quality events. Maintenance and supervision are also improved by combining trending analytics with proactive digital services aligned with the ABB Ability™ platform →6.

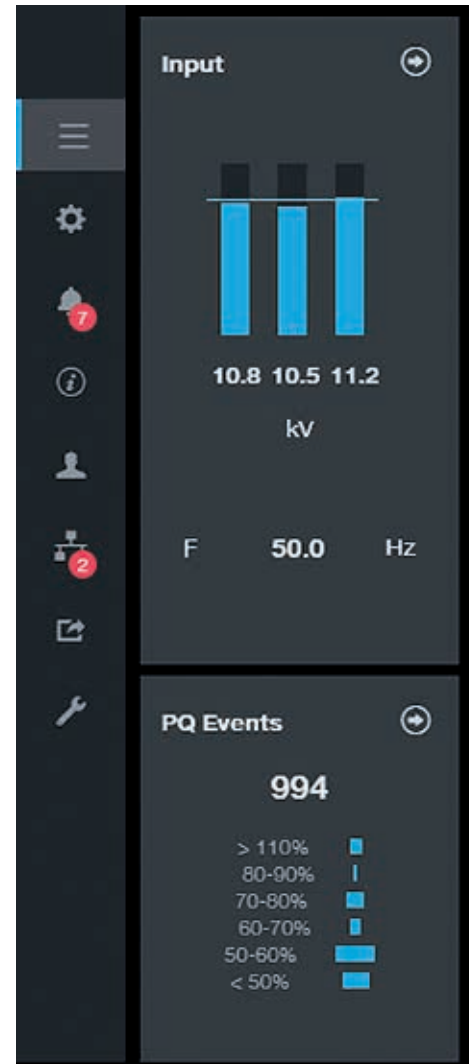

— 06 PCS120 MV UPS new digital interface with extensive event analysis capability and pro-active serviceability.

References

[1] M. Stansberry, "Uptime Institute Data Center Industry Survey 2015." Uptime Institute, 2015.

[2] Emerson Network Power, "Understanding the Cost of Data Center Downtime: An Analysis of the Financial Impact on Infrastructure Vulnerability," White Paper, 2011.

[3] CCG Facilities Integration Incorporated, "Medium Voltage Electrical Systems for Data Centers.," 15 Sept. 2012.

One ABB

In addition to the PCS120 MV UPS system, ABB's global portfolio of products also include the Unigear Digital medium voltage switchgear as well

— The beauty of the ZISC design lies in its duet of simplicity and robustness. The only equipment kept at medium voltage are the isolating line reactor and the coupling transformer.

as ABB's own digital protection relays. The digital IEC 61850 integration between the PCS120 MV UPS and the switchgear provides added reliability with distributed control capabilities. The comprehensive in-house package is designed for a seamless connection to the ABB Ability platform.

Moreover, ABB's unified corporate structure, with local organizations across the world, provide customer support as well as dedicated project management teams to make sure project deliverables and schedules are kept.

The "One ABB" solution offers medium voltage power protection customers a one-stop-shop with an array of excellent products as exemplified by the ZISC architecture and PCS120 MV UPS as well as the previously described services. Thereby following the ABB philosophy of meeting customer demands in a rapidly developing and competitive market. ●

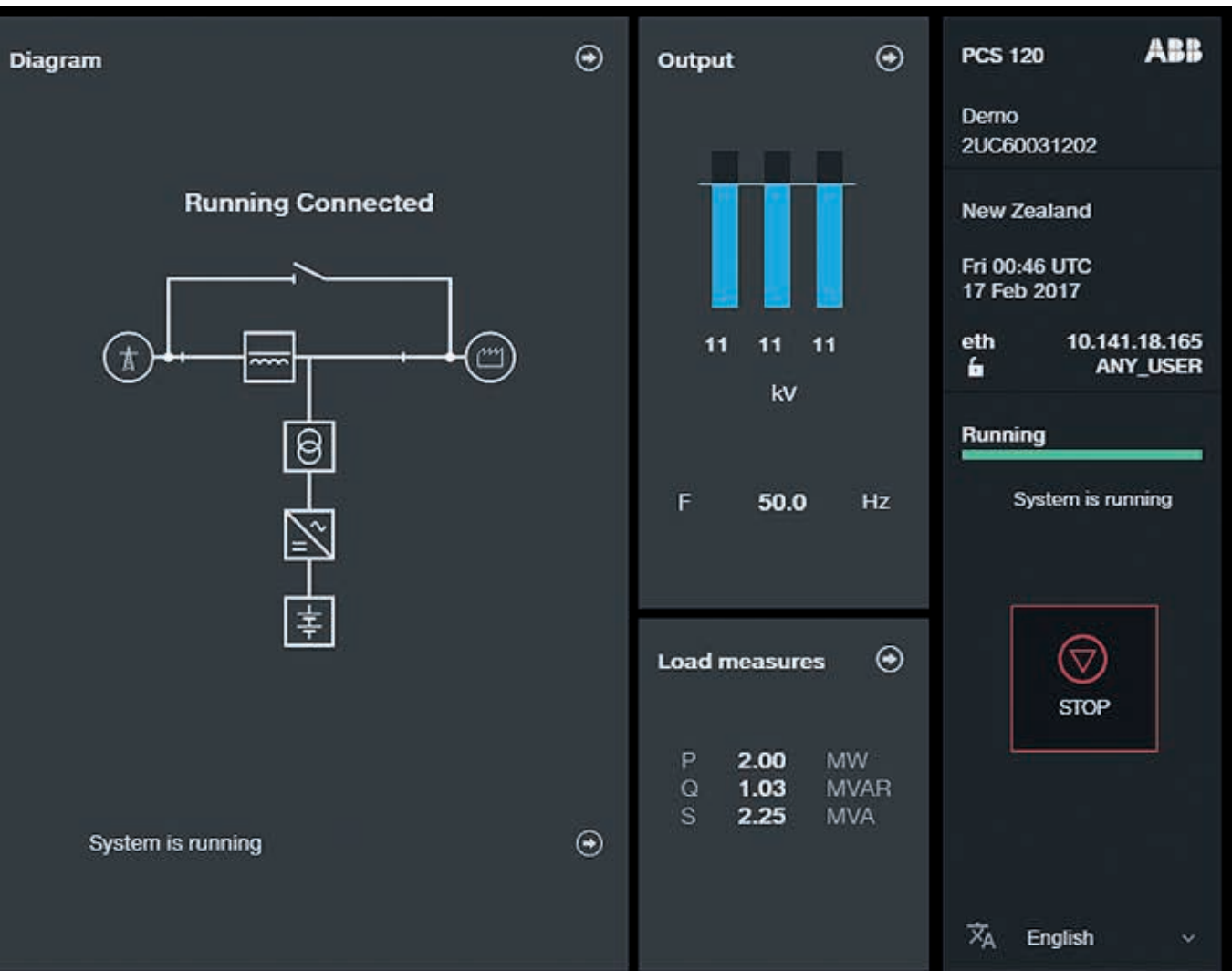

## PROTECTION AND SAFETY

# Ekip Link logic-zone discrimination protection system

A modern dynamically positioned (DP) vessel will have a sophisticated electrical power system driving the propulsion that keeps it on station. Logic-zone discrimination using Emax 2 with Ekip Link in DP vessels with closed bus ties ensures the highest reliability and flexibility.

**Antonio Fidigatti**  
**Borje Axelsson**  
**Carlo Collotta**  
 ABB Electrification  
 Products Division  
 Bergamo, Italy

antonio.fidigatti@it.abb.com  
 borje.axelsson@se.abb.com  
 carlo.collotta@it.abb.com

Any seagoing vessel is subject to forces from wind, waves and currents. Dynamic positioning is the ability to maintain a vessel's position automatically in the face of these forces of nature by using its propulsion system. DP vessels come in many shapes and sizes – rock dumpers, diving or ROV support vessels, pipe layers, crane ships, drill ships, offshore support vessels, etc. →1.

Dynamic positioning is the ability to maintain a vessel's position automatically, using its propulsion system.

What these vessels all have in common is the need for exact stationkeeping: They must maintain their position and heading precisely even in the roughest seas or strongest tides.

## DP – components and levels

A DP system has three main elements:

- **Power system.** Everything that is needed to supply the DP system with electrical power, including generators, switchboards, electrical distribution systems (cabling and cable routing) and power management.
- **Thruster system.** All components and systems necessary to supply the DP system with thrust force and direction. The thruster system includes thrusters with drive units and electronic and manual thruster controls.
- **DP control system.** All DP control components and systems (including software) necessary to dynamically position the vessel, consisting of a computer and joystick controller (for manual backup), position reference (using satellites), DP sensor system and operator panels.

Not all DP vessels are the same in terms of redundancy. IMO (International Maritime Organization) rules define three basic redundancy levels for DP vessels:

- **Class 1 (DP1).** No redundancy required.
- **Class 2 (DP2).** Redundancy to make the system tolerant to a single fault. Loss of position should not occur from a single fault of an active component nor system such as generators, thrusters, switchboards, remote controlled valves, etc., but may occur after failure of a static component such as cable, pipe, manual valve, etc.

—  
01 Marine vessels often have to maintain a very exact position and heading.

- **Class 3 (DP3).** In addition to Class 2 requirements, the redundant systems shall be physically separated. Equipment must withstand fire or flood in any one compartment without the system failing. Loss of position should not occur from any single failure including a completely burnt out fire subdivision or a flooded watertight compartment [1] →2.

—  
A DP vessel's electrical power system must have the highest reliability and flexibility, which is a challenge given the restricted space, complex power system and hostile environment.

#### The all-electric DP vessel

Like some other marine vessel classes, there is a strong trend amongst DP vessels toward electrification. For DP vessels, the all-electric ship (AES) approach is the only one that permits, in an easy and efficient way, complete and precise position control under all relevant marine environment conditions.

The performance required from a DP vessel necessitates an electrical power system with the highest availability and flexibility. But the restricted space available, the reliability issues raised by the complex power system and the hostile marine environment make this task challenging. Fault management is, therefore, a critical aspect of DP vessel operation and must effectively do the following:

- Isolate the faulty component or system before the failure propagates from one system to another.
- Guarantee a disconnection strategy for a faulty system based on detection of fault direction.
- Guarantee flexible and redundant power protection systems.
- Provide self-monitoring to limit hidden failures.



DP class notation												
IMO equipment class	ABS	BV	CCS	DNV Det Norske Veritas (Norway)	GL	IRS	KR	LR	NK	RINA	RS	
	American Bureau of Shipping (USA)	Bureau Veritas (France)	China Classification Society (China)		Germanischer Lloyd (Germany)	Indian Register of Shipping (India)	Korean Register of Shipping (Korea)	Lloyds Register (UK)	Nippon Kaiji Kyokai (Japan)	Registro Italiano Navale (Italy)	Russian Maritime Register of Shipping (Russia)	
	DPS-0	DYNAPOS SAM		DYNAPOS AUTS	DPS-0			DP (CM)		DYNAPOS SAM		
Class 1	DPS-1	DYNAPOS AM/AT	DP-1	DYNAPOS AUT	DPS-1	DP 1	DP(1)	DP (1)	DP (AM)	Class A DP	DYNAPOS AM/AT	DYNPOS-1
Class 2	DPS-2	DYNAPOS AM/AT R	DP-2	DYNAPOS AUTR	DPS-2	DP 2	DP(2)	DP (2)	DP (AA)	Class B DP	DYNAPOS AM/AT R	DYNPOS-2
Class 3	DPS-3	DYNAPOS AM/AT RS	DP-3	DYNAPOS AUTO	DPS-3	DP 3	DP( 3)	DP ( 3)	DP (AAA)	Class C DP	DYNAPOS AM/AT RS	DYNPOS-3

02

**Closed bus tie operation**

Marine power systems are typically of the isolated type, with four to eight generators and the overall power system split into two, three or four sections. The power bus of each section is connected to the others by a bus tie, which utilizes a circuit breaker. When closed, this interconnection makes the power system flexible (any generator then being able to provide power to any consumer, eg, thrusters).

—  
An efficient way to handle electrical faults is zone selectivity, which allows rapid fault isolation without users, other than those directly affected, seeing any effect.

Closed bus tie operation allows the vessel to run with a few engines at high power rather than operating all engines at low power. This mode of operation significantly reduces operating costs (eg, fuel consumption is cut by around 3 to 5 percent) and maintenance costs (30 percent lower).

Emissions are reduced too. Closed bus tie operation is, therefore, desirable and it is possible to design fault-tolerant systems for closed bus tie and closed ring operation. This approach to fault management is possible thanks to the circuit breaker inside the closed ring system →3.

**Emax 2 and Ekip Link modules**

Emax 2 is more than a circuit breaker as traditionally defined: Compactness and the high reliability that results from pretesting makes Emax 2 highly suitable for applications in marine vessels. Emax 2 is an innovative all-in-one concept. In fact, it is the first intelligent circuit breaker designed to protect, connect and optimize low-voltage microgrid applications. Accessories (modules) are added to the breaker to achieve all the additional functions needed. One such basic accessory is the electronic trip unit or protection relay. Ekip Hi Touch or Ekip G Hi Touch are examples of such units, in which a dual set of protection settings delivers the flexibility to change the system configuration.

03

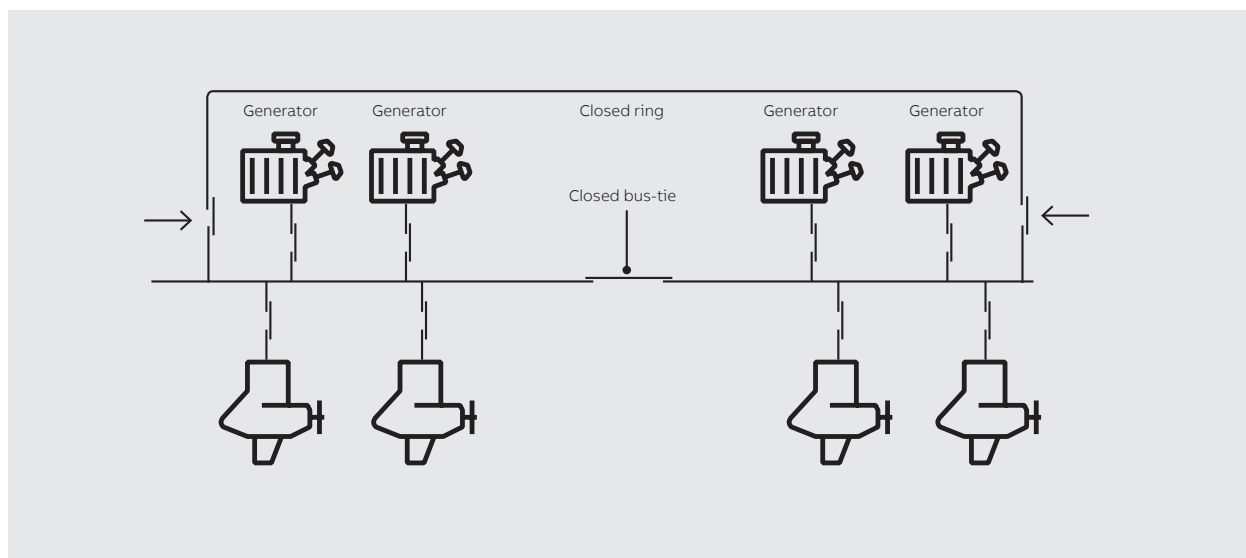



—  
02 DP classifications have worldwide commonalities.  
Note: The equivalent to IMO DP class is approximate because of differences between the various classifications, local exemptions, etc.

—  
03 Closed bus ties enable more efficient operation.

—  
04 Ekip Link module.

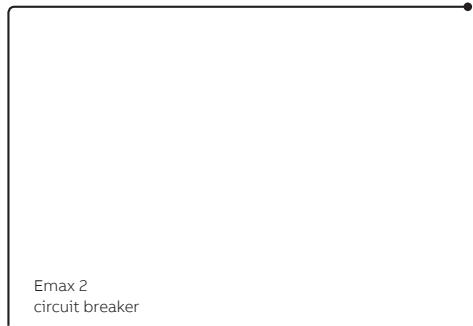

Ekip Link module



04

DP applications require other signaling and this additional flexibility is achieved through programmable contacts.

—  
Directional protection is useful in closed ring systems with several generators where it is essential to define the direction of the power flow that supplies the fault.

Ekip Link, the ABB communication module for low-voltage circuit breakers, handles communication between circuit breakers using an internal ABB proprietary bus →4.

All circuit breakers can intercommunicate using only one Ekip Link connected to the main switch via Ethernet. If more than two breakers are involved in the selectivity chain, an Ethernet switch can be used to handle the signals pertaining to the different Ekip Link units →5.

Using the ABB communication protocol, Ekip Link can:

- Create complex logic selectivity without using complex wiring.
- Provide redundancy, using both Ekip Link bus and standard wiring.
- Provide diagnostics (configurable) to test the wiring selectivity.

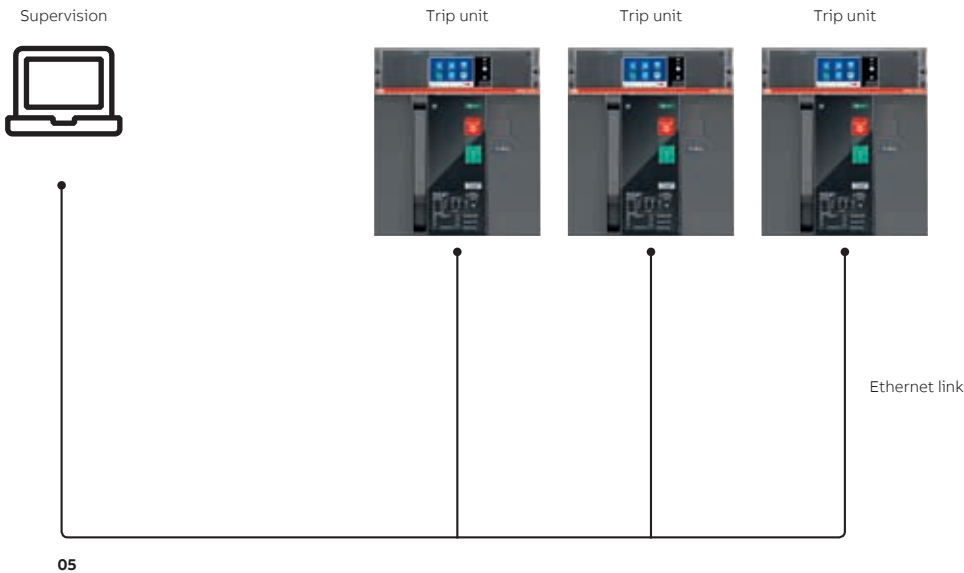

**Logic-zone discrimination with Emax 2 equipped with Ekip Link**

A major element of DP vessel power system design is protection against electrical faults. One very efficient method of handling faults is logic-zone selectivity (or “discrimination”), which allows rapid fault isolation without users – other than those directly involved – seeing any effect.

This approach can accurately isolate the fault branch by quickly opening adjacent circuit breaker(s), and reduce the transitory fault time and electrical stresses.

—  
 Logic-zone discrimination combines zone selectivity and directional protection and is often required in DP2 and DP3 vessels.

**Logic-zone selectivity combines zone selectivity and directional protection**

In contrast to traditional selectivity methods, which are based on time and/or current, the principle of zone selectivity is that the breaker that should trip for a fault sends a blocking signal to other (upstream) breakers to prevent them from tripping →6. In other words, the principally impacted breaker can block other breakers from tripping, when appropriate.

Behind this scheme lies a logic that defines which breakers should and should not trip in certain situations. With Emax 2, the blocking signal can be realized by traditional hardwiring or by bus communication using Ekip Link. It is also possible to use both in parallel (redundancy).

**Directional protection**

Directional protection is useful in ring- and grid-type systems with several power sources (generators) where it is essential to define the direction of the power flow that supplies the fault. ABB’s Emax 2 is the first low-voltage circuit breaker with fully integrated directional protection and zone-directional selectivity functions.

To use directional protection, the reference direction of current has to be set. Different threshold and delay times for the different directions may also be set.

— 05 Every trip unit (protection relay) is connected to an Ekip Link module and thence to a main switch.

— 06 The principally impacted breaker can block other breakers from tripping, when appropriate.

— 07 Ethernet-based connection eliminates fault-prone twisted-pair cabling.

**Reference**

[1] Ian C. Giddings, "IMO Guidelines for Vessels with Dynamic Positioning Systems." Available: [http://dynamic-positioning.com/proceedings/dp2013/quality\\_giddings\\_pp.pdf](http://dynamic-positioning.com/proceedings/dp2013/quality_giddings_pp.pdf)

**Connecting with Ekip Link**

With the Ekip Link connection, all the circuit breakers involved in logic-zone selectivity are connected through an Ethernet-based proprietary bus. This approach eliminates the traditional hardwired twisted-pair cabling that previously made installation, commissioning and testing difficult →7.

The use of a proprietary bus guarantees very fast and predictable communication that is independent of traffic on other buses.

The Ekip Link modules must be installed in all circuit breakers. During the setup process, ABB's Ekip Connect software is used to configure the trip units' logic-zone selectivity options – ie, define which signals will be received and which will be transmitted to the next circuit breaker; establish the nodes in the system; and determine the IP address of each actor. Here, a node is a defined group of circuit breakers, one of which is nominated as the "unit reference" and in which logic-zone selectivity options are configured using Ekip Connect. The actors are the remaining breakers in the group.

With the Emax 2 and Ekip Link approach, tripping using logic-zone selectivity with high precision and reliability takes 100 ms.

**Positioning for the future**

The Emax 2 air circuit breaker equipped with Ekip Link forms the basis of a unique solution for low-voltage logic-zone discrimination that has been designed to meet the most demanding requirements of reliability, flexibility and efficiency in DP vessels with closed bus ties. This solution is easy to install, commission and test.

The Emax 2 and Ekip Link techniques described here can also be applied to other microgrid applications or complex power systems – for example, data centers – where zone selectivity can provide major benefits. ●

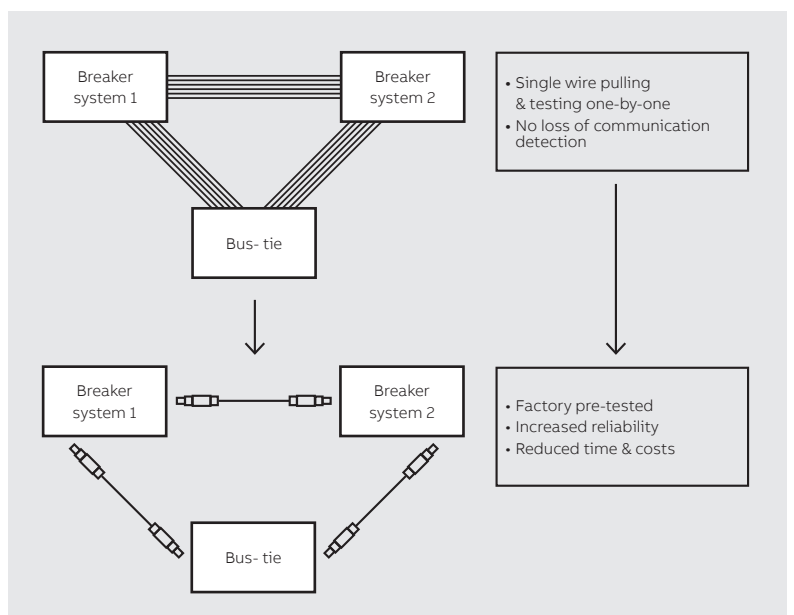
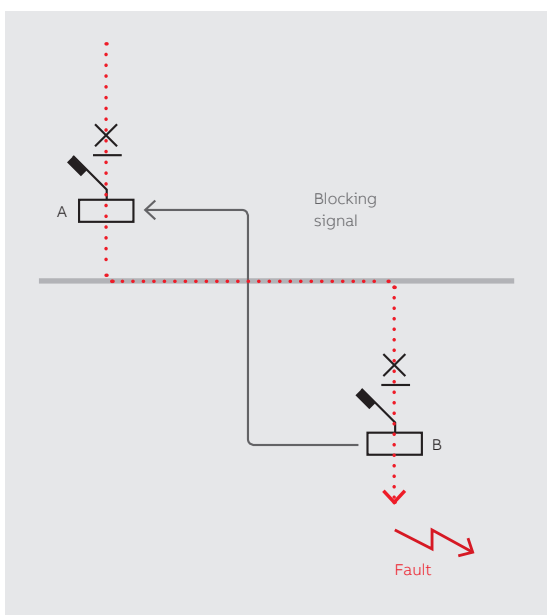

## PROTECTION AND SAFETY

# ABB's Emax 2 protects, monitors and manages microgrids

ABB's Emax 2, the all-in-one innovation for microgrids, makes small-scale power networks even more flexible and cost-efficient. With all essential microgrid functionality integrated and with advanced features, the solution makes a wide range of on-grid and off-grid requirements simple to manage.



**Fabio Monachesi**  
Low Voltage Air  
Circuit Breaker  
ABB Electrification  
Products  
Perugia, Italy

fabio.monachesi@  
it.abb.com

Power grids are undergoing change on a scale not seen since power distribution first emerged. The main agents driving this dramatic development are the rapid growth of renewable energy and the rise of the microgrid.

The fundamental shifts in power grids brought about by distributed renewable energy resources – as well as by more exacting requirements for power grid resilience and complete system integration – have raised new questions for power grid architectures. Microgrids provide the answers.

Fundamental changes brought about by distributed renewable energy resources have created new challenges for power grid architectures.

Microgrids are low-voltage (LV) grids that are either connected to the utility grid or that operate in standalone mode in a coordinated and controlled way. Microgrids are often diesel generators and energy storage systems (flywheels, lithium-ion batteries, etc.) supplemented by renewable power sources, such as solar generators.



In 2016, more than 1.5 GW in LV microgrid power was installed worldwide; estimates for 2020 range up to 4 GW. This context is ideal for ABB's Emax 2 →1.

—

**Emax 2 is the first circuit breaker with embedded programmable logic able to manage automatic transfer switch function.**

#### **ABB Emax 2**

Emax 2 is the first intelligent circuit breaker intended for LV microgrids. In just one product, Emax 2 provides advanced protection, full connectivity and logic capabilities as well as load, generation and storage management. Emax 2 is the all-in-one innovation designed to protect, connect and optimize LV microgrid applications.

Although Emax 2 is the most compact air circuit breaker on the market (about 30 percent more compact than equivalent devices), it packs in a lot of advanced functionality:

#### **Protection**

The circuit breaker can fully protect loads and generators. For example, the connection of a generator to an LV microgrid or a medium-voltage (MV) network through a transformer adds specific protection requirements such as machine protection and synchronism between generators and grid. For these, and other requirements, Emax 2 generator protection trip units offer a wide range of new protection functions and paralleling checks.

The transition from on-grid to off-grid modifies the network configuration and short-circuit requirements. A representative example of this would be a microgrid with utility supply (on-grid) and an emergency supply generator (off-grid). Emax 2 ensures adaptive protection settings for each scenario, guaranteeing coordination under all conditions.



Zone selectivity is the most advanced method for making fast, coordinated network protection decisions. Zone selectivity is based on having a network in which all devices can send and receive

—  
Although Emax 2 is about 30 percent more compact than equivalent devices, it packs in a lot of advanced functionality.

signals to and from one another. Under fault conditions, the Emax 2 breaker closest to the fault takes appropriate action and informs the others to continue working. The intelligent circuit breaker guarantees the highest level of reliability thanks to redundant zone selectivity based on two coordination networks: electrical and digital (Ethernet).

Interface protection functions based on voltage and frequency measurements are required when disconnecting the microgrid from the main grid. Emax 2 is the breaker at the microgrid point of common coupling (PCC) and it includes these functions, in compliance with international standards.

**Logic**

Service continuity in a microgrid is essential. If a fault occurs in the utility network, an automatic transfer switch (ATS) manages the switchover of supply from the main power line to a local generator line. Emax 2 is the first circuit breaker with embedded programmable logic able to manage this ATS function. These new functions maximize service continuity and enable a reduction of up to 30 percent in the switchgear needed.

Interlock functions increase electrical system reliability and the safety of personnel in an LV microgrid connected to an MV grid. Emax 2 can distinguish earth fault types (restricted or unrestricted) and, via programmable contacts, command the MV grid to disconnect, without additional external relays. Furthermore, when the MV breaker trips, the LV breaker is required to open, avoiding reverse fault power flow. Using Emax 2 communication protocols or programmable contacts, it is possible to perform functions such as these and interlock the MV and LV sides.

02



—  
01 Emax 2, all-in-one innovation.

—  
02 Ekip Connect 3 commissioning tool.

### Connectivity

The network analyzer embedded in the Emax 2 understands power quality and a wide set of electrical measurements. System integration is guaranteed by full connectivity via communication protocols such as IEC 61850, Modbus TCP, Modbus RTU, Ethernet IP, Profibus, ProfiNet, DeviceNet, Ekip Link and openADR. Ekip View and Ekip Control Panel microScada are also available.

The ABB Ability™ Electrical Distribution Control System is a cloud-based platform that can monitor and analyze the flow of power within any facility, leveraging the intelligence and connectivity of Emax 2 air circuit breakers. It allows the evaluation of live data and the remote control and management of industrial power systems and buildings.

### Management

Fast load shedding can support the islanding of the microgrid during the transition from on-grid to off-grid or the steady state. Emax 2, using its rate of change of frequency (ROCOF) function, disconnects loads only when an emergency imbalance condition arises →4. Emax 2 realizes the load shedding logic using digital contacts embedded in the breaker or installed externally in DIN rail modules.

—  
**Zone selectivity is the most advanced method for making fast, coordinated network protection decisions.**

Peak shaving and load shifting are used to control microgrid power flow, reduce maximum demand charges and optimize the plant absorption. Emax 2 is ready for virtual power plant (aggregation of clients and loads) applications and demand response programs thanks to communication protocols. A patented power management algorithm is embedded in Emax 2.

Emax 2 delivers much functionality in a single device, thus replacing multiple devices and providing a simple, inexpensive and intelligent solution.

During its life, an LV utility-tied microgrid has four operational stages (islanding, islanded, reconnection and grid-connected) and Emax 2 can control each one.

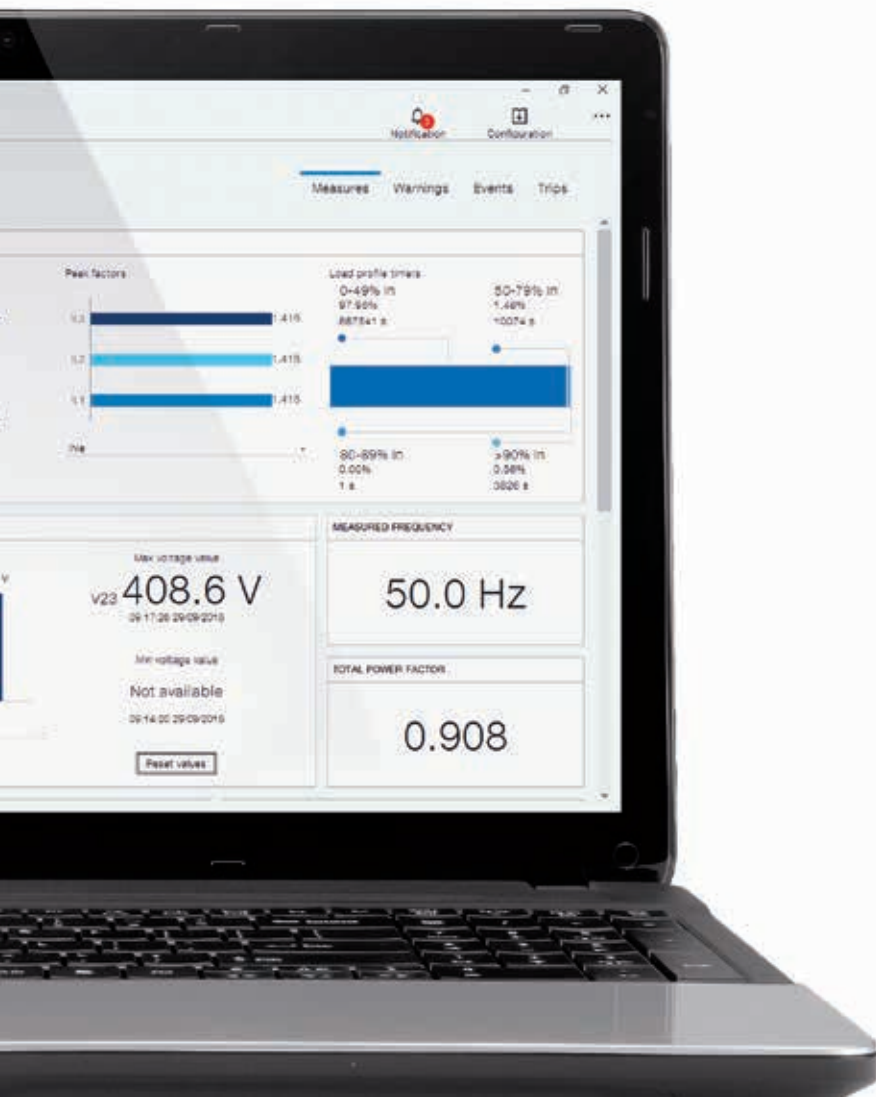

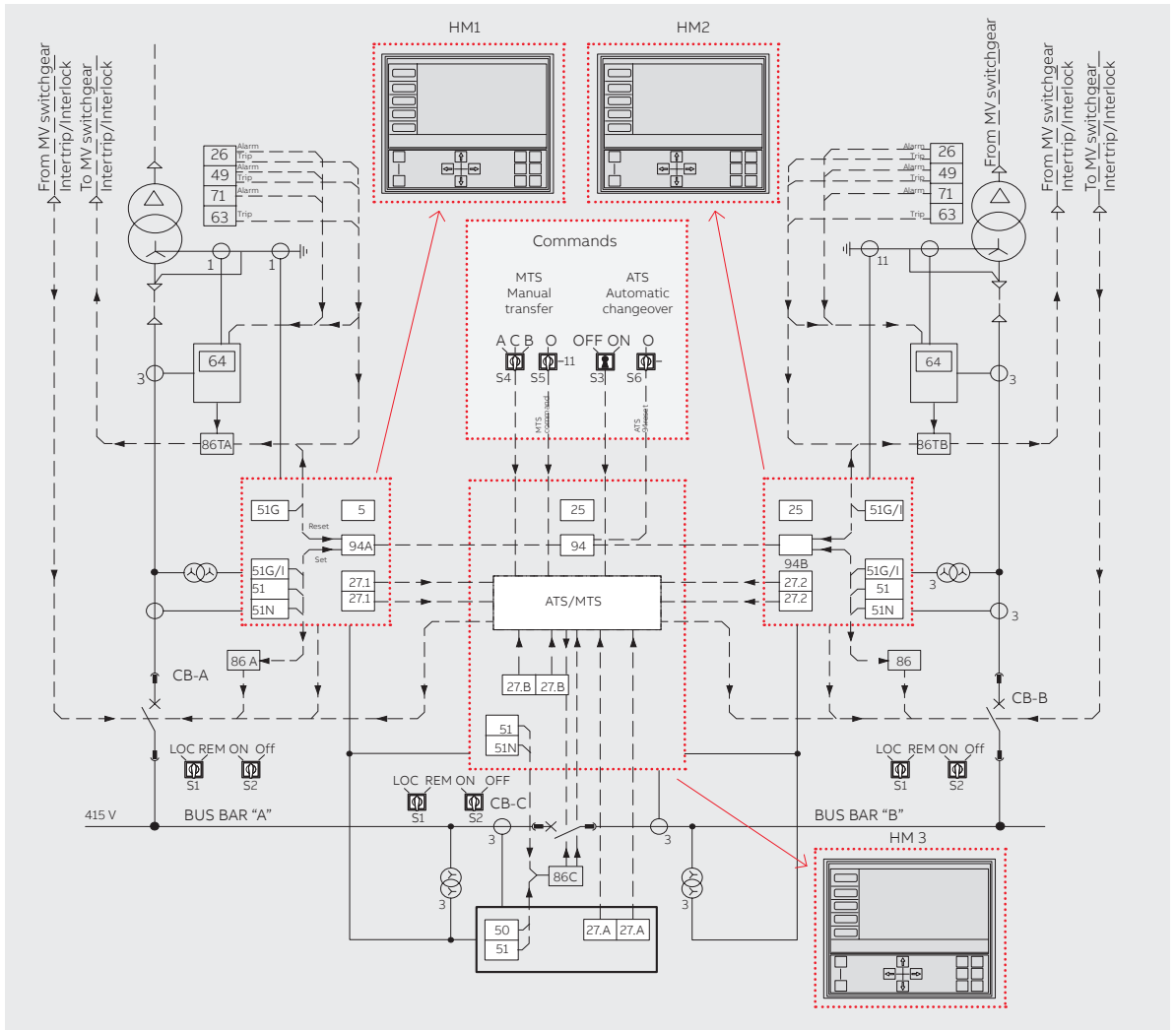

03a

**Microgrid islanding**

Emax 2 is usually installed immediately downstream of the MV/LV transformer as the interface point between the microgrid and the main grid. If there is a fault in the MV grid, Emax 2 can detect it and quickly change voltage- and frequency-based

Emax 2 has a patented integrated fast load-shedding method that exploits the device’s current and voltage measurements to reduce the risk of frequency drop.

protection thresholds. The interface protection system built into the breaker disconnects the microgrid from the main grid to let it work in standalone mode. Emax 2 then automatically changes the feeder protection settings according to the new microgrid conditions. In particular,

the short-circuit protection values should be reduced as there is no longer a contribution to the fault from the utility side. Thanks to this adaptive protection, coordination among the different resources remains guaranteed even off-grid.

Ekip Link is the ABB proprietary bus tool that facilitates horizontal communication among the breakers, enabling digital selectivity. Direct communication between the Emax 2 breakers eliminates the need for a supervising device or master, speeding up data exchange.

During the microgrid islanding transition, it is very important to avoid a frequency drop in case instability, or even a blackout, occurs.



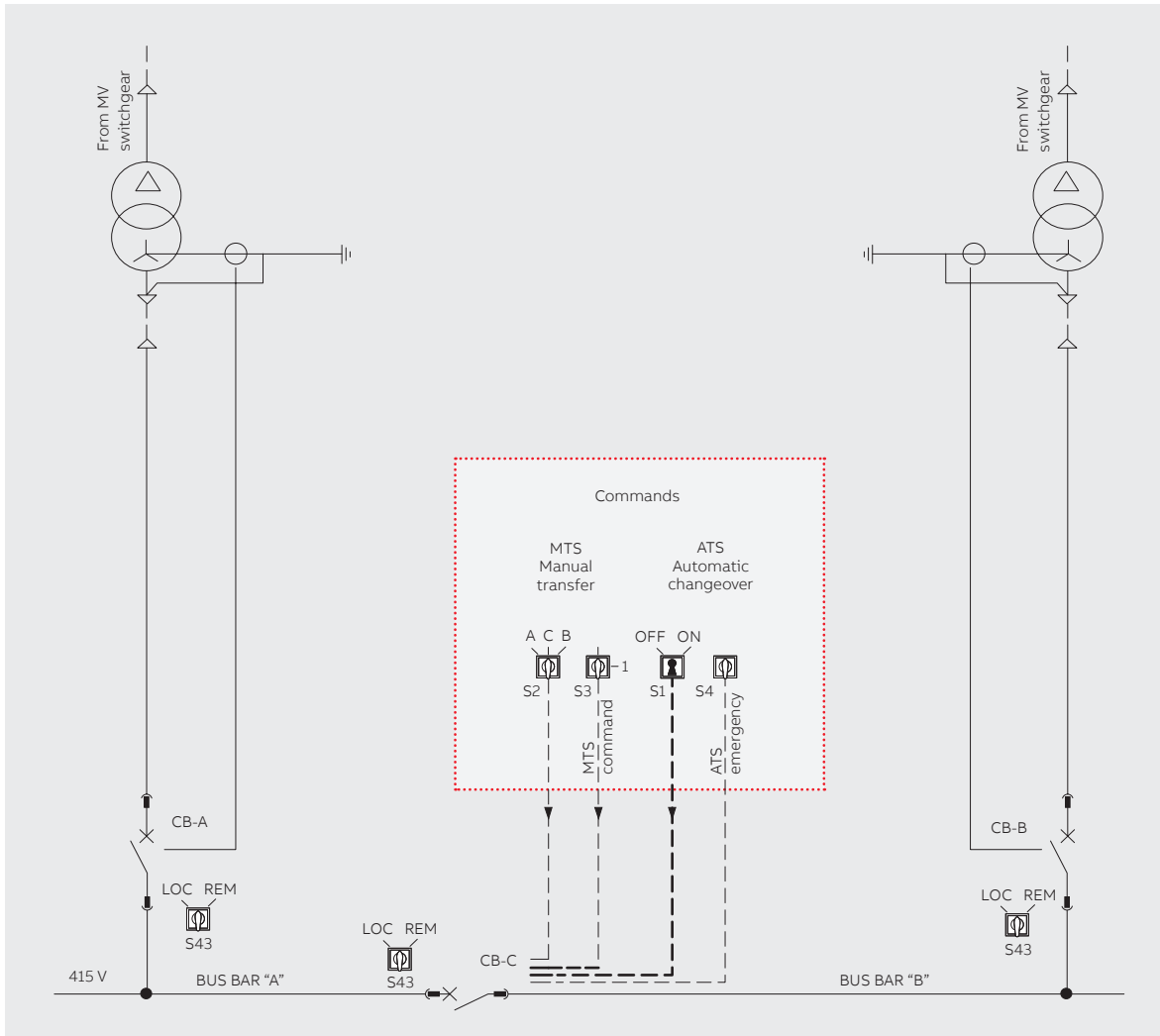

03b

03 Embedded ATS reduces the number of components required for the transfer switching logic.

03a Typical setup.

03b With embedded ATS.

Emax 2 has a patented integrated fast load-shedding method that exploits the device’s current and voltage measurements to reduce the risk of such an event. In accordance with the microgrid power consumption and frequency measurements, the adaptive load shedding quickly sheds less critical loads to maintain power balance and avoid black-outs. As it is possible to add or lose power sources after the islanding event – eg, a backup generator starting or an inverter with anti-islanding

The ABB Ability™ Electrical Distribution Control System is a cloud-based platform that can monitor and analyze the flow of power within any facility.

protection kicking in – Emax 2 load shedding has dedicated configurations: One for an emergency genset and another for solar power that takes into account plant geography, solar panel inclination, orientation and size.

**Microgrid islanded**

When the microgrid is in standalone mode, it is possible to start up other resources, such as backup generators. As described above, Emax 2’s embedded ATS logic manages the transfer from the main line to an emergency line to minimize problems caused by faulty conditions in the public network or MV grid. ABB’s embedded ATS is a high-performance energy automation system that is easy to install and program. The ATS takes advantage of the new capabilities provided by the Ekip Connect 3 commissioning software tool →2 and the Emax 2 to deliver a compact and reliable solution →3. The embedded ATS solution is as compact as the Emax 2 because nothing needs to be added apart from internal trip units and Ekip Link communication. If required, Ekip Synchrocheck modules can be installed to handle synchronism during paralleling.

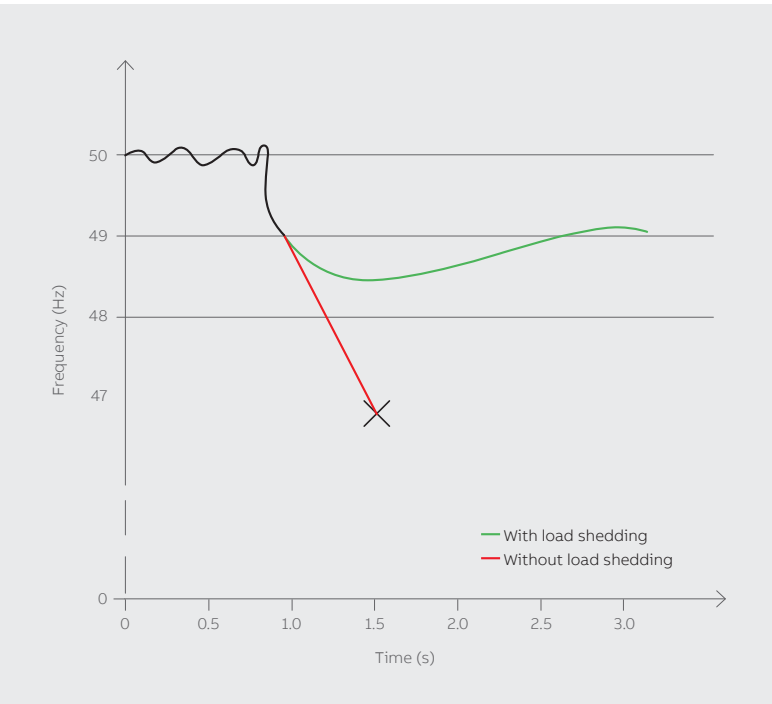

04a

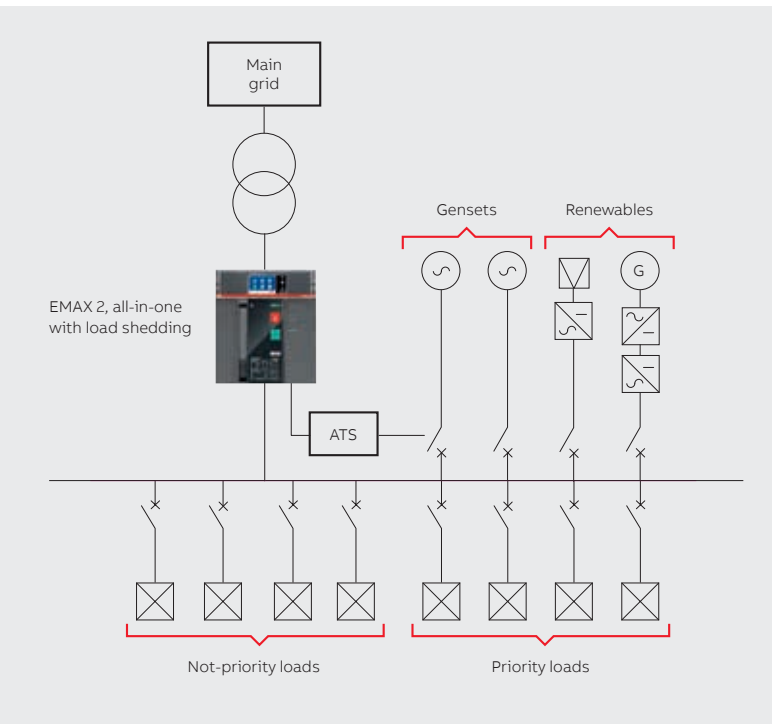

04b

Emax 2’s ATS reduces the PLC programming skills and electrical knowledge needed to program a power automation switchboard by providing general templates – tested and ready-to-go – that can be customized via a graphical user interface (GUI). When the user is satisfied, a simple tool allows the template to be uploaded to the devices. Parameters can be subsequently changed by simply connecting a laptop and using the same GUI. The time saved in microgrid ATS engineering is estimated to be around 95 percent.

The network analyzer embedded in the Emax 2 understands power quality and a wide set of electrical measurements.

**Microgrid reconnection**

The ability to resynchronize the microgrid with the grid when it is in a steady-state condition is one of Emax 2’s integral features.

Neither an external synchrocheck relay nor synchronizing equipment is required for the paralleling operation. Voltage sensors at the microgrid side are integrated into the Emax 2 circuit breaker, so only one single-phase transformer is needed at the main grid side.

Using the Ekip Synchrocheck cartridge module, Emax 2 monitors the most important reconnecting parameters and adapts the microgrid voltage and frequency to those of the grid. The secondary regulation of the local generator controllers is realized by Ekip Signaling contacts so that synchronization can be reached. The circuit breaker automatically recloses when it understands that the synchronism is achieved using Ekip Synchrocheck together with the integrated closing coil →5.

**Microgrid grid-connected**

Because any power peaks can mean higher bills, and demand response applications need to control the power flowing at the PCC, the Emax 2 has a patented embedded power management algorithm that performs a slow load and generator disconnection or power modulation. The algorithm is based on the limit of the average power flow towards the microgrid according to the power-handling capabilities of the transformer, on the contractual power or on the signal received for demand response strategies. For this last case, Emax 2 leverages the openADR protocol to communicate with load aggregators or utilities as a virtual end node.

—  
04 Load shedding protects the microgrid from a rapid frequency drop. The plant remains live and can work in standalone mode with priority loads always supplied.

04a A rapid frequency drop is to be avoided.

04b Load shedding scheme.

—  
05 Microgrid embedded solution with the ABB Ability Ekip Com Hub.

—  
06 Synchro-reclosing function enables microgrid reconnection to the main grid without external synchronizer.

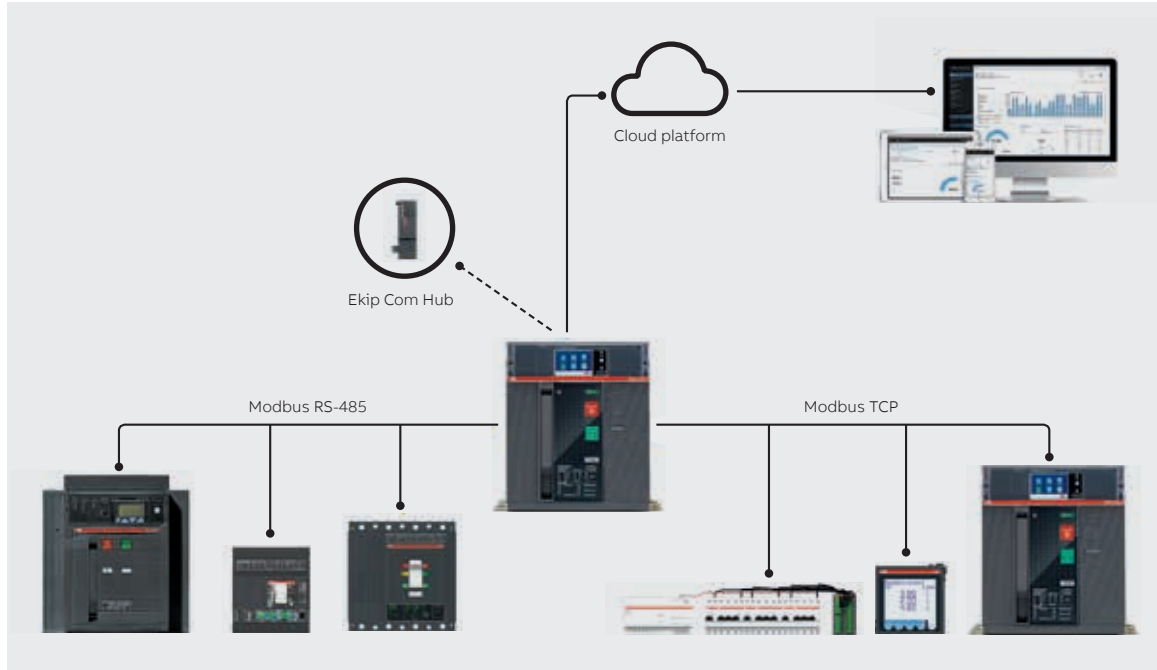

05

Emax 2 can help the microgrid manager in many other ways too. For example, the cloud-based platform, ABB Ability Electrical Distribution Control System, allows authorized persons to monitor, optimize and control the microgrid from anywhere. All that is needed is a cartridge-type communication module, the Ekip Com Hub, to be installed on the terminal box to establish the cloud connection →6.

As microgrids continue to proliferate, ABB's Emax 2 intelligent circuit breaker will enable operators to lower their costs and increase their capabilities. Protection, control, monitoring and management can all be handled with a single device to ensure microgrid loads and generators work in a controlled fashion, whether the microgrid is connected to the grid or is operating in a standalone mode. ●

This cloud architecture has been developed together with Microsoft to enhance performance and guarantee the highest reliability and security. For the first time, intelligent circuit breakers can provide extensive monitoring and management in widespread LV networks.

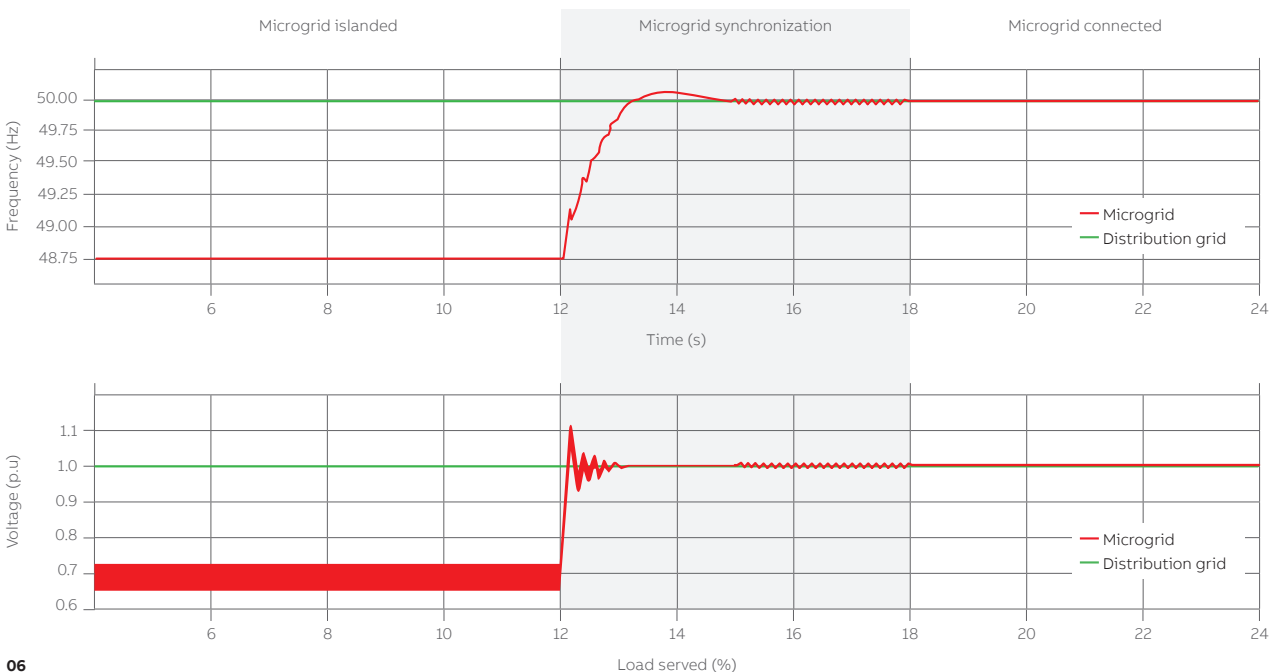

06



# Universal connectio

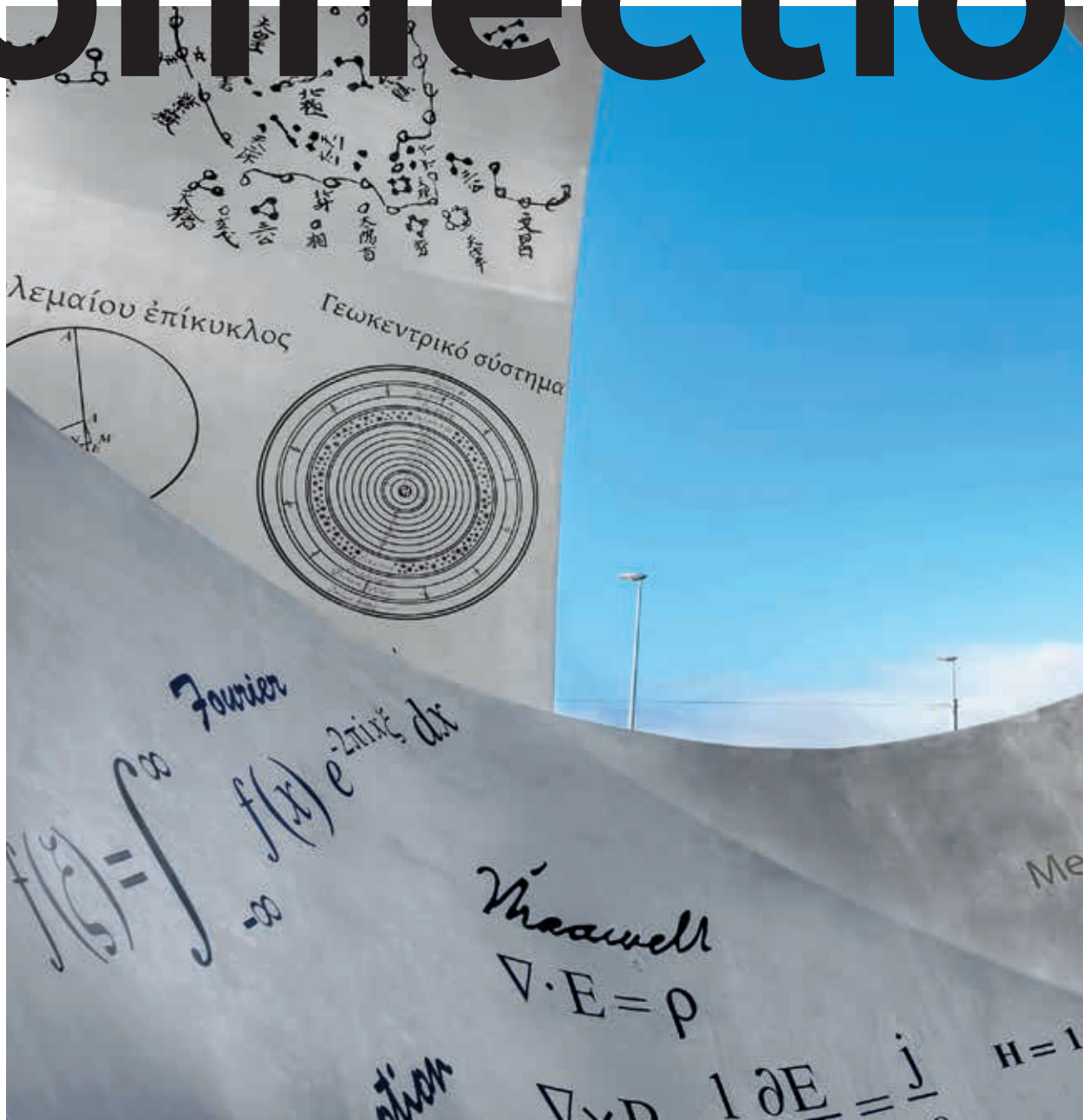

What do most people associate ABB with? Many will probably name products and applications from the power grid to the factory floor. But ABB is much more than this. In this section ABB Review visits some probably less well known applications: converters powering experiments at CERN and clean air in ports.

- 70 Bespoke MV MFT for a disCERNing customer
- 76 Plugging in cruise liners and container vessels

# ns



## UNIVERSAL CONNECTIONS

# Bespoke MV MFT for a disCERNing customer

Medium-frequency transformers (MFTs) provide a key feature lacking in today's traditional power electronic systems: medium-voltage galvanic insulation. Thanks to MFT, power electronic systems can be extended to the medium-voltage (MV) range and can replace the traditional converter plus grid frequency transformer pairing in a more compact way. ABB's extensive experience of MFT capabilities, coupled with the ability to deliver customized MFTs, are the reasons why ABB is the only supplier worldwide, as of today, that is capable of delivering a MFT that meets the demanding needs of the European Organization for Nuclear Research (CERN) →1.

**Toufann Chaudhuri**  
**Stephane Isler**  
**Marie-Azeline Faedy**  
 ABB Sécheron SA  
 Geneva, Switzerland

toufann.chaudhuri@ch.abb.com  
 stephane.isler@ch.abb.com  
 marie-azeline.faedy@ch.abb.com

Low-frequency transformers (LFTs) are transformers directly connected to the grid. The operating frequency (fundamental frequency) is essentially the grid frequency, ie, 16.7, 50, 60 Hz. In some special applications (for example traction) the transformer is, in addition, subject to some harmonic content of up to several kHz (fundamental + harmonic content).

MFTs are transformers connected to converters (DC/AC, AC/DC, DC/DC) for weight/dimension reduction purposes, compared to a LFT solution.

—

MFT are transformers connected to converters (DC/AC, AC/DC, DC/DC) for weight/dimension reduction purposes, compared to a LFT solution.

In this case, the fundamental frequency is already at several kHz or more. The waveform also often contains harmonics at much higher frequencies (tens of kHz).

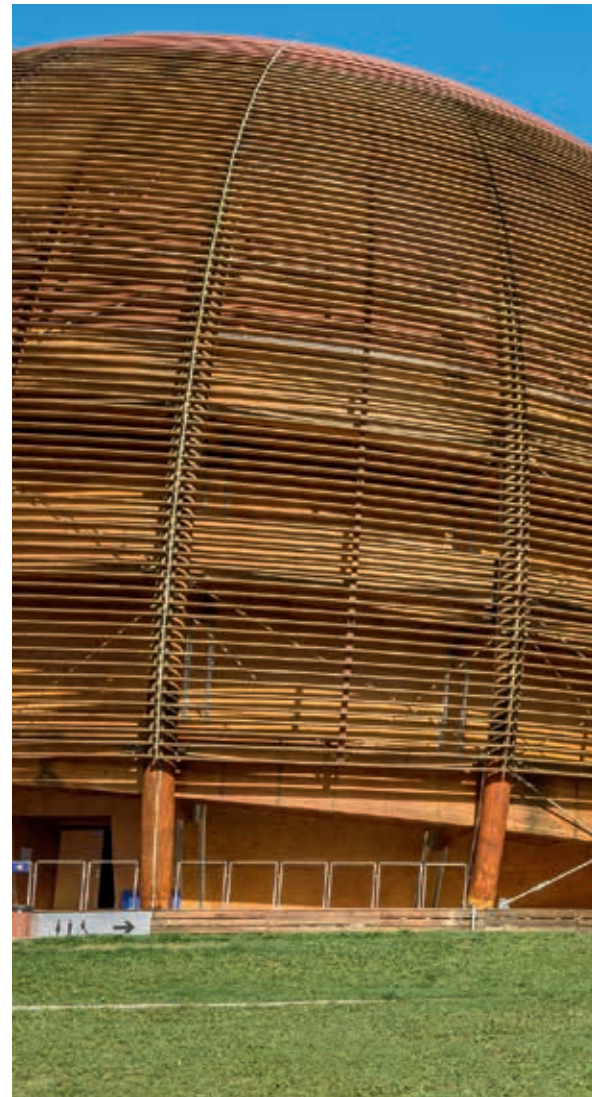

—  
01 CERN headquarters in  
Geneva, Switzerland  
Photograph © CERN.

### Physical matters

There are some key physical differences when comparing LFT with MFT. Medium frequencies have consequences on the behavior of the materials. The losses caused by the flux at medium frequency are much higher than for low frequency, which means that standard core materials cannot be used. To limit core losses, much thinner steel sheets (down to a couple of  $\mu\text{m}$  thickness) or ferri-

—  
The combination of reduced winding diameter and lower number of turns drastically reduces the conductor total length, hence the electrical resistance, which is the main reason why MFTs are much more efficient than LFTs.

tes must be used. Similarly, the medium-frequency content in the current has a very strong impact on copper losses, and in the same way, the conductors have to be split into many parallel cables with a very small cross-section (so called Litz wire).

For that reason, MFTs are built with core and conductor materials that are different from LFTs. Both the magnetic flux and the number of turns are inversely proportional to the frequency. Assuming a constant flux density, increasing the frequency enables a reduction of the core cross-section and of the number of turns in the windings. The transformer size therefore reduces very significantly when the frequency increases. Moreover, the combination of reduced winding diameter and lower number of turns drastically reduces the conductor total length, hence the electrical resistance, which is the main reason why MFTs are much more efficient than LFTs.



## INTERVIEW

# CERN and ABB Review talk transformers



## Dr. Davide Aguglia

Closely involved in the MFT project for the Proton Synchrotron upgrade, Davide Aguglia talks to ABB Review about the technical challenges and the outcomes of the project.

Electrical Power Converter group, CERN  
Geneva, Switzerland

**AR** **ABB Review (AR):** Can you describe for us in what way the MFTs relate to your work at CERN?

**DA** **Davide Aguglia (DA):** I'm a section leader in the Electrical Power Converter group. The group provides power solutions for the majority of magnets and radio frequency (RF) equipment. Magnets are required to guide the particle beam and RF is required to accelerate the beam. There are eight sections in the group and the MFTs are for the Fast Pulsed Converter section and are being installed for the Proton Synchrotron (PS) accelerator. The PS is one of the accelerators feeding the Large Hadron Collider (LHC) as well as other experiments at CERN.

**AR** Why did CERN start a project to replace the existing transformers?

**DA** The LHC needs to increase its luminosity: luminosity being the number of particle collisions per second. To achieve this objective, CERN is undergoing a phase of consolidation and upgrade of its accelerators complex, for which new power converters for the PS's RF system are required for accelerating the particles. The MFTs being the core sub-components of the new power converters.

**AR** Can you summarize for our readers what's special about the energy requirements for the PS?

**DA** A constant 25 kV must be supplied, irrespective of the load changes in time. The RF load consists of electronics tubes (RF amplifiers) that convert electrical power into RF power. The characteristics of the RF load change according to the type of acceleration being applied. This means that the load changes but the supplied 25 kV power must remain constant. We basically need to create a perfect, or ideal, voltage source.

**AR** What were the unique technical challenges for this project?



In addition to consuming less raw material than the equivalent power grid frequency transformer, while increasing efficiency, the reduced footprint of an MFT is another one of its key benefits →2.

#### **ABB's response to the MFT challenge**

ABB has wide experience with MFTs. Traditionally, when entering the MV range, any size reduction is limited because the insulation distances become a limiting factor, ie, size reduction is limited by dielectric distances. However, due to the excellent performance of oil insulation, it is possible to benefit from the compactness offered by MF even for increased insulation voltage requirements. Thanks to the oil insulation, different cooling methods can be used: natural or forced oil, and indirect water, forced air or natural air cooling are all possible.

One of the challenges that comes with offering a high insulation voltage, while also reducing the size by several orders of magnitude, is linked to bushings. While standard high-voltage bushings

—  
In addition to consuming less raw material than the equivalent power grid frequency transformer, the reduced footprint of MFT is one of the key benefits of MFT.

represent only a fraction of the size of an LFT, they are bigger than a complete MFT, meaning they can no longer be used. Instead, small bushings must be used through an insulating cover of the oil enclosure. Ensuring proper clearance and creepage distances requires extensive dielectric knowledge and FEM (finite element method) simulation capabilities.

**DA** Well, this is clear for me. There are three specific demands that had to be met in one piece of equipment. And that didn't exist anywhere. To my knowledge, it still doesn't. As far as I know, this is the first transformer ever to combine: high-voltage insulation at 25 kV, medium frequency at 20 kHz and power at 100 kW.

In addition to this, the specification from CERN required the converters to be modular. So that they could also be used by CERN in the future and not just for the PS consolidation and upgrade.

**AR** The first converter has now been installed. How are things going?

**DA** Five power converters have been ordered. That means an order of 17 MFTs. Three for each converter and two spares. The prototype is in operation. It is still being analysed but it is behaving well. Three more converters are due to be put into operation this autumn.

**AR** ABB and CERN are both large organizations. Do you think that created synergies or challenges during the project?

**DA** A specific contract was created to meet the needs of the project. Covering the risks associated with such a challenging project for both parties led to a more elaborate purchasing phase.

ABB's size was certainly an advantage for myself and all the technical people involved at CERN. ABB's size meant that all phases of the project could be done within ABB. Nothing was subcontracted and everything was done in-house. This made collaboration much quicker and easier and also meant that the division of responsibilities was nice and clear and just between two parties.

**AR** What was the key ABB differentiator?

**DA** Great with ABB was the high expertise in the domain. What stood out for me was being received in Geneva by the ABB engineers, technicians and the R&D leader. For example, the technicians were included in the early discussions about design. It is a very technical project, and being able to talk directly to the ABB engineers and access their vast range of experience was definitely a highlight for me.

**AR** That's certainly lovely to hear. Thank you for time and this interview.

## CERN

Founded in 1954, CERN sits astride the border between France and Switzerland, near Geneva. It uses the world's largest and most complex scientific

—

For this demanding application ABB is the only supplier world-wide, as of today, that is capable of delivering such a product to CERN.

instruments [1] to study the basic constituents of matter – the fundamental particles. The instruments used at CERN are purpose-built particle accelerators and detectors. There are nine accelerators at CERN, including the Proton Synchrotron.

### Proton Synchrotron modernization

The Proton Synchrotron (PS) is described by CERN as its “work horse” and first accelerated protons in 1959. It is a linear accelerator which accelerates particles for many experiments at CERN →3. It holds radio frequency cavities that require a very well stabilized DC voltage of 25 kV. By 2013, the PS was due for modernization, as part of which its MFT was to be integrated within CERN's DC/DC



03





—  
02 Medium-frequency transformer.

—  
03 CERN's Proton Synchrotron where ABB's MFT is installed. Photo © CERN.

—  
**References**  
[1] <https://home.cern/about>.  
Accessed 21.02.2017.

converter. In addition, the power was being upgraded but the replacement MFT had to be no larger than the previous one, since it was being installed in the existing space.

The main specifications for the replacement MFTs consisted of:

- 22kHz operating frequency
- 160kVA rated power, ester oil insulated
- KNAN cooling
- Two primary and 24 secondary windings
- PD free at 30kVrms
- Maximum size: 580 × 480 × 400 mm
- Maximum weight: 90 kg

ABB built on its experience of designing and delivering PETT (power electronic traction transformers) that have been 38kV insulated, with a 2kHz operating frequency with 180 kW of power. In the MFTs for CERN is the unique addition of 24 high-voltage windings.

During 2016, ABB successfully delivered 17 MFT units meeting all of these specifications. The MFTs passed all tests performed by the CERN team who are fully satisfied with the product that ABB developed for them. ABB is capable of testing an MFT at the actual frequency (in this case 20kHz), for the no-load and load losses, and for the inductances.

The ability to test the MFT under the final operating conditions guarantees optimal testing and helps to make sure that the product fully meets the customer's specifications. Installation and commissioning took place in the first half of 2017. For this demanding application, ABB is the only supplier worldwide, as of today, that is capable of delivering such a product to CERN.

#### **The power to accelerate**

ABB is one of the very few suppliers of customized MFTs for demanding high-voltage power electronics application. The advantage of MFTs are many and varied but are best summarized as:

- Very high power density for MV insulation level or high-power designs
- Smaller footprint, more compact, lightweight
- Easy to adapt to integrate into modular converters
- Improved energy efficiency
- Flexible cooling possibility
- Less copper, less iron and less oil
- 100 percent free of maintenance

With ABB's MFT delivering these advantages it allows customers, such as CERN, to get on with dealing with matters of matter. ●

## UNIVERSAL CONNECTIONS

# Plugging in cruise liners and container vessels

At berth, a large ship can consume up to 20 MVA – usually supplied by its diesel engines. However, dockside air quality and noise are coming under regulatory scrutiny. Pre-engineered solutions based on ABB's ACS6000 medium-voltage converter family deliver compliant and reliable shore-to-ship power with the highest power quality at an optimized cost per MVA →1–2.



**Roberto Bernacchi**  
ABB Power Grids,  
Grid Integration  
Sesto San Giovanni, Italy

roberto.bernacchi@  
it.abb.com

Often, when in port, ocean-going vessels generate electrical power using their diesel engines. However, marine engines are not known for their environmental friendliness and dockside emissions and noise are increasingly subject to regulatory scrutiny – especially as ports are often located in sensitive marine environments or large, densely populated cities. Indeed, of the top 10 environmental priorities that the European Sea Ports Organization (ESPO) has identified for major ports to take into account, the first three places feature the management of air quality, energy efficiency and noise [1].

### Shore-to-ship power

To reduce emissions when a ship is at berth, port authorities often provide a shore-to-ship power link. However, ultralarge – such as super-post-Panamax class – container vessels can consume as much as 7.5 MVA and large cruise ships 20 MVA. If several large container vessels are connected at the same time, the quayside energy provision can be considerable.



**Ester Guidi**  
ABB Robotic and Motion,  
Medium Voltage Drives  
Turgi, Switzerland

ester.guidi@ch.abb.com

Supplying such power levels places high demands on port electrical infrastructure both in terms of capital outlay, equipment complexity, running costs and maintenance. Moreover, vessels can have a 50 Hz or 60 Hz onboard grid (the majority use 60 Hz), so the SFC must not only handle high power levels but also adapt the local grid frequency to that of each vessel.

—  
ABB launched a project to integrate the ABB ACS6000 SFC medium-voltage drive platform into a range of pre-engineered, high-end static frequency conversion solutions.

### ABB ACS6000 SFC

To address this high-power-consumption vessel segment and with the aim of delivering state-of-the-art, shore-to-ship power for customers, ABB launched a project to integrate the ABB ACS6000 modular medium-voltage drive product platform into a range of pre-engineered, high-end static frequency conversion solutions: the ACS6000 SFC.



## 01

—  
01 At berth, ships can consume large amounts of power. Often, this power is supplied by the vessel's diesel engines, which can have an adverse impact on the local environment.

These solutions ensure a reliable power supply of the highest power quality to vessels – in full compliance with global standards – at an optimized cost per MVA.

—  
To reduce emissions when a ship is at berth, port authorities often provide a shore-to-ship power link.

The ACS6000 SFC integrated shore-to-ship power solution can provide the following core functions:

- Static conversion of the 50/60 Hz three-phase port grid power to match the 60/50 Hz vessel network.
- Full active and reactive power control of the vessel grid.
- Load flow balance with parallel-connected frequency converter systems supplying the load-side distribution infrastructure.
- Defined short-circuit current to allow downstream protection devices to operate.
- Low harmonic performance grid side and vessel side

The enhanced ACS6000 SFC platform chosen for this application has 12 variants covering the entire range of power requirements: From that of a single container vessel through multiple container vessels right up to the biggest cruise vessels currently in service.

Important design considerations were to minimize the impact of grid-side harmonics and maximize the vessel-side power quality. To reduce

—  
Dockside emissions and noise are increasingly subject to regulatory scrutiny.

harmonic content on the three-phase grid, either a twelve- or 24-pulse diode rectifier – line supply unit (LSU) – or a double/triple active rectifier unit (ARU) was used.



02

On the vessel side, each inverter unit (INU) is connected to a separate winding of the output transformer, with the load-side windings in series connection to form the desired load-side grid. This series connection, combined with phase shifting of the individual windings in conjunction with

—  
**The solutions ensure a reliable power supply of the highest power quality to vessels – in full compliance with global standards – at an optimized cost per MVA.**

a special design filter, allows characteristic converter harmonics to be greatly reduced. Standard ACS6000 SFC configurations are shown in →3. When selecting the SFC, high importance was given to its efficiency in order to minimize end-user OPEX. The selection of the converter cooling method is of significance here: with a water-cooled SFC, a conversion efficiency higher than 98 percent can

be achieved. Moreover, when compared to a rotating frequency converter, efficiency at partial load is close to the maximum, at over 97 percent, even down to a 30 percent loading factor.

ACS6000 SFC integration into the port grid takes into account the most stringent requirements of the global standard IEC/ISO/IEEE 80005-1 “High Voltage Shore Connection” and the class rules for the vessel defined by the certification companies. As an example, the optimized pulse pattern used to generate the sinusoidal waveform for the vessel is chosen such that the low-end harmonics – up to the 50th – are either eliminated or controlled to an acceptable level. A custom RC or RLC filter is then added to attenuate the remaining higher-order harmonics (up to the 100th) to achieve total voltage harmonic distortion levels of below 4 percent. The choice of frequency conversion platform is only the first step in delivering a reliable solution to shore-to-ship power system to end-users.

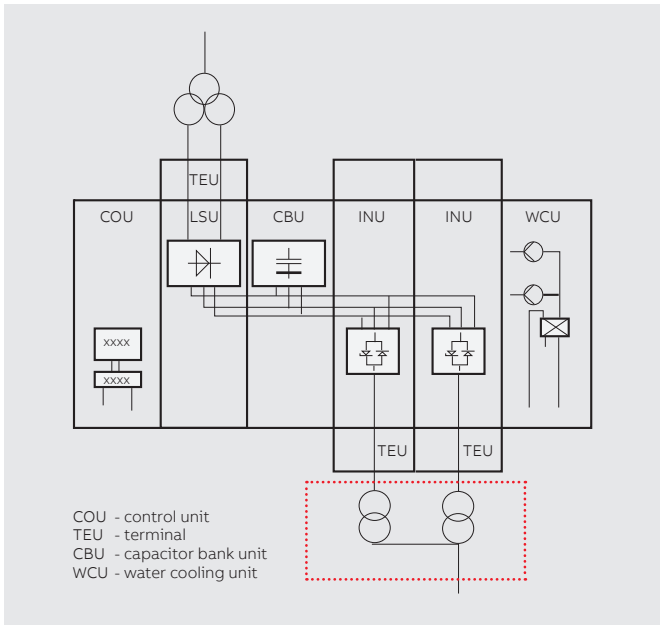

03a

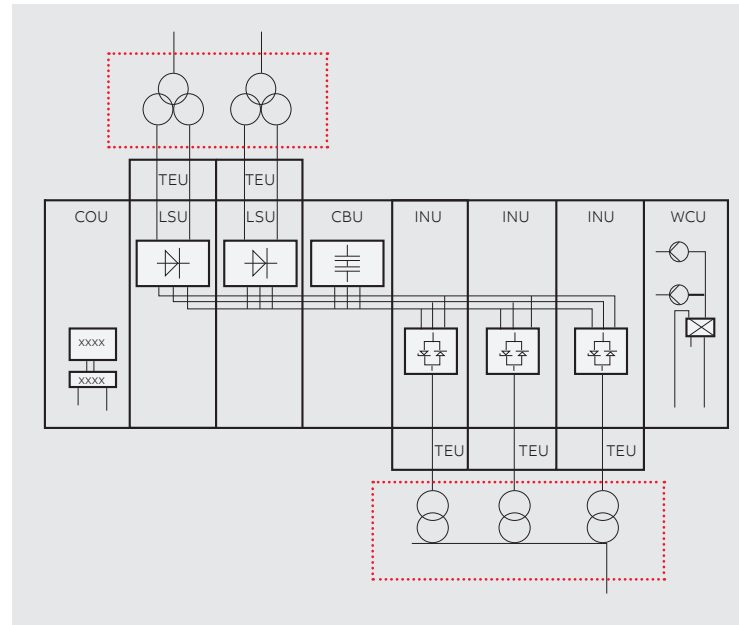

03b

02 ABB's ACS6000.

03 Standard ACS6000 SFC configurations.

03a ACS6000 SFC Double (up to 14 MVA).

03b ACS6000 SFC Triple (up to 24 MVA).

04 Converter system and delivery scope overview.

Several additional ship-specific aspects must be taken into consideration:

- System voltage for the ship supply: 6.6 kV, or 11 kV via a step-up transformer. The transformer requires an off-load tap changer to switch between these two voltage levels.
- Synchronization and load sharing with the on-board diesel generator, particularly during the transition immediately after vessel connection to the shore-to-ship power facility.
- Any reverse power flow from the vessel to shore should be managed through a dedicated braking resistor to avoid power feedback into the port grid as this is not acceptable in some national grid codes.
- Real-time power factor control (active and reactive power management) should be achieved, taking into account the different vessel grids.

- Downstream selectivity when selecting the short-circuit current capability of the converter as well as overloading arising from onboard switching loads.

The enhanced ACS6000 SFC platform chosen for this application has 12 variants covering the entire range of power requirements.

- Full electrical control and protection of the vessel and converter should be provided through the arrangement of load-side and ship-side switchgear.

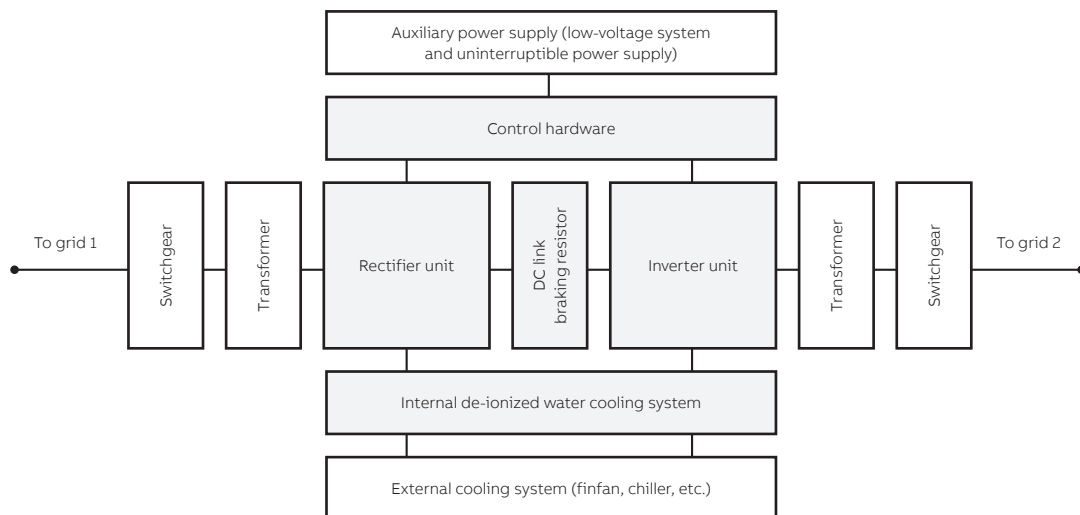

04

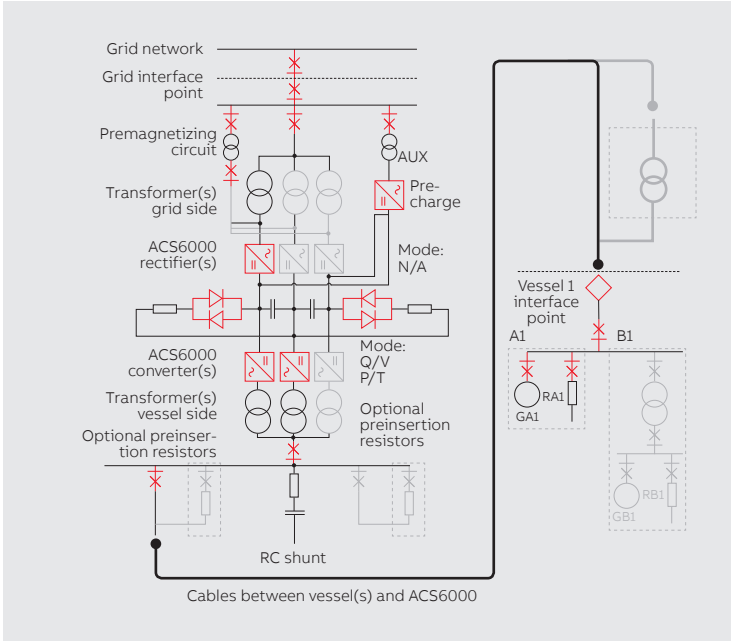

05a

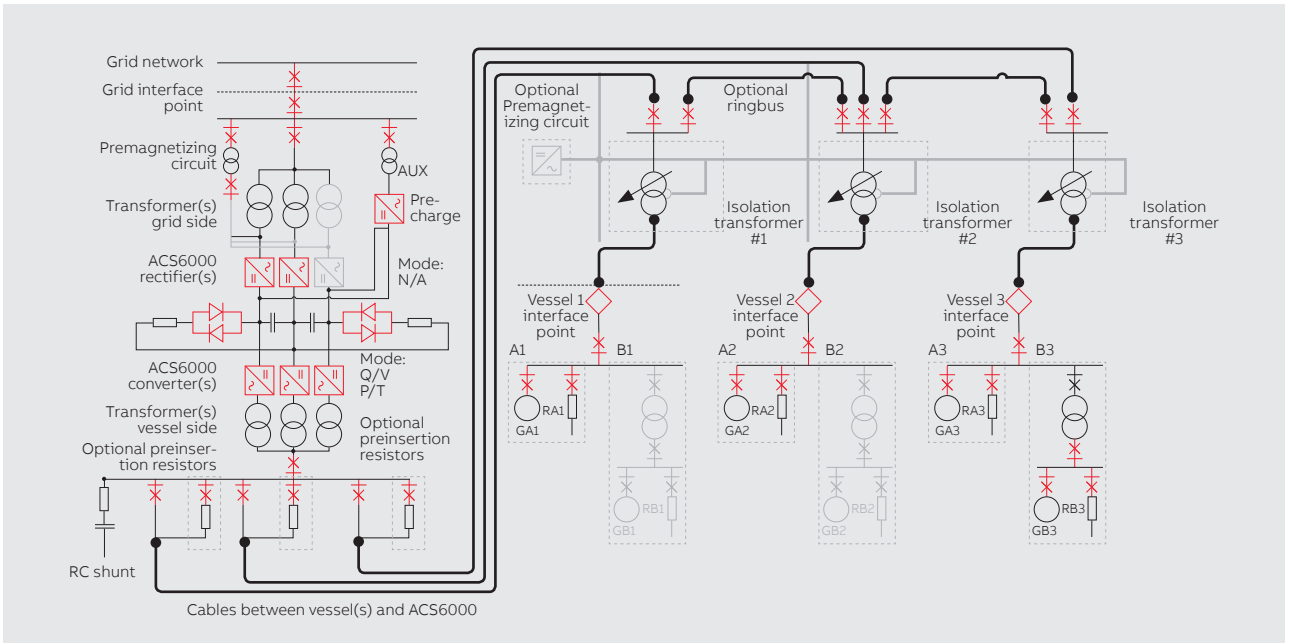

05b

Given the above, particular attention is paid to the selection of the converter dimensioning, transformer (input and output) specification, cooling system, and protection and control devices →4.

—  
**Important design considerations were to minimize the impact of grid-side harmonics and maximize the vessel-side power quality.**

As an example, a single-berth/single-vessel solution is characterized by the selection of an ACS6000 SFC that not only complies with the vessel's nominal power requirement but that also accommodates the overload arising from the startup of large direct-on-line motors and the energization of onboard transformers, as well the selectivity necessary to isolate faults on the vessel's electrical network →5a. Specific attention is given to the premagnetization of the grid-side transformer in order to minimize potential voltage drops in the port grid.

The integration of the ACS6000 SFC into a pre-engineered solution allows a smooth execution for any project configuration.



—  
05 Pre-engineered solutions allow smooth execution.

05a Single-berth configuration.

05b Multi-berth configuration.

—  
06 Smart ports need a lean and efficient grid integration that successfully balances supply and demand.

—  
**Reference**  
[1] “ESPO / EcoPorts Port Environmental Review 2016 – Insight on port environmental performance and its evolution over time,” April 2016. Available: [http://www.espo.be/media/news/ESPO\\_EcoPorts%20Port%20Environmental%20Review%202016.pdf](http://www.espo.be/media/news/ESPO_EcoPorts%20Port%20Environmental%20Review%202016.pdf)

A multi-berth installation can have a lower overall OPEX since a single frequency conversion substation can be used to supply several vessels at the same time →5b. An additional assessment of the specific load presented by a single vessel should be performed to make sure that the substation capabilities match the overall load, taking into account the premagnetization needs of the onshore transformer that ensures the galvanic isolation between the vessels.





—  
When selecting the SFC, high importance was given to its efficiency in order to minimize end-user OPEX.

**Port electrification – a holistic view**

Due to the complexity of the solution and related constraints, a shore-to-ship power installation in a port grid requires an engineering perspective that extends beyond the shore-to-ship system itself to cover the port electrification as a whole. The port grid should be seen as a dynamic environment into which new electricity consumers or producers can enter at any time. For this reason, a strong port

grid is a critical ingredient: To maintain a successful balance between demand and supply, the port grid must be robust all the way from the incoming high-voltage (HV) substation down to the low-voltage user →6. An HV substation upgrade or port grid repowering can accommodate the introduction into the port area of e-mobility consumers both on the blue side (electric or hybrid ferries) and on the land side (electric vehicles) and facilitate the integration of renewable power sources such as wind farms or photovoltaic plants.

In a nutshell, shore-to-ship power and port electrification promote ports in their role as vital regional economic engines – in a traditional way, as transit hubs for people and goods, and in a modern way, as sustainable business entities wholly integrated with the surrounding community. Clean energy provision and elimination of diesel emissions and noise will improve the working, transit and living environment in and around ports. Electrification is the only cost-effective way to reduce on-site emissions by almost 100 percent and ensure long-term port growth. ●

Power & Automation for ...	Overview	Benefits
Shore-to-ship power 	<ul style="list-style-type: none"> <li>• Infrastructure to power ships with electricity from shore when staying at berth</li> </ul>	<ul style="list-style-type: none"> <li>• Eliminate 98% of emissions and all noise and vibration</li> <li>• Improve quality of life near port</li> </ul>
Port electrification 	<ul style="list-style-type: none"> <li>• HV substation</li> <li>• MV/LV electrification</li> <li>• Power transformers</li> </ul>	<ul style="list-style-type: none"> <li>• ABB as a single interface for whole port electrification</li> <li>• High reliability HV products</li> </ul>
Port grid integration 	<ul style="list-style-type: none"> <li>• Port distribution grid automation</li> <li>• Renewables integration</li> <li>• Communication networks</li> </ul>	<ul style="list-style-type: none"> <li>• Improved reliability of supply</li> <li>• Self-sufficient port microgrid</li> <li>• Secure/powerful communication</li> </ul>
E-mobility solutions 	<ul style="list-style-type: none"> <li>• Battery-hybrid ferries charging infrastructure</li> <li>• EV-chargers</li> </ul>	<ul style="list-style-type: none"> <li>• Zero emission port calls</li> <li>• Integrated transportation (from railway to e-vehicles)</li> </ul>
Service/retrofit 	<ul style="list-style-type: none"> <li>• Consulting for optimal solution</li> <li>• Retrofit of existing installation</li> <li>• Maintenance contracts/spares</li> </ul>	<ul style="list-style-type: none"> <li>• Major improvement in reliability, safety and performance</li> <li>• Extended system life cycle</li> </ul>



# Control a productiv





92

Control and productivity could be at risk if data are unavailable or corrupted, or if a small variance is mistaken for a larger one (or vice versa). ABB has developed and implemented some of the most advanced and reliable control methods available, often relying not only on “smart” automatic systems, but enabling the development of smart scheduling and processes.

- 84 Saving the day – electric driven gas compressor control
- 92 An easy-to-use and flexible scheduling component

84

## CONTROL AND PRODUCTIVITY

# Saving the day – electric driven gas compressor control

Nowadays, virtually all technical systems rely on automatic control. Not being as tangible as hardware components, its essential role in technical systems is less visible and innovations in the domain of control often go unnoticed. This lies in stark contrast to the popularity of innovative products that would not exist without automatic control: Take quadcopters, autonomous vehicles or industrial robots as examples. In this case, an innovative control system was developed for electric driven gas compressors, where modern control helps to save millions of dollars – where automatic control is literally saving the day.

**Thomas Besselmann**  
**Andrea Cortinovis**  
**Mehmet Mercangöz**  
ABB Corporate Research  
Baden-Daettwil,  
Switzerland

thomas.besselmann@  
ch.abb.com  
andrea.cortinovis@  
ch.abb.com  
mehmet.mercangoez@  
ch.abb.com

**Arne-Marius Ditlefsen**  
**Harald Fretheim**  
**Jan Wiik**  
ABB Industrial Auto-  
mation, Oil, Gas and  
Chemicals  
Oslo, Norway

arne-marius.ditlefsen@  
no.abb.com  
harald.fretheim@  
no.abb.com  
jan.wiik@no.abb.com

**Sture Van de moortel**  
**Pieder Joerg**  
ABB Robotics and  
Motion, Drives  
Turgi, Switzerland

sture.vandemoortel@  
ch.abb.com  
pieder.joerg@ch.abb.com

Centrifugal gas compressors are widely used in many industrial oil and gas applications covering the whole range from upstream, midstream and downstream processes. The purpose of centrifugal gas compressors is to compress and pump natural gas along pipeline systems from its source to the end consumers. These large rotating machines are typically the largest energy consumers in a processing plant and the most critical equipment, due to the fact that downtimes automatically lead to large economic losses. Therefore, high availability together with dedicated control and safety systems play a key role in their operation.

Large rotating machines can be powered by conventional gas turbines or by electric motors powered by variable-speed drives. Electric driven gas compressors (EDCs) have several advantages compared to gas turbines: Higher efficiencies, faster response times, a wider operating range, decreased maintenance cost and zero local greenhouse emissions count among others.



In this article, EDCs are considered and how the availability and reliability of these machines can be increased by automatic control, using both an advanced process protection system called Dynamic Time to Surge (DT2S), and an advanced drive control system called model predictive torque control (MPTC).

The focus of this work is on electrical grid disturbances, resulting in a fast loss of drive torque, which puts the gas compression process at risk of a harmful phenomenon called surge.

#### Gas compression process

A typical industrial arrangement of an EDC is depicted in →1. The electrical system consists of an LCI (load commutated inverter) with input transformer, line and machine converters, synchronous motor and excitation system. The electrical system is connected to the gas compressor through a flexible shaft with a gearbox that splits the shaft into a low-speed motor shaft and a high-speed compressor shaft.

Natural gas enters the gas compression process from the suction header, through the suction valve and scrubber to the inlet of the centrifugal compressor. Driven by the electric motor torque, the gas is compressed in the centrifugal compressor

—  
The developed solution provides electric driven compressors with better ride through capabilities at lower risk compared to existing protection schemes.

and discharged through the discharge valve to the discharge header before being cooled in the cooler. Two recycle paths are used to influence the compressor operation by connecting the discharge of the compressor with its suction side. When a recycle valve is opened, it results in a lower resistance, and thus decreases the pressure ratio between suction and discharge, and increases the flow through the compressor. The opening of the cold recycle valve can be changed continuously, albeit rather slowly within the range of seconds, and is



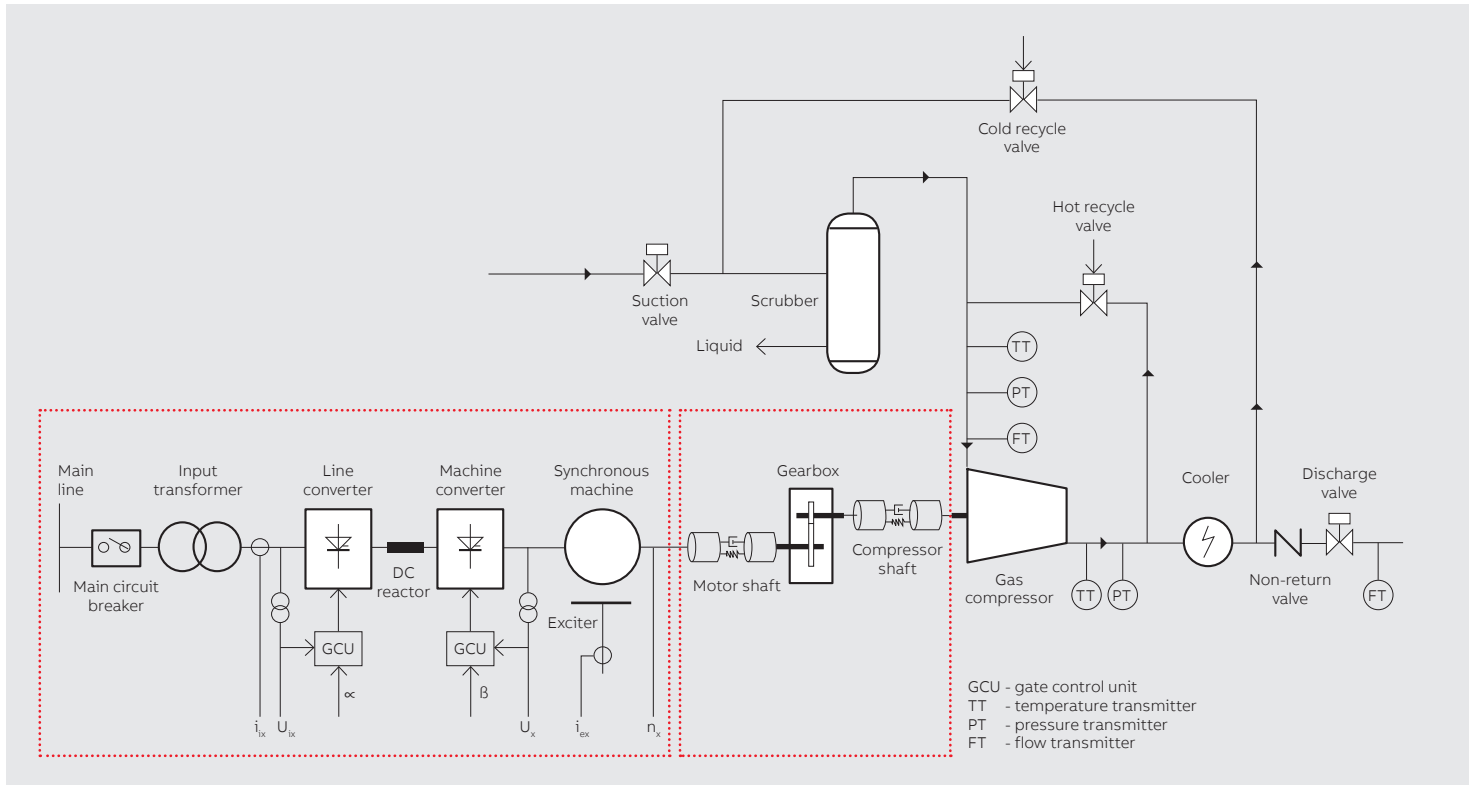

01

used to change the operating conditions to protect the compressor from surge conditions. In contrast, the hot recycle valve can only be opened completely, yet within the range of hundreds of milliseconds, and is used to trip the compression process for protection reasons.

The steady-state operation of a centrifugal compressor is often represented by a compressor map, which shows the relationship between compressor head and flow. The compressor head describes the amount of work applied to one unit of gas.

The compressor head is related to the pressure rise between suction and discharge, however the pressure rise produced by a given amount of compressor head varies with the density of the processed gas. As illustrated in →2, several operating constraints need to be met during the operation of the machine. The most important one is the surge limit. During surge, the compressor experiences oscillating process conditions, and increased vibration and temperature levels, which may result in increased wear or even failure of the equipment, and therefore have to be avoided as far as possible.

#### ABB's Megadrive-LCI

The energy-intensive nature of gas compression naturally leads to the choice of high-power solutions for the variable-speed drives. A typical configuration of the variable-speed drive system comprises a synchronous machine fed by an LCI such as ABB's Megadrive-LCI.

ABB's Megadrive-LCI, depicted in →3, constitutes a decades-long success story in the medium-voltage drive business. The reasons for its continuing market success lie foremost in its proven robustness and efficiency, and its ability to handle very high voltages and powers. Over the years, ABB has produced the Megadrive-LCI in a power range from a few to more than 100 MW.

A sketch of such a variable-speed drive system is shown in the lower left corner of →1. On the line side, the LCI is connected via a transformer to the medium-voltage grid, and on the machine side to the synchronous machine. The LCI itself comprises a line-side converter, an inductive DC link and a machine-side converter, and thus belongs to the class of current source converters. The power part of the Megadrive-LCI is based on thyristor technology, which enables operation in high power applications.

In motoring mode, the fixed-frequency AC power of the medium-voltage grid is first converted to DC power and subsequently to AC power of variable frequency, which enables the efficient operation of the synchronous machine at variable speeds.

—  
01 EDC industrial arrangement.

—  
02 Centrifugal compressor map.

### Typical challenges

Gas processing plants are usually located at remote locations where grid conditions are prone to electrical disturbances. Weather phenomena such as winter storms, high winds and iced overhead lines occasionally cause short impairments of the power lines, resulting in a sudden reduction of the grid voltage in one or more phases. Typically, the grid voltage is affected over a time of 50 to 150 ms. Even if their duration is brief, the consequences of these voltage dips can be severe.

Voltage dips constitute a major challenge to the control system of an LCI. Depending on the ability of the control system to react to these disturbances, the LCI might leave the area of safe operation, which causes the LCI to trip. A common phenomenon is an overcurrent trip due to the inrush current at the return of the grid voltage.

A common industrial solution to these difficulties is to interrupt the operation of the LCI until the grid voltage has returned. For many applications, this is a reasonable approach, however not for electric driven gas compressors: Due to the sudden loss of drive torque, the compressor quickly diverges towards surge, the compression process is thus tripped in the case of a voltage dip as a precaution to avoid mechanical damage and wear.

In either case, the operation of the gas compressor is stopped and a time-consuming restarting procedure needs to take place.

Deciding about if and when to stop the gas compression process is a delicate question: Stopped too early, the considerable financial consequences due to loss of production might be unnecessary. Stopped too late, the system enters surge, risking mechanical damage to the system.

The decision is even more challenging considering the relatively slow response of the recycle valves. Even the fast response time of the hot recycle valve amounts to a few hundred milliseconds and requires the opening decision to be made early enough. By the same token, a trip decision only becomes effective after a few hundred milliseconds, leaving the compressor system unprotected in the meantime.

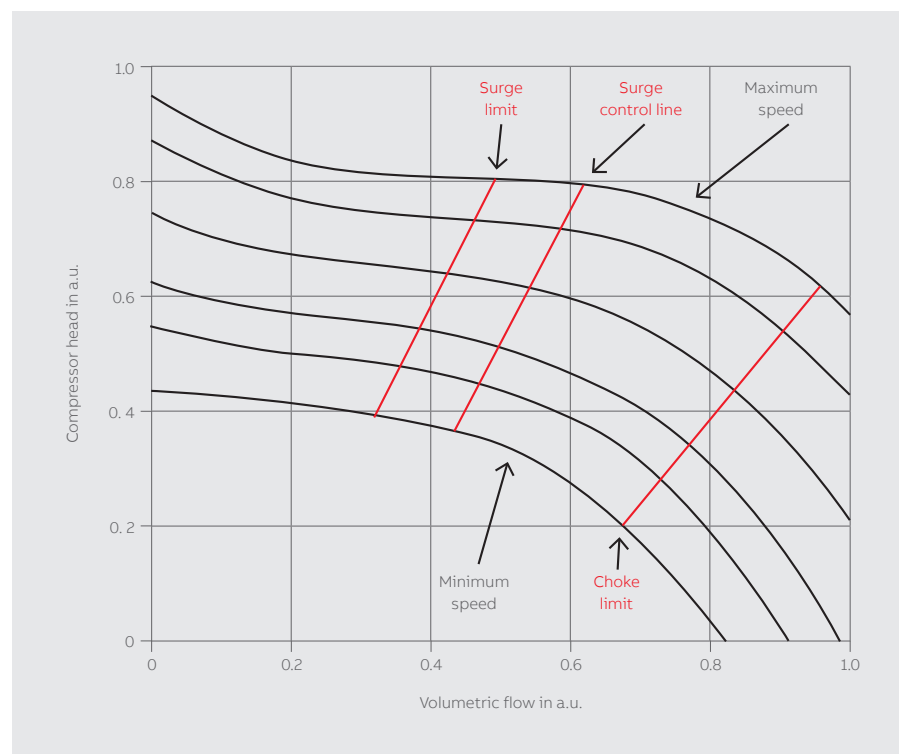

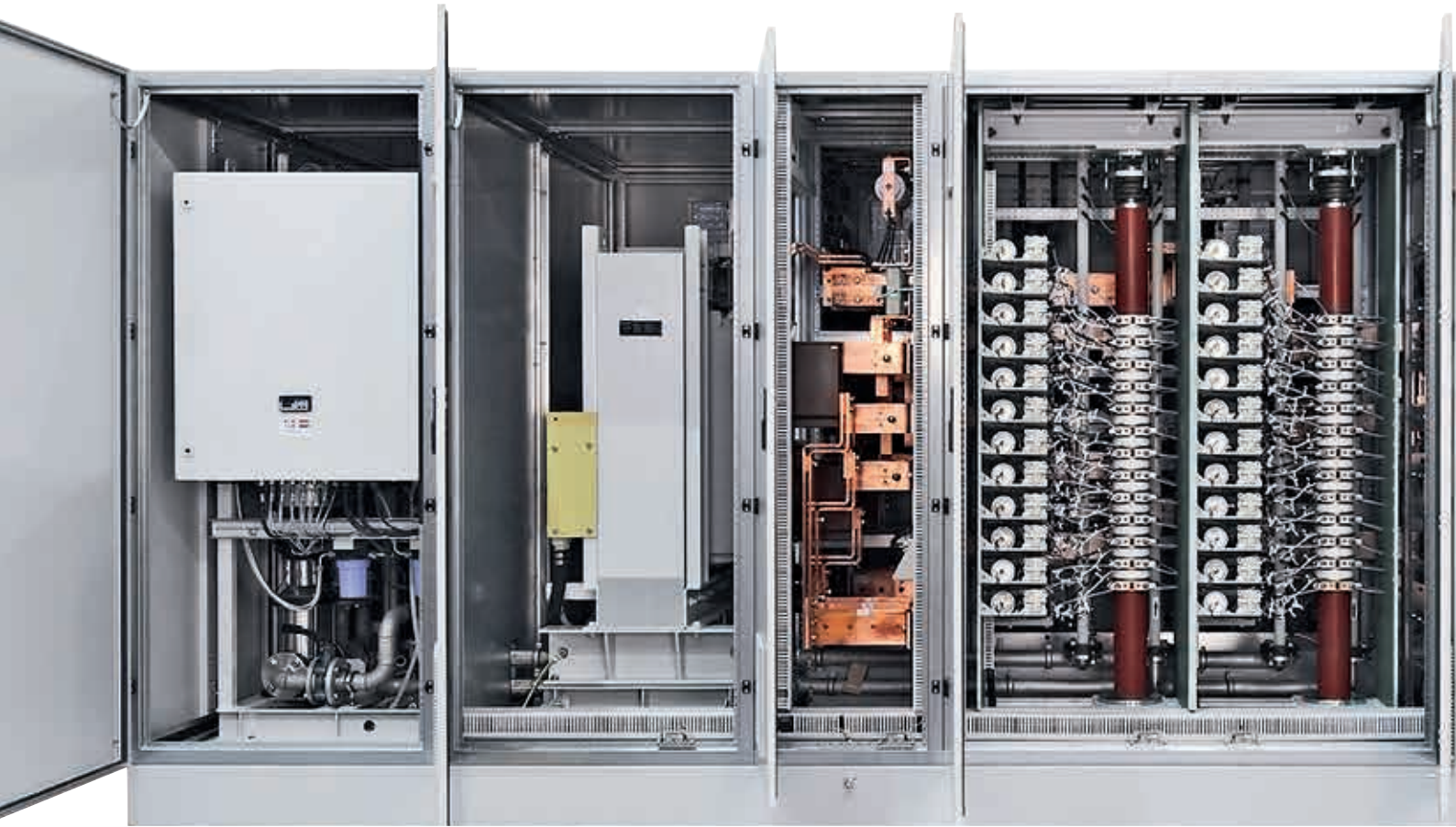

03

#### Automation system architecture

In order to improve the robustness of the gas compression system in undervoltage situations, an automation system was devised, comprising two main ingredients:

- A control solution for ABB's Megadrive-LCI that is capable of riding through voltage dips without tripping the drive.
- A model-based surge protection system for the compression process, which ensures safe operation of the compressor system without unnecessary trips in the case of voltage dips.

The architecture used to support the compressor protection system is illustrated in →4. The compressor protection system is installed on a separate control board, providing the possibility to employ the same system also in other electric drive configurations not containing ABB's Megadrive-LCI. Combining the protection system with ABB's Megadrive-LCI, however, has further advantages, as will be elaborated below.

A prerequisite for the suggested protection scheme is a fast-response estimate of motor speed in order to react precisely during the voltage dips and provide consistent safety margins to surge. This is provided by the LCI controller with a millisecond update rate.

The compressor protection system installed on the separate control board comprises the dynamic time to surge calculation and a monitoring part.

#### Dynamic time to surge

In the case of voltage dip events, conventional anti-surge control systems are not always able to cope with these very fast disturbances, putting the compression system at potential risk of surge events. On the other hand, the operation should only be shut down when it is strictly necessary from a safety point of view. This gives rise to the question of how to safely ride through voltage dips. It turns out that this question can be answered in a safe and efficient way by integrating the information coming from the electrical system and the gas compression system.

For handling voltage dip disturbances in EDCs, there is no clear state-of-the-art solution. One possible solution could be based on computing a static time to surge in a high-fidelity off-line simulation, reducing the problem to a look-up table in the real-time setting as a function of some process variables. However, this approach does not incorporate varying operating conditions, eg, boundary conditions or changes in system resistance. Moreover, these approaches are typically designed for worst-case conditions resulting in over-conservative solutions causing excessive shutdowns.





03 ABB's Megadrive-LCI.

04 Automation system architecture. Example of how the developed automation system for compressor protection can be deployed on site.

In order to solve the problem of operating the EDC safely but also maximizing the ride-through capabilities during voltage dips, a new solution was developed. This new solution is based on combining the electrical system information with the process information and predicting the future evolution of the process trajectory using a process model. Electrical and process measurements are sampled at different sampling rates and fed to an initialization routine. This routine determines the initial process operating point and the expected partial torque during the dip. This information is fed to a model of the gas compression process that

is then numerically integrated over a given prediction window. The system trajectories are then used to determine when a crossing with the surge line is taking place within the prediction window.

This value is called the dynamic time to surge (DT2S) and is re-computed in real-time every 5 to 10 ms. The DT2S can then be used as a ride-through or shutdown criterion when compared to a safety margin. The safety margin corresponds to the maximum expected reaction time of the safety system.

In addition to the protection algorithm, a monitoring system is included in the DT2S solution.

In addition to the protection algorithm, a monitoring system is included in the DT2S solution. A monitoring feature provides exposure of online data and as well as high-resolution snapshots during transient events. All data are stored in a historian that can be used to analyze particular events or developments over time. The monitoring part also includes vibration measurements of compressor and motor.

By using the monitoring data, it is possible to:

- confirm safe operation of the compressor during voltage dips
- support the setting of protection level by eg, evaluating vibrations during voltage dip events
- track possible changes in compressor characteristic that might influence the protection function settings.

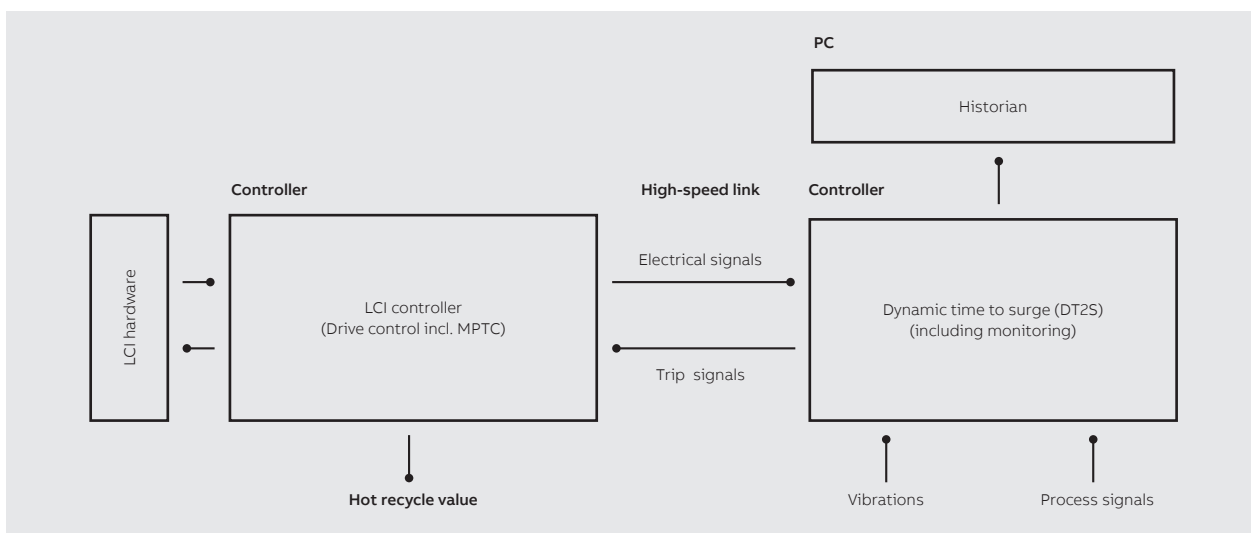

**Model predictive torque control**

Model predictive torque control (MPTC) is a newly developed control system for ABB's Megadrive-LCI. MPTC uses a control algorithm based on model predictive control (MPC) that ensures the operation of the drive during power and grid disturbances in order to provide the compressor with partial torque, preventing the compressor from going into surge.

MPC is a control algorithm that has its roots in the process industries and that has been in use in chemical plants and oil refineries since the 1980s. In comparison with traditional control techniques, MPC intelligently predicts the future behavior of the system to be controlled via a mathematical model and solves an optimization problem to compute the best control action with respect to given criteria and limits of operations.

The key challenge of controlling the LCI with MPTC stems from the necessity to react quickly to grid voltage changes: A nonlinear optimization problem is formulated, linearized and solved on ABB's AC 800PEC control board every millisecond →5. The entire MPTC algorithm consumes only a minor fraction of the computational resource such that the whole control system can be executed on time.

Apart from the ability to handle limits on operation variables such as the current, and thus avoid overcurrent trips, MPTC decides on the firing of the thyristors in a coordinated way, improving the ability to reject disturbances and thus improving the ability to ride through voltage dips.

More specifically, with MPTC the LCI is capable of riding through voltage dips while providing partial torque to the compression system. How much power can be provided depends on the type and the depth of the voltage dip →6. With partial torque, the divergence into surge might be avoided entirely, or at least it will be delayed, allowing for a longer grace period for the grid voltage to return or for protective measures to be taken. Consequentially, safety and availability of the whole compression system are increased by MPTC.



05

06

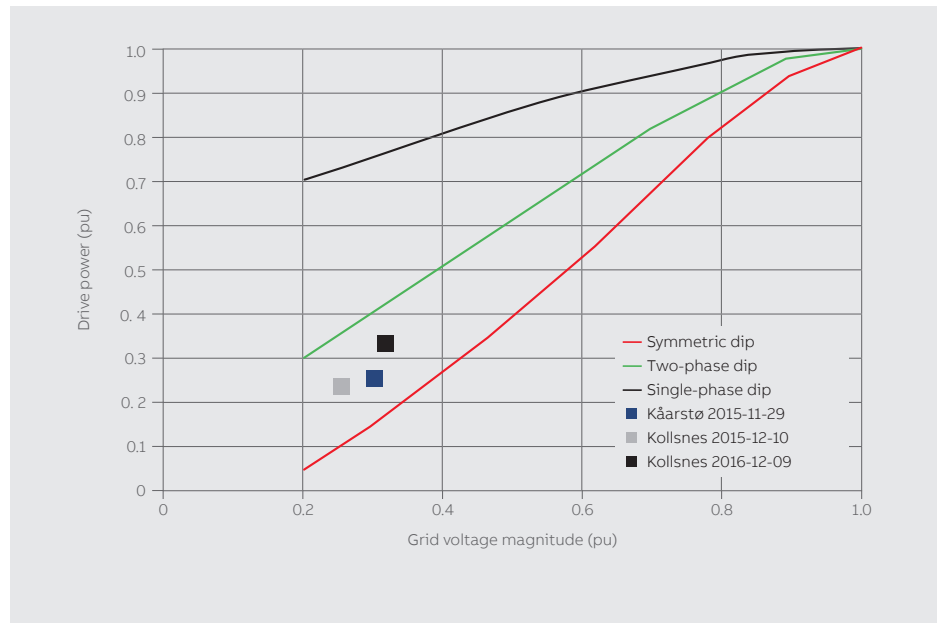

05 ABB's AC 800PEC – the embedded control board used in the Megadrive-LCI.

06 Expected drive power during grid voltage disturbance for single-phase, two-phase and symmetric dips. Measured drive power during some symmetric grid voltage disturbances in Kollsnes and Kårstø.

07 Example of a voltage dip ride through.

#### References

[1] A. Cortinovis, M. Mercangöz, T.O. Stava, S. Van de moortel, E. Lunde, "Dynamic Time to Surge Computation for Electric Driven Gas Compressors during Voltage Dips," 11th IFAC Symposium on Dynamics and Control of Process Systems DYCOPS-CAB 2016, Trondheim, Norway, 6–8 June 2016.

[2] T. Besselmann, P. Jörg, K. Terje, E. Lunde, T.O. Stava, S. Van de moortel, "Partial Torque Ride Through with Model Predictive Control," 2016 Petroleum and Chemical Industry Conference Europe (PCIC Europe), Berlin, June 2016, pp. 1–8.

[3] T. Besselmann, S. Van de moortel, S. Almér, P. Jörg, and H.J. Ferreau, "Model Predictive Control in the Multi-Megawatt Range," in IEEE Transactions on Industrial Electronics, vol. 63, no. 7, pp. 4641–4648, July 2016.

[4] R. Bhatia, H. Krattiger, A. Bonanini, D. Schafer, J. Inge, and G. Sydnor, "Adjustable speed drive with a single 100-MW synchronous motor," ABB Review, vol. 6, pp. 14–20, 1998.

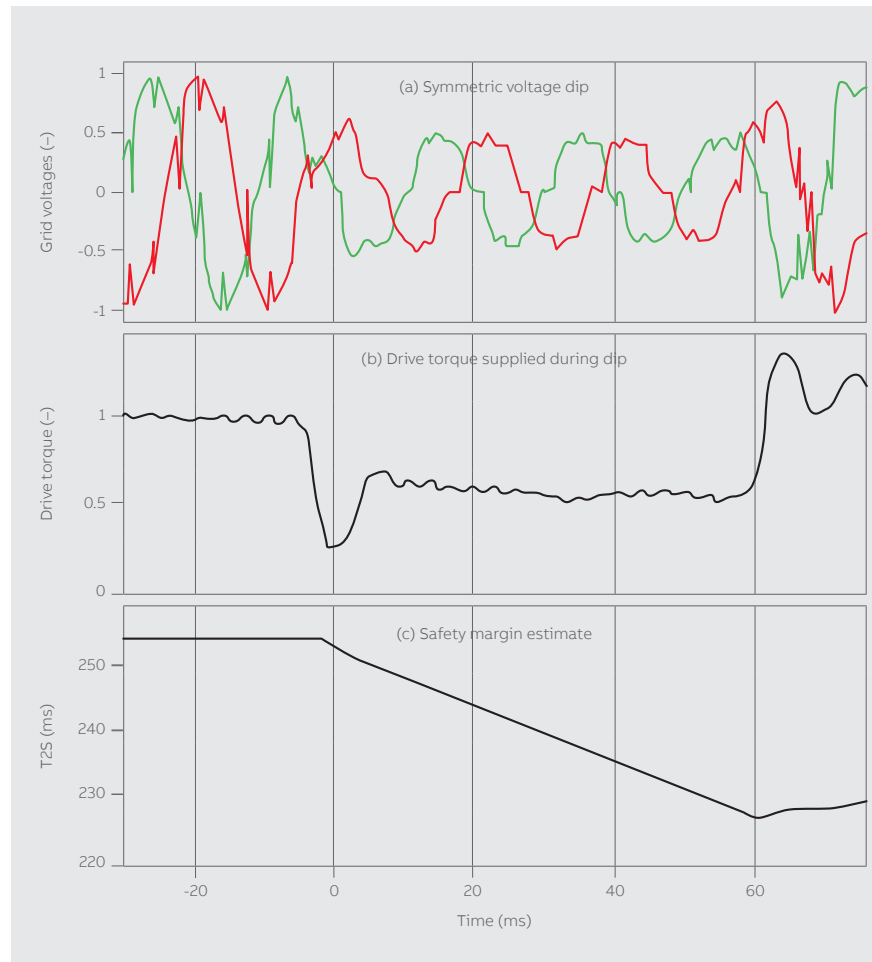

07

#### Pilot installations

The system described here was installed at an electric drive compressor system on Statoil's gas processing and export plant, Kollsnes, in 2016. This included both the MPTC and the DT2S with monitoring. The DT2S system was run in an open loop mode for a period to collect data used for tuning the system and determining the safety limits. The safety limits were set to minimize the risk of damage and to maximize the ride-through capability of the EDC during voltage dips.

After tuning, the system was activated by closing the control loop, meaning the system was protecting the 41.2MW electric driven gas compressor system in case of a grid voltage dip.

After activation, the system was successfully riding through voltage dips. The recording of an event is shown in →7. The symmetrical voltage dip lasts for approximately 60 ms. The LCI manages to supply torque during the dip, making movement towards a surge condition slower. At the same time, the DT2S evaluates the situation as safe with no need to trip the compressor system. After voltage recovers, the compressor is again accelerating and increasing the distance to the surge line.

#### Business aspects

Electric drives constitute an important part of ABB's portfolio for the oil and gas industry. There is an ongoing trend to replace gas turbines with electric drives, due to both lower maintenance costs and emission regulations. Other advantages include larger operating range, increased efficiency and more dynamic torque changes. Consequently, electric drives have become the de facto standard for onshore facilities.

A few large players dominate the market for large medium-voltage drives. Price, obviously, is an important factor for customers, but also that the product can deliver high availability. The amount of gas exported is directly related to availability, and thus, the financial cost related to downtime is significant. ●

#### EXPERT CONSULTATION

Expert support is available to optimize the process performance of your drive system.

ABB provides consultation with leading drive system experts to help you develop customized solutions to optimize your drive system assets. Start improving your drive system here:  
<http://new.abb.com/drives/services/engineering-and-consulting/drive-system-consulting>

## CONTROL AND PRODUCTIVITY

# An easy-to-use and flexible scheduling component

For many, production scheduling is still a complex and exotic functionality that seldom finds its way onto the shop floor. ABB has used the ISA-95 standard as a neutral data-exchange platform upon which to base an easy-to-use and flexible Gantt-chart scheduling technology. This technology is available to businesses in the form of building blocks for industry-specific products.

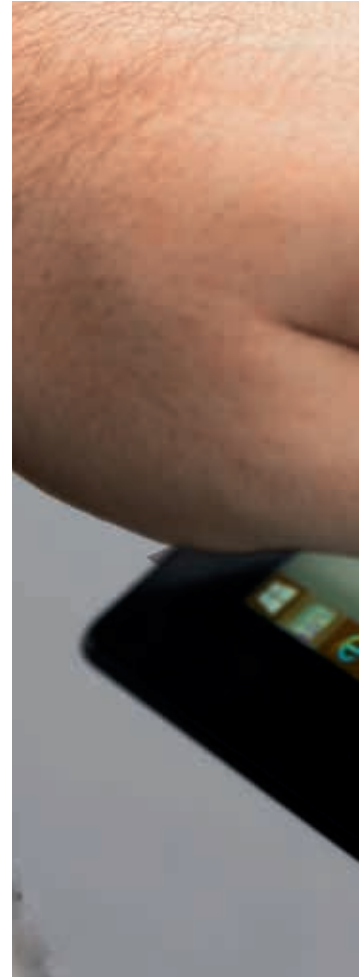

**iiro Harjunkoski**  
**Martin Hollender**  
**Reinhard Bauer**  
**Jens Doppelhamer**  
**Subanatarajan Subbiah**  
 ABB Corporate  
 Research Center  
 Ladenburg, Germany

iiro.harjunkoski@  
 de.abb.com  
 martin.hollender@  
 de.abb.com  
 reinhard.bauer@  
 de.abb.com  
 jens.doppelhamer@  
 de.abb.com  
 subanatarajan.subbiah@  
 de.abb.com

**Werner Schmidt**  
 Former ABB employee

Over the past two decades, there have been many significant achievements in the development of scheduling models, methods and solutions. Nevertheless, an extremely important and still partly unresolved technical challenge remains: How to

—  
**A scheduling solution should be closely connected to the production environment in order to be able to automatically obtain all the production and process data necessary for scheduling.**

deploy these solutions efficiently in an industrial context. A common approach is to connect plant experts and process owners with optimization specialists to build a local solution. This approach often results in strongly tailored implementations that are normally not reusable and difficult to maintain due to their complexity. These restrictions inhibit wider distribution and lead to islanded software solutions.

However, with the ever-increasing availability of data and a higher level of automation and electrification, production scheduling can no longer be seen as an autonomous solution. Concepts such as Internet-of-Things, smart grids, smart manufacturing, Big Data, Industry 4.0 and software-as-a-service (SaaS) as well as heightened emphasis on enterprise-wide optimization topics [1] increase the pressure to connect to and interact with neighboring solutions and systems.

In most industrial environments, a scheduling solution should be closely connected to the production environment – for instance, to a distributed control system (DCS), manufacturing execution system (MES) or collaborative production management (CPM) system – to automatically obtain all the production and process data necessary for scheduling. A connection to the enterprise resource planning (ERP) system is often essential since production is usually triggered by customer orders entered via an ERP interface. ERP systems are also used for procurement to ensure that the appropriate material and resources are available when called for by the production plan.



For successful scheduling, the following must be known:

- Resource availability – equipment, materials, personnel, utilities, etc.
- Dependencies and rules related to the process steps.
- Current state of production and capacity of the production resources to absorb further production demand.
- Production orders with their due dates and priorities.
- A target for the scheduling.

—  
 One of the cornerstones of the scheduling component is the ISA-95 standard, which was created to act as an interface between business and control systems.

Some data may change from minute to minute, which highlights the need for connectivity that ensures the schedule is kept up-to-date. In the approach considered here, most of this dynamic type of information has been modeled using the ISA-95 standard [2], which makes it easy to share and communicate between system components.

#### Benefits of scheduling

It is very important to understand what industrial production companies truly need. In times of hype and trends, the technologies themselves easily become the drivers and in the enthusiasm of embracing them it may be forgotten what the primary needs of a typical customer are. Some of the most sought-after aspects of advanced scheduling solutions are:

- Safety: Scheduling can improve safety by, for instance, providing an overview of future operations or by avoiding complex changeovers or larger simultaneous operations on the plant floor.
- Lower cost and simplified operations: This becomes more critical with increasing process complexity. An operator who uses the solutions should be able to get a better grip of the cost and feel supported by the solution.

- Production efficiency: Throughput maximization and minimization of setup times.
- Better asset utilization (return on assets): It is important to ensure that best use is made of expensive assets. Here, scheduling can help and can even indicate if there are redundant assets.
- More effective decisions: An automation system should primarily help to manage the process and assist in faster and more reliable decision making.

All input information for a scheduling problem can be provided through B2MML.

In general, a working scheduling solution contributes to a better overview of plant operations and early detection of bottlenecks. It can also improve performance through more balanced machine utilization and higher reliability. Also, automated scheduling can help to adapt to rapidly changing situations and identify high-quality schedules, independent of the operator’s skills. The benefits, trends and challenges of practical scheduling deployment projects have been well documented [3].

**The scheduling component**

For a successful scheduling solution, it must be ensured that the main challenges that apply to the productization of scheduling solutions can be addressed:

- Define a landscape that can host the algorithmic environment, gather the necessary data and communicate the results to the production process.
- Find a generic problem description that can express realistic problem instances.
- Provide algorithms that work efficiently for various cases and provide good and feasible solutions.
- Maintain the solution through a suitable for non-experts configuration environment.

**Landscape**

One of the cornerstones of the prototype developed by ABB is the ISA-95 standard, which was created to act as an interface between business and control systems. It defines most of the required data fields and offers an XML-based implementation for the integration called B2MML (business to manufacturing markup language) [4]. The standard offers supporting functions such as XML schemas and many programming languages have built-in support to enable easy handling of XML data. All input information for a scheduling problem can be provided through B2MML. Similarly, the scheduling results are provided in the same format. Most common scheduling-related information is directly supported and can be complemented through extensions.

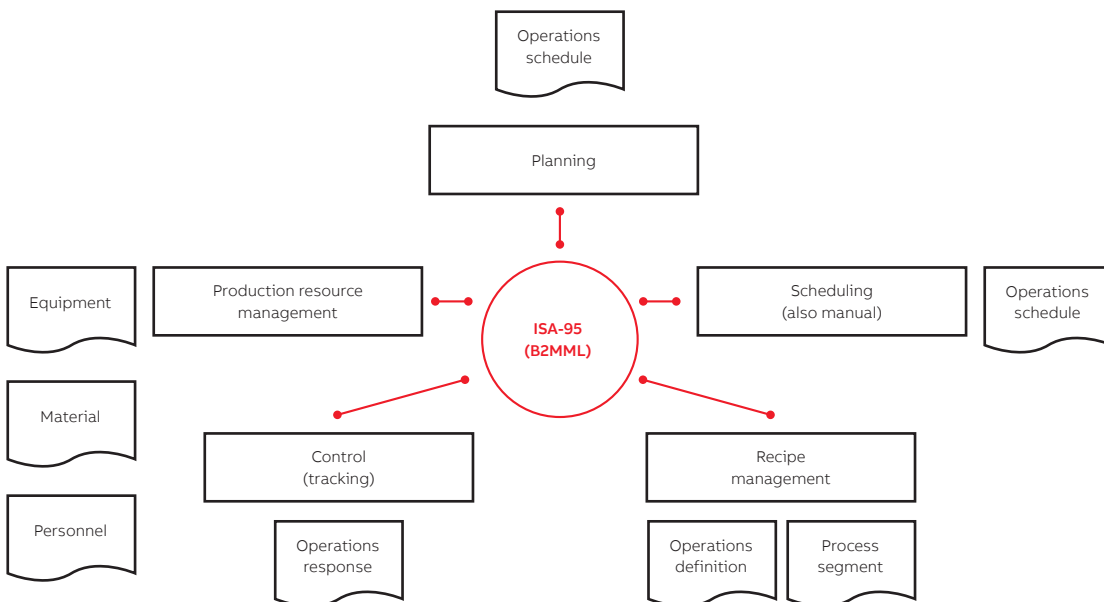

—  
01 ISA-95 and B2MML elements providing all the information required for scheduling.

—  
02 Example of a workflow using B2MML data exchange.

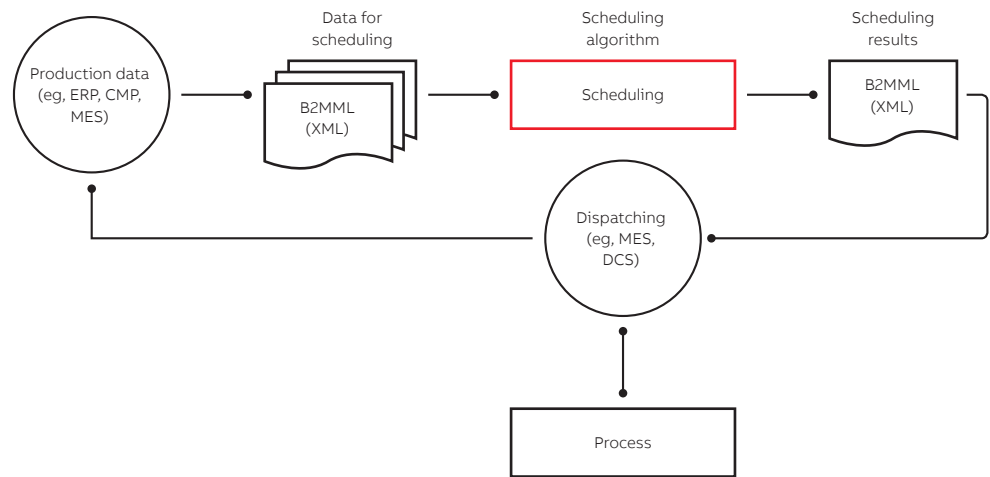

02

As can be seen in →1, information related to equipment, material, personnel, production recipes and production targets are included in the environment defined by ISA-95. The current production situation is communicated through the operations response data structures. The data is passed to the scheduling algorithm only through XML, which offers the flexibility to integrate the scheduling functionality and allows the use of various types of algorithms as the input data is neutral and usable by any selected solution approach.

—  
The scheduling tool hosts a set of heuristic algorithms that quickly finds a feasible and good solution.

In →2, an example of the workflow with B2MML is shown. First, the production data (ERP, CPM, etc.) for scheduling is collected from various systems. The data can be acquired by a push or pull principle. After executing the scheduling algorithm, the scheduling results are provided to a dispatching system, which interacts directly with the process. Ideally, the entire ISA-95 dataset can be stored in a common database that is regularly updated by all related software components.

### Algorithms

The scheduling tool hosts a set of heuristic algorithms – a natural choice since the aim was to provide a fast-responding generic algorithm that does not necessarily reach the global optimum (ie, best possible solution) but quickly finds a feasible and good solution. The algorithm can take into account all major equipment constraints, working hours and standard limitations in energy, material and personnel. Thus, the scheduling system can track the consumption of utilities as well as the use and production of material →3.

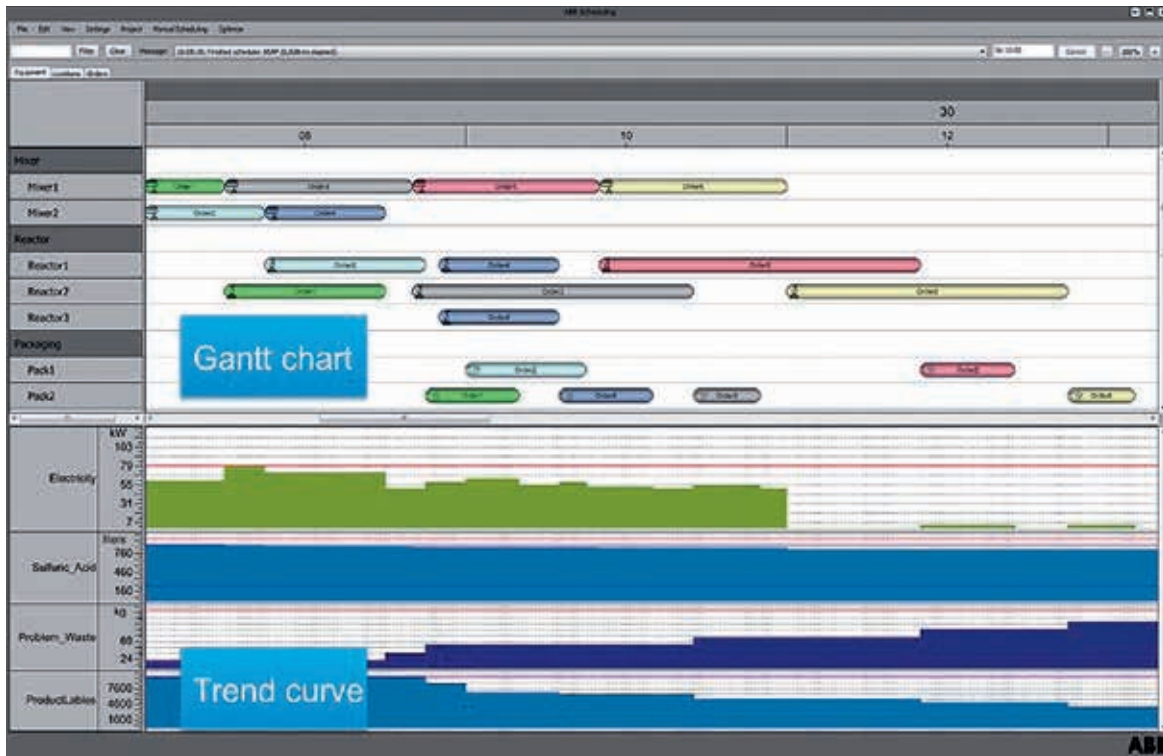

03

A novel feature of the prototype is its manual drag-and-drop functionality. Due to the fast algorithmic performance, it is possible to combine the automatic algorithm with the manual drag-and-drop functionality.

The scheduling solution can operate in various modes ranging from a purely visual manual tool to a complex algorithmic solver. In the purely manual-driven mode, for instance, the decision logic is left fully to the operator without any repair actions. Orders are moved using the drag-and-drop functionality and a sanity check is performed

—  
The algorithm can take into account all major equipment constraints, working hours and standard limitations in energy, material and personnel.

against the production recipes – if the rules are violated the move is rejected. Alternatively, the manual actions can be supported by algorithms that, for instance, redo the complete schedule or parts thereof based on the manually initiated change. The manual option allows intuitive rule-based actions to be performed that would be too complex to reflect in a generic algorithm.

It is also possible to extend the prototype with additional algorithms, which can be implemented in any .net language.

**Configuration**

Configuration mainly involves the creation of the required B2MML files →4. The use of a standard such as ISA-95 makes it easier to agree on a data model and simplifies communication between systems from different vendors. Maintaining generic data in an ISA-95 database is much easier than collecting proprietary model data. Further, ISA-95 has established itself as the standard of choice for integration between ERP and the manufacturing layer, and ever more professionals are trained in B2MML.

Ideally, the B2MML data would be used to model the scheduling problem in an operator-friendly way – for instance, through tailored GUI elements and using familiar terminology.



—  
03 The scheduling system showing a typical Gantt chart and the trend curves for tracking electricity and material.

—  
04 Example of a B2MML file. The text in black reflects the case-specific data; ISA-95 standard tags are shown in red.

#### References

[1] I.E. Grossmann, "Challenges in the application of mathematical programming in the enterprise-wide optimization of process industries," Theoretical Foundations of Chemical Engineering, 48 (5), pp. 555–573, 2014.

[2] ISA-95: The international standard for the integration of enterprise and control systems, <http://www.isa-95.com/>

[3] I. Harjunkoski, et al., "Scope for industrial applications of production scheduling models and solution methods," Computers and Chemical Engineering, 62, pp. 161–193, 2014.

[4] I. Harjunkoski and R. Bauer, "Sharing data for production scheduling using the ISA-95 standard," Frontiers in Energy Research, 26 October 2014, <http://journal.frontiersin.org/article/10.3389/fenrg.2014.00044/full>

## Scheduling the future

The prototype solution has been successfully tested on several example problems in different industrial domains and shows a high benefit potential. It adds to the technology and procedures available to businesses as building blocks for industry-specific products and has already been used in mining. The heuristic approach is scalable and flexible, and,

Information related to equipment, material, personnel, production recipes and production targets are included in the environment defined by ISA-95.

with its fast execution time, the prototype can act as an interactive solution. It provides a straightforward way to model various requirements and can easily be extended to accommodate future needs.

Technical trends are changing the traditional automation pyramid hierarchy in which decisions are taken in an isolated manner. As a consequence, complex systems are becoming simpler to manage. Since scheduling is less worthy in a standalone form, integration is the key to improvement. It is also important to align technology and business properly to ensure meaningful and valuable results. The natural home for a scheduling solution is within a production management system, where the short-term decisions are made and where the necessary process information is available. ●

```

- <OperationsSchedule xmlns="http://www.wbf.org/xml/B2MML-V05">
  <ID>Factory A schedule requests</ID>
  <Description>This example shows the schedule *after* optimization</Description>
  <StartTime>2012-08-30T08:00:00</StartTime>
  <EndTime>2012-08-30T17:30:00</EndTime>
  <ScheduleState>Forecast</ScheduleState>
  <PublishedDate>2012-08-30T07:40:00</PublishedDate>
  - <OperationsRequest>
    <ID>Order1</ID>
    <StartTime>2012-08-30T08:00:00</StartTime>
    <EndTime>2012-08-31T08:00:00</EndTime>
    <Priority>1</Priority>
    <OperationsDefinitionID>Chemical1</OperationsDefinitionID>
    - <SegmentRequirement>
      <ProcessSegmentID>Mix</ProcessSegmentID>
      <EarliestStartTime>2012-08-30T08:00:00</EarliestStartTime>
      <LatestEndTime>2012-08-30T08:30:00</LatestEndTime>
      <Duration>PT0H30M</Duration>
      - <PersonnelRequirement>
        <PersonnelClassID>Mixeroperator</PersonnelClassID>
        <PersonID>Mixeroperator-2</PersonID>
      </PersonnelRequirement>
      - <EquipmentRequirement>
        <EquipmentClassID>Mixer</EquipmentClassID>
        <EquipmentID>Mixer1</EquipmentID>
      </EquipmentRequirement>
      - <MaterialRequirement>
        <MaterialClassID>Electricity</MaterialClassID>
        <MaterialUse>Consumable</MaterialUse>
        - <Quantity>
          <QuantityString>30.0</QuantityString>
          <DataType>double</DataType>
          <UnitOfMeasure>kW</UnitOfMeasure>
        </Quantity>
      </MaterialRequirement>
    </SegmentRequirement>
  </OperationsRequest>
  - <OperationsRequest>
    <ID>Order2</ID>
    <StartTime>2012-08-30T08:00:00</StartTime>

```

BUZZWORD DEMISTIFIER

# Blockchain

ABB Review is launching a new series seeking to explain in a brief and simple way complex themes relevant to technology. In the first of these articles, the term blockchain is explained.

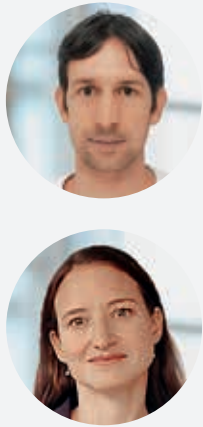
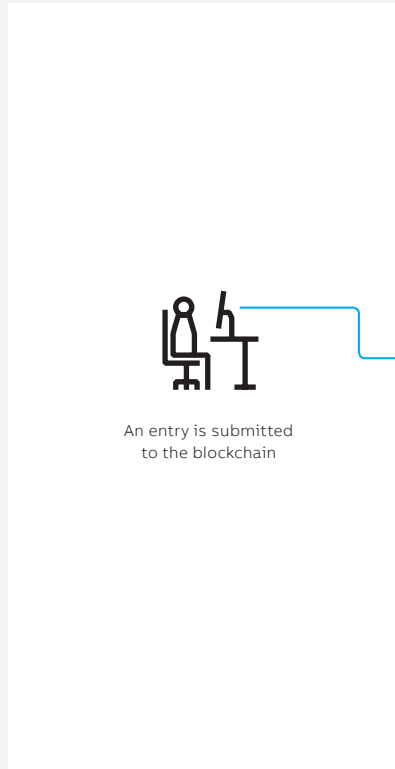

**Thomas Locher**  
**Yvonne-Anne Pignolet**  
 ABB Corporate Research  
 Baden-Dättwil, Switzerland

thomas.locher@ch.abb.com  
 yvonne-anne.pignolet@ch.abb.com

A blockchain is a distributed database that is used to maintain a continuously growing list of records. A distributed database is a database that is replicated across multiple machines to achieve fault tolerance. Lists of records are compiled into so-called blocks, which further contain a timestamp and a link to the previous block, thus forming a chain of blocks. The machines ensure consistency among the replicas in a peer-to-peer fashion by executing a protocol to verify validity conditions and ensure agreement on the next block to be added to the blockchain. Since consensus on the blocks is required, it is infeasible for a single machine to deviate, thereby guaranteeing immutability of records →1.

The blockchain concept was invented to enable the exchange of the virtual currency Bitcoin without having to rely on trust or centralized control by any one institution. Subsequently, other use cases and blockchains with different properties have been proposed. In general, a blockchain can serve as a distributed ledger that can store arbitrary records involving one or multiple parties efficiently and in a verifiable and permanent way. For example, the finance industry envisions simplified international inter-bank communication and transactions using blockchain technology. In an industrial context, provenance, ownership and tracking of virtual and physical goods might benefit from the immutability, fault-tolerance and scalability properties of blockchain-based approaches. ●

- 
- AT A GLANCE**
- No central ledger, meaning it is much more difficult to manipulate than is the case for traditional records.
  - Based on consensus rather than authority.
  - Although best known for Bitcoin, the blockchain principle can be adapted to record any type of digital information.
- 



01 Principle of blockchain.

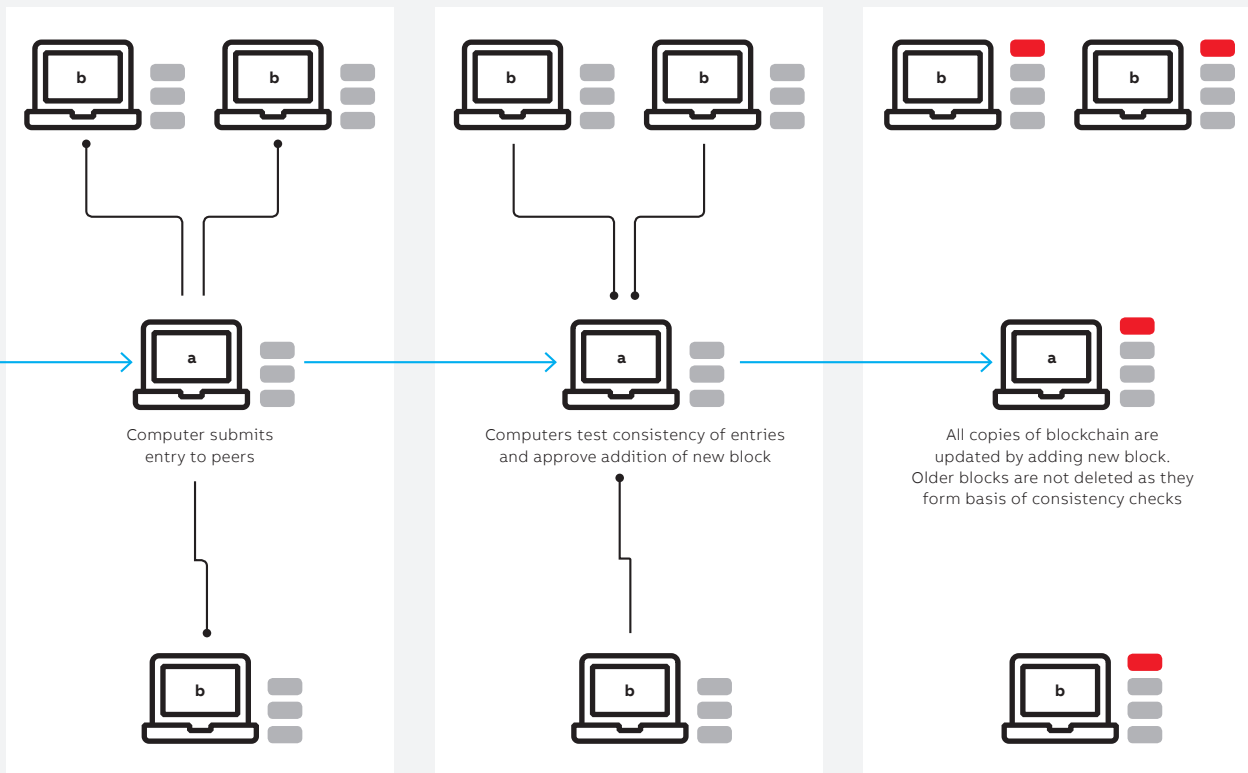

01

Imprint

Editorial Board

**Bazmi Husain**  
Chief Technology Officer  
Group R&D and Technology

**Adrienne Williams**  
Senior Sustainability  
Advisor

**Christoph Sieder**  
Head of Corporate  
Communications

**Reiner Schoenrock**  
Technology and Innova-  
tion Communications

**Roland Weiss**  
R&D Strategy Manager  
Group R&D and Technology

**Andreas Moglestue**  
Chief Editor, ABB Review  
andreas.moglestue@  
ch.abb.com

Publisher

ABB Review is published  
by ABB Group R&D and  
Technology.

ABB Switzerland Ltd.  
ABB Review  
Segelhofstrasse 1K  
CH-5405 Baden-Daettwil  
Switzerland  
abb.review@ch.abb.com

ABB Review is published  
four times a year  
in English, French,  
German and Spanish.  
ABB Review is free of  
charge to those with an  
interest in ABB's tech-  
nology and objectives.

For a subscription, please  
contact your nearest  
ABB representative or  
subscribe online at  
www.abb.com/abbreview

Partial reprints or  
reproductions are  
permitted subject to  
full acknowledgement.  
Complete reprints require  
the publisher's written  
consent.

Publisher and copyright  
©2017  
ABB Switzerland Ltd.  
Baden/Switzerland

Printer

Vorarlberger  
Verlagsanstalt GmbH  
6850 Dornbirn/Austria

Layout

DAVILLA AG  
Zurich/Switzerland

Disclaimer

The information con-  
tained herein reflects  
the views of the authors  
and is for informational  
purposes only. Readers  
should not act upon the  
information contained  
herein without seeking  
professional advice. We  
make publications availa-  
ble with the understand-  
ing that the authors are  
not rendering technical  
or other professional  
advice or opinions on  
specific facts or matters  
and assume no liability  
whatsoever in connection  
with their use.

The companies of the ABB  
Group do not make any  
warranty or guarantee,  
or promise, expressed or  
implied, concerning the  
content or accuracy of the  
views expressed herein.

ISSN: 1013-3119

<http://www.abb.com/abbreview>



Tablet edition

ABB Review is  
also available  
for your tablet.

Please visit  
[abb.com/abbreviewapp](http://abb.com/abbreviewapp)

Stay informed...

Have you ever missed a copy of ABB Review?  
Sign up for the email alert at  
[abb.com/abbreview](http://abb.com/abbreview)  
and never miss another edition.

Please note that when you register for this alert, you will  
receive an email with a confirmation link. Please ensure that  
you have confirmed your registration.



---

Next 04/2017

## **Making the transition**

**There are two big revolutions going on: The first is in electrical generation and distribution, the other in digital communication and controls. No business will remain untouched, and every company needs to embrace transformative change, now and going forward. The next issue of ABB Review will reveal those first steps, and explore how companies can go from where they are ... to where they need to be.**

READERSHIP SURVEY 2017

# Your opportunity to review ABB Review



Because reader perception and satisfaction are important in charting the future course of ABB Review, you are invited to take part in this short, 10 question, survey. All participants will have the chance to win one of five bluetooth sound stations. Your opinions matter to us and we thank you for your time. This survey is also available online at [www.abb.com/abbrevreview](http://www.abb.com/abbrevreview).

The survey can also be completed online at [www.abb.com/abbrevreview](http://www.abb.com/abbrevreview)

Survey closes on the 3th of November 2017.

**Q1 What is your relationship to ABB?  
(choose only one answer)**

- Customer
- Supplier
- Employee
- Media
- Investor
- Competitor
- Education
- Other

**Q2 Which of these categories describes your main area of interest?  
(choose only one answer)**

- Power generation
- Power transmission and distribution
- Other utility
- Oil and gas
- Other energy
- Mining and minerals
- Pulp and paper
- Food and beverage
- Chemicals
- Other process manufacturing
- Automotive manufacturing
- Other discrete manufacturing or handling
- Building automation
- Other automation
- Marine
- Other transportation
- Data Centers
- Other

**Q3 Which age category are you in?  
(choose only one answer)**

- 15-24
- 25-34
- 35-44
- 45-54
- 55-64
- 65+
- Answer declined

**Q4 How do you use ABB Review?  
(multiple responses permitted)**

- To better understand ABB's technologies
- To better understand technology in general
- To better understand ABB's offerings
- For sales/marketing purposes
- For training/education purposes
- For recruitment processes
- For research purposes
- Other

**Q5 How do you receive your copy of ABB Review?  
(choose only one answer)**

- Personal subscription (print)
- Direct contact with ABB staff
- Borrowed from a library
- Circulated at my company
- Read it online (pdf)
- Read the tablet/phone version
- Other

**Q6 To help us to optimize our distribution channels, how would you prefer to receive your copy of ABB Review? (choose only one answer)**

- Personal subscription (print)
- Direct contact with ABB staff
- Borrowed from a library
- Circulated at my company
- Read it online (pdf)
- Read the tablet/phone version
- Other

**Q7 ABB Review is currently available in four languages. If you could choose one additional language for ABB Review, which would it be? (choose only one answer)**

- Arabic
- Italian
- Chinese
- Portuguese
- Russian
- Other (specify) \_\_\_\_\_



ABB Review  
 ABB Switzerland Ltd.  
 Segelhofstrasse 1K  
 CH-5405 Baden-Daettwil  
 Switzerland

—  
 Please complete  
 and return the  
 form in a stamped  
 envelope  
 to the address  
 shown by  
 3 November 2017.

Please fold here

**ABB Review launched a new look from edition 1/2017. For the remaining questions, please only think about the new look ABB Review.**

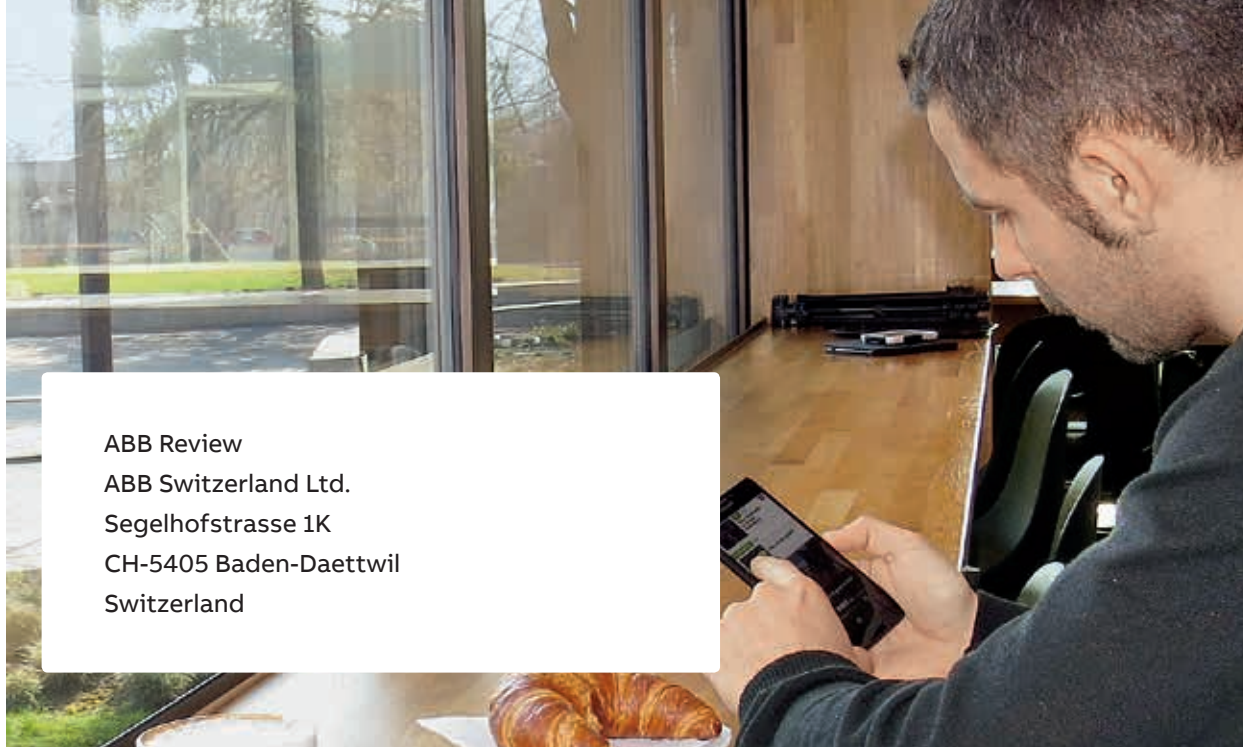
**Q8 How satisfied are you with the level of technical content in ABB Review articles? (choose only one answer)**

- Usually not technical enough
- Sometimes not technical enough
- Technical content is good
- Sometimes too technical
- Usually too technical

**Q9 How satisfied are you with the number of articles per edition of ABB review? (choose only one answer)**

- I would prefer a lot more
- I would prefer more
- Satisfied
- I would prefer less
- I would prefer a lot less

**Q10 How satisfied are you with the new layout/navigation of ABB Review? (choose only one answer)**

- I find navigation very easy
- I find navigation fairly easy
- Satisfied
- I find navigation fairly difficult
- I find navigation very difficult

**Any comments or feedback on how ABB Review can be improved?**

---



---



---



---



---



---

By providing your name and email address, you will be entered into a drawing for one of five bluetooth sound stations. Your personal information will be used solely for improving ABB Review and for the prize drawer. Your personal information will not be shared or published. We thank you for your feedback. The results of this survey will be published in a future edition of ABB Review. This survey is also available online at [www.abb.com/abbreview](http://www.abb.com/abbreview).

First name

---

Last name

---

Country

---

Email address

---