



BERNINA Q SERIES
LONGARM QUILTING MACHINES

NO SMALL THING.



made to create **BERNINA**



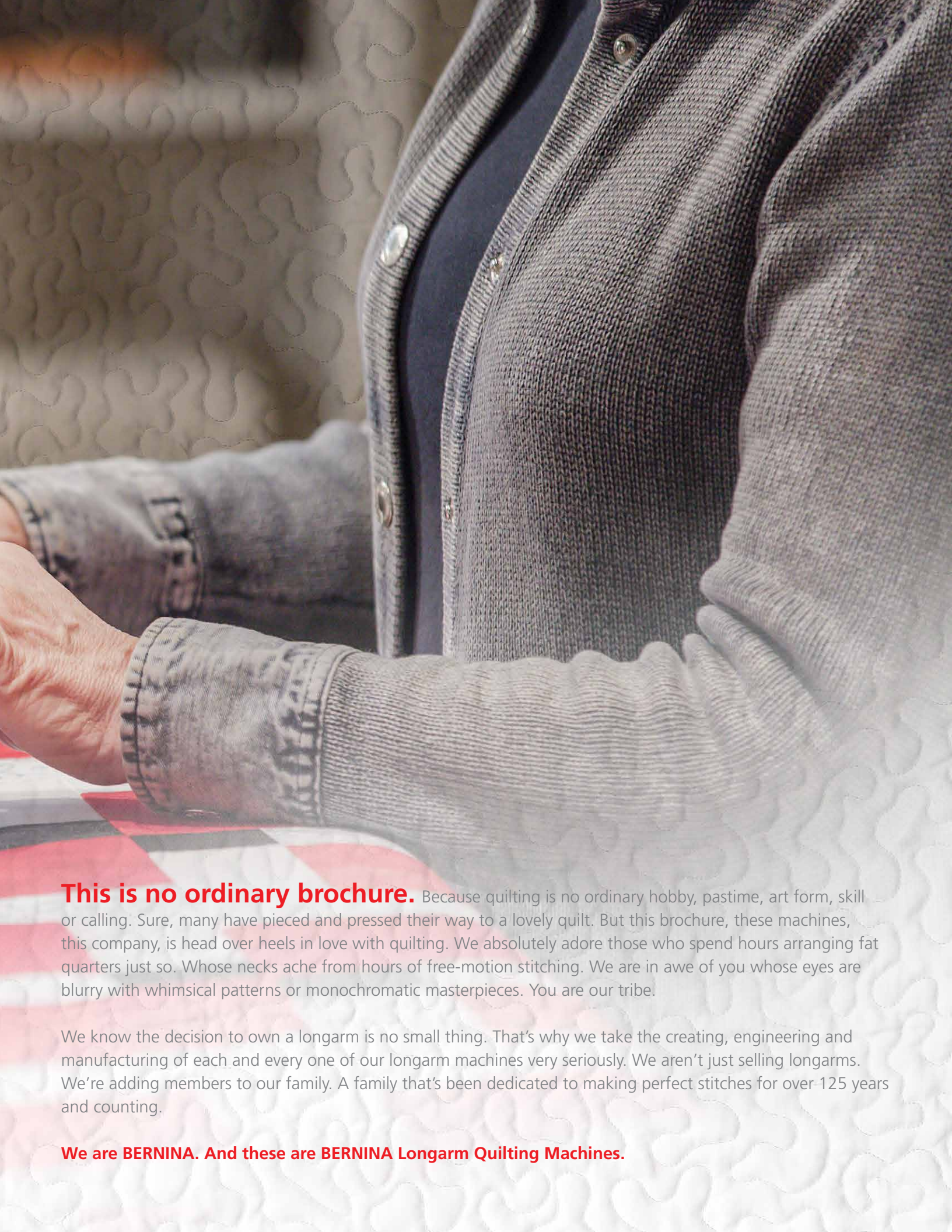

This is no ordinary brochure. Because quilting is no ordinary hobby, pastime, art form, skill or calling. Sure, many have pieced and pressed their way to a lovely quilt. But this brochure, these machines, this company, is head over heels in love with quilting. We absolutely adore those who spend hours arranging fat quarters just so. Whose necks ache from hours of free-motion stitching. We are in awe of you whose eyes are blurry with whimsical patterns or monochromatic masterpieces. You are our tribe.

We know the decision to own a longarm is no small thing. That's why we take the creating, engineering and manufacturing of each and every one of our longarm machines very seriously. We aren't just selling longarms. We're adding members to our family. A family that's been dedicated to making perfect stitches for over 125 years and counting.

We are BERNINA. And these are BERNINA Longarm Quilting Machines.

HELLO, Q SERIES LONGARMS.

Where have you been all my life?

If all quilters were alike, we'd offer just one amazing longarm system. But every one of you quilts your own way. Some of you sit and move your quilt through the machine with the skill of a seasoned artist. Others stand, with the machine as your brush, moving it over the quilt with precision as you create your masterpiece. Some of you have plenty of room for a longarm. Others will sacrifice the dining room table. We get it. That's why BERNINA offers a variety of systems to meet the specific needs and quilting style of every kind of quilter.

Not only do we offer a solution for every quilting style and a solution for every kind of space issue, but we address another common longarm question: "Will I be able to do it?" We've got you covered. BERNINA has spent over 125 years developing domestic sewing machines that are a joy to create with. And we bring all that innovation, convenience and ease-of-use to our Q Series Longarm Quilting Machines. These machines feel familiar. Because we've spent years making sure you experience a simple learning curve with nary a roadblock on your longarm journey.

Now, what kind of quilter are you?

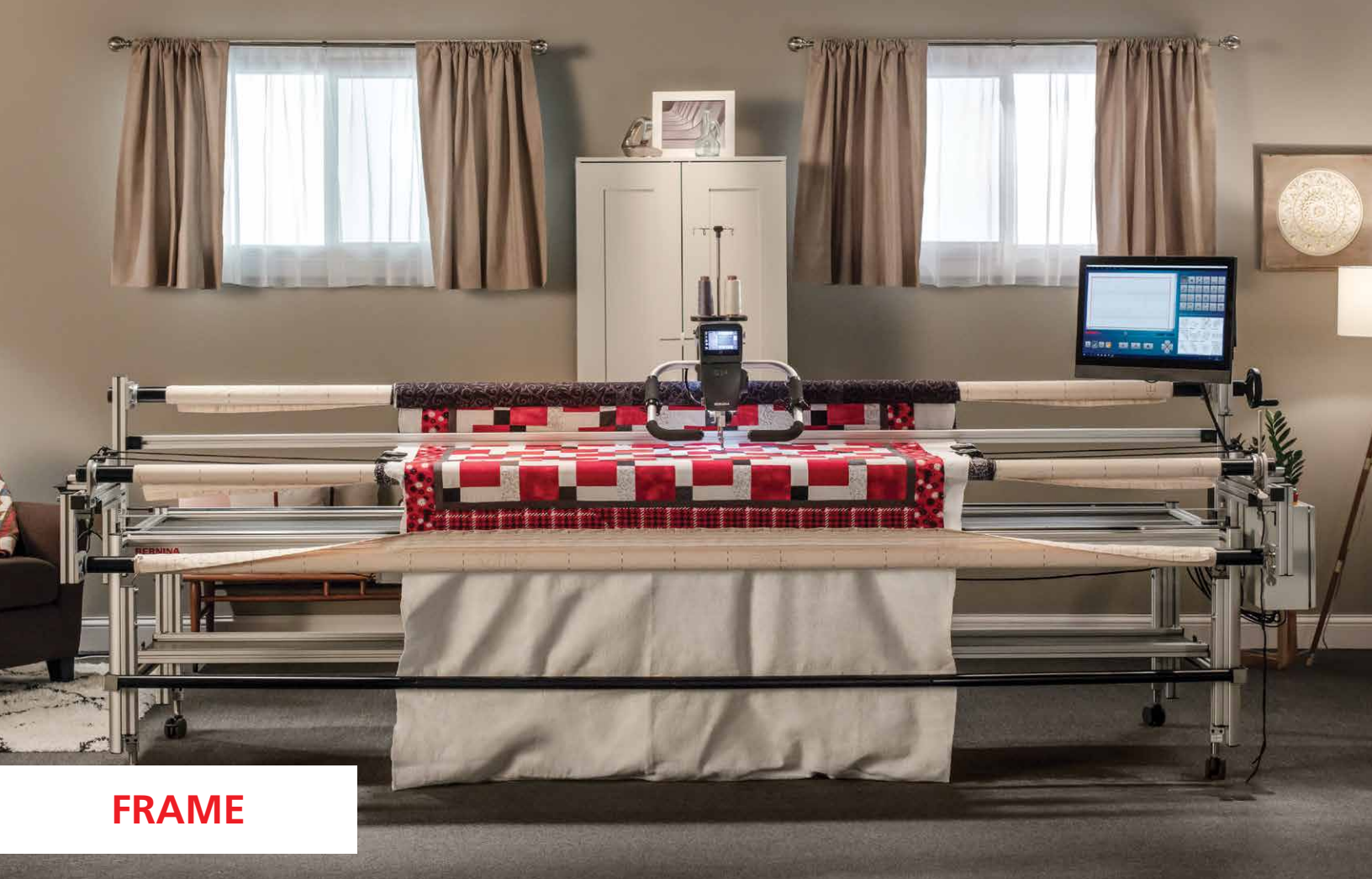

FRAME



SIT-DOWN



FOLDABLE-SIT-DOWN



IT'S TIME TO RETIRE
THE **DINING ROOM TABLE.**

THE MACHINE IS YOUR BRUSH. THIS IS YOUR FRAME.

BERNINA Q 24 and Q 20 on Frame

If you stand for perfect stitches, precise designs and creativity for days, then a Q Series Longarm on Frame meets and exceeds all your quilting dreams. Made of anodized aluminum, BERNINA Frames are lightweight, strong and easily handle the weight, size and speed of any BERNINA Q Series Longarm Quilting Machine. Available in three sizes—large, classic and small—to accommodate both your individual quilting style as well as your unique floor space needs. Quality from top to bottom, the Q 24 and Q 20 on frame have a professional look, quilt beyond your wildest dreams and let your creativity do the driving.



OVERVIEW OF THE THREE BERNINA FRAMES

| FRAME | LARGE | CLASSIC | SMALL |
|---------------------------|------------------------------|------------------------------|------------------------------|
| Size (length x depth) | 13' x 3.9' (4.00 x 1.2 m) | 12' x 3.9' (3.60 x 1.2 m) | 9' x 3.9' (2.75 x 1.2 m) |
| Leader | 132" / 11' (ca. 3.36 m) | 120" / 10' (ca. 3.07) | 83" / 6.9' (ca. 2.12 m) |
| Adjustable working height | 35" to 47" (0.9 to 1.2 m) | 35" to 47" (0.9 to 1.2 m) | 35" to 47" (0.9 to 1.2 m) |
| Total weight* | 330 lbs (150 kg) | 286 lbs (130 kg) | 200 lbs (100 kg) |
| Number of legs | 6 | 6 | 4 |
| Hydraulic lift | optional | optional | not available |

*Includes Q 20, Q 24 and all optional accessories

STRONG AND SMART.

The BERNINA Frame has it all.

- Adjustable foot pads for perfect leveling
- Continuous X and Y-axis track system with no joints
- Angled tracks and wheel axles for accurate and smooth movement of the sewhead to allow even quilting
- Friction-free 16-wheel system
- Leg system for maximum stability
- Multi-step ratchet system for perfect fabric tension
- Integrated latch system for maximum fabric holding power, yet easy release
- Pivot pick-up of magnetically-secured top rail, which allows fabric separation to smooth batting
- Dead bar for perfect fabric height no matter the length of your quilt
- Large diameter rails eliminate rail flex when tensioning the quilt
- Heavy duty canvas leaders with positioning markings for years of quilt loading ease
- Spacious pantograph tabletop to easily align your rolled patterns
- 4 bungee clamps to align every quilt to perfection
- Convenient tool trays for your longarm quilting tools



CREATIVITY NEEDS ELBOW ROOM.

Remember to save 2 feet of space beyond the specs listed here for the pantograph kit.





ALL THE BELLS.

ALL THE WHISTLES.

Q-MATIC. THE BRAINS BEHIND ALL THAT QUILTING BRAWN.

Remember quilting circles? That's what automated quilting is like. It makes your quilting life easier, faster and way more convenient. Q-matic turns tedious tasks into simple, at-your-fingertip commands so you have more time to focus on taking your creativity, and your quilts, to the next level.

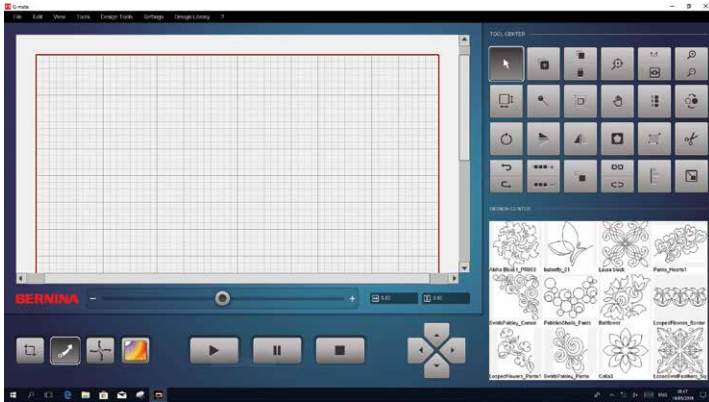

REASONS TO LOVE.

- One-touch quick belt release system
- Simple switch between automated and freehand quilting
- Compact belt drive system (stepper motor with planetary gear)
- 21.5" all-in-one touch PC with Windows 10 Pro and WiFi connectivity
- Sewhead interaction functions
- More than 600 designs included
- Import .bqm and .dxf file formats
- Art & Stitch quilt design and digitizing software included
- Easily add Q-matic to your BERNINA Longarm Quilting System at anytime



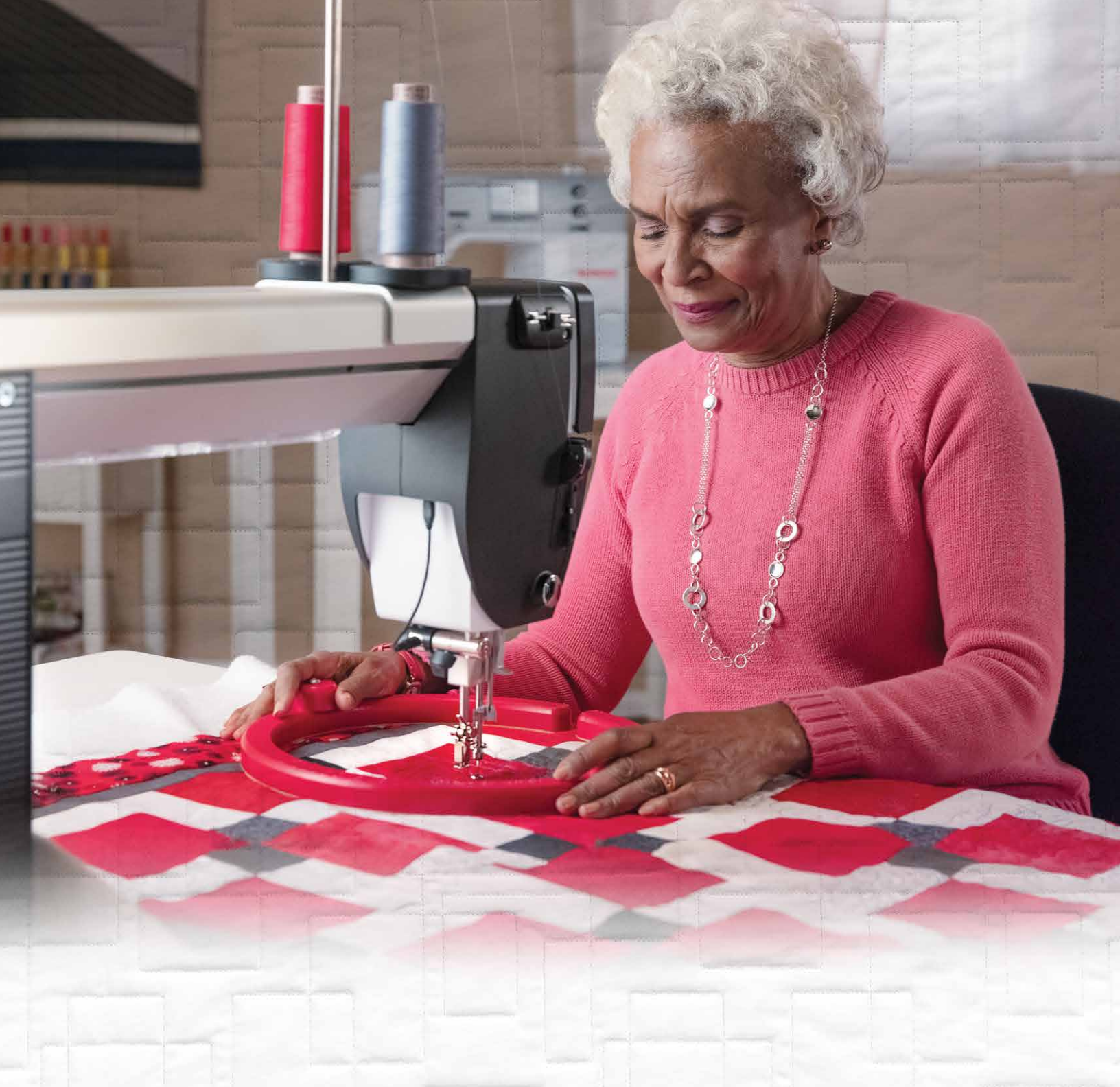

FROM MANY PIECES,
MASTERPIECES.

MEET THE HAND-GUIDED QUILTER'S LONGARM.

BERNINA Q 20 Sit-down Model

Transitioning from a domestic sewing machine to a BERNINA Q Series Sit-down Longarm could not be easier. Our spacious throat space lets you move your quilt with incredible ease. More workspace means more creative options and fewer adjustments. Your free-motion quilting is only limited by your imagination as you comfortably guide your quilt to perfection.



GOT LOADS OF CREATIVITY?

Table it.

The sturdy, elegant table perfectly handles the speed and weight of the Q 20 for optimal performance. With a variety of colors to choose from, this sit-down table is the perfect addition to any quilting room.

- Table size, basic: 36" x 45"
- Table size, expanded: approx. 36" x 77"
- Variable working height: 29", 32", 35"
- Total weight including Q 20: 265 lbs
- Generous storage space



HARD WORKING.

Great looking.

Choose from two standard colors:

-  English White Ash
-  Asian Golden Teak

Additional color options available:

-  American Birdseye Maple
-  North American Oak
-  Brazilian Cherry

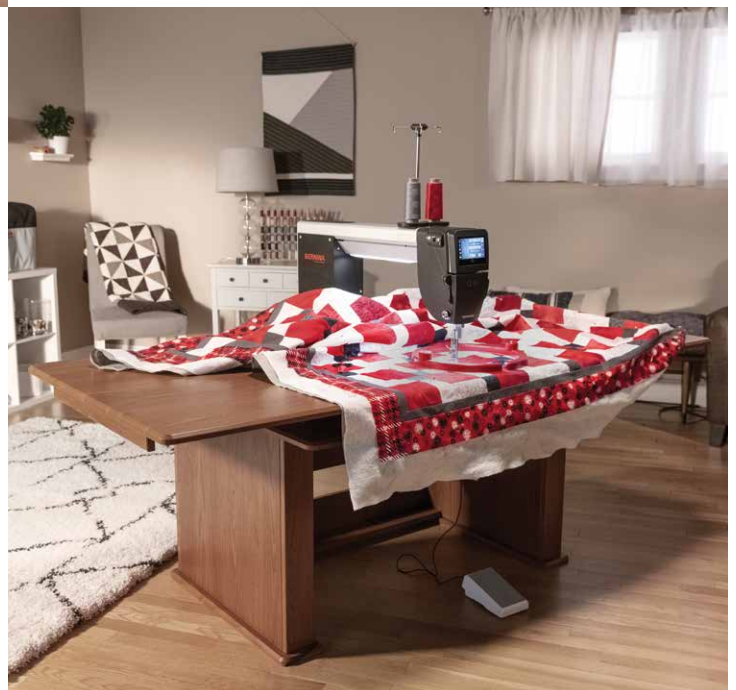

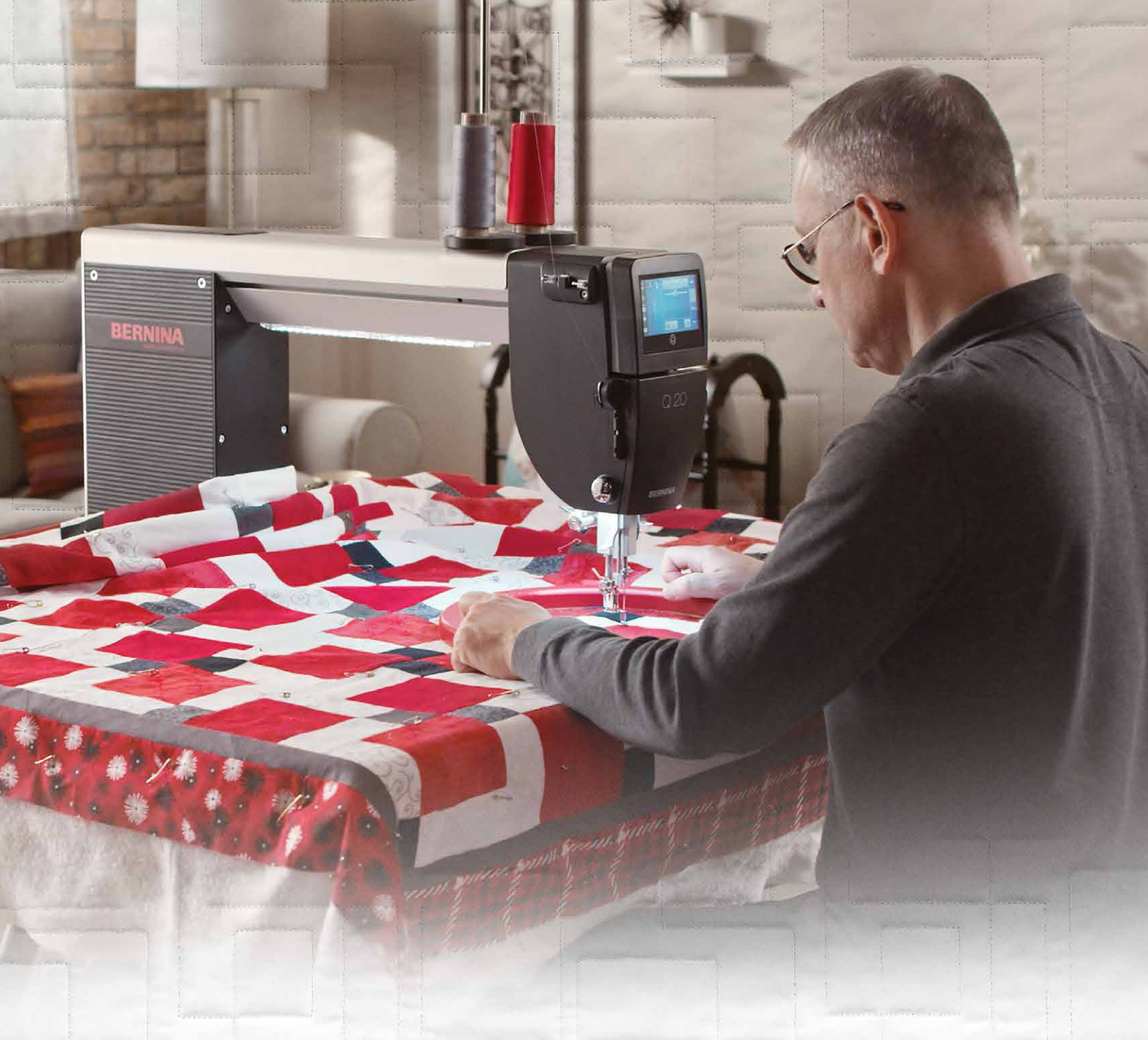

SMALL SPACES.

BIG IDEAS.

NO SPACE? NO PROBLEM.

BERNINA Q 20 Foldable Table

Sometimes your quilting dreams are bigger than your space. The BERNINA Q 20 Foldable Table is the perfect solution. It is spacious enough for your biggest projects, sturdy enough to handle all the performance features of the Q 20 Longarm and discreetly tucks away when not in use. Like we said, perfect.

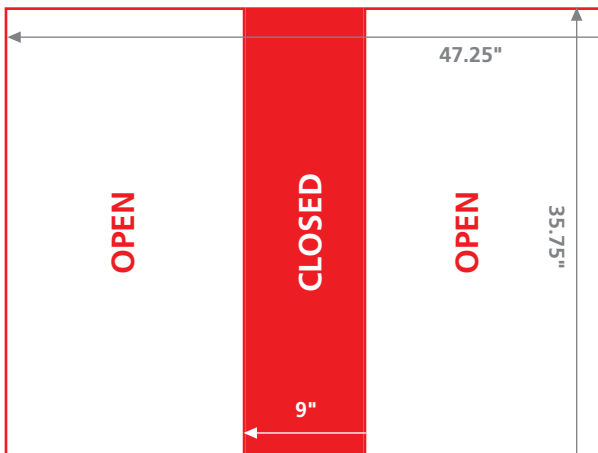

- Only 9" wide tucked away
- Closed: 35.75" d x 9" w x 39" h
- Open: 35.75" d x 47.25" w x 39" h
- Sturdy and easily handles speed, weight and performance of the Q 20
- Fast and easy to set up in minutes—no tools required
- Fabrics glide easily over smooth table surface

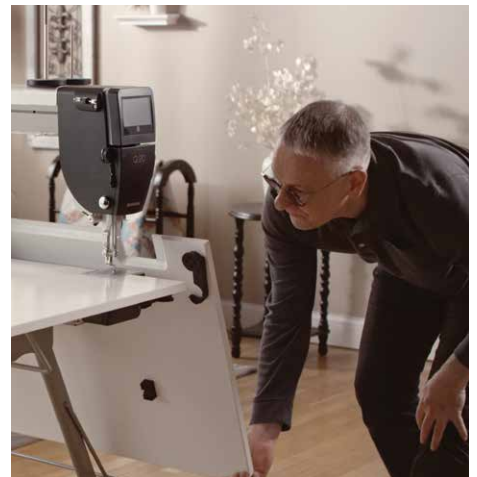

THE EXTRAS THAT MAKE THINGS EASIER, FASTER, PRETTIER.

Optional frame accessories



Pantograph Kit

- Pantograph handles (attach to the back of the machine)
- Rear touch screen
- Laser light
- Stylus (metal)
- Holder for laser light and stylus
- Sample pantograph
- Transparent plastic cover

Ruler Work Kit

- Ruler foot #96
- Ruler base
- Ruler

Channel Lock

Use the channel locks for locking the X and Y-axis of your machine and carriage.

Other Accessories

- Q-matic kit (automation)*
- Additional shelving*
- Hydraulic lift*
- Casters
- Batting roll holder*

**The Q-matic kit, additional shelving, hydraulic lift and batting roll holder are not compatible with the small frame version.*

Optional machine accessories

Twin Needle Stitch Plate

Use a twin needle and the twin needle stitch plate to achieve interesting ribbonlike effects. Experiment with two colors or shades of thread to produce 3D effects.

Compatible with BERNINA Free-motion Feet

- Embroidery foot #15
- Free-motion embroidery foot #24
- Drop-shaped embroidery foot #26
- Quilting foot #29
- Free-motion couching foot #43
- Echo-quilting and CutWork foot #44C

BERNINA Presser Feet Accessories

- Echo-quilting clips
- Cup clip
- Couching inserts
- Ruler foot #96
- Adjustable ruler foot #72
- Adjustable stippling foot #73

For a full list of longarm accessories visit bernina.com

WHY BERNINA?

Simple. We offer over 125 years of renowned quality, innovative technology that produces perfect stitches every time, a company that treats you like family and exclusive features engineered to make quilting easier, faster, more convenient and more creative. If you want the best of the best from the longarm people who aren't going anywhere and who support their quilters at every turn, then you want a BERNINA.

We know quilters. That's why we've developed all the features you expect and nine more that exceed your wildest dreams. Pay special attention to the exclusive innovations unique to BERNINA, created to make your quilting life markedly better.



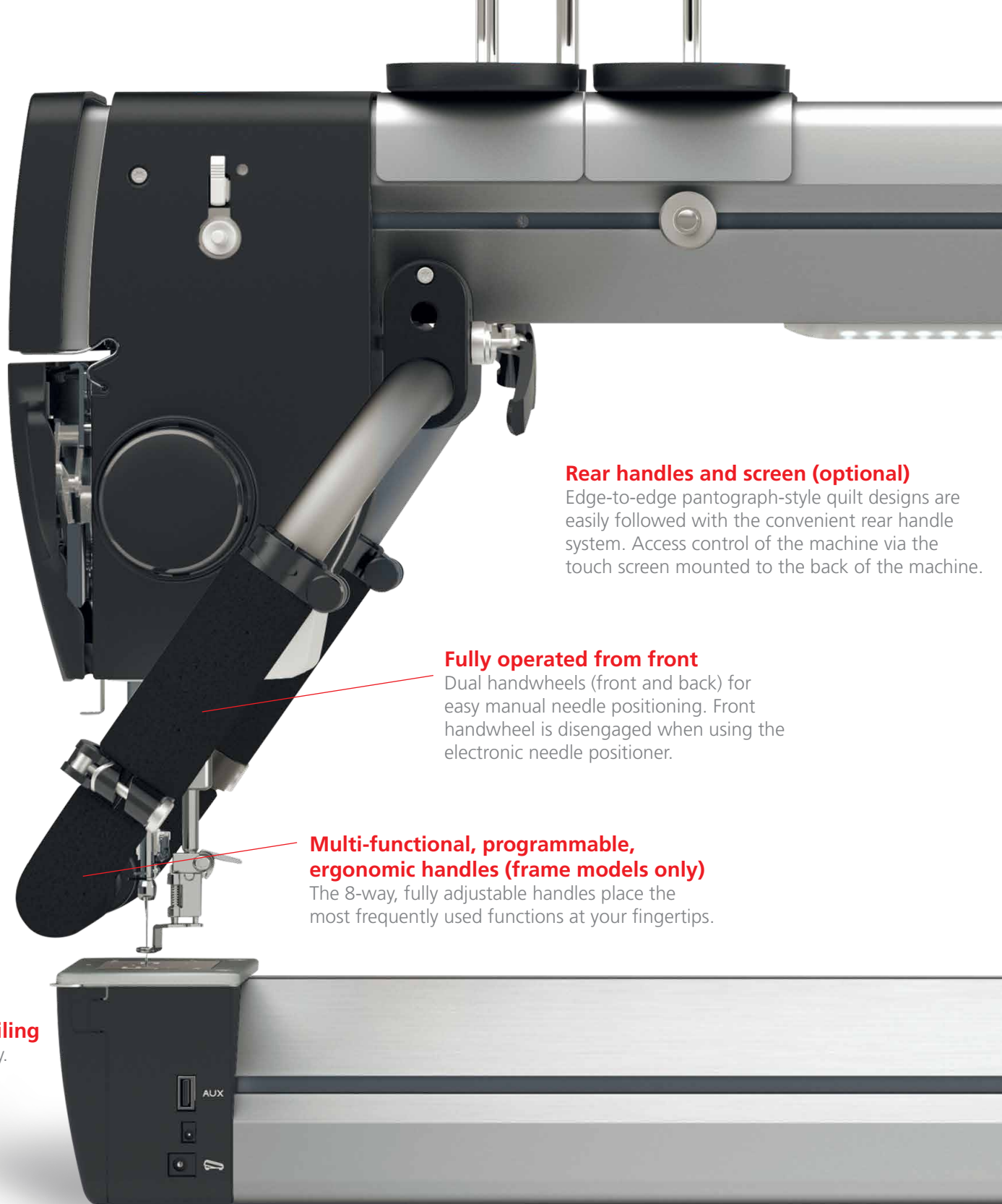

Rear handles and screen (optional)

Edge-to-edge pantograph-style quilt designs are easily followed with the convenient rear handle system. Access control of the machine via the touch screen mounted to the back of the machine.

Fully operated from front

Dual handwheels (front and back) for easy manual needle positioning. Front handwheel is disengaged when using the electronic needle positioner.

Multi-functional, programmable, ergonomic handles (frame models only)

The 8-way, fully adjustable handles place the most frequently used functions at your fingertips.

Minimum oiling

One point only.

Speed

With high-speed precision stitching for hand-guided quilting, you complete more quilts faster than ever.

BERNINA

Designed and engineered in Switzerland.

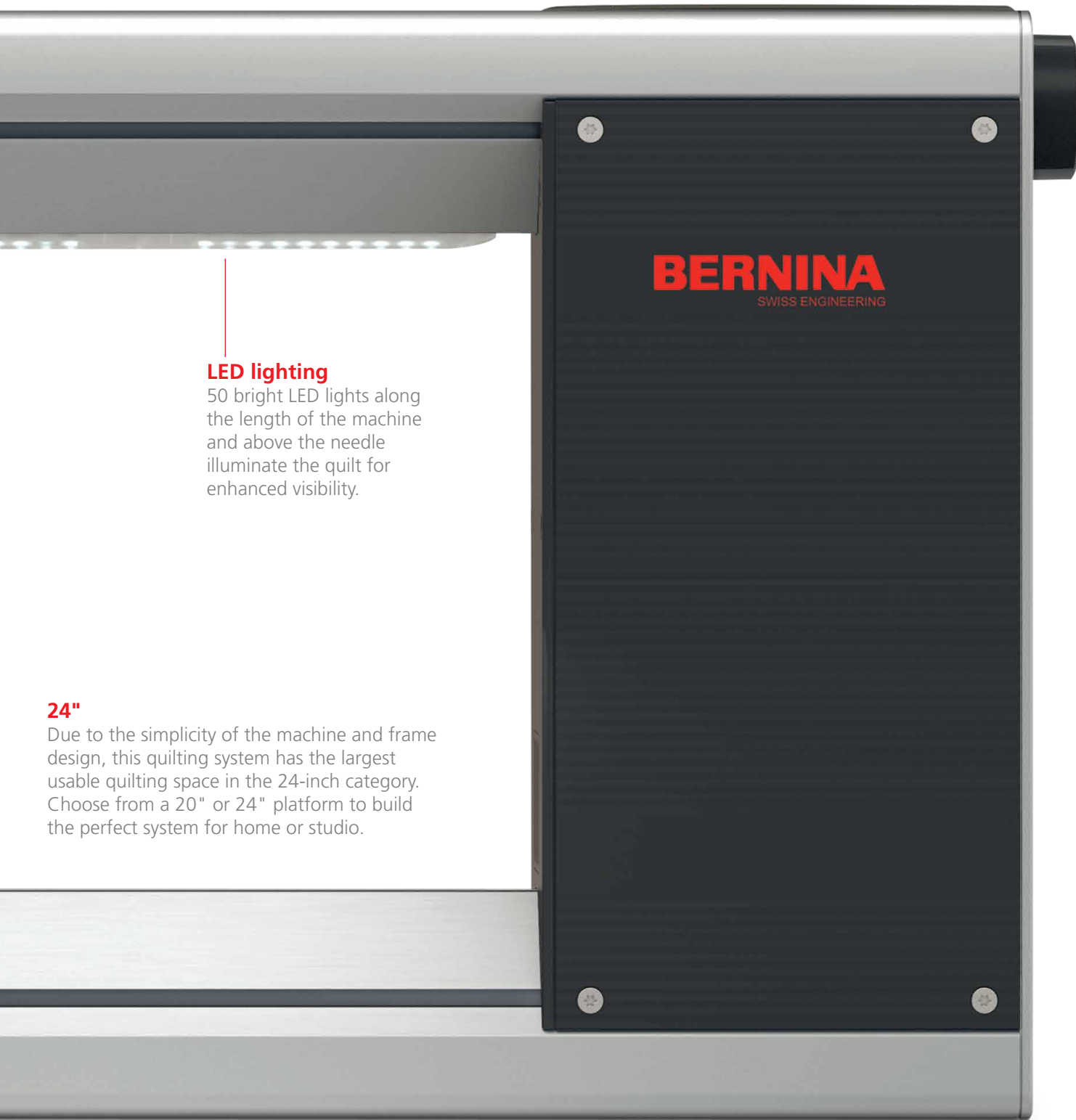

LED lighting

50 bright LED lights along the length of the machine and above the needle illuminate the quilt for enhanced visibility.

24"

Due to the simplicity of the machine and frame design, this quilting system has the largest usable quilting space in the 24-inch category. Choose from a 20" or 24" platform to build the perfect system for home or studio.

Quiet quilting

Quiet gear mesh design and internal motor. High-speed sealer bearings require no oil maintenance.

BERNINA EXCLUSIVES

BERNINA STITCH REGULATOR

Master hand-guided quilting quickly with the assistance of the integrated BERNINA Stitch Regulator, available on sit-down and frame models. Keep your stitches even and consistent regardless of how simple or complex your quilt motif may be. Both Q Series Longarm Machines are equipped with two internal, integrated BERNINA Stitch Regulators, one on each side of the stitch hole in the needle plate, to allow for very precise sensing of the machine/fabric movement. This is the first system with no mechanical encoders. The BERNINA Stitch Regulator is simple to activate and customizable using the machine's touch screen. A manual mode with no stitch regulation is also available.

DIGITAL THREAD TENSION ADJUSTMENT

Electronically adjustable and numeric. Easily adjust thread tension and track settings for your favorite thread types and combinations, no external tension assembly required.

NO TOOLS REQUIRED FOR FOOT INSTALLATION/REMOVAL

It's never been easier to be as creative as you want to be with BERNINA feet that utilize tool-less installation and removal. It's easy and convenient to swap out feet to achieve the exact stitch you need to complete your design.

NEEDLE THREADER

No more struggles threading the needle. Let your BERNINA Q Series Longarm take care of that for you. Simple, easy, done!

TWIN AND DOMESTIC MACHINE NEEDLE COMPATIBLE

No need for special needles that only work on one machine. Add convenience to the list of benefits as you utilize needles you already use on your other sewing machines. Also, you can use a twin needle and the twin needle stitch plate to achieve interesting ribbonlike effects. Or experiment with two colors or shades of thread to produce 3D effects.

KICKSTART FUNCTION FOR QUILTING WITHOUT FOOT CONTROL

Available only on Q 20 Sit-down model

The KickStart function allows quilting in a continuous sewing mode without having to keep the foot control constantly pressed.

USER INTERFACE

BERNINA brings the best of the domestic machine world to longarm machines with a simple-to-navigate color touch screen. Totally customizable, it includes useful functions, such as five user profiles, a stitch counter and built-in tutorials that assist with threading the machine, oiling, winding the bobbin and other processes.

INTEGRATED BOBBIN WINDER

The on-board bobbin winder (M Class bobbin) conveniently winds coordinating bobbin threads for projects, independent of machine operation. The integrated, separately-running bobbin winder is just one of the many details that make this machine unique.

THREADING PATH

The well-positioned spool holders and forward threading path are easy to reach and simple to follow.

Q SERIES OVERVIEW.

Key features of the Q 24 and Q 20 on Frame or Sit-down version.

| TECHNICAL DATA | Q 24 | Q 20 |
|---|----------------------------------|--------------|
| Throat space | 24" (610 mm) | 20" (508 mm) |
| Color touch screen | 4.3" (109 mm) | |
| Full length freearm illumination | Yes, 50 LEDs | |
| Hook System | M Class Rotary Hook | |
| Needle Threader | Yes | |
| Thread tension | Numerically/digitally-adjustable | |
| Presser foot lift | Electronic | |
| Upper thread break sensor | Yes | |
| BERNINA Stitch Regulator | Dual Stitch Regulators | |
| Connection (basic) | USB host/slave | |
| Connection (additional purpose) | HDMI | |
| Updateable | Yes | |
| Multi-functional, programmable, ergonomic handles | Yes (frame version only) | |

| SEWING | Q 24 | Q 20 |
|--|-------------------|------|
| Sewing speed maximum | 2,200 spm | |
| Stitch length minimum | 1.05 mm (24 spi*) | |
| Stitch length maximum | 25.4 mm (1 spi*) | |
| User profiles | 5 | |
| Bobbin thread indicator | Yes | |
| On-board bobbin winder | Yes | |
| Compatible with domestic machine needles | Yes | |
| Compatible with BERNINA free-motion presser feet | Yes | |

| STANDARD ACCESSORIES | Q 24 | Q 20 |
|-------------------------|---------------------|------|
| Standard presser foot** | Free-motion foot #9 | |
| Two spool holders | Yes | |
| Metal accessory box | Yes | |

*Stitches per inch

** Wide range of optional free-motion presser feet

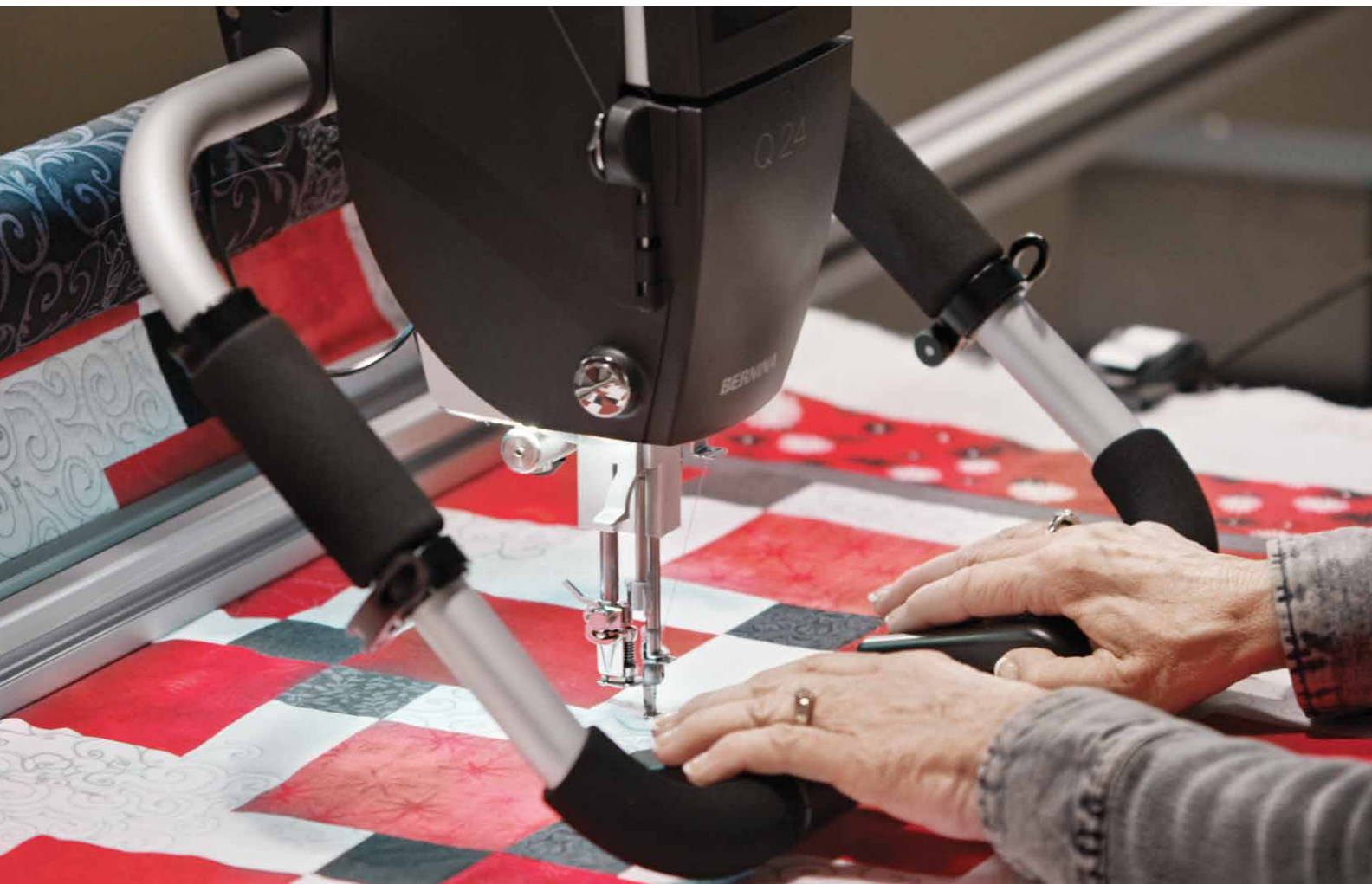

OF ALL THE THINGS TO FINANCE, DREAMS SHOULD TOP THE LIST.

We've partnered with these companies in order to offer you the most ideal financing solutions.

Red Thread Financial

An experienced lender in the creative services industry, Red Thread Financial has served creative people and businesses by financing machines, accessories and other equipment for years. They make the dream of owning quilting equipment a reality.

Unlike a bank, the equipment is the only collateral used. The documentation process is streamlined, easy and hassle-free. The minimal upfront costs require only two advance payments (based on credit approval). Response times are fast and you always talk to a real person.

Visit your local BERNINA store or learn more at redthreadfinancial.com

The BERNINA Credit Card

There are several special financing options* available. Simply visit your local BERNINA store and talk with your Dealer to learn more about the BERNINA Credit Card's spectacular financing offers.

The BERNINA Credit Card offers:

- Instant credit decision
- Convenient monthly payments
- No early payoff penalty
- Use on any BERNINA products

**Subject to credit approval. Minimum monthly payments required. See store for details.*

BE A BERNINA FAMILY MEMBER FOR LIFE.

We know customer service is no small thing. That's why, as a family-owned company, we go above and beyond to make sure every longarm quilter, both sit-down and frame, benefits from our commitment to supporting their creativity from day one. That includes guiding you on your purchasing journey and providing you with white-glove delivery, set up services, superior technical support, service calls, classes and loads of inspiration and project ideas on bernina.com.

Plus, every BERNINA Longarm Dealer and Service Technician is specifically trained and certified in the care and maintenance of the Q Series Longarm machines. All that know-how is at your disposal from the moment you make a BERNINA Longarm Quilting Machine yours.

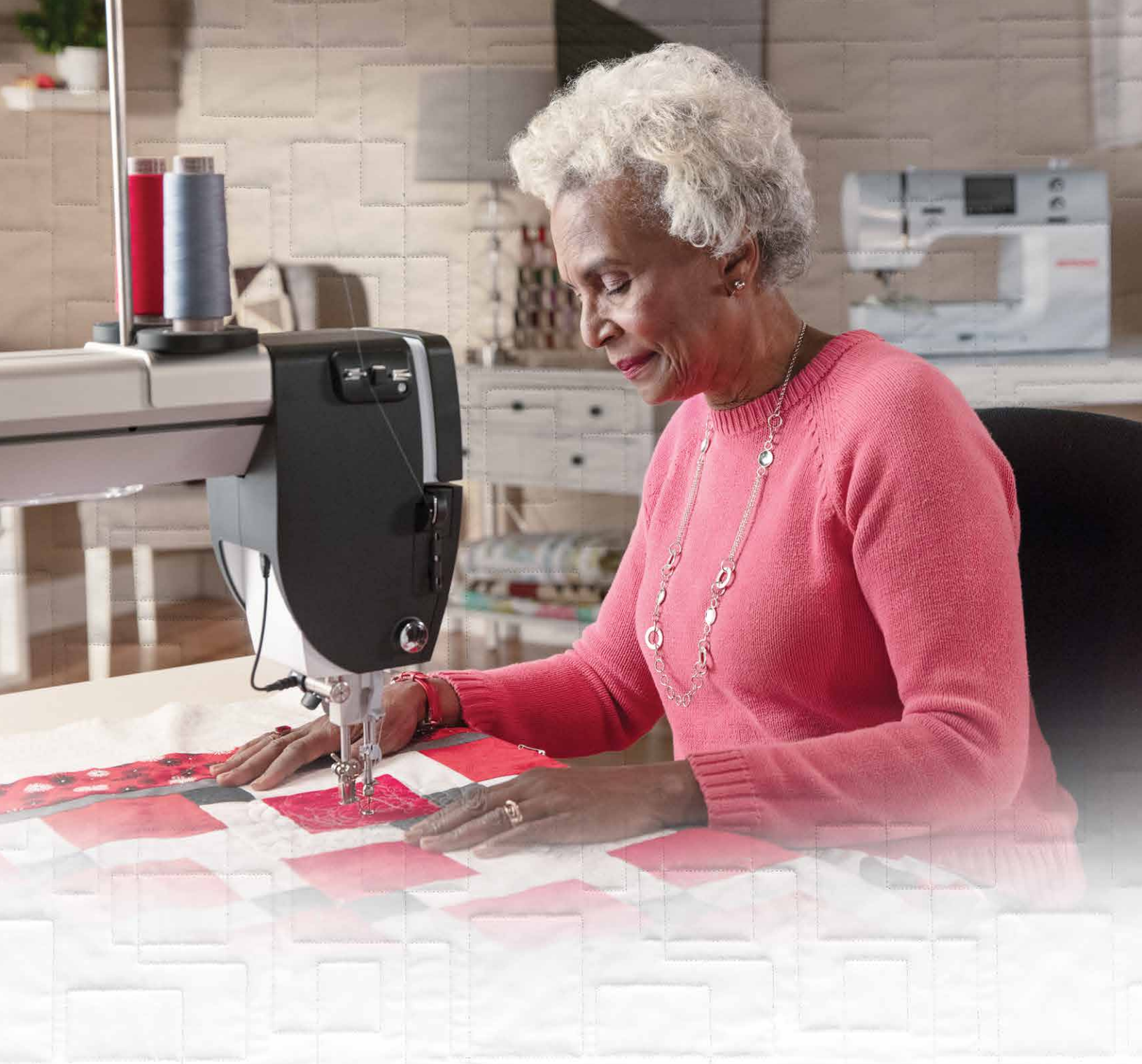

It's no small thing. Changing the way you quilt to take it to a whole new level—there's a lot to consider. Space. Learning curve. Cost. Support. We totally get that this is a really big deal. The best dreams usually are. We understand that you haven't gotten here on a whim. You've most likely been quilting for quite some time. You've got a machine you love or one you loathe. You've got tons of room to expand or you're going to fit this into whatever space you can find. You've saved for what seems like forever or you're going to need some help. No matter how you got here, you're here now. And we've been waiting for you. Making room. Moving barriers. Making it easier. Presenting possibilities.

So in the end, you have every reason to choose BERNINA.



MAKE YOUR QUILTING DREAMS COME TRUE.

When it comes to a BERNINA Q Series Longarm Quilting Machine, seeing isn't believing. Trying is. Visit a BERNINA store today and become the longarm quilter you've always wanted to be.

Find your BERNINA store at bernina.com



made to create **BERNINA**

© 2019 BERNINA of America