

Eyecon

Pill Counting, Inventory, and Validation System



Instruction Manual

Avery Weigh-Tronix is a trademark of the Illinois Tool Works group of companies whose ultimate parent company is Illinois Tool Works Inc (“Illinois Tool Works”). Copyright © 2016 Illinois Tool Works. All rights reserved.

No part of this publication may be reproduced by making a facsimile copy, by the making of a copy in three dimensions of a two-dimensional work and the making of a copy in two dimensions of a three-dimensional work, stored in any medium by electronic means, or transmitted in any form or by any means, including electronic, mechanical, broadcasting, recording or otherwise without the prior written consent of the copyright owner, under license, or as permitted by law.

This publication was correct at the time of going to print, however Avery Weigh-Tronix reserves the right to alter without notice the specification, design, price or conditions of supply of any product or service at any time.

Table of Contents

Chapter 1 General Information and Warnings	7
About this Manual	7
Text Conventions	7
Special Messages	7
Installation	8
Unpacking	8
Intended Use	8
General Description	9
Product Identification	9
Setup	10
Sulfa and Penicillin Platter	10
External Scanner	12
Preparing the Eyecon for Use	14
Turn on the Eyecon	15
Routine Maintenance	16
Cleaning the Machine	16
Funnel and Slide Gate	16
Rapid Fill Counting Tray	17
Sharp Objects	18
Training	18
Scanner / Laser	19
Scanner Specifications	19
Licensing Agreement	20
Medi-Span Copyright and Disclaimer Information	20
Software Updates	21
Update Warnings	21
Install Software Updates	21
Turn off the Eyecon (Shutdown)	23
Restart	23
Shutdown	23
About Eyecon Screen	23
Warranty Policy	24
Specifications	25
FCC Statement	25
ETL	25
Back up the Eyecon Data	26
Helpful Hints	26
Navigating the Touch Screen	26
Automatic Update from the Website	26
Symphony Software	26
Chapter 2 Settings Menu	27
General	27
Launch Windows Applications	30
Users	30
Add or Delete a User	31
User Scan-Out	32
No User ID Lookup	33
Test	34
Barcode	35
Barcode Type	35
Rx Barcode Examples (Validation Only)	36
RX Scan During Count Mode	39
Barcode Setup Help	40

Test Mode	41
Data	42
Report Data	43
Physical Inventory Data	46
Files	48
Auto Updates	49
TCP/IP	51
Listening Server Settings	52
Remote Server	53
Inventory Interface (McKesson Enterprise Rx)	54
Multi	55
Double Check	55
Double-Counts	55
Back-Counts	56
Chapter 3 Eyecon Native Modes	57
Start-up Screen	57
Count Only Mode	58
Rx Dispensing and Pill Counting	58
Unit of Use	61
Hand-Count	62
Accumulate Count Method	63
Rx Validation / Workflow	65
Rx Validation and Dispensing	65
Partial Fill	70
Unit of Use	71
GPI Substitution	72
Double Count (DEA Controlled Substances)	74
Back Count (DEA Controlled Substances)	76
Hand-Count	79
Accumulate Count Method	80
Manual Login	82
Physical Inventory Mode	83
Count Inventory	83
Unit of Use	86
Hand-Count	87
Accumulate / Counting	88
Manual Login	89
Re-Train an Existing Pill Image	90
Train Pill Image	91
Train Hand-Count	91
Manual NDC Entry	92
NDC Not Found	93
Edit Drug Database	94
Drug Photo	96
Train a New Pill	96
Chapter 4 PMSS Modes	98
Package Settings	98
Pill Counting	99
Partial Fill	104
Unit of Use	105
GPI Substitution	106
Hand-Count	108
Accumulation	109
Manual Login	111
Manual NDC Entry	111

NDC Not Found	112
Edit Drug Database	113
Previously Entered Drug	114
Drug Photo	114
Re-Train an Existing Pill Image	115
Train Pill Image	115
Hand-Count	116
Rx PMSS Data Viewer	117
McKesson Enterprise Rx	117
Setup	117
Access Inventory Mode	118
Chapter 5 Workflow Mode	121
Pharmacy Package Settings	121
Settings	122
Server	122
Local TCP/IP Settings	123
Network Share	124
Workflow Diagnostics and Setup	125
Shutdown or Restart	126
Restart	126
Shutdown	126
Basic Test	126
About Eyecon	127
Eyecon Setup	128
Common	129
Troubleshooting	130
Network Setup	132
Server	133
Local TCP/IP Settings	134
Network Share	135
Chapter 6 Downloaded Inventory Data	136
Access Downloaded Files	136
.CSV Files	136
Text Files	138
Chapter 7 User Login Barcodes	142
Chapter 8 Report Download Data and Photos	144
Access Downloaded Files	144
Downloaded Report Data	145
Locate Tray Photo	145
Photo (Image) Numbering	145
File Names	145
Unit of Use Fill Types	146
Rx Information on Photo (Image)	146
Example of Downloaded Pill Images	146
Chapter 9 File Sharing	151
File Sharing Setup	151
Needed Items	151
Eyecon Setup	151
Computer Setup	152
Adjust Back-Count Discrepancy Reasons	153
Chapter 10 Audit Reports	154
Access Eyecon Auditor from the Start-up Screen	154
Initial Use	154

Specify and View a Report	155
Accessing the Saved Photos and Reports	157
Chapter 11 Accuracy Verification Procedure	159

1 General Information and Warnings

1.1 About this Manual

This manual is divided into chapters by the chapter number and the large text at the top of a page. Subsections are labeled as shown by the 1 and 1.1 headings shown above. The names of the chapter and the next subsection level appear at the top of alternating pages of the manual to remind you of where you are in the manual. The manual name and page numbers appear at the bottom of the pages.

1.1.1 Text Conventions

The buttons used to interface with the Eyecon are via the touch screen display. The buttons are shown as they would be seen on the display (i.e. ).

Screen headings will appear in **bold** (i.e. **Start-up**).

Displayed messages appear in ***bold italic*** type and reflect the case of the displayed message.

1.1.2 Special Messages

Examples of special messages you will see in this manual are defined below. The signal words have specific meanings to alert you to additional information or the relative level of hazard.



DANGER!
THIS IS A DANGER SYMBOL.
DANGER MEANS THAT FAILURE TO FOLLOW SPECIFIC PRACTICES OR PROCEDURES WILL CAUSE INJURY OR DEATH.



CAUTION!
This is a Caution symbol.
Cautions give information about procedures that, if not observed, could result in damage to equipment or corruption to and loss of data.



NOTE: *This is a Note symbol. Notes give additional and important information, hints and tips that help you to use your product.*

1.2 Installation



DANGER: RISK OF ELECTRICAL SHOCK. NO USER SERVICEABLE PARTS. DO NOT ATTEMPT TO SERVICE THE EYECON BY REMOVING THE COVER OR OPENING THE UNIT. REFER TO QUALIFIED SERVICE PERSONNEL FOR SERVICE.



DO NOT EXPOSE THE EYECON TO RAIN OR MOISTURE. DO NOT EXPOSE THE EYECON UNIT TO DRIPPING OR SPLASHING LIQUIDS.

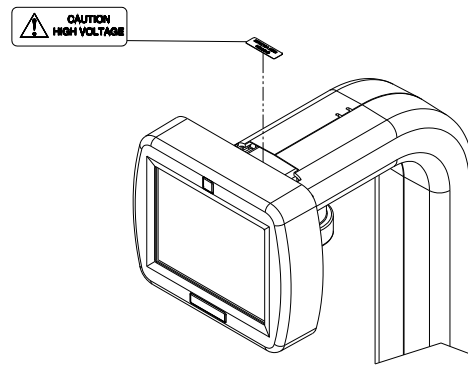

Figure 1.1 High Voltage Warning Label



CAUTION!
Class 2 laser radiation when open. Refer to page 19 for more details.

1.2.1 Unpacking

Caution! *The Eyecon contains components that can be damaged by rough handling. Unpack all items carefully.*

1.2.2 Intended Use

Eyecon™ utilizes machine vision technology to accurately count tablets and capsules for prescription dispensing.

Machine vision technology allows for identification of most foreign substances and pill variations during the counting and dispensing process.

The specialized technology of the Eyecon™ does not support the counting of gel caps.

1.2.3 General Description

Refer to the diagram below for part descriptions for field replaceable and non-field replaceable parts.

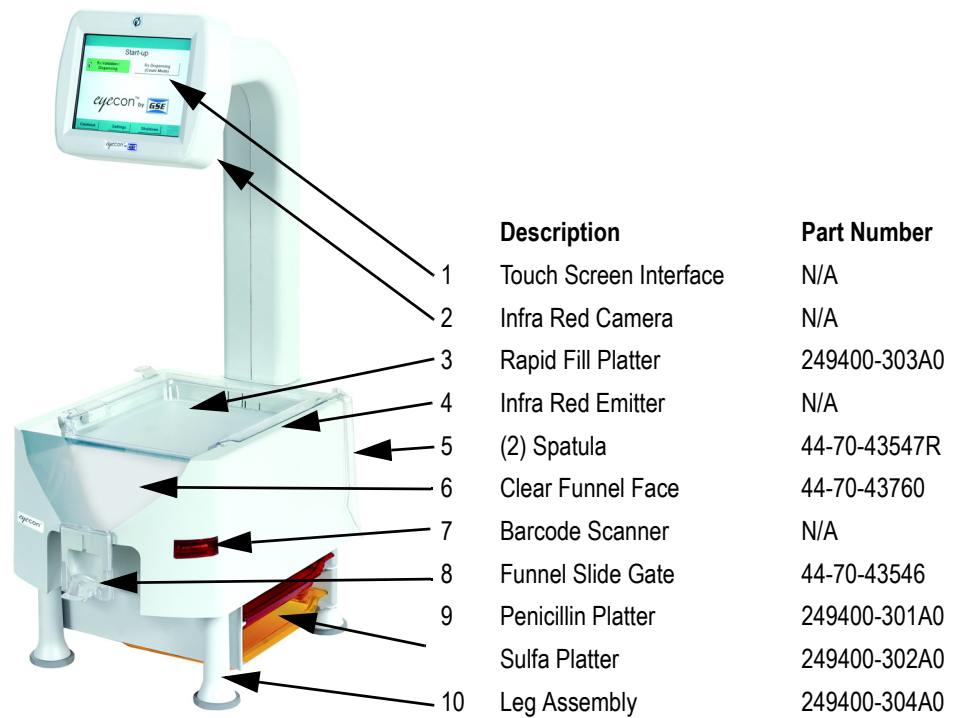

1.2.4 Product Identification

Each Eyecon has a specific part number and a unique serial number. Please refer to [Figure 1.2](#).

This information will be needed for periodic updates, service, and warranty claims.

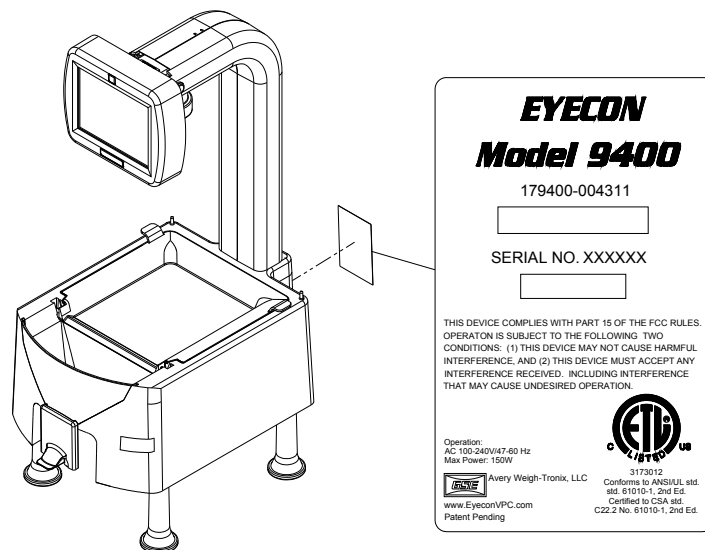

Figure 1.2 Product Markings

1.3 Setup

Place the Eyecon on a level surface and away from direct sunlight. Refer to [Figure 1.3](#) for dimensions of the Eyecon.

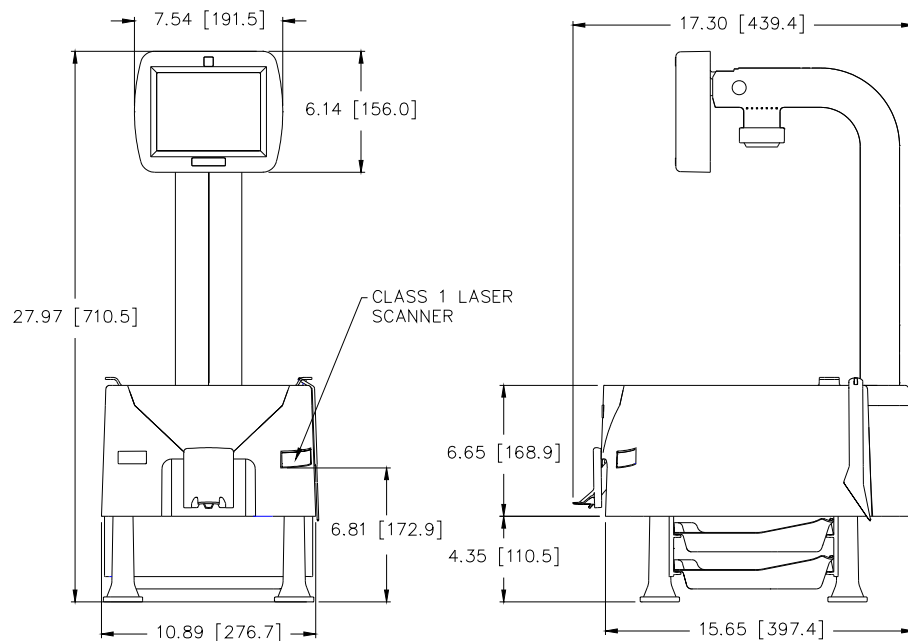

Figure 1.3 Eyecon Dimensions

1.3.1 Sulfa and Penicillin Platter

The sulfa (yellow) and penicillin (red) platters are used to avoid cross contamination and are standard with Model # 179400-004311. The platters store easily under the base of the Eyecon.

The platters are also available for purchase in a kit or separately.

- When ordering both platters and hardware, use part number 249400-300A0.
- When ordering the Penicillin platter only, use part number 249400-301A0.
- When ordering the Sulfa platter only, use part number 249400-302A0.

Sulfa and Penicillin Platter Kit Installation

No need to remove leg assembly to install optional counting platter brackets.

1. Gently turn the Eyecon unit on its side being careful to not drop the Eyecon on the display.
2. Remove adhesive tabs from platter holder located in two places per holder (refer to [Figure 1.4](#)).
3. Position one of the platter holders on the chassis with the ridges facing the inside (refer to [Figure 1.5](#) for an illustration).

4. Line the four snaps of the platter bracket up with 4 holes on chassis. Push until holders snap into place. Holders can only be installed one way, if holes don't line up turn holders around and try again. Apply light pressure to platter holder for approximately 15 seconds allowing adhesive to set.
5. Carefully stand the Eyecon upright.
6. Insert the sulfa and penicillin platters in between the brackets (refer to [Figure 1.6](#)).

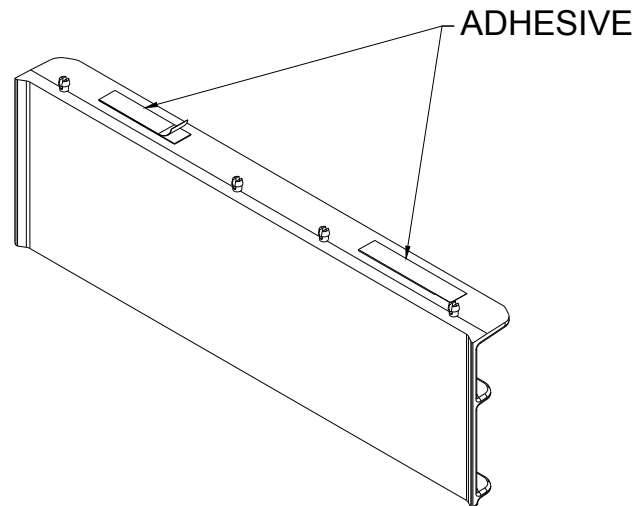

Figure 1.4 Platter Bracket

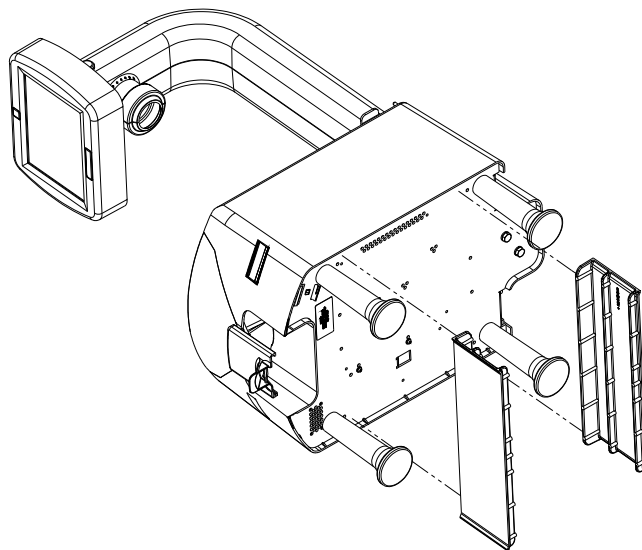

Figure 1.5 Platter Bracket Installation

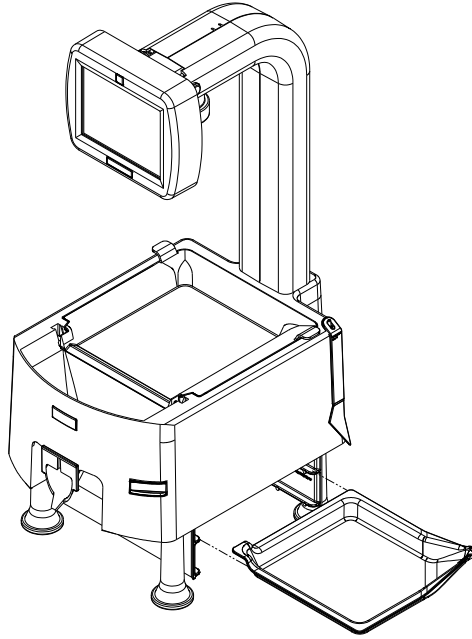

Figure 1.6 Storing Sulfa and Penicillin Platters

1.3.2 External Scanner

An optional omni-directional scanner is available for mounting externally to the Eyecon enclosure. The scanner comes with an interface cable and double-sided tape for mounting. The kit part number is 249400-430C0.

Refer to the following photos and instructions for enabling the scanner and recommended mounting configurations.

Mounting

1. Apply double-sided tape to bottom of scanner. Stick scanner on the Eyecon enclosure with the scan beam pointing outward.
2. Install cable tie holder by peeling off the backing and adhering to the bottom plate of the Eyecon.

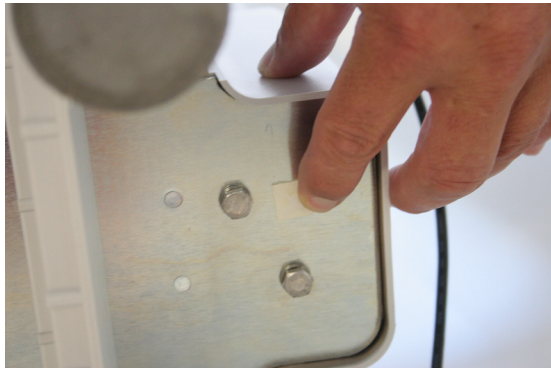

3. Insert cable tie through hole of holder.

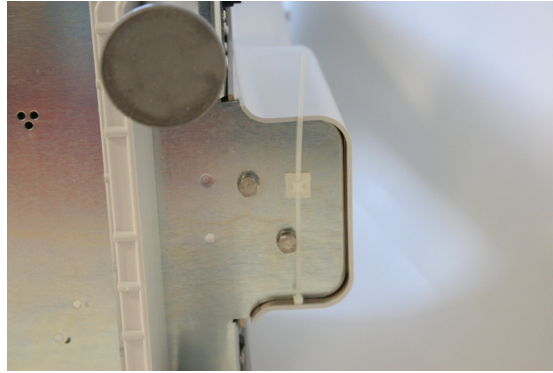

4. Plug the USB end into an available USB port on the back of the unit.
5. Bundle excess cable and pull the cable tie tight.



6. Plug the DB9 end of the cable into the scanner. Secure the cable by tightening the two screws.
7. Plug in the scanner cable into the USB port.



8. Plug the USB end of the scanner cable into an available USB port located on the rear of the Eyecon unit.

Enable Scanner

By default the scanner internal to the Eyecon unit is set to be the primary scanner used. In order to use the external scanner, the internal scanner must be disabled by changing the scanner port number within the settings menu of all modes being used.

Enable the external scanner by entering a 4 as the port number under the General>Scanner Port setting. The Eyecon must be rebooted before the changed setting will be saved. Refer to [page 29](#) for instructions on setting the port number.

1.4 Preparing the Eyecon for Use

1. Insert the power cable into the receptacle located in between the power switch and fan on the back of the Eyecon. Refer to [Figure 1.7](#).
2. The Eyecon must be installed near an easily accessible socket outlet. Plug the Eyecon power cord into the outlet.

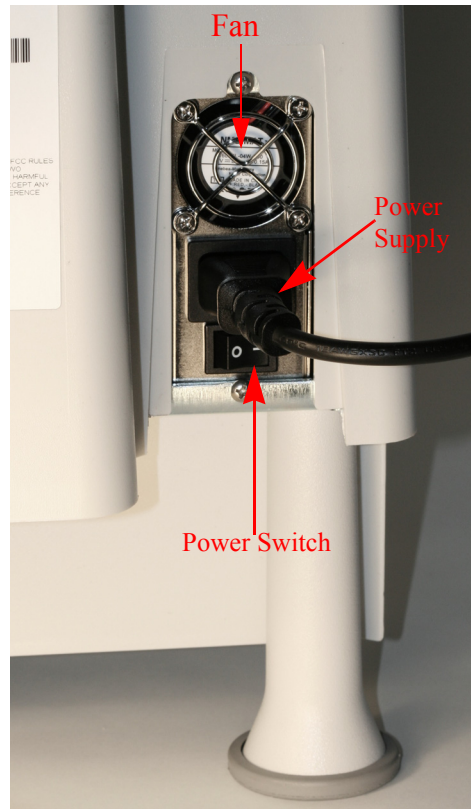

Figure 1.7 Power Supply

1.5 Turn on the Eyecon

1. Make sure the power switch is in the ON (I) position. Refer to [Figure 1.7](#) for location.
2. Fully depress and release the power push button to turn on the Eyecon (Refer to [Figure 1.8](#)). The display area will illuminate within a few seconds.



Do not use the power switch to turn off the Eyecon. Refer to [Figure 1.7](#) for power switch location. The Eyecon is designed to be turned off through the touch screen menus. Refer to [page 23](#) for details on shutting down the Eyecon.

If power is lost, fully depress and release the power push button to turn on the Eyecon. Refer to [Figure 1.8](#) for power push button location

If a network cable is to be connected plug it into the receptacle on the back. Refer to [Figure 1.8](#).

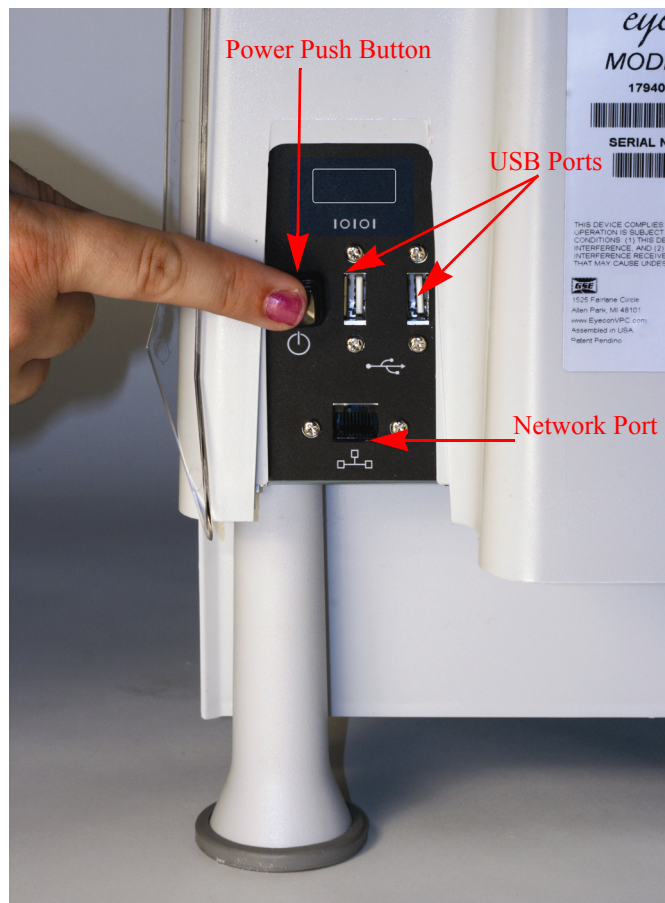

Figure 1.8 Eyecon Back Panel

1.6 Routine Maintenance

Always turn off the machine and unplug the power cord before starting any routine maintenance to avoid the possibility of electric shock.

Make sure that it is placed securely on a flat and level surface.

1.7 Cleaning the Machine

Be sure to keep the Eyecon unit clean and free of dust. Do not use harsh detergents or spray water on the Eyecon unit.

It is recommended the Eyecon unit be cleaned on a daily basis. Powder and pill dust tends to accumulate on surfaces such as the rapid fill tray and funnel gate. Follow the steps below for effective cleaning.

1.7.1 Funnel and Slide Gate

1. Slide the gate up while pulling out away from the housing as shown in the photo below.



2. Clean the clear funnel gate by running it under a faucet. Make sure it is completely dry before reattaching to housing.



3. Clean the pill funnel by running a slightly damp rag through it a few times.
4. Clean the funnel gate bracket rails to remove all pill dust.
5. Reinstall the funnel gate by sliding down the funnel post until it snaps into place.

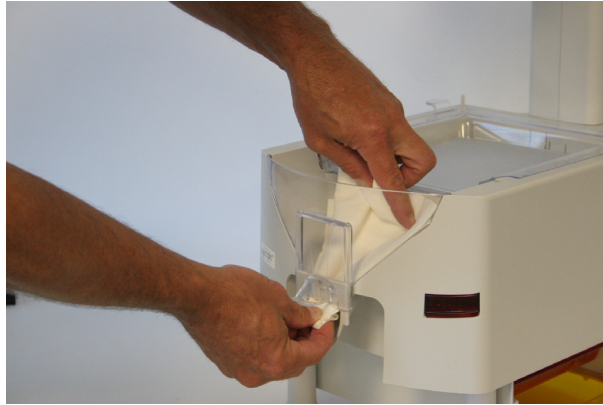

1.7.2 Rapid Fill Counting Tray

1. Lift the counting tray up to a vertical position.

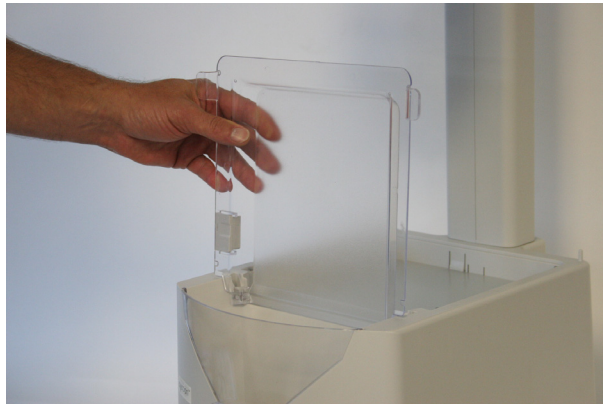

2. Tilt the tray to the left, the right side should pull out of the enclosure.

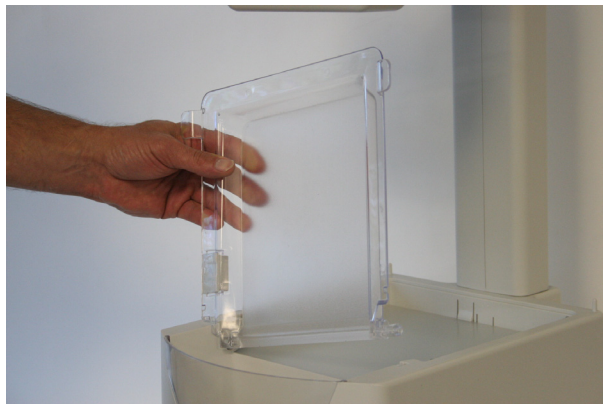

3. Pull up on the tray to remove completely.
4. Clean the tray by running under a faucet. Make sure it is completely dry before reattaching to housing.



5. Before reinstalling the tray, clean the diffuser surface under the tray with a soft damp cloth.



6. Reinstall rapid fill tray onto Eyecon unit by holding the tray vertical and push it into the slots in the housing.

1.8 Sharp Objects

Do not use sharp objects such as screwdrivers or long fingernails to operate the buttons.

1.9 Training

Do not attempt to operate or complete any procedure on the Eyecon unless you have received the appropriate training or read the Instruction Manual.

To avoid the risk of RSI (Repetitive Strain Injury), place the machine on a surface which is ergonomically satisfactory to the user. Take frequent breaks during prolonged usage.

1.10 Scanner / Laser

The Eyecon comes standard with a Class 1 laser product. When the unit is open Class 2 laser radiation is present. Refer to the **CAUTION** statement below and [Figure 1.9](#) for an illustration of the label and location.



CAUTION: Use of controls or adjustments or performance of procedures other than those specified herein may result in hazardous radiation exposure.

CAUTION: Class 2 laser radiation when open. Do not stare into the beam.

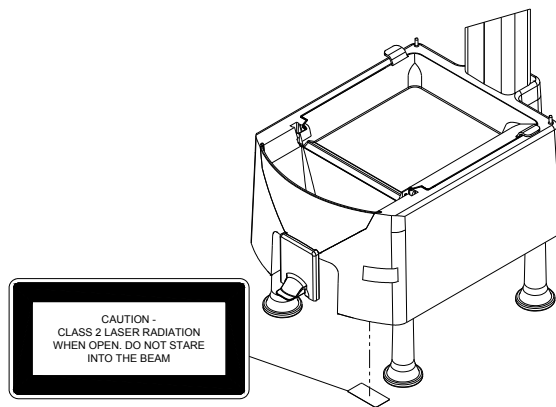

Figure 1.9 Class 2 Laser Radiation Warning Label Location

1.10.1 Scanner Specifications

External		
Laser Radiation	15.47 μ W	Class 1
Wavelength	650 nm	
Internal Laser Rating		
Wavelength	650 nm	Class 2
Max Output Power	460 μ W	

1.11 Licensing Agreement

When the Eyecon is powered up for the first time a Software Product Licensing Agreement will be displayed after a pharmacy package is chosen.

Before the Eyecon can be used, you must agree to the terms of the license.

1. Read the agreement thoroughly and agree to the terms by pressing the

button.

- 1a. If the button was pressed, a warning screen will be displayed.

Press the button to return to the Licensing Agreement.

Press the button to turn off the Eyecon.

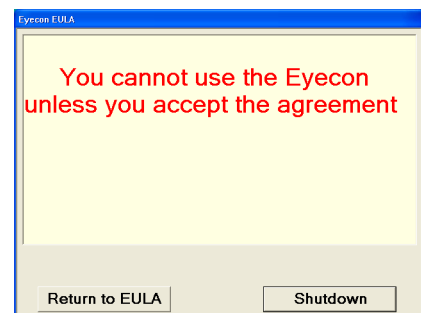
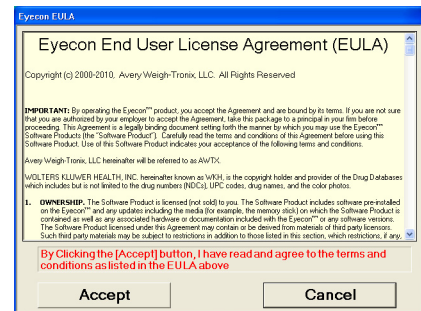

1.11.1 Medi-Span Copyright and Disclaimer Information

Copyright: Copyright© 2005 by Wolters Kluwer Health, Inc.

All rights reserved. The Master Drug Data Base (MDDB v2.5) Documentation Manual and the database supplied with it may not be reproduced in any form or by any means, in whole or in part, without written consent from the publisher. Any unauthorized use of this copyrighted material will be subject to legal action.

Medi-Span is a division of Wolters Kluwer Health, Inc.

Master Drug Data Base (MDDB®) is a registered trademark of Wolters Kluwer Health, Inc.

Copyright: Copyright © 2003 Wolters Kluwer Health, Inc.

All rights reserved. The Drug Image Database Documentation Manual and the database supplied with it may not be reproduced in any form or by any means, in whole or in part, without written consent from the publisher. Any unauthorized use of this copyrighted material will be subject to legal action.

Disclaimer: The information contained in the Medi-Span databases is intended to supplement the knowledge of physicians, pharmacists, and other healthcare professionals regarding drug therapy problems and patient counseling information. This information is advisory only and is not intended to replace sound clinical judgment in the delivery of healthcare services. You are advised to review the definitions, functionality, and limitations of each Medi-Span database.

Medi-Span disclaims all warranties, whether expressed or implied, including any warranty as to the quality, accuracy, and suitability of this information for any purpose.

1.12 Software Updates

The software must be updated quarterly to uphold the Licensing Agreement. Download the software update from www.eyeconvpc.com. These updates are comprised of drug photo updates and application enhancements.

It is suggested to download the file(s) to a computer desktop and then transfer the file(s) to a USB memory stick.

1.12.1 Update Warnings

Warnings will be provided when the expiration date on the data has passed. Warning interval will be dependent on the length of time since the expiration date has passed.

Table 1.1 Update Warning Frequency

1st week post expiration:	One warning per day.
2nd week post expiration:	One warning per 4 hours.
3rd week post expiration:	One warning per hour.
Beyond 3rd week post expiration:	One warning per entering count mode.

1.12.2 Install Software Updates

1. Download the latest software updates from the Eyecon website (www.eyeconvpc.com).
2. Copy the downloaded file to the root folder of a USB memory stick. Be sure the memory stick does not contain an older version of an update file before copying the current update file.
3. Plug the USB memory stick into an unoccupied USB port of the Eyecon. See [Figure 1.10](#) for USB port location.

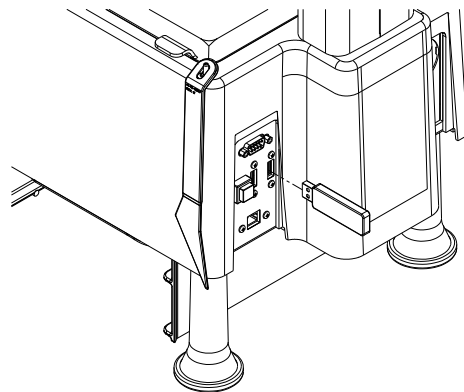

Figure 1.10 USB memory stick Installation

4. Follow the prompts displayed on the Eyecon.

- 4a. If the following message is displayed, click **No**. This message is an indication that the particular USB memory stick type inserted is new to this Eyecon.



- 4b. Answer **Yes** if the following prompt appears.

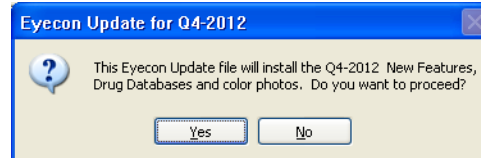

- 4c. If no message appears when the USB memory stick is plugged in, then follow the instructions below.

Stand-Alone Mode

- Go to Settings>Files
 - The update prompts should be displayed within a few seconds.
5. First you will see a message advising the outdated files are being removed.
6. Next a progress bar will advance quickly from 0 to 100% while the integrity of the update file is verified.
7. Another progress bar will advance more slowly while the updates are installed.
8. Once the installation is complete, click the **[Close]** button.
9. The Eyecon should shut down and restart within a minute or so.
- 9a. If the Eyecon does not automatically restart, manually shut the Eyecon down by using the **Shutdown** button on the screen. **DO NOT USE THE SWITCHES IN THE BACK TO SHUTDOWN THE EYECON!!!**

1.13 Turn off the Eyecon (Shutdown)



Do not unplug or shutdown the Eyecon with the power switch on the backside of the unit. This could cause corruption of files which would require the Eyecon to be returned for factory service.

The **Shutdown** button in the Start-up screen is used for restarting or turning off the Eyecon.

Again it is very important to use the **Shutdown** button to turn off the Eyecon. **DO NOT USE THE POWER SWITCHES IN THE BACK TO TURN OF THE EYECON UNIT.**

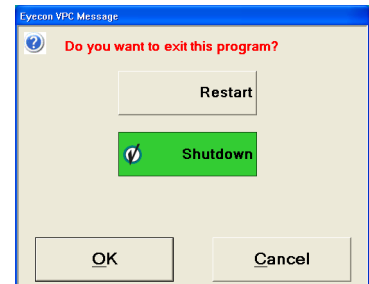

1.13.1 Restart

1. Press the **Restart** button in order to initialize a reboot sequence and return to the **Start-up** screen.
2. Press **OK** to accept.

1.13.2 Shutdown

1. Press the **Shutdown** button to turn off the Eyecon. Press **OK** to accept.
2. Press **Cancel** to terminate the process.

1.14 About Eyecon Screen

The **About Eyecon** screen provides information specific to the Eyecon. Including software release date, serial number and Medi-Span data.

1. While in *Eyecon Native* mode **Start-up** screen, press in the area right or left of the Eyecon by GSE logo.
2. Press **OK** to return to the **Start-up** screen or press **View EULA** to view the Software Licensing Agreement.

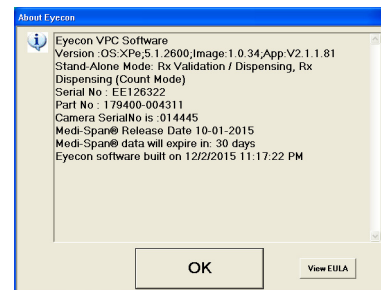

1.15 Warranty Policy

GSE/Avery Weigh-Tronix warrants its products to be free from defects in material and workmanship for a period of two (2) years from the original date of purchase. Standard "Terms and Conditions of Sale" apply.

Factory parts and labor are provided at no charge for up to two full years from the original date of purchase.

The obligation of GSE is limited to repairing or replacing equipment and components that upon inspection, testing and verification by GSE are found defective. GSE extends this warranty only upon proper installation and use of the equipment in the application for which it was intended and does not warranty equipment that has been subject to any of the following conditions:

- Alterations, misuse or unusual physical or electrical stress beyond the written specifications of that equipment.
- Exposure of electronic components to Electrostatic Discharge (ESD) resulting from improper handling or installation.
- Damage caused by freight carriers, negligence, fire, flood or other natural disaster.

In the event, equipment is repaired or replaced under the terms of the warranty, the warranty of the repaired or replaced equipment is limited to the remaining portion of the original warranty period or 90 days, whichever is greater.

GSE is responsible for repair, replacement or, at the sole discretion of GSE, credit of nonconforming equipment under the conditions and terms of this warranty. GSE is not liable for the cost of repairs, on-site labor or any travel-related expenses performed by another party unless otherwise agreed in writing.

Transportation charges for material shipped to GSE for warranty repair is paid by the shipper. GSE will pay the transportation charges, via standard carrier, for the return of items repaired or replaced under warranty. Failure to handle and ship equipment correctly will void the warranty on that equipment.

The sole remedy under this warranty is to repair, replace or provide credit for equipment at the sole discretion of GSE. GSE is not liable for expenses either direct or consequential that arise from the use of or inability to use the product. GSE is not responsible or liable for losses, injury, or property damage due to the installation or failure of the product.

For warranty, product service, and product registration visit www.eyeconvpc.com or call 866-260-6540.

1.16 Specifications

Platter Surface Area	48 sq inch
Dimensions	28" H x 11" W x 17.5" D
Screen	6.5" Color LCD flat panel touch screen
Barcode Scanner	Integrated Class I laser
listed symbologies	UPC/EAN, Code 39, 1 2 of 5
Supply Voltage	100 VAC - 240 VAC
Frequency Range	47 Hz - 63 Hz
Power	150 Watt
Temperature Range	50 - 90 °f
Communication	(2) USB, (1) Ethernet
Interface	Contact GSE for details on workflow integration
Accuracy	99.97% count accuracy
Design	Open flow, easy to clean
Approvals	FCC, ETL
Warranty	Two year limited

1.17 FCC Statement

This equipment has been tested and found to comply with the limits for a Class A digital device, pursuant to Part 15 of the FCC Rules. These limits are designed to provide reasonable protection against harmful interference when the equipment is operated in a commercial environment.

This equipment generates, uses, and can radiate radio frequency energy and, if not installed and used in accordance with the instruction manual, may cause harmful interference to radio communications.

Operation of this equipment in a residential area may cause harmful interference in which case the user will be required to correct the interference at his/her own expense.

1.18 ETL

Classified to IEC 60825-1: 2007

1.19 Back up the Eyecon Data



CAUTION!

The Eyecon is a computer based device and it is strongly suggested to back up all transaction data and images periodically. Otherwise saved data can be permanently lost!!!.

Refer to page [42](#) for more details on backing up report data and images.

1.20 Helpful Hints

1.20.1 Navigating the Touch Screen

Use the tip of one of the provided spatulas to navigate the settings menus and counting procedure.

1.20.2 Automatic Update from the Website

If the Eyecon is connected to a network in which automatic update is approved, the updated software can be loaded directly onto the Eyecon without using a USB drive.

1.21 Symphony Software

If you have a legacy unit and work with Symphony Software, contact Innovation Company for technical support.

2 Settings Menu

Press the **Settings** button from the **Start-Up** screen to enter the setting choices menu.

The currently selected setting tab will be designated in **BLUE**. The following menus are available for diagnostics and configuration.

Table 2.1 List of Setting Tabs

Tab	Description	Page
General	Miscellaneous settings	27
Users	Add and delete user profiles	30
Test	Test the scanner, camera and other hardware such as the touch screen and speaker	34
Barcode	Setup barcode format, select barcode type	35
Data	Download or delete report data.	42
Files	Save all Eyecon data, restore Eyecon data or check for update	48
TCP/IP	Network settings, select PMSS provider	51
Remote Server	Set server protocol and McKesson Enterprises configuration	53
Multi	Used for VA sites only. Future Feature	55
Double Check	Setup double counts or back counts.	55

2.1 General

This tab is used for calibrating the pill counting platter, user login, stock bottle verification, scanner port and set time & date. If another menu is desired simply press the corresponding tab on the screen.

Auto Close Transaction Recorded Message

If this box is checked, the Auto Close Transaction Recorded Message will be skipped when a count is performed.

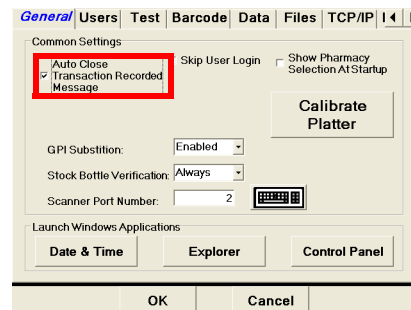

Uncheck the box to enable the Transaction recorded message. This message will appear after every counting transaction. Press **OK** after the pills have been removed from the counting tray.

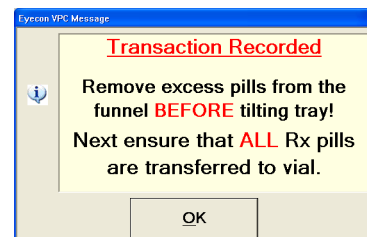

Skip User Login

Check the box to disable (skip) the **Scan User Login** screen and go directly to the **Scan Vial Label** screen. If disabled, no users will be able to login.

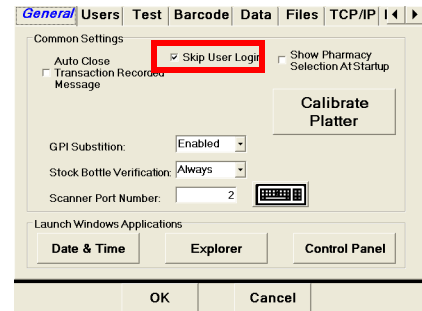

Pharmacy Package Selection

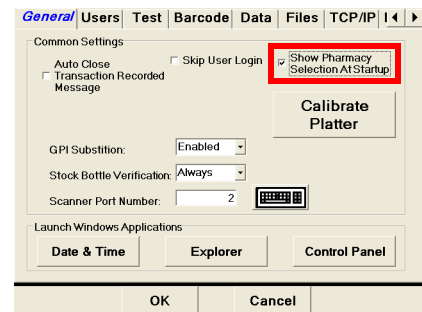

Choose whether to display the **Configure Pharmacy Package** screen on restart or boot up.

If the box is checked the screen will be shown on power up. Otherwise the screen will be skipped and the currently selected package will be accessed.



Calibrate Platter

This function is used to calibrate the counting platter viewing area if the count is unstable.

1. Remove all foreign objects from the counting platter.
2. Press the  button and the platter will be automatically calibrated by the software.
3. Platter calibration successful will be displayed when the calibration is complete.
4. Press  to complete calibration.

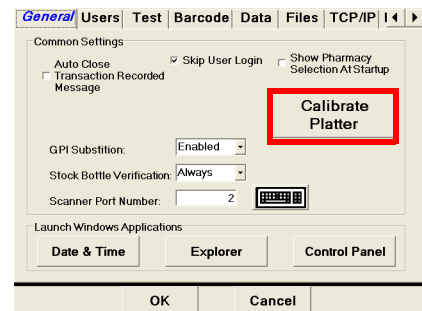

*If **Unable to calibrate** message appears, clean surface of counting platter and light diffuser. Try the Calibrate Platter process again.*

GPI Substitution

Choose whether to allow a user to substitute an NDC that does not match the prescribed NDC if the GPI code of the scanned NDC matches the GPI of the prescribed NDC.

If *GPI Substitution* is set to **Disabled**, the substitution is not allowed.

If *GPI Substitution* is set to **Enabled**, the substitution is allowed.

If *GPI Substitution* is set to **NoWarning**, the substitution is allowed with a warning message being displayed.

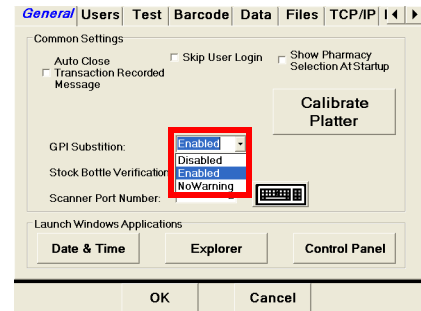

Stock Bottle Verification

Choose whether to verify a stock bottle scan every time, never or per user.

- If *Stock Bottle Verification* is set to **Always**, the **Scan Stock Bottle** screen will appear every time the Rx label is scanned.
- If *Stock Bottle Verification* is set to **Never**, the **Scan Stock Bottle** screen will never appear after the Rx label is scanned and will go to the **Counting** screen.
- If *Stock Bottle Verification* is set to **User**, scan the stock bottle to proceed or press the  button to proceed to the **Counting** screen.

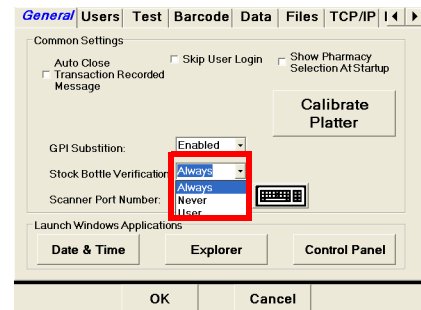

Scanner Port

Selects the port for either the internal or external scanner. **The Eyecon must be restarted before the port change will take affect.**

Use the keyboard icon button to the right of the scanner port window to enter the port number.

2 = internal scanner
4 = external scanner

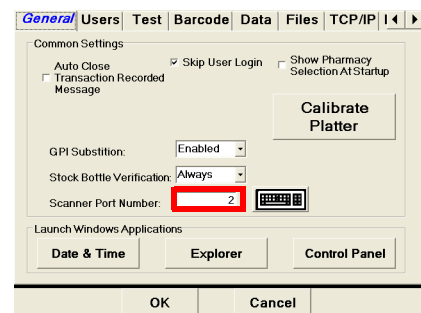

2.1.1 Launch Windows Applications

Date and Time

The time and date may be set by pressing the **Date & Time** button. Choose the correct time and date from the calendar and clock displayed. Press **OK** to accept the current settings or changed values. Press **Cancel** to abort.

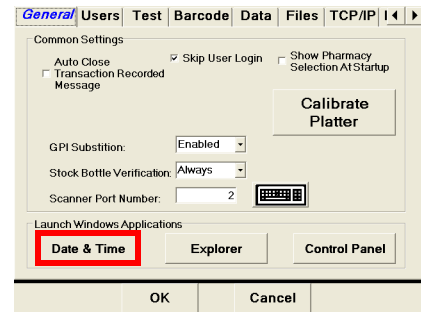

Windows Explorer and Control Panel

The choices available are Windows Explorer and Control Panel. These will work the same as standard Windows operating system. Press the **Explorer** or **Control Panel** button to launch either application.

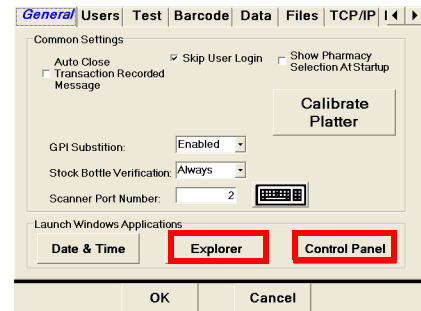

2.2 Users

The Administrative section used for adding and deleting users, determine whether a scan-out will be necessary or to allow the use of an RDAC. Only available with the *Rx Validation/Workflow* and *Physical Inventory* modes.

The administrator is able to add or delete users and determine whether they are able to train pill images. An access code is required to enter the Administrative screens.

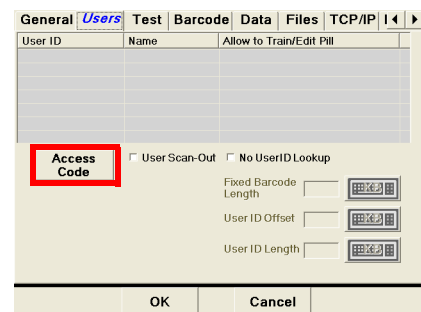

To enable User Logging, go to the **General Tab** and uncheck the **Skip User Login** box.

2.2.1 Add or Delete a User

Pressing the  button will display the code entry screen. This button will be disabled once the Manage Users mode is accessed.

Key in the administration access code and press . Existing users will be displayed.

NOTE: The default access code is 'ADMIN'



The image shows a 'Keyboard' dialog box with the text 'ADMIN' at the top. Below the text is a numeric keypad (1-0) and a 'Backspace' button. Underneath is a QWERTY keyboard layout. At the bottom, there are buttons for 'CAPS LOCK', 'Space Bar', and 'Clear'. At the very bottom are 'OK' and 'Cancel' buttons.

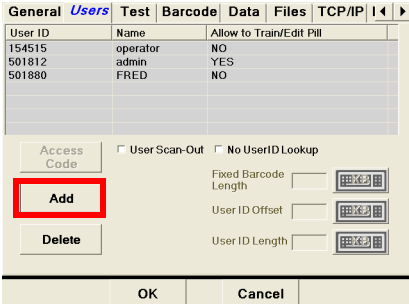

Add User

1. Press the  button.



The image shows the 'Users' management window with tabs for 'General', 'Users', 'Test', 'Barcode', 'Data', 'Files', and 'TCP/IP'. The 'Users' tab is active, showing a table with columns 'User ID', 'Name', and 'Allow to Train/Edit Pill'. Below the table are checkboxes for 'User Scan-Out' and 'No UserID Lookup', and input fields for 'Fixed Barcode Length', 'User ID Offset', and 'User ID Length'. The 'Add' button is highlighted with a red box.

User ID	Name	Allow to Train/Edit Pill
154515	operator	NO
501812	admin	YES
501880	FRED	NO

2. Press the keyboard icon to the right of the User ID entry window. Key in the desired six digit number for the user. Press the  button to accept.
3. Press the keyboard icon to the right of the User Name window. Enter the name of the user and press the  button.
4. Choose whether the user has permission to enter a new drug or change an existing drug by pressing YES or NO under the "Train Pill" and "Edit Drug Database" option.
5. Press  to accept the user.

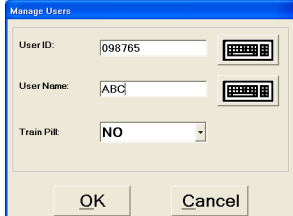

The image shows the 'Manage Users' dialog box. It has three input fields: 'User ID' with the value '098765', 'User Name' with the value 'ABC', and 'Train Pill' with the value 'NO'. Each field has a keyboard icon to its right. At the bottom are 'OK' and 'Cancel' buttons.

Delete User

Choose the user to be deleted (highlighted in blue) and press the **Delete** button.

Press the **OK** button to exit

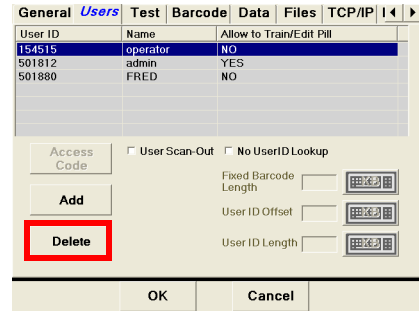

2.2.2 User Scan-Out

Used to require a user badge scan at the end of an Rx Count and/or an inventory Count.

Check the **User Scan-Out** box.

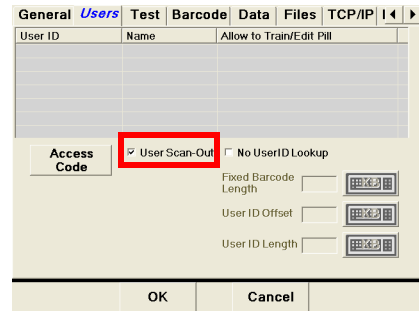

If the **User Scan-Out** box is checked, the count menu Finish button will be replaced with

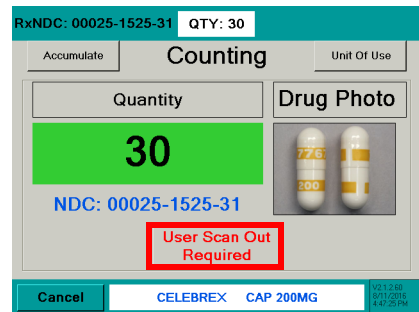
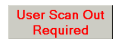

2.2.3 No User ID Lookup

Allow the use of an RDAC.

1. Check the **No User ID Lookup** box.

The screenshot shows the 'Barcode' tab of the 'Users' configuration window. The 'No User ID Lookup' checkbox is checked and highlighted with a red box. The 'Fixed Barcode Length' is set to 22, 'User ID Offset' is 6, and 'User ID Length' is 8. The 'Access Code' section is also visible.

2. Press the keyboard icon to the right of the Fixed Barcode Length, User ID Offset, and User ID Length windows to enter the values which will define the user barcode and the digits within that barcode.

The screenshot shows the 'Barcode' tab of the 'Users' configuration window. The 'Fixed Barcode Length', 'User ID Offset', and 'User ID Length' input fields are highlighted with a red box. The 'Fixed Barcode Length' is 22, 'User ID Offset' is 6, and 'User ID Length' is 8. The 'No User ID Lookup' checkbox is also checked.

McKesson Enterprise RDAC Barcode

Use the following values:

Fixed Barcode Length: 14

User ID Offset: 0

User ID Length: 6

2.3 Test

This tab is used for testing various hardware of the Eyecon unit. The chosen test button will be green with the check mark.



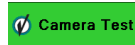
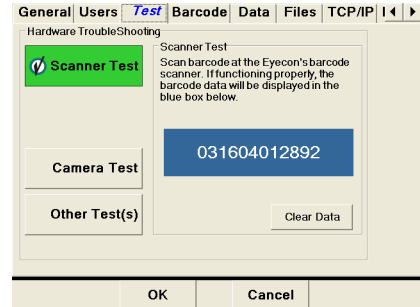

Test the scanner by scanning a stock bottle NDC barcode. If the scanner is operating properly, the NDC will be displayed in the blue bar.

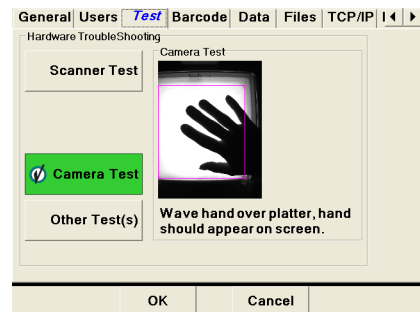

Verify the camera is operating properly with the camera test. Pour pills in the pill platter or hold hand over the platter to confirm an image is being displayed.

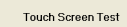

Provides additional testing modes for the touch screen display and internal speaker.

- Test the touch screen display to verify proper operation. Press the  button to access the five point touch screen test.
- Calibrate the touch screen display if not operating properly. Press the  button to access the calibration screen.

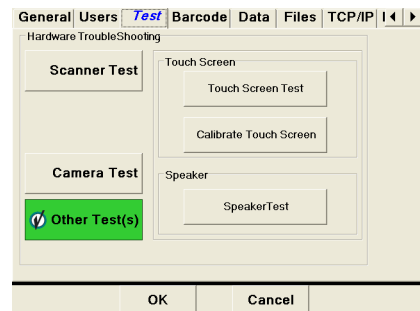

- Test audible speaker. Press the  button to test for sound.

Calibrate Touch Screen

Calibrate the touch screen display. Touch the "+" on the display.

Be sure to only touch where the "+" is during touch screen calibration. Otherwise problems could occur with the display.

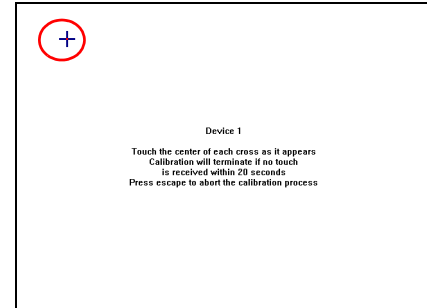

2.4 Barcode

The Rx Barcode is formatted to 'find' the NDC number embedded in the pharmacy barcode. This is the format that the barcode reader uses to extract data from the barcode.

Consult with your network administrator for further information on Rx label and NDC label formats.

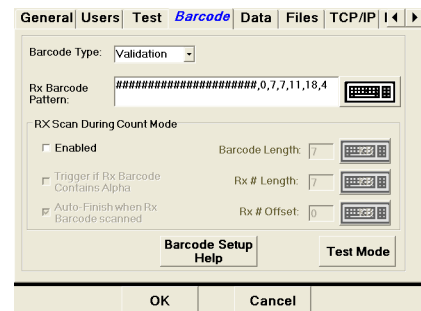

2.4.1 Barcode Type

Select a method of prescription filling (Validation) or PMSS.

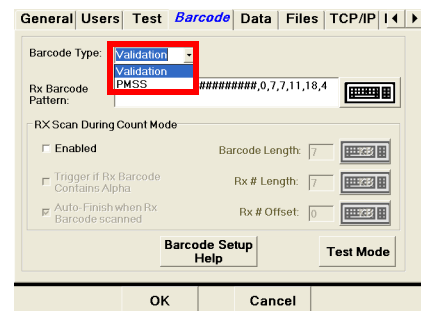

Validation

This selects the Rx Validation mode. The barcode is able to be changed within the Validation selection.

Enter the pattern for Rx number, NDC number and quantity of the barcode label being scanned. Press the keyboard icon to the right of the entry window to enter a valid barcode pattern. Refer to the Rx barcode examples below for more details on different types of barcodes.

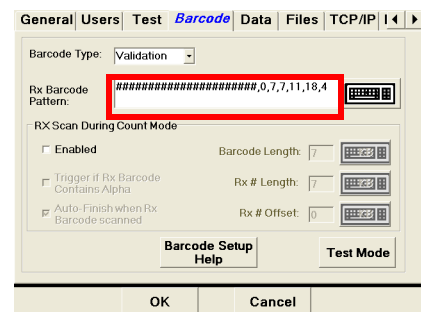

PMSS

This selects PMSS mode. The PMSS type must also be selected under the **TCP/IP** tab. Refer to [page 51](#) for details. The barcode string can't be updated.

2.4.2 Rx Barcode Examples (Validation Only)

Press the keyboard icon to the right of the entry window to configure a barcode.

The barcode format always starts with the position of the Rx number no matter where on the label it is located (designated with green in the following examples).

The string that will be typed into the **Rx Barcode Pattern** window must start with a # for each digit or the number of the string length in the barcode label followed by a comma and then the barcode data.

In the examples below, count the digits in the example barcode and that will determine how many #'s are used or which number to use for the string length (either method is correct). Compare your result with the String Length in the provided table. Next, determine the location of the Rx number and its length. Then follow that with the NDC number and Quantity if applicable.

The length of the quantity segment can be an asterisk (*) and any non-numeric digits will be ignored. A variable length segment will also be accepted.

Example 1

In this example the barcode starts with the string length (19), Rx number, NDC number, and then the quantity.



		Rx number			NDC number			Quantity	
	Label	77777			50580044963			050	
	String Length (#)	Start Position	Length of Rx	Start Position	Length of NDC	Start Position	Length of Quantity		
Rx Barcode Pattern Window	19	0	5	5	11	16	3		
	19,0,5,5,11,16,3								

Position	0	1	2	3	4	5	6	7	8	9	10	11	12	13	14	15	16	17	18
Data	7	7	7	7	7	5	0	5	8	0	0	4	4	9	6	3	0	5	0
	Rx number					NDC number										Quantity			

Example 2

In this example the barcode starts with the string length (19 #'s), NDC number, Rx number, and then the quantity.



		NDC number			Rx number			Quantity		
	Label	50580044963			88888			200		
	String Length (#)	Start Position	Length of Rx	Start Position	Length of NDC	Start Position	Length of Quantity			
Rx Barcode Pattern Window	19	0	11	11	5	16	3			
	#####,11,5,0,11,16,3									

Position	0	1	2	3	4	5	6	7	8	9	10	11	12	13	14	15	16	17	18
Data	5	0	5	8	0	0	4	4	9	6	3	8	8	8	8	8	2	0	0
	NDC number										Rx number					Quantity			

Example 3

In this example the barcode starts with the string length (22), Rx number, NDC number, and the quantity is last. The Rx number is seven digits and the quantity is four digits.



		Rx number		NDC number		Quantity	
Label		9999999		50580044963		0120	
String Length (#)	Start Position	Length of Rx	Start Position	Length of NDC	Start Position	Length of Quantity	
22	0	7	7	11	18	4	
22,0,7,7,11,18,4							

Position	0	1	2	3	4	5	6	7	8	9	10	11	12	13	14	15	16	17	18	19	20	21
Data	9	9	9	9	9	9	9	5	0	5	8	0	0	4	4	9	6	3	0	1	2	0
	Rx number							NDC number							Quantity							

Example 4

In this example the barcode starts with the string length (24 #'s), a hard coded RX followed by the NDC number. The NDC number and Rx numbers are separated by an 'A' and the quantity is three digits.



		NDC number		Rx number		Quantity					
Label		RX		50580044963		A		6666666		090	
String Length (#)	Start Position	Length of RX	Start Position	Length of Rx #	Start Position	Length of NDC	Start Position	Length of Quantity			
24	N/A	N/A	2	11	N/A	14	7	21	3		
#####,14,7,2,11,21,3											

Position	0	1	2	3	4	5	6	7	8	9	10	11	12	13	14	15	16	17	18	19	20	21	22	23
Data	R	X	5	0	5	8	0	0	4	4	9	6	3	A	6	6	6	6	6	6	6	0	9	0
	NDC number													Rx number						Quantity				

2.4.3 RX Scan During Count Mode

Allows an Rx label to be scanned while in the count mode.

Enabled

The Rx scan in the count mode is enabled when the *Enabled* box is checked.

The screenshot shows the 'Barcode Setup' dialog box with the 'Barcode' tab selected. The 'Barcode Type' is set to 'Validation'. The 'Rx Barcode Pattern' is '#####0,7,7,11,18,4'. In the 'RX Scan During Count Mode' section, the 'Enabled' checkbox is checked and highlighted with a red box. Other options include 'Trigger if Rx Barcode Contains Alpha' (unchecked), 'Auto-Finish when Rx Barcode scanned' (checked), 'Barcode Length' (7), 'Rx # Length' (7), and 'Rx # Offset' (0). Buttons for 'Barcode Setup Help', 'Test Mode', 'OK', and 'Cancel' are visible.

Trigger if Rx Barcode Contains Alpha

A barcode containing an alpha character such as a letter can be process by checking this box.

The screenshot shows the 'Barcode Setup' dialog box with the 'Barcode' tab selected. The 'Barcode Type' is 'Validation' and the 'Rx Barcode Pattern' is '24,14,7,2,11,21,3'. In the 'RX Scan During Count Mode' section, the 'Trigger if Rx Barcode Contains Alpha' checkbox is checked and highlighted with a red box. Other options include 'Enabled' (checked), 'Auto-Finish when Rx Barcode scanned' (checked), 'Barcode Length' (7), 'Rx # Length' (7), and 'Rx # Offset' (0). Buttons for 'Barcode Setup Help', 'Test Mode', 'OK', and 'Cancel' are visible.

Auto-Finish when RX Barcode Scanned

The *Enabled* and *Auto-Finish when Rx barcode scanned* both need to be checked.

The screenshot shows the 'Barcode Setup' dialog box with the 'Barcode' tab selected. The 'Barcode Type' is 'Validation' and the 'Rx Barcode Pattern' is '#####0,7,7,11,18,4'. In the 'RX Scan During Count Mode' section, both the 'Enabled' and 'Auto-Finish when Rx Barcode scanned' checkboxes are checked and highlighted with red boxes. Other options include 'Trigger if Rx Barcode Contains Alpha' (unchecked), 'Barcode Length' (7), 'Rx # Length' (7), and 'Rx # Offset' (0). Buttons for 'Barcode Setup Help', 'Test Mode', 'OK', and 'Cancel' are visible.

Rx # Offset

Define the Rx number offset. Press the keyboard to the right of the entry window to make necessary changes.

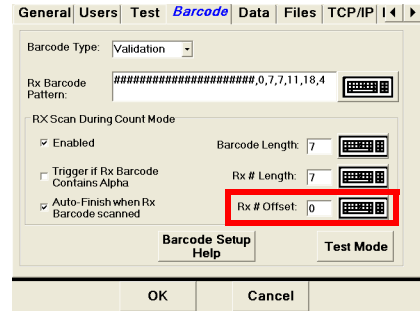

Barcode Length

Define the barcode length. Press the keyboard to the right of the entry window to make necessary changes.

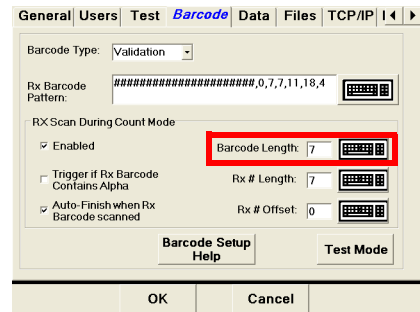

Rx # Length

Define the Rx number length. Press the keyboard to the right of the entry window to make necessary changes.

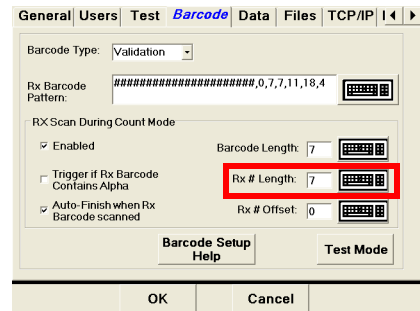

2.4.4 Barcode Setup Help

If you need assistance with a barcode, call Eyecon Technical Support and (866) 260-6540 and select option 2.

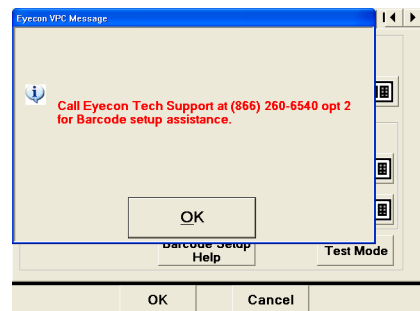

2.4.5 Test Mode

Compare both the Rx and NDC labels to see if they match.

1. Press the **Test Mode** button to enter the **Rx / NDC Barcode Test Mode** screen.

The screenshot shows the 'Barcode Format' window with the 'Test Mode' button highlighted in a red box. The window includes tabs for General, Users, Test, Barcode, Data, Files, and TCP/IP. The 'Barcode Type' is set to 'Validation'. The 'Rx Barcode Pattern' is '#####0,7,7,11,18,4'. Under 'RX Scan During Count Mode', there are checkboxes for 'Enabled', 'Trigger if Rx Barcode Contains Alpha', and 'Auto-Finish when Rx Barcode scanned'. There are also input fields for 'Barcode Length', 'Rx # Length', and 'Rx # Offset'. At the bottom, there are buttons for 'Barcode Setup Help' and 'Test Mode' (highlighted), and 'OK' and 'Cancel' buttons.

2. Scan the Rx vial label. The output string will be displayed in the Scan Vial Label window.
 - 2a. If the wrong label was scanned or the label format was not recognized, a message will be displayed under the Scan Stock Bottle Label window.

The screenshot shows the 'Vial Barcode Test Mode' window. The 'Scan Vial Label' field contains the NDC number '777700025152531030', which is highlighted in a red box. There is a 'Clear Data' button next to it. Below, the 'Rx Data' is displayed as 'Rx Data is : 77777; Drug Number is : 00025152531; Total Qty is : 030'. At the bottom, there are 'Start Over' and 'Exit' buttons.

Press **Clear Data** to clear only the scanned NDC label or press

Start Over to clear both the scanned Rx label and NDC label.

3. Press **Exit** to return to the **Barcode Format** screen.

2.5 Data

The Data tab has choices for report data and physical inventory data.

The Eyecon will store transaction history reports which can be downloaded to a computer via a USB memory stick. This feature is *enabled* by default.

The report consists of transaction number, time/date, user login, user name, Rx number, NDC, drug name, target quantity, actual number dispensed. Drug images are also stored as separate files. The data can be viewed in text or spreadsheet format. See Appendix C for examples of stored data and the formats. **BE SURE TO BACK UP THIS DATA PERIODICALLY AS THE EYECON IS A COMPUTERIZED DEVICE AND DATA COULD BE LOST OR ACCIDENTLY DELETED.**

Tray Photo Count Button

This button is used for troubleshooting purposes. This will display the number of current images stored on the Eyecon.

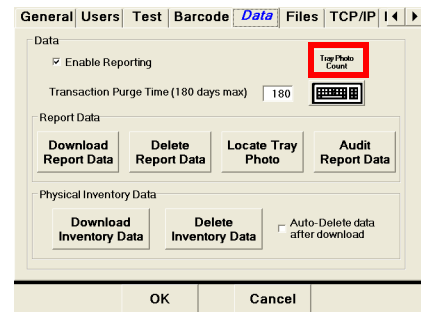

Enable Report Mode

The report mode is enabled when the box is checked.

Press **OK** to save the enabled setting. The **Settings** screen be exited and the **Start-up** screen will be displayed.

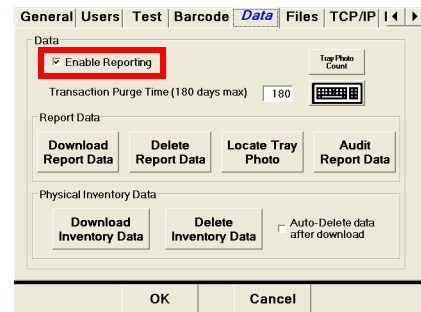

Purge Data

Enter the number of days in which the report data is purged from the database. Use the keyboard icon button to the right of the entry window to enter a value. Maximum of 180 days.

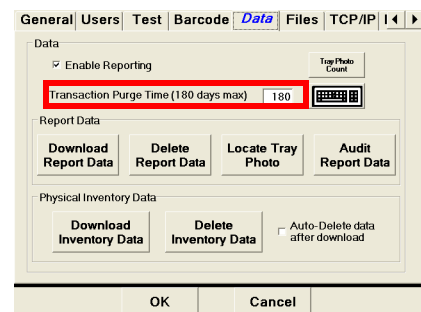

2.5.1 Report Data

Download Report Data

Insert a USB memory stick in one of the available USB ports on the rear of the Eyecon. Refer to [page 21](#) for an illustration the of USB port location.

1. Press the **Download Report Data** button to start download.

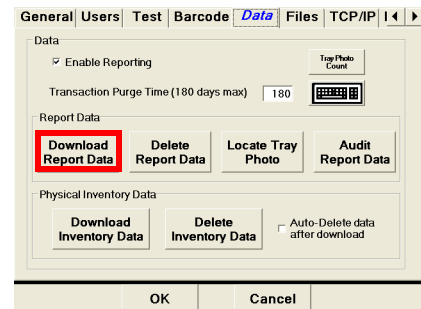

2. A message screen will be displayed. Insert a USB memory stick and press **Yes** to download the report or press **No** to cancel and return to the [Data](#) setting screen.

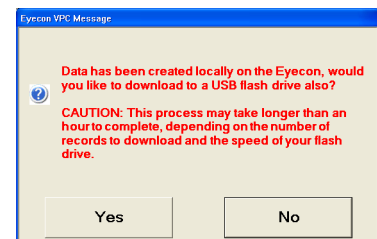

Delete Report Data

Delete inventory data stored on the Eyecon. **This option will delete all report data including pill images.**

1. Press the **Delete Report Data** button.

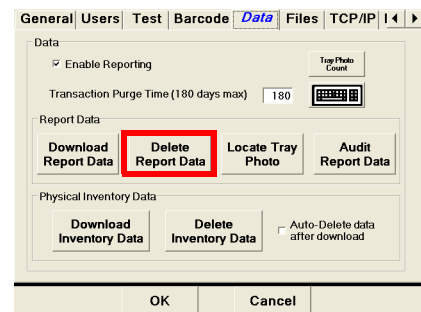

2. A message screen will be displayed. Press **Yes** to delete report data or press **No** to cancel and return to the [Data](#) setting screen.

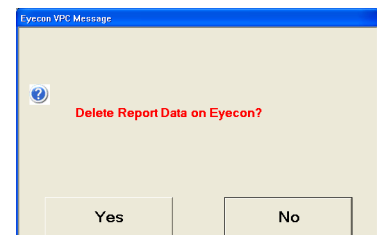

- If the **Yes** button was pressed in the previous step, the following screen will be displayed. Press **Yes** to permanently delete report data or press **No** to cancel and return to the *Data* setting screen.
- If the **Yes** button was pressed in the previous step, the following screen will be displayed. Press **Yes** to permanently delete report data and images or press **No** to cancel and return to the *Data* setting screen.

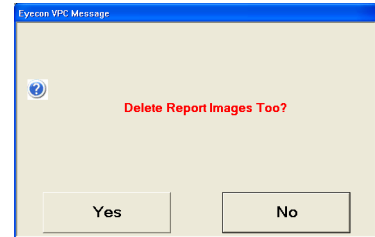
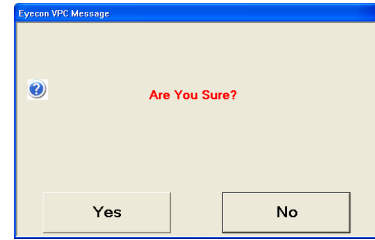

Locate Tray Photo

Find a specific pill image photo of a previously counted prescription. Refer to Appendix C on [page 145](#) for a sample of tray photos.

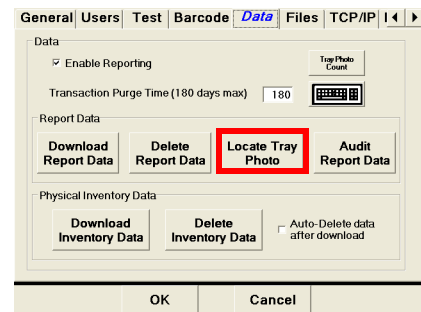

Specify Rx Criteria

Enter a specific Rx or NDC number, then press the **Search Now** button.

To narrow the search while using the NDC number, check the box next to the left of the date field. Choose a specific date using the arrow to the right of the date field. A calendar will be displayed.

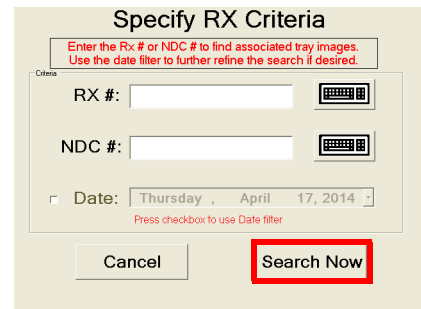

To view the photos, they must be saved to a memory stick and then put onto a computer. Be sure to insert the memory stick into an available USB slot in the rear of the Eyecon.

Press the **Save** button to save the data.

Press **Cancel** to abort.

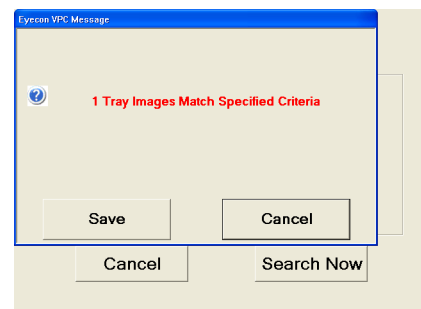

Audit Report Data

View reports on the Eyecon. Press the  button to access the **Eyecon Auditor** screen.

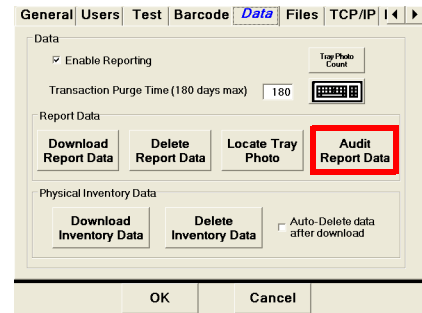

NOTE: The first time the Auditor is used, a unique store name needs to be entered. Enter the store name and press the  button.

Select the desired type of report with the drop down menu and choose the number of days to report. Refer to Chapter 10 for details on filtering reports and viewing.



Disable Report Mode

When the report mode is disabled, the report options such as purge data and download features will be grayed out and not accessible. Only the *Locate Tray Photo* button will be accessible.

The report feature is disabled when the *Enabled* box is not checked.

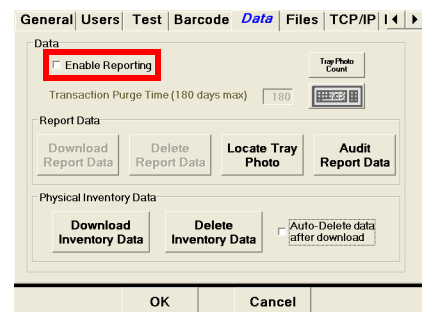

2.5.2 Physical Inventory Data



This menu allows you to download or delete saved inventory count data.

Download Inventory Data

Save downloaded inventory counts data to the Eyecon or send to a USB memory stick.

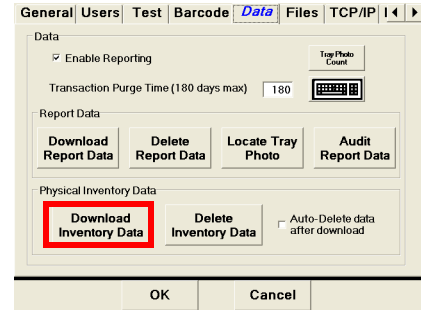
1. Press the  button.



2. A message screen will be displayed.
 - 2a. If the data will only be stored on the Eyecon, press the  button.
 - 2b. If the data will be stored on a USB memory stick, insert a USB memory stick in one of the available USB ports on the rear of the Eyecon. Refer to [page 21](#) for an illustration the of USB port location. Press the  button to start download.

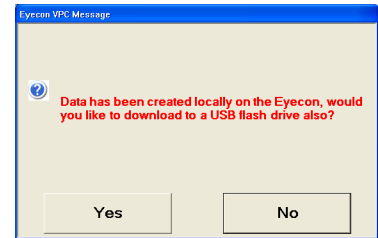

A message will be displayed for a few seconds acknowledging the data was transferred successfully.



Ensure that the memory stick does not have any files in the root folder that end with a .eyecon or .eyecon2 suffix. Otherwise you will be prompted to install a software update.





Refer to Appendix A for assistance in using the downloaded data on your computer.

Delete Inventory Data

Delete inventory data stored on the Eyecon.

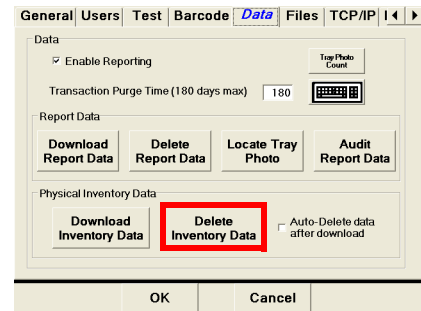

1. Press the  button.

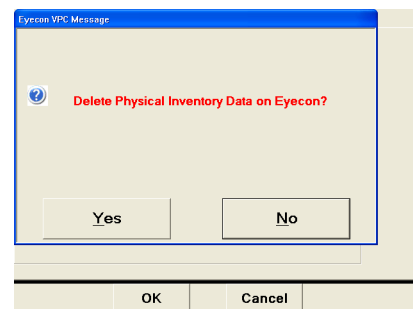

2. To delete the data press the  button.

Otherwise press the  button to abort and return to the Data tab.



3. Another message screen will be displayed to verify you want to delete the inventory data. Press the  button to delete the data.
- 3a. Otherwise press the  button to abort and return to the Data tab.



NOTE: *It is recommended that you verify the data has been successfully transferred to your computer before deleting the data from the Eyecon!*

Auto Delete Data

Check the check box to have the inventory data deleted from the Eyecon after a download.

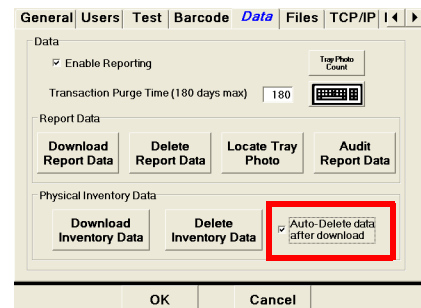

2.6 Files

As with any computerized device it is recommended that stored data on a hard drive is backed up periodically. The **Files** tab provides choices for backup of all Eyecon data to a memory stick and to restore Eyecon data from a memory stick to the Eyecon. Backed up data can then be transferred to a computer or copied to a CD-ROM for safe keeping.



It is recommended to backup Eyecon data on occasion.

Backup all Eyecon Data.

The data saved includes train images,

Insert a USB memory stick device into an unoccupied USB port on the rear of the

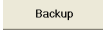
Eyecon. Press the  button.

For a detailed illustration on USB port location refer to [Figure 1.10](#) on [page 21](#).

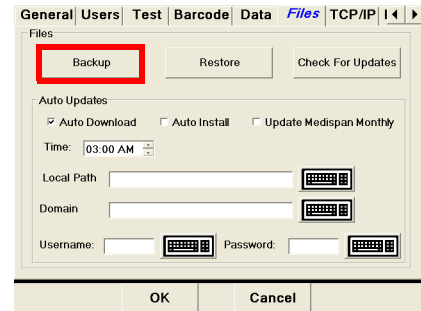

This feature is not yet released.

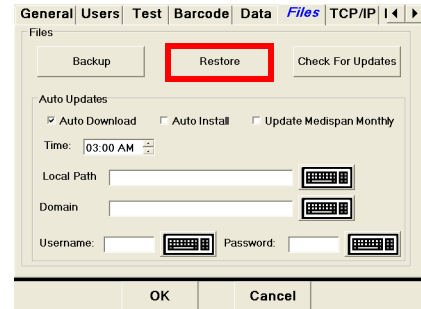

Application updates provide new features. To download the latest application updates go to www.eyeconvpc.com and register your Eyecon.

The latest software can be loaded with a memory stick or downloaded directly to the Eyecon. Refer to the following instructions on the different methods of checking for and loading the latest version of Eyecon software.

Load Software from a USB Memory Stick.

Insert a USB memory stick device that contains the latest software update file into an unoccupied USB port on the rear of the Eyecon.

For a detailed illustration on USB port location refer to [Figure 1.10](#) on [page 21](#).

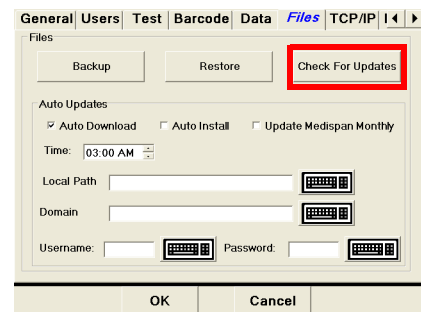

If software version 1.5.5 (or later) is installed, and the USB memory stick is not auto-recognized, use the  button to force the Eyecon to check for a file named xxxxx.Update.Eyecon2.

2.6.1 Auto Updates

Update the Eyecon software and/or Medispan pill database. Set the time of download, path, and a username and password if necessary.

Auto Download

Automatically download the Eyecon software if checked.

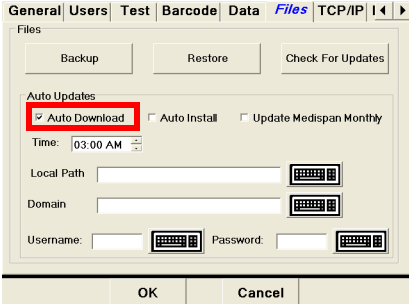

General Users Test Barcode Data Files TCP/IP |< |>

Files

Backup Restore Check For Updates

Auto Updates

Auto Download Auto Install Update Medispan Monthly

Time: 03:00 AM

Local Path

Domain

Username: Password:

OK Cancel

Auto Install

Automatically install the update by setting the path to the downloaded file. A Local Path Username and password can also be set.

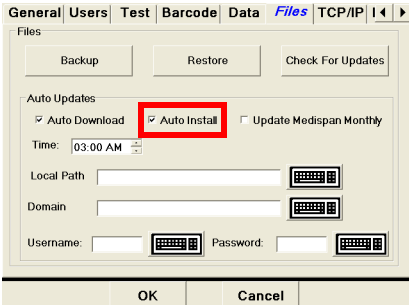

General Users Test Barcode Data Files TCP/IP |< |>

Files

Backup Restore Check For Updates

Auto Updates

Auto Download Auto Install Update Medispan Monthly

Time: 03:00 AM

Local Path

Domain

Username: Password:

OK Cancel

Update Medispan Monthly

Automatically download the Medispan pill database on a monthly basis if checked.

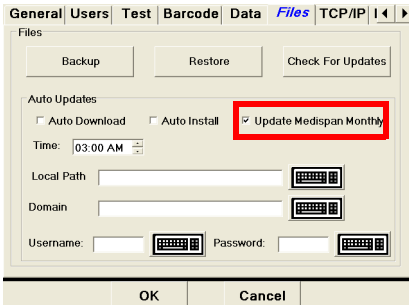

General Users Test Barcode Data Files TCP/IP |< |>

Files

Backup Restore Check For Updates

Auto Updates

Auto Download Auto Install Update Medispan Monthly

Time: 03:00 AM

Local Path

Domain

Username: Password:

OK Cancel

Time

Set the time for the for the software and/or the Medispan monthly update. The time is set in 24 hour format.

The screenshot shows the 'Files' settings window with the 'Auto Updates' section. The 'Time' field is highlighted in red and contains the value '03:00 AM'. Other options include 'Auto Download', 'Auto Install', and 'Update Medispan Monthly' (checked). There are also fields for 'Local Path', 'Domain', 'Username', and 'Password'.

Local Path

Set the path location of the downloaded update files. This path can be on a network. Press the keyboard icon to the right of the path window to enter the file location

The screenshot shows the 'Files' settings window with the 'Local Path' field highlighted in red and containing the text 'H:Eyecon/software update'. The 'Time' field is set to '03:00 AM'. Other options include 'Auto Download', 'Auto Install', and 'Update Medispan Monthly' (checked).

Domain

Set the domain name of the network server. Press the keyboard icon to the right of the path window to enter the domain name.

The screenshot shows the 'Files' settings window with the 'Domain' field highlighted in red and containing the text 'Our network'. The 'Local Path' is 'H:Eyecon/software update' and the 'Time' is '03:00 AM'. Other options include 'Auto Download', 'Auto Install', and 'Update Medispan Monthly' (checked).

Set Username and Password

Enter a unique Username and Password to set the local path. Press the keyboard icon to the right of the path window to enter the Username and Password.

The screenshot shows the 'Files' settings window with the 'Username' and 'Password' fields highlighted in red. Both fields contain asterisks. The 'Domain' is 'Our network' and the 'Local Path' is 'H:Eyecon/software update'. Other options include 'Auto Download', 'Auto Install', and 'Update Medispan Monthly' (checked).

2.7 TCP/IP

Primarily used when the Eyecon is integrated with pharmacy workflow software.

This tab is used for setting the IP address and Mask for the Eyecon when connected to a LAN. Consult with your IT department for additional information. **The Eyecon must be restarted after changing the port number or IP address within PMSS interface.**

MAC Address

The MAC address can be viewed but cannot be changed.

The screenshot shows the 'TCP/IP' configuration window. The 'MAC Address' field is highlighted with a red box and contains the value '00:05:07:06:CC:46'. Below it, there are radio buttons for 'Dynamic Address (DHCP)' and 'Static Address (Manual)'. The 'Dynamic Address (DHCP)' option is selected. The IP Address field contains '10.130.25.118', Subnet Mask contains '255.255.255.0', and Gateway contains '10.130.25.1'. There are 'Update' and 'Refresh' buttons. The 'Listening Server Settings' section includes 'Listening Port' (1050) and 'Photo Retriever Listening Port' (80). The 'PMSS Provider' is set to 'Eyecon Native' and 'Enable Photo Retriever' is unchecked. The 'PMSS Data Purge Time' is set to '120 days'. There is a 'Clear PMSS Data' button. At the bottom are 'OK' and 'Cancel' buttons.

Dynamic Address

The Dynamic address is automatically chosen by the network.

This screenshot is identical to the previous one, but the 'Dynamic Address (DHCP)' radio button is highlighted with a red box, indicating it is the selected option.

Static Address

The Static address is an IP address, Subnet Mask and Gateway that are entered by the administrator. Enter the desired IP address, Subnet Mask and Gateway and press the **Update** button to save the change.

Be sure to connect a cable before pressing the **Update button, otherwise the IP address may be displayed as zeros.**

Use the **Refresh** button after network connection has been lost and reestablished to refresh the display with the IP address and submask value.

Enter a specific IP address or Subnet mask by pressing the keyboard icon to the right of the entry window.

Key in the value with the numeric keys and use a decimal point between each group of numbers. Press **OK** to accept the entry. **Example: 10.123.16.9**

This screenshot is identical to the previous ones, but the IP Address, Subnet Mask, and Gateway input fields are highlighted with a red box, indicating they are the focus of the static address configuration.

2.7.1 Listening Server Settings

Port Setting

Configure the listening server port number. If the port number is not known, contact your Network Administrator for further assistance.

Press the keyboard icon next to the port number to enter a new port number. Press **OK** to accept the entry.

General Users Test Barcode Data Files TCP/IP | < >

MAC Address: 00.05.B7.06.CC.46

Dynamic Address (DHCP) Static Address (Manual) Update

IP Address: 10.130.25.116 [Keyboard Icon]

Subnet Mask: 255.255.255.0 [Keyboard Icon] Refresh

Gateway: 10.130.25.1 [Keyboard Icon]

Listening Server Settings:

Listening Port: 1050 [Keyboard Icon] Photo Retriever Listening Port: 80 [Keyboard Icon]

PMSS Provider: Eyecon Native Enable Photo Retriever

PMSS Data Purge Time: 120 days [Keyboard Icon] Clear PMSS Data

OK Cancel

Photo Retriever Listening Port

Retrieve photos from your network. If the port number is not known, contact your Network Administrator for further assistance.

Press the keyboard icon next to the port number to enter a new port number. Press **OK** to accept the entry.

General Users Test Barcode Data Files TCP/IP | < >

MAC Address: 00.05.B7.06.CC.46

Dynamic Address (DHCP) Static Address (Manual) Update

IP Address: 10.130.25.116 [Keyboard Icon]

Subnet Mask: 255.255.255.0 [Keyboard Icon] Refresh

Gateway: 10.130.25.1 [Keyboard Icon]

Listening Server Settings:

Listening Port: 1050 [Keyboard Icon] Photo Retriever Listening Port: 80 [Keyboard Icon]

PMSS Provider: Eyecon Native Enable Photo Retriever

PMSS Data Purge Time: 120 days [Keyboard Icon] Clear PMSS Data

OK Cancel

PMSS Provider

Choose from one of the offered PMSS providers.

- Computer Rx
- Computer Rx #2
- Cost Effective
- Eyecon Native
- HCC
- Liberty Software
- McKesson Enterprise Rx (see [page 117](#) for details)
- Pioneer Rx
- QS1
- Rx30 - Prism
- Rx30 - #2
- RxSafe
- ScriptPro
- ScriptPro - USB
- Speed Script
- SRS Pharmacy Systems

After making a selection press the **OK** button to accept the mode. The screen will exit to the **Start-up** screen. Press the **Settings** button to return to the settings mode.

General Users Test Barcode Data Files TCP/IP | < >

MAC Address: 00.05.B7.06.CC.46

Dynamic Address (DHCP) Static Address (Manual) Update

IP Address: 10.130.25.116 [Keyboard Icon]

Subnet Mask: [Keyboard Icon] Refresh

Gateway: [Keyboard Icon]

Listening Server Settings:

Listening Port: [Keyboard Icon] Photo Retriever Listening Port: 80 [Keyboard Icon]

PMSS Provider: Eyecon Native Enable Photo Retriever

PMSS Data Purge Time: 120 days [Keyboard Icon] Clear PMSS Data

OK Cancel

PMSS Data Purge Time

Set the number of days in which PMSS data will purge. The maximum number of days is 450.

Press the keyboard icon to the right of the day entry window to enter the number of days.

Press **OK** to accept the entry.

The screenshot shows the 'TCP/IP' configuration window. The 'PMSS Data Purge Time' field is highlighted with a red box and contains the value '120 days'. Other fields include MAC Address, IP Address (10.130.25.118), Subnet Mask (255.255.255.0), Gateway (10.130.25.1), Listening Server Settings (Listening Port: 1050, Photo Retriever Listening Port: 80), and PMSS Provider (Eyecon Native). Buttons for 'Update', 'Refresh', and 'Clear PMSS Data' are also visible.

Clear PMSS Data

Allow clearing all of the PMSS RX transactions from the Eyecon. This can be used if the Eyecon is being moved to a new site or the database were to be corrupted. this will clear it out.

2.8 Remote Server

Used for bi-directional communication between the Eyecon and a remote server. Bi-directional must be checked in order to be enabled.

The IP address and port number setting for the connected pharmacy system.

The screenshot shows the 'Remote Server' configuration window. The checkbox for 'Provide Count Results to Pharmacy System (Bidirectional)' is unchecked. The IP Address is 10.130.25.103 and the Port No. is 1050. Under 'Inventory Interface Configuration', 'Enable Sending Inventory Counts' and 'Display Quantity On Hand (QOH)' are checked. The Store Number is 007.

Bi-directional

Check the box to the left of Provide Count Results to Pharmacy System (Bidirectional). The IP Address and Port No. will no longer be grayed out.

Press the keyboard icon next to the IP Address to configure the IP address. and port number of the server.

Press the keyboard icon next to the port number to enter a new port number. Press **OK** to accept the entry. If the port number is not known, contact your Network Administrator for further assistance.

The screenshot shows the 'Remote Server' configuration window with the 'Provide Count Results to Pharmacy System (Bidirectional)' checkbox checked. The IP Address and Port No. fields are now active. The IP Address is 10.130.25.103 and the Port No. is 1050. The 'Inventory Interface Configuration' section remains the same as in the previous screenshot.

2.8.1 Inventory Interface (McKesson Enterprise Rx)

It is possible to use McKesson Enterprise to track inventory using the Eyecon. This will require third party software be loaded on a PC.

Enabled the McKesson mode under the *TCP/IP* tab, Listening Server Settings/PMSS provider. Refer to [page 52](#) for details.

Enable or Disable Sending Inventory Counts

Choose whether to send inventory counts to the server. This is enabled when checked and disabled when not checked.

The screenshot shows a dialog box titled 'Remote Server' with tabs for 'Files', 'TCP/IP', 'Remote Server', 'Multi', and 'Double Check'. Under the 'Remote Server' tab, there are fields for 'IP Address' (10.130.25.103) and 'Port No.' (1050). In the 'Inventory Interface Configuration' section, the checkbox for 'Enable Sending Inventory Counts' is checked and highlighted with a red box. Other options include 'Provide Count Results to Pharmacy System (Bidirectional)', 'Display Quantity On Hand (QOH)', and 'Store Number' (007).

Display Quantity On Hand (QOH)

This is enabled when checked and disabled when not checked. When enabled, the quantity left in stock will be displayed in the upper middle of the display in the Physical Inventory mode.

The screenshot shows the same dialog box as above. In the 'Inventory Interface Configuration' section, the checkbox for 'Display Quantity On Hand (QOH)' is checked and highlighted with a red box. The 'Enable Sending Inventory Counts' checkbox is also checked.

Store Number

Enter the store number of 001 by pressing the keyboard icon to the right of the entry window. This store number is used to communicate with the inventory software.

The screenshot shows the same dialog box. The 'Store Number' field, which contains the value '007', is highlighted with a red box. The keyboard icon to its right is also visible.

2.9 Multi

Future Feature

Intended for VA sites to allow one Eyecon to send Rx Fill Data to another Eyecon for verification counting.

2.10 Double Check

This tab allows for the configuration of back-count and/or double-counts of controlled substances.

2.10.1 Double-Counts

Will prompt the user to re-count the dispensed amount for specified DEA controlled items, while capturing a 2nd set of tray photos to document the re-count. This is enabled when checked and disabled when not checked.

TCP/IP Remote Server Multi **Double Check** Inventor

Double-Counts

Require Double-Counts

DEA Code Off

Cost Threshold 0.00

Back-Counts

Require Back-Counts

Require Adjust Reasons

DEA Classification Off

Cost Threshold 0.00

Require Stock item re-scan

OK Cancel

DEA Code

Choose which class of drugs will be double counted.

TCP/IP Remote Server Multi **Double Check** Inventor

Double-Counts

Require Double-Counts

DEA Code CII and CIII

Cost Threshold 0.00

Back-Counts

Require Back-Counts

Require Adjust Reasons

DEA Classification Off

Cost Threshold 0.00

Require Stock item re-scan

OK Cancel

Cost Threshold

Future feature

2.10.2 Back-Counts

Will prompt the user to count the remainder in the stock bottle for specified DEA controlled items. This is enabled when checked and disabled when not checked.

TCP/IP Remote Server Multi Double Check Inventor

Double-Counts

Require Double-Counts

DEA Code CII_and_CIII

Cost Threshold 0.00

Back-Counts

Require Back-Counts

Require Adjust Reasons

DEA Classification Off

Cost Threshold 0.00

Require Stock Item re-scan

OK Cancel

Require Adjust Reasons

Checking this box results in a pop-up menu with various reason codes to choose from when the Back-Count amount does not match the expected amount.

TCP/IP Remote Server Multi Double Check Inventor

Double-Counts

Require Double-Counts

DEA Code CII_and_CIII

Cost Threshold 0.00

Back-Counts

Require Back-Counts

Require Adjust Reasons

DEA Classification Off

Cost Threshold 0.00

Require Stock Item re-scan

OK Cancel

DEA Classification

Select which class of drugs the back count will apply to.

TCP/IP Remote Server Multi Double Check Inventor

Double-Counts

Require Double-Counts

DEA Code CII_and_CIII

Cost Threshold 0.00

Back-Counts

Require Back-Counts

Require Adjust Reasons

DEA Classification CII-only

Cost Threshold 0.00

Require Stock Item re-scan

OK Cancel

Cost Threshold

Future feature

Require Stock Item Re-scan

Future feature

3 Eyecon Native Modes

3.1 Start-up Screen

Three modes of operation are offered in the Stand-Alone mode.

- **Count Only** is a basic counting mode where the stock bottle NDC barcode is scanned or the NDC is manually entered recalling associated drug information. Rx is then counted by dispensing pills on the counting platter.
- **Rx Validation / Workflow** provides an additional level of patient safety by assuring the stock bottle NDC barcode is associated with the Rx label barcode.
- **Physical Inventory** offers a means of maintaining an inventory count / cycle count of stock on hand.

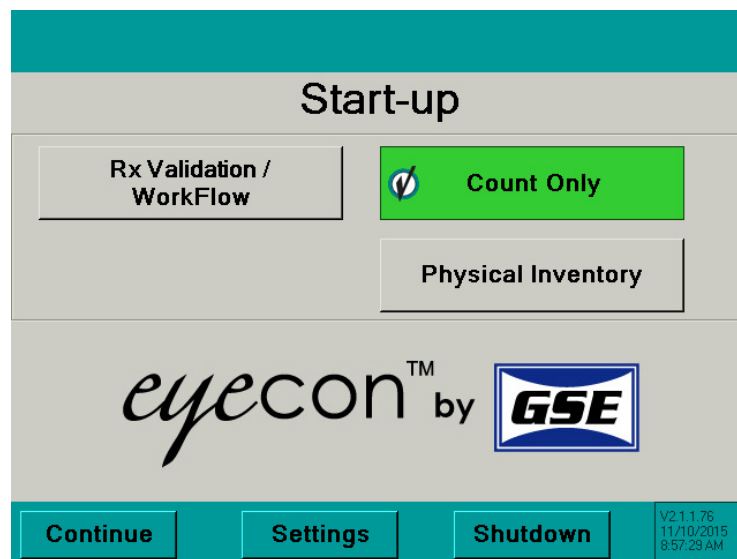

Button	Description	Reference Page(s)
Rx Validation / WorkFlow	Advance to the Rx Validation or PMSS mode	65, 98
Count Only	Advance to the Count Only mode	58
Physical Inventory	Advance to the Physical Inventory mode	83
Continue	Advance to the next screen	58, 65, 83
Settings	Change Eyecon settings	27
Shutdown	Restart or turn off Eyecon	23

3.2 Count Only Mode

This mode is used to dispense a prescription which does not need to be validated and count pills quickly.

Use the *Physical Inventory* mode for cycle count or count store inventory.



Press **Cancel** to backup one screen.

Refer to page 64 for settings menu.

3.2.1 Rx Dispensing and Pill Counting

Start

1. From the **Start-Up** screen activate Rx Dispensing mode by pressing the **Count Only** button. The button will be highlighted green when this mode is selected.
2. Press the **Continue** button to proceed.

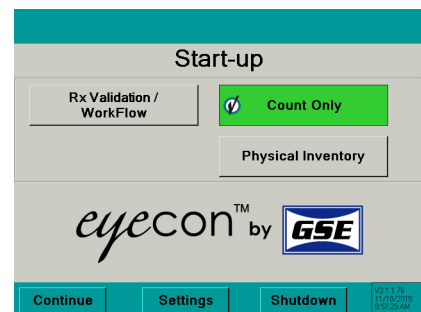

Scan Stock Bottle

3. Scan the Stock Bottle Label NDC barcode.

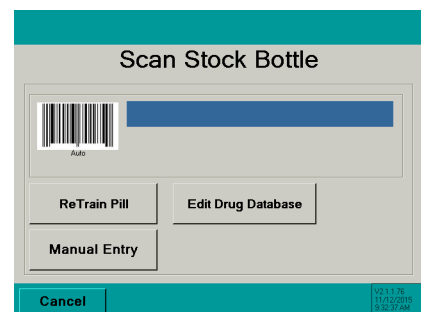

If multiple stock bottles are being used to complete a transaction, be sure to scan each one before pouring the pills on the counting platter.



Refer to page 90 to Re-Train an existing pill image.

See page 92 if the barcode does not scan. Refer to the **Manual NDC Entry** section.

If NDC information is not present in database, **NDC not found!** screen will appear. Refer to page 93 for further information.

See page 96 for information on how to edit the drug name, chose an NDC number or enable/disable the current drug photo.

Counting

4. Pour pills onto counting platter utilizing the entire platter surface. Be sure not to stack the pills on top of each other.
- 4a. If drug photo does not exist in the Eyecon database "**Not Found or Disabled**" will appear in place of the photo.

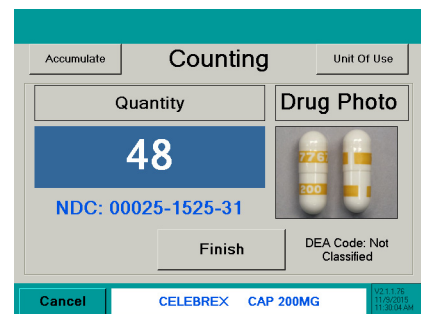

- 4b. If *Reports* are enabled (*Data* setting tab), the **Counting** screen will have a **Finish** button that needs to be pressed after the count is displayed. The count will be recorded into the database. A message and an audible beep will identify a recorded transaction has been made.

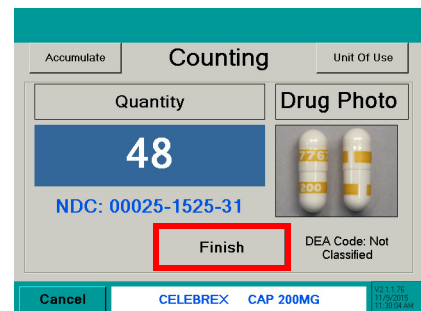

- 4c. If the **Finish** button was pressed with a count of 0, a message screen will be displayed. Press **Record Count of ZERO** to record the zero count or press **Resume Counting** to cancel and return to the **Counting** screen.

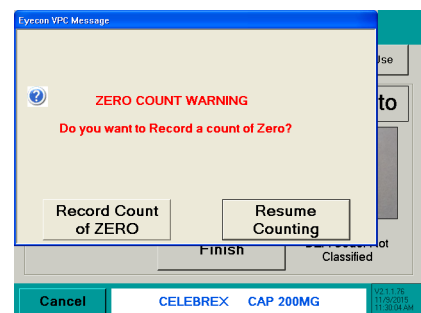

- 4d. If the **Unit Of Use** button was pressed with pills on the platter, a warning message will be displayed.



- 4e. If the pills are stacked on one another the screen may change, highlighting the position of the pills that were not able to be counted.

Lightly shake the pill counting platter until the pills are no longer stacked.

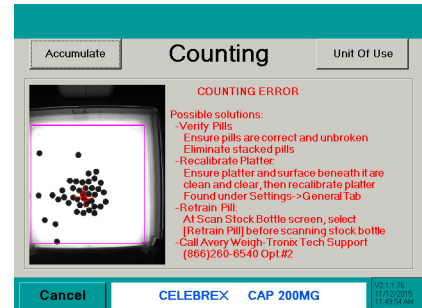

- 4f. If the required count was exceeded, remove excess pills from the platter with the spatula into the dispensing funnel. Place stock bottle under funnel gate and lift.

Fill Patient Vial

5. Dispense pills by placing the tongue of the funnel inside of the patient vial.
6. Cup hand around the outside of the vial opening. Push the bottle up to raise the funnel gate.
7. Lift the pill counting platter upward to pour pills through the funnel into the vial.
8. Validate all pills were dispensed into vial to avoid cross contamination.
9. Ensure funnel gate is returned to the closed position.
10. Scan another stock bottle or press **Cancel** to return to the **Scan Stock Bottle** screen.

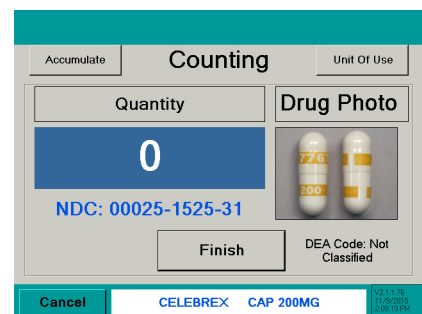

3.2.2 Unit of Use

Used to dispense a full bottle or manually entered quantity. The quantity will be recorded to the Report Database. The combining of Eyecon counted pills with the full bottle or manually entered quantity is also allowed.

1. With the pill tray empty, press the **Unit Of Use** button from the **Counting** screen.

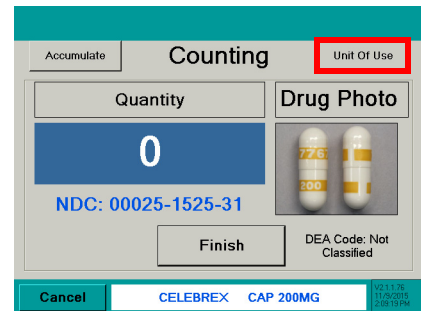

2. A keypad will be displayed. The entry window is pre-populated with the package quantity. To change the quantity, press **Clear** and enter the appropriate quantity.
3. Press the **OK** button to accept the entered quantity.

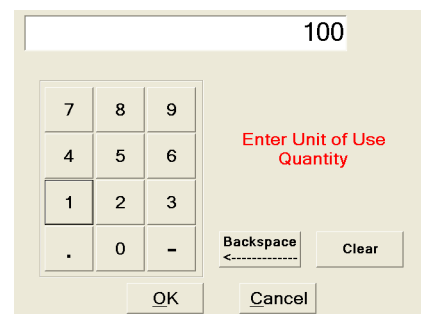

4. The screen will return to **Counting** mode with **Accumulate** turned on.
 - Add to the current quantity.
 - or
 - Scan another bottle and pour additional pills on the tray to achieve the desired quantity.
 - or
 - Press the **Unit Of Use** button to include another full bottle or manually enter a quantity.

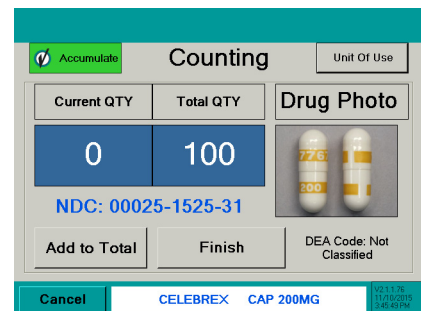

- 4a. If Reporting is enabled, press the **Finish** button and the total quantity dispensed will be recorded.

Refer to Appendix C on page 145 for information regarding recorded data and pill photo examples.

- 4b. If the package quantity is a fractional value, it is rounded off to the nearest whole number.

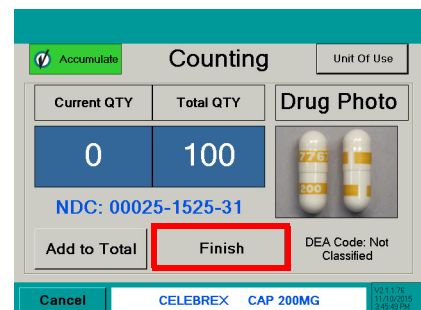

3.2.3 Hand-Count

If the drug is a unit of use (such as an ointment, cream, inhaler, syringe or blister pack) or was trained as a hand count drug, the **Hand-Count** screen will be displayed.

1. Press the **Unit Of Use** button in the top right hand corner.
2. The unit of use value is automatically filled in (for example: 15 is for 15mg). If the value is acceptable, press the **OK** button.
- 2a. If a change needs to be made, press the **Clear** button. The entry window will be blank. Use the numeric keys to enter the correct value and press the **OK** button.
3. After the OK button has been pressed, the **Hand-Count** screen will be displayed with the entered value.
4. Press the **Finish** button to save the entry. The screen will return to **Scan Stock Bottle**.
- 4a. If the **Finish** button was pressed with a count of 0, a message screen will be displayed. Press **Yes** to record the zero count or press **No** to cancel and return to the **Hand-Count** screen.

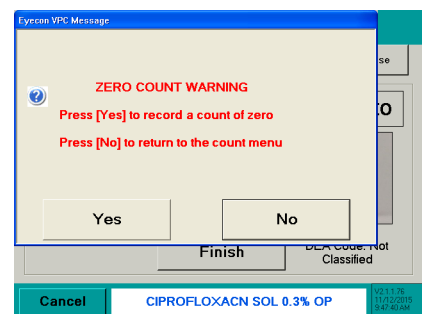
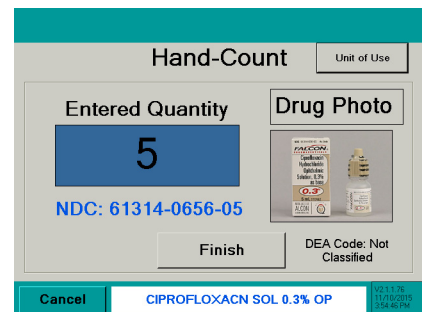
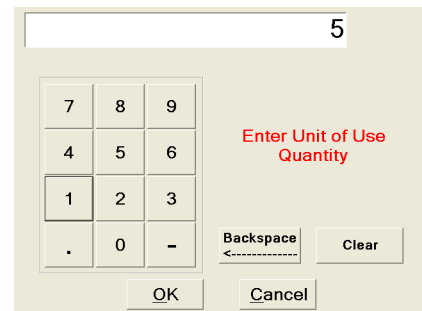
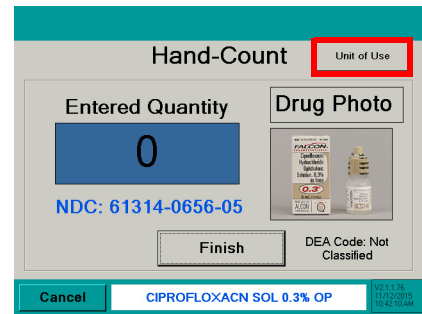

3.2.4 Accumulate Count Method

1. Press the **Accumulate** button. The button will turn green indicating that the accumulate function has been selected.

Notice the two blue windows Current QTY and Total QTY.

- **Current QTY** - The quantity currently on the counting platter.
- **Total QTY** - The accumulated (added) number of pills.

2. Pour pills onto counting platter utilizing the entire platter surface. Be sure not to stack the pills on top of each other.
 - 2a. If drug photo does not exist in the Eyecon database "**Not Found or Disabled**" will appear in place of the photo.

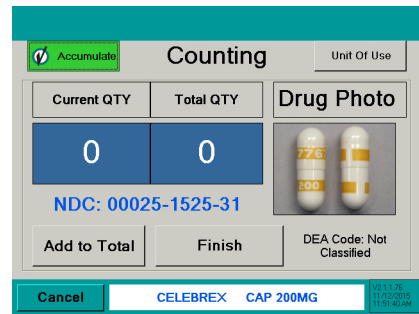

- 2b. If the pills are stacked on one another the screen may change, highlighting the position of the pills that were not able to be counted.

Lightly shake the pill counting platter until the pills are no longer stacked.

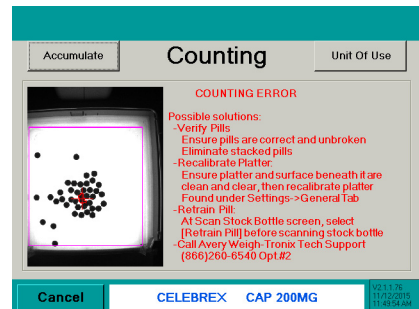

- 2c. If the required count was exceeded, remove excess pills from the platter with the spatula into the dispensing funnel. Place stock bottle under funnel gate and lift.

3. Press the **Add to Total** button to accumulate (add) the **Current QTY** count to the **Total QTY**.

- 3a. If **Total QTY** displayed exceeds desired quantity, remove excess pills from the platter with the spatula into the dispensing funnel. Place stock bottle under funnel gate and lift.

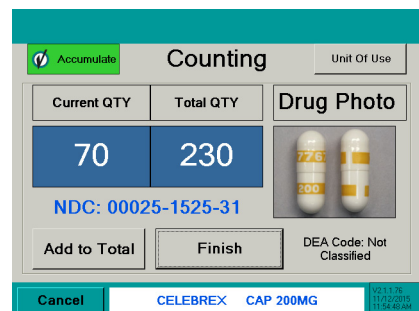

Fill Patient Vial or Return Pills to Stock Bottle

- After adding the **Current QTY** to the **Total QTY**, the following message screen will appear. The current quantity must be dispensed before continuing.

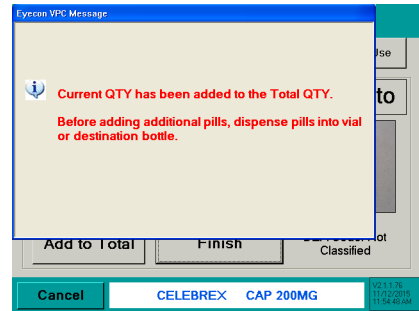

- Dispense pills by placing the tongue of the funnel inside of the patient vial or stock bottle.
- Cup hand around the outside of the bottle opening. Push the bottle up to raise the funnel gate.
- Lift the pill counting platter upward to pour pills through the funnel into the bottle.
- Validate all pills were dispensed into bottle to avoid cross contamination.
- Ensure funnel gate is returned to the closed position.
- Repeat the previous steps until accumulation is finished. Press the **Finish** button complete the accumulation and record the count into the database.



- Scan another stock bottle or press **Cancel** to return to the **Scan Stock Bottle** screen.

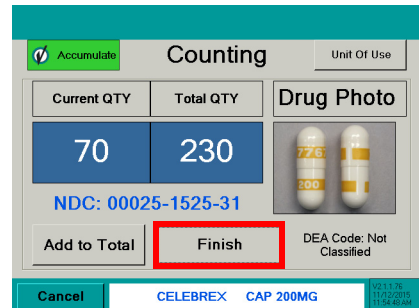

The display will time out and return to the **Scan Stock Bottle** screen based on the value set at the **General** tab screen (Refer to [page 27](#) for details).

3.3 Rx Validation / Workflow

Ensures the proper medication is dispensed by validating an 11 digit NDC printed on the patient vial label or Rx pamphlet matches the NDC on the stock bottle. Contact customer support at (866) 260- 6540 for additional information on validation.

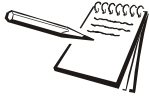



Refer to page [page 23](#) for details to Shutdown the Eyecon.

Refer to [page 27](#) for Settings menu.

Refer to [page 98](#) for PMSS mode instructions.

3.3.1 Rx Validation and Dispensing

Start

- From the **Start-Up** screen activate Rx Validation / Workflow mode by pressing the  button. The button will be highlighted green when this mode is selected.
- Press the  button to proceed.

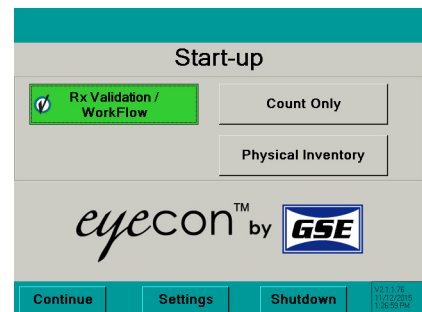

The User ID barcode can be scanned from the **Start-Up** screen when the Rx Validation / Workflow button is highlighted. The display will go right to the **Scan Vial Label** screen.

Scan User Login

- The Scan User Login feature is available for added system security. The login ID can be scanned or manually entered.

The **User Login** screen is disabled by default and can be enabled within the settings menu. See [page 28](#) for details.

- If Login was scanned or manually entered, proceed to step 4.
- If manually entering the user login number, refer to [page 82](#) for details.
- If disabled, this screen would be skipped and the **Scan Vial Label** screen will be displayed.

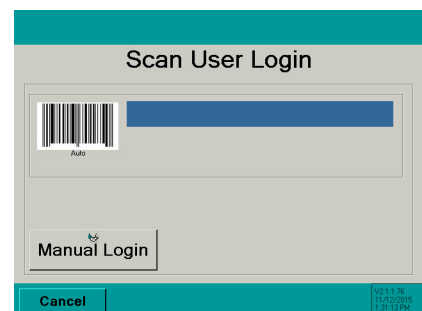

Scan Vial Label

4. Scan the 11 digit NDC barcode on the vial label or patient pamphlet.

4a. If *Scan User Login* is disabled use the **Cancel** button to return to the **Start-up** screen.

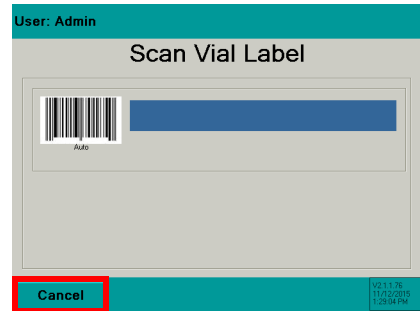

4b. If *Scan User Login* is enabled use the **Log Off** button to log off of the system and return to the **Scan User Login** screen.

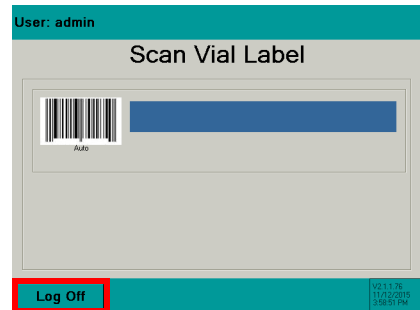

4c. If *Stock Bottle Verification* is set to **Always**, proceed to the **Scan Stock Bottle** screen.

4d. If *Stock Bottle Verification* is set to **Never**, proceed to the **Counting** screen.

4e. If *Stock Bottle Verification* is set to **User**, scan the stock bottle to proceed or press the **Skip Validation** button to proceed to the **Counting** screen.



Scan Stock Bottle

- Scan the Stock Bottle Label NDC barcode.

See page 90 to train an existing pill image.

See page 92 if the barcode does not scan. Refer to the Manual NDC Entry section.

See page 29 to choose the stock bottle verification method.

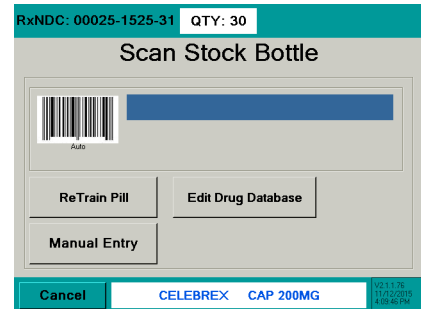

If multiple stock bottles are being used to complete a transaction, be sure to scan each one before pouring the pills on the counting platter.



If NDC information is not present in database, *NDC not found!* screen will appear. Refer to page 93.

See page 96 for information on how to edit the drug name, chose an NDC number or enable/disable the current drug photo.

Government Regulations

Specific size stock bottles must be used in filling prescriptions to control costs.

If a scanned stock bottle does not meet specific government requirements, a message screen will appear. It is possible to override this message by pressing **Yes** or press **No** to go back to the **Scan Stock Bottle** screen.

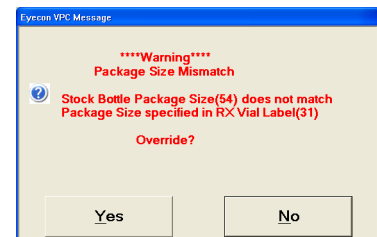

Counting

- Pour pills onto counting platter utilizing the entire platter surface. Be sure not to stack the pills on top of each other.
- If drug photo does not exist in the Eyecon database "**Not Found or Disabled**" will appear in place of the photo.

The prescription target quantity can be included with the 11digit NDC data and compiled into one barcode that is scanned. If the quantity is included, it will be displayed in the top center of the display as a quantity.

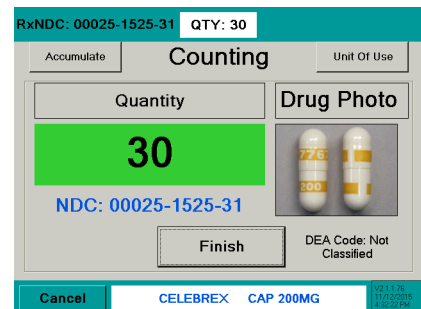

- When the **Quantity** matches the **QTY** the window will turn **green**.

- If the number of pills poured exceeds the **QTY** value, the **Quantity** window will turn **red**.

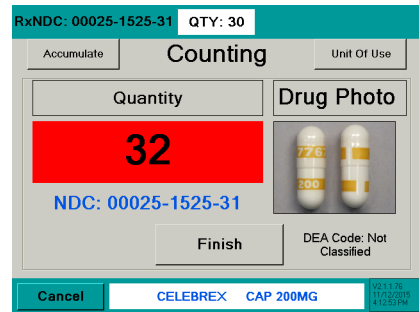

- If the number of pills poured is less than the **QTY** value, the **Quantity** window will turn **yellow**.

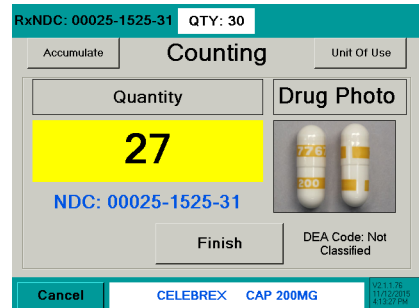

- 6b. If the **Finish** button is pressed while the pill count is out of tolerance or a partial fill, a **Quantity Mismatch** screen will be displayed. This screen will not appear if the pill count is the same as the **QTY** displayed in the upper QTY window.

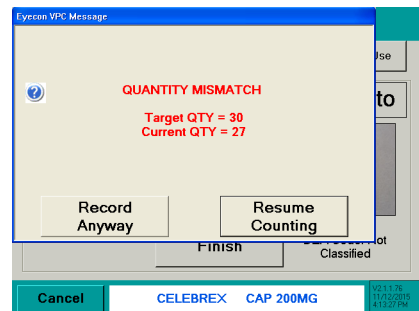

Press the **Record Anyway** button to continue filling the prescription or press the **Resume Counting** button to return to the **Counting Pills** screen.

- 6c. If the **Finish** button was pressed with a count of 0, a message screen will be displayed. Press **Record Anyway** to record the zero count or press **Resume Counting** to cancel and return to the **Counting** screen.

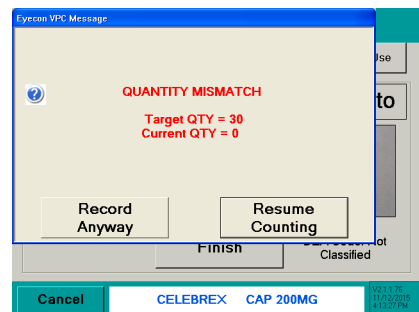

- 6d. If the pills are stacked on one another the screen may change, highlighting the position of the pills that were not able to be counted.

Lightly shake the counting platter until the pills are no longer stacked.

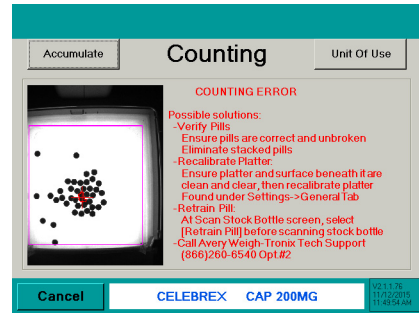

- 6e. If the required count was exceeded, remove excess pills from the platter with the spatula into the pill dispensing funnel. Place stock bottle under funnel gate and lift.

Fill Patient Vial

7. Dispense pills by placing the tongue of the funnel inside of the patient vial. Cup hand around the outside of the vial opening. Push the bottle up to raise the funnel gate.
8. Lift the pill counting platter upward to pour pills through the funnel into the vial.
9. Validate all pills were dispensed into vial to avoid cross contamination. Ensure funnel gate is returned to the closed position.
10. Scan another Rx NDC barcode or press



Finish to return to the **Scan Vial Label** screen.

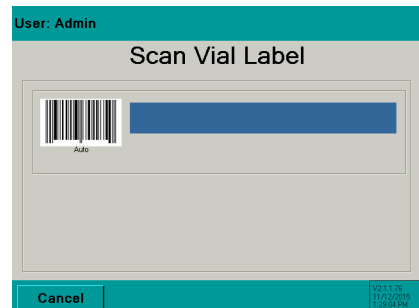
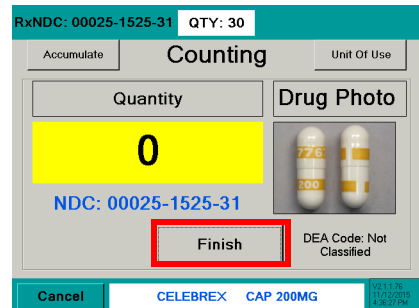

3.3.2 Partial Fill

If a prescription can only be partially filled, the Eyecon will store the partial fill information and when the remainder is ready to be filled, the prescription is recalled. Reporting must be enabled in the **Data** tab under the **Settings** menu.

1. Pour pills onto the counting platter.
2. Press the **Finish** button to record the transaction.

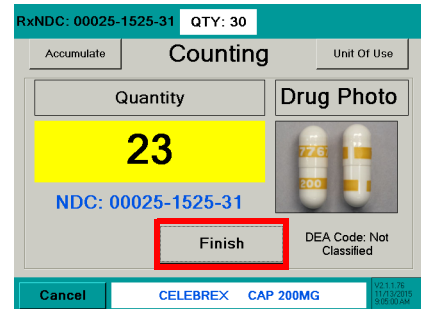

- 2a. If the prescription is a partial fill, the **Quantity Mismatch** screen will be displayed. This screen will not appear if the pill count is the same as the **QTY** displayed in the upper QTY window.

Press the **Record Anyway** button to save the prescription for filling at a later time or

Press the **Resume Counting** button to return to the **Counting Pills** screen.

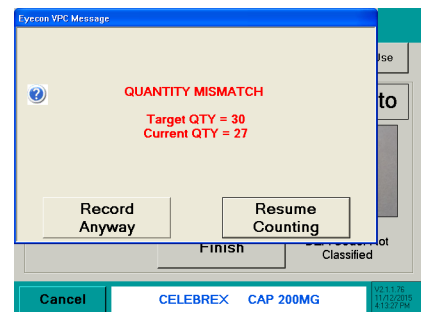

Fill the Remainder of the Prescription

3. When the prescription can be filled, scan the vial label.
4. Next, scan the stock bottle. A warning screen will be displayed.

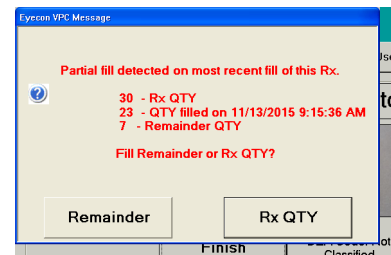

- 4a. Press the **Remainder** button to finish filling the prescription.

Add the pills and press the **Finish** button. The transaction will be recorded to the database as a completed fill.

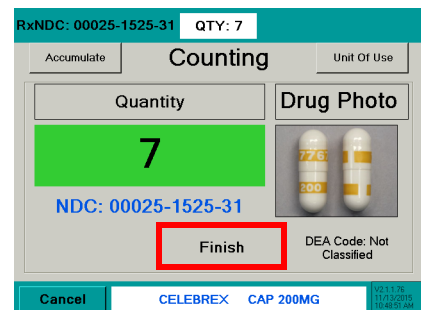

- 4b. Press the **Rx QTY** button to fill the prescribed quantity.

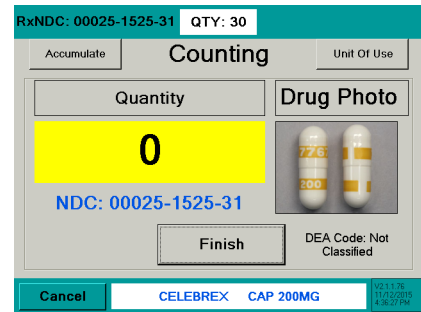

3.3.3 Unit of Use

Used to dispense a full bottle or manually entered quantity. The quantity will be recorded to the Report Database. The combining of Eyecon counted pills with the full bottle or manually entered quantity is also allowed.

1. With the pill tray empty, press the **Unit Of Use** button from the **Counting** screen.

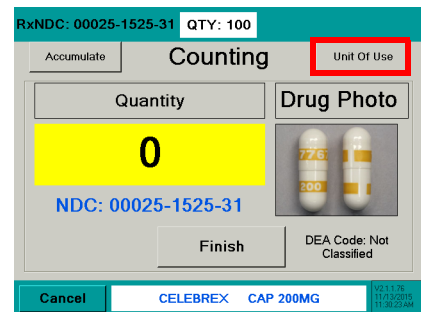

2. A keypad will be displayed. The entry window is pre-populated with the package quantity. To change the quantity, press **Clear** and enter the appropriate quantity.
3. Press the **OK** button to accept the entered quantity.

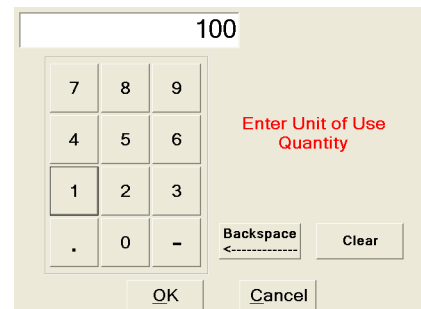

4. The screen will return to **Counting** mode with **Accumulate** turned on.
- Add to the current quantity
or
 - Scan another bottle and pour additional pills on the tray to achieve the desired quantity
or
 - Press the **Unit Of Use** button to include another full bottle or manually enter a quantity.

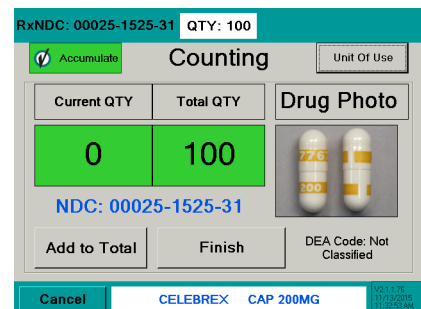

- 4a. If Reporting is enabled, press the **Finish** button and the total quantity dispensed will be recorded.

Refer to Appendix C on page 145 for information regarding recorded data and pill photo examples.

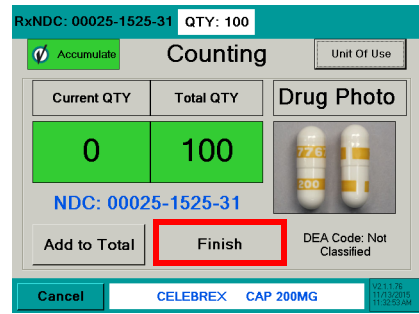

- 4b. If the package quantity is a fractional value, it is rounded off to the nearest whole number.
- 4c. If the total exceeds the prescribed quantity, a warning will be displayed. Press the **Yes** button to continue filling the prescription or press the **No** button to revise the quantity.

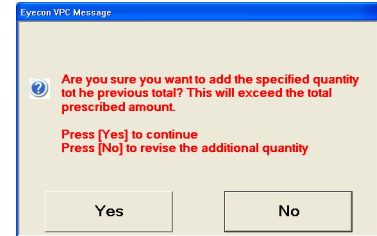

3.3.4 GPI Substitution

This mode allows a generic equivalent to be counted instead of the adjudicated NDC. A GPI equivalent can only be substituted at the initial **Scan Stock Bottle** screen. GPI Substitution must be enabled in the **General** settings tab (refer to page 29).

1. Scan stock bottle.
2. Scan generic NDC.
3. One of the following message screens will appear depending on the NDC scanned. Follow the instructions on the displayed screen.



Message Screens

When a GPI is scanned, a warning screen will appear for GPI substitution.

- At the **Scan Stock Bottle** screen, a stock bottle is scanned that is not the NDC specified. Press the **Yes** button to approve or press the **No** button to escape.

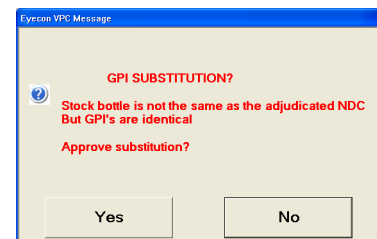

- If the stock bottle scanned is non-matching this warning will be displayed. Press the **OK** button to return to the previous screen.

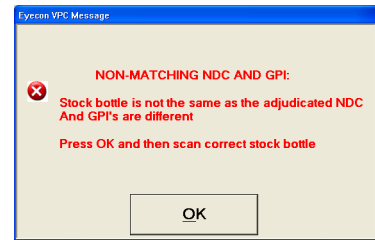

- When the last two digits of the scanned NDC (stock bottle) are different from the specified NDC. Press the **Yes** button to approve or press the **No** button to escape.

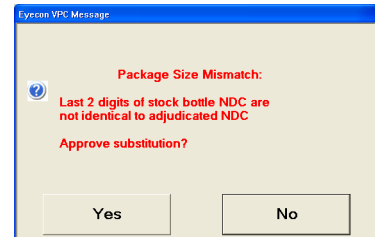

- If a non-matching stock bottle is scanned that has the same GPI but is a different NDC than specified. Press the **OK** button to return to the previous screen.

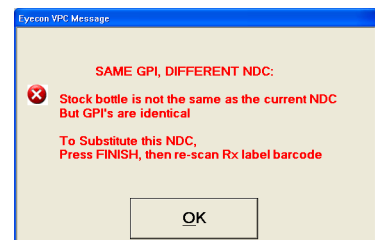

- If already in the count mode and a stock bottle with the same first 9 digits of the NDC but the last 2 digits (package size) are different. Press the **OK** button to return to the previous screen.

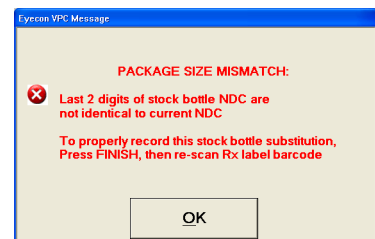

- If a stock bottle with an equivalent GPI is scanned but the GPI substitution feature is disabled. Press the **Yes** button to approve or press the **No** button to escape.

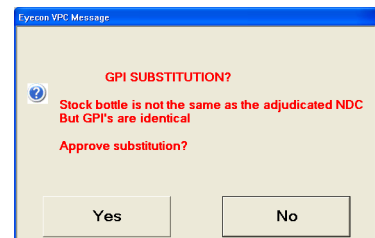

- If while using the Unit-of-Use feature and [OK] was pressed with an entry amount greater than the target quantity. Press the **Yes** button to approve or press the **No** button to escape.

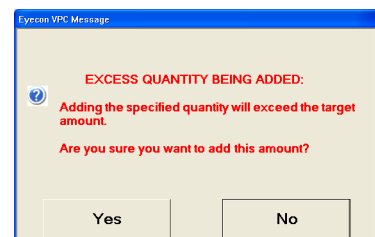

- If the **Finish** button was pressed with a count of zero. Press the **Yes** button to record a zero value or press the **No** button to escape.

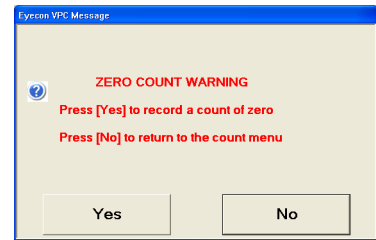

3.3.5 Double Count (DEA Controlled Substances)

If the Rx being dispensed is a controlled substance, a double count may be necessary depending on the setting under the **Double Check** tab. Refer to section 2.10 on page 55.

1. Scan the 11 digit NDC barcode on the vial label or patient pamphlet.
2. Scan stock bottle.

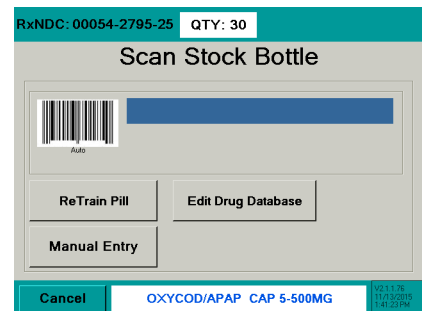

3. Pour pills onto counting platter utilizing the entire platter surface. Be sure not to stack the pills on top of each other.

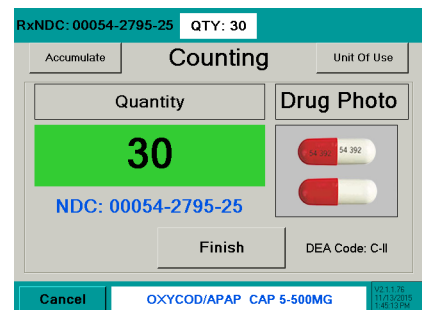

- When the **Quantity** matches the **QTY** the window will turn **green**.
- If the number of pills poured exceeds the **QTY** value, the **Quantity** window will turn **red**.

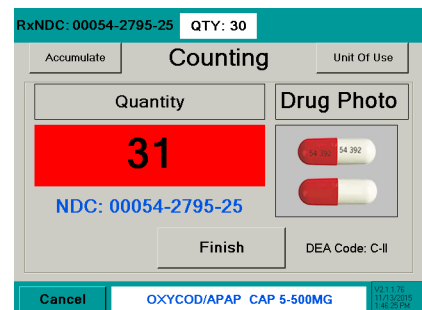

- If the number of pills poured is less than the **QTY** value, the **Quantity** window will turn **yellow**.

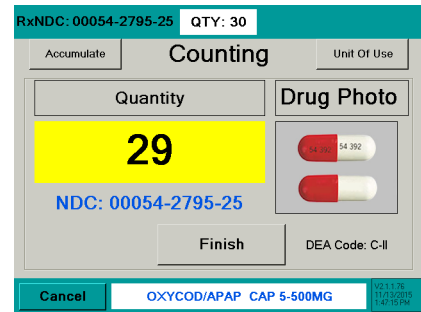

4. Press the **Finish** button. The transaction will be recorded. A message screen will be displayed. A second count will need to be performed.

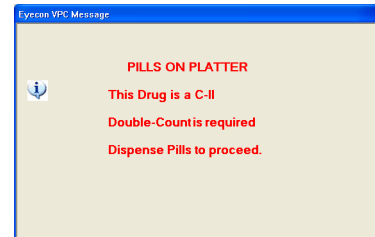

- 4a. If the **Finish** button is pressed while the pill count is out of tolerance a **Quantity Mismatch** screen will be displayed. This screen will not appear if the pill count is the same as the **QTY** displayed in the upper QTY window.

Press the **Record Anyway** button to continue with double-count or

press the **Resume Counting** button to return to the **Counting Pills** screen.

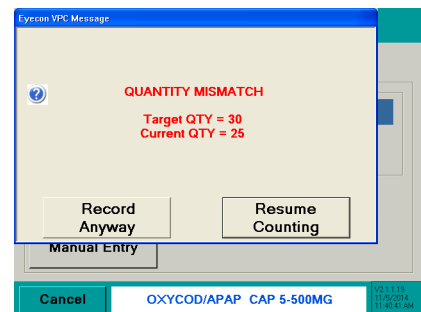

5. Remove pills from the counting platter. The **Double Count** screen will be displayed.

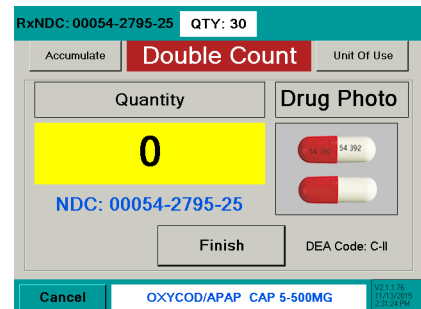

6. Re-pour pills on the platter. Press the **Finish** button to finalize the double count. The transaction will be recorded.

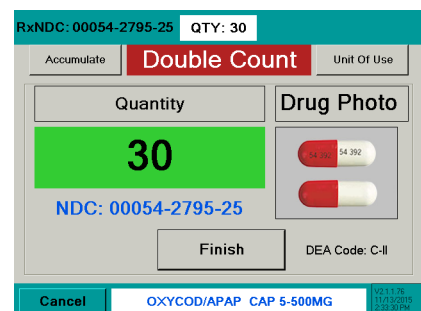

- 6a. If back-count is enabled, the **Back Count** screen will be displayed. Dispense the pills and proceed to the Back-Count section step 3.

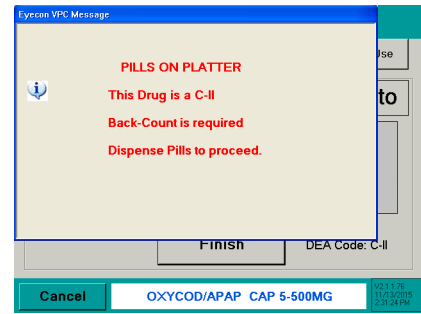

3.3.6 Back Count (DEA Controlled Substances)

The Back-Count feature is used to count the remaining pills in the stock bottle after every controlled substance dispense. **Back Count** must be checked under the **Double Check** tab. Refer to section 2.10 on page 55.

The user is prompted to count the remainder and the Eyecon supplies the expected back-count based on the prior back-count minus the dispensed amount. If the dispense results in opening a new stock bottle, the Eyecon takes that into account by adding in the full bottle quantity. The expected back-count amount is displayed at the top of the count screen, in the same manner as the target quantity for Rx filling.

1. Scan the 11 digit NDC barcode on the vial label or patient pamphlet.
2. Scan stock bottle.



3. Pour pills onto counting platter utilizing the entire platter surface. Be sure not to stack the pills on top of each other.

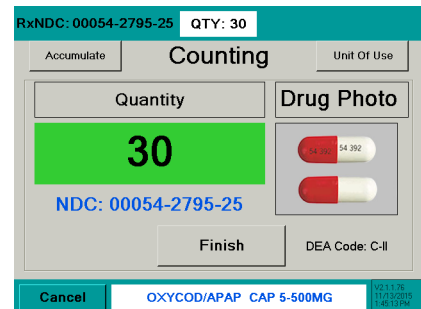

- When the **Quantity** matches the **QTY** the window will turn **green**.
- If the number of pills poured exceeds the **QTY** value, the **Quantity** window will turn **red**.

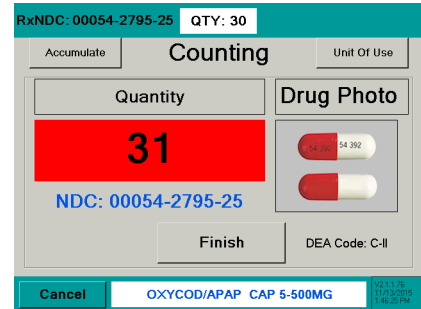

- If the number of pills poured is less than the **QTY** value, the **Quantity** window will turn **yellow**.

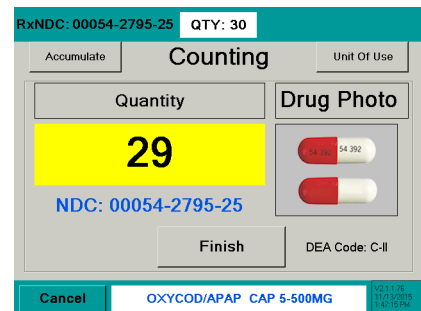

4. Press the **Finish** button. The transaction will be recorded. A message screen will be displayed. A back-count will be needed.

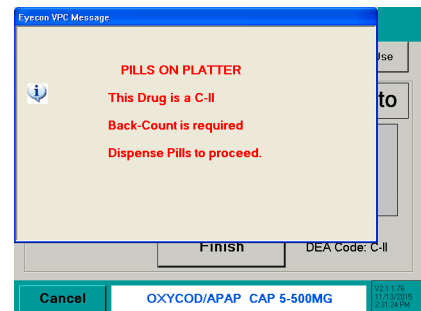

5. Dispense the pills. The **Back Count** screen will be displayed. The expected amount for the Back Count is shown at the top of the screen. If this is the first time that the current NDC is being back-counted, the expected amount is the full bottle amount.

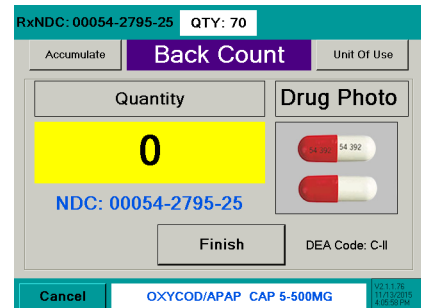

Back Count Quantity Mismatch

If the final Back Count achieved doesn't match the expected Back Count amount, the count window back-ground color will be **yellow** if it is lower, and **red** if it is over.

- If **Finish** is pressed and the amount is a mismatch the following warning message appear.

If all of the pills in the open bottle for the NDC have been counted, press the **Record Anyway** button or

press the **Resume Back-Count** button to return to the **Counting Pills** screen.

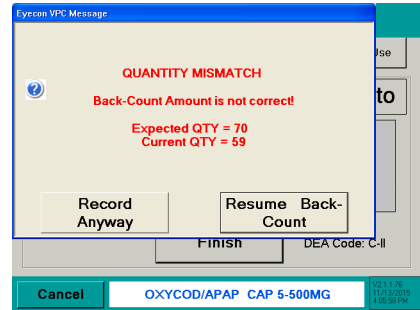

- If *Require Adjust Reasons* box was checked in the **Double Check** setting tab, a reason menu will be displayed.

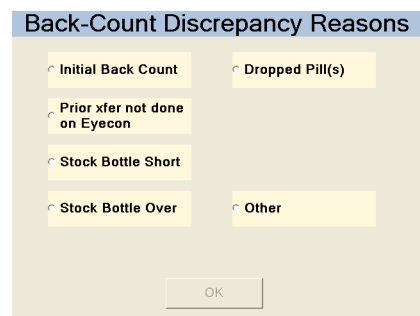

Select a reason and press the **OK** button. The display will return to **Scan Vial Label**.

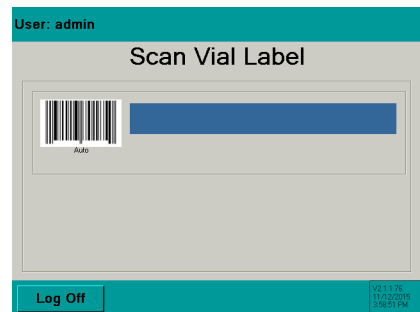

3.3.7 Hand-Count

If the drug is a unit of use (such as an ointment, cream, inhaler, syringe or blister pack) or was trained as a hand count drug, the **Hand-Count** screen will be displayed.

1. Press the **Unit Of Use** button in the top right hand corner.
2. The unit of use value is automatically filled in (for example: 5 is for 5 ml). If the value is acceptable, press the **OK** button.
- 2a. If a change needs to be made, press the **Clear** button. The entry window will be blank. Use the numeric keys to enter the correct value and press the **OK** button.
3. After the OK button has been pressed, the **Hand-Count** screen will be displayed with the entered value.
4. Press the **Finish** button to save the entry. The screen will return to **Scan Stock Bottle**.
- 4a. If the **Finish** button was pressed with a count of 0, a message screen will be displayed. Press **Yes** to record the zero count or press **No** to cancel and return to the **Hand-Count** screen.

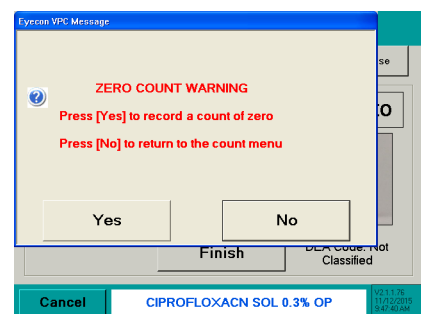
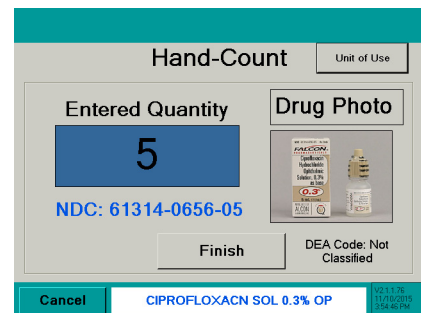
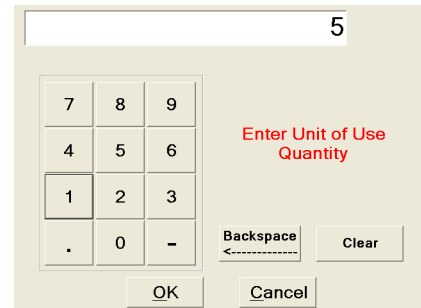
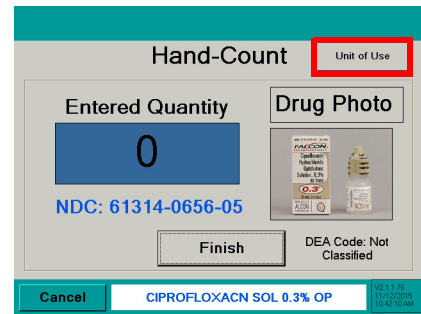

3.3.8 Accumulate Count Method

1. Press the **Accumulate** button. The button will turn **green** indicating that the accumulate function has been chosen.

Notice the two windows **Current QTY** and **Total QTY**. The windows will change color depending on the target quantity in the right hand corner.

yellow = below

red = above

green = target quantity.

Current QTY - The quantity currently on the counting platter.

Total QTY - The accumulated (added) number of pills.

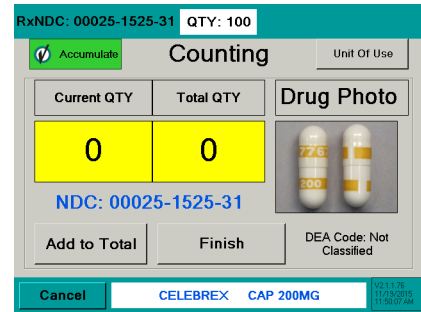

- 1a. If drug photo does not exist in the Eyecon database "**Not Found or Disabled**" will appear in place of the photo.
2. Pour pills onto counting platter utilizing the entire platter surface. Be sure not to stack the pills on top of each other.



- 2a. If the pills are stacked on one another the screen may change highlighting the position of the pills that were not able to be counted.

Lightly shake the counting platter until the pills are no longer stacked.

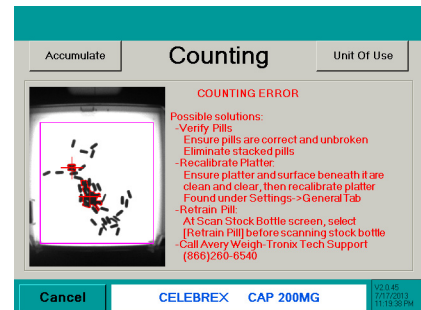

- Press the **Add to Total** button to accumulate (add) the **Current QTY** count to the **Total QTY**.

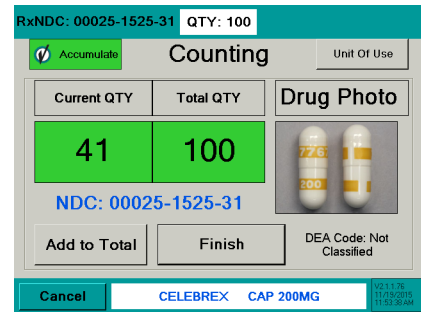

Fill Patient Vial or Return Pills to Stock Bottle

- After adding the **Current QTY** to the **Total QTY**, the following message screen will appear.

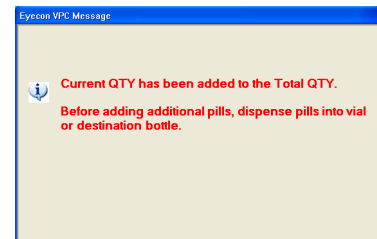

- Dispense pills by placing the tongue of the funnel inside of the patient vial. Cup hand around the outside of the vial opening. Push the bottle up to raise the funnel gate.
- Lift the pill counting platter upward to pour pills through the funnel into the vial.
- Validate all pills were dispensed into vial to avoid cross contamination. Ensure funnel gate is returned to the closed position.
- Repeat the previous steps until accumulation is finished.
- Press **Finish** to return to the **Scan Vial Label** screen.

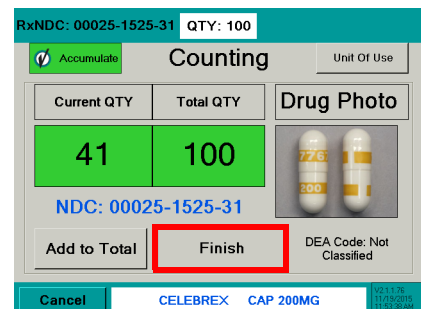

3.3.9 Manual Login

Enter a User ID number if it is unable to be scanned.

1. From the **Scan User Login** screen press the **Manual Login** button.

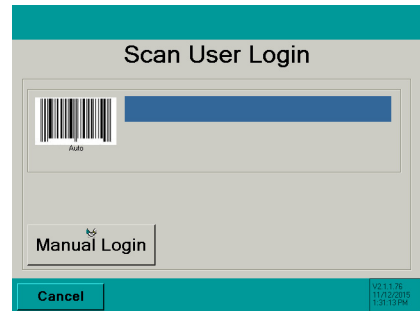

2. Key in the user login ID number with the numeric buttons.

Default code is 501812

3. Press the **OK** button to accept the entry.
 - The **Backspace** button moves the entry cursor back one space.
 - The **Clear** button clears the entire entry.
4. If the login ID was accepted the **Scan Vial Label** screen will be displayed.
5. Return to the **Rx Validation / Workflow** section.

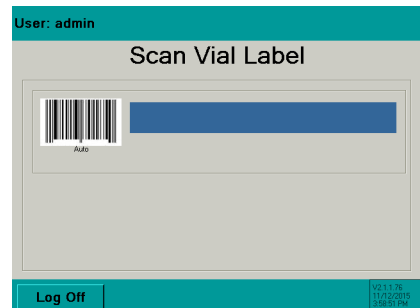
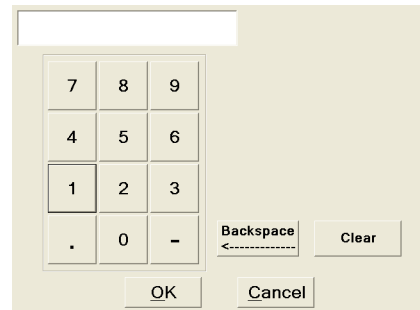

3.4 Physical Inventory Mode

The Physical Inventory mode provides a way to maintain accurate inventory levels. Scan the stock bottle or manually enter the NDC number. Data is saved to the Eyecon database and can be retrieved with a USB memory stick. See Appendix A on [page 136](#) for details on importing data to a computer.



NOTE: Press **Cancel** in any of the sub-menus to backup one screen.

3.4.1 Count Inventory

Start

1. From the **Start-Up** screen enter the **Physical Inventory Mode** by pressing the **Physical Inventory** button. The button will be highlighted green when this mode is selected.
- 1a. If User Login is enabled, the User ID barcode can be scanned from the **Start-Up** screen when the Physical Inventory button is highlighted in **green**. The display will go right to the **Scan Stock Bottle** screen.
2. Press the **Continue** button to proceed.

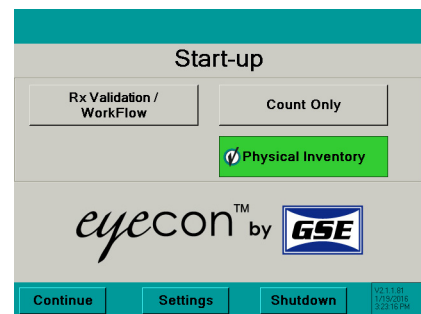

Previous Inventory Data Warning

This message will be displayed only when existing inventory data is stored in the Eyecon database and the **Physical Inventory Mode** was restarted.

If a new physical inventory is being performed press the **Delete Existing Data** button. The Eyecon will advance to the menu shown under the Data heading on [page 46](#) to delete or download the existing data.

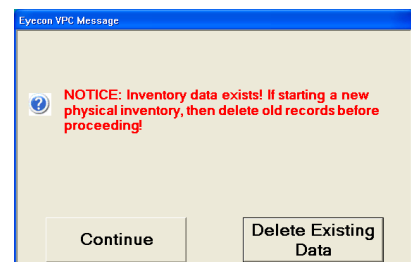

If an existing inventory is being resumed, then press the **Continue** button.

Scan User Login

3. The Scan User Login feature is available for added system security. The login ID can be scanned or manually entered.
 - The **User Login** screen is disabled by default and can be enabled within the settings menu. See [page 28](#) for details.
- 3a. If Login was scanned or manually entered, proceed to step 4.
- 3b. If manually entering the user login number, refer to [page 89](#) for details.
- 3c. If disabled, this screen would be skipped and the **Scan Stock Bottle** screen will be displayed.

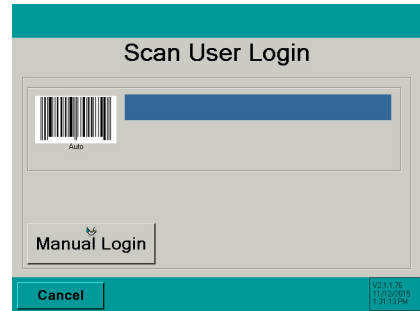

Scan Stock Bottle

4. Scan the Stock Bottle Label NDC barcode.
 - See [page 92](#) if the barcode does not scan. Refer to the Manual NDC Entry section.
- 4a. If NDC information is not present in database, **NDC not found!** screen will appear. Refer to [page 93](#).
 - See [page 96](#) for information on how to edit the drug name, choose an NDC number or disable the current drug photo.

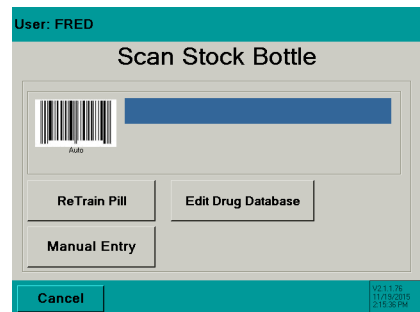

If multiple stock bottles are being used to complete a transaction, be sure to scan each one before pouring the pills on the counting platter.

Count Inventory

5. Pour pills onto counting platter utilizing the entire platter surface. Be sure not to stack the pills on top of each other.
 - NOTE: If you have more pills than will easily fit on the pill platter, then use the Accumulate function as described on [page 88](#).
- 5a. If drug photo does not exist in the Eyecon database "**Not Found or Disabled**" will appear in place of the photo.

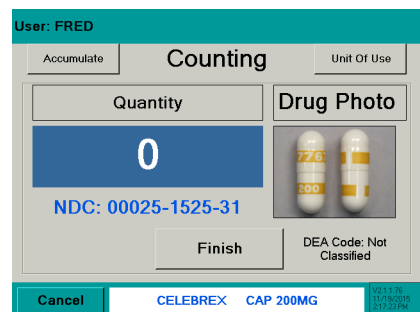

- 5b. If the pills are stacked on one another the screen will highlight the position of the pills that were not able to be counted.

Lightly shake the counting platter until the pills are no longer stacked.

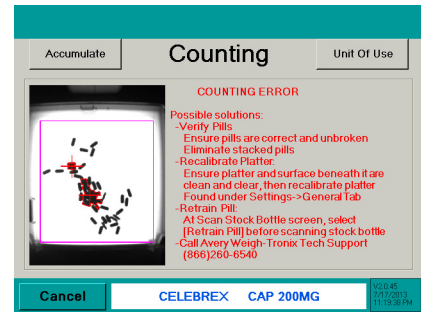

6. Press the **Finish** button to record the quantity to the Eyecon database.

A message will be displayed briefly along with an audible sound indicating the transaction was recorded.

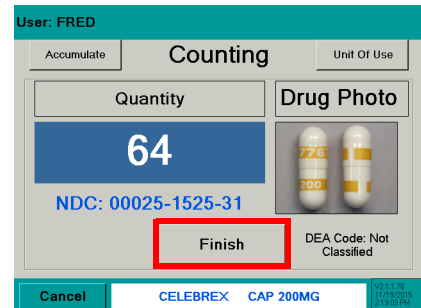

- 6a. If the **Finish** button was pressed with a count of 0, a message screen will be displayed. Press **Yes** to record the zero count or press **No** to cancel and return to the **Counting** screen.

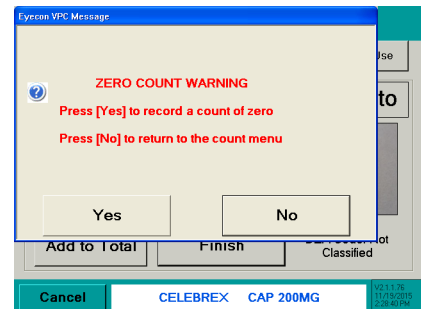

Return Pills to Stock Bottle

7. Dispense pills by placing the tongue of the funnel inside of the stock bottle. Cup hand around the outside of the bottle opening.
8. Push the bottle up to raise the funnel gate.
9. Lift the pill counting platter upward to pour pills through the funnel into the bottle.
10. Validate all pills were dispensed into the stock bottle to avoid cross contamination. Ensure funnel gate is returned to the closed position.
11. Return to step 4 to count more inventory.



3.4.2 Unit of Use

Used to count a full bottle or manually entered quantity. The quantity will be recorded to the Report Database. The combining of Eyecon counted pills with the full bottle or manually entered quantity is also allowed.

1. With the pill tray empty, press the **Unit Of Use** button from the **Counting** screen.

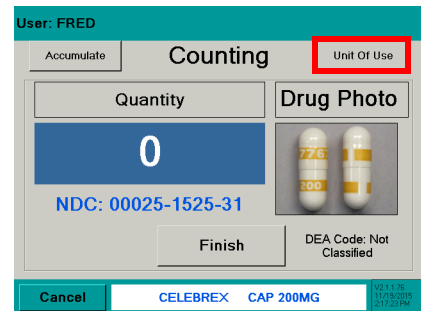

2. A keypad will be displayed. The entry window is pre-populated with the package quantity. To change the quantity, press **Clear** and enter the appropriate quantity.
3. Press the **OK** button to accept the entered quantity.

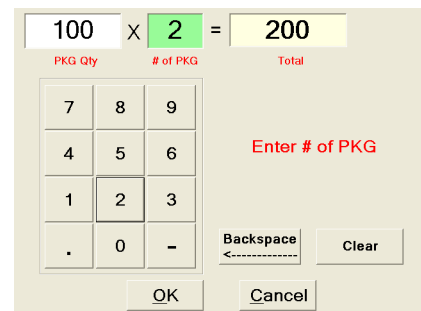

4. The screen will return to **Counting** mode with **Accumulate** turned on.
 - Add to the current quantity.
 - or
 - Scan another bottle and pour additional pills on the tray to achieve the desired quantity.
 - or
 - Press the **Unit Of Use** button to include another full bottle or manually enter a quantity.

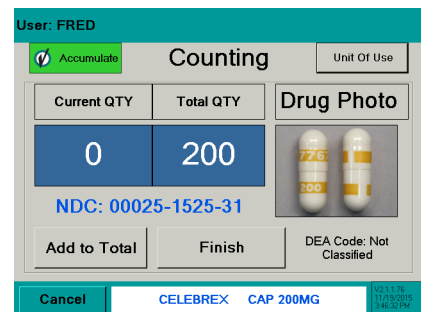

- 4a. If Reporting is enabled, press the **Finish** button and the total quantity dispensed will be recorded.

Refer to Appendix C on page 145 for information regarding recorded data and pill photo examples.

- 4b. If the package quantity is a fractional value, it is rounded off to the nearest whole number.

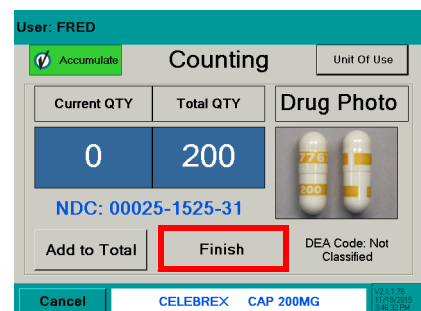

3.4.3 Hand-Count

If the drug is a unit of use (such as an ointment, cream, inhaler, syringe or blister pack) or was trained as a hand count drug, the **Hand-Count** screen will be displayed.

1. Press the **Unit Of Use** button in the top right hand corner.
2. The unit of use value is automatically filled in (for example: 5 is for 5 ml). If the value is acceptable, press the **OK** button.
- 2a. If a change needs to be made, press the **Clear** button. The entry window will be blank. Use the numeric keys to enter the correct value and press the **OK** button.
3. After the OK button has been pressed, the **Hand-Count** screen will be displayed with the entered value.
4. Press the **Finish** button to save the entry. The screen will return to **Scan Stock Bottle**.
- 4a. If the **Finish** button was pressed with a count of 0, a message screen will be displayed. Press **Yes** to record the zero count or press **No** to cancel and return to the **Hand-Count** screen.

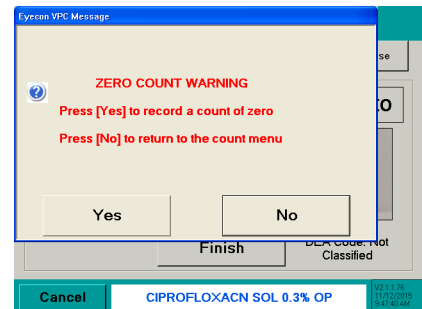
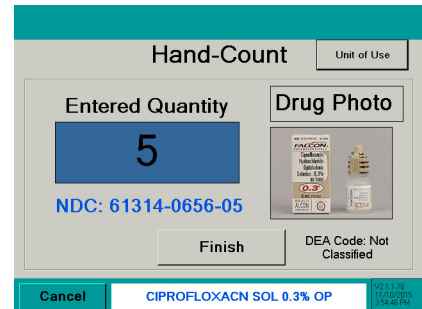
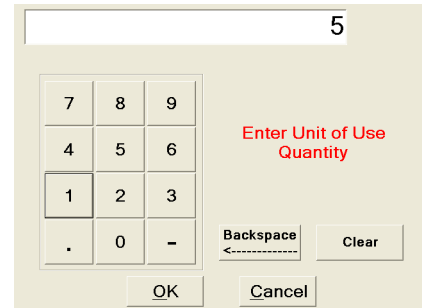
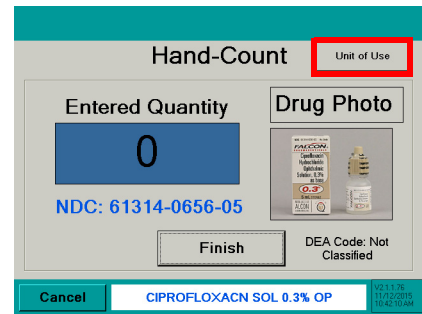

3.4.4 Accumulate / Counting

1. Press the **Accumulate** button from the **Counting** screen. The button will turn green indicating that the accumulate function has been chosen.

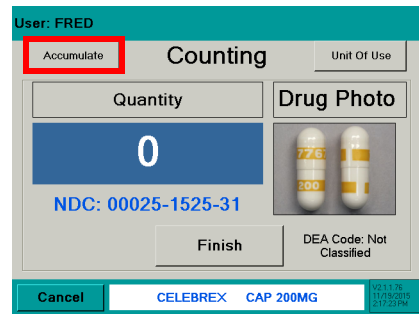

Current QTY - The quantity currently on the counting platter.

Total QTY - The accumulated (added) number of pills.

- 1a. If drug photo does not exist in the Eyecon database "**Not Found or Disabled**" will appear in place of the photo.
- 1b. If the stock bottle is unopened, use the Full Stock Bottle feature. Refer to page 86 for details.
- 1c. If the NDC scanned was unit item refer to the **Hand-Count** section on page 87 for details.

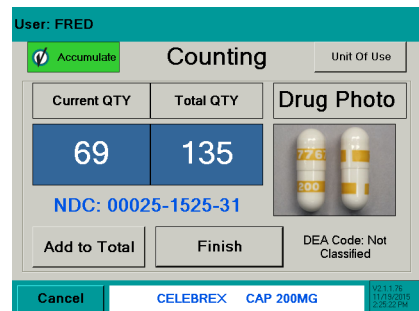

2. Pour pills onto counting platter utilizing the entire platter surface. Be sure not to stack the pills on top of each other.
 - 2a. If the pills are stacked on one another the screen may change highlighting the position of the pills that were not able to be counted.



Lightly shake the counting platter until the pills are no longer stacked.

3. Press the **Add to Total** button to accumulate (add) the **Current QTY** count to the **Total QTY**.

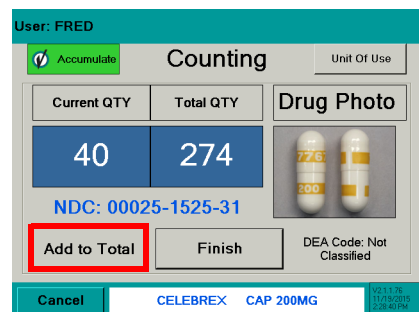

Return Pills to Stock Bottle

After adding the **Current QTY** to the **Total QTY**, the following message screen will appear.

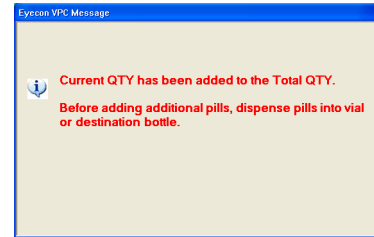

4. Dispense pills by placing the tongue of the funnel inside of the stock bottle. Cup hand around the outside of the bottle opening. Push the bottle up to raise the funnel gate.
5. Lift the pill counting platter upward to pour pills through the funnel into the stock bottle.
6. Validate all pills were dispensed into stock bottle to avoid cross contamination. Ensure funnel gate is returned to the closed position.
7. Press **Finish** to record the transaction.



A message will be displayed briefly along with an audible sound indicating the transaction was recorded.

The screen will return to **Scan Stock Bottle**. To continue counting, go back to step 4 on page 84.

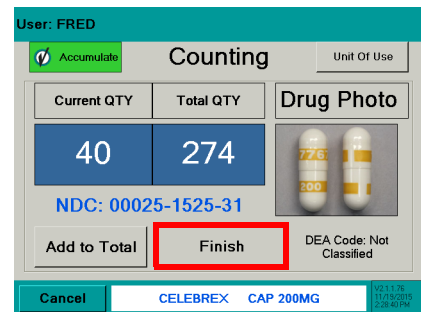

3.4.5 Manual Login

Enter a User ID number if it is unable to be scanned.

1. From the **Scan User Login** screen press the **Manual Login** button.

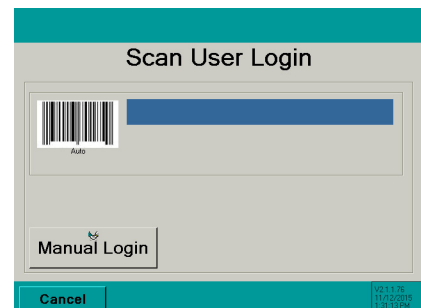

2. Key in the user login number with the numeric buttons.
 - Default code is 501812

3. Press the **OK** button to accept the entry.

The **Backspace** button moves the entry cursor back one space.

The **Clear** button clears the entire entry.

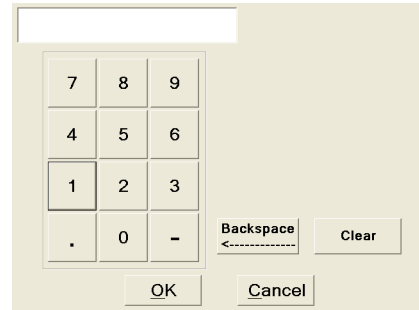

- 3a. If the login ID was accepted the **Scan Stock Bottle** screen will be displayed.
4. Return to the **Physical Inventory** section to continue with counting inventory.

3.5 Re-Train an Existing Pill Image

The trained pill image is a shadow image used as a reference for counting.

The process below is used to update existing pill images in the event the pill size/shape changes or the count is incorrect or unstable.

1. From the **Scan Stock Bottle** screen press the **ReTrain Pill** button. The button will be highlighted in green when selected.
2. Scan the stock bottle label or manually enter the NDC number. Refer to page 92 for details on how to manually enter an NDC.

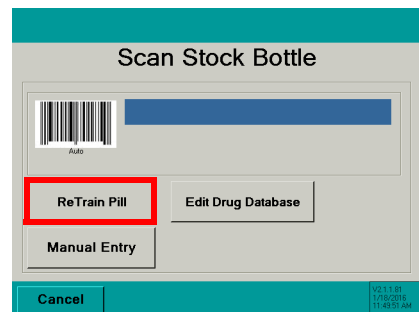

If the drug scanned is a pill or capsule press the **Train Pill** button to train the pill image. Go to Train Pill Image section on page 96.

If the drug is a unit of use (such as an ointment, cream or blister pack), press the **Hand-Count** button. Go to the Hand-Count section on the next page.



3.5.1 Train Pill Image

Two sample pills will be needed.

- Place one pill flat and the other on its edge on the pill counting platter.

If pill will not stand on edge, lay it flat.

- Press the **Train Pill** button.
- If the pills were trained properly, the pill images will be displayed. There should be a flat image and a side image of the pill. This is a correctly trained image.

- To accept the pill images, press the **Yes** button. The **Counting** screen will be displayed. Refer to the **Counting** section for more details.

If the pill images are not correct, press the **No** button. The **Train Pill Image** screen will be displayed. Go back to step 3.

The re-trained pill images will be stored to the internal database automatically after the images are accepted.

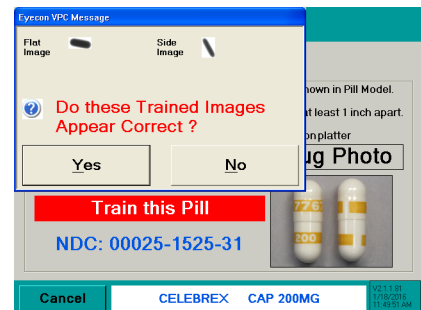

3.5.2 Train Hand-Count

- If the drug is a unit of use (such as an ointment, cream or blister pack), press the **Hand-Count** button.



- Press the **Unit Of Use** button in the top right corner.

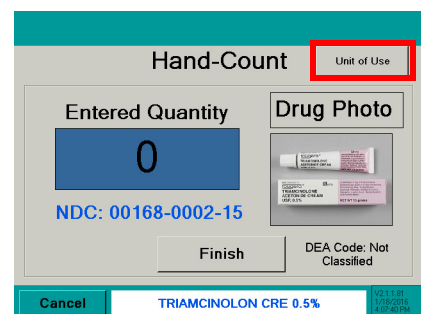

3. The unit of use value is automatically filled in (for example: 15 is for 15mg). If the value is acceptable, press the **OK** button.
- 3a. If a change needs to be made, press the **Clear** button. The entry window will be blank. Use the numeric keys to enter the correct value and press the **OK** button.
4. After the OK button has been pressed, the **Hand-Count** screen will be displayed with the entered value
5. Press **Finish** to save the entry. The screen will return to the **Scan Stock Bottle** screen.

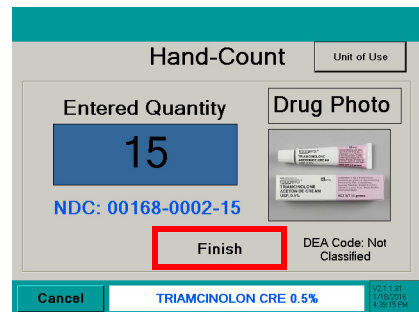
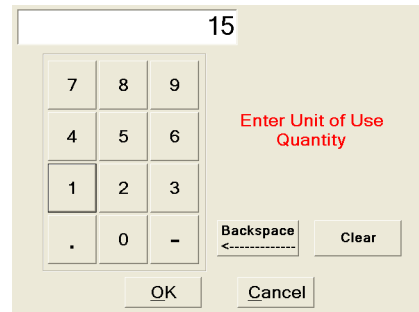

3.6 Manual NDC Entry

If the stock bottle's NDC barcode is damaged or not present, use the **Manual Entry** button to access the keyboard screen.

In addition, if the pill image is not already stored it will need to be trained by the Eyecon. Refer to page 96 for details.

1. With the keyboard, enter the stock bottle's NDC number exactly as shown on the stock bottle including the dashes. Enter the NDC number and press **OK**.

For Example:

Stock Bottle NDC = 1234-5678-90

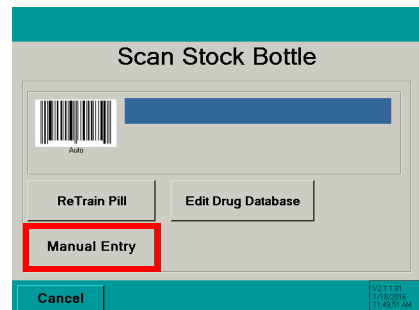

2. If the NDC number was not found in the database, the **NDC not found!** screen will be accessed. Refer to section 3.6.1 for more information.

3. If the NDC number was found in the database, the **Counting** screen will be accessed.

If the NDC number was not found the **NDC not found!** screen will be displayed. Follow the steps below to add a new NDC and drug name.

3.6.1 NDC Not Found

- 3a. If the drug entered previously was not found in the database, the **NDC not found!** screen will be displayed.
- 3b. If the NDC number is correct, press the **Accept NDC** button.

- 3c. The **Specify Drug Name** screen will be displayed. Press the keyboard icon to the right of Drug Name entry window to enter the drug name.

- 3d. Enter the drug name and press **OK**.

If **OK** is pressed without entering a Drug Name, enter it at this time.

Press **OK** to return to the **NDC not found!** screen and follow step 2.

- 3e. If the pill image was not found the **Train Pill Image** screen will appear next. Refer to page 96 for details on training a new pill image.

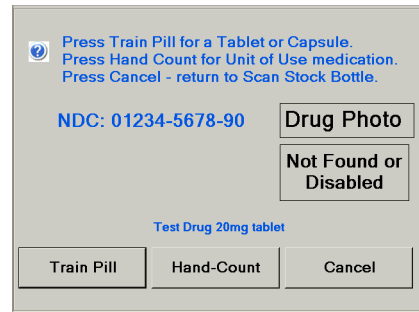

- 3f. If the drug name and pill image were found the **Counting** screen will appear next.

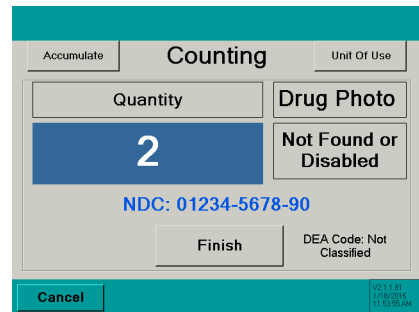

3.7 Edit Drug Database

It is possible to edit the drug name, NDC number and enable or disable the current drug photo stored in the database.

Press **Cancel** at any time to backup one screen.

1. From the **Scan Stock Bottle** screen press the **Edit Drug Database** button.
2. Scan the stock bottle label. The NDC number cannot be manually entered with this option.

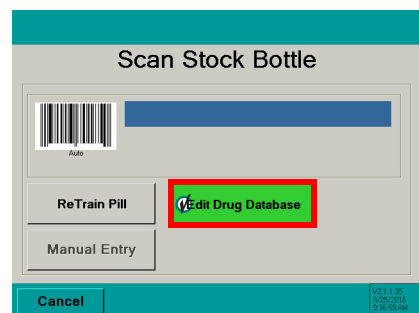

The Eyecon will look up the scanned barcode to determine the NDC and display the NDC number.

- If the NDC number is correct, press the **Accept NDC** button.
- If the NDC is incorrect, click the keyboard icon adjacent to the NDC and enter the correct value and press **OK** to continue. Press the **Accept NDC** button.

The NDC, Drug Name, Package Quantity and Drug Photo will be shown. The Drug Name and Package Quantity fields can be edited by pressing the keyboard icon to the right of the entry window.

Press the **Next** button once the information is acceptable.

The DEA code may be adjusted if the displayed DEA code is not the correct code for your particular jurisdiction.

Select the correct DEA code and press the **Back** button to update the Eyecon database.

The Eyecon will advance to the Count mode and is ready to dispense the edited NDC.

3.7.1 Drug Photo

Use Drug Photo

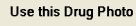
If a drug photo is shown, press the  button until highlighted in green to accept the drug photo.

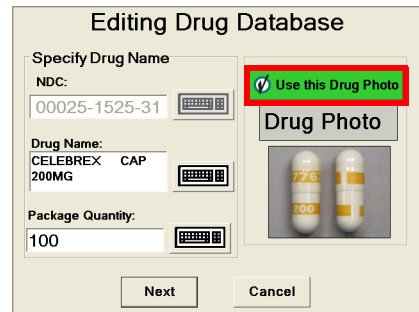

Do not Use Drug Photo

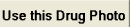
If the drug photo shown is wrong or will not be used, press the  button until it is not highlighted. If no photo is available the button will be disabled.

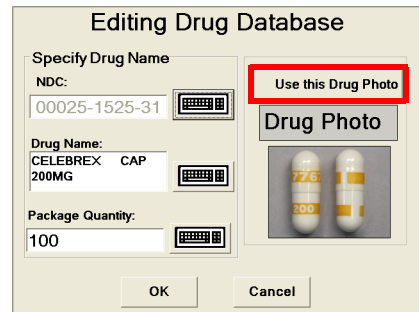

3.8 Train a New Pill

The trained pill image is a shadow image used as a reference for counting.

This method is only accessible if the pill image is not found in the drug database.

After the stock bottle is scanned and no pill image is found, the following screen will appear.

Press the  button.



Two Sample Pills will be Needed.

1. Place one pill flat and the other on its edge on the pill counting platter.
 - 1a. If pill will not stand on edge, lay it flat.
2. Press the **Train Pill** button.
3. If the pills were trained properly, the pill images will be displayed. There should be a flat image and a side image of the pill. This is a correctly trained image.
 - 3a. To accept the pill images, press the **Yes** button. The **Counting** screen will be displayed.
 - 3b. If the pill images are not correct, press the **No** button. The **Train Pill Image** screen will be displayed. Go back to step 1.

The trained images will be stored to the internal database automatically after the images are accepted.

4. The **Counting** screen will now be displayed.

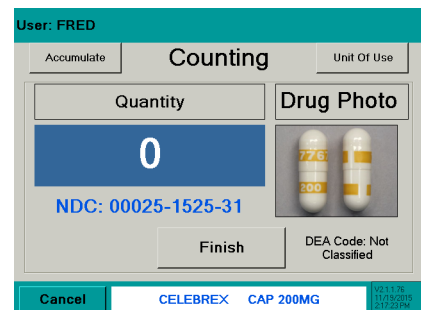
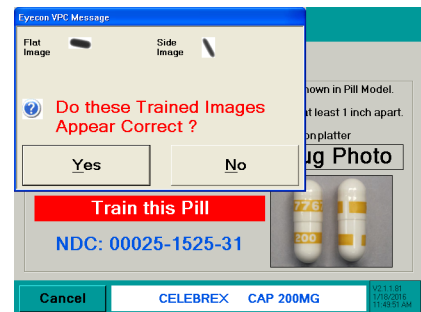

4 PMSS Modes

The following modes are available within PMSS. Each mode has the same appearance but perform differently in the background.

- Computer Rx
- Computer Rx - #2
- Cost Effective
- Eyecon Native
- HCC
- Liberty Software
- McKesson Enterprise Rx (refer to [page 117](#) for details)
- Pioneer Rx
- QS1
- Rx30 - Prism
- Rx30 #2
- Rx Safe
- ScriptPro
- ScriptPro - USB
- Speed Script
- SRS Pharmacy System

4.1 Package Settings

Set PMSS mode by following the instructions below. Refer to [chapter 2, Settings Menu](#) for more detail on system settings or to change the existing settings.

1. Press the **Settings** from the **Start-up** screen to access the settings menu.

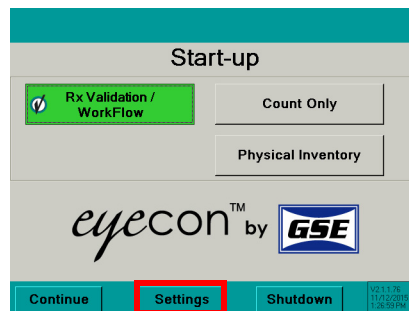

TCP/IP Setting Tab

2. Go to the **TCP/IP** tab.
3. Select the PMSS provider from the list. Use the scroll bar to view all selections.

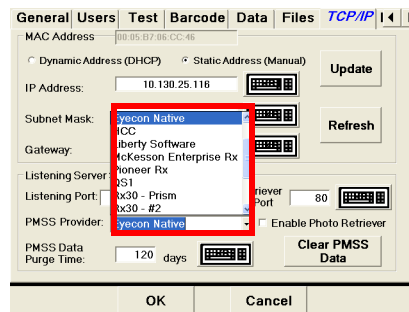

Barcode Setting Tab

4. Go to the Barcode tab.
5. Select barcode type PMSS from the drop down menu.
6. Press the **OK** to accept the changes and return to the **Start-up** screen.

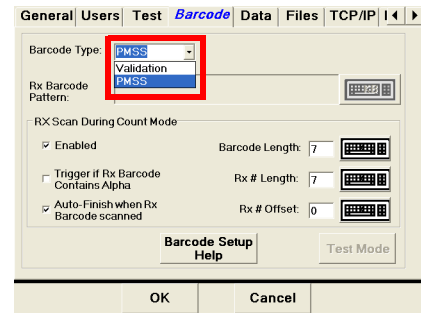

7. From the **Start-Up** screen activate Rx Validation / Workflow mode by pressing the **Rx Validation / Workflow** button. The button will be highlighted green when this mode is selected.
8. Press the **Continue** button to proceed.

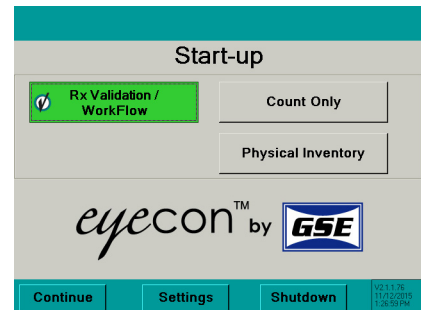

4.2 Pill Counting

Scan User Login

1. The Scan User Login feature is available for added system security. The login ID can be scanned or manually entered.

The **User Login** screen is disabled by default and can be enabled within the settings menu. See [page 28](#) for details.

- 1a. If Login was scanned or manually entered, proceed to step 4.
- 1b. If manually entering the user login number, refer to [page 111](#) for details.
- 1c. If disabled, this screen would be skipped and the **Scan Vial Label** screen will be displayed.

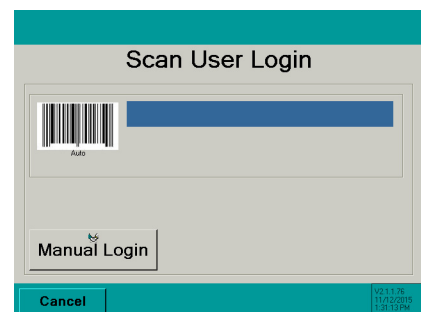

Scan Vial Label

2. Scan the 11 digit NDC barcode on the vial label or patient pamphlet.

2a. If *Scan User Login* is disabled use the **Cancel** button to return to the **Start-up** screen.

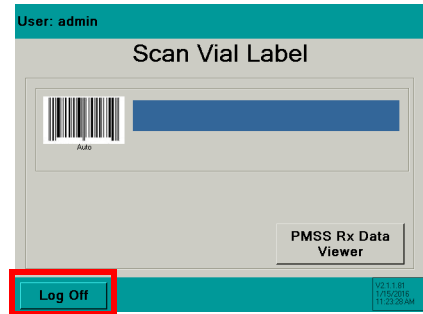

2b. If *Scan User Login* is enabled use the **Log Off** button to log off of the system and return to the **Scan User Login** screen.

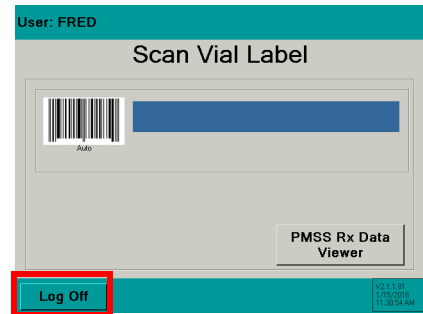

2c. If *Stock Bottle Verification* is set to **Always**, proceed to the **Scan Stock Bottle** screen.

2d. If *Stock Bottle Verification* is set to **Never**, proceed to the **Counting** screen.

2e. If *Stock Bottle Verification* is set to **User**, scan the stock bottle to proceed or press the **Skip Validation** button to proceed to the **Counting** screen.

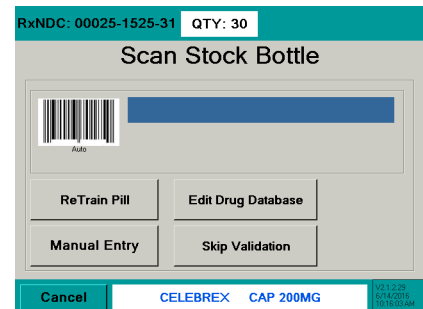

Scan Stock Bottle

3. Scan the Stock Bottle Label NDC barcode.

See [page 115](#) to train an existing pill image.

See [page 117](#) if the barcode does not scan. Refer to the Manual NDC Entry section.

See [page 29](#) to chose the stock bottle verification method.

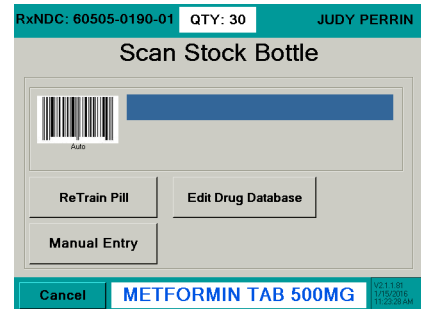

If multiple stock bottles are being used to complete a transaction, be sure to scan each one before pouring the pills on the counting platter.



If NDC information is not present in database, *NDC not found!* screen will appear. Refer to [page 112](#).

See [page 113](#) for information on how to edit the drug name, chose an NDC number or enable/disable the current drug photo.

Government Regulations

Specific size stock bottles must be used in filling prescriptions to control costs.

If a scanned stock bottle does not meet specific government requirements, a message screen will appear. It is possible to override this message by pressing or press to go back to the **Scan Stock Bottle** screen.

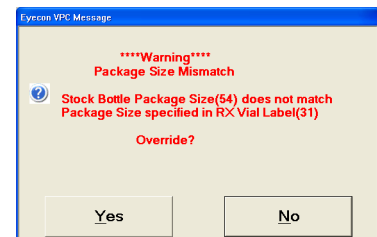

Counting

4. Pour pills onto counting platter utilizing the entire platter surface. Be sure not to stack the pills on top of each other.
- 4a. If drug photo does not exist in the Eyecon database "**Not Found or Disabled**" will appear in place of the photo.

The target quantity data can be included with the 11 digit NDC data and compiled into one barcode that is scanned. If the quantity data is included, it will be displayed in the top right corner.

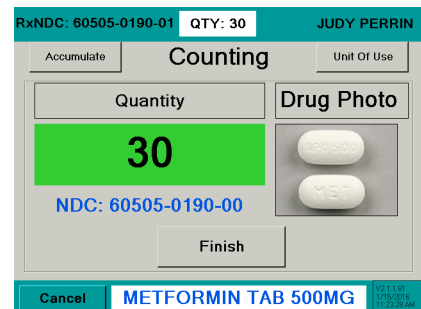

- When the **Quantity** matches the **QTY** the window will turn **green**.

- If the number of pills poured exceeds the **Qty** value, the **Quantity** window will turn **red**.

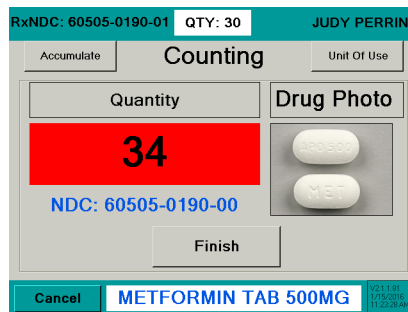

- If the number of pills poured is less than the **Qty** value, the **Quantity** window will turn **Yellow**.

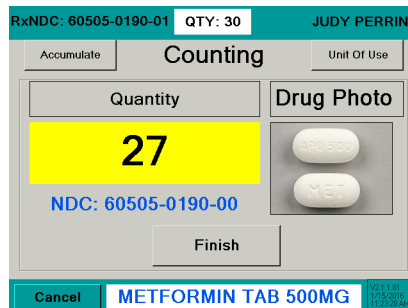

- 4b. If the **Finish** button is pressed while the pill count is out of tolerance a **Quantity Mismatch** screen will be displayed. This screen will not appear if the pill count is the same as the QTY prescribed.

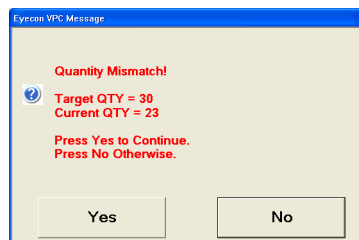

Press the **Yes** button to continue filling the prescription or press the **No** button to return to the **Counting** screen.

- 4c. If the **Finish** button was pressed with a count of 0, a message screen will be displayed. Press **Yes** to record the zero count or press **No** to cancel and return to the **Counting** screen.

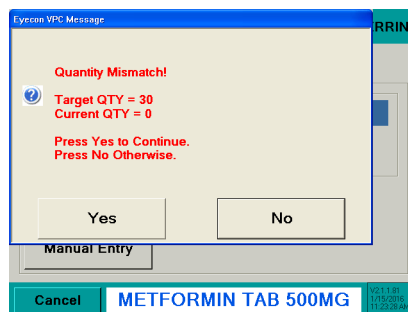

- 4d. If the pills are stacked on one another the screen may change, highlighting the position of the pills that were not able to be counted.

Lightly shake the counting platter until the pills are no longer stacked.

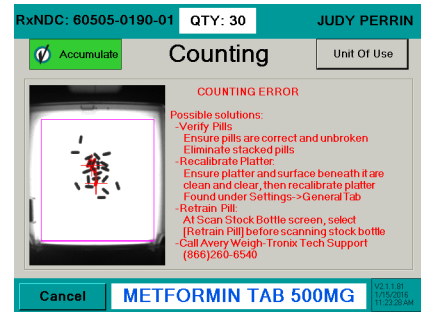

- 4e. If the required count was exceeded, remove excess pills from the platter with the spatula into the pill dispensing funnel. Place stock bottle under funnel gate and lift.

Fill Patient Vial

5. Scan another Rx NDC barcode or press **Finish** to return to the **Scan Vial Label** screen.

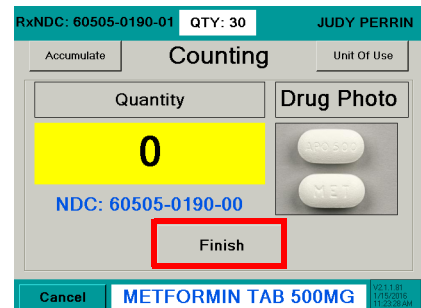

6. Dispense pills by placing the tongue of the funnel inside of the patient vial. Cup hand around the outside of the vial opening. Push the bottle up to raise the funnel gate.
7. Lift the pill counting platter upward to pour pills through the funnel into the vial.
8. Validate all pills were dispensed into vial to avoid cross contamination. Ensure funnel gate is returned to the closed position.



4.2.1 Partial Fill

If a prescription can only be partial filled at the time, the Eyecon will store the partial fill and when the remainder is ready to be filled, the prescription is recalled. Reporting must be enabled in the *Data* tab under the *Settings* menu.

1. Pour pills onto the counting platter.
2. Press the **Finish** button to record the transaction.

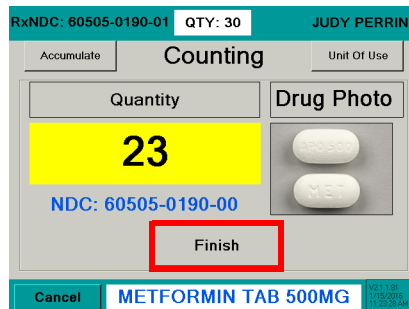

3. When the prescription can be filled, Scan the vial label.
4. Next, scan the stock bottle. A warning screen will be displayed.

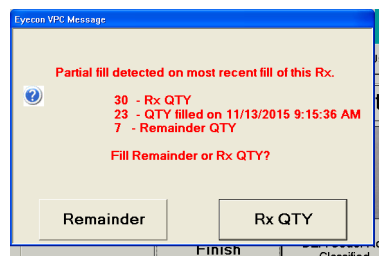

- 4a. Press the **Remainder** button to finish filling the prescription.

Add the pills and press the **Finish** button. The transaction will be recorded to the database as a completed fill.

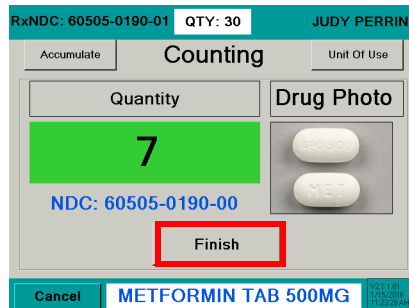

- 4b. Press the **Rx QTY** button to fill the prescribed quantity.

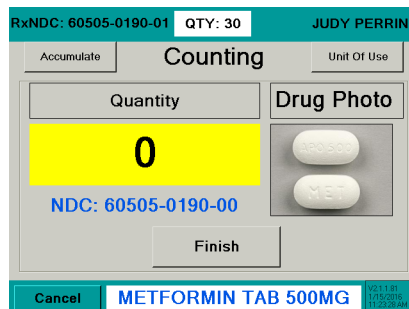

4.2.2 Unit of Use

Used to dispense a full bottle or manually entered quantity. The quantity will be recorded to the Report Database. The combining of Eyecon counted pills with the full bottle or manually entered quantity is also allowed.

1. With the pill tray empty, press the **Unit Of Use** button from the **Counting** screen.

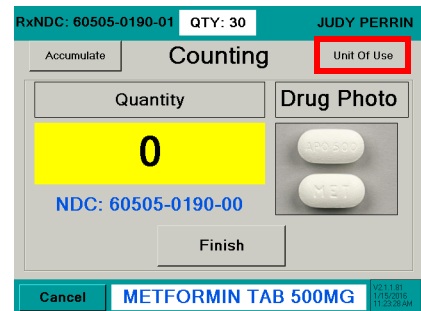

2. A keypad will be displayed. The entry window is pre-populated with the package quantity. To change the quantity, press **Clear** and enter the appropriate quantity.
3. Press the **OK** button to accept the entered quantity.

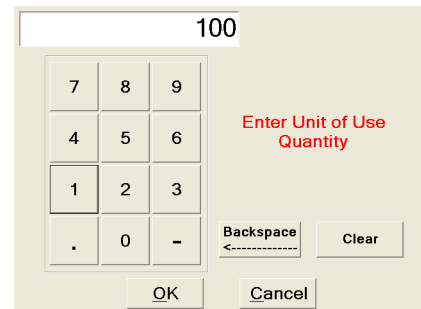

4. The screen will return to **Counting** mode with **Accumulate** turned on.
 - Add to the current quantity
or
 - Scan another bottle and pour additional pills on the tray to achieve the desired quantity.
or
 - Press the **Unit Of Use** button to include another full bottle or manually enter a quantity.

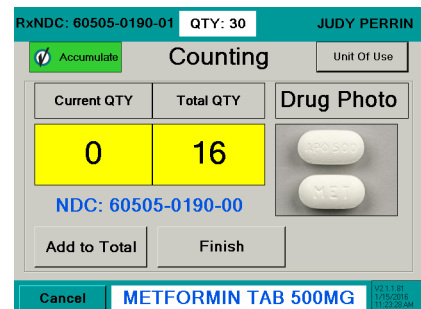

- 4a. If Reporting is enabled, press the **Finish** button and the total quantity dispensed will be recorded.
- 4b. If the package quantity is a fractional value, it is rounded off to the nearest whole number.

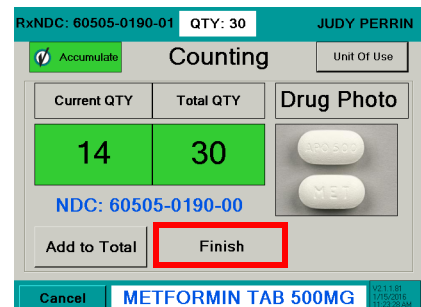

- 4c. If the total exceeds the prescribed quantity, a warning will be displayed. Press the **Yes** button to continue filling the prescription or press the **No** button to revise the quantity.

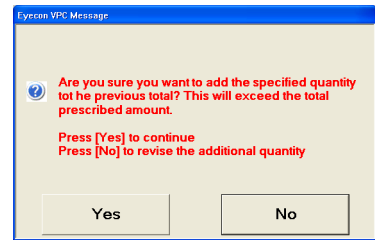

4.2.3 GPI Substitution

This mode allows a generic equivalent to be counted instead of the adjudicated NDC. A GPI equivalent can only be substituted at the initial **Scan Stock Bottle** screen. GPI Substitution must be enabled in the **General** settings tab (refer to page 29).

1. Scan stock bottle.
2. Scan generic NDC.
3. One of the following message screens will appear depending on the NDC scanned. Follow the instructions on the displayed screen.



Message Screens

When a GPI is scanned, a warning screen will appear for GPI substitution.

- At the **Scan Stock Bottle** screen, a stock bottle is scanned that is not the NDC specified. Press the **Yes** button to approve or press the **No** button to escape.
- If the stock bottle scanned is non-matching this warning will be displayed. Press the **OK** button to return to the previous screen.

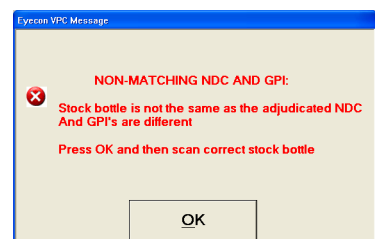
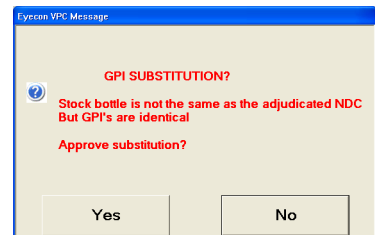

- When the last two digits of the scanned NDC (stock bottle) are different from the specified NDC. Press the **Yes** button to approve or press the **No** button to escape.

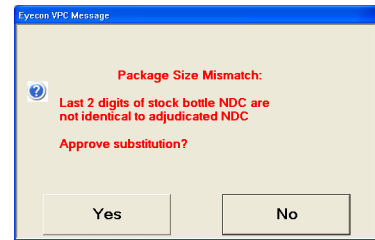

- If already in the count mode and a non-matching stock bottle is scanned with the same GPI but is a different NDC than specified. Press the **OK** button to return to the previous screen.

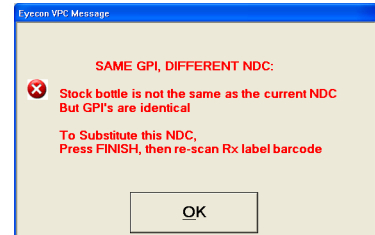

- If already in the count mode and a stock bottle with the same first 9 digits of the NDC but the last 2 digits (package size) are different. Press the **OK** button to return to the previous screen.

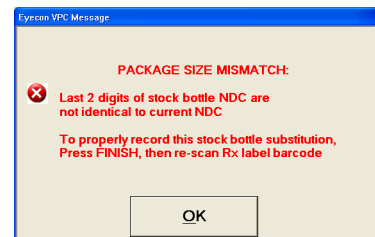

- If a stock bottle with an equivalent GPI is scanned but the GPI substitution feature is disabled. Press the **Yes** button to approve or press the **No** button to escape.

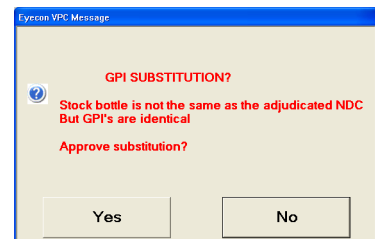

- If while using the Unit-of-Use feature and [OK] was pressed with an entry amount greater than the target quantity. Press the **Yes** button to approve or press the **No** button to escape.

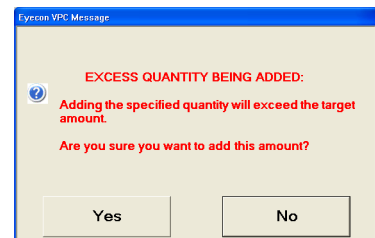

- If the [FINISH] button was pressed with a count of zero. Press the **Yes** button to record a zero value or press the **No** button to escape.

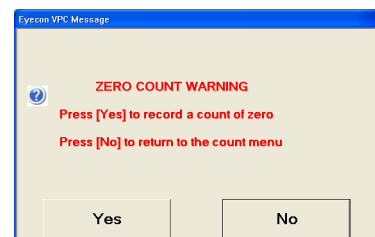

4.2.4 Hand-Count

If the drug is a unit of use (such as an ointment, cream, inhaler, syringe or blister pack) or was trained as a hand count drug, the **Hand-Count** screen will be displayed.

1. Press the **Unit Of Use** button in the top right hand corner.
2. The unit of use value is automatically filled in (for example: 15 is for 15mg). If the value is acceptable, press the **OK** button.
- 2a. If a change needs to be made, press the **Clear** button. The entry window will be blank. Use the numeric keys to enter the correct value and press the **OK** button.
3. After the OK button has been pressed, the **Hand-Count** screen will be displayed with the entered value.
4. Press the **Finish** button to save the entry. The screen will return to **Scan Stock Bottle**.
- 4a. If the **Finish** button was pressed with a count of 0, a message screen will be displayed. Press **Yes** to record the zero count or press **No** to cancel and return to the **Counting** screen.

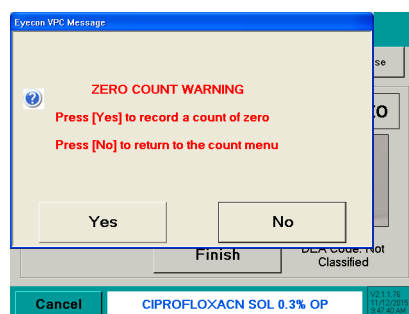
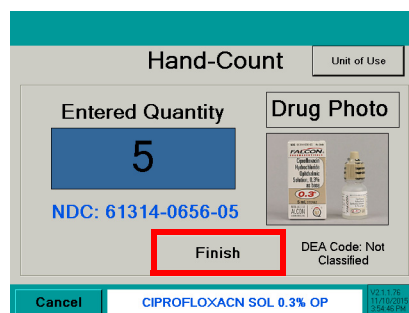
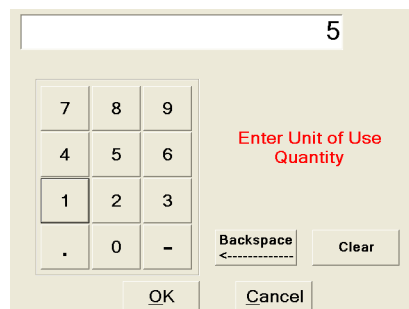
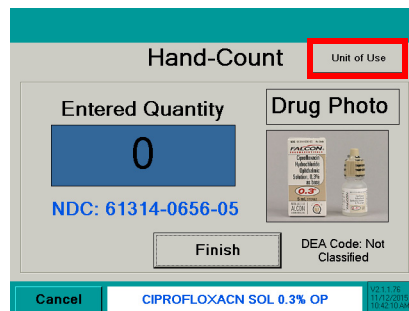

4.2.5 Accumulation

1. Press the  button. The button will turn **green** indicating that the accumulate function has been chosen.

Notice the two windows **Current QTY** and **Total QTY**. The windows will change color depending on the target quantity in the right hand corner.

yellow = below

red = above

green = target quantity.

Current QTY - The quantity currently on the counting platter.

Total QTY - Is the current quantity plus pills already counted.

- 1a. If drug photo does not exist in the Eyecon database "**Not Found or Disabled**" will appear in place of the photo.
2. Pour pills onto counting platter utilizing the entire platter surface. Make sure not to stack the pills on top of each other.

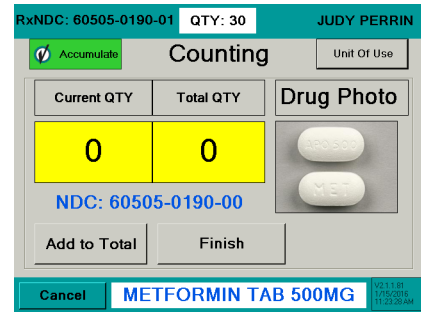

- 2a. If the pills are stacked on one another the screen may change highlighting the position of the pills that were not able to be counted.

Lightly shake the counting platter until the pills are no longer stacked.

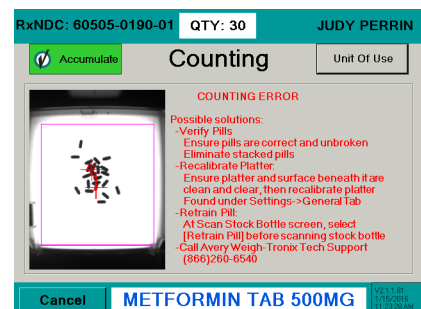

- Press the **Add to Total** button to accumulate (add) the **Current QTY** count to the **Total QTY**.

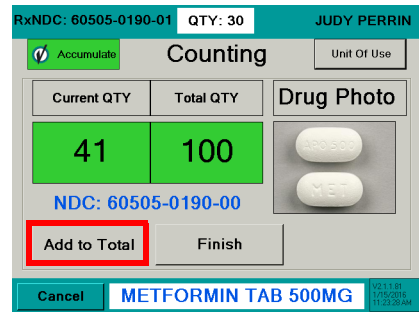

Fill Patient Vial or Return Pills to Stock Bottle

- After adding the **Current QTY** to the **Total QTY**, the following message screen will appear.



- Dispense pills by placing the tongue of the funnel inside of the patient vial. Cup hand around the outside of the vial opening. Push the bottle up to raise the funnel gate.
- Lift the pill counting platter upward to pour pills through the funnel into the vial.
- Validate all pills were dispensed into vial to avoid cross contamination. Ensure funnel gate is returned to the closed position.
- Repeat the previous steps until accumulation is finished.
- Press **Finish** to return to the **Scan Vial Label** screen.

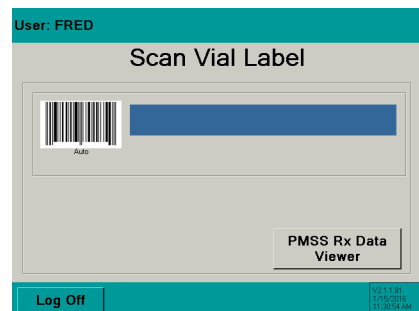

4.2.6 Manual Login

Enter a User ID number if it is unable to be scanned.

1. From the **Scan User Login** screen press the **Manual Login** button.

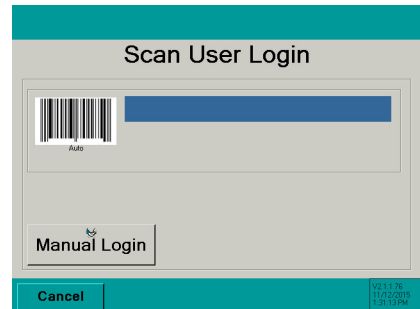

2. Key in the user login ID number with the numeric buttons.

Default code is 501812

3. Press the **OK** button to accept the entry.
 - The **Backspace** button moves the entry cursor back one space.
 - The **Clear** button clears the entire entry.
4. If the login ID was accepted the **Scan Vial Label** screen will be displayed.
5. Return to the **Rx Validation / Dispensing section**.

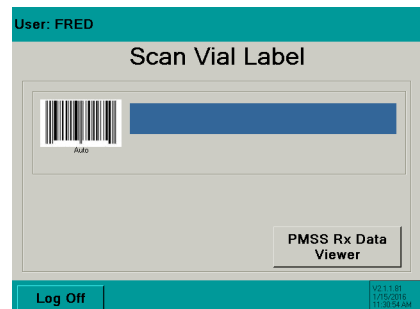
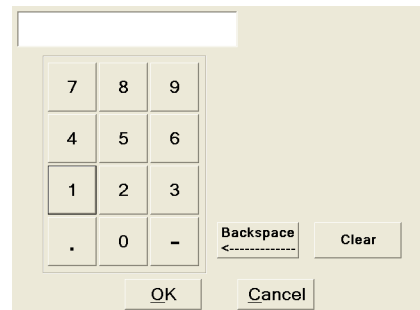

4.3 Manual NDC Entry

If the stock bottle's NDC barcode is damaged or not present, use the **Manual Entry** button to access the keyboard screen.

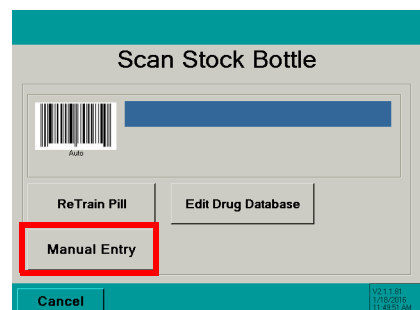

In addition, if the pill image is not already stored it will need to be trained by the Eyecon. Refer to [page 115](#) for details.

1. With the keyboard, enter the stock bottle's NDC number exactly as shown on the stock bottle including the dashes. Enter the NDC number and press **OK**.

For Example:

Stock Bottle NDC = 1234-5678-90

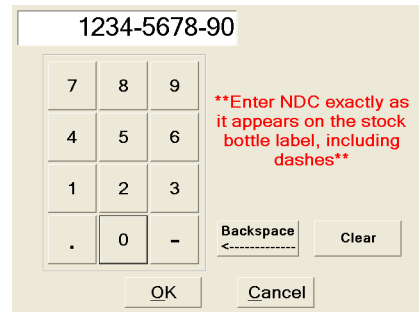

2. If the NDC number was found in the database, the **Counting** screen will be accessed.

If the NDC number was not found the **NDC not found!** screen will be displayed. Follow the steps below to add a new NDC and drug name.

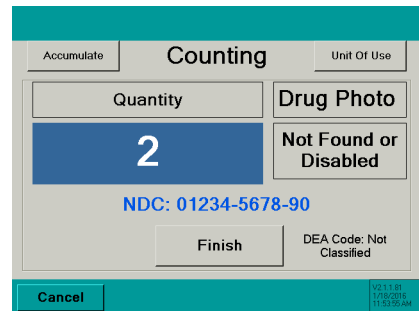

4.3.1 NDC Not Found

- 2a. If the drug entered previously was not found in the database, the **NDC not found!** screen will be displayed.
- 2b. Press the keyboard icon to the right of Drug Name entry window.

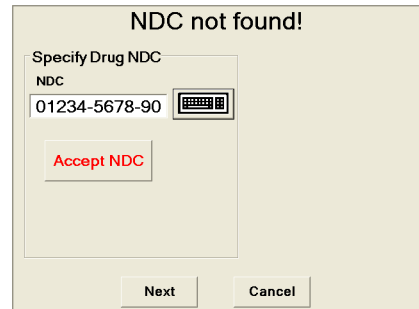

- 2c. Enter the drug name and press **OK**.
If **OK** is pressed without entering a Drug Name, enter it at this time.
Press **OK** to return to the **NDC not found!** screen and follow step 2.

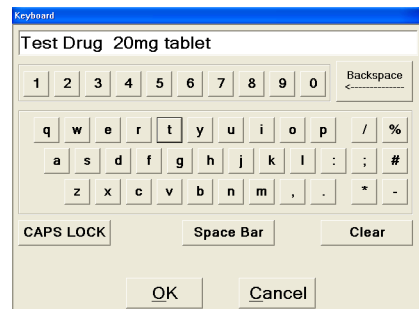

- 2d. If the pill image was not found the **Train Pill Image** screen will appear next. Refer to [page 115](#) for details on training a new pill image.

- 2e. If the drug name and pill image were found the **Counting** screen will appear next.

4.4 Edit Drug Database

It is possible to edit the drug name, NDC number and enable or disable the current drug photo stored in the database.

Press **Cancel** at any time to backup one screen.

1. From the **Scan Stock Bottle** screen press the **Edit Drug Database** button.
2. Scan the stock bottle label. The NDC number cannot be manually entered with this option.

4.4.1 Previously Entered Drug

1. Press the keyboard icon to the right of the drug name field.
2. Enter the drug name and press **OK**.
3. Press **OK** from the **Editing Drug Database** screen to continue.

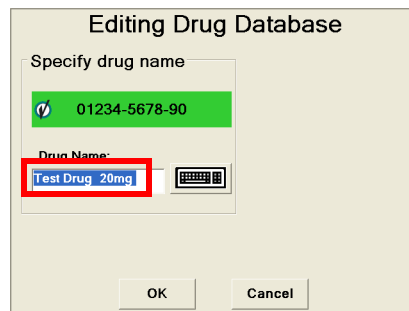

4. The **Counting** screen will be displayed.

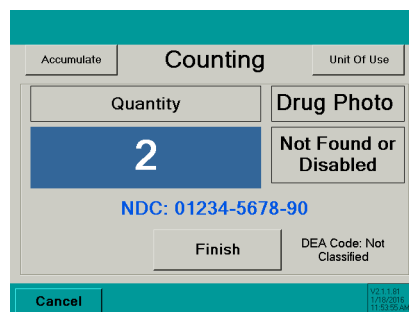

4.4.2 Drug Photo

Use Drug Photo

If a drug photo is shown, press the **Use this Drug Photo** button until highlighted in green to accept the drug photo.

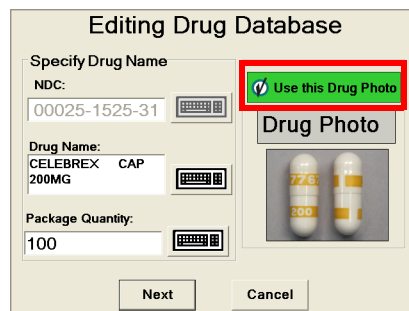

Do not Use Drug Photo

If the drug photo shown is wrong or will not be used, press the **Use this Drug Photo** button until it is not highlighted. If no photo is available the button will be disabled.

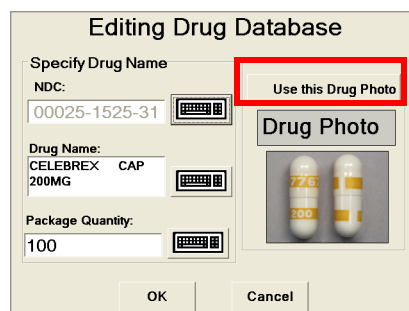

4.5 Re-Train an Existing Pill Image

The trained pill image is a shadow image used as a reference for counting.

The process below is used to update existing pill images in the event the pill size/shape changes or the count is incorrect or unstable.

- From the **Scan Stock Bottle** screen press the **ReTrain Pill** button. The button will be highlighted in green when selected.
- Scan the stock bottle label or manually enter the NDC number. Refer to page 117 for details on how to manually enter an NDC.

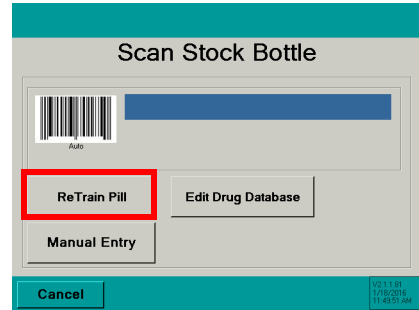

If the drug scanned is a pill or capsule press the

Train Pill button to train the pill image.

If the drug is a unit of use (such as an ointment, cream or blister pack), press the **Hand-Count** button. Go to the Hand-Count section on the next page.



4.5.1 Train Pill Image

Two sample pills will be needed.

- Place one pill flat and the other on its edge on the pill counting platter.

If pill will not stand on edge, lay it flat.
- Press the **Train Pill** button.
- If the pills were trained properly, the pill images will be displayed. There should be a flat image and a side image of the pill. This is a correctly trained image.



6. To accept the pill images, press the **Yes** button. The **Counting** screen will be displayed. Refer to the **Counting** section for more details.

If the pill images are not correct, press the **No** button. The **Train Pill Image** screen will be displayed. Go back to step 3.

The re-trained pill images will be stored to the internal database automatically after the images are accepted.

Refer to Appendix C on page 145 for information regarding recorded data and pill photo examples.

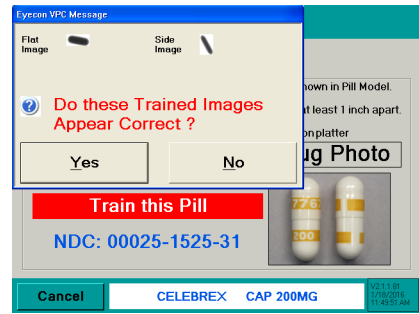

4.5.2 Hand-Count

1. If the drug is a unit of use (such as an ointment, cream or blister pack), press the **Hand-Count** button.



2. Press the keyboard icon to the right of the entry window.
- 2a. Key in the quantity with the numeric keys.
3. Press **Finish** to save the entry. The screen will return to the **Scan Stock Bottle** screen.

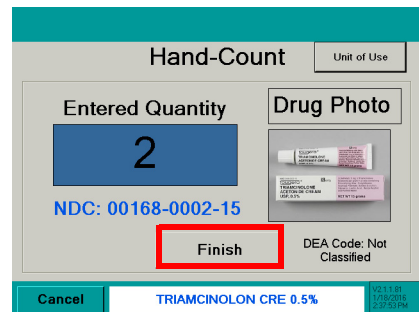

4.6 Rx PMSS Data Viewer

View Rx PMSS prescription data.

Use the **>>** button to move forward one screen or use the **<<** button to backup one screen.

Press the **Exit** button to return to the previous operating screen.

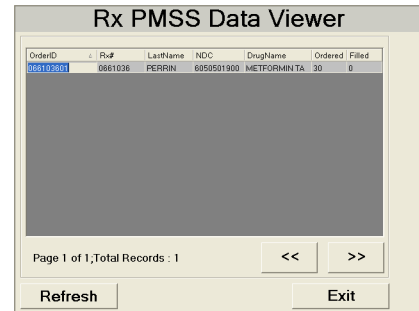

4.7 McKesson Enterprise Rx

McKesson inventory mode.

NOTE: Certain settings must be made in order to use this mode.

4.7.1 Setup

1. **Barcode** tab: Set barcode type as PMSS

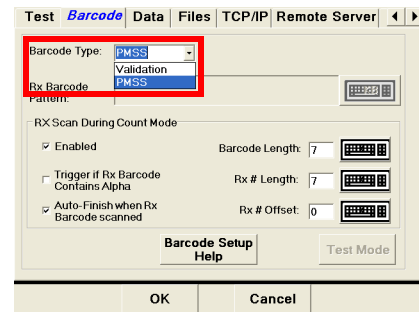

2. **TCP/IP** tab: set PMSS provider as McKesson Enterprise Rx

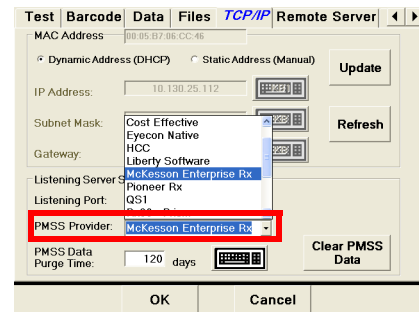

3. After making a selection press the **OK** button to accept the mode. The screen will exit to the **Start-up** screen. Press the **Settings** button to return to the settings mode.

4. **Remote Server** tab: Check enable sending inventory counts

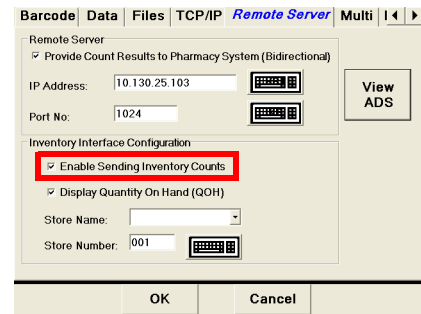

5. **Remote Server** tab: Enter store number by pressing the keyboard icon to the right of the store number. Enter the store number and press the **OK** button.
6. **Remote Server** tab: Set IP address and port number by pressing the keyboard icon to the right. Enter the number and press the **OK** button.
7. Press the **OK** button to save the changes and exit the **Settings** menu.

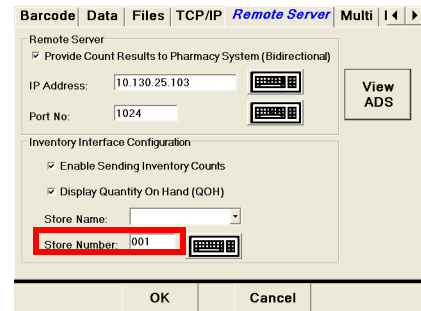

4.7.2 Access Inventory Mode

1. From the **Start-up** screen press the **Physical Inventory** button to highlight it and press the **Continue** button to access the inventory mode.

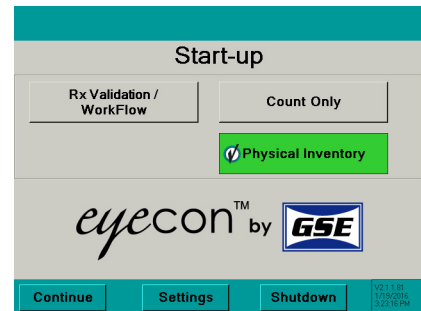

Previous Inventory Data Warning

This message will be displayed only when existing inventory data is stored in the Eyecon database and the **Physical Inventory Mode** was restarted.

If a new physical inventory is being performed press the **Delete Existing Data** button. The Eyecon will advance to the menu shown under the Data heading on [page 46](#) to delete or download the existing data.

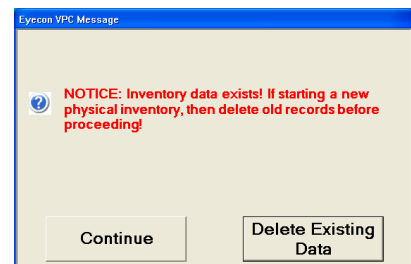

If an existing inventory is being resumed, then press the **Continue** button.

Scan User Login

2. The Scan User Login feature is available for added system security. The login ID can be scanned or manually entered.
 - The **User Login** screen is disabled by default and can be enabled within the settings menu. See [page 28](#) for details.
- 2a. If Login was scanned or manually entered, proceed to step 4.
- 2b. If manually entering the user login number, refer to [page 111](#) for details.
- 2c. If disabled, this screen would be skipped and the **Scan Stock Bottle** screen will be displayed.

Scan Stock Bottle

3. Scan the Stock Bottle Label NDC barcode.
 - See [page 117](#) if the barcode does not scan. Refer to the Manual NDC Entry section.
- 3a. If NDC information is not present in database, **NDC not found!** screen will appear. Refer to [page 112](#).
 - See [page 95](#) for information on how to edit the drug name, choose an NDC number or disable the current drug photo.



If multiple stock bottles are being used to complete a transaction, be sure to scan each one before pouring the pills on the counting platter.

4. Select an inventory adjust reason and press the **OK** button.

5. The **Scan Stock Bottle** screen will be displayed. Follow the Physical Inventory instructions starting on [page 83](#) to count inventory.

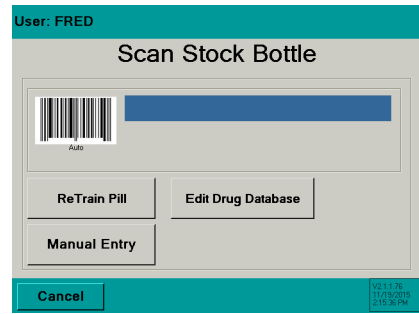

5 Workflow Mode

The Workflow mode consists of the Symphony version.

5.1 Pharmacy Package Settings

Press the **Settings** button from the **Configure Pharmacy Package** screen to access the setting choices menu.

The currently selected setting tab will be designated in **BLUE**. The following menus are available for diagnostics and configuration.

The screenshot shows a settings dialog box with three tabs: **Server** (selected and highlighted in blue), **Local TCP/IP**, and **Network Share**. The **Server** tab contains two sections:

- Workflow Server Settings:**
 - IP Address: 10.72.80.93
 - Port No: 15111
- Miscellaneous:**
 - Stand Alone Mode Enabled
 - Display Message Timeout (secs): 10

At the bottom of the dialog are **OK** and **Cancel** buttons.

After the software package settings are configured, press **OK** to return to the **Configure Pharmacy Package** screen. Press **Finish** in order to finalize the configuration. The next screen displayed will be "Are you sure?". Press **Yes** to continue or **No** to go back to the **Configure Pharmacy Package** screen.

These settings are also available after the Workflow Package is chosen. See page [132](#).

5.2 Settings

5.2.1 Server

Set the communication port settings.

Workflow Server Settings

Configure the IP address and port number of the server. If the port number is not known, contact your Network Administrator for further assistance.

Press the keyboard icon next to the port number to enter a new port number. Press **OK** to accept the entry.

Standalone Mode

If the box is checked, the Eyecon database will be used.

Display Message Timeout

Specify the amount of time in seconds in which a message is displayed. Default time is 10 seconds.

Press the keyboard icon to change the time and then press **OK** to accept the entry.

5.2.2 Local TCP/IP Settings

Primarily used when the Eyecon is integrated with pharmacy workflow software.

This tab is used for setting the IP address and Mask for the Eyecon when connected to a LAN. Consult with your Network Administrator for additional information.

The **Update** button is used to accept an entry and the **Refresh** sets the screen to factory default.

Be sure to connect a cable before pressing the **Update button, otherwise the IP address may be displayed as zeroes.**

Dynamic Address

The Dynamic address is automatically chosen by the network. The IP address is viewed under Local TCP/IP Settings.

The screenshot shows the 'Local TCP/IP Settings' dialog box. The 'Dynamic Address' radio button is selected and highlighted with a red box. The IP Address field displays '0.0.0.0'. The Subnet Mask field is empty. The 'Refresh' and 'Update' buttons are visible at the bottom of the dialog.

Static Address

The Static address is an IP address and submask that are entered by the administrator.

Enter the desired IP address and submask and press the **Update** button to save the change.

Use the **Refresh** button after network connection has been lost and reestablished to refresh the display with the IP address and submask value.

Enter a specific IP address or Subnet mask by pressing the keyboard icon to the right of the entry window.

Key in the value with the numeric keys and use a decimal point between each group of numbers. Press **OK** to accept the entry.

Example
123.10.123.1

The screenshot shows the 'Local TCP/IP Settings' dialog box. The 'Static Address' radio button is selected and highlighted with a red box. The IP Address field displays '0.0.0.0'. The Subnet Mask field is empty. The 'Refresh' and 'Update' buttons are visible at the bottom of the dialog.

5.2.3 Network Share

Set the Eyecon as the local server or shared on a network.

Local

Press the  button to use only the local Eyecon.

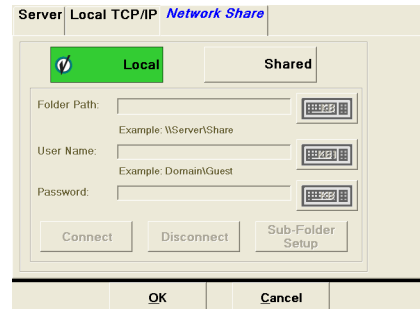

Shared

Press the  button when this Eyecon is on a shared network.

Press the  to connect the Eyecon to the network.

Press the  to disconnect the Eyecon from the network.

Press the  button to map trained images, drug photos or software updates.

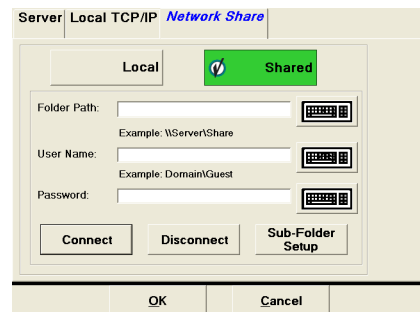

5.3 Workflow Diagnostics and Setup

Press the  button from the **Scan Label** screen or any of the counting screens to enter the setting choices menu. NOTE: the Menu button may have a different number after the v then shown in the example.

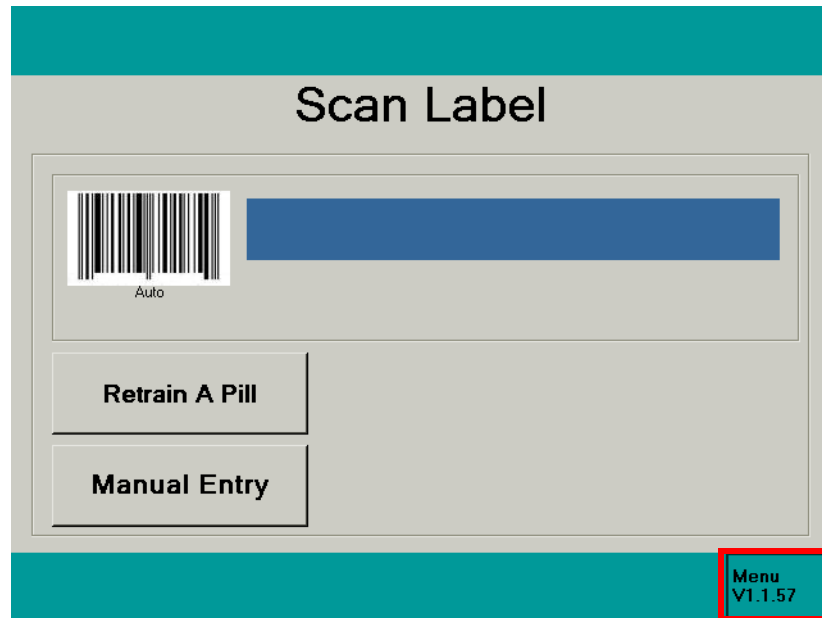

The currently selected setting tab will be designated in **BLUE**. The following menus are available for diagnostics and configuration.

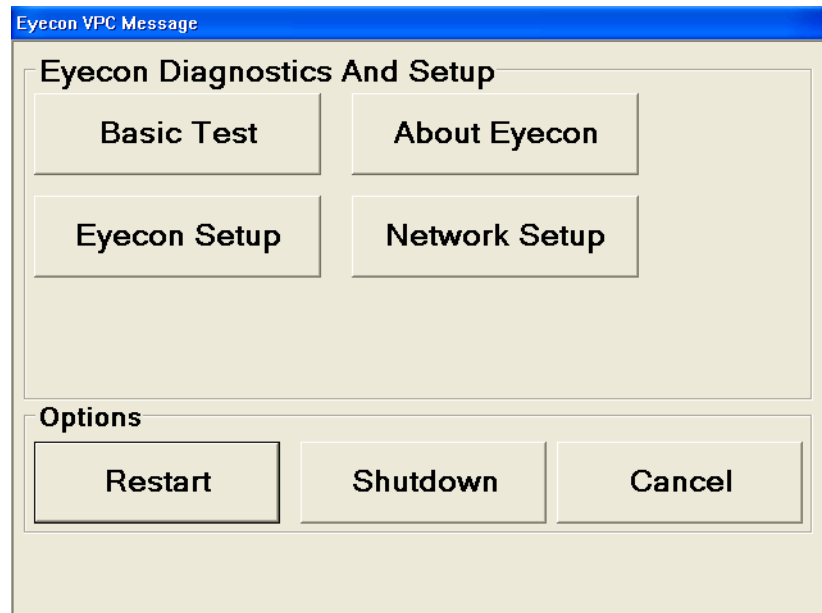

5.3.1 Shutdown or Restart



Do not unplug or shutdown the Eyecon with the power switch on the backside of the unit. This could cause corruption of files which would require the Eyecon to be returned for factory service.

The **Shutdown** button in the Start-up screen is used for restarting or turning off the Eyecon.

Again it is very important to use the **Shutdown** button to turn off the Eyecon. **DO NOT USE THE POWER SWITCHES IN THE BACK TO TURN OFF THE EYECON UNIT.**

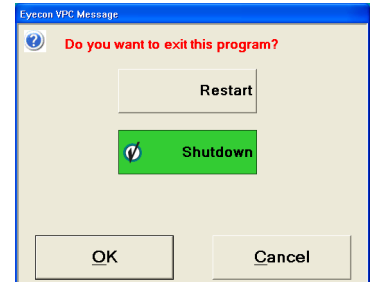

5.3.2 Restart

1. Press the **Restart** button in order to initialize a reboot sequence and return to the **Start-up** screen.
2. Press **OK** to accept.

5.3.3 Shutdown

1. Press the **Shutdown** button to turn off the Eyecon. Press **OK** to accept.
2. Press **Cancel** to terminate the process.

5.3.4 Basic Test

This selection is used for quick troubleshooting of the scanner. No administrative log in is required.

Press **Basic Test** to access the menu.

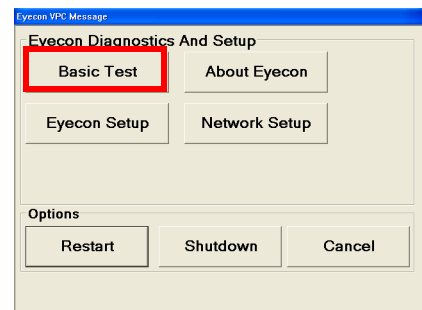

Troubleshooting

This choice is used for diagnostics of the scanner.



Test the scanner by scanning a stock bottle NDC barcode. If the scanner is operating properly, the NDC will be displayed in the blue bar.

Press the  button to clear the scan window.

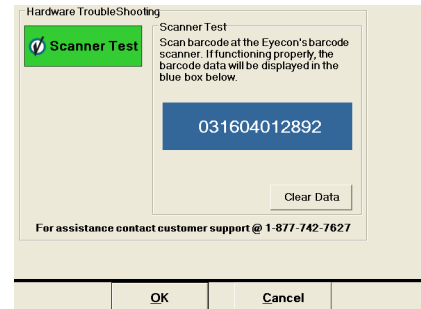

5.3.5 About Eyecon

This selection is used for quick glance of the system diagnostics.

Press  to access the information screen.

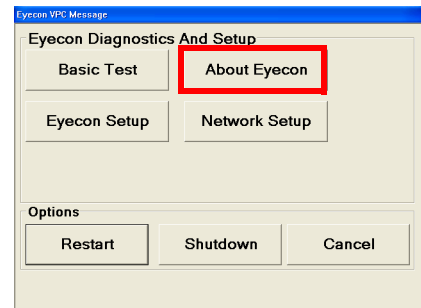

The **About Eyecon** screen shows valuable troubleshooting information such as; Eyecon software version, the current Eyecon mode being used, Medi-Span version, etc.

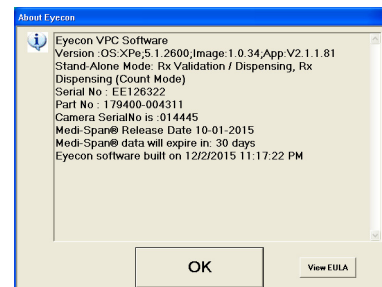

5.3.6 Eyecon Setup

This selection requires a user log in be entered before the menu is accessible.

Calibrate the counting platter, update software or troubleshoot the Eyecon's performance.

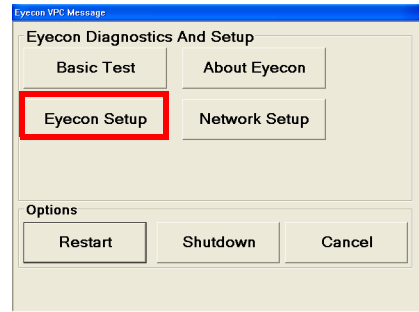

Support Logon

After the  button is pressed, the logon screen will appear.

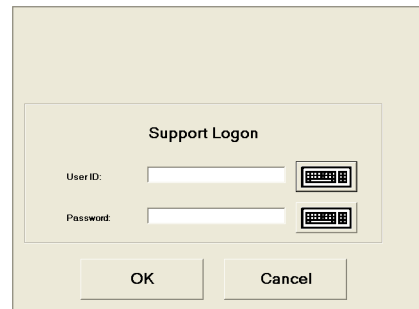

Enter a User ID or Password by pressing the keyboard icon to the right of the entry window.

Key in the correct User ID and password.

Default User ID: innovat
Default Password: gse

Press the  button to access the Advanced Support choices.

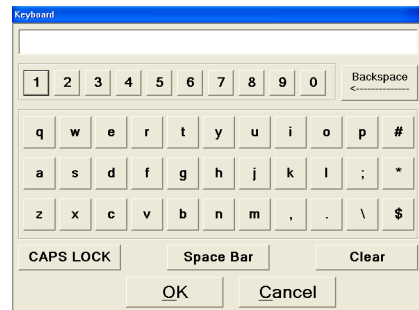

5.3.7 Common

This screen is used for calibrating the pill counting platter or updating the software. If troubleshooting system components is necessary, simply press the **Troubleshooting** tab on the screen.

Calibrate Platter

This function is used to calibrate the counting platter viewing area if the count is unstable.

Remove all foreign objects from the counting platter.

Press the **Calibrate Platter** button and the platter will be automatically calibrated by the software.

Platter calibration successful will be displayed and a beep will sound when the calibration is complete.

Press **OK** to complete calibration.

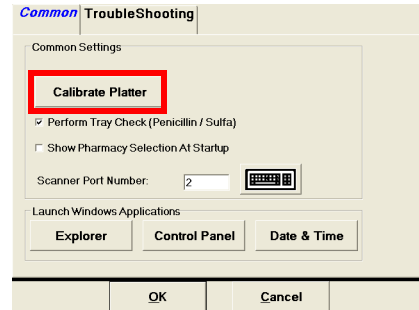

Sulfa and Penicillin Tray Calibration

Check the Perform Tray Check (Penicillin / Sulfa) box to calibration with the sulfa or penicillin trays on the platter.



*If **Unable to calibrate** message appears, clean surface of counting platter and light diffuser. Try the **Calibrate Platter** process again.*

Pharmacy Package Selection

Chose whether to display the Configure **Pharmacy Package** screen on restart or boot up.

If the box is checked the screen will be shown on power up. Otherwise the screen will be skipped and the currently selected package will be accessed.

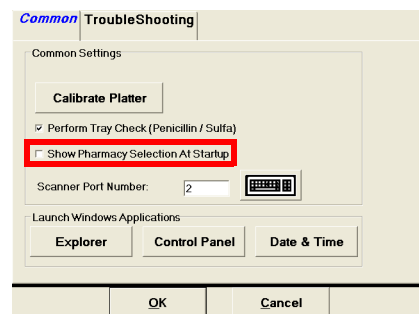

Scanner Port

Selects the port for either the internal or external scanner.



Use the keyboard icon button to the right of the scanner port window to enter the port number.

2 = internal scanner

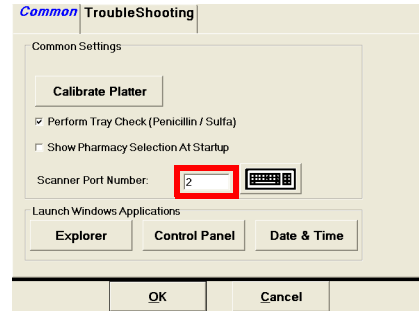
4 = external scanner



Launch Windows Applications

The choices available are Windows Explorer, Control Panel, and time & date. These will work the same as standard Windows operating system. Press the  ,  or  button to launch the application.

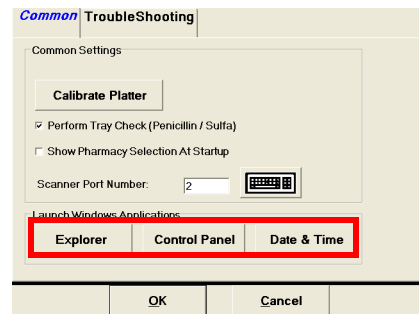

5.3.8 Troubleshooting

This tab is used for testing various hardware of the Eyecon unit. The chosen test button will be green with the check mark.



Test the scanner by scanning a stock bottle NDC barcode. If the scanner is operating properly, the NDC will be displayed in the blue bar.

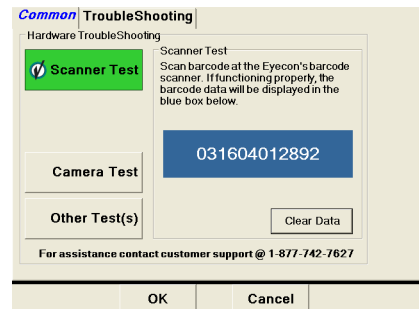

Camera Test

Verify the camera is operating properly with the camera test. Pour pills in the pill platter or hold hand over the platter to confirm an image is being displayed.

**Other Test(s)**

Additional testing modes are provided for the touch screen display and internal speaker.

Test the touch screen display to verify proper operation. Press the **Touch Screen Test** button to access the five point touch screen test.

Calibrate the touch screen display if not operating properly. Press the **Calibrate Touch Screen** button to access the calibration screen.

Test audible speaker. Press the **Speaker Test** button to test for sound.

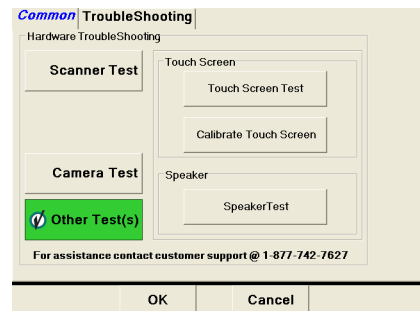
**Touch Screen Test**

Press the **Click Me (1)** button to start the test.

Continue to press the **Click Me (2)** buttons as they appear on the screen until all five have been pressed.

After the test is complete the Test tab will be displayed.



Calibrate Touch Screen

Calibrate the touch screen display. Touch the "+" on the display.

Be sure to only touch where the "+" is during touch screen calibration. Otherwise problems could occur with the display.

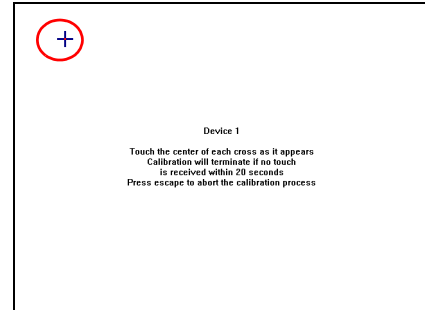

5.3.9 Network Setup

This selection requires a user log in be entered before the menu is accessible.

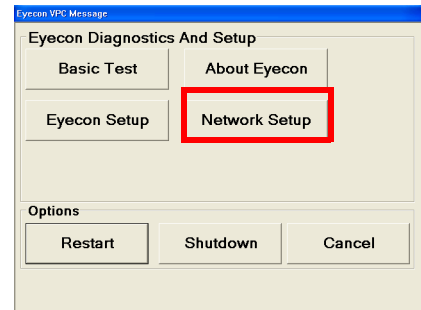

Support Logon

After the  button is pressed, the logon screen will appear.

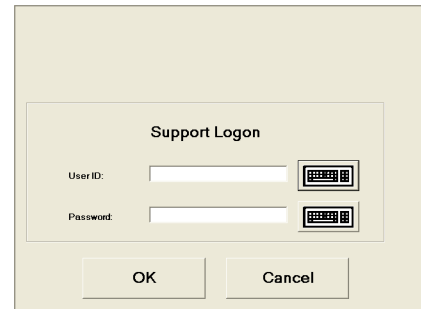

Enter a User ID or Password by pressing the keyboard icon to the right of the entry window and press .

Key in the correct User ID and password.

Default User ID: innovat

Default Password: gse

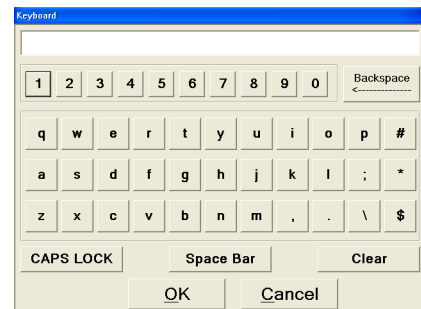

5.3.10 Server

Set the communication port settings.

Workflow Server Settings

Configure the IP address and port number of the server. If the port number is not known, contact your Network Administrator for further assistance.

Press the keyboard icon next to the port number to enter a new port number. Press to accept the entry.

Server Local TCP/IP Network Share

Workflow Server Settings

IP Address: 10.72.80.93

Port No.: 15111

Miscellaneous

Stand Alone Mode Enabled

Display Message Timeout (secs): 10

OK Cancel

Standalone Mode

If the box is checked, the Eyecon database will be used.

Server Local TCP/IP Network Share

Workflow Server Settings

IP Address: 10.72.80.93

Port No.: 15111

Miscellaneous

Stand Alone Mode Enabled

Display Message Timeout (secs): 10

OK Cancel

Display Message Timeout

Specify the amount of time in seconds in which a message is displayed. Default time is 10 seconds.

Press the keyboard icon to change the time and then press **OK** to accept the entry.

Server Local TCP/IP Network Share

Workflow Server Settings

IP Address: 10.72.80.93

Port No.: 15111

Miscellaneous

Stand Alone Mode Enabled

Display Message Timeout (secs): 10

OK Cancel

5.3.11 Local TCP/IP Settings

Primarily used when the Eyecon is integrated with pharmacy workflow software.

This tab is used for setting the IP address and Mask for the Eyecon when connected to a LAN. Consult with your Network Administrator for additional information.

The **Update** button is used to accept an entry and the **Refresh** sets the screen to factory default.

Be sure to connect a cable before pressing the **Update button, otherwise the IP address may be displayed as zeroes.**

Dynamic Address

The Dynamic address is automatically chosen by the network. The IP address is viewed under Local TCP/IP Settings.

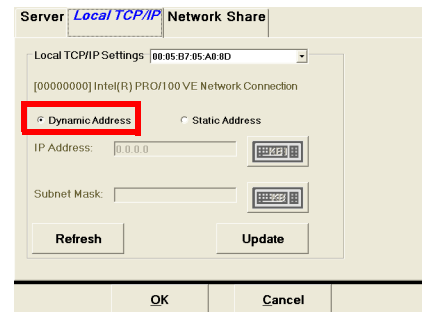

Static Address

The Static address is an IP address and submask that are entered by the administrator.

Enter the desired IP address and submask and press the **Update** button to save the change.

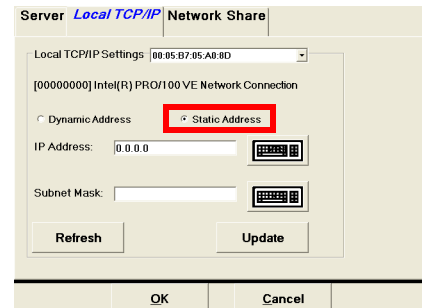

Use the **Refresh** button after network connection has been lost and reestablished to refresh the display with the IP address and submask value.

Enter a specific IP address or Subnet mask by pressing the keyboard icon to the right of the entry window.

Key in the value with the numeric keys and use a decimal point between each group of numbers. Press **OK** to accept the entry.

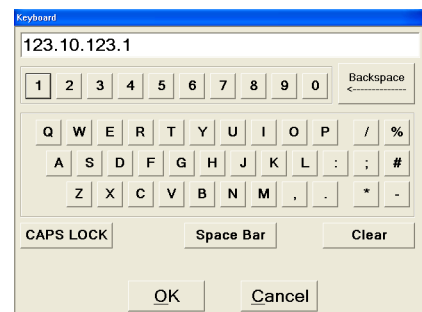

Example
123.10.123.1

5.3.12 Network Share

Set the Eyecon as the local server or shared on a network.

Local

Press the  button to use only the local Eyecon.

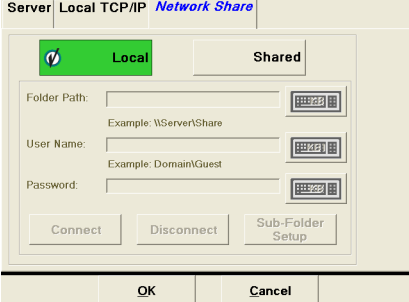



The screenshot shows the 'Network Share' dialog box with the 'Local' button selected. The 'Folder Path' field is empty, and the 'User Name' and 'Password' fields are also empty. The 'Connect', 'Disconnect', and 'Sub-Folder Setup' buttons are visible at the bottom of the dialog.

Shared

Press the  button when this Eyecon is on a shared network.

Press the  to connect the Eyecon to the network.

Press the  to disconnect the Eyecon from the network.

Press the  button to map trained images, drug photos or software updates.

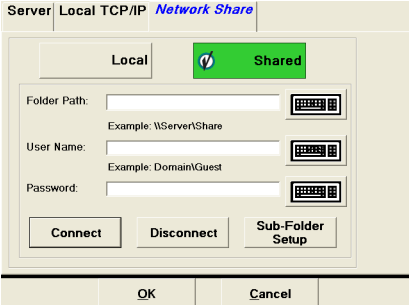

The screenshot shows the 'Network Share' dialog box with the 'Shared' button selected. The 'Folder Path' field is empty, and the 'User Name' and 'Password' fields are also empty. The 'Connect', 'Disconnect', and 'Sub-Folder Setup' buttons are visible at the bottom of the dialog.

6 Downloaded Inventory Data

The summary and transaction data can be loaded into the program of your choice such as Microsoft Excel or Works for further analysis.

6.1 Access Downloaded Files

1. Insert the USB memory stick used to download the data from the Eyecon into an available USB port of your PC. See [page 46](#) for details on downloading data.
2. Find the USB memory stick in Windows Explorer and double click on the Inventory_XXXXXX folder (where the X's represent the serial number of the Eyecon the data was extracted from).

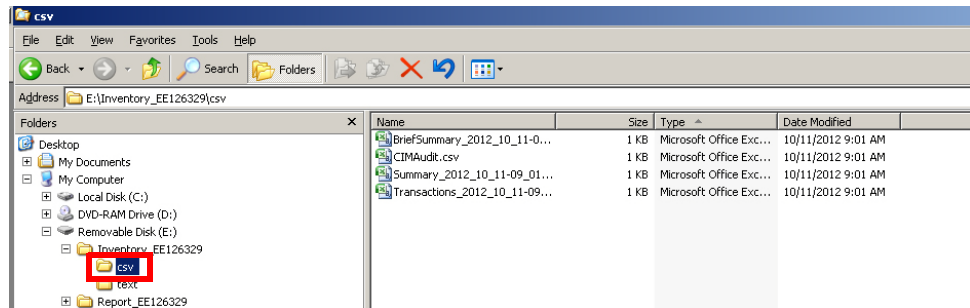

To use comma delimited files, click on the .csv folder. For text files with a pipe (|) delimiter, click on the text folder.

3. The individual data files will be displayed in the right hand pane. Double click on the file you want to open.

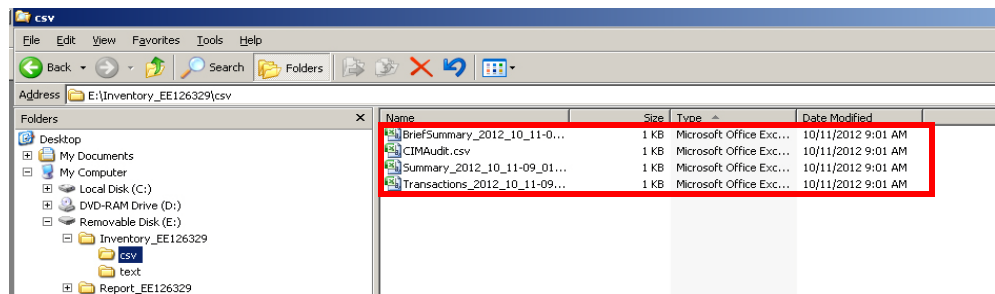

6.2 .CSV Files

Each .csv file will offer different inventory information. Refer to the following examples.

Brief Summary

The file names starting with “BriefSummary” will have the NDC and quantity counted without headings.

	A	B	C	D	E	F	G	H	I
1	25152531	264							
2	50580012603	5100							
3	54008826	10							
4	591038705	132							
5									
6									

CIM Audit

The file names starting with “CIMAudit” will have the date of transaction, NDC number and quantity counted with headings.

	A	B	C	D	E	F	G	H	I
1	Created	NDC	Qty						
2	11/19/2015	25152531	264						
3	12/3/2015	50580012603	5100						
4	12/3/2015	54008826	10						
5	1/21/2016	591038705	132						
6									

Summary

The file names starting with "Summary" will have one summary record per 11 digit NDC.

	A	B	C	D	E	F
1	Drug #	Drug Name	Quantity	# of Transactions		
2	00025-1525-31	CELEBREX CAP 200MG	264	3		
3	50580-0126-03	ASPIRIN LOW TAB 81MG EC	5100	4		
4	00054-0088-26	CALC ACETATE CAP 667MG	10	2		
5	00591-0387-05	HYDROCO/APAP TAB 7.5-750	132	2		
6						
7						

Transaction

The files beginning with "Transaction" will have one record for every bottle scanned and counted.

Transaction ID	Transaction Date	Drug #	Drug Name	Quantity	Count Method	User ID	User Name
1	11/19/2015 14:20	00025-1525-31	CELEBREX CAP 200MG	64	Eyecon	501880	FRED
2	11/19/2015 14:22	00025-1525-31	CELEBREX CAP 200MG	0	Eyecon	501880	FRED
3	11/19/2015 16:06	00025-1525-31	CELEBREX CAP 200MG	200	UnitOfUse	501880	FRED
4	12/3/2015 11:19	50580-0126-03	ASPIRIN LOW TAB 81MG EC	1800	UnitOfUse	0	None
5	12/3/2015 11:21	50580-0126-03	ASPIRIN LOW TAB 81MG EC	1500	UnitOfUse	0	None
6	12/3/2015 11:22	50580-0126-03	ASPIRIN LOW TAB 81MG EC	30	UnitOfUse	0	None
7	12/3/2015 11:30	50580-0126-03	ASPIRIN LOW TAB 81MG EC	1770	UnitOfUse	0	None
8	12/3/2015 11:43	00054-0088-26	CALC ACETATE CAP 667MG	5	Eyecon	0	None
9	12/3/2015 16:22	00054-0088-26	CALC ACETATE CAP 667MG	5	Eyecon	0	None
10	1/21/2016 10:22	00591-0387-05	HYDROCO/APAP TAB 7.5-750	81	Eyecon	501880	FRED
11	1/21/2016 10:25	00591-0387-05	HYDROCO/APAP TAB 7.5-750	51	Eyecon	501880	FRED



Excel will automatically place each record of data into a row and each field into a column, as shown in the examples above.

6.3 Text Files

Downloaded inventory data is also stored in a text format. This data can be imported into a spreadsheet.

```
Drug #|Drug Name|Quantity|# of Transactions
01234-5678-90|Test Drug 20mg tablet|4|2
00378-1052-01|ENALAPRIL TAB 5MG|98|1
00378-0018-01|METOPROLOL TAR TAB 25MG|44|1
00025-1525-31|CELEBREX CAP 200MG|177|2
```

The file is delimited by a | character which is used as a separator.

1. Open the spreadsheet program (e.g. Microsoft Excel).
2. Click on Open. A browse window will appear.

3. Highlight the desired .txt file and .click [Open.]

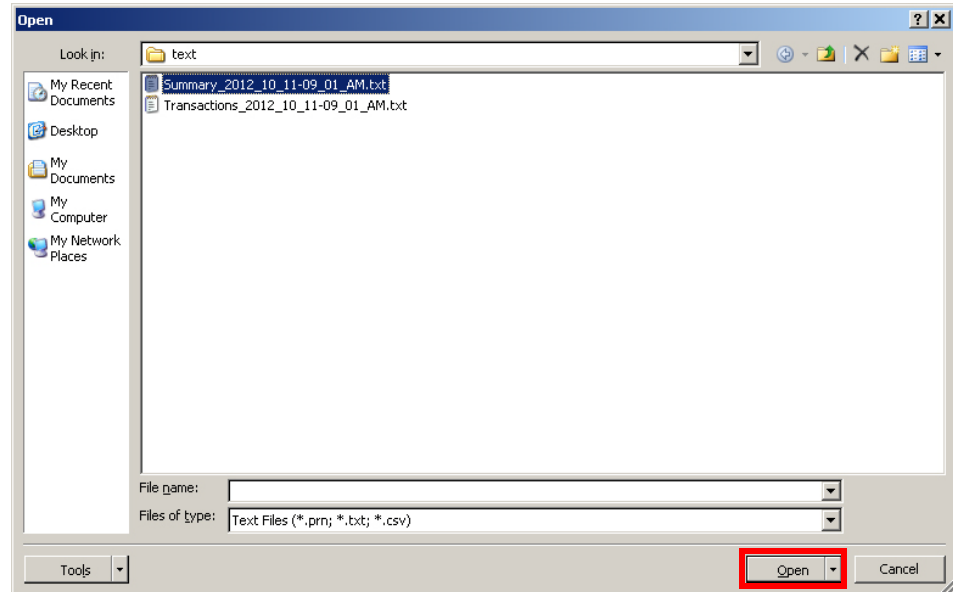

4. A file import window will appear. Delimited should be chosen. Click [Next] to proceed.

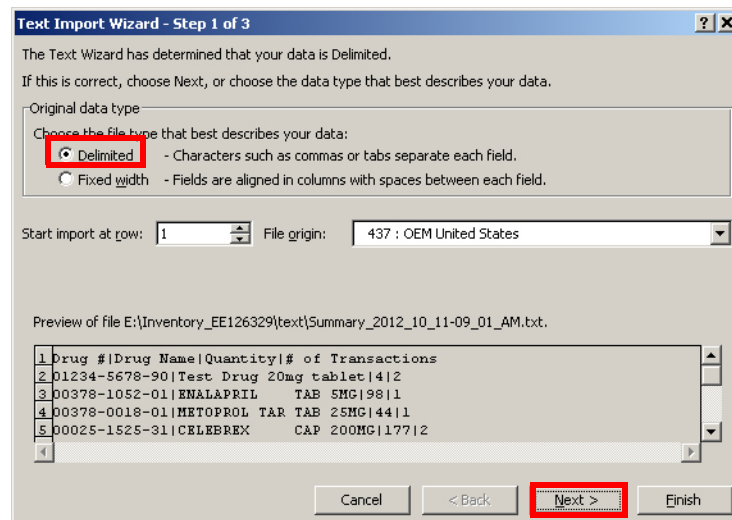

5. Uncheck **Tab** under delimiters and check **Other**. Enter a | into the box to the right of **Other**. Click [Next].

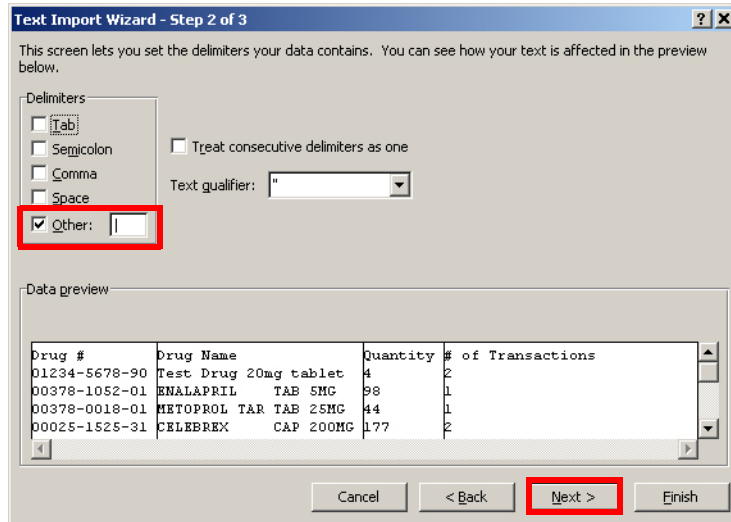

6. Be sure **General** is selected un *Column data format*. Click [Finish] to complete the import.

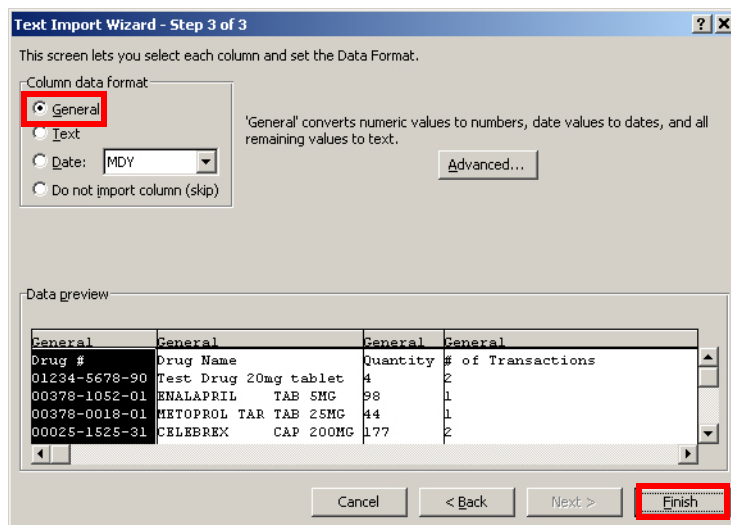

7. The file will import into Excel.

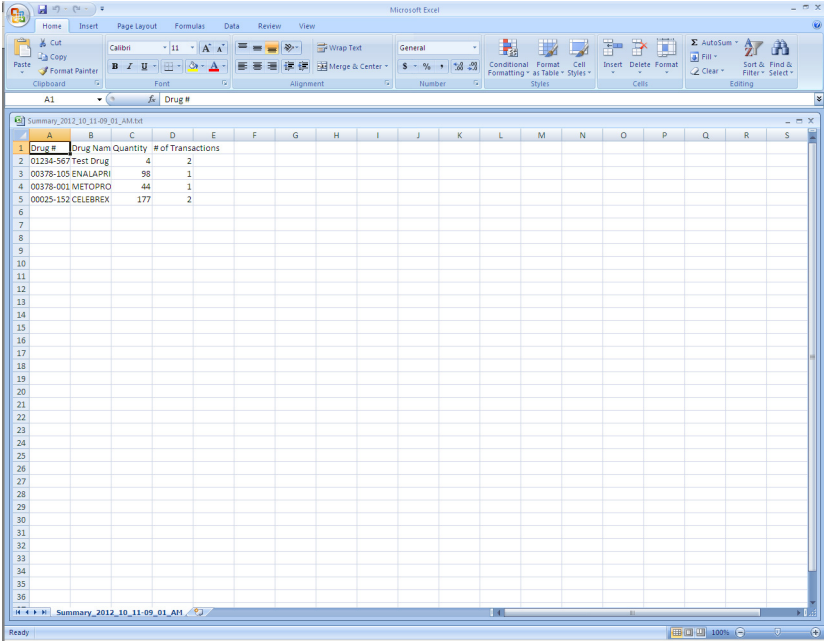

7 User Login Barcodes

Using Barcodes for User Logins

In order to simplify the login process, it is possible to create barcodes that are recognized by the Eyecon specifically as User ID labels. Any barcode that begins with the characters "ID+" followed by up to ten numeric digits will be processed as a user login. Therefore, it won't be necessary to return to the main menu in order to change users. You can simply scan a User Login label and the scanned user ID will be established as the new current user.

Any of the example labels can be scanned at the Eyecon Scanner Test menu (refer to [page 39](#)) to determine which 6 digit code it contains. The User ID's encoded in the barcode labels will still need to be entered into the User Login table as described on in each Stand-alone mode.

If you'd like to implement user barcodes in your pharmacy but don't have the resources to print custom barcode labels, you can copy the example barcodes on the next page, apply them to a small badge, and issue to your personnel. However, if you need to maintain a high level of security where ID numbers are only known by an administrator, you will need to create badges with unique login codes.

User Login Barcodes

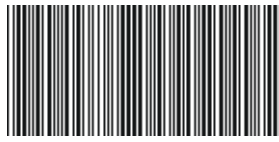
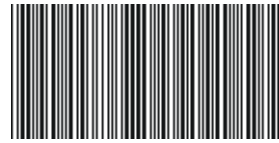
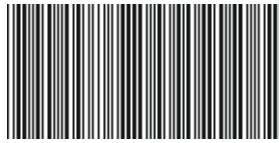
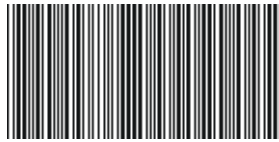

8 Report Download Data and Photos

Report data downloaded from the Rx Dispensing (Count Mode) and Rx Validation/Workflow modes utilize two methods of viewing the data.

One method is an Excel spreadsheet which includes a heading for each column. Another method is in a text file saved in a delimited format.

A picture of the pill image is included in the download as a separate .jpg file. A pill image is saved for each transaction within an Rx fill or accumulation. See examples below.

8.1 Access Downloaded Files

1. Insert the USB memory stick used to download the data from the Eyecon into an available USB port of your PC. See [page 46](#) for details on downloading data.
2. Find the USB memory stick in Windows Explorer and double click on the Report_XXXXXX folder (where the X's represent the serial number of the Eyecon the data was extracted from).

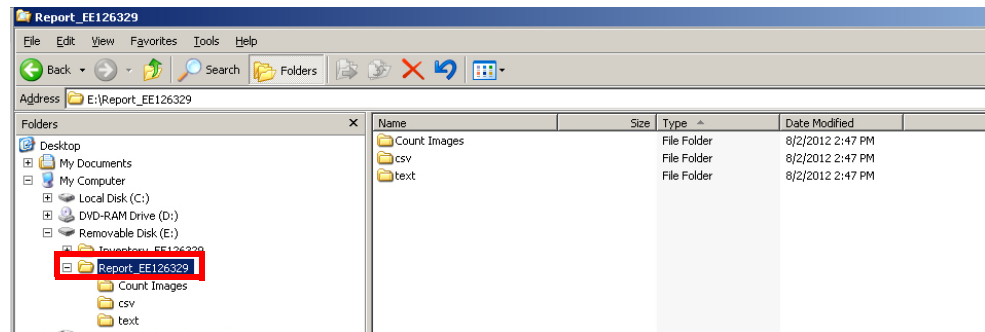

3. To use comma delimited files, click on the csv folder. For text files with a pipe (|) delimiter, click on the text folder. For tray photos, click on the Count Images folder.
4. The individual data files will be displayed in the right hand pane. Double click on the file you want to open.

8.2 Downloaded Report Data

Example of Downloaded Report Data Excel File

Transaction ID	Transaction Date	Rx #	Rx Drug #	Rx Drug Name	Target Quantity	Dispensed Quantity	Count Method	Fill Status	User ID	User Name	Stock Bottle 1 Drug # 1
1	10/4/2012 11:32	77777	25152531	CELEBREX CAP 200MG	30	30	Eyecon	Complete	501393	FRED	25152531 00025-1525-31
2	10/4/2012 12:04	88888	168000215	TRIAMCINOLON CRE 0.5%	30	30	UnitOfUse	Complete	501393	FRED	168000215 00168-0002-15
3	10/4/2012 13:30	77777	25152531	CELEBREX CAP 200MG	30	21	Eyecon	Partial	501393	FRED	25152531 00025-1525-31
4	10/4/2012 14:03	77777	25152531	CELEBREX CAP 200MG	9	9	Eyecon	Complete	501393	FRED	25152531 00025-1525-31
5	10/4/2012 14:04	88888	168000215	TRIAMCINOLON CRE 0.5%	30	30	UnitOfUse	Complete	501393	FRED	168000215 00168-0002-15
6	10/4/2012 14:20	77777	25152531	CELEBREX CAP 200MG	100	100	Eyecon	Complete	501393	FRED	25152531 00025-1525-31
7	10/4/2012 15:32	661035	60505019001	METFORMIN TAB 500MG	30	23	Eyecon	Partial	501393	FRED	6050501900 60505-0190-00
8	10/4/2012 15:33	661035	60505019001	METFORMIN TAB 500MG	7	7	Eyecon	Complete	501393	FRED	6050501900 60505-0190-00

Example of Downloaded Report Data Text File

```

Transaction ID|Transaction Date|Rx #|Rx Drug #|Rx Drug Name|Target Quantity|Dispensed Quantity|Count Method|Fill Status|User
1|10/4/2012 11:32:25 AM|77777|00025152531|CELEBREX CAP 200MG|30|30|Eyecon|Complete|501393|FRED|0025152531|00025-1525-31|
2|10/4/2012 12:04:24 PM|88888|00168000215|TRIAMCINOLON CRE 0.5%|30|30|UnitOfUse|Complete|501393|FRED|00168000215|00168-0002-15|
3|10/4/2012 1:30:03 PM|77777|00025152531|CELEBREX CAP 200MG|30|21|Eyecon|Partial|501393|FRED|0025152531|00025-1525-31|
4|10/4/2012 2:03:07 PM|77777|00025152531|CELEBREX CAP 200MG|9|9|Eyecon|Complete|501393|FRED|0025152531|00025-1525-31|
5|10/4/2012 2:04:14 PM|88888|00168000215|TRIAMCINOLON CRE 0.5%|30|30|UnitOfUse|Complete|501393|FRED|00168000215|00168-0002-15|
6|10/4/2012 2:20:09 PM|77777|00025152531|CELEBREX CAP 200MG|100|100|Eyecon|Complete|501393|FRED|0025152531|00025-1525-31|
7|10/4/2012 3:32:28 PM|0661035|60505019001|METFORMIN TAB 500MG|30|23|Eyecon|Partial|501393|FRED|6050501900|60505-0190-00|
8|10/4/2012 3:33:12 PM|0661035|60505019001|METFORMIN TAB 500MG|7|7|Eyecon|Complete|501393|FRED|6050501900|60505-0190-00|

```

8.3 Locate Tray Photo

8.3.1 Photo (Image) Numbering

The saved photos will have sequential numbers starting with '1' placed on top of each of the pills so that the count can be more easily confirmed by a pharmacist or a patient. The numbering will start in the upper left corner and numbered scanning left to right, then moving down to continue the numbering. Numbering for successive tray photos will resume at the next number from the previous photo for that Rx fill.

For example, the first image may be numbered 1 - 92, the next 93 - 172, and the final, 173 - 270, for a 270 count Rx.

8.3.2 File Names

The tray photo name is determined by which mode was used to generate the photo.

- Count Only - A sequential transaction number will be assigned as the file name. (i.e. 000001.jpg, 000002.jpg, 000003.jpg etc.)
- Rx Validation - The Rx number used will be assigned as the file name. (i.e. 77777.jpg)

- Accumulation - A sequential transaction number will be assigned as the file name followed by an underscore (_) and lower case letter starting with a for each accumulation. (000001_a.jpg).

8.3.3 Unit of Use Fill Types

There are three different scenarios for recording the unit of use fill type.

- Unit of Use - If the Eyecon did not count any pills
- Combo - If some pills were counted and some were from a full bottle
- Auto - If all pills were Eyecon counted

8.4 Rx Information on Photo (Image)

The information available for an Rx fill is included on the saved photo to be a complete record that includes everything known about the Rx, per the attached photo. However, the image may not have any pills shown if the Add to Total button was pressed with the last of the pills to be added. See the example photos below.

8.4.1 Example of Downloaded Pill Images

From Count Only Mode

Each saved photo is given a transaction number as the reference number.

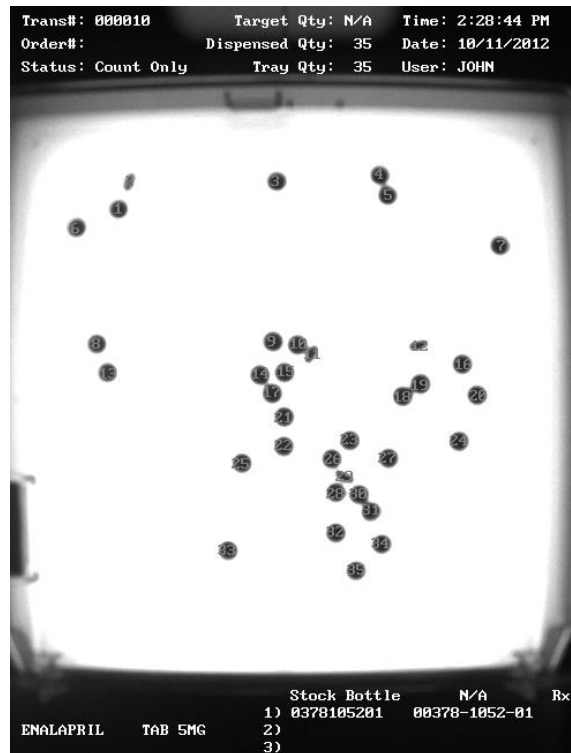

From the Rx Validation Mode

Each saved photo uses the Rx number as the reference number.

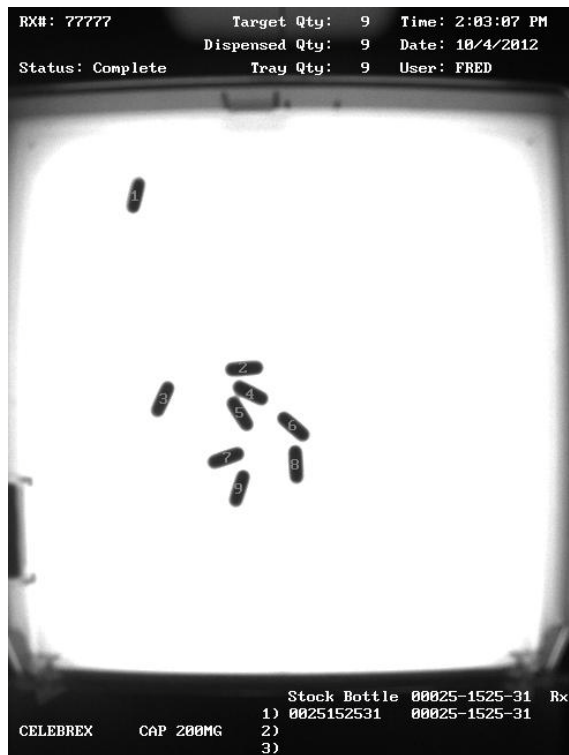
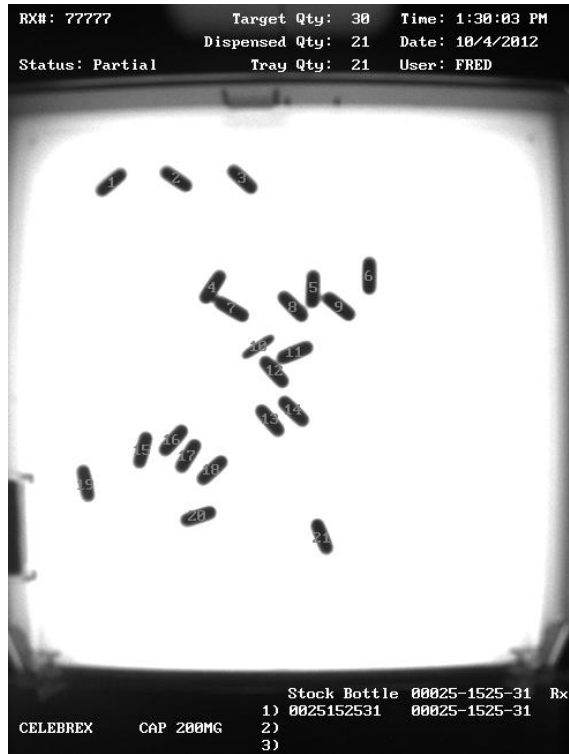

From Accumulate Mode (Rx Validation)

First Accumulation

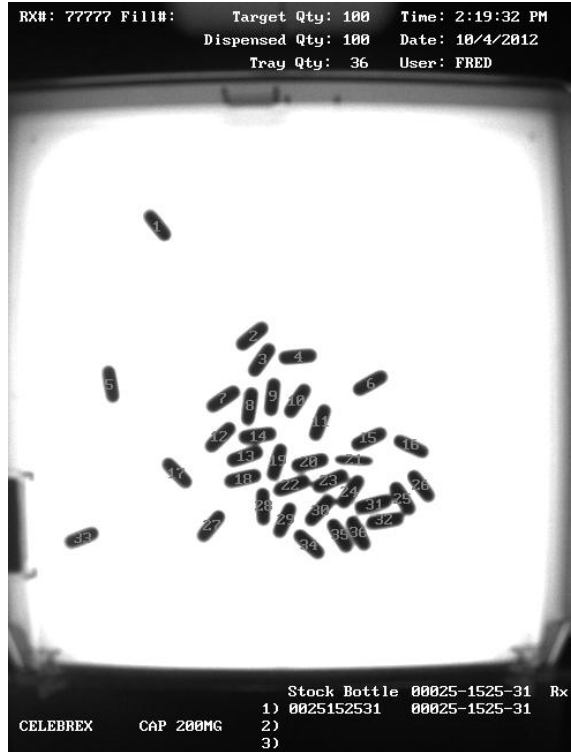

Second Accumulation

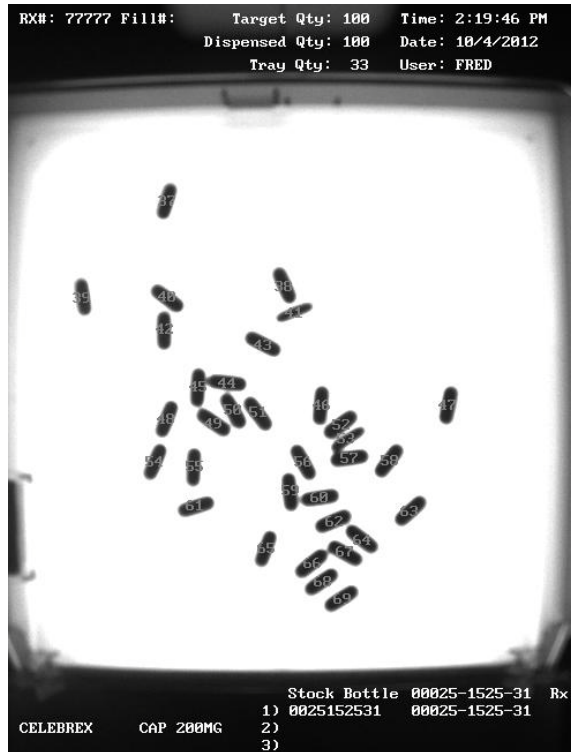

Third Accumulation



From PMSS Mode (Partial Fill)

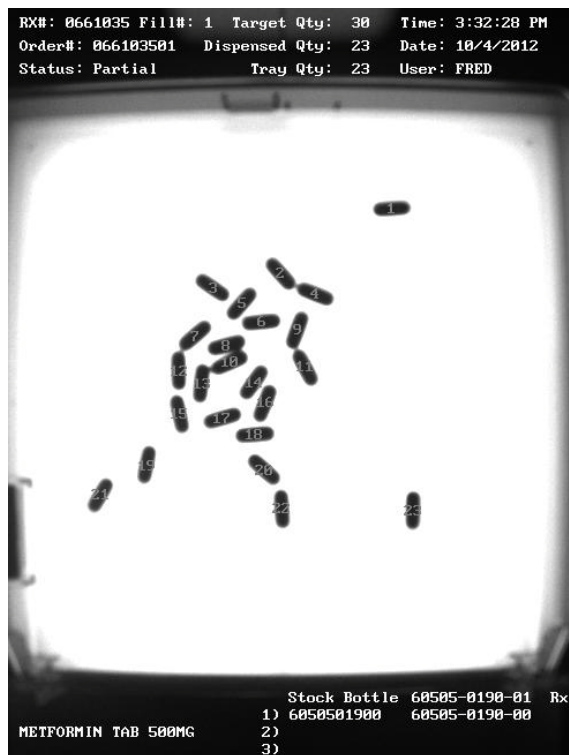

Fill Complete



Unit of Use (Full Bottle)



9 File Sharing

Share files between the Eyecon and a computer.

9.1 File Sharing Setup

Steps and needed items for file sharing setup.

9.1.1 Needed Items

- Eyecon running version 1.6.8 or later
- Ethernet cable
- Available Ethernet connection
- Windows® Based PC

9.1.2 Eyecon Setup

1. Plug in Ethernet cable into back of the Eyecon.
2. Plug opposite end of Ethernet cable into an available Ethernet port that has access to the network.
3. From the Eyecon **Start-Up** Screen press the **Settings** button.
4. Go to the **TCP/IP** Tab..
5. Ensure "Dynamic Address (DHCP)" is selected or consult your IT department about IP configuration.
6. Press the **Update** button.
7. Press the **Refresh** button.
8. Note the IP Address that is now displayed on the Eyecon:
 _____-_____-_____-_____

The screenshot shows the 'TCP/IP' configuration window with the following details:

- MAC Address: 90 85 B7 06 CC 46
- Dynamic Address (DHCP) is selected; Static Address (Manual) is unselected.
- IP Address: 10.130.25.116
- Subnet Mask: 255.255.255.0
- Gateway: 10.130.25.1
- Listening Server Settings:
 - Listening Port: 1050
 - Photo Retriever Listening Port: 80
- PMSS Provider: Eyecon Native
- Enable Photo Retriever: unchecked
- PMSS Data Purge Time: 120 days

9.1.3 Computer Setup

9. Right-click on the Start button.
10. Select "Explore All Users".
11. In the Address Bar enter "\\ followed by the Eyecon's IPAddress (as recorded above) per the picture: (NOTE: do NOT use the forward slash: '/').
12. Press the **[Enter]** key on the keyboard.

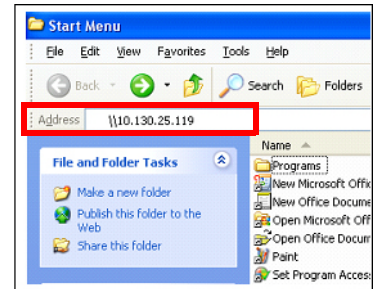

13. User name: gse Password: eyecon.
14. Check "Remember my password" box.
15. Press Enter or click OK.



16. A window should open with a GSE folder.
17. Open the GSE folder.
18. Right click on "EyeconVPC" folder.
19. Select "Create Shortcut".
20. Cut and Paste the shortcut to your desktop.
21. File sharing setup is complete.

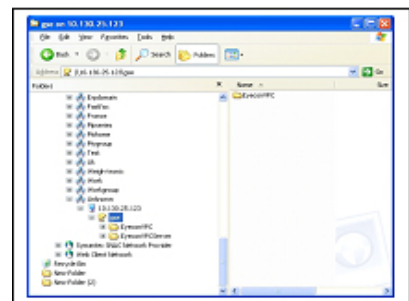

9.1.4 Adjust Back-Count Discrepancy Reasons

If setup file sharing of the Eyecon drive is on your computer, the back-count reasons may be edited on the Eyecon. Follow the instructions below.

1. Copy the shortcut to the Eyecon.
2. Add the following to the end of the shortcut path:
 Misc\BackCountReasons.txt
3. Rename the shortcut to EyeconBackCountReasons (or something you find more appropriate).
4. Click on the new shortcut, which should open Notepad on your computer. This will allow you to view and edit the file to customize your reasons and specify which reason(s) should bring up the comments editor.
5. The contents of the file are shown below. The format required in the file is specified within the file itself:

```
Back Count Adjust Reason
Back-Count Discrepancy Reasons

1) Initial Back Count | |
2) Prior xfer not done on Eyecon || C
3) Stock Bottle Short | | C
4) Stock Bottle Over | | C
5) Dropped Pill(s)
END
```

Notes:

- Any text past the 'END' marker is ignored by the Eyecon.
- 1st line text should not be changed. It identifies the file type.
- 2nd Line contains the title text. Whatever is on the 2nd line will be displayed as the title when these choices are displayed.
- Subsequent lines contain the selectable choices for this menu.
- Line Numbers are optional can be any value and are not displayed.
- The pipe (|) character separates the reason description and the adjustment sign.
- Valid adjust signs are '+', '-', and 'o' or 'over-write'; (These apply to Inventory adjusts ONLY)
- If a 2nd pipe character exists, then a 'C' or 'Comment' may follow it.
- If the selected reason code has a 2nd pipe followed by a 'C' or 'Comment' then after pressing FINISH, the user is prompted to key in a comment (or scan in a value such as an order # for receipts, or any other barcoded value)

10 Audit Reports

Audit reports can be viewed from the Eyecon display, copied to a computer via USB memory stick or sent over the pharmacy Ethernet connection.

The report automatically starts with the most recent data.

10.1 Access Eyecon Auditor from the Start-up Screen

1. Press the **Settings** button from the **Start-up** screen.
2. Select the **Data** tab.
3. Press the **Audit Report Data** button.

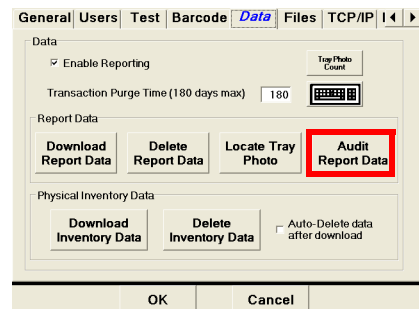

4. Once selected the Eyecon Auditor menu appears.

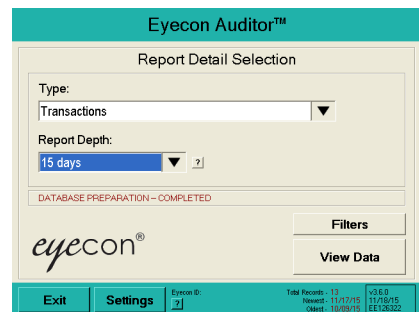

10.2 Initial Use

The first time you use the Auditor, it is suggested the Eyecon be named. This will ensure that any reports saved are appropriately named so the source of the data can be identified.

1. Press the **Settings** button.

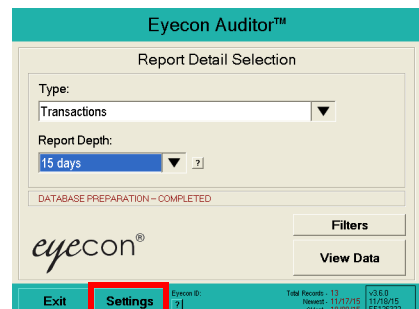

- Press the keyboard icon and type in a unique name for this Eyecon, such as Store123, then press the **OK** button. There should be no spaces or special characters in the name.
- Press the **Back** button to return to the **Eyecon Auditor** screen.

General Settings

Transaction Filters

Eyecon ID: STORE 123

Rx Entry: Alpha-Numeric

Back

10.3 Specify and View a Report

- Select the desired report type with the drop down menu (only Transaction and Daily Usage by Count type at this time).
- Specify the depth of the report (how far back prior to the newest record you would like included in the report) with the drop down menu.
- Select the filters by pressing the **Filters** button. The **Transaction Report Filters** screen will be displayed.
- After selecting the desired filters, press the **Back** button to return to the **Eyecon Auditor** screen.
- Press the **View Data** button to run the report. This could take a while depending on the size of the report.

Eyecon Auditor™

Report Detail Selection

Type: Transactions

Report Depth: 15 days

DATABASE PREPARATION - COMPLETED

eyecon®

Filters

View Data

Exit Settings

Transaction Report Filters

Transaction Filters

Rx#: NDC Dispensed: NDC#:

Order ID: Count Method: Eyecon

DEA Class: Use Size Diff

Fill Status: Quantity:

Back

Eyecon Auditor™

Report Detail Selection

Type: Transactions

Report Depth: 180 days

DATABASE PREPARATION - COMPLETED

eyecon®

Filters

View Data

Exit Settings

- The report will be displayed according to the filters set. Use the scroll bars on the bottom and side of the screen to view the entire report.

Transactions

Rx#	Rx NDC	Drug Name	UPC Dispensed	NDC Dispensed	Target Qty	Dispensed Qty
77777	00054-2795-25	OXYCODIAP	00054279525	00054-2795-25	40	30
77777	00054-2795-25	OXYCODIAP	00054279525	00054-2795-25	30	30
77777	00054-2795-25	OXYCODIAP	00054279525	00054-2795-25	30	30
77777	00054-2795-25	OXYCODIAP	00054279525	00054-2795-25	70	70
77777	00054-2795-25	OXYCODIAP	00054279525	00054-2795-25	30	30
77777	00054-2795-25	OXYCODIAP	00054279525	00054-2795-25	30	30

Period: 11/03/15 thru 11/7/15 Audit Records: 6

View Tray Photos

- To view a specific tray photo, select the specific record and press the button.

Transactions

Rx#	Rx NDC	Drug Name	UPC Dispensed	NDC Dispensed	Target Qty	Dispensed Qty
77777	00054-2795-25	OXYCODIAP	00054279525	00054-2795-25	40	30
77777	00054-2795-25	OXYCODIAP	00054279525	00054-2795-25	30	30
77777	00054-2795-25	OXYCODIAP	00054279525	00054-2795-25	30	30
77777	00054-2795-25	OXYCODIAP	00054279525	00054-2795-25	70	70
77777	00054-2795-25	OXYCODIAP	00054279525	00054-2795-25	30	30
77777	00054-2795-25	OXYCODIAP	00054279525	00054-2795-25	30	30

Period: 11/03/15 thru 11/7/15 Audit Records: 6

- The tray image will be displayed. If more than one image is available, use the arrows to scroll to the other images.

Press the button to save the displayed photo and the last viewed report to the Eyecon.

Press the  button to zoom the photo.

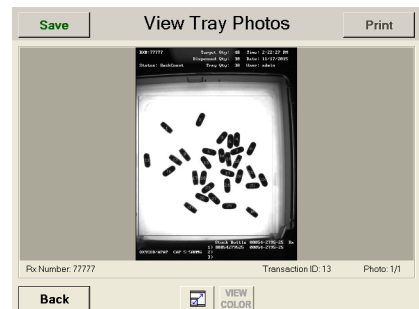

- Press the button to return to the report **Transactions** screen.

Transactions

Rx#	Rx NDC	Drug Name	UPC Dispensed	NDC Dispensed	Target Qty	Dispensed Qty
77777	00054-2795-25	OXYCODIAP	00054279525	00054-2795-25	40	30
77777	00054-2795-25	OXYCODIAP	00054279525	00054-2795-25	30	30
77777	00054-2795-25	OXYCODIAP	00054279525	00054-2795-25	30	30
77777	00054-2795-25	OXYCODIAP	00054279525	00054-2795-25	70	70
77777	00054-2795-25	OXYCODIAP	00054279525	00054-2795-25	30	30
77777	00054-2795-25	OXYCODIAP	00054279525	00054-2795-25	30	30

Period: 11/03/15 thru 11/7/15 Audit Records: 6

- Press the **Back** button again to exit to the **Eyecon Auditor** screen.



- Press the **Exit** button from the main Audit menu when done viewing. You will be prompted to save the Audit file to a USB memory stick. Insert a USB drive and press **Yes**. Otherwise press **No** to exit.

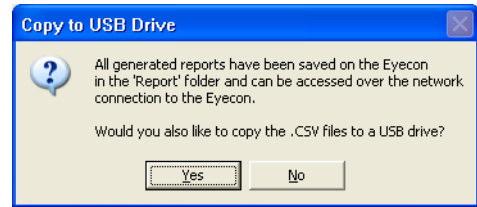

10.3.1 Accessing the Saved Photos and Reports

- Insert the USB drive into your computer USB drive slot.
- Open Windows Explorer.

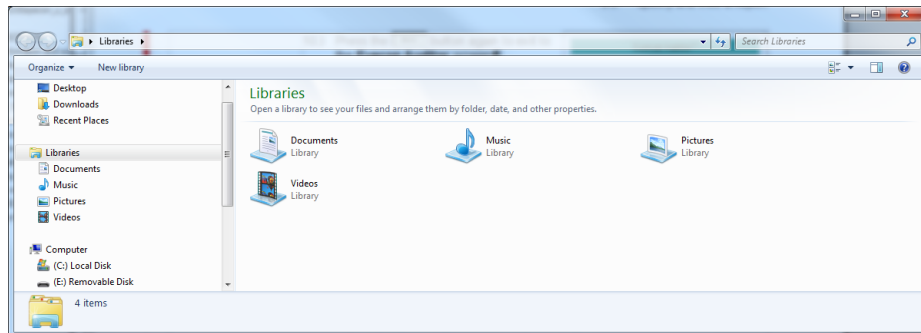

- Click on the drive letter of the USB drive in the left window. The drive letter should be highlighted.

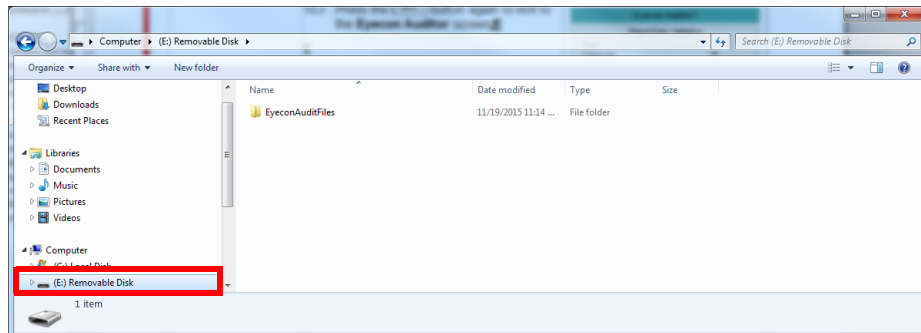

4. In the right window is a folder named "EyeconAuditFiles'. Double click on this folder to open it.

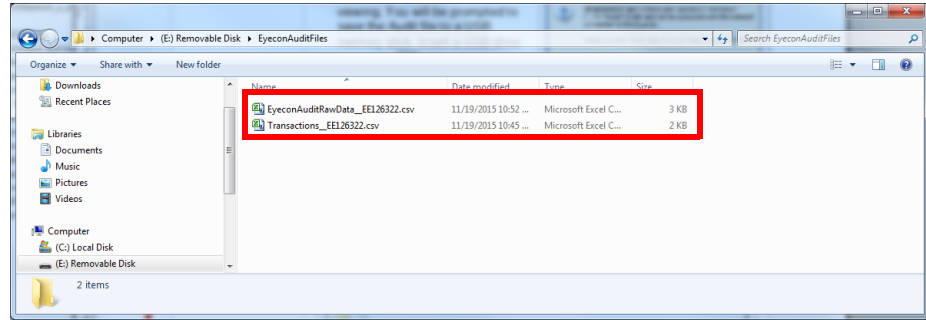

5. Double click on the desired file to open. The file will automatically open in Excel.

11 Accuracy Verification Procedure

In order to confirm that counts provided by the Eyecon are accurate, it is recommended to follow the procedure below on a monthly basis, or whenever there is any question regarding the accuracy.

This check may be required by some states' Boards of Pharmacy.

1. Clean the Eyecon pill platter, top and bottom, as well as the surface below the tray to remove any pill dust build-up.

2. From the Eyecon **Start-Up** screen, press the **Settings** button.

3. Select the **General** tab.

4. Press the **Calibrate Platter** button and the platter will be automatically calibrated by the software.

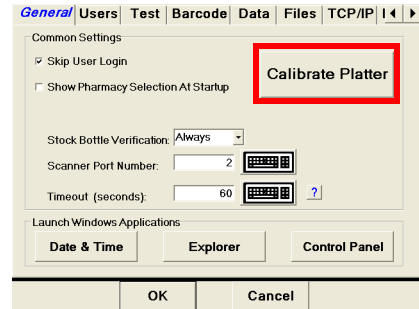

5. Platter calibration successful will be displayed when the calibration is complete.

6. Press **OK** to accept the calibration.

7. Press **OK** to exit the Settings mode.

8. From the Eyecon **Start-Up** screen, press the **Count Only** button.

9. Press the **Continue** button.

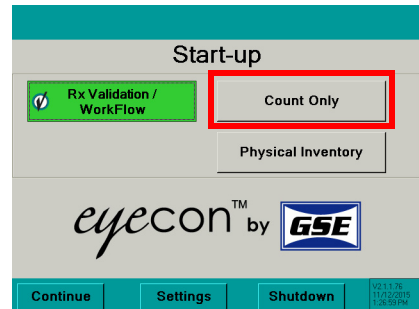

10. Scan the barcode of a selected bottle of tablets.

11. Pour any quantity pills onto the Eyecon counting tray (preferably 30 or more).

12. Ensure that none of the pills are stacked upon each other.

13. Note the quantity displayed on the Eyecon screen.

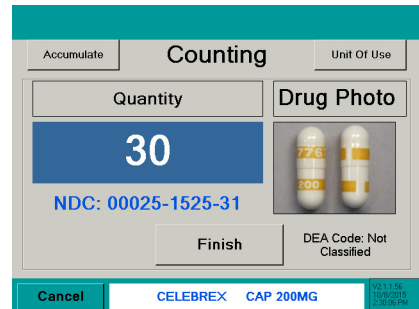

14. Lift the pill tray, dumping the pills into funnel. Transfer pills from the funnel into a vial, and then dump pills on the tray again.

15. Verify the count is the same as the first count.

16. Manually count the pills by scraping them into the funnel on the front of the Eyecon.
17. Confirm that the manual count matches the Eyecon count.
- 17a. If a discrepancy is found, re-perform the manual count to check the results.
- 17b. If there are still discrepancies, contact Eyecon Technical Support for assistance at (866) 260-6540.
18. Record these results in a log book to create a record of the verification having been performed.
19. The next page may be printed to create pages for a log book.

Index

A

- About Eyecon23
- Access Eyecon Auditor154
- Accumulate count method80
- Accumulation
 - PMSS mode109
- Audit report data45
- Audit reports154, 159
- Auto Delete Data47
- Auto Updates49
- Auto updates
 - auto download49
 - auto install49
 - domain50
 - local path50
 - time50
 - update medispans monthly49
 - username and password50

B

- Back up data26
- Back-Count Discrepancy Reasons153
- Back-Counts56
- Backup data48
- Barcode
 - barcode type35
 - Rx barcode examples36
 - Rx barcode pattern36
 - test mode41
- Barcode menu35
- Barcode Setup Help40
- Barcode type35

C

- Calibrate platter28
- Calibrate touch screen35
- Check for updates48
- Cleaning16
- Clear PMSS data53
- Count mode
 - hand count62
- Count only mode
 - accumulation63
 - hand count62, 79, 87
 - unit of use61

D

- Data
 - enable report mode42
 - purge data42
 - tray photo count button42
- Data menu42
- Delete Inventory Data47
- Delete report data43
- Disable report mode45
- Double Check55
- Double-Counts55
- Download inventory data46
- download report data43

E

- Edit drug database94
 - PMSS mode113
- External scanner12
- Eyecon Native Modes57

F

- File sharing151
- Files menu48
 - backup48
 - check for updates48

G

- General
 - calibrate platter28
 - date and time30
 - GPI substitution29
 - pharmacy package selection28
 - scanner port29
 - skip user login28
 - stock bottle verification29
 - windows explorer30
- General menu27
- GPI substitution72
 - PMSS mode106

H

- Hand count62, 79, 87
 - PMSS mode108

I

Install Software Updates21
Installation10
Inventory Interface54

L

Launch Windows applications30
Licensing agreement20
Listening Server Settings52
Locate tray photo44, 145

M

Maintenance16
Manual NDC entry92
 PMSS mode111

N

New pill
 train96

P

Package settings
 PMSS98
Partial fill70
 PMSS mode104
Pharmacy package
 configure20
Pharmacy package settings
 Workflow mode121
Physical Inventory57
Physical Inventory Data46
Physical inventory mode83
 count83
 manual login89
 unit of use86
Pill Counting58
Platter
 sulfa and penicillin10
PMSS
 McKesson Enterprise Rx117
 pill counting99
PMSS data viewer117
PMSS mode
 manual login111
PMSS Modes98
PMSS package settings98
PMSS provider52

Power

 off23
 on15
Product9

R

Remote Server menu53
Report
 report data43
Report download data144
Restart Eyecon126
Retrain pill image90
 PMSS mode115
Rx barcode examples36
Rx Dispensing58
Rx Dispensing (Count Mode)57, 58
RX Scan During Count Mode39
Rx validation
 accumulate80
 GPI substitution72
 hand count79
 manual login82
 partial fill70
 unit of use71
Rx Validation / Workflow57, 65

S

Scanner19
 external12
Serial number
 location9
Settings menu
 barcode35
 data42
 files48
 General27
 remote server53
 TCP/IP51
 test34
 Users30
Shutdown23
Shutdown Eyecon126
Software Updates21
Specifications25
Start-up Screen57

T

- TCP/IP menu51
 - dynamic address51
 - mac address51
 - static address51
- Test menu34
 - calibrate touch screen34
 - camera test34
 - scanner test34
 - speaker test34
 - touch screen test34
- Train hand count91
- Train pill image91
- Turn off the Eyecon23
- Turn on the Eyecon15

U

- Unit of use61, 71
 - PMSS mode105
- Updates
 - software21
- User login barcodes142
- Users
 - add user31
 - delete user32
- Users menu30

V

- View a Report155

W

- Warranty Policy24
- Workflow
 - about Eyecon127
 - diagnostics and setup125
- Workflow mode121
 - pharmacy package settings121
 - settings122

Avery Weigh-Tronix



Avery Weigh-Tronix USA

1000 Armstrong Dr.

Fairmont MN 56031 USA

Tel:507-238-4461

Fax:507-238-4195

Email: usinfo@awtxglobal.com

www.averyweigh-tronix.com

Avery Weigh-Tronix UK

Foundry Lane,

Smethwick, West Midlands,

England B66 2LP

Tel:+44 (0) 8453 66 77 88

Fax: +44 (0)121 224 8183

Email: info@awtxglobal.com

www.averyweigh-tronix.com