

## Maestro RF 0–10 V Sensor Dimmer and RF Sensor Switch Applications

This document serves as a supplement to the Maestro RF 0–10 V Sensor Dimmer/RF Sensor Switch Installation Guide for the following model numbers:

- MRF2S-8SD010: RF 0–10 V Occupancy/Vacancy Sensor Dimmer
- MRF2S-8SDV010: RF 0–10 V Vacancy Sensor Dimmer
- MRF2S-8SS: RF Occupancy/Vacancy Sensor Switch
- MRF2S-8SSV: RF Vacancy Sensor Switch

Note: For performance specifications, including load ratings, see the **Maestro RF 0–10 V Sensor Dimmer/RF Sensor Switch** spec submittal (Lutron document number 3691097) at [www.lutron.com/TechnicalDocumentLibrary/3691097.pdf](http://www.lutron.com/TechnicalDocumentLibrary/3691097.pdf)

### Maestro RF 0–10 V Sensor Dimmer and RF Sensor Switch User Interface (shown without faceplate)

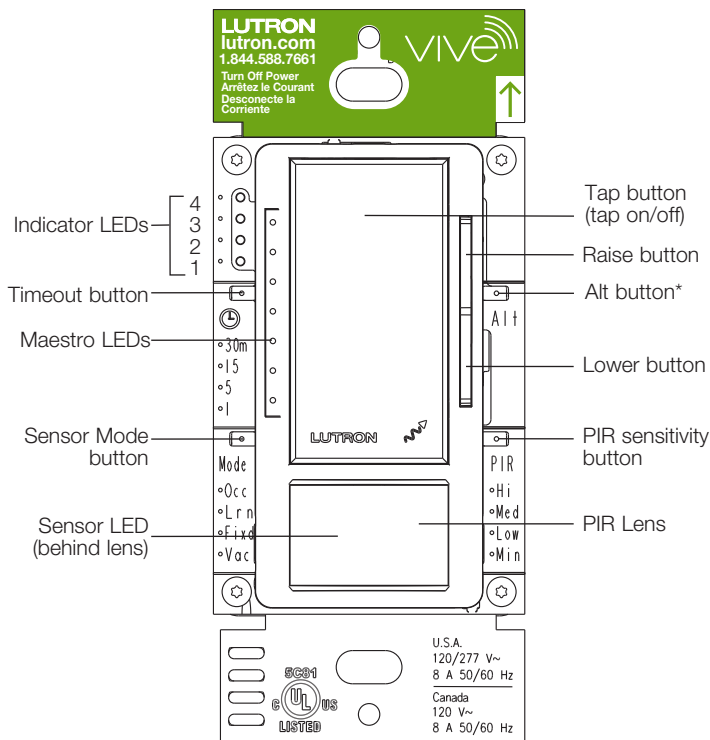

**Maestro RF 0–10 V Sensor Dimmer**

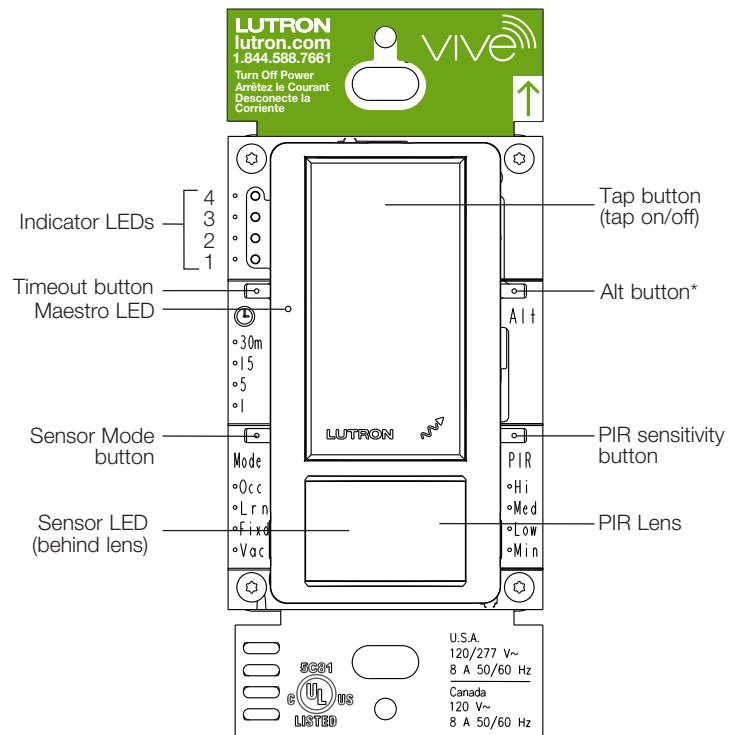

**Maestro RF Sensor Switch**

\* Alt button is always used in conjunction with another button.

---

## Contents

Glossary . . . . .	3
Placement, Sensor Operation, and Sensor Coverage Area . . . . .	4
Settings Overview . . . . .	5
High-End Trim . . . . .	6
Low-End Trim . . . . .	7
Occupancy Level . . . . .	8
Vacancy Level . . . . .	9
PIR Sensitivity . . . . .	10
Timeout . . . . .	11
Walk-Thru Mode . . . . .	12
Electronic Off . . . . .	13
Sensor Mode . . . . .	14
Fixed ALD Light Level . . . . .	15
Learning Ambient Light Detect (ALD) . . . . .	16
Off While Occupied . . . . .	16
Test Mode . . . . .	17
Reset Factory Default Settings . . . . .	17
Wiring Connections . . . . .	18
Single-Pole Installation . . . . .	19
3-Way and Multi-Location Installation . . . . .	20
NEMA 410 Inrush Current . . . . .	22
Common Applications and Questions . . . . .	22
Sink vs. Source . . . . .	22
Energy Codes Requiring Daylighting . . . . .	22
Troubleshooting . . . . .	23
Contact Information . . . . .	25

## Glossary

- High-End Trim** . . . . . Highest achievable light level to which the sensor dimmer can be adjusted.
- Low-End Trim** . . . . . Lowest achievable light level to which the sensor dimmer can be adjusted.
- Major Motion** . . . . . Large movements (e.g., walking, standing up, sitting down).
- Minor Motion** . . . . . Small movements (e.g., drinking a cup of coffee).
- Fine Motion** . . . . . Very small movements (e.g., turning pages while reading a magazine).
- Occupancy** . . . . . The sensor automatically turns On when you enter the room, and turns Off when you vacate the room and motion has not been detected for the Timeout period.
- Occupancy Level** . . . . . A programmable setting that determines the light level to which the sensor dimmer will go to once occupancy has been detected.
- ALD** . . . . . Ambient Light Detect. The device has a built in sensor to detect the ambient light in the room. If the selected Sensor Mode uses ALD the device can make an intelligent decision on whether or not to turn the lights on based on how much ambient light is in the room.
- Occupancy with Fixed ALD** . . . . . The sensor automatically turns the lights On when you enter a room in which there is not enough ambient light. If there is enough light, it will NOT turn the lights On. The sensor will determine how much ambient light is enough based on a fixed level you select. The sensor will turn the lights Off when the room is vacated.
- Occupancy with Learning ALD** . . . . . The sensor automatically turns the lights On when you enter a room in which there is not enough ambient light. If there is enough light, it will NOT turn the lights On. If the sensor does not respond as you desired, press the Tap button within 5 seconds of entering the room to change the state of the lights. Based on these interactions, the sensor will learn your preference for how much ambient light is sufficient. The sensor will turn the lights Off when the room is vacated.
- Off While Occupied** . . . . . Feature that keeps the lights Off when the device has been manually turned Off but motion is still detected.
- Vacancy** . . . . . The lights will turn On only if the Tap button is pressed. The sensor will turn the lights Off when the room is vacated and motion has not been detected for the Timeout period.
- Vacancy Level** . . . . . A programmable setting that determines the light level to which the sensor dimmer will go to once vacancy has been detected.
- PIR Sensitivity** . . . . . Setting that adjusts the level of Passive Infrared sensitivity that your sensor will use to detect motion.
- Sensor LED** . . . . . LED under the sensor lens that are used to show when motion is detected during Test Mode.
- Sensor Mode** . . . . . Setting that determines how your sensor will respond upon detecting occupancy. There are four available settings: Occupancy (Occ), Occupancy with Learning ALD (Lrn), Occupancy with Fixed ALD (Fixd), and Vacancy (Vac).
- Indicator LEDs** . . . . . LEDs that are used when programming the sensor dimmer and sensor switch.
- Maestro LEDs** . . . . . LEDs that indicate the current load level.
- Tap Button** . . . . . Large button used for manually turning the load On/Off.
- Test Mode** . . . . . A short Timeout with LED feedback that helps the user determine sensor coverage in the space.
- Timeout** . . . . . Setting that determines how long the lights will remain On after the room has been vacated and motion has not been detected.
- Electronic Off** . . . . . When enabled, the product relay is kept closed and the load is kept powered when the lights are turned Off. The product dims to low-end and then turns Off the lights via the 0–10 V control lines if the load supports electronic off. When disabled, the product relay is used to turn the load and lights On and Off by turning power On and Off to the load.
- Walk-Thru Mode** . . . . . Setting that turns the lights Off before Timeout has expired if occupancy is detected only for a brief period of less than 3 minutes.

## Placement, Sensor Operation, and Sensor Coverage Area

- The ability of the sensor dimmer/switch to detect motion requires line-of-sight of room occupants and must have an unobstructed view.
- Hot objects and moving air currents can affect the performance of the sensor dimmer/switch. For best performance, the sensor dimmer/switch should be mounted at least 4 ft (1.2 m) away from HVAC vents and light bulbs.
- The performance of the sensor dimmer/switch depends on a temperature differential between the ambient room temperature and that of room occupants. Warmer rooms may reduce the ability of the sensor dimmer/switch to detect occupants.

### NEMA WD7 Test Grid Coverage

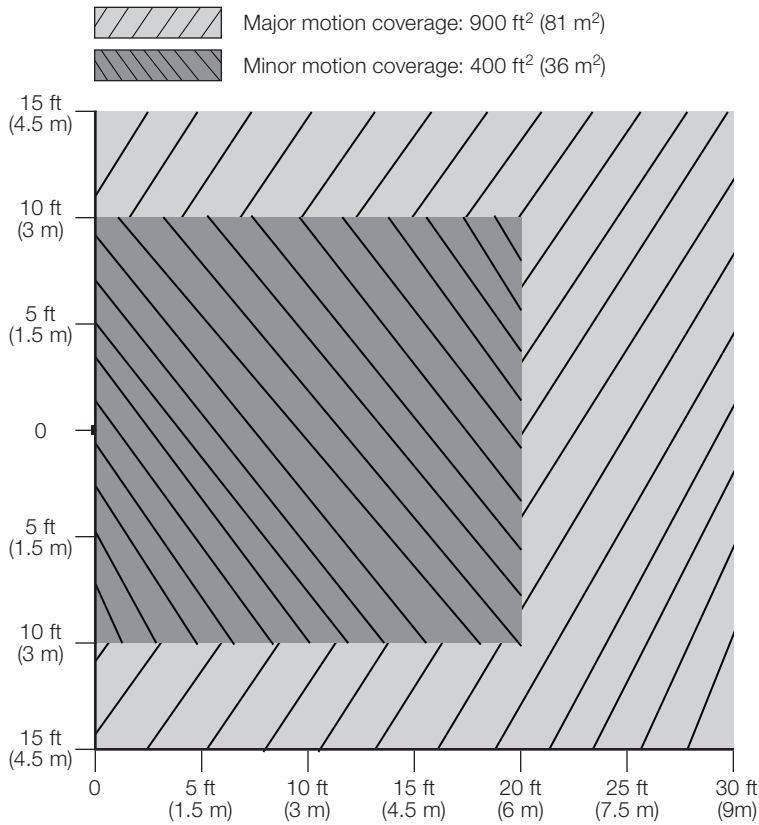

### Horizontal Beam Diagram

(For Reference Only)

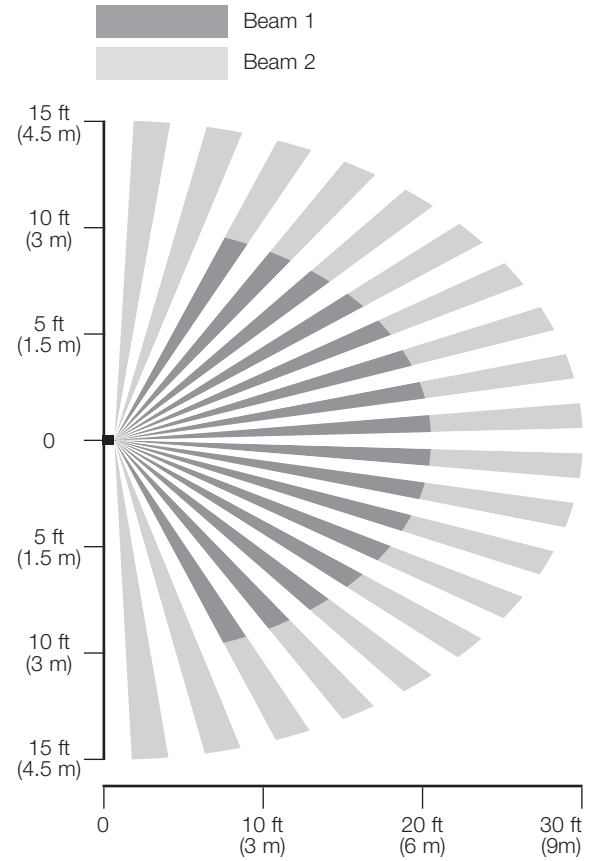

### Vertical Beam Diagram

(For Reference Only)

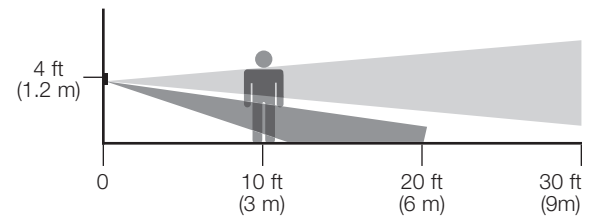

## Settings Overview

The Maestro RF 0–10 V sensor dimmer/RF sensor switch has many features that allow you to configure the unit to meet your individual needs. This page includes all the button press shortcuts for modifying those features. For detailed information on each setting, please see the corresponding pages. Note the pages in this document detail the adjustment of these settings while device is NOT in a Vive system. If device is added to a Vive system, settings must be adjusted from the Vive User Interface (UI) App.

### To display the existing settings

Tap the Timeout (⌚), Sensor Mode (M), or PIR Sensitivity (P) button. The indicator LED (IL) that corresponds to the existing setting will illuminate.

### To change the existing settings

Press and hold the desired button (⌚, M, or P) until an IL begins to flash (about 3 seconds).

Tap the same button to cycle to your desired setting.

Press and hold the same button until the IL turns solid to lock your selection (about 3 seconds).

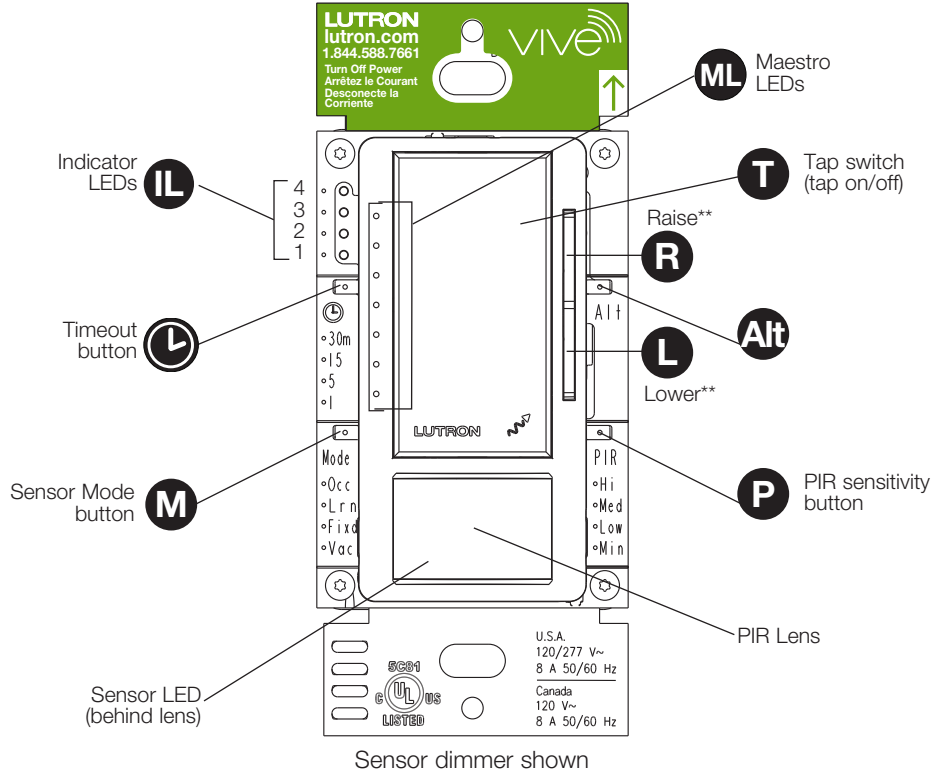

\*\* Supported in sensor dimmer only

## Button Press Shortcuts (default settings are shown in bold)

### High-End Trim page 6

↑ 100% **T + R**  
 ↓ 55%

### Low-End Trim page 7

↑ 45% **T + L**  
 ↓ 1%

### Occupancy Level page 8

↑ 100% **M + R**  
 ↓ 1%

### Vacancy Level page 9

↑ 100% **M + L**  
 ↓ 0%

### PIR Sensitivity page 10

**High** **P**  
 Medium  
 Low  
 Minimum

### Timeout page 11

30 minutes  
**15 minutes** **⌚**  
 5 minutes  
 1 minute

### Walk-Thru Mode page 12

(unused) **⌚ + Alt**  
 (unused)  
**Disabled**  
 Enabled

### Electronic Off page 13

(unused) **M + ⌚**  
 (unused)  
 Enabled  
**Disabled**

### Sensor Mode page 14

**Occupancy (Auto-ON / Auto-OFF)<sup>4</sup>** **M**  
 Occupancy with Learning ALD<sup>2, 5</sup>  
 Occupancy with Fixed ALD<sup>2, 6</sup>  
 Vacancy (Manual-On / Auto-Off)<sup>4</sup>

### Fixed ALD Light Level page 15

High (turn On lights unless area has a lot of light) **M + Alt**  
 Medium  
**Low**  
 Minimum (turn On lights only when room is dark)

## High-End Trim (Sensor Dimmer Only)

High-end trim is adjustable from 6–10.5 V. The maximum light output of connected fixtures can be decreased for energy savings or personal preference in over-lit spaces.

### Changing the High-End Trim

1. **Press and hold** **T** and **R** simultaneously until a Maestro LED (**ML**) begins to flash (about 6 seconds).
2. **Press and hold** **R** until the top **ML** is reached and the lights brighten no further.
3. **Hold or tap** **L** to decrease the high-end trim level until the desired level is achieved. The top 3 **ML** LEDs give visual feedback of where the high-end trim setting is within the adjustable range. If you want to increase the high-end trim during programming process, press **R**.
4. **Press and hold** **T** until the **ML** stays off to lock your selection (about 6 seconds).

**High-End Trim**

**ML** Settings

100% ↑	○	<b>High range (default)</b>
	○	Medium range
55% ↓	○	Low range
	○	
	○	
	○	

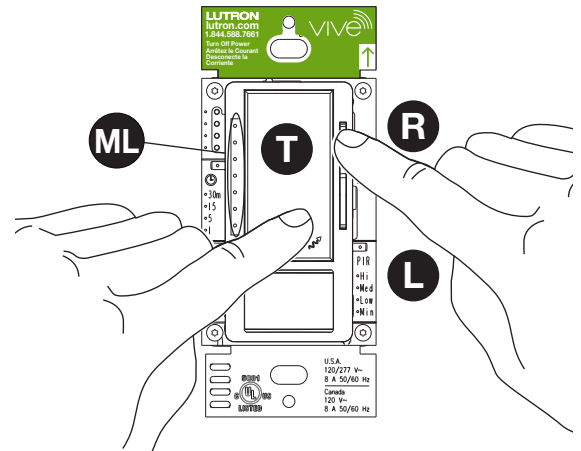

## Low-End Trim (Sensor Dimmer Only)

Low-end trim is adjustable from 0.02–4.6 V. Trimmable low-end can ensure a stable light level. Some fixtures will flicker or drop out if trimmed too low.

### Changing the Low-End Trim

1. **Press and hold** **T** and **L** simultaneously until a **ML** begins to flash (about 6 seconds).
2. **Press and hold** **L** until the bottom **ML** is reached and the lights dim down no further.
3. **Hold or tap** **R** to increase the low-end trim until the desired level is achieved and/or all lights are On and stable (no flickering). The bottom 3 **ML** LEDs give visual feedback of where the low-end trim setting is within the adjustable range. If you want to decrease the low-end trim during the programming process, press **L**.
4. **Press and hold** **T** until the **ML** stays off to lock your selection (about 6 seconds).

### Low-End Trim

#### **ML** Settings

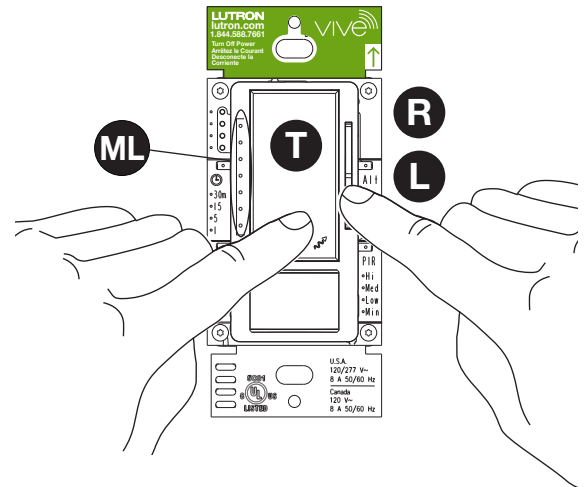
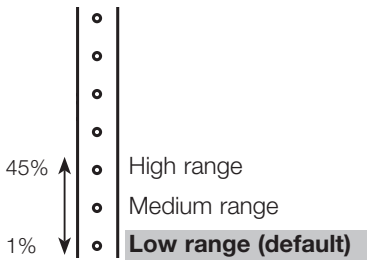

## Occupancy Level (Sensor Dimmer Only)

A programmable setting that determines the light level to which the sensor dimmer will go to once occupancy has been detected. Fully adjustable from 1% to 100% within high-end and low-end trim range.

### Changing the Occupancy Level

1. **Press and hold** **M** and **R** **simultaneously** until a **ML** begins to flash (about 6 seconds).
2. **Press and hold** **R** until the top **ML** is reached and the lights brighten no further.
3. **Hold or tap** **L** to decrease the occupancy level until the desired level is achieved. The 7 **ML** LEDs give visual feedback of where the occupancy level setting is within the adjustable range. If you want to increase the occupancy level during programming process, press **R**.
4. **Press and hold** **M** until the **ML** turns off to lock your selection (about 6 seconds).

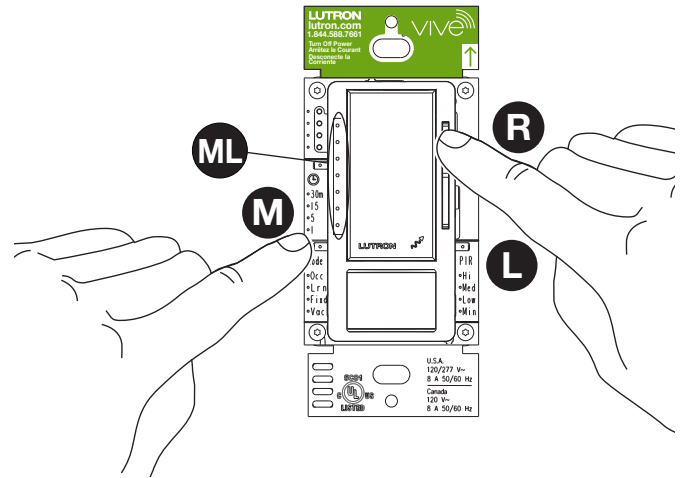
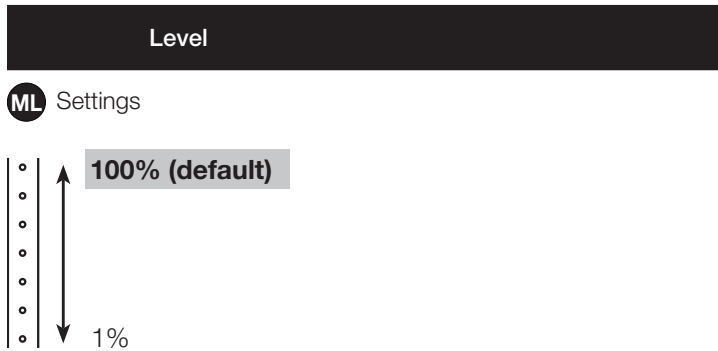



## Vacancy Level (Sensor Dimmer Only)

A programmable setting that determines the light level to which the sensor dimmer will go to once vacancy has been detected. Fully adjustable from 1% to 100% within high-end and low-end trim range or Off.

### Changing the Vacancy Level

1. **Press and hold M** and **L** simultaneously until a **ML** begins to flash (about 6 seconds).
2. **Press and hold L** until the bottom **ML** is reached and the lights dim down no further.
3. To set the vacancy level to off, **press and hold L** until all **ML** LEDs flash (about 3 seconds). Otherwise, **hold or tap R** to increase the vacancy level until the desired light level is achieved. The 7 **ML** LEDs give visual feedback of where the vacancy level setting is within the adjustable range. If you want to decrease the vacancy level during programming process, press **L**.
4. **Press and hold M** until the **ML** turns off to lock your selection (about 6 seconds).

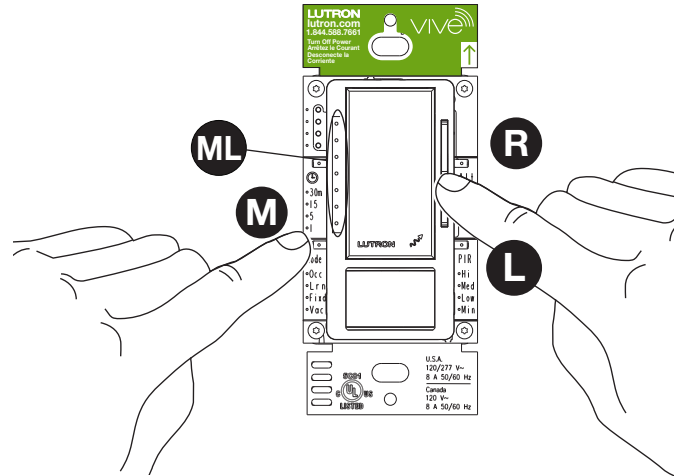
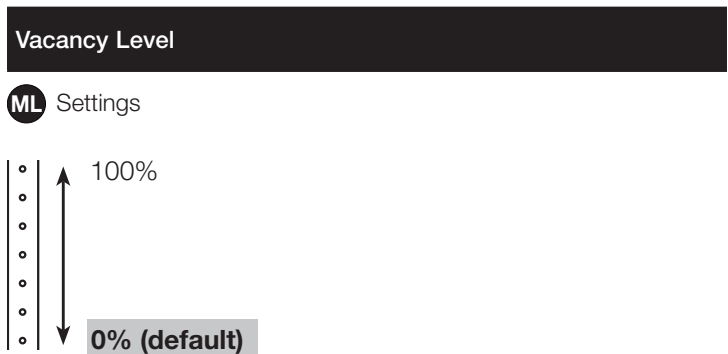

## PIR Sensitivity

The PIR sensitivity of the sensor can be adjusted based on the expected level of activity in the room. The default setting is “High Sensitivity” which will perform best for most applications. Rarely, if the sensor is placed near external noise sources (e.g., heating and cooling vents), it may turn the lights on without occupancy. If this occurs, lowering the sensitivity to Medium, Low, or Minimum may resolve the problem.

### Which do I want?

The type of activity and amount of foot traffic will help dictate at which setting the sensor should be set.

- **High Sensitivity:** Recommended for spaces in which the occupants will often be seated for long periods of time and performing fine motions (e.g., turning a page).
- **Low Sensitivity:** Recommended for spaces that generally experience only large motions (e.g., as foot traffic).

Additionally, if the sensor sees a specific area that is not desired (e.g., a hallway outside of the room in which the sensor is installed), Lutron offers a lens mask kit (Lutron P/N 50013614) that can be ordered through Customer Assistance (1.844.LUTRON1). Alternatively, selectively placing opaque tape (e.g., painters’ tape, electrical tape, masking tape) over certain parts of the lens can limit its field of vision to block undesired detection areas. Masking the lens may affect ALD performance.

### Changing the PIR Sensitivity

1. **Press and hold P** until an indicator LED (IL) begins to flash (about 3 seconds).
2. **Tap P to cycle** to your desired setting.
3. **Press and hold P** until the IL turns solid **to lock** your selection (about 3 seconds).

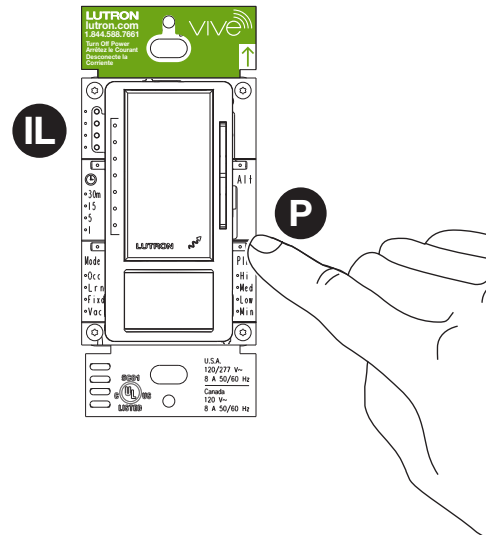
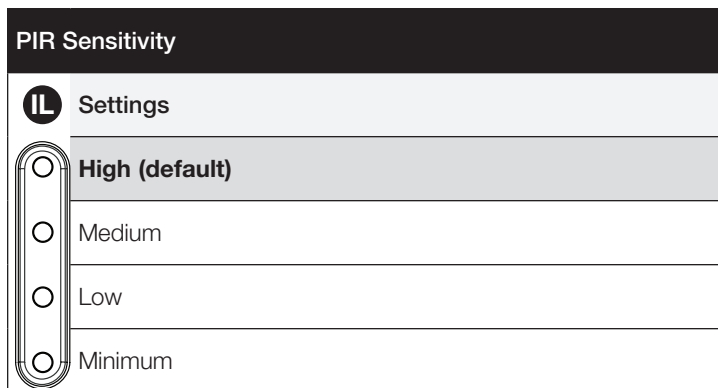





## Timeout

Timeout is the time after which the lights will go out after the last motion is detected. The Timeout can be adjusted to 1, 5, 15, or 30 minutes.

### Which do I want?

- The ideal Timeout for an application may vary depending on the size of the room in which the unit is installed.
- The position of the sensor in relation to activity as well as the typical duration of stay will influence your desired Timeout setting.
- In a room where occupants dwell for longer periods of time, a longer Timeout value is recommended. For most conference rooms and offices, a Timeout of no less than 5 minutes is advised to ensure that the desired light level is maintained throughout occupancy of the space.
- In applications where the sensor dimmer is controlling fluorescent or CFL bulbs, a Timeout of no less than 15 minutes is recommended to maintain bulb life.

### Changing the Timeout

1. **Press and hold**  until an indicator LED () begins to flash (about 3 seconds).
2. **Tap**  to cycle to your desired setting.
3. **Press and hold**  until the  turns solid **to lock** your selection (about 3 seconds).

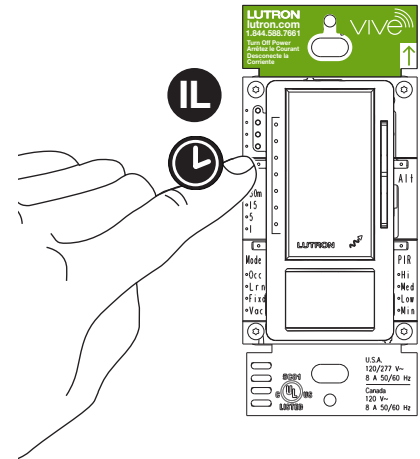
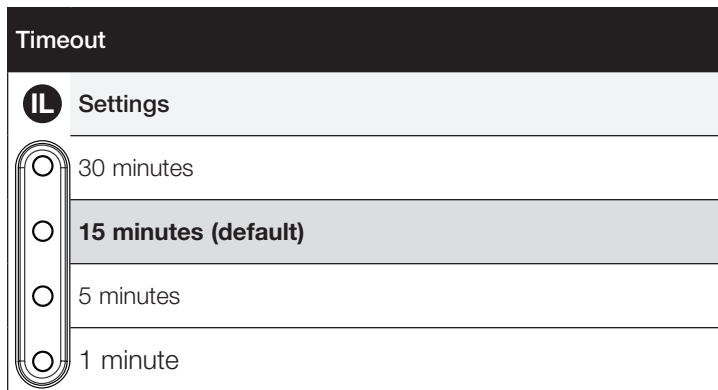

## Walk-Thru Mode (MRF2S-8SD010 and MRF2S-8SS only)









Walk-Thru Mode is a setting that allows lights set with a long timeout to shut Off after a short duration when the space is occupied only momentarily. After initial occupancy, this mode allows the sensor to turn the lights in the room Off if the space is occupied for a very brief amount of time (less than 3 minutes). If motion is detected consistently within 3 minutes of initial occupancy, the sensor will keep the lights On for the normal timeout setting.

- **Walk-Thru Mode Enabled:** If the space is occupied momentarily, the lights will turn off after 3 minutes instead of the normal timeout setting.
- **Walk-Thru Mode Disabled:** The lights will always remain On for the full timeout duration.

### Which do I want?

- If you would like the lights in your space to turn off quickly when the space is only briefly occupied, select “Enabled”. This setting is ideal for conference rooms with long timeouts that may experience periodic brief occupancy events, such as a second-shift cleaning crew or a security guard checking the campus of a commercial building.
- If you prefer consistent sensor behavior or use CFL or fluorescent lights in your application, Walk-Thru Mode should be “Disabled”.

### Changing the Walk-Thru Mode

1. **Press and hold**  and  simultaneously until the indicator LED () begins to flash (about 3 seconds).
2. The Walk-Thru Mode setting will now be displayed on the . **Tap**  or  to cycle to your desired setting.
3. **Press and hold**  or  until the  turns solid to lock your selection (about 3 seconds).

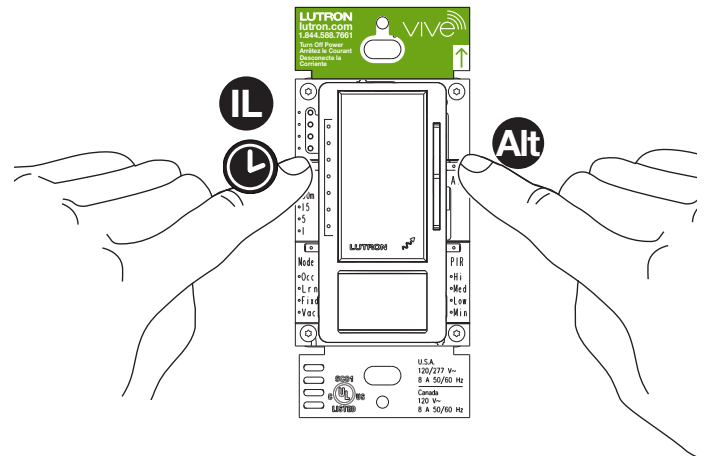
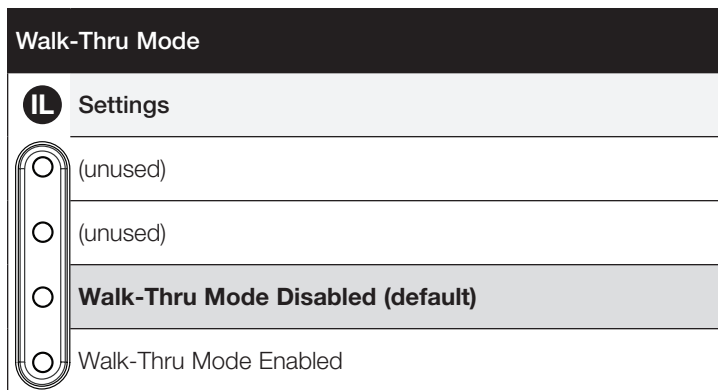

#### Notes:

- To maintain bulb life, the recommended minimum timeout for fluorescent bulbs is 15 minutes. Walk-Thru Mode is not recommended for applications with CFL or fluorescent lights.
- If Walk-Thru Mode is enabled, that setting will override a 1-minute timeout setting if that setting is also selected. The lights will remain On for a minimum of 3 minutes if Walk-Thru Mode is enabled.
- ***This setting is only available in Stand-Alone and not available when a device is associated with a Vive system.***

## Electronic Off (Sensor dimmer only)

Affects how the lights are turned Off. If enabled, the driver remains powered, but the lights turn Off. This requires that the driver supports this method of control. If disabled, the driver has power removed every time the lights are turned Off. All drivers support this method of control.

### Which do I want?

- If your load is not performing as expected choosing “Electronic Off - Enabled” may help.
- If you want a faster load response choosing “Electronic Off - Enabled” may help.
- If your load is performing fine choose “Electronic Off - Disabled.”

### Changing the Electronic Off:

1. **Press and hold** **Ⓢ** and **Ⓜ** simultaneously until an indicator LED (**Ⓢ**) begins to flash (about 3 seconds).
2. The electronic off setting will now be displayed by the **Ⓢ**. **Tap** **Ⓢ** or **Ⓜ** to cycle to the desired setting.
3. **Press and hold** **Ⓢ** or **Ⓜ** until the **Ⓢ** turns solid to lock your selection (about 3 seconds).

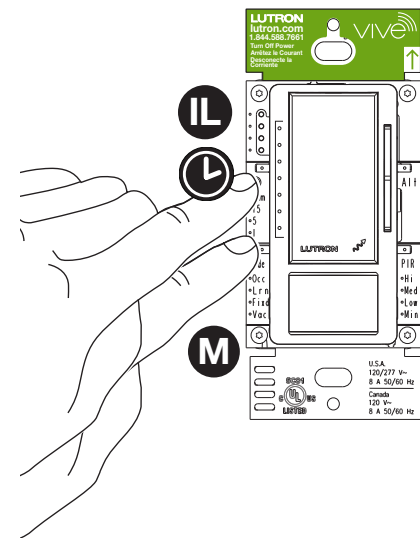
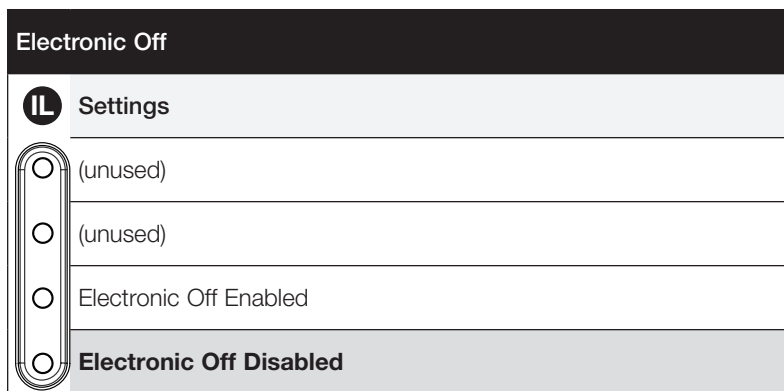

#### Note:

- *This setting is only available in Stand-Alone and not available when a device is associated with a Vive system.*

## Sensor Mode

The automatic functionality of the sensor can be adjusted to change how the lights respond upon occupancy. All sensor modes will turn the lights Off when no motion has been detected and the Timeout has expired.

- **Occupancy (Auto-On/Auto-Off):** The lights will always turn On when motion is detected.
- **Occupancy with Learning ALD:** The lights will turn On when motion is detected and ambient light is too low. The lights will remain Off if there is sufficient ambient light in the room. For more information, see “Learning ALD: How it Works” on page 16.
- **Occupancy with Fixed ALD:** The lights will turn On when motion is detected and ambient light is too low. The lights will remain Off if there is sufficient ambient light in the room. The default fixed level is “Low”. To change your fixed light level, see “Changing the Fixed ALD Light Level” on page 15).
- **Vacancy (Manual-On/Auto-Off):** The lights will NOT turn On automatically. Lights will turn On only when **T** has been pressed.

### Which do I want?

- If you want the lights to always turn On automatically when someone enters the room, choose “Occupancy (Auto-On/Auto-Off)”.
- If you want the lights to turn On only when **T** is pressed, choose Vacancy (Manual-On/Auto-Off). The unit will turn Off automatically only when occupancy is no longer detected. For most users, bedrooms are a typical application where Manual-On mode would work better than Auto-On mode.
- If you want the lights to automatically turn On, but want to keep the lights Off when there’s plenty of daylight, choose “Occupancy with Learning ALD” to teach the sensor your preferred light level for when lights should remain Off.
- If you want the lights to automatically turn On, but want to keep the lights Off when there’s plenty of daylight, and you’d like to Lock the setting that determines how much light is needed to keep lights Off, choose “Occupancy with Fixed ALD”. This setting is ideal for conference rooms with many different users and plenty of natural light. In a busy conference room, this setting will provide consistent, convenient energy savings and ambiance.

### Changing the Sensor Mode:

1. Press and hold **M** until an indicator LED (**IL**) begins to flash (about 3 seconds).
2. Tap **M** to cycle to your desired setting.
3. Press and hold **M** until the **IL** turns solid to lock your selection (about 3 seconds).

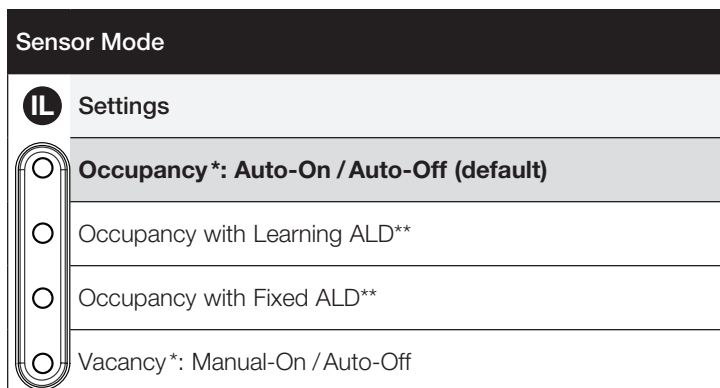

\* Sensor mode is locked as “Vacancy” in the MRF2S-8SDV010 and MRF2S-8SSV and cannot be changed in stand alone mode. This restriction is removed in the Vive system.

\*\* Setting not available once device is configured in the Vive system.

Note: ALD stands for Ambient Light Detect

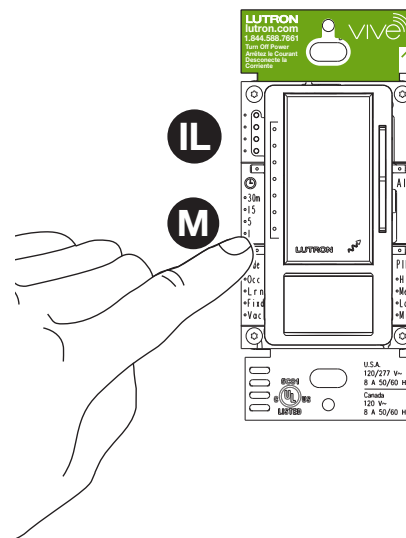

## Fixed Ambient Light Detect (ALD) Light Level

When a unit is set to “Occupancy with Fixed ALD” mode, the light level at which the lights will remain Off when the space is occupied can be adjusted. If the light level in the room is higher than the level set by the user, the lights will remain Off. If the light level in the room is lower than the light level set, the lights will turn On.

### Which do I want?

- High: The lights will almost always turn On when motion is detected. The only time the lights will not turn On when motion is detected is when it is extremely bright in the room.
- Minimum: The lights will almost always remain Off. The lights will turn On only when motion is detected and there is very little ambient light in the room.

### Changing the Fixed ALD Light Level

1. Press and hold **M** and **Alt** simultaneously until the indicator LED (**IL**) begins to flash (about 3 seconds).
2. The Ambient Light Detect light level will now be displayed on the **IL**. Tap **M** or **Alt** to cycle to your desired setting.
3. Press and hold **M** or **Alt** until the **IL** turns solid to lock your selection (about 3 seconds).

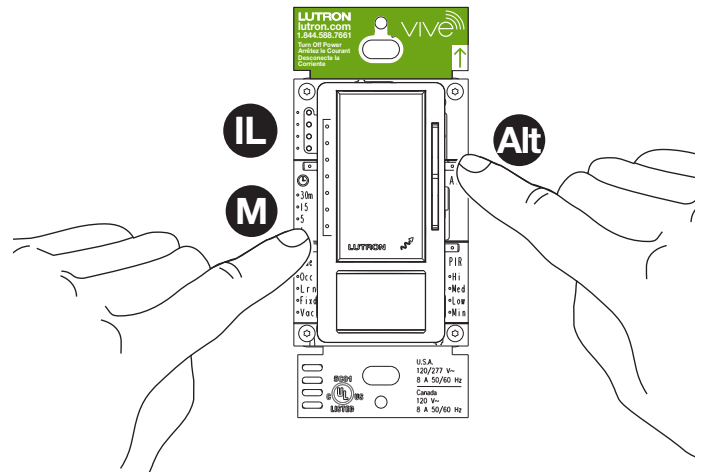
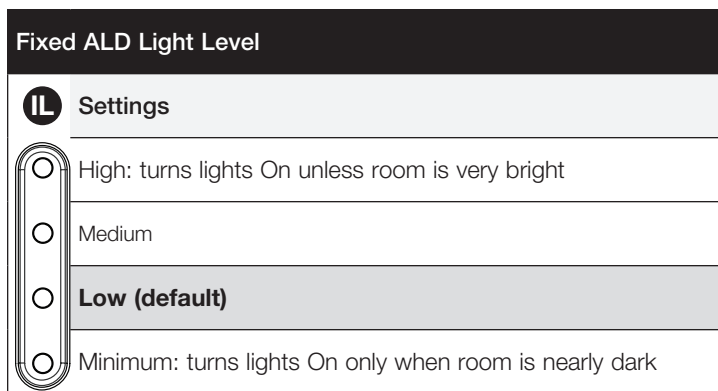

Note:

- *This setting is only available in Stand-Alone and not available when a device is associated with a Vive system.*

## Learning Ambient Light Detect (ALD)

### How it Works

Ambient Light Detect (ALD) is a feature that allows you to maximize savings by keeping lights Off when there is enough natural light in a space to fulfill your lighting requirements.

The Lutron Learning ALD feature learns your preference as you live with the product in your space. The learning algorithm employs user inputs to determine when ambient light is sufficient.

#### *Will my sensor use Learning ALD?*

Your sensor will use Learning ALD if you've selected "Occupancy with Learning ALD" (Lrn) mode while programming your unit.

#### *How does the sensor learn my preference?*

Whenever you enter a room with a sensor dimmer or sensor switch using the Learning ALD feature the sensor will either turn the lights On or keep the lights Off based on its current ALD light level threshold. If you enter the room and the lights do not respond as you'd like, press the **T** button on your unit to turn the lights On (or Off, if that was your preference) within 5 seconds of entering the room. The sensor will now begin learning your preferred ALD threshold. It may take multiple interactions for the sensor's adjustments to match your preferred ALD threshold. Here is an example to illustrate the learning process:

1. You enter the room and the lights stay Off, but you decide you want the lights On because there is not enough ambient light in the space.
2. You press the **T** button (within 5 seconds of entering the room).
3. The unit has learned from this, and has begun to adjust its ALD light threshold towards your preference.

## Off While Occupied

### How it Works

Off While Occupied is a feature that keeps the device Off even though there is occupancy detected in a space. The Off While Occupied feature is turned On by manually turning Off the lights after the lights have automatically turned On due to sensed motion. The unit will then ignore all sensed motion and the lights will remain Off. The unit will exit this mode by one of two ways: 1) the room is vacated and no motion is detected for greater than the set Timeout period, or 2) the lights are manually turned back On and then the room is vacated and the lights then automatically turn Off after the set Timeout.

An example of where this mode of operation is useful is if the user wants the lights Off to watch TV or make a presentation. Once in this mode, motion of the user and/or audience is ignored and the lights will not come back On due to motion.

### FAQs

*If I press a button AFTER 5 seconds of being in a room, will my unit "learn" that preference?*

No, you must interact within the first 5 seconds of entering the room.

*How many times do I have to interact with the sensor to get it to learn my settings?*

The sensor typically learns the appropriate threshold within 6–10 consistent interactions.

*I believe I'm using Learning ALD correctly, but I'm still not getting the response I expect. What could be happening?*

- You may have multiple users with widely different preferences. If multiple users continue to "teach" the unit separate preferences, it will continue to try to adjust to meet the threshold, but may be stuck somewhere in between the preferences of the two users. Consider using "Occupancy with Fixed ALD" at one of the four light level thresholds.
- You may not be able to reach your unit within 5 seconds. If your interactions do not happen within 5 seconds, you will not be teaching the unit a new threshold. This lack of interaction is reinforcing the current threshold (because the sensor thinks you like the current setting).

*Many people use the room in which the sensor is located. How can I "lock" an ALD light level so it doesn't change daily?*

Use the "Occupancy with Fixed ALD" mode. The Fixed ALD light level threshold you choose will not change based on user interactions.



## Test Mode

When in Test Mode, Occupancy has a short Timeout (less than 15 seconds) that can be used to test the coverage area of the sensor with the existing settings.

### Enabling Test Mode

1. **Press and hold T** until the Sensor LED under the PIR lens turns on and illuminates the PIR lens (about 3 seconds). This indicates that you are in Test Mode. Once you let go of the **T**, the Sensor LED will go out. However, it will turn on with any detected motion and stay on until the 15 second Timeout is allowed to expire.
2. The device will exit Test Mode automatically after 5 minutes of inactivity or when **T** is pressed.

#### Notes:

- The amber sensor LED illuminates to indicate PIR motion detection (Occupancy). If no motion is detected for the entire duration of the shorter Timeout (15 seconds), the load(s) being controlled by the RF 0–10 V sensor dimmer/RF sensor switch will turn Off. The load(s) will turn back On when motion is detected.
- If Test Mode is entered within 2 minutes of power-up, sensor LED will blink twice quickly and repeat every 2 seconds until the sensor is ready.

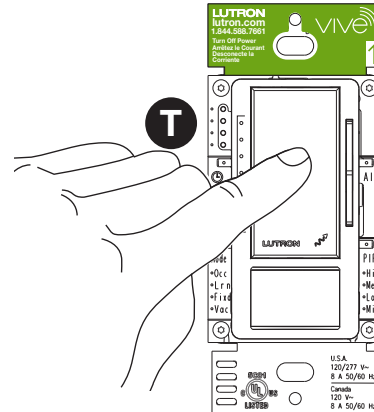

## Reset Factory Default Settings

The RF 0–10 V sensor dimmer/RF sensor switch has the ability to be returned to its original factory default settings. This ability allows the programmer a risk-free experience to try multiple setting configurations.

### Restoring Default Settings

1. Triple-tap **T** and hold until the **ML** lights and the load lights begin to flash rapidly (for the switch) or brighten and dim rapidly (for the dimmer). Then release **T**.
2. Within 1 second of releasing **T**, rapidly tap **T** three times again (release after 3<sup>rd</sup> tap). The **ML** lights and the load lights will begin to flash slowly (for the switch) or brighten and dim slowly (for the dimmer). This indicates that the device will reset to factory defaults. Give the device about 10 seconds to complete the reset process.

### Default settings

Fixed ALD Light Level . . . . .	Low
High-End Trim . . . . .	High range
Low-End Trim. . . . .	Low range
Occupied Level . . . . .	100%
Vacancy Level . . . . .	0%
PIR Sensitivity . . . . .	High
Timeout. . . . .	15 minutes
Sensor Mode . . . . .	Occupancy (Auto-ON/Auto-OFF)
Walk-Thru Mode . . . . .	Walk-Thru Mode Disabled
Electronic Off . . . . .	Electronic Off Disabled

**Notes:** After restoring the default settings, the sensor dimmer or sensor switch will reset. This will take about 10 seconds. During this time, the sensor dimmer or sensor switch will not respond to motion or button presses. It will take 2 minutes for the device to respond to motion after the reset. Any device associations or programming previously set up with the sensor dimmer/switch will be erased and will need to be re-programmed after resetting to factory defaults.

## Wiring Connections

Before installing wallplate, program all desired settings. Note that Vive accessible settings can be adjusted in the Vive system while the wallplate is installed.

### Dimmer

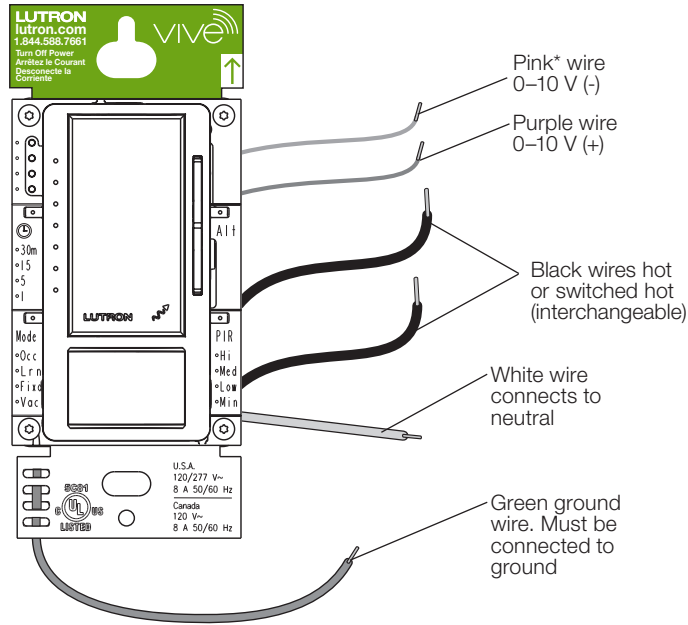

### Switch

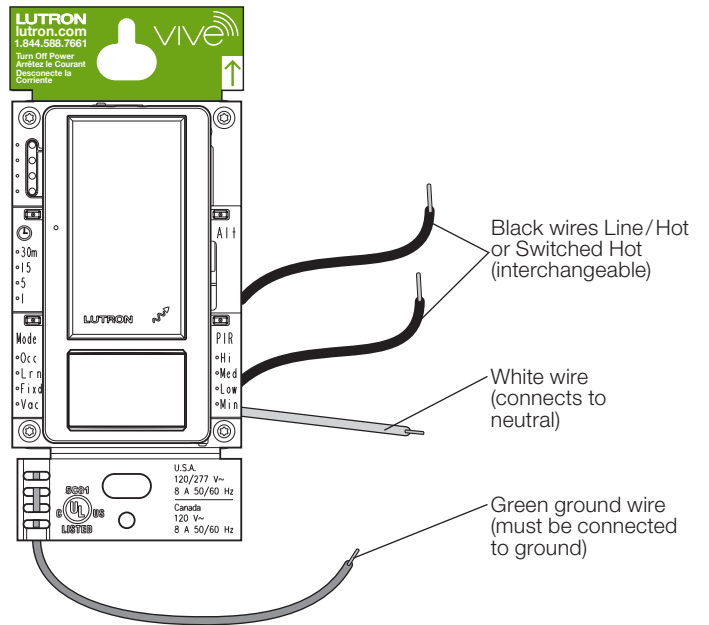

\* This wire/terminal may be gray on older products or in retrofit applications.

## Wiring Connections (continued)

### Sensor Dimmer: Single-Pole Wiring

Neutral Connection Required

Up to 25 drivers total and up to 50 mA maximum

Up to 25 drivers total and up to 8 A maximum

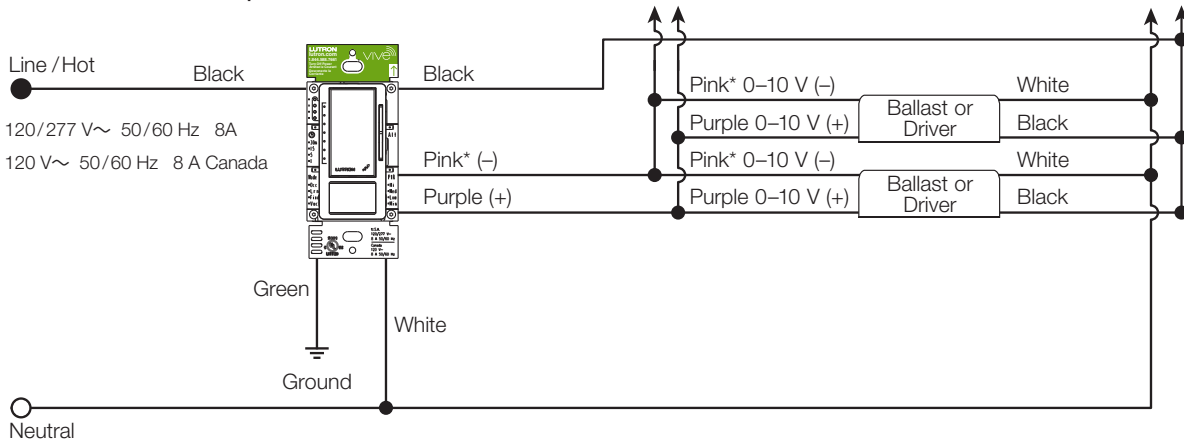

### Sensor Switch: Single-Pole Wiring

Neutral Connection Required

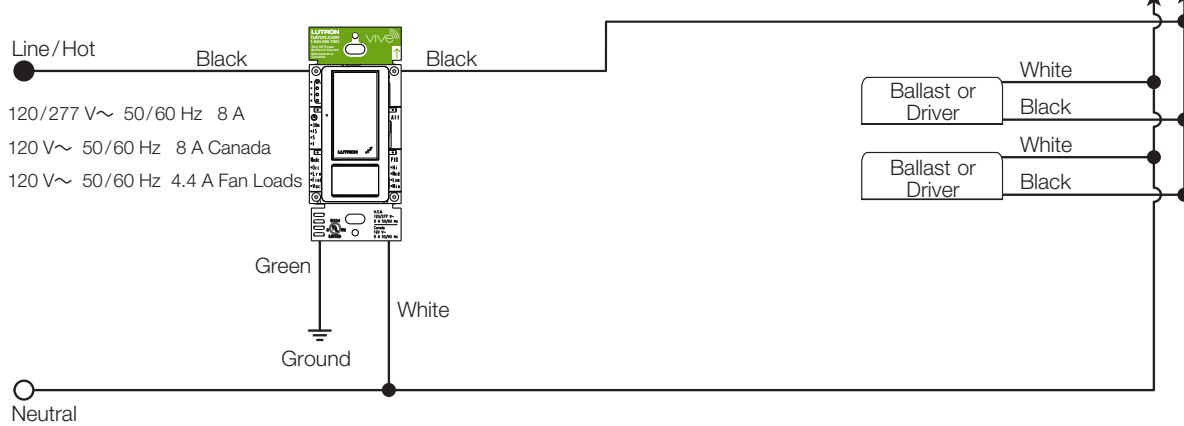

\* This wire/terminal may be gray on older products or in retrofit applications.

## Wiring Connections (continued)

### 3-Way and Multi-Location Installation

**Note:** The two black wires are interchangeable; either one can be wired to hot or switched hot.

1. Turn Off power at the circuit breaker or fuse.



**WARNING: Electric Shock Hazard.** May result in Serious Injury or Death.  
Turn Off power at circuit breaker or fuse before installing or servicing the unit.

Turn Off power



2. Remove existing 3-way switches and disconnect wires.

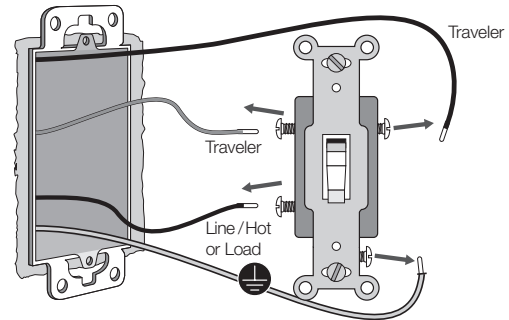
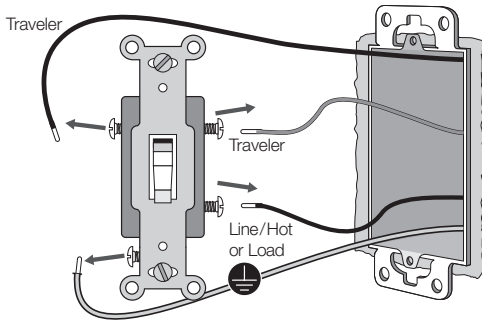

**Note:** Steps 3-5 cover the directions for the wallbox location where a Pico remote control will be installed to replace one of the old 3-way switches.

3. In the desired wallbox location, connect one of the Travelers and the Line/Hot wires together with a wire nut. Note which color traveler is connected to the Line/Hot wire. Cap the Ground wire with a wire nut. Cap the other Traveler wire with another wire nut.

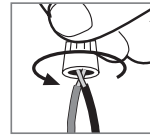
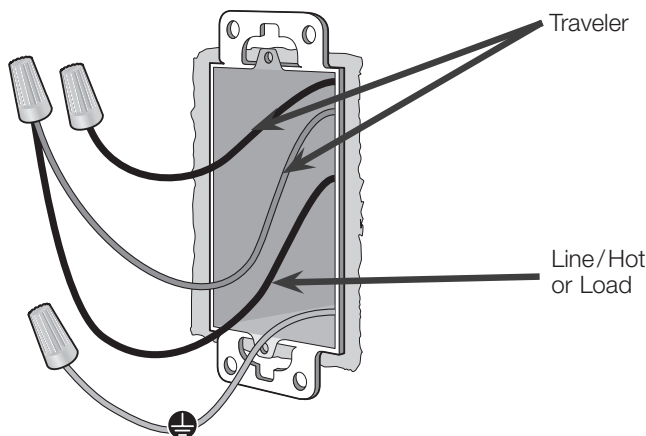

4. Install a Pico Wallbox Adapter, Lutron P/N PICO-WBX-ADAPT, and a Wireless Wall Mount Pico remote control to control the Switch(es) and/or Dimmer(s) from this location. Note that you must associate the Pico remote control with the device(s) you intend to control in order for this installation to function correctly. For details on how to associate the Pico remote control to the device(s), see the installation instructions for the device(s). Note that this association will have to be done after the device(s) is (are) installed and powered. Install the Pico remote control in the Wallbox Adapter after associating it with the device(s).

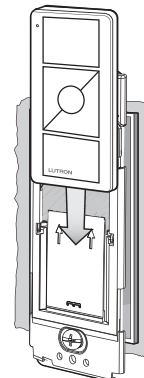
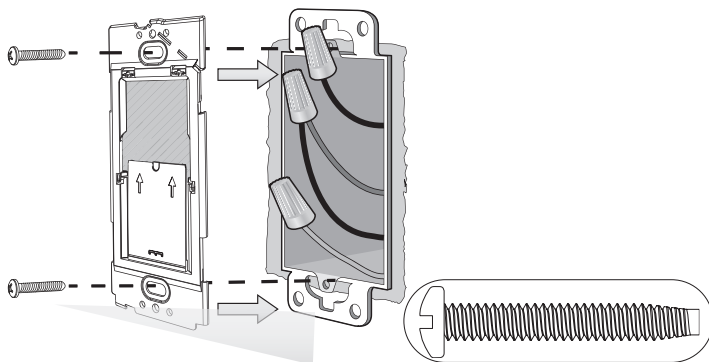

## Wiring Connections (continued)

### 3-Way and Multi-Location Installation

- The dimmer or switch will be installed in the other wallbox. Note that a switch installation is shown. Connect the same colored traveler wire that was connected to Line /Hot in step 3 to one of the black wires on the device. Connect the other black wire on the device to the Line /Hot wire in this box. Connect the Neutral wire in the wallbox to the white wire of this device. Connect the Ground wire to the green wire on the device. Cap the other traveler wire with a wire nut.

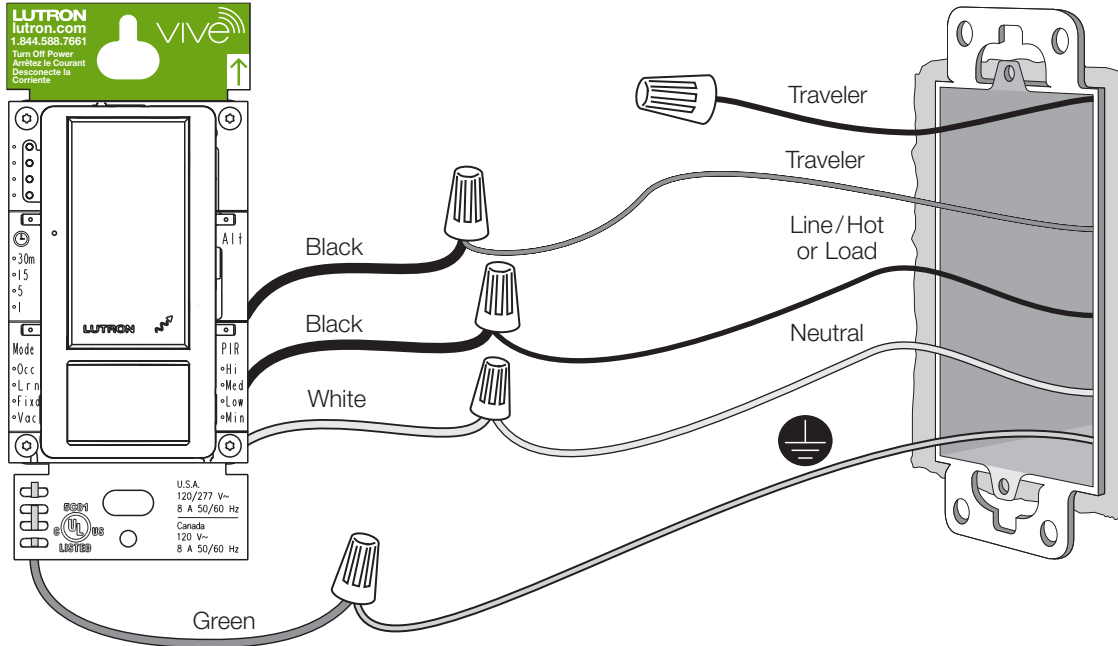

**Note:** Neutral connection is required for the device to function properly.

- Install the device into the wallbox but don't install the wallplate yet.

- Turn on power at circuit breaker or fuse.

Turn ON power

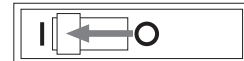

- Wait two minutes.

- The sensor dimmer/switch will manually control the load after the first 10 seconds.
- Once power has been restored, the sensor dimmer/switch will automatically control the load after the first two minutes.

- Program all desired settings before installing the wallplate.

- See the other sections of this document or the installation guide for details on how to program settings.

## NEMA 410 Inrush Current

MRF2S-8SD010 or MRF2S-8SS are rated to work with electronic ballast and driver installations that comply with NEMA 410. These loads typically exhibit a high amplitude (short duration) inrush current the moment power is applied. That inrush current can be many times larger than the steady state current.

There exist electronic ballast and driver installations whose inrush current is significantly greater than that specified in NEMA 410. In some circumstances, manufacturers of these devices recommend switching them on one at a time because they may trip the breaker. The MRF2S-8SD010 and MRF2S-8SS have been tested to comply with NEMA 410 standards and are not recommended nor rated for use in conjunction with installations that do not comply.

This product complies with NEMA 410 standards for inrush current per the chart below.

### Peak Current Requirements

Steady state current (A)	Peak current (A) 120 V~	I <sup>2</sup> t* (A <sup>2</sup> sec) 120 V~	Peak current (A) 277 V~	I <sup>2</sup> t* (A <sup>2</sup> sec) 277 V~
0.5	75	11	77	11
1	107	24	131	27
2	144	41	205	76
3	166	51	258	111
5	192	74	320	205
8	221	98	370	274

\* I<sup>2</sup>t values based on peak current with a 2 ms duration.

## Common Applications and Questions

### Sink vs. Source

MRF2S-8SD010 and MRF2S-8SDV010 are “sink-only” devices. This type of device requires the ballast or driver to supply the power necessary to drive the 0–10 V<sub>DC</sub> control wires.

These devices work with all ballasts and drivers that provide a 0–10 V<sub>DC</sub> control signal that is compliant with IEC 60629 Annex E.2. Note that some LED drivers are sink-only (they require the lighting control to provide the power to drive the 0–10 V<sub>DC</sub> control wires). These will be incompatible with MRF2S-8SD010 or MRF2S-8SDV010 alone.

### Energy Codes Requiring Daylighting (e.g., ASHRAE 90.1)

Certain codes require daylighting sensing/control. MRF2S-8SD010 and MRF2S-8SS contains an ambient light sensor, which is not a solution to ASHRAE 90.1. The option below will help the installer comply with ASHRAE 90.1 and other energy codes requiring daylighting:

Use MRF2S-8SD010 and MRF2S-8SS in conjunction with a daylight sensor, such as the LRF2-DCRB-WH RPS daylight sensor (<http://www.lutron.com/TechnicalDocumentLibrary/369262.pdf>). The RPS sensor wirelessly communicates the light levels to the associated sensor dimmer/switch.

## Troubleshooting

Symptom	Possible Cause	Likely Solution
Lights can not be manually turned On or Off with the newly installed sensor dimmer/switch.	Wiring maybe incorrect.	Wait 10 seconds and try to turn On or Off again. Verify proper wiring: Neutral must be connected for product to function properly. Refer to Wiring Connections section of this document.
Sensor dimmer/switch will not associate to Radio Powr Savr sensor(s) or a Pico remote control.	Wireless device is out of range. Wireless performance is being affected by the physical setup of the space. Battery is dead in the device.	Move device closer. Replace battery in the Radio Powr Savr sensor(s) or Pico remote control.
Not all of the sensor modes are available when programming.	Sensor modes are limited for vacancy only models (MRF2S-8SDV010 and MRF2S-8SSV). Device may be part of a Vive System.	Access those features through a Vive system.
After installation, sensor does not seem to function.	Sensor will not be active for first 2 minutes after installation.	Wait 2 minutes after restoring power for sensor to become operational.
	Wiring may be incorrect.	Verify proper wiring. Refer to the Wiring Connections section of this document.
After installation or following power failure, lights will turn On suddenly after lights are manually turned Off.	Sensor takes up to 2 minutes to perform a calibration following a power cycle. If lights are Off and the calibration completes while the space is occupied, lights will turn On.	Wait at least 2 minutes for calibration to complete.
Lights do not turn On when space is occupied.	Sensor mode is set to "Vacancy" (Vac) mode.	Refer to the Sensor Mode section of this document to set the Sensor Mode to Occupancy.
	Sensor mode is set to "Occupancy with Learning ALD" (Lrn) mode and light level in room is too bright.	Turn lights On within 5 seconds of entering room to teach sensor that it should turn On at current light level.
	Sensor mode is set to "Occupancy with Fixed ALD" (Fixd) mode and light level in room is too bright.	Lower Fixed ALD Light level until lights turn On in current light level (Default level is "Low").
	Sensor does not have full view of room and its occupants.	Move objects blocking sensor's line-of-sight; you must be able to see sensor for sensor to "see" you.
	Room may be too large for this application.	Add a Radio Powr Savr ceiling or wall occupancy sensor. See <a href="http://www.lutron.com">www.lutron.com</a> for more information.
	Wiring may be incorrect.	Verify proper wiring. Refer to Wiring Connections section of this document.
	Sensor mode is set permanently to Vacancy.	The sensor dimmer/switch is a vacancy only model (MRF2S-8SDV010 and MRF2S-8SSV) and the mode cannot be changed.
	Device has been put into Off While Occupied mode.	Device must not sense motion for greater than the set Timeout period to reset into normal occupancy mode.

Continued on the next page...

**Troubleshooting** (continued)

Symptom	Possible Cause	Likely Solution
Lights turn Off while space is occupied.	Sensor's Timeout is too short for this application: if Timeout is set to 1 minute and you are not moving much for 1 minute, sensor may Timeout without motion.	Refer to the Timeout section of this document for instructions on increasing the Timeout duration.
	Sensor does not have full view of room and its occupants.	Move objects blocking sensor's line-of-sight. Sensor will perform better if it has line-of-sight to "see" you.
	PIR sensitivity is set too low.	Refer to the PIR Sensitivity section of this document for instructions on increasing PIR Sensitivity.
Lights never turn Off, or stay On longer than desired.	Sensor's Timeout has not yet expired.	Refer to the Timeout section of this document for instructions on reducing "Timeout" setting if current setting lasts too long.
	Sensors that are mounted close to doorways can respond to motion outside of room.	Use "Test Mode" to determine which areas are triggering sensor to respond when not desired.  Selectively cover parts of the lens with electrical tape, or with a lens mask (Lutron P/N 50013614), which can be ordered through Customer Assistance (1.884.LUTRON1). Masking the lens may affect ALD performance.
		Refer to the PIR Sensitivity section of this document for instructions on lowering PIR sensitivity.
	Motion is being detected from an external noise source such as an HVAC vent. Some unintended environmental vibrations may trigger sensor, keeping lights On.	Use "Test Mode" to determine which areas are triggering sensor to respond when not desired. Test Mode will respond based on existing sensitivity settings of each sensor.
Refer to the PIR Sensitivity section of this document for instructions on lowering PIR sensitivity.		
Lights turn On in Vacancy mode.	Lights can turn On in 15 second grace period following Timeout.	Grace period is intended to allow user to move after lights go Off, if you want lights to come back On. If you want to check that unit is functioning properly, wait 30 seconds AFTER Timeout has expired before re-entering the room to verify that lights do NOT turn On.
	Sensor mode may be set to something other than Vacancy mode.	Refer to the Sensor Mode section of this document for instructions on how to change sensor mode.
Lights turn On when space is unoccupied.	Motion is being detected from an external noise source such as an HVAC vent.  Sensors that are mounted close to doorways can respond to motion outside of room.	Refer to the PIR Sensitivity section of this document for instructions on lowering PIR sensitivity.
		Use "Test Mode" to determine which areas are triggering sensor to respond when not desired.  Selectively cover parts of the lens with electrical tape, or with a lens mask (Lutron P/N 50013614), which can be ordered through Customer Assistance (1.844.LUTRON1). Masking the lens may affect ALD performance.
While using "Occupancy with Learning ALD" modes, lights do NOT stay Off when unit is turned Off.	Sensor dimmer has not yet learned your light level preference.	Continue to turn lights Off as needed until the unit learns your preference and keeps the lights Off.
While using "Occupancy with Fixed ALD" mode, lights do NOT stay Off when unit is turned Off.	Light level is currently set too low.	Raise "Fixed ALD" light level using instructions found in the Fixed ALD Light Level section of this document.

Continued on the next page...



## Troubleshooting (continued)

Symptom	Possible Cause	Likely Solution
Lights turn On to full, then dim back down.	Sensor dimmer has "Fade to On" feature that transitions lights from Off to preset On level over a period of time up to 2 seconds. Some 0–10 V drivers exist which may negate this behavior and make the lights turn On immediately to 100% before ballast or driver detects the control signal and then dims lights down to proper level.	This is a symptom of a problem with ballast or driver: <ul style="list-style-type: none"> <li>• Try a different ballast/driver.</li> </ul>
Lights cannot be dimmed.	Driver / ballast does not comply with IEC 60929 Annex E.2. Ballast or driver being used requires power on control wires from another source.	See "Sink vs. Source" section.
	Pink* and purple wires are miswired.	Refer to wiring diagram on the instruction sheet.

\* This wire/terminal may be gray on older products or in retrofit applications.

Lutron, Maestro, Pico, Radio Powr Savr, and PowPak are trademarks or registered trademarks of Lutron Electronics Co., Inc. in the US and/or other countries.

### Lutron Contact Numbers

#### WORLD HEADQUARTERS USA

Lutron Electronics Co., Inc.  
7200 Suter Road  
Coopersburg, PA 18036-1299  
TEL: +1.610.282.3800  
FAX: +1.610.282.1243  
support@lutron.com  
www.lutron.com/support

#### North & South America Customer Assistance

**USA, Canada, Caribbean:**  
1.844.LUTRON1 (1.844.588.7661)  
**Mexico:**  
+1.888.235.2910  
**Central/South America:**  
+1.610.282.6701

#### UK AND EUROPE

Lutron EA Limited  
125 Finsbury Pavement  
4th floor, London EC2A 1NQ  
United Kingdom  
TEL: +44.(0)20.7702.0657  
FAX: +44.(0)20.7480.6899  
FREEPHONE (UK): 0800.282.107  
Technical Support: +44.(0)20.7680.4481  
lutronlondon@lutron.com

#### ASIA

Lutron GL Ltd.  
390 Havelock Road  
#07-04 King's Centre  
Singapore 169662  
TEL: +65.6220.4666  
FAX: +65.6220.4333  
Technical Support: 800.120.4491  
lutronsea@lutron.com

#### Asia Technical Hotlines

Northern China: 10.800.712.1536  
Southern China: 10.800.120.1536  
Hong Kong: 800.901.849  
Indonesia: 001.803.011.3994  
Japan: +81.3.5575.8411  
Macau: 0800.401  
Taiwan: 00.801.137.737  
Thailand: 001.800.120.665853  
Other Countries: +65.6220.4666