ADT-HC4500

CNC Flame/Plasma Controller

User Manual



ADTECH 众为兴

ADTECH (SHENZHEN) CNC TECHNOLOGY CO., LTD

5th Floor, 27-29th Building, Tianxia IC Industrial Park, Yiyuan road, Nanshan District,

Shenzhen Post code: 518052

Tel: 0755-26099116 Fax: 0755-26722718

E-mail: sales02@machine-controller.com <http://www.machine-controller.com>

Copyright

All property rights of this user manual are reserved by Adtech (Shenzhen) CNC Technology Co., Ltd (ADTECH for short). No institution or person is allowed to counterfeit, copy, transcribe or translate this user manual without permission of ADTECH. This user manual does not include warranty, standpoint expression, or other hints in any form. ADTECH does not bear any responsibility for any data outflow, benefit loss or business termination due to the product info contained or mentioned by this user manual. All products and data mentioned are for reference only. Contents are subject to change without prior notice.

All Rights Reserved

ADTECH (SHENZHEN) CNC TECHNOLOGY CO., LTD

Upgrade Information

Item No.	Version No.	Revision Date	Remark
HC4500 (General)	0.1.4	2011/02/24	Edition 4

Note: Meanings of the three numbers in version number are as follows:

0

1

4

Library main version No. Library secondary version No. Reserved

Remark:

1. This user manual is strictly emended and checked by ADTECH (SHENZHEN) CNC TECHNOLOGY CO., LTD, however, it is not guaranteed that the user manual has no any mistake or error.
2. ADTECH (SHENZHEN) CNC TECHNOLOGY CO., LTD commits itself to improving the product functions and the service quality consistently. Therefore, the company reserves the right of changing any products as described, any software program, and the content of the user manual, without prior notice.

Safety Notice

Read this safety notice before operating.

I. Notice

1、 Notice on safety:

- Original copy of safety notice should be dispensed to every operator.
- Do not open the controller cover without permission; otherwise, it would be out of the range of guarantee.
- Cut off the power supply in case the machine is not used for a long time.
- Pay attention not to drop any dust or iron powder into the controller.
- Do not pour any liquid into the controller.
- Handle with care, and do not cause any damage.
- Abide by the accident prevention provision and regulations.
- Abide by the accident prevention provision and regulations on Oxygen cutting.
- Wear the mask when performing the plasma arc cutting, for the plasma arc will generate UV-b radiation.

2、 Notice on correct application:

- Our control system is capable of anti-interfering, but it is still required that your plasma power supply have shielding function and the plasma controller have good grounding. Otherwise, it will bring serious result.
- Please set all parameters of the controller strictly according to the user manual; otherwise, it may lead to failure of control system or even cause serious consequences.
- The controller uses the 24V DC power supply. To avoid short circuit, please pay attention to the voltage, negative or positive electrode of power supply when installing.
- Do not insert or pull out any output plug of controller while the power supply is connected; otherwise, it will damage the inside of controller.
- If the output relay is non-solid-state relay, a freewheeling diode should be connected in parallel on relay coil. Check the applied power supply to see whether it is up to requirements, avoid burning out the controller.
- Controller lifetime has a great relationship with ambient temperature. Install a cooling fan if the temperature in processing area is too high. The allowable ambient temperature of the controller is between 0°C and 60°C.
- Do some protection measures if the machine is used in high temperature, damp, or dusty environment, or environment with corrosive gas.
- In place with strong vibration, add a rubber anti-vibration pad to weaken the vibration.

II. Statement:

We offer one year factory warranty or lifetime maintenance for any malfunction arising under the normal use. In case of man-made damage or if the warranty expired, ADTECH will charge a certain cost price of parts. However, the warranty is not applied to the following conditions:

- The label of serial number is torn down.
- Any damage caused by personal factors
- Any damage caused by natural disasters
- Disassembly, modification, or repair without permission

III. Maintenance

1. Notice for maintenance and inspection:

- Cut off the power supply of major loop before maintaining or repairing the controller.
- To prevent the accident, the operator should confirm the power supply is cut off.

2. Inspection item and period:

Under the general operating conditions (Daily average 30°C, load rate 80%, operating ratio 12 hours per day), carry out the following items to do the route and periodical inspections.

Route inspection	Daily	<ul style="list-style-type: none"> ● Check whether the ambient temperature, dust and foreign matters exceed the criteria ● Check whether there is abnormal vibration or sound
Periodical inspection	Half year	<ul style="list-style-type: none"> ● Check whether the firm parts are loosened ● Check whether the terminal board is damaged

Content

Upgrade Information	2
Safety Notice	3
Chapter I. Introduction	8
1. Function introduction	8
2. Features	8
3. Application environment	9
Chapter II Quick Start	10
1. Help information	10
2. Restore factory default	11
3. Figure library	11
4. Copying processing files	12
5. Calling in processing file	13
6. Adjustment of cutting speed[Adju]	13
7. Adjustment of Manual Speed	15
8. Control of Turning Quality	15
9. Adjustment of preheating time in flame cutting [Adju]	17
10. Power Failure Treatment	19
11. Break point setup	19
12. Change of cutting gun nozzle	19
13. Displacement perforating	20
14. Movement of work piece	21
15. Line and point selection	21
16. Array	错误! 未定义书签。
17. Mirror	24
18. Rotation	25
19. Calibration	26
20. Tool Setting	29
Chapter III Operations and Details	30
1. Auto	30
1.1 Details of program running	31
1.2 Details of submenu in auto interface	33
1.3 Basic operations	40
2. Figure library	41
2.1 Operations	41
2.2 Hole-cutting and slicing	错误! 未定义书签。
2.3 Edge-sharing cut	错误! 未定义书签。
3. Edition	42
3.1 Explanation of sub-menu	43
3.2 Editing processing file	50
3.3 Basic operations	53
4. Parameter	54
4.1 System	54
4.2 Speed	56

4.3 Adjustment (Adju).....	58
4.4 Control (Ctrl).....	58
4.5 Accuracy (Prec).....	60
4.6 Save	62
5. Diagnosis (Diag)	62
5.1 Sub-menu	62
6. Upgrade (Upgd).....	65
6.1 Description of sub-menu	65
6.2 Restoration (Rev)	66
6.3 Upgraded by USB disk (Udsk).....	69
6.4 Backup/Restoration of HC6500 system files.....	错误！未定义书签。
6.5 Upgrade via PC	错误！未定义书签。
6.6 Recording program.....	73
6.7 Upgrade in BIOS interface via PC	74
7. Help system.....	76
8. Multi-language operations.....	77
Chapter IV Instruction System	79
1. Explanation of programming symbol	79
2. Coordinate explanation	79
2.1 Relative coordinate.....	79
2.2 Absolute coordinate.....	80
3. G instruction.....	80
3.1. G92 reference point setup.....	80
3.2. G21/G20 Metric /Imperial setting	80
3.3. G00 idle motion.....	81
3.4. G01 linear cutting.....	81
3.5. G02/G03 circular arc cutting	81
3.6. G04 Pause/Delay instruction	82
3.7. G26, G27, G28 Back to reference point	82
3.8. G22/G80 cycle processing.....	82
3.9. G81 workpiece counting	83
3.10. G91/G90 relative/absolute coordinate programming	83
3.11. G41/G42/G40	83
4. Common M instructions.....	84
Chapter V Hardware	86
1. Overall dimension	86
2. System input/output interface.....	87
2.1 Back cover.....	87
2.2 Specifications	87
2.3 Electrical connection	88
3. Connection mode of motor.....	96
3.1 Connection of Differential Driver	96
3.2 Connection of common-anode driver	100
3.3 Connection of Panasonic servo motor	101
4. Key Points for Installation & Test	101
4.1 NCS's Requirement on Impulse Equivalent Value.....	101

4.2 Current adjustment of driver	102
4.3 Test method of impulse equivalent	102
4.4 Anti-interference measures	102
Chapter VI Troubleshooting	104
1. Why the U-disk cannot be read?	104
2. Why there is an error in the cutting?	104
3. Why the cutting quality of the turning is poor?	104
4. Why the cutting square is changed to rectangle?	104
5. Why the cutting circle is changed to ellipse?	104
6. Why there is wave shake in the opposite angles when cutting the circle?	104
7. Why the motor does not work or is similar to death when it is in “Auto” state?	104
8. Why the motor does not work or is similar to death when it is in “Manual” state?	105
9. The processing code has the “Return” instructions. However, why the device does not return to the home position after having finished the track?	105
10. Why the right angle of the cutting square is not vertical?	105
11. Why the anti-interference performance of plasma is poor?	105
12. Why, one of the solenoid valves cannot work?	105
Annex II Illustration of edition and processing	107
1. Standard circle	108
2. Square	109
3. Triangle	110
4. Quincunx	111
5. Four figures	112
Annex III G Instruction Quick Reference	114
Annex IV M Instruction Quick Reference	115

Chapter I. Introduction

1. Function introduction

HC4500 is a newest generation of high-performance flame/plasma controller developed by ADTECH. The control circuit adopts the ARM9 high-speed microprocessor, large-scale custom-tailor IC chip, and multi-layer PCB, and the display adopts 7" color display screen. Surface mount devices are used throughout the entire process. The controller is developed basing on powerful R&D capacity of ADTECH for many years, and the software integrates advantages of factories from home and abroad. The hardware of this controller is highly stable in operation, and the software is perfect in performance, making it a trusted and highly cost-efficient flame/plasma controller.

2. Features

- 1) Adopt 32-bit high performance CPU and super-large programmable FPGA, real-time multi-task control technology and hardware interpolation technology, realizing a fast and stable operation.
- 2) ARM9 processor technologies, achieving quick running speed of program and refreshing speed
- 3) Reasonable process structure, combining with all Optocoupler isolation control and powerful plasma anti-interference capacity
- 4) 256M storage space for processing files, satisfying the running and processing of all kinds of complex programs, and capable of handling the running of large program easily
- 5) Capable of controlling 3 stepper/servo motors at the same time, as well as synchronizing of double axes or developing the function of third axis in accordance with the actual requirements
- 6) 7" color display screen, human-friendly operating interface, easy to operate, and the interface supports display in many languages
- 7) Support plasma and flame cutting, and the system software contains the perfect cutting processes for both kinds of cutting
- 8) Figure library is provided, capable of selecting hole-cutting or slicing of figure in figure library as required
- 9) Figure processing function allows it possible to rotate, calibrate, or do X/Y mirror for the processing figure
- 10) Provided with array, rectangle edge-sharing cutting functions
- 11) Delay, preheating, and perforating control
- 12) Plasma arcing detection, initial positioning, and corner signal speed control, supporting THC
- 13) Cutting gun nozzle changing, replacement perforating, and part moving
- 14) Breakpoint restoration, and power-off protection during the processing
- 15) The functions including idling, testing graph scope, retroversion etc..
- 16) Gap compensation and backlash compensation
- 17) Figure display, real-time track movement display
- 18) The stepper motor adopts high-subdivision driver, with high accuracy and stable running.
- 19) Cutting gun can be adjusted up and down as required.
- 20) Diagnosis function is provided for helping users to solve the machine errors quickly.
- 21) Capable of copying processing files in NCS to USB disk.

- 22) File name can be displayed in Chinese so that users know clearly the content of files.
- 23) Users can download the latest upgrade via the USB disk for updating the application.
- 24) End users can restore the factory default and system files using the one-key backup and restoration function, which better protects the system parameters and system files.
- 25) Procedure input has two modes: processing file after USB disk transfers CAD and nests, and on-site compiling G code manually.
- 26) USB and RS232 serial port communication control; capable of reading files via USB disk, it is convenient for the on-site operations
- 27) Help system makes the operations easier for the primary users.
- 28) **Speed range** : 0---15000MM / MIN , **Distance of travel** : (+)99999.999—(-)99999.999 mm.

3. Application environment

Power supply: DC 24V 50/60Hz

Power consumption: <4W

Operating temperature: 0°C —60°C

Storage temperature: -20°C —80°C

Operating humidity: 20%—95%

Storage humidity: 0%—95%

Chapter II Quick Start

ADT-HC4500 flame/plasma controller can be used in machine tool to control flame or plasma cutting gun for cutting. This system is displayed with window prompt by grade. In the menu of an interface, you can press [F1] to [F6] to select the relevant functions, or press [◀] or [▶] to return to the previous menu.

This chapter introduces the general operating procedures for using the system, allowing users to be able to use quickly. However, to master every skill or details, you have to read through the user manual.

Once connecting to the power supply and entering into the main interface, a greeting word will be shown as follows:



Picture 2 Main interface

Press [F1] to [F6] to enter the interfaces of different functions:

Press [F1] to enter the auto process, manual, figure display and processing interfaces

Press [F2] to enter the figure library.

Press [F3] to enter the interface for calling processing files, manual editing of processing files, and copying files.

Press [F4] to enter the parameter setting and adjusting interface.

Press [F5] to enter the system diagnosis, version enquiry, and user-defined outlet editing interfaces.

Press [F6] to enter the system parameter restoration, application upgrade, and help interfaces.

1. Help information

In most interfaces of main menu, you can press [INS] to get the relevant text help information. For example, in main interface, press [F1] (Auto) to enter the auto interface, where pressing [INS] allows you to get the help information on this interface.

Main menu →Press [F6] to enter the upgrade interface →Press [F6] (Help) to search for the relevant help information.

2. Restore factory default

In case there is a condition of abnormal speed or accuracy due to the improper adjustment of system parameters, you can, in main menu of system, press [F6] (Upgd) →Press [F1] (LEV)→Press [F1] (LEV)→Press [ENTER] to restore the parameters to factory default.

In HC4500, you can also press [F6] (Upgrade) in main menu→ [F3] (Restore) →Press [F1] (Restore)→Press [ENTER] to restore the system configuration files, help files, and figure library files.

Note: If the factory has not saved the factory default, it is not allowed to restore the parameters, and the corresponding dialogue box will be shown.



Picture 2.2 Parameter revert

It can refer to the chape 3 system details operation and specification (6.2) Revert fuction

3. Figure library

For the convenience of processing and for reducing workload of operators and increasing the usability of system, the system is provided with 33 common figures of processing part and 1 testing figure. In the main menu interface, press [F2] (Grap) to enter the figure library interface as follows, and select the corresponding figure to process.

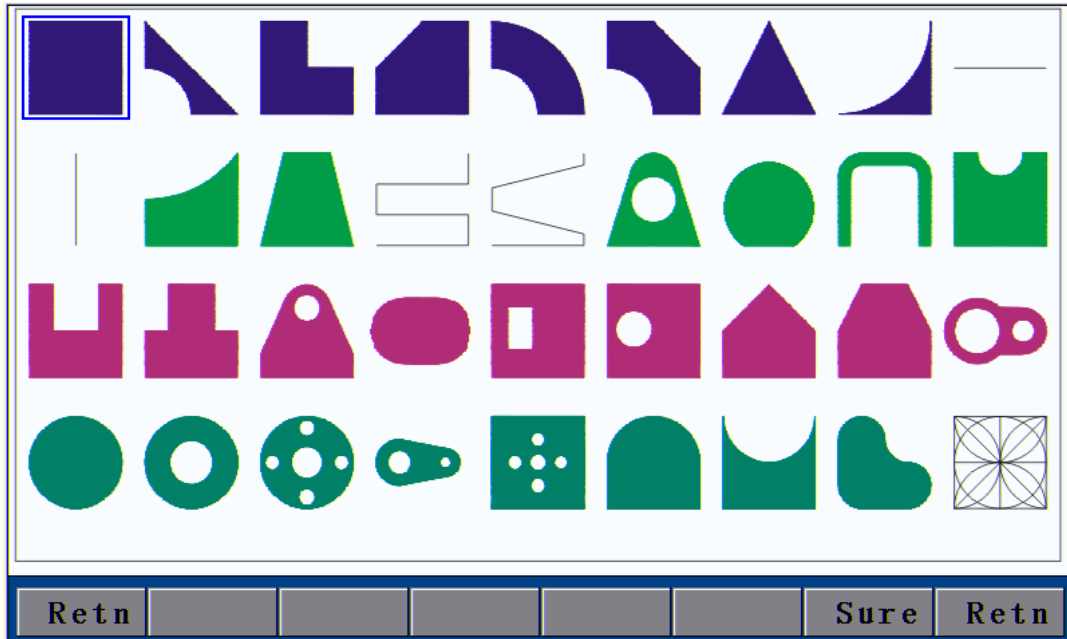

Picture 2.3 Figure library interface

Operation: Press [X+], [X-], [Y+], or [Y-] to move the cursor up, down, left or right. Press [S↑], [S↓] to page up or down, and press [ENTER] to enter the figure.

4. Copying processing files

Insert the USB disk with copied processing files into the USB port of control system. In main menu, press [F3] (Edit) → [F3] (Udsk). If it is connected successfully, the interface will show the file names of files stored in USB disk, as the following picture shows:

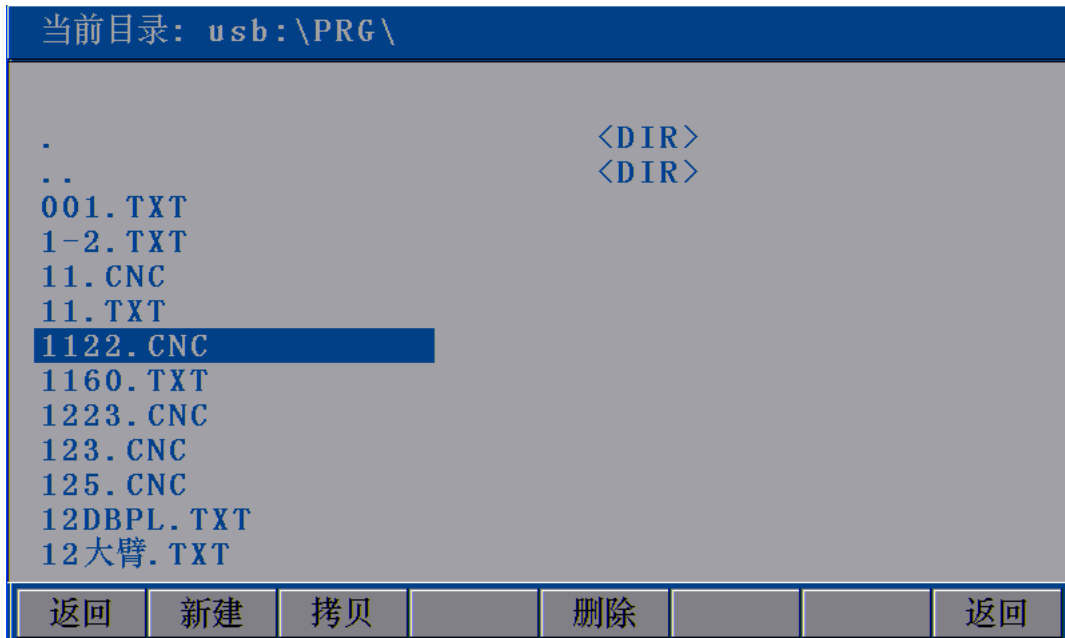

Picture 2.4 Copying processing files

At this time, press [Y+] or [Y-] to select the processing files to be copied, and press [F2] (SCpy) or [ENTER] to copy. After that, a prompt will pop up when you can press any key to return to the main menu

interface.

5. Calling in processing file

In main interface, press [F3] → [F2] to enter the interface for calling in files as follows:

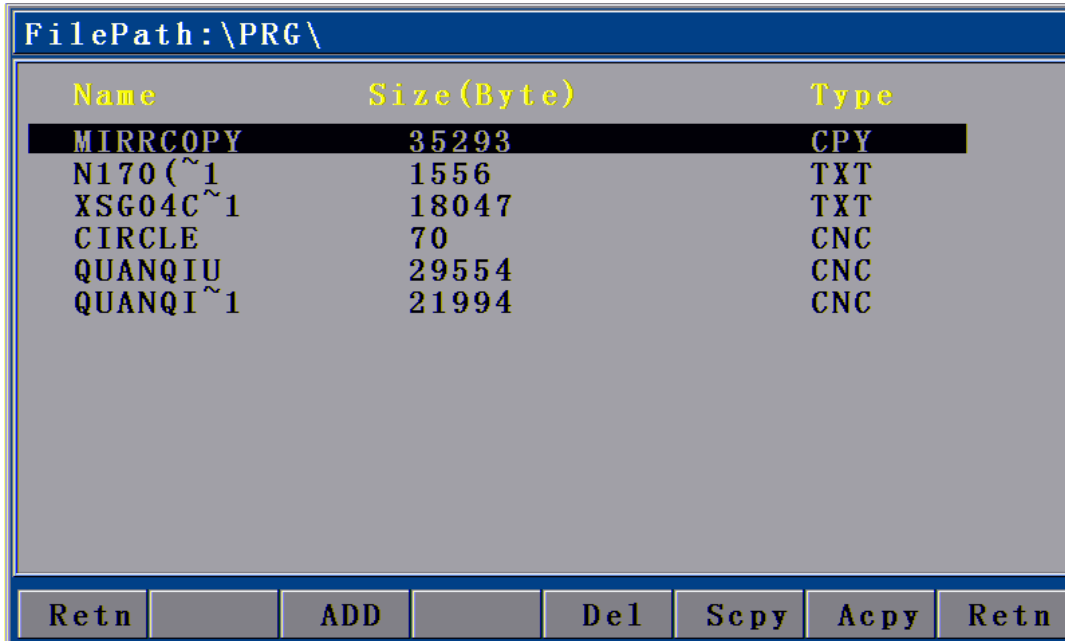

The screenshot shows a terminal window titled "FilePath:\PRG\". It displays a table of files with columns for Name, Size(Byte), and Type. The file "MIRRCOPY" is highlighted. At the bottom, there are buttons for Retn, ADD, Del, Scpy, Acpy, and Retn.

Name	Size(Byte)	Type
MIRRCOPY	35293	CPY
N170 (~1	1556	TXT
XSG04C ~1	18047	TXT
CIRCLE	70	CNC
QUANQIU	29554	CNC
QUANQI ~1	21994	CNC

Picture 2.5 File calling interface

After entering the above interface, press [Y+] or [Y-] to select the processing file, and then press [F2] or [ENTER] to confirm and enter the processing code editing interface. You can press ◀ ▶ to exit and go back to the main interface, when you can press [F1] to enter the auto interface to carry out the processing with selected files.

6. Adjustment of cutting speed[Adju]

In main interface, you can press [F4] (Para) → [F2] (Speed) to enter speed setting interface.

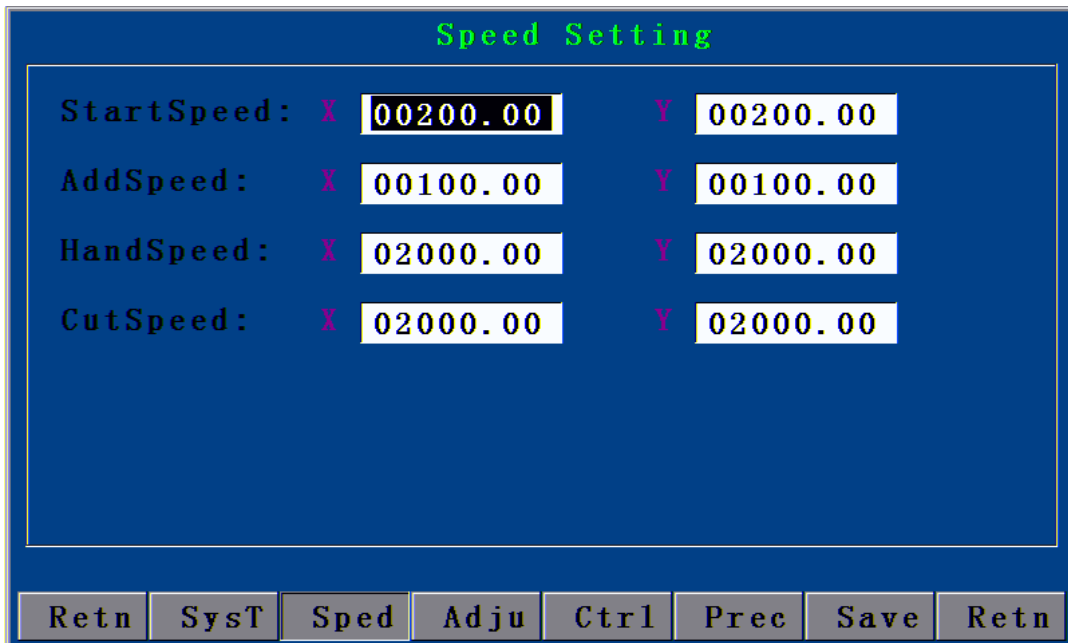

2.6.1 Speed setting interface

First, set the processing speed in the interface as above picture. The speed is the max speed that the actual processing can achieve.

Press [X+], [X-], [Y+], or [Y-] to move the cursor to make the selection, and then press the number key on left of panel to input the value.

After setting the speed, press ◀ ▶ to return to main menu. Press [F1] again to enter the auto processing interface:



2.6.2 Auto processing interface

Processing speed is determined by the “CutSpeed” in speed setting interface and the “Speed” rate in auto processing interface.

$$\text{Actual Processing Speed} = \text{CutSpeed} \times \text{Speed Rate}$$

Note: Speed rate can be adjusted by pressing [F↑] and [F↓] on the panel, or just the [F] key.

7. Adjustment of Manual Speed

In main interface, press [F4] (Para) → [F2] (Speed) to enter the speed setting interface.

See section “HSpeed” for the interface picture. Set the manual speed with the same method as setting cutting speed, and exit to the main interface.

In main interface, press [F1] (Auto) → [F2] (Manual) to enter the manual interface:

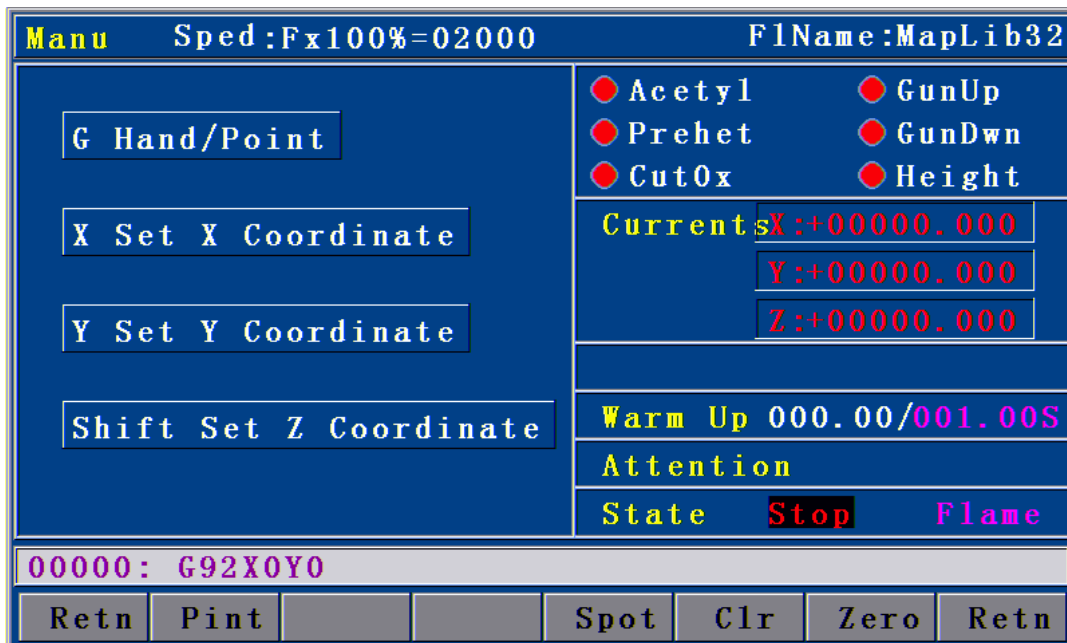

2.7 Manual interface

$$\text{Actual Manual Speed} = \text{HSpeed} \times \text{Speed Rate}$$

Note: Speed rate can be adjusted by pressing [F↑] and [F↓] on the panel, or just the [F] key.

8. Control of Turning Quality

During the flame cutting and plasma cutting, there is a process of acceleration and deceleration when turning. Whether the acceleration or the deceleration is properly set or not, it directly influences the cutting quality of the turning. **Especially when it is flame cutting, the fast speed of turning may easily cause flameout or halfway cutting; and if the turning speed is too slow, it may easily burn the turning to be**

circular arc shape.

The system acceleration and deceleration are set as follows: Press [F4] (Para) in main menu interface, and press [F2] (Speed), then, set the speed in “StrSpeed” and “AddSpeed” (See picture below). Detailed definitions are as follows:

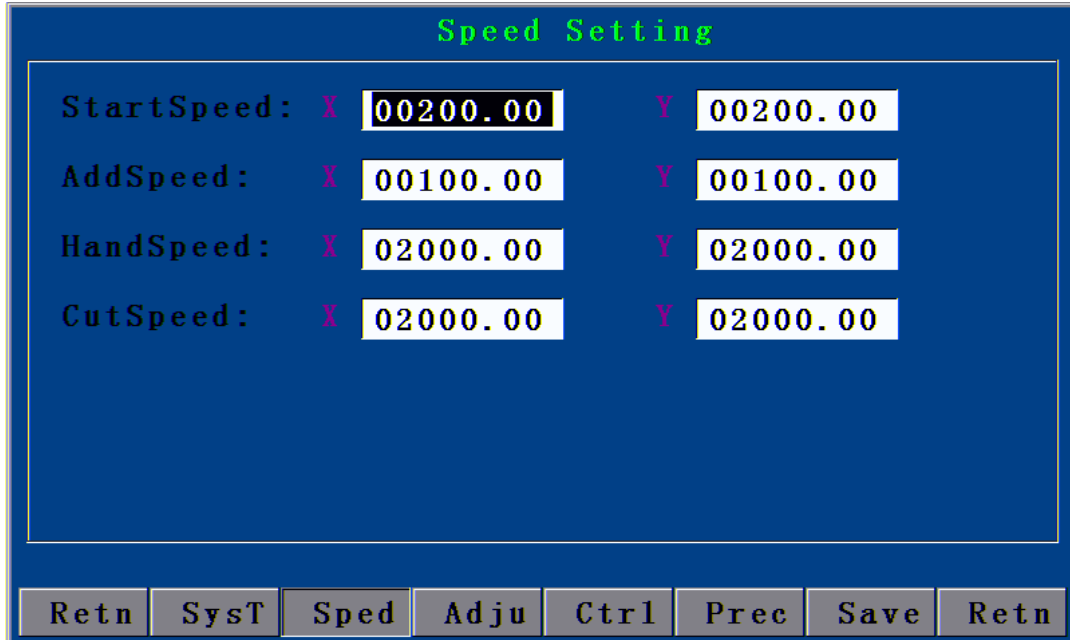

2.8 Speed settings

1. [StrSpeed]--Start-up speed: Track-Move, a speed of starting up. For example, if the “StrSpeed” is set to be 300, the system speed is 0.3m at the just beginning. The value of start-up speed is determined by the processing speed. The following list shows the reference value of start-up speed; actual data are subject to the on-scene cutting effect.

CutSpeed (mm/minute)	StrSpeed (mm/minute)
100-200	100
200-500	200
500-700	300
700-800	500
800-1000	600
1000-1300	700
1600-2000	1000
2000-3000	1500
3000-4000	2000

Table 2.8.1

2. [AddSpeed]-- Acceleration: It is an average increment of increasing the processing speed from start-up speed to the highest speed. For example, if the start-up speed is 300, acceleration is 100, and highest speed is 1000, then, the speed is increased to 300, 400, 500...1000 at 100 intervals; if the acceleration is 50, then, the speed is increased by 50 each time.

The acceleration is determined by the **Precision** (In main menu, press [F4] (Para) → [F5] (Prec)).

Precision: refer to the distance the corresponding machine moves when the control system gives an impulse.

The following list shows the reference value of impulse equivalent and the acceleration; the actual data are subject to the on-scene cutting effect.

Precision	Addeleration (mm/minute)
0.001000-0.002000	10
0.002000-0.003000	20
0.003000-0.004000	30
0.004000-0.005000	40
0.005000-0.006000	50
0.006000-0.007000	60
0.007000-0.008000	70
0.008000-0.009000	80
0.009000-0.010000	90
0.010000-0.011000	100
0.011000-0.012000	110
0.012000-0.013000	120

Table 2.8.2

9. Adjustment of preheating time in flame cutting [Adju]

In main menu, press [F4] (Para) → [F4] (Ctrl) to set the “Preheat Delay” in the second row as the required time.

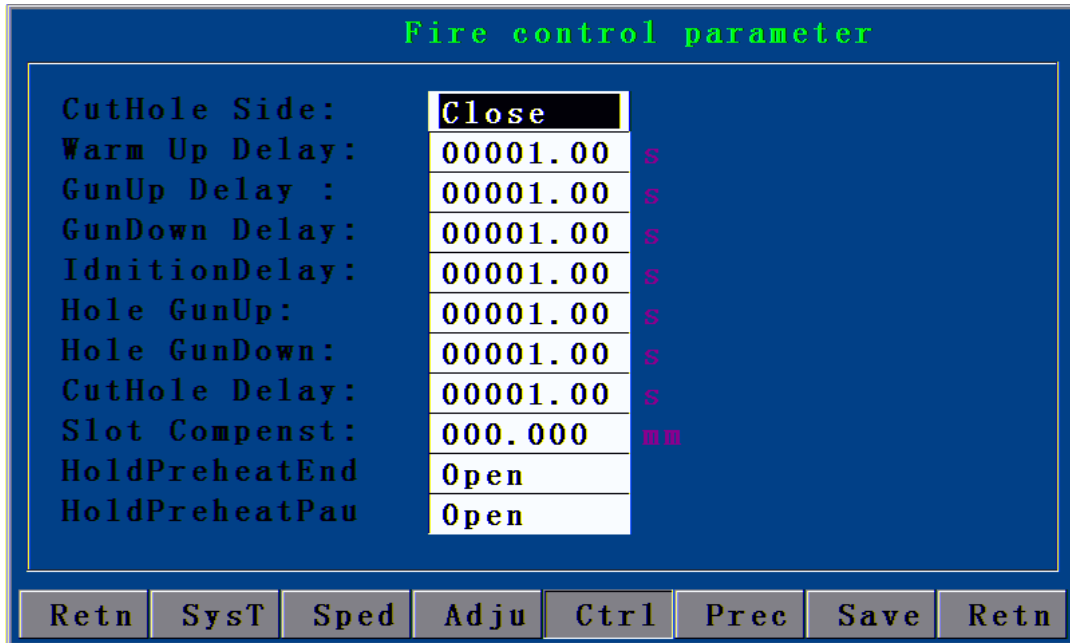

2.9.1 Control interface

In auto cutting interface, it will carry out preheating before perforating. Total preheating time and the current preheating time will be shown on the right bottom of the interface; on the left bottom there will show “Record & GO, Press [G]; Stop, press [START]; Go-on, Press [STOP].” As prompted, if you press [START], the system will stop preheating immediately and go to the next action without saving the preheating time. If you press [STOP], the preheating time will be extended without limit. Press [G] to stop preheating, and the system will save the “Current preheating time” automatically as the “Preheating time” for the future.

In main menu, press [F1] (Auto):

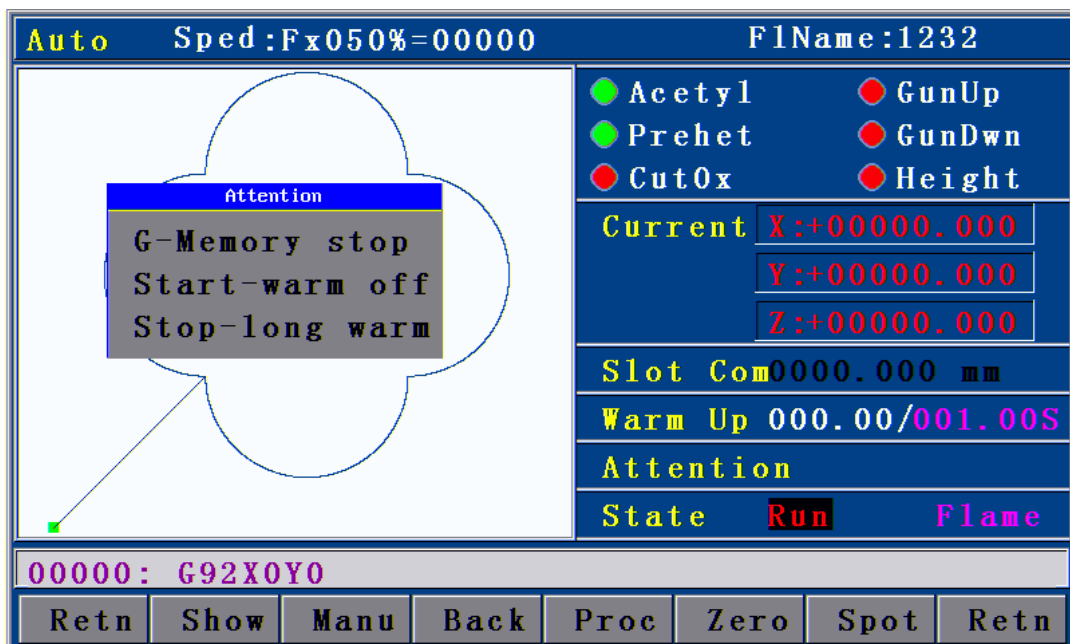

2.9.2 Preheating in auto interface

10. Power Failure Treatment

In order to avoid the waste of raw materials caused by the sudden power failure, the system equips with a power-off protection function. If the device is powered off during the processing, the system will automatically save the last processing track as a break point. When the power supply is resumed and you want to resume the coordinate before power-off, you just have to press [F1] (Auto) in main menu → [F6] (Break point) or [F1] (Auto) → [F4] (Break point).

Note: Do not move the cutting nozzle when the power is off, and make sure to set the current coordinate when the power is resumed; otherwise, all the memory coordinate will be wrong.

11. Break point setup

If you exit the automatic processing interface (press [F1] (Auto) to enter) and want to return next time, you need to resume to the current stop coordinate. This can be made by pressing “Pause” during the automatic processing and pressing [F6] (Spot), then, the system will automatically save the current processing point (where the cutting nozzle is located) as a break point. This point is saved forever; no matter it is power off or on. The coordinate will be the saved break point coordinate when you enter the “Auto” interface next time, as long as the current program has not changed.

If you restart the device after the power-off, you just have to press [F6] (Spot) in the “Auto” interface to restore the break point, and press the [Start] key to resume processing.

12. Change of cutting gun nozzle

If cutting gun nozzle is damaged during the processing, please follow the following steps to change it:

① In main menu, Press [F1] (Auto) → ② Press [Stop] key → ③ Press the corresponding [X+], [X-], [Y+], and [Y-] keys to move the cutting gun to a proper place for changing the nozzle → ④ Press [START] → ⑤ select the relevant item in the popped up dialogue box as Picture 2.12 → ⑥ Press [ENTER], the coordinate will be moved to the current break point automatically and proceed the processing of selected item.

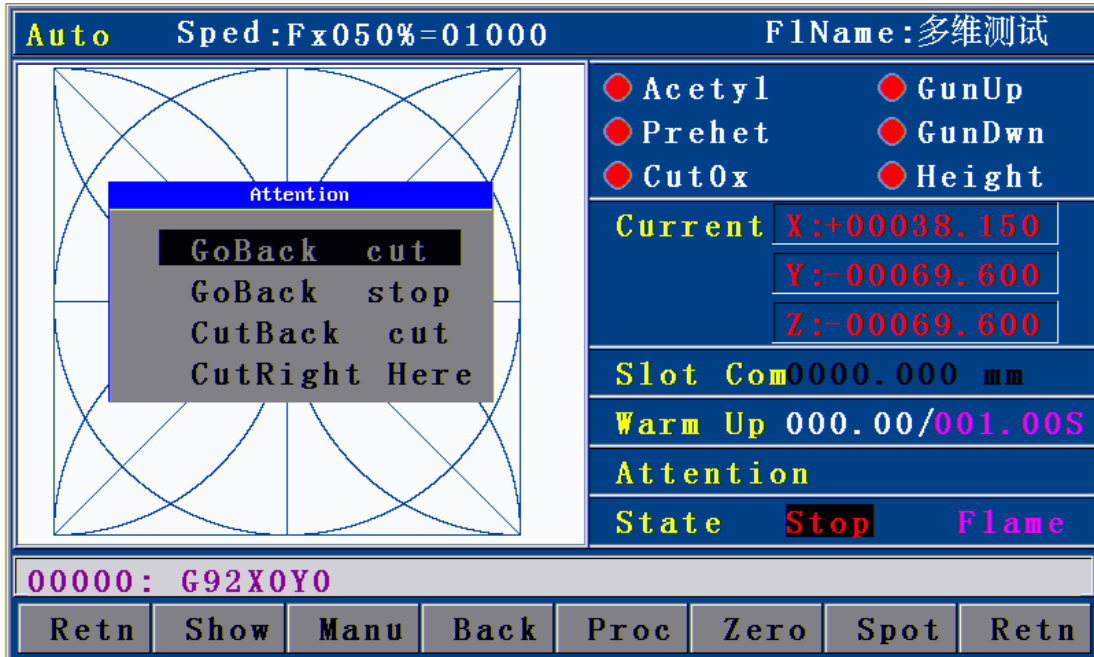

2.12 Change of cutting gun nozzle

FBack and Cutting : Go back to the interrupt with no cut then cut continue the program.

FBack and Stop : Go back to the interrupt with no cut then stop program..

CBack and Cutting : Go back to the interrupt with cutting then then cut continue program.

Process ringht here : cut continue program right here.

13. Displacement perforating

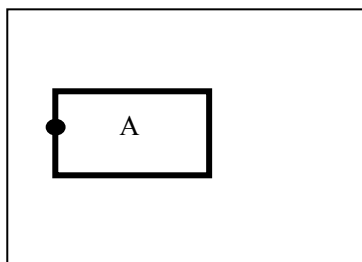

Picture 1

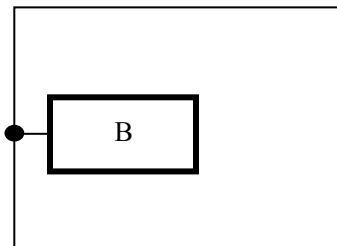

Picture 2

As picture 1, the outer is square steel plate and the inside rectangle is the workpiece to be cut. Assuming that it is to cut the work piece from point A and the steel plate is of thick materials; then, it will cost a lot of time to perforate. However, if it is to cut from the edge of steel plate (point B), the time of preheating perforating may be saved. Detailed operations are as follows:

① In automatic processing → ② Press [STOP] → ③ Press the corresponding X, and Y keys to move the cutting gun to the edge of the steel plate → ④ Press [Start] again → ⑤ Select the relevant item in the popped up dialogue box → ⑥ Press [ENTER], the coordinate will be moved to the current break point automatically and proceed the processing of selected item.

14. Movement of work piece

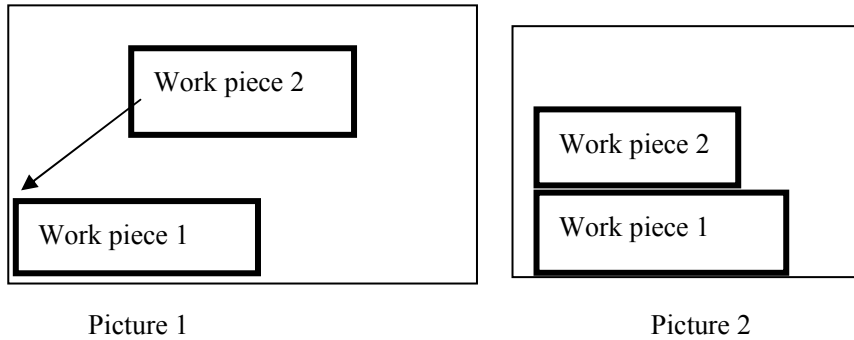

To save the steels during the processing, you can move the tracks of work piece to a certain place for processing when cutting some kinds of figures. As shown in above pictures, the out frame is the steel plate, and the inside frame is the figure to be cut. For example, it may waste many materials if you cut the “work piece 2” directly after having cut the “work piece 1”, because they are a certain distance away. Therefore, you can move the track of work piece to a proper place as Picture 2 before cutting, which can save many materials. Detailed operations are as follows:

Press [STOP] key after you have cut the “work piece 1” → Press [X+], [X-], [Y+], and [Y-] to move the cutting gun to the proper position.

15. Line and point selection

This function allows you to select any line of G code of the figure for processing.

In main menu, press [F1] (Auto) → [F4] (Grap) → [F4] (Pro) → [F2] (ChoG) to enter the interface of positioning mode as follows:

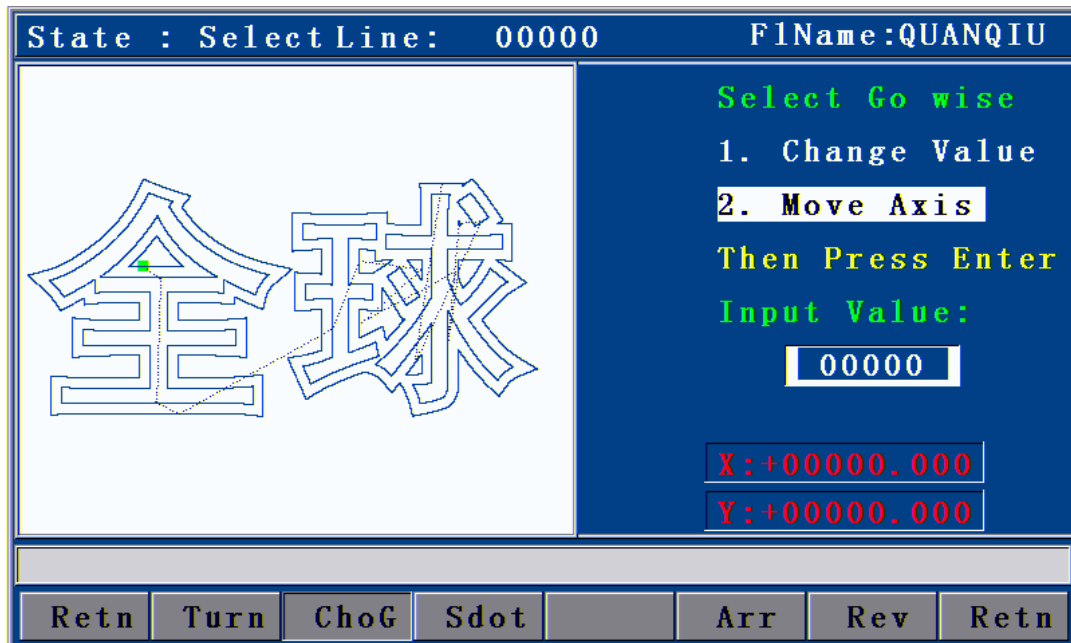

Picture 2.15.1 Positioning mode of line selection

Direct change coordinate: the cutting gun does not move, but the coordinate is changed to the coordinate of this line directly.

Auto move Gun: the cutting gun moves from the current position to the coordinate of selected program line.

You can press [Y+] or [Y-] to change the mode of positioning when selecting line, and press [ENTER] to select the line number (as Picture 2.15.2 shown below).

Input the line number by pressing the number key and then press [ENTER]. In case of doing fine adjustment, you can press [X+] or [X-] to select the next line number.

16. Array

When you need to cut a single figure on big steel plate for several times, you can use the array function to realize the simple array of this repeated figure.

In main menu interface, press [F1] (Auto) → [F4] (Grap) → [F4] (Pro):

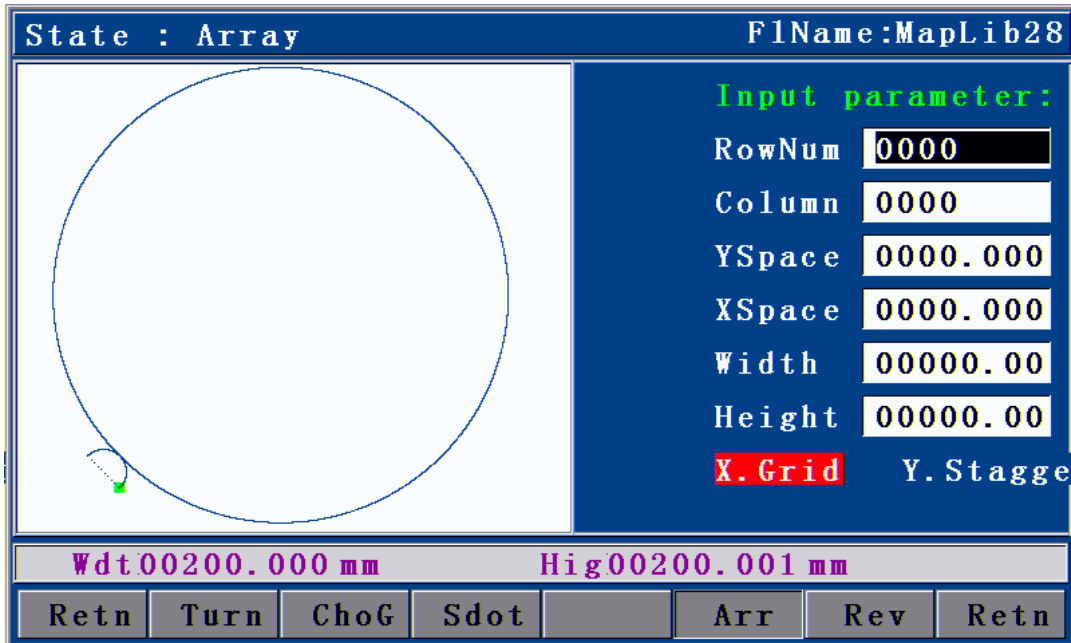

Picture 2.16.1 before arraying (Processing interface)

The acquiescent deviant is the space usage size as above picture, which it means the single graph height and width. Suitable adjust the width and height can make the arraying more reasonable.

Press the No. key input the parameter value, press **【Y+】**、**【Y-】** select item of paramters, input correct parameter, press **【Confirm】** enter into the direction selection of arraying.

In above interface, press [F5] (Arr) to enter the array parameter setting interface.

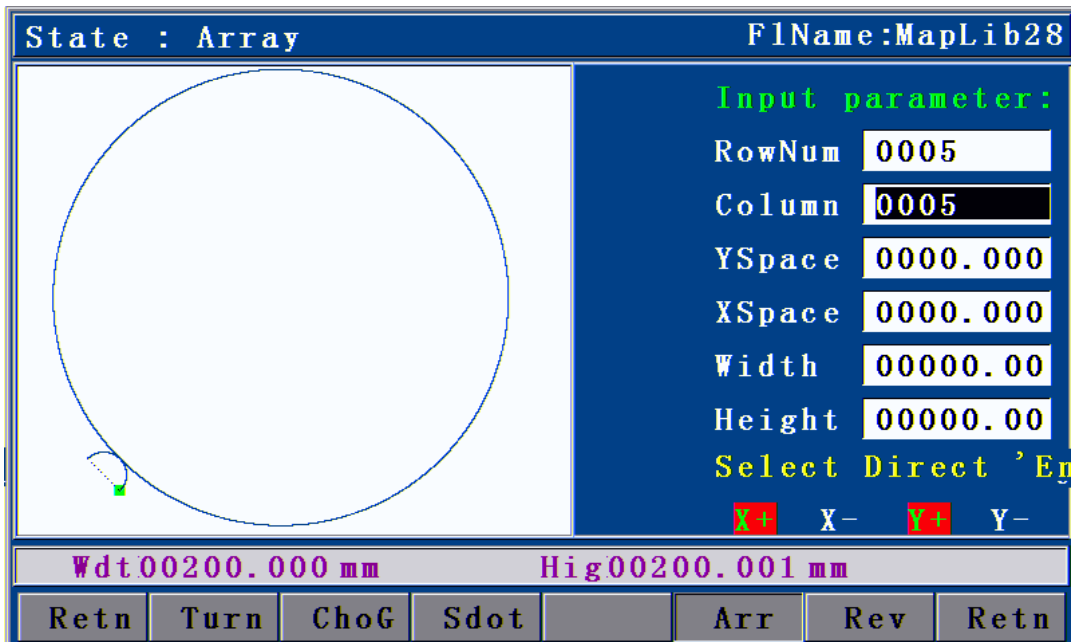

Picture 2.16.2 Array parameter settings

Press **【X+】**、**【X-】**、**【Y+】**、**【Y-】** select cursor movement to arraying direction, after selected, press **【Confirm】** , finished all of the step of arraying, graph will finished array immedately.

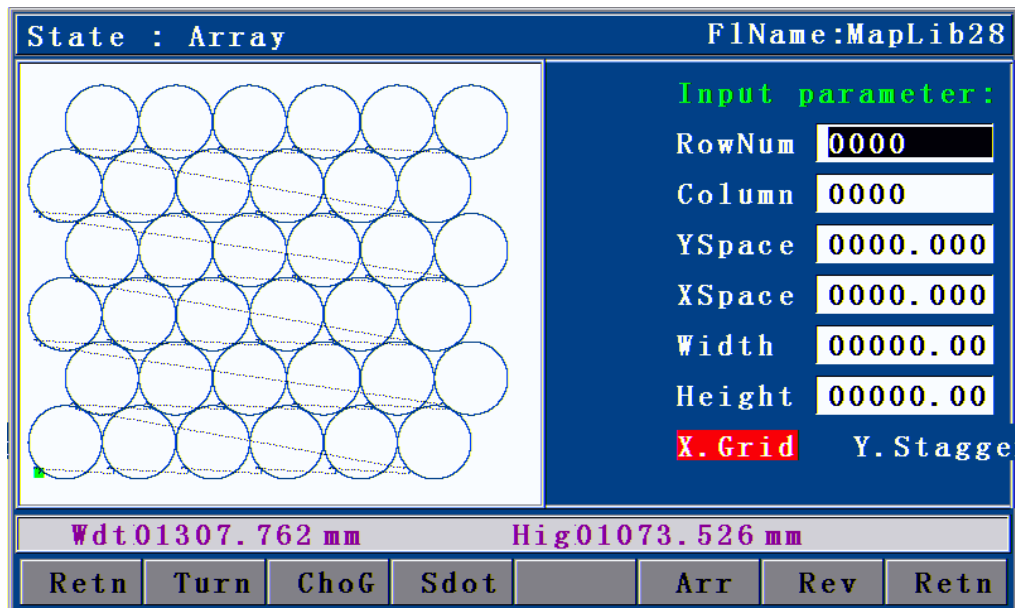

Picture 2.16.3 After array graph

Matters need attention when you operate arraying

- 1) After the array, it will not save the original process file, like stop coordinate etc.
- 2) After Array, press **【Retn】** enter into dealing interface, It can check if the size suitable the plate or not. Afresh Array press **【F6】** (restore)

17. Mirror

If you need to exchange the start point and the final point of the figure horizontally at 180° during the cutting, you can do it by mirror function.

Press [F1] (Auto) → [F4] (Figure) → [F4] (Process) → [F1] (Rotate) → and press [F1] (Y mirror) / [F2] (X mirror) / [F3] (XY mirror). As shown in the following picture:

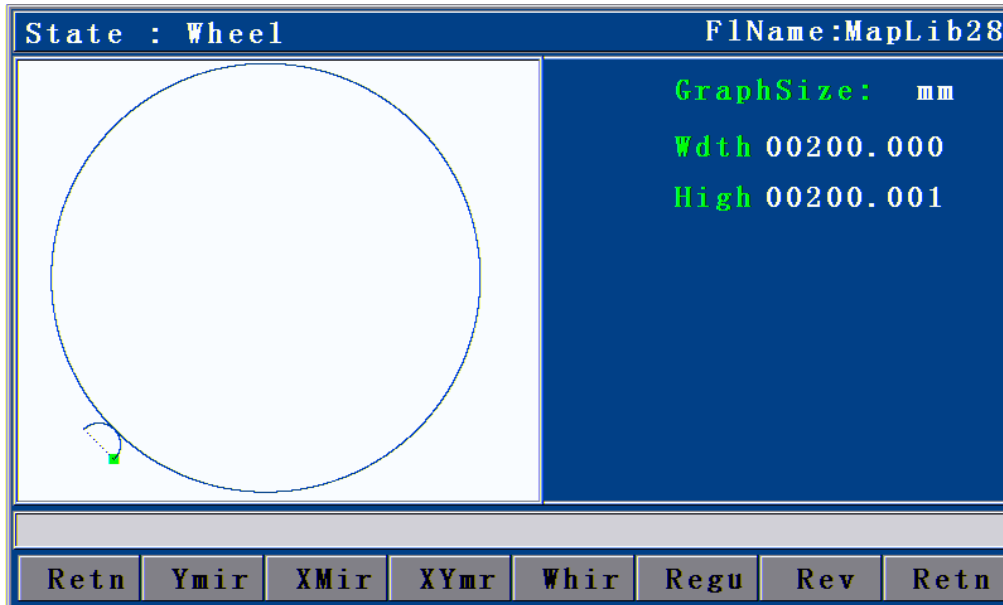

Picture 2.17.1 Before X mirroring

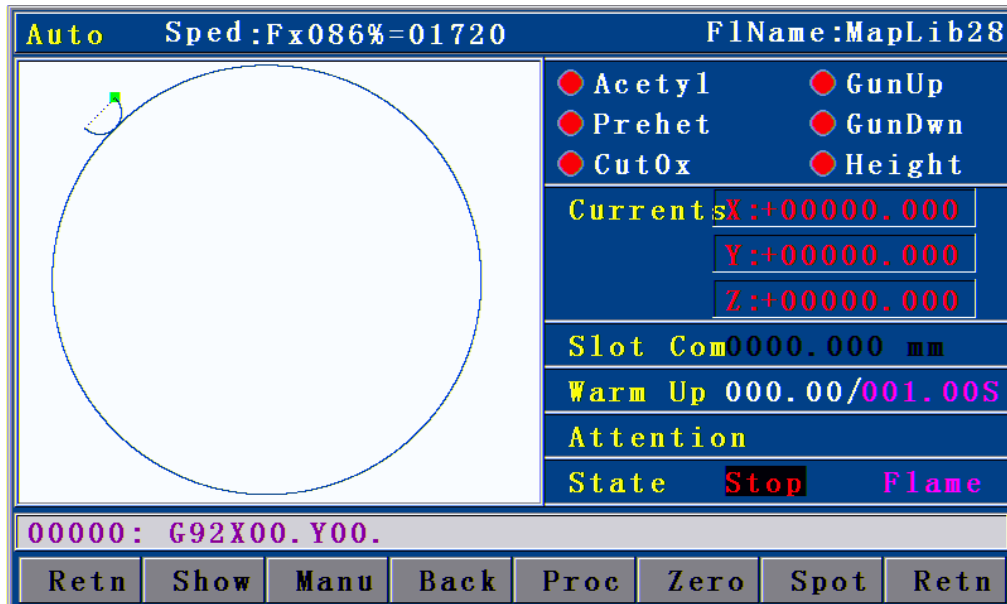

Picture 2.17.2 After X mirroring

18. Rotation

Sometimes, the position and angle of the steel plate are required to meet the XY axis of the cutting machine during the cutting. However, in the actual processing, it is hard to avoid the XY axes on steel plate deviating from the XY axes of cutting machine for an angle.

In virtue of rotation function, it is allowed to achieve the auto calibration of steel plate so that you do not have to move the steel plate or cutting machine. The operations are as: in main menu, press [F1] (Auto) → [F4] (Figure) → [F4] (Process) → [F1] (Rotate) → [F4] (Rotate), and then input the rotation parameter to finish the figure rotation.

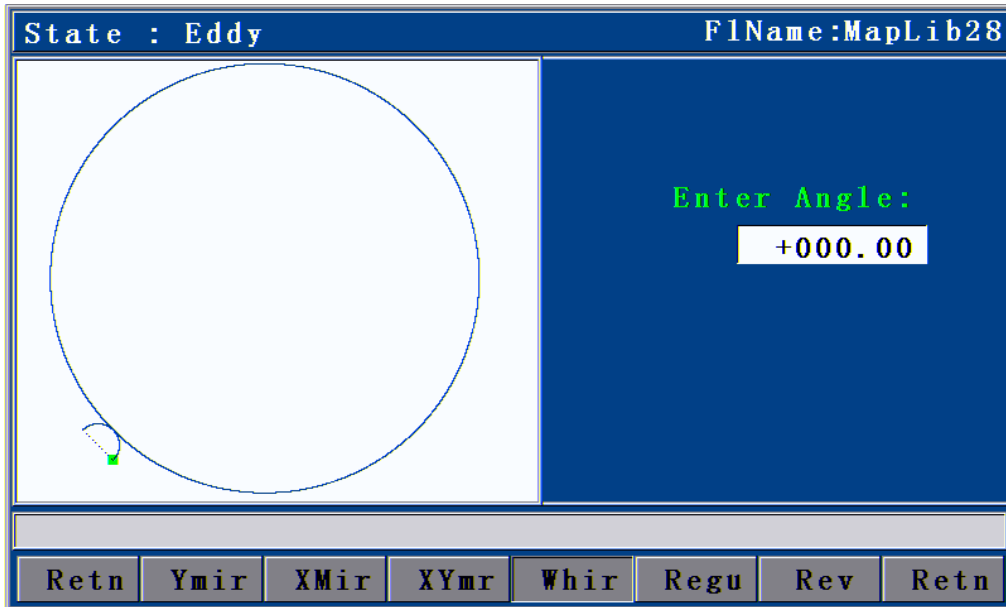

Picture 2.18 Rotation

19. Calibration

If rotation angle is uncertain when calibrating the steel plate, we can get a correct rotation angle by calibration function.

First, a reference axis is required, around which the figure is rotated at a certain angle when calibrating. To select the reference axis, press [F1] (Auto) in main interface → [F4] (Figure) → [F4] (Process) → [F1] (Rotate) → [F5] (Calibrate), and a dialogue box will show up for selecting the reference axis (HC4200 can only take X as the reference axis).

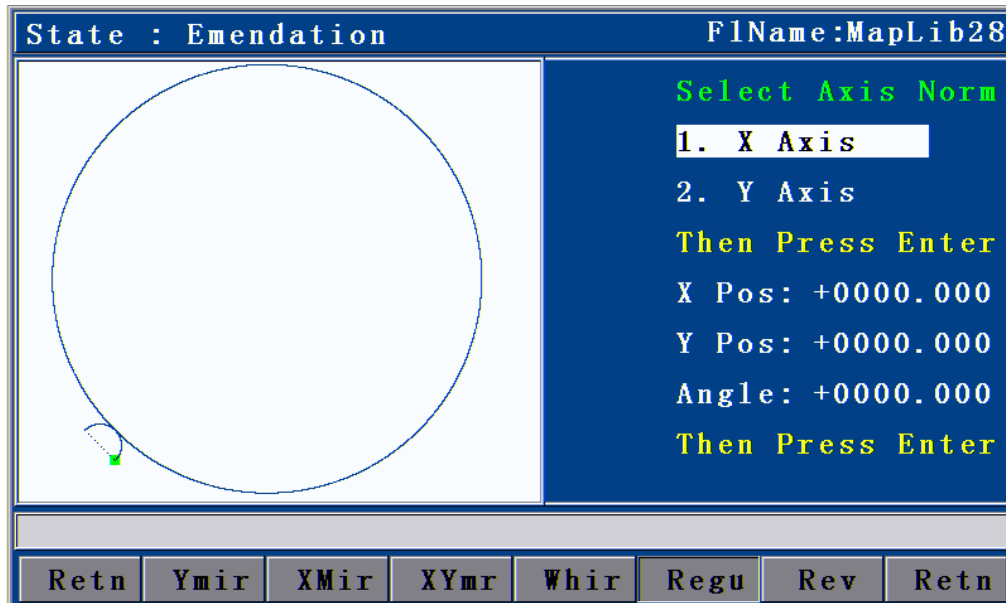

Picture 2.19.1 Selection of calibration reference

Reference axis X: the offset angle of steel plate is the angle formed by X axis of steel plate

and the X axis of reference coordinate.

Reference axis Y: the offset angle of steel plate is the angle formed by Y axis of steel plate and the Y axis of reference coordinate.

Press **【X+】【X-】【Y+】【Y-】** to select the move cutting gun, at the same time, the system will calculate the angel automatically.

The following calibration takes X axis as the reference axis.

The principle of calibration taking X axis as reference axis is as follows:

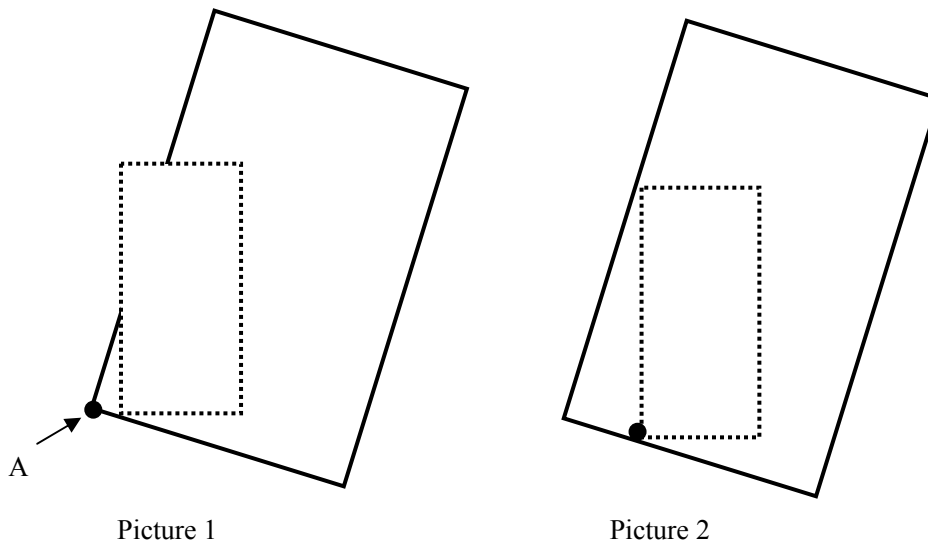

- 1) In Picture 1, the large frame (Real line) is the steel plate, the small frame (Dashed line) is the figure to be cut, and point A is the start point of the cutting gun. If it is cut according to Picture 1, the figure outside may not be cut; and if it is cut when the start point is moved to the middle of the steel plate as Picture 2, obviously it will waste the steel plate.
- 2) At this point, without moving the steel plate, you just have to figure out the slope angle of the plate, and incline the figure to be processed at the corresponding angle before cutting effectively.

Way of calibrating the steel plate:

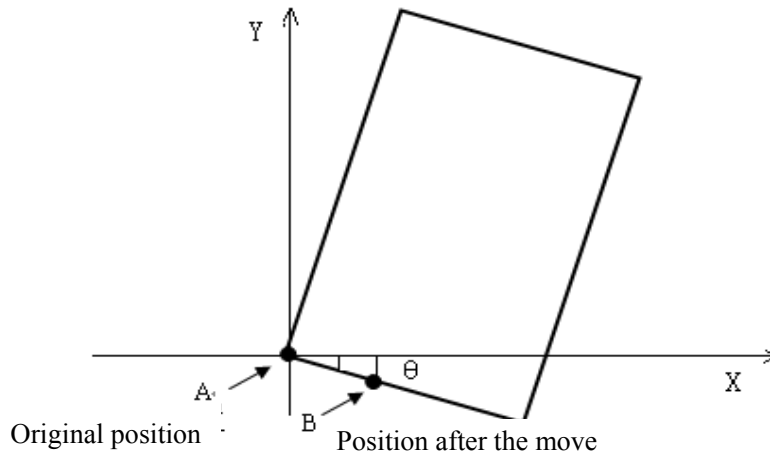

- 1) As above picture, point A is the start point of cutting gun. You can figure out the slope angle of the steel plate by moving the cutting gun to any point of its base line. Press [X+] → [Y-], or [Y-] → [X+]; then, press [ENTER] to confirm.
- 2) Then, the figure displayed on the controller will be rotated at a certain degree. The position of figure to be processed and the steel plate is shown as follows:

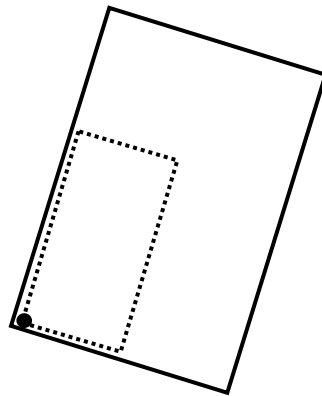

- 3) If the steel plate is inclined as follows, then, the calibration method is as below:

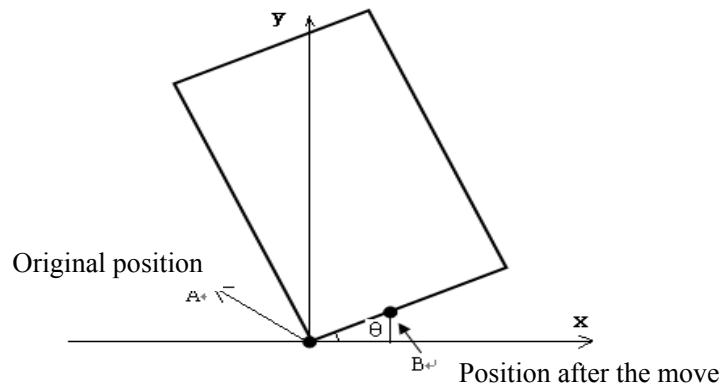

Press [X+] → [Y+], or [Y+] → [X+], then, press [ENTER] to confirm. The position of figure to be processed and the steel plate is shown as follows:

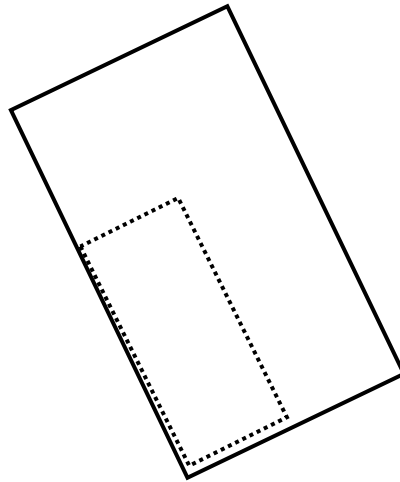

20. Tool Setting

Main Interface after power on, press **【F1】** Auto---**【F4】** Graph, Enter into Graph track follow interface, Press key **【G】**.

Graph Original start point will turn to position of lower left quarter, Press Key **【G】**, The graph start point will positioned 5 directions like original point, lower left quarter, Lower Right Corner, top right corner, top left corner.

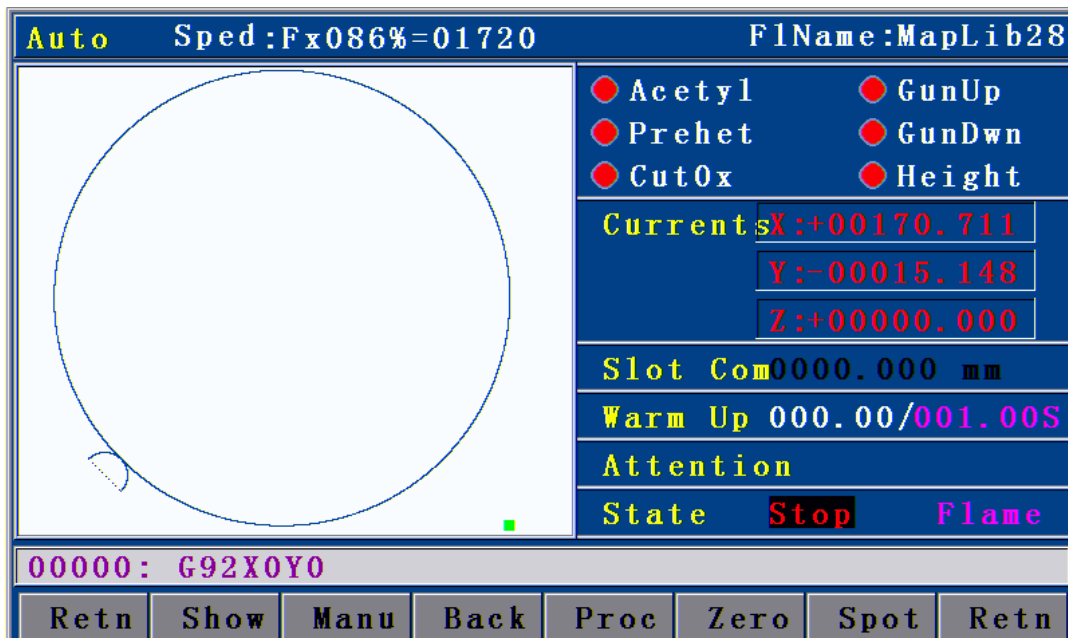

Picture 2.20 Positioning process Set start to lower right corner

The program will restore automatically when used this function.

When you press key of **【Start】** for processing, cutting gun will start move from “select start” to program original point, then make the processing

Chapter III Operations and Details

1. Auto

In main interface, press [F1] (Auto) to enter the auto processing interface as follows:

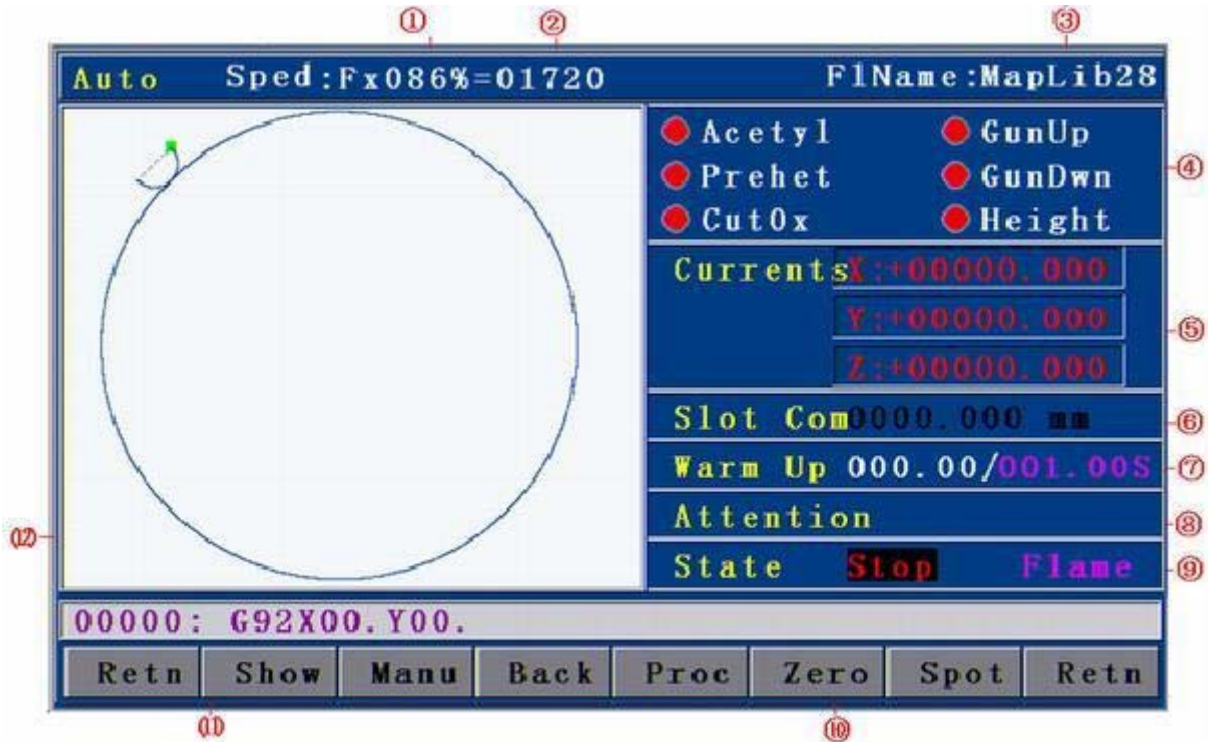

Picture 3.1 ① Flame mode

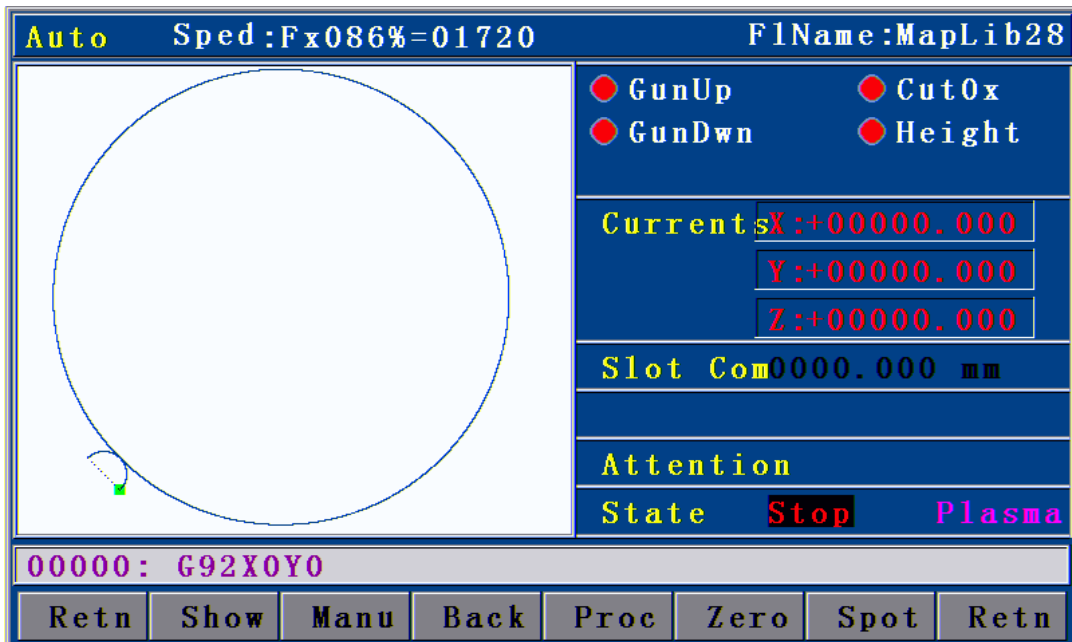

Picture 3.1 ② Plasma mode

Picture 3.1① Flame mode interface details:

- 1) Speed in %: can be adjusted by pressing [F↑] and [F↓]
- 2) Current moving speed
- 3) Name of processing file
- 4) Status of all electrovalves
- 5) Current The real-time coordinate value of X ,Y,Z
- 6) Current Gun gas of cutting diameter compensation
- 7) Preheating time of preheat oxygen when perforating in flame cutting
- 8) Current working status of the system
- 9) Cutting machine model remind
- 10) System current working status remind
- 11) System current remind of function mode status
- 12) Track display of current process graph

For plasma and flame mode interface, the difference is that the plasma mode does not have preheating time and some electrovalves are different.

1.1 Details of program running

In interface as shown in Picture 3.1① and 3.1②, you can press [Start] to run the current program. Once you have pressed the [Start] key, in any cutting mode, the cutting gun will start perforating on steel plate (M07 is default as perforating instruction), and then cutting. After the cutting, close the cutting oxygen. For M07 instruction, see section 4 of Chapter IV in this user manual.

If pause key is pressed during the cutting, the interface will be shown as Picture 3.1.1 and [F2] is changed from [Manual] to [Forward]. If you press [F2] [Forward], the machine will travel forward along the track, and when you press [◀] or [▶], [Forward] will be changed to [Manual], and the interface operations are of the same.

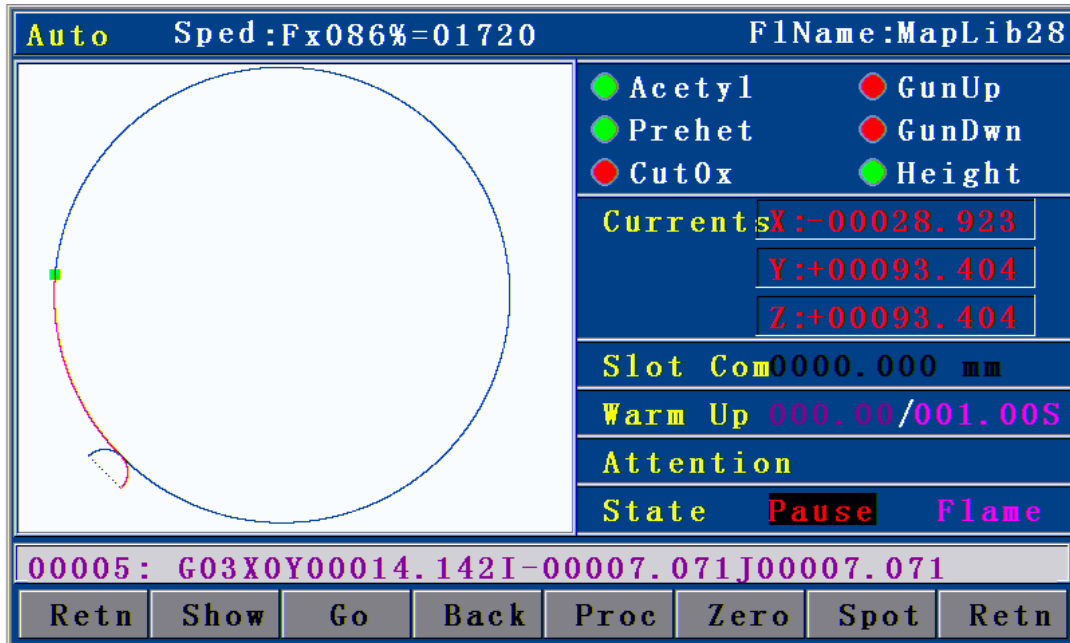

Picture 3.1.1 Pause in auto mode

Processing in pause (displacement perforating and gun changing)

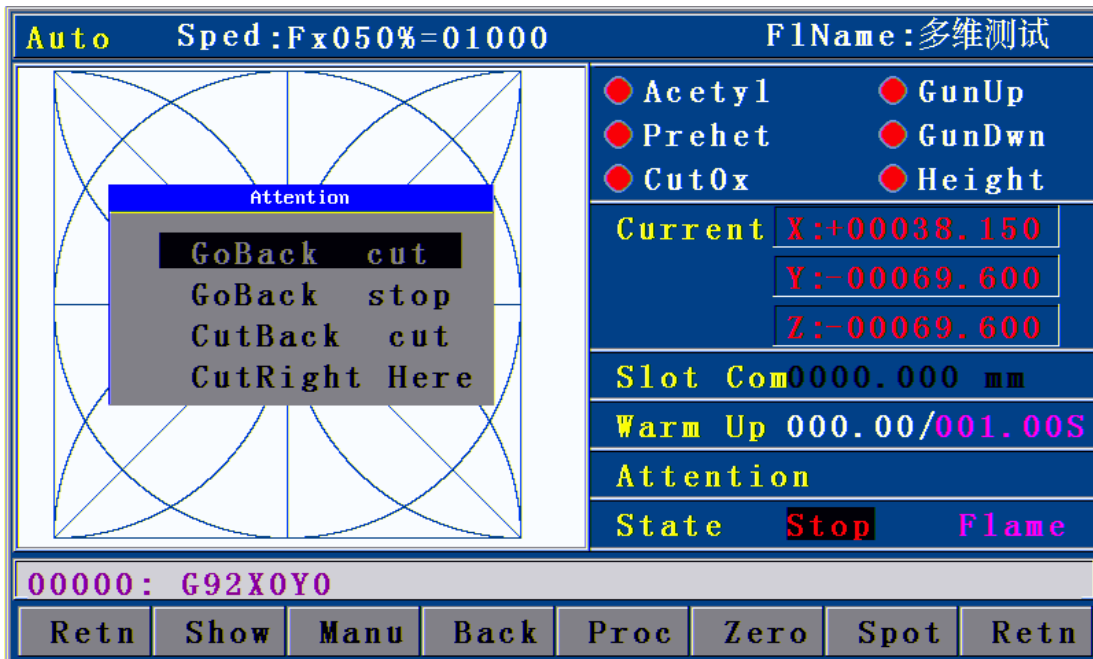

Picture 3.1.1.2 Pause processing

During the cutting, if [Pause] is pressed, according to whether the cutting gun has been moved manually, there are the following treatments:

1) If there is no manual movement after the pause, the controller will start perforating once you press the [Start] button, and then proceed running the program.

2) After the pause, if the cutting gun is moved deviating from the running track of processing file, when you press the [Start] button, the interface as Picture ③ above will show up.

[1]. the controller travels back to where the processing program pauses, enables the cutting

cycle, and then runs the processing program.

[2]. the controller travels back to where the processing program pauses, and then stops.

[3]. the controller enables the cutting at current position, and then returns to where the processing program pauses and runs the processing program. The three options can be selected by pressing [Y+] or [Y-] to move “←” up and down. After that, press [ENTER] to run the relevant function.

[4]. Proceed running the program code at offset position, and does not return to where the track is located when paused.

Press [ESC] to cancel, and wait at the current position for the users to decide whether to continue processing.

3) Perforating instruction will be performed automatically according to the program status.

You can press pause to stop the M07 instruction.

1.2 Details of submenu in auto interface

1.2.1 Travel

(Auto)→ [F1] (Travel): the system only runs X, and Y tracks, and the switches of preheating oxygen, acetylene, cutting oxygen, arcing, and cornering are not opened. It is for calculating whether the track and the size of running steel plate are correct.

(Auto) → **【Y】** , testing plate function. System will run automation an idling process picture of min rectangle figure

Travel and TEST speed is the maximum manual speed, and is not controlled by the speed percentage.

1.2.2 Manual

In main menu → [F1] (Auto) → [F2] (Manual) to enter the manual interface:

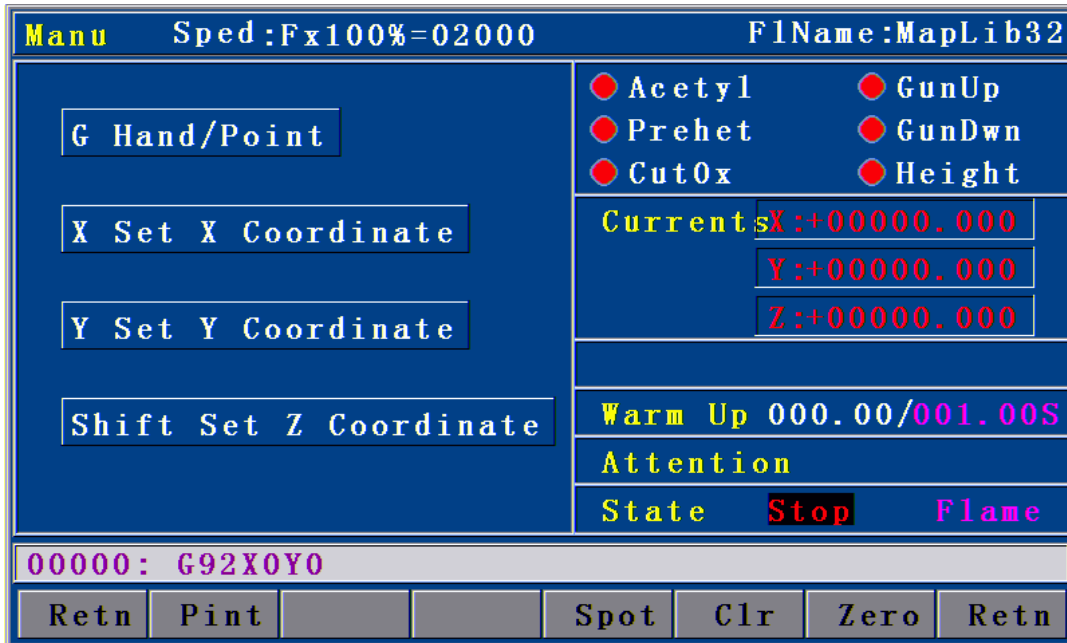

Picture 3.1.2.2 Manual interface in flame mode

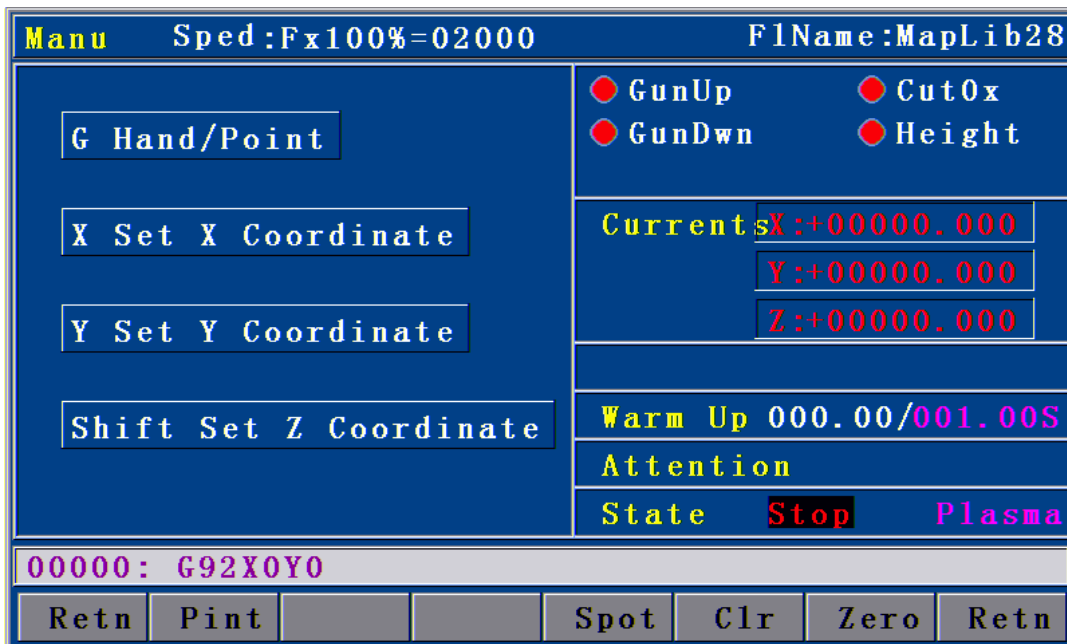

Picture 3.1.2.2 Manual interface in plasma mode

1.2.2.1 Inching

In manual interface as Picture 3.1.2.2, press [F1] (Point), and the above interface will show up when the “Inching” is highlighted, with an input prompt “Input L value” at the bottom of the screen. Press the number keys to input the length of inching, unit in mm. Then, you can press [X+], [X-], [Y+] or [Y-] to allow the motor to run the input length relatively for each time. It’s the same for the plasma function (Picture is omitted)

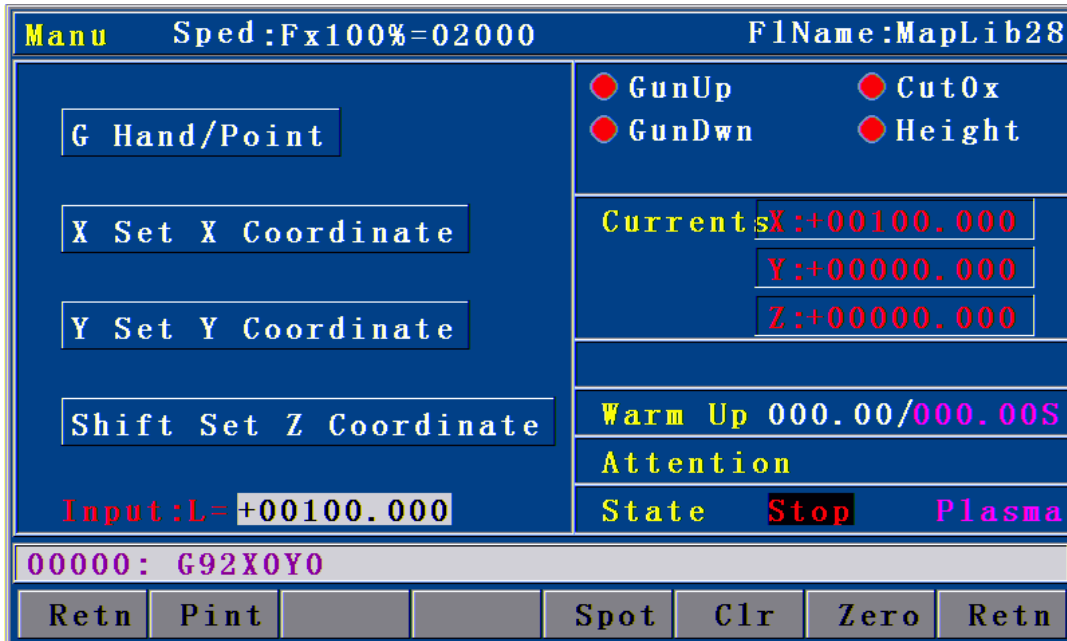

Picture 3.1.2.2.1 Inching setting interface

If “Inching” is not highlighted, it is default that once [X+], [X-], [Y+], or [Y-] is released, all axes are doing continuous motion until these keys are pressed again or the [Stop] key is pressed when the system will decrease and stop moving.

If you press [G] key, the system will be switched between manual and inching. If in inching state, keep holding [X+], [X-], [Y+], or [Y-] and the related axis will perform the continuous motion until they are released when the system will decrease and stop moving.

1.2.2.2 Breakpoint

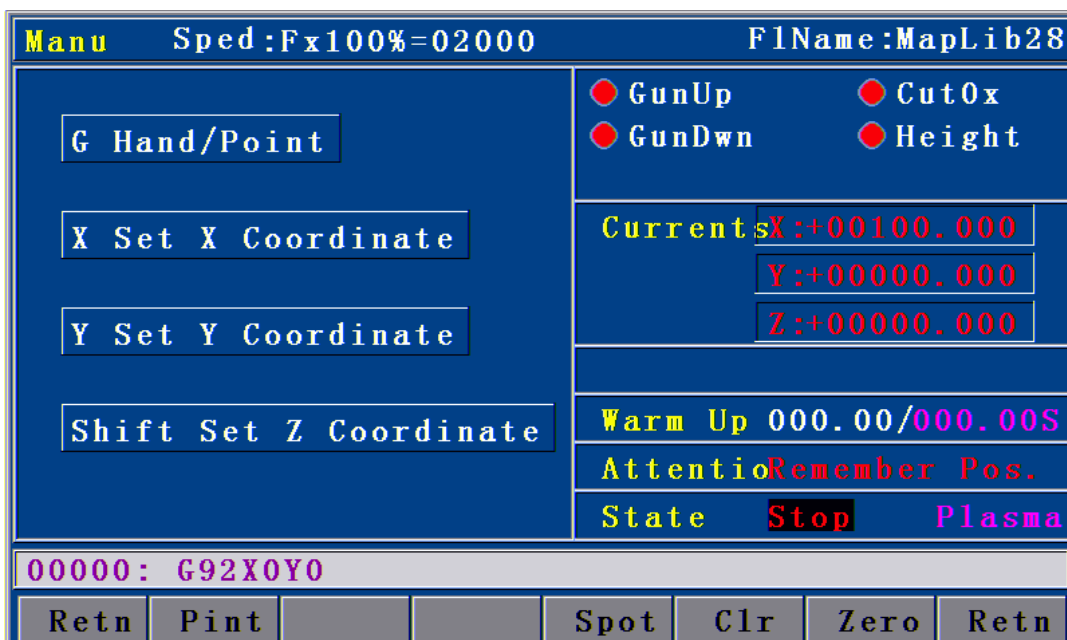

Picture 3.1.2.2.2 Breakpoint interface

It is the same as [F6] (spot) in auto interface, please refer to “Breakpoint” in 1.27 in this chapter.

1.2.2.3 Clear

In manual interface, you can press [F5] to clear the parameter in counting. If you press [X] or [Y] → [F5] (Clear) → [ENTER], it is to clear the entire line of X and Y coordinates. To clear the last digit of value, you can just press [DEL] on the panel.

1.2.2.4 Back to origin

In manual interface, when you press [F6], the coordinate value of X and Y is returned to 0 coordinate.

1.2.2.5 X, Y coordinate setting

In manual interface, pressing [X] and [Y] keys on panel enables to modify or clear the value of X and Y.

Once [X] or [Y] key is pressed, the interface on the left bottom will show the current coordinate, for example “Input X value: X=+00123.456”, and at this time you can press [DEL] to clear the coordinate value or press [F5] (Clear) to clear the entire line of value. After the setting, press [ENTER].

1.2.3 Backward

It is used in auto interface to return along original track due to the incomplete cutting when processing, and the procedures are:

In auto processing → Press [Stop] to stop → Press [F3] (Backward) to enter backward function → if the required position is arrived, press [Stop] → If it exceeds the required position, press [F1] (Travel) to move forward → Once the system is stable, you can then press [Start]. The system will run M07 perforating instruction again directly and process in accordance with the program.

One backward action can only return to the previous perforating point.

1.2.4 Forward

During the processing, travel or backward motion in auto mode, if you press [Stop] to stop, the original “Manual” displayed in menu will be changed to “Forward”. At this time, if you press [F2], the system will

move forward at actual processing speed without running M switching instruction, which is equal to traveling at processing speed.

1.2.5. Figure processing (Pro)

In figure interface as Picture 3.1.2.5 above, → you can press [F4] (Pro) to enter the figure processing interface as follows:

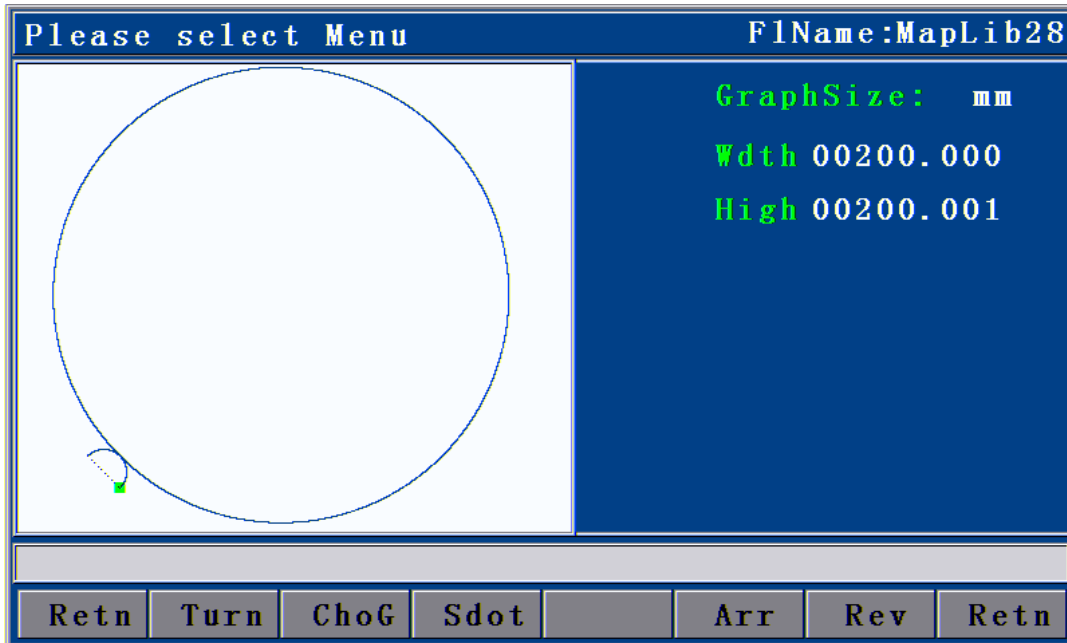

Picture 3.1.2.5.1 Interface of figure processing

1.2.5.1.1 Rotation (Turn)

In above processing interface, press [F1] (Turn) to enter the rotation interface.

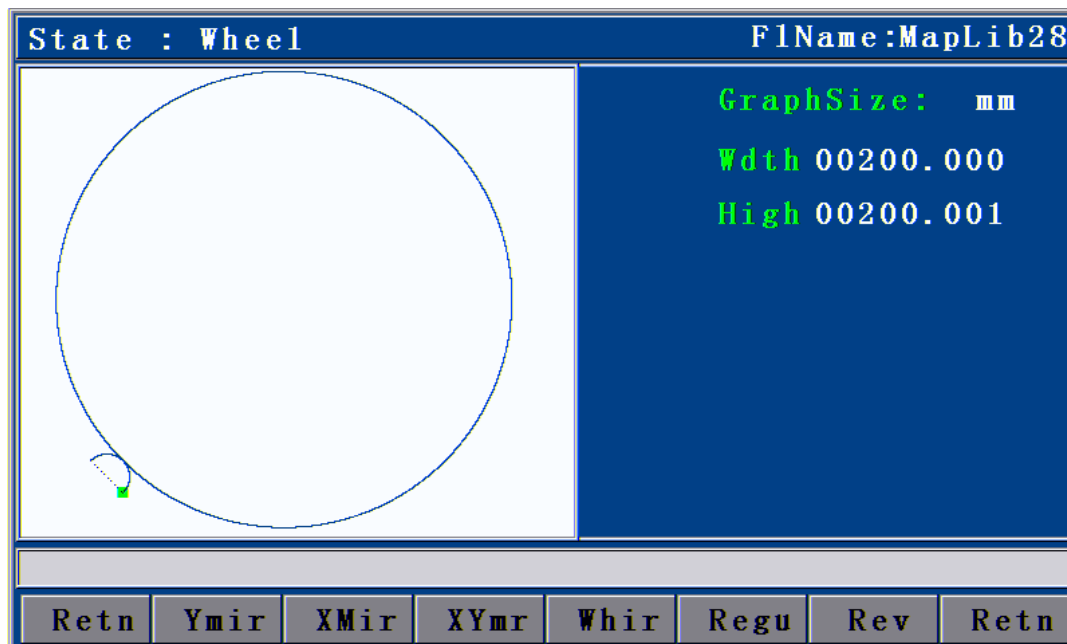

Picture 3.1.2.5.1.1 Interface of figure processing

1.2.5.1.2. X, Y mirror

See “Mirror” in section 17 of chapter II.

1.2.5. 1.3 Rotation (Whir)

See “Calibration” in section 18 of Chapter II.

1.2.5. 1.4 Calibration

See “Calibration” in section 19 of Chapter II.

1.2.5. 1.5 Restoration

In rotation interface, you can press [F6] to restore the current figure to figure before mirroring, rotating or calibrating.

1.2.5.1.6 Select line

See “Select line” in section 15 of Chapter II.

1.2.5.1.7 Select point (Sdot)

In processing interface as Picture 3.1.2.5.1, press [F3] (Sdot) to enter the interface of selecting point:

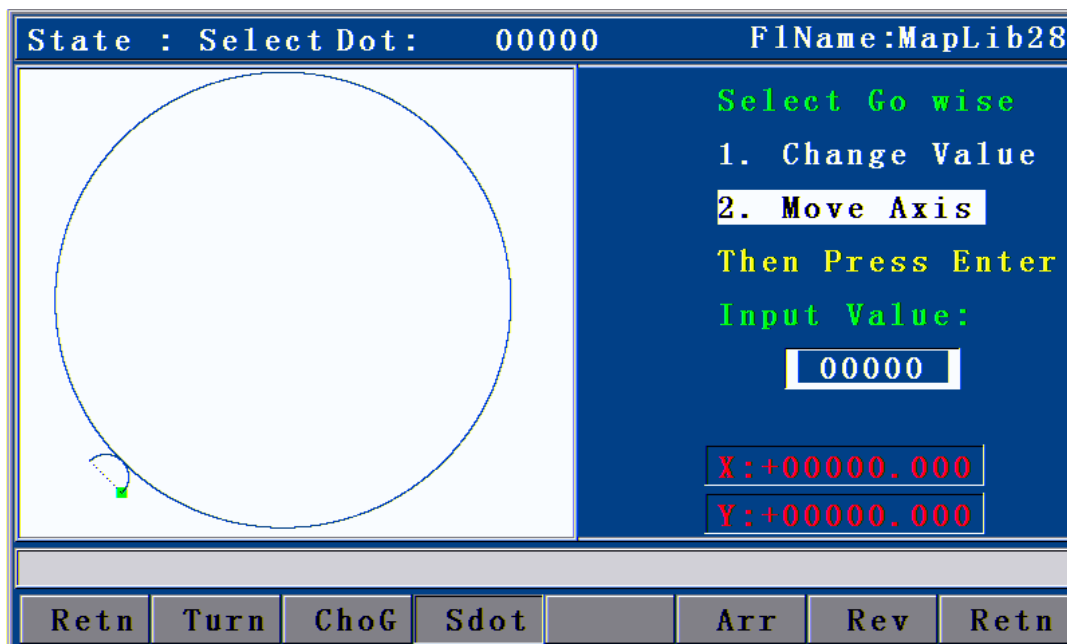

Picture 3.1.2.5.1.7 Select point

You can press [Y+] or [Y-] to change the positioning method for selecting perforating point.

Direct change coordinate refers to that the cutting gun does not move but the coordinate is changed to the coordinate of perforating point directly.

Auto move gun refers to that the cutting gun is moved from current position to perforating point.

After that, select any M07 perforating point during the figure processing to process, and input the perforating point and press [ENTER]. To make fine adjustment, you can press [X+] or [X-] to select the next perforating point.

1.2.5.1.8 Array

See “Array” in section 16 of Chapter II.

1.2.5.1.9 Restoration (Rev)

In processing interface as Picture 3.1.2.5.1, press [F6] (Rev) to restore the figure after the array, point/line selection to the shape when loading.

Note: In rotation interface, it can only restore the figure to the state before rotating

Only in processing interface can the figure after the array operation be restored.

1.2.6 Back to origin

In auto interface, press [F5] and the cutting gun will return to origin at the current manual speed. When in auto running, it's required to press [Stop] to allow system to be stable before pressing [F5].

1.2.7 Breakpoint (Spot)

Functions of breakpoint:

- 1) Find the coordinate before power down when the power supply is resumed.
- 2) Set a breakpoint memory on the current track for changing the cutting nozzle.
- 3) Set a breakpoint memory on the current track for displacement perforating.

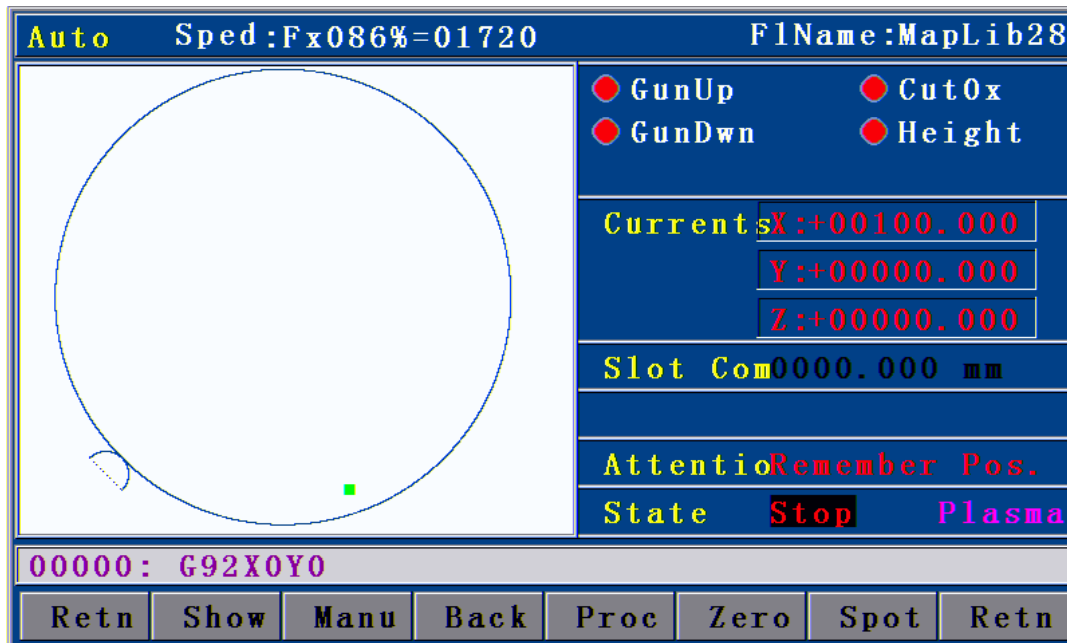

In case of manual pause in auto processing, when you press [F6] (breakpoint), the system will save the current working track (current position of cutting gun) as a breakpoint automatically. This breakpoint is saved permanently. When you restart the machine or re-enter the auto mode, as long as the current program is not changed, you can press [F6] (Breakpoint) to restore based on the breakpoint. Once the breakpoint is found, press [Start] and the system will continue the processing from the breakpoint. It is the same for the plasma function.

1.3 Basic operations

1) I/O

Flame: Before processing, you can also select the strong electricity key manually to control the ignition, acetylene, preheating oxygen, cutting oxygen, and cutting gun rising/falling/stop. Note: when you press the ignition key, if the acetylene is not opened, it will open the acetylene valve before switching on the ignition switch, and then switch off the ignition switch after an ignition delay (see Parameter-Control-Ignition Delay). Press [Perforating] and it will perform preheating perforating (see M07 Fixed Cycle of Preheating Perforating in section 4 of Chapter III). Pressing [Main switch] is to close all IO outputs.

Plasma: You can use the arcing switch (Cutting Oxygen switch of flame cutting) to control the arcing before processing and the system gives an arcing signal to the height-adjusting system. If there is no height-adjusting system, the system will open the arcing switch; press [Perforate] to starting arcing and perforating (See M07 arcing & perforating cycle in point 4, section 3); press [Shut down] to shut all the output.

2) [F↑] and [F↓] allows you to increase or decrease the moving speed rate. In standby mode, you can press and hold this key to increase or decrease the speed continuously. If in the process, each press would increase or decrease the speed by 1.

3) [Pgup/S↑] and [Pgdn/S↓] are composite keys. Press [Pgup/S↑] (or [Pgdn/S↓]) key, the cutting gun will move upward (or downward) until it is released. It is to page up or down when editing.

- 4) [F] key allows you to switch the speed ratio swiftly. Press [F] key if the ratio is between 50%--100%, the speed ratio will be switched to 5%; and if the ratio is between 1%--50% when you press [F], the speed ratio will be switched to 80%.
- 5) Figure interface operation: You can press the number key to enlarge the figure. 0 -: resume the figure to original state; 1- Zoom in×1, 2- zoom in×2... and so on. For example, if you press [2], the figure is enlarged×2, and press [0] to resume to the original size; if you press [2] for twice successively, the figure is enlarged at $2*2=4$ times, and so on.
- 6) [INS] key is to enable the “Help” of the current interface.

2. Figure library

2.1 Operations

Press [F2] in the system main interface to enter the figure library as Picture 2.1. There are 33 figures available in the library. You can press [Y+], [Y-], [X+], and [X-] to select the figure, or press [pgup] / [pgdn] to turn the page to select. When you have selected a figure, you can press [ENTER] to enter the figure library setup.

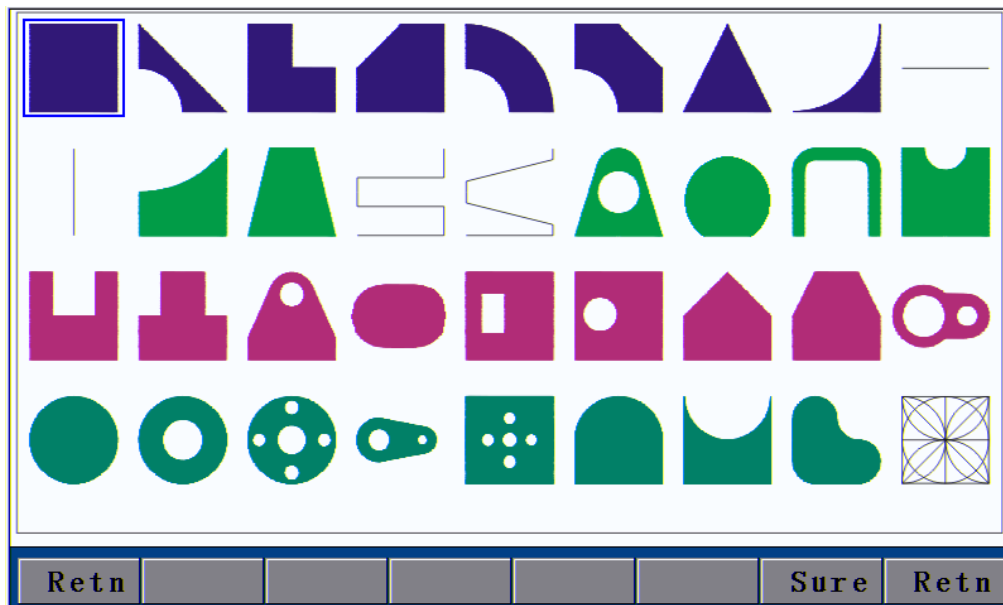

Picture 2.1

Take “Convex polygon with hole” for example. Highlight the “w.h.p.p.po.” white on black. (See Picture 2.2)

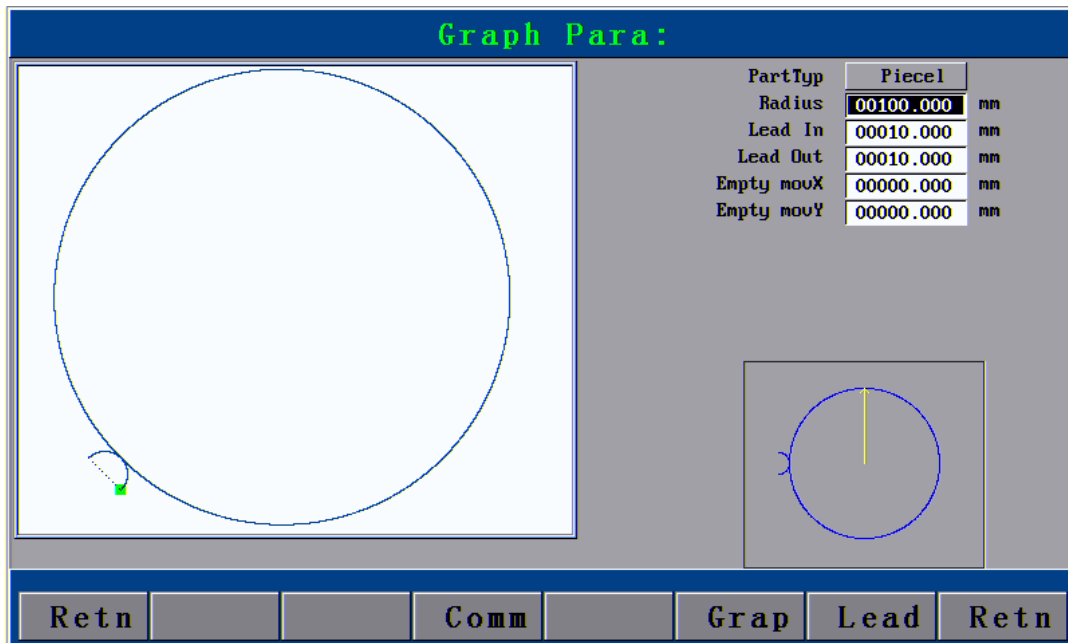

Picture 2.2

User can get the difference process graph based on the parameter setting.

Parts Type: Hole-cutting and slicing. Related workpiece in the inner of graph when slicing; Related workpiece in the outside of the graph when hole-cutting.

Lead in/out Line: Lead-in line (arc) is a reserved lead line (Arc) for avoided to over-burning of point in the cross the hole. Leads out line (arc) are special function for plasma cutting, because lead-out line or lead-in line will happening brake of arc under the plasma cutting. Lead in/out line (arc) hole-cutting is the inner of graph, but the slicing is in the outside of graph.

Idle line: Idle distance from start point of process to start of cross-hole point.

Parameter setting of graphics library is limited, diameter of round hole can not bigger than diameter of outside arc and the height from round hole center to bottom side of hemline, the length if hemline can not less than two times of top diameter. Because It can not show the correct composite figures if the the parameter exceed the related scope. After set parameter, Press **【F5】** for preview, If Parameter exceed the related scope, system will make the reminding, then restore parameter as before set. If parameter setting correct, Press **【F6】** leading-in, enter into auto interface, then Process file in the system had been changed to file of graphics library.

When you set the parameter, Press **【DEL】** it can delete the last no of current parameter, press key of number for input value. Press **【CAN】** parameter will clear, Press **【Y+】**, **【Y-】** select parameter setting.

3. Edition

In main interface, press **【F3】** to enter the window of editing function menu as Picture 3.1, in which shows

the code of file being processed. The code can be viewed only, and cannot be edited. If there is more than one page, you can press [pgup↑] or [pgdn↓] to page up or down.

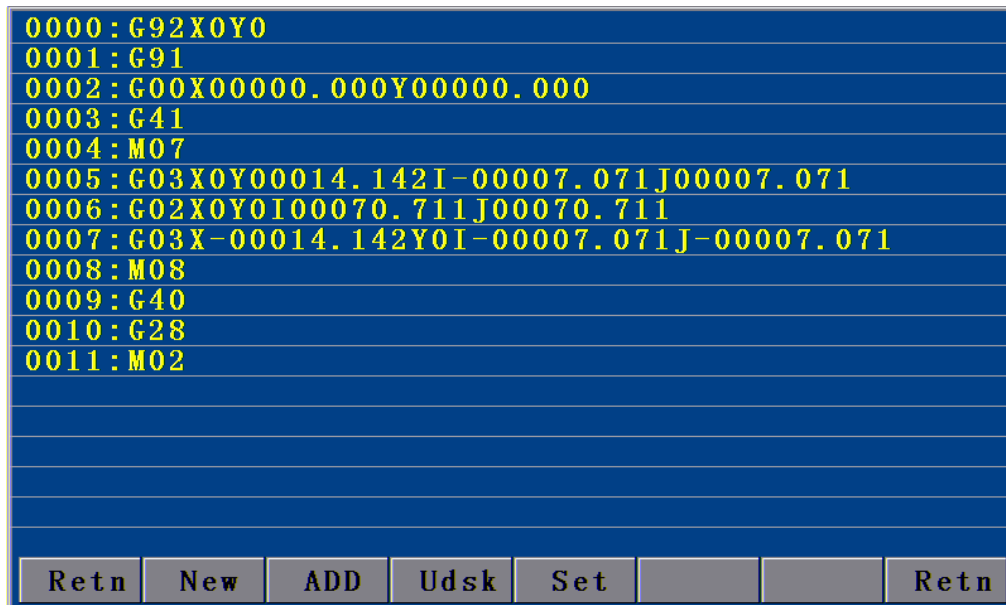

Picture 3.1 Window of editing function menu 3.1 Explanation of sub-menu

3.1.1 New

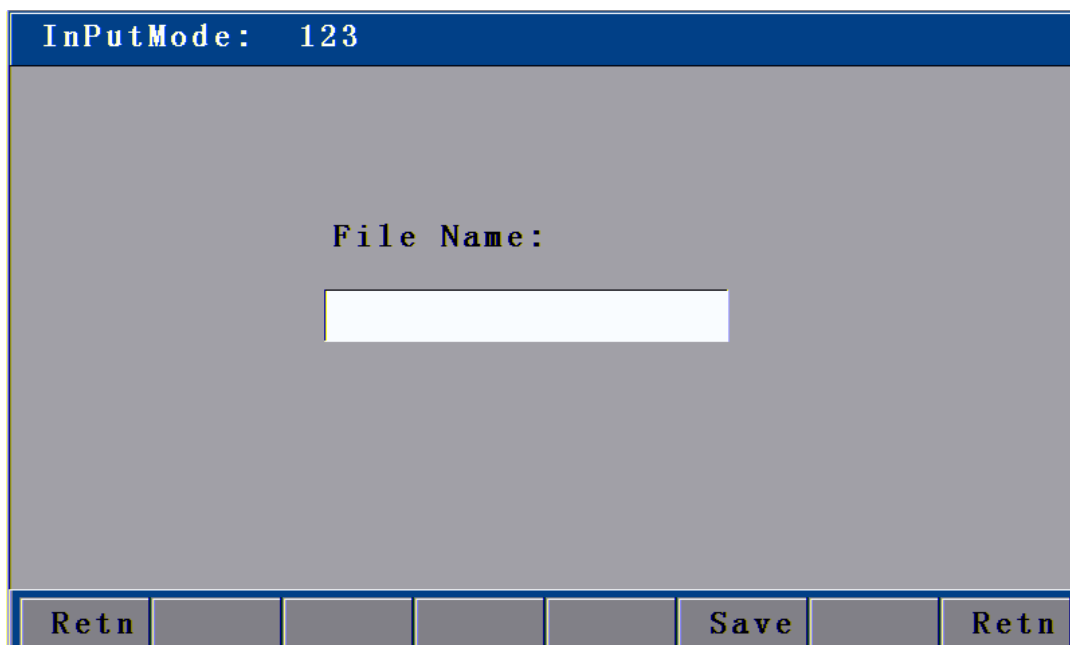

Picture 3.1.1 Interface of creating new file

In editing interface as Picture 3.1, press [F1] to enter the interface of creating new file as Picture 3.1.1, where you can edit the file name by pressing the number keys directly. After that, press [F5] to save the settings. You can also press [shift] key to change the input methods between letter input and Pinyin input, as the following picture shows:

Operations of Pinyin input are as follows:

1. Press [ENTER] to select the current character
2. Press [ESC] to delete all the input characters
3. Press [shift] to change the input method
4. Press [DEL] to delete the last character
5. Press [Y+], or [Y-] to select the previous or next character
6. Press [X+] or [X-] to page up or down the listed characters
7. Letters on panel are defined as:

u↵	v↵	h↵	g↵	z↵
i↵	j↵	r↵	x↵	DEL↵
m↵	s↵	t↵	y↵	p↵
n↵	l↵	d↵	f↵	q↵
Shift↵	OK↵	CAN CEL↵	a↵	o↵
↵	PRE↵	W↵	e↵	b↵
Pgup↵	NEXT↵	Pgdn↵	c↵	k↵

Press [ENTER] key after the input. If the input name exists, there will be a prompt as Picture 3.1.1.2 below as you press [ENTER]. Otherwise, it will enter the file editing interface, as Picture 3.1.1.3.

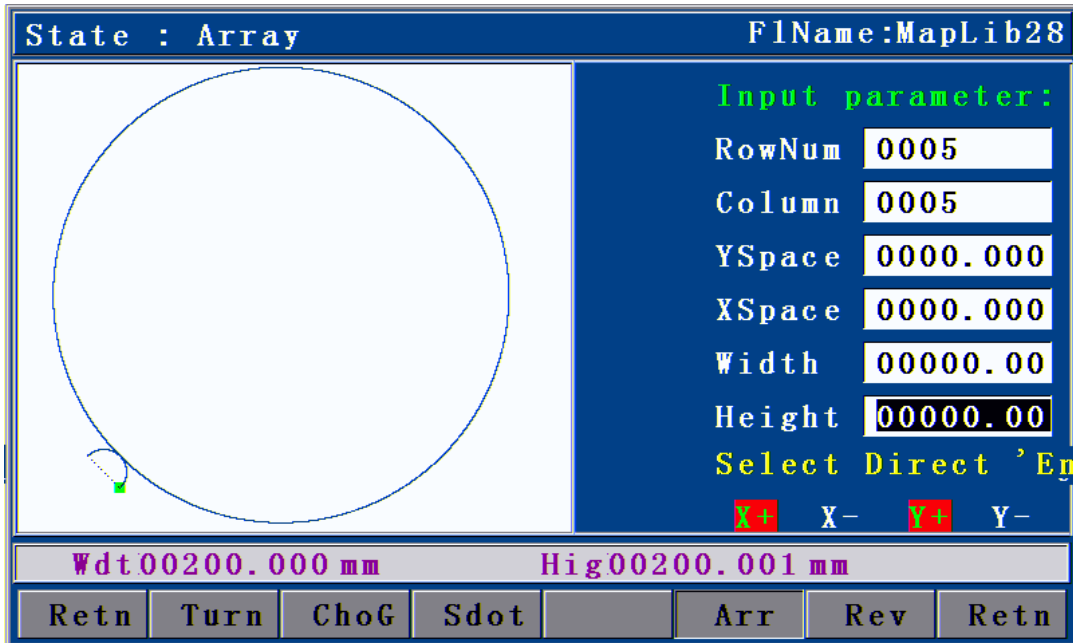

Picture 3.1.1.2 Interface for prompting the exist of input file name

In this prompt interface, you can press [ENTER] to cover the original file and enter the interface as Picture 3.1.1.2; otherwise, press [ESC] to exit to interface as Picture 3.1.1.

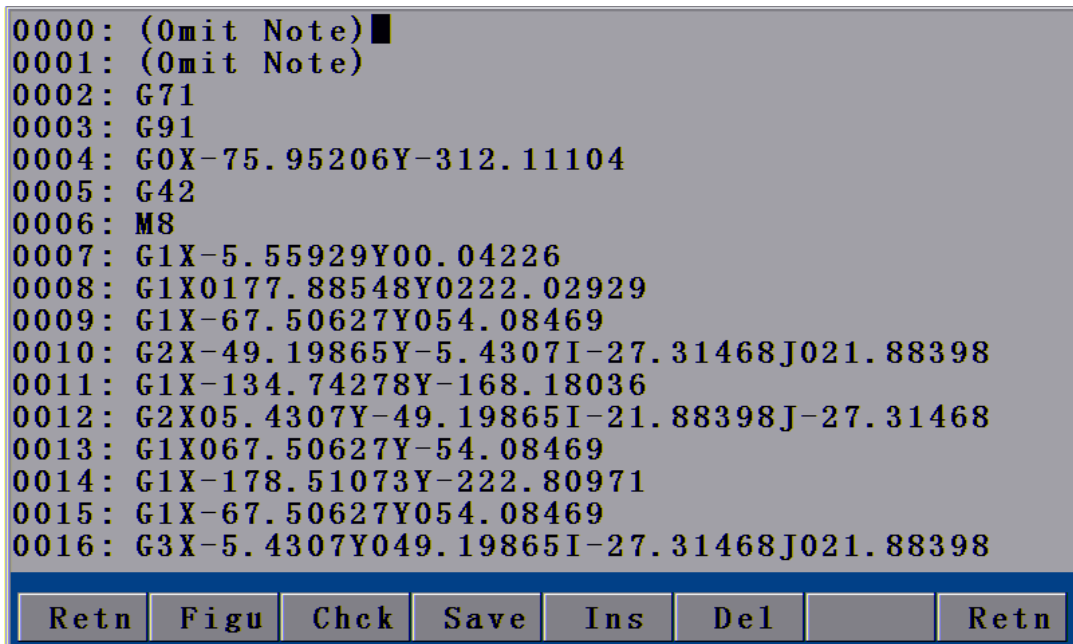

Picture 3.1.1.3 Interface of editing new file

Once a new processing file is created, you can edit the required code of processing file in editing area. For detailed editing of code, see “3.2 Editing processing file”.

3.1.2 Load

1) In window of editing function menu as Picture 3.1, press [F2] to enter the file loading interface as follows:

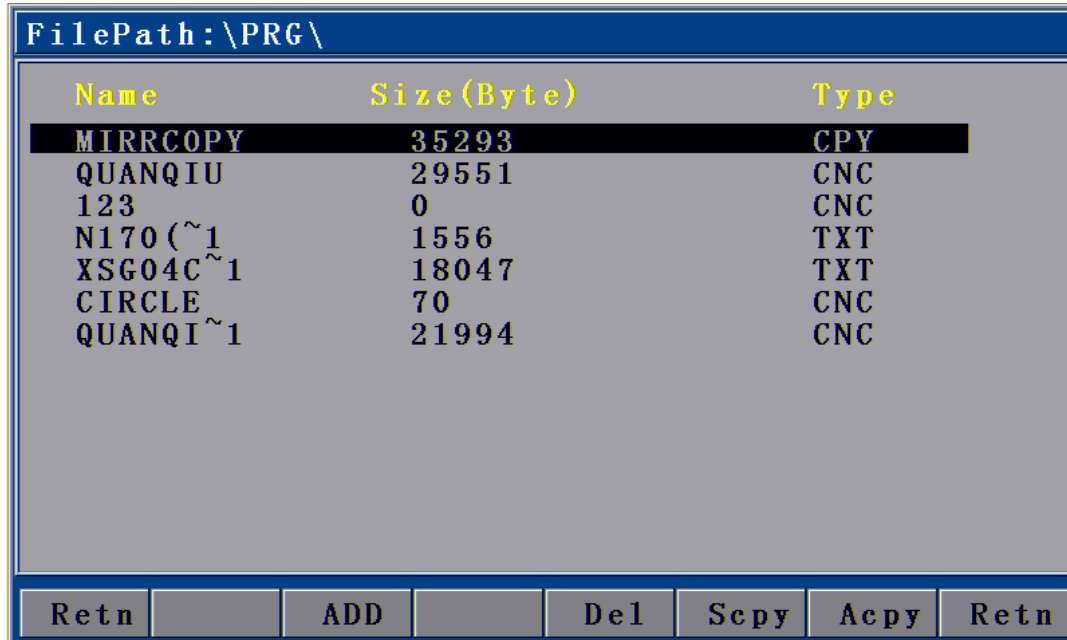

Name	Size(Byte)	Type
MIRRCOPY	35293	CPY
QUANQIU	29551	CNC
123	0	CNC
N170 (~1	1556	TXT
XSG04C~1	18047	TXT
CIRCLE	70	CNC
QUANQI~1	21994	CNC

Picture 3.1.2

File loading interface After entering into the above interface, press [F↑] or [F↓] to select the processing file, and press [F2] or [ENTER] to select, and then enter the processing code editing interface. For file edition, see “3.2 Editing processing file”.

2) [INS] key: Enable the help system of the current interface.

3.1.2.1 Copy

In file loading interface as Picture 3.1.2, you can press [F5] “Copy” to copy the current selected single processing file in controller to the USB disk, or press [F6] “Copy All” to copy all processing files of controller to the USB disk.

Note: When copying all files, if you need to quit for some reasons, you can just press and hold the CANCEL key to exit the interface as Picture 3.1.2.

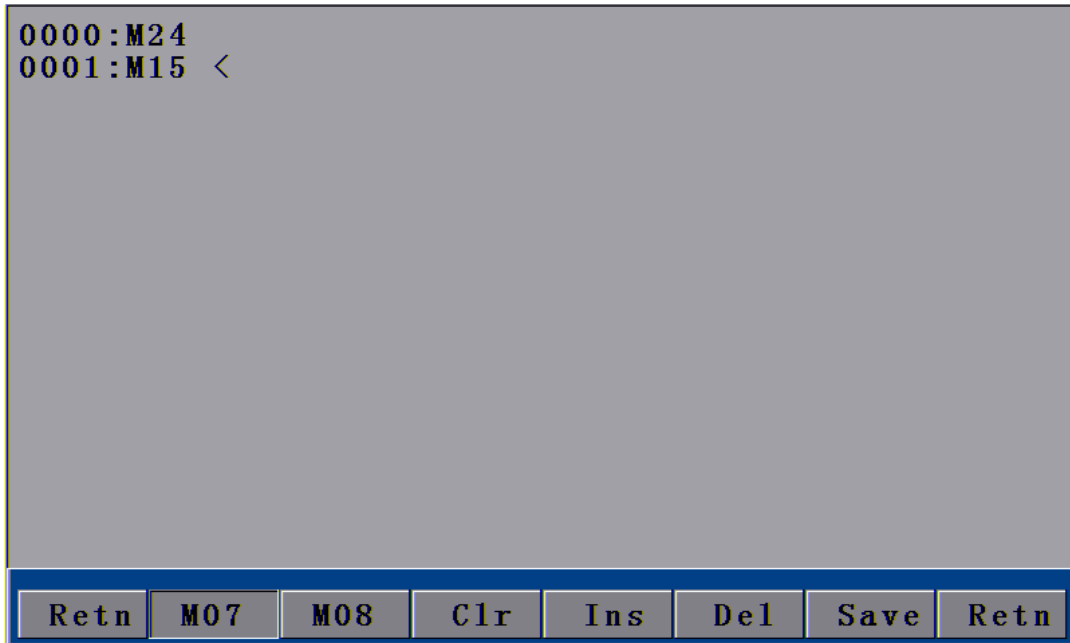

Picture 3.1.2.1 File copy function

3.1.2.2 Delete

In processing file loading interface, you can choose to delete files in system catalog. When deleting the processing file, the system will ask whether to delete, you can press [ENTER] to delete or [ESC] not to delete

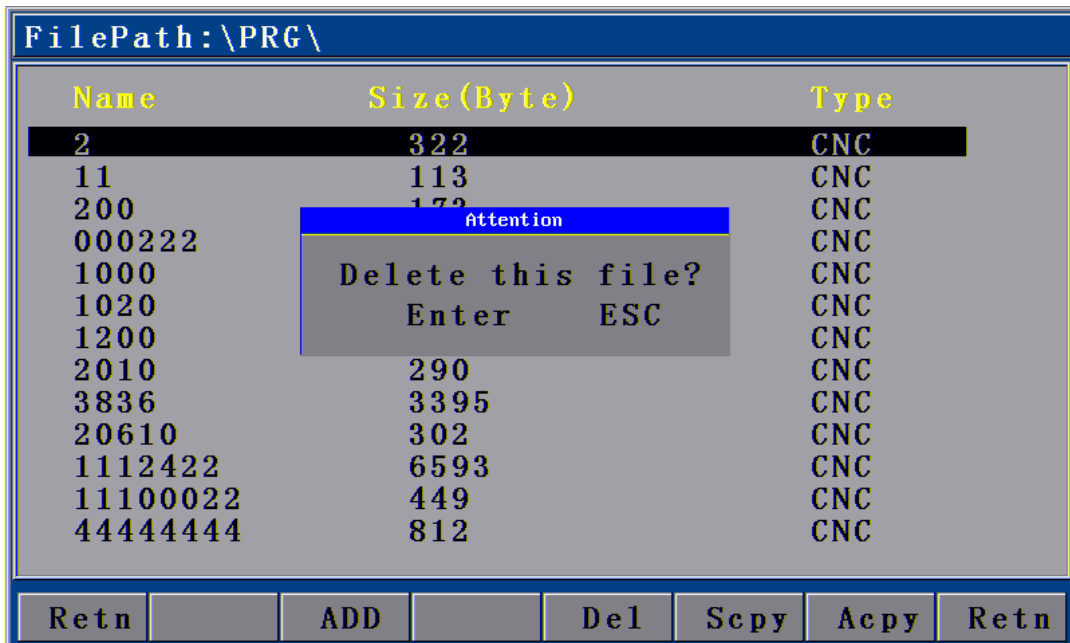

Picture 3.1.2.2 Delete interface

3.1.3 USB disk

In interface as Picture 3.1, press [F3] to enable the USB disk connecting function. If the USB disk is not connected well or if the format of USB disk is not compatible with the system, the following interface will show up:

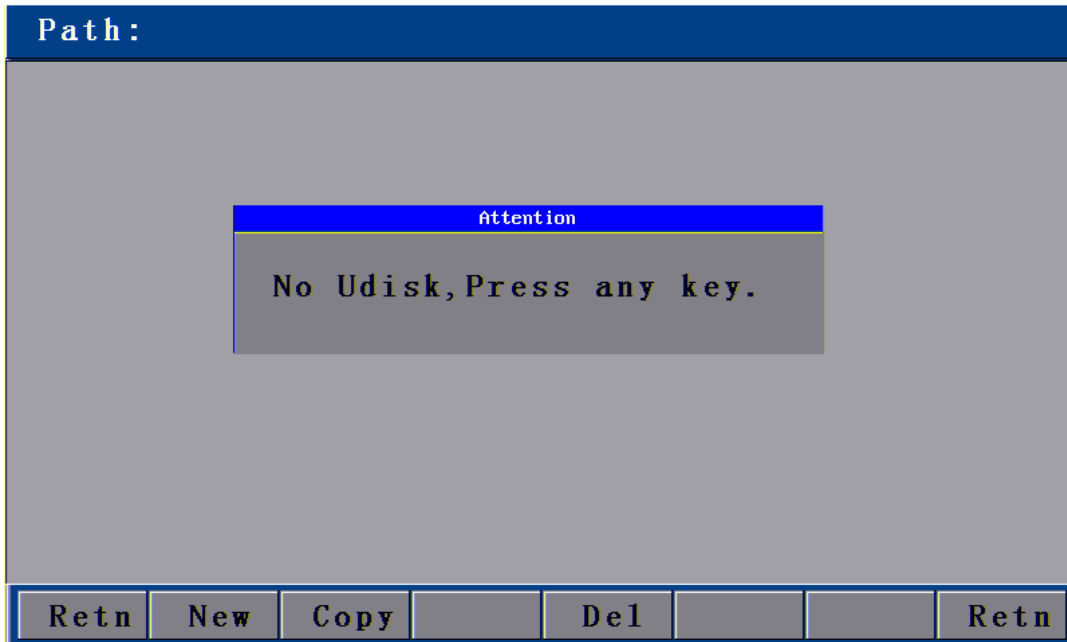

Picture 3.1.3 USB disk is not connected

If the USB disk is connected, the interface will show the name of file stored in the USB disk, as the following picture shows:

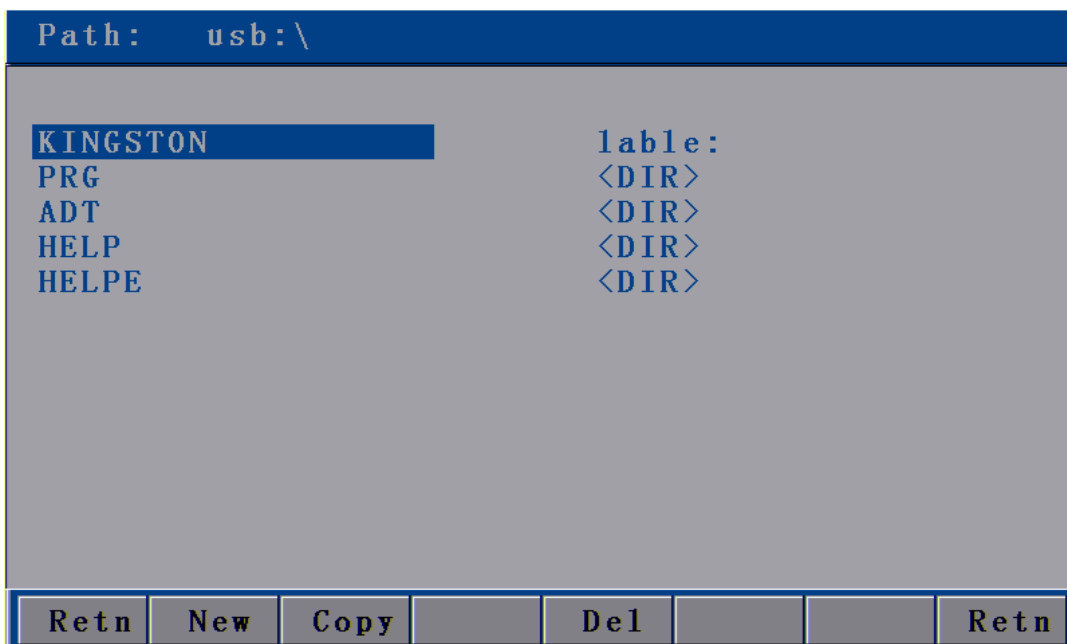

Picture 3.1.3.1 USB disk is connected successfully

At this time, press [Y+] or [Y-] to select the processing files that need to be copied, and then press [F2]

(Copy) or [ENTER]. After the copy, the system will pop up a prompt “Data are completely copied, press any key to return”, you can then press any key to exit.

3.1.4 Define

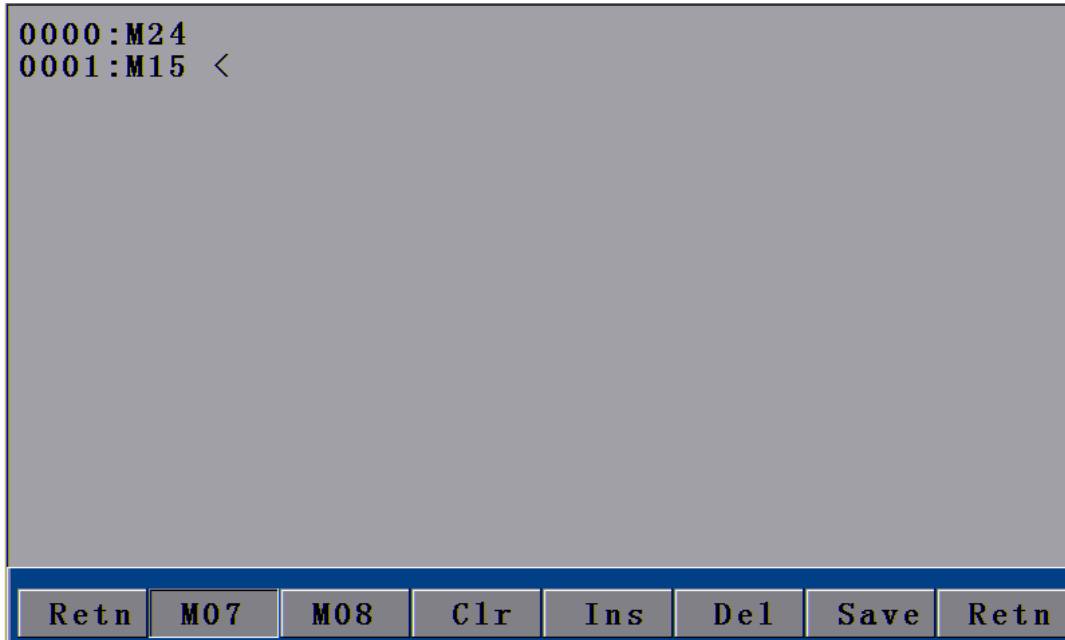

3.1.4 Definition interface

As Picture 3.1 shows, in editing interface, press [F4] (Define) to enter the definition interface.

- 3) In this interface, press [F1] to define the M07 instruction. The system default M07 perforating instruction is as follows:

Flame:

- ① Ignition Fixed Cycle, M52
- ② Cutting gun falling (Fixed Cycle), M71
- ③ Preheating on (Fixed Cycle), M74
- ④ Perforating cutting gun rising (Fixed Cycle), M72
- ⑤ Cutting oxygen on, M12
- ⑥ Perforating cutting gun falling (Fixed Cycle), M73

Plasma:

A. With height-adjusting system:

- ① Enable M22
- ② Arcing M12
- ③ Waiting for arc voltage detection signal (IN0)

After arcing, the height-adjusting control starts performing initial location (With initial location function); perforating and perforating delay automatically, and gives a signal of successful arc voltage detection to the controller.

B. Without height-adjusting system:

- ① Arcing, arcing delay M12
 - ② Perforating, perforating delay
- Start the following actions

Users can define the functions of M07 as required.

- 4) [F2] is used to define the M08 instruction. The system default M08 instruction for closing cutting oxygen is as follows:

Flame:

- ① Cutting oxygen off, M13
- ② Cutting gun rising (Fixed Cycle), M70

Plasma:

- ① Close striking arc M13
- ② Close the height-adjusting control M23

Users can define M08 to M80 (close all output) according to their actual demand. All valves will be closed when performing M08 to save gas.

- 5) [F3]: Clear the data of current line.
- 6) [F4]: Add a new line below the current line.
- 7) [F5]: Delete the current line.
- 8) [F6]: Save the content.
- 9) [INS]: Open the help system of the current interface

Note: After you have defined M07 and M08 instructions, you should set [F1] (Configuration) in [F4] (Parameter) as “user-defined”; otherwise, the instructions would not be effective.

3.2 Editing processing file

As shown in Picture 3.1 at the beginning of this section, in the interface of editing, if you create a new file or load a file, and enter the edition interface, you can then edit the processing file as follows:

```
0000: (Omit Note)
0001: (Omit Note)
0002: G71
0003: G91
0004: G0X-75.95206Y-312.11104
0005: G42
0006: M8
0007: G1X-5.55929Y00.04226
0008: G1X0177.88548Y0222.02929
0009: G1X-67.50627Y054.08469
0010: G2X-49.19865Y-5.4307I-27.31468J021.88398
0011: G1X-134.74278Y-168.18036
0012: G2X05.4307Y-49.19865I-21.88398J-27.31468
0013: G1X067.50627Y-54.08469
0014: G1X-178.51073Y-222.80971
0015: G1X-67.50627Y054.08469
0016: G3X-5.4307Y049.19865I-27.31468J021.88398
```

Retn	Figu	Chck	Save	Ins	Del		Retn
------	------	------	------	-----	-----	--	------

Picture 3.2 Processing file editing interface

3.2.1 Figure

In processing file editing interface as above, Press [F1] and the interface will show the preview figure you are editing for your reference.

3.2.2 Test

In processing file editing interface as Picture 3.2, after enter the code of processing file or loading the code of nest software, you can press [F2] to detect whether the code of processing file has error. If there is an error, the error line will be highlighted in the interface and the error type will be shown on the bottom as follows:

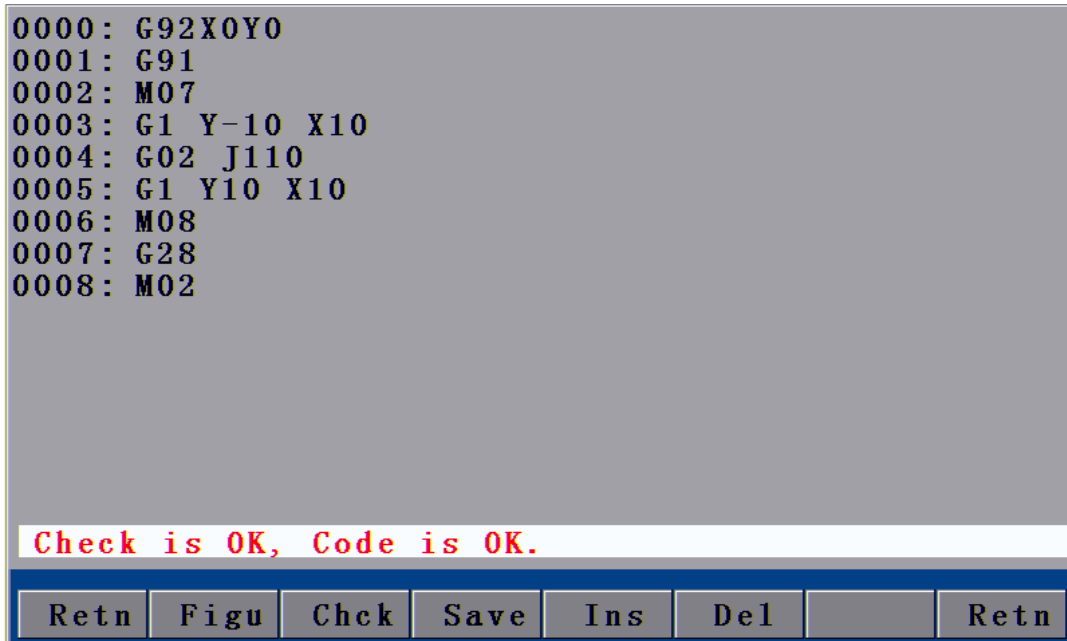

Picture 3.2.1.2 Error code detection interface

In case of the interface as above picture, press [ENTER] and the cursor will stop at the error code line, and you can then modify the error character line. After the modification, you can press [F2] to test the processing file, while the system will pop up the following dialogue box:

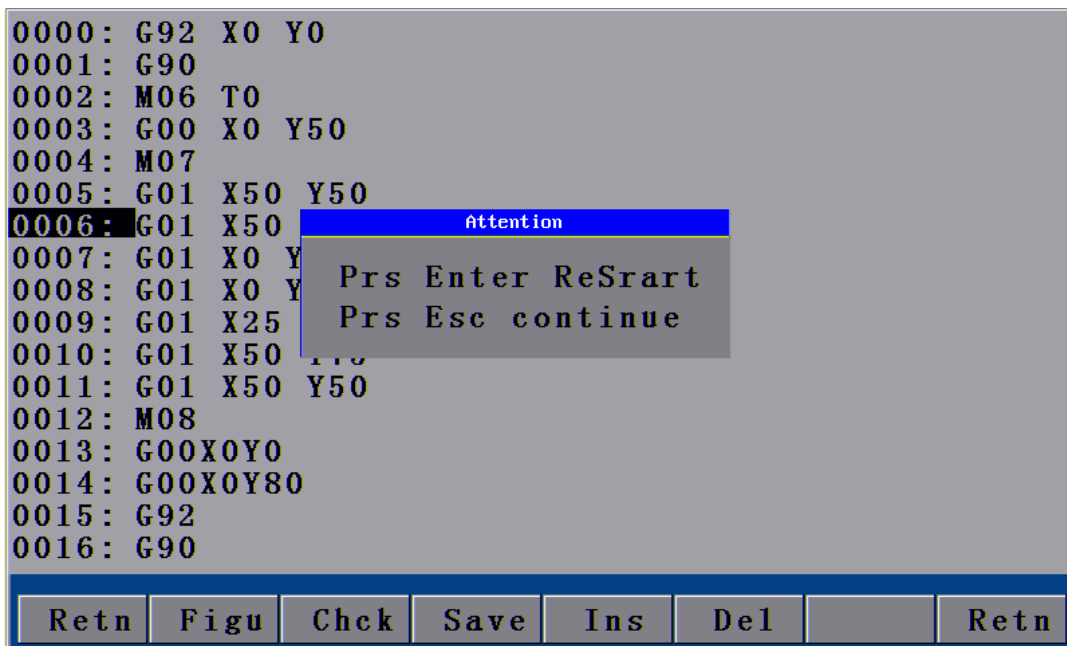

Picture 3.2.1.2.1 Code re-testing interface

In the above interface, press [ENTER] to re-test from the first line, and when you press [ESC], the system will test beginning from the cursor.

3.2.3 Save

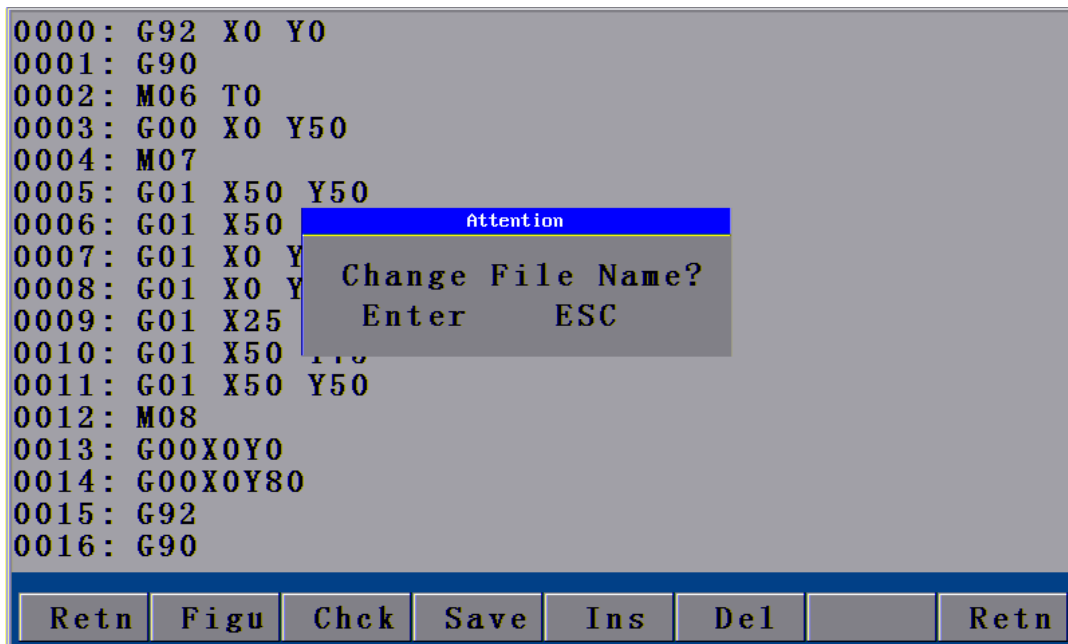

3.2.1.3 Saving file

When the processing code is entered or the code is tested, you should press [F3] to save it before exiting the interface; otherwise, the system cannot memorize the current processing file. Press [F3] and the system will ask whether to save as other file (as Picture 3.2.1.3). If you press CANCEL], the system will cover the original file. If you press [ENTER], the system will ask you to input the file name. Once you have entered the name, press [F5] to save the file.

If there is no need to save the current file, you can press [◀] or [▶] to return to the main interface.

3.2.4 New/Delete line

New line: During the editing, you can press [F4] or [ENTER] to add a line of code under the cursor.

Delete line: During the editing, you can press [F5] to delete the code line where the cursor is located.

3.3 Basic operations

- 1) Keys on panel are divided into two categories, composite key and single function key. Generally, you are entering the value of lower shift when you press the composite key. If you press [Shift] first and then a composite key, it becomes the upper shift key. This function is only available in program editing state.
- 2) When the cursor is moving up/down, the cursor is located at the end of program automatically. It moves a line each time you press it.
- 3) Page Up/Down: You can press [Pagup / S↑] or [Pagdn / S↓] to page up or down.
- 4) The line number in processing program is generated automatically.
- 5) You can press [DEL] key on panel to delete a character of instruction where current cursor is located.
- 6) You can press [INS] on panel to insert a space in the middle of a line.

4. Parameter

In main interface, press [F4] to enter the parameter setting function, and the options are as follows:



Picture 4 System parameter setting interface

4.1 System

In system parameter setting interface as above, press [F1] to enter the system parameter setting interface:

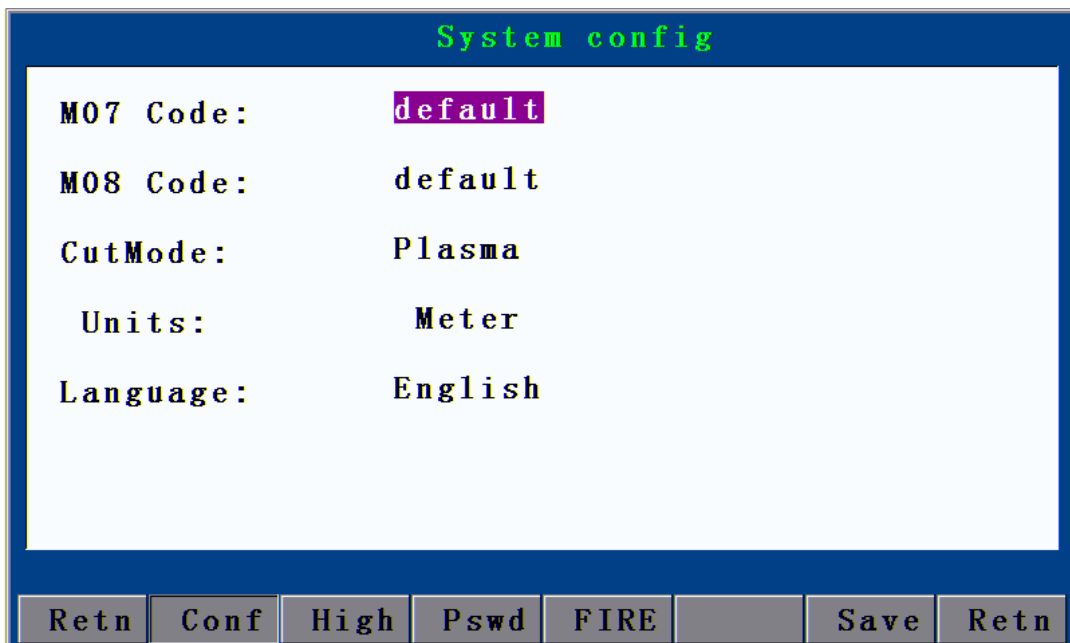

Picture 4.1 Configuration interface

M07/M08 instruction: Users can choose the M07 or M08 preheating perforating instruction as system

default or user-defined mode. For definition, see “Definition” in section 3.

Language: Choose the language. The system supports operating interface of many languages.

Machine: Two cutting processes are provided, flame cutting or plasma cutting.

Theunit(Metric/Imperial): It is only available before entering into the auto mode or testing the program.

Operation mode: You can press [Y+] or [Y-] to move the cursor up or down, [X+] or [X-] to change the mode, or [F6] to save the parameters.

4.1.1 Height-adjusting (Pset)

In configuration parameter setting interface as above, you can press [F2] to enter the interface of height-adjusting parameter settings:

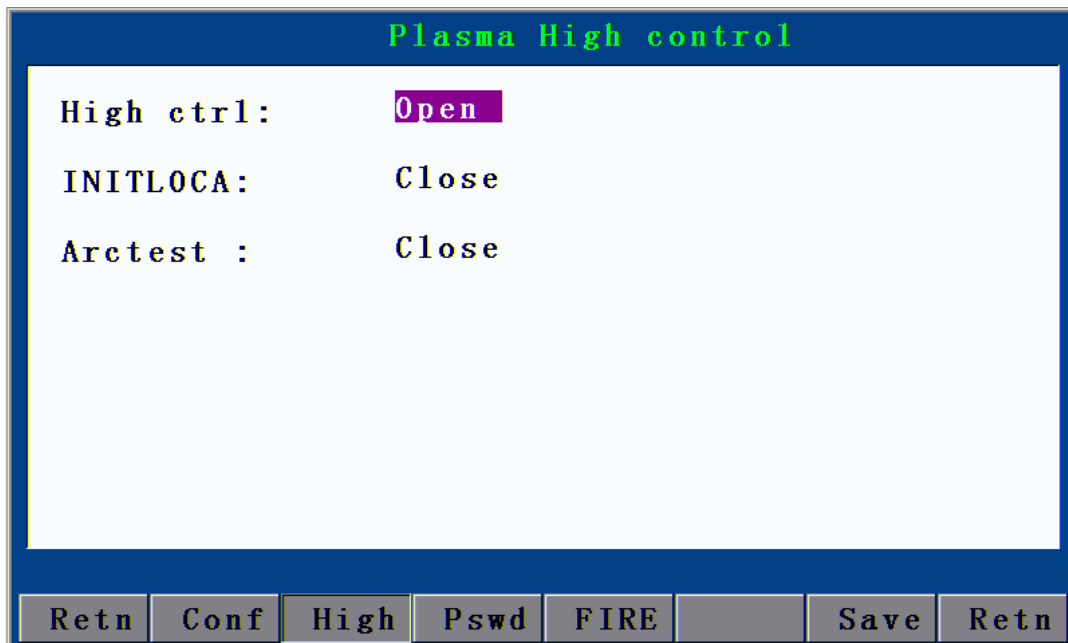

Picture 4.1.1 Height adjusting

Perallow: An extra arc voltage adjustor is added to control when the arc voltage adjusting starts to work and when it stops.

INITLOCA(Initial positioning): The cutting gun runs a fixed rising height when encountering the steel plate.

Arc test: A signal is fed back by plasma power supply, with which the system will run the track in case of successful arcing; otherwise, it will stop running the track.

Operation mode: You can press [Y+] or [Y-] to move the cursor up or down, [X+] or [X-] to change the mode, or [F6] to save the parameters.

4.1. 2 Flame Step Torch Height

Press **【F4】** flame in the config parameter setting interface, enter flame step torch height parameter setting interface: press figure input parameter value, Press **【Y+】** **【Y-】** select parameter.

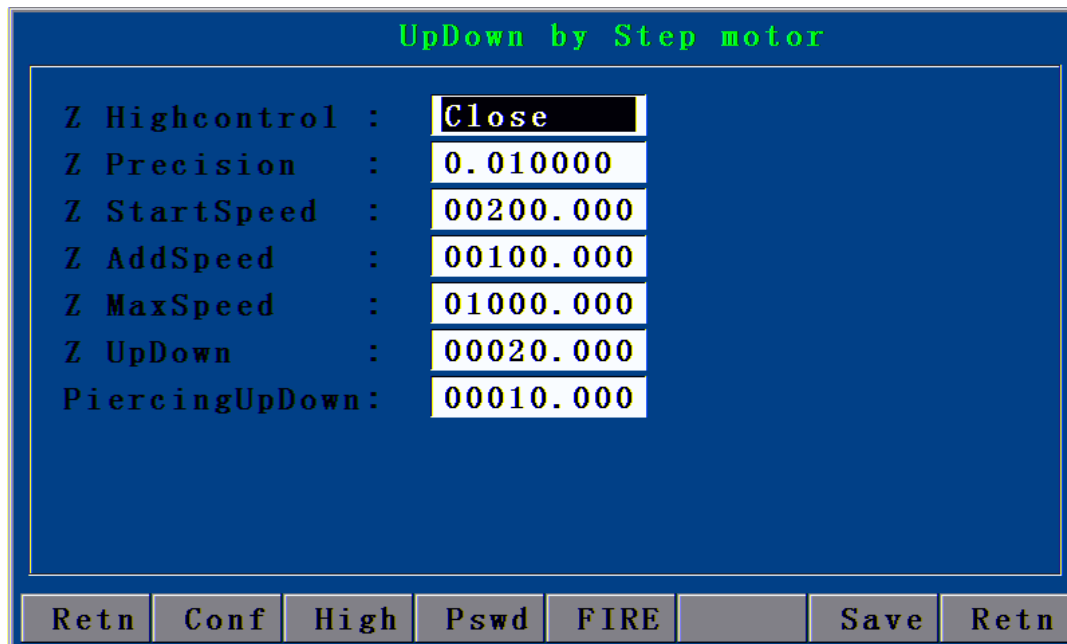

Picture 4.1.2 Flame step Torch Height

Parameters Details:

- 1) Z axis Torch height allow: When Status “Open”, Flame cutting of system can accept Z axis make the gun make adjustment of height
- 2) Z axis pulse equivalent: Z Axis setting of precision, See 4.5.1 (Pulse equivalent Setting)
- 3) Z Axis initial speed: See 4.2.1 (speed setting)
- 4) Z axis acceleration: See 4.2.1 (speed setting)
- 5) Z axis end speed: See 4.2.1 (speed setting)
- 6) Gun up-down speed: Distance of first time down to preheat height (Distance of gun from cutting safe height up to initial height)
- 7) Cross hole up-down distance: the distance from cutting height up to safe height (Distance of Gun from safe height down to cutting height), to avoid the schmelze enter into gun nozzle when high temperature

After related parameter input finished, press **【F6】** for save.

4.2 Speed

In system parameter setting interface as Picture 4, press [F2] and the interface will become as the following

picture, when you can set all the speed parameters including speed, hand speed and acceleration or deceleration.

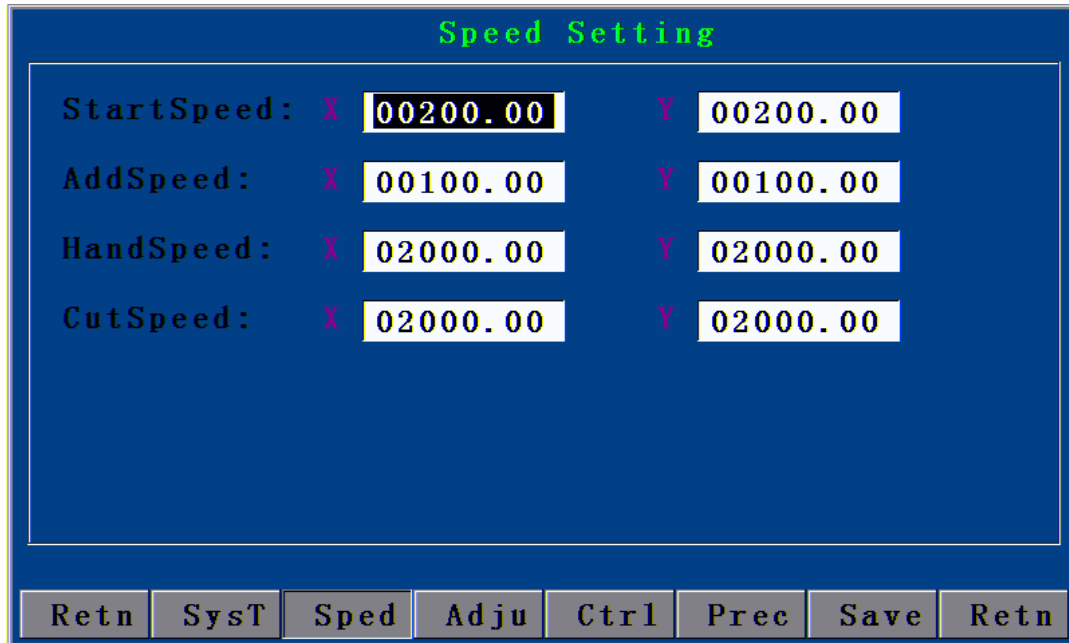

Picture 4.2 Speed parameter settings

4.2.1 Speed settings

Parameter	Explanation	Unit
Start-up speed	Start-up speed of X/Y axis	mm/minute
Acceleration	the speed increased each time for X/Y axis from the start-up speed to the maximum speed	mm/minute
Hand speed	X/Y axis speed, G00 and the speed of returning back to origin in hand motion	mm/minute
Processing speed	X/Y axis speed, and the speed of G01,G02,G03 during the processing	mm/minute

Table 4.2.1

Note:

In practical cutting, you need to perform acceleration/deceleration operations at the corner. Too fast an acceleration/deceleration at the corner would lead to halfway cutting or flame-out, and too slow the speed may not form a right angle at the corner or lead to circular arc. In this way, the “start-up speed” and “acceleration” in “Speed” setup should be set for several times according to the current pulse equivalent to the optimum state.

Reference value:

Processing speed	Pulse equivalent	Start-up speed	Acceleration
500mm/Minute	0.008000	300	80-100 (Adjusted with emphases)
500 mm/Minute	0.001000	300	5-15 (Adjusted with emphases)

Table 4.2.2

4.3 Adjustment (Adju)

In system parameter setting interface as Picture 4, press [F3] and the interface will become as the following picture, when you can set the limit coordinate, origin coordinate, and backlash.

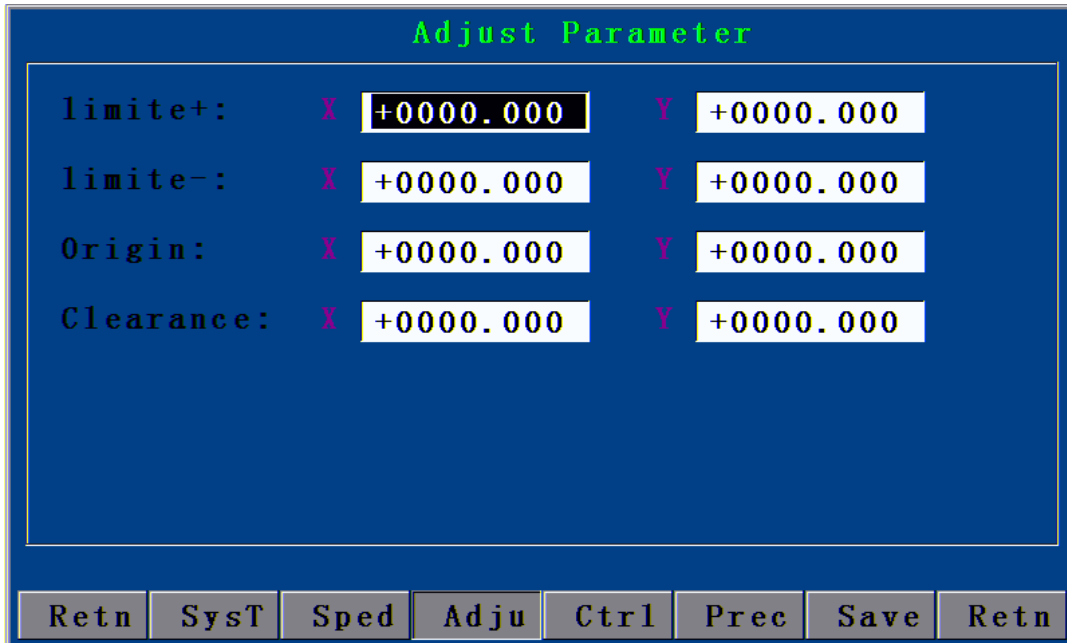

Picture 4.3 Adjusting parameter settings

4.3.1 Adjustment settings

Parameter	Explanation	Unit
Limit +	Positive limit of system; when the current position is larger than this value, the system will stop automatically	mm
Limit -	Negative limit of system; when the current position is smaller than this value, the system will stop automatically	mm
Mac(hine)origin	Origin position of machine	mm
Reccleara(X)	Gap compensation when X axis is reversing	mm
Reccleara (Y)	Gap compensation when Y axis is reversing	mm

Table 4.3.1

4.4 Control (Ctrl)

In system parameter setting interface as Picture 4, press [F4] and the interface will become as the following picture, when you can set the X/Y motor moving speed, preheating and cutting gun rising/falling time during the auto processing.

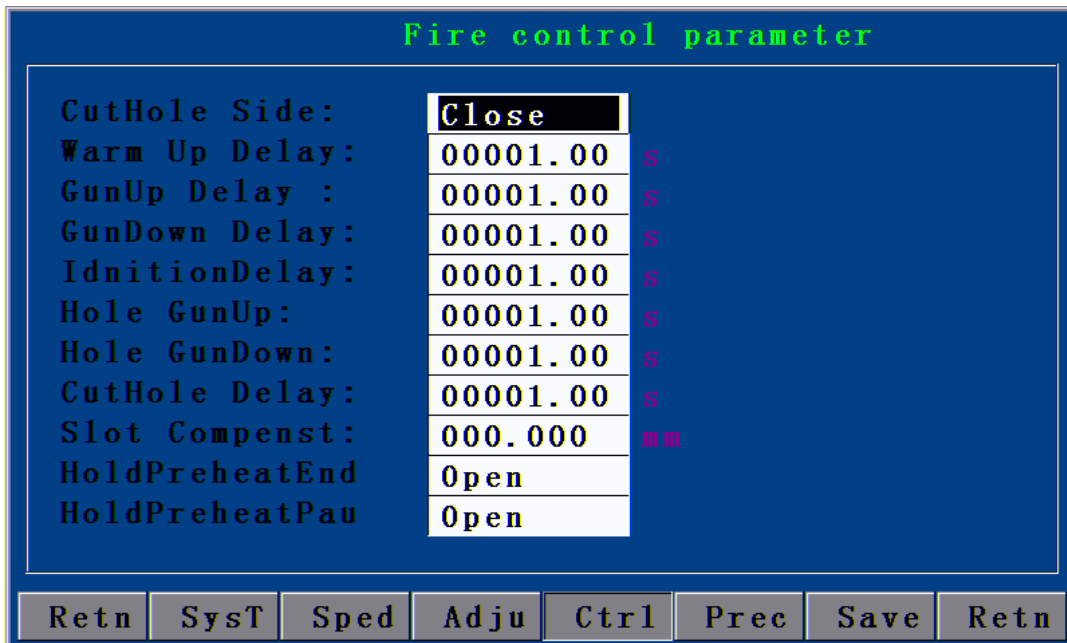

Picture 4.4.1 ① Flame

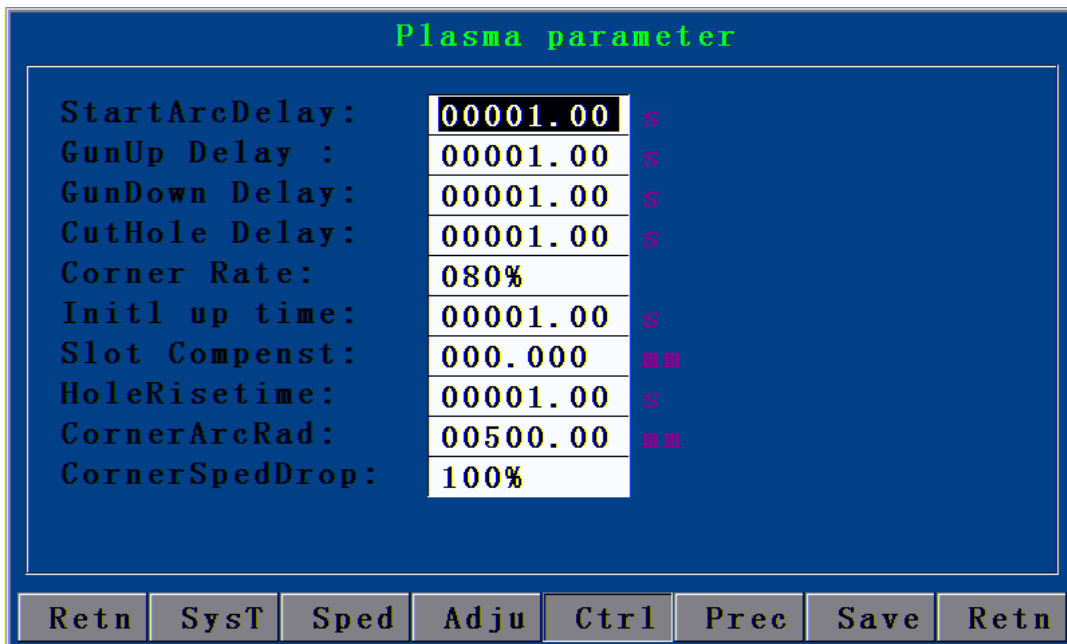

Picture 4.4.2 ② Plasma

Parameter	Explanation	Unit
CutHoleOutside	Whether to enable the edge perforating prompt when perforating	
Preheat delay	Preheating time of perforating on the steel plate, which can be adjusted	0.01 sec
CutGun rising delay	It is usually used before G00 shifting position to lift the cutting gun to a proper height with a purpose of avoiding the collision of cutting gun and steel plat when re-transferring.	0.01 sec
Cutgun falling delay	It's the opposite action of cutting gun rising delay. Lower the cutting gun to a proper height, and after G00 transfer, it is required to lower the cutting gun	0.01 sec

	before processing. Due to the gravity action, the falling time of cutting gun is shorter than the rising time.	
Ignition delay	Time to maintain the contact of high-voltage ignition coil during the ignition	0.01 sec
Holecutgun rises	During the fixed cycle of preheating perforating, after the preheating, the cutting gun will rise quickly, and the perforating cutting gun rising delay, at this time open the cutting oxygen and the cutting gun starts to fall, and the perforating cutting gun falling delays. Before opening the cutting oxygen, the cutting gun rises; it is mainly to prevent the spray of molten steel blocking the mouth of cutting gun.	0.01 sec
Holecutgun falls	During the fixed cycle of preheating perforating, the cutting gun falls, after the delay of perforating cutting gun falls, the cycle ends. Due to the gravity action, the falling time of cutting gun is shorter than the rising time.	0.01 sec
Startarcdelay	You should delay a period before processing when the arching switch is started. (Plasma processing)	0.01 sec
BroeaHole delay	It is a time of continuous arcing in case of failed arcing after the arcing switch has been started.	0.01 sec
InitLocaUp time	Set the initial location rising time during the plasma processing	0.01 sec
Slot compensat	Radius of the flame/plasma cutting	mm
Hole rise delay	It is the cutting gun rising time when the plasma is carrying out the perforating delay operation	0.01 sec
(Height) adjusting rate	(Plasma) when processing speed rate is decreased to this value, height-adjusting signal is closed, and when it is increased to this value, the height-adjusting signal is opened.	%
Corner arc rad	(Plasma) the critical value of circular arc radius when setting the processing circular arc; When the radius of processing circular arc is smaller than this value, the speed will be slowed down	mm
Corner Drop speed	(Plasma) when setting processing circular arc, and when the radius is smaller than that of corner circular arc, the speed will be decreased to this rate. Speed =F× Processing speed rate × Corner fall speed	%

Table 4.4

4.5 Accuracy (Prec)

Picture 4, in system parameter setting interface, press [F5] and the interface will become as the following picture, you can then set how far in mm can each pulse runs for the X/Y axis. This value will determine the accuracy of track.

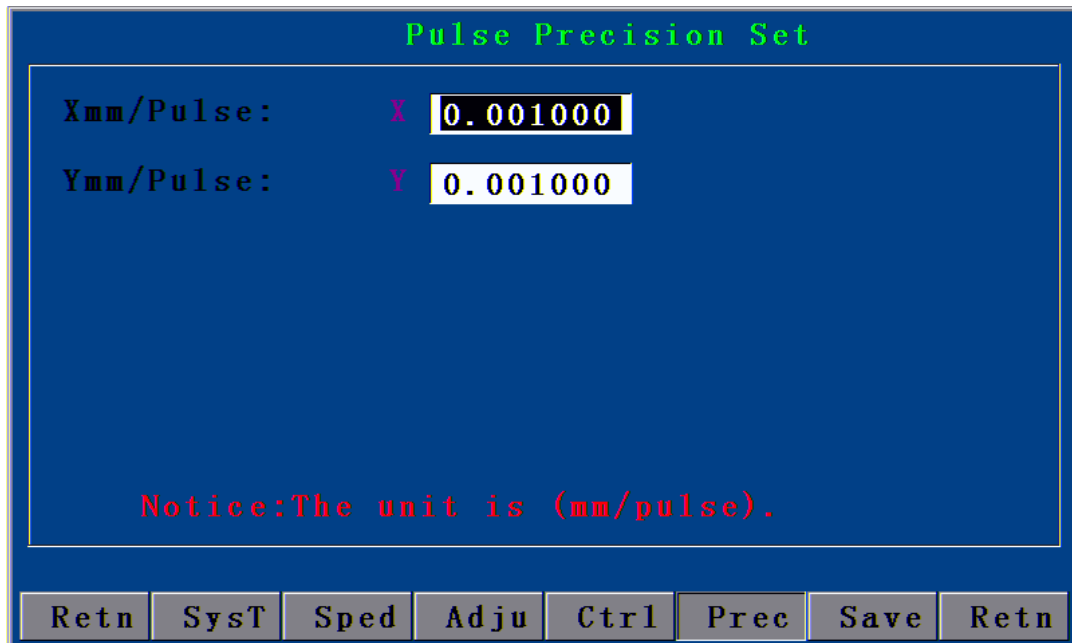

Picture 4.5 Accuracy parameter interface

4.5.1 Pulse equivalent setting

1) In main interface, press [F4] and then [F5] to enter the accuracy setting interface, and set the X and Y pulse equivalent as

0.010000 (at this time, the control system gives a pulse and the motor moves 0.01MM).

After the setting, press [F6] to save and exit to the main interface.

2) Press [F1] and then [F2] to enter the manual interface, and then press [F1] again when “Inching increment: L=+00000.000” will show up

Input the required length of inching, suppose setting the inching unit as 1000MM

3) Press any key of [X+] [X-] or [Y+] [Y-] to start inching. Suppose the actual moving distance is 578MM

Calculation formula: $(578 \times 0.01) \div 1000 = 5.78 \div 1000 = 0.005780$

Actual moving distance	×	0.01	÷	1000	= 5.78 ÷ 1000 = 0.005780
↑		↑		↑	
Actual moving distance		Pulse equivalent of current system		Actual inching distance	

1) Back to the main interface, press [F4] and [F5] to enter the accuracy setting interface, and input 0.005780 as the pulse equivalent of X and Y axes.

Note: Usually, there will be a minor error between the pulse equivalent of X and Y of the same device; therefore, they should be set respectively during the test.

4.6 Save

You should press [F6] once every time when the value of a submenu in “Parameter” is modified; otherwise, the modified value would not be saved.

5. Diagnosis (Diag)

Press [F5] in main interface, and the system will enter the diagnosis interface as Picture 2.6 below:



Picture 5 Diagnosis interface

5.1 Sub-menu

1) Diagnosis interface

In diagnosis interface as Picture 5, press [F1] to enter the diagnosis testing interface as Picture

5.1.1:

Operating instructions:

[F1]: Test the positive rotation of X axis

[F2]: Test the contrarotation of X axis

[F3]: Test the positive rotation of Y axis

[F4]: Test the contrarotation of Y axis

[F5]: Stop the current X/Y rotation

You can press [X+], [X-], [Y+], or [Y-] to move the output cursor, and then press OK to output the relevant switching signal.

If there is an input signal, a '*' will show below the relevant pin sign of input diagnosis.

This function can be used to judge whether the input/output port is correct, damaged or normal.

Diagnose										
OUT:	M10	M14	M20	M22	M40	M28	M34	M38		
	☀	☀	☀	☀	☀	☀	☀	☀		
	M12	M16	M18	M24	M26	M32	M36	M42		
	☀	☀	☀	☀	☀	☀	☀	☀		
IN:	AVT	ORI	HAD	PAU	X+	Y+	SP+	UP	>X+	X-<
	☀	☀	☀	☀	☀	☀	☀	☀	☀	☀
	>Y+	Y-<	STP	STA	X-	Y-	SP-	DOW	FWD	BAK
	☀	☀	☀	☀	☀	☀	☀	☀	☀	☀
KEY:	00									
	Retn	X+	X-	Y+	Y-	Stop				Retn

Picture 5.1.1 diagnosis testing interface

2) Define backup I/O interface

In diagnosis interface as Picture 5, you can press [F2] to show user-defined outlet interface, and press [X+] [X-] [Y+] or [Y-] to set the relevant settings. (As Picture 5.1.2) “Default” is the default outlet settings of system, and “Backup” is the settings when the system is accessing the backup outlet. For the definition of outlet, see “2.3 Electrical Connection” in Chapter V.

Note: “Backup” is used only when the system considers there is error for the outlet Optocoupler. Generally, “Default” is used.

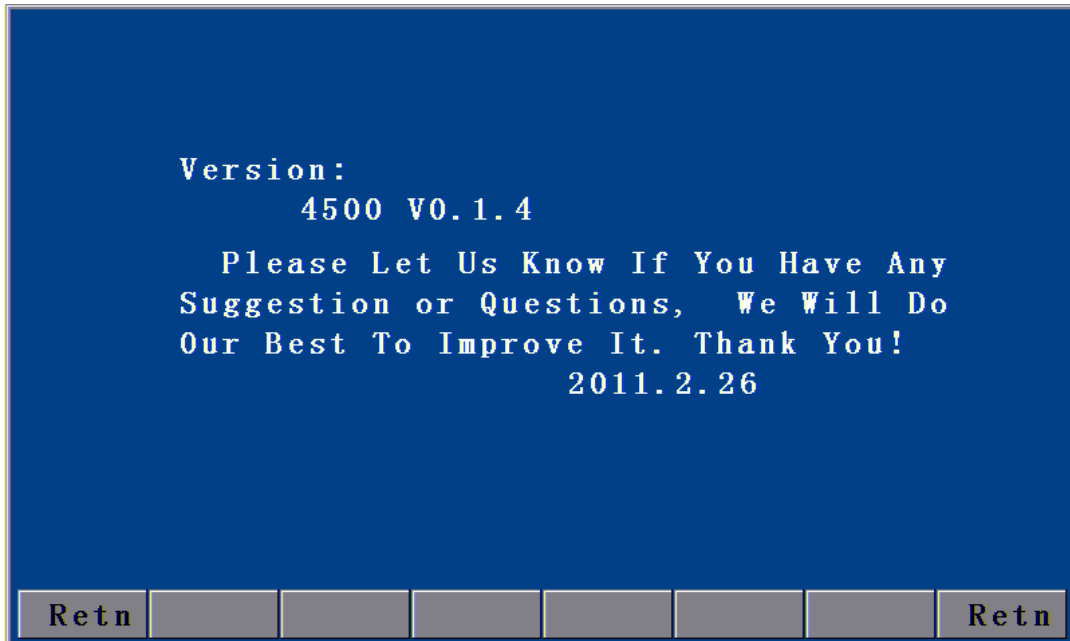

Picture 5.1.3 ① Description of HC4500 version

6. Upgrade (Upgd)

Upgrade function is provided for users to upgrade the software to the latest functions. In main interface, press [F6] to enter the system upgrade options interface as picture 6:

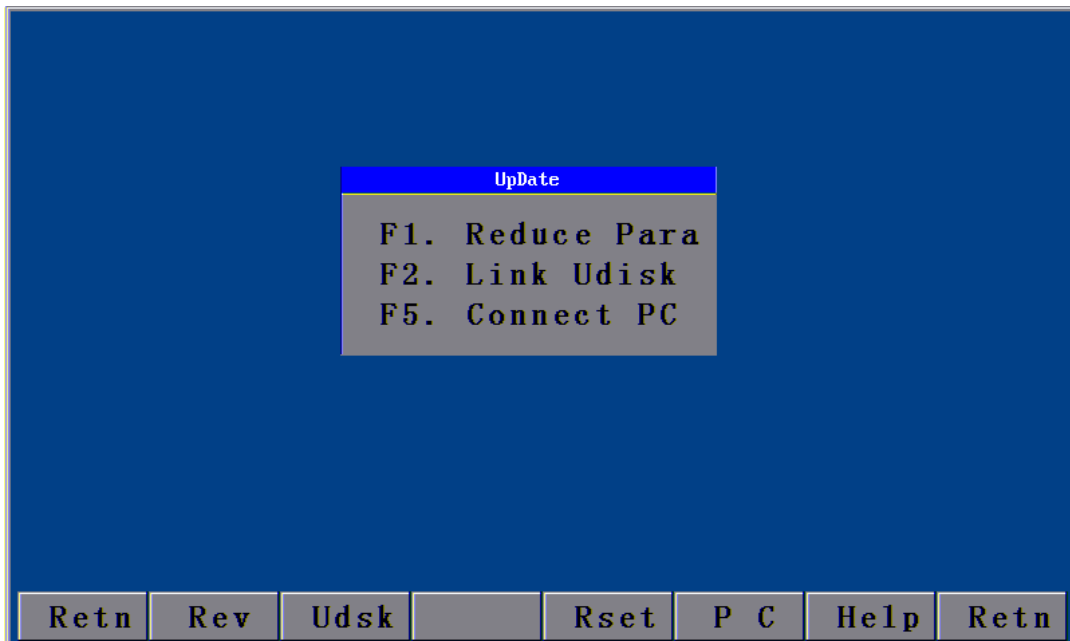

Picture 6 .1 System upgrade options interface

6.1 Description of sub-menu

[F1]: Restore system default

- [F2]: Connect the USB disk
- [F3]: Reserved, not in use for the moment
- [F4]: Restart the control system
- [F5]: Connect the computer
- [F6]: Main help system
- [INS]: Enable the help system of current interface

6.2 Restoration (Rev)

In upgrade interface as Picture 6.1, you can press [F1] to enter the system parameter restoration/storage interface.

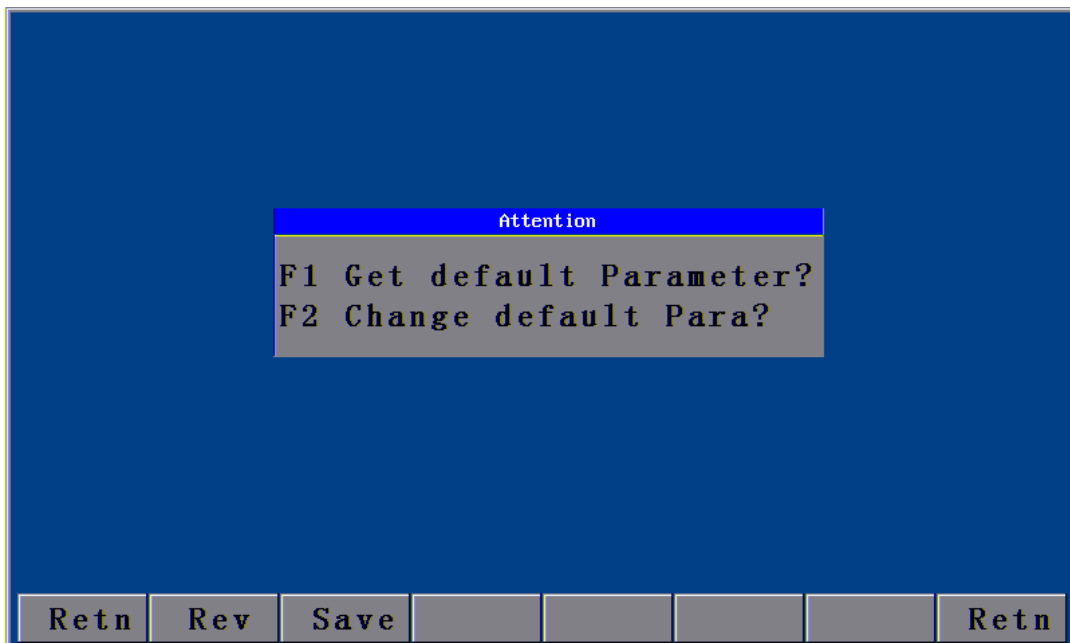

Picture 6.2.1 System parameter restoration/storage interface

In this interface, the system asks users to restore or to set factory default. To restore, press [F1]. After that, the system will give a prompt showing the system is restored, as picture 6.2.3. If you press [F1], the system will enter the interface prompting the factory default, as Picture 6.2.4; otherwise, press [ESC] to return to the previous interface.

Note: If the system parameters have never been saved, the parameters will be messed after the restoration. In this situation, it is not allowed to be restored. The operating interface is as Picture 6.2.2.



Picture 6.2.2 Parameters cannot be restored

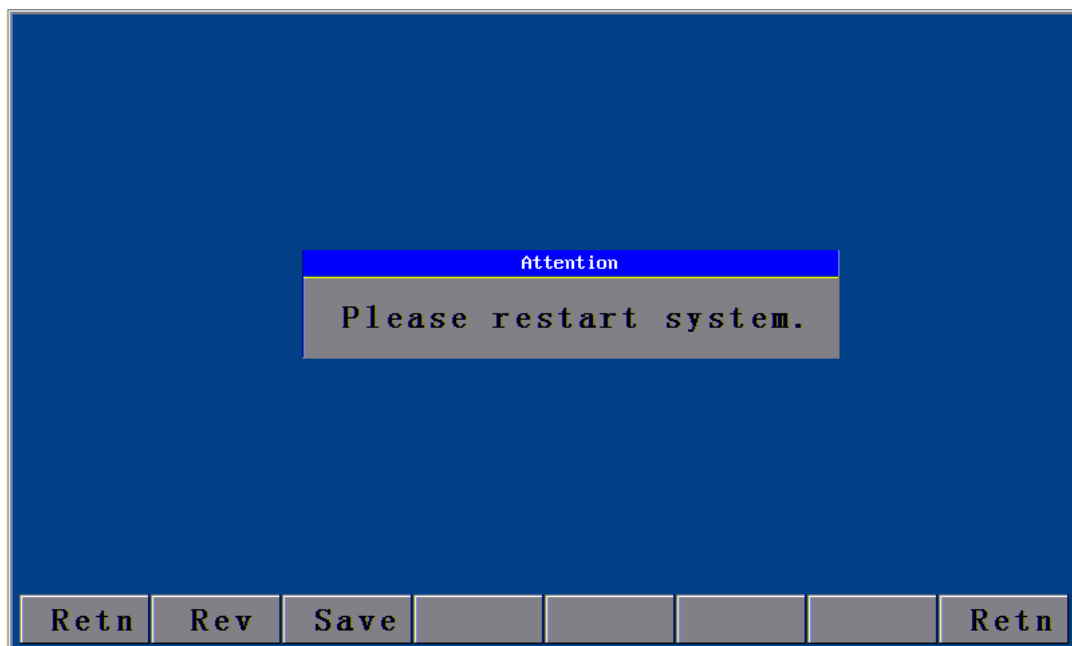

Picture 6.2.3 Parameters are restored

To save parameters in system parameter restoration/storage interface, it's required to input the correct password. To not to save the parameters, you can press [◀] or [▶] to exit.

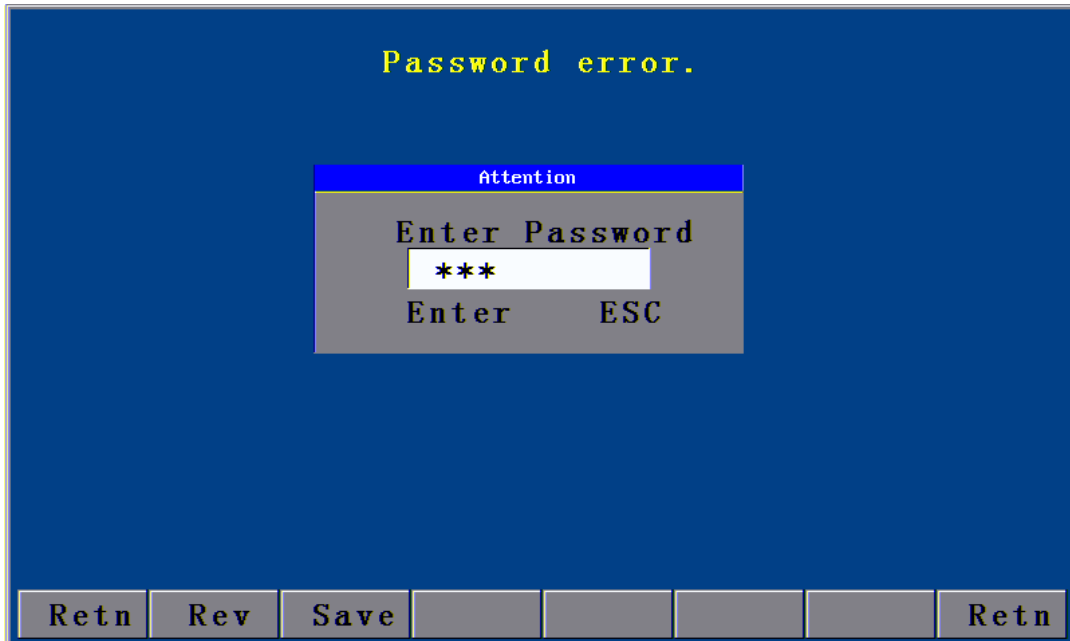

Picture 6.2.4 Interface of setting factory default verification

After entering the correct password in interface as above, the following interface will show up:

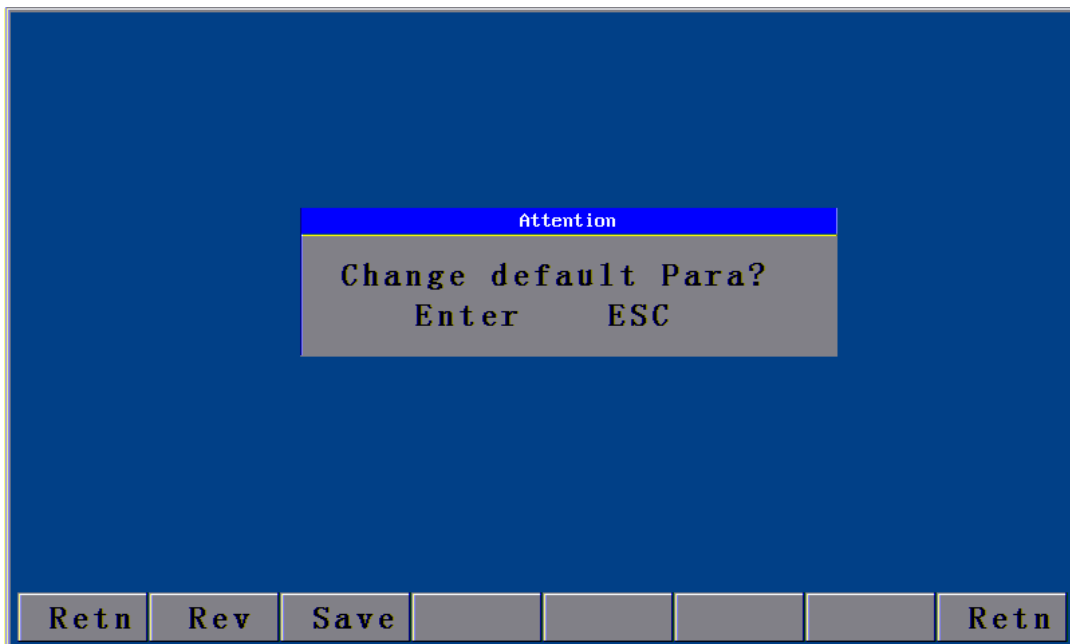

Picture 6.2.5 Interface of setting factory default prompt

In this interface, press [ENTER] and the system will set the parameters set in “Parameter” options to factory default. After each “restoration”, the parameters will be restored to the previous stored factory default. Once the settings are saved, the system will show a prompt interface as Picture 6.2.6. If you do not want to set the current settings as factory default, you can press [ESC] to cancel and press [◀] or [▶] to exit.

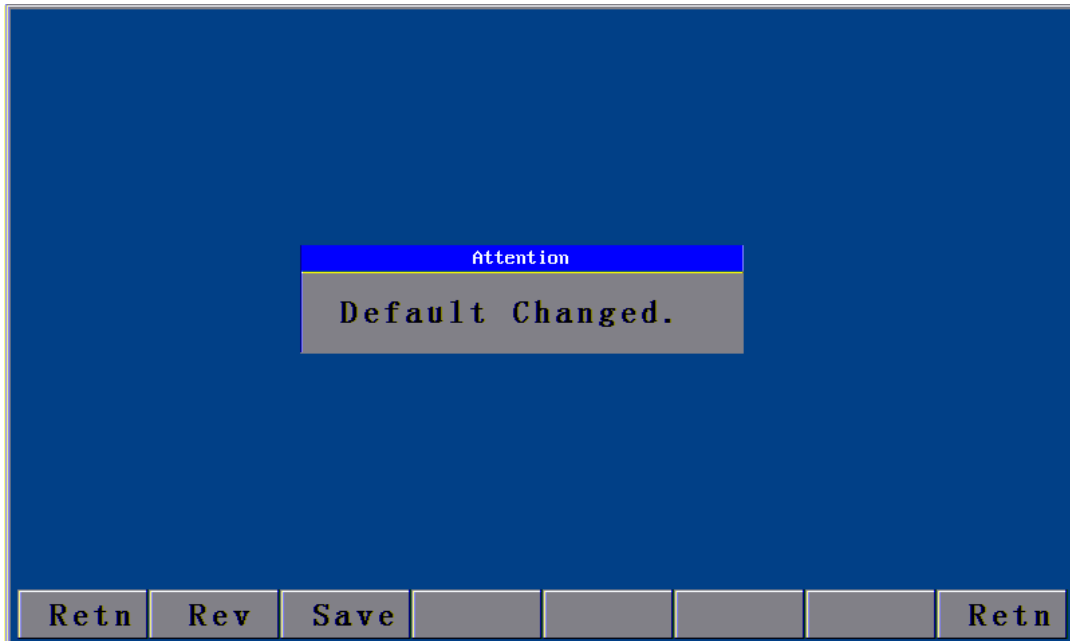

Picture 6.2.6 Prompt interface after the factory default is set

6.3 Upgraded by USB disk (Udsk)

1) Connection of USB disk fails

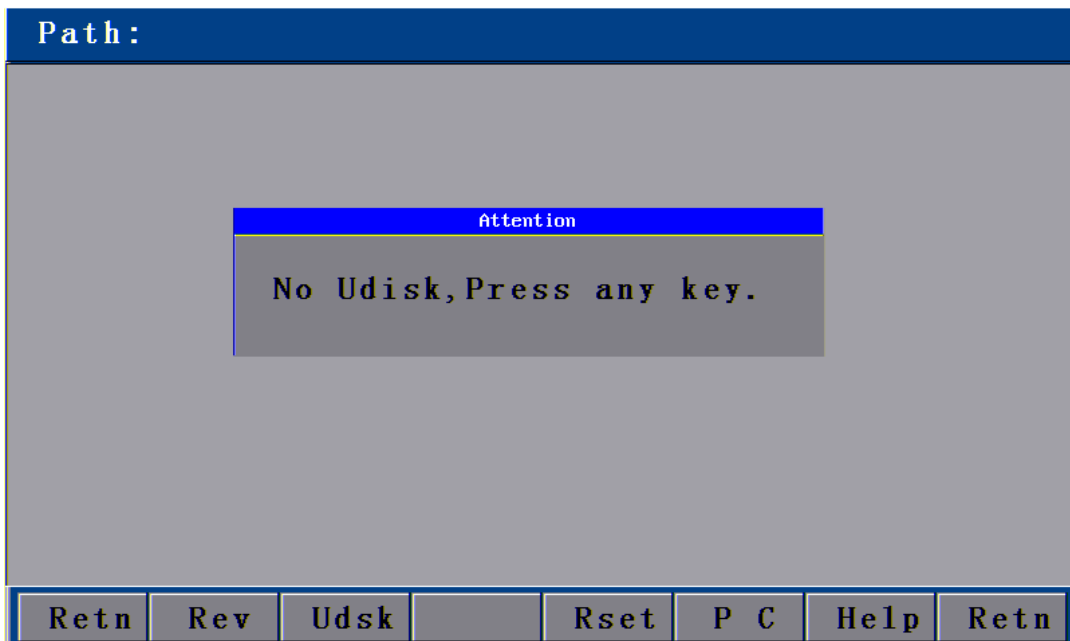

Picture 6.3.1 Connection of USB disk fails

Download the latest program to USB disk, insert the USB disk into USB port, and press [F6] in main interface to enter the upgrade interface, and then press [F2]. If the connection fails, the system will show the interface as Picture . 6.3.1, on which you can press any key to return to the main interface.

2) USB disk is connected

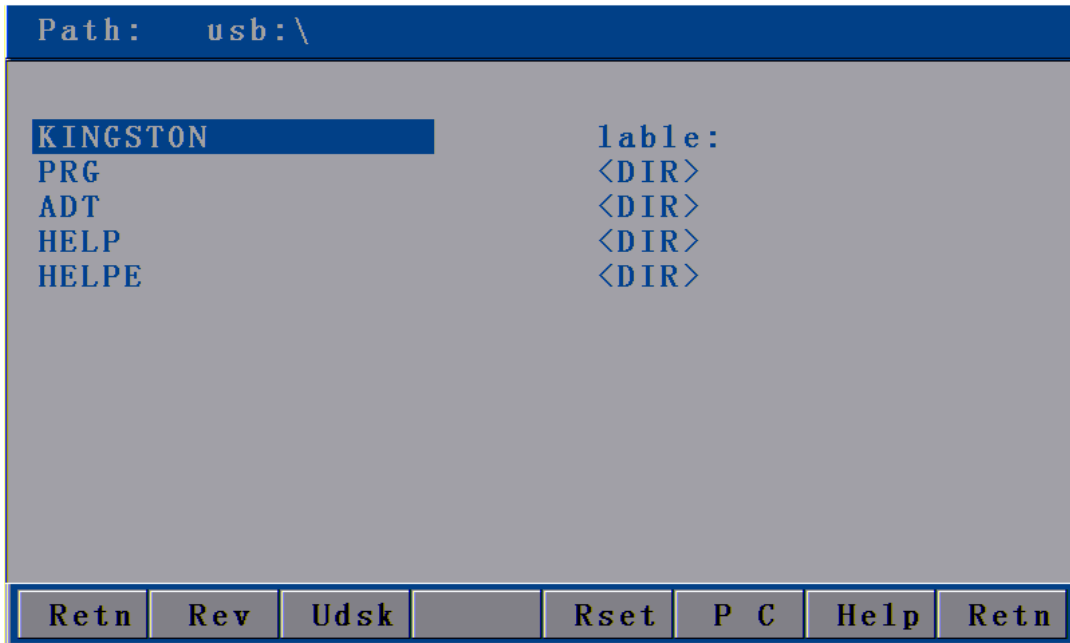

Picture 6.3.2 USB disk is connected

If USB disk is successfully connected, press [Y+] or [Y-] to move the cursor to “ADTROM.BIN” in the catalog and press [ENTER], the interface will become as follows:

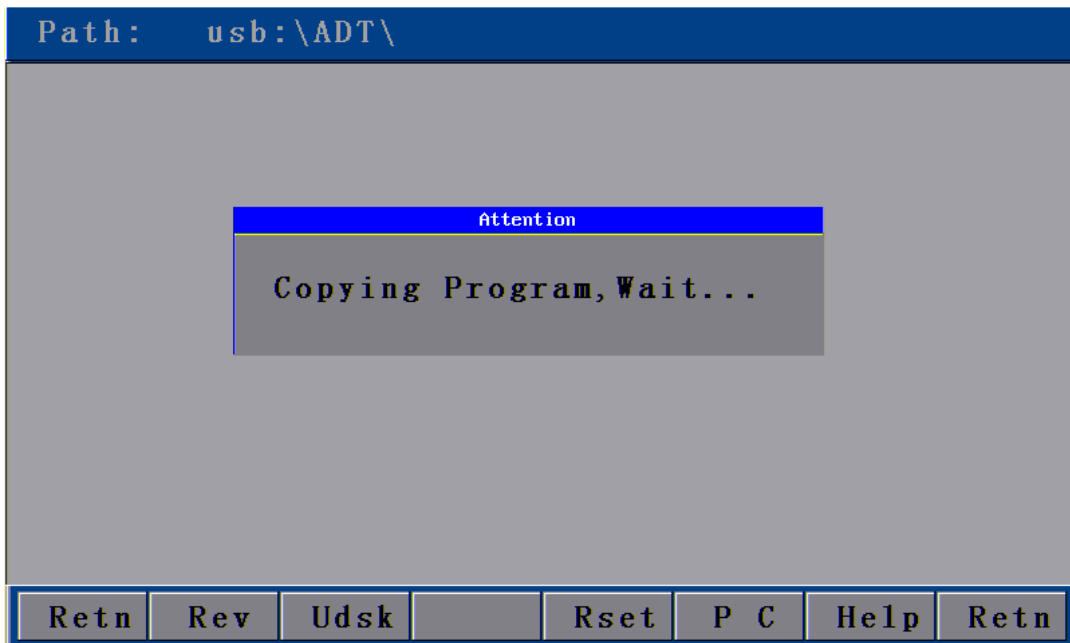

Picture 6.3.3 System is upgrading

If the selected file is not the type for upgrading, the system will give a prompt, as Picture 6.3.4:

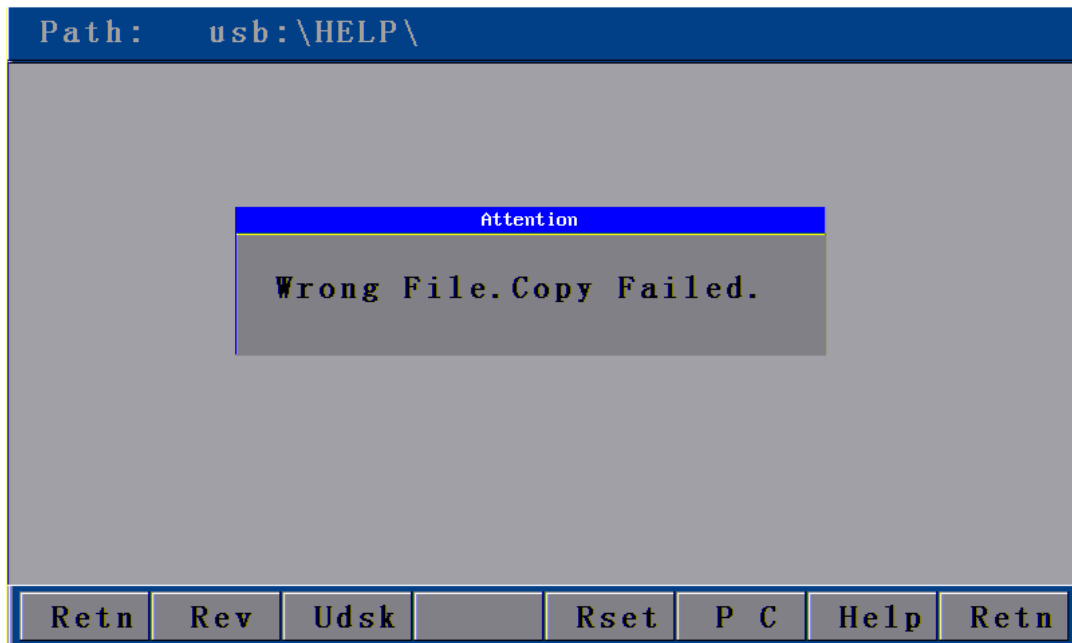

Picture 6.3.4 Upgrade fails

If the selected file is correct, after the download of program, the interface will be displayed as:

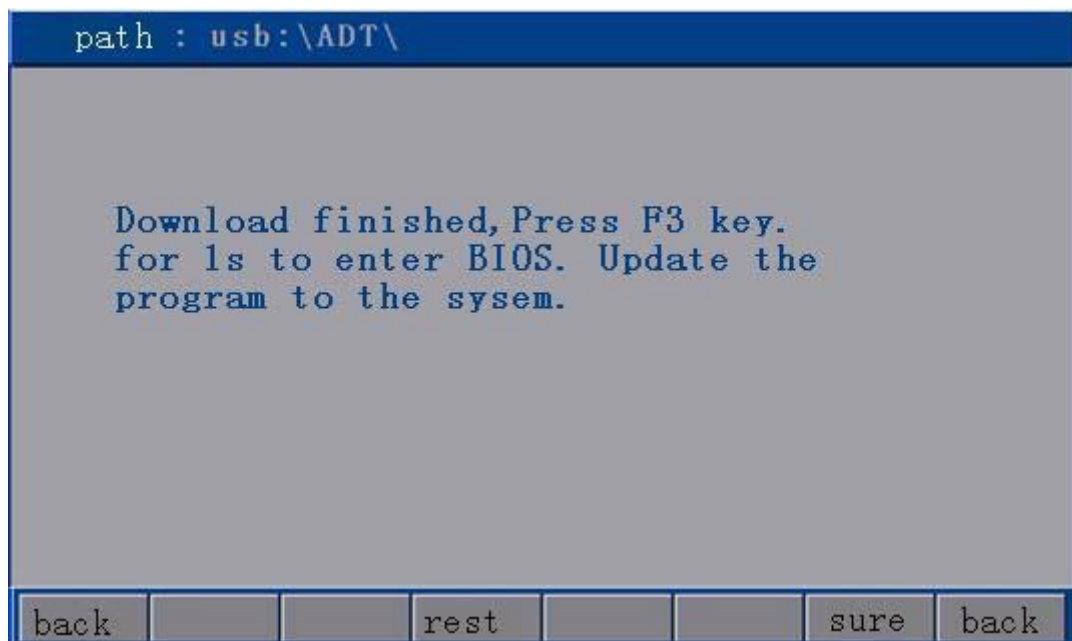

Picture 6.3.5 System upgrade completes

At this time, press [F3] to restart and then press [ESC] when having entered the interface for about 1s, or shut the power supply and press and hold [ESC] to connect to the power supply for few seconds to enter interface as Picture 6.3.5. Then, upgrade the program in BIOS in accordance with the recording methods in section 6.3.5 in this chapter.

6.4 Upgrade the Interface connect PC

Press **【F6】** in the system mani interface, Press **【F5】**, connect computer communication

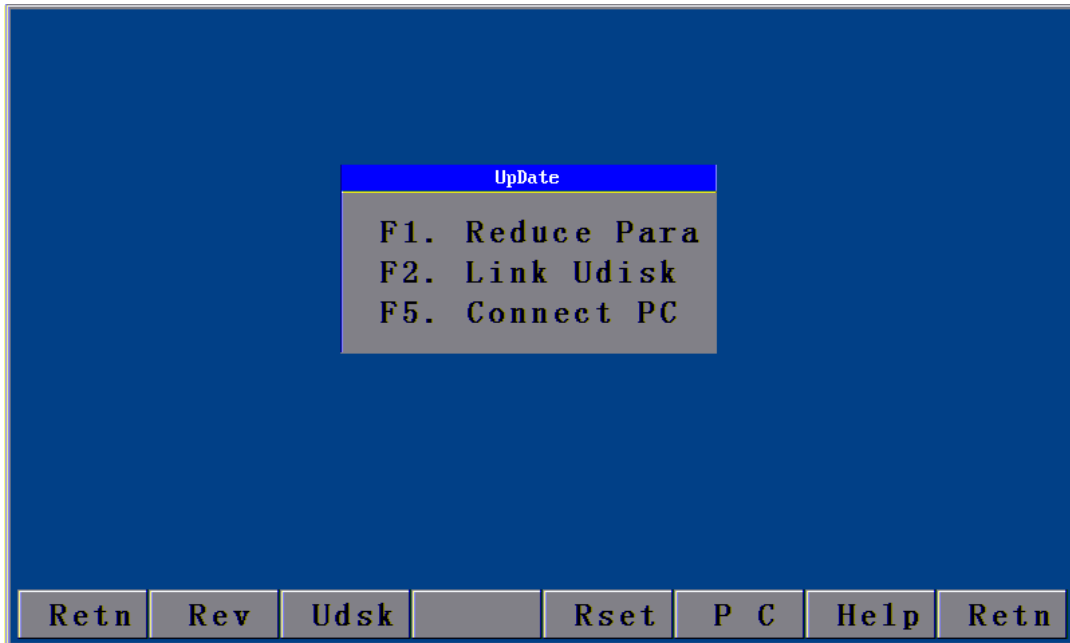

Picture 6.4.1 connect computer

USB Line(As below picture) one side connect with computer, another side connect controller, press **【F5】** connect computer, press “my computer” in PC, at this price computer like as 256M U disk will display in your computer, press” U disk”, then copy the newest “adtrom.bin” file to “ADT” folder. After the finished the copy, press turn off the power, press **【CAN】**, power on, press the newest program in BOIS. Details operation see 6.6 part.



Picture 6.4.1 USB connecting line

6.5 Recording program

When you have copied the latest application software to controller, you need to save the software to the controller BIOS so that the controller can operate the software. To do this, you should cut the controller power supply first, press and hold [ESC] key when the controller is restarted. The interface will ask you to input the password as follows:

```
2440  BIOS  V1.00

CurDate:2011/03/14  Curtime: 05:58:26

0---System Set
1---BIOS Set
2---U disk
3---System Check
5---LCD Select
6---language
Press num key start opt , [ESC]QUIT
```

6.6.1 Password entry interface for entering the BIOS interface

Input correct password to enter the following interface. Refer to supplier for the password.

```
2440  BIOS  V1.00

CurDate:2011/03/14  Curtime: 05:58:26

Please Sel Modify Section:

0---BIOS Sec
1---Prog Sec
2---HZK16 Sec
3---HZK24 SEC

Press num key start opt , [ESC]QUIT
```

6.6.2 Setting interface for entering BIOS interface

Use [↑] or [↓] to move the cursor to “B. BIOS”, and press [ENTER]. Then, move the cursor to “2. Upgrade PRG” with the same method and press [ENTER] again, the system will give a prompt “Do you really want to upgrade the program, Y/N?” press [ENTER] to confirm. After that, the system will prompt the files are found and are refreshing. As the upgrade completes, the system will prompt “Upgrade complete, please restart the machine”. Shut the power supply and restart the controller.

After the upgrade, you should check whether the starting mode is “Normal boot”, as the following picture shows:

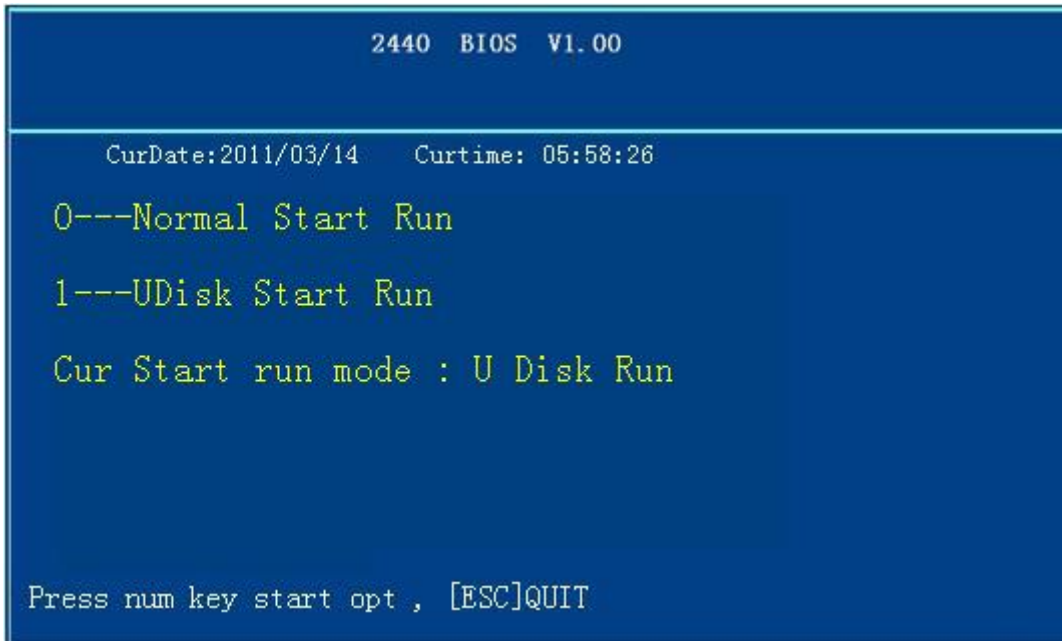

6.6.3 Starting mode

Use [Y+] or [Y-] to move the cursor to “E. Starting mode” and press [ENTER], if the highlight area is not “Normal start”, you should move it to “Normal start” and then press [ENTER].

6.7 Upgrade in BIOS interface via PC

Decompress the compressed files of client programs in computer.

Connect one end of the connecting wire to computer, and the other end to control system.

First, cut the power supply of controller, and then press and hold the [ESC] key on panel to connect the power supply, the interface will ask you to input the password, as follows:

```
2440  BIOS  V1.00

CurDate:2011/03/14  Curtime: 05:58:26

0---System Set
1---BIOS Set
2---U disk
3---System Check
5---LCD Select
6---language
Press num key start opt , [ESC]QUIT
```

6.6.4 Password entry interface to BIOS interface

Input correct password to enter the following interface. Refer to supplier for the password.

```
2440  BIOS  V1.00

CurDate:2011/03/14  Curtime: 05:58:26

0---USB communication
1---Format U disk
2---U disk Data Copy
3---Format YAFFS2

Press num key start opt , [ESC]QUIT
```

6.6.5 Enter USB disk interface in BIOS

Use [↑] or [↓] to move the cursor to “C. U disk”, and press [ENTER]; then, move the cursor to “1. Communication Connecting” with the same method, and press [ENTER].

Return back to the computer and find the system, which is displayed as a disk drive in form of USB disk on the computer.

Copy “ADT”“PRG”“ADTLIB”“HELP” after the decompression of client program on computer (To copy English: Rename English “HELP” to “help” before copying) to the disk on control system. After the copy,

press [ESC] to exit the communication connecting.

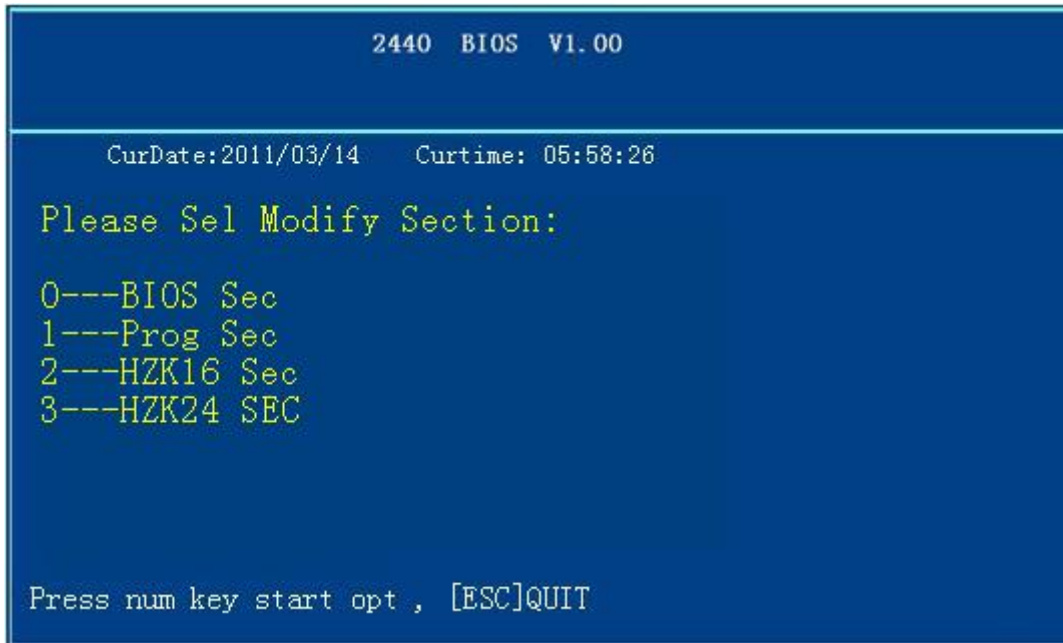

6.6.6 Enter the setting interface of BIOS

Use [Y+] or [Y-] to move the cursor to “B. Setting BIOS”, press [ENTER]; then, move the cursor to “2. Upgrade PRG” with [X+] or [X-], and press [ENTER] again. The system will give a prompt “Do you really want to upgrade the program, Y/N?” press [ENTER] to confirm. After that, the system will prompt the files are found and are refreshing. As the upgrade completes, the system will prompt “Upgrade complete, please restart the machine”. Shut the power supply and restart the controller.

7. Help system

To help your operations, a help system is provided:

- 1) You can press [INS] key in any interface to enable the help system of the interface, which provides the basic operations and notes.
- 2) You can press [F6] in upgrade interface to enter the main help system as Picture 7.1, in which you can search for some basic help contents. You can input the content and press [F5] to start searching. The system will highlight the first searched content. You can also do not input the searching content, in this way, the system will read the help file from the beginning.

Note: The content of help system includes G code, M code, common instructions, etc. that are easily to be forgotten.

- 3) You can press [pgup↑] or [pgdn↓] to page up/down, [◀] or [▶] to exit the help system and return to the current interface.

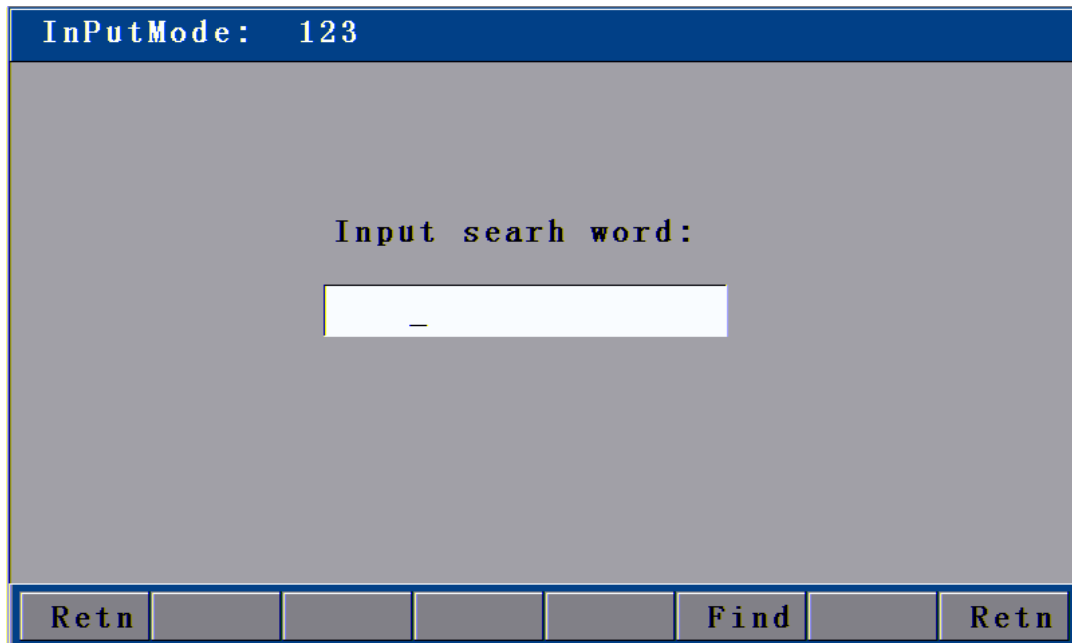

Picture 7.1 Help system

8. Multi-language operations

ADTLIB figure library: **(It is default that the folder ADTLIB includes Chinese and English figure libraries)**

Name the four Chinese figures in accordance with the S/N as PIC000.bmp, PIC001.bmp, PIC002.bmp, and PIC003.bmp.

Name the four English figures in sequence as EPIC000.BMP, EPIC001.BMP, EPIC002.BMP, and EPIC003.BMP;

In case of figures in other languages, please name as OPIC000.BMP, OPIC001.BMP, OPIC002.BMP, and OPIC003.BMP;

Multi-language operations of HC4500 system:

Put the configuration file into ADT catalog of controller in accordance with CONFIG1.INI, CONFIG2.INI, CONFIG3.INI files and details on these files provided by our company or client's translator. In this catalog, the language files named as CONFIG1.INI, CONFIG2.INI, and CONFIG3.INI are the current valid files, in which CONFIG1.INI is the English configuration file, CONFIG2.INI and CONFIG3.INI are configuration files of other languages required by customers.

When selecting the language in system parameter setting interface, if there is no relevant language file in ADT folder or if the file is blank, the controller will consider the language as Chinese.

Translation specification of the language configuration file:

1. Make a copy of this file and open it with the Notepad.

2. In case of similar Chinese with two Bytes a word, please name it as config2.ini,
In case of similar English with one Byte a letter, please name it as config3.INI
3. Translate the content behind “=” in new file to Chinese, while other contents do not change.
4. For any question, please compare the English configuration file of config1 with the Chinese one in folder ADT.

Note:

1. Character ‘;’ acting as the ending mark of configuration value, can be followed by remark.
2. It is not allowed to have sign ‘=’ in remark and the value of configuration parameter.
3. It is not allowed to change the sequence of parameter in every interface, and do not use ‘[]’;
4. To add new parameter, please add at the end of the interface;
5. When translating, due to the small controller screen, the number of character should be strictly controlled for the parameters;
6. The content in ‘[]’ should not be translated;
7. If it is blank behind the equal sign, it is to reserve a space for the previous line, which means that it can write the exceeding part of translation of the previous line.

For example: (Chinese)

- 1.[开机界面]
[1] =深圳众为兴数控技术有限公司;(≤60 Byte)
[2]=;
[3] = ...;

Translation:

1. [Starting interface]
[1]=ADTECH CNC TECHNOLOGY;
[2]= CO., LTD (SHENZHEN);
[3] = ...;

5. If there is any doubt, Please refer to translation docomet or contact supplier.

Chapter IV Instruction System

1. Explanation of programming symbol

Every motion of the CNC processing is done following the due process, every processing program is composed by several instruction segments, each instruction segment is composed by several function words, and each function word should be started with a letter following by the parameter value.

Definition of function word:

- G Preparatory function
- M M-function
- L Cycle index or delay time
- X Coordinate of X axis: It is relative coordinate in G91 (default), and absolute coordinate in G90.
- Y Coordinate of Y axis: It is relative coordinate in G91 (default), and absolute coordinate in G90.
- I during the circular arc processing, the center coordinate value minus the original value of X axis
- J during the circular arc processing, the center coordinate value minus the original value of Y axis
- R Specify the radius of circular arc

2. Coordinate explanation

2.1 Relative coordinate

In coordinate system, if the coordinate of current point is calculated from the previous coordinate, it is called relative coordinate. As the picture shows:

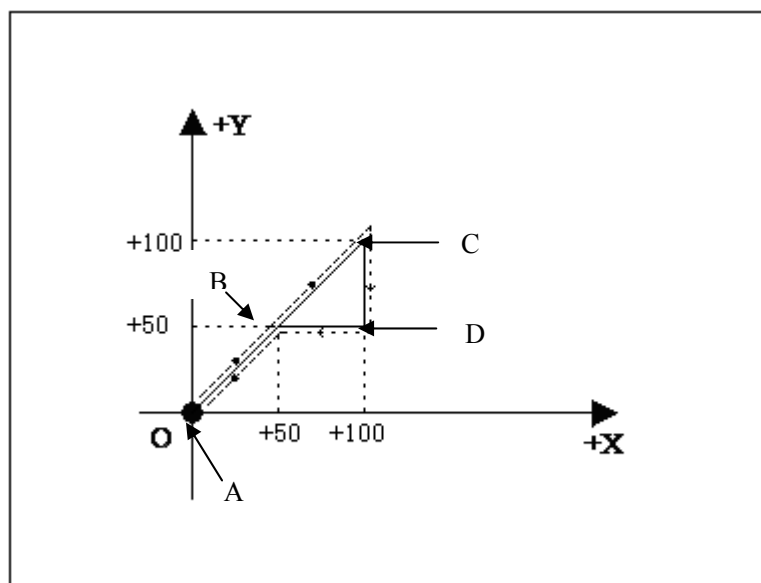

Picture 2.1

As the above picture, if calculated by relative coordinate, the coordinate of the points in picture are as follows:

1. Point A is the origin, the coordinate is (X0, Y0);
2. Point B is (X50, Y50) relative to point A;
3. Point C is (X50, Y50) relative to point B;
4. Point D is Y-50 relative to point C;
5. Point D returns to point B, and the coordinate is X-50;

2.2 Absolute coordinate

In coordinate system, if the coordinate of current point is calculated from the origin, it is called absolute coordinate. As picture 2.1, if calculated by absolute coordinate, the coordinate of the points in picture are as follows

1. Point A is the origin, the coordinate is (X0, Y0);
2. Point B is (X50, Y50) relative to point A;
3. Point C is (X100, Y100) relative to point A;
4. Point D is (X100, Y50) relative to point A;
5. Point D returns to point B, and is (X50, Y50);

3. G instruction

3.1. G92 reference point setup

Set the coordinate of processing origin (reference point) of program. It should be put at the beginning of program.

Format: G92 X0 Y0

If G92 is not followed with X/Y coordinate, the current coordinate (X, Y) is taken as the reference point. Usually, when locating using the machine origin, G92 would not have X and Y content.

3.2. G21/G20 Metric /Imperial setting

Set the unit of length for the processing. The default is metric system.

G20: Imperial (Unit: inch)

G21: Metric (Unit: mm)

Format: G21

This instruction is for setting the length unit during the processing as (mm). It is usually written in the second line of program (unless otherwise change temporarily), which is the next line of G92, without

any content following. It works until the next G20 or G21 instruction is detected.

3.3. G00 idle motion

This instruction enables you to travel to the appointed position quickly. During the travel, the system moves from the starting point to end point in rectilinear motion at the manual limiting speed. It would not be influenced by the speed rate.

Format: G00 Xn Yn

For example: G92 X0 Y0

G00 X75 Y75

M02

- Current position of cutting gun
- Expected position of cutting gun

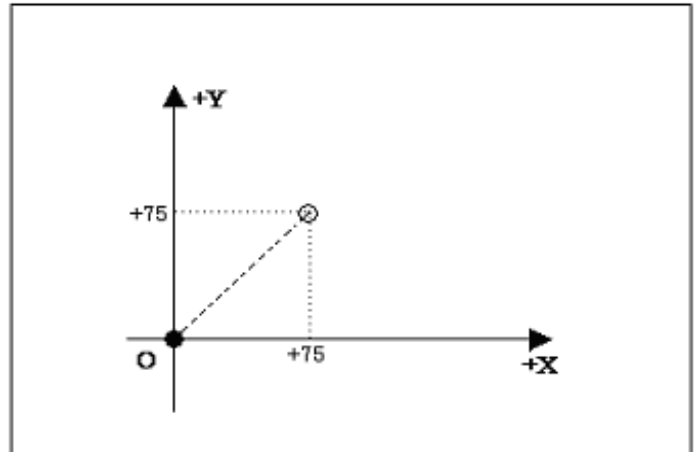

3.4. G01 linear cutting

This instruction enables you to feed the cutting gun to the appointed position in linear way. As the cutting motion instruction, single-axis or dual-axis linear interpolation is available.

Format: G01 Xn Yn

For example:

G92 X0 Y0

G00 X100 Y50

G01 X30 Y90

M02

- Current position of cutting gun
- Expected position of cutting gun

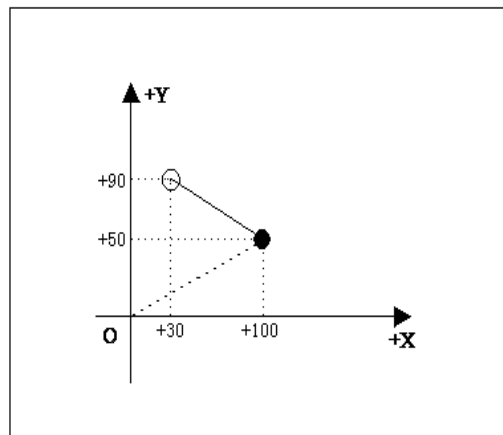

3.5. G02/G03 circular arc cutting

This instruction is used to cut a circle or circular arc. The circle is divided into G02 (clockwise) and G03 (anti-clockwise).

Format: G02 [03] In

For example (G02):

G92 X0 Y0

G00 X55 Y55

G02 I35

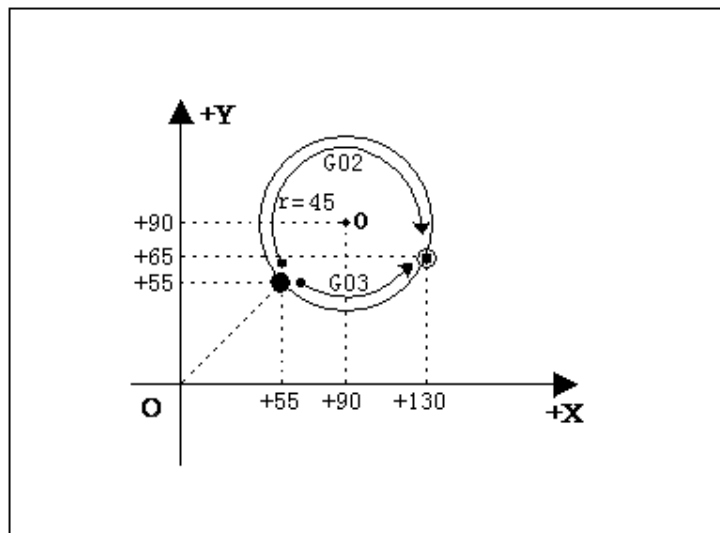

M02

For example (G03):

G92 X0 Y0

G00 X55 Y55

G03 I35

M02

●Current position of cutting gun

○Expected position of cutting gun

Explanation:

I and J are the increment of center at X and Y-axis direction relative to the origin. When you are writing processing files, if you want to write a circle with a diameter of 100MM, to make it simple you can enter :I50 directly. If the circle diameter is 150MM, you can just enter: I75.

3.6. G04 Pause/Delay instruction

This instruction is used to set the time delay. When the program performs this instruction, it will delay the stated time. The time unit is in second.

Format: G04 Ln

For example: G04 L3.6 (3.6s delay)

If G04 does not have Ln behind, the system will delay without time limit once G04 is performed until you press [Start] key.

3.7. G26, G27, G28 Back to reference point

This instruction allows the cutting torch to return to reference point automatically. It runs at travel speed, the maximum manual speed, which is not controlled by the percentage.

Format:

G26: X axis back to reference point

G27: Y axis back to reference point

G28: X and Y axes back to reference point at the same time

For example: G28 (X and Y axes back to reference point at the same time, equal to run G00)

3.8. G22/G80 cycle processing

This instruction can be used to perform cycle processing. G22 is the beginning of loop, and cycle time L is appointed. G80 is the end mark of loop. G22 and the nearest G80 below form a loop.

Format: G22 Ln_ (L specifies the cycle times)

Loop

G80 (End mark of loop)

For example: 0000 G92 X100 Y100

0001: G22 L10000 ——Cycle starts

0002: G00 X50 Y50

0003: G01 X80 Y80

0004: G80 ——Cycle ends

0005: M02

3.9. G81 workpiece counting

This instruction is used by the system to count the total workpiece automatically.

Format: G81

For example: 0000 G92 X0 Y0

0001: G22 L3 ——Cycle starts

0002: G01 X50 Y50

0003: G81 ——Counting

0004: G80 ——Cycle ends

0005: M02

3.10. G91/G90 relative/absolute coordinate programming

In G91 (default), it is relative coordinate while in G90 it is absolute coordinate.

Format: G91

G01 X100

3.11. G41/G42/G40

Set the cutting gap compensation. It is usually set before perforating and cutting of steel plate, and cancelled in M08 instruction.

Programming format:

G41 Left compensation

G42 Right compensation

G40 Cancel compensation

4. Common M instructions

1) Common M instructions:

Users only need to know the functions of M07, M08, and M02 instructions. M07 refers to fixed cycle of preheating and perforating. When the track is processed and come to perform M08, the system will close all related valves. In the end, perform M02 to finish the processing. Detailed functions of codes are as follows:

① M07 Fixed cycle of preheating and perforating, operating sequence is as follows:

Flame:

1. Open acetylene valve; M10
2. Ignition on; M20
3. Drop the cutting gun; M16
4. Open the preheating valve and start preheating; M24
5. Lift the perforating cutting gun; M14
6. Open cutting oxygen valve; M12
7. Drop the perforating cutting gun; M16
8. Perforation complete, and go to the next motion.

Plasma:

A). with height-adjusting system:

- ① Enable M22
- ② Arcing M12
- ③ Waiting for arc voltage detection signal (IN0)

After arcing, the height-adjusting control starts performing initial location (With height adjustor for initial positioning, at this time the initial positioning in parameter is disabled), perforating and perforating delay automatically, and gives a signal of successful arc voltage detection to the controller. The control system begins the next motion when it detects the arc voltage signal.

B). without height-adjusting system and initial positioning:

1. Arcing, arcing delay M12
2. Perforating, perforating delay
3. Cutting gun falls
4. Start cutting

② M08 Close the cutting fixed cycle. The operating sequence is as follows:

Flame

1. Close the cutting oxygen valve;
2. Lift the cutting gun.

Plasma:

1. Close striking arc M13
2. Close the height-adjusting control M23 (If height-adjusting and initial positioning are not enabled, the cutting gun will rise)

③ M02 program end instruction

2) Other M instructions:

- ① M10/M11 switch of acetylene valve, M10 (Open), M11 (Closed)
- ② M12/M13 switch of cutting oxygen valve, M12 (Open), M13 (Closed)
- ③ M14/M15 switch for controlling the rise of cutting gun, M14 (Open), M15 (Closed)
- ④ M20/M21 ignition switch, M20 (Open), M21 (Closed)
- ⑤ M24/M25 switch of preheating oxygen valve, M24 (Open), M25 (Closed)
- ⑥ M52 ignition fixed cycle (controlled by time in “Control” interface)
- ⑦ M70 fixed cycle of cutting gun rising (controlled by time in “Control” interface)
- ⑧ M71 fixed cycle of cutting gun falling (controlled by time in “Control” interface)
- ⑨ M72 fixed cycle of perforating cutting gun rising (controlled by time in “Control” interface)
- ⑩ M73 fixed cycle of perforating cutting gun falling (controlled by time in “Control” interface)
- ⑪ M74 fixed cycle of preheating (controlled by time in “Control” interface)
- ⑫ M80 main switch, all output ports are closed if M80 is performed.

Chapter V Hardware

1. Overall dimension

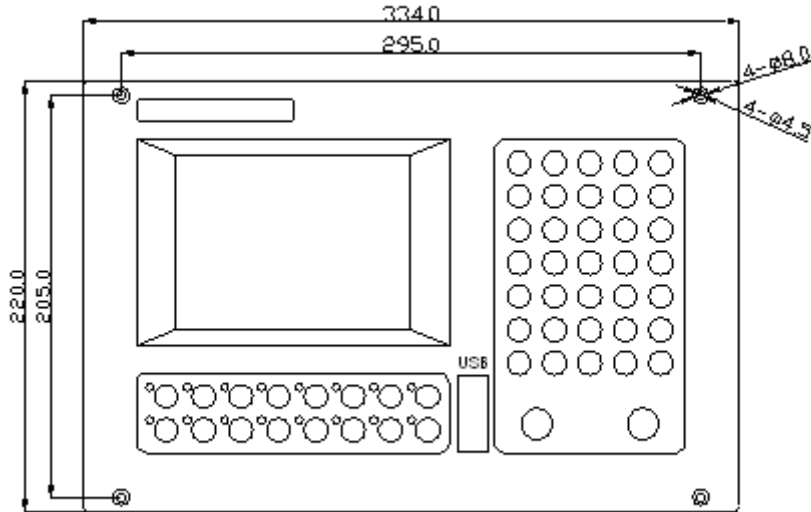

Picture 1.1 Front view

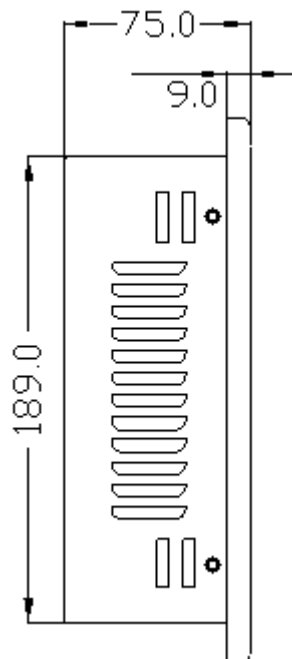

Picture 2.1 Side view

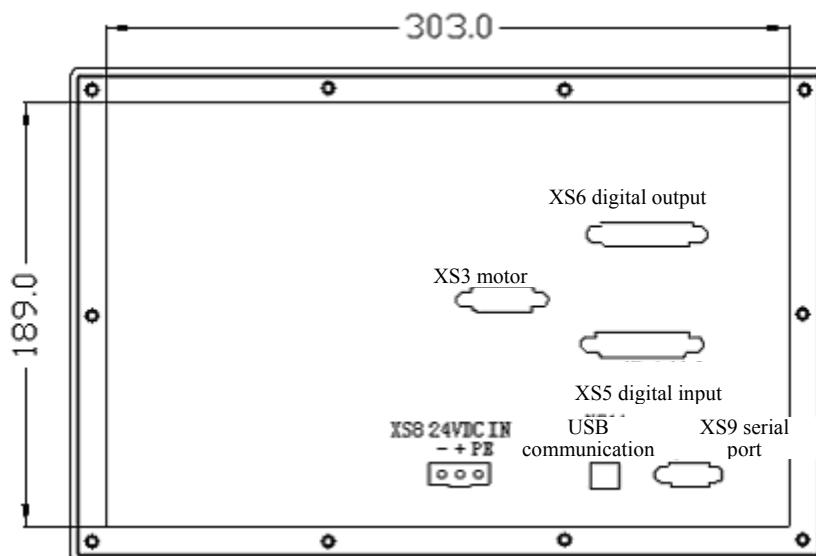

Picture 2.1 Rear view

Note: the above length is unit in “mm”.

2. System input/output interface

2.1 Back cover

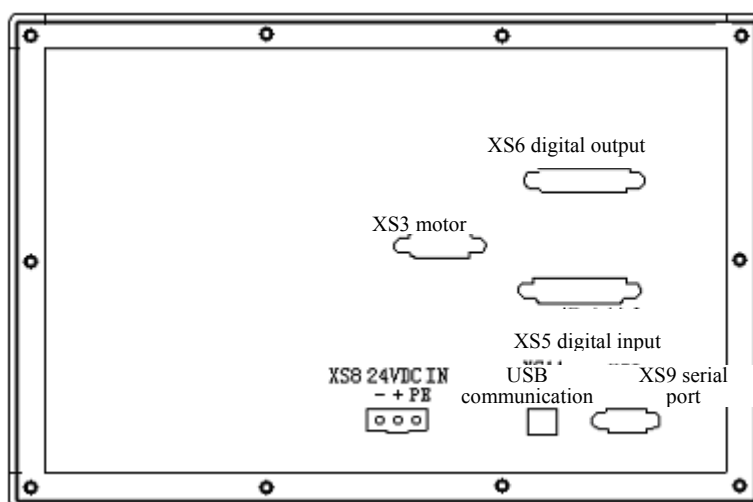

2.2 Specifications

Digital input:

Channel: 32, all photovoltaic isolation

Input voltage: 12-24V DC

High level > 4.5V

Low level < 1.0V

Isolation voltage: 2500V DC

Counting input:

Channel: Main axis ABZ-phase coding input, all photovoltaic isolation

Maximum counting frequency: 2MHz

Input voltage: 5-24V DC

High level >1.5V

Low level <1.0V

Isolation voltage: 2500V DC

Pulse output:

Channel: 3 pulses, 3 directions, all photovoltaic isolation

Maximum pulse frequency: 2MHz

Output type: 5V differential output

Output mode: Pulse + Direction, or Pulse + Pulse

Digital output:

Output channel: 16 channels, all photovoltaic isolation

Output type: NPN open-collector output 12-24VDC, maximum current can reach 100mA

RS-232 baud rate (bps):

1200, 2400, 4800, 9600, 19200, 38400, 57600, 115200

2.3 Electrical connection

2.2.1 Motor control interface——15-core socket (Male)

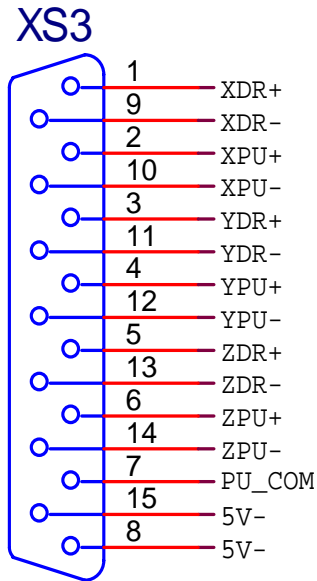

Line S/N	Name	Function
1	XDR+	X direction signal +
9	XDR-	X direction signal -
2	XPU+	X pulse signal +
10	XPU-	X pulse signal -
3	YDR+	Y direction signal +
11	YDR-	Y direction signal -
4	YPU+	Y pulse signal +
12	YPU-	Y pulse signal -
5	ZDR+	Z direction signal +
13	ZDR-	Z direction signal -
6	ZPU+	Z pulse signal +
14	ZPU-	Z pulse signal -
7	PU_COM	Internal 5V positive, not allowed to connect the external power supply (for driver with single-end input)
15	5V-	Internal 5V negative, not allowed to connect the external power supply
8	5V-	Internal 5V negative, not allowed to connect the external power supply

Connection mode of pulse output signal

◆ Differential mode:

For stepper motor driver with individual pulse and direction input, and most of servo motor driver, it is recommended to use this mode to get the better anti-interference performance.

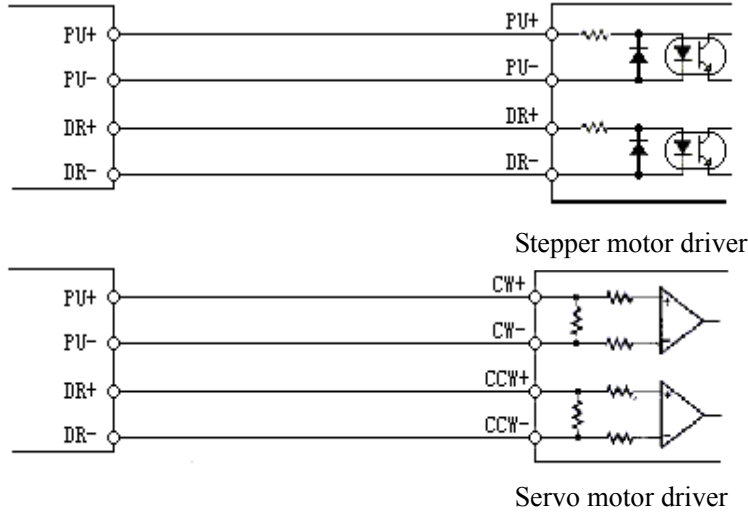

◆ Single-end mode:

It is applicable to the earlier stepper motor driver whose pulse and direction anodes are connected together.

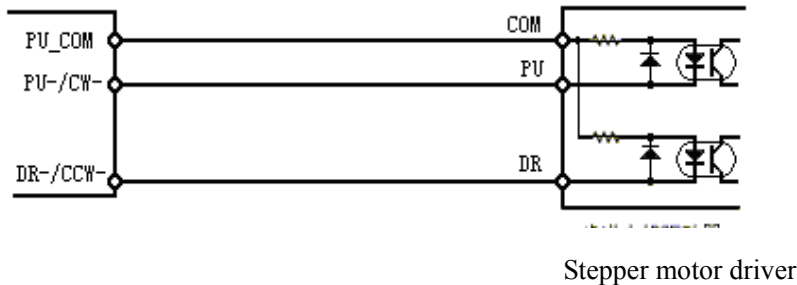

Note: It is not applicable to the some stepper motor drivers whose pulse and direction cathodes are connected together.

PU_COM and 5V- are especially set for adapting the stepper or servo driver control signal, not the differential signal, at this time the driver uses the common-anode or common-cathode connection. If the control signal of driver is of differential connection, the PU_COM and 5V- are not required to be connected. **Especially note that PU_COM is exclusively used in non-differential connection of motor pulse. It should not be used for other purposes, or it may damage the internal circuit of controller.**

Note: Any two pins of PU+, PU-, DR+ and DR- cannot be connected together; otherwise, it may damage the pulse interface.

2.2.2 Input control interface——25-core socket (Male)

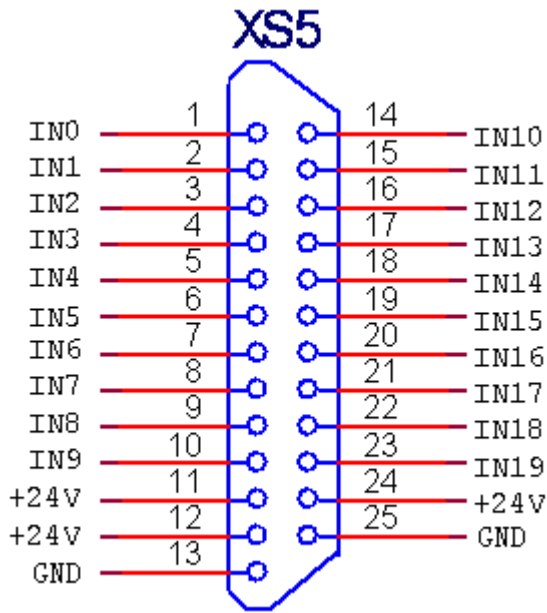

Line S/N	Name	Function
1	IN0	Arc voltage signal detection (AVT) (plasma cutting need testing Arc then connect)
2	IN1	Original positioning signal detection (ORI) (Z Axis negative limit under Flame step torch height control)
3	IN2	Manual/Auto switching (For backup, invalid for the moment) (HAD) (Z Axis negative limit under Flame step torch height control)
4	IN3	External pause key (PAU)
5	IN4	External handheld box X+ positive control (X+)
6	IN5	External handheld box Y+ positive control (Y+)
7	IN6	Acceleration control key of external control box (SP+)
8	IN7	Gun rising control key of external control box (UP)
9	IN8	X positive limit (>X+)
10	IN9	X negative limit (X-<)
11	+24V	Internal 24V+ of controller (do not connect any circuit)
12	+24V	Internal 24V+ of controller (do not connect any circuit)
13	GND	Internal 24V grounding of controller

14	IN10	Y positive limit (>Y+)
15	IN11	Y negative limit (Y-<)
16	IN12	External emergency stop (STP)
17	IN13	External start key (STA)
18	IN14	External handheld box X- positive control (X-)
19	IN15	External handheld box Y- positive control (Y-)
20	IN16	Deceleration control key of external handheld box (SP-)
21	IN17	Gun down control key of external handheld box (DOW)
22	IN18	Forward
23	IN19	Backward
24	+24V	Internal 24V+ of controller (do not connect any circuit)
25	GND	0V

Connection mode of input signal

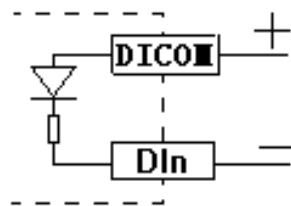

Optical coupler input

DICOM is connected to the positive end of internal power supply, and the input signal is connected to the relevant terminal.

2.2.3 Output control interface—25-core socket (Female)

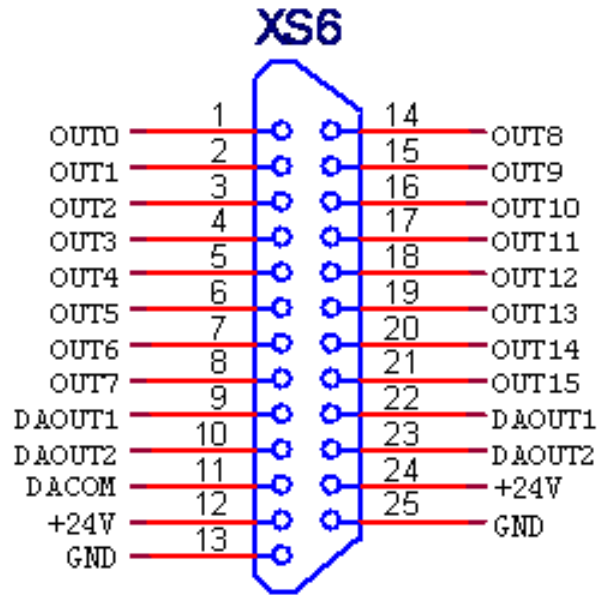

Line S/N	Name	Function
1	OUT0	Flame cutting Acetylene valve control, M10 (Open), M11 (Closed)
2	OUT1	Cutting gun rising control, M14 (Open), M15 (Closed)
3	OUT2	Flame cutting Ignition control, M20 (Open), M21 (Closed)
4	OUT3	Plasma Turning speed rate control, M22 (Open), M23 (Closed)
5	OUT4	Backup acetylene control, M40 (Open), M41 (Closed)
6	OUT5	Backup cutting gun rising, M28 (Open), M29 (Closed)
7	OUT6	Backup ignition control, M34 (Open), M35 (Closed)
8	OUT7	Backup turning speed rate control, M38 (Open), M39 (Closed)
9	NC	Null
10	NC	Null
11	NC	Null
12	+24V	Internal 24V+ of controller (do not connect any circuit)
13	GND	Internal 24V grounding of controller

14	OUT8	Cutting Oxygen / Plasma (arcing) control , M12 (Open), M13 (Closed)
15	OUT9	Cutting gun falling control, M16 (Open), M17 (Closed)
16	OUT10	Backup, M18 (Open), M19 (Closed)
17	OUT11	Flame cutting Preheating oxygen valve control, M24 (Open), M25 (Closed)
18	OUT12	Backup preheating oxygen control, M26 (Open), M27 (Closed)
19	OUT13	Backup Oxygen/arcing cutting control, M32 (Open), M33 (Closed)
20	OUT14	Backup cutting gun falling control, M36 (Open), M37 (Closed)
21	OUT15	{Flame} Torch Height control, M42(open), M43(close)
22	NC	Null
23	NC	Null
24	+24V	Internal 24V+ of controller (do not connect any circuit)
25	GND	0V

Connection mode of output signal:

The output is the open-collector output, if the external load is inductive load such as relay; a freewheeling diode should be connected, as the following picture shows:

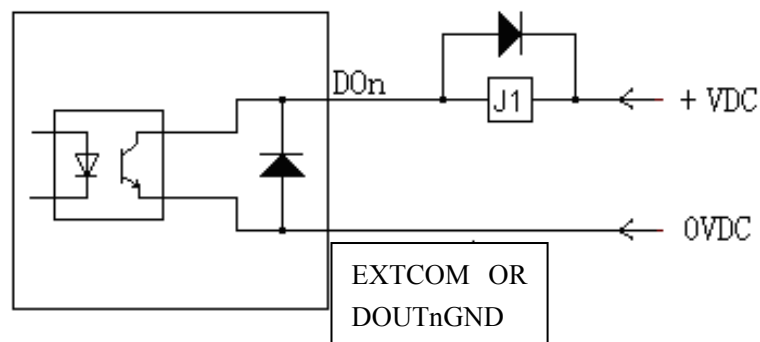

EXTCOM is connected to the negative end of internal power supply, and the output signal is connected to the relevant terminal.

It is suggested that the supply voltage be < 24V; it is better not to exceed 30V. Positive and negative poles should not be connected reversely and the load should not be in short circuit; otherwise, it may cause unexpected damage.

2.2.4 Serial port communication interface— 9-core socket (Male)

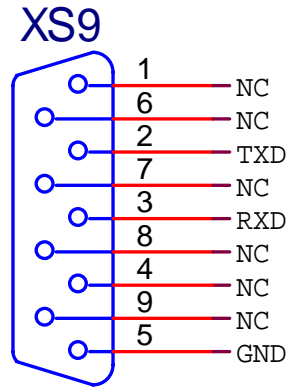

Line S/N	Name	Function
1	NC	Null
2	TXD	Transmitting data (For software engineer use)
3	RXD	Receiving data (For software engineer use)
4	NC	Null
5	GND	Grounding
6	NC	Null
7	NC	Null
8	NC	Null
9	NC	Null

Connection mode of communication signal:

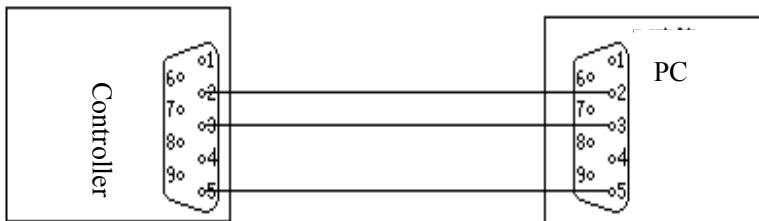

RS-232 communication mode

Note: IN20 panel-Stop, IN21 panel-Start

IN22-Null, IN23-Null

2.2.5 Wiring of SX8 power supply

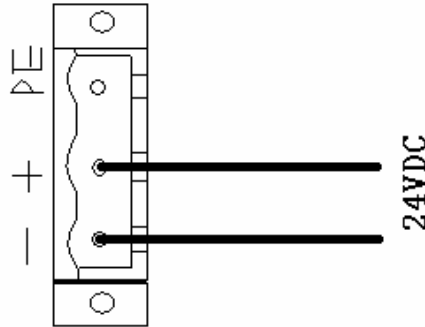

2.2.6 SX11 standard USB device interface

3. Connection mode of motor

3.1 Connection of Differential Driver

The following connecting diagram shows the connection of controller and ADTECH Q2BYG404MA driver:

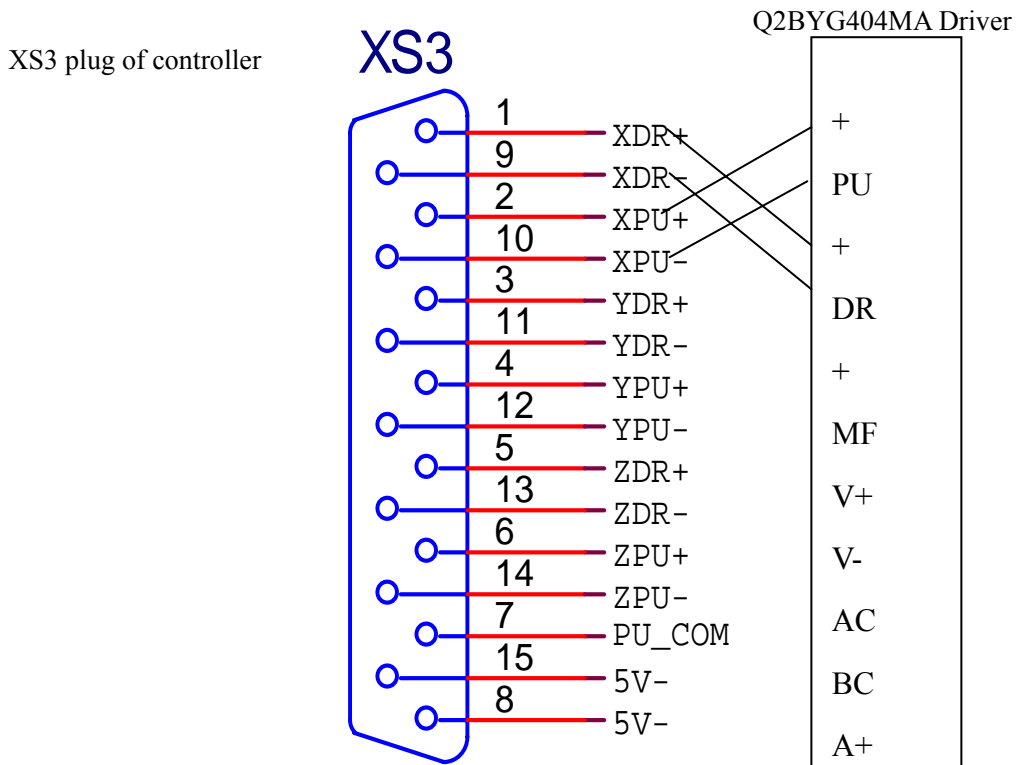

The following connecting diagram shows the connection of ADTECH Q2BYG404MA driver and 56BYGH630C stepping motor:

Q2BYG404MA driver

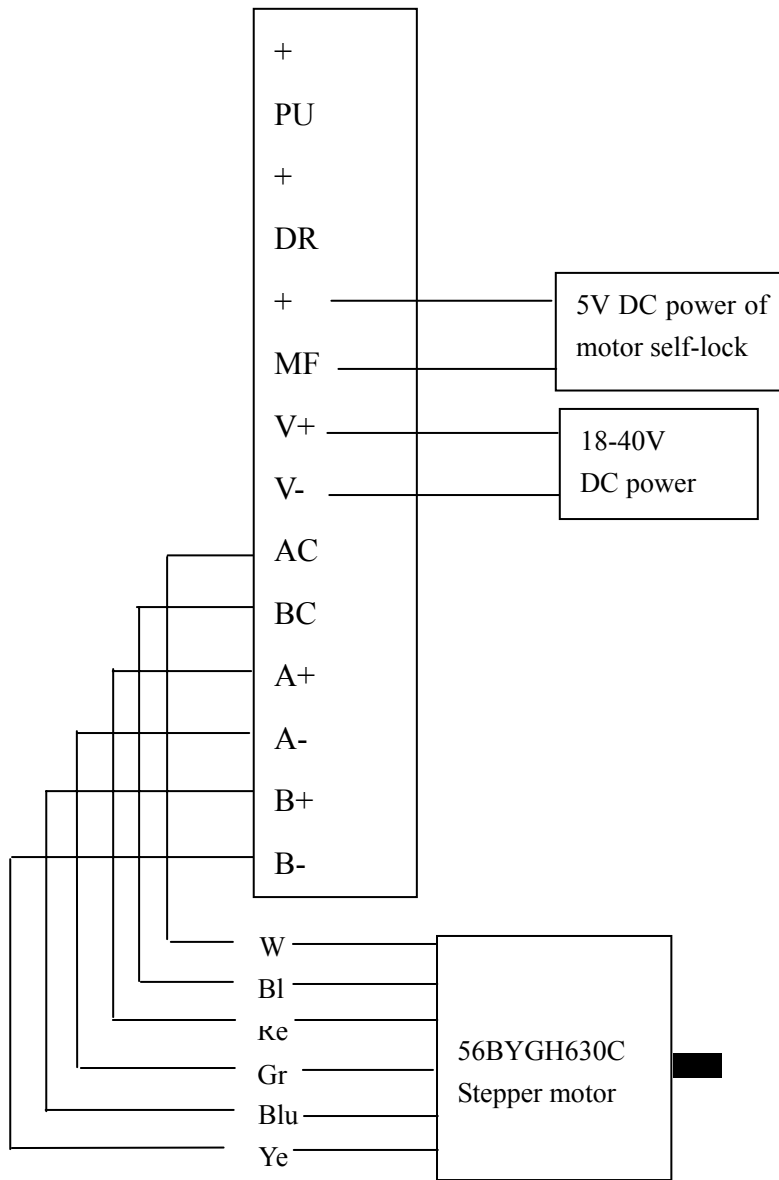

The following connecting diagram shows the connection of ADTECH Q2BYG404MA driver and 56BYGH630EJP stepping motor:

Q2BYG404MA driver

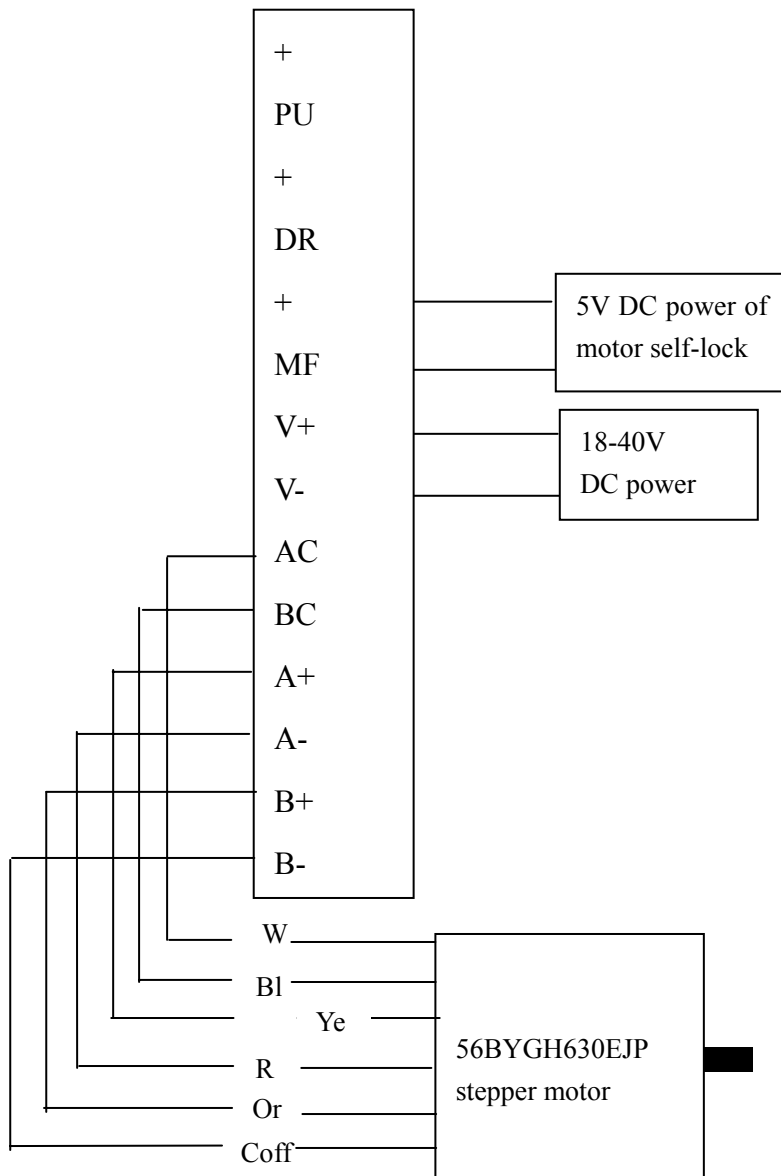

The following connecting diagram shows the connection of ADTECH Q2BYG404MA driver and 85BYGH830A stepping motor:

Q2BYG404MA driver

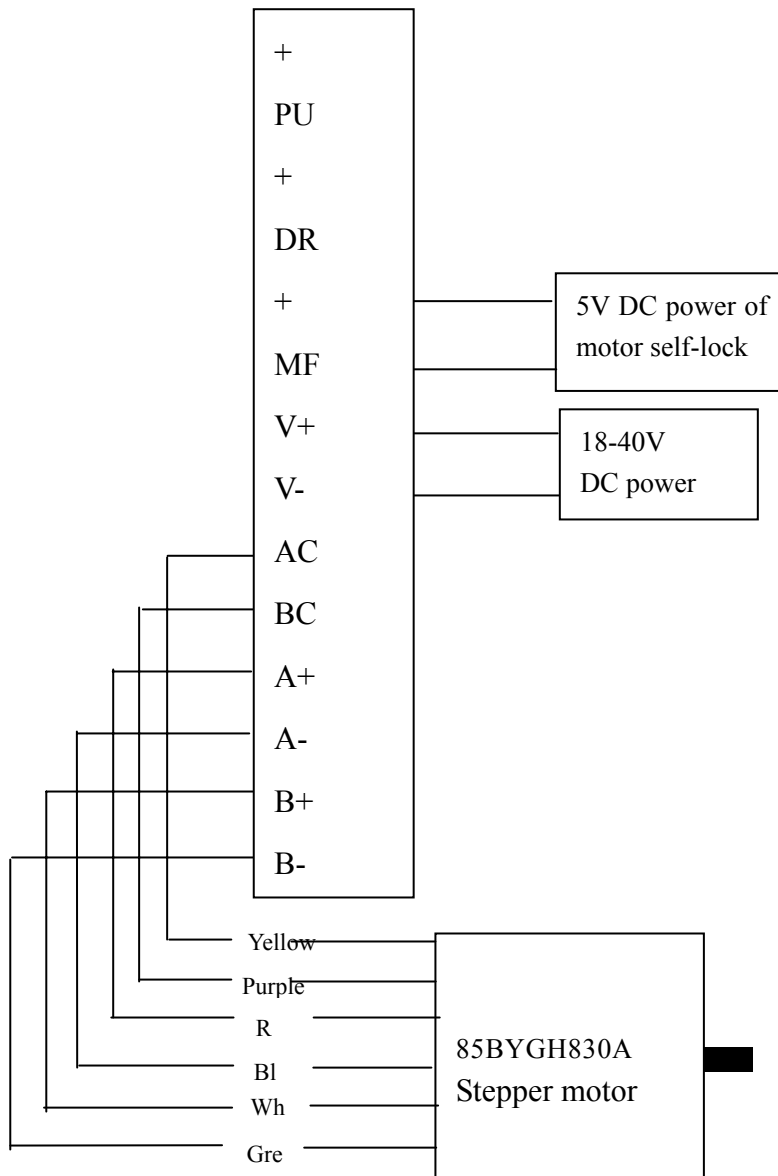

Remark:

- 1) Please adjust the subdivision of driver and the current code switch properly when using. The subdivision of driver is recommended to be 64 subdivisions, and the current to be 1.2 times of motor current.
- 2) The power supply for self-lock removing function is external 5V DC power. If it is 12V DC power, please connect in series a 1K resistor, whose power should be over 1/4W, to the pin of MF. Connect in series a 2K, over 1/4W resistor if it is 24V DC power.

3.2 Connection of common-anode driver

XS3 plug of controller

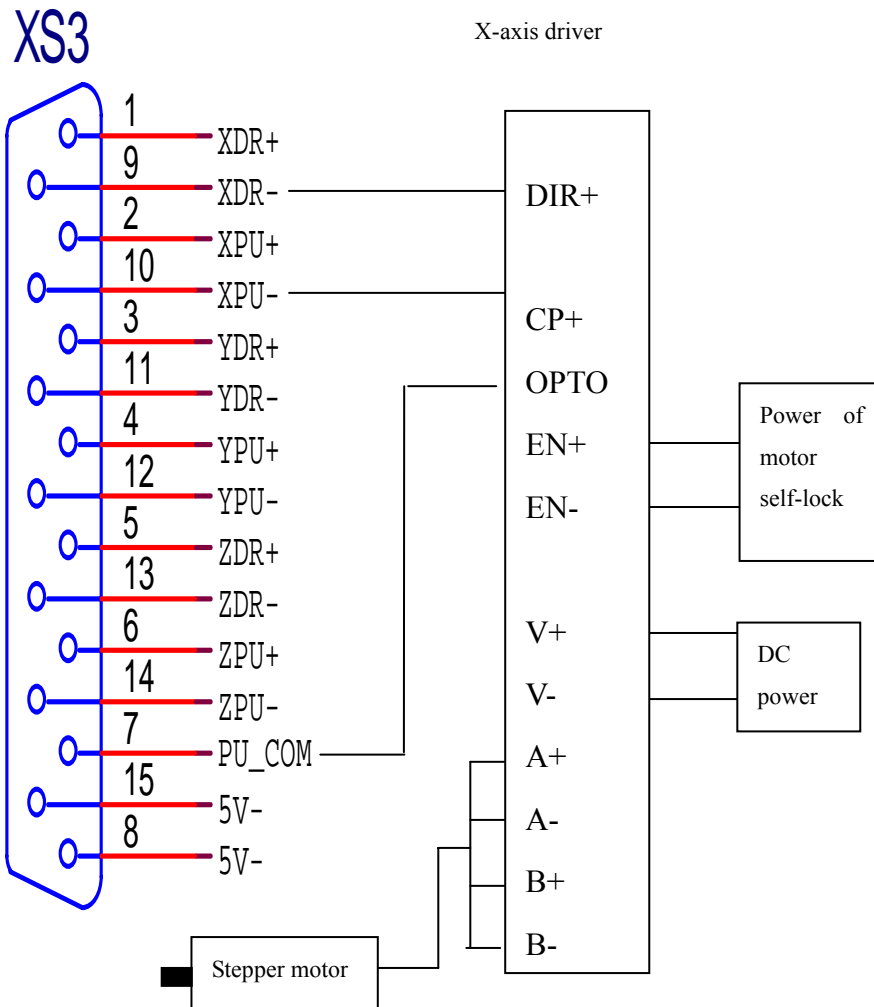

3.3 Connection of Panasonic servo motor

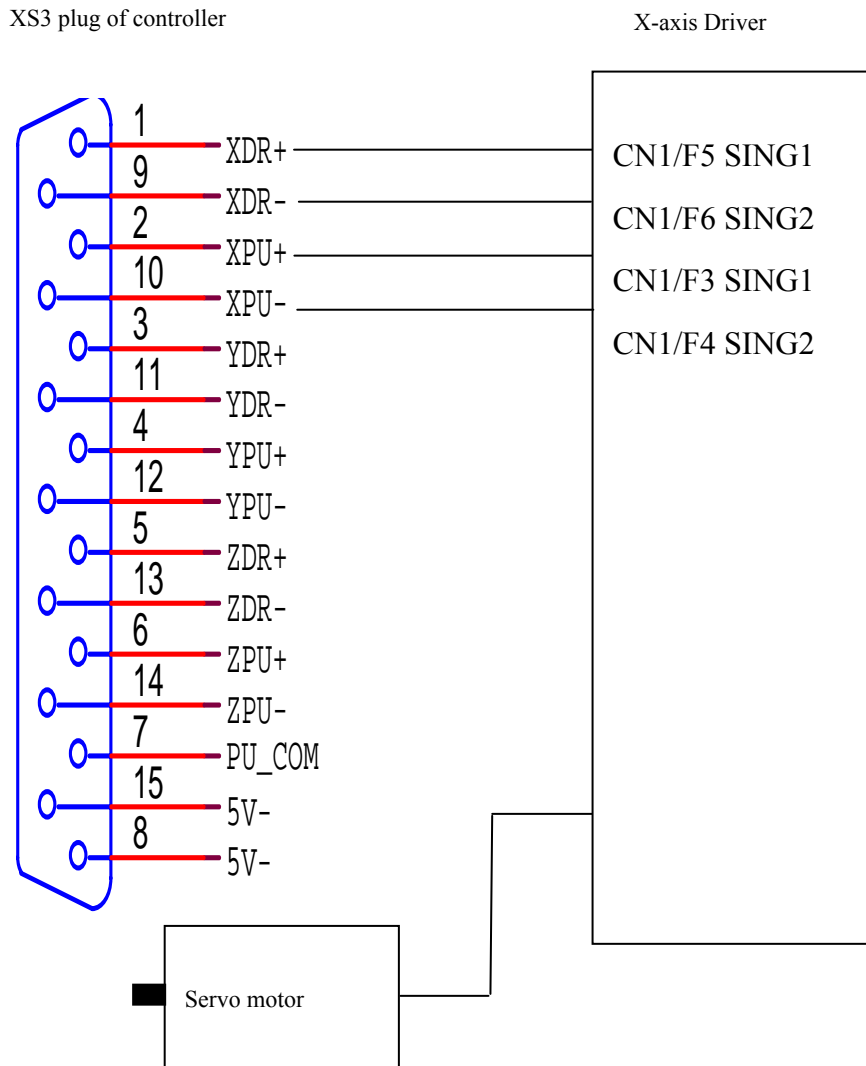

4. Key Points for Installation & Test

4.1 NCS's Requirement on Impulse Equivalent Value

To improve the device precision, it is recommended to adjust the impulse equivalent value of NCS to be 0.004000—0.006000. Details are as follows:

- 1) If stepping motor is used, the required value can be achieved by adjusting the subdivision of driver. The larger the value of driver subdivision is, the more precise of impulse equivalent value will be. For example, the impulse equivalent value is 0.008000 when the stepping driver is of 32 subdivisions, while it is of 64 subdivision, the impulse equivalent value will be doubled to as precise as 0.004000.
- 2) If servomotor is used, the required value can be achieved by adjusting the electric gear ratio of driver.

- 3) However, though the impulse equivalent value is adjusted as precise as 0.001000, the processing speed of the system will be slowed down. Therefore, too small an impulse equivalent value is not recommended.

4.2 Current adjustment of driver

Please adjust the current following the driver instructions of different factories. If you use equipped stepping driver Q2BYG404MA+56BYGH630C of ADTECH, please adjust the current of driver to be 1.2 times of motor current.

4.3 Test method of impulse equivalent

Please see Chapter II— Quick Start — 1 Parameter Settings— 1.5 Precision Settings (Page 18) in this user manual.

4.4 Anti-interference measures

Follow the following steps to carry out the anti-interference measures:

- 1) PE input port (Ground terminal) of NCS 24V power supply should be connected to the ground.

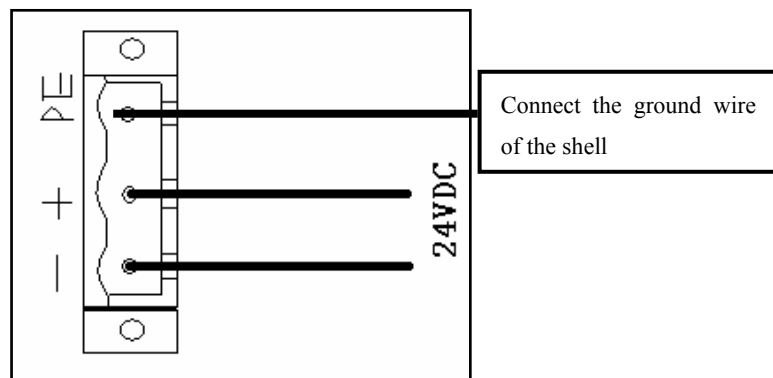

2) A magnetic loop should be used in the input line of NCS 24V power supply. As shown below:



Picture 5.5.4

Note: Do not circle the PE port (Ground wire) inside the magnetic loop.

3) A magnetic loop should be used in the end of the X and Y signal output lines, as shown below:



Chapter VI Troubleshooting

1. Why the U-disk cannot be read?

Answer: If the controller cannot read the U-disk, you can change the “File system” of U-disk on the computer, and then format it. Detailed operations are as follows: Insert the U-disk to the computer → Open “My Computer” → Find the removable U-disk → Right click the mouse → Click “Format (A)” → change the format of “File system” from “FAT32” to “FAT” → Click “Start” to start formatting. Copy the processed files to the U-disk to test again. Change for a new U-disk if it still cannot be read.

2. Why there is an error in the cutting?

Answer: 1. Check whether the impulse equivalent in the precision setup has been changed; or calibrate the impulse equivalent again.

2. Check the level of machine and check whether the cutting nozzle is vertical to the steel plate.

3. Why the cutting quality of the turning is poor?

Answer: Please check whether the start-up speed and the acceleration are set to be the reasonable values.

4. Why the cutting square is changed to rectangle?

Answer: please check whether the impulse equivalent is correct, and whether the actual precision of X or Y movement is correct. If these two values are correct, check whether the roller and the slide rail of the machine are of no failures.

5. Why the cutting circle is changed to ellipse?

Answer: please check whether the impulse equivalent is correct, and whether the actual precision of X or Y movement is correct. If these two values are correct, check whether the roller and the slide rail of the machine are of no failures.

6. Why there is wave shake in the opposite angles when cutting the circle?

Answer: Please adjust the backlash of the “Adjustment” in “Parameter”.

7. Why the motor does not work or is similar to death when it is in “Auto” state?

Answer: Please check the “Auto speed limit” to see whether it is a proper speed, and check whether percentage of manual processing is too low.

If the auto speed is set as 0, the system will have this problem.

8. Why the motor does not work or is similar to death when it is in “Manual” state?

Answer: Please check the “Manual speed limit” to see whether it is a proper speed, and check whether percentage of manual processing is too low.

If the manual speed is set as 0, the system will have this problem.

9. The processing code has the “Return” instructions. However, why the device does not return to the home position after having finished the track?

Answer: Please check the “Manual speed limit” to see whether it is a proper speed, and check whether percentage of manual processing is too low.

10. Why the right angle of the cutting square is not vertical?

Answer: Debug the start-up speed and the acceleration of “Speed” in “Parameter” again.

11. Why the anti-interference performance of plasma is poor?

Answer: Check whether all ground wires are connected well, or whether the external power filter is isolating the high frequency.

12. Why, one of the solenoid valves cannot work?

Answer: You can judge whether it is caused by the system damage or relay/solenoid valves damage in the following ways.

- 1) Change for a new solenoid valve of the same type to judge whether it is broken, or press [Ignition] in the “Auto” interface, and press [Preheat Oxygen], [Acetylene] and [Cutting Oxygen] to output a signal manually, then, use a multimeter to test the input end of the solenoid valve to see whether there is voltage signal.
- 2) If there is no voltage signal in the input end of the solenoid valve, then, open the case and use the same method as above to test the input end of the relay to see whether there is voltage signal, and to judge whether it is damaged or not.
- 3) If the relay has no voltage signal, that may be the damage of output end of NCS. Change for the backup output according to the following steps.
- 4) Open the case and the output port as the following picture:



- 5) Find out the corresponding backup output pin according to the following list:

Serial number	Default Pin	Backup Pin
Ignition	3	7
Preheat oxygen	17	18
Acetylene	1	5
Cutting Oxygen/Arcing	14	19
Cutting gun rising	2	6
Cutting gun falling	15	20
Turning speed ratio(Turn up)	4	8

- 6) Weld the default pins of the plug shown in the following picture to the backup pins according to the above corresponding connection.



- 7) Connect to the power supply after the installation; in the start-up interface, press [F5] (Diagnose) → [F2] (Define), use [Y↑] and [Y↓] to select upwards and downwards, and use [X→], [X←] to select the state, then, press “Save” to change the corresponding port to the backup state.

Annex II Illustration of edition and processing

Press [F3] key in main interface to enter the edition option interface, where you can press [F1] key to create a new processing file. Then, you can enter a file name and press [ENTER] key to enter the file edition interface. In this chapter, we take cutting the following figure as an example. (Dashed line and arrow refer to the direction of motion, solid line refers to the track of cutting, and “●” is the starting point of cutting.)

Remark: Because absolute coordinate is not used often, we do not introduce it in this chapter. In this chapter, we use the relative coordinate.

1. Standard circle

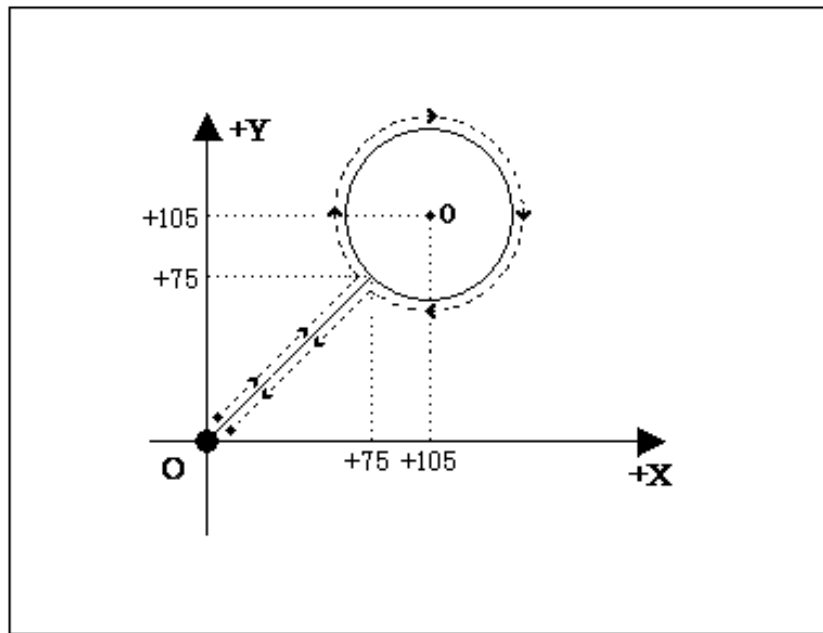

The program is as follows:

Relative coordinates programming and explanation of graph codes:

- 0000: G92 X0 Y0——set the reference point;
- 0001: G22 L3——L: set the processing loops; “3” means loop for 3 times;
- 0002: G41——Left compensation
- 0003: M07——It is the preheating perforating function. Prompt: Please set all the time parameters in [Control] option in [Parameter] according to the actual demand.
- 0004: G01 X75 Y75——perforating and wire bonding;
- 0005: G02 I30 J0——Clockwise circle processing;
- 0006: M08——Cutting oxygen valve closed
- 0007: G00 X-75 Y-75——travel to the origin at the highest manual speed;
- 0007: G81——Counting instruction, it counts once for each loop automatically;
- 0009: G40——Compensation ends
- 0010: G28——Back to reference point
- 0011: G80——cycle ends;
- 0012: M02——processing ends

2. Square

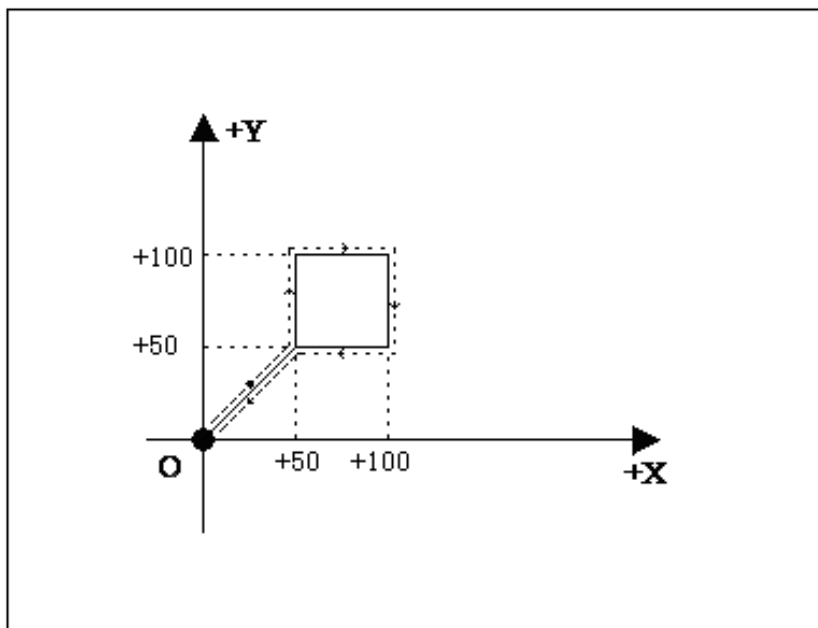

Relative coordinates programming and explanation of graph codes:

0000: G92 X0 Y0

0001: G41—Left compensation

0002: M07—Perforating;

0003: G01 X50 Y50—Perforation and wire bonding;

0004: Y50—the first side, if the above instruction is G01, this G01 as well as X0 of this instruction cannot omitted for the convenience of editing codes manually.

0005: X50—the second side;

0006: Y-50—the third side;

0007: X-50—the four side;

0008: M08—close the cutting oxygen

0009: G40—Finish the compensation

0010: G28—travel to the origin at the highest manual speed;

0011: M02—processing ends

3. Triangle

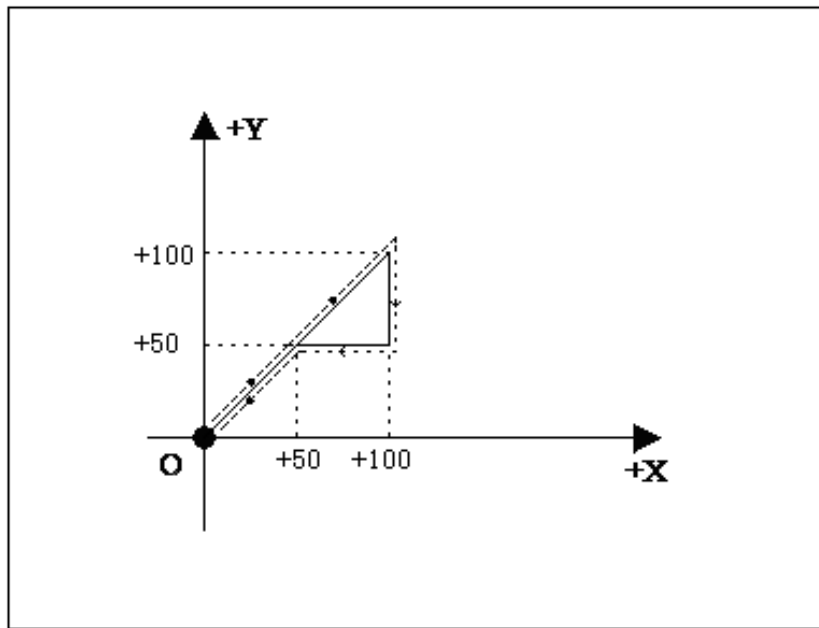

Relative coordinate programming

```
0000: G92 X0    Y0
0001: G21
0002: G41
0003: M07
0004: G01  X50   Y50
0005: X50   Y50
0006: Y-50
0007: X-50
0008: G40
0009: M08
0010: G28
0011: M02
```

4. Quincunx

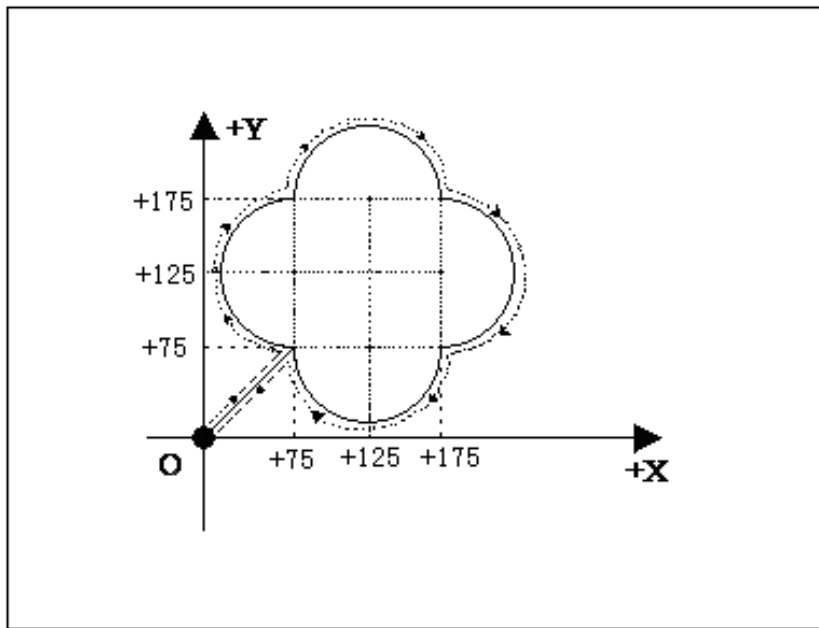

Relative coordinate programming

```
0000: G92 X0    Y0
0001: G21
0002: G41
0003: M07
0004: G00  X75   Y75
0005: G02  Y100  I0  J50
0006: X100  I50  J0
0007: Y-100 I0  J-50
0008: X-100 I-50 J0
0009: G40
0010: M08
0011: G28
0012: M02
```

5. Four figures

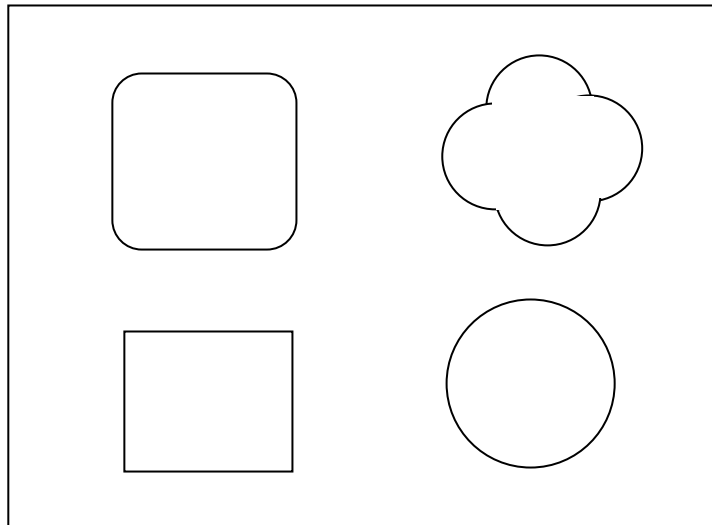

Relative coordinate programming

0000: G92X0Y0

0001: G21

0002: G22 L1

0003: G41

0004: M07

0005: G0 X50

0006: G1 Y200

0007: X200

0008: Y-200

0009: X-200

0010: M08

0011: G00 Y400

0012: M07

0013: G1 Y50

0014: G2 X50 Y50 I50 J0

0015: G1 X100

0016: G2 X50 Y-50 I0 J-50

0017: G1 Y-100

0018: G2 X-50 Y-50 I-50 J0

0019: G1 X-100

0020: G2 X-50 Y50 I0 J50

0021: G1 Y50

0022: M08

0023: G00 X400 Y50

0024: M07

0025: G2 X100 Y0 I50 J0

0026: Y-100 I0 J-50

0027: X-100 I-50 J0

0028: Y100 I0 J50

0029: G00 X-50 Y-350

0030: G2 X0 Y0 I100 J0

0031: M08

0032: G28

0033: G81

0034: G80

0035: M02

Annex III G Instruction Quick Reference

S/N	Name of Instruction	Explanation
1	G00	Quick positioning motion (Dry run)
2	G01	Linear processing
3	G02	Clockwise circle processing
4	G03	Anti-clockwise circle processing
5	G04	Pause/Delay
6	G26	X axis returns to reference point
7	G27	Y axis returns to reference point
8	G28	X and Y axes return to reference point at the same time
9	G22	Cycle starts (should be used combining G80)
10	G80	Cycle ends (should be used combining G22)
11	G81	Counting function
12	G40	Cancel cutting gap compensation
13	G41	Left compensation
14	G42	Right compensation
15	G92	Set the reference point of processing

Annex IV M Instruction Quick Reference

S/N	Name of Instruction	Explanation
1	M02	Program ends
2	M07	Start the fixed cycle of preheating and perforating
3	M08	Close the fixed cycle of cutting oxygen (plasma arcing)
4	M10/M11	Switch of acetylene valve, M10 (Open), M11 (Closed)
5	M12/M13	Switch of cutting oxygen valve (switch of plasma arcing), M12 (Open), M13 (Closed)
6	M14/M15	switch for controlling the rise of cutting gun, M14 (Open), M15 (Closed)
7	M20/M21	ignition switch, M20 (Open), M21 (Closed)
8	M24/M25	switch of preheating oxygen valve, M24 (Open), M25 (Closed)
9	M52	ignition fixed cycle (controlled by time in "Control" interface)
10	M70	fixed cycle of cutting gun rising (controlled by time in "Control" interface)
11	M71	fixed cycle of cutting gun falling (controlled by time in "Control" interface)
12	M72	fixed cycle of perforating cutting gun rising (controlled by time in "Control" interface)
13	M73	fixed cycle of perforating cutting gun falling (controlled by time in "Control" interface)
14	M74	fixed cycle of preheating (controlled by time in "Control" interface)
15	M16	switch for controlling the falling of cutting gun, M16 (Open), M17 (Closed)
16	M80	main switch, all output ports are closed if M80 is performed