

Operating Instructions

Proline Prowirl R 200

HART

Vortex flowmeter

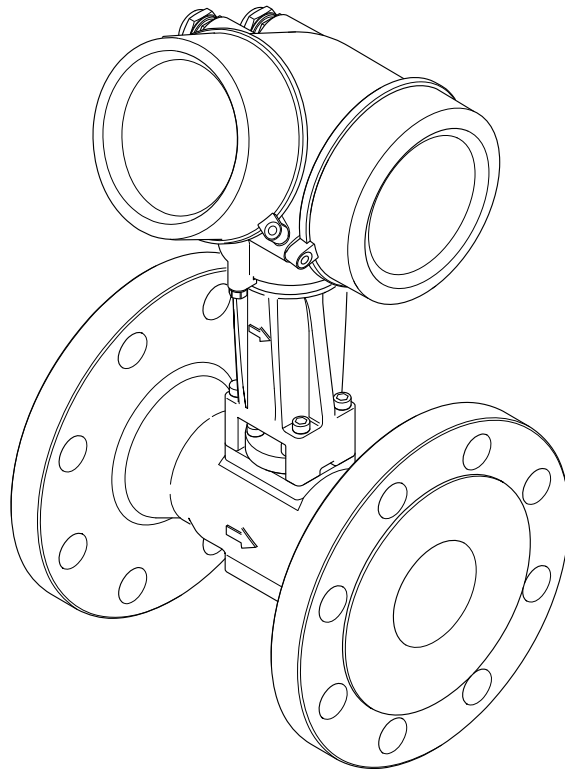

- Make sure the document is stored in a safe place such that it is always available when working on or with the device.
- To avoid danger to individuals or the facility, read the "Basic safety instructions" section carefully, as well as all other safety instructions in the document that are specific to working procedures.
- The manufacturer reserves the right to modify technical data without prior notice. Your Endress+Hauser Sales Center will supply you with current information and updates to these instructions.

Table of contents

1	About this document	6	6	Installation	22
1.1	Document function	6	6.1	Installation conditions	22
1.2	Symbols	6	6.1.1	Mounting position	22
1.2.1	Safety symbols	6	6.1.2	Environment and process requirements	26
1.2.2	Electrical symbols	6	6.1.3	Special mounting instructions	27
1.2.3	Communication symbols	6	6.2	Mounting the measuring device	28
1.2.4	Tool symbols	7	6.2.1	Required tools	28
1.2.5	Symbols for certain types of information	7	6.2.2	Preparing the measuring device	28
1.2.6	Symbols in graphics	7	6.2.3	Mounting the sensor	28
1.3	Documentation	8	6.2.4	Mounting the pressure measuring unit	29
1.3.1	Standard documentation	8	6.2.5	Mounting the transmitter of the remote version	31
1.3.2	Supplementary device-dependent documentation	8	6.2.6	Turning the transmitter housing	32
1.4	Registered trademarks	8	6.2.7	Turning the display module	33
2	Safety instructions	9	6.3	Post-installation check	33
2.1	Requirements for the personnel	9	7	Electrical connection	35
2.2	Designated use	9	7.1	Connection conditions	35
2.3	Workplace safety	10	7.1.1	Required tools	35
2.4	Operational safety	10	7.1.2	Connecting cable requirements	35
2.5	Product safety	10	7.1.3	Connecting cable for remote version	36
2.6	IT security	11	7.1.4	Terminal assignment	37
2.7	Device-specific IT security	11	7.1.5	Requirements for the supply unit	39
2.7.1	Protecting access via hardware write protection	11	7.1.6	Preparing the measuring device	40
2.7.2	Protecting access via a password	11	7.2	Connecting the measuring device	40
2.7.3	Access via fieldbus	11	7.2.1	Connecting the compact version	41
3	Product description	12	7.2.2	Connecting the remote version	42
3.1	Product design	12	7.2.3	Connecting the connecting cable for the pressure measuring cell	47
4	Incoming acceptance and product identification	14	7.2.4	Ensuring potential equalization	47
4.1	Incoming acceptance	14	7.3	Ensuring the degree of protection	47
4.2	Product identification	14	7.4	Post-connection check	47
4.2.1	Transmitter nameplate	15	8	Operation options	49
4.2.2	Sensor nameplate	16	8.1	Overview of operation options	49
4.2.3	Pressure measuring cells nameplate	19	8.2	Structure and function of the operating menu	50
4.2.4	Symbols on measuring device	19	8.2.1	Structure of the operating menu	50
5	Storage and transport	20	8.2.2	Operating philosophy	51
5.1	Storage conditions	20	8.3	Access to the operating menu via the local display	52
5.2	Transporting the product	20	8.3.1	Operational display	52
5.2.1	Measuring devices without lifting lugs	20	8.3.2	Navigation view	53
5.2.2	Measuring devices with lifting lugs	21	8.3.3	Editing view	55
5.2.3	Transporting with a fork lift	21	8.3.4	Operating elements	57
5.3	Packaging disposal	21	8.3.5	Opening the context menu	57
			8.3.6	Navigating and selecting from list	59
			8.3.7	Calling the parameter directly	59
			8.3.8	Calling up help text	60
			8.3.9	Changing the parameters	61

8.3.10	User roles and related access authorization	62	10.9	Application-specific commissioning	122
8.3.11	Disabling write protection via access code	62	10.9.1	Steam application	122
8.3.12	Enabling and disabling the keypad lock	63	10.9.2	Liquid application	123
8.4	Access to the operating menu via the operating tool	63	10.9.3	Gas applications	124
8.4.1	Connecting the operating tool	63	10.9.4	Calculation of the measured variables	127
8.4.2	Field Xpert SFX350, SFX370	64	11	Operation	132
8.4.3	FieldCare	65	11.1	Reading the device locking status	132
8.4.4	DeviceCare	66	11.2	Adjusting the operating language	132
8.4.5	AMS Device Manager	66	11.3	Configuring the display	132
8.4.6	SIMATIC PDM	67	11.4	Reading measured values	132
8.4.7	Field Communicator 475	67	11.4.1	Process variables	133
9	System integration	68	11.4.2	"Totalizer" submenu	135
9.1	Overview of device description files	68	11.4.3	Input values	136
9.1.1	Current version data for the device	68	11.4.4	Output values	136
9.1.2	Operating tools	68	11.5	Adapting the measuring device to the process conditions	137
9.2	Measured variables via HART protocol	68	11.6	Performing a totalizer reset	137
9.3	Other settings	70	11.6.1	Function scope of the "Control Totalizer" parameter	138
10	Commissioning	73	11.6.2	Function scope of the "Reset all totalizers" parameter	138
10.1	Function check	73	11.7	Showing data logging	139
10.2	Switching on the measuring device	73	12	Diagnostics and troubleshooting	142
10.3	Setting the operating language	73	12.1	General troubleshooting	142
10.4	Configuring the measuring device	74	12.2	Diagnostic information on local display	144
10.4.1	Defining the tag name	74	12.2.1	Diagnostic message	144
10.4.2	Setting the system units	75	12.2.2	Calling up remedial measures	146
10.4.3	Selecting and setting the medium	79	12.3	Diagnostic information in FieldCare or DeviceCare	146
10.4.4	Configuring the current input	81	12.3.1	Diagnostic options	146
10.4.5	Configuring the current output	83	12.3.2	Calling up remedy information	148
10.4.6	Configuring the pulse/frequency/switch output	84	12.4	Adapting the diagnostic information	148
10.4.7	Configuring the local display	89	12.4.1	Adapting the diagnostic behavior	148
10.4.8	Configuring the output conditioning	91	12.4.2	Adapting the status signal	149
10.4.9	Configuring the low flow cut off	91	12.5	Overview of diagnostic information	149
10.5	Advanced settings	93	12.5.1	Operating conditions for displaying the following diagnostics information	153
10.5.1	Setting the medium properties	94	12.5.2	Emergency mode in the event of pressure compensation	153
10.5.2	Performing external compensation	107	12.5.3	Emergency mode in event of temperature compensation	153
10.5.3	Carrying out a sensor adjustment	109	12.6	Pending diagnostic events	153
10.5.4	Configuring the totalizer	111	12.7	Diagnostic list	154
10.5.5	Carrying out additional display configurations	112	12.8	Event logbook	155
10.5.6	Configuration management	114	12.8.1	Reading out the event logbook	155
10.5.7	Using parameters for device administration	116	12.8.2	Filtering the event logbook	155
10.6	Configuration management	116	12.8.3	Overview of information events	156
10.6.1	Function scope of the "Configuration management" parameter	117	12.9	Resetting the measuring device	157
10.7	Simulation	118	12.9.1	Function scope of the "Device reset" parameter	157
10.8	Protecting settings from unauthorized access	120	12.10	Device information	157
10.8.1	Write protection via access code	120	12.11	Firmware history	159
10.8.2	Write protection via write protection switch	121			

13	Maintenance	160
13.1	Maintenance tasks	160
13.1.1	Exterior cleaning	160
13.1.2	Interior cleaning	160
13.1.3	Replacing seals	160
13.1.4	Adjusting the pressure measuring cell	160
13.2	Measuring and test equipment	161
13.3	Endress+Hauser services	161
14	Repair	162
14.1	General notes	162
14.1.1	Repair and conversion concept	162
14.1.2	Notes for repair and conversion	162
14.2	Spare parts	162
14.3	Endress+Hauser services	163
14.4	Return	163
14.5	Disposal	163
14.5.1	Removing the measuring device	163
14.5.2	Disposing of the measuring device ..	164
15	Accessories	165
15.1	Device-specific accessories	165
15.1.1	For the transmitter	165
15.1.2	For the sensor	166
15.2	Communication-specific accessories	166
15.3	Service-specific accessories	167
15.4	System components	168
16	Technical data	169
16.1	Application	169
16.2	Function and system design	169
16.3	Input	169
16.4	Output	176
16.5	Power supply	179
16.6	Performance characteristics	181
16.7	Installation	185
16.8	Environment	185
16.9	Process	187
16.10	Mechanical construction	189
16.11	Operability	197
16.12	Certificates and approvals	198
16.13	Application packages	200
16.14	Accessories	200
16.15	Supplementary documentation	200
Index	202	

1 About this document

1.1 Document function

These Operating Instructions contain all the information that is required in various phases of the life cycle of the device: from product identification, incoming acceptance and storage, to mounting, connection, operation and commissioning through to troubleshooting, maintenance and disposal.

1.2 Symbols

1.2.1 Safety symbols

DANGER

This symbol alerts you to a dangerous situation. Failure to avoid this situation will result in serious or fatal injury.

WARNING

This symbol alerts you to a dangerous situation. Failure to avoid this situation can result in serious or fatal injury.





CAUTION

This symbol alerts you to a dangerous situation. Failure to avoid this situation can result in minor or medium injury.

NOTICE

This symbol contains information on procedures and other facts which do not result in personal injury.



1.2.2 Electrical symbols

Symbol	Meaning
	Direct current
	Alternating current
	Direct current and alternating current
	Ground connection A grounded terminal which, as far as the operator is concerned, is grounded via a grounding system.
	Protective Earth (PE) A terminal which must be connected to ground prior to establishing any other connections. The ground terminals are situated inside and outside the device: <ul style="list-style-type: none"> ▪ Inner ground terminal: Connects the protectiv earth to the mains supply. ▪ Outer ground terminal: Connects the device to the plant grounding system.













1.2.3 Communication symbols

Symbol	Meaning
	Wireless Local Area Network (WLAN) Communication via a wireless, local network.





1.2.4 Tool symbols

Symbol	Meaning
	Flat blade screwdriver
	Allen key
	Open-ended wrench

1.2.5 Symbols for certain types of information

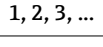
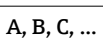
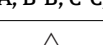
Symbol	Meaning
	Permitted Procedures, processes or actions that are permitted.
	Preferred Procedures, processes or actions that are preferred.
	Forbidden Procedures, processes or actions that are forbidden.
	Tip Indicates additional information.
	Reference to documentation.
	Reference to page.
	Reference to graphic.
	Notice or individual step to be observed.
	Series of steps.
	Result of a step.
	Help in the event of a problem.
	Visual inspection.

1.2.6 Symbols in graphics

Symbol	Meaning
	Item numbers
	Series of steps
	Views
	Sections
	Hazardous area
	Safe area (non-hazardous area)
	Flow direction

1.3 Documentation

 For an overview of the scope of the associated Technical Documentation, refer to the following:

- *W@M Device Viewer* (www.endress.com/deviceviewer): Enter the serial number from nameplate
- *Endress+Hauser Operations App*: Enter the serial number from the nameplate or scan the 2D matrix code (QR code) on the nameplate

 Detailed list of the individual documents along with the documentation code
→  200

1.3.1 Standard documentation

Document type	Purpose and content of the document
Technical Information	Planning aid for your device The document contains all the technical data on the device and provides an overview of the accessories and other products that can be ordered for the device.
Sensor Brief Operating Instructions	Guides you quickly to the 1st measured value - Part 1 The Sensor Brief Operating Instructions are aimed at specialists with responsibility for installing the measuring device. <ul style="list-style-type: none"> ▪ Incoming acceptance and product identification ▪ Storage and transport ▪ Installation
Transmitter Brief Operating Instructions	Guides you quickly to the 1st measured value - Part 2 The Transmitter Brief Operating Instructions are aimed at specialists with responsibility for commissioning, configuring and parameterizing the measuring device (until the first measured value). <ul style="list-style-type: none"> ▪ Product description ▪ Installation ▪ Electrical connection ▪ Operation options ▪ System integration ▪ Commissioning ▪ Diagnostic information
Description of Device Parameters	Reference for your parameters The document provides a detailed explanation of each individual parameter in the Expert operating menu. The description is aimed at those who work with the device over the entire life cycle and perform specific configurations.

1.3.2 Supplementary device-dependent documentation

Additional documents are supplied depending on the device version ordered: Always comply strictly with the instructions in the supplementary documentation. The supplementary documentation is an integral part of the device documentation.

1.4 Registered trademarks

HART®

Registered trademark of the FieldComm Group, Austin, Texas, USA

KALREZ®, VITON®

Registered trademarks of DuPont Performance Elastomers L.L.C., Wilmington, DE USA

GYLON®

Registered trademark of Garlock Sealing Technologies, Palmyra, NY, USA

2 Safety instructions

2.1 Requirements for the personnel

The personnel for installation, commissioning, diagnostics and maintenance must fulfill the following requirements:

- ▶ Trained, qualified specialists must have a relevant qualification for this specific function and task.
- ▶ Are authorized by the plant owner/operator.
- ▶ Are familiar with federal/national regulations.
- ▶ Before starting work, read and understand the instructions in the manual and supplementary documentation as well as the certificates (depending on the application).
- ▶ Follow instructions and comply with basic conditions.

The operating personnel must fulfill the following requirements:

- ▶ Are instructed and authorized according to the requirements of the task by the facility's owner-operator.
- ▶ Follow the instructions in this manual.

2.2 Designated use

Application and media

The measuring device described in this manual is intended only for flow measurement of liquids with a minimum conductivity of 20 $\mu\text{S}/\text{cm}$.

Depending on the version ordered, the measuring device can also measure potentially explosive, flammable, poisonous and oxidizing media.

Measuring devices for use in hazardous areas, in hygienic applications or where there is an increased risk due to process pressure, are labeled accordingly on the nameplate.

To ensure that the measuring device remains in proper condition for the operation time:

- ▶ Keep within the specified pressure and temperature range.
- ▶ Only use the measuring device in full compliance with the data on the nameplate and the general conditions listed in the Operating Instructions and supplementary documentation.
- ▶ Based on the nameplate, check whether the ordered device is permitted for the intended use in the hazardous area (e.g. explosion protection, pressure vessel safety).
- ▶ Use the measuring device only for media to which the process-wetted materials are sufficiently resistant.
- ▶ If the ambient temperature of the measuring device is outside the atmospheric temperature, it is absolutely essential to comply with the relevant basic conditions as specified in the device documentation →  8.
- ▶ Protect the measuring device permanently against corrosion from environmental influences.

Incorrect use

Non-designated use can compromise safety. The manufacturer is not liable for damage caused by improper or non-designated use.

WARNING

Danger of breakage due to corrosive or abrasive fluids and ambient conditions!

- ▶ Verify the compatibility of the process fluid with the sensor material.
- ▶ Ensure the resistance of all fluid-wetted materials in the process.
- ▶ Keep within the specified pressure and temperature range.

NOTICE**Verification for borderline cases:**

- ▶ For special fluids and fluids for cleaning, Endress+Hauser is glad to provide assistance in verifying the corrosion resistance of fluid-wetted materials, but does not accept any warranty or liability as minute changes in the temperature, concentration or level of contamination in the process can alter the corrosion resistance properties.

Residual risks**⚠ WARNING**

The electronics and the medium may cause the surfaces to heat up. This presents a burn hazard!

- ▶ For elevated fluid temperatures, ensure protection against contact to prevent burns.

2.3 Workplace safety

For work on and with the device:

- ▶ Wear the required personal protective equipment according to federal/national regulations.

For welding work on the piping:

- ▶ Do not ground the welding unit via the measuring device.

If working on and with the device with wet hands:

- ▶ Due to the increased risk of electric shock, gloves must be worn.

2.4 Operational safety

Risk of injury.

- ▶ Operate the device in proper technical condition and fail-safe condition only.
- ▶ The operator is responsible for interference-free operation of the device.

Conversions to the device

Unauthorized modifications to the device are not permitted and can lead to unforeseeable dangers.

- ▶ If, despite this, modifications are required, consult with Endress+Hauser.

Repair

To ensure continued operational safety and reliability,

- ▶ Carry out repairs on the device only if they are expressly permitted.
- ▶ Observe federal/national regulations pertaining to repair of an electrical device.
- ▶ Use original spare parts and accessories from Endress+Hauser only.

2.5 Product safety

This measuring device is designed in accordance with good engineering practice to meet state-of-the-art safety requirements, has been tested, and left the factory in a condition in which it is safe to operate.

It meets general safety standards and legal requirements. It also complies with the EU directives listed in the device-specific EU Declaration of Conformity. Endress+Hauser confirms this by affixing the CE mark to the device.

2.6 IT security

Our warranty is valid only if the device is installed and used as described in the Operating Instructions. The device is equipped with security mechanisms to protect it against any inadvertent changes to the settings.

IT security measures, which provide additional protection for the device and associated data transfer, must be implemented by the operators themselves in line with their security standards.

2.7 Device-specific IT security

The device offers a range of specific functions to support protective measures on the operator's side. These functions can be configured by the user and guarantee greater in-operation safety if used correctly. An overview of the most important functions is provided in the following section.

2.7.1 Protecting access via hardware write protection

Write access to the device parameters via the local display or operating tool (e.g. FieldCare, DeviceCare) can be disabled via a write protection switch (DIP switch on the motherboard). When hardware write protection is enabled, only read access to the parameters is possible.

2.7.2 Protecting access via a password

A password can be used to protect against write access to the device parameters.

This password locks write access to the device parameters via the local display or another operating tool (e.g. FieldCare, DeviceCare) and, in terms of functionality, is equivalent to hardware write protection. If the service interface CDI RJ-45 is used, read access is only possible if the password is entered.

User-specific access code

Write access to the device parameters via the local display or operating tool (e.g. FieldCare, DeviceCare) can be protected by the modifiable, user-specific access code (→  120).

When the device is delivered, the device does not have an access code and is equivalent to 0000 (open).

General notes on the use of passwords

- The access code and network key supplied with the device should be changed during commissioning.
- Follow the general rules for generating a secure password when defining and managing the access code or network key.
- The user is responsible for the management and careful handling of the access code and network key.
- For information on configuring the access code or on what to do if you lose the password, see the "Write protection via access code" section →  120

2.7.3 Access via fieldbus

Cyclic fieldbus communication (read and write, e.g. measured value transmission) with a higher-order system is not affected by the restrictions mentioned above.

3 Product description

The device consists of a transmitter and a sensor.

Two device versions are available:

- Compact version – transmitter and sensor form a mechanical unit.
- Remote version - transmitter and sensor are mounted in separate locations.

3.1 Product design

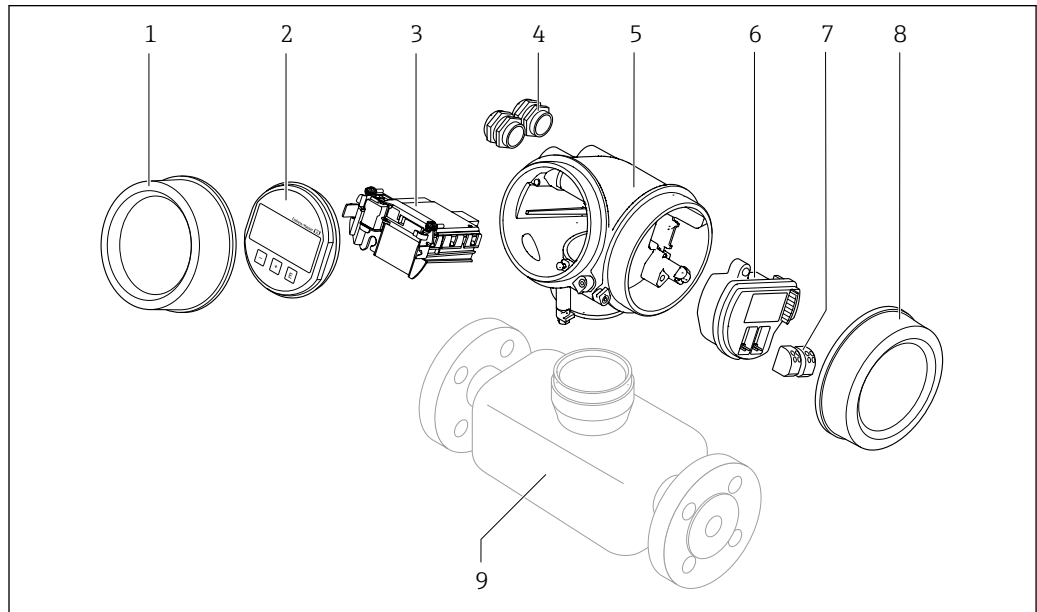

A0020649

1 Important components of a measuring device

- 1 Electronics compartment cover
- 2 Display module
- 3 Main electronics module
- 4 Cable glands
- 5 Transmitter housing (incl. HistoROM)
- 6 I/O electronics module
- 7 Terminals (spring loaded terminals, pluggable)
- 8 Connection compartment cover
- 9 Sensor

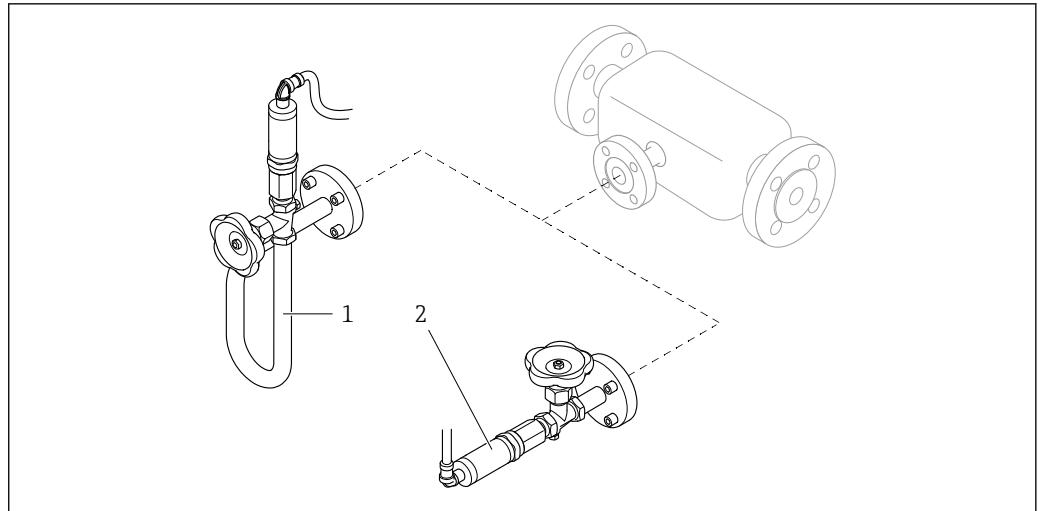

A0034152

 2 Versions of pressure measuring unit

- 1 Order code for "Sensor version; DSC sensor; measuring tube", option DA "Mass steam"
- 2 Order code for "Sensor version; DSC sensor; measuring tube", option DB "Mass gas/liquid"

 For order code for "Sensor version; DSC sensor; measuring tube", option DA "Mass steam" and DB "Mass gas/liquid", the following applies:
Oil-free or grease-free cleaning is not possible

4 Incoming acceptance and product identification

4.1 Incoming acceptance

Are the order codes on the delivery note (1) and the product sticker (2) identical?

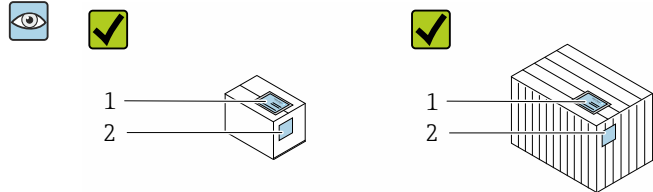

Are the goods undamaged?

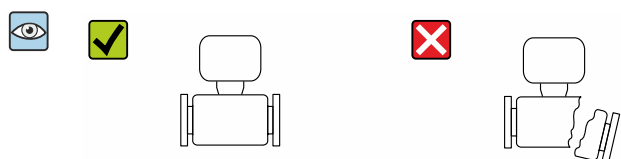

Do the nameplate data match the ordering information on the delivery note?

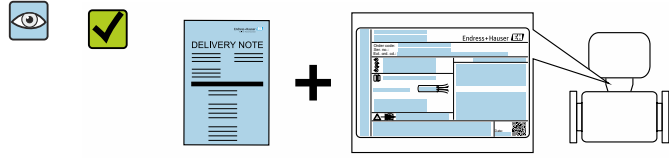

Is the envelope present with accompanying documents?

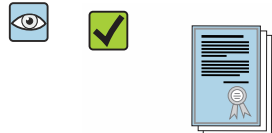

- i** ■ If one of the conditions is not satisfied, contact your Endress+Hauser Sales Center.
- Depending on the device version, the CD-ROM might not be part of the delivery! The Technical Documentation is available via the Internet or via the *Endress+Hauser Operations App*, see the "Product identification" section → 15.

4.2 Product identification

The following options are available for identification of the device:

- Nameplate specifications
- Order code with breakdown of the device features on the delivery note
- Enter serial numbers from nameplates in the *W@M Device Viewer* (www.endress.com/deviceviewer): All information about the device is displayed.
- Enter the serial number from nameplates in the *Endress+Hauser Operations App* or scan the 2-D matrix code (QR code) on the nameplate using the *Endress+Hauser Operations App*: All information about the device is displayed.

For an overview of the scope of the associated Technical Documentation, refer to the following:

- The "Additional standard documentation on the device" → 8 and "Supplementary device-dependent documentation" → 8 sections
- The *W@M Device Viewer*: enter the serial number from the nameplate (www.endress.com/deviceviewer)
- The *Endress+Hauser Operations App*: Enter the serial number from the nameplate or scan the 2-D matrix code (QR code) on the nameplate.

4.2.1 Transmitter nameplate

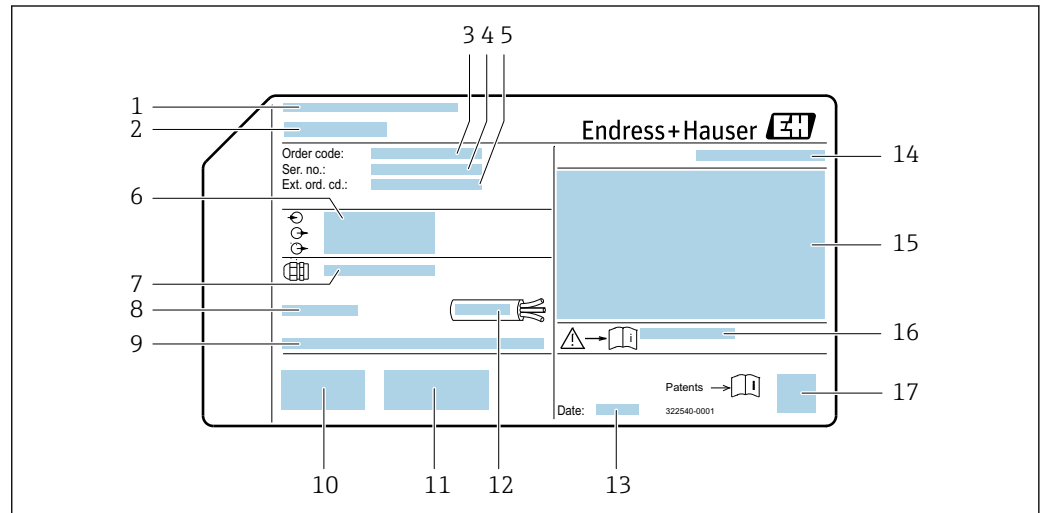

3 Example of a transmitter nameplate

- 1 Manufacturing location
- 2 Name of the transmitter
- 3 Order code
- 4 Serial number (ser. no.)
- 5 Extended order code (Ext. ord. cd.)
- 6 Electrical connection data, e.g. available inputs and outputs, supply voltage
- 7 Type of cable glands
- 8 Permitted ambient temperature (T_a)
- 9 Firmware version (FW) and device revision (Dev.Rev.) from the factory
- 10 CE mark, C-Tick
- 11 Additional information on version: certificates, approvals
- 12 Permitted temperature range for cable
- 13 Manufacturing date: year-month
- 14 Degree of protection
- 15 Approval information for explosion protection
- 16 Document number of safety-related supplementary documentation
- 17 2-D matrix code

4.2.2 Sensor nameplate

Order code for "Housing" option B "GT18 dual compartment, 316L, compact" and option K "GT18 dual compartment, 316L, remote"

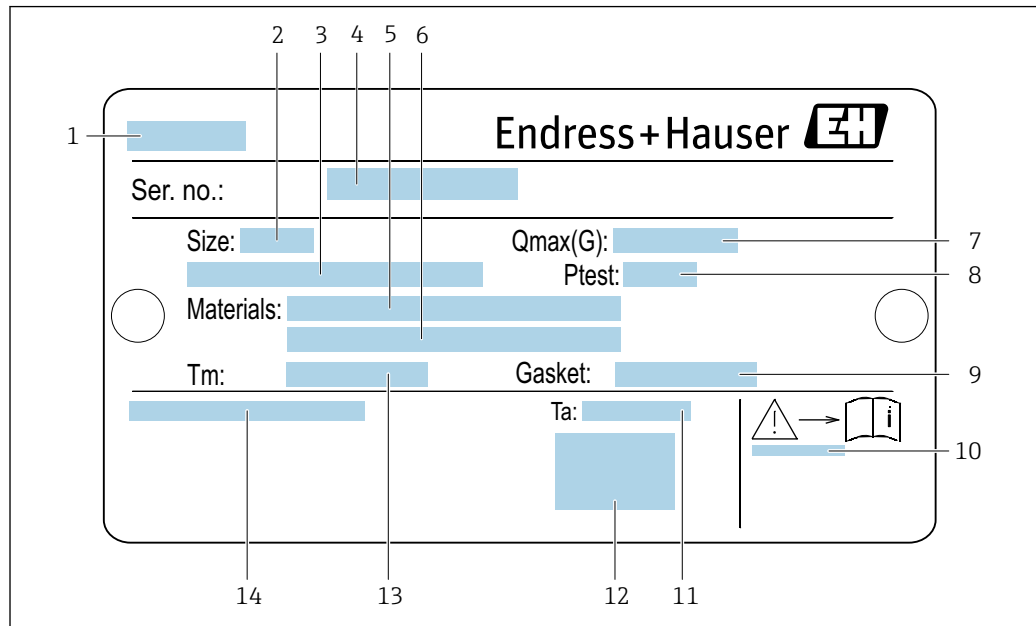

A0034423

4 Example of a sensor nameplate

- 1 Name of the sensor
- 2 Nominal diameter of sensor
- 3 Flange nominal diameter/nominal pressure
- 4 Serial number (ser. no.)
- 5 Measuring tube material
- 6 Measuring tube material
- 7 Maximum permitted volume flow (gas/steam): Q_{max} → 170
- 8 Test pressure of the sensor: OPL → 188
- 9 Seal material
- 10 Document number of safety-related supplementary documentation → 201
- 11 Ambient temperature range
- 12 CE mark
- 13 Medium temperature range
- 14 Degree of protection

Order code for "Housing" option C "GT20 dual compartment, aluminum, coated, compact"

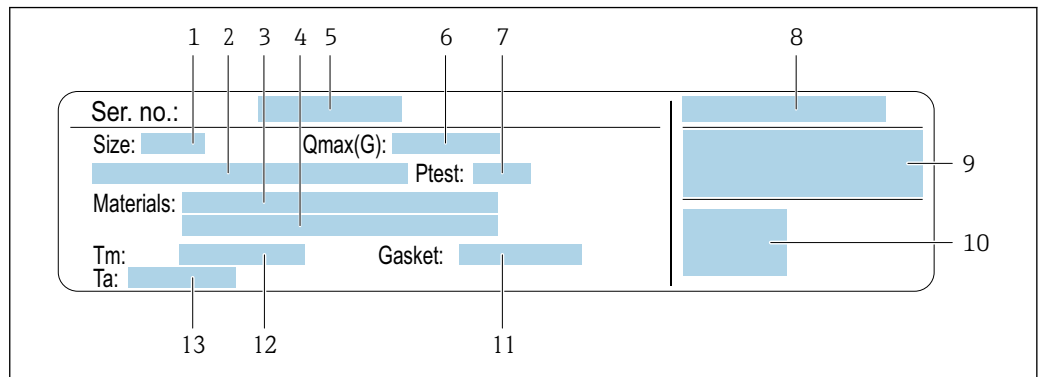

A0034161

5 Example of a sensor nameplate

- 1 Nominal diameter of sensor
- 2 Flange nominal diameter/nominal pressure
- 3 Measuring tube material
- 4 Measuring tube material
- 5 Serial number (ser. no.)
- 6 Maximal permitted volume flow (gas/steam)
- 7 Test pressure of the sensor
- 8 Degree of protection
- 9 Approval information for explosion protection and Pressure Equipment Directive → 201
- 10 CE mark
- 11 Seal material
- 12 Medium temperature range
- 13 Ambient temperature range

Order code for "Housing" option J "GT20 dual compartment, aluminum, coated, remote"

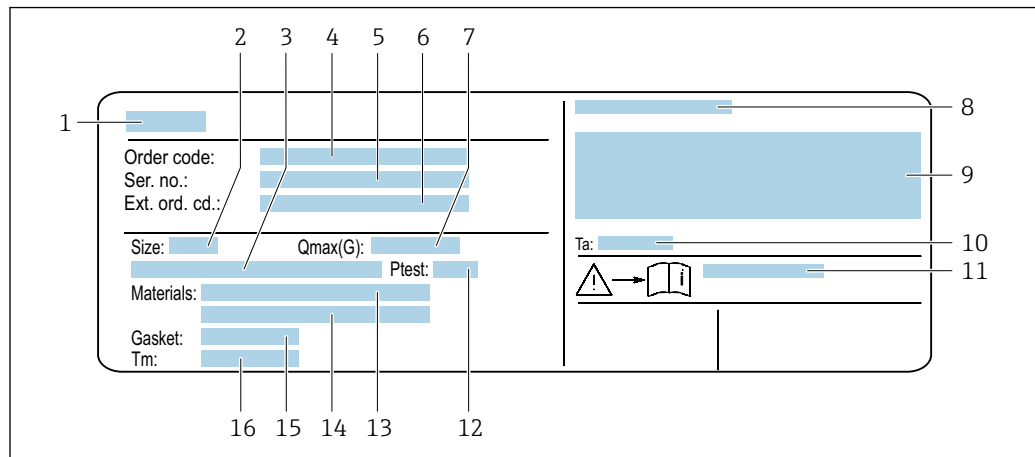

A0034162

6 Example of a sensor nameplate

- 1 Name of the sensor
- 2 Nominal diameter of sensor
- 3 Flange nominal diameter/nominal pressure
- 4 Order code
- 5 Serial number (ser. no.)
- 6 Extended order code (Ext. ord. cd.)
- 7 Maximal permitted volume flow (gas/steam)
- 8 Degree of protection
- 9 Approval information for explosion protection and Pressure Equipment Directive
- 10 Ambient temperature range
- 11 Document number of safety-related supplementary documentation → 201
- 12 Test pressure of the sensor
- 13 Measuring tube material
- 14 Measuring tube material
- 15 Seal material
- 16 Medium temperature range

i Order code

The measuring device is reordered using the order code.

Extended order code

- The device type (product root) and basic specifications (mandatory features) are always listed.
- Of the optional specifications (optional features), only the safety and approval-related specifications are listed (e.g. LA). If other optional specifications are also ordered, these are indicated collectively using the # placeholder symbol (e.g. #LA#).
- If the ordered optional specifications do not include any safety and approval-related specifications, they are indicated by the + placeholder symbol (e.g. XXXXXX-ABCDE +).

4.2.3 Pressure measuring cells nameplate

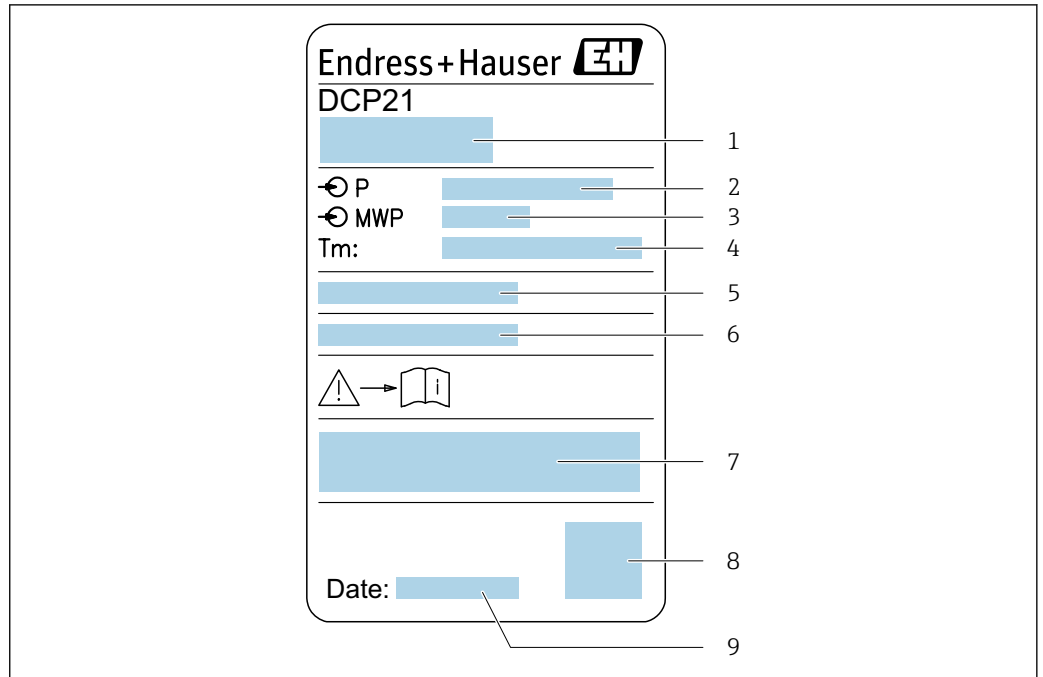

A0034354

7 Example of pressure measuring cell nameplate

- 1 Manufacturer address
- 2 Pressure range
- 3 Maximum permitted pressure
- 4 Ambient temperature range
- 5 Serial number or XPD structure
- 6 Degree of protection
- 7 CE mark, C-Tick mark
- 8 QR code
- 9 Manufacturing date

4.2.4 Symbols on measuring device

Symbol	Meaning
	WARNING! This symbol alerts you to a dangerous situation. Failure to avoid this situation can result in serious or fatal injury.
	Reference to documentation Refers to the corresponding device documentation.
	Protective ground connection A terminal which must be connected to ground prior to establishing any other connections.

5 Storage and transport

5.1 Storage conditions

Observe the following notes for storage:

- ▶ Store in the original packaging to ensure protection from shock.
- ▶ Do not remove protective covers or protective caps installed on process connections. They prevent mechanical damage to the sealing surfaces and contamination in the measuring tube.
- ▶ Protect from direct sunlight to avoid unacceptably high surface temperatures.
- ▶ Store in a dry and dust-free place.
- ▶ Do not store outdoors.

Storage temperature: -50 to +80 °C (-58 to +176 °F)

5.2 Transporting the product

Transport the measuring device to the measuring point in the original packaging.

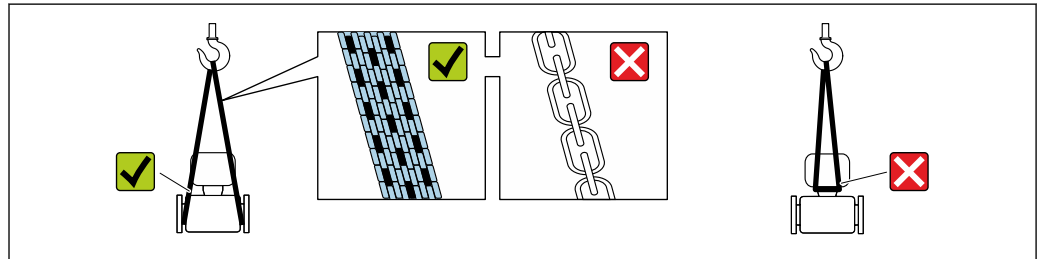

A0029252

- i** Do not remove protective covers or caps installed on process connections. They prevent mechanical damage to the sealing surfaces and contamination in the measuring tube.

5.2.1 Measuring devices without lifting lugs

⚠ WARNING

Center of gravity of the measuring device is higher than the suspension points of the webbing slings.

Risk of injury if the measuring device slips.

- ▶ Secure the measuring device against slipping or turning.
- ▶ Observe the weight specified on the packaging (stick-on label).

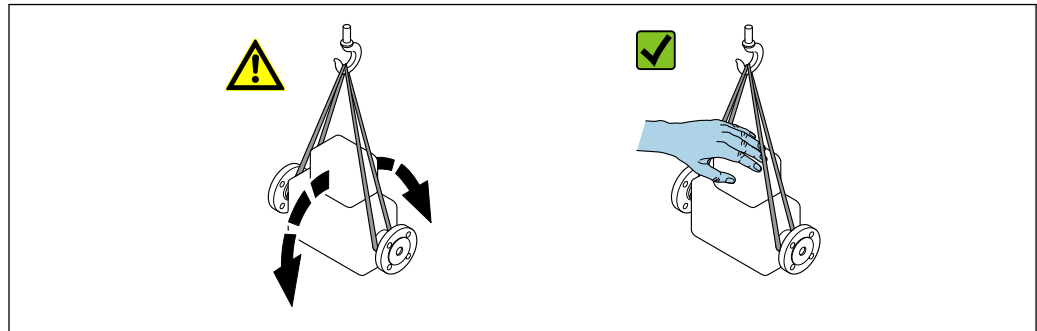

A0029214

5.2.2 Measuring devices with lifting lugs

⚠ CAUTION

Special transportation instructions for devices with lifting lugs

- ▶ Only use the lifting lugs fitted on the device or flanges to transport the device.
- ▶ The device must always be secured at two lifting lugs at least.

5.2.3 Transporting with a fork lift

If transporting in wood crates, the floor structure enables the crates to be lifted lengthwise or at both sides using a forklift.

5.3 Packaging disposal

All packaging materials are environmentally friendly and 100 % recyclable:

- Outer packaging of device
 - Polymer stretch wrap that complies with EU Directive 2002/95/EC (RoHS)
- Packaging
 - Wooden crate treated in accordance with ISPM 15 standard, confirmed by IPPC logo
 - Cardboard box in accordance with European packaging guideline 94/62EC, recyclability confirmed by Resy symbol
- Carrying and securing materials
 - Disposable plastic pallet
 - Plastic straps
 - Plastic adhesive strips
- Filler material
 - Paper pads

6 Installation

6.1 Installation conditions

6.1.1 Mounting position

Mounting location

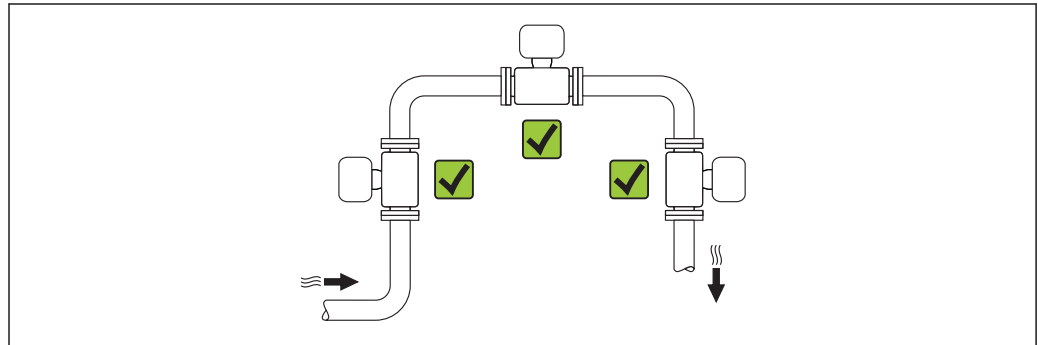

A0015543

Orientation

The direction of the arrow on the sensor nameplate helps you to install the sensor according to the flow direction (direction of medium flow through the piping).

Vortex meters require a fully developed flow profile as a prerequisite for correct volume flow measurement. Therefore, please note the following:

Orientation		Compact version	Remote version
A	Vertical orientation	✓✓ ¹⁾	✓✓
B	Horizontal orientation, transmitter head up	✓✓ ^{2) 3)}	✓✓
C	Horizontal orientation, transmitter head down	✓✓ ⁴⁾	✓✓
D	Horizontal orientation, transmitter head at side	✓✓	✓✓

- 1) In the case of liquids, there should be upward flow in vertical pipes to avoid partial pipe filling (Fig. A). Disruption in flow measurement! In the case of vertical orientation and downward flowing liquid, the pipe always needs to be completely filled to ensure correct liquid flow measurement.
- 2) Danger of electronics overheating! If the fluid temperature is $\geq 200\text{ °C}$ (392 °F), orientation B is not permitted for the wafer version (Prowirl D) with nominal diameters of DN 100 (4") and DN 150 (6").
- 3) In the case of hot media (e.g. steam or fluid temperature (TM) $\geq 200\text{ °C}$ (392 °F)): orientation C or D
- 4) In the case of very cold media (e.g. liquid nitrogen): orientation B or D

i The "mass" sensor version (integrated pressure/temperature measurement) is available only for measuring devices in the HART communication mode.

Pressure measuring cell

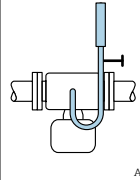
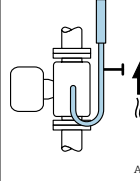
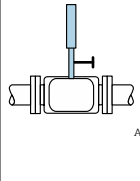
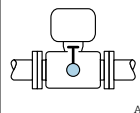
Steam pressure measurement			Option DA
E	<ul style="list-style-type: none"> With the transmitter installed at the bottom or at the side Protection against rising heat 	 <p>A0034057</p>	✓✓
F	<ul style="list-style-type: none"> Reduction in temperature to almost ambient temperature due to siphon ¹⁾ 	 <p>A0034058</p>	✓✓
Gas pressure measurement			Option DB
G	<ul style="list-style-type: none"> Pressure measuring cell with shutoff device above tapping point Discharge of any condensate into the process 	 <p>A0034092</p>	✓✓
Liquid pressure measurement			Option DB
H	Device with shutoff device at the same level as tapping point	 <p>A0034091</p>	✓✓

1) Note max. permitted ambient temperature of transmitter → 26.

Minimum spacing and cable length

Order code for "Sensor version", option "mass" DA, DB

i The "mass" sensor version (integrated pressure/temperature measurement) is available only for measuring devices in the HART communication mode.

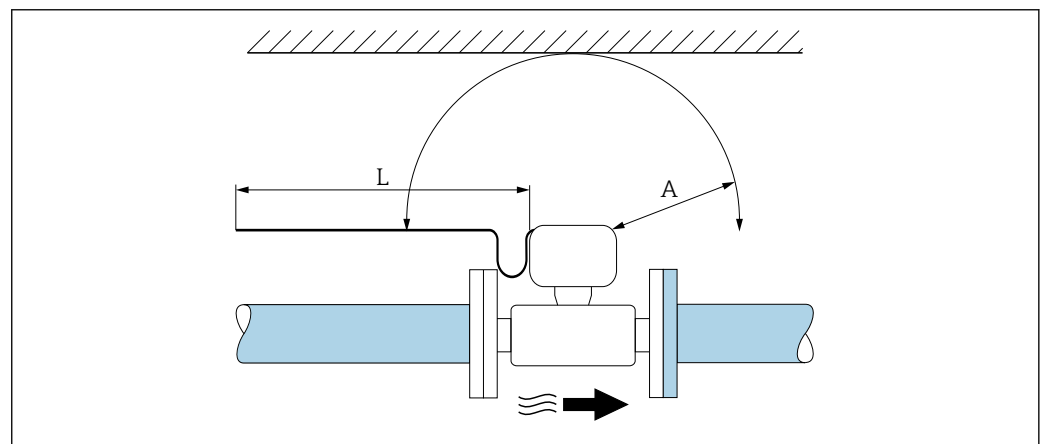

A Minimum spacing in all directions
 L Required cable length

A0019211

The following dimensions must be observed to guarantee problem-free access to the device for service purposes:

- A = 100 mm (3.94 in)
- L = L + 150 mm (5.91 in)

Inlet and outlet runs

To attain the specified level of accuracy of the measuring device, the inlet and outlet runs mentioned below must be maintained at the very minimum.

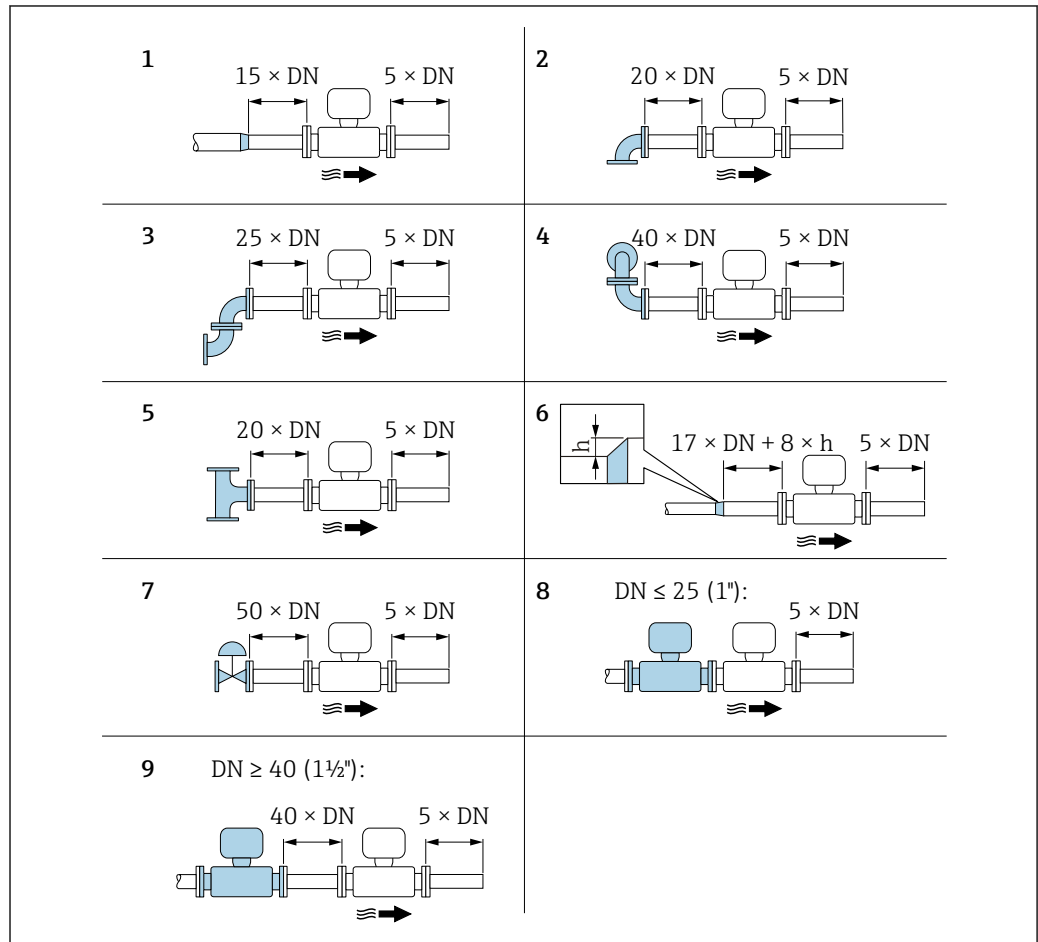

A0019189

8 Minimum inlet and outlet runs with various flow obstructions

- h* Difference in expansion
- 1 Reduction by one nominal diameter size
- 2 Single elbow (90° elbow)
- 3 Double elbow (2 × 90° elbows, opposite)
- 4 Double elbow 3D (2 × 90° elbows, opposite, not on one plane)
- 5 T-piece
- 6 Expansion
- 7 Control valve
- 8 Two measuring devices in a row where DN ≤ 25 (1"): directly flange on flange
- 9 Two measuring devices in a row where DN ≥ 40 (1½"): for spacing, see graphic

- i** ■ If there are several flow disturbances present, the longest specified inlet run must be maintained.
- If the required inlet runs cannot be observed, it is possible to install a specially designed flow conditioner → 24.

Flow conditioner

If the inlet runs cannot be observed, the use of a flow conditioner is recommended.

The flow conditioner is fitted between two pipe flanges and centered by the mounting bolts. Generally this reduces the inlet run needed to $10 \times DN$ with full accuracy.

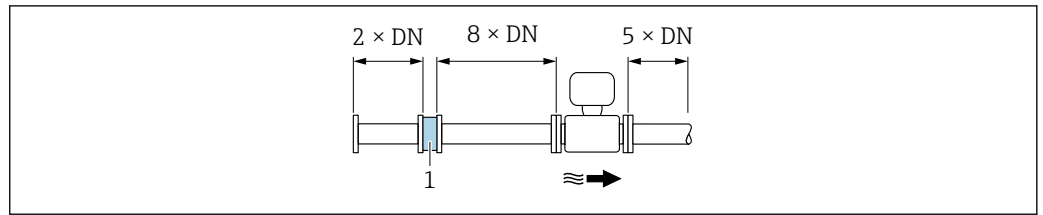

A0019208

1 Flow conditioner

The pressure loss for flow conditioners is calculated as follows: $\Delta p \text{ [mbar]} = 0.0085 \cdot \rho \text{ [kg/m}^3\text{]} \cdot v^2 \text{ [m/s]}$

Example for steam

$p = 10 \text{ bar abs.}$

$t = 240 \text{ }^\circ\text{C} \rightarrow \rho = 4.39 \text{ kg/m}^3$

$v = 40 \text{ m/s}$

$\Delta p = 0.0085 \cdot 4.39 \cdot 40^2 = 59.7 \text{ mbar}$

Example for H₂O condensate (80 °C)

$\rho = 965 \text{ kg/m}^3$

$v = 2.5 \text{ m/s}$

$\Delta p = 0.0085 \cdot 965 \cdot 2.5^2 = 51.3 \text{ mbar}$

ρ : density of the process medium

v : average flow velocity

abs. = absolute



For the dimensions of the flow conditioner, see the "Technical Information" document, "Mechanical construction" section

Outlet runs when installing external devices

If installing an external device, observe the specified distance.

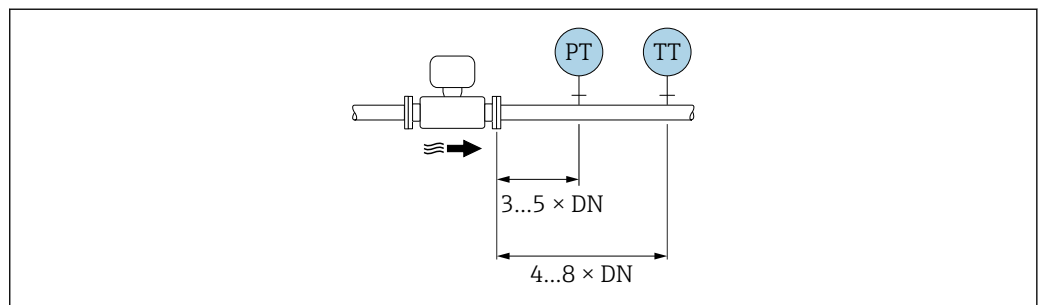

A0019205

PT Pressure

TT Temperature device

Installation dimensions



For the dimensions and installation lengths of the device, see the "Technical Information" document, "Mechanical construction" section.

6.1.2 Environment and process requirements

Ambient temperature range

Compact version

Measuring device	Non-hazardous area:	-40 to +80 °C (-40 to +176 °F) ¹⁾
	Ex i, Ex nA, Ex ec:	-40 to +70 °C (-40 to +158 °F) ¹⁾
	Ex d, XP:	-40 to +60 °C (-40 to +140 °F) ¹⁾
	Ex d, Ex ia:	-40 to +60 °C (-40 to +140 °F) ¹⁾
Local display		-40 to +70 °C (-40 to +158 °F) ^{2) 1)}

- 1) Additionally available as order code for "Test, certificate", option JN "Transmitter ambient temperature - 50 °C (-58 °F)".
- 2) At temperatures < -20 °C (-4 °F), depending on the physical characteristics involved, it may no longer be possible to read the liquid crystal display.

Remote version

Transmitter	Non-hazardous area:	-40 to +80 °C (-40 to +176 °F) ¹⁾
	Ex i, Ex nA, Ex ec:	-40 to +80 °C (-40 to +176 °F) ¹⁾
	Ex d:	-40 to +60 °C (-40 to +140 °F) ¹⁾
	Ex d, Ex ia:	-40 to +60 °C (-40 to +140 °F) ¹⁾
Sensor	Non-hazardous area:	-40 to +85 °C (-40 to +185 °F) ¹⁾
	Ex i, Ex nA, Ex ec:	-40 to +85 °C (-40 to +185 °F) ¹⁾
	Ex d:	-40 to +85 °C (-40 to +185 °F) ¹⁾
	Ex d, Ex ia:	-40 to +85 °C (-40 to +185 °F) ¹⁾
Local display		-40 to +70 °C (-40 to +158 °F) ^{2) 1)}

- 1) Additionally available as order code for "Test, certificate", option JN "Transmitter ambient temperature - 50 °C (-58 °F)".
- 2) At temperatures < -20 °C (-4 °F), depending on the physical characteristics involved, it may no longer be possible to read the liquid crystal display.

► If operating outdoors:

Avoid direct sunlight, particularly in warm climatic regions.



You can order a weather protection cover from Endress+Hauser. → 165.

Thermal insulation

For optimum temperature measurement and mass calculation, heat transfer at the sensor must be avoided for some fluids. This can be ensured by installing thermal insulation. A wide range of materials can be used for the required insulation.

This applies for:

- Compact version
- Remote sensor version

The maximum insulation height permitted is illustrated in the diagram:

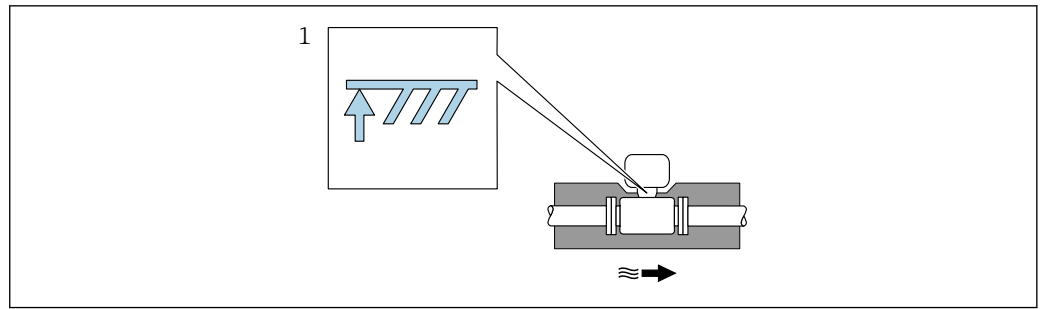

A0019212

1 Maximum insulation height

- ▶ When insulating, ensure that a sufficiently large area of the housing support remains exposed.

The uncovered part serves as a radiator and protects the electronics from overheating and excessive cooling.

NOTICE

Electronics overheating on account of thermal insulation!

- ▶ Observe the maximum permitted insulation height of the transmitter neck so that the transmitter head and/or the connection housing of the remote version is completely free.
- ▶ Observe information on the permissible temperature ranges.
- ▶ Note that a certain orientation might be required, depending on the fluid temperature.

6.1.3 Special mounting instructions

Installation for delta heat measurements

- Order code for "Sensor version", option CA "mass; 316L; 316L (integrated temperature measurement), -200 to +400 °C (-328 to +750 °F)"
- Order code for "Sensor version", option CB "mass; Alloy C22; 316L (integrated temperature measurement), -200 to +400 °C (-328 to +750 °F)"
- Order code for "Sensor version", option DA "mass steam; 316L; 316L (integrated pressure/temperature measurement), -200 to +400 °C (-328 to +750 °F)"
- Order code for "Sensor version", option DB "mass gas/liquid; 316L; 316L (integrated pressure/temperature measurement), -40 to +100 °C (-40 to +212 °F)"

The second temperature measurement is taken using a separate temperature sensor. The measuring device reads in this value via a communication interface.

- In the case of saturated steam delta heat measurements, the measuring device must be installed on the steam side.
- In the case of water delta heat measurements, the device can be installed on the cold or warm side.

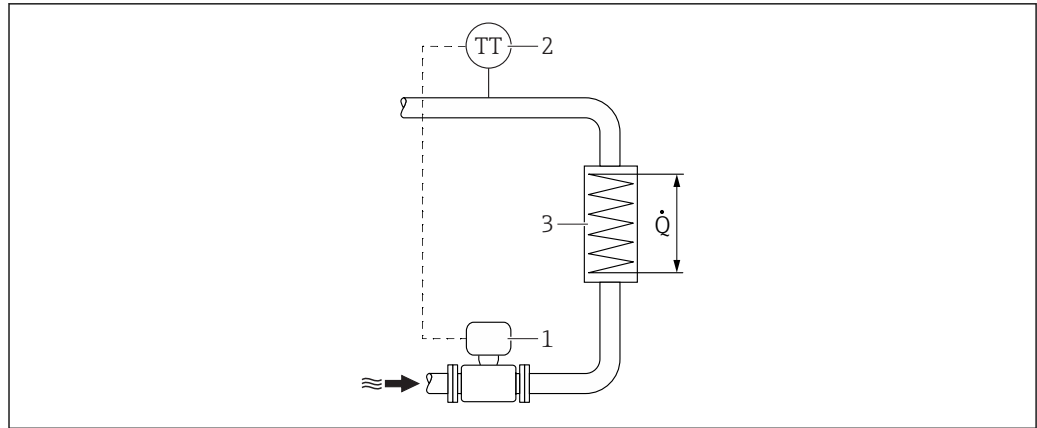

A0019209

9 Layout for delta heat measurement of saturated steam and water

- 1 Measuring device
- 2 Temperature sensor
- 3 Heat exchanger
- Q Heat flow

Protective cover

Observe the following minimum head clearance: 222 mm (8.74 in)

i For information on the weather protection cover, see → **165**

6.2 Mounting the measuring device

6.2.1 Required tools

For transmitter

- For turning the transmitter housing: Open-ended wrench 8 mm
- For opening the securing clamps: Allen key 3 mm

For sensor

For flanges and other process connections: Corresponding mounting tools

6.2.2 Preparing the measuring device

1. Remove all remaining transport packaging.
2. Remove any protective covers or protective caps present from the sensor.
3. Remove stick-on label on the electronics compartment cover.

6.2.3 Mounting the sensor

WARNING

Danger due to improper process sealing!

- ▶ Ensure that the inside diameters of the gaskets are greater than or equal to that of the process connections and piping.
- ▶ Ensure that the gaskets are clean and undamaged.
- ▶ Install the gaskets correctly.

1. Ensure that the direction of the arrow on the sensor matches the flow direction of the medium.

2. To ensure compliance with device specifications, install the measuring device between the pipe flanges in a way that it is centered in the measurement section.
3. Install the measuring device or turn the transmitter housing so that the cable entries do not point upwards.

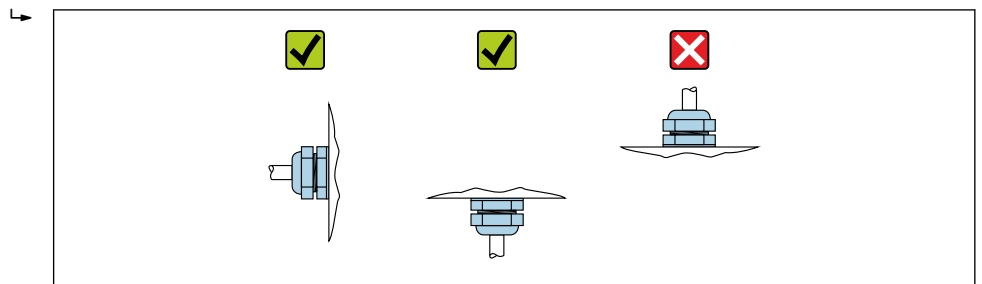

A0029263

6.2.4 Mounting the pressure measuring unit

Preparation

1. Prior to mounting the pressure measuring unit, install the measuring device in the pipe.
2. When mounting the pressure measuring unit, use only the seal provided. The use of a different sealing material is not permitted.

Removing the blind flange

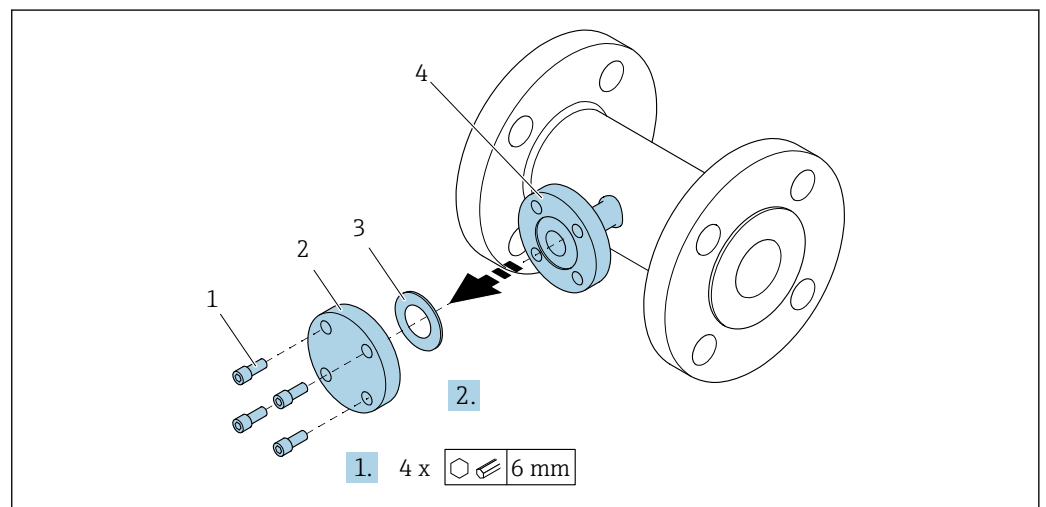

A0034355

- 1 Mounting screws
- 2 blind flange
- 3 Seal
- 4 Flange connection on sensor side

NOTICE

When replacing the seal following commissioning, fluid may escape when the flange connection is opened!

- ▶ Ensure that the measuring device is not under pressure.
 - ▶ Ensure that there is no fluid in the measuring device.
1. Release the mounting screws on the blind flange.
 - ↳ The screws are needed again to mount the pressure measuring unit.
 2. Remove the internal seal.

Mounting the pressure measuring unit

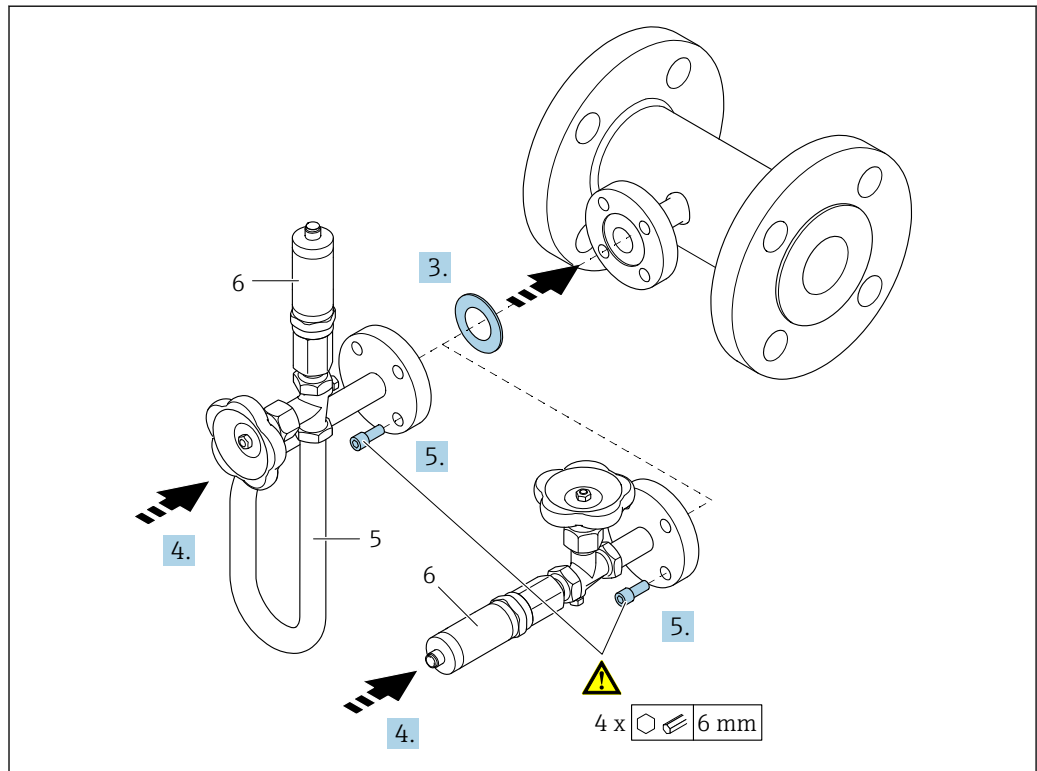

A0035442

- 5 Siphon
6 Pressure measuring cell

3. NOTICE

Damage to seal!

The seal is made of expanded graphite. It can therefore be used only once. If a coupling is released, a new seal must be installed.

- ▶ Use the additional seals provided. If necessary, these can be ordered as separate spare parts at a later stage.

Insert the enclosed seal into the groove of the flange connection on the sensor side.

4. Align the flange connection on the pressure measuring unit and tighten the screws by hand.
5. Tighten the screws with a torque wrench in three steps.
- ↳ 1. 10 Nm in criss-cross sequence
 - 2. 15 Nm in criss-cross sequence
 - 3. 15 Nm in circular sequence

Connecting the pressure measuring unit

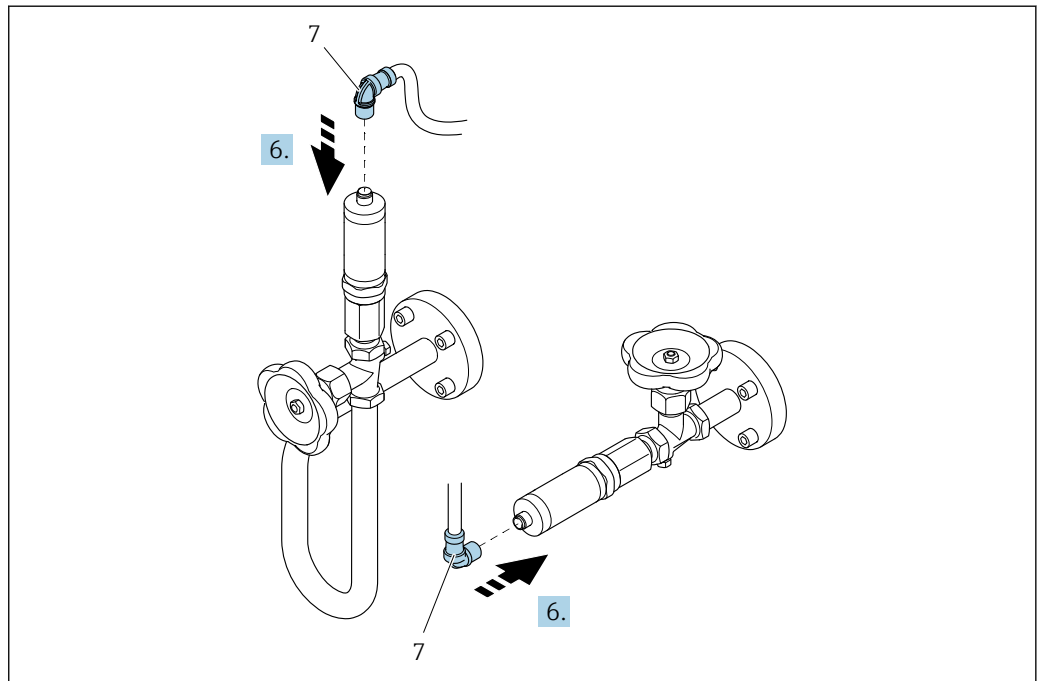

A0035443

7 Device plug

6. Insert the plug for electrical connection of the pressure measuring cell and screw into place.

6.2.5 Mounting the transmitter of the remote version

CAUTION

Ambient temperature too high!

Danger of electronics overheating and housing deformation.

- ▶ Do not exceed the permitted maximum ambient temperature .
- ▶ If operating outdoors: Avoid direct sunlight and exposure to weathering, particularly in warm climatic regions.

CAUTION

Excessive force can damage the housing!

- ▶ Avoid excessive mechanical stress.

The transmitter of the remote version can be mounted in the following ways:

- Wall mounting
- Pipe mounting

Wall mounting

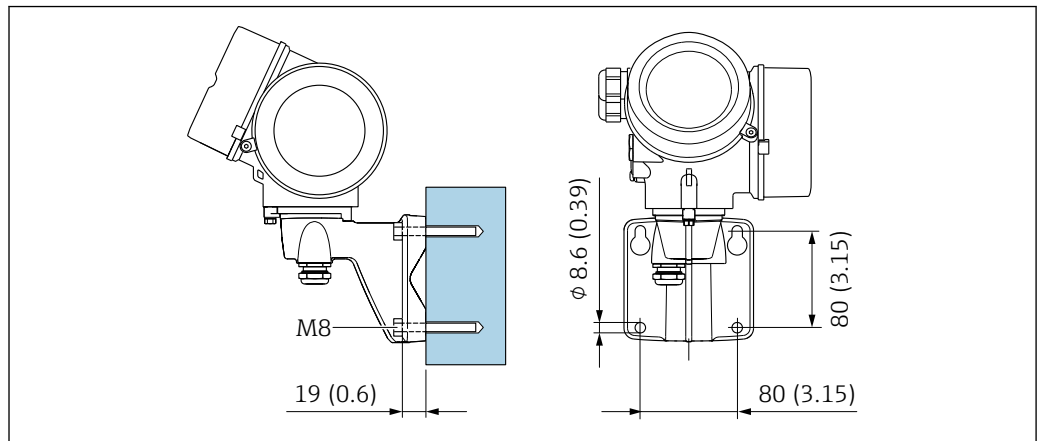

A0033484

10 mm (in)

Post mounting

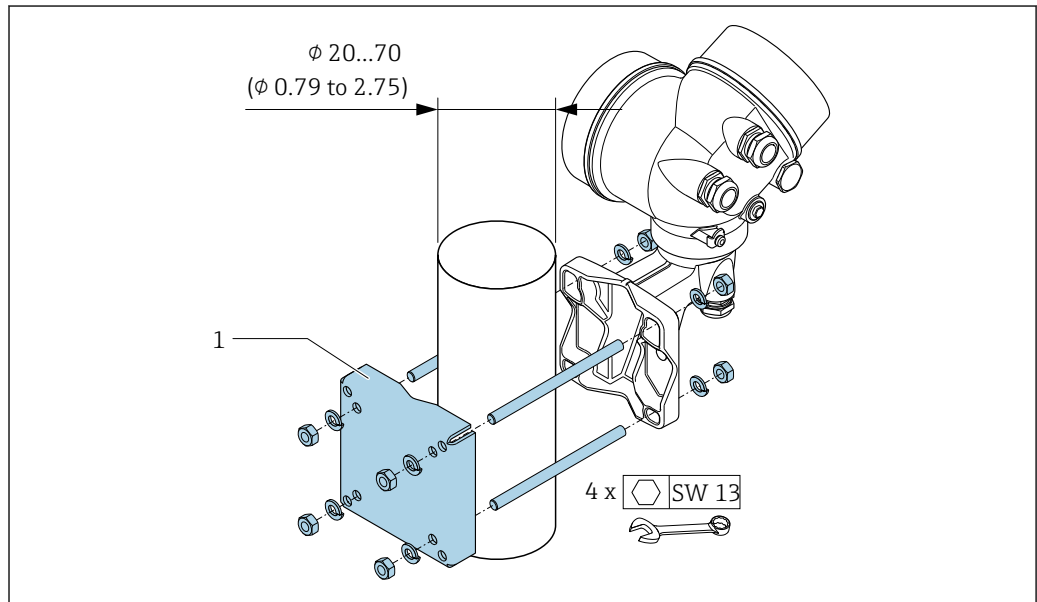

A0033486

11 mm (in)

6.2.6 Turning the transmitter housing

To provide easier access to the connection compartment or display module, the transmitter housing can be turned.

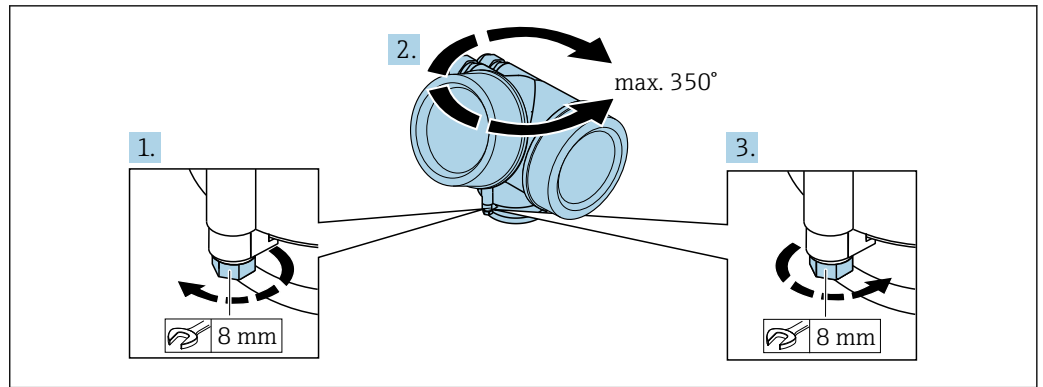

A0032242

1. Release the fixing screw.
2. Turn the housing to the desired position.
3. Firmly tighten the securing screw.

6.2.7 Turning the display module

The display module can be turned to optimize display readability and operability.

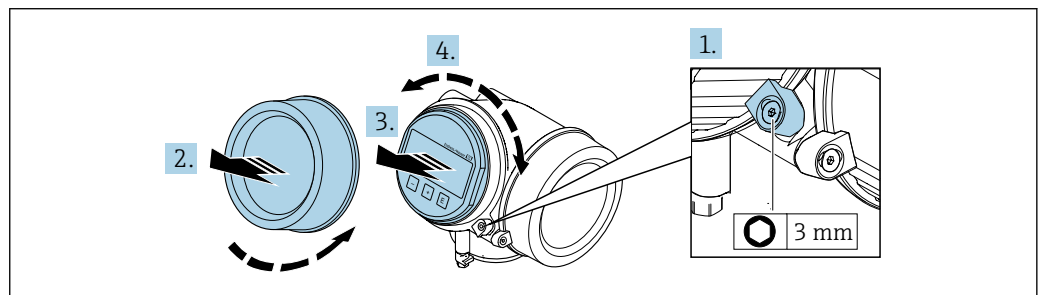

A0032238

1. Loosen the securing clamp of the electronics compartment cover using an Allen key.
2. Unscrew cover of the electronics compartment from the transmitter housing.
3. Optional: pull out the display module with a gentle rotational movement.
4. Turn the display module to the desired position: max. $8 \times 45^\circ$ in every direction.
5. Without display module pulled out:
Allow display module to engage at desired position.
6. With display module pulled out:
Feed the cable into the gap between the housing and main electronics module and plug the display module into the electronics compartment until it engages.
7. Reverse the removal procedure to reassemble the transmitter.

6.3 Post-installation check

Is the device undamaged (visual inspection)?	<input type="checkbox"/>
Does the measuring device conform to the measuring point specifications? For example: <ul style="list-style-type: none"> ▪ Process temperature → 187 ▪ Process pressure (refer to the section on "Pressure-temperature ratings" in the "Technical Information" document → 200) ▪ Ambient temperature ▪ Measuring range → 170 	<input type="checkbox"/>

<p>Has the correct orientation for the sensor been selected → 22?</p> <ul style="list-style-type: none"> ▪ According to sensor type ▪ According to medium temperature ▪ According to medium properties (outgassing, with entrained solids) 	<input type="checkbox"/>
<p>Does the arrow on the sensor nameplate match the direction of flow of the fluid through the piping → 22?</p>	<input type="checkbox"/>
<p>Are the measuring point identification and labeling correct (visual inspection)?</p>	<input type="checkbox"/>
<p>Is the device adequately protected against precipitation and direct sunlight?</p>	<input type="checkbox"/>
<p>Are the securing screw and securing clamp tightened securely?</p>	<input type="checkbox"/>
<p>Has the maximum permitted insulation height been observed?</p>	<input type="checkbox"/>
<ul style="list-style-type: none"> ▪ Has the pressure range been observed → 188? ▪ Was the correct orientation selected → 23? ▪ Is the pressure unit mounted correctly → 29? ▪ Have the pressure gauge valve and the siphon with pressure sensor been mounted using the prescribed seal and the specified torque → 29? 	<input type="checkbox"/>

7 Electrical connection

7.1 Connection conditions

7.1.1 Required tools

- For cable entries: Use corresponding tools
- For securing clamp: Allen key 3 mm
- Wire stripper
- When using stranded cables: Crimper for wire end ferrule
- For removing cables from terminal: Flat blade screwdriver ≤ 3 mm (0.12 in)

7.1.2 Connecting cable requirements

The connecting cables provided by the customer must fulfill the following requirements.

Electrical safety

In accordance with applicable federal/national regulations.

Permitted temperature range

- The installation guidelines that apply in the country of installation must be observed.
- The cables must be suitable for the minimum and maximum temperatures to be expected.

Signal cable

Current output 4 to 20 mA HART

A shielded cable is recommended. Observe grounding concept of the plant.

Current output 4 to 20 mA

Standard installation cable is sufficient.

Pulse/frequency/switch output

Standard installation cable is sufficient.

Current input

Standard installation cable is sufficient.

Cable diameter

- Cable glands supplied:
M20 \times 1.5 with cable ϕ 6 to 12 mm (0.24 to 0.47 in)
- Plug-in spring terminals for device version without integrated overvoltage protection:
wire cross-sections 0.5 to 2.5 mm² (20 to 14 AWG)
- Screw terminals for device version with integrated overvoltage protection: wire cross-sections 0.2 to 2.5 mm² (24 to 14 AWG)

7.1.3 Connecting cable for remote version

Connecting cable (standard)

Standard cable	2 × 2 × 0.5 mm ² (22 AWG) PVC cable with common shield (2 pairs, pair-stranded) ¹⁾
Flame resistance	According to DIN EN 60332-1-2
Oil-resistance	According to DIN EN 60811-2-1
Shielding	Galvanized copper-braid, opt. density approx. 85 %
Cable length	5 m (16 ft), 10 m (32 ft), 20 m (65 ft), 30 m (98 ft)
Operating temperature	When mounted in a fixed position: -50 to +105 °C (-58 to +221 °F); when cable can move freely: -25 to +105 °C (-13 to +221 °F)

- 1) UV radiation may cause damage to the outer jacket of the cable. Protect the cable from exposure to sun as much as possible.

Connecting cable (reinforced)

Cable, reinforced	2 × 2 × 0.34 mm ² (22 AWG) PVC cable with common shield (2 pairs, pair-stranded) and additional steel-wire braided sheath ¹⁾
Flame resistance	According to DIN EN 60332-1-2
Oil-resistance	According to DIN EN 60811-2-1
Shielding	Galvanized copper-braid, opt. density approx. 85%
Strain relief and reinforcement	Steel-wire braid, galvanized
Cable length	5 m (16 ft), 10 m (32 ft), 20 m (65 ft), 30 m (98 ft)
Operating temperature	When mounted in a fixed position: -50 to +105 °C (-58 to +221 °F); when cable can move freely: -25 to +105 °C (-13 to +221 °F)

- 1) UV radiation may cause damage to the outer jacket of the cable. Protect the cable from exposure to sun as much as possible.

Connecting cable (option "mass pressure-/temperature-compensated")

Order code for "Sensor version; DSC sensor; measuring tube", option DA, DB

Standard cable	[(3 × 2) + 1] × 0.34 mm ² (22 AWG) PVC cable with common shield (3 pairs, pair-stranded) ¹⁾
Flame resistance	According to DIN EN 60332-1-2
Oil-resistance	According to DIN EN 60811-2-1
Shielding	Galvanized copper-braid, opt. density approx. 85%
Cable length	10 m (32 ft), 30 m (98 ft)
Operating temperature	When mounted in a fixed position: -50 to +105 °C (-58 to +221 °F); when cable can move freely: -25 to +105 °C (-13 to +221 °F)

- 1) UV radiation may cause damage to the outer jacket of the cable. Protect the cable from exposure to sun as much as possible.

7.1.4 Terminal assignment

Transmitter

4-20 mA HART connection version with additional inputs and outputs

<small>A0033475</small>	<small>A0033475</small>
<p>Maximum number of terminals Terminals 1 to 6: Without integrated overvoltage protection</p>	<p>Maximum number of terminals for order code for "Accessory mounted", option NA "Overvoltage protection"</p> <ul style="list-style-type: none"> ■ Terminals 1 to 4: With integrated overvoltage protection ■ Terminals 5 to 6: Without integrated overvoltage protection
<p>1 Output 1 (passive): supply voltage and signal transmission 2 Output 2 (passive): supply voltage and signal transmission 3 Input (passive): supply voltage and signal transmission 4 Ground terminal for cable shield</p>	

Order code for "Output"	Terminal numbers					
	Output 1		Output 2		Input	
	1 (+)	2 (-)	3 (+)	4 (-)	5 (+)	6 (-)
Option A	4-20 mA HART (passive)		-		-	
Option B ¹⁾	4-20 mA HART (passive)		Pulse/frequency/switch output (passive)		-	
Option C ¹⁾	4-20 mA HART (passive)		4-20 mA analog (passive)		-	
Option D ^{1) 2)}	4-20 mA HART (passive)		Pulse/frequency/switch output (passive)		4-20 mA current input (passive)	

- 1) Output 1 must always be used; output 2 is optional.
- 2) The integrated overvoltage protection is not used with option D: Terminals 5 and 6 (current input) are not protected against overvoltage.

Connecting cable for remote version

Transmitter and sensor connection housing

In the case of the remote version, the sensor and transmitter are mounted separately from on another and connected by a connecting cable. Connection is performed via the sensor connection housing and the transmitter housing.

i How the connecting cable is connected in the transmitter housing depends on the measuring device approval and the version of the connecting cable used.

In the following versions, only terminals can be used for connection in the transmitter housing:

- Certain approvals: Ex nA, Ex ec, Ex tb and Division 1
- Use of reinforced connecting cable
- Order code for "Sensor version; DSC sensor; measuring tube", option DA, DB

In the following versions, an M12 device connector is used for connection in the transmitter housing:

- All other approvals
- Use of connecting cable (standard)

Terminals are always used to connect the connecting cable in the sensor connection housing (tightening torques for screws for cable strain relief: 1.2 to 1.7 Nm).

Connecting cable (standard, reinforced)

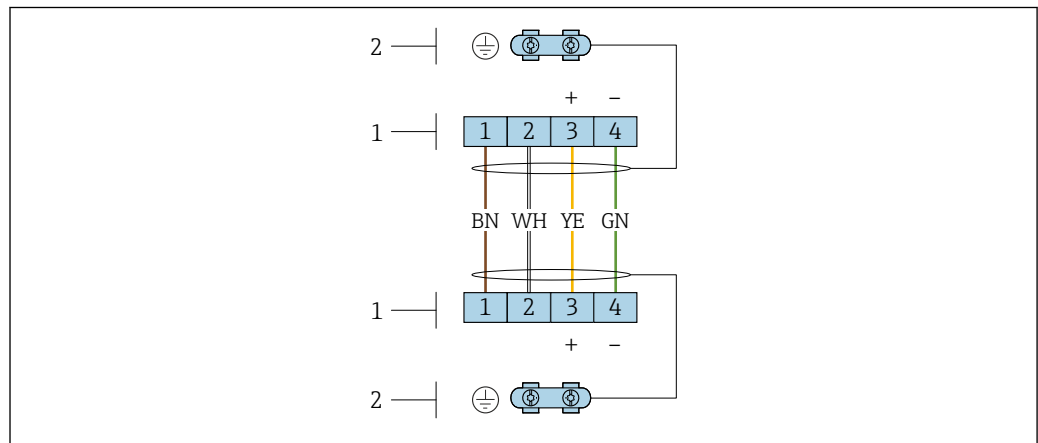

12 Terminals for connection compartment in the transmitter wall holder and the sensor connection housing

- 1 Terminals for connecting cable
- 2 Grounding via the cable strain relief

Terminal number	Assignment	Cable color Connecting cable
1	Supply voltage	Brown
2	Grounding	White
3	RS485 (+)	Yellow
4	RS485 (-)	Green

Connecting cable (option "mass pressure-/temperature-compensated")

Order code for "Sensor version; DSC sensor; measuring tube", option DA, DB

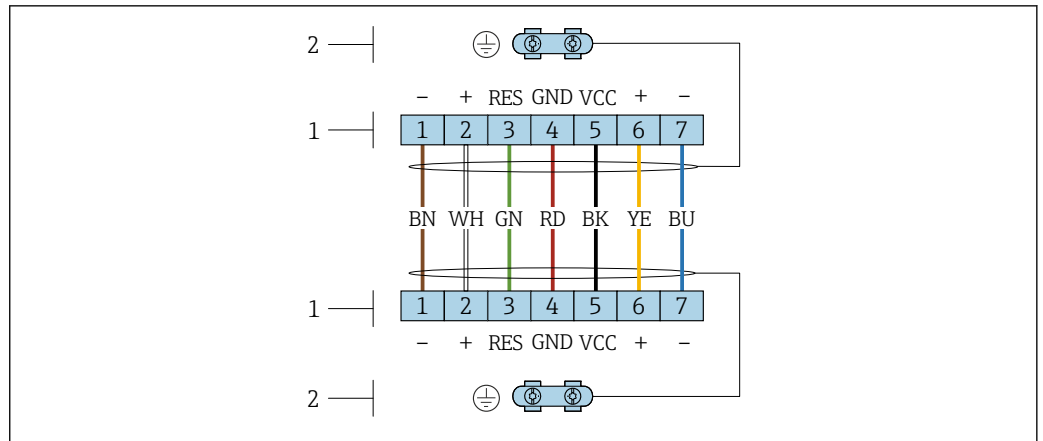

A0034571

13 Terminals for connection compartment in the transmitter wall holder and the sensor connection housing

- 1 Terminals for connecting cable
- 2 Grounding via the cable strain relief

Terminal number	Assignment	Cable color Connecting cable
1	RS485 (-) DPC	Brown
2	RS485 (+) DPC	White
3	Reset	Green
4	Supply voltage	red
5	Grounding	Black
6	RS485 (+)	Yellow
7	RS485 (-)	Blue

7.1.5 Requirements for the supply unit

Supply voltage

Transmitter

An external power supply is required for each output.

The following supply voltage values apply for the outputs available:

Load

Load for current output: 0 to 500 Ω, depending on the external supply voltage of the power supply unit

Calculation of the maximum load

Depending on the supply voltage of the power supply unit (U_S), the maximum load (R_B) including line resistance must be observed to ensure adequate terminal voltage at the device. In doing so, observe the minimum terminal voltage

- For $U_S = 17.9$ to 18.9 V: $R_B \leq (U_S - 17.9 \text{ V}): 0.0036 \text{ A}$
- For $U_S = 18.9$ to 24 V: $R_B \leq (U_S - 13 \text{ V}): 0.022 \text{ A}$
- For $U_S = \geq 24$ V: $R_B \leq 500 \text{ } \Omega$

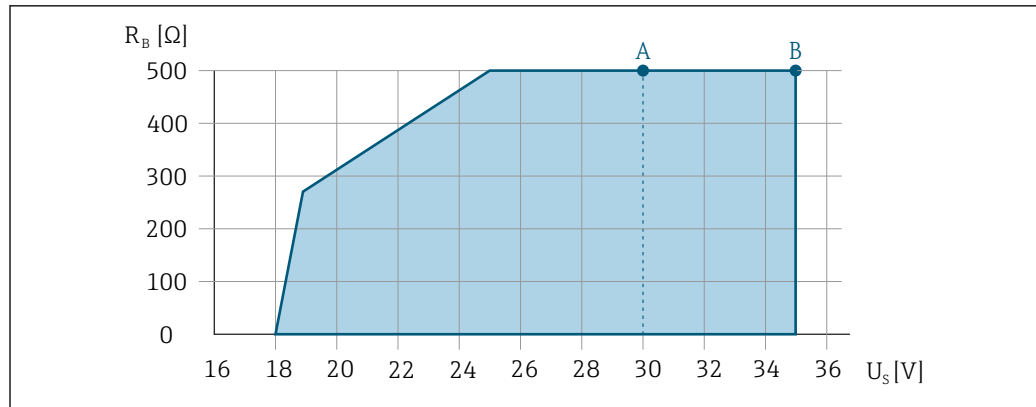

A0013563

- A Operating range for order code for "Output", option A "4-20 mA HART"/option B "4-20 mA HART, pulse/frequency/switch output" with Ex i and option C "4-20 mA HART + 4-20 mA analog"
- B Operating range for order code for "Output", option A "4-20 mA HART"/option B "4-20 mA HART, pulse/frequency/switch output" with non-Ex and Ex d

Sample calculation

Supply voltage of power supply unit: $U_S = 19 \text{ V}$

Maximum load: $R_B \leq (19 \text{ V} - 13 \text{ V}) : 0.022 \text{ A} = 273 \Omega$

7.1.6 Preparing the measuring device

Carry out the steps in the following order:

1. Mount the sensor and transmitter.
2. Connection housing, sensor: Connect connecting cable.
3. Transmitter: Connect connecting cable.
4. Transmitter: Connect signal cable and cable for supply voltage.

NOTICE

Insufficient sealing of the housing!

Operational reliability of the measuring device could be compromised.

- Use suitable cable glands corresponding to the degree of protection.

1. Remove dummy plug if present.
2. If the measuring device is supplied without cable glands:
Provide suitable cable gland for corresponding connecting cable.
3. If the measuring device is supplied with cable glands:
Observe requirements for connecting cables → 35.

7.2 Connecting the measuring device

NOTICE

Limitation of electrical safety due to incorrect connection!

- Have electrical connection work carried out by appropriately trained specialists only.
- Observe applicable federal/national installation codes and regulations.
- Comply with local workplace safety regulations.
- Always connect the protective ground cable \ominus before connecting additional cables.
- For use in potentially explosive atmospheres, observe the information in the device-specific Ex documentation.

7.2.1 Connecting the compact version

Connecting the transmitter

Connection via terminals

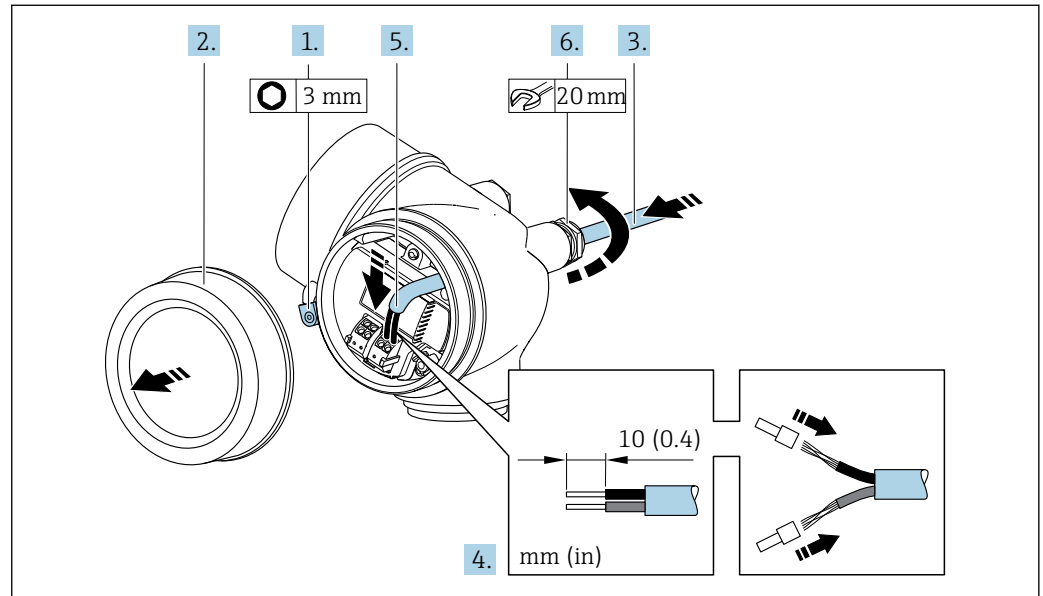

A0032239

1. Loosen the securing clamp of the connection compartment cover.
2. Unscrew the connection compartment cover.
3. Push the cable through the cable entry . To ensure tight sealing, do not remove the sealing ring from the cable entry.
4. Strip the cable and cable ends. In the case of stranded cables, also fit ferrules.
5. Connect cable in accordance with terminal assignment → 37. For HART communication: when connecting the cable shielding to the ground clamp, observe the grounding concept of the facility.

6. **⚠ WARNING**

Housing degree of protection may be voided due to insufficient sealing of the housing.

- ▶ Screw in the screw without using any lubricant. The threads on the cover are coated with a dry lubricant.

Firmly tighten the cable glands.

7. Reverse the removal procedure to reassemble the transmitter.

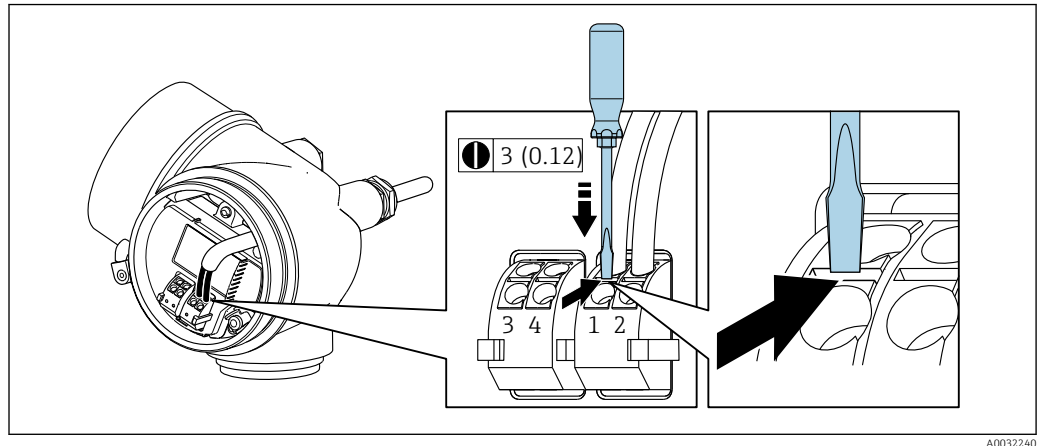
Removing a cable

- ▶ To remove a cable from the terminal, use a flat-blade screwdriver to push the slot between the two terminal holes while simultaneously pulling the cable end out of the terminal.

7.2.2 Connecting the remote version

⚠ WARNING

Risk of damaging the electronic components!

- ▶ Connect the sensor and transmitter to the same potential equalization.
- ▶ Only connect the sensor to a transmitter with the same serial number.

The following procedure (in the action sequence given) is recommended for the remote version:

1. Mount the sensor and transmitter.
2. Connect the connecting cable for the remote version.
3. Connect the transmitter.

i How the connecting cable is connected in the transmitter housing depends on the measuring device approval and the version of the connecting cable used.

In the following versions, only terminals can be used for connection in the transmitter housing:

- Certain approvals: Ex nA, Ex ec, Ex tb and Division 1
- Use of reinforced connecting cable
- Order code for "Sensor version; DSC sensor; measuring tube", option DA, DB

In the following versions, an M12 device connector is used for connection in the transmitter housing:

- All other approvals
- Use of connecting cable (standard)

Terminals are always used to connect the connecting cable in the sensor connection housing (tightening torques for screws for cable strain relief: 1.2 to 1.7 Nm).

Connecting the sensor connection housing

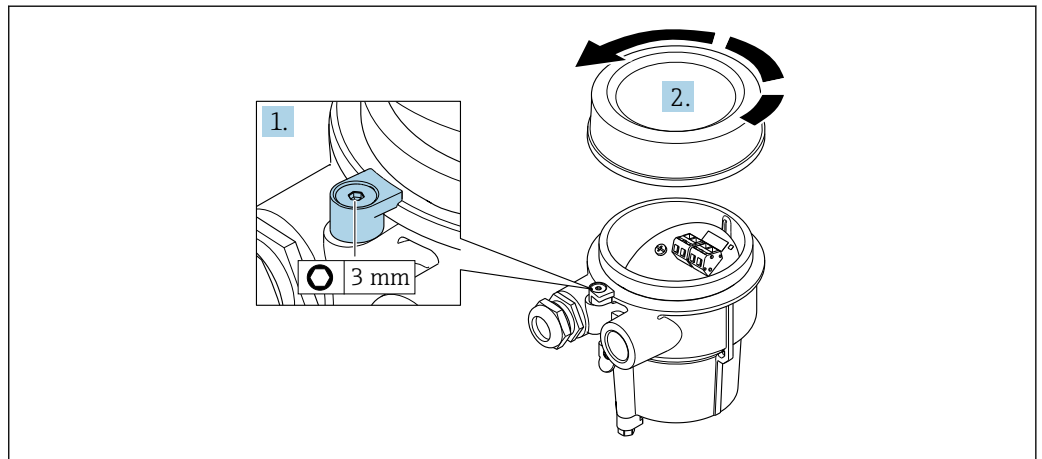

A0034167

1. Loosen the securing clamp.
2. Unscrew the housing cover.

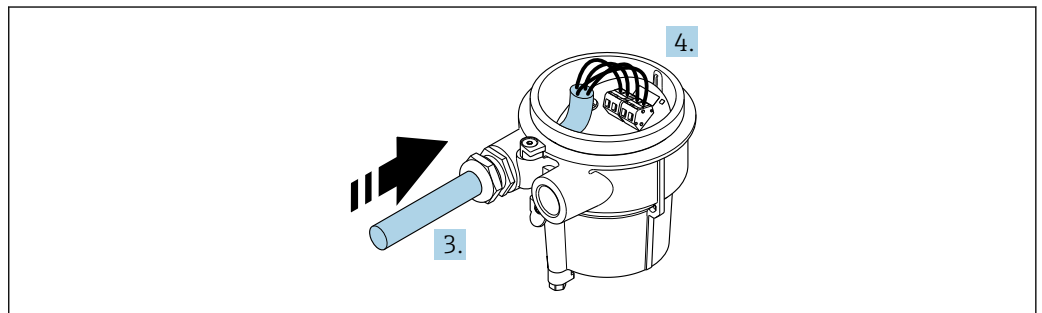

A0034171

14 Sample graphic

Connecting cable (standard, reinforced)

3. Guide the connecting cable through the cable entry and into the connection housing (if using a connecting cable without an M12 device plug, use the shorter stripped end of the connecting cable).
4. Wire the connecting cable:
 - ↳ Terminal 1 = brown cable
 - Terminal 2 = white cable
 - Terminal 3 = yellow cable
 - Terminal 4 = green cable
5. Connect the cable shield via the cable strain relief.
6. Tighten the screws for the cable strain relief using a torque in the range of 1.2 to 1.7 Nm.
7. Reverse the removal procedure to reassemble the connection housing.

Connecting cable (option "mass pressure-/temperature-compensated")

3. Guide the connecting cable through the cable entry and into the connection housing (if using a connecting cable without an M12 device plug, use the shorter stripped end of the connecting cable).

4. Wire the connecting cable:
 - ↳ Terminal 1 = brown cable
 - Terminal 2 = white cable
 - Terminal 3 = green cable
 - Terminal 4 = red cable
 - Terminal 5 = black cable
 - Terminal 6 = yellow cable
 - Terminal 7 = blue cable
5. Connect the cable shield via the cable strain relief.
6. Tighten the screws for the cable strain relief using a torque in the range of 1.2 to 1.7 Nm.
7. Reverse the removal procedure to reassemble the connection housing.

Connecting the transmitter

Connecting transmitter via plug

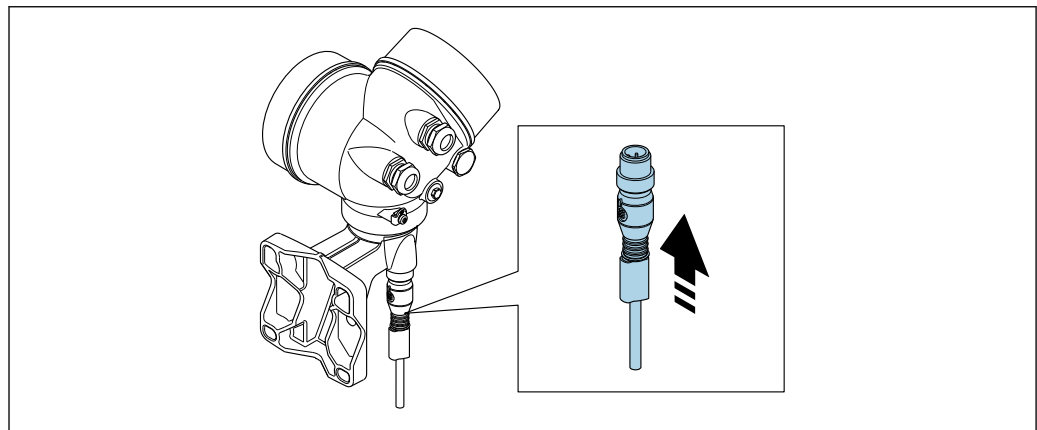

A0034172

- ▶ Connect the plug.

Connecting transmitter via terminals

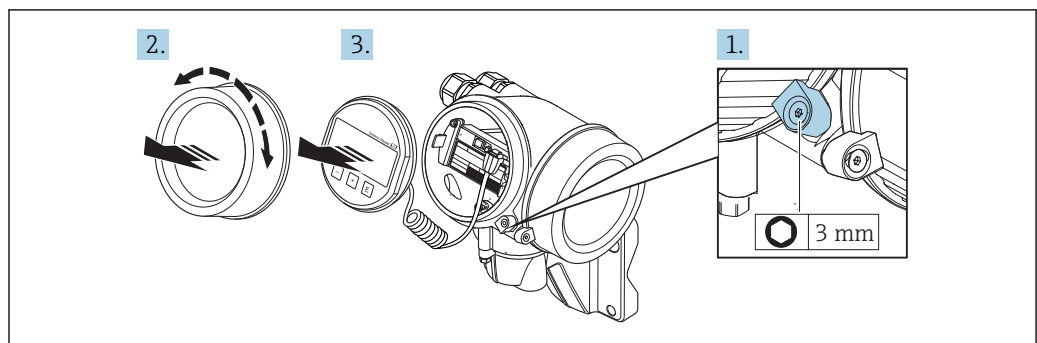

A0034173

1. Loosen the securing clamp of the electronics compartment cover.
2. Unscrew the electronics compartment cover.
3. Pull out the display module with a gentle rotational movement. To make it easier to access the lock switch, attach the display module to the edge of the electronics compartment.

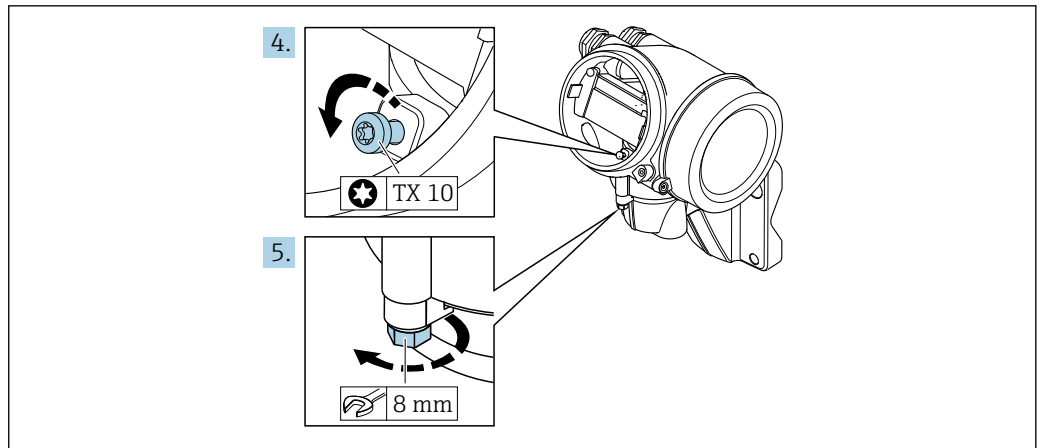

A0034174

- 4. Loosen the locking screw of the transmitter housing.
- 5. Loosen the securing clamp of the transmitter housing.

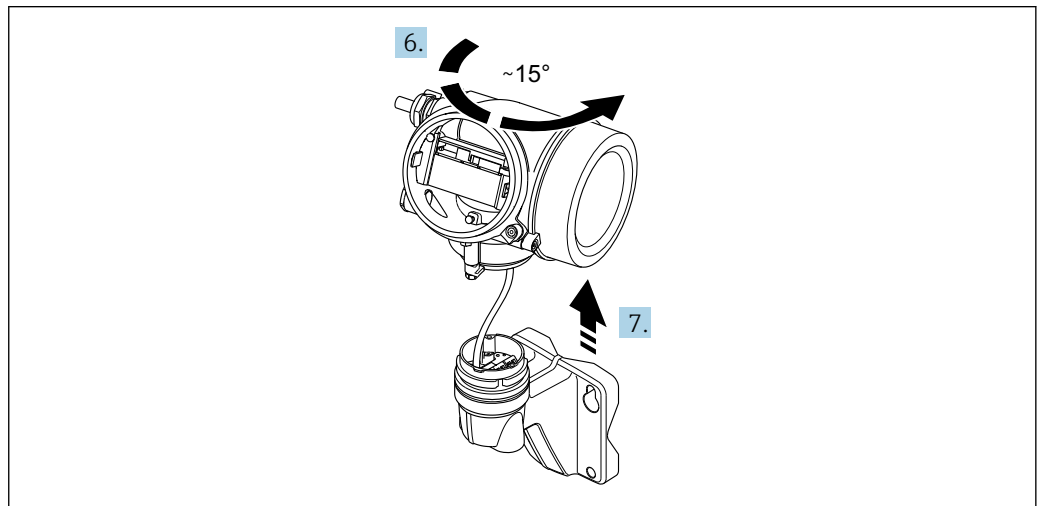

A0034175

15 Sample graphic

- 6. Turn the transmitter housing to the right until it reaches the marking.

7. **NOTICE**

The connection board of the wall housing is connected to the electronics board of the transmitter via a signal cable!

- ▶ Pay attention to the signal cable when lifting the transmitter housing!

Lift the transmitter housing.

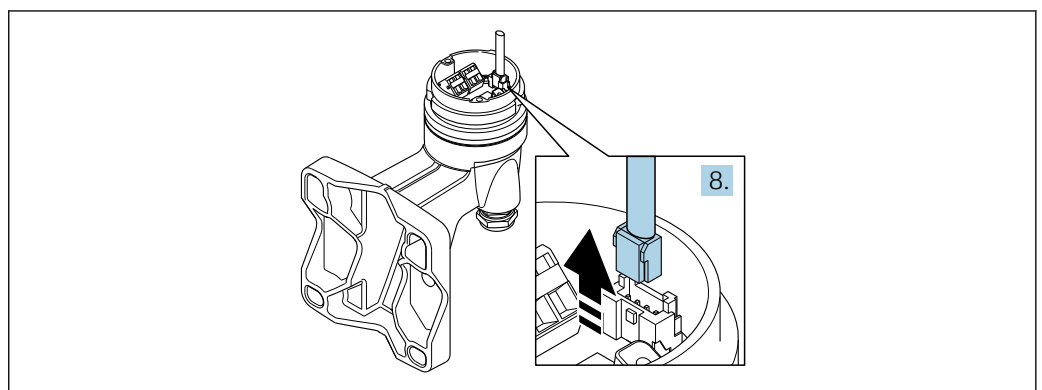

A0034176

16 Sample graphic

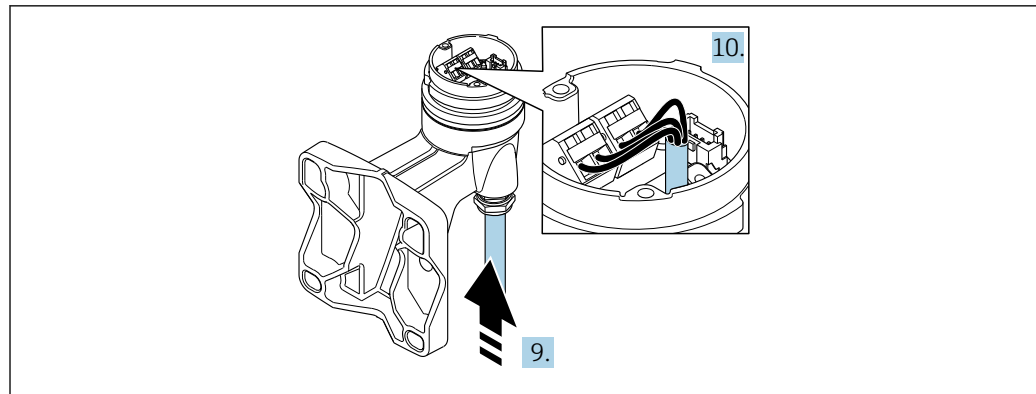

A0034177

17 Sample graphic

Connecting cable (standard, reinforced)

8. Disconnect the signal cable from the connection board of the wall housing . by pressing in the locking clip on the connector. Remove the transmitter housing.
9. Guide the connecting cable through the cable entry and into the connection housing (if using a connecting cable without an M12 device plug, use the shorter stripped end of the connecting cable).
10. Wire the connecting cable:
 - ↳ Terminal 1 = brown cable
 - Terminal 2 = white cable
 - Terminal 3 = yellow cable
 - Terminal 4 = green cable
11. Connect the cable shield via the cable strain relief.
12. Tighten the screws for the cable strain relief using a torque in the range of 1.2 to 1.7 Nm.
13. Reverse the removal procedure to reassemble the transmitter housing.

Connecting cable (option "mass pressure-/temperature-compensated")

8. Disconnect both signal cables from the connection board of the wall housing. by pressing in the locking clip on the connector. Remove the transmitter housing.
9. Guide the connecting cable through the cable entry and into the connection housing (if using a connecting cable without an M12 device plug, use the shorter stripped end of the connecting cable).
10. Wire the connecting cable:
 - ↳ Terminal 1 = brown cable
 - Terminal 2 = white cable
 - Terminal 3 = green cable
 - Terminal 4 = red cable
 - Terminal 5 = black cable
 - Terminal 6 = yellow cable
 - Terminal 7 = blue cable
11. Connect the cable shield via the cable strain relief.
12. Tighten the screws for the cable strain relief using a torque in the range of 1.2 to 1.7 Nm.
13. Reverse the removal procedure to reassemble the transmitter housing.

7.2.3 Connecting the connecting cable for the pressure measuring cell

When delivered to the customer, the connecting cable is connected as follows:

- Compact version: to transmitter housing
- Remote version: to sensor connection housing

For connection to sensor and pressure measuring cell:

- ▶ Insert M12 plug of connecting cable into pressure measuring cell and screw into place.

7.2.4 Ensuring potential equalization

Requirements

Please consider the following to ensure correct measurement:

- Same electrical potential for the fluid and sensor
- Remote version: same electrical potential for the sensor and transmitter
- Company-internal grounding concepts
- Pipe material and grounding

7.3 Ensuring the degree of protection

The measuring device fulfills all the requirements for the IP66/67 degree of protection, Type 4X enclosure.

To guarantee IP66/67 degree of protection, Type 4X enclosure, carry out the following steps after the electrical connection:

1. Check that the housing seals are clean and fitted correctly.
2. Dry, clean or replace the seals if necessary.
3. Tighten all housing screws and screw covers.
4. Firmly tighten the cable glands.
5. To ensure that moisture does not enter the cable entry:
Route the cable so that it loops down before the cable entry ("water trap").

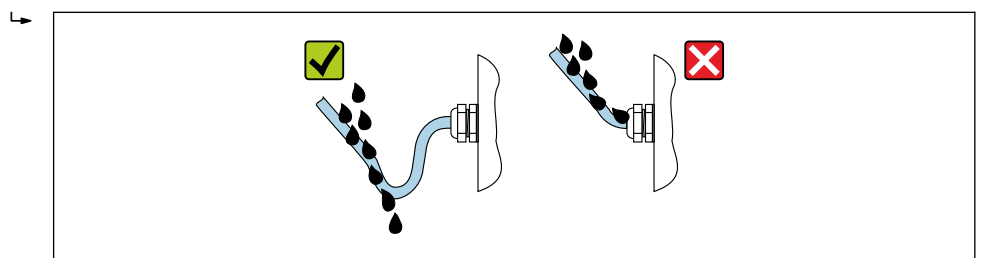



A0029278

6. Insert dummy plugs into unused cable entries.

7.4 Post-connection check

Are cables or the device undamaged (visual inspection)?	<input type="checkbox"/>
Do the cables used meet the requirements → 35?	<input type="checkbox"/>
Do the mounted cables have adequate strain relief?	<input type="checkbox"/>
Are all cable glands installed, securely tightened and leak-tight? Cable run with "water trap" → 47?	<input type="checkbox"/>
Depending on the device version, are all the device plugs firmly tightened → 41?	<input type="checkbox"/>

Only for remote version: is the sensor connected to the right transmitter? Check the serial number on the nameplate of the sensor and transmitter.	<input type="checkbox"/>
Does the supply voltage match the specifications on the transmitter nameplate?	<input type="checkbox"/>
Is the terminal assignment correct ?	<input type="checkbox"/>
If supply voltage is present, do values appear on the display module?	<input type="checkbox"/>
Are all the housing covers installed and tightened?	<input type="checkbox"/>
Is the securing clamp tightened correctly?	<input type="checkbox"/>
Have the screws for the cable strain relief been tightened using the correct torque→  42?	<input type="checkbox"/>
Has the M12 plug of the connecting cable been correctly connected to the pressure measuring cell→  47?	<input type="checkbox"/>

8 Operation options

8.1 Overview of operation options

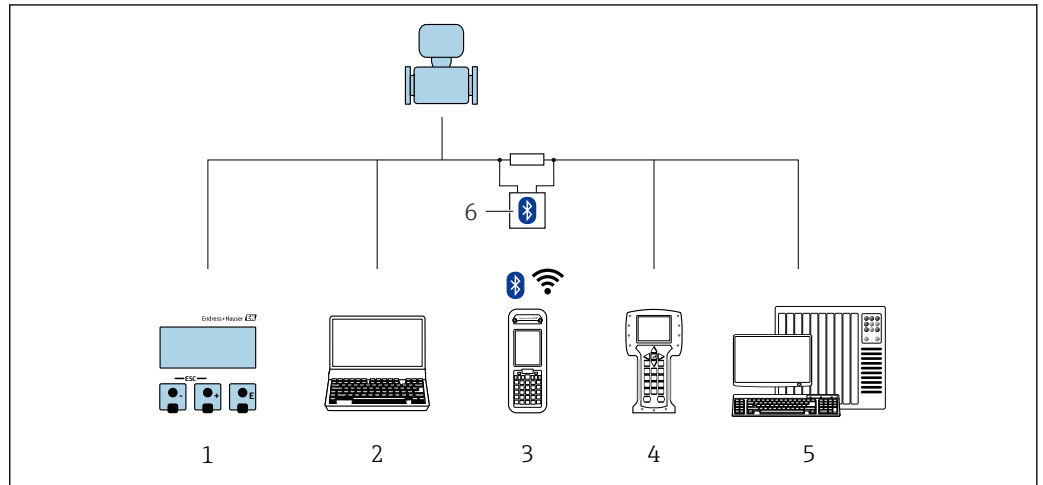

A0032226

- 1 Local operation via display module
- 2 Computer with operating tool (e.g. FieldCare, DeviceCare, AMS Device Manager, SIMATIC PDM)
- 3 Field Xpert SFX350 or SFX370
- 4 Field Communicator 475
- 5 Control system (e.g. PLC)
- 6 VIATOR Bluetooth modem with connecting cable

8.2 Structure and function of the operating menu

8.2.1 Structure of the operating menu

 For an overview of the operating menu for experts: "Description of Device Parameters" document supplied with the device

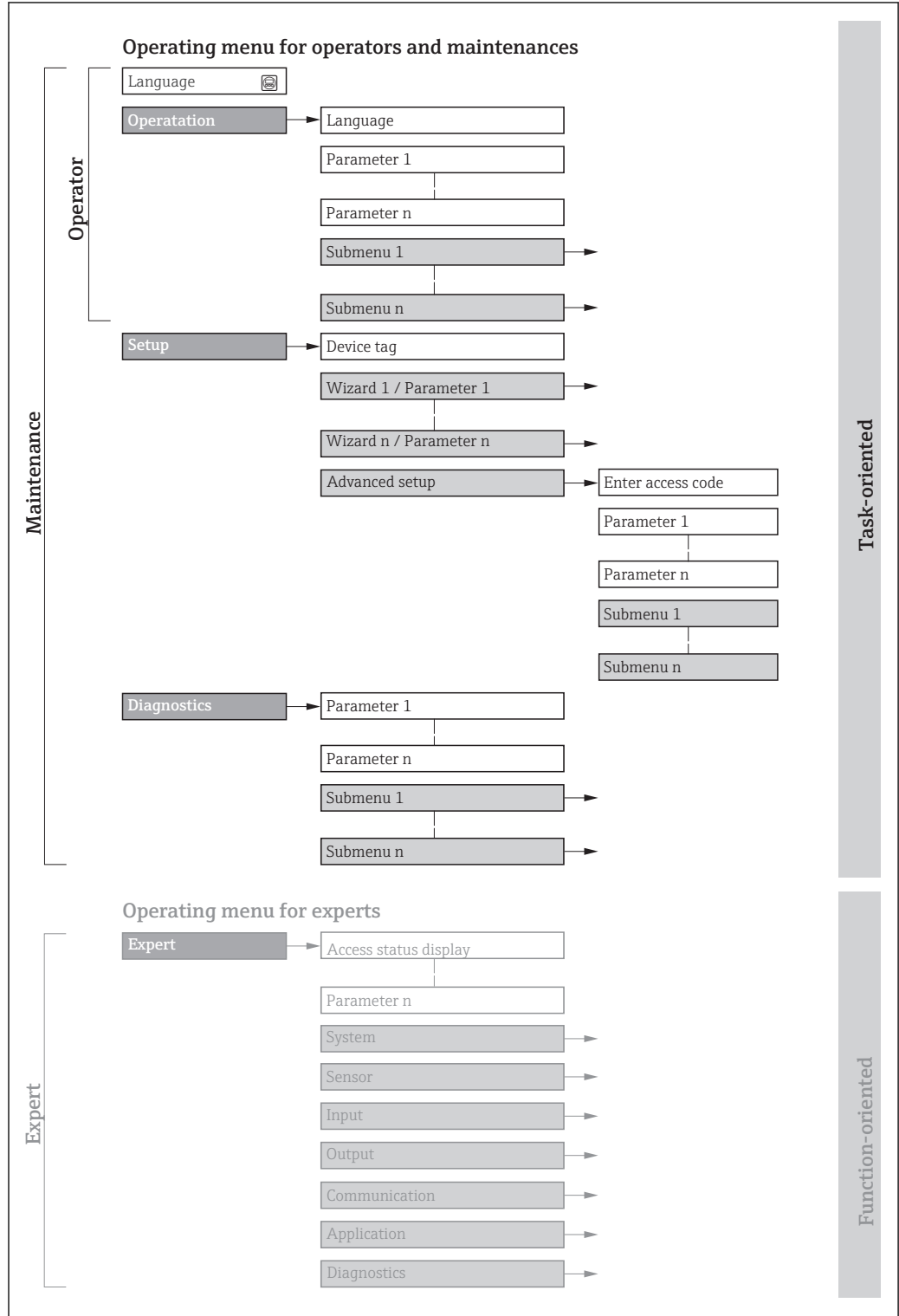

 18 Schematic structure of the operating menu

A0018237-EN

8.2.2 Operating philosophy

The individual parts of the operating menu are assigned to certain user roles (operator, maintenance etc.). Each user role contains typical tasks within the device lifecycle.

Menu/parameter		User role and tasks	Content/meaning
Language	task-oriented	Role "Operator", "Maintenance" Tasks during operation: <ul style="list-style-type: none"> ▪ Configuring the operational display ▪ Reading measured values 	<ul style="list-style-type: none"> ▪ Defining the operating language ▪ Resetting and controlling totalizers
Operation			<ul style="list-style-type: none"> ▪ Configuring the operational display (e.g. display format, display contrast) ▪ Resetting and controlling totalizers
Setup		"Maintenance" role Commissioning: <ul style="list-style-type: none"> ▪ Configuration of the measurement ▪ Configuration of the inputs and outputs 	Wizards for fast commissioning: <ul style="list-style-type: none"> ▪ Setting the system units ▪ Defining the medium ▪ Configuring the current input ▪ Configuring the outputs ▪ Configuring the operational display ▪ Defining the output conditioning ▪ Setting the low flow cut off Advanced setup <ul style="list-style-type: none"> ▪ For more customized configuration of the measurement (adaptation to special measuring conditions) ▪ Configuration of totalizers ▪ Configuring the WLAN settings ▪ Administration (define access code, reset measuring device)
Diagnostics		"Maintenance" role Fault elimination: <ul style="list-style-type: none"> ▪ Diagnostics and elimination of process and device errors ▪ Measured value simulation 	Contains all parameters for error detection and analyzing process and device errors: <ul style="list-style-type: none"> ▪ Diagnostic list Contains up to 5 currently pending diagnostic messages. ▪ Event logbook Contains event messages that have occurred. ▪ Device information Contains information for identifying the device. ▪ Measured values Contains all current measured values. ▪ Data logging submenu with "Extended HistoROM" order option Storage and visualization of measured values ▪ Heartbeat The functionality of the device is checked on demand and the verification results are documented. ▪ Simulation Is used to simulate measured values or output values.
Expert	function-oriented	Tasks that require detailed knowledge of the function of the device: <ul style="list-style-type: none"> ▪ Commissioning measurements under difficult conditions ▪ Optimal adaptation of the measurement to difficult conditions ▪ Detailed configuration of the communication interface ▪ Error diagnostics in difficult cases 	Contains all the parameters of the device and makes it possible to access these parameters directly using an access code. The structure of this menu is based on the function blocks of the device: <ul style="list-style-type: none"> ▪ System Contains all higher-order device parameters which do not concern the measurement or the communication interface. ▪ Sensor Configuration of the measurement. ▪ Input Configuration of the input. ▪ Output Configuration of the outputs. ▪ Communication Configuration of the digital communication interface. ▪ Application Configuration of the functions that go beyond the actual measurement (e.g. totalizer). ▪ Diagnostics Error detection and analysis of process and device errors and for device simulation and Heartbeat Technology.

8.3 Access to the operating menu via the local display

8.3.1 Operational display

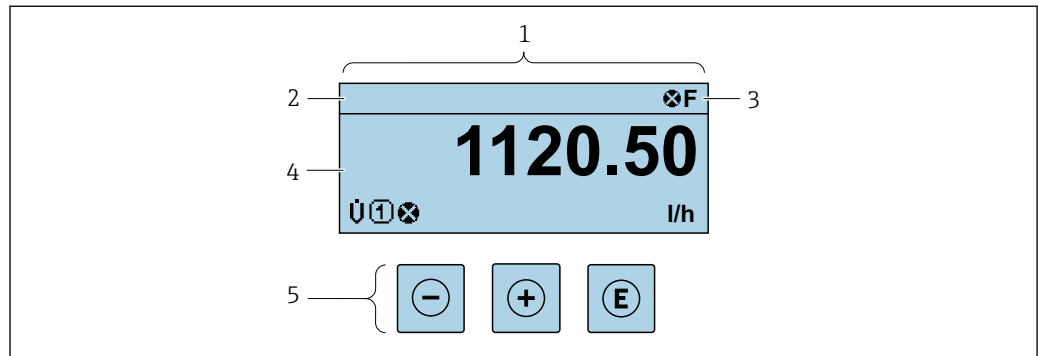

A0029346

- 1 Operational display
- 2 Device tag → 74
- 3 Status area
- 4 Display area for measured values (4-line)
- 5 Operating elements → 57

Status area

The following symbols appear in the status area of the operational display at the top right:

- Status signals → 144
 - **F**: Failure
 - **C**: Function check
 - **S**: Out of specification
 - **M**: Maintenance required
- Diagnostic behavior → 145
 - **⊗**: Alarm
 - **⚠**: Warning
 - **🔒**: Locking (the device is locked via the hardware)
 - **↔**: Communication (communication via remote operation is active)

Display area

In the display area, each measured value is prefaced by certain symbol types for further description:

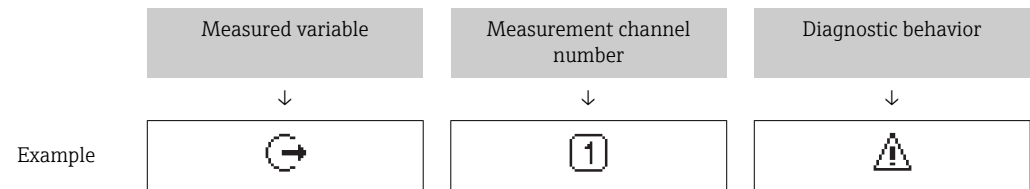

Appears only if a diagnostics event is present for this measured variable.

Measured values

Symbol	Meaning
Û	Volume flow

	<p>Totalizer</p> <p> The measurement channel number indicates which of the three totalizers is displayed.</p>
	<p>Output</p> <p> The measurement channel number indicates which of the two current outputs is displayed.</p>

Measurement channel numbers

Symbol	Meaning
	Measurement channel 1 to 4

The measurement channel number is displayed only if more than one channel is present for the same measured variable type (e.g. Totalizer 1 to 3).

Diagnostic behavior

The diagnostic behavior pertains to a diagnostic event that is relevant to the displayed measured variable. For information on the symbols → 145

The number and display format of the measured values can be configured via the **Format display** parameter (→ 90).

8.3.2 Navigation view

In the submenu	In the wizard
<p>1 Navigation view</p> <p>2 Navigation path to current position</p> <p>3 Status area</p> <p>4 Display area for navigation</p> <p>5 Operating elements → 57</p>	

Navigation path

The navigation path - displayed at the top left in the navigation view - consists of the following elements:



	<ul style="list-style-type: none"> ▪ In the submenu: Display symbol for menu ▪ In the wizard: Display symbol for wizard 	Omission symbol for operating menu levels in between	Name of current <ul style="list-style-type: none"> ▪ Submenu ▪ Wizard ▪ Parameters
	↓	↓	↓
Examples			

 For more information about the icons in the menu, refer to the "Display area" section →  54

Status area





The following appears in the status area of the navigation view in the top right corner:

- In the submenu
 - The direct access code for the parameter you are navigating to (e.g. 0022-1)
 - If a diagnostic event is present, the diagnostic behavior and status signal
- In the wizard
 - If a diagnostic event is present, the diagnostic behavior and status signal





-  ▪ For information on the diagnostic behavior and status signal →  144
- For information on the function and entry of the direct access code →  59

Display area

Menus

Symbol	Meaning
	Operation Appears: <ul style="list-style-type: none"> ▪ In the menu next to the "Operation" selection ▪ At the left in the navigation path in the Operation menu
	Setup Appears: <ul style="list-style-type: none"> ▪ In the menu next to the "Setup" selection ▪ At the left in the navigation path in the Setup menu
	Diagnostics Appears: <ul style="list-style-type: none"> ▪ In the menu next to the "Diagnostics" selection ▪ At the left in the navigation path in the Diagnostics menu
	Expert Appears: <ul style="list-style-type: none"> ▪ In the menu next to the "Expert" selection ▪ At the left in the navigation path in the Expert menu



Submenus, wizards, parameters

Symbol	Meaning
	Submenu
	Wizard
	Parameters within a wizard  No display symbol exists for parameters in submenus.

Locking

Symbol	Meaning
	Parameter locked When displayed in front of a parameter name, indicates that the parameter is locked. <ul style="list-style-type: none"> ▪ By a user-specific access code ▪ By the hardware write protection switch

Wizard operation

Symbol	Meaning
	Switches to the previous parameter.
	Confirms the parameter value and switches to the next parameter.
	Opens the editing view of the parameter.



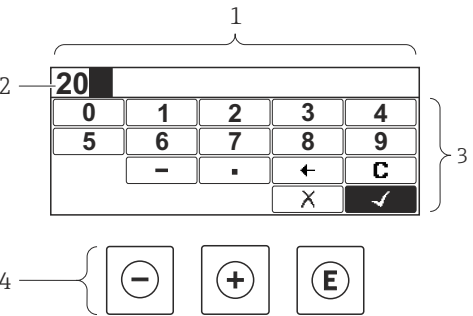
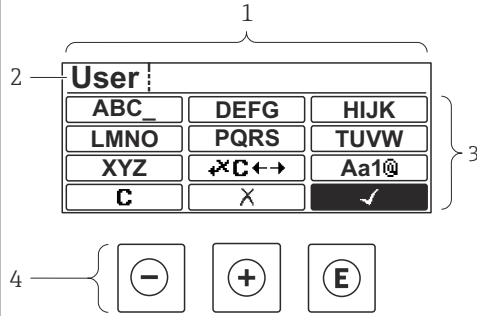



8.3.3 Editing view

Numeric editor	Text editor
	
<p>1 Editing view</p> <p>2 Display area of the entered values</p> <p>3 Input mask</p> <p>4 Operating elements → 57</p>	<p>1 Editing view</p> <p>2 Display area of the entered values</p> <p>3 Input mask</p> <p>4 Operating elements → 57</p>

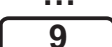









Input mask

The following input symbols are available in the input mask of the numeric and text editor:





Numeric editor

Symbol	Meaning
	Selection of numbers from 0 to 9.
	
	Inserts decimal separator at the input position.
	Inserts minus sign at the input position.
	Confirms selection.
	Moves the input position one position to the left.
	Exits the input without applying the changes.
	Clears all entered characters.







Text editor

Symbol	Meaning
	Toggle <ul style="list-style-type: none"> ▪ Between upper-case and lower-case letters ▪ For entering numbers ▪ For entering special characters
 ... 	Selection of letters from A to Z.
 ... 	Selection of letters from a to z.
 ... 	Selection of special characters.
	Confirms selection.
	Switches to the selection of the correction tools.
	Exits the input without applying the changes.
	Clears all entered characters.

Correction symbols under 

Symbol	Meaning
	Clears all entered characters.
	Moves the input position one position to the right.
	Moves the input position one position to the left.
	Deletes one character immediately to the left of the input position.

8.3.4 Operating elements

Operating key(s)	Meaning
	<p>Minus key</p> <p><i>In a menu, submenu</i> Moves the selection bar upwards in a picklist.</p> <p><i>With a Wizard</i> Confirms the parameter value and goes to the previous parameter.</p> <p><i>With a text and numeric editor</i> In the input screen, moves the selection bar to the left (backwards).</p>
	<p>Plus key</p> <p><i>In a menu, submenu</i> Moves the selection bar downwards in a picklist.</p> <p><i>With a Wizard</i> Confirms the parameter value and goes to the next parameter.</p> <p><i>With a text and numeric editor</i> Moves the selection bar to the right (forwards) in an input screen.</p>
	<p>Enter key</p> <p><i>For operational display</i> Pressing the key for 2 s opens the context menu.</p> <p><i>In a menu, submenu</i></p> <ul style="list-style-type: none"> ▪ Pressing the key briefly: <ul style="list-style-type: none"> ▪ Opens the selected menu, submenu or parameter. ▪ Starts the wizard. ▪ If help text is open, closes the help text of the parameter. ▪ Pressing the key for 2 s for parameter: <ul style="list-style-type: none"> ▪ If present, opens the help text for the function of the parameter. <p><i>With a Wizard</i> Opens the editing view of the parameter.</p> <p><i>With a text and numeric editor</i></p> <ul style="list-style-type: none"> ▪ Pressing the key briefly: <ul style="list-style-type: none"> ▪ Opens the selected group. ▪ Carries out the selected action. ▪ Pressing the key for 2 s confirms the edited parameter value.
	<p>Escape key combination (press keys simultaneously)</p> <p><i>In a menu, submenu</i></p> <ul style="list-style-type: none"> ▪ Pressing the key briefly: <ul style="list-style-type: none"> ▪ Exits the current menu level and takes you to the next higher level. ▪ If help text is open, closes the help text of the parameter. ▪ Pressing the key for 2 s returns you to the operational display ("home position"). <p><i>With a Wizard</i> Exits the wizard and takes you to the next higher level.</p> <p><i>With a text and numeric editor</i> Closes the text or numeric editor without applying changes.</p>
	<p>Plus/Enter key combination (press and hold down the keys simultaneously)</p> <p>Increases the contrast (darker setting).</p>
	<p>Minus/Plus/Enter key combination (press the keys simultaneously)</p> <p><i>For operational display</i> Enables or disables the keypad lock (only SD02 display module).</p>

8.3.5 Opening the context menu

Using the context menu, the user can call up the following menus quickly and directly from the operational display:

- Setup
- Configuration backup display
- Simulation

Calling up and closing the context menu

The user is in the operational display.

1. Press the \square and \square keys for longer than 3 seconds.
↳ The context menu opens.

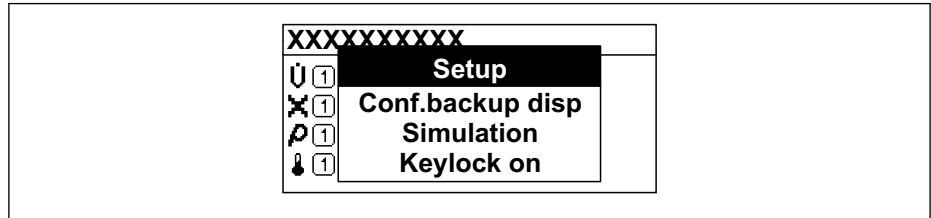

2. Press \square + \square simultaneously.
↳ The context menu is closed and the operational display appears.

Calling up the menu via the context menu

1. Open the context menu.
2. Press \square to navigate to the desired menu.
3. Press \square to confirm the selection.
↳ The selected menu opens.

8.3.6 Navigating and selecting from list

Different operating elements are used to navigate through the operating menu. The navigation path is displayed on the left in the header. Icons are displayed in front of the individual menus. These icons are also shown in the header during navigation.

i For an explanation of the navigation view with symbols and operating elements → 53

Example: Setting the number of displayed measured values to "2 values"

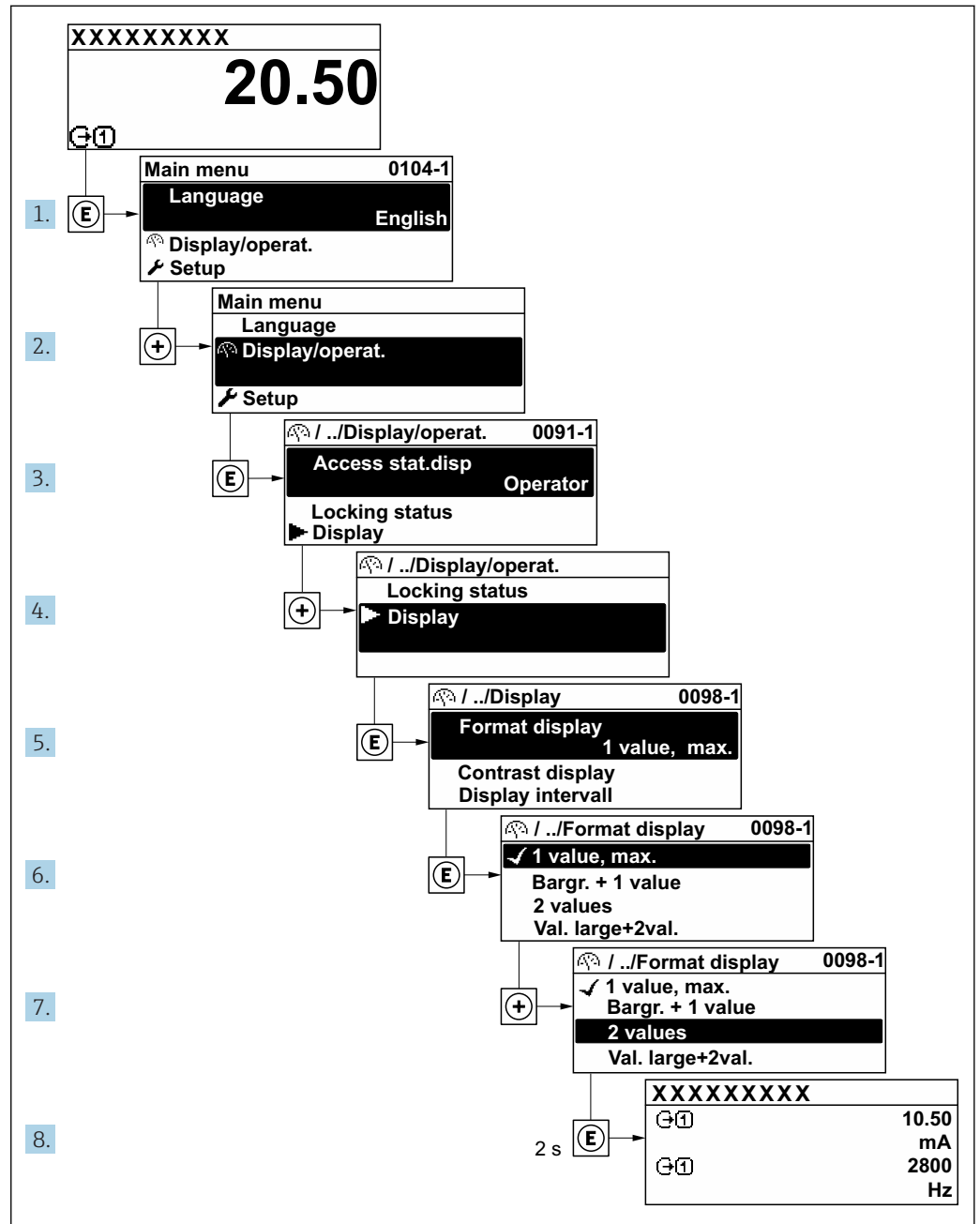

A0029562-EN

8.3.7 Calling the parameter directly

A parameter number is assigned to every parameter to be able to access a parameter directly via the onsite display. Entering this access code in the **Direct access** parameter calls up the desired parameter directly.

Navigation path

Expert → Direct access

The direct access code consists of a 5-digit number (at maximum) and the channel number, which identifies the channel of a process variable: e.g. 00914-2. In the navigation view, this appears on the right-hand side in the header of the selected parameter.

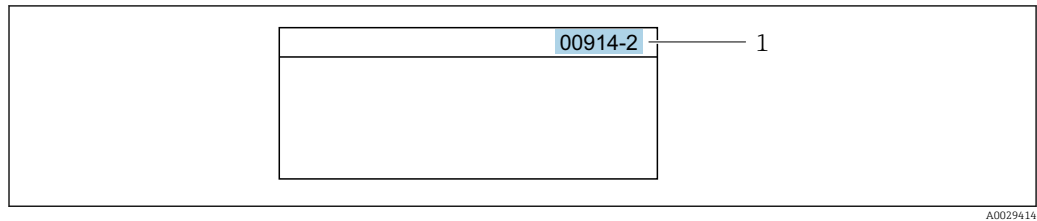

1 Direct access code

Note the following when entering the direct access code:

- The leading zeros in the direct access code do not have to be entered.
Example: Enter "914" instead of "00914"
- If no channel number is entered, channel 1 is accessed automatically.
Example: Enter 00914 → **Assign process variable** parameter
- If a different channel is accessed: Enter the direct access code with the corresponding channel number.
Example: Enter 00914-2 → **Assign process variable** parameter



For the direct access codes of the individual parameters, see the "Description of Device Parameters" document for the device

8.3.8 Calling up help text

Help text is available for some parameters and can be called up from the navigation view. The help text provides a brief explanation of the parameter function and thereby supports swift and safe commissioning.



Calling up and closing the help text

The user is in the navigation view and the selection bar is on a parameter.

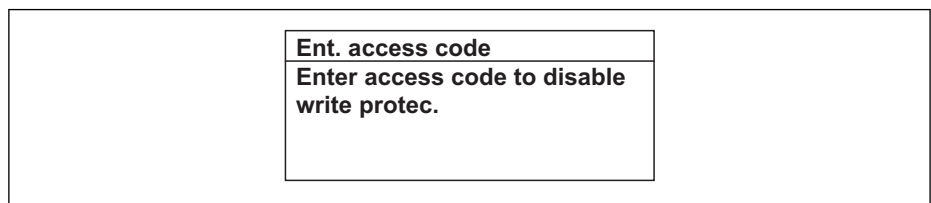
1. Press  for 2 s.
↳ The help text for the selected parameter opens.



19 Example: Help text for parameter "Enter access code"

2. Press  +  simultaneously.
↳ The help text is closed.

8.3.9 Changing the parameters

i For a description of the editing view - consisting of the text editor and numeric editor - with symbols → 55, for a description of the operating elements → 57

Example: Changing the tag name in the "Tag description" parameter from 001-FT-101 to 001-FT-102

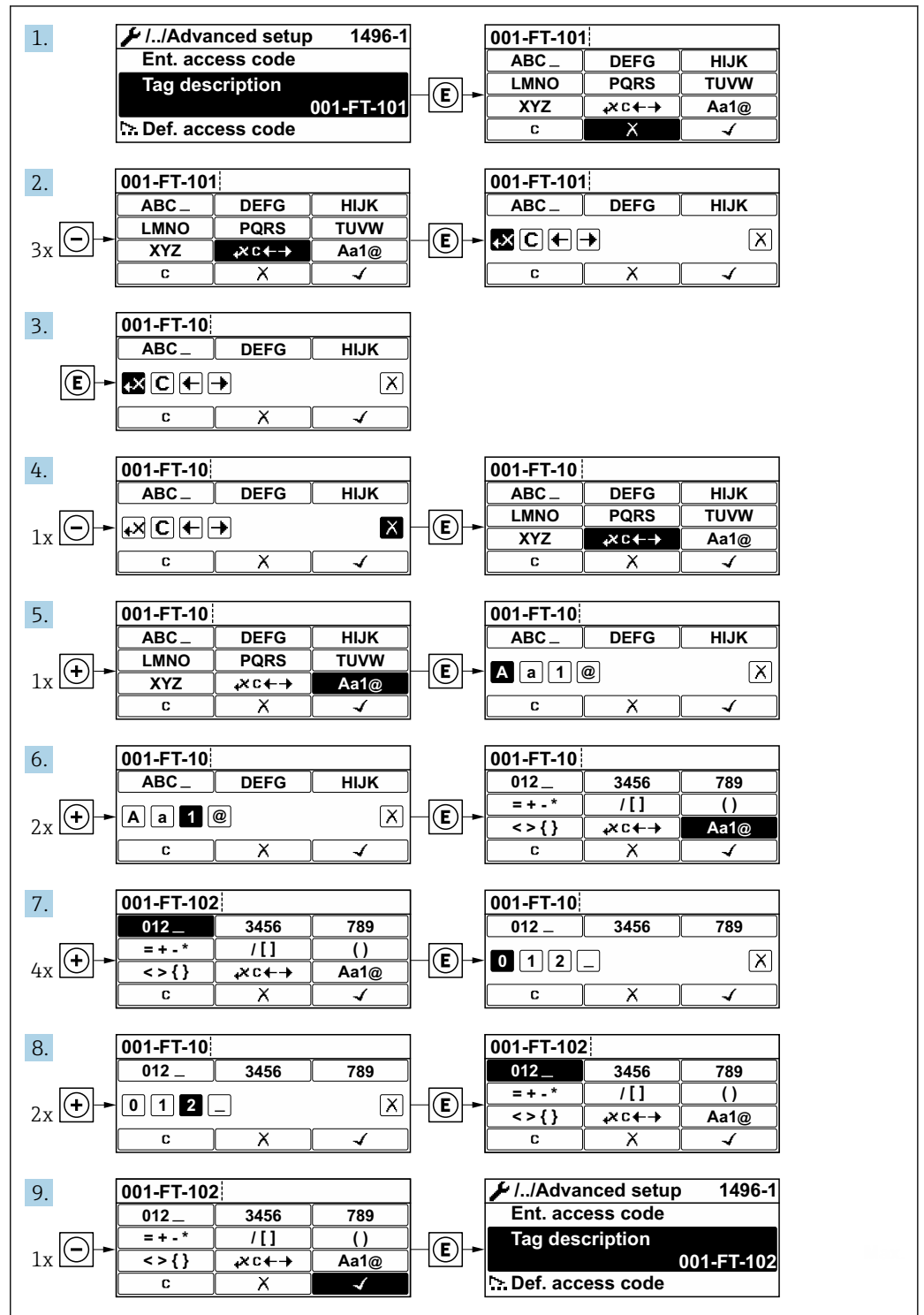

A0029563-EN

A message is displayed if the value entered is outside the permitted value range.

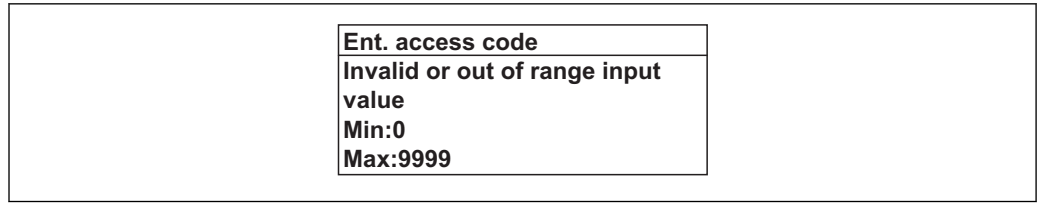

A0014049-EN

8.3.10 User roles and related access authorization

The two user roles "Operator" and "Maintenance" have different write access to the parameters if the customer defines a user-specific access code. This protects the device configuration via the local display from unauthorized access .

Defining access authorization for user roles

An access code is not yet defined when the device is delivered from the factory. Access authorization (read and write access) to the device is not restricted and corresponds to the "Maintenance" user role.

- ▶ Define the access code.
 - ↳ The "Operator" user role is redefined in addition to the "Maintenance" user role. Access authorization differs for the two user roles.

Access authorization to parameters: "Maintenance" user role

Access code status	Read access	Write access
An access code has not yet been defined (factory setting).	✓	✓
After an access code has been defined.	✓	✓ ¹⁾

1) The user only has write access after entering the access code.

Access authorization to parameters: "Operator" user role

Access code status	Read access	Write access
After an access code has been defined.	✓	-- ¹⁾

1) Despite the defined access code, certain parameters can always be modified and thus are exempted from the write protection, as they do not affect the measurement. Refer to the "Write protection via access code" section

i The user role with which the user is currently logged on is indicated by the **Access status display** parameter. Navigation path: Operation → Access status display

8.3.11 Disabling write protection via access code

If the -symbol appears on the local display in front of a parameter, the parameter is write-protected by a user-specific access code and its value cannot be changed at the moment using local operation → 120.

Parameter write protection via local operation can be disabled by entering the user-specific access code in the **Enter access code** parameter via the respective access option.

1. After you press , the input prompt for the access code appears.
2. Enter the access code.
 - ↳ The -symbol in front of the parameters disappears; all previously write-protected parameters are now re-enabled.

8.3.12 Enabling and disabling the keypad lock

The keypad lock makes it possible to block access to the entire operating menu via local operation. As a result, it is no longer possible to navigate through the operating menu or change the values of individual parameters. Users can only read the measured values on the operational display.

The keypad lock is switched on and off via the context menu.



Switching on the keypad lock

For the SD03 display only

The keypad lock is switched on automatically:



- If the device has not been operated via the display for > 1 minute.
- Each time the device is restarted.

To activate the keylock manually:

1. The device is in the measured value display.
Press the  and  keys for 3 seconds.
↳ A context menu appears.
2. In the context menu select the **Keylock on** option.
↳ The keypad lock is switched on.

 If the user attempts to access the operating menu while the keypad lock is active, the **Keylock on** message appears.

Switching off the keypad lock

- ▶ The keypad lock is switched on.
Press the  and  keys for 3 seconds.
↳ The keypad lock is switched off.

8.4 Access to the operating menu via the operating tool

The structure of the operating menu in the operating tools is the same as for operation via the local display.

8.4.1 Connecting the operating tool

Via HART protocol

This communication interface is available in device versions with a HART output.

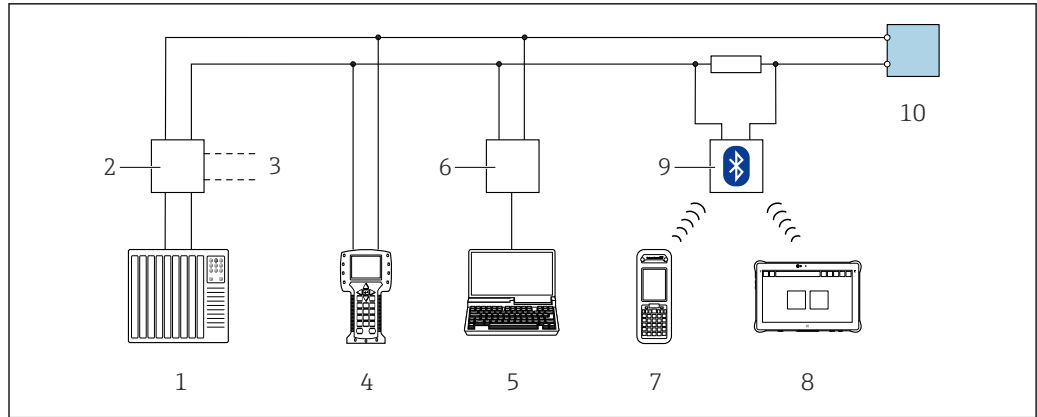

A0028746

20 Options for remote operation via HART protocol (passive)

- 1 Control system (e.g. PLC)
- 2 Transmitter power supply unit, e.g. RN221N (with communication resistor)
- 3 Connection for Commubox FXA195 and Field Communicator 475
- 4 Field Communicator 475
- 5 Computer with web browser (e.g. Internet Explorer) for accessing computers with operating tool (e.g. FieldCare, DeviceCare, AMS Device Manager, SIMATIC PDM) with COM DTM "CDI Communication TCP/IP"
- 6 Commubox FXA195 (USB)
- 7 Field Xpert SFX350 or SFX370
- 8 VIATOR Bluetooth modem with connecting cable
- 9 Transmitter

Via service interface (CDI)

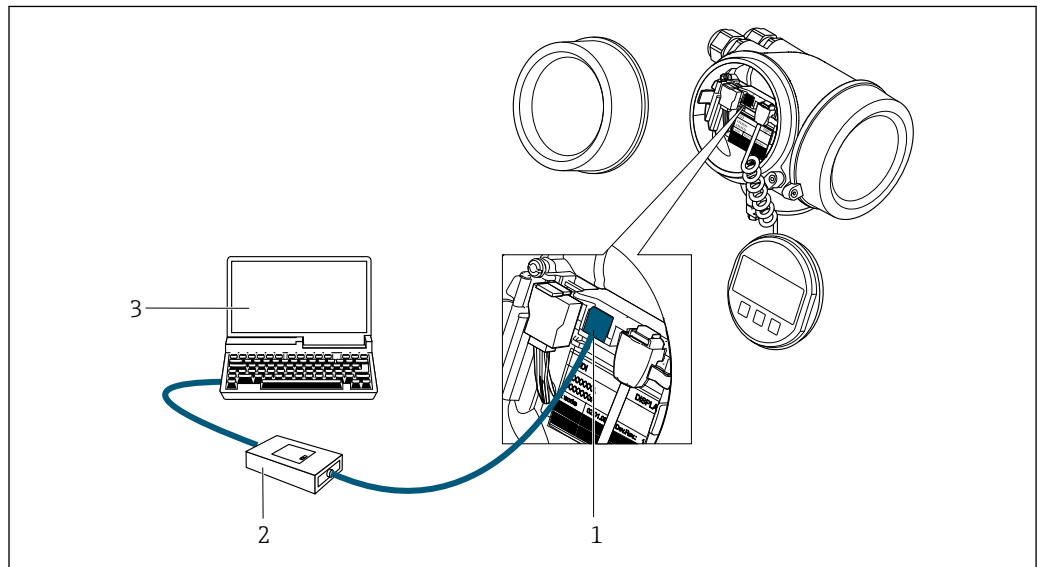

A0034056

- 1 Service interface (CDI = Endress+Hauser Common Data Interface) of the measuring device
- 2 Commubox FXA291
- 3 Computer with FieldCare operating tool with COM DTM CDI Communication FXA291

8.4.2 Field Xpert SFX350, SFX370

Function range

Field Xpert SFX350 and Field Xpert SFX370 are mobile computers for commissioning and maintenance. They enable efficient device configuration and diagnostics for HART and

FOUNDATION Fieldbus devices in the **non-hazardous area** (SFX350, SFX370) and **hazardous area** (SFX370).



For details, see Operating Instructions BA01202S

Source for device description files

See information →  68

8.4.3 FieldCare

Function scope

FDT-based plant asset management tool from Endress+Hauser. It can configure all smart field devices in a system and helps you manage them. By using the status information, it is also a simple but effective way of checking their status and condition.

Access is via:

- HART protocol
- CDI service interface →  64

Typical functions:

- Configuring parameters of transmitters
- Loading and saving device data (upload/download)
- Documentation of the measuring point
- Visualization of the measured value memory (line recorder) and event logbook



For additional information about FieldCare, see Operating Instructions BA00027S and BA00059S

Source for device description files

See information →  68

Establishing a connection



For additional information, see Operating Instructions BA00027S and BA00059S

User interface

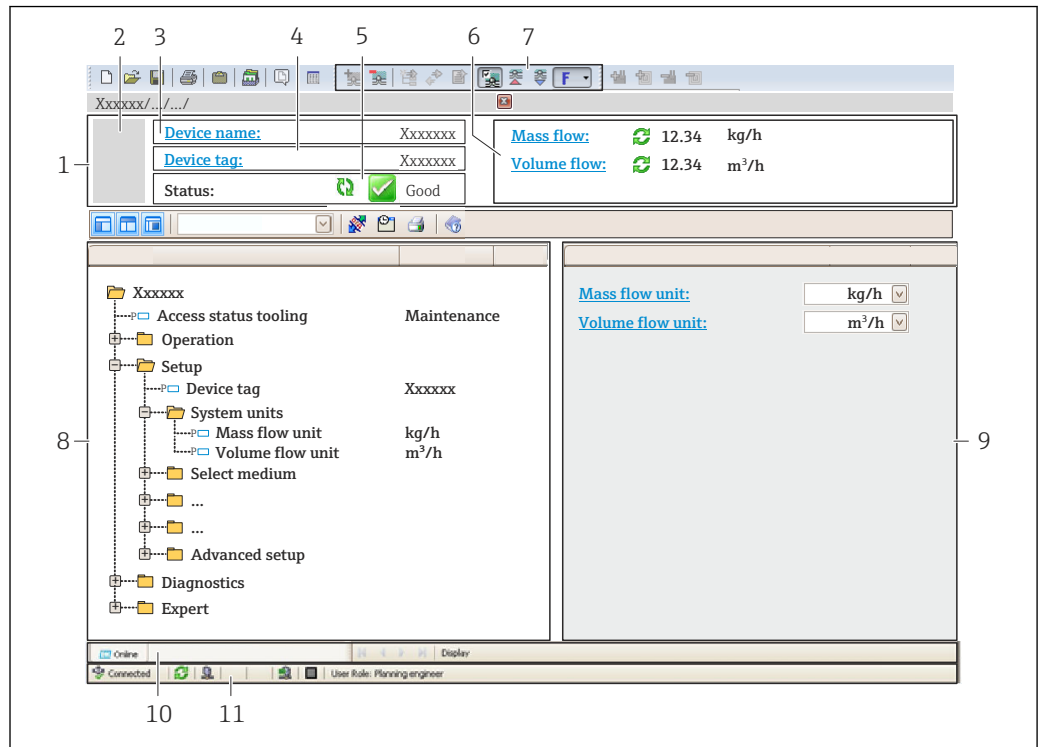

A0021051-EN

- 1 Header
- 2 Picture of device
- 3 Device name
- 4 Device tag
- 5 Status area with status signal → 147
- 6 Display area for current measured values
- 7 Edit toolbar with additional functions such as save/restore, event list and create documentation
- 8 Navigation area with operating menu structure
- 9 Working area
- 10 Range of action
- 11 Status area

8.4.4 DeviceCare

Function scope

Tool to connect and configure Endress+Hauser field devices.

The fastest way to configure Endress+Hauser field devices is with the dedicated "DeviceCare" tool. Together with the device type managers (DTMs) it presents a convenient, comprehensive solution.

 For details, see Innovation Brochure IN01047S

Source for device description files

See information → 68

8.4.5 AMS Device Manager

Function scope

Program from Emerson Process Management for operating and configuring measuring devices via HART protocol.

Source for device description files

See data →  68

8.4.6 SIMATIC PDM**Function scope**

SIMATIC PDM is a standardized, manufacturer-independent program from Siemens for the operation, configuration, maintenance and diagnosis of intelligent field devices via HART protocol.

Source for device description files

See data →  68

8.4.7 Field Communicator 475**Function scope**

Industrial handheld terminal from Emerson Process Management for remote configuration and measured value display via HART protocol.

Source for device description files

See data →  68

9 System integration

9.1 Overview of device description files

9.1.1 Current version data for the device

Firmware version	01.03.00	<ul style="list-style-type: none"> ▪ On the title page of the Operating Instructions ▪ On the transmitter nameplate ▪ Firmware version parameter Diagnostics → Device information → Firmware version
Release date of firmware version	01.2018	---
Manufacturer ID	0x11	Manufacturer ID parameter Diagnostics → Device information → Manufacturer ID
Device type ID	0x38	Device type parameter Diagnostics → Device information → Device type
HART protocol revision	7	---
Device revision	4	<ul style="list-style-type: none"> ▪ On the transmitter nameplate ▪ Device revision parameter Diagnostics → Device information → Device revision



For an overview of the different firmware versions for the device

9.1.2 Operating tools

The suitable device description file for the individual operating tools is listed in the table below, along with information on where the file can be acquired.

Operating tool via HART protocol	Sources for obtaining device descriptions
FieldCare	<ul style="list-style-type: none"> ▪ www.endress.com → Download Area ▪ CD-ROM (contact Endress+Hauser) ▪ DVD (contact Endress+Hauser)
DeviceCare	<ul style="list-style-type: none"> ▪ www.endress.com → Download Area ▪ CD-ROM (contact Endress+Hauser) ▪ DVD (contact Endress+Hauser)
<ul style="list-style-type: none"> ▪ Field Xpert SFX350 ▪ Field Xpert SFX370 	Use update function of handheld terminal
AMS Device Manager (Emerson Process Management)	www.endress.com → Download Area
SIMATIC PDM (Siemens)	www.endress.com → Download Area
Field Communicator 475 (Emerson Process Management)	Use update function of handheld terminal

9.2 Measured variables via HART protocol

The following measured variables (HART device variables) are assigned to the dynamic variables at the factory:

Dynamic variables	Measured variables (HART device variables)
Primary dynamic variable (PV)	Volume flow
Secondary dynamic variable (SV)	Temperature
Tertiary dynamic variable (TV)	Totalizer 1
Quaternary dynamic variable (QV)	Totalizer 2

The assignment of the measured variables to the dynamic variables can be modified and assigned as desired via local operation and the operating tool using the following parameters:

- Expert → Communication → HART output → Output → Assign PV
- Expert → Communication → HART output → Output → Assign SV
- Expert → Communication → HART output → Output → Assign TV
- Expert → Communication → HART output → Output → Assign QV

The following measured variables can be assigned to the dynamic variables:

Measured variables for PV (primary dynamic variable)

- Off
- Volume flow
- Corrected volume flow
- Mass flow
- Flow velocity
- Temperature
- Pressure
- Calculated saturated steam pressure
- Total mass flow
- Energy flow
- Heat flow difference

Measured variables for SV, TV, QV (secondary, tertiary and quaternary dynamic variable)

- Volume flow
- Corrected volume flow
- Mass flow
- Flow velocity
- Temperature
- Calculated saturated steam pressure
- Total mass flow
- Energy flow
- Heat flow difference
- Condensate mass flow
- Reynolds number
- Totalizer 1...3
- HART input
- Density
- Pressure
- Specific volume
- Degrees of superheat

Device variables

The device variables are permanently assigned. A maximum of 8 device variables can be transmitted:

- 0 = volume flow
- 1 = corrected volume flow
- 2 = Mass flow
- 3 = flow velocity
- 4 = temperature
- 5 = calculated saturated steam pressure

- 7 = total mass flow
- 8 = energy flow
- 9 = heat flow difference
- 17 = pressure

9.3 Other settings

Burst mode functionality in accordance with HART 7 Specification:

Navigation

"Expert" menu → Communication → HART output → Burst configuration → Burst configuration 1 to n

► Burst configuration	
► Burst configuration 1 to n	
Burst mode 1 to n	→ 71
Burst command 1 to n	→ 71
Burst variable 0	→ 71
Burst variable 1	→ 71
Burst variable 2	→ 71
Burst variable 3	→ 71
Burst variable 4	→ 71
Burst variable 5	→ 71
Burst variable 6	→ 71
Burst variable 7	→ 71
Burst trigger mode	→ 71
Burst trigger level	→ 71
Min. update period	→ 72
Max. update period	→ 72

Parameter overview with brief description

Parameter	Description	Selection / User entry	Factory setting
Burst mode 1 to n	Activate the HART burst mode for burst message X.	<ul style="list-style-type: none"> ■ Off ■ On 	Off
Burst command 1 to n	Select the HART command that is sent to the HART master.	<ul style="list-style-type: none"> ■ Command 1 ■ Command 2 ■ Command 3 ■ Command 9 ■ Command 33 ■ Command 48 	Command 2
Burst variable 0	For HART command 9 and 33: select the HART device variable or the process variable.	<ul style="list-style-type: none"> ■ Volume flow ■ Corrected volume flow ■ Mass flow ■ Flow velocity ■ Temperature ■ Calculated saturated steam pressure * ■ Total mass flow * ■ Energy flow * ■ Heat flow difference * ■ Condensate mass flow * ■ Reynolds number * ■ Totalizer 1 ■ Totalizer 2 ■ Totalizer 3 ■ HART input ■ Density * ■ Pressure * ■ Specific volume * ■ Degrees of superheat * ■ Percent of range ■ Measured current ■ Primary variable (PV) ■ Secondary variable (SV) ■ Tertiary variable (TV) ■ Quaternary variable (QV) ■ Not used 	Volume flow
Burst variable 1	For HART command 9 and 33: select the HART device variable or the process variable.	See the Burst variable 0 parameter.	Not used
Burst variable 2	For HART command 9 and 33: select the HART device variable or the process variable.	See the Burst variable 0 parameter.	Not used
Burst variable 3	For HART command 9 and 33: select the HART device variable or the process variable.	See the Burst variable 0 parameter.	Not used
Burst variable 4	For HART command 9: select the HART device variable or the process variable.	See the Burst variable 0 parameter.	Not used
Burst variable 5	For HART command 9: select the HART device variable or the process variable.	See the Burst variable 0 parameter.	Not used
Burst variable 6	For HART command 9: select the HART device variable or the process variable.	See the Burst variable 0 parameter.	Not used
Burst variable 7	For HART command 9: select the HART device variable or the process variable.	See the Burst variable 0 parameter.	Not used
Burst trigger mode	Select the event that triggers burst message X.	<ul style="list-style-type: none"> ■ Continuous ■ Window ■ Rising ■ Falling ■ On change 	Continuous
Burst trigger level	Enter the burst trigger value. Together with the option selected in the Burst trigger mode parameter the burst trigger value determines the time of burst message X.	Signed floating-point number	-

Parameter	Description	Selection / User entry	Factory setting
Min. update period	Enter the minimum time span between two burst commands of burst message X.	Positive integer	1 000 ms
Max. update period	Enter the maximum time span between two burst commands of burst message X.	Positive integer	2 000 ms

* Visibility depends on order options or device settings

10 Commissioning

10.1 Function check

Before commissioning the measuring device:

- ▶ Make sure that the post-installation and post-connection checks have been performed.
- "Post-installation check" checklist → 33
- "Post-connection check" checklist → 47

10.2 Switching on the measuring device

- ▶ After a successful function check, switch on the measuring device.
 - ↳ After a successful startup, the local display switches automatically from the startup display to the operational display.

If nothing appears on the local display or a diagnostic message is displayed, refer to the section on "Diagnostics and troubleshooting" → 142.

10.3 Setting the operating language

Factory setting: English or ordered local language

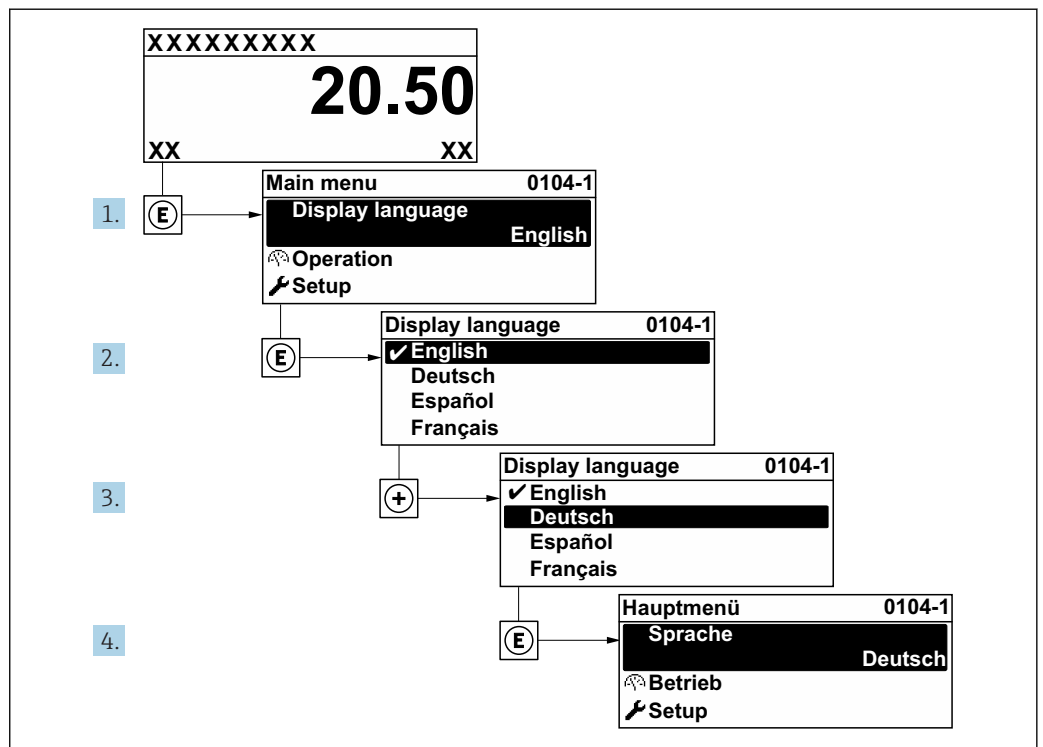

21 Taking the example of the local display

A0029420

10.4 Configuring the measuring device

- The **Setup** menu with its guided wizards contains all the parameters needed for standard operation.
- Navigation to the **Setup** menu

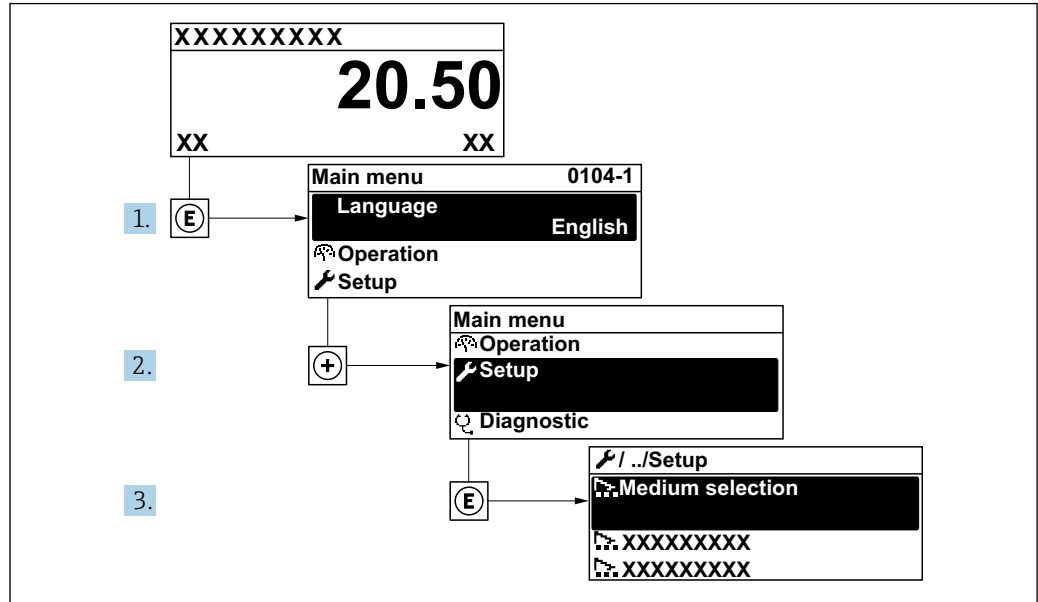

A0034189-EN

22 Taking the example of the local display

🔧 Setup	
Device tag	→ 📖 75
▶ System units	→ 📖 75
▶ Medium selection	→ 📖 79
▶ Current input	→ 📖 81
▶ Current output 1 to n	→ 📖 83
▶ Pulse/frequency/switch output	→ 📖 84
▶ Display	→ 📖 89
▶ Low flow cut off	→ 📖 91
▶ Advanced setup	→ 📖 93

10.4.1 Defining the tag name

To enable fast identification of the measuring point within the system, you can enter a unique designation using the **Device tag** parameter and thus change the factory setting.

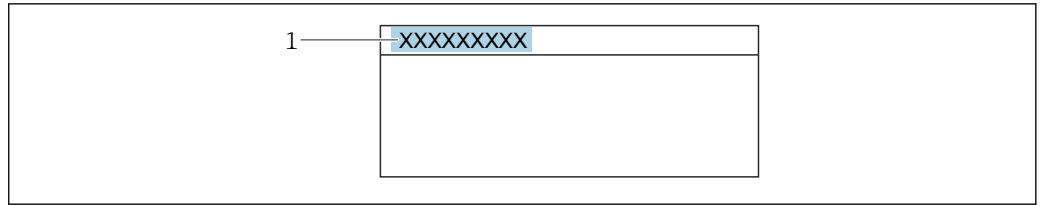

A0029422

23 Header of the operational display with tag name

1 Tag name

i Enter the tag name in the "FieldCare" operating tool → 66

Navigation

"Setup" menu → Device tag

Parameter overview with brief description

Parameter	Description	User entry	Factory setting
Device tag	Enter the name for the measuring point.	Max. 32 characters, such as letters, numbers or special characters (e.g. @, %, /).	Prowirl

10.4.2 Setting the system units







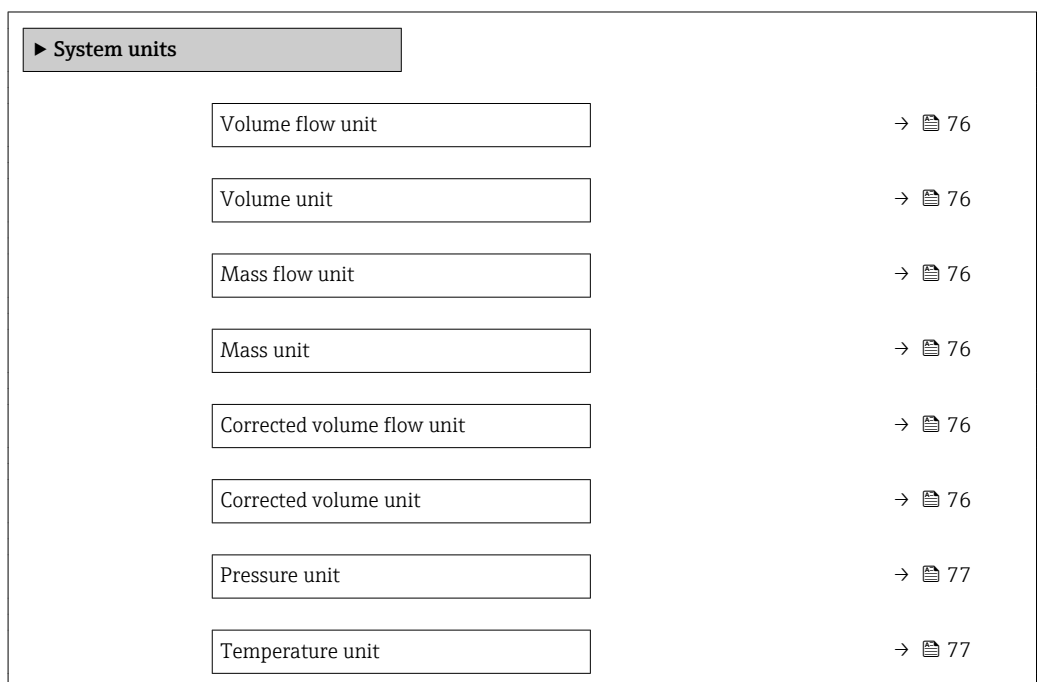

In the **System units** submenu the units of all the measured values can be set.

i The number of submenus and parameters can vary depending on the device version. Certain submenus and parameters in these submenus are not described in the Operation Instructions. Instead a description is provided in the Special Documentation for the device (→ "Supplementary documentation" section).

Navigation

"Setup" menu → System units



Energy flow unit	→  77
Energy unit	→  77
Calorific value unit	→  77
Calorific value unit	→  78
Velocity unit	→  78
Density unit	→  78
Specific volume unit	→  78
Dynamic viscosity unit	→  78
Length unit	→  78

Parameter overview with brief description

Parameter	Prerequisite	Description	Selection	Factory setting
Volume flow unit	–	Select volume flow unit. <i>Result</i> The selected unit applies for: <ul style="list-style-type: none"> ▪ Output ▪ Low flow cut off ▪ Simulation process variable 	Unit choose list	Country-specific: <ul style="list-style-type: none"> ▪ m³/h ▪ ft³/min
Volume unit	–	Select volume unit.	Unit choose list	Country-specific: <ul style="list-style-type: none"> ▪ m³ ▪ ft³
Mass flow unit	–	Select mass flow unit. <i>Result</i> The selected unit applies for: <ul style="list-style-type: none"> ▪ Output ▪ Low flow cut off ▪ Simulation process variable 	Unit choose list	Country-specific: <ul style="list-style-type: none"> ▪ kg/h ▪ lb/min
Mass unit	–	Select mass unit.	Unit choose list	Country-specific: <ul style="list-style-type: none"> ▪ kg ▪ lb
Corrected volume flow unit	–	Select corrected volume flow unit. <i>Result</i> The selected unit applies for: Corrected volume flow parameter (→  133)	Unit choose list	Country-specific: <ul style="list-style-type: none"> ▪ Nm³/h ▪ Sft³/h
Corrected volume unit	–	Select corrected volume unit.	Unit choose list	Country-specific: <ul style="list-style-type: none"> ▪ Nm³ ▪ Sft³

Parameter	Prerequisite	Description	Selection	Factory setting
Pressure unit	With order code for "Sensor version": <ul style="list-style-type: none"> ▪ option "Mass (integrated temperature measurement)" or ▪ option "Mass (integrated pressure/temperature measurement)" 	Select process pressure unit. <i>Result</i> The unit is taken from: <ul style="list-style-type: none"> ▪ Calculated saturated steam pressure ▪ Atmospheric pressure ▪ Maximum value ▪ Fixed process pressure ▪ Pressure ▪ Reference pressure 	Unit choose list	Country-specific: <ul style="list-style-type: none"> ▪ bar ▪ psi
Temperature unit	–	Select temperature unit. <i>Result</i> The selected unit applies for: <ul style="list-style-type: none"> ▪ Temperature ▪ Maximum value ▪ Minimum value ▪ Average value ▪ Maximum value ▪ Minimum value ▪ Maximum value ▪ Minimum value ▪ 2nd temperature delta heat ▪ Fixed temperature ▪ Reference combustion temperature ▪ Reference temperature ▪ Saturation temperature 	Unit choose list	Country-specific: <ul style="list-style-type: none"> ▪ °C ▪ °F
Energy flow unit	With order code for "Sensor version": <ul style="list-style-type: none"> ▪ option "Mass (integrated temperature measurement)" or ▪ option "Mass (integrated pressure/temperature measurement)" 	Select energy flow unit. <i>Result</i> The selected unit applies for: <ul style="list-style-type: none"> ▪ Heat flow difference parameter ▪ Energy flow parameter 	Unit choose list	Country-specific: <ul style="list-style-type: none"> ▪ kW ▪ Btu/h
Energy unit	With order code for "Sensor version": <ul style="list-style-type: none"> ▪ option "Mass (integrated temperature measurement)" or ▪ option "Mass (integrated pressure/temperature measurement)" 	Select energy unit.	Unit choose list	Country-specific: <ul style="list-style-type: none"> ▪ kWh ▪ Btu
Calorific value unit	The following conditions are met: <ul style="list-style-type: none"> ▪ Order code for "Sensor version", <ul style="list-style-type: none"> ▪ option "Mass (integrated temperature measurement)" or ▪ option "Mass (integrated pressure/temperature measurement)" ▪ The Gross calorific value volume option or the Net calorific value volume option is selected in the Calorific value type parameter. 	Select calorific value unit. <i>Result</i> The selected unit applies for: Reference gross calorific value	Unit choose list	Country-specific: <ul style="list-style-type: none"> ▪ kJ/Nm³ ▪ Btu/Sft³

Parameter	Prerequisite	Description	Selection	Factory setting
Calorific value unit (Mass)	The following conditions are met: <ul style="list-style-type: none"> ▪ Order code for "Sensor version", <ul style="list-style-type: none"> ▪ Option "Mass (integrated temperature measurement)" or ▪ Option "Mass (integrated pressure/temperature measurement)" ▪ The Gross calorific value mass option or the Net calorific value mass option is selected in the Calorific value type parameter. 	Select calorific value unit.	Unit choose list	Country-specific: <ul style="list-style-type: none"> ▪ kJ/kg ▪ Btu/lb
Velocity unit	–	Select velocity unit. <i>Result</i> The selected unit applies for: <ul style="list-style-type: none"> ▪ Flow velocity ▪ Maximum value 	Unit choose list	Country-specific: <ul style="list-style-type: none"> ▪ m/s ▪ ft/s
Density unit	–	Select density unit. <i>Result</i> The selected unit applies for: <ul style="list-style-type: none"> ▪ Output ▪ Simulation process variable 	Unit choose list	Country-specific: <ul style="list-style-type: none"> ▪ kg/m³ ▪ lb/ft³
Specific volume unit	With order code for "Sensor version": <ul style="list-style-type: none"> ▪ Option "Mass (integrated temperature measurement)" or ▪ Option "Mass (integrated pressure/temperature measurement)" 	Select the unit for the specific volume. <i>Result</i> The selected unit applies for: Specific volume	Unit choose list	Country-specific: <ul style="list-style-type: none"> ▪ m³/kg ▪ ft³/lb
Dynamic viscosity unit	–	Select dynamic viscosity unit. <i>Result</i> The selected unit applies for: <ul style="list-style-type: none"> ▪ Dynamic viscosity parameter (gases) ▪ Dynamic viscosity parameter (liquids) 	Unit choose list	Pa s
Length unit	–	Select length unit for nominal diameter. <i>Result</i> The selected unit applies for: <ul style="list-style-type: none"> ▪ Inlet run ▪ Mating pipe diameter 	Unit choose list	Country-specific: <ul style="list-style-type: none"> ▪ mm ▪ in

10.4.3 Selecting and setting the medium

The **Medium selection** wizard systematically guides the user through all the parameters that must be configured in order to select and set the medium.

Navigation

"Setup" menu → Medium selection

► Medium selection	
Select medium	→ 79
Select gas type	→ 79
Gas type	→ 80
Relative humidity	→ 80
Select liquid type	→ 80
Steam calculation mode	→ 80
Enthalpy calculation	→ 81
Density calculation	→ 81
Enthalpy type	→ 81

Parameter overview with brief description

Parameter	Prerequisite	Description	Selection / User entry	Factory setting
Select medium	–	Select medium type.	<ul style="list-style-type: none"> ■ Gas ■ Liquid ■ Steam 	Steam
Select gas type	The following conditions are met: <ul style="list-style-type: none"> ■ Order code for "Sensor version", ■ Option "Mass (integrated temperature measurement)" or ■ Option "Mass (integrated pressure/temperature measurement)" ■ The Gas option is selected in the Select medium parameter parameter. 	Select measured gas type.	<ul style="list-style-type: none"> ■ Single gas ■ Gas mixture ■ Air ■ Natural gas ■ User-specific gas 	User-specific gas

Parameter	Prerequisite	Description	Selection / User entry	Factory setting
Gas type	The following conditions are met: <ul style="list-style-type: none"> ▪ In the Select medium parameter, the Gas option is selected. ▪ In the Select gas type parameter, the Single gas option is selected. 	Select measured gas type.	<ul style="list-style-type: none"> ▪ Hydrogen H2 ▪ Helium He ▪ Neon Ne ▪ Argon Ar ▪ Krypton Kr ▪ Xenon Xe ▪ Nitrogen N2 ▪ Oxygen O2 ▪ Chlorine Cl2 ▪ Ammonia NH3 ▪ Carbon monoxide CO ▪ Carbon dioxide CO2 ▪ Sulfur dioxide SO2 ▪ Hydrogen sulfide H2S ▪ Hydrogen chloride HCl ▪ Methane CH4 ▪ Ethane C2H6 ▪ Propane C3H8 ▪ Butane C4H10 ▪ Ethylene C2H4 ▪ Vinyl Chloride C2H3Cl 	Methane CH4
Relative humidity	The following conditions are met: <ul style="list-style-type: none"> ▪ In the Select medium parameter, the Gas option is selected. ▪ In the Select gas type parameter, the Air option is selected. 	Enter humidity content of air in %.	0 to 100 %	0 %
Steam calculation mode	The Steam option is selected in the Select medium parameter parameter.	Select calculation mode of steam: based on saturated steam (T-compensated) or automatic detection (p-/T-compensated).	<ul style="list-style-type: none"> ▪ Saturated steam (T-compensated) ▪ Automatic (p-/T-compensated) 	Saturated steam (T-compensated)
Select liquid type	The following conditions are met: <ul style="list-style-type: none"> ▪ Order code for "Sensor version", <ul style="list-style-type: none"> ▪ Option "Mass (integrated temperature measurement)" or ▪ Option "Mass (integrated pressure/temperature measurement)" ▪ The Liquid option is selected in the Select medium parameter parameter. 	Select measured liquid type.	<ul style="list-style-type: none"> ▪ Water ▪ LPG (Liquefied Petroleum Gas) ▪ User-specific liquid 	Water

Parameter	Prerequisite	Description	Selection / User entry	Factory setting
Fixed process pressure	<p>The following conditions are met:</p> <ul style="list-style-type: none"> ▪ Order code for "Sensor version", ▪ Option "Mass flow (integrated temperature measurement)" or ▪ Option "Mass flow (integrated pressure/temperature measurement)" ▪ In the External value parameter (→ 82) the Pressure option is not selected. 	<p>Enter fixed value for process pressure.</p> <p><i>Dependency</i> The unit is taken from the Pressure unit parameter.</p> <p> For detailed information on the calculation of the measured variables with steam: → 127</p>	0 to 250 bar abs.	0 bar abs.
Enthalpy calculation	<p>The following conditions are met:</p> <ul style="list-style-type: none"> ▪ Order code for "Sensor version", ▪ Option "Mass (integrated temperature measurement)" or ▪ Option "Mass (integrated pressure/temperature measurement)" ▪ In the Select medium parameter, the Gas option is selected and in the Select gas type parameter, the Natural gas option is selected. 	Select the norm the enthalpy calculation is based on.	<ul style="list-style-type: none"> ▪ AGA5 ▪ ISO 6976 	AGA5
Density calculation	<p>The following conditions are met:</p> <ul style="list-style-type: none"> ▪ In the Select medium parameter, the Gas option is selected. ▪ In the Select gas type parameter, the Natural gas option is selected. 	Select the norm the density calculation is based on.	<ul style="list-style-type: none"> ▪ AGA Nx19 ▪ ISO 12213- 2 ▪ ISO 12213- 3 	AGA Nx19
Enthalpy type	<p>The following conditions are met:</p> <ul style="list-style-type: none"> ▪ In the Select gas type parameter, the User-specific gas option is selected. <p>Or</p> <ul style="list-style-type: none"> ▪ In the Select liquid type parameter, the User-specific liquid option is selected. 	Define which kind of enthalpy is used.	<ul style="list-style-type: none"> ▪ Heat ▪ Calorific value 	Heat

10.4.4 Configuring the current input

The "**Current input**" wizard guides the user systematically through all the parameters that have to be set for configuring the current input.

Navigation

"Setup" menu → Current input

► Current input		
External value		→ 82
Atmospheric pressure		→ 82
Current span		→ 82
4 mA value		→ 82
20 mA value		→ 82
Failure mode		→ 82
Failure value		→ 82

Parameter overview with brief description

Parameter	Prerequisite	Description	Selection / User entry	Factory setting
External value	With order code for "Sensor version": <ul style="list-style-type: none"> ▪ Option "Mass (integrated temperature measurement)" or ▪ Option "Mass (integrated pressure/temperature measurement)" 	Assign variable from external device to process variable.  For detailed information on the calculation of the measured variables with steam: → 127	<ul style="list-style-type: none"> ▪ Off ▪ Pressure ▪ Gauge pressure ▪ Density ▪ Temperature ▪ 2nd temperature delta heat 	Off
Atmospheric pressure	In the External value parameter, the Gauge pressure option is selected.	Enter atmospheric pressure value to be used for pressure correction. <i>Dependency</i> The unit is taken from the Pressure unit parameter	0 to 250 bar	1.01325 bar
Current span	–	Select current range for process value output and upper/lower level for alarm signal.	<ul style="list-style-type: none"> ▪ 4...20 mA ▪ 4...20 mA NAMUR ▪ 4...20 mA US 	Country-specific: <ul style="list-style-type: none"> ▪ 4...20 mA NAMUR ▪ 4...20 mA US
4 mA value	–	Enter 4 mA value.	Signed floating-point number	0
20 mA value	–	Enter 20 mA value.	Signed floating-point number	Depends on country and nominal diameter
Failure mode	–	Define input behavior in alarm condition.	<ul style="list-style-type: none"> ▪ Alarm ▪ Last valid value ▪ Defined value 	Alarm
Failure value	In the Failure mode parameter, the Defined value option is selected.	Enter value to be used by the device if input value from external device is missing.	Signed floating-point number	0

10.4.5 Configuring the current output

The **Current output** wizard guides you systematically through all the parameters that have to be set for configuring the current output.

Navigation

"Setup" menu → Current output 1 to n

▶ Current output 1 to n		
Assign current output 1 to n	→	📖 83
Current span	→	📖 83
4 mA value	→	📖 83
20 mA value	→	📖 84
Fixed current	→	📖 84
Damping output 1 to n		
Failure mode	→	📖 84
Failure current	→	📖 84

Parameter overview with brief description

Parameter	Prerequisite	Description	Selection / User entry	Factory setting
Assign current output	–	Select process variable for current output.	<ul style="list-style-type: none"> ▪ Off ▪ Volume flow ▪ Corrected volume flow ▪ Mass flow ▪ Flow velocity ▪ Temperature ▪ Pressure ▪ Calculated saturated steam pressure * ▪ Total mass flow * ▪ Energy flow * ▪ Heat flow difference * 	Volume flow
Current span	–	Select current range for process value output and upper/lower level for alarm signal.	<ul style="list-style-type: none"> ▪ 4...20 mA NAMUR ▪ 4...20 mA US ▪ 4...20 mA ▪ Fixed current 	Country-specific: <ul style="list-style-type: none"> ▪ 4...20 mA NAMUR ▪ 4...20 mA US
4 mA value	In the Current span parameter (→ 📖 83), one of the following options is selected: <ul style="list-style-type: none"> ▪ 4...20 mA NAMUR ▪ 4...20 mA US ▪ 4...20 mA 	Enter 4 mA value.	Signed floating-point number	Country-specific: <ul style="list-style-type: none"> ▪ 0 m³/h ▪ 0 ft³/min

Parameter	Prerequisite	Description	Selection / User entry	Factory setting
20 mA value	One of the following options is selected in the Current span parameter (→ 83): <ul style="list-style-type: none"> ■ 4...20 mA NAMUR ■ 4...20 mA US ■ 4...20 mA 	Enter 20 mA value.	Signed floating-point number	Depends on country and nominal diameter
Fixed current	The Fixed current option is selected in the Current span parameter (→ 83).	Defines the fixed output current.	3.59 to 22.5 mA	4 mA
Failure mode	A process variable is selected in the Assign current output parameter (→ 83) and one of the following options is selected in the Current span parameter (→ 83): <ul style="list-style-type: none"> ■ 4...20 mA NAMUR ■ 4...20 mA US ■ 4...20 mA 	Define output behavior in alarm condition.	<ul style="list-style-type: none"> ■ Min. ■ Max. ■ Last valid value ■ Actual value ■ Defined value 	Max.
Failure current	The Defined value option is selected in the Failure mode parameter.	Enter current output value in alarm condition.	3.59 to 22.5 mA	22.5 mA

* Visibility depends on order options or device settings

10.4.6 Configuring the pulse/frequency/switch output

The **Pulse/frequency/switch output** wizard guides you systematically through all the parameters that can be set for configuring the selected output type.

Navigation

"Setup" menu → Pulse/frequency/switch output

Pulse/frequency/switch output

Operating mode
→ 84

Parameter overview with brief description

Parameter	Description	Selection	Factory setting
Operating mode	Define the output as a pulse, frequency or switch output.	<ul style="list-style-type: none"> ■ Pulse ■ Frequency ■ Switch 	Pulse

Configuring the pulse output

Navigation

"Setup" menu → Pulse/frequency/switch output

Pulse/frequency/switch output

Assign pulse output 1
→ 85

Value per pulse	→ 85
Pulse width	→ 85
Failure mode	→ 85
Invert output signal	→ 85

Parameter overview with brief description

Parameter	Prerequisite	Description	Selection / User entry	Factory setting
Assign pulse output 1	The Pulse option is selected in the Operating mode parameter parameter.	Select process variable for pulse output.	<ul style="list-style-type: none"> ■ Off ■ Volume flow ■ Corrected volume flow ■ Mass flow ■ Total mass flow * ■ Energy flow * ■ Heat flow difference * 	Volume flow
Value per pulse	The Pulse option is selected in the Operating mode parameter (→ 84) and a process variable is selected in the Assign pulse output parameter (→ 85).	Enter measured value at which a pulse is output.	Positive floating point number	Depends on country and nominal diameter
Pulse width	The Pulse option is selected in the Operating mode parameter (→ 84) and a process variable is selected in the Assign pulse output parameter (→ 85).	Define time width of the output pulse.	5 to 2 000 ms	100 ms
Failure mode	The Pulse option is selected in the Operating mode parameter (→ 84) and a process variable is selected in the Assign pulse output parameter (→ 85).	Define output behavior in alarm condition.	<ul style="list-style-type: none"> ■ Actual value ■ No pulses 	No pulses
Invert output signal	–	Invert the output signal.	<ul style="list-style-type: none"> ■ No ■ Yes 	No

* Visibility depends on order options or device settings

Configuring the frequency output

Navigation

"Setup" menu → Pulse/frequency/switch output

Pulse/frequency/switch output	
Assign frequency output	→ 86
Minimum frequency value	→ 86

Maximum frequency value	→ 86
Measuring value at minimum frequency	→ 86
Measuring value at maximum frequency	→ 87
Failure mode	→ 87
Failure frequency	→ 87
Invert output signal	→ 87

Parameter overview with brief description

Parameter	Prerequisite	Description	Selection / User entry	Factory setting
Assign frequency output	The Frequency option is selected in the Operating mode parameter (→ 84).	Select process variable for frequency output.	<ul style="list-style-type: none"> ▪ Off ▪ Volume flow ▪ Corrected volume flow ▪ Mass flow ▪ Flow velocity ▪ Temperature ▪ Pressure ▪ Calculated saturated steam pressure * ▪ Total mass flow * ▪ Energy flow * ▪ Heat flow difference * 	Off
Minimum frequency value	The Frequency option is selected in the Operating mode parameter (→ 84) and a process variable is selected in the Assign frequency output parameter (→ 86).	Enter minimum frequency.	0 to 1 000 Hz	0 Hz
Maximum frequency value	The Frequency option is selected in the Operating mode parameter (→ 84) and a process variable is selected in the Assign frequency output parameter (→ 86).	Enter maximum frequency.	0 to 1 000 Hz	1 000 Hz
Measuring value at minimum frequency	The Frequency option is selected in the Operating mode parameter (→ 84) and a process variable is selected in the Assign frequency output parameter (→ 86).	Enter measured value for minimum frequency.	Signed floating-point number	Depends on country and nominal diameter

Parameter	Prerequisite	Description	Selection / User entry	Factory setting
Measuring value at maximum frequency	The Frequency option is selected in the Operating mode parameter (→ 84) and a process variable is selected in the Assign frequency output parameter (→ 86).	Enter measured value for maximum frequency.	Signed floating-point number	Depends on country and nominal diameter
Failure mode	The Frequency option is selected in the Operating mode parameter (→ 84) and a process variable is selected in the Assign frequency output parameter (→ 86).	Define output behavior in alarm condition.	<ul style="list-style-type: none"> ■ Actual value ■ Defined value ■ 0 Hz 	0 Hz
Failure frequency	The Frequency option is selected in the Operating mode parameter (→ 84) and a process variable is selected in the Assign frequency output parameter (→ 86).	Enter frequency output value in alarm condition.	0.0 to 1250.0 Hz	0.0 Hz
Invert output signal	–	Invert the output signal.	<ul style="list-style-type: none"> ■ No ■ Yes 	No

* Visibility depends on order options or device settings



Configuring the switch output

Navigation

"Setup" menu → Pulse/frequency/switch output

Pulse/frequency/switch output

Switch output function	→ 88
Assign diagnostic behavior	→ 88
Assign limit	→ 88
Assign flow direction check	→ 88
Assign status	→ 88
Switch-on value	→ 88
Switch-off value	→ 89
Switch-on delay	→ 89
Switch-off delay	→ 89

Failure mode	→  89
Invert output signal	→  89

Parameter overview with brief description

Parameter	Prerequisite	Description	Selection / User entry	Factory setting
Switch output function	The Switch option is selected in the Operating mode parameter.	Select function for switch output.	<ul style="list-style-type: none"> ▪ Off ▪ On ▪ Diagnostic behavior ▪ Limit ▪ Status 	Off
Assign diagnostic behavior	<ul style="list-style-type: none"> ▪ In the Operating mode parameter, the Switch option is selected. ▪ In the Switch output function parameter, the Diagnostic behavior option is selected. 	Select diagnostic behavior for switch output.	<ul style="list-style-type: none"> ▪ Alarm ▪ Alarm or warning ▪ Warning 	Alarm
Assign limit	<ul style="list-style-type: none"> ▪ The Switch option is selected in the Operating mode parameter. ▪ The Limit option is selected in the Switch output function parameter. 	Select process variable for limit function.	<ul style="list-style-type: none"> ▪ Volume flow ▪ Corrected volume flow ▪ Mass flow ▪ Flow velocity ▪ Temperature ▪ Pressure ▪ Calculated saturated steam pressure[*] ▪ Total mass flow[*] ▪ Energy flow[*] ▪ Heat flow difference[*] ▪ Reynolds number[*] ▪ Totalizer 1 ▪ Totalizer 2 ▪ Totalizer 3 	Volume flow
Assign flow direction check	<ul style="list-style-type: none"> ▪ The Switch option is selected in the Operating mode parameter. ▪ The Flow direction check option is selected in the Switch output function parameter. 	Select process variable for flow direction monitoring.	<ul style="list-style-type: none"> ▪ Off ▪ Volume flow ▪ Mass flow ▪ Corrected volume flow 	Volume flow
Assign status	<ul style="list-style-type: none"> ▪ The Switch option is selected in the Operating mode parameter. ▪ The Status option is selected in the Switch output function parameter. 	Select device status for switch output.	Low flow cut off	Low flow cut off
Switch-on value	<ul style="list-style-type: none"> ▪ The Switch option is selected in the Operating mode parameter. ▪ The Limit option is selected in the Switch output function parameter. 	Enter measured value for the switch-on point.	Signed floating-point number	Country-specific: <ul style="list-style-type: none"> ▪ 0 m³/h ▪ 0 ft³/h

Parameter	Prerequisite	Description	Selection / User entry	Factory setting
Switch-off value	<ul style="list-style-type: none"> The Switch option is selected in the Operating mode parameter. The Limit option is selected in the Switch output function parameter. 	Enter measured value for the switch-off point.	Signed floating-point number	Country-specific: <ul style="list-style-type: none"> 0 m³/h 0 ft³/h
Switch-on delay	<ul style="list-style-type: none"> The Switch option is selected in the Operating mode parameter. The Limit option is selected in the Switch output function parameter. 	Define delay for the switch-on of status output.	0.0 to 100.0 s	0.0 s
Switch-off delay	<ul style="list-style-type: none"> The Switch option is selected in the Operating mode parameter. The Limit option is selected in the Switch output function parameter. 	Define delay for the switch-off of status output.	0.0 to 100.0 s	0.0 s
Failure mode	–	Define output behavior in alarm condition.	<ul style="list-style-type: none"> Actual status Open Closed 	Open
Invert output signal	–	Invert the output signal.	<ul style="list-style-type: none"> No Yes 	No

* Visibility depends on order options or device settings

10.4.7 Configuring the local display

The **Display** wizard guides you systematically through all the parameters that can be configured for configuring the local display.

Navigation

"Setup" menu → Display

► Display

- Format display → 90
- Value 1 display → 90
- 0% bargraph value 1 → 90
- 100% bargraph value 1 → 90
- Value 2 display → 90
- Value 3 display → 90
- 0% bargraph value 3 → 90
- 100% bargraph value 3 → 90
- Value 4 display → 90

Parameter overview with brief description

Parameter	Prerequisite	Description	Selection / User entry	Factory setting
Format display	A local display is provided.	Select how measured values are shown on the display.	<ul style="list-style-type: none"> ■ 1 value, max. size ■ 1 bargraph + 1 value ■ 2 values ■ 1 value large + 2 values ■ 4 values 	1 value, max. size
Value 1 display	A local display is provided.	Select the measured value that is shown on the local display.	<ul style="list-style-type: none"> ■ Volume flow ■ Corrected volume flow ■ Mass flow ■ Flow velocity ■ Temperature ■ Calculated saturated steam pressure * ■ Total mass flow * ■ Condensate mass flow * ■ Energy flow * ■ Heat flow difference * ■ Reynolds number * ■ Density * ■ Pressure * ■ Specific volume * ■ Degrees of superheat * ■ Totalizer 1 ■ Totalizer 2 ■ Totalizer 3 ■ Current output 1 ■ Current output 2 * 	Volume flow
0% bargraph value 1	A local display is provided.	Enter 0% value for bar graph display.	Signed floating-point number	Country-specific: <ul style="list-style-type: none"> ■ 0 m³/h ■ 0 ft³/h
100% bargraph value 1	A local display is provided.	Enter 100% value for bar graph display.	Signed floating-point number	Depends on country and nominal diameter
Value 2 display	A local display is provided.	Select the measured value that is shown on the local display.	For the picklist, see the Value 1 display parameter (→ 90)	None
Value 3 display	A local display is provided.	Select the measured value that is shown on the local display.	For the picklist, see the Value 1 display parameter (→ 90)	None
0% bargraph value 3	A selection was made in the Value 3 display parameter.	Enter 0% value for bar graph display.	Signed floating-point number	Country-specific: <ul style="list-style-type: none"> ■ 0 m³/h ■ 0 ft³/h
100% bargraph value 3	A selection was made in the Value 3 display parameter.	Enter 100% value for bar graph display.	Signed floating-point number	0
Value 4 display	A local display is provided.	Select the measured value that is shown on the local display.	For the picklist, see the Value 1 display parameter (→ 90)	None

* Visibility depends on order options or device settings

10.4.8 Configuring the output conditioning

The **Output conditioning** wizard guides you systematically through all the parameters that have to be set for configuring the output conditioning.

Navigation

"Setup" menu → Output conditioning

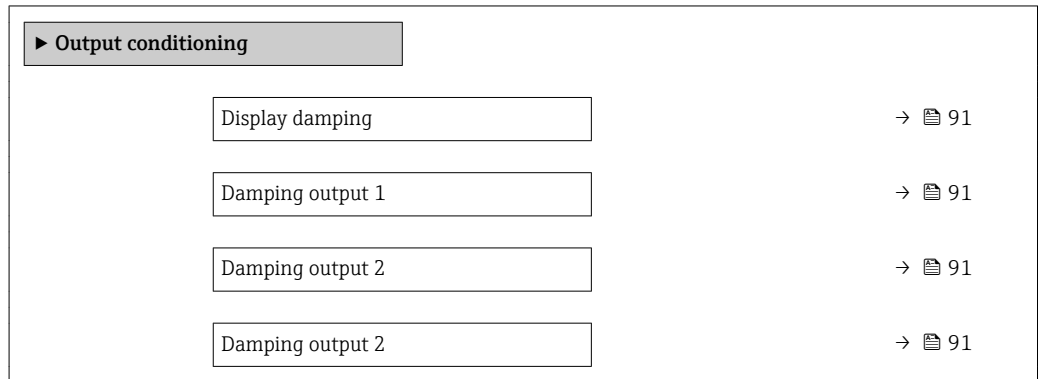

Parameter overview with brief description

Parameter	Prerequisite	Description	User entry	Factory setting
Display damping	–	Set display reaction time to fluctuations in the measured value.	0.0 to 999.9 s	0.0 s
Damping output 1	–	Set the reaction time of the output signal of the current output to fluctuations in the measured value.	0 to 999.9 s	1 s
Damping output 2	The measuring device has a second current output.	Set the reaction time of the output signal of the second current output to fluctuations in the measured value.	0 to 999.9 s	1 s
Damping output 2	The measuring device has a pulse/frequency/switch output.	Set the reaction time of the output signal of the frequency output to fluctuations in the measured value.	0 to 999.9 s	1 s

10.4.9 Configuring the low flow cut off

The **Low flow cut off** wizard systematically guides the user through all the parameters that must be set to configure low flow cut off.

The measuring signal must have a certain minimum signal amplitude so that the signals can be evaluated without any errors. Using the nominal diameter, the corresponding flow can also be derived from this amplitude. The minimum signal amplitude depends on the setting for the sensitivity of the DSC sensor (s), the steam quality (x) and the force of the vibrations present (a). The value mf corresponds to the lowest measurable flow velocity without vibration (no wet steam) at a density of 1 kg/m³ (0.0624 lbm/ft³). The value mf can be set in the range from 6 to 20 m/s (1.8 to 6 ft/s) (factory setting 12 m/s (3.7 ft/s)) with the **Sensitivity** parameter (value range 1 to 9, factory setting 5).

The lowest flow velocity that can be measured on account of the signal amplitude v_{AmpMin} is derived from the **Sensitivity** parameter and the steam quality (x) or from the force of vibrations present (a).

Navigation

"Setup" menu → Low flow cut off

▶ Low flow cut off	
Sensitivity	→ 92
Turn down	→ 92

Parameter overview with brief description

Parameter	Description	User entry	Factory setting
Sensitivity	<p>Adjust sensitivity of the device in the lower flow range. Lower sensitivity leads to more robustness against external interference.</p> <p>The parameter determines the level of sensitivity at the lower end of the measuring range (start of measuring range). Low values can improve the robustness of the device with regard to external influences. The start of measuring range is then set to a higher value. The smallest specified measuring range is when sensitivity is at a maximum.</p>	1 to 9	5
Turn down	<p>Adjust the turn down. Lower turn down increases the minimum measureable flow frequency.</p> <p>The measuring range can be limited with this parameter, if necessary. The upper end of the measuring range is not affected. The start of the low end of the measuring range can be changed to a higher flow value, making it possible to cut off low flows, for example.</p>	50 to 100 %	100 %

10.5 Advanced settings

The **Advanced setup** submenu together with its submenus contains parameters for specific settings.

Navigation to the "Advanced setup" submenu

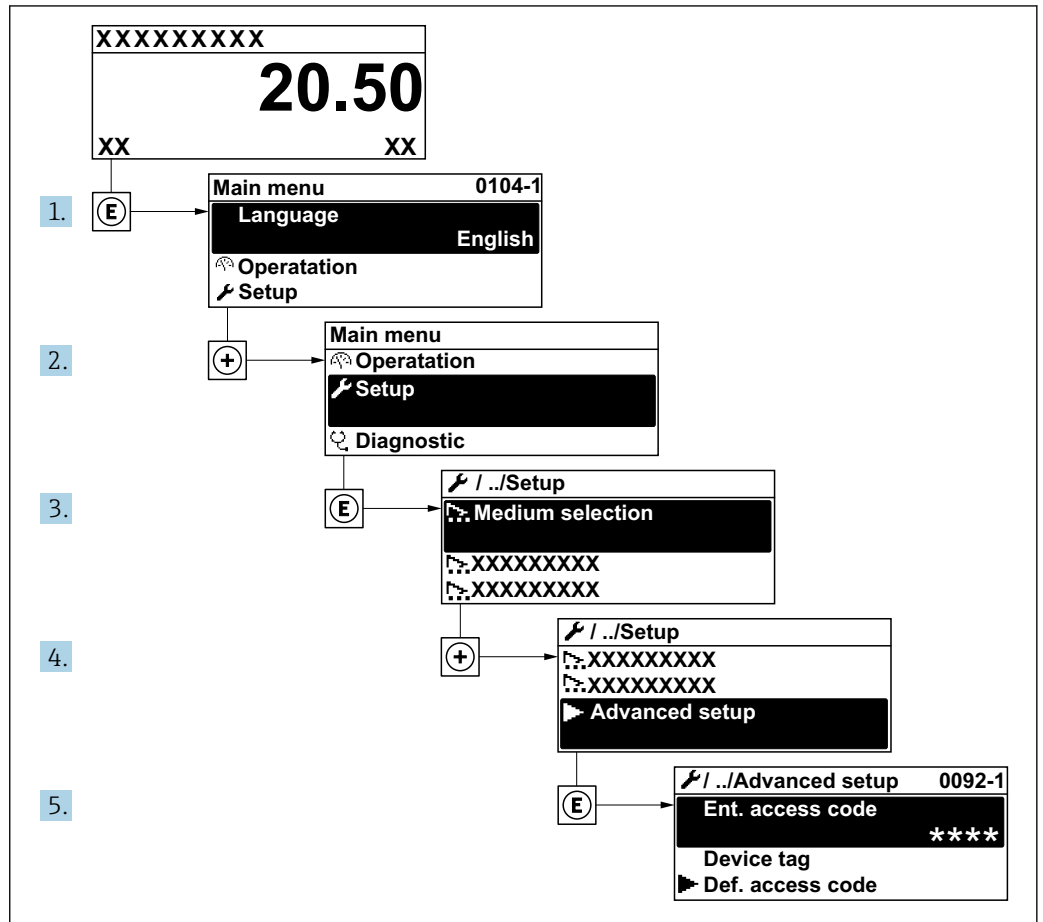

A0034208-EN

i The number of submenus can vary depending on the device version. Some submenus are not dealt with in the Operating Instructions. These submenus and the parameters they contain are explained in the Special Documentation for the device.

Navigation

"Setup" menu → Advanced setup

▶ Advanced setup	
Enter access code	
▶ Medium properties	→ 94
▶ External compensation	→ 107
▶ Sensor adjustment	→ 109
▶ Totalizer 1 to n	→ 111

▶ SIL confirmation	
▶ Deactivate SIL	
▶ Display	→ 112
▶ Heartbeat setup	
▶ Configuration backup display	→ 114
▶ Administration	→ 116

10.5.1 Setting the medium properties

In the **Medium properties** submenu the reference values for the measuring application can be set.

Navigation

"Setup" menu → Advanced setup → Medium properties

▶ Medium properties	
Enthalpy type	→ 95
Calorific value type	→ 95
Reference combustion temperature	→ 95
Reference density	→ 95
Reference gross calorific value	→ 95
Reference pressure	→ 96
Reference temperature	→ 96
Reference Z-factor	→ 96
Linear expansion coefficient	→ 96
Relative density	→ 96
Specific heat capacity	→ 96
Calorific value	→ 97
Z-factor	→ 97
Dynamic viscosity	→ 97

Dynamic viscosity	→ 97
▶ Gas composition	→ 97

Parameter overview with brief description

Parameter	Prerequisite	Description	Selection / User entry	Factory setting
Enthalpy type	The following conditions are met: <ul style="list-style-type: none"> In the Select gas type parameter, the User-specific gas option is selected. Or In the Select liquid type parameter, the User-specific liquid option is selected. 	Define which kind of enthalpy is used.	<ul style="list-style-type: none"> Heat Calorific value 	Heat
Calorific value type	The Calorific value type parameter is visible.	Select calculation based on gross calorific value or net calorific value.	<ul style="list-style-type: none"> Gross calorific value volume Net calorific value volume Gross calorific value mass Net calorific value mass 	Gross calorific value mass
Reference combustion temperature	The Reference combustion temperature parameter is visible.	Enter reference combustion temperature to calculate the natural gas energy value. <i>Dependency</i> The unit is taken from the Temperature unit parameter	-200 to 450 °C	20 °C
Reference density	The following conditions are met: <ul style="list-style-type: none"> In the Select gas type parameter, the User-specific gas option is selected. Or In the Select liquid type parameter, the Water option or User-specific liquid option is selected. 	Enter fixed value for reference density. <i>Dependency</i> The unit is taken from the Density unit parameter	0.01 to 15 000 kg/m ³	1 000 kg/m ³
Reference gross calorific value	The following conditions are met: <ul style="list-style-type: none"> In the Select medium parameter, the Gas option is selected. In the Select gas type parameter, the Natural gas option is selected. In the Density calculation parameter, the ISO 12213-3 option is selected. 	Enter reference gross calorific value of the natural gas. <i>Dependency</i> The unit is taken from the Calorific value unit parameter	Positive floating-point number	50 000 kJ/Nm ³

Parameter	Prerequisite	Description	Selection / User entry	Factory setting
Reference pressure	The following conditions are met: <ul style="list-style-type: none"> Order code for "Sensor version", <ul style="list-style-type: none"> Option "Mass (integrated temperature measurement)" or Option "Mass (integrated pressure/temperature measurement)" The Gas option is selected in the Select medium parameter parameter. 	Enter reference pressure for the calculation of the reference density. <i>Dependency</i> The unit is taken from the Pressure unit parameter.	0 to 250 bar	1.01325 bar
Reference temperature	The following conditions are met: <ul style="list-style-type: none"> The Gas option is selected in the Select medium parameter. Or The Liquid option is selected in the Select medium parameter. 	Enter reference temperature for calculating the reference density. <i>Dependency</i> The unit is taken from the Temperature unit parameter	-200 to 450 °C	20 °C
Reference Z-factor	In the Select gas type parameter, the User-specific gas option is selected.	Enter real gas constant Z for gas under reference conditions.	0.1 to 2	1
Linear expansion coefficient	The following conditions are met: <ul style="list-style-type: none"> The Liquid option is selected in the Select medium parameter. The User-specific liquid option is selected in the Select liquid type parameter. 	Enter linear, medium-specific expansion coefficient for calculating the reference density.	$1.0 \cdot 10^{-6}$ to $2.0 \cdot 10^{-3}$	$2.06 \cdot 10^{-4}$
Relative density	The following conditions are met: <ul style="list-style-type: none"> In the Select medium parameter, the Gas option is selected. In the Select gas type parameter, the Natural gas option is selected. In the Density calculation parameter, the ISO 12213-3 option is selected. 	Enter a relative density of the natural gas.	0.55 to 0.9	0.664
Specific heat capacity	The following conditions are met: <ul style="list-style-type: none"> Selected medium: <ul style="list-style-type: none"> In the Select gas type parameter, the User-specific gas option is selected. Or In the Select liquid type parameter, the User-specific liquid option is selected. In the Enthalpy type parameter, the Heat option is selected. 	Enter the specific heat capacity of the medium. <i>Dependency</i> The unit is taken from the Specific heat capacity unit parameter	0 to 50 kJ/(kgK)	4.187 kJ/(kgK)

Parameter	Prerequisite	Description	Selection / User entry	Factory setting
Calorific value	The following conditions are met: <ul style="list-style-type: none"> ▪ Selected medium: <ul style="list-style-type: none"> ▪ In the Select gas type parameter, the User-specific gas option is selected. Or ▪ In the Select liquid type parameter, the User-specific liquid option is selected. ▪ In the Enthalpy type parameter, the Calorific value option is selected. ▪ In the Calorific value type parameter, the Gross calorific value volume option or Gross calorific value mass option is selected. 	Enter gross calorific value to calculate the energy flow.	Positive floating-point number	50 000 kJ/kg
Z-factor	In the Select gas type parameter, the User-specific gas option is selected.	Enter real gas constant Z for gas under operation conditions.	0.1 to 2.0	1
Dynamic viscosity (Gases)	The following conditions are met: <ul style="list-style-type: none"> ▪ Order code for "Sensor version", <ul style="list-style-type: none"> ▪ Option "Volume" or ▪ Option "Volume high temperature" ▪ The Gas option or the Steam option is selected in the Select medium parameter. or ▪ The User-specific gas option is selected in the Select gas type parameter. 	Enter fixed value for dynamic viscosity for a gas/steam. <i>Dependency</i> The unit is taken from the Dynamic viscosity unit parameter.	Positive floating-point number	0.015 cP
Dynamic viscosity (Liquids)	The following conditions are met: <ul style="list-style-type: none"> ▪ Order code for "Sensor version", <ul style="list-style-type: none"> ▪ Option "Volume" or ▪ Option "Volume high temperature" ▪ The Liquid option is selected in the Select medium parameter. or ▪ The User-specific liquid option is selected in the Select liquid type parameter. 	Enter fixed value for dynamic viscosity for a liquid. <i>Dependency</i> The unit is taken from the Dynamic viscosity unit parameter.	Positive floating-point number	1 cP











Configuring the gas composition

In the **Gas composition** submenu the gas composition for the measuring application can be set.

Navigation

"Setup" menu → Advanced setup → Medium properties → Gas composition

▶ Gas composition	
Gas mixture	→ 100
Mol% Ar	→ 100
Mol% C ₂ H ₃ Cl	→ 100
Mol% C ₂ H ₄	→ 101
Mol% C ₂ H ₆	→ 101
Mol% C ₃ H ₈	→ 101
Mol% CH ₄	→ 101
Mol% Cl ₂	→ 102
Mol% CO	→ 102
Mol% CO ₂	→ 102
Mol% H ₂	→ 102
Mol% H ₂ O	→ 103
Mol% H ₂ S	→ 103
Mol% HCl	→ 103
Mol% He	→ 103
Mol% i-C ₄ H ₁₀	→ 104
Mol% i-C ₅ H ₁₂	→ 104
Mol% Kr	→ 104
Mol% N ₂	→ 104
Mol% n-C ₁₀ H ₂₂	→ 104
Mol% n-C ₄ H ₁₀	→ 105
Mol% n-C ₅ H ₁₂	→ 105

Mol% n-C6H14	→  105
Mol% n-C7H16	→  105
Mol% n-C8H18	→  106
Mol% n-C9H20	→  106
Mol% Ne	→  106
Mol% NH3	→  106
Mol% O2	→  106
Mol% SO2	→  107
Mol% Xe	→  107
Mol% other gas	→  107

Parameter overview with brief description

Parameter	Prerequisite	Description	Selection / User entry	Factory setting
Gas mixture	The following conditions are met: <ul style="list-style-type: none"> ▪ In the Select medium parameter, the Gas option is selected. ▪ In the Select gas type parameter, the Gas mixture option is selected. 	Select measured gas mixture.	<ul style="list-style-type: none"> ▪ Hydrogen H2 ▪ Helium He ▪ Neon Ne ▪ Argon Ar ▪ Krypton Kr ▪ Xenon Xe ▪ Nitrogen N2 ▪ Oxygen O2 ▪ Chlorine Cl2 ▪ Ammonia NH3 ▪ Carbon monoxide CO ▪ Carbon dioxide CO2 ▪ Sulfur dioxide SO2 ▪ Hydrogen sulfide H2S ▪ Hydrogen chloride HCl ▪ Methane CH4 ▪ Ethane C2H6 ▪ Propane C3H8 ▪ Butane C4H10 ▪ Ethylene C2H4 ▪ Vinyl Chloride C2H3Cl ▪ Others 	Methane CH4
Mol% Ar	The following conditions are met: In the Select medium parameter, the Gas option is selected. <ul style="list-style-type: none"> ▪ In the Select gas type parameter, the Gas mixture option is selected and in the Gas mixture parameter, the Argon Ar option is selected. Or <ul style="list-style-type: none"> ▪ In the Select gas type parameter, the Natural gas option is selected and in the Density calculation parameter, the ISO 12213-2 option is selected. 	Enter amount of substance for the gas mixture.	0 to 100 %	0 %
Mol% C2H3Cl	The following conditions are met: <ul style="list-style-type: none"> ▪ In the Select medium parameter, the Gas option is selected. ▪ In the Select gas type parameter, the Gas mixture option is selected. ▪ In the Gas mixture parameter, the Vinyl Chloride C2H3Cl option is selected. 	Enter amount of substance for the gas mixture.	0 to 100 %	0 %

Parameter	Prerequisite	Description	Selection / User entry	Factory setting
Mol% C2H4	The following conditions are met: <ul style="list-style-type: none"> ▪ In the Select medium parameter, the Gas option is selected. ▪ In the Select gas type parameter, the Gas mixture option is selected. ▪ In the Gas mixture parameter, the Ethylene C2H4 option is selected. 	Enter amount of substance for the gas mixture.	0 to 100 %	0 %
Mol% C2H6	The following conditions are met: In the Select medium parameter, the Gas option is selected. <ul style="list-style-type: none"> ▪ In the Select gas type parameter, the Gas mixture option is selected and in the Gas mixture parameter, the Ethane C2H6 option is selected. Or <ul style="list-style-type: none"> ▪ In the Select gas type parameter, the Natural gas option is selected and in the Density calculation parameter, the ISO 12213-2 option is selected. 	Enter amount of substance for the gas mixture.	0 to 100 %	0 %
Mol% C3H8	The following conditions are met: In the Select medium parameter, the Gas option is selected. <ul style="list-style-type: none"> ▪ In the Select gas type parameter, the Gas mixture option is selected and in the Gas mixture parameter, the Propane C3H8 option is selected. Or <ul style="list-style-type: none"> ▪ In the Select gas type parameter, the Natural gas option is selected and in the Density calculation parameter, the ISO 12213-2 option is selected. 	Enter amount of substance for the gas mixture.	0 to 100 %	0 %
Mol% CH4	The following conditions are met: In the Select medium parameter, the Gas option is selected. <ul style="list-style-type: none"> ▪ In the Select gas type parameter, the Gas mixture option is selected and in the Gas mixture parameter, the Methane CH4 option is selected. Or <ul style="list-style-type: none"> ▪ In the Select gas type parameter, the Natural gas option is selected. 	Enter amount of substance for the gas mixture.	0 to 100 %	100 %

Parameter	Prerequisite	Description	Selection / User entry	Factory setting
Mol% Cl ₂	The following conditions are met: <ul style="list-style-type: none"> ▪ In the Select medium parameter, the Gas option is selected. ▪ In the Select gas type parameter, the Gas mixture option is selected. ▪ In the Gas mixture parameter, the Chlorine Cl₂ option is selected. 	Enter amount of substance for the gas mixture.	0 to 100 %	0 %
Mol% CO	The following conditions are met: In the Select medium parameter, the Gas option is selected. <ul style="list-style-type: none"> ▪ In the Select gas type parameter, the Gas mixture option is selected and in the Gas mixture parameter, the Carbon monoxide CO option is selected. Or <ul style="list-style-type: none"> ▪ In the Select gas type parameter, the Natural gas option is selected and in the Density calculation parameter, the ISO 12213-2 option is selected. 	Enter amount of substance for the gas mixture.	0 to 100 %	0 %
Mol% CO ₂	The following conditions are met: In the Select medium parameter, the Gas option is selected. <ul style="list-style-type: none"> ▪ In the Select gas type parameter, the Gas mixture option is selected and in the Gas mixture parameter, the Carbon dioxide CO₂ option is selected. Or <ul style="list-style-type: none"> ▪ In the Select gas type parameter, the Natural gas option is selected. 	Enter amount of substance for the gas mixture.	0 to 100 %	0 %
Mol% H ₂	The following conditions are met: In the Select medium parameter, the Gas option is selected. <ul style="list-style-type: none"> ▪ In the Select gas type parameter, the Gas mixture option is selected and in the Gas mixture parameter, the Hydrogen H₂ option is selected. Or <ul style="list-style-type: none"> ▪ In the Select gas type parameter, the Natural gas option is selected and in the Density calculation parameter, the AGA Nx19 option is not selected. 	Enter amount of substance for the gas mixture.	0 to 100 %	0 %

Parameter	Prerequisite	Description	Selection / User entry	Factory setting
Mol% H ₂ O	The following conditions are met: <ul style="list-style-type: none"> ▪ In the Select medium parameter, the Gas option is selected. ▪ In the Select gas type parameter, the Natural gas option is selected. ▪ In the Density calculation parameter, the ISO 12213-2 option is selected. 	Enter amount of substance for the gas mixture.	0 to 100 %	0 %
Mol% H ₂ S	The following conditions are met: In the Select medium parameter, the Gas option is selected. <ul style="list-style-type: none"> ▪ In the Select gas type parameter, the Gas mixture option is selected and in the Gas mixture parameter, the Hydrogen sulfide H₂S option is selected. Or <ul style="list-style-type: none"> ▪ In the Select gas type parameter, the Natural gas option is selected and in the Density calculation parameter, the ISO 12213-2 option is selected. 	Enter amount of substance for the gas mixture.	0 to 100 %	0 %
Mol% HCl	The following conditions are met: <ul style="list-style-type: none"> ▪ In the Select medium parameter, the Gas option is selected. ▪ In the Select gas type parameter, the Gas mixture option is selected. ▪ In the Gas mixture parameter, the Hydrogen chloride HCl option is selected. 	Enter amount of substance for the gas mixture.	0 to 100 %	0 %
Mol% He	The following conditions are met: In the Select medium parameter, the Gas option is selected. <ul style="list-style-type: none"> ▪ In the Select gas type parameter, the Gas mixture option is selected and in the Gas mixture parameter, the Helium He option is selected. Or <ul style="list-style-type: none"> ▪ In the Select gas type parameter, the Natural gas option is selected and in the Density calculation parameter, the ISO 12213-2 option is selected. 	Enter amount of substance for the gas mixture.	0 to 100 %	0 %

Parameter	Prerequisite	Description	Selection / User entry	Factory setting
Mol% i-C4H10	The following conditions are met: <ul style="list-style-type: none"> ▪ In the Select medium parameter, the Gas option is selected. ▪ In the Select gas type parameter, the Natural gas option is selected. ▪ In the Density calculation parameter, the ISO 12213-2 option is selected. 	Enter amount of substance for the gas mixture.	0 to 100 %	0 %
Mol% i-C5H12	The following conditions are met: <ul style="list-style-type: none"> ▪ In the Select medium parameter, the Gas option is selected. ▪ In the Select gas type parameter, the Natural gas option is selected. ▪ In the Density calculation parameter, the ISO 12213-2 option is selected. 	Enter amount of substance for the gas mixture.	0 to 100 %	0 %
Mol% Kr	The following conditions are met: <ul style="list-style-type: none"> ▪ In the Select medium parameter, the Gas option is selected. ▪ In the Select gas type parameter, the Gas mixture option is selected. ▪ In the Gas mixture parameter, the Krypton Kr option is selected. 	Enter amount of substance for the gas mixture.	0 to 100 %	0 %
Mol% N2	The following conditions are met: In the Select medium parameter, the Gas option is selected. <ul style="list-style-type: none"> ▪ In the Select gas type parameter, the Gas mixture option is selected and in the Gas mixture parameter, the Nitrogen N2 option is selected. Or <ul style="list-style-type: none"> ▪ In the Select gas type parameter, the Natural gas option is selected and in the Density calculation parameter, the AGA Nx19 option or the ISO 12213-2 option is selected. 	Enter amount of substance for the gas mixture.	0 to 100 %	0 %
Mol% n-C10H22	The following conditions are met: <ul style="list-style-type: none"> ▪ In the Select medium parameter, the Gas option is selected. ▪ In the Select gas type parameter, the Natural gas option is selected. ▪ In the Density calculation parameter, the ISO 12213-2 option is selected. 	Enter amount of substance for the gas mixture.	0 to 100 %	0 %

Parameter	Prerequisite	Description	Selection / User entry	Factory setting
Mol% n-C ₄ H ₁₀	<p>The following conditions are met:</p> <ul style="list-style-type: none"> ▪ In the Select medium parameter, the Gas option is selected. ▪ In the Select gas type parameter, the Gas mixture option is selected and in the Gas mixture parameter, the Butane C₄H₁₀ option is selected. <p>Or</p> <ul style="list-style-type: none"> ▪ In the Select gas type parameter, the Natural gas option is selected and in the Density calculation parameter, the ISO 12213- 2 option is selected. <ul style="list-style-type: none"> ▪ Or ▪ In the Select medium parameter, the Liquid option is selected and in the Select liquid type parameter, the LPG option is selected. 	Enter amount of substance for the gas mixture.	0 to 100 %	0 %
Mol% n-C ₅ H ₁₂	<p>The following conditions are met:</p> <ul style="list-style-type: none"> ▪ In the Select medium parameter, the Gas option is selected. ▪ In the Select gas type parameter, the Natural gas option is selected. ▪ In the Density calculation parameter, the ISO 12213- 2 option is selected. 	Enter amount of substance for the gas mixture.	0 to 100 %	0 %
Mol% n-C ₆ H ₁₄	<p>The following conditions are met:</p> <ul style="list-style-type: none"> ▪ In the Select medium parameter, the Gas option is selected. ▪ In the Select gas type parameter, the Natural gas option is selected. ▪ In the Density calculation parameter, the ISO 12213- 2 option is selected. 	Enter amount of substance for the gas mixture.	0 to 100 %	0 %
Mol% n-C ₇ H ₁₆	<p>The following conditions are met:</p> <ul style="list-style-type: none"> ▪ In the Select medium parameter, the Gas option is selected. ▪ In the Select gas type parameter, the Natural gas option is selected. ▪ In the Density calculation parameter, the ISO 12213- 2 option is selected. 	Enter amount of substance for the gas mixture.	0 to 100 %	0 %

Parameter	Prerequisite	Description	Selection / User entry	Factory setting
Mol% n-C8H18	The following conditions are met: <ul style="list-style-type: none"> ▪ In the Select medium parameter, the Gas option is selected. ▪ In the Select gas type parameter, the Natural gas option is selected. ▪ In the Density calculation parameter, the ISO 12213-2 option is selected. 	Enter amount of substance for the gas mixture.	0 to 100 %	0 %
Mol% n-C9H20	The following conditions are met: <ul style="list-style-type: none"> ▪ In the Select medium parameter, the Gas option is selected. ▪ In the Select gas type parameter, the Natural gas option is selected. ▪ In the Density calculation parameter, the ISO 12213-2 option is selected. 	Enter amount of substance for the gas mixture.	0 to 100 %	0 %
Mol% Ne	The following conditions are met: <ul style="list-style-type: none"> ▪ In the Select medium parameter, the Gas option is selected. ▪ In the Select gas type parameter, the Gas mixture option is selected. ▪ In the Gas mixture parameter, the Neon Ne option is selected. 	Enter amount of substance for the gas mixture.	0 to 100 %	0 %
Mol% NH3	The following conditions are met: <ul style="list-style-type: none"> ▪ In the Select medium parameter, the Gas option is selected. ▪ In the Select gas type parameter, the Gas mixture option is selected. ▪ In the Gas mixture parameter, the Ammonia NH3 option is selected. 	Enter amount of substance for the gas mixture.	0 to 100 %	0 %
Mol% O2	The following conditions are met: In the Select medium parameter, the Gas option is selected. <ul style="list-style-type: none"> ▪ In the Select gas type parameter, the Gas mixture option is selected and in the Gas mixture parameter, the Oxygen O2 option is selected. Or <ul style="list-style-type: none"> ▪ In the Select gas type parameter, the Natural gas option is selected and in the Density calculation parameter, the ISO 12213-2 option is selected. 	Enter amount of substance for the gas mixture.	0 to 100 %	0 %

Parameter	Prerequisite	Description	Selection / User entry	Factory setting
Mol% SO ₂	The following conditions are met: <ul style="list-style-type: none"> ▪ In the Select medium parameter, the Gas option is selected. ▪ In the Select gas type parameter, the Gas mixture option is selected. ▪ In the Gas mixture parameter, the Sulfur dioxide SO₂ option is selected. 	Enter amount of substance for the gas mixture.	0 to 100 %	0 %
Mol% Xe	The following conditions are met: <ul style="list-style-type: none"> ▪ In the Select medium parameter, the Gas option is selected. ▪ In the Select gas type parameter, the Gas mixture option is selected. ▪ In the Gas mixture parameter, the Xenon Xe option is selected. 	Enter amount of substance for the gas mixture.	0 to 100 %	0 %
Mol% other gas	The following conditions are met: <ul style="list-style-type: none"> ▪ In the Select medium parameter, the Gas option is selected. ▪ In the Select gas type parameter, the Gas mixture option is selected. ▪ In the Gas mixture parameter, the Others option is selected. 	Enter amount of substance for the gas mixture.	0 to 100 %	0 %

10.5.2 Performing external compensation

The **External compensation** submenu contains parameters which can be used to enter external or fixed values. These values are used for internal calculations.



Navigation

"Setup" menu → Advanced setup → External compensation

► External compensation	
External value	→ 108
Atmospheric pressure	→ 108
Delta heat calculation	→ 108
Fixed density	→ 108
Fixed density	→ 108
Fixed temperature	→ 108

2nd temperature delta heat	→  109
Fixed process pressure	→  109

Parameter overview with brief description

Parameter	Prerequisite	Description	Selection / User entry	Factory setting
External value	With order code for "Sensor version": <ul style="list-style-type: none"> ▪ Option "Mass (integrated temperature measurement)" or ▪ Option "Mass (integrated pressure/temperature measurement)" 	Assign variable from external device to process variable.  For detailed information on the calculation of the measured variables with steam: →  127	<ul style="list-style-type: none"> ▪ Off ▪ Pressure ▪ Gauge pressure ▪ Density ▪ Temperature ▪ 2nd temperature delta heat 	Off
Atmospheric pressure	In the External value parameter, the Gauge pressure option is selected.	Enter atmospheric pressure value to be used for pressure correction. <i>Dependency</i> The unit is taken from the Pressure unit parameter	0 to 250 bar	1.01325 bar
Delta heat calculation	The Delta heat calculation parameter is visible.	Calculates the transferred heat of a heat exchanger (= delta heat).	<ul style="list-style-type: none"> ▪ Off ▪ Device on cold side ▪ Device on warm side 	Device on warm side
Fixed density	With order code for "Sensor version": <ul style="list-style-type: none"> ▪ Option "Volume" or ▪ Option "Volume high temperature" 	Enter fixed value for medium density. <i>Dependency</i> The unit is taken from the Density unit parameter.	0.01 to 15 000 kg/m ³	1 000 kg/m ³
Fixed density	With order code for "Sensor version": <ul style="list-style-type: none"> ▪ Option "Volume" or ▪ Option "Volume high temperature" 	Enter fixed value for medium density. <i>Dependency</i> The unit is taken from the Density unit parameter.	0.01 to 15 000 kg/m ³	5 kg/m ³
Fixed temperature	–	Enter a fixed value for process temperature. <i>Dependency</i> The unit is taken from the Temperature unit parameter	–200 to 450 °C	20 °C

Parameter	Prerequisite	Description	Selection / User entry	Factory setting
2nd temperature delta heat	The 2nd temperature delta heat parameter is visible.	Enter 2nd temperature value to calculate the delta heat. <i>Dependency</i> The unit is taken from the Temperature unit parameter	-200 to 450 °C	20 °C
Fixed process pressure	The following conditions are met: <ul style="list-style-type: none"> ▪ Order code for "Sensor version", ▪ Option "Mass flow (integrated temperature measurement)" or ▪ Option "Mass flow (integrated pressure/ temperature measurement)" ▪ In the External value parameter (→ ⓘ 82) the Pressure option is not selected. 	Enter fixed value for process pressure. <i>Dependency</i> The unit is taken from the Pressure unit parameter.  For detailed information on the calculation of the measured variables with steam: → ⓘ 127	0 to 250 bar abs.	0 bar abs.

10.5.3 Carrying out a sensor adjustment

The **Sensor adjustment** submenu contains parameters that pertain to the functionality of the sensor.

Navigation

"Setup" menu → Advanced setup → Sensor adjustment

► Sensor adjustment	
Inlet configuration	→ ⓘ 110
Inlet run	→ ⓘ 110
Mating pipe diameter	→ ⓘ 110
Installation factor	→ ⓘ 110

Parameter overview with brief description

Parameter	Prerequisite	Description	Selection / User entry	Factory setting
Inlet configuration	The inlet run correction feature: <ul style="list-style-type: none"> Is a standard feature and can only be used in Prowirl F 200. Can be used for the following pressure ratings and nominal diameters: DN 15 to 150 (1 to 6") <ul style="list-style-type: none"> EN (DIN) ASME B16.5, Sch. 40/80 	Select inlet configuration.	<ul style="list-style-type: none"> Off Single elbow Double elbow Double elbow 3D Reduction 	Off
Inlet run	The inlet run correction feature: <ul style="list-style-type: none"> Is a standard feature and can only be used in Prowirl F 200. Can be used for the following pressure ratings and nominal diameters: DN 15 to 150 (1 to 6") <ul style="list-style-type: none"> EN (DIN) ASME B16.5, Sch. 40/80 	Define length of the straight inlet run. <i>Dependency</i> The unit is taken from the Length unit parameter	0 to 20 m	0 m
Mating pipe diameter	–	Enter diameter of mating pipe to enable diameter mismatch correction. Detailed information on diameter mismatch correction: →  110 <i>Dependency</i> The unit is taken from the Length unit parameter.	0 to 1 m (0 to 3 ft) Input value = 0: Diameter mismatch correction is disabled.	Country-specific: <ul style="list-style-type: none"> 0 m 0 ft
Installation factor	–	Enter factor to adjust for installation conditions.	Positive floating-point number	1.0

Diameter mismatch correction

 The measuring device is calibrated according to the ordered process connection. This calibration takes account of the edge at the transition from the mating pipe to the process connection. If the mating pipe used deviates from the ordered process connection, a diameter mismatch correction can compensate for the effects. The difference between the internal diameter of the ordered process connection and the internal diameter of the mating pipe used must be taken into consideration.

The measuring device can correct shifts in the calibration factor which are caused, for example, by a diameter mismatch between the device flange (e.g. ASME B16.5/Sch. 80, DN 50 (2")) and the mating pipe (e.g. ASME B16.5/Sch. 40, DN 50 (2")). Only apply diameter mismatch correction within the following limit values (listed below) for which test measurements have also been performed.

Flange connection:

- DN 15 (½"): ±20 % of the internal diameter
- DN 25 (1"): ±15 % of the internal diameter
- DN 40 (1½"): ±12 % of the internal diameter
- DN ≥ 50 (2"): ±10 % of the internal diameter

If the standard internal diameter of the ordered process connection differs from the internal diameter of the mating pipe, an additional measuring uncertainty of approx. 2 % o.r. must be expected.

Example

Influence of the diameter mismatch without using the correction function:

- Mating pipe DN 100 (4"), Schedule 80
- Device flange DN 100 (4"), Schedule 40
- This installation position results in a diameter mismatch of 5 mm (0.2 in). If the correction function is not used, an additional measuring uncertainty of approx. 2 % o.r. must be expected.
- If the basic conditions are met and the feature is enabled, the additional measuring uncertainty is 1 % o.r.

10.5.4 Configuring the totalizer

In the "**Totalizer 1 to n**" submenu the individual totalizer can be configured.

Navigation

"Setup" menu → Advanced setup → Totalizer 1 to n

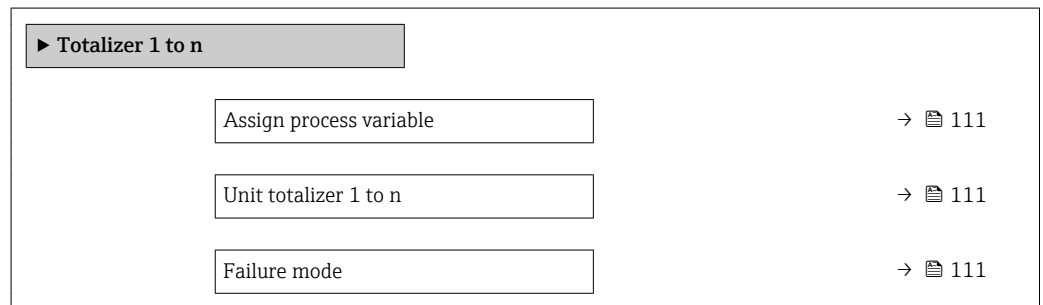
**Parameter overview with brief description**

Parameter	Prerequisite	Description	Selection	Factory setting
Assign process variable	–	Select process variable for totalizer.	<ul style="list-style-type: none"> ▪ Off ▪ Volume flow ▪ Corrected volume flow ▪ Mass flow ▪ Total mass flow * ▪ Condensate mass flow * ▪ Energy flow * ▪ Heat flow difference * 	<ul style="list-style-type: none"> ▪ Totalizer 1: Volume flow ▪ Totalizer 2: Mass flow ▪ Totalizer 3: Corrected volume flow
Unit totalizer 1 to n	A process variable is selected in the Assign process variable parameter (→ ⓘ 111) of the Totalizer 1 to n submenu.	Select process variable totalizer unit.	Unit choose list	Country-specific: <ul style="list-style-type: none"> ▪ m³ ▪ ft³
Totalizer operation mode	A process variable is selected in the Assign process variable parameter (→ ⓘ 111) of the Totalizer 1 to n submenu.	Select totalizer calculation mode.	<ul style="list-style-type: none"> ▪ Net flow total ▪ Forward flow total ▪ Reverse flow total 	Net flow total
Failure mode	A process variable is selected in the Assign process variable parameter (→ ⓘ 111) of the Totalizer 1 to n submenu.	Define totalizer behavior in alarm condition.	<ul style="list-style-type: none"> ▪ Stop ▪ Actual value ▪ Last valid value 	Stop

* Visibility depends on order options or device settings

10.5.5 Carrying out additional display configurations



In the **Display** submenu you can set all the parameters associated with the configuration of the local display.

Navigation

"Setup" menu → Advanced setup → Display

► Display	
Format display	→ 113
Value 1 display	→ 113
0% bargraph value 1	→ 113
100% bargraph value 1	→ 113
Decimal places 1	→ 113
Value 2 display	→ 113
Decimal places 2	→ 113
Value 3 display	→ 113
0% bargraph value 3	→ 113
100% bargraph value 3	→ 113
Decimal places 3	→ 114
Value 4 display	→ 114
Decimal places 4	→ 114
Language	→ 114
Display interval	→ 114
Display damping	→ 114
Header	→ 114
Header text	→ 114
Separator	→ 114
Backlight	→ 114

Parameter overview with brief description

Parameter	Prerequisite	Description	Selection / User entry	Factory setting
Format display	A local display is provided.	Select how measured values are shown on the display.	<ul style="list-style-type: none"> ■ 1 value, max. size ■ 1 bargraph + 1 value ■ 2 values ■ 1 value large + 2 values ■ 4 values 	1 value, max. size
Value 1 display	A local display is provided.	Select the measured value that is shown on the local display.	<ul style="list-style-type: none"> ■ Volume flow ■ Corrected volume flow ■ Mass flow ■ Flow velocity ■ Temperature ■ Calculated saturated steam pressure * ■ Total mass flow * ■ Condensate mass flow * ■ Energy flow * ■ Heat flow difference * ■ Reynolds number * ■ Density * ■ Pressure * ■ Specific volume * ■ Degrees of superheat * ■ Totalizer 1 ■ Totalizer 2 ■ Totalizer 3 ■ Current output 1 * ■ Current output 2 * 	Volume flow
0% bargraph value 1	A local display is provided.	Enter 0% value for bar graph display.	Signed floating-point number	Country-specific: <ul style="list-style-type: none"> ■ 0 m³/h ■ 0 ft³/h
100% bargraph value 1	A local display is provided.	Enter 100% value for bar graph display.	Signed floating-point number	Depends on country and nominal diameter
Decimal places 1	A measured value is specified in the Value 1 display parameter.	Select the number of decimal places for the display value.	<ul style="list-style-type: none"> ■ x ■ x.x ■ x.xx ■ x.xxx ■ x.xxxx 	x.xx
Value 2 display	A local display is provided.	Select the measured value that is shown on the local display.	For the picklist, see the Value 1 display parameter (→  90)	None
Decimal places 2	A measured value is specified in the Value 2 display parameter.	Select the number of decimal places for the display value.	<ul style="list-style-type: none"> ■ x ■ x.x ■ x.xx ■ x.xxx ■ x.xxxx 	x.xx
Value 3 display	A local display is provided.	Select the measured value that is shown on the local display.	For the picklist, see the Value 1 display parameter (→  90)	None
0% bargraph value 3	A selection was made in the Value 3 display parameter.	Enter 0% value for bar graph display.	Signed floating-point number	Country-specific: <ul style="list-style-type: none"> ■ 0 m³/h ■ 0 ft³/h
100% bargraph value 3	A selection was made in the Value 3 display parameter.	Enter 100% value for bar graph display.	Signed floating-point number	0

Parameter	Prerequisite	Description	Selection / User entry	Factory setting
Decimal places 3	A measured value is specified in the Value 3 display parameter.	Select the number of decimal places for the display value.	<ul style="list-style-type: none"> ▪ x ▪ x.x ▪ x.xx ▪ x.xxx ▪ x.xxxx 	x.xx
Value 4 display	A local display is provided.	Select the measured value that is shown on the local display.	For the picklist, see the Value 1 display parameter (→  90)	None
Decimal places 4	A measured value is specified in the Value 4 display parameter.	Select the number of decimal places for the display value.	<ul style="list-style-type: none"> ▪ x ▪ x.x ▪ x.xx ▪ x.xxx ▪ x.xxxx 	x.xx
Language	A local display is provided.	Set display language.	<ul style="list-style-type: none"> ▪ English ▪ Deutsch * ▪ Français * ▪ Español * ▪ Italiano * ▪ Nederlands * ▪ Portuguesa * ▪ Polski * ▪ русский язык (Russian) * ▪ Svenska * ▪ Türkçe * ▪ 中文 (Chinese) * ▪ 日本語 (Japanese) * ▪ 한국어 (Korean) * ▪ العربية (Arabic) * ▪ Bahasa Indonesia * ▪ ภาษาไทย (Thai) * ▪ tiếng Việt (Vietnamese) * ▪ čeština (Czech) * 	English (alternatively, the ordered language is preset in the device)
Display interval	A local display is provided.	Set time measured values are shown on display if display alternates between values.	1 to 10 s	5 s
Display damping	A local display is provided.	Set display reaction time to fluctuations in the measured value.	0.0 to 999.9 s	0.0 s
Header	A local display is provided.	Select header contents on local display.	<ul style="list-style-type: none"> ▪ Device tag ▪ Free text 	Device tag
Header text	In the Header parameter, the Free text option is selected.	Enter display header text.	Max. 12 characters such as letters, numbers or special characters (e.g. @, %, /)	-----
Separator	A local display is provided.	Select decimal separator for displaying numerical values.	<ul style="list-style-type: none"> ▪ . (point) ▪ , (comma) 	. (point)
Backlight	Order code for "Display; operation", option E "SD03 4-line, illum.; touch control + data backup function"	Switch the local display backlight on and off.	<ul style="list-style-type: none"> ▪ Disable ▪ Enable 	Disable

* Visibility depends on order options or device settings

10.5.6 Configuration management

After commissioning, you can save the current device configuration, copy it to another measuring point or restore the previous device configuration.

You can do so using the **Configuration management** parameter and the related options found in the **Configuration backup display** submenu.

Navigation

"Setup" menu → Advanced setup → Configuration backup display

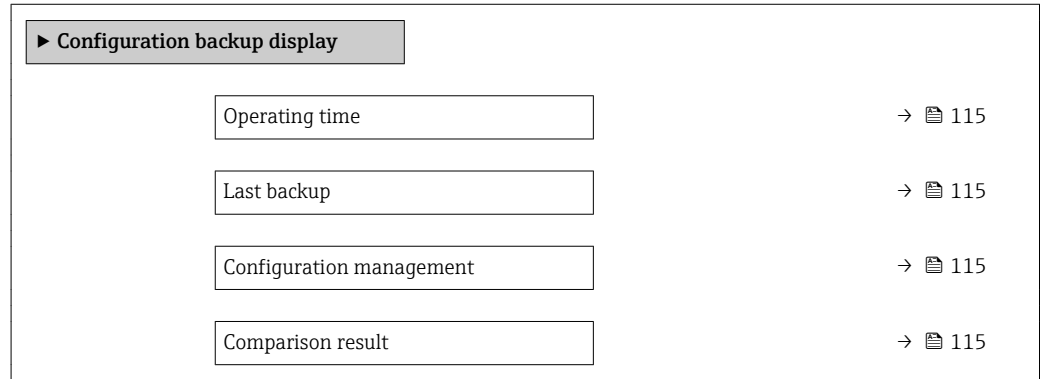

Parameter overview with brief description

Parameter	Prerequisite	Description	User interface / Selection	Factory setting
Operating time	–	Indicates how long the device has been in operation.	Days (d), hours (h), minutes (m) and seconds (s)	–
Last backup	A local display is provided.	Indicates when the last data backup was saved to the display module.	Days (d), hours (h), minutes (m) and seconds (s)	–
Configuration management	A local display is provided.	Select action for managing the device data in the display module.	<ul style="list-style-type: none"> ■ Cancel ■ Execute backup ■ Restore ■ Duplicate ■ Compare ■ Clear backup data 	Cancel
Comparison result	A local display is provided.	Comparison between present device data and display backup.	<ul style="list-style-type: none"> ■ Settings identical ■ Settings not identical ■ No backup available ■ Backup settings corrupt ■ Check not done ■ Dataset incompatible 	Check not done

Function scope of the "Configuration management" parameter

Options	Description
Cancel	No action is executed and the user exits the parameter.
Execute backup	A backup copy of the current device configuration is saved from the HistoROM backup to the display module of the device. The backup copy includes the transmitter data of the device.
Restore	The last backup copy of the device configuration is restored from the display module to the device's HistoROM backup. The backup copy includes the transmitter data of the device.
Compare	The device configuration saved in the display module is compared with the current device configuration of the HistoROM backup.

Options	Description
Duplicate	The transmitter configuration from another device is duplicated to the device using the display module.
Clear backup data	The backup copy of the device configuration is deleted from the display module of the device.

 **HistoROM backup**
 A HistoROM is a "non-volatile" device memory in the form of an EEPROM.

 While this action is in progress, the configuration cannot be edited via the local display and a message on the processing status appears on the display.

10.5.7 Using parameters for device administration

The **Administration** submenu systematically guides the user through all the parameters that can be used for device administration purposes.

Navigation

"Setup" menu → Advanced setup → Administration

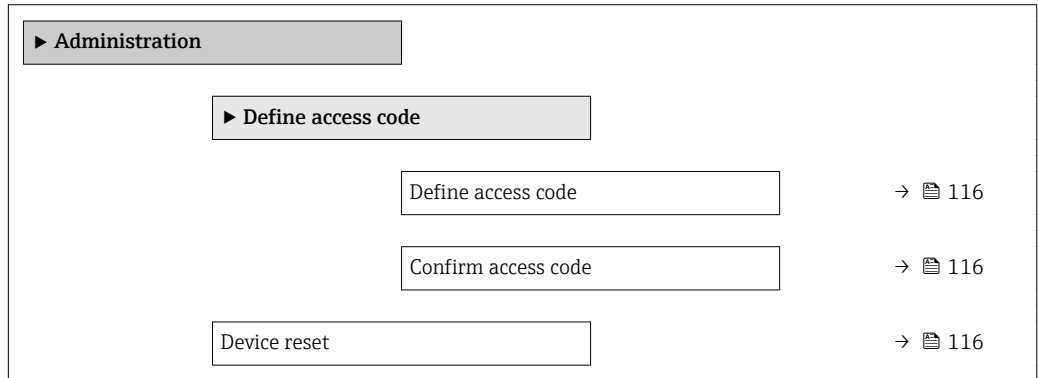

Parameter overview with brief description

Parameter	Description	User entry / Selection	Factory setting
Define access code	Restrict write-access to parameters to protect the configuration of the device against unintentional changes via the local display.	0 to 9 999	0
Confirm access code	Confirm the entered access code.	0 to 9 999	0
Device reset	Reset the device configuration - either entirely or in part - to a defined state.	<ul style="list-style-type: none"> ■ Cancel ■ To factory defaults ■ To delivery settings ■ Restart device 	Cancel

10.6 Configuration management

After commissioning, you can save the current device configuration, copy it to another measuring point or restore the previous device configuration.

You can do so using the **Configuration management** parameter and the related options found in the **Configuration backup display** submenu.

Navigation

"Setup" menu → Advanced setup → Configuration backup display

▶ Configuration backup display	
Operating time	→ ⓘ 115
Last backup	→ ⓘ 115
Configuration management	→ ⓘ 115
Comparison result	→ ⓘ 115

Parameter overview with brief description

Parameter	Prerequisite	Description	User interface / Selection	Factory setting
Operating time	–	Indicates how long the device has been in operation.	Days (d), hours (h), minutes (m) and seconds (s)	–
Last backup	A local display is provided.	Indicates when the last data backup was saved to the display module.	Days (d), hours (h), minutes (m) and seconds (s)	–
Configuration management	A local display is provided.	Select action for managing the device data in the display module.	<ul style="list-style-type: none"> ▪ Cancel ▪ Execute backup ▪ Restore ▪ Duplicate ▪ Compare ▪ Clear backup data 	Cancel
Comparison result	A local display is provided.	Comparison between present device data and display backup.	<ul style="list-style-type: none"> ▪ Settings identical ▪ Settings not identical ▪ No backup available ▪ Backup settings corrupt ▪ Check not done ▪ Dataset incompatible 	Check not done

10.6.1 Function scope of the "Configuration management" parameter

Options	Description
Cancel	No action is executed and the user exits the parameter.
Execute backup	A backup copy of the current device configuration is saved from the HistoROM backup to the display module of the device. The backup copy includes the transmitter data of the device.
Restore	The last backup copy of the device configuration is restored from the display module to the device's HistoROM backup. The backup copy includes the transmitter data of the device.
Compare	The device configuration saved in the display module is compared with the current device configuration of the HistoROM backup.

Options	Description
Duplicate	The transmitter configuration from another device is duplicated to the device using the display module.
Clear backup data	The backup copy of the device configuration is deleted from the display module of the device.

 **HistoROM backup**

A HistoROM is a "non-volatile" device memory in the form of an EEPROM.













 While this action is in progress, the configuration cannot be edited via the local display and a message on the processing status appears on the display.



10.7 Simulation

The **Simulation** submenu enables you to simulate, without a real flow situation, various process variables in the process and the device alarm mode and to verify downstream signal chains (switching valves or closed-control loops).





Navigation

"Diagnostics" menu → Simulation

▶ Simulation	
Assign simulation process variable	→  119
Process variable value	→  119
Current input 1 simulation	→  119
Value current input 1	→  119
Current output 1 to n simulation	→  119
Value current output 1 to n	→  119
Frequency output simulation	→  119
Frequency value	→  119
Pulse output simulation	→  119
Pulse value	→  119
Switch output simulation	→  120
Switch status	→  120
Device alarm simulation	→  120

Diagnostic event category	→  120
Diagnostic event simulation	→  120

Parameter overview with brief description

Parameter	Prerequisite	Description	Selection / User entry	Factory setting
Assign simulation process variable	–	Select a process variable for the simulation process that is activated.	<ul style="list-style-type: none"> ▪ Off ▪ Mass flow ▪ Flow velocity ▪ Volume flow ▪ Corrected volume flow ▪ Temperature ▪ Calculated saturated steam pressure * ▪ Total mass flow * ▪ Condensate mass flow * ▪ Energy flow ▪ Heat flow difference * ▪ Reynolds number 	Off
Process variable value	A process variable is selected in the Assign simulation process variable parameter (→  119).	Enter the simulation value for the selected process variable.	Depends on the process variable selected	0
Current input 1 simulation	–	Switch simulation of the current input on and off.	<ul style="list-style-type: none"> ▪ Off ▪ On 	Off
Value current input 1	In the Current input simulation parameter, the On option is selected.	Enter the current value for simulation.	3.59 to 22.5 mA	3.59 mA
Current output 1 to n simulation	–	Switch the simulation of the current output on and off.	<ul style="list-style-type: none"> ▪ Off ▪ On 	Off
Value current output 1 to n	In the Current output 1 to n simulation parameter, the On option is selected.	Enter the current value for simulation.	3.59 to 22.5 mA	3.59 mA
Frequency output simulation	In the Operating mode parameter, the Frequency option is selected.	Switch the simulation of the frequency output on and off.	<ul style="list-style-type: none"> ▪ Off ▪ On 	Off
Frequency value	In the Frequency output simulation parameter, the On option is selected.	Enter the frequency value for the simulation.	0.0 to 1250.0 Hz	0.0 Hz
Pulse output simulation	In the Operating mode parameter, the Pulse option is selected.	Set and switch off the pulse output simulation.  For Fixed value option: Pulse width parameter (→  85) defines the pulse width of the pulses output.	<ul style="list-style-type: none"> ▪ Off ▪ Fixed value ▪ Down-counting value 	Off
Pulse value	In the Pulse output simulation parameter (→  119), the Down-counting value option is selected.	Enter the number of pulses for simulation.	0 to 65535	0

Parameter	Prerequisite	Description	Selection / User entry	Factory setting
Switch output simulation	In the Operating mode parameter, the Switch option is selected.	Switch the simulation of the switch output on and off.	<ul style="list-style-type: none"> ▪ Off ▪ On 	Off
Switch status	In the Switch output simulation parameter (→  120) Switch output simulation 1 to n parameter Switch output simulation 1 to n parameter, the On option is selected.	Select the status of the status output for the simulation.	<ul style="list-style-type: none"> ▪ Open ▪ Closed 	Open
Device alarm simulation	–	Switch the device alarm on and off.	<ul style="list-style-type: none"> ▪ Off ▪ On 	Off
Diagnostic event category	–	Select a diagnostic event category.	<ul style="list-style-type: none"> ▪ Sensor ▪ Electronics ▪ Configuration ▪ Process 	Process
Diagnostic event simulation	–	Select a diagnostic event to simulate this event.	<ul style="list-style-type: none"> ▪ Off ▪ Diagnostic event picklist (depends on the category selected) 	Off

* Visibility depends on order options or device settings

10.8 Protecting settings from unauthorized access

The following options exist for protecting the configuration of the measuring device from unintentional modification after commissioning:

- Write protection via access code
- Write protection via write protection switch
- Write protection via keypad lock

10.8.1 Write protection via access code

The effects of the user-specific access code are as follows:

- Via local operation, the parameters for the measuring device configuration are write-protected and their values can no longer be changed.
- Device access is protected via the Web browser, as are the parameters for the measuring device configuration.

Defining the access code via local display

1. Navigate to the **Enter access code** parameter.
2. Define a max. 16-digit character string comprising numbers, letters and special characters as the access code.
3. Enter the access code again in the to confirm the code.
 - ↳ The -symbol appears in front of all write-protected parameters.

The device automatically locks the write-protected parameters again if a key is not pressed for 10 minutes in the navigation and editing view. The device locks the write-protected

parameters automatically after 60 s if the user skips back to the operational display mode from the navigation and editing view.

- i
 - If parameter write protection is activated via an access code, it can also only be deactivated via this access code → [62](#).
 - The user role with which the user is currently logged on via the local display → [62](#) is indicated by the **Access status display** parameter. Navigation path: Operation → Access status display

Parameters which can always be modified via the local display

Certain parameters that do not affect the measurement are excepted from parameter write protection via the local display. Despite the user-specific access code, they can always be modified, even if the other parameters are locked.

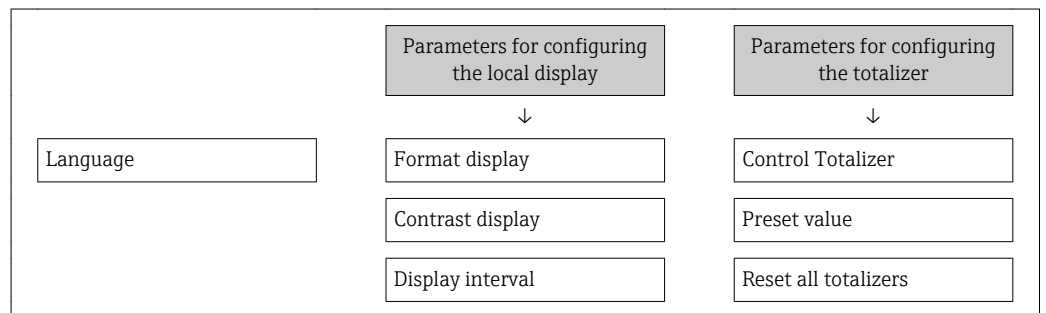

10.8.2 Write protection via write protection switch

Unlike parameter write protection via a user-specific access code, this allows write access to the entire operating menu - except for the **"Contrast display" parameter** - to be locked.

The parameter values are now read only and cannot be edited any more (exception **"Contrast display" parameter**):

- Via local display
- Via service interface (CDI)
- Via HART protocol

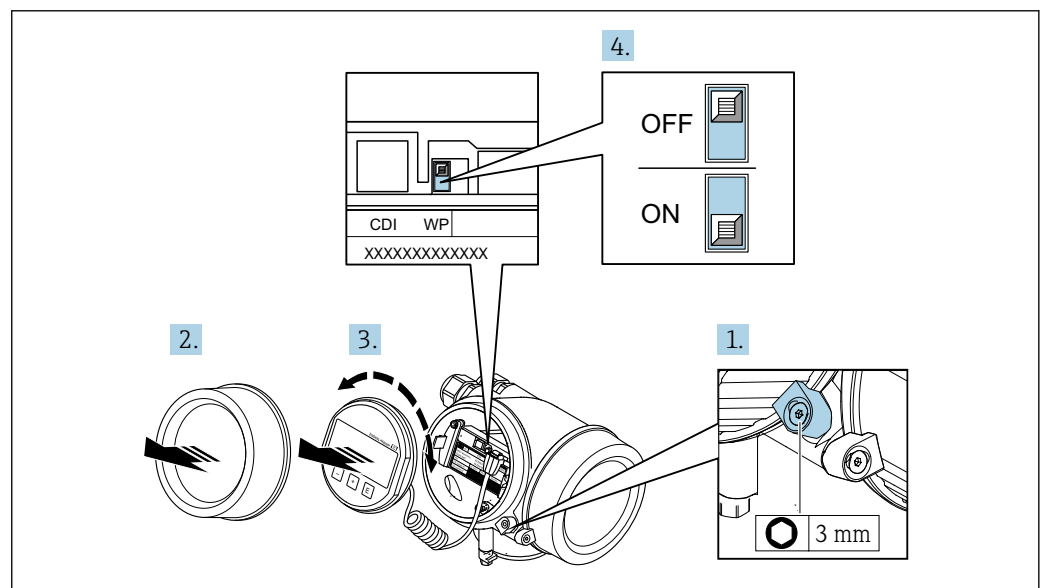

1. Loosen the securing clamp.
2. Unscrew the electronics compartment cover.

3. Pull out the display module with a gentle rotational movement. To make it easier to access the write protection switch, attach the display module to the edge of the electronics compartment.
 - ↳ Display module is attached to the edge of the electronics compartment.

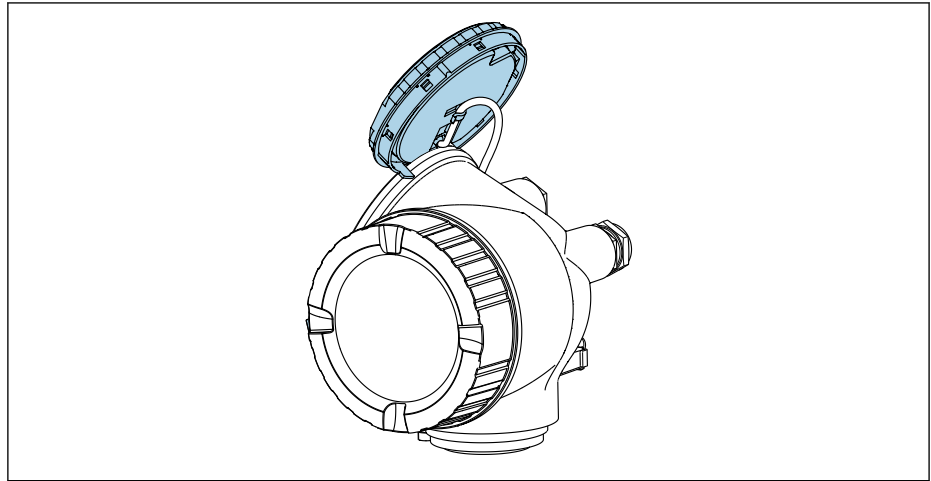

A0032236

4. Setting the write protection switch (WP) on the main electronics module to the **ON** position enables hardware write protection. Setting the write protection switch (WP) on the main electronics module to the **OFF** position (factory setting) disables hardware write protection.
 - ↳ If the hardware write protection is enabled: The **Hardware locked** option is displayed in the **Locking status** parameter . In addition, on the local display the -symbol appears in front of the parameters in the header of the operational display and in the navigation view.

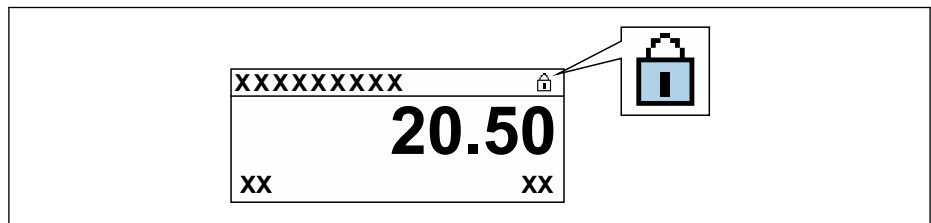

A0029425

If the hardware write protection is disabled: No option is displayed in the **Locking status** parameter . On the local display, the -symbol disappears from in front of the parameters in the header of the operational display and in the navigation view.

5. Feed the cable into the gap between the housing and main electronics module and plug the display module into the electronics compartment in the desired direction until it engages.
6. Reverse the removal procedure to reassemble the transmitter.

10.9 Application-specific commissioning

10.9.1 Steam application

Select medium

Navigation:

Setup → Medium selection

1. Call up the **Medium selection** wizard.

2. In the **Select medium** parameter, select the **Steam** option.
3. When pressure measured value is read in ¹⁾:
In the **Steam calculation mode** parameter, select the **Automatic (p-/T-compensated)** option.
4. If pressure measured value is not read in:
In the **Steam calculation mode** parameter, select the **Saturated steam (T-compensated)** option.
5. In the **Steam quality value** parameter, enter the steam quality present in the pipe.
↳ Measuring device uses this value to calculate the mass flow of the steam.

Configuring the current output

6. Configure current output →  83.

10.9.2 Liquid application

User-specific liquid, e. g. heat carrier oil

Select medium

Navigation:

Setup → Medium selection

1. Call up the **Medium selection** wizard.
2. In the **Select medium** parameter, select the **Liquid** option.
3. In the **Select liquid type** parameter, select the **User-specific liquid** option.
4. In the **Enthalpy type** parameter, select the **Heat** option.
↳ **Heat** option: Non-flammable liquid that serves as a heat carrier.
Calorific value option: Flammable liquid whose combustion energy is calculated.

Configuring fluid properties

Navigation:

Setup → Advanced setup → Medium properties

5. Call up the **Medium properties** submenu.
6. In the **Reference density** parameter, enter the reference density of the fluid.
7. In the **Reference temperature** parameter, enter the fluid temperature associated with the reference density.
8. In the **Linear expansion coefficient** parameter, enter the expansion coefficient of the fluid.
9. In the **Specific heat capacity** parameter, enter the heat capacity of the fluid.
10. In the **Dynamic viscosity** parameter, enter the viscosity of the fluid.

1) Sensor version option "mass (integrated pressure and temperature measurement)", Pressure read in via current input/HART/

10.9.3 Gas applications

i For accurate mass or corrected volume measurement, it is recommended to use the pressure-/temperature-compensated sensor version. If this sensor version is not available, read in the pressure via the current input/HART. If neither of these two options is possible, the pressure can also be entered as a fixed value in the **Fixed process pressure** parameter.

i Flow computer available only with the order code for "Sensor version", option "mass" (integrated temperature measurement)" or option "mass (integrated pressure/temperature measurement)".

Single gas

Combustion gas, e. g. methane CH₄

Select medium

Navigation:

Setup → Medium selection

1. Call up the **Medium selection** wizard.
2. In the **Select medium** parameter, select the **Gas** option.
3. In the **Select gas type** parameter, select the **Single gas** option.
4. In the **Gas type** parameter, select the **Methane CH₄** option.

Configuring fluid properties

Navigation:

Setup → Advanced setup → Medium properties

5. Call up the **Medium properties** submenu.
6. In the **Reference combustion temperature** parameter, enter the reference combustion temperature of the fluid.
- 7.

Configuring the current output

8. Configure the current output for the "energy flow" process variable →  83.

Configuring optional fluid properties for output of corrected volume flow

Navigation:

Setup → Advanced setup → Medium properties

9. Call up the **Medium properties** submenu.
10. In the **Reference pressure** parameter, enter the reference pressure of the fluid.
11. In the **Reference temperature** parameter, enter the reference temperature of the fluid.

Gas mixture

Forming gas for steel mills and rolling mills, e. g. N₂/H₂

Select medium

Navigation:

Setup → Medium selection

1. Call up the **Medium selection** wizard.
2. In the **Select medium** parameter, select the **Gas** option.

3. In the **Select gas type** parameter, select the **Gas mixture** option.

Configuring gas composition

Navigation:

Setup → Advanced setup → Medium properties → Gas composition

4. Call up the **Gas composition** submenu.
5. In the **Gas mixture** parameter, select the **Hydrogen H2** option and the **Nitrogen N2** option.
6. In the **Mol% H2** parameter, enter the quantity of hydrogen.
7. In the **Mol% N2** parameter, enter the quantity of nitrogen.
 - ↳ All quantities must add up to 100 %.
 - The density is determined according to NEL 40.

Configuring optional fluid properties for output of corrected volume flow

Navigation:

Setup → Advanced setup → Medium properties





8. Call up the **Medium properties** submenu.
9. In the **Reference pressure** parameter, enter the reference pressure of the fluid.
10. In the **Reference temperature** parameter, enter the reference temperature of the fluid.

Air

Select medium

Navigation:

Setup → Medium selection

1. Call up the **Medium selection** wizard.
2. In the **Select medium** parameter (→  79), select the **Gas** option.
3. In the **Select gas type** parameter (→  79), select the **Air** option.
 - ↳ The density is determined according to NEL 40.
4. Enter the value in the **Relative humidity** parameter (→  80).
 - ↳ The relative humidity is entered as a %. The relative humidity is converted internally to absolute humidity and is then factored into the density calculation according to NEL 40.
5. In the **Fixed process pressure** parameter (→  81), enter the value of the process pressure present.

Configuring fluid properties

Navigation:

Setup → Advanced setup → Medium properties

6. Call up the **Medium properties** submenu.
7. In the **Reference pressure** parameter (→  96) enter the reference pressure for calculating the reference density.
 - ↳ Pressure that is used as a static reference for combustion. This makes it possible to compare combustion processes at different pressures.

8. In the **Reference temperature** parameter (→ ⓘ 96) enter the temperature for calculating the reference density.

 Endress+Hauser recommends the use of active pressure compensation. This fully rules out the risk of measured errors due to pressure variations and incorrect entries .

Natural gas

Select medium

Navigation:

Setup → Medium selection

1. Call up the **Medium selection** wizard.
2. In the **Select medium** parameter (→ ⓘ 79), select the **Gas** option.
3. In the **Select gas type** parameter (→ ⓘ 79), select the **Natural gas** option.
4. In the **Fixed process pressure** parameter (→ ⓘ 81), enter the value of the process pressure present.
5. In the **Enthalpy calculation** parameter (→ ⓘ 81), select one of the following options:
 - ↳ AGA5
ISO 6976 option (contains GPA 2172)
6. In the **Density calculation** parameter (→ ⓘ 81), select one of the following options.
 - ↳ AGA Nx19
ISO 12213- 2 option (contains AGA8-DC92)
ISO 12213- 3 option (contains SGERG-88, AGA8 Gross Method 1)

Configuring fluid properties

Navigation:

Setup → Advanced setup → Medium properties

7. Call up the **Medium properties** submenu.
8. In the **Calorific value type** parameter, select one of the options.
9. In the **Reference gross calorific value** parameter, enter the reference gross calorific value of the natural gas.
10. In the **Reference pressure** parameter (→ ⓘ 96) enter the reference pressure for calculating the reference density.
 - ↳ Pressure that is used as a static reference for combustion. This makes it possible to compare combustion processes at different pressures.
11. In the **Reference temperature** parameter (→ ⓘ 96) enter the temperature for calculating the reference density.
12. In the **Relative density** parameter, enter the relative density of the natural gas.

 Endress+Hauser recommends the use of active pressure compensation. This fully rules out the risk of measured errors due to pressure variations and incorrect entries .

Ideal gas

The unit "corrected volume flow" is often used to measure industrial gas mixtures, in particular natural gas. To do so, the calculated mass flow is divided by a reference density. To calculate the mass flow, knowledge of the exact composition of the gas is essential. In practice, however, this information is often not available (e. g. as it varies over time). In this case, it can be useful to regard the gas as an ideal gas. This means that only the operating temperature and operating pressure variables as well as the reference temperature and reference pressure variables are needed to calculate the corrected volume

flow. The error resulting from this assumption (typically 1 to 5 %) is often considerably smaller than the error caused by inaccurate composition data. This method should not be used for condensing gases (e. g. saturated steam).

Select medium

Navigation:

Setup → Medium selection

1. Call up the **Medium selection** wizard.
2. In the **Select medium** parameter, select the **Gas** option.
3. In the **Select gas type** parameter, select the **User-specific gas** option.
4. For non-flammable gas:
In the **Enthalpy type** parameter, select the **Heat** option.

Configuring fluid properties

Navigation:

Setup → Advanced setup → Medium properties

5. Call up the **Medium properties** submenu.
6. In the **Reference density** parameter, enter the reference density of the fluid.
7. In the **Reference pressure** parameter, enter the reference pressure of the fluid.
8. In the **Reference temperature** parameter, enter the fluid temperature associated with the reference density.
9. In the **Reference Z-factor** parameter, enter the value **1**.
10. If specific heat capacity is to be measured:
In the **Specific heat capacity** parameter, enter the heat capacity of the fluid.
11. In the **Z-factor** parameter, enter the value **1**.
12. In the **Dynamic viscosity** parameter, enter the viscosity of the fluid under operating conditions.

10.9.4 Calculation of the measured variables

A flow computer can be found in the electronics of the measuring device with order code for "Sensor version", option "mass (integrated temperature measurement)" and option "mass (integrated pressure/temperature measurement)". This computer can calculate the following secondary measured variables directly from the primary measured variables recorded using the pressure value (entered or external) and/or temperature value (measured or entered).

Mass flow and corrected volume flow

Medium	Fluid	Standards	Explanation
Steam ¹⁾	Water vapor	IAPWS-IF97/ ASME	<ul style="list-style-type: none"> ■ For integrated temperature measurement ■ For fixed process pressure, pressure measured directly at the meter body or if the pressure is read in via current input/HART
Gas	Single gas	NEL40	For fixed process pressure, pressure measured directly at the meter body or if the pressure is read in via current input/HART
	Gas mixture	NEL40	
	Air	NEL40	
	Natural gas	ISO 12213-2	<ul style="list-style-type: none"> ■ Contains AGA8-DC92 ■ For fixed process pressure, pressure measured directly at the meter body or if the pressure is read in via current input/HART

Medium	Fluid	Standards	Explanation
		AGA NX-19	For fixed process pressure, pressure measured directly at the meter body or if the pressure is read in via current input/HART
		ISO 12213-3	<ul style="list-style-type: none"> Contains SGERG-88, AGA8 Gross Method 1 For fixed process pressure, pressure measured directly at the meter body or if the pressure is read in via current input/HART
	Other gases	Linear equation	<ul style="list-style-type: none"> Ideal gases For fixed process pressure, pressure measured directly at the meter body or if the pressure is read in via current input/HART
Liquids	Water	IAPWS-IF97/ ASME	-
	Liquefied gas	Tables	Propane and butane mixture
	Other liquid	Linear equation	Ideal liquids

- 1) The measuring device is capable of calculating the volume flow, and other measured variables derived from the volume flow, across all steam types with full compensation using the pressure and temperature. To configure device behavior →  107

Mass flow calculation

Volume flow × operating density

- Operating density for saturated steam, water and other liquids: depends on the temperature
- Operating density for superheated steam and all other gases: depends on the temperature and process pressure

Corrected volume flow calculation

(Volume flow × operating density)/reference density

- Operating density for water and other liquids: depends on the temperature
- Operating density for all other gases: depends on the temperature and process pressure

Energy flow

Medium	Fluid	Standards	Explanation	Heat/energy option
Steam ¹⁾	-	IAPWS-IF97/ASME	For fixed process pressure or if the pressure is read in via current input/HART	Heat Gross calorific value ²⁾ in relation to mass Net calorific value ³⁾ in relation to mass Gross calorific value ²⁾ in relation to corrected volume Net calorific value ³⁾ in relation to corrected volume
Gas	Single gas	ISO 6976	<ul style="list-style-type: none"> Contains GPA 2172 For fixed process pressure or if the pressure is read in via current input/HART 	
	Gas mixture	ISO 6976	<ul style="list-style-type: none"> Contains GPA 2172 For fixed process pressure or if the pressure is read in via current input/HART 	
	Air	NEL40	For fixed process pressure or if the pressure is read in via current input/HART	

Medium	Fluid	Standards	Explanation	Heat/energy option
	Natural gas	ISO 6976	<ul style="list-style-type: none"> ■ Contains GPA 2172 ■ For fixed process pressure or if the pressure is read in via current input/HART 	
		AGA 5	–	
Liquids	Water	IAPWS-IF97/ASME	–	
	Liquefied gas	ISO 6976	Contains GPA 2172	
	Other liquid	Linear equation	–	

- 1) The measuring device is capable of calculating the volume flow, and other measured variables derived from the volume flow, across all steam types with full compensation using the pressure and temperature. To configure device behavior →  107
- 2) Gross calorific value: combustion energy + condensation energy of the flue gas (gross calorific value > net calorific value)
- 3) Net calorific value: only combustion energy



Mass flow and energy flow calculation

NOTICE

The process pressure (p) in the process pipe is required to calculate the process variables and the limit values of the measuring range.

- ▶ With the HART device, the process pressure can be entered via the 4 to 20mA current input or via HART from an external pressure measuring device (e. g. Cerabar M) or entered as a fixed value in the **External compensation** submenu (→  107).

Steam is calculated based on the following factors:

- Fully compensated calculation of density using the "pressure" and "temperature" measured variables
- Calculation based on overheated steam until saturation point is reached
Configuration of diagnostic behavior of the **△S871 Near steam saturation limit** diagnostic message **Assign behavior of diagnostic no. 871** parameter set to **Off** option (factory setting) as standard →  149
Optional configuration of diagnostic behavior to the **Alarm** option or **Warning** option →  148 option.
At 2 K above saturation, activation of the **△S871 Near steam saturation limit** diagnostic message.
- The smaller of the following two pressure values is always used to calculate the density:
 - Pressure measured directly at meter body or pressure read in via current input/HART
 - Saturated steam pressure, which is derived from the saturated steam line (IAPWS-IF97/ASME)
- Depending on setting in the **Steam calculation mode** parameter (→  80)
 - If **Saturated steam (T-compensated)** option is selected, the measuring device only calculates on the saturated steam curve using temperature compensation.
 - If **Automatic (p-/T-compensated)** option is selected, the device calculates using full compensation either along the saturation line or in the superheated region, depending on the steam state.

 For detailed information on how to perform external compensation, see →  107.

Calculated value

The unit calculates the mass flow, heat flow, energy flow, density and specific enthalpy from the measured volume flow and the measured temperature and/or the pressure based on international standard IAPWS-IF97/ASME.

Formulae for calculation:

- Mass flow: $\dot{m} = \dot{v} \cdot \rho (T, p)$
- Heat flow: $\dot{Q} = \dot{v} \cdot \rho (T, p) \cdot h_D (T, p)$

\dot{m} = Mass flow

\dot{Q} = Heat flow

\dot{v} = Volume flow (measured)

h_D = Specific enthalpy

T = Process temperature (measured)

p = Process pressure

ρ = Density ²⁾

Pre-programmed gases

The following gases are pre-programmed in the flow computer:

Hydrogen ¹⁾	Helium 4	Neon	Argon
Krypton	Xenon	Nitrogen	Oxygen
Chlorine	Ammonia	Carbon monoxide ¹⁾	Carbon dioxide
Sulfur dioxide	Hydrogen sulfide ¹⁾	Hydrogen chloride	Methane ¹⁾
Ethane ¹⁾	Propane ¹⁾	Butane ¹⁾	Ethylene (ethene) ¹⁾
Vinyl chloride	Mixtures of up to 8 components of these gases ¹⁾		

- 1) The energy flow is calculated as per ISO 6976 (contains GPA 2172) or AGA5 - in relation to the net calorific value or gross calorific value .

Energy flow calculation

Volume flow × operating density × specific enthalpy

- Operating density for saturated steam and water: depends on the temperature
- Operating density for superheated steam, natural gas ISO 6976 (contains GPA 2172), natural gas AGA5: depends on the temperature and pressure

Heat flow difference

- Between saturated steam upstream from a heat exchanger and condensate downstream from the heat exchanger (second temperature read in via current input/HART) in accordance with IAPWS-IF97/ASME →  27
- Between warm and cold water (second temperature read in via current input/HART) in accordance with IAPWS-IF97/ASME

Vapor pressure and steam temperature

The measuring device can perform the following in saturated steam measurements between the feed line and return line of any heating liquid (second temperature read in via current input/HART and Cp value entered:

2) From steam data as per IAPWS-IF97 (ASME), for the measured temperature and the specified pressure

- Calculation of saturation pressure of steam from the measured temperature and output in accordance with IAPWS-IF97/ASME
- Calculation of saturation temperature of steam from the preset pressure and output in accordance with IAPWS-IF97/ASME



11 Operation

11.1 Reading the device locking status

Device active write protection: **Locking status** parameter



Operation → Locking status

Function scope of the "Locking status" parameter

Options	Description
None	The access status displayed in the Access status display parameter applies →  62. Only appears on local display.
Hardware locked	The DIP switch for hardware locking is activated on the main electronics module. This locks write access to the parameters (e.g. via local display or operating tool) →  121.
SIL locked	The SIL mode is enabled. This locks write access to the parameters (e.g. via local display or operating tool).
Temporarily locked	Write access to the parameters is temporarily locked on account of internal processes running in the device (e.g. data upload/download, reset etc.). Once the internal processing has been completed, the parameters can be changed once again.



11.2 Adjusting the operating language

 Detailed information:

- To configure the operating language →  73
- For information on the operating languages supported by the measuring device →  197

11.3 Configuring the display

Detailed information:





- On the basic settings for the local display →  89
- On the advanced settings for the local display →  112

11.4 Reading measured values

With the **Measured values** submenu, it is possible to read all the measured values.

Navigation

"Diagnostics" menu → Measured values → Process variables

▶ Measured values	
▶ Process variables	→  133
▶ Totalizer	→  135
▶ Input values	→  136
▶ Output values	→  136

11.4.1 Process variables

The **Process variables** submenu contains all the parameters needed to display the current measured values for each process variable.

Navigation

"Diagnostics" menu → Measured values → Process variables

► Process variables		
Volume flow	→	📖 133
Corrected volume flow	→	📖 133
Mass flow	→	📖 134
Flow velocity	→	📖 134
Temperature	→	📖 134
Calculated saturated steam pressure	→	📖 134
Energy flow	→	📖 134
Heat flow difference	→	📖 134
Reynolds number	→	📖 134
Density	→	📖 134
Specific volume	→	📖 135
Pressure	→	📖 135
Compressibility factor	→	📖 135
Degrees of superheat	→	📖 135

Parameter overview with brief description

Parameter	Prerequisite	Description	User interface
Volume flow	–	Displays the volume flow that is currently measured. <i>Dependency</i> The unit is taken from the Volume flow unit parameter (→ 📖 76).	Signed floating-point number
Corrected volume flow	–	Displays the corrected volume flow that is currently calculated. <i>Dependency</i> The unit is taken from the Corrected volume flow unit parameter (→ 📖 76).	Signed floating-point number

Parameter	Prerequisite	Description	User interface
Mass flow	–	Displays the mass flow currently calculated. <i>Dependency</i> The unit is taken from the Mass flow unit parameter (→ 76).	Signed floating-point number
Flow velocity	–	Displays the flow velocity that is currently calculated. <i>Dependency</i> The unit is taken from the Velocity unit parameter (→ 78).	Signed floating-point number
Temperature	–	Displays the temperature that is currently measured. <i>Dependency</i> The unit is taken from the Temperature unit parameter (→ 77).	Signed floating-point number
Calculated saturated steam pressure	The following conditions are met: <ul style="list-style-type: none"> Order code for "Sensor version", <ul style="list-style-type: none"> option "Mass (integrated temperature measurement)" or option "Mass (integrated pressure/temperature measurement)" The Steam option is selected in the Select medium parameter (→ 79). 	Displays the saturated steam pressure that is currently calculated. <i>Dependency</i> The unit is taken from the Pressure unit parameter (→ 77).	Signed floating-point number
Energy flow	With order code for "Sensor version": <ul style="list-style-type: none"> option "Mass (integrated temperature measurement)" or option "Mass (integrated pressure/temperature measurement)" 	Displays the energy flow that is currently calculated. <i>Dependency</i> The unit is taken from the Energy flow unit parameter (→ 77).	Signed floating-point number
Heat flow difference	The following conditions are met: <ul style="list-style-type: none"> Order code for "Sensor version" <ul style="list-style-type: none"> option "Mass (integrated temperature measurement)" or option "Mass (integrated pressure/temperature measurement)" In the Select gas type parameter (→ 79), one of the following options is selected: <ul style="list-style-type: none"> Single gas Gas mixture Natural gas User-specific gas 	Displays the heat flow difference that is currently calculated. <i>Dependency</i> The unit is taken from the Energy flow unit parameter (→ 77).	Signed floating-point number
Reynolds number	With order code for "Sensor version": <ul style="list-style-type: none"> option "Mass (integrated temperature measurement)" or option "Mass (integrated pressure/temperature measurement)" 	Displays the Reynolds number that is currently calculated.	Signed floating-point number
Density	With order code for "Sensor version": <ul style="list-style-type: none"> Option "Mass (integrated temperature measurement)" or Option "Mass (integrated pressure/temperature measurement)" 	Displays the density currently measured. <i>Dependency</i> The unit is taken from the Density unit parameter.	Positive floating-point number

Parameter	Prerequisite	Description	User interface
Specific volume	With order code for "Sensor version": <ul style="list-style-type: none"> ▪ Option "Mass (integrated temperature measurement)" or ▪ Option "Mass (integrated pressure/ temperature measurement)" 	Displays the current value for the specific volume. <i>Dependency</i> The unit is taken from the Specific volume unit parameter.	Positive floating-point number
Pressure	One of the following conditions is met: <ul style="list-style-type: none"> ▪ Order code for "Sensor version", <ul style="list-style-type: none"> ▪ Option "Mass (integrated temperature measurement)" or ▪ Option "Mass (integrated pressure/ temperature measurement)" or ▪ The Pressure option is selected in the External value parameter. 	Displays the current process pressure. <i>Dependency</i> The unit is taken from the Pressure unit parameter.	0 to 250 bar
Compressibility factor	The following conditions are met: Order code for "Sensor version" <ul style="list-style-type: none"> ▪ Option "Mass (integrated temperature measurement)" or ▪ Option "Mass (integrated pressure/ temperature measurement)" The Gas option or the Steam option is selected in the Select medium parameter.	Displays the compressibility factor currently calculated.	0 to 2
Degrees of superheat	In the Select medium parameter, the Steam option is selected.	Displays the degree of superheating currently calculated.	0 to 500 K

11.4.2 "Totalizer" submenu

The **Totalizer** submenu contains all the parameters needed to display the current measured values for every totalizer.

Navigation

"Diagnostics" menu → Measured values → Totalizer

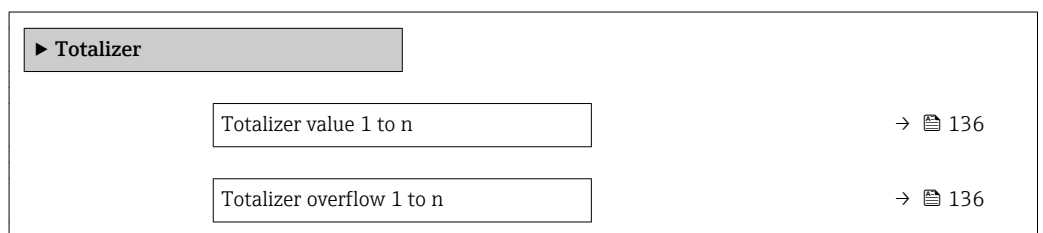

Parameter overview with brief description

Parameter	Prerequisite	Description	User interface
Totalizer value 1 to n	One of the following options is selected in the Assign process variable parameter (→ ⓘ 111) of the Totalizer 1 to n submenu: <ul style="list-style-type: none"> ■ Volume flow ■ Corrected volume flow ■ Mass flow ■ Total mass flow * ■ Condensate mass flow * ■ Energy flow * ■ Heat flow difference * 	Displays the current totalizer counter value.	Signed floating-point number
Totalizer overflow 1 to n	One of the following options is selected in the Assign process variable parameter (→ ⓘ 111) of the Totalizer 1 to n submenu: <ul style="list-style-type: none"> ■ Volume flow ■ Corrected volume flow ■ Mass flow ■ Total mass flow * ■ Condensate mass flow * ■ Energy flow * ■ Heat flow difference * 	Displays the current totalizer overflow.	Integer with sign

* Visibility depends on order options or device settings

11.4.3 Input values

The **Input values** submenu guides you systematically to the individual input values.

 The submenu appears only if the device was ordered with a current input.

Navigation

"Diagnostics" menu → Measured values → Input values

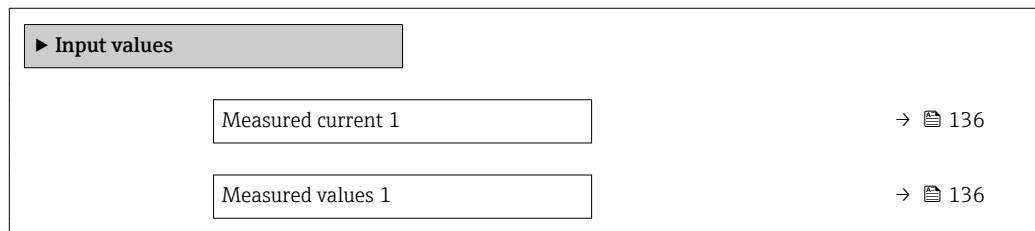

Parameter overview with brief description

Parameter	Description	User interface
Measured current 1	Displays the current value of the current input.	3.59 to 22.5 mA
Measured values 1	Displays the current input value. <i>Dependency</i> The display depends on the option selected in the External value parameter.	Signed floating-point number

11.4.4 Output values

The **Output values** submenu contains all the parameters needed to display the current measured values for every output.

Navigation

"Diagnostics" menu → Measured values → Output values

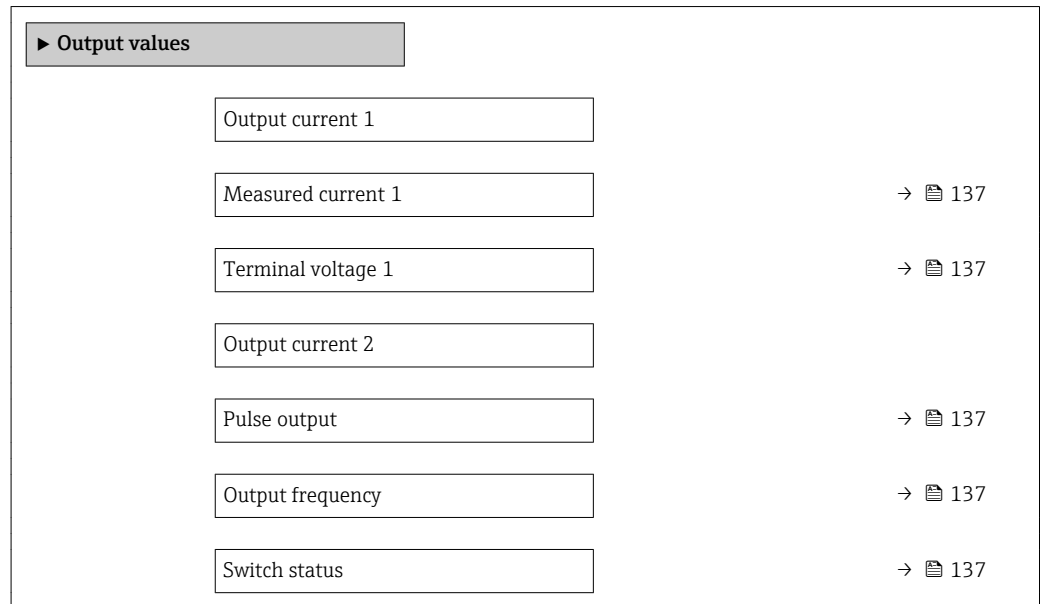

Parameter overview with brief description

Parameter	Prerequisite	Description	User interface
Output current 1	–	Displays the current value currently calculated for the current output.	3.59 to 22.5 mA
Measured current 1	–	Displays the current value currently measured for the current output.	0 to 30 mA
Terminal voltage 1	–	Displays the current terminal voltage that is applied at the output.	0.0 to 50.0 V
Output current 2	–	Displays the current value currently calculated for the current output.	3.59 to 22.5 mA
Pulse output	The Pulse option is selected in the Operating mode parameter parameter.	Displays the pulse frequency currently output.	Positive floating-point number
Output frequency	In the Operating mode parameter, the Frequency option is selected.	Displays the value currently measured for the frequency output.	0 to 1250 Hz
Switch status	The Switch option is selected in the Operating mode parameter.	Displays the current switch output status.	<ul style="list-style-type: none"> ■ Open ■ Closed

11.5 Adapting the measuring device to the process conditions

The following are available for this purpose:

- Basic settings using the **Setup** menu (→ 74)
- Advanced settings using the **Advanced setup** submenu (→ 93)

11.6 Performing a totalizer reset

The totalizers are reset in the **Operation** submenu:

- Control Totalizer
- Reset all totalizers

Navigation

"Operation" menu → Totalizer handling

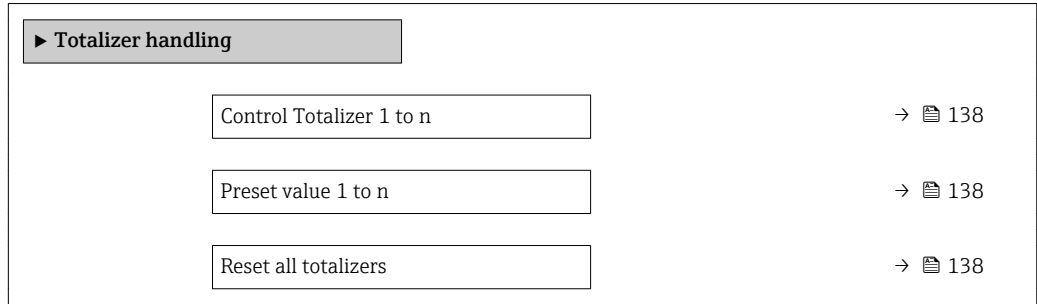

Parameter overview with brief description

Parameter	Prerequisite	Description	Selection / User entry	Factory setting
Control Totalizer 1 to n	A process variable is selected in the Assign process variable parameter (→ 111) of the Totalizer 1 to n submenu.	Control totalizer value.	<ul style="list-style-type: none"> ▪ Totalize ▪ Reset + hold ▪ Preset + hold ▪ Reset + totalize ▪ Preset + totalize ▪ Hold 	Totalize
Preset value 1 to n	A process variable is selected in the Assign process variable parameter (→ 111) of the Totalizer 1 to n submenu.	Specify start value for totalizer. <i>Dependency</i> The unit of the selected process variable is specified for the totalizer in the Unit totalizer parameter (→ 111).	Signed floating-point number	Country-specific: <ul style="list-style-type: none"> ▪ 0 m³ ▪ 0 ft³
Reset all totalizers	-	Reset all totalizers to 0 and start.	<ul style="list-style-type: none"> ▪ Cancel ▪ Reset + totalize 	Cancel

11.6.1 Function scope of the "Control Totalizer" parameter



Options	Description
Totalize	The totalizer is started or continues running.
Reset + hold	The totaling process is stopped and the totalizer is reset to 0.
Preset + hold	The totaling process is stopped and the totalizer is set to its defined start value from the Preset value parameter.
Reset + totalize	The totalizer is reset to 0 and the totaling process is restarted.
Preset + totalize	The totalizer is set to the defined start value from the Preset value parameter and the totaling process is restarted.

11.6.2 Function scope of the "Reset all totalizers" parameter

Options	Description
Cancel	No action is executed and the user exits the parameter.
Reset + totalize	Resets all totalizers to 0 and restarts the totaling process. This deletes all the flow values previously totalized.

11.7 Showing data logging

The **Extended HistoROM** application package must be enabled in the device (order option) for the **Data logging** submenu to appear. This contains all the parameters for the measured value history.

 Data logging is also available via:
Plant Asset Management Tool FieldCare →  65.

Function range

- A total of 1000 measured values can be stored
- 4 logging channels
- Adjustable logging interval for data logging
- Displays the measured value trend for each logging channel in the form of a chart

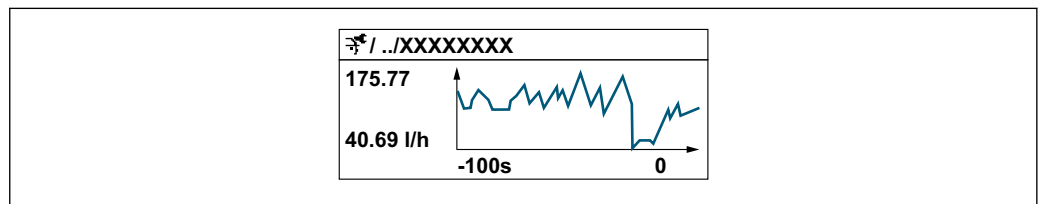

A0034952







- x-axis: depending on the number of channels selected displays 250 to 1000 measured values of a process variable.
- y-axis: displays the approximate measured value span and constantly adapts this to the ongoing measurement.

 If the length of the logging interval or the assignment of the process variables to the channels is changed, the content of the data logging is deleted.







Navigation

"Diagnostics" menu → Data logging

▶ Data logging

Assign channel 1	→  140
Assign channel 2	→  140
Assign channel 3	→  140
Assign channel 4	→  140
Logging interval	→  141
Clear logging data	→  141
▶ Display channel 1	
▶ Display channel 2	
▶ Display channel 3	
▶ Display channel 4	

Parameter overview with brief description

Parameter	Prerequisite	Description	Selection / User entry	Factory setting
Assign channel 1	The Extended HistorOM application package is available.	Assign process variable to logging channel.	<ul style="list-style-type: none"> ▪ Off ▪ Volume flow ▪ Corrected volume flow ▪ Mass flow ▪ Flow velocity ▪ Temperature ▪ Calculated saturated steam pressure[*] ▪ Steam quality[*] ▪ Total mass flow[*] ▪ Condensate mass flow[*] ▪ Energy flow[*] ▪ Heat flow difference[*] ▪ Reynolds number[*] ▪ Current output 1 ▪ Current output 2[*] ▪ Density[*] ▪ Pressure[*] ▪ Specific volume[*] ▪ Degrees of superheat[*] ▪ Vortex frequency ▪ Electronic temperature 	Off
Assign channel 2	The Extended HistorOM application package is available.  The software options currently enabled are displayed in the Software option overview parameter.	Assign process variable to logging channel.	Picklist, see Assign channel 1 parameter (→  140)	Off
Assign channel 3	The Extended HistorOM application package is available.  The software options currently enabled are displayed in the Software option overview parameter.	Assign process variable to logging channel.	Picklist, see Assign channel 1 parameter (→  140)	Off
Assign channel 4	The Extended HistorOM application package is available.  The software options currently enabled are displayed in the Software option overview parameter.	Assign process variable to logging channel.	Picklist, see Assign channel 1 parameter (→  140)	Off

Parameter	Prerequisite	Description	Selection / User entry	Factory setting
Logging interval	The Extended HistoROM application package is available.	Define the logging interval for data logging. This value defines the time interval between the individual data points in the memory.	1.0 to 3 600.0 s	1.0 s
Clear logging data	The Extended HistoROM application package is available.	Clear the entire logging data.	<ul style="list-style-type: none"> ■ Cancel ■ Clear data 	Cancel

* Visibility depends on order options or device settings

12 Diagnostics and troubleshooting

12.1 General troubleshooting

For local display





Error	Possible causes	Solution
Local display dark and no output signals	Supply voltage does not match the value indicated on the nameplate.	Apply the correct supply voltage → 41.
Local display dark and no output signals	The polarity of the supply voltage is wrong.	Correct the polarity.
Local display dark and no output signals	No contact between connecting cables and terminals.	Check the connection of the cables and correct if necessary.
Local display dark and no output signals	Terminals are not plugged into the I/O electronics module correctly.	Check terminals.
Local display dark and no output signals	I/O electronics module is defective.	Order spare part → 162.
Local display dark and output signals in failure current	Sensor short-circuit, electronics module short-circuit	1. Contact service.
Local display is dark, but signal output is within the valid range	Display is set too bright or too dark.	<ul style="list-style-type: none"> ▪ Set the display brighter by simultaneously pressing \boxplus + \boxminus. ▪ Set the display darker by simultaneously pressing \boxminus + \boxplus.
Local display is dark, but signal output is within the valid range	The cable of the display module is not plugged in correctly.	Insert the plug correctly into the main electronics module and display module.
Local display is dark, but signal output is within the valid range	Display module is defective.	Order spare part → 162.
Backlighting of local display is red	Diagnostic event with "Alarm" diagnostic behavior has occurred.	Take remedial measures → 149
Text on local display appears in a foreign language and cannot be understood.	Incorrect operating language is configured.	<ol style="list-style-type: none"> 1. Press \boxminus + \boxplus for 2 s ("home position"). 2. Press \boxminus. 3. Set the desired language in the Display language parameter (→ 114).
Message on local display: "Communication Error" "Check Electronics"	Communication between the display module and the electronics is interrupted.	<ul style="list-style-type: none"> ▪ Check the cable and the connector between the main electronics module and display module. ▪ Order spare part → 162.

For output signals

Error	Possible causes	Solution
Signal output outside the valid range	Main electronics module is defective.	Order spare part → 162.
Signal output outside the valid current range (< 3.6 mA or > 22 mA)	I/O electronics module is defective.	Order spare part → 162.

Error	Possible causes	Solution
Device shows correct value on local display, but signal output is incorrect, though in the valid range.	Configuration error	Check and correct the parameter configuration.
Device measures incorrectly.	Configuration error or device is operated outside the application.	1. Check and correct parameter configuration. 2. Observe limit values specified in the "Technical Data".

For access

Error	Possible causes	Solution
No write access to parameters	Hardware write protection enabled	Set the write protection switch on main electronics module to the OFF position →  121.
No write access to parameters	Current user role has limited access authorization	1. Check user role →  62. 2. Enter correct customer-specific access code →  62.
No connection via HART protocol	Communication resistor missing or incorrectly installed.	Install the communication resistor (250 Ω) correctly. Observe the maximum load .
No connection via HART protocol	Commubox <ul style="list-style-type: none"> ▪ Connected incorrectly ▪ Configured incorrectly ▪ Drivers not installed correctly ▪ USB interface on computer configured incorrectly 	Observe the documentation for the Commubox.  FXA195 HART: Document "Technical Information" TI00404F
No connection via service interface	Incorrect configuration of USB interface on PC or driver not installed correctly.	Observe the documentation for the Commubox.  FXA291: Document "Technical Information" TI00405C

12.2 Diagnostic information on local display

12.2.1 Diagnostic message

Faults detected by the self-monitoring system of the measuring device are displayed as a diagnostic message in alternation with the operational display.

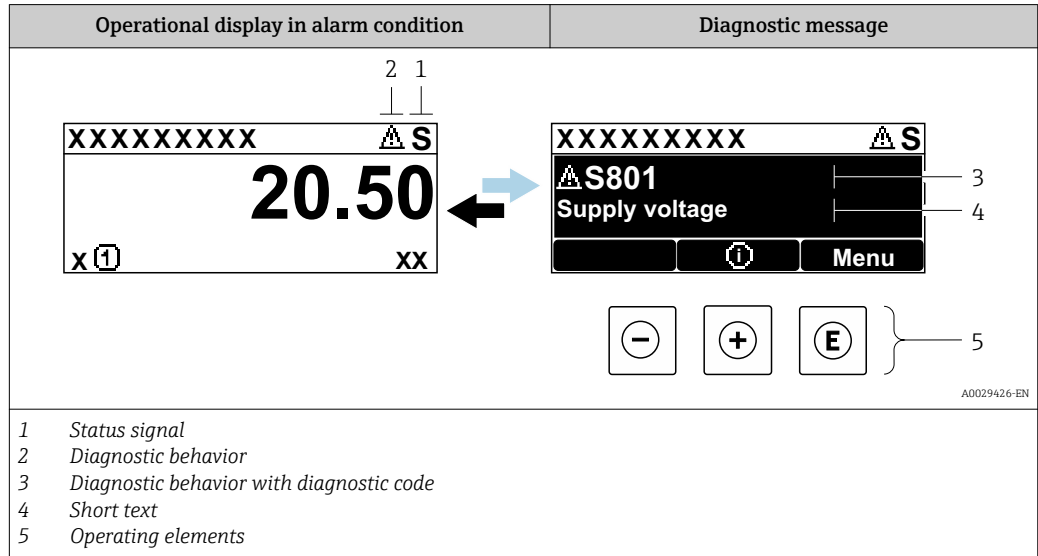

If two or more diagnostic events are pending simultaneously, only the message of the diagnostic event with the highest priority is shown.

- i** Other diagnostic events that have occurred can be displayed in the **Diagnostics** menu:
 - Via parameter → 153
 - Via submenus → 154



Status signals

The status signals provide information on the state and reliability of the device by categorizing the cause of the diagnostic information (diagnostic event).

- i** The status signals are categorized according to VDI/VDE 2650 and NAMUR Recommendation NE 107: F = Failure, C = Function Check, S = Out of Specification, M = Maintenance Required

Symbol	Meaning
F	Failure A device error has occurred. The measured value is no longer valid.
C	Function check The device is in service mode (e.g. during a simulation).
S	Out of specification The device is operated: <ul style="list-style-type: none"> ▪ Outside its technical specification limits (e.g. outside the process temperature range) ▪ Outside of the configuration carried out by the user (e.g. maximum flow in parameter 20 mA value)
M	Maintenance required Maintenance is required. The measured value remains valid.

Diagnostic behavior



Symbol	Meaning
	Alarm <ul style="list-style-type: none"> Measurement is interrupted. Signal outputs and totalizers assume the defined alarm condition. A diagnostic message is generated. For local display with touch control: the background lighting changes to red.
	Warning Measurement is resumed. The signal outputs and totalizers are not affected. A diagnostic message is generated.

Diagnostic information

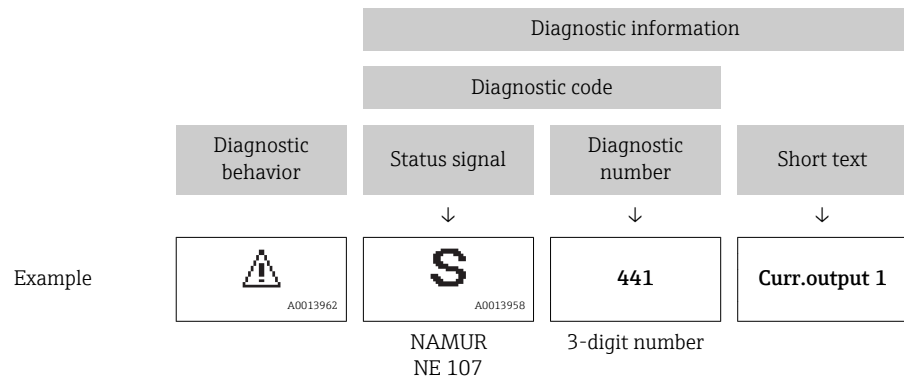
The fault can be identified using the diagnostic information. The short text helps you by providing information about the fault. In addition, the corresponding symbol for the diagnostic behavior is displayed in front of the diagnostic information on the local display.



Operating elements

Key	Meaning
	Plus key <i>In a menu, submenu</i> Opens the message about remedy information.
	Enter key <i>In a menu, submenu</i> Opens the operating menu.

12.2.2 Calling up remedial measures

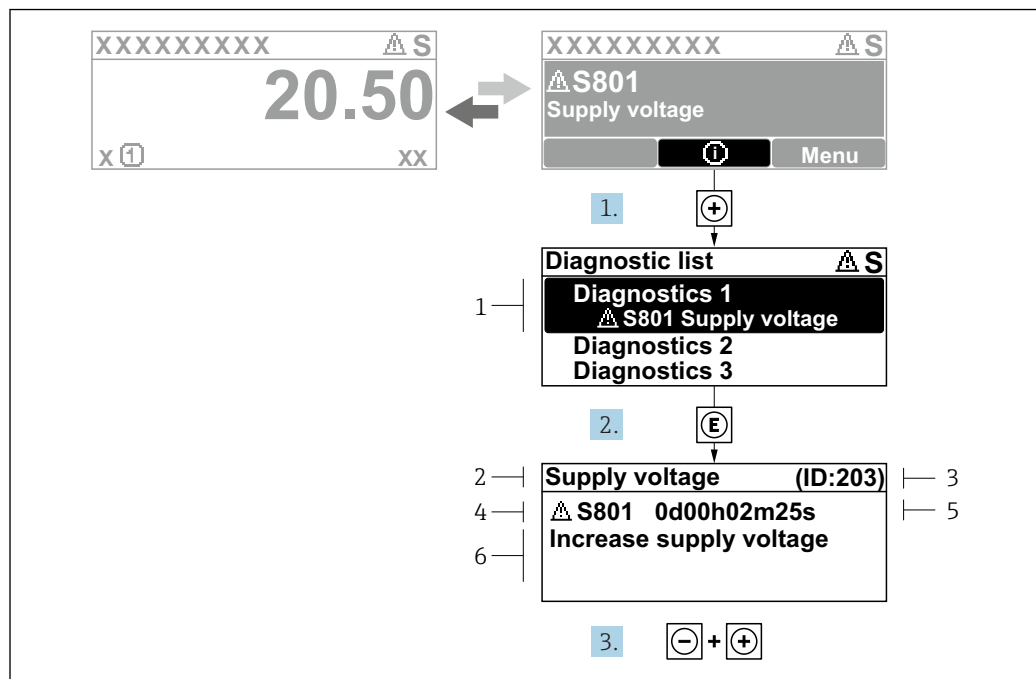

24 Message about remedial measures

- 1 Diagnostic information
- 2 Short text
- 3 Service ID
- 4 Diagnostic behavior with diagnostic code
- 5 Operation time of occurrence
- 6 Remedial measures

1. The user is in the diagnostic message.
Press \oplus (ⓘ symbol).
↳ The **Diagnostic list** submenu opens.
2. Select the desired diagnostic event with \oplus or \ominus and press \boxtimes .
↳ The message about the remedial measures opens.
3. Press $\ominus + \oplus$ simultaneously.
↳ The message about the remedial measures closes.

The user is in the **Diagnostics** menu at an entry for a diagnostics event, e.g. in the **Diagnostic list** submenu or **Previous diagnostics** parameter.

1. Press \boxtimes .
↳ The message for the remedial measures for the selected diagnostic event opens.
2. Press $\ominus + \oplus$ simultaneously.
↳ The message for the remedial measures closes.

12.3 Diagnostic information in FieldCare or DeviceCare

12.3.1 Diagnostic options

Any faults detected by the measuring device are displayed on the home page of the operating tool once the connection has been established.

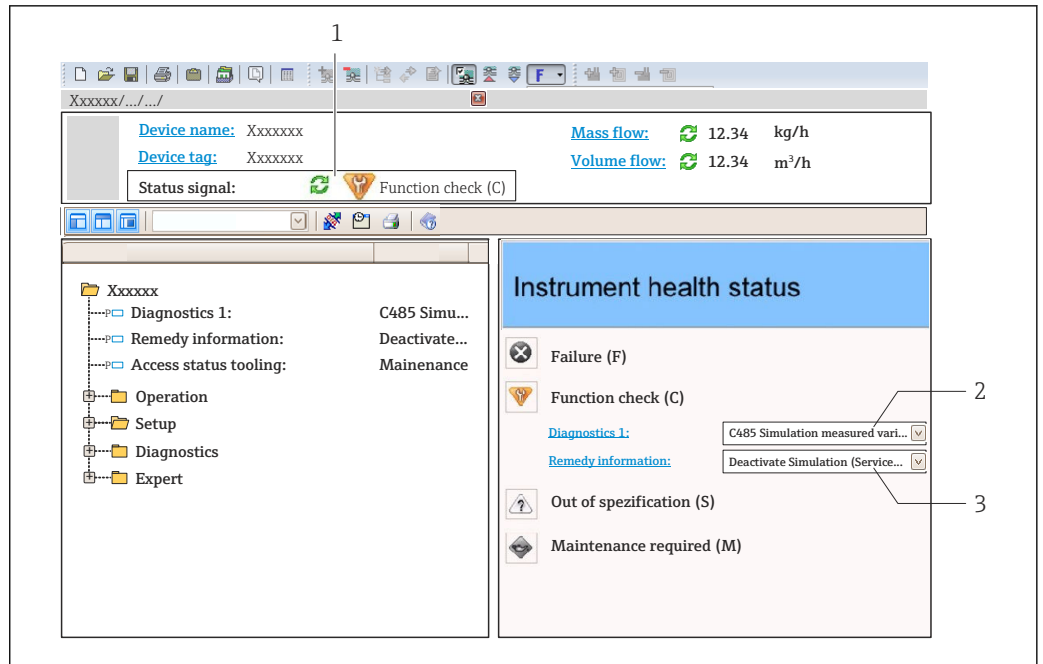

- 1 Status area with status signal → 144
- 2 Diagnostic information → 145
- 3 Remedy information with Service ID

i In addition, diagnostic events which have occurred can be shown in the **Diagnostics** menu:

- Via parameter → 153
- Via submenu → 154

Status signals

The status signals provide information on the state and reliability of the device by categorizing the cause of the diagnostic information (diagnostic event).

Symbol	Meaning
	Failure A device error has occurred. The measured value is no longer valid.
	Function check The device is in service mode (e.g. during a simulation).
	Out of specification The device is operated: <ul style="list-style-type: none"> ▪ Outside its technical specification limits (e.g. outside the process temperature range) ▪ Outside of the configuration carried out by the user (e.g. maximum flow in parameter 20 mA value)
	Maintenance required Maintenance is required. The measured value is still valid.

i The status signals are categorized in accordance with VDI/VDE 2650 and NAMUR Recommendation NE 107.

Diagnostic information

The fault can be identified using the diagnostic information. The short text helps you by providing information about the fault. In addition, the corresponding symbol for the diagnostic behavior is displayed in front of the diagnostic information on the local display.

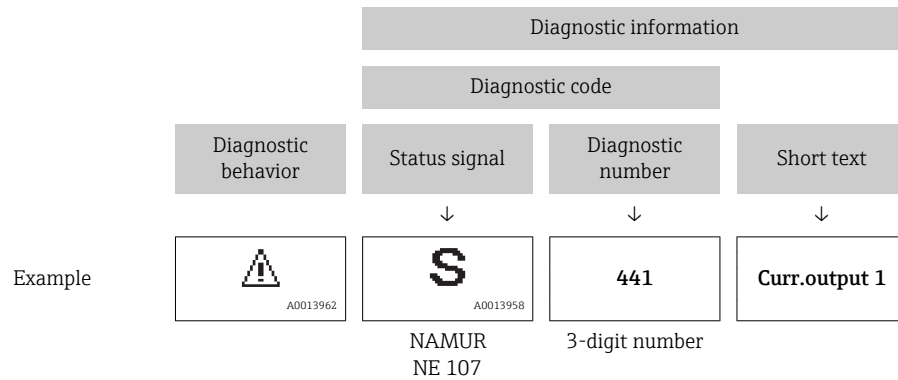

12.3.2 Calling up remedy information

Remedy information is provided for every diagnostic event to ensure that problems can be rectified quickly:

- On the home page
Remedy information is displayed in a separate field below the diagnostics information.
- In the **Diagnostics** menu
Remedy information can be called up in the working area of the user interface.

The user is in the **Diagnostics** menu.

1. Call up the desired parameter.
2. On the right in the working area, mouse over the parameter.
↳ A tool tip with remedy information for the diagnostic event appears.

12.4 Adapting the diagnostic information

12.4.1 Adapting the diagnostic behavior

Each item of diagnostic information is assigned a specific diagnostic behavior at the factory. The user can change this assignment for specific diagnostic information in the **Diagnostic behavior** submenu.

Expert → System → Diagnostic handling → Diagnostic behavior

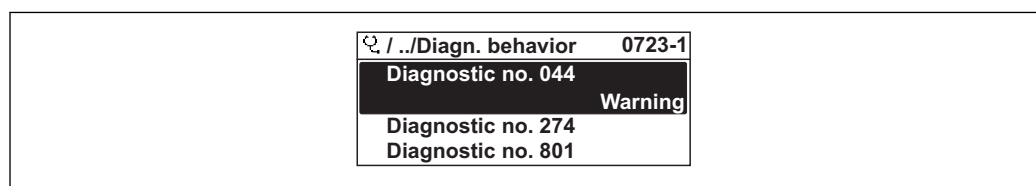

25 Taking the example of the local display

You can assign the following options to the diagnostic number as the diagnostic behavior:

Options	Description
Alarm	The device stops measurement. The signal outputs and totalizers assume the defined alarm condition. A diagnostic message is generated. For local display with touch control: the background lighting changes to red.
Warning	The device continues to measure. The signal outputs and totalizers are not affected. A diagnostic message is generated.

Options	Description
Logbook entry only	The device continues to measure. The diagnostic message is displayed only in the Event logbook submenu (Event list submenu) and is not displayed in alternation with the operational display.
Off	The diagnostic event is ignored, and no diagnostic message is generated or entered.

12.4.2 Adapting the status signal

Each item of diagnostic information is assigned a specific status signal at the factory. The user can change this assignment for specific diagnostic information in the **Diagnostic event category** submenu.

Expert → Communication → Diagnostic event category

Available status signals

Configuration as per HART 7 Specification (Condensed Status), in accordance with NAMUR NE107.

Symbol	Meaning
F <small>A0013956</small>	Failure A device error is present. The measured value is no longer valid.
C <small>A0013959</small>	Function check The device is in service mode (e.g. during a simulation).
S <small>A0013958</small>	Out of specification The device is being operated: <ul style="list-style-type: none"> ▪ Outside its technical specification limits (e.g. outside the process temperature range) ▪ Outside of the configuration carried out by the user (e.g. maximum flow in parameter 20 mA value)
M <small>A0013957</small>	Maintenance required Maintenance is required. The measured value is still valid.
N <small>A0023076</small>	Has no effect on the condensed status.

12.5 Overview of diagnostic information

 The amount of diagnostic information and the number of measured variables affected increase if the measuring device has one or more application packages.

 In the case of some items of diagnostic information, the status signal and the diagnostic behavior can be changed. Change the diagnostic information →  148

Diagnostic number	Short text	Remedy instructions	Status signal [from the factory]	Diagnostic behavior [from the factory]
Diagnostic of sensor				
004	Sensor defective	1. Check plug connections 2. Change pre-amplifier 3. Change DSC sensor	F	Alarm
022	Temperature sensor defective	1. Check plug connections 2. Change pre-amplifier 3. Change DSC sensor	F	Alarm ¹⁾
046	Sensor limit exceeded	1. Check plug connections 2. Change pre-amplifier 3. Change DSC sensor	S	Warning

Diagnostic number	Short text	Remedy instructions	Status signal [from the factory]	Diagnostic behavior [from the factory]
062	Sensor connection defective	1. Check plug connections 2. Change pre-amplifier 3. Change DSC sensor	F	Alarm
082	Data storage	1. Check module connections 2. Contact service	F	Alarm
083	Memory content	1. Restart device 2. Restore S-Dat data 3. Change sensor	F	Alarm
114	Sensor leaky	Change DSC sensor	F	Alarm
122	Temperature sensor defective	1. Check plug connections 2. Change pre-amplifier 3. Change DSC sensor	M	Warning ¹⁾
170	Pressure cell connection defective	1. Check plug connections 2. Replace pressure cell	F	Alarm
171	Ambient temperature too low	Increase ambient temperature	S	Warning
172	Ambient temperature too high	Reduce ambient temperature	S	Warning
173	Sensor range exceeded	1. Check process cond. 2. Increase system pressure	S	Warning
174	Pressure cell electronics defective	Replace pressure cell	F	Alarm
175	Pressure cell deactivated	Enable pressure cell	M	Warning
Diagnostic of electronic				
242	Software incompatible	1. Check software 2. Flash or change main electronics module	F	Alarm
252	Modules incompatible	1. Check if correct electronic modul is plugged 2. Replace electronic module	F	Alarm
261	Electronic modules	1. Restart device 2. Check electronic modules 3. Change I/O Modul or main electronics	F	Alarm
262	Module connection	1. Check module connections 2. Change electronic modules	F	Alarm
270	Main electronic failure	Change main electronic module	F	Alarm
271	Main electronic failure	1. Restart device 2. Change main electronic module	F	Alarm
272	Main electronic failure	1. Restart device 2. Contact service	F	Alarm
272	ECC settings faulty		F	Alarm
273	Main electronic failure	1. Emergency operation via display 2. Change main electronics	F	Alarm
275	I/O module defective	Change I/O module	F	Alarm
276	I/O module faulty	1. Restart device 2. Change I/O module	F	Alarm
276	I/O module faulty		F	Alarm
277	Electronics defective	1. Change pre-amplifier 2. Change main electronic module	F	Alarm
282	Data storage	1. Restart device 2. Contact service	F	Alarm

Diagnostic number	Short text	Remedy instructions	Status signal [from the factory]	Diagnostic behavior [from the factory]
283	Memory content	1. Transfer data or reset device 2. Contact service	F	Alarm
302	Device verification active	Device verification active, please wait.	C	Warning
311	Electronic failure	Maintenance required! 1. Do not perform reset 2. Contact service	M	Warning
350	Pre-amplifier defective	Change pre-amplifier	F	Alarm ¹⁾
351	Pre-amplifier defective	Change pre-amplifier	F	Alarm
370	Pre-amplifier defective	1. Check plug connections 2. Check cabel connection of remote version 3. Change pre-amplifier or main electronic module	F	Alarm
371	Temperature sensor defective	1. Check plug connections 2. Change pre-amplifier 3. Change DSC sensor	M	Warning ¹⁾
Diagnostic of configuration				
410	Data transfer	1. Check connection 2. Retry data transfer	F	Alarm
412	Processing download	Download active, please wait	C	Warning
431	Trim 1 to n	Carry out trim	C	Warning
437	Configuration incompatible	1. Restart device 2. Contact service	F	Alarm
438	Dataset	1. Check data set file 2. Check device configuration 3. Up- and download new configuration	M	Warning
441	Current output 1 to n	1. Check process 2. Check current output settings	S	Warning ¹⁾
442	Frequency output	1. Check process 2. Check frequency output settings	S	Warning ¹⁾
443	Pulse output	1. Check process 2. Check pulse output settings	S	Warning ¹⁾
444	Current input 1	1. Check process 2. Check current input settings	S	Warning ¹⁾
453	Flow override	Deactivate flow override	C	Warning
484	Failure mode simulation	Deactivate simulation	C	Alarm
485	Measured variable simulation	Deactivate simulation	C	Warning
486	Current input 1 simulation	Deactivate simulation	C	Warning
491	Current output 1 to n simulation	Deactivate simulation	C	Warning
492	Simulation frequency output	Deactivate simulation frequency output	C	Warning
493	Simulation pulse output	Deactivate simulation pulse output	C	Warning
494	Switch output simulation	Deactivate simulation switch output	C	Warning

Diagnostic number	Short text	Remedy instructions	Status signal [from the factory]	Diagnostic behavior [from the factory]
495	Diagnostic event simulation	Deactivate simulation	C	Warning
538	Flow computer configuration incorrect	Check input value (pressure, temperature)	S	Warning
539	Flow computer configuration incorrect	1. Check input value (pressure, temperature) 2. Check allowed values of the medium properties	S	Alarm
540	Flow computer configuration incorrect	Check entered reference value using the document Operating Instructions	S	Warning
570	Inverted delta heat	Check configuration of mounting location (parameter Installation direction)	F	Alarm
Diagnostic of process				
801	Supply voltage too low	Increase supply voltage	F	Alarm ¹⁾
803	Current loop	1. Check wiring 2. Change I/O module	F	Alarm
828	Ambient temperature too low	Increase ambient temperature of pre-amplifier	S	Warning ¹⁾
829	Ambient temperature too high	Reduce ambient temperature of pre-amplifier	S	Warning ¹⁾
832	Electronic temperature too high	Reduce ambient temperature	S	Warning ¹⁾
833	Electronic temperature too low	Increase ambient temperature	S	Warning ¹⁾
834	Process temperature too high	Reduce process temperature	S	Warning ¹⁾
835	Process temperature too low	Increase process temperature	S	Warning ¹⁾
841	Flow velocity too high	Reduce flow velocity	S	Warning ¹⁾
842	Process limit	Low flow cut off active! 1. Check low flow cut off configuration	S	Warning
844	Sensor range exceeded	Reduce flow velocity	S	Warning ¹⁾
870	Measuring inaccuracy increased	1. Check process 2. Increase flow volume	S	Warning ¹⁾
871	Near steam saturation limit	Check process conditions	S	Warning ¹⁾
872	Wet steam detected	1. Check process 2. Check plant	S	Warning ¹⁾
873	Water detected	Check process (water in piping)	S	Warning ¹⁾
874	X% spec invalid	1. Check pressure, temperature 2. Check flow velocity 3. Check for flow fluctuation	S	Warning ¹⁾
882	Input signal	1. Check input configuration 2. Check external device or process conditions	F	Alarm
945	Sensor range exceeded	Check immediately process conditions (pressure-temperature rating)	S	Warning ¹⁾

Diagnostic number	Short text	Remedy instructions	Status signal [from the factory]	Diagnostic behavior [from the factory]
946	Vibration detected	Check installation	S	Warning
947	Vibration exceeded	Check installation	S	Alarm ¹⁾
948	Signal quality bad	1. Check process conditions: wet gas, pulsation 2. Check installation: vibration	S	Warning
972	Degrees of superheat limit exceeded	1. Controll process conditions 2. Install pressure transmitter or enter correct fixed pressure value	S	Warning ¹⁾

1) Diagnostic behavior can be changed.

12.5.1 Operating conditions for displaying the following diagnostics information

-  Operating conditions for displaying the following diagnostics information:
- **871 Near steam saturation limit** diagnostic message: The process temperature is less than 2K from the saturated steam line.
 - Diagnostics information 872: The measured steam quality has dropped below the configured limit value for the steam quality (limit value: Expert → System → Diagnostic handling → Diagnostic limits → Steam quality limit).
 - Diagnostics information 873: The process temperature is ≤ 0 °C.
 - Diagnostics information 972: The degree of superheat has exceeded the configured limit value (limit value: Expert → System → Diagnostic handling → Diagnostic limits → Degrees of superheat limit).

12.5.2 Emergency mode in the event of pressure compensation







- ▶ Disable the pressure measuring cell: in the **Disable pressure cell** parameter (7747) select the **Yes** option.
 - ↳ The measuring device uses the fixed process pressure to calculate.

12.5.3 Emergency mode in event of temperature compensation

- ▶ Change temperature measurement: PT1+PT2 to the **PT1** option, **PT2** option or the **Off** option.
 - ↳ If the **Off** option is selected, the measuring device calculates by using the fixed process pressure.

12.6 Pending diagnostic events

The **Diagnostics** menu allows the user to view the current diagnostic event and the previous diagnostic event separately.

-  To call up the measures to rectify a diagnostic event:
- Via local display →  146
 - Via "FieldCare" operating tool →  148
 - Via "DeviceCare" operating tool →  148
-  Other pending diagnostic events can be displayed in the **Diagnostic list** submenu →  154

Navigation

"Diagnostics" menu

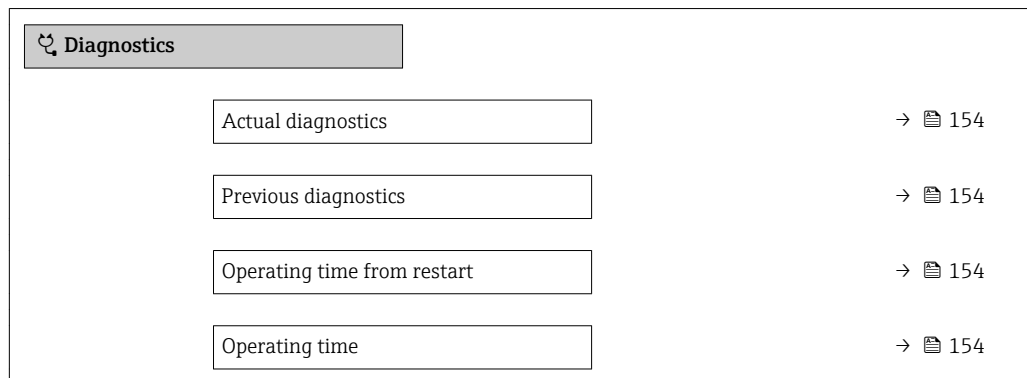
**Parameter overview with brief description**

Parameter	Prerequisite	Description	User interface
Actual diagnostics	A diagnostic event has occurred.	Shows the current occurred diagnostic event along with its diagnostic information.  If two or more messages occur simultaneously, the message with the highest priority is shown on the display.	Symbol for diagnostic behavior, diagnostic code and short message.
Previous diagnostics	Two diagnostic events have already occurred.	Shows the diagnostic event that occurred prior to the current diagnostic event along with its diagnostic information.	Symbol for diagnostic behavior, diagnostic code and short message.
Operating time from restart	-	Shows the time the device has been in operation since the last device restart.	Days (d), hours (h), minutes (m) and seconds (s)
Operating time	-	Indicates how long the device has been in operation.	Days (d), hours (h), minutes (m) and seconds (s)

12.7 Diagnostic list

Up to 5 currently pending diagnostic events can be displayed in the **Diagnostic list** submenu along with the associated diagnostic information. If more than 5 diagnostic events are pending, the events with the highest priority are shown on the display.

Navigation path

Diagnostics → Diagnostic list

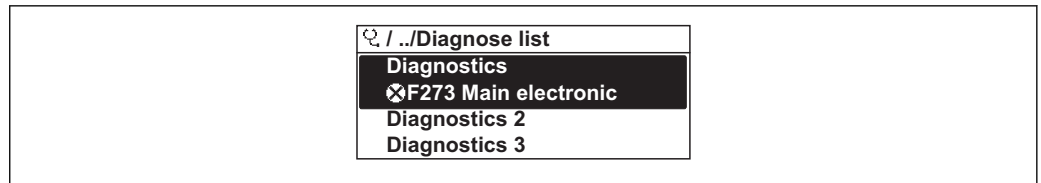

A0014006-EN

26 Taking the example of the local display

- i** To call up the measures to rectify a diagnostic event:
- Via local display → 146
 - Via "FieldCare" operating tool → 148
 - Via "DeviceCare" operating tool → 148

12.8 Event logbook

12.8.1 Reading out the event logbook

A chronological overview of the event messages that have occurred is provided in the **Events list** submenu.

Navigation path

Diagnostics menu → **Event logbook** submenu → Event list

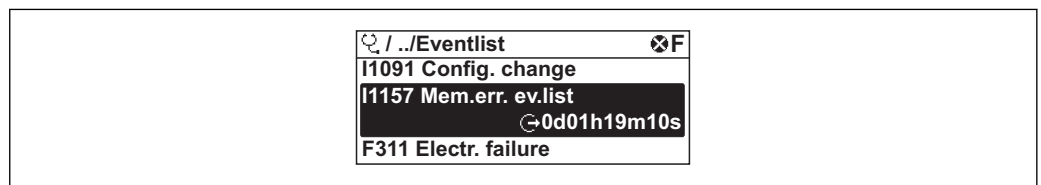

A0014008-EN

27 Taking the example of the local display

- A maximum of 20 event messages can be displayed in chronological order.
- If the **Extended HistoROM** application package (order option) is enabled in the device, the event list can contain up to 100 entries .

The event history includes entries for:

- Diagnostic events → 149
- Information events → 156

In addition to the operation time of its occurrence, each event is also assigned a symbol that indicates whether the event has occurred or is ended:

- Diagnostic event
 - ☉: Occurrence of the event
 - ☺: End of the event
- Information event
 - ☉: Occurrence of the event

- i** To call up the measures to rectify a diagnostic event:
- Via local display → 146
 - Via "FieldCare" operating tool → 148
 - Via "DeviceCare" operating tool → 148

- i** For filtering the displayed event messages → 155

12.8.2 Filtering the event logbook

Using the **Filter options** parameter you can define which category of event message is displayed in the **Events list** submenu.

Navigation path

Diagnostics → Event logbook → Filter options

Filter categories

- All
- Failure (F)
- Function check (C)
- Out of specification (S)
- Maintenance required (M)
- Information (I)

12.8.3 Overview of information events

Unlike a diagnostic event, an information event is displayed in the event logbook only and not in the diagnostic list.

Info number	Info name
I1000	----- (Device ok)
I1079	Sensor changed
I1089	Power on
I1090	Configuration reset
I1091	Configuration changed
I1092	HistoROM backup deleted
I1110	Write protection switch changed
I1137	Electronic changed
I1151	History reset
I1154	Reset terminal voltage min/max
I1155	Reset electronic temperature
I1156	Memory error trend
I1157	Memory error event list
I1185	Display backup done
I1186	Restore via display done
I1187	Settings downloaded with display
I1188	Display data cleared
I1189	Backup compared
I1227	Sensor emergency mode activated
I1228	Sensor emergency mode failed
I1256	Display: access status changed
I1264	Safety sequence aborted
I1335	Firmware changed
I1397	Fieldbus: access status changed
I1398	CDI: access status changed
I1444	Device verification passed
I1445	Device verification failed
I1459	I/O module verification failed
I1461	Sensor verification failed
I1512	Download started
I1513	Download finished

Info number	Info name
I1514	Upload started
I1515	Upload finished
I1552	Failed: Main electronic verification
I1553	Failed: Pre-amplifier verification
I1554	Safety sequence started
I1555	Safety sequence confirmed
I1556	Safety mode off

12.9 Resetting the measuring device

Using the **Device reset** parameter (→ ⓘ 116) it is possible to reset the entire device configuration or some of the configuration to a defined state.

12.9.1 Function scope of the "Device reset" parameter

Options	Description
Cancel	No action is executed and the user exits the parameter.
To factory defaults	Every parameter is reset to its factory setting.
To delivery settings	Every parameter for which a customer-specific default setting was ordered is reset to this customer-specific value. All other parameters are reset to the factory setting.  This option is not visible if no customer-specific settings have been ordered.
Restart device	The restart resets every parameter whose data are in the volatile memory (RAM) to the factory setting (e.g. measured value data). The device configuration remains unchanged.

12.10 Device information

The **Device information** submenu contains all parameters that display different information for device identification.





Navigation

"Diagnostics" menu → Device information

▶ Device information	
Device tag	→ ⓘ 158
Serial number	→ ⓘ 158
Firmware version	→ ⓘ 158
Device name	→ ⓘ 158
Order code	→ ⓘ 158
Extended order code 1	→ ⓘ 158

Extended order code 2	→ ⓘ 158
Extended order code 3	→ ⓘ 158
ENP version	→ ⓘ 158
Device revision	→ ⓘ 159
Device ID	→ ⓘ 159
Device type	→ ⓘ 159
Manufacturer ID	→ ⓘ 159



Parameter overview with brief description

Parameter	Description	User interface	Factory setting
Device tag	Shows name of measuring point.	Max. 32 characters, such as letters, numbers or special characters (e.g. @, %, /).	Prowirl
Serial number	Shows the serial number of the measuring device.	Max. 11-digit character string comprising letters and numbers.	–
Firmware version	Shows the device firmware version installed.	Character string in the format xx.yy.zz	–
Device name	Shows the name of the transmitter.  The name can be found on the nameplate of the transmitter.	Max. 32 characters such as letters or numbers.	Prowirl
Order code	Shows the device order code.  The order code can be found on the nameplate of the sensor and transmitter in the "Order code" field.	Character string composed of letters, numbers and certain punctuation marks (e.g. /).	–
Extended order code 1	Shows the 1st part of the extended order code.  The extended order code can also be found on the nameplate of the sensor and transmitter in the "Ext. ord. cd." field.	Character string	–
Extended order code 2	Shows the 2nd part of the extended order code.  The extended order code can also be found on the nameplate of the sensor and transmitter in the "Ext. ord. cd." field.	Character string	–
Extended order code 3	Shows the 3rd part of the extended order code.  The extended order code can also be found on the nameplate of the sensor and transmitter in the "Ext. ord. cd." field.	Character string	–
ENP version	Shows the version of the electronic nameplate (ENP).	Character string	2.02.00

Parameter	Description	User interface	Factory setting
Device revision	Shows the device revision with which the device is registered with the HART Communication Foundation.	2-digit hexadecimal number	0x03
Device ID	Shows the device ID for identifying the device in a HART network.	6-digit hexadecimal number	–
Device type	Shows the device type with which the measuring device is registered with the HART Communication Foundation.	2-digit hexadecimal number	0x0038 (for Prowirl 200)
Manufacturer ID	Shows the manufacturer ID device is registered with the HART Communication Foundation.	2-digit hexadecimal number	0x11 (for Endress+Hauser)

12.11 Firmware history

Release date	Firmware version	Order code for "Firmware version"	Firmware changes	Documentation type	Documentation
01.2018	01.03.zz	Option 72	<ul style="list-style-type: none"> ▪ Support for "mass vortex" order option ▪ Upgrade to Heartbeat Technology application package ▪ Permanent activation of natural gas, air and industrial gases application packages ▪ Extension of low flow cut off ▪ Extension of measuring range for steam ▪ Extension of two-phase measurement 	Operating Instructions	BA01688D/06/EN/01.18

-  It is possible to flash the firmware to the current version or the previous version using the service interface.
-  For the compatibility of the firmware version with the previous version, the installed device description files and operating tools, observe the information about the device in the "Manufacturer's information" document.
-  The manufacturer's information is available:
 - In the Download Area of the Endress+Hauser web site: www.endress.com → Downloads
 - Specify the following details:
 - Product root: e.g. 7F2C
The product root is the first part of the order code: see the nameplate on the device.
 - Text search: Manufacturer's information
 - Media type: Documentation – Technical Documentation

13 Maintenance

13.1 Maintenance tasks

No special maintenance work is required.

13.1.1 Exterior cleaning

When cleaning the exterior of measuring devices, always use cleaning agents that do not attack the surface of the housing or the seals.

13.1.2 Interior cleaning

NOTICE

The use of unsuitable equipment or cleaning liquids can damage the transducer.

- ▶ Do not use pigs to clean the pipe.

13.1.3 Replacing seals

Replacing sensor seals

NOTICE

Seals in contact with fluid must always be replaced!

- ▶ Only Endress+Hauser sensor seals may be used: replacement seals

Replacing housing seals

NOTICE

When using the device in a dusty atmosphere:

- ▶ only use the associated Endress+Hauser housing seals.

1. Replace defect seals only with original seals from Endress+Hauser.
2. The housing seals must be clean and undamaged when inserted into their grooves.
3. Dry, clean or replace the seals if necessary.

13.1.4 Adjusting the pressure measuring cell

Navigation:

Expert → Sensor → Sensor adjustment

1. Apply reference pressure to pressure measuring cell.
2. Enter this reference pressure as a value in the **Reference pressure** parameter (7748).
3. Select an option in the **Pressure cell adjustment** parameter (7754):
 - ↳ **Yes** option: Confirm entry.
 - Cancel** option: Cancel entry by entering "Cancel".
 - Discard offset** option: Reset offset to 0.

The **Pressure cell offset value** parameter (7749) indicates the calculated offset value.

13.2 Measuring and test equipment

Endress+Hauser offers a wide variety of measuring and test equipment, such as W@M or device tests.

 Your Endress+Hauser Sales Center can provide detailed information on the services.

List of some of the measuring and testing equipment: →  167

13.3 Endress+Hauser services

Endress+Hauser offers a wide variety of services for maintenance such as recalibration, maintenance service or device tests.

 Your Endress+Hauser Sales Center can provide detailed information on the services.

14 Repair

14.1 General notes

14.1.1 Repair and conversion concept

The Endress+Hauser repair and conversion concept provides for the following:

- The measuring devices have a modular design.
- Spare parts are grouped into logical kits with the associated Installation Instructions.
- Repairs are carried out by Endress+Hauser Service or by appropriately trained customers.
- Certified devices can only be converted to other certified devices by Endress+Hauser Service or at the factory.

14.1.2 Notes for repair and conversion

For repair and modification of a measuring device, observe the following notes:

- ▶ Use only original Endress+Hauser spare parts.
- ▶ Carry out the repair according to the Installation Instructions.
- ▶ Observe the applicable standards, federal/national regulations, Ex documentation (XA) and certificates.
- ▶ Document every repair and each conversion and enter them into the *W@M* life cycle management database.

14.2 Spare parts

Some interchangeable measuring device components are listed on an overview sign in the connection compartment cover.

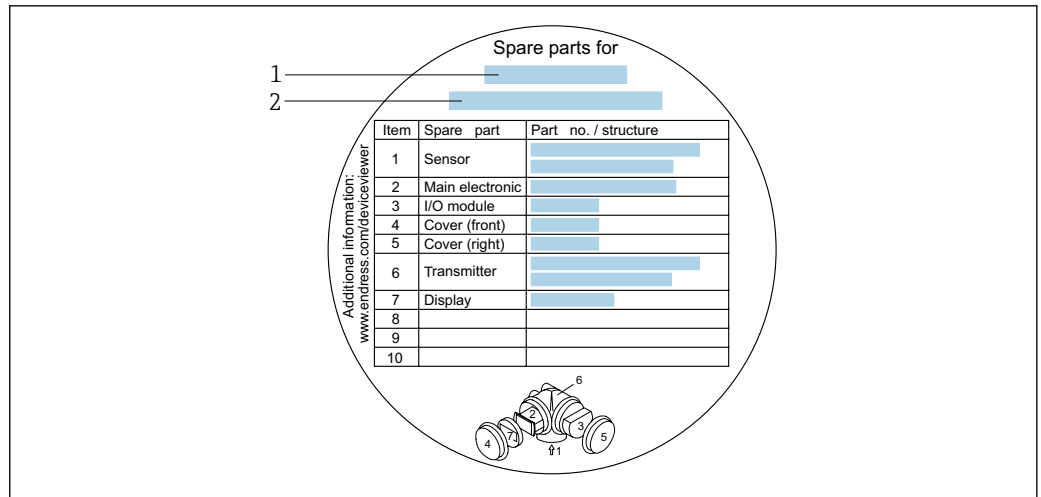

The spare part overview sign contains the following information:

- A list of the most important spare parts for the measuring device, including their ordering information.
- The URL for the *W@M Device Viewer* (www.endress.com/deviceviewer):
All the spare parts for the measuring device, along with the order code, are listed here and can be ordered. If available, users can also download the associated Installation Instructions.



 28 Example for "Spare part overview sign" in connection compartment cover

- 1 Measuring device name
- 2 Measuring device serial number

-  Measuring device serial number:
- Is located on the device nameplate and the spare part overview sign.
 - Can be read out via the **Serial number** parameter (→  158) in the **Device information** submenu.

14.3 Endress+Hauser services

Endress+Hauser offers a wide range of services.

-  Your Endress+Hauser Sales Center can provide detailed information on the services.

14.4 Return

The requirements for safe device return can vary depending on the device type and national legislation.

1. Refer to the website for more information:
<http://www.endress.com/support/return-material>
2. Return the device if repairs or a factory calibration are required, or if the wrong device was ordered or delivered.

14.5 Disposal



If required by the Directive 2012/19/EU on waste electrical and electronic equipment (WEEE), the product is marked with the depicted symbol in order to minimize the disposal of WEEE as unsorted municipal waste. Do not dispose of products bearing this marking as unsorted municipal waste. Instead, return them to Endress+Hauser for disposal under the applicable conditions.

14.5.1 Removing the measuring device

1. Switch off the device.

⚠ WARNING**Danger to persons from process conditions.**

- ▶ Beware of hazardous process conditions such as pressure in the measuring device, high temperatures or aggressive fluids.

2. Carry out the mounting and connection steps from the "Mounting the measuring device" and "Connecting the measuring device" sections in reverse order. Observe the safety instructions.

14.5.2 Disposing of the measuring device

⚠ WARNING**Danger to personnel and environment from fluids that are hazardous to health.**

- ▶ Ensure that the measuring device and all cavities are free of fluid residues that are hazardous to health or the environment, e.g. substances that have permeated into crevices or diffused through plastic.

Observe the following notes during disposal:





- ▶ Observe valid federal/national regulations.
- ▶ Ensure proper separation and reuse of the device components.





15 Accessories

Various accessories, which can be ordered with the device or subsequently from Endress+Hauser, are available for the device. Detailed information on the order code in question is available from your local Endress+Hauser sales center or on the product page of the Endress+Hauser website: www.endress.com.

15.1 Device-specific accessories

15.1.1 For the transmitter





Accessories	Description
Prowirl 200 transmitter	<p>Transmitter for replacement or storage. Use the order code to define the following specifications:</p> <ul style="list-style-type: none"> ▪ Approvals ▪ Output, Input ▪ Display/operation ▪ Housing ▪ Software <p> Installation Instructions EA01056D</p> <p> (Order number: 7X2CXX)</p>
Remote display FHX50	<p>FHX50 housing for accommodating a display module .</p> <ul style="list-style-type: none"> ▪ FHX50 housing suitable for: <ul style="list-style-type: none"> ▪ SD02 display module (push buttons) ▪ SD03 display module (touch control) ▪ Length of connecting cable: up to max. 60 m (196 ft) (cable lengths available for order: 5 m (16 ft), 10 m (32 ft), 20 m (65 ft), 30 m (98 ft)) <p>The measuring device can be ordered with the FHX50 housing and a display module. The following options must be selected in the separate order codes:</p> <ul style="list-style-type: none"> ▪ Order code for measuring device, feature 030: Option L or M "Prepared for FHX50 display" ▪ Order code for FHX50 housing, feature 050 (device version): Option A "Prepared for FHX50 display" ▪ Order code for FHX50 housing, depends on the desired display module in feature 020 (display, operation): <ul style="list-style-type: none"> ▪ Option C: for an SD02 display module (push buttons) ▪ Option E: for an SD03 display module (touch control) <p>The FHX50 housing can also be ordered as a retrofit kit. The measuring device display module is used in the FHX50 housing. The following options must be selected in the order code for the FHX50 housing:</p> <ul style="list-style-type: none"> ▪ Feature 050 (measuring device version): option B "Not prepared for FHX50 display" ▪ Feature 020 (display, operation): option A "None, existing displayed used" <p> The FHX50 remote display cannot be combined with the order code for "Sensor version; DSC sensor; measuring tube":</p> <ul style="list-style-type: none"> ▪ option DA "Mass steam; 316L; 316L (integrated pressure/temperature measurement), -200 to +400 °C (-328 to +750 °F)" ▪ option DB "Mass gas/liquid; 316L; 316L (integrated pressure/temperature measurement), -40 to +100 °C (-40 to +212 °F)" <p> Special Documentation SD01007F</p> <p>(Order number: FHX50)</p>









Accessories	Description
Overvoltage protection for 2-wire devices	<p>Ideally, the overvoltage protection module should be ordered directly with the device. See product structure, feature 610 "Accessory mounted", option NA "Overvoltage protection". Separate order necessary only if retrofitting.</p> <ul style="list-style-type: none"> ▪ OVP10: For 1-channel devices (feature 020, option A): ▪ OVP20: For 2-channel devices (feature 020, options B, C, E or G) <p> Special Documentation SD01090F</p> <p>(Order number OVP10: 71128617) (Order number OVP20: 71128619)</p>
Protective cover	<p>Is used to protect the measuring device from the effects of the weather: e.g. rainwater, excess heating from direct sunlight or extreme cold in winter.</p> <p> Special Documentation SD00333F</p> <p>(Order number: 71162242)</p>
Connecting cable for remote version	<ul style="list-style-type: none"> ▪ Connecting cable available in various lengths: <ul style="list-style-type: none"> ▪ 5 m (16 ft) ▪ 10 m (32 ft) ▪ 20 m (65 ft) ▪ 30 m (98 ft) ▪ Armored cables available on request. <p> Standard length: 5 m (16 ft) Is always supplied if no other cable length has been ordered.</p>
Post mounting kit	<p>Post mounting kit for transmitter.</p> <p> The post mounting kit can only be ordered together with a transmitter.</p> <p>(Order number: DK8WM-B)</p>

15.1.2 For the sensor









Accessories	Description
Flow conditioner	<p>Is used to shorten the necessary inlet run. (Order number: DK7ST)</p>

15.2 Communication-specific accessories







Accessories	Description
Commubox FXA195 HART	<p>For intrinsically safe HART communication with FieldCare via the USB interface.</p> <p> Technical Information TI00404F</p>
Commubox FXA291	<p>Connects Endress+Hauser field devices with a CDI interface (= Endress+Hauser Common Data Interface) and the USB port of a computer or laptop.</p> <p> Technical Information TI405C/07</p>
HART Loop Converter HMX50	<p>Is used to evaluate and convert dynamic HART process variables to analog current signals or limit values.</p> <p> <ul style="list-style-type: none"> ▪ Technical Information TI00429F ▪ Operating Instructions BA00371F </p>
Wireless HART adapter SWA70	<p>Is used for the wireless connection of field devices. The WirelessHART adapter can be easily integrated into field devices and existing infrastructures, offers data protection and transmission safety and can be operated in parallel with other wireless networks with minimum cabling complexity.</p> <p> Operating Instructions BA00061S</p>

Fieldgate FXA42	<p>Is used to transmit the measured values of connected 4 to 20 mA analog measuring devices, as well as digital measuring devices</p> <ul style="list-style-type: none">  Technical Information TI01297S  Operating Instructions BA01778S  Product page: www.endress.com/fxa42
Field Xpert SMT70	<p>The Field Xpert SMT70 tablet PC for device configuration enables mobile plant asset management in hazardous and non-hazardous areas. It is suitable for commissioning and maintenance staff to manage field instruments with a digital communication interface and to record progress.</p> <p>This tablet PC is designed as an all-in-one solution with a preinstalled driver library and is an easy-to-use, touch-sensitive tool which can be used to manage field instruments throughout their entire life cycle.</p> <ul style="list-style-type: none">  Technical Information TI01342S  Operating Instructions BA01709S  Product page: www.endress.com/smt70
Field Xpert SMT77	<p>The Field Xpert SMT77 tablet PC for device configuration enables mobile plant asset management in areas categorized as Ex Zone 1.</p> <ul style="list-style-type: none">  Technical Information TI01418S  Operating Instructions BA01923S  Product page: www.endress.com/smt77

15.3 Service-specific accessories

Accessories	Description
Applicator	<p>Software for selecting and sizing Endress+Hauser measuring devices:</p> <ul style="list-style-type: none">  Choice of measuring devices for industrial requirements  Calculation of all the necessary data for identifying the optimum flowmeter: e.g. nominal diameter, pressure loss, flow velocity and accuracy.  Graphic illustration of the calculation results  Determination of the partial order code, administration, documentation and access to all project-related data and parameters over the entire life cycle of a project. <p>Applicator is available:</p> <ul style="list-style-type: none">  Via the Internet: https://portal.endress.com/webapp/applicator  As a downloadable DVD for local PC installation.
W@M	<p>W@M Life Cycle Management</p> <p>Improved productivity with information at your fingertips. Data relevant to a plant and its components is generated from the first stages of planning and during the asset's complete life cycle.</p> <p>W@M Life Cycle Management is an open and flexible information platform with online and on-site tools. Instant access for your staff to current, in-depth data shortens your plant's engineering time, speeds up procurement processes and increases plant uptime.</p> <p>Combined with the right services, W@M Life Cycle Management boosts productivity in every phase. For more information, visit www.endress.com/lifecyclemanagement</p>
FieldCare	<p>FDT-based plant asset management tool from Endress+Hauser. It can configure all smart field units in your system and helps you manage them. By using the status information, it is also a simple but effective way of checking their status and condition.</p> <ul style="list-style-type: none">  Operating Instructions BA00027S and BA00059S
DeviceCare	<p>Tool to connect and configure Endress+Hauser field devices.</p> <ul style="list-style-type: none">  Innovation brochure IN01047S

15.4 System components

Accessories	Description
Memograph M graphic data manager	<p>The Memograph M graphic data manager provides information on all the relevant measured variables. Measured values are recorded correctly, limit values are monitored and measuring points analyzed. The data are stored in the 256 MB internal memory and also on a SD card or USB stick.</p> <ul style="list-style-type: none">  ■ Technical Information TI00133R  ■ Operating Instructions BA00247R
RN221N	<p>Active barrier with power supply for safe separation of 4-20 mA standard signal circuits. Offers bidirectional HART transmission.</p> <ul style="list-style-type: none">  ■ Technical Information TI00073R  ■ Operating Instructions BA00202R
RNS221	<p>Supply unit for powering two 2-wire measuring devices solely in the non-hazardous area. Bidirectional communication is possible via the HART communication jacks.</p> <ul style="list-style-type: none">  ■ Technical Information TI00081R  ■ Brief Operating Instructions KA00110R

16 Technical data

16.1 Application

The measuring device is intended only for the flow measurement of liquids with a minimum conductivity of 20 $\mu\text{S}/\text{cm}$.

To ensure that the device remains in proper operating condition for its service life, use the measuring device only for media against which the process-wetted materials are sufficiently resistant.

16.2 Function and system design

Measuring principle Vortex meters work on the principle of the *Karman vortex street*.

Measuring system The device consists of a transmitter and a sensor.
Two device versions are available:

- Compact version – transmitter and sensor form a mechanical unit.
- Remote version - transmitter and sensor are mounted in separate locations.

For information on the structure of the device →  12

16.3 Input

Measured variable **Direct measured variables**

Order code for "Sensor version; DSC sensor; measuring tube"		
Option	Description	Measured variable
AA	Volume; 316L; 316L	Volume flow
AB	Volume; Alloy C22; 316L	
BA	Volume high-temperature; 316L; 316L	
BB	Volume high-temperature; Alloy C22; 316L	

Order code for "Sensor version; DSC sensor; measuring tube"		
Option	Description	Measured variable
CA	Mass; 316L; 316L (integrated temperature measurement)	<ul style="list-style-type: none"> ▪ Volume flow ▪ Temperature
CB	Mass; Alloy C22; 316L (integrated temperature measurement)	

Order code for "Sensor version; DSC sensor; measuring tube"		
Option	Description	Measured variable
DA	Mass steam; 316L; 316L (integrated pressure/temperature measurement)	<ul style="list-style-type: none"> ▪ Volume flow ▪ Temperature ▪ Pressure
DB	Mass gas/liquid; 316L; 316L (integrated pressure/temperature measurement),	

Calculated measured variables

Order code for "Sensor version; DSC sensor; measuring tube"		
Option	Description	Measured variable
AA	Volume; 316L; 316L	Under constant process conditions: <ul style="list-style-type: none"> ■ Mass flow ¹⁾ ■ Corrected volume flow
AB	Volume; Alloy C22; 316L	
BA	Volume high-temperature; 316L; 316L	The totalized values for: <ul style="list-style-type: none"> ■ Volume flow ■ Mass flow ■ Corrected volume flow
BB	Volume high-temperature; Alloy C22; 316L	

1) A fixed density must be entered for calculating the mass flow (Setup menu → Advanced setup submenu → External compensation submenu → Fixed density parameter).

Order code for "Sensor version; DSC sensor; measuring tube"		
Option	Description	Measured variable
CA	Mass; 316L; 316L (integrated temperature measurement)	<ul style="list-style-type: none"> ■ Corrected volume flow ■ Mass flow ■ Calculated saturated steam pressure ■ Energy flow ■ Heat flow difference ■ Specific volume ■ Degrees of superheat
CB	Mass; Alloy C22; 316L (integrated temperature measurement)	
DA	Mass steam; 316L; 316L (integrated pressure/temperature measurement)	
DB	Mass gas/liquid; 316L; 316L (integrated pressure/temperature measurement)	

Measuring range

The measuring range is dependent on the nominal diameter, the fluid and environmental influences.

 The following specified values are the largest possible flow measuring ranges (Q_{min} to Q_{max}) for each nominal diameter. Depending on the fluid properties and environmental influences, the measuring range may be subject to additional restrictions. Additional restrictions apply to both the lower range value and the upper range value.

Flow measuring ranges in SI units

DN [mm]	Liquids [m ³ /h]	Gas/steam [m ³ /h]
25R, 40S	0.1 to 4.9	0.52 to 25
40R, 50S	0.32 to 15	1.6 to 130
50R, 80S	0.78 to 37	3.9 to 310
80R, 100S	1.3 to 62	6.5 to 820
100R, 150S	2.9 to 140	15 to 1 800
150R, 200S	5.1 to 240	25 to 3 200
200R, 250 S	11 to 540	57 to 7 300

Flow measuring ranges in US units

DN [in]	Liquids [ft ³ /min]	Gas/steam [ft ³ /min]
1R, 1½S	0.061 to 2.9	0.31 to 15
1½R, 2S	0.19 to 8.8	0.93 to 74
2R, 3S	0.46 to 22	2.3 to 180

DN	Liquids	Gas/steam
[in]	[ft ³ /min]	[ft ³ /min]
3R, 4S	0.77 to 36	3.8 to 480
4R, 6S	1.7 to 81	8.6 to 1 100
6R, 8S	3 to 140	15 to 1 900
8R, 10S	6.8 to 320	34 to 4 300

Flow velocity

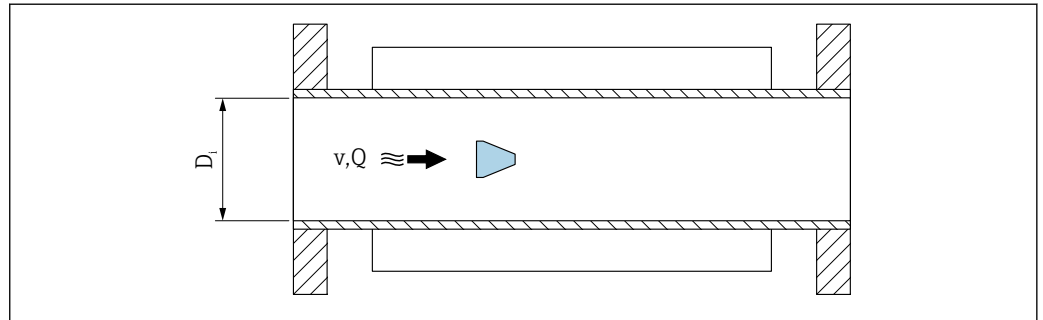

A0033468

D_i Internal diameter of measuring tube (corresponds to dimension K)

v Velocity in measuring tube

Q Flow



The internal diameter of measuring tube D_i is denoted in the dimensions as dimension K.

For detailed information, see the Technical Information. → 200

Calculation of flow velocity:

$$v \text{ [m/s]} = \frac{4 \cdot Q \text{ [m}^3\text{/h]}}{\pi \cdot D_i \text{ [m]}^2} \cdot \frac{1}{3600 \text{ [s/h]}}$$

$$v \text{ [ft/s]} = \frac{4 \cdot Q \text{ [ft}^3\text{/min]}}{\pi \cdot D_i \text{ [ft]}^2} \cdot \frac{1}{60 \text{ [s/min]}}$$

A0034301

Lower range value

A restriction applies to the lower range value due to the turbulent flow profile, which only occurs with Reynolds numbers greater than 5 000. The Reynolds number is dimensionless and indicates the ratio of the inertia force of a fluid to its viscous force when flowing and is used as a characteristic variable for pipe flows. In the case of pipe flows with Reynolds numbers less than 5 000, periodic vortices are no longer generated and flow rate measurement is no longer possible.

The Reynolds number is calculated as follows:

$$Re = \frac{4 \cdot Q \text{ [m}^3\text{/s]} \cdot \rho \text{ [kg/m}^3\text{]}}{\pi \cdot D_i \text{ [m]} \cdot \mu \text{ [Pa} \cdot \text{s]}}$$

$$Re = \frac{4 \cdot Q \text{ [ft}^3\text{/s]} \cdot \rho \text{ [lbm/ft}^3\text{]}}{\pi \cdot D_i \text{ [ft]} \cdot \mu \text{ [lbf} \cdot \text{s/ft}^2\text{]}}$$

A0034291

Re	Reynolds number
Q	Flow
D_i	Internal diameter of measuring tube (corresponds to dimension K)
μ	Dynamic viscosity
ρ	Density

The Reynolds number, 5 000 together with the density and viscosity of the fluid and the nominal diameter, is used to calculate the corresponding flow rate.

$$Q_{Re = 5000} \text{ [m}^3\text{/h]} = \frac{5000 \cdot \pi \cdot D_i \text{ [m]} \cdot \mu \text{ [Pa} \cdot \text{s]}}{4 \cdot \rho \text{ [kg/m}^3\text{]}} \cdot 3600 \text{ [s/h]}$$

$$Q_{Re = 5000} \text{ [ft}^3\text{/h]} = \frac{5000 \cdot \pi \cdot D_i \text{ [ft]} \cdot \mu \text{ [lbf} \cdot \text{s/ft}^2\text{]}}{4 \cdot \rho \text{ [lbm/ft}^3\text{]}} \cdot 60 \text{ [s/min]}$$

A0034302

$Q_{Re = 5000}$	Flow rate is dependent on the Reynolds number
D_i	Internal diameter of measuring tube (corresponds to dimension K)
μ	Dynamic viscosity
ρ	Density

The measuring signal must have a certain minimum signal amplitude so that the signals can be evaluated without any errors. Using the nominal diameter, the corresponding flow can also be derived from this amplitude. The minimum signal amplitude depends on the setting for the sensitivity of the DSC sensor (s), the steam quality (x) and the force of the vibrations present (a). The value mf corresponds to the lowest measurable flow velocity without vibration (no wet steam) at a density of 1 kg/m³ (0.0624 lbm/ft³). The value mf can be set in the range from 6 to 20 m/s (1.8 to 6 ft/s) (factory setting 12 m/s (3.7 ft/s)) with the **Sensitivity** parameter (value range 1 to 9, factory setting 5).

The lowest flow velocity that can be measured on account of the signal amplitude v_{AmpMin} is derived from the **Sensitivity** parameter and the steam quality (x) or from the force of vibrations present (a).

$$v_{AmpMin} \text{ [m/s]} = \max \left\{ \frac{mf \text{ [m/s]}}{x^2} \cdot \sqrt{\frac{1 \text{ [kg/m}^3\text{]}}{\rho \text{ [kg/m}^3\text{]}}} \right.$$

$$v_{AmpMin} \text{ [ft/s]} = \max \left\{ \frac{mf \text{ [ft/s]}}{x^2} \cdot \sqrt{\frac{0.062 \text{ [lb/ft}^3\text{]}}{\rho \text{ [lb/ft}^3\text{]}}} \right.$$

A0034303

v_{AmpMin}	Minimum measurable flow velocity based on signal amplitude
mf	Sensitivity
x	Steam quality
ρ	Density

$$Q_{\text{AmpMin}} [\text{m}^3/\text{h}] = \frac{v_{\text{AmpMin}} [\text{m/s}] \cdot \pi \cdot D_i [\text{m}]^2}{4 \cdot \sqrt{\frac{\rho [\text{kg/m}^3]}{1 [\text{kg/m}^3]}}} \cdot 3600 [\text{s/h}]$$

$$Q_{\text{AmpMin}} [\text{ft}^3/\text{min}] = \frac{v_{\text{AmpMin}} [\text{ft/s}] \cdot \pi \cdot D_i [\text{ft}]^2}{4 \cdot \sqrt{\frac{\rho [\text{lbm/ft}^3]}{0.0624 [\text{lbm/ft}^3]}}} \cdot 60 [\text{s/min}]$$

A0034304

Q_{AmpMin} Minimum measurable flow rate based on signal amplitude

v_{AmpMin} Minimum measurable flow velocity based on signal amplitude

D_i Internal diameter of measuring tube (corresponds to dimension K)

ρ Density

The effective lower range value Q_{Low} is determined using the largest of the three values Q_{min} , $Q_{\text{Re} = 5000}$ and Q_{AmpMin} .

$$Q_{\text{Low}} [\text{m}^3/\text{h}] = \max \begin{cases} Q_{\text{min}} [\text{m}^3/\text{h}] \\ Q_{\text{Re} = 5000} [\text{m}^3/\text{h}] \\ Q_{\text{AmpMin}} [\text{m}^3/\text{h}] \end{cases}$$

$$Q_{\text{Low}} [\text{ft}^3/\text{min}] = \max \begin{cases} Q_{\text{min}} [\text{ft}^3/\text{min}] \\ Q_{\text{Re} = 5000} [\text{ft}^3/\text{min}] \\ Q_{\text{AmpMin}} [\text{ft}^3/\text{min}] \end{cases}$$

A0034313

Q_{Low} Effective lower range value

Q_{min} Minimum measurable flow rate

$Q_{\text{Re} = 5000}$ Flow rate is dependent on the Reynolds number

Q_{AmpMin} Minimum measurable flow rate based on signal amplitude

 The Applicator is available for calculation purposes.

Upper range value

The measuring signal amplitude must be below a certain limit value to ensure that the signals can be evaluated without error. This results in a maximum permitted flow rate Q_{AmpMax} :

$$Q_{\text{AmpMax}} [\text{m}^3/\text{h}] = \frac{350 [\text{m/s}] \cdot \pi \cdot D_i [\text{m}]^2}{4 \cdot \sqrt{\frac{\rho [\text{kg/m}^3]}{1 [\text{kg/m}^3]}}} \cdot 3600 [\text{s/h}]$$

$$Q_{\text{AmpMax}} [\text{ft}^3/\text{min}] = \frac{1148 [\text{ft/s}] \cdot \pi \cdot D_i [\text{ft}]^2}{4 \cdot \sqrt{\frac{\rho [\text{lbm/ft}^3]}{0.0624 [\text{lbm/ft}^3]}}} \cdot 60 [\text{s/min}]$$

A0034316

- Q_{AmpMax} Maximum measurable flow rate based on signal amplitude
- D_i Internal diameter of measuring tube (corresponds to dimension K)
- ρ Density

For gas applications, an additional restriction applies to the upper range value with regard to the Mach number in the measuring device, which must be less than 0.3. The Mach number Ma describes the ratio of the flow velocity v to the sound velocity c in the fluid.

$$Ma = \frac{v \text{ [m/s]}}{c \text{ [m/s]}}$$

$$Ma = \frac{v \text{ [ft/s]}}{c \text{ [ft/s]}}$$

A0034321

- Ma Mach number
- v Flow velocity
- c Sound velocity

The corresponding flow rate can be derived using the nominal diameter.

$$Q_{Ma=0.3} \text{ [m}^3\text{/h]} = \frac{0.3 \cdot c \text{ [m/s]} \cdot \pi \cdot D_i \text{ [m]}^2}{4} \cdot 3600 \text{ [s/h]}$$

$$Q_{Ma=0.3} \text{ [ft}^3\text{/min]} = \frac{0.3 \cdot c \text{ [ft/s]} \cdot \pi \cdot D_i \text{ [ft]}^2}{4} \cdot 60 \text{ [s/min]}$$

A0034337

- $Q_{Ma=0.3}$ Restricted upper range value is dependent on Mach number
- c Sound velocity
- D_i Internal diameter of measuring tube (corresponds to dimension K)
- ρ Density

The effective upper range value Q_{High} is determined using the smallest of the three values Q_{max} , Q_{AmpMax} and $Q_{Ma=0.3}$.

$$Q_{High} \text{ [m}^3\text{/h]} = \min \begin{cases} Q_{max} \text{ [m}^3\text{/h]} \\ Q_{AmpMax} \text{ [m}^3\text{/h]} \\ Q_{Ma=0.3} \text{ [m}^3\text{/h]} \end{cases}$$

$$Q_{High} \text{ [ft}^3\text{/min]} = \min \begin{cases} Q_{max} \text{ [ft}^3\text{/min]} \\ Q_{AmpMax} \text{ [ft}^3\text{/min]} \\ Q_{Ma=0.3} \text{ [ft}^3\text{/min]} \end{cases}$$

A0034338

- Q_{High} Effective upper range value
- Q_{max} Maximum measurable flow rate

Q_{AmpMax} Maximum measurable flow rate based on signal amplitude

$Q_{Ma=0.3}$ Restricted upper range value is dependent on Mach number

For liquids, the occurrence of cavitation may also restrict the upper range value.

 The Applicator is available for calculation purposes.

Operable flow range

The value, which is typically up to 49: 1, may vary depending on the operating conditions (ratio between upper range value and lower range value)

Input signal



Current input

Current input	4-20 mA (passive)
Resolution	1 μ A
Voltage drop	Typically: 2.2 to 3 V for 3.6 to 22 mA
Maximum voltage	\leq 35 V
Possible input variables	<ul style="list-style-type: none"> ▪ Pressure ▪ Temperature ▪ Density

External measured values

To increase the accuracy of certain measured variables or to calculate the corrected volume flow, the automation system can continuously write different measured values to the measuring device:

- Operating pressure to increase accuracy (Endress+Hauser recommends the use of a pressure measuring device for absolute pressure, e.g. Cerabar M or Cerabar S)
- Medium temperature to increase accuracy (e.g. iTEMP)
- Reference density for calculating the corrected volume flow

-  Various pressure measuring devices can be ordered as accessories from Endress+Hauser.
- If using pressure measuring devices, pay attention to outlet runs when installing external devices \rightarrow  25.

If the measuring device does not have pressure or temperature compensation ³⁾, it is recommended that external pressure measurement values be read in so that the following measured variables can be calculated:

- Energy flow
- Mass flow
- Corrected volume flow

Integrated pressure and temperature measurement

The measuring device can also directly record external variables for density and energy compensation.

3) Order code for "Sensor option", option DA, DB

This product version offers the following benefits:

- Measurement of pressure, temperature and flow in a true 2-wire version
- Recording of pressure and temperature at the same point, thus ensuring maximum accuracy of density and energy compensation.
- Continuous monitoring of pressure and temperature, thus enabling complete integration in Heartbeat.
- Easy testing of pressure measurement accuracy:
 - Application of pressure by pressure calibration unit, followed by input into measuring device
 - Automatic error correction performed by device in the event of a deviation
- Availability of calculated line pressure.

Current input

The measured values are written from the automation system to the measuring device via the current input →  175.

HART protocol

The measured values are written from the automation system to the measuring device via the HART protocol. The pressure transmitter must support the following protocol-specific functions:

- HART protocol
- Burst mode

16.4 Output

Output signal

Current output

Current output 1	4-20 mA HART (passive)
Current output 2	4-20 mA (passive)
Resolution	< 1 µA
Damping	Adjustable: 0.0 to 999.9 s
Assignable measured variables	<ul style="list-style-type: none"> ■ Volume flow ■ Corrected volume flow ■ Mass flow ■ Flow velocity ■ Temperature ■ Pressure ■ Calculated saturated steam pressure ■ Total mass flow ■ Energy flow ■ Heat flow difference

Pulse/frequency/switch output

Function	Can be set to pulse, frequency or switch output
Version	Passive, open collector
Maximum input values	<ul style="list-style-type: none"> ■ DC 35 V ■ 50 mA
Voltage drop	<ul style="list-style-type: none"> ■ For ≤ 2 mA: 2 V ■ For 10 mA: 8 V
Residual current	≤ 0.05 mA
Pulse output	
Pulse width	Adjustable: 5 to 2 000 ms

Maximum pulse rate	100 Impulse/s
Pulse value	Adjustable
Assignable measured variables	<ul style="list-style-type: none"> ▪ Mass flow ▪ Volume flow ▪ Corrected volume flow ▪ Total mass flow ▪ Energy flow ▪ Heat flow difference
Frequency output	
Output frequency	Adjustable: 0 to 1 000 Hz
Damping	Adjustable: 0 to 999 s
Pulse/pause ratio	1:1
Assignable measured variables	<ul style="list-style-type: none"> ▪ Volume flow ▪ Corrected volume flow ▪ Mass flow ▪ Flow velocity ▪ Temperature ▪ Calculated saturated steam pressure ▪ Total mass flow ▪ Energy flow ▪ Heat flow difference ▪ Pressure
Switch output	
Switching behavior	Binary, conductive or non-conductive
Switching delay	Adjustable: 0 to 100 s
Number of switching cycles	Unlimited
Assignable functions	<ul style="list-style-type: none"> ▪ Off ▪ On ▪ Diagnostic behavior ▪ Limit value <ul style="list-style-type: none"> ▪ Volume flow ▪ Corrected volume flow ▪ Mass flow ▪ Flow velocity ▪ Temperature ▪ Calculated saturated steam pressure ▪ Total mass flow ▪ Energy flow ▪ Heat flow difference ▪ Pressure ▪ Reynolds number ▪ Totalizer 1-3 ▪ Status ▪ Status of low flow cut off

Signal on alarm

Depending on the interface, failure information is displayed as follows:

Current output 4 to 20 mA

4 to 20 mA

Failure mode	Choose from: <ul style="list-style-type: none"> ▪ 4 to 20 mA in accordance with NAMUR recommendation NE 43 ▪ 4 to 20 mA in accordance with US ▪ Min. value: 3.59 mA ▪ Max. value: 22.5 mA ▪ Freely definable value between: 3.59 to 22.5 mA ▪ Actual value ▪ Last valid value
---------------------	--

Pulse/frequency/switch output

Pulse output	
Failure mode	No pulses
Frequency output	
Failure mode	Choose from: <ul style="list-style-type: none"> ▪ Actual value ▪ 0 Hz ▪ Defined value: 0 to 1250 Hz
Switch output	
Failure mode	Choose from: <ul style="list-style-type: none"> ▪ Current status ▪ Open ▪ Closed

Local display

Plain text display	With information on cause and remedial measures
Backlight	Additionally for device version with SD03 local display: red lighting indicates a device error.

 Status signal as per NAMUR recommendation NE 107

Interface/protocol

- Via digital communication:
 - HART protocol
- Via service interface
 - CDI service interface

Plain text display	With information on cause and remedial measures
--------------------	---

Load →  39

Low flow cut off The switch points for low flow cut off are preset and can be configured.

Galvanic isolation All inputs and outputs are galvanically isolated from one another.

Protocol-specific data

Manufacturer ID	0x11
Device type ID	0x0038
HART protocol revision	7
Device description files (DTM, DD)	Information and files under: www.endress.com
HART load	<ul style="list-style-type: none"> ▪ Min. 250 Ω ▪ Max. 500 Ω
System integration	For information on system integration, see →  68 <ul style="list-style-type: none"> ▪ Measured variables via HART protocol ▪ Burst Mode functionality

16.5 Power supply

Terminal assignment →  37

Supply voltage

Transmitter

An external power supply is required for each output.

The following supply voltage values apply for the outputs available:

Supply voltage for a compact version without a local display ¹⁾

Order code for "Output; input"	Minimum terminal voltage ²⁾	Maximum terminal voltage
Option A: 4-20 mA HART	≥ DC 12 V	DC 35 V
Option B: 4-20 mA HART, pulse/frequency/switch output	≥ DC 12 V	DC 35 V
Option C: 4-20 mA HART + 4-20 mA analog	≥ DC 12 V	DC 30 V
Option D: 4-20 mA HART, pulse/frequency/switch output, 4-20 mA current input ³⁾	≥ DC 12 V	DC 35 V

- 1) In event of external supply voltage of the power supply unit with load
- 2) The minimum terminal voltage increases if local operation is used: see the following table
- 3) Voltage drop 2.2 to 3 V for 3.59 to 22 mA

Increase in minimum terminal voltage

Order code for "Display; operation"	Increase in minimum terminal voltage
Option C: Local operation SD02	+ DC 1 V
Option E: Local operation SD03 with lighting (backlighting not used)	+ DC 1 V
Option E: Local operation SD03 with lighting (backlighting used)	+ DC 3 V

Order code for "Sensor version; DSC sensor; measuring tube"	Increase in minimum terminal voltage
Option DA: Mass steam; 316L; 316L (integrated pressure/temperature measurement)	+ DC 1 V
Option DB: Mass gas/liquid; 316L; 316L (integrated pressure/temperature measurement)	+ DC 1 V

Power consumption

Transmitter

Order code for "Output; input"	Maximum power consumption
Option A: 4-20 mA HART	770 mW
Option B: 4-20 mA HART, pulse/frequency/switch output	<ul style="list-style-type: none"> ■ Operation with output 1: 770 mW ■ Operation with output 1 and 2: 2 770 mW

Order code for "Output; input"	Maximum power consumption
Option C: 4-20 mA HART + 4-20 mA analog	<ul style="list-style-type: none"> ■ Operation with output 1: 660 mW ■ Operation with output 1 and 2: 1 320 mW
Option D: 4-20 mA HART, pulse/frequency/switch output, 4-20 mA current input	<ul style="list-style-type: none"> ■ Operation with output 1: 770 mW ■ Operation with output 1 and 2: 2770 mW ■ Operation with output 1 and input: 840 mW ■ Operation with output 1, 2 and input: 2840 mW

Current consumption

Current output

For every 4-20 mA or 4-20 mA HART current output: 3.6 to 22.5 mA

 If the option **Defined value** is selected in the **Failure mode** parameter : 3.59 to 22.5 mA

Current input

3.59 to 22.5 mA

 Internal current limiting: max. 26 mA

Power supply failure

- Totalizers stop at the last value measured.
- Depending on the device version, the configuration is retained in the device memory or in the pluggable data memory (HistoROM DAT).
- Error messages (incl. total operated hours) are stored.

Electrical connection

→  40

Potential equalization

→  47

Terminals

- For device version without integrated overvoltage protection: plug-in spring terminals for wire cross-sections 0.5 to 2.5 mm² (20 to 14 AWG)
- For device version with integrated overvoltage protection: screw terminals for wire cross-sections 0.2 to 2.5 mm² (24 to 14 AWG)

Cable entries



- Cable gland: M20 × 1.5 with cable ϕ 6 to 12 mm (0.24 to 0.47 in)
- Thread for cable entry:
 - NPT 1/2"
 - G 1/2"

Cable specification

→  35



Overvoltage protection

The device can be ordered with integrated overvoltage protection for diverse approvals: *Order code for "Accessory mounted", option NA "Overvoltage protection"*

Input voltage range	Values correspond to supply voltage specifications →  39 →  179 ¹⁾
Resistance per channel	2 · 0.5 Ω max.
DC sparkover voltage	400 to 700 V
Trip surge voltage	< 800 V
Capacitance at 1 MHz	< 1.5 pF



Nominal discharge current (8/20 μs)	10 kA
Temperature range	-40 to +85 °C (-40 to +185 °F)

1) The voltage is reduced by the amount of the internal resistance $I_{min} \cdot R_i$

-  Depending on the temperature class, restrictions apply to the ambient temperature for device versions with overvoltage protection .
-  For detailed information on the temperature tables, see the "Safety Instructions" (XA) for the device.

16.6 Performance characteristics

Reference operating conditions

- Error limits following ISO/DIN 11631
 - +20 to +30 °C (+68 to +86 °F)
 - 2 to 4 bar (29 to 58 psi)
 - Calibration system traceable to national standards
 - Calibration with the process connection corresponding to the particular standard
-  To obtain measured errors, use the *Applicator* sizing tool →  167

Maximum measured error

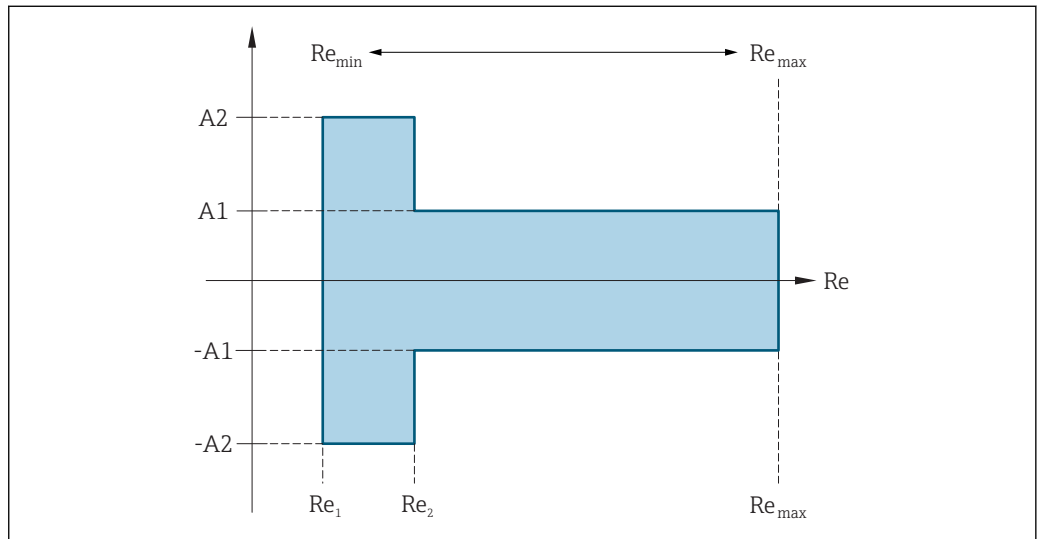

Base accuracy

o.r. = of reading



A0034077

Reynolds number	
Re ₁	5 000
Re ₂	10 000
Re _{min}	Reynolds number for minimum permitted volume flow in measuring tube <ul style="list-style-type: none"> ■ Standard ■ Option N "0.65% volume PremiumCal 5-point"

Reynolds number	
	$Q_{\text{AmpMin}} [\text{m}^3/\text{h}] = \frac{v_{\text{AmpMin}} [\text{m/s}] \cdot \pi \cdot D_i [\text{m}]^2}{4 \cdot \sqrt{\frac{\rho [\text{kg/m}^3]}{1 [\text{kg/m}^3]}}} \cdot 3600 [\text{s/h}]$ $Q_{\text{AmpMin}} [\text{ft}^3/\text{min}] = \frac{v_{\text{AmpMin}} [\text{ft/s}] \cdot \pi \cdot D_i [\text{ft}]^2}{4 \cdot \sqrt{\frac{\rho [\text{lbm/ft}^3]}{0.0624 [\text{lbm/ft}^3]}}} \cdot 60 [\text{s/min}]$
Re _{max}	Defined by internal diameter of measuring tube, Mach number and maximum permitted velocity in measuring tube $Re_{\text{max}} = \frac{\rho \cdot 4 \cdot Q_{\text{Heigh}}}{\mu \cdot K}$
	 Further information on effective upper range value Q _{High} →  173

Volume flow

Medium type		Incompressible		Compressible	
Reynolds number range	Measured value deviation	PremiumCal ¹⁾	Standard	PremiumCal ¹⁾	Standard
Re ₂ to Re _{max}	A1	< 0.65 %	< 0.75 %	< 0.9 %	< 1.0 %
Re ₁ to Re ₂	A2	< 2.5 %	< 5.0 %	< 2.5 %	< 5.0 %

1) Order code for "Calibration flow", option N "0.65% volume PremiumCal 5-point"

Temperature

- Saturated steam and liquids at room temperature, if T > 100 °C (212 °F):
< 1 °C (1.8 °F)
- Gas: < 1 % o.r. [K]
- Volume flow: 70 m/s (230 ft/s): 2 % o.r.
- Rise time 50 % (stirred under water, following IEC 60751): 8 s

Pressure

Order code for "Pressure component" ¹⁾	Nominal value [bar abs.]	Pressure ranges and measured errors ²⁾	
		Pressure range [bar abs.]	Maximum measured error
Option B Pressure measuring cell 2 bar_a	2	0.01 ≤ p ≤ 0.4 0.4 ≤ p ≤ 2	0.5 % of 0.4 abs. 0.5 % o.r.
Option C Pressure measuring cell 4 bar_a	4	0.01 ≤ p ≤ 0.8 0.8 ≤ p ≤ 4	0.5 % of 0.8 bar abs. 0.5 % o.r.
Option D Pressure measuring cell 10 bar_a	10	0.01 ≤ p ≤ 2 2 ≤ p ≤ 10	0.5 % of 2 bar abs. 0.5 % o.r.
Option E Pressure measuring cell 40 bar_a	40	0.01 ≤ p ≤ 8 8 ≤ p ≤ 40	0.5 % of 8 bar abs. 0.5 % o.r.

- 1) The "mass" sensor version (integrated pressure/temperature measurement) is available only for measuring devices in HART communication mode.
- 2) The specific measured errors refer to the position of the measurement in the measuring tube and do not correspond to the pressure in the pipe connection line upstream or downstream from the measuring

device. No measured error is specified for the measured error for the "pressure" measured variable that can be assigned to the outputs.

Mass flow saturated steam

Sensor version				Mass (integrated temperature measurement)		Mass (integrated pressure/temperature measurement) ¹⁾	
Process pressure [bar abs.]	Flow velocity [m/s (ft/s)]	Reynolds number range	Measured value deviation	PremiumCal ²⁾	Standard	PremiumCal ²⁾	Standard
> 4.76	20 to 50 (66 to 164)	Re ₂ to Re _{max}	A1	< 1.6 %	< 1.7 %	< 1.4 %	< 1.5 %
> 3.62	10 to 70 (33 to 230)	Re ₂ to Re _{max}	A1	< 1.9 %	< 2.0 %	< 1.7 %	< 1.8 %

In all cases not specified here, the following applies: < 5.7 %

- 1) Sensor version available only for measuring devices in HART communication mode.
- 2) Order code for "Calibration flow", option N "0.65% volume PremiumCal 5-point"

Mass flow of superheated steam/gases⁴⁾

Sensor version				Mass (integrated pressure/temperature measurement) ¹⁾		Mass (integrated temperature measurement) ²⁾ + external pressure compensation ²⁾	
Process pressure [bar abs.]	Flow velocity [m/s (ft/s)]	Reynolds number range	Measured value deviation	PremiumCal ³⁾	Standard	PremiumCal ³⁾	Standard
< 40	All velocities	Re ₂ to Re _{max}	A1	< 1.4 %	< 1.5 %	< 1.6 %	< 1.7 %
< 120		Re ₂ to Re _{max}	A1	< 2.3 %	< 2.4 %	< 2.5 %	< 2.6 %

In all cases not specified here, the following applies: < 6.6 %

- 1) Sensor version available only for measuring devices in HART communication mode.
- 2) The use of a Cerabar S is required for the measured errors listed in the following section. The measured error used to calculate the error in the measured pressure is 0.15 %.
- 3) Order code for "Calibration flow", option N "0.65% volume PremiumCal 5-point"

Water mass flow

Sensor version				Mass (integrated temperature measurement)	
Process pressure [bar abs.]	Flow velocity [m/s (ft/s)]	Reynolds number range	Measured value deviation	PremiumCal ¹⁾	Standard
All pressures	All velocities	Re ₂ to Re _{max}	A1	< 0.75 %	< 0.85 %
		Re ₁ to Re ₂	A2	< 2.6 %	< 2.7 %

- 1) Order code for "Calibration flow", option N "0.65% volume PremiumCal 5-point"

Mass flow (user-specific liquids)

To specify the system accuracy, Endress+Hauser requires information about the type of liquid and its operating temperature or information in table form about the dependency between the liquid density and the temperature.

4) single gas, gas mixture, air: NEL40; natural gas: ISO 12213-2 contains AGA8-DC92, AGA NX-19, ISO 12213-3 contains SGERG-88 and AGA8 Gross Method 1

Example

- Acetone is to be measured at fluid temperatures from +70 to +90 °C (+158 to +194 °F).
- For this purpose, the **Reference temperature** parameter (7703) (here 80 °C (176 °F)), **Reference density** parameter (7700) (here 720.00 kg/m³) and **Linear expansion coefficient** parameter (7621) (here 18.0298 × 10⁻⁴ 1/°C) must be entered in the transmitter.
- The overall system uncertainty, which is less than 0.9 % for the example above, is comprised of the following measurement uncertainties: uncertainty of volume flow measurement, uncertainty of temperature measurement, uncertainty of the density-temperature correlation used (including the resulting uncertainty of density).

Mass flow (other media)

Depends on the selected fluid and the pressure value, which is specified in the parameters. Individual error analysis must be performed.

Accuracy of outputs

The outputs have the following base accuracy specifications.

Current output

Accuracy	±10 µA
----------	--------

Pulse/frequency output

o.r. = of reading

Accuracy	Max. ±100 ppm o.r.
----------	--------------------

Repeatability

o.r. = of reading

$$r = \left\{ \frac{100 \cdot D_1^3}{V} \right\}^{1/2} \% \text{ o.r.}$$

A0042121-EN

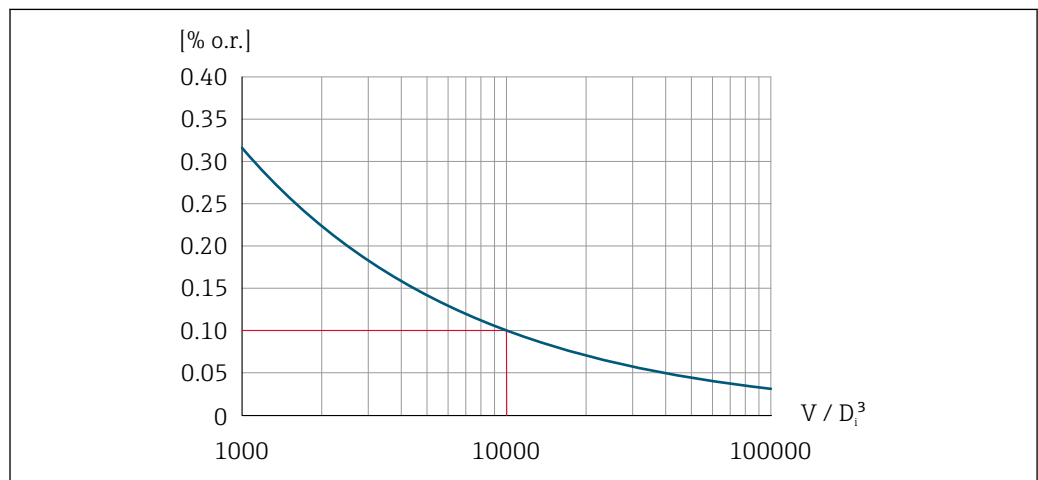

A0042123-EN

29 Repeatability = 0.1 % o.r. with a measured volume [m³] of V = 10 000 · D₁³

The repeatability can be improved if the measured volume is increased. Repeatability is not a device characteristic but a statistical variable that is dependent on the boundary conditions indicated.

Response time

If all the configurable functions for filter times (flow damping, display damping, current output time constant, frequency output time constant, status output time constant) are set to 0, in the event of vortex frequencies of 10 Hz and higher a response time of $\max(T_v, 100 \text{ ms})$ can be expected.

In the event of measuring frequencies $< 10 \text{ Hz}$, the response time is $> 100 \text{ ms}$ and can be up to 10 s. T_v is the average vortex period duration of the flowing fluid.

Influence of ambient temperature

Current output

o.r. = of reading

Additional error, in relation to the span of 16 mA:

Temperature coefficient at zero point (4 mA)	0.02 %/10 K
Temperature coefficient with span (20 mA)	0.05 %/10 K

Pulse/frequency output

o.r. = of reading

Temperature coefficient	Max. $\pm 100 \text{ ppm o.r.}$
-------------------------	---------------------------------

16.7 Installation

Installation conditions →  22

16.8 Environment

Ambient temperature range →  26

Temperature tables

 Observe the interdependencies between the permitted ambient and fluid temperatures when operating the device in hazardous areas.

 For detailed information on the temperature tables, see the separate document entitled "Safety Instructions" (XA) for the device.

Storage temperature

All components apart from the display modules:
 $-50 \text{ to } +80 \text{ }^\circ\text{C}$ ($-58 \text{ to } +176 \text{ }^\circ\text{F}$)

Display modules

All components apart from the display modules:
 $-50 \text{ to } +80 \text{ }^\circ\text{C}$ ($-58 \text{ to } +176 \text{ }^\circ\text{F}$)

Remote display FHX50:
 $-50 \text{ to } +80 \text{ }^\circ\text{C}$ ($-58 \text{ to } +176 \text{ }^\circ\text{F}$)

Climate class DIN EN 60068-2-38 (test Z/AD)

<p>Degree of protection</p>	<p>Transmitter</p> <ul style="list-style-type: none"> ■ As standard: IP66/67, type 4X enclosure ■ When housing is open: IP20, type 1 enclosure ■ Display module: IP20, type 1 enclosure <p>Sensor</p> <p>IP66/67, type 4X enclosure</p>
<p>Vibration resistance</p>	<p>Vibration, sinusoidal according to IEC 60068-2-6</p> <ul style="list-style-type: none"> ■ Order code for "Housing", option C "GT20 two-chamber, aluminum, coated, compact", J "GT20 two-chamber, aluminum, coated, remote", K "GT18 two-chamber, 316L, remote" <ul style="list-style-type: none"> ■ 2 to 8.4 Hz, 7.5 mm peak ■ 8.4 to 500 Hz, 2 g peak ■ Order code for "Housing", option B "GT18 two-chamber, 316L, compact" <ul style="list-style-type: none"> ■ 2 to 8.4 Hz, 3.5 mm peak ■ 8.4 to 500 Hz, 1 g peak ■ Order code for "Sensor version; DSC sensor; measuring tube", option DA "mass steam; 316L; 316L (integrated pressure/temperature measurement)" or option DB "mass gas/liquid; 316L; 316L (integrated pressure/temperature measurement)" <ul style="list-style-type: none"> ■ 2 to 8.4 Hz, 3.5 mm peak ■ 8.4 to 500 Hz, 1 g peak <p>Vibration broad-band random, according to IEC 60068-2-64</p> <ul style="list-style-type: none"> ■ Order code for "Housing", option C "GT20 two-chamber, aluminum, coated, compact", J "GT20 two-chamber, aluminum, coated, remote", K "GT18 two-chamber, 316L, remote" <ul style="list-style-type: none"> ■ 10 to 200 Hz, 0.01 g²/Hz ■ 200 to 500 Hz, 0.003 g²/Hz ■ Total 2.7 g rms ■ Order code for "Housing", option B "GT18 two-chamber, 316L, compact" <ul style="list-style-type: none"> ■ 10 to 200 Hz, 0.003 g²/Hz ■ 200 to 500 Hz, 0.001 g²/Hz ■ Total 1.54 g rms ■ Order code for "Sensor version"; DSC sensor; measuring tube", option DA "mass steam; 316L; 316L (integrated pressure/temperature measurement)" or option DB "mass gas/liquid; 316L; 316L (integrated pressure/temperature measurement)" <ul style="list-style-type: none"> ■ 2 to 8.4 Hz, 3.5 mm peak ■ 8.4 to 500 Hz, 1 g peak
<p>Shock resistance</p>	<p>Shock, half-sine according to IEC 60068-2-27</p> <ul style="list-style-type: none"> ■ Order code for "Housing", option C "GT20 two-chamber, aluminum, coated, compact", J "GT20 two-chamber, aluminum, coated, remote", K "GT18 two-chamber, 316L, remote" <ul style="list-style-type: none"> 6 ms, 50 g ■ Order code for "Housing", option B "GT18 two-chamber, 316L, compact" <ul style="list-style-type: none"> 6 ms, 30 g
<p>Shock resistance</p>	<p>Shock due to rough handling following IEC 60068-2-31</p>
<p>Electromagnetic compatibility (EMC)</p>	<p>As per IEC/EN 61326 and NAMUR Recommendation 21 (NE 21)</p> <p> Details are provided in the Declaration of Conformity.</p>

16.9 Process

Medium temperature range *DSC sensor*¹⁾

Order code for "Sensor version; DSC sensor; measuring tube"		
Option	Description	Medium temperature range
AA	Volume; 316L; 316L	-40 to +260 °C (-40 to +500 °F), stainless steel
AB	Volume; Alloy C22; 316L	
BA	Volume high-temperature; 316L; 316L	-200 to +400 °C (-328 to +752 °F), stainless steel
BB	Volume high-temperature; Alloy C22; 316L	
CA	Mass; 316L; 316L	-200 to +400 °C (-328 to +752 °F), stainless steel
CB	Mass; Alloy C22; 316L	

1) Capacitance sensor

Order code for "Sensor version; DSC sensor; measuring tube"		
Option	Description	Medium temperature range
	For order code for "Sensor version; DSC sensor; measuring tube", option DA "Mass steam" and DB "Mass gas/liquid", the following applies: <ul style="list-style-type: none"> Only available for measuring devices with the HART communication protocol Oil-free or grease-free cleaning is not possible 	
DA	Mass steam; 316L; 316L	-200 to +400 °C (-328 to +752 °F), stainless steel ^{1) 2)}
DB	Mass gas/liquid; 316L; 316L	-40 to +100 °C (-40 to +212 °F), stainless steel ²⁾

- 1) Siphon enables use for extended temperature range (up to +400 °C (+752 °F)).
- 2) In steam applications, in conjunction with the siphon, the steam temperature may be higher (up to +400 °C (+752 °F)) than the permitted temperature of the pressure measuring cell. Without a siphon, the gas temperature is restricted due to the maximum permitted temperature of the pressure measuring cell. This applies regardless of whether or not a stop cock is present.

Pressure measuring cell

Order code for "Pressure component"		
Option	Description	Medium temperature range
B	Pressure measuring cell 2bar/29psi abs	-40 to +100 °C (-40 to +212 °F)
C	Pressure measuring cell 4bar/58psi abs	
D	Pressure measuring cell 10bar/145psi abs	
E	Pressure measuring cell 40bar/580psi abs	

Seals

Order code for "DSC sensor seal"		
Option	Description	Medium temperature range
A	Graphite (standard)	-200 to +400 °C (-328 to +752 °F)
B	Viton	-15 to +175 °C (+5 to +347 °F)
C	Gylon	-200 to +260 °C (-328 to +500 °F)
D	Kalrez	-20 to +275 °C (-4 to +527 °F)

Pressure-temperature ratings



An overview of the pressure-temperature ratings for the process connections is provided in the "Technical Information" document

Nominal pressure of sensor The following overpressure resistance values apply to the sensor shaft in the event of a membrane rupture:

Sensor version; DSC sensor; measuring tube	Overpressure, sensor shaft in [bar a]
Volume	200
Volume high-temperature	200
Mass (integrated temperature measurement)	200
Mass steam (integrated pressure/temperature measurement) Mass gas/liquid (integrated pressure/temperature measurement)	200

Pressure specifications

- i** For order code for "Sensor version; DSC sensor; measuring tube", option DA "Mass steam" and DB "Mass gas/liquid", the following applies:
- Only available for measuring devices with the HART communication protocol
 - Oil-free or grease-free cleaning is not possible

The OPL (over pressure limit = sensor overload limit) for the measuring device depends on the lowest-rated element, with regard to pressure, of the selected components, i.e. the process connection has to be taken into consideration in addition to the measuring cell. Also observe pressure-temperature dependency. For the appropriate standards and further information →  182. The OPL may only be applied for a limited period of time.

The MWP (maximum working pressure) for the sensors depends on the lowest-rated element, with regard to pressure, of the selected components, i.e. the process connection has to be taken into consideration in addition to the measuring cell. Also observe pressure-temperature dependency. For the appropriate standards and further information →  182. The MWP may be applied at the device for an unlimited period. The MWP can also be found on the nameplate.

⚠ WARNING

The maximum pressure for the measuring device depends on the lowest-rated element with regard to pressure.

- ▶ Note specifications regarding pressure range →  182.
- ▶ The Pressure Equipment Directive (2014/68/EU) uses the abbreviation "PS". The abbreviation "PS" corresponds to the MWP of the device.
- ▶ MWP: The MWP is indicated on the nameplate. This value refers to a reference temperature of +20 °C (+68°F) and may be applied to the device for an unlimited time. Note temperature dependence of MWP.
- ▶ OPL: The test pressure corresponds to the over pressure limit of the sensor and may be applied only temporarily to ensure that the measurement is within the specifications and no permanent damage occurs. In the case of sensor range and process connection combinations where the OPL of the process connection is less than the nominal value of the sensor, the device is set at the factory, at the very maximum, to the OPL value of the process connection. If using the entire sensor range, select a process connection with a higher OPL value.

Sensor	Maximum sensor measuring range		MWP	OPL
	Lower (LRL)	Upper (URL)		
	[bar (psi)]	[bar (psi)]	[bar (psi)]	[bar (psi)]
2 bar (30 psi)	0 (0)	+2 (+30)	6.7 (100.5)	10 (150)
4 bar (60 psi)	0 (0)	+4 (+60)	10.7 (160.5)	16 (240)
10 bar (150 psi)	0 (0)	+10 (+150)	25 (375)	40 (600)
40 bar (600 psi)	0 (0)	+40 (+600)	100 (1500)	160 (2 400)

Pressure loss

For a precise calculation, use the Applicator →  167.

Vibrations

16.10 Mechanical construction

Design, dimensions



For the dimensions and installation lengths of the device, see the "Technical Information" document, "Mechanical construction" section.

Weight

Compact version

Single inner diameter line size reduction

Weight data:

- Including the transmitter:
 - Order code for "Housing", option C "GT20, two-chamber, aluminum, coated, compact" 1.8 kg (4.0 lb):
 - Order code for "Housing", option B "GT18 two-chamber, 316L, compact" 4.5 kg (9.9 lb):
- Excluding packaging material

Weight in SI units

All values (weight) refer to devices with EN (DIN), PN 40 flanges. Weight information in [kg].

DN [mm]	Internal diameter [mm]	Weight [kg]	
		Order code for "Housing", option C "GT20 two-chamber, aluminum, coated, compact" ¹⁾	Order code for "Housing", option B "GT18 two-chamber, 316L, compact" ¹⁾
25R	15	6.1	8.8
40R	25	10.1	12.8
50R	40	12.1	14.8
80R	50	16.1	18.8
100R	80	23.1	25.8
150R	100	42.1	44.8
200R	150	63.1	65.8

1) For high-temperature/low-temperature version: values + 0.2 kg

Weight in US units

All values (weight) refer to devices with ASME B16.5, Class 300/Sch. 40 flanges. Weight information in [lbs].

DN [in]	Internal diameter [in]	Weight [lbs]	
		Order code for "Housing", option C "GT20 two-chamber, aluminum, coated, compact" ¹⁾	Order code for "Housing", option B "GT18 two-chamber, 316L, compact" ¹⁾
1R	½	18.0	23.9
1½R	1	22.4	28.3
2R	1½	26.8	32.7
3R	2	48.8	54.8
4R	3	68.7	74.6

DN [in]	Internal diameter [in]	Weight [lbs]	
		Order code for "Housing", option C "GT20 two-chamber, aluminum, coated, compact" ¹⁾	Order code for "Housing", option B "GT18 two-chamber, 316L, compact" ¹⁾
6R	4	121.6	127.5
8R	6	165.7	171.6

1) For high-temperature/low-temperature version: values + 0.4 lbs

Transmitter remote version

Wall-mount housing

Dependent on the material of wall-mount housing:

- Order code for "Housing" option J "GT20 two-chamber, aluminum, coated, remote" 2.4 kg (5.2 lb):
- Order code for "Housing", option K "GT18 two-chamber, 316L, remote" 6.0 kg (13.2 lb):

Sensor remote version

Single inner diameter line size reduction

Weight data:

- Including sensor connection housing:
 - Order code for "Housing" option J "GT20 two-chamber, aluminum, coated, remote" 0.8 kg (1.8 lb):
 - Order code for "Housing", option K "GT18 two-chamber, 316L, remote" 2.0 kg (4.4 lb):
- Excluding the connecting cable
- Excluding packaging material

Weight in SI units

All values (weight) refer to devices with EN (DIN), PN 40 flanges. Weight information in [kg].

DN [mm]	Internal diameter [mm]	Weight [kg]	
		sensor connection housing Order code for "Housing", option J "GT20 two-chamber, aluminum, coated, remote" ¹⁾	sensor connection housing Order code for "Housing", option K "GT18 two-chamber, 316L, remote" ¹⁾
25R	15	5.1	6.3
40R	25	9.1	10.3
50R	40	11.1	12.3
80R	50	15.1	16.3
100R	80	22.1	23.3
150R	100	41.1	42.3
200R	150	62.1	63.3

1) For high-temperature/low-temperature version: values + 0.2 kg

Weight in US units

All values (weight) refer to devices with ASME B16.5, Class 300/Sch. 40 flanges. Weight information in [lbs].

DN [in]	Internal diameter [in]	Weight [lbs]	
		sensor connection housing Order code for "Housing", option J "GT20 two-chamber, aluminum, coated, remote" ¹⁾	sensor connection housing Order code for "Housing", option K "GT18 two-chamber, 316L, remote" ¹⁾
1R	½	15.6	18.3
1½R	1	20.0	22.7
2R	1½	24.4	27.2
3R	2	46.4	49.2
4R	3	66.3	69.0
6R	4	119.2	122.0
8R	6	163.3	166.0

1) For high-temperature/low-temperature version: values + 0.4 lbs

Accessories

Flow conditioner

Weight in SI units

DN ¹⁾ [mm]	Pressure rating	Weight [kg]
15	PN 10 to 40	0.04
25	PN 10 to 40	0.1
40	PN 10 to 40	0.3
50	PN 10 to 40	0.5
80	PN 10 to 40	1.4
100	PN10 to 40	2.4
150	PN 10/16 PN 25/40	6.3 7.8
200	PN 10 PN 16/25 PN 40	11.5 12.3 15.9
250	PN 10 to 25 PN 40	25.7 27.5

1) EN (DIN)

DN ¹⁾ [mm]	Pressure rating	Weight [kg]
15	Class 150 Class 300	0.03 0.04
25	Class 150 Class 300	0.1
40	Class 150 Class 300	0.3
50	Class 150 Class 300	0.5
80	Class 150 Class 300	1.2 1.4
100	Class 150 Class 300	2.7

DN ¹⁾ [mm]	Pressure rating	Weight [kg]
150	Class 150	6.3
	Class 300	7.8
200	Class 150	12.3
	Class 300	15.8
250	Class 150	25.7
	Class 300	27.5

1) ASME

DN ¹⁾ [mm]	Pressure rating	Weight [kg]
15	20K	0.06
25	20K	0.1
40	20K	0.3
50	10K	0.5
	20K	
80	10K	1.1
	20K	
100	10K	1.80
	20K	
150	10K	4.5
	20K	
200	10K	9.2
	20K	
250	10K	15.8
	20K	

1) JIS

Weight in US units

DN ¹⁾ [in]	Pressure rating	Weight [lbs]
½	Class 150	0.07
	Class 300	0.09
1	Class 150	0.3
	Class 300	
1½	Class 150	0.7
	Class 300	
2	Class 150	1.1
	Class 300	
3	Class 150	2.6
	Class 300	
4	Class 150	6.0
	Class 300	
6	Class 150	14.0
	Class 300	

DN ¹⁾ [in]	Pressure rating	Weight [lbs]
8	Class 150	27.0
	Class 300	35.0
10	Class 150	57.0
	Class 300	61.0

1) ASME

Materials

Transmitter housing

Compact version

- Order code for "Housing", option B "GT18 two-chamber, 316L, compact":
Stainless steel, CF3M
- Order code for "Housing", option C "GT20, two-chamber, aluminum, coated, compact":
Aluminum, AlSi10Mg, coated
- Window material: glass

Remote version

- Order code for "Housing" option J "GT20 two-chamber, aluminum, coated, remote":
Aluminum, AlSi10Mg, coated
- Order code for "Housing", option K "GT18 two-chamber, 316L, remote":
For maximum corrosion resistance: Stainless steel, CF3M
- Window material: glass

Cable entries/cable glands

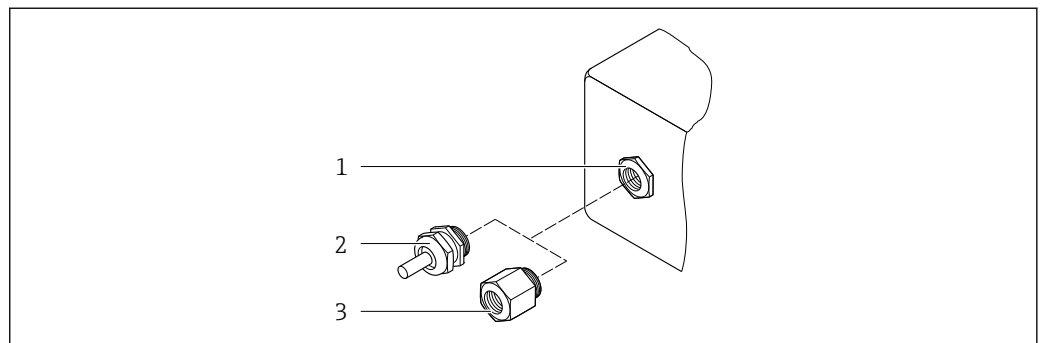

A0020640

30 Possible cable entries/cable glands

- 1 Female thread M20 × 1.5
- 2 Cable gland M20 × 1.5
- 3 Adapter for cable entry with female thread G ½" or NPT ½"

Order code for "Housing", option B "GT18 dual compartment, 316L, compact" option K "GT18 dual compartment, 316L, remote"

Cable entry/cable gland	Type of protection	Material
Cable gland M20 × 1.5	<ul style="list-style-type: none"> ■ Non-hazardous area ■ Ex ia ■ Ex ic ■ Ex nA, Ex ec ■ Ex tb 	Stainless steel ,1.4404
Adapter for cable entry with female thread G ½"	Non-hazardous area and hazardous area (except for XP)	Stainless steel, 1.4404 (316L)
Adapter for cable entry with female thread NPT ½"	Non-hazardous area and hazardous area	

Order code for "Housing": option C "GT20 dual compartment, aluminum, coated, compact", option J "GT20 dual compartment, aluminum, coated remote"

i Applies also to the following device versions in combination with HART communication mode:

Order code for "Sensor version; DSC sensor; measuring tube", option DA "Mass steam; 316L; 316L", option DB "Mass gas/liquid; 316L; 316L"

Cable entry/cable gland	Type of protection	Material
Cable gland M20 × 1.5	<ul style="list-style-type: none"> ■ Non-hazardous area ■ Ex ia ■ Ex ic 	Plastic
	Adapter for cable entry with female thread G ½"	Nickel-plated brass
Adapter for cable entry with female thread NPT ½"	Non-hazardous area and hazardous area (except for XP)	Nickel-plated brass
Thread NPT ½" via adapter	Non-hazardous area and hazardous area	

Connecting cable for remote version

- Standard cable: PVC cable with copper shield
- Reinforced cable: PVC cable with copper shield and additional steel wire braided jacket

Connecting cable, pressure measuring cell

i For order code for "Sensor version; DSC sensor; measuring tube", option DA "Mass steam" and DB "Mass gas/liquid", the following applies:

- Only available for measuring devices with the HART communication protocol
- Oil-free or grease-free cleaning is not possible

Standard cable: PVC cable with copper shield

Sensor connection housing

The material of the sensor connection housing is dependent on the material selected for the transmitter housing.

- Order code for "Housing" option J "GT20 two-chamber, aluminum, coated, remote": Coated aluminum AlSi10Mg
- Order code for "Housing", option K "GT18 two-chamber, 316L, remote": Stainless cast steel, 1.4408 (CF3M)
Compliant with:
 - NACE MR0175
 - NACE MR0103

Measuring tubes

DN 25R to 200R (1R to 8R)/DN 40S to 250S (1½S to 10S), pressure ratings PN 10/16/25/40, Class 150/300, as well as JIS 10K/20K:

Stainless cast steel, CF3M/1.4408

Compliant with:

- NACE MR0175
- NACE MR0103
- DN15 to 150 (½ to 6"): AD2000, permitted temperature range -10 to +400 °C (+14 to +752 °F) restricted)

DSC sensor

Order code for "Sensor version; DSC sensor; measuring tube", option **AA, BA, CA, DA, DB**

Pressure ratings PN 10/16/25/40, Class 150/300, as well as JIS 10K/20K:

Parts in contact with medium (marked as "wet" on the DSC sensor flange):

- Stainless steel 1.4404 and 316 and 316L
- Compliant with:
 - NACE MRO175/ISO 15156-2015
 - NACE MRO103/ISO 17945-2015

Parts not in contact with medium:

Stainless steel 1.4301 (304)

Order code for "Sensor version; DSC sensor; measuring tube", option **AB, BB, CB**

Pressure ratings PN 10/16/25/40, Class 150/300, as well as JIS 10K/20K:

Parts in contact with medium (marked as "wet" on the DSC sensor flange):

- Alloy C22, UNS N06022 similar to Alloy C22/2.4602
- Compliant with:
 - NACE MRO175/ISO 15156-2015
 - NACE MRO103/ISO 17945-2015

Parts not in contact with medium:

Alloy C22, UNS N06022 similar to Alloy C22/2.4602

Pressure measuring cell

 For order code for "Sensor version; DSC sensor; measuring tube", option DA "Mass steam" and DB "Mass gas/liquid", the following applies:

- Only available for measuring devices with the HART communication protocol
- Oil-free or grease-free cleaning is not possible
- Wetted parts:
 - Process connection
Stainless steel, 1.4404/316L
 - Membrane
Stainless steel, 1.4435/316L
- Non-wetted parts:
 - Housing
Stainless steel, 1.4404

Order code for "Sensor version; DSC sensor; measuring tube", option DA, DB

- Siphon ⁵⁾
Stainless steel, 1.4571
- Adjusting nut
Stainless steel, 1.4571
- Pressure gauge valve
Stainless steel, 1.4571
- Welded connection on meter body
Stainless steel, multiple certifications 1.4404/316/316L
- Seals
Copper

Process connections

DN 25R to 200R (1R to 8R)/DN 40S to 250S (1½S to 10S), pressure ratings PN 10/16/25/40, Class 150/300, as well as JIS 10K/20K:

5) Only with order code for "Sensor version; DSC sensor; measuring tube", option DA available.

- "R-type" with single inner diameter line size reduction: 25R to 200R (1R to 8R")
Compliant with:
 - NACE MRO175-2003
 - NACE MRO103-2003
- "S-type" with double inner diameter line size reduction: DN 40S to 250S (1½S to 10S")
Compliant with:
 - NACE MRO175-2003
 - NACE MRO103-2003

The following materials are available depending on the pressure rating:
Stainless steel, multiple certifications, 1.4404/F316/F316L



Available process connections

Seals

- Graphite (standard)
Sigraflex foil™ (BAM-tested for oxygen applications, "high-grade in the context of TA-Luft Clean Air Guidelines")
- FPM (Viton™)
- Kalrez 6375™
- Gylon 3504™ (BAM-tested for oxygen applications, "high-grade in the context of TA-Luft clean air guidelines")

Order code for "Sensor version; DSC sensor; measuring tube", option DA, DB
Copper

Housing support

Stainless steel, 1.4408 (CF3M)

Screws for DSC sensor

- Order code for "Sensor version", option AA, BA, CA, DA, DB
Stainless steel, A2-80 according to ISO 3506-1 (304)
- Order code for "Additional approval", option LL "AD 2000 (including option JA+JB+JK) > DN25 including option LK"
Stainless steel, A4-80 according to ISO 3506-1 (316)
- Order code for "Sensor version", option AB, AC, BB, CB, CC
Stainless steel, 1.4980 according to EN 10269 (Gr. 660 B)

Accessories

Protective cover

Stainless steel, 1.4404 (316L)

Flow conditioner

- Stainless steel, multiple certifications, 1.4404 (316, 316L)
- Compliant with:
 - NACE MRO175-2003
 - NACE MRO103-2003

- "R-type" with single inner diameter line size reduction: 25R to 200R (1R to 8R")
Compliant with:
 - NACE MRO175-2003
 - NACE MRO103-2003
- "S-type" with double inner diameter line size reduction: DN 40S to 250S (1½S to 10S")
Compliant with:
 - NACE MRO175-2003
 - NACE MRO103-2003

The following materials are available depending on the pressure rating:
Stainless steel, multiple certifications, 1.4404/F316/F316L)

 Available process connections

16.11 Operability

Languages

Can be operated in the following languages:

- Via local display:
 - English, German, French, Spanish, Italian, Dutch, Portuguese, Polish, Russian, Swedish, Turkish, Chinese, Japanese, Korean, Bahasa (Indonesian), Vietnamese, Czech
- Via "FieldCare" operating tool:
 - English, German, French, Spanish, Italian, Chinese, Japanese

Local operation

Via display module

Two display modules are available:

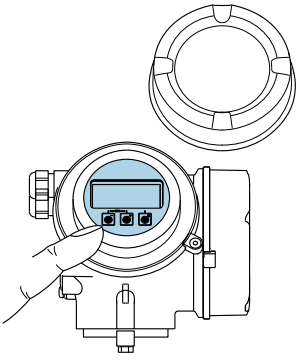
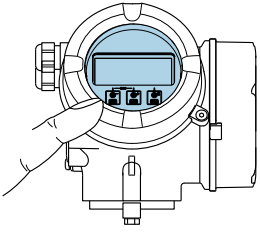
Order code for "Display; Operation", option C "SD02"	Order code for "Display; Operation", option E "SD03"
 <p style="text-align: right; font-size: small;">A0032219</p>	 <p style="text-align: right; font-size: small;">A0032221</p>
1 Operation with pushbuttons	1 Operation with touch control

Display elements

- 4-line, illuminated, graphic display
- White background lighting; switches to red in event of device errors
- Format for displaying measured variables and status variables can be individually configured
- Permitted ambient temperature for the display: -20 to +60 °C (-4 to +140 °F)
The readability of the display may be impaired at temperatures outside the temperature range.



Operating elements

- Operation with 3 push buttons with open housing: ⊕, ⊖, ⊞
or
- External operation via touch control (3 optical keys) without opening the housing: ⊕, ⊖, ⊞
- Operating elements also accessible in the various zones of the hazardous area

Additional functionality

- Data backup function
The device configuration can be saved in the display module.
- Data comparison function
The device configuration saved in the display module can be compared to the current device configuration.
- Data transfer function
The transmitter configuration can be transmitted to another device using the display module.

Via remote display FHX50

-  The remote display FHX50 can be ordered as an optional extra →  165.
- The remote display FHX50 cannot be combined with the order code for "Sensor version; DSC sensor; measuring tube", option DA "mass steam" or option DB "mass gas/liquid".

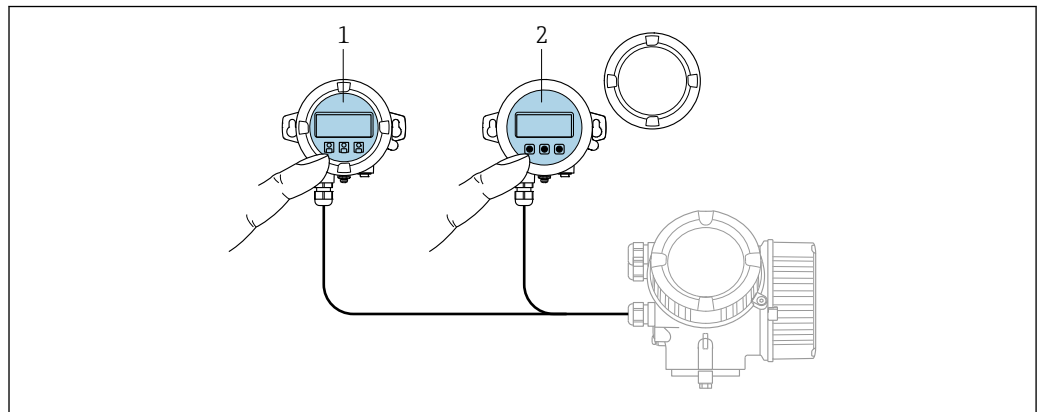

 31 FHX50 operating options

- 1 SD02 display and operating module, push buttons: cover must be opened for operation
- 2 SD03 display and operating module, optical buttons: operation possible through cover glass

Display and operating elements



The display and operating elements correspond to those of the display module .

Remote operation →  63

Service interface →  64

16.12 Certificates and approvals

-  Currently available certificates and approvals can be called up via the product configurator.

CE mark	<p>The device meets the legal requirements of the applicable EU Directives. These are listed in the corresponding EU Declaration of Conformity along with the standards applied.</p> <p>Endress+Hauser confirms successful testing of the device by affixing to it the CE mark.</p>
RCM-tick symbol	<p>The measuring system meets the EMC requirements of the "Australian Communications and Media Authority (ACMA)".</p>
Ex approval	<p>The devices are certified for use in hazardous areas and the relevant safety instructions are provided in the separate "Safety Instructions" (XA) document. Reference is made to this document on the nameplate.</p>
Functional safety	<p>The measuring device can be used for flow monitoring systems (min., max., range) up to SIL 2 (single-channel architecture; order code for "Additional approval", option LA) and SIL 3 (multichannel architecture with homogeneous redundancy) and is evaluated and certified in accordance with IEC 61508.</p> <p>The following types of monitoring in safety equipment are possible:</p> <p> Functional Safety Manual with information on the SIL device →  201</p>
Pressure Equipment Directive	<ul style="list-style-type: none"> ■ With the identification PED/G1/x (x = category) on the sensor nameplate, Endress+Hauser confirms conformity with the "Essential Safety Requirements" specified in Appendix I of the Pressure Equipment Directive 2014/68/EU. ■ Devices not bearing this marking (PED) are designed and manufactured according to good engineering practice. They meet the requirements of Article 4 paragraph 3 of the Pressure Equipment Directive 2014/68/EU. The range of application is indicated in tables 6 to 9 in Annex II of the Pressure Equipment Directive 2014/68/EU.
Experience	<p>The Prowirl 200 measuring system is the official successor to Prowirl 72 and Prowirl 73.</p>
Other standards and guidelines	<ul style="list-style-type: none"> ■ EN 60529 Degrees of protection provided by enclosures (IP code) ■ DIN ISO 13359 Measurement of conductive liquid flow in closed conduits - Flanged-type electromagnetic flowmeters - Overall length ■ EN 61010-1 Safety requirements for electrical equipment for measurement, control and laboratory use - general requirements ■ IEC/EN 61326 Emission in accordance with Class A requirements. Electromagnetic compatibility (EMC requirements). ■ NAMUR NE 21 Electromagnetic compatibility (EMC) of industrial process and laboratory control equipment ■ NAMUR NE 32 Data retention in the event of a power failure in field and control instruments with microprocessors ■ NAMUR NE 43 Standardization of the signal level for the breakdown information of digital transmitters with analog output signal. ■ NAMUR NE 53 Software of field devices and signal-processing devices with digital electronics

- NAMUR NE 105
Specifications for integrating fieldbus devices in engineering tools for field devices
- NAMUR NE 107
Self-monitoring and diagnosis of field devices
- NAMUR NE 131
Requirements for field devices for standard applications

16.13 Application packages

Many different application packages are available to enhance the functionality of the device. Such packages might be needed to address safety aspects or specific application requirements.

The application packages can be ordered with the device or subsequently from Endress+Hauser. Detailed information on the order code in question is available from your local Endress+Hauser sales center or on the product page of the Endress+Hauser website: www.endress.com.



Detailed information on the application packages:
Special Documentation for the device

16.14 Accessories



Overview of accessories available for order → 165

16.15 Supplementary documentation



For an overview of the scope of the associated Technical Documentation, refer to the following:

- *W@M Device Viewer* (www.endress.com/deviceviewer): Enter the serial number from nameplate
- *Endress+Hauser Operations App*: Enter the serial number from the nameplate or scan the 2D matrix code (QR code) on the nameplate

Standard documentation

Brief Operating Instructions

Brief Operating Instructions for the sensor

Measuring device	Documentation code
Prowirl R 200	KA01325D

Brief Operating Instructions for transmitter

Measuring device	Documentation code
Prowirl 200	KA01326D

Technical Information

Measuring device	Documentation code
Prowirl R 200	TI01335D

Description of Device Parameters

Measuring device	Documentation code
Prowirl 200	GP01109D

Supplementary device-
dependent documentation

Safety instructions



Content	Documentation code
ATEX/IECEX Ex d, Ex tb	XA01635D
ATEX/IECEX Ex ia, Ex tb	XA01636D
ATEX/IECEX Ex ic, Ex ec	XA01637D
cCSA _{US} XP	XA01638D
cCSA _{US} IS	XA01639D
NEPSI Ex d	XA01643D
NEPSI Ex i	XA01644D
NEPSI Ex ic, Ex nA	XA01645D
INMETRO Ex d	XA01642D
INMETRO Ex i	XA01640D
INMETRO Ex nA	XA01641D
EAC Ex d	XA01684D
EAC Ex nA	XA01685D
JPN Ex d	XA01766D

Special documentation

Contents	Documentation code
Information on the Pressure Equipment Directive	SD01614D
Functional Safety Manual	SD02025D

Contents	Documentation code		
	HART	FOUNDATION Fieldbus	PROFIBUS PA
Heartbeat Technology	SD02029D	SD02030D	SD02031D

Installation Instructions

Contents	Comment
Installation instructions for spare part sets and accessories	<ul style="list-style-type: none"> ▪ Access the overview of all the available spare part sets via <i>W@M Device Viewer</i> →  162 ▪ Accessories available for order with Installation Instructions →  165

Index

A

- Access authorization to parameters
 - Read access 62
 - Write access 62
- Access code 62
 - Incorrect input 62
- Adapting the diagnostic behavior 148
- Adapting the status signal 149
- Ambient temperature
 - Influence 185
- Ambient temperature range 26
- AMS Device Manager 66
 - Function 66
- Application 169
- Applicator 170
- Approvals 198

B

- Burst mode 70

C

- Cable entries
 - Technical data 180
- Cable entry
 - Degree of protection 47
- CE mark 10, 199
- Certificates 198
- Check
 - Connection 47
 - Installation 33
- Checklist
 - Post-connection check 47
 - Post-installation check 33
- Cleaning
 - Exterior cleaning 160
 - Interior cleaning 160
 - Replacing housing seals 160
 - Replacing seals 160
 - Replacing sensor seals 160
- Climate class 185
- Commissioning 73
 - Advanced settings 93
 - Configuring the measuring device 74
- Communication-specific data 68
- Connecting cable 35
- Connecting the measuring device 40
- Connection
 - see Electrical connection
- Connection preparations 40
- Connection tools 35
- Context menu
 - Calling up 57
 - Closing 57
 - Explanation 57
- Current consumption 180

D

- Declaration of Conformity 10
- Define access code 120
- Degree of protection 47, 186
- Designated use 9
- Device components 12
- Device description files 68
- Device documentation
 - Supplementary documentation 8
- Device locking, status 132
- Device name
 - Pressure measuring cell 19
 - Sensor 16
 - Transmitter 15
- Device repair 162
- Device revision 68
- Device type ID 68
- DeviceCare 66
 - Device description file 68
- Diagnostic behavior
 - Explanation 145
 - Symbols 145
- Diagnostic information
 - Design, description 145, 147
 - DeviceCare 146
 - FieldCare 146
 - Local display 144
 - Overview 149
 - Remedial measures 149
- Diagnostic list 154
- Diagnostic message 144
- Diagnostics
 - Symbols 144
- DIP switches
 - see Write protection switch
- Direct access 59
- Direct access code 54
- Disabling write protection 120
- Display
 - see Local display
- Display area
 - For operational display 52
 - In the navigation view 54
- Display values
 - For locking status 132
- Disposal 163
- Document
 - Function 6
 - Symbols 6
- Document function 6

E

- Electrical connection
 - Commubox FXA195 (USB) 63
 - Commubox FXA291 64
 - Degree of protection 47

- Field Communicator 475 63
- Field Xpert SFX350/SFX370 63
- Measuring device 35
- Operating tool (e.g. FieldCare, AMS Device Manager, SIMATIC PDM) 63
- Operating tools
 - Via HART protocol 63
 - Via service interface (CDI) 64
- Transmitter power supply unit 63
- VIATOR Bluetooth modem 63
- Electromagnetic compatibility 186
- Enabling write protection 120
- Enabling/disabling the keypad lock 63
- Endress+Hauser services
 - Maintenance 161
 - Repair 163
- Environment
 - Ambient temperature 26
 - Shock resistance 186
 - Storage temperature 185
 - Vibration resistance 186
- Error messages
 - see Diagnostic messages
- Event list 155
- Event logbook 155
- Ex approval 199
- Experience 199
- Extended order code
 - Pressure measuring cell 19
 - Sensor 16
 - Transmitter 15
- Exterior cleaning 160
- F**
- Field Communicator
 - Function 67
- Field Communicator 475 67
- Field of application
 - Residual risks 10
- Field Xpert
 - Function 64
- Field Xpert SFX350 64
- FieldCare 65
 - Device description file 68
 - Establishing a connection 65
 - Function 65
 - User interface 66
- Filtering the event logbook 155
- Firmware
 - Release date 68
 - Version 68
- Firmware history 159
- Flow direction 22
- Function check 73
- Function range
 - Field Xpert 64
- Function scope
 - AMS Device Manager 66
 - Field Communicator 67
- Field Communicator 475 67
- SIMATIC PDM 67
- Functional safety (SIL) 199
- Functions
 - see Parameters
- G**
- Galvanic isolation 178
- H**
- Hardware write protection 121
- HART protocol
 - Device variables 68
 - Measured variables 68
- Help text
 - Calling up 60
 - Closing 60
 - Explanation 60
- HistoROM 114, 116
- I**
- I/O electronics module 12, 41
- Identifying the measuring device 14
- Incoming acceptance 14
- Influence
 - Ambient temperature 185
- Information on the document 6
- Inlet runs 24
- Input 169
- Input mask 55
- Inspection
 - Received goods 14
- Installation 22
- Installation conditions
 - Inlet and outlet runs 24
 - Installation dimensions 25
 - Mounting location 22
 - Orientation 22
 - Thermal insulation 26
- Installation dimensions 25
- Interior cleaning 160
- L**
- Languages, operation options 197
- Line recorder 139
- Load 39
- Local display 197
 - Editing view 55
 - Navigation view 53
 - see Diagnostic message
 - see In alarm condition
 - see Operational display
- Low flow cut off 178
- M**
- Main electronics module 12
- Maintenance tasks 160
- Managing the device configuration 114, 116
- Manufacturer ID 68
- Manufacturing date 15, 16, 19

Materials	193
Maximum measured error	181
Measured values	
Calculated	170
Measured	169
see Process variables	
Measuring and test equipment	161
Measuring device	
Configuration	74
Conversion	162
Disposal	164
Mounting the sensor	28
Preparing for electrical connection	40
Preparing for mounting	28
Removing	163
Repairs	162
Structure	12
Switch-on	73
Measuring principle	169
Measuring range	170
Measuring system	169
Medium temperature range	187
Menu	
Diagnostics	153
Setup	74
Menus	
For measuring device configuration	74
For specific settings	93
Mounting dimensions	
see Installation dimensions	
Mounting location	22
Mounting preparations	28
Mounting tools	28
N	
Nameplate	
Pressure measuring cell	19
Sensor	16
Transmitter	15
Navigation path (navigation view)	53
Navigation view	
In the submenu	53
In the wizard	53
Nominal pressure	
Sensor	188
Numeric editor	55
O	
Operable flow range	175
Operating elements	57, 145
Operating keys	
see Operating elements	
Operating menu	
Menus, submenus	50
Structure	50
Submenus and user roles	51
Operating philosophy	51
Operation	132
Operation options	49

Operational display	52
Operational safety	10
Order code	14, 15, 16, 19
Orientation (vertical, horizontal)	22
Outlet runs	24
Output	176
Output signal	176
P	
Packaging disposal	21
Parameter	
Changing	61
Entering a value	61
Parameter settings	
Administration (Submenu)	116
Burst configuration 1 to n (Submenu)	70
Configuration backup display (Submenu)	114, 116
Current input (Wizard)	81
Current output 1 to n (Wizard)	83
Data logging (Submenu)	139
Device information (Submenu)	157
Diagnostics (Menu)	153
Display (Submenu)	112
Display (Wizard)	89
External compensation (Submenu)	107
Gas composition (Submenu)	97
Input values (Submenu)	136
Low flow cut off (Wizard)	91
Medium properties (Submenu)	94
Medium selection (Wizard)	79
Output conditioning (Wizard)	91
Output values (Submenu)	136
Process variables (Submenu)	133
Pulse/frequency/switch output (Wizard)	84, 85, 87
Sensor adjustment (Submenu)	109
Setup (Menu)	74
Simulation (Submenu)	118
System units (Submenu)	75
Totalizer (Submenu)	135
Totalizer 1 to n (Submenu)	111
Totalizer handling (Submenu)	137
Performance characteristics	181
Post-connection check (checklist)	47
Post-installation check	73
Post-installation check (checklist)	33
Potential equalization	47
Power consumption	179
Power supply failure	180
Pressure Equipment Directive	199
Pressure loss	188
Pressure-temperature ratings	187
Process	
Pressure loss	188
Process conditions	
Medium temperature	187
Product safety	10
Protecting parameter settings	120

R

RCM-tick symbol	199
Read access	62
Reading measured values	132
Recalibration	161
Reference operating conditions	181
Registered trademarks	8
Remedial measures	
Calling up	146
Closing	146
Remote operation	198
Remote version	
Connecting the connecting cable	42
Repair	162
Repair of a device	162
Repairs	
Notes	162
Repeatability	184
Replacement	
Device components	162
Replacing seals	160
Requirements for personnel	9
Response time	185
Return	163

S

Safety	9
Sensor	
Mounting	28
Serial number	15, 16, 19
Setting the operating language	73
Settings	
Adapting the measuring device to the process	
conditions	137
Administration	116
Advanced display configurations	112
Current input	81
Current output	83
Device reset	157
External compensation	107
Gas composition	97
Local display	89
Low flow cut off	91
Managing the device configuration	114, 116
Medium	79
Medium properties	94
Operating language	73
Output conditioning	91
Pulse output	84
Pulse/frequency/switch output	84, 85
Resetting the totalizer	137
Sensor adjustment	109
Simulation	118
Switch output	87
System units	75
Tag name	74
Totalizer	111
Totalizer reset	137
Shock resistance	186

Showing data logging	139
Signal on alarm	177
SIL (functional safety)	199
SIMATIC PDM	67
Function	67
Spare part	162
Spare parts	162
Standards and guidelines	199
Status area	
For operational display	52
In the navigation view	54
Status signals	144, 147
Storage conditions	20
Storage temperature	20
Storage temperature range	185
Structure	
Measuring device	12
Operating menu	50
Submenu	
Administration	116
Advanced setup	93
Burst configuration 1 to n	70
Configuration backup display	114, 116
Data logging	139
Device information	157
Display	112
Event list	155
External compensation	107
Gas composition	97
Input values	136
Medium properties	94
Output values	136
Overview	51
Process variables	132, 133
Sensor adjustment	109
Simulation	118
System units	75
Totalizer	135
Totalizer 1 to n	111
Totalizer handling	137
Supplementary documentation	200
Supply unit	
Requirements	39
Supply voltage	39, 179
Symbols	
For communication	52
For correction	55
For diagnostic behavior	52
For locking	52
For measured variable	52
For measurement channel number	52
For menus	54
For parameters	54
For status signal	52
For submenu	54
For wizard	54
In the status area of the local display	52
In the text and numeric editor	55

- System design
 - Measuring system 169
 - see Measuring device design
- System integration 68
- T**
- Technical data, overview 169
- Temperature range
 - Storage temperature 20
- Terminal assignment 37, 41
- terminal voltage 39
- Terminals 180
- Text editor 55
- Thermal insulation 26
- Tool tip
 - see Help text
- Tools
 - Electrical connection 35
 - Installation 28
 - Transport 20
- Totalizer
 - Configuration 111
- Transmitter
 - Connecting the signal cables 41
 - Turning the display module 33
 - Turning the housing 32
- Transporting the measuring device 20
- Troubleshooting
 - General 142
- Turning the display module 33
- Turning the electronics housing
 - see Turning the transmitter housing
- Turning the transmitter housing 32
- U**
- Use of the measuring device
 - Borderline cases 9
 - Incorrect use 9
 - see Designated use
- User interface
 - Current diagnostic event 153
 - Previous diagnostic event 153
- User roles 51
- V**
- Version data for the device 68
- Vibration resistance 186
- W**
- W@M 161, 162
- W@M Device Viewer 14, 162
- Weight
 - Compact version
 - SI units 189
 - US units 189
 - Flow conditioner 191
 - Sensor remote version
 - SI units 190
 - US units 190
 - Transport (notes) 20
- Wizard
 - Current input 81
 - Current output 1 to n 83
 - Display 89
 - Low flow cut off 91
 - Medium selection 79
 - Output conditioning 91
 - Pulse/frequency/switch output 84, 85, 87
- Workplace safety 10
- Write access 62
- Write protection
 - Via access code 120
 - Via write protection switch 121
- Write protection switch 121

www.addresses.endress.com
