Contents

How To Use This Handbook

General
Numbering System
Reference Symbols
Acronyms and Abbreviations

Introduction

0-1	Policy Statement
0-2	Overview
0-3	Facility Types & Programs
0-4	Deviation Policy
0-5	Retail Design Review Policy
0-6	Directory Structure
0-7	USPS Reference Documents
Appendices	Appendix A Feedback Form
	Appendix B Deviation Request Form
	Appendix C Headquarters Design Review Form

Module 1: General Criteria

Chapter 1	Civil
Chapter 2	Architectural
Chapter 3	Structural
Chapter 4	Mechanical
Chapter 5	Electrical

Module 2: Specific Criteria

2A Mail Processing Facilities

Note that the criteria related to the facility type known as Mail Processing Facilities has been extracted and compiled in a separate folder named “MPF” (Mail Processing Facilities) in the Building Design Standards.

2B Medium Standard Building Designs (MSBD)

Chapter 1	Civil (Not used, refer to Module 1, Chapter 1)
Chapter 2	Architectural
Chapter 3	Structural (Not used, refer to Module 1, Chapter 3)
Chapter 4	Mechanical
Chapter 5	Electrical

2C Small Standard Building Designs (SSBD)

Chapter 1	Civil (Not used, refer to Module 1, Chapter 1)
Chapter 2	Architectural
Chapter 3	Structural (Not used, refer to Module 1, Chapter 3)
Chapter 4	Mechanical (Not used, refer to Module 1, Chapter 4)
Chapter 5	Electrical

Module 3: Special Facility Types

- 3A** **Vehicle Maintenance Facilities (VMF)** [See new MPF folder]
- 3B** **Modular Post Offices**
- 3C** **Storage Buildings** [See new MPF folder]
- 3D** **Historic Buildings and Fine Arts**
- 3E** **Flat Sequencing System** [See new MPF folder]

Module 4: Special Components

- 4A** **Retail Design Standards**
- 4B** **Fuel Islands** [See new MPF folder]
- 4C** **Underground Storage Tanks** [See new MPF folder]
- 4D** **Mechanization / Automation** [See new MPF folder]
- 4E** **Business Mail Entry Unit** [See new MPF folder]
- 4F** **Exterior Signage**
- 4G** **Not Used**
- 4H** **Repair & Alterations**

[This page intentionally left blank.]

How To Use This Handbook

General

The *Standard Design Criteria* is organized into four modules:

- Module 1 - Criteria that is common and applicable to the two primary facility types (MSBD & SSBD).
- Module 2 - Criteria that is unique to the facility type (MSBD or SSBD).
- Module 3 - Criteria for special facility types other than the two primary facility types.
- Module 4 - Criteria for those special components that at times may be a part of any of the facilities.

For each facility type (MSBD & SSBD), Module 1 must be used in conjunction with the appropriate section of Module 2 in order to obtain the complete criteria. In addition, portions of Module 3 or 4 may be required, depending on the particular project.



Note that the criteria related to the facility type formerly known as “Majors” has been extracted and compiled in a separate folder named “MPF” (Mail Processing Facilities) in the Building Design Standards.

Numbering System

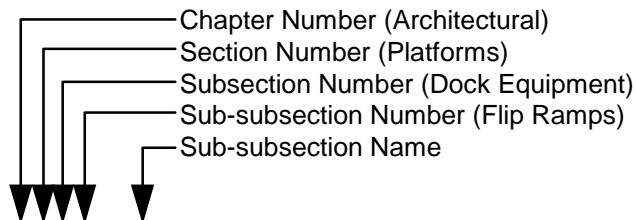

Sample Number: **2-3.8.1 Flip Ramps**

For example, “2-3.8.1 Flip Ramps” can be found in Chapter 2 (Architectural), Section 3 (Platforms), Subsection 8 (Dock Equipment). Module name and number are noted in the footer on each page.

Reference Symbols

- **Facility Type Reference Box**

The facility type reference box is used in Module 1 to prompt the user of all or additional information on a particular topic found in Module 2, Specific Design Criteria.

Example:

2-2.2 Wire Screen Enclosures

MSBD

Indicates all or additional information regarding wire screen enclosures applicable only to MSBD is located in Module 2 Specific Criteria. However, there is no SSBD-specific criteria on wire screen enclosures.

▪ Related Module Reference Box

The facility type reference box is used to prompt the user of all or additional information on a particular topic found in another Module.

Example:

Landscaping at Signs

Module 4F

Indicates all or additional information regarding landscaping at signs is located in Module 4F.

▪ USPS Document Reference Symbol

This symbol prompts the user to refer to a USPS document for additional information which does not reside within the *Standard Design Criteria*.

See the Introduction chapter, Section 0-7 for a listing of USPS Reference Manuals.

Example:

2-6.1.2 Windows

USPS Handbook RE-5

Indicates reference to Handbook RE-5 is required for additional security issues concerning windows.

▪ Standard Detail Reference Symbol

This symbol is used to reference the standard detail(s) applicable to a particular design criteria item.

Example:

2-3.8.5 Bumpers

 2-3-8a→c1

Indicates reference to the bumper detail numbers. The details, including an explanation of their numbering system, can be found in the *Standard Detail Library*.

▪ Exclamation Point

Used to draw the user's attention to a particular design criteria item.



- **Checklists**

The Checklists located at the end of the Module have been compiled for the A/E's convenience, and not required by USPS. They are not all-inclusive, and can be expanded or reduced at the discretion of the A/E. Refer to the Standard Design Criteria for clarification of checklist content.

- **Revisions Sidebar**

The revisions sidebar in the left margin is to indicate changes to content since the last version of the Standard Design Criteria. Changes include additions, revisions, and deletions of content.

Acronyms and Abbreviations

AABC	Associated Air Balancing Council
A/E	Architect/Engineer of Record
AFF	Above Finished Floor
AFUE	Annual Fuel Utilization Efficiency
AMF	Air Mail Facility
AMC	Air Mail Concourse
APC	Automated Postal Center
ANSI	American National Standards Institute
APPS	Automated Package Processing System
AQ	Alternate Quarters
ASHRAE	American Society of Heating, Refrigeration and Air Conditioning Engineers
ASME	American Society of Mechanical Engineers
ASTM	American Society of Testing Materials
BDS	Building Design Standards
BDS	Bio-detection System
BFF	Below Finish Floor
BMC	Bulk Mail Center
BMEU	Business Mail Entry Unit
BOCA	Building Officials and Code Administrators
BTU	British Thermal Unit
CARS	Contract Access Retail System
CB	Circuit Breaker or Call Button
CCTV	Closed Circuit TV
CFC	Chlorofluorocarbon
CFS	Computer Forwarding System
CFR	Code of Federal Regulations
CCR	Consolidated Computer Room
CIP	Camera Interface Panel
COP	Coefficient of Performance
CP	Consolidation Point
CPI	Consumer Price Index
CPI	Crime Prevention Index
CPU	Contract Postal Unit
DAR	Decision Analysis Report
DB	Dry Bulb
D/B	Design/Build
D/B/B	Design/Bid/Build
DBE	Design Build Entity
D&C	Design and Construction

DOT	Department of Transportation
DV	Direct Vendor
EA	Environmental Assessment
EAS	Electronic Article Surveillance
eDCCS	Electronic Design and Construction Contract System
EEMS	Enterprise Energy Management System
EER	Energy Efficiency Ratio
EMT	Electric Metallic Tubing
EPA	Environmental Protection Agency
eRECS	Electronic Real Estate Contract System
ER	Equipment Room (for telecommunication equipment)
EWT	Entering Water Temperature
FDC	Fiber Optics Distribution Center
FDS	Functional Design Specifications
FICS	Facility Investment Cost Sheet
FPC	Facility Planning Concept
FPO	Federal Preservation Officer
FRP	Fiberglass Reinforced Plastic
FRRM	Facility Risk Rating Model
FSD	Facility Survey Data
FSS	Flat Sequencing System
FSSP	Facilities Single Source Provider
FT	Foot/Feet
FXP	Fixture Piece
FSO	Facility Service Office
HC	Handicapped
HC	Horizontal Cross Connect
HCFC	Hydro Chloro Fluorocarbons
HDD	Heating Degree Days
HEBR	Hyper Electronic Badge Reader
HOA	Hand-off Automatic
HSPF	Heating Seasonal Performance Factor
HVAC	Heating, Ventilation & Air Conditioning
IAQ	Indoor Air Quality
IAT	Inside Air Temperature
IBC	International Building Code
IDF	Intermediate Distribution Frame (old term – see HC)
IDS	Intrusion Detection System
IES	Illuminating Engineering Society
IMPC	International Mail Processing Center
IN	Inch(es)
IO	Investigative Office
I/O	Information Outlet (old term – see T/O)
IPSS	Image Processing Sub-System
IPLV	Integrated Part Load Value
IRT	Integrated Retail Terminal
IS	Investigative System
ISDN	Integrated Services Digital Network
ITSC	Information Technology Service Center
JOC	Job Order Contract
JOE	Justification of Expenditure
KWH	Kilowatt Hour
LAN	Local Area Network
LCC	Life Cycle Cost
L&DC	Logistics and Distribution Center
LEC	Local Exchange Carrier

LLV	Long Life Vehicle
LPG	Liquid Propane Gas
LSM	Letter Sorting Machine
MAP	Modular Assembly Program
MAX	Maximum
MC	Main Cross Connect
MDF	Main Distribution Frame (old term – see MC)
MDF	Medium Density Fiberboard
MER	Mechanical Equipment Room
MFO	Major Facilities Office
MHS	Material Handling System
MIN	Minimum
ML	Magnetic Lock
MLB	Materials Logistic Bulletin
MPFS	Mail Processing Facility Specifications
MSBD	Medium Standard Building Designs
NCL	New Construction Leased
NCO	New Construction Owned
NDSS	National Directory Support System
NEBB	National Environmental Balancing Bureau
NEC	National Electrical Code
NFPA	National Fire Protection Association
NIST	National Institute of Standards & Technology
NLECC	National Law Enforcement Communication Center
NPDES	National Pollutant Discharge Elimination System
NRCA	National Roofing Contractors Association
OAT	Outside Air Temperature
OCR	Optical Character Reader
ODP	Ozone Depleting Potential
OIG	Office of the Inspector General
OSHA	Occupational Safety and Health Administration
OSL	Operational System Layout
PCI	Precast Concrete Institute
PACS	Physical Access Control System
P&DC	Processing & Distribution Center
P&DF	Processing & Distribution Facility
POE	Post Occupancy Evaluation or Post Office Express
POS	Point of Service
PM	Purchasing Manual
PMPC	Priority Mail Processing Center
PSDS	Postal Service Data System (now referred to as TACS)
PSF	Per Square Foot
PSTN	Postal Satellite Training Network
R&A	Repair and Alterations
RBCS	Residential Bar Code Sorter
RH	Relative Humidity
SBD	Standard Building Code
SDC	Standard Design Criteria
SDL	Standard Detail Library
SDO	Stamp Distribution Office
SEER	Seasonal Energy Efficiency Ratio
SF	Square Feet
SPDES	State Pollutant Discharge Elimination System
SPV	Single Present Value
SSA	Sales Service Associate

SSBD	Small Standard Building Designs
STC	Sound Transmission Coefficient
STP	Shielded Twisted Pair
SCS	Structured Cabling System
SUQ	Start-up Questionnaire
TACS	Time and Attendance Control System
TC	Telecommunications Closet
T/O	Telecommunications Outlet
UBC	Uniform Building Code
UL	Underwriters Laboratory
UPV	Uniform Present Value
USPS	United States Postal Service
UTP	Unshielded Twisted Pair
VAV	Variable Air Volume
VMF	Vehicle Maintenance Facility
VSAT	Very Small Aperture Terminal
VT/SC	Visible Transmittance/Shading Coefficient
WAN	Wide Area Network
WOS	Window Operations Survey
WTIL	Wait Time In Line

[This page intentionally left blank.]

Standard Design Criteria

Introduction

0-1 Policy Statement

0-1.1 Coordination of FedEx Boxes

0-2 Overview

0-3 Facility Types and Programs

0-3.1 Major Facilities (Major Facilities Standard Designs)

0-3.2 Medium Size Post Offices (Medium Standard Building Designs)

0-3.3 Small Size Post Offices (Small Standard Building Designs)

0-3.4 Modular Post Offices

0-3.5 Vehicle Maintenance Facilities

0-3.6 Retail Design Standards

0-3.7 Alternate Quarters (AQ)

0-3.8 Repair & Alterations (R&A)

0-3.9 Storage Buildings

0-4 Deviation Policy

0-4.1 Building Design Deviations

0-4.2 Space Requirements and Planning Deviations

0-4.3 Retail Planning Deviations

0-4.4 Exterior Signage Deviations

0-5 Retail Design Review Policy

0-6 Directory Structure

0-7 USPS Reference Manuals

Appendices

Appendix A Building Design Standards Feedback Form

Appendix B Building Design Deviation Request Form

Appendix C Headquarters Design Review Form

[This page intentionally left blank.]

Introduction

0-1 Policy Statement

The Standard Design Criteria is an integral part of the USPS Building Design Standards. Together with the other Standards components -- such as the Standard Detail Library, the USPS Master Specification and the various standard building designs -- the Standard Design Criteria conveys the necessary information to define how Postal facilities are to be designed and constructed.

The Building Design Standards are to be used on all facility-related projects, using the appropriate documents based on facility size and type. This policy applies equally to all design and construction related activities regardless of size, whether new construction or repair and alteration, owned or leased. Where any requirement is specified by a particular program name, i.e., SSBD or MSBD, such requirements shall be construed as applicable to any facility of that size range.

0-1.1 Coordination of FedEx Boxes

The FSO Real Estate Specialist responsible for the project must forward to the district FedEx coordinator a copy of the award letter for any construction projects that will result in the closing or moving of a facility with an existing FedEx box and all award letters for new construction projects so the district coordinators can give FedEx notice of new facility locations.

0-2 Overview

Various standard programs have been established within the USPS Building Design Standards to address the particular needs of different facility and project types. These components are as follows:

- **Standard Design Criteria** - This document acts as an umbrella and establishes the overall performance criteria for all facility types, including site adapt standard designs, alternate quarters and repair and alteration projects.
- **Standard Designs** - These documents provide 10 percent to 90 percent complete designs of various facility types.
- **Standard Details** - These drawings form a library of Postal specific construction details for use on all facility types.
- **USPS Master Specification** - This document provides a single unified source for guideline construction specifications for small and medium standard design projects as well as alternate quarters and repair and alterations projects.

-
- **Mail Processing Facilities (MPF)** - The requirements for this program have been extracted from the various BDS components and are now contained under a separate folder on the Building Design Standards CD-ROM.

Together, these components establish the design standards for all postal facilities.

The Design Standards do not, however, serve as relief from full A/E responsibility for the design adequacy of the project. The A/E's responsibility includes verifying and ensuring the accuracy and completeness of this USPS data as furnished, and compliance with all applicable codes, regulations and Federal legislative requirements.

A/E design solutions are required to be compliant with the more stringent applicable requirements of current national, state and local building codes and standards, including: the International Building Code, NFPA 101 Life Safety Code; OSHA General Industry Standards; and USPS Handbook RE-4 "Standards for Facility Accessibility by the Physically Handicapped". The requirements contained in USPS Handbook RE-5 "Building and Site Security Requirements" have now been incorporated into the Standard Design Criteria.

Various editions of the International Building Code (IBC) have been adopted by all 50 states within the United States. For this reason, the IBC shall be deemed as the model building code for the USPS. Where, state or local governments have amended the IBC, the current version of state and local amendments shall apply to USPS projects within that jurisdiction. All codes in force at the time of solicitation shall apply.

The Postal Inspection Service is solely responsible for evaluating and approving the need for security-related equipment and for security personnel (see ASM 271.4). All security-related CCTV systems, access control systems, bullet-resistant screenlines, and burglar or duress alarms must be evaluated and approved by the Inspection Service when the design of those systems deviates from the requirements found in this document. After developing a risk analysis and/or security survey recommendations, the Inspection Service determines the need for these or other security products and services, and provides the results of the analysis, in writing, to local Postal Service management. Any deviation must be submitted in writing in accordance with the submittal process described in section 0-4. It shall be the responsibility of the FSO to ensure that a copy of a recently completed risk analysis is submitted with all deviation requests involving modification to any security related design requirements.

In areas of discrepancy between the standard design programs, the *Standard Design Criteria, Handbook AS-503* shall take precedence. In order of priority, from highest order of precedence to lowest, the following hierarchy shall be followed: Standard Design Criteria, specifications, standard drawings, standard details, and program manuals. All such discrepancies should be brought to the attention of the Team Leader, HQ Design and Construction Programs to allow for correction to the design standards. **The Standards for Facility Accessibility Handbook RE-4 carries the force and effect of law and, as such, shall supercede in areas of discrepancy between the design standards programs and the RE-4. Similarly, requirements mandated by local codes shall be followed in the design of USPS facility design.** A/Es are encouraged to submit suggestions for improvements to any of the design standards, using the A/E Feedback Form found in the Appendix at the end of this section.

The current Standard Design Criteria include revisions to the 2006 version. Any sections that have been changed are marked with a vertical line in the left margin of the page.

0-3 Facility Types & Programs

Over the years the Postal Service has developed several facility types and programs. The most common USPS facilities and programs associated with providing customer service and collecting, processing and distributing mail include the following:

- **Mail Processing Facilities**, approximately 60,000 SF and larger.
- **Medium Size Post Offices and Carrier Annexes**, approximately 10,000 SF to 60,000 SF.
- **Small Size Post Offices**, up to 10,000 SF.
- **Modular Post Offices**, from 550 to 1500 SF.
- **Vehicle Maintenance Facilities (VMF)**.
- **Retail Design Standards**.
- **Alternate Quarters**
- **Repair & Alterations (R&A)**
- **Storage Buildings**.

Following is a brief description of each facility type or program and the standards components. **Throughout the document each facility type is referred to by the standard design program associated with it (Major Facilities, Medium Standard Building Designs, etc.).**

0-3.1 Mail Processing Facilities

These buildings provide mail processing and distribution to the local post office as well as other smaller distribution facilities, and are usually equipped with fixed mechanization for mail processing. Major components include workroom, mailing platforms, employee facilities, support areas, Investigative System, Business Mail Entry Units, and sometimes, retail functions.

This building program includes facility operational types such as;

- AMC (Air Mail Center)
- AMF (Air Mail Facility)
- APPS (Automated Package Processing System)
- BMC (Bulk Mail Center)
- COLOC (Local Processing Center)
- FSS (Flats Sequencing System)
- HASP (Hub and Spoke Operation)
- ISC (International Service Center)
- L&DC (Logistics and Distribution Center)
- LPC (Co-located facility)

-
- MTESC (Mail Transport Equipment Service Center)
 - P&DC (Processing and Distribution Center)
 - P&DF (Processing and Distribution Facility)
 - PMPC (Priority Mail Processing Center)
 - RDC (Regional Distribution Center)

Note that the criteria related to the facility type formerly known as “Majors” has been extracted and compiled in a separate folder named “MPF” (Mail Processing Facilities) in the Building Design Standards.

0-3.2 Medium Size Post Offices (Medium Standard Building Designs)

These buildings range in size from approximately 10,000 SF to 60,000 SF and provide mail distribution and collection to and from the local community. Retail services are also provided, except in carrier annexes. Major components include the retail area with administrative support, workroom, mailing platforms and employee support areas. Larger facilities may also include Business Mail Entry Units.

Standards:

- Standard Design Criteria - Module 1, Module 2B, and applicable portion of Module 4A Retail Design Standards.
- Medium Standard Building Designs (MSBDs).
 - 30% complete documents (floor plans, elevations, schedules, and MSBD specific details).
 - Project Manager’s Manual.
- Details from Standard Detail Library.
- Specification sections from USPS Master Specification.

0-3.3 Small Size Post Offices (Small Standard Building Designs)

These buildings are up to 10,000 SF and provide mail distribution and collection to and from the local community. Retail services are also provided. Major components include workroom, a small dock area, minimal support areas, and a retail lobby.

Standards:

- Standard Design Criteria - Module 1, Module 2C, and applicable portion of Module 4A Retail Design Standards.
- Small Standard Building Designs (SSBDs).
 - 30% complete documents for 17 prototype designs ranging from 1500 SF to 10000 SF (floor plans, elevations, schedules, SSBD specific details).
 - Project Manager’s Manual.
 - Design Manual.

-
- Details from Standard Detail Library.
 - Specification sections from USPS Master Specification.

In addition, a Site MAP (Modular Assembly Program) has been developed as a site design layout software package that USPS Project Managers can use to facilitate the preliminary site design process. Site MAP can be also be used on MSBD or other projects.

0-3.4 Modular Post Offices (Modular Building Program)

Modular Post Offices vary in size from 550 to 1,500 SF. They are typically used for small rural areas to provide mail distribution and collection to and from local communities. Retail services are also provided.

Standards:

- Standard Design Criteria - Module 3B.
- Standard Designs.
 - 100% complete documents for 5 standard plans.
- Modular Program Specifications.
- Project Manager's Manual.

0-3.5 Vehicle Maintenance Facilities

These buildings typically serve as repair garages for USPS vehicles. Along with the expected repair and wash bays and associated support areas these facilities include an administrative area, employee facilities and fuel islands.

Standards:

- Standard Design Criteria - Module 3A.
- Applicable portions of Module 1.

0-3.6 Retail Design Standards

These facilities provide retail service to local communities. Major components include Self-Service, P.O. Box and Full Service Counters. This program is typically used for alternate quarters, major repair and alteration projects, and other facilities with retail components.

Standards:

- Standard Design Criteria - Module 4A.
- MSBD Retail Modules.
- Details from Standard Detail Library.
- Specification sections from USPS Master Specification.

0-3.7 Alternate Quarters (AQ)

Non-retail alternate quarters must comply with the appropriate documents and materials of the Building Design Standards, based on the size and type of the facility in question. For retail Aqs, see 0-3.6 above.

Standards:

- Standard Design Criteria - Appropriate Module(s) and Chapter(s)
- Details from Standard Detail Library.
- Specification sections from USPS Master Specification.

0-3.8 Repair & Alterations (R&A)

In addition to retail-related R&A as mentioned in 0-3.6, all types of repair and alteration projects (including expansions) must comply with the appropriate documents and materials of the Building Design Standards. Examples of typical R&A projects include building expansion, roof repair or replacement, and addition of a Investigative System.

Standards:

- Standard Design Criteria - Module 4H Repair and Alterations and Appropriate Module(s) and Chapter(s)
- Details from Standard Detail Library.
- Specification sections from USPS Master Specification.

0-3.9 Storage Buildings

These buildings are an available option with each new Major Facility. They are pre-engineered metal buildings with slab-on-grade, and provide storage space for equipment and supplies which are used only occasionally. Standard sizes range from 3,780 to 25,200 gross SF.

Standards:

- Standard Design Criteria - Module 3C

0-4 Deviation Policy

0-4.1 Building Design Deviations

The Standard Design Criteria, in conjunction with the various other Building Design Standards programs, must be used on all building-related projects. Deviation from the use of these programs or from their specific requirements is not permitted without written authorization from the Team Leader, HQ Design and Construction Programs.

Requests for deviation approval are to be forwarded by the Manager, Facilities Service Office, or Manager, Major Facilities Design and Construction, using the form located in Appendix B of this Section.

Deviation requests which impact Retail areas must include a current WOS Earned-Actual Staffing Graph, plus the Start-Up Questionnaire. Deviation requests which impact security requirements (whether to increase or decrease security measures) must be supported by a risk assessment from the Inspection Service. A copy of the recently completed risk management assessment must be submitted with all deviation requests involving impact to security related items listed in section 0-2."

Note that exterior signage deviation requests are to follow the policy in Module 4F, Section 2-3.

0-4.2 Space Requirements and Planning Deviations

The Facility Planning Concept (FPC), the 919-FPC, and the Space Requirements Handbook AS-504 have been coordinated with the Building Design Standards to establish a simplified and efficient planning process. Deviation from the policies contained in the AS-504 or from the requirements generated by the FPC/919-FPC is not permitted without prior approval from the Manager, Facilities Planning and Approval at Headquarters.

Requests for deviation approval must provide written justification with appropriate supporting information, and should be submitted during the planning phase of the proposed project.

0-4.3 Retail Planning Deviations

The Retail Start-Up Questionnaire is used to determine retail planning requirements such as number of Full Service Counters, cash registers, and type of product merchandising. Requests for deviation from the requirements generated by the Start-Up Questionnaire must be forwarded to the Manager, Retail Operations in accordance with the procedures listed in the Questionnaire. The revenue threshold for open merchandising is \$1 million.

0-5 Retail Design Review Policy

All historic retail projects and all retail facilities with projected revenue above two million dollars must submit a 10% plan for Headquarters Retail Operations design review. Subsequent submissions on these projects will vary based on the nature of the specific project and will be stipulated in Retail Operations' 10% review comments. Retail projects under two million dollars in projected revenue are exempt from this 10% review submittal.

All projects with open merchandise displays (excluding limited open displays) must submit a 100% fixture plan to Headquarters Retail Operations. This information will be used to track projects and identify retail equipment and allow for correct distribution of core products and merchandise. All plans must be submitted at 1/8" scale.

0-6 Directory Structure

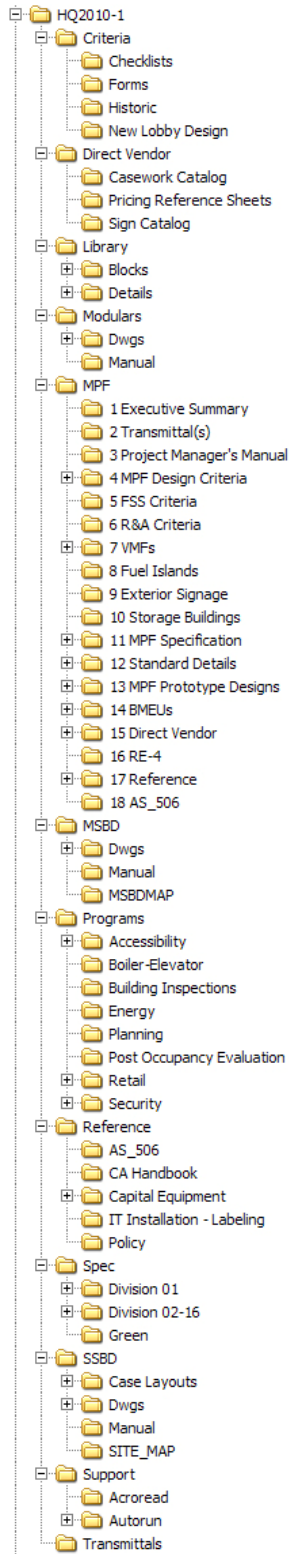

Exhibit 0-6a
USPS Digital File Directory Structure

0-7 USPS Reference Manuals

It is the USPS Facility Service Office's responsibility to distribute all current and/or updated relevant information to the A/E for development of the appropriate construction documentation package.

Following is a list of USPS documents that are either referenced or have been used as a basis for stating the requirements in the Standard Design Criteria.

NAME	ISSUE DATE
USPS Handbook RE-4: Standards for Facility Accessibility by the Physically Handicapped	September 17, 2005
USPS Handbook RE-5: Building and Site Security Requirements	To Be Issued at a Later Date
USPS Handbook RE-6: The Facilities Environmental Guidebook	December 1997
USPS Handbook AS-504: Space Requirements	July 1999
USPS Handbook AS-506: Architect/Engineer Project Requirements	March 2000
USPS Handbook P-2: Design and Construction Purchasing Practices	March 31, 1999
USPS Handbook E-31: Registry Operations System Guidelines	August 1982
Management Instruction AS-530-2004-1: Safety Inspection of Heating Boilers, Unfired pressure Vessels, Elevators, Escalators, and Dumbwaiters	October 1, 2004
Management Instruction EL-810-94-3: Asbestos-Containing Building Materials Control Program	February 23, 1994
MI-AS-550-92-7: Stormwater Management	March 16, 1992
Management Instruction AS-550-95-18: Clean Air Act Compliance	
Retail Operations Support: Renovation Standards Guidelines	March 1999
Retail Operations Support: Renovation Guidelines for Historic Facilities	March 1999
Construction Administration and Facilities Inspection Handbook	September 2001

[This page intentionally left blank.]

Appendix A

Building Design Standards Feedback Form

Receiving feedback on the strengths and weaknesses of the Design Standards is essential for continuous improvement. All end users of the Standards programs, whether A/Es, contractors, District personnel, or FSO, are encouraged to share their insights on how to make the programs even more successful. A feedback form has been developed and should be used when suggesting changes to the Standard Design Criteria, or any of the Building Design Standards programs.

Use the Microsoft Word file titled "Feedback.doc", which can be found in the "...\\Criteria\\Forms\\" folder on the CD-Rom.

[This page intentionally left blank.]

Appendix B

Building Design Deviation Request Form

Requests for deviation from USPS Building Design Standards shall be submitted in accordance with the procedures outlined in Section 0-4 Deviation Policy.

Use the Microsoft Word file titled "Deviate.doc", which can be found in the "...Criteria\FORMS\" folder on the CD-Rom.

[This page intentionally left blank.]

Appendix C

Headquarters Design Review

Project designs shall be submitted to HQ for review and approval prior to proceeding with FSO approval of the A/E firm's 30% design submission.

Use the Microsoft Word file titled "Design Review.doc", which can be found in the "...Criteria\Forms\" folder on the CD-Rom.

[This page intentionally left blank.]

Module 1 General Criteria

Chapter 1 Civil

1-1 Site Information

- 1-1.1 Site Survey
- 1-1.2 Subsurface Investigation
- 1-1.3 Environmental Assessment
- 1-1.4 Codes and Standards

1-2 Site Design

- 1-2.1 Utilities
- 1-2.2 Stormwater Management
- 1-2.3 Sediment and Erosion Control
- 1-2.4 Parking and Drives
- 1-2.5 Stairs, Ramps, Walks and Retaining Walls
- 1-2.6 Landscaping
- 1-2.7 Fencing
- 1-2.8 Not Used
- 1-2.9 Construction Waste Disposition/Recycling
- 1-2.10 Safety
- 1-2.11 Off-Site Improvements

Appendices

- Appendix A Boundary and Topographic Site Survey
- Appendix B Specifications for Subsurface Exploration

Checklist

[This page intentionally left blank.]

Chapter 1 Civil

1-1 Site Information

1-1.1 Site Survey

AS-506

USPS-furnished topographical data, location of available utilities, wetlands (if applicable), boundary survey and any other existing conditions information shall be verified by the A/E prior to completion of final design documents for possible changed conditions, and confirmation that permanent corner monuments are in place for use by the contractor. On a given project, the USPS may or may not provide survey data for the A/E's use. In either case, the A/E is responsible for obtaining any additional survey data necessary to complete the design. The A/E assumes full responsibility for the accuracy of data furnished if the data is used as a basis for professional judgments or incorporated into the construction documents. A copy of the most current boundary and topographic survey shall be included in the construction documents. The final survey shall identify the extent and location of all existing site features (e.g. buildings, structures, easements, foundations, wells, underground tanks, utilities, etc.). See Appendix to this Chapter for specific requirements.

The A/E is responsible for the preparation, review and coordination of a Surface Investigation showing locations, genus and species of all isolated trees in excess of 4 inch caliper, and/or any other landscape features typical of the region. The Surface Investigation will be utilized together with the Subsurface Investigation and the Environmental Assessment (EA) in order to determine the areas of the site with the most potential for development of all the program elements. The A/E should retain as many of the existing landscape features in the final site design as possible.

1-1.2 Subsurface Investigation

AS-506

Any preliminary geotechnical investigation data developed during the site selection process will be furnished to the A/E by USPS. The A/E assumes full responsibility for the accuracy of data furnished if the data is used as a basis for professional judgments or incorporated into the construction documents. The A/E is responsible for the preparation, review and coordination of a full geotechnical subsurface investigation as well as the review of county geotechnical reports. This information shall be considered when locating proposed site improvements as well as providing the basis for the design of paving, building foundations and the selection of proposed plant materials. The selection of a geotechnical consultant shall be subject to USPS approval.

The A/E is responsible for verifying that the final design takes into consideration the recommendations contained in the final geotechnical report. A copy of the report shall be included in the construction documents.

1-1.3 Environmental Assessment

A copy of the Environmental Assessment (EA) and/or any other environmental reports, including those recommending mitigation for the site, will be furnished to the A/E by USPS before the design phase. The A/E is responsible for verifying and coordinating information from the EA and/or other reports into each project design.

The A/E shall give special consideration to mitigation measures which impact design and construction activities, including projection of costs associated with mitigation. While there are standard mitigation measures (e.g. controlling erosion and sedimentation; preventing excess noise and air pollution during normal business hours; maintenance of construction vehicles and equipment), special attention shall be given to all case-specific mitigation measures indicated in the report.

The A/E shall be responsible for delineating the full extent of any wetlands on the project site, if applicable.

1-1.4 Codes and Standards

1-1.4.1 Easements, Zoning, Covenants

All on-site and off-site easements, zoning restrictions and/or property covenants which affect the design or future use of the site shall be identified by the A/E. Those which are determined to impact the design shall be immediately brought to the attention of the Contracting Officer and confirmed in writing.

1-1.4.2 National/State Pollutant Discharge Elimination Systems (N/SPDES)

Construction shall be performed in accordance with 40 CFR 122-124. Under this regulation, an NPDES or SPDES permit is required for construction disturbing five (5) or more acres (considered an "industrial" activity). Most states have been delegated the authority to administer these permits.

1-1.4.3 Materials, Testing, and Construction

All materials, testing, and construction specifications shall meet the requirements of the Standard Specifications for Road and Structures issued by the Department of Transportation (or equivalent) in the state where the project is located.

1-2 Site Design

Existing or proposed development by local authorities, community planning agencies, and transportation departments for areas in the project vicinity shall be reviewed and considered for impact with regard to each facility site design. The A/E shall evaluate and recommend to USPS the benefit or detriment, associated with accommodating these plans and incorporate their determinations into a functional and cost effective site design.

When the facility is located in a climatic zone, which requires snow removal, an area for snow storage shall be provided.

The orientation of the building should take into consideration local climatic conditions, including prevailing winds, snowdrift at docks and natural light.

 G1-2-0a→4c

Where possible, in cold climate the building shall be oriented so that the loading docks are not facing the direction of prevailing winds.

For MSBDs and SSBDs use the following criteria as the basis for the overall design: Two (2) separate and distinct means of access to the site: one for truck and employee traffic, the other for visitors and retail customers are preferred.

1-2.1 Utilities

Availability of all utilities required for a complete and usable facility (including gas, water, electric, sanitary sewer, and stormwater) shall be confirmed by the A/E. Copies of "will serve" letters from applicable agencies and/or utility companies shall be furnished to USPS as soon as they are received by the A/E.

Existing utility services shall be shown on a plot drawing and shall include sizes, elevations, pressures, capacities, test reports, etc., as applicable.

1-2.2 Stormwater Management

Drainage techniques shall satisfy the local stormwater management regulations for quality and quantity control, and local rainfall intensity duration data shall be used for design computations.

Utilize existing natural drainage patterns wherever possible, and where feasible, vegetation shall be used to filter storm water for metals and nutrients with methods such as basins with wetlands species, channeling flow through grass swales, or directing storm water through vegetated buffer strips. Best Management Practices (BMPs) shall be utilized for all stormwater runoff quality controls.

Underground storm lines shall be outlet on-site where practical. However, sanitary and storm sewer lines shall be separate within the site boundary even if the local jurisdiction will allow them to be combined. Surface drainage techniques are to be used wherever practical, however in cold climate regions, water shall not be allowed to drain across paved areas. Water accumulation can form icy patches in freezing weather on parking lots, sidewalks, and other paved areas (see 1-2.4.1 for paved area slope requirements). Sheetflow from grassed areas shall not be permitted to flow across pavements. Finish grading immediately outside buildings shall be below finished floor elevation. Do not locate storm drain inlets within driving lanes or concrete aprons. Provide oil-water separators and similar pollution control systems where required by authorities having jurisdiction.

Stormwater drainage shall be a combination of sheet flow into swales and drain inlets to a piped conduit system connecting to the detention/retention stormwater facilities. When feasible and cost effective, use open channels in lieu of trench drains to transport parking lot stormwater run-off. Consolidate mass stormwater detention/retention facilities in one location wherever possible. No standing water within the site shall be permitted at facilities in close proximity to an airport.

1-2.3 Sediment and Erosion Control

A sediment and erosion plan shall be developed in accordance with local, state and federal laws. Plan requirements for all projects shall, at a minimum, include:

- Minimizing amount and duration of soil exposure.

-
- Sequencing construction.
 - Preventing eroded sediment from entering water bodies or other habitats.

Incorporate organic means of erosion control wherever possible, such as the use of plant root mats in final site design.

1-2.4 **Parking and Drives**

USPS Handbook RE-4

Storm water runoff from all paved areas shall be treated for pollutants in accordance with the requirements of the local storm water management regulations. If practical, allow storm water runoff to flow across vegetated areas in order to treat storm water for pollutants. Provide parking islands only when required by local ordinance.

- Vehicle parking requirements are as designated in the planning documents.

Design parking to maximize free circulation without dead-ends.

Locate handicap accessible employee parking spaces as close as possible to the employee entrance.

The minimum size of parking spaces (excluding driveways) and turning radii for some of the postal vehicles is contained in Exhibit 1-2a. For vehicle space requirements at docks refer to the standard plans.







Type of Vehicle	Size of Space (W x L)	Turning Radius
Tractor 	12'-0" x 20'-0"	46' - 60'
Trailer 	12'-0" x 40'-0" for 40' trailers or 12'-0" x 55'-0" for trailers longer than 40'	
5, 7, 9-Ton Cargo Van 	12'-0" x 30'-0"	55' - 66'
1, 1-1/2, 2 Ton Parcel Delivery Truck 	10'-0" x 23'-0"	52'-54'
Long Life Vehicle (LLV) 	10'-0" x 20'-0"	40'
Jeep 	10'-0" x 20'-0"	36'
Minivan 	10'-0" x 20'-0"	40'
Standard Cars	9'-0" x 18'-0"	
Compact Cars	8'-0" x 16'-0"	
Van Accessible (HC) Space ¹	11'-6" x 18'-0" plus 5'-6" access aisle. Spaces can be 8'-6" when the access aisle is increased to 8'-6" wide.	
Car Accessible (HC) Space ²	8'-6" x 18'-0" plus 5'-6" access aisle.	

Exhibit 1-2a

Typical Postal Vehicle Parking Requirements

Note 1: For tight sites, 11' (min) x 18' plus 5' (min) aisle or 8' (min) x 18' plus 8' (min) aisle are acceptable.

Note 2: For tight sites, 8' (min) x 18' plus 5' (min) aisle is acceptable.

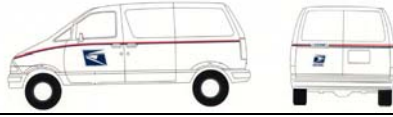
1-2.4.1 Paving

Each facility shall be designed for the minimum amount of impervious surface area possible. Use of open concrete pavers should be considered on a case specific basis to further reduce impervious area. Pervious paving should be used for large parking areas designated for "vehicles awaiting sale" and for emergency access where local codes permit.

Provide rigid concrete paving for the full width of the mailing platform, dock aprons, and at trash and recycling dumpster(s)/compactor(s). Provide 10 ft. wide concrete strips for trailer parking stalls. For all other paved areas, a Life-Cycle Cost (LCC) analysis shall be performed to determine the most cost-effective solution. The analysis should compare rigid concrete to flexible asphalt pavement for a 20-year period.

A 70' deep concrete dock apron (measured from face of dock) is required at any docks subject to use by tractor trailers. A 30' deep concrete dock apron is required for docks where tractor-trailers will not be used. For dock aprons at Customer Service Facilities, heavy duty asphalt may be used in lieu of concrete if justified by a cost-benefit analysis. Slope the dock apron away from the building at 1% for the full distance (Refer to Exhibit 2-3a in Module 1, Chapter 2 Architectural).

Reinforce concrete pavement with minimum 6x6 W2.9xW2.9 welded wire fabric or polypropylene fibers. Space expansion joints a maximum of 60 feet on center, contraction joints 24 times slab thickness but no more than a maximum of 15 feet on center. Jointing details shall be as specified in the "Standard Details for Road and Bridge Construction" in the state where the project is located. Shear transfer shall be provided across all joints in rigid pavement. Seal all pavement joints in accordance with state DOT, or local regulations, whichever is more stringent. Where state or local requirements are not available, the minimum requirements for sealing pavement joints shall be as stated in AASHTO, Section 1. Base rigid pavement design on a 20-year life span. Unless thicker pavement is required by the geotechnical report, the minimum slab thickness for rigid pavement subject to truck traffic is 6 inches.

All other pavement subject to vehicular traffic may be flexible pavement unless otherwise noted. Rigid pavement may be substituted for flexible pavement where first cost of rigid pavement does not exceed first cost of flexible pavement. Design flexible bituminous pavement to support AASHTO HS-20 loading in accordance with the latest edition of the AASHTO Guide for Design of Pavement Structures and/or State Department of Transportation specifications, whichever is more stringent. Base design on 10-year projection of traffic volumes plus 25%. Minimum flexible pavement thickness shall be as per AASHTO or the recommendation of the Geotechnical report (where applicable); with the most stringent requirement taking precedence.

Required minimum depth of paved area, from the face of the mail platform to the back of the truck maneuvering area, is dependent upon the size of the vehicles. The design of the truck maneuvering area should be based on the requirements of the trucks expected to use the facility. These trucks may be

non-USPS owned vehicles, which are larger and require more space than USPS vehicles. Verify vehicle size requirements with USPS Contracting Officer before proceeding with site design.

Design pavement slopes to provide adequate drainage and in accordance with the table below.

Area	Minimum Slope		Maximum Slope	
	Centerline	Crown or Cross Slope	Centerline	Crown or Cross Slope
Driveways:				
Without curb	1.0%	2.0%	5.5% ¹	2.0%
With curb	2.0% ¹	2.0%	5.5% ¹	2.0%
Sidewalks:				
Walks	0.5%	0.5%	5% ²	1.0%
Landings	-----	0.5%	-----	2.0%
Plazas	-----	2.0%	-----	3.0%
Parking & Maneuvering	2.0%	-----	4.0%	-----

G1-2-4c→g

Exhibit 1-2b

Parking Slopes

USPS Handbook RE-4

Note 1: Centerline slope of driveways in areas where vehicles may be at a complete stop (gates, queuing areas, stop signs, etc.) shall be 2% for the full length of the vehicle.

Note 2: See RE-4 for ramps exceeding 5% Slope

If snorkel/mail drop-off lane(s) are required they should be located in flat areas to prevent vehicle accidents or slipping during inclement weather. Snorkel/mail drop-off lane(s) shall be designed to permit the driver to drop off the mail from the vehicle.

Design all paving and similar work to avoid differential settlement and control cracking due to shrinkage and other causes.

1-2.4.2

Curbs and Curb Cuts

Use straight concrete curb construction, except for SBBB facilities. SBBBs should be designed without the need for curbs unless required by local authorities. Curbs are to be reinforced unless joints align. Curb and gutter shall only be used with an approved deviation. Curbs shall not be higher than 6 in. above paved areas. Curbs supporting handrails shall have chamfered tops.

USPS Handbook RE-4

G1-2-4e

Provide ramps or depressed curbs to facilitate moving lawn care equipment in/out of landscaped areas and Building and Grounds storage areas.

Avoid using wheel stops. Avoid using landscape islands with raised curbs where they can interfere with snow plowing.

1-2.4.3

Site Signage and Pavement Markings

Traffic signs shall be provided for control of all vehicles entering and exiting the site. Standard Department of Transportation (DOT) traffic control signs shall be used for Stop, Yield, No Left Turn, One Way, etc. These signs shall

USPS Handbook RE-4

USPS Handbook RE-5

be specified by the project Architect and installed by the local General Contractor. Locate painted arrows on paving to clearly identify ingress, egress, and circulation patterns. Stripe all parking spaces, including truck spaces.

Reflective paint stripes at dock and platform locations shall extend 50 ft. from the face of a high dock (over 2 ft. 6 in. high), and 30 ft. from the face of a low dock (2 ft. 6 in. or less). The stripe on the driver's side shall extend up the building face to the bottom edge of the door seal. All pavement markings shall comply with Federal Specifications (FS TT-P-1952), Waterborne Traffic and Airfield Marking Paint. Retaining walls (or warped pavements) and highway guard rails between high and low dock aprons shall be painted safety reflective yellow.

Vehicles entering USPS property are subject to inspection by USPIS as per CFR Title 39. A sign shall be posted at gated employee parking entrances and truck entrances; see signage catalog.

1-2.5 Stairs, Ramps, Walks and Retaining Walls

USPS Handbook RE-4

Provide a slip-resistant surface on all stairs, ramps, and sidewalks. Provide accessible concrete sidewalk with curb ramps, connecting neighboring pedestrian walks to the designated building entrance. If snorkel lane drop boxes are required, provide a concrete pad for drop boxes connected by accessible concrete walks to the designated building entrance.

Provide guardrails at drops greater than 7 inches. At site specific location exceptions may be obtained from the Contracting Officer. Comply with the most stringent provisions of applicable codes and standards for guardrails. If there is a change in the elevation of a walking surface, especially if the change is not obvious, consider painting the surface transition with a safety yellow stripe.

Retaining walls should be used only where essential to accommodate site grading requirements. Retaining walls shall be constructed of reinforced concrete. Other materials may be used with an approved deviation. Walls or warped pavements used to separate the grade difference between low and high dock aprons shall be provided with properly designed highway type guard rails. Where warped pavement is used, provide guard rails on the high and low side. Minimize the length of walls by warping paving and adjusting grades where it is practical and safe.

1-2.6 Landscaping

USPS Handbook RE-5

Landscape design should reflect the existing site topography and may include terracing or other design features to integrate site conditions into built features.

Building orientation and landscaping should be used to facilitate energy conservation to the greatest extent possible (e.g. natural cooling with shade trees; cooling of west-facing glass with evergreen trees and shrubs; wind protection with evergreen trees).

In the areas of the main entrance, low (36 inches maximum) planting is acceptable. Trees shall be set back a minimum of 10 feet to center line of trunk from building face so as not block exterior camera views; depending on the growth pattern of the trees, this distance may need to be increased to 20 feet or more.

Provide low-maintenance landscaping materials, indigenous to the locale, preferably with no irrigation requirements (known as Xeriscaping) and. Large expanses of grass and lawn areas should be kept to a minimum.

Irrigation systems shall be provided only where required by local regulations. Required irrigation systems shall be water-conserving drip type, except at lawns, ground cover and seasonal planting areas where drip type systems are impractical.

Existing vegetation and topsoil shall be preserved and protected as much as possible during construction and erosion control devices shall be utilized. A/E shall comply with local regulations, including minimum landscaping requirements.

1-2.6.1 Soil Improvement

Soils shall be analyzed to determine the need for soil improvements to support indigenous plants, particularly where the site has already been filled. Improvements may include:

- Addition of organic matter to enhance plant growth.
- Minimizing the use of chemical fertilizers.
- Addition of inorganic materials (sand, gypsum, etc.) to improve workability and drainage capacity of soils.

1-2.6.2 Plant Selection

Plant materials shall be ornamental and tolerant of the site's existing soils and climate. Indigenous plants that do not require supplemental irrigation or excessive fertilization once established should be used to the extent possible.

The installation of planting materials and landscaping shall be limited to public areas and the main street façade of the facility. Only grass, groundcovers, mulches, stones and wood chips shall be installed in all non-public areas.

The branching habit of all plants shall be full form, free from disfigurements and conforming to the *American Standard for Nursery Stock* as published by the American Association of Nurserymen (ANSI Z60.1-1986, or later revision).

1-2.6.3 Mulches

Mulches shall be used in appropriate areas to reduce weed growth, evaporation and erosion. Organic mulches shall be used for erosion control and plant material establishment. Examples include: hydraulic mulch products with 100 percent post-consumer paper content and yard trimming composts; wood mulch from a properly permitted recycler of stump/tree parts. Inorganic mulches shall be used in unplanted areas (e.g. pea gravel or crushed granite).

In the vicinity of outdoor break areas, the use of organic mulches shall be avoided. Utilize inorganic mulches, such as pea gravel or crushed granite.

At feature landscape areas, provide non-woven polypropylene landscape fabric underneath mulches to control weed growth.

1-2.6.4 Sound and Visual Barriers

For sites located in noise sensitive areas (e.g. private residences, schools and religious buildings) design should minimize impacts for noise created by

facility operations. Recommended abatement techniques include earth berms, barrier walls constructed of concrete or masonry with no openings, and buffer areas to increase distance from source to receiving sensitive areas. Coordinate requirements with local authorities.

Berms at the perimeter of the property are also acceptable as visual screening if necessary to mitigate aesthetic issues, or to meet local ordinances.

1-2.6.5 Landscaping at Signs

Module 4F

See Module 4F Exterior Signage, Section 2-4.1 for landscaping at signs.

1-2.7 Fencing

Perimeter fencing is required for all facilities over 10,000 square feet, to separate public accessible areas (i.e.: customer/visitor parking, BMEU) from restricted USPS areas, unless directed otherwise by USPS. Provide 6 ft. high chain link fencing with gate access as required. Fencing over 6 feet in height and the use of barbed wire / tape are to be allowed only when a deviation supported by a risk analysis has been approved. Also, employee parking at Customer Service Facilities can be fenced only when a deviation supported by a risk analysis has been approved.

USPS Handbook RE-5

 G1-2-7a→c

Installations may reduce the linear run of fence by shortcutting across USPS property, provided all stormwater management areas or other areas undesirable for public access are still contained within the fence line. Provide 6' high chain link fencing with 10' wide double swing gate around stormwater detention/retention areas over 4' deep. At Postal Inspector's entrance, the fence line shall not prevent the inspector's access to the building from the public side.

No Trespassing signs must be posted 5 feet above the ground at 100-foot intervals. See USPS Direct Vendor Signage Catalog on CD-ROM for fence regulatory sign. For large sites with remaining undeveloped property, provide fencing around developed areas (buildings, postal operations, parking areas, etc.) only. If the entire site is not fenced, the perimeter of the unfenced portion must be posted with No Trespassing signs at 100-foot intervals.

Chain link shall be 9-gauge minimum; provide vinyl coating if directed by Contracting Officer. For support, provide a tension wire along top of chain link, with a brace rail at base only. Gate installations may receive brace rails at both the top and base of gate. Gates shall be designed such that no object 4 inches or larger in height can pass underneath. To ensure proper clearance, the curb may need to be notched or a speed bump (hump) needs to be installed under the gate. Verify ground conditions at all points. Allow fence to terminate on firm, compacted, non-shifting soil or on a paved surface.

1-2.8 Not Used

1-2.9 Construction Waste Disposition/Recycling

Where practical, construction wastes shall be recycled to the greatest extent possible, including the material generated during clearing of the site, demolition of existing structures, and all other construction activities. Firms and facilities used for recycling and disposal shall be appropriately permitted

for the intended use, to the extent required by Federal, State, and local regulations.

A recycling plan shall be developed and instituted prior to and during construction. The recycling plan shall include at least the following:

- Identification of the types of materials to be recycled with corresponding names of properly permitted/registered haulers and recycling centers.
- Description of the specific approaches to be used in recycling various materials generated, including specification of areas and equipment to be used for processing, sorting, and temporary storage of construction and demolition wastes.
- All disposed materials, including anticipated hazardous wastes, shall include names of haulers and disposal sites and copies of their permits/registrations.
- Identification and written justification for materials that cannot be recycled.

Materials which shall be considered for recycling include: stumps, lumber, brush, wallboard, asphalt, windows, doors, concrete, light fixtures, brick, carpeting, metals, roofing, and cardboard.

Whether a specific material from a particular facility can be reasonably recycled will depend on such factors as the availability of viable markets, the condition of the material, and the ability to provide the material in a condition and quantity acceptable to available markets.

1-2.10 Safety

1-2.10.1 Site Access

Coordinate site entrance locations with the local authorities having jurisdiction. The need for deceleration and/or acceleration lanes into and out of the flow of traffic for facilities located adjacent to heavily traveled highways and streets shall be evaluated.

1-2.10.2 Fire Lanes

Provide fire lanes to comply with NFPA-1 or local requirements, whichever is more stringent. Lanes shall be appropriately designated and wide enough to accommodate fire fighting equipment used by local fire departments.

1-2.10.3 Parking

Parking areas shall not encroach into fire hydrant zones, post indicator valves, approaches to corners, loading zones, or designated means of safe egress.

1-2.10.4 Flammable Outside Storage

The design and construction of both above-ground and underground storage tanks shall comply with all NFPA-30, OSHA, and EPA requirements. Provide a diked area and drainage path for surface water and spilled flammables in accordance with NFPA-30 and OSHA requirements.

1-2.11 Off-Site Improvements

All off-site improvements necessary to construct a complete and usable facility (including any work necessary to restore areas disturbed by off-site construction) shall be included in the design, unless otherwise directed by

USPS. This work may include relocation and/or construction of accessible routes (per RE-4), streets, sidewalks, utilities, storm drainage systems, etc. The A/E shall contact the appropriate authorities and secure the necessary permits prior to engagement in improvements outside the USPS property line.

Appendix A

Boundary and Topographic Site Survey

[This page intentionally left blank.]

Boundary and Topographic Site Survey Specifications

Intent The purpose of these specifications is to designate and describe the minimum requirements for a boundary and topographic site survey for use in the acquisition of real property and the design and construction of new or modified postal buildings and other site improvements.

General The Surveyor shall perform all field work necessary to accurately determine the property lines and existing physical conditions of the site, mark corner in accordance with appropriate State Board of Land Surveyor requirements, establish bench mark, and ascertain and record on a topographic and boundary survey drawing the information and data as required and hereinafter specified. The Surveyor shall obtain from public records such information and data as may be required to complete the work. All data and information required by these specifications shall be shown on the survey drawing or designated as nonexistent.

Survey Drawing (Map) The survey drawing shall be prepared using AutoCAD, latest version. When plotted, the size of the site survey drawing shall be: 30" x 42" with 1-1/2" margin on the left edge for binding and a 1/2" margin on the remaining sides. The drawing shall be prepared, so when half-sized, it is legible. Where the size of the site is such that the specified size is deemed impractical, the Surveyor may, with the approval of the Contracting Officer, modify the above-specified dimension.

The survey drawing shall be prepared at a scale of one inch equals 20 feet, except when authorized otherwise by the Contracting Officer.

The drawing shall be of such material (mylar, velum, or other material in customary use) and shall be plotted in pen as will assure quality reproduction of easily readable prints.

North Arrow The compass direction shall be shown by an accurately positioned North Arrow designated as (a) magnetic north, or (b) true north.

Land Description The survey drawing shall contain a legal description of the property of each ownership within the boundary lines of the site.

Bench Mark A bench mark referenced to an established datum shall be marked on a permanent object adjacent to the site and clearly located and described on the survey drawing.

Boundary Lines Boundary lines of the site shall be shown in bearings and distances.

Corners All corners of the site and boundary line intersections not previously marked shall be so marked in accordance with appropriate State Board of Land Surveyor requirements.

Area The total area within the boundary lines shall be designated on the drawing in square feet and acres. If more than one parcel makes up the subject property, the area of the property of each ownership within the boundary lines must be identified.

Closure Report Provide a copy of the closure report confirming that the metes and bounds are accurate.

Easements Indicate location, description and dimensions of easements of record. If there are no easements, that fact shall be noted on the drawing.

Encroachments Any and all encroachments on the property being surveyed shall be accurately and clearly indicated.

Improvements Indicate the position, size, and material of any and all improvements on the property including buildings, retaining walls, architectural walls, areaways, driveways, paving, etc. Indicate the existence and location of off-site structures within 20 feet of the property lines.

Trees and Vegetation Indicate the location and size of trees over 4 inches in trunk diameter and wooded or vegetated areas where trees of smaller diameter or vegetation are in profusion. Thickly wooded or vegetated areas may be designated with number or size of trees or type of vegetation.

Building Line Note whether or not an "official building line" has been established and, if so, its location with respect to streets and property lines. Indicate location, if any, of adjacent building lines.

Adjoining Property Owners Note names of owners of adjoining properties.

Streets and Alleys The following data shall be indicated on the survey drawing for all streets, alleys, roads, highways and rights of way adjacent to the site:

- (a) Name and/or route number.
- (b) Direction of traffic.
- (c) Distance from property lines and between curbs.
- (d) Type, dimension and condition of paving. Where no paving exists, so note.
- (e) Elevations along center lines at 25 feet intervals and intersections.
- (f) Description of all proposed streets, alleys, roads, highways and rights of way including contemplated dates of installation and proposed locations and elevations.

Sidewalks, Curbs and Gutters The following data shall be indicated for all sidewalks, curbs, and gutters on or adjacent to the site (where no sidewalks, curbs or gutters exist, that fact shall be noted):

- (a) Distance from property lines and dimensions.
- (b) Type and condition of material.
- (c) Cross-sections of each type of curb and gutter.
- (d) Elevations of sidewalk along edge nearest site at 25 feet intervals, at corners, and points of slope change.
- (e) Elevations of top of curbs and flow line of gutters at 25 feet intervals, at corners and points of slope change.
- (f) Description of all proposed sidewalks, curbs and gutter improvement including contemplated dates of installation and proposed locations and elevations.

Utilities & Telephone The following information pertaining to utilities adjacent to the site shall be shown and noted on the survey drawing:

- (a) Electric & Telephone. Location, type and capacity of available electric & telephone service. Location of electric & telephone lines, poles and manholes.
- (b) Water. Location of water mains, hydrants and manholes. Indicate size of water mains.
- (c) Gas. Location and size of gas mains including type, pressure, and source of gas supply.
- (d) Sewers. Location, size, direction of flow, rate of fall, and type of material of sanitary, storm, or combined sewer mains. Indicate whether public or private and whether the use is exclusively for sanitary wastes, or storm water drainage. Indicate elevations of flowline, location of manholes and elevation of "in" and "out" inverts.

If a utility is not available at the site, determine the nearest location where the service is available in the community.

Elevations and Contour Lines Elevations of the site shall be taken on a grid suitable to the topography and size of the site, and shall include elevations 25 feet outside of the property boundary.

Contour lines shall be drawn at intervals, which will accurately reflect the existing topography of the site but in no case at more than 2 feet intervals. Elevations shall be marked on contour lines at regular intervals.

Floodplain The surveyor shall state whether all or any part of the site lies within a known floodplain or floodway fringe (ESRI/FEMA). If none of the site lies within a floodplain or floodway fringe, note it as such.

Other Information Note other information pertaining to site conditions, such as abandoned underground structures, ditches, culverts, wells, excavations, erosion problems, known seismic fault zones, slide areas, existing stream courses, etc.

Public Records The surveyor, in addition to other contractual services, shall obtain and/or verify requisite information and data from public records, including names, locations, dimensions and elevations of streets, curbs, gutters, sidewalks, established building lines, easements, utilities, proposed improvements, condemnations etc., necessary for, and incidental to, a complete site survey, preparation of the drawing thereof, and the certification by the Surveyor that the data represented thereon is true and correct.

Copies of Survey Drawing Upon completion of the boundary and topographic site survey, the Surveyor shall submit one (1) CD ROM containing boundary and topographic site survey and one (1) mylar or velum reproducible drawing to the Postal Service for reproduction by others, along with three (3) non-reproducible copies for immediate use.

Surveyor's Certification The survey drawing shall contain a signed certification by the Surveyor that the survey of the described property was made under his supervision and that the data shown thereon is true and correct. The drawing and the Record of Survey when required shall also have the imprint of the surveyor's registration seal, or in lieu thereof a certification as to his State registration or license. The following certification is required: (check one)

- New Construction Leased Site – The Surveyor shall provide an industry standard certification on the survey drawing.
- New Construction Owned Site – In order to comply with the recommendations of Postal Service Legal Counsel, the survey shall be certified to the United States Postal Service AND the title insurance company designated by the Postal Service. The following paragraph shall appear directly on the survey drawing:

To (name of client and name of title insurance company, if known):

This is to certify that this map or plat and the survey on which it is based were made in accordance with the current Minimum Standard Detail Requirements for ALTA/ACSM Land Title Surveys and the Accuracy Standards for ALTA-ACSM Land Title Surveys (available at www.alta.org or www.acsm.net/alta.html).

(SURVEYOR'S SEAL)

License Number

Signature of Surveyor

Cooperation with Title Company For property that will be owned by the US Postal Service, the Surveyor shall cooperate with the title company, abstractor, or attorneys selected by the Postal Service to furnish title information in connection with the site, in order that the numbering of certificates or opinions of title will correspond with the maps furnished by the Surveyor. In addition, a narrative metes and bounds description consistent with the description that will appear on an owner's title policy, shall be prepared on a separate sheet(s). The Surveyor shall complete the boundary and topographic survey in accordance with ALTA specifications sufficient for the title company to issue 1991 US Policy to the US Postal Service. For property that will be leased by the US Postal Service, the Surveyor shall provide a narrative metes and bounds description on the survey or attached on a separate sheet.

[This page intentionally left blank]

Appendix B

Specifications for Subsurface Explorations

[This page intentionally left blank.]

FacilityName/Location

A. SOILS AND FOUNDATIONS REPORT

A report containing an evaluation of site conditions and definitive recommendations for building foundation and pavement design shall be prepared by a registered geotechnical engineer. The geotechnical engineer must be present while borings are taken and provides expertise with on-site and laboratory analysis. The geotechnical engineer is responsible for issuing the final report that includes all data collected during the field exploration, including the following:

1. Logs of borings showing top elevations, depth, soil identifications and description in accordance with the Unified Soils Classification System.
2. Standard Penetration test blow counts.
3. Stratum thickness.
4. Elevation of the water table.
5. Laboratory analysis, consisting of:
 - a. Moisture, density, composition and grain size analysis of granular soils.
 - b. Moisture, density, composition, Atterberg Limit Tests and unconfined compression test on cohesive soils.
6. Charts and graphs indicating test results.
7. Recommended safe bearing values of the soils.

The report must also include an evaluation of the data collected and recommendations for site development and foundation design to aid the designer in the selection of the optimum foundation system. The report should include specific recommendations for parameters to be used in design, including the following, as applicable:

8. Allowable soil-bearing pressure and recommended depth of footings.
9. Active and passive lateral soil pressure.
10. Pile capacities, pile-driving criteria and requirements for tests, if pile foundation is recommended.
11. Estimates of settlement, and recommendation for foundation design under all loading conditions, including seismic load.
12. Requirements for fill, including data required for the preparation of construction specifications and inspection requirements for fill.
13. Suitability of the material excavated from the site for possible use as back fill on the site.
14. Values of the California Bearing Ratio (CBR) and the modulus of sub-grade reaction (K) of the compacted sub-grade under pavements and slabs on grade, and the compaction procedures required to obtain these values in the field.
15. Recommendations for pavement design.
16. Highest anticipated ground water level and probable seasonable variations.
17. Estimated quantity of subsurface water infiltration into foundation drains (per linear foot of drain).
18. Presence of deleterious substances in the soils, including those that will generate gases, their expected effect on foundations and utility lines and recommended preventive action.
19. History of foundation or leakage trouble experienced in the neighborhood.
20. Anticipated construction problems resulting from existing subsurface conditions.
21. Identification of observed, or suspected hazardous/toxic soil conditions which may pose health, safety, or design concerns for future site use (i.e., hydrocarbons, benzene, toluene, xylene, asbestos, and/or other known, or suspected toxic/hazardous materials), on or adjacent to the site.
22. Review known or suspected past and present use(s) of buildings and improvements (i.e., gas stations, manufacturing, warehousing etc.) and related land use(s) (i.e., railroad storage yard, farming, residential etc.).

B. SUBMITTAL OF REPORT

Five (5) copies of the report shall be submitted typed on bond paper along with logs of the borings, and tabular data, signed and sealed by a geotechnical engineer registered as a professional engineer in the state where the site is located. A draft of the report must be submitted for USPS review within thirty (30) calendar days from notice of award, or as stipulated in the contract.

C. BORINGS-NUMBER LOCATION AND DEPTH

The suggested number, location and depth of borings will be indicated on the Site Utilization Plan or other site plan furnished by the Postal Service. It shall be the contractor's responsibility to determine if these parameters are adequate to prepare the report. Any change in these parameters must be approved by the Postal Service. The finalized parameters shall be indicated on a Site Utilization Plan which shall be made a part of the contract.

As a minimum, four (4) boreholes will be drilled within the building area, one at each corner of the building, to a minimum depth of 25 feet, unless bedrock is encountered before the end of the boring. A borehole will be drilled to a minimum depth of 10 feet within each parking lot and maneuvering area. Typically, a minimum of seven boreholes will be drilled to gain a good understanding of the subsurface conditions. When unsuitable soils conditions are encountered, such as fill or muskeg, the boreholes must be terminated to at least 5 feet below the bottom of the unsuitable soil.

D. SEALING OF BOREHOLES

All boreholes will be backfilled and properly abandoned and the ground surface restored to the original conditions

E. DISPOSITION OF SAMPLES

All samples obtained from the borings will be suitably boxed in a manner that will prevent damage to the samples during storage. The samples will be stored by the contractor for a period of twelve (12) months from the date the borings were made, and will be disposed of by the contractor thereafter.

Checklist

[This page intentionally left blank.]

Civil Checklist

Facility Name:

City, State, Zip:

Project Phase:

Reviewer (Individual/Firm Names):

Telephone Number:

Date:

Section No.	✓	Item	Comment
1-1		SITE INFORMATION	
1-1.1		Existing conditions information has been verified.	
1-1.2		Subsurface investigation has been prepared, reviewed and coordinated.	
		Soils report included in final construction documents.	
1-1.3		Environmental Assessment has been coordinated with design.	
1-1.4		Easements, zoning restrictions and/or property covenants have been identified in writing.	
1-2		SITE DESIGN	
1-2		Facility is located on the site plan and tied to property lines/benchmarks.	
		Finished floor elevation is established.	
1-2.1		Availability of utilities has been confirmed. Tie-ins are shown and coordinated with utility companies and respective A/E disciplines.	
1-2.2		A stormwater management plan is in place and has been approved by the appropriate governing agency prior to 30% design completion.	
1-2.3		Sediment/erosion control plan has been developed.	
1-2.4		Site design checked against 919/929 for compliance with parking requirements (number of spaces and sizes).	
1-2.4		Impervious paving is kept to a minimum.	
1-2.4		Concrete paving is used in appropriate locations. Islands/wheelstops are not provided.	

Section No.	✓	Item	Comment
1-2.4		Mail platform maneuvering area is properly sized. Verify vehicle size requirements with USPS Contracting Officer.	
1-2.4		Paving slopes away from building, provides adequate drainage and sloped between 2% and 4%.	
1-2.4		Snorkel lanes are flat and designed for one-way traffic.	
1-2.4		Curbs are only used when necessary for directing flow of water.	
1.2.4		Where concrete curbs are used they are straight curb type.	
1-2.4		Traffic signs are provided, parking spaces are cleared striped, and handicapped parking spaces are properly designated.	
1-2.5		Slip resistant surfaces are specified at stairs, ramps and sidewalks.	
1-2.5		Retaining walls are used only where essential to grading requirements.	
1-2.6		Landscaping is designed for low maintenance and water conservation. Specified plants are indigenous to locale.	
1-2.6		Requirements for irrigation are confirmed and system provided as required.	
1-2.7		Perimeter fencing is used to separate public areas from USPS restricted areas.	
1-2.8		Proper connection is made for wastewater disposal at vehicle washing areas (if provided).	
1-2.9		A construction waste disposition/recycling plan has been developed.	
1-2.10		Need for acceleration/deceleration lanes has been evaluated.	
1-2.10		Fire lanes are provided and comply with local code requirements.	
1-2.10		Parking areas do not encroach into fire hydrant or loading zones.	
1-2.10		A diked area and drainage path for surface water and spilled flammables has been provided.	
1-2.11		Permits have been secured for off-site improvements, if necessary.	

[This page intentionally left blank.]

Module 1 General Criteria

Chapter 2 Architectural

2-1 Introduction

- 2-1.1 Scope
- 2-1.2 Codes and Standards

2-2 Workrooms

- 2-2.1 Mail Sorting Carrier Casework
- 2-2.2 Wire Screen Enclosures
- 2-2.3 Height Requirements
- 2-2.4 [Reserved]

2-3 Platforms

- 2-3.1 Open Mail Platforms
- 2-3.2 Enclosed Mail Platforms
- 2-3.3 Carrier Platforms
- 2-3.4 [Reserved]
- 2-3.5 Columns
- 2-3.6 Ramps
- 2-3.7 Stairs
- 2-3.8 Dock Equipment
- 2-3.9 Vestibules

2-4 Support Areas

- 2-4.1 Employee Entrance
- 2-4.2 Toilet Facilities
- 2-4.3 Locker Rooms / Areas
- 2-4.4 Lunchroom / Break Area
- 2-4.5 Administrative Offices
- 2-4.6 Custodial Storage Room
- 2-4.7 Janitor's Closet
- 2-4.8 Vault
- 2-4.9 Outside Storage Area
- 2-4.10 [Reserved]
- 2-4.11 Not Used

-
- 2-4.12 [Reserved]
 - 2-4.13 Not Used
 - 2-4.14 [Reserved]
 - 2-4.15 [Reserved]
 - 2-4.16 [Reserved]
 - 2-4.17 [Reserved]
 - 2-4.18 [Reserved]
 - 2-4.19 [Reserved]
 - 2-4.20 Not Used
 - 2-4.21 Business Mail Entry Unit (BMEU)
 - 2-4.22 Not Used
 - 2-4.23 [Reserved]
 - 2-4.24 [Reserved]
 - 2-4.25 Not Used
 - 2-4.26 [Reserved]
 - 2-4.27 Not Used
 - 2-4.28 Not Used
 - 2-4.29 Carrier Annex - Mail Pick Up Lobby
 - 2-4.30 [Reserved]
 - 2-4.31 [Reserved]
 - 2-4.32 [Reserved]
 - 2-4.33 [Reserved]

2-5 Retail Design Standards

- 2-5.1 Customer Entrance
- 2-5.2 Self Service
- 2-5.3 Not Used
- 2-5.4 P.O. Box
- 2-5.5 Full Service Counters
- 2-5.6 Passport Acceptance Counters

2-6 Exterior Envelope

- 2-6.1 Walls
- 2-6.2 Roof
- 2-6.3 Energy Conservation

2-7 Miscellaneous Building Components

- 2-7.1 Interior Partitions
- 2-7.2 Doors and Hardware
- 2-7.3 Vertical Circulation
- 2-7.4 Protective Barriers
- 2-7.5 Building Identification and Signage
- 2-7.6 Building Materials

2-7.7 Entry Feature

2-8 Fire Protection

2-8.1 Occupancy/Hazard Rating

2-8.2 Fire Extinguishers

2-8.3 Sprayed-on Fire Protection

2-9 Investigative Systems

2-9-1 Investigative Office

2-10 Safety

2-10.1 Egress

2-10.2 Walking Surfaces

Checklist

[This page intentionally left blank.]

Chapter 2 Architectural

2-1 Introduction

2-1.1 Scope

The basic functional components common to the primary USPS building types are workrooms, platforms, administrative and employee support areas.

These components should be reasonably expandable and adaptable without significant interruption to ongoing operations. The standard designs dictate layouts for each facility type with a varying degree of flexibility. Whether standard or custom designs are used, careful planning and development of the building layout, as well as the design of flexible interior spaces and support systems, is necessary. Use standard designs unless otherwise directed by USPS.

2-1.2 Codes and Standards

Exhibit 2-1a summarizes the use group and construction type for the two primary programs covered by the USPS Standard Design Criteria. This summary is for reference only; the A/E is responsible for compliance with local codes.

PROGRAM SPACE	USE GROUP				CONSTRUCTION TYPE			
	BOCA	UBC	SBC	IBC	BOCA	UBC	SBC	IBC
MSBD								
Workroom	F-1	B	B	F-1	2C	III	V	II B
Support Areas	F-1	B	B	F-1	2C	III	V	II B
Office/Admin.	B	B	B	B	2C	III	V	II B
Lobby	B	B	B	B	2C	III	V	II B
SSBD								
Workroom	F-1	B	B	F-1	5A	V N	VI	II B
Support Areas	F-1	B	B	F-1	5A	V N	VI	II B
Office/Admin.	B	B	B	B	5A	V N	VI	II B
Lobby	B	B	B	B	5A	V N	VI	II B

Exhibit 2-1a
Code and Standards Summary

Notes:

1. See Module 1, Sections 2-8 and 4-5 for NFPA Fire Protection Occupancy Classifications.
2. Exhibit 2-1a is applicable to one story facilities only. For two story facilities, refer to the local building code.

2-1.2.1 Building and Life Safety Codes

All facilities shall be designed in accordance with the requirements set forth by the applicable Federal, state and/or local codes enforced at the time of design. In addition, the USPS standard design criteria contained in this document shall be followed. Where two or more codes, standards or USPS criteria are in conflict, the more stringent shall apply.

2-1.2.2 Accessibility Standards

Postal property is subject to the Architectural Barriers Act of 1968, as implemented in Handbook RE-4, Standards for Facility Accessibility by the Physically Handicapped. Existing leased facilities fall under the RE-4 Section F202.6 4.1.8 – Accessible Buildings: Leasing of Space in Accessible Buildings. In designing new postal facilities, attention should be paid to changes in the standards for building entrances and emergency exits that were incorporated in the 2005 edition of the Handbook. These changes include:

- Section F206.4.1 requires that at least 60% of "public entrances" be accessible to persons with disabilities. If a building has one or more "unrestricted" public entrances, at least 60% must connect with an accessible route.
- Normally, entrances used by postal employees are considered "restricted" entrances as defined by Handbook RE-4. Section F206.4.7 requires that at least one restricted entrance be accessible to persons with disabilities.
- Normally, fully accessible entrances can also serve as emergency "means of egress". RE-4 Section F207.1 identifies section 1003.2.13 of the International Building Code as the reference for applicable standards. RE-4 Section F210 references technical standards for stairs that are part of required emergency means of egress.

Vertical grab bars in the accessible toilet stall are not required by the RE-4 but may be required by state or local codes. They are considered good practice and should be provided, even if not required by state or local authorities.

2-1.2.3 Occupational Safety Standards

Postal facilities, whether owned or leased, must comply with Occupational Safety and Health Administration (OSHA) regulations.

2-2 Workrooms

The workroom contains all of the mail staging, sorting, and distribution activities in a postal facility. It is generally an open plan which must remain highly flexible to accommodate the changing needs of the various activities in the workroom. Many of these activities require the use of special casework, mechanization, and equipment to facilitate mail delivery.

Finish flooring must be sealed concrete. Use of asphalt plank is no longer allowed in new construction.

Steel roof structure must be primed but not painted. Steel roof decking must be galvanized and not be primed or painted.

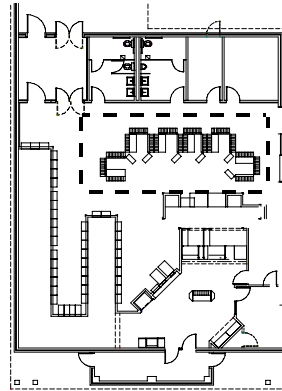
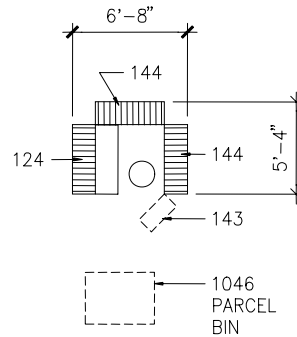

Exhibit 2-2a
Typical Carrier Facility Workroom

2-2.1 Mail Sorting Carrier Casework

Each postal mail carrier uses casework arranged in the workroom for mail sorting activities. Each workstation represents a postal delivery route for a particular zip code zone. Prior to space layout, the A/E shall review the Delivery Environment Matrix below and verify the delivery environment to determine the appropriate carrier casework type and configuration. Workstations may be made up of as many as 3 types of carrier cases (Fixtures pieces (Fxp.) 124, 144, & 143). Each route also has a corresponding canvas parcel bin (Fxp. 1046) for packages larger than file size.



Delivery Environment	Fixture piece 124	Fixture piece 144	Fixture piece 124c	Fixture piece 144c	Fixture pieces 143c
City-FSS	X				
City- Non FSS	X	X			
Rural			X	Note 1	Note 1

Note 1- Rural routes could have either a supplemental 143c or 144c

Exhibit 2-2b
Delivery Environment Matrix

The A/E shall coordinate the layout of this USPS supplied equipment with USPS for adequate type, quantity, spacing, security sight lines and proper provision of power requirements for carrier case task lighting.

2-2.2 Wire Screen Enclosures

Wire mesh enclosures are required at Registry Cages, Satellite Maintenance areas, workroom side of parcel drops with openings of 8" X 8" or larger, and within the Stamp Distribution Office (SDO). See USPS supplied Operational

 G2-2-2a

USPS Handbook RE-5

Space Layout (OSL) for locations of these spaces. Pre-manufactured cages meeting the following requirements are acceptable.

Where accountable paper and Registered Mail are stored, closures are required. Closures shall eliminate any spaces over ¼-inch through which mail could be passed, including, but not limited to, toe spaces and around gates.

Wire mesh shall consist of 10 gauge minimum woven diamond mesh steel wire with steel frames. Wire mesh shall be configured to prevent the passage of a sphere 1 ½ in. diameter.

Finish of the mesh, posts and frames shall be factory applied gray powder coat finish. Bolts, fasteners and washers shall be galvanized. Install a 2"x3"x1/4" angle closure between floor post supports. Paint angle gray to match mesh.

All cage partitions shall extend full height to underside of structure above, or be limited to a height of 9'-0" with a wire screen ceiling of similar construction, and capable of supporting surface-mounted light fixtures.

Registry Cage entry doors shall be swing type, self-closing and self-locking with 4'-0" opening. Doors shall be secured with a mortised cylindrical lock that is only accessible by Registered Mail Employees. All locks shall be supplied with USPIS approved strike shrouds to prevent surreptitious entry. A 1/4" thick clear acrylic panel shall be secured covering the entry/egress door to prevent access to the interior latch mechanism.

All entry/egress doors and door hardware shall comply with requirements of RE-4 related to handicap accessibility and shall comply with applicable life-safety codes.

In facilities that are planned to receive access control, or already have access control see MPFDC, Chapter 2-2.2 for further door hardware guidance.

All Registered Mail cages shall be located on the facility workroom floor away from public view and access, in close proximity to the inbound HCR and MVS trucks, near but not in direct sight lines of a loading dock or in other less secure areas.

A/E shall provide detailed floor plan of Registry Cages including indication of all FF&E. Coordinate/submit preliminary design for approval by USPIS.

Registry Cages shall not contain toilet facilities, storage closets or other similarly enclosed spaces, except for vaults, within the perimeter of the cage enclosure nor shall such spaces be contiguous to any cage. Registry Cages shall not be located directly adjacent to exterior walls.

Provide each Registered Mail Section with a logical and physical workflow system to include verification, opening, distribution, dispatch and filing based on information in the E-31 handbook and according to the Standard Details.

In addition to compliance with the design requirements in the SDC and MPFDC, Registry Cage design and Standard Operating Procedures shall comply with requirements of DM-901 and Handbook E-31.

2-2.3 Height Requirements

MSBD, SSBD

2-2.4 [Reserved]

2-3 Platforms

Mail (open or enclosed) and carrier platforms serve as the principle areas for mail to arrive or depart from a USPS facility. These platforms receive a high volume of truck and rolled cart traffic, and must be designed for utility, durability and ease of maintenance. Specific dock height requirements shall be coordinated with USPS based on local facility needs.

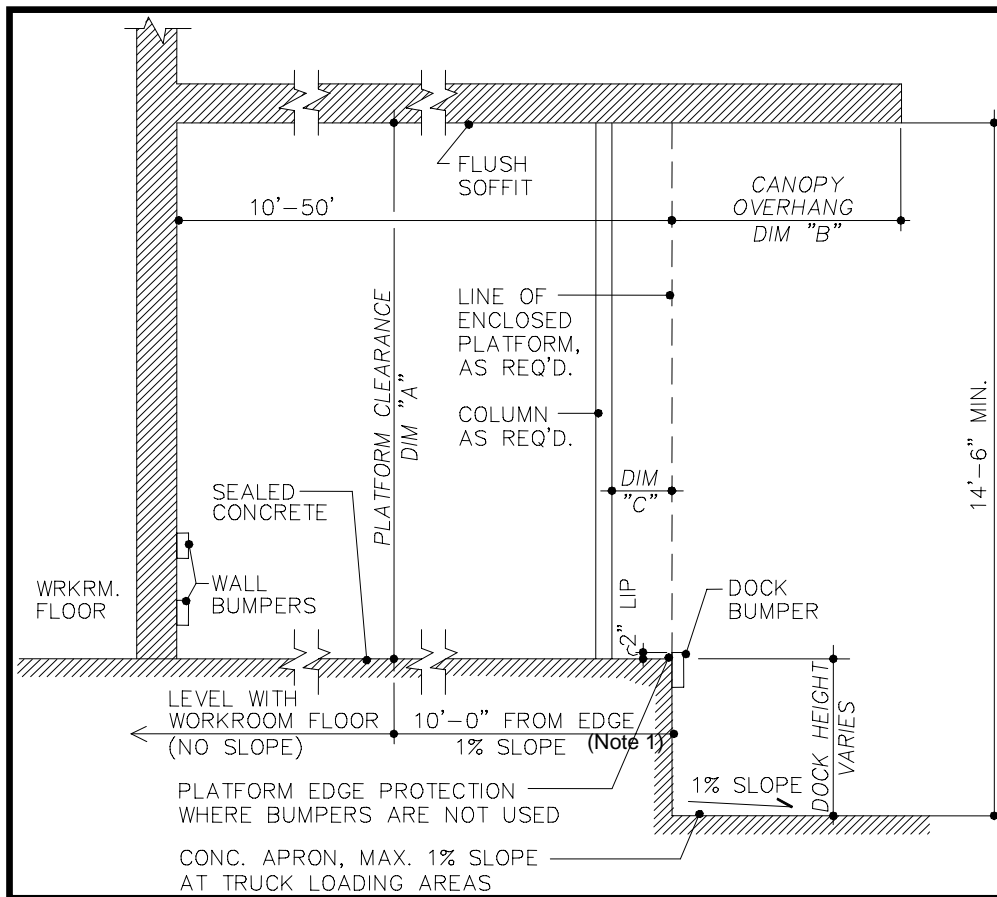

PLATFORM TYPE	DIM A	DIM B	DIM C
Open Mail Platforms (MSBD, SSBD)	10 ft. 0 in. (min.)	7 ft. 0 in. (MSBD) See Standard plans (SSBD)	1 ft. 6 in.
Enclosed Mail Platforms (MSBD, SSBD)	10 ft. 0 in. (min.)	3 ft. 10 in. (MSBD) See Standard plans (SSBD)	N/A

NOTES:

(1) 1% slope for last 10 feet of dock is for open docks only. 0% slope for closed docks.

Exhibit 2-3a

Typical Mail Platform Dimensions and Requirements

2-3.1 Open Mail Platforms

MSBD, SSBD



Exhibit 2-3b

Open and Enclosed Mail Platforms

2-3.2 Enclosed Mail Platforms

Enclosed mail platforms have a roof and exterior wall with overhead doors at the truck dock side. The full length of the platform slab shall be level with the workroom floor. A platform canopy, with a flush soffit underneath, shall extend 3 ft. 10 in. beyond the outside face of the platform. Vestibules are encouraged but not required between the workroom and any enclosed mail platform.

2-3.3 Carrier Platforms

MSBD

2-3.4 [Reserved]

2-3.5 Columns

On open mail and carrier platforms locate columns with a setback of 1 ft. 6 in. between the dock face and the closest face of the column. On enclosed mail platforms, the exterior face of walls between overhead doors shall be flush with the outside face of the platform and columns shall be located within or contiguous to platform walls. Columns shall be located between dock positions and coordinated with dock opening locations.

G1-2-4a

G2-3-3a

2-3.6 Ramps

Ramps are required at platforms to facilitate the movement of cart and other traffic into carrier and other areas. The minimum clear width of ramps shall be 4 ft. 0 in. at SSBD platforms and 5 ft. 6 in. at MSBD platforms, with a maximum allowable slope of 1:12. (Local code requirements shall govern if more stringent. In particular, some codes limit the slope of handicapped accessible ramps to 1:20.) Where these ramps are the only accessible

USPS Handbook RE-4

G2-3-6a→a1

means of egress from the platform, and are therefore, required units of egress from the building, they shall be in compliance with RE-4 and local codes.

2-3.7 Stairs

MSBD

USPS Handbook RE-4

 G2-3-7a→c

2-3.8 Dock Equipment

All dock equipment, including flip ramps, dock levelers, scissors lifts, door seals, truck shelters and bumpers shall be coordinated with platform door sizes and applicable USPS truck fleet requirements. Provide protective barriers as required to protect such equipment and door tracks.

2-3.8.1 Flip Ramps

Provide electro-hydraulic, front-mounted adjustable flip ramps (also known as edge-of-dock levelers) in the quantity and locations required, including maintenance struts, as directed by USPS.

 G2-3-8d

2-3.8.2 Dock Levelers

Provide air powered air bag type dock levelers as directed by USPS.

 G2-3-8e→e5

Levelers shall have one center or two side maintenance struts (to support platform and lip), sized for 10,000 lbs. rollover. Strut(s) shall be capable of accepting OSHA lockout/tagout locks and shall provide visual signal (above the leveler) that strut is in use.

Levelers shall have free fall protection; safety legs (air bag type).

Dock levelers are typically recessed into concrete mail platforms, and are 6 ft. 0 in. wide x 10 ft. 0 in. deep, and are in a 2'-0" pit.

2-3.8.3 Scissors Lifts

Provide electro-hydraulic scissor lift(s) in the quantity and locations required, as directed by USPS. Scissor lifts are to be 6 ft. 0 in. wide x 8 ft. 0 in. or 8 ft. x 10 ft. long based on USPS requirement.

 G2-3-8f→f4

2-3.8.4 Dock Door Seals

Provide door seals at all docks at enclosed platforms. Door seals shall be heavy duty, have fixed headers with curtains, and be fabricated of compressible polyurethane covered with fabric. Reinforcing wire pads shall have replaceable guide strips. The seals shall have compression vents, drain holes and be secured to corrosion resistant metal or a pressure-treated wood frame. If inflatable units are used, the seals shall be activated by the dock door position.

2-3.8.5 Bumpers

 G2-3-8a→c1

Install dock bumpers continuously along the face of open mail platforms except at stairs, steps, ramp, dock levelers, flip ramps and/or scissors lifts. Bumpers shall project 2 in. above the top of the dock. On open platforms install a 2 in. high section of steel channel or angle to keep equipment from rolling off sides of the platform.

2-3.9 Vestibules

MSBD, SSBD

 G2-3-9a

2-4 Support Areas

USPS Handbook RE-4

2-4.1 Employee Entrance

Provide only one designated employee entrance.

2-4.2 Toilet Facilities

MSBD, SSBD

Toilet facilities shall be located near the employee workstation areas. Provide space for toilet rooms per the following chart.

 G2-4-2a→c1

EMPLOYEES (Peak Hour) (²)	MALE			FEMALE	
	Water Closets	Lavatories	Urinals	Water Closets	Lavatories
0-10 ⁽¹⁾	1	1	1	2	1
11-24	2	2	1	3	2
25-35	2	2	2	4	2
36-55	3	3	2	5	3
56-75	4	4	2	6	4
76-95	5	4	3	8	4
96-114	5	5	4	9	5
115 or more	Add one water closet and one lavatory per gender for every 30 additional employees.				

Exhibit 2-4a

Toilet Fixture Requirements

Notes:

- (1) For facilities with less than six employees (combined male and female peak hour), provide one toilet room (with one water closet and one lavatory), or as directed by USPS.
- (2) Quantities in the EMPLOYEES (Peak Hour) column represent the individual totals of male and female employees and not the combined totals. Note that this approach differs from the Mail Processing Facility Design Criteria.

USPS Handbook RE-4

 G2-4-3a→a2

The custodial products used by the USPS are available through a national strategic partnership (MLB-CO-01-012; ... National Sources for Custodial Products). As part of the agreement, the suppliers provide the dispenser along with the custodial product. This arrangement ensures compatibility of custodial products (paper towels, toilet tissue, soap, etc.) with the dispenser. Therefore, in lieu of including them in the project solicitation, the dispensers are to be provided by the custodial product supplier. On projects using the

custodial products national agreement, the A/E will need to coordinate the selection and location of all toilet accessories (e.g. mirrors, soap dispensers, waste receptacles, paper towel dispensers, etc.) with the Contracting Officer and edit the project specifications as appropriate.

2-4.3 Locker Rooms / Areas

Double tier half-height lockers with sloping tops or full height half-wide lockers w/ sloping tops shall be provided for the employee complement specified in the planning documents.

MSBD, SSBD

Locker rooms / areas shall be made accessible and provided with accessible lockers. The quantity of accessible lockers shall be as required by RE-4, but in no case less than the number of accessible employee parking spaces.

In Zone III, provide full size lockers.

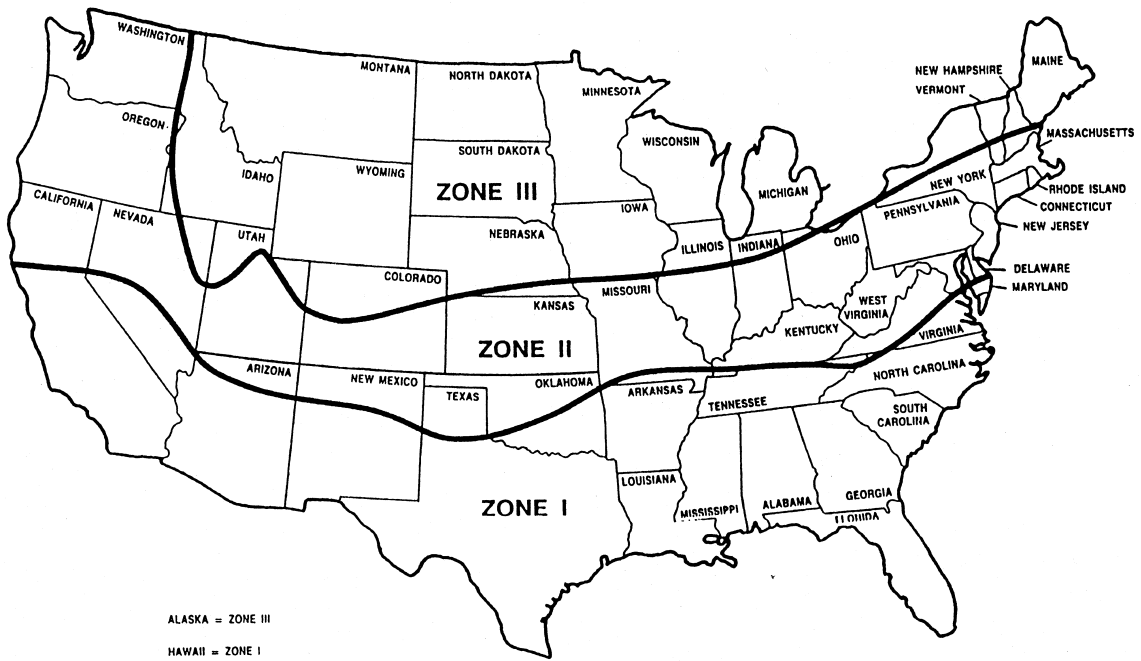

2-4.4 Lunchroom / Break Area

MSBD, SSBD

2-4.5 Administrative Offices

G2-4-4a→c

2-4.6 Custodial Storage Room

MSBD

G2-4-5a→b

Provide mop sink, mop/broom holder, storage shelves and eye wash station (at rooms where chemicals will be mixed). Provide epoxy floor with painted epoxy walls at mop sink.

2-4.7 **Janitor's Closet**

MSBD, SSBD

2-4.8 **Vault**

MSBD

 G2-4-8a→d

2-4.9 **Outside Storage Area**

MSBD, SSBD

2-4.10 **[Reserved]**

2-4.11 **Not Used**

2-4.12 **[Reserved]**

2-4.13 **Not Used**

2-4.14 **[Reserved]**

2-4.15 **[Reserved]**

2-4.16 **[Reserved]**

2-4.17 **[Reserved]**

2-4.18 **[Reserved]**

2-4.19 **[Reserved]**

2-4.20 **Not Used**

2-4.21 **Business Mail Entry Unit (BMEU)**

The BMEU lobby, customer entrance, parking, truck maneuvering area, and loading dock should be totally separated from the Postal secured compound. However, when this cannot be achieved due to site constraints, the following general criteria should be followed:

- If the site does not allow for vehicle separation, the BMEU should be placed at the end of the building closest to the public access.
- If a loading platform is shared between BMEU customer trucks and Postal trucks, it shall be designed so there is no vehicular or pedestrian cross traffic.
- Shared platforms shall have a fence, with a gate for the flow of mail, separating the customer and Postal areas.
- Shared platforms shall also have a fixed CCTV camera observing the BMEU customer area.

For detailed criteria refer to the Mail Processing Facilities Design Criteria.

2-4.22 Not Used

2-4.23 [Reserved]

2-4.24 [Reserved]

2-4.25 Not Used

2-4.26 [Reserved]

2-4.27 Not Used

2-4.28 Not Used

2-4.29 Carrier Annex - Mail PickUp Lobby

With an approved Planning deviation request, the Mail Pickup Lobby may be included in Carrier Annex designs. If used, the A/E should integrate the design concepts into the Construction Documents.

2-4.30 [Reserved]

2-4.31 [Reserved]

2-4.32 [Reserved]

2-4.33 [Reserved]

MSBD

 M2-4-28a

2-5 Retail Design Standards

The design and configuration of the Retail Design Standards allow the USPS to better serve its customers and improve the financial performance of its retail facilities. The Retail Design Standards arrange spaces to present a hierarchy of service options to the customer that will speed transactions and lower overall labor costs while improving the image and profitability of the USPS.

The basic components of the Retail Design Standards are: Customer Entrance, Self Service, P.O. Box, and Full-Service Counters. Refer to Module 4A, Retail Design Standards, for more detailed design criteria.

Module 4A

USPS Handbook RE-5

USPS Handbook RE-4

 G2-5-1a→e3

 G2-5-1f→f6

2-5.1 Customer Entrance

It is essential that customers arrive at a site and be able to easily identify/access the point of entry.

2-5.2 Self Service

 G2-5-2a→e2

The Self Service area is the first area customers see as they enter a retail facility. This area provides the mechanical equivalents of personal service with current vending capabilities to allow a customer a quick and easy way to conduct normal mailing services. This area shall be designed to allow for the capability of 24 hour access.

2-5.3 Not Used

2-5.4 P.O. Box

In this area, mail and parcels are available to customers for self service retrieval through secured post office boxes, called 'P.O. Box'. This area shall be designed to allow for the capability of 24 hour access. Parcel lockers in this area allow customers the ability to retrieve packages which are too large to fit into a P.O. Box.

 G2-5-4a→1

2-5.5 Full Service Counters

This is the traditional counter service where Sales Service Associates conduct complex transactions with a customer. It is important to maintain a clearly understood queuing system with clear lines of sight to all featured retail areas. Coordinate layout with USPS supplied full service and accessible counter workstations in this area.

 G2-5-5a→f1

2-5.6 Passport Acceptance Counters

If a Passport acceptance counter is required the Contracting Officer shall incorporate the space requirements indicated below for the specific Passport service designated. It is important to note that Passport services are affected by wait time in line (WTIL) service concerns. The counters are subject to RE-4 requirements.

DESCRIPTION	SPACE REQUIRED	SERVICES	CONSTRAINTS	SIGNAGE
Service Counter	None	Forms and mailing	Not to be employed when there are service concerns (WTIL)	None
Space in Lobby	5 ft by 5 ft – out of area of parcel slide and main traffic flow	Forms and mailing	Not to be employed when there are service concerns (WTIL)	Define area with services offered and hours of operation.
Office off Lobby	Counter for one person / waiting area sized to expected business volume / table or	Forms, mailing and photos	Not to be employed when there are service concerns (WTIL) unless Passport	Define area with services offered and hours of operation. Directional

DESCRIPTION	SPACE REQUIRED	SERVICES	CONSTRAINTS	SIGNAGE
	wall mounted counters for forms completion.		acceptance is staffed to accept payment for all services.	signage to promote ease of customer use required.

Exhibit 2-5a

Passport Acceptance Counter Alternatives

2-6 Exterior Envelope

SSBD

USPS Handbook RE 5

Building appearance plays an important role in representing our organization, our employees, and our products and services. Our buildings must be friendly and easily identifiable, and portray an efficient, businesslike and professional image. Decision making factors should include surrounding architectural environment, cost and maintenance. Security issues will also be important in the design of a building's exterior.

The standard design programs do not dictate the external appearance of the building itself, nor do they impose the use of certain materials or architectural elements. However, the materials should be carefully selected with respect to reducing construction cost without negatively impacting building performance. For example, use of split-face block may be used in lieu of brick.

In design of SSBD facilities, where wood frame construction is utilized, the design A/E shall follow the US Department of Energy criteria known as "Advanced Framing Techniques" where fully compliant with local structural code requirements.

The standard designs provide suggested elevations which may be used "as is" or with certain variations. The intent is not to dictate the exterior, but to provide guidance on the general appearance expected. An A/E, in conjunction with the Postal Project Manager, shall follow good design practice in deciding whether the default elevation will be used or new elevations will be developed. For some facilities, the standard designs may not be the most cost effective solution. These facilities may be better suited to a custom design or a pre-engineered building.

2-6.1 Walls

2-6.1.1 Materials

Exterior wall finishes shall be selected to provide a durable, low maintenance, weathertight enclosure with a minimum 30-year life span and shall be compatible with the local environment. Materials may vary depending on the type of construction.

Exterior building surfaces and materials shall be selected so they are compatible with the exterior signage programs. Strong colors, bold textures, patterns, and unusual surface treatments shall be avoided. Architectural reveal lines and physical surface patterns must work in harmony with wall attached sign elements.

Refer to Module 1, Chapter 4-2.6 for building envelope U-Factors.

2-6.1.2 Windows

In addition to functional requirements, the use of windows shall be based on energy efficiency, and wall orientation considerations. Windows in the administrative offices and related support areas should generally not exceed 30 percent of the exterior wall area.

If the building does not have an IDS or is a 24 hour operation, all windows on the non-public side of the security wall require security film if they are located such that the sill is lower than 8'-0" above grade or above any surface which could provide access from the exterior. The requirements for IDS are listed in Module 1 Chapter 5-7.3. Based on their risk assessment, existing facilities without IDS may be required to have security film.

The Postal Service does not usually install operable windows; however, if they are used, a security key locking device must be provided. Operable windows must not open more than 4 inches. Neither glass bricks nor glass blocks are acceptable for lobby windows; however, glass block may be used in other locations provided that it does not cause glare for security cameras. If interior glass doors control access to the full-service counter area, vertical blinds or some other means must be installed to provide closeout security.

Baseline facility security discourages placing windows in storage rooms, equipment rooms, toilet rooms, locker rooms, or utility rooms.

When the Inspection Service has determined that high security measures are required, fixed glass with a heavy metal frame must be used. Space the mullions at 8 inches OC or less, both horizontally and vertically, to prevent the passage of a person's body. Window panes must contain burglar-resistant glass in accordance with the criteria listed in Handbook RE-5. Bullet-resistant glazing and stronger grades of burglar-resistant glazing are all high security devices and may be required in some situations.

Bullet-resistant, and/or blast-resistant glazing applications are only to be used when supported by an Inspection Service risk analysis and considerations such as location in a high crime area, a history of robbery and assaults, data from local law enforcement, and practices of surrounding businesses. These glazing measures require a deviation request to be sent to Headquarters for approval.

The contractor must provide a letter of certification from the glazing manufacturer or supplier, along with the shop drawings, to the contracting officer stating that standards for security window treatment have been met.

The design of the Retail Service Lobby, Self-Service area, Box Lobbies, and walk-up and drive-up windows must ensure that there is sufficient visibility from outside the building to discourage criminal activity within the building. The glass must have the following performance characteristics:

- Visible transmittance not less than 65 percent.
- Visible reflectance not greater than 15 percent.

Other glazing requirements are as follows:

- U-factor: See Module 1 Section 4-2.6.

- Visible Transmittance/Shading Coefficient (VT/SC) Ratio shall be greater than or equal to 1 when daylight is being used to reduce artificial lighting requirements.
- All glass shall be double-glazed, low-E emissivity. In climates below 3000 HDD, the low-E coating shall be placed on the second surface (inner side of outer panel); in climates above 3000 HDD, the low-E coating shall be placed on the third surface (outer side of inner panel).
- Provide insulating frames and thermal breaks.
- Exterior glazed systems are permitted. Safety glass shall be used where required by applicable codes and regulations.

2-6.2 Roof

2-6.2.1 General

 G2-6-2a→c

All roof systems shall comply with National Roofing Contractors Association (NRCA) and Factory Mutual Global (FMG) requirements, including fire certification and wind, uplift and blow-off protection. The A/E shall verify fire rating requirements for all roofing assemblies.

All flashing, coping, equipment curbs, joints, etc. shall be approved by the system/roofing manufacturer, and inspected with the roof.

Roofs shall have a minimum pitch of 1/4 in. per ft. (1/2 in. per ft. for standing seam metal roofing). Dead level roofs are not acceptable. Pitch pockets are prohibited and roof penetrations shall be kept to a minimum.

2-6.2.2 Roof Types

Roof types utilized on USPS facilities shall be built-up, modified bituminous, single-ply membrane, standing seam metal, or shingles (SSBDs only). The roof type shall be selected based on specific project requirements and regional practice. All roofs are to be Energy Star Rated.

a. Built-up and Modified Bituminous Roofing

The roofing system shall meet the criteria described in 2-6.2.1 above. Further criteria are as follows:

- (1) Gravel topped built-up roofing and mineral-cap sheet roofing are allowed.
- (2) Asphalt shall be applied at the manufacturer's recommended equiviscous temperature (the temperature at which a bitumen attains the proper viscosity for built-up membrane application to ensure proper workability and adhesion).

b. Single-Ply Membrane Roofing

The membrane roofing system shall meet the criteria described in 2-6.2.1 above. Further membrane roofing criteria are as follows:

- (1) The A/E shall provide a written evaluation of the following:
 - The A/E's personal experience with the product on similar type buildings.

-
- Data on the performance of the product during at least the last 10 years of use.
 - Current regulations and licensing requirements for the installers.
- (2) Provide continuous pavers where heavy roof traffic is anticipated.
 - (3) Provide control or contraction joints every 100 to 200 ft. depending on local climate conditions. These joints shall not restrict the flow of water.
- c. Structural Standing Seam Metal Roofing

The structural standing seam metal roofing system shall meet the criteria described in 2-6.2.1 above. Further criteria are as follows:

- (1) SSMR shall be manufactured of preformed metal panels of 24 gauge minimum steel or .032 in. minimum aluminum and shall have factory color/mill finish.
- (2) To determine the load carrying capacity, the system shall be tested in accordance with the U.S. Army Corps of Engineers "Standard Test Method for Structural Performance of SSMRs by Uniform Static Air Pressure Difference" described in the Corps of Engineers Guide Specifications (CEGS).
- (3) Details shall be designed so as to accommodate movement of the roof under thermal loading to assure weathertightness and structural integrity. Roof panels should be free to move (without detrimental effect) in response to the expansion and contraction forces resulting from a total 100° temperature difference between the inside structural framework and the temperature of the roof panel.
- (4) Metal roofing details shall be designed to eliminate heat loss caused by compression of the blanket insulation between purlins and roof panels.
- (5) In regions where sliding snow or ice is a potential hazard, snow guards shall be provided; however, mechanical fasteners that penetrate the metal roof shall not be used to install the guards. Snow guards shall be of a material compatible with the roofing material.
- (6) Roof panels shall be fastened to framing members with concealed fastening clips or other concealed devices.
- (7) Factory finish on metal roofing panels shall be guaranteed by the manufacturer for 20 years against fading, chalking, blistering, peeling and chipping.
- (8) Provide a minimum pitch of 1/2" per ft.

2-6.2.3 Roof Components

a. Insulation

-
- (1) Batt Insulation. If installed under the roof deck, batt insulation shall have a vapor barrier on the interior side of the insulation. Provide vented air space between insulation and roof structure.
 - (2) Rigid Insulation. Rigid insulation provided on top of roof decks shall be installed in a minimum number of layers and include separation board as required by NRCA. Rigid urethane roof insulation on metal decks shall be provided with 1/2-inch layer of fiberboard on the deck and on top of the urethane to receive the built-up roofing (if applicable).
 - (3) Crickets. Provide crickets as required to prevent ponding at roof-mounted equipment, skylights, smoke vents and along roof edge or valleys. Place crickets under the roof insulation when the two are made of different materials.
 - (4) Fastening. Built-up roof insulation shall be installed per roofing membrane manufacturer's recommendations.
 - (5) Ozone Depleting Potential (ODP). Building insulation shall not be manufactured with CFCs or HCFCs. The only exceptions are extruded polystyrene insulation with HCFCs, which may be used where moisture-resistant rigid board insulation is required, and polyisocyanurate with HCFCs. Extruded polystyrene insulation manufactured with CFCs is prohibited.
 - (6) Urea Formaldehyde Foam Insulation is prohibited in all new postal construction.



b. Vapor Retarders

Vapor retarders for built-up roofs on metal decks are discouraged, except over interior spaces with high humidity uses, such as vehicle wash bays.

c. Roof Drains

Locate roof drains away from flashings and at the mid-span of the structure rather than at columns or along parapet walls to avoid ponding at the flashings and to ensure positive drainage. Provide overflow drainage protection by using dual drains, overflow type drains, scuppers or gutters. Where scuppers drain onto a lower roof provide concrete splash block.

d. Walkways

Provide an appropriate walking surface to provide a direct route to and around all roof-mounted equipment. Walking surfaces shall be designed so as not to restrict drainage and shall be provided at all sides of equipment (4 ft. 0 in. minimum width). If rooftop equipment will require maintenance work within 10 feet of the edge of the roof, provide 3'-6" high parapet or railing.

e. Rooftop Equipment

Mount equipment to roof curbs. Provide a minimum of 12 inches below curb-mounted equipment to facilitate roof maintenance and repair. Where possible locate all rooftop equipment in one area.

f. Heat and Smoke Vents

Where heat and smoke vents are required by the building code, provide hatch-type vents with 12" high insulated aluminum curb, welded or sealed mechanical corners and integral condensation gutter and flashing. Fabricate with automatic opening double glazed acrylic or polycarbonate dome type lids. Provide units which have been tested and are UL listed and FMG approved. Gravity or drop-out vents which function by heat melting the acrylic dome are not acceptable. Provide white or frosted domes to prevent glare. Domes shall provide a minimum 60% light transmission. Coordinate location of vents with ducts, utilities, etc. to avoid obstructing daylight. Provide fall protection screens, railings or grilles at all roof openings to satisfy OSHA Standard 1910.23 and local regulations.

g. Skylights

Select skylights for weatherproofness, energy efficiency and security. Unit skylights shall be double-glazed with insulated curbs and integral flashing. Provide fall protection screens, railings or grilles at all roof openings if the skylight glazing does not meet OSHA Standard 1910.23 and local regulations.

h. Burglar Protection

In non-24 hour facilities, openings (such as skylights and duct penetrations) larger than 16"X16" require security grilles or similar Inspection Service approved device, coordinate entry protection with local inspector. Note that security grilles may also satisfy fall-protection requirements.

i. Roof Warranties

Warranties are not mandatory for roofs and should be specified only when the Contracting Officer deems them necessary and provides written justification to the A/E.

j. Roof Inspection

The USPS encourages the use of full-time roof inspection during roof construction to ensure professional workmanship and full compliance with the specifications.

2-6.3 Energy Conservation

2-6.3.1 Conservation/Environmental Policies and Goals

The Energy Policy Act of 2005 (EPA05) and the Energy Independence and Security Act of 2007 (EISA) mandate energy conservation measures that must be considered. These laws require the incorporation of energy efficiency and sustainability measures into federal agency facility operations. Facility energy consumption must be reduced 30 percent by 2015, compared to a 2003 baseline. The purchase of bio-based and recycled content based products is required (in place of conventional products) when they are available and cost effective. The laws further require the expanded use of products made of recyclable materials (those in the upper 20 percent of

energy efficiency for all similar products, or products that are at least 10 percent more efficient than the minimum level that meets Federal standards).

USPS organizational goals include reducing energy, water, and waste in our facilities and supporting the overall corporate mission and objectives with the lowest possible facility-related energy cost and impact to the environment. These objectives benefit the USPS by minimizing energy-related expenses, maximizing return on energy investments, and complying with federal energy mandates.

2-6.3.2 Conservation/Environmental Measures

All new construction and energy impacting R&A projects are to be as energy efficient as life cycle cost effective, and all new construction is to improve upon ASHRAE 90.1-2004 by at least 30%, or the largest amount practicable.

To meet the explicit requirements to maximize energy-efficiency and minimize life-cycle costs, multiple alternative designs **must** be considered in order to justify a 'best' final selection.

To meet the overall energy reduction goals, the design shall incorporate the following:

- Standardized HVAC systems to allow remote management and control in MSBD buildings greater than or equal to 15,000 square feet.
- Detailing of building envelope must avoid thermal bridging, including window and door frames.
- Orient building to minimize wind pressure at platforms, wherever site allows.
- Orient platforms to the south to minimize snow and ice build-up in cold climates.
- Low-infiltration windows and doors.
- Energy Star certification where possible.

The A/E shall consider the following energy conservation measures:

- High mass for exterior wall systems.
- Textured exterior wall finishes to increase surface air film coefficient.
- Minimal paving adjacent to buildings in warm climates (to reduce reflected heat).
- Overhangs to increase wall surface shading in warm climates.
- Low absorption roof (MSBDs).
- Orient building to minimize wind pressure at entrances, without restricting visibility.
- Air-infiltration barriers within exterior walls and ceilings (SSBDs).
- Triple glazing in severe climates.

The USPS Building Design Standards incorporate sustainable building design concepts and construction practices to provide environmentally conscious facilities for our employees and our customers. When these design requirements and construction practices are applied to new construction projects, those projects qualify for LEED certification, but actual qualification is dependant on many project specific factors. While it is not USPS policy to attain LEED certification, project teams are encouraged to

seek opportunities to implement life cycle cost effective sustainability best practices.

Both repair and alteration and new construction projects shall take advantage of *state and local government* and local utility incentive, grant, and rebate programs. The design/build entity and/or A/E shall provide documentation to the USPS Project Manager that demonstrates a reasonable effort to research and use these programs.

Refer to 4-2.1 Energy Conservation in Module 1, Chapter 4 Mechanical for additional energy conservation measures.

USPS Handbook RE-4

2-7 Miscellaneous Building Components

 G2-7-0d

2-7.1 Interior Partitions

2-7.1.1 Partition Types

USPS Handbook RE-5

a. Security Walls

 G2-7-1a1→1sl

Interior security walls that separate public areas from USPS work areas must have vertical studs spaced 16 inches OC and covered on both sides with 5/8-inch gypsum board.

For Postal Service facilities in a multi-tenant location, the minimum required demising wall construction is to space the studs 16 to 24 inches OC with a layer of 5/8-inch (minimum) plywood or OSB, 1/4-inch tempered hardboard, number 13 cold rolled flattened expanded metal, or a 22-gauge cold rolled steel sheet installed under the gypsum board.

Walls for the retail lobby, workroom, vestibules, box lobby, building and grounds room, stamp storage rooms, and specified administrative areas must be continuous from the finished floor to the bottom of joists, beams, and/or trusses.

The security wall above an accessible suspended ceiling must be constructed (at a minimum) in accordance with the requirements in this section.

Security wall construction is also required for the header space above any door or grille providing access to the workroom.

b. Temporary Barriers

Temporary barriers are used in renovation, alteration, remodeling, or expansion projects. Temporary walls are to be constructed using a minimum of 5/8-inch plywood or OSB secured to studs spaced at 16 to 24 inches OC from the floor to the underside of the permanent structural members above (joists, beams, and/or trusses).

For expansion projects, temporary walls must be constructed in a manner such that interior temperature and existing security are maintained.

At the direction of the Contracting Officer, the height of an interior temporary wall can be limited to 12 feet above finished floor (AFF) in 24-hour facilities.

The wall may be constructed of the same materials mentioned in the previous paragraph, or of 9 gauge woven wire mesh panels secured with non-removable fasteners.

2-7.1.2 **Sound Transmission**

Sound transmission control shall be provided between spaces as follows:

SPACE	ADJACENT SPACE	MINIMUM STC RATING
Offices	Other Offices, Toilet Rooms, Hall, Lobby, Workroom, Mech. Room	42
Investigative Office	Workroom, Offices, Mech. Room	45 for walls 35 for windows
Non-Domicile Inspection Office	Hall, Workroom, Mech. Room	45
Data Processing	Hall, Workroom, Mech. Room	42
Counselors (EAP, Credit Union, etc) and Medical Offices	Other counseling offices and all surrounding spaces	47
Conference Room	Offices, Lobby, Corridors	42
	Toilet Rooms, Workroom, Mech. Room	47

Exhibit 2-7a

Sound Transmission Class

Noise levels shall not exceed 80 decibels (dBA) at task location in occupied spaces when measured on the "A" scale of a standard sound level meter at slow response in accordance with OSHA. Refer to 4-4.4 Sound and Vibration Control in Module 1, Chapter 4 Mechanical for additional recommended noise levels in various facility spaces.

2-7.2 Doors and Hardware

G2-7-2a

		DOOR SCHEDULE																										
FACIL.		SIZE (W x H)					LEAF			ACTION		MATERIAL/TYPE					FRAME			DOOR ELEV	NOTE							
MSBD	SSBD	3'-0" x 7'-0"	4'-0" x 7'-0"	6'-0" x 7'-0"	1'-2" x 9'-0"	varies x 9'-0"	7'-0" x 8'-0"	SINGLE	DOUBLE	SPECIAL	SINGLE ACTING	DOUBLE ACTING	SPECIAL	HM	SCW	Wd. (special)	Alum. (special)	Stl. (special)	Wood/Glass	Alum/Glass	Alum/Polycarbonate	Polyethylene	Steel tube/channel	Hollow metal	Aluminum	Wood		
	LOCATION																											
■	Workroom egress	●					●	●	●	●	●	●	●	●									●				A	
■	Wire mesh/day gates						●	●	●	●	●	●	●	●									●				N	7
■	Criminal Investigative Office Exterior	●					●	●	●	●	●	●	●	●									●				G	
■	Criminal Investigative Office Interior	●					●	●	●	●	●	●	●	●									●				H	
■	Carrier vestibule exterior impact			●			●	●	●	●	●	●	●	●								●	●				E	
■	Carrier vestibule interior impact			●			●	●	●	●	●	●	●	●								●	●				E	
■	Carrier vestibule exterior personnel	●					●	●	●	●	●	●	●	●									●				A	
■	Carrier vestibule interior personnel	●					●	●	●	●	●	●	●	●									●				A	
■	Mail vestibule exterior impact			●			●	●	●	●	●	●	●	●								●	●				E	2
■	Mail vestibule interior impact			●			●	●	●	●	●	●	●	●								●	●				E	2
■	Mail vestibule exterior personnel	●					●	●	●	●	●	●	●	●									●				A	
■	Mail vestibule interior personnel	●					●	●	●	●	●	●	●	●									●				A	
■	Mail vestibule combo personnel			●			●	●	●	●	●	●	●	●								●	●				A	
■	Enclosed platform overhead					●		●	●	●	●	●	●	●								●	●				L	9
■	Administration/Office Areas	●					●	●	●	●	●	●	●	●								●					A	
■	Building and Grounds			●			●	●	●	●	●	●	●	●								●					A	
■	Conference Room	●					●	●	●	●	●	●	●	●								●						6
■	Custodial Supplies	●					●	●	●	●	●	●	●	●								●					A	
■	Electrical Room	●					●	●	●	●	●	●	●	●								●					A	
■	General Storage	●					●	●	●	●	●	●	●	●								●					A	
■	Janitor's Closet	●					●	●	●	●	●	●	●	●								●					A	
■	Locker Room	○					●	●	●	●	●	●	●	●								●					A	1
■	Mechanical Room	●					●	●	●	●	●	●	●	●								●					A	
■	Postal Equipment Storage	●		●			●	●	●	●	●	●	●	●								●					A	
■	Records	●					●	●	●	●	●	●	●	●								●					A	
■	Stamp Storage	●					●	●	●	●	●	●	●	●								●					A	
■	Stockroom	●		●			●	●	●	●	●	●	●	●								●					A	
■	Toilet Room	○					●	●	●	●	●	●	●	●								●					A	1
■	Vault	●					●	●	●	●	●	●	●	●								●					M	
■	Folding grille, Full Service			●			●	●	●	●	●	●	●	●								●					J	5
■	Grille closet, Full Service			●			●	●	●	●	●	●	●	●								●					I	4
■	Customer storefront vestibule	●					●	●	●	●	●	●	●	●								●					B	10
■	Folding grille, Postal Store			●			●	●	●	●	●	●	●	●								●					J	5
■	Grille closet, Postal Store			●			●	●	●	●	●	●	●	●								●					I	4
■	R-box alcove (egress only)	●					●	●	●	●	●	●	●	●								●					G	
■	Wicket						●	●	●	●	●	●	●	●								●					F	3
■	Wicket						●	●	●	●	●	●	●	●								●					F	3
■	BMEU exterior	●					●	●	●	●	●	●	●	●								●					A	
■	BMEU interior	●					●	●	●	●	●	●	●	●								●					D	

● TYPICAL ○ OPTIONAL, REQUIRES USPS APPROVAL

DOOR SCHEDULE NOTES:

- 1 Door may not be required if adequate screening is provided.
- 2 An 8'-0" set of doors may be required to ease future equipment installation.
- 3 Door has hinged panel and shelf in top half (not a Dutch door).
- 4 Wood door is laminated with masonite both sides.
- 5 Special door required per specifications.
- 6 Door may have sidelight.
- 7 Dutch door or sliding door are optional.
- 8 For door elevations, see USPS Standard Detail G2-7-2a
- 9 SSBD platform doors are 7'-0" x 10'-0"
- 10 Bi-parting automatic sliding doors are optional

2-7.2.1 Doors

All hollow-metal doors other than storefront doors shall be 18 gauge steel with 16 gauge steel frames.

 G2-7-2d-2d3

USPS Handbook RE-4

a. Building Entrances

All building entrances should be designed to promote maximum energy efficiency, so as not to excessively waste heating or cooling resources. Further, in areas of poor air quality (non-attainment areas as defined by the Clean Air Act), similar considerations shall be made to ensure that excess outside air is not unnecessarily brought into the building.

USPS Handbook RE-5

MSBD, SSBD

b. Mail and Carrier Vestibule Doors

c. Sectional Overhead Doors

Typically, 7 ft. w x 8 ft. h (7 ft. w x 10 ft. h at SSBDs) overhead doors will be required. Overhead doors at platform spaces without dock equipment may use 6 ft. w x 8 ft. h doors. All doors shall be manufactured as a sandwich of galvanized steel panels with an insulation core, weather sealed with two (2) secure vision panels. Doors shall be lockable and manually operated.

Provide knockout panel doors in facilities where fork lifts or other vehicles operate on Platforms.

Place 6" diameter steel concrete filled bollards at base to a height of 4 ft. above the finished floor and metal fabricated frames at head to protect doors from damage.

d. Locker Room and Toilet Room Doors

If approved by USPS, doors may not be required when proper visual screening can be provided. If doors are provided, they shall swing out from the locker room and be recessed into an alcove or have guard rails or bollards provided to prevent accidents.

e. Wicket Doors

Provide wicket doors in the public lobby as required by the Retail Design Standards. Wicket doors may be either 18 GA steel or 1-3/4" structural composite lumber (SCL) with 16 GA frames.

 G2-7-2b

f. Automatic Doors

Automatic doors are to be used at the main customer entry of all new construction customer service facilities 4,000 square feet and greater. Both push-button and sensor type operators are acceptable. If recommended by the operator manufacturer, guiderails shall be provided on swing side of such doors to prevent accidents, and shall be designed for child safety. If automatic doors are utilized at facilities where the lobby is not open 24 hours a day, provide a keyswitch and/or timer to shut off power after-hours.

g. Wire Mesh Doors

Provide standard size door levers at wire mesh doors, where provided.

h. Exit Doors

Provide tactile signs as required by RE-4.

2-7.2.2 Hardware

USPS Handbook RE-4

a. General

USPS Handbook RE-5

Hardware selections shall be based on ANSI series standards and functions.

All door handles shall be lever type.

Provide push-pull hardware on all multiple fixture toilet and locker room doors.

All doors designated emergency exit only shall have the following features:

USPS Handbook RE-5

- No exterior hardware allowing entry from the outside.
- Local alarm powered by a 110V source with battery back-up and 110db horn with strobe light above the door.
- Security butt hinges with non-removable pins.
- Security viewer, if required.
- UL-rated security exit device.
- A sign stating “Emergency Exit Only – Reentry Prohibited” and alarm will sound if door is opened.

See Module 1, Section 5-7.5 for additional requirements.

b. Security

Use mechanical or electro-mechanical controlled access devices at facilities less than 6,500 SF. For facilities 6,500 SF and over, use electro-mechanical device and electronic key pads.

Provide deadbolt/mortise lock at all exterior doors and doors leading from public space(s) to the workroom, or other approved Inspection Service door locks.

All doors that have lock cylinders exposed to the public, as well as entry doors to designated secured rooms, shall have lock cylinder security collars.

All doors with hinges exposed to the public, as well as designated secured room doors that swing outward, shall have security hinges.

Extended metal door shoes (without weatherstripping), metal C-channels, or similar devices must be installed on all doors in the security envelope, including wicket doors, so that the clear space between the bottom of the door and the floor or threshold does not exceed 1/8 inch.

If removable core locks are used, the lock cylinder shall be equipped with a security collar to prevent cylinder removal when the door is closed.

Delayed-exiting devices are not authorized for use in Postal facilities.

Consult with the local postal inspector for hardware security requirements beyond those described above.

c. Keying

Door hardware shall be keyed with the following considerations:

- Locks shall incorporate a security system to assure that keys used during construction will not open doors after USPS occupancy.
- Grand master keying is prohibited.
- The key side of all locks on doors adjacent to public spaces shall be on the public side.
- All locks shall be keyed differently except within individual groups/functions (as applicable), which shall be keyed alike as indicated below:
 - Mechanical and Electrical Equipment Rooms.
 - Custodial Storage and Custodial/Janitor's Closets.
 - Bulletin boards and directories.
 - Electrical panelboards.
 - Telecommunications Closets

Individual keying is mandatory for all areas requiring individual accountability, such as stamp storage rooms, personnel records rooms and Postal Retail Stores.

Typically, only Postmasters may carry a master key. This master key, however, is not a grandmaster key, which would open all doors in the facility.

A lockable key cabinet shall be provided and sized to hold all keys for the facility. The key cabinet should be installed in the stamped envelope storage rooms in MSBD facilities. Fire Department lock boxes are discouraged and can only be provided with an approved deviation.

d. Wicket Doors

Wicket doors require a hotel type hardware set, a security viewer and if required, an extended metal door shoe to prohibit manipulation of the hardware set. Provide a doorbell for customers to signal need for assistance.

e. Vestibule Impact Doors

Vestibule impact doors require a 1 5/8 in. (inside diam.) chain hole and either cane bolts (top and bottom) or slide bars for daytime security. If the slide bar option is implemented, the bar shall be ½ in x 2 in. (min.) hot rolled steel. The length will vary depending on the door thickness. The bar shall be lockable when in the secured position.

f. Building and Grounds Room

When double doors are used, provide a three-point locking system. The inactive leaf shall have 1" steel pins at the door head and at the floor (set in a concrete sleeve). Hinges shall be security type with non-removable pins.

g. Roof Scuttle

Provide a hasp for padlock (padlock by USPS) at the roof scuttle, installed from the inside of the building.

2-7.3 Vertical Circulation

 G2-7-3a→a2

Permanent and safe means of access shall be provided to all mechanical equipment, including roof-mounted equipment (if applicable) requiring maintenance.

2-7.3.2 Stairs and Ladders

MSBD

2-7.4 Protective Barriers

MSBD, SSBD

In the Workroom, recess such items as electrical panels, water coolers, conduits, switch boxes, outlets, storm drain leaders, and fire sprinkler risers to prevent damage by postal traffic and/or eliminate unsafe obstructions or wall projections. When recessing is not feasible, provide protective barriers, bollards, or pipe rails. Where possible, locate fire extinguishers inside the flanges of columns for protection. Platform stair railings shall be protected by bollards.

 G2-7-4a→e2

Walls and partitions in workrooms, mailing vestibules, and carrier vestibules shall be protected with fiberglass reinforced plastic (FRP) panels. On platforms and carrier slabs, where wall materials are subject to be easily damaged, i.e. gypsum board, cement plaster, etc., provide wood or wood polymer bumper protection. Generally provide double bumpers on platform walls and single bumpers on carrier slabs. If CMU, cast concrete, and other walls that can withstand abuse are used leave unprotected.

Wall bumpers are to be manufactured from recyclable plastic and are to be non-toxic and shall not support combustion or present any toxic danger from burning. Wood bumpers may be used only in expansion projects to match existing conditions at the direction of the Contracting Officer.

2-7.5 Building Identification and Signage

 G2-7-5a→m1

All room identification signs and signs at exit doors shall be tactile signs, with raised characters and Braille.

2-7.5.1 Exterior Signage

Module 4F

A sign with the building address number should only be provided if requested by the local authorities. If one is provided, then its size and design must be in character with the building design.

 G2-7-5h→y1

For detailed criteria, refer to Module 4F, Exterior Signage.

2-7.5.2 Retail Areas

Module 4A

For detailed criteria refer to Module 4A Retail Design Standards.

2-7.5.3 **Workroom**

Provide emergency exit signs with directional arrows to points of egress. Signs shall be mounted at a height that will prevent damage from rolling equipment.

MSBD

2-7.5.4 **Platforms**

MSBD

2-7.5.5 **Administrative Support and Other Non-Retail Areas**

Identify rooms with signs indicating room title and number as requested by USPS. The sign shall be designed to have removable inserts for easy replacement.

USPS Handbook RE-4

 G2-7-5z→z3

2-7.5.6 **Flagpole**

Provide a single, seamless tapered aluminum or anodized cone flagpole, complete with all accessories (flag is furnished by USPS). The height of the flagpole shall be 22 ft. 0 in. (min.) above grade. Consideration should be given to the height of the flagpole in relationship to the height of the building. The pole shall be located to the left of the principal entrance as one faces the building and shall be grounded for lightning protection. Provide lighting if the flag is to remain flying after dark, based on the operational hours of the facility.

 G2-7-5z3

2-7.6 Building Materials

To the extent possible, the 'green' version of the USPS Master Specification (applicable to SSBD and MSBD) shall be considered.

Building material selection and specification should consider the impact on human health and natural environment over the full life cycle of the building material or product. Consideration shall be given to materials with recycled content. An attempt should be made to improve the indoor air quality by limiting the amount of VOCs and considering materials free from urea formaldehyde. Materials which have water based formulations are preferred over solvent based materials.

Use of green or sustainable products should not be considered if the product is inferior to commonly used products or has not been tested or proven in its application.

Use of lead-based paint is prohibited in the design and construction of USPS facilities. Use of asbestos-containing materials in excess of one percent as defined by applicable EPA regulations, is prohibited in the design and construction of USPS facilities.



2-7.6 Entry Feature

MSBD

2-8 Fire Protection

The use of halon or carbon dioxide extinguishing systems in new construction and repair & alteration projects is strictly prohibited. Halon contains chlorofluorocarbons (CFCs), ozone depleting substances that are being phased out of production in accordance with the Clean Air Act Amendments of 1990. Carbon dioxide systems present excessive danger to personnel in confined spaces.

In lieu of halon or carbon dioxide, automatic sprinkler protection is recommended. In order to minimize damage to computers or other equipment located in sprinkler protected areas, NFPA 75 requires a disconnect means to interrupt the power to all electronic equipment in the computer room. Fire wall separations are also recommended as a means to control and limit damage. Where the space contains a raised floor, provide smoke detection sensors with an alarm system.

The design of computer room fire suppression systems should consider an on-off sprinkler (pre-action) system using smoke/heat detectors.

2-8.1 Occupancy/Hazard Ratings

Exhibit 2-8a indicates minimum requirements only. Local codes govern where more stringent.

SPACE³	NFPA 13 OCCUPANCY¹
Workroom & Platform	Ordinary Hazard, Group 2
Lobbies and Support Areas	Ordinary Hazard, Group 2
Office/Admin. Areas	Ordinary Hazard, Group 1 ²

Exhibit 2-8a

Occupancy/Hazard Ratings

Footnotes:

1. Exhibit 2-8a is applicable to one story facilities only. For two story facilities, refer to the local building code.
2. Requires fire-rated separation from the Workroom and other Group 2 areas. Otherwise Ordinary Hazard Group 2 is required.
3. All facilities shall be deemed "Class B" per OSHA classification criteria.

2-8.1.1 Workrooms

The decision to install sprinklers in the workroom shall be based on occupancy classification, the size of the building, construction classification and exiting distances. Other factors, such as fire zone, accessibility for fire fighting equipment, and distance from other structures, etc., shall also be evaluated to assure compliance with NFPA 101 and national and local codes.

2-8.1.2 Lobbies and Support Areas

These areas will generally have the same classification as the Workroom. Where the support areas have contents of higher hazard, such areas shall

be separately classified and isolated from the workroom with fire-rated enclosures.

2-8.2 Fire Extinguishers

Fire extinguishers shall comply with NFPA 10, "Portable Fire Extinguishers", and shall be the approved ABC, multipurpose dry chemical type (10-pound minimum capacity). Use of portable halon fire extinguishers containing CFCs is prohibited.

 G2-8-2a

Maximum travel distance to extinguishers is 50 ft. Placement of extinguishers shall be coordinated with USPS Safety. When located in retail lobbies, fire extinguishers shall be located in lockable, break-glass cabinets.

Fire extinguisher cabinets shall be recessed so that the outside frame of the cabinets is flush with the wall at all locations except workroom, where they may be surface-mounted.

2-8.3 Sprayed-on Fire Protection

All materials for sprayed-on fire protection shall be either 1) factory mixed cementitious materials having a minimum applied dry density of 18 pounds per cubic foot, or 2) factory mixed mineral fibers with integral inorganic binders having a minimum applied dry density of 15 pounds per cubic foot. Asbestos is not permitted.



The bonding adhesive for fibrous fire protection materials shall be as recommended and supplied by the fire protection material manufacturer. The adhesive may be an integral part of the material or applied separately to the surface receiving fire protection.

The sealer for fibrous materials shall be as recommended and supplied by the fire protection material manufacturer. The sealer shall be an integral part of the material or applied separately to the exposed surface. It shall be fungus resistant and have fire hazard classifications as follows:

- Flame Spread: 25 or less
- Fuel Contributed: 50 or less
- Smoke Developed: 50 or less

When firestopping materials, such as sealants are used, they are to be paintable type and shall be painted.

2-9 Investigative Systems

MSBD

Investigative Systems (IS) may include video surveillance cameras with a Investigative Office (IO). These Investigative components are used exclusively by the Inspection Service and the Office of the Inspector General (OIG), in the performance of their investigative missions.

Facilities under 60,000 SF shall require an Investigative System when the USPS planning requirements dictate a 10-year projected complement of 29 or more carrier routes. The Investigative Systems (IS) will consist of video surveillance cameras, CCTV components, and a Investigative Office (IO).

The IS cameras and associates cabling are provided under the general construction contract.

Refer to Chapter 5 Electrical in Modules 1 and 2 for electrical design criteria for Investigative CCTV Systems.

2-9.1 Investigative Office (IO)

The IO houses the CCTV console, equipment, and controls. A covert entrance shall be provided to the Investigative Office for use by the Inspection Service and Office of the Inspector General in an area remote from the primary employee entrance, and should be either recessed into the building or screened with a privacy wall or fence.

When determined to be required in a SSBD facility, refer to SSBD Plan 100C for sizing and layout.

MSBD

 G2-9-1a

USPS Handbook RE-5

2-10 Safety

2-10.1 Egress

Facility mailing vestibule doors, if applicable, are for transporting mail to and from the loading docks. These vestibule doors are not an approved means of egress and must be designated and/or identified with a 'NOT AN EMERGENCY EXIT' sign.

No less than two means of egress shall be provided from the Workroom – no exceptions.

All egress routes shall lead to exits that discharge to open space that allows for safe access to a public way.



 G2-7-5b

2-10.2 Walking Surfaces

Provide slip-resistant walking surfaces on stairs; in locker rooms; and on toilet and customer lobby floors. Steel-troweled concrete with a light broom finish is required on platforms, ramps, and platform and carrier vestibules.

[This page intentionally left blank.]

Checklist

[This page intentionally left blank.]

Architectural Checklist

Facility Name:

City, State, Zip:

Project Phase:

Reviewer (Individual/Firm Names):

Telephone Number:

Date:

NOTE: The "Facility Type" column indicates the facility type to which the checklist item is applicable. A blank cell in this column indicates that the checklist item is General and applies to Majors, MSBD and SSBBD facilities.

Section No.	Facility Type	✓	Item	Comment
2-1			INTRODUCTION	
2-1.1			Design complies with USPS program document (919/929).	
2-2			WORKROOMS	
2-2			Workroom layout is as contiguous and rectilinear as possible.	
2-2			There is secure separation of workroom from public spaces.	
2-2			Workroom roof deck is galvanized and left unpainted.	
2-2			Workroom roof structure is primed and not painted.	
2-2	MSBD		Mechanization(if provided)/automation equipment is coordinated for space and power requirements.	
2-2.1			Casework equipment layout has been coordinated with USPS.	
2-2.2	MSBD		Wire screen enclosures comply with criteria. Sides and top are secure.	
2-2.3			Workroom height complies with criteria. For MSBD facilities, a ceiling is not provided.	
2-3			PLATFORMS	
2-3			Required dock types have been verified with USPS.	
2-3			Mail platforms meet dimensional criteria.	
2-3			Platform heights comply with 919/929.	

Section No.	Facility Type	✓	Item	Comment
2-3.3	MSBD		Carrier platforms meet dimensional criteria.	
2-3.5			Columns are set back 1'-6" from edge of platform(s) and protected.	
2-3.6			Ramps are provided for cart access to postal vehicles not located at docks, and for handicapped accessibility.	
2-3.7			Stairs comply with criteria.	
2-3.8			All dock equipment is coordinated dimensionally and for power requirements.	
2-3.8.1			Hydraulic, front-mounted adjustable ramps are provided.	
2-3.8.2			Dock levelers are provided in accordance with 919/929 and comply with USPS criteria.	
2-3.8.4			Scissors lifts are provided in accordance with 919/929.	
2-3.8.5			Bumpers are provided at mail and elevated carrier platforms. Steel channel is provided at open platforms.	
2-4			SUPPORT AREAS	
2-4.2			Toilet fixture counts comply with criteria.	
2-4.2			Toilet accessories are coordinated with USPS.	
2-4.2			Fixtures/partitions are properly mounted per criteria.	
2-4.3			Locker room requirements comply with criteria. Locker size, i.e. half height/full width or half width/full height, has been coordinated with USPS.	
2-4.4			Floor drains are provided at vending areas.	
2-4.5	MSBD		Open office systems furniture layout has been provided.	
2-4.8	MSBD		Vault(s) are located per criteria and are either poured in place or modular.	
2-4.9			Requirement for outside storage area has been verified with USPS. If required, the design complies with criteria.	
2-4.14	MSBD		Battery charging area design complies with criteria.	
2-5			RETAIL DESIGN STANDARDS	

Section No.	Facility Type	✓	Item	Comment
2-5			If an Open Merchandise area is provided, the design complies with Retail Design Standards criteria (see Module 4A).	
2-6			EXTERIOR ENVELOPE	
2-6.1.1			Materials are low-maintenance and compatible with locale.	
2-6.1.2			Windows at administrative and related support offices (if provided) do not exceed 30% of exterior wall area.	
2-6.1.2			Windows meet glazing and security requirements per criteria and Handbook RE-5.	
2-6.2.3d			Walkways are provided to all roof mounted equipment.	
2-6.3			Energy conservation measures have been considered.	
2-7			MISCELLANEOUS BUILDING COMPONENTS	
2-7.1.2			STC ratings comply with criteria.	
2-7.2.1			Building entrances are designed to promote maximum energy efficiency.	
2-7.2.1b 2-7.2.2			Mail and carrier vestibules are coordinated for door swing direction and door protection (bollards, overhead stops), hardware and signage.	
2-7.2.1.d			If doors are provided at locker/toilet rooms, do they swing out and are they recessed in alcove?	
2-7.2.2			Hardware has been coordinated with USPS inspection services.	
2-7.3			Permanent, safe access is provided to all mechanical equipment.	
2-7.4			Protective barriers are provided per criteria. FRP wall protection is provided at workroom.	
2-7.5			Exterior signage complies with Pub. 500D.	
2-7.5			Interior signage meets RE-4 and criteria requirements.	
2-7.5			All signage requirements are coordinated with USPS.	
2-7.5.4	MSBD		Truck dock positions are numbered, inside and out.	
2-7.5.5			Interior signage complies with Handbook RE-4 and is coordinated with USPS.	

Section No.	Facility Type	✓	Item	Comment
2-7.5.6			Flagpole complies with criteria.	
2-7.6			Products with recycled content have been considered.	
2-7.6			Asbestos containing materials are not specified.	
2-8			FIRE PROTECTION	
2-8			Halon/carbon dioxide extinguishing systems are not specified.	
2-8			Requirement for pre-action sprinkler system has been verified with USPS.	
2-8.1.1			Requirement for sprinkler head on the workroom side of the Self-Service area has been verified.	
2-8.2			Maximum travel distance to fire extinguishers is 50 ft.	
2-9			INVESTIGATIVE SYSTEM	
2-9			An Investigative System is provided where required by the criteria.	
2-9.1			Covert entrance is provided to the Investigative Office.	
2-9.1			Investigative Office complies with all criteria and Handbook RE-5.	
2-10			SAFETY	
2-10.1			Vestibule doors at loading docks are identified with a "NO EXIT" sign.	
2-10.2			Slip resistant and troweled concrete surfaces are provided per the criteria.	

[This page intentionally left blank.]

Module 1 General Criteria

Chapter 3 Structural

3-1 Introduction

3-1.1 Codes and Standards

3-2 Design

3-2.1 Geographic Considerations

3-2.2 Foundations

3-2.3 Design Loads

3-2.4 Column Design/Framing Systems

3-2.5 Exterior Wall Systems

3-3 Computations

Checklist

[This page intentionally left blank.]

Chapter 3 Structural

3-1 Introduction

3-1.1 Codes and Standards

All facilities shall be designed in accordance with the requirements set forth by the applicable state and/or local codes and construction material codes in force at the time of design. In addition, the following USPS minimum design criteria shall be followed. Where two or more codes, standards or USPS criteria are in conflict, the more stringent shall apply.

3-2 Design

3-2.1 Geographic Considerations

All appropriate building systems shall be designed in accordance with site specific local requirements for snow, wind, frost depth and seismic zone. Follow the seismic provisions of the model code (UBC, BOCA, or SBC) commonly adopted in the area where the facility will be located or provisions of the local code, whichever is more stringent.

3-2.2 Foundations

Foundation and ground floor slab design shall be based on site specific geotechnical evaluation and recommendations. The design engineer shall take into consideration the full effects of differential settlement when designing foundations. The geotechnical engineer shall develop his foundation system recommendations so as to limit differential settlement between columns as follows (S = span in feet between columns):

Facilities without fixed mechanization = $\frac{S(12)}{1000}$ in.

Facilities with fixed mechanization = $\frac{S(12)}{1500}$ in.

For example, a facility (without fixed mechanization) with a 50 ft. x 50 ft. bay size should be designed for a maximum differential settlement of $(50)(12)/1000 = 0.60$ in. between column foundations.

Where compacted controlled fill is utilized, spread footings should not be supported on deep (in excess of 3 ft. 0 in.) structural soil fill due to problems experienced with compaction and differential settlement. All compacted structural fill, when required, shall be placed under the direction of a qualified

geotechnical engineer and the contractor shall submit certified compaction results. These requirements may be waived by the USPS when the A/E provides full justification for their use, accompanied by a detailed description of quality control procedures.

3-2.3 Design Loads

3-2.3.1 Minimum Design Loads

Calculate design dead loads based on minimum code requirements or actual weights of the material specified, whichever is greater. Include weight of snow (including drift), and other equipment, utilities and services in seismic calculations where required by applicable codes.

Design live loads, including wind and snow loads, shall be in accordance with all applicable codes or the following table, whichever is more stringent:

LOCATION	MINIMUM DESIGN LIVE LOAD (PSF)
Workroom Floor	150 ¹
Platform, Support Areas and Retail Store Floors	150 ¹
Mechanical Room Floor	150 ³
Roof	20 ⁷
Building Utilities/Services (Hanging Load) above Mechanical Equipment Rooms	30 ³
Building Utilities/Services (Hanging Load) above all rooms other than Mechanical Equipment Rooms	5 ^{2,3}

Exhibit 3-2a

Minimum Design Loads

Footnotes:

1. Floors in workrooms, platforms, storage rooms and all other spaces accessible to forklift traffic shall be designed for the live load indicated or for the effects of a fully loaded 3000 lb. capacity forklift (8,400 lb. axle load), or for the mechanization loads given below, whichever is more stringent.

Where floor supported mechanization is used, if the floor can be used for mail storage below the mechanization equipment then the uniform load used shall be 150 psf plus the actual mechanization load, otherwise the uniform load used shall be the larger of the 150 psf or the actual mechanization load.

Verify floor load requirements for RCS (Robotic Containerization System)

2. Add 3 psf or actual ceiling loading, whichever is greater, where ceilings are required.
3. Or actual equipment and services, whichever is greater. At mechanical room floors, consider concrete housekeeping pads as additional dead load, not to be included in the live load allowance.
4. Not Used.

5. Not Used
6. Not Used
7. Plus hanging loads indicated. In regions where snow load is less than 20 psf, reduction in general roof live load below 20 psf may be made only where permitted by all applicable Codes.

3-2.3.2 **Not Used**

3-2.3.3 **Contract Drawings**

Include the following structural criteria on the contract drawings as a minimum:

- Listing of applicable building codes.
- Tabulation of zones, exposure categories and calculated basic loading values for wind, snow and seismic loads.
- Design dead and live load key plan and schedule, with separate entries for (1) beams, (2) girders and (3) columns and foundations where appropriate.
- Snow drift and wind uplift loading diagrams.

3-2.4 Column Design/Framing Systems

3-2.4.1 **Column Design and Bay Sizes**

All columns shall be designed to support roof-supported mechanization (if applicable). Columns shall be located to minimize effect on Postal operations.

Bay sizes shall be as large as practical to maximize clear floor space within the facility workroom and retail space. Following are typical bay sizes for postal facilities.

FACILITY TYPE	BAY SIZE (ft.)
MSBD	20 x 40
SSBD	See Standard plans

Exhibit 3-2b
Bay Sizes

3-2.4.2 **Roof Systems/Deflection**

All roof framing shall be designed to support roof-supported mechanization (if applicable). Roofs shall be designed with a minimum pitch of ¼ in. per ft. (½ in. per ft. for standing seam metal roofs) and maximum live load deflection of L/360, with a maximum total load deflection of L/240.

Standing seam metal roofing (SSMR) panel deflection under full dead and live and/or wind load shall not exceed 1/180 times the span between supports.

Consider all live and dead load deflection that the structural systems may be subjected to, such as mechanical, electrical and architectural features that

are supported by and or fastened to the structure in addition to allowing for positive drainage of the roof system.

3.2.4.3 Structural Wood Systems

Structural wood systems are permissible, if approved by USPS. Trusses shall be designed by the most economical method, e.g. two parts with a center support (if a clear span is not essential), shorter lengths to avoid special shipping permits, etc.

3-2.5 Exterior Wall Systems

Design provisions shall be made for connection of the wall system to the primary structural system with full consideration of the serviceability requirements of the wall type selected.

3-3 Computations

Structural computations shall be prepared for all load carrying members, in a neat, orderly and understandable manner. They shall be complete with appropriate references and sources of design input and shall be submitted for review along with scheduled design submittals.

Provide a Table of Contents with the computations. Computations shall be signed and sealed by a professional engineer licensed in the state where the project is located.

[This page intentionally left blank.]

Checklist

[This page intentionally left blank.]

Structural Checklist

Facility Name:

City, State, Zip:

Project Phase:

Reviewer (Individual/Firm Names):

Telephone Number:

Date:

Section No.	✓	Item	Comment
3-2		DESIGN	
3-2.1		Structural systems comply with site specific requirements (snow, wind, frost depth, seismic), as applicable.	
3-2.2		Foundation/floor slab design is based on geotechnical recommendations.	
3-2.2		If identified by geotechnical report, surface/subsurface conditions affecting design, such as high moisture content in surface soils, unsuitable fill, buried trash, presence of perched or high groundwater levels, etc. have been evaluated.	
3-2.2		Foundation system and retaining wall (if applicable) are designed according to geotechnical recommendations; differential settlement analysis has been performed.	
3-2.2		If site requires controlled compacted structural fill under building foundations, the fill depth does not exceed 3'-0".	
3-2.3		Design live/dead loads comply with criteria/local codes.	
3-2.3		Mechanization loads (if applicable) have been considered.	
3-2.4.1		Column bay spacing, sizing, orientation and numbering are coordinated with the architectural plans.	
3-2.4.2		Structural systems comply with deflection criteria.	
3-2.5		Exterior wall sections are dimensionally coordinated with architectural and structural details, showing clearances and support requirements.	

Section No.	✓	Item	Comment
3-2.6		Not Used	
3-3		COMPUTATIONS	
3-3		Structural computations have been prepared and submitted for all load carrying members, complete with code references to sources of design input.	

[This page intentionally left blank.]

Module 1 General Criteria

Chapter 4 Mechanical

4-1 Introduction

- 4-1.1 Scope
- 4-1.2 Codes and Standards
- 4-1.3 Commissioning
- 4-1.4 Measurement and Verification (M&V)

4-2 HVAC

- 4-2.1 Energy Conservation
- 4-2.2 Outside Design
- 4-2.3 Inside Design
- 4-2.4 Space Specific Requirements
- 4-2.5 Design Loads
- 4-2.6 Thermal Transmittance (U-Factors)
- 4-2.7 Computations
- 4-2.8 Zoning
- 4-2.9 HVAC Controls
- 4-2.10 [Reserved]
- 4-2.11 Central Heating Systems
- 4-2.12 Air Handling Systems
- 4-2.13 Not Used
- 4-2.14 Not Used
- 4-2.15 Miscellaneous HVAC Requirements

4-3 Plumbing

- 4-3.1 Water Supply Systems
- 4-3.2 Sanitary Drainage Systems
- 4-3.3 Plumbing Fixtures
- 4-3.4 Storm Drainage
- 4-3.5 Fuel Systems
- 4-3.6 [Reserved]
- 4-3.7 Miscellaneous Plumbing Requirements
- 4-3.8 [Reserved]
- 4-3.9 [Reserved]

4-4 Miscellaneous HVAC/Plumbing Components

- 4-4.1 Motors and Starters
- 4-4.2 Pumps, Piping and Fittings
- 4-4.3 Insulation
- 4-4.4 Sound and Vibration Control

4-5 Fire Protection

- 4-5.1 Sprinkler Systems
- 4-5.2 Standpipe and Hose Systems
- 4-5.3 Duct Mounted Smoke Detectors
- 4-5.4 Food Service

4-6 Construction Closeout

Checklist

Chapter 4 Mechanical

4-1 Introduction

4-1.1 Scope

The design criteria within this document specify mechanical requirements for design and construction of new SSBD's and MSBD's. The mechanical systems shall provide year-round control of temperature, humidity, air circulation, ventilation, and air cleaning to the degree required to ensure the safe and efficient use of space by occupants and equipment.

4-1.2 Codes and Standards

MSBD

The design criteria within this document specify mechanical requirements for design and construction of new SSBD's and MSBD's. The mechanical systems shall provide year-round control of temperature, humidity, air circulation, ventilation, and air cleaning to the degree required to ensure the safe and efficient use of space by occupants and equipment.

Whenever unique problems or conditions not covered herein are encountered, the AE/Designer shall follow generally accepted industry practices as reflected in the latest issue of the American Society of Heating, Refrigeration and Air-conditioning Engineers (ASHRAE) handbooks and the National Institute for Occupational Safety and Health (NIOSH) Criteria for a Recommended Standard for Occupational Exposure to Hot Environments. Refer potential solutions and their recommendations to USPS Design and Construction (D&C) Authority for final approval.

The AE shall provide a complete mechanical, plumbing and fire protection design for the facility in accordance with the issuance of site specific program requirements. The AE shall be responsible for the complete performance and installation of all systems; the provided systems shall be fully coordinated between disciplines, trades and existing conditions, functional and consistent with the architectural design developed for the building along with site specific facility functional requirements.

Buildings shall be designed in accordance with the requirements set forth by the applicable national, state and/or local codes and standards enforced at the time of design. In addition, the design criteria contained in this document shall be followed. Where two or more codes, standards or USPS criteria are in conflict, the more stringent shall apply.

Design all new Postal facilities to comply with the Energy Policy Act (EPACT) of 2005 and the "Energy Independence and Security Act of 2007" in accordance with the USPS Criteria and ASHRAE 90.1-2004. When the two latter standards are in conflict, follow whichever is more stringent, unless

explicitly excluded within the Standard Design Criteria. These mandates require that all new facilities be designed to exceed the ASHRAE 90.1-2004 Compliant Base Case by 30 percent or the greatest extent practicable.

If the additional 30 percent savings is not life-cycle cost-effective, evaluate the cost-effectiveness of alternative designs at successive decrements below 30 percent (e.g., 25 percent, 20 percent, etc.) in order to identify the most energy-efficient design that is life-cycle cost-effective for that building. However, the building must remain compliant with ASHRAE Standard 90.1-2004.

An Energy Compliance Certification (ECC) form must be submitted to the FSO Energy Manager for all new SSBD's and major R&A projects at the 30% and 100% design submissions. The ECC must be submitted for all new MSBD's and major R&A projects at the 30% design submission and again at project acceptance, after Commissioning and M&V have been completed. The purpose of the form is for the AE or Contractor to demonstrate that the HVAC design is energy efficient and complies with Postal Standards. The FSO Energy Manager must approve the design before it can be implemented. The ECC forms are available from the Facilities Service Office (FSO) having jurisdiction over the project.

The AE shall submit the following documentation with the 30% and 100% design levels as a minimum, and as specified by the Contracting Officer. Forms and drawings submitted shall be stamped by a Professional Engineer.

- Performance Rating Report **
- Building Envelope Compliance Documentation **
- HVAC Mandatory Provisions **
- Service Water Heating Compliance Documentation **
- Equipment selections and alternatives documented in a Life Cycle Cost Analysis (LCCA). The LCCA shall utilize the:
 - Latest edition of NIST Handbook 135, Life-Cycle Costing Manual for the Federal Energy Management Program.
 - Current USPS economic factors. These factors can be obtained from the USPS Intranet and will be provided by the USPS (USPS Memorandum titled "Decision Analysis Report Factors/Cost of Borrowing/New Facility Start-up Costs Update").
- Building heating and cooling load calculation summary output from the load simulation program.
- Provide an electronic archive of the building models from the software system used to perform the simulations along with a brief description of the software and release version used to perform the simulation.

* Available from the FSO Energy Manager.

** ASHRAE 90.1 Appendix G Compliance Forms are available at www.ashrae.org under Interactive 90.1-2004 Compliance Forms.

Energy consumption for the purposes of calculating the 30 percent savings shall include space heating, space cooling, ventilation, service water heating, lighting and all other energy consuming systems normally specified as part of the building design except for receptacle and process loads.

These requirements apply to all new construction and additions greater than 15,000 square feet.

The energy consumption levels for both the baseline building and proposed building shall be determined by using the Performance Rating Method found in Appendix G of ASHRAE 90.1 – 2004 except the formula for calculating the Performance Rating in paragraph G1.2 shall be modified regarding exclusion of receptacle and process loads to read as follows:

Percent improvement = $100 \times [(B_1 - P_1) / B_1]$ where,

B_1 = Baseline building consumption (w/o receptacle and process loads)

P_1 = Proposed building consumption (w/o receptacle and process loads)

Materials, equipment and systems shall be designed and installed to comply with the EPA Safe Drinking Water Act.

Where required by the building code, provide seismic bracing and anchors. Comply with SMACNA Seismic Restraint Manual.

4-1.3 Commissioning

The basic purpose behind commissioning building systems (HVAC, Lighting) for the USPS is to confirm that the functionality of the new equipment meets the original design intent, operates efficiently, and demonstrates that all of the required features of the new system are functioning as specified in the design documents. Commissioning shall be performed on a sampling basis. If a systemic problem is discovered or suspected during the commissioning process, the scope of the commissioning effort may be expanded to evaluate that feature or performance characteristic on all units.

The USPS shall provide independent Commissioning Services through their preapproved vendors. The AE shall be responsible for coordinating with this independent contractor as necessary to assist them in completing the Commissioning Report. In particular, the Contractor shall be responsible for providing assistance from their test and balance contractor, BAS controls contractor, mechanical contractor, etc. to confirm that the functionality of the new equipment meets the original design intent, operates efficiently, and demonstrates that all of the required features of the new system are functioning as specified in the design documents.

The degree of commissioning that will be required shall be specified by the AE and the Contracting Officer. The standard commissioning requirements for MSBDs and SSBs are listed below; however the Contracting Officer may require other mission critical systems to be commissioned, such as sprinkler system water pumps, or sewage ejector pumps, for any project.

4-1.3.1 MSBD Commissioning Requirements

- The HVAC system(s) shall be commissioned.
- When commissioning a new MSBD system, the priority should be placed on the operational dynamics of the equipment. MSBD specification 18101 “Commissioning Requirements and Functional Performance Testing” shall be utilized to develop the Commissioning Plan and associated Test Procedures.

4-1.3.2 SSBD Commissioning Requirements

Formal commissioning is not required. Instead, all new HVAC systems, Lighting systems, and related controls, shall be inspected by the Energy Manager/Project Manager/AE to ensure proper installation and operation.

4-1.4 Measurement and Verification (M&V)

4-1.4.1 MSBD M&V Requirements

M&V is a requirement for projects that are justified on the basis of saving energy. For all significant energy saving projects that are being performed with the primary objective of reducing energy consumption including replacement HVAC and Lighting systems, shall be measured and verified to determine actual energy savings performance at construction completion. M&V results should utilize FEMP Option A, short term measurements and calculations, combined with Option D, if applicable, computer simulation of energy consumption. Long term field measurements and data logging is not required. Option D should be used to estimate energy use for off-season periods.

- USPS does not require formal M&V on new buildings unless advanced technologies (solar, wind, geothermal, etc.) have been incorporated into the design. However, in order to establish baseline energy use for buildings in the USPS portfolio, some form of verification of energy consumption is required. After commissioning of the equipment, the AE of record must validate the results, either with the final ECC-S submittal or a combination of the ECC-S and short term measurements. The estimated energy use projected during the design phase and the final energy use determined after commissioning should be comparable.
- The total energy consumption that results from the project are to be submitted to the local FSO Energy Manager in an ECC-S package for review, acceptance, and input into eFMS.

The FEMP (Federal Energy Management Program) Guidelines are an application of the International Performance Measurement and Verification Protocol (IPMVP). Refer to the FEMP document for determining the level of M&V needed and the methodologies required for the general categories, or options, outlined in Table 4-1 "Overview of M&V Options A, B, C and D". Confer with the USPS FSO Energy Manager for application of the specific M&V Options. The guideline is available electronically at <http://www1.eere.energy.gov/femp/>.

4-1.4.2 SSBD M&V Requirements

M&V is not required, either before or after construction, unless otherwise directed by the Contracting Officer.

4-2 HVAC

The Postal Service prohibits the use of any refrigerant that contains CFC (chlorofluorocarbon) or HCFC (hydro-chlorofluorocarbon) that is on the EPA Regulatory Phase-out Schedule.

Starting January 1, 2008 all packaged and split systems purchased for new construction or replacement shall utilize R-134a or R-410a refrigerants.

4-2.1 Energy Conservation

Refer to Chapter 2 Architectural - General, Section 2-6.3 Energy Conservation, for detailed energy mandate statement.

4-2.1.1 Not Used

4-2.1.2 Conservation/Environmental Measures

When applicable, the following measures shall be adhered to by the designers when designing systems and selecting equipment:

- Cooling equipment, heating equipment and domestic water heaters shall carry the Energy Star label.
- Systems shall not be oversized because such systems are not energy efficient or cost-effective.
- Part load performance shall be analyzed and kept as high as practical. To keep part load efficiencies high, while providing redundancy, multiple smaller systems shall be used. Analysis demonstrating this part load performance shall be provided to the USPS.
- Block loads (building heating and cooling requirements) should reflect the basic building requirements without adding safety factors and shall utilize peak coincident loads to take into account plant/system diversity.
- Provide systems that avoid reheating and/or re-cooling for humidity control.
- Provide automatic controls to de-energize heating, cooling, and fan equipment when not needed.
- Provide heat pumps in lieu of resistance heat. Straight resistance heat may be used only if proven cost-effective.
- Provide the most efficient heating and cooling systems available considering the building operation and local weather conditions, e.g., evaporative cooling or precooling systems in dry weather conditions. Also, consider air-air heat exchangers or heat wheels for preheating or pre-cooling ventilation air requirements.
- Exterior snow melt systems for roofs and parking are not to be used.
- Consider energy recovery ventilators to reduce the cost of outside air.
- Consider Demand Control Ventilation with CO2 monitors, see section 4-2.15.10.
- Consider geothermal heat pumps.
- Consider renewable energy systems.

When applicable and proven cost effective, the following additional energy conservation measures shall also be considered:

- In colder climates, consider heat exchangers, heat wheels, etc. to preheat makeup air.
- Provide automatic blowdown controls in the boiler plants to avoid continuous blowdown, which is very wasteful.
- Provide a boiler blow down, waste heat recovery heat exchanger system to preheat boiler feed water.
- Provide a variable frequency drive at one of the centrifugal chillers in the plant to improve the chiller part load efficiency.
- Limit the chiller pressure drop through condenser and evaporator bundles to no higher than 10 ft. of water column.

4-2.1.3 Equipment Performance

Select HVAC equipment efficiencies based on the following table or latest edition of ASHRAE 90.1. When there is a conflict, use the stricter of the two.

UNIT SIZE	SPLIT SYSTEM EFFICIENCY STD. (including heat pumps)	PACKAGED SYSTEM EFFICIENCY STD. (including heat pumps)
≤ 5 tons	15.00 SEER	14.00 SEER
≥ 5 Tons < 10 tons	11.00 EER	11.00 EER
≥ 10 Tons < 20 tons	11.00 EER	11.00 EER
≥ 20 Tons	10.00 EER	10.00 EER

Where life-cycle cost effective, HVAC equipment shall be Energy Star certified.

4-2.2 Outside Design

The design shall be based on weather data provided in the latest edition of the ASHRAE Fundamentals Handbook.

SEASON	BASIS
Summer	1% column for Cooling DB/MCWB 1% column for Dehumidification DP/MCDB
Winter	99% column for Humidification DP/MCDB 99% column heating DB

Notes:

1. DB = Dry Bulb Temperature, MCWB= Mean Coincident Wet Bulb Temperature, DP = Dew point Temperature, MCDB = Mean Coincident Dry Bulb Temperature.

For locations not listed in the ASHRAE Fundamentals Handbook, design shall be based on local climatological data obtained from the U.S. Department of Commerce, Environmental Science Services Administration, or from Air Force, Army and Navy Manual AFM 88-29, Engineering Weather Data.

4-2.3 Inside Design

If the indoor relative humidity within a facility cannot be maintained naturally at a minimum of 20% RH in the winter, humidification shall be provided for the occupied spaces. In those cases, humidification systems shall be designed to maintain a 20% relative humidity. Include water filtration if required by the humidifier manufacturer when the local water source is considered too "hard" or the mineral content would cause system maintenance issues.

Design conditions for spaces shall be in accordance with the following table, where applicable.

SPACE SEE NOTE 5	SUMMER (MINIMUM) SEE NOTE 2	WINTER (MAXIMUM) SEE NOTES 2
Administrative Offices (See note 3)	78°F DB See note 9.	65°F DB
Employee Support Areas	78°F DB See note 9.	65°F DB
Corridors	See note 1.	See note 1.
Custodial Closets	See note 1.	See note 1.
Electrical Rooms	Ventilation	55°F DB
Enclosed Mail Platforms (SSBD only)	Ventilation	No Heating See notes 7 & 8.
Enclosed Mail Platforms (MSBD only)	Ventilation	45°F DB See notes 7 & 8.
Mechanical Rooms	Ventilation	55°F DB
Money/Stamp Vaults	Ventilation (Gravity Type)	No Heating See note 4.
Recycling Rooms	Ventilation	No Heating
Toilet Rooms	See note 1.	See note 1.
Trash Rooms	Ventilation	No Heating
Vestibules	No Cooling	55°F DB
Workroom (See notes 3 and 7)	78°F DB See note 9.	65°F DB

Notes:

1. Maintain conditions required for the area where the corridor or room is located. Use transferred air from other spaces to the extent possible.
2. DB = Dry Bulb temperature.
3. When unoccupied, setback inside design conditions to heating of 55°F and cooling to 85°F and with no humidity control.
4. Provide winter humidification to maintain interior conditions of 55% RH at 71-75°F.
5. The operating hours, conditions, and population at various times of the Facility, used for analysis shall be developed in conjunction with Plant personnel. These assumptions used shall be stated in reports to USPS.
6. Not Used.
7. Per MS-49, Energy Conservation and Maintenance Contingency Planning TL-3.
8. Platform shall meet all applicable ASHRAE ventilation and outside air standards and shall be designed to meet all OSHA standards including but not limited to Wet Bulb globe temperature. Special consideration shall be given to use of economizer cycles in appropriate climates.
4. The design of the HVAC system should provide a Leaving Air Temperature (LAT) to maintain the stated design temperature and a maximum 50% Relative Humidity.

4-2.4 Space Specific Requirements

4-2.4.1 Non-Heated Spaces

Prevent freezing of piping located in non-heated spaces by providing minimum heating or heat trace.

4-2.4.2 Toilets

Mechanical exhaust directly to the outside as required per ASHRAE. Utilize occupancy control whenever possible

4-2.4.3 Parking Structures

Parking structures shall be classified and designed to meet the minimum requirements of NFPA-88A, OSHA, and all applicable local codes. Ventilation systems controlled by carbon monoxide monitors are to be used as required by code.

4-2.4.4 Postal Retail Stores

To the extent possible, self-service and P.O. Box areas that will be open after business hours shall have their own HVAC zone.

4-2.4.5 Rewrap Area

4-2.4.6 Not Used

4-2.4.7 Not Used

4-2.4.8 Not Used

4-2.4.9 Not Used

4-2.4.10 Locker Rooms

MSBD

4-2.5 Design Loads

4-2.5.1 Heat Gain from Equipment

Heat gains from the lighting systems and automation/mechanization equipment shall be based on the actual loads released to the space.

4-2.5.2 Heat Gain from Occupants

Heat gain from occupants shall be as follows:

HEAT GAIN FROM OCCUPANTS	WORKROOM	OFFICE
Sensible Heat Gain (BTU/hour/person)	345	230
Latent Heat Gain (BTU/hour/person)	435	190

4-2.5.3 Occupancy Ratios

When actual occupancies of spaces are not known, calculations shall be based on the following amounts of net floor area per occupant:

SPACE	SF/OCCUPANT
Office Area	150 ¹
Workroom	300
Conference Room	15
Lunchroom	15

Footnote:

¹ Include one personal computer per employee in calculations.

4-2.6 Thermal Transmittance (U-Factor)

U-factors for all buildings shall be taken from ASHRAE 90.1-2004 based on the geographic zone and construction method for the roof, walls, glazing, and floor.

To cost effectively meet the energy conservation requirements (refer to 4-2.1 Energy Conservation) it may be necessary for the A/E to recommend U-factors lower (ie – higher R-value) than those listed in ASHRAE 90.1-2004. The A/E shall provide a study to justify the actual U-factors used in the design. Walls, roofs, glass, floors and other building components including HVAC and lighting systems should be designed to provide a maximum overall U-factor (maximum heat loss coefficient). U-factors shall be provided to assure thermal comfort of occupants and account for radiant temperature losses. . R-value of insulation shall be based on diminished thermal performance as the insulation ages.

4-2.7 Computations

MSBD

Provide the following computations as well as any other applicable computations as required for proper sizing of the systems to USPS for review:

a. Heating Capacity Sizing

The heating capacity shall be based on maximum instantaneous overall building envelope (block) heating load.

b. Cooling Capacity Sizing

The cooling capacity shall be based on maximum instantaneous overall building envelope (block) cooling load.

d. Individual Zone Heating and Cooling Loads

The individual zone loads shall be based on the time of day which its individual peak occurs.

e. Ventilation

Provide minimum and maximum ventilation requirements for the total building. Provide minimum ASHRAE recommended positive building pressurization during all operational conditions to prevent excess intrusion of unconditioned air. Workrooms should be considered with fully closed doors when calculating for pressurization requirements.

f. Static Pressure Drop

Provide static pressure drop calculations for fans and air handling units.

g. Expansion Tank Sizing

i. Psychrometric Analysis

A psychrometric chart study shall be prepared for each type of air handling unit. The study shall include the following, if applicable:

- Outside and inside design temperatures.
- Temperature rise caused by return-air.
- Temperature rise caused by fans.
- Return and outside air mixture conditions.
- Coil exiting conditions.
- Bypass and exiting air mixture conditions.

- Space sensible heat factor lines.
- Air volumes (supply, return, exhaust, etc.)

j. Completion of ECC-S form.

4-2.8 Zoning

MSBD

Zoning shall be arranged according to occupancy, hours of operation, mechanization, lighting heat gains, exposure, etc., so as to affect maximum comfort, efficiency, energy conservation, and economy operation for the total system.

Reheat or supplement cooling coils shall be avoided because of their high energy consumption.

System design and zoning shall be such that simultaneous operations of both heating and cooling plants shall be avoided.

Investigative Offices shall be considered a sub-zone of the adjacent HVAC zone. The Investigative Office shall have independent flow control utilizing dedicated motorized dampers or VAV boxes as appropriate for the adjacent HVAC system.

4-2.9 HVAC Controls

4-2.9.1 General Requirements

The control systems shall be the simplest that will serve the purpose with due consideration for controlling space conditions, monitoring (if applicable) and maintaining heating, ventilation and air-conditioning systems, conserving energy, and affecting operating economies. Control diagrams with sequence of operation for all systems shall be prepared and placed on contract drawings. Workrooms, large multiple support areas, and public spaces (lobbies) shall be provided with tamper-proof controls or remote sensors which are not readily susceptible to damage. The Investigative Office must have a thermostat to control the dedicated motorized dampers or VAV boxes as appropriate for the system. Provide filters for incoming air to these spaces.

4-2.9.2 Facilities Smaller than 15,000SF

SSBD and MSBD facilities smaller than 15,000SF, shall utilize low voltage digital electronic wall mounted thermostats for space temperature control of all packaged heating and cooling equipment. Refer to HVAC Instrumentation and Controls Specifications 15901.

4-2.9.3 Enterprise Energy Management System

MSBD facilities equal to or larger than 15,000SF shall utilize remote communicating thermostats for space temperature control of all packaged heating and cooling equipment. The system shall provide temperature control, the ability to adjust parameters remotely, remote access for monitoring, alarming, trending of data, and to provide integration with the EEMS. Control systems shall utilize the BACnet IP communication requirements for all data communication to the EEMS. Internal

communication protocols may be BACnet or MODbus. Additional monitoring and control points may be warranted including control of fans and terminal equipment, if deemed appropriate and cost effective.

The standard installation of HVAC controls at the MSBD level shall include the following:

- Monitoring of heating/cooling voltage/amperage/kW/kWh on all roof top units individually
- Installation of revenue grade advanced metering for main utilities servicing the building (electric, gas, water, fuel oil). Gas and water advanced metering shall consist of pulse initiator/pulse contacts installed by the local utility.
- Installation of supply duct temperature sensors for all roof top units
- Installation of two-way communicating space thermostats for each RTU
- Installation of a microprocessor-based, centralized controller that collects the metering, sensor, and thermostat data and makes it viewable graphically via a BACnet IP web connection
- Reports temperature, humidity, and electrical load, analyzes trends and performs load shedding on HVAC units

The following specifications apply:

- 15900 HVAC Instrumentation and Controls
- 15910 Energy Management System Communication to Remote Enterprise Server

4-2.10 [Reserved]

4-2.11 Central Heating Systems

4-2.11.1 Not Used

4-2.11.2 Not Used

4-2.11.3 Not Used

4.2.11.4 Unit Heaters

Thermostatically controlled propeller-fan-type unit heaters shall be used for the heating of areas that are listed to be heated but not air conditioned, or where quick response is required to compensate for the opening and closing of doors in cold climate areas. The unit heater type (i.e., electric, gas fired, or hot water) for each application shall be selected based a Life Cycle Cost Analysis that consider such factors as on the initial cost and the annual energy consumption.

4-2.12 Air Handling Systems

 G4-2-12a→d

4-2.12.1 Not Used

4-2.12.2 Not Used

4-2.12.3 Air Distribution System

MSBD

All ductwork shall be designed in accordance with the latest ASHRAE and SMACNA criteria. The design analysis submitted shall include complete calculations for all duct runs, pressure losses, volume control devices, and air diffusers.

Ductwork shall be insulated only as necessary to avoid condensation. Insulation shall be installed on the exterior of the ductwork.

All Low-Pressure ductwork shall be designed using the "equal friction" method with friction loss rate of .08 in. water column per 100 ft. of duct

Ductwork in workroom areas may be exposed, but shall be installed as high as is practical. It shall be run above the ceiling whenever suspended ceilings are used.

To minimize the installation of return ductwork, corridors or common spaces shall be used to the maximum extent for transmitting return air where permitted by code.

When return air path is obstructed by physical barriers, return air ducting shall be extended around such obstructions a minimum of 2'-0", so as to minimize their effect on air circulation.

Ceiling diffusers shall be coordinated with light fixtures and a modular arrangement shall be considered in administrative areas. Diffusers adjacent to pendant-mounted lamp fixtures shall be mounted at the same height as the lights. Light troffers for supply air distribution are not acceptable, however, they may be used for return air.

Ductwork at the fan outlet shall be sized to the fan outlet area for at least one duct diameter. Duct transitions between fan outlet and the duct distribution system shall be a maximum of 15°. No elbows shall be used within 3 wheel diameters of the fan outlet.

Flex duct shall only used for the final connection of branch to diffuser and shall not exceed five (5) feet in length.

4-2.13 Not Used

4-2.14 Not Used

4-2.15 Miscellaneous HVAC Requirements

4-2.15.1 Room Air Quantities

The primary air supply to individual rooms or spaces shall be based on the room heat load and the supply air temperature differential. Room air requirements shall be established in accordance with ASHRAE 90.1-2004.

4-2.15.2 Minimum Outside Air

Outside air (OA) shall be based on the requirements of ASHRAE 62.1. Utilize occupancy schedule to minimize OA during unoccupied periods.

4-2.15.3 Indoor Air Quality Standards

These standards encompass control technologies that provide for the health and safety of building occupants by controlling thermal conditions and contaminant levels in the building interior. Since each building is unique in location and use, various methods of maintaining indoor air quality shall be examined to select the best plan for the building. At a minimum the following considerations shall be made when planning a system:

- Design shall be guided by site characteristics including, but not limited to, ambient air quality, temperature and humidity, exterior air quality contaminants (e.g., auto/truck exhaust, in loading platforms and parking areas, power generation, hydrocarbon exhausts, nearby sources), soil gas contamination, building operations, occupancy levels, and site location.
- Plans and Specifications shall at a minimum be based on the latest published ASHRAE standards, specifically Standards: 52 (for filtration); 55 (for thermal comfort); and 62 (for ventilation).

The ventilation system design shall, at a minimum, incorporate:

- Ventilation, outside air, and re-circulation rates per ASHRAE 62.1 utilizing actual anticipated occupant densities and not occupancy based on code default values, if allowed by code or the Authority Having Jurisdiction. This will limit the requirement for excess ventilation air and will reduce the size of equipment required to properly condition excess ventilation air.

In order to allow for initial off-gassing of the facility, project specification shall require that significantly greater levels of air distribution and fresh air intake and exhaust during installation of interior finishes and during initial occupancy be attained. Further, the HVAC system shall be continuously operated for one (1) week prior to occupancy with maximized use of outside air while maintaining the indoor design conditions inside the space. After construction, testing and balancing of the HVAC system shall be done to ensure peak performance.

Contaminants generated during construction shall be kept to a minimum to eliminate their accumulation in building materials and release into the building after occupancy. As per NIST and EPA guidelines, the building shall be continually vented with a minimum of 10 percent outdoor air during construction. Where possible, a temporary exhaust air system shall be installed on each floor. Temporary ventilation systems shall be fitted with the appropriate filter for the existing conditions. Filters shall be changed as

specified by the manufacturer. Finally, all building air movement equipment and ductwork shall be protected from contaminants during the construction process. These activities shall be documented as part of maintenance program requirements.

For indoor parking and maneuvering areas, CO/CO₂ alarm detection systems shall be installed.

4-2.15.4 Flammable Materials Storage

Flammable materials shall be stored in NFPA approved cabinets. Cabinets are to be provided by USPS. Provide supplemental ventilation in accordance with OSHA and NFPA-30.

4-2.15.6 Equipment Location

All mechanical equipment shall be designed, specified and suitably located to assure accessibility for safe and efficient operation and maintenance (e.g., chillers, boilers, condensing units, pumps, air handling units, fans, filters, dampers, intakes, coils, fan coil units, VAV boxes, etc. as applicable).

Ceiling-mounted equipment (except dust collectors) inside the workroom is not acceptable because of access and maintenance limitations and objectionable noise.

Equipment shall be located to avoid the use of prime floor space, to prevent objectionable noise in the occupied spaces, and to maintain satisfactory exterior appearance of the building.

4-2.15.7 Evaporative Cooling

In hot, dry climates, evaporative cooling systems should be evaluated and implemented to provide cooling for the Workroom/platform when justified by life cycle cost analysis.

4-2.15.8 Control

Provide a motorized outside air damper to close when the building is not occupied.

4-2.15.9 Intake Location

Install outside air intakes away from pollutant exhaust sources (boiler stacks, toilet room exhaust, vehicle exhausts, etc.).

Secure outside air intakes from potential tampering. Locate intakes as high as feasible; air intakes located less than 15 feet above grade shall be fenced off from public access.

Return air grilles in publicly-accessible areas shall not be located in walls, so as to reduce the potential for tampering.

4-2.15.10 Demand Control Ventilation and Economizers

Demand Control Ventilation (DCV) regulates fresh air for occupants in a building by measuring the CO₂ levels inside the space then adjusting the amount of fresh air that gets delivered to the space. The advantage that DCV

MSBD

MSBD

controls offer is that many times the fresh air requirement is adequately met by normal daily building activity such as dock doors opening and closing, air infiltration thru cracks and seals, etc. Under those conditions unconditioned outside fresh air is not needed, which reduces energy costs if the DCV damper is closed.

If DCV is recommended, the AE must demonstrate the benefits when applied to the typical USPS mail processing environment.

Whether or not DCV is utilized, outside air brought in by the HVAC system on to the workroom floor/dock areas should take into account all sources of natural air infiltration when determining OA damper settings.

If justifiable, through life-cycle cost analysis, Demand Control Ventilation shall be applied to a facility based on ASHRAE 62.1-2007 "Ventilation For Acceptable Indoor Air Quality".

An economizer is a controls logic that opens outside air dampers to allow a cooling system to supply outdoor air to reduce or eliminate the need for mechanical cooling during mild or cold weather, usually in the spring and fall. Economizers should be evaluated and utilized whenever cost effective.

Economizers shall be specified in an HVAC design in accordance with ASHRAE 90.1-2004 geographic zones.

4-2.15.11 Excess Air

4-2.15.12 Personnel Cooling Fans

Ceiling, wall-mounted, and column-mounted fans may be used in delivery units, manual distribution operations, docks, trailers, elevated keying areas, and administrative offices.

The feed sections on the following types of equipment have some form of pinch belt where bio-hazards could likely escape from either letters or flats. To lower potential exposure or spread of air-borne contamination in areas where individual letters are processed, do not provide fans directed at the feed sections of the following equipment:

- AFCS
- DBCS
- CSBCS
- MPBCS
- AFSM 100
- MLOCR
- FSM 1000 (once the AFF/OCR is installed)
- Flats Cancellers

4-3 Plumbing

4-3.1 Water Supply Systems

 G4-3-1a→c

4-3.1.1 General Requirements

MSBD

USPS Handbook RE-6

Confirm availability of adequate municipal water service pressure. If water pressure is not sufficient to meet the water supply system requirements, provide a triplex booster pump package with each pump sized for 50 percent of calculated peak demand.

Chemical analysis and water treatment (if required) shall be provided to ensure compliance with all applicable codes.

The potable water distribution system shall be provided with backflow preventers as required by codes and local authorities to protect against the back flow of water or other liquids from all sources.

4-3.1.2 Drinking Water

All potable water piping, fittings, fixtures and solder used for connections shall be lead free in accordance with EPA and local codes.

Electric water coolers shall be provided throughout the facility, generally located in readily accessible open areas no farther than 100 ft. (walking distance, not straight line) from any workstation. Water coolers shall be lead free. Recess coolers into walls or alcoves wherever possible. Water coolers should not protrude into aisles. Provide dual height water coolers. See RE-4 for accessibility requirements.

USPS Handbook RE-4

Electric water coolers shall be provided at the following locations where applicable:

- In Workrooms and Platforms
- Near toilet rooms.
- In lunchrooms and cafeteria rooms.

4-3.1.3 Water Outlets

Valved and capped domestic cold water outlets shall be provided with minimum 1/2-inch pipe at the following locations where applicable:

- Vending machine areas.
- Lunchroom/Cafeterias.

At a minimum, the following spaces inside the building shall be provided with hose bibbs (where applicable):

- Trash areas.
- Building and Grounds Room.
- Recycling Areas.

Exterior hose bibbs shall be non-freeze type (depending on outdoor conditions) and shall be protected from physical damage as required. Provide hose bibbs at the following areas (where applicable):

- One every 100 ft. around the periphery of the building.
- One in the vicinity of the cooling tower.
- One close to the trash compactor.
- At each exterior Break Area.
- For the maintenance of Rooftop HVAC Units, provide a hose bib within 75 feet of all units.

4-3.1.4 Domestic Water Heaters

High efficient type water heaters shall be located near the area served, but may also be wall-mounted in custodial closets to increase usable floor area.

Long hot water runs and hot water re-circulation systems shall be avoided to the extent possible. Hot water re-circulation systems shall not be used for pipe runs shorter than 50 ft.

Point-of-use electric water heaters shall be used for lavatories and hand sinks located away from the domestic hot water mains in the building, if an evaluation shows that they are equal to or more efficient than using a hot water recirculation system.

Use electric tank type water heaters, unless proven more economical to use gas fired type water heaters for the facility.

The following table shall be used as a guide in selecting water heaters:

NO. OF LAVATORIES	GAS		ELECTRIC		INSTANTANEOUS COIL-GPH
	Tank Storage Gallons	Recovery Rate GPH	Tank Storage Gallon	Heater	
2	--	--	5	1@ 1.5 KW	240
3-5	30	30	40	2@ 2.5 KW	240
6-12	40	40	40	2@ 5.0 KW	300
13-20	60	60	60	3@ 5.0 KW	360
21-28	80	80	80	3@ 5.0 KW	420
39-36	100	100	100	6@ 5.0 KW	480
37-43	120	120	120	6@ 5.0 KW	540

Notes:

1. Capacity. This table indicates the storage and recovery capacities, at 100°F temperature rise.
2. Temperature Requirements. The domestic water heating equipment shall be automatically controlled and shall have sufficient capacity to deliver 105°F water at all times.
3. This table does not apply to the facilities with a kitchen or cafeteria. Larger storage and recovery capacities, as well as a separate 180°F supply water for cafeteria equipment are required in these facilities.
4. Water heaters should carry the Energy Star label.

4-3.1.5 **Water Conservation**

The following water efficiency standards are required unless more restrictive values are required by codes:

- The maximum water use allowed for a lavatory is 0.5 gal/min, kitchen faucets and showerheads is 1.5 gal/min.
- The maximum water use allowed in gallons per flush for any of the following water closets and urinals is:

FIXTURE	GALLONS OF WATER/ FLUSH
Gravity tank-type toilets	1.28
Pressure-Assist tank-type toilets	1.1
Electromechanical hydraulic toilets	1.1
Flush valve toilets	1.28
Urinals	0.13

4-3.1.6 **Emergency Showers and Eye-wash**

MSBD

4-3.2 Sanitary Drainage Systems

4-3.2.1 **General Requirements**

 G4-3-2a

Sanitary sewer piping shall be configured and sized to accommodate initial building needs.

Sanitary sewer piping shall not be combined with storm sewer piping, unless permitted by code. When such interconnection is allowed, however, it shall occur only at or near the property line. Adequate venting and cleanouts shall be provided.

Floor cleanouts must be strong enough to safely carry the loads of anticipated traffic and be of adjustable type to insure flush installation with finished floor. For foot and light vehicular traffic, use heavy duty nickel bronze tops. For heavy vehicular traffic (including all areas subject to forklift traffic), use round, heavy duty cast iron tops with non-tilt tractor-type covers.

Where possible, sanitary system shall be drained to the public sewer or private sewage disposal system by gravity. Where gravity drainage is not possible, provide duplex sewage ejectors with each pump sized for 100% of system requirements. Pump control shall provide for single and two pump operation.

Horizontal drainage piping shall be run at a uniform pitch of not less than ¼ in. per ft. Where it is impractical to obtain a ¼ in. per ft. slope due to elevation of street sewer, or structural features, piping 4 in. and larger may be uniformly pitched at not less than 1/8 in. per ft.

Provide cellular foam insulation for any horizontal run or offset of sanitary drainage originating from a mechanical equipment room that passes over a finished ceiling, workroom area, or dock platform.

4-3.2.2 Acid Waste Systems

MSBD

4-3.2.3 Floor Drains

Floor drains shall be provided as follows:

- Provide three inch diameter drains (as applicable):
 - Toilet rooms with 2 or more toilet fixtures (i.e. water closets and urinals).
 - Scale pits.
 - Vending machine rooms.
 - Lift pits.
 - Rewrap room.
 - Adjacent to all air handlers.
 - Adjacent to any air compressors with an external condensate drain..
 - Recycling Areas.
- Provide four-inch diameter drains (as applicable):
 - Enclosed carrier loading, vehicle parking, and storage areas.
 - Sumps:

For adjacent elevator and lift pits, the floor drains shall be connected to a common sump. For nonadjacent elevator and lift pits, individual sumps shall be provided. It shall be covered level with the pit floor. The sump shall have a warning device to indicate when liquid is present or be equipped with a sump pump. The sump pump shall discharge into open air holding reservoir outside the pit and hoistway and not be connected to any drain.

4-3.3 Plumbing Fixtures

4-3.3.1 General Requirements

USPS Handbook RE-4

The minimum number of toilet plumbing fixtures of each type shall be provided as indicated in Module 1 Chapter 2 Architectural, Section 2-4.2 Toilet Facilities, Exhibit 2-4a. Water closets, urinals, flush valves and faucets must bear WaterSense label and the manufactures must be a WaterSense partner with US EPA.

4-3.3.2 Fixture Types

a. Water Closets

White vitreous china office and industrial type with elongated bowl, exposed large diaphragm top supply flush-o-meter with side oscillating handle, siphon jet wall outlet, wall hung on heavy-duty chair carrier, and white open front molded plastic seat. Provide floor mounted tank type water closets for SSBD facilities.

b. Urinals

White vitreous china, bowl type with integral flush distribution, wall hung with integral trap and extended shields, blowout or siphon jet flushing action, large exposed diaphragm handle operated flush-o-meter.

c. Lavatories

White vitreous china straight back with single center set compression faucets, strainer drain, angle stops, complete with adjustable type P-trap with separate long tube to wall.

d. Mop Basins

In custodial closets and custodial storage, provide floor receptor type sinks, complete with faucet.

e. Kitchen Sinks

Corrosion-resisting formed steel, complete with faucets, stopper type drain and P-traps.

f. Emergency Shower and Eyewash

Provide tepid water to both the shower and eyewash system in accordance with the most current ANSI standard.

MSBD

4-3.4 Storm Drainage

MSBD

Design storm drainage to prevent accumulation of water which can form icy patches in freezing weather on parking lots, walkways, or other paved areas.

4-3.5 Fuel Systems

4-3.5.1 Natural/Propane Gas

Natural/Propane gas piping systems shall conform with the National Fuel Gas Code, NFPA 54, and all applicable local codes. Gas piping and valves shall not be located in confined spaces where leaking gas might collect and cause an explosion.

4-3.5.2 Heating Fuel Oil

Fuel oil systems shall include above ground tanks, pumps, piping accessories, and all required controls. The system shall conform to all applicable requirements of USPS standards, NFPA 30, NFPA 31 and all applicable local, state and national codes.

4-3.6 [Reserved]

4-3.7 Miscellaneous Plumbing Requirements

All piping, except fixture runouts, shall be completely concealed in finished spaces such as offices, office corridors, lobbies, toilet rooms, and locker rooms (if applicable).

Fixture runouts shall be kept to a minimum and shall be chrome-plated.

Piping in work areas shall be protected.

4-3.8 [Reserved]

4-3.9 [Reserved]

4-4 Miscellaneous HVAC/Plumbing Components

4-4.1 Motors and Starters

Motors shall be of sufficient capacity to operate the driven equipment through its total range without exceeding the motor capacity. Motors 1 hp or greater in continuous service shall be premium efficiency type as listed in NEMA MG-1 Standards. Care shall be taken to prevent over sizing of motors.

Three-phase power shall be used for all motors ½ hp and greater.

Sealed ball bearings shall be used to reduce maintenance frequency and discourage over-greasing.

Starters shall be combination circuit breaker and across-the-line automatic, except where reduced voltage starting may be required by the local power company.

Starters for major mechanical equipment shall generally be located in the motor control center. See Module 1 Chapter 5 Electrical for additional criteria.

4-4.2 Pumps, Piping and Fittings

4-4.2.1 Pumps

Pumps shall be selected and installed to match the head and flow requirements of the system.

In-line or close-coupled centrifugal pumps should generally be used for capacities up to 100 gpm. For larger capacities, base-mounted pumps shall be used.

Provide mechanical shaft seals to reduce leakage and maintenance.

Provide drain lines from bed plates to open drains.

4-4.2.2 Piping

Provide adequate supports, vibration isolators, and allowance for expansion and contraction for piping systems.

The piping shall be properly sloped and equipped with all necessary vents and drains.

Provide adequate shutoffs and drains for all piping exposed to freezing conditions.

Conceal piping in lobbies, offices, and similar areas.

All piping systems in the building shall be identified and color coded in accordance with American National Standards Institute Standard, "Scheme for the Identification of Piping Systems", ANSI A13.1, latest edition.

Provide proper cleanout quantities and types.

Piping in workrooms shall be adequately protected to avoid damage.

No water piping of any description shall be installed above electrical equipment, including above the code required clear space around the equipment.

4-4.2.3 Fittings

Isolating valves shall be provided at each piece of equipment and be located in such a manner to not interfere with the removal or maintenance of equipment.

Drain valves of sufficient size to drain the branch quickly shall be applied at low points near each shut-off.

When open sight drains are not available, threaded hose connections shall be provided at the valve.

Install pressure gauges at the following locations:

- Suction and discharge of all pumps.
- Entrance and exit of all heat exchangers.
- Entrance and exit of all chillers' evaporator, and condenser sections.
- Where determined necessary of other equipment.

Install test ports at the following locations:

- Suction and discharge of all pumps.
- Entrance and exit of all heat exchangers.
- Entrance and exit of all chillers' evaporator, and condenser sections.
- Entrance, exit and bypass of all water coils.
- Where determined necessary of other equipment.

Install thermometers at the following locations:

- Entrance and exit of all heat exchangers.
- Entrance and exit of all chillers' evaporator and condenser sections.
- Exit of all domestic water heaters.
- Entrance and exit of all AHUs' water coil.
- Where determined necessary for other equipment.

Sufficient sectionalizing valves to permit servicing major branches of runouts without draining the entire hot or chilled water system shall be provided.

For multistory buildings, shut-off valves shall be provided for each floor as close to the heaters as practicable.

Flow-measuring devices shall be tabulated on the contract drawings with heat exchangers, zones, pumps, and coils data. Flow control stations suitable for use with a portable flow meter shall be specified.

4-4.2.4 Piping and Fittings Material Schedule

4-4.2.5 Valves

4-4.3 Insulation

Thermal insulation shall be provided on pipes, tanks, breechings, ducts, chillers, boilers, pumps, etc. (if applicable), for safety, energy conservation, and condensation prevention. Ductwork in Workrooms can be uninsulated when there is a very low possibility of condensation. When required, the insulation shall be placed on the exterior surface of the duct.

Minimum insulation thickness shall be in accordance with ASHRAE 90.1. Additional thickness may be required to ensure surface temperatures that are below 100° F and to prevent condensation on cold surfaces.

Perimeter insulation shall be provided when required by climatic conditions and as outlined in the ASHRAE Handbook of Fundamentals.

Hangers, anchors, and other details shall be designed so as not to damage vapor barriers or insulation and shall not themselves permit condensation.

4-4.4 Sound and Vibration Control

Care shall be exercised in the design, approval and installation of mechanical equipment and components to obtain acceptable noise levels in all occupied spaces (see table below). The noise level produced by mechanical equipment shall conform with the latest OSHA standards and ASHRAE handbooks requirements. Refer to Module 1 Chapter 2 Architectural, Section 2-7.1.2 Sound Transmission, for additional criteria.

SPACE	NC LEVEL
Private Offices & Conference Rooms	30
Open Office Areas, Corridors, & Lobbies	35
Workrooms, Computer Rooms	45

4-5 Fire Protection

4-5.1 Sprinkler Systems

Provide sprinkler systems where required by local code and as directed by USPS. Sprinkler systems shall be designed in accordance with NFPA 13, Installation of Sprinkler Systems, using the hydraulic method for pipe sizing.

 G4-5-0a→b

Dry systems shall be used for any area where freezing temperatures could occur.

All flow switches shall be equipped with a retard device to prevent false alarms due to pressure surges.

Sprinkler piping is deemed foreign to electric service equipment by NFPA code. As such, sprinkler piping shall not be routed directly above electrical switchgear or transformers.

Provide a sprinkler head with inline manual shut-off approximately 30 ft. from the sprinkler head at workroom side of Self-Service area drop boxes.

Refer to Module 1 Chapter 2 Architectural, Section 2-8 Fire Protection, for additional criteria.

4-5.2 Standpipe and Hose Systems

In facilities where standpipes are required by code, Class III systems for use by either fire departments and those trained in handling heavy hose streams (2 ½ in. hose) or by the building occupants (1 ½ in. hose) shall be provided as required. Adapters for fire department use shall be provided on site.

Standpipe systems shall be designed to meet local code requirements and NFPA 14 (Standards for the Installation of Standpipe and Hose Systems).

The number of hose stations for Class III services in each building and in each section of a building divided by fire walls shall be such that all portions of each story of the building are within 30 ft. of a nozzle attached to not more than 100 ft. of hose.

4-5.3 Duct Mounted Smoke Detectors

Smoke detectors shall be installed in air handling systems, in accordance with NFPA 90A, and local codes, Installation of Air Conditioning and Ventilating Systems, to automatically shut down the fan for that system and to indicate an alarm at the facility fire alarm panel.

For air handling systems not specifically included under NFPA 90A, smoke detectors shall be provided as required by the local code.

4-6 Construction Closeout

Replace all air filters with new and clean air filters. Balance, test, adjust, and commission (if applicable) all air conditioning systems prior to occupancy of the building. Test reports indicating compliance with the design documents shall be provided to the USPS contracting officer prior to the final acceptance inspection. This is to include the final commissioning report and ECC-S.

Prior to commencing air and water balancing (if applicable), the testing organization shall have been approved by the Contracting Officer and shall be a certified member of the Associated Air Balance Council (AABC), National Environmental Balancing Bureau (NEBB), or shall have submitted adequate documentation to satisfy the Contracting Officer of its competence.

[This page intentionally left blank.]

Checklist

[This page intentionally left blank.]

Mechanical Checklist

Facility Name:

City, State, Zip:

Project Phase:

Reviewer (Individual/Firm Names):

Telephone Number:

Date:

NOTE: The "Facility Type" column indicates the facility type to which the checklist item is applicable. A blank cell in this column indicates that the checklist item is General and applies to MAJORS, MSBD and SSB facilities.

Section No.	Facility Type	✓	Item	Comment
4-1			Introduction	
4.1.2			Facility is designed per the Department of Energy's Energy Conservation Standards	
4-1.2			All materials, equipment, and systems are designed and installed to comply with the EPA Safe Drinking Water Act	
4-2			HVAC	
General			Verify horsepower ratings and motor speeds for major pieces of equipment match on mechanical, electrical drawings and specifications.	
General			Provide vibration isolation as required for equipment.	
General			Ensure all drains from expansion tanks, air separators, strainers, and other equipment are extended to floor drains.	
General			Cover sharp edges of all equipment or supports below 8 feet with insulating material for protection.	
General			Verify exit passageways, stairs, ramps, and other exits are not used as a part of the supply, return, or exhaust system servicing other areas of the building.	
General			Coordinate diffuser type with ceiling/non-ceiling areas.	
General			When using propane gas fired HVAC equipment, provide natural gas conversion kit for future use.	

Section No.	Facility Type	✓	Item	Comment
General			Ensure all air filters are replaced and all strainers are cleaned prior to final systems acceptance.	
4-2	MAJORS		Verify energy and life cycle cost analysis is performed per criteria.	
4-2	NAJORS MSBD		Provide rooftop units with DX cooling and gas heating.	
4-2.1			Energy conservation measures have been addressed and followed.	
4-2.1.3			Verify minimum performance criteria is met for HVAC equipment.	
4-2.3			Verify inside design conditions for unoccupied spaces are per criteria.	
4-2.4.6	MAJORS		Verify personnel occupancy of Consolidated Computer Room and design HVAC per Criteria.	
4-2.6			Verify thermal transmittance (U-factor) requirements are met.	
4-2.8			Verify zoning avoids simultaneous heating and cooling plant operation.	
4-2.8			Verify zoning arrangement takes into consideration the hours of operation, lighting heat gain, mechanization, etc.	
4-2.10.5	MAJORS		Verify mechanical space is adequately protected for refrigerant selected (i.e. alarms, separate rooms, etc.).	
4-2.12.3			Verify ductwork in workrooms is installed as high as practical.	
4-2.12.3			Verify ceiling diffusers are coordinated with light fixtures.	
4-2.15.1			Check room cfm against calculations. Locate supply and return to avoid short-cycling of air.	
4-2.15.2			Verify minimum outside air is greater of 20 cfm/person or 5% of supply air quantity plus air exhaust air quality.	
4-2.15.3			IAQ standards are met per criteria.	
4-2.15.6			Mechanical equipment takes into consideration accessibility for safe and efficient operation and maintenance.	
4-2.15.8			Motorized outside air dampers are provided.	
4-2.15.9			Check the location of intake ducts and confirm that other hazards will not be introduced into building, e.g. exhaust from trucks at loading dock.	
4-3			PLUMBING	

Section No.	Facility Type	✓	Item	Comment
General			Proper backflow prevention with drain is provided. Drain extends to floor drain.	
General			Provide water and gas meters as required.	
General			Coordinate floor drain locations with architectural plans.	
4-3.1.1			Confirm that adequate municipal water service pressure is available.	
4-3.1.1			Verify requirement for chemical analysis and water treatment.	
4-3.1.2			Verify potable water piping, fittings, fixtures, and solder are lead free.	
4-3.1.2			Verify potable water system has been tested for lead content and result submitted to CO.	
4-3.1.3			Verify water outlets are provided per criteria.	
4-3.1.4			Verify long hot water runs and hot water re-circulation systems are avoided.	
4-3.1.4			Verify point-of-use electric hot water heaters are used for lavatories and hand sinks located away from domestic water mains.	
4-3.1.5			Verify maximum water use at lavatories, kitchen faucets and shower heads is 2.5 gal/min per criteria.	
4-3.1.5			Verify maximum water use in gal./flush for water closets is per criteria.	
4-3.1.6	MAJORS MSBD		Emergency eyewash and showers are provided.	
4-3.2.1			Verify sanitary sewer piping is not combined with storm water piping, unless permitted by code.	
4-3.2.1			Pump control provides for single and two-pump operation.	
4-3.2.2	MAJORS MSBD		Acid waste systems installed in photo processing areas meet local code requirements.	
4-3.2.3			Verify floor drains are provided per criteria.	
4-3.4			Verify design of storm drainage prevents icy patches in freezing weather in parking lots, drives, etc.	
4-4			MISCELLANEOUS HVAC/PLUMBING COMPONENTS	

Section No.	Facility Type	✓	Item	Comment
4-4.3			Verify insulation is provided per criteria.	
4-4.4			Verify sound and vibration control requirements are met per criteria.	
4-5			FIRE PROTECTION	
General			Verify sprinkler systems and supply pipes are protected from freezing.	
General			Sprinkler heads in high temperature areas (e.g. directly below skylights) should be rated for such conditions.	
4-5.1			Verify sprinkler systems are properly classified and designed in accordance with the latest NFPA requirements. Indicate building classification on the documents.	
4-5.1			Verify dry sprinkler system is used where freezing temperature could occur.	
4-5.1			Verify sprinkler head is provided on work room side of Self-Service area.	
4-5.2			Verify standpipe and hose system requirements comply with criteria.	
4-5.3			Check location of HVAC controls/alarms and ensure fire and smoke dampers are controlled by an automatic alarm device.	
4-6			CONSTRUCTION CLOSEOUT	
General			Verify air and water balancing and testing organization qualifications per criteria.	

[This page intentionally left blank.]

Module 1 General Criteria

Chapter 5 Electrical

5-1 Introduction

- 5-1.1 Scope
- 5-1.2 Codes and Standards
- 5-1.3 Energy Conservation
- 5-1.4 Computations
- 5-1.5 Commissioning
- 5-1.6 Measurement and Verification (M&V)

5-2 Power Distribution

- 5-2.1 Incoming Electrical Service
- 5-2.2 Distribution Voltage Levels
- 5-2.3 Main Service Equipment
- 5-2.4 Panelboards
- 5-2.5 Secondary Dry-Type Transformers
- 5-2.6 Motors and Controllers
- 5-2.7 Wiring Methods and Materials
- 5-2.8 Convenience Outlets
- 5-2.9 Not Used
- 5-2.10 Not Used
- 5-2.11 [Reserved]

5-3 Lighting

- 5-3.1 Interior Lighting
- 5-3.2 Exterior Lighting

5-4 Communications

- 5-4.1 Scope
- 5-4.2 Incoming Service
- 5-4.3 Telecommunications - Structured Cabling System
- 5-4.4 Not Used
- 5-4.5 Pay Telephones
- 5-4.6 Not Used
- 5-4.7 Not Used
- 5-4.8 [Reserved]
- 5-4.9 Satellite Communications
- 5-4.10 Call Bell Systems

5-5 Fire Protection

- 5-5.1 Fire Alarm System
- 5-5.2 Smoke Detectors
- 5-5.3 Heat Detectors
- 5-5.4 [Reserved]
- 5-5.5 [Reserved]

5-6 Lightning Protection

- 5-6.1 [Reserved]
- 5-6.2 [Reserved]

5-7 Integrated Security and Investigative Platform (ISIP)

- 5-7.1 Robbery Countermeasure/Retail CCTV Cameras
- 5-7.2 Security and Access Control CCTV Cameras
- 5-7.3 Intrusion Detection System (IDS)
- 5-7.4 Physical Access Control System (PACS)
- 5-7.5 Investigative CCTV Cameras
- 5-7.6 Exit Door Alarm
- 5-7.7 Vault Alarms

5-8 Not Used

5-9 [Reserved]

5-10 Construction Closeout

- 5-10.1 As-Built Riser Diagrams
- 5-10.2 Operations and Maintenance Manuals
- 5-10.3 Operations and Maintenance Training
- 5-10.4 Testing

5-11 [Reserved]

Checklist

Chapter 5 Electrical

5-1 Introduction

5-1.1 Scope

The electrical design shall be complete and shall cover all phases of the project. Information related to the adequacy, dependability, number, characteristics and regulation of the supply lines, recommended interrupting capacity of main fuses or circuit breakers total connected load and estimated demand shall be furnished with the design. Electrical service shall include 20% future spare capacity to allow for expansion without significant interruptions to ongoing operations. Whenever specific problems or conditions are encountered, the A/E shall follow general industry practices as reflected in the latest edition of the National Electrical Code and present to USPS for final approval. Facilities with automation equipment shall be provided with power line filtering devices and surge suppressers in the electrical distribution apparatus.

5-1.2 Codes and Standards

All facilities shall be designed in accordance with the requirements set forth by the applicable state and/or local codes enforced at the time of design, including the latest edition of the National Electrical Code and the International Building Code in addition the following USPS Electrical Design criteria shall be followed. Where two or more codes, standards, or USPS criteria are in conflict, the more stringent shall apply.

5-1.3 Energy Conservation

Refer to Module 1 Chapter 2 Architectural, Section 2-6.3 Energy Conservation, for detailed energy mandate statement.

Refer to Form ECC-S for energy analysis requirements. Where possible, equipment shall carry Energy Star Label.

5-1.4 Computations

5-1.4.1 Fault Current (Short Circuit) Computations

Verify the available fault current amperage of the electrical utility company. Indicate bracing rating (AIC, ampere interrupting capacity) for the incoming electrical system and distribution equipment accordingly. Conduct a fault current calculation that shows the fault current let-through at all equipment. Indicate on drawings that all circuit breakers shall be part of a fully coordinated series rated system, utilizing RMS (Root Mean Square) symmetrical amperes. The power line filters and surge suppressers, when

installed, shall be adequately grounded to safely dissipate the transient impulse voltages and surge energy to ground.

5-1.4.2 Lighting

Lighting calculations shall be performed in accordance with methods established by the Illuminating Engineering Society for all rooms over 225 sq. ft. Lighting level, lamp and fixture type shall be provided in accordance with Section 5-3 Lighting. For exterior lighting at parking lots, the point-by-point lighting calculation shall be performed at the task for the illumination uniformity level. Where applicable, the fluorescent and HID ballasts shall be the solid state energy saving electronic type with maximum total harmonic distortion (THD) of 10 percent to prevent power line interference with computer controlled mail processing equipment.

5-1.4.3 Voltage Drop

Voltage drop calculations shall be performed for feeder and branch circuits. The total voltage drop for feeder and branch circuits shall not exceed five percent.

5-1.4.4 Load Computations

Load computations shall be performed to include transformer capacities, primary and secondary feeder sizes, and distribution feeder sizes based on panelboard loads. Panelboard load computations shall indicate continuous and non-continuous loads connected, demand loads, and spare capacities.

5-1.5 Commissioning

The basic purpose behind commissioning building systems (HVAC, Lighting) for the USPS is to confirm that the functionality of the new equipment meets the original design intent, operates efficiently, and demonstrates that all of the required features of the new system are functioning as specified in the design documents. Commissioning shall be performed on a sampling basis. If a systemic problem is discovered or suspected during the commissioning process, the scope of the commissioning effort may be expanded to evaluate that feature or performance characteristic on all units.

The USPS shall provide independent Commissioning Services through their preapproved vendors. The AE shall be responsible for coordinating with this independent contractor as necessary to assist them in completing the Commissioning Report. In particular, the Contractor shall be responsible for providing assistance from their test and balance contractor, BAS controls contractor, electrical contractor, etc. to confirm that the functionality of the new equipment meets the original design intent, operates efficiently, and demonstrates that all of the required features of the new system are functioning as specified in the design documents.

The degree of commissioning that will be required shall be specified by the AE and the Contracting Officer. The standard commissioning requirements for MSBDs and SSBs are listed below; however the Contracting Officer may require other mission critical systems to be commissioned, such as:

- Generators and Emergency Power Distribution System.
- Fire Alarm System.

-
- Security/Access Control CCTV System.
 - Paging System.
 - Electrical Submetering.

5-1.5.1 MSBD Commissioning Requirements

- HVAC and Lighting systems shall be commissioned.
- Priority should be placed on the operational dynamics of the equipment. MSBD specification 18101 “Commissioning Requirements and Functional Performance Testing” shall be utilized to develop the Commissioning Plan and associated Test Procedures.

5-1.5.2 SSBD Commissioning Requirements

Formal commissioning is not required. Instead, all new HVAC systems, Lighting systems, and related controls, shall be inspected by the Energy Manager/Project Manager/AE to ensure proper installation and operation.

5-1.6 Measurement and Verification (M&V)

5-1.6.1 MSBD M&V Requirements

M&V is a requirement for projects that are justified on the basis of saving energy. For all significant energy saving projects that are being performed with the primary objective of reducing energy consumption including replacement HVAC and Lighting systems, shall be measured and verified to determine actual energy savings performance at construction completion. M&V results should utilize FEMP Option A, short term measurements and calculations, combined with Option D, if applicable, computer simulation of energy consumption. Long term field measurements and data logging is not required. Option D should be used to estimate energy use for off-season periods.

- USPS does not require formal M&V on new buildings unless advanced technologies (solar, wind, geothermal, etc.) have been incorporated into the design. However, in order to establish baseline energy use for buildings in the USPS portfolio, some form of verification of energy consumption is required. After commissioning of the equipment, the AE of record must validate the results, either with the final ECC-S submittal or a combination of the ECC-S and short term measurements. M&V shall be performed after commissioning of the new system is complete. The estimated energy use projected during the design phase and the final energy use determined after commissioning should be comparable.
- The total energy consumption that results from the project are to be submitted to the local FSO Energy Manager in an ECC-S package for review, acceptance, and input into eFMS.

The FEMP (Federal Energy Management Program) Guidelines are an application of the International Performance Measurement and Verification Protocol (IPMVP). Refer to the FEMP document for determining the level of M&V needed and the methodologies required for the general categories, or options, outlined in Table 4-1 “Overview of M&V Options A, B, C and D”. Confer with the USPS FSO Energy Manager for application of the specific

M&V Options. The guideline is available electronically at <http://www1.eere.energy.gov/femp/>.

5-1.6.2 **SSBD M&V Requirements**

M&V is not required, either before or after construction, unless otherwise directed by the Contracting Officer.

5-2 Power Distribution

Design for distribution systems shall include all computations for transformer capacities, interrupting capacity of substation secondary breakers and calculations for sizing the primary and secondary feeders, including voltage drop (refer to Section 5-1.4.3).

 G5-2-0a→c

5-2.1 Incoming Electrical Service

Incoming electrical service shall consist of the incoming power supply line(s), transformer(s), when required, meter and fused main disconnect switch(es), or main circuit breaker(s). Incoming service shall be selected to ensure and maintain the lowest and most economical rate possible. Dual service is not required.

5-2.1.1 **Underground Service**

MSBD, SSBD

5-2.1.2 **Coordination with Utility Companies**

The voltage level and availability of electric service shall be determined. Investigate the reliability of the utility company's power distribution system and report findings to USPS during the 30% design review.

Electrical systems shall be designed to take advantage of Utility Company rebate programs.

5-2.1.3 **System Capacity**

MSBD, SSBD

5-2.1.4 **Emergency Power**

MSBD

5-2.1.5 **Utility Company Metering**

Incoming utility company metering of total building requirements shall be installed in a manner to assure that the lowest possible rates for electric current are obtained. Coordinate establishment of electrical service with the USPS Utility Commodity Management Team Facilities Portfolio. The method of metering shall be governed by the class of service available and selected service. There is no requirement for centralized metering of electrical system other than utility company metering.

5-2.1.7 **Advanced Metering**

Advanced metering of utility-level electric, water, and heating fuels is required on all new MSBD construction equal to or larger than 15,000SF. The building contractor is responsible for ensuring that the information

collected by the meters tie into the EEMS system through a field panel communicating in BACnet IP and that EEMS connectivity is achieved. The metering data shall be collected by the monitoring and control system addressed in Section 4-2.9.1. See Specifications 15900 and 15910 for technical requirements.

5-2.2 Distribution Voltage Levels

MSBD, SSBD

5-2.2.1 Miscellaneous Loads

Vending machines, incandescent lighting, convenience outlets and certain special USPS furnished equipment (including time clocks, task lighting, scales and etc.) shall be served from 208/120Y volt panelboards.

5-2.2.2 Mechanization/Automation Loads

5-2.3 Main Service Equipment

5-2.3.1 Location

MSBD

5-2.3.2 Not Used

5-2.3.3 Transformers

MSBD

Shielded transformers shall be provided to supply panelboards, and computer and/or high harmonic generating loads.

5-2.3.4 Switchboards

MSBD

5-2.4 Panelboards

5-2.4.1 Types and Ratings

MSBD, SSBD

5-2.4.2 Location and Protection

Provide and maintain a clear floor space dimension in front of electrical panelboards and equipment as required by Article 110 of the National Electric Code. Panelboards in the Workroom shall be located on walls or columns at the center of the load or area served, and shall be protected with guardrails, bollards, or other type of protection. All 120/208V panelboards shall be equipped with transient surge suppressers.

5-2.4.3 Sizing and Spare Capacity

MSBD

Panelboard's shall be sized such that all demand and diversity factors allowed by code and local authority shall be applied to load determination calculations, and shall include 20 percent spare capacity. Space for 1 spare breaker of each type used in panelboard shall be provided in each panelboard.

5-2.5 Secondary Dry-Type Transformers

MSBD

5-2.6 Motors and Controllers

MSBD

Building equipment motors shall be controlled and protected by combination circuit breaker type motor starters installed in motor control centers, except when design and economic considerations dictate the use of individual motor starters. Control voltages shall not exceed 120 volt to ground. Three-phase running overcurrent protection shall be provided and each starter shall be supplied with a hands-off-automatic (HOA) switch. Twenty percent spare feeder capacity and starter space for load growth shall be provided in the motor control center. Motors shall be high efficiency type, and motors 5hp and larger shall be power factor corrected.

Motors 1 hp or greater in continuous service shall be premium efficiency type as listed in NEMA MG-1 Standards.

5-2.6.1 Ventilating Fan Motor Controllers

Ventilating fan motor controllers shall be arranged to stop fans on actuation of the area smoke detectors, or smoke detectors in the individual systems, in accordance with code requirements.

5-2.7 Wiring Methods and Materials

All interior power, lighting and line voltage control conductors shall be run per the NEC. MC cable is permitted within the restrictions prescribed by the NEC and other sections of this criteria.

Provide a separate ground conductor in all feeders and branch circuit conduits, including lighting branch circuits.

5-2.7.1 Conduit

Electrical metallic tubing (EMT) conduit shall only be installed in dry interior spaces. Electrical metallic tubing shall not be installed below grade in areas subject to severe corrosive conditions or embedded in concrete. Rigid galvanized steel conduit shall be installed for conduit elbows, conduits turning up through the building slab and all exposed conduits less than 8 ft. above finished floor. Conduits encased in concrete ductbank shall be PVC with a minimum 3 inch concrete coverage. All direct buried conduits shall be PVC or rigid galvanized steel. Provide a concrete cover for PVC conduits running below vehicle traffic areas.

5-2.7.2 Not Used

5-2.7.3 Conductors

Conduit embedded in a concrete structural slab shall comply with the applicable provisions of American Concrete Institute (ACI), Standard 318.

The minimum size of wire for power and lighting shall be #12 AWG. Conductors shall be copper, except for conductors #1/0 and larger, which shall be AA-8000 series electrical aluminum alloy aluminum if properly designed and installed. The design shall be based on the ampacity of copper conductors.

PHASE	208/120Y VOLTS	480/277Y VOLTS
A	Black	Brown
B	Red	Orange
C	Blue	Yellow
Neutral	White	Gray
Ground	Green	Green

5-2.7.4 Exterior Wiring

All underground wiring shall be installed in PVC or rigid galvanized steel conduit. All exterior underground conduit shall be a minimum of one inch, buried at a depth of not less than 2 ft. below grade. Provide a concrete cover for PVC conduits running below vehicle traffic areas. Conduits or ducts terminating below grade shall be sealed to prevent entry of dirt or moisture.

5-2.7.5 Grounding

MSBD, SSBD

5-2.7.6 Identification

Permanent tags shall be connected to all feeders at intermediate pullboxes to provide identification for future use. Identify panel and circuit number of all electrical devices, i.e. receptacles, disconnect switches and motor starters, using a minimum 1/8" high self-stick labels with block lettering, protected with clear tape.

5-2.8 Convenience Outlets

G5-2-8a

5-2.8.1 Type and Location

Provide NEMA specification grade, 2-pole, 3-wire, 20-A, 125 Volt, duplex grounding type outlets with nonconductive faceplates at 18 in. AFF, unless otherwise noted, in accordance with the following schedule.

LOCATION	OUTLET REQUIREMENTS
Workroom:	
Workroom	Two outlets per column @ 78" AFF, as directed by USPS (located in web of column, not on flange and not on the same circuit) and one per 25 linear feet of perimeter wall, recessed @ 78 in. AFF with metal faceplates. See Section 5-2.8.3 for drop cord twist lock receptacles.
Time clock / PSDS	Coordinate with specific facility requirements. Provide a dedicated circuit.
Registry Cage	One per 12' @ 46" AFF max. (top of outlet) with metal faceplates. Provide a dedicated circuit.
Investigative Office	One duplex outlet on every wall Provide 20

LOCATION	OUTLET REQUIREMENTS
	AMP dedicated circuits. For MSBDs, provide a panel to serve CCTV equipment and cameras within the IO space.
Delivery Confirmation	One duplex outlet. Two required if over 32 carriers.
Platforms:	
Mailing/Carrier Platform (Customer Service)	Recessed on platform wall, 25 ft. on center, 46 in. AFF (top of outlet). On platform exterior, place one on parking side of every fourth column. Provide weatherproof type outlets with ground fault interrupter circuit breakers if platform is open. Provided switches in employee areas to control these receptacles.
Support Areas:	
Lunch Room and Break areas	Max. 4 ft. on center at vending machine locations @ 46 in. AFF (top of outlet). At countertops, provide 2 outlets for coffee machines and microwave ovens. Each outlet to be on a separate circuit.
Water coolers/ microwave/ refrigerator/ coffee machine/etc.	One at each piece of equipment, on dedicated circuit.
Corridors	One per 30 linear feet of corridor.
Open Offices	One per 12 linear feet of perimeter wall plus one quadruplex outlet per employee (see 929).
Private Offices	One per 12 linear feet of wall with a minimum of one outlet per wall. Two of these outlets (at expected desk location) shall be quadruplex
Telecommunications Equipment Room (ER), Telecommunications Closet (TC)	See Section 5-4 Communications.
Toilets	Away from lavatories, provide ground fault interrupter type receptacles.
Vaults (interior)	Provide one duplex outlet.
Training Rooms	One per 10 linear feet of wall
Lobby (Retail and BMEU)	One duplex outlet per 30 ft. of lobby length, no less than two receptacles per lobby. Provide switches with pilot light in employee area to control lobby receptacles.
Retail:	
Full Service Counters	2-duplex outlets for each IRT. Provide a 20 AMP circuit.
Open Merchandise	One isolated ground receptacle for each register at cashwrap. One quadruplex receptacle for each register at cashwrap. Provide a dedicated circuit.
Self Service	One duplex receptacle for electronic scale or APC unit. For APC and Parcel Drop design details, see Program Folder, Retail, APC.

LOCATION	OUTLET REQUIREMENTS
Other:	
Exterior mechanical equipment	Weatherproof convenience outlets with ground fault interrupter for servicing.
Dish Antenna	Provide one outlet.
Stairwells	One at each floor.
Mechanical, transformer, and electrical equipment rooms	One per 20 linear feet of wall (not less than 2 per room).
All other rooms	One per 12 linear feet of wall with a minimum of one outlet per wall.

Exhibit 5-2a

Outlet Requirements

5-2.8.2 **Clocks**

Coordinate location of time clock outlets with USPS to insure a fully compatible and operational system. Each time clock requires a duplex electrical outlet and a single jack telecommunication outlet in a split double-gang box installed at 50 1/2" AFF.

5-2.8.3 **Twist Lock Receptacles**

For workrooms in all facilities a twist lock grounding type receptacle, NEMA L5-20R with drop cord shall be provided; one per 625 sq. ft., or as indicated on standard plans, for carrier case lighting. Twist lock receptacles in the ceiling shall be recessed and secured to the building structure. The drop cords shall have a twist lock plug at one end and a straight blade receptacle at the other. The drop cord lengths shall be field verified so that twist lock receptacles are located 6 ft. 6 in. above finished floor. Provide Kellum wire reinforcements at cord and receptacle.

 G5-2-8b

5-2.8.4 **Scales**

MSBD

5-2.9 **Not Used**

5-2.10 **Not Used**

5-2.11 **[Reserved]**

5-3 Lighting

USPS Handbook RE-5

The USPS is implementing energy conservation standards to minimize the operating cost for each facility. Lighting currently represents a large percentage of the utility costs. The approach that should be taken by the AE is one that meets the foot candle requirements using the fixtures specified for the lowest life-cycle cost. From a practical viewpoint, the Workroom lighting grid should be as large as possible while still complying with the 3:1 uniformity factor described herein.

The lighting system design shall include all computations for determining the lighting levels in a building. For both interior and exterior lighting solutions this is to include the types of fixtures and lighting controls used, the light distribution/photometrics, and the mounting heights. The same information shall be provided for exterior areas such as driveways, parking and maneuvering areas and security lighting systems, as applicable. Calculations are to indicate both initial and maintained lighting levels in footcandles,. The lighting system shall be 277 Volts, when available.

All buildings 5,000 square feet or larger shall utilize automatic control devices to turn off lighting in all spaces without occupant intervention. See ASHRAE 90.1-2004.

Except for workrooms, provide 3-way switches and occupancy sensors to control lighting in large spaces with multiple entrances, such as Mechanical/Electrical rooms, maintenance shops, training rooms, etc.

Light fixtures located on exterior of building shall be of weatherproof construction, and installed with non-ferrous metal screws finished to match the fixture. Light Fixtures shall be designed so that no direct illumination glare reaches drivers or pedestrians coming toward the facility.

All fixtures shall be furnished complete with suitable pendants, canopies, cover, ceiling roundels, opening flanges, hangers, plaster rings or frames if recessed, necessary rubber cords, chains, and all other accessories required for proper installation.

5-3.1 Interior Lighting

5-3.1.1 Workroom Lighting

MSBD, SSBD

- Fluorescent lamps used in USPS facilities shall be low mercury, high output, long life lamps.
- Utilize as few different lamps and ballasts types as possible in the facility, and avoid using different lamps and ballasts in the same areas such as workroom and administration space.
- Refer to USPS MSBD Specification "Section 16510 - Interior Lighting" for available fixture/lamp options for Workroom lighting fixtures.
- Refer to USPS SSBD Specification "Section 16510 - Interior Lighting" for available fixture/lamp options for Workroom lighting fixtures.

Lighting in the workroom area shall be limited to an Average Maintained level of 25 footcandles. Fixtures (ie – ballasts) shall utilize bi-level AC switching wired to a timing circuit based on scheduled use. Average maintained hi-level lighting is limited to 25 footcandles, low level lighting to 12.5 footcandles.

As a general rule, the workroom lighting shall be divided into zones of approximately 10,000 SF each to allow for turning lights off in areas that are not actively being used, or "off schedule" times.

Each zone shall be wired to a mushroom style switch on the wall adjacent to the zone. When the button is pushed, high level lighting should come on for a period of three (3) hours. Lighted buttons are preferred.

The AE shall develop;

-
- Layouts of areas where task lighting is applicable such as offices, stockrooms, and spaces with manual operations, and locations of manual override buttons.

The AE shall include, as part of the 30% Design submission, a photometric plan for the entire workroom floor and dock area indicating the proposed lighting layout with point-by-point footcandle levels on a maximum 5' X 5' grid pattern. Also provide statistical summaries to demonstrate the following:

- Average maintained footcandles
- Minimum footcandles
- Maximum footcandles
- Uniformity factor

Criteria for acceptance of the Workroom lighting system shall be based on light meter readings taken in one or more representative lighting zones covering a minimum area of 2,500 square feet. The USPS Contracting Officer shall approve the representative area(s) chosen.

Final acceptance shall be based on the measurement of initial footcandle levels, not maintained levels. Initial footcandle levels shall average 120% (+/-3%) of those prescribed in Exhibit 5.3a.

The light meter used shall have been recently calibrated with an accuracy of $\pm 3\%$ or better and shall be positioned in a horizontal plane on a portable stand at 30" AFF.

Light meter readings shall be taken after fixtures have been re-lamped and cleaned and lamps have been in operation for a minimum of 100 hours. Readings may have to be taken after normal work hours to avoid the influence of extraneous ambient light.

5-3.1.2 Platform Lighting

MSBD, SSBD

5-3.1.3 Retail Lighting

 G5-3-1a

The Retail area depends heavily on the proper application and intensity of lighting. The intended effect is to provide proper levels of retail lighting to establish the distinction between areas, and accent special elements with downlights, wall washers, cove lights, and under cabinet lights. Fixture selection and footcandle levels shall comply with Sections 5-3.1.7 and 5-3.1.8.

- Provide good quality light to enable customers and clerks to carry out visual tasks effectively and comfortably using lights as specified (do not substitute light fixture, lamp, or ballast types, although alternate sources may be considered).
- Highlight the parcel slide, slatwall, gondolas, and writing surfaces with downlights or wall washers to facilitate locating these items and merchandise.
- Sufficient lighting (1 footcandle minimum) is required to stay on 24 hours a day in the Retail areas to allow the CCTV system to function properly. This allows the CCTV system to record an identifiable picture and to record it if an alarm is triggered.

- Locate switches for lobby lighting in employee areas, or use key switches. Clearly arrange and circuit light switches to allow zone control of lights.
- In all Box Lobbies, lighting shall have a base ambient lighting level of 12.5 footcandles and a high level of 30 footcandles.
 - In 24-hour Box Lobbies, a timeclock or timing circuit shall be provided to setback the lighting level to the ambient of 12.5 footcandles after full service hours. Also, occupancy sensor(s) shall be used to bring the light level up to 30 footcandles when a patron enters and timing out after 30 minutes of unoccupied sensing.

5-3.1.4 **Exit Lighting**

Exit signs shall be provided to mark locations of exits and exit routes as required to meet code. Signs shall be energy efficient “LED” type have maintenance-free battery back-up, if applicable, and meet the minimum UL requirements for brightness and distribution. Where exit signage is required by code, photoluminescent signage maybe used to augment electric exit signage but shall not be used in lieu of electric exit signage.

5-3.1.5 **Emergency Lighting**

MSBD, SSBD

Emergency lighting shall be provided to comply with National Fire Protection Association 101 Life Safety Code and in accordance with this standard, the more stringent shall apply. Lighting shall be circuited so that the standby lighting system in an area is energized when the power to the lighting in that area fails. Since the standard for lighting in all new facilities are T8 fluorescents, the emergency lighting shall be T8's with battery backup fully integrated into the overall lighting system design. A minimum of one emergency light shall be located at the main service panelboard. Provide an average of 1 footcandle to illuminate designated routes of egress per NFPA 101.

Emergency lights shall have manual push test switches.

5-3.1.6 **Daylighting**

MSBD

5-3.1.7 **Footcandle Levels and Power Density**

The following parameters for footcandle and power density levels shall be met in the selection of lighting fixtures to ensure quality of materials, ease of maintenance and good performance.

Refer to Interior Fixture Application chart, Exhibit 5-3b, and Exterior Fixture Application chart, Exhibit 5-3d, for cross-reference to the standard Postal fixture types contained in the Postal specifications. Refer to the USPS Master Specifications for further description of these types.

AREA	LOCATION/ DESCRIPTION	AVERAGE MAINTAINED FOOTCANDLES (FC) (At 2'-6" AFF unless otherwise noted) ^{11, 12}		UNI- FORMI TY	LAMPS ¹⁴	MAX. POWER DENSITY ¹³ (W/SF)	FACILITY TYPE
		Horizontal	Vertical				
Workroom ⁵	Workroom	12.5/25 ⁴	10	3:1	F	0.5	MSBD SSBD
Platforms	Open Mail	12.5/25 ⁴		3:1	F ¹⁰	0.5	MSBD, SSBD
	Enclosed Mail	12.5/25 ⁴		3:1	F ¹⁰	0.5	MSBD, SSBD
	Carrier	12.5/25 ⁴		3:1	F ¹⁰	0.5	MSBD, SSBD
	Vestibule	12.5/25 ⁴		3:1	F	0.5	MSBD, SSBD
Support Areas ¹	Building And Grounds Room	20			F	0.2	MSBD
	BMEU	50			F	0.9	MSBD
	Conference and Training Room ²	50			F	0.9	MSBD
	Corridor	20			F	0.5	MSBD
	Custodial Storage	20			F	0.3	MSBD
	Equipment Room, Electrical & Mech. Rooms	20			F	0.6	MSBD, SSBD
	Custodial Closet	20			F	0.6	MSBD, SSBD
	Locker Rooms/Areas	30			F	0.8	MSBD, SSBD
	Lunch Room	30			F	0.7	MSBD, SSBD
	Offices ⁶	30			F	1.1	MSBD, SSBD
	Storage Room	20			F	0.3	MSBD, SSBD
	Telecommunications Equipment Room (ER)	20			F	0.6	MSBD
	Telecommunications Closet (TC)	20			F	0.6	MSBD
	Toilet Rooms	20			F	0.7	MSBD, SSBD
	Vaults	50	5		F	0.9	MSBD, SSBD
	Investigative Office ⁷	20 ambient 40 task	3 5		F	0.9	MSBD, SSBD
Retail	Lobby	30	3		F	0.9	MSBD, SSBD
Retail	Full Service	50	10		F	0.9	MSBD, SSBD
	Self-Service	30	5		F	0.9	MSBD, SSBD
Other	All Other Rooms	30			F	0.9	MSBD, SSBD

Exhibit 5-3a
Footcandle Levels and Power Density

Footnotes:

¹In facilities 5,000 SF and greater, provide occupancy sensors in restrooms, lunchrooms, conference and training rooms, and storage rooms. Sensor shall have zero to thirty minutes adjustable delay.

²Provide dimming capability.

³ Provide task lighting as necessary at equipment operation locations in order to achieve 50 fc

⁴Indicates bi-level AC switching for levels of illumination. Lower number is general ambient, higher number for periods of high activity.

⁵Provide dual switching in all bays to achieve prescribed footcandle levels. Coordinate with EEMS system.

⁶ Provide occupancy sensors with manual override switches.

⁷ Provide dimmable ballasts and 3-way switching with dimmer control.

⁸ Not used.

⁹ As defined by the I.E.S., Maintained Footcandle Level is to be interpreted as "Average Maintained Footcandle Level" for all interior rooms. Illumination levels for exterior areas are minimum footcandles on a horizontal plane at ground level.

¹⁰ For climates where temperatures reach below 0°F, metal halide fixtures may be used in lieu of fluorescent.

¹¹ USPS shall receive maximum benefit of the rated life of all lamps. Do not install lamps sooner than two weeks prior to the date established for final acceptance of an area. If any part of the permanent lighting system is utilized for construction purposes, contractor shall thoroughly clean and re-lamp fixtures no sooner than two weeks prior to final acceptance.

¹² Final acceptance will be based on measurement of initial lighting levels, not maintained lighting levels.

¹³ Represents a ~25% reduction in the values established in ASHRAE/IESNA 90.1 2004 using the Building Area Method.

¹⁴ Lamping: MH = Metal Halide, F = Fluorescent

5-3.1.8 Interior Fixture Application

AREA	LOCATION/ DESCRIPTION	FACILITY TYPE	POSTAL TYPE	FIXTURE DESCRIPTION	CONTROLS 5,6
Workroom	Workroom	MSBD	W1/W2	8'/'4' Cable/chain hung industrial fluorescent with 1, 2, or 3 lamps, wired/relay for two level switching.	1,2
		SSBD	A5	2' x 4' Recessed lensed fluorescent troffer with 4 lamps, two level switching.	3
Platforms	Open/Enclosed Mail	MSBD	PL1	12" Recessed Metal Halide Lensed Downlight, shallow housing, horizontal lamp.	4
			EM2	Dual head emergency lighting unit with battery.	
	SSBD	MH2	Square surface mounted Metal Halide luminaire with horizontal lamp.		
		EM2	Dual head emergency lighting unit with battery.		
Carrier Canopy	MSBD	PL1	12" Recessed Metal Halide Lensed Downlight, shallow housing, horizontal lamp.		
		EM4	Wet location emergency lighting unit.		

AREA	LOCATION/ DESCRIPTION	FACILITY TYPE	POSTAL TYPE	FIXTURE DESCRIPTION	CONTROLS 5,6	
		SSBD	MH2	Square surface mounted Metal Halide luminaire with horizontal lamp.		
	Vestibule (Carrier & Mail)	MSBD, SSBD	A2	2' x 4' Recessed Lensed Fluorescent Troffer with 2 lamps.		
Platform Dock	Platform Task Light	MSBD, SSBD	P1	Dock Light Fixture.	8	
Support Areas	Building And Grounds Room	MSBD	B1	Enclosed Industrial Fluorescent with high impact acrylic diffuser.	3	
			EM3	Industrial 2-head emergency lighting unit with battery.		
		SSBD	CL1	Surface Mounted 2 lamp fluorescent strip light with wireguard.	3	
	BMEU	MSBD	A3	2' x 4' Recessed lensed fluorescent troffer with 3 lamps.		
			EM1	Recessed square emergency lighting unit.		
	Conference and Training Room	MSBD	A3	2' x 4' Recessed lensed fluorescent troffer with 3 lamps.	3	
			EM2	Dual head emergency lighting unit with battery.		
	Corridor	MSBD SSBD	A2	2' x 4' Recessed Lensed Fluorescent troffer with 2 lamps.		
	Custodial Storage	MSBD SSBD	CL1	Surface Mounted 2 lamp fluorescent strip light with wireguard	3	
	Equipment Room, Electrical & Mech. Rooms	All	CL1		Pendant Mounted 2 lamp fluorescent strip light with wireguard.	3
				EM3	Industrial 2-head emergency lighting unit with battery.	
	Custodial Closet	All	CL1	Surface Mounted 2 lamp fluorescent strip light with wireguard	3	
	Locker Rooms/Areas	All	A1		2' x 4' Recessed lensed and gasketed troffer with 2 lamps.	3
				EM2	Dual head emergency lighting unit with battery.	
	Toilet Rooms	MSBD	A2	2' x 4' Recessed lensed fluorescent troffer with 2 lamps.	3	
			SSBD	A1		2' x 4' Recessed lensed and gasketed troffer with 2 lamps.
Lunch Room	All	A1		2' x 4' Recessed lensed and gasketed troffer with 2 lamps.	3	
			EM2	Dual head emergency lighting unit with battery.		
Offices	MSBD	A3	2' x 4' Recessed lensed fluorescent troffer with 3 lamps.	3		
		SSBD	A6		2' x 4' Recessed lensed fluorescent troffer with 2 lamps.	
Storage Room	All	CL1	Pendant Mounted 2 lamp fluorescent strip light with wireguard	3		
Telecommunication Equipment Room (ER)	All	CL1		Pendant Mounted 2 lamp fluorescent strip light with wireguard.	3	
			EM3	Industrial 2-head emergency lighting unit with battery.		
Telecommunication Closet (TC)	All	CL1		Pendant Mounted 2 lamp fluorescent strip light with wireguard.	3	
			EM3	Industrial 2-head emergency lighting unit with battery.		

AREA	LOCATION/ DESCRIPTION	FACILITY TYPE	POSTAL TYPE	FIXTURE DESCRIPTION	CONTROLS 5,6
	Vaults	MSBD	A3 EM2	2' x 4' Recessed lensed fluorescent troffer with 3 lamps. Dual head emergency lighting unit with battery.	3
	Investigative Office	MSBD	A5 CIO2 EM2	2' x 4' Recessed lensed fluorescent troffer with 4 lamps, two level switching. Recessed step light with louver face, LED lamp. Dual head emergency lighting unit with battery.	7
Retail	Lobby	MSBD	R1 R3 EM1	Compact Fluorescent down light. 2' x 4' Parabolic fluorescent troffer with 12 cells, 2 lamps. Recessed square emergency lighting unit.	
		SSBD	A3	2' x 4' Recessed lensed fluorescent troffer with 3 lamps.	
	Box Lobby	MSBD	R3 CV1 EM1	2' x 4' Parabolic fluorescent troffer with 12 cells, 2 lamps. Cove mounted single lamp fluorescent strip with paracube louver. Recessed square emergency lighting unit.	
		SSBD	A5	2' x 4' Recessed lensed fluorescent troffer with 4 lamps, two level switching.	
	Full Service	MSBD	R1 R3 EM1	Compact Fluorescent down light. 2' x 4' Parabolic fluorescent troffer with 12 cells, 2 lamps. Recessed square emergency lighting unit.	
		SSBD	R1 A5	Compact fluorescent down light. 2' x 4' Recessed lensed fluorescent troffer with 4 lamps, two level switching.	
	Self-Service	MSBD	R1 R2 R3 EM1	Compact fluorescent down light. Compact fluorescent wallwasher. 2' x 4' Parabolic fluorescent troffer with 12 cells, 2 lamps. Recessed square emergency lighting unit.	
		SSBD	A3 CV3	2' x 4' Recessed lensed fluorescent troffer with 3 lamps. Cove mounted single lamp fluorescent strip with paracube louver.	
Other	All Other Rooms	All	A6 A5	2' x 4' Recessed lensed fluorescent troffer with 2 lamps. 2' x 4' Recessed lensed fluorescent troffer with 4 lamps, two level switching.	3

Exhibit 5-3b
Interior Fixture Application

Controls Notes

¹ Provide 2 – level AC switching with occupancy sensor override.

² Fixture shall be used for all levels of lighting, including emergency egress lighting with battery backup. Contact the Manufacturer to identify part numbers for the battery backup version of the same luminaire. These part numbers are not provided in Specification Section 16510 Interior Lighting.

- ³ Provide occupancy sensor to override the switching.
- ⁴ Provide photocell control.
- ⁵ Provide daylight controls where daylighting contributes to illumination.
- ⁶ Provide on/off switches unless noted otherwise.
- ⁷ Provide dimming ballasts and wall box dimmers.
- ⁸ Provide timer switch for on/off control.

5-3.2 Exterior Lighting

Light pole locations and heights, as well as lamp distribution characteristics, should be carefully considered to minimize the number of exterior fixtures required. The ratio between maximum and minimum lighting intensities shall not exceed 20 to 1.

 G5-3-2b→d1

Exterior lighting design shall take into consideration the street and/or adjacent property lighting, and eliminate light trespass for adjacent properties. Make use of direct illumination with full cutoff optics for pole mounted luminaires, and full cut-off optics for all wall mounted luminaires. Flag pole illumination shall be the only use of uplighting, the wattage of these metal halide sources shall not exceed 400 Watts.

Bolts for attaching poles to concrete bases are to be painted to match finish of pole prior to installation. Install poles plumb and provide non-shrink grout at base.

5-3.2.1 Parking and Maneuvering Areas

All light pole foundations located within parking and maneuvering areas, or adjacent to driveways or curbs, shall be protected at the base by reinforced concrete pedestals to minimize damage to poles. All lights shall be fused with in-line fuses in the base for service and protection.

 G1-2-0b

5-3.2.2 Security Requirements

Lighting system shall be coordinated with latest building and site security requirements to prevent unauthorized entry or exit and to assist in maintaining acceptable levels of facility protection. Conductors shall be located underground to minimize the possibility of sabotage or vandalism. The design shall provide for simplicity and economy in system maintenance and require a minimum of shutdowns for routine repairs, cleaning and lamp replacement. All breakers or switches for security lighting circuits shall have locking devices, or be located in a locked room, to prevent operation by unauthorized personnel.

USPS Handbook RE-5

5-3.2.3 Signage

All electrical runs and connections to signs are to be concealed. Signs shall be placed on a photocell/time clock system. Refer to electrical and mounting connection details located in the USPS Standard Detail Library. Care and good judgment should be used to select time frames and dates for the illumination of signs that will maximize the exposure to the USPS image while still creating environmentally and fiscally responsible use of natural resources. Highly traveled areas may benefit from having a single primary

 G5-3-2b→d1

sign illuminated during extended hours while other secondary signs may be turned off. Always turn off a wall sign cabinet and stripes together as a unit. Do not have a wall sign cabinet illuminated without illuminating the associated striping.

5-3.2.4 Not Used

5-3.2.5 Building Perimeter

Provide UL wet location listed emergency egress lighting at all egress doors. Emergency egress luminaires to be connected to the line side of the corridor lighting circuit leading to the egress door, such that an interruption of the power to this circuit will activate the lighting.

5-3.2.6 Exterior Footcandle Levels and Power Density

Lighting levels in Exhibit 5-3c shall be used unless higher light levels are required by local code and/or CCTV camera requirements.

AREA	LOCATION/ DESCRIPTION	AVERAGE MAINTAINED HORIZONTAL FOOTCANDLE (FC) LEVEL (at Grade unless noted otherwise)	LAMP TYPE ^{6,7}	POWER DENSITY ⁴ (W/SF = Watts per sq. foot) or (W/LF = Watts per linear Foot)	FACILITY TYPE
		Horizontal			
Exterior ³	Perimeter Fence	.33	MH	0.2 W/SF	MSBD, SSBD
	Vehicular Entrances ²	.50	MH	0.15 W/SF	MSBD, SSBD
	Pedestrian Entrance ⁵	1.0	MH	30 W/LF of Door Width	MSBD, SSBD
	Public Entrance Canopy ⁵	1.0	MH	30 W/LF of Door	All
	Pedestrian Walkways	.33	MH	0.15 W/SF	All
	Parking-Employee	.33	MH	0.15 W/SF	MSBD, SSBD
	Parking- Maneuvering	.33	MH	0.15 W/SF	MSBD, SSBD
	Parking-Customer ²	1.0	MH	0.15 W/SF	MSBD, SSBD
	Snorkel Lane	1.0	MH	0.2 W/SF	MSBD, SSBD

Exhibit 5-3c
Exterior Footcandle Levels and Power Density

Footnotes:

- ¹ Not used.
- ² Not to drop below 0.5 foot-candles minimum.
- ³ Provide photocell control or time-clock control
- ⁴ According to ASHRAE/IESNA 90.1 2001.
- ⁵ Not Used
- ⁶ Lamping: MH = Metal Halide, F = Fluorescent

⁷ In warmer climates, consider compact fluorescents for wall mounted luminaires, and electrodeless sources for the pole mounted luminaires.

General Notes:

1. As defined by the I.E.S., Maintained Footcandle Level is to be interpreted as "Average Maintained Footcandle Level" on a horizontal plane at ground level. Refer to Handbook RE-5 for additional requirements.
2. USPS shall receive maximum benefit of the rated life of all lamps. Do not install lamps sooner than two weeks prior to the date established for final acceptance of an area. If any part of the permanent lighting system is utilized for construction purposes, contractor shall thoroughly clean and re-lamp fixtures no sooner than two weeks prior to final acceptance.
3. Final acceptance will be based on measurement of initial lighting levels, not maintained lighting levels.

5-3.2.7 Exterior Fixture Application

AREA	LOCATION/ DESCRIPTION	FACILITY TYPE	POSTAL TYPE	FIXTURE DESCRIPTION	NOTES
Exterior	Parking Perimeter Fence	All	SP2	Full Cut-off luminaire with horizontal metal halide lamp mounted on pole (2 per pole where required)	1, 2
	Vehicular Entrance	All	SP1	Full Cut-off luminaire with horizontal metal halide lamp mounted on pole	1, 2
	Snorkel Lane	All	SP2	Full Cut-off luminaire with horizontal metal halide lamp Mounted on Pole (2 per pole where required)	1, 2
	Pedestrian Entrance & Walkways	All	SP5	Full cut-off luminaire with horizontal metal halide lamp mounted on pole	1, 2, 3
	Public Entrance Canopy	All	PL1	12" Recessed Metal Halide Lensed Downlight, shallow housing, horizontal lamp.	2
	Building Perimeter	All	MH3	Wall mounted half-cylinder metal halide full cut-off luminaire.	2
	Emergency Egress	All	EM4	Wet location emergency lighting unit, with halogen lamps.	4

Exhibit 5-3d
Exterior Fixture Application

Fixture Application Notes

- ¹ Pole height restrictions are dependent upon local jurisdiction.
- ² Provide photocell control of site lighting.
- ³ Lower wattage source in comparison to area/roadway luminaires, on a shorter pole.
- ⁴ Connected to line side of normal lighting circuit leading to egress door.

5-4 Communications

 G5-4-0a→d1

5-4.1 Scope

A building's communications system consists of voice and data telecommunications, paging and intercommunications, Postal Vision /Postal

Satellite Training Network (PSTN), and call bell systems. Some facilities may not include all systems, however, all Postal facilities will use a Structured Cabling System (SCS) for the majority of the telecommunication cabling. This cabling system is designed to be as “applications independent” as possible. It provides maximum flexibility to support current and future system requirements.

The following is a brief description of the communications systems, services, and hardware that use the SCS and may be implemented within a Postal facility:

- Voice grade services, such as basic telephony, facsimile, Internet access and dial-up data circuits via modem.
- Digital data services such as Integrated Services Digital Network (ISDN), Switched 56kb services or Frame Relay services.
- Local area network (LAN) services such as on-line information processing, batch information transfer, file storage and sharing, electronic-mail, shared printing, point-of-service and mail processing equipment applications. LAN hardware supported by this cabling infrastructure includes: Personal computers, printers, HEBR time clocks, POS terminals, and mail processing equipment (MPE).

The design documents also reference other low-voltage “communications” cable systems. The speaker wire, shielded twisted pair (STP) cabling, and other cabling specified for these systems are proprietary and design specific. The following systems are currently **not** part of the SCS and may be implemented within a Postal facility:

- The Paging system, which is telephone activated and therefore connects to the telephone system, but its components and cabling are independent.
- Postal Vision/Postal Satellite Training Network (PSTN), which delivers Postal Service messages, information, and training via televisions, desktop networks and dedicated kiosks
- Call Bell systems, which include door bells and the assistance buzzer in Retail and BMEU facilities.

5-4.1.1 Terminology

The telecommunications industry has recently revised the terminology used to describe various commonly used components. This document is based on these new terms, as defined in the Electronic Industry Association and Telecommunications Industries Association (TIA/EIA) documents 568B and 569. The following table summarizes the changes in the terms:

Old USPS Terminology	New USPS Terminology
Structured Wiring System (SWS)	Structured Cabling System (SCS)
Main Distribution Frame (MDF)	Main Cross Connect (MC)
Intermediate Distribution Frame (IDF)	Horizontal Cross Connect (HC)
MDF/Telephone Room	Telecommunications Equipment Room (ER)
IDF Room	Telecommunications Closet (TC)
Multi-Port Zone Box	Consolidation Point (CP)
Information Outlet (IO)	Telecommunications Outlet (T/O)

Exhibit 5-1a

Terminology Matrix

5-4.2 Incoming Service

The A/E shall coordinate with the local telephone service provider to establish the point of incoming service. Communications service providers, including the telephone company(s) and cable TV company(s), shall service the facility by extending their network cable running along the adjacent roadways into the building. These services shall be brought to the facility site via underground ductbanks (MSBD facilities) or direct buried conduit (SSBD facilities) or as required based on availability.

To connect to these networks, the Postal facility's primary communications service entrance in the Telecommunications Equipment Room (ER) or Consolidated Computer Room (CCR) shall consist of, at a minimum, two 4 in. conduit runs for MSBD facilities, or a minimum of one 4" conduit run for SSBD facilities from the communications main cross connect to the property line. Multi-cell, textile innerducts with pull wires shall be provided for empty conduits. Conduit(s) may be run below slab and stubbed up into the building with rigid metal conduit. Final connection of the conduit at the property line shall be made by the service providers. All unused conduit shall be capped and sealed to prevent water from entering the building.

Communications service shall not share service entrance with electrical service provider. All aspects of this pathway requirement shall be coordinated with the service providers at the onset of the project to ensure that conduit run distances and conduit bend constraints imposed by the service providers are properly met. Communications conduits shall not run parallel to power conduits unless minimum distance separation or other shielding requirements are met per Building Industry Consulting Service International's (BICSI) current Telecommunications Distribution Methods (TDM) and TIA/EIA-569 Telecommunications Pathways and Space Standard. Proper termination, grounding, and electrical protection of all building entrance cables shall be provided per National Electrical Safety Code (ANSI 2) NFPA 70 - National Electric Code (NEC), TIA/EIA-607 and all local codes governing electrical and fire safety.

5-4.3 Telecommunications - Structured Cabling System

MSBD, SSBD

The Structured Cabling System (SCS) is an infrastructure wiring system that carries both voice and data. At a minimum, depending on facility size and type, the SCS is comprised of telecommunication outlets (T/O), horizontal cabling, and a main cross connect (MC). For larger or more complicated facilities, additional components are required: horizontal cross connect (HC), cable backbone systems, and campus cable systems. The specific components required for Postal facilities of various sizes are shown in each Standard Design Program drawings, Module 2 of the Criteria, and in the USPS Master Specifications.

The SCS shall use patch panel fields for terminating all cabling (voice and data) at MCs or HCs. A completely patchable system for voice and data will provide maximum flexibility to support current and future system requirements. The USPS Specification section 16705 reflects the structured cabling requirements outlined in this section of the SDC.

The space, power, and HVAC requirements for the main cross connect and the horizontal cross connect vary depending on their complexity. The main cross connect is in the Telecommunication Equipment Room (ER). The horizontal cross connect, if required, is in the Telecommunication Closet (TC). Each of the USPS Standard Design Programs has specific program requirements for these spaces.

5-4.3.1 Not Used

5-4.3.2 Not Used

5-4.3.3 Telecommunications Horizontal Cabling System

Telecommunications horizontal cabling is defined as the cabling that connects the Telecommunications Outlets (T/O) to the Main Cross-connect (MC) or to the Horizontal Cross-connect (HC). The system shall be designed in a hierarchical star topology, as defined in TIA/EIA 568B. The term "horizontal" does **not** describe how the actual cables are physically routed (up, down, right, left, etc.), it refers to its role within the telecommunications hierarchy. Telecommunications horizontal cabling connects TOs that are on one "level" of the hierarchy back to the MC or HC that define the "level". If required, backbone cabling and campus cabling systems (discussed below) are used to connect "levels" between MCs and HCs. In some of the drawings, telecommunication horizontal cabling is referred to simply as telecommunications cabling.

Telecommunications horizontal cabling shall be home run from each workstation/area telecommunication outlet to either the MC or the HC, and shall not exceed 295 ft (actual cable length) for any continuous cable run to a standard Telecommunications outlet or 230 feet to a Consolidation Point or Multi-User Telecommunications Outlet. Horizontal cabling on the work room floor and platform shall not exceed 230 feet. Horizontal cabling shall not be installed within conduits installed underground or under the slab.

5-4.3.4 Backbone Cabling

Backbone cabling connects the MC with the HC. There are two types of backbone cabling used on Structured Cabling Systems:

-
- Copper Voice backbone, Category 3 (24 gauge cabling)
 - Multimode Fiber Optic 50/125 micron laser optimized Cabling.

Backbone cable running between floors of multistory buildings is referred to as riser cable. Voice backbone cable shall be sized by multiplying the number of outlets being connected to the HC by 2, and adding 40 percent growth. A 24 strand, 50/125 micron, tight buffered, "1500/500" laser-optimized, 10-Gigabit-Ethernet-compliant, multimode fiber optic cable is required for each TC when required in a MSBD Facility. More detailed information concerning backbone cabling systems can be found in TIA/EIA-568B.

Backbone cabling from each HC to the MC shall be run in EMT or cable tray. When fiber optic cabling from multiple HCs is run in a common raceway, each individual cable shall be in inner duct. Backbone cabling shall not be installed within conduit installed underground or under the slab.

5-4.3.5 Campus Cabling (For remote buildings on the same property as main building)

Campus cable subsystems provide voice and data connectivity between main building MC and HCs of adjacent buildings (VMF, Annex, etc.) located on the same property as the main building. One exterior grade, voice campus copper cable, and a minimum of one exterior grade 24 strand, 50/125 micron, tight or loose buffered, "1500/500" laser-optimized, 10-Gigabit-Ethernet-compliant, multimode fiber optic cable is required. Distances in excess of 1000 feet may require a "hybrid" multimode and singlemode fiber optic cable. Voice campus copper cabling requires lightning protection. Campus cabling shall be enclosed in underground conduit and shall not use direct burial.

The amount and size of voice campus cable is determined by multiplying the number of outlets being serviced by the adjacent building MC by 2 plus 40 percent growth.

5-4.3.6 Termination, Testing, and Patching

All cabling (horizontal, voice and fiber backbone, and campus) shall be tested for signal continuity and signal performance as per the above referenced standard before handoff to the USPS.

Patching between cable termination equipment and system transport electronics shall be accommodated with the least amount of patching hardware that is practical. Connections between horizontal cable terminations and transport electronics will be made directly, through the use of an appropriate patch cord. Where necessary, connections between horizontal cables terminated on rack mounted hardware and remote rack or wall mounted equipment shall be made via the use of an intermediate modular "tie" field adjacent to the rack mounted patching system. When a tie field is utilized, the hardware in the field shall be compliant with the requirements of TIA/EIA-568B and compatible with the specific media and applications being utilized. Connection between horizontal termination fields and tie fields, and from patch panels to equipment ports, shall be made through the use of pre-manufactured patch cords.

All cables, TOs and patch panels shall be labeled and cross-referenced to the outlet plans and the cable termination schedules. These documents along with the cable test results shall be submitted to the Postal facility administrator and the District Information Systems Manager at the project's completion.

5-4.3.7 Telecommunication Outlets (T/O)

Unless specified otherwise, each telecommunication outlet (T/O) shall be provided with three telecommunication horizontal cables as specified above. Each cable shall be terminated with an 8-pin modular connector with TIA/EIA-“T568A” pinning at the workstation, and with 8-pin modular patch panels with TIA/EIA-“T568A” pinning, at the MC, or HC. A minimum 10 foot service loop, coiled so as not to exceed the minimum bend ratio of the cable, shall be installed in the ceiling at the at the end of the conduit/EMT stub except where the entire cable run is encased in conduit or EMT. The terminations shall match the requirements listed for telecommunication horizontal cabling above. The size of outlet boxes varies among different Postal Standard Building Designs:

USPS PROGRAM	BOX SIZE	FACEPLATE
MSBD	double-gang, 2 ½”Depth w/ single device cover	single- gang
SSBD	single-gang, 2 ½”Depth	non-conductive

T/Os shall be wall mounted at 18 in. AFF to top of outlet, unless otherwise noted, at the following locations:

LOCATION	TELECOMMUNICATION OUTLET (T/O) ⁽¹⁾ REQUIREMENTS
Workroom (SSBD & MSBD)	One T/O for every 20,000SF of the Workroom floor. Column mounted TOs @ 78 in. AFF, (located in web of column, not on flange) on opposite side of column as the location of the power convenience outlet. Place TOs on workroom perimeter wall, @40' OC, @ 78 in. AFF. Refer to the OSL ⁽²⁾ for determining the location of T/Os.
Wireless Access Point HEBR (Time clock)	If required, refer to MPF Design Criteria. Provide one duplex T/O at each time clock except where multiple clocks are immediately adjacent to each other in which case one T/O is required for every three clocks. Install the T/O behind the HEBR next to a power outlet. (Where multiple clocks are installed the space should be coordinated with time card space requirements.)
Registry Cage	One T/O for registry cage. One T/O in Registry Cage Vault
Investigative Office	One T/O for SSBDs; one T/O on each sidewall below writing surface For all other facilities
Delivery Confirmation	One T/O per every 16 carriers.

LOCATION	TELECOMMUNICATION OUTLET (T/O) ⁽¹⁾ REQUIREMENTS
Support Areas:	
Open Offices (regardless of sq ft)	Provide one T/O per individual modular furniture workstation supplied by Type 2 or Type 3 Consolidation Point. In addition provide a minimum of two wall or column mounted T/O for office equipment adjacent to a power outlet. Refer to the FF&E plan for the exact locations.
Private Offices	Two T/O per office, coordinate location with FF&E Plan.
Telecommunications Equipment Room (ER), MSBD, and SSBD	Locate T/O's on exposed overhead ladder trays at 7'- 6" to 8'-0" above finished floor ⁽³⁾ . Install one 3-port T/O per 6 linear feet of ladder tray ⁽⁴⁾ on each side staggered or as directed by USPS with a minimum of one T/O per ladder rack. Provide two individual cable tray runs the length of the room in each direction.
Lunchroom	One T/O for every three Job Bidding Kiosks.
Conference and Training Rooms	Provide one T/O per wall and a minimum of one T/O for each training console. If Wireless Access Point is required refer to MPFDC.
BMEU	Provide one T/O per BMEU counter, one T/O over each MERLIN machine and one T/O for every three dock doors. T/Os are not required for the customer side of the Retail Lobby.
General Shops	400 SF or less: Provide minimum of two T/Os per room. Over 400 SF: Provide one T/O every 24 feet of wall with a minimum one T/O per wall.
Supply Rooms	200 SF or less: Provide minimum of one T/O per room. Over 200 SF: Provide two T/Os on opposite walls.
Vaults	One T/O inside vault near door.
Retail:	
Full Service Counters	One T/O for each counter.
Self Service	One T/O is required for APC unit, even if APC is not provided at this time. For APC and Parcel Drop design details, see Program Folder, Retail, APC.
Automated Postal Center	Coordinate with USPS Retail/Marketing
Lobby	No T/O's in Lobby
Other:	
All other rooms	Per standard plans.

Exhibit 5-3b

Telecommunication Outlet Requirements

Notes:

1. All T/Os are tri-plex unless stated otherwise.

2. Operational Systems Layout (OSL) provided by USPS
3. As an alternate, provide one 4-port T/O per 8 linear feet of ladder rack.
4. If 84" cabinets are used then 7'-6" is the recommended ladder tray height.

Patch cords from Consolidation Points and Telecommunications Outlets to all telephones, computers, mail processing equipment, etc. will be provided and installed by the local facility.

5-4.3.8 Outlets for Wall-Mounted Telephones

Outlets for wall-mounted telephones shall meet the same standards as telecommunication outlets (T/O) except that only one telecommunication horizontal cable and termination shall be provided. A minimum 10 foot service loop, coiled so as not to exceed the minimum bend ratio of the cable, shall be installed in the ceiling at the end of the conduit/EMT stub except where the entire cable run is encased in conduit or EMT. Arrange the cables from these single-cable T/Os on the lowest patch panel away from the standard three-cable T/Os. The outlets shall be provided with a box and face plate capable of supporting a wall-mount telephone.

Wall telephone outlets shall be wall mounted at 42 in. AFF to top of outlet, unless otherwise noted, at the following locations:

LOCATION	WALL TELEPHONE OUTLET REQUIREMENTS
Support Areas:	
Administrative Break areas	One wall telephone outlet per room, as indicated on standard plans, or when required for a specific facility.
Courtesy & Entrance	One wall telephone outlet per room, as indicated on standard plans, or when required for a specific facility.

Exhibit 5-3c

Wall Telephone Outlet Requirements

5-4.3.9 Not Used

5-4.3.10 Cable Pathways

Cable distribution pathways shall be designed to provide the capacity and capability to properly install telecommunications cables during construction as well as in the future. These cables will include horizontal, backbone, and campus cables.

Underground or below-slab conduits shall only be permitted for incoming service entrance and for campus cabling between main building and remote buildings on the same site. All other cable pathway routes shall be overhead.

All cable pathway routes shall be coordinated with other building services (electrical, mechanical, plumbing, etc.) to assure proper clearances and accessibility. The cable pathway routes must be coordinated with the electrical distribution system. Where electrical and telecommunications cabling cross, it shall be at right angles only. Avoid long runs of telecommunications cable in close proximity to parallel runs of electrical

power cable. Maintain a minimum one foot separation between power and communications cables when running in parallel unless both power and communications cables are in conduit. Distribution of telecommunications cabling shall conform to ANSI/TIA/EIA-568B and ANSI/TIA/EIA-569.

Telecommunications horizontal cabling shall be distributed in conduit, in cable trays, or supported by cable supports, as specified in the drawings and USPS Specification for each Building Standard Design. Cable tray and/or conduit shall be used in any area where the cabling system is exposed and a suspended ceiling system is not present. Where cable supports are used, cables shall be aggregated into common runs or bundles allowing a controlled and manageable cable installation. Individual cable runs shall collect at right angles to the main cable bundle whenever possible, and shall avoid running diagonally across the ceiling at all times. Cables shall be supported at the highest possible point along their route, to keep them away from other electrical and mechanical components. Cabling shall be supported by elements of the building structure, and not simply tied to conduit. J-hooks or other devices designated suitable for the support of Category 6 cable may be used. Where cable trays are used, telecommunication cabling shall not be in the same compartment as power cabling.

Backbone cabling from each HC to the MC shall be run in conduit or cable trays. When fiber-optic cabling from multiple HCs is run in a common raceway, each individual cable shall be in inner duct. Cable tray and/or conduit shall be used in any area where the cabling system is exposed and a suspended ceiling system is not present.

Where cables pass through partitions and walls, conduit sleeves shall be provided in the wall to allow the cables to pass. Conduit sleeves in fire rated partitions and walls must be properly firestopped.

Telecommunications horizontal cabling from TOs shall be routed in conduit inside partitions and stubbed out above the ceiling. Conduit shall not be "looped" between outlets. The size of the conduit varies among the Postal Standard Building Designs:

USPS PROGRAM	CONDUIT SIZE (DIAMETER)
MSBD	1"
SSBD	3/4"

Where T/Os are provided in the workroom area and are to be column mounted, conduit shall be provided to a cable tray or trunk conduit to protect the cable from damage due to activities in the workroom. Coordinate the mounting height of telecommunication outlets with power outlets.

Where local codes mandate cables be placed in conduit or enclosed in a metal wireway, telecommunications cables shall be routed in conduit to common enclosed wireways to the ER or TC.

Where wall mounted TOs are not possible or practical due to use of modular furniture (at the Full Service Counter) or use of millwork (at the Cashwrap Counter), conduit stub-ups shall be provided to route cables to the base of the furniture, where the cables will transition into a raceway system incorporated into the furniture. Cables shall route through the raceway to the T/O location. A metal divider must separate cables from power. T/O

faceplates may be surface mounted to the raceway cover or may be installed into a knockout position in the raceway cover.

All conduit installations shall have appropriate sleeves and bushings installed to eliminate potential for damage to telecommunications cabling.

All components of the structured cabling system shall be rated for the return air environment in which they are installed. Refer to Specification Section 16705 for requirement of components in a plenum or non-plenum environment.

5-4.3.11 Telecommunication Equipment Room (ER)

MSBD, SSBD

The Telecommunication Equipment Room (ER) serves as the point of demarcation for incoming communications services and the interface point between the incoming service and the Structured Cabling System. The ER for standard SSBDs and RSDs is a room shared with other functions. MSBD facilities have dedicated Equipment Rooms.

Within the ER, space shall be provided for incoming service equipment, the facility's telephone system, and Local Area Network equipment. Equipment installed in this room will be either wall mounted or floor mounted. All horizontal cabling within the specified distance limitations established by TIA/EIA-568B will terminate on patch panels in this room. All voice and data (fiber optic) backbone cables will terminate in this room. The room design shall follow the TIA/EIA-569. The RSD, SSBD, and MSBD Drawings and the USPS Standard Details Library show the standard ER layouts for Postal facilities. Information on equipment and sizing of equipment (such as patch panels) is included in the USPS Master Specifications.

The ER room shall adhere to the following specification list:

- Provide fire rated, 4' X 4' or 4' X 8' sheets of plywood for backboards, where indicated on plans
- Adequate space will be reserved for LEC termination fields, splice cases, specialized circuit components, etc.
- Grounding and bonding of all contractor provided hardware and cabling must be completed in accordance with the TIA/EIA-607 specifications as well the NFPA-70 NEC and any applicable local codes.
- Continuous temperature and humidity controls may be required to maintain telecommunications equipment within manufacturer's recommendations.

5-4.3.12 Telecommunications Closet (TC)

MSBD

The Telecommunications Closet (TC) is a room or cabinet that houses the horizontal cross-connect (HC) that serves as a transition point between the backbone and horizontal cable systems. A TC is required when the horizontal distribution distance (including vertical rise and fall of cabling as well as service loops) exceeds 295 feet for a standard telecommunications outlet or 230 feet if serving a consolidation point or MUTOA. A minimum of one Telecommunications Closet is required per floor in a multistory building

5-4.3.12.1 The TC room supporting Administrative areas shall adhere to the following specification list:

-
- Floor mounted equipment rack spacing formula: One rack mount space (RMS) equals 1.75". All high-density 48 port patch panels require 2 RMS. All horizontal wire managers equal 2 RMS. One horizontal wire manager is required between each patch panel. Place one 4RMS horizontal wire manager at the top of each equipment rack.
 - One 7' H x 19" W x 3' D floor mounted equipment rack will support up to 34 RMS to include cabinet/rack UPS. If more than 34 RMS are required, add additional 7' H x 19" W, 3' D floor mounted equipment racks.
 - All floor mounted equipment racks shall have 36 inches of free and clear space from the front of any installed equipment racks as well as 48 inches free and clear from the furthest rearward mounted piece of equipment installed in any rack.
 - Allocate a minimum of one floor mounted equipment rack for LAN and WAN electronic components to be supplied and installed by the USPS.
 - Grounding and bonding of all contractor-provided hardware and cabling must be completed in accordance with the EIA/TIA-607 specifications as well as the NFPA-70 NEC and any applicable codes. #6 AWG THHN ground wire shall be installed from approved electrical ground to contractor supplied TMGB (Telecommunications Main Grounding Bussbar). Attachment to bussbar to be performed by contractor.
 - An overhead cable tray system, suspended from exposed structure above, must be provided. Installation guidelines covered in USPS 16705 document.
 - Maximum horizontal cabling distances shall not exceed 295' for a standard telecommunications outlet and 230' if serving a Consolidation Point. This horizontal distance is to include all vertical distances plus required service loops.
 - Provide a rack mounted, minimum 1.5 KVA UPS unit with 30 minute backup in each TC room.

5-4.3.12.2 The TC Cabinets supporting the Mail Processing (WRF) Workroom Floor environment shall adhere to the following specification list:

- If required refer to MPFDC Section 5-4.3.6.2

5-4.4 Not Used

5-4.5 Pay Telephones

Pay Telephones are not part of the SCS. Provide one 4-pair Category 6 cable between each pay telephone location and the Telecommunications Equipment Room (ER). At the ER the cable is terminated on a 4-pair, modular telephone "biscuit" jack mounted on the plywood backboard near the telephone company entrance service. The cable end at the pay telephone location will be left unterminated with an adequate service loop for the pay telephone provider. An electrical outlet shall be located within or adjacent to any location deemed necessary to contain a Text Telephone (TTY) compliant pay telephone in compliance with the Americans with Disabilities Act (ADA). The pay telephone provider must meet all requirements of the ADA including, but not limited to, access heights, clearances, volume controls, hearing aid compatibility, TTY device space/compatibility, and handset cord length. Provide a minimum of one pay

telephone for each Satellite Break Area, Lunchroom/Cafeteria and Contract Drivers Lounge.

5-4.6 Not Used

5-4.7 Not Used

5-4.8 [Reserved]

5-4.9 Satellite Communications

5-4.9.1 Not Used

5-4.9.2 Very Small Aperture Terminal (VSAT)

 G5-4-9a

Very Small Aperture Terminal (VSAT) communication utilizes satellite technology to transmit and receive data between individual post offices and the nationwide USPS telecommunications network. The network will support a wide range of applications including the Point-Of-Service One (POS One) program.

VSAT units are currently provided and installed by others under a separate contract with USPS. The preferred installation method is by through-wall mount. Pole-mounted elsewhere on the site is an option. The units can also be roof mounted using a non-penetrating roof mount, if no other alternative is available. The unit is approximately 3.5 feet in diameter and weighs approximately 90 pounds. With the rooftop ballast, it has a distributed load of 20 pounds per square foot.

The project design must accommodate infrastructure to support the VSAT equipment installed by others. During the project planning phase District Information Technology must coordinate and fund installation and connection of the VSAT equipment.

During the design phase, consideration should be given to the best location for the VSAT unit, so as to shield it from public view. If the unit is to be roof mounted, the parapet wall should be high enough to provide adequate screening. If the unit is to be wall mounted, locate the mounting bracket on an inconspicuous wall of the mailing platform, where it will not be susceptible to damage by trucks. In either case, conduit with pull string should be provided to facilitate future installation of the VSAT cabling.

5-4.10 Call Bell Systems

MSBD, SSBD

5-5 Fire Protection System

5-5.1 Fire Alarm System

Sprinkler flow alarms, smoke detectors, and other detection devices shall be provided in accordance with NFPA and local codes.

Audible alarms shall not be less than 81 dBA and not exceed 110 dBA (measured at a 10'-0" distance) and shall be distinctly audible in all areas of the facility. Strobe type visual alarms shall be visible in all habitable areas of the facility, including but not limited to locker rooms, lounge areas, toilet rooms, lunch rooms and vending machine areas. Special tactile alarm devices shall be installed as required by code.

Visual and audible evacuation alarms shall be installed in all facilities with over ten employees or as required by local code, whichever is more stringent. The alarms shall be automatically activated when the fire alarm panel is not constantly attended. In facilities not continuously occupied, alarm signals shall be automatically transmitted to local fire departments or central station supervisory services, unless this is not permitted by the local authority.

Verify with USPS anticipated central station supervisory service company of choice. Confer with service company regarding specific equipment requirements.

Fire alarm pull station boxes shall be red and may be either the break-glass type or open door, pull-lever type. Provide suitable protection and markings where required. Alarm boxes shall be located so that the travel distance to the nearest fire alarm box will not exceed 200 ft measured horizontally on the same floor along the routes of egress (where applicable). Route fire alarm wiring as required by NFPA and local codes.

5-5.2 Smoke Detectors

Refer to Module 1 Chapter 4 Mechanical, Section 4-5 Fire Protection, for duct-mounted smoke detector criteria.

5-5.3 Heat Detectors

Heat detectors are a valuable alarm initiating device in areas where flash fires occur with little or no smoke. They shall be provided in all mechanical and electrical rooms.

5-5.4 [Reserved]

5-5.5 [Reserved]

5-6 Lightning Protection

Refer to NFPA 780 Standard for the Installation of Lightning Protection Systems, latest edition.

The following requirements are based on the 2004 edition. The Lightning Risk Assessment contained in Annex L of NFPA 780-2004 shall be performed. Lightning Protection shall be provided when the calculated Lightning Strike Frequency (N_d) exceeds the Tolerable Lightning Frequency (N_c).

Unless otherwise directed by the USPS, the following values shall be used:

- C_3 Structure Contents Coefficient = 3.0 (Exceptional Value)
- C_4 Structural Occupancy Coefficient = 1.0 (Normally Occupied)
- C_5 Lightning Consequence Factor = 5.0 (Continuity of Service Required)

Other factors and coefficients used in the Lightning Risk Assessment are site specific or construction dependent.

Coordinate details of attachment of roof mounted lightning arresters and conductors with roof design. Attach roof mounted equipment using methods approved by roof manufacturer. Conceal all lightning protection down leads within new construction.

5-6.1 [Reserved]

5-6.2 [Reserved]

5-7 Integrated Security and Investigative Platform (ISIP)

USPS Handbook RE-5

The ISIP is the centralized video platform for all CCTV systems located within USPS facilities. Cameras from the three traditional CCTV areas; Robbery Countermeasure, Security/Access Control, and Investigative, are to be integrated within the single platform. Some USPS facilities may include all three types of CCTV cameras, or components of the three may be used in combination depending on the operational use of the building.

5-7.1 Robbery Countermeasure/Retail CCTV Cameras

Robbery countermeasure/Retail CCTV cameras are required in the full service area if the retail facility is located in a high crime area, as indicated by a recently completed risk analysis. Where required, mount one fixed camera for every two counters, on side or rear walls, to view the customer. If Open Merchandising is provided, robbery countermeasure/retail CCTV cameras are required. CCTV cameras for Open Merchandise areas consist of fixed cameras viewing the stamp merchandise displayed in the Open Merchandise space.

 G5-7-1a→1c

Cameras are not permitted to monitor the post office box alcove areas. Deviation requests to add cameras in the post office box lobby will not be approved unless the risk analysis demonstrates a threat to postal employees or postal property. If deviation approval is granted, a sign must be posted to notify the public that “Cameras may be recording, but are not monitored.”

Cameras located on the dock or in areas accessible 24 hours a day to the public shall be secured in vandal-resistant housings and all wiring must be in a flexible armored conduit entering the housing. The mounts for these cameras must be secured to prevent easy removal. They can also be installed in a deep ceiling with a wedge housing to maintain viewing angle.

5-7.2 Security and Access Control CCTV Cameras

Postal facilities over 60,000SF and those facilities with a Stamp Distribution Office (SDO) require Security and Access Control CCTV cameras. The cameras will observe registry unloading and entrances to storage areas, entrances to the registry cage on the workroom floor, stamp depository and employee entrances. Observation may be required at all gates to employee and compound parking. The cameras will also monitor all access controlled entrances, both pedestrian (building) and vehicular. A deviation is required to install security and access control CCTV cameras in SSBs and MSBs.

Cameras located on the dock or in areas accessible 24 hours a day to the public shall be secured in vandal-resistant housings and all wiring must be in a flexible armored conduit entering the housing. The mounts for these cameras must be secured to prevent easy removal. They can also be installed in a deep ceiling with a wedge housing to maintain viewing angle. Dock or canopy cameras viewing doors shall view door opening (i.e., the non-hinged side of the doors).

Under certain circumstances, the Inspection Service may require site security and access control CCTV cameras. The cameras must cover all pedestrian and vehicle entries into the site and all employee entries into the facility. The cameras must cover all employee and customer parking areas, including business mail entry unit (BMEU), entry points into and exit points from the truck parking and maneuvering areas, vehicle maintenance facility (VMF) operating areas, warehouse operations, driver training areas, employee outdoor break areas, and maintenance areas.

Route CAT-5e, fiber optic, and low voltage power wiring via cable tray and wide base cable hangers rated for proper support of cables.

5-7.2.1 Registry Cage Surveillance

Fixed cameras shall be provided for all registry cages as efficiently as possible to provide surveillance of the registry service windows and door of the registry cage.

Prior to its submission of ten percent construction documents, the A/E shall obtain a written determination from the USPIS as to whether or not if the facility under consideration is deemed a Banking Consolidation Point, that is, a facility which receives bank remittances and/or armored car service. A copy of this letter shall be provided by the designer concurrent with the ten percent submission.

In all major facilities that are deemed Banking Consolidation Points a minimum of four cameras shall be provided, one at each of the following locations:

- Registry service windows and door of the registry cage (fixed at cage exterior)
- Two fixed interior cameras, one in each of two opposite corners of the cage, located to provide coverage of the entire interior of the cage.
- At parking locations where armored car deliveries occur, one fixed exterior camera shall be provided on the loading dock covering the doors leading into the building.

These cameras are considered security cameras and should be continuously recorded but should not be viewable from the SM/PM monitor.

5-7.3 Intrusion Detection System (IDS)

Any postal facility handling or processing registered mail, sorting stamp stock that maintains an accountability greater than \$250,000, has a history of burglaries, or has an Open Merchandise area, requires an intrusion detection system (IDS). The Investigative Office also requires an IDS.

 G5-7-3a→3b1

For facilities that are occupied by USPS personnel 24 hours per day, 7 days per week, do not provide IDS sensors monitoring perimeter doors and windows. Within these facilities, provide IDS coverage of the SDO, the IO, and breakout doors if present.

Any Postal Service facility handling or processing high volumes of valuable or classified registered mail, storing stamp stock overnight that maintains an accountability greater than \$250,000, having a history of burglaries or crime in the geographic area, or having an open merchandise retail operation is required to have an IDS, unless an Inspection Service risk assessment deems it unnecessary. A risk assessment shall be conducted before an intrusion detection system is installed.

SPACE	IDS COMPONENTS
Vault	Vault type vibration sensor
Stamped Envelope Room	Door contacts with motion sensor in the room
Full Service IRT Area	Motion sensor on employee side
Open Merchandise area	Motion sensor(s), ceiling or wall mounted
Wicket Door	Motion sensor on Workroom side of door with keypad with 10-20 second delay on the workroom side (if this is a designated employee entrance)
Registry Cage	Motion sensor on wall or column inside cage (required only at non 24 hour facilities)
Carrier and Mail Vestibules	Motion sensor on Workroom floor side of inner set of double impact doors. Provide keypad with 10-20 second delay inside employee

	entrance in vestibule. Optional location of keypad is on Workroom side of inner set of impact doors.
24 Hour Lobby	At door leading from public lobby into the Workroom or other Postal-only spaces (folding grilles excluded), provide motion sensor on Workroom/Postal side of door.
Non-24 Hour Lobby	Motion sensors in Box Lobby to ensure coverage of all doors and windows.
Open Platform	Motion sensor on Workroom side of door at inner personnel doors; keypad in Mail Vestibule adjacent to personnel door
Enclosed Platform	Motion sensor on Workroom side of door on personnel door between Platform and Workroom; keypad on platform side of personnel door
Emergency Exits from Box Lobby	Door contacts
Emergency Exits from Workroom	Motion sensor on Workroom side of door
COD or Parcel Cages	Motion sensor on wall or column inside cage
Stamp Distribution Office (SDO)	Motion sensor and door contacts
Investigative Office	Motion sensor in IO and keypad with 10-20 second delay located adjacent to Inspector's entry.

Exhibit 5-7a

IDS Requirements

All new Postal facilities that are required to have an Intrusion Detection System (IDS) shall comply with the zone coverage as outlined in the table below.

SSBD STANDARD

Area of Coverage ^{1, 2}	Zone Assignment
Workroom	Zone 1
Safes	Zone 2
Retail Counter	Zone 3
Postal Store	Zone 4
Office	Zone 5
Registry cage	Zone 6

MSBD STANDARD

Area of Coverage^{1, 2}	Zone Assignment
Workroom	Zone 1
Safes/Vault ³	Zone 2
Retail Counter	Zone 3
Postal Store	Zone 4
Admin offices and corridor	Zone 5
Registry cage	Zone 6
IO (programmed area 2)	Zone 7
Business Mail Entry Unit (BMEU)	Zone 8
Electrical room	Zone 9
Recycling room	Zone 10

Exhibit 5-7b

IDS Zone Requirements

Footnotes:

¹All areas do not exist in all facilities. If an area does not exist in the specific facility then its zone number shall be skipped.

²Workrooms and other areas may require more than 1 sensor for adequate coverage. See standard plans for suggested sensor locations.

³A motion sensor is required outside the vault and vibration sensors are required on the walls inside the vault.

An IDS consists of a combination of security panel, key pad, and motion sensors. All motion sensors shall be dual technology (passive infrared and microwave) sensors. A dedicated telephone line for the IDS system shall be provided for the remote monitoring station and shall be located in a lockable room. A key pad shall be provided at the designated employee entrance door to energize and de-energize the IDS. If the key pad is within a sensor zone, a delay should be programmed for that zone.

Investigative Offices (IO) IDS components shall be wired as separate zones. The system shall be designed so that the alarm panel records, but does not display, the status of the IDS components associated with the IO.

The system will be purchased and installed by the contractor. The final design layout of the system shall be coordinated with the local Inspection Service. There shall be no deviations from the manufacturers and products listed in the USPS Master Specifications.

5-7.4 Physical Access Control System (PACS)

A physical access control system can only be used in MSBD and SSBD sized facilities with an approved deviation. If approved, see the Mail Processing Facilities Criteria and Specifications for system details.

USPS Handbook RE-5

 G5-8-3a→3d

5-7.5 Investigative CCTV Cameras

When required by Module 1 Section 2.9, provide a CCTV system per the following criteria.

5-7.5.1 Cameras and Junction Boxes

MSBD

5-7.5.2 Video and Control Wiring

Video wiring is to be routed to the equipment rack in the Investigative Office with 10 ft. of pigtail at final point of demarcation in room. All video signal runs must be continuous (not spliced) from camera to demarcation point. Refer to 5-4.3.10 Cable Pathways for cable support requirements.

5-7.5.3 Camera Systems

Provide lockable panelboards as required, located in the IO to serve all CCTV cameras. Comply with National Electric Code clearance requirements.

When a facility has an investigative CCTV system AND a robbery countermeasure/retail system, cameras for both systems are required at the full service and BMEU counters. Mount one fixed Investigative CCTV camera over each drawer at the service counter. Mount one fixed robbery countermeasure/retail CCTV camera for every two full service and BMEU workstations, on side or rear walls.

5-7.6 Exit Door Alarm

See Module 1 Section 2-7.2.2.a for hardware requirements.

The following doors shall be equipped with Exit Alarm:

- Exterior doors from Workroom used for emergency egress only.
- Doors leading to exterior from smoking/break area near lunchroom.
- Any other site specific doors as directed by plant manager and local inspector.

The following equipment shall be installed at doors described above:

- A 120db horn, installed 10 ft. above the finished floor and directly over the door. It shall sound every time the door is opened and continue to sound for as long as the door is open. It requires a 110V circuit and shall have a back-up battery which will power the alarm for one hour in the event of a loss of power.
- The door shall be equipped with a visual device such as a strobe to notify hearing impaired employees.
- If the door is not located on the workroom floor, it shall have a remotely located signaling device as directed by USPS Contracting Officer, installed to notify management that the door is being used. In buildings over 60,000 sq. ft., a remote alarm shall be provided in the same room as the fire and sprinkler alarm panels. The system shall be tied to the fire alarm system if required by life safety codes.

-
- In facilities requiring a security and access control CCTV system, fixed cameras shall be installed at each door to view the door opening and the surrounding area.
 - These doors shall be labeled, "EMERGENCY EXIT ONLY - RE-ENTRY PROHIBITED."

Delaying exiting devices are prohibited.

At locations with a CCTV security system, the door alarms shall be tied into the matrix switcher or digital video recorder through the ACS.

In facilities with ACS, the exit-only door alarms shall be tied to the ACS.

5-7.7 Vault Alarms

Walk-in vaults shall be equipped with manually-actuated emergency electric alarms. A pushbutton alarm switch and pilot light shall be located within the vault at a readily visible and accessible point and shall be clearly identified by a printed sign indicating its function. A loud horn shall be located immediately outside the vault door and shall be clearly marked. Vaults shall be provided with a motion detector which is connected to the IDS.

5-8 Not Used (See Section 5-7.5)

USPS Handbook RE-5

5-9 [Reserved]

5-10 Construction Closeout

5-10.1 As-Built Riser Diagrams

An as-built copy of the power distribution riser diagram shall be posted in the main electrical room, framed and mounted under glass. Posted instructions shall indicate how to energize or de-energize each major component of the system and shall advise what action shall be taken in an emergency, how to restore power following an outage and what precautions to be taken when maintenance is required.

5-10.2 Operation and Maintenance Manuals

Complete operating and maintenance manuals covering all electrical equipment and systems shall be provided. Manufacturer's maintenance instructions and shop drawings shall be assembled and bound for use by operating personnel.

5-10.3 **Operation and Maintenance Training**

Time shall be devoted to train USPS employees in the proper operation and maintenance of each category of major electrical equipment. Training shall be performed by qualified instructors and shall be included in the contract.

5-10.4 **Testing**

Voltage, insulation and resistance tests shall be performed on switchgear, grounding systems and all cables rated over 600 volts which are not furnished or installed by the local utility company to ensure that the integrity of the material has been maintained during installation. All operating equipment furnished under this contract shall be demonstrated to a USPS representative to confirm compliance with contract documents.

Provide infrared scan of all low voltage and medium voltage switchgear and switchboards and of main feeder terminations (under load).

5-11 **[Reserved]**

[This page intentionally left blank.]

Checklist

[This page intentionally left blank.]

Electrical Checklist

Facility Name:

City, State, Zip:

Project Phase:

Reviewer (Individual/Firm Names):

Telephone Number:

Date:

NOTE: The "Facility Type" column indicates the facility type to which the checklist item is applicable. A blank cell in this column indicates that the checklist item is General and applies to Majors, MSBD and SSB facilities.

Section No.	Facility Type	✓	Item	Comment
5-1			INTRODUCTION	
5-1.2			Voltage level and availability of electrical service has been determined.	
5-1.4.1			Bracing rating (A/C rating) for incoming service/distribution equipment has been verified.	
5-1.4.3			Voltage drop calculation for feeder and branch circuit wiring has been performed.	
5-1.4.4 5-2.1.3			Connected and demand load calculations for sizing the panelboards and transformers have been performed.	
5-2			POWER DISTRIBUTION	
5-2.1			Ductbanks and conduits for underground incoming feeders comply with criteria.	
5-2.1.1			Check incoming power and telephone service locations with civil site/utility plans.	
5-2.1.1			Incoming service is coordinated with the utility company for underground service.	
5-2.1.3			System capacity meets criteria.	
5-2.1.4	MSBD		Need for emergency generator has been evaluated per criteria.	
5-2.2.1			Branch circuits serving miscellaneous loads are coordinated with equipment schedules.	

Section No.	Facility Type	✓	Item	Comment
5-2.3.1	MSBD		Check for proper clearance for electrical equipment and exit and entrance.	
5-2.4.3			Sizing and spare capacity meet criteria.	
5-2.4.3			20% spare capacity and spare breakers in each panelboard have been provided.	
5-2.4.3			Verify branch circuit is not overloaded.	
5-2.6	MSBD		Motor control center is sized for 20% spare capacity.	
5-2.6	MSBD		All 3 phase-motors are controlled and protected by circuit breaker type motor starters equipped with HOA switch and indicating lights.	
5-2.6.1			Auxiliary contacts are provided in smoke detectors to interlock with ventilation fans.	
5-2.7.1			Conduits meet criteria for different locations.	
5-2.7.3			Conductors smaller than #1/0 are copper. Conductors, if aluminum or aluminum alloy, are #1/0 or larger in accordance with NEC.	
5-2.7.4			Exterior wiring runs in minimum 1" conduit and meets criteria.	
5-2.7.5	MSBD		Check quantity and location of ground rods and sizes of grounding loop conductors. Verify electric service grounding connections and transformer secondary grounding connections.	
5-2.8.1			Outlets are located per criteria.	
5-2.8.4	MSBD		Check convenience outlet and empty conduit with pullwire for BMEU (if applicable).	
5-3			LIGHTING	
5-3			Design meets footcandle level and power density criteria for interior and exterior lighting.	
5-3			Fixture types/lamps meet criteria.	
5-3			Light fixture mounting type and height are coordinated with ceiling finishes.	
5-3	MSBD		Quartz emergency restrike lamps are specified one per bay for HID light fixtures.	
5-3.1.1	MSBD		Workroom lights have dual switching per criteria.	
5-3.1.4	MSBD		Daylighting has been considered in the workroom.	

Section No.	Facility Type	✓	Item	Comment
5-3.1.5			Exit lights clearly indicate normal paths of egress and are unobstructed.	
5.3.1.5			Exit lights are energy efficient LED type and have maintenance-free battery backup.	
5.3.1.5			Emergency lighting meets criteria and minimum UL requirements for brightness and distribution.	
5-3.1.8			Occupancy sensors are provided for lighting specific rooms per criteria.	
5-3.2			Lighting intensity ratio in parking and maneuvering areas does not exceed 10:1.	
5-3.2.1			Pole bases are protected per criteria.	
5-3.2.2			Exterior lighting meets requirements of USPS Handbook RE-5.	
5-4			COMMUNICATIONS	
5-4.2			Point of service and size of telephone service have been determined.	
5-4.2			Service is brought to the site via underground ductbanks (Majors, MSBD) or direct buried cable (SSBD).	
5-4.3	MSBD SSBD		Recommended: telecommunications drawings and specifications developed or reviewed by a BICSI Registered Communication Distribution Designer (RCDD)	
5-4.3.3			Cable home runs do not exceed 295 feet.	
5-4.3.7			Check telecommunication outlets requirements per schedule.	
5-4.3.11			Dedicated circuits are provided for Telecommunications Equipment Room	
5-4.3.11			Riser cable conduits are coordinated with telephone board in Telecommunications Equipment Room	
5-4.8.1			Verify that paging and telephone systems are compatible and meet criteria.	
5-5			FIRE PROTECTION	
5-5.1			Visual and audible alarms are provided per RE-4 requirements.	
5-5.1			Pull boxes are located at each designated exit and not more than 400' apart along the route of egress.	
5-5.2			Smoke detectors comply with NFPA 72.	

Section No.	Facility Type	✓	Item	Comment
5-5.3			Heat detectors are provided in mechanical and electrical rooms.	
5-6			LIGHTNING PROTECTION	
5-6			Lightning protection is provided if risk assessment value is 3 or higher.	
5-7			SECURITY SYSTEMS	
5-7.1			CCTV cameras provide adequate viewing area coverage.	
5-7.2			Adequate power is provided for CCTV monitors, control equipment, and digital recorders.	
5-7.2			Underfloor conduit run and recessed floor junction boxes are provided at EAS panels.	
5-7.2			EAS system interface for CCTV system is provided and clearly marked.	
5-7.2			CAT-5e wiring is used for camera wiring.	
5-7.2			Route wiring via cable tray and hangers.	
5-7.3			IDS Key pad is located at the employee entrance door.	
5-7.4			Physical Access control system meets criteria.	
5-7.5			Verify with USPS the requirement for exit only door alarms.	
5-7.6	MSBD		Vault alarms meet criteria.	
5-7.7			Call bells/buzzers are provided per criteria.	
5-8			INVESTIGATIVE SYSTEM	
5-8.1			Check for adequate dedicated electrical service for the Investigative Office.	
5-8.2			Not Used	
5-8.3			Not Used	
5-8.3.2			CAT-5e wiring is used for camera wiring.	
5-8.3.3			Video/control wiring and cable raceway are properly routed.	
5-8.3.4			Camera systems comply with criteria.	
5-9			SPECIAL OCCUPANCIES	

[This page intentionally left blank.]

Module 2B Specific Criteria Medium Standard Building Designs

Refer to this chapter in conjunction with Module 1 Chapter 2 - Architectural.

Chapter 2 Architectural

2-2 Workrooms

2-2.3 Height Requirements

2-3 Platforms

2-3.1 Open Mail Platforms

2-3.3 Carrier Platforms

2-3.7 Stairs

2-3.9 Vestibules

2-4 Support Areas

2-4.2 Toilet Facilities

2-4.3 Locker Rooms

2-4.4 Lunchroom

2-4.5 Administrative Offices

2-4.7 Janitor's Closet

2-4.8 Vault

2-4.9 Outside Storage Area

2-4.14 Not Used

2-4.29 Carrier Annex - Mail PickUp Lobby

2-7 Miscellaneous Building Components

2-7.2 Doors and Hardware

2-7.3 Vertical Circulation

2-7.4 Protective Barriers

2-7.5 Building Identification and Signage

2-7.7 Entry Feature

2-9 Investigative System

2-9.1 Investigative Office

[This page intentionally left blank.]

Chapter 2 Architectural

Refer to this chapter in conjunction with Module 1 Chapter 2 - Architectural.



Exhibit 2a
Medium Standard Building Design

2-2 Workrooms

2-2.3 Height Requirements

The height of lighting fixtures in the workroom shall be 11 ft. 0 in. above the finished floor to the bottom of the fixtures. The overall building roof height is established by taking into consideration the structural and HVAC systems required above 11 ft. 0 in.

2-3.1 Open Mail Platforms

Open mail platforms have a roof canopy, but no wall or overhead doors at the truck dock side. The platform is typically constructed of sealed concrete, poured level and at the same elevation as the workroom floor out to within 10 ft. 0 in. of the edge of the slab. The front 10 ft. of the slab shall have a 1 percent slope to maintain drainage away from the building. A platform canopy, with flush soffit underneath, shall extend a minimum of 7 ft. 0 in. beyond the outside face of the platform.

2-3.3 Carrier Platforms

G2-3-3a

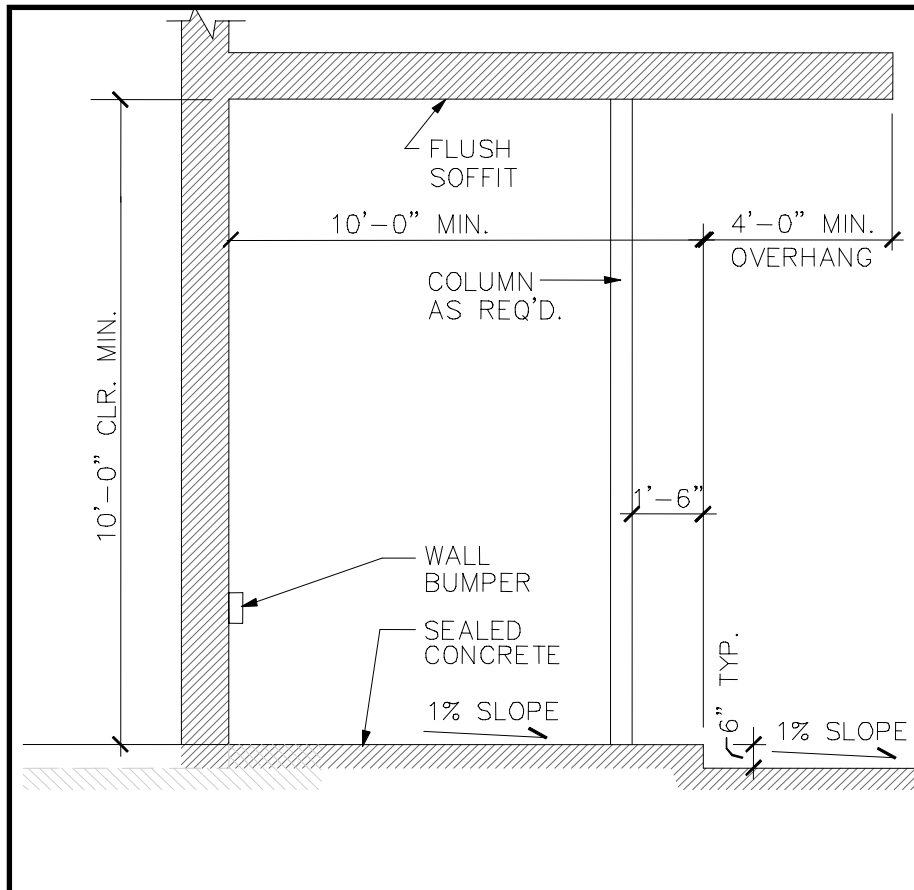



Exhibit 2-3a
Carrier Platform Diagram

Carrier platforms may extend beyond the building face into a "Finger Dock" condition and shall not be covered. A finger dock may be accessible to USPS vehicles from both sides.

Coordinate platform height with USPS requirements (typically 6 in.). If adjacent to a building wall, the carrier platform shall be 10 ft. wide. Provide a 4 ft. overhanging canopy with a 10 ft. vertical clearance between underside of canopy soffit and the platform below. Provide curb ramp(s) as required by code, and USPS use requirements. At carrier slabs, use a rolled curb, a curb and gutter, or a straight curb; any other curb requires an approved deviation from USPS HQ.

2-3.7 Stairs

At open and enclosed mail platforms, provide stairs down to the pavement. The stairs should be located opposite the personnel doors and between the scissors lifts and the dock levelers, as shown in the MSBD Platform Modules. Overhead signs shall be installed on the interior of the platform area indicating all stair locations.

 G1-2-4a→b and e

 G2-3-7a→c

2-3.9 Vestibules

Vestibules are used at facilities with open mail and carrier platforms to minimize the heat gained or lost due to intermittent high volume cart traffic passing from the workroom to mail and carrier platforms.

 G2-3-9a→b

Each vestibule has four sets of impact doors, two designated for ingress and two for egress, to help control the circulation route for heavy push cart traffic. Pedestrian traffic accesses the platform through a set of two personnel doors.

2-4 Support Areas

USPS Handbook RE-4

2-4.2 Toilet Facilities

Water closets shall be wall mounted with reinforced hangers. Toilet partitions shall be baked enamel or solid plastic and floor-mounted.

 G2-4-2a→c1

2-4.3 Locker Rooms

Locker rooms shall be located near the designated employee entrance. Space must be allocated for one double-tier half-size locker with sloping top per employee.

 G2-4-3a→a2

USPS Handbook RE-4

Standard plans provide one accessible bench with adjacent clear floor space per locker room per RE-4 Requirements. Additional non-RE-4 benches are provided in the larger locker rooms.

2-4.4 Lunchroom/Break Area

The lunchroom shall be located for easy access from employee locker rooms, and be designed with a generous amount of daylighting (windows and/or skylights) and landscaping in front of the windows. Design and layout of seating shall be based on the employee count in the planning documents and shall be coordinated for use by USPS Purchasing.

 G2-4-4a→d

 M2-4-4a

Basic lunchroom requirements include:

- Sink with hot and cold water.
- Utility wall and base cabinets with laminated counter workspace.
- Electric outlets for refrigerator and microwave oven.
- Vending area. Provide floor drains, and all utility hook-ups as required. Also provide secured vending storage near the lunchroom area.

Separate, built-in undercounter recycling bins (minimum 30 gallon capacity each) shall be provided with labels for glass, aluminum, and plastic.

All machines should be integrated with wall design to appear to be built-in. Allow additional space as necessary for aisles and operating areas around the vending machines.

If directed to provide an outdoor break area by the Contracting Officer, it shall consist of a slab on grade and chain link fencing.

2-4.5 Administrative Offices

 G2-4-5a→b

Where applicable, provide a layout of open office systems furniture coordinated with telecommunications requirements, providing maximum flexibility for future modifications.

2-4.7 Janitor's Closet

Provide a mop sink, mop/broom holder, and storage shelves. Provide a 4 ft. high fiberglass reinforced plastic (FRP) sheet wainscot at mop sink. The top, bottom, and side edges, intermediate joints, and corners must be continuously caulked.

2-4.8 Vault

USPS Handbook RE-5

Vaults may be poured in place or modular units which are site-assembled.

 G2-4-8a→d

2-4.9 Outside Storage Area

Provide an outside storage area as directed by USPS.

2-4.29 Carrier Annex - Mail PickUp Lobby

 M2-4-28a

With an approved Planning deviation request, the Mail Pickup Lobby may be included in Carrier Annex designs. If it is prescribed in the project PS919, the room shall be designed to be 10 ft. wide x 12 ft. long and shall have security walls. Automatic entrance doors, Stamp Vending machine, and Letter Drops are optional. The entrance and customer parking shall be outside the postal secured area. Coordinate accessible route and signage requirements with the RE-4.

2-7 Miscellaneous Building Components

2-7.2 Doors and Hardware

2-7.2.1 Doors

b. Mail and Carrier Vestibule Doors

Mail and carrier vestibule doors are typically provided in sets, one for inbound traffic and one for outbound traffic. These doors accommodate mail cart movement, and are therefore double acting with impact-resistant bumpers and heavy-duty steel hinges and frames. They are additionally protected from damage by placing bollards or steel channels at both the head and base. For safety, employee circulation through vestibules is not permitted by use of the impact doors. A separate set of single acting personnel doors shall be provided. These personnel door(s) shall be a viable means of egress; impact doors do not constitute a means of egress.

 M2-7-2a→c7

f. Automatic Doors

The customer entry doors are automatic bi-parting sliding doors. Automatic high-energy swinging doors are optional, however guide rails must be provided to prevent accidents.

2-7.3 Vertical Circulation

2-7.3.2 Stairs and Ladders

Permanent, safe means of access shall be provided to the roof (including roofs at differing heights) and all mechanical equipment requiring maintenance.

Access to the roof shall be located in the Buildings and Grounds Room by means of either an alternating rung or ship's ladder.

 M2-7-2d

2-7.4 Protective Barriers

Provide fiberglass reinforced plastic (FRP) panels on all interior walls of the workroom and on each wall of the carrier and mail vestibule.

 G2-7-4a→d2

2-7.5 Building Identification and Signage

2-7.5.3 Workroom

Paint designated numbers on workroom columns, visible from a minimum distance of 50 ft. and placed at a height of 8 to 10 ft. above the floor.

2-7.5.4 Platforms

Platform truck dock positions shall be identified with consecutive numbers on both the exterior and interior of the platform wall. The numbers shall be visible if doors are open or closed and shall be visible at night.

2-7.7 Entry Feature

 M2-7-7a→e

The entry feature is an optional element of MSBD retail facilities. The design may be modified to accommodate specific site issues.

The standard details show an illuminated covered structure designed to provide some shelter for customers approaching the building entrance. Gutters and downspouts may be revised, omitted, or used as shown. In addition, the downspouts may be connected to the underground storm water system, if available.

2-9 Investigative Areas

USPS Handbook RE-5

2-9.1 Investigative Office (IO)

 M2-9-1a→g

The Investigative Office occupies approximately 200 square feet of the Workroom. The standard layout does not include a toilet.

The finished floor of the Investigative Office is at the same level as the Workroom floor. A finished ceiling is required in the office. Walls shall extend to the underside of the structure above and maintain an STC of 45. The walls and ceiling of the office shall be painted eggshell black and the floor surface shall be dark grey or black vinyl composition tile (VCT).

USPS Handbook RE-5

[This page intentionally left blank.]

Module 2B Specific Criteria Medium Standard Building Designs

Refer to this chapter in conjunction with Module 1 Chapter 4 - Mechanical.

Chapter 4 Mechanical

4-2 HVAC

- 4-2.4 Space Specific Requirements
- 4-2.7 Computations
- 4-2.8 Zoning
- 4-2.9 HVAC Controls
- 4-2.12 Air Handling Systems
- 4-2.15 Miscellaneous HVAC Requirements

4-3 Plumbing

- 4-3.1 Water Supply Systems
- 4-3.2 Sanitary Drainage Systems
- 4-3.3 Plumbing Fixtures
- 4-3.4 Storm Drainage

[This page intentionally left blank.]

Chapter 4 Mechanical

Refer to this chapter in conjunction with Module 1 Chapter 4 - Mechanical.

4-2 HVAC

4-2.4 Space Specific Requirements

4-2.4.10 Locker Rooms

The conditioned air supplied to locker rooms may be returned to the air handling units, provided the space is separated from adjacent spaces such as toilet rooms.

4-2.7 Computations

4-2.8 Zoning

Separate zones of control shall be provided for each area of workroom, support areas, and office spaces. In addition, all offices and support areas with similar internal and external loading shall be grouped for control of temperature.

4-2.12 Air Handling Systems

Provide packaged type rooftop units. The units may be placed on the carrier canopy, platform roof, or on the ground if proven to be more economical or if required on a specific project.

In heat pump applications, specify "intelligent recovery" thermostats.

4-2.12.3 Air Distribution System

4-2.15 Miscellaneous HVAC Requirements

4-2.15.7 Building Pressurization

4-2.15.8 Control

4-2.15.9 Intake Location

4-2.15.10 Economizer Cycle

4-2.15.11 Excess Air

Excess air from the space shall be relieved through the lower part of the walls to mailing platforms, enclosed loading docks, carrier and mail

vestibules, and similar locations. Relief through the roof is not permitted in order to minimize air conditioning requirements for other areas listed above.

4-3 Plumbing

4-3.1 Water Supply Systems

4-3.1.1 General Requirements

Incoming water supply shall be divided to supply domestic and fire protection systems. The domestic water supply shall be metered while the fire protection water supply shall be metered only if required by the local water company.

4-3.1.6 Emergency Showers and Eye-Wash

Emergency combination deluge shower and eye wash fountain shall be provided in the following areas:

- Custodial areas where cleaning materials are mixed.

4-3.2 Sanitary Drainage Systems

4-3.2.2 Acid Waste Systems

Acid waste systems shall be designed and installed in battery charging and photo processing areas to meet local code requirements.

Wastes from all fixtures and equipment where acids are or may be used should be diluted or neutralized to an acceptable pH level before discharge in the sanitary drainage system. Every fixture should have an individual trap. Individual acid neutralizing basins shall be used for isolated fixtures to avoid long runs of acid-resistant piping. Neutralizing basins shall be located clear of traffic paths.

All waste piping from acid using fixtures and equipment to the dilution or neutralizing basin and all vent piping for these fixtures and equipment should be of acid resistant material. Discharge from the dilution or neutralizing basin should be of the same material as the sanitary drainage system.

Acid vent piping may not be connected to the sanitary venting systems, but shall be run independently through the roof. Glass pipe should not be used for vent extensions through the roof. When glass pipe is used for the acid waste system, a transition from glass to another type of acid-resistant pipe should be made before penetrating the roof.

4-3.3 Plumbing Fixtures

4-3.3.2 Fixture Types

Emergency Shower and Eyewash

The units shall be complete with shower head and eye and face wash, and hard piped tempered (hot and cold) water connection.

4-3.4 Storm Drainage

Roof drain design shall be based on the one-hour rainfall, 25-year chart, as published in U.S. Department of Commerce Technical paper No. 40 and with the National Plumbing Code, ANSI A40.8, or local code whichever is most stringent.

[This page intentionally left blank.]

Module 2B Specific Criteria Medium Standard Building Designs

Refer to this chapter in
conjunction with Module
1 Chapter 5 - Electrical.

Chapter 5 Electrical

5-2 Power Distribution

- 5-2.1 Incoming Electrical Service
- 5-2.2 Distribution Voltage Levels
- 5-2.3 Main Service Equipment
- 5-2.4 Panelboards
- 5-2.5 Secondary Dry-Type Transformers
- 5-2.6 Motors and Controllers
- 5-2.7 Wiring Methods and Materials
- 5-2.8 Convenience Outlets

5-3 Lighting

- 5-3.1 Interior Lighting

5-4 Communications

- 5-4.3 Telecommunications - Structured Cabling System
- 5-4.10 Call Bell Systems

5-7 Integrated Security and Investigative Platform (ISIP)

- 5-7.5 Investigative CCTV Cameras

[This page intentionally left blank.]

Chapter 5 Electrical

Refer to this chapter in conjunction with Module 1 Chapter 5 - Electrical.

5-2 Power Distribution

5-2.1 Incoming Electrical Service

5-2.1.1 Underground Service

Incoming service shall be coordinated with utility company for underground service. Conduits shall be PVC-40 encased in a 3 inch minimum concrete envelope. Minimum of one spare duct capped approximately 6 inches above finished grade shall be provided. The top of the duct bank shall not be less than 24 inches below finished grade and shall extend to a point 5 feet from the building or property line for utility connection. Zinc coated rigid steel conduit shall be used for conduit elbows and conduits turning up into the building.

5-2.1.3 System Capacity

The incoming service shall be designed such that all demand and diversity factors allowed by code and local authority shall be applied to load determination calculations and shall include 20 percent spare capacity. The transformer primary and secondary wiring shall be sized to accommodate full capacity of transformer.

5-2.1.4 Emergency Power

In geographical areas where experience and records indicate electrical failures totaling more than 12 times for longer than 30 minutes or more than 24 cumulating hours annually, the installation of an emergency generator plant shall be evaluated for cost effectiveness. Emergency power shall be provided to Life Safety Equipment including fire alarm system, exit and emergency lights, security system and security lights, telecommunications system and automation.

5-2.2 Distribution Voltage Levels

Power distribution shall be 480/277Y volt, 3 phase, 4 wire secondaries with solidly grounded neutrals. Unless otherwise designated, all voltage references hereinafter shall be at a frequency of 60 Hz. A distribution arrangement requiring high interrupting capacities and long feeders shall be avoided. Size homerun branch circuit conductors from the panelboard to the first outlet in accordance with the following maximum circuit length limits, using center of load served as the basis for computing circuit lengths.

5-2.3 Main Service Equipment

5-2.3.1 Location

Main service equipment shall be located in rooms or spaces dedicated exclusively to such equipment. Space around all equipment shall in no case be less than that required by code and for adequate safety, maintenance and removal clearances. Provisions for removal of the equipment without structural, piping or lighting changes in the building shall be made. Ducts, piping and appurtenances of all systems foreign to the electrical systems shall not be installed in, or pass through, switchgear rooms or vaults. All freestanding main service equipment shall be mounted on a 6 inch high concrete pad.

5-2.3.3 Transformers

Transformers shall be the 3-phase type with a minimum of four 2-1/2 percent taps, two above and two below the rated voltage. The transformers shall be set to provide normal 480/277Y volt under full load conditions. Capacities selected shall be based on a self-cooled rating to accommodate a minimum of 100 percent of total facility demand load, as calculated herein. All indoor transformers shall be the dry type. Provisions for the future addition of forced-air cooling shall be made. Oil-filled transformers, when used at exterior conditions, shall be pad mounted. Standard NEMA accessories shall be required. High temperature and low-oil-level sensors to indicate alarm conditions shall be provided. All transformers to be high efficiency type.

5-2.3.4 Switchboards

Switchboards, including those integral with unit substations, shall be of the dead front, free standing type. Protective elements shall be coordinated to provide a fully selective system. At least one spare protective device and two spaces for future feeder positions shall be provided in each switchboard. All switchboards shall be provided with a main protective device and an equipment grounding bus. A 2x neutral bus shall be provided. Secondary lighting arresters and surge capacitors shall be provided, connected immediately down stream of the secondary main breaker.

5-2.3.5 Not Used

5-2.4 Panelboards

5-2.4.1 Types and Ratings

Lighting and receptacle panelboards shall be the bolted circuit breaker type. Feeder or distribution panelboards shall also be the circuit breaker type, depending upon short circuit current limitation requirements. All circuit overcurrent and protective devices shall have interrupting ratings no less than those required for the duty to be performed. Minimum interrupting ratings for 480/277 volt panelboards shall be 14,000 symmetrical amps.

Circuit breakers shall be the bolted type. A main circuit breaker or disconnect shall be provided on all panelboards when two or more panelboards are

supplied from the same feeder. All panelboards shall be provided with insulated neutral terminals and equipment grounding terminals. Two-section lighting and appliance branch circuit panelboards are not permitted. A typed label and directory shall be provided to clearly designate the load on each breaker on each panelboard and substation with the location (designated by room name, or column location in workroom) it services.

5-2.4.3 Sizing and Spare Capacity

Circuits in 277/480 volt panelboards serving dry-type transformers shall be considered loaded to the full capacity of the transformers rather than to the actual loading of panelboards fed by the transformer.

5-2.5 Secondary Dry-Type Transformers

Transformers shall be the 208/120Y volt, 3-phase, Faraday shielded type to service miscellaneous low voltage loads served by 208/120Y volt panelboards. These transformers shall be subfed from the adjacent 480/277Y volt lighting panelboards served by the same area and shall be column mounted in the workroom where feasible. Transformers shall have six 2-1/2 percent full capacity taps, two above and four below 480 volts. All panel transformers serving automation equipment loads shall be of the Faraday shielded type between primary and secondary windings. Transformer neutral terminals shall be properly grounded.

The need for K-rated transformers and/or harmonic canceling equipment for automation equipment shall be determined by the Solicitation A/E.

Workroom transformers shall be trapeze mounted on the building structure with vibration isolators or platform mount on the workroom columns near the panelboards.

5-2.6 Motors and Controllers

Generally, ½ hp and larger motors shall be designed for 480 volt, 3-phase power, unless otherwise noted for specific postal equipment. Motors smaller than ½ hp shall generally be designed to operate on 120 volt, single-phase circuits.

5-2.7 Wiring Methods and Materials

5-2.7.5 Grounding

A grid-type grounding system shall be installed around each building or buildings. The grounding system shall provide ground resistivity of 5 ohms at the substation or main service equipment and 5 ohms around the building. Each ground grid shall consist of a buried loop of copper wire, not smaller than number 4/0, solid copper cable which encircles each area. Ground rods shall be driven along this loop and a number of cross-connections to connect building steel and equipment to the ground grid shall be installed such that each major piece of equipment, including the main switchboard and main water supply or structure, shall have common ground paths.

All connections and joints shall be the exothermic weld type. The individual ground grids shall be tied together with an interconnecting ground wire.

Building steel and conductive enclosures of electrical equipment shall be connected to the ground system. At the main switchgear two ground cables shall connect to the switchgear ground terminal to allow for testing of the loop ground.

5-2.8 Convenience Outlets

5-2.8.4 Scales

One-inch conduit with pullwire shall be provided from the platform scale location to the BMEU counter for data transmission. Provide convenience outlets for scale operation as required.

5-3 Lighting

5-3.1 Interior Lighting

5-3.1.1 Workroom Lighting

Refer to USPS Standard Design Criteria and Master Specification 16510 for available fixture/lamp options for Workroom fixtures.

5-3.1.2 Platform Lighting

a. Dock Lighting

In addition to ambient lighting, provide adjustable dock lights with integral control switches at all truck positions at platforms higher than 2'-6" above grade. At open platforms, the dock light fixture shall be supported from the platform ceiling or beams and mounted in the center of each truck space, 8' – 6" above finished floor of the platform and clear of all mail-handling equipment. Wall or column-mounted switches shall be provided to control the adjustable dock lights on open docks.

b. Dock Traffic Lights

At each enclosed dock position, provide an exterior red and green signal light safety warning system visible through the left rear view mirror of the vehicle. Provide a limit switch activated by the overhead door to energize system when the door is closed. Traffic Light fixtures shall be mounted to provide protection from truck damage.

5-3.1.5 Emergency Lighting

Emergency lighting shall be provided to comply with NFPA 101 Life Safety Code requirements. Lighting units shall be circuited so that the standby lighting system in an area is energized when the power supply to the lighting panel for that area fails. In stairwells, lighting units shall be mounted approximately 8' above the step level below the fixture. In the workroom, they shall be mounted approximately as required to illuminate elevated workstations and routes of egress. A minimum of one emergency light shall be located at the main service panelboard, and positioned to illuminate the interior of the panel with the panel door open.

Emergency lights with battery packs shall have manual push test switches.

5-3.1.6 Day Lighting

Day Lighting in the workroom shall be considered based on the local District preference, and in areas where USPS may receive an economic benefit (electric company rebates) or where various roof penetrations (e.g. smoke vents) are required.

5-4 Communications

5-4.3 Telecommunications - Structured Cabling System

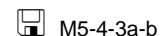

M5-4-3a-b

It is mandatory that telecommunications drawings and specifications be developed or reviewed by a BICSI Registered Communication Distribution Designer (RCDD). The FSO Project Manager is required to contact the respective District Information Technology (IT) Office's Telecommunication Specialist of new projects in their District at the 10%, 30%, 70%, and 100% design phase.

5-4.3.11 Telecommunication Equipment Room (ER)

The Telecommunication Equipment Room (ER) serves as the point of demarcation for incoming communications services and the interface point between the incoming service and the Structured Cabling System. MSBD facilities have dedicated Equipment Rooms.

Within the ER, space shall be provided for incoming service equipment electronic key telephone system (EKTS), and Local Area Network equipment. Equipment installed in this room will be in a wall mounted equipment rack. All horizontal cabling within the specified distance limitations established by ANSI/EIA/TIA-568-B standards will terminate on patch panels in this room. All voice and data backbone cables will terminate in this room. If the facility has TCs, the fiber interconnect center required to support data (fiber) cable requirements shall be mounted on the equipment rack. The room design shall follow the EIA/TIA-569. The MSBD Drawings and the USPS Standard Details Library show the standard ER layouts. Information on equipment and sizing of equipment (such as patch panels) is included in the USPS Master Specifications.

The ER room shall adhere to the following specification list :

- Provide 4' X 8' sheets of void-free, smooth plywood for backboards, coated with white or light grey fire retardant paint where indicated on plans.
- Wall mounted equipment rack spacing formula: One rack mount space (RMS) equals 1.75". All high-density 48 port patch panels require 2 RMS. All horizontal wire managers equal 2 RMS. One horizontal wire manager is required between each patch panel.
- One 7' H x 19" W x 18" D wall mounted equipment rack will support up to 40 RMS. If more than 40 RMS are required, add additional 7' H x 19" W, 18" D wall mounted equipment racks.

- Allocate approximately 4' x 4' space on plywood backboard for EKTS.
- Allocate a 3' W x 4' H space on plywood backboard for LEC termination fields, splice cases, specialized circuit components, etc.
- Where required, fiber optic cables supporting HCs (backbone) will all terminate in a fiber optic distribution center (FDC) on wall mounted interconnect center (WIC).
- Where required, voice backbone cabling will terminate in this room on patch panels on a wall mounted equipment rack, or wall mounted brackets if there is limited space on the rack.
- Grounding and bonding of all contractor provided hardware and cabling must be completed in accordance with the EIA/TIA-607 specifications as well the NFPA-70 NEC and any applicable local codes.
- Continuous temperature and humidity controls may be required to maintain telecommunications equipment within manufacturer's recommendations.
- Provide a 84"H x 19"W wall mounted equipment rack with vertical and horizontal wire management for mounting patch panels, and fiber distribution center (FDC).
- Provide 6 dedicated 120V nominal, non-switched, AC, duplex, 20Amp outlets in each ER.
- Provide a minimum 3kVA of uninterruptible power in the ER.

5-4.3.12 Telecommunications Closet (TC)

The Telecommunications Closet (TC) is the room that houses the horizontal cross-connect (HC) that serves as a transition point between the backbone and horizontal cable systems. The TC provides a controlled environment to house voice, data equipment, and connecting hardware.

MSBD facilities do not usually require a TC. A TC is required when the horizontal distribution distance exceeds 295 feet. A TC may also be required in facilities with Admin areas greater than 10,000 SF. Where required in a multi-story building, there shall be a minimum of one TC per floor. All TCs shall be a minimum of 6' x 6' clear interior space with ventilation, sufficient lighting, and lockable doors.

One voice backbone (riser) cable and one fiber optic cable will be required from each TC to the MC. EIA/TIA-569 specifies additional general requirements for the TC. USPS AS 504, Space Requirements Handbook, identifies space requirements.

The TC shall adhere to the following specification list :

- Provide void-free, smooth plywood coated with white or grey fire-retardant paint for backboards to cover entire back wall of TC.
- One rack mount space (RMS) equals 1.75". All high-density 48 port patch panels require 2 RMS. All horizontal wire managers equal 2 RMS. One horizontal wire manager is required between each patch panel.
- One 4' H x 19" W x 14" D wall mounted equipment rack will support up to 22 RMS. If more than 22 RMS are required, add additional 4' H x 19" W, 14"D wall mounted equipment racks.
- Fiber optic cables connecting this room to the ER shall terminate in a wall mounted interconnect center (WIC) on plywood backboard.

-
- Voice backbone cabling connecting this room to the ER shall terminate on patch panels on wall mounted rack.
 - Provide two dedicated 120V nominal, non-switched, AC, duplex, 20Amp outlets in each TC.
 - Provide a minimum 3kVA of uninterruptible power in each TC.

5-4.8 Sound System

5-4.8.1 Paging

Provide a selective and overall paging system with separate zones for the Workroom, support, administrative and platform areas. Individual speakers shall have adjustable volume control. Select equipment which will permit additions to the system in the future. Access to the paging system shall be by telephone.

Ambient noise level in the Workroom is approximately 76-78 dB.

5-4.10 Call Bell Systems

5-4.10.1 Door Bell

Provide a door bell push-button at the personnel door for employee use and at the wicket door for customer use in retail facilities. Set the bell for the wicket door to double chime and the bell at the personnel door to single chime. These bells should produce sounds that are audibly different from the assistance buzzer. In BMEUs, provide a door bell push-button outside the customer entrance and another one in the scale room.

5-4.10.2 Assistance Buzzer

In customer service facilities, one assistance buzzer push-button shall be provided at the Full Service Counter and one shall be provided at the cash wrap in the Open Merchandising area. In BMEUs, provide an assistance buzzer push-button at the workstation. The buttons are to be located so that they are easily accessible by the clerk but hidden from customer view. The buzzers are provided as a means for a clerk to signal the need for additional staff in the retail area, and are not intended for use as a duress switch. The buzzers should produce a sound that is audibly different from the door bells and should be located in the Workroom.

5-7 Integrated Security and Investigative Platform (ISIP)

 G5-8-3a-d

USPS Handbook RE-5

5-7.5 Investigative CCTV Cameras

5-7.5.1 Cameras and Junction Boxes

Cameras shall be powered with 20 Amp. breakers on a panel in the Investigative Office. All cabling shall be home runs.

Mount junction boxes as high as practical where exposed.

Cameras shall be placed as follows to allow viewing of all critical areas:

- One pan tilt zoom (PTZ) for every four carrier routes.
- One pan tilt zoom per 40 ft. grid on the workroom floor.
 - Workroom PTZ must provide visual access to registry cage and vault doors
 - Workroom PTZ must provide visual access of the workroom side of the PO Boxes.
- One PTZ in the dock area positioned to allow viewing into the truck bed with one PTZ per 3 dock positions.
- One fixed camera over every full service counter.
- One PTZ every 60 ft. on the carrier loading slab.
- One PTZ in the BMEU.
- One PTZ in the lunch/break room.
- One fixed camera viewing trash/recycling area, if the area cannot be viewed by adjacent carrier loading area cameras.

5-7.5.3 Camera Systems

Provide and install cameras at all junction box locations.

All non-investigative cameras shall be looped to the equipment provided in the Postmaster's office. In addition, cameras shall also loop back to Investigative Office.

[This page intentionally left blank.]

Module 2C Specific Criteria Small Standard Building Designs

Refer to this chapter in conjunction with Module 1 Chapter 2 - Architectural.

Chapter 2 Architectural

2-2 Workrooms

2-2.3 Height Requirements

2-3 Platforms

2-3.1 Open Mail Platforms
2-3.9 Vestibules

2-4 Support Areas

2-4.2 Toilet Facilities
2-4.3 Locker Rooms
2-4.4 Lunchroom / Break Area
2-4.7 Janitor's Closet
2-4.9 Outside Storage Area

2-6 Exterior Envelope

2-7 Miscellaneous Building Components

2-7.2 Doors and Hardware
2-7.4 Protective Barriers

[This page intentionally left blank.]

Chapter 2 Architectural

Refer to this chapter in conjunction with Module 1 Chapter 2 - Architectural.



Exhibit 2a
SSBD

2-2 Workrooms

2-2.3 Height Requirements

The height of the finished ceiling in the workroom shall be 9 ft. 0 in. min. above the finished floor. The truss bearing height is established by taking into consideration HVAC and recessed lighting requirements above the ceiling.

2-3 Platforms

2-3.1 Open Mail Platforms

Open mail platforms have a roof canopy, but no wall or overhead doors at the truck dock side. The platform is typically constructed of sealed concrete, poured level and at the same elevation as the workroom floor out to within 10 ft. 0 in. of the edge of the slab. The front 10 ft. of the slab shall have a 1 percent slope to maintain drainage away from the building. A platform canopy, with flush soffit underneath, shall extend a minimum of 5 ft. 0 in. beyond the outside face of the platform. A vestibule is required between the workroom and any open mail platform.

In locations where the threat of driving rain or snow is minimal, the mail platform may be open on one, two or three sides. The determination to eliminate any or all enclosing walls must take into consideration the climatic conditions of the particular site and the building orientation. However, in all

cases, a roof shall be provided over the entire platform and canopy overhang area.

2-3.9 Vestibules

 G2-3-9a

Vestibules are used at facilities with open mail platforms to minimize the heat gained or lost due to intermittent high volume cart traffic passing from the workroom to mail and carrier platforms throughout the day. The mail vestibule may also serve as temporary storage of mail dropped off overnight or when the facility is closed.

2-4 Support Areas

2-4.2 Toilet Facilities

 G2-4-2a→c1

Use of either floor or wall mounted water closets is acceptable. Toilet partitions (if applicable) shall be floor mounted.

2-4.3 Locker Rooms / Areas

 G2-4-3a→a2

Do not provide a locker room; however, space must be allocated for one double-tier half-size locker with sloping top per employee. Coordinate layout and provision requirements with USPS.

2-4.4 Lunchroom / Break Area

 G2-4-4a→c

A break area counter may be provided at the edge of the workroom area in buildings 4,000 sq. ft. or larger, if directed by USPS.

Basic break area requirements include:

- Sink with hot and cold water.
- Wall and base cabinets with laminated counter workspace.
- Electric outlets for refrigerator and microwave oven (appliances provided by USPS).

2-4.7 Janitor's Closet

 S2-4-7a

Provide a mop sink, mop/broom holder, and storage shelves. Provide a 4 ft. high fiberglass reinforced plastic (FRP) sheet wainscot at mop sink. The top, bottom, and side edges, intermediate joints, and corners must be continuously caulked.

2-4.9 Outside Storage Area

An enclosed storage area may be added to the mail platform if requested by USPS. Provide a lockable door accessible to the mail platform.

2-6 Exterior Envelope

 S2-6-1a→1r

 S2-6-2a→f

For standard exterior wall construction, see the details referenced to the right. Other exterior materials may be used when appropriate to the context, and if directed by USPS.

2-7 Miscellaneous Building Components

 S2-7-2a→f

2-7.2 Doors and Hardware

2-7.2.1 Doors

a. Mail and Carrier Vestibule Doors

Provide a single set of impact doors for inbound and outbound traffic. A separate personnel door must be provided adjacent to the impact doors for use by pedestrian traffic and as a means of egress.

 S2-7-2a→f

In buildings 3000 sq. ft. or less, replace the impact doors with a single 4 ft. 0 in. door serving both mail traffic and pedestrian/egress traffic. This door shall be provided with hardware as required to protect it from wheeled equipment.

b. Automatic Doors

For facilities 4,000SF and over, the customer entry doors use low energy automatic swinging doors which do not require the installation of guide rails. Automatic sliding doors with motion sensor operators may be used in lieu of swinging doors.

2-7.4 Protective Barriers

 G2-7-4a→d2

Provide fiberglass reinforced plastic (FRP) panels on all interior walls of the workroom.

USPS Handbook RE-5

[This page intentionally left blank.]

Module 2C Specific Criteria

Small Standard Building Designs

Refer to this chapter in conjunction with Module 1 Chapter 5 - Electrical.

Chapter 5 Electrical

5-2 Power Distribution

- 5-2.1 Incoming Electrical Service
- 5-2.2 Distribution Voltage Levels
- 5-2.4 Panelboards
- 5-2.7 Wiring Methods and Materials

5-3 Lighting

- 5-3.1 Interior Lighting

5-4 Communications

- 5-4.3 Telecommunications - Structured Cabling System
- 5-4.10 Call Bell Systems

5-7 Integrated Security and Investigative Platform (ISIP)

- 5-7.5 Investigative CCTV Cameras

[This page intentionally left blank.]

Chapter 5 Electrical

Refer to this chapter in conjunction with Module 1 Chapter 5 - Electrical.

5-2 Power Distribution

5-2.1 Incoming Electrical Service

5-2.1.1 Underground Service

Incoming service shall be coordinated with utility company for underground service. Conduits shall be PVC-40 direct buried minimum 24 in. below finished grade and extend to 5 ft. from the building or property line for utility connection. Zinc coated rigid steel conduit shall be used for conduit elbows and conduits turning up into the building.

5-2.1.3 System Capacity

The incoming service shall be designed such that all demand and diversity factors allowed by code and local authority shall be applied to load determination calculations, and shall include 20 percent spare capacity..

5-2.2 Distribution Voltage Levels

Power distribution shall be 120/240 volt, single phase unless the size of the building is such that 120/208Y volt, 3 phase, 4 wire distribution system is justified. Unless otherwise designated, all voltage references hereinafter shall be at a frequency of 60 Hz. A distribution arrangement requiring high interrupting capacities and long feeders shall be avoided. Branch circuit wiring shall not exceed 100 ft. for 208/120 volt system.

5-2.2.1 Motors

Generally, ½-hp and larger motors shall be designed for 208 volt, 3 phase or single phase power, unless otherwise noted for specific postal equipment. Motors smaller than ½-hp shall generally be designed to operate on 120 volt, single phase circuits.

5-2.4 Panelboards

5-2.4.1 Types and Ratings

Lighting and receptacle panelboards shall be the bolted circuit breaker type. Feeder or distribution panelboards shall be the circuit breaker type. All circuit overcurrent and protective devices shall have interrupting ratings no less than those required for the duty to be performed.

Circuit breakers shall be the bolted type. A main circuit breaker or disconnect shall be provided on all panelboards. All panelboards shall be provided with

insulated neutral terminals and equipment grounding terminals. Two-section lighting and appliance branch circuit panelboards are not permitted. A typed label and directory shall be provided to clearly designate the load on each breaker on each panelboard with the location (designated by room name, or column location in workroom) it services.

5-2.7 Wiring Methods and Materials

5-2.7.5 Grounding

The grounding system shall have a separate equipment grounding conductor installed in each feeder and branch circuit conduit except for lighting branch circuits. At the main switchgear two ground cables shall connect to the switchgear ground terminal to allow for testing of the loop ground.

5-3 Lighting

5-3.1 Interior Lighting

5-3.1.1 Workroom Lighting

Refer to USPS Standard Design Criteria and Master Specification 16510 for available fixture/lamp options for Workroom fixtures.

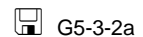

5-3.1.2 Platform Lighting

a. Dock Lighting

In addition to ambient lighting, provide ceiling mounted dock lights on flexible pendants with integral control switches at all truck positions at platforms higher than 2'-6" above grade..

At open platforms, the dock light fixture shall be supported from the platform ceiling or beams and mounted in the center of each truck space, 8'-6" above finished floor of the platform, and clear of all mail-handling equipment. Wall or column-mounted switches shall be provided to control the adjustable dock lights on open docks.

5-3.1.6 Emergency Lighting

Emergency lighting shall be provided to comply with NFPA 101 Life Safety Code requirements. Lighting units shall be circuited so that the standby lighting system in an area is energized when the power supply to the lighting panel for that area fails. Lighting units shall be mounted to provide a minimum of 1 fc to means of egress. A minimum of one emergency light shall be located at the main service panelboard positioned to illuminate the interior of the panel with the panel door open.

Emergency lights with battery pack shall have manual push test switches.

5-4 Communications

5-4.3 Telecommunications - Structured Cabling System

It is mandatory that telecommunications drawings and specifications be developed or reviewed by a BICSI Registered Communication Distribution Designer (RCDD). The FSO Project Manager is required to contact the respective District Information Technology (IT) Office's Telecommunication Specialist of new projects in their District at the 10%, 30%, 70%, and 100% design phase.

5-4.3.11 Telecommunication Equipment Room (ER)

The Telecommunication Equipment Room (ER) serves as the point of demarcation for incoming communications services and the interface point between the incoming service and the Structured Cabling System. In standard SSBD facilities, there is no dedicated Equipment Room. The ER is part of the Mechanical Room. Within this room, space shall be provided for incoming service equipment, electronic key telephone system (EKTS) (for facilities 4,000 SF and over), and Local Area Network equipment. Equipment installed in this room will be wall mounted. All horizontal cabling will terminate on patch panels in this room. The room design shall follow the EIA/TIA-569. The SSBD Drawings and the USPS Standard Details Library show the standard layouts. Information on equipment and sizing of equipment (such as patch panels) is included in the USPS Master Specifications.

The ER room shall adhere to the following specification list :

- Provide 4' X 4' or 4' X 8' sheets of smooth, void-free plywood coated with white or light grey fire-retardant paint for backboards, where indicated on plans.
- For facilities 4,000SF and over, allocate approximately 4' x 4' space on plywood backboard for EKTS.
- Wall mounted brackets shall be used to support patch panels and equipment.
- Ensure proper separation between telecommunications equipment and cabling, and mechanical and electrical equipment, per EIA/TIA standards. For example, a 4' minimum separation is required between structured wiring and power panels, transformers, class-1 alarm panels, etc.
- Grounding and bonding of all contractor provided hardware and cabling must be completed in accordance with the EIA/TIA-607 specifications as well the NFPA-70 NEC and any applicable local codes.
- Adequate space shall be reserved for LEC termination fields, splice cases, specialized circuit components, etc.
- Continuous temperature and humidity controls may be required to maintain telecommunications equipment within manufacturer's recommendations.
- Provide two dedicated 120V nominal, non-switched, AC, duplex, 20Amp outlets in each ER.
- Provide a minimum 3kVA uninterruptible power in each ER.

5-4.10 Call Bell Systems

5-4.10.1 Door Bell

Provide a door bell push-button at the personnel door for employee use and at the wicket door for customer use in retail facilities. Set the bell for the wicket door to double chime and the bell at the personnel door to single chime. These bells should produce sounds that are audibly different from the assistance buzzer.

5-4.10.2 Assistance Buzzer

In customer service facilities, one assistance buzzer push-button shall be provided at the Full Service Counter and one shall be provided at the cash wrap in the Open Merchandising area. The buttons are to be located so that they are easily accessible by the clerk but hidden from customer view. The buzzers are provided as a means for a clerk to signal the need for additional staff in the retail area, and are not intended for use as a duress switch. The buzzers should produce a sound that is audibly different from the door bells and should be located in the Workroom.

5-7 Integrated Security and Investigative Platform (ISIP)

USPS Handbook RE-5

5-7.5 Investigative CCTV Cameras

Cameras shall be placed as follows to allow viewing of all critical areas when a Investigative CCTV System is required:

- One fixed camera at the platform.
- One fixed camera per each Full Service Counter.
- One PTZ camera in the Workroom for Plans 40 through 65.
- Two PTZ cameras in the Workroom for Plan 80 and 100.

[This page intentionally left blank.]

Module 3B Modular Post Offices

- 1 Program Overview**
- 2 Standard Designs**

[This page intentionally left blank.]

Module 3B Modular Post Offices



Exhibit 3a
Modular Building, Eagleville, MO

1 Program Overview

Modular Buildings are fabricated in a highly controlled factory environment, according to Postal specifications. The building manufacturer transports the unit to the site, which is prepared in advance by a separate, site-installation contractor.

The units are shipped to the site virtually complete, allowing for a consistent, high-quality product in all locations, even where local contractors may not be familiar with USPS facilities standards.

2 Standard Designs

There are a total of five standard Modular Building designs, ranging in size from approximately 500 sq. ft. to 1500 sq. ft.

Within the five standard plan sizes, there are two basic configurations: single-wide and double-wide units.

- Single-wide units are delivered to the site and placed on the foundation by the modular building manufacturer, then secured in place by the site-installation contractor.
- Double-wide units are transported to the site in two separate pieces, then hoisted by crane onto the foundation, where the modular building manufacturer splices the two together.

In both cases, the site-installation contractor is responsible for site preparation, including foundations, sidewalks, utility connections, and completion of all exterior elements, such as entry canopy and building-mounted signage.

Complete drawings, specifications, standards and information on possible options for the design of Modular Buildings can be found in the Modular Building Program (Version 2.0).

[This page intentionally left blank.]

Module 3D Historic Buildings & Fine Arts

1 General

2 Historic Buildings

3 Fine Arts in Postal Buildings

3-1 Murals

3-2 Sculptures

[This page intentionally left blank.]

1 General

(Reserved for future information.)

2 Historic Buildings

(Reserved for future information.)

3 Fine Arts in Postal Buildings

The USPS fine arts inventory, which includes over 1,000 murals and sculptures owned and controlled by the Postal Service, forms a vital part of America's national heritage. This collection was created between 1934 and 1943 as part of President Roosevelt's New Deal agenda to get people back to work and to restore the economy. As guardian of this collection, it is the Postal Service's policy not to sell, abandon, or destroy any part of the inventory.

Recognizing the importance of this collection, the Postal Service makes every effort to preserve and safeguard it for future generations by providing for the relocation of these works into the new building when it is necessary to move from an existing building. Architects for any new postal-owned facility must be made aware of any works of fine art in the existing building that need to be accommodated in the lobby design of the new building. Any changes to the standard plans as necessary to accommodate the art work shall follow the deviation policy outlined in the Introduction chapter of this handbook.

The Postal Service's Federal Preservation Officer (FPO) at Facilities Headquarters has responsibility for the fine arts collection. Relocation of any work of fine art must be reported in writing to the FPO. Similarly, if a work of fine art cannot be relocated for some reason, the FPO must be notified.

3-1 Murals

Murals were typically created using one of two media: either painted on canvas which is then glued to the wall, or painted directly on the wall surface as a fresco. A canvas painting should be carefully removed and relocated to an area of the new building for viewing by the general public, usually in the lobby. Unfortunately, a fresco is prohibitively expensive to move and must remain as an integral part of the existing building.

Sculptures

Sculptures were produced from various materials such as metal, stone, plaster, wood, or other types of common material. Sculptures should be examined carefully and a decision made by the Contracting Officer as to the feasibility of relocation to the new building. If it is not feasible to relocate the sculpture, Facilities personnel responsible for disposing of postal buildings coordinate with the FPO to determine other means of preserving the sculpture.

[This page intentionally left blank.]

Checklists

[This page intentionally left blank.]

10% Design Checklist

Facility Name:

City, State, Zip:

Reviewer (Individual/Firm Names):

Telephone Number:

Date:

Section No.	Detail/ Ref	✓	Item	Comment
2			CRITICAL LAYOUT RELATIONSHIPS	
			Self-Service area and the Display Slatwall area are immediately visible to the customer from the entry.	
			Full Service Counters are placed at the rear of the facility, and SSA's have unobstructed visual contact with all elements of the Display Slatwall area.	
			The Display Slatwall area is on the right-hand side of the facility upon entry.	
			Full Service SSA's have a clear view of the entry.	
			Full Service Counter, POS, P.O. box and parcel locker requirements are provided per Start-Up Questionnaire.	
3			AREA FUNCTIONAL REQUIREMENTS	
3-1			Electronic Article Surveillance (EAS) system is provided.	
			Walk-off floor mat is provided at entry.	
			Writing desk is provided near entry.	
3-2			Self-Service items are placed in a linear fashion.	
			A Standard layout has been used.	
3-3			No windows are shown in the back of the and cash register drawer and storage area are not visible from the outside of the facility.	
			If windows are existing, details are provided to eliminate or cover them with slatwall on the interior, and to conceal the construction from the outside with spandrel glass.	
			The flooring transition is 3" inside the line of the rolling grille track .	

Section No.	Detail/ Ref	✓	Item	Comment
			Gondolas do not block the visual contact between the Full Service Counters and the Display Slatwall. Gondolas are placed at an angle so clerks can see down rows for better surveillance.	
			Circulation around gondolas meets requirements of USPS Handbook RE-4.	
			An adequately sized closet has been provided to accommodate the folding security grille. The hinges for the closet door are on the exterior edge (public side).	
3-3.1			The parcel slide is a dog-legged unit with end cap. It includes a minimum of one handicapped writing desk/forms counter, and one waste unit.	
			The dog-leg is parallel to the Full Service counters and angles toward the Display Slatwall so that the queue forms on the Display Slatwall side of the parcel slide.	
			The parcel slide terminates 4'-0" to 5'-0" from the Full Service Counters to deter customers from forming a second queue.	
			A 2- or 3-post pedestrian guidance barrier is provided to initiate queue formation.	
3-4			P.O. boxes and parcel lockers are arranged in a saw-tooth wall pattern so that all parts of the P.O.-Box area are visible to the customer from outside the facility.	
			If deeper alcoves are required to meet local requirements, entry to the alcoves follow the saw-tooth pattern, and clear lines of sight from the entry of the alcove to all interior parts of the alcove have been maintained.	
			P.O. box alcoves have been sized to meet standard panel opening dimensions.	
			No hiding places (i.e. columns, pilasters, writing desks) are included in the design.	
			Writing desks are provided, and have been placed in the entry to the alcove so as not to block visibility.	

Section No.	Detail/ Ref	✓	Item	Comment
			Sufficient clearance has been maintained to push hampers behind the P.O. boxes (44" min. preferred for saw-tooth layout, 6'-0" min. for straight hallway).	
3-5			Full Service Counters are placed 1'-0" back from the edge of adjacent walls to provide space for a roll-down shutter (which will pass in front of the counter to the floor).	
			Minimum equipment requirements have been provided for the Full Service Screenline, including one unit of each of the following items: Tub/Tray Storage Unit, Pouch/Hamper Unit, Meter-Setting Cabinet and Left Notice Cabinet.	
			Screenline cabinets are in customer view so that clerks can be seen as they use the screenline cabinets.	
			Screenline cabinets and walls are configured to conceal the workroom from customer view without impeding employee access to the workroom.	
3-6			An enclosed office has been provided for the Station Manager, which is adjacent to the Full Service Counters and convenient to the lobby.	
			Space for safes has been provided near the Manager's Office.	

[This page intentionally left blank.]

30% Design Checklist

Facility Name:

City, State, Zip:

Reviewer (Individual/Firm Names):

Telephone Number:

Date:

Section No.	Detail/ Ref	✓	Item	Comment
2			CRITICAL LAYOUT RELATIONSHIPS	
			Elevations are coordinated with standard elevations for exact locations of all signage.	
3			AREA FUNCTIONAL REQUIREMENTS	
3-1			The Branch name is applied to the entry door as a decal or with vinyl letters.	
	Arch. Signage Manual;		A clean layout detail is provided for the placement of all decals on the entry door or adjacent side panels.	
	Arch. Signage Manual		Hours of operation signage is visible from the exterior.	
3-2			Letter Drops have been specified with a durable powder-coated finish.	
			Focused accent lighting is provided over equipment.	
			Letter drops and counters meet all handicapped accessibility requirements for a side approach.	
	Arch. Signage Manual; 12/A.6		The collection times wall plaque is located between letter drops.	
3-3			The ceiling height in this area is 9'-0".	
			Track mounted wall washers are placed 3'-0" from face of slatwall, and are evenly spaced. Track lighting is centered on posters.	
			All partitions (including structure above the security grille) are of a security type.	
			All fixtures (slatwall, writing desks, gondolas,) are bolted to the floor or wall.	
			Each cash register (POS System) has an isolated ground with a separate circuit (20 amp) (4 outlets) for power, an RJ45 data jack, a credit card jack, and a voice telephone jack.	

Section No.	Detail/ Ref	✓	Item	Comment
3-3.1			Architectural Reflected Ceiling Plan shows recessed downlights over the parcel slide for task lighting.	
			The pedestrian guidance barrier is secured to the floor.	
3-4			The flooring material in the P.O.Box area is resilient floor tile.	See finishes schedule for tile type
3-5			The "menu board" is located at the back edge of the Full Service Counter returns, and extends the width within the counter opening, in accordance with menuboard requirements.. Adequate structural support for menu board suspension has been provided.	
			2' x 4' fluorescent fixtures are provided above the Full Service Counters and in front of the Full Service Screenline. Downlights (one per counter) are located to highlight transaction counters.	
			Adequate outlets have been provided for the equipment and tasks required. Additional power strips have been provided at the Full Service Counters as directed by USPS.	
			The clerk service push button has been located adjacent to the wicket door on the lobby side. The buzzer has been located so that it can be heard in the workroom, but not in the Full Service Counter area.	
3-6			The floor in the Manager's Office is resilient floor tile.	
			The monitor for the CCTV cameras is clearly visible from the Manager's Office.	
			Adequate space and sufficient electrical outlets have been provided for the size and placement of equipment (CCTV monitor, personal computer, etc.).	
3-8			A power outlet is provided at 42" AFF at each work counter.	
4			GENERAL	
4-1			Security walls are provided between the public areas of the facility, workroom and leased spaces.	
			A security partition is provided above the ceiling to the underside of the slab at all security grille locations (Full Service areas).	
			Electronic Article Surveillance (EAS) panels are provided at the entry. Junction boxes are properly located, centered under the EAS panels with conduit below the floor.	

Section No.	Detail/ Ref	✓	Item	Comment
			Cameras are placed in accordance with the Security Plan.	
			Security system devices, such as CCTV and alarm systems, are on their own circuits. Coordinate specific security and power requirements with local Postal Inspector.	
			Minimum 36" clear aisles are provided throughout for circulation (increase width if required by local code). A 44" minimum aisle width is desired at open display areas.	
			Security design complies with USPS Handbook RE-5.	
4-2			All public area furnishings and casework are anchored to the floor or wall.	
			Floor tile runs under casework to accommodate future modifications.	

[This page intentionally left blank.]

Module 4A Retail Design Standards

1 Introduction

2 Critical Layout Relationships

3 Area Functional Requirements

- 3-1 Customer Entrance
- 3-2 Self Service
- 3-3 Full-Service Lobby
- 3-4 Post Office Box
- 3-5 Manager's Office

4 Application of the Prototypes

- 4-1 Lengthen the Self Service Wall
- 4-2 Increase/Decrease Post Office Box Sections
- 4-3 Decreasing the Lobby Footprint
- 4-4 Mirroring the Plan

5 Interior Signage and Graphics

- 5-1 Self Service Area Signage
- 5-2 Dimensional Letter Service Descriptors
- 5-3 Menu Boards
- 5-4 Frames for Mandatory Posters
- 5-5 Box Availability Plaques
- 5-6 Post Office Box Information Plaque
- 5-7 Ring Bell for Service
- 5-8 Push/Pull Door Decals
- 5-9 Next Station Please Counter Plaques
- 5-10 Dedicatory Plaque
- 5-11 Employees Only Beyond This Point Plaque

6 General

- 6-1 Security
- 6-2 Materials and Finishes
- 6-3 Casework

Checklists

[This page intentionally left blank.]

Module 4A Retail Design Standards

1 Introduction

 G2-5-1a→d2

Retail Designs in MSBD & SSBD Standards shall be used for the design of all new, renovation and alternate quarters construction of retail facilities that are not otherwise defined within Medium Standard Building Designs and Small Standard Building Designs.

The Retail Designs in MSBD & SSBD Standards were developed to better serve USPS customers and improve the financial performance of retail facilities. The designs set a standard for consistency of style, color, materials, and graphics that are cost effective, durable, and easy to maintain. They are designed to convey a professional, efficient and consistent image beneficial to the United States Postal Service.

Retail Designs in MSBD & SSBD Standards were developed with several design features and relationships essential to the success of a retail facility. The following elements are included in most retail facilities. Consult USPS Pub AS504 for Retail prototype design selection requirements.

- Self Service
- Display Slatwall
- Post OfficeBox
- Full Service Lobby

The layout of these elements presents a hierarchy of service options, which allow for speed and cost efficiency. This arrangement improves the promotion of Postal products and services by providing easy visual and physical access between areas. Designated changes in floor materials, ceiling heights and graphics help to define these distinct areas.

2 Critical Layout Relationships

The Retail Designs in MSBD & SSBD Standards maximize efficient use of square footage while creating a professional environment for customers and employees. The following critical relationships ensure successful implementation of the Design Standards concepts:

- The Self Service Area is immediately visible to the customer from the entry. These areas are easily accessible.
- The Full Service Counters are placed at the rear of the facility, and Sale Service Associates (SSA's) have unobstructed visual contact toward the Display Slatwall and Entry area to create visual security control.
- The Display Slatwall area is preferably located to the right-hand side of the facility upon entry (due to the natural tendency of a customer to move to the right).

- In certain cases, the layout relationships may be “mirrored” to accommodate existing conditions. See 4-5, Mirroring the Plan.
- Full Service counters, POS, P.O. Box and parcel locker requirements are provided per the Start-Up Questionnaire.

3 Area Functional Requirements

3-1 Customer Entrance

 G2-5-1e→e3

The entry must present a consistent, identifiable image to the customer. It must be easily visible from the exterior of the building and from the customer's main arrival route.

Provide only one point of entry into the main retail area. Other entry points cause confusion in the Full Service Counter queue and are a security concern.

Windows with clear (unetched) glass should be installed to provide good, unobstructed visibility between the exterior and the interior. Security requires elimination of the view to cash register money drawers and the back of SSA's stations. Security issues must be addressed in the construction detailing, and coordinate with local Postal Inspector.

The drywall ceiling in alternate quarters projects is 12 ft. 0 in. AFF in the entry area to allow for coordination with leasing requirements and the storefront system, and to differentiate this space from adjacent areas. This ceiling height may vary depending on the height of the storefront glazing. If space allows, writing tables may be provided in the entry area.

3-2 Self Service

 G2-5-2a→d

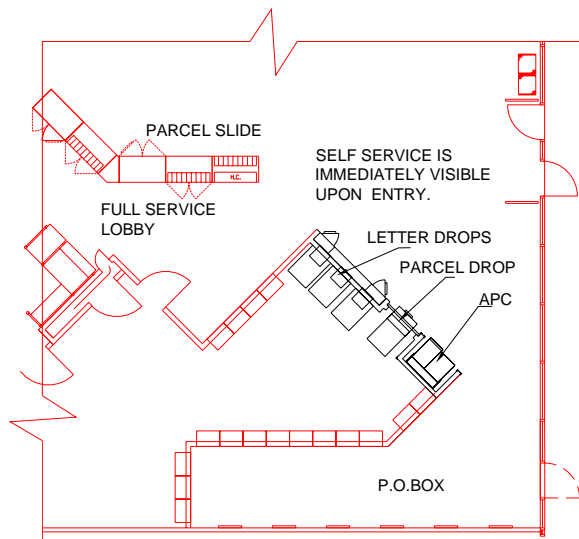

*Note, the self-service areas have been redesigned. The graphic above is for visual reference and to show adjacencies only. For APC and Parcel Drop design details, see Program Folder, Retail, APC.

Exhibit 3-2a

Self Service Area

NOTE: Stamp vending machine equipment is being phased out of Post Offices and no new machines should be installed. The self service areas on standard drawings have been updated to reflect the new designs.

Self Service is the first area the customers see as they enter the facility. This area provides the automated equivalent to personal service for the majority (but not all) of the transactions currently performed at the full service counters, such as weighing parcels, purchasing postage, mailing letters and packages. This minimizes the customer's waiting time and enables RA's to focus on services for which their assistance is essential (return receipts, money orders, etc.)

The core elements of the Self Service Area include letter drops and a Scale Unit. In selected locations, the Self Service Area elements will be augmented by the introduction of the Automated Postal Center (APC) and an in-wall parcel drop. For APC and Parcel Drop design details, see Program Folder, Retail, APC.

All the elements of the Self Service area must be visible from the entry. All core equipment and letter drops must be located in a single area of the facility.

Letter Drops 1577D should be easy for customers to identify. A 2 ft. 0 in. blank wall or an additional letter drop should be provided in the Self Service area to accommodate future vending needs.

The electronic scale requires a duplex outlet and can be installed in an alcove or as a free standing element.

The Self Service area must be perceived as a distinct area. The lighting level should be brighter than the main circulation path, and focused accent lighting should be provided over equipment.

Self Service items are to be placed in a linear fashion (weigh/stamp/mail). If spatial constraints require an alternative Self Service layout, these items should be located in a recessed alcove, not wrapped convexly around a corner. This configuration allows the customer to view all of their Self Service options from a single vantage point.

3-3 Full Service Lobby

G2-5-3a→e

3-3.1 Full Service Counters

G2-5-5a→f1

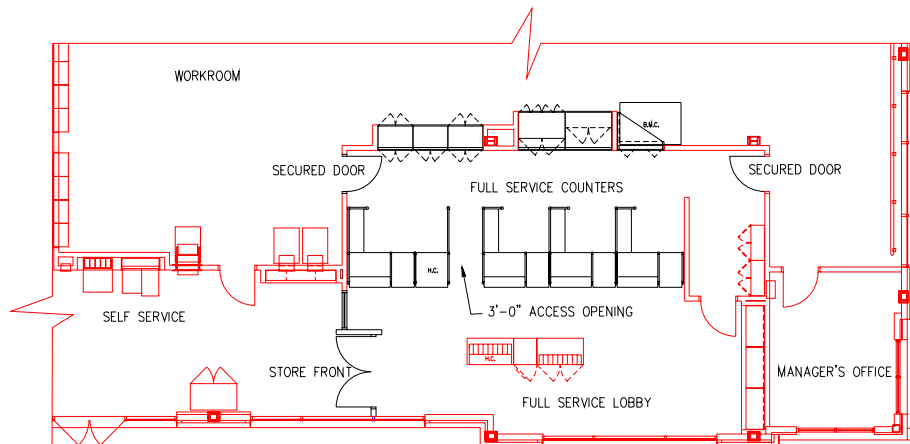

*Note, the graphic above is for visual reference and to show adjacencies only. See paragraph below for clarification on the requirements to accommodate the 3'-0" opening between the counters.

Exhibit 3-3.1a

Full Service Counter with 3'- 0" Opening Between Counters

Full Service Counters are located at the rear of the lobby. This is the customer's primary contact with postal employees and they derive an important part of their impression of the United States Postal Service from this interaction.

Provide a clearly delineated, single queue system using the parcel slide and tensor tape. Provide customers with a clear line of sight to all Full Service Counters from the front of the queue. Ceiling-mounted information menuboards should be provided for easy identification of available services. They should be located above and behind the Full Service Counter return.

A sliding grille is required so that Full Service Counters can be secured during non-service hours. It extends to the floor in front of Full Service Counters. It should be key-lockable and secured with bolts with a minimum 1 in. throw.

Sorting procedures and the combination of equipment units required must be coordinated with the USPS. The fixtures available are:

- 1 Tub/Tray Storage Unit.
- 1 Pouch/Hamper Unit.
- 1 Meter-Setting Cabinet. (optional, since meter setting provisions have been accommodated at all workstations in the full service counter)
- 2 Left Notice Cabinets.
- Bulk Mail Acceptance Unit Cabinet

Locate screenline cabinetry directly behind Full Service Counters to provide easy SSA access and eliminate the need for clerks to leave the customer view. The optimal distance between the front of the screenline cabinetry and the back of the Full Service Counter return is 5 ft. 0 in. Customers should be able to see SSAs as they use screenline cabinets, the meter-setting counter (optional) and pass-throughs. However, customers must not be able to see into the workroom. One handicapped accessible Full-Service counter must be provided in each retail facility.

Designs must accommodate the current Baker full service counter foot print along with a 3'-0" opening between counters to allow for retail staff to access the customer lobby (this opening is not to be provided when only one counter is required). Screen line cabinetry must be coordinated with the new opening (for example, don't provide critical screen line cabinetry where the opening is provided).

To accommodate the 3'-0" opening between the counters, power and data outlets/supply must be provided on both walls adjacent to the full service counters.

The full service area must be secured from the workroom with keyed, lockable doors. Door type shall be Door Type-G. Door hardware shall be SSBD Set 11, which includes lockset L-1, hinges, door stop and closer. Threshold and bottom shoe which is typically provided with this hardware set may be omitted. These doors shall be placed behind the full service counters to secure workroom area from retail lobby area.

In lieu of providing security grille, which is typically located in front of full service counters, storefront shall be provided to separate the service lobby from the box lobby. Storefront door(s) shall have panic hardware in full compliance with Building and Life-Safety code requirements.

The floor tile plan must indicate a color transition in the floor tile at the clerk side edge of the counters. The intent is that the line created by the color transition will reinforce that the clerk area is not a part of the public lobby.

3-3.2 Parcel Slide

The parcel slide is a series of fixtures designed for multi-purpose use. It provides a visual and physical guide to direct customers to the Full Service queue. It also provides a place for forms to be displayed and filled out while providing a resting place for customer parcels.

The queue must be formed on the Display Slatwall side of the parcel slide (preferably to the right) so that customers can look at display items in the store while they wait. The parcel slide creates a barrier between the clerk stations and customers in line, and must be placed 4 ft. 0 in. (min.) to 5 ft. 0 in (max.), from the Full Service Counter to deter customers from forming a second queue.

The handicapped writing desk and forms unit shall be placed at the entry point of the parcel slide, with the accessible portion on the side opposite the queue. The waste component shall be adjacent to the accessible writing surface. Large facilities provide forms at a separate work counter area.

The configuration of the parcel slide should allow customers to read menuboards while in line. The intent is to inform customers of available

services prior to their arrival at the Full Service Counters in order to reduce transaction time.

The following fixtures represent the typical requirements for a parcel slide:

- C311 Corner Filler
- C340 Handicapped writing desk/forms counter.
- C310 Storage/Waste Unit.
- C312 Forms Storage Unit.

Additional 300-series fixtures may be added as space allows.

3-4 Post Office Boxes

 G2-5-4a→h2

P.O. Box signage should be properly located so that it is clearly visible to the customer from the entry. Visibility shall be maintained to all parts of the P.O. Box area from outside the facility. Provide clear lines of site to all interior parts of the P.O. Box alcoves. Avoid designs with hiding places behind columns, pilasters or writing desks. If necessary, use convex mirrors to allow surveillance of all parts of the P.O. Box area.

P.O. Boxes and parcel lockers are logically arranged and clearly numbered. Parcel lockers are not designated by number on the fixtures plan and shall be ordered separately to coordinate with P.O. boxes. Size 2904 and 2905 P.O. boxes (with self-trapping keys) may also be used as parcel lockers. Both P.O. box frames and parcel lockers frames should be powder coated before installation. Boxes are often a long lead item requiring close coordination with USPS.

Locate writing desks within or near the P.O. Box area to provide customers with a place to sort their mail.

Provide a wicket door with extended hours in this area for will call customers. A wicket door has a panel openable to the workroom (a dutch door is not acceptable). Verify that a wicket door is required by the local station master and local postal inspector. If not required, substitute a standard door with a peephole for employee access to and from the workroom.

USPS Handbook RE-5

Maintain clearance to push hampers behind P.O. Boxes (44 in. min. preferred for saw-tooth layout, 6 ft. 0 in. min. for straight hallway) and provide adequate work space for workers to sort mail behind the boxes. Space is also required to store full and empty hampers (usually behind the Self Service area). Provide sufficient accountable mail storage based on local requirements.

Architectural elements which help define this area include an accent tile border and a saw-tooth alcove wall layout. Lighting should be at a level sufficient for reviewing mail and locating P.O. box numbers.

Coordinate recycling requirements with district. Incorporate recycling receptacles as required.

3-5 Manager's Office

Provide an enclosed office for the station manager, adjacent to SSA's workstations and accessible to the full service lobby. The manager's office should have a professional appearance and be convenient to customers.

Coordinate the size and placement of manager's equipment, personal computer, and CCTV monitor. The monitor for CCTV cameras should be clearly visible at the manager's desk. Associated equipment should be placed in a lockable metal cabinet or in the Investigative Office (IO) (if present).

4 Application of the Prototypes

Ideally, a Retail Design Standards prototype will fit within the available design space, without any alteration to the plan. Most often, however, it is necessary to shift elements within the Retail Design Standards prototypes to enable the plan to fit within a specific site, or to meet specific project requirements.

4-1 Lengthen the Self Service Wall

If there is additional equipment to be installed in the Self Service wall, create extra space by shifting the entire Self Service wall toward the Full Service counters. This will decrease the size of the adjacent, saw-toothed P.O. Box alcove, while maintaining the Self Service wall's orientation toward the entry and the main circulation path.

4-2 Sizing the Box Lobby

Expanding the Box Lobby

Often, the number of P.O. boxes required for a particular site is greater than the number of boxes shown in the Retail Design Standards. When more boxes are warranted, expand the box lobby, as required. Additional box alcoves are to be added, in a uniform manner, maintaining security sightlines from the building exterior into each alcove.

Decreasing the Box Sections

Occasionally, the number of P.O. boxes required for a particular site is less than the number of boxes shown in the Retail Design Standards.

4-3 Decreasing the Lobby Footprint

It may be necessary to reduce the Retail footprint in order to fit the critical design elements within the available space. By shifting the Display Slatwall area the security sightlines from all of the SSA to all of the displays are maintained.

4-4 Mirroring the Plan

Whenever possible, the functional areas within the Retail Design Standards should be oriented as they are shown in the prototype plans (Display Slatwall to right of circulation path, Self Service to left of circulation path, etc.) There are cases, however, where existing conditions demand that the plan be

“mirrored”, so that the Display Slatwall is to the left of the circulation path, and so on. When the plan is mirrored, each individual Full Service counter must be remirrored so that the return portion of the workstation is to the right of the SSA (as it would be in the standard, unmirrored plan). Self Service equipment and signage must be mirrored back to the proper order from left to right. Also, when the overall plan is mirrored, extra attention should be paid to the customers’ circulation path. Studies show a natural tendency for entering customers to move to the right. In a mirrored plan (with the Display Slatwall area on the left) it is often useful to shift the parcel slide slightly to the right of its normal position, to help guarantee that customers will queue on the left side of the parcel slide.

5 Interior Signage and Graphics

This section defines sign selection and positioning guidelines for all interior retail signage and graphic elements. Refer to sample elevations found in the Standard Building Designs for additional placement and use examples of the interior signage elements.

No Retail Identifier is to be used within post office facilities. Only the Corporate Brand Signature may be used. The Corporate Brand Signature occurs on such applications as uniforms, product packaging, Merchandise, menu board inserts, and packaging supplies. Refer to Module 4F, Exterior Signage, for definitions and illustrations of the Retail Identifier and Corporate Brand Signature.

The following are the interior signage and graphic elements for retail facilities:

- 5” high white or blue dimensional letter sets
- 3 1/4” high white or blue dimensional letter sets
- Frames for mandatory posters
- Collection times plaque
- Box mail availability plaque
- Post office box information plaque
- Push/Pull door decals
- non-illuminated (sustaining) menuboard hardware
- Mail drop box identification plaques
- Next Station Please service counter plaques

5-1 Self Service Area Signage

 G2-7-5p,q,r,s,t

The Self Service area in Postal retail facilities is an important service feature of the delivery system. Consistency of presentation is an important attribute of the overall program. The interior sign elements that are used in the Self Service area are, mail drop identification plaques, mail collection times plaque and parcel security decals.

5-1.1 Mail Drop Identification Plaques

 G2-7-5s

Mail drop boxes must be labeled with the appropriate identification plaque. Only the following titles are approved for use: Stamped Letters, Metered Letters, Local, Out of Town, Mail, Metered, Express Mail, Priority, Parcels, Global Priority, and International Express. Plaques should be centered over and mounted above the slot opening. When mail slots are flushed into a wall surface, place plaque so that the bottom edge is 1/2" above the top opening of the slot. When placing the plaque on a letter/bundle drop plate, align the top edge of the plaque with the top edge of the plate. When several mail drop openings are positioned next to each other, all plaques must align vertically with one another.

5-1.2 Parcel Security Decal

 G2-7-5s

The parcel security decal must be placed on all mail drop boxes. Decals must be centered, horizontally and vertically, on the doors. For mail slots without bundled mail openings, position the decal centered 1/2" below the mail slot opening. Decals must align vertically with each other.

5-1.3 Mail Collection Times Plaque

 G2-7-5t

The mail collection times plaque must be placed at all mail drop areas. The information on the plaque is changeable. Position the mail collections times plaque on the mail drop wall. Align the top edge of the plaque with the top edge of the mail drop identification plaques. Center the plaque on the wall between the mail drop boxes.

5-2 Dimensional Letter Service Descriptors

 G2-7-5p2

Dimensional letter sets identify important functions and services to customers. Service descriptors shall be selected and located so that they receive the maximum visibility from customers approaching and entering the facility.

Letter sets are available in two sizes: 3-1/4" capital letters and 5" capital letters. Only the following descriptor titles are approved for use: P.O.Box, and Passports. 5" dimensional letters are to be used.

Dimensional letter sets are available in either white or blue. Refer to the 'Self Service' dimensional lettering positioning information in 5-2.1 for positioning and color selection guidelines. Center all descriptor titles above the respective service function.

5-3 Menuboards

 G2-7-5y,y1

Menuboards provide customers with information and costs regarding postal products and services sizes of menuboard units vary according to system type.

The Non-illuminated menuboard systems (also referred to as "sustaining hardware") are lightweight graphic and aluminum hardware suspension systems in one of two horizontal formats (34 1/2"w x 23 5/8"h or 25" 3/8w x 18"h). All non-illuminated menuboard configurations consist of a minimum of three (3) and a maximum of six (6) menuboards. The preferred number of

menuboard is six (6) so that promotional displays are maximized. See elevations of each plans size for exact menuboard configuration.

Menuboard are to be positioned above and behind the service counters so they are visible by customers waiting in line or standing at the service counter. Menuboard displays must run parallel to the service counters. For maximum viewing and customer attention, the standard location requires the front face of the menuboard be aligned with the back edge of the service counter. If, however, the menu board display cannot be located in the standard position because of limited ceiling height, architectural or structural constraint, it may be positioned on a back wall behind the service counter. In either case, Inspection Service security cameras viewing angles must be maintained.

5-4 Frames for Mandatory Posters

 G2-7-5n

Mandatory Posters display essential legal and community information to postal customers. These elements must be placed in close proximity to the front entrance of the facility in the Self Service area. Each poster frame measures 8 5/8" x 1'-11 7/8" and holds two 8 1/2" x 11" vertical format sheets of paper.

Provide two (2) poster frame units at each facility for a total of four (4) displays. Mount frames at 6'-0" to the top edge of the poster frame so the top edge of the frame aligns with the top edge of the post office boxes. When wall space is limited, frames can be separated into two groups of two and placed in close proximity to each other. The fifth mandatory poster is the Hazmat poster which is available in two sizes (18" x 24" or 24" x 36"). This poster is to be placed on the wall in an aluminum frame adjacent to the full service counter.

5-5 Box Mail Availability Plaques

 G2-7-5u

The box mail availability plaque provides information to customers regarding 'P.O. Box' mail delivery times. This sign should be placed in a highly visible location so it can be seen by customers as they approach the box lobby area. This sign is always displayed with the post office box information plaque. Align the top edge of the box mail availability plaque with top of the post office boxes. Position the plaque horizontally so that it is visually balanced with the architectural features in the space. For example, when placing the plaque on a column or narrow wall space, center the plaque leaving equal distance on either side.

5-6 Post Office Box Information Plaque

 G2-7-5u1

The Post Office Box information plaque provides customers with the box sizes, rental rates and availability information. It must be centered 1" below the box mail availability plaque.

5-7 Ring Bell for Service

 G2-7-5v

The Ring Bell for Service plaque provides customers the ability to pick-up packages (from call) or ask other questions when the full service counters

are closed. Position the plaque at the wicket door above the bell push button. Mount the plaque 60" from the floor to the centerline of the sign.

5-8 Push/Pull Door Decals

 G2-7-5w

Push Pull door decals reinforce entry and exit pathways for customers. Each set of decals is placed on either the inside or the outside of the glass. For situations where there is heavily tinted glass, the decals must be placed on both the outside and the inside surface of the glass so they are visible from both directions. In these situations, decals on opposing sides of a common glass surface must be aligned with each other exactly. For situations where glass is clear or lightly tinted, only application of the decal to the interior side of the glass surface is required. The entry decal must be positioned 2" below the Hours of Operation vinyl sign. One decal should align with the left hand margin of the Hours of Operation vinyl sign. The corresponding decal must be positioned at an equal distance from the door pull to create a symmetrical display.

5-9 Next Station Please Counter Plaque

 G2-7-5x

A Next Station Please plaque must be provided for every service counter in a retail facility.

5-10 Dedicatory Plaque

 G2-7-5d3

When a Postal Service building is designated by an Act of Congress to honor a person (or persons), Government Relations will notify the district manager and provide a copy of the legislation.

As part of the post office naming process, the district must obtain the dedicatory plaque by following local procurement procedures. It is the responsibility of the district manager to obtain a supplier for the plaque. The delivery date is crucial for planning the dedication ceremony.

The plaque may be displayed in a prominent area within the building not in the Full-Service area if possible. The plaque must never be placed on the exterior of the building. The plaque will be made of cast aluminum, measuring 11" wide by 14" high. The lettering on the plaque will be ribbon style. The plaque will be mounted with concealed stainless steel fasteners.

5-11 Employees Only beyond This Point Plaque

The Employees Only Beyond This Point plaque is to be provided when there is an opening in the full service counter line to allow Sales and Service Associates to engage with customers in the lobby. The Employees Only Beyond This Point plaque shall be placed on the front of the full service counter closest to the opening in the counter line.

6 General

6-1 Security

CCTV cameras shall be placed so that they cover the retail area.

Provide a 180 degree peep hole, doorbell and security lighting at the back entrance.

Locate safes near the manager's office. When more than 5 security containers are required, consideration should be given to providing a UL rated, Class M, modular vault in the workroom for storage of stock, as it is more efficient than multiple containers. Coordinate requirements with local Postal Inspector.

Provide a security wall between the Post Office and other leased spaces as well as a security wall between the public areas of the Post Office and workroom spaces. At security grill location at the Full Service Counters, provide a security partition to the underside of the deck above.

6.2 Materials and Finishes

The materials and color scheme have been carefully selected for all floor, wall and ceiling applications in each area of the Retail Store. Deviations from these established standards are not allowed. Material and color selection for retail facilities shall be consistent with the Design Standards.



6.3 Casework

Standard casework exists for each area of the retail facility. Consistent use and placement of all casework items shall be coordinated with the Design Standards. The casework has been designed and detailed to meet safety and RE-4 requirements.

Only Headquarters-approved retail lobby casework or furniture may be installed in a postal retail lobby. No custom designed or constructed casework may be used. However, in historical properties, custom millwork may be considered, which will require an approved deviation.

All retail lobby casework or furniture must be inherently tip-resistant, so that a horizontal force applied to the working surface in the short dimension equals or exceeds 100 lbs. without tipping the unit. All lobby casework must be fastened securely to the floor; however, the fastening system is a second, independent safety system in addition to the tip-resistance.

A list of USPS casework items can be found in the USPS Casework Catalog.

USPS Handbook RE-4

 G2-5-7f→f6

[This page intentionally left blank.]

Module 4F Exterior Signage

1 Introduction

2 General

- 2-1 Retail Signs - Components
- 2-2 Corporate Signs - Components
- 2-3 Selection Procedures
- 2-4 Placement
- 2-5 Installation Requirements

3 Standard Applications

- 3-1 Major Facility Retail Signs
- 3-2 Major Facility Corporate Signs
- 3-3 MSBD Retail Signs
- 3-4 MSBD Corporate Signs
- 3-5 SSBD Retail Signs
- 3-6 SSBD Corporate Signs
- 3-7 Modular Post Office Retail Signs
- 3-8 Alternate Quarters Retail Signs (StorCAD/D)
- 3-9 Signs for Non-Standard Buildings

Appendix

Site Survey Package

[This page intentionally left blank.]

Module 4F - Exterior Signage

1 Introduction

Facility signage is an important aspect of facility design standards. The Postal Service has established a Direct Vendor source for exterior signs in the following two categories:

- Retail Signs, used for facilities that have public retail space.
- Corporate Signs, used for non-Retail facilities.

Retail Signs provide customers with an aggressive and dynamic sign signal, that clearly differentiates USPS retail outlets from competition. This sign system is generally internally illuminated in all facility applications and features a fully lighted flexible sign face, which creates strong customer appeal in both day and nighttime viewing conditions. Retail Signs call for aggressive placement, size and quantities of signs to be displayed at our Post Office locations.

Retail Signs incorporate the use of a unique Retail Graphic referred to as the Retail Identifier. The Retail Identifier differs from the Corporate United States Postal Service Signature. It features a modified eagle and special typography for the words "United States Post Office" surrounded by a thin blue border. **This Retail Identifier is to be used only on exterior retail signs; no other use of this graphic is permitted.**



Exhibit 1a
Retail Identifier

Corporate Signs are to be used only for Postal Service locations that do not have Retail services, such as free standing Carrier Annexes, Remote Encoding Offices, Vehicle Maintenance Facilities and Administrative Offices. **Corporate Signs are to be used at Corporate (non-retail) entrances and facilities only.** Corporate Signs utilize the Corporate Brand Signature, which includes the words "United States Postal Service." The primary sign faces are fabricated using routed aluminum. Graphics are rear illuminated on a non-illuminated painted metal background.



Exhibit 1b

Corporate Brand Signature for Non- Retail signage

The proper use of the two exterior sign types will increase the awareness of USPS products, services, and locations, allowing facilities to be easily located and accessed by customers. Together Retail and Corporate Signs communicate quality and professionalism, effectively competing for customer business.

The following guidelines provide information for the proper use and selection of signs for both sign types. Additional information on sizing, application and ordering may be found in the resources listed below:

- Standard Detail Library for illustrations and dimensional information regarding each sign component;
- Master Specification for general contractor responsibilities.
- Direct Vendor Folder for pricing forms and Direct Vendor Signage Catalog.

 G2-7-5a-m1

 G5-3-2b→c

2 General

2-1 Retail Signs - Components

2-1.1 Pylon and Monument Signs

 G2-7-5a→b2

Freestanding pylon or monument signs shall be located at most retail facilities. Various sizes of pylon and monument signs are provided to address differing site layouts, architectural footprints, viewing conditions, square footage requirements, and city ordinances. **Pylon signs are preferred over monument signs in larger facilities (MSBDs and some of the larger SBDs) when either will work because pylon signs provide additional desired visibility.** The monument sign may be appropriate to use when a property is heavily landscaped with trees and the lower profile monument sign would be more visible under a tree canopy. The horizontal monument format is preferred over the vertical (square) monument format. (See exhibit 2-4b)

Freestanding retail signs do not incorporate community identification as a standard policy. **For special circumstances or requirements, community identification may be obtained on monument signs only.**

This is done by an approved deviation through Headquarters Design and Construction.

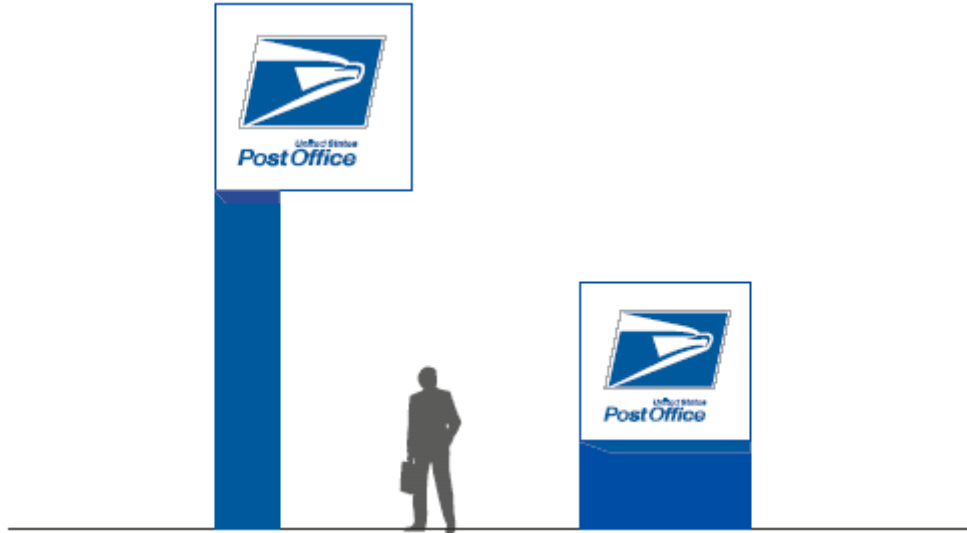



Exhibit 2-1a Pylon and Vertical (Square) Monument Signs

2-1.2 Wall Attached Cabinet Signs

 G2-7-5c→c2

A cabinet sign displays the Retail Identifier, the presentation of the cabinet sign is called the 'Retail Signature'. If site conditions do not allow for the use of the full signature components, approval of the Headquarters signage consultant is required.



Exhibit 2-1b Horizontal and Vertical (Square) Cabinets (Retail Signature)

2-1.3 Tenant Signs

When tenant sign panels are required for landlord provided signs, contact the Headquarters signage consultant. These signs require custom layout and sizing of the Retail Identifier to fit the landlord's sign face opening and sign illumination requirements.

2-1.4 Entrance Signage

 G2-7-5d→d4

Every facility must display the facility name, city and state in a predominant position at the main entrance. This information appears on a facility / station identification plaque (preferred option). If a wall surface is not

available this information is to be displayed as white vinyl letters applied to the glass window next to the front entry doors. Display of the facility identification information is to be positioned on the left hand glass panel if there is glass on both sides of the entrance door. If a glass sidelight is not available next to the front entry doors this information shall be applied above the hours of operation information positioned on the main entrance. No Zip codes are to be used on facility / identification plaques or vinyls. (See Exhibits 2-1c through 2-1e).

Three sizes of identification plaques are available to meet varying viewing distance conditions. Select an identification plaque size that is visible from the nearest curbside viewing point to the front entrance area where the plaque will be positioned. Select the size that is appropriate to each particular facility situation by using a formula of 32 feet of viewing distance per inch of capital letter height. The smallest identification plaque has a 2" capital letter height and is readable from 64'-0".

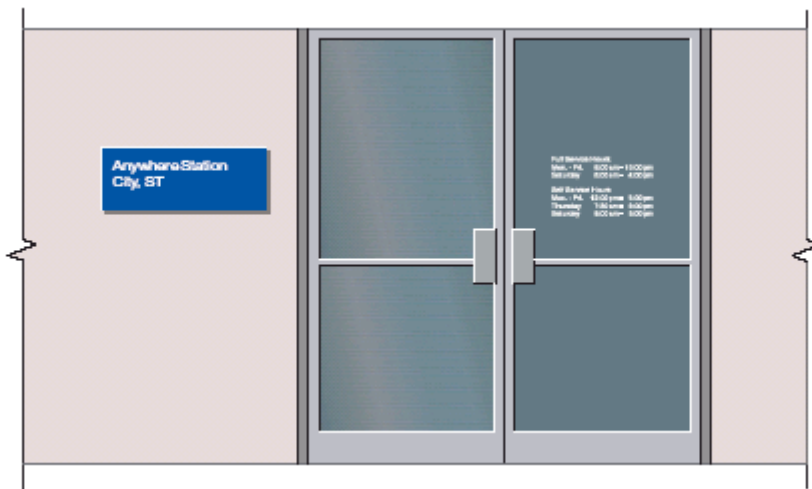

Exhibit 2-1c
Identification Plaque and Hours Vinyl

Hours of operation are displayed on glass entry doors using white vinyl lettering, and indicate both Retail and Box Lobby hours. Hours vinyls are always positioned on the left hand door, typically the exit door. Vinyl applied copy shall always be first surface applied to the outside of the glass. List hours information on the Signage Pricing Forms in or the Direct Vendor Folder.

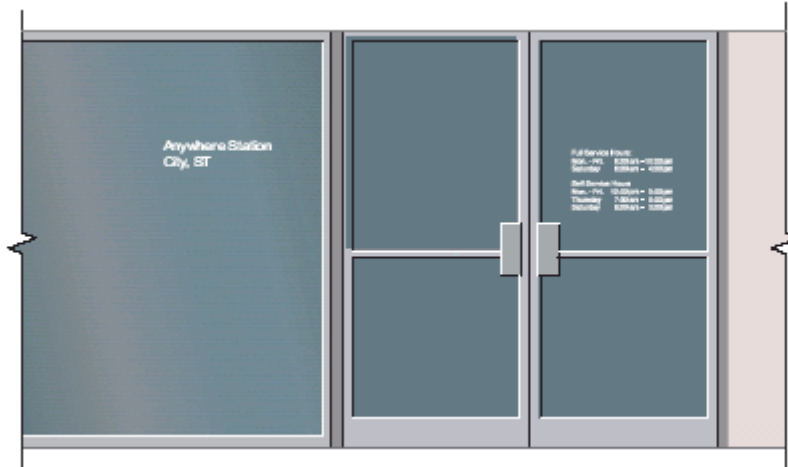

Exhibit 2-1d
Facility / Station Identification and Hours Vinyls

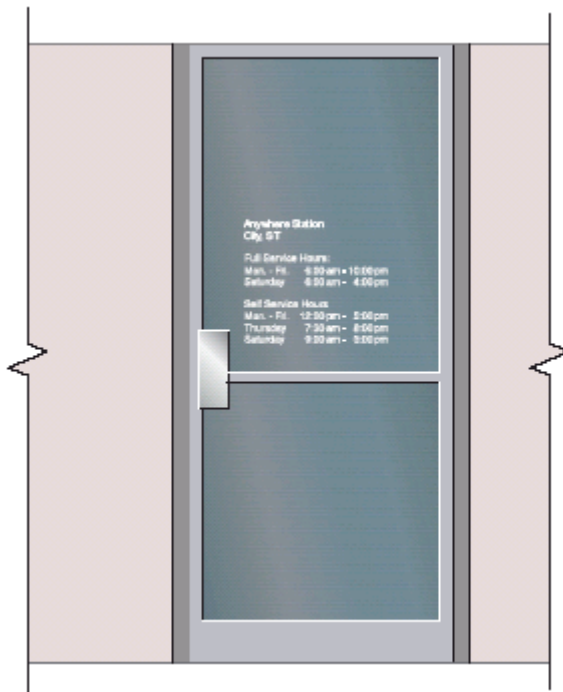



Exhibit 2-1e
Facility / Station Identification and Hours Vinyls Combined

2-1.5

Directional Signs

 G2-7-5e→f4

Directional signs lead customers to important service areas at our facilities. Directional signs used for Retail facilities and Non-Retail facilities are identical. (See exhibit 2-1f)



Exhibit 2-1f

Directional Signs

Directional signs are used at the primary entry points to a facility and at critical decision points on the property. Directional signs guide customers to and provide important information such as Mail Drops, Parking, Additional Parking, Exit, BMEU, or other important services. Use the approved messages supplied on the signage pricing forms in the Direct Vendor Folder ('Dir_Vend') when appropriate.

2-1.6 Regulatory Signs

Regulatory signs are used for displaying regulatory parking information. These signs shall never be used as traffic control signs. These are available as free-standing pole signs, wall or fence attached signs. Three sizes are available for each sign application. Regulatory signs for the Corporate and Retail programs are identical. Use the approved messages found on the signage pricing forms.

2-1.7 Traffic Control Signs

See Module 1, Chapter 1 - Civil for DOT Traffic signs such as Stop, Yield, No Left Turn, One Way, etc.

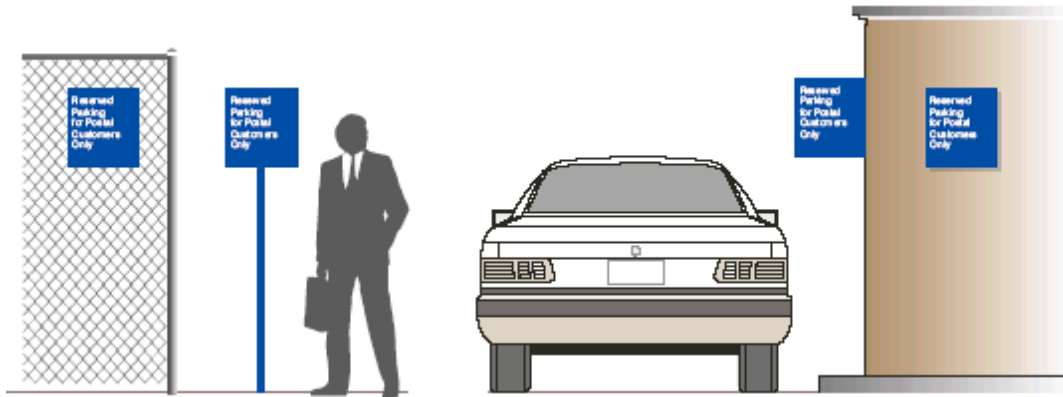
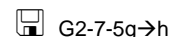

Exhibit 2-1g
Regulatory Signs (flag, pole, fence and wall mounted)

2-2 Corporate Signs - Components

2-2.1 Monument Signs



Corporate monument signs must be located at a non-retail facility whenever possible. This sign reinforces the USPS corporate identity. Various sizes of monument signs address the need of differing site layouts, architectural footprints, viewing conditions, square footage requirements, and city ordinances. (See Exhibit 2-2a)



Exhibit

2-2a
Monument Sign

2-2.2 Wall Attached Cabinet Signs

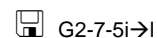

Wall attached cabinet signs may be used as primary signs when zoning or property size restrict the use of a monument. Wall signs may also be used when visibility would be improved by the use of this type of sign.



Both horizontal and vertical cabinet signs are available for use on facility walls. The horizontal stacked cabinet is preferred over the horizontal or square format cabinets. (See Exhibit 2-2b)

Exhibit 2-2b

Horizontal Stacked, Vertical (Square) and Horizontal Cabinet Signs

2-2.3 Entrance Signage

 G2-7-5m→m1

Every facility must have the facility name, city and state displayed in a predominant position at the main entrance. This information can either appear on a facility identification plaque (preferred option) or appear as vinyls, either on the doors or on a glass sidelight. (See Exhibit 2-2c through 2-2d)



Exhibit 2-2c

Facility Identification Plaque and Hours Vinyls

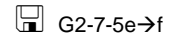

Exhibit 2-2d
Facility Identification and Hours Vinyls

2-2.3.5 **Traffic Control Signs**

See Module 1, Chapter 1 - Civil for DOT Traffic signs such as Stop, Yield, No Left Turn, One Way, etc.

2-2.4 **Directional Signs**



Directional signs lead customers to important service areas at our facilities. Directional signs used for Retail facilities and Non-Retail facilities are identical. (See exhibit 2-1f)

Directional signs are used at the primary entry points to a facility and at critical decision points on the property. Directional signs guide customers to and provide important information such as Mail Drops, Parking, Additional Parking, Exit, BMEU, or other important services. Use the approved messages supplied on the sign pricing forms in the Direct Vendor Folder when appropriate.

2-2.5 **Regulatory Signs**

Regulatory signs are used for displaying regulatory parking information. These signs shall never be used as traffic control signs. These are available as free-standing pole signs, wall or fence attached signs. Three sizes are available for each sign application. Regulatory signs for the Corporate and Retail programs are identical. Use only the approved messages found on the pricing forms in the Master Specification.

2-3 Selection Procedures

2-3.1 **Sign Selection and Support Services**

Standard sign selection and placement for SSBs, MSBs, Alternate Quarters and Modular Post Offices is indicated in section 3, Standard Applications.

Only projects requiring nonstandard signs and/or custom signs (including unusual architectural conditions or historic sites, and alternate quarters that do not conform to Section 3.8) must be sent to the HQ signage consultant for review during the design process. In addition, all Major Facilities require the involvement of the USPS Headquarters signage consultant.

Architects and USPS project managers must use the Facility Signage/Site Survey Package for all non-standard facilities, whether existing or new; if an AQ project can accommodate the standard signage per section 3-8, that project is exempt from the site survey requirement. The site survey package is found in the attached Appendix.

Refer to Signage Pricing Forms in the Direct Vendor Folder for Retail and Corporate (Non-Retail) Exterior Signage.

The USPS Headquarters signage consultant will provide site location plans showing the location of selected sign types, scaled elevation drawings showing the location of building attached sign elements and power requirements, fabrication design control drawings for all custom signs, landlord approval services, and a completed order form for site signs. The Headquarters signage consultant will *not* specify Department of Transportation (DOT) traffic control signs.

2-3.2 Deviations

Deviations from the decisions of the USPS Headquarters signage consultant must be submitted in accordance with the Deviation Policy.



2-3.3 Codes and Standards

It is the USPS policy to comply with all state and local codes and ordinances in leased and owned buildings. However, if sign regulations seem overly restrictive, the Facilities Contracting Officer may elect to pursue a sign variance.

2-4 Placement

Primary freestanding signs are either pylon or monument style signs. Primary signs must be placed so that they are visible from the street to receive the most exposure by passing viewers. Pylon and monument signs should always be placed perpendicular to the street, except that when signs are best located on corners, a placement at a 45-degree angle to the street is preferred. However, in some cases it may be desirable to position a freestanding sign at a corner perpendicular to a more highly traveled roadway. This is an allowable option. Pylon signs must always be oriented so that the pole is toward the building (exhibit 2-1a).

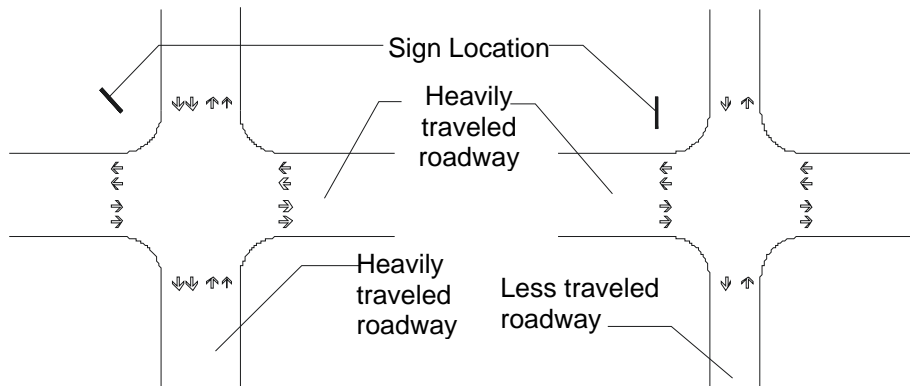

Exhibit 2-4a
Pylon or Monument placement relative to traffic flow

In some cases the use of a monument sign may provide better visibility than a taller pylon sign. If a large tree canopy exists, a lower level monument sign, visible below the tree canopy, may be a better sign choice.



Exhibit 2-4b
Monument placement relative to tree canopy

A primary freestanding sign must be placed as close to the front property line as allowable by code. Care must be given to place the sign toward the most appropriate entrance. Even though more visibility might be gained by having a primary sign located toward one end of a property, placement in that location might be confusing and could cause customers to use a secondary entrance that was intended to be used by USPS service vehicles or employees.

2-4.1 Landscaping at Signs

Position new landscaping so that mature trees and shrubs do not interfere with the viewing lines to signs. Do not plant trees near pylon or monument signs. Low level landscaping may be positioned around the base of pylon signs. Do not put landscaping materials that, when mature, will interfere with the servicing or viewing lines to graphic information on low level monument signs.

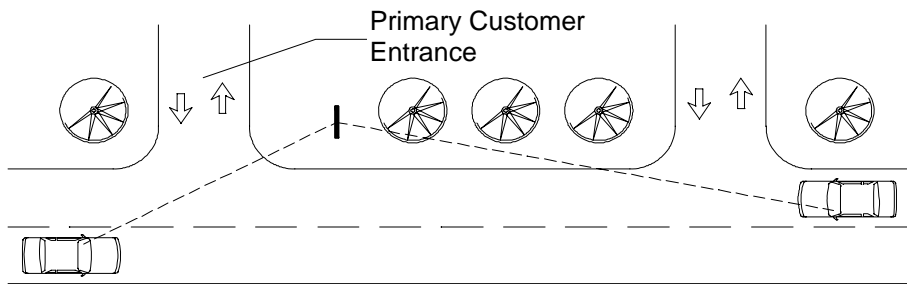

Exhibit 2-4c
Improper placement of new landscaping - Restricted sight line

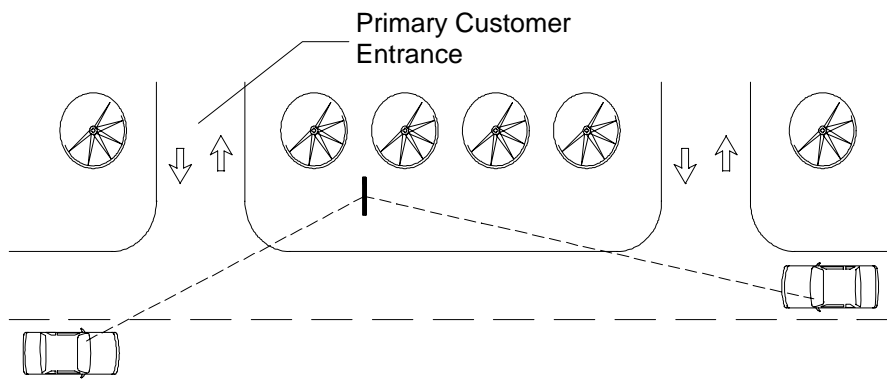

Exhibit 2-4d
Proper placement of new landscaping - Open site line

2-5 Installation Requirements

Prior to the installation of signs at USPS facilities, certain structural and electrical requirements must be met for each specific sign location.

2-5.1 Electrical

Signs requiring illumination must have power supplied to the sign location as specified in the standard detail library. **All circuits for standard retail illuminated sign types are to be 120 volts.** The required amperage for all standard retail illuminated signs are listed in the matrices at the end of this section.

2-5.2 Structural

When selecting a sign for wall attached applications certain requirements must be met in the design of the wall materials and structure. These requirements are to accommodate the weight load distribution of the standard sign types. Sign weights for the primary retail identification signs are provided in the following matrices.

Retail Sign Information Guide – Pylon and Monument Signs

Sign Type	Sign Description	Volts	Amps	Weight in lbs.
RA18	18'-0" Illuminated Pylon	120	4.4	1175
RA20	20'-0" Illuminated Pylon	120	6.0	1540
RA25	25'-0" Illuminated Pylon	120	6.6	2400
RB6	6'-0" illuminated vertical (square) monument	120	2.2	360
RB8	8'-0" illuminated vertical (square) monument	120	4.1	640
RB10	10'-0" illuminated vertical (square) monument	120	5.4	990

Exhibit 2-5a

Retail Pylon and Monument information guide

Retail Sign Information Guide – Wall Signs

Sign Type	Sign Description	Volts	Amps	Weight in lbs.
RC-3	2'-1" Illuminated Horizontal Cabinet	120	2.0	110
RC-4	2'-10" Illuminated Horizontal Cabinet	120	2.8	196
RC-5	3'-7" illuminated Horizontal Cabinet	120	5.4	310
RC-7	5'-0" Illuminated Horizontal Cabinet	120	9.4	600
RC-3NI	2'-1" Non-Illuminated Horizontal Cabinet	-	-	90
RC-4NI	2'-10" Non-Illuminated Horizontal Cabinet	-	-	140
RC-5NI	3'-7" Non- illuminated Horizontal Cabinet	-	-	195
RC-7NI	5'-0" Non-Illuminated Horizontal Cabinet	-	-	335

Exhibit 2-5b

Retail wall sign information guide

Retail Sign Information Guide – Vertical (Square) Wall Signs

Sign Type	Sign Description	Volts	Amps	Weight in lbs.
RD-5	4'-3 7/8" Illuminated Vertical (Square) Cabinet	120	2.0	130
RD-6	5'-1 5/8" Illuminated Vertical (Square) Cabinet	120	4.1	185
RD-7	5'-11 3/8" Illuminated Vertical (Square) Cabinet	120	4.1	250
RD-8	6'-9 1/4" Illuminated Vertical (Square) Cabinet	120	5.4	320
RD-10	8'-4 3/4" Illuminated Vertical (Square) Cabinet	120	6.0	490
RD-5NI	4'-3 7/8" Non-Illuminated Vertical (Square) Cabinet	-	-	85
RD-6NI	5'-1 5/8" Non-Illuminated Vertical (Square) Cabinet	-	-	110
RD-7NI	5'-11 3/8" Non-Illuminated Vertical (Square) Cabinet	-	-	140
RD-8NI	6'-9 1/4" Non-Illuminated Vertical (Square) Cabinet	-	-	175
RD-10NI	8'-4 3/4" Non-Illuminated Vertical (Square) Cabinet	-	-	245

Exhibit 2-5c

Retail Sign information guide

3 Standard Applications

Examples shown in this document show sample positioning for all sign types. These sign selection examples may not always be appropriate, so care and good judgment must be used if a more appropriate sign position would improve the visibility and functionality of the site. (See 2-3.1 for sign selection and support services).

3-1 Major Facility Retail Signs

For assistance in sign selection and placement for Major Facilities contact the USPS Headquarters signage consultant (see section 2-3).

3-2 Major Facility Corporate Signs

For assistance in sign selection and placement for Major Facilities contact the USPS Headquarters signage consultant (see section 2-3).

3-3 MSBD Retail Signs

3-3.1 Primary Signs

The following examples show the application of the retail sign program to Medium Standard Building Designs (MSBDs). A pylon sign is the required freestanding primary sign. A monument sign may be used only if local sign regulations forbid the pylon.

3-3.2 Exterior Wall Attached Signs

Use a cabinet sign to fit comfortably with the architecture, as shown in the sample elevations (exhibit 3-3c). Two sets of the cabinet signs may be used if additional visibility would be gained, such as when a site has frontage on two streets (see 3-3b).

3-3.3 Entrance Signs

Each facility must be identified with a Facility / Station ID Plaque as shown on the following examples. The plaque shall be placed on the outward face of the facility, facing towards the main parking as shown. (See exhibit 3-3d)

The entrance vestibule shall be identified at each main entry location with the facility name, city and state in white vinyls placed on the outbound side light next to the entry door. Do not include ZIP codes, as those may change. The hours of operation shall be placed on the door in white vinyl letters. (See exhibit 3-3d)

No vinyls are to be placed on secondary or box lobby entrances.

If the facility contains a BMEU, a corporate sign will be provided at the entrance to the BMEU. The facility descriptor copy should be modified so that "Business Mail Entry Unit" is inserted at "Facility Name", and the city and state are deleted.

3-3.4 Directional and Regulatory Signs

Follow exhibit 3-3a for selecting the directional and regulatory signs, using only approved messages. Approved messages are listed on the Pricing Forms located in the Direct Vendor Folder.

3-3.5 Sign Selection

Retail Exterior Sign Selection Guide – MSBD Plans R1, R2 & R3

Usage	Sign Description	Sign Type	Qty	Comments
Req.	Pylon Sign (20'-0" min.)	RA20	1	Size may increase depending on scale of site
Req.	Horizontal Cabinet Sign	RC7	1	Preferred size; Provide one per elevation on major street
Req.	2'-6" Wall Plaque	RS1	1	Size may increase for better visibility
Req.	Door vinyls (hrs)	RN1	1	1 per main entrance door
Req.	Business Mail Entry	J-X	1	Size may vary for better visibility
As Req.	Directional Signs	K-6		Varies by project
As Req.	Regulatory Signs	L-X		Varies by project
As Req.	DOT Signs	DOT		Varies by project

Exhibit 3-3a

Retail Sign Selection for MSBD Plans

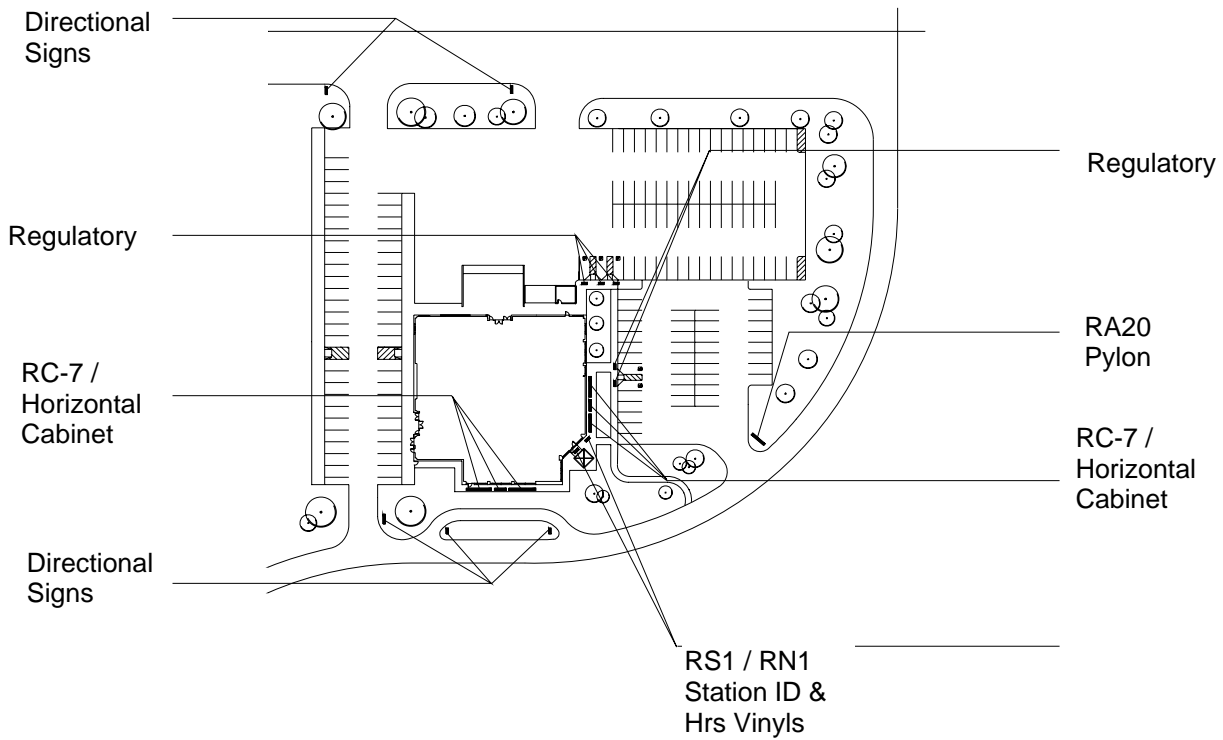

Exhibit 3-3b
Typical site plan showing sign placement for MSBD plans

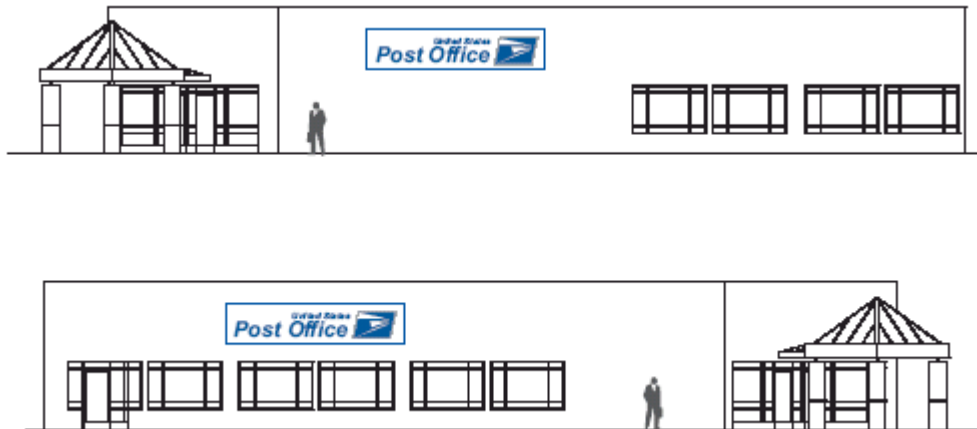

Exhibit 3-3c
Typical elevations showing primary signage locations for MSBD plans

Note: Placement of wall attached signs is dictated by actual street frontage. If a building has frontage on only one street, only one cabinet is necessary.

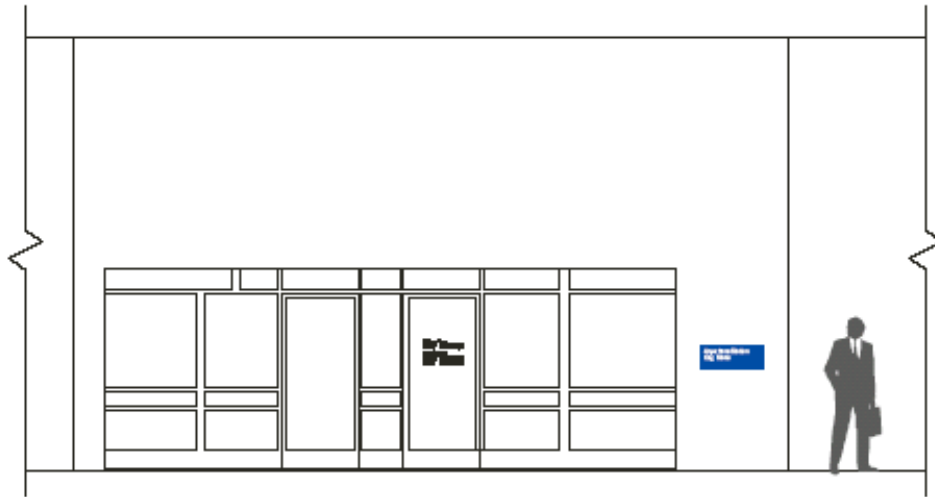

Exhibit 3-3d
Typical elevation of entrance showing Facility / Station ID Plaque and Vinyl on MSBD plans

3-4 MSBD Corporate Signs

3-4.1 Primary Signs

A monument sign is the only freestanding sign style approved for non-retail MSBDs. The size of the monument sign shall be scaled appropriately to the facility and property configuration. Select the position of the sign elements based on the program guidelines described in Section 2-4.

3-4.2 Exterior Wall Attached Signs

A wall attached cabinet sign may be used in combination with a monument sign or as an option to a monument sign when appropriate. However, do not over sign a facility with Corporate (Non-Retail) Signage. These facilities are not intended to draw Retail customers.

The preferred format for wall attached signage is a horizontal stacked cabinet sign. Signs shall be placed to align with the architectural features of the building.

3-4.3 Entrance Signs

A wall plaque and hours vinyls should be used at the main entry point to the facility. Position the plaque so that it is oriented in the most visible position to users entering the facility or viewing the facility from the primary parking area. In some cases, the plaque may be next to the entry doors; in other cases it may be best positioned on an adjacent wall.

If the facility contains a BMEU, a corporate plaque must be provided at the entrance to the BMEU. The corporate plaque text should be modified so that "Business Mail Entry Unit" is inserted at "Facility Name" and the city and state are deleted.

3-4.4 Directional and Regulatory Signs

Follow exhibit 3-4a for selecting the directional and regulatory signs, using only approved messages. All approved messages are listed on the Pricing Forms located in the Direct Vendor Folder.

3-4.5 Sign Selection

Corporate Exterior Sign Selection – MSBD Plans				
Usage	Sign Description	Sign Type	Qty	Comments
Req.	Monument	B-8	1	Size may vary depending on scale of site
As Req.	Business Mail Entry	J-X	1	Size may vary for better visibility
Option	Horizontal Stacked Cabinet	C-3	1	Use C-3 if monument will not work
As Req.	Door vinyls (hrs)	N-1	1	1 per main entrance door
As Req.	Directional Signs	K-6		Varies by project
As Req.	Regulatory Signs	L-X		Varies by project
As Req.	DOT Signs	DOT		Varies by project

Exhibit 3-4a

Corporate Sign Selection for MSBD plans

3-5 SSBD Retail Signs

3-5.1 Primary Signs

The following examples show the application of the Retail Sign Program to Small Standard Building Designs (SSBDs). Because these facilities are generally small in scale, a monument sign is used in smaller plan sizes and a small 18'-0" high Retail Pylon sign is used for some of the larger facilities, see exhibits 3-5a through 3-5k. When a pylon sign is not permitted by local ordinance or site restrictions, a small Retail Monument sign may be used. The sign must be selected and sized to fit the site and viewing conditions encountered at each facility.

Refer to the Sign Selection Exhibits 3-5a, 3-5e, and 3-5i for the sign requirements used at various building plan sizes.

3-5.2 Exterior Wall Attached Signs

A cabinet sign is applied to the gabled front of the larger SSBD buildings (see exhibit 3-5l and 3.5m).

3-5.3 Entrance Signage

Each facility must be identified with a Facility / Station ID Plaque. The plaque shall be placed on the outward face of the facility, facing towards the main parking as shown. (See exhibit 3-5k)

The entrance vestibule shall be identified at each main entry location with the facility name, city and state in white vinyls placed on the left side light next to the entry door. The hours of operation shall be placed on the door in white vinyl letters. (See exhibit 3-5d, 3-5h and 3-5l)

No vinyls are to be placed on secondary or box lobby entrance doors.

3-5.4 Directional and Regulatory Signs

Follow exhibits 3-5a, 3-5e and 3-5i for selecting the directional and regulatory signs, using only approved messages. All approved messages are listed on the Pricing Forms located in the Direct Vendor Folder.

3-5.5 Selection

Retail Exterior Sign Selection – SSBD Plan 15				
Usage	Sign Description	Sign Type	Qty	Comments
Req.	Square Monument	RB-6	1	
Req.	2'-6" Wall Plaque (facility ID)	RS1	1	1 per facility
Req.	Door vinyls (hours)	RN1	1	1 per main entrance door
Req.	Window vinyls (facility ID)	RN3	1	1 per main entrance door
As Req.	Regulatory Signs	L-X		Varies by project

Exhibit 3-5a

Retail Sign Selection for SSBD 15

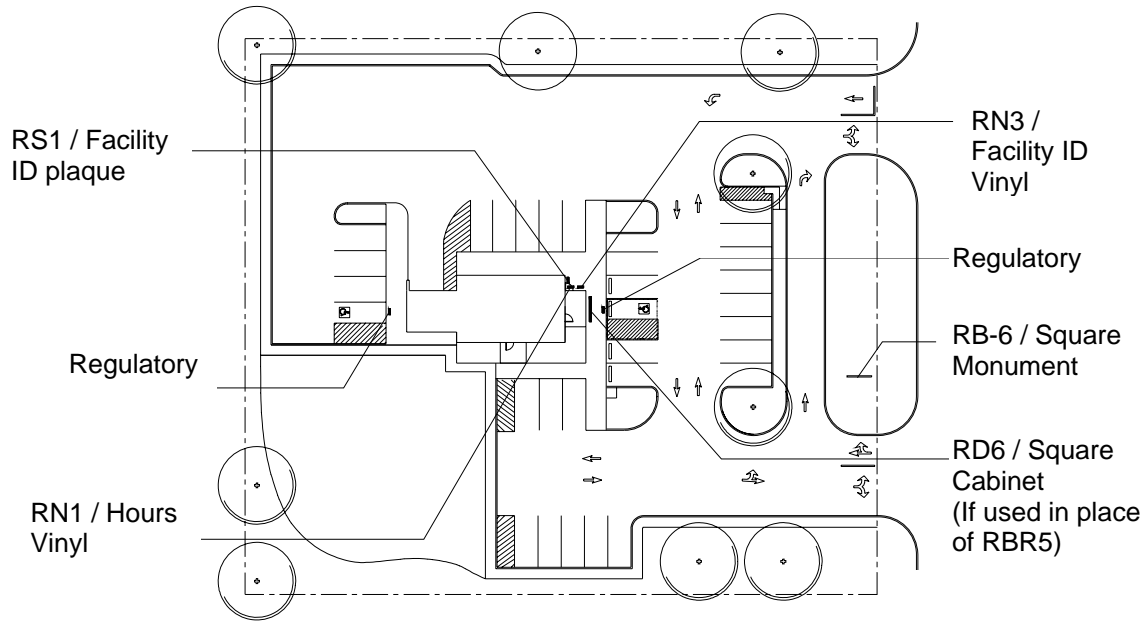

Exhibit 3-5b
Typical site plan showing sign placement for SSBD plan 15

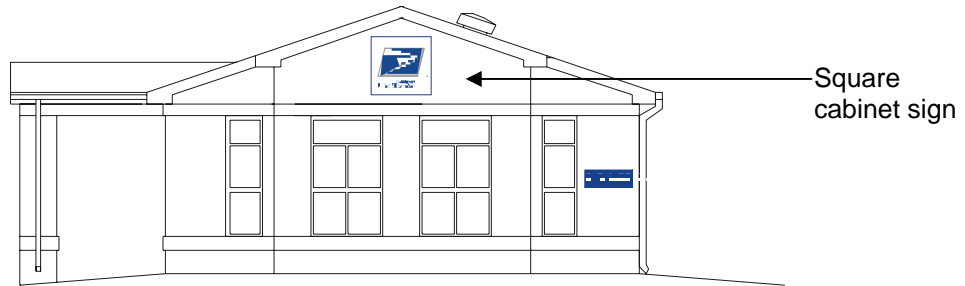

Exhibit 3-5c
Typical elevation showing placement of Square Cabinet sign (if provided) and Facility / Station ID Plaque for SSBD plan 15



Exhibit 3-5d
Typical elevation of entrance with vinyl placement for SSBD plan 15

Retail Exterior Sign Selection – SSBD Plans 20, 25 & 30				
Usage	Sign Description	Sign Type	Qty	Comments
Req.	Square Monument	RB-6	1	See notes below
Req.	2'-6" Wall Plaque (facility ID)	RS1	1	1 per facility
Req.	Door vinyls (hours)	RN1	1	1 per main entrance door
Req.	Window vinyls (facility ID)	RN3	1	1 per main entrance door
As Req.	Regulatory Signs	L-X		Varies by project

Exhibit 3-5e
Retail Sign Selection for SSBD plans 20, 25 & 30

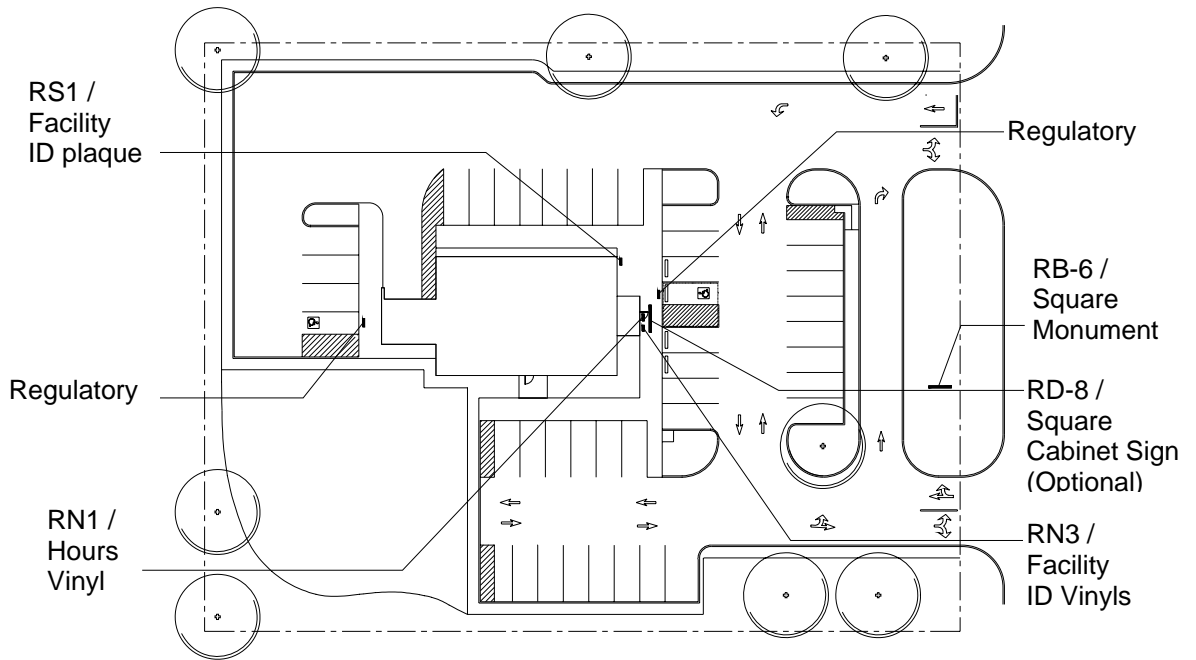

Exhibit 3-5f
Typical site plan showing sign placement for SSBD plans 20, 25 & 30

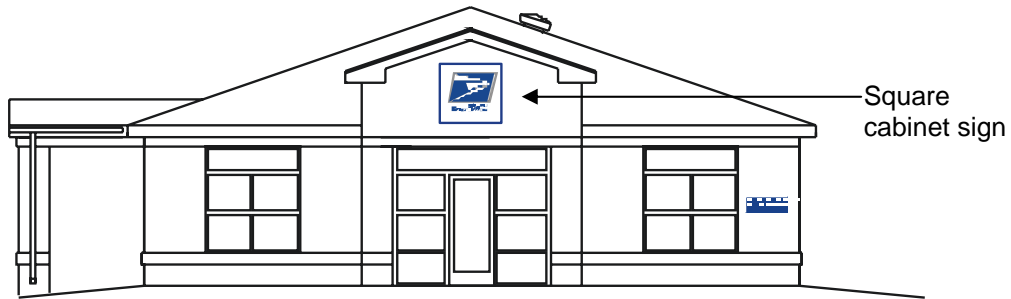

Exhibit 3-5g
Typical elevation showing placement of Square Cabinet Sign (if provided) and Facility / Station ID Plaque for SSBD plans 20, 25 & 30

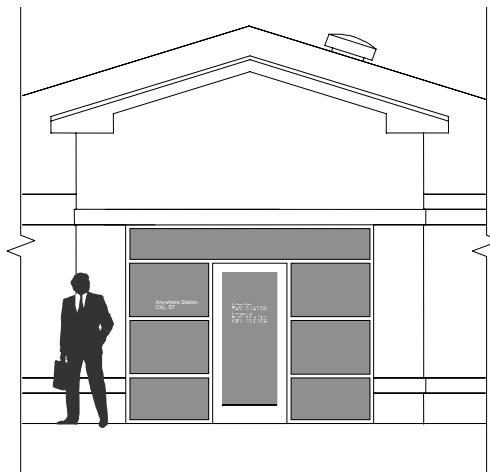

Exhibit 3-5h
Typical elevation of entrance with vinyl placement for SSBD plans 20, 25 & 30

Retail Exterior Sign Selection – SSBD Plans 40, 50, and 65A				
Usage	Sign Description	Sign Type	Qty	Comments
Req.	Monument	RB-8	1	RA18 is an approved option
Req.	Square Wall Cabinet	RD-8	1	
Req.	2'-6" Wall Plaque (facility ID)	RS1	1	1 per facility
Req.	Door vinyls (hrs)	RN1	1	1 per main entrance door
Req.	Window vinyls (facility ID)	RN3	1	1 per main entrance door
As Req.	Directional Signs	K-6		Varies by project

As Req.	Regulatory Signs	L-X		Varies by project
As Req.	DOT Signs	DOT		Varies by project

Exhibit 3-5i

Retail Sign Selection for SSBD plans 40, 50, and 65A

Retail Exterior Sign Selection – SSBD Plans 80A and 100A				
Usage	Sign Description	Sign Type	Qty	Comments
Req.	Pylon Sign	RA18	1	RB-8 is an approved option only if restricted by local codes or landlord requirements
Req.	Square Wall Cabinet	RD-8	1	
Req.	2'-6" Wall Plaque (facility ID)	RS1	1	1 per facility
Req.	Door vinyls (hrs)	RN1	1	1 per main entrance door
Req.	Window vinyls (facility ID)	RN3	1	1 per main entrance door
As Req.	Directional Signs	K-6		Varies by project
As Req.	Regulatory Signs	L-X		Varies by project
As Req.	DOT Signs	DOT		Varies by project

Exhibit 3-5j

Retail Sign Selection for SSBD plans 80A and 100A

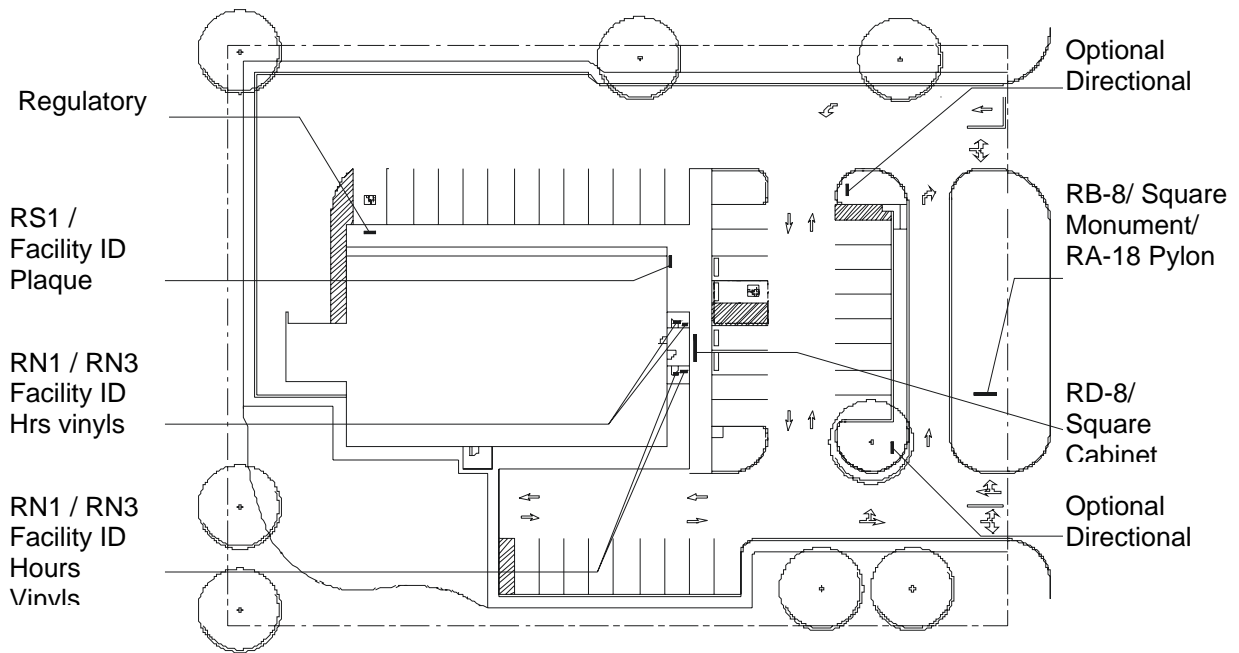

Exhibit 3-5k
Typical site plan showing sign placement for SSBSD plans 40, 50, 65A, 80A, and 100A



Exhibit 3-5m
Typical elevation showing placement of Primary Signage and Facility / Station ID Plaque for SSBD plans 40, 50, 65A, 80A, and 100A



Exhibit 3-5n
Typical elevation of entrance with vinyl placement for SSBD plans 40, 50, 65A, 80A, and 100A

3-6 SSBD Corporate Signs

Corporate Signs are used on SSBD Carrier Annexes.

3-6.1 Selection

Corporate Exterior Sign Selection – SSBD Plan 15				
Usage	Sign Description	Sign Type	Qty	Comments
Option	Monument	B-6	1	B-6 is an approved option
Req.	Horizontal Stacked Cabinet	C-3NI	1	
As Req.	Door vinyls (hours)	N-1	1	1 per main entrance door

Not Used	Directional Signs	K-6	0	Not Used
As Req.	Regulatory Signs	L-X		Varies by project
As Req.	DOT Signs	DOT		Varies by project

Corporate Exterior Sign Selection – SSBBD Plans 20,25 &30

Usage	Sign Description	Sign Type	Qty	Comments
Req.	Monument	B-6	1	
Option	Horizontal Stacked Cabinet	C-4	1	C-4 is an approved option
As Req.	Door vinyls (hours)	N-1	1	1 per main entrance door
Not Used	Directional Signs	K-6		Not Used
As Req.	Regulatory Signs	L-X		Varies by project
As Req.	DOT Signs	DOT		Varies by project

Corporate Exterior Sign Selection – SSBBD Plans 40, 50, 65, 80 & 100

Usage	Sign Description	Sign Type	Qty	Comments
Req.	Monument	B-6	1	
Option	Horizontal Stacked Cabinet	C-4	1	C-4 is an approved option
As Req.	Door vinyls (hours)	N-1	1	1 per main entrance door
Not Used	Directional Signs	K-6		Not Used
As Req.	Regulatory Signs	L-X		Varies by project
As Req.	DOT Signs	DOT		Varies by project

Exhibit 3-6a

SSBD Corporate Sign Selection

3-7 Modular Post Office Retail Signs

3-7.1 Monument Sign

A non-illuminated or illuminated monument sign may be used in lieu of a building-mounted cabinet sign, if it is determined to offer better visibility.

3-7.2 Exterior Wall Attached Signs

Building attached non-illuminated horizontal cabinet signs are used on all Modular Buildings. If required, an illuminated cabinet sign can be used as an approved option. Locate the wall sign on the primary building side viewed by the customers entering the facility or viewing the facility from the main parking area. In most cases, this will place the cabinet sign on the long face of the facility. In some cases, the sign will have better visibility if located on the shorter end of the facility. A monument sign may be used in lieu of a cabinet sign if the monument sign will be more visible.

3-7.3 Entrance Signs

A Facility / Station Identification Plaque must be positioned adjacent to the entry doors so that it is oriented in the most visible location to customers entering or viewing the facility from the primary parking area.

The hours of operation information should be placed on the main glass entry doors using white vinyl lettering.

3-7.4 Directional and Regulatory Signs

Follow exhibit 3-7a for selecting the directional and regulatory signs if required by site conditions, using only approved messages. Approved messages are listed on the Pricing Forms located in the Direct Vendor Folder.

3-7.5 Selection

Retail Exterior Sign Selection Guide – Modular Buildings				
Usage	Sign Description	Sign Type	Qty	Comments
Option	Monument	RB-8	1	
Req.	Horizontal Cabinet Sign	RC-3NI	1	Illuminated is an approved option if it offers better visibility.
Req.	2'-6" Wall Plaque (Facility ID)	RS1-WO	1	1 required per site
Req.	Door vinyls (hours)	RN1-WO	1	1 required per site
As Req.	Regulatory Signs	L-1A-WO		Varies by project
As Req.	DOT Signs	DOT		Varies by project

Exhibit 3-7a

Retail Exterior Sign Selection Guide for Modular Buildings

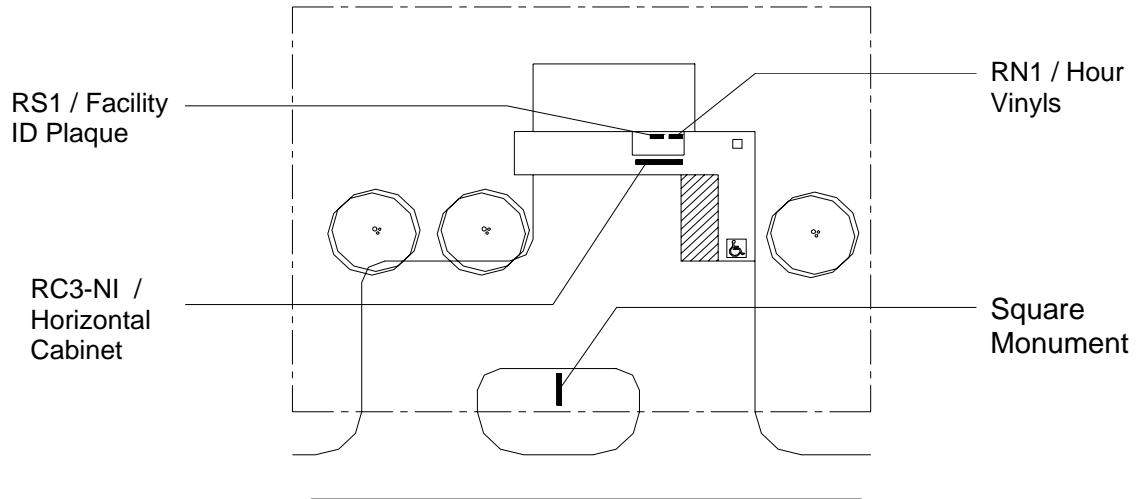

Exhibit 3-7b
Typical site plan of Modular Building with sign placement



Exhibit 3-7c
Typical elevation of Modular Building sign placement

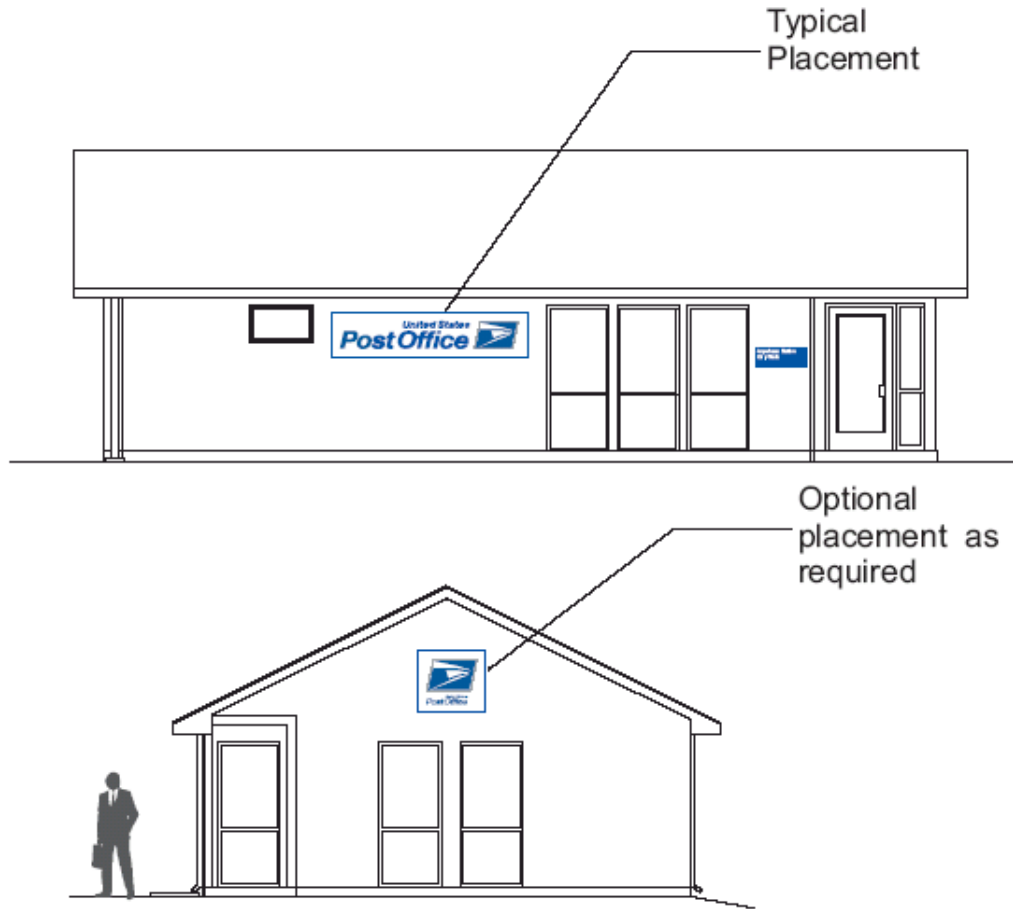

Exhibit 3-7d
Typical and Optional Modular Post Office sign placement



Exhibit 3-7e
Typical Facility / Station ID and hours vinyl placement

3-8 Alternate Quarters Retail Signs (StorCAD/D)

The following examples show the application of the Retail Sign Program to typical Alternate Quarters facilities. If actual facility conditions are not similar contact Headquarters sign consultant for sign selection and placement (see section 2-3).

3-8.1 Primary Signs

Either the pylon or monument style signs are appropriate for use and will depend on the site conditions. The pylon is the preferred choice when either one can be used.

3-8.2 Exterior Wall Attached Signs

A cabinet sign must be used when space allows. When applying the cabinet to a wall surface, maximize the entire leased frontage whenever possible. (see exhibit 3-8a).



Exhibit 3-8a
Elevation of sign placement for Alternate Quarters

3-8.3 Entrance Signs

When Alternate Quarters feature a single entry point with adequate wall space, a facility identification plaque must be used. Position the plaque so that it is oriented in the most visible position to customers entering the facility or viewing the facility from the primary parking area.

The hours of operation information and Facility / Station ID when appropriate, should be placed on the glass doors using white vinyl lettering

3-8.4 Directional and Regulatory Signs

Follow exhibit 3-8b for selecting the directional and regulatory signs, using only approved messages. All approved messages are listed on the Pricing Forms located in the Direct Vendor Folder.

3-8.5 Selection

Retail Exterior Sign Selection - Alternate Quarters				
Usage	Sign Description	Sign Type	Qty	Comments
Req.	Pylon Sign (preferred)	RA20	1	Size may vary depending on scale of site
Req.	Horizontal Cabinet Sign	RC-3	1	Size may vary depending on site scale
Req.	2'-6" Wall Plaque (Facility ID)	RS1	1	1 per facility if architecture will allow
Req.	Door Vinyls (hrs)	RN1	1	1 one per main entrance door
Option	Window Vinyls (Facility ID)	RN3	1	Optional ID format if RS1 sign does not fit
As Req.	Directional Signs	K-6		Varies by project
As Req.	Regulatory Signs	L-X		Varies by project
As Req.	DOT Signs	DOT		Varies by project

Exhibit 3-8b

Retail Sign Selection for Alternate Quarters

3-9 Signs for Non-Standard Buildings

Contact the Headquarters signage consultant for design services (section 2-3) and assistance in selecting Retail signs for any *non-standard* building design including: all Retail sign projects that are not specifically addressed in sections 3-1 through 3-8 (Major Facilities, MSBDs, SSBDs, Modular Post Offices and Alternate Quarters); historic buildings; and other unusual architectural conditions.

The following table illustrates approved Corporate sign options for non-standard building designs.

Sign Type	Carrier Annex	Carrier Annex with Mail Pick-Up Lobby	Business Mail Entry Unit	Remote Encoding Office	Majors (Custom, R&A)	Postal Business Center	General office freestanding	
							Sole Occupant	Multiple Occupant
Freestanding Signs								
Corporate Monument	■	■			■		■	
Exterior Wall Attached I.D.s								
Corporate Horizontal Stacked Cabinet (preferred)	□	■			□		□	■
Entrance Signage								
I.D. Plaque		■	■		□		□	●
Door Decal & Hours Vinyls	■	■		■	■	■	■	■
Support Signage								
Directional		■			■			
Regulatory	■	■			■			
DOT	■	■			■			

Exhibit 3-9a

Exterior Corporate Sign Application Matrix for Non-Standard Buildings

■ Standard Facility Signage. Support signage may vary with site conditions.

□ Approved sign option.

◆ A deviation request required for the use of these sign types.

● Mounted to interior wall only.

[This page intentionally left blank.]

Appendix

Site Survey Package

[This page intentionally left blank.]

Module 4H Repair & Alterations

Introduction

0-1 Policy Statement

0-2 Overview

0-3 Facility Types and Programs

Chapter 1 Civil

1-1 Site Information

1-1.3 Environmental Assessment

1-2 Site Design

1-2.4 Parking and Drives

1-2.10 Safety

Chapter 2 Architectural

2-1 Introduction

2-1.2 Codes and Standards

2-2 Workrooms

2-3 Platforms

2-3.7 Stairs

2-3.8 Dock Equipment

2-4 Support Areas

2-4.2 Toilet Facilities

2-4.3 Locker Rooms / Areas

2-4.5 Administrative Offices

2-4.14 Battery Charging Areas

2-5 Retail Design Standards

- 2-5.2 Self Service
- 2-5.3 Open Merchandise (aka Postal Store)
- 2-5.5 Full Service Counters
- 2-5.6 Passport Acceptance Counters

2-6 Exterior Envelope

- 2-6.1 Walls
- 2-6.2 Roof

2-7 Miscellaneous Building Components

- 2-7.2 Doors and Hardware
- 2-7.4 Protective Barriers
- 2-7.6 Building Materials

2-9 Investigative Systems

Chapter 4 Mechanical

4-1 Introduction

- 4-1.2 Codes and Standards
- 4-1.3 Commissioning
- 4-1.4 Measurement and Verification (M&V)

4-2 HVAC

- 4-2.1 Energy Conservation
- 4-2.9 HVAC Controls
- 4-2.10 Central Cooling Systems
- 4-2.11 Central Heating Systems
- 4-2.12 Air Handling Systems

4-3 Plumbing

- 4-3.3 Plumbing Fixtures

Chapter 5 Electrical

5-1 Introduction

- 5-1.2 Codes and Standards
- 5-1.5 Commissioning

5-1.6 Measurement and Verification (M&V)

5-2 Power Distribution

5-2.6 Motors and Controllers
5-2.8 Convenience Outlets
5-2.10 Power Factor

5-3 Lighting

5-3.1 Interior Lighting

5-4 Communications

5-4.3 Telecommunications - Structured Cabling System

5-7 Integrated Security and Investigative Platform (ISIP)

5-7.1 Robbery Countermeasure/Retail CCTV System
5-7.2 Security and Access Control CCTV System
5-7.3 Intrusion Detection System (IDS)
5-7.4 Physical Access Control System (PACS)
5-7.5 Electronic Article Surveillance (EAS) System

Appendices

Appendix A Boiler Replacement Reference Guide
Appendix B Randolph-Sheppard Act Sample Letter
Appendix C Abatement Project Design

[This page intentionally left blank.]

Module 4H Repair & Alterations

Introduction

0-1 Policy Statement

Repair and alterations (R&A) projects are to be treated as part of an integrated effort to maintain, expand, renovate, or alter existing facilities while meeting the changing needs and standards of the Postal Service. All repair and alterations projects must meet the intent of the USPS Building Design Standards (BDS), including the Standard Design Criteria, Standard Designs, the Standard Detail Library, and the USPS Specification.

Each FSO is accountable to make the best decisions for the Postal Service. Facilities Headquarters will be conducting audits to review compliance with current Postal policies, design standards, and economic factors. The decision to repair, replace with same as existing, or replace with new standards should be evaluated based on cost, performance, operational, safety, environmental, and other factors. If a cost analysis is performed, it shall be on a life-cycle cost (LCC) basis, including impact on future expenses. For example, R&A work related to HVAC equipment will typically require an LCC analysis to determine if future energy savings will offset any additional first costs for more efficient equipment.

One of the most common questions regarding repair and alterations projects is how much of an existing building must be upgraded to meet the current codes. The Postal Service policy on accessibility issues is detailed in Postal Bulletin 22153 (issued 4/28/05), see the excerpt in the "Alterations_Policy.doc" file in the \Reference\RE_4 folder for detailed information. For other code requirements, such as electrical, fire, and life safety, there is no single policy that applies nationwide. The requirements to upgrade existing facilities vary by state, county, and local jurisdictions. Typically, the likelihood that a building, or portion of a building, must be upgraded increases as the scope and extent of the repair and alterations work grows. How this is applied in each specific case will need to be reviewed and possibly discussed with the authority having jurisdiction.

Another topic that may have a big impact on an R&A project is whether or not the building is considered "historically significant". Usually, "historic" buildings are older structures, but there are some newer buildings that are classified as "historically significant" for other reasons. The USPS "Renovation Guidelines for Historic Buildings" provides guidance on how to deal with such facilities. This document is in the \Criteria\Renovate folder. If there is any question about the status of a building or if it has been determined that a building is "historic" then the state historic preservation officer (SHPO) must be contacted.

Lastly, the potential presence of Asbestos Containing Material in R&A projects must be considered. Where ACM have been determined to be or are likely to be present, a written abatement project design plan must be furnished by the asbestos contractor as outlined in Appendix C.

0-1.1 Existing Food Service Facilities

In accordance with the 1974 amendments to the Department of Education's Randolph-Sheppard act, Public Law 93-516, the state licensing agency's rehabilitation department in your area must be notified of any Federal Facilities where food service is provided. Therefore, if any alterations are made to an existing food service facility, it is imperative that the USPS Project Manager assists the Activation Coordinator in early planning and implementing of the steps to ensure that the Postal Service meets its legal obligations. See Appendix B for a sample letter.

0-2 Overview

This module is not meant to provide comprehensive direction on all aspects of design and construction for repair and alteration of USPS facilities. The objective of this module is to provide guidance on specific Postal Service requirements, issues, and conditions. Current industry practice and professional judgment should be used for items not covered.

This module is formatted to match the paragraph numbering of Module 1, General Criteria. It is intended to simplify cross-referencing topics from this module with the current design criteria in Module 1.

The USPS specifications provide a set of Division 1 documents for use on Repair and Alterations projects. These documents include items unique to R&A work requiring coordination with the local facility and possibly with utility companies, such as minimizing construction noise and dust, and how to deal with interruptions of electricity, water, and other utilities. Also, any USPS specifications sections that are designated as "mandatory" cannot be revised without an approved deviation.

0-3 Facility Types and Programs

Repairs and alterations to all facility types must follow the design criteria and standards in the USPS Building Design Standards (BDS) as appropriate for the facility type:

- Facilities smaller than 10,000SF must use the Criteria, details, and specifications that are designated for Small Standard Building Designs (SSBD).
- Customer Service Facilities larger than 10,000SF must use the Criteria, details, and specifications that are designated for Medium Standard Building Designs (MSBD).

-
- Mail Processing Facilities must use the Criteria, details, and outline specifications (MPFS) that are designated for Mail Processing Facilities (MPF).

When renovating a space for Alternate Quarters (AQ) space the BDS must be employed to the fullest extent possible, including accessibility and security requirements.

[This page intentionally left blank.]

Chapter 1 Civil

1-1 Site Information

1-1.3 Environmental Assessment

Depending on project requirements, use the information in the following links as a guide to determine the best solution for underground storage tanks:

<http://blue.usps.gov/cpim/ftp/manage/a550959.pdf>

USPS Handbook RE-6

1-2 Site Design

1-2.4 Parking and Drives

1-2.4.2 Curbs and Curb Cuts

Current criteria mandate the use of straight curbs only. If expanding a paved area with curbs other than straight curbs, the existing curb type can be used for the expanded area without obtaining a deviation.

USPS Handbook RE-4

 G1-2-4e

1-2.10 Safety

1-2.10.2 Fire Lanes

Make sure to maintain required fire lanes when reconfiguring parking areas and driveways.

[This page intentionally left blank.]

Chapter 2 Architectural

2-1 Introduction

2-1.2 Codes and Standards

2-1.2.2 Accessibility Standards

Major renovation projects in lobby and/or workroom areas may require upgrades to the path of travel, the restrooms, telephones, and drinking fountains serving the altered area, to ensure these areas are usable by persons with disabilities. Refer to Postal Bulletin 22153 (4-48-05)

2-1.2.3 Occupational Safety Standards

Depending on project requirements, use the information in the following links as a guide in handling asbestos containing material and lead paint:

<http://blue.usps.gov/cpim/ftp/manage/e8900074.pdf>

<http://blue.usps.gov/cpim/ftp/manage/e8900071.pdf>

2-2 Workrooms

The current standard for workroom flooring is sealed concrete. If a workroom has existing asphalt plank or vinyl composition tile (VCT) that is damaged, then replace with the same flooring material as the existing flooring material unless the majority needs to be replaced, in which case the new standards shall be used.

Current Workroom ceiling standard for facilities less than 10,000 square feet is 2' x 4' acoustical ceiling tile (ACT); for new facilities over 10,000 square feet, no ceiling is required. Existing Facilities over 10,000 square feet currently with ACT in the Workroom are not required to comply with the "no ceiling" requirement. Damaged ceiling tiles in existing facilities may be replaced to match existing.

2-3 Platforms

2-3.8 Dock Equipment

In general, for most dock equipment, if a piece of equipment is damaged, then repair the existing equipment if it is cost effective. If not repairable, then replace with the new standards.

Truck restraints are only permitted in facilities with fork lift traffic in Climate Zone 3. If a truck restraint is broken and/or damaged in a facility not in Climate Zone 3 or is without fork lift traffic, the truck restraint shall be removed.

USPS Handbook RE-4

 G2-3-7a→c

 G2-3-8d

 G2-3-8e→e5

 G2-3-8f→f4

2-3.8.7 Dock Lights

 G2-3-8a→c1

All damaged or broken dock lights are to be replaced with the standard flexible pendent fixture unless physical restrictions prohibit installation. If installation is restricted, replace in kind.

2-4 Support Areas

The current standard for the flooring in most support areas is sealed concrete. If a room or area has existing vinyl composition tile (VCT) that is damaged then replace with same as existing unless the majority needs to be replaced, in which case the new standards should be used.

USPS Handbook RE-4

2-4.2 Toilet Facilities

 G2-4-2a→c1

Current USPS design standards do not provide toilet rooms for customers.

 G2-4-3a→a2

2-4.3 Locker Rooms / Areas

Current standards require half-size lockers for Climate Zones 1 and 2 and full-size lockers for Zone 3. If expanding a facility in Zone 1 or 2 with a significant increase in lockers and if the existing lockers are full-size, then perform a cost analysis to determine if replacing the existing lockers with the new standard mitigates the need to expand the existing locker room. If the locker area or room is being renovated and lockers are being replaced then the new locker requirements must be applied. If this results in reduced locker area and room size, then consider how to best utilize the excess space.

When adding lockers in Climate Zones 1 and 2, half-size lockers must be utilized regardless of current locker size.

2-4.5 Administrative Offices

 G2-4-5a→b

If existing carpet is damaged, replace with the same flooring material as the adjacent area(s) only up to a clear line of delineation such as a doorway, threshold, or line of work stations, otherwise replace the entire area with resilient floor tile, where this would be more cost effective.

2-4.14 Battery Charging Areas

Battery charging rooms are no longer used in new facilities, battery charging areas are used instead. Depending on the scope of the R&A work, consider replacing lead-acid batteries with sealed gel batteries and provide a battery charging area instead of a room. This option may also require some minor modifications to the equipment that runs on the batteries. When renovating existing battery charging rooms the following items must be provided:

- Design the room for drive-through operation, wherever possible. Refer to standard details. All requirements shall be coordinated with USPS and developed in accordance with applicable standards and building codes.
- Design the room, including walls, doors, floors and ceilings to ensure that gases and vapors are released only through the exhaust system. Floors shall be hardened concrete with a steel trowel finish.

-
- Provide tactile warnings on room entrance hardware in accordance with Handbook RE-4.
 - Provide modular battery charging racks, constructed with pressure-treated lumber or plastic decks and designed to support the weight of the batteries and chargers: see Major Facilities Outline Specification Section 16240. Provide a bridge crane for moving the batteries and other equipment.
 - For Lead-Acid Batteries: Locate battery charging racks within curbed areas and provide tepid water safety eyewash/full body shower with containment curb within the room.
 - For Sealed Gel Batteries: Provide portable safety eyewash within room. Curbed areas at battery charging racks are not required.

2-5 Retail Design Standards

2-5.2 Self Service

The Self-Service areas in new facilities have been reconfigured and no longer include stamp vending machines. The vending machines in existing facilities are to be removed per the Material Logistic Bulletin dated June 21, 2006.

The need for floor area, electrical outlets and signage for copier is to be reviewed with Contracting Officer.

2-5.3 Open Merchandise (aka Postal Store)

Open Merchandise Areas are no longer provided in new facilities. For existing facilities which already have open merchandise areas, the slat walls, gondolas, cash wrap, sliding grille and the counter can remain in place, but it is recommended that no accountable merchandise is displayed in this area. If this area is not used for display of non-accountable merchandise then consider other uses such as a passport acceptance counter and photograph back drop.

If the floor is carpeted and the carpet needs to be replaced, then replace it with the same flooring material as the adjacent area(s).

2-5.5 Full Service Counters

Menuboard requirements have been revised over the years. If a menuboard is damaged it should be replaced using the current standards.

2-5.6 Passport Acceptance Counters

Passport Acceptance Counters must be in a publicly accessible area in or directly accessible from the Customer Lobby. If an unused Open Merchandise area is available then consideration should be given to use it for the passport counter and photo area. The counters are subject to RE-4 requirements.

2-6 Exterior Envelope

2-6.1 Walls

2-6.1.2 Windows

The security requirements for windows in new facilities have changed in recent years. If a facility needs to have windows replaced, then follow current standards for the facility type and coordinate with USPIS to determine the proper security measures.

USPS Handbook RE-5

2-6.2 Roof

Roofs are a common part of repair and alteration work. The following specific topics have been identified for repair and alteration work:

Building Expansions: A major consideration in any building expansion is what and how the new roof relates to the old roof. Proper design should be used to ensure that the new roof will drain effectively without interfering with the drainage of the old roof. If the roofs intersect, proper detailing and materials should be selected to ensure compatibility between the old and new roofs.

Re-roofing: Initial analysis should consider replacing high pitch roofs with the same type as the existing roof. For low pitch roofs, utilize only the systems identified in the USPS specifications. A life cycle cost analysis should be performed to determine if additional insulation is cost effective. The condition of the existing insulation should be evaluated and any wet insulation should be replaced. This evaluation should include core cuts to be analyzed in addition to testing (infrared, nuclear, etc...) in the field. Dry areas of insulation may be salvaged if it is feasible. When replacing a roof, especially one near the end of its expected life, then it is recommended that roof drains also be replaced since they are also likely to be near the end of their expected life.

Consideration should be given to using roofing consultants to determine the most appropriate solution and full-time inspection during roof installation.

Repairing: Perform a cost analysis to determine if the roof should be repaired or replaced.

Pitch Pockets: Installing pitch pockets should be avoided in new facilities, however when re-roofing a facility that has existing pitch pockets make sure a metal cover is installed over the pitch pocket to avoid UV deterioration.

 G2-6-2a→c

2-7 Miscellaneous Building Components

 G2-7-2a

2-7.2 Doors and Hardware

Sectional Overhead Doors: If replacing one or more sectional overhead door(s) they must be manually operated doors, automatic door openers are NOT to be installed.

Impact Vestibule Doors: When replacing impact doors, both doors within a single frame must be replaced at the same time, as a set, and must be replaced using doors from the Direct Vendor. Verify existing conditions and accommodate them into the door order. Items could include jamb protection that encroaches into the door panel and non-standard hardware installations. When ordering a custom size door through Chase Doors, the Direct Vendor, it may be necessary to use the Proline door rather than the Durulite door depending on the door size.

Customer entrance doors:

- For R&A projects in buildings 4000SF and over, if doors are being replaced, they must be replaced with automatic doors from the current Direct Vendor if practical and historically correct. Note that for high-energy automatic swinging doors, specific guide rails are required by code.
- For new AQ projects 4000SF and over, if customer entry doors are being replaced, they must be replaced with automatic doors from the current Direct Vendor. Note that for high-energy automatic swinging doors, specific guide rails are required by code.
- For new AQ projects 4000SF and over, if customer entry doors are not being replaced, there is no need to make them automatic.

Overhead Coiling Doors at Full Service Counters: The current standards do not use overhead coiling doors at the full service counters. If a facility has an existing overhead coiling door that is damaged, then repair if it is cost effective. If not repairable, then replace it with the current standard unless site conditions make this cost prohibitive, in which case replace it with the same as the existing.

Folding Closures (Grilles): The current standards use folding closures from Pre-Approved Vendors. If a facility has a folding closure that is damaged, then repair it when cost effective. If not repairable, then replace it with the new standards from one of the current Pre-Approved Vendors, unless site constraints require changes to the support structure making it cost prohibitive.

Sectional Knock-out Doors: The current standards use a Selected Vendor for sectional knock-out doors. If a facility has a sectional knock-out door that is damaged, then repair it when cost effective. If not repairable, then replace it with the new standards, from the current Selected Vendor, unless site constraints require changes to the support structure making it cost prohibitive

2-7.3.1 Elevators

R&A work on elevators and escalators requires FSO BEI involvement during design and construction.

2-7.4 Protective Barriers

 G2-7-4a→e2

The preferred protective barrier is fiberglass reinforced plastic (FRP) per the current Criteria and USPS specifications. Wall bumpers may be used to

match existing adjacent wall bumpers when a portion of existing wall bumpers are being replaced.

2-7.6 Building Materials

Painting

The Current SDC will be followed when painting is involved in all R&A Projects. Areas that are not to be painted, per the SDC, should be scraped of all loose paint. Exceptions would be exposed steel, (where rust can occur), drywall, exposed decking, and maintenance of historical facilities. Lead paint encapsulation and abatement must follow the current MI.

2-9 Investigative Systems

Look out galleries (LOGs) are no longer used in new construction, however there are many existing facilities that still have them in operation. If a facility with an existing LOG is being expanded, a cost analysis must be performed to determine whether to expand the LOG system, or use a CCTV system only in the expansion. Note that an approved deviation is required for the construction of new LOGs in building expansions.

If repairs or alterations will affect existing LOGs or if approval has been given to use LOGs in a building expansion, the details in the Standard Detail Library must be used. The details are in the P2-9.2 and P5-8.2 series.

2-9.1 Investigative Office (IO)

Most current SSBD standard plans do not include a IO since they do not meet the threshold requirements. In SSBD facilities where an IO is no longer required, it should be abandoned and reconfigured to meet other space requirements if possible. Coordinate with the Inspection Service before any work begins and also to determine if USPIS/OIG will remove unused equipment.

USPS Handbook RE-5

 G2-9-1a

Chapter 4 Mechanical

4-1 Introduction

4-1.2 Codes and Standards

See Module 4H paragraph 0-1 for Postal Service policies on meeting current codes in R&A projects.

4-1.3 Commissioning

The Contracting Officer may require other mission critical systems to be commissioned, such as sprinkler system water pumps, or sewage ejector pumps, for any project.

4-1.3.1 MSBD Commissioning Requirements

Major R&A

- HVAC upgrades shall be commissioned if a significant portion of the system has been altered or replaced.

Minor R&A

- The level of commissioning shall be determined by the Contracting Officer taking into account the work performed, the cost of commissioning, and the impact to Operations should a failure occur. In most cases, no commissioning will be required.

4-1.3.2 SSBD Commissioning Requirements

Formal commissioning is not required. Instead, all replacement HVAC systems and related controls, shall be inspected by the Energy Manager/Project Manager/AE to ensure proper installation and operation.

4-1.4 Measurement and Verification (M&V)

4-1.4.1 MSBD M&V Requirements

Major R&A

- M&V shall be performed before construction and after commissioning of the new equipment. The objective is to measure, or accurately estimate, the energy consumption prior to renovations and again after final commissioning of the new equipment. The estimated energy use projected during the design phase and the final energy use determined should be comparable.
- The total energy savings that results from the project are to be submitted to the local FSO Energy Manager in an ECC-S package for review, acceptance, and input into eFMS.

Minor R&A

- M&V is not required, unless otherwise directed by the Contracting Officer.

4-1.4.2 SSBD M&V Requirements

- M&V is not required, unless otherwise directed by the Contracting Officer.

4-2 HVAC

The use of chlorofluorocarbon (CFC) refrigerants is prohibited in Postal Service facilities. The use of hydrochlorofluorocarbon (HCFC) refrigerants is not supported by the Postal Service Facilities standards.

The value of refrigerant that exist in chilled water machines to be replaced shall be credited to the owner unless a specific directive has been issued otherwise. Refrigerant removed from a chiller can only be utilized by another owner or sold if it has been reclaimed per the American Refrigeration Institute's (ARI) standards. Simple recovery (capture of removed refrigerant), or recycling (capture of removed refrigerant with limited processing, usually oil and moisture removal) is not sufficient for the resale or reuse by a different owner. The reclaimed refrigerant shall be cleaned and processed to ARI standards. The credit associated with the reclaimed refrigerant shall be based on the amount and current fair market value.

Disposal of reclaimed refrigerant shall be performed by a licensed contractor and verification of proper disposal shall be submitted to USPS.

For more information on Postal Service policies regarding the use or replacement of refrigerants see the Clarification of HVAC Refrigerant and Equipment Selection for USPS Facilities issued January 29, 2007. This document can be found in the Reference\Policy folder.

4-2.1 Energy Conservation

Postal Service Repair and Alteration (R&A) projects are required to be in compliance with Energy Policy Act (EPACT) 2005 and Department Of Energy's "Energy Conservation Standards for New Federal Commercial and Multi-Family High-Rise Residential Buildings and New Federal Low-Rise Residential Buildings", Interim Final Rule dated December 4, 2006. In order to comply to the energy conservation requirements of these federal mandates ASHRAE Standard 90.1-2004 will be adopted as part of this Standard Design Criteria Handbook as modified herein.

4-2.1.1 Repair Projects

Repair of an existing building component is defined in ASHRAE as the repair of internal parts of the component and not the replacement of the component as a whole and the repairs will be carried out in a manner that retains the component's original energy efficiency. Exceptions may be requested as applicable in the Technical Performance Sections of ASHRAE Standard 90.1-2004. For repair projects as defined by ASHRAE, there is no need to create an energy cost budget simulation model.

Repair of building systems as defined by USPS may involve whole component replacements. For USPS defined repair projects, the new

replacement equipment will be subject to meeting the minimum standards set out in Module 1 Chapter 4 Mechanical – General Criteria of this Handbook.

If the area served by the component has not significantly changed from original installation and documented operation indicates that the component has performed satisfactorily, a one for one replacement may be selected without revisiting building block loading calculations or simulations. If the component is at the end of its useful life, most likely other components in the system are as well and the complete system should be evaluated for possible replacement or upgrade.

For facilities larger than 60,000 square feet, replacement of a major component (chiller, air handlers, controls) due to end of life needs, should be considered an alteration project and evaluated in accordance with the alteration requirements indicated below.

4-2.1.2 Alteration Projects

Alteration projects are considered major overhauls of existing building systems. When Alteration projects are designed, the selection process for replacement building components will follow one of the following two categories and Compliance Paths as defined in the Technical Sections of ASHRAE Standard 90.1-2004.

Facilities larger than 60,000 square feet or a central plant: The designer will provide documentation demonstrating compliance with all ASHRAE Standard 90.1-2004 Mandatory Provisions applicable to the Alteration Project, an analysis using the Section 11 Energy Cost Budget Method as modified by Appendix G to determine a Performance Rating. The goal of the Performance Rating will be to exceed the Baseline Building Performance by 30%, as calculated in ASHRAE Standard 90.1-2004 Appendix G section G1.2. Trade-offs will be allowed between building elements as allowed within ASHRAE Standard 90.1-2004. A life cycle cost analysis will be used to show the cost effectiveness of offered alternatives to achieve the desired performance rating for USPS use in the decision making process. However, in all cases the minimum efficiency requirements of the Standard Design Criteria Handbook or ASHRAE Mandatory Provisions, whichever is more stringent, will be demonstrated and met.

Facilities less than 60,000 square feet and no central plant: The designer will provide documentation demonstrating that USPS Standard efficiencies for equipment or components are selected. Any ASHRAE 90.1-2004 Prescriptive Measures or USPS prescriptive measures considered in the selection should be documented. A statement will be prepared by the designer indicating that the USPS Standard Design Criteria was followed and the anticipated Performance Rating for the altered component is based on ASHRAE 90.1 Baseline Systems.

4-2.1.3 General R&A Project Energy Conservation Measures

For all Repair and Alteration Projects, the following energy conservation measures shall be considered by the designer when designing systems and selecting equipment:

- Cooling equipment, heating equipment and domestic water heaters shall carry the Energy Star label when available in the market.

-
- Provide systems that avoid reheating and/or re-cooling for humidity control.
 - Provide automatic controls to de-energize heating, cooling, and/or pumping and fan equipment when not needed.
 - Analyze estimated energy consumption including peak consumption and recommend alternatives to proposed building roof or wall insulation, window to wall ratios, heating or cooling system sizes for part load performance, heat recovery possibilities, and other items from ASHRAE 90.1-2004 Prescriptive Measures that may be justified to reduce peak consumption or reduce size of mechanical equipment or lighting loads.

4-2.9 HVAC Controls

4-2.9.1 General Requirements

Follow SDC Section 4-2.9.1 in Module 1 - General Criteria for requirements.

4-2.9.2 Facilities Smaller than 15,000SF

Follow SDC Section 4-2.9.2 in Module 1 - General Criteria for requirements.

4-2.9.3 Enterprise Energy Management System

Major R&A projects in facilities equal to or larger than 15,000SF shall follow SDC Section 4-2.9.3 in Module 1 - General Criteria for requirements, except that advanced metering for gas and water shall be installed only if the cost to install and connect to the EEMS does not exceed 10% of the annual gas/water bill.

4-2.10 Central Cooling Systems

When considering repairing or replacement of packaged units, perform a life cycle cost analysis to determine if replacement with current, energy efficient equipment, is more cost effective than repairing the existing system.

4-2.10.1 Refrigeration System

Many USPS central cooling systems were designed under previous USPS standards that recommended the use of a chiller plant. The current USPS standards recommend the use of roof top HVAC air handling units with DX cooling and gas heat. When an old chiller requires replacement, the building/mechanical system should be analyzed to determine if a new roof top air handling unit with DX cooling can be added to replace the old chiller instead of replacing with a new chiller. Some things to consider include: the age of the existing air handling unit, whether available roof space exists, the age of any other existing chillers, how a new DX rooftop unit could be integrated into the existing system, and the age of the existing cooling towers (if the chiller system is water cooled).

A life-cycle cost analysis, accompanied by heating and cooling load calculations, shall be provided to determine which option is the most cost effective. If it is determined that it is feasible to replace the "old" chiller with a new DX Rooftop HVAC air handling unit, then refer to USPS –Mail Processing Facilities Design Criteria, Chapter 4, Section 4-2.1.2 for the

design criteria. If it is not, refer below for the criteria of replacing an old chiller with a new one.

The primary consideration when replacing chillers within Postal Service facilities shall be to improve the overall efficiency of the chilled water process. Attention must be given to the related factors such as capacity, load, system integration and associated equipment.

Older chiller plants serving Postal Service facilities may not be of a capacity that is representative of the current load of the facility served. Replacement chillers shall consider building load increases that have occurred due to building modifications and process equipment changes. Modern mail handling practices, such as the use of ventilation filtration systems (VFS) that serve mail sorting machines, have increased internal equipment gains.

The design operating conditions of replacement chillers must match the existing parameters, unless it can be shown that the altered operating conditions can be supported by the greater chilled water system and are beneficial to plant operation.

Replacement chillers shall be completely functional and compatible with the overall chilled water system in which they are installed. The design of chiller replacements shall analyze the existing support systems, including chilled water pumping, condenser water pumping, cooling towers, and water treatment.

It is anticipated that a chiller replacement for increased efficiency will incorporate a controls upgrade to some extent. The replacement equipment must perform, at a minimum, the same control functions and provide the same status and setpoint reporting as the existing equipment. If proposed replacements intend to move portions or all of the existing controls logic and/or functions into or out of the chiller control panel, the change shall be fully coordinated with the existing building automation system. In all cases, all necessary controls hardware, software and programming shall be provided for a complete working system as intended by the chiller replacement.

4-2.10.3 Cooling Tower

When a cooling tower needs replacement, the entire system shall be studied to determine if the central cooling system will remain a chilled water system with water cooled chillers. The new USPS standard is to install DX Rooftop HVAC air handling units instead of chilled water plants. If it is life-cycle cost effective to use the new standards, given the age of the other equipment in the system, then refer to section 4-2.10.1. If it is not practical to replace the chiller/air handling unit as well as the cooling tower, refer to the requirements below.

In general, replacement cooling towers shall match existing capacities of replaced equipment. Whenever possible cross-flow, draw through cooling towers should be the basis of design for replacement towers in an attempt to reduce the motor brake horse power requirements.

Variable frequency drive (VFD) control of cooling tower motors not only reduces electrical energy usage of cooling towers, but enhances control of the condenser water supply temperature and prolongs component life through reducing equipment run time and eliminating motor hard starts. Unless special circumstances exist, all replacement cooling tower systems shall incorporate VFD control of at least one tower cell.

4-2.10.4 Chiller Rooms

4-2.11 Central Heating Systems

4-2.11.1 Boilers

Heat generating equipment shall be the highest efficiency equipment available that is proven to meet ASME CSD-1 for boilers in the size range of 400,000 BTUH input to 12,000,000 BTUH input. For boiler systems under 400,000 BTUH, coordinate with the USPS Project Manager for CSD-1 requirements.

Select boilers based on part load requirements of the building and provide staging controls to minimize the number of operating boilers while maintaining space comfort.

Select primarily 2-way control valves to allow variable speed pump control, matching flow rate delivered with building demand and number of boilers in operation. Ensure that minimum pump flow is maintained to prevent dead-head pump operation.

Appendix A is the Boiler Replacement Guide developed by the Great Lakes Facilities Service Office. This guide should be used for boiler replacement projects.

R&A work on boilers and unfired pressure vessels (UPVs) require FSO BEI involvement during design and construction.

4-2.12 Air Handling Systems

The preferred type of air handling unit for most USPS facilities is DX Roof Top Unit equipment. However, where necessary to match existing air handling systems, or where space or structural limitations may dictate or where it is more economical given the geographic location, indoor modular equipment is acceptable. A life-cycle cost analysis including heating and cooling load calculations shall be provided to determine which option is most economical and efficient. Variable speed drives shall be used when life-cycle cost effective.

4-3 Plumbing

4-3.3 Plumbing Fixtures

4-3.3.2 Fixture Types

When replacing water closets, match the existing fixtures in the facility. If all fixtures are being replaced, then they should be replaced with fixtures meeting the requirements listed in the USPS Specifications.

Chapter 5 Electrical

5-1 Introduction

5-1.2 Codes and Standards

See Module 4H paragraph 0-1 for Postal Service policies on meeting current codes in R&A projects.

5-1.5 Commissioning

Major R&A

- Lighting upgrades shall be commissioned if a significant portion of the system has been altered or replaced.

Minor R&A

- The level of commissioning shall be determined by the Contracting Officer taking into account the work performed, the cost of commissioning, and the impact to Operations should a failure occur. In most cases, no commissioning will be required.

5-1.6 Measurement and Verification (M&V)

5-1.6.1 MSBD M&V Requirements

Major R&A

- M&V shall be performed before construction and after commissioning of the new equipment. The objective is to measure, or accurately estimate, the energy consumption prior to renovations and again after final commissioning of the new equipment. The estimated energy use projected during the design phase and the final energy use determined should be comparable.
- The total energy savings that results from the project are to be submitted to the local FSO Energy Manager in an ECC-S package for review, acceptance, and input into eFMS.

Minor R&A

- M&V is not required, unless otherwise directed by the Contracting Officer.

5-1.6.2 SSBD M&V Requirements

- M&V is not required, unless otherwise directed by the Contracting Officer.

5-2 Power Distribution

5-2.6 Motors and Controllers

Motors shall be of sufficient capacity to operate the driven equipment through its total range without exceeding the motor capacity.

Motors 1 hp or greater in continuous service shall be premium efficiency type as listed in NEMA MG-1 Standards.

Three-phase power shall be used for all motors ½ hp and greater. Contractor to verify proper motor operating voltage.

Sealed ball bearings shall be used to reduce maintenance frequency and discourage overgreasing.

5-2.8 Convenience Outlets

Any new convenience outlets installed in the Workroom/platform area shall be mounted per the SDC mounting height requirements.

5-2.10 Power Factor Correction

Where a Postal Facility is subject to penalties imposed by the local utility and where the facility experiences a low power factor, the application of power factor correction capacitors shall be required.

Power Factor Correction Capacitors shall be the fixed load type applied at specific loads exhibiting low power factor.

Power factor correction capacitors shall be housed in separate housing appropriate for the environment where installed and shall be connected into the electrical distribution system in accordance with manufacturer recommendations.

The power factor should not be overcompensated to produce a leading power factor. Capacitors should normally be sized to maintain a level sufficient to avoid utility company penalties or to accommodate other system characteristics.

When applying capacitors for power factor correction, include provisions for dealing with potential hazards and negative consequences of their use, such as:

- Resonance: The harmonic content of building loads may incite resonance voltage conditions which could damage capacitors.
- Nonlinear Loads: Where non-linear loads are a significant factor of building loads, care must be taken to ensure that capacitors do not form a harmonic filter which could damage capacitors.

If analysis indicates capacitance should be added in a condition where harmonics or significant non-linear loads are present, provide an anti-resonant, harmonic filtered, power factor correction unit.

Where an energy monitoring and control system (BAS) is present, provide automatic power factor correction units with remote alarm reporting capabilities and connect to building monitoring system.

5-3 Lighting

Follow SDC Section 5-3 Module 1 – General Criteria for all R&A lighting projects.

Relamping:

When a lamp burns out in normal use it should be replaced with a lamp of the same specification as the old one.

When light levels diminish because the lamps in a given area are approaching the end of their useful life, an analysis should be done to determine the cost to re-lamp the entire affected area, and compare to the cost to upgrade the area with new ballasts and lamps that offer more energy efficiency. The lighting standards in Module 1 of the current Criteria and the current USPS specifications should be used as the basis for the upgrade. The payback calculations should be done to determine the cost difference, ROI and life cycle costs and payback. Particular attention should be paid to what the light levels will be and that they are in accordance to the USPS standards.

Reballasting:

When a ballast fails, the ballast used to replace it should be an energy efficient electronic ballast. The fixture should be retrofitted with lamps, and holders if it did not previously have them, specified in the current USPS specifications. The lamps used should have similar color to the other lamps prevalent in the area. If the lamps are good, they can be returned to stock and used to replace lamps in another fixture.

If multiple ballast failures are occurring, the cost to convert all the ballasts and lamps in the area should be determined. Using the same criteria outlined above consideration should be given to changing the lamps and ballasts out with more energy efficient ones.

5-3.1 Interior Lighting

If metal halide lighting is used, a design study and cost analysis should be performed, as outlined above under relamping, to determine if the fixtures should be replaced with more energy efficient ones, per the current USPS specifications.

5-3.1.4 Exit Lighting

For R&A retrofits to existing exit signs, photo-luminescent signs may only be used if allowed by local code and the minimum ambient light requirements to energize the sign are met. Otherwise, photoluminescent signage maybe used to augment code-required electric exit signage but shall not be used in lieu of electric exit signage.

5-4 Communications

5-4.3 Telecommunications - Structured Cabling System

Telecommunications cabling standards have changed over the years. If a few existing cables are damaged, then replace with the same as the existing

to ensure system compatibility. If an entire network or sub-network is being replaced or added to an existing system then use the current standards, but make sure that the resulting network cabling will be compatible with any remaining and new system components before proceeding with the work.

5-4.3.7 Telecommunication Outlets (T/O)

If expanding the workroom, place new telecommunications outlets and their associated power outlets per the SDC mounting height requirements. In existing workrooms, only relocate telecommunications and power outlets if they are being disturbed.

5-7 Integrated Security and Investigative Platform (ISIP)

USPS Handbook RE-5

5-7.1 Robbery Countermeasure/Retail CCTV System

 G5-7-1a→1c

When adding or replacing, cameras to an existing CCTV system, a cost analysis must be performed to determine whether to use equipment from the current Direct Vendor or to match the existing.

Open Merchandising Areas are no longer provided in new facilities. Existing cameras viewing the Open Merchandising slat wall and EAS areas can remain, since removing them would add costs. Since the function of those cameras is loss prevention, the decision to repair non-functioning cameras in those areas is driven by operational specifics, such as type of product, if any, displayed and analysis of actual shrinkage.

5-7.2 Security and Access Control CCTV System

When adding or replacing, cameras to an existing CCTV system, a cost analysis must be performed to determine whether to use equipment from the current Direct Vendor or to match the existing.

5-7.3 Intrusion Detection System (IDS)

The IDS requirements for new facilities have changed in recent years. If a facility has a non-functioning IDS, then follow current standards for the facility type and coordinate with USPIS to determine if it is still required.

5-7.4 Physical Access Control System (PACS)

All access control projects must use the Physical Access Control System specification (PACS) included in the USPS MPF specifications unless an approved deviation request has been issued. The decision to proceed with an access control project needs to be judicious and approved when security is compromised due to broken or failed system components. Upgrades to functional access control systems are not authorized.

Additionally, when it is determined that an access control project must proceed, the procurement of the computer hardware is not to be in our construction contracts. To have a certified solution, the software and computer hardware acquisition must be managed and approved by the Headquarters IT Portfolio and must meet a strict set of requirements.

 G5-8-3a→3d

5-7.5 **Electronic Article Surveillance (EAS) System**

With the elimination of Open Merchandising Areas in new facilities, EAS systems will no longer be installed in new customer service facilities. For existing facilities, the EAS panels can remain, since removing them will add cost and create an undesirable floor aesthetic, but repairs are not to be made to non-functioning EAS components. Existing cameras viewing EAS areas and Store slat wall can remain (again, since removing them adds costs). Since the function of those cameras is loss prevention, the decision to repair non-functioning cameras in those areas is driven by operational specifics (such as type of product, if any, displayed and analysis of actual shrinkage.)

[This page intentionally left blank.]

Appendix A

Boiler Replacement Reference Guide

United States Postal Service

Reference Guide for Boiler Replacement Projects for the Design Engineer

This booklet *mainly* focuses on the application of and compliance with the CSD-1 code as well as some boiler operation requirements which may seem *unique* to those unfamiliar with Postal requirements, which demand a *higher standard in safety*. This booklet highlights historical problem areas.

Application: Most cast iron sectional boilers, having a BTU input of 400,000 or more, and less than 2.5 million. (approximately 75% of Postal boilers)

This material not intended for distribution outside the realm and scope of the U.S. Postal Service and its affiliates.

Table of Contents

Format, Editorial note, and Disclaimer

Initial Assessment Checklist for Boiler Replacement Projects

Listing & Explanation of Historical Problems found during Final Inspection as related to original design specifications and drawings

Recommended hot water boiler, probe type, LWCO drawing

Recommended steam boiler, probe type, LWCO drawing

New Technology and the term, “Code Case”, cast aluminum boilers.

Example Photos:

Power burner and controls

Newly installed cast iron boiler

Example Photos, Alternate heating methods:

High Efficient Condensing units for smaller offices
VMF--options--Infrared heating

Format:

This booklet *mainly* focuses on the application of and compliance with the CSD-1 code as well as some boiler operation requirements which may seem *unique* to those unfamiliar with Postal requirements, which demand a *higher standard in safety*.

This booklet is *not* intended to cover all of the code requirements. The design engineer and the mechanical contractor should already be familiar with the codes contained within the more commonly known code books such as the A.S.M.E. Sect IV, VI, VIII.

Recommended, Initial Assessment Checklist

Intended to be utilized prior to the actual writing of the "Scope of Work"

It is often that minor yet quite important details fail to be noted in the initial scope and contract. Viewing or checking the following items can help to avoid contract modifications.

- 1) *Age of circulation pumps:*
10 years of age or older? If so, replace, or rebuild.
- 2) *Expansion tank/Condensate tank:*
15 years of age or older? Is it properly sized for the new unit to be installed?
Note: If the system utilizes a safety or safety relief valve of 30 lbs or less, then the less expensive bladder type tank may be used. But if the system is to use a larger valve such as a 50 lb, then the more costly ASME rated expansion tank must be used.
- 3) *Backflow preventor:*
It is recommended to always ask for replacement. Also, most states now require the device to be re-located to a position within 4 foot of the floor so as to allow for inspection and testing. Note location of backflow preventor and pressure reducing valve and related piping. Do these items need to be relocated to make accessible for inspection and testing?
- 5) *Stack:*
Does the stack need to be replaced? If there is an existing brick type chimney, there may need to be an insert of some type placed into it. If the new unit is to be a *condensing* boiler, the stack may need to be of stainless steel or PVC type construction.
- 6) *Pad:*
Is there an existing pad for the unit? Is it re-useable?
- 7) *Existing controls:*
Are the existing temperature and/or boiler controls compatible with the newly proposed boiler unit?
- 8) *Motorized Outdoor Air Dampers (If applicable):*
Check the outdoor air damper assembly thoroughly!
This is very important. On several previous occasions, neither the design engineer nor the contractor realized that the assembly did not function. Some of these larger damper assemblies are quite costly. Contract modifications may be avoided by checking this very important item.

Listing of Historical Problems found during initial acceptance inspections, as related to the original design specifications.

ITEM:

- 1) *Pilot control:*

On power burner units, be sure to specify an “interrupted pilot”, not the “intermittent”. The interrupted is *required* upon boilers that are 2.5 Million btu and above. It is considered to be safer. When ordering a new unit, simply state that *all* power burners be equipped with the controller that operates with the interrupted pilot. Also, the intermittent type pilot is a constant maintenance problem, due to the pilot valve solenoid failures. This solenoid is energized at all times the boiler is operating. With an interrupted pilot, this solenoid is only utilized during start up.
- 2) *Motorized Outdoor air damper (if utilized):*

There must be an end switch attached directly to the moving member of the outdoor air damper that proves their opening prior to firing of the boiler. There must be a *reasonable* means of testing this switch. Additionally, it is highly *desired*, that the dampers close anytime the boiler disconnect is opened, the boiler control is turned off, or the boiler goes into a safety shut-down. This will aid in preventing boiler room piping freeze ups in event of a shutdown during a winter weekend. This is *not* a specific code requirement.
- 3) *Outside air induced draft fan (if utilized):*

If a fan is used to provide outdoor combustion air, there must be a switch which proves its operation prior to the firing of the boiler. There must be a *reasonable* means of testing this switch.
- 4) *Probe type low water cut off devices:*

The probe type low water cut out device, if utilized, shall be a manual reset type. The device must remain in a locked out condition, after a low water condition, should there be a power loss and reinstatement.
- 5) *High limit control:*

The high limit or high pressure control shall be of the *manual reset* type.
- 6) *Test gauge ports:*

All gauges shall have an inspectors test port installed to allow for an inspector’s gauge to be attached and verify the unit’s gauges.
- 7) *Backflow preventor:*

A new backflow preventor is to be provided. The unit is to be located within 4 foot of floor level to allow for inspection and testing. The unit shall have overflow piping plumbed to the floor drain.
- 8) *Hydrostatic testing:*

Provide documentation of hydrostatic testing, at 1 and ½ times max allowed pressure, at time of acceptance inspection.
- 9) *Initial burner adjustment settings and readings:*

Provide combustion efficiency test and burner adjustment documentation at time of acceptance inspection.
- 10) *Provide isolation valve(s) for the expansion tank.*

A means to isolate the expansion tank shall be provided.
- 11) *Safety relief valve or relief valve discharge piping:*

The discharge piping shall be supported and *should* terminate at approx 6 to 10 inches above floor level. The piping shall be *angle-cut* to prevent *capping*. The code does not give a specific height above floor level. Contractors continually ask the height of the cut.

12) *Marking and tagging of valves:*

All valves shall be tagged. Ex: Supply valve, N/O.

13) *Concrete or grout pad(s):*

The boiler, as well as the expansion tank, if mounted at floor level, shall be provided with a pad of 4 inches high minimum.

14) *Pressure reducing valve and bypass:*

Provide a bypass around the make up water pressure reducing valve.
Do *not* provide a bypass around the backflow preventor.

15) *Power supply and control circuit:*

The codes require that the control circuit be *fused*. It is simpler, just to state that the boiler shall be provided with a fused and lockable disconnect.

16) *Single power source:*

It is highly desired, that all items attached directly to the boiler, as well as the outdoor air damper motor or fan motor, as applicable, be powered through a single lockable, preferably fused, disconnect. The disconnect shall be as close to, or attached, to the boiler as is possible. Additionally, the newer OSHA codes now require that an "Arc Flash" warning sticker be placed upon the disconnect.

17) *Insulation:*

It is usually preferred, that all piping be neatly cleaned and painted and/or insulated as applicable. Hot water piping within reach of the floor level must be insulated to prevent scalding an employee.

18) *Proper mechanical support:*

All piping shall have proper mechanical support.

19) *Adequate clearances:*

Provide adequate clearances around boiler and equipment so as to allow for inspection, maintenance and testing. Any low level piping should be re-located to a higher level so as to prevent head injury by an employee, if at all possible.

20) *Fuel Train:*

The fuel train shall not be supported by any drip legs. The codes require low and high gas pressure switches on units 2.5 million btu and up.

The preference is for switches on most all units.

The fuel line piping must be painted yellow, or be clearly identified with the proper type and size yellow stickers, as required by the ANSI 13.1.

21) *Purge timer:*

The CSD-1 requires *90 second pre-purge timer*, not the 30 which is often standard issue.

22) *USPS, Heating Boilers* must comply with the applicable CSD-1 code requirements.

23) *USPS, Domestic Hot Water* type boilers, which have an input rating of 200,000 BTUs or more, and/or have a capacity of 120 gallons or more, are subject to the USPS Boiler Inspection program. These units must comply with applicable CSD-1 requirements.

24) In most cases, Postal policy applies the more stringent CSD-1 codes. There is a written policy which deals with hot water heaters that states the lesser stringent Z-21 code is not to be recognized.

25) In reference to the outdoor air damper assemblies (if used), the code required end switch which proves opening of the dampers, prior to the firing, **must** be mounted on the **driven member**. A driving motor with an internal switch does **not** meet the CSD-1 requirements.

26) Be sure to include a listing of any applicable codes, such as:

BOILER INSTALLATION CODE LIST

The LATEST EDITION of the applicable Codes and Standards shall be utilized. The listing includes, but is not limited to:

- A) ASME - Boiler and Pressure Vessel Code Section IV
- B) ASME - Boiler and Pressure Vessel Code Section VI
- C) ASME - Boiler and Pressure Vessel Code Section VIII
- D) ASME CSD-1 - Controls and Safety Devices for Automatically Fired Boilers.
- E) ANSI Z-223.1/NFPA 54 - National Fuel Gas Code.
- F) National Boiler Inspection Code.
- G) National Electric Code
- H) National Plumbing Code.
- I) ANSI - A13.1 - Scheme for the identification of piping systems.
- J) OSHA - Regulations
- K) National Building Codes (UBC - BOCA - SBC).
- L) Local Codes - It is the policy of the U.S. Postal Service that the contractor must comply with all state and local building code requirements unless otherwise specifically provided. Matters concerning the applicability and/or conflict of any codes and regulations shall be brought to the immediate attention of the Contracting Officer via the Project Manager.

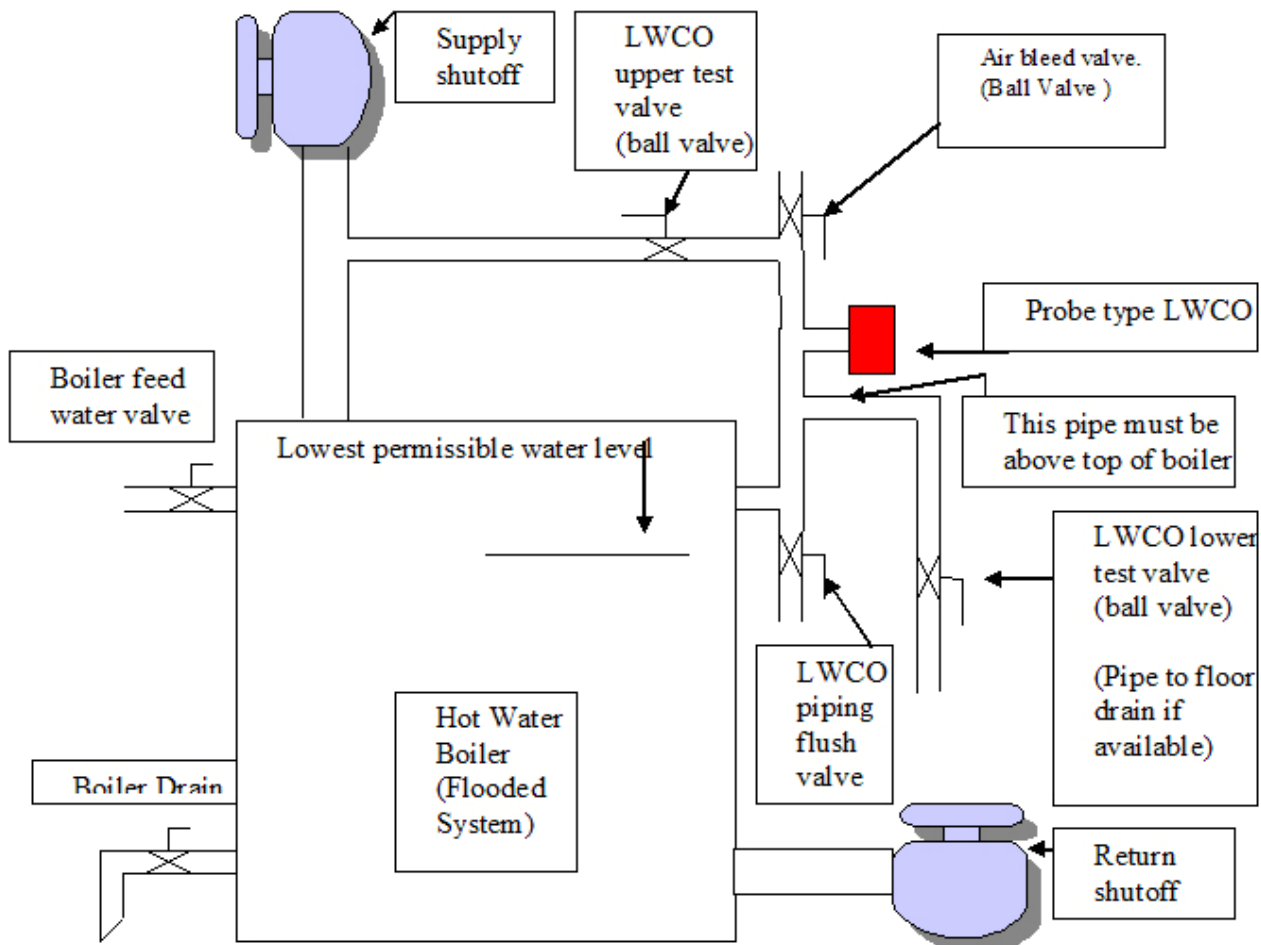

Test procedure for the probe type LWCO, when utilized upon a Hot Water Boiler.

- 1) Isolate the boiler by shutting off the Supply, Return and Feed water valves. The Expansion tank may also have to be isolated.
- 2) Open Boiler Drain just long enough to obtain 0 psi in the boiler. Close drain valve.
- 3) Close the upper LWCO test valve and Open the lower LWCO test valve to drain.
This will drain the water in the LWCO piping. The probe is now exposed.
The probe type LWCO should go into a lock-out condition within 90 seconds.
- 4) Close the lower test valve and air bleed valve.
- 5) Open the boiler feed water valve.
- 6) Carefully bleed air from the piping with the air bleed valve.
- 7) Open the upper test valve.
- 8) The LWCO should remain in a locked out condition.
- 9) Shut off power to Boiler Controls for a moment then restore power.
- 10) Verify that the LWCO remains in a locked out condition.
- 11) Insure that all valves are in normal operating positions.
- 12) Reset the LWCO probe type device and verify that the equipment is operating properly.

NOTE : All piping for the LWCO must be 1 inch NPS.

NOTE : *Nearly*, any configuration of the above, which accomplishes the same task, is acceptable.

The objective is to *positively* test the device with absolute minimum loss of water and treatment.

Drawing by M. Tyler, USPS.-GL-FSO

Test procedure for testing a probe style LWFC on a steam boiler.

- 1) Isolate boiler by shutting off Supply and Return valves.
 - 2) Heat boiler to a low pressure 1 or 2psi or lower.
 - 3) Open LWFC test valve.
- NOTE:** The drain piping for this valve shall be to a safe area and anchored. Or, if applicable, to the condensate return tank.
- 4) When mostly steam and little water come from the drain, the probe should be exposed.
 - 5) The LWCO should go into a lockout condition.
 - 6) Close the LWCO test valve, the device should remain in lockout condition.
 - 7) Remove power to boiler.
 - 8) Restore all valves to their normal operating position.
 - 9) Restore power; Verify that the LWCO remains in a lockout condition.
 - 10) Reset the probe type low water cutoff device.
 - 11) Verify that the boiler operates normally.
 - 12) Insure that all items have been restored to their normal operating condition.

Note:

The lowest LWCO shall be set to function 1/4" above the lowest visible spot in the sight glass and above the lowest permissible safe water level.

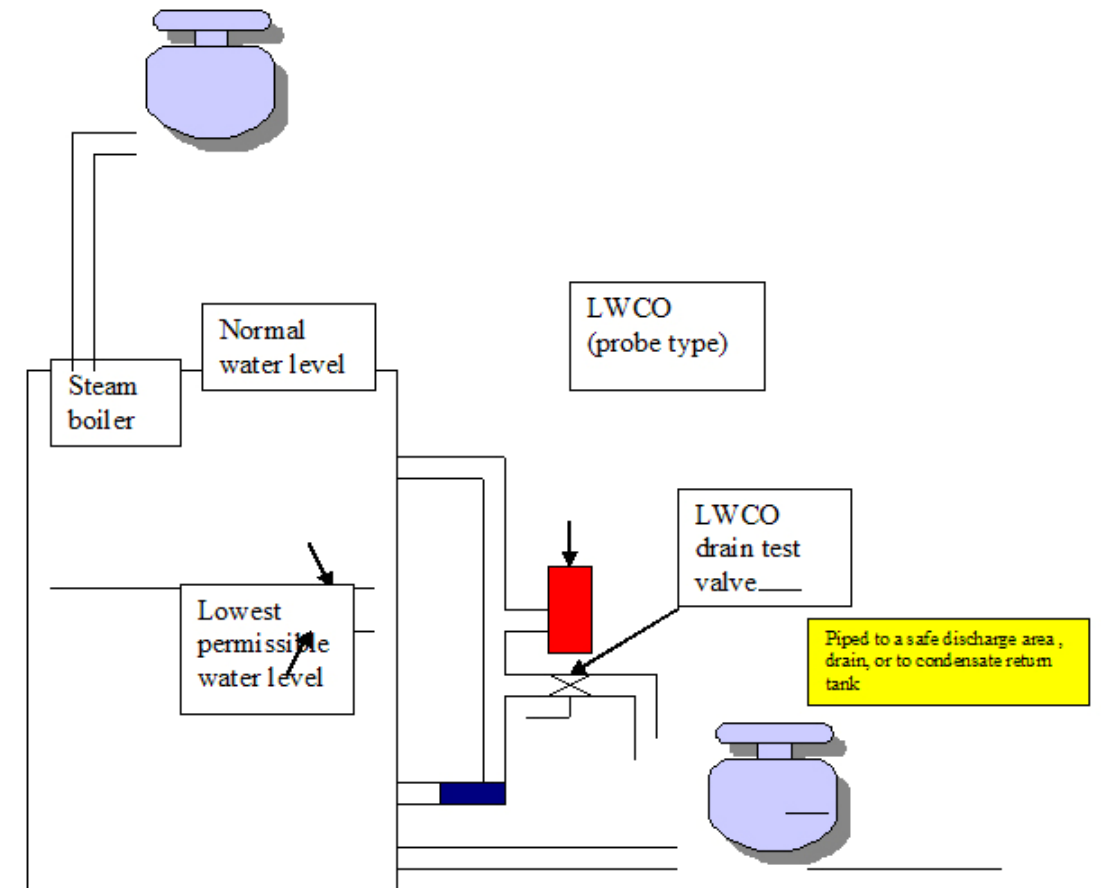

New Technology and the term “Code Case”, cast aluminum boilers

The following narrative refers to the newer type, cast aluminum condensing boilers that are now available on the market.

The continuing demand for more efficient and dependable heating systems is the driving force behind new technology. The various code committees and their related code books can not always maintain pace with heating industry advances.

When a manufacturer designs and builds a unit, such as a cast aluminum condensing boiler, and wants to place it onto the market, there is a standard procedure that should be followed.

Caution: Not all manufacturers follow this procedure.

This procedure includes submitting drawings, specifications, and design criteria concerning the proposed unit to be offered for sale. This information is then sent to the A.S.M.E. asking for approval. If the various committees agree that the proposed unit is safe for operation, although there is no specific allowance for the unit in the actual ASME Sect IV code book, then a “Code Case” is approved.

When a code case is approved, the manufacturer is then allowed to display the ASME sticker, bearing the “H” stamp upon the shell of the boiler. *However*, there is *not* an actual “H” stamp placed into or upon the cast aluminum vessel itself.

The “Weil McLain Ultra” condensing boiler is one example of this type of boiler, which has gone through the procedure and has received the “Code Case” approvals.

At the present time the ASME Sect IV, has no language or allowances for a cast aluminum vessel. It has been stated that these types of vessels will be included in future editions of the code.

Caution:

Check with your locally assigned USPS boiler inspector prior to installing one of these units to verify that he or she will certify it for use. And remember, *not all* of the manufacturers selling this type of boiler have actually performed required procedures and obtained the necessary code case approvals.

There is a photo of one of these newer type units in the following pages of this booklet.



This photo shows a typical power burner installation upon an 800,000 BTU input cast iron boiler. Notice the additional indicator lights on the unit itself. This particular unit is manufactured by "Power Flame Co." Any burner which meets the CSD-1 requirements is allowed, however, this particular manufacturer has re-designed this unit with additional safety enhancements. This burner is equipped with additional relays that enable the contractor to wire the outdoor air dampers in such a way that they will close any time there is a safety shut-down. This prevents any boiler room freeze up conditions during a weekend where there has been a shut-down occurrence. This photo also shows the typical indicator lights that are desired upon a power burner.

Some units will have even more lights which will aid in troubleshooting, etc.

This particular unit is called the "Power Flame CSD-1 Burner". This burner is equipped with lights showing, power on, pilot flame, main flame, flame failure, and low water.

In addition to the above, the unit is equipped with a "Honeywell" 7800 series controller, with the optional read-out panel, which assists in troubleshooting the unit. This readout panel will also give an "indication of point of failure" upon the loss of the combustion air motor. (power burner type unit)

When the "Honeywell" controller is utilized, it is *highly desired* that it be equipped with this readout panel. *Some* inspectors may actually *require* it. The "jumpers" MUST be properly configured for the particular application according to size of the boiler.

Also, there must be a 90 second purge timer installed, *not* the 30 second timer.

The contractor or mechanic is allowed to use the "Fireye" controller instead of the "Honeywell". However, if utilized, it MUST be equipped with the indication lights showing the various point of failure indications which are required by code.

NOTE: Most any brand controller is allowed as long as it meets the code requirements. Any brand of power burner is allowed as long as it meets the requirements.



Photo of a newly installed boiler, Sept-2005. This is a 787,000 BTU input cast iron, *Weil McLain* boiler, equipped with a *Power Flame* burner.



The photo above shows one acceptable alternative for smaller Postal facilities where space is a problem. This is a “Weil McLain Ultra”, high efficient condensing, *cast aluminum*, hot water heating boiler. The vessel itself holds only 1 ½ gallons of water. This unit is a 230,000 btu unit. An optional CSD-1 kit, was also installed with the unit.

This unit bears the ASME sticker with the “H” stamp. It does *not* have an actual H stamp in the vessel itself. The sticker means that the unit has been “Code Cased”. For more information on “Code Case” see explanation earlier in this appendix.

If you would like to use one of these units, check with your locally assigned USPS Boiler Inspector to verify that he, or she, will certify it following the installation.

This particular unit has been in operation at the Kendallville, Indiana Postal facility for the past 2 heating seasons, without any breakdown problems. A substantial energy savings has already been realized.

The expected life is about 15 years. The unit itself, following the initial installation, can be replaced for less than \$4000.



This photo shows an acceptable heating alternative for Postal Vehicle Maintenance Facilities. Use of this type of system shall be coordinated with the Contracting Officer.

Often times there is a problem controlling the different heated areas of the offices and the outer work bays.

In this Indianapolis V.M.F. project, the boiler was *down-sized*. Additional *infra-red*, gas fired heating units were then installed in the work bay areas. The theory behind this concept is that *infa-red* (object-heating) system is not as affected by the opening and closing of the work bay doors, when compared to the more conventional type *convection* (ambient air-heating) systems.

This particular manufacturer produces a unit that it is equipped with many safety features and indicator failure lights. This includes flame failure, combustion air failure, etc.

These particular units are called "*Ambi-Rad Heating Systems*" which are manufactured by a company called "*ARS--Advanced Radiant Systems*", of Fishers, Indiana.

[This page intentionally left blank.]

Appendix B

Randolph-Sheppard Act Sample Letter

[This page intentionally left blank.]



Date:

Address:

RE:

Dear Mr. / Mrs. X:

This letter is to advise you that the United States Postal Service is altering a facility for which notification to you is required by Department of Education regulations implementing 1974 Amendments to the Randolph-Sheppard Act, Public Law 93-516. For your information, local Postal officials have engaged the State in preliminary talks about providing food service in this Facility.

The facility is known as the Oklahoma City Processing & Distribution Center. It is located at 4025 West Reno Avenue and contains approximately 800,000 square feet of interior space. The total complement of employees is expected to be approximately 1100 individuals spread between three (3) shifts as follows:

Tour 1	Midnight – 8:00am	500
Tour 2	8:00am - 4:00pm	250
Tour 3	4:00pm - Midnight	350

Scheduled completion of the alterations is May 2008. Three areas totaling 2500 square feet have been included in the design to serve as possible vending locations for operation by blind persons. There is also a 350 square foot break area in the Vehicle Maintenance Facility to be located at the same address that may contain vending machines. The facility contains a central lunchroom. Operation of the lunchroom must meet the schedules of our Postal employees as determined by local management.

I would appreciate your written response to me regarding this notification pursuant to 34 C.F.R. 369.31 within the next 30 days. Please include in your response your agency's intent to establish and operate the proposed vending locations and central lunchroom in the facility.

Sincerely,

Todd Taylor
Manager, Facilities Planning and Construction

Cc: Secretary, Department of Education
Division of the Blind and Visually Impaired
330 C Street, SW, Washington, DC 20201-0001

Mr. / Mrs. X, USPS – Corporate Personnel
Mr. / Mrs. X, USPS – XXX District

[This page intentionally left blank.]

Appendix C

Abatement Project Design

[This page intentionally left blank.]

An abatement project design must be a written plan furnished by the abatement contractor which includes the following information to be considered complete. The purpose of this document is to ensure an adequate project understanding and how the abatement contractor intends to comply with applicable EH&S regulations as well as USPS policies in an effort to promote open communication amongst the involved parties, and prevent work stoppages. The USPS and a third-party industrial hygienist will review work plan for completeness and compliance with applicable federal, state, and local regulations prior to initiation of site activities.

- Estimated abatement time (which days, hours per day, shift start and end time, etc.) and proposed schedule including project phasing.
- Description of the type, quantity, and location of asbestos containing building material to be abated.
- Written of description of the construction of regulated areas, including but not limited to:
 - Critical barrier construction and placement;
 - Negative air machines (NAMs) utilization and placement;
 - Decontamination unit and waste load-out design;
 - HVAC isolation;
- A basic site sketch showing area/building materials to be abated, the containment system, NAM placement and exhaust, airlocks, etc.
- Air exchange calculations for NAMs (if utilized).
- Detailed description of all asbestos work practices to be employed during the abatement including techniques and equipment. If Negative Exposure Assessments (NEAs) are to be utilized for any work practices, supporting documentation and data shall be provided.
- Description of asbestos waste management, transportation, and disposal practices including but not limited to:
 - Waste bagging practices;
 - Proposed method of transportation; and
 - Name and location of waste disposal facility
- Description of Personal Protective Equipment (PPE) to be donned by abatement crew.
- Description of personal air monitoring to be conducted including number of employees to be monitored.
- Copy of 10-day notification and/or permit to the appropriate NESHAP authority (US EPA, state environmental agency, or local air quality agency). If notification and/or permit are not required the abatement contractor shall state why.
- Copies of Material Safety Data Sheets (MSDSs) for all products and chemicals to be brought onsite.
- Copies of current certification and/or licenses for all asbestos supervisors and workers working onsite. Abatement contractor shall furnish OSHA-required respirator fit test and medical clearance documentation for each person entering the regulated area.
- Contact information for the abatement supervisor(s).

ABATEMENT CONTRACTOR SHALL BE RESPONSIBLE FOR FURNISHING COPIES OF ALL PERSONAL AIR MONITORING RESULTS AND FINAL SIGNED WASTE

[This page intentionally left blank.]

Exterior Signage/Site Survey Instructions

General Information

All existing facilities requiring the services of the USPS HQ sign consultant (Alternate Quarters, renovations, signage replacement projects, non-standard and historic) must submit this package (see Standard Design Criteria, Exterior Signage, Module 4f, section 2-3). Please provide the following information on the sheet titled "General Information" enclosed in this survey package:

- Site Name
- Post Office Name
- FMS Project #
- MFO/FSO/District Name
- Postmaster and phone #
- Project Manager and phone #
- Architectural Firm and phone #
- Site Address (including Street, City, State, and Zip Code)
- Hours of Operation
- Facility Plan Type: Retail; Combined Retail and Non-Retail; Non-Retail

Photographing the Site

A picture is worth a thousand words, so please follow the suggestions for taking meaningful pictures of the site. Please shoot an entire roll of 36 exposure color film per site (or more if needed). If possible please note where the photos are being taken from (on the site plan). It is helpful to first look at /or drive around the site to determine what shots would be most effective.

Distance shots: important in showing the site's layout, and how approaching traffic is able to see the site and its signs. Please check the surrounding area for any outlying or multi-tenant signs (pylons; monuments). (Exhibits 1, 6 & 7)

Close-range shots: Take these shots to show what foot traffic may see while walking by or inside the site. Take shots of currently existing signs as well as possible locations for future signs. Be sure to take shots of entrance(s). (Exhibits 2, 3, 4, 8 & 9)

Detail shots: Extreme close-up shots are sometimes useful for sign placement and copy content. When in doubt, take the shot (Exhibit 5)

Site Survey Drawings

Please provide the following information to properly document the site conditions:

- Overview of the site (including cross-streets, mall name, traffic patterns, outlying signs, neighboring businesses; denote North orientation etc.).
- Plan view drawing of the site (exterior and interior).
- Elevations (exterior and interior) to show existing sign or building conditions.
- Measurements of existing architectural elements for tolerances and possible placement of the new signs (brick sizes, column dimensions, fascia heights, window/door sizes, etc.).
- Note existing signs (type, location, and size). Please take note of materials used, letters sizes, color constraints (imposed by city or landlord), etc. Also note the size of any signs that could have acrylic panels replaced with new faces (monuments and pylons).
- Electrical conditions and location of nearest available electrical feed.
- CAD drawings of the site plan with exterior elevations if available - preferably AutoCAD releases 12-14 or ".dxf" files. (Usually provided by the architect.)

Mail Survey To:

Monigle Associates
150 Adams Street
Denver, CO 80206
Phone: (303) 388-9358
Fax: (303) 321-7939

Photographic Examples



Exhibit 1
Distance Shot (showing building and traffic flow)



Exhibit 2
Building - West Elevation – Close Range



Exhibit 3
Building - South Elevation – Close Range



Exhibit 4
Directional/ Drive-up – Close Range



Exhibit 5
Building Construction - Detail Shot



Exhibit 6
Distance Shot (showing tenant pylon & strip mall)



Exhibit 7
Distance Shot (showing pylon & traffic flow)



Exhibit 8
Building – South Elevation – Close Range



Exhibit 9
Entrance – Close Range

Drawing Examples

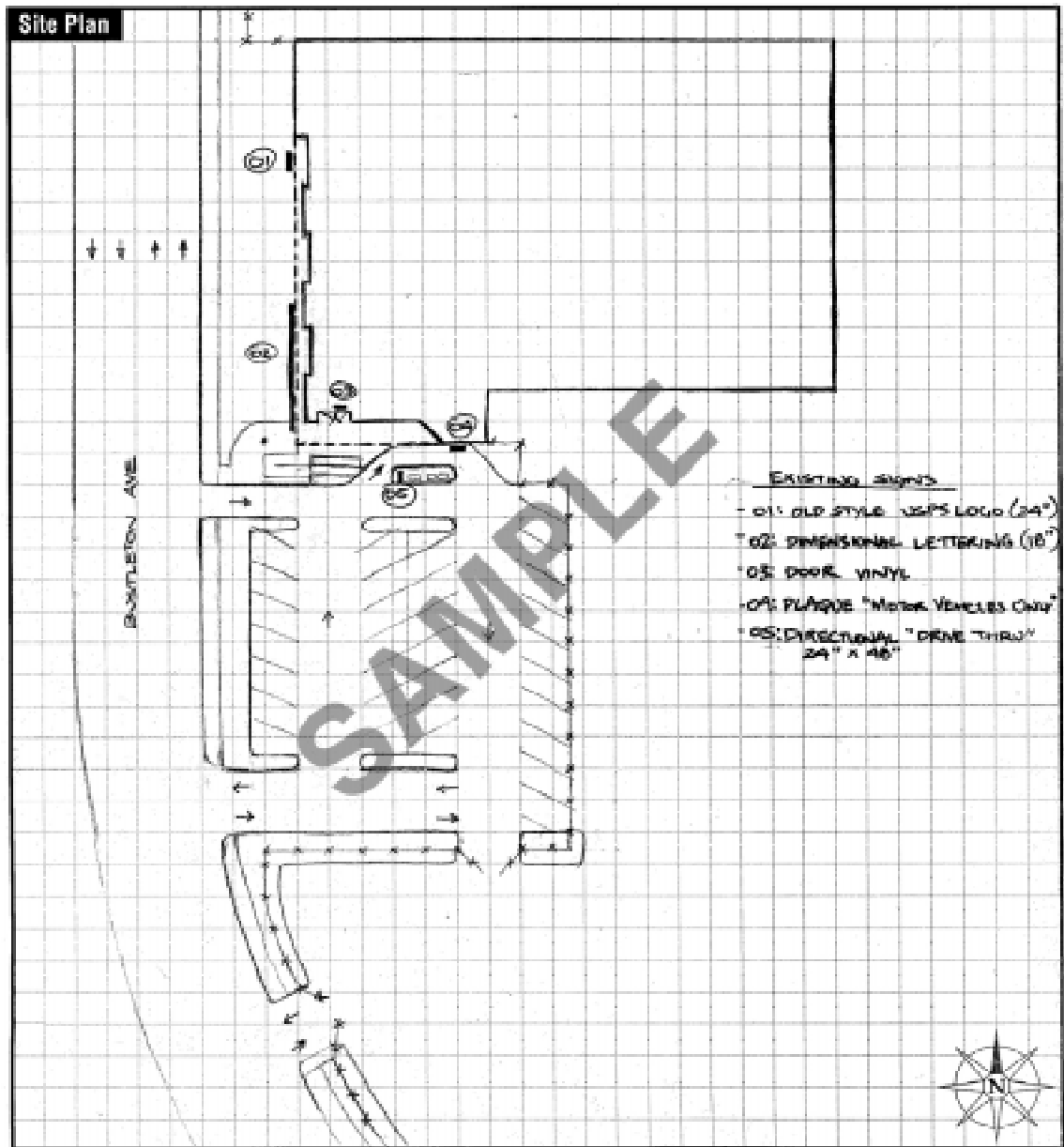

Exhibit 10
Typical Exterior Plan View-Freestanding Post Office

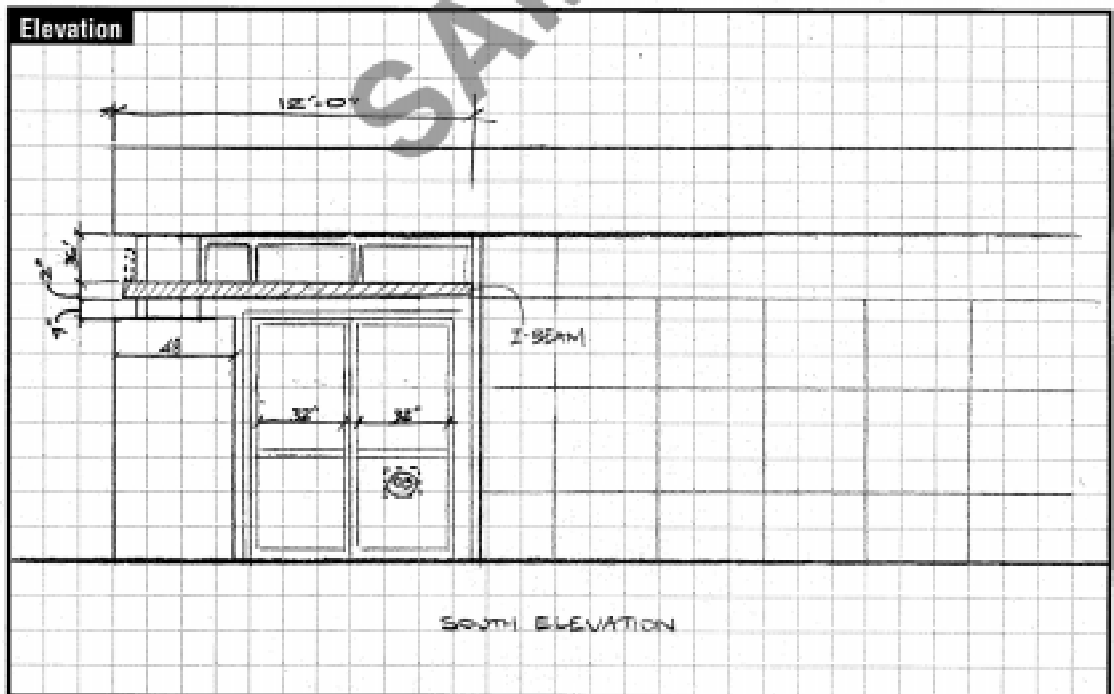
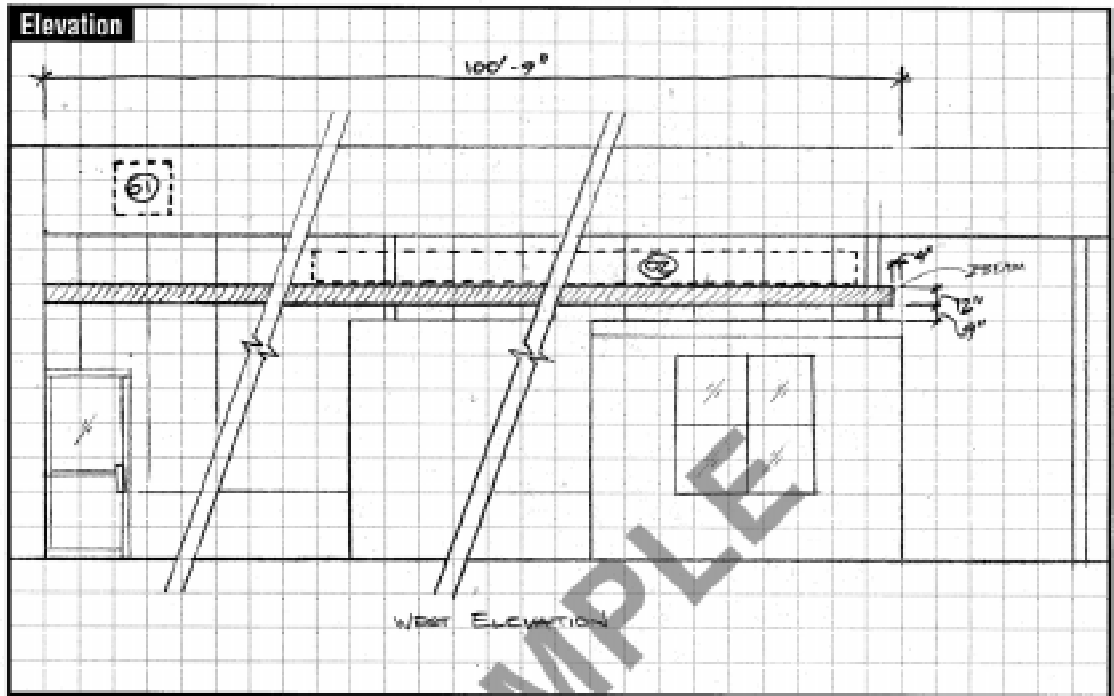

Exhibit 11
 Typical Exterior Elevation-Freestanding Post Office

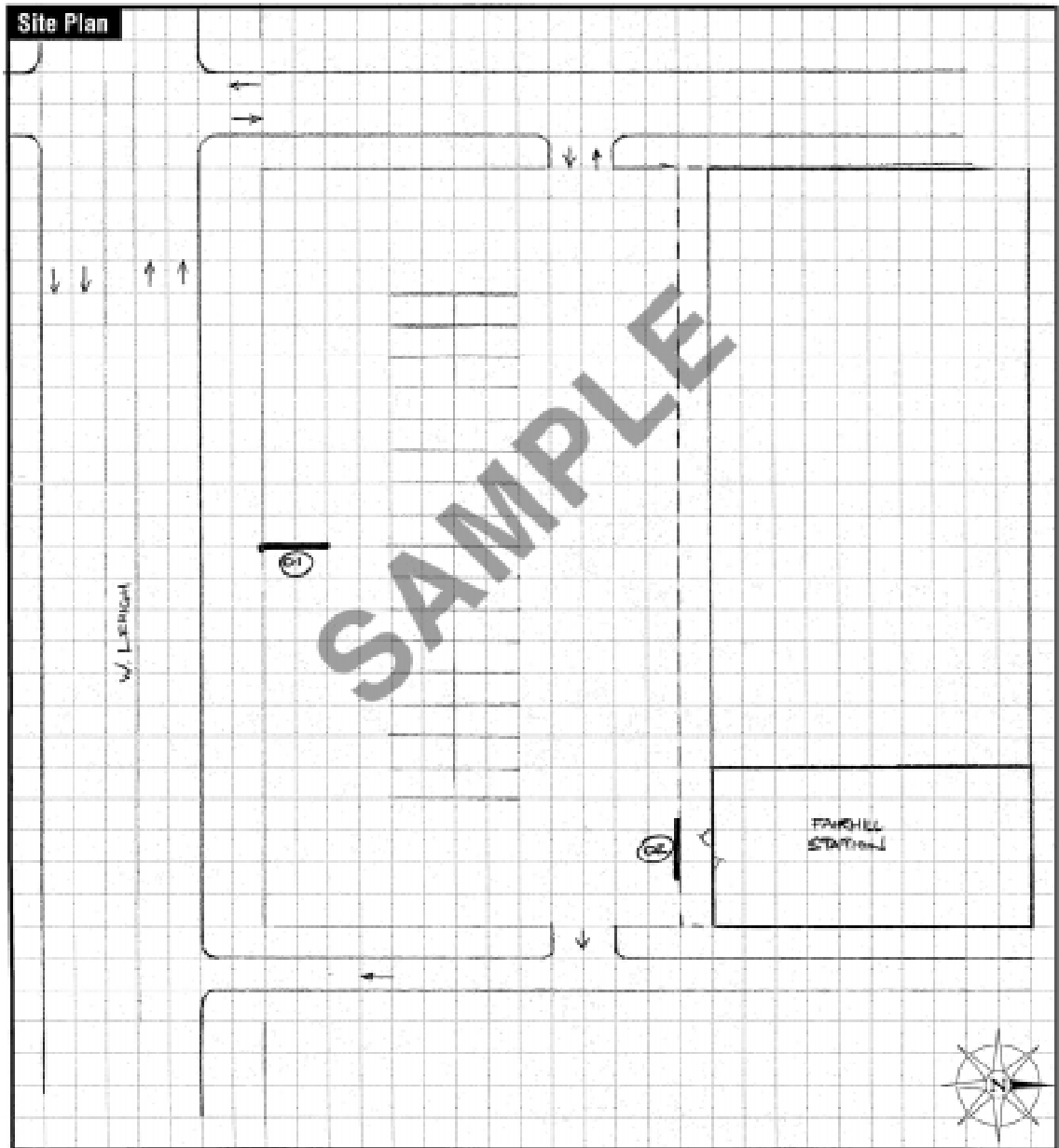

Exhibit 12
Typical Exterior Plan View -Post Office as Mall Tenant

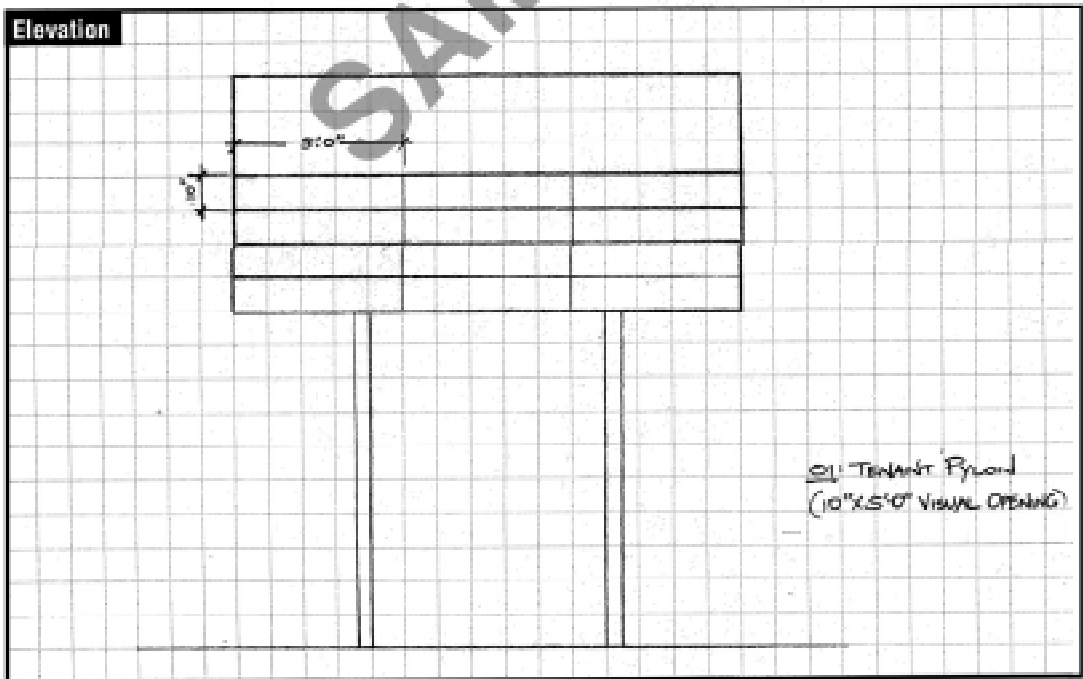
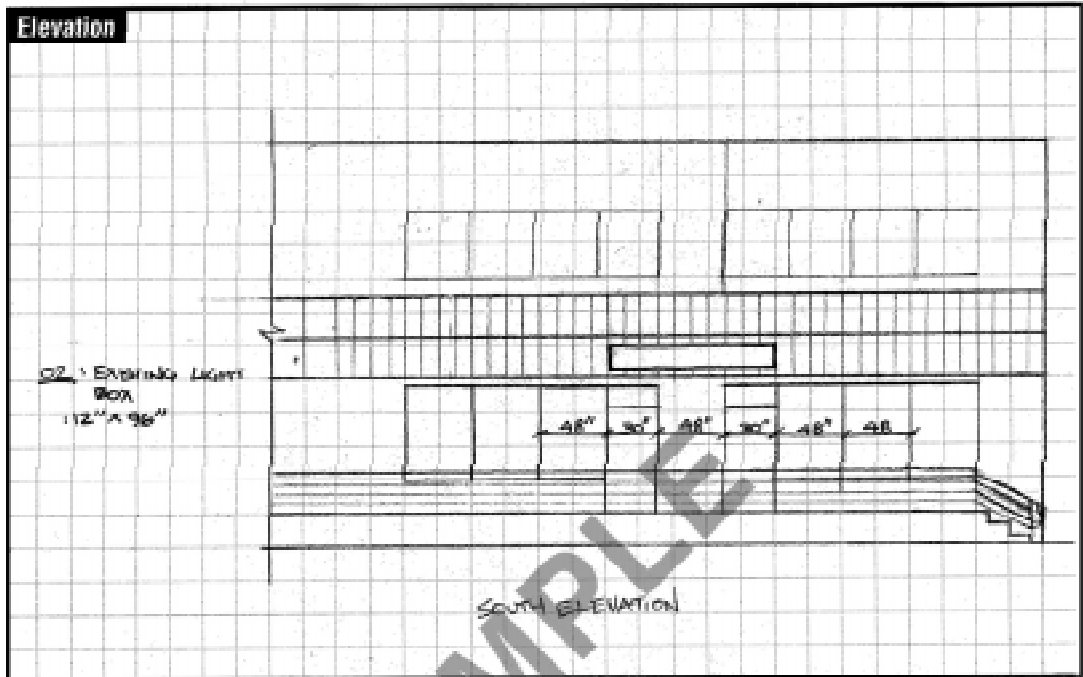

Exhibit 13
Typical Exterior Elevation-Post Office as Mall Tenant

Photo Mounting Sheet

Site Name: _____



PLACE
3 1/2"x 5"
PHOTO HERE



Photo # _____

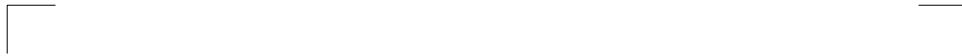

PLACE
3 1/2"x 5"
PHOTO HERE

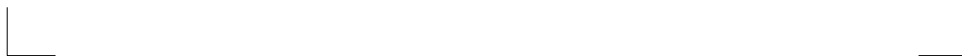

Photo # _____

Sheet ____ of ____

[This page intentionally left blank.]