

**Ultrasound Diagnostic System**

**MODEL: SonoTouch 30**



**OPERATION MANUAL**

**Direction: CHUM-001a**

**V1.5  
Dec 10, 2014**

*We reserve the right to make changes to this manual without prior notice*

## Regulatory Requirement



This product conforms to the essential requirements of the Medical Device Directive 93/42/EEC. Accessories without the CE mark are not guaranteed to meet the Essential Requirements of the Medical Device Directive.

This manual is a reference for the SonoTouch 30. Please verify that you are using the latest revision of this document. If you need the latest revision, contact your distributor.

### **NOTE:**

#### Important

1. No part of this manual may be reduced, modified, copied or reprinted, in whole or in part, without written permission from CHISON.
2. The contents of this manual are subject to change without prior notice and without our legal obligation.
3. Before operating the system, please read and understand this manual. After reading, keep this manual in an easily accessible place. If you have any question or doubt, please contact CHISON's authorized service engineer.
4. CHISON's Warranty only cover material and parts costs for repair, but do not cover any labor cost or onsite service cost at end user's side.

## **NOTE:**

### Important information

1. It is the customer's responsibility to maintain and manage the system after delivery.
2. The warranty does not cover the following items, even during the warranty period:
  - a) Damage or loss due to misuse or abuse with system and probes, for example, drop the probe, the liquid or the metal part fall into the system.
  - b) Damage or loss caused by Acts of God such as fires, earthquakes, floods, lightning, etc.
  - c) Damage or loss caused by failure to meet the specified conditions for this system, such as inadequate power supply, improper installation or environmental conditions.
  - d) Damage or loss caused by non approved transportation by CHISON.
  - e) Damage or loss due to use the system outside the region where the system was originally sold.
  - f) Damage or loss involving the system purchased from a source other than CHISON or its authorized agents.
3. Do not make changes or modifications to the software or hardware of this system and probes.
4. During operate the system, if user has any doubt, difficulty or any unclear, please contact CHISON's authorized service engineer immediately. Please describe the situation clearly to solve the question in time. Before solve the question, please don't operate the system.
5. This system shall not be used by persons other than fully qualified and certified medical personnel.
6. It is prohibited to use the device for fetal sex examination, except for necessary medical needs. The device can only be sold to qualified medical institutions or doctors. The users shall fully understand and master the devices before operating. The users shall have got the qualification, and shall comply with the local laws and regulations, the local religion and customs, etc.
7. The System modified or repaired by people other than CHISON's qualified service engineers, CHISON shall not be liable for the system.
8. The purpose of this system is to provide physicians with data for clinical diagnosis. It is the physician's responsibility for diagnostic procedures. CHISON shall not be liable for the results of diagnostic procedures
9. This manual contains warnings regarding foreseeable potential dangers, but user shall always be alert to dangers other than those indicated as well. CHISON shall not be liable for damage or loss that results from negligence or from ignoring the precautions and operating instructions described in this operation manual.
10. Due to negligence not following operation manual, CHISON shall not be liable for the results.
11. Each time before and after ultrasound examination, please check the probe surface, probe cable and sheath whether they are abnormal, such as cracking, peeling and deformation. Also check whether the lens is strongly fixed. Abnormal probes may cause electric shock and injure the patient. Once any abnormal, user must stop using and contact CHISON's authorized service engineer.
12. If the probe is dropped or scratched by hard part, please stop using the probe immediately. And contact CHISON's authorized service engineer to make sure the safety and effectiveness is in good condition before use.
13. If there is any liquid or metal to enter to the system, please power off the system and stop using it immediately. Please first contact CHISON's authorized service engineer to make sure it's safe before restart using it.
14. Please don't use solvents (such as paint thinner, benzine, or alcohol) or abrasive cleansers for cleaning the system (including monitor and probes, etc). It may corrode the system and probes.
15. While the system or probe is over life time, please refer to operation manual section 15.4
16. Important data must be backed up on external memory media. CHISON shall not be liable for loss of data stored in the memory of this system caused by operator error or accidents.
17. Please put this operation manual with the system to ensure operator and manager can reach it at any time.
18. LCD display screen may have some dark or light dots, it is normal for the LCD. It does not mean

that LCD screen is defective.

 **Caution:** It is prohibited to use the device for fetal sex examination, except for necessary medical needs. The device can only be sold to qualified medical institutions or doctors. The users shall fully understand and master the devices before operating. The users shall have got the qualification, and shall comply with the local laws and regulations, the local religion and customs, etc.

 **Caution:** The users should read the operation manual carefully before operating the devices. Turning on the device means the users have read the operation manual and accept the listed cautions, warnings, and notes in the manuals. If the users disagree and cannot accept the cautions, the users can ask for returning the device.

## TABLE OF CONTENTS

<i>Chapter 1 Introduction</i> .....	1
1.1 System Overview .....	1
1.2 Contact Information .....	1
<i>Chapter 2 System Safety</i> .....	2
2.1 Safety Overview .....	2
2.2 Electrical Safety .....	3
2.3 Labels .....	4
2.4 Patient Environmental Devices.....	6
2.5 Biological Safety .....	8
2.6 Scanning Patients and Education .....	9
<i>Chapter 3 Preparing the System for Use</i> .....	15
3.1 Site Requirement.....	15
3.2 System Specifications.....	16
3.3 System Positioning & Transporting .....	19
3.4 Powering the System.....	20
3.5 Probes.....	20
<i>Chapter 4 Control panel</i> .....	22
4.1 Overview of display area .....	22
4.2 Operating area of active state .....	22
4.3 Operation area of color mode .....	25
4.4 Operation area of PW mode .....	25
4.5 Operation area of freezing state .....	26
4.6 Information area for machine state.....	27
4.7 The thumbnail area of saving images.....	27
4.8 Image parameter area .....	27
4.9 Cine memory bar .....	27
4.10 Soft iconboard .....	27
<i>Chapter 5 Imaging</i> .....	28
5.1 Select display mode .....	28
5.2 Select Examination mode .....	28
5.3 Image control and adjustment .....	29
5.4 Adjustment in color flow mode.....	32
5.5 Adjustment in PW mode .....	33
5.6 Image parameter transform.....	34
<i>Chapter 6 Measurement and Calculation</i> .....	35
6.1 Measurement methods: .....	35
6.2 Normal measurement and calculation in B, B/B and 4B mode.....	36
6.3 OB measurement and calculation.....	38
6.4 GYN Measurement .....	41
6.5 Small parts measurement and calculation.....	43
6.6 Urology measurement and calculation.....	43
6.7 Normal measurement and calculation in M, B/M mode .....	45
6.8 Measurement in M mode.....	46
6.9 Measurement in B mode.....	48
6.10 measurement in PW mode .....	49
<i>Chapter 7 Cine-Memory</i> .....	50

7.1 Store the real-time image .....	50
7.2 Manual playback.....	50
7.3 Automatic playback.....	50
7.4 Cine Save/Recall.....	50
<i>Chapter 8 Annotation .....</i>	<i>51</i>
8.1 Introduction.....	51
8.2 Input characters through the soft iconboard Operation:.....	51
8.3 Move the annotation .....	52
8.4 Edit the annotation .....	52
8.5 Clear the annotation .....	52
<i>Chapter 9 Body Marks .....</i>	<i>53</i>
9.1 Introduction.....	53
9.2 Operation of body marks .....	54
<i>Chapter 10 Archive Management.....</i>	<i>55</i>
10.1 Path selecting.....	55
10.2 Information viewing .....	55
10.3 Documentation .....	55
<i>Chapter 11 Biopsy.....</i>	<i>56</i>
11.1 Enter into/ Exit from Biopsy status.....	56
11.2 Use biopsy kit .....	56
<i>Chapter 12 Reports .....</i>	<i>58</i>
12.1 Introduction.....	58
12.2 Content.....	58
12.3 Import image.....	58
12.4 Print .....	58
12.5 Save .....	58
12.6 Export .....	58
<i>Chapter 13 Preset.....</i>	<i>59</i>
13.1 General setting .....	59
13.2 Calculation.....	59
13.3 Set annotation database.....	60
13.4 DICOM .....	60
13.5 User interface .....	61
13.6 Touch Screen.....	61
13.7 Net .....	61
13.8 System .....	61
<i>Chapter 14 System Maintenance.....</i>	<i>63</i>
14.1 Cleaning.....	63
14.2 Probe maintenance .....	63
14.3 Safety check.....	64
14.4 Troubleshooting .....	64
<i>Appendix A: The Information of EC Representative .....</i>	<i>79</i>
<i>Appendix B: Maximum Acoustic Output Report.....</i>	<i>80</i>
<i>Appendix C: Measurement Results Summary .....</i>	<i>131</i>
<i>Appendix D: Guidance and Manufacturer's Declaration.....</i>	<i>133</i>
<i>Appendix E: Display Accuracy and Acoustic Measurement Uncertainties .....</i>	<i>136</i>
<i>Appendix F: Transducer Maximum Surface Temperature.....</i>	<i>137</i>

# Chapter 1 Introduction

This manual contains necessary information for safe system operation.

Read and understand all instructions in this manual before operating the system. Always keep this manual with the equipment, and periodically review the procedures for operation and safety precautions.

## 1.1 System Overview

### Indications for Use

The device is a general-purpose ultrasonic imaging instrument intended for use by a qualified physician for evaluation of Fetal/OB; Abdominal (GYN & Urology); Pediatric; Small Organ(breast, testes, thyroid); Cardiac (adult & pediatric); Peripheral Vascular, Musculoskeletal Conventional & Superficial, Transrectal and Transvaginal.

### Contraindication

The system is NOT intended for Ophthalmic use or any use that causes the acoustic beam to pass through the eye.

## 1.2 Contact Information

For additional information or assistance, please contact your local distributor or the appropriate support resource shown below:

**CHISON website** [www.chison.com](http://www.chison.com)

**Service Support** CHISON Medical Imaging Co., Ltd.  
Tel: 0086-400-8878-020; 0086-0510-85311707  
Fax: 0086-0510-85310726  
E-mail: [service@chison.com.cn](mailto:service@chison.com.cn)

**Placing an Order** CHISON Medical Imaging Co., Ltd.  
Tel: 0086-0510-8531-0593/0937  
Fax: 0086-0510-85310726  
Email: [export@chison.com.cn](mailto:export@chison.com.cn)

**Manufacturer** CHISON Medical Imaging Co., Ltd.  
No.228, ChangJiang East Road, Block 51 and 53 Phase 5 Industrial Park, ShuoFang,  
New District, Wuxi, Jiangsu, China, 214142

**US Agent:** MR. NANPING WU, 3040 Edenberry Street, Madison, WI 53711 USA  
Phone: 608-277-9432, Fax: 920-648-1584  
Email: [nanpingwu@yahoo.com](mailto:nanpingwu@yahoo.com)



**Caution: Federal law restricts the device to sale by or on the order of a licensed practitioner or therapist.**

# Chapter 2 System Safety

## 2.1 Safety Overview

This section discusses measures to ensure the safety of both the operator and patient. To ensure the safety of both operator and patient, please read the relevant details in this chapter carefully before operating this system.

**Disregarding the warnings or violation of relevant rules may result in personal injury or even loss of life for operator or patient.**

**Users should observe the following precautions:**

- This system complies with Type BF general equipment, and the IEC standard. Please follow Chapter 1 “System Safety” in the user’s manual to use this system properly.
- Do not modify this system in any way. Necessary modifications must be made only by the manufacturer or its designated agents.
- This system has been fully adjusted at the factory. Do not adjust any fixed adjustable parts.
- In the event of a malfunction, turn off the system immediately and inform the manufacturer or its designated agents.
- The power cable of the system should only be connected to a grounded power socket. Do not remove the ground cable for any reason.
- Only connect this system, either electronically or mechanically, with devices that comply with the EN60601-1 standard. Recheck the leakage current and other safety performance indices of the entire system to avoid potential system damage caused by leakage from a current superposition.
- The system does not incorporate any specialized protective measures in the event it is configured with high-frequency operation devices. The operator should use caution in these types of applications.
- The system should be installed only by personnel authorized by the manufacturer. Do not attempt to install the system by yourself.
- Only an authorized service engineer may perform maintenance.
- Only a qualified operator, or someone under qualified supervision, should use the system.
- Do not use this system in the presence of flammable substances, otherwise an explosion may occur.
- Do not continuously scan the same part of a patient or expose the patient to prolonged scanning, otherwise it may harm the patient.
- When using the system for ultrasound testing, use only qualified ultrasound gel that complies with system standards.
- Do not unplug probe when the system is in active operation. Always go to EXAM screen when need to remove the probe.
- To prevent from arm or neck injury, the operator should not stay at the same position for too long during patient scanning without taking break.
- Do not put liquid on top of the main unit.

### **NOTE**

*\*The system has built-in screen saver to avoid the tic mark on the display. It is not recommended*



to constantly turn on and off the unit.

*\*To dispose of this product properly, please call your local service department.*

## 2.2 Electrical Safety

### Type of protection against electric shock

- **Class I Equipment**

CLASS I EQUIPMENT in which protection against electric shock does not rely on BASIC INSULATION only, but includes a protective earth ground. This additional safety precaution prevents exposed metal parts from becoming LIVE in the event of an insulation failure.

 **NOTE:** The mains supply shall be cut off after disconnecting the power line and the net power.

### Degree of protection against electric shock

- **Type BF Applied part** (for Probes marked with BF symbol)

TYPE BF APPLIED PART providing a specified degree of protection against electric shock, with particular regard to allowable LEAKAGE CURRENT

### Level of protection against harmful ingress of water

- The IP Classification of System is Ordinary Equipment (IPX0)

### Safety level when used in the presence of FLAMMABLE ANAESTHETIC MIXED WITH AIR (or WITH OXYGEN or WITH NITROUS OXIDE):

The Equipment is not suitable for use in the environment with FLAMMABLE ANAESTHETIC MIXED WITH AIR (or WITH OXYGEN or WITH NITROUS OXIDE)

### Mode of operation

- Continuous Operation

For maximum safety, always follow these guidelines:

- Proper grounding of the system is critical to avoid electrical shock. For protection, ground the chassis with a three-wire cable and plug, and plug the system into a hospital-grade, three-hole outlet.
- Do not remove or circumvent the grounding wire.
- Do not remove the protective covers on the system. These covers protect users from hazardous voltages. Cabinet panels must remain in place while the system is in use. A qualified electronic technician must make all internal replacements.
- Do not operate this system in the presence of flammable gases or anesthetics.
- All peripheral devices (unless certified as medical grade) that are connected to the system must be powered through the electrical outlet through an optional isolation transformer.

### Notice upon Installation of Product

Separation distance and effect from fixed radio communications equipment: field strengths from fixed transmitters, such as base stations for radio (cellular/cordless) telephones and land mobile radios, amateur radio, AM and FM radio broadcast, and TV broadcast transmitter cannot be predicted theoretically with accuracy. To assess the

electromagnetic environment due to fixed RF transmitters, an electromagnetic site survey should be considered. If the measured field strength in the location in which the ultrasound system is used exceeds the applicable RF compliance level as stated in the immunity declaration, the ultrasound system should be observed to verify normal operation. If abnormal operation is observed, additional measures may be necessary, such as re-orienting or relocating the ultrasound system or using an RF shielded examination room may be necessary.

- Use either power supply cords provided by or designated by CHISON. Products equipped with a power source plug should be plugged into the fixed power socket which has the protective grounding conductor. Never use any adaptor or converter to connect with a power source plug (e.g. three-prong-to-two-prong converter).
- Locate the equipment as far away as possible from other electronic equipment.
- Be sure to use only the cables provided by or designated by CHISON. Connect these cables following the installation procedures (e.g. wire power cables separately from signal cables).
- Lay out the main equipment and other peripherals following the installation procedures described in this manual.

### **Notice against User Modification**

The user should never modify this product.

User modifications may cause degradation in Electrical Safety . Modification of the product includes changes in:

- Cables (length, material, wiring, etc.)
- System configuration/components

User modifications may cause degradation in EMC performance. Modification of the product includes changes in:

- Cables (length, material, wiring, etc.)
- System installation/layout
- System configuration/components
- Securing system parts (cover open/close, cover screwing)

## **2.3 Labels**

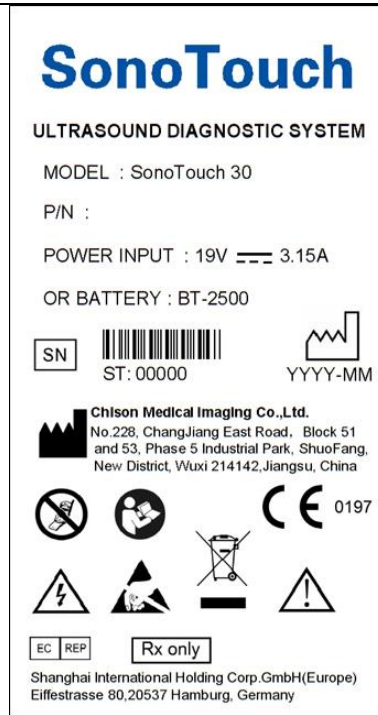















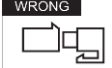

Fig.2-1 Real panel label

### 2.3.1 Warning Symbols

 <p>Caution, consult accompanying documents. This symbol advises the reader to consult the accompanying documents for important safety related information such as warnings and pre-cautions that can not be presented on the device itself.</p>	 <p>Dangerous electric voltage. Unplug the main plug before opening the system!</p>
 <p>Do not use the following devices near this equipment: cellular phone, radio receiver, mobile radio transmitter, radio controlled toy, etc. Use of these devices near this equipment could cause this equipment to perform outside the published specifications. Keep power to these devices turned off when near this equipment.</p>	 <p>Be careful of static.</p>
 <p><b>WASTE OF ELECTRICAL AND ELECTRONIC EQUIPMENT (WEEE):</b> This symbol is used for Environment Protection, it indicates that the waste of electrical and electronic equipment must not be disposed as unsorted waste and must be collected separately. Please contact your local Authority or distributor of the manufacturer for information concerning the decommissioning of your equipment.</p>	 <p>The CE mark of Conformity indicates this equipment conforms with the Council Directive 93/42/EEC</p>

 <p>AUTHORIZED REPRESENTATIVE IN THE EUROPEAN COMMUNITY: This symbol is accompanied by the name and the address of the authorized representative in the European Community.</p>	 <p>Type-BF applied part</p>
 <p>This symbol is followed by the serial number of the device.</p>	 <p>MANUFACTURER: This symbol is accompanied by the name and the address of the manufacturer.</p>
 <p>Power On/off. CAUTION: This Power Switch cannot isolate Mains Supply completely.</p>	 <p>This symbol signifies that the user manual must be read.</p>
 <p>The “Alternating current” symbol indicates that the equipment is suitable for alternating current only.</p>	<p><b>Rx only</b></p> <p>This symbol indicates that in the united states of America, Federal law restricts the device to sale by or on the order of a licensed practitioner or therapist.</p>
 <p>This symbol is followed by the manufacturing date of the device in the form YYYY-MM.</p>	 <p>LOCK OPEN This symbol is probe locked button</p>
 <p>CORRECT</p>  <p>WRONG</p> <p>CORRECT: The correct connection of the battery connector WRONG: The wrong connection of the battery connector</p>	

## 2.4 Patient Environmental Devices

**Profile side** (refer to Fig. 3-1 b in Chapter 3):

- Ethernet port
- USB port
- VGA port
- Video port
- Power port
- Probe
- Probe socket lock switch

**Rear panel** (refer to Fig.3-1 d in Chapter 3)

- Touch pen
- Probe socket lock switch
- Probe Anti-theft lock interface
- Bracket
- Battery box
- Power switch

## **Acceptable Devices**

The Patient Environmental devices shown above are specified to be suitable for use within the PATIENT ENVIRONMENT.

### **CAUTION:**

- DO NOT connect any probes or accessories without approval by CHISON within the PATIENT ENVIRONMENT.
- DO NOT touch patient and devices without IEC/EN 60601-1 approval to avoid the leakage current risk within the PATIENT ENVIRONMENT.

## **Unapproved Devices**

### **CAUTION:**

- DO NOT use unapproved devices.
- If devices are connected without the approval of CHISON, the warranty will be INVALID.
- The system can't be used with HF surgical equipment, otherwise the burns to patient may occur.

Any device connected to this system must conform to one or more of the requirements listed below:

- IEC standard or equivalent standards appropriate to devices.
- The devices shall be connected to PROTECTIVE EARTH (GROUND).

** CAUTION:** Unsafe operation or malfunction may result. Use only the accessories, options and supplies approved or recommended in these instructions for use.

## **Peripheral used in the patient environment**

The system has been verified for overall safety, compatibility and compliance with the following on-board image recording devices:

B/W video printer: Mitsubishi P93W; Sony UP-897MD, Sony UP-D711MD

The system may also be used safely while connected to devices other than those recommended above if the devices and their specifications, installation, and interconnection with the system conform to the requirements of IEC/EN 60601-1-1.

The connection of equipment or transmission networks other than as specified in the user instructions can result in an electric shock hazard or equipment malfunction. Substitute or alternate equipment and connections require verification of compatibility and conformity to IEC/EN 60601-1-1 by the installer. Equipment modifications and possible resulting malfunctions and electromagnetic interference are the responsibility of the owner.

General precautions for installing an alternate off-board, remote device or a network would include:

- The added device(s) must have appropriate safety standard conformance and CE Marking.

- There must be adequate mechanical mounting of the device and stability of the combination.
- Risk and leakage current of the combination must comply with IEC/EN 60601-1.
- Electromagnetic emissions and immunity of the combination must conform to IEC/EN 60601-1-2.

### **Peripheral used in the non-patient environment**

The system has been verified for compatibility, and compliance for connection to a local area network (LAN) via a wire LAN, provided the LAN components are IEC/EN 60950 compliant.

General precautions for installing an alternate off-board, remote device or a network would include:

- The added device(s) must have appropriate safety standard conformance and CE Marking.
- The added device(s) must be used for their intended purpose having a compatible interface.

## **2.5 Biological Safety**

This product, as with all diagnostic ultrasound equipment, should be used only for valid reasons and should be used both for the shortest period of time and at the lowest power settings necessary (**ALARA** - As Low As Reasonably Achievable) to produce diagnostically acceptable images. The AIUM offers the following guidelines:

### ***Clinical Safety Quoted from AIUM***

*Approved March 26, 1997*

*Diagnostic ultrasound has been in use since the late 1950s. Given its known benefits and recognized efficacy for medical diagnosis, including use during human pregnancy, the American Institute of Ultrasound in Medicine herein addresses the clinical safety of such use:*

*There are no confirmed biological effects on patients or instrument operators caused by exposures from present diagnostic ultrasound instruments. Although the possibility exists that such biological effects may be identified in the future, current data indicate that the benefits to patients of the prudent use of diagnostic ultrasound outweigh the risks, if any that may be present.*

**Heating:** Elevating tissue temperature during obstetrical examinations creates medical concerns. At the embryo development stage, the rise in temperature and the length of time exposed to heat combine to determine potential detrimental effects. Exercise caution particularly during Doppler/Color exams. The Thermal Index (TI) provides a statistical estimate of the potential temperature elevation (in centigrade) of tissue temperature. Three forms of TI are available: Soft Tissue Thermal Index (**TIS**), Bone Thermal Index (**TIB**) and Cranial Bone Thermal Index (**TIC**).

**Soft Tissue Thermal Index (TIS).** Used when imaging soft tissue only, it provides an estimate of potential temperature increase in soft tissue.

**Bone Thermal Index (TIB).** Used when bone is near the focus of the image as in the third trimester OB examination, it provides an estimate of potential temperature increase in the bone or adjacent soft tissue.

**Cranial Bone Thermal Index (TIC).** Used when bone is near the skin surface as in transcranial examination, it provides an estimate of potential temperature increase in the bone or adjacent soft tissue.

**Cavitation:** Cavitation may occur when sound passes through an area that contains a cavity, such as a gas bubble or air pocket (in the lung or intestine, for example). During the process of cavitation, the sound wave

may cause the bubble to contract or resonate. This oscillation may cause the bubbles to explode and damage the tissue. The Mechanical Index (MI) has been created to help users accurately evaluate the likelihood of cavitation and the related adverse effects.

**MI** recognizes the importance of non-thermal processes, cavitation in particular, and the Index is an attempt to indicate the probability that they might occur within the tissue.

## 2.6 Scanning Patients and Education

The **Track-3** or **IEC60601-2-37** output display standard allows users to share the responsibility for the safe use of this ultrasound system. Follow these usage guidelines for safe operation:

- In order to maintain proper cleanliness of the probes, always clean them between patients.
- Always use a disinfected sheath on all EV/ER probes during every exam.
- Continuously move the probe, rather than staying in a single spot, to avoid elevated temperatures in one part of the patient's body.
- Move probe away from the patient when not actively scanning.
- Understand the meaning of the TI, TIS, TIB, TIC and MI output display, as well as the relationship between these parameters and the thermal/cavitation bioeffect to the tissue.
- Expose the patient to only the very lowest practical transmit power levels for the shortest possible time to achieve a satisfactory diagnosis (**ALARA** - As Low As Reasonably Achievable).

### Safe Scanning Guidelines

- Ultrasound should only be used for medical diagnosis and only by trained medical personnel.
- Diagnostic ultrasound procedures should be done only by personnel fully trained in the use of the equipment, in the interpretation of the results and images, and in the safe use of ultrasound (including education as to potential hazards).
- Operators should understand the likely influence of the machine controls, the operating mode (e.g. B-mode, color Doppler imaging or spectral Doppler) and probe frequency on thermal and cavitation hazards.
- Select a low setting for each new patient. Output should only be increased during the examination if penetration is still required to achieve a satisfactory result, and after the Gain control has been moved to its maximum value.
- Maintain the shortest examination time necessary to produce a useful diagnostic result.
- Do not hold the probe in a fixed position for any longer than is necessary. It should be removed from the patient whenever there is no need for real-time imaging or spectral Doppler acquisition. The frozen frame and Cine loop capabilities allow images to be reviewed and discussed without exposing the patient to continuous scanning.
- Do not use endo-cavitary probes if there is noticeable self heating of the probe when operating in the

air. Although applicable to any probe, take particular care during trans- vaginal exams during the first eight weeks of gestation.

- Take particular care to reduce output and minimize exposure time of an embryo or fetus when the temperature of the mother is already elevated.
- Take particular care to reduce the risk of thermal hazard during diagnostic ultrasound when exposing: an embryo less than eight weeks after gestation; or the head, brain or spine of any fetus or neonate.
- Operators should continually monitor the on-screen thermal index (TI) and mechanical index (MI) values and use control settings that keep these settings as low as possible while still achieving diagnostically useful results. In obstetric examinations, TIS (soft tissue thermal index) should be monitored during scans carried out in the first eight weeks after gestation, and TIB (bone thermal index) thereafter. In applications where the probe is very close to bone (e.g. trans-cranial applications), TIC (cranial bone thermal index) should be monitored.

MI > 0.3            There is a possibility of minor damage to neonatal lung or intestine. If such exposure is necessary, reduce the exposure time as much as possible.

MI > 0.7            There is a risk of cavitation if an ultrasound contrast agent containing gas microspheres is being used. There is a theoretical risk of cavitation without the presence of ultrasound contrast agents. The risk increases with MI values above this threshold.

TI > 0.7            The overall exposure time of an embryo or fetus should be restricted in accordance with **Table 2-2** below as a reference:

TI	Maximum exposure time (minutes)
0.7	60
1.0	30
1.5	15
2.0	4
2.5	1

Table 2-2 Maximum recommended exposure times for an embryo or fetus

- Non-diagnostic use of ultrasound equipment is not generally recommended. Examples of non-diagnostic uses of ultrasound equipment include repeated scans for operator training, equipment demonstration using normal subjects, and the production of souvenir pictures or videos of a fetus. For equipment of which the safety indices are displayed over their full range of values, the TI should always be less than 0.5 and the MI should always be less than 0.3. Avoid frequent repeated exposure of any subject. Scans in the first trimester of pregnancy should not be carried out for the sole purpose of producing souvenir videos or photographs, nor should their production involve increasing the exposure levels or extending the scan times beyond those needed for clinical purposes.



- Diagnostic ultrasound has the potential for both false positive and false negative results. Misdiagnosis is far more dangerous than any effect that might result from the ultrasound exposure. Therefore, diagnostic ultrasound system should be performed only by those with sufficient training and education.

## Understanding the MI/TI Display

**Track-3** follows the Output Display Standard for systems that include fetal Doppler applications. The acoustic output will not be evaluated on an application-specific basis, but the **global maximum de-rated Ispta** must be  $\leq 720 \text{ mW/cm}^2$  and either the **global maximum MI** must be  $\leq 1.9$  or the **global maximum de-rated Isppa** must be  $\leq 190 \text{ W/cm}^2$ . An exception is for ophthalmic use, in which case the  $\text{TI} = \max(\text{TIS}_{\text{as}}, \text{TIC})$  is not to exceed 1.0;  $\text{Ispta.3} \leq 50 \text{ mW/cm}^2$ , and  $\text{MI} \leq 0.23$ . **Track-3** gives the user the freedom to increase the output acoustic power for a specific exam, and still limit output acoustic power within the **global maximum de-rated Ispta**  $\leq 720 \text{ mW/cm}^2$  under an Output Display Standard.

For any diagnostic ultrasonic systems, **Track-3** provides an Output Indices Display Standard. The diagnostic ultrasound systems and its operator's manual contain the information regarding an **ALARA** (As Low As Reasonably Achievable) education program for the clinical end-user and the acoustic output indices, **MI** and **TI**. The MI describes the likelihood of cavitation, and the TI offers the predicted maximum temperature rise in tissue as a result of the diagnostic examination. In general, a temperature increase of  $2.5 \text{ }^\circ\text{C}$  must be present consistently at one spot for 2 hours to cause fetal abnormalities. Avoiding a local temperature rise above  $1 \text{ }^\circ\text{C}$  should ensure that no thermally induced biologic effect occurs. When referring to the TI for potential thermal effect, a TI equal to 1 does not mean the temperature will rise 1 degree C. It only means an increased potential for thermal effects can be expected as the TI increases. A high index does not mean that bioeffects are occurring, but only that the potential exists and there is no consideration in the TI for the scan duration, so minimizing the overall scan time will reduce the potential for effects. These operator control and display features shift the safety responsibility from the manufacturer to the user. So it is very important to have the Ultrasound systems display the acoustic output indices correctly and the education of the user to interpret the value appropriately.

### **RF: (De-rating factor)**

In Situ intensity and pressure cannot currently be measured. Therefore, the acoustic power measurement is normally done in the water tank, and when soft tissue replaces water along the ultrasound path, a decrease in intensity is expected. The fractional reduction in intensity caused by attenuation is denoted by the de-rating factor (RF),

$$\text{RF} = 10^{(-0.1 a f z)}$$

Where  $a$  is the attenuation coefficient in  $\text{dB cm}^{-1} \text{ MHz}^{-1}$ ,  $f$  is the transducer center frequency, and  $z$  is the distance along the beam axis between the source and the point of interest.

De-rating factor RF for the various distances and frequencies with attenuation coefficient  $0.3 \text{ dB cm}^{-1} \text{ MHz}^{-1}$  in homogeneous soft tissue is listed in the following table. An example is if the user uses  $7.5 \text{ MHz}$  frequency, the power will be attenuated by .0750 at 5cm, or  $0.3 \times 7.5 \times 5 = -11.25 \text{ dB}$ . The De-rated Intensity is also referred to as '.3' at the end (e.g. Ispta.3).

Distance (cm)	Frequency (MHz)			
	1	3	5	7.5
1	0.9332	0.8128	0.7080	0.5957
2	0.8710	0.6607	0.5012	0.3548
3	0.8128	0.5370	0.3548	0.2113
4	0.7586	0.4365	0.2512	0.1259
5	0.7080	0.3548	0.1778	0.0750
6	0.6607	0.2884	0.1259	0.0447
7	0.6166	0.2344	0.0891	0.0266
8	0.5754	0.1903	0.0631	0.0158

$I' = I * R_F$  Where  $I'$  is the intensity in soft tissue,  $I$  is the time-averaged intensity measured in water.

### **Tissue Model:**

Tissue temperature elevation depends on power, tissue type, beam width, and scanning mode. Six models are developed to mimic possible clinical situations.

Thermal Models	Composition	Mode	Specification	Application	
1	TIS	Soft tissue	Unscanned	Large aperture (>1cm <sup>2</sup> )	Liver PW
2	TIS	Soft tissue	Unscanned	Small aperture (<1cm <sup>2</sup> )	Pencil Probe
3	TIS	Soft tissue	Scanned	Evaluated at surface	Breast color
4	TIB	Soft tissue and bone	Scanned	Soft tissue at surface	Muscle color
5	TIB	Soft tissue and bone	Unscanned	Bone at focus	Fetus head PW
6	TIC	Soft tissue and bone	Unscanned/scanned	Bone at surface	Transcranial

### **Soft tissue:**

Describes low fat content tissue that does not contain calcifications or large gas-filled spaces.

### **Scanned:** (auto-scan)

Refers to the steering of successive burst through the field of view, e.g. B and color mode.

### **Unscanned:**

Emission of ultrasonic pulses occurs along a single line of sight and is unchanged until the transducer is moved to a new position. For instance, the PW, CW and M mode.

### **TI:**

TI is defined as the ratio of the In Situ acoustic power ( $W_3$ ) to the acoustic power required to raise tissue temperature by 1 °C ( $W_{deg}$ ),  $TI = W_3/W_{deg}$ .

Three TIs corresponding to soft tissue (TIS) for abdominal; bone (TIB) for fetal and neonatal cephalic; and cranial bone (TIC) for pediatric and adult cephalic, have been developed for applications in different exams.

An estimate of the acoustic power in milliwatts necessary to produce a 1 °C temperature elevation in soft tissue is:

$$W_{deg} = 210/f_c, \quad \text{for model 1 to 4, where } f_c \text{ is the center frequency in MHz.}$$

$$W_{deg} = 40 K D \quad \text{for model 5 and 6, where } K \text{ (beam shape factor) is 1.0, } D \text{ is the aperture diameter in cm at the depth of interest.}$$

### **MI:**

Cavitation is more likely to occur at high pressures and low frequencies in pulse ultrasound wave in the tissue, which contains the bubble or air pocket (for instance, the lung, intestine, or scan with gas contrast agents). The threshold under optimum conditions of pulsed ultrasound is predicted by the ration of the peak pressure to the square root of the frequency.

$$MI = Pr' / \text{sqrt}(fc)$$

Pr' is the de-rated (0.3) peak rare-fractional pressure in Mpa at the point where PII is the maximum, and fc is the center frequency in MHz. PII is the Pulse Intensity Integral that the total energy per unit area carried by the wave during the time duration of the pulse. The peak rare-fractional pressure is measured in hydrophone maximum negative voltage normalized by the hydrophone calibration parameter.

### **Display Guideline:**

For different operation modes, different indices must be displayed. However, only one index needs to be shown at a time. Display is not required if maximum **MI** is less than 1.0 for any setting of the operating mode, or if maximum **TI** is less than 1.0 for any setting of the operating mode. For **TI**, if the **TIS** and **TIB** are both greater than 1.0, the scanners need not be capable of displaying both indices simultaneously. If the index falls below 0.4, no display is needed.

### **Display and Report in Different Mode**

Located on the upper middle section of the system display monitor, the acoustic output display provides the operator with real-time indication of acoustic levels being generated by the system.

For B-Scan Mode

Only display and report **MI**, and start from 0.4 if maximum **MI** > 1.0, display in increments of 0.2.

For Color Mode

Only display and report **TIS or TIB** and start from 0.4 if maximum **TI** > 1.0, display in increments of 0.2 for values of indices of 2.0 or less, and 0.5 for values of indices greater than 2.0.

Below is a simple guideline for the user when TI exceeds one limit exposure time to  $4^{(6-TI)}$  minutes based on the 'National Council on Radiation Protection. Exposure Criteria for Medical Diagnostic Ultrasound: I. Criteria Based on Thermal Mechanisms. Report No.113 1992'.

### **Operator Control Features:**

The user should be aware that certain operator controls may affect the acoustic output. It is recommended to use the default (or lowest) output power setting and compensate using Gain control to acquire an image. Other than the output power setting in the soft-menu, which has the most direct impact on the power; the PRF, image sector size, frame rate, depth, and focal position also slightly affect the output power. The default setting is normally around 70% of the allowable power depending on the exam application mode.

### **Controls Affecting Acoustic Output**

The potential for producing mechanical bioeffects (MI) or thermal bioeffects (TI) can be influenced by certain controls.

Direct: The Acoustic Output control has the most significant effect on Acoustic Output.

Indirect: Indirect effects may occur when adjusting controls. Controls that can influence MI and TI are detailed under the Bioeffects portion of each control in the Optimizing the Image chapter.

Always observe the Acoustic Output display for possible effects.

### **Best practices while scanning**

**HINTS:** Raise the Acoustic Output only after attempting image optimization with controls that have no effect on Acoustic Output, such as Gain and TGC.

 **WARNING:** Be sure to have read and understood control explanations for each mode used before attempting to adjust the Acoustic Output control or any control that can effect Acoustic Output.

Use the minimum necessary acoustic output to get the best diagnostic image or measurement during an examination. Begin the exam with the probe that provides an optimum focal depth and penetration.

### **Acoustic Output Default Levels**

In order to assure that an exam does not start at a high output level, the system initiates scanning at a reduced default output level. This reduced level is preset programmable and depends upon the exam icon and probe selected. It takes effect when the system is powered on or New Patient is selected. To modify acoustic output, adjust the Power Output level on the Soft Menu.

# Chapter 3 Preparing the System for Use

## 3.1 Site Requirement

### 3.1.1 Operation Environmental Requirement

The following environmental conditions are within system tolerances for operation:

Temperature:	10 °C ~ 40 °C
Relative Humidity:	30%~75%, non-condensing
Atmosphere Pressure:	700hPa ~ 1060hPa

Strong radiation sources or powerful electromagnetic waves (e.g. electro-magnetic waves from radio broadcasting) may result in image ghosting or noise. The system should be isolated from such radiation sources or electromagnetic waves.

### 3.1.2 Transport and Storage Environmental Requirement

The following environmental transport and storage conditions are within system tolerances:

Temperature:	-5 °C ~ 40 °C
Relative Humidity:	≤ 80% non-condensing
Atmosphere Pressure:	700hPa ~ 1060hPa

### 3.1.3 Electrical Requirements

#### Power Requirements

Input: 100-250V~1.5-0.75A, 50-60Hz

Battery Pack: BT-2500, 4400mAh, DONGGUAN POWER INC

**Power Consumption:** less than 60 watts

#### Voltage Fluctuation

#### **WARNING**

*Maintain a fluctuation range of less than  $\pm 10\%$  of voltage labeling on rear panel of the system, otherwise the system may be damaged.*

#### **NOTE**

- *Please follow the outlined power requirements. Only use power cables that meet the system guidelines—failure to follow these procedures may produce system damage.*
- *Line power may vary in different geographic locations. Refer to the detailed ratings on the rear panel of the system for detailed information.*
- **Battery**  
*To avoid the battery bursting, igniting, or fumes from the battery; causing equipment damage, observe the following precautions: Do not immerse the battery in water or allow it to get wet. Do not put the battery into a microwave oven or pressurized container. If the battery leaks or emits an odor, remove it from all possible flammable sources. If the battery emits an odor or heat, is deformed or discolored, or in a way appears abnormal during use, recharging or storage, immediately remove it and stop using it. If you have any questions about the battery, Short term (less than one month)*

storage of battery pack: Store the battery in a temperature range between 0 degrees C (32 degrees F) and 50 degrees C(122 degrees F).

Long term (3 months or more) storage of battery pack: Store the battery in a temperature range between -20 degrees C (-4 degrees F) and 45 degrees C(113 degrees F); Upon receipt of the SonoTouch and before first time usage, it is highly recommended that the customer performs one full discharge/charge cycle. If the battery has not been used for >2 months, the customer is recommended to perform one full discharge/charge cycle. It is also recommended to store the battery in a shady and cool area with FCC (full current capacity). • One Full Discharge/Charge Cycle Process: 1. Full discharge of battery to let the SonoTouch automatically shut down. 2. Charge the SonoTouch to 100% FCC (full current capacity). 3. Discharge of Venue 40 for complete shut down(takes one hour for discharge). • When storing packs for more than 6 months, charge the pack at least once during the 6 month timeframe to prevent leakage and deterioration in performance

## 3.2 System Specifications

### 3.2.1 Console Overview



Fig. 3-1 a: Console Overview

The following pictures show the system in different views.

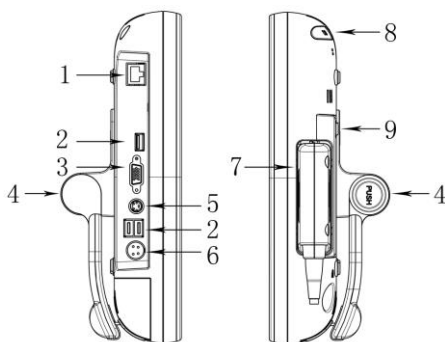

Fig. 3-1 b: System Side View

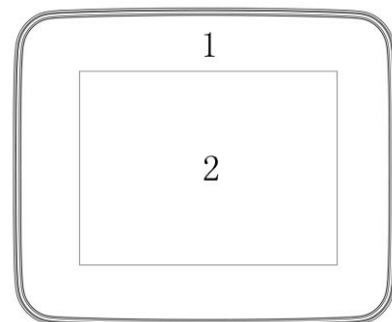

Fig. 3-1 c: System Front View

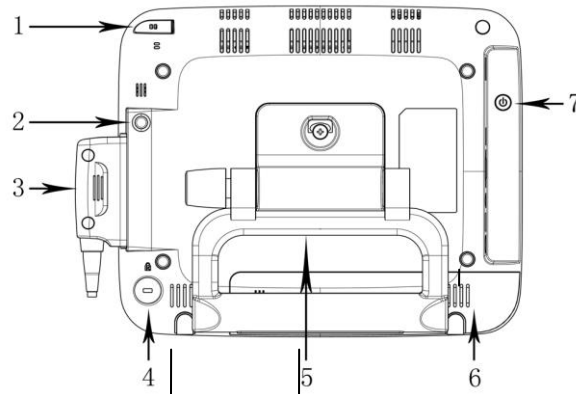

Fig. 3-1 d: System Rear View

### 3.2.2 Physical Specifications

Dimensions of main unit (approx.): 55mm (Width) \*315mm (Length) \*264mm (Height)

### 3.2.3 Icon System Features

- Full digital transmitting and receiving beam-former
- Full digital demodulation and detection
- Wideband pulser receiver
- Super low noise TGC with high resolution ADC
- Progressive dynamic receiving focusing
- Progressive dynamic aperture opening
- Progressive dynamic apodization
- Compound imaging
- Support dual and quad display format
- Flexible hardware and firmware reconfiguration and software upgrade
- Multi-language
- Native resolution scan converter for LED display
- Support Convex, Linear, Micro-convex
- Cardiac, Ob measurement package
- Digital Clips saving in System or PC format
- Biopsy guide display
- DICOM interface
- VGA port output for external image display and peripherals
- USB2.0 flash mobile drive
- Built-in Easy network for direct PC image accessing
- Full function unit designed for general practice and specialist clinic

### 3.2.4 Image Modes

- B mode
- Multiple screen format
- Color Doppler Imaging
- PW mode
- B/M mode
- Tissue Harmonic Imaging
- Dual display (Dual B and real time dual color)
- Quad display

### 3.2.5 Accessories

#### Transducers:

- C3, 3.5MHz Convex Array
- MC3, 3.0MHz Convex Array
- V6, 6.0MHz Micro-convex Array
- L7M, 7.5MHz Linear Array
- L7S, 9.0MHz Linear Array
- R7, 7.5MHz Linear Array
- P3, 3.0MHz Phased Array
- L7L, 10.0MHz Linear Array
- MC5V, 5.0MHz Convex Array
- MC6, 6.0MHz Convex Array

#### Peripherals

VGA output for external monitor

S -VIDEO/ output for B&W video printer or Color video printer

Ethernet for DICOM and image review station

USB 2.0 for flash drive

AC/DC adapter: MDS-060AAS19 B

Input: 100-250V~1.5-0.75A, 50-60Hz

Output: 19V $\overline{\text{~}}$ 3.15A

DELTA ELECTRONICS, INC.

Battery Pack: BT-2500, 4400mAh, DONGGUAN POWER INC

### 3.2.6 Configuration of the System

1. Display mode: B, B/B, 4B, B/M, M Color mode and PW mode. In the M or B/M mode, 4 steps sweep speeds.
2. Multi-step display magnification, depth adjustment;
3. Setting adjustment of total gain, and 8 segments of TGC slides for selection and adjustment;
4. Multifocal firing focus, edge enhancement, frame averaging, compound ;
5. Image freezing and storage function, Built-in 16GB high-speed memory, and external USB memory disk can be connected to the system for mass storage through USB port; and the stored images can be retrieved for analysis;
6. 256 frames of real-time images can be stored in Cine-memory;
7. Probe scanning direction can be changed and the image can be reversed in left/right, up/down direction;
8. Measurements as distance, area, circumference, volume, OB etc. are available; and automatic calculation of OB, cardiology are available, direct display of gestation age and expected date of child delivery, and can direct measure heart rate;
9. Real-time clock displays the date and time automatically;
10. Display of body marks with corresponding probe position indication;
11. Biopsy function;
12. Annotation function in image area of the screen, special annotation terms for different exam-mode can be added according to user's requirement;



13. Standard PAL or NTSC video frequency signal and VGA signal output;
14. Print or export graphic reports;
15. DICOM transmit, print;
16. Multilingual support

### 3.3 System Positioning & Transporting

#### Moving the System

When moving or transporting the system, take the precautions described below to ensure maximum safety for personnel, the system and other equipments.

#### Before Moving the System

- Completely switch off the system..
- Unplug the power cord (if the system is plugged into wall outlet).
- Disconnect all cables from off-board peripheral devices (external printer, etc.) from the console.

#### **NOTE**

*To prevent damage to the power cord, DO NOT pull excessively on the cord or sharply bend the cord while wrapping it.*

- Store all probes in their original cases or wrap them in soft cloth or foam to prevent damage.
- Replace gel and other essential accessories in the appropriate storage case.
- Ensure that no loose items are left on the console.
- Unlock the wheels.

#### When Moving the System

- Use the rear handle to move the system.
- Take extra care when you move the system long distances and on inclines. Ask for help if necessary. Avoid ramps that are too steeper to tip over the system. Utilize additional care and personnel when moving on steep incline ( $> 5^\circ$ ) or loading into a vehicle for transport.
- Use the foot brake (pedal), located on the bottom of the system in the front, when necessary.
- Use extra care when crossing door or elevator thresholds.
- Lock the wheels once the destination is reached.

#### **CAUTION**

- *Walk slowly and carefully when moving the system.*
- *Be sure the pathway is clear.*
- *Use two or more persons to move the system on inclines or long distances.*
- *Do not let the system strike walls or doorframe.*

#### Transporting the System

Use extra care when transporting the system in a vehicle. After preparing the system as described above, take the following additional precautions:

- Only use vehicles that are suitable for transport of the system.
- Before transporting, place the system in its original storage carton.
- Load and unload the system to a vehicle parked on a level surface.
- Load the unit aboard the vehicle carefully and over its center of gravity. Keep the unit still and upright.
- Ensure that the transporting vehicle can bear the weight of system plus the passengers.

- While the system is on a lift, lock the system first. Ensure that the lift is capable of bear the weight of the system and the passengers. To avoid the movement of the system, secure the system by using wood chocks, restraining straps or other similar types of constraints.
- Employ two to three persons to load and unload safely from a vehicle.
- Secure the system firmly with straps or as directed within the vehicle to prevent movement during transport. Any movement, coupled with the weight of the system, could cause it to break loose.
- Drive carefully to prevent damage from vibration. Avoid unpaved roads, excessive speeds, and erratic stops or starts.

## 3.4 Powering the System

### 3.4.1 Acclimation Time

After being transported, the unit requires one hour for each 2.5 °increment if its temperature is below 10 °C or above 40 °C.

#### **NOTE**

*Please keep at least 20 to 30 cm spare space away from the back of the system to ensure well ventilation. Otherwise, with the increasing of the temperature inside the unit, malfunction may occur.*

### 3.4.2 Connecting the electric power

After making sure that the AC power supply in hospital is in normal status, and this AC voltage type matches to the power requirements indicated on the label of system, then please connect the plug of power cord to the POWER IN socket at the rear panel of the system, and connect the other end of power cord to the AC power supply socket in hospital.

Please use the power cable provided by the manufacturer, other type of power cable is not allowed.

#### **CAUTION**

Connecting the system to the wrong AC power supply may cause damage to the system and danger to the operators and animals.

## 3.5 Probes

#### **CAUTION**

Before connecting the probe, please carefully check the probe lens, probe cable and probe connector to see whether there is anything abnormal, such as cracks, falls off. Abnormal probe is not allowed to connect to the system; otherwise there is possibility of electricity shock.

- Hold the probe connector lock switch, and insert the connector socket vertically.
- Release the probe lock switch.
- Check the locked probe with one hand to make sure that it's not loose, and it's securely connected

#### **CAUTION**

- Only power supply at “turn off” state, can install / take-down the probe, otherwise it will damage the machine or the probe.
- Before inserting the probe to the socket, please check the lock knob and lock tongue position, otherwise it will cause damage of the probe and system.
- If probe is not correctly or completely inserted to the probe, or if probe is not securely connected to the

socket, this may cause mis-operation, e.g. the probe cannot be recognized by the system, mis-recognized, or the probe may drop off from the main unit and be damaged.

- When installing and disassembling probe, please put the probe head inside the probe holder, it can prevent the probe falling down to the ground.

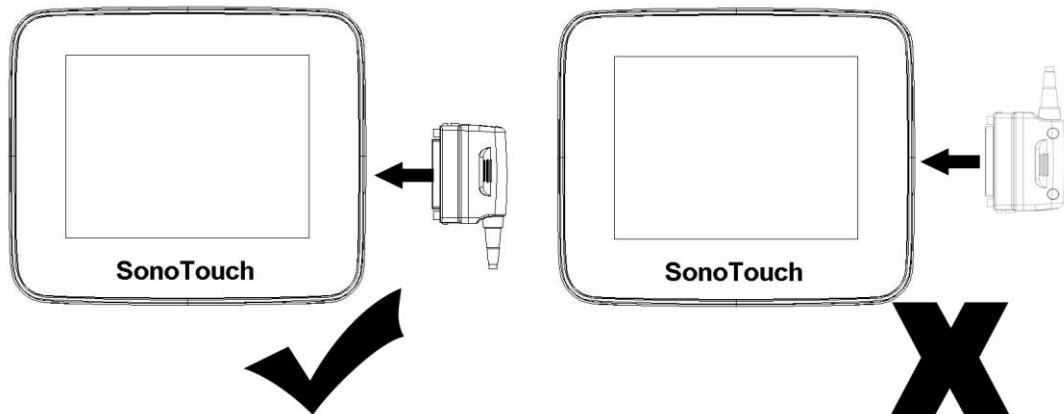

Fig.3-2 Schematic diagram of the probe Insertion direction

### Deactivating the Probe

Press and hold the probe lock switch and pull out the probe vertically.

# Chapter 4 Control panel

## 4.1 Overview of display area

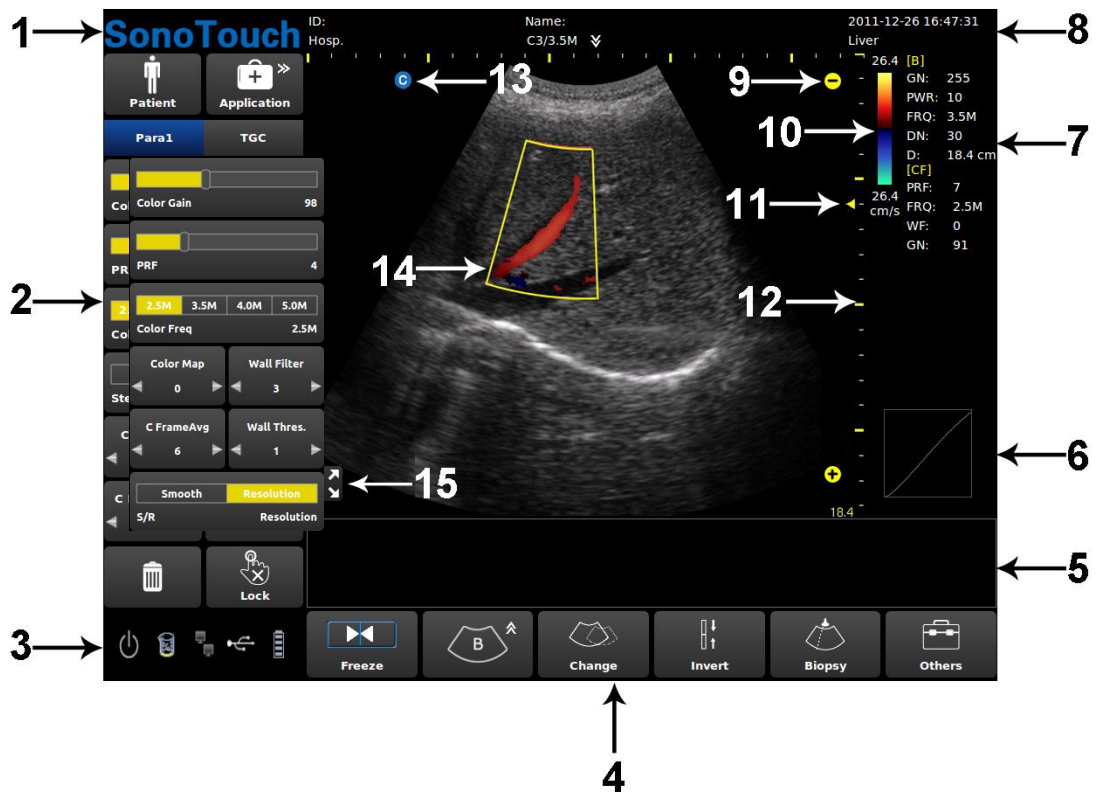

Fig 4.1a Display Interface

- 1, SonoTouch Logo
- 2, Parameter control area
- 3, Information indicating area
- 4, Operating area of the image
- 5, saving area of the image
- 6,  $\gamma$  correction
- 7, Parameter display area
- 8: Patient information, time, date and check mode display area
- 9, Depth of the adjustment button
- 10, color bar
- 11, Focus NO. and position
- 12 Rulers
- 13, Start mark of sweeping
- 14, color sample box
- 15, Image fullscreen button

## 4.2 Operating area of active state

### 4.2.1 PATIENT



Set up a new patient data, and can input animal name and other information.

### 4.2.2 APPLICATION



Touch this icon of Selection of examination mode, it will pop out the selection interface of correspond probe

### 4.2.3 Para1

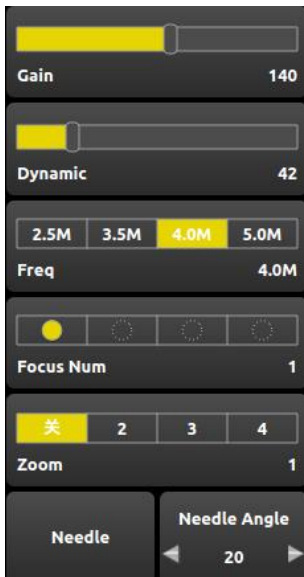

Parameters area1: Include Gain, Dynamic, Frequency, Focus number, Zoom, Needle, Needle Angle.

### 4.2.4 Para2



Parameters area2: Include Acoustic, Scan Width, High Density, Smooth, Edge, Frame Avg., i-Image, B Color Map, M color Map, Compound(CPD), SRA, THI, MB.

This parameter is required to open at real time state through the [Others] button.

### 4.2.5 TGC

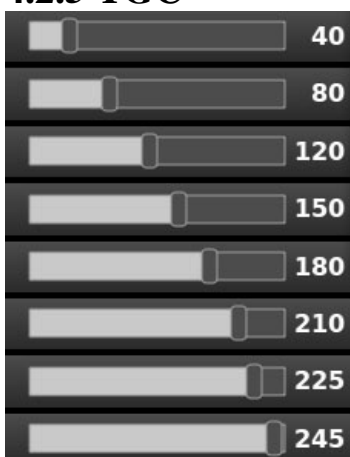

8 segment TGC.

## 4.2.6 Freeze



When touch this icon, it freeze or de-freeze the image, and after freezing, it will appear the function icon of the freezing mode.

## 4.2.7 B



When touch this icon, B/2B/4B can switch each other or cancel color mode...

## 4.2.8 Color



When touch this icon, color mode will be in use.

## 4.2.9 L/R



Imaging invert: including invert from Left and Right or from Up and Down.

## 4.2.10 Biopsy



When touch this icon, it will appear or disappear biopsy function.

## 4.2.11 Others



This icon including Setup, Archive, Print, Other Para icon.

## 4.2.12 Setup



When touch this icon, it will get into the setup interface, and you can set the system setup.

## 4.2.13 Archive



File management system of animal, and you can view and edit animal data.

## 4.2.14 Print



Print the screen image directly when video printer is connected to the system

If the DICOM function is opened, you can also choose DICOM Print.

## 4.2.15 Other Para.

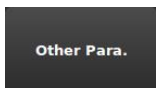

When touch this icon, it will switch to Para2 parameter area.

## 4.2.16 Trash



Clear measurement track, annotation, body-marker and other information, or rollback functions for measuring process.

## 4.2.17 Lock



Close or open the sliding operate parameters function in the image area

## 4.2.18 Image fullscreen mode



Enlarge the image to fullscreen display

## 4.3 Operation area of color mode

### 4.3.1 Para1

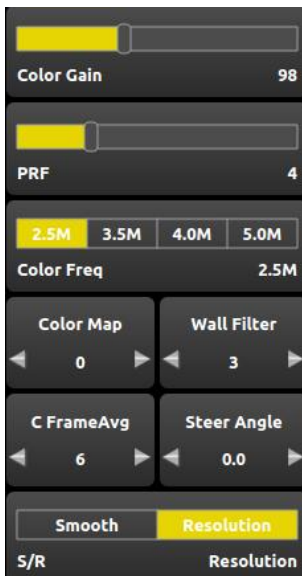

Para1: contains of Color Gain, PRF, Color Freq, Color Map, Wall Filter, C Frame Avg, Steer Angle and Smooth/Resolution.

### 4.3.2 Change



When touch this icon, moving state and zoom state of color sampling box can switch each other

### 4.3.3 Invert



Blood flow can be flipped.◦

## 4.4 Operation area of PW mode

### 4.4.1 Para 1

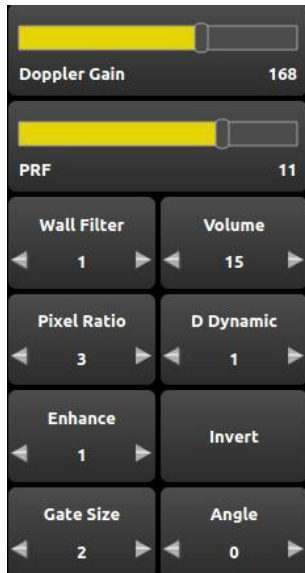

Para1: contains of Doppler Gain, PRF, Wall Filter, Volume, Pixel Ratio, D Dynamic, Enhance, Invert, Gate Size, Angle

## 4.5 Operation area of freezing state

### 4.5.1 Measure



Touch this icon to enter into the measurement state of current examination mode measurement state.

### 4.5.2 Body



Touch this icon to enter Body mark working status, select the body mark and confirm the probe scanning position on the screen. It is only available in frozen status.

### 4.5.3 Annotation



Touch this icon to enter into comment status, and add comments in the image area on the screen.

### 4.5.4 Arrow



Add arrows icon to the image area.

### 4.5.5 Report



When in the report interface, can view and edit patient information

### 4.5.6 Archive



File management system of animal, and you can view and edit animal data.



## 4.6 Information area for machine state



Left-to-right: shut down, Hard disk, cable network, USB, battery gauge, touch the icon, it will appears corresponding information and operation.

## 4.7 The thumbnail area of saving images

The saved cine or image would be displayed under the image area for users choosing playback or post-processing quickly.

## 4.8 Image parameter area

Display different parameters under different mode. The different display mode has different parameters.

## 4.9 Cine memory bar



Display the frame of current cine memory. By touching on the screen manually or automatically to playback and display two B-type images side by side.

## 4.10 Soft iconboard



Fig 4.1b Soft iconboard

- 1: Sensitive switch icon    2: digital character iconboard switching icon  
 3: Chinese and English input switching icon    4: the backspace icon    5: the shift icon  
 6: the hidden iconboard icons

### **Caution**

The system has Chinese input defaults to the double-spelling input.

# Chapter 5 Imaging

This chapter will introduce image display modes and the operation of image control and adjustment.

## 5.1 Select display mode

There are five image display modes: B, B/B, 4B, M, B/M, and color mode can be shifted by the mode icon.



### 5.1.1 Single B mode

Touch [B] icon to display single B mode image. B mode is the basic operating mode for two-dimensional scanning and diagnosis.

### 5.1.2 B/B Mode

Touch [B/B] icon display double B mode images side by side. One image is in real-time status; the other is in frozen status. The real-time image has start scan marker and ruler marker. Touch B/B icon in [B/B] mode, the original active image is frozen while the original frozen image is activated and is ready for real-time scan.

### 5.1.3 4B Mode

Touch [4B] icon, to enter 4B mode, screen displays four B mode images side by side, but only one image is in real-time status. Touch 4B icon can switch the real-time status among four images.

### 5.1.4 B/M Mode

Touch [B/M] icon to display real time B-mode image and real-time M-mode image at the same time. And a dotted sampling line will appear in the B-mode image area, which indicates the active sampling position for M image on the B image area. Touch the position which you are interested on the B image area to fix the position of sampling line.

### 5.1.5 M Mode

Press [B/M] icon again, B mode image will disappear; M mode image is still active in the whole screen.

### 5.1.6 Color Mode

Color mode is a technique for displaying blood flow's velocity and direction on B mode image. Based on Doppler effect. Normally the blood flow, which moves toward the probe scan direction is marked in red, while blood flow which moves away from probe scan direction is marked in blue. Touch [Color] icon, screen only displays color mode operation interface.

### 5.1.7 PW mode

PW mode is a technique for displaying measurement data for tissue in movement and speed of blood. Examine the blood selectively from a small range named as sample gate. Touch [PW] icon, screen displays PW mode operation interface.

## 5.2 Select Examination mode

### 5.2.1 Probe identify

When you connect one probe, the system will identify the probe automatically.



**Caution**

When inserting the probe, please make sure the surface which has CHISON green logo is always upside.

### 5.2.2 Select examination mode

Touch 『Application』 icon, the examination interface will pop-up, according to the type of probe and the sex of people, different examination will be activated. Touch the icon to enter into the preset which you want.

## 5.3 Image control and adjustment

Most of parameters are displayed on the parameter control area. It looks like the following illustration

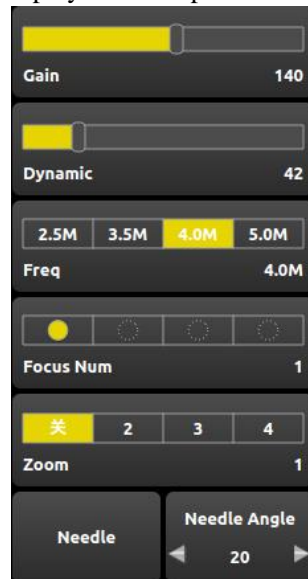

Fig 5-5 Para1



Fig 5-6 Para 2

### 5.3.1 Total Gain

At the real-time status, drag the slide of gain to adjust the gain value from 0 to 255, the least adjustable level 1.

### 5.3.2 Dynamic range

Dynamic range is used for adjusting the contrast resolution of B mode image and mode image, compressing or enlarging the display range of gray scale.

At the real-time status, drag the slide of dynamic to adjust the gain value from 30 to 90.16 steps for adjust.

### 5.3.3 Frequency

Touch the numerical value of frequency to choose it. The range of the frequency depends on different probe.

### 5.3.4 Focus number

In B mode, maximum 4 focus points can be selected simultaneously, and the number of focus depend on the depth.

Touch the dot to adjust the focus number, adjust range from 1~4.

#### **Note**

There is only 1 focus in B/M or M display mode, so Focus number cannot be changed in B/M or M display mode.

### 5.3.5 Focus position

Touch on focus icon and keep pressing it, when the focus becomes big. Then drag it up and down to adjust the focus position.

A long press on the B mode image area where you are interested in also can fit the focus position.

When changing the focus position, multiple focuses can move at the same time (if Focus No. is more than 1), and the focus cannot be moved out of the image display area.

### 5.3.6 Compound

Touch [on] or [Off] on [Compound] icon to turn on/off the compound function.

### 5.3.7 SRA

Touch [on] or [Off] on [SRA] icon to turn on/off the SRA function.

### 5.3.8 THI

Touch [on] or [Off] on [THI] icon to turn on/off the harmonic function.

### 5.3.9 Zoom

Choose the step by touching the icon 『Zoom』 .

Press the B mode image area, and then drag it to fit the position where you are interested in

### 5.3.10 Depth

Touch the “+” or “-” to adjust the depth.

You can also drag the image area up and down on the screen to adjust the depth, when the [Lock] is not opened...

### 5.3.11 Acoustic

Acoustic power means the acoustic power transmitting from the probe.

At the real-time status, drug the slide of gain to adjust the acoustic value, the least adjustable level is 1 dB/level.

### 5.3.12 Scan Width

At the real-time status, touch 『Other』 icon.

Touch the arrow on the 『Scan Width』 icon to adjust the scan width. Its range is 0~3.

### 5.3.13 High Density

Scan Line Density function is used to adjust the density of the scan lines on B mode image. This function is only valid for the image in B mode, B/B mode, B/M mode or 4B mode image. The line density has two types: high density and low density. High density means better image quality while low density image has higher frame rate.

To do the adjustment, please touch [Others] icon at the real-time first, and then touch the arrow on the [High Density] icon to adjust the high density. Its range is 0~1.

### 5.3.14 Smooth

Smoothness function is used for restraining the image noise and performing axial smooth processing to make the image smoother.

To do the adjustment, please touch [Others] icon at the real-time first, and then touch the arrow on the [Smooth] icon to adjust the smooth. Its range is 0~7.

### 5.3.15 Edge enhance

Edge enhancement is used for enhancing the image outline. In this way the user can view the tissue structure more clearly. Its range is 0~3. 0 stands for no edge enhancement, and 3 stands for the maximum edge enhancement.

To do the adjustment, please touch [Others] icon at the real-time first, and then touch the arrow on the [Edge] icon to adjust the edge enhance. Its range is 0~7.

### 5.3.16 Frame Avg.

Frame averaging function is used to overlap and average the adjacent B mode images so as to reduce the imaging noise and make the image clearer.

To do the adjustment, please touch 『Other』 icon at the real-time first, and then touch the arrow on the 『Frame Avg. 』 Icon to adjust the frame avg. Its range is 0~7.

### 5.3.17 B Reject

This function is used for restraining image signals that below a certain level of gray scale.

To do the adjustment, please touch 『Other』 icon at the real-time first, and then touch the arrow on the 『B Reject』 icon to adjust the B reject. Its range is 0~7.

### 5.3.18 MB

Through opening MB to improve image quality

Touch 『MB』 icon to open or close MB

### 5.3.19 B Color Map

Select B color map

Touch the arrow under [B Color Map] to adjust B color map, range 0~31.

### 5.3.20 M Color Map

Select M color map

Touch the arrow under [M Color Map] to adjust M color map, range 0~8.

### 5.3.21 I-image

Image optimization function.

Touch the arrow under [I-image] to adjust parameters, range 0~3

Needle Angel

### 5.3.22 TGC

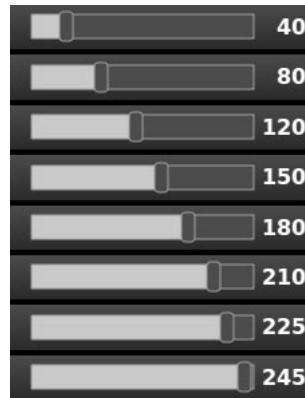

Fig 1-7 8 TGC

TGC curves can be used for adjusting gain compensation in different image depth.

There are two methods for adjustment, as follows:

- 1: Drag the slide of 『TGC』 to adjust the value.
- 2: You can also drag the image area left and right in different depth on the screen to adjust the depth, when the 『Lock』 is not opened.

During adjustment, the TGC curve will appear automatically on the left of the screen.

TGC curve will disappear automatically 1 second later after stopping adjustment.

### 5.3.23 Image reversing

B mode image and B/M mode image can be reversed horizontally and vertically.

Touch the 『L/R』 icon, the displayed image is reversed in the right-left horizontal direction.

Touch the 『Up/Down』 icon, the displayed image is reversed in the up-down direction.



Fig 5-8 Vertical, horizontal flip button

### 5.3.24 M Speed

M Speed function is to adjust the sweep speed of M mode image.

The method of adjustment:

- 1: Touch the ruler on the top of the M image area and keep pressing it.
- 2: The icon of ruler will become big, and the drag it left and right to adjust the M speed.

#### **⚠ Caution**

M Speed cannot be adjusted when the image is frozen.

### 5.3.25 Gray-scale Curve

Touch on gray-scale curve, showing gray-scale curve dialog box, touch the sliding contacts on the curve to adjust, image, article gray-scale changed. Or through the drop-down box choose pre-settings parameters to show, including standard, High, Low, Equal, Negative.

### 5.3.26 Needle

Press the [Needle] button to open or close the function.

### 5.3.27 Needle Angle

Press [Needle Angle], adjust the angle of the line, adjusting range -20/-10/-5/0/5/10/20.

## 5.4 Adjustment in color flow mode

### Parameters in Color mode

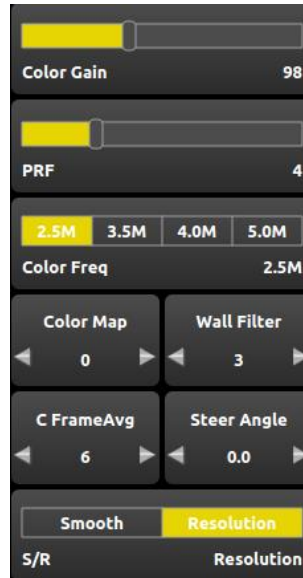

Fig 5-9 Para1

#### 5.4.1 ColorGain

At real-time state, drag 『Color Gain』 slide to adjust the size of color gain, adjustment range from 0~255, the smallest unit of adjustment is 1.

#### 5.4.2 PRF

At real-time state, drag 『PRF』 slide to adjust the size of sampling frequency, adjustment range from 0~15, the smallest unit of adjustment is 1

#### 5.4.3 Color Freq

Touch frequency value of 『Color Freq』 to select the value, the adjustment range depend on the probe

#### 5.4.4 Color Map

Touch button arrow on [Color Map] to change the type of color map, adjustment range from 0~8.

#### 5.4.5 Wall Filter

Touch bottom arrow on 『Wall Filter』 to change Wall Filter, adjustment range from 0~3 『Wall Filter』.

#### 5.4.6 C FrameAvg

Touch bottom arrow on 『C FrameAvg』 to change average frame, adjustment range from 0~7 『C FrameAvg』.

#### 5.4.7 Wall Thres.

Touch bottom arrow on 『Wall Thres.』 to change Wall Filter, adjustment range from 0~3.

#### 5.4.8 Smooth/Resolution

Touch 『Smooth』 or 『Resolution』 icon to turn on the function.

#### 5.4.9 Steer

Touch the lower left or right of sampling frame to change the frame angle in color mode.

Touch the lower of sample frame in color mode, the frame return to the default.

Tips: the function is only used for Linear probe in color mode.

### 5.4.10 Color density

This parameter is required to open at real time state through the [Others] button in color mode.

Touch the arrow under [High density] to adjust color density, range 0~1.

### 5.4.11 Velocity

In interface of parameter 2, touch the arrow under [velocity] to adjust velocity, range 0~2.

## 5.5 Adjustment in PW mode

### Parameters in PW mode:

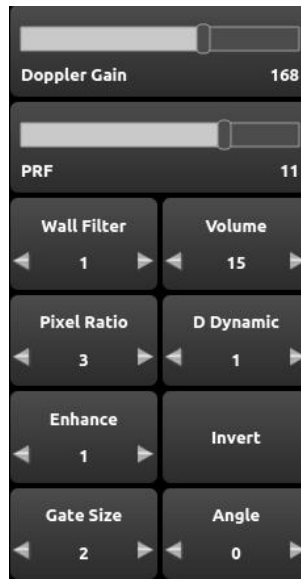

#### 5.5.1 Doppler Gain

In real time state, drag 『Doppler Gain』 slide to adjust the value of Doppler gain, range 0~255, the minimum unit is 1

#### 5.5.2 PRF

In real time state, drage [PRF] slide to adjust the value of PRF, range 0~14, the minimum is 1.

#### 5.5.3 Wall Filter

Touch the arrow under [Wall Filter] to adjust Wall Filter, range 0~3.

#### 5.5.4 Volume

Touch the arrow under [Volume] to adjust the volume of PW sound, range 0~15.

#### 5.5.5 Pixel Ratio

Touch the arrow under 『Pixel Ratio』 to adjust Pixel Ratio, range 0~3.

#### 5.5.6 D Dynamic

Touch the arrow under 『D Dynamic』 to adjust D Dynamic, range 0~7.

#### 5.5.7 Enhance

Touch the arrow under 『Enhance』 to adjust Enhance, range 0~3.

#### 5.5.8 Invert

Touch 『Invert』 icon to turn on/off the Invert function.

#### 5.5.9 Gate Size

Touch the arrow under 『Gate Size』 to adjust Gate Size, range 0~7.

### **5.5.10 Angle**

Touch the arrow under 『Angle』 to adjust angle of sampling line, range -70~70, the minimum unit is 10.

### **5.5.11 Baseline**

In real time state, drag baseline to the target position, then leave the touch point, the baseline will move to the target position.

### **5.5.12 Update**

Touch 『Update』 icon to turn on/off the PW function.

## **5.6 Image parameter transform**

Image parameters can be saved, import, export, default.

Touch the arrow on 『Application』 icon the menu will display Save, Import, Export, Default, you can touch it to choose the function, which you want.



# Chapter 6 Measurement and Calculation

Main content of this chapter:

Normal calculation and measurement on B mode image and M mode image, OB calculation and Uromasurement etc,system can enter into corresponding measurement mode depend on current exam mode.

## 6.1 Measurement methods:

The system contains Distance, Ellipse, and Trace.

### 6.1.1 Distance

Measurement steps:

- 1: Touch the [Distance]icon under the measurement menu to enter into measurement.
- 2: Touch in the B image area; it will display a segment with two “+”icon. One of the “+” is active, you can move it by dragging your finger to fit the one point of the line.
- 3: Touch [Switch]icon to change the activated point, and fit the another point of the line.
- 4: After you finish it, touch [Done] icon to complete the measurement. The result will display in the measurement results dialog and image area.
5. Repeat the steps from 1 to 4 to start next “distance” measurement. Short press[Trash] icon to delete the last measurement. Long press [Trash] icon to delete all the measurements.



#### Note:

Each group of measurement is limited, if the measurement results beyond, it will begin a new group of measurement automatically.

Use of rapid measurement, the measurement results dialog does not display, measurement results show only the image area.

### 6.1.2 Ellipse

- 1: Touch the [Ellipse] icon under the measure menu to enter into measurement.
- 2: Touch in the B image area, it will display a ellipse with 4 “+”, you can move the “+” by dragging your finger on B image area to fit it’s position.
- Touch [Switch] icon to change the 4 activated“+”.
- 3: After you finish it, touch [Done] icon to complete the measurement. The result will display in the measurement results dialog and image area.
4. Repeat the steps from 1 to 3 to start next “Ellipse” measurement. Short press [Trash] icon to delete the last measurement, and long press [Trash] icon to delete all the measurements.



#### Note:

Each group of measurement is limited, if the measurement results beyond, it will began a new group of measurement automatically; use of rapid measurement, the measurement results dialog does not display, measurement results show only the image area.

### 6.1.3 Trace

Measurement steps:

1. Touch the [Trace] icon under the measure menu to into measurement.
2. Touch in the B image area to fit the start point of measurement, and keep pressing it.
3. Move your finger to draw a trace along the edge of required area, the traced line can be closed.
4. Move out you finger, the starting point and end point of trace line will be closed by a straight line., The result will displayed in the measurement results dialog and image area.
5. Repeat the steps from 1 to 4 to start next “Trace” measurement. Short press [Trash] icon delete the last measurement. Long press [Trash] icon delete all the measurements.



#### Note:

Each group of measurement is limited, if the measurement results beyond, it will began a new group of measurement automatically; use of rapid measurement, the measurement results dialog does not display, measurement results show only in the image area.

## 6.2 Normal measurement and calculation in B, B/B and 4B mode

Touch display icon - [B], [B/B] or 4B to enter into B, B/B or 4B mode, then touch **【MEAS】** icon and choose [B NORMAL MEAS.] to enter into measurement status.

### **Note**

When measure all the images in B/B, 4B modes, please makes sure every image in the same depth. Or it makes no sense.

### 6.2.1 Distance Measurement

Same as 6.1.1

### 6.2.2 CIR/ AREA Measurement

There are two methods ellipse and trace .measurement method are same as 6.1.2and 6.1.3Respectively

### 6.2.3 Volume Measurement

There are three methods ellipse, two-axis and three-axis.

#### 6.2.3.1 Volume measurement (Two-axis method)

Two-axis method: Vertical section of the target needs to be measured.

◆The formula of Two-axis method:

$$V = (\pi/6) \times A \times B^2 / 1000$$

In the formula, A is the long axis of the ellipse and B is the short axis of the ellipse. The unit of V is ml, the unit of A and B is mm.

The measurement of Volume by Two-axis method is same as 6.1.2

#### 6.2.3.2 Volume measurement (Three-axis method)

Three-axis method: Both the vertical section and the horizontal section of the target need to be measured.

◆The formula of Three-axis method:

$$V = (\pi/6) \times A \times B \times M / 1000$$

In the formula, M is the length of the third axis. The unit of V is ml, the unit of A, B, M is mm.

Measurement steps:

- ①In B mode, scan one of the vertical section or the horizontal section of measurement target, freeze the image and touch [Meas.] Icon.
- ②Touch the menu item-“VOLUME” in [B NORMAL MEAS.] Menu, its submenu “TWO-AXIS” and “THREE-AXIS” will appear automatically. Touch “THREE-AXIS” menu item of submenu to enter into measurement.
- ③Draw an ellipse which is the similar shape and size as the measurement target area on the screen, so the 2 axis on the first section is measured. The method of drawing an ellipse is same as 6.1.2.
- ④Defreeze the image, re-scan another section of the target which is perpendicular to the previous image section, then freeze the image and measure the length of the third axis. The method is same as 6.1.1.
- ⑤After the above measurement, the measured result of the volume is displayed in the measurement result area.

### 6.2.4 Ratio measurement

Ratio measurement is used to calculate the ratio between two measured distance or area values. The first value is used as the numerator and the second value is used as the denominator.

Take distance for example

Measurement steps:

- ①In B mode, freeze the image and touch [Meas.] Icon. Touch the menu item-“RATIO” in [B NORMAL MEAS.] menu, its submenu “DISTANCE”, “ELLIPSE AREA” and “TRACE AREA” will appear automatically. Touch “DISTANCE” menu item of submenu to enter into measurement.

②Measure the first distance, and then measure the second one. The method is the same as how to measure “DISTANCE”, please refer 6.1.1.

③After the measurements are finished, the final calculated result of ratio will be displayed in the measurement result area.

④Repeat the steps from 1 to 3 to start next “Ratio” measurement.

### 6.2.5 Angle measurement

Angle measurement is used to measure the angle between two straight lines (0~90°).

Measurement steps:

①In B mode, freeze the image and touch [Meas.] icon .Choose the menu-item-“ANGLE” in [B NORMAL MEAS.] menu.

②First draw first line along one edge of the angle, then draw second line along another edge of the angle. The method is same as 6.1.1.

③After the above measurements, the angle between two lines and the length of two lines will be displayed in the measurement result area

④Repeat the steps from 1 to 3 to start next “Angle” measurement.

### 6.2.6 % Stenosis Measurement

% Stenosis measurement is to measure and calculate the stenosis level of the blood vessels. The stenosis distance ratio and the stenosis area ratio will be calculated to determine the stenosis level.

◆The formulae of % stenosis:

Distance % Stenosis=  $((D1-D2) \div D1) \times 100\%$

Area % Stenosis=  $((A1-A2) \div A1) \times 100\%$

In the formula, D1 and A1 represent respectively the distance and area at the non-stenosis position. D2 and A2 represent respectively the distance and area at the stenosis position.

In the formula, the unit of D1, D2 is mm, the unit of A1, A2 is cm<sup>2</sup>.

1. Measurement steps for stenosis distance ratio:

①In B mode, freeze the image and touch the menu item-“%STENOSIS” in [B NORMAL MEAS.] Menu, its submenu “DISTANCE” and “AREA” will appear automatically. Then choose “DISTANCE”

②Measure the distance D1 at the non-stenosis position. The method is the same as how to measure distance, please refer to 6.1.1.

③Measure the distance D2 at the stenosis position. The method is the same as how to measure distance, please refer to 6.1.1. After the measurements, the final calculated result of the stenosis distance ratio is displayed in the measurement result area.

④Repeat the steps from 1 to 3 to start next measurement for stenosis distance ratio.

2. Measurement steps for stenosis area ratio:

①In B mode, freeze the image and touch the menu item-“%STENOSIS” in [B NORMAL MEAS.] Menu, its submenu “DISTANCE” and “AREA” will appear automatically. Then choose “AREA”..

②Measure the area A1 at the non-stenosis position and the area A2 at the stenosis position. The method is the same as measurement in “CIR/AREA” (Ellipse method), please refer to 6.1.2.

③After the measurements, the calculated value of the stenosis area ratio is displayed in the measurement result area.

④Repeat the steps from 1 to 3 to start next measurement for stenosis area ratio.

## 6.2.7 Histogram

Histogram is used to calculate the gray distribution of the ultrasound echo signals within a specified area. Use the rectangle, ellipse or trace method to draw along the desired measurement area. The result is shown in the form of histogram.

Histogram can be measured only on the frozen image.

◆ Measurement steps by rectangular method:

- ① Touch **【FREEZE】** icon to freeze the image.
- ② Touch **【Meas.】** icon , and choose [B NORMAL MEAS].
- ③ Touch the menu item-“HISTOGRAM” in [B NORMAL MEAS.] Menu, its submenu “RECTANGULAR”, “ELLIPSE” and “TRACE” will appear automatically. Touch “RECTANGULAR” menu item of submenu to enter into measurement.
- ④ Press the screen in the B image area, and drag your finger to fix one apex of the rectangle.
- ⑤ Touch [Switch] to fix the diagonal point of the rectangle, the method is same as the last step.
- ⑥ Touch [Done] .The calculated result of the histogram will be displayed at the centre of the screen. To close the dialog box-“ Histogram”, please touch [ × ] icon at top right corner of the dialog box.

◆ Measure the histogram by ellipse or trace method: The method is the same as that to measure “CIR/AREA” by ellipse or trace method, please refer to 6.1.1&6.1.2.

The horizontal axis represents the gray scale of the image ranging from 0 to 255.

The vertical axis represents the distribution ratio of each gray scale. The value shown on the top of vertical axis represents the percentage of the maximally distributed gray in the whole gray distribution.

## 6.2.8 Profile

Profile is used to measure the gray distribution of the ultrasound signals in the vertical or horizontal direction on a certain profile (section).

This measurement is only available in the frozen mode.

Measurement steps:

- ① Touch **【FREEZE】** icon to freeze the image.
- ② Touch **【Meas.】** icon , and choose [B NORMAL MEAS].
- ③ Touch the menu item-“PROFILE” in [B NORMAL MEAS.] Menu to enter into measurement.
- ④ Draw a straight line at the measuring position. The method is the same as that to measure distance, please refer to 6.1.1.
- ⑤ Touch [Done] .The calculated result of the profile will be displayed at the centre of the screen. To close the dialog box-“ Profile”, please touch [ × ] icon at top right corner of the dialog box.

1-The horizontal (or vertical) axis represents the projection of the profile line on the horizontal direction.

2-The vertical (or horizontal) axis represents the gray distribution of the corresponding points on the profile line.

The range is 0 to 255.

## 6.3 OB measurement and calculation

Normally OB measurement and calculation are performed in B mode image. Choose OB exam mode. Freeze the required image, then touch [Meas.] icon to enter into OB measurement status.

### 6.3.1 Fetal growth measurement

The parameters given as below are general indexes used to evaluate the fetal growth.

GS-Gestation Sac

CRL- Crown Rump Length

BPD- Biparietal Diameter

FL-Femur Length

HC-Head Circumference

AC-Abdominal Circumference

After measuring each parameter, the system will automatically calculate the GA and EDD based on the measured results. Take GS measurement for example:

Measurement steps::

- ① Touch menu item-“GS” to enter into measurement.
- ② Do GS measurement, the method is the same as “Distance” measurement in B mode, please refer to “Distance” measurement in 6.1.1.
- ③ After the above measurement, the result of measured GS, GA and EDD will be displayed in the measurement result area.
- ④ Repeat the steps from 1 to 3 to start next “GS” measurement.

For CRL, BPD and FL, the measurement method is the same as GS. Please refer 6.1.1.

For HC and AC, Ellipse and trace method are provided for measurement, the operation is the same as the measurement of area and circumference in B mode, please refer 6.1.2&6.1.3.

### 6.3.2 Fetal weight calculation

By measuring some parameters of fetal growth, fetal weight can be calculated.

There are three formulas available to calculate fetal weight as below:

Tokyo University Formula:

$$EFBW=1.07 \times BPD^3 + 3.42 \times APTD \times TTD \times FL$$

APTD means anterior-posterior trunk diameter, TTD means trunk transverse diameter

In the formula, the unit of EFBW is g, the unit of BPD, APTD, TTD and FL is cm.

Osaka University Formula:

$$EFBW=1.25647 \times BPD^3 + 3.50665 \times FTA \times FL + 6.30994$$

FTA means fetal trunk cross-sectional area.

In the formula, the unit of EFBW is g, the unit of BPD and FL is cm, the unit of FTA is cm<sup>2</sup>

HADLOCK Formula:

$$EFBW=EXP \left( (1.304+0.05281 \times AC+0.1938 \times FL-0.004 \times FL \times AC) \times \ln 10 \right)$$

In the formula, the unit of EFBW is g, the unit of AC and FL is cm.

Please select the desired formula from above and preset it according to 13.3.3 Set calculation formulas in Chapter 13-Preset. of Information Manual.

Take Tokyo University Formula for example:

- ① Choose [EFBW] menu item in [B OB MEAS.] Menu, and touch it to enter into measurement.
- ② The EDD items for measurement will appear on the bottom of the menu.
- ③ Measure the EDD items (BPD, APTD, TTD, FL, FTA) one by one.
- ④ After the above measurements are finished, the calculated fetal weight will be displayed in the measurement result area.



the unit of EFBW is g.

### 6.3.3 AFI-

Measurement

- ① Choose the Menu, and touch
- ② The same as please refer to
- ③ When the 4th the result of the measurement

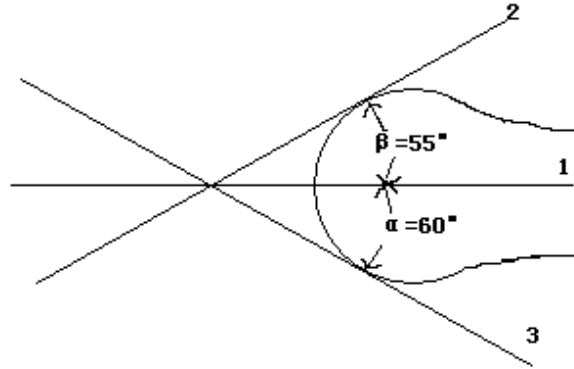

### Amniotic Fluid Index

steps:

- menu item-“AFI” in [B OB MEAS.] it icon to select this item.
- measurement operations are the “Distance” measurement in B mode, 6.1.1.
- “Distance” measurement is finished, measured AFI will be displayed in result area.

◆ AFI calculation formula:  $AFI (total) = AFI(D1) + AFI(D2) + AFI(D3) + AFI(D4)$ .

### 6.3.4 HIP function

HIP function is used for evaluating the fetal hip growth. In order to make calculation, three lines need to be added on the image, which is to conform to the fetal anatomic structure. The system will calculate and display two angles for doctor’s reference.

Measurement steps:

- Choose [EFBW] menu item in [B OB MEAS.] menu, and touch it to enter into measurement. It will display a segment with “+”, Touch 『Switch』 icon to change the active “+”, end point or midpoint.
- Midpoint “+” is activated, press the line and move it to fit its position.
- End point is activated, press the line and move it to adjust its angle.
- Repeat the steps from 1-3 to fit the second and third segment.
- After the above operations are finished, the result of measured ANGLE will be displayed in the measurement result area.

#### **Caution**

Line 3 shows bias line between protruding of conjunction and fringe of cotyle

Line 2 shows direct line between osileum and cotyle

Line 1 shows base line between cotyle, joint purse, gristle periosteum and ilium.

$\beta$  is the angle between Line 1 and Line 2 (acute angle);  $\alpha$  is the angle between Line 1 and Line 3 (acute angle)

Fig 2 Hip Angle

## 6.3.5 Estimate EDD (estimated date of delivery)

### 6.3.5.1 Calculating EDD by LMP (Last menstrual period)

1. Touch the menu item-“EDD” in [B OB MEAS.] menu, submenu – “by LMP” and “by BBT” will appear automatically. Choose “by LMP” menu item of submenu.
2. A dialog box-“Input LMP date” appears. Select the LMP date from the dialog box-“Check Date”.
3. Touch [Done] icon and to confirm the selected LMP date. Or input LMP date through the iconboard directly (the date format should be YYYYMMDD). The calculated EDD value will appear in the center of screen and the result measurement area,

### 6.3.5.2 Calculating EDD by BBT (Basal body temperature)

1. Touch the menu item-“EDD” in [B OB MEAS.] menu, submenu – “by LMP” and “by BBT” will appear automatically. Choose “by BBT” menu item of submenu.
2. To get the EDD calculation, please follow the steps from 2 to 4 in 6.3.5.1- Calculate EDD by LMP.

### 6.3.5.3 Growth curves

Function: Growth curves comparison is used to compare the measured data of the fetus with the normal growth curve in order to judge whether the fetus grows normally.

Measurement steps:

- Measure one or more parameters of fetal growth, such as GS, CRL, BPD, FL, AC, and HC.
- Input LMP value or BBT value.
- Touch the menu item- “GROWTH CURVE” in [B OB MEAS.] menu.
- A dialog box-“Growth curve” appears in the center of the screen. Open [GS] page on the dialog box, the normal growth curve and the measured GS value marked by a “+” are displayed, which can be compared for doctor’s reference.
- The curve represents the normal growth curve based on the selected formula set through PRESET function.
- “+” represents the current fetal growth data: its ordinate represents GA value calculated by LMP or BBT input.
- Touch [×] icon on the dialog box to exit.

## 6.4 GYN Measurement

GYN measurement includes measurement of UT-D (uterus diameter), ENDO (endometrium), CX-L (Uterine cervix length), LEFT OV and RIGHT OV (volume of left and right ovary) and LEFT FO and RIGHT FO (left and right follicle). The result will be calculated and displayed automatically on the screen by measuring relevant parameters. Freeze the required image under GYN examination, then touch [Meas.] icon to enter into GYN measurement status.

### 6.4.1 UT\_D -Uterus Diameter

Function: Uterus diameter is calculated by measuring the length, width and height of uterus.

Formula:  $UT = UT-L + UT-W + UT-H$

The meaning of parameters in the formula:

UT: Uterus Diameter

UT-L: Uterus Length

UT-W: Uterus Width

**UT-H: Uterus Height**

The unit of each item is mm.

Measurement steps:

- ① Select menu item-“UT\_D” in the submenu of “GYN MEAS.”
- ② Measure the item UT-L , UT-W and UT-H one by one. The measurement of each item is the same as “Distance” measurement in B mode, please refer 6.1.1.
- ③ After the above measurement, the value of Uterus Diameter will be displayed in the measurement result area.
- ④ To start next measurement, please repeat the steps from 1 to 3.

**6.4.2 CX-L (Uterine cervix length)**

Function: to measure Uterine cervix length.

Measurement steps:

- ① Select menu item-“CX-L” in the submenu of “GYN MEAS.”.
- ② Measure the Uterine cervix length. The measurement method is the same as “Distance” measurement in B mode.
- ③ After the measurement, the value of Uterine cervix length will be displayed in the measurement result area. If UT-L is measured before the measurement of CX-L, the ratio of UT-L/CX-L will also be displayed on the screen automatically.
- ④ To start next measurement, please repeat the steps from 1 to 3.

**6.4.3 Endo-Endometrium**

Function: to measure the thickness of Endometrium.

Measurement steps:

- ① Select menu item-“ENDO” in the submenu of “GYN MEAS.”
- ② Measure the thickness of endometrium. The measurement method is the same as “Distance” measurement in B mode, please refer to 6.1.1.
- ③ After the above measurement, the value of Endometrium will be displayed in the measurement result area.
- ④ To start next measurement, please repeat the steps from 1 to 3.

**6.4.4 OVARY**

Function: Ovary volume is calculated by measuring the length, width and height of Ovary.

Formula:  $OV-V = 0.52 \times OV-L \times OV-W \times OV-H / 1000$

The meaning of parameters in the formula:

OV-V: Ovary Volume

OV-L: Ovary Length

OV-W: Ovary Width

OV-H: Ovary Height

The unit of OV-V is ml; the unit of other items is mm.

Measurement steps:

- ① Select menu item-“OVARY” in the submenu of “GYN MEAS.”, its submenu “LEFT” and “RIGHT” will appear automatically. Take “LEFT” for example, it means the left ovary.
  - ② Measure the item L.OV-L, L.OV-W and L.OV-H one by one. The measurement method is the same as “Distance” measurement in B mode, please refer to 6.1.1.
  - ③ After the above measurement, the value of Left Ovary Volume will be displayed in the measurement result area.
- To start next measurement, please repeat the steps from 1 to 3.



## 6.4.5 FO - Follicle

Function: Follicle is calculated by measuring the length and width of Follicle.

Measurement steps:

- ① Select menu item-“FOLLICE” in the submenu of “GYN MEAS.”, its submenu “LEFT” and “RIGHT” will appear automatically. Take “LEFT” for example, it means the left follicle.
- ② Measure the item L.FO-L, L.FO-W and L.FO-H one by one. The measurement method is the same as “Distance” measurement in B mode, please refer to 6.1.1.
- ③ After the above measurement, the value of Left Ovary Volume will be displayed in the measurement result area. To start next measurement, please repeat the steps from 1 to 3.

## 6.5 Small parts measurement and calculation

Freeze the required image under Small parts examination, then touch [Meas.] icon to enter into small parts measurement status.

### 6.5.1 Thyroid

Function: the volume of thyroid is calculated by measuring the length, width and height of the thyroid.

Formula: Thyroid volume (cm<sup>3</sup>) = 0.497 × Length(mm) × Width(mm) × Height(mm)

Measurement steps:

- ① Select menu item-“THYROID” in the submenu of “SMALL PARTS.”, its submenu “LEFT” and “RIGHT” will appear automatically. Take “LEFT” for example, it means the left thyroid
- ② Measure each item: Length, Width and Height of the left kidney one by one. The method is the same as “Distance” measurement in B mode. , please refer to 6.1.1.
- ③ After the above measurements are finished, the value of Left Thyroid Volume will appear in the measurement result area.
- ④ To start next measurement, please repeat the steps from 1 to 3.

## 6.6 Urology measurement and calculation

Normally urology measurements are performed in B and B/B mode.

Freeze the required image under Urology examination, then touch [Meas.] icon to enter into small parts measurement status.

### 6.6.1 Residual urine

Function: the volume of residual urine is calculated by measuring the width, thickness and height of the RUV.

Formula: Residual urine (ml) = 0.7 × Width(mm) × Thick(mm) × Height(mm)

Measurement steps:

- ① Select menu item-“RESIDUAL” in the submenu of “UROLOGY MEAS.”.
- ② Measure each item: Width, Thick and Height of the RUV one by one. The method is the same as “Distance” measurement in B mode, please refer to 6.1.1.
- ③ After the above measurements are finished, the value of RUV will appear in the measurement result area.
- ④ To start next measurement, please repeat the steps from 1 to 3.

### 6.6.2 Kidney

Function: the volume of kidney is calculated by measuring the length, width and height of the kidney.

Formula: Kidney volume (cm<sup>3</sup>) = 0.52 × Length(mm) × Width(mm) × Height(mm)

Measurement steps:

- ① Select menu item-“KIDNEY” in the submenu of “UROLOGY MEAS..”, its submenu “LEFT” and “RIGHT” will appear automatically. Take “LEFT” for example, it means the left kidney.
- ② Measure each item: Length, Width and Height of the left kidney one by one. The method is the same as “Distance” measurement in B mode, please refer to 6.1.1.
- ③ After the above measurements are finished, the value of Left Kidney Volume will appear in the measurement result area.
- ④ To start next measurement, please repeat the steps from 1 to 3.

### 6.6.3 Bladder

Function: the volume of bladder is calculated by measuring the length, width and height of the thyroid.

Formula: Kidney volume (cm<sup>3</sup>) = 0.497 × Length(mm) × Width(mm) × Height(mm)

Measurement steps:

- ① Select menu item-“Bladder” in the submenu of “UROLOGY MEAS..”.
- ② Measure each item: Length, Width and Height of the bladder one by one. The method is the same as “Distance” measurement in B mode, please refer to 6.1.1.
- ③ After the above measurements are finished, the value of bladder Volume will appear in the measurement result area.
- ④ To start next measurement, please repeat the steps from 1 to 3.

### 6.6.4 Prostate measurement

Prostate measurement includes SPSA input, PV (Prostate Volume), PPSA (Prediction of the Prostate Special Antigen Density), PSAD (Prostate Special Antigen Density).

SPSA stands for the Serum Prostate Special Antigen; it will be used for prostate measurement.

### 6.6.5 How to input SPSA:

1. Select menu item-“PROSTATE” in the submenu of “UROLOGY MEAS..”, its submenu “INPUT SPSA” and “PV” will appear automatically. Choose “INPUT SPSA”.
2. A dialog box for SPSA input appears, input SPSA value (the range is from 0.01~100ng), touch “DONE” icon to finish SPSA input and exit. If you touch [ × ] button at top right corner of the dialog box, it will exit from input status without saving the input value

### 6.6.6 Prostate calculation.

Formula:

Prostate Volume (ml) = 0.52 × Length (mm) × Width (mm) × Height (mm) / 1000

PPSA(ng/ml) = 0.12 × Prostate Volume

PSAD(ng/ml) = SPSA / Prostate Volume

Measurement steps:

- ① Select menu item-“PROSTATE” in the submenu of “UROLOGY MEAS..”, its submenu “INPUT SPSA” and “PV” will appear automatically. Choose “PV”.
- ② Measure each item: Length, Width and Height of the prostate one by one. The method is the same as “Distance” measurement in B mode, please refer to 6.1.1.
- ③ After the above measurements are finished, the value of Prostate Volume, PPSA will be automatically displayed in the measurement result area. If SPSA is input before “Prostate” measurement, the value of PSAD will

also appear on the screen.

- ④ To start next measurement, please repeat the steps from 1 to 3.

## 6.7 Normal measurement and calculation in M, B/M mode

At real-time status, touch **【B/M】** icon twice to enter M mode, press **【MEAS】** icon to enter into M mode measurement status.

OR

At real-time status, touch **【B/M】** icon to enter B/M mode, press **【MEAS】** icon to enter into M mode measurement status.

### 6.7.1 Distance

Measurement steps:

- ① Select menu item-“Distance” to enter into measurement.
- ② Touch on the M image area, it will display a blue dotted line with two horizontal short line. The blue dotted line represents the position need to be measured. The distance between the two short lines is the distance you want to measure. The yellow short line represents it's in active status. Touch it and drag the short line to anywhere you want to put.
- ③ Touch Switch icon to active the two short line in turns and drag them to change the distance between them.
- ④ After the measurement, press done icon to finish this operation. The measurement result will be displayed on the result area.

### 6.7.2 Time

Measurement steps:

- ① Select menu item 『Time』 to enter into measurement.
- ② Touch on the M image area, it will display two blue straight dotted line. The blue dotted line with one yellow short line on it represents it is in active status. The distance between the two straight lines stands for time you want to measure. You can drag the active straight line to anywhere you want to change the measured time.
- ③ Touch Switch icon to active the two straight line in turns and drag them to change the distance between them.
- ④ After the measurement, press [Done] icon to finish this operation. The measurement result will be displayed on the result area.

### 6.7.3 Heart rate

Heart rate is used to calculate the number of heart beats per minute from cardiac image.

Measurement steps::

- ① Choose 『Heart rate』 menu item to enter into measurement.
- ② The method is same as Time , please refer to 6.7.2
- ③ After the above measurement, the calculated heart rate result is displayed in the measurement result area.
- ④ Repeat the steps form1 to 3 to start next measurement.

### 6.7.4 Velocity

Measurement step:

- ① Choose 『Velocity』 menu item to enter into measurement.
- ② Select the start point of the measurement and touch on the screen. The yellow “+” cursor is active. Drag

the cursor to the peak systolic wave.

- ③ Touch on the Switch icon to active another point. Drag the active point to the end diastolic wave.
- ④ Repeat 1-3 to do another measurement.

## 6.8 Measurement in M mode

At real-time status, touch **【B/M】** icon twice to enter M mode, touch **【MEAS】** icon to enter into M mode cardiology measurement status.

### 6.8.1 Distance

Same as “Distance” measurement in M mode, please refer to 6.7.1.

### 6.8.2 Heart rate

Same as “Heart rate” measurement in M mode, please refer to 6.7.3.

#### **Caution**

To get the result of heart rate, you need to measure 2 cardiac cycles.

### 6.8.3 Ejection time

Same as “Time” measurement in M mode

### 6.8.4 Input

The value of Heart rate, Ejection time, height and weight may be input directly by “Input” function.

After the value of height and weight is input, the result of BSA will appear in the measurement result area.

Formula:  $BSA=0.0061 \times \text{Height} + 0.0128 \times \text{Weight} - 0.1529$

BSA: Body surface area

In the formulae, the unit of BSA is m<sup>2</sup>, the unit of Height is cm, and the unit of Weight is kg.

### 6.8.5 Left ventricular function measurement

Left ventricular measurement in M mode is performed by measuring Left ventricular short axis diameter both at end diastole and at end systole. After Left ventricular measurement, the relevant parameters including SV (Stroke volume), EF (Ejection fraction), SF (Shortening fraction) will be calculated and displayed on the screen automatically. If other operations are performed before Left ventricular measurement, such as measuring or inputting heart rate and ejection time, inputting height and weight, the parameters of CO, CI, SI, LVMW and MVCF will be calculated and displayed on the screen after Left ventricular measurement.

Left ventricular measurement Formula:

$$EDV=7.0 \times LVIDd^3 / (LVIDd+2.4)$$

$$ESV=7.0 \times LVIDs^3 / (LVIDs+2.4)$$

$$SV=|EDV-ESV|$$

$$EF=SV/EDV \times 100\%$$

$$SF=(LVIDd-LVIDs)/LVIDd \times 100\%$$

EDV: End-diastolic left ventricular volume

ESV: End-systolic left ventricular volume

LVIDd: Left ventricular short axis diameter at end diastole

LVIDs: Left ventricular short axis diameter at end systole

SV: Stroke volume

EF: Ejection fraction

SF: Shortening fraction

In the above formulae:

The unit of EDV and ESV is ml, the unit of LVIDd and LVIDs is cm,

the unit of SV is ml, the unit of EF and SF is %, the unit of CO is l/min, the unit of HR is bpm.

## 6.8.6 Mitral valve measurement

Mitral Valve measurement includes the following items:

EF Speed: Mitral valve closing speed

AC Speed: AC descending speed

A/E: Amplitude of the A wave / Amplitude of the A wave

QMV: Mitral valve volume

Measurement method of EF Speed: same as “Velocity” measurement in M mode

Measurement method of AC Speed: same as “Velocity” measurement in M mode.

Measurement method of A/E is the same as “Distance” measurement in M mode.

Measurement method of QMV (Mitral valve volume)

Formula:  $QMV=4 \times DEV \times DCT$

In the above formula:

DEV represents the Mitral valve opening speed

DCT represents the Mitral valve opening time.

The unit of QMV is ml, the unit of DEV is cm/s, and the unit of DCT is s.

Measurement steps:

- ① Choose menu item-“QMV” in Mitral valve measurement submenu.
- ② Do the measurement of DEV first; the measurement method is the same as “Velocity” measurement in M mode.
- ③ Then do the measurement of DCT, the measurement method is the same as “Time” measurement in M mode.
- ④ After the above measurements are finished, the result of Mitral valve volume will appear in the measurement result area.
- ⑤ To start next measurement, please repeat the steps from 1 to4.

## 6.8.7 Aortic valve measurement

Aortic valve measurement includes the following items:

LAD: The diameter of the left atrium

AOD: The diameter of the aorta

LAD/AOD: Ratio of left atrium to aorta

AVSV: Aortic valve volume

### 6.8.7.1 Measurement steps -LAD/AOD:

- ① Choose menu item-“LAD/AOD” in Aortic valve measurement submenu.
- ② Do the measurement of LAD and AOD respectively, the measurement method is the same as “Distance” measurement in M mode, please refer to 6.7.1.
- ③ After the above measurements are finished, the result of LAD/AOD will appear in the measurement result area.

### 6.8.7.2 Aorta valve volume (AVSV):

Formula:  $AVSV = (MAVO1 + MAVO2) \times LVET \times 50 + AA$

In the formula:

MAVO1: The opening diameter of the aorta valve at the beginning.

MAVO2: The opening diameter of the aorta valve at the end.

AA: The amplitude of the aorta posterior wall

The unit of AVSV is ml, the unit of MAVO1, MAVO2 and AA is cm, and the unit of LVET is s.

Measurement steps:

- ① Choose the menu item-“AVSV” in Aortic valve measurement submenu.
- ② Measure MAVO1 and MAVO2, the measurement method is the same “Distance” measurement in M mode, please refer to 6.7.1.
- ③ Do the measurement of LVET, the measurement method is the same as “Time” measurement in M mode, please refer to 6.7.2.
- ④ Do the measurement of AA, the measurement method is the same “Distance” measurement in M mode, please refer to 6.7.1.
- ⑤ After the above measurements are finished, the value of Aorta valve volume will appear in the measurement result area.

## 6.9 Measurement in B mode

In B mode, freeze the desired image under cardiology examination, touch **【MEAS】** icon to enter into measurement.

### 6.9.1 Distance

Refer to “Distance” measurement in B mode.

### 6.9.2 EF SV measurement

Left ventricular measurement on B mode image is performed on the basis of the calculated result of both left ventricular systolic volume and left ventricular diastolic volume. However, when use different formula, the parameters to be measured are different.

There are four formulae available for calculating left ventricular volume in B mode.

#### 6.9.2.1 Single-plane Ellipse formula:

Measure on the long axis section of left ventricular (cardiac apex two-chamber or four-chamber section). The left ventricular volume is calculated based on the formula below:

$$V = (\pi/6) \times L \times D^2 / 1000$$

In the above formula:

L represents the long axis diameter of left ventricular.

D represents the short axis diameter of left ventricular.

The unit of V is ml, the unit of L and D is mm.

#### 6.9.2.2 Bi-plane Ellipse formula

After obtaining the horizontal short axis section of mitral valve and cardiac apex two-chamber section, or cardiac apex four-chamber section, the system calculates the left ventricular volume based on the formula below:

$$V = (8/3) \times A_m \times A_i / (\pi \times D)$$

In the above formula:

D represents the short axis diameter of left ventricular

$A_m$  represents the left ventricular area of the horizontal section of mitral valve

$A_i$  represents the left ventricular area of the apex chamber section.

The unit of V is ml, the unit of  $A_m$  and  $A_i$  is  $cm^2$ , the unit of D is cm.

### 6.9.2.3 Bullet volume formula

After obtaining the short axis section of mitral valve, and cardiac apex two-chamber or four-chamber section, you can calculate the left ventricular volume based on the formula below:

$$V = (5/6) \times A_m \times L$$

In the above formula:

$A_m$  represents the left ventricular area of the horizontal section mitral valve.

L represents the long axis diameter of left ventricular.

The unit of V is ml, the unit of  $A_m$  is  $cm^2$ , and the unit of L is cm.

### 6.9.2.4 Modified SIMPSON formula:

$$V = (A_m/2 + 5 \times A_p/18) \times L$$

In the above formula:

$A_m$  represents short axis area of left ventricular of the horizontal section mitral valve.

$A_p$  represents short axis area of left ventricular at the horizontal section of papillary muscle.

L represents the long axis diameter of left ventricular.

The unit of V is ml, the unit of  $A_m$  and  $A_p$  is  $cm^2$ , the unit of L is cm.

## 6.10 measurement in PW mode

PW measurement includes velocity and auto trace measurement. PW measurement is only operated in spectrum area.

In PW mode, Touch [measure] icon to enter PW measurement mode.

### 6.10.1 Velocity

Measurement method:

Select the position needed to be measured in spectrum area, move cursor to the position, touch [complete], The measurement result is displayed.

### 6.10.2 Auto Trace measurement(double cycle)

Measurement method:

1. Touch [Auto Trace measurement] in measurement menu, the frequency spectrum range is auto traced.
2. Select 2 cycle, move the lines to choose double cycles, touch [complete]. The result of measurement is displayed.

## Chapter 7 Cine-Memory

This chapter introduces the theory of saving images in Cine-memory and the operation of image playback in Cine-memory.

### 7.1 Store the real-time image

At real time status, images in B-mode can be stored in Cine-memory at the unit of frame in time sequence. If the storage is full of images, when storing a latest new frame image, the first saved frame image will be removed out of Cine-memory. Therefore there are always the latest images in the storage. All the images in Cine-memory can be played back manually or automatically.

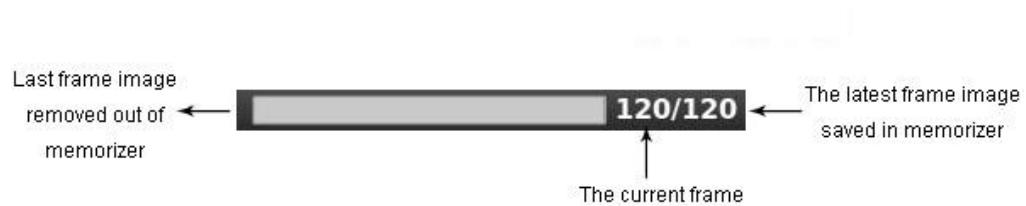

Fig 7-1 Movie playback bar diagram

### 7.2 Manual playback

Freeze the image, it will bring up the cine bar. At this time, touch the image area and drag the image left and right to playback the cine manually. The cine will be played back in increasing sequence when you drag the image to the right direction. Otherwise it will be played back in decreasing sequence.

### 7.3 Automatic playback

Touch the frozen image and slide your fingers quickly on the screen. The cine will be played back automatically.

### 7.4 Cine Save/Recall

After you input the animal information to establish the animal's record, touch [Cine] icon in any status to enter into saving cine status. There will be a thumbnail of the saved cine in the storage area. Touch the thumbnail in any status to recall the cine.



# Chapter 8 Annotation

## 8.1 Introduction

Annotation function allows users to add comments by inputting the characters or symbols on the image.

Enter into annotation status:

Freeze the image, touch 『Annotation』 icon , the soft iconboard will be displayed.

Touch the B image area, where you want to annotate, a blank frame appears and the cursor changes as twinkling “|”, which means the operator is allowed to input comments.

Exit from annotation status:

Touch [Back] icon to exit.

Annotation can be made by inputting characters from the soft iconboard or recalling the terms saved in annotation database.

The annotation database of the system is classified as following according to examination.:

Classification	Function description
Abdomen	Anatomy terms for Abdomen or general examination
OB	Anatomy terms for Obstetrics
Gynecologist	Anatomy terms for Gynecology
Cardiac	Anatomy terms for Cardiology
Small parts	Anatomy terms for Small parts
Pathological change	Normal terms for pathological change of Abdomen, OB, Gynecology, Cardiac and small parts

## 8.2 Input characters through the soft iconboard Operation:

- Touch [Annotation] to enter into comment status, and the soft iconboard and comment box will be displayed.
  - Touch the B image area, where you want to annotate, a blank frame appears and the cursor changes as twinkling “|”, which means the operator is allowed to input comments. Then you can input the annotation by the soft iconboard. If you want to input special characters, please touch 『123#』 at first , Number sign input interface be switched, and now you can press corresponding icon.
  - Input annotation in the comment box, touch 『Done』 icon, annotation will be displayed in the image area, or touch in the need image area, the annotation will be located there. touch again, a box will be displayed in the image area, now cursor will be displayed as "|"
  - after hide soft iconboard, touch 『Back』 icon , to exit from annotation status.
- Input annotation from the database
- Touch [Annotation] to enter into comment status, and the annotation database will be displayed
  - Choose the annotation which you want, touch 『Done』 icon to add the comment.。
  - If you want to comment quickly, hide soft iconboard ,it will appear quick annotation item, select and touch appropriate item

### 8.3 Move the annotation

- Under annotation status, touch the annotation which you want to move, and keep pressing it.
- Drag it to move, when you confirm it move out your finger.
- Loose contact point, this annotation will be fixed.

### 8.4 Edit the annotation

- Under annotation status, touch the annotation which you want to edit.
- Then you can input or delete characters directly.
- After editing, touch outside the comment area to finish the editing.

### 8.5 Clear the annotation

Clear the inputted characters

During annotation status, active the annotation which characters need to clear, then touch where you want to delete” ” will appear there then press the Backspace icon on the soft iconboard to clear the character.

#### 8.5.1 Clear a single character

Active the annotation which need to clear, short press [Trash] icon to clear the annotation.

#### 8.5.2 Clear all the annotations on the image area

A long press 【Trash】 icon to clear all the annotations on the image area.

 Caution: After pressing 【Trash】 icon, all the measurements and the body marks will be cleared at the same time.

# Chapter 9 Body Marks

## 9.1 Introduction

Body mark is used to point out the body part being examined and the scanning direction of the probe. In fact the body mark acts as a comment on the image.

Seven categories of body marks are available: abdomen, obstetrics, cardiology, small parts etc.

Each category has different body marks; please refer to the following figures:

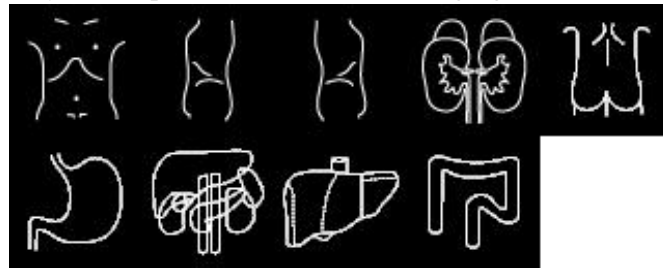

Fig. .9-1Body marks for abdomen.

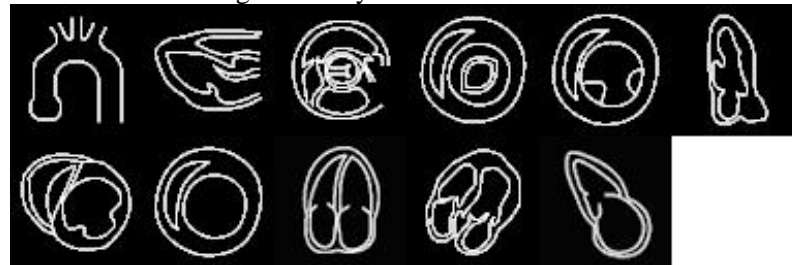

Fig. .9-2Body marks for cardiology.



Fig. .9-3 Body marks for GYN.

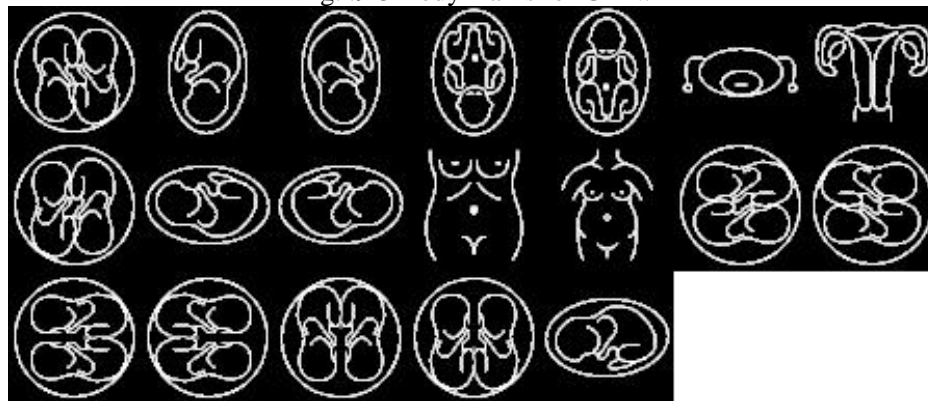

Fig.9-4 Body marks for OB.

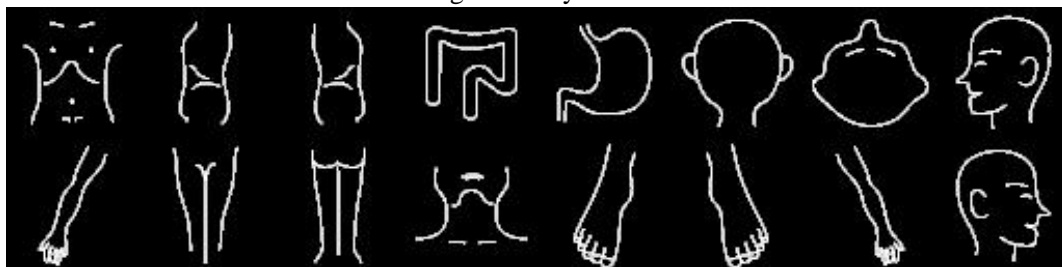

Fig. .9-5 Body marks for pediatrics.

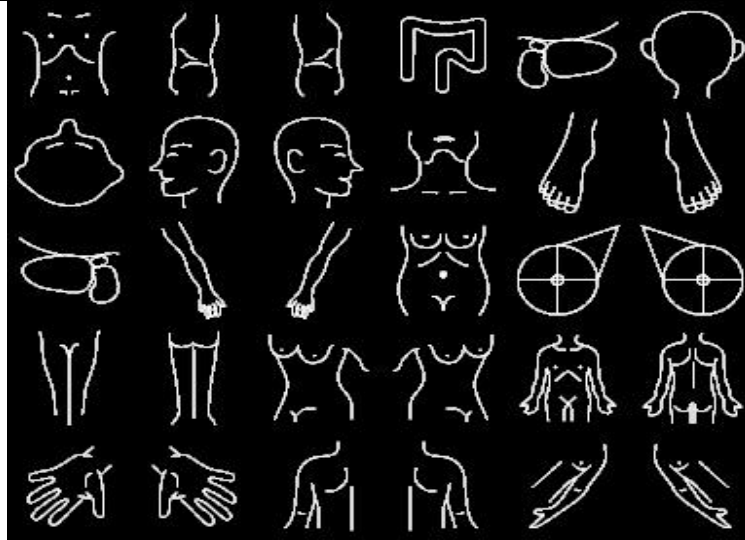

Fig. .9-6 Body marks for small parts.



Fig. .9-7 Body marks for urology.

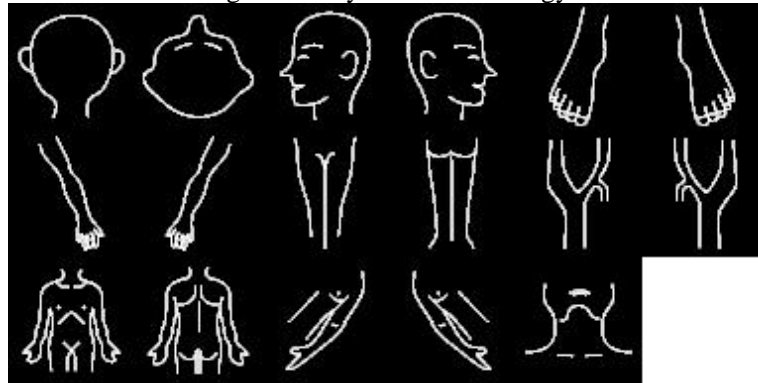

Fig.9-8 Body marks for vessel.

## 9.2 Operation of body marks

- 1: Freeze the image touch [Body] icon, the dialogue box for selecting body mark will appear.
- 2: Click the icon which you want, the icon will become bigger. Touch it again, the arrow will be displayed and now you can move or rotate the arrow...touch [Done] icon, body mark will be displayed.
- 3: Drag the arrow to confirm its position and direction, then touch [Done] to add the body mark on the image.
- 4: If body mark is not in the current interface, you can slide body mark area to turn over pages.
- 5: If you want to delete the body mark, please short press [Trash] icon.

## Chapter 10 Archive Management

Archive Management can view, recall, edit, animal information, which is stored in the local disk or U disk.

### 10.1 Path selecting

When U disk is inserted in, Archive Management interface can switch in local disk and U disk. Touch on the path where need to view to activate the path, current active path label displays high bright.

### 10.2 Information viewing

Select and touch the patient information which needs to view, the patient information such as: name, ID, date of birth will appear on the left of the dialog box.

### 10.3 Documentation

Touch patient information two times to enter the patient information directory, the picture, film file and report, etc will be displayed. Change the display usage of the files by output format; touch the left and right arrows to flip.

#### 10.3.1 File reviewing

Touch the file which needs to view to enlarge review of the file.

#### 10.3.2 File operation

##### 10.3.2.1 Copy/Paste

Touch the file which you want, then touch [copy] icon, and switch to the path which you want to paste, then touch "Paste" icon.

##### 10.3.2.2 Delete

Touch the file which you want, and touch [Delete] icon to delete.

##### 10.3.2.3 Recall

Touch the file which you want, and touch recall, then animal information will be recalled and the archive management interface will be closed.

##### 10.3.2.4 Send

Touch the file which you want, and touch "send", the file will be stored to DICOM (the DICOM should be opened at first) DICOM.

##### 10.3.2.5 Search

In archive management, touch "Search" icon, pop-up search dialog box, input the keywords to search the animal information.

##### 10.3.2.6 New Dir

In U disk path, touch New Folder icon, pop-up New Folder dialog box, input the folder name to create a new file.

##### 10.3.2.7 Multi

After touch the icon, you can touch multiple files continuously and do operation.

# Chapter 11 Biopsy

## 11.1 Enter into/ Exit from Biopsy status

### How to enter into Biopsy status:

- At real-time status, touch [BIOPSY] to enter into Biopsy status; it will display biopsy sample line in the image area.
- Press the biopsy sample line and drag it to adjust its angle, when the line becomes blue.
- If the line becomes red, it means you can't move it.

### How to exit from Biopsy status:

At real-time status, touch [BIOPSY] again to exit from Biopsy status, the biopsy sample line will disappear.

## 11.2 Use biopsy kit

### Caution

Only the biopsy kit provided by CHISON Company is allowed to use with the system!

### 11.2.1 Check before using the biopsy kit:

Before using the biopsy kit on real patient, users must do necessary check and adjustment to make sure the biopsy needle scan line conforms to the biopsy sample line in the image area.

Please refer to biopsy kit user manual for the details of check and adjustment method.

Please carefully use biopsy kit to do the operation. We'll not take any responsibility for any damage caused by the improper use of the biopsy kit or the improper operation of the puncture process.

### 11.2.2 Sterilization and disinfection

Before and after using the biopsy kit, please make sure the probe and biopsy kit to be sterilized and disinfected to meet standard medical application requirement.

Recommended sterilization and disinfection method as below:

1. Please take good care of the probe and biopsy kit. Collision and dropping is strongly prohibited;
2. Please use the ultrasound gel which is acknowledged by the manufacture of the unit. AQUASONIC Gel made by R. P. Kincheloe Company in USA is recommended.
3. Wash the probe and biopsy kit:

#### 1) Probe tip

Rinsing: rinse the surface with running water, and use a sponge or soft cloth to gently remove the dirt and gel on probe tip.

2) The connector, cable and other part of the probe tip must not be soaked in a solution. Simply clean it by using a soft cloth moistened with alcohol and then dry it.

4. Disinfection: When necessary, soaking the probe tip in disinfection solution. The recommended disinfection solution is CIDEX ACTIVATED DIALDEHYDE SOLUTION. (Manufacturer: Johnson and Johnson Medical). It has been approved by the FDA; its 510(K) number is K924434. The following instructions are provided by Johnson and Johnson Medical. For more detail, please contact Johnson and Johnson Medical

- 1) Soaking temperature: 10°C~40°C
- 2) Atmospheric pressure: 700hPa~ 1060hPa
- 3) Soaking time: by the FDA requirements, CIDEX Activated Dialdehyde Solution requires 45 minute processing

at 25°C for high level disinfection. The 45 minute processing time was established as the time to kill 6 logs of the test organism.

5. Rinsing: Sufficiently rinse the probe by using water to remove chemicals.
6. Aeration and let the probe become dry in normal temperature.
7. Please strictly keep the probe away from the paint thinner, ethylene oxide, other organic solvent, etc
8. Please keep the probe inside the probe case when it is not in use.
9. Dipping the probe or the cable into any liquid is strongly prohibited.

### **Caution**

Please immediately stop using the probe and system if there is any broken phenomenon on the electricity cable or the probe transducer. Otherwise there will be a danger of the electricity shock.

### **Accessories**

To order biopsy guides; and other supplies and accessories, contact CIVCO Medical Solutions:

CIVCO Medical Solutions

102 First Street South, Kalona, IA 52247-9589

Telephone: 800-445-6741 (USA and Canada), +1 319-656-4447 (International)

Fax: 877-329-2482 (USA and Canada), +1 319-656-4451 (International)

E-mail: [info@civco.com](mailto:info@civco.com)

Internet: [www.civco.com](http://www.civco.com)

### **NOTE**

Model or part numbers in the following tables are subject to change.

#### Biopsy Guides

Transducer	Compatible Biopsy Guide Model
V6	610-1093 (10041823)

# Chapter 12 Reports

## 12.1 Introduction

Reports function is used to store and recall the patient's examination report, allow doctors to read and manage the patient's information..

Touch [Report] icon, it will pop-up graphic reports interface of current examination mode default.

## 12.2 Content

The content of the report contains: patient, hospital information, and a description of animal disease in clinical diagnosis and what doctors see in ultrasound. specific data of measurement, conclusions, image import, etc

Touch [X] icon to exit.

## 12.3 Import image

Touch [Touch to select images] icon, a dialog box-'open file' appears, choose the image, which you want

## 12.4 Print

After finishing the report, touch 『Print』, patient information will be printed

## 12.5 Save

After finishing the report, touch 『save』, patient report will be saved to the corresponding directory automatically.

## 12.6 Export

Report can be exported as PDF files page and viewed on a computer, touch "Export" icon to export the report to the U disk directory automatically.



# Chapter 13 Preset

This chapter introduces the operation to make settings of the system through preset menu at preset mode.

Preset function is used to set up working environment and status, parameters of each examination mode. The setting will be stored in the memory of system and not be lost even after the system is switched off. When the system is switched on, it will work automatically with the status which is required by the operator.

## 13.1 General setting

Touch [Others] icon, and choose [Setup] to enter into setup interface.

Touch the [×] icon or [Exit] icon to exit.

Function name	Setting method	Function description
Hospital	Input freely	Set up the hospital name which is shown at top left corner of “General Setting” dialog box, 20 characters Max. can be input
Department	Input freely	Set up the department name shown at top left corner of “General Setting” dialog box, 20 characters Max. can be input
Current date	Set up freely	Set up the system date (calendar format), select current date directly. Date format can be changed by format setting.
Current time	Set up freely	Set up the working clock of the system.
Format	Set up freely	Set up date format
Language	Select language	Select the language of operation interface(English、Chinese and etc.)
Screen Type	Touch to choose	Select the type of only image, image and patient information, full screen
Default save cine to	Touch to choose	Local hard disk and U disk

## 13.2 Calculation

Calculation setting including calculation method, measurement method, and user-define method setting.

### 13.2.1 Calculation formulae`

Measurement item	Formula to be selected
BPD	China / HADLOCK / GA -USER
CRL	China/ Tokyo University / HADLOCK / GA-USER
HC	HADLOCK / Hansmann / GA-USER
FL	China/ HADLOCK / GA-USER
GS	China/ Tokyo University / GA-USER
AC	HADLOCK / Hansmann / GA-USER
Fetal Weight	Tokyo University / Osaka University / HADLOCK

### 13.2.2 Set up user-defined formula

Set up user-defined formula suitable for different people.

Operation procedure:

1. Select the item to be user-defined, e.g. BPD, and the relevant GA table appears.
2. Choose the required user-defined value at the right of the data list. 3 kinds of parameters will show at the left of the dialog box, the parameters of Week/ Day can be modified.
3. After modifying the parameters of Week/Day, touch “MODIFY” icon to confirm the modification.
4. Touch “EXIT” icon or [×] icon at top right corner after complete modification to exit from the editing

interface. When user-defined formula is selected for EDD items (e.g. BPD) later, the system will recall the user-defined parameters according to the modified values.

## 13.3 Set annotation database

### 13.3.1 Search option

Search annotation

Search short name

### 13.3.2 Check type

Classification of the preset annotation database: Abdomen, OB, GYN, Cardiac, Small parts and Pathological change. Each category has saved many in-built annotation terms before delivery. Users can add or delete user-defined annotation term by setting annotation database.

### 13.3.3 Edit annotation database

#### 13.3.3.1 Modify annotation term:

Operation:

- 1 Select the item which need to add annotation database.
- 2 modify the phrase of annotation and annotation contents, then touch [modify] icon, current comment will be modifies in the comment library.

#### 13.3.3.2 Add annotation item

Operation:

1. Select the item which needs to add annotation database.
2. Touch on the blank of [annotation], the cursor is displayed as "|", pop-up soft iconboard to type your own comments terms and phrases of the comments
3. Touch the "Add" icon, current comment will be added to the comment library

#### 13.3.3.3 Delete annotation item

Operation:

- 1、 Select the item which need to delete.
- 2、 Touch "Delete" icon, delete current comment.

## 13.4 DICOM

1. Touch 『Add』 icon to pop-up a dialogue box。 Drop-down type of service contains: DICOM Storage, DICOM Worklist, DICOM print or DICOM structured report
2. Choose DICOM print, input the Service, IP address, SCP, Time Out one by one。
3. To DICOM setting which exist ,you can select and then edit、 delete 、 verify and other operations
4. In addition, you can check the saved pictures or movies at the same time send DICOM files, including image files or data; for DICOM print can be set specific rules
5. After finishing, touch [Done], and close dialog box, the setting can be saved in the list. At this point all DICOM functions work properly
6. Note: DICOM Storage, DICOM Worklist, DICOM Print and DICOM structured report settings can only be set separately for each item

## 13.5 User interface

### 13.5.1 Control color setting:

Default, Pink, Sliver, User defined., User defined color can be set by the top, bottom, left, right control column and cursor color respectively.

Operation:

1. Choose the control which you want to modify, and touch it. Then the select color dialogue box will bring out.
2. Choose the color you want, and touch the **【Done】** to save and exit. Then the color of control will change.

### 13.5.2 Render color

The operation is same as control color.

### 13.5.3 Location of the close button

Location of the close button: left or right .system default to right location..

## 13.6 Touch Screen

### 13.6.1 Sensitivity

Horizontal inertial: range 1~20。

Vertical inertial: range 1~20。

Move: range 1~20。

Slide min power: 50~200

### 13.6.2 Calibrate

Touch screen calibration, set the coordinate position of touch screen, after touching, it will pop-up correct interface, touch “+”continuously to complete setting follow the prompts, Correction icons on your request to Chison Company, If failed, please sit tight, 20s later calibrate it again.

Attention: you should be careful with this operation, mis-operation will cause touch screen does not function

## 13.7 Net

Set up the IP address.

You can also test the network connection.

## 13.8 System

### 13.8.1 System information.

Display the software version, Hardware version, System version.

### 13.8.2 Update

Software and Hardware can be updated by USB flash drives.

Software update File Path: “X\update\”, Hardware update File Path: “X\fpga\_update”, X means USB flash drives. It should restart manually after hardware update, and after software update, machine can be restarted automatically.

### 13.8.3 Function Setting.

DICOM: Touch 『Open』 icon, it will bring up the DICOM Icon Input dialog box. In put the DICOM SN, and touch 『OK』 icon to save and exit.

### 13.8.4 Installment setting

Input relevant icon to open trial function, and please contact Chison Company to the special open icon.

### **13.8.5 Video VGA**

Choose the video data: NTSC or PAL.

Video opened: Choose the item to open this function.

VGA opened: Choose the item to open this function.

### **13.8.6 USB video printer option**

Adjust the Function parameter of USB video printer: dark, light, clarity, gamma

Choose the parameters to adjust, press [ENTER] button and rolling the trackball to adjust the parameters in the parameters of the sliding block.

# Chapter 14 System Maintenance

## 14.1 Cleaning

### Caution

Before clean any part of the system, please make sure that the system is turned off and the power cord is disconnected from the power supply socket. Otherwise there will be danger of electricity shock.

Cleaning method of the icon board, outer-frame, probe holder and monitor:

Please use a piece of soft and dry cloth to clean the system. If there's some dirty difficult to be cleaned, please use wet cloth to clean system, and then use dry cloth to wipe off the water on the system.

### Caution

1. Please don't use organic solvent to clean the probe; otherwise it will damage the probe surface.

Please never allow any liquid get inside the system or probe, otherwise it will damage the system and cause electronic short.

If the probe connector, TGC slide or any peripheral device is required to be cleaned, please contact our authorized agent in your country in advance. Any cleaning by unauthorized person may result in system malfunction or affect its features.

## 14.2 Probe maintenance

According to the purposes, the probes of this system can be divided into 2 categories: those used on the surface of patient body, or those used inside the body of patient.

### Caution

No matter which type of examination is performed, please always try to reduce the unnecessary radiation of ultrasound wave to the patient during the ultrasound examination

### Caution

1. Probe can only be used by professional doctor who has received professional training of ultrasound.
2. It is forbidden to sterilize and disinfect probe by high pressure. If it needs to be used in sterilized occasion, please use a sterilized disposable probe cover on the probe.
3. Please avoid drop off or hitting the probe by anything.
4. Don't scratch the probe surface while using it.
5. Please use the authorized ultrasound gel during scanning. Using un-authorized gel may cause scratch or damage to probe surface.
6. Don't bend or pull the probe cable with force.
7. Please don't put the probe connector and its adjacent probe cable part into any liquid.
8. Please keep the probe clean and dry.
9. Please connect or disconnect the probe only after the system is turned off.
10. Please don't use or preserve the probe where it is over 50°C.
11. Please carefully check the probe surface, probe cable and probe connector before using. If there is any abnormal phenomenon (eg. there's a leakage on the probe surface), please stop using the probe immediately and contact our authorized agent in your country as soon as possible. If you don't know the contact number of your authorized agent, please contact us by detail contact information at the end of this chapter.

## Probe maintenance

Please take good care of the probe. Collision and dropping is strongly prohibited.

Please use the ultrasound gel which is acknowledged by the manufacture of the unit. We recommend AQUASONIC Gel made by R. P. Kincheloe Company in USA.

Plug and unplug of probe in real-time is strongly prohibited.

Bending and pulling the probe or the probe cable by strength is prohibited.

Wash the probe:

### 1) Probe tip

Rinsing: rinse the surface with running water, and use a sponge or soft cloth to remove gently the dirt and gel on probe tip

2) Connector, Cable, other part of the probe tip must not be soaked in a solution. Simply clean it using a soft cloth moistened with alcohol and then dry it.

Disinfection: When necessary, soaking the probe tip in disinfection solution. The recommended disinfection solution is CIDEX ACTIVATED DIALDEHYDE SOLUTION. (Manufacturer: Johnson and Johnson Medical). It has been approved by the FDA, its 510(K) number is K924434. The following instructions are provided by Johnson and Johnson Medical. For more detail, please contact Johnson and Johnson Medical

1) Soaking temperature: 10°C~40°C

2) Atmospheric pressure: 700hPa~ 1060hPa

3) Soaking time: Under FDA requirements, CIDEX Activated Dialdehyde Solution requires 45 minutes processing at 25°C for high level disinfection. The 45 minutes processing time was established as the time to kill 6 logs of the test organism.

Rinsing: Sufficiently rinse the probe by using water to remove chemicals.

Aeration and let the probe become dry in normal temperature.

Please strictly keep the probe away from the paint thinner, ethylene oxide, other organic solvent, etc

Please keep the probe inside the probe case when it is not in use.

Dipping the probe or the cable into any liquid is strongly prohibited.

### **Caution**

Please immediately stop using the probe and system if there is any broken phenomenon on the electricity cable or the probe transducer. Otherwise there will be a danger of the electricity shock.

## 14.3 Safety check

To ensure the system work normally, please make a maintenance plan, check the safety of the system periodically. If there is any abnormal phenomenon with the machine, please contact our authorized agent in your country as soon as possible.

If there is no image or menu on the screen or other phenomenon appears after switching on the machine, please do troubleshooting first according to the following check list. If the trouble is still not solved, please contact our authorized agent in your country as soon as possible.

## 14.4 Troubleshooting

According to the most frequently occurred errors and system messages, the list of possible causes and relevant solutions is attached as below:

<b>Errors &amp; Messages</b>	<b>Possible Cause</b>	<b>Solution</b>
When turn on the system, power-indicating lamp is not lit.	1) AC power supply may not work normally. 2) Power cord may not be connected, or may not be well connected to the power supply socket.	1) Check the AC power supply to make sure it is normal. 2) Check the power cord connection to make sure it's good.
When turn on the system, power indicating lamp is lit, but no images on the monitor.	1) The system is restarted too shortly after it is switched off.	1) Wait for 1 minute to restart the system after switching off.
Menu bar displays on the screen but no scanning image	Transmission frequency, gain or TGC control is not set properly. No probe is connected or probe is connected improperly the system is in frozen status	Adjust the transmission frequency, gain or TGC control. Ensure the probe is connect correctly Defreeze the system by pressing the FREEZE icon.
Image quality is abnormal	Examination mode is not correct Image processing parameters are set improperly	Set the exam mode correctly. Adjust the setting of image processing or set it to default setting
Wrong probe type show on screen.	The probe is not connected well with probe connector. Internal circuit protection	Reconnect probe correctly. Restart machine

## Chapter 15 Probes

### 15.1 General Description

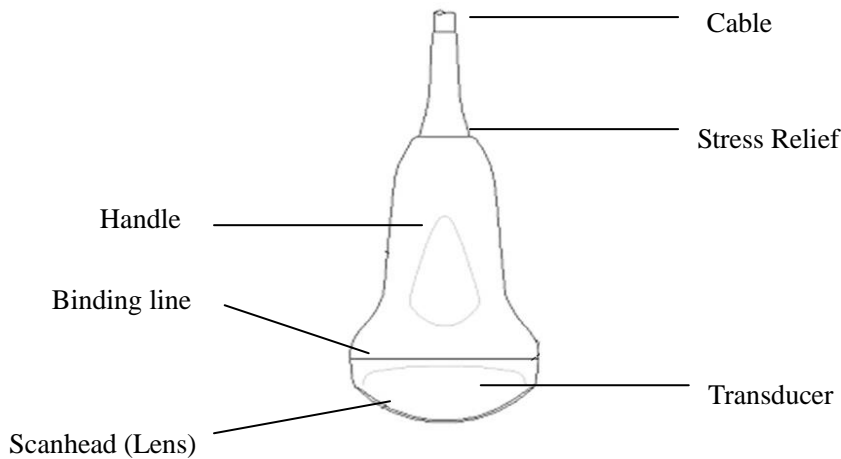

Fig.6-1: Convex Probe Overview

The probes provide high spatial and contrast ultrasound imaging of frequencies from 2.0MHz to 13.0MHz. These probes operate by pulsing sound waves into the body and listening to the returning echoes to produce high-resolution brightness mode, and a real time display.

### 15.2 Care and Maintenance

The probes that come with the system are designed to be durable and dependable. These precision instruments should be inspected daily and handled with care. Please observe the following precautions:

- Do not drop the transducer on hard surface. This can damage the transducer elements and compromise the electrical safety of the transducer.
- Avoid kinking or pinching the transducer cable.
- Use only approved ultrasonic coupling gels.
- Follow the instructions for cleaning and disinfecting that come with each probe.

#### 15.2.1 Inspecting Probes

*Before and after each use*, inspect carefully the probe's lens, cable, casing, and connector. Look for any damage that would allow liquid to enter the probe. If any damage is suspected, do not use the probe until it has been inspected and repaired/replaced by an authorized Service Representative.

#### **⚠NOTE**

*Keep a log of all probe maintenance, along with a picture of any probe malfunction.*



**⚠ WARNING**

*The probes are designed to be used only with this ultrasound system. Use of these probes on any other system or a non-qualified probe may cause electrical shock or damage on the system/transducer.*

**15.2.2 Cleaning and Disinfecting**

- Place the probe into the solution of cleaning-disinfectant. Make sure not to immerse the probe into the liquid beyond the immersion level given in the pictures below. Make sure that the probe is covered with the cleaning-disinfectant up to the immersion level during the complete disinfection time.
- For the recommended cleaning and disinfection time, please see your Operating Manual .
- Scrub the probe as needed using a soft sponge, gauze, or cloth to remove all visible residue from the probe surface.
- Rinse the probe with enough clean, potable water to remove all disinfectant residues.
- Use a soft cloth to clean the cable and the user section of the probe with the cleaning disinfectant liquid. Make sure that the surface of the probe and cable is wetted thoroughly with the cleaning-disinfectant.
- Allow probe to air dry completely.
- Reconnect the probe to the ultrasound console and place the probe into it's holder.

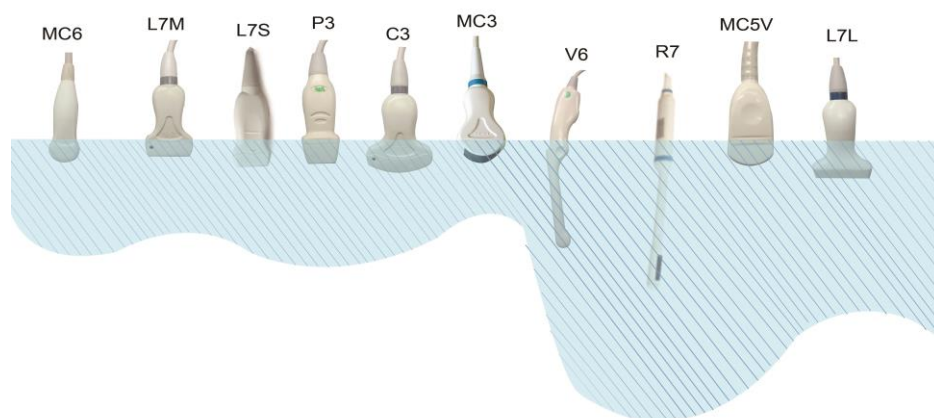
**Probe Immersion Levels****⚠ CAUTION**

*These transducers are not designed to withstand heat sterilization methods. Exposure to temperatures in excess of 60 °C will cause permanent damage. The transducers are not designed to be totally submerged in fluid, as permanent damage will result if the entire transducer is submerged.*

**Probe Safety****Handling precautions**

Ultrasound probes are highly sensitive medical instruments that can easily be damaged by improper handling. Use care when handling and protect from damage when not in use. DO NOT use a damaged or defective probe. Failure to follow these precautions can result in serious injury and equipment damage.

**Electrical shock hazard:**

The probe is driven with electrical energy that can injure the patient or user if live internal parts are contacted by conductive solution:

- DO NOT immerse the probe into any liquid beyond the level indicated by the immersion level diagram. Never immerse the probe connector into any liquid.
- Prior to each use, visually inspect the probe lens and case area for cracks, cuts, tears, and other signs of physical damage. DO NOT use a probe that appears to be damaged until you verify functional and safe performance. You need to perform a more thorough inspection, including the cable, strain relief, and connector, each time you clean the probe.
- Before inserting the connector into the probe port, inspect the probe connector pins. If a pin is bent, DO NOT use the probe until it has been inspected and repaired/replaced by a CHISON Service Representative.
- Electrical leakage checks should be performed on a routine basis by CHISON Service or qualified hospital personnel.

### **Mechanical hazard:**

A defective probe or excess force can cause patient injury or probe damage:

- Observe depth markings and do not apply excessive force when inserting or manipulating endocavitary probe.
- Inspect probes for sharp edges or rough surfaces that may injure sensitive tissue.
- DO NOT apply excessive force to the probe connector when inserting into the probe port. The pin of a probe connector may bend.

### **Special handling instructions**

#### **Using protective sheaths**

The use of market cleared probe sheaths is recommended for clinical applications. Reference FDA March 29, 1991 "Medical Alert on Latex Products".

Protective sheaths may be required to minimize disease transmission. Probe sheaths are available for use with all clinical situations where infection is a concern. Use of legally marketed, sterile probe sheaths is strongly recommended for endo-cavitary procedures.

DO NOT use pre-lubricated condoms as a sheath. In some cases, they can damage the probe. Lubricants in these condoms may not be compatible with probe construction.

Devices containing latex may cause severe allergic reaction in latex sensitive individuals. Refer to FDA's March 29, 1991 Medical Alert on latex products.

DO NOT use an expired probe sheath. Before using a sheath, verify if it has expired.

#### **Endocavitary Probe Handling Precautions**

If the sterilization solution comes out of the endocavitary probe, please follow the cautions below:

**Sterilant Exposure to Patient (e.g., Cidex):** Contact with a sterilant to the patient's skin for mucous membrane may cause an inflammation. If this happens, refer to instruction manual of the sterilant.

**Sterilant Exposure from Probe handle to Patient (e.g. Cidex):** DO NOT allow the sterilant to contact the patient. Only immerse the probe to its specified level. Ensure that no solution has entered the probe's handle before scanning the patient. If sterilant comes into contact with the patient, refer to the sterilant's instruction manual.

**Sterilant Exposure from Probe connector to Patient (e.g. Cidex):** DO NOT allow the sterilant to contact the patient. Only immerse the probe to its specified level. Ensure that no solution has entered the probe's connector before scanning the patient. If sterilant comes into contact with the patient, refer to the sterilant's instruction manual.

**Endocavitary Probe Point of Contact:** Refer to the sterilant's instruction manual.

### **Probe handling and infection control:**

This information is intended to increase user awareness of the risks of disease transmission associated with using this equipment and provide guidance in making decisions directly affecting the safety of the patient as well as the equipment user.

Diagnostic ultrasound systems utilize ultrasound energy that must be coupled to the patient by direct physical contact.

Depending on the type of examination, this contact occurs with a variety of tissues ranging from intact skin in a routine exam to recirculating blood in a surgical procedure. The level of risk of infection varies greatly with the type of contact.

One of the most effective ways to prevent transmission between patients is with single use or disposable devices. However, ultrasound transducers are complex and expensive devices that must be reused between patients. It is very important, therefore, to minimize the risk of disease transmission by using barriers and through proper processing between patients.

### **Risk of Infection**

ALWAYS clean and disinfect the probe between patients to the level appropriate for the type of examination and use FDA-cleared probe sheaths where appropriate.

Adequate cleaning and disinfection are necessary to prevent disease transmission. It is the responsibility of the equipment user to verify and maintain the effectiveness of the infection control procedures in use. Always use sterile, legally marketed probe sheaths for intra-cavitary procedures.

### **Probe Cleaning process:**

DO disconnect the probe from the system prior to cleaning/disinfecting the probe. Failure to do so could damage the system.

### **Perform Cleaning probe after each use**

- Disconnect the probe from the ultrasound console and remove all coupling gel from the probe by wiping with a soft cloth and rinsing with flowing water.
- Wash the probe with mild soap in lukewarm water. Scrub the probe as needed using a soft sponge, gauze, or cloth to remove all visible residue from the probe surface. Prolonged soaking or scrubbing with a soft

bristle brush (such as a toothbrush) may be necessary if material has dried onto the probe surface.

### **⚠WARNING**

*To avoid electrical shock, always turn off the system and disconnect the probe before cleaning the probe.*

### **⚠CAUTION**

*Take extra care when handling the lens face of the Ultrasound transducer. The lens face is especially sensitive and can easily be damaged by rough handling. NEVER use excessive force when cleaning the lens face.*

- *Rinse the probe with enough clean potable water to remove all visible soap residue.*
- *Air dry or dry with a soft cloth.*

### **⚠CAUTION**

*To minimize the risk of infection from blood-borne pathogens, you must handle the probe and all disposables that have contacted blood, other potentially infectious materials, mucous membranes, and non-intact skin in accordance with infection control procedures. You must wear protective gloves when handling potentially infectious material. Use a face shield and gown if there is a risk of splashing or splatter.*

### **Disinfecting the probes:**

*After each use, please disinfect the probes.* Ultrasound probes can be disinfected using liquid chemical germicides. The level of disinfection is directly related to the duration of contact with the germicide. Increased contact time produces a higher level of disinfection.

In order for liquid chemical germicides to be effective, all visible residue must be removed during the cleaning process. Thoroughly clean the probe, as described earlier before attempting disinfection.

You MUST disconnect the probe from the system prior to cleaning/disinfecting the probe. Failure to do so could damage the system.

DO NOT soak probes in liquid chemical germicide for longer than is stated by the germicide instructions for use. Extended soaking may cause probe damage and early failure of the enclosure, resulting in possible electric shock hazard.

- Prepare the germicide solution according to the manufacturer's instructions. Be sure to follow all precautions for storage, use and disposal. The transducer is not designed to be totally submerged in fluid. Permanent damage will result if the entire transducer is submerged. The immersed part shall not exceed the transducer binding line.
- Place the cleaned and dried probe in contact with the germicide for the time specified by the germicide manufacturer. High-level disinfection is recommended for surface probes and is required for endocavitary

probes (follow the germicide manufacturer's recommended time).

- After removing from the germicide, rinse the probe following the germicide manufacturer's rinsing instructions. Flush all visible germicide residue from the probe and allow to air dry.

Ultrasound transducers can easily be damaged by improper handling and by contact with certain chemicals. Failure to follow these precautions can result in serious injury and equipment damage

- Do not immerse the probe into any liquid beyond the level specified for that probe. Never immerse the transducer connector or probe adapters into any liquid.
- Avoid mechanical shock or impact to the transducer and do not apply excessive bending or pulling force to the cable.
- Transducer damage can result from contact with inappropriate coupling or cleaning agents:
  - Do not soak or saturate transducers with solutions containing alcohol, bleach, ammonium chloride compounds or hydrogen peroxide
  - Avoid contact with solutions or coupling gels containing mineral oil or lanolin
  - Avoid temperatures above 60 °C. Under no circumstances should the transducer be subjected to heat sterilization method. Exposure to temperatures above 60 °C will cause permanent damage to the transducer.
- Inspect the probe prior to use for damage or degeneration to the housing, strain relief, lens and seal. Do not use a damaged or defective probe.

### **Coupling gels**

DO NOT use unrecommended gels (lubricants). They may damage the probe and void the warranty. AQUASONIC Gel made by R. P. Kincheloe Company in USA is recommended.

In order to assure optimal transmission of energy between the patient and probe, a conductive gel must be applied liberally to the patient where scanning will be performed.

DO NOT apply gel to the eyes. If there is gel contact to the eye, flush eye thoroughly with water.

Coupling gels should not contain the following ingredients as they are known to cause probe damage:

- Methanol, ethanol, isopropanol, or any other alcohol-based product.
- Mineral oil
- Iodine
- Lotions
- Lanolin
- Aloe Vera
- Olive Oil
- Methyl or Ethyl Parabens (para hydroxybenzoic acid)
- Dimethylsilicone

### **Planned maintenance**

The following maintenance plan is suggested for the system and probes to ensure optimum operation and safety.

**Daily:** inspect the probes

**After each use:** clean the probes, disinfect the probes.

**As necessary:** inspect the probes, clean the probes, disinfect the probes.

### **Returning/Shipping Probes and Repair Parts**

Transportation dept. and our policy require that equipment returned for service **MUST** be clean and free of blood and other infectious substances.

When you return a probe or part for service, you need to clean and disinfect the probe or part prior to packing and shipping the equipment.

Ensure that you follow probe cleaning and disinfection instructions provided in this Manual.

This ensures that employees in the transportation industry as well as the people who receive the package are protected from any risk.

### **AIUM outlines cleaning the endocavitary transducer:**

#### **Guidelines for Cleaning and Preparing Endocavitary Ultrasound Transducers Between Patients From AIUM**

*Approved June 4, 2003*

The purpose of this document is to provide guidance regarding the cleaning and disinfection of transvaginal and transrectal ultrasound probes.

All sterilization/disinfection represents a statistical reduction in the number of microbes present on a surface. Meticulous cleaning of the instrument is the essential icon to an initial reduction of the microbial/organic load by at least 99%. This cleaning is followed by a disinfecting procedure to ensure a high degree of protection from infectious disease transmission, even if a disposable barrier covers the instrument during use.

Medical instruments fall into different categories with respect to potential for infection transmission. The most critical level of instruments are those that are intended to penetrate skin or mucous membranes. These require sterilization. Less critical instruments (often called "semi-critical" instruments) that simply come into contact with mucous membranes such as fiber optic endoscopes require high-level disinfection rather than sterilization.

Although endocavitary ultrasound probes might be considered even less critical instruments because they are routinely protected by single use disposable probe covers, leakage rates of 0.9% - 2% for condoms and 8%-81% for commercial probe covers have been observed in recent studies. For maximum safety, one should therefore perform **high-level disinfection** of the probe between each use and use a probe cover or condom as an aid in keeping the probe clean.

There are four generally recognized categories of disinfection and sterilization. **Sterilization** is the complete elimination of all forms of microbial life including spores and viruses.

**Disinfection**, the selective removal of microbial life, is divided into three classes:

**High-Level Disinfection** - Destruction/removal of all microorganisms except bacterial spores.

**Mid-Level Disinfection** - Inactivation of Mycobacterium Tuberculosis, bacteria, most viruses, fungi, and some bacterial spores.

**Low-Level Disinfection** - Destruction of most bacteria, some viruses and some fungi. Low-level disinfection will not necessarily inactivate Mycobacterium Tuberculosis or bacterial spores.

The following specific recommendations are made for the use of Endocavitary ultrasound transducers. Users should also review the Centers for Disease Control and Prevention document on sterilization and disinfection of medical devices to be certain that their procedures conform to the CDC principles for disinfection of patient care equipment.

## 1. CLEANING

After removal of the probe cover, use running water to remove any residual gel or debris from the probe. Use a damp gauze pad or other soft cloth and a small amount of mild non-abrasive liquid soap (household dishwashing liquid is ideal) to thoroughly cleanse the transducer. Consider the use of a small brush especially for crevices and areas of angulation depending on the design of your particular transducer. Rinse the transducer thoroughly with running water, and then dry the transducer with a soft cloth or paper towel.

## 2. DISINFECTION

Cleaning with a detergent/water solution as described above is important as the first step in proper disinfection since chemical disinfectants act more rapidly on clean surfaces. However, the additional use of a high level liquid disinfectant will ensure further statistical reduction in microbial load. Because of the potential disruption of the barrier sheath, additional high level disinfection with chemical agents is necessary. Examples of such high level disinfectants include but are not limited to:

- 2.4-3.2% glutaraldehyde products (a variety of available proprietary products including "Cidex," "Metricide," or "Procide").
- Non-glutaraldehyde agents including Cidex OPA (o-phthalaldehyde), Cidex PA (hydrogen peroxide & peroxyacetic acid).
- 7.5% Hydrogen Peroxide solution.
- Common household bleach (5.25% sodium hypochlorite) diluted to yield 500 parts per million chlorine (10 cc in one liter of tap water). This agent is effective, but generally not recommended by probe manufacturers because it can damage metal and plastic parts.

Other agents such as quaternary ammonium compounds are not considered high level disinfectants and should not be used. Isopropanol is not a high level disinfectant when used as a wipe and probe manufacturers generally do not recommend soaking probes in the liquid.

The FDA has published a list of approved sterilants and high level disinfectants for use in processing reusable medical and dental devices. That list can be consulted to find agents that may be useful for probe disinfection.

Practitioners should consult the labels of proprietary products for specific instructions. They should also consult

instrument manufacturers regarding compatibility of these agents with probes. Many of the chemical disinfectants are potentially toxic and many require adequate precautions such as proper ventilation, personal protective devices (gloves, face/eye protection, etc.) and thorough rinsing before reuse of the probe.

### 3. PROBE COVERS

The transducer should be covered with a barrier. If the barriers used are condoms, these should be nonlubricated and nonmedicated. Practitioners should be aware that condoms have been shown to be less prone to leakage than commercial probe covers, and have a six-fold enhanced AQL (acceptable quality level) when compared to standard examination gloves. They have an AQL equal to that of surgical gloves. Users should be aware of latex-sensitivity issues and have available nonlatex-containing barriers.

### 4. ASEPTIC TECHNIQUE

For the protection of the patient and the health care worker, all endocavitary examinations should be performed with the operator properly gloved throughout the procedure. Gloves should be used to remove the condom or other barrier from the transducer and to wash the transducer as outlined above. As the barrier (condom) is removed, care should be taken not to contaminate the probe with secretions from the patient. At the completion of the procedure, hands should be thoroughly washed with soap and water.

 **Note:** *Obvious disruption in condom integrity does NOT require modification of this protocol. These guidelines take into account possible probe contamination due to a disruption in the barrier sheath.*

In summary, routine high-level disinfection of the endocavitary probe between patients, plus the use of a probe cover or condom during each examination is required to properly protect patients from infection during endocavitary examinations. For all chemical disinfectants, precautions must be taken to protect workers and patients from the toxicity of the disinfectant.

Amis S, Ruddy M, Kibbler CC, Economides DL, MacLean AB. Assessment of condoms as probe covers for transvaginal sonography. *J Clin Ultrasound* 2000;28:295-8.

Rooks VJ, Yancey MK, Elg SA, Brueske L. Comparison of probe sheaths for endovaginal sonography. *Obstet. Gynecol* 1996;87:27-9.

Milki AA, Fisch JD. Vaginal ultrasound probe cover leakage: implications for patient care. *Fertil Steril* 1998;69:409-11.

Hignett M, Claman P. High rates of perforation are found in endovaginal ultrasound probe covers before and after oocyte retrieval for in vitro fertilization-embryo transfer. *J Assist Reprod Genet* 1995;12:606-9.

Sterilization and Disinfection of Medical Devices: General Principles. Centers for Disease Control, Division of Healthcare Quality Promotion. <http://www.cdc.gov/ncidod/hip/sterile/sterilgp.htm> (5-2003).



ODE Device Evaluation Information--FDA Cleared Sterilants and High Level Disinfectants with General Claims for Processing Reusable Medical and Dental Devices, March 2003.  
<http://www.fda.gov/cdrh/ode/germlab.html> (5-2003).

## 15.3 Probe Operation Instructions

For details on connecting, activating, deactivating, disconnecting, transporting and storing the probes.

### 15.3.1 Scanning the Patient

In order to assure optimal transmission of energy between the patient and probe, a conductive gel must be applied liberally to the patient where scanning will be performed.

After the examination is complete, follow the cleaning and disinfecting, or sterilizing procedures as appropriate.

### 15.3.2 Operating Transvaginal probe

The transvaginal probe is an endo-cavity probe, for the operation safety, please refer to “Care and Maintenance” for cleaning and disinfection.

Transvaginal probe should be used with FDA approved condom or probe cover. See the following instructions to put the probe into the condom:

#### **CAUTION**

- Some patients may be allergic to natural rubber or medical device with rubber contains. FDA suggests that the user to identify these patients and be prepared to treat allergic reactions promptly before scanning.
- Only water-solvable solutions or gel can be used. Petroleum or mineral oil-based materials may harm the cover.
- When the transvaginal probe is activated outside patient’s body, its acoustic output level should be decreased to avoid any harmful interference with other equipment.

#### Operation Procedure:

- Put on medical sterile glove
- Get the condom for the package.
- Unfold the condom.
- Load some ultrasound gel into condom.
- Take the condom with one hand, and put the probe head into the condom.
- Fasten the condom on the end of the probe handle.
- Confirm the integrity of the condom, and repeat the above steps to the condom if any damage to the condom is found.

### 15.3.3 Cleaning and Disinfecting TV and TR Probes

**We strongly recommend wearing gloves when cleaning and disinfecting any endocavitary probe.**

- Every time before and after each exam, please clean the probe handle and disinfect the transvaginal and transrectal probes probe using liquid chemical germicides
- If the probe is contaminated with body fluids, you should disinfect the probe after cleaning.
- Regard any exam waste as potentially infectious and dispose of it accordingly.

**⚠ CAUTION**

- Since the probe is not waterproof, you should disconnect it from the system before cleaning or disinfecting.

Before and after each exam, please clean the probe handle and disinfect the transvaginal and transrectal probes using liquid chemical germicides.

**Cleaning**

You can clean the transvaginal and transrectal probes to remove all coupling gel by wiping with a soft cloth and rinsing with flowing water. Then wash the probe with mild soap in lukewarm water. Scrub the probe as needed and use a soft cloth to remove all visible residues from the transvaginal probe surface. Rinse the probe with enough clean potable water to remove all visible soap residues, and let the probe air dry.

**⚠ CAUTION**

- *Please remove the cover (if any) before cleaning the probe.(The cover like condom is one time usable).*
- *When cleaning the TV and TR probes, it is important to be sure that all surfaces are thoroughly cleaned.*

**Disinfecting**

2 Glutaraldehyde-based solutions have been shown to be very effective for this purpose. Cidex is the only germicide that has been evaluated for compatibility with the material used to construct the probes.

To keep the effectiveness of the disinfection solutions, a thoroughly cleaning must be done to the probe before the disinfecting, make sure no residues remain on the probe.

**Disinfecting Procedure:**

- Following all precautions for storage, use and disposal, prepare the germicide solution according to the manufacturer's instructions.
- Place the cleaned and dried probe to contact with the germicide, being careful not to let the probe drop to the bottom of the container and thus damage the probe.
- After placing/immersing, rotate and shake the probe while it is below the surface of the germicide to eliminate air pockets. Allow the germicide to remain in contact with the fully immersed probe. For high level disinfection, follow the manufacturer's recommended time.
- Following all precautions for storage, use and disposal, prepare the germicide solution according to the

manufacturer's instructions.

- After removing from the germicide, rinse the probe according to the germicide manufacturer's rinsing instructions.
- Flush all visible germicide residues from the probe and allow to air dry.

## 15.4 Service Responsibility

If users install, use and maintain the system fully according to CHISON's installation manual, operation manual and service manual, then SONOTOUCH main unit has a life time of 5 years and SONOTOUCH probes have life time of 5 years after ex-work.

The warranty of the system and probes after ex-work is as the time in the warranty card.

The system is a precise electronic system. Only the CHISON's authorized service engineer could replace the defective parts. Any assembly, disassembly, handling, repair, or replacement by any other people may have adverse impact on the safety and effectiveness of the systems and probes, and thus will reduce the life time of the system and probes, and such systems and probes will not be covered by CHISON warranty after the above improper handling. Standard maintenance must be performed by CHISON's authorized service engineer during the life time of the product.



**CAUTION:** When the above life time is expired, the effectiveness and safety of system and probes maybe greatly affected, so it's NOT suggested to continue using the system and probes even the system and probes seem work properly. But if user still wants to continue using the system and probes, user should first contact CHISON service center at CHISON headquarter to arrange the necessary safety check and calibration by CHISON's authorized service engineer. If CHISON headquarter service center provides the calibration certificate for the related system or probe, then user could continue use the system or probes according to the calibration certificate. However, if CHISON headquarter service center concludes that the system or probe is no longer complied to the safety and effectiveness standard, then user should immediately stop using the system or probe. User understands that such check and calibration cost will be born by the user. Systems and probes keep on using after the life time may also be difficult to repair and maintain, so it's suggested to renew the product after the life time.

### REFERENCE:

1. AIUM/NEMA: Standard For Real-Time Display of Thermal and Mechanical Acoustic Output Indices On Diagnostic Ultrasound Equipment, Revision 2. NEMA Standards Publication UD 3-2004; American Institute

- 
- of Ultrasound in Medicine, Laurel MD; National Electrical Manufacturers Association, Rosslyn, VA; 2004a.
2. Implementation of the Principle of As Reasonably Achievable (ALARA) for Medical and Dental Personnel, National Council on Radiation Protection and Measurements (NCRP), report NO.107, December 31,1990
  3. FDA Center for Devices and radiological Health (CDRH), 510(K) Guidance for Diagnostic Ultrasound and Fetal Doppler Ultrasound Medical Devices, September 8 1989 draft
  4. FDA/CDRH,510(K) Diagnostic Ultrasound Guidance Update of 1991, April 26, 1991 draft
  5. Biological Effects of Ultrasound: Mechanisms and Clinical Implications, NCRP Report No. 74, December 30,1983
  6. Exposure Criteria for Medical Diagnostic Ultrasound: I. Criteria Based on Thermal Mechanisms, NCRP Report No.113, June 1,1992
  7. Bioeffects Considerations for the safety of Diagnostic Ultrasound, Journal of Ultrasound in Medicine, AIUM, September1988
  8. Geneva Report on Safety and Standardization in Medical Ultrasound, WFUMB, May 1990 Medical Ultrasound Safety, AIUM, 1994
  9. Medical Electrical Equipment standard IEC 60601-1, IEC60601-1-1, IEC60601-1-2, IEC 60601-2-37, IEC 60601-2-4
  10. Diagnostic Ultrasound Physics and Equipment, edit by P. R. Hoskins, in 2003

## **Appendix A: The Information of EC Representative**

Shanghai International Holding Corp.GmbH(Europe)

Add: Eiffestrasse 80,20537 Hamburg,Germany

Tel: 0049-40-2513175

Fax:0049-40-255726

E-mail: [antonsissi@hotmail.com](mailto:antonsissi@hotmail.com) [shholding@hotmail.com](mailto:shholding@hotmail.com)

## Appendix B: Maximum Acoustic Output Report

**System:** Ultrasound Diagnostic System

**Transducer Model:** C3 Convex Array

**Operating Mode:** B

Index Label		MI	TIS			TIB	TIC	
			scan	non-scan		non-scan		
				A <sub>aprt</sub> ≤1	A <sub>aprt</sub> >1			
Global Maximum Index Value		0.58	0.05				#	
Associated Acoustic Parameter	P <sub>r,3</sub> (MPa)	0.99						
	W <sub>o</sub> (mW)		20				#	
	min of [W <sub>.3</sub> (z <sub>1</sub> ), I <sub>TA,3</sub> (z <sub>1</sub> )] (mW)							
	z <sub>1</sub> (cm)							
	z <sub>bp</sub> (cm)							
	z <sub>sp</sub> (cm)							
	z@PII <sub>.3max</sub> (cm)	4.55						
	d <sub>eq</sub> (z <sub>sp</sub> ) (cm)							
	f <sub>c</sub> (MHz)	2.92	3.30				#	
	Dim of A <sub>aprt</sub>	X (cm)		2.09				#
Y (cm)			1.10				#	
Other Information	PD (μsec)	0.29						
	PRF (Hz)	2283						
	p <sub>r</sub> @PII <sub>max</sub> (MPa)	1.55						
	d <sub>eq</sub> @PII <sub>max</sub> (cm)							
	Focal Length	FL <sub>x</sub> (cm)		0.30				#
		FL <sub>y</sub> (cm)		0.98				#
	I <sub>PA,3</sub> @ MI <sub>max</sub> (W/cm <sup>2</sup> )	31.78						
Operating Control Conditions	Mode	B	B				#	
	Focus (cm)	6	3				#	
	Power (%)	100	100				#	

**Notes:** (a) This index is not required for this operating mode. see section 4.1.3.1. of the Output Display Standard (NEMA UD-3).

(b) This probe is not intended for transcranial or neonatal cephalic uses.

(c)

This formulation for TIS is less than that for an alternate formulation in this mode.

# No data are reported for this operating condition since the global maximum index value is not reported for the reason listed.

**System:** Ultrasound Diagnostic System

**Transducer Model:** C3 Convex Array

**Operating Mode:** THI-B

Index Label		MI	TIS		TIB	TIC	
			scan	non-scan			non-scan
				A <sub>aprt</sub> ≤1	A <sub>aprt</sub> >1		
Global Maximum Index Value		0.85	0.02			#	
Associated Acoustic Parameter	P <sub>r,3</sub> (MPa)	1.46					
	W <sub>o</sub> (mW)		2			#	
	min of [W <sub>.3</sub> (z <sub>1</sub> ), I <sub>TA,3</sub> (z <sub>1</sub> )] (mW)						
	z <sub>1</sub> (cm)						
	z <sub>bp</sub> (cm)						
	z <sub>sp</sub> (cm)						
	z@PII <sub>.3max</sub> (cm)	4.85					
	d <sub>eq</sub> (z <sub>sp</sub> ) (cm)						
	f <sub>c</sub> (MHz)	2.95	2.98				#
	Dim of A <sub>aprt</sub>	X (cm)		2.09			#
Y (cm)			1.10			#	
Other Information	PD (μsec)	0.85					
	PRF (Hz)	2381					
	p <sub>r</sub> @PII <sub>max</sub> (MPa)	2.38					
	d <sub>eq</sub> @PII <sub>max</sub> (cm)						
	Focal Length	FL <sub>x</sub> (cm)		0.60			#
		FL <sub>y</sub> (cm)		0.94			#
I <sub>PA,3</sub> @ MI <sub>max</sub> (W/cm <sup>2</sup> )	66.63						
Operating Control Conditions	Mode	B	B			#	
	Focus (cm)	6	2			#	
	Power (%)	100	100			#	

**Notes:** (a) This index is not required for this operating mode. see section 4.1.3.1. of the Output Display Standard (NEMA UD-3).

(b) This probe is not intended for transcranial or neonatal cephalic uses.

(c)

This formulation for TIS is less than that for an alternate formulation in this mode.

# No data are reported for this operating condition since the global maximum index value is not reported for the reason listed.

**System: Ultrasound Diagnostic System**

**Transducer Model: C3 Convex Array**

**Operating Mode: B+M**

Index Label		MI	TIS		TIB	TIC	
			scan	non-scan			non-scan
				A <sub>aprt</sub> ≤1	A <sub>aprt</sub> >1		
<b>Global Maximum Index Value</b>		0.51		0.09	0.19	#	
Associated Acoustic Parameter	P <sub>r,3</sub> (MPa)	0.87					
	W <sub>o</sub> (mW)				20	#	
	min of [W <sub>.3</sub> (z <sub>1</sub> ), I <sub>TA,3</sub> (z <sub>1</sub> )] (mW)			6.29			
	z <sub>1</sub> (cm)			4.25			
	z <sub>bp</sub> (cm)						
	z <sub>sp</sub> (cm)				2.60		
	z@PII <sub>.3max</sub> (cm)	4.25					
	d <sub>eq</sub> (z <sub>sp</sub> ) (cm)				1.94		
	f <sub>c</sub> (MHz)	2.90		2.90	3.13	#	
	Dim of A <sub>aprt</sub>	X (cm)			6.96	6.96	#
Y (cm)				1.10	1.10	#	
Other Information	PD (μsec)	0.33					
	PRF (Hz)	668.9					
	p <sub>r</sub> @PII <sub>max</sub> (MPa)	1.25					
	d <sub>eq</sub> @PII <sub>max</sub> (cm)				1.94		
	Focal Length	FL <sub>x</sub> (cm)			0.30		#
		FL <sub>y</sub> (cm)			0.98		#
	I <sub>PA,3</sub> @ MI <sub>max</sub> (W/cm <sup>2</sup> )	22.80					
Operating Control Conditions	Mode	B+M		B+M	B+M	#	
	Focus (cm)	6		6	3	#	
	Power (%)	100		100	100	#	

**Notes:** (a) This index is not required for this operating mode. see section 4.1.3.1. of the Output Display Standard (NEMA UD-3).

(b) This probe is not intended for transcranial or neonatal cephalic uses. (c)

This formulation for TIS is less than that for an alternate formulation in this mode.

# No data are reported for this operating condition since the global maximum index value is not reported for the reason listed.



**System: Ultrasound Diagnostic System**

**Transducer Model: C3 Convex Array**

**Operating Mode: B+C**

Index Label		MI	TIS		TIB	TIC	
			scan	non-scan			non-scan
				A <sub>aprt</sub> ≤1	A <sub>aprt</sub> >1		
<b>Global Maximum</b> Index Value		0.56	0.14			#	
Associated Acoustic Parameter	P <sub>r,3</sub> (MPa)	1.01					
	W <sub>o</sub> (mW)		49.8			#	
	min of [W <sub>.3</sub> (z <sub>1</sub> ), I <sub>TA,3</sub> (z <sub>1</sub> )] (mW)						
	z <sub>1</sub> (cm)						
	z <sub>bp</sub> (cm)						
	z <sub>sp</sub> (cm)						
	z@PII <sub>.3max</sub> (cm)	3.35					
	d <sub>eq</sub> (z <sub>sp</sub> ) (cm)						
	f <sub>c</sub> (MHz)	3.24	3.23			#	
	Dim of A <sub>aprt</sub>	X (cm)		2.09			#
Y (cm)			1.10			#	
Other Information	PD (μsec)	1.23					
	PRF (Hz)	6097					
	p <sub>r</sub> @PII <sub>max</sub> (MPa)	1.59					
	d <sub>eq</sub> @PII <sub>max</sub> (cm)						
	Focal Length	FL <sub>x</sub> (cm)		0.51			#
		FL <sub>y</sub> (cm)		0.74			#
I <sub>PA,3</sub> @ MI <sub>max</sub> (W/cm <sup>2</sup> )	31.52						
Operating Control Conditions	Mode	B+C	B+C			#	
	Focus (cm)	5	7			#	
	Power (%)	100	100			#	

**Notes:** (a) This index is not required for this operating mode. see section 4.1.3.1. of the Output Display Standard (NEMA UD-3).

(b) This probe is not intended for transcranial or neonatal cephalic uses.

(c)

This formulation for TIS is less than that for an alternate formulation in this mode.

# No data are reported for this operating condition since the global maximum index value is not reported for the reason listed.

**System: Ultrasound Diagnostic System**

**Transducer Model: C3 Convex Array**

**Operating Mode: PW**

Index Label		MI	TIS			TIB	TIC	
			scan	non-scan		non-scan		
				A <sub>aprt</sub> ≤1	A <sub>aprt</sub> >1			
Global Maximum Index Value		0.59		0.34		1.08	#	
Associated Acoustic Parameter	P <sub>r,3</sub> (MPa)	1.00						
	W <sub>o</sub> (mW)			40		36	#	
	min of [W <sub>.3</sub> (z <sub>1</sub> ), I <sub>TA,3</sub> (z <sub>1</sub> )] (mW)							
	z <sub>1</sub> (cm)							
	z <sub>bp</sub> (cm)							
	z <sub>sp</sub> (cm)					4.95		
	z@PII <sub>.3max</sub> (cm)	5						
	d <sub>eq</sub> (z <sub>sp</sub> ) (cm)					0.28		
	f <sub>c</sub> (MHz)	2.89		2.89		2.89	#	
	Dim of A <sub>aprt</sub>	X (cm)			6.96		6.96	#
Y (cm)				1.10		1.10	#	
Other Information	PD (μsec)	1.28						
	PRF (Hz)	4386						
	p <sub>r</sub> @PII <sub>max</sub> (MPa)	1.60						
	d <sub>eq</sub> @PII <sub>max</sub> (cm)					0.28		
	Focal Length	FL <sub>x</sub> (cm)			0.26			#
		FL <sub>y</sub> (cm)			0.56			#
I <sub>PA,3</sub> @ MI <sub>max</sub> (W/cm <sup>2</sup> )	36.31							
Operating Control Conditions	Mode	PW		PW		PW	#	
	Focus (cm)	3		7		3	#	
	Power (%)	100		100		100	#	

**Notes:** (a) This index is not required for this operating mode. see section 4.1.3.1. of the Output Display Standard (NEMA UD-3).

(b) This probe is not intended for transcranial or neonatal cephalic uses.

(c)

This formulation for TIS is less than that for an alternate formulation in this mode.

# No data are reported for this operating condition since the global maximum index value is not reported for the reason listed.

**System: Ultrasound Diagnostic System**

**Transducer Model: MC3 Convex Array**

**Operating Mode: B**

Index Label		MI	TIS			TIB	TIC
			scan	non-scan		non-scan	
				A <sub>aprt</sub> ≤1	A <sub>aprt</sub> >1		

Global Maximum Index Value		0.39	0.02				#	
Associated Acoustic Parameter	$P_{r,3}$ (MPa)	0.69						
	$W_o$ (mW)		4.32				#	
	min of $[W_{.3}(z_1), I_{TA,3}(z_1)]$ (mW)							
	$z_1$ (cm)							
	$z_{bp}$ (cm)							
	$z_{sp}$ (cm)							
	$z@PII_{.3max}$ (cm)	3.35						
	$d_{eq}(z_{sp})$ (cm)							
	$f_c$ (MHz)	3.20	3.54				#	
	Dim of $A_{aprt}$	X (cm)		1.15				#
Y (cm)			1.1				#	
Other Information	PD ( $\mu$ sec)	0.35						
	PRF (Hz)	2299						
	$p_r@PII_{max}$ (MPa)	1.00						
	$d_{eq}@PII_{max}$ (cm)							
	Focal Length	$FL_x$ (cm)		0.46				#
		$FL_y$ (cm)		0.32				#
$I_{PA,3}@MI_{max}$ ( $W/cm^2$ )	14.50							
Operating Control Conditions	Mode	B	B				#	
	Focus (cm)	7	3				#	
	Power (%)	100	100				#	

**Notes:** (a) This index is not required for this operating mode. see section 4.1.3.1. of the Output Display Standard (NEMA UD-3).

(b) This probe is not intended for transcranial or neonatal cephalic uses. (c)

This formulation for TIS is less than that for an alternate formulation in this mode.

# No data are reported for this operating condition since the global maximum index value is not reported for the reason listed.

**System: Ultrasound Diagnostic System**  
**Transducer Model: MC3 Convex Array**

**Operating Mode: THI-B**

Index Label	MI	TIS		TIB	TIC	
		scan	non-scan			non-scan
			$A_{aprt} \leq 1$	$A_{aprt} > 1$		
Global Maximum Index Value	0.37	0.12			#	
$P_{r,3}$ (MPa)	0.64					
$W_o$ (mW)		4.32			#	

Associated Acoustic Parameter	min of $[W_{.3}(z_1), I_{TA.3}(z_1)]$ (mW)						
	$z_1$ (cm)						
	$z_{bp}$ (cm)						
	$z_{sp}$ (cm)						
	$z@PII_{.3max}$ (cm)		3.35				
	$d_{eq}(z_{sp})$ (cm)						
	$f_c$ (MHz)		2.95	2.96			#
	Dim of $A_{aprt}$	X (cm)		1.15			#
Y (cm)			1.10			#	
Other Information	PD ( $\mu$ sec)		0.35				
	PRF (Hz)		2299				
	$p_r@PII_{max}$ (MPa)		1.12				
	$d_{eq}@PII_{max}$ (cm)						
	Focal Length	FL <sub>x</sub> (cm)		0.46			#
		FL <sub>y</sub> (cm)		0.32			#
	$I_{PA.3}@MI_{max}$ ( $W/cm^2$ )		12.02				
Operating Control Conditions	Mode		THI-B	THI-B			#
	Focus (cm)		7	3			#
	Power (%)		100	100			#

**Notes:** (a) This index is not required for this operating mode. see section 4.1.3.1. of the Output Display Standard (NEMA UD-3).

(b) This probe is not intended for transcranial or neonatal cephalic uses. (c)

This formulation for TIS is less than that for an alternate formulation in this mode.

# No data are reported for this operating condition since the global maximum index value is not reported for the reason listed.

**System: Ultrasound Diagnostic System**

**Transducer Model: MC3 Convex Array**

**Operating Mode: B+M**

Index Label		MI	TIS		TIB	TIC	
			scan	non-scan			non-scan
				A <sub>aprt</sub> ≤1	A <sub>aprt</sub> >1		
<b>Global Maximum Index Value</b>		0.40		0.02	0.04	#	
Associated Acoustic Parameter	P <sub>r,3</sub> (MPa)	0.69					
	W <sub>o</sub> (mW)				2	#	
	min of [W <sub>.3</sub> (z <sub>1</sub> ), I <sub>TA,3</sub> (z <sub>1</sub> )] (mW)			1.29			
	z <sub>1</sub> (cm)			2			
	z <sub>bp</sub> (cm)			1.90			
	z <sub>sp</sub> (cm)				3.45		
	z@PII <sub>.3max</sub> (cm)	3.45					
	d <sub>eq</sub> (z <sub>sp</sub> ) (cm)				0.58		
	f <sub>c</sub> (MHz)	2.95		2.95	2.95	#	
	Dim of A <sub>aprt</sub>	X (cm)			3.84	3.84	#
Y (cm)				1.1	1.1	#	
Other Information	PD (μsec)	0.33					
	PRF (Hz)	668.9					
	p <sub>r</sub> @PII <sub>max</sub> (MPa)	1.03					
	d <sub>eq</sub> @PII <sub>max</sub> (cm)				0.56		
	Focal Length	FL <sub>x</sub> (cm)			0.36		#
		FL <sub>y</sub> (cm)			0.49		#
I <sub>PA,3</sub> @ MI <sub>max</sub> (W/cm <sup>2</sup> )	14.70						
Operating Control Conditions	Mode	B+M		B+M	B+M	#	
	Focus (cm)	7		7	7	#	
	Power (%)	100		100	100	#	

**Notes:** (a) This index is not required for this operating mode. see section 4.1.3.1. of the Output Display Standard (NEMA UD-3).

(b) This probe is not intended for transcranial or neonatal cephalic uses.

(c)

This formulation for TIS is less than that for an alternate formulation in this mode.

# No data are reported for this operating condition since the global maximum index value is not reported for the reason listed.

**System: Ultrasound Diagnostic System**

**Transducer Model: MC3 Convex Array**

**Operating Mode: B+C**

Index Label		MI	TIS			TIB	TIC	
			scan	non-scan		non-scan		
				A <sub>aprt</sub> ≤1	A <sub>aprt</sub> >1			
<b>Global Maximum Index Value</b>		0.61	0.12				#	
Associated Acoustic Parameter	P <sub>r,3</sub> (MPa)	1.05						
	W <sub>o</sub> (mW)		12				#	
	min of [W <sub>.3</sub> (z <sub>1</sub> ), I <sub>TA,3</sub> (z <sub>1</sub> )] (mW)							
	z <sub>1</sub> (cm)							
	z <sub>bp</sub> (cm)							
	z <sub>sp</sub> (cm)							
	z@PII <sub>.3max</sub> (cm)	3.66						
	d <sub>eq</sub> (z <sub>sp</sub> ) (cm)							
	f <sub>c</sub> (MHz)	2.95	2.95				#	
	Dim of A <sub>aprt</sub>	X (cm)		1.15				#
Y (cm)			1.10				#	
Other Information	PD (μsec)	0.24						
	PRF (Hz)	6097						
	p <sub>r</sub> @PII <sub>max</sub> (MPa)	1.25						
	d <sub>eq</sub> @PII <sub>max</sub> (cm)							
	Focal Length	FL <sub>x</sub> (cm)		0.36				#
		FL <sub>y</sub> (cm)		0.49				#
I <sub>PA,3</sub> @ MI <sub>max</sub> (W/cm <sup>2</sup> )	42.16							
Operating Control Conditions	Mode	B+C	B+C				#	
	Focus (cm)	5	5				#	
	Power (%)	100	100				#	

**Notes:** (a) This index is not required for this operating mode. see section 4.1.3.1. of the Output Display Standard (NEMA UD-3).

(b) This probe is not intended for transcranial or neonatal cephalic uses.

(c)

This formulation for TIS is less than that for an alternate formulation in this mode.

# No data are reported for this operating condition since the global maximum index value is not reported for the reason listed.

**System: Ultrasound Diagnostic System**

**Transducer Model: MC3 Convex Array**

**Operating Mode: PW**

Index Label		MI	TIS			TIB	TIC	
			scan	non-scan		non-scan		
				$A_{aprt} \leq 1$	$A_{aprt} > 1$			
<b>Global Maximum</b> Index Value		0.40		0.21		0.38	#	
Assoc Acoustic Parameter	$P_{r,3}$ (MPa)	0.65						
	$W_o$ (mW)			10		10	#	
	min of $[W_{.3}(z_1), I_{TA,3}(z_1)]$ (mW)							
	$z_1$ (cm)							
	$z_{bp}$ (cm)							
	$z_{sp}$ (cm)					3.65		
	$z@PII_{.3max}$ (cm)	3.55						
	$d_{eq}(z_{sp})$ (cm)					0.13		
	$f_c$ (MHz)	2.58		2.58		2.58	#	
	Dim of $A_{aprt}$	X (cm)			3.02		3.02	#
Y (cm)				0.8		0.8	#	
Other Information	PD ( $\mu$ sec)	0.65						
	PRF (Hz)	6098						
	$p_r@PII_{max}$ (MPa)	1.41						
	$d_{eq}@PII_{max}$ (cm)					0.18		
	Focal Length	$FL_x$ (cm)			3.84			#
		$FL_y$ (cm)			1.10			#
	$I_{PA,3}@MI_{max}$ ( $W/cm^2$ )	23.63						
Operating Control Conditions	Mode	PW		PW		PW	#	
	Focus (cm)	3		3		3	#	
	Power (%)	100		100		100	#	

**Notes:** (a) This index is not required for this operating mode. see section 4.1.3.1. of the Output Display Standard (NEMA UD-3).

(b) This probe is not intended for transcranial or neonatal cephalic uses. (c)

This formulation for TIS is less than that for an alternate formulation in this mode.

# No data are reported for this operating condition since the global maximum index value is not reported for the reason listed.

**System: Ultrasound Diagnostic System**  
**Transducer Model: V6 Micro-convex Array**  
**Operating Mode: B**

Index Label		MI	TIS			TIB	TIC	
			scan	non-scan		non-scan		
				A <sub>aprt</sub> ≤1	A <sub>aprt</sub> >1			
Global Maximum Index Value		0.69	0.03				#	
Associated Acoustic Parameter	P <sub>r,3</sub> (MPa)	1.72						
	W <sub>o</sub> (mW)		3.48				#	
	min of [W <sub>.3</sub> (z <sub>1</sub> ), I <sub>TA,3</sub> (z <sub>1</sub> )] (mW)							
	z <sub>1</sub> (cm)							
	z <sub>bp</sub> (cm)							
	z <sub>sp</sub> (cm)							
	z@P <sub>II,3max</sub> (cm)	2.40						
	d <sub>eq</sub> (z <sub>sp</sub> ) (cm)							
	f <sub>c</sub> (MHz)	6.21	6.23				#	
	Dim of A <sub>aprt</sub>	X (cm)		0.86				#
Y (cm)			0.70				#	
Other Information	PD (μsec)	0.21						
	PRF (Hz)	3846.2						
	p <sub>r</sub> @P <sub>II,max</sub> (MPa)	2.57						
	d <sub>eq</sub> @P <sub>II,max</sub> (cm)							
	Focal Length	FL <sub>x</sub> (cm)		0.46				#
		FL <sub>y</sub> (cm)		0.23				#
I <sub>PA,3</sub> @ MI <sub>max</sub> (W/cm <sup>2</sup> )	201.06							
Operating Control Conditions	Mode	B	B				#	
	Focus (cm)	2	1				#	
	Power (%)	100	100				#	

**Notes:** (a) This index is not required for this operating mode. see section 4.1.3.1. of the Output Display Standard (NEMA UD-3).

(b) This probe is not intended for transcranial or neonatal cephalic uses.

(c)

This formulation for TIS is less than that for an alternate formulation in this mode.

# No data are reported for this operating condition since the global maximum index value is not reported for the reason listed.



**System: Ultrasound Diagnostic System**  
**Transducer Model: V6 Micro-convex Array**  
**Operating Mode: THI-B**

Index Label		MI	TIS		TIB	TIC	
			scan	non-scan			non-scan
				A <sub>aprt</sub> ≤1	A <sub>aprt</sub> >1		
<b>Global Maximum Index Value</b>		0.56	0.32			#	
Associated Acoustic Parameter	P <sub>r,3</sub> (MPa)	1.33					
	W <sub>o</sub> (mW)		18			#	
	min of [W <sub>.3</sub> (z <sub>1</sub> ), I <sub>TA,3</sub> (z <sub>1</sub> )] (mW)						
	z <sub>1</sub> (cm)						
	z <sub>bp</sub> (cm)						
	z <sub>sp</sub> (cm)						
	z@PII <sub>.3max</sub> (cm)	3.4					
	d <sub>eq</sub> (z <sub>sp</sub> ) (cm)						
	f <sub>c</sub> (MHz)	5.74	5.74			#	
	Dim of A <sub>aprt</sub>	X (cm)		0.86			#
Y (cm)			0.70			#	
Other Information	PD (μsec)	0.22					
	PRF (Hz)	4854					
	p <sub>r</sub> @PII <sub>max</sub> (MPa)	2.56					
	d <sub>eq</sub> @PII <sub>max</sub> (cm)						
	Focal Length	FL <sub>x</sub> (cm)		0.14			#
		FL <sub>y</sub> (cm)		0.18			#
I <sub>PA,3</sub> @ MI <sub>max</sub> (W/cm <sup>2</sup> )	84.23						
Operating Control Conditions	Mode	B	B			#	
	Focus (cm)	3.5	3			#	
	Power (%)	100	100			#	

**Notes:** (a) This index is not required for this operating mode. see section 4.1.3.1. of the Output Display Standard (NEMA UD-3).

(b) This probe is not intended for transcranial or neonatal cephalic uses. (c)

This formulation for TIS is less than that for an alternate formulation in this mode.

# No data are reported for this operating condition since the global maximum index value is not reported for the reason listed.

**System: Ultrasound Diagnostic System**  
**Transducer Model: V6 Micro-convex Array**  
**Operating Mode: B+M**

Index Label		MI	TIS		TIB	TIC		
			scan	non-scan			non-scan	
				$A_{aprt} \leq 1$	$A_{aprt} > 1$			
<b>Global Maximum Index Value</b>		0.77		0.05		0.05	#	
Associated Acoustic Parameter	$P_{r,3}$ (MPa)	1.76						
	$W_o$ (mW)			2		2	#	
	min of $[W_{.3}(z_1), I_{TA,3}(z_1)]$ (mW)							
	$z_1$ (cm)							
	$z_{bp}$ (cm)							
	$z_{sp}$ (cm)					1.75		
	$z@PII_{.3max}$ (cm)	2.05						
	$d_{eq}(z_{sp})$ (cm)					0.52		
	$f_c$ (MHz)	5.30		5.56		5.56	#	
	Dim of $A_{aprt}$	X (cm)			2.87		2.87	#
Y (cm)				0.70		0.70	#	
Other Information	PD ( $\mu$ sec)	0.24						
	PRF (Hz)	668.9						
	$p_r@PII_{max}$ (MPa)	2.36						
	$d_{eq}@PII_{max}$ (cm)					0.50		
	Focal Length	FL <sub>x</sub> (cm)			0.78			#
		FL <sub>y</sub> (cm)			0.50			#
$I_{PA,3}@MI_{max}$ ( $W/cm^2$ )	152.28							
Operating Control Conditions	Mode	B+M		B+M		B+M	#	
	Focus (cm)	1.5		1		1	#	
	Power (%)	100		100		100	#	

**Notes:** (a) This index is not required for this operating mode. see section 4.1.3.1. of the Output Display Standard (NEMA UD-3).

(b) This probe is not intended for transcranial or neonatal cephalic uses. (c)

This formulation for TIS is less than that for an alternate formulation in this mode.

# No data are reported for this operating condition since the global maximum index value is not reported for the reason listed.

**System: Ultrasound Diagnostic System**  
**Transducer Model: V6 Micro-convex Array**  
**Operating Mode: B+C**

Index Label		MI	TIS		TIB	TIC	
			scan	non-scan			non-scan
				A <sub>aprt</sub> ≤1	A <sub>aprt</sub> >1		
<b>Global Maximum Index Value</b>		0.34	0.02			#	
Associated Acoustic Parameter	P <sub>r,3</sub> (MPa)	0.83					
	W <sub>o</sub> (mW)		2			#	
	min of [W <sub>.3</sub> (z <sub>1</sub> ), I <sub>TA,3</sub> (z <sub>1</sub> )] (mW)						
	z <sub>1</sub> (cm)						
	z <sub>bp</sub> (cm)						
	z <sub>sp</sub> (cm)						
	z@PII <sub>.3max</sub> (cm)	1.55					
	d <sub>eq</sub> (z <sub>sp</sub> ) (cm)						
	f <sub>c</sub> (MHz)	6.23	6.23				#
	Dim of A <sub>aprt</sub>	X (cm)		0.86			#
Y (cm)			0.70			#	
Other Information	PD (μsec)	0.69					
	PRF (Hz)	6097					
	p <sub>r</sub> @PII <sub>max</sub> (MPa)	1.12					
	d <sub>eq</sub> @PII <sub>max</sub> (cm)						
	Focal Length	FL <sub>x</sub> (cm)		0.23			#
		FL <sub>y</sub> (cm)		0.42			#
	I <sub>PA,3</sub> @ MI <sub>max</sub> (W/cm <sup>2</sup> )	28.18					
Operating Control Conditions	Mode	B+C	B+C			#	
	Focus (cm)	1	1			#	
	Power (%)	100	100			#	

**Notes:** (a) This index is not required for this operating mode. see section 4.1.3.1. of the Output Display Standard (NEMA UD-3).

(b) This probe is not intended for transcranial or neonatal cephalic uses. (c)

This formulation for TIS is less than that for an alternate formulation in this mode.

# No data are reported for this operating condition since the global maximum index value is not reported for the reason listed.

**System: Ultrasound Diagnostic System**  
**Transducer Model: V6 Micro-convex Array**  
**Operating Mode: PW**

Index Label		MI	TIS			TIB	TIC	
			scan	non-scan		non-scan		
				A <sub>aprt</sub> ≤1	A <sub>aprt</sub> >1			
Global Maximum Index Value		0.32		0.35		0.39	#	
Associated Acoustic Parameter	P <sub>r,3</sub> (MPa)	0.78						
	W <sub>o</sub> (mW)			12		12	#	
	min of [W <sub>.3</sub> (z <sub>1</sub> ), I <sub>TA,3</sub> (z <sub>1</sub> )] (mW)							
	z <sub>1</sub> (cm)							
	z <sub>bp</sub> (cm)							
	z <sub>sp</sub> (cm)					3.3		
	z@PII <sub>.3max</sub> (cm)	3.25						
	d <sub>eq</sub> (z <sub>sp</sub> ) (cm)					0.23		
	f <sub>c</sub> (MHz)	6.16		6.16		6.15	#	
	Dim of A <sub>aprt</sub>	X (cm)			2.87		2.87	#
Y (cm)				0.70		0.70	#	
Other Information	PD (μsec)	0.61						
	PRF (Hz)	6098						
	p <sub>r</sub> @PII <sub>max</sub> (MPa)	1.45						
	d <sub>eq</sub> @PII <sub>max</sub> (cm)					0.22		
	Focal Length	FL <sub>x</sub> (cm)			0.40			#
		FL <sub>y</sub> (cm)			0.17			#
	I <sub>PA,3</sub> @ MI <sub>max</sub> (W/cm <sup>2</sup> )	20.67						
Operating Control Conditions	Mode	PW		PW		PW	#	
	Focus (cm)	1.5		5.5		8.5	#	
	Power (%)	100		100		100	#	

**Notes:** (a) This index is not required for this operating mode. see section 4.1.3.1. of the Output Display Standard (NEMA UD-3).

(b) This probe is not intended for transcranial or neonatal cephalic uses.

(c)

This formulation for TIS is less than that for an alternate formulation in this mode.

# No data are reported for this operating condition since the global maximum index value is not reported for the reason listed.

**System: Ultrasound Diagnostic System**  
**Transducer Model: L7M Linear Array**  
**Operating Mode: B**

Index Label		MI	TIS		TIB	TIC	
			scan	non-scan			non-scan
				$A_{aprt} \leq 1$	$A_{aprt} > 1$		
<b>Global Maximum Index Value</b>		0.26	0.11			#	
Associated Acoustic Parameter	$P_{r,3}$ (MPa)	0.70					
	$W_o$ (mW)		16			#	
	min of $[W_{.3}(z_1), I_{TA,3}(z_1)]$ (mW)						
	$z_1$ (cm)						
	$z_{bp}$ (cm)						
	$z_{sp}$ (cm)						
	$z@PII_{.3max}$ (cm)	1.95					
	$d_{eq}(z_{sp})$ (cm)						
	$f_c$ (MHz)	7.23	7.21			#	
Dim of $A_{aprt}$	X (cm)		1.22			#	
	Y (cm)		0.45			#	
Other Information	PD ( $\mu$ sec)	0.20					
	PRF (Hz)	3846.2					
	$p_r@PII_{max}$ (MPa)	1.02					
	$d_{eq}@PII_{max}$ (cm)						
	Focal Length	FL <sub>x</sub> (cm)		0.44			#
		FL <sub>y</sub> (cm)		0.24			#
$I_{PA,3}@MI_{max}$ ( $W/cm^2$ )	32.96						
Operating Control Conditions	Mode	B	B			#	
	Focus (cm)	2	6			#	
	Power (%)	100	100			#	

- Notes:** (a) This index is not required for this operating mode. see section 4.1.3.1. of the Output Display Standard (NEMA UD-3).  
 (b) This probe is not intended for transcranial or neonatal cephalic uses.  
 (c) This formulation for TIS is less than that for an alternate formulation in this mode.  
 # No data are reported for this operating condition since the global maximum index value is not reported for the reason listed.

**System: Ultrasound Diagnostic System****Transducer Model: L7M Linear Array****Operating Mode: THI-B**

Index Label		MI	TIS		TIB	TIC	
			scan	non-scan			non-scan
				$A_{\text{aprt}} \leq 1$	$A_{\text{aprt}} > 1$		
<b>Global Maximum Index Value</b>		0.69	0.02			#	
Associated Acoustic Parameter	$P_{r,3}$ (MPa)	1.75					
	$W_o$ (mW)		2			#	
	min of $[W_{.3}(z_1), I_{TA,3}(z_1)]$ (mW)						
	$z_1$ (cm)						
	$z_{bp}$ (cm)						
	$z_{sp}$ (cm)						
	$z@PII_{.3max}$ (cm)	1.35					
	$d_{eq}(z_{sp})$ (cm)						
	$f_c$ (MHz)	6.85	6.85				#
	Dim of $A_{\text{aprt}}$	X (cm)		1.22			#
Y (cm)			0.45			#	
Other Information	PD ( $\mu\text{sec}$ )	0.23					
	PRF (Hz)	4082					
	$p_r@PII_{max}$ (MPa)	2.34					
	$d_{eq}@PII_{max}$ (cm)						
	Focal Length	FL <sub>x</sub> (cm)		0.25			#
		FL <sub>y</sub> (cm)		0.22			#
	$I_{PA,3}@MI_{max}$ ( $\text{W}/\text{cm}^2$ )	105.36					
Operating Control Conditions	Mode	THI-B	THI-B			#	
	Focus (cm)	3	3			#	
	Power (%)	100	100			#	

**Notes:** (a) This index is not required for this operating mode. see section 4.1.3.1. of the Output Display Standard (NEMA UD-3).

(b) This probe is not intended for transcranial or neonatal cephalic uses.

(c) This formulation for TIS is less than that for an alternate formulation in this mode.

# No data are reported for this operating condition since the global maximum index value is not reported for the reason listed.

**System: Ultrasound Diagnostic System**

**Transducer Model: L7M Linear Array**

**Operating Mode: B+M**

Index Label		MI	TIS			TIB	TIC	
			scan	non-scan		non-scan		
				$A_{aprt} \leq 1$	$A_{aprt} > 1$			
<b>Global Maximum Index Value</b>		0.32		0.28		0.10	#	
Associated Acoustic Parameter	$P_{r.3}$ (MPa)	0.83						
	$W_o$ (mW)			10		10	#	
	min of $[W_{.3}(z_1), I_{TA.3}(z_1)]$ (mW)							
	$z_1$ (cm)							
	$z_{bp}$ (cm)							
	$z_{sp}$ (cm)					1.30		
	$z@PII_{.3max}$ (cm)	1.40						
	$d_{eq}(z_{sp})$ (cm)					1.65		
	$f_c$ (MHz)	6.86		6.85		6.82	#	
	Dim of $A_{aprt}$	X (cm)			4.08		4.08	#
Y (cm)				0.45		0.45	#	
Other Information	PD ( $\mu$ sec)	0.20						
	PRF (Hz)	668.9						
	$p_r@PII_{max}$ (MPa)	1.12						
	$d_{eq}@PII_{max}$ (cm)					1.65		
	Focal Length	FL <sub>x</sub> (cm)			0.44			#
		FL <sub>y</sub> (cm)			0.24			#
$I_{PA.3}@MI_{max}$ ( $W/cm^2$ )	34.41							
Operating Control Conditions	Mode	B+M		B+M		B+M	#	
	Focus (cm)	4		7.5		3.5	#	
	Power (%)	100		100		100	#	

**Notes:** (a) This index is not required for this operating mode. see section 4.1.3.1. of the Output Display Standard (NEMA UD-3).

(b) This probe is not intended for transcranial or neonatal cephalic uses.

(c) This formulation for TIS is less than that for an alternate formulation in this mode.

# No data are reported for this operating condition since the global maximum index value is not reported for the reason listed.

**System: Ultrasound Diagnostic System**

**Transducer Model: L7M Linear Array**

**Operating Mode: B+C**

Index Label		MI	TIS			TIB	TIC	
			scan	non-scan		non-scan		
				$A_{aprt} \leq 1$	$A_{aprt} > 1$			
<b>Global Maximum Index Value</b>		0.39	0.15				#	
Associated Acoustic Parameter	$P_{r,3}$ (MPa)	1.09						
	$W_o$ (mW)		16				#	
	min of $[W_{.3}(z_1), I_{TA,3}(z_1)]$ (mW)							
	$z_1$ (cm)							
	$z_{bp}$ (cm)							
	$z_{sp}$ (cm)							
	$z@PII_{.3max}$ (cm)	1.30						
	$d_{eq}(z_{sp})$ (cm)							
	$f_c$ (MHz)	7.87	7.87				#	
	Dim of $A_{aprt}$	X (cm)		1.22				#
Y (cm)			0.45				#	
Other Information	PD ( $\mu$ sec)	0.61						
	PRF (Hz)	6097						
	$p_r@PII_{max}$ (MPa)	1.55						
	$d_{eq}@PII_{max}$ (cm)							
	Focal Length	FL <sub>x</sub> (cm)		0.44				#
		FL <sub>y</sub> (cm)		0.24				#
	$I_{PA,3}@MI_{max}$ ( $W/cm^2$ )	37.77						
Operating Control Conditions	Mode	B+C	B+C				#	
	Focus (cm)	1	1				#	
	Power (%)	100	100				#	

**Notes:** (a) This index is not required for this operating mode. see section 4.1.3.1. of the Output Display Standard (NEMA UD-3).

(b) This probe is not intended for transcranial or neonatal cephalic uses.

(c) This formulation for TIS is less than that for an alternate formulation in this mode.

# No data are reported for this operating condition since the global maximum index value is not reported for the reason listed.



**System: Ultrasound Diagnostic System**

**Transducer Model: L7M Linear Array**

**Operating Mode: PW**

Index Label		MI	TIS			TIB	TIC	
			scan	non-scan		non-scan		
				$A_{aprt} \leq 1$	$A_{aprt} > 1$			
<b>Global Maximum Index Value</b>		0.80		0.91		0.84	#	
Associated Acoustic Parameter	$P_{r.3}$ (MPa)	1.98						
	$W_o$ (mW)			34		34	#	
	min of $[W_{.3}(z_1), I_{TA.3}(z_1)]$ (mW)							
	$z_1$ (cm)							
	$z_{bp}$ (cm)							
	$z_{sp}$ (cm)					1.5		
	$z@PII_{.3max}$ (cm)	3.35						
	$d_{eq}(z_{sp})$ (cm)					0.27		
	$f_c$ (MHz)	6.87		6.83		6.83	#	
	Dim of $A_{aprt}$	X (cm)			4.08		4.08	#
Y (cm)				0.45		0.45	#	
Other Information	PD ( $\mu$ sec)	0.59						
	PRF (Hz)	6970						
	$p_r@PII_{max}$ (MPa)	3.17						
	$d_{eq}@PII_{max}$ (cm)					0.27		
	Focal Length	FL <sub>x</sub> (cm)			0.37			#
		FL <sub>y</sub> (cm)			0.26			#
$I_{PA.3}@MI_{max}$ ( $W/cm^2$ )	179.38							
Operating Control Conditions	Mode	PW		PW		PW	#	
	Focus (cm)	8.5		3.5		3.5	#	
	Power (%)	100		100		100	#	

**Notes:** (a) This index is not required for this operating mode. see section 4.1.3.1. of the Output Display Standard (NEMA UD-3).

(b) This probe is not intended for transcranial or neonatal cephalic uses.

(c) This formulation for TIS is less than that for an alternate formulation in this mode.

# No data are reported for this operating condition since the global maximum index value is not reported for the reason listed.

**System: Ultrasound Diagnostic System**

**Transducer Model: L7S Linear Array**

**Operating Mode: B**

Index Label		MI	TIS		TIB	TIC	
			scan	non-scan			non-scan
				A <sub>aprt</sub> ≤1	A <sub>aprt</sub> >1		
<b>Global Maximum Index Value</b>		0.43	0.15			#	
Associated Acoustic Parameter	P <sub>r,3</sub> (MPa)	1.08					
	W <sub>o</sub> (mW)		12			#	
	min of [W <sub>.3</sub> (z <sub>1</sub> ), I <sub>TA,3</sub> (z <sub>1</sub> )] (mW)						
	z <sub>1</sub> (cm)						
	z <sub>bp</sub> (cm)						
	z <sub>sp</sub> (cm)						
	z@PII <sub>.3max</sub> (cm)	1.55					
	d <sub>eq</sub> (z <sub>sp</sub> ) (cm)						
	f <sub>c</sub> (MHz)	6.30	6.57			#	
	Dim of A <sub>aprt</sub>	X (cm)		0.77			#
Y (cm)			0.50			#	
Other Information	PD (μsec)	0.18					
	PRF (Hz)	3831					
	p <sub>r</sub> @PII <sub>max</sub> (MPa)	1.48					
	d <sub>eq</sub> @PII <sub>max</sub> (cm)						
	Focal Length	FL <sub>x</sub> (cm)		0.22			#
		FL <sub>y</sub> (cm)		0.19			#
	I <sub>PA,3</sub> @ MI <sub>max</sub> (W/cm <sup>2</sup> )	56.11					
Operating Control Conditions	Mode	B	B			#	
	Focus (cm)	3	7.5			#	
	Power (%)	100	100			#	

- Notes:** (a) This index is not required for this operating mode. see section 4.1.3.1. of the Output Display Standard (NEMA UD-3).
- (b) This probe is not intended for transcranial or neonatal cephalic uses.
- (c) This formulation for TIS is less than that for an alternate formulation in this mode.
- # No data are reported for this operating condition since the global maximum index value is not reported for the reason listed.

**System: Ultrasound Diagnostic System**

**Transducer Model: L7S Linear Array**

**Operating Mode: THI-B**

Index Label		MI	TIS		TIB	TIC	
			scan	non-scan			non-scan
				A <sub>aprt</sub> ≤1	A <sub>aprt</sub> >1		
<b>Global Maximum Index Value</b>		0.34	0.11			#	
Associated Acoustic Parameter	P <sub>r,3</sub> (MPa)	0.85					
	W <sub>o</sub> (mW)		12			#	
	min of [W <sub>.3</sub> (z <sub>1</sub> ), I <sub>TA,3</sub> (z <sub>1</sub> )] (mW)						
	z <sub>1</sub> (cm)						
	z <sub>bp</sub> (cm)						
	z <sub>sp</sub> (cm)						
	z@PII <sub>.3max</sub> (cm)	1.52					
	d <sub>eq</sub> (z <sub>sp</sub> ) (cm)						
	f <sub>c</sub> (MHz)	6.15	6.42			#	
	Dim of A <sub>aprt</sub>	X (cm)		0.77			#
Y (cm)			0.50			#	
Other Information	PD (μsec)	0.21					
	PRF (Hz)	3831					
	p <sub>r</sub> @PII <sub>max</sub> (MPa)	1.14					
	d <sub>eq</sub> @PII <sub>max</sub> (cm)						
	Focal Length	FL <sub>x</sub> (cm)		0.22			#
		FL <sub>y</sub> (cm)		0.19			#
I <sub>PA,3</sub> @ MI <sub>max</sub> (W/cm <sup>2</sup> )	45.26						
Operating Control Conditions	Mode	THI-B	THI-B			#	
	Focus (cm)	3	7.5			#	
	Power (%)	100	100			#	

**Notes:** (a) This index is not required for this operating mode. see section 4.1.3.1. of the Output Display Standard (NEMA UD-3).

(b) This probe is not intended for transcranial or neonatal cephalic uses.

(c) This formulation for TIS is less than that for an alternate formulation in this mode.

# No data are reported for this operating condition since the global maximum index value is not reported for the reason listed.

**System: Ultrasound Diagnostic System**

**Transducer Model: L7S Linear Array**

**Operating Mode: B+M**

Index Label		MI	TIS		TIB	TIC	
			scan	non-scan			non-scan
				$A_{aprt} \leq 1$	$A_{aprt} > 1$		
<b>Global Maximum Index Value</b>		0.33		0.13	0.06	#	
Associated Acoustic Parameter	$P_{r,3}$ (MPa)	0.84					
	$W_o$ (mW)			4	4	#	
	min of $[W_{.3}(z_1), I_{TA,3}(z_1)]$ (mW)						
	$z_1$ (cm)						
	$z_{bp}$ (cm)						
	$z_{sp}$ (cm)					2	
	$z@PII_{.3max}$ (cm)	2.00					
	$d_{eq}(z_{sp})$ (cm)					0.69	
	$f_c$ (MHz)	6.37		7.06		6.37	#
	Dim of $A_{aprt}$	X (cm)			2.56		2.56
Y (cm)				0.50		0.50	#
Other Information	PD ( $\mu$ sec)	0.17					
	PRF (Hz)	668.9					
	$p_r@PII_{max}$ (MPa)	1.31					
	$d_{eq}@PII_{max}$ (cm)					0.66	
	Focal Length	FL <sub>x</sub> (cm)			0.22		#
		FL <sub>y</sub> (cm)			0.19		#
$I_{PA,3}@MI_{max}$ ( $W/cm^2$ )	37.32						
Operating Control Conditions	Mode	B+M		B+M		B+M	#
	Focus (cm)	4		2		4	#
	Power (%)	100		100		100	#

**Notes:** (a) This index is not required for this operating mode. see section 4.1.3.1. of the Output Display Standard (NEMA UD-3).

(b) This probe is not intended for transcranial or neonatal cephalic uses.

(c) This formulation for TIS is less than that for an alternate formulation in this mode.

# No data are reported for this operating condition since the global maximum index value is not reported for the reason listed.

**System: Ultrasound Diagnostic System**

**Transducer Model: L7S Linear Array**

**Operating Mode: B+C**

Index Label		MI	TIS		TIB	TIC	
			scan	non-scan			non-scan
				A <sub>aprt</sub> ≤1	A <sub>aprt</sub> >1		
<b>Global Maximum Index Value</b>		0.48	0.54			#	
Associated Acoustic Parameter	P <sub>r,3</sub> (MPa)	1.22					
	W <sub>o</sub> (mW)		46			#	
	min of [W <sub>.3</sub> (z <sub>1</sub> ), I <sub>TA,3</sub> (z <sub>1</sub> )] (mW)						
	z <sub>1</sub> (cm)						
	z <sub>bp</sub> (cm)						
	z <sub>sp</sub> (cm)						
	z@PII <sub>.3max</sub> (cm)	1.85					
	d <sub>eq</sub> (z <sub>sp</sub> ) (cm)						
	f <sub>c</sub> (MHz)	6.30	6.30			#	
	Dim of A <sub>aprt</sub>	X (cm)		0.77			#
Y (cm)			0.50			#	
Other Information	PD (μsec)	0.67					
	PRF (Hz)	6097					
	p <sub>r</sub> @PII <sub>max</sub> (MPa)	1.70					
	d <sub>eq</sub> @PII <sub>max</sub> (cm)						
	Focal Length	FL <sub>x</sub> (cm)		0.30			#
		FL <sub>y</sub> (cm)		0.98			#
	I <sub>PA,3</sub> @ MI <sub>max</sub> (W/cm <sup>2</sup> )	55.67					
Operating Control Conditions	Mode	B+C	B+C			#	
	Focus (cm)	6.5	6.5			#	
	Power (%)	100	100			#	

**Notes:** (a) This index is not required for this operating mode. see section 4.1.3.1. of the Output Display Standard (NEMA UD-3).

(b) This probe is not intended for transcranial or neonatal cephalic uses.

(c) This formulation for TIS is less than that for an alternate formulation in this mode.

# No data are reported for this operating condition since the global maximum index value is not reported for the reason listed.

**System: Ultrasound Diagnostic System**

**Transducer Model: L7S Linear Array**

**Operating Mode: PW**

Index Label		MI	TIS		TIB	TIC	
			scan	non-scan			non-scan
				$A_{aprt} \leq 1$	$A_{aprt} > 1$		
<b>Global Maximum Index Value</b>		0.75		0.44	0.71	#	
Associated Acoustic Parameter	$P_{r,3}$ (MPa)	1.86					
	$W_o$ (mW)			28	30	#	
	min of $[W_{.3}(z_1), I_{TA,3}(z_1)]$ (mW)						
	$z_1$ (cm)						
	$z_{bp}$ (cm)						
	$z_{sp}$ (cm)				1.5		
	$z@PII_{.3max}$ (cm)	3.35					
	$d_{eq}(z_{sp})$ (cm)				0.27		
	$f_c$ (MHz)	6.13		6.35	6.35	#	
	Dim of $A_{aprt}$	X (cm)			2.56	2.56	#
Y (cm)				0.50	0.50	#	
Other Information	PD ( $\mu$ sec)	0.59					
	PRF (Hz)	6970					
	$p_r@PII_{max}$ (MPa)	3.17					
	$d_{eq}@PII_{max}$ (cm)				0.27		
	Focal Length	FL <sub>x</sub> (cm)			0.37		#
		FL <sub>y</sub> (cm)			0.26		#
$I_{PA,3}@MI_{max}$ ( $W/cm^2$ )	141.73						
Operating Control Conditions	Mode	PW		PW	PW	#	
	Focus (cm)	7.5		3	3.5	#	
	Power (%)	100		100	100	#	

- Notes:** (a) This index is not required for this operating mode. see section 4.1.3.1. of the Output Display Standard (NEMA UD-3).
- (b) This probe is not intended for transcranial or neonatal cephalic uses.
- (c) This formulation for TIS is less than that for an alternate formulation in this mode.
- # No data are reported for this operating condition since the global maximum index value is not reported for the reason listed.

**System: Ultrasound Diagnostic System**

**Transducer Model: R7 Rectal Array**

**Operating Mode: B**

Index Label		MI	TIS		TIB	TIC	
			scan	non-scan			non-scan
				A <sub>aprt</sub> ≤1	A <sub>aprt</sub> >1		
<b>Global Maximum Index Value</b>		0.26	0.11			#	
Associated Acoustic Parameter	P <sub>r,3</sub> (MPa)	0.70					
	W <sub>o</sub> (mW)		16			#	
	min of [W <sub>.3</sub> (z <sub>1</sub> ), I <sub>TA,3</sub> (z <sub>1</sub> )] (mW)						
	z <sub>1</sub> (cm)						
	z <sub>bp</sub> (cm)						
	z <sub>sp</sub> (cm)						
	z@PII <sub>.3max</sub> (cm)	1.95					
	d <sub>eq</sub> (z <sub>sp</sub> ) (cm)						
	f <sub>c</sub> (MHz)	7.23	7.21			#	
	Dim of A <sub>aprt</sub>	X (cm)		1.22			#
Y (cm)			0.45			#	
Other Information	PD (μsec)	0.20					
	PRF (Hz)	3846.2					
	p <sub>r</sub> @PII <sub>max</sub> (MPa)	1.02					
	d <sub>eq</sub> @PII <sub>max</sub> (cm)						
	Focal Length	FL <sub>x</sub> (cm)		0.44			#
		FL <sub>y</sub> (cm)		0.24			#
	I <sub>PA,3</sub> @ MI <sub>max</sub> (W/cm <sup>2</sup> )	32.96					
Operating Control Conditions	Mode	B	B			#	
	Focus (cm)	2	6			#	
	Power (%)	100	100			#	

**Notes:** (a) This index is not required for this operating mode. see section 4.1.3.1. of the Output Display Standard (NEMA UD-3).

(b) This probe is not intended for transcranial or neonatal cephalic uses.

(c) This formulation for TIS is less than that for an alternate formulation in this mode.

# No data are reported for this operating condition since the global maximum index value is not reported for the reason listed.

**System: Ultrasound Diagnostic System**

**Transducer Model: R7 Rectal Array**

**Operating Mode: THI-B**

Index Label		MI	TIS			TIB	TIC	
			scan	non-scan		non-scan		
				A <sub>aprt</sub> ≤1	A <sub>aprt</sub> >1			
<b>Global Maximum Index Value</b>		0.69	0.02				#	
Associated Acoustic Parameter	P <sub>r,3</sub> (MPa)	1.75						
	W <sub>o</sub> (mW)		2				#	
	min of [W <sub>.3</sub> (z <sub>1</sub> ), I <sub>TA,3</sub> (z <sub>1</sub> )] (mW)							
	z <sub>1</sub> (cm)							
	z <sub>bp</sub> (cm)							
	z <sub>sp</sub> (cm)							
	z@PII <sub>.3max</sub> (cm)	1.35						
	d <sub>eq</sub> (z <sub>sp</sub> ) (cm)							
	f <sub>c</sub> (MHz)	6.85	6.85				#	
	Dim of A <sub>aprt</sub>	X (cm)		1.22				#
Y (cm)			0.45				#	
Other Information	PD (μsec)	0.23						
	PRF (Hz)	4082						
	p <sub>r</sub> @PII <sub>max</sub> (MPa)	2.34						
	d <sub>eq</sub> @PII <sub>max</sub> (cm)							
	Focal Length	FL <sub>x</sub> (cm)		0.25				#
		FL <sub>y</sub> (cm)		0.22				#
	I <sub>PA,3</sub> @ MI <sub>max</sub> (W/cm <sup>2</sup> )	105.36						
Operating Control Conditions	Mode	THI-B	THI-B				#	
	Focus (cm)	3	3				#	
	Power (%)	100	100				#	

**Notes:** (a) This index is not required for this operating mode. see section 4.1.3.1. of the Output Display Standard (NEMA UD-3).

(b) This probe is not intended for transcranial or neonatal cephalic uses.

(c) This formulation for TIS is less than that for an alternate formulation in this mode.

# No data are reported for this operating condition since the global maximum index value is not reported for the reason listed.



**System: Ultrasound Diagnostic System**

**Transducer Model: R7 Rectal Array**

**Operating Mode: B+M**

Index Label		MI	TIS		TIB	TIC	
			scan	non-scan			non-scan
				$A_{aprt} \leq 1$	$A_{aprt} > 1$		
<b>Global Maximum Index Value</b>		0.32		0.28	0.10	#	
Associated Acoustic Parameter	$P_{r,3}$ (MPa)	0.83					
	$W_o$ (mW)			10	10	#	
	min of $[W_{.3}(z_1), I_{TA,3}(z_1)]$ (mW)						
	$z_1$ (cm)						
	$z_{bp}$ (cm)						
	$z_{sp}$ (cm)					1.30	
	$z@PII_{.3max}$ (cm)	1.40					
	$d_{eq}(z_{sp})$ (cm)					1.65	
	$f_c$ (MHz)	6.86		6.85		6.82	#
	Dim of $A_{aprt}$	X (cm)			4.08	4.08	#
Y (cm)				0.45	0.45	#	
Other Information	PD ( $\mu$ sec)	0.20					
	PRF (Hz)	668.9					
	$p_r@PII_{max}$ (MPa)	1.12					
	$d_{eq}@PII_{max}$ (cm)					1.65	
	Focal Length	FL <sub>x</sub> (cm)			0.44		#
		FL <sub>y</sub> (cm)			0.24		#
$I_{PA,3}@MI_{max}$ ( $W/cm^2$ )	34.41						
Operating Control Conditions	Mode	B+M		B+M		B+M	#
	Focus (cm)	4		7.5		3.5	#
	Power (%)	100		100		100	#

**Notes:** (a) This index is not required for this operating mode. see section 4.1.3.1. of the Output Display Standard (NEMA UD-3).

(b) This probe is not intended for transcranial or neonatal cephalic uses.

(c) This formulation for TIS is less than that for an alternate formulation in this mode.

# No data are reported for this operating condition since the global maximum index value is not reported for the reason listed.

**System: Ultrasound Diagnostic System**

**Transducer Model: R7 Rectal Array**

**Operating Mode: B+C**

Index Label		MI	TIS		TIB	TIC	
			scan	non-scan			non-scan
				A <sub>aprt</sub> ≤1	A <sub>aprt</sub> >1		
<b>Global Maximum Index Value</b>		0.39	0.15			#	
Associated Acoustic Parameter	P <sub>r,3</sub> (MPa)	1.09					
	W <sub>o</sub> (mW)		16			#	
	min of [W <sub>.3</sub> (z <sub>1</sub> ), I <sub>TA.3</sub> (z <sub>1</sub> )] (mW)						
	z <sub>1</sub> (cm)						
	z <sub>bp</sub> (cm)						
	z <sub>sp</sub> (cm)						
	z@PII <sub>.3max</sub> (cm)	1.30					
	d <sub>eq</sub> (z <sub>sp</sub> ) (cm)						
	f <sub>c</sub> (MHz)	7.87	7.87			#	
	Dim of A <sub>aprt</sub>	X (cm)		1.22			#
Y (cm)			0.45			#	
Other Information	PD (μsec)	0.61					
	PRF (Hz)	6097					
	p <sub>r</sub> @PII <sub>max</sub> (MPa)	1.55					
	d <sub>eq</sub> @PII <sub>max</sub> (cm)						
	Focal Length	FL <sub>x</sub> (cm)		0.44			#
		FL <sub>y</sub> (cm)		0.24			#
I <sub>PA.3</sub> @ MI <sub>max</sub> (W/cm <sup>2</sup> )	37.77						
Operating Control Conditions	Mode	B+C	B+C			#	
	Focus (cm)	1	1			#	
	Power (%)	100	100			#	

**Notes:** (a) This index is not required for this operating mode. see section 4.1.3.1. of the Output Display Standard (NEMA UD-3).

(b) This probe is not intended for transcranial or neonatal cephalic uses.

(c) This formulation for TIS is less than that for an alternate formulation in this mode.

# No data are reported for this operating condition since the global maximum index value is not reported for the reason listed.

**System: Ultrasound Diagnostic System**

**Transducer Model: R7 Rectal Array**

**Operating Mode: PW**

Index Label		MI	TIS		TIB	TIC	
			scan	non-scan			non-scan
				$A_{aprt} \leq 1$	$A_{aprt} > 1$		
<b>Global Maximum Index Value</b>		0.80		0.91	0.84	#	
Associated Acoustic Parameter	$P_{r,3}$ (MPa)	1.98					
	$W_o$ (mW)			34	34	#	
	min of $[W_{.3}(z_1), I_{TA,3}(z_1)]$ (mW)						
	$z_1$ (cm)						
	$z_{bp}$ (cm)						
	$z_{sp}$ (cm)					1.5	
	$z@PII_{.3max}$ (cm)	3.35					
	$d_{eq}(z_{sp})$ (cm)					0.27	
	$f_c$ (MHz)	6.87		6.83		6.83	#
	Dim of $A_{aprt}$	X (cm)			4.08	4.08	#
Y (cm)				0.45	0.45	#	
Other Information	PD ( $\mu$ sec)	0.59					
	PRF (Hz)	6970					
	$p_r@PII_{max}$ (MPa)	3.17					
	$d_{eq}@PII_{max}$ (cm)					0.27	
	Focal Length	FL <sub>x</sub> (cm)			0.37		#
		FL <sub>y</sub> (cm)			0.26		#
	$I_{PA,3}@MI_{max}$ ( $W/cm^2$ )	179.38					
Operating Control Conditions	Mode	PW		PW	PW	#	
	Focus (cm)	8.5		3.5	3.5	#	
	Power (%)	100		100	100	#	

**Notes:** (a) This index is not required for this operating mode. see section 4.1.3.1. of the Output Display Standard (NEMA UD-3).

(b) This probe is not intended for transcranial or neonatal cephalic uses.

(c) This formulation for TIS is less than that for an alternate formulation in this mode.

# No data are reported for this operating condition since the global maximum index value is not reported for the reason listed.

**System: Ultrasound Diagnostic System**

**Transducer Model: P3 Phased Array**

**Operating Mode: B**

Index Label		MI	TIS		TIB	TIC	
			scan	non-scan			non-scan
				A <sub>aprt</sub> ≤1	A <sub>aprt</sub> >1		
<b>Global Maximum Index Value</b>		0.76	0.21			#	
Associated Acoustic Parameter	P <sub>r,3</sub> (MPa)	1.18					
	W <sub>o</sub> (mW)		48			#	
	min of [W <sub>.3</sub> (z <sub>1</sub> ), I <sub>TA,3</sub> (z <sub>1</sub> )] (mW)						
	z <sub>1</sub> (cm)						
	z <sub>bp</sub> (cm)						
	z <sub>sp</sub> (cm)						
	z@PII <sub>.3max</sub> (cm)	6.94					
	d <sub>eq</sub> (z <sub>sp</sub> ) (cm)						
	f <sub>c</sub> (MHz)	2.42	2.42				#
	Dim of A <sub>aprt</sub>	X (cm)		0.58			#
Y (cm)			1.40			#	
Other Information	PD (μsec)	0.69					
	PRF (Hz)	2967					
	p <sub>r</sub> @PII <sub>max</sub> (MPa)	2.10					
	d <sub>eq</sub> @PII <sub>max</sub> (cm)						
	Focal Length	FL <sub>x</sub> (cm)		0.63			#
		FL <sub>y</sub> (cm)		0.40			#
I <sub>PA,3</sub> @ MI <sub>max</sub> (W/cm <sup>2</sup> )	64.39						
Operating Control Conditions	Mode	B	B			#	
	Focus (cm)	13	13			#	
	Power (%)	100	100			#	

**Notes:** (a) This index is not required for this operating mode. see section 4.1.3.1. of the Output Display Standard (NEMA UD-3).

(b) This probe is not intended for transcranial or neonatal cephalic uses. (c)

This formulation for TIS is less than that for an alternate formulation in this mode.

# No data are reported for this operating condition since the global maximum index value is not reported for the reason listed.

**System: Ultrasound Diagnostic System**

**Transducer Model: P3 Phased Array**

**Operating Mode: THI-B**

Index Label		MI	TIS		TIB	TIC	
			scan	non-scan			non-scan
				A <sub>aprt</sub> ≤1	A <sub>aprt</sub> >1		
<b>Global Maximum Index Value</b>		0.72	0.07			#	
Associated Acoustic Parameter	P <sub>r,3</sub> (MPa)	1.08					
	W <sub>o</sub> (mW)		20			#	
	min of [W <sub>.3</sub> (z <sub>1</sub> ), I <sub>TA,3</sub> (z <sub>1</sub> )] (mW)						
	z <sub>1</sub> (cm)						
	z <sub>bp</sub> (cm)						
	z <sub>sp</sub> (cm)						
	z@PII <sub>.3max</sub> (cm)	5.13					
	d <sub>eq</sub> (z <sub>sp</sub> ) (cm)						
	f <sub>c</sub> (MHz)	2.25	2.55				#
	Dim of A <sub>aprt</sub>	X (cm)		0.58			#
Y (cm)			1.40			#	
Other Information	PD (μsec)	1.19					
	PRF (Hz)	2967					
	p <sub>r</sub> @PII <sub>max</sub> (MPa)	1.58					
	d <sub>eq</sub> @PII <sub>max</sub> (cm)						
	Focal Length	FL <sub>x</sub> (cm)		0.63			#
		FL <sub>y</sub> (cm)		0.40			#
I <sub>PA,3</sub> @ MI <sub>max</sub> (W/cm <sup>2</sup> )	33.26						
Operating Control Conditions	Mode	B	B			#	
	Focus (cm)	9	9			#	
	Power (%)	100	100			#	

**Notes:** (a) This index is not required for this operating mode. see section 4.1.3.1. of the Output Display Standard (NEMA UD-3).

(b) This probe is not intended for transcranial or neonatal cephalic uses. (c)

This formulation for TIS is less than that for an alternate formulation in this mode.

# No data are reported for this operating condition since the global maximum index value is not reported for the reason listed.

**System: Ultrasound Diagnostic System**

**Transducer Model: P3 Phased Array**

**Operating Mode: B+M**

Index Label		MI	TIS		TIB	TIC	
			scan	non-scan			non-scan
				A <sub>aprt</sub> ≤1	A <sub>aprt</sub> >1		
<b>Global Maximum Index Value</b>		0.76		0.10	0.25	#	
Associated Acoustic Parameter	P <sub>r,3</sub> (MPa)	1.22					
	W <sub>o</sub> (mW)				14	#	
	min of [W <sub>.3</sub> (z <sub>1</sub> ), I <sub>TA,3</sub> (z <sub>1</sub> )] (mW)			8.30			
	z <sub>1</sub> (cm)			2.95			
	z <sub>bp</sub> (cm)			2.77			
	z <sub>sp</sub> (cm)				5.85		
	z@PII <sub>.3max</sub> (cm)	5.90					
	d <sub>eq</sub> (z <sub>sp</sub> ) (cm)				0.46		
	f <sub>c</sub> (MHz)	2.57		2.57	2.57	#	
	Dim of A <sub>aprt</sub>	X (cm)			1.92	1.92	#
Y (cm)				1.40	1.40	#	
Other Information	PD (μsec)	0.46					
	PRF (Hz)	800					
	p <sub>r</sub> @PII <sub>max</sub> (MPa)	1.88					
	d <sub>eq</sub> @PII <sub>max</sub> (cm)				0.44		
	Focal Length	FL <sub>x</sub> (cm)			0.63		#
		FL <sub>y</sub> (cm)			0.40		#
I <sub>PA,3</sub> @ MI <sub>max</sub> (W/cm <sup>2</sup> )	69.21						
Operating Control Conditions	Mode	B+M		B+M	B+M	#	
	Focus (cm)	7		7	7	#	
	Power (%)	100		100	100	#	

**Notes:** (a) This index is not required for this operating mode. see section 4.1.3.1. of the Output Display Standard (NEMA UD-3).

(b) This probe is not intended for transcranial or neonatal cephalic uses.

(c)

This formulation for TIS is less than that for an alternate formulation in this mode.

# No data are reported for this operating condition since the global maximum index value is not reported for the reason listed.

**System: Ultrasound Diagnostic System**

**Transducer Model: P3 Phased Array**

**Operating Mode: B+C**

Index Label		MI	TIS		TIB	TIC	
			scan	non-scan			non-scan
				A <sub>aprt</sub> ≤1	A <sub>aprt</sub> >1		
<b>Global Maximum Index Value</b>		1.46	0.53			#	
Associated Acoustic Parameter	P <sub>r,3</sub> (MPa)	2.25					
	W <sub>o</sub> (mW)		112			#	
	min of [W <sub>.3</sub> (z <sub>1</sub> ), I <sub>TA,3</sub> (z <sub>1</sub> )] (mW)						
	z <sub>1</sub> (cm)						
	z <sub>bp</sub> (cm)						
	z <sub>sp</sub> (cm)						
	z@PII <sub>.3max</sub> (cm)	5.40					
	d <sub>eq</sub> (z <sub>sp</sub> ) (cm)						
	f <sub>c</sub> (MHz)	2.37	2.37				#
	Dim of A <sub>aprt</sub>	X (cm)		1.92			#
Y (cm)			1.40			#	
Other Information	PD (μsec)	1.59					
	PRF (Hz)	3521					
	p <sub>r</sub> @PII <sub>max</sub> (MPa)	3.42					
	d <sub>eq</sub> @PII <sub>max</sub> (cm)						
	Focal Length	FL <sub>x</sub> (cm)		0.63			#
		FL <sub>y</sub> (cm)		0.40			#
I <sub>PA,3</sub> @ MI <sub>max</sub> (W/cm <sup>2</sup> )	221.44						
Operating Control Conditions	Mode	B+C	B+C			#	
	Focus (cm)	9	9			#	
	Power (%)	100	100			#	

**Notes:** (a) This index is not required for this operating mode. see section 4.1.3.1. of the Output Display Standard (NEMA UD-3).

(b) This probe is not intended for transcranial or neonatal cephalic uses. (c)

This formulation for TIS is less than that for an alternate formulation in this mode.

# No data are reported for this operating condition since the global maximum index value is not reported for the reason listed.

**System: Ultrasound Diagnostic System**

**Transducer Model: P3 Phased Array**

**Operating Mode: PW**

Index Label		MI	TIS		TIB	TIC	
			scan	non-scan			non-scan
				A <sub>aprt</sub> ≤1	A <sub>aprt</sub> >1		
<b>Global Maximum Index Value</b>		0.64		1.02	1.21	#	
Associated Acoustic Parameter	P <sub>r,3</sub> (MPa)	0.97					
	W <sub>o</sub> (mW)				110	#	
	min of [W <sub>.3</sub> (z <sub>1</sub> ), I <sub>TA,3</sub> (z <sub>1</sub> )] (mW)			95.26			
	z <sub>1</sub> (cm)			2.83			
	z <sub>bp</sub> (cm)			2.77			
	z <sub>sp</sub> (cm)				7.40		
	z@PII <sub>.3max</sub> (cm)	7.48					
	d <sub>eq</sub> (z <sub>sp</sub> ) (cm)				0.46		
	f <sub>c</sub> (MHz)	2.26		2.26	2.26	#	
	Dim of A <sub>aprt</sub>	X (cm)			1.92	1.92	#
Y (cm)				1.40	1.40	#	
Other Information	PD (μsec)	1.68					
	PRF (Hz)	6000					
	p <sub>r</sub> @PII <sub>max</sub> (MPa)	1.65					
	d <sub>eq</sub> @PII <sub>max</sub> (cm)				0.46		
	Focal Length	FL <sub>x</sub> (cm)			0.63		#
		FL <sub>y</sub> (cm)			0.40		#
I <sub>PA,3</sub> @ MI <sub>max</sub> (W/cm <sup>2</sup> )	40.38						
Operating Control Conditions	Mode	PW		PW	PW	#	
	Focus (cm)	15		15	15	#	
	Power (%)	100		100	100	#	

**Notes:** (a) This index is not required for this operating mode. see section 4.1.3.1. of the Output Display Standard (NEMA UD-3).

(b) This probe is not intended for transcranial or neonatal cephalic uses.

(c)

This formulation for TIS is less than that for an alternate formulation in this mode.

# No data are reported for this operating condition since the global maximum index value is not reported for the reason listed.



**System: Ultrasound Diagnostic System**

**Transducer Model: P3 Phased Array**

**Operating Mode: CW**

Index Label		MI	TIS		TIB	TIC	
			scan	non-scan			non-scan
				A <sub>aprt</sub> ≤1	A <sub>aprt</sub> >1		
<b>Global Maximum Index Value</b>		0.04		0.80	1.99	#	
Associated Acoustic Parameter	P <sub>r,3</sub> (MPa)	0.06					
	W <sub>o</sub> (mW)				178	#	
	min of [W <sub>.3</sub> (z <sub>1</sub> ), I <sub>TA,3</sub> (z <sub>1</sub> )] (mW)			84.42			
	z <sub>1</sub> (cm)			5.40			
	z <sub>bp</sub> (cm)			1.96			
	z <sub>sp</sub> (cm)				6.80		
	z@PII <sub>.3max</sub> (cm)	6.80					
	d <sub>eq</sub> (z <sub>sp</sub> ) (cm)				0.80		
	f <sub>c</sub> (MHz)	2		2	2	#	
	Dim of A <sub>aprt</sub>	X (cm)			1.92	1.92	#
Y (cm)				1.40	1.40	#	
Other Information	PD (μsec)	20					
	PRF (Hz)	0					
	p <sub>r</sub> @PII <sub>max</sub> (MPa)	0.09					
	d <sub>eq</sub> @PII <sub>max</sub> (cm)				0.79		
	Focal Length	FL <sub>x</sub> (cm)			0.63		#
		FL <sub>y</sub> (cm)			0.40		#
I <sub>PA,3</sub> @ MI <sub>max</sub> (W/cm <sup>2</sup> )	0.13						
Operating Control Conditions	Mode	CW		CW	CW	#	
	Focus (cm)	3		3	3	#	
	Power (%)	100		100	100	#	

**Notes:** (a) This index is not required for this operating mode. see section 4.1.3.1. of the Output Display Standard (NEMA UD-3).

(b) This probe is not intended for transcranial or neonatal cephalic uses. (c)

This formulation for TIS is less than that for an alternate formulation in this mode.

# No data are reported for this operating condition since the global maximum index value is not reported for the reason listed.

**System: Ultrasound Diagnostic System**

**Transducer Model: L7L Linear Array**

**Operating Mode: B**

Index Label		MI	TIS		TIB	TIC	
			scan	non-scan			non-scan
				A <sub>aprt</sub> ≤1	A <sub>aprt</sub> >1		
<b>Global Maximum Index Value</b>		0.45	0.12			#	
Associated Acoustic Parameter	P <sub>r,3</sub> (MPa)	1.29					
	W <sub>o</sub> (mW)		18			#	
	min of [W <sub>.3</sub> (z <sub>1</sub> ), I <sub>TA,3</sub> (z <sub>1</sub> )] (mW)						
	z <sub>1</sub> (cm)						
	z <sub>bp</sub> (cm)						
	z <sub>sp</sub> (cm)						
	z@PII <sub>.3max</sub> (cm)	1.85					
	d <sub>eq</sub> (z <sub>sp</sub> ) (cm)						
	f <sub>c</sub> (MHz)	8.25	8.25			#	
	Dim of A <sub>aprt</sub>	X (cm)		1.16			#
Y (cm)			0.5			#	
Other Information	PD (μsec)	0.28					
	PRF (Hz)	6711					
	p <sub>r</sub> @PII <sub>max</sub> (MPa)	2.07					
	d <sub>eq</sub> @PII <sub>max</sub> (cm)						
	Focal Length	FL <sub>x</sub> (cm)		0.16			#
		FL <sub>y</sub> (cm)		0.22			#
I <sub>PA,3</sub> @ MI <sub>max</sub> (W/cm <sup>2</sup> )	63.57						
Operating Control Conditions	Mode	B	B			#	
	Focus (cm)	4	4			#	
	Power (%)	100	100			#	

**Notes:** (a) This index is not required for this operating mode. see section 4.1.3.1. of the Output Display Standard (NEMA UD-3).

(b) This probe is not intended for transcranial or neonatal cephalic uses.

(c) This formulation for TIS is less than that for an alternate formulation in this mode.

# No data are reported for this operating condition since the global maximum index value is not reported for the reason listed.

**System: Ultrasound Diagnostic System****Transducer Model: L7L Linear Array****Operating Mode: THI-B**

Index Label		MI	TIS		TIB	TIC	
			scan	non-scan			non-scan
				$A_{aprt} \leq 1$	$A_{aprt} > 1$		
<b>Global Maximum Index Value</b>		0.44	0.06			#	
Associated Acoustic Parameter	$P_{r,3}$ (MPa)	1.21					
	$W_o$ (mW)		10			#	
	min of [ $W_{.3}(z_1)$ , $I_{TA,3}(z_1)$ ] (mW)						
	$z_1$ (cm)						
	$z_{bp}$ (cm)						
	$z_{sp}$ (cm)						
	$z@PII_{.3max}$ (cm)	1.85					
	$d_{eq}(z_{sp})$ (cm)						
	$f_c$ (MHz)	7.75	7.75				#
Dim of $A_{aprt}$	X (cm)		1.16			#	
	Y (cm)		0.5			#	
Other Information	PD ( $\mu$ sec)	0.30					
	PRF (Hz)	6711					
	$p_r@PII_{max}$ (MPa)	1.79					
	$d_{eq}@PII_{max}$ (cm)						
	Focal Length	$FL_x$ (cm)		0.16			#
		$FL_y$ (cm)		0.24			#
$I_{PA,3}@MI_{max}$ ( $W/cm^2$ )	69.06						
Operating Control Conditions	Mode	B	B			#	
	Focus (cm)	4	4			#	
	Power (%)	100	100			#	

**Notes:** (a) This index is not required for this operating mode. see section 4.1.3.1. of the Output Display Standard (NEMA UD-3).

(b) This probe is not intended for transcranial or neonatal cephalic uses.

(c) This formulation for TIS is less than that for an alternate formulation in this mode.

# No data are reported for this operating condition since the global maximum index value is not reported for the reason listed.

**System: Ultrasound Diagnostic System**

**Transducer Model: L7L Linear Array**

**Operating Mode: B+M**

Index Label		MI	TIS			TIB	TIC	
			scan	non-scan		non-scan		
				A <sub>aprt</sub> ≤1	A <sub>aprt</sub> >1			
<b>Global Maximum Index Value</b>		0.56		0.08		0.04	#	
Associated Acoustic Parameter	P <sub>r,3</sub> (MPa)	1.59						
	W <sub>o</sub> (mW)			2		2	#	
	min of [W <sub>.3</sub> (z <sub>1</sub> ), I <sub>TA,3</sub> (z <sub>1</sub> )] (mW)							
	z <sub>1</sub> (cm)							
	z <sub>bp</sub> (cm)							
	z <sub>sp</sub> (cm)					1.7		
	z@PII <sub>.3max</sub> (cm)	1.7						
	d <sub>eq</sub> (z <sub>sp</sub> ) (cm)					0.47		
	f <sub>c</sub> (MHz)	8.05		8.05		8.05	#	
Dim of A <sub>aprt</sub>	X (cm)			6.14		6.14	#	
	Y (cm)			0.5		0.5	#	
Other Information	PD (µsec)	0.22						
	PRF (Hz)	400						
	p <sub>r</sub> @PII <sub>max</sub> (MPa)	2.53						
	d <sub>eq</sub> @PII <sub>max</sub> (cm)					0.47		
	Focal Length	FL <sub>x</sub> (cm)			0.24			#
		FL <sub>y</sub> (cm)			0.22			#
	I <sub>PA,3</sub> @ MI <sub>max</sub> (W/cm <sup>2</sup> )	45.85						
Operating Control Conditions	Mode	B+M		B+M		B+M	#	
	Focus (cm)	4		4		4	#	
	Power (%)	100		100		100	#	

**Notes:** (a) This index is not required for this operating mode. see section 4.1.3.1. of the Output Display Standard (NEMA UD-3).

(b) This probe is not intended for transcranial or neonatal cephalic uses.

(c) This formulation for TIS is less than that for an alternate formulation in this mode.

# No data are reported for this operating condition since the global maximum index value is not reported for the reason listed.

**System: Ultrasound Diagnostic System**

**Transducer Model: L7L Linear Array**

**Operating Mode: B+C**

Index Label		MI	TIS		TIB	TIC	
			scan	non-scan			non-scan
				$A_{aprt} \leq 1$	$A_{aprt} > 1$		
<b>Global Maximum Index Value</b>		0.45	0.12			#	
Associated Acoustic Parameter	$P_{r,3}$ (MPa)	1.29					
	$W_o$ (mW)		18			#	
	min of $[W_{.3}(z_1), I_{TA,3}(z_1)]$ (mW)						
	$z_1$ (cm)						
	$z_{bp}$ (cm)						
	$z_{sp}$ (cm)						
	$z@PII_{.3max}$ (cm)	1.85					
	$d_{eq}(z_{sp})$ (cm)						
	$f_c$ (MHz)	8.25	8.25				#
	Dim of $A_{aprt}$	X (cm)		1.16			#
Y (cm)			0.5			#	
Other Information	PD ( $\mu$ sec)	0.28					
	PRF (Hz)	6097					
	$p_r@PII_{max}$ (MPa)	2.07					
	$d_{eq}@PII_{max}$ (cm)						
	Focal Length	FL <sub>x</sub> (cm)		0.16			#
		FL <sub>y</sub> (cm)		0.22			#
	$I_{PA,3}@MI_{max}$ ( $W/cm^2$ )	45.25					
Operating Control Conditions	Mode	B+C	B+C			#	
	Focus (cm)	4	4			#	
	Power (%)	100	100			#	

**Notes:** (a) This index is not required for this operating mode. see section 4.1.3.1. of the Output Display Standard (NEMA UD-3).

(b) This probe is not intended for transcranial or neonatal cephalic uses.

(c) This formulation for TIS is less than that for an alternate formulation in this mode.

# No data are reported for this operating condition since the global maximum index value is not reported for the reason listed.

**System: Ultrasound Diagnostic System**

**Transducer Model: L7L Linear Array**

**Operating Mode: PW**

Index Label		MI	TIS			TIB	TIC	
			scan	non-scan		non-scan		
				$A_{aprt} \leq 1$	$A_{aprt} > 1$			
<b>Global Maximum</b> Index Value		0.25		0.29		0.42	#	
Associated Acoustic Parameter	$P_{r,3}$ (MPa)	0.71						
	$W_o$ (mW)			12		12	#	
	min of [ $W_{.3}(z_1)$ , $I_{TA,3}(z_1)$ ] (mW)							
	$z_1$ (cm)							
	$z_{bp}$ (cm)							
	$z_{sp}$ (cm)					1.6		
	$z@PII_{.3max}$ (cm)	1.65						
	$d_{eq}(z_{sp})$ (cm)					0.37		
	$f_c$ (MHz)	7.81		7.81		7.81	#	
	Dim of $A_{aprt}$	X (cm)			6.14		6.14	#
Y (cm)				0.5		0.5	#	
Other Information	PD ( $\mu$ sec)	0.79						
	PRF (Hz)	4000						
	$p_r@PII_{max}$ (MPa)	1.01						
	$d_{eq}@PII_{max}$ (cm)					0.36		
	Focal Length	FL <sub>x</sub> (cm)			0.35			#
		FL <sub>y</sub> (cm)			0.27			#
	$I_{PA,3}@MI_{max}$ ( $W/cm^2$ )	19.02						
Operating Control Conditions	Mode	PW		PW		PW	#	
	Focus (cm)	4		4		4	#	
	Power (%)	100		100		100	#	

**Notes:** (a) This index is not required for this operating mode. see section 4.1.3.1. of the Output Display Standard (NEMA UD-3).

(b) This probe is not intended for transcranial or neonatal cephalic uses.

(c) This formulation for TIS is less than that for an alternate formulation in this mode.

# No data are reported for this operating condition since the global maximum index value is not reported for the reason listed.

**System: Ultrasound Diagnostic System**

**Transducer Model: MC5V Convex Array**

**Operating Mode: B**

Index Label		MI	TIS		TIB	TIC	
			scan	non-scan			non-scan
				A <sub>aprt</sub> ≤1	A <sub>aprt</sub> >1		
<b>Global Maximum Index Value</b>		0.45	0.05			#	
Associated Acoustic Parameter	P <sub>r,3</sub> (MPa)	0.99					
	W <sub>o</sub> (mW)		20			#	
	min of [W <sub>.3</sub> (z <sub>1</sub> ), I <sub>TA,3</sub> (z <sub>1</sub> )] (mW)						
	z <sub>1</sub> (cm)						
	z <sub>bp</sub> (cm)						
	z <sub>sp</sub> (cm)						
	z@PII <sub>.3max</sub> (cm)	4.55					
	d <sub>eq</sub> (z <sub>sp</sub> ) (cm)						
	f <sub>c</sub> (MHz)	4.92	4.90				#
	Dim of A <sub>aprt</sub>	X (cm)		2.09			#
Y (cm)			1.10			#	
Other Information	PD (μsec)	0.29					
	PRF (Hz)	2283					
	p <sub>r</sub> @PII <sub>max</sub> (MPa)	1.55					
	d <sub>eq</sub> @PII <sub>max</sub> (cm)						
	Focal Length	FL <sub>x</sub> (cm)		0.30			#
		FL <sub>y</sub> (cm)		0.98			#
I <sub>PA,3</sub> @ MI <sub>max</sub> (W/cm <sup>2</sup> )	31.78						
Operating Control Conditions	Mode	B	B			#	
	Focus (cm)	6	3			#	
	Power (%)	100	100			#	

**Notes:** (a) This index is not required for this operating mode. see section 4.1.3.1. of the Output Display Standard (NEMA UD-3).

(b) This probe is not intended for transcranial or neonatal cephalic uses. (c)

This formulation for TIS is less than that for an alternate formulation in this mode.

# No data are reported for this operating condition since the global maximum index value is not reported for the reason listed.

**System: Ultrasound Diagnostic System**

**Transducer Model: MC5V Convex Array**

**Operating Mode: THI-B**

Index Label		MI	TIS		TIB	TIC	
			scan	non-scan			non-scan
				A <sub>aprt</sub> ≤1	A <sub>aprt</sub> >1		
<b>Global Maximum Index Value</b>		1.05	0.08			#	
Assoc Acoustic Parameter	P <sub>r,3</sub> (• MPa)	2.15					
	W <sub>o</sub> (mW)		12			#	
	min of [W <sub>.3</sub> (z <sub>1</sub> ), I <sub>TA,3</sub> (z <sub>1</sub> )] (mW)						
	z <sub>1</sub> (cm)						
	z <sub>bp</sub> (cm)						
	z <sub>sp</sub> (cm)						
	z@PII <sub>.3max</sub> (cm)	1.85					
	d <sub>eq</sub> (z <sub>sp</sub> ) (cm)						
	f <sub>c</sub> (MHz)	4.23	4.21			#	
	Dim of A <sub>aprt</sub>	X (cm)		2.09			#
Y (cm)			1.10			#	
Other Information	PD (μsec)	0.51					
	PRF (Hz)	3846.2					
	p <sub>r</sub> @PII <sub>max</sub> (MPa)	2.93					
	d <sub>eq</sub> @PII <sub>max</sub> (cm)						
	Focal Length	FL <sub>x</sub> (cm)		0.47			#
		FL <sub>y</sub> (cm)		0.21			#
I <sub>PA,3</sub> @ MI <sub>max</sub> (W/cm <sup>2</sup> )	185.52						
Operating Control Conditions	Mode	THI-B	THI-B			#	
	Focus (cm)	3	6			#	
	Power (%)	100	100			#	

**Notes:** (a) This index is not required for this operating mode. see section 4.1.3.1. of the Output Display Standard (NEMA UD-3).

(b) This probe is not intended for transcranial or neonatal cephalic uses.

(c)

This formulation for TIS is less than that for an alternate formulation in this mode.

# No data are reported for this operating condition since the global maximum index value is not reported for the reason listed.



**System: Ultrasound Diagnostic System**

**Transducer Model: MC5V Convex Array**

**Operating Mode: B+M**

Index Label		MI	TIS		TIB	TIC	
			scan	non-scan			non-scan
				A <sub>aprt</sub> ≤1	A <sub>aprt</sub> >1		
<b>Global Maximum Index Value</b>		0.51		0.09	0.19	#	
Associated Acoustic Parameter	P <sub>r,3</sub> (MPa)	1.05					
	W <sub>o</sub> (mW)				20	#	
	min of [W <sub>.3</sub> (z <sub>1</sub> ), I <sub>TA,3</sub> (z <sub>1</sub> )] (mW)			6.29			
	z <sub>1</sub> (cm)			4.25			
	z <sub>bp</sub> (cm)						
	z <sub>sp</sub> (cm)				2.60		
	z@PII <sub>.3max</sub> (cm)	4.25					
	d <sub>eq</sub> (z <sub>sp</sub> ) (cm)				1.94		
	f <sub>c</sub> (MHz)	4.25		4.25	4.16	#	
	Dim of A <sub>aprt</sub>	X (cm)			6.96	6.96	#
Y (cm)				1.10	1.10	#	
Other Information	PD (μsec)	0.33					
	PRF (Hz)	668.9					
	p <sub>r</sub> @PII <sub>max</sub> (MPa)	1.25					
	d <sub>eq</sub> @PII <sub>max</sub> (cm)				1.94		
	Focal Length	FL <sub>x</sub> (cm)			0.30		#
		FL <sub>y</sub> (cm)			0.98		#
I <sub>PA,3</sub> @ MI <sub>max</sub> (W/cm <sup>2</sup> )	22.80						
Operating Control Conditions	Mode	B+M		B+M	B+M	#	
	Focus (cm)	6		6	3	#	
	Power (%)	100		100	100	#	

**Notes:** (a) This index is not required for this operating mode. see section 4.1.3.1. of the Output Display Standard (NEMA UD-3).

(b) This probe is not intended for transcranial or neonatal cephalic uses.

(c)

This formulation for TIS is less than that for an alternate formulation in this mode.

# No data are reported for this operating condition since the global maximum index value is not reported for the reason listed.

**System: Ultrasound Diagnostic System**

**Transducer Model: MC5V Convex Array**

**Operating Mode: B+C**

Index Label		MI	TIS			TIB	TIC	
			scan	non-scan		non-scan		
				A <sub>aprt</sub> ≤1	A <sub>aprt</sub> >1			
<b>Global Maximum Index Value</b>		0.51	0.09				#	
Assoc Acoustic Parameter	P <sub>r,3</sub> (MPa)	1.14						
	W <sub>o</sub> (mW)		12				#	
	min of [W <sub>.3</sub> (z <sub>1</sub> ), I <sub>TA,3</sub> (z <sub>1</sub> )] (mW)							
	z <sub>1</sub> (cm)							
	z <sub>bp</sub> (cm)							
	z <sub>sp</sub> (cm)							
	z@PII <sub>.3max</sub> (cm)	3.4						
	d <sub>eq</sub> (z <sub>sp</sub> ) (cm)							
	f <sub>c</sub> (MHz)	4.89	4.89					#
	Dim of A <sub>aprt</sub>	X (cm)		2.09				#
Y (cm)			1.10				#	
Other Information	PD (μsec)	0.45						
	PRF (Hz)	6097						
	p <sub>r</sub> @PII <sub>max</sub> (MPa)	1.90						
	d <sub>eq</sub> @PII <sub>max</sub> (cm)							
	Focal Length	FL <sub>x</sub> (cm)		0.28				#
		FL <sub>y</sub> (cm)		0.20				#
I <sub>PA,3</sub> @ MI <sub>max</sub> (W/cm <sup>2</sup> )	60.11							
Operating Control Conditions	Mode	B+C	B+C				#	
	Focus (cm)	5	5				#	
	Power (%)	100	100				#	

**Notes:** (a) This index is not required for this operating mode. see section 4.1.3.1. of the Output Display Standard (NEMA UD-3).

(b) This probe is not intended for transcranial or neonatal cephalic uses.

(c)

This formulation for TIS is less than that for an alternate formulation in this mode.

# No data are reported for this operating condition since the global maximum index value is not reported for the reason listed.

**System: Ultrasound Diagnostic System**

**Transducer Model: MC5V Convex Array**

**Operating Mode: PW**

Index Label		MI	TIS			TIB	TIC	
			scan	non-scan		non-scan		
				A <sub>aprt</sub> ≤1	A <sub>aprt</sub> >1			
<b>Global Maximum Index Value</b>		0.38		0.25		0.47	#	
Assoc Acoustic Parameter	P <sub>r,3</sub> (MPa)	0.82						
	W <sub>o</sub> (mW)			10		10	#	
	min of [W <sub>.3</sub> (z <sub>1</sub> ), I <sub>TA,3</sub> (z <sub>1</sub> )] (mW)							
	z <sub>1</sub> (cm)							
	z <sub>bp</sub> (cm)							
	z <sub>sp</sub> (cm)					3.65		
	z@P <sub>II,3</sub> max (cm)	3.7						
	d <sub>eq</sub> (z <sub>sp</sub> ) (cm)					0.13		
	f <sub>c</sub> (MHz)	4.65		4.65		4.65	#	
	Dim of A <sub>aprt</sub>	X (cm)			6.96		6.96	#
Y (cm)				1.10		1.10	#	
Other Information	PD (μsec)	0.72						
	PRF (Hz)	6098						
	p <sub>r</sub> @P <sub>II</sub> max (MPa)	1.50						
	d <sub>eq</sub> @P <sub>II</sub> max (cm)					0.18		
	Focal Length	FL <sub>x</sub> (cm)			0.41			#
		FL <sub>y</sub> (cm)			0.18			#
I <sub>PA,3</sub> @ MI <sub>max</sub> (W/cm <sup>2</sup> )	41.013							
Operating Control Conditions	Mode	PW		PW		PW	#	
	Focus (cm)	3		3		3	#	
	Power (%)	100		100		100	#	

**Notes:** (a) This index is not required for this operating mode. see section 4.1.3.1. of the Output Display Standard (NEMA UD-3).

(b) This probe is not intended for transcranial or neonatal cephalic uses. (c)

This formulation for TIS is less than that for an alternate formulation in this mode.

# No data are reported for this operating condition since the global maximum index value is not reported for the reason listed.

**System: Ultrasound Diagnostic System**

**Transducer Model: MC6 Convex Array**

**Operating Mode: B**

Index Label		MI	TIS		TIB	TIC	
			scan	non-scan			non-scan
				A <sub>aprt</sub> ≤1	A <sub>aprt</sub> >1		
<b>Global Maximum Index Value</b>		0.76	0.19			#	
Associated Acoustic Parameter	P <sub>r,3</sub> (MPa)	1.85					
	W <sub>o</sub> (mW)		18			#	
	min of [W <sub>.3</sub> (z <sub>1</sub> ), I <sub>TA,3</sub> (z <sub>1</sub> )] (mW)						
	Z <sub>1</sub> (cm)						
	Z <sub>bp</sub> (cm)						
	Z <sub>sp</sub> (cm)						
	Z@PII <sub>.3max</sub> (cm)	3.20					
	d <sub>eq</sub> (Z <sub>sp</sub> ) (cm)						
	f <sub>c</sub> (MHz)	5.86	5.89				#
	Dim of A <sub>aprt</sub>	X (cm)		0.73			#
Y (cm)			0.70			#	
Other Information	PD (μsec)	0.25					
	PRF (Hz)	4854					
	p <sub>r</sub> @PII <sub>max</sub> (MPa)	3.11					
	d <sub>eq</sub> @PII <sub>max</sub> (cm)						
	Focal Length	FL <sub>x</sub> (cm)		0.95			#
		FL <sub>y</sub> (cm)		0.24			#
I <sub>PA,3</sub> @ MI <sub>max</sub> (W/cm <sup>2</sup> )	90.12						
Operating Control Conditions	Mode	B	B			#	
	Focus (cm)	3	8.5			#	
	Power (%)	100	100			#	

**Notes:** (a) This index is not required for this operating mode. see section 4.1.3.1. of the Output Display Standard (NEMA UD-3).

(b) This probe is not intended for transcranial or neonatal cephalic uses. (c)

This formulation for TIS is less than that for an alternate formulation in this mode.

# No data are reported for this operating condition since the global maximum index value is not reported for the reason listed.

**System: Ultrasound Diagnostic System**

**Transducer Model: MC6 Convex Array**

**Operating Mode: THI-B**

Index Label		MI	TIS		TIB	TIC	
			scan	non-scan			non-scan
				A <sub>aprt</sub> ≤1	A <sub>aprt</sub> >1		
<b>Global Maximum Index Value</b>		0.63	0.18			#	
Associated Acoustic Parameter	P <sub>r,3</sub> (MPa)	1.49					
	W <sub>o</sub> (mW)		20			#	
	min of [W <sub>.3</sub> (z <sub>1</sub> ), I <sub>TA,3</sub> (z <sub>1</sub> )] (mW)						
	z <sub>1</sub> (cm)						
	z <sub>bp</sub> (cm)						
	z <sub>sp</sub> (cm)						
	z@PII <sub>.3max</sub> (cm)	3.30					
	d <sub>eq</sub> (z <sub>sp</sub> ) (cm)						
	f <sub>c</sub> (MHz)	5.68	5.67				#
	Dim of A <sub>aprt</sub>	X (cm)		1.22			#
Y (cm)			0.70			#	
Other Information	PD (μsec)	0.29					
	PRF (Hz)	4854					
	p <sub>r</sub> @PII <sub>max</sub> (MPa)	3.01					
	d <sub>eq</sub> @PII <sub>max</sub> (cm)						
	Focal Length	FL <sub>x</sub> (cm)		0.50			#
		FL <sub>y</sub> (cm)		0.26			#
I <sub>PA,3</sub> @ MI <sub>max</sub> (W/cm <sup>2</sup> )	90.26						
Operating Control Conditions	Mode	B	B			#	
	Focus (cm)	3	4			#	
	Power (%)	100	100			#	

**Notes:** (a) This index is not required for this operating mode. see section 4.1.3.1. of the Output Display Standard (NEMA UD-3).

(b) This probe is not intended for transcranial or neonatal cephalic uses. (c)

This formulation for TIS is less than that for an alternate formulation in this mode.

# No data are reported for this operating condition since the global maximum index value is not reported for the reason listed.

**System: Ultrasound Diagnostic System**

**Transducer Model: MC6 Convex Array**

**Operating Mode: B+M**

Index Label		MI	TIS		TIB	TIC	
			scan	non-scan			non-scan
				$A_{aprt} \leq 1$	$A_{aprt} > 1$		
<b>Global Maximum Index Value</b>		0.26		0.42	0.04	#	
Associated Acoustic Parameter	$P_{r,3}$ (MPa)	0.61					
	$W_o$ (mW)			16	16	#	
	min of $[W_{.3}(z_1), I_{TA,3}(z_1)]$ (mW)						
	$z_1$ (cm)						
	$z_{bp}$ (cm)						
	$z_{sp}$ (cm)				1.95		
	$z@P_{II,3max}$ (cm)	2.05					
	$d_{eq}(z_{sp})$ (cm)				3.39		
	$f_c$ (MHz)	5.56		5.46	5.46	#	
	Dim of $A_{aprt}$	X (cm)			2.43	2.43	#
Y (cm)				0.70	0.70	#	
Other Information	PD ( $\mu$ sec)	0.25					
	PRF (Hz)	400					
	$p_r@P_{II,max}$ (MPa)	0.75					
	$d_{eq}@P_{II,max}$ (cm)				3.27		
	Focal Length	FL <sub>x</sub> (cm)			0.80		#
		FL <sub>y</sub> (cm)			0.48		#
$I_{PA,3}@MI_{max}$ ( $W/cm^2$ )	12.25						
Operating Control Conditions	Mode	B+M		B+M	B+M	#	
	Focus (cm)	3		5	5	#	
	Power (%)	100		100	100	#	

**Notes:** (a) This index is not required for this operating mode. see section 4.1.3.1. of the Output Display Standard (NEMA UD-3).

(b) This probe is not intended for transcranial or neonatal cephalic uses. (c)

This formulation for TIS is less than that for an alternate formulation in this mode.

# No data are reported for this operating condition since the global maximum index value is not reported for the reason listed.

**System: Ultrasound Diagnostic System**

**Transducer Model: MC6 Convex Array**

**Operating Mode: B+C**

Index Label		MI	TIS		TIB	TIC	
			scan	non-scan			non-scan
				A <sub>aprt</sub> ≤1	A <sub>aprt</sub> >1		
<b>Global Maximum Index Value</b>		0.46	0.51			#	
Associated Acoustic Parameter	P <sub>r,3</sub> (MPa)	1.11					
	W <sub>o</sub> (mW)		46			#	
	min of [W <sub>.3</sub> (z <sub>1</sub> ), I <sub>TA,3</sub> (z <sub>1</sub> )] (mW)						
	Z <sub>1</sub> (cm)						
	Z <sub>bp</sub> (cm)						
	Z <sub>sp</sub> (cm)						
	Z@PII <sub>.3max</sub> (cm)	2.55					
	d <sub>eq</sub> (Z <sub>sp</sub> ) (cm)						
	f <sub>c</sub> (MHz)	5.89	5.89				#
	Dim of A <sub>aprt</sub>	X (cm)		0.73			#
Y (cm)			0.70			#	
Other Information	PD (μsec)	0.99					
	PRF (Hz)	6097					
	p <sub>r</sub> @PII <sub>max</sub> (MPa)	1.45					
	d <sub>eq</sub> @PII <sub>max</sub> (cm)						
	Focal Length	FL <sub>x</sub> (cm)		0.73			#
		FL <sub>y</sub> (cm)		0.46			#
I <sub>PA,3</sub> @ MI <sub>max</sub> (W/cm <sup>2</sup> )	32.65						
Operating Control Conditions	Mode	B+C	B+C			#	
	Focus (cm)	4	4			#	
	Power (%)	100	100			#	

**Notes:** (a) This index is not required for this operating mode. see section 4.1.3.1. of the Output Display Standard (NEMA UD-3).

(b) This probe is not intended for transcranial or neonatal cephalic uses. (c)

This formulation for TIS is less than that for an alternate formulation in this mode.

# No data are reported for this operating condition since the global maximum index value is not reported for the reason listed.

**System: Ultrasound Diagnostic System**

**Transducer Model: MC6 Convex Array**

**Operating Mode: PW**

Index Label		MI	TIS		TIB	TIC	
			scan	non-scan			non-scan
				A <sub>aprt</sub> ≤1	A <sub>aprt</sub> >1		
<b>Global Maximum Index Value</b>		0.21		0.98	0.75	#	
Associated Acoustic Parameter	P <sub>r,3</sub> (MPa)	0.49					
	W <sub>o</sub> (mW)			82	82	#	
	min of [W <sub>.3</sub> (z <sub>1</sub> ), I <sub>TA,3</sub> (z <sub>1</sub> )] (mW)						
	z <sub>1</sub> (cm)						
	z <sub>bp</sub> (cm)						
	z <sub>sp</sub> (cm)				2.30		
	z@PII <sub>.3max</sub> (cm)	0.01					
	d <sub>eq</sub> (z <sub>sp</sub> ) (cm)				1.24		
	f <sub>c</sub> (MHz)	5.23		5.23	5.23	#	
	Dim of A <sub>aprt</sub>	X (cm)			2.43	2.43	#
Y (cm)				0.7	0.7	#	
Other Information	PD (μsec)	1.02					
	PRF (Hz)	4000					
	p <sub>r</sub> @PII <sub>max</sub> (MPa)	0.57					
	d <sub>eq</sub> @PII <sub>max</sub> (cm)				0.57		
	Focal Length	FL <sub>x</sub> (cm)			0.52		#
		FL <sub>y</sub> (cm)			0.52		#
I <sub>PA,3</sub> @ MI <sub>max</sub> (W/cm <sup>2</sup> )	8.52						
Operating Control Conditions	Mode	PW		PW		#	
	Focus (cm)	5		5		#	
	Power (%)	100		100		#	

**Notes:** (a) This index is not required for this operating mode. see section 4.1.3.1. of the Output Display Standard (NEMA UD-3).

(b) This probe is not intended for transcranial or neonatal cephalic uses. (c)

This formulation for TIS is less than that for an alternate formulation in this mode.

# No data are reported for this operating condition since the global maximum index value is not reported for the reason listed.



## Appendix C: Measurement Results Summary

### C3, 3.5MHz Convex Array

Measurement	Unit	Useful Range	Accuracy
Axial Distance	mm	Full Screen (0~230mm)	<±5%
Lateral Distance	mm	Full Screen (0~230mm)	<±5%
Circumference: trace method,ellipse method	mm	Full Screen (0~230mm)	<±5%
Area: trace method,ellipse method	mm <sup>2</sup>	Full Screen (0~230mm)	<±10%

### L7M, 7.5MHz Linear Array

Measurement	Unit	Useful Range	Accuracy
Axial Distance	mm	Full Screen (0~100mm)	<±5%
Lateral Distance	mm	Full Screen (0~100mm)	<±5%
Circumference: trace method,ellipse method	mm	Full Screen (0~100mm)	<±5%
Area: trace method,ellipse method	mm <sup>2</sup>	Full Screen (0~100mm)	<±10%

### L7S, 9.0MHz Linear Array

Measurement	Unit	Useful Range	Accuracy
Axial Distance	mm	Full Screen (0~100mm)	<±5%
Lateral Distance	mm	Full Screen (0~100mm)	<±5%
Circumference: trace method,ellipse method	mm	Full Screen (0~100mm)	<±5%
Area: trace method,ellipse method	mm <sup>2</sup>	Full Screen (0~100mm)	<±10%

### MC3, 3.0MHz Micro Convex Array

Measurement	Unit	Useful Range	Accuracy
Axial Distance	mm	Full Screen (0~230mm)	<±5%
Lateral Distance	mm	Full Screen (0~230mm)	<±5%
Circumference: trace method,ellipse method	mm	Full Screen (0~230mm)	<±5%
Area: trace method,ellipse method	mm <sup>2</sup>	Full Screen (0~230mm)	<±10%

### V6, 6.0MHz Micro Convex Array

Measurement	Unit	Useful Range	Accuracy
Axial Distance	mm	Full Screen (0~100mm)	<±5%
Lateral Distance	mm	Full Screen (0~100mm)	<±5%
Circumference: trace method,ellipse method	mm	Full Screen (0~100mm)	<±5%
Area: trace method,ellipse method	mm <sup>2</sup>	Full Screen (0~100mm)	<±10%

### R7, 7.5MHz Linear Array

Measurement	Unit	Useful Range	Accuracy
Axial Distance	mm	Full Screen (0~100mm)	<±5%
Lateral Distance	mm	Full Screen (0~100mm)	<±5%
Circumference:	mm	Full Screen (0~100mm)	<±5%

trace method,ellipse method			
Area: trace method,ellipse method	mm <sup>2</sup>	Full Screen (0~100mm)	<±10%

**P3, 3.0MHz Phased Array**

Measurement	Unit	Useful Range	Accuracy
Axial Distance	mm	Full Screen (0~200mm)	<±5%
Lateral Distance	mm	Full Screen (0~200mm)	<±5%
Circumference: trace method,ellipse method	mm	Full Screen (0~200mm)	<±5%
Area: trace method,ellipse method	mm <sup>2</sup>	Full Screen (0~200mm)	<±10%

**L7L, 10.0MHz Linear Array**

Measurement	Unit	Useful Range	Accuracy
Axial Distance	mm	Full Screen (0~100mm)	<±5%
Lateral Distance	mm	Full Screen (0~100mm)	<±5%
Circumference: trace method,ellipse method	mm	Full Screen (0~100mm)	<±5%
Area: trace method,ellipse method	mm <sup>2</sup>	Full Screen (0~100mm)	<±10%

**MC5V, 5.0MHz Convex Array**

Measurement	Unit	Useful Range	Accuracy
Axial Distance	mm	Full Screen (0~160mm)	<±5%
Lateral Distance	mm	Full Screen (0~160mm)	<±5%
Circumference: trace method,ellipse method	mm	Full Screen (0~160mm)	<±5%
Area: trace method,ellipse method	mm <sup>2</sup>	Full Screen (0~160mm)	<±10%

**MC6, 6.0MHz Convex Array**

Measurement	Unit	Useful Range	Accuracy
Axial Distance	mm	Full Screen (0~100mm)	<±5%
Lateral Distance	mm	Full Screen (0~100mm)	<±5%
Circumference: trace method,ellipse method	mm	Full Screen (0~100mm)	<±5%
Area: trace method,ellipse method	mm <sup>2</sup>	Full Screen (0~100mm)	<±10%

## Appendix D: Guidance and Manufacturer's Declaration

<b>1. Guidance and manufacturer's declaration – electromagnetic emissions</b>			
The SonoTouch 30 is intended for use in the electromagnetic environment specified below. The customer or the user of the SonoTouch 30 should assure that it is used in such an environment.			
<b>Emissions test</b>	<b>Compliance</b>	<b>Electromagnetic environment – guidance</b>	
RF emissions CISPR 11	Group 1	The SonoTouch 30 uses RF energy only for its internal function. Therefore, its RF emissions are very low and are not likely to cause any interference in nearby electronic equipment.	
RF emissions CISPR 11	Class A	The SonoTouch 30 is suitable for use in all establishments, including domestic establishments and those directly connected to the public low-voltage power supply network that supplies buildings used for domestic purposes.	
Harmonic emissions IEC 61000-3-2	Class A		
Voltage fluctuations/ flicker emissions IEC 61000-3-3	Complies		
<b>2. Guidance and manufacturer's declaration – electromagnetic immunity</b>			
The SonoTouch 30 is intended for use in the electromagnetic environment the SonoTouch 30 should assure that it is used in such an environment.			
<b>Immunity test</b>	<b>IEC 60601 test level</b>	<b>Compliance level</b>	<b>Electromagnetic environment – guidance</b>
Electrostatic discharge (ESD) IEC 61000-4-2	±6 kV contact ±8 kV air	±6 kV contact ±8 kV air	Floors should be wood, concrete or ceramic tile. If floors are covered with synthetic material, the relative humidity should be at least 30 %.
Electrical fast transient/burst IEC 61000-4-4	±2 kV for power supply lines ±1 kV for input/output lines	±2 kV for power supply lines ±1 kV for input/output lines	Mains power quality should be that of a typical commercial or hospital environment.
Surge IEC 61000-4-5	±1 kV line(s) to line(s) ±2 kV line(s) to earth	±1 kV line(s) to line(s) ±2 kV line(s) to earth	Mains power quality should be that of a typical commercial or hospital environment.
interruptions and voltage variations on power supply input lines IEC 61000-4-11	<5 % <i>UT</i> (>95 % dip in <i>UT</i> ) for 0,5 cycle 40 % <i>UT</i> (60 % dip in <i>UT</i> ) for 5 cycles 70 % <i>UT</i> (30 % dip in <i>UT</i> ) for 25 cycles <5 % <i>UT</i> (>95 % dip in <i>UT</i> )	<5 % <i>UT</i> (>95 % dip in <i>UT</i> ) for 0,5 cycle 40 % <i>UT</i> (60 % dip in <i>UT</i> ) for 5 cycles 70 % <i>UT</i> (30 % dip in <i>UT</i> ) for 25 cycles <5 % <i>UT</i> (>95 % dip in <i>UT</i> )	Mains power quality should be that of a typical commercial or hospital environment. If the user of the SonoTouch 30 requires continued operation during power mains interruptions, it is recommended that the

	for 5 sec	for 5 sec	SonoTouch 30 be powered from an uninterruptible power supply or a battery.
Power frequency magnetic field IEC 61000-4-8	3 A/m	3 A/m	Power frequency magnetic fields should be at levels characteristic of a typical location in a typical commercial or hospital environment.
NOTE UT is the a.c. mains voltage prior to application of the test level.			

**3 Guidance and manufacturer’s declaration – electromagnetic immunity**

The SonoTouch 30 is intended for use in the electromagnetic environment specified below. The customer or the user of the SonoTouch 30 should assure that it is used in such an environment.

<b>3.1. Immunity test</b>	<b>IEC 60601 test level</b>	<b>IEC 60601 test level</b>	<b>Electromagnetic environment – guidance</b>
Conducted RF IEC 61000-4-6 Radiated RF IEC 61000-4-3	3 Vrms 150 kHz to 80 MHz 3 V/m 80 MHz to 2,5 GHz	3 Vrms 3 V/m	<p>Portable and mobile RF communications equipment should be used no closer to any part of the SonoTouch 30, including cables, than the recommended separation distance calculated from the equation applicable to the frequency of the transmitter.</p> <p><b>Recommended separation distance</b></p> $d = 1,2 \sqrt{P}$ $d = 1,2 \sqrt{P} \quad 80 \text{ MHz to } 800 \text{ MHz}$ $d = 2,3 \sqrt{P} \quad 800 \text{ MHz to } 2.5 \text{ GHz}$ <p>where <i>P</i> is the maximum output power rating of the transmitter in watts (W) according to the transmitter manufacturer and <i>d</i> is the recommended separation distance in metres (m)</p> <p>Field strengths from fixed RF transmitters, as determined by an electromagnetic site survey, should be less than the compliance level in each frequency range.</p> <p>Interference may occur in the vicinity of equipment marked with the following symbol:</p> 

NOTE 1 At 80 MHz and 800 MHz, the higher frequency range applies.

NOTE 2 These guidelines may not apply in all situations. Electromagnetic propagation is affected by absorption and reflection from structures, objects and people.

a Field strengths from fixed transmitters, such as base stations for radio (cellular/cordless) telephones and land mobile radios, amateur radio, AM and FM radio broadcast and TV broadcast cannot be predicted theoretically with accuracy. To assess the electromagnetic environment due to fixed RF transmitters, an electromagnetic site survey should be considered. If the measured field strength in the location in which the SonoTouch 30 is used exceeds the applicable RF compliance level above, the SonoTouch 30 should be observed to verify normal operation. If abnormal performance is observed, additional measures may be necessary, such as reorienting or relocating the SonoTouch 30.

b Over the frequency range 150 kHz to 80 MHz, field strengths should be less than 3 V/m.

<b>Recommended separation distances between portable and mobile RF communications equipment and the SonoTouch 30</b>			
The SonoTouch 30 is intended for use in an electromagnetic environment in which radiated RF disturbances are controlled. The customer or the user of the SonoTouch 30 can help prevent electromagnetic interference by maintaining a minimum distance between portable and mobile RF communications equipment (transmitters) and the SonoTouch 30 as recommended below, according to the maximum output power of the communications equipment.			
Rated maximum output power of transmitter W	Separation distance according to frequency of transmitter m		
	150 kHz to 80 MHz $d = 1,2 \sqrt{P}$	80 MHz to 800 MHz $d = 1,2 \sqrt{P}$	800 MHz to 2,5 GHz $d = 2,3 \sqrt{P}$
0,01	0,12	0,12	0,23
0,1	0,38	0,38	0,73
1	1,2	1,2	2,3
10	3,8	3,8	7,3
100	12	12	23
For transmitters rated at a maximum output power not listed above, the recommended separation distance $d$ in metres (m) can be estimated using the equation applicable to the frequency of the transmitter, where $P$ is the maximum output power rating of the transmitter in watts (W) according to the transmitter manufacturer. NOTE 1 At 80 MHz and 800 MHz, the separation distance for the higher frequency range applies. NOTE 2 These guidelines may not apply in all situations. Electromagnetic propagation is affected by absorption and reflection from structures, objects and people.			

## Appendix E: Display Accuracy and Acoustic Measurement Uncertainties

According to IEC60601-2-37 and NEMA UD-3 2004, the display accuracy and acoustic measurement uncertainties are summarized in the table below.

Display accuracy of MI is  $\pm 20\%$ , and TI is  $\pm 40\%$  or  $< 0.1$ , if MI, TI below 0.5.

Item	Measurement Uncertainty (Percentage, 95% Confidence Value)
Center Frequency	$\pm 15\%$
Acoustic Power	$\pm 30\%$
Acoustic Intensity	$\pm 30\%$
Peak Rarefactional Pressure	$\pm 15\%$

## Appendix F: Transducer Maximum Surface Temperature

According to the requirements of the section 42.3 in the standard IEC 60601-2-37:2007, the transducer surface temperature has been tested in two kinds of conditions: the transducer suspended in still air or transducer contacting human-tissue mimicking material. The calculation of the expanded uncertainty is based on the ISO Guide to the Expression of uncertainty in measurement. Three transducer samples have been tested and the confidence coefficient is at 95%, the value of  $t_{0.975}$  is 4.30.

The measurement data were obtained under the test conditions employed at CHISON.

<b>Transducer model</b>	<b>Maximum surface temperature(°C)</b>
<b>C3</b>	<b>&lt;41.0</b>
<b>L7V</b>	<b>&lt;41.0</b>
<b>P3</b>	<b>&lt;41.0</b>
<b>MC6</b>	<b>&lt;41.0</b>
<b>L7M</b>	<b>&lt;41.0</b>
<b>L7L</b>	<b>&lt;41.0</b>
<b>R7</b>	<b>&lt;41.0</b>
<b>L7S</b>	<b>&lt;41.0</b>
<b>MC3</b>	<b>&lt;41.0</b>
<b>V6</b>	<b>&lt;41.0</b>