

Instructions for use

Evita 4 / Evita 4 *edition*



WARNING

To properly use this medical device,
read and comply with these instructions
for use.

**Intensive Care Ventilator
Software 4.n**

Working with these Instructions for Use

Header line – the title... of the main chapter

The title of the specific sub-section is printed underneath the main header – to help you find your way quickly from subject to subject.

Page body... the Instructions for Use

in combined text/illustrations. The information is expressed in the form of practical actions, giving the user direct hands-on experience in learning how to use the machine.

Left-hand column – the text...

provides explanations and instructs the user step-by-step in the practical use of the product, with short, clear instructions in easy-to-follow sequence.

- Bullet points indicate the steps to be followed,
- 1 Where several steps are described, the numbers refer to the illustration. Numbering starts from 1 again on each new page,
- Dashes indicate lists of data, options or objects.

Right-hand column – the illustrations...

provide the visual reference for the text and make it easier to locate the various parts of the equipment. Elements mentioned in the text are highlighted. Unnecessary details are avoided.

Screen displays prompt the user to proceed and confirm correct actions.

Operation

Calibrating

The last calibration/zeroing values remain stored until the next calibration/zero calibration, even when the machine is switched off.
 Calibration of the pressure sensors for measuring the airway pressure is automatic.
 The flow sensor and O₂ sensor are automatically calibrated once per day.
 Manual calibration of the flow sensor can be performed at any time, even during ventilation.
 Manual calibration of the O₂ sensor can be performed at any time, even during ventilation. The applied O₂ concentration is not affected by calibration.
 The calibration of the CO₂ sensor can be checked during ventilation.

Calibrating the O₂ sensor

- Before operation, during the device check.
- After replacing the O₂ sensor (wait for the 15 minute warm-up time of the O₂ sensor).
- If the measured value and set value deviate from each other by more than 2 Vol%.

The O₂ sensor can be calibrated during ventilation.

Start calibration:

- Press »Calibration« key.

Display (example):

- Touch the »O₂« screen key.

The LED in the screen key changes colour to yellow.



Message in the help line at the bottom of the screen:

»O₂-calibration«
 After calibration is complete, the yellow LED in the screen key goes out.

Instructions for Use Evita 4 / Evita 4 edition SW 4.n 109

Trademarks

Trademark	Trademark owner
Evita®	Dräger
AutoFlow®	Dräger
BIPAP ¹⁾	

1) Trademark used under license

Safety information definitions

WARNING

A WARNING statement provides important information about a potentially hazardous situation which, if not avoided, could result in death or serious injury.

CAUTION

A CAUTION statement provides important information about a potentially hazardous situation which, if not avoided, may result in minor or moderate injury to the user or patient or in damage to the medical device or other property.

NOTE

A NOTE provides additional information intended to avoid inconvenience during operation.

Abbreviations and Symbols

Please refer to "Abbreviations" on page 206 and "Symbols" on page 207 for explanations.

Definition of target groups

For this product, users, service personnel, and experts are defined as target groups.

These target groups must have received instruction in the use of the product and must have the necessary training and knowledge to use, install, reprocess, maintain, or repair the product.

The product must be used, installed, reprocessed, maintained, or repaired exclusively by defined target groups.

Users

Users are persons who use the product in accordance with its intended use.

Service personnel

Service personnel are persons who are responsible for the maintenance of the product.

Service personnel must be trained in the maintenance of medical devices and install, reprocess, and maintain the product.

Experts

Experts are persons who perform repair or complex maintenance work on the product.

Experts must have the necessary knowledge and experience with complex maintenance work on the product.

Evita 4 edition

The Evita 4 *edition* is identical to the Evita 4. Both devices have identical components, options and functionalities. This refers to all electrical, electronic and pneumatic components as well as to the trolley, the installed software and the available options.

The terms "Evita 4" and "Evita 4 *edition*" are used synonymously in these Instructions for Use.

What's new in Evita 4 software 4.n*

Specification of the humidifier used

- »Active humidifier«
or
- »HME/Filter« (artificial nose)
- for more accurate measurement of the volume parameters

Apnoea ventilation On/Off

- can be selected as starting configuration

Extended range of settings for the alarm time

»TApnoea $\sqrt{\wedge}$ «

- from 5 to 60 seconds (formerly 15 to 60 seconds)

Frequency can be reduced to 0

- for BIPAP and SIMV, for weaning without transitions

Ventilation mode BIPAPAssist

- for pressure-controlled assisted ventilation

Patient mode »prev. patient« can be selected

- to adopt the settings, including alarms, which were effective before switching off the equipment

Leakage compensation On/Off

- for activation and deactivation of the automatic leakage compensation function

Extended logbook entries

- Evita 4 4.n identifies alarms which are active but not displayed with an asterisk

Monitoring of tube blockages

- new alarm message »Tube blocked !!!«

Additional weaning parameters

available as software version 4.n plus upgrade
in addition to the parameter occlusion pressure P 0.1

Evita 4 4.n also determines the parameters

- RSB Rapid Shallow Breathing index
and
- NIF Negative Inspiratory Force index

External flow source

available as software version 4.n plus upgrade

- The amount of external flow is calculated by Evita 4 4.n (e. g. for additional tracheal gas insufflation) and adjusts the volume monitoring tolerances in order to avoid inadvertent alarms

Extended use of loop presentations

available as software version 4.n plus upgrade

- Loops can be zoomed and frozen
- Loops can be displayed permanently in the upper part of the screen

Evita Remote (Remote Pad)

optionally available

- Remote control pad for parallel remote operation of function keys on Evita 4

NIV

optionally available

- Application mode to support non-invasive ventilation therapies

Nurse call

optionally available

- Connection for transmitting alarm signals to a central hospital alarm station

* Please refer to page 209 onwards for new features in software versions 2.n and 3.n

Contents

Trademarks	2	Configuration	123
Safety information definitions	3	Sound	124
Definition of target groups	3	Screen	125
For your safety and that of your patients	7	Ventilation	128
General safety information	8	System defaults	138
Product-specific safety information	10	Alarm – Cause – Remedy	141
Intended medical application	13	Cleaning, disinfection and sterilization	149
Operating concept	17	Safety information on reprocessing	150
Structure of the control unit	18	Dismantling	150
The power switch	19	Reprocessing procedures	153
On-screen controls	20	Reprocessing list	155
Screen pages	23	Assembling	157
Control unit location	29	Before reusing on patient	158
Preparation	31	Maintenance	159
Information on preparation	32	Overview	160
Preparing the EvitaMobil trolley	32	Inspection	160
Positioning the control unit	33	Preventive maintenance	160
Fitting the device components	35	Repair	161
Using HME, bacterial filters and hose systems	38	Clean or replace cooling air filter	162
Attaching a breathing gas humidifier	39	Removing and reinserting ambient-air filter	162
Fitting ventilation hoses	40	Removing and inserting filter for heating patient part	162
Fitting temperature sensor	41	Clean covering grid for heating patient part	162
Fitting a CO ₂ cuvette and CO ₂ sensor (optional)	42	Disposal	163
Connecting to supplies	43	Disposing of the medical device	164
Connecting Evita Remote (optional)	45	Disposing of non-rechargeable batteries	164
Connecting the nurse call (optional)	47	Disposal of O ₂ sensors	164
Before using for the first time	49	Disposal of flow sensor	164
Device check	51	What is what	165
Transportation within the hospital	58	Technical data	171
Switching piped gas supply to cylinder supply	58	Environmental conditions	172
No instrument tray (optional)	59	Settings	172
Operation	61	Performance data	173
Starting up	62	Measured value displays	175
Patient mode	63	Computed value displays	177
Starting ventilation	64	Monitoring	178
Setting ventilation modes	65	Operating data	179
ILV	79	Machine outputs	180
Apnoea Ventilation	86	Materials used	181
Setting alarm limits	87	For nurse call (optional)	182
In the event of an alarm	88	EMC declaration	182
Displaying curves and measured values	90	Description	185
Displaying measured values	91	Ventilation modes	186
Trends	92	Weaning parameters	197
Loops	93	Insp. O ₂ concentration during medication nebulisation	200
Logbook	95	Principle of measurement	201
Screen freeze	96	Alarm – Detection/Description	202
Special functions	97	Abbreviations	206
Switching off monitor functions	106	Symbols	207
Selecting standby mode	108	Bibliography	208
Calibrating	109		

What was new in Evita 4 software 2.n.	209
What was new in Evita 4 software 3.n.	210
Index	211
Labels for options.	214
Access code for Evita 4 / Evita 4 edition SW 4.n.	215
Information on the access code	215

For your safety and that of your patients

General safety information	8
Strictly follow these instructions for use	8
Maintenance	8
Accessories	8
Not for use in areas of explosion hazard	8
Safe connection with other electrical equipment	8
Connected devices	8
Connection to other devices	8
Patient safety	9
Patient monitoring	9
Information on electromagnetic compatibility	9
Installing accessories	9
Storing the instructions for use	9
Product-specific safety information	10
Functional safety	10
Monitoring ventilation	11
Backup ventilation with an independent manual ventilation device	11

General safety information

The following WARNING and CAUTION statements apply to general operation of the medical device.

WARNING and CAUTION statements specific to subsystems or particular features of the medical device appear in the respective sections of these instructions for use or in the instructions for use of another product being used with this medical device.

Strictly follow these instructions for use

WARNING

Risk of incorrect operation and of incorrect use
Any use of the medical device requires full understanding and strict observation of all sections of these instructions for use. The medical device must only be used for the purpose specified under "Intended medical application" auf Seite 13 and in conjunction with appropriate patient monitoring (see page 9). Strictly observe all WARNING and CAUTION statements throughout these instructions for use and all statements on medical device labels. Failure to observe these safety information statements constitutes a use of the medical device that is inconsistent with its intended use.

Maintenance

WARNING

Risk of medical device failure and of patient injury
The medical device must be inspected and serviced regularly by service personnel. Repair and complex maintenance carried out on the medical device must be performed by experts.
If the above is not complied with, medical device failure and patient injury may occur. Observe chapter "Maintenance".
Dräger recommends that a service contract is obtained with DrägerService and that all repairs are performed by DrägerService. For maintenance Dräger recommends the use of authentic Dräger repair parts.

Accessories

WARNING

Risk due to incompatible accessories
Dräger has tested only the compatibility of accessories listed in the current list of accessories. If other, incompatible accessories are used, there is a risk of patient injury due to medical device failure.
Dräger recommends that the medical device is only used together with accessories listed in the current list of accessories.

Not for use in areas of explosion hazard

WARNING

Risk of fire

The medical device is not approved for use in areas where combustible or explosive gas mixtures are likely to occur.

Safe connection with other electrical equipment

WARNING

Risk of patient injury

Electrical connections to equipment not listed in these instructions for use or these assembly instructions must only be made when approved by each respective manufacturer.

Connected devices

WARNING

Risk of electric shock and of device malfunction

Any connected devices or device combinations not complying with the requirements mentioned in these instructions for use can compromise the correct functioning of the medical device and lead to an electric shock. Before operating the medical device, strictly comply with the instructions for use of all connected devices or device combinations.

Connection to other devices

Device combinations (Dräger devices + Dräger devices or Dräger devices + third-party devices) approved by Dräger (see instructions for use of the individual devices) meet the requirements of the following standards:

- IEC 60601-1 (2nd edition)
Medical electrical equipment
Part 1: General requirements for safety
- IEC 60601-1-1
Medical electrical equipment
Part 1-1: General requirements for safety
Collateral standard: Safety requirements for medical electrical systems
- IEC 60601-1-2
Medical electrical equipment
Part 1-2: General requirements for safety and essential performance
Collateral standard: Electromagnetic compatibility – Requirements and tests
- IEC 60601-1-4
Medical electrical equipment
Part 1-4: General requirements for safety
Collateral standard: Programmable electrical medical systems
- IEC 60601-1-8
Medical electrical equipment
Part 1-8: General requirements for safety
Collateral standard: General requirements, tests, and guidance for alarm systems in medical equipment and medical electrical systems

If a device combination is not approved by Dräger, proper operation of the devices can be compromised. The operator must ensure that the device combination meets the applicable standards. Strictly observe instructions for use and assembly instructions of all connected devices.

Patient safety

The design of the medical device, the accompanying documentation, and the labeling on the medical device are based on the assumption that the purchase and the use of the medical device are restricted to persons familiar with the most important inherent characteristics of the medical device. Instructions and WARNING and CAUTION statements are therefore largely limited to the specifics of the Dräger medical device.

The instructions for use do not contain any information on the following points:

- Risks that are obvious to users
- Consequences of obvious improper use of the medical device
- Potentially negative effects on patients with different underlying diseases

Medical device modification or misuse can be dangerous.

CAUTION

Risk of patient injury

Do not make therapeutic decisions based solely on individual measured values and monitoring parameters.

Patient monitoring

The user of the medical device is responsible for choosing a suitable patient monitoring system that provides appropriate information on medical device performance and patient condition.

Patient safety can be achieved by a wide variety of means ranging from electronic surveillance of medical device performance and patient condition to direct observation of clinical signs.

The responsibility for selecting the best level of patient monitoring lies solely with the user of the medical device.

Information on electromagnetic compatibility

General information on electromagnetic compatibility (EMC) according to international EMC standard IEC 60601-1-2: Medical electrical equipment is subject to special precautionary measures concerning electromagnetic compatibility (EMC) and must be installed and put into operation in accordance with the EMC information provided on page 222. Portable and mobile radio frequency communication equipment can affect medical electrical equipment.

WARNING

Risk of electric shock



Do not connect connectors with an ESD warning symbol and do not touch their pins without implementing ESD protective measures. Such protective measures can include antistatic clothing and shoes, touching a potential equalization pin before and during connection of the pins, or using electrically insulating and antistatic gloves.

All users concerned must be instructed in these ESD protective measures.

WARNING

Risk of device failure

Electromagnetic fields can compromise proper operation of the device. Electromagnetic fields are generated by, e.g., radio frequency communication equipment such as:

- Mobile phones
- Radio frequency electrosurgical equipment
- Defibrillators
- Shortwave therapy equipment

Use radio frequency equipment only with a sufficient safety margin, see "EMC declaration" auf Seite 182.

Installing accessories

CAUTION

Risk of device failure

Install accessories to the basic device in accordance with the instructions for use of the basic device. Make sure that there is a safe connection to the basic device.

Strictly observe instructions for use and assembly instructions.

Storing the instructions for use

CAUTION

Risk of incorrect use

Instructions for use must be kept accessible to the user.

Product-specific safety information

WARNING

Risk of operating error

This medical device is only intended to be used by the target group "users".

WARNING

Risk of fire

Do not use the medical device in conjunction with flammable gases or flammable solutions that can mix with air, oxygen, or nitrous oxide or with other sources of ignition since the medical device could ignite.

Do not allow the medical device to come into contact with sources of ignition.

WARNING

Risk of patient injury

Hyperbaric chambers may impair correct functioning of the medical device.

Do not use the medical device in hyperbaric chambers.

WARNING

Risk of patient injury

Magnetic resonance imaging (MRI, NMR, NMI) may impair correct functioning of the medical device.

Do not use the medical device during magnetic resonance imaging.

WARNING

Risk of electric shock

There are live components under the housing cover.

Do not open the housing of the medical device.

WARNING

Risk of fire

Due to oxygen enrichment in the ambient air, the medical device can ignite. Medical device malfunctions can increase the O₂ concentration in the ambient air.

Only use the medical device in sufficiently ventilated rooms.

WARNING

Risk of patient injury

Penetrating liquid may cause malfunction of or damage to the device, which may endanger the patient.

Do not place any containers with liquid on or above the device.

WARNING

Risk of fire

If medications or other substances based on flammable solvents, such as alcohol, reach the breathing system, there is a risk of fire.

If highly flammable substances are used for disinfection, sufficient airing must be ensured.

WARNING

Do not obstruct the gas inlet for the safety valve. Otherwise, spontaneous breathing via the emergency breathing valve is not possible in the event of a device failure.

WARNING

With neonates, the administration of increased O₂ concentrations can lead to retinopathy of prematurity.

Use additional monitoring, e.g., external SpO₂.

CAUTION

Keep away from sources of heat such as direct sunlight, heat radiators or spotlights. Otherwise the medical device may become too hot.

CAUTION

Do not obstruct or close off the vents on the medical device. Air must be able to enter freely. Otherwise the medical device may become too hot. An alarm is triggered if the medical device overheats during operation.

CAUTION

Positive-pressure ventilation can lead to negative effects, such as barotrauma or strain on the circulatory system.

Functional safety

The essential performance consists in controlled and monitored patient ventilation with user-defined settings for the monitoring functions

- minimum breathing gas flow,
- maximum airway pressure,
- minimum and maximum oxygen concentration in the breathing gas,

or, if a set limit is exceeded, by an appropriate alarm. The device is equipped with basic safety features to reduce the possibility of patient injury while the cause of an alarm is remedied.

Monitoring ventilation

The following parameters are monitored by the built-in monitoring facilities:

- Airway pressure, P_{aw}
- Expiratory minute volume, MV
- Inspiratory O₂ concentration, FiO_2
- Inspiratory breathing gas temperature, T
- Expiratory CO₂ concentration, $etCO_2$ (optional)
- Inspiratory breathing volume, V_{Ti}
- Apnoea time
- Tachypnoea monitoring

Changes in these parameters may be caused by:

- Acute changes in the patient's condition
- Incorrect settings and faulty handling
- Equipment malfunctions
- Failure of power and gas supplies

If a fault occurs in this equipment, separate measuring instruments should be used.

Backup ventilation with an independent manual ventilation device

WARNING

Risk of patient injury

If a fault is detected in the medical device, its life-support functions may no longer be assured.

Ventilation of the patient using an independent ventilation device must be started without delay, if necessary with PEEP and/or an increased inspiratory O₂ concentration (e.g., with manual breathing bag MR-100).

This page intentionally left blank.

Intended medical application

Scope of application	14
With the following ventilation modes	14
Supplements	14
Diagnostic functions	15
Monitoring	15
DC power supply unit (optional)	15
Evita 4 Link (optional)	15
MEDIBUS	15
Automatic gas switch-over	15
Areas of use	15

Scope of application

Evita 4 – long-term ventilator for intensive care.
For adults, children and neonates.
For premature babies with the "NeoFlow" option.

With the following ventilation modes

IPPV (Intermittent Positive Pressure Ventilation)

Volume-controlled ventilation with fixed mandatory minute volume.

With the options:

- CPPV (**C**ontinuous **P**ositive **P**ressure **V**entilation)
Controlled ventilation with continuous positive airway pressure
- PLV (**P**ressure **L**imited **V**entilation)
Pressure limited constant-volume ventilation
- AutoFlow®
for automatic regulation of "Insp. Flow" and "P_{insp}"
- IRV (**I**nversed **R**atio **V**entilation)
Ventilation with inversed inspiration/expiration ratio.

SIMV (Synchronized Intermittent Mandatory Ventilation)

Combines mechanical (volume-controlled) ventilation with spontaneous breathing.

With the options:

- PLV (**P**ressure **L**imited **V**entilation)
Pressure limited constant-volume ventilation
- AutoFlow®
for automatic regulation of "Insp. Flow" and "P_{insp}".

MMV (Mandatory Minute Volume Ventilation)

Spontaneous breathing with automatic adjustment of mandatory ventilation to the patient's minute volume requirement.

With the options:

- PLV (**P**ressure **L**imited **V**entilation)
Pressure limited constant-volume ventilation
- AutoFlow®
for automatic regulation of "Insp. Flow" and "P_{insp}".

SB (Spontaneous Breathing)

Spontaneous breathing at ambient pressure.

CPAP (Continuous Positive Airway Pressure)

Spontaneous breathing with positive airway pressure.

ASB (Assisted Spontaneous Breathing)

Pressure-assisted spontaneous breathing.

BIPAP (Biphasic Positive Airway Pressure)

Pressure-controlled ventilation combined with free spontaneous breathing during the complete breathing cycle and adjustable pressure assist on CPAP level.

BIPAPAssist (Biphasic Positive Airway Pressure Assisted)

Pressure-controlled assisted ventilation.

APRV (Airway Pressure Release Ventilation)

Spontaneous breathing on two pressure levels with long time ranges – independently adjustable.

PPS (Proportional Pressure Support) (optional)

For differentiated proportional support of spontaneous breathing with pathological compliance and/or resistance.

ILV (Independent Lung Ventilation)

Separate, differentiated, synchronised ventilation with two Evita units, independently ventilating each lung.

Supplements

Automatic Tube Compensation ATC (optional)

Can be used for all ventilation modes.
Compensates the tube resistance.

Apnoea ventilation

For switching over automatically to volume-controlled mandatory ventilation, if breathing stops.

If apnoea occurs, Evita 4 emits an alarm after the preset alarm period »T_{Apnoea} /[⌘]« and starts volume-controlled ventilation.

NIV mask ventilation (optional)

Non-invasive ventilation

For ventilation with a nasal or facial mask to support non-invasive ventilation of patients with spontaneous breathing. Choice available between mask ventilation and ventilation of intubated patients.

Diagnostic functions**Intrinsic PEEP measurement**

For determining intrinsic PEEP when air trapping occurs.

Occlusion pressure measurement

For evaluating breathing drive during spontaneous breathing.

Negative Inspiratory Force NIF (optional)

For measuring the patient's maximum inspiratory effort following expiration.

Monitoring

Airway pressure P_{aw}

Expiratory minute volume MV

Inspiratory tidal volume V_{Ti}

Inspiratory O₂ concentration FiO_2

Inspiratory breathing gas temperature T

Apnoea time

Tachypnoea

Expiratory CO₂ concentration $etCO_2$ (optional)

DC power supply unit (optional)

Integrated DC power supply unit, supplying Evita 4 with power from two DC sources:

- Two internal 12 V lead-gel batteries in the DC power supply unit

and

- optionally via additional external 12 V or 24 V lead-gel batteries.

For uninterrupted operation following failure of the mains power supply, by automatically switching over to the external or internal battery.

For supplying power from the internal batteries or additionally from external batteries during in-house transport.

Evita 4 Link (optional)

Interface card

For output of measured values, status messages and alarm messages to on-line equipment for monitoring, documentation or processing.

MEDIBUS

Software protocol for the transfer of data between Evita 4 and an external medical or non-medical device (e. g. patient monitors or computers for data management systems) via an RS 232 port, see "MEDIBUS for Dräger Intensive Care Devices" (90 28 329).

WARNING

All transferred data are for information only and should not be used as basis for diagnostic or therapeutic decisions. Danger to the patient cannot be excluded.

To protect the patient and the user against electrical hazards, it is essential that all systems consisting of medical devices as well as other electrical devices which are not restricted to computers, printers etc., are only assembled by experts. The system must meet the requirements of the IEC/EN 60601-1-1 and IEC/EN 60601-1-2 standards.

Automatic gas switch-over

In the event of a gas failure, the unit automatically changes over to the other gas supply available.

Areas of use

In the intensive care ward or in the recovery room and with the optional DC power supply unit when transporting ventilated patients within the hospital.

This page intentionally left blank.

Operating concept

Structure of the control unit	18
The power switch	19
On-screen controls	20
Screen keys for selecting functions without confirmation .	20
Screen keys for function selection, adjustment and confirmation	21
Screen knobs for setting parameters	22
Screen pages	23
Standard page	24
Screen page »Mode settings«	24
»Alarm limits« screen page	26
»Values measured« screen page	27
Display logbook	27
»Special procedure« screen page	28
»Calibration« screen page	28
»Configuration« screen page	29
Control unit location	29

Structure of the control unit

The main components of the control unit are the screen, a set of **fixed function**, keys and the **central rotary dial-knob**. The function keys are used to call up the screen pages appropriate to the application.

In addition to curves, measured values and status displays, the screen contains, in a separate field, touch-sensitive keys and touch-sensitive rotary knobs for parameter setting. The touch-sensitive **screen keys** and the **screen knobs** are used in a similar way to ordinary keys and knobs: Touching with the fingertip is equivalent to pressing a key or taking hold of a knob. The display always contains only the screen keys and screen knobs required for function selection and/or adjustment. Settings and confirmations are made by turning and pressing the central, rotary knob.

NOTE

Do not cover the black plastic frame around the screen and do not place any objects in the frame. The touch-sensitive screen keys and knobs will no longer function correctly.

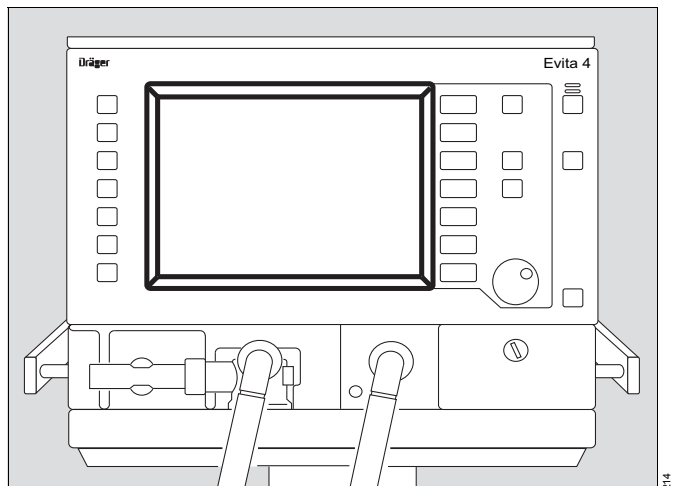
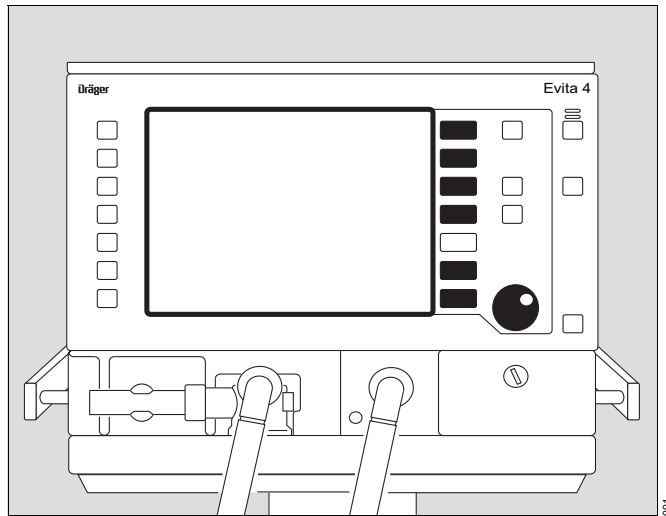

The keys for routine functions are placed to the right and left on the outside of the front panel. Frequently used function keys are placed on the right, e. g. the key »« for selecting the standard page or the »**Alarm Reset**« key for resetting or confirming messages.

Less frequently used function keys are placed on the left-hand side of the front panel, e. g. the key »« for switching the medication nebuliser on/off, or the »**O2 ↑ Suction**« key for bronchial suctioning.

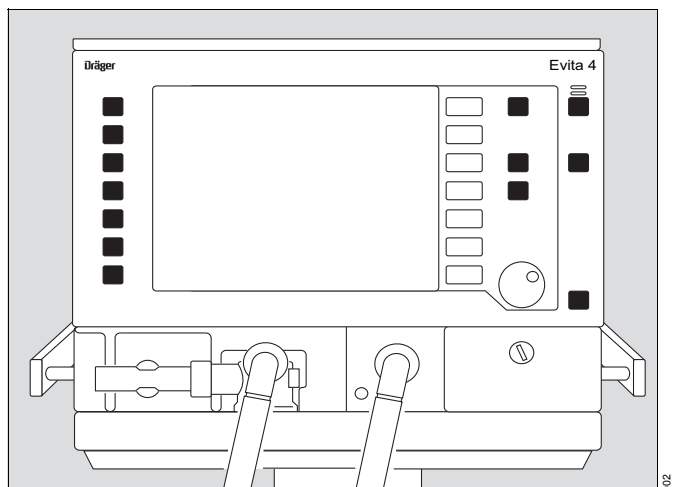

The power switch

for switching the device on/off.

The power switch is located on the back panel and has a pivoting cover to protect against being inadvertently switched off.

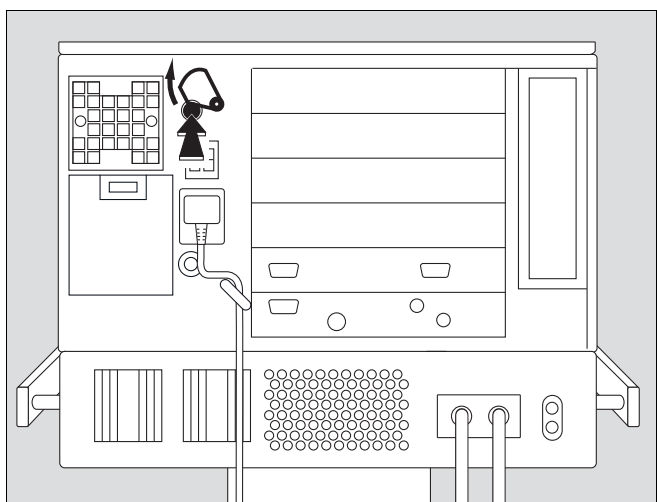
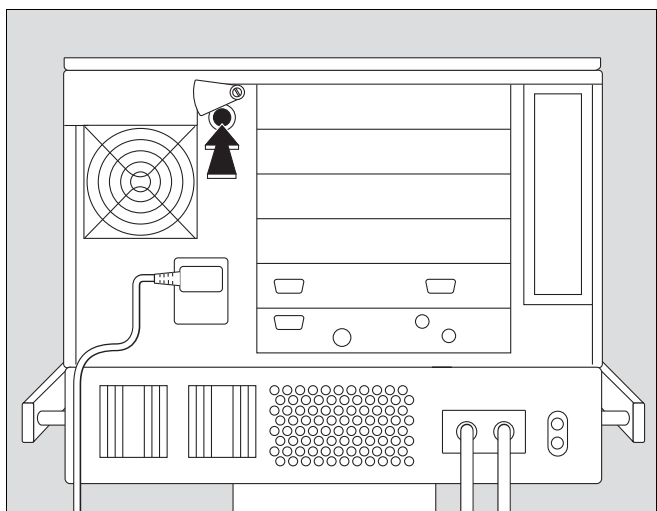

On-screen controls

The lower half of the screen contains touch-sensitive coloured **screen keys** and **screen knobs**.

Touching these controls with the fingertip is equivalent to pressing key or taking hold of a knob.
The colour displays the status of the "control" and "LEDs":

- green = usable
- white = not usable
- yellow = adjust/confirm
- black = effective function/display

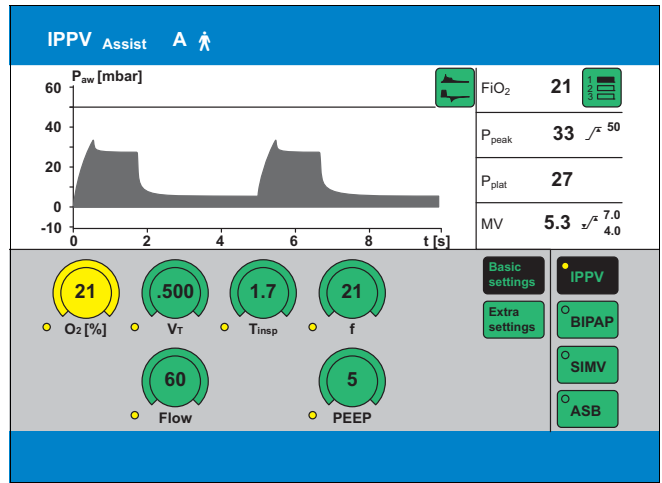

Screen keys for selecting functions without confirmation

e. g. for paging through the system on-screen
for changing the menu
for switching over displays.

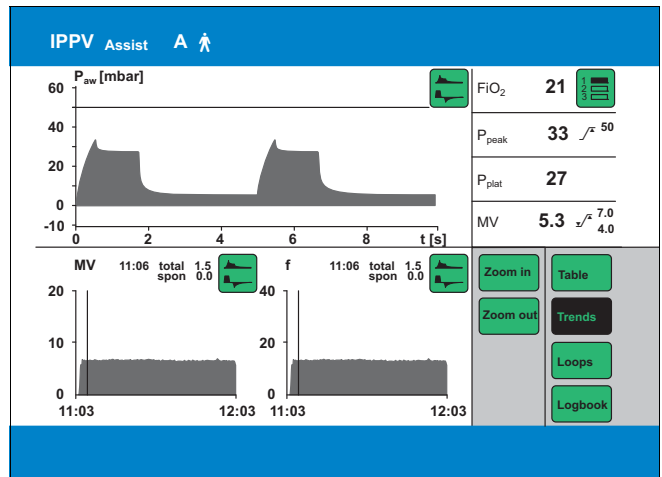

Example:

- Press the »Table« key = select display.
The key goes black to show that the function is active.

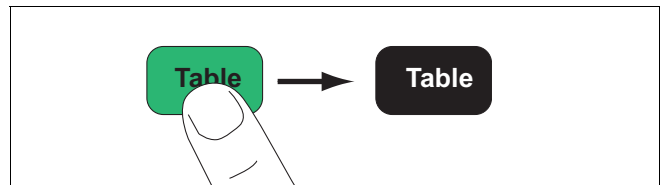

Screen keys for function selection, adjustment and confirmation

Display (example):

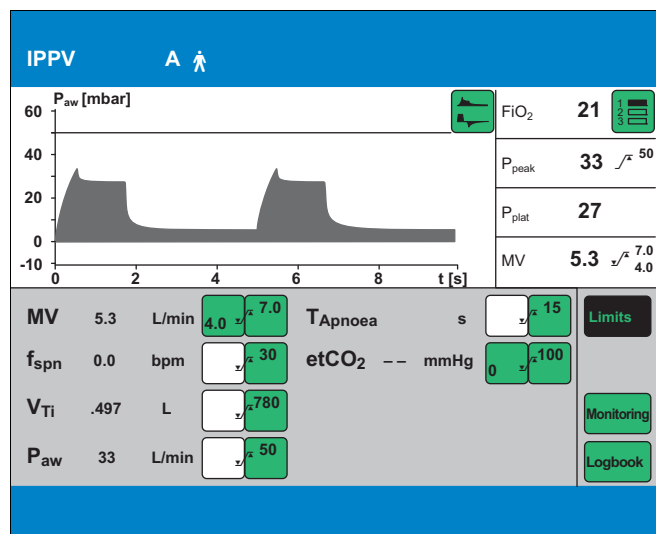

- 1 Touch the relevant screen key for the alarm limits, e. g.: **MV 2.3 L/min** » «
The colour changes from green to yellow = setting function is set.
- 2 Turn the rotary knob = adjust the alarm limit. The value is displayed in the screen key.
- 3 Press the rotary knob = the colour changes from yellow to green, and the set alarm limit is confirmed and effective.

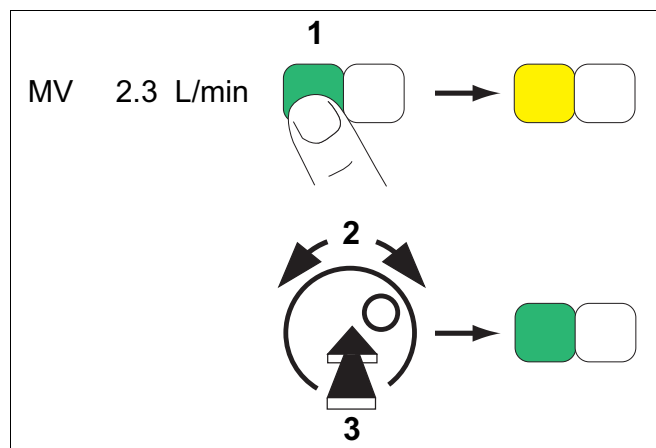

To cancel the setting:

- Touch the screen key again or
- touch another screen key.

Screen knobs for setting parameters

Display (example):

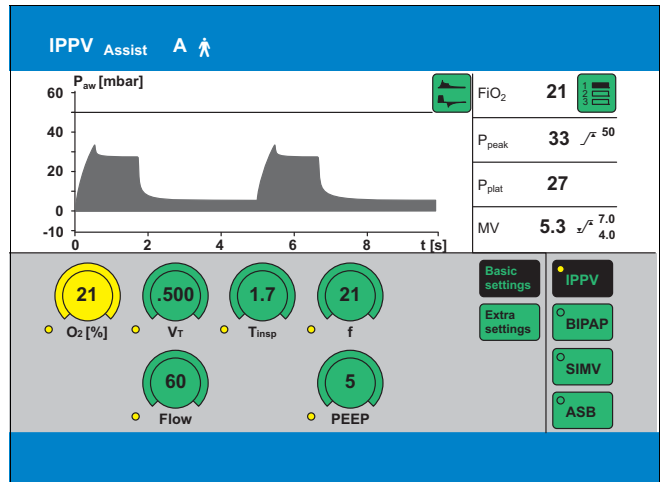

e. g. »PEEP« screen knob.

Touch the »PEEP« screen knob:

- 1 It changes colour from green to yellow = setting function selected.
- 2 Turn rotary knob = Adjust setting. The value is displayed in the knob.
- 3 Press rotary knob = Confirm. The knob changes colour from yellow to green, and the setting is validated and takes effect.

While pressure values, such as P_{max}, are being set, they are displayed in the P_{aw} (t) curve as a dashed black line.

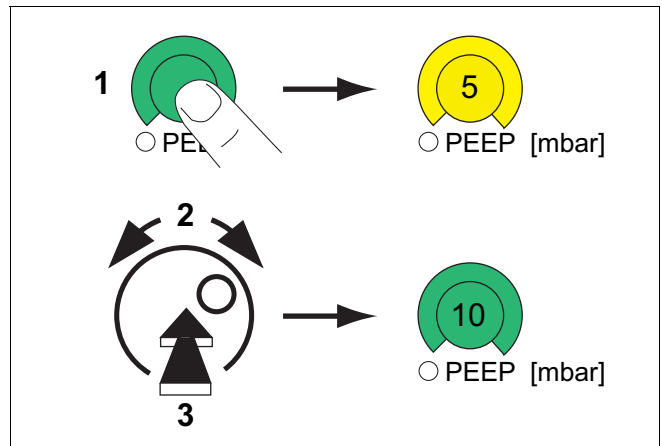





To cancel the setting:

- Press the screen knob again
- or
- press another screen knob.

Screen pages

All the screen pages have the same structure, i.e. their contents are always arranged in the same positions on the screen: Messages indicating ventilation modes and alarms, displays of measured values and curves, and help functions, always appear in the same position on the screen:

- 1 The **active ventilation mode/patient mode** is displayed on the left-hand side of the top line.
The ventilation mode is indicated by its abbreviation, e. g. BIPAP.
The patient mode is indicated by a symbol:
A  for adults,
P  for paediatric.
In the case of spontaneous breathing activity by the patient, a lung symbol  is briefly displayed as indicator.
- 2 **Curves** are displayed in the upper left-hand quarter of the screen.
- 3 The lower half of the screen shows curves and measured values or **screen keys** and **screen knobs** – depending which screen page is selected.
- 4 **Alarms** are displayed on the right of the top line.
- 5 **Measured values** are displayed in the upper right-hand quarter of the screen.
- 6 **Help functions** appear in the bottom line of the screen. On the right, Evita 4 provides setting instructions. On the left, Evita 4 provides information on the current status – this information can be accessed by pressing key »  «.

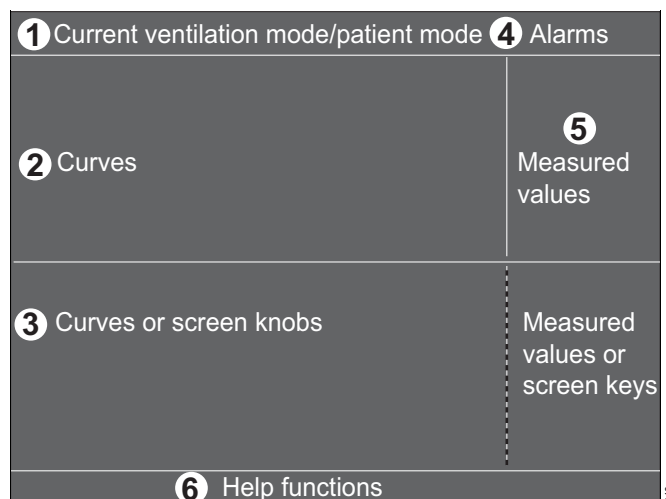

The solid function keys to the right of the screen are used to select the screen pages for the following specific application situations:

- **Mode settings**
- **Alarm limits**
- **Values measured**
- **Special procedure**
- **Calibration**
- **Configuration**

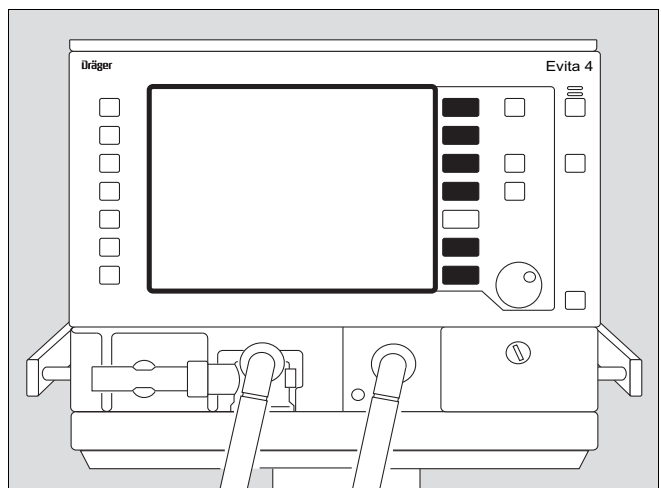

Standard page

For displaying the ventilation status

- Press »« key.
Display (example):

The standard page shows the ventilation situation at a glance – reduced to the most important measurement parameters and curves.

Four measured values are shown on the right, and two curves on the left.

Other measured values and curves can be selected in the standard page and all subsequent screen pages.

To select other measured value combinations:

- Touch screen key »« repeatedly.

To select other curves:

- Touch key »« and touch the screen key corresponding to the desired curve.

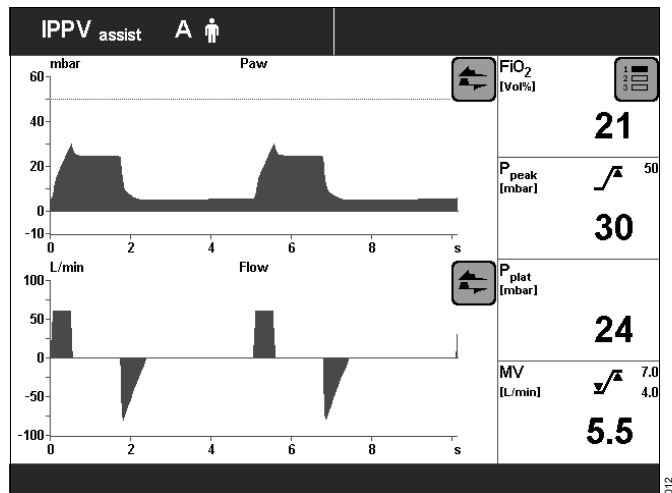

Screen page »Mode settings«

For displaying the setting parameters

The bottom right-hand side of the screen contains the screen keys for selecting the ventilation modes.

The screen key displayed in black (IPPV in the example) represents the currently activated ventilation mode.

The bottom left-hand side of the screen contains the on-screen rotary control knobs.

The values of the setting parameters are displayed in the screen knobs relevant to the ventilation mode.

The user-definable start-up settings are marked by an arrow (▶) on the scales of the screen knobs. See "Configuration" on page 123 onwards.

Changing the settings of an active ventilation mode

- Touch the appropriate screen knob, which will change colour from green to yellow = setting function enabled.
- Turn the rotary knob on the control unit = adjustment of the value of setting in the screen knob.
- Press the rotary knob: the screen knob changes colour from green to yellow = the setting is confirmed (validated) and active.

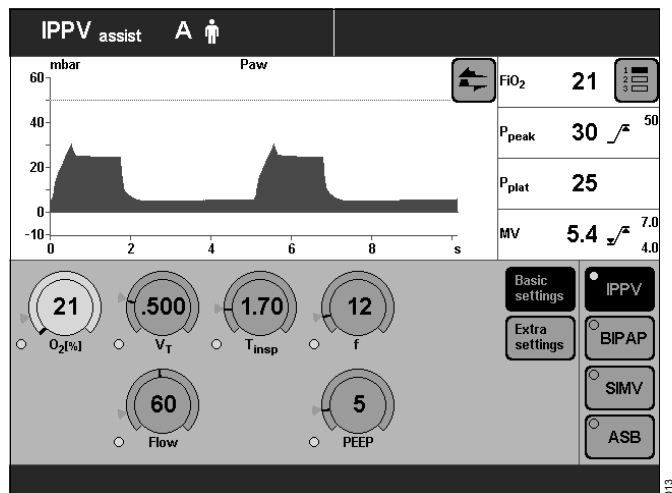

Selecting another ventilation mode and setting its parameters

- Touch the appropriate screen key, e. g. »BIPAP«. The key changes colour from green to yellow, and the parameter setting page for BIPAP is displayed.

To set the parameters for BIPAP:

- Touch the screen knob, which changes colour from green to yellow = adjustment function selected.
- Turn rotary knob = adjust value displayed in screen knob.
- Press rotary knob: the screen knob changes colour from yellow to green = setting validated and effective.

If the indicator "LED" next to a screen knob is illuminated white, the knob setting will only be effective after the new ventilation mode has been switched on (example: »PASB« knob). If the indicator "LED" is illuminated yellow, the relevant knob setting is already active in the existing ventilation mode (example: »O₂« knob).

The start-up values effective on switching on the ventilator are marked on the relevant knob-scale with an arrow (▶).

(example: PASB = 0 mbar)

- Press the rotary knob: the screen key changes colour from yellow to black = the ventilation mode is active.

For detailed instructions on setting the ventilation modes, please refer to page 65 onwards.

Cancel selection of ventilation mode:

- Press the black screen key for the effective ventilation mode again
or
- touch another screen key for selecting ventilation modes.

Cancel parameter setting:

- Touch screen key or screen knob again
or
- press another screen key or another screen knob.

To quit a screen page:

- 1 Press »« key = return to standard page
or
- 2 press any of the function keys next to the screen on the right.

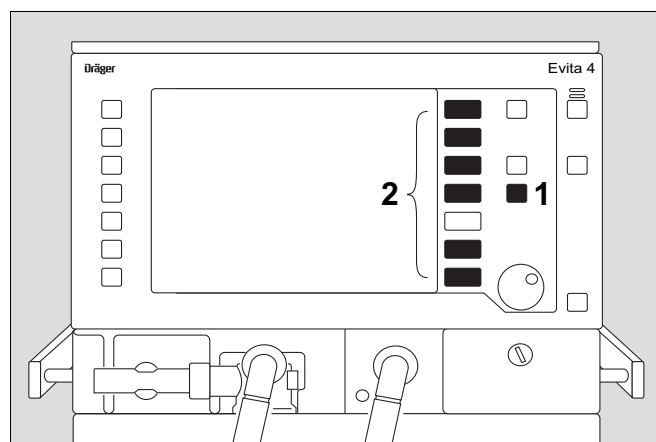
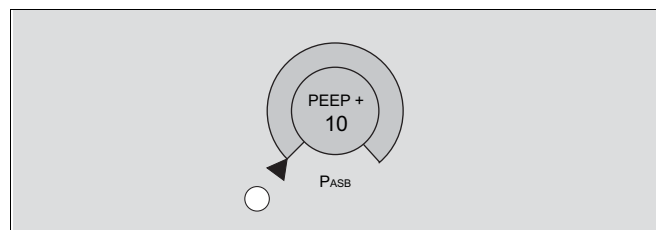
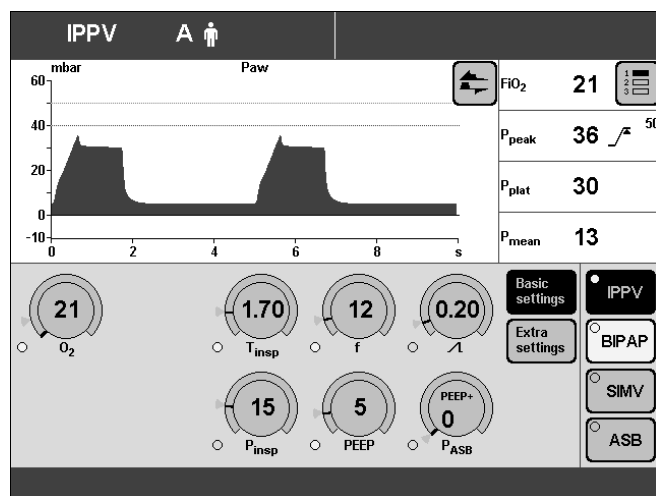

»Alarm limits« screen page

Displaying the measured values and the corresponding alarm limits.

Setting the alarm limits.

Setting the monitoring function.

Displaying the logbook.

The alarm limits are grouped together in a field and combined with a curve and four measured values.

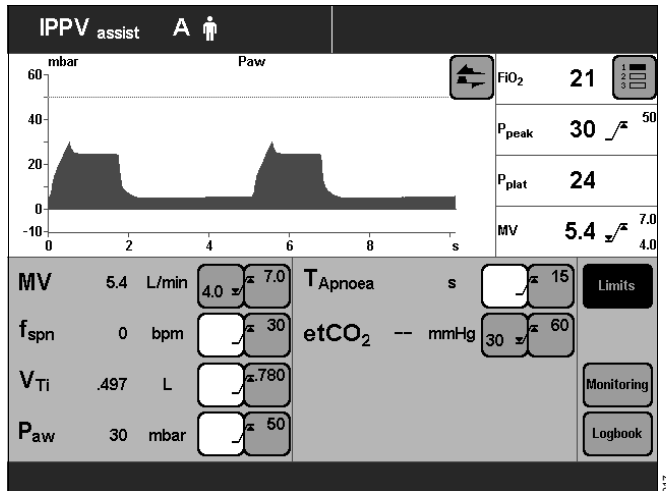

Limits, monitoring and logbook are selected by the screen keys on the right of the screen.

The currently activated screen key is highlighted in black.

Displaying/Setting Alarm Limits

- Touch the **»Limits«** screen key. The screen key will change to black. The monitored measured values will be displayed, together with their alarm limits.

Example:

MV 5.4 L/min

Left-hand screen key = lower alarm limit.

Right hand screen key = upper alarm limit.

Set the alarm limit:

- Touch the relevant screen key.
- The key changes colour to yellow = adjustable.
- Turn the rotary knob = adjust value displayed in the key.
- Press the dial-knob. The screen key changes colour to green = setting confirmed. The alarm limit is now effective.

For detailed operating instructions, please refer to page 87.

»Values measured« screen page

This page is used to display:

- the measured values in table format
- the trend curve
- loops
- logbook.

Tables, trend, loop and logbook are selected by the right-hand block of screen keys.

Example table of measured values **»Table 1«**

For detailed operating instructions, please refer to page 91.

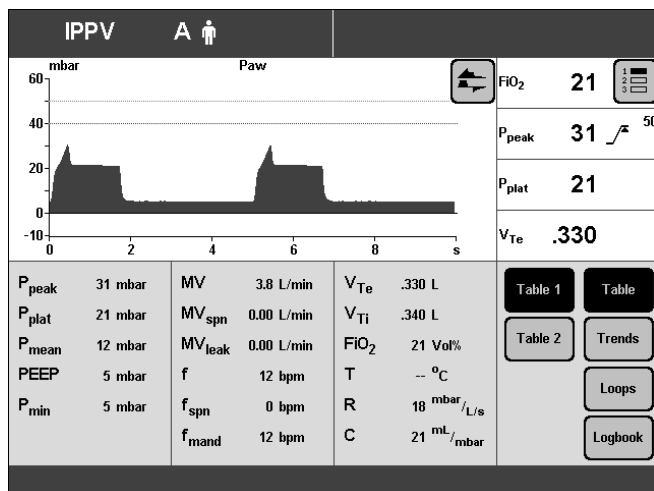

Display logbook

- Touch the **»Logbook«** screen key.
- Turn the dial-knob = select alarm events.

For detailed operating instructions, please refer to page 95.

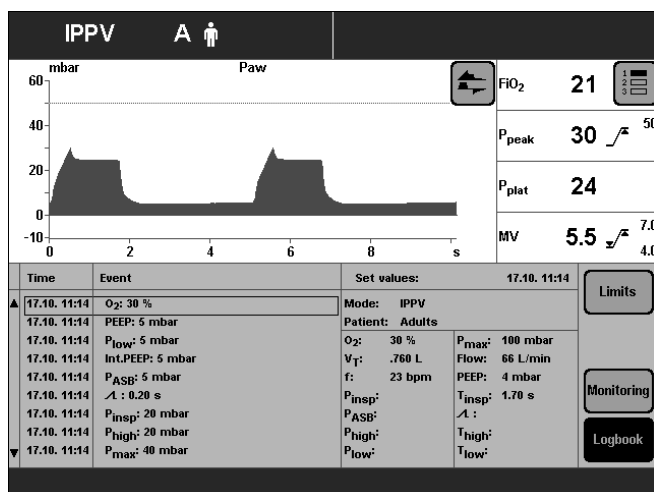

»Special procedure« screen page

This page is used to display and perform the following special measuring procedures:

- Intrinsic PEEP
and
- Occlusion pressure P 0.1

The desired special procedure is selected by the appropriate screen key on the right. The result of the last special procedure is displayed.

Example: Intrinsic PEEP

To start the special procedure:

- Touch the »Start« screen key.

For detailed operating instructions, please refer to page 104 and page 105.

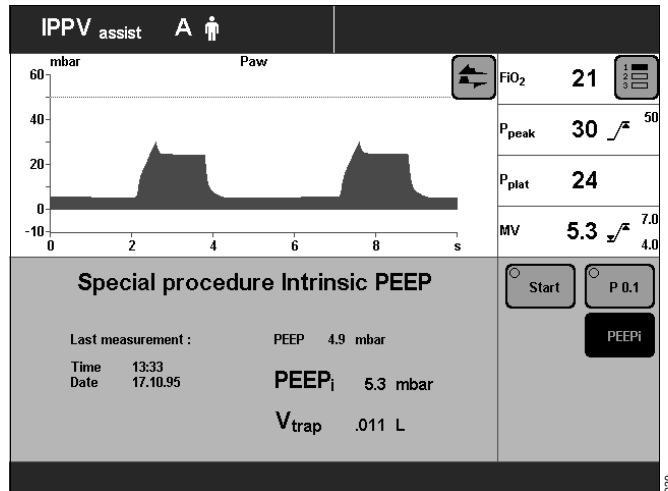

»Calibration« screen page

This page is used for calibrating

- the O₂ sensor
- the Flow sensor
- the CO₂ sensor

- Select the desired sensor with the »O₂«, »Flow« or »CO₂« screen keys.

Evita 4 provides the necessary calibration instructions in the Help Function line at the bottom of the screen.

For detailed operating instructions, please refer to page 109 onwards.

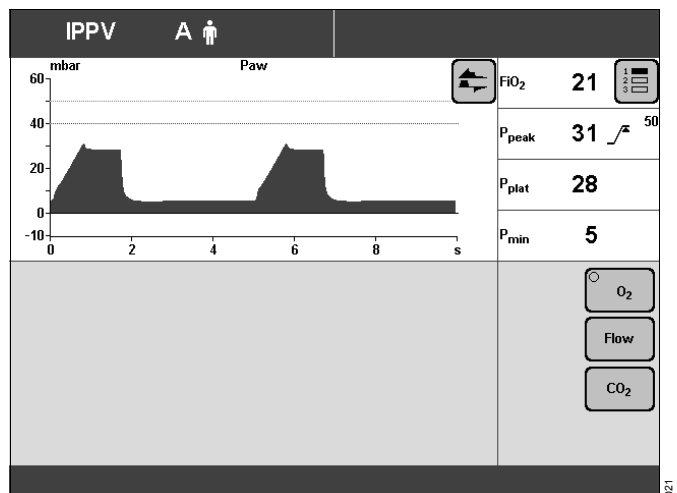

»Configuration« screen page

For selecting/adjusting the following functions:

Sound

Setting the volume of the alarm tone.

Screen

Selecting the displayed measured values.

Selecting the displayed curves.

Selecting the displayed trends.

Ventilation

Selecting ventilation modes.

Selecting the patient mode.

Selecting the initial setting.

System Defaults

Setting the external interface.

Setting the time and date.

Selecting the language and measurement units.

Selecting service diagnosis.

For detailed operating instructions, refer to page 123.

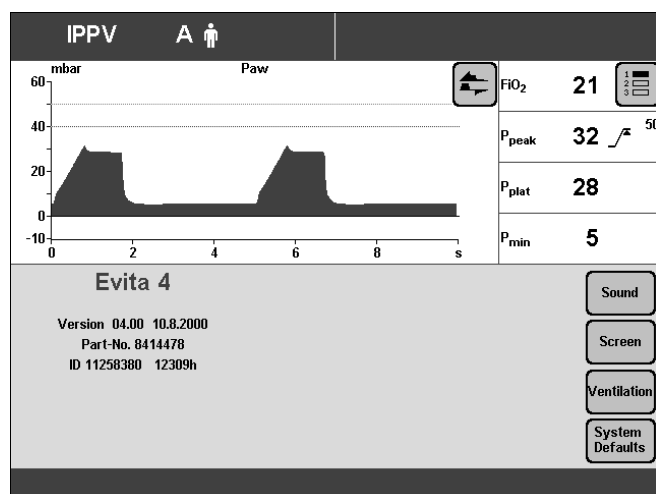

Control unit location

To adapt to the situation of the ventilation location, the control unit can be hooked onto the device

or

separately, on a wall rail.

For detailed instructions on placing, refer to page 33.

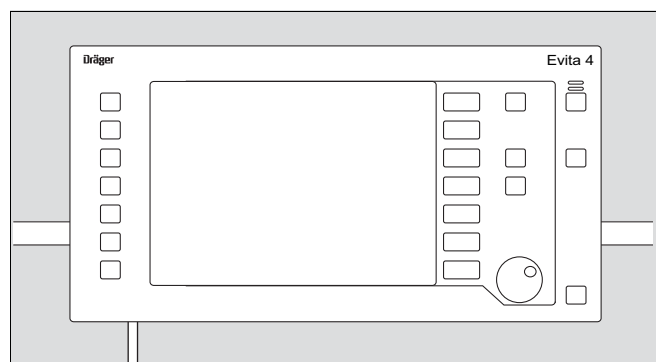

Ergonomic positioning

To ensure best viewing, free of reflections.

- 1 Hold down the blue segments on the right and left and
- 2 at the same time, tilt the control unit to the desired position.

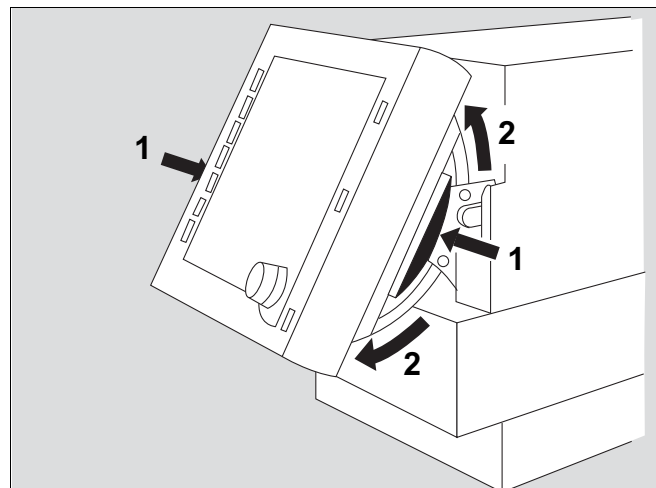

This page intentionally left blank.

Preparation

Information on preparation	32	No instrument tray (optional)	59
Preparing the EvitaMobil trolley	32		
Positioning devices	33		
Positioning the control unit	33		
Positioning on the unit	33		
Positioning on the wall rail	34		
Fitting the device components	35		
Fitting the expiration valve	35		
Fitting the flow sensor	35		
Flow sensor flap	36		
Fitting the O ₂ sensor capsule	37		
Using HME, bacterial filters and hose systems	38		
Attaching a breathing gas humidifier	39		
Aquapor EL breathing gas humidifier	39		
"Fisher & Paykel MR 850" breathing gas humidifier	39		
Fitting ventilation hoses	40		
Breathing circuit for adults and children	40		
Breathing circuit for infants	41		
Fitting temperature sensor	41		
Fitting a CO₂ cuvette and CO₂ sensor (optional)	42		
Connecting to supplies	43		
Connecting to the power supply	43		
Note on the use of a socket strip for ancillary equipment .	43		
Reaction in the case of a short-term interruption of the power supply	43		
Connecting the gas supply	44		
Connecting Evita Remote (optional)	45		
Note automatic self-test	46		
Connecting the nurse call (optional)	47		
Before using for the first time	49		
Setting the language of the screen texts	49		
Device check	51		
Preparing the adult test lung	51		
Preparing the paediatric test lung (8409742)	52		
Performing the device check	52		
Entering the humidifier type	54		
Check that the optional DC power supply unit is ready for operation	56		
Checking the hose system for leaks	57		
Transportation within the hospital	58		
Switching piped gas supply to cylinder supply	58		

Information on preparation

- Always use properly reprocessed parts, see "Cleaning, disinfection and sterilization", page 149.
- Hospital infection control regulations must be observed.

Preparing the EvitaMobil trolley

Required accessories should be installed by experts according to the instructions provided:

- Humidifier holder
- Batteries
- DC connecting cable
- Breathing air compressor
- Cylinder holder for compressed gas cylinders
- Monitor bracket with counterweight kit

WARNING

Monitors with monitor brackets should only be installed on the Evita 4 when the EvitaMobil trolley is equipped with a counter weight mounted under the base plate (in that case the label "Counter Weight is mounted" (part no. 8415824) is on the front side of the base plate) or when a breathing air compressor is mounted. High risk for the ventilator to tip over!



Conditions for tilt stability of the Evita 4 on the EvitaMobil trolley:

WARNING

The EvitaMobil trolley with the Evita 4 must not be tilted more than 5°. Increased tilting hazard!

WARNING

Do not move the EvitaMobil trolley with the Evita 4 any faster than normal walking pace. There is a higher risk of it tilting over at thresholds, on uneven floors and on ramps. Reduce speed.

- Do not place items weighing more than 50 kg on the lower base plate of the EvitaMobil (e. g. compressed gas cylinders, breathing air compressor).
- Do not place items weighing more than 40 kg on the upper console of the EvitaMobil trolley (e. g. the device or hinged arm).
- Only when a monitor bracket is mounted on the Evita 4 and a counterweight or a breathing air compressor is mounted under the lower base plate on the EvitaMobil trolley: Do not place items weighing more than 50 kg on the upper console of the EvitaMobil trolley (e. g. device, patient monitor and hinged arm).
- Only place humidifiers in the optional humidifier holders.

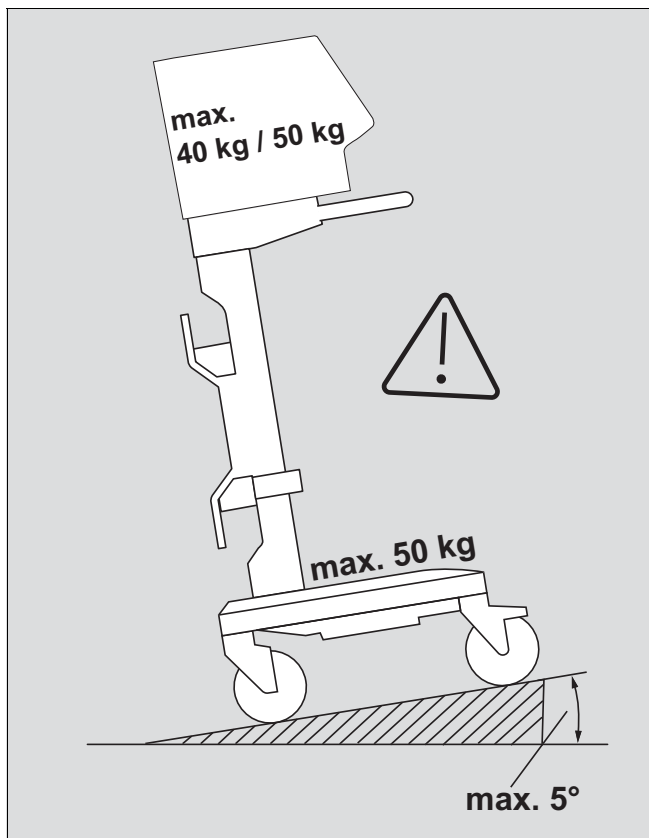

Positioning devices

- Place device on the console and allow the engaging mechanism to click into place. The device must be secured to the trolley on both sides.
- Place a maximum of 4 compressed gas cylinders on the cylinder holders and secure with the Velcro straps.
- Secure humidifiers on optional humidifier holders only. Follow the Instructions for Use for the humidifier.

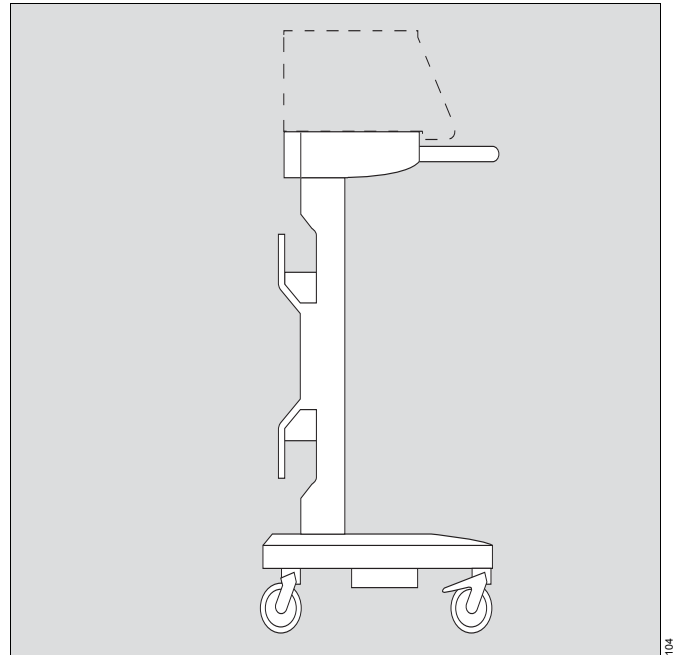

Positioning the control unit

- The control unit must not be stood up or leant against anything, nor may it be laid face downwards! It must always be laid on its back when changing over.

Positioning on the unit

- Hook the control unit into the mount on the Evita 4 until it engages.

To adjust the position:

- 1 Press and hold the segments on the right and left, at the same time tilting the control unit into the required position.

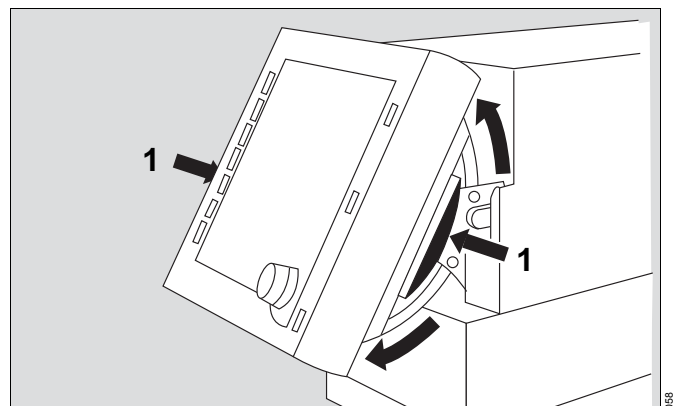

Positioning on the wall rail

1 Press and hold the segments on the right and left, tilting the control unit down completely at the same time.

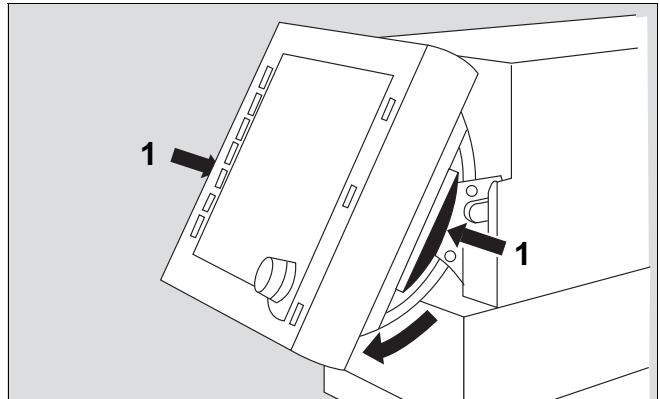

2 Press and hold the unlocking buttons on the right and left, lifting the control unit out of the mount on the Evita 4 at the same time.

- Unwind the required length of cable.
- Hook the control unit into the wall rail and

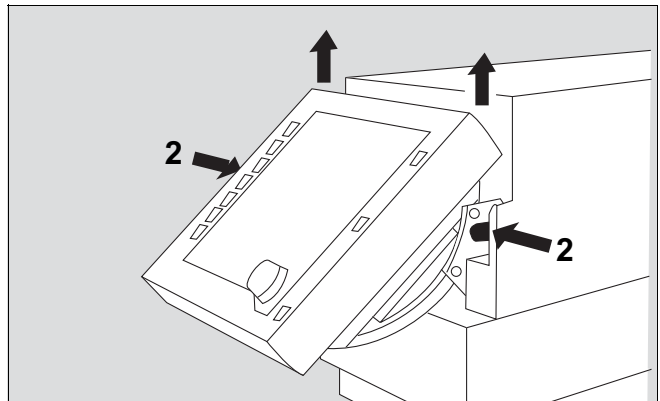

3 Lock it into position = pull tab under the holder down and turn it towards the wall rail.

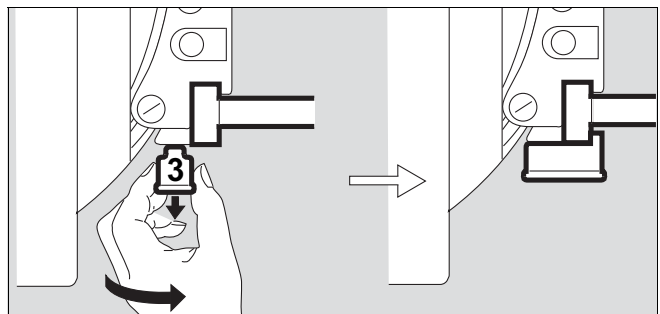

Fitting the device components

Fitting the expiration valve

- 1 Tilt the control unit upwards, pressing the segments on the right and left at the same time.
- 2 Push the expiration valve as far as it will go into the mounting. Check that it is properly secured by gently pulling the port.

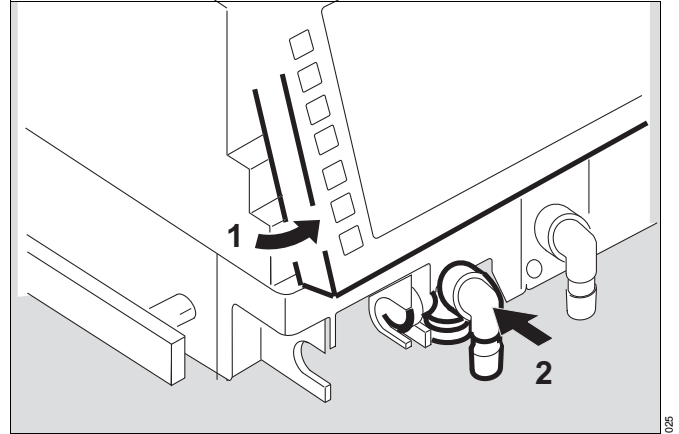

Fitting the flow sensor

- 3 Push the socket to the left as far as it will go.

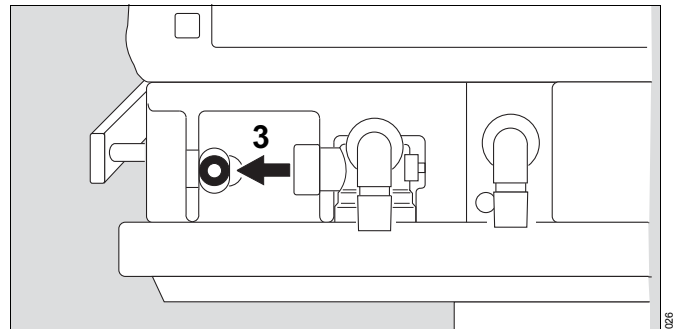

- 4 Fit flow sensor – with the connector facing towards the ventilator – into the mounting and push into the socket as far as it will go.

Then:

- 5 Push flow sensor to the right as far as it will go into the rubber lip of the expiration valve.

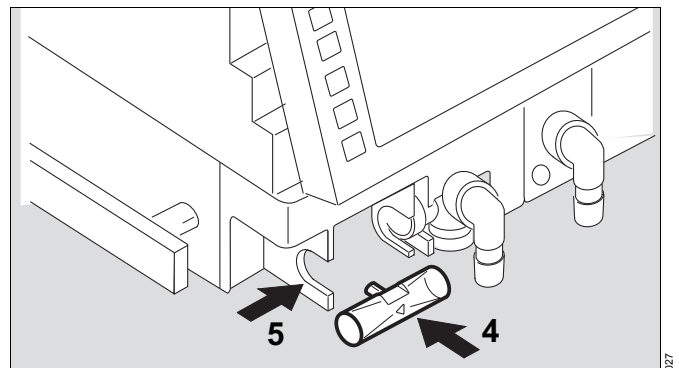

Flow sensor flap

The flap prevents the formation of condensation in the flow sensor when using an active humidifier and when heated expiratory hoses are connected.

Insert the flap:

- 1 Slightly press together the spring arms of the flap sideways and
- 2 push the spring arms into the mount on the device.

NOTE

The flap can be removed for transport purposes.

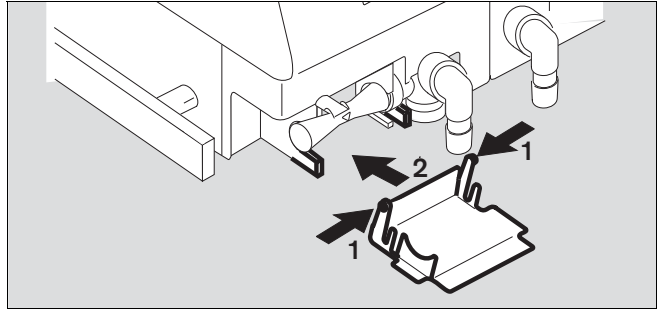

NOTE

The flow sensor and the expiration valve can only be inserted or removed when the flap is open. Keep the flap closed during ventilation.

Open the flap:

- 3 Pull the flap forwards. The flap swivels downwards.

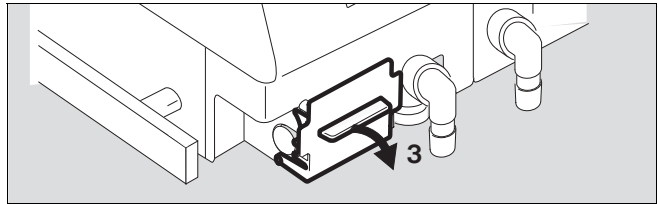

Fitting the O₂ sensor capsule

- When using the system for the first time
 - If the following message appears:
»O₂ measurement inop. !!!«
 - When calibration can no longer be performed
- Ensure device is in standby or ventilator is switched off.
 - Tilt the control unit upwards, pressing the segments on the right and left at the same time.
- 1 Turn the inspiratory port to the left.
 - 2 Use coin to loosen screw, and remove protective cover.

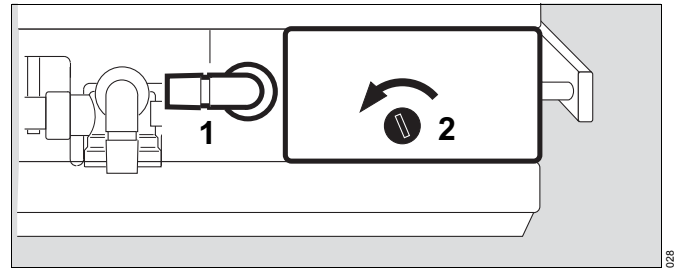

- 3 Loosen the two knurled screws and open the sensor housing.

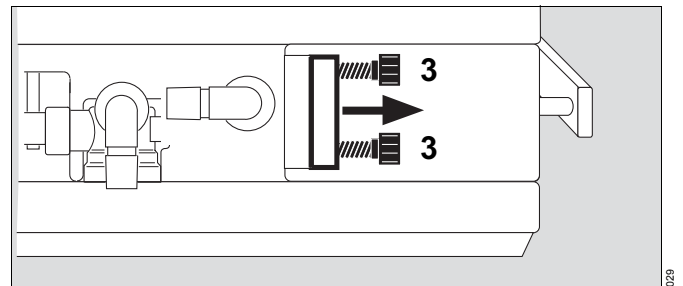

- 4 Remove old sensor capsule and fit a new capsule. The end with the circular tracks remains visible.
- 3 Close the sensor housing securely with the two knurled screws.
- 2 Screw protective cover back in place.
- Dispose of the used O₂ sensor capsule, page 164.

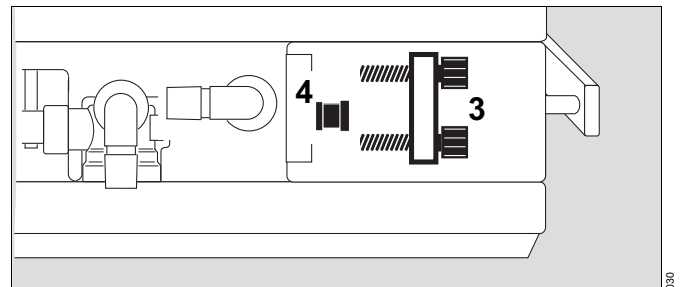

Using HME, bacterial filters and hose systems*

Additional components in the breathing system or components which diverge from the standard hose system can considerably increase the inspiratory and expiratory breathing resistance and exceed standard requirements.

Examples: Insp./exp. filters, HME**, coaxial hoses

In general, the Evita 4 is designed to minimise the breathing effort made by the patient and is therefore not intended for the use of insp./exp bacterial filters.

WARNING

Using bacterial filters or HMEs therefore requires special caution and monitoring by the user. Especially during medication nebulisation and humidifying, the resistance of the expiratory filter may increase gradually.

A higher breathing resistance leads to a greater breathing and trigger effort during assisted ventilation. Under unfavourable conditions, this can lead to an undesirable intrinsic PEEP. This can be recognised by the fact that the expiratory flow does not return to "0" at the end of expiration. If the PEEP is unacceptably high, it is indicated by the alarm »PEEP high !!!«. The current PEEP is then approx. 8 mbar above the set PEEP. Check and replace the bacterial filter or HME if they are the cause of the PEEP alarm.

Breathing resistances in the patient connection cannot be directly monitored by the ventilator. Therefore:

- Determine inspiratory and expiratory breathing resistance in the patient system before ventilation in standby by means of the device check.
- Check the condition of the patient and the ventilator's measured values for volume and resistance frequently.
- Observe the Instructions for Use for the HME, filter and coaxial hose systems in use.

WARNING

Do not use an HME together with a medication nebuliser or breathing gas humidifier. This can lead to a greater breathing resistance.

* Only applies to hose systems which are not described in these Instructions for Use.

** Heat moisture exchanger

Attaching a breathing gas humidifier

- Set the ventilator to breathing gas humidifier, see page 54.

WARNING

When using a breathing gas humidifier, do not use additional heat and moisture exchangers! Risk of increased breathing resistance because of condensation.

WARNING

Do not place any liquid container (e. g. infusion container) above or on top of the Evita 4. Any liquid getting into the device could prevent Evita 4 from working properly or damage it, and endanger the patient.

Aquapor EL breathing gas humidifier

- Prepare Aquapor EL humidifier in accordance with the corresponding instructions for use.
- 1 Using a rail clamp, hang Aquapor EL onto the humidifier holder and screw firmly into place.
 - 2 Insert elbow connector into Aquapor EL.
 - 3 Insert double nozzle into elbow connector.
 - 4 Fill the Aquapor EL tank up to the upper filling mark with sterile distilled water.

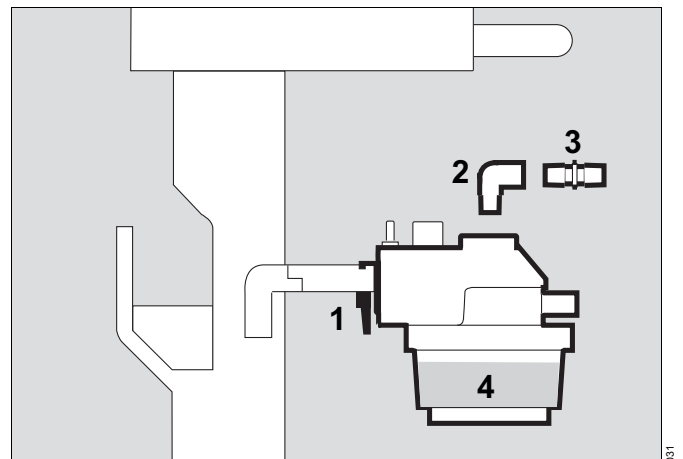

"Fisher & Paykel MR 850" breathing gas humidifier

- Prepare "Fisher & Paykel MR 850" humidifier in accordance with the corresponding instructions for use.
- Using a rail clamp, hang the breathing gas humidifier onto the F&P holder and screw firmly into place.

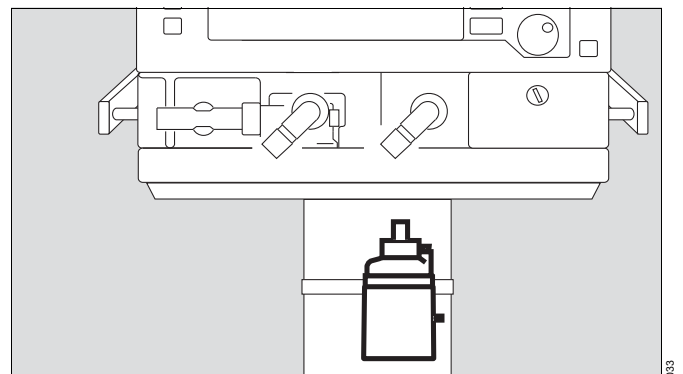

Whenever a breathing gas humidifier has been changed:

- Perform a leak test, page 57.

Fitting ventilation hoses

WARNING

Do not use antistatic or conductive ventilation hoses. The use of such materials increases the risk of electric shock to the patient and the risk of fire in an oxygen-enriched environment.

IEC 60601-2-12 Appendix AA and EN 794-1 Appendix AA: The use of antistatic and/or electrically conductive material in the breathing system of the lung ventilator is not considered to contribute any improvement in safety. In fact, the use of such materials increases the risk of electric shock for the patient.

Depending on the desired position of the ventilator in relation to the bed, the hinged arm can be fitted to either side of the machine.

Attachment on **left-hand** side:

- 1 Turn both ports to the left.
- 2 Turn Aquapor EL to the left.

The following description applies when the breathing circuit has been positioned on the **left-hand** side.

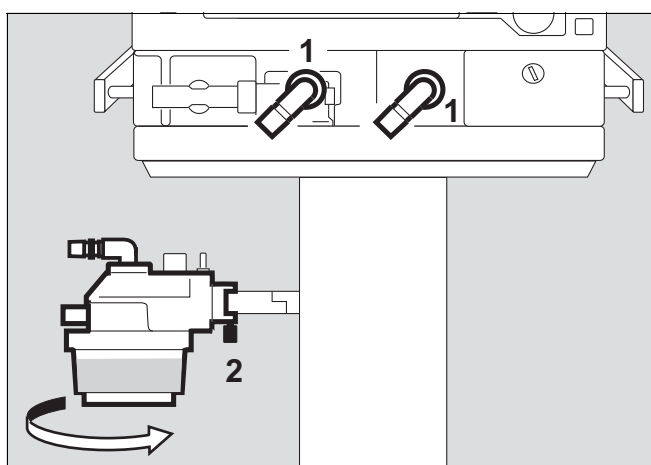

Breathing circuit for adults and children

From 100 mL tidal volume V_T upwards: »**Adult**« patient mode
Example using Aquapor EL breathing gas humidifier:

- 3 Hang the hinged arm from the rail on the left-hand side and tighten screws.
- Fit the ventilation hoses. Check the hose lengths (metres).
- 4 Turn ports in direction of hoses.
- 5 Install water traps in vertical position.
- 6 Connect the Y-piece, with the rubber sleeve of the Y-piece on the inspiratory side.
- 7 Insert the Y-piece in the opening of the hinged arm.

Whenever the ventilation hoses have been changed:

- Perform a leak test, page 57.

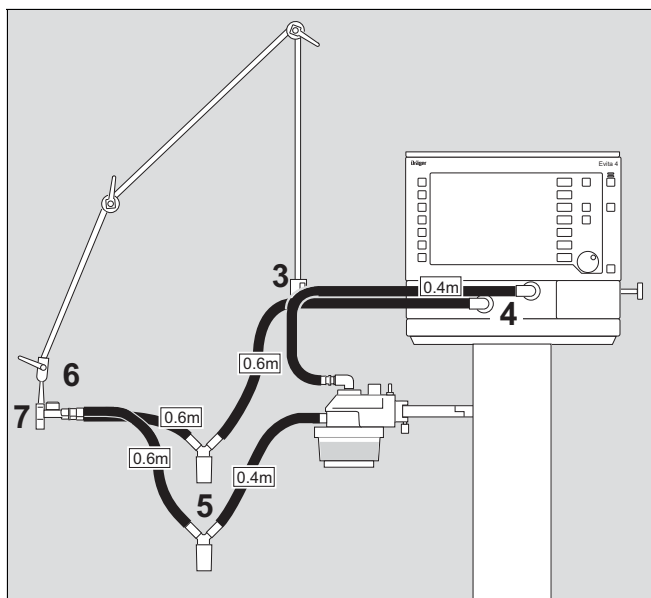

Breathing circuit for infants

- Set the ventilator to breathing gas humidifier, see page 54.
Up to 300 mL tidal volume VT: »**Paediatric**« patient mode

Example using "Fisher & Paykel MR 850" breathing gas humidifier:

- 1 Hang the hinged arm with a bracket to the rail on the left-hand side, and tighten the screws.
- Fit the ventilation hoses. Check the hose lengths (metres).
- 2 Fit the water trap in the vertical position.

Whenever the ventilation hoses have been changed:

- Perform a leak test, page 57.

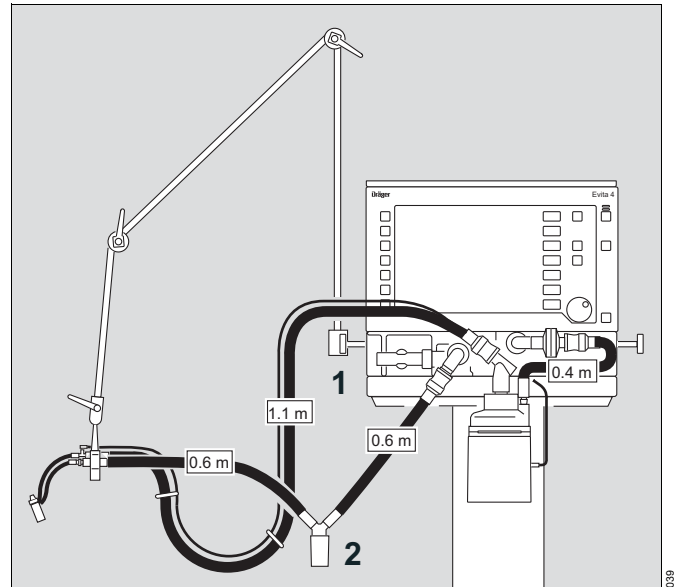

Fitting temperature sensor

Only with Aquapor EL

- 3 Push sensor as far as it will go into the rubber sleeve on the inspiratory side of the Y-piece. Align the Y-piece so that the sensor is at the top in order to avoid condensation in the sensor.
- 4 Attach the sensor cable with hose clips.

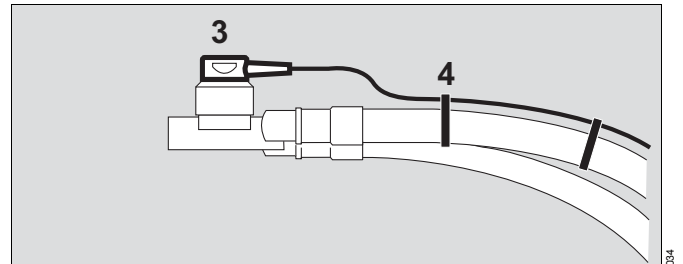

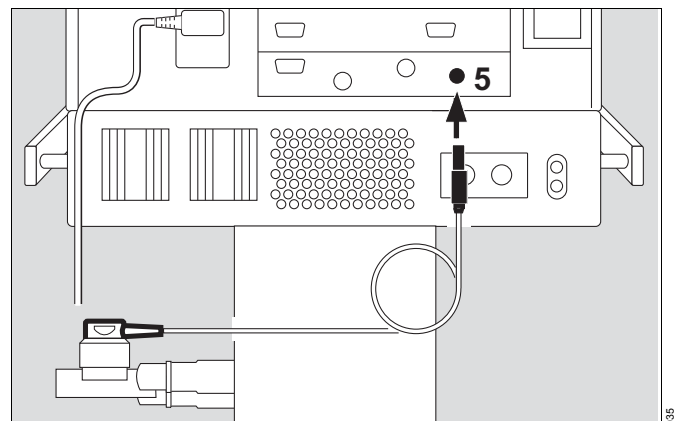

- 5 Insert the connector for the temperature-sensor into the »Temp  « socket at the rear of the unit.

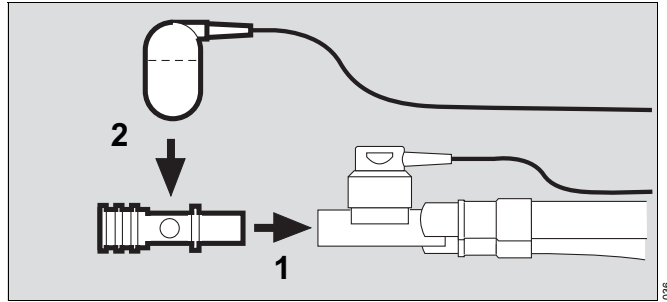

Fitting a CO₂ cuvette and CO₂ sensor (optional)

- 1 Fit the cuvette to the patient connection of the Y-piece, with the cuvette windows facing the side.
- 2 Push the CO₂-sensor on to the cuvette, with the cable trailing towards the unit.



- 3 Plug the CO₂-sensor connector into the »CO₂  « socket on the rear of the device.

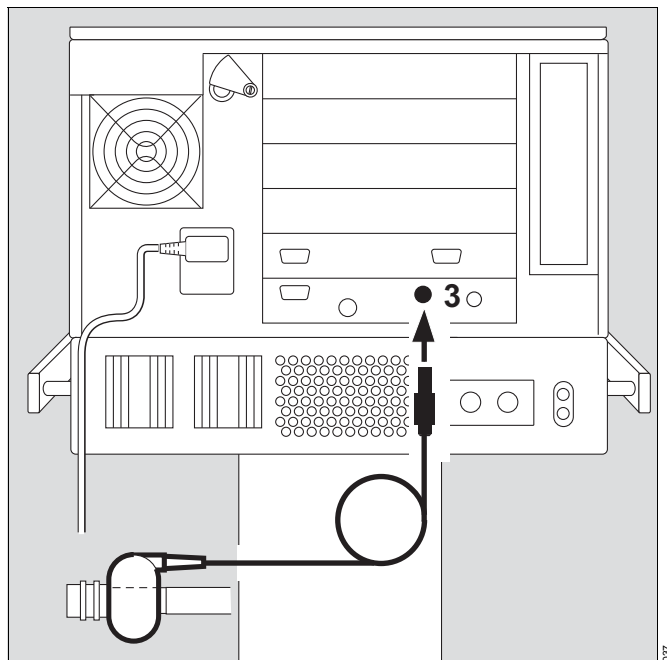

Connecting to supplies

Connecting to the power supply

For mains operation:

Either : 220 V to 240 V

or : 100 V to 127 V

- Insert the plug into the mains socket.

For operation with DC-power supply unit and external battery (optional)

- Connect optional external battery via cable.

WARNING

Refer to the Instructions for Use for the optional DC power supply unit. Otherwise, readiness for operation of the optional DC power supply unit cannot be assured.

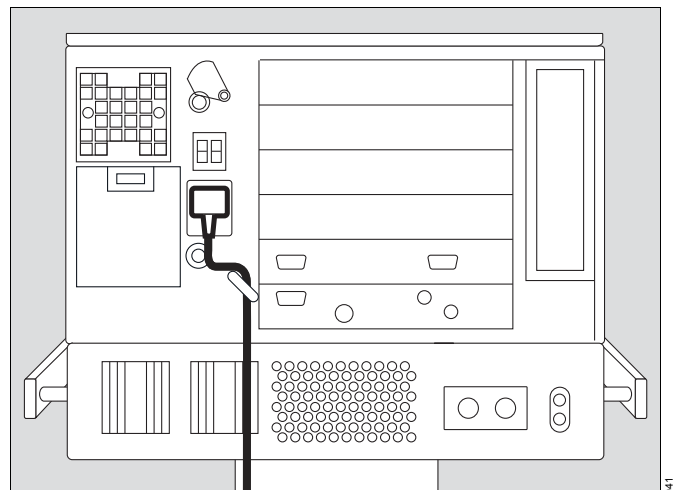
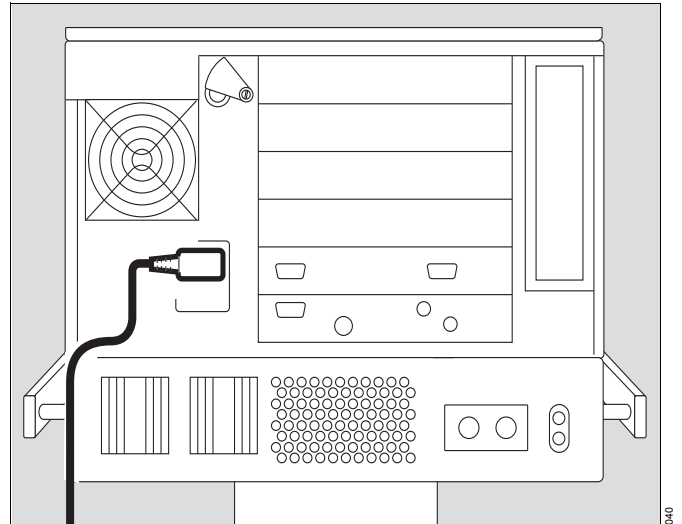

Note on the use of a socket strip for ancillary equipment

Connecting other equipment to the extension socket strip may cause the patient leakage current to rise above the permitted values if a protective earth conductor should fail. In such cases, the risk of electric shock cannot be excluded.

Reaction in the case of a short-term interruption of the power supply

e. g. if hospital reserve power supply is activated.

Without optional DC-power supply unit:

During an interruption of the power supply, Evita 4 outputs a continuous alarm tone for max. 2 minutes. The duration of this alarm tone may be shorter if the Evita 4 was switched on for less than 15 minutes.

The Evita 4 tolerates power interrupts lasting less than 10 milliseconds – without influencing ventilation.

In the case of power interrupts lasting longer than 10 milliseconds, the machine restarts with a short self-test lasting about 8 seconds – ventilation is continued with the same values that were set before the power interruption.

If a lower alarm limit has been set for the minute volume, the »**MV low !!!**« alarm is activated until the measured value has risen above the lower alarm limit.

With optional DC-power supply unit:
Refer to the Instructions for Use for the DC-power supply unit.

WARNING

Other equipment, e. g. printers or computers, may only be connected to the ports if Evita 4 is connected to the mains power supply via a mains power cable or if it has been earthed via the earth connection on the back of the unit.

Electric power may pose a hazard in all other cases.

Connecting the gas supply

- Screw the connecting hose for medical air (Air) onto the Air connection on the back panel and plug the connector into the Air wall delivery outlet.
- Screw the connecting hose for oxygen (O₂) into the O₂ connection on the back panel and plug the connector into the O₂ wall delivery outlet.

The gas delivered through compressed gas hoses is used as fresh gas (FRESH GAS).

WARNING

The compressed gases must be dry, and free from dust and oil. Gas pressure must be 3 to 6 bar. Otherwise the correct functioning of the device is not assured.

Observe operating data on page 179.

WARNING

Only supply medical air (Air) to the Air connection and oxygen (O₂) to the O₂ connection on the back panel of the device. Otherwise inspiratory flow delivery and flow measurement will not be accurate.

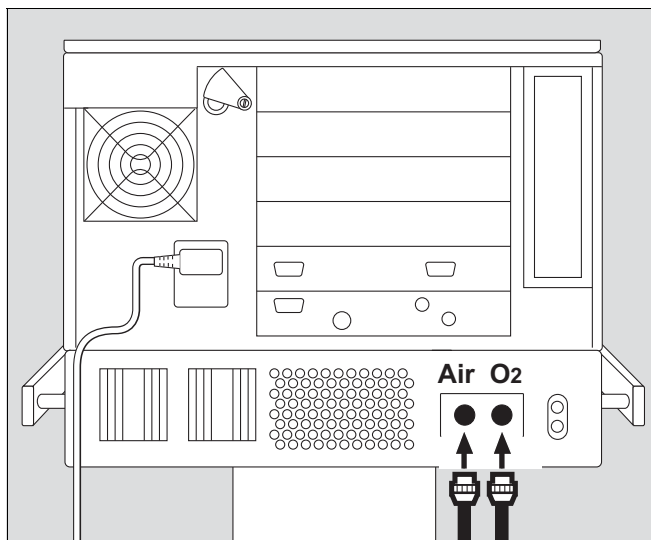

In the case of air/gas supply via a breathing air compressor, follow the Instructions for Use of the breathing air compressor. Gas supply via an O₂ or air cylinder is described in the section "Switching piped gas supply to cylinder supply" on page 58.



Connecting Evita Remote (optional)

- The plug-in card for Evita Remote may only be installed and programmed by experts.

For remote control of the unit via the Remote Pad for parallel, remote operation of the following LED and key functions:

- 1 red LED – to indicate warning messages
- 2 yellow LED – to indicate caution and advisory messages
- 3 »« or »*« key – to suppress the alarm tone for approx. 2 minutes
- 4 »**Alarm Reset**« key – to acknowledge alarm messages
- 5 » **Neb.**« key – to start and end medication nebulisation
- 6 »**O₂ ↑ suction**« key – for oxygenation for bronchial suctioning
- 7 »**Insp. hold**« key – for sustained, manually induced inspiration
- 8 »**Exp. hold**« key – for extended and sustained expiration

The function of the respective LEDs and keys is the same as on Evita 4 and is described in the application chapters of these Instructions for Use.

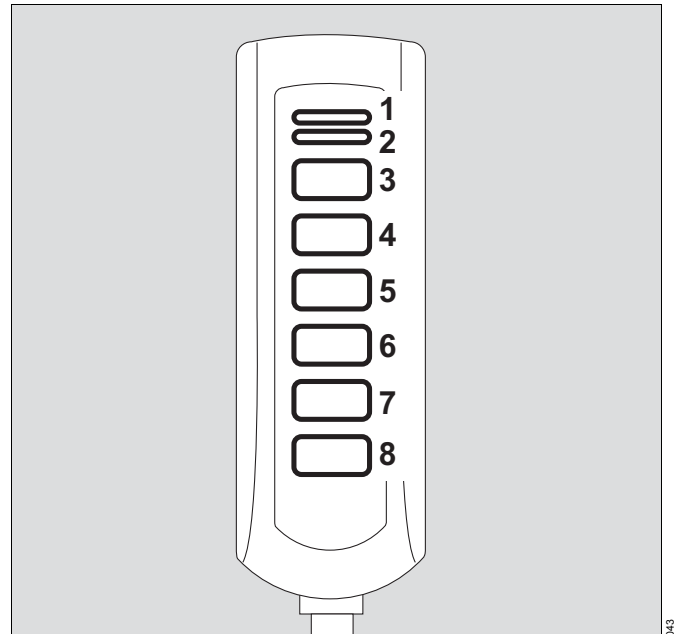

* Depending on the Remote Pad used.

Connection

- 1 Plug the lead of the Remote Pad into the »⏏« socket on the rear of the Evita 4.
The connector can be plugged in or unplugged at any time. This does not influence the operation of the Evita 4.

- Hook holder onto a standard rail and clamp into place.
- Hang Remote Pad into holder from above.

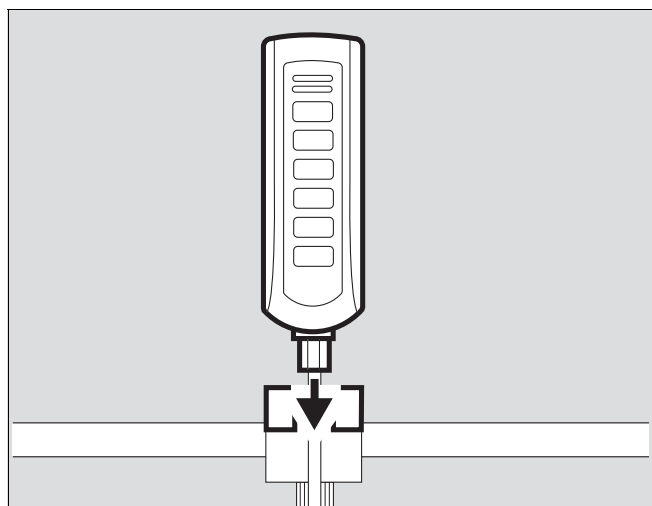
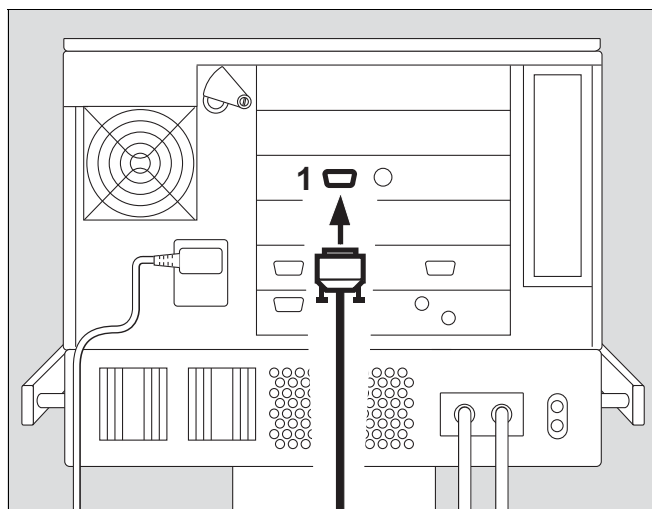

Note automatic self-test

- when connecting the Remote Pad while the unit is switched on
- or
- when switching the unit on after connecting the Remote Pad.

- Do not press any keys on the Remote Pad.
- All LEDs on the Remote Pad light up for 5 seconds:
 - 2 red LED
 - 3 yellow LED
 - 4 yellow LEDs in the keys
- Evita 4 tests the Remote Pad. An advisory message is output if a fault is detected, see "", page 141.

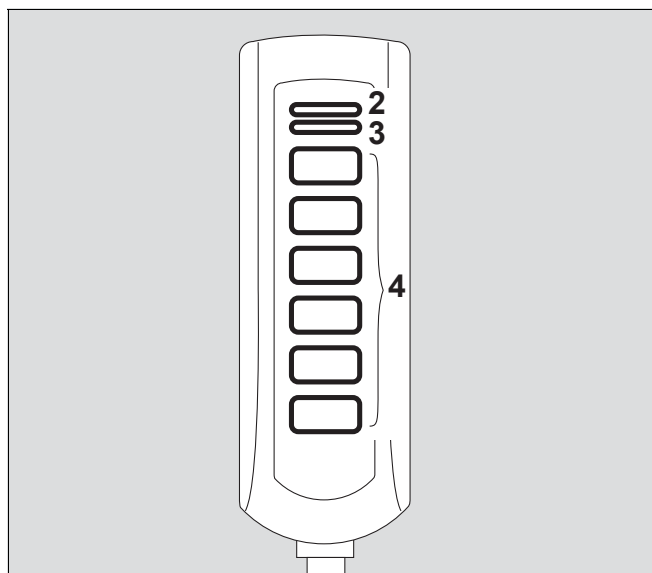

Connecting the nurse call (optional)

Connection on the rear of the Evita 4 for connecting top-priority alarm signals to a central alarm station in the hospital.

- Installation of the supplementary equipment must only be carried out by experts.
For details of the characteristics, refer to the technical data, page 181.
- The 6-pin DIN-plug (female connector) must be connected to the lead for the central alarm station in the hospital by experts.

When the Evita 4 displays an alarm message, the connection 3-5 is closed and the nurse call system is active.

WARNING

The central hospital alarm system may only be connected to the nurse call if the Evita 4 is connected to the mains via a mains cable or if it has been earthed via the earth connection on the back of the device.
Electric power may pose a hazard in all other cases.

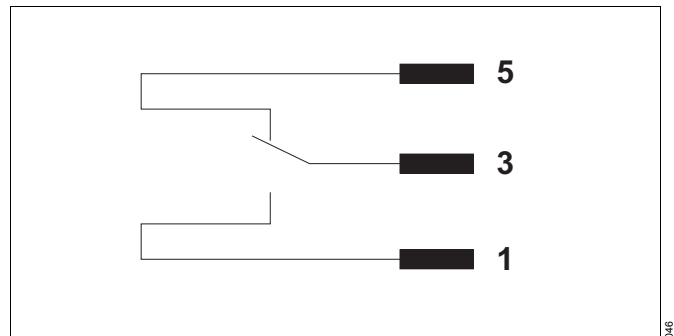



- Push the plug into the »« socket on the back and screw in tightly.

CAUTION

Only warnings (top-priority alarm signals, refer to page 88) will be transmitted.

Alarm messages are displayed in the top line of the screen in red and with three exclamation marks, refer to page 88. Caution and advisory messages are not transferred. The nurse call system is also activated when the internal loudspeaker for the alarm tone on the device is defective.

If, in the case of an alarm, the »« key is pressed, the acoustic alarm on the Evita 4 and the nurse call are suppressed for 2 minutes.

If, in the case of the »**Standby activated !!!**« alarm, the »« key is pressed, the nurse call is suppressed for 2 minutes. The acoustic alarm on the Evita 4 continues to sound.

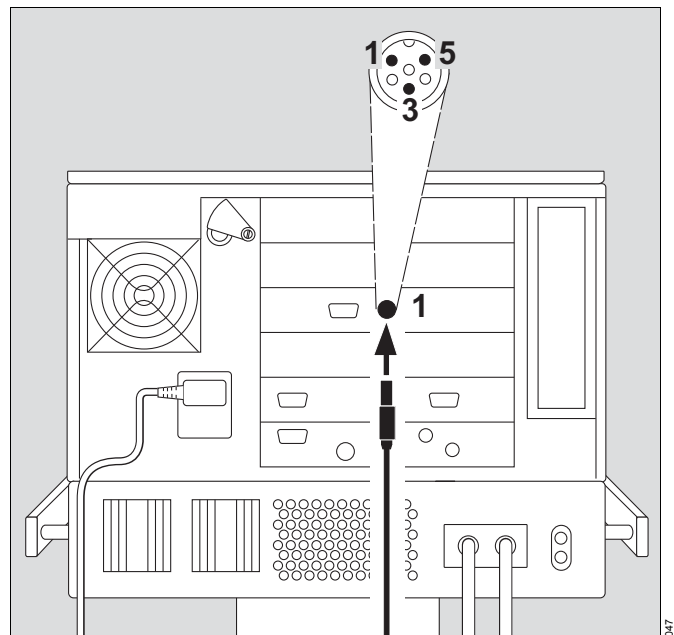

- Check that the connected nurse call system is operating correctly.

WARNING

Connection of a nurse call does not relieve staff of their duty to check the monitoring on the Evita 4 screen at regular intervals.

Screen displays must be checked regularly.

WARNING

A fault in any of the components in the link between nurse call and the central hospital alarm system (e. g. in the electronics for nurse call in the Evita 4, in the Evita 4 power supply or in the alarm generator of the central hospital alarm system, etc.) may result in failure of the nurse call.

Hospital central alarm system connections are usually single-channel design. The nurse call electronics are therefore also single-channel design.

Before using for the first time

Setting the language of the screen texts

The Evita 4 is set by the manufacturer to the language of the ventilator's owner.

The following alternative languages can be selected:

- German
- French
- Italian
- Spanish
- Dutch
- Swedish
- American English
- Japanese
- Greek
- Russian
- Portuguese
- Arabic
- Chinese
- Turkish

- If necessary, ask experts to change the labels on the control unit keys.
- Switch on machine = pivot flap* upwards and press power switch on the back panel until it clicks into position. The flap falls over the button to protect against inadvertent switching off.

Evita 4 runs through its self-test procedure,

- Wait until the 10-second test phase is complete.

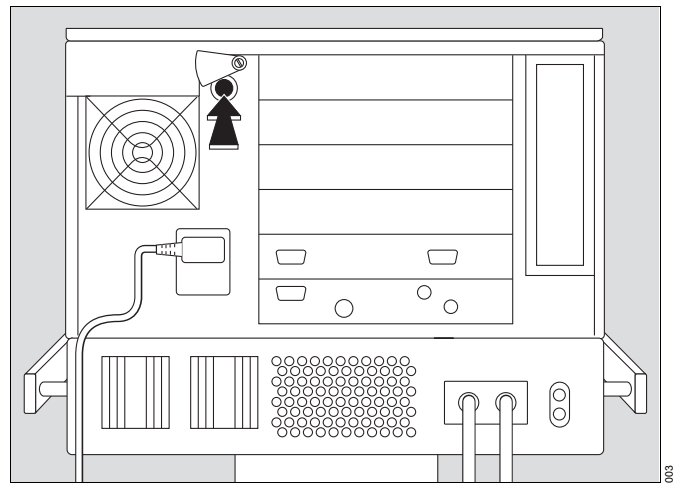

* Flaps may differ, depending on the power supply used, refer to "Switching on", page 62.

After the self-test:

- 1 Switch Evita 4 to Standby = hold down key »- Touch the »**System Defaults**« screen key.
- Touch the »**Language/Units**« screen key.
- Touch the »**Language**« key.
- Select the desired language and confirm. The selected language is now active.

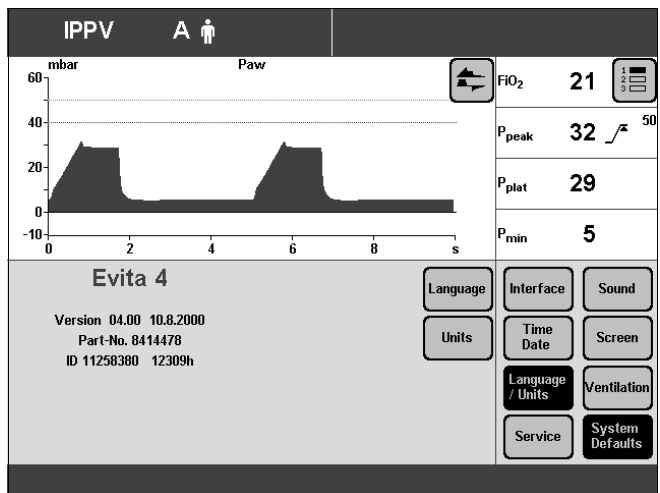
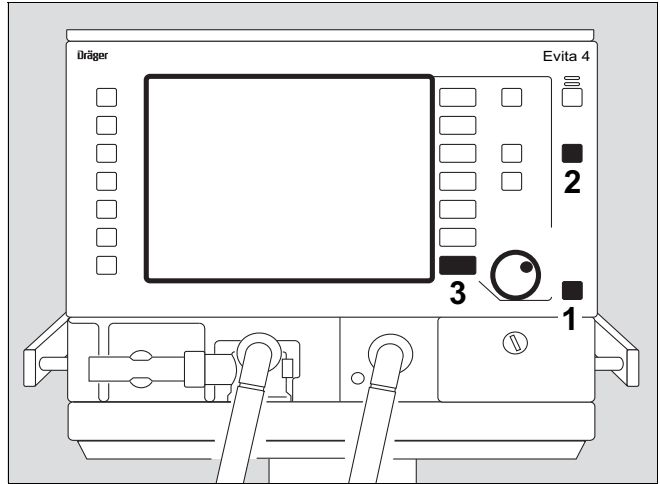

Device check

WARNING

The device check must be carried out before each use on a patient in order to confirm that the ventilator is operating correctly. If the device check is not carried out, the readiness for operation cannot be assured.

Evita 4 supports this device check by means of a built-in checklist that guides the user through the test in a dialogue mode.

The device check consists of the »Check«, the »Airtight check« and checking of the optional DC power supply. In the context of the »Check«, the following tests are performed:

- Checking that the machine assembly is complete,
- Testing of the auxiliary alarm and power failure alarm
- Testing the expiratory valve
- Testing the Air-O₂ change-over valve
- Testing the safety valve
- Calibrating the flow sensor
- Calibrating the O₂ sensor
- Calibrating the CO₂ sensor
- Testing the leakproofing of the hose system
- Checking the compliance of the hose system

The test results obtained from this device check and the calibration and zero-checking values of the sensors remain stored until the next calibration – even if the device is switched off. If the hose system, type of humidification or patient mode is changed after performing the device check, the leak test must be repeated before starting operation.

Preparing the adult test lung

For testing the adult breathing circuit, the adult test lungs 8403201 or MP02400 can be used.

NOTE

The adult test lung 8403201 consists of an elbow connector for connection to the Y-piece, a 7 mm diameter catheter connection for simulating the resistance of the airways and a 2 L breathing bag to simulate compliance.

CAUTION

Overextended or leaking breathing bags or test lungs with low compliance must not be used as they may cause artefacts during the device check.

- The adult test lung must not be plugged into the patient connection of the Y-piece until requested by Evita 4.

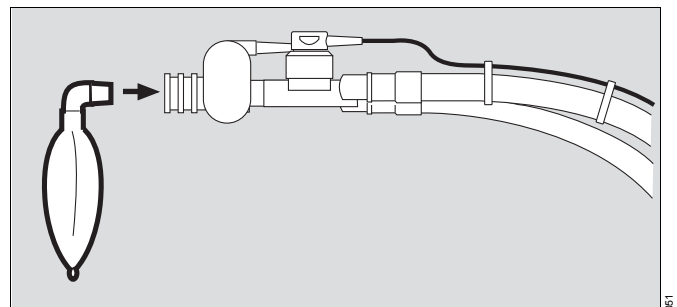

Preparing the paediatric test lung (8409742)

for the paediatric breathing circuit

The test lung consists of a tracheal tube CH 12 to simulate the resistance of the airways and a small bellows to simulate compliance.

- Only insert the elbow connector into the Y-piece when Evita 4 advises you to do so on the screen.

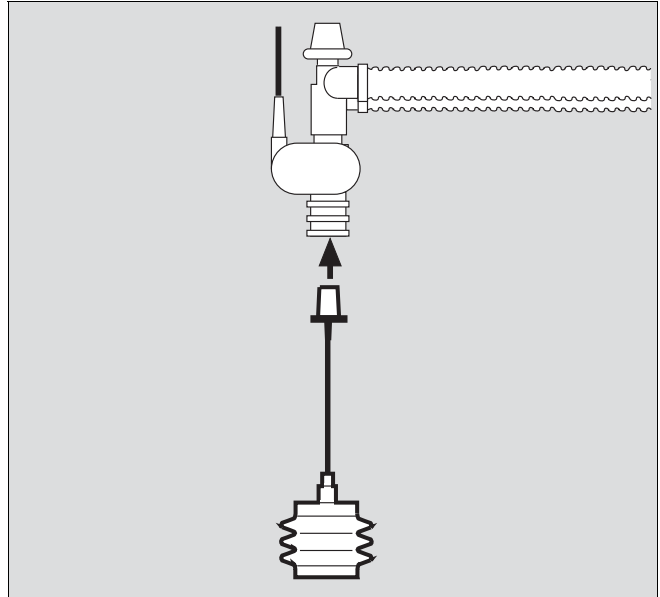

Performing the device check

- Switch on machine = pivot flap* upwards and press power switch on the back panel until it clicks into position.
- Evita 4 runs through its self-test procedure.
- Wait until the 10-second test phase has been completed.

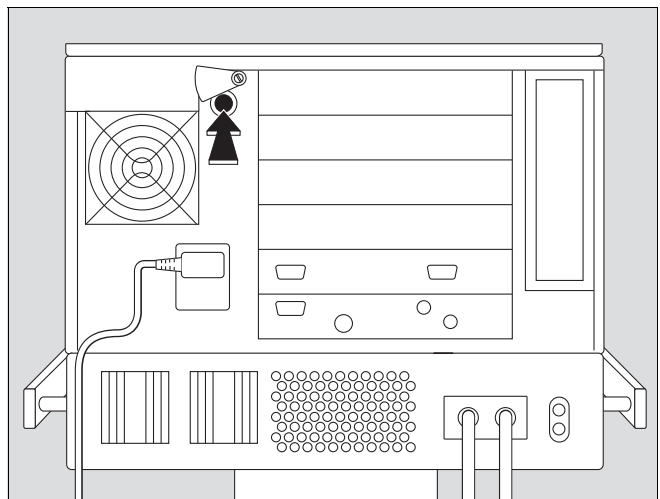

* Flaps may differ, depending on the power supply used, refer to "Switching on", page 62.

After the self-test:

- 1 Switch Evita 4 to standby = Hold down key »« for about 3 seconds.
 - 2 Switch off the standby alarm tone with the »**Alarm Reset**« key.
- Touch the »**Device check**« screen key.

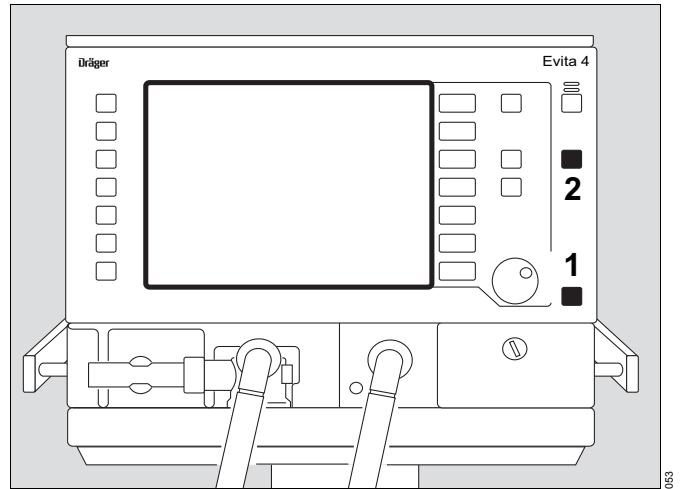

Display:

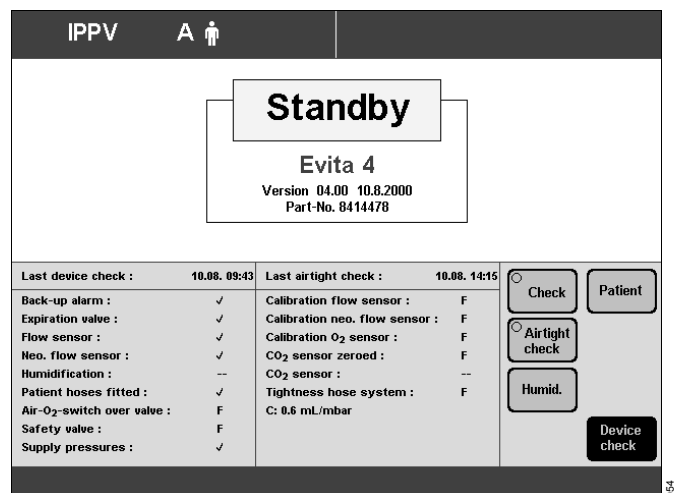

Entering the humidifier type

Before starting the check, enter the type of humidifier selected:

- Active humidifier, e. g. Dräger Aquapor EL
or
- HME/Filter (artificial nose)

If the type of humidifier is known, Evita 4 can take the temperature and moisture situation into account when measuring the volume parameters.

- Touch the »Humid.« screen key.

Display:

- Touch the »Active Humid.« screen key
or
- Touch the »HME/Filter« screen key.
- Confirm selection = press rotary knob.

The selected type of humidifier is indicated by a yellow LED. The humidifier selection is saved and remains effective even when the equipment is switched on again.

If the type of humidifier is changed and has to be reselected on the screen, the following test steps are shown to be invalid (– –) after the device check:

- Humidification
- Air tight check

The operator is prompted to repeat the device check for these two steps.

Start the check procedure:

- Press the »Check« screen key.

Evita 4 starts running through the dialogue-oriented check. The check procedure is semi-automatic. During the device check, the user is instructed by Evita 4 to perform specific actions on the device.

A device check cannot be performed during automatic calibration of the flow sensor or O₂ sensor:

- Wait until calibration is complete and start the device check again.

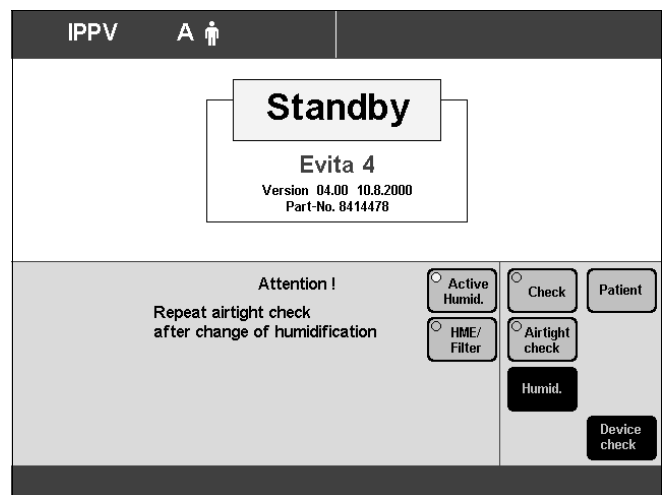

055

The following tests are performed during the device check:

- Correct operation of auxiliary and power failure alarms
- Seating and clear passage of the expiratory valve
- Seating of the flow sensor
- Seating of the neonate flow sensor
(if "NeoFlow" option is installed)
- Type of humidifier
- Completeness of hose system
- Function of the Air-O₂ changeover valve
- Function of the safety valve
- Gas supply
- Calibration of the flow sensor
- Calibration of the neonate flow sensor
(if "NeoFlow" option is installed)
- Calibration of the O₂ sensor
- Leakproofing of the hose system
- Zero calibration of the CO₂ sensor
- Position of CO₂ sensor

Observe the following when performing zero calibration of the CO₂ sensor (optional):

- When using reusable cuvettes, perform zero calibration on the park bracket and do not breathe in the direction of the park bracket, page 114.
- When using disposable cuvettes, do not perform zero calibration on the park bracket on the device, but only on a disposable cuvette. Perform the calibration in the ambient air and do not breathe in the direction of the cuvette, page 115. For this purpose, it is not essential that zero calibration be performed on the cuvette that is to be used, but rather it is sufficient to perform zero calibration on an unused, identical disposable cuvette.

WARNING

When using disposable cuvettes, zero calibration must only be performed on a disposable cuvette and not on the park bracket. Do not breathe in the direction of the cuvette. Otherwise there will be a zero point deviation of up to ± 1 Vol% CO₂.

On completion of the device check, a checklist is displayed on the screen to show the results of the check.

Correct result : ✓
 Incorrect result : F
 Check not performed : --

In the event of incorrect results, e. g. if the hose system is not sufficiently leakproof:

- Eliminate the cause of the fault
- Touch the »Repeat check« screen key.

Only the tests with incorrect results are repeated.

Check that the optional DC power supply unit is ready for operation

- Disconnect mains plug.

With the optional DC power supply unit:

- the device switches over to internal or external battery mode and does not interrupt operation.

Without the optional DC power supply unit:

- acoustic power failure alarm*

- Reconnect mains plug.

The device switches back to mains operation*.

WARNING

Refer to the Instructions for Use for the optional DC power supply unit. Otherwise, readiness for operation of the optional DC power supply unit cannot be assured.

After successful completion of the device check, and checking the optional DC power supply unit, Evita 4 is ready for operation.

Either:

- immediately start up Evita 4 by pressing key »«

or:

- leave Evita 4 in standby mode

or:

- switch off Evita 4 for later use. Switch on back panel = pivot flap to the side and press button in fully and release.

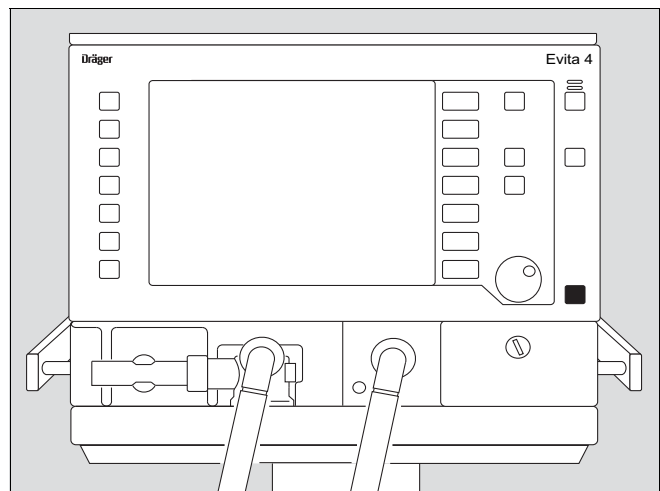

* Refer to page 43 "Reaction in the case of a short-term interruption of the power supply".

Checking the hose system for leaks

The hose system is tested for leaks during the device check but must also be monitored independently of the device check, e. g. after changing the hose system.

WARNING

If the leak test is not performed, the following deviations may occur:

- With volume-controlled ventilation, the applied MV in »Paediatric« patient mode may be reduced by up to 10 %, as hose system compliance has not been correctly taken into account. In »Adult« patient mode, the deviation is less.
- When ventilating with the NeoFlow option, the actual PEEP compared to the set PEEP may be reduced by up to 1 mbar without nebulisation or up to 2 mbar with nebulisation using a pneumatic medication nebuliser, as hose system resistance has not been correctly taken into account.
- Leaks in the hose system are not detected.

Perform the leak test after changing the hose system or the humidifier.

- Touch the »Airtight check« screen key.

During the test, the current leakage flow is continuously displayed. A leakage flow of 300 mL/min at a pressure of 60 mbar is permitted.

After the leak test, the Evita 4 unit determines the compliance and resistance of the hose system.

The calculated compliance of the hose system is used by Evita 4 for automatically correcting the volumecontrolled ventilation strokes and the measured values of the flow monitoring system, refer to page 194.

The calculated resistance of the hose system is used by Evita 4 to correct the pressure measurement in the presence of a basic flow (NeoFlow option).

When changing the patient mode or type of humidifier, the device automatically sets the hose compliance and resistance to the default values.

By checking the system for leaks, the device determines the momentary compliance and resistance.

Therefore:

When changing the patient mode, hose system or type of humidifier:

- Always perform the leak test!

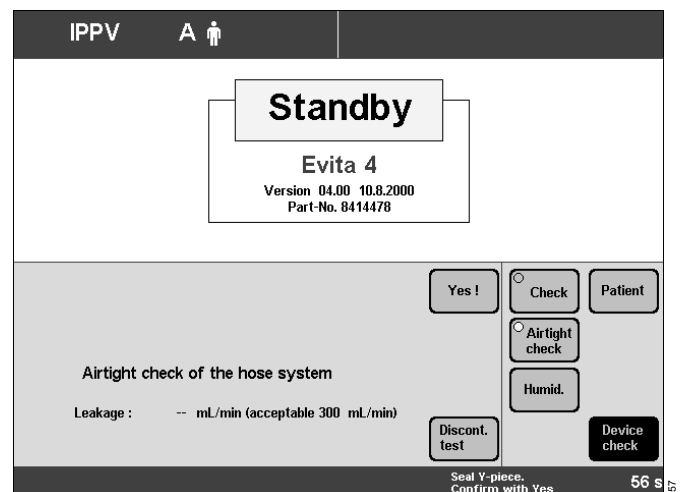

Transportation within the hospital

WARNING

To prevent the device from tipping over, only use the Evita 4 up to a maximum inclination of 5°!

WARNING

In order to ensure tilt stability during transport within the hospital, position the control unit on the front of the Evita 4, refer to page 33.

WARNING

Do not place Evita 4 on the bed during transportation within the hospital.

Evita 4 must be secured so it cannot topple over/fall down

To ensure that the equipment cannot topple over, the accessories must be moved to the most advantageous position:

- Hinged arm set to minimum deflection.
- Close the drawers.
- Hoses and cables hooked as close as possible to the trolley.
- Humidifier secured to the trolley, not to the unit itself.

Switching piped gas supply to cylinder supply

If it is necessary to switch over gas supply without interruption:

- First disconnect and reconnect one gas type, then disconnect and reconnect the second gas type.

WARNING

Supply via medical air (Air) and/or oxygen (O₂) cylinders with pressure reducers must comply with technical data for gas supply. This is described in the "Operating data" section in the chapter "Technical Data".

WARNING

In accordance with EN 794-1 and IEC 60601-2-12, pressure reducers according to EN 738 or ISO 10524 shall be used if Evita 4 is supplied with medical gases from an O₂ or compressed air gas cylinder. The pressure reducers have to limit the gas pressure for the Evita 4 to max. 10 bar even in the case of a fault. Using incorrect pressure reducers will endanger the patient.

If only one gas type (O₂ or Air) is available for transportation within the hospital:

- Connect only the gas type that is available to the rear panel.

In this regard, the concentration of the inspiratory O₂ corresponds to that of the gas type connected (O₂ or Air).

WARNING

If only one gas type is being used (O₂ or Air) the concentration of the inspiratory O₂ cannot be changed. The concentration of the O₂ corresponds to the O₂ concentration of the gas type connected. If Air only is connected, the concentration of the inspiratory O₂ is 21 Vol% O₂; if O₂ only is connected, it is 100 Vol% O₂.

No instrument tray (optional)

If the device does not have an Instrument Tray (optional), use the rubber caps to close slits on the top of the device:

- 1 Insert the round caps into the front slits with the rounded side facing outwards.
- 2 Insert the flat caps into the slits on the rear of the device.

WARNING

Do not place any liquid container (e. g. infusion container) above or on top of the Evita 4.

Any liquid getting into the device could prevent Evita 4 from working properly or damage it, and endanger the patient.

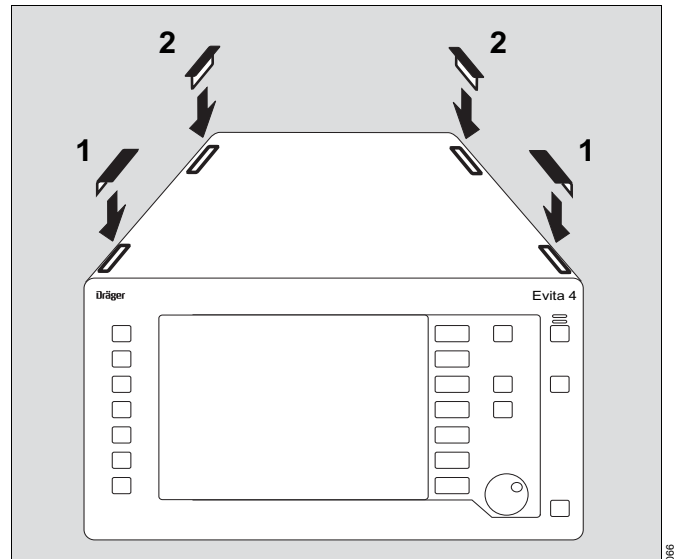

This page intentionally left blank.

Operation

Starting up	62	P 0.1 occlusion pressure measuring procedure	105
Switching on	62	Switching off monitor functions	106
Patient mode	63	O ₂ monitoring	106
Selecting the patient mode	64	Flow monitoring	106
Starting ventilation	64	Selecting standby mode	108
Setting ventilation modes	65	Calibrating	109
IPPV	65	Calibrating the O ₂ sensor	109
SIMV, SIMV/ASB	68	Calibrating the flow sensor	110
BIPAP, BIPAP/ASB	71	External flow source	110
BIPAPAssist	73	Zero/check/calibrate CO ₂ sensor	112
CPAP, CPAP/ASB	74	Performing CO ₂ zero calibration when using reusable cuvettes	114
MMV, MMV/ASB	76	Performing CO ₂ zero calibration when using disposable cuvettes	115
APRV	78	Checking CO ₂ calibration with test filter	116
ILV	79	Checking CO ₂ calibration with calibration gas	118
Setting the Master and Slave device	81	Calibrating the CO ₂ sensor	120
Setting ILV/Master	81	Resetting CO ₂ calibration	122
Setting ILV/Slave	83		
ILV/Master and Slave synchronisation	84		
Apnoea Ventilation	86		
Setting alarm limits	87		
In the event of an alarm	88		
Warning = top priority message	88		
Caution = medium priority message	88		
Note = low priority message	88		
Suppressing the alarm tone	89		
Information	89		
Position of the user to the alarm system	89		
Displaying curves and measured values	90		
Displaying measured values	91		
Trends	92		
Loops	93		
Reference curve displays	93		
Single stroke displays	93		
Zoom loops (optional)	93		
Display loops in the upper graphic area (optional)	94		
Logbook	95		
Screen freeze	96		
Special functions	97		
Manual inspiration	97		
Expiration hold	97		
Medication nebulisation	98		
Oxygen enrichment for bronchial suction	102		
Special measuring procedure: Intrinsic PEEP	104		

Starting up

Switching on

WARNING

If condensation is visible on the Evita 4, do not switch on the device. If it is operated with condensation, its performance may be impaired. Wait until the device has reached ambient temperature and the condensation has disappeared. The waiting time is approx. 1 hour for each 10 °C temperature increase.

- Switch on machine = press power switch on the back panel until it clicks into position.
The flap falls over the button to protect against inadvertent switching off.
To switch off, pivot the flap upwards and press the button in fully.

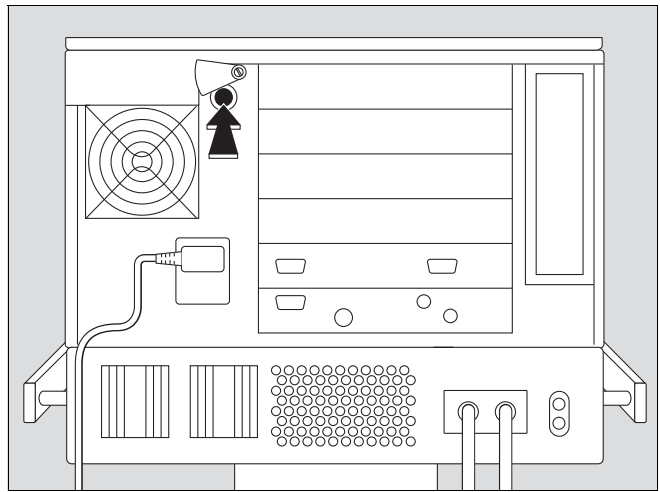

Machines with DC power supply MB:

- Switch on machine = pivot flap upwards and press power switch on the back panel until it clicks into position.
The flap falls over the button to protect against inadvertent switching off.
To switch off, pivot the flap upwards and press the button in fully.

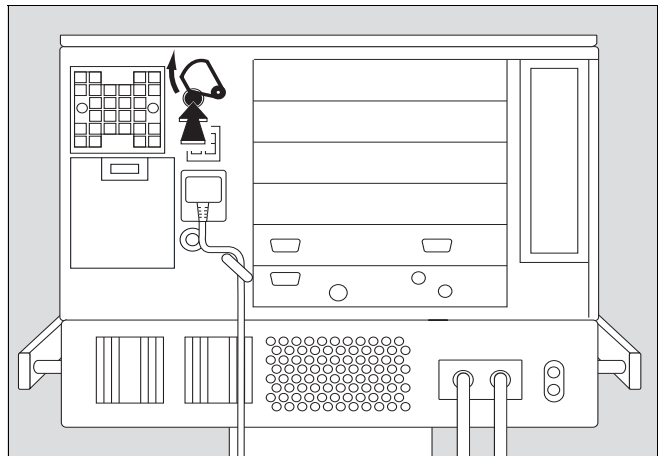

Evita 4 runs a self-test.

- Wait until the 10-second test phase is complete.
- Evita 4 always begins ventilation with the start-up values marked by an arrow on the on-screen knobs.
To select these start-up values, please refer to page 134 onwards.
After power cuts and after standby mode, the settings valid immediately before the interruption of operation remain in use.

Patient mode

After switching on, Evita 4 displays a choice of patient modes:

- »Adults« = adult patients
- »Paed.« = children
- »Neo.« = neonates (when using the "NeoFlow" option)
- »prev. patient« = previous patient

The device also asks the user to enter the weight of the patient (ideal body weight).

Example:

Adult ventilation

With this information, Evita 4 defines the adjustment ranges and the start-up values of the ventilation parameters.

The starting procedure, with selection of the patient mode, can be configured by the user, see "Configuration" on page 123 onwards.

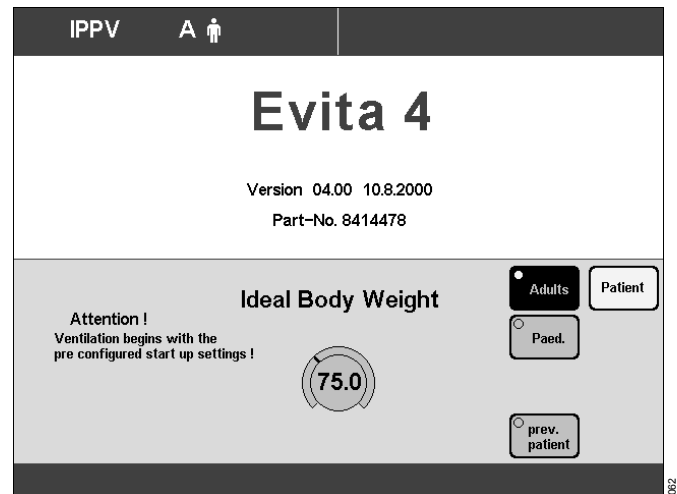

The screen key »prev. patient« can be used to restore the specific patient settings, including alarm limits and monitoring status, effective before switching off the device.

Example:

Previous patient

The previous modes are displayed in the status line:

- Previous ventilation mode
- Previous patient mode
- Previous application mode (tube or mask for optional NIV)

The key »prev. patient« is not displayed by Evita 4 following a loss of data or removal of a previously used option (e. g. NeoFlow), thus preventing restoration of the previous setting. Restoration of the previous setting is similarly prevented by Evita 4 if it was configured in such a way before switching off that the former patient mode is no longer available.

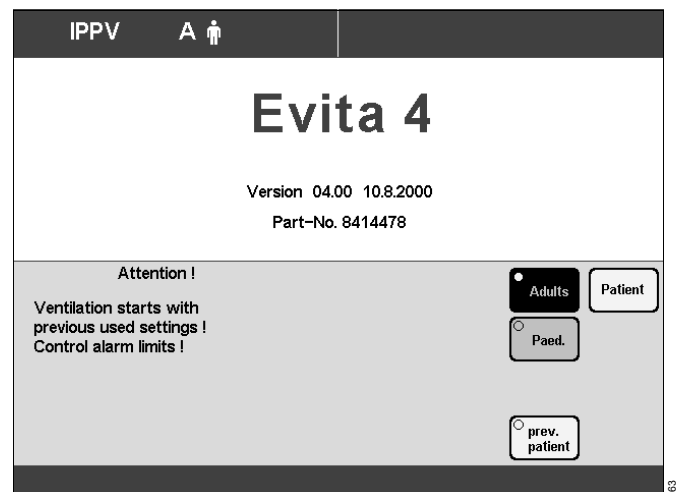

Selecting the patient mode

if configured

Either:

- the »Adults« key or
- the »Paed.« key or
- the »Neo.« key (NeoFlow option) and

enter the ideal body weight

if configured

With the ideal body weight, Evita 4 determines the start-up settings of the ventilation parameters. The start-up value is marked on the relevant screen knob by an arrow (▶).

- Touch the screen knob.
- Enter the ideal body weight [kg] with the manual dial-knob = turn rotary knob.
- Confirm the setting = press rotary knob.

or:

Select the previous settings

- Touch the key »prev. patient«.
- Confirm = press rotary knob.

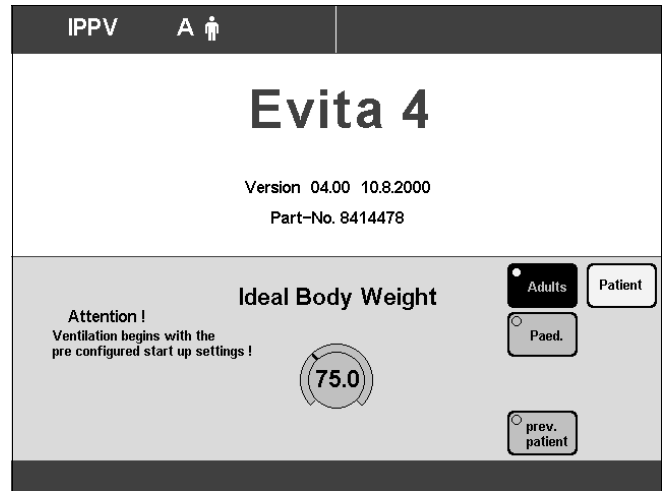

062

Starting ventilation

- Press the rotary knob again.

Evita 4 starts ventilation with the ventilation mode configured by the user.

The machine is factory-set to IPPV.

Evita 4 displays the »Mode settings« screen page. The user can check and correct the settings on the screen.

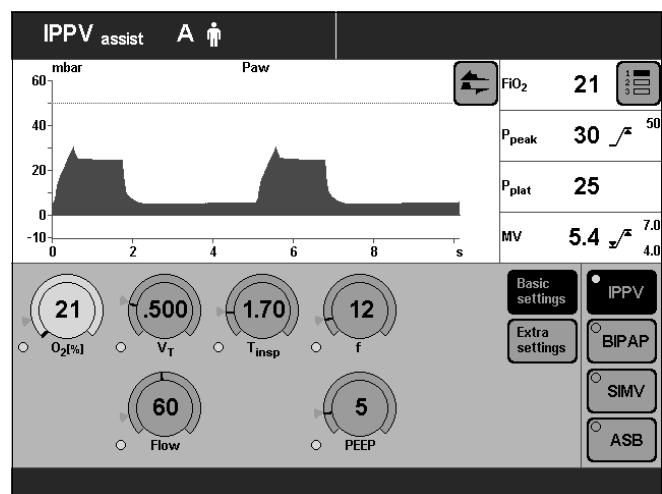

013

Setting ventilation modes

The ventilation modes IPPV, BIPAP, SIMV and ASB are already configured in the unit. If other ventilation modes are used, please refer to page 128 "Selecting ventilation modes".

IPPV

Intermittent Positive Pressure Ventilation

Volume-controlled ventilation with fixed, mandatory minute volume MV and user-adjusted tidal volume V_T and frequency f . For patients having no spontaneous breathing.

Set the pattern of ventilation for IPPV with the ventilation parameters:

Tidal volume »**VT**«

Insp. Flow »**Flow**«

Frequency »**f**«

Inspiration time »**T_{insp}**«

O₂ concentration »**O₂**«

Positive end-expiratory pressure »**PEEP**«

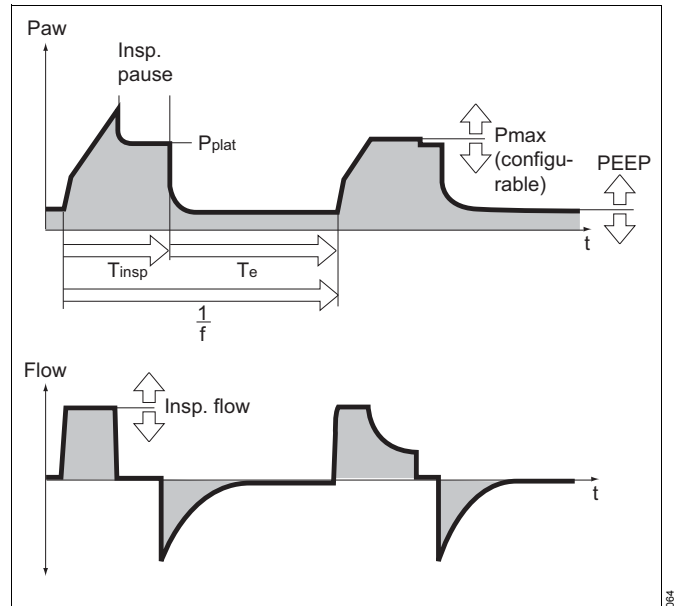

To set:

- Touch the relevant screen knob.
- Adjust value = turn rotary knob.
- Confirm setting = push rotary knob.

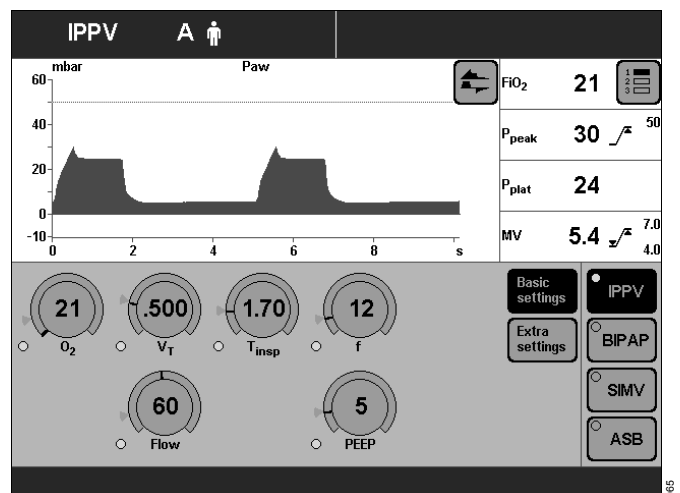

IPPV can be expanded by the following ventilation parameters:

Flow trigger (IPPVAssist) for synchronisation with attempted spontaneous breathing by the patient.

By switching on the flow trigger and setting the trigger level, the mandatory strokes are synchronised with the patient's spontaneous breathing attempts.

Spontaneous breathing activity by the patient is indicated by the brief display of a lung symbol instead of the usual symbol for the patient mode.

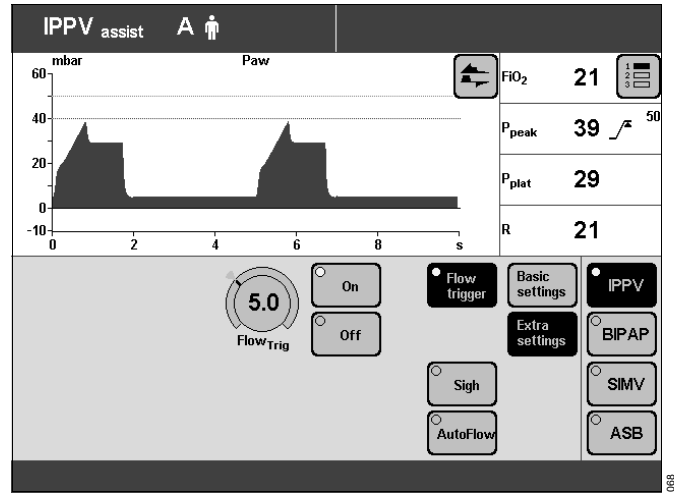

Sigh – for prophylactic treatment of atelectasis.

Atelectasis can be prevented by switching on the Sigh function and setting the sigh in the form of an intermittent PEEP.

When the Sigh function is activated, the end-expiratory pressure increases for two ventilation strokes every 3 minutes by the set value of the intermittent PEEP.

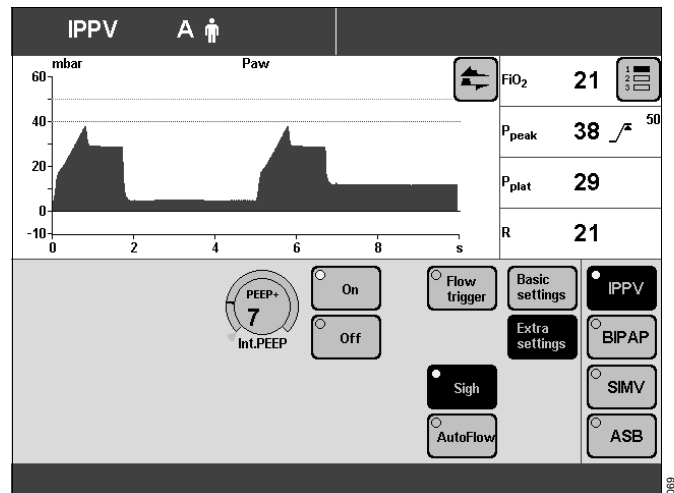

AutoFlow[®] – for automatic regulation of the inspiration flow. With AutoFlow*, the inspiration flow is decelerated and regulated, so that at the selected tidal volume V_T with the current lung compliance a minimum airway pressure is reached and pressure peaks are avoided.

Evita 4 delivers additional inspiration flow if and when the patient breathes in – limited by the alarm limit V_{Ti} $\sqrt{\Delta}$.

The patient can also breathe out during the inspiratory plateau phase.

The inspiratory pressure is limited by the Paw $\sqrt{\Delta}$ alarm limit.

* Please refer to page 187 for a detailed description of AutoFlow.

Set the alarm limits MV ∇/\surd and MV \surd/∇ in order to avoid excessive or insufficient flow following rapid changes in compliance.

To set:

- Touch the »**Extra settings**« screen key.
- Touch the screen key corresponding to the desired function.

For Flow trigger and Sigh:

- Touch the appropriate screen key.
- Adjust the desired value = turn the rotary knob
- Confirm the desired setting = press the rotary knob
- Switch on the function = touch the »**On**« screen button and press the rotary knob.

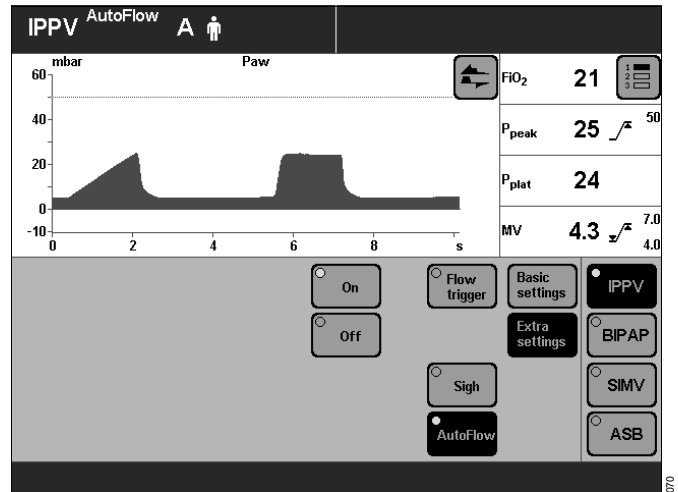

IPPV can be configured for the additional ventilation parameter Pmax. Selecting Pmax pressure limiting, refer to page 130.

Pressure Limited Ventilation (PLV)* – for manually limiting pressure peaks using the Pmax pressure limit. The tidal volume remains constant as long as the pressure curve shows a plateau and the inspiratory flow curve shows a brief flow pause between inspiration and expiration.

- To set the "Pmax" pressure limit, please refer to page 130. The value of Pmax is displayed as a dashed blue line in the Paw (t) curve.

The »**Volume not constant !!**« alarm is always active. It is triggered automatically if the tidal volume VT can no longer be applied.

This visual and audible alarm can be suppressed with the »**Alarm Reset**« key until the cause of the alarm is remedied.

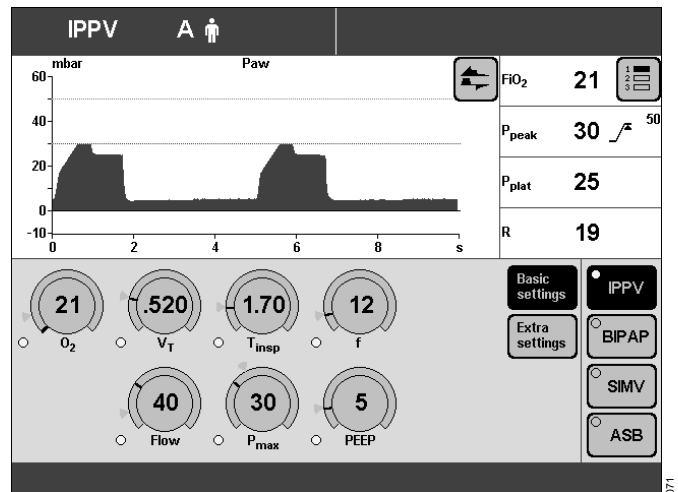

* Please refer to page 186 for a detailed description of PLV.

SIMV, SIMV/ASB

**Synchronized Intermittent Mandatory Ventilation*
Assisted Spontaneous Breathing****

Fixed mandatory minute volume MV set with tidal volume V_T and frequency f . Between the mandatory ventilation strokes, the patient can breathe spontaneously, thereby contributing to the minute volume. Spontaneous breathing can be supported by ASB.

For patients with insufficient spontaneous breathing or for patients who are being weaned by progressive reduction of the mandatory proportion of the total minute volume.

The frequency can be reduced to 0 during the weaning process. The device automatically changes to the ventilation mode CPAP or CPAP/ASB. This ventilation mode is also indicated on the screen.

The screen key »SIMV« and the screen knobs for setting the SIMV parameters remain on display.

Set the pattern of ventilation for SIMV and SIMV/ASB with the ventilation parameters:

Tidal volume »VT«

Insp. Flow »Flow«

Frequency »f«

Inspiration time »T_{insp}«

O₂ concentration »O₂«

Positive end-expiratory pressure »PEEP«

Pressure support »PASB«

Pressure rise time » Δ «

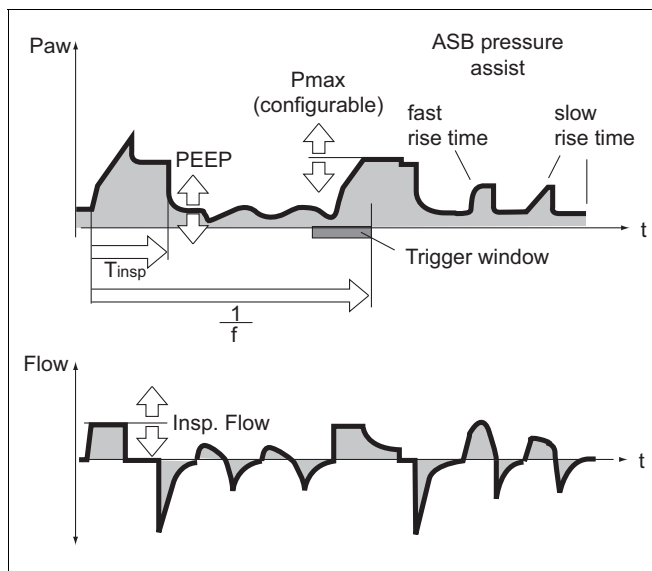

To set:

- Touch the appropriate screen knob.
- Adjust to the desired value = turn rotary knob.
- Confirm setting = press the rotary knob.

SIMV and SIMV/ASB can be expanded with the following ventilation parameters:

Flow trigger – for synchronisation with attempted spontaneous breathing by the patient.

By setting on the flow trigger level, the mandatory strokes are synchronised with the patient's spontaneous breathing attempts.

Spontaneous breathing activity by the patient is indicated by the brief display of a lung symbol instead of the usual symbol for the patient mode.

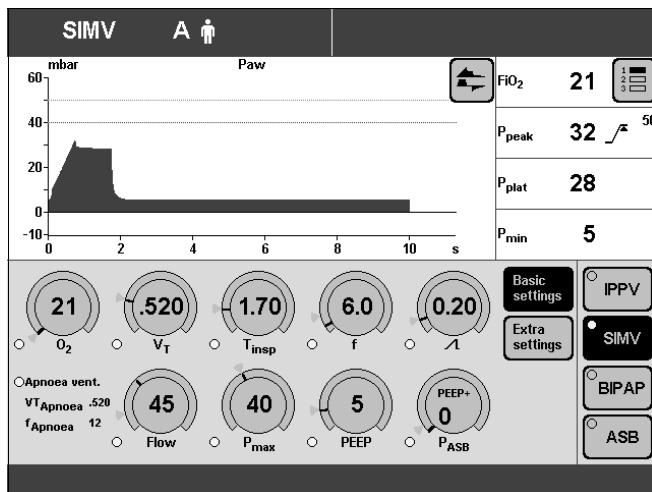

* Please refer to page 189 for a detailed description of SIMV.

** Please refer to page 190 for a detailed description of ASB.

Apnoea Ventilation – for automatic switch-over to volume-controlled mandatory ventilation if the patient stops breathing. If breathing stops, Evita 4 emits an alarm after the set alarm time » T_{Apnoea} / $\bar{\Delta}$ « and starts volume-controlled ventilation with the set ventilation parameters:
 Frequency » f_{Apnoea} «
 Tidal volume » VT_{Apnoea} «

AutoFlow® – for automatic optimisation of the inspiration flow. With AutoFlow* the inspiration flow is decelerated and regulated, so that at the selected tidal volume V_T with the current lung compliance a minimum airway pressure is reached and pressure peaks are avoided. Evita 4 delivers additional inspiration flow when the patient breathes in – limited by the alarm limit V_{Ti} / $\bar{\Delta}$. The patient can also breathe out during the inspiratory plateau phase. The inspiratory pressure is limited by the Paw / $\bar{\Delta}$ alarm limit.

- Set the alarm limits MV $\bar{\Delta}$ and MV / $\bar{\Delta}$ in order to avoid excessive or insufficient flow following rapid changes in compliance.

To set (example: Apnoea Ventilation)

- Touch the »**Extra settings**« screen key.
- Touch the screen key corresponding to the desired function, e. g. »**Apnoea vent.**«.
- Switch on the function = touch the »**On**« screen knob and press in the rotary knob.
- Set values = touch the corresponding screen knob, turn and press rotary knob.

SIMV and SIMV/ASB can be configured with the additional ventilation parameter P_{max} . Select P_{max} pressure limiting, refer to page 130.

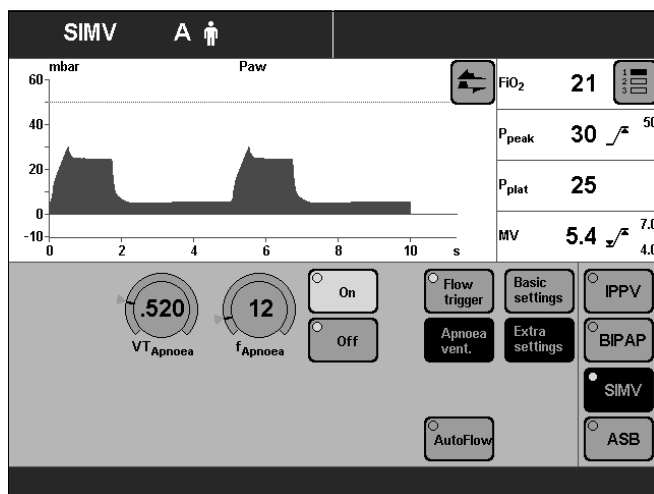
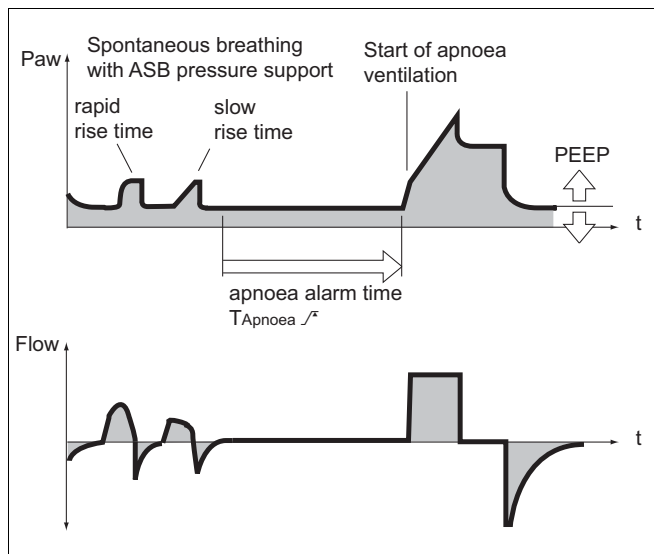

* Please refer to page 187 for a detailed description of AutoFlow.

Pressure Limited Ventilation (PLV)* – for manually limiting pressure peaks using the Pmax pressure limit. The tidal volume remains constant as long as the pressure curve shows a plateau and the inspiratory flow curve shows a brief flow pause between inspiration and expiration.

- To set the Pmax pressure limit, please refer to page 130. The value of Pmax is displayed as a dashed blue line in the Paw (t) curve.

The »**Volume not constant !!**« alarm is always active. It is triggered automatically if the tidal volume VT can no longer be applied.

This visual and audible alarm can be suppressed with the »**Alarm Reset**« key until the cause of the alarm is remedied.

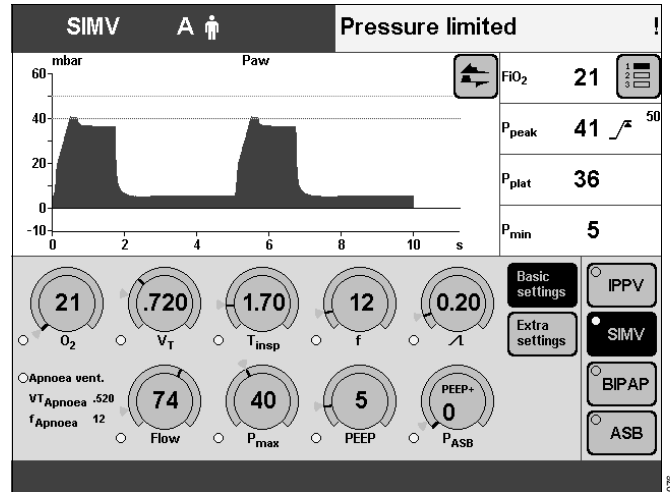

* Please refer to page 186 for a detailed description of PLV.

BIPAP, BIPAP/ASB

Biphasic Positive Airway Pressure

Assisted Spontaneous Breathing

Pressure-controlled ventilation combined with free spontaneous breathing during the complete breathing cycle, and adjustable pressure support at CPAP level.

The mandatory proportion of the total minute volume MV is set with inspiratory pressure P_{insp} above PEEP and Frequency f . For a range of patients, from those unable to breathe spontaneously to those breathing spontaneously before extubation. Patients are weaned off the ventilator by progressive reduction of the mandatory proportion of the overall minute volume MV and reduction of the pressure support PASB.

The frequency can be reduced to 0 during the weaning process. The device automatically changes to the ventilation mode CPAP or CPAP/ASB. This ventilation mode is also indicated on the screen.

The screen key »BIPAP« and the screen knobs for setting the BIPAP parameters remain on display.

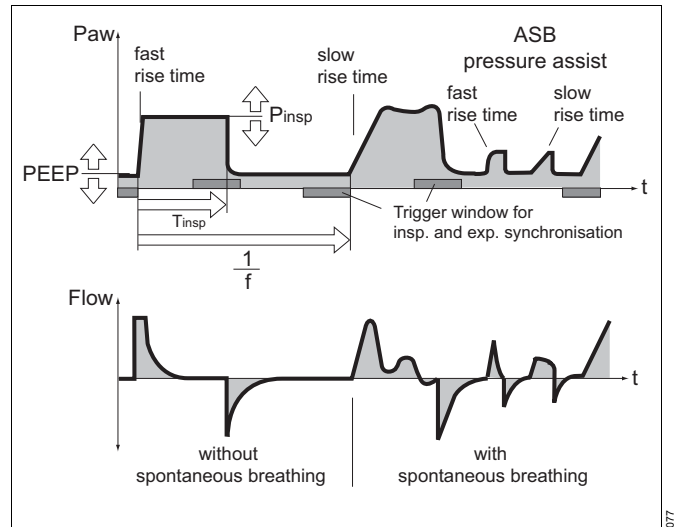

Set the pattern of ventilation for BIPAP and BIPAP/ASB with the ventilation parameters:

Inspiration pressure » P_{insp} «

Frequency » f «

Time » T_{insp} «

O₂ concentration » O_2 «

Positive end-expiratory pressure »PEEP«

Pressure support »PASB«

Pressure rise time » Δ «

The inspiration pressure » P_{insp} « can be reduced to the PEEP level, in which case the ventilation pattern corresponds to CPAP or CPAP/ASB.

The inspiration pressure » P_{insp} « is set as an absolute value. Pressure support »PASB« is set relative to the PEEP level.

To set:

- Touch the appropriate screen knob.
- Adjust to the desired value = turn rotary knob.
- Confirm setting = press the rotary knob.

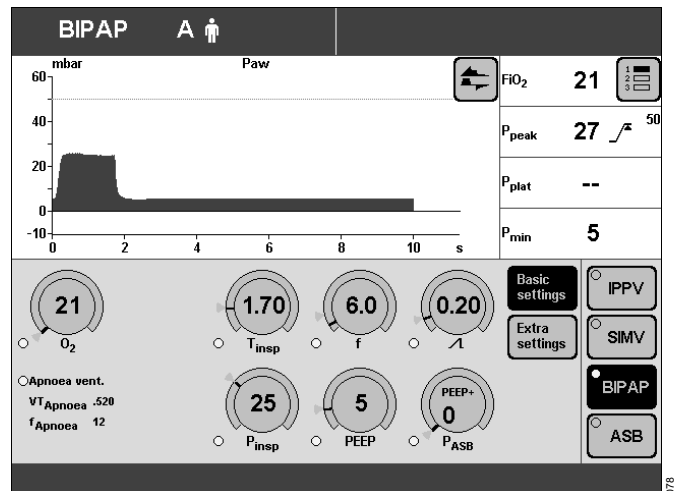

BIPAP and BIPAP/ASB can be expanded with the following ventilation parameters:

Flow trigger – for synchronisation with attempted spontaneous breathing by the patient.

By setting on the flow trigger level, the mandatory strokes are synchronised with the patient's spontaneous breathing attempts.

Spontaneous breathing activity by the patient is indicated by the brief display of a lung symbol instead of the usual symbol for the patient mode.

Apnoea Ventilation – for automatic switch-over to volume-controlled mandatory ventilation if the patient stops breathing. If breathing stops, Evita 4 emits an alarm after the set alarm time »**TApnoea** /^h« and starts volume-controlled ventilation with the set ventilation parameters:

Frequency »**fApnoea**«

Tidal volume »**VTApnoea**«

To set (example: Flow trigger)

- Touch the »**Extra settings**« screen key.
- Touch the screen key corresponding to »**Flow trigger**«.
- Set values = touch the »**FlowTrig**« screen knob, and turn and press the rotary knob.

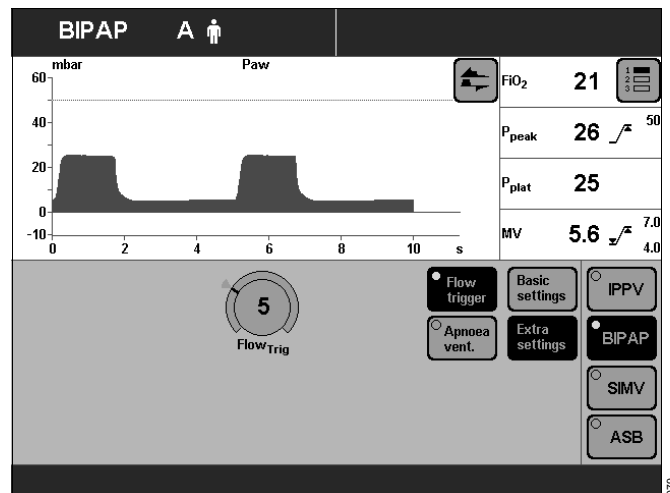

BIPAP_{Assist}

Biphasic Positive Airway Pressure Assisted pressure-controlled, assisted ventilation. The inspiratory strokes are the same as for BIPAP, but the changeover from P_{insp} to PEEP is not synchronised with expiration by the patient.

The patient can breathe spontaneously at PEEP level through the entire ventilation process.

Every spontaneous breathing activity by the patient triggers a synchronised inspiratory stroke.

A non-synchronised inspiratory stroke is started by the device at the latest upon expiry of the time $\gg f \ll$.

For all patients, from those unable to breathe spontaneously to those breathing spontaneously before being weaned off the ventilator.

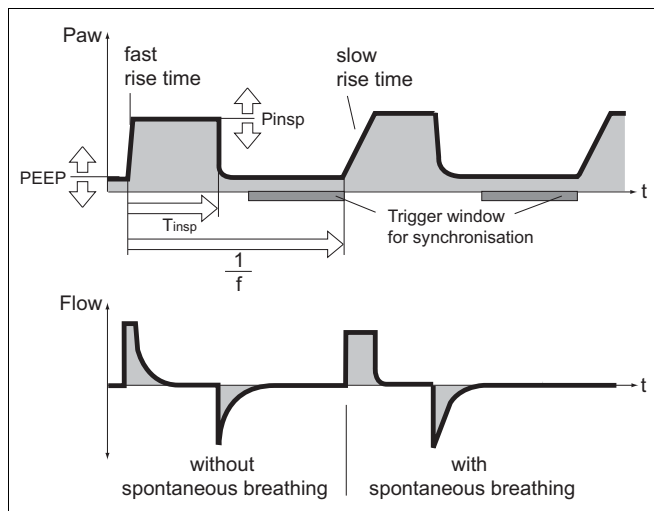

Set ventilation pattern for BIPAP_{Assist} with the following parameters:

- Inspiratory pressure $\gg P_{insp} \ll$
- Frequency $\gg f \ll$
- Inspiration time $\gg T_{insp} \ll$
- O₂ concentration $\gg O_2 \ll$
- Positive end-expiratory pressure $\gg PEEP \ll$
- Pressure rise time $\gg \Delta \ll$
- Flow trigger $\gg FlowTrig \ll$

The inspiratory pressure $\gg P_{insp} \ll$ is set as an absolute value.

To set:

- Touch the appropriate screen knob.
- Adjust to the desired value = turn rotary knob.
- Confirm setting = press the rotary knob.

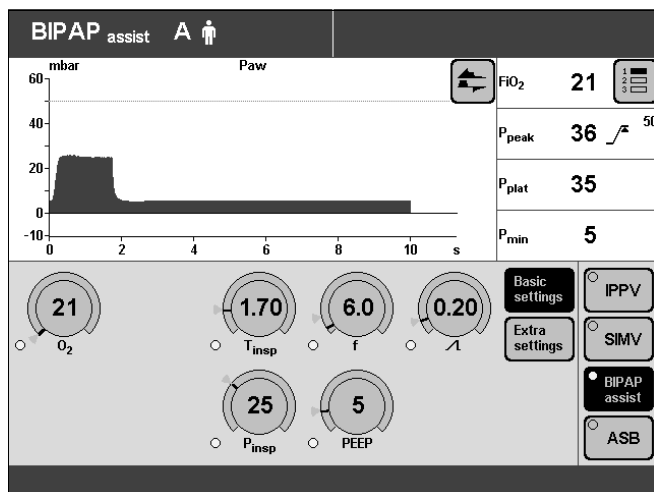

CPAP, CPAP/ASB

Continuous Positive Airway Pressure

Assisted Spontaneous Breathing

Spontaneous breathing at a raised pressure level in order to increase the functional residual capacity (FRC). Spontaneous breathing can be assisted with additional pressure by ASB. For patients breathing spontaneously.

Set the pattern of ventilation for CPAP and CPAP/ASB with the following ventilation parameters:

- O₂ concentration »O₂«
- Positive end-expiratory pressure »PEEP«
- Pressure support »PASB«
- Pressure rise time » Δ /L«

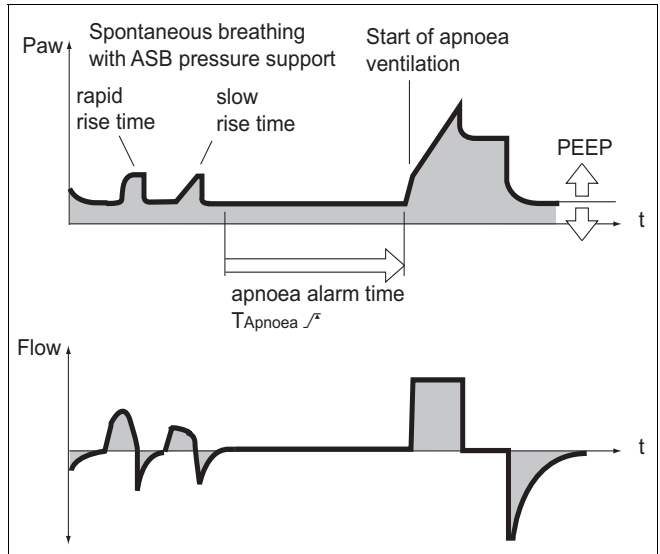

To set:

- Touch the appropriate screen knob.
- Adjust to the desired value = turn rotary knob.
- Confirm setting = press the rotary knob.

CPAP and CPAP/ASB can be expanded with the following ventilation parameters:

Flow trigger – for synchronisation with attempted spontaneous breathing by the patient.

By setting the trigger level, the mandatory ventilation strokes are synchronised with the patient's spontaneous breathing attempts.

Spontaneous breathing activity by the patient is indicated by the brief display of a lung symbol instead of the usual symbol for the patient mode.

Apnoea Ventilation – for automatic switch-over to volume-controlled mandatory ventilation if the patient stops breathing.

If breathing stops, Evita 4 emits an alarm after the set alarm time »T_{Apnoea} / Δ « and starts volume-controlled ventilation with the set ventilation parameters:

- Frequency »f_{Apnoea}«
- Tidal volume »V_TApnoea«

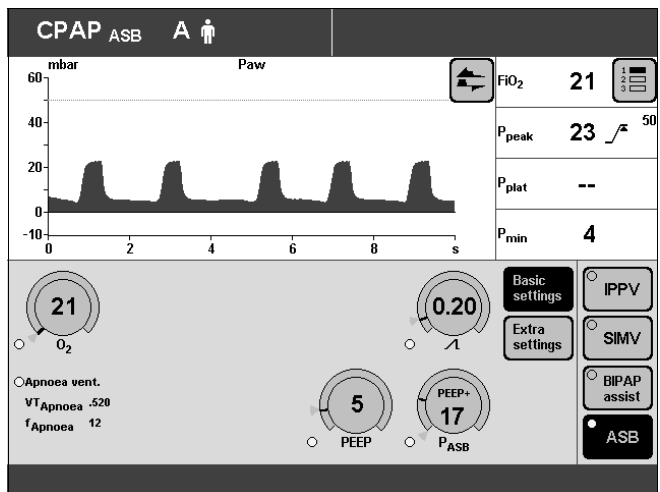

To set (example: Flow trigger)

- Touch the »**Extra settings**« screen key.
- Touch the »**Flow trigger**« screen key.
- Set the value = touch the »**FlowTrig**« screen knob, and turn and press the rotary knob.

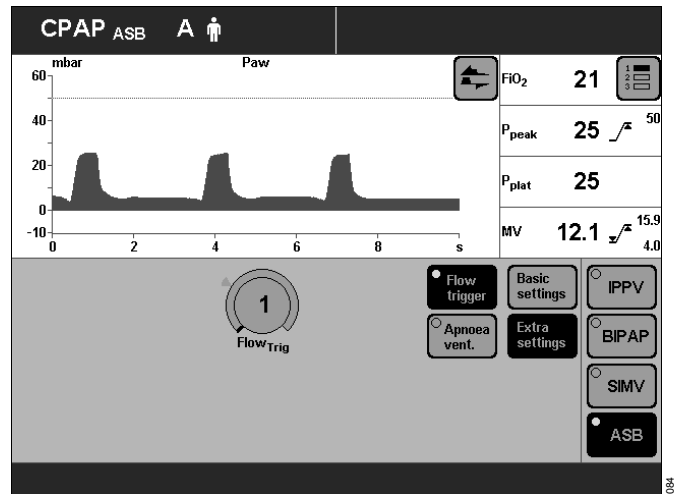

MMV, MMV/ASB

Mandatory Minute Volume Ventilation

Assisted Spontaneous Breathing

The overall minute volume is preset to a mandatory level, which can be adjusted by means of the tidal volume V_T and frequency f .

The patient can breathe spontaneously, thereby contributing a portion of the overall minute volume.

The difference between the spontaneously breathed minute volume and the set minute volume is covered by the mandatory ventilation strokes. Spontaneous breathing can be assisted by ASB pressure support.

This mode is intended for patients being weaned off the ventilator by progressively reducing the mandatory proportion of the overall minute volume.

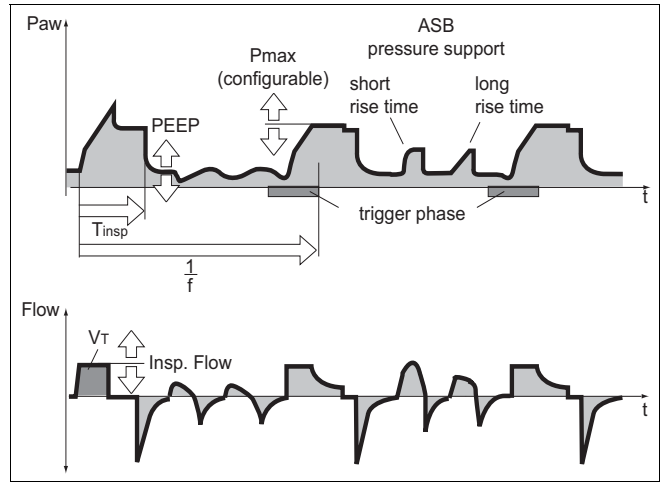

Set the pattern of ventilation for MMV and MMV/ASB with the ventilation parameters:

Tidal volume »**VT**«

Insp. flow »**Flow**«

Frequency »**f**«

Inspiration time »**T_{insp}**«

O₂ concentration »**O₂**«

Positive end-expiratory pressure »**PEEP**«

Pressure support »**PASB**«

Pressure rise time »**∧/∟**«

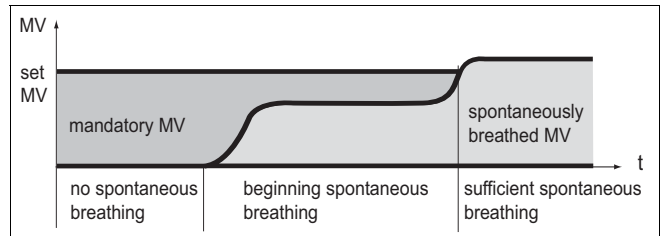

To set:

- Touch the appropriate screen knob.
- Adjust to the desired value = turn rotary knob.
- Confirm setting = press the rotary knob.

MMV and MMV/ASB can be expanded with the following ventilation parameters:

Flow trigger – for synchronisation with attempted spontaneous breathing by the patient.

By setting on the flow trigger level, the mandatory strokes are synchronised with the patient's spontaneous breathing attempts.

Spontaneous breathing activity by the patient is indicated by the brief display of a lung symbol instead of the usual symbol for the patient mode.

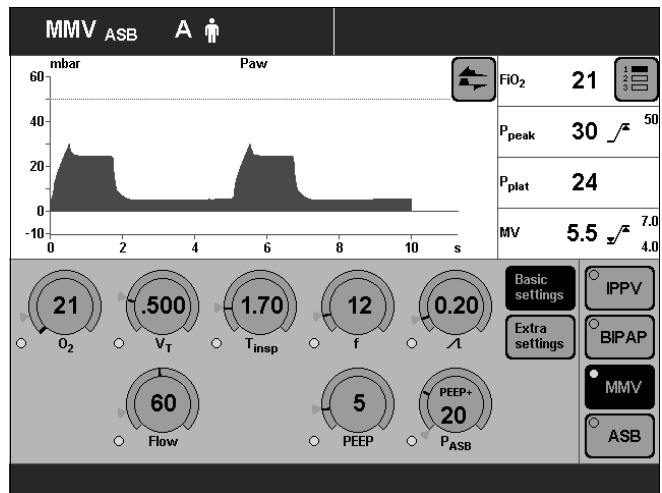

APRV

Airway Pressure Release Ventilation

Free spontaneous breathing at a raised CPAP pressure level together with a short period of low pressure (Release). This mode is intended for patients who are breathing spontaneously but who need assistance with CO₂ removal.

Set the pattern of ventilation for APRV with the ventilation parameters:

- Inspiration time »**T_{high}**«
- Expiration time »**T_{low}**«
- Inspiration pressure »**P_{high}**«
- Positive end-expiratory pressure »**P_{low}**«
- O₂ concentration »**O₂**«

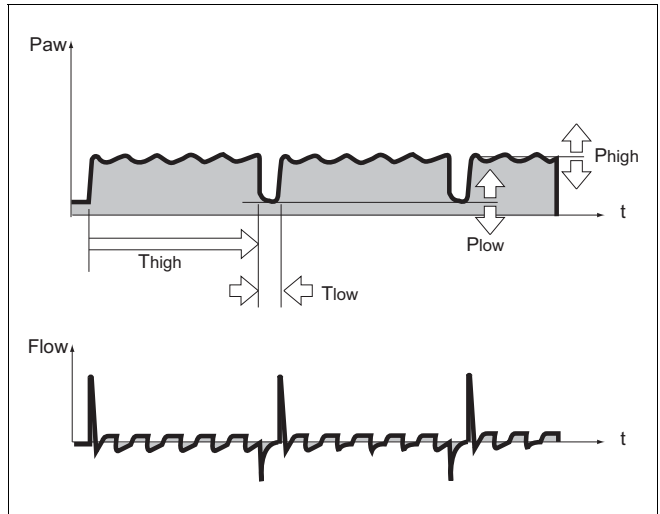

To set:

- Touch the appropriate screen knob.
- Adjust to the desired value = turn rotary knob.
- Confirm setting = press the rotary knob.

APRV can be expanded with the following ventilation parameters:

Apnoea Ventilation – for automatic switch-over to volume-controlled mandatory ventilation if the patient stops breathing. If breathing stops, Evita 4 emits an alarm after the set alarm time »**T_{Apnoea}** / **f_{Apnoea}**« and starts volume-controlled ventilation with the set ventilation parameters:
 Frequency »**f_{Apnoea}**«
 Tidal volume »**V_{TApnoea}**«

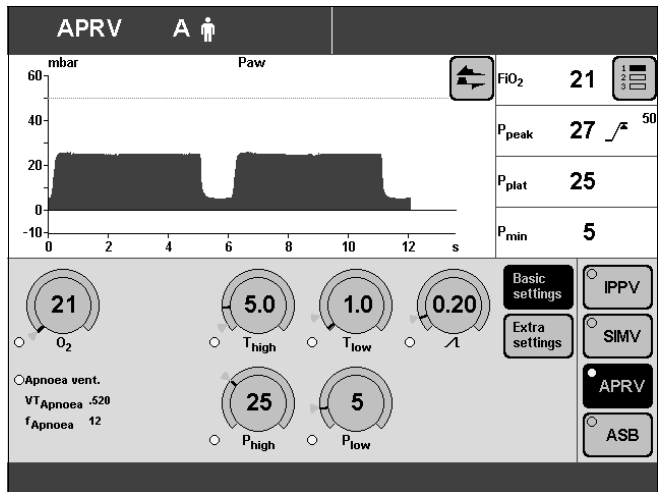

To set (example: Apnoea Ventilation)

- Touch the »**Extra settings**« screen key.
- Touch the »**Apnoea vent.**« screen key.
- Switch on the function = touch the »**On**« screen knob and press in the rotary knob.
- Set values = touch the corresponding screen knob, turn and press rotary knob.

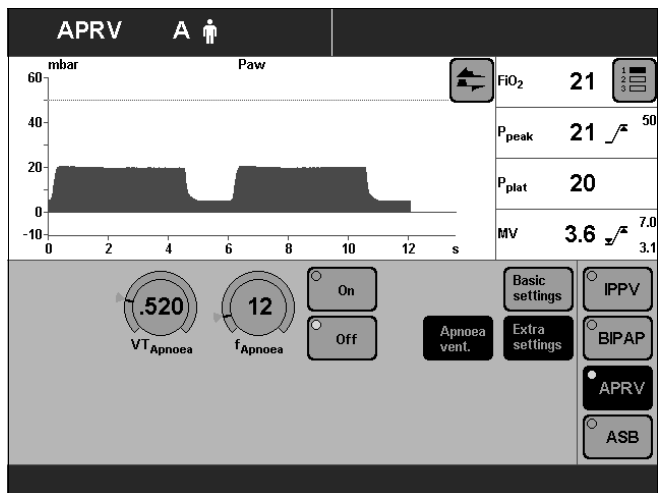

ILV

ILV = Independent Lung Ventilation

Separate, differentiated, synchronised ventilation with two Evita units, one for each lung. The two Evita units are connected by analogue interfaces.

The two devices operate together in master/slave mode. The master device controls the operation.

Preparation

If a protective cap is fitted:

- Remove cap from ILV connection.

The following device combinations are possible:

- Combination of two Evita 4 units
- Combination of Evita 4 and EvitaXL
- Combination of Evita 4 and Evita 2 dura
- Combination of Evita 4 and Evita 2
- Combination of Evita 4 and Evita.

Requirements for combinations:

- Evita 2 or Evita units must be fitted with the EvitaBus analogue interface (optional).
- Connecting cable 8411794 must be used to connect Evita 4 to another Evita 4 or with an Evita 2 dura.
- Connecting cable 8411793 must be used to connect Evita 4 to an Evita 2 or Evita.

CAUTION

The ILV cable should only be connected when the unit is switched off!

For the combination:

Evita 4 – EvitaXL

and

Evita 4 – Evita 2 dura

and

Evita 4 – Evita 4:

- Connect the ILV ports of the two Evita units using connecting cable 8411794.

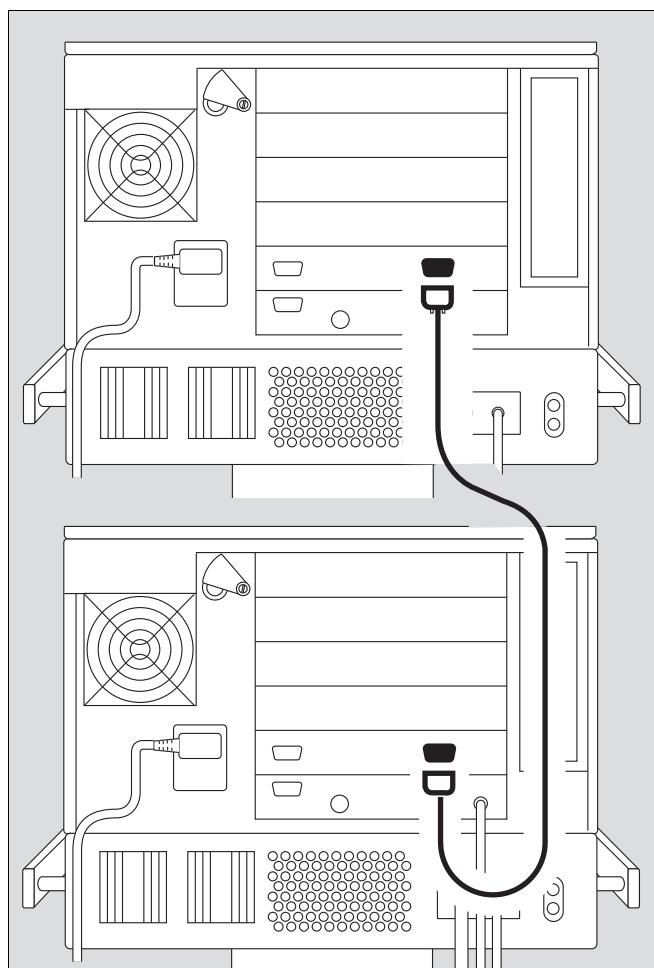

for Evita 4 – Evita 2
and
Evita 4 – Evita:

- Connect the ILV port of the Evita 4 to the analogue interface of the other Evita unit using connecting cable 8411793.

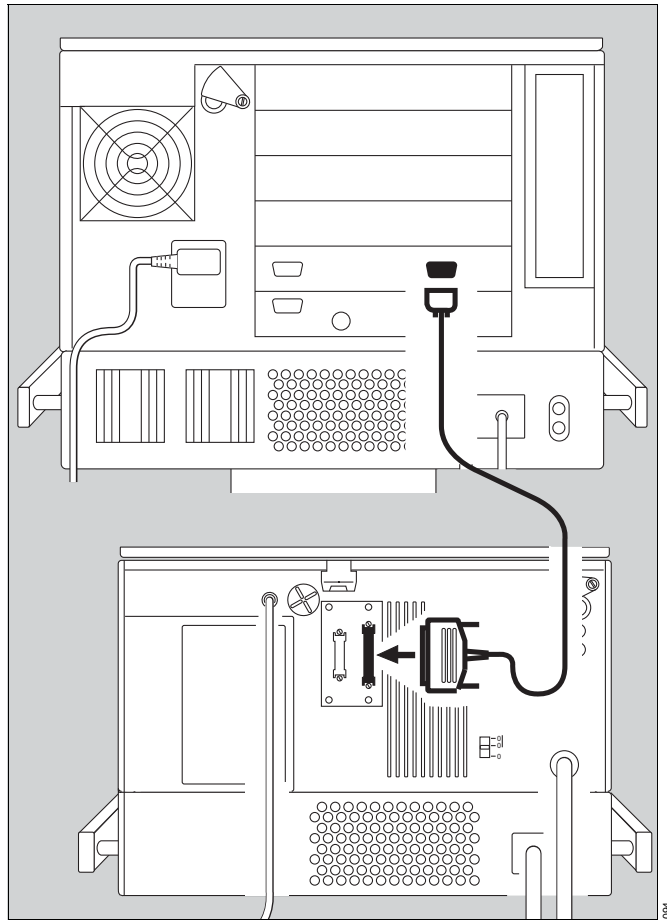

Setting the Master and Slave device

To perform independent lung ventilation:

- Set up one device for ILV/Master mode and
- the other device for ILV/Slave mode.
- Set the desired parameters – refer to page 85.
- **Do not activate ILV mode until all the parameters for the ILV/Master and ILV/Slave are fully set.**

Setting ILV/Master

Volume-controlled ventilation with fixed, mandatory minute volume MV, set with tidal volume VT and frequency f. For independent lung ventilation of patients with no spontaneous breathing.

Set the ILV ventilation pattern with the parameters:

Tidal volume »VT«

Insp. Flow »Flow«

Frequency »f«

Inspiration time »T_{insp}«

O₂ concentration »O₂«

Positive end-expiratory pressure »PEEP«

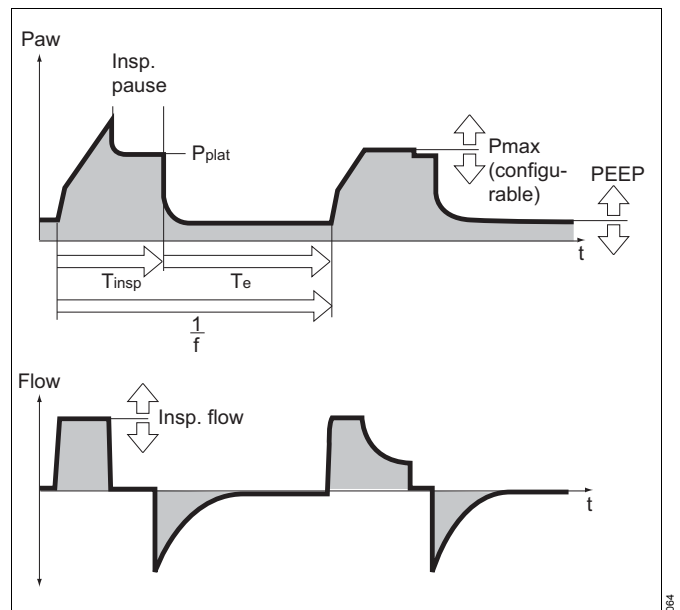

To set:

- Touch the appropriate screen knob.
- Adjust the desired value = turn rotary knob.
- Confirm setting = press rotary knob.

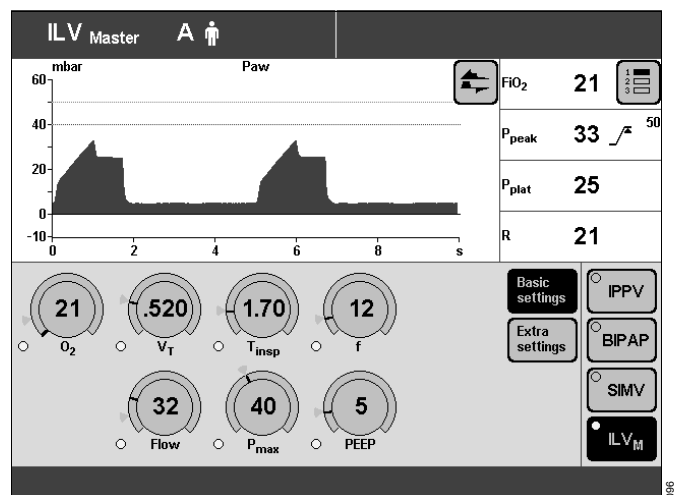

ILV/Master can be supplemented by the following ventilation parameters:

Flow trigger (ILV/MasterAssist) – for synchronisation with attempted spontaneous breathing by the patient.

By switching on the flow trigger and setting the trigger level, the mandatory strokes are synchronised with the patient's spontaneous breathing attempts.

Spontaneous breathing activity by the patient is indicated by the brief display of a lung symbol instead of the usual symbol for the patient mode.

Sigh – for prophylactic treatment of atelectasis.

Atelectasis can be prevented by switching on the sigh function and setting the sigh in the form of an intermittent PEEP.

When the Sigh function is activated, the end-expiratory pressure is increased by the set value of the intermittent PEEP for 2 ventilation strokes every 3 minutes.

ILV/Master can also be configured with the additional ventilation parameter Pmax. To set the Pmax pressure limit, please refer to page 130.

Pressure Limited Ventilation (PLV) – for manually limiting pressure peaks using the Pmax pressure limit. The tidal volume remains constant as long as the pressure curve shows a plateau and the flow curve shows a brief flow pause between inspiration and expiration.

- To set the Pmax pressure limit, refer to page 130.

The value of Pmax is displayed as a dashed blue line in the Paw (t) curve.

The tidal volume is constantly monitored. If the tidal volume VT can no longer be applied, the »Volume not constant« alarm is automatically triggered.

This visual and audible alarm can be suppressed with the »Alarm Reset« key until the cause of the alarm is remedied.

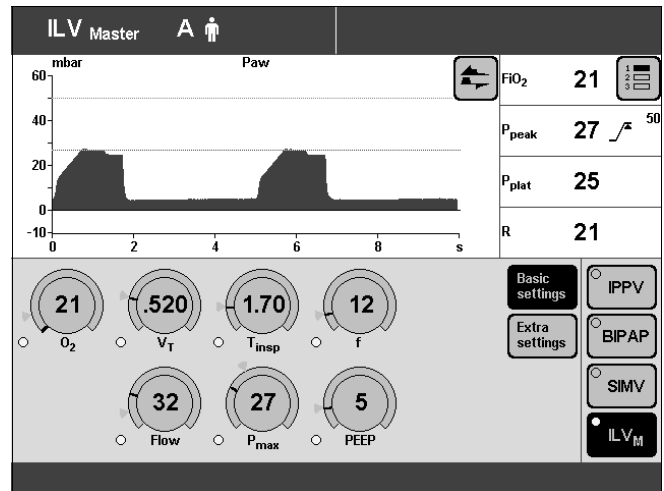

Setting ILV/Slave

Volume-controlled ventilation with fixed, mandatory minute volume MV, set with the tidal volume V_T and frequency f of the ILV Master device and selectable Slave mode.

For independent lung ventilation of patients with no spontaneous breathing.

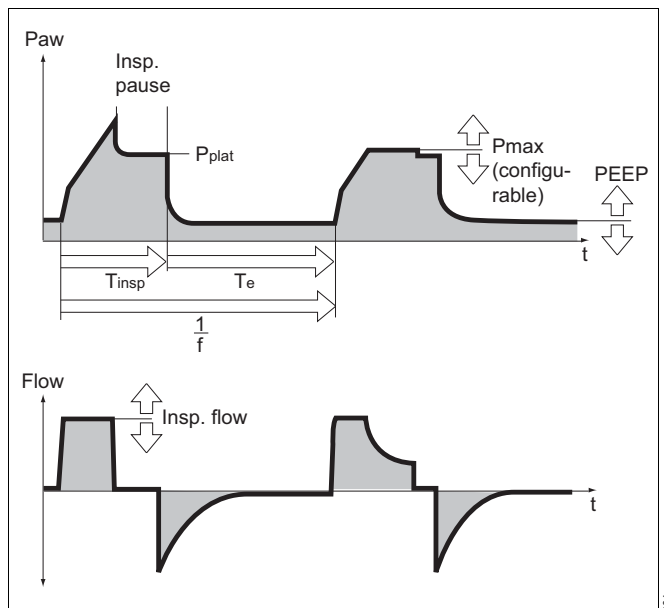

To set Slave mode:

- Touch the »Extra settings« screen key.
- Touch the »Slave Mode« screen key

To select the desired slave mode (e. g. »Async.«):

- Touch the appropriate screen key and press the rotary knob.

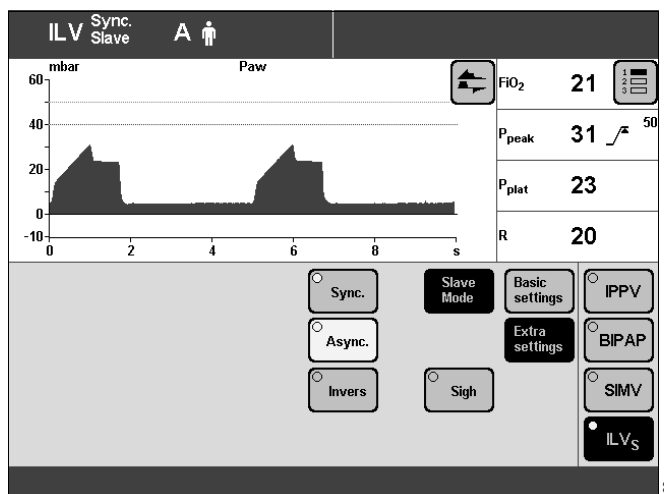

ILV/Master and Slave synchronisation

Master device

I:E-ratio

Slave device:

Sync. – The I:E ratio of the slave device is determined by the I:E ratio of the master device.

The start of inspiration is synchronised with the inspiration of the master device.

Slave device

Async. – The start of inspiration is synchronised with the inspiration of the master device.

The end of inspiration (incl. pause time) is determined by the »T_{insp}« setting. The I:E ratio of the slave device is freely selectable.

Slave device

Inverse – The start of inspiration is synchronised with the start of expiration of the master device and vice versa.

The I:E ratio of the slave device is the inverse of the I:E ratio of the master device.

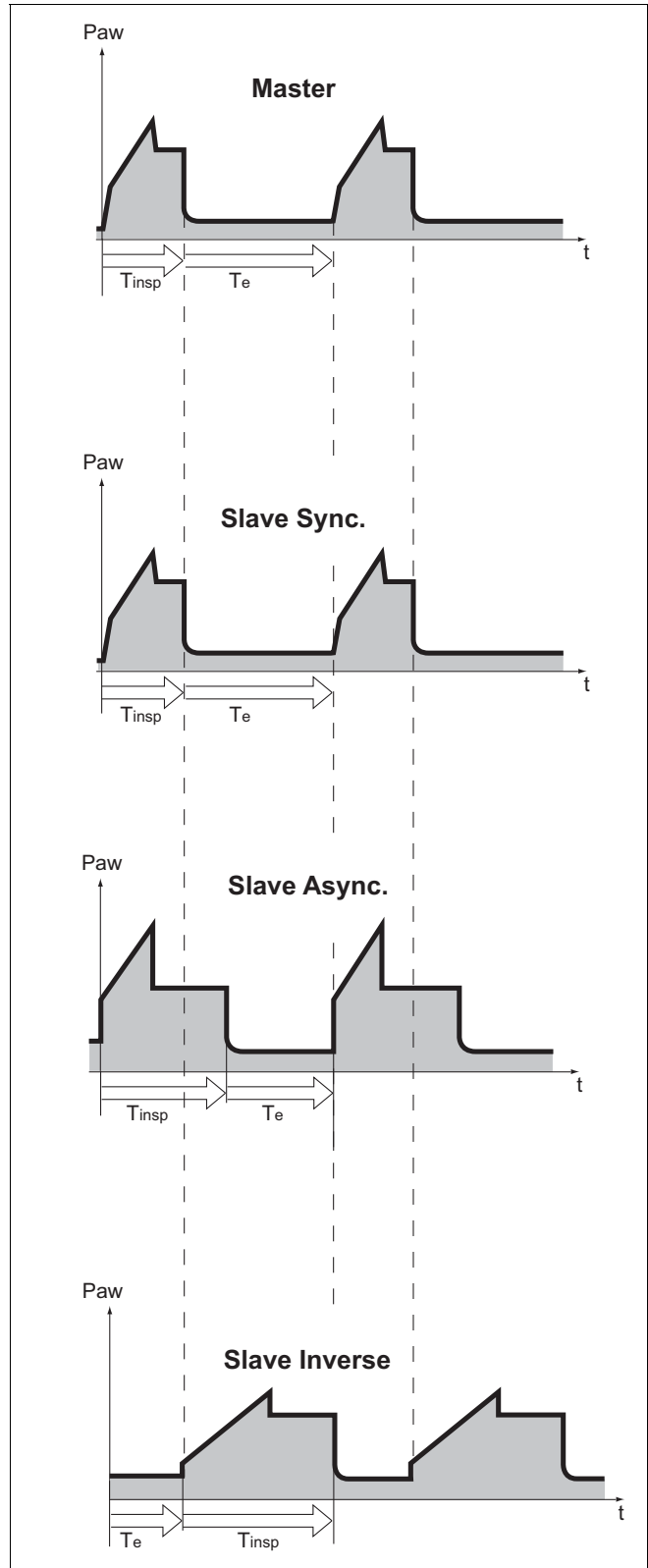

Set the ventilation pattern for ILV/Slave with the following ventilation parameters:

Tidal volume »**VT**«

Insp. Flow »**Flow**«

Frequency »**f**«

Inspiration time »**T_{insp}**«

O₂ concentration »**O₂**«

Positive end-expiratory pressure »**PEEP**«

To set:

- Touch the appropriate screen knob.
- Adjust the desired value = turn rotary knob.
- Confirm setting = press rotary knob.

The »**f**« setting is not immediately effective.

Nevertheless, to make sure that the two lung compartments are not ventilated with different frequencies in the event of inadvertent separation of the two devices:

Set »**f**« on the slave device to the same value as on the master = safety setting.

In »**Async.**« slave mode, the »**T_{insp}**« setting is immediately effective.

In »**Sync.**« and »**Invers**« modes, »**T_{insp}**« is only effective if the devices are inadvertently separated.

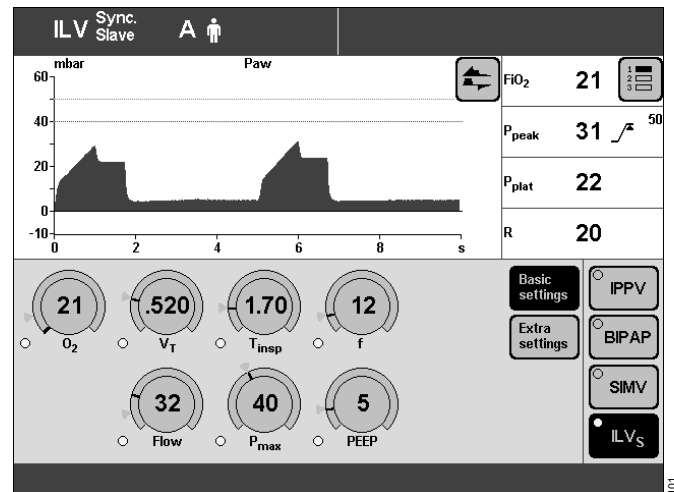

ILV/Slave can be supplemented by the following ventilation parameters:

Sigh – for prophylactic treatment of atelectasis.

Atelectasis can be prevented by switching on the Sigh function and setting the sigh in the form of an intermittent PEEP.

When the Sigh function is activated, the end-expiratory pressure is increased by the set value of the intermittent PEEP for 2 ventilation strokes every 3 minutes.

ILV/Slave can also be configured with the additional ventilation parameter P_{max}. To set the P_{max} pressure limit, please refer to page 130.

Pressure Limited Ventilation (PLV) – for manually limiting pressure peaks using the P_{max} pressure limit. The tidal volume remains constant as long as the pressure curve shows a plateau and the flow curve shows a brief flow pause between inspiration and expiration.

To set the P_{max} pressure limit, please refer to page 130.

The value of P_{max} is displayed as a dashed blue line in the Paw (t) curve.

The tidal volume is constantly monitored. If the tidal volume V_T can no longer be applied, the »**Volume not constant !!**« alarm is automatically triggered.

This visual and audible alarm can be suppressed with the »**Alarm Reset**« key until the cause of the alarm is remedied.

Apnoea Ventilation

For automatic switch-over to volume-controlled mandatory ventilation if the patient stops breathing.

It can be switched on in the ventilation modes SIMV, BIPAP, CPAP, APRV.

Evita 4 emits an Apnoea alarm if during the set alarm period » T_{Apnoea} « no expiration flow is measured or insufficient inspiratory gas is delivered.

If breathing stops, Evita 4 emits an alarm after the set alarm time » T_{Apnoea} « and starts volume-controlled ventilation with the set ventilation parameters:

Frequency » f_{Apnoea} «

Tidal volume » $V_{TApnoea}$ «

The ventilation parameters » O_2 « and »PEEP« correspond to the settings effective at the time.

The inspiration time for Apnoea ventilation is determined from the set Apnoea frequency » f_{Apnoea} « and a fixed I:E ratio of 1:2.

As in SIMV, the patient can breathe spontaneously during Apnoea ventilation, and the mandatory ventilation strokes will be synchronised with the patient's spontaneous breathing. The Apnoea ventilation frequency remains constant.

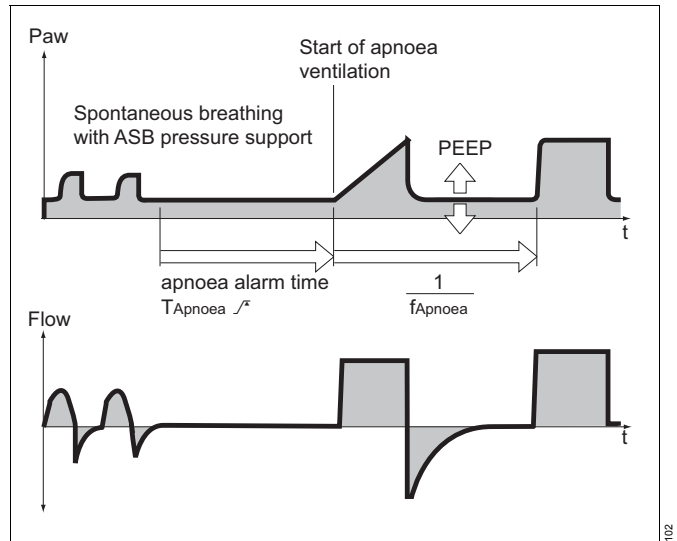

To set (example: Apnoea Ventilation)

- Touch the »**Extra settings**« screen key.
- Touch the »**Apnoea vent.**« screen key.
- Switch on the function = touch the screen knob marked »**On**«, and press the rotary knob.
- Set values = touch the appropriate screen knob, and then turn and press the rotary control.

Status and settings for Apnoea ventilation are displayed by Evita 4 on the Settings screen.

To terminate Apnoea Ventilation:

- Press the »**Alarm Reset**« key: the device will continue operating in its previous ventilation mode or
- select another ventilation mode.

For configuring the status of apnoea ventilation when switching on the device, refer to page 132.

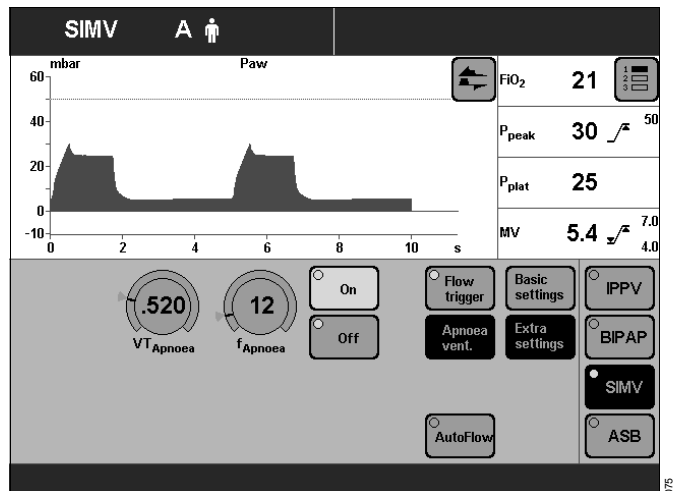

Setting alarm limits

WARNING

The alarm limits must be set to meet the needs of the therapy required by the current patient. The patient may otherwise be jeopardized.

CAUTION

Risk of patient injury due to incorrect settings
 If several same or similar devices are used in the care areas, the alarm limits of the devices may be configured differently and, thus, may not be suitable for the current patient.
 Check the alarm limits and adapt them to the current patient and the required therapy.
 Make sure that extreme alarm limits or alarm limits that are turned off do not make the alarm system useless.

- Press key »Alarm limits«.
- Display screen »Limits« (example):
 This page displays all the adjustable alarm limits.

✓ = lower alarm limit
 /^ = upper alarm limit

Example: Lower alarm limit for minute volume MV.

- Touch the screen key ✓ for MV: the key changes colour from green to yellow.
- Set the alarm limit and confirm by turning and pressing the rotary knob. The new alarm limit will now be effective.

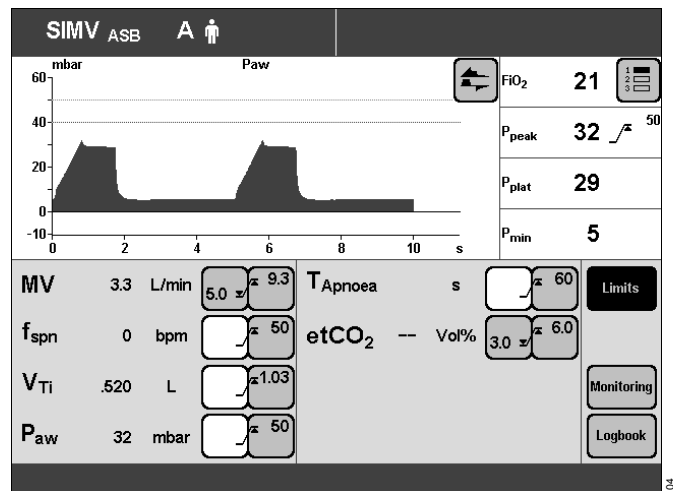

The lower alarm limits do not have to be set for the airway pressure Paw, which is automatically coupled with the PEEP setting.

The alarm limits do not have to be set for the O₂ concentration. These limits are automatically coupled to the O₂ concentration setting.

Lower alarm limit:

- Setting -4 Vol% (for settings up to 60 Vol%)
- Setting -6 Vol% (for settings from 60 to 100 Vol%)

Upper alarm limit:

- Setting +4 Vol% (for settings up to 60 Vol%)
- Setting +6 Vol% (for settings from 60 to 100 Vol%)

Setting ranges for alarm limits, see "Technical Data", page 178.

In the event of an alarm

- 1 the red lamp or yellow lamp flashes.
- 2 The alarm message is displayed in the right-hand corner of the top line of the screen.

Evita 4 assesses the alarm message with corresponding priority, marks the text with exclamation marks and different coloured backgrounds and generates the various alarm tone sequences.

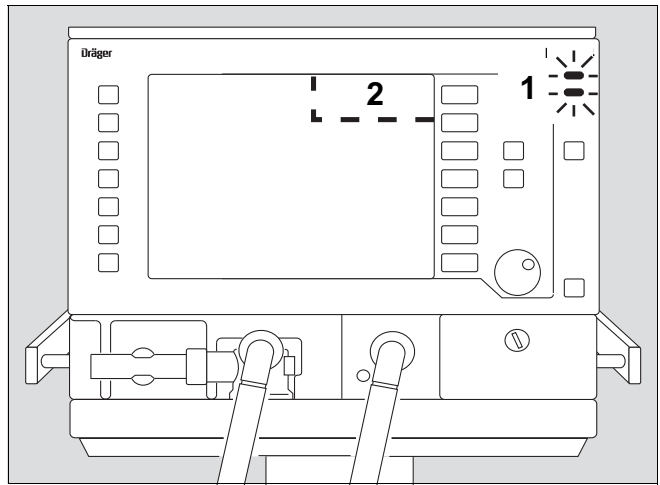

Warning = top priority message

The red lamp flashes.

The alarm messages are marked with three exclamation marks

Example: **Apnoea !!!**

Warning messages are displayed against a red background.

Evita 4 generates a 5-tone sequence that is sounded twice and is repeated every 7 seconds.

Caution = medium priority message

The yellow lamp flashes.

Warning messages are marked with two exclamation marks.

Example: **O₂ supply pressure high !!**

Caution messages are displayed against a yellow background. Evita 4 generates a 3-tone sequence that is repeated every 20 seconds.

Note = low priority message

The yellow lamp remains constantly lit.

Note messages are marked with one exclamation mark.

Example: **Malfunction fan !**

Advisory messages are displayed against a yellow background. Evita 4 generates a 2-tone sequence that sounds only once.

If the loudspeaker for audible alarms fails on account of a defect, an auxiliary signal will sound continuously. This continuous tone also serves as power failure alarm, refer to page 43, if power is interrupted while the ventilator is in use.

To remedy the faults, please refer to the "Alarm – Cause – Remedy" section starting on page 141.

Once the fault has been remedied, the alarm tone is switched off. Caution and advisory messages disappear automatically. Warning messages (!!!) are displayed in the colour of the status line and must be acknowledged:

1 Press »Alarm Reset« key.

The message is erased from the screen. However, it is stored in Evita 4 and can be displayed with the logbook function in the »Alarm limits« screen page, see page 95.

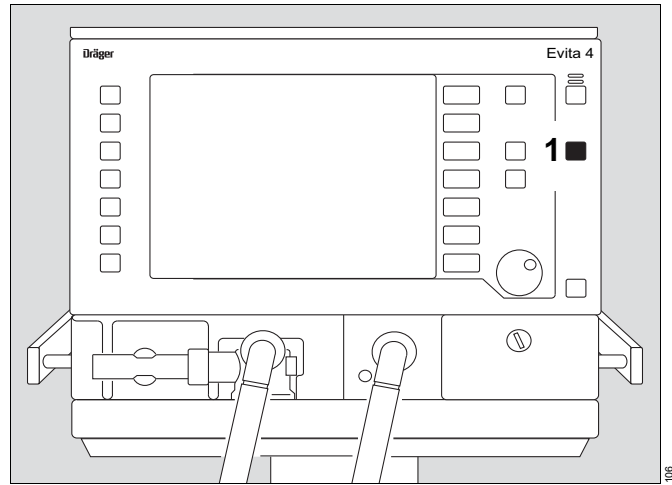

Suppressing the alarm tone

for max. 2 minutes:

2 Press the »« key with the lit yellow indicator LED. The acoustic alarm will be suppressed for 2 minutes. If the fault that triggered the alarm is still not remedied, the acoustic alarm starts up again.

If you wish to reactivate the acoustic alarm temporarily:

2 Press the »« key (with the yellow LED now switched off) again.

3 Press »Alarm Reset« to acknowledge the alarms that can be suppressed with »Alarm Reset«, please refer to the "Alarm – Cause – Remedy" section starting on page 141.

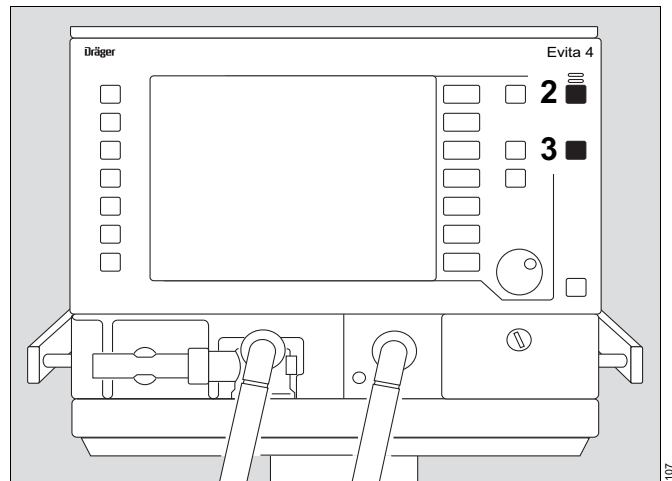

Information

- For help in operating the system – with setting instructions.
- For help in troubleshooting.

4 Press the »« key: information is displayed in the bottom line of the screen.

To erase the message:

4 Press the »« key again.

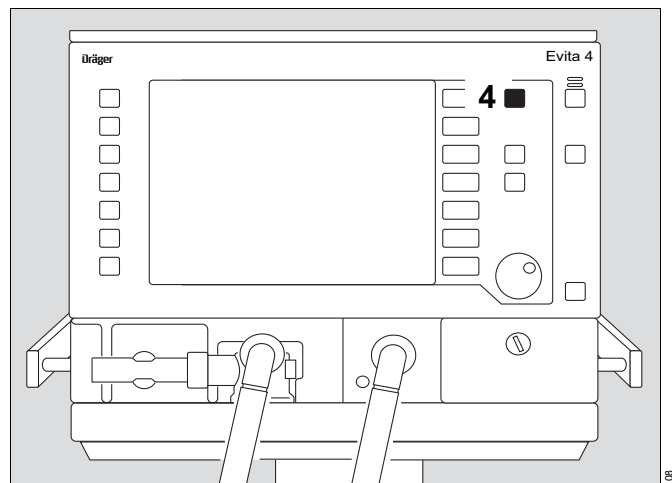

Position of the user to the alarm system

The alarm system is designed such that the user can recognize alarm messages from a distance of 1 m (39 in). The specified volume of the alarm tone applies to a distance of 1 m (39 in) in front of the device and a height of 1.5 m (59 in).

Displaying curves and measured values

In the standard page

- Press »« key.

»Standard page« display:

In the right-hand field: 4 measured values

In the left-hand field: 2 curves

To select one of the three measured value combinations:

- Touch screen key »« repeatedly.

To select one of the three measured value combinations:

- Touch screen key »« and touch the relevant screen key. Measured values and curves can be selected, see configuration, page 125 or page 126 onwards.

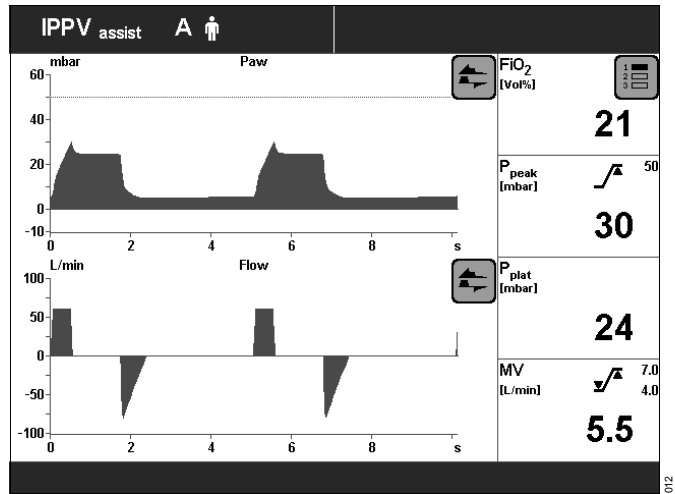

In all other screen pages

e. g. »Settings page«

- Press »Mode settings« key.

»Mode settings« display:

Right-hand field: 4 measured values (as in the standard page)

left-hand field: 1 curve.

To select one of the three measured value combinations:

- Touch the screen key »« repeatedly.

To select three other curves:

- Touch the screen key »« and touch the relevant screen key.

Measured values and curves can be selected, see configuration, page 125 or page 126 onwards.

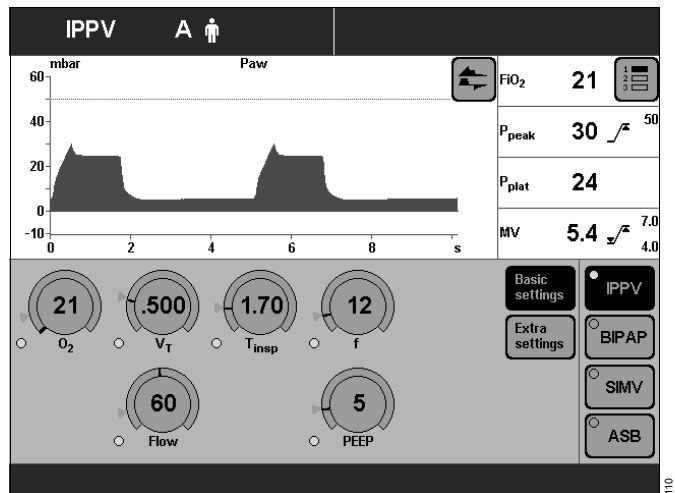

Displaying measured values

- Press the »Values measured« key.

»Table 1« display:

Evita 4 displays the measured values with the units of measure in the form of a table. The measured values are summarised in Table 1 and Table 2.

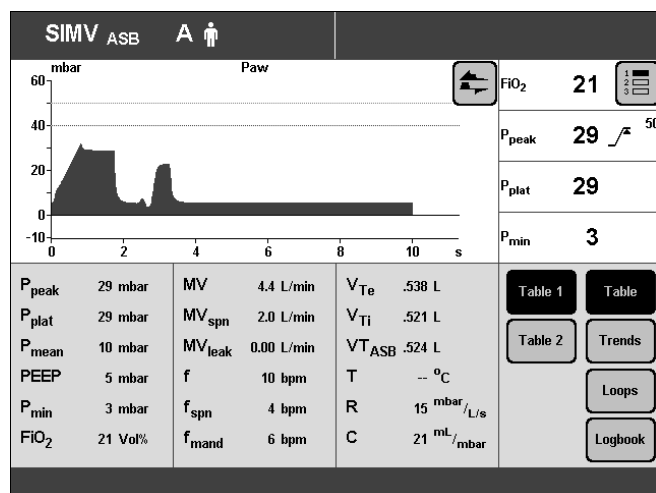

»Table 2« display:

The following are displayed optionally:

VTASB – inspiratory breathing volume during an ASB stroke

RSB – Rapid Shallow Breathing*

NIF – Negative Inspiratory Force**

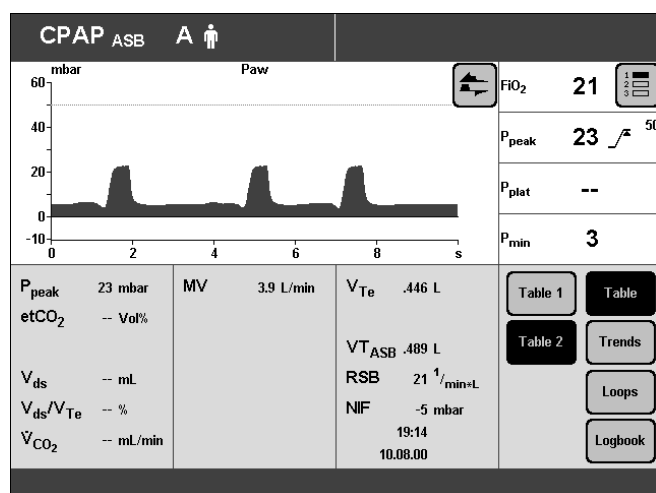

* For a detailed description of RSB, refer to the Annex, page 198.

** For a detailed description of NIF, refer to the Annex, page 198.
For information on using NIF, refer to "Expiration hold", page 97.

Trends

- Touch the »Trends« screen key.
- »Trend« display:
The trend of two measured values is displayed.

To enlarge the time window (zoom function):

- Touch the »Zoom out« screen key.

To reduce the time window:

- Touch the »Zoom in« screen key.

To evaluate the measured value at a specific time

- Position the ▼ cursor on the time by turning the rotary knob.

The time and associated measured value are displayed above the trend curve.

To display another preset measured value trend:

- Touch the »↕« screen key, and touch the corresponding screen key.

To preselect measured values for the trend display, please refer to Configuration on page 127.

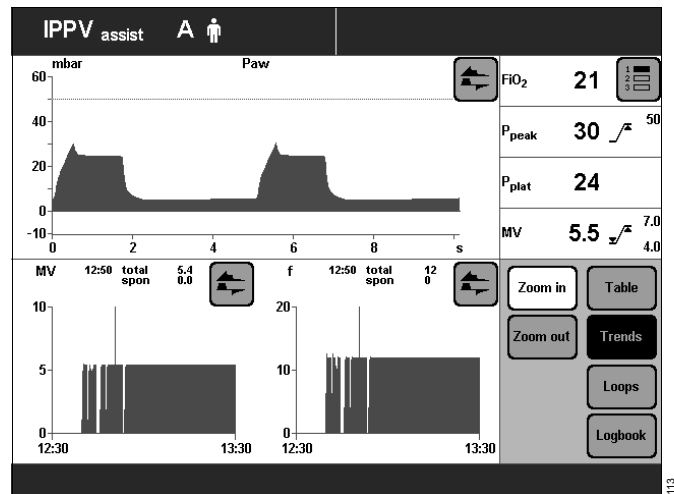

Loops

- Touch the »Loops« screen key.

»Loops« display:

Two pairs of measured values plotted against each other appear in the ventilation cycle as a loop, e. g. the Paw-V loop and the Flow-Paw loop.

To select another preset pair of measured values as a loop:

- Touch the »↕« screen key in the Loop display.

Reference curve displays

To display the recorded loop of a particular breathing cycle as a permanent on-screen reference for the current loop:

Date and time of the reference are displayed on the screen.

- Press the »Reference« screen key.

The date and time of the reference curve appear below the »Reference« screen key (optional).

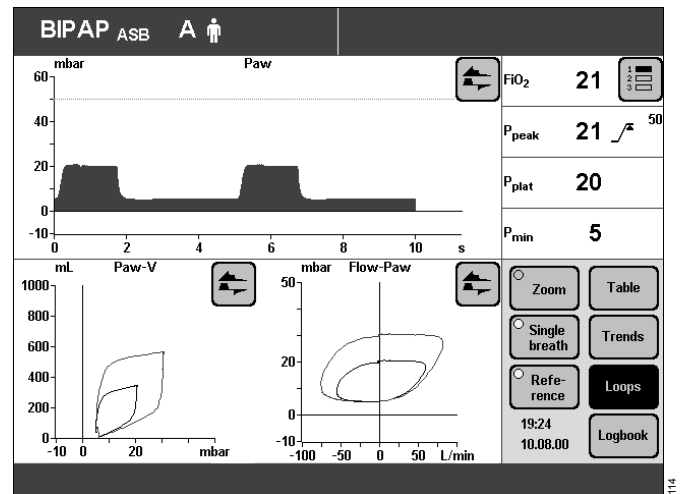

Single stroke displays

To display an individual breathing cycle in ventilation modes that have both mechanical and spontaneous components, e. g. SIMV:

- Press the »Single breath« screen key.

If no single stroke is selected for display, the entire breathing activity from mandatory stroke to mandatory stroke will be recorded.

Zoom loops (optional)

The right-hand loop can be zoomed to fill the full screen including the graphic areas at the top and bottom.

- Touch the »Zoom« screen key.

»Loops« display.

The right-hand loop is zoomed and the other loop disappears with the time-based curves.

The loop to be displayed can be selected even when zoomed. The functions »Reference« and »Single breath« are retained.

Return to the normal loop display:

- Touch the »Zoom« screen key.

The time-based curve automatically reappears when the loop page is exited.

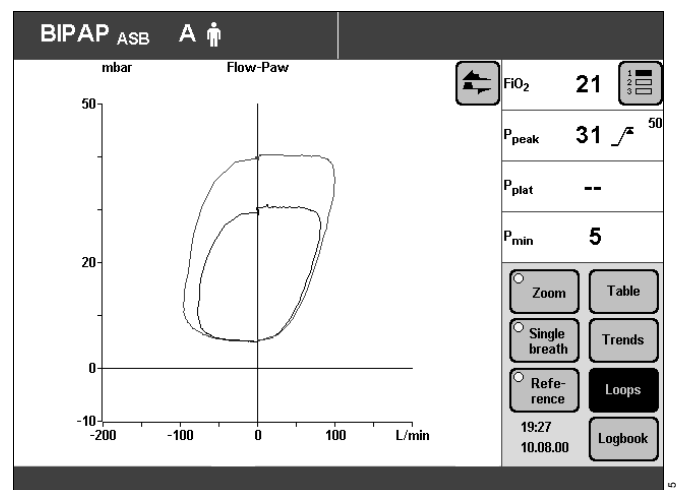

Display loops in the upper graphic area (optional)

- Touch the »▲« screen key.
- Touch the »Loops« screen key.

The time-based curves are replaced by the two loops in the upper graphic area.
The Freeze function can also be used with loops in the upper graphic area.

Loops in the upper graphic area cannot be configured when:

- the »Loops« menu is open,
- the »Configuration« key has been selected.

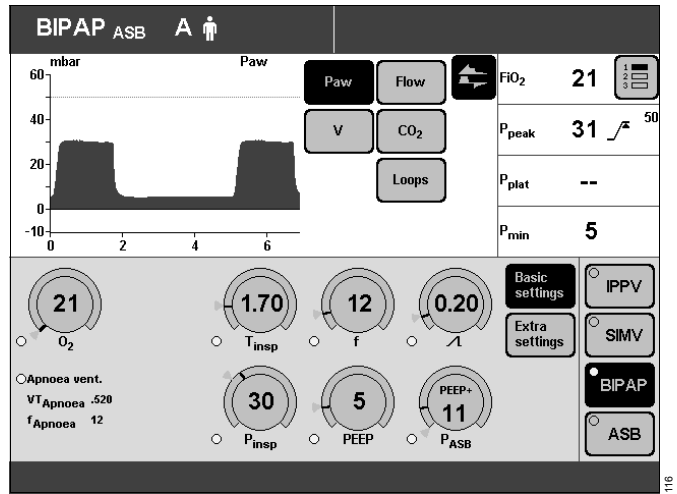

To restore the time-based curves in the upper graphic area:

- Touch the right-hand »▲« screen key.
- Touch the »Curves« screen key.

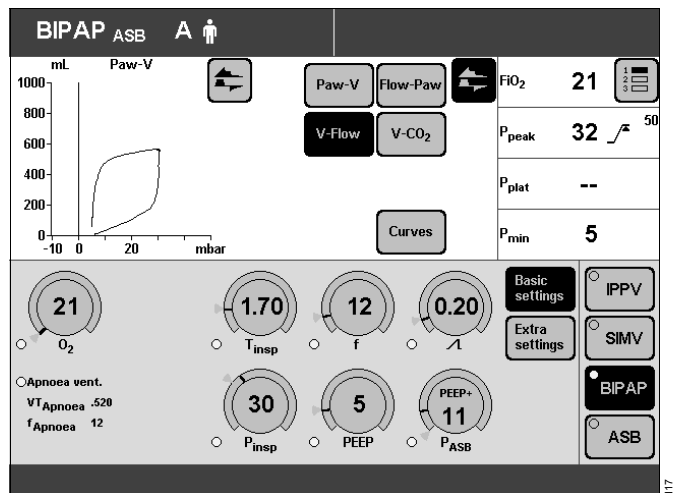

Logbook

Settings and alarms are entered in the logbook in chronological order by Evita 4.

NOTE

The number of entries is restricted to the last 1000 according to time. Older entries are deleted automatically.

The entries in the logbook are also retained after the device has been switched off and on again, or following a power supply failure.

Display logbook:

- Touch the »Logbook« screen key.

»Logbook« display (example):

Alarms and settings are presented in a vertical list in chronological order.

The status of the setting is displayed with date and time on the right, next to the logbook.

To select an older entry:

- Turn the rotary knob clockwise and position the box cursor over the desired line.

Example: 29.01. 18:06 Flow: 17 -> 28 L/min

To select a more recent entry:

- Turn the rotary knob counter-clockwise, and position the box cursor over the desired line.

Evita 4 enters all alarms in the logbook. If an alarm is not displayed on the screen immediately when it occurs, for instance because the device has signalled an alarm with higher priority, the undisplayed alarm is correspondingly highlighted with an asterisk (*) in the logbook.

Alarms are listed without asterisk if they are displayed on the screen when they occur.

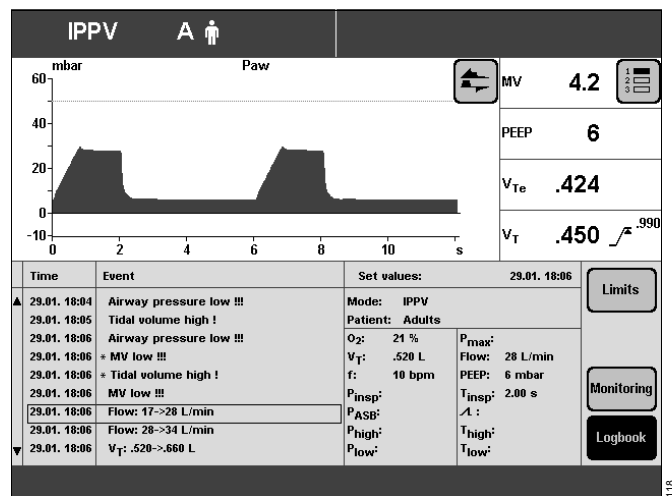

Screen freeze

To "freeze" the curves and loops (freezing loops is optional)

1 Press »**Freeze**« key.

To display the pair of measured values, a point on the curve or loop:

2 Position the cursor on the relevant point by turning the rotary knob.

The corresponding pair of measured values is displayed above and beside the curve.

The Reference key remains disabled as long as the Freeze function is active.

To display new curves / loops again:

1 Press »**Freeze**« key again.

Screen freeze mode is automatically terminated 3 minutes after the rotary control was last turned.

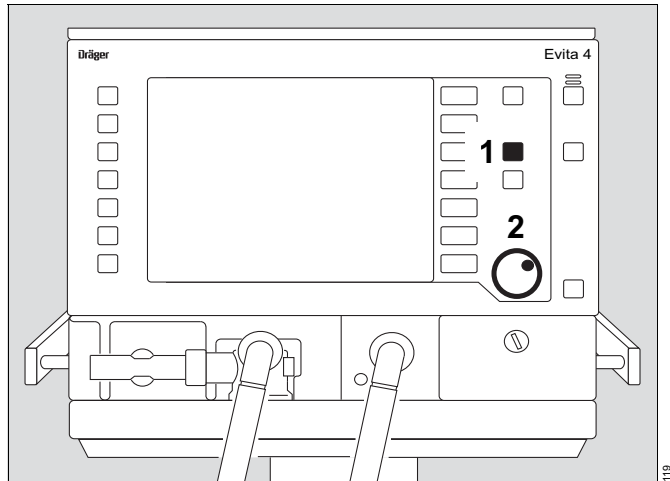

Special functions

Manual inspiration

This function may be used in all modes except CPAP without ASB pressure support.

Depending on the start time, an automatic ventilation stroke is prolonged for a maximum of 15 seconds.

Or:

Between two automatic ventilation strokes, a ventilation stroke can be manually started and held for max. 15 seconds.

The pattern of the manually started ventilation stroke corresponds to the ventilation pattern of the currently active automatic ventilation mode.

In CPAP/ASB:

a pressure-assisted ventilation stroke (defined by the PASB setting) is triggered.

- 1 Press »**Insp. hold**« key and hold it down for as long as inspiration is required.

Either a just activated automatic ventilation stroke will be prolonged or a new ventilation stroke will be started and appropriately prolonged – max. 15 seconds.

Expiration hold

This function may be used in all ventilation modes.

For determining the measured NIF* value for weaning

- 2 Hold down the »**Exp. hold**« key.

The expiration phase remains effective as long as the key is held down and Evita 4 determines the measured NIF value.

If the key is not released, the device automatically terminates the expiration phase after 15 seconds.

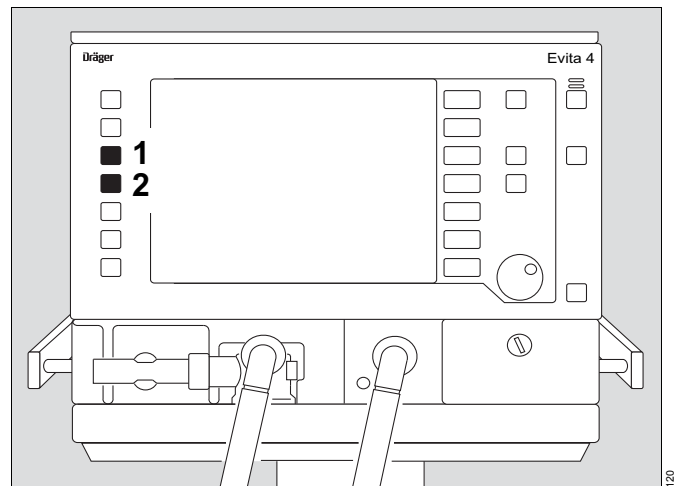

* Display NIF, refer to page 91.
For a detailed description of NIF, refer to the Annex, page 198.

Medication nebulisation

WARNING

Flammable agents must not be nebulised! They may be ignited by the glowing flow sensor.

Pneumatic medication nebuliser 8412935

During adult ventilation

Applicable in every ventilation mode.

Evita 4 applies the medicament aerosol in synchronisation with the inspiratory flow phase and maintains the minute volume constant.

The medication nebuliser is supplied by the ventilator with medical air, oxygen or a mixture of medical air and oxygen according to the set O₂ concentration. Deviations in O₂ concentration are therefore kept to a minimum. In extreme cases (with a minimum inspiration flow of 15 L/min), the deviations can be up to ± 4 Vol%*. To avoid greater deviations, medication nebulisation is automatically switched off with inspiration flows below 15 L/min.

During paediatric ventilation

Medication nebulisation is possible in the pressure-controlled paediatric ventilation modes.

In volume-controlled ventilation modes, medication nebulisation is only possible with AutoFlow[®].

Unlike in adult ventilation, the medication nebuliser nebulises continuously in paediatric ventilation, but the aerosol generated during expiration does not reach the lungs.

Depending on the set O₂ concentration, the medication nebuliser is supplied by the ventilator with medical air, oxygen or a mixture of medical air and oxygen. Deviations in O₂ concentration are therefore kept to a minimum.

We recommend that you do not use the medication nebuliser at breathing rates of less than 12 bpm.

For breathing rates above 12 bpm, please refer to the graph on page 200. The maximum possible deviations in O₂ concentration are ± 4 Vol%.

WARNING

For breathing rates of less than 12 bpm, the deviations in O₂ concentration may be much greater. These deviations cannot be detected by the device's internal O₂ concentration monitor.

WARNING

The minute and tidal volumes displayed may be considerably higher or lower than those actually applied to the patient on account of tolerances in the nebuliser flow. Pressure-controlled ventilation is therefore recommended during nebulisation. Compare the currently measured values for minute and tidal volumes with the values measured before nebulisation.

If the VT and MV values diverge strongly, the ventilation pressure can be used for assessment of the ventilation.

VT and MV values can be compared by comparing the difference between PEEP and plateau pressure before and during nebulisation.

In order to avoid false alarms and ensure monitoring:

- Adjust both alarm limits for MV in line with the actual value.
- If necessary, use additional monitors, e. g. external SpO₂.

The medication nebuliser is automatically switched off after 30 minutes.

After administration of the aerosol, the flow sensor is automatically cleaned and calibrated in order to prevent malfunctions in flow measurement.

WARNING

Only the pneumatic medication nebuliser 8412935 (with white middle part) may be used.

If other pneumatic medication nebulisers are used, there may be major deviations in tidal volume and inspiratory O₂ concentration!

- Prepare the medication nebuliser in accordance with the accompanying instructions for use.

* For a detailed description of the inspiratory O₂ Concentration During Medication Nebulisation, refer to page 200

For use during adult ventilation

- 1 Connect the nebuliser to the inspiratory side (temperature sensor side) of the Y-piece.
- 2 Connect the inspiration hose to the medication nebuliser.
- Place the medication nebuliser in the vertical position.
- Using clamps, route the nebuliser hose back to the ventilator along the expiratory hose.

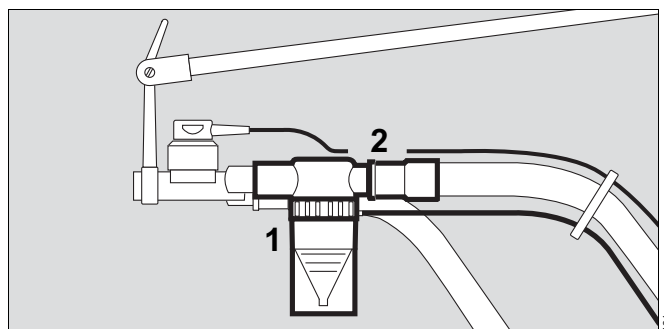
**For use during paediatric ventilation**

- 3 Insert the catheter connector (ISO cone Ø15 / Ø11) in the inlet of the medication nebuliser.
- 4 Insert the adapter (ISO cone Ø22 / Ø11) in the outlet.
- 5 Fit the corrugated hose (0.13 m long) to the outlet adapter.

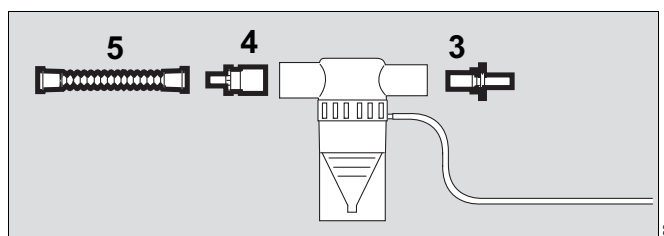

- 6 Remove the corrugated hose of the breathing circuit from the inspiratory adapter of the Y-piece and connect it to the inlet adapter of the medication nebuliser.
- 7 Connect the free end of the corrugated hose at the outlet of the medication nebuliser to the inspiratory adapter of the Y-piece.

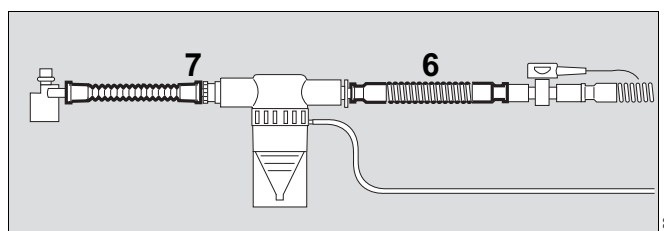

- 1 Connect the nebuliser hose to the port on the front panel of the Evita 4.
- Fill the medication nebuliser in accordance with the specific Instructions for Use.

WARNING

The effect of aerosols on sensors, the expiration valve, filters and heat and moisture exchangers (HME) must be taken into account.

The measuring function of the flow sensor may be impaired.

Aerosol residues in the expiration valve may cause it to malfunction. Depending on the medication aerosol applied, replace the expiration valve following nebulisation if necessary.

A heater increases the temperature of the expiration valve. This can increase the build-up of aerosol residue.

Do not place a bacterial filter or HME on the nebuliser outlet during nebulisation!

The flow resistance of filters is liable to increase and may impair ventilation.

WARNING

During medication nebulisation, do not use a heat and moisture exchanger (HME) at the Y-piece. Risk of increased breathing resistance!

- 2 Hold down »« key until the yellow LED lights up. Note message on-screen: »Nebuliser on !« The nebuliser operates for 30 minutes.

If medication nebulisation needs to be stopped prematurely:

- 2 Press »« key again. The yellow LED goes out, and the nebuliser is switched off.

The flow sensor is then automatically cleaned and calibrated. Screen display: »Flow Calibration«

- Remove any left-over medicament. Follow the Instructions for Use of the medication nebuliser.

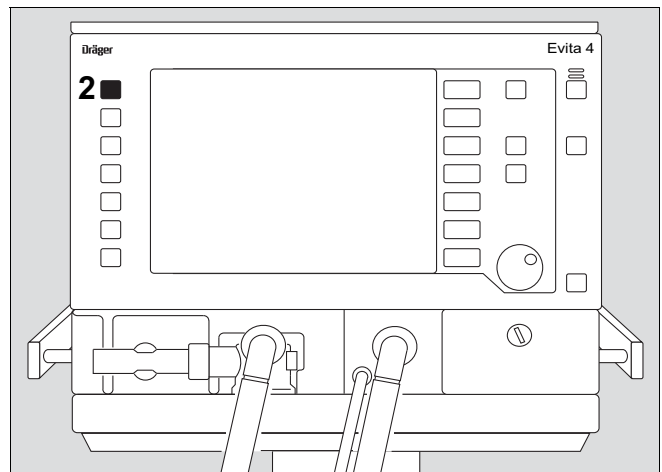
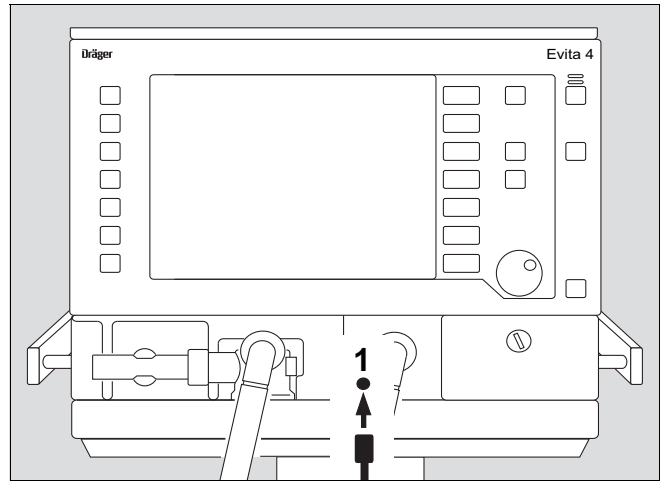

Active nebuliser "Aeroneb Pro" MP01010

- Follow the Instructions for Use of the "Aeroneb Pro" nebuliser.
- Observe the notes on the use of filters, refer to page 38.

WARNING

The effect of aerosols on sensors, the expiration valve, filters and heat and moisture exchangers (HME) must be taken into account.

The measuring function of the flow sensor may be impaired.

Aerosol residues in the expiration valve may cause it to malfunction. Depending on the medication aerosol applied, replace the expiration valve following nebulisation if necessary.

A heater increases the temperature of the expiration valve. This can increase the build-up of aerosol residue.

Do not place a bacterial filter or HME on the nebuliser outlet during nebulisation!

The flow resistance of filters is liable to increase and may impair ventilation.

WARNING

During medication nebulisation, do not use a heat and moisture exchanger (HME) at the Y-piece. Risk of increased breathing resistance!

If a filter is used in order to protect the flow sensor or the expiration valve,

- replace the filter after nebulisation or remove and
- recalibrate the flow sensor.

Aerosols distort the flow measurement!

- Do **not** switch on the "Nebulisation" function on the Evita 4. Because the pneumatic nebuliser flow not used during medication nebulisation is taken into account in the volume delivery, the tidal volume delivered by the Evita 4 would be too low.

Oxygen enrichment for bronchial suction

To avoid any risk of hypoxia during bronchial suction, Evita 4 offers a program for oxygen enrichment during the removal of secretions.

After the program is started, Evita 4 ventilates the patient in the selected ventilation mode for an initial oxygen enrichment phase of 180 seconds.

- In adult mode, the ventilator supplies 100 % oxygen by volume, and in paediatric mode it delivers the set O₂ concentration plus 25 % (for example: setting = 60 % by vol.; administered = 75 % by vol.)

When the ventilator is disconnected for suction, the Evita 4 interrupts ventilation for 120 seconds. During the suction phase, the audible alarms associated with the disconnection are suppressed.

After suction and automatically recognised reconnection, Evita 4 delivers an increased O₂ concentration for the final oxygen enrichment phase of 120 seconds.

- In adult mode, the O₂ concentration is 100 % by volume. In paediatric mode, the enriched concentration is 25 % higher than the set concentration.

During suction and for 2 minutes afterwards, the lower alarm limit for the minute volume is switched off.

Other alarms are switched off during suction and for 15 seconds afterwards.

NOTE

Oxygen enrichment is only possible with a fully functioning flow sensor and if flow monitoring is switched on!

Before suction

- 1 Hold down the »O₂ ↑ Suction« key until the yellow LED comes on.

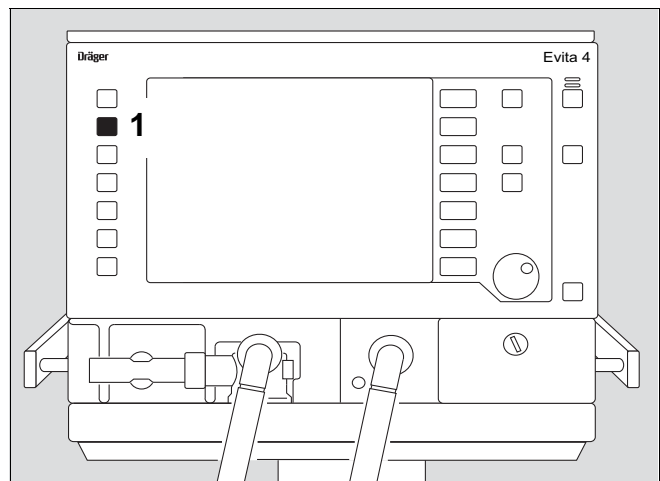

Evita 4 ventilates the patient in the set ventilation mode with increased O₂ concentration: 100 % O₂ by volume in adult mode, and 25 % higher O₂ concentration than the set value in paediatric mode.

If PEEP is not set to more than 4 mbar, PEEP will be applied automatically at 4 mbar. This PEEP will enable Evita 4 to detect any subsequent disconnection. The other ventilation parameters remain unaffected.

Display in the help line at the bottom edge of the screen:

»**O₂ enrichment 180 s**«

The remaining time is counted down continuously. This initial oxygen enrichment lasts for a maximum of 180 seconds. During this time, Evita 4 waits for a dis-connection for suction. If there is no disconnection after expiry of the 180 seconds, the oxygen enrichment program is terminated.

After disconnection for suction

Evita 4 delivers a minimal flow for the duration of suction in order to detect automatically the end of the disconnection phase. In the help line at the bottom edge of the screen, the time available for suction is displayed continuously in seconds (example):

»**Execute suction and reconnect 120 s**«

If suction is ended and the system is reconnected within the displayed time, Evita 4 terminates the disconnection phase.

Automatic interruption of oxygen enrichment

If there is still no reconnection after 120 seconds, the oxygen enrichment program is interrupted. All alarms are immediately reactivated. Evita 4 continues ventilating in the set ventilation mode.

After reconnection

After reconnection, Evita 4 continues ventilating in the set ventilation mode, except that for 120 seconds the increased oxygen concentration of 100 % by volume for adults and 25 % above the set concentration for paediatric ventilation will continue to be delivered for final (post-suction) oxygen enrichment.

Display in the help line at the bottom of the screen:

»**Final O₂ enrichment 120 s**«

The remaining time is counted down continuously.

If you need to interrupt oxygen enrichment:

1 Press the »**O₂ ↑ Suction**« key again.

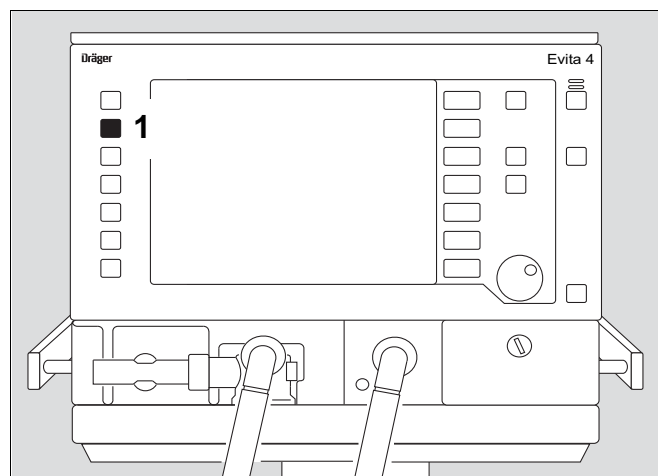

Special measuring procedure: Intrinsic PEEP

Intrinsic PEEP* is the actual end-expiratory pressure in the lung.

Due to the dynamics of lung mechanics (resistance, compliance and closing volume) and the ventilation setting parameters, the intrinsic PEEP differs from the PEEP in the upper airways.

The Intrinsic PEEP measuring procedure also measures the trapped volume resulting from the different PEEP values, i.e. the amount of air trapped in the lungs and not taking part in the gas exchange process.

This special procedure can be performed in all ventilation modes.

WARNING
Activity by the patient during this procedure can distort the measured values.

Select the Intrinsic PEEP special procedure:

- Press the »**Special procedure**« key and touch the »**PEEPi**« screen key.

Display (example):

The measured values and the time of the last measurement are displayed on the screen.

To start the Intrinsic PEEP measurement:

- Touch the »**Start**« screen key.

The Intrinsic PEEP measurement runs automatically. At the end of the procedure, the new measured values PEEP_i and V_{trap} are displayed.

The displayed curve is automatically stopped.

To evaluate the measured value at a particular time:

- Position the ▼-cursor on the time by turning the dial knob. The associated measured value is displayed above the curve.

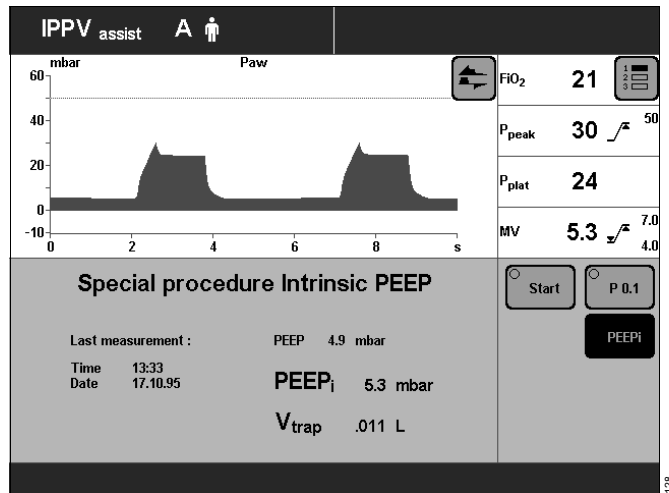

* Please refer to page 199 for a detailed description of Intrinsic PEEP.

P 0.1 occlusion pressure measuring procedure

The occlusion pressure P 0.1 characterises the negative pressure during a short occlusion (0.1 s) at the start of spontaneous inspiration.

It is a direct measure of the neuro-muscular breathing drive.

For patients with healthy lungs and regular breathing P 0.1 is -3 to -4 mbar.

High values represent a high breathing drive which can only be maintained for a short time.

Values below -6 mbar for a patient with chronic obstructive pulmonary disease indicate impending exhaustion (respiratory muscle fatigue).

This special measuring procedure can be used in all ventilation modes in order to check the breathing drive of a spontaneously breathing patient or to assess the amount of spontaneous breathing during controlled ventilation.

To select the P 0.1 occlusion pressure measuring procedure:

- Press the »**Special procedure**« key and touch screen key »**P 0.1**«.

Display (example):

The measured value and time of the last measurement is displayed on the screen.

To start the P 0.1 occlusion pressure measuring procedure:

- Touch the »**Start**« screen key.

The P 0.1 special procedure runs automatically.

At the end of the procedure, the displayed curve is automatically stopped.

To evaluate the measured value at a particular time:

- Position the ▼-cursor on the time by turning the dial-knob.
- The relevant measured value is displayed above the curve.

Evita 4 displays the P 0.1 value as a negative pressure without the minus sign.

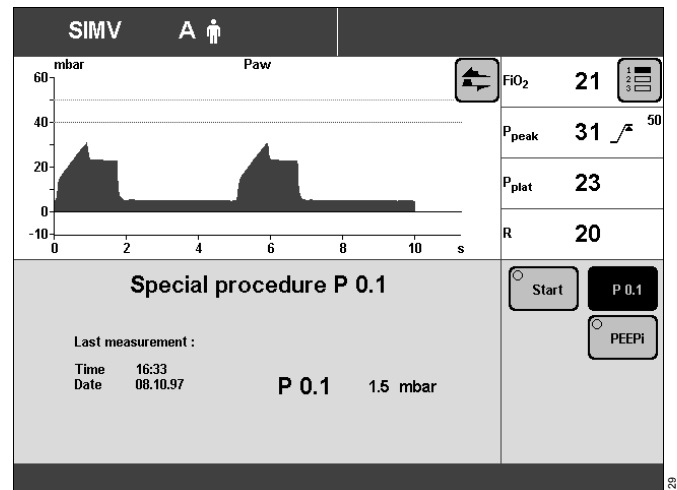

Switching off monitor functions

O₂ monitoring

Switch off O₂ monitoring if a spent O₂ sensor cannot be replaced at the moment for instance.

When the O₂ monitoring function is switched off, the indicator for the FiO₂ measured value and monitoring of the inspiratory O₂ concentration is switched off.

The O₂ monitoring function can be replaced by an adequate external replacement monitoring function. The O₂ alarm limits of the replacement monitoring function must be set in accordance with the current FiO₂ setting:

FiO₂ <60 Vol% → Alarm limits O₂ ±4 Vol%

FiO₂ ≥60 Vol% → Alarm limits O₂ ±6 Vol%

WARNING

Set up an appropriate external O₂ monitoring function immediately!

Flow monitoring

The monitoring function should only be switched off temporarily if a spent flow sensor cannot currently be replaced. Replace flow sensor immediately, calibrate flow sensor and switch on flow monitoring again.

When the flow monitoring function is switched off, the indicators for flow and the calculated readings, such as tidal volumes and minute volumes for instance, and the monitoring function for the minute volume are switched off.

The expiratory flow monitoring function cannot be fully replaced by an adequate external replacement monitoring function. The MV alarm limits of the replacement monitoring function must be set accordingly.

WARNING

Without an expiratory flow sensor, ventilation functions are restricted. A spent or disconnected expiratory flow sensor can lead to deviations in the minute and tidal volumes, in the PEEP and inspiratory pressure, or cause self-triggering. Depending on the lung characteristics (resistance and compliance) a deactivated flow monitoring function may affect oxygenation of the patient and CO₂ elimination.

Replace spent expiratory flow sensor immediately, calibrate flow sensor and switch on the flow monitoring function again.

WARNING

If the flow monitoring function is switched off while an expiratory flow sensor that is plugged in is functioning, the flow sensor will continue to be used to control the ventilation function. Failure of the flow sensor, however, is not monitored and does not trigger an alarm.

Hence a spent or incorrectly connected flow sensor is not recognised by Evita 4. Deviations in the minute and tidal volumes, in the PEEP and inspiratory pressure, or self-triggering may result. Depending on the lung characteristics (resistance and compliance) a deactivated flow monitoring function may affect oxygenation of the patient and CO₂ elimination.

Switch on the flow monitoring immediately.

Example: Switching off Flow Monitoring.

- Press »Alarm limits« key.

Display (example):

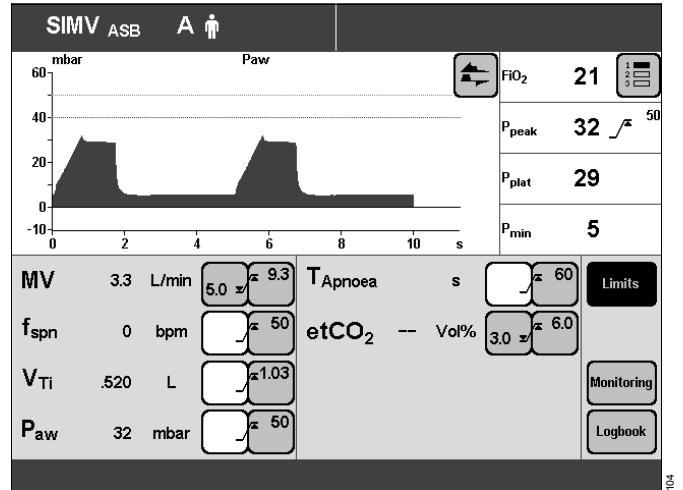

- Touch »Monitoring« screen key.

Display (example):

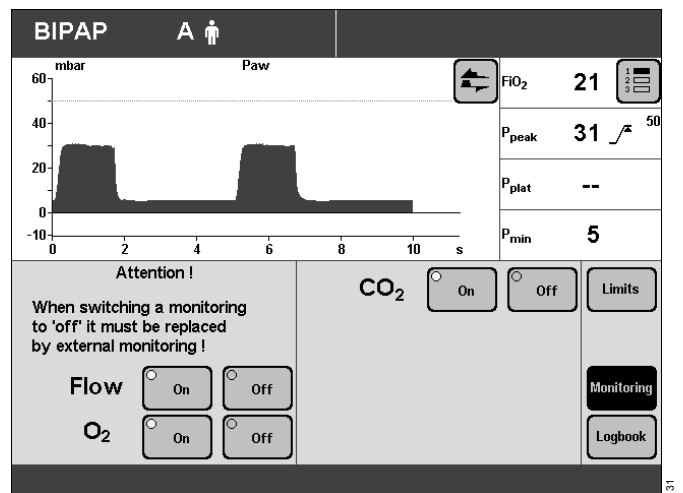

For the example of switching off flow monitoring:

- Touch the »Flow Off« screen key.
The key changes colour from green to yellow

To confirm that you wish to switch off Flow Monitoring:

- Press rotary knob. Flow Monitoring is switched off, and the corresponding measured values disappear. The alarm function is switched off.

After replacing the sensor:

- Switch the monitor function back on.

Selecting standby mode

- to perform the device check,
- to maintain Evita 4 ready for operation while the patient is absent,
- to change patient mode.

WARNING

**Ventilation does not take place in standby mode!
Only switch the device to standby when no patient is connected to the device. Otherwise, there may be danger to the patient!**

- 1 Hold down the »⏻« key for about 3 seconds.
An alarm tone sounds after switching on standby.

To switch off the standby alarm tone:

- 2 Press »Alarm Reset« key.
The standby alarm tone cannot be suppressed with the »🔔« key.

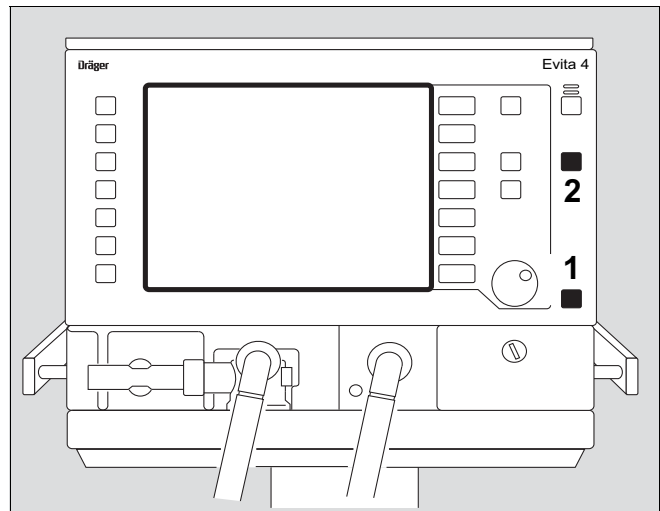

Display (example):

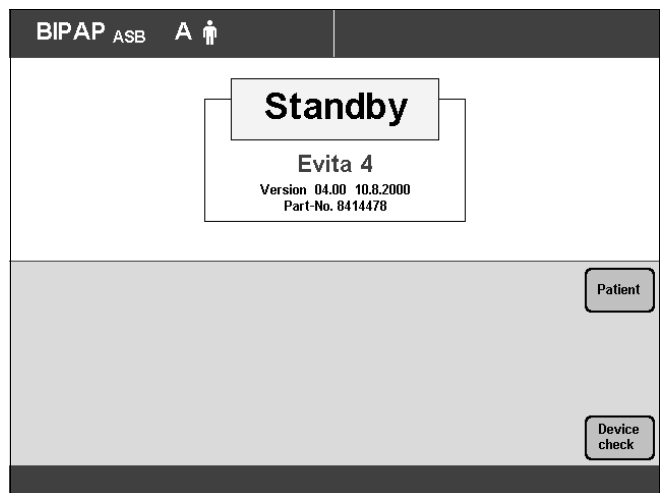

If the patient mode or ideal body weight should be changed during Standby, Evita 4 will determine new start values for ventilation, refer to page 64.

Terminating standby mode

- to continue ventilation.
- 1 Press »⏻« key.
The LED goes out, and the current ventilation parameters are again effective.

Calibrating

The last calibration/zeroing values remain stored until the next calibration/zero calibration, even when the machine is switched off.

Calibration of the pressure sensors for measuring the airway pressure is automatic.

The flow sensor and O₂ sensor are automatically calibrated once per day.

Manual calibration of the flow sensor can be performed at any time, even during ventilation.

Manual calibration of the O₂ sensor can be performed at any time, even during ventilation. The applied O₂ concentration is not affected by calibration.

The calibration of the CO₂ sensor can be checked during ventilation.

Calibrating the O₂ sensor

- Before operation, during the device check.
- After replacing the O₂ sensor (wait for the 15 minute warmup time of the O₂ sensor).
- If the measured value and set value deviate from each other by more than 2 Vol%.

The O₂ sensor can be calibrated during ventilation.

Start calibration:

- Press »**Calibration**« key.

Display (example):

- Touch the »**O₂**« screen key.

The LED in the screen key changes colour to yellow.

Message in the help line at the bottom of the screen:

»**O₂-calibration**«

After calibration is complete, the yellow LED in the screen key goes out.

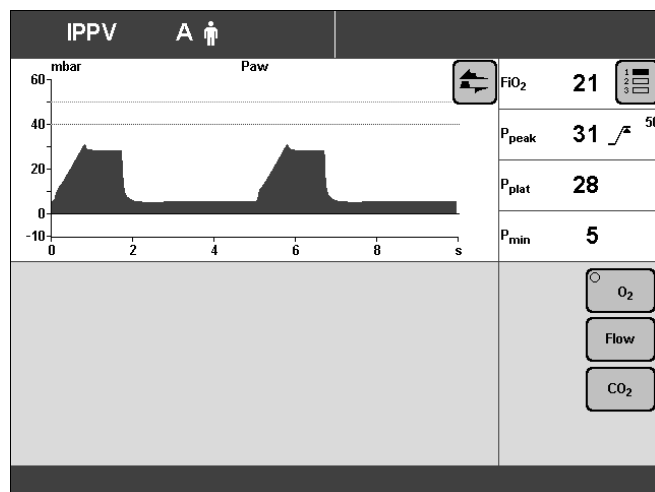

Calibrating the flow sensor

- Before operation, during the device check.
- After replacing the flow sensor.

The flow sensor is automatically cleaned before each calibration.

After using the medication nebuliser, the flow sensor is automatically cleaned and calibrated.

WARNING

Avoid flammable gases (e. g. alcohol vapours after disinfection).

Flow sensors which have been disinfected in ethanol must be aired for at least 30 minutes.

To start calibration:

- Press the »**Calibration**« key.
- Touch the »**Flow**« screen key.
- Touch the »**Cal. Start**« screen key.
The LED in the screen key turns yellow.

Display:

Evita 4 uses the next inspiration phase for the calibration. Short inspiration times are prolonged to about 1 second. Message in the help line at the bottom of the screen:

»**Flow calibration**«

The yellow LED in the screen key goes out when calibration is complete.

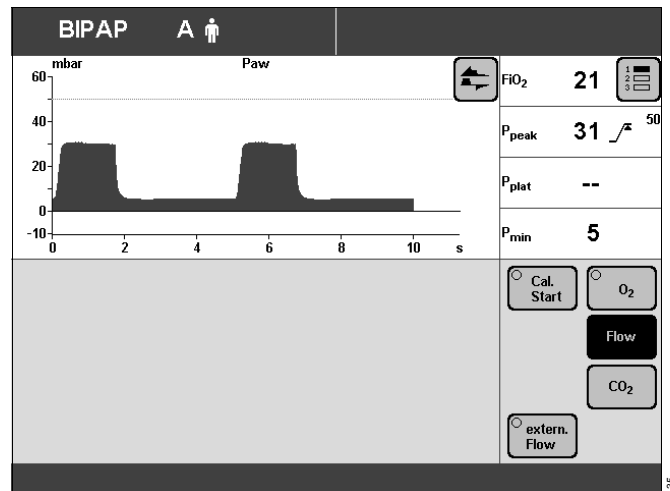

External flow source

When a constant external flow of up to 12 L/min is supplied (e. g. for medication nebulisation with separate gas supply or for separate tracheal gas insufflation TGI), this flow can be calculated by the unit and the tolerance increased for the flow sensor monitoring parameters in order to avoid generation of the alarm »**Flow measurement inop. !!!**« during these applications. The originally measured expiratory volume is maintained: The Evita 4 measures a correspondingly higher value for V_{Te} and MV. The V_{Ti} displayed is too low. The tidal volume actually applied to the patient during volume-controlled ventilation is higher than that set. Pressure-controlled ventilation is therefore recommended in combination with an external flow.

In order to avoid false alarms and ensure monitoring:

- Adjust both alarm limits for MV in line with the actual value.
- If necessary, use additional monitors, e. g. external SpO₂.

For initial calculation of the external flow:

- Start external flow.
- Press the »**Calibration**« key.
- Touch the »**Flow**« screen key.
- Touch the »**extern. Flow**« screen key.
- Touch the »**Measure**« screen key, confirm = press rotary knob.
- Yellow LED in »**Measure**« key lights up.

Evita 4 calculates the external flow.

The following message is displayed on Evita 4 during this time: »**External flow is being measured**«

When the external flow is calculated the Evita 4 displays it with time and date.

The following prompt is also displayed on Evita 4:

»**Confirm value with**  «

- Confirm = press rotary knob.

Calculation of the external flow is interrupted by Evita 4 if it is greater than 12 L/min or the flow measurement function is defective.

Once the external flow has been calculated successfully, it is taken into account automatically:

The yellow LED in the »**On**« key lights up.

The advisory message

»**External flow !**«

is displayed as long as the external flow is taken into account by Evita 4.

If an external flow is not applied:

- Switch off: touch the »**Off**« key, confirm = press rotary knob.

Once the value of the external flow has been calculated by Evita 4, its inclusion can be reactivated at any time:

- Touch the »**On**« screen key, confirm = press rotary knob.

If the external flow changes:

- Touch the screen key »**Measure**« again and the new external flow is calculated by the Evita 4.

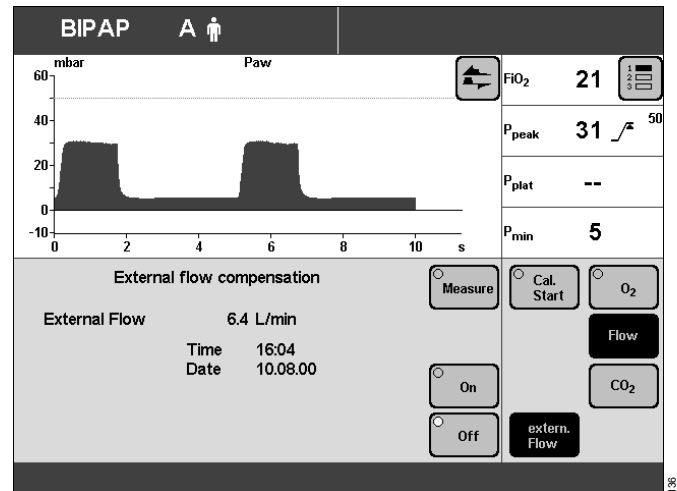

Zero/check/calibrate CO₂ sensor

(if CapnoPlus option is installed)

The CO₂ sensor is works-calibrated and can be used without further calibration on any Evita 4 unit.

Before measurement and when transferring the sensor to another Evita 4, the zero indication of the sensor should be checked and zero calibration performed if required.

- When using reusable cuvettes, on the device-side park bracket.
- When using disposable cuvettes, on a disposable cuvette only.

WARNING

The cuvette windows of the reusable cuvette and the park bracket have different optical properties in comparison with the cuvette windows of disposable cuvettes. When using reusable cuvettes, zero calibration must only be performed on the device-side park bracket or on a clean reusable cuvette and not on a disposable cuvette.

When using disposable cuvettes, zero calibration must only be performed on a new disposable cuvette and not on the device-side park bracket or on a reusable cuvette.

Otherwise there will be a zero point deviation of up to ± 1 Vol.% CO₂.

CO₂ zero calibration is performed as part of the device check. However, zero calibration can also be performed manually at any time.

There must not be any increased CO₂ concentration between the windows of the park bracket when checking the zero indication or performing zero calibration. In other words only the background concentration of approx. 0.4 Torr or 0.05 % by volume normally present in rooms may be present.

For this reason:

- Do not breathe onto the park bracket when checking the zero indication or performing zero calibration.

The calibration (sensitivity) of the sensor can be roughly checked with the test filter attached to the sensor lead; it can be checked more precisely with calibration gas.

Calibration must be checked with calibration gas:

- if the result of testing with the test filter is unsatisfactory,
- but at least every six months in conjunction with the device inspection.

Recalibration of the sensor is only required if the specified calibration values are not met when testing calibration with the calibration gas.

Zero calibration on the park bracket, testing of the calibration with test filter or calibration gas and recalibration of the sensor can all be performed during ventilation.

Error messages relating to CO₂ measurement can be found in the chapter "Alarm – Cause – Remedy" starting on page 141.

Notes concerning the alarm »**CO₂ sensor? !!!**«:

If the message »**CO₂ sensor? !!!**« is displayed although the sensor is connected and the cuvette is fitted, it may be that the windows on the park bracket, the disposable cuvette used for zeroing or the windows of the sensor are soiled:

- When using reusable cuvettes, perform zero calibration on the cleaned park bracket with cleaned sensor and do not breathe in the direction of the park bracket.
- When using disposable cuvettes, only perform zero calibration on a new disposable cuvette with cleaned sensor and do not breathe in the direction of the cuvette.

If, when using a reusable cuvette, the dirt on the park bracket cannot be removed:

- Perform zero calibration on a clean reusable cuvette – particularly with clean windows – in room air, and do not breathe in the direction of the cuvette.
- To replace the park bracket, call DrägerService.

Notes concerning the alarm »**CO₂ zero ? !!!**«:

- Check whether the cuvette windows are soiled, clean the reusable cuvette if necessary or use a different, clean reusable cuvette

or

- use a new disposable cuvette (if a disposable cuvette was used previously).

Despite design measures to minimize the zero shift, major soiling of the cuvette windows, e. g. with deposits due to medication nebulisation, may result in a zero shift with incorrect CO₂ measured values long before the alarm »**Clean CO₂ cuvette !!!**« appears due to excessively low intensity of the measuring light.

If the message »**CO₂ zero? !!!**« does not subsequently disappear or if the measured values remain suspect, a zero calibration must be performed:

- When using a reusable cuvette on a clean park bracket, do not breathe in the direction of the park bracket.
- When using disposable cuvettes on a disposable cuvette only, do not breathe in the direction of the cuvette.

If the measured values are still suspect:

- Perform zero calibration on a clean cuvette in room air, taking care not to breathe in the direction of the cuvette, and continue measurement with the cuvette used for zero calibration.

Notes concerning the message »**CO₂-cal./-zero/-check impossible**« in the bottom line of the screen:

If the message »**CO₂-cal./-zero/-check impossible**« appears after pressing the screen key »**Zero**«, »**Filter Check**«,

»**Gas Check**« or »**Cal.**« either:

– the CO₂ sensor has not been plugged in,

● connect CO₂ sensor

or

– the CO₂ sensor is defective,

● replace CO₂ sensor

or

– the CO₂ electronics in the unit is defective,

● call DrägerService.

Performing CO₂ zero calibration when using reusable cuvettes

Only possible with a clean park bracket and clean sensor!

- Switch on Evita 4 and wait at least 3 minutes for the CO₂ sensor to complete its warm-up phase.

After three minutes, the measured values will be inside the specified tolerance range.

- Press the »**Calibration**« key.
- Touch the »**CO₂**« screen key.

Display (example):

- Touch the »**Zero**« screen key.

Message:

»**Park CO₂ sensor**
Confirm with «

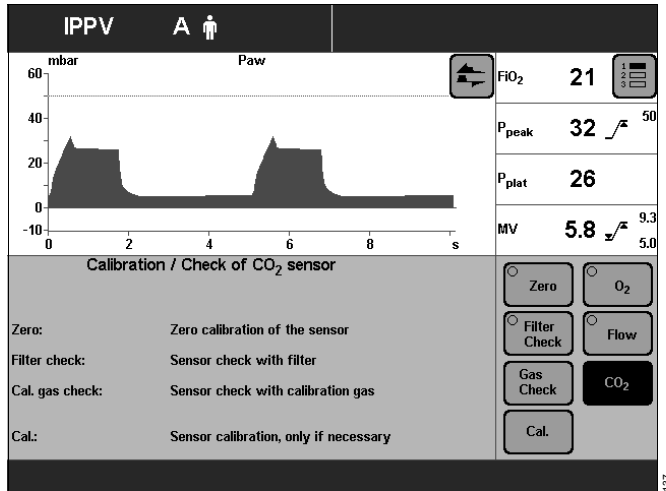

- 1 Remove CO₂ sensor from the cuvette,

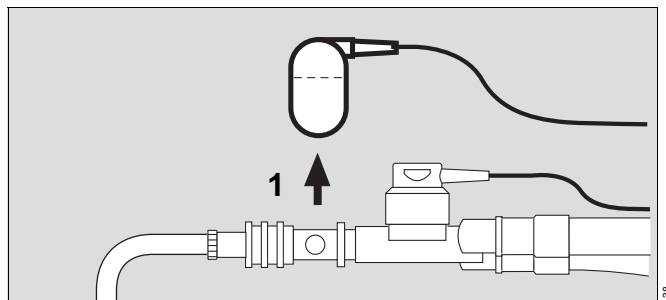

- 2 place the sensor on its park bracket, taking care not to breathe onto the park bracket.

- Confirm with rotary knob.

CO₂ zero calibration will now be performed.

Display:

»**CO₂ zero calibration**«

After about 5 seconds, the device confirms with the message:

»**CO₂ zero ok**«

- Fit the sensor back on the cuvette.

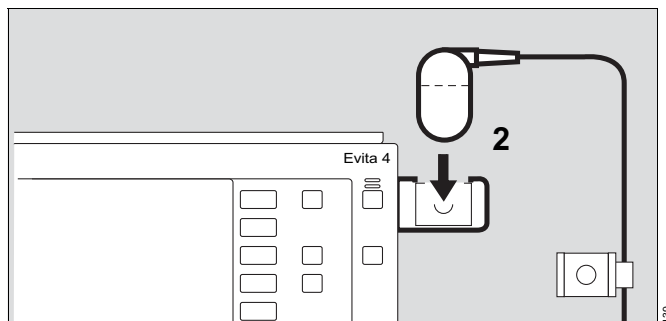

Incorrect zero calibration is indicated by the Evita 4 with the following message:

»**CO₂ sensor not zeroed**«

- Repeat CO₂ zero calibration.

If zero calibration is still impossible:

- Check whether the park bracket or sensor is soiled and clean it if necessary.

If the sensor is defective:

- Replace sensor and repeat zero calibration.

Performing CO₂ zero calibration when using disposable cuvettes

Only possible with a new disposable cuvette and clean sensor!

- Switch on Evita 4 and wait at least 3 minutes for the CO₂ sensor to complete its warm-up phase.

After three minutes, the measured values will be inside the specified tolerance range.

- Press the »**Calibration**« key.
- Touch the »**CO₂**« screen key.

Display (example):

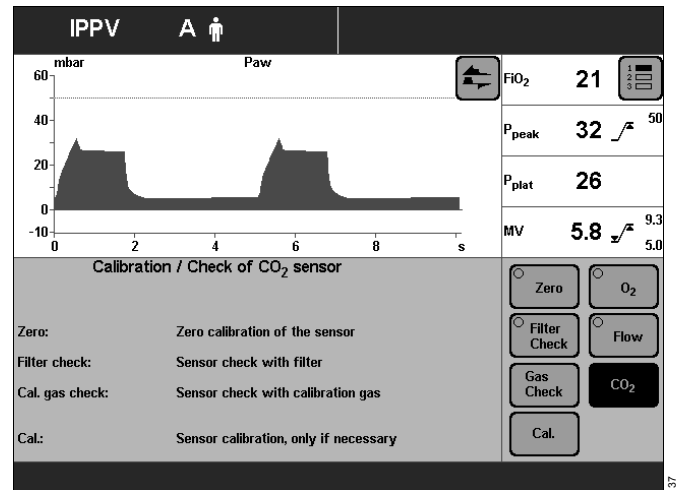

- Touch the »**Zero**« screen key.

Message:

»**Park CO₂ sensor**
Confirm with 

- Attach the **CO₂** sensor to a new disposable cuvette, which must not be installed in the ventilation hose system. Perform the calibration in the ambient air and do not breathe in the direction of the cuvette. It is not essential that zero calibration be performed on the cuvette that is to be used for measurement, but rather it is sufficient to perform zero calibration on an unused, identical disposable cuvette.

WARNING

When using disposable cuvettes, zero calibration must only be performed on a new disposable cuvette and not on the device-side park bracket. Do not breathe in the direction of the cuvette. Otherwise there will be a zero point deviation of up to 1 Vol% CO₂.

- Confirm with rotary knob.

CO₂ zero calibration is now performed by Evita 4.

Display:

»**CO₂ zero calibration**«

After approx. 5 seconds, Evita 4 confirms with the message:

»**CO₂ zero OK**«

Incorrect zero calibration is indicated by the unit with the following message: »**CO₂ sensor not zeroed**«

- Repeat CO₂ zero calibration.

If zero calibration is still impossible:

- Check whether the sensor is soiled and clean it if necessary.

If the sensor is defective:

- Replace sensor and repeat zero calibration.

Checking CO₂ calibration with test filter

- Perform once a month.

CAUTION

Before checking with the test filter, perform CO₂ zero calibration on the park bracket or on a clean reusable cuvette and not with a disposable cuvette. The check with test filter will otherwise exceed the tolerance range.

Use the test filter on the cable of the CO₂ sensor.

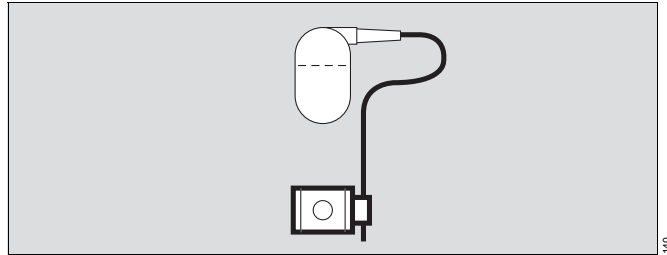

- Switch on Evita 4, and wait for about 3 minutes for the CO₂ sensor to complete its warm-up phase.

- Press the »**Calibration**« key.
- Touch the »**CO₂**« screen key.

Display (example):

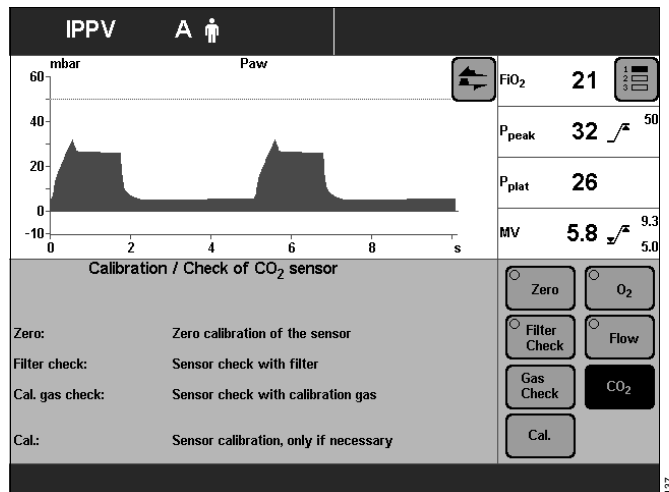

- First, perform CO₂ zero calibration on the park bracket or a clean, reusable cuvette, see "Performing CO₂ zero calibration when using reusable cuvettes", page 114, then
- Touch the »**Filter Check**« screen key.

Display (example):

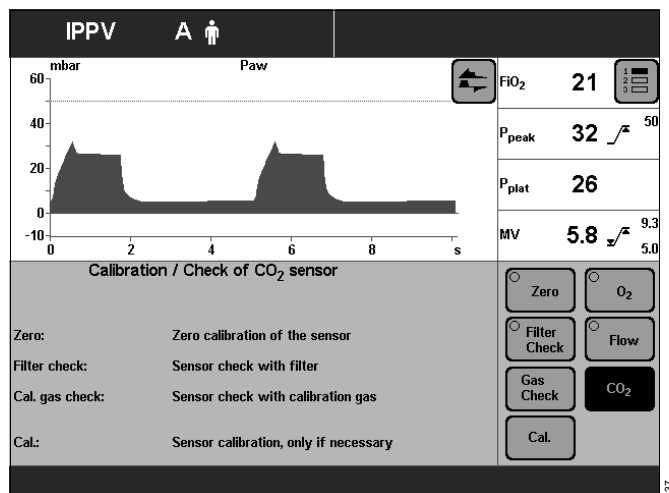

- Place the test filter in the CO₂ sensor.

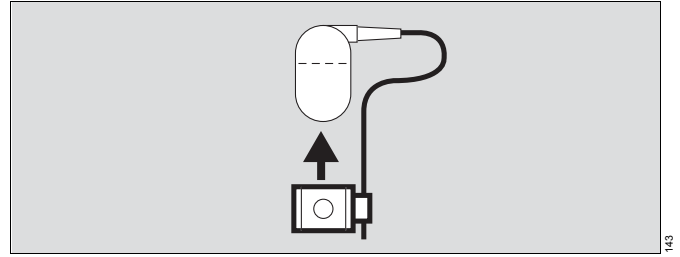

The screen displays the test value of the CO₂ concentration FCO₂.

This value must agree to within ± 0.3 Vol% with the specification on the test filter.

Example: 4.1 Vol% on the filter:

permitted value range: 3.8 to 4.4 Vol%

If the test value is outside the permitted tolerance, the test gas must be checked or calibrated.

- Push the CO₂ sensor back on to the cuvette.

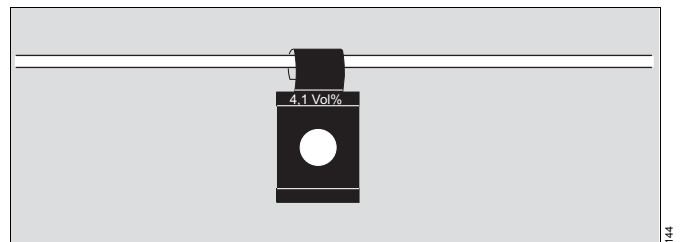

Checking CO₂ calibration with calibration gas

- If the specified calibration value was not met when testing with the test filter
- at least once every six months.

WARNING

Do not use test gases containing N₂O for testing and calibration purposes. Using test gases containing N₂O can result in indication deviations of ±0.5 Vol% CO₂.

CAUTION

Checking of the CO₂ calibration with calibration gas can only be performed after zero calibration has been performed on the park bracket or on a clean, reusable cuvette. After zero calibration on a disposable cuvette and subsequent checking of the CO₂ calibration with calibration gas with the cuvette from the calibration set, deviations of more than 2 Vol% CO₂ may occur.

- Switch on Evita 4 and wait at least 3 minutes for the CO₂ sensor to complete its warm-up phase.

- Press the »**Calibration**« key.
- Touch the »**CO₂**« screen key.

Display (example):

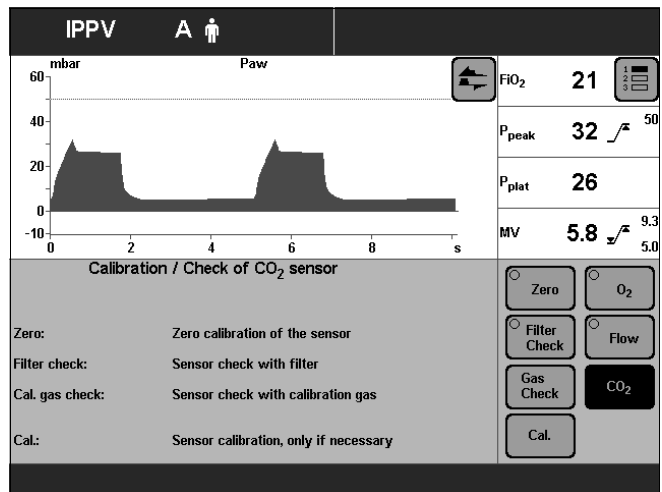

- First, perform CO₂ zero calibration, see "Performing CO₂ zero calibration when using reusable cuvettes", page 114, then

- Touch the »**Gas Check**« screen key.

Display (example):

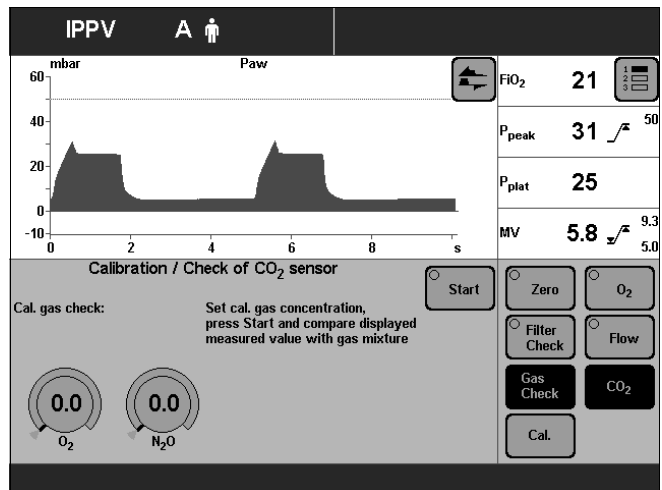

- Connect the calibration gas supply.
Use the cuvette from the calibration set!
- 1 Connect the calibration gas cylinder and cuvette of the calibration set to the hose.
- 2 Remove the CO₂ sensor from its park bracket and fit it to the calibration set cuvette.
- 3 Read the CO₂ and O₂ concentration (if applicable) of the calibration gas from the calibration gas cylinder.

Enter these concentrations with the screen setting knob:

- Touch the screen knob,
- enter the concentration = turn knob,
- confirm = press knob.

If the calibration gas comprises CO₂, O₂ and N₂:

- Enter the O₂ concentration read from the cylinder and set the N₂O concentration to »0«.

If the calibration gas comprises CO₂ and N₂ only:

- Set the O₂ and N₂O concentration to »0«.

- Touch the »**Start**« screen key.

The CO₂ concentration **FCO₂** is displayed on-screen.

After approx. 10 seconds, the FCO₂ value should match to within ± 0.2 Vol% the CO₂ content of the calibration gas read from the calibration gas cylinder.

If the calibration value is outside the permitted tolerance, the CO₂ sensor must be recalibrated with test gas.

- Push CO₂ sensor back on the cuvette.

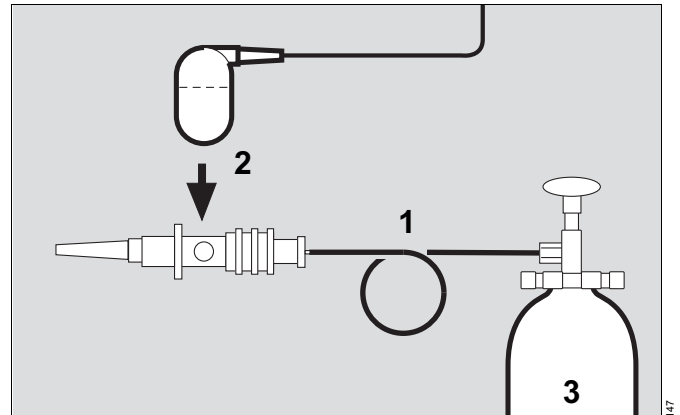

Calibrating the CO₂ sensor

- If the check values are not met on checking calibration with filter or calibration gas.

WARNING
Do not use test gases containing N₂O for testing and calibration purposes. Using test gases containing N₂O can result in indication deviations of ±0.5 Vol% CO₂.

WARNING
Calibration of the CO₂ sensor with calibration gas can only be performed after zero calibration has been performed on the park bracket or on a clean, reusable cuvette. After zero calibration on a disposable cuvette and subsequent calibration of the CO₂ sensor with calibration gas with the cuvette from the calibration set, deviations of more than 2 Vol% CO₂ may occur. These deviations can lead to a misinterpretation of the patient's respiratory status during ventilation.

- Switch on Evita 4 and wait at least 3 minutes for the CO₂ sensor to complete its warm-up phase.

- Press the »Calibration« key.
- Touch the »CO₂« screen key.

Display (example):

- First, perform CO₂ zero calibration, see "Performing CO₂ zero calibration when using reusable cuvettes", page 114, then

- Touch the »Cal.« screen key.

Display (example):

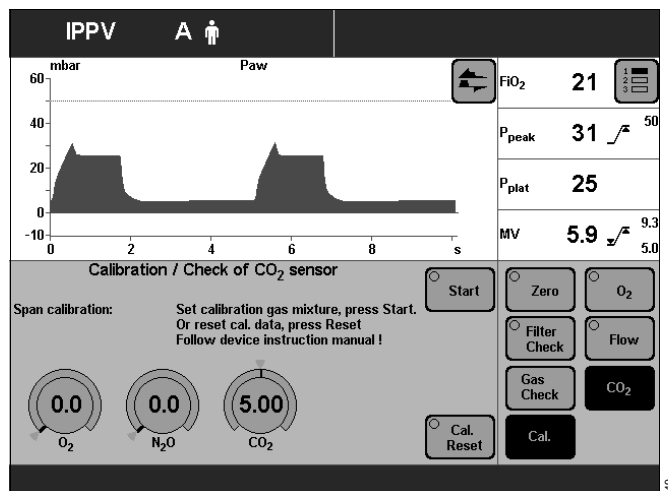
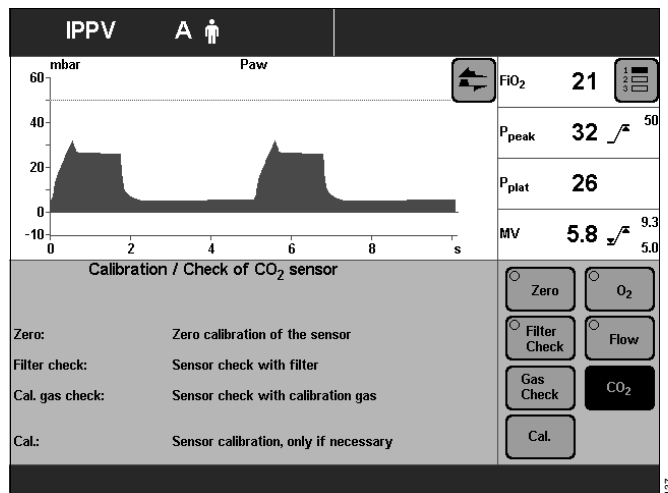

- Connect the calibration gas supply.
Use the cuvette from the calibration set!
- 1 Connect the calibration gas cylinder and the cuvette of the calibration set to the hose.
- 2 Remove the CO₂ sensor from its park bracket and fit it to the cuvette of the calibration set.
- 3 Read the CO₂ and O₂ concentrations (Vol%) of the calibration gas from the test cylinder.

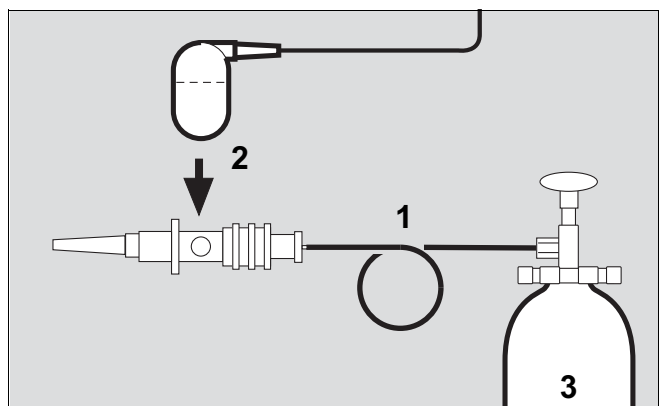

Enter these concentrations with the screen setting knob:

- touch the screen knob,
- enter the concentration = turn knob,
- confirm = press knob.

- Set the N₂O concentration to »0«.

When using the standard calibration gas
(5 Vol% CO₂ and 95 Vol% N₂):

- Set the O₂ and N₂O concentration to »0«, and the
CO₂ concentration to »5«.

- Touch the »Start« screen key.

During calibration, the following message is displayed on the screen:

»CO₂ calibration. Please wait«

Evita 4 carries out calibration and confirms with the message:

»CO₂ calibration ok«

Failed calibration is indicated by the device with the message:

»CO₂-calibration interrupted«

or

»CO₂-calibration not ok«

- Repeat the calibration of the CO₂ sensor.

If calibration still proves impossible, the CO₂ concentration value entered may not be the same as that in the cylinder:

- Check CO₂ value entered,

or

calibration gas cylinder is empty:

- Use a new calibration gas cylinder

or

sensor is defective:

- Replace sensor.

Resetting CO₂ calibration

– If calibration with calibration gas was unsuccessful, the factory-set calibration value can initially be used.

- Press »**Calibration**« key.
- Touch »**CO₂**« screen key.
- On the CO₂ calibration side, touch the »**Cal.**« screen key and then touch the »**Cal. Reset**« screen key.

After about 5 seconds, resetting is complete, and the factory-set calibration value is active.

- Test sensor with calibration gas!

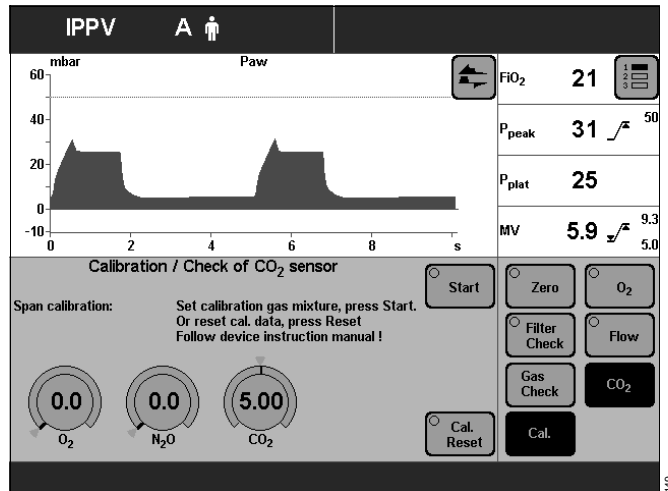

Configuration

Sound	124
Adjusting the volume of the alarm tone	124
Screen	125
Selecting displayed measured values	125
Selecting displayed curves	126
Selecting displayed trends	127
Ventilation	128
Selecting ventilation modes	128
Selecting Pmax pressure limit	130
Selecting AutoFlow [®] as start-up ventilation mode	131
Apnoea ventilation On/Off	132
Selecting patient mode	133
Start-up values for ventilation parameters and alarm limits	134
Setting start-up values for ventilation parameters »VT, f«	134
Setting the start-up values for the »Pressure, O ₂ , I:E« ..	135
Leakage compensation On/Off	136
Setting the start-up values of the alarm limits	137
System defaults	138
Setting the external interface	138
Setting time and date	139
Selecting language and units	140
Service diagnosis	140

Sound

Adjusting the volume of the alarm tone

- Press the »Configuration« key.
- Touch the »Sound« screen key.

Display (example):

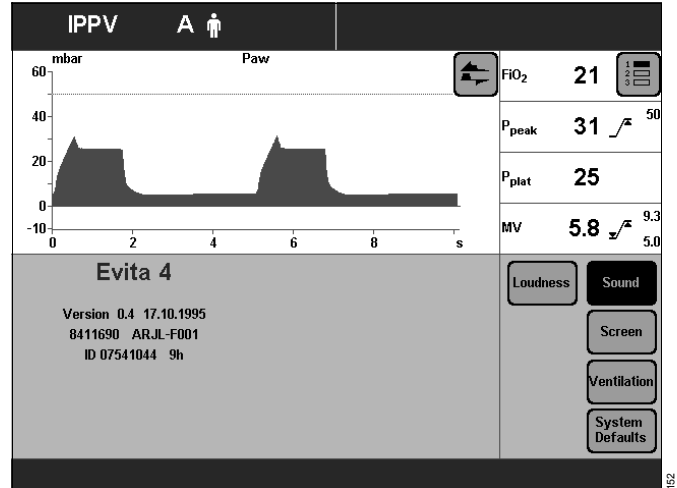

- Touch the »Loudness« screen key.

Display (example):

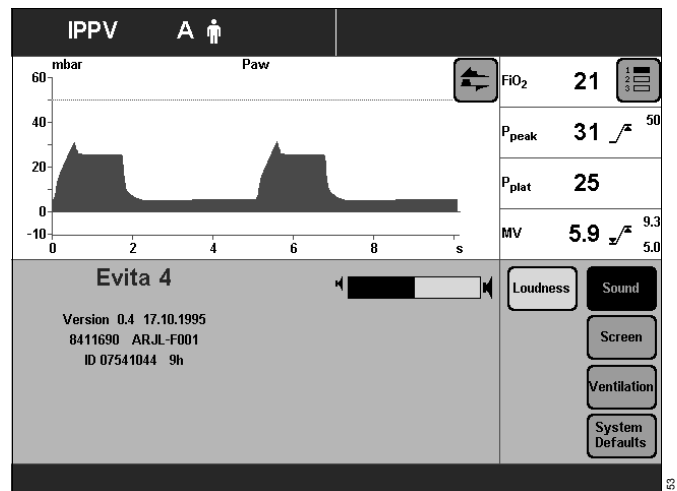

- Adjust volume = turn rotary knob.
The band displayed on the screen shows the current setting between minimum and maximum.

- Confirm setting = press rotary knob.

After confirmation, the alarm tone is sounded to test the volume.

WARNING

Adjust volume of the acoustic alarm so that an alarm cannot be overheard!

Screen

Selecting displayed measured values

Evita 4 displays a group of 4 measured values in the right-hand field of each screen page.

A second or third group can be displayed by touching the »« key. These groups can be put together in the configuration page.

- Press the »**Configuration**« key.
- Touch the »**Screen**« screen key.

Display (example):

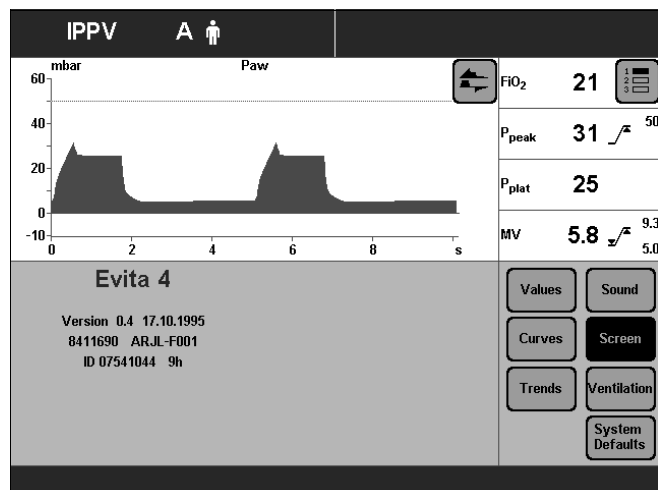

- Touch the »**Values**« screen key.

Display (example):

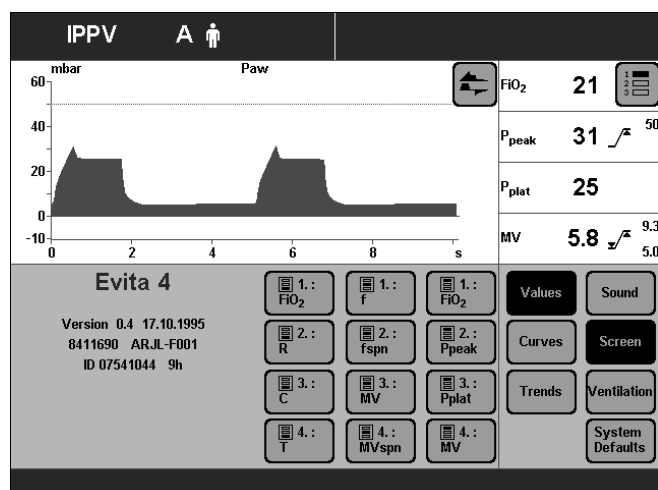

To replace one displayed measured value by another:

- Touch the corresponding screen key.

The selection list with all available measured values is displayed next to the screen keys.

- Select the other measured value, e. g. »**R**« (Resistance) = turn rotary knob.
- Confirm selection = press rotary knob.

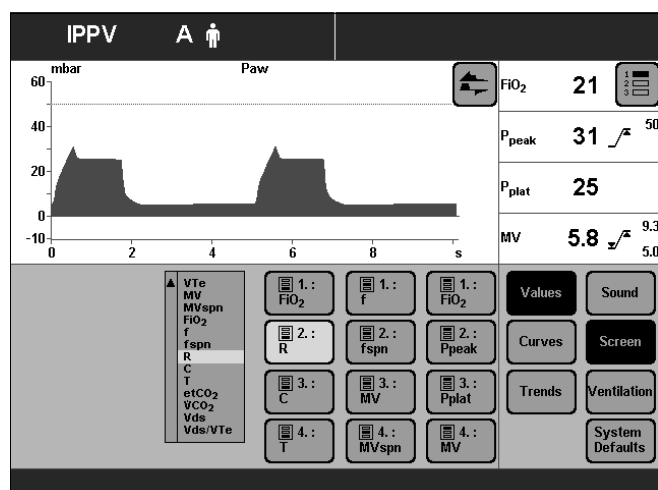

Selecting displayed curves

This function serves to combine the two displayed curves on the standard page.

- Press the »**Configuration**« key.
- Touch the »**Screen**« screen key.

Display (example):

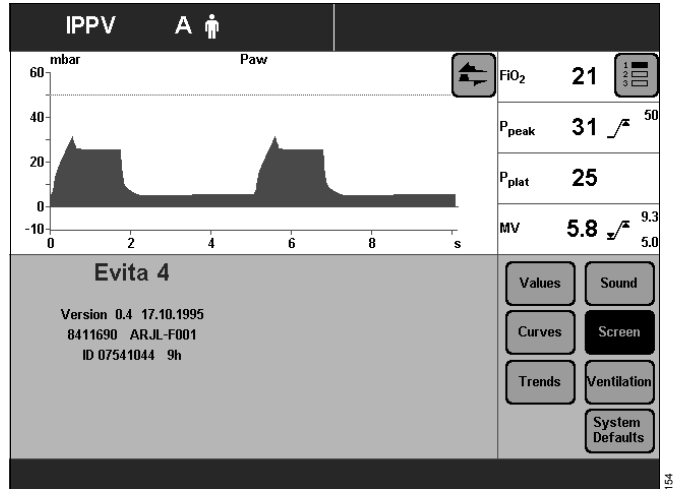

- Touch the »**Curves**« screen key.
- Display (example):

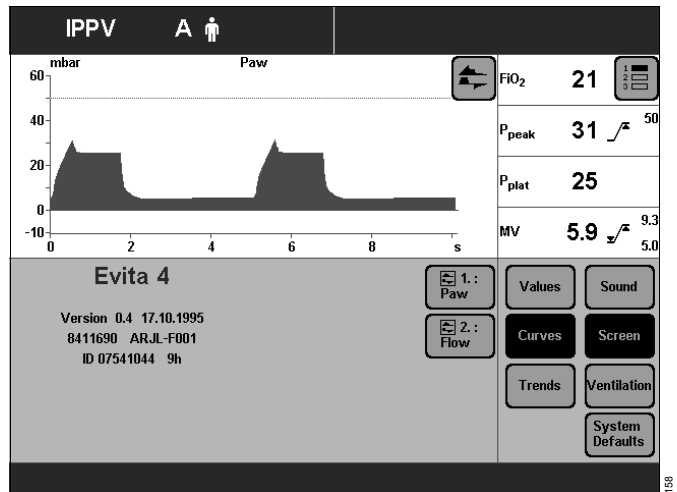

Replace one displayed curve by another:

- Touch the corresponding screen key.

Display (example »**Flow**«):

The selection list containing all available curves is displayed next to the screen keys.

- Select the other curve = turn rotary knob.
- Confirm selection = press rotary knob.

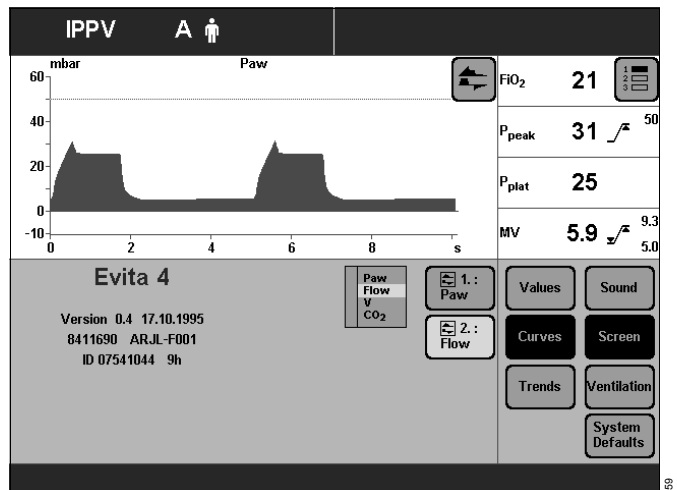

Selecting displayed trends

This function serves to select 8 measured values that are stored by Evita 4 as a trend.

- Press the »**Configuration**« key.
- Touch the »**Screen**« screen key.

Display (example):

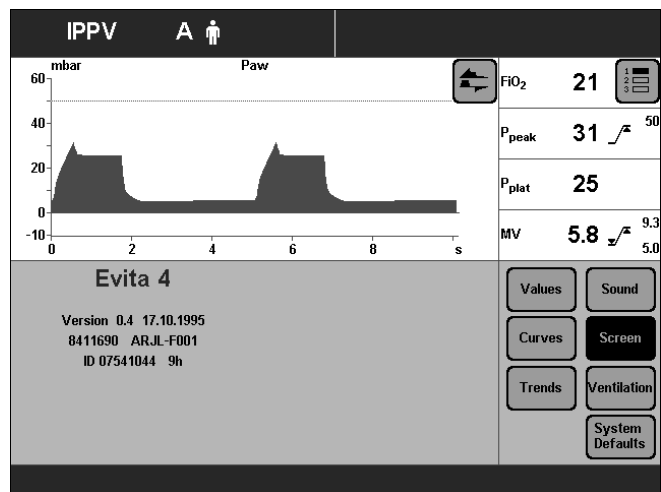

- Touch the »**Trends**« screen key.
- Display (example):

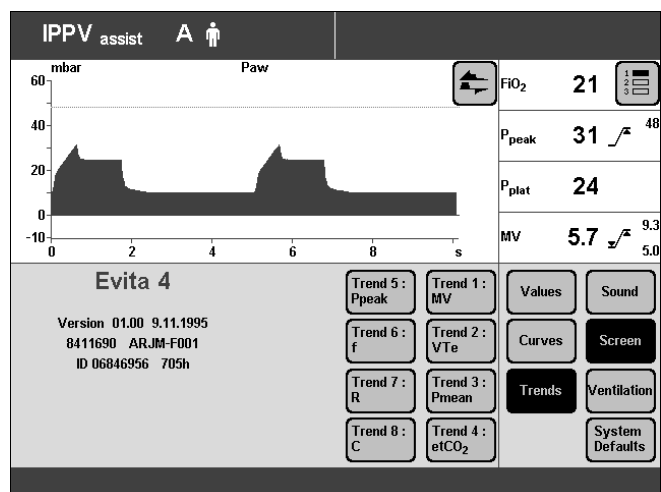

To replace one displayed trend by another:

- Touch the relevant screen key.

Display (example: »**Trend 1: MV**«):

The selection list containing all available measured values is displayed next to the screen keys.

- Select the other measured value, e. g. »**FiO2**« for the trend display = turn rotary knob.
- Confirm selection = press rotary knob.

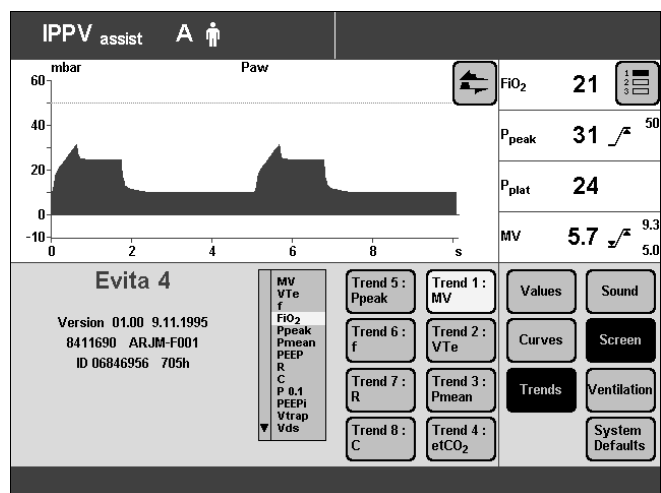

Ventilation

- To select the available ventilation modes for the »**Mode settings**« screen page and to select the initial ventilation mode.
- To select the patient mode active on switching on the device.
- To set the ventilation parameters and alarm limits active on switching on the device.

The configuration menu for the ventilation criteria can only be opened after entering the access code. This precaution is intended to prevent unauthorised modifications to the ventilation criteria. For additional information on the access code, see page 215.

Selecting ventilation modes

To select the ventilation modes on the »**Mode settings**« screen page.

- Press the »**Configuration**« key.

Display:

- Touch the »**Ventilation**« screen key.

Enter access code:

- Touch the corresponding screen keys.

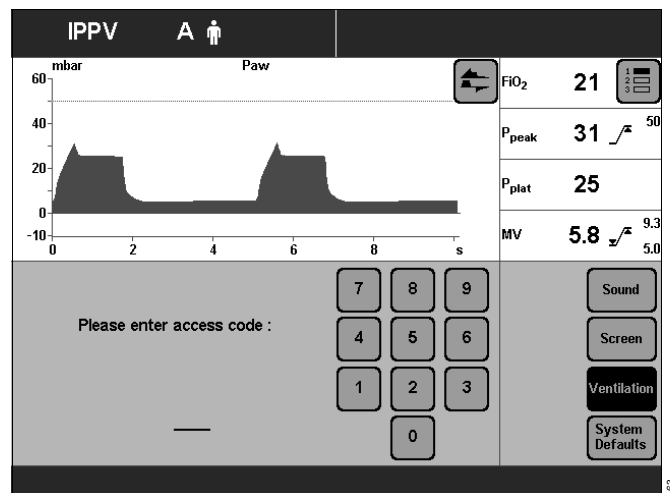

Display (example):

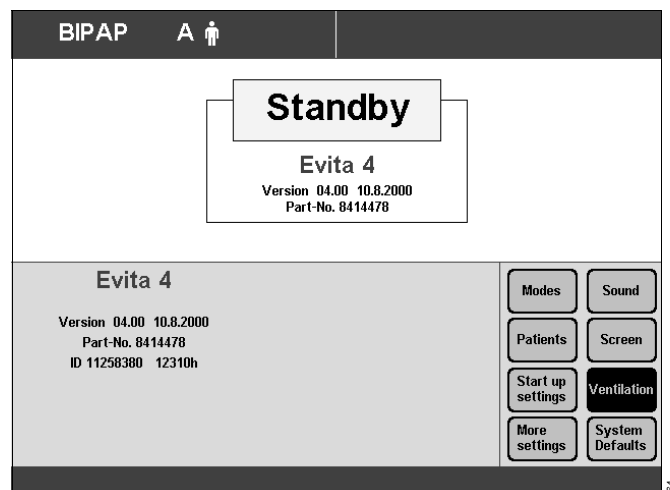

- Touch the »Modes« screen key.

Display (example):

The ventilation mode displayed in the top screen key is the factory-set start-up ventilation mode (in this example: »IPPV«).

Evita 4 starts in this ventilation mode immediately after being switched on.

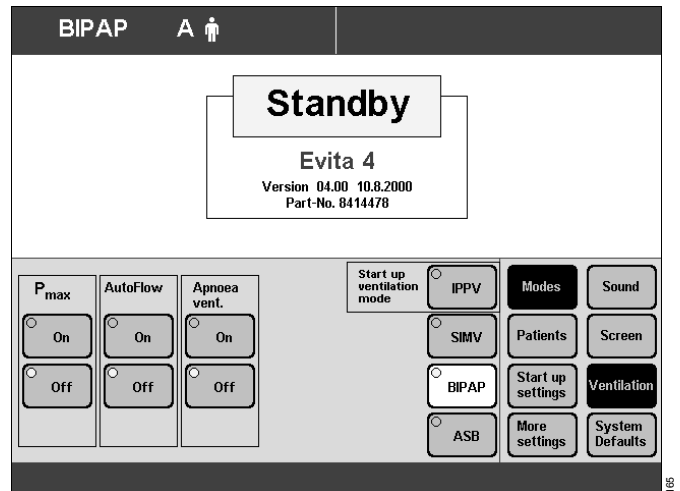

To replace one displayed mode by another:

- Touch the corresponding screen key.

Display (example »IPPV«):

The selection list with all available ventilation modes is displayed next to the screen keys.

- Select another mode = turn rotary knob.
- Confirm selection = press rotary knob.

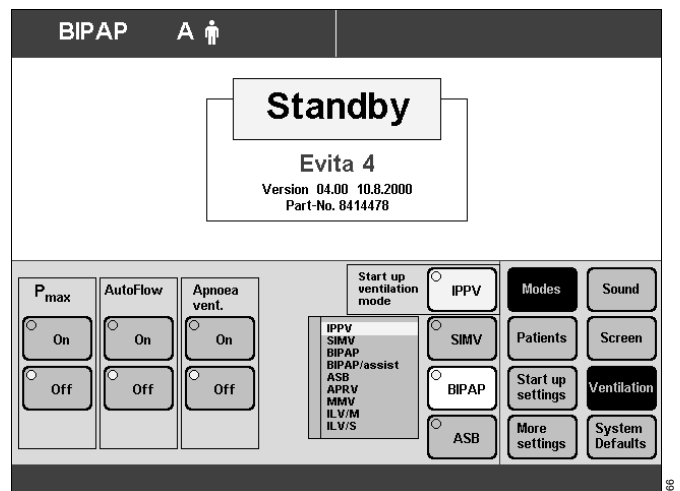

Selecting Pmax pressure limit

This function serves to limit the ventilation pressure in ventilation modes IPPV, SIMV, MMV.

- Press the »**Configuration**« key.
- Touch »**Ventilation**« screen key.

Display (example):

Enter access code:

- Touch the corresponding screen keys.

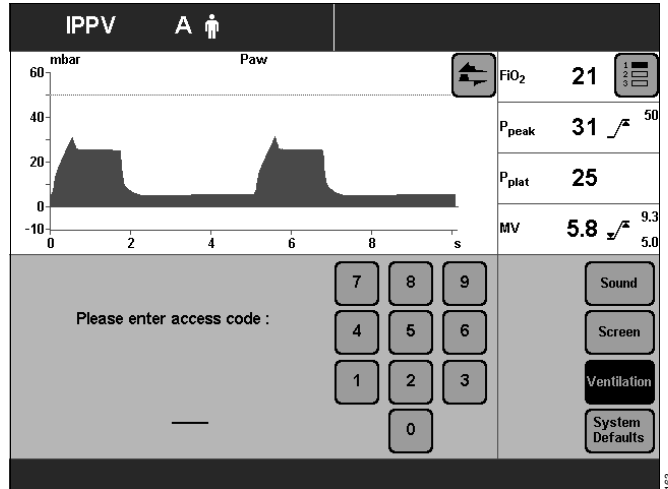

163

Display (example):

- Touch the »**Modes**« screen key.

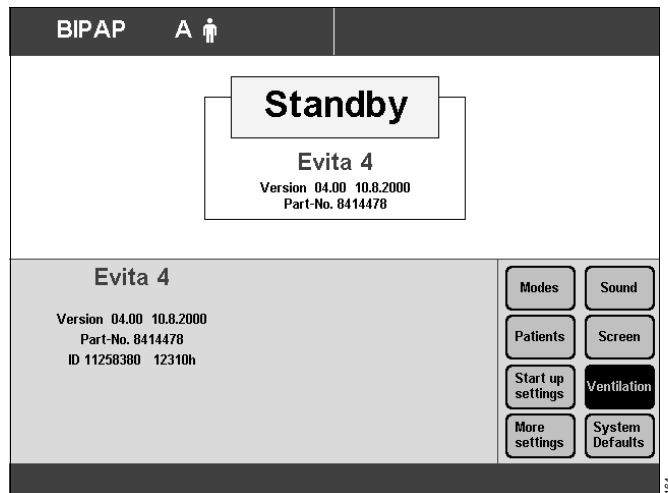

164

Display (example):

- Touch the screen key Pmax »**On**«.
 - Confirm selection = press rotary knob.
- Pmax pressure limiting is selected.
The »**Pmax**« screen knob is displayed on the »**Mode settings**« screen page.

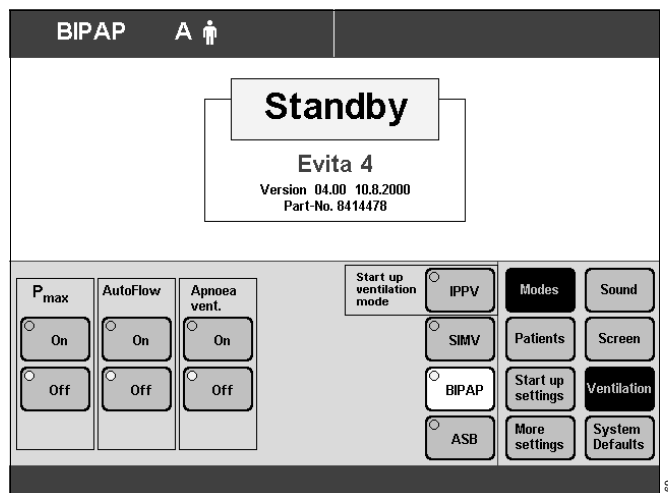

169

Selecting AutoFlow® as start-up ventilation mode

- For automatically setting the AutoFlow® ventilation option after switching on the apparatus. The user can define whether the additional AutoFlow® option is active or not after switching on

- Press the »**Configuration**« key.
- Touch »**Ventilation**« screen key.

Display (example):

Enter access code:

- Touch the corresponding screen keys.

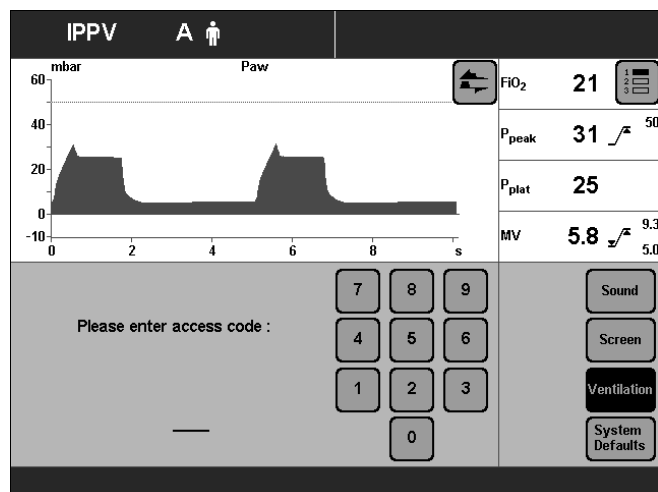

Display (example):

- Touch the »**Modes**« screen key.

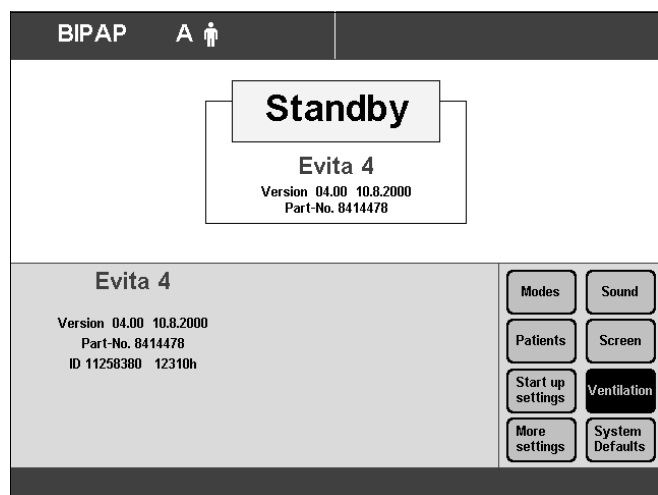

Display (example):

To activate AutoFlow® in the start-up ventilation mode:

- Touch the »**Modes**« screen key.
- Touch screen key AutoFlow »**On**«.
- Confirm selection = press rotary knob.

The AutoFlow® option will be automatically activated the next time the apparatus is switched on.

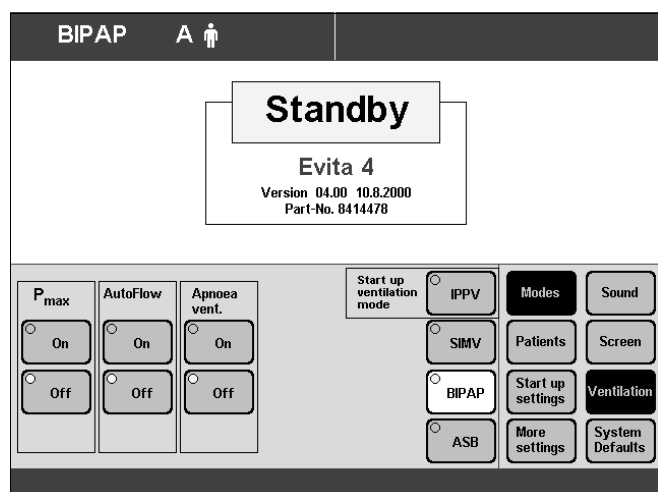

Apnoea ventilation On/Off

To determine whether apnoea ventilation is automatically ready for use when starting.

- Press the »**Configuration**« key.
- Touch the »**Ventilation**« screen key.

Display (example):

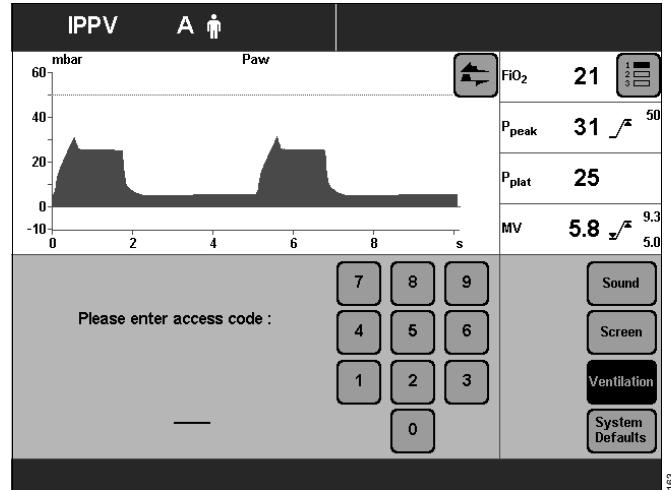

Enter access code:

- Touch the corresponding screen keys.

Display (example):

- Touch the »**Modes**« screen key.

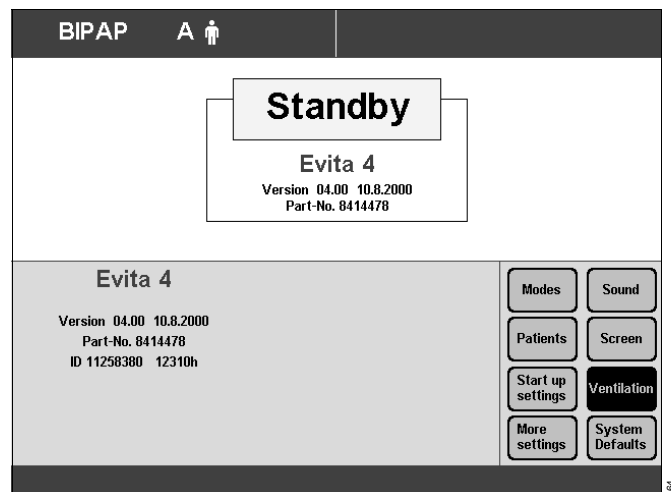

Display (example):

To prepare apnoea ventilation:

- Touch the Apnoea vent. »**On**« screen key.
- Confirm = press rotary knob. The LED in the key lights up.

Apnoea ventilation is automatically ready for use when the device is switched on again.

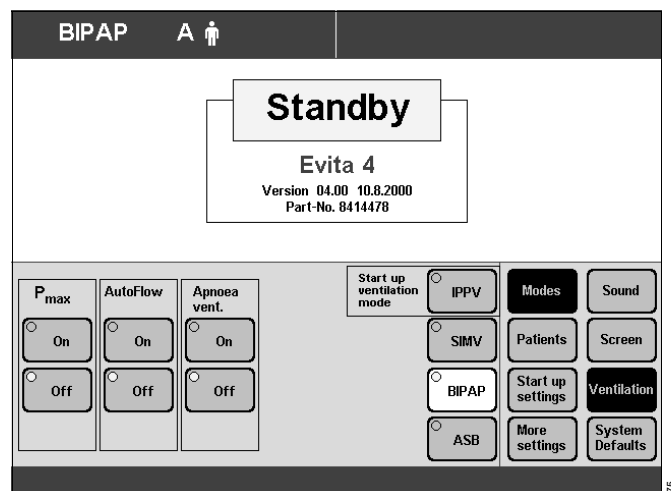

Selecting patient mode

Adults/Paediatrics

- To select the patient mode you would like automatically activated on switching on, or
- To select whether the device should first ask for the patient mode.

- Press the »**Configuration**« key.
- Touch the »**Ventilation**« screen key.

Display (example):

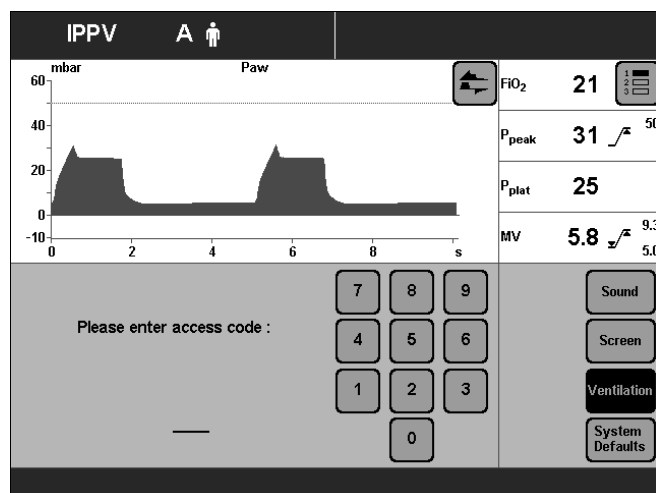

Enter access code:

- Touch the corresponding screen keys.

Display (example):

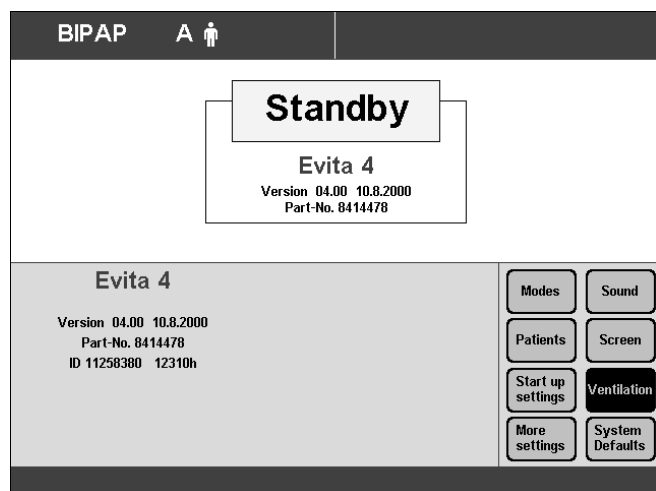

- Touch the »**Patients**« screen key.

Display (example):

The selection list with the two patient modes appears next to the screen keys.

- Select the corresponding patient mode = turn rotary knob.
- Confirm the patient mode = press rotary knob.

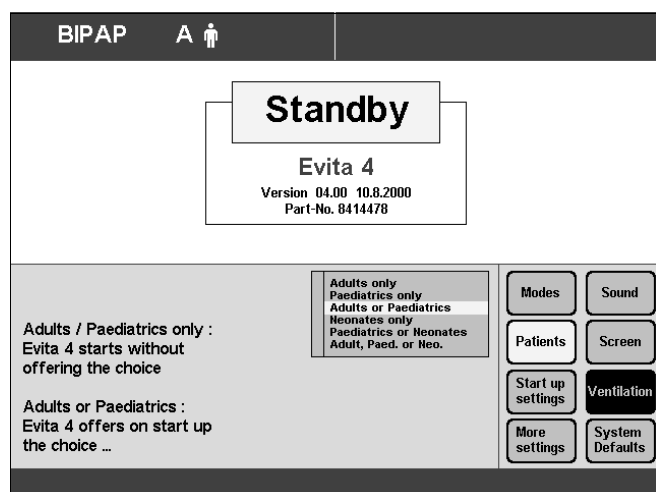

Start-up values for ventilation parameters and alarm limits

- To set the ventilation parameters and alarm limits you would like to be activated on switching on the device.

WARNING
The alarm limits must be set to meet the needs of the therapy required by the current patient. The patient may otherwise be jeopardized.

Setting start-up values for ventilation parameters »VT, f«

The start-up values for the tidal volume »VT« and frequency »f« required for the patient are determined by Evita 4:

- either as a function of the ideal body weight
- or
- as a function of the patient mode (paediatrics or adults).
- Press the »**Configuration**« key.
- Touch the »**Ventilation**« screen key.

Enter access code:

- Touch the corresponding screen keys.

- Touch the »**Start up settings**« screen key.

Display (example):

To determine the start-up values of the ventilation parameters »VT, f« on the basis of the ideal body weight:

- Touch the screen key »**VT, f by weight**« and confirm with the rotary knob.

To determine the start-up values of the ventilation parameters »VT, f« on the basis of the patient mode:

- Touch the screen key »**VT, f by patient**« and confirm with the rotary knob.

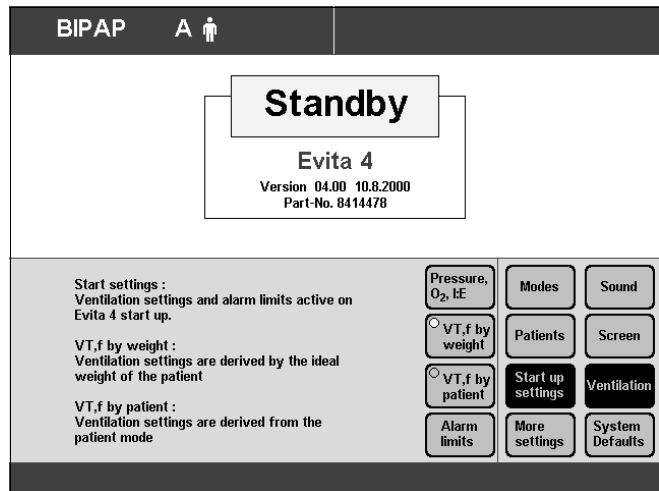

Start-up values »VT, f« dependent on ideal weight. The values are selected with reference to the Radford nomogram:

Weight kg	Factory settings		Hospital-specific settings	
	Tidal volume VT mL	Ventilation frequency f bpm	Tidal volume VT mL	Ventilation frequency f bpm
3	20	30		
15	110	26		
65	450	13		
100	700	10		

The hospital-specific start-up values can be entered in the table.

Start-up values »VT, f« dependent on patient mode.

Patient mode	Factory settings		Hospital-specific settings	
	Tidal volume VT mL	Ventilation frequency f bpm	Tidal volume VT mL	Ventilation frequency f bpm
Paed.	50	29		
Adults	500	12		

The hospital-specific start-up values can be entered in the table.

To change the start-up values of »VT, f«:

- Touch the screen key of the parameter to be changed.
- Change value = turn rotary knob.
- Confirm value = press rotary knob.

If you wish to return to the factory settings:

- Touch »Dräger Reset« screen key.

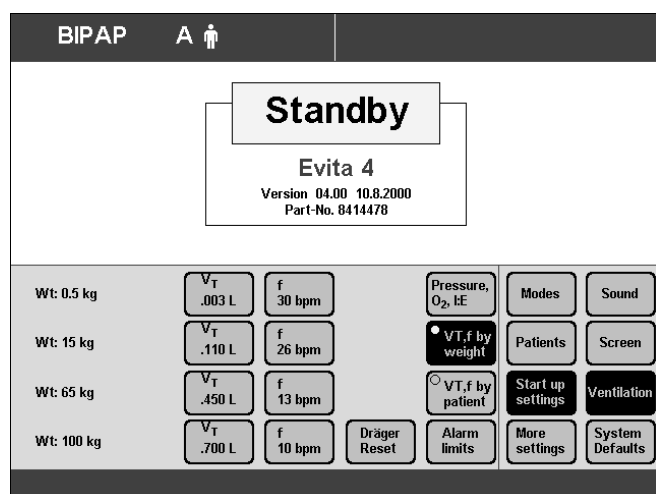

Setting the start-up values for the »Pressure, O2, I:E«

- Press the »Configuration« key.
- Touch »Ventilation« screen key.

Enter access code:

- Touch the corresponding screen keys.

- Touch the »Start up settings« screen key.

Display (example):

- Touch the »Pressure, O2, I:E« screen key.

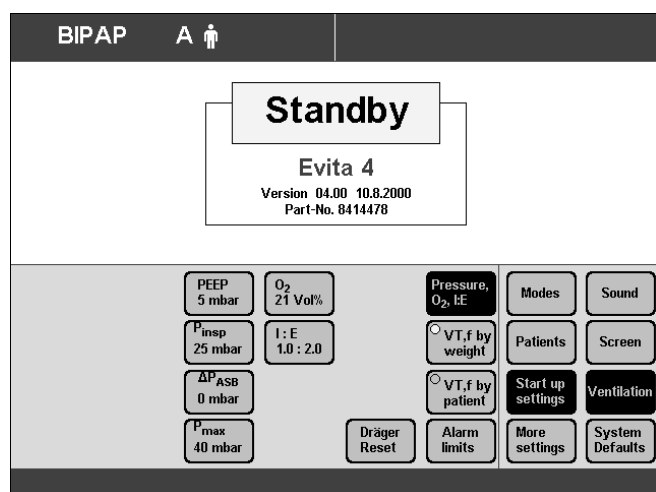

Starting values of »Pressure, O₂, I:E«

	PEEP mbar	P _{insp} mbar	ΔPASB ¹⁾ mbar	P _{max} mbar	O ₂ Vol%	I:E
Factory settings	5	15	0	40	30	1:2
Hospital specific settings						

1) ΔPASB = PASB – PEEP

The hospital-specific start-up settings can be entered in the table.

To change the start-up values of »Pressure, O₂, I:E«:

- Touch the screen key for the parameter to be changed.
- Change value = turn rotary knob.
- Confirm value = press rotary knob.

Leakage compensation* On/Off

The automatic leakage compensation function is used by the device to compensate leakages of up to 100 % of the set tidal volume in all volume-controlled ventilation modes.

The selection "leakage compensation on/off" is saved and reactivated when the device is restarted.

- Press the »**Configuration**« key.
- Touch the »**Ventilation**« screen key.

Enter access code:

- Touch the corresponding screen keys.

- Touch the »**More settings**« screen key.

Display:

- Touch the »**Leak Comp.**« screen key.
- Touch the »**On**« or »**Off**« screen key.
- Confirm = press rotary knob. The selected key is highlighted by the yellow LED.

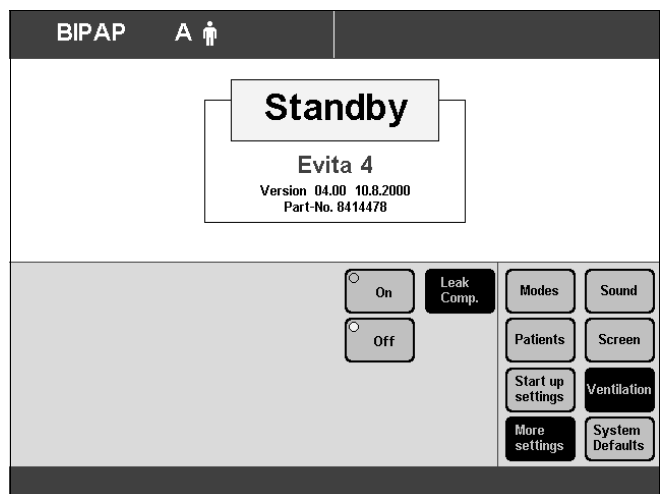

* For a detailed description of leakage compensation, see page 196.

Setting the start-up values of the alarm limits

- Press the »**Configuration**« key.
- Touch the »**Ventilation**« screen key.

Enter access code:

- Touch the corresponding screen keys.

- Touch the »**Start up settings**« screen key.
- Touch the »**Alarm limits**« screen key.

Display (example):

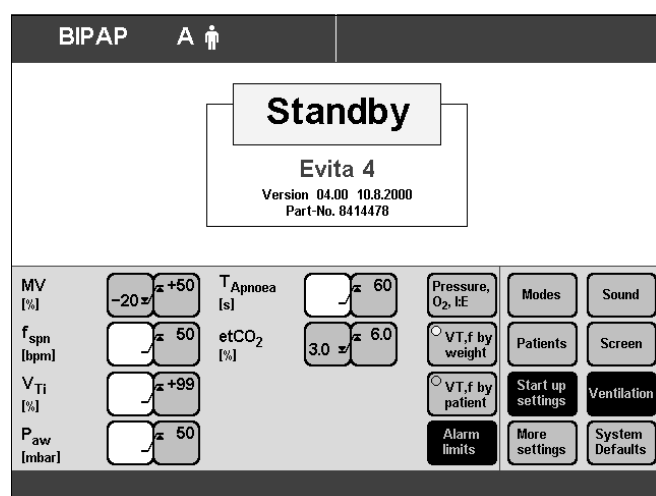

Start-up values of the alarm limits:

Alarm limit	Factory settings	Hospital-specific settings
Paw high [mbar]	50	
MV low [L/min]	$(V_T \times f) - 20 \%$	
MV high [L/min]	$(V_T \times f) + 50 \%$	
VT high [L]	$V_T + 100 \%$	
etCO ₂ low [mmHg]	30	
etCO ₂ high [mmHg]	60	
f _{spn} [bpm]	50	
T _{Apnoea} [s]	15	

The factory-specific start-up settings can be entered in the table.

To change the start-up values of the alarm limits:

- Touch the screen key of the alarm limit you wish to change.
- Change value = turn rotary knob.
- Confirm value = press rotary knob.

System defaults

Setting the external interface

Evita 4 offers the following interface protocols:

- Printer
- MEDIBUS (Dräger communications protocol for medical equipment)
- LUST (list-driven universal interface driver program, compatible with the Evita RS 232 interface from software version 7.n).

WARNING

Other equipment, e. g. printers, may only be connected to the COM port if Evita 4 is connected to the mains power supply via a mains power cable or if it has been earthed via the earth connection on the back of the unit. Electric power may pose a hazard in all other cases.

- Press the »**Configuration**« key.
- Touch the »**System Defaults**« screen key.
- Select the required port with screen keys »**COM1**«, »**COM2**«, »**COM3**« (COM2 and COM3 are optional).
- Select the required interface protocol with the screen keys »**Printer**«, »**MEDIBUS**« and »**LUST**«

Display (example):

Select the interface parameters for the selected interface protocol:

- Touch the screen key for the parameter, e. g. »**Baud rate**«
- Change value = turn rotary knob.
- Confirm value = press rotary knob.

For MEDIBUS protocol:

Baud rate

Parity check bits (see Operating Manual of the connected device)

Number of stop bits (see Operating Manual of the connected device)

For LUST protocol:

Baud rate

For printer protocol:

Baud rate (see Operating Manual of the printer)

Print interval (set in accordance with protocol requirement)

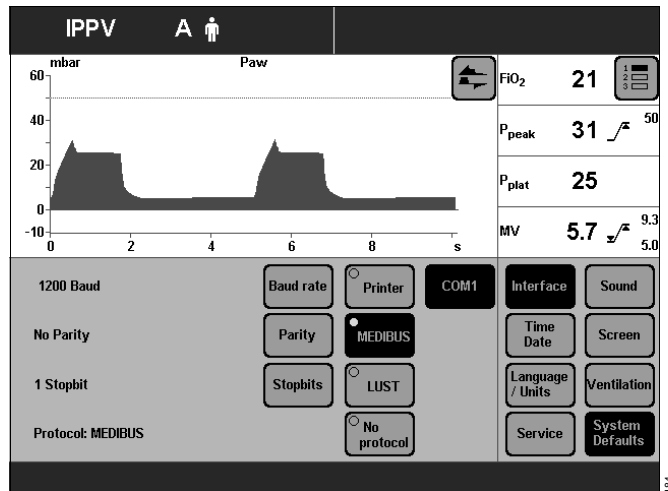

To connect a printer to Evita 4 (HP Deskjet 500 and compatible printers with serial interface).

At a programmable regular interval (0 to 60 minutes), all important measured values of the Evita 4 and all settings modified since the last printout are automatically printed out. If the print time interval is set to 0 no printout occurs. Regardless of the selected time interval, all alarms are printed out when the alarm conditions occur.

In addition, printout can be manually started by pressing the »Printer« screen key. The time interval in progress will remain unaffected.

Setting time and date

- Press the »Configuration« key.
- Touch »System Defaults« screen key and
- touch »Time Date« screen key.

Display (example):

- Change value in cursor (Example [95]) = turn rotary knob.
- Confirm value = press rotary knob.

CAUTION

Evita 4 does not automatically adjust for summer time (daylight saving time) and winter time (standard time). This must be done by the user.

Otherwise the times shown in the display and the times recorded for saved values and actions (e. g. in the logbook) are incorrect.

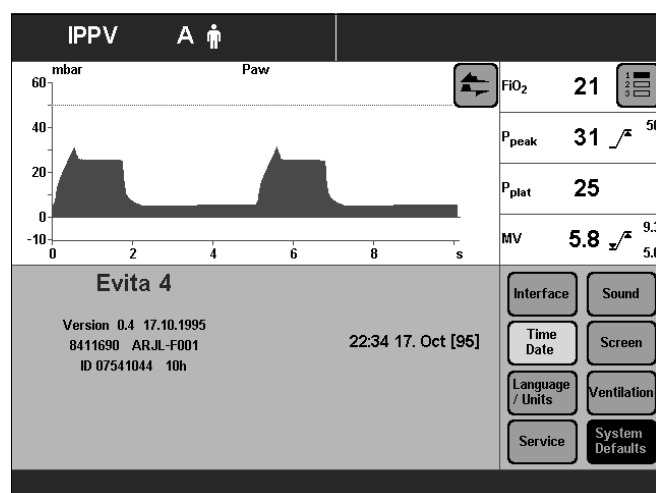

Selecting language and units

To select the desired language for the screen texts.
To select the units for pressure and CO₂ concentration.

- Press the »**Configuration**« key.
- Touch the »**System Defaults**« screen key.

Display (example):

Select language:

- Touch the »**Language / Units**« screen key.
- Touch the »**Language**« screen key.
- Select language = turn rotary knob.
- Confirm language = press rotary knob.

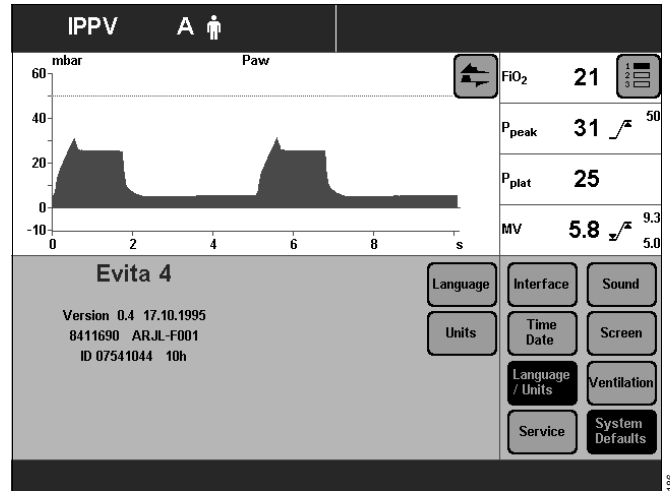

Select unit:

- Touch the »**Units**« screen key.

Display (example):

- Touch the relevant screen key, e. g. »**pressure**«.
- Select unit = turn rotary knob.
- Confirm unit = press rotary knob.

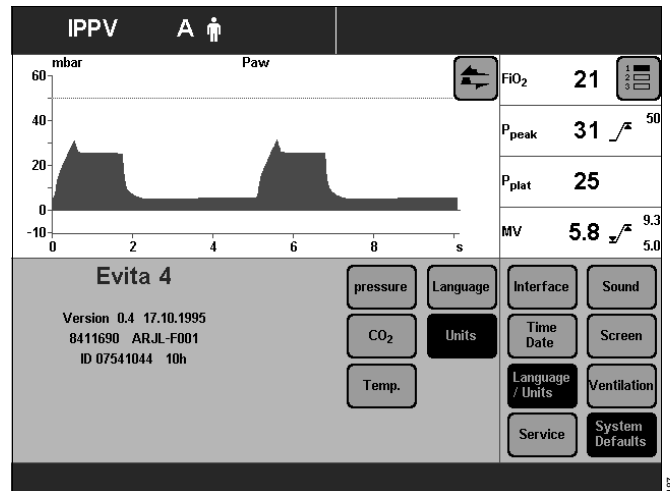

Service diagnosis

- Only for experts with the appropriate servicing documentation.

Alarm – Cause – Remedy

Alarm messages are displayed in hierarchical order in the alarm message field of the header bar.

If several alarms occur at the same time, the most critical alarm is displayed in the alarm message field of the header bar.



Alarm priority is indicated by different background colors and also by exclamation marks.

Color	Priority of the alarm message			Action required
Red	Warning	Alarm with high priority	!!!	Immediate action required to avert acute danger
Yellow	Caution	Alarm with medium priority	!!	Quick action required to avert danger
Yellow	Note	Alarm with low priority	!	Attention and action required



Within an alarm category, alarm messages are assigned internal priorities. In the following table, internal priorities are indicated as numbers behind the exclamation marks. The alarm message with the highest priority receives number 255. The lower the priority, the lower the number.

In the following table, the alarm messages are listed in alphabetical order. The table shows possible causes for an alarm and corresponding remedies. Causes and remedies must be worked through in the order listed until the alarm has been resolved.

Message	Priority	Cause	Remedy
Air supply down	!!! 250	Air supply pressure too low.	Make sure pressure is greater than 3 bar.
Air supply down	! 250	Air supply pressure too low. Air supply pressure not required when FiO ₂ = 100 Vol%.	Make sure pressure is greater than 3 bar.
Air supply pressure high	!! 100	Air supply pressure too high.	Ensure pressure is less than 6 bar.
Air supply pressure high	! 60	Air supply pressure too high. Air supply is not needed for FiO ₂ = 100 Vol%.	Ensure pressure is less than 6 bar.
Airway pressure high	!!! 205	The upper alarm limit for the airway pressure has been exceeded. The patient is "fighting" the ventilator, cough.	Check patient condition, Check ventilation pattern, Correct alarm limit if necessary.
		Ventilation hose buckled.	Check hose system and tube.
Airway pressure low	!!! 204	Leaking cuff.	Inflate cuff and perform leak test.
		Leak or disconnection.	Check hose system for tight connections. Check that the expiration valve is properly engaged.
Apnoea	!!! 181	Patient's spontaneous breathing has stopped.	Apply controlled ventilation.
		Stenosis	Check condition of patient. Check tube
		Flow sensor not calibrated or faulty.	Calibrate flow sensor. Replace if necessary.

Message	Priority	Cause	Remedy
Apnoea alarm off	! 255	Flow monitoring switched off.	Switch on flow monitoring again, page 106 or immediately ensure an appropriate external monitoring function.
		114 In NIV mode: Apnoea monitoring has been switched off.	Reset the upper alarm limit for apnoea monitoring to the required value. Follow the Instructions for Use for NIV.
Apnoea ventilation	!! 230	Due to detected apnoea, the system has switched over automatically to mandatory ventilation.	Check ventilation procedure. Return to the original ventilation procedure with »Alarm Reset«. Check condition of patient. Check tube.
ASB > 1.5 s	! 180	Only appears in paediatric mode. The ASB cycle has been switched off 3 times due to time limitation.	Test ventilation system for leaks.
ASB > 4 s	!!! 148	Only appears in adult mode. The ASB cycle has been switched off 3 times due to time limitation.	Test ventilation system for leaks.
Check frequency ILV Slave Message on slave device	! 020	The frequency (breathing rate) of the master and slave devices differ by more than 12 %.	Adjust the frequency of the slave device to that of the master.
Check settings	!! 205	Software Version 4.11 and higher: Ventilation began after the device was switched on with the configured start values.	Check pattern of ventilation and alarm limits. Confirm message with key »Alarm Reset«.
		Fault while setting pattern of ventilation or the alarm limits.	Check pattern of ventilation and alarm limits. The following settings are affected: O ₂ concentration »O ₂ « »Paw  « alarm limit »MV  « alarm limit Status of external flow source Status of oxygen enrichment for bronchial suction »  « key (suppress alarm tone) »Alarm Reset« key »Insp. hold« key »Exp. hold« key Deactivate O ₂ monitoring Deactivate flow monitoring Confirmation with rotary knob Acknowledge message by pressing »Alarm Reset« key.
Clean CO₂ cuvette	!!! 144	Cuvette window dirty.	Use clean reusable cuvette or new disposable cuvette.
		Sensor window dirty.	Clean CO ₂ sensor.
CO₂ measurement inop	!!! 145	CO ₂ sensor faulty.	Replace faulty CO ₂ sensor.
		CO ₂ measurement incorrect.	Call DrägerService.
CO₂ monitoring off	! 092	CO ₂ monitoring is switched off.	Switch CO ₂ monitoring on again, page 106, or ensure adequate external monitoring without delay.

Message	Priority	Cause	Remedy
CO₂ sensor ?	!!! 146	Probe of CO ₂ sensor withdrawn during operation.	Reinsert probe.
		CO ₂ sensor not positioned on cuvette.	Place CO ₂ sensor on cuvette.
		Last zero calibration was performed with a soiled park bracket or soiled CO ₂ sensor.	Clean park bracket or CO ₂ sensor and carry out zero calibration, page 114. Or perform zero calibration with clean cuvette in room air, page 114.
		CO ₂ sensor faulty.	Replace defective CO ₂ sensor.
CO₂ zero ?	!!! 142	Cuvette window or sensor window soiled, e. g. with deposits from medication nebulisation.	Use clean reusable cuvette or new disposable cuvette (depending on which type of cuvette was used previously) or clean CO ₂ sensor. Perform CO ₂ zero calibration correctly, see page 114 when using reusable cuvettes or page 115 when using disposable cuvettes.
		Zero point outside the permissible tolerance.	Perform zero calibration, see page 114 when using reusable cuvettes or page 115 when using disposable cuvettes.
Device failure	!!! 253	Device has detected device failure.	Ventilation can be continued if the message disappears when the »Alarm Reset« key is pressed. Check the settings. If the fault recurs, or if the message does not disappear despite pressing the »Alarm Reset« key: Disconnect the patient from the device and continue ventilation with another independent ventilator. Call DrägerService.
etCO₂ high	!!! 140	End-expiratory CO ₂ concentration above upper alarm limit.	Check condition of patient, check pattern of ventilation, correct alarm limit if necessary.
etCO₂ low	!!! 140	End-expiratory CO ₂ concentration below lower alarm limit.	Check condition of patient, check pattern of ventilation, correct alarm limit if necessary.
Evita Remote ?	! 010	The Remote Pad has not been identified correctly.	Remove Remote Pad. Confirm message with key »Alarm Reset«. Call DrägerService at the next opportunity.
Evita Remote inop.	! 010	Key pressed on Remote Pad during selftest.	Confirm message with key »Alarm Reset«. Remove Remote Pad and reconnect. Ensure that no key is pressed on the Remote Pad during selftest.
		Remote Pad faulty.	Confirm message with key »Alarm Reset«. Remove Remote Pad. Call DrägerService at the next opportunity.
Execute device check	!! 210	Device check not performed.	Perform device check, page 52. Confirm message with »Alarm Reset« key.

Message	Priority	Cause	Remedy
Exp. hold interrupted	! 230	The » Exp. hold « key has been pressed for more than 15 seconds.	Release the » Exp. hold « key.
Exp. valve inop.	!!! 220	Expiration valve not properly connected to socket.	Push expiration valve firmly into socket until it clicks into place.
		Flow sensor not calibrated.	Flow sensor calibration, see page 110.
		Expiration valve faulty.	Replace expiration valve.
External Flow	! 011	Evita 4 calculates the externally supplied flow when monitoring correct functioning of the flow measurement.	Deactivate calculation of the external flow, see page 110.
Fan failure	!!! 050	Fan failure.	Call DrägerService.
FiO₂ high	!!! 130	O ₂ sensor not calibrated.	Calibrate O ₂ sensor, page 109.
		Faulty mixer function. The ventilation function is affected. This can lead to deviations in the O ₂ concentration and the tidal volume	Disconnect the patient from the device and continue ventilation with another independent ventilator. Call DrägerService.
FiO₂ low	!!! 130	O ₂ sensor not calibrated.	Calibrate O ₂ sensor, page 109.
		Faulty mixer function. The ventilation function is affected. This can lead to deviations in the O ₂ concentration and the tidal volume	Disconnect the patient from the device and continue ventilation with another independent ventilator. Call DrägerService.
Flow measurement inop.	!!! 235	Water in flow sensor.	Dry flow sensor.
		Flow sensor not calibrated.	Calibrate flow sensor, page 110, replace if necessary.
		Flow measurement malfunction.	The ventilator functions are only available to a limited extent (page 106). Disconnect the patient from the device and continue ventilation with another independent ventilator. Call DrägerService.
Flow monitoring off	! 100	Flow monitoring is switched off.	Switch on flow monitoring again promptly, page 106 or immediately ensure an appropriate external monitoring function.
Flow sensor ?	!!! 228	Flow sensor not fully inserted in rubber lip of expiration valve.	Insert flow sensor correctly.
Hard key xx failed	!! 200	Key xx (e. g. »  «) can no longer be pressed.	Call DrägerService.
High frequency	!!! 150	Patient is breathing at a high spontaneous frequency.	Check condition of patient, check pattern of ventilation, correct alarm limit if necessary.
ILV Sync. inop. Message on both devices	!!! 080	Frequency on master device less than 4 breaths per minute.	Set a higher frequency. Call DrägerService.
		Device defective.	Call DrägerService.
Insp. hold interrupted	! 230	The » Insp. hold « key was held down longer than 15 seconds.	Release » Insp. hold « key.
Insp / Exp cycle failure	!!! 180	The device does not deliver any gas.	Check the P _{max} /PEEP setting. Set an IPPV frequency of at least 4/min. Increase » TApnoea  « alarm time.
		Device faulty.	Call DrägerService.

Message	Priority	Cause	Remedy
Key overused ?	!! 200	Due to very frequent key use, the screen contents of the display are repeatedly redrawn.	Confirm message with key » Alarm Reset «.
		Brief communication failure between the display processor and main processor.	Confirm message with key » Alarm Reset «. If this message occurs again, call DrägerService.
Key xx overused ?	!! 200	Key has been pressed several times in a short period (e. g. »  «).	Confirm message with key » Alarm Reset «. If this message occurs repeatedly, call DrägerService.
Leakage	! 009	The measured leakage minute volume MV _{Leak} is 20 % higher than the minute volume measured on the expiration side.	Check that the patient hose connection has no leaks. Check that the tube is correctly fitted.
Loss of data	!!! 252	Lithium battery discharged.	Call DrägerService.
Malfunction fan	! 016	Temperature in machine too high.	Check fan function, clean cooling-air filter or call DrägerService.
		Fan failure.	Disconnect the patient from the device and continue ventilation with another independent ventilator. Call DrägerService.
MEDIBUS COM. inop.	! 012	The connector of the MEDIBUS cable was unplugged during operation.	Plug the connector in again and secure it against disconnection with the two screws.
		MEDIBUS cable defective.	Use a new MEDIBUS cable.
		Interface defective.	Call DrägerService.
Mixer inop.	!!! 240	Mixer malfunction. FiO ₂ and volumes may deviate.	Disconnect the patient from the device and continue ventilation with another independent ventilator. Call DrägerService.
Multi functional board inop.	!! 200	The multi-functional board for operating the nurse call or Remote Pad is faulty.	Confirm message with key » Alarm Reset «. Call DrägerService at the next opportunity. The original ventilation functions of Evita 4 are not affected. Correct functioning of the nurse call or Remote Pad is not guaranteed, however: remove the nurse call and/or Remote Pad.
Multi functional board inop.	! 010	The multi-functional board for operating the nurse call or Remote Pad is faulty.	Confirm message with key » Alarm Reset «. Call DrägerService at the next opportunity. The original ventilation functions of Evita 4 are not affected. Correct functioning of the nurse call or Remote Pad is not guaranteed, however: remove the nurse call and/or Remote Pad.

Message	Priority	Cause	Remedy
MV high	!!! 160	The minute volume has exceeded the upper alarm limit.	Check condition of patient, check pattern of ventilation, correct alarm limit if necessary.
		Flow sensor not calibrated or faulty.	Calibrate flow sensor, page 110, replace if necessary.
		Water in flow sensor.	Empty water traps. Dry or replace flow sensor.
		Machine malfunction.	Call DrägerService.
MV low	!!! 160	The minute volume has fallen below the lower alarm limit.	Check condition of patient, check pattern of ventilation, correct alarm limit if necessary.
		Stenosis.	Check condition of patient. Check tube.
		Leak in breathing system.	Establish leakproof breathing system.
		Flow sensor not calibrated.	Calibrate flow sensor, see page 110.
		Machine malfunction.	Call DrägerService.
Nebulisation interrupted	!! 110	Only in paediatric patient mode: Nebulisation is only possible in pressure-controlled ventilation or with AutoFlow.	Select the patient mode. Restart nebulisation. Acknowledge the alarm with »Alarm Reset«.
		Only in paediatric patient mode, only for ventilation with AutoFlow: Flow sensor not ready for measurement.	Switch on flow monitoring or calibrate flow sensor, page 110, or replace flow sensor or change mode. Restart nebulisation. Acknowledge the alarm with »Alarm Reset«.
Nebuliser on	! 070	The medication nebuliser is switched on, page 98.	Switch off the medication nebuliser if necessary, page 100.
O2 measurement inop.	!!! 132	O2 sensor provides invalid measured values.	Calibrate O2 sensor page 109, replace if necessary.
		O2 measurement malfunction.	Call DrägerService.
O2 Monitoring off	! 095	O2 monitoring switched off.	Switch on O2 monitoring again, as described on page 106 or immediately ensure an adequate monitor function.
O2 supply down	!!! 249	O2 supply pressure too low.	Make sure pressure is greater than 3 bar.
O2 supply down	! 249	O2 supply pressure too low. O2 supply pressure is not required when FiO2 = 21 Vol%.	Make sure pressure is greater than 3 bar.
O2 supply pressure high	!! 099	O2 supply pressure too high.	Make sure pressure is less than 6 bar.
O2 supply pressure high	! 060	O2 supply pressure too high. O2 supply pressure is not required when FiO2 = 21 Vol%.	Make sure pressure is less than 6 bar.
PEEP high	!!! 216	Expiratory system obstructed.	Check hose system and expiration valve.
		Expiratory resistance is increasing.	Check bacterial filter. Replace if necessary.
		Machine faulty.	Disconnect the patient from the device and continue ventilation without delay, using another independent ventilator. Call DrägerService.

Message	Priority	Cause	Remedy
PEEP valve inop.	!!! 203	Hose system opened; PEEP cannot be achieved.	Ensure that breathing system is leak proof.
		Internal PEEP valve faulty.	Disconnect the patient from the device and continue ventilation with another independent ventilator. Call DrägerService.
Pressure limited	! 080	Pmax pressure limit is active.	Check condition of patient, check pattern of ventilation, correct setting if necessary.
Pressure meas. inop.	!!! 170	Fluid in expiration valve.	Replace expiration valve, see page 152, then clean and dry.
		Pressure measurement malfunction.	Disconnect patient from the device and continue ventilation without delay, using another independent ventilator. Call DrägerService.
Standby activated	!!! 255	Evita 4 has been switched to standby.	Confirm standby with » Alarm Reset « key.
Temperature high	!!! 090	Breathing gas temperature higher than 40 °C.	Switch off humidifier.
Temperature meas. inop.	!!! 091	Temperature sensor faulty.	Fit new temperature sensor, see page 41.
Temperature sensor ?	!!! 090	Temperature sensor probe has been disconnected during operation.	Reconnect probe.
		Sensor cable broken.	Fit new temperature sensor.
Tidal volume high	!!! 165	The upper alarm limit of the applied inspiratory tidal volume V_T has been exceeded during three consecutive ventilation strokes.	Check condition of patient, check pattern of ventilation, correct alarm limit if necessary.
		Leak or disconnection.	Check that hose system connections are leakproof.
Tidal volume high	! 190	The inspiratory tidal volume V_T has exceeded the upper alarm limit.	Check condition of patient, check pattern of ventilation, correct alarm limit if necessary.
		Leak or disconnection.	Check that hose system connections are leakproof.
Tube blocked	!!! 230	Evita 4 only applies a very small volume with each mechanical stroke, e. g. because the tube is blocked.	Check condition of patient, check tube.
		Patient "fights" against the mechanical strokes in pressure-controlled ventilation, so that the set inspiratory pressure volume is achieved with only a very small volume.	Check condition of patient, check machine settings.
Volume not constant	!! 220	Due to pressure limit or time limit, the set tidal volume V_T has not been applied.	Prolong inspiratory time » T_{insp} « Increase inspiratory flow » Flow « Increase pressure limit » P_{max} «. Press the » Alarm Reset « key to suppress the visual and acoustic alarm until the cause of the alarm is remedied.

This page intentionally left blank.

Cleaning, disinfection and sterilization

Safety information on reprocessing	150
Dismantling	150
Before dismantling	150
CO ₂ sensor (optional)	150
Temperature sensor	151
Medication nebuliser (optional)	151
Ventilation hoses	151
Flow sensor	151
Expiration valve	152
Breathing gas humidifier	153
Reprocessing procedures	153
Classification of medical devices	153
Testing of procedures and agents	153
Uncritical medical devices	153
Semicritical medical devices	153
Visual inspection	154
Sterilization	154
Reprocessing list	155
After cleaning and disinfection	156
Assembling	157
Mounting the expiration valve	157
Medication nebuliser	158
Breathing gas humidifier	158
Before reusing on patient	158

Safety information on reprocessing

WARNING

Risk of infection or damage to device

Clean, disinfect, and sterilize the device and accessories using validated processes.

CAUTION

Risk of infection

If reusable medical devices are not reprocessed, there is an increased risk of infection to both hospital staff and patients. Clean and disinfect reusable medical devices after each use. Protective clothing, eye protection etc. must be worn.

- Observe the hospital hygiene regulations!
- Reprocess the device after every patient.

Recommendation:

- Change the breathing circuit and expiration valve every 24 hours. Keep replacement systems ready.

CAUTION

The screen is made of Plexiglas.

Do not treat with alcohol or agents containing alcohol. Danger of cracking.

Dismantling

Before dismantling

- Switch off the ventilator and humidifier, and remove their power plugs.
- Drain the water traps and ventilation hoses.
- Drain the water container of the humidifier.

CO₂ sensor (optional)

- 1 Remove from the cuvette. Unplug the connector from the back of the unit.
 - 2 Remove the cuvette of the CO₂ sensor from the Y-piece.
 - 3 Remove the catheter cone from the cuvette.
- Prepare the CO₂ sensor for wipe disinfecting.
 - Reprocess the reusable cuvette e. g. in a washer-disinfector (do not use rinse aid), see page 155.
 - The disposable cuvette cannot be reprocessed and must be disposed of.

CAUTION

Only the reusable cuvette (6870279 or 6870280) may be reprocessed. The disposable cuvette cannot be reprocessed, it is not resistant to high temperatures and would be destroyed.

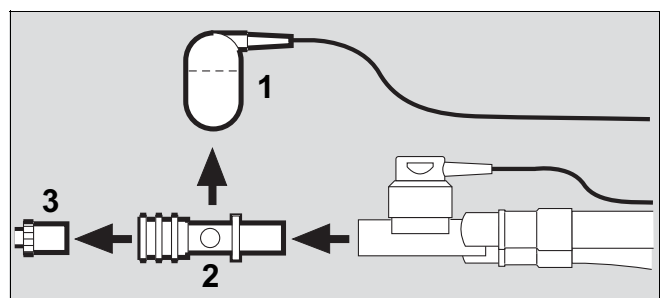

Temperature sensor

- 1 Remove from the Y-piece or from the mounting of breathing circuit. Do not pull the cable.
- Unplug the connector from the back of the Evita 4.
 - Prepare the temperature sensor for wipe disinfecting.

WARNING

The temperature sensor must not be reprocessed in a washer-disinfector, nor placed in a disinfectant bath. Liquid can get inside and disrupt the function!

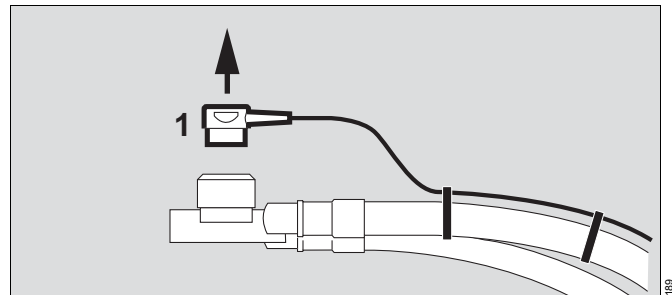

Medication nebuliser (optional)

- 2 Remove the nebuliser hose from the nebuliser and from the port on the device.
 - 3 Remove the medication nebuliser from the adult breathing circuit or
- 3 Dismantle the medication nebuliser from the paediatric hose system.
 - 4 Remove the catheter connector (ISO cone $\varnothing 15 / \varnothing 11$) from the inlet.
 - 5 Remove adapter (ISO cone $\varnothing 22 / \varnothing 11$) from the outlet.
 - 6 Remove corrugated hose from the adapter.
- Dismantle and reprocess the medication nebuliser in accordance with its specific Instructions for Use.
 - Reprocess the adapter parts in a washer-disinfector, see page 155.

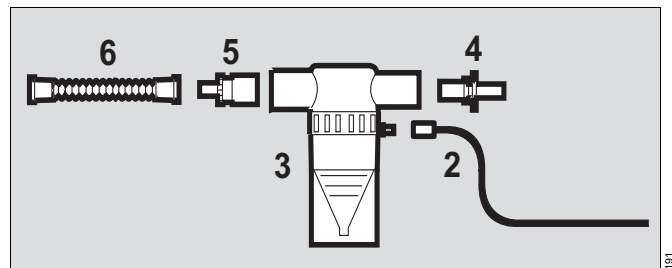
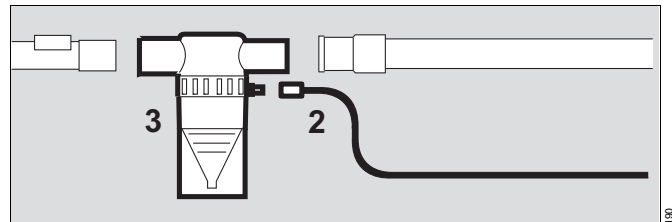

Ventilation hoses

- Remove from the adapters and ports.
- Remove the water traps from the ventilation hoses. Remove the collecting jars from the water traps.
- Ventilation hoses, water traps and their collecting jars and the Y-piece are reprocessed in a washer-disinfector, see page 155.

Flow sensor

- Tilt the control unit upwards, pressing the segments on the right and left down and at the same time tilting the control unit into the required position.
- 7 Push the flow sensor to the left as far as it will go and
 - 8 pull out.
- Reprocess the flow sensor in accordance with its instructions for use.
 - Inspect visually for residues of dried mucus, medication aerosols, or fluff, especially on the measuring wires and their pins. If there are visible deposits that were not removed during reprocessing, dispose of the flow sensor.

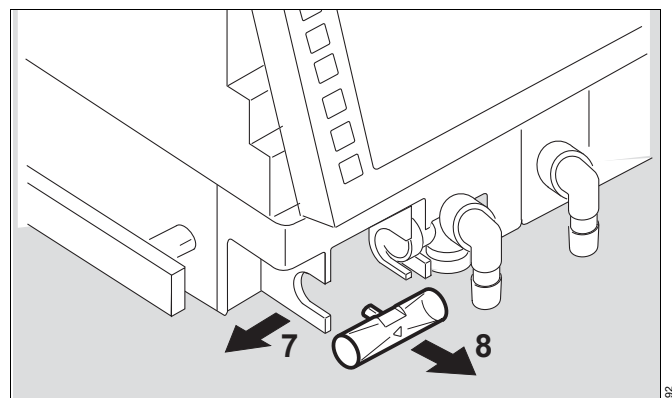

WARNING

Contamination may lead to deviations during flow measurement and to destruction of the flow sensor.

WARNING

After disinfecting with highly flammable substances, air the flow sensor for at least 30 minutes or rinse with sterile water. Otherwise, vapors could ignite during calibration. Risk of fire!

The flow sensor can be reused for as long as automatic calibration is successful.

Expiration valve

- 1 Push the catch to the right while at the same time
- 2 pulling out the expiration valve.

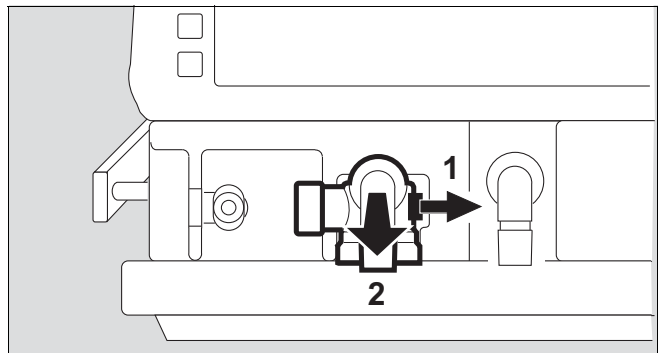

If the expiration valve is fitted with an optional water trap:

- Pull off the collecting jar.

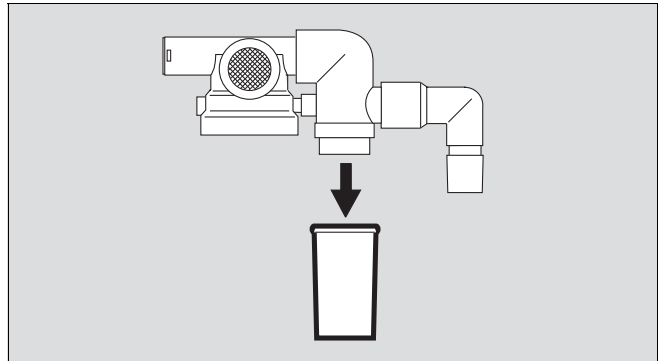

CAUTION

Reprocess the white reusable expiration valve only. The blue disposable expiration valve cannot be reprocessed.

Only strip down the expiration valve if badly soiled:

- Unscrew the stopper by hand and remove together with the diaphragm.
- Do not disassemble the expiration valve any further.
- The expiration valve is reprocessed in a washer-disinfector, see page 155, and
- prepare the expiration valve for hot steam sterilisation.
- Place the open expiration valve in the basket so that it cannot be damaged by other parts.

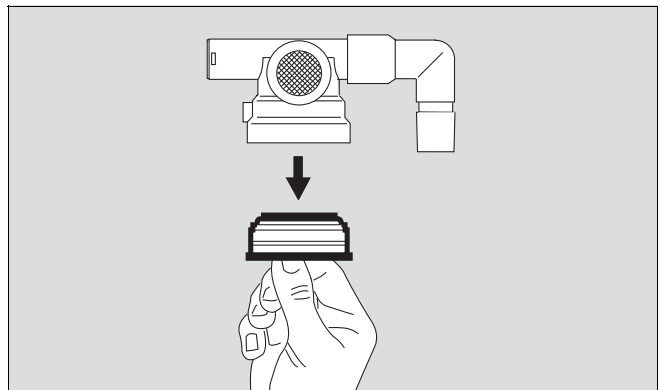

- Dispose of disposable expiration valves in the same way as infectious special waste.

Breathing gas humidifier

- Dismantle in accordance with the specific Instructions for Use and prepare for disinfecting/sterilising.

Reprocessing procedures

Classification of medical devices

For reprocessing, medical devices and their components are divided by type of application and the resulting risk:

- Uncritical medical devices: surfaces accessible to users and patients, e.g., device surfaces, cables
- Semicritical medical devices: parts conducting breathing gases, e.g., breathing hoses, masks

Testing of procedures and agents

Cleaning, disinfection, and sterilization of medical devices has been tested with the following procedures and agents. At the time of testing, the following procedures and agents showed good material compatibility and effectiveness:

Uncritical medical devices

Manual disinfection and simultaneous cleaning:

- Buraton 10F by Schülke & Mayr

Semicritical medical devices

Manual cleaning:

- Neodisher LM2 by Dr. Weigert

Manual disinfection:

- Korsolex extra by Bode Chemie

Machine cleaning:

- Neodisher MediClean by Dr. Weigert

Machine disinfection:

- Thermal, 93 °C (199.4 °F) for 10 min

Sterilization:

- Hot steam, 134 °C (273.2 °F) for 5 min

Observe corresponding instructions for use. The medical device may have been tested with other agents and under other conditions.

Uncritical medical devices

Manual disinfection and simultaneous cleaning

Perform manual disinfection preferably with disinfectants based on aldehydes or quaternary ammonium compounds. For choosing the appropriate disinfectant, observe country-specific lists of disinfectants. Strictly observe the manufacturer's instructions for using disinfectants. The composition of disinfectants may change.

Procedure:

- Remove dirt immediately with a wipe soaked in disinfectant.

WARNING

Risk of electric shock or device malfunction

Penetrating liquid may cause malfunction of or damage to the device, which may endanger the patient.

Only scrub-and-wipe-disinfect device surfaces and cables and make sure no liquids penetrate into the device.

- Perform surface disinfection (scrub-and-wipe disinfection).
- After the contact time has elapsed, remove disinfectant residues.

Semicritical medical devices

Manual cleaning

Perform manual cleaning preferably under running water and with commercially available cleaning agents (pH value ≤ 12).

Procedure:

- Wash off surface dirt under running water.
- Use cleaning agents in accordance with the manufacturer's instructions. Make sure that all surfaces and interior spaces which must be cleaned are reached. If necessary, use suitable brushes.
- Rinse items thoroughly under running water until cleaning agent residues are no longer discernible.
- Check items for visible dirt and damage. If necessary, repeat manual cleaning.

Manual disinfection

Perform manual disinfection preferably with disinfectants based on aldehydes or quaternary ammonium compounds. For choosing the appropriate disinfectant, observe country-specific lists of disinfectant. Strictly observe the manufacturer's instructions for using disinfectants. The composition of disinfectants may change.

Procedure:

- Immerse items in disinfectant.
- After the contact time has elapsed, rinse items thoroughly under running water until disinfectant residues are no longer discernible.
- Check items for visible dirt and damage. If necessary, repeat manual disinfection.

- Thoroughly shake out residual water. Allow items to dry completely.

Machine cleaning and disinfection

Perform machine cleaning and disinfection using a washer-disinfector in accordance with EN ISO 15883, preferably with a cart for anesthesia accessories and ventilation accessories.

Procedure:

- Observe instructions for use of the washer-disinfector.
- Securely position items in the basket. Make sure that all interior spaces and surfaces are completely flushed and that water can drain off freely.
- Use suitable cleaning agent.
- Select suitable program, preferably anesthesia program.
 - Cleaning must be carried out at 40 °C to 60 °C (104 °F to 140 °F) for at least 5 min.
 - Thermal disinfection must be carried out at 80 °C to 95 °C (176 °F to 203 °F) and with corresponding contact time.
- Carry out final rinsing with deionized water.
- Immediately remove items from the washer-disinfector.
- Check parts for visible dirt and damage. If necessary, repeat program or perform manual cleaning and disinfection.
- Allow items to dry thoroughly.

Visual inspection

Check all items for damage and external signs of wear, such as cracking, embrittlement, or pronounced hardening, and residual dirt.

CAUTION

Risk due to faulty accessories

Even reusable accessories have a limited service life, e.g., disinfectant residues can corrode the material during autoclaving. External signs of wear can occur, e.g., cracks, deformations, discolorations, or peeling.

If there are external signs of wear, exchange affected accessories.

Sterilization

Sterilization frees semicritical medical devices from living microorganisms and dries residual water in the items' interior spaces.

- Only sterilize cleaned and disinfected items.

For sterilization, use a vacuum steam sterilizer (in accordance with DIN EN 285), preferably with fractionated vacuum.

CAUTION

Health hazard

Do not sterilize parts in ethylene oxide. Ethylene oxide may diffuse into the items.

Reprocessing list

Applicable to non-infectious patients.

The reprocessing list contains approximate values only. The instructions of the hospital's infection control officer responsible have priority.

Non-critical medical devices

Components which can be reprocessed	Recommended reprocessing intervals	Manual	
		Cleaning	Disinfection
Ventilator Evita 4	Per patient	Outside	Outside
Trolley	Per patient	Outside	Outside
Hinged arm	Per patient	Outside	Outside
Compressed gas hose	Per patient	Outside	Outside
Flow sensor flap	Per patient	Outside	Outside

Semi-critical medical devices

Components which can be reprocessed	Recommended reprocessing intervals	Pre-cleaning	Machine cleaning and disinfection	Manual		Sterilization
				Cleaning	Disinfection	
Ventilation hoses	Per patient/weekly	Yes	Yes	Possible	Possible	Yes
Y-piece						
Water traps ¹⁾						
Collecting jars						
Expiration valve (reusable)	Per patient/weekly ²⁾	Yes	Yes	Possible	Possible	Yes
Diaphragm						
Collecting jar of the water trap						
CO ₂ sensor (optional)	Per patient	No	No	Outside	Outside ³⁾	No
Reusable cuvette of the CO ₂ sensor	Per patient/if soiled	Yes	Yes ⁴⁾	Yes	Yes	Yes
Test filter for CO ₂ sensor	If soiled	No	No	Yes	Yes ⁵⁾	No
Temperature sensor	Per patient/weekly	No	No	Outside ⁶⁾	Outside ⁶⁾	Yes
Flow sensor	Per patient/weekly ²⁾	According to the corresponding Instructions for Use				
Breathing gas humidifier	Per patient/weekly	According to the corresponding Instructions for Use				
Medication nebuliser ¹⁾	According to the corresponding Instructions for Use					
Parts for adapting	Per patient/weekly	Yes	Yes	Possible	Possible	Yes
Bacterial filter	According to the corresponding Instructions for Use					

1) Keep spring-loaded valves (water trap, pneumatic medication nebuliser) open during reprocessing.

2) Nebulisation may lead to increased deposits making it necessary to exchange the parts more often.

3) Wipe disinfection, e.g., with 70 % ethanol. Do not disinfect CO₂ sensor by immersing.

4) Only cleaning agent, and no rinse aid, must be used for automatic cleaning of the cuvette. Otherwise, there is a risk of cracks developing.

5) Wipe disinfection, e.g., with 70 % ethanol. Avoid residues on the test filter.

6) For additional information, see "Manually reprocessing the breathing gas temperature sensor" on page 156.

Manually reprocessing the breathing gas temperature sensor

During manual cleaning, perform the following additional measures:

- Immerse the breathing gas temperature sensor in the solution avoiding bubbles.
- Before the start of contact time and after contact time, clean the sensor in the bath by means of vigorous brushing.

During manual disinfection, perform the following additional measures:

Prerequisite: Use of disinfectant in accordance with manufacturer's specifications and double contact time.

- Immerse the breathing gas temperature sensor in the solution avoiding bubbles.
- Before the start of contact time and after contact time, clean the sensor in the bath by means of vigorous brushing.

After cleaning and disinfection

Expiration valve

- After cleaning and disinfecting, always dry the expiration valve by means of hot steam sterilization at 134 °C (273.2 °F) to ensure that all remaining liquid is dried completely in the interior areas.

The expiration valve can be reused as long as the corresponding test step of the device check is passed. Exchange the expiration valve if signs of wear become visible, such as cracks in the plastic parts, deformation and hardening of the rubber parts. Discolorations of the metal insert do not impair its function.

Assembling

Mounting the expiration valve

CAUTION

Reprocess the white reusable expiration valve only. The blue disposable expiration valve cannot be reprocessed.

The parts must be entirely dry to prevent malfunctioning.

- The diaphragm assembly consists of the diaphragm, sealing washer and aluminium disk.
- Hold stopper by the flange and place diaphragm assembly on the collar of the stopper. Be careful to fit the diaphragm assembly properly.

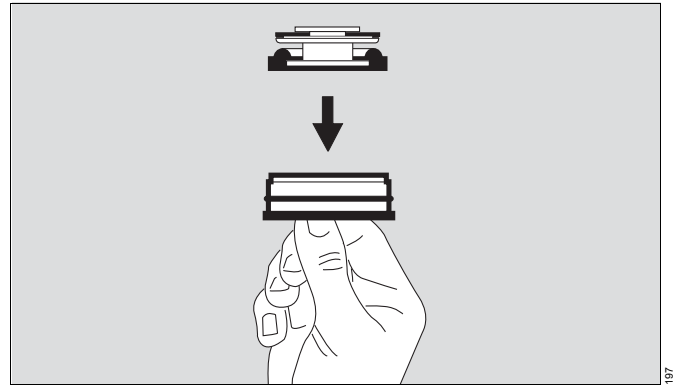

- Insert stopper with diaphragm assembly on top into the housing from below and screw in tightly.

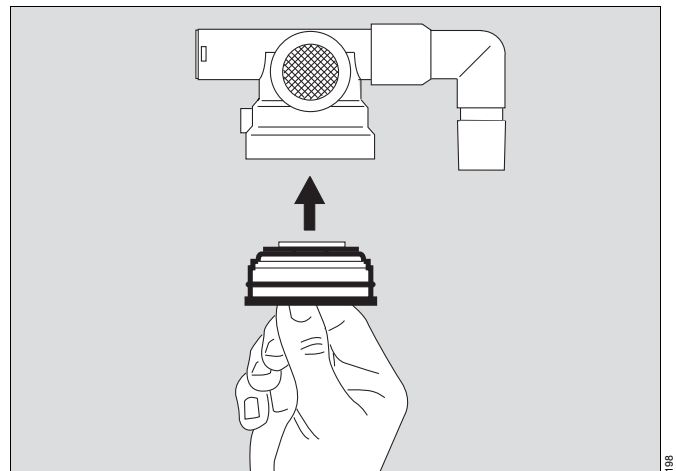

If the expiration valve has an optional water trap:

- Fit the collecting jar.

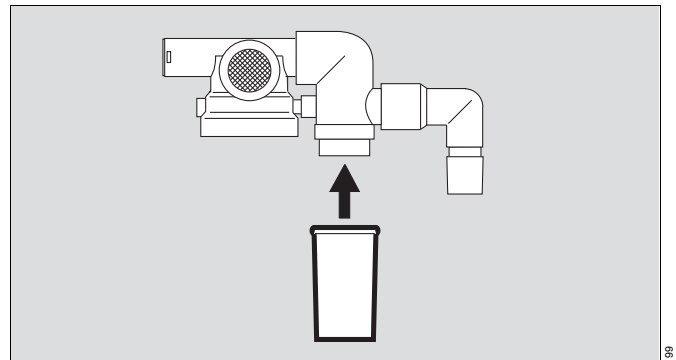

Medication nebuliser

- Assemble in accordance with separate Instructions for Use.
- Install, see page 99.

Breathing gas humidifier

- Assemble in accordance with separate Instructions for Use

Before reusing on patient

- Assemble machine as described under "Preparation" on page 31 onwards.
- Carry out checks to ensure readiness for operation, see "Device Check" on page 51.

Maintenance

Overview	160
Inspection	160
Preventive maintenance	160
Repair	161
Clean or replace cooling air filter	162
Removing and reinserting ambient-air filter	162
Removing and inserting filter for heating patient part	162
Clean covering grid for heating patient part	162

Overview

This chapter describes the maintenance measures required to maintain the proper functioning of the medical device. Maintenance measures must be performed by the personnel responsible.

Note the maintenance intervals for the options installed as specified in the corresponding Instructions for Use of the options.

WARNING

Risk of infection

Users and service personnel can become infected with pathogenic germs.

Disinfect and clean device or device parts before any maintenance measures and also before returning the medical device for repair.

WARNING

Risk of electric shock

Current-carrying components are located under the cover.

- **Do not remove the cover.**
- **Maintenance measures must be performed by the personnel responsible. Dräger recommends DrägerService to perform these measures.**

Definition of maintenance concepts

Concept	Definition
Maintenance	All measures (inspection, preventive maintenance, repair) intended to maintain and restore the functional condition of a medical device
Inspection	Measures intended to determine and assess the actual state of a medical device
Preventive maintenance	Recurrent specified measures intended to maintain the functional condition of a medical device
Repair	Measures intended to restore the functional condition of a medical device after a device malfunction

Inspection

Perform inspections at regular intervals and observe the following specifications.

Checks	Interval	Personnel responsible
Inspection	Every 6 months	Experts

Preventive maintenance

WARNING

Risk of faulty components

Device failure is possible due to wear or material fatigue of the components.

To maintain the proper operation of all components, this device must undergo inspection and preventive maintenance at specified intervals.

WARNING

Risk of electric shock

Before performing any maintenance work, disconnect all electrical connectors and gas connectors from power supply and gas supply.

The following table shows the preventive maintenance intervals:

Component	Interval	Measure	Personnel responsible
O ₂ sensor capsule	In event of display message »O ₂ measurement inop !!!« and if calibration is impossible.	Replace, see page 37	Users
Ambient-air filter, cooling-air filter, filter for heating patient part	Every 4 weeks	Clean or replace, see page 162	Users
	Every 12 months	Replace, see page 162	Users
Covering grid for heating patient part	Every 4 weeks	Clean, see page 162 Dirt blocks the air inlet and reduces the heating output.	Users
Reusable expiration valve:			
– Diaphragm and sealing washer	Every 12 months	Replace	Experts
– Diaphragm assembly consisting of diaphragm, sealing washer, and aluminum disk	Every 12 months	Replace: 1 Disassemble expiration valve, see page 152 2 Replace diaphragm assembly 3 Assemble expiration valve, see page 157	Service personnel
Filters in the compressed gas inlets	Every 2 years	Replace	Experts
Lithium battery for data backup	Every 2 years	Replace	Experts
Safety valve diaphragm assembly	Every 6 years	Replace	Experts
Clock module	Every 6 years	Replace	Experts
Pressure reducer	Every 6 years	Replace	Experts
Plug connection for expiratory flow sensor	Every 6 years	Replace	Experts
Fans for cooling the electronic components of the pneumatic system	Every 6 years or after a maximum of 33000 hours of operation - whichever occurs first.	Replace	Experts
Display backlighting	After 25000 hours	Replace Not applicable to either Toshiba LTA104A261F display or MSC display as of production year 2008.	Experts
Lead-acid gel batteries (option DC power supply)	Refer to Instructions for Use of the DC power supply option		Experts

Repair

Dräger recommends that all repairs are carried out by DrägerService and that only authentic Dräger repair parts are used.

Clean or replace cooling air filter

- Filter must be cleaned or replaced when soiled or at the latest after 4 weeks.
Replace after 1 year at the latest.
- 1 Remove cooling-air filter from its slot on the back of machine.
- Replace or clean in warm water with detergent added; dry well.
- Insert cooling-air filter in slot, taking care not to crease it.
- Dispose of used cooling-air filter with domestic waste.

Note the Instructions for Use of the option when using the DC power supply MB (optional).

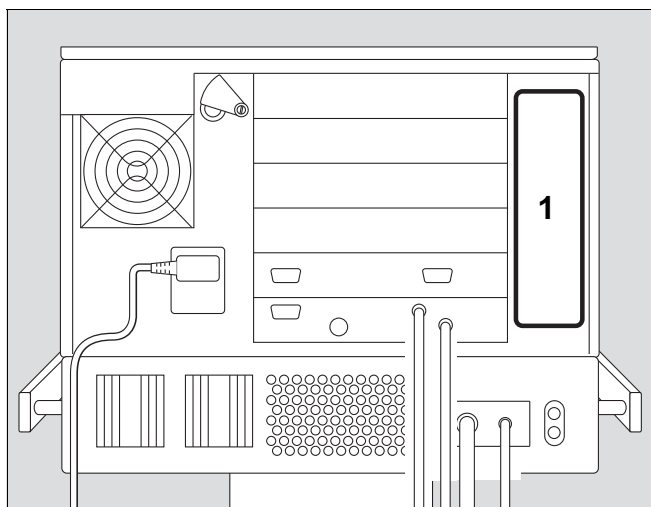

Removing and reinserting ambient-air filter

- Filter must be cleaned or replaced when soiled or at the latest after 4 weeks.
Replace filter every year.
- 2 If necessary, swivel port to the left.
- 3 Loosen screw with a coin, and remove the protective cover.
- 4 Remove the ambient-air filter from the protective cover.
- Slide the new or cleaned ambient air filter under the tabs.
- Replace protective cover, and tighten screw with a coin.
- Dispose of used ambient-air filter with domestic waste.

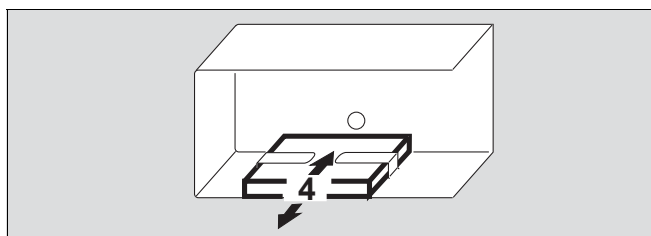
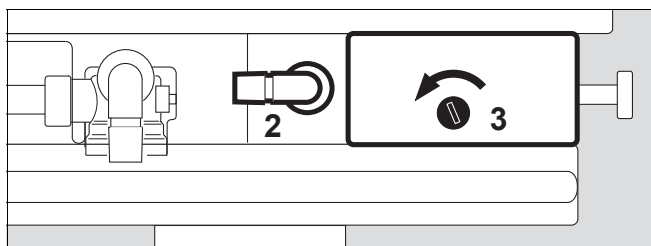

Removing and inserting filter for heating patient part

The filter is required to remove coarse contamination and dust particles from the ambient air. The filter is located on the underside of the device next to the expiration valve.

- Clean or replace if soiled or after 4 weeks at the latest.
Replace after 1 year at the latest.
- 5 Remove the filter from the housing.
- Dispose of used filter with domestic waste.
- 6 Insert new / cleaned filter in the housing.

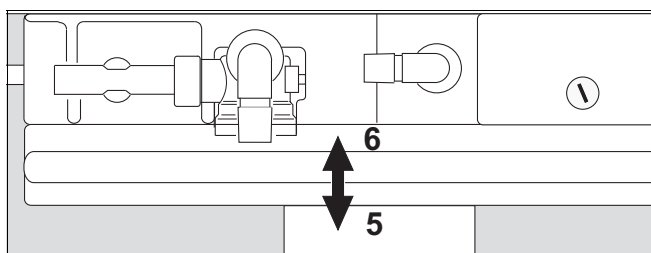

Clean covering grid for heating patient part

- Clean if soiled or after 4 weeks.
- Remove dirt on the covering grid using a disposable tissue. Do not let any moisture get into the unit!

Disposal

Disposing of the medical device	164
For countries subject to the EU Directive 2002/96/EC ..	164
Disposing of non-rechargeable batteries	164
Disposal of O₂ sensors	164
Disposal of flow sensor	164

Disposing of the medical device

At the end of its service life:

- Have the medical device appropriately disposed of in accordance with applicable laws and regulations.

For countries subject to the EU Directive 2002/96/EC

This device is subject to EU Directive 2002/96/EC (WEEE). In order to comply with its registration according to this directive, this device may not be disposed of at municipal collection points for waste electrical and electronic equipment. Dräger has authorized a company to collect and dispose of this device. To initiate collection or for further information, visit Dräger on the Internet at www.draeger.com. Use the Search function with the keyword "WEEE" to find the relevant information. If access to Dräger's website is not possible, contact the local Dräger organization.

Disposing of non-rechargeable batteries

WARNING

Risk of explosion and of chemical burns
Improper handling of batteries can result in explosions and chemical burns.
Do not throw batteries into fire. Do not force batteries open.

- Do not recharge batteries.

Observe the applicable laws and regulations for battery disposal.

Disposal of O₂ sensors

WARNING

Risk of explosion! Do not throw O₂ sensors into fire.
Risk of chemical injury! Do not open O₂ sensors using force.

O₂ sensors must be disposed of as special waste:

- Disposal must conform to local waste disposal regulations. For information consult your local environmental agency, local government offices or appropriate waste disposal companies.

Disposal of flow sensor

- Dispose of in the same way as infectious special waste. Can be incinerated with little pollution at temperatures above 800 °C.

What is what

Control unit	166
Front connections	167
Back panel	168
Rear view with DC power supply MB	169

Control unit

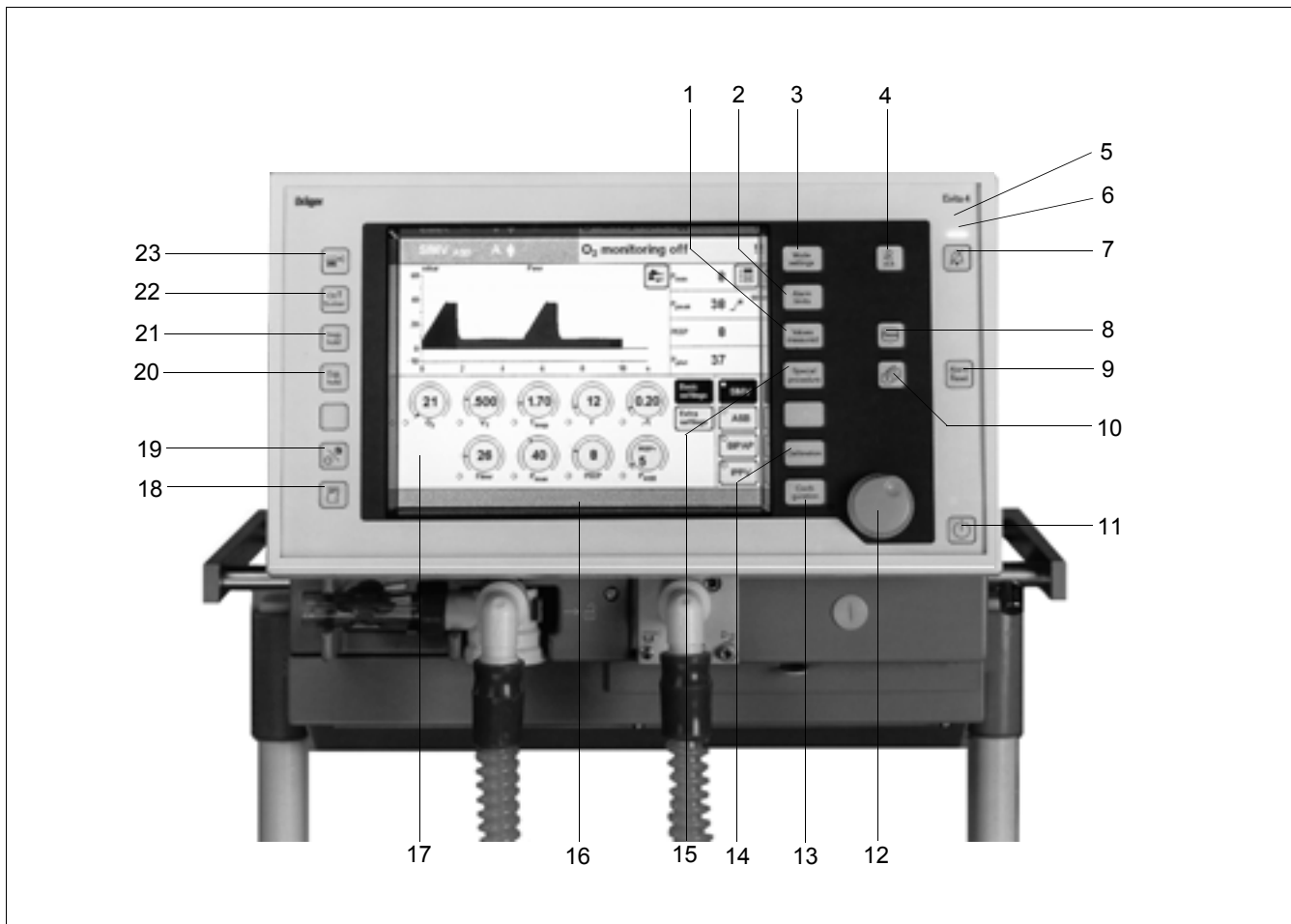

- | | |
|---|---|
| <p>1 Key for displaying the »Values measured« screen page.</p> <p>2 Key for displaying the »Alarm limits« screen page.
For displaying the measured values and alarm limits, and for setting the alarm limits.</p> <p>3 Key for displaying the »Mode settings« screen page.
For setting the ventilation modes and ventilation parameters.</p> <p>4 »i« key for displaying help information for settings.</p> <p>5 Red LED to indicate warnings</p> <p>6 Yellow LED to indicate cautions and advisory messages</p> <p>7 »🔔« key for suppressing the acoustic alarm for 2 minutes.</p> <p>8 »Freeze« key for "freezing" curves.</p> <p>9 »Alarm Reset« key for acknowledging alarm messages.</p> <p>10 »🏠« key for selecting the standard screen page.</p> <p>11 »⏻« key for switching between operating and standby mode.</p> | <p>12 Central rotary dial-knob for selecting and confirming settings.</p> <p>13 Key for displaying the »Configuration« screen page.</p> <p>14 Key for displaying the »Calibration« screen page.</p> <p>15 Key for displaying the »Special procedure« screen page.
For measuring PEEPi and Occlusion Pressure.</p> <p>16 Plastic frame (ensures correct functioning of the touch-sensitive screen)</p> <p>17 Touch-sensitive screen for displaying application-specific screen pages.</p> <p>18 »🖨« key for manual printer logging.</p> <p>19 »☀/🌑« key for switching the screen to bright or dark.</p> <p>20 »Exp. hold« key for prolonging/holding expiration.</p> <p>21 »Insp. hold« key for manual inspiration.</p> <p>22 »O₂ ↑ Suction« key for oxygenation for bronchial suction.</p> <p>23 »💧« key for switching on the medication nebuliser.</p> |
|---|---|

Front connections

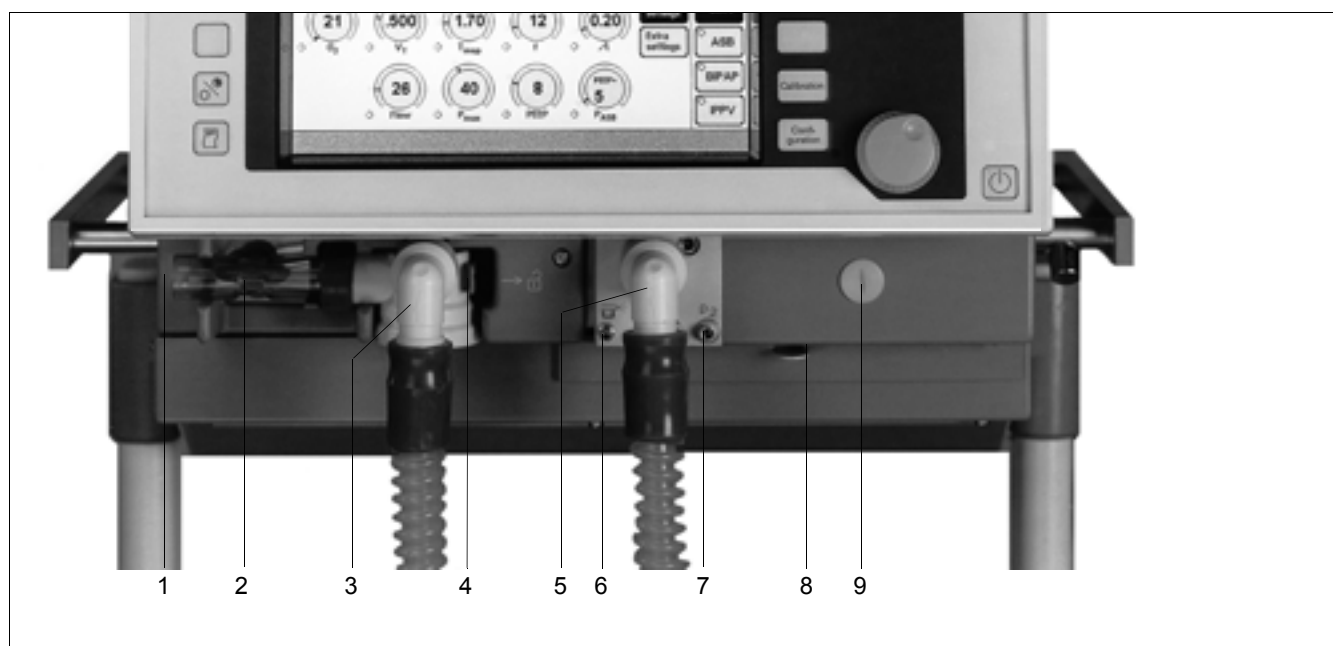

- 1 Gas outlet (EXHAUST – NOT FOR SPIROMETERS)
- 2 Flow sensor
- 3 Expiration valve with expiration port (GAS RETURN)
- 4 Latch for expiration valve
- 5 Inspiration port (GAS OUTPUT)
- 6 Gas supply port for the medication nebuliser
- 7 Ports for optional pressure measurement p1/p2 (not assigned)
- 8 Gas inlet for the safety valve (Emergency air intake), do not obstruct
- 9 Locking screw for protective cover (behind it: O₂ sensor and ambient air filter)

Back panel

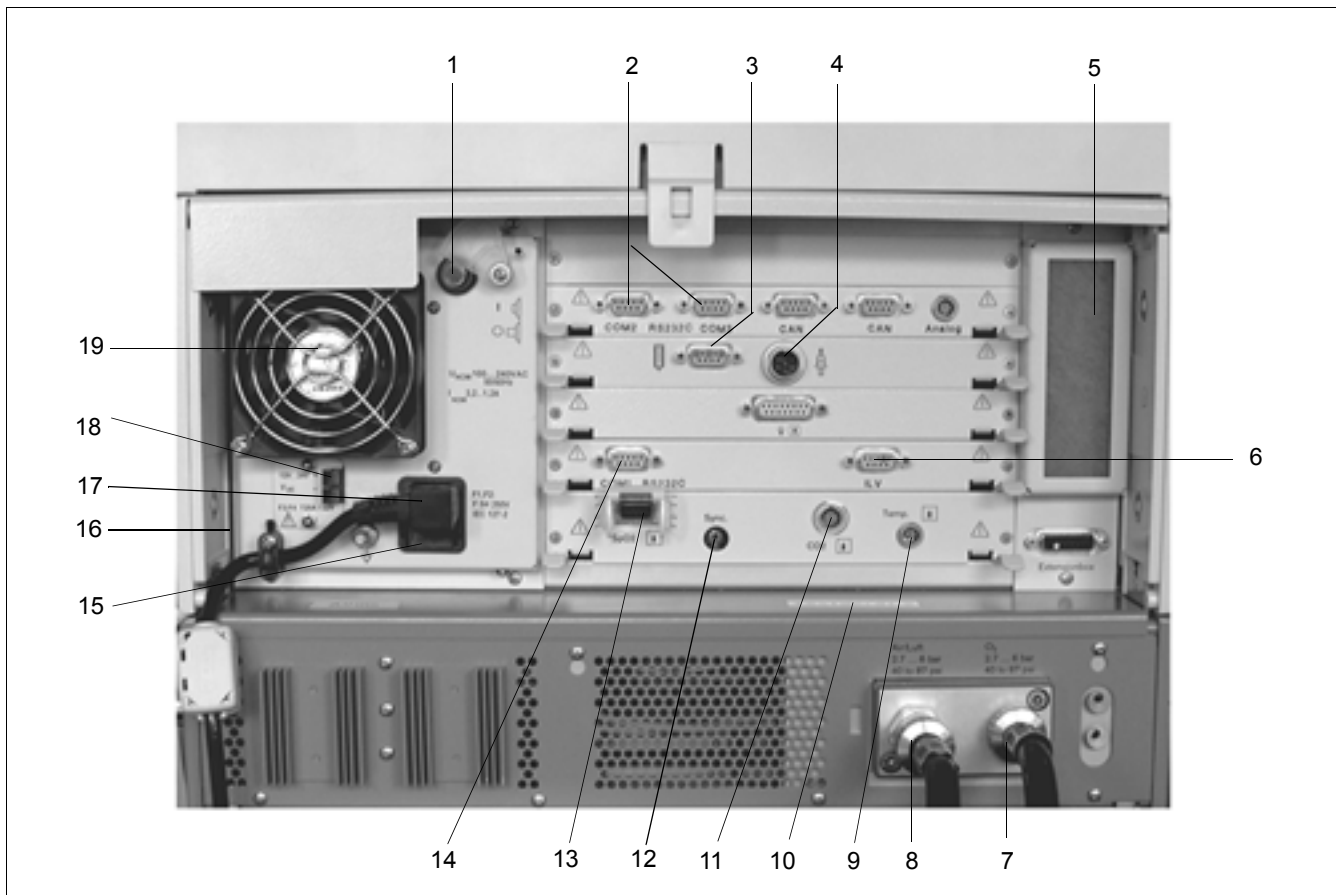



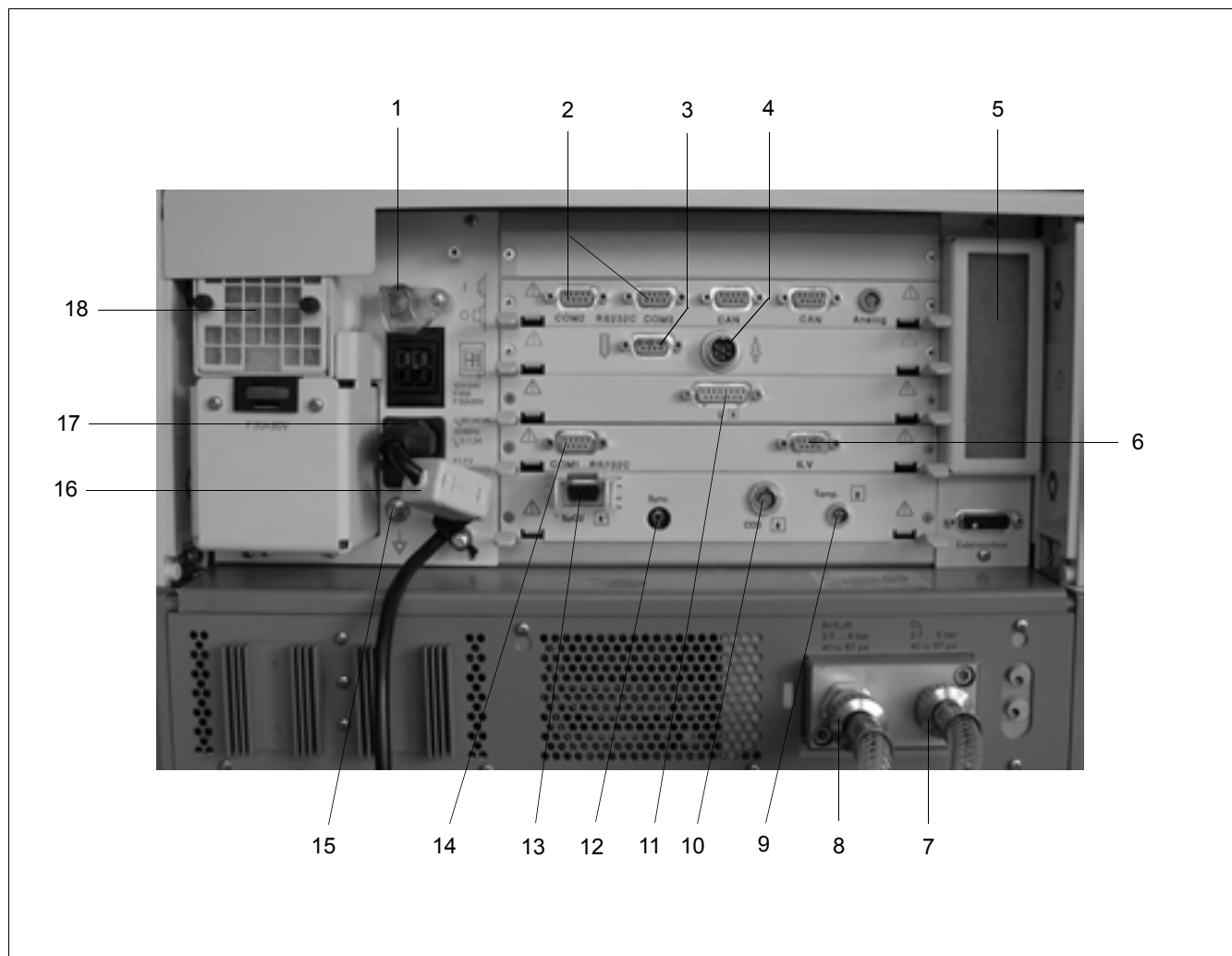

- | | |
|--|--|
| <ul style="list-style-type: none"> 1 Power switch with protective flap 2 »COM2«, »COM3« ports for RS 232 and analogue interfaces (optional) 3 Connection » « for Remote Pad (optional) 4 Connection » « for nurse call (optional) 5 Cooling air filter 6 ILV socket 7 Connection for O₂ 8 Connection for medical air (Air) 9 »Temp [person icon]« socket for temperature sensor 10 Rating plate (possible position) | <ul style="list-style-type: none"> 11 »CO₂ [person icon]« socket for CO₂ sensor (optional) 12 »Sync.« socket for C-Lock-ECG synchronisation for optional SpO₂ measurement 13 »SpO₂ [person icon]« socket for functional SpO₂ measurement (optional) 14 »COM1 RS232C« port for RS 232 interface, e. g. for printer 15 Mains fuses 16 Rating plate (possible position) 17 Connector for power cord 18 DC socket 19 Fan |
|--|--|

Ruechsenle_Evita_4

Rear view with DC power supply MB



- | | |
|---|---|
| <p>1 Power switch with protective flap</p> <p>2 »COM2«, »COM3« ports for RS 232 and analogue interfaces (optional)</p> <p>3 »« connection for Remote Pad (optional)</p> <p>4 »« connection for nurse call (optional)</p> <p>5 Cooling air filter</p> <p>6 ILV socket</p> <p>7 Connection for O₂</p> <p>8 Connection for medical air (Air)</p> <p>9 »Temp « socket for temperature sensor</p> <p>10 »CO₂ « socket for CO₂ sensor (optional)</p> | <p>11 Connection for neonatal flow sensor (optional)</p> <p>12 »Sync.« socket for C-Lock-ECG synchronisation for optional SpO₂ measurement</p> <p>13 »SpO₂ « socket for functional SpO₂ measurement (optional)</p> <p>14 »COM1 RS232C« port for RS 232 interface, e. g. for printer</p> <p>15 Earth connection</p> <p>16 Mains fuses</p> <p>17 Connector for power cord</p> <p>18 Fan with filter</p> |
|---|---|

This page intentionally left blank.

Technical data

Environmental conditions	172
Settings	172
Performance data	173
Measured value displays	175
Computed value displays	177
Monitoring	178
Operating data	179
Machine outputs	180
Materials used	181
For nurse call (optional)	182
EMC declaration	182
General information	182
Electromagnetic emissions	182
Electromagnetic immunity	183
Recommended separation distances to portable and mobile radio frequency communication devices	184
Reduced separation distances to portable and mobile radio frequency communication devices	184

Environmental conditions

In operation

Temperature	10 to 40 °C
Atmospheric pressure	700 to 1060 hPa
Rel. humidity	5 to 90 %, without condensation

In storage and transport

Temperature	-20 to 60 °C
Atmospheric pressure	500 to 1060 hPa
Rel. humidity	0 to 100 %

Settings

Ventilation frequency f	0 to 100/min
Inspiration time T_{insp}	0.1 to 10 s
Tidal volume V_T	
Paediatrics	0.02 to 0.3 L, BTPS ¹⁾
Accuracy	±10 % of set value, or ±10 mL, whichever is greater.
Adults	0.1 to 2.0 L, BTPS ¹⁾
Accuracy	±10 % of set value, or ±25 mL, whichever is greater.
Inspiratory Flow	
Paediatrics	6 to 30 L/min
Adults	6 to 120 L/min
Inspiratory pressure P_{insp}	0 to 80 mbar
Inspiratory pressure limit P_{max}	0 to 100 mbar
O ₂ concentration	21 to 100 Vol%
Accuracy	±5 % of set value, or ±2 Vol%, whichever is greater.
Positive end-expiratory pressure PEEP or interm. PEEP	0 to 35 mbar
Trigger sensitivity	0.3 to 15 L/min
Pressure assist PASB	0 to 80 mbar
Rise time for pressure assist	0 to 2 s
Independent lung ventilation (ILV)	
Master	with trigger / without trigger
Slave	synchr. / asynchr. / inverse I:E

1) BTPS = Body Temperature, Pressure, Saturated.
Measured values relating to the conditions of the patient lung: body temperature 37 °C, steam-saturated gas, ambient pressure.

Performance data

Control principle	time-cycled, volume-constant, pressure-controlled
Intermittent PEEP frequency	2 cycles every 3 minutes
Medication nebulisation	for 30 minutes
Bronchial suction	
Disconnection detection	automatic
Reconnection detection	automatic
Oxygen enrichment	max. 3 minutes
Active suction phase	max. 2 minutes
Final oxygen enrichment	2 minutes
Valve response time $T_{0...90}$	≤ 5 ms
Supply system for spontaneous breathing and ASB	adaptive CPAP system with high initial flow
max. flow rate	2 L/s in 8 ms
max. inspiratory flow	180 L/min
Device compliance with breathing circuit	
Breathing circuit for adults	
Breathing circuit 8414986 with empty humidifier chamber Fisher & Paykel MR 370	≤ 1.5 mL/mbar
Breathing circuit 8412092 with breathing gas humidifier Aquapor EL with minimum filling level	≤ 2.3 mL/mbar
HME breathing circuit 8412860 (without filter)	≤ 1.0 mL/mbar
Breathing circuit for children and neonates (neonates with NeoFlow option)	
Breathing circuit 8414987 with empty humidifier chamber Fisher & Paykel MR 340	≤ 1.0 mL/mbar
Breathing circuit 8412344 with breathing gas humidifier Aquapor EL with minimum filling level	≤ 2.0 mL/mbar
Device resistance with breathing circuit during spontaneous breathing	
Breathing circuit for adults in Adult patient mode	
Breathing circuit 8414986 with empty humidifier chamber Fisher & Paykel MR 370	≤ 2.8 mbar at 60 L/min
Breathing circuit 8412092 with breathing gas humidifier Aquapor EL with minimum filling level	≤ 2.3 mbar at 60 L/min
HME breathing circuit 8412860 (without filter)	≤ 1.5 mbar at 60 L/min
Breathing circuit for children in Paediatrics patient mode	
Breathing circuit 8414987 with empty humidifier chamber Fisher & Paykel MR 340	≤ 9 mbar at 30 L/min
Breathing circuit 8412344 with breathing gas humidifier Aquapor EL with minimum filling level	≤ 9 mbar at 30 L/min
Breathing circuit for neonates in Neonates patient mode (only with NeoFlow option)	
Breathing circuit 8414987 with empty humidifier chamber Fisher & Paykel MR 340	≤ 2.3 mbar at 5 L/min

Inspiratory resistance with breathing circuit following device failure

Breathing circuit for adults

Breathing circuit 8414986 with empty humidifier chamber Fisher & Paykel MR 370	≤6 mbar at 60 L/min
Breathing circuit 8412092 with breathing gas humidifier Aquapor EL with minimum filling level	≤6 mbar at 60 L/min
HME breathing circuit 8412860 (without filter)	≤4 mbar at 60 L/min

Breathing circuit for children

Breathing circuit 8414987 with empty humidifier chamber Fisher & Paykel MR 340	≤10 mbar at 30 L/min
Breathing circuit 8412344 with breathing gas humidifier Aquapor EL with minimum filling level	≤10 mbar at 30 L/min

Breathing circuit for neonates (only with NeoFlow option)

Breathing circuit 8414987 with empty humidifier chamber Fisher & Paykel MR 340	≤1.5 mbar at 5 L/min
---	----------------------

Expiratory resistance with breathing circuit

During operation with breathing circuit for adults in Adult patient mode

Breathing circuit 8414986 with empty humidifier chamber Fisher & Paykel MR 370	≤4.3 mbar at 60 L/min
Breathing circuit 8412092 with breathing gas humidifier Aquapor EL with minimum filling level	≤4.3 mbar at 60 L/min
HME breathing circuit 8412860 (without filter)	≤4.3 mbar at 60 L/min

During operation with breathing circuit for children in Paediatrics patient mode

Breathing circuit 8414987 with empty humidifier chamber Fisher & Paykel MR 340	≤6 mbar at 30 L/min
Breathing circuit 8412344 with breathing gas humidifier Aquapor EL with minimum filling level	≤9 mbar at 30 L/min

During operation with breathing circuit for neonates in Neonates patient mode (only with NeoFlow option)

Breathing circuit 8414987 with empty humidifier chamber Fisher & Paykel MR 340	≤2.0 mbar at 5 L/min
---	----------------------

Following device failure with breathing circuit for adults

Breathing circuit 8414986 with empty humidifier chamber Fisher & Paykel MR 370	≤3.7 mbar at 60 L/min
Breathing circuit 8412092 with breathing gas humidifier Aquapor EL with minimum filling level	≤3.7 mbar at 60 L/min
HME breathing circuit 8412860 (without filter)	≤3.7 mbar at 60 L/min

Following device failure with breathing circuit for children

Breathing circuit 8414987 with empty humidifier chamber Fisher & Paykel MR 340	≤6 mbar at 30 L/min
Breathing circuit 8412344 with breathing gas humidifier Aquapor EL with minimum filling level	≤8 mbar at 30 L/min

Following device failure with breathing circuit for neonates (only with NeoFlow option)

Breathing circuit 8414987 with empty humidifier chamber Fisher & Paykel MR 340	≤1.1 mbar at 5 L/min
---	----------------------

Additional functions

Inspiratory relief valve

opens if medical air supply fails (pressure <1.2 bar), enables spontaneous breathing with filtered ambient air.

Safety valve

opens the breathing system at 100 mbar.

Measured value displays

Airway pressure measurement

Max. airway pressure

P_{peak}

Plateau pressure

P_{plat}

Pos. end-exp. pressure

PEEP

Mean airway pressure

P_{mean}

Min. airway pressure

P_{min}

Range

0 to 99 mbar

Resolution

1 mbar

Accuracy

2 % (4 % when displayed in cmH₂O)

O₂ measurement in main flow (inspiratory side)

Inspiratory O₂ concentration FiO₂

Range

15 to 100 Vol%

Resolution

1 Vol%

Accuracy

±3 Vol%

Drift of measurement accuracy

2 Vol.% over 24 hours

T_{0...90}

<15 s

Flow Measurement

Minute Volume MV

Spontaneously breathed minute volume MV_{spn}

Range

0 to 99 L/min, BTPS¹⁾

Resolution

0.1 L/min or for values less than 1 L/min: 0.01 L/min

Accuracy

±8 % of measured value

T_{0...90}

approx. 35 s

Tidal volume V_{T_e}

Spontaneously breathed tidal volume V_{T_{spn}}

Range

0 to 3999 mL, BTPS¹⁾

Resolution

1 mL

Accuracy

±8 % of measured value

Tidal volume V_{TASB}

Inspiratory tidal volume during an ASB stroke

Range

0 to 3999 mL, BTPS¹⁾

Resolution

1 mL

Accuracy

±8 % of measured value

1) BTPS = Body Temperature, Pressure, Saturated.

Measured values based on the conditions of the patient lung: body temperature 37 °C, steam-saturated gas, ambient pressure.

Frequency Measurement

Breathing frequency f_{total}

Spontaneous breathing frequency f_{spn}

Range	0 to 150 /min
Resolution	1 /min
Accuracy	± 1 /min
T0...90	approx. 35 s

Breathing gas temperature measurement

Range	18 to 51 °C
Resolution	1 °C
Accuracy	± 1 °C

CO₂ measurement in main flow

End-expiratory CO₂ concentration $etCO_2$

Range	0 to 100 mmHg or 0 to 13.3 Vol% or 0 to 13.3 kPa
Resolution	1 mmHg or 0.1 Vol% or 0.1 kPa
Accuracy	
for 0 to 40 mmHg	± 2 mmHg
for 40 to 100 mmHg	± 5 % of measured value
Drift of measurement accuracy	1 % of measured value over 6 hours
T0...90	≤ 25 ms
Warm-up time	max. 3 minutes

CO₂ production $\dot{V}CO_2$

Range	0 to 999 mL/min, STPD ¹⁾
Resolution	1 mL/min
Accuracy	± 9 % of measured value
T0...90	12 minutes

Serial dead space V_{ds}

Range	0 to 999 mL, BTPS
Resolution	0.1 mL
Accuracy	± 10 % of measured value or ± 10 mL, whichever is greater

Dead space ventilation V_{ds}/V_T

Range	0 to 99 %
Resolution	1 %
Accuracy	± 10 % of measured value

With reference to the displayed measured values, the following dead space volumes must be taken into account

CO ₂ cuvette, adults (6870279, MP01062)	4.3 mL
CO ₂ cuvette, pediatric patients (6870280, MP01063)	1.9 mL

1) STPD = Standard Temperature, Pressure, Dry.
Dry Measured values based on normal physical conditions 0 °C, 1013 hPa, dry.

Computed value displays

Compliance C	
Range	0 to 300 mL/mbar
Resolution	
Range 0 to 99.9 mL/mbar	0.1 mL/mbar
Range 100 to 300 mL/mbar	1 mL/mbar
Accuracy	±20 % of measured value ¹⁾
Resistance R	
Range	0 to 600 mbar/L/s
Resolution	
Range 0 to 99.9 mbar/L/s	0.1 mbar/L/s
Range 100 to 600 mbar/L/s	1 mbar/L/s
Accuracy	±20 % of measured value ²⁾
Leakage minute volume MV _{Leak}	
Range	0 to 99 L/min, BTPS
Resolution	0.1 L/min or for values less than 0.1 L/min: 0.01 L/min
Accuracy	±18 % of measured value
T _{0...90}	approx. 35 s
Rapid Shallow Breathing RSB	
Range	0 to 9999 1/(min x L)
Resolution	1/(min x L)
Accuracy	see measurement of V _T and f
Negative Inspiratory Force NIF	
Range	-45 to 0 mbar
Resolution	1 mbar
Accuracy	±2 mbar
Curve displays	
Airway pressure P _{aw} (t)	-10 to 100 mbar
Flow (t)	-150 to 180 L/min
Volume V (t)	0 to 2000 mL
Exp. CO ₂ concentration FCO ₂	0 to 100 mmHg or 0 to 13 kPa or 0 to 13 Vol%
P 0.1	0 to 25 mbar

1) C-values may be considerably falsified as spontaneous breathing increases; compliance with the measuring accuracy therefore cannot be guaranteed for spontaneous breathing.

2) R-values may be considerably falsified as spontaneous breathing increases; compliance with the measuring accuracy therefore cannot be guaranteed for spontaneous breathing

Monitoring

Expiratory minute volume **MV**

Upper alarm limit alarm

when MV exceeds the upper alarm limit.

Setting range

0.1 to 41 L/min, in 0.1 L/min steps

Lower alarm limit alarm

when MV falls below the lower alarm limit.

Setting range

0.01 to 40 L/min, in 0.1 L/min steps

Airway pressure **Paw**

Upper alarm limit alarm

if the "Paw high" value is exceeded.

Setting range

10 to 100 mbar

Lower alarm limit alarm

if the value "PEEP + 5 mbar" (coupled with the PEEP set value) is not exceeded for at least 96 ms in 2 successive ventilation strokes.

Insp. O₂ concentration **FiO₂**

Upper alarm limit alarm

if FiO₂ exceeds the upper alarm limit for at least 20 seconds.

Lower alarm limit alarm

if FiO₂ falls below the lower alarm limit for at least 20 seconds.

Range

both alarm limits are automatically allocated to the set value: under 60 Vol% with ±4 Vol%
over 60 Vol% with ±6 Vol%

Endexpiratory CO₂ concentration **etCO₂**

Upper alarm limit alarm

if the upper alarm limit has been exceeded

Setting range

1 to 100 mmHg or 0.1 to 15 kPa or Vol%

Lower alarm limit alarm

if the lower alarm limit fell below

Setting range

0 to 99 mmHg or 0 to 14.9 kPa or Vol%

Insp. breathing gas temperature

Upper alarm limit alarm

when temperature reaches 40 °C.

(Evita 4 can also be used without temperature sensor if the sensor is not connected on switching on.)

Tachypnoea monitoring **f_{spn}**

Alarm

during spontaneous breathing, when the spontaneous breathing frequency has been exceeded.

Setting range

5 to 120/min

Volume monitoring **V_{Ti}**

Lower alarm limit alarm

if the set tidal volume V_T (coupled with the set value V_T) has not been supplied.

Upper alarm limit alarm

if the applied tidal volume exceeds the value of the alarm limit, inspiration is interrupted and the expiration valve is opened.

Setting range

21 to 4000 mL

Apnoea alarm time **T_{Apnoea}**



Alarm

If no breathing activity is detected.

Setting range

5 to 60 s, adjustable in 1 second steps.

Operating data

Mains power connection	100 V to 240 V, 50/60 Hz
Current	3.2 A to 1.2 A
Power consumption	typically approx. 125 W
Machine fuses	
Range 100 V to 240 V	F 5 H 250 V IEC 127-2 (2x), subject to technical modifications. Device labels must be observed.
Protection class	
Machine	Class I
CO ₂ sensor (sensor connected)	Type BF 
Temperature sensor AWT 01 (sensor connected)	Type BF 
Expiration valve and ventilation hoses	Type BF 
Gas supply	
O ₂ gauge pressure	3 bar –10 % to 5.5 bar +10 %
Requirement for the central gas supply system ¹⁾	at least 60 L/min continuous flow and 200 L/min peak flow for at least 4 s
Requirement for the supply from a breathing air compressor or from compressed gas cylinders ¹⁾	at least 30 L/min continuous flow and 180 L/min peak flow for at least 0,8 s
O ₂ connection thread	depending on configuration: DIN, NIST, DISS, Air Liquide
Air gauge pressure	3 bar –10 % to 5.5 bar +10 %
Requirement for the central gas supply system ¹⁾	at least 60 L/min continuous flow and 200 L/min peak flow for at least 4 s
Requirement for the supply from a breathing air compressor or from compressed gas cylinders ¹⁾	at least 30 L/min continuous flow and 180 L/min peak flow for at least 0,8 s
Air connection	depending on configuration: DIN, NIST, DISS, Air Liquide
Dew point	5 °C below ambient temperature
Oil concentration	<0,1 mg/m ³
Particle size	Dust-free air (filtered with pore size <1 µm)
Gas consumption of control system	Medical air or O ₂ approx. 3.5 L/min
Output for pneumatic medication nebuliser	Medical air or O ₂ max. 2.25 bar, max. 11 L/min
Automatic gas switch-over	if one gas fails (inlet pressure <1.5 bar), the device switches to the other gas.

1) If gas is supplied by a breathing air compressor or a compressed gas cylinder and the more stringent requirements for central gas supply systems are not met, the ventilation capabilities of the device are limited. The limitation applies when large flows above 30 L/min are supplied for a longer period of time as may be the case when there is a device malfunction (opened breathing circuit) during the ventilation of adults or when there are large leakages (NIV). In that case the alarm message »Air supply down !!!« or »O₂ supply down !!!« is shown. If one gas source (Air or O₂) does not provide the required pressure, the device switches to the other gas source. This may result in the FiO₂ concentration deviating from the set concentration. If there is no sufficient gas supply, ventilation will be interrupted until the required inlet pressure is restored. When providing gas by a breathing air compressor or compressed gas cylinder, avoid large flows.

Sound pressure level

Alarm sound pressure level of the device during operation Operator's position: at front of device Free field measurement in accordance with ISO 3744 at a distance of 1 m (39 in) and a height of 1.5 m (59 in)	max. 47 dB (A)
Alarm sound pressure level of the alarm tone at operator's position Operator's position: at front of device Free field measurement in accordance with ISO 3744 at a distance of 1 m (39 in) and a height of 1.5 m (59 in)	
Alarm sound pressure level of the acoustic alarm generator (speaker)	60 dB(A) to 85 dB(A), adjustable
Alarm sound pressure level of the mains supply failure alarm and auxiliary alarm at the rear of the device Free field measurement in accordance with ISO 3744 at a distance of 1 m (39 in) and a height of 1.5 m (59 in)	
Alarm sound pressure level of the mains supply failure alarm and auxiliary alarm	70 dB(A) to 85 dB(A)

Dimensions (W x H x D)





Basic machine	530 x 290 x 450 mm
Machine with trolley	580 x 1335 x 660 mm

Weight

Basic machine	approx. 27 kg
Basic machine with trolley incl. cabinet 8H	approx. 69 kg

Machine outputs

Digital output COM 1	Output and reception via an RS 232 C interface LUST protocol Baud rate: 1200, 2400, 4800, 9600, 19200 baud Data bits: 7 Parity: even Stop bits: 1 MEDIBUS protocol Baud rate: 1200, 2400, 4800, 9600, 19200 baud Data bits: 8 Parity: even, odd, no Stop bits: 1 or 2 (19200 baud are required for transmission of high-speed data, e. g. for flow curve) Printer protocol HP Deskjet, series 500 Baud rate: 1200, 2400, 9600, 19200 baud Data bits: 8 Parity: no Stop bits: 1
Cable length	Up to 15 m
Load impedance	3000 to 7000 Ω
Signal level (at load impedance 3000 to 7000 Ω)	
Low	Between 3 and 15 V
High	Between -3 and -15 V
Electrical isolation	Port COM 1 is electrically isolated from the machine electronics. The test voltage for the electrical isolation equals 1500 V.

Pin assignment	Pin 2 RxD Pin 3 TxD Pin 5 GND Connector housing Machine housing
Digital output	Output for independent lung ventilation (ILV)
Digital output (optional)	for output and reception via two RS 232 C interfaces
Digital output (optional)	for output and reception via a CAN interface
Analogue output (optional)	for output of analog data
Electromagnetic compatibility (EMC)	
Evita 4 from year of manufacture 2005*	IEC 60601-1-2:2004/EN 60601-1-2:2006
Evita 4 up to and including year of manufacture 2004*	IEC 60601-1-2:1993/EN 60601-1-2:1993
* From 2001 onwards, the year of manufacture is indicated on the type plate.	
Evita 4 from software 4.25	IEC 60601-1-8:2006 Exception: Instead of the »  Audio paused 2 min.« symbol the »  « symbol is used.
Evita 4 up to and including software 4.24	IEC 60601-1-8:2006 Exceptions: – Deviations in the tone sequences can only be detected by measurement techniques. – The flashing rate of the alarm lamp is too high. – Instead of the »  Audio paused 2 min.« symbol the »  « symbol is used.
Classification as per EC Directive 93/42/EEC Annex IX	II b
UMDNS Code Universal Medical Device Nomenclature System – Nomenclature for medical products	17-429

Materials used

Part	Appearance	Material
Ventilation hose	milky, transparent	silicone rubber
Water traps	yellow, transparent	polysulphone
Y-piece with connector for temperature measurement	milky, transparent yellow, transparent	polysulphone silicone rubber
Expiration valve housing, closure	white	polyamide
Diaphragm	whitish and grey	silicone rubber and aluminium
Reusable CO2 cuvette	yellow, transparent	polysulphone with glass windows
Disposable CO2 cuvette	transparent	styrene Butadiene Copolymer (SBC)
Temperature sensor / cable	milky / green or blue	silicone rubber
CO2 sensor / cable	grey / grey	polyurethane

For nurse call (optional)

Pin assignment

6-pin round DIN socket

Floating DC contact

Input voltage max. 40 V DC

Input current max. 500 mA

Switching capacity max. 15 W

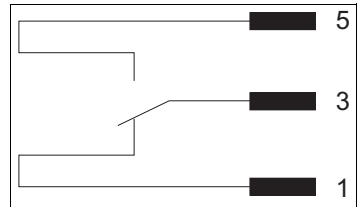

EMC declaration

General information

The EMC compliance of the product has been evaluated with the external cables, transducers, and accessories specified in the list of accessories. Other accessories which do not affect EMC compliance may be used if no other reasons forbid their use (see other sections of the instructions for use). The use of noncompliant accessories can result in increased emissions or decreased immunity of the medical device.

The medical device must only be used adjacent to or stacked with other devices if this configuration is approved by Dräger. If adjacent or stacked use of non-approved configurations is inevitable, verify normal operation of the medical device in the configuration in which it will be used. In any case, strictly observe the instructions for use of the other devices.

Electromagnetic emissions

When using wireless networking, be aware that the system operates at 2.4 GHz range. Other equipment, even if compliant with CISPR emission requirements, can interfere with reception of wireless data. When selecting wireless systems (wireless communication media, pager systems, etc.) for use in installations where wireless networking is used, care must always be used to ensure that operating frequencies are compatible. For example, selecting wireless communication media that operate at 2.4 GHz will likely cause difficulty with the networking components. Low-level signals such as ECG signals are particularly susceptible to interference from electromagnetic energy. Even if the equipment meets the test requirements described below, smooth operation cannot be guaranteed – the ‘quieter’ the electrical environment the better. In general, increasing the distance between electrical devices decreases the likelihood of interference.

Detailed radio frequency characteristics

Communication devices in accordance with IEEE 802.11b:

- 2412 to 2472 MHz
- DSSS (direct-sequence spread spectrum) limited to 100 mW
- Applicable to access points and client adapters

Communication devices in accordance with IEEE 802.15.1:

- 2400 to 2485 MHz
- FHSS (frequency-hopping spread spectrum) limited to 2.5 mW

See the instructions for use of the wireless devices for further details.

Electromagnetic environment

The medical device is intended for use in an electromagnetic environment as specified below. The user must ensure that the medical device is used in such an environment.

Emissions	Compliance according to	Electromagnetic environment
Radio frequency emissions (CISPR 11)	Group 1	The medical device uses radio frequency energy only for its internal function. Therefore, its radio frequency emissions are very low and are not likely to cause any interference in nearby electronic equipment.
	Class A	The medical device is suitable for use in all establishments other than domestic establishments and those directly connected (without transformer) to the public low-voltage power supply network that supplies buildings used for domestic purposes.
Harmonic emissions (IEC 61000-3-2)	Not applicable	
Voltage fluctuations/flicker emissions (IEC 61000-3-3)	Not applicable	

Electromagnetic immunity

The medical device is intended for use in an electromagnetic environment as specified below. The user must ensure that the medical device is used in such an environment.

Immunity against	Test level (IEC 60601-1-2)	Compliance level (medical device)	Electromagnetic environment
Electrostatic discharge (ESD) (IEC 61000-4-2)	Contact discharge: ± 6 kV	$\pm 2, 4, 6$ kV	Floors should be wood, concrete, or ceramic tiles. If floors are covered with synthetic material, the relative humidity should be at least 30 %.
	Air discharge: ± 8 kV	$\pm 2, 4, 8$ kV, except interfaces bearing an ESD symbol 	
Electrical fast transients/bursts (IEC 61000-4-4)	Power supply lines: ± 2 kV	± 2 kV	Mains voltage quality should be that of a typical commercial or hospital environment.
	Longer input/output lines: ± 1 kV	± 1 kV	
Surge on AC mains lines/surges (IEC 61000-4-5)	Common mode: ± 2 kV	± 2 kV	Mains voltage quality should be that of a typical commercial or hospital environment.
	Differential mode: ± 1 kV	± 1 kV	
Power frequency magnetic field (50/60 Hz) (IEC 61000-4-8)	3 A/m	3 A/m	Power frequency magnetic fields should be at levels characteristic of a typical commercial or hospital environment.
Voltage dips and short interruptions on AC mains input lines (IEC 61000-4-11)	Dip >95 %, 0.5 periods	>95 %, 0.5 periods	Mains voltage quality should be that of a typical commercial or hospital environment. If the user of the medical device requires continued operation during mains power supply interruptions, it is recommended the medical device is powered from an uninterruptible power supply or a battery.
	Dip 60 %, 5 periods	60 %, 5 periods	
	Dip 30 %, 25 periods	30 %, 25 periods	
	Dip >95 %, 5 seconds	>95 %, 5 seconds	

Immunity against	Test level (IEC 60601-1-2)	Compliance level (medical device)	Electromagnetic environment
Radiated radio frequency (IEC 61000-4-3)	80 MHz to 2.5 GHz: 10 V/m	10 V/m	Recommended minimum distance to portable and mobile radio frequency transmitters with transmission power P_{EIRP} to the medical device including its lines: (1.84 m x $\sqrt{P_{EIRP}}$) ¹⁾
Conducted radio frequency (IEC 61000-4-6)	150 kHz to 80 MHz: 10 V inside ISM bands ²⁾	10 V	Recommended minimum distance to portable and mobile radio frequency transmitters with transmission power P_{EIRP} to the medical device including its lines: (1.84 m x $\sqrt{P_{EIRP}}$) ¹⁾
	150 kHz to 80 MHz: 3 V outside ISM bands ²⁾	3 V	

- 1) For P_{EIRP} , insert the highest possible "equivalent isotropic radiated power" of the adjacent radio frequency transmitter. In the vicinity of equipment marked with the symbol (⚡), interference can occur. Field strengths from fixed, portable, or mobile radio frequency transmitters at the location of the medical device should be less than 3 V/m in the frequency range from 150 kHz to 2.5 GHz and less than 1 V/m above 2.5 GHz.
- 2) ISM bands in this frequency range are: 6.765 MHz to 6.795 MHz; 13.553 MHz to 13.567 MHz; 26.957 MHz to 27,283 MHz; 40.66 MHz to 40.70 MHz.

Recommended separation distances to portable and mobile radio frequency communication devices

The following separation distances are in accordance with the specifications of IEC 60601-1-2.

Max. P_{EIRP} (W)	150 kHz to 2.5 GHz	All other frequencies	Examples
0.03	0.32 m (1.05 ft)	0.96 m (3.15 ft)	WLAN 5250/5775 (Europe)
0.10	0.58 m (1.90 ft)	1.75 m (5.74 ft)	WLAN 2440 (Europe)
0.17	0.76 m (2.49 ft)	2.28 m (7.48 ft)	Bluetooth, RFID 2.5 GHz
0.20	0.82 m (2.69 ft)	2.47 m (8.10 ft)	WLAN 5250 (not in Europe)
0.25	0.92 m (3.02 ft)	2.76 m (9.06 ft)	UMTS mobiles
0.41	1.18 m (3.87 ft)	3.53 m (11.58 ft)	Cordless DECT devices
0.82	1.67 m (5.48 ft)	5.00 m (16.40 ft)	RFID 13.56 MHz
1.00	1.84 m (6.04 ft)	5.52 m (18.11 ft)	WLAN 5600 (not in Europe)
1.64	2.36 m (7.74 ft)	7.07 m (23.20 ft)	GSM 1800/GSM 1900
3.28	3.33 m (10.93 ft)	10.00 m (32.81 ft)	GSM 900 mobiles, RFID 868 MHz

Reduced separation distances to portable and mobile radio frequency communication devices

The following separation distances are based on additional tests performed by Dräger to determine the minimum separation distances absolutely necessary. These reduced separation distances are valid only for mobile radio frequency communication devices using the standards listed.

Mobile radio frequency communication device using ...	Separation distance
GSM 850, GSM 900, RFID 868 MHz (limited to 2 W ERP)	0.13 m (0.43 ft)
GSM 1800, GSM 1900 (limited to 1 W ERP)	0.05 m (0.16 ft)
UMTS, DECT (limited to 0.25 W ERP)	0.02 m (0.07 ft)
Bluetooth, WLAN 2450, RFID 2450 (limited to 0.1 W ERP)	0.03 m (0.10 ft)

Description

Ventilation modes	186
Volume-controlled ventilation with PLV and AutoFlow® ..	186
Sigh	188
SIMV	189
ASB	190
BIPAP	191
BIPAP ^{Assist}	192
APRV	193
MMV	193
Flow measurement	194
Automatic leakage compensation	196
Weaning parameters	197
Occlusion pressure P 0.1	197
Rapid Shallow Breathing RSB	198
Negative Inspiratory Force NIF	198
Intrinsic PEEP	199
Insp. O₂ concentration during medication nebulisation	200
Principle of measurement	201
Expiratory flow measurement	201
Neonatal flow measurement (optional)	201
O ₂ measurement	201
CO ₂ measurement	201
Alarm – Detection/Description	202
Abbreviations	206
Symbols	207
Bibliography	208

Ventilation modes

Volume-controlled ventilation with PLV and AutoFlow®

AutoFlow is a new additional function that regulates inspiratory flow during the mandatory ventilation stroke in the constant-volume ventilation modes IPPV, SIMV and MMV.

To explain the improvement achieved by this function, the conventional methods are explained first:

Classic volume constant mandatory ventilation stroke

In mandatory ventilation strokes without AutoFlow, the »Insp. Flow« parameter restricts the inspiration flow. If the inspiration flow is so high that the set tidal volume V_T is attained before the inspiration time T_{insp} has fully elapsed, the inspiration valve closes, and the breathing gas supply stops. The expiration valve remains closed until the end of the inspiration time T_{insp} . This phase, the inspiratory pause, can be identified in the curve $P_{aw}(t)$ as the plateau P_{plat} .

This type of mandatory ventilation stroke, which for technical reasons is found in the same form in almost all intensive care ventilators, has two serious drawbacks:

- If the lungs are extremely non-homogeneous, the pressure peaks can lead to the overdistension of specific lung areas, and
- the limited inspiration flow and closed inspiration and expiration valves during the inspiratory pause can cause the patient to "fight" the machine, unless the pattern of ventilation is regularly adapted to the needs of the spontaneously breathing patient.

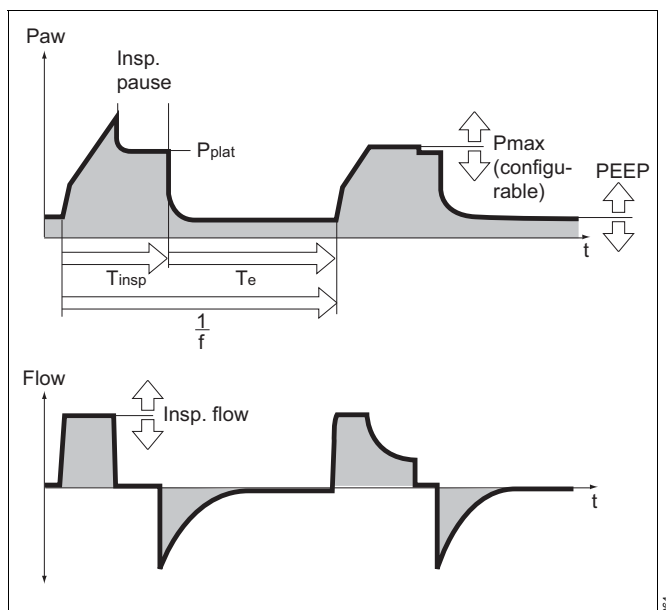

Manual pressure limiting with Pmax

Evita 4 can prevent pressure peaks, while maintaining the set tidal volume V_T , by means of the pressure limit P_{max} . The tidal volume V_T remains constant as long as a pressure plateau P_{plat} is still detectable and the flow curve shows a brief zero flow between inspiration and expiration.

Evita 4 performs this function by reducing the Insp. Flow on reaching the set P_{max} value. If the tidal volume V_T can no longer be attained with the selected pressure P_{max} , due to reduced compliance, the alarm »Volume not constant !!« is automatically generated. Manual pressure limiting can be performed with all Evita models.

AutoFlow®

The AutoFlow function can be activated in the »**Extra settings**« menu. AutoFlow takes over the task of setting both »**Insp. Flow**« and »**Pmax**«: the screen knobs for these parameters are no longer displayed.

With AutoFlow, the inspiration flow is automatically adjusted to changes in lung conditions (C, R) and to the spontaneous breathing demand of the patient.

Always set the alarm limit »Paw $\sqrt{\text{A}}$ « in order to generate an alarm in the event of an increase in airway pressure with reduced compliance.

Typically, the selected inspiration time T_{insp} is much longer than the lung filling time. The inspiration pressure P_{insp} corresponds to the minimum value calculated from the tidal volume V_T and compliance C of the lung.

The inspiration flow is automatically controlled so that there is no pressure peak caused by the resistances of the tube and the airways. The plateau pressure P_{plat} varies with changes in compliance C, as is normal in all constant-volume ventilation strokes. With AutoFlow, these variations occur in maximum steps of 3 mbar between ventilation strokes.

If the tidal volume V_T is reached (inspiration flow = 0) before the inspiration time T_{insp} has fully elapsed, the control system for the inspiration and expiration valves ensures that the patient can breathe in and out during the remaining inspiration time, even during a constant pressure plateau P_{plat} .

If the patient breathes in or out during mandatory inspiration, the plateau pressure P_{plat} is not changed for this ventilation stroke: only the inspiration and expiration flow are adapted to the patient's demand. The individually applied tidal volume V_T may differ from the set tidal volume V_T in specific ventilation strokes, but on average over time a constant tidal volume V_T is supplied.

Any overstepping of the tidal volume V_T can be limited by the alarm limit »**V_{Ti} $\sqrt{\text{A}}$** «. If the set alarm limit is exceeded once, Evita 4 generates an advisory (!); if the alarm limit is exceeded three times, Evita 4 generates a warning (!!!). In the above examples the volume is actively limited to the alarm limit value »**V_{Ti} $\sqrt{\text{A}}$** « by switching over to the PEEP level.

- **Set the alarm limits **MV $\sqrt{\text{V}}$** and **MV $\sqrt{\text{A}}$** in order to avoid excessive or insufficient flow following rapid changes in compliance.**

A set inspiration time T_{insp} shorter than the lung filling time can be recognised from the flow curve: the flow at the end of the inspiration time has not dropped to zero. Here, it must be decided whether the current condition of the patient permits prolongation of the inspiration time in order to reduce the peak pressure even further.

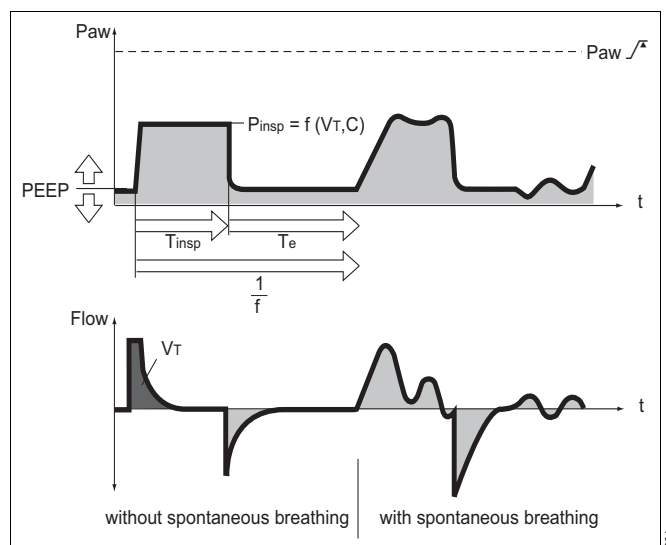

This effect can also be caused during ventilation, e. g. due to a build-up of secretion. In this situation, the pressure is limited by the alarm limit »Paw $\sqrt{\wedge}$ «. The pressure rise stops 5 mbar below the alarm limit »Paw $\sqrt{\wedge}$ « and the alarm »Volume not constant !!« is only given when the set tidal volume V_T is not longer applied.

The start of mandatory inspiration can be synchronised with the patient's own efforts with the aid of the variable Flowtrigger. Only in IPPV mode can Flowtrigger be fully switched off (IPPVAssist -> IPPV).

The steepness of the pressure rise from the PEEP level to the inspiration level can be even more closely adapted to the needs of the patient in SIMV and MMV modes by means of the pressure rise timet » \wedge «.

Start-up procedure with AutoFlow

On switching on the AutoFlow function, Evita 4 applies the set tidal volume V_T through a volume-controlled ventilation stroke with minimum inspiration flow and subsequent inspiratory pause. The plateau pressure P_{plat} calculated for this ventilation stroke serves as start-up inspiration pressure for the AutoFlow function.

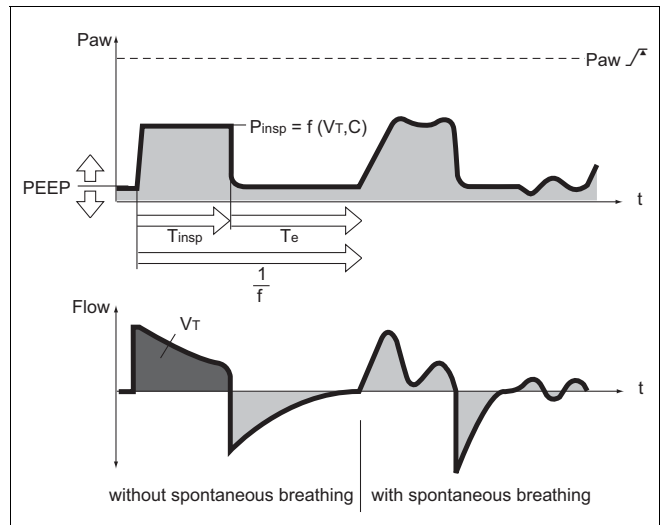

Sigh

Sigh is operative in the form of intermittent PEEP in IPPV, IPPVAssist and ILV.

The purpose of expiratory sigh during ventilation is to open collapsed areas of the lung, or to keep open "slow" areas of the lung.

Since atelectatic alveoli have a longer time constant – also caused by obstructed bronchioles – increased airway pressure maintained over a longer period is required to open them. In many cases, the sigh function is achieved by increasing the ventilation stroke; however, due to the short time available, the filling of the "slow" alveoli is only marginally improved.

In Evita 4, the sigh operates during expiration with an intermittent PEEP for two ventilation strokes every 3 minutes.

The average airway pressure is higher, and a longer filling time is normally available.

To avoid overinflation of the lung, the pressure peaks during the sigh phase can be limited by pressure limitation P_{max} , without impairing the sigh function.

During the sigh phase, the »Volume not constant !!« alarm is disabled.

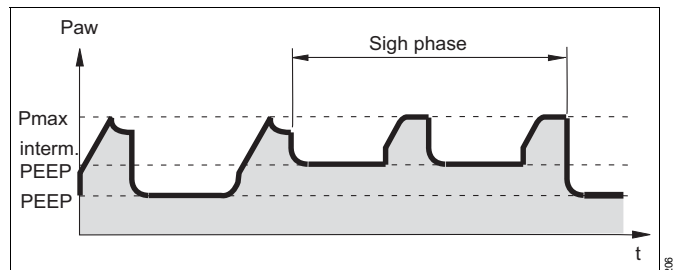

SIMV

Synchronized Intermittent Mandatory Ventilation

Combination of machine ventilation and spontaneous breathing.

SIMV enables the patient to breathe spontaneously in regular prescribed cycles, with the mechanical mandatory ventilation strokes providing a minimum ventilation during the remaining cycles. The minimum ventilation is controlled by the two set values tidal volume (V_T) and ventilation frequency (f) and is determined from the product of $V_T \times f$.

The ventilation pattern results from the set values V_T , Insp. Flow, frequency f and inspiration time T_{insp} . To prevent the mandatory ventilation stroke being applied during spontaneous expiration, the Flowtrigger of the machine ensures that the ventilation stroke is triggered in synchrony with the patient's spontaneous inspiratory effort within a "trigger window".

The "trigger window" is 5 seconds long in adult mode and 1.5 seconds long in paediatric mode. If the expiration times are less than 5 seconds or 1.5 seconds, the "trigger window" covers the entire expiration time.

Since the synchronisation of the mandatory ventilation stroke reduces the effective SIMV time, which would result in an undesirable increase in effective IMV frequency, Evita 4 prolongs the subsequent breathing time by the missing time difference ΔT . Thus preventing an increase in SIMV frequency. The frequency parameter f remains constant. This parameter, in combination with the tidal volume V_T , sets the minimum ventilation. If the inspiratory volume of the patient is considerable at the beginning of the "trigger window", the machine reduces the subsequent mandatory ventilation stroke by shortening the time for the inspiratory flow phase and the inspiration time. In this way, the tidal volume V_T remains constant, and overinflation of the lungs is avoided.

During the spontaneous breathing phases, the patient can be assisted with pressure by ASB pressure support.

In the further weaning process, the frequency f on the ventilation unit is further reduced, thereby prolonging the spontaneous breathing time, until finally the required minute volume is entirely covered by spontaneous breathing.

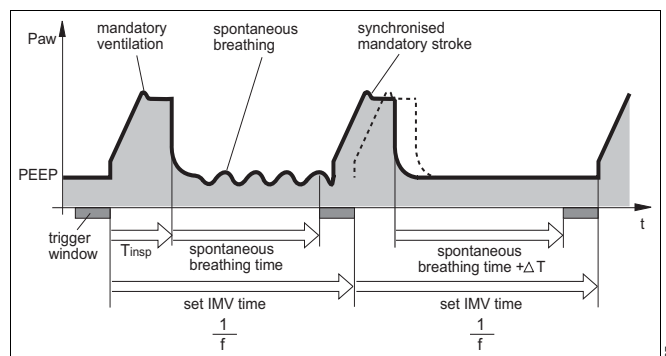

ASB**Assisted Spontaneous Breathing**

Pressure support for insufficient spontaneous breathing.

The function of the machine in assisting insufficient spontaneous breathing is similar to that of the anaesthetist who manually assists and monitors the patient's spontaneous breathing by feeling the breathing bag.

The machine takes over part of the inhalation function, with the patient maintaining control of spontaneous breathing.

The CPAP system supplies the spontaneously breathing patient with the breathing gas, even if the inspiration effort is weak.

The pressure support of the ASB system is started:

- when the spontaneous inspiration flow reaches the set value of the Flowtrigger, or at the latest
- when the spontaneous inspired volume exceeds 25 mL (12 mL in paediatric mode).

The machine then produces an increase in pressure up to the preselected ASB pressure PASB, which is adjustable to the breathing requirement of the patient.

The time for this pressure increase is adjustable from 64 milliseconds to 2 seconds.

With a rapid increase in pressure \nearrow

Evita 4 supports the insufficient spontaneous breathing of the patient with a high peak flow.

With a slow increase in pressure \nearrow

Evita 4 begins gently with regular inspiratory flow. The patient has to take over more breathing effort, and tone of breathing muscles improves.

With the patient adjusted pressure increase \nearrow and the present ASB level, the patient's own breathing activity defines the required inspiration flow, which can rise in 8 ms to 2 L/s.

ASB is terminated:

- when the inspiration flow returns to zero during phase I, i.e. when the patient exhales or fights the ventilator, or
- when the inspiration flow in phase II falls below a certain ratio of the maximum value previously supplied:
for adult ventilation: 25 % Insp. Flow
for paediatric ventilation: 25 % Insp. Flow
or
- at the latest after 4 seconds (1.5 seconds in paediatric ventilation) if the two other criteria have not come into operation.

If this 4-second criteria occurs three times in succession, Evita 4 sounds an alarm and warns of a possible leak in the ventilation system.

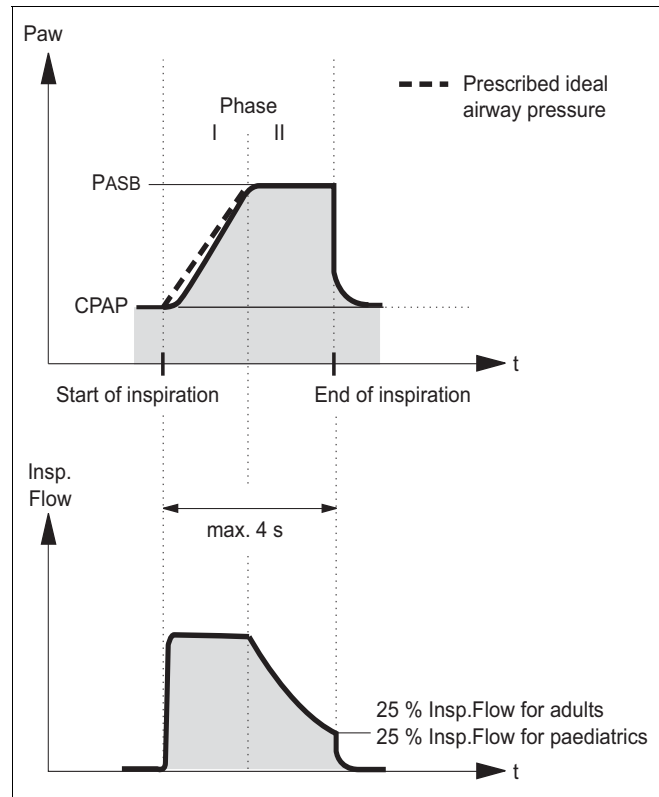

BIPAP

Biphasic Positive Airway Pressure

The BIPAP ventilation mode is a pressure/time-cycled ventilation mode in which the patient can always breathe spontaneously. BIPAP is therefore often described as a time-cycled alternation between two CPAP levels*.

The time-cycled change of pressure gives controlled ventilation, which corresponds to pressure-controlled ventilation PCV. However, the constant option of spontaneous breathing allows the transition from controlled breathing to independent spontaneous breathing to take place smoothly via the weaning phase, without requiring any change the ventilation mode. To adapt easily to the patient's spontaneous breathing pattern, the change-over from expiratory pressure level to inspiratory pressure level, and also the changeover from inspiratory pressure level to expiratory pressure level, are synchronised with the patient's spontaneous breathing.

The frequency of the change-over is kept constant, even when synchronisation occurs via a "trigger window" with fixed time constant.

The "trigger window" is 5 seconds long in adult mode and 1.5 seconds long in paediatric mode. For expiration times shorter than 5 seconds or 1.5 seconds, the "trigger window" covers the entire expiration time. At P_{insp} level, the "trigger window" is $1/4 \times T_{\text{insp}}$ seconds long.

As recent clinical research** has shown, this smooth adaptation to the patient's spontaneous breathing requires less sedation, so that the patient returns to spontaneous breathing more rapidly.

As in all pressure-controlled ventilation modes, the patient is not prescribed a fixed tidal volume (V_T).

The tidal volume results principally from the pressure difference between the settings for PEEP and P_{insp} .

Changes in lung compliance and airways, as well as active breathing by the patient can lead to changes in tidal volume. This is a desired effect in this ventilation mode.

With the knowledge that the tidal volume, and therefore the minute volume, are not constant, the alarm limits for minute volume must be adjusted with care.

The display of the expiratory measured tidal volume V_{Te} must be used to set the required difference between the two pressure levels. Any increase in differential will cause an increased BIPAP ventilation stroke.

* Bibliography (3), (4), (7), (11), (12), page 208.

** Bibliography (8), page 208.

As with SIMV, the time pattern is set using the basic setting parameters of frequency f and T_{insp} . The resulting inspiration and expiration times are calculated by Evita 4 and displayed in the lower half of the screen below the curve setting. The lower pressure level is set with the PEEP parameter, while the upper level is set with P_{insp} . When switching over from SIMV to BIPAP mode, only the P_{insp} setting needs to be changed. The steepness of the increase from the lower pressure level to the upper pressure level is controlled by the setting Δ . The effective time for the increase in pressure cannot become greater than the set inspiratory time T_{insp} . This precaution ensures that the upper pressure level P_{insp} is reached safely during inspiration. The transition from controlled ventilation to fully spontaneous breathing is achieved by a gradual reduction of inspiratory pressure P_{insp} and/or frequency f .

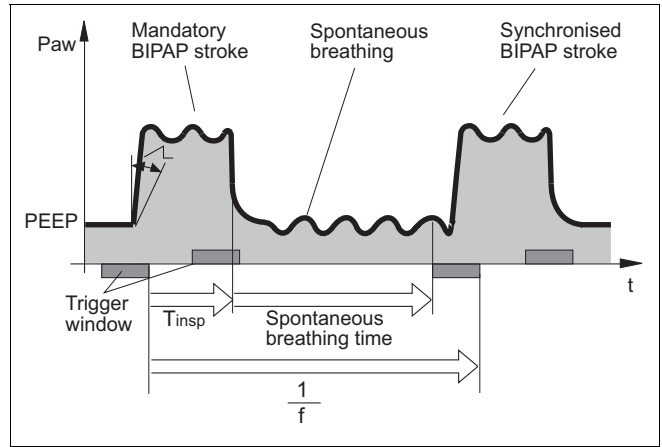

BIPAPAssist

Biphasic Positive Airway Pressure Assisted Pressure-controlled, assisted ventilation

The inspiratory strokes are the same as for BIPAP, except that the change from P_{insp} to PEEP is not synchronised with expiration by the patient. The duration of P_{insp} depends on T_{insp} . The patient can breathe spontaneously throughout the ventilation process.

Every detected spontaneous breathing activity by the patient triggers a synchronised inspiration stroke.

A non-synchronised inspiratory stroke is triggered by the machine at the latest upon expiry of the inspiration time defined by »f« and »T_{insp}«.

For all patients, from those unable to breathe spontaneously to those breathing spontaneously before being weaned off the ventilator.

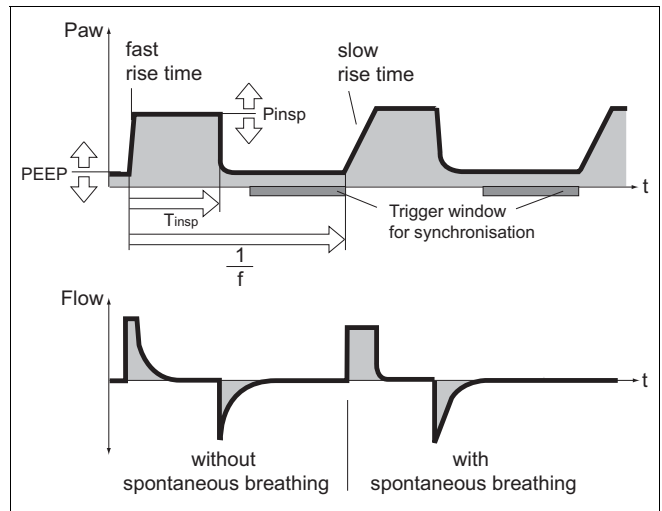

APRV

Airway Pressure Release Ventilation

Spontaneous breathing under continuous positive airway pressure with brief pressure release. This ventilation mode is suitable for patients with a poor gas exchange. The patient breathes spontaneously at a high pressure level P_{high} for an adjustable length of time T_{high} . For very short expiration times T_{low} , Evita 4 switches to a low pressure level P_{low} . The normal lung areas are emptied, but the "slow" lung areas only change volume to a lesser extent.*

In this way, the ventilation/perfusion ratio can be improved for patients with a poor gas exchange.

The steepness of the increase from the lower pressure level to the upper pressure level is controlled by the setting \sphericalangle . The effective time for the increase in pressure cannot become greater than the set time T_{high} .

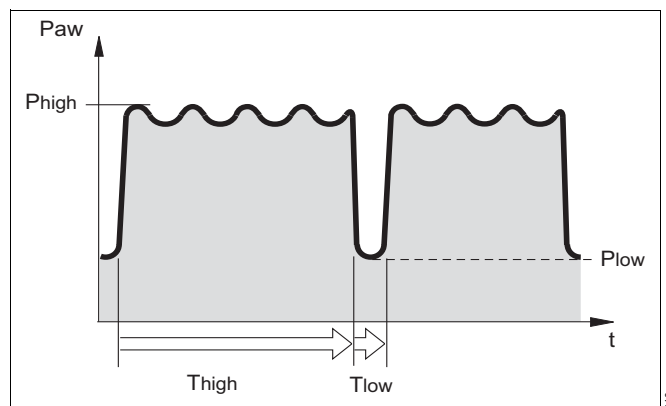

MMV

Mandatory Minute Volume Ventilation

In contrast to SIMV, the MMV ventilation mode gives mandatory breathing only if spontaneous breathing is not yet sufficient and has fallen below a pre-selected minimum ventilation. This minimum ventilation is controlled by the two set values tidal volume V_T and frequency f , and results from the product $V_T \times f$.

Unlike SIMV, the mandatory strokes are not given regularly but only in cases of insufficient ventilation.

The frequency of mandatory strokes is determined by the level of spontaneous breathing: if spontaneous breathing is sufficient, mandatory strokes are not used. If spontaneous breathing is not sufficient, intermittent mandatory strokes of the set tidal volume V_T are applied. If there is no spontaneous breathing at all, the mandatory strokes are applied at the set frequency f .

Evita 4 continuously balances the difference between spontaneous breathing and the set minimum ventilation. As soon as the balance becomes negative, because spontaneous breathing is no longer sufficient, Evita 4 applies a mandatory ventilation stroke at the set tidal volume V_T , so that the balance is again positive.

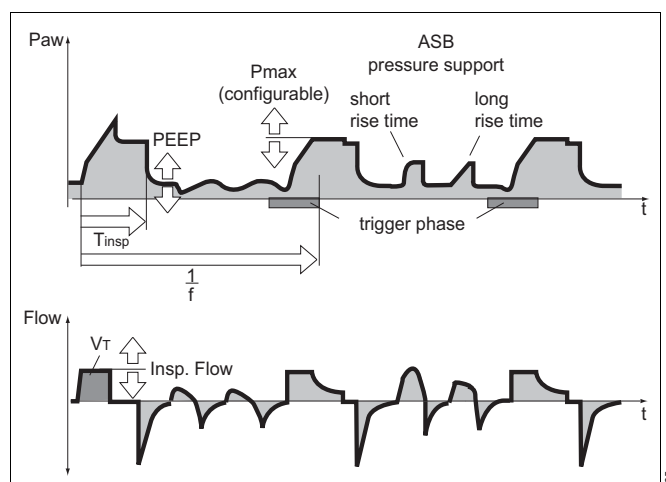

* Bibliography (6), (7), (8), (9), page 208.

Experience shows, patients breathe very irregularly. Phases of weak breathing alternate with phases of heavy breathing. In order to allow for these individual fluctuations, the balancing process also takes account of the extent by which the set minimum ventilation has been exceeded. This positive allowance is progressively reduced to zero by Evita 4 within a maximum of 7.5 seconds after apnoea.

In other words, the response time of Evita 4 before activating mandatory ventilation is automatically adapted to the preceding cycle of spontaneous breathing:

If this spontaneous breathing was close to the minimum ventilation, the machine responds rapidly within the IMV time.

By contrast, if the patient's spontaneous breathing was much higher than the set minimum ventilation, Evita 4 tolerates a longer breathing pause. In extreme cases of sudden apnoea after a phase of heavy breathing, the response time will be 7.5 seconds plus the trigger time, with a minimum of 1 IMV cycle time.

Response times longer than 15 seconds may only occur if the minimum ventilation with a low IMV frequency f is set to correspondingly low values.

In this case, Evita 4 triggers an apnoea alarm that is cancelled again as soon as the mandatory ventilation strokes have been applied. If the IMV is set to a longer period than the T_{Apnoea} alarm limit, and if there is no spontaneous breathing between the mandatory ventilation strokes, the apnoea alarm will be regularly triggered.

Example:

$f = 3/\text{min} = \text{IMV time} = 20 \text{ seconds}$

$T_{Apnoea} = 15 \text{ seconds}$

This system is designed to prevent mandatory ventilation being prematurely triggered in the event of irregular spontaneous breathing, whilst at the same time giving an alarm for any long period of low ventilation.

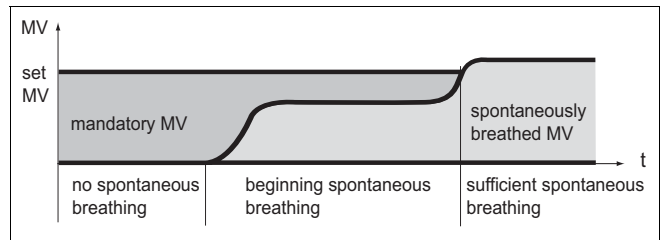
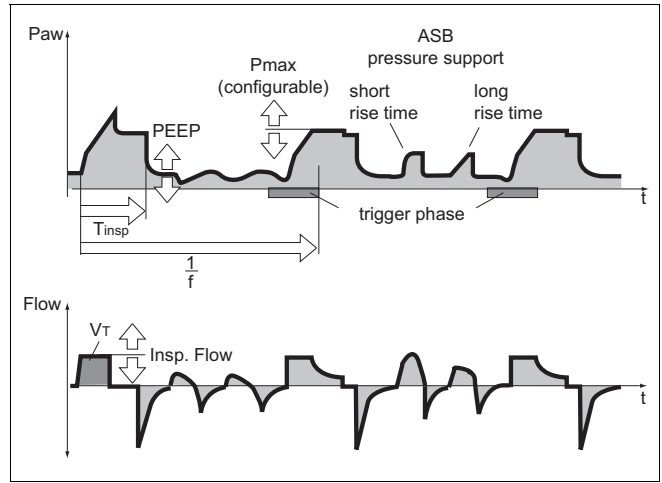

Flow measurement

Regardless of whether ventilation is volume-controlled or pressure-controlled, positive pressures are generated in both the breathing system and patient lung during the inspiration phase. Depending on the ratio of lung compliance to hose system compliance, the volume delivered by the ventilator is distributed to the patient's lung and to the hose system installed between the ventilator and patient. Deviations in the measured expiration flow and derived values, such as the minute volume and breath volume, are low for adult patients, due to their relatively high lung compliance in relation to the much lower compliance of the ventilation hoses.

However, since only the volume attained and surrendered by the lung is relevant to the efficiency of ventilation, and since higher differences are possible during paediatric ventilation, Evita 4 provides basic compensation for hose compliance during ventilation.

Compensation of the effect of hose system compliance

During the device check before ventilation, Evita 4 determines the compliance of the ventilation hoses, and then, during ventilation, compensates for the effect of compliance on volumetric flow measurement.

Depending on the airway pressure, Evita 4 increases the tidal volume by the amount that remains in the ventilation hoses.

In addition to hose system compliance, flow/volume measurement is influenced by the environmental factors of temperature and humidity and by leaks in the hose system.

Evita 4 takes these factors into account and corrects the settings and measured values accordingly.

Conversion according to ambient conditions

The volume occupied by a gas depends on the ambient conditions of temperature, pressure and humidity. In lung physiology, the minute volume and tidal volume are related to the ambient conditions in the lung:

37 °C body temperature, pressure in the lung,
100 % relative humidity.

The flow and volume values measured under these conditions are marked with BTPS*. On the other hand, medical gases from cylinders or from the central supply are dry (approx. 0 % r.h.) and are delivered by the ventilator at 20 °C. The flow and volume values measured under these conditions are marked NTPD**. The difference between measured values under NTPD and BTPS conditions is typically approx. 12 %. Example: a tidal volume of 500 mL NTPD is increased to 564 mL BTPS by heating to 37 °C and humidifying to 100 % r.h. Evita 4 delivers the tidal volume after conversion, so that the set tidal volume is effective in the lung under BTPS conditions.

* BTPS = Body Temperature, Pressure, Saturated.

** NTPD = Normal Temperature Pressure Dry.

Automatic leakage compensation

Evita 4 determines the difference between the delivered flow on the inspiration side and the measured flow on the expiration side.

This difference provides a measure of the amount of leakage and is displayed by Evita 4 as the leakage minute volume MV_{Leak} . Evita 4 can compensate for this leakage in volume-controlled ventilation.

Example:

Tidal volume setting $V_T = 500$ mL,
10 % leakage in tube.

The leakage minute volume MV_{Leak} also takes the inspiratory leaks into account. The sum of the minute volume MV + the leakage minute volume MV_{Leak} is consequently greater than the inspiratory minute volume delivered to the patient. Unlimited volume compensation is inappropriate.

Evita 4 compensates for losses of up to 100 % of the set tidal volume V_T . Due to technical tolerances, a small leakage minute volume may be displayed even if the hose system is leakproof.

Leakage compensation Off

Evita 4 delivers 500 mL. This is indicated as the inspiratory tidal volume V_{Ti} . 50 mL escape as leakage during inspiration, and 450 mL reach the lung. 450 mL are expired, and 45 mL again escape as leakage. A tidal volume of 405 mL is measured on the expiration side and indicated as V_{Te} . With a ventilation rate of 10 strokes per minute, a minute volume of 5.0 L/min is delivered on the inspiration side and a minute volume of 4.05 L/min is measured on the expiration side. The lung is ventilated with an MV of 4.5 L/min.

Without leakage compensation, the set V_T determines the volume delivered by Evita 4.

Leakage compensation On

With automatic leakage compensation, Evita 4 delivers 550 mL on the basis of the measured leakage minute volume, instead of the 500 mL set. 500 mL enter the lung and the displayed inspiratory tidal volume V_T is 500 mL. The volume of 450 mL measured on the expiration side is displayed without compensation, even when leakage compensation is activated. The minute volume measured on the expiration side is 4.5 L/min and is also uncompensated. If this were not so, the alarm for a low minute volume could be inhibited by the expiratory leakage compensation. Evita 4 must always emit an alarm if the minute volume is too low.

With leakage compensation, the set V_T determines the volume to be delivered to the patient.

This example has been simplified:

In fact, the calculated leakage correction takes into account the pressures in the hose system. A higher percentage volume is lost on the inspiration side than on the expiration side because the pressure during inspiration is higher. The displayed leakage minute volume MV_{Leak} is based on the mean pressure P_{mean} .

Weaning parameters

P 0.1, RSB, NIF:

A number of criteria must be taken into account by the doctor when deciding whether or not a patient is ready to be weaned off the ventilator. In addition to the results of examinations and laboratory analyses, ventilation parameters can also be used to judge whether the patient can be weaned successfully.

The following weaning parameters are calculated by Evita 4:

- Occlusion pressure P 0.1
- Rapid Shallow Breathing RSB
- Negative Inspiratory Force NIF

Occlusion pressure P 0.1

Breathing drive can be measured at the start of inspiration by measuring the mouth pressure during a short-term occlusion: within 100 ms, the pressure is not influenced by physiological compensation reaction (e. g. reflected breathing stop or increased breathing drive). This pressure is always dependent on the muscle strength of the diaphragm. Therefore, the negative mouth pressure P 0.1 after 0.1 seconds is a direct measure of neuro-muscular breathing drive*.

For patients with healthy lungs and regular breathing, P 0.1 will be about -3 to -4 mbar. A higher P 0.1 signifies a high breathing drive which can only be maintained for a limited period. P 0.1 values about -6 mbar, e. g. for a COPD** patient, indicate impending exhaustion (RMF – respiratory muscle fatigue).

When weaning COPD patients off the Ventilator, measurement of P 0.1 can define the weaning point. To measure P 0.1, Evita 4 keeps the inspiratory valve closed after one expiration and measures the airway pressure produced by the inspiratory effort during 100 ms (P1). The 100 ms time interval starts when a negative pressure of -0.5 mbar is measured as a result of the inspiratory effort.

A second pressure value (P2) is activated after 100 ms. Simultaneously, the inspiratory valve is opened so that the patient can breathe normally again.

The occlusion pressure P 0.1 is the difference between the pressure values P2 – P1.

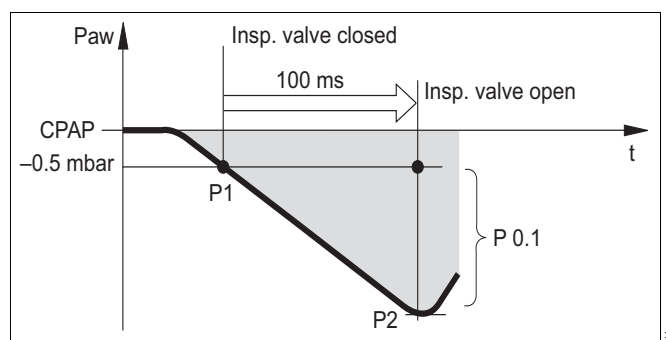

* Bibliography (10), (15), page 208.

** COPD = Chronic Obstructive Pulmonary Disease

Rapid Shallow Breathing RSB

The Rapid Shallow Breathing index (RSB)* is the quotient of the spontaneous breathing frequency (spontaneously breathed breaths per minute) and the tidal volume:

$$\text{RSB [1/(min x L)]} = \frac{f_{\text{spn}} [1/\text{min}]}{V_T [\text{L}]}$$

The lower the RSB index for a patient with spontaneous breathing, the more probably he or she can be weaned successfully. The significance of the RSB index is due to the fact that patients who can be weaned successfully tend to have a lower spontaneous breathing frequency and a higher tidal volume than those who are not yet ready to be weaned. In their 1991 study*, Yang and Tobin showed that the RSB index is an effective instrument for predicting the success of an attempt to wean the patient. Patients with an RSB index <100 1/(min x L) were weaned with a probability of 80 %, while 95 % of those with an RSB index >100 were not yet ready to be weaned. Evita 4 indicates the RSB index in CPAP/ASB and PPS modes.

Negative Inspiratory Force NIF

The Negative Inspiratory Force index (NIF)** measures the patient's maximum inhalation effort after exhaling. The patient system is closed during measurement of the NIF. This value is also known as the Maximum Inspiratory Pressure (MIP). As a result of the inhalation effort during manually extended expiration, the patient generates a negative pressure in relation to PEEP. The probability that the patient can be weaned successfully increases with the magnitude of this negative pressure. Patients with a NIF < -30 mbar can in all probability be weaned successfully, while those with a NIF of up to -20 mbar will most probably prove unsuccessful.

Evita 4 determines the NIF value during manually extended expiration. The patient system closes following expiration by the patient while the »**Exp. hold**« key is held down and Evita 4 measures the maximum inhalation effort made by the patient. The NIF is measured as a pressure against PEEP. The measuring procedure is ended when the »**Exp. hold**« key is released or after not more than 15 seconds. The last measured NIF value and the time of measurement are shown in Table 2 on the screen.

* Bibliography (16), page 208.

** Bibliography (17), (18), page 208.

Intrinsic PEEP

Evita 4 keeps the inspiratory valve and expiratory valve closed during measuring time 1, so that it is impossible for gas either to flow into the ventilation system from inspiration or to escape from it. During this closed phase, pressure is equalised between the lungs and the ventilation system. Evita 4 measures the pressure curve.

Measuring phase 1 is ended:

- when there is no further change in the pressure curve but at the earliest after 0.5 seconds.
- at the latest after 3 seconds in adult mode and after 1.5 seconds in paediatric mode.

The start value corresponds to PEEP, and the value at the end of the closed phase is the Intrinsic PEEP.

At the end of measuring time 1, Evita 4 opens the expiration valve and measures the expiratory flow generated by Intrinsic PEEP during a defined measuring time 2. During this period, the lung is depressurised to PEEP.

Measuring phase 2 is ended:

- when the expiration flow has returned to 0 but at the earliest after 0.5 seconds.
- at the latest after 7 seconds in adult mode or after 3.5 seconds in paediatric mode.

The integrated flow corresponds to the air volume trapped in the lungs (V_{trap}) by Intrinsic PEEP.

Measuring times of the measuring phase 1 for Intrinsic PEEP:

For adult ventilation	max. 3 seconds
For paediatric ventilation	max. 1.5 seconds

Measuring times of the measuring phase 2 for V_{trap} :

For adult ventilation	max. 7 seconds
For paediatric ventilation	max. 3.5 seconds

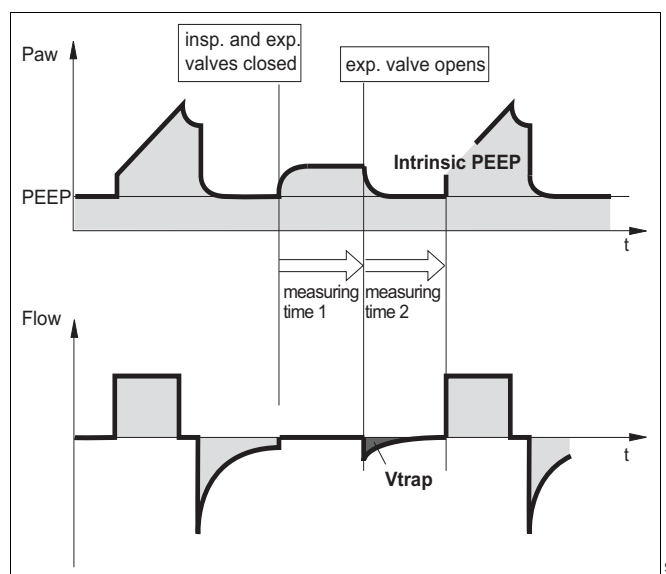

Insp. O₂ concentration during medication nebulisation

WARNING

Use only medication nebuliser 84 12 935 (white central section).

If other medication nebulisers are used, considerable deviations may occur in the tidal volume and the inspiratory O₂ concentration.

To minimise the deviation from the set O₂ concentration, Evita 4 uses a mixed gas to drive the medication nebuliser. In adult ventilation, this mixed gas is generated by switching over between compressed gases (medical air and oxygen) in synchronisation with inspiration.

In paediatric ventilation, the nebuliser is operated continuously, with medical air or oxygen in alternation.

The drive gas of the medication nebuliser therefore roughly corresponds to the set FiO₂.

The graph shows the possible deviations of the applied O₂ concentration as a function of the set FiO₂ with a minimal inspiratory flow (15 L/min) in adult ventilation or at ventilation frequencies above 12 bpm in paediatric ventilation.

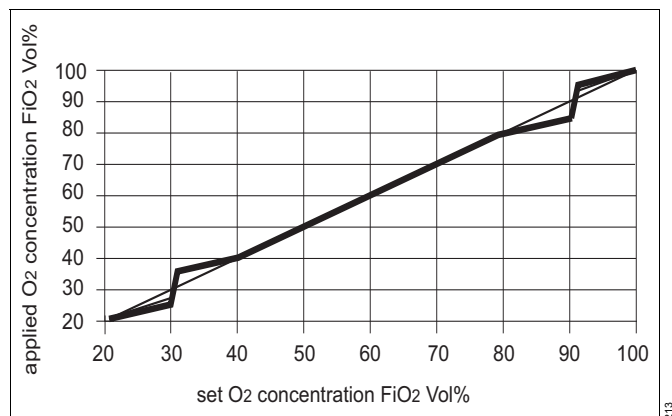

Principle of measurement

Expiratory flow measurement

Expiratory flow is measured with a hot wire anemometer. The amount of energy required to maintain the wire at a temperature of 180 °C (356 °F) is used as a measure of the flow passing through the sensor, cooling the hot wire in the process.

Neonatal flow measurement (optional)

The flow is measured with a hot wire anemometer between the Y-piece and the tube. The flow direction is detected by the use of two hot wires, one of which is shielded on one side.

The amount of energy required to maintain the wire at a temperature of 400 °C (752 °F) is used as a measure of the flow passing through the sensor, cooling the hot wire in the process.

The lowest flow at which detection functions reliably is 0.2 L/min. Lower flow values are therefore suppressed and displayed as zero.

O₂ measurement

Oxygen measurement is based on the principle of a galvanic cell. Monitored gas diffuses into the electrolyte of the sensor via a membrane. The electrolyte contains a working electrode and an opposing electrode. Oxygen is chemically reduced and the resulting current is proportional to the O₂ partial pressure in the gas.

CO₂ measurement

CO₂ is measured via a mainstream system based on absorption measurement. A light source generates a spectrum and two light detectors record the characteristic absorption spectrum and supply electrical signals that change with the CO₂ concentration. These signals are then evaluated and displayed. Heating the CO₂ sensor probe prevents condensation.

Alarm – Detection/Description

Generally, visual and audible alarms are immediately output when the alarm conditions have been detected. However, detection of the alarm conditions depends upon the ventilation parameters and filter algorithms.

Cases in which Evita 4 alarm messages are subject to delay times are described below.

The table contains only those alarm messages which are either subject to an alarm delay time or for which detection is additionally described. The alarm messages are listed in alphabetical order.

Message		Detection/Description
Air supply down Air supply down	!!! !	The gas supply pressure at the Air inlet connector is less than: – 1.2 bar (17.4 psi) for 3 seconds – 2.5 bar (36.3 psi) for max. 15 seconds In the event of an alarm, Evita 4 switches the gas supply over to oxygen.
Air supply pressure high Air supply pressure high	!! !	The gas supply pressure at the Air inlet connector is greater than 6 bar (87 psi).
Airway pressure high	!!!	The upper alarm limit for the airway pressure has been exceeded. The device immediately reduces the airway pressure to the set PEEP. If this is not successful and the upper alarm limit is exceeded by 5 mbar, the airway pressure is reduced to ambient pressure.
Airway pressure low	!!!	Only effective at a set PEEP of at least 3 mbar. The set PEEP has not been reached during expiration. The alarm delay time is dependent on the extent of the pressure difference and is not shorter than 5 seconds.
Apnoea	!!!	Insufficient inspiratory and expiratory breathing activity of the patient has been measured within the set T _{Apnoea} alarm limit time. The apnoea measurement time of the set T _{Apnoea} alarm limit is restarted by: – Intrinsic PEEP measurement – Expiratory Hold – Manual inspiration (inspiratory hold) The alarm is delayed due to a pending » Airway pressure low !!! « alarm
Apnoea ventilation	!!	The device has detected apnoea and has automatically switched over to apnoea ventilation. The start of apnoea ventilation is delayed due to the » Airway pressure high !!! « and » Airway pressure low !!! « alarms. Apnoea ventilation cannot be performed in the IPPV, ILV, MMV, and BIPAP _{Assist} ventilation modes.
Back-up ventilation (only when the NeoFlow option is available)	!!!	Only displayed in the Neonatal patient category, but not in the Mask (NIV) application mode. The inspiratory flow for 5 mandatory breaths is too low. Neonatal flow measurement is defective or deactivated. In case of » Airway pressure low !!! « alarm.
Clean CO₂ cuvette (only when the CapnoPlus option is available)	!!!	The alarm message is displayed when the intensity of the measuring light is excessively low. Possible causes: – Cuvette or sensor windows are dirty – Bulb in sensor is faulty The alarm delay time is 10 seconds.

Message		Detection/Description
CO₂ sensor ? (only when the CapnoPlus option is available)	!!!	Possible causes: <ul style="list-style-type: none"> – The CO₂ sensor is not connected when CO₂ monitoring is activated – The CO₂ sensor is not mounted on the cuvette after zero calibration – The CO₂ sensor is used on a clean cuvette following zero calibration of the CO₂ sensor on a dirty park bracket or a cuvette with dirty windows. – The sensor is defective The alarm delay time is 5 seconds.
CO₂ zero ? (only when the CapnoPlus option is available)	!!!	The measured CO ₂ partial pressure is negative (below –3 mmHg). The alarm delay time is 20 seconds.
etCO₂ high	!!!	Upper alarm limit for end-expiratory CO ₂ concentration has been exceeded. The alarm is delayed by 15 seconds.
etCO₂ low	!!!	Lower alarm limit for end-expiratory CO ₂ concentration has been exceeded. The alarm is delayed by 15 seconds.
Execute device check	!!	When the device is switched on, the currently measured ambient pressure is compared with the stored ambient pressure measured during the last device check. The deviation is greater than 8 %.
Exp. valve inop.	!!!	Only in volume-controlled ventilation modes: A high expiratory volume has been measured during three consecutive mandatory inspiratory breaths.
Ext. battery reversed poles (only when the DC Power Pack option is available)	!	Polarity of the external battery has been reversed during connection. The voltage measured is negative. The message is delayed by 50 seconds.
Ext. battery too high (only when the DC Power Pack option is available)	!	The voltage of the connected external battery is too high. The message is delayed by 48 seconds.
Fan failure	!!!	Temperature in device is too high (>70 °C (158 °F)). See also » Malfunction fan ! « message.
FiO₂ high	!!!	Upper alarm limit for inspiratory O ₂ concentration has been exceeded for at least 20 seconds. In the case of FiO ₂ settings up to 59 Vol.%, the permitted deviation is +4 Vol.%, In the case of FiO ₂ settings above 60 Vol.%, the permitted deviation is +6 Vol.%. The message is suppressed for 60 seconds: <ul style="list-style-type: none"> – when the device is switched on – when the FiO₂ setting is changed – when standby mode is ended – when O₂ therapy is ended
FiO₂ low	!!!	Lower alarm limit for inspiratory O ₂ concentration has been exceeded for at least 20 seconds. In the case of FiO ₂ settings up to 59 Vol.%, the permitted deviation is –4 Vol.%, In the case of FiO ₂ settings above 60 Vol.%, the permitted deviation is –6 Vol.%. The message is suppressed for 60 seconds: <ul style="list-style-type: none"> – when the device is switched on – when the FiO₂ setting is changed – when standby mode is ended – when O₂ therapy is ended
Flow measurement inop.	!!!	The expiratory flow sensor cannot be calibrated. Expiratory flow sensor wire is broken. A flow exceeding 100 L/min has been measured for 15 seconds. The measured expiratory minute volume has been 20 % higher than the delivered inspiratory minute volume for 60 seconds.

Message		Detection/Description
Insp / Exp cycle failure	!!!	No sufficient inspiratory breathing activity has been detected in the patient for 15 seconds or the set T _{Apnoea} alarm limit time (whichever is longer). The detection time is restarted by: <ul style="list-style-type: none"> – Intrinsic PEEP measurement – Expiratory hold – Manual inspiration (inspiratory hold) In the Mask (NIV) application mode, with the T _{Apnoea} alarm limit deactivated, the detection time is 60 seconds.
Loss of data	!!!	The stored ventilation and configuration parameters have been detected as faulty following start-up of the device. If the parameters cannot be restored, EvitaMobil starts up with the factory settings.
Malfunction fan	!	Temperature in device is too high (exceeds 65 °C (149 °F)). See also » Fan failure !!!« message.
MEDIBUS COM. inop.	!	The data connection to the COM interface has been interrupted. The alarm is delayed by 120 seconds.
MV high	!!!	The minute volume has exceeded the upper alarm limit. The message is suppressed for 120 seconds: <ul style="list-style-type: none"> – when the device is switched on – when bronchial suctioning is ended – when standby mode is ended
MV low	!!!	The minute volume has fallen below the lower alarm limit. The message is suppressed for 120 seconds: <ul style="list-style-type: none"> – when the device is switched on – when bronchial suctioning is ended – when standby mode is ended
Neo.flow measuring fault (only when the NeoFlow option is available)	!!!	The neonatal flow sensor cannot be calibrated. Neonatal flow sensor wire is broken. The measured expiratory minute volume has been 20 % higher than the measured inspiratory minute volume for 60 seconds.
Neo.flow sensor ? Neo.flow sensor ? (only when the NeoFlow option is available)	!!! !	The neonatal flow sensor is not installed in the breathing circuit. Adequate inspiratory flow and expiratory flow are not measured within 8 seconds. In the Neonatal patient category, a Warning message is displayed. In the Pediatric patient category, a Note message is displayed.
O2 measurement inop.	!!!	The O ₂ sensor cannot be calibrated. The measured O ₂ value is lower than 15 Vol.%. The measured O ₂ value is higher than 106 Vol.%.
O2 supply down O2 supply down	!!! !	The gas supply pressure at the O ₂ inlet connector is less than: <ul style="list-style-type: none"> – 1.2 bar (17.4 psi) for 3 seconds – 2.5 bar (36.3 psi) for max. 15 seconds In the event of an alarm, Evita 4 switches the gas supply over to compressed air.
O2 supply pressure high O2 supply pressure high	!! !	The gas supply pressure at the O ₂ inlet connector is greater than 6 bar (87 psi).
PEEP high	!!!	The measured PEEP is higher than the set value: <ul style="list-style-type: none"> – higher by 8 mbar for 2 ventilation cycles or 15 seconds – higher by 5 mbar for 10 ventilation cycles
PEEP valve inop.	!!!	The measured PEEP is 5 mbar lower than the set value for 10 ventilation cycles.
Pressure limited	!	The maximum airway pressure is limited to P _{max} . In ATC and PPS application mode: The resulting airway pressure has reached the pressure limit of P _{aw} $\sqrt{\Delta}$ – 5 mbar during two consecutive ventilation cycles and is limited to that pressure limit.























Message		Detection/Description
Pressure meas. inop.	!!!	The internal pressure sensors cannot be automatically calibrated. The pressure difference between inspiratory and expiratory pressure sensors has been greater than 5 mbar for 30 seconds. The pressure difference between the first and second measurement channel of the inspiratory pressure sensor has been greater than 5 mbar for 30 seconds.
Temperature high	!!!	Breathing gas temperature is above 40 °C (104 °F).
Temperature meas. inop.	!!!	The device has detected a short circuit in the breathing gas temperature sensor for 1 second.
Temperature sensor ?	!!!	Temperature sensor probe has been disconnected during operation. The alarm remains active until the sensor is reconnected. If the sensor cannot be reconnected, the device must be switched off and back on again.
Tidal volume high Tidal volume high	!!! !	The upper alarm limit for the applied inspiratory tidal volume V_{Ti} has been exceeded. If the message » Tidal volume high !!! « is displayed during three consecutive mandatory breaths
Tube blocked	!!!	Detection in the Adult and Pediatric patient categories (without neonatal flow sensor): Too little of the applied and leakage-compensated volume reaches the patient for 3 ventilation cycles. Detection when using a neonatal flow sensor: inspiratory flow is too low for 5 ventilation cycles.
Volume not constant	!!	The set volume is not reached for 2 mandatory breaths.

Abbreviations









Abreivation	Definition	Abreivation	Definition
APRV	Airway Pressure Release Ventilation Spontaneous breathing at continuous positive airway pressure with short-term pressure release	KG	Body weight [kg]
ASB	Assisted Spontaneous Breathing Pressure supported spontaneous breathing	MMV	Mandatory Minute Volume Ventilation
BIPAP	Biphasic Positive Airway Pressure Ventilation mode for spontaneous breathing at continuous positive airway pressure with two different pressure levels	MV	Minute Volume
BIPAPAssist	Biphasic Positive Airway Pressure Assisted Ventilation mode for assisted ventilation with continuous positive airway pressure with two different pressure levels	MV _{Leak}	Leakage minute volume
bpm	breath per minute	MV _{spn}	Spontaneous breathed minute volume
BTPS	Body Temperatur, Pressure. Saturated Measured values based on the condition of the patient's lungs, with body temperature 37 °C, steam-saturated gas, atmospheric pressure	NIF	Negative Inspiratory Force Maximum inhalation effort
C	Compliance	O ₂	Set value for inspiratory oxygen concentration [Vol%]
CPAP	Continuous Positive Airway Pressure Breathing with continuous positive pressure in the airways	P 0.1	100 ms occlusion pressure
etCO ₂	End-expiratory CO ₂ concentration	P _{ASB}	Set value of ASB pressure support
FeCO ₂	Expiratory CO ₂ concentration	P _{aw}	Airway pressure
f	Frequency	PEEP	Positive End-Expiratory Pressure
f _{Apnoea}	Frequency setting for apnoea ventilation	PEEP _i	Intrinsic Positive End-Expiratory Pressure
f _{mand}	Mandatory mechanical portion of overall breathing frequency	P _{high}	Set value of the upper pressure level APRV
f _{spn}	Spontaneous breathing portion of overall breathing frequency	P _{insp}	Set value of the upper pressure level in BIPAP
Fail to cycle	Breathing cycle failure. Machine detects no inspiration	P _{max}	Set value for pressure limited ventilation
FiO ₂	Inspiratory O ₂ concentration	P _{mean}	Mean airway pressure
Flow	Set value of the maximum inspiratory flow	PLV	Pressure Limited Ventilation
FlowTrig	Set value of the flow trigger threshold	P _{peak}	Peak pressure
ILV	Independent Lung Ventilation Ventilation with 2 ventilators, 1 for each lung	P _{plat}	End-inspiratory airway pressure
Int. PEEP	Intermittent Positive End-Expiratory Pressure = Sigh	P _{low}	Set value of the lower pressure level in APRV
IPPV	Intermittent Positive Pressure Ventilation	PS	Pressure Support
IPPVAssist	Trigger Assist Intermittent Positive Pressure Ventilation	R	Resistance
IRV	Inversed Ratio Ventilation Ventilation with inversed inspiration/expiration ratio	RSB	Rapid Shallow Breathing Quotient of spontaneous breathing frequency and tidal volume
ISO 5369	International standard for mechanical ventilators – "Lung Ventilation"	SIMV	Synchronized Intermittent Mandatory Ventilation
I : E	Ratio of Inspiration to Expiration	T	Inspiratory breathing gas temperature
		T _{Apnoea}	Apnoea alarm time
		T _e	Expiration time
		TGI	Tracheal Gas Insufflation
		T _{high}	Time for the upper pressure level in APRV
		T _{insp}	Set value of the inspiratory time
		T _{low}	Time for the lower pressure level in APRV
		ṀCO ₂	CO ₂ production [L/min]
		V _{ds}	Serial dead space
		V _T	Setting for tidal volume
		V _{TApnoea}	Setting for tidal volume of apnoea ventilation
		V _{TASB}	Inspiratory breathing volume during an ASB stroke
		V _{Te}	Expiratory tidal volume
		V _{Ti}	Inspiratory tidal volume

Abreviation	Definition
Vtrap	Volume trapped in the lung by intrinsic PEEP, and exhaled during subsequent expiration

Symbols

Symbols	Definition
	Switch medication nebuliser on/off
O ₂ ↑ Suction	Switch oxygen enrichment for bronchial suction on/off
Insp. hold	Manual inspiration
Exp. hold	Manual expiration
	Blank/unblank screen display
	Manual printer logging
	Switch help function on/off
	"Freeze" curves in screen
	Back to standard page
 	Suppresses the acoustic alarm for 2 minutes
Alarm Reset	Alarms
	Standby/Operation
	Select other measured value combination
	Select other curve(s)
	Time setting for pressure increase during PASB
	Lower / upper alarm limit
	Caution: observe important safety-relevant warnings and precautions in the Instructions for Use
	Observe Instructions for Use!
	Warning! Strictly observe Instructions for Use
	Counter weight 8415824 in EvitaMobil trolley
	Requirements to avoid Evita 4 with the EvitaMobil trolley tipping over
	Marking on device surfaces where the risk of toppling over is increased when pushed, leaned against, used as a support, etc.
	Type B
	Type BF
	Insert flow sensor
	Unlocking expiration valve
Exp.	Exp. expiration port (GAS RETURN)

Symbols Definition

Insp.	Insp. inspiratory port (GAS OUTPUT) ¹⁾
	Gas outlet (EXHAUST – NOT FOR SPIROMETER)*
A 	Patient mode Adults
P 	Patient mode Paediatrics
	Spontaneous breathing activity by the patient
	Evita Remote Pad
	Nurse call
	Earth
	ESD warning label
	Disposal information

1) additional, depending on equipment status

Bibliography

- [1] Baum, M.; Benzer, H.; Mutz, N.; Pauser, G.; Tonczar, L.: Inversed Ratio Ventilation (IRV)
Die Rolle des Atemzeitverhältnisses in der Beatmung beim ARDS
Anaesthesist 29 (1980): 592-596
- [2] Geyer, A.; Goldschmied, W.; Koller, W.; Winter, G.: Störung der Gerätefunktion bei Anbringung eines Bakterienfilters in den Expirationsschenkeln des Beatmungssystems
Anaesthesist 34 (1985): 129-133
- [3] Baum, M.; Benzer, H.; Putensen, Ch.; Koller, W.; Putz, G.:
Biphasic Positive Airway Pressure (BIPAP) – eine neue Form der augmentierenden Beatmung
Anaesthesist 38 (1989): 452-458
- [4] Luger, Th.J.; Putensen, Ch.; Baum, M.; Schreithofer, D.; Morawetz, R.F.; Schlager, A.:
Entwöhnung eines Asthmatikers mit Biphasic Positive Airway Pressure (BIPAP) unter kontinuierlicher Sufentanil Gabe
Anaesthesist 39 (1990): 557-560
- [5] Hensel, I.:
Atemnotsyndrom nach Beinahe-Ertrinken
Rettung durch neuartiges Beatmungsprogramm?
Rettungsdienst 11 (Nov. 1991): 737-739
- [6] Meyer, J.:
Neue Beatmungsformen
Anästhesiol. Intensivmed. Notfallmed. Schmerzther. 26 (1991) 337 - 342
- [7] Vincent, J.-L.:
Yearbook of Intensive Care and Emergency Medicine Springer-Verlag 1993
- [8] Stock, M. C.; Downs J.B.; Frolicher, D.:
Airway pressure release ventilation.
Critical Care Medicine 15 (1987): 462 - 466
- [9] Räsänen, J.; Cane, R.; Downs, J.; et al.:
Airway pressure release ventilation during acute lung injury: A prospective multicenter trial.
Critical Care Medicine 19 (1991): 1234 - 1241
- [10] Sasso C. S. H.; Te, T.T.; Mahutte, C. K.; Light, R. W.:
Airway occlusion pressure. An important indicator for successful weaning in patients with chronic obstructive pulmonary disease.
Am Rev. Respir. Dis. (1987); 135:107-113
- [11] Voigt, E.:
BIPAP Anwendungshinweise und Kasuistik.
Dräger-Mitteilungen "Medizintechnik aktuell" 1/94
- [12] Bahns, E.:
BIPAP – Zwei Schritte nach vorn in der Beatmung
Dräger Fibel zur Evita Beatmung
- [13] Burchardi, H.; Rathgeber, J.; Sydow, M.:
The Concept of Analgo-Sedation Depends on the Concept of Mechanical Ventilation
Yearbook of Intensive Care and Emergency Medicine, 1995, Springer
- [14] Sydow, M.; Burchardi, H.; Ephraim, E.; Zeilmann, S.; Crozier, T.:
Long-term Effects of Two Different Ventilatory Modes on Oxygenation in Acute Lung Injury
American Journal of Respiratory and Critical Care Medicine, Vol 149, 1994
- [15] Kuhlen, R.; Hausmann S.; Pappert, D.; Slama, K.; Rossaint, R.; Falke, K.:
A new method for P0.1 measurement using standard respiratory equipment
Intensive Care Med. 21 (1995)
- [16] Yang, K.L.; Tobin, M.J.:
A Prospective Study of Indexes Predicting the Outcome of Trials of Weaning from Mechanical Ventilation
The New England Journal of Medicine, 324 (1991), 1445-1450
- [17] Tobin, Jubran, A.:
Advances in Respirators Monitoring During Mechanical Ventilation
CHEST 1999, 116, S. 1416-1425
- [18] Tobin, M.J.; Charles, G.A.:
Discontinuation of Mechanical Ventilation
in: Tobin, M.J., Principles and Practice of Mechanical Ventilation, 1994, 1177-1206

What was new in Evita 4 software 2.n

P_{insp} not linked to PEEP during BIPAP

- The ventilation parameter P_{insp} is set as an absolute value. P_{insp} is no longer affected by changes in PEEP.

Aids for setting pressure ventilation parameters

- While setting the listed pressure ventilation parameters, the parameter concerned appears as a dashed line in the pressure curve P_{aw}.

Continuous indication of the hose system leakage during the leak test

- The test step "Tightness of hose system" can be selected separately in the "Device check" menu. Corrective measures can be undertaken with the aid of the continuous leakage indication.

Compensation of the hose system compliance

- The hose system compliance determined during the leak test is indicated at the end of the test.
- The volume-controlled ventilation strokes are automatically corrected with the calculated hose system compliance, as are the measured values for flow monitoring.

Leakage monitoring and compensation

- Evita 4 compares the minute volume delivered on the inspiration side with that measured on the expiration side, balances the leakage and indicates this as the measured value MV_{Leak}.
- The applied tidal volume V_{Ti} is automatically corrected by the amount of the measured MV_{Leak}. The same also applies for the Flow and V_{Te} values measured on the expiratory side.
- The measured minute volume values are not corrected for safety reasons.

Apnoea ventilation with SIMV pattern

- The patient can breathe spontaneously during apnoea ventilation.
- The apnoea ventilation frequency remains constant.

AutoFlow On/Off as start-up parameter

- The AutoFlow function can be configured as a start-up parameter so that AutoFlow is switched on automatically when the device is switched on.

Loop display also for single strokes

- In addition to the loop for a complete ventilation cycle, e. g. in IPPV, the loop for a single breath (ventilated or spontaneous) can now also be displayed, for instance in such "mixed" ventilation modes as SIMV.

NeoFlow (optional)

- Paediatric flow monitoring in paediatric and neonatal ventilation is extended to include a flow sensor specifically for neonates and positioned close to the patient.

Breathing Support Package (optional)

- To support spontaneous breathing.
- To compensate the elastic and resistive resistance of the respiratory system.

What was new in Evita 4 software 3.n

Additional screen languages

- Portuguese
- Russian
- Arabic
- Greek
- Chinese

Additional function key »☀/●«

- For blanking / unblanking the screen.

Independent lung ventilation ILV

- For independent ventilation of each lung using two Evita ventilators.

Additional function key »Exp. hold«

- To extend expiration.
- To occlude the ventilation system following expiration.

Medication nebulisation

- Can also be applied during paediatric ventilation.

Bronchial suctioning

- In the patient modes »Paediatric« and »Neonates«, Evita 4 increases the set O₂ concentration commensurately, but not up to 100 % by volume.

Warning »Volume not constant !!«

- Can be suppressed.

Automatic Tube Compensation ATC (optional)

- For specific reduction of the breathing effort attributable to the tube.

Index

A

Abbreviations	206
Access code	215
Accessories	8
Alarm	88
Alarm – Cause – Remedy	141
Alarm – Detection/Description	202
Alarm limits	87
Alarm tone, suppressing	89
Ambient-air filter	162
Apnoea ventilation	86
APRV	78, 193
ASB	190
Assembling	157
AutoFlow	187

B

Bacterial filter	38
Before using for the first time	49
Bibliography	208
BIPAP	191
BIPAP, BIPAP/ASB	71
BIPAPAssist	73, 192
Breathing gas humidifier	39

C

Calibrating	109
Caution	88
Central alarm	47
Checking for leaks	57
Cleaning, disinfection and sterilisation	149
CO ₂ calibration, resetting	122
CO ₂ cuvette	42
CO ₂ measurement, description	201
CO ₂ sensor	42
calibrate	112
CO ₂ zero calibration	114
Configuration	123
Control unit location	29
Cooling air filter	162
CPAP, CPAP/ASB	74
Curves	90

D

Date	139
Definitions	3
Description	185
Device check	51
Dismantling	150
Disposal	163

E

EMC declaration	182
Evita remote	45
Expiration hold	97
Expiration valve	35
External flow source	110
External interface	138

F

Filter	162
Flow measurement, description	201
Flow sensor	
calibrating	110
fitting	35
Flow sensor flap	36
Flowtrigger	66
Functional safety	10

G

Gas supply	44
------------	----

H

HME (heat and moisture exchanger)	38
Hose systems	38

I

In case of alarm	88
Independent lung ventilation	79
Initial use	49
Intended medical application	13
Intrinsic PEEP	104, 199
IPPV	65

L

Language	49
Leakage compensation	136, 196
Logbook	95
Loops	93

M

Maintenance	8, 159
Manual inspiration	97
Measured values	90
Measurement	201
Medication nebulisation	98, 200
Message	141
MMV	193
MMV, MMV/ASB	76
Multiple socket outlet	43

N

Neonatal flow measurement, description	201
NIF	198
Note	88
Nurse call	47
Technical data	182

O

O ₂ measurement, description	201
O ₂ sensor	
calibrating	109
disposal	164
O ₂ sensor capsule	37

Occlusion pressure	105, 197
On-screen controls	20
Operating concept	17
Operation	61
Oxygen enrichment for bronchial suction	102

Z

Zoom (loops)	93
--------------------	----

P

Patient mode	63
Patient monitoring	9
Patient safety	9
Power supply	43
Preparation	31
Pressure limiting with Pmax	186
Principle of measurement	201

R

Reprocessing	149
Reprocessing list	155
Reprocessing procedures	153
RSB (rapid shallow breathing)	198

S

Safety information	
general	8
product-specific	10
Screen freeze	96
Screen page	23
»Alarm Limits«	26
»Calibration«	28
»Configuration«	29
»Measured Values«	27
»Mode settings«	24
»Special Procedures«	28
SIMV	189
SIMV, SIMV/ASB	68
Standard page	24
Standby	108
Symbols	207

T

Technical data	171
Temperature sensor	41
Test filter	116
Time	139
Trademarks	2
Transportation	58
Trends	92

U

UMDNS Code	181
Units	140

V

Ventilation hoses	40
Ventilation modes	65

W

Weaning parameters	197
What is what	165

This page intentionally left blank.

Labels for options

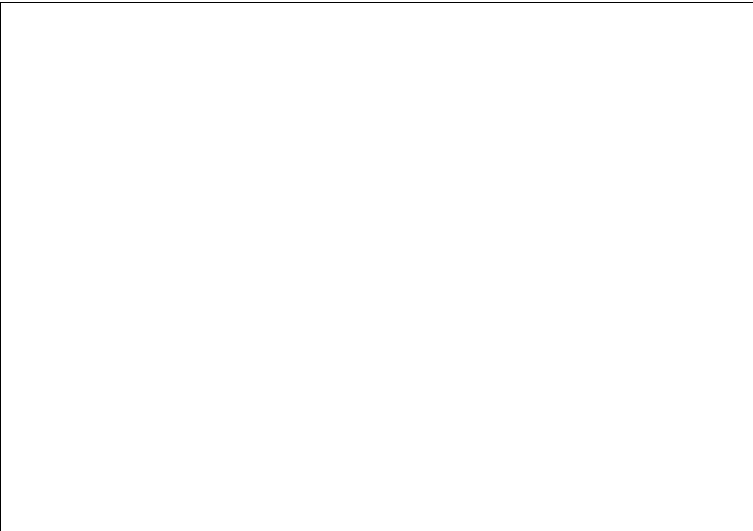

Access code for Evita 4 / Evita 4 *edition* SW 4.n

Cut out from the Instructions for Use Evita 4 / Evita 4 *edition*
SW 4.n

To prevent unauthorized adjustments, the following pages are
access code-protected:

3032

- **Configuration > Ventilation >**
 - **Modes**
 - **Patients**
 - **Start up settings**
 - **More settings**

Information on the access code

To prevent unauthorized adjustments, the configuration menu
for the ventilation criteria are access code-protected:

- **Configuration > Ventilation >**
 - **Modes**
 - **Patients**
 - **Start up settings**
 - **More settings**

The access code appears on this page of the Instructions for
Use. Cut out the area with the access code and keep in a place
which is safe from access by unauthorized persons.

If the area with the access code has been removed, ask the
person responsible for your device about making adjustments
to the pages specified.

This page intentionally left blank.

This page intentionally left blank.

These Instructions for Use only apply to
Evita 4 / Evita 4 edition SW 4.n
with the Serial No.:

If no Serial No. has been filled in by
Dräger, these Instructions for Use are
provided for general information only
and are not intended for use with any
specific machine or device.
This document is provided for customer
information only, and will not be updated
or exchanged without customer request.



Directive 93/42/EEC
concerning Medical Devices

 Manufacturer

Dräger Medical GmbH

 Moislinger Allee 53 – 55
D-23542 Lübeck
Germany

 +49 451 8 82-0

FAX +49 451 8 82-20 80

 <http://www.draeger.com>

9039485 – GA 5664.554 en

© Dräger Medical GmbH

Edition: 5 – 2015-01

(Edition: 1 – 2007-07)

Dräger reserves the right to make modifications to the equipment without prior notice.



As of 2015-08:
Dräger Medical GmbH
changes to
Drägerwerk AG & Co. KGaA