

EZ-ZONE[®] PM

User's Guide



Integrated Controller Models



1241 Bundy Boulevard., Winona, Minnesota USA 55987
Phone: +1 (507) 454-5300, Fax: +1 (507) 452-4507 <http://www.watlow.com>



ISO 9001



Registered Company
Winona, Minnesota USA



Safety Information







We use note, caution and warning symbols throughout this book to draw your attention to important operational and safety information.







A “NOTE” marks a short message to alert you to an important detail.

A “CAUTION” safety alert appears with information that is important for protecting your equipment and performance. Be especially careful to read and follow all cautions that apply to your application.

A “WARNING” safety alert appears with information that is important for protecting you, others and equipment from damage. Pay very close attention to all warnings that apply to your application.

The electrical hazard symbol, ⚡ (a lightning bolt in a triangle) precedes an electric shock hazard CAUTION or WARNING safety statement.

Symbol	Explanation
	CAUTION – Warning or Hazard that needs further explanation than label on unit can provide. Consult User's Guide for further information.
	ESD Sensitive product, use proper grounding and handling techniques when installing or servicing product.
	Unit protected by double/reinforced insulation for shock hazard prevention.
	Do not throw in trash, use proper recycling techniques or consult manufacturer for proper disposal.
	Enclosure made of Polycarbonate material. Use proper recycling techniques or consult manufacturer for proper disposal.
	Unit can be powered with either alternating current (ac) voltage or direct current (dc) voltage.
	Unit is a Listed device per Underwriters Laboratories®. It has been evaluated to United States and Canadian requirements for Process Control Equipment. UL 61010 and CSA C22.2 No. 61010. File E185611 QUYX, QUYX7. See: www.ul.com

	Unit is a Listed device per Underwriters Laboratories®. It has been evaluated to United States and Canadian requirements for Hazardous Locations Class 1 Division II Groups A, B, C and D. ANSI/ISA 12.12.01-2007. File E184390 QUZW, QUZW7. See: www.ul.com
	Unit is compliant with European Union directives. See Declaration of Conformity for further details on Directives and Standards used for Compliance.
	Unit has been reviewed and approved by Factory Mutual as a Temperature Limit Device per FM Class 3545 standard. See: www.fmglobal.com
	Unit has been reviewed and approved by CSA International for use as Temperature Indicating-Regulating Equipment per CSA C22.2 No. 24. See: www.csa-international.org
	Unit has been reviewed and approved by ODVA for compliance with DeviceNet communications protocol. See: www.odva.org
	Unit has been reviewed and approved by ODVA for compliance with Ethernet/IP communications protocol. See: www.odva.org

Warranty

The EZ-ZONE® PM is manufactured by ISO 9001-registered processes and is backed by a three-year warranty to the first purchaser for use, providing that the units have not been misapplied. Since Watlow has no control over their use, and sometimes misuse, we cannot guarantee against failure. Watlow’s obligations hereunder, at Watlow’s option, are limited to replacement, repair or refund of purchase price, and parts which upon examination prove to be defective within the warranty period specified. This warranty does not apply to damage resulting from transportation, alteration, misuse or abuse. The purchaser must use Watlow parts to maintain all listed ratings.

Technical Assistance

If you encounter a problem with your Watlow controller, review your configuration information to verify that your selections are consistent with your application: inputs, outputs, alarms, limits, etc. If the problem persists, you can get technical assistance from your local Watlow representative (see back cover), by e-mailing your questions to wintechsupport@watlow.com or by dialing +1 (507) 494-5656 between 7 a.m. and 5 p.m., Central Standard Time (CST). Ask for for an Applications Engineer. Please have the following information available when calling:

- Complete model number

- All configuration information
- User's Guide
- Factory Page

Return Material Authorization (RMA)

1. Call Watlow Customer Service, (507) 454-5300, for a Return Material Authorization (RMA) number before returning any item for repair. If you do not know why the product failed, contact an Application Engineer or Product Manager. All RMA's require:
 - Ship-to address
 - Bill-to address
 - Contact name
 - Phone number
 - Method of return shipment
 - Your P.O. number
 - Detailed description of the problem
 - Any special instructions
 - Name and phone number of person returning the product.
2. Prior approval and an RMA number from the Customer Service Department is required when returning any product for credit, repair or evaluation. Make sure the RMA number is on the outside of the carton and on all paperwork returned. Ship on a Freight Prepaid basis.
3. After we receive your return, we will examine it and try to verify the reason for returning it.
4. In cases of manufacturing defect, we will enter a repair order, replacement order or issue credit for material returned. In cases of customer misuse, we will provide repair costs and request a purchase order to proceed with the repair work.
5. To return products that are not defective, goods must be in new condition, in the original boxes and they must be returned within 120 days of receipt. A 20 percent restocking charge is applied for all returned stock controls and accessories.
6. If the unit is not repairable, you will receive a letter of explanation. and be given the option to have the unit returned to you at your expense or to have us scrap the unit.
7. Watlow reserves the right to charge for no trouble found (NTF) returns.

The EZ-ZONE PM User's Guide is copyrighted by Watlow Electric, Inc., © April 2013 with all rights reserved.

EZ-ZONE PM is covered by U.S. Patent Numbers:

6005577; D553095; D553096; D553097; D560175; D55766;
and OTHER PATENTS PENDING



Table of Contents

- Chapter 1: Overview 4**
 - Standard Features and Benefits 4
 - Optional Features and Benefits 5
 - A Conceptual View of the PM 6
 - Getting Started Quickly 7

- Chapter 2: Install and Wire 16**
 - Dimensions 16
 - Installation 20
 - Wiring 22
 - Network Status 36
 - Module Status 36
 - Activity Status 36
 - Link Status 36
 - Network Status 38
 - Module Status 38

- Chapter 3: Keys and Displays 42**
 - Attention Codes 43

- Chapter 4: Home Page 45**

- Chapter 5: Operations Page 52**
 - Analog Input Menu 54
 - Linearization Menu 54
 - Process Value Menu 55
 - Digital Input/Output Menu 56
 - Limit Menu 57
 - Monitor Menu 57
 - Control Loop Menu 58
 - Alarm Menu 61
 - Current Menu 62
 - Math Menu 63
 - Special Output Function Menu 64
 - Profile Status Menu 65



Table of Contents (cont.)

Chapter 6: Setup Page	67
Analog Input Menu	69
Linearization Menu	71
Process Value Menu	74
Digital Input / Output Menu	75
Limit Menu	79
Control Loop Menu	80
Output Menu	85
Alarm Menu	88
Current Menu	91
Math Menu	92
Special Output Function Menu	93
Function Key	94
Global Menu	95
Communications Menu	98
Real Time Clock Menu	102
Chapter 7: Profiling Page	103
Profile Setup	103
Starting a Profile	104
Profiling Menu	107
Chapter 8: Factory Page	113
Custom	114
Lock Menu	114
Unlock Menu	116
Diagnostics Menu	116
Calibration Menu	118
Chapter 9: Features	119
Changing PM Integrated Model Number to PM Express	121
Tuning the PID Parameters	123
Inputs	125
Outputs	128
Resetting a Tripped Limit	130
Control Methods	131
Alarms	136



Table of Contents (cont.)

Current Sensing	138
Open Loop Detection	138
Programming the EZ Key/s.	138
Using Lockout and Password Security.	139
Using Lockout Method 1 (Read and Set Lock).	139
Using Lockout Method 2 (Password Enable)	140
Modbus - Using Programmable Memory Blocks	142
CIP - Communications Capabilities	142
CIP Implicit Assemblies	143
Compact Assembly Class	143
Modifying Implicit Assembly Members	143
Profibus DP - (Decentralized Peripherals)	144
Software Configuration.	144
Searching Network for Devices.	145
Available Network Devices Displayed.	145
Chapter 10: Applications	148
Example 1: Single Loop Control	148
Example 2: Sensor Backup.	148
Example 3: Square Root.	149
Example 4: Ratio.	149
Example 5: Differential	150
Example 6: Cascade.	150
Example 7: Wet Bulb / Dry Bulb	152
Example 8: Vaisala	152
Example 9: Motorized Valve Control	153
Chapter 11: Appendix	154
Troubleshooting Alarms, Errors and Control Issues.	154
Modbus - Programmable Memory Blocks	158
CIP Implicit Assembly Structures.	160
Compact Class Assembly Structure	161
Specifications	168
Ordering Information for PM Integrated Controller Models	171
Index.	172
How to Reach Us	178

1

Chapter 1: Overview

The EZ-ZONE® PM takes the pain out of solving your thermal loop requirements.

Watlow's EZ-ZONE PM controllers offer options to reduce system complexity and the cost of control-loop ownership. You can order the EZ-ZONE PM as a PID controller or an over-under limit controller, or you can combine both functions in the PM Integrated Limit Controller. You now have the option to integrate a high-amperage power controller output, an over-under limit controller and a high-performance PID controller all in space-saving, panel-mount packages. You can also select from a number of serial communications options to help you manage system performance.

It just got a whole lot easier to solve the thermal requirements of your system. Because the EZ-ZONE PM controllers are highly scalable, you only pay for what you need. So if you are looking for a PID controller, an over-under limit controller or an integrated controller, the EZ-ZONE PM is the answer.

Standard Features and Benefits

Advanced PID Control Algorithm

- TRU-TUNE+® Adaptive tune provides tighter control for demanding applications.
- Auto Tune for fast, efficient start ups

EZ-ZONE configuration communications and software

- Saves time and improves the reliability of controller set up

FM Approved Over-under Limit with Auxiliary Outputs

- Increases user and equipment safety for over-under temperature conditions
- To meet agency requirements, output 4 is the fixed limit output. Other outputs can be configured to mirror the limit output (4).

Parameter Save & Restore Memory

- Reduces service calls and down time

Agency approvals: UL Listed, CSA, CE, RoHS, W.E.E.E. FM, SEMI F47-0200, Class 1, Div 2 rating on selected models

- Assures prompt product acceptance
- Reduces end product documentation costs

EZ-Key/s

- Programmable EZ-Key enables simple one-touch operation of repetitive user activities

Programmable Menu System

- Reduces set up time and increases operator efficiency

Three-year warranty

- Demonstrates Watlow's reliability and product support

Touch-safe Package

- IP2X increased safety for installers and operators

P3T Armor Sealing System

- NEMA 4X and IP66 offers water and dust resistance, can be cleaned and washed down (indoor use only)
- Backed up by UL 50 independent certification to NEMA 4X specification

Removable cage clamp wiring connectors

- Reliable wiring, reduced service calls
- Simplified installation

Heat-Cool Operation

- Provides application flexibility with accurate temperature and process control

Optional Features and Benefits

High-amperage Power Control Output

- Drives 15 amp resistive loads directly
- Reduces component count
- Saves panel space and simplifies wiring
- Reduces the cost of ownership

Integrated PID and Limit Controller

- Reduces wiring time and termination complexity compared to connecting discrete products
- Decreases required panel space
- Lowers installation costs
- Increases user and equipment safety for over/under temperature conditions

Current Monitoring

- Detects heater current flow and provides alarm indication of a failed output device or heater load

Serial Communications Capabilities

- Provides a wide range of protocol choices including Modbus[®] RTU, EtherNet/IP[™], PCCC (Programmable Controller Communications Commands), DeviceNet[™], Modbus[®] TCP, and Profibus DP
- Supports network connectivity to a PC or PLC

Dual Channel Controller

- For selected models provides two PID controllers in one space saving package

Enhanced Control Capabilities

- Easily handle complex process problems such as cascade, ratio, differential, square-root, motorized valve control without slidewire feedback, wet-bulb/dry-bulb and compressor control

Full-featured Alarms

- Improves operator recognition of system faults
- Control of auxiliary devices

Ten Point Linearization Curve

- Improves sensor accuracy

Remote Set Point Operation

- Supports efficient set point manipulation via a master control or PLC

Retransmit Output

- Supports industry needs for product process recording

Profile Capability

- Preprogrammed process control
- Ramp and soak programming with four files and 40 total steps

A Conceptual View of the PM

The flexibility of the PM's software and hardware allows a large range of configurations. Acquiring a better understanding of the controller's overall functionality and capabilities while at the same time planning out how the controller can be used will deliver maximum effectiveness in your application.

It is useful to think of the controller in terms of functions; there are internal and external functions. An input and an output would be considered external functions where the PID calculation or a logic function would be an internal function. Information flows from an input function to an internal function to an output function when the controller is properly configured. A single PM controller can carry out several functions at the same time, for instance closed-loop control, monitoring for several different alarm situations, performing logical operations and operating switched devices, such as lights and motors. Each process needs to be thought out carefully and the controller's various functions set up properly.

Input Functions

The inputs provide the information that any given programmed procedure can act upon. In a simple form, this information may come from an operator pushing a button or as part of a more complex procedure it may represent a remote set point being received from another controller.

Each analog input typically uses a thermocouple, thermistor or RTD to read the temperature of something. It can also read volts, current or resistance, allowing it to use various devices to read humidity, air pressure, operator inputs and others values. The settings in the Analog Input Menu (Setup Page) for each analog input must be configured to match the device connected to that input.

Each digital input reads whether a device is active or inactive. A PM with digital input-output (DIO) hardware can include up to eight DIO each of which can be used as either an input or an output. Each DIO must be configured to function as either an input or output with the Direction parameter in the Digital Input/Output Menu (Setup Page).

The Function or EZ Key on the front panel of the PM also operates as a digital input by toggling the function assigned to it in the Digital Input Function parameter in the Function Key Menu (Setup Page).

Internal Functions

Functions use input signals to calculate a value. A function may be as simple as reading a digital input to set a state to true or false, or reading a temperature to set an alarm state to on or off. Or, it could compare the temperature of a process to the set point and calculate the optimal power for a heater.

To set up an internal function, it's important to tell it what source, or instance, to use. For example, an alarm may be set to respond to either analog input 1 or 2 (instance 1 or 2, respectively).

Output Functions

Outputs can perform various functions or actions in response to information provided by a function, such as operating a heater, driving a compressor, turning a light on or off, unlocking a door etc...

Assign an output to a Function in the Output Menu or Digital Input/Output Menu. Then select which instance of that function will drive the selected output. For example, you might assign an output to respond to alarm 4 (instance 4) or to retransmit the value of analog input 2 (instance 2).

You can assign more than one output to respond to a single instance of a function. For example, alarm 2 could be used to trigger a light connected to output 1 and a siren connected to digital output 5.

Input Events and Output Events

Input and output events are internal states that are used exclusively by profiles. The source of an event input can come from a real-world digital input or an output from another function. Likewise, event outputs may control a physical output such as an output function block or be used as an input to another function.

Getting Started Quickly

The PM control has a page and menu structure that is listed below along with a brief description of its purpose.

<p>Setup Page Push and hold the up and down keys (▲ ▼) for 6 seconds to enter. (See the Setup Page for further information)</p>	<p>Once received, a user would want to setup their control prior to operation. As an example, define the input type and set the output cycle time.</p>
<p>Operations Page Push and hold the up and down keys (▲ ▼) for 3 seconds to enter. (See the Operations Page for further information)</p>	<p>After setting up the control to reflect your equipment, the Operations Page would be used to monitor or change run-time settings. As an example, the user may want to see how much time is left in a profile step or perhaps change the limit high set point.</p>
<p>Factory Page Push and hold the Infinity and the green Advance keys (∞ ⏩) for 6 seconds to enter. (See the Factory Page for further information)</p>	<p>For the most part the Factory Page has no bearing on the control when running. A user may want to enable password protection, view the control part number or perhaps create a custom Home Page.</p>
<p>Home Page The control is at the Home Page when initially powered up.</p>	<p>Pushing the green Advance key (⏩) will allow the user to see and change such parameters as the control mode, enable autotune and idle set point to name a few.</p>
<p>Profile Page Push and hold the the green Advance key (⏩) for 6 seconds to enter. (See the Profile Page for further information)</p>	<p>If equipped with this feature a user would want to go here to configure a profile.</p>

The default PM loop configuration out of the box is shown below:

- Analog Input functions set to thermocouple, type J
- Heat algorithm set for PID, Cool set to off
- Output 1 set to Heat
- Control mode set to Auto
- Set point set to 75 °F

If you are using the input type shown above, simply connect your input and output devices to the control. Power up the control and push the up arrow (▲) on the face of the control to change the set point from the default value of 75 °F to the desired value. As the Set Point increases above the Process Value, output 1 will come on and it will now begin driving your output device. The PV function as shown in the graphic below is only available with PM4/8/9 models.

Note:

The output cycle time will have a bearing on the life of mechanical relay outputs and can be different based on the type of output ordered. The output cycle time can be changed in the Setup Page under the Output Menu.

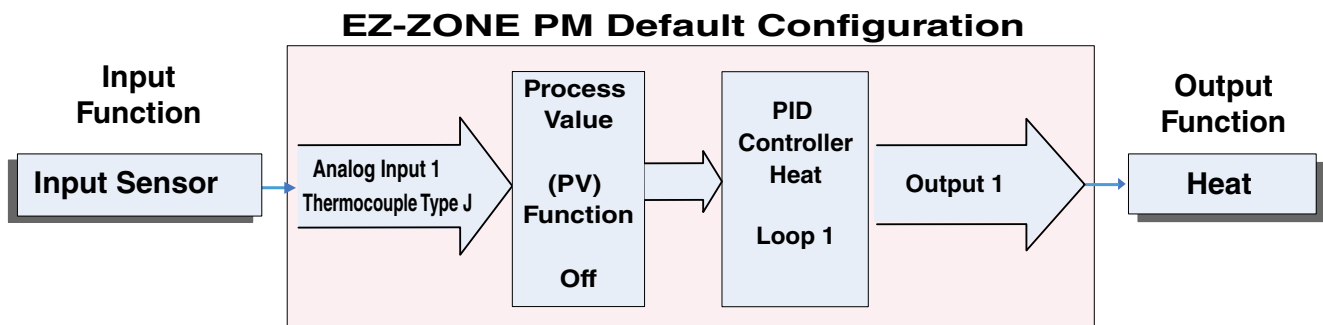

EZ-ZONE® PM Integrated Model 1/16 DIN System Diagram With a Current Transformer, Without Communications Card (Slot B)

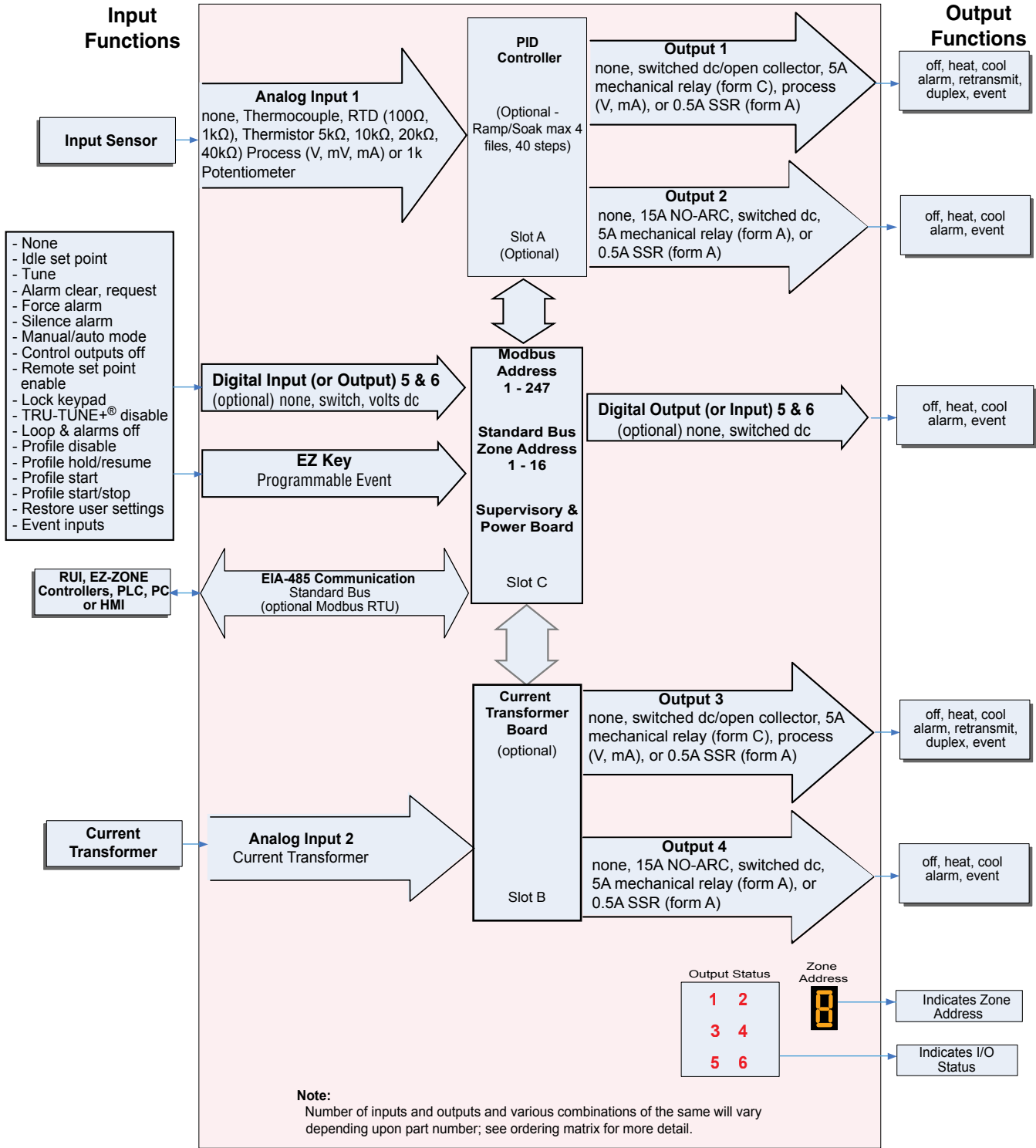

Current Monitoring

- detects heater current flow
- provides an alarm indication of a failed-load issue.

EZ-ZONE[®] PM Integrated Model 1/16 DIN System Diagram With Auxillary Input, Without Communications Card (Slot B)

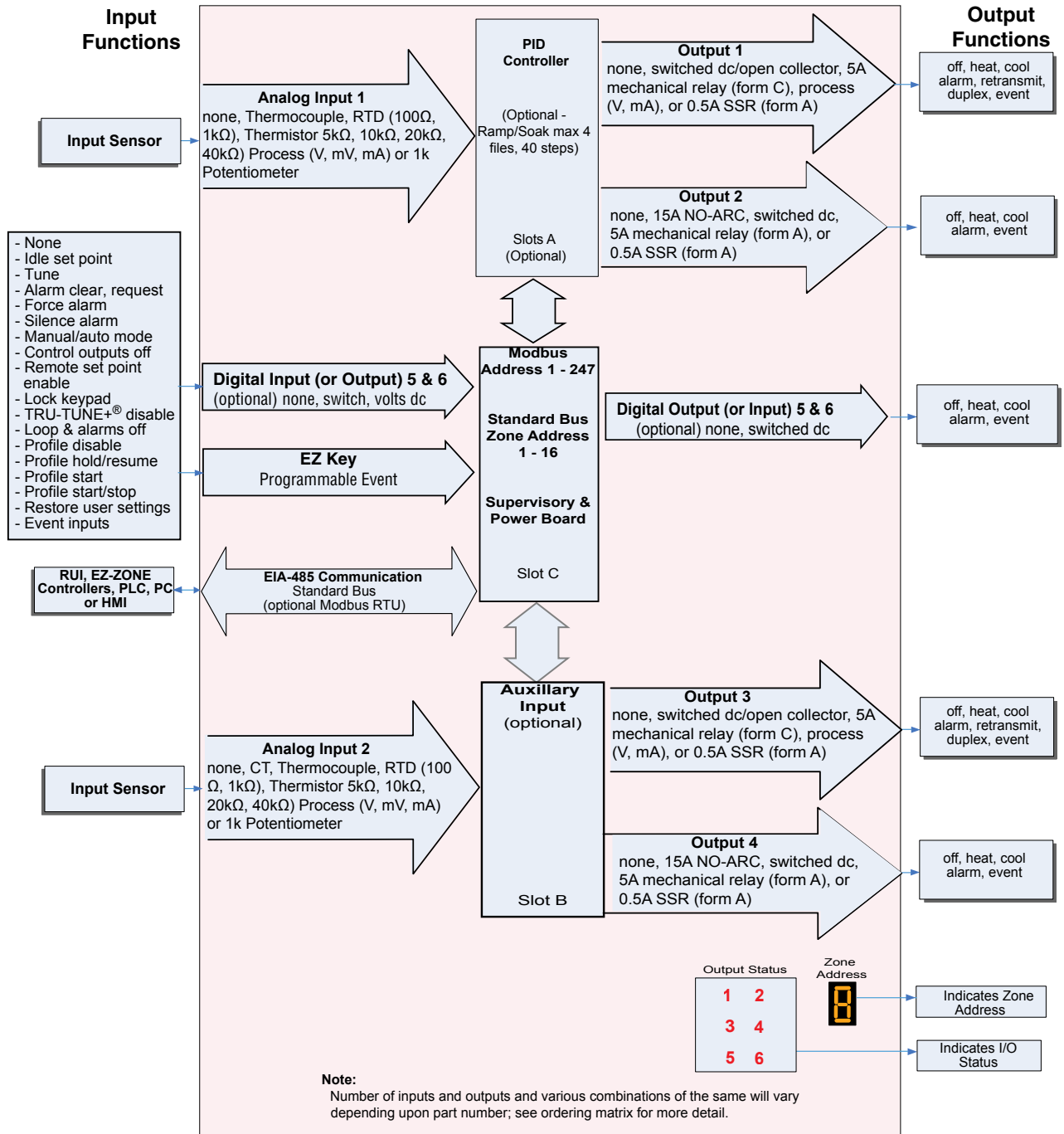

Remote Set Point Operation

- Supports efficient set point manipulation from a remote device, such as a master control or PLC.

EZ-ZONE® PM Integrated Model 1/16 DIN With Limit, System Diagram Without Communications Card (Slot B)

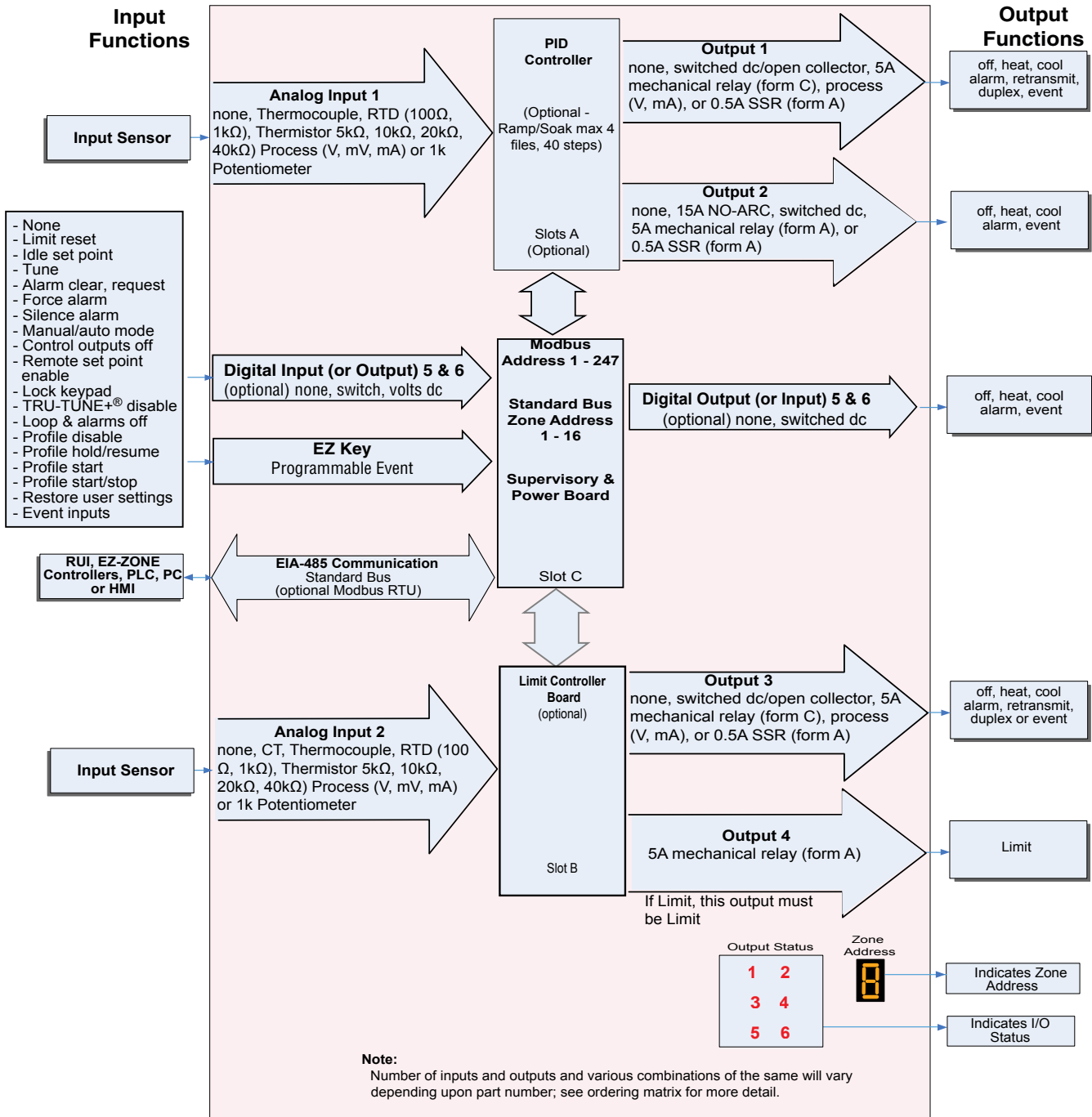

Integrated PID and Limit Controller

- Reduces wiring time and termination complexity compared to connecting separate products
- Reduces panel space
- Reduces installation costs
- Increases dependability with backup control sensor operation
- Increases user and equipment safety for over-under temperature conditions

EZ-ZONE® PM Integrated Model 1/16 DIN System Diagram with Expanded Communications (Slot B)

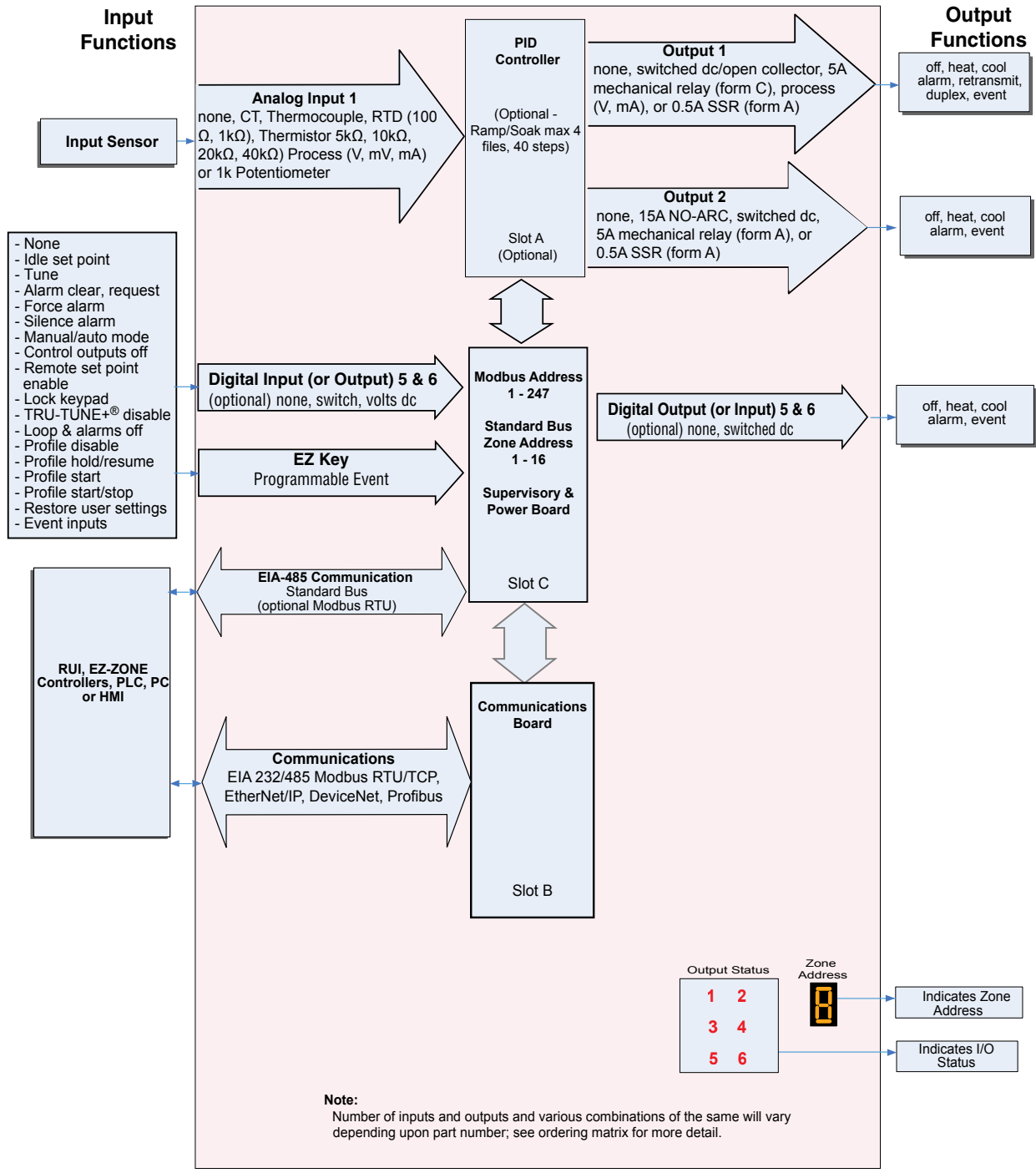

Serial Communication Capabilities

- Supports network connectivity to a PC or PLC
- Available in a wide range of protocol choices, including Modbus RTU, EtherNet/IP™, Modbus TCP

EZ-ZONE® PM Integrated Model 1/8 and 1/4 DIN System Diagram Without 6 Digital I/O (slot D), Without Communications (slot E)

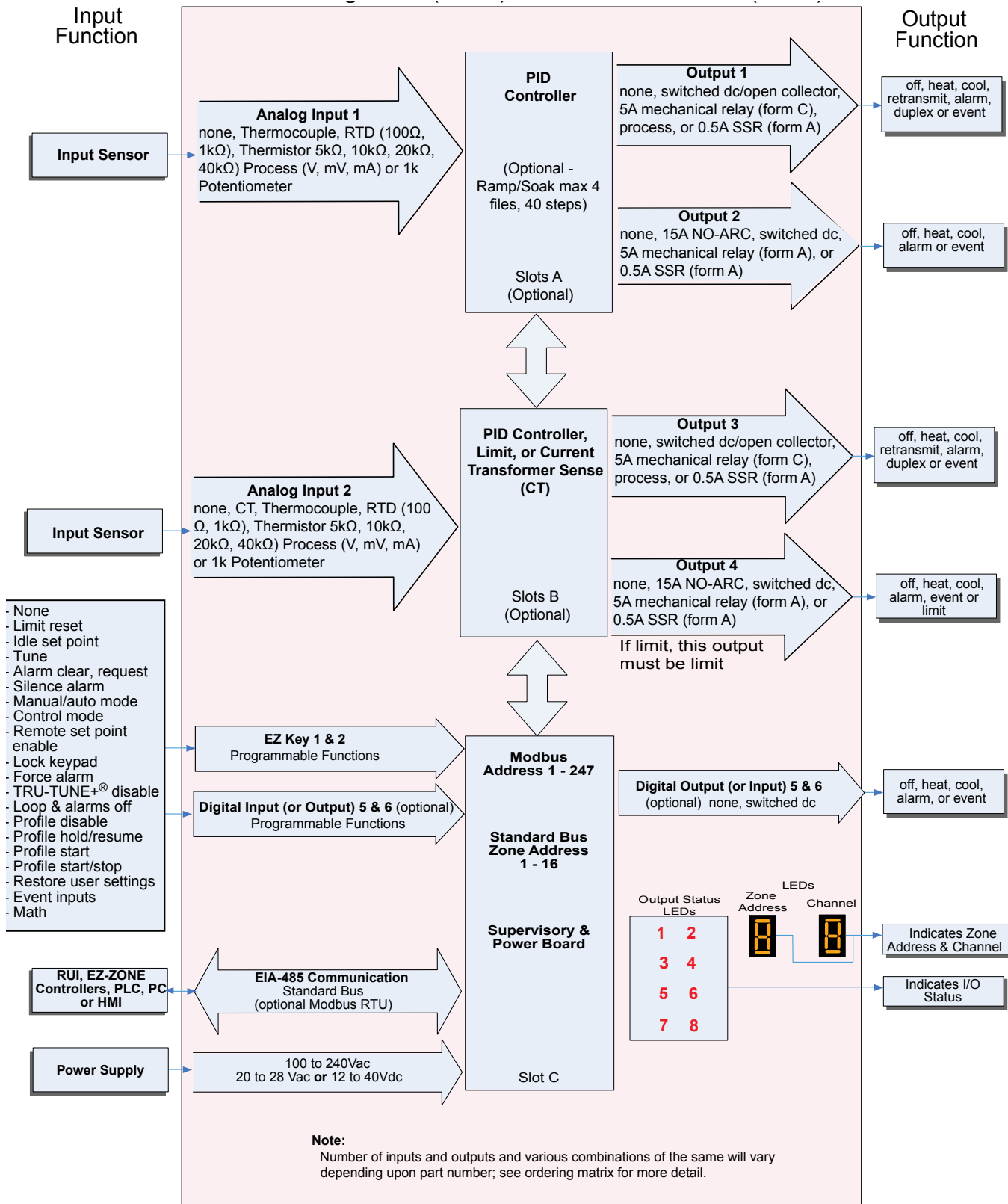

EZ-ZONE® PM Integrated Model 1/8 and 1/4 DIN System Diagram With 6 Digital I/O (slot D), Without Communications (slot E)

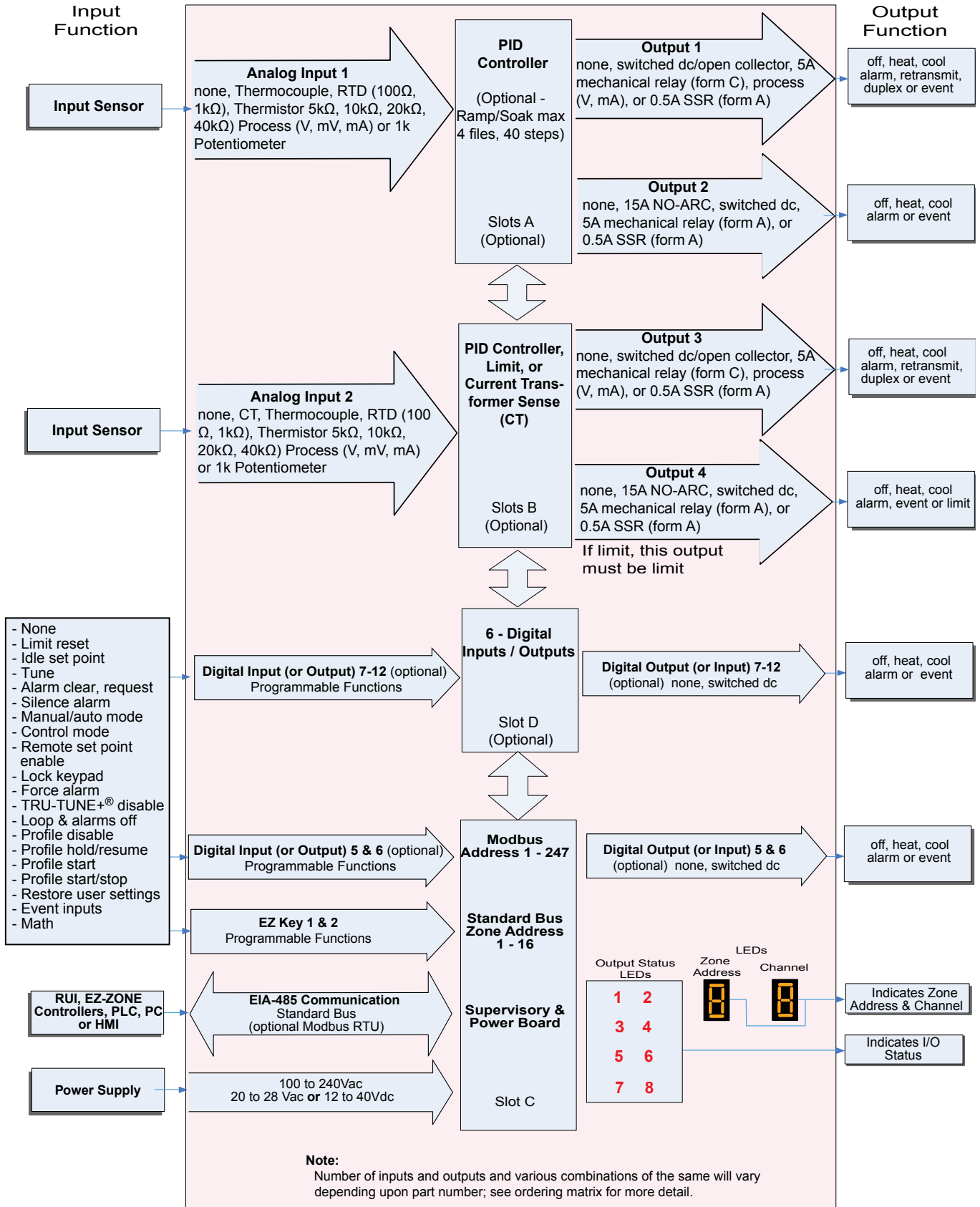

EZ-ZONE® PM Integrated Model 1/8 and 1/4 DIN with CT System Diagram Without 6 Digital I/O (slot D), Without Communications (slot E)

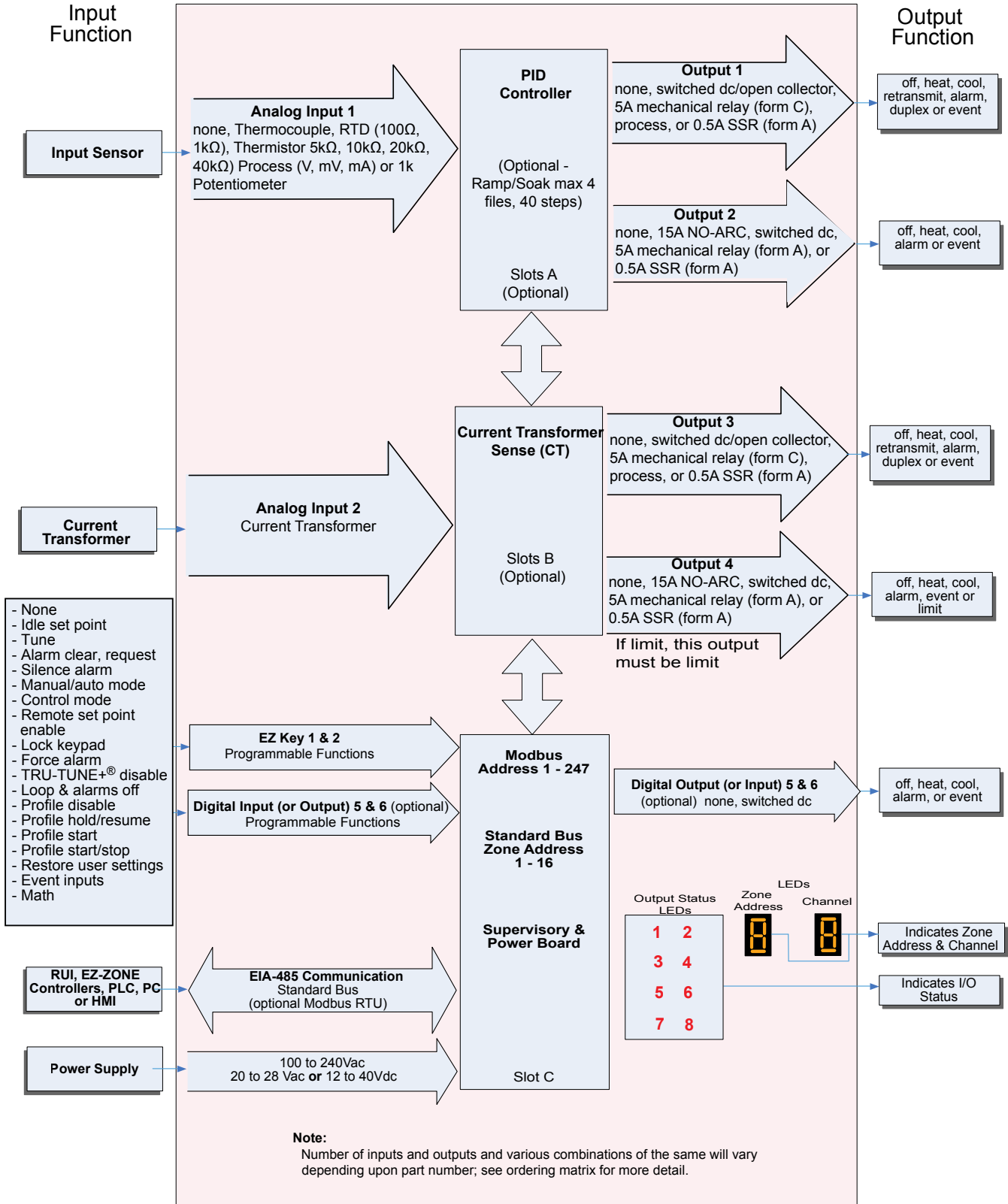

EZ-ZONE® PM Integrated Model 1/8 and 1/4 DIN System Diagram Without 6 Digital I/O (slot D), With Communications (slot E)

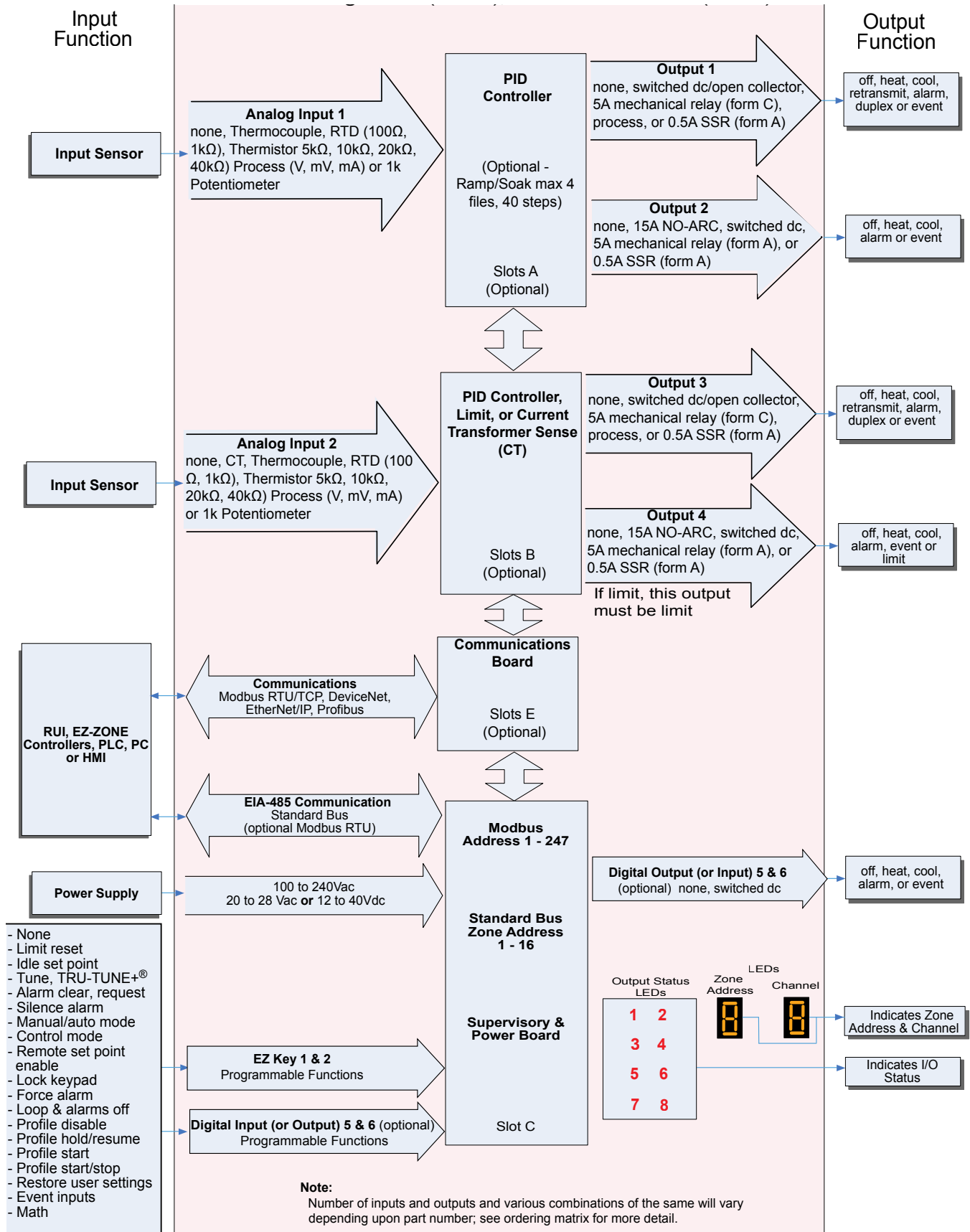

2

Chapter 2: Install and Wire

Dimensions

1/16 DIN (PM6)

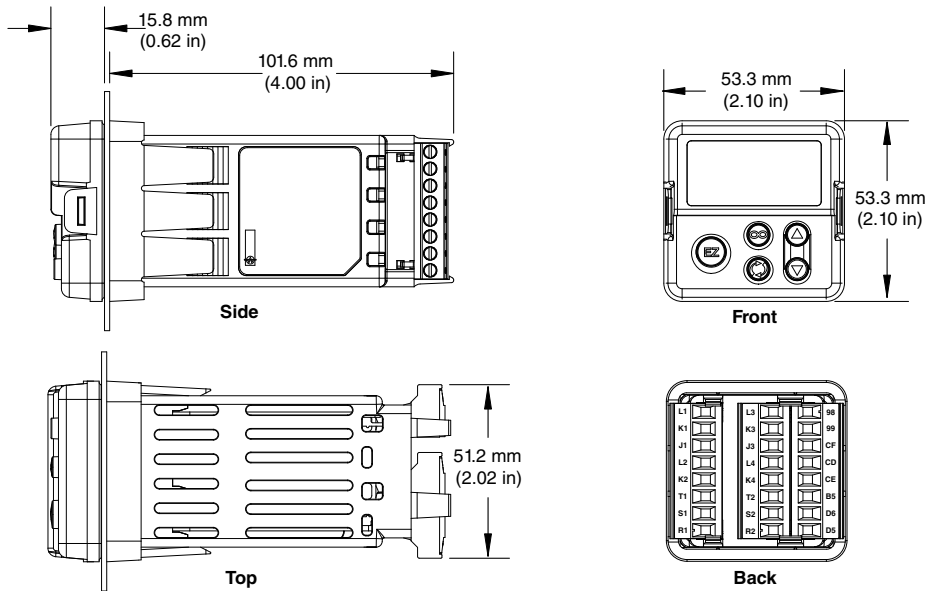

1/16 DIN (PM6) Recommended Panel Spacing

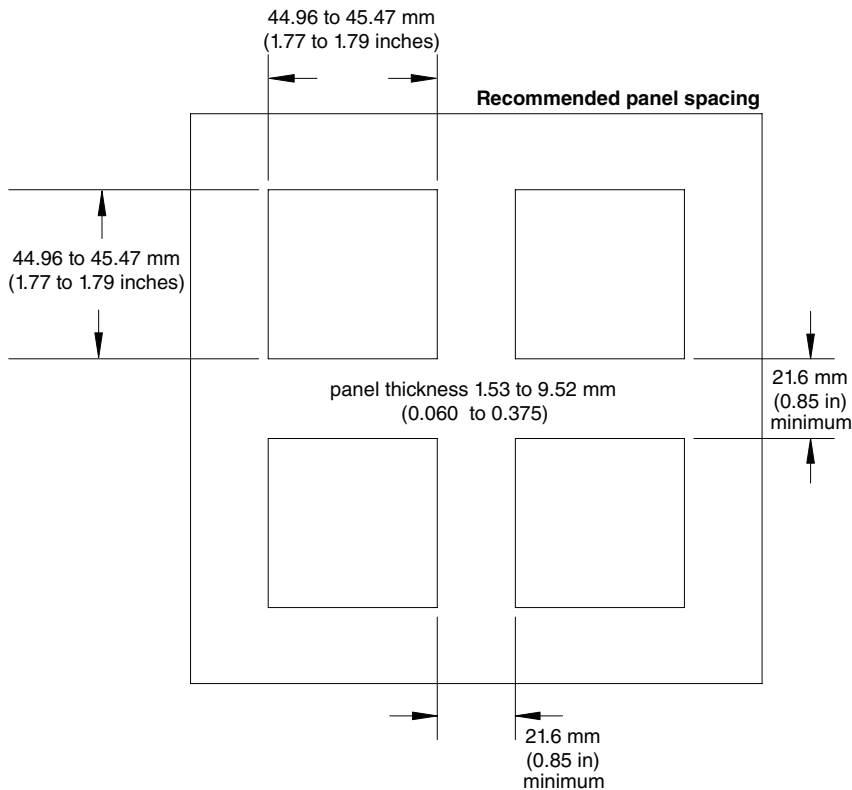

1/8 DIN (PM8) Vertical Dimensions

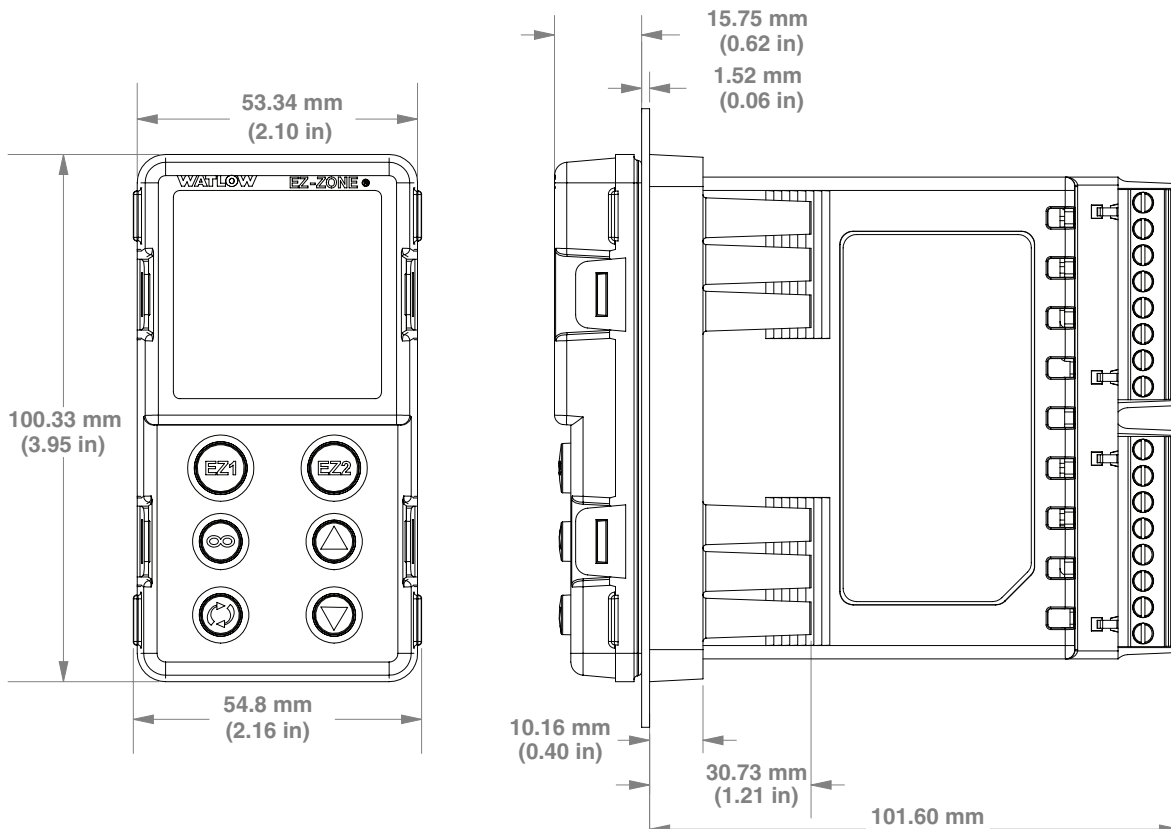

1/8 DIN (PM8) Vertical Recommended Panel Spacing

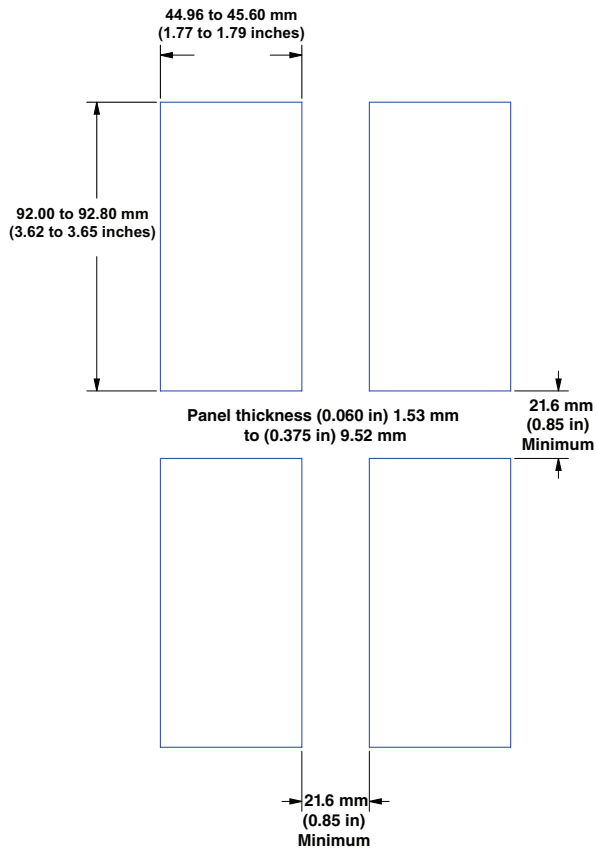

1/8 DIN (PM9) Horizontal Dimensions

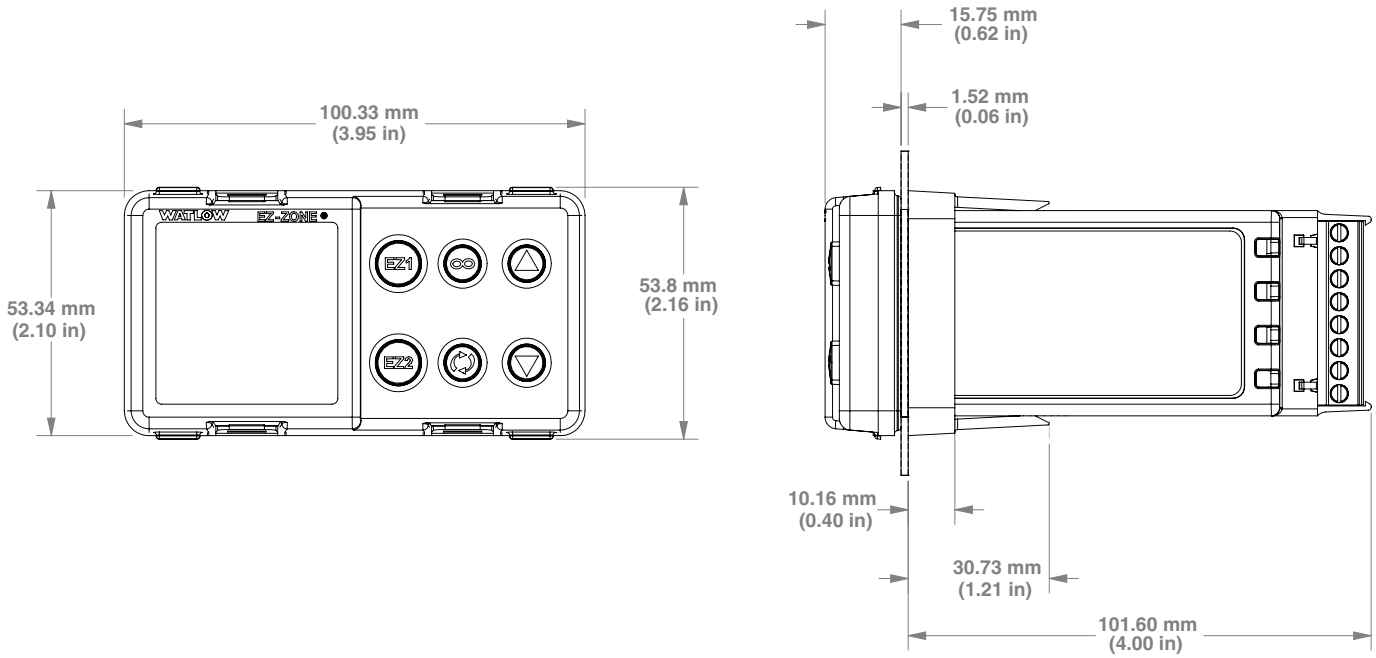

1/8 DIN (PM9) Horizontal Recommended Panel Spacing

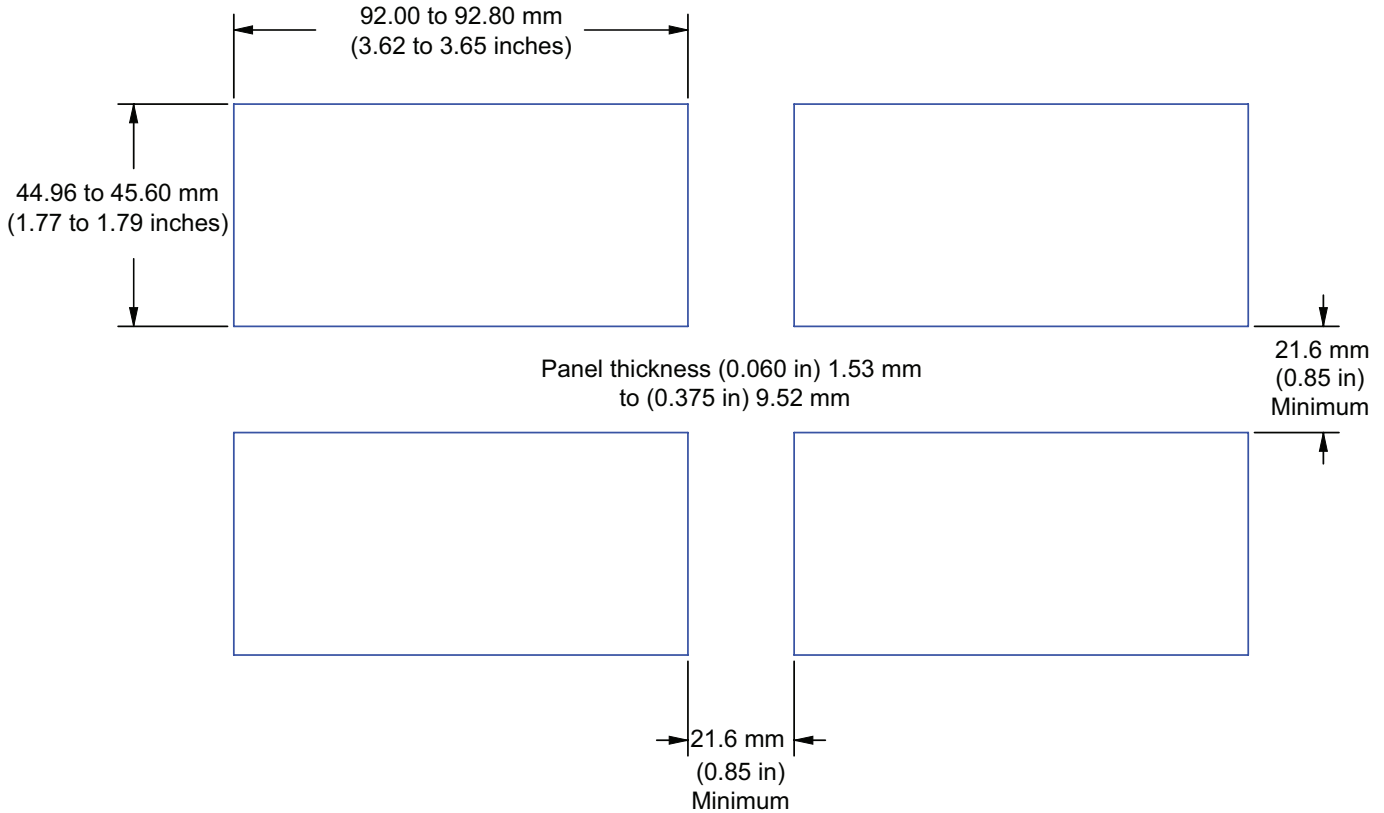

1/4 DIN (PM4) Dimensions

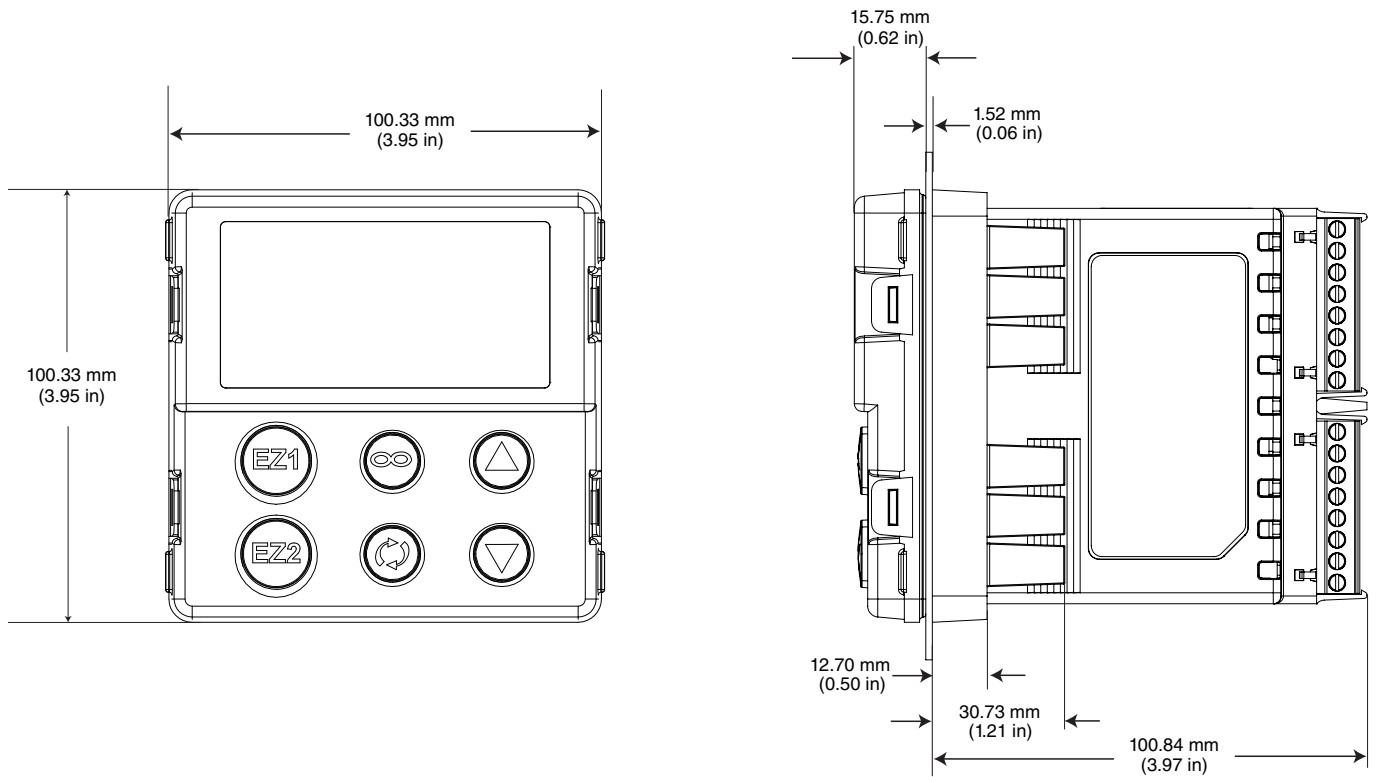

1/4 DIN (PM4) Recommended Panel Spacing

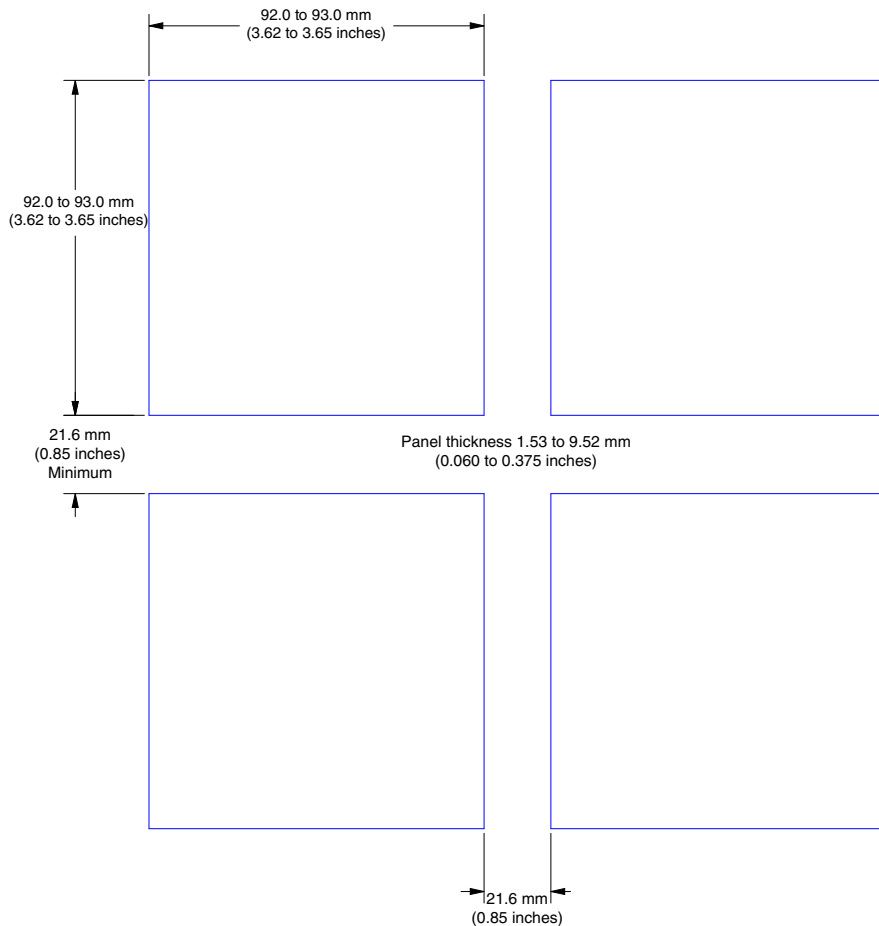

Installation

1. Make the panel cutout using the mounting template dimensions in this chapter.

Insert the case assembly into the panel cutout.

2. While pressing the case assembly firmly against the panel, slide the mounting collar over the back of the controller.

If the installation does not require a NEMA 4X seal, simply slide together until the gasket is compressed.

3. For a NEMA 4X (UL50, IP66) seal, alternately place and push the blade of a screwdriver against each of the four corners of the mounting collar assembly. Apply pressure to the face of the controller while pushing with the screwdriver. Don't be afraid to apply enough pressure to properly install the controller. The seal system is compressed more by mating the mounting collar tighter to the front panel (see pictures above). If you can move the case assembly back and forth in the cutout, you do not have a proper seal. The tabs on each side of the mounting collar have teeth that latch into the ridges on the sides of the controller. Each tooth is staggered at a different depth from the front so that only one of the tabs, on each side, is locked onto the ridges at a time.

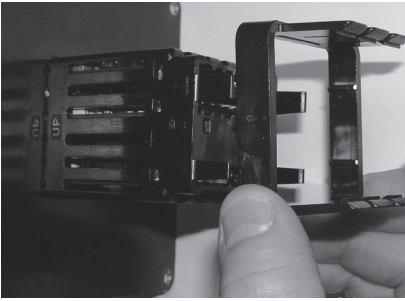
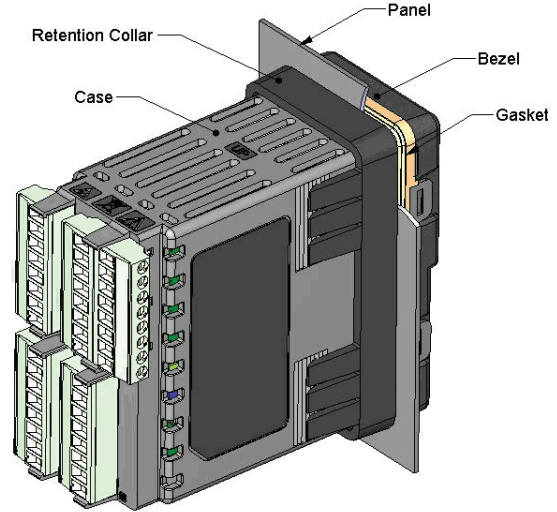

Slide the mounting collar over the back of the controller.

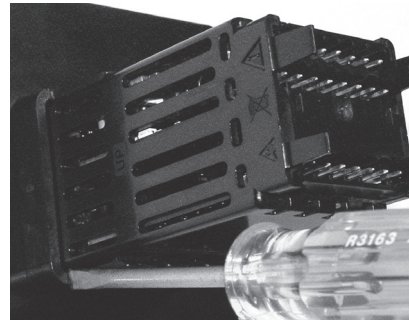

Place the blade of a screwdriver in any of the corner of the mounting collar assembly.

Note:

There is a graduated measurement difference between the upper and lower half of the display to the panel. In order to meet the seal requirements mentioned above, ensure that the distance from the front of the top half of the display to the panel is 16 mm (0.630 in.) or less, and the distance from the front of the bottom half and the panel is 13.3 mm (0.525 in.) or less.

Removing the Mounted Controller from Its Case

1. From the controller's face, pull out the tabs on each side until you hear it click.

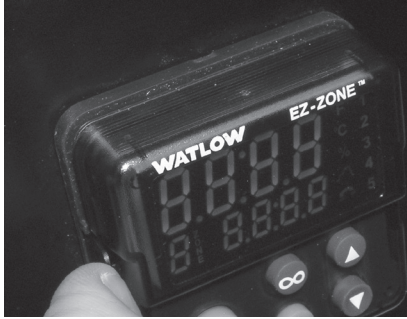

Pull out the tab on each side until you hear it click.

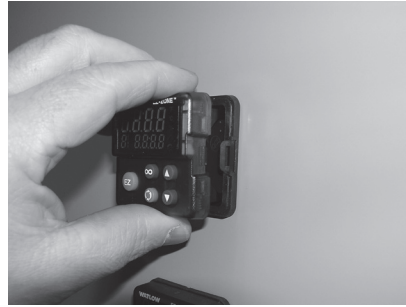

Grab the unit above and below the face and pull forward.

2. Grab the unit above and below the face with two hands and pull the unit out. On the PM4/8/9 controls slide a screwdriver under the pry tabs and turn.

Warning:

- This equipment is suitable for use in class 1, div. 2, Groups A, B, C and D or Non-Hazardous locations only. Temperature Code T4A.
- WARNING – EXPLOSION HAZARD. Substitution of component may impair suitability for class 1, div. 2.
- WARNING – EXPLOSION HAZARD. Do not disconnect equipment unless power has been switched off or the area is known to be nonhazardous.

Returning the Controller to its Case

1. Ensure that the orientation of the controller is correct and slide it back into the housing.

Note:

The controller is keyed so if it feels that it will not slide back in do not force it. Check the orientation again and reinsert after correcting.

2. Using your thumbs push on either side of the controller until both latches click.

Chemical Compatibility

This product is compatible with acids, weak alkalis, alcohols, gamma radiation and ultraviolet radiation.

This product is not compatible with strong alkalis, organic solvents, fuels, aromatic hydrocarbons, chlorinated hydrocarbons, esters and keytones.

Warning:

All electrical power to the controller and controlled circuits must be disconnected before removing the controller from the front panel or disconnecting other wiring.

Failure to follow these instructions may cause an electrical shock and/or sparks that could cause an explosion in class 1, div. 2 hazardous locations.

Wiring

Slot A	Slot B	Slot D	Slot E								
Inputs				Terminal Function				Configuration			
1	2	7 - 12									
T1 S1 R1	T2 S2 R2						S2 (RTD) or current + S3 (RTD), thermocouple -, current - or volts - -, potentiometer wiper, thermistor S1 (RTD), thermocouple + or volts +, thermistor, potentiometer	Universal / Thermistor Input input 1: all configurations input 2: PM _____ [R,L] _____			
	T2 S2						mA ac mA ac	Current Transformer PM _____ [T] _____			
		B7					Common	Digital Inputs PM[4,8,9] _____ [C, D] _____			
		D7					digital input or output				
		D8					digital input or output				
		D9					digital input or output				
		D10					digital input or output				
		D11					digital input or output				
		D12					digital input or output				
		Z7					Internal Supply				
Outputs				Terminal Function				Configuration			
1	2	3	4	7 - 12							
X1 W1 Y1		X3 W3 Y3					common (Any switched dc output can use this common.) dc- (open collector) dc+	Switched dc/open collector output 1: PM _____ [C] - _____ output 3: PM _____ [C] _____			
	W2 Y2		W4 Y4				dc- dc+	Switched dc output 2: PM _____ [C] - _____ output 4: PM _____ [C] _____			
F1 G1 H1		F3 G3 H3					voltage or current - voltage + current +	Universal Process output 1: PM _____ [F] - _____ output 3: PM _____ [F] _____			
L1 K1 J1		L3 K3 J3					normally open common normally closed	Mechanical Relay 5 A, Form C output 1: PM _____ [E] - _____ output 3: PM _____ [E] _____			
	L2 K2		L4 K4				normally open common	NO-ARC 15 A, Form A output 2: PM _____ [H] - _____ [H*] _____			
	L2 K2		L4 K4				normally open common	Mechanical Relay 5 A, Form A output 2: PM _____ [J] - _____ output 4: PM _____ [J] _____			
L1 K1	L2 K2	L3 K3	L4 K4				normally open common	Solid-state Relay 0.5 A, Form A output 1: PM _____ [K] - _____ output 2: PM _____ [K] - _____ output 3: PM _____ [K] - _____ output 4: PM _____ [K] - _____			
				B7			Common	Digital Outputs PM[4,8,9] _____ [C, D] _____			
				D7			switched dc/open collector output				
				D8			switched dc/open collector output				
				D9			switched dc/open collector output				
				D10			switched dc/open collector output				
				D11			switched dc/open collector output				
				D12			switched dc/open collector output				
				Z7			Internal Supply				
Slot A	Slot B	Slot D	Slot E								

* Output 4, PM4, PM8 and PM9 only

Communications				Terminal Function	Configuration
CB	CA	CC	CB	Modbus RTU EIA-485 T+/R+	Modbus RTU 232/485 Communications Slot B: PM6 _____ - [2] A A A ____ Slot E: PM[4,8,9] _____ - [2] _____
CA	CC	CA	Modbus RTU EIA-485 T-/R-		
CC	CB	CC	Modbus RTU EIA-485 common		
CB	CA	CB	Modbus RTU EIA-485 T+/R+		
CA	CC	CA	Modbus RTU EIA-485 T-/R-		
C5	C3	C5	Modbus RTU EIA-232 common		
C3	C2	C3	Modbus RTU EIA-232 to DB9 pin 2		
C2		C2	Modbus RTU EIA-232 to DB9 pin 3		
V+	CH	SH	V+	DeviceNet™ power	DeviceNet™ Communications Slot B: PM6 _____ - [5] A A A ____ Slot E: PM[4,8,9] _____ - [5] _____
CH	SH	CL	CH	Positive side of DeviceNet™ bus	
SH	CL	V-	SH	Shield interconnect	
CL	V-		CL	Negative side of DeviceNet™ bus	
V-			V-	DeviceNet™ power return	
E8	E7	E6	E8	EtherNet/IP™ and Modbus TCP unused	Ethernet 10/100 supporting EtherNet/IP™ and Modbus TCP Slot B: PM6 _____ - [3] A A A ____ Slot E: PM[4,8,9] _____ - [3] _____
E7	E6	E5	E7	EtherNet/IP™ and Modbus TCP unused	
E6	E5	E4	E6	EtherNet/IP™ and Modbus TCP receive -	
E5	E4	E3	E5	EtherNet/IP™ and Modbus TCP unused	
E4	E3	E2	E4	EtherNet/IP™ and Modbus TCP unused	
E3	E2	E1	E3	EtherNet/IP™ and Modbus TCP receive +	
E2	E1		E2	EtherNet/IP™ and Modbus TCP transmit -	
E1			E1	EtherNet/IP™ and Modbus TCP transmit +	
VP	B	DG	VP	Voltage Potential	Profibus Communications Slot B: PM6 _____ - [6] A A A ____ Slot E: PM [4, 8, 9] _____ - [6] A A A A A A
B	DG	trB	B	EIA-485 T+/R+	
A	trB	B	A	EIA-485 T-/R-	
DG	B	A	DG	Digital ground (common)	
trB	A	trA	trB	Termination resistor B	
B	trA		B	EIA-485 T+/R+	
A			A	EIA-485 T-/R-	
trA			trA	Termination resistor A	
Slot A	Slot B	Slot D	Slot E		

Terminal Definitions for Slot C.

Slot C	Terminal Function	Configuration
98	Power input: ac or dc+	all
99	Power input: ac or dc-	
CC	Standard Bus or Modbus RTU EIA-485 common	Standard Bus or Modbus PM _____ - [1] _____
CA	Standard Bus or Modbus RTU EIA-485 T-/R-	
CB	Standard Bus or Modbus RTU EIA-485 T+/R+	
CF	Standard Bus EIA-485 common	PM _____ - [A,D,2,3,5] _____
CD	Standard Bus EIA-485 T-/R-	
CE	Standard Bus EIA-485 T+/R+	
B5	Digital input-output common	PM __ [2] __ - _____ PM __ [4] __ - _____
D6	Digital input or output 6	
D5	Digital input or output 5	

Back View
Slot Orientation 1/8
DIN Vertical PM8

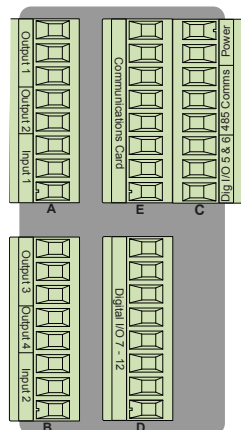

Back View
Slot Orientation
1/8 DIN Horizontal PM9

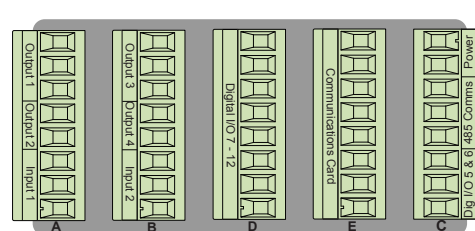

**Back View
Slot Orientation
1/4 DIN Horizontal PM4**

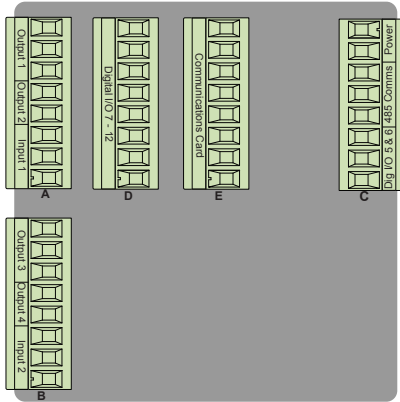

**Back View
Slot Orientation
1/16 DIN PM6**

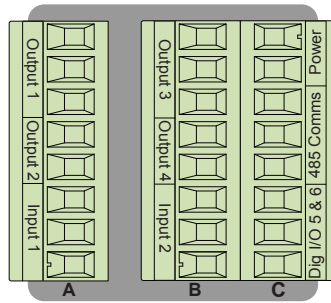

Note:
Slot B above can also be configured with a communications card.

PM Integrated Isolation Block

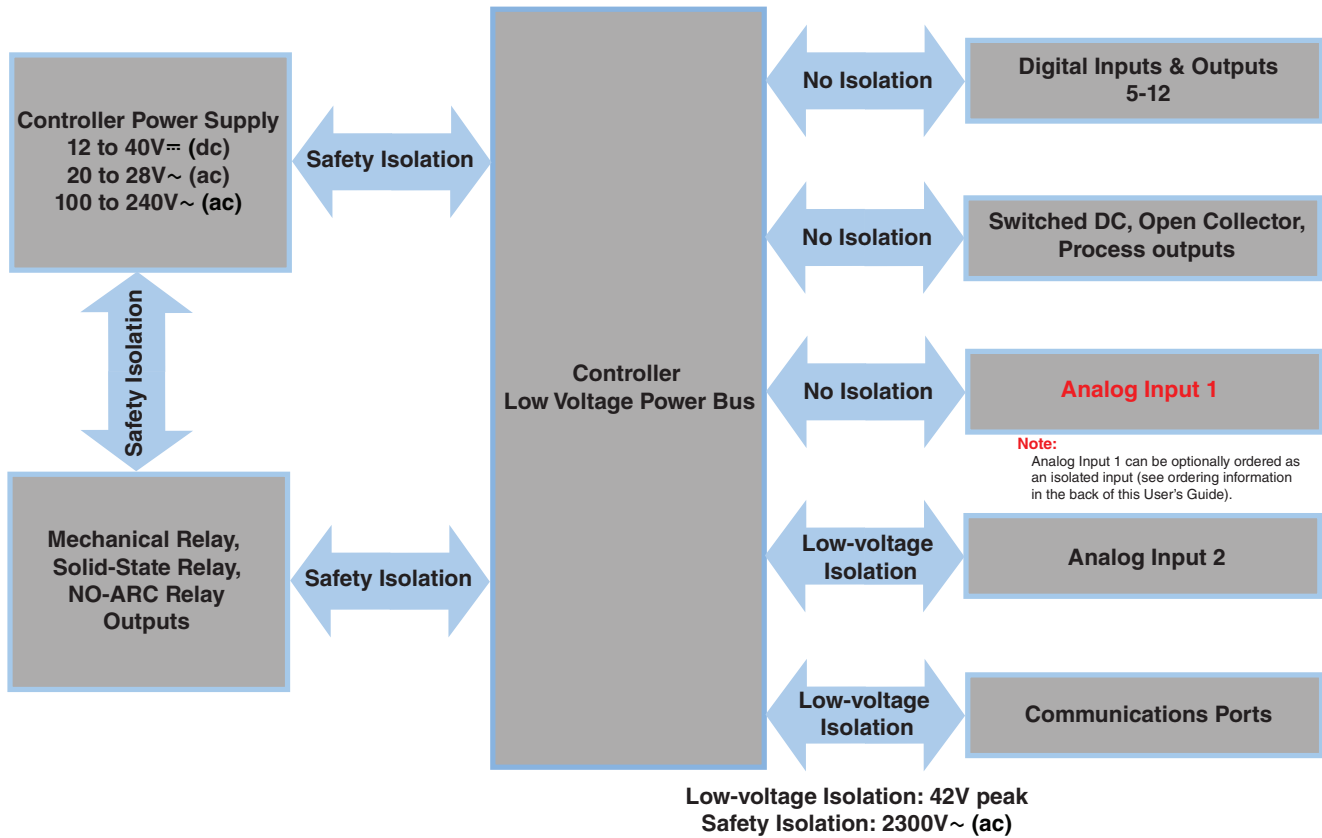



Warning:

Use National Electric (NEC) or other country-specific standard wiring and safety practices when wiring and connecting this controller to a power source and to electrical sensors or peripheral devices. Failure to do so may result in damage to equipment and property, and/or injury or loss of life.

Note:

Maximum wire size termination and torque rating:

- 0.0507 to 3.30 mm² (30 to 12 AWG) single-wire termination or two 1.31 mm² (16 AWG)
- 0.8 Nm (7.0 lb.-in.) torque

Note:

Adjacent terminals may be labeled differently, depending on the model number.

Note:

To prevent damage to the controller, do not connect wires to unused terminals.

Note:

Maintain electrical isolation between analog input 1, digital input-outputs, switched dc/open collector outputs and process outputs to prevent ground loops.

Note:

The control output common terminal and the digital common terminal are referenced to different voltages and must remain isolated.

Note:

This Equipment is suitable for use in CLASS I, DIVISION 2, Groups A, B, C and D or Non-Hazardous locations only. Temperature Code T4A

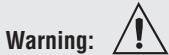

Warning:

Explosion Hazard - Dry contact closure Digital Inputs shall not be used in Class I Division 2 Hazardous Locations unless switch used is approved for this application.



Warning:

Explosion Hazard – Substitution of component may impair suitability for CLASS I, DIVISION 2.



Warning:

Explosion Hazard - Do not disconnect while the circuit is live or unless the area is known to be free of ignitable concentrations of flammable substances.

Low Power

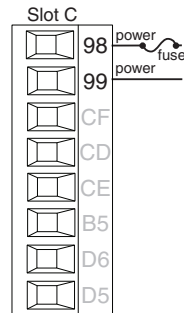

- Minimum/Maximum Ratings
 - 12 to 40V $\overline{\text{=}}$ (dc)
 - 20 to 28V \sim (ac) Semi Sig F47
 - 47 to 63 Hz
 - 14VA maximum power consumption (PM4, 8 and 9)
 - 10VA maximum power consumption (PM6)
- PM_ _ [3,4] _ _ - - - - -

High Power

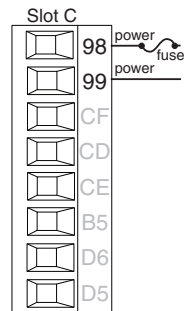

- Minimum/Maximum Ratings
 - 85 to 264V \sim (ac)
 - 100 to 240V \sim (ac) Semi Sig F47
 - 47 to 63 Hz
 - 14VA maximum power consumption (PM4, 8 and 9)
 - 10VA maximum power consumption (PM6)
- PM_ _ [1,2] _ _ - - - - -

Digital Input 5 - 6

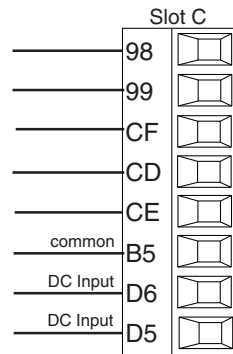

Digital Input

- Update rate 10 Hz
- Dry contact or dc voltage

DC Voltage

- Input not to exceed 36V at 3 mA
- Input active when > 3V @ 0.25 mA
- Input inactive when < 2V

Dry Contact

- Input inactive when > 500 Ω
 - Input active when < 100 Ω
 - maximum short circuit 13 mA
- PM_ _ [2,4] _ _ - - - - -

Voltage Input

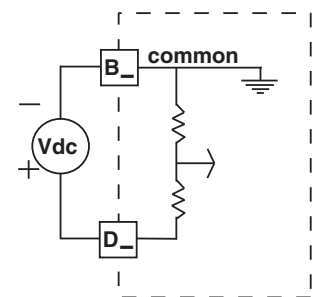

Dry Contact

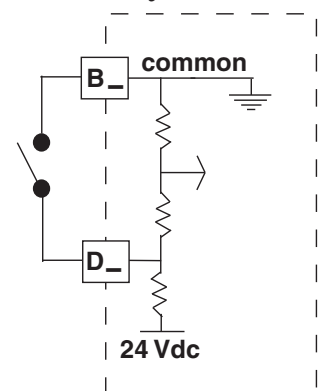



Warning:

Use National Electric (NEC) or other country-specific standard wiring and safety practices when wiring and connecting this controller to a power source and to electrical sensors or peripheral devices. Failure to do so may result in damage to equipment and property, and/or injury or loss of life.

Note:

- Maximum wire size termination and torque rating:
 - 0.0507 to 3.30 mm² (30 to 12 AWG) single-wire termination or two 1.31 mm² (16 AWG)
 - 0.8 Nm (7.0 lb.-in.) torque

Note:

Adjacent terminals may be labeled differently, depending on the model number.

Note:

To prevent damage to the controller, do not connect wires to unused terminals.

Note:

Maintain electrical isolation between analog input 1, digital input-outputs, switched dc/open collector outputs and process outputs to prevent ground loops.

Note:

The control output common terminal and the digital common terminal are referenced to different voltages and must remain isolated.

Note:

This Equipment is suitable for use in CLASS I, DIVISION 2, Groups A, B, C and D or Non-Hazardous locations only. Temperature Code T4A

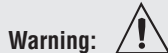

Warning:

Explosion Hazard - Dry contact closure Digital Inputs shall not be used in Class I Division 2 Hazardous Locations unless switch used is approved for this application.

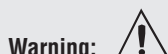

Warning:

Explosion Hazard – Substitution of component may impair suitability for CLASS I, DIVISION 2.

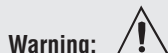

Warning:

Explosion Hazard - Do not disconnect while the circuit is live or unless the area is known to be free of ignitable concentrations of flammable substances.

Digital Input 7 - 12

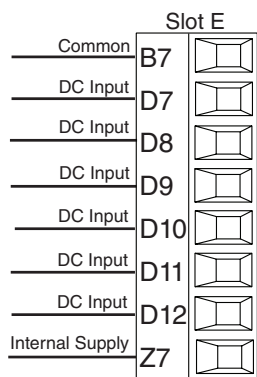

Digital Input Event Conditions

- Dry Contact
 - Input inactive when > 100KΩ
 - Input active when < 50Ω
- Voltage
 - Input inactive when < 2V
 - Input active when > 3V

- Six user configurable digital inputs/outputs per slot
- Slot E DIO 7-12

PM [4,6,8] _____ - [C,D] _____

Voltage Input

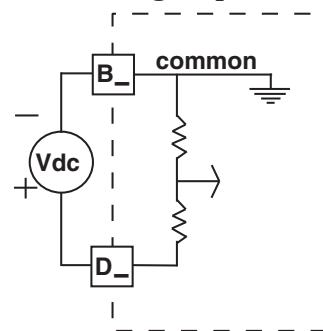

Dry Contact

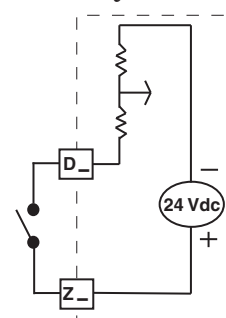

Input 1, 2 Thermocouple

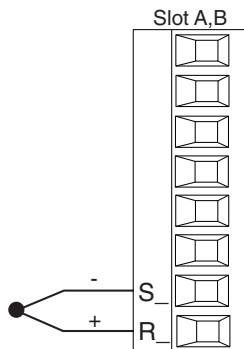

- 2K Ω maximum source resistance
- >20 MΩ input impedance
- 3 microampere open-sensor detection
- Thermocouples are polarity sensitive. The negative lead (usually red) must be connected to S1 and/or S2.
- To reduce errors, the extension wire for thermocouples must be of the same alloy as the thermocouple.

Input 1: PM _ [C,R,B*] _____ (S1/R1)

Input 2: PM _____ - [C,R,L] _____ (S2/R2)

*PM(4, 8 and 9) only

Input 1, 2 RTD

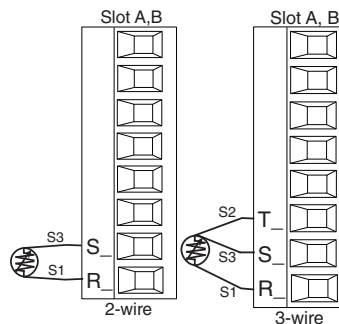

- platinum, 100 and 1,000 Ω @ 0°C
- calibration to DIN curve (0.00385 Ω/Ω°C)
- 20 Ω total lead resistance
- RTD excitation current of 0.09 mA typical. Each ohm of lead resistance may affect the reading by 0.03°C.
- For 3-wire RTDs, the S1 lead (usually white) must be connected to R1 and/or R2
- For best accuracy use a 3-wire RTD to compensate for lead-length resistance. All three lead wires must have the same resistance

Input 1: PM _ [C,R,B*] _____ (S1/R1),(T1/S1/R1)

Input 2: PM _____ - [C,R,L] _____ (S2/R2),(T2/S2/R2)

*PM(4, 8 and 9) only



Warning:

Use National Electric (NEC) or other country-specific standard wiring and safety practices when wiring and connecting this controller to a power source and to electrical sensors or peripheral devices. Failure to do so may result in damage to equipment and property, and/or injury or loss of life.

Note:

Maximum wire size termination and torque rating:

- 0.0507 to 3.30 mm² (30 to 12 AWG) single-wire termination or two 1.31 mm² (16 AWG)
- 0.8 Nm (7.0 lb.-in.) torque

Note:

Adjacent terminals may be labeled differently, depending on the model number.

Note:

To prevent damage to the controller, do not connect wires to unused terminals.

Note:

Maintain electrical isolation between analog input 1, digital input-outputs, switched dc/open collector outputs and process outputs to prevent ground loops.

Note:

The control output common terminal and the digital common terminal are referenced to different voltages and must remain isolated.

Note:

This Equipment is suitable for use in CLASS I, DIVISION 2, Groups A, B, C and D or Non-Hazardous locations only. Temperature Code T4A

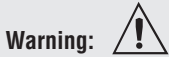

Warning:

Explosion Hazard - Dry contact closure Digital Inputs shall not be used in Class I Division 2 Hazardous Locations unless switch used is approved for this application.



Warning:

Explosion Hazard – Substitution of component may impair suitability for CLASS I, DIVISION 2.



Warning:

Explosion Hazard - Do not disconnect while the circuit is live or unless the area is known to be free of ignitable concentrations of flammable substances.

Input 1, 2 Process

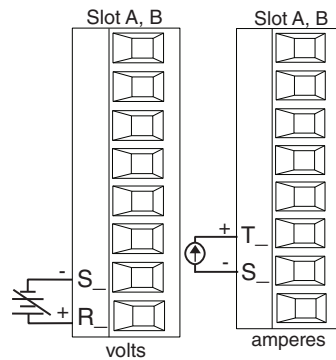

- 0 to 20 mA @ 100 Ω input impedance
- 0 to 10V_{rms} (dc) @ 20 kΩ input impedance
- 0 to 50 mV_{rms} (dc) @ 20 kΩ input impedance
- scalable

Input 1: PM _ [C,R,B*] _ _ _ _ _ (-S1/+R1),(+T1/-S1)

Input 2: PM _ _ _ _ _ [C,R,L] _ _ _ _ _ (-S2/+R2),(+T2/-S2)

*PM(4, 8 and 9) only

Input 1,2 Potentiometer

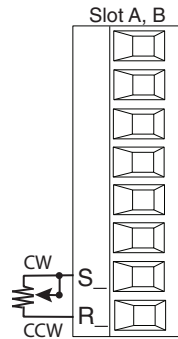

- Use a 1 kΩ potentiometer.

Input 1: PM _ [C,R,B*] _ _ _ _ _ (S1/R1)

Input 2: PM _ _ _ _ _ [C,R,L] _ _ _ _ _ (S2/R2)

*PM(4, 8 and 9) only

Input 1, 2 Thermistor

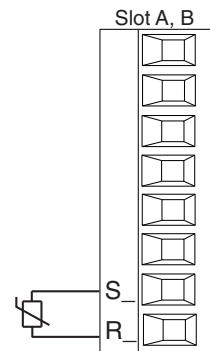

- >20 MΩ input impedance
- 3 microampere open-sensor detection

Input 1: PM _ [J,N,E] _ _ _ _ _ (S1/R1)

Input 2: PM _ _ _ _ _ [J,P,M] _ _ _ _ _ (S2/R2)

Note:

For input 1, option E is available with PM4, 8 and 9 models only.

Input 2 Current Transformer

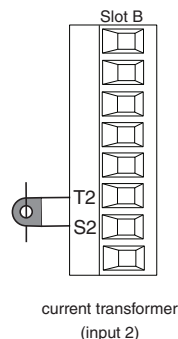

- Input range is 0 to 50 mA.
- current transformer part number: 16-0246
- 100 Ω input impedance
- response time: 1 second maximum
- accuracy +/-1 mA typical

PM _ _ _ _ _ [T] _ _ _ _ _



Warning:

Use National Electric (NEC) or other country-specific standard wiring and safety practices when wiring and connecting this controller to a power source and to electrical sensors or peripheral devices. Failure to do so may result in damage to equipment and property, and/or injury or loss of life.

Note:

Maximum wire size termination and torque rating:

- 0.0507 to 3.30 mm² (30 to 12 AWG) single-wire termination or two 1.31 mm² (16 AWG)
- 0.8 Nm (7.0 lb.-in.) torque

Note:

Adjacent terminals may be labeled differently, depending on the model number.

Note:

To prevent damage to the controller, do not connect wires to unused terminals.

Note:

Maintain electrical isolation between analog input 1, digital input-outputs, switched dc/open collector outputs and process outputs to prevent ground loops.

Note:

The control output common terminal and the digital common terminal are referenced to different voltages and must remain isolated.

Note:

This Equipment is suitable for use in CLASS I, DIVISION 2, Groups A, B, C and D or Non-Hazardous locations only. Temperature Code T4A

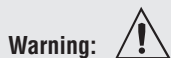

Warning:

Explosion Hazard - Dry contact closure Digital Inputs shall not be used in Class I Division 2 Hazardous Locations unless switch used is approved for this application.

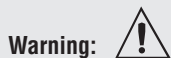

Warning:

Explosion Hazard – Substitution of component may impair suitability for CLASS I, DIVISION 2.

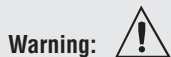

Warning:

Explosion Hazard - Do not disconnect while the circuit is live or unless the area is known to be free of ignitable concentrations of flammable substances.

Quencharc Note:

Switching pilot duty inductive loads (relay coils, solenoids, etc.) with the mechanical relay, solid state relay or open collector output options requires use of an R.C. suppressor.

Example: Using a Current Transformer

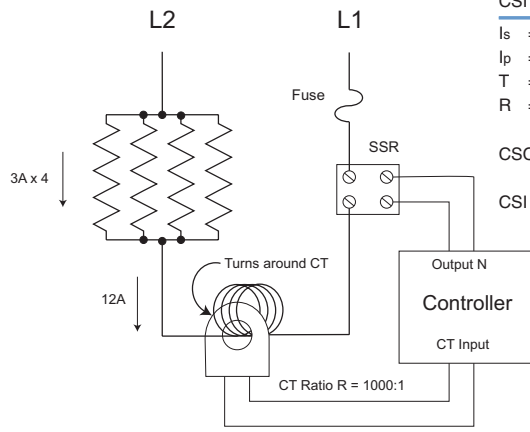

12A x 4 = 48A : 48mA

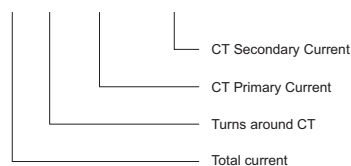

$I_s = I_p T / R = 50\text{mA}$

$CSC = I_p(\text{full scale}) = 50\text{mA}(R)/T$

$CSI = \text{Output N}$

I_s = Current in secondary of current transformer

I_p = Current in primary of current transformer

T = Number of turns through the primary of the transformer

R = Number of turns in the secondary of the current transformer (Turns ratio, assuming one primary turn)

CSC = Current Scaling (parameter found in Current Menu of Setup Page)

CSI = Current Source Instance (parameter found in Current Menu of Setup Page)

Digital Output 5 - 6

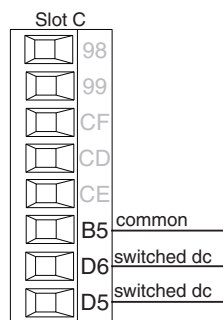

Digital Output

- Update rate 10 Hz
- Output voltage 24V
- Current limit, Output 5, 24 mA maximum
- Current limit, Output 6, 10 mA maximum driving single pole DIN-A-MITE
- *Capable of driving a 3-pole DIN-A-MITE
- Open-circuit voltage 22 to 32V_{DC} (dc)

PM __ [2,4] _ _ _ _ _

* Output 5 only

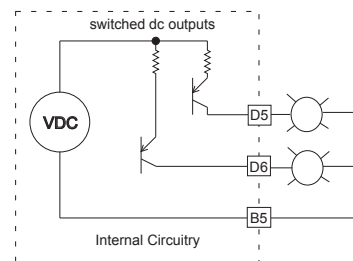



Warning:

Use National Electric (NEC) or other country-specific standard wiring and safety practices when wiring and connecting this controller to a power source and to electrical sensors or peripheral devices. Failure to do so may result in damage to equipment and property, and/or injury or loss of life.

Note:

- Maximum wire size termination and torque rating:
 - 0.0507 to 3.30 mm² (30 to 12 AWG) single-wire termination or two 1.31 mm² (16 AWG)
 - 0.8 Nm (7.0 lb.-in.) torque

Note:

Adjacent terminals may be labeled differently, depending on the model number.

Note:

To prevent damage to the controller, do not connect wires to unused terminals.

Note:

Maintain electrical isolation between analog input 1, digital input-outputs, switched dc/open collector outputs and process outputs to prevent ground loops.

Note:

The control output common terminal and the digital common terminal are referenced to different voltages and must remain isolated.

Note:

This Equipment is suitable for use in CLASS I, DIVISION 2, Groups A, B, C and D or Non-Hazardous locations only. Temperature Code T4A

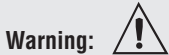

Warning:

Explosion Hazard - Dry contact closure Digital Inputs shall not be used in Class I Division 2 Hazardous Locations unless switch used is approved for this application.

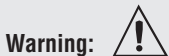

Warning:

Explosion Hazard – Substitution of component may impair suitability for CLASS I, DIVISION 2.

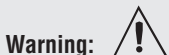

Warning:

Explosion Hazard - Do not disconnect while the circuit is live or unless the area is known to be free of ignitable concentrations of flammable substances.

Quencharc Note:

Switching pilot duty inductive loads (relay coils, solenoids, etc.) with the mechanical relay, solid state relay or open collector output options requires use of an R.C. suppressor.

Switched DC Wiring Example Using DO 5-6

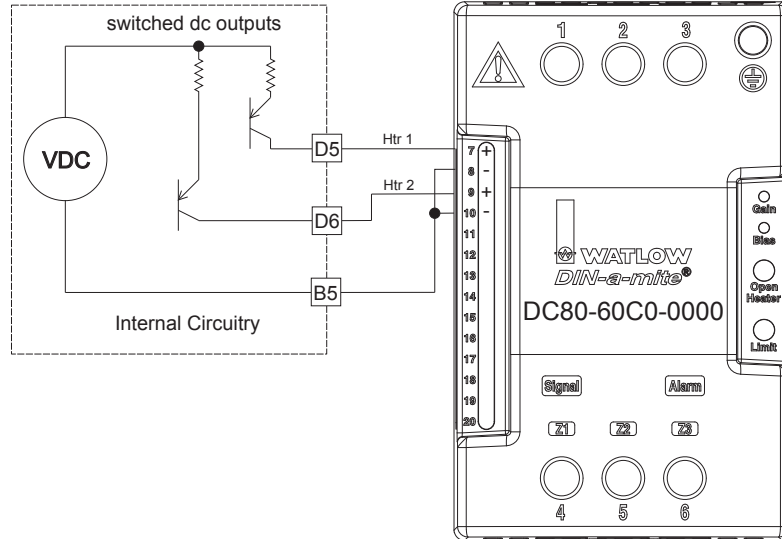

Digital Output 7 - 12

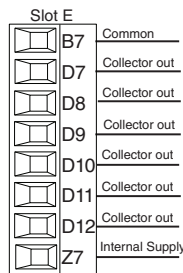

- Maximum switched voltage is 32V^{DC} (dc)
 - Internal supply provides a constant power output of 750mW
 - Maximum output sink current per output is 1.5A (external class 2 or *SELV supply required)
 - Total sink current for all outputs not to exceed 8A
 - Do not connect outputs in parallel
- PM [4,6,8] --- [C,D] ---

*Safety Extra Low Voltage

Open Collector Outputs

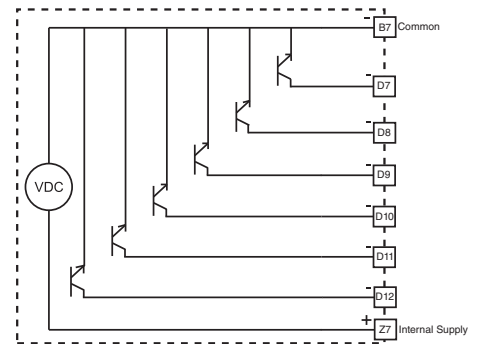

Internal Circuitry

Switched DC Wiring Example Using DO 7-12

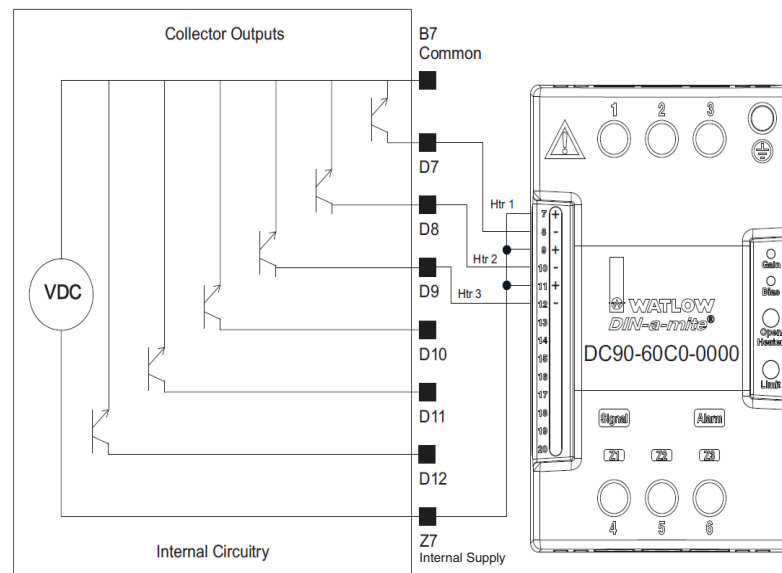



Warning:

Use National Electric (NEC) or other country-specific standard wiring and safety practices when wiring and connecting this controller to a power source and to electrical sensors or peripheral devices. Failure to do so may result in damage to equipment and property, and/or injury or loss of life.

Note:

- Maximum wire size termination and torque rating:
 - 0.0507 to 3.30 mm² (30 to 12 AWG) single-wire termination or two 1.31 mm² (16 AWG)
 - 0.8 Nm (7.0 lb.-in.) torque

Note:

Adjacent terminals may be labeled differently, depending on the model number.

Note:

To prevent damage to the controller, do not connect wires to unused terminals.

Note:

Maintain electrical isolation between analog input 1, digital input-outputs, switched dc/open collector outputs and process outputs to prevent ground loops.

Note:

The control output common terminal and the digital common terminal are referenced to different voltages and must remain isolated.

Note:

This Equipment is suitable for use in CLASS I, DIVISION 2, Groups A, B, C and D or Non-Hazardous locations only. Temperature Code T4A

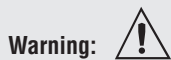

Warning:

Explosion Hazard - Dry contact closure Digital Inputs shall not be used in Class I Division 2 Hazardous Locations unless switch used is approved for this application.

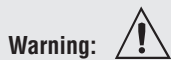

Warning:

Explosion Hazard – Substitution of component may impair suitability for CLASS I, DIVISION 2.

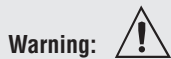

Warning:

Explosion Hazard - Do not disconnect while the circuit is live or unless the area is known to be free of ignitable concentrations of flammable substances.

Quencharc Note:

Switching pilot duty inductive loads (relay coils, solenoids, etc.) with the mechanical relay, solid state relay or open collector output options requires use of an R.C. suppressor.

Note:

As a switched DC output; this output is a constant current output delivering 750 mW, current limited to 400 mA. The internal supply does have a maximum open circuit voltage of 22 VDC and minimum open circuit voltage of 19 VDC. Pin Z7 is shared to all digital outputs. This type of output is meant to drive solid state relays, not mechanical relays.

As an open collector output, use an external power supply with the negative wired to B7, the positive to the coil of a pilot mechanical relay and the other side of the coil wired to D_. Each open collector output can sink 1.5 A with the total for all open collector outputs not exceeding 8 amperes. Ensure that a kickback diode is reversed wired across the relay coil to prevent damage to the internal transistor.

Open Collector Wiring Example Using DO 7-12

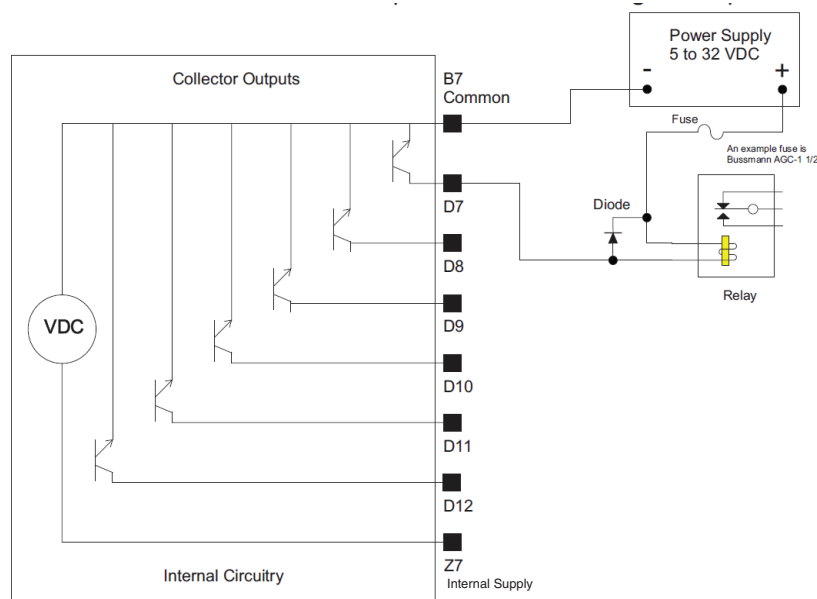



Warning:

Use National Electric (NEC) or other country-specific standard wiring and safety practices when wiring and connecting this controller to a power source and to electrical sensors or peripheral devices. Failure to do so may result in damage to equipment and property, and/or injury or loss of life.

Note:

- Maximum wire size termination and torque rating:
 - 0.0507 to 3.30 mm² (30 to 12 AWG) single-wire termination or two 1.31 mm² (16 AWG)
 - 0.8 Nm (7.0 lb.-in.) torque

Note:

Adjacent terminals may be labeled differently, depending on the model number.

Note:

To prevent damage to the controller, do not connect wires to unused terminals.

Note:

Maintain electrical isolation between analog input 1, digital input-outputs, switched dc/open collector outputs and process outputs to prevent ground loops.

Note:

The control output common terminal and the digital common terminal are referenced to different voltages and must remain isolated.

Note:

This Equipment is suitable for use in CLASS I, DIVISION 2, Groups A, B, C and D or Non-Hazardous locations only. Temperature Code T4A



Warning:

Explosion Hazard - Dry contact closure Digital Inputs shall not be used in Class I Division 2 Hazardous Locations unless switch used is approved for this application.

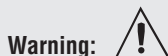

Warning:

Explosion Hazard – Substitution of component may impair suitability for CLASS I, DIVISION 2.

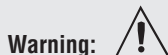

Warning:

Explosion Hazard - Do not disconnect while the circuit is live or unless the area is known to be free of ignitable concentrations of flammable substances.

Quencharc Note:

Switching pilot duty inductive loads (relay coils, solenoids, etc.) with the mechanical relay, solid state relay or open collector output options requires use of an R.C. suppressor.

Output 1, 3 Switched DC/Open Collector

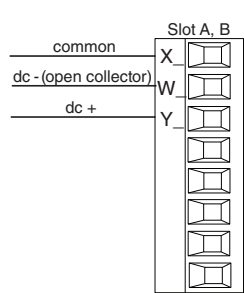

Switched DC

- 30 mA dc maximum supply current
- Short circuit limited to <50 mA
- 22 to 32V \approx (dc) open circuit voltage
- Use dc- and dc+ to drive external solid-state relay.
- DIN-A-MITE compatible
- Single-pole: up to 4 in parallel or 4 in series
- 2-pole: up to 2 in parallel or 2 in series
- 3-pole: up to 2 in series

Open Collector

- 100 mA maximum output current sink
- 30V \approx (dc) maximum supply voltage
- Any switched dc output can use the common terminal.
- Use an external power supply to control a dc load, with the load positive to the positive of the power supply, the load negative to the open collector and common to the power supply negative.

Output 1: (X1,-W1,+Y1)
 PM ____ [C] _ - - - - -
 Output 3: (X3,-W3,+Y3)
 PM _ - - - - - [C] _ - - - - -

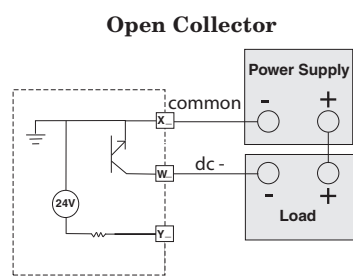
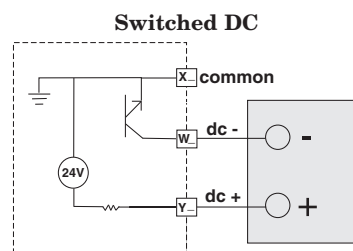

Output 1, 3 Mechanical Relay, Form C

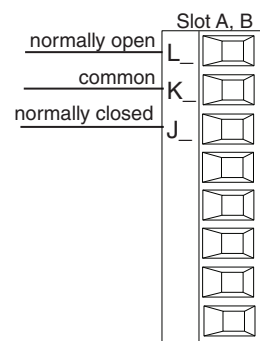

- 5 A at 240V \sim (ac) or 30V \approx (dc) maximum resistive load
- 20 mA at 24V minimum load
- 125 VA pilot duty at 120/240V \sim (ac), 25 VA at 24V \sim (ac)
- 100,000 cycles at rated load
- Output does not supply power.
- for use with ac or dc

See Quencharc note.
 Output 1: (L1,K1,J1)
 PM ____ [E] _ - - - - -
 Output 3: (L3,K3,J3)
 PM _ - - - - - [E] _ - - - - -

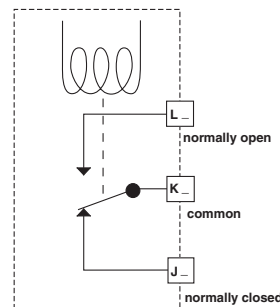

Output 1, 3 Universal Process

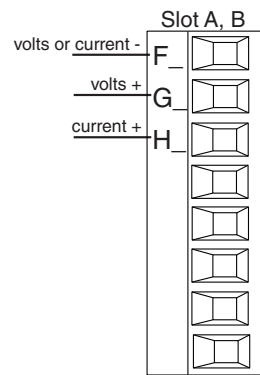

- 0 to 20 mA into 800 Ω maximum load
- 0 to 10V \approx (dc) into 1 k Ω minimum load
- scalable
- output supplies power
- cannot use voltage and current outputs at same time
- Output may be used as re-transmit or control.

Output 1: (F1,G1,H1)
 PM ____ [F] _ - - - - -
 Output 3: (F3,G3,H3)
 PM _ - - - - - [F] _ - - - - -

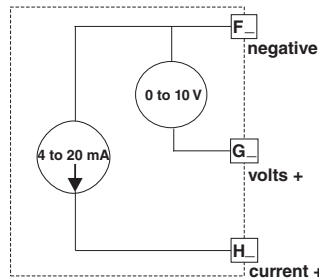



Warning:

Use National Electric (NEC) or other country-specific standard wiring and safety practices when wiring and connecting this controller to a power source and to electrical sensors or peripheral devices. Failure to do so may result in damage to equipment and property, and/or injury or loss of life.

Note:

Maximum wire size termination and torque rating:
 • 0.0507 to 3.30 mm² (30 to 12 AWG) single-wire termination or two 1.31 mm² (16 AWG)
 • 0.8 Nm (7.0 lb.-in.) torque

Note:

Adjacent terminals may be labeled differently, depending on the model number.

Note:

To prevent damage to the controller, do not connect wires to unused terminals.

Note:

Maintain electrical isolation between analog input 1, digital input-outputs, switched dc/open collector outputs and process outputs to prevent ground loops.

Note:

The control output common terminal and the digital common terminal are referenced to different voltages and must remain isolated.

Note:

This Equipment is suitable for use in CLASS I, DIVISION 2, Groups A, B, C and D or Non-Hazardous locations only. Temperature Code T4A

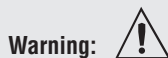

Warning:

Explosion Hazard - Dry contact closure Digital Inputs shall not be used in Class I Division 2 Hazardous Locations unless switch used is approved for this application.

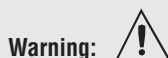

Warning:

Explosion Hazard – Substitution of component may impair suitability for CLASS I, DIVISION 2.

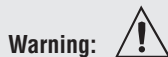

Warning:

Explosion Hazard - Do not disconnect while the circuit is live or unless the area is known to be free of ignitable concentrations of flammable substances.

Output 1, 3 Solid-State Relay, Form A

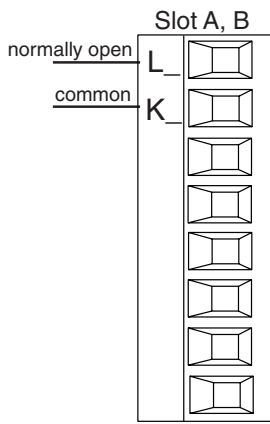

- 0.5 A at 20 to 264V~ (ac) maximum resistive load
- 20 VA 120/240V~ (ac) pilot duty
- opto-isolated, without contact suppression
- maximum off state leakage of 105 microamperes
- output does not supply power
- Do not use on dc loads.
- See Quencharc note.

Output 1: (L1, K1)
 PM ____ [K] - - - - -
 Output 3: (L3, K3)
 PM - - - - - [K] ____

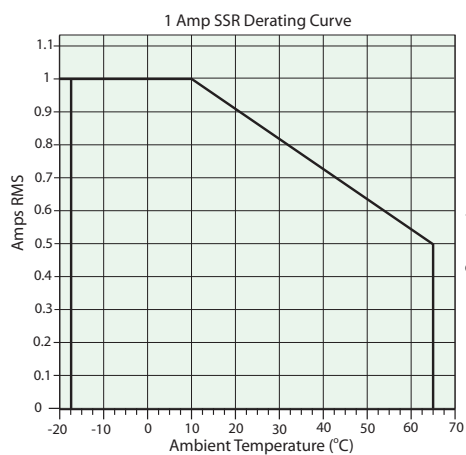
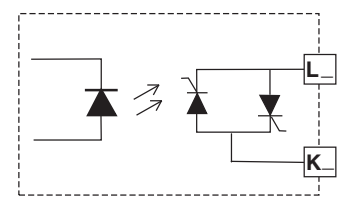

Output 2, 4 Switched DC

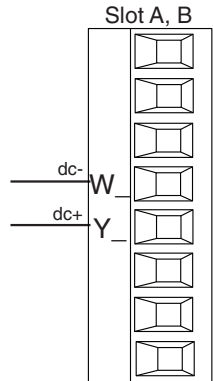

- 10 mA DC maximum supply current
- short circuit limited to <50 mA
- 22 to 32V= (dc) open circuit voltage
- use dc- and dc+ to drive external solid-state relay
- DIN-A-MITE compatible
- single-pole: up to 2 in series, none in parallel

Output 2: (-W2, +Y2)
 PM ____ [C] - - - - -
 Output 4: (-W4, +Y4)
 PM - - - - - [C] ____

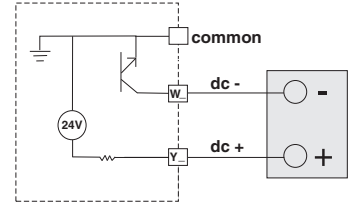



Warning:

Use National Electric (NEC) or other country-specific standard wiring and safety practices when wiring and connecting this controller to a power source and to electrical sensors or peripheral devices. Failure to do so may result in damage to equipment and property, and/or injury or loss of life.

Note:

- Maximum wire size termination and torque rating:
- 0.0507 to 3.30 mm² (30 to 12 AWG) single-wire termination or two 1.31 mm² (16 AWG)
 - 0.8 Nm (7.0 lb.-in.) torque

Note:

Adjacent terminals may be labeled differently, depending on the model number.

Note:

To prevent damage to the controller, do not connect wires to unused terminals.

Note:

Maintain electrical isolation between analog input 1, digital input-outputs, switched dc/open collector outputs and process outputs to prevent ground loops.

Note:

The control output common terminal and the digital common terminal are referenced to different voltages and must remain isolated.

Note:

This Equipment is suitable for use in CLASS I, DIVISION 2, Groups A, B, C and D or Non-Hazardous locations only. Temperature Code T4A

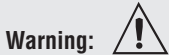

Warning:

Explosion Hazard - Dry contact closure Digital Inputs shall not be used in Class I Division 2 Hazardous Locations unless switch used is approved for this application.

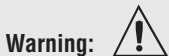

Warning:

Explosion Hazard – Substitution of component may impair suitability for CLASS I, DIVISION 2.

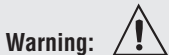

Warning:

Explosion Hazard - Do not disconnect while the circuit is live or unless the area is known to be free of ignitable concentrations of flammable substances.

Output 2, 4 NO-ARC Relay, Form A

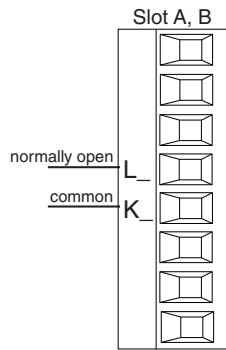

- 15 A at 85 to 264V~ (ac) resistive load only
 - 2,000,000 cycle rating for NO-ARC circuit
 - 100 mA minimum load
 - 2 mA maximum off state leakage
 - Do not use on dc loads.
 - Output does not supply power.
- Output 2: (L2, K2)
PM _____ [H] _____
- Output 4: (L4, K4)
PM [4, 8, 9] _____ [H] _____

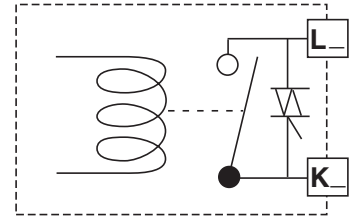

Output 2, 4 Mechanical Relay, Form A

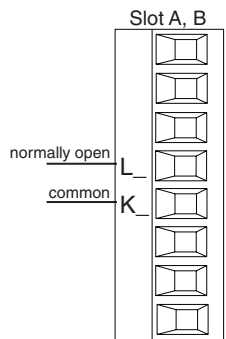

- 5 A at 240V~ (ac) or 30V= (dc) maximum resistive load
 - 20 mA at 24V minimum load
 - 125 VA pilot duty @ 120/240V~ (ac), 25 VA at 24V~ (ac)
 - 100,000 cycles at rated load
 - Output does not supply power.
 - for use with ac or dc
- See Quencharc note.
- Output 2: (L2, K2)
PM _____ [J] _____
- Output 4: (L4, K4)
PM _____ [J] _____

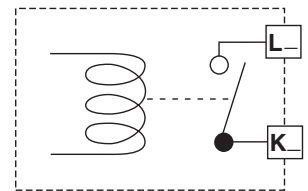

Output 2, 4 Solid-State Relay, Form A

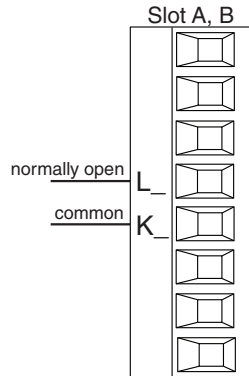

- 0.5 A at 20 to 264V~ (ac) maximum resistive load
 - 20 VA 120/240V~ (ac) pilot duty
 - opto-isolated, without contact suppression
 - maximum off state leakage of 105 microamperes
 - Output does not supply power.
 - Do not use on dc loads.
- See Quencharc note.
- Output 2: (L2, K2)
PM _____ [K] _____
- Output 4: (L4, K4)
PM _____ [K] _____

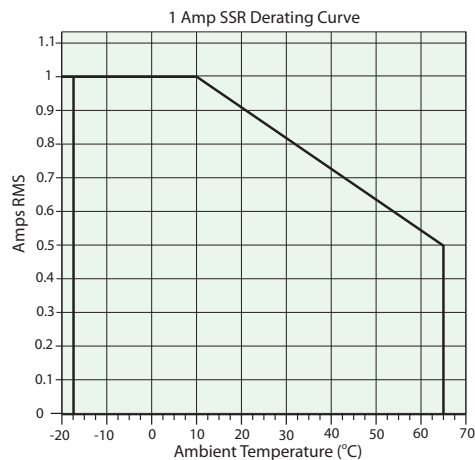
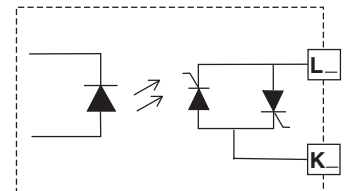



Warning:

Use National Electric (NEC) or other country-specific standard wiring and safety practices when wiring and connecting this controller to a power source and to electrical sensors or peripheral devices. Failure to do so may result in damage to equipment and property, and/or injury or loss of life.

Note:

- Maximum wire size termination and torque rating:
 - 0.0507 to 3.30 mm² (30 to 12 AWG) single-wire termination or two 1.31 mm² (16 AWG)
 - 0.8 Nm (7.0 lb.-in.) torque

Note:

Adjacent terminals may be labeled differently, depending on the model number.

Note:

To prevent damage to the controller, do not connect wires to unused terminals.

Note:

Maintain electrical isolation between analog input 1, digital input-outputs, switched dc/open collector outputs and process outputs to prevent ground loops.

Note:

The control output common terminal and the digital common terminal are referenced to different voltages and must remain isolated.

Note:

This Equipment is suitable for use in CLASS I, DIVISION 2, Groups A, B, C and D or Non-Hazardous locations only. Temperature Code T4A

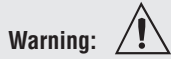

Warning:

Explosion Hazard - Dry contact closure Digital Inputs shall not be used in Class I Division 2 Hazardous Locations unless switch used is approved for this application.

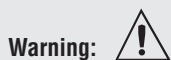

Warning:

Explosion Hazard – Substitution of component may impair suitability for CLASS I, DIVISION 2.

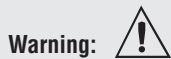

Warning:

Explosion Hazard - Do not disconnect while the circuit is live or unless the area is known to be free of ignitable concentrations of flammable substances.

Quencharc Wiring Example

In this example the Quencharc circuit (Watlow part# 0804-0147-0000) is used to protect PM internal circuitry from the counter electromagnetic force from the inductive user load when de-energized. It is recommended that this or an equivalent Quencharc be used when connecting inductive loads to PM outputs.

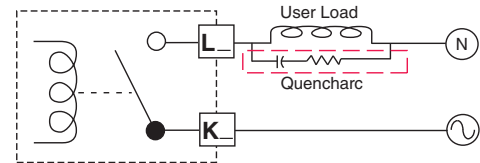

Standard Bus EIA-485 Communications

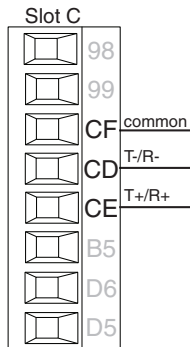

- Wire T-/R- to the A terminal of the EIA-485 port.
- Wire T+/R+ to the B terminal of the EIA-485 port.
- Wire common to the common terminal of the EIA-485 port.
- Do not route network wires with power wires. Connect network wires in daisy-chain fashion when connecting multiple devices in a network.
- Do not connect more than 16 EZ-ZONE PM controllers on a network.

- Maximum network length: 1,200 meters (4,000 feet)
- 1/8th unit load on EIA-485 bus PM [4,6,8,9] _____ - [*] _____

* All models include Standard Bus communications (instance 1)

Note:

Do not leave a USB to EIA-485 converter connected to Standard Bus without power (i.e., disconnecting the USB end from the computer while leaving the converter connected on Standard Bus). Disturbance on the Standard Bus may occur.

Modbus RTU or Standard Bus EIA-485 Communications

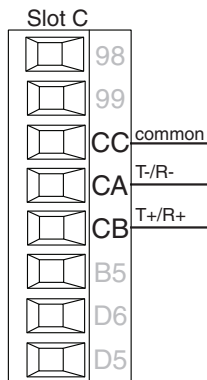

- Wire T-/R- to the A terminal of the EIA-485 port.
- Wire T+/R+ to the B terminal of the EIA-485 port.
- Wire common to the common terminal of the EIA-485 port.
- Do not route network wires with power wires. Connect network wires in daisy-chain fashion when connecting multiple devices in a network.
- A termination resistor may be required. Place a 120 Ω resistor across T+/R+ and T-/R- of last controller on network.
- Only one protocol per port is available at a time: either Modbus RTU or Standard Bus.
- Do not connect more than 16 EZ-ZONE controllers on a Standard Bus network.
- Maximum number of EZ-ZONE controllers on a Modbus network is 247.
- maximum network length: 1,200 meters (4,000 feet)
- 1/8th unit load on EIA-485 bus.
- Communications instance 1 PM [4,6,8,9] _____ - [1] _____

Note:

Do not leave a USB to EIA-485 converter connected to Standard Bus without power (i.e., disconnecting the USB end from the computer while leaving the converter connected on Standard Bus). Disturbance on the Standard Bus may occur.



Warning:

Use National Electric (NEC) or other country-specific standard wiring and safety practices when wiring and connecting this controller to a power source and to electrical sensors or peripheral devices. Failure to do so may result in damage to equipment and property, and/or injury or loss of life.

Note:

- Maximum wire size termination and torque rating:
 - 0.0507 to 3.30 mm² (30 to 12 AWG) single-wire termination or two 1.31 mm² (16 AWG)
 - 0.8 Nm (7.0 lb.-in.) torque

Note:

Adjacent terminals may be labeled differently, depending on the model number.

Note:

To prevent damage to the controller, do not connect wires to unused terminals.

Note:

Maintain electrical isolation between analog input 1, digital input-outputs, switched dc/open collector outputs and process outputs to prevent ground loops.

Note:

The control output common terminal and the digital common terminal are referenced to different voltages and must remain isolated.

Note:

This Equipment is suitable for use in CLASS I, DIVISION 2, Groups A, B, C and D or Non-Hazardous locations only. Temperature Code T4A



Warning:

Explosion Hazard - Dry contact closure Digital Inputs shall not be used in Class I Division 2 Hazardous Locations unless switch used is approved for this application.



Warning:

Explosion Hazard – Substitution of component may impair suitability for CLASS I, DIVISION 2.



Warning:

Explosion Hazard - Do not disconnect while the circuit is live or unless the area is known to be free of ignitable concentrations of flammable substances.

EIA-232/485 Modbus RTU Communications

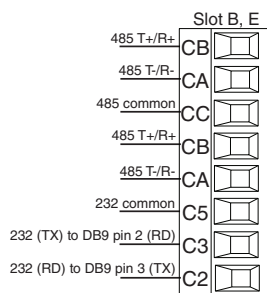

- Wire T-/R- to the A terminal of the EIA-485 port.
 - Wire T+/R+ to the B terminal of the EIA-485 port.
 - Wire common to the common terminal of the EIA-485 port.
 - Do not route network wires with power wires. Connect network wires in daisy-chain fashion when connecting multiple devices in a network.
 - A termination resistor may be required. Place a 120 Ω resistor across T+/R+ and T-/R- of last controller on network.
 - Do not wire to both the EIA-485 and the EIA-232 pins at the same time.
 - Two EIA-485 terminals of T/R are provided to assist in daisy-chain wiring.
 - Do not connect more than one EZ-ZONE PM controller on an EIA-232 network.
 - Do not connect more than 16 EZ-ZONE controllers on a Standard Bus EIA-485 network.
 - Maximum number of EZ-ZONE controllers on a Modbus network is 247.
 - maximum EIA-232 network length: 15 meters (50 feet)
 - maximum EIA-485 network length: 1,200 meters (4,000 feet)
 - 1/8th unit load on EIA-485 bus.
 - Communications instance 2
- Slot B
PM [6] _____ - [2] _____
- Slot E
PM [4,8,9] _____ - [2] _____

Modbus-IDA Terminal	EIA/TIA-485 Name	Watlow Terminal Label	Function
DO	A	CA or CD	T-/R-
D1	B	CB or CE	T+/R+
common	common	CC or CF	common

EtherNet/IP™, PCCC and Modbus TCP Communications

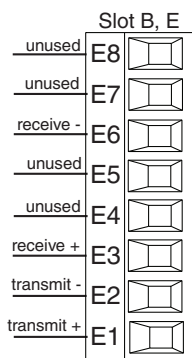

RJ-45 pin	T568B wire color	Signal	Slot B, E
8	brown	unused	E8
7	brown & white	unused	E7
6	green	receive -	E6
5	white & blue	unused	E5
4	blue	unused	E4
3	white & green	receive +	E3
2	orange	transmit -	E2
1	white & orange	transmit +	E1

- Do not route network wires with power wires.
 - Connect one Ethernet cable per controller to a 10/100 Mbps ethernet switch. Both Modbus TCP and EtherNet/IP™ are available on the network.
 - Communications instance 2
- Slot B
PM [6] _____ - [3] _____
- Slot E
PM [4,8,9] _____ - [3] _____

EtherNet/IP™ and Modbus TCP communications to connect with a 10/100 switch.

Note:

When changing the fixed IP address cycle module power for new address to take effect.

Ethernet LED Indicators

Viewing the control from the front and then looking on top four LEDs can be seen aligned vertically front to back. The LEDs are identified accordingly: closest to the front reflects the Network (Net) Status, Module (Mod) Status is next, Activity status follows and lastly, the LED closest to the rear of the control reflects the Link status.



Warning: Use National Electric (NEC) or other country-specific standard wiring and safety practices when wiring and connecting this controller to a power source and to electrical sensors or peripheral devices. Failure to do so may result in damage to equipment and property, and/or injury or loss of life.

Note: Maximum wire size termination and torque rating:

- 0.0507 to 3.30 mm² (30 to 12 AWG) single-wire termination or two 1.31 mm² (16 AWG)
- 0.8 Nm (7.0 lb.-in.) torque

Note: Adjacent terminals may be labeled differently, depending on the model number.

Note: To prevent damage to the controller, do not connect wires to unused terminals.

Note: Maintain electrical isolation between analog input 1, digital input-outputs, switched dc/open collector outputs and process outputs to prevent ground loops.

Note: The control output common terminal and the digital common terminal are referenced to different voltages and must remain isolated.

Note: This Equipment is suitable for use in CLASS I, DIVISION 2, Groups A, B, C and D or Non-Hazardous locations only. Temperature Code T4A

Warning: Explosion Hazard - Dry contact closure Digital Inputs shall not be used in Class I Division 2 Hazardous Locations unless switch used is approved for this application.

Warning: Explosion Hazard – Substitution of component may impair suitability for CLASS I, DIVISION 2.

Warning: Explosion Hazard - Do not disconnect while the circuit is live or unless the area is known to be free of ignitable concentrations of flammable substances.

Note: When using Modbus TCP, the Network Status and Module Status LEDs are not used.

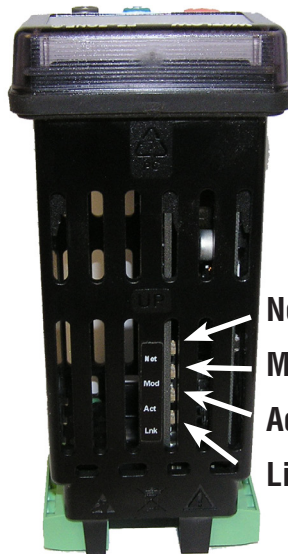

Network Status
Module Status
Activity Status
Link Status

Network Status

Indicator State	Summary	Requirement
Steady Off	Not powered, no IP address	If the device does not have an IP address (or is powered off), the network status indicator shall be steady off.
Flashing Green	No connections	If the device has no established connections, but has obtained an IP address, the network status indicator shall be flashing green.
Steady Green	Connected	If the device has at least one established connection (even to the Message Router), the network status indicator shall be steady green.
Flashing Red	Connection timeout	If one or more of the connections in which this device is the target has timed out, the network status indicator shall be flashing red. This shall be left only if all timed out connections are reestablished or if the device is reset.
Steady Red	Duplicate IP	If the device has detected that its IP address is already in use, the network status indicator shall be steady red.
Flashing Green / Red	Self-test	While the device is performing its power up testing, the network status indicator shall be flashing green / red.

Module Status

Indicator State	Summary	Requirement
Steady Off	No power	If no power is supplied to the device, the module status indicator shall be steady off.
Steady Green	Device operational	If the device is operating correctly, the module status indicator shall be steady green.
Flashing Green	Standby	If the device has not been configured, the module status indicator shall be flashing green.
Flashing Red	Minor fault	If the device has detected a recoverable minor fault, the module status indicator shall be flashing red. NOTE: An incorrect or inconsistent configuration would be considered a minor fault.



Warning:

Use National Electric (NEC) or other country-specific standard wiring and safety practices when wiring and connecting this controller to a power source and to electrical sensors or peripheral devices. Failure to do so may result in damage to equipment and property, and/or injury or loss of life.

Note:

Maximum wire size termination and torque rating:

- 0.0507 to 3.30 mm² (30 to 12 AWG) single-wire termination or two 1.31 mm² (16 AWG)
- 0.8 Nm (7.0 lb.-in.) torque

Note:

Adjacent terminals may be labeled differently, depending on the model number.

Note:

To prevent damage to the controller, do not connect wires to unused terminals.

Note:

Maintain electrical isolation between analog input 1, digital input-outputs, switched dc/open collector outputs and process outputs to prevent ground loops.

Note:

The control output common terminal and the digital common terminal are referenced to different voltages and must remain isolated.

Note:

This Equipment is suitable for use in CLASS I, DIVISION 2, Groups A, B, C and D or Non-Hazardous locations only. Temperature Code T4A

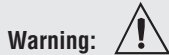

Warning:

Explosion Hazard - Dry contact closure Digital Inputs shall not be used in Class I Division 2 Hazardous Locations unless switch used is approved for this application.



Warning:

Explosion Hazard – Substitution of component may impair suitability for CLASS I, DIVISION 2.



Warning:

Explosion Hazard - Do not disconnect while the circuit is live or unless the area is known to be free of ignitable concentrations of flammable substances.

Module Status (cont.)		
Indicator State	Summary	Requirement
Steady Red	Major fault	If the device has detected a non-recoverable major fault, the module status indicator shall be steady red.
Flashing Green / Red	Self-test	While the device is performing its power up testing, the module status indicator shall be flashing green / red.

Activity Status

Indicator State	Summary	Requirement
Flashing Green	Detects activity	If the MAC detects activity, the LED will be flashing green.
Red	----	If the MAC detects a collision, the LED will be red.

Link Status

Indicator State	Summary	Requirement
Steady Off	Not powered, unknown link speed	If the device cannot determine link speed or power is off, the network status indicator shall be steady off.
Green	----	If cable is wired and connected correctly, the LED will be Green.

DeviceNet™ Communications

	Terminal	Signal	Function
V+	V+	V+	DeviceNet™ power
CAN_H	CH	CAN_H	positive side of DeviceNet™ bus
shield	SH	shield	shield interconnect
CAN_L	CL	CAN_L	negative side of DeviceNet™ bus
V-	V-	V-	DeviceNet™ power return

- Communications instance 2

Slot B (PM [6] _____ - [5] _____)

Slot E (PM [4,8,9] _____ - [5] _____)



Warning: Use National Electric (NEC) or other country-specific standard wiring and safety practices when wiring and connecting this controller to a power source and to electrical sensors or peripheral devices. Failure to do so may result in damage to equipment and property, and/or injury or loss of life.

Note: Maximum wire size termination and torque rating:

- 0.0507 to 3.30 mm² (30 to 12 AWG) single-wire termination or two 1.31 mm² (16 AWG)
- 0.8 Nm (7.0 lb.-in.) torque

Note: Adjacent terminals may be labeled differently, depending on the model number.

Note: To prevent damage to the controller, do not connect wires to unused terminals.

Note: Maintain electrical isolation between analog input 1, digital input-outputs, switched dc/open collector outputs and process outputs to prevent ground loops.

Note: The control output common terminal and the digital common terminal are referenced to different voltages and must remain isolated.

Note: This Equipment is suitable for use in CLASS I, DIVISION 2, Groups A, B, C and D or Non-Hazardous locations only. Temperature Code T4A

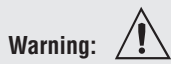

Warning: Explosion Hazard - Dry contact closure Digital Inputs shall not be used in Class I Division 2 Hazardous Locations unless switch used is approved for this application.

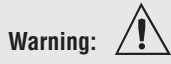

Warning: Explosion Hazard – Substitution of component may impair suitability for CLASS I, DIVISION 2.

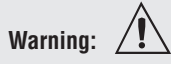

Warning: Explosion Hazard - Do not disconnect while the circuit is live or unless the area is known to be free of ignitable concentrations of flammable substances.

DeviceNet LED Indicators

Viewing the control from the front and then looking on top two LEDs can be seen aligned vertically front to back. The LED closest to the front is identified as the network (Net) LED where the one next to it would be identified as

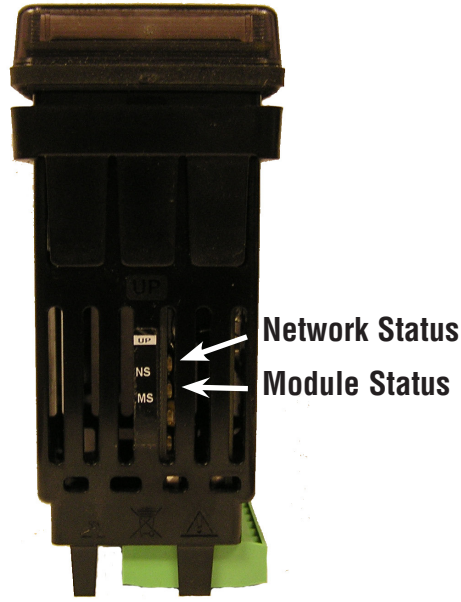

the module (Mod) LED.

Network Status

Indicator LED	Description
Off	The device is not online and has not completed the duplicate MAC ID test yet. The device may not be powered.
Green	The device is online and has connections in the established state (allcated to a Master).
Red	Failed communication device. The device has detected an error that has rendered it incapable of communicating on the network (duplicate MAC ID or Bus-off).
Flashing Green	The device is online, but no connection has been allocated or an explicit connection has timed out.
Flashing Red	A poll connection has timed out.

Module Status

Indicator LED	Description
Off	No power is applied to the device.
Flashing Green-Red	The device is performing a self-test.
Flashing Red	Major Recoverable Fault.
Red	Major Unrecoverable Fault.



Warning:

Use National Electric (NEC) or other country-specific standard wiring and safety practices when wiring and connecting this controller to a power source and to electrical sensors or peripheral devices. Failure to do so may result in damage to equipment and property, and/or injury or loss of life.

Note:

Maximum wire size termination and torque rating:

- 0.0507 to 3.30 mm² (30 to 12 AWG) single-wire termination or two 1.31 mm² (16 AWG)
- 0.8 Nm (7.0 lb.-in.) torque

Note:

Adjacent terminals may be labeled differently, depending on the model number.

Note:

To prevent damage to the controller, do not connect wires to unused terminals.

Note:

Maintain electrical isolation between analog input 1, digital input-outputs, switched dc/open collector outputs and process outputs to prevent ground loops.

Note:

The control output common terminal and the digital common terminal are referenced to different voltages and must remain isolated.

Note:

This Equipment is suitable for use in CLASS I, DIVISION 2, Groups A, B, C and D or Non-Hazardous locations only. Temperature Code T4A



Warning:

Explosion Hazard - Dry contact closure Digital Inputs shall not be used in Class I Division 2 Hazardous Locations unless switch used is approved for this application.



Warning:

Explosion Hazard – Substitution of component may impair suitability for CLASS I, DIVISION 2.



Warning:

Explosion Hazard - Do not disconnect while the circuit is live or unless the area is known to be free of ignitable concentrations of flammable substances.

Green	The device is operating normally.
-------	-----------------------------------

Profibus DP Communications

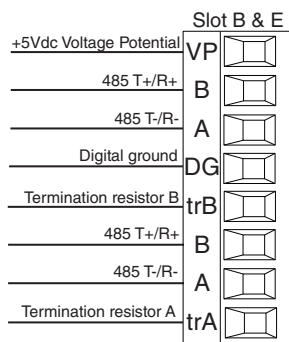

- Wire T-/R- to the A terminal of the EIA-485 port.
- Wire T+/R+ to the B terminal of the EIA-485 port.
- Wire Digital Ground to the common terminal of the EIA-485 port.
- Do not route network wires with power wires. Connect network wires in daisy-chain fashion when connecting multiple devices in a network.
- A termination resistor should be used if this control is the last one on the network.
- If using a 150 Ω cable Watlow provides internal termination. Place a jumper across pins trB and B and trA and A.
- If external termination is to be used with a 150 Ω cable place a 390 Ω resistor across pins VP and B, a 220 Ω resistor across pins B and A, and lastly, place a 390 Ω resistor across pins DG and A.
- Do not connect more than 32 EZ-ZONE PM controllers on any given segment.
- Maximum EIA-485 network length: 1,200 meters (4,000 feet)
- 1/8th unit load on EIA-485 bus.
- Communications instance 2

Slot B: PM [6] _ _ _ _-[6] _ _
 _ _ _ _
 Slot E: PM [4, 8, 9] _ _ _ _-[6]
 _ _ _ _ _

Profibus Terminal	EIA/TIA-485 Name	Watlow Terminal Label	Function
VP (Voltage Potential)	- - - -	VP	+5Vdc
B-Line	B	B	T+/R+
A-Line	A	A	T-/R-
DP-GND	common	DG	common

Profibus DP LED Indicators

Viewing the unit from the front and then looking on top of the controller two bi-color LEDs can be seen where only the front one is used. Definition follows:

Closest to the Front

Indicator LED	Description
Red	Profibus network not detected
Red Flashing	Indicates that the Profibus card is waiting for data exchange.
Green	Data exchange mode



Warning: Use National Electric (NEC) or other country-specific standard wiring and safety practices when wiring and connecting this controller to a power source and to electrical sensors or peripheral devices. Failure to do so may result in damage to equipment and property, and/or injury or loss of life.

Note: Maximum wire size termination and torque rating:

- 0.0507 to 3.30 mm² (30 to 12 AWG) single-wire termination or two 1.31 mm² (16 AWG)
- 0.8 Nm (7.0 lb.-in.) torque

Note: Adjacent terminals may be labeled differently, depending on the model number.

Note: To prevent damage to the controller, do not connect wires to unused terminals.

Note: Maintain electrical isolation between analog input 1, digital input-outputs, switched dc/open collector outputs and process outputs to prevent ground loops.

Note: The control output common terminal and the digital common terminal are referenced to different voltages and must remain isolated.

Note: This Equipment is suitable for use in CLASS I, DIVISION 2, Groups A, B, C and D or Non-Hazardous locations only. Temperature Code T4A

Warning: Explosion Hazard - Dry contact closure Digital Inputs shall not be used in Class I Division 2 Hazardous Locations unless switch used is approved for this application.

Warning: Explosion Hazard – Substitution of component may impair suitability for CLASS I, DIVISION 2.

Warning: Explosion Hazard - Do not disconnect while the circuit is live or unless the area is known to be free of ignitable concentrations of flammable substances.

Wiring a Serial EIA-485 Network

Do not route network wires with power wires. Connect network wires in daisy-chain fashion when connecting multiple devices in a network.

A termination resistor may be required. Place a 120 Ω resistor across

T+/R+ and T-/R- of the last controller on a network.

Only one protocol per port is available at a time: either Modbus RTU or Standard Bus.

A network using Watlow's Standard Bus and an RUI/Gateway.

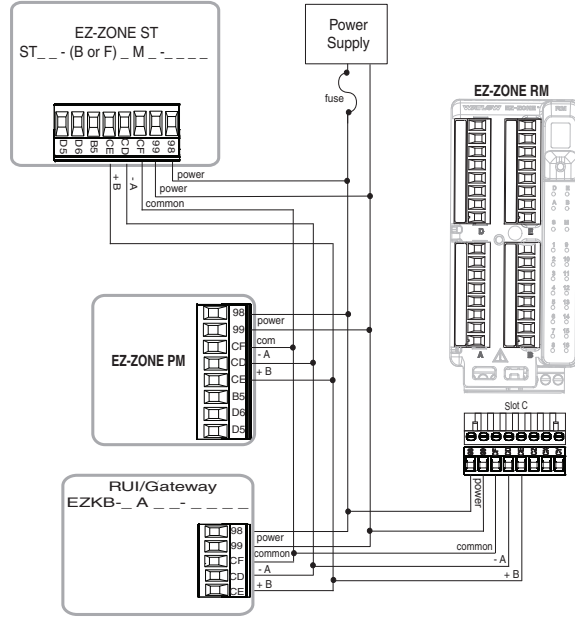

A network with all devices configured using Modbus RTU.

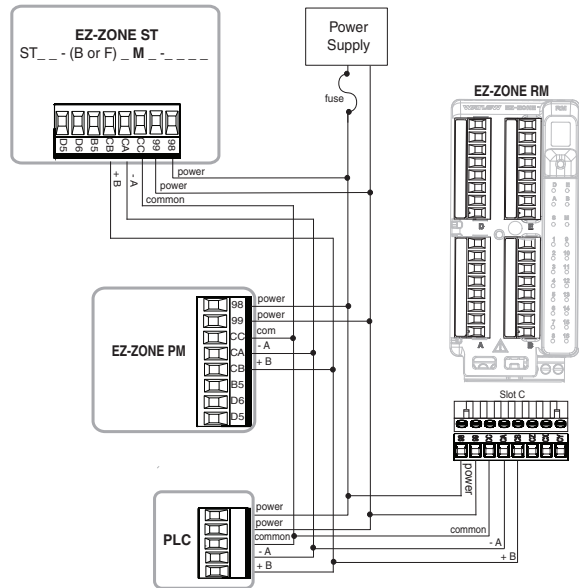



Warning:

Use National Electric (NEC) or other country-specific standard wiring and safety practices when wiring and connecting this controller to a power source and to electrical sensors or peripheral devices. Failure to do so may result in damage to equipment and property, and/or injury or loss of life.

Note:

- Maximum wire size termination and torque rating:
 - 0.0507 to 3.30 mm² (30 to 12 AWG) single-wire termination or two 1.31 mm² (16 AWG)
 - 0.8 Nm (7.0 lb.-in.) torque

Note:

Adjacent terminals may be labeled differently, depending on the model number.

Note:

To prevent damage to the controller, do not connect wires to unused terminals.

Note:

Maintain electrical isolation between analog input 1, digital input-outputs, switched dc/open collector outputs and process outputs to prevent ground loops.

Note:

The control output common terminal and the digital common terminal are referenced to different voltages and must remain isolated.

Note:

This Equipment is suitable for use in CLASS I, DIVISION 2, Groups A, B, C and D or Non-Hazardous locations only. Temperature Code T4A



Warning:

Explosion Hazard - Dry contact closure Digital Inputs shall not be used in Class I Division 2 Hazardous Locations unless switch used is approved for this application.



Warning:

Explosion Hazard – Substitution of component may impair suitability for CLASS I, DIVISION 2.



Warning:

Explosion Hazard - Do not disconnect while the circuit is live or unless the area is known to be free of ignitable concentrations of flammable substances.

Connecting a Computer to PM Controls Using B&B 485 to USB Converter

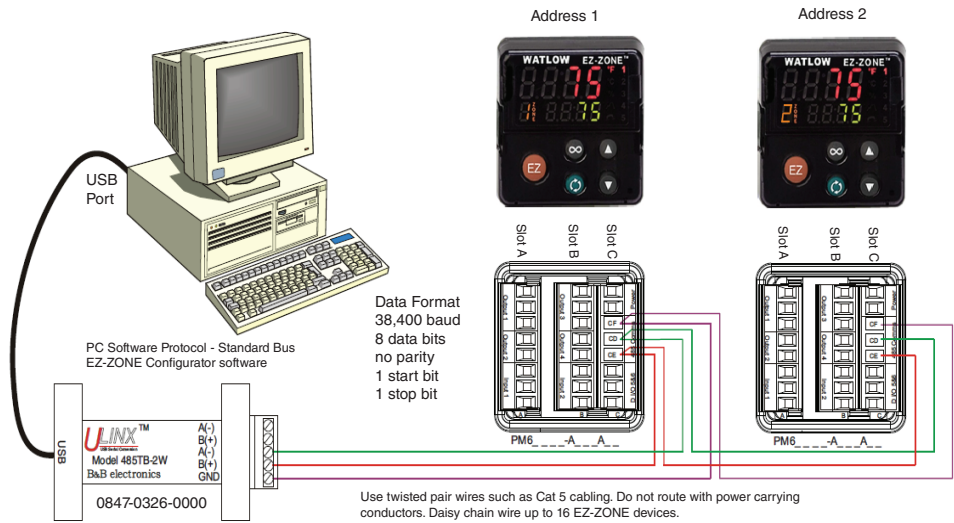

Note:

Do not leave a USB to EIA-485 converter connected to Standard Bus without power (i.e., disconnecting the USB end from the computer while leaving the converter connected on Standard Bus). Disturbance on the Standard Bus may occur.

Note:

When connecting the USB converter to the PC it is suggested that the Latency Timer be changed from the default of 16 msec to 1 msec. Failure to make this change may cause communication loss between the PC running ZE-ZONE Configurator software and the control.

To modify Latency Timer settings follow the steps below:

1. Navigate to Device Manager.
2. Double click on Ports.
3. Right click on the USB serial port in use and select Properties.
4. Click the tab labeled Port settings and then click the Advance button.

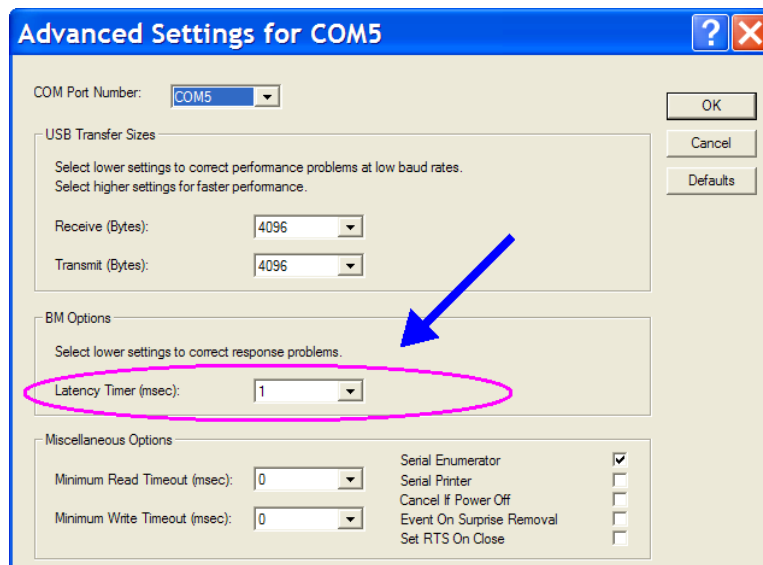

3

Chapter 3: Keys and Displays

Upper Display:

In the Home Page, displays the process value, otherwise displays the value of the parameter in the lower display.

Zone Display:

Indicates the controller zone.

1 to 9 = zones 1 to 9

A = zone 10 E = zone 14
 b = zone 11 F = zone 15
 C = zone 12 h = zone 16
 d = zone 13

Lower Display:

Indicates the set point or output power value during operation, or the parameter whose value appears in the upper display.

EZ Key/s:

This key can be programmed to do various tasks, such as starting a profile.

Channel Display:

Indicates the channel for any given EZ-ZONE module.

- Available with the PM4, 8 and 9 only.

Advance Key

Advances through parameter prompts.

1/8 DIN (PM9) Horizontal

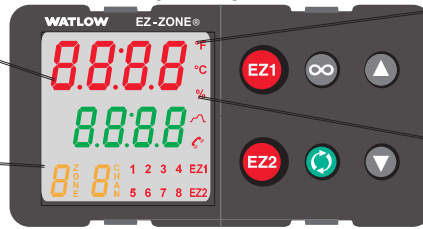

Temperature Units:

Indicates whether the temperature is displayed in Fahrenheit or Celsius.

Percent Units:

Lights when the controller is displaying values as a percentage or when the open-loop set point is displayed.

Output Activity:

Number LEDs indicate activity of outputs. A flashing light indicates output activity.

Profile Activity:

Lights when a profile is running. Flashes when a profile is paused.

1/16 (PM6) DIN

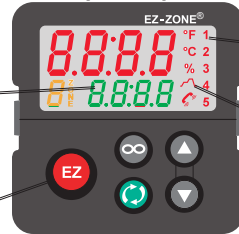

1/8 DIN (PM8) Vertical

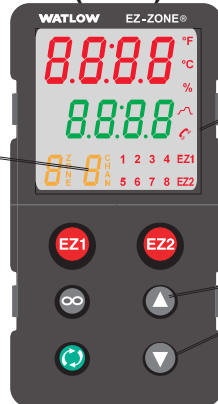

Communications Activity

Flashes when another device is communicating with this controller.

Up and Down Keys

In the Home Page, adjusts the set point in the lower display. In other pages, changes the upper display to a higher or lower value, or changes a parameter selection.

1/4 DIN (PM4)

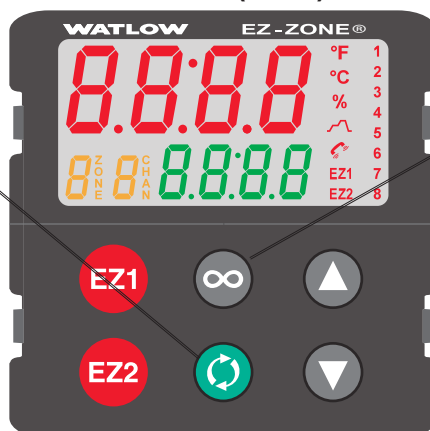

Infinity Key

Press to back up one level, or press and hold for two seconds to return to the Home Page. From the Home Page clears alarms and errors if clearable.

Note:

If integrated limit, the Infinity Key is labeled Reset

Note:

Upon power up, the upper or left display will briefly indicate the firmware revision and the lower or right display will show PM representing the model.

Responding to a Displayed Message

Attention Codes

An active message (see Home Page for listing) will cause the display to toggle between the normal settings and the active message in the upper display and Attention **ATTN** in the lower display.

Your response will depend on the message and the controller settings. Some messages, such as Ramping and Tuning, indicate that a process is underway. If the message was generated by a latched alarm or limit condition, the message can be cleared when the condition no longer exists by simply pushing the Infinity **∞** or the Reset **⏏** key or alternatively by following the steps below. If an alarm has silencing enabled, it can also be silenced.

Push the Advance Key **⏏** to display Ignore **IGNR** in the upper display and the message source (such as Limit High **L.H.1**) in the lower display. Use the Up **▲** and Down **▼** keys to scroll through possible responses, such as Clear **CLR** or Silence **SIL**. Then push the Advance **⏏** or Infinity **∞** key to execute the action. See the Home Page for further information on the Attention Codes.

Display	Parameter Name Description	Setting	Range	Default	Appears If
ATTN	<p>Attention An active message will cause the display to toggle between the normal settings and the active message in the upper display and ATTN in the lower display.</p> <p>Your response will depend on the message and the controller settings. Some messages, such as Ramping and Tuning, indicate that a process is underway. If the message was generated by a latched alarm or limit condition, the message can be cleared when the condition no longer exists. If an alarm has silencing enabled, it can be silenced.</p> <ol style="list-style-type: none"> 1. Push the Advance Key ⏏ to display IGNR in the upper display and the message source (such as L.H.1) in the lower display. <p>Note: If the limit is tripped and the trip condition is no longer present the limit can be reset by pressing the Reset Key ⏏ (Infinity Key is labeled Reset).</p> <ol style="list-style-type: none"> 2. Use the Up ▲ and Down ▼ keys to scroll through possible responses, such as Clear CLR or Silence SIL. 3. Push the Advance ⏏ or Infinity ∞ key to execute the action. <p>Alternatively, rather than scrolling through all messages simply push the Infinity ∞ button to generate a clear.</p>		<p>ALL1 ALL2 ALL3 ALL4 Alarm Low 1 to 4</p> <p>ALH1 ALH2 ALH3 ALH4 Alarm High 1 to 4</p> <p>ALE1 ALE2 ALE3 ALE4 Alarm Error 1 to 4</p> <p>ERI1 ERI2 Error Input 1 or 2</p> <p>L.L.1 Limit Low 1</p> <p>L.H.1 Limit High 1</p> <p>L.E.1 Limit Error 1</p> <p>TUN1 TUN2 Tuning 1 or 2</p> <p>RP1 RP2 Ramping 1 or 2</p> <p>LPO1 LPO2 Loop Open Error 1 or 2</p> <p>LPR1 LPR2 Loop Reversed Error 1 or 2</p> <p>CEr1 Current Error</p> <p>HEr1 Heater Error</p> <p>uALh Value to high to be displayed in 4 digit LED display >9999</p> <p>uALL Value to low to be displayed in 4 digit LED display <-1999</p>		an alarm or error message is active.

Navigating the EZ-ZONE PM Integrated Controller

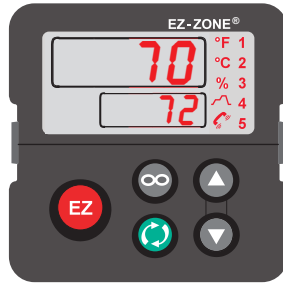

Home Page from anywhere: Press the Infinity Key ∞ for two seconds to return to the Home Page.



Operations Page from Home Page: Press both the Up \blacktriangle and Down \blacktriangledown keys for three seconds.



Note:

Keys must be held continuously until **SEt** is displayed in green. If keys are released when **OPER** is displayed, press the infinity key or reset key to exit and repeat until **SEt** is displayed.

Setup Page from Home Page: Press both the Up \blacktriangle and Down \blacktriangledown keys for six seconds.

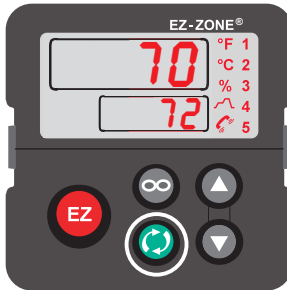

Profiling Page from Home Page: Press the Advance Key $\textcircled{\curvearrowright}$ for three seconds





Factory Page from Home Page: Press both the Advance $\textcircled{\curvearrowright}$ and Infinity ∞ keys for six seconds.

4

Chapter 4: Home Page

Default Home Page Parameters

Watlow's patented user-defined menu system improves operational efficiency. The user-defined Home Page provides you with a shortcut to monitor or change the parameter values that you use most often. The default Home Page is shown on the following page. When a parameter normally located in the Setup Page or Operations Page is placed in the Home Page, it is accessible through both. If you change a parameter in the Home Page, it is automatically changed in its original page. If you change a parameter in its original page it is automatically changed in the Home Page. Use the Advance Key  to step through the other parameters. When not in pairs, the parameter prompt will appear in the lower display, and the parameter value will appear in the upper display. You can use the Up  and Down  keys to change the value of writable parameters, just as you would in any other menu.

Note:







If a writable value is placed on the upper display and is paired with another read only parameter on the lower display, the arrow keys affect the setting of the upper display. If two writable parameters are paired, the arrow keys affect the lower display.

- The Attention **ALERT** parameter appears only if there is an active message. An example of an active message could be a Current Error **CEr I**, or it could be for information only like Autotune **EUN I** taking place.
- If Control Mode is set to Auto, the Process Value is in the upper display and the Closed Loop Set Point (read-write) is in the lower display.
- If a profile is running, the process value is in the upper display and the Target Set Point (read only) is in the lower display. If Control Mode is set to Manual, the Process Value is in the upper display and the output power level (read-write) is in the lower display.
- If Control Mode is set to Off, the Process Value is in the upper display and **OFF** (read only) is in the lower display.
- If a sensor failure has occurred, dashes **---** will be displayed in the upper display and the output power level (read-write) is in the lower display.



Changing the Set Point

You can change the set point by using the Up  or Down  keys when a profile is not running.







Starting a Profile from the Home Page

1. When at the Home Page, press the Advance Key  to locate Profile Start and select the file or step number to start. The upper display will show **_____ I** and the lower display will show **P.Sr I**.
2. Press the Up  or Down  key to choose the file or step number.
3. Press the Advance Key  to select the Profile Action Request. The upper display will show [none] and the lower display will show **P.ACr I**.
4. Press the Up  or Down  keys to select the Profile Start. The upper display will show **PrOF** and the lower display will show **P.ACr I**.
5. Press the Infinity Key to return Home. The Profile will Start

Ending a Profile from the Home Page

1. Press the Advance Key  to select the Profile Action Request. The upper display will show **nonE** and the lower display will show **P.ACr I**.
2. Press the Up  or Down  keys to select the End. The upper display will show **End** and the lower display will show **P.ACr I**.
3. Press the Infinity Key to return Home. The Profile will End.

Modifying the Home Page

1. Push and hold the Advance  key and the Infinity  key for approximately six seconds. Upon entering the Factory Page the first menu will be the Custom Menu **[CUSE]**.
2. Push the Advance  key where the lower display will show **[CUSE]** and the upper display will show **[1]**.
3. Push the Advance  button where the prompt for the Process Value **[RCPV]** will be displayed on top and Parameter **[PRP]** in the bottom. There are twenty positions available that can be customized.
4. Pushing the Up  or Down  arrow keys will allow for a customized selection to be made (see list of available parameters below).

Custom Menu Parameter Options	
Description	Prompt *
If 4 th or 9 th digit of part number is L or M	
Limit Set Point Low	[LLS1]
Limit Set Point High	[LhS1]
Limit Hysteresis	[LhY1]
Limit Status	[LSE1]
All Models	
None	Blank
Analog Input Value	[Rin1] [Rin2]
Cal In Offset	[iCR1] [iCR2]
Display Units	[CF1]
Load Parameter Set	[USr.1] [USr.2]
Alarm Low Set Point	[R.Lo1] [R.Lo2] [R.Lo3] [R.Lo4]
Alarm High Set Point	[R.h.1] [R.h.2] [R.h.3] [R.h.4]
Alarm Hysteresis	[R.hY1] [R.hY2] [R.hY3] [R.hY4]
If 4 th digit of part number is B, E, C, R, J, or N	
Closed Loop Set Point	[C.SP1] [C.SP2]
Active Process Value	[RCP1] [RCP2]
Active Set Point	[RCS1] [RCS2]
Open Loop Set Point	[o.SP1] [o.SP2]
Autotune	[Aut1] [Aut2]
Control Mode	[CP71] [CP72]
Heat Power	[h.Pr1] [h.Pr2]
Cool Power	[C.Pr1] [C.Pr2]
Time Integral	[t.i1] [t.i2]
Time Derivative	[td1] [td2]
Dead Band	[db1] [db2]
Heat Prop Band	[h.Pb1] [h.Pb2]
Heat Hysteresis	[h.hY1] [h.hY2]
Cool Prop Band	[C.Pb1] [C.Pb2]
Cool Hysteresis	[C.hY1] [C.hY2]
If 4 th digit of part number is B, E, C, R, J, or N	
Ramp Rate	[r.rt1] [r.rt2]
TRU-TUNE+ Enable	[t.tu1] [t.tu2]
Idle Set Point	[id.S1] [id.S2]

Custom Menu Parameter Options	
Description	Prompt *
If 4 th digit of part number is B, E, R or N	
Profile Start	P.S <i>1</i>
Profile Action Request	P.A <i>1</i>
Guaranteed Soak Deviation 1	95 <i>1</i>
If 9 th digit of part number is T	
Current Read	C <i>U</i> .r <i>1</i>

* The numerical digit shown in the prompts above (last digit), represents the parameter instance and can be greater than one.

Modifying the Display Pairs

The Home Page, being a customized list of as many as 20 parameters can be configured in pairs of up to 10 via the Display Pairs **[dPrS]** prompt found in the Diagnostic Menu **[d,rg]** (Factory Page). The listing in the table that follows is what one may typically find in the Home Page as defaults based on controller part numbers. It is important to note that some of the prompts shown may not appear simply because the feature is not being used or is turned off. As an example, the prompt shown in position 7 (loop 1) and position 12 (loop 2) **[CPr]** will not appear unless the Cool algorithm **[C,rg]** is turned on in the Setup Page under the Loop menu.

If the ninth digit of the part number is C, J, L or M (PM _____ - [C, J, L, M] _____) the Display Pairs **[dPrS]** prompt will default to 2; otherwise, it will be equal to one.

As stated above, the user can define pairs of prompts to appear on the display every time the Advance **[A]** key is pushed. The first pair will always be as defined in the Custom Menu and as stated will default (factory settings) to the Active Process Value loop 1 **[ACP*1*]**, and the Active Set Point loop 1 **[ACSP*1*]**. If two channels are present the first 2 pairs will be the same in that the first pair will represent channel 1 Active Process Value and Active Set Point and the second being the same for channel 2. If another pair is created where the Display Pairs **[dPrS]** prompt is equal to 3 using the default prompts, when the Advance key **[A]** is pushed two times from the Home Page the upper display will reflect the current control mode and the bottom display would show the output power. When configuring the Custom Menu to your liking it should be noted that if a writable value is placed on the upper display and is paired with another read only parameter on the lower display, the arrow keys will affect the setting of the upper display. Also, if 2 changeable (writable) prompts are displayed in a Pair, i.e., Control Mode on top and Idle Set Point on the bottom, only the lower display (Idle Set Point) can be changed.

The display can be configured to scroll customized pairs by going to the Factory Page under the Diagnostic Menu and changing the Display Time **[d,t]** prompt to something greater than 0 and by changing the Display Pairs **[dPrS]** to something greater than 1. If the Display Time **[d,t]** is set to 2, the display will toggle every 2 seconds from the first display pair to the second and then the third, etc... If the control has more than one channel and one of the configured pairs is set as instance 2, the channel indicator (LED) will change from 1 to 2 reflecting the channel of the pair being displayed. The display will continue to toggle through all of the custom pairs at the specified time interval.

	Possible Home Page Defaults (Dependent on Part Number)	Home Page Display	Parameter Page and Menu
All Models			
1	Active Process Value (1)	Numerical value	Operations Page, Monitor Menu
2	Active Set Point (1)	Numerical value	Operations Page, Monitor Menu
If 9th digit of part number is equal to: PM _____ - [L, M] _____			
3	Process Value (2)	Numerical value	Operations Page, Monitor Menu
4	Limit Status	SAFE or FAIL	Home Page

	Possible Home Page Defaults (Dependent on Part Number)	Home Page Display	Parameter Page and Menu
If 9th digit of part number is equal to: PM _ _ _ _ _ - - [A, C, J, R, P, T] _ _ _ _ _			
3	Active Process Value (2)	P_uR₂	Operations Page, Monitor Menu
4	Closed Loop Set Point (2)	C_SP₂	Operations Page, Monitor Menu
5	Control Mode (1)	C_P7₁	Operations Page, Monitor Menu
If 9th digit of part number is equal to: PM _ _ _ _ _ - - [A, C, J, R, P, T] _ _ _ _ _			
6	Heat Power (1)	h_Pr₁	Operations Page, Monitor Menu
7	Cool Power (1)	C_Pr₁	Operations Page, Monitor Menu
8	Autotune (1)	A_ut₁	Operations Page, Loop Menu
9	Idle Set Point(1)	i_dS₁	Operations Page, Loop Menu
10	Control Mode (2)	C_P7₂	Operations Page, Monitor Menu
11	Heat Power (2)	h_Pr₂	Operations Page, Monitor Menu
12	Cool Power (2)	C_Pr₂	Operations Page, Monitor Menu
13	Autotune (2)	A_ut₂	Operations Page, Loop Menu
14	Idle Set Point (2)	i_dS₂	Operations Page, Loop Menu
15	Limit Low Set Point	L_LS₁	Operations Page, Limit Menu
16	Limit High Set Point	L_HS₁	Operations Page, Limit Menu
17	Profile Start	P_St₁	
18	Action Request	P_AC₁	
19	None		
20	None		

Note:

The numerical digit shown in the prompts (last digit) and within the parentheses above, represents the parameter instance and can be greater than one.

Conventions Used in the Menu Pages

To better understand the menu pages that follow review the naming conventions used. When encountered throughout this document, the word "default" implies as shipped from the factory. Each page (Operations, Setup, Profile and Factory) and their associated menus have identical headers defined below:

Header Name	Definition
Display	Visually displayed information from the control.
Parameter Name	Describes the function of the given parameter.
Range	Defines options available for this prompt, i.e., min/max values (numerical), yes/no, etc... (further explanation below).
Default	Values as delivered from the factory.
Modbus Relative Address	Identifies unique parameters using either the Modbus RTU or Modbus TCP protocols (further explanation below).
CIP (Common Industrial Protocol)	Identifies unique parameters using either the DeviceNet or EtherNet/IP protocol (further explanation below).
Profibus Index	Identifies unique parameters using Profibus DP protocol (further explanation below).
Parameter ID	Identifies unique parameters used with other software such as, LabVIEW.

Conventions Used in the Menu Pages (cont.)

Data Type R/W	uint = Unsigned 16 bit integer dint = Signed 32-bit, long string = ASCII (8 bits per character) float = IEEE 754 32-bit RWES= R eadable W ritable E EPROM (saved) S et (saved)
---------------	---

Display

Visual information from the control is displayed to the observer using a fairly standard 7 segment display. Due to the use of this technology, several characters displayed need some interpretation, see the list below:

= 1	= 0	= i	= r
= 2	= A	= J	= S
= 3	= b	= K	= t
= 4	= c	= L	= u
= 5	= d	= M	= v
= 6	= E	= n	= W
= 7	= F	= o	= y
= 8	= g	= P	= Z
= 9	= h	= q	

Range

Within this column notice that on occasion there will be numbers found within parenthesis. This number represents the enumerated value for that particular selection. Range selections can be made simply by writing the enumerated value of choice using any of the available communications protocols. As an example, turn to the Setup Page and look at the Analog Input menu and then the Sensor Type prompt. To turn the sensor off using Modbus simply write the value of 62 (off) to register 368 and send that value to the control.

Communication Protocols

When using a communications protocol in conjunction with the EZ-ZONE PM there are two possible ports (instances) used. Port 1 or instance 1 is always dedicated to Standard Bus communications. This same instance can also be used for Modbus RTU if ordered. Depending on the controller part number port 2 (instance 2) can be used with Modbus, CIP and Profibus. For further information read through the remainder of this section.

Modbus Introduction to the Modbus Protocol

Gould Modicon, now called AEG Schneider, first created the protocol referred to as "Modbus RTU" used in process control systems. Modbus provides the advantage of being extremely reliable in exchanging information, a highly desirable feature for industrial data communications. This protocol works on the principle of packet exchanges. The packet contains the address of the controller to receive the information, a command field that says what is to be done with the information, and several fields of data. Each PM parameter has a unique Modbus address and they can be found in the following Operations, Setup, Profiling, and Factory Pages.

Modbus Introduction to the Modbus Protocol (cont.)

All Modbus registers are 16-bits and as displayed in this User's Guide are relative addresses (actual). Some legacy software packages limit available Modbus registers to 40000 to 49999 (5 digits). Many applications today require access to all available Modbus registers which range from 400000 to 465535 (6 digits). For parameters listed as float, notice that only one (low order) of the two registers is listed; this is true throughout this document. By default, the low order word contains the two low bytes of the 32-bit parameter. As an example, look in the Operations Page for the Analog Input Value. Find the column identified in the header as Modbus and notice that it lists register 360. Because this parameter is a float it is actually represented by registers 360 (low order bytes) and 361 (high order bytes). The Modbus specification does not dictate which register should be high or low order therefore, Watlow provides the user the ability to swap this order (Setup Page, **[CoPq]** Menu) from the default low/high **[LoHl]** to high/low **[hLo]**.

Note:

With the release of firmware revision 7.00 and above new functions were introduced into this product line. With the introduction of these new functions there was a reorganization of Modbus registers. Notice in the column identified as Modbus the reference to Map 1 and Map 2 registers for each of the various parameters. If the new functions, namely; Math, Linearization, Process Value, Real Time Clock and the Special Output Function are to be used than use Map 2 Modbus registers. If the new functions of this product line are not to be used, Map 1 (legacy PM controls) Modbus registers will be sufficient. The Modbus register mapping **[PqRP]** can be changed in the Setup Page under the **[CoPq]** Menu. This setting will apply across the control.

It should also be noted that some of the cells in the Modbus column contain wording pertaining to an offset. Several parameters in the control contain more than one instance; such as, profiles (4), alarms (4), analog inputs (2), etc... The Modbus register shown always represents instance one. Take for an example the Alarm Silence parameter found in the Setup Page under the Alarm Menu. Instance one of Map 1 is shown as address 1490 and +50 is identified as the offset to the next instance. If there was a desire to read or write to instance 3 simply add 100 to 1490 to find its address, in this case, the instance 3 address for Alarm Silence is 1590.

The Modbus communications instance can be either 1 or 2 depending on the part number.

Instance 1:

PM _____ - [1] _____

Instance 2:

PM _____ - [2] _____

To learn more about the Modbus protocol point your browser to <http://www.modbus.org>.

Common Industrial Protocol (CIP) Introduction to CIP

Both DeviceNet and EtherNet/IP use open object based programming tools and use the same addressing scheme. In the following menu pages notice the column header identified as CIP. There you will find the Class, Instance and Attribute in hexadecimal, (decimal in parenthesis) which makes up the addressing for both protocols.

The CIP communications instance will always be instance 2.

Data Types Used with CIP

int	= Signed 16-bit integer
uint	= Signed 16-bit integer
dint	= Signed 32-bits, long
real	= Float, IEEE 754 32-bit
string	= ASCII, 8 bits per character
sint	= Signed 8 bits , byte

To learn more about the DeviceNet and EtherNet/IP protocol point your browser to <http://www.odva.org>.

Profibus DP

To accommodate for Profibus DP addressing the following menus contain a column identified as Profibus Index. Data types used in conjunction with Profibus DP can be found in the table below.

The Profibus communications instance will always be instance 2.

real	= Float, IEEE 754 32-bit
int	= Signed 16-bit integer
byte	= 8-bits

To learn more about the Profibus DP protocol point your browser to <http://www.profibus.org>

5

Chapter 5: Operations Page

Navigating the Operations Page

To navigate to the Operations Page, follow the steps below:

1. From the Home Page, press both the Up ▲ and Down ▼ keys for three seconds. **OPER** will appear in the upper display and **OPER** will appear in the lower display.
2. Press the Up ▲ or Down ▼ key to view available menus.
3. Press the Advance Key ⏩ to enter the menu of choice.
4. If a submenu exists (more than one instance), press the Up ▲ or Down ▼ key to select and then press the Advance Key ⏩ to enter.
5. Press the Up ▲ or Down ▼ key to move through available menu prompts.
6. Press the Infinity Key ∞ to move backwards through the levels: parameter to submenu; submenu to menu; menu to Home Page.
7. Press and hold the Infinity Key ∞ for two seconds to return to the Home Page.

On the following pages, top level menus are identified with a yellow background color.

Note:

Some of these menus and parameters may not appear, depending on the controller's options. See model number information in the Appendix for more information. If there is only one instance of a menu, no sub-menus will appear.

Note:

Some of the listed parameters may not be visible. Parameter visibility is dependent upon controller part number.

- AI** Analog Input Menu
 - AI** Analog Input (1 to 2)
 - AIN** Analog Input Value
 - IER** Input Error
 - ICR** Calibration Offset
- LR** Linearization Menu
 - LR** Linearization (1 to 2)
 - SUR** Source Value A
 - OFF** Offset
 - OU** Output Value
- PV** Process Value Menu
 - PV** Process Value (1 to 2)
 - SUR** Source Value A
 - SUB** Source Value B
 - OFF** Offset
 - OU** Output Value
- DI/O** Digital Input/Output Menu
 - DI/O** Digital I/O (5 to 12)
 - DO** Output State
 - DI** Input State
 - ES** Event Status

- LM** Limit Menu
 - LLS** Limit Low Set Point
 - LHS** Limit High Set Point
 - LCR** Limit Clear Request
 - LSE** Limit State
- MON** Monitor Menu
 - MON** (1 to 2)
 - CPMA** Control Mode Active
 - HP** Heat Power
 - CP** Cool Power
 - CLSP** Closed Loop Set Point
 - PVA** Process Value Active
- LOOP** Control Loop Menu
 - LOOP** Control Loop (1 to 2)
 - REN** Remote Enable
 - CM** Control Mode
 - ATS** Autotune Set Point
 - AUT** Autotune
 - CLSP** Closed Loop Set Point
 - IS** Idle Set Point
 - HPB** Heat Proportional Band
 - HH** Heat Hysteresis
 - CPB** Cool Proportional Band
 - CH** Cool Hysteresis
 - TI** Time Integral

- TD** Time Derivative
- DB** Dead Band
- OSP** Open Loop Set Point
- ALM** Alarm Menu
 - ALM** Alarm (1 to 4)
 - ALO** Alarm Low Set Point
 - AHI** Alarm High Set Point
 - ALCR** Alarm Clear Request
 - ASR** Alarm Silence Request
 - AST** Alarm State
- CUR** Current Menu
 - CHI** Current High Set Point
 - CLI** Current Low Set Point
 - CR** Current Read
 - CE** Current Error
 - HER** Heater Error
- MATH** Math Menu
 - SUR** Source Value A
 - SUB** Source Value B
 - SE** Source Value E
 - OFF** Offset
 - OU** Output Value

- S_{oF}**
- oP_Er** Special Output Function
 - S_{uA}** Source Value 1
 - S_{uB}** Source Value 2
 - o_{u1}** Output Value 1
 - o_{u2}** Output Value 2

- P_SE_R**
- oP_Er** Profile Status Menu
 - P_SE_r** Profile Start
 - P_AC_r** Profile Action Request
 - S_EP** Current Step
 - S_EY_P** Step Type
 - T_SP₁** Target Set Point Loop 1
 - T_SP₂** Target Set Point Loop 2
 - R_CS_P** Produced Set Point 1
 - P_SP₂** Produced Set Point 2
 - h_ou_r** Hours
 - m_in** Minutes
 - S_EC** Seconds
 - E_nt₁** Event 1
 - E_nt₂** Event 2
 - J_C** Jump Count Remaining

Operations Page

Display	Parameter name Description	Range	Default	Modbus Relative Ad- dress	CIP Class Instance Attribute hex (dec)	Profibus Index	Param- eter ID	Data Type & Read/ Write
oPEr Analog Input Menu								
Ain [Ain]	<i>Analog Input (1 to 2)</i> Analog Input Value View the process value. Note: Ensure that the Input Error (below) indicates no error (61) when reading this value using a field bus protocol. If an error exists, the last known value prior to the error occurring will be returned.	-1,999.000 to 9,999.000°F or units -1,128.000 to 5,537.000°C		Instance 1 <i>Map 1 Map 2</i> 360 360 Instance 2 <i>Map 1 Map 2</i> 440 450	0x68 (104) 1 to 2 1	0	4001	float R
iEr [i.Er]	<i>Analog Input (1 to 2)</i> Input Error View the cause of the most recent error. If the REtE message is Er.i1 or Er.i2 , this parameter will display the cause of the input error.	nonE None (61) OPEn Open (65) FRIL Fail (32) Shrt Shorted (127) ErM Measurement Error (140) ErCAL Bad Calibration Data (139) ErAb Ambient Error (9) ErEd RTD Error (141) NSrc Not Sourced (246)	None	Instance 1 <i>Map 1 Map 2</i> 362 362 Instance 2 <i>Map 1 Map 2</i> 442 452	0x68 (104) 1 to 2 2	1	4002	uint R
iCA [i.CA]	<i>Analog Input (1 to 2)</i> Calibration Offset Offset the input reading to compensate for lead wire resistance or other factors that cause the input reading to vary from the actual process value.	-1,999.000 to 9,999.000°F or units -1,110.555 to 5,555.000°C	0.0	Instance 1 <i>Map 1 Map 2</i> 382 382 Instance 2 <i>Map 1 Map 2</i> 462 472	0x68 (104) 1 to 2 0xC (12)	2	4012	float RWES
Linr oPEr Linearization Menu								
SuA [Su.A]	<i>Linearization (1 to 2)</i> Source Value A View the value of Source A. Source A of Linearization 1 is connected to Analog Input 1 Source A of Linearization 2 is connected to Analog Input 2	-1,999.000 to 9,999.000°F or units -1,128.000 to 5,537.000°C		Instance 1 <i>Map 1 Map 2</i> - - - - 3566 Instance 2 <i>Map 1 Map 2</i> - - - - 3636	0x86 (134) 1 to 2 4	- - - -	34004	float R
oFSt [oFSt]	<i>Linearization (1 to 2)</i> Offset Set an offset to be applied to this function's output.	-1,999.000 to 9,999.000°F or units -1,128.000 to 5,537.000°C	0	Instance 1 <i>Map 1 Map 2</i> - - - - 3570 Instance 2 <i>Map 1 Map 2</i> - - - - 3640	0x86 (134) 1 to 2 6	- - - -	34006	float RWES
Note: Some values will be rounded off to fit in the four-character display. Full values can be read with other interfaces.								R: Read W: Write E: EEPROM S: User Set

Operations Page

Display	Parameter name Description	Range	Default	Modbus Relative Address	CIP Class Instance Attribute hex (dec)	Profibus Index	Parameter ID	Data Type & Read/ Write
o.v [o.v]	<i>Linearization (1 to 2)</i> Output Value View the value of this function's output.	-1,999.000 to 9,999.000°F or units -1,128.000 to 5,537.000°C		Instance 1 <i>Map 1 Map 2</i> ---- 3572 Instance 2 <i>Map 1 Map 2</i> ---- 3642	0x86 (134) 1 to 2 7	----	34007	float R
No Display	<i>Linearization (1 to 2)</i> Output Error View reported cause for Linearization output malfunction.	none None (61) oPEr Open (65) Shrt Shorted (127) ErM Measurement error (140) ECAL Bad calibration data (139) ErAb Ambient error (9) Ertd RTD error (14) FRIL Fail (32) ErM Math error (1423) nSrc Not sourced (246) StAL Stale (1617) noPr Can't process (1659)	None	Instance 1 <i>Map 1 Map 2</i> ---- 3614 Instance 2 <i>Map 1 Map 2</i> ---- 3684	0x86 (134) 1 to 2 0x1C (28)	----	34028	uint R
PU oPEr Process Value Menu								
SuA [Sv.A]	<i>Process Value (1 to 2)</i> Source Value A View the value of Source A. Linearization 1 is connected to Source A of Process Value 1 Linearization 2 is connected to Source A of Process Value 2	-1,999.000 to 9,999.000°F or units -1,128.000 to 5,537.000°C		Instance 1 <i>Map 1 Map 2</i> ---- 3310 Instance 2 <i>Map 1 Map 2</i> ---- 3380	0x7E (126) 1 to 2 0x10 (16)	----	26016	float R
SuB [Sv.b]	<i>Process Value (1 to 2)</i> Source Value B View the value of Source B. Linearization 2 is connected to Source B of Process Value 1 Linearization 1 is connected to Source B of Process Value 2	-1,999.000 to 9,999.000°F or units -1,128.000 to 5,537.000°C		Instance 1 <i>Map 1 Map 2</i> ---- 3312 Instance 2 <i>Map 1 Map 2</i> ---- 3382	0x7E (126) 1 to 2 0x11 (17)	----	26017	float R
oFSt [oFSt]	<i>Process Value (1 to 2)</i> Offset Set an offset to be applied to this function's output.	-1,999.000 to 9,999.000°F or units -1,128.000 to 5,537.000°C	0	Instance 1 <i>Map 1 Map 2</i> ---- 3324 Instance 2 <i>Map 1 Map 2</i> ---- 3394	0x7E (126) 1 to 2 0x17 (23)	----	26023	float RWES
Note: Some values will be rounded off to fit in the four-character display. Full values can be read with other interfaces.								R: Read W: Write E: EEPROM S: User Set

Operations Page

Display	Parameter name Description	Range	Default	Modbus Relative Address	CIP Class Instance Attribute hex (dec)	Profibus Index	Parameter ID	Data Type & Read/ Write
<input type="checkbox"/> o.v [o.v]	<i>Process Value (1 to 2)</i> Output Value View the value of this function block's output.	-1,999.000 to 9,999.000°F or units -1,128.000 to 5,537.000°C	0.0	Instance 1 <i>Map 1 Map 2</i> ---- 3322 Instance 2 <i>Map 1 Map 2</i> ---- 3392	0x7E (126) 1 to 2 0x16 (22)	----	26022	float R
No Display	<i>Process Value (1 to 2)</i> Output Error View reported cause for Process output malfunction.	<input type="checkbox"/> none None (61) <input type="checkbox"/> open Open (65) <input type="checkbox"/> short Shorted (127) <input type="checkbox"/> err Measurement error (140) <input type="checkbox"/> cal Bad calibration data (139) <input type="checkbox"/> errAb Ambient error (9) <input type="checkbox"/> errtd RTD error (14) <input type="checkbox"/> fail Fail (32) <input type="checkbox"/> errm Math error (1423) <input type="checkbox"/> nsrc Not sourced (246) <input type="checkbox"/> stale Stale (1617) <input type="checkbox"/> noPr Can't process (1659)	None	Instance 1 <i>Map 1 Map 2</i> ---- 3332 Instance 2 <i>Map 1 Map 2</i> ---- 3402	0x86 (134) 1 to 2 0x1B (27)	----	26027	uint R
<input type="checkbox"/> di <input type="checkbox"/> oPer Digital Input/Output Menu								
<input type="checkbox"/> do.S [do.S]	<i>Digital Output (5 to 12)</i> Output State View the state of this output.	<input type="checkbox"/> off Off (62) <input type="checkbox"/> on On (63)		Instance 5 <i>Map 1 Map 2</i> 1012 1132 Offset to next instance equals +30	0x6A (106) 5 to C (12) 7	90	6007	uint R
<input type="checkbox"/> di.S [di.S]	<i>Digital Input (5 to 12)</i> Input State View this event input state.	<input type="checkbox"/> off Off (62) <input type="checkbox"/> on On (63)	----	Instance 5 <i>Map 1 Map 2</i> 1020 1140 Offset to next instance equals +30	0x6A (106) 5 to C (12) 0xB (11)	----	6011	uint R
<input type="checkbox"/> Ei.S [Ei.S]	<i>Digital Input (5 to 6)</i> Event Status View this event input state.	<input type="checkbox"/> inact Inactive (41) <input type="checkbox"/> act Active (5)		Instance 5 <i>Map 1 Map 2</i> 1408 1648 Offset to next instance equals +20	0x6E (110) 5 to 6 5	140	10005	uint R
<input type="checkbox"/> Ei.S [Ei.S]	<i>Digital Input (7 to 12)</i> Event Status View this event input state.	<input type="checkbox"/> inact Inactive (41) <input type="checkbox"/> act Active (5)		Instance 7 <i>Map 1 Map 2</i> 1448 1688 Offset to next instance equals +20	0x6E (110) 7 to C (12) 5	140	10005	uint R
No Display	<i>EZ-Key/s (1 to 2)</i> Event Status View this event input state.	<input type="checkbox"/> inact Inactive (41) <input type="checkbox"/> act Active (5)	Off	Instance 1 <i>Map 1 Map 2</i> 1328 1568 Instance 2 <i>Map 1 Map 2</i> 1348 1588	0x6E (110) 3 to 4 5	140	10005	uint R
Note: Some values will be rounded off to fit in the four-character display. Full values can be read with other interfaces.								R: Read W: Write E: EEPROM S: User Set

Operations Page

Display	Parameter name Description	Range	Default	Modbus Relative Address	CIP Class Instance Attribute hex (dec)	Profibus Index	Parameter ID	Data Type & Read/ Write
Limit Menu								
LLS [LLS]	<i>Limit (1)</i> Limit Low Set Point Set the low process value that will trigger the limit.	-1,999.000 to 9,999.000°F or units -1,128.000 to 5,537.000°C	0.0°F or units -18.0°C	Instance 1 <i>Map 1</i> <i>Map 2</i> 684 724	0x70 (112) 1 3	38	12003	float RWES
LHS [Lh.S]	<i>Limit (1)</i> Limit High Set Point Set the high process value that will trigger the limit.	-1,999.000 to 9,999.000°F or units -1,128.000 to 5,537.000°C	0.0°F or units -18.0°C	Instance 1 <i>Map 1</i> <i>Map 2</i> 686 726	0x70 (112) 1 4	39	12004	float RWES
No Dis- play	<i>Limit (1)</i> Limit State Clear limit once limit condition is cleared.	OFF Off (62) none None (61) Lh Limit High (51) Ll Limit Low (52) Err Error (28)	----	Instance 1 <i>Map 1</i> <i>Map 2</i> 690 730	0x70 (112) 1 6	----	12006	uint R
LCr [LCr]	<i>Limit (1)</i> Limit Clear Request Clear limit once limit condition is cleared.	CLr Clear (0) Ignr Ignore (204)	----	Instance 1 <i>Map 1</i> <i>Map 2</i> 680 720	0x70 (112) 1 1	----	12001	uint W
LSE [L.St]	<i>Limit (1 to 4)</i> Limit Status Reflects whether or not the limit is in a safe or failed mode.	FAIL Fail (32) SAFE Safe (1667)	----	Instance 1 <i>Map 1</i> <i>Map 2</i> ---- 744	0x70 (112) 1 0x0D (13)	----	12013	uint R
Monitor Menu								
CPMA [C.MA]	<i>Monitor (1 to 2)</i> Control Mode Active View the current control mode.	OFF Off (62) AUTO Auto (10) MAN Manual (54)		Instance 1 <i>Map 1</i> <i>Map 2</i> 1882 2362 Instance 2 <i>Map 1</i> <i>Map 2</i> 1952 2432	0x97 (151) 1 to 2 2	----	8002	uint R
hPr [h.Pr]	<i>Monitor (1 to 2)</i> Heat Power View the current heat output level.	0.0 to 100.0%	0.0	Instance 1 <i>Map 1</i> <i>Map 2</i> 1904 2384 Instance 2 <i>Map 1</i> <i>Map 2</i> 1974 2454	0x97 (151) 1 to 2 0xD (13)	----	8011	float R
CPPr [C.Pr]	<i>Monitor (1 to 2)</i> Cool Power View the current cool output level.	-100.0 to 0.0%	0.0	Instance 1 <i>Map 1</i> <i>Map 2</i> 1906 2386 Instance 2 <i>Map 1</i> <i>Map 2</i> 1976 2456	0x97 (151) 1 to 2 0xE (14)	----	8014	float R
CSP [C.SP]	<i>Monitor (1 to 2)</i> Closed Loop Set Point View the set point currently in effect.	-1,999.000 to 9,999.000°F or units -1,128.000 to 5,537.000°C		Instance 1 <i>Map 1</i> <i>Map 2</i> 2172 2652 Instance 2 <i>Map 1</i> <i>Map 2</i> 2252 2732	0x6B (107) 1 to 2 7	----	8029	float R
Note: Some values will be rounded off to fit in the four-character display. Full values can be read with other interfaces.								R: Read W: Write E: EEPROM S: User Set

Operations Page

Display	Parameter name Description	Range	Default	Modbus Relative Address	CIP Class Instance Attribute hex (dec)	Profibus Index	Parameter ID	Data Type & Read/ Write
<input type="checkbox"/> PvA [Pv.A]	<i>Monitor (1 to 2)</i> Process Value Active View the current filtered process value using the control input.	-1,999.000 to 9,999.000°F or units -1,128.000 to 5,537.000°C		Instance 1 <i>Map 1</i> <i>Map 2</i> 402 402 Instance 2 <i>Map 1</i> <i>Map 2</i> 482 492	0x68 (104) 1 to 2 0x16 (22)	----	8031	float R
No Display	<i>Monitor (1 to 2)</i> Set Point Active Read the current active set point.	-1,999.000 to 9,999.000°F or units -1,128.000 to 5,537.000°C		Instance 1 <i>Map 1</i> <i>Map 2</i> 2172 2652 Instance 2 <i>Map 1</i> <i>Map 2</i> 2252 2732	0x6B (107) 1 to 2 7	----	7018	float R
No Display	<i>Monitor (1 to 2)</i> Autotune Status Read the present status of Autotune.	<input type="checkbox"/> OFF Off (62) <input type="checkbox"/> ESIP Waiting for cross 1 positive (119) <input type="checkbox"/> ESIN Waiting for cross 1 negative (120) <input type="checkbox"/> ES2P Waiting for cross 2 positive (121) <input type="checkbox"/> ES2N Waiting for cross 2 negative (122) <input type="checkbox"/> ES3P Waiting for cross 3 positive (123) <input type="checkbox"/> ES3N Waiting for cross 3 negative (150) <input type="checkbox"/> P7N Measuring maximum peak (151) <input type="checkbox"/> P7R Measuring minimum peak (152) <input type="checkbox"/> ALC Calculating (153) <input type="checkbox"/> PLT Complete (18) <input type="checkbox"/> to Timeout (118)		Instance 1 <i>Map 1</i> <i>Map 2</i> 1932 2412 Instance 2 <i>Map 1</i> <i>Map 2</i> 2002 2482	0x97 (151) 1 to 2 27	----	8027	uint R
<input type="checkbox"/> Loop <input type="checkbox"/> OPER Control Loop Menu								
<input type="checkbox"/> r.En [r.En]	<i>Control Loop (1 to 2)</i> Remote Enable Enable this loop to switch control to the remote set point.	<input type="checkbox"/> no No (59) <input type="checkbox"/> YES Yes (106)	No	Instance 1 <i>Map 1</i> <i>Map 2</i> 2200 2680 Instance 2 <i>Map 1</i> <i>Map 2</i> 2280 2760	0x6B (107) 1 to 2 0x15 (21)	48	7021	uint RWES
<input type="checkbox"/> r.ty [r.ty]	<i>Control Loop (1 to 2)</i> Remote Set Point Type Enable this loop to switch control to the remote set point.	<input type="checkbox"/> Auto Auto (10) <input type="checkbox"/> MAN Manual (54)	Auto	Instance 1 <i>Map 1</i> <i>Map 2</i> 2202 2682 Instance 2 <i>Map 1</i> <i>Map 2</i> 2282 2762	0x6B (107) 1 to 2 0x16 (22)	----	7022	uint RWES
<input type="checkbox"/> [C.M] [C.M]	<i>Control Loop (1 to 2)</i> Control Mode Select the method that this loop will use to control.	<input type="checkbox"/> OFF Off (62) <input type="checkbox"/> Auto Auto (10) <input type="checkbox"/> MAN Manual (54)	Auto	Instance 1 <i>Map 1</i> <i>Map 2</i> 1880 2360 Instance 2 <i>Map 1</i> <i>Map 2</i> 1950 2430	0x97 (151) 1 to 2 1	63	8001	uint RWES
Note: Some values will be rounded off to fit in the four-character display. Full values can be read with other interfaces.								R: Read W: Write E: EEPROM S: User Set

Operations Page

Display	Parameter name Description	Range	Default	Modbus Relative Address	CIP Class Instance Attribute hex (dec)	Profibus Index	Parameter ID	Data Type & Read/ Write
[A.tSP] [A.tSP]	<i>Control Loop (1 to 2)</i> Autotune Set Point Set the set point that the autotune will use, as a percentage of the current set point.	50.0 to 200.0%	90.0	Instance 1 <i>Map 1 Map 2</i> 1918 2398 Instance 2 <i>Map 1 Map 2</i> 1988 2468	0x97 (151) 1 to 2 0x14 (20)	----	8025	float RWES
[AUt] [AUt]	<i>Control Loop (1 to 2)</i> Autotune Start an autotune. While the autotune is active, the Home Page will display [A.tSP] [EUn1] or [EUn2] . When the autotune is complete, the message will clear automatically.	[No] No (59) [YES] Yes (106)	No	Instance 1 <i>Map 1 Map 2</i> 1920 2400 Instance 2 <i>Map 1 Map 2</i> 1990 2470	0x97 (151) 1 to 2 0x15 (21)	64	8026	uint RW
[C.SP] [C.SP]	<i>Control Loop (1 to 2)</i> Closed Loop Set Point Set the set point that the controller will automatically control to.	Low Set Point to High Set Point (Setup Page)	75.0°F or units 24.0°C	Instance 1 <i>Map 1 Map 2</i> 2160 2640 Instance 2 <i>Map 1 Map 2</i> 2240 2720	0x6B (107) 1 to 2 1	49	7001	float RWES
[id.S] [id.S]	<i>Control Loop (1 to 2)</i> Idle Set Point Set a closed loop set point that can be triggered by an event state.	Low Set Point to High Set Point (Setup Page)	75.0°F or units 24.0°C	Instance 1 <i>Map 1 Map 2</i> 2176 2656 Instance 2 <i>Map 1 Map 2</i> 2197 2736	0x6B (107) 1 to 2 9	50	7009	float RWES
[h.Pb] [h.Pb]	<i>Control Loop (1 to 2)</i> Heat Proportional Band Set the PID proportional band for the heat outputs.	0.001 to 9,999.000°F or units -1,110.555 to 5,555.000°C	25.0°F or units 14.0°C	Instance 1 <i>Map 1 Map 2</i> 1890 2370 Instance 2 <i>Map 1 Map 2</i> 1960 2440	0x97 (151) 1 to 2 6	65	8009	float RWES
[h.hy] [h.hy]	<i>Control Loop (1 to 2)</i> Heat Hysteresis Set the control switching hysteresis for on-off control. This determines how far into the “on” region the process value needs to move before the output turns on.	0.001 to 9,999.000°F or units 0.001 to 5,555.000°C	3.0°F or units 2.0°C	Instance 1 <i>Map 1 Map 2</i> 1900 2380 Instance 2 <i>Map 1 Map 2</i> 1970 2450	0x97 (151) 1 to 2 0xB (11)	66	8010	float RWES
[C.Pb] [C.Pb]	<i>Control Loop (1 to 2)</i> Cool Proportional Band Set the PID proportional band for the cool outputs.	0.001 to 9,999.000°F or units 0.001 to 5,555.000°C	25.0°F or units 14.0°C	Instance 1 <i>Map 1 Map 2</i> 1892 2372 Instance 2 <i>Map 1 Map 2</i> 1962 2442	0x97 (151) 1 to 2 7	67	8012	float RWES
Note: Some values will be rounded off to fit in the four-character display. Full values can be read with other interfaces.								R: Read W: Write E: EEPROM S: User Set

Operations Page

Display	Parameter name Description	Range	Default	Modbus Relative Address	CIP Class Instance Attribute hex (dec)	Profibus Index	Parameter ID	Data Type & Read/ Write
<input type="checkbox"/> Chy [C.hy]	<i>Control Loop (1 to 2)</i> Cool Hysteresis Set the control switching hysteresis for on-off control. This determines how far into the “on” region the process value needs to move before the output turns on.	0.001 to 9,999.000°F or units 0.001 to 5,555.000°C	3.0°F or units 2.0°C	Instance 1 <i>Map 1 Map 2</i> 1902 2382 Instance 2 <i>Map 1 Map 2</i> 1972 2522	0x97 (151) 1 to 2 0xC (12)	68	8013	float RWES
<input type="checkbox"/> ti [ti]	<i>Control Loop (1 to 2)</i> Time Integral Set the PID integral for the outputs.	0 to 9,999 seconds per repeat	180 seconds per repeat	Instance 1 <i>Map 1 Map 2</i> 1894 2374 Instance 2 <i>Map 1 Map 2</i> 1964 2444	0x97 (151) 1 to 2 8	69	8006	float RWES
<input type="checkbox"/> td [td]	<i>Control Loop (1 to 2)</i> Time Derivative Set the PID derivative time for the outputs.	0 to 9,999 seconds	0 seconds	Instance 1 <i>Map 1 Map 2</i> 1896 2376 Instance 2 <i>Map 1 Map 2</i> 1966 2446	0x97 (151) 1 to 2 9	70	8007	float RWES
<input type="checkbox"/> db [db]	<i>Control Loop (1 to 2)</i> Dead Band Set the offset to the proportional band. With a negative value, both heating and cooling outputs are active when the process value is near the set point. A positive value keeps heating and cooling outputs from fighting each other.	-1,000.0 to 1,000.0°F or units -556 to 556°C	0	Instance 1 <i>Map 1 Map 2</i> 1898 2378 Instance 2 <i>Map 1 Map 2</i> 1968 2448	0x97 (151) 1 to 2 0xA (10)	71	8008	float RWES
<input type="checkbox"/> o.SP [o.SP]	<i>Control Loop (1 to 2)</i> Open Loop Set Point Set a fixed level of output power when in manual (open-loop) mode.	-100 to 100% (heat and cool) 0 to 100% (heat only) -100 to 0% (cool only)	0.0	Instance 1 <i>Map 1 Map 2</i> 2162 2642 Instance 2 <i>Map 1 Map 2</i> 2242 2722	0x6B (107) 1 to 2 2	51	7002	float RWES
No Display	<i>Control Loop (1 to 2)</i> Loop Error Open Loop detect deviation has been exceeded.	<input type="checkbox"/> none None (61) <input type="checkbox"/> LPo Open Loop (1274) <input type="checkbox"/> LPr Reversed Sensor (1275)	----	Instance 1 <i>Map 1 Map 2</i> 1928 2408 Instance 2 <i>Map 1 Map 2</i> 1998 2478	0x6C (108) 1 0x30 (48)	----	8048	uint R
No Display	<i>Control Loop (1 to 2)</i> Clear Loop Error Current state of limit output.	<input type="checkbox"/> CLR Clear (129) <input type="checkbox"/> IGNR Ignore (204)	----	Instance 1 <i>Map 1 Map 2</i> 1930 2410 Instance 2 <i>Map 1 Map 2</i> 2000 2480	0x6C (108) 1 0x31 (49)	----	8049	uint W
Note: Some values will be rounded off to fit in the four-character display. Full values can be read with other interfaces.								R: Read W: Write E: EEPROM S: User Set

Operations Page

Display	Parameter name Description	Range	Default	Modbus Relative Address	CIP Class Instance Attribute hex (dec)	Profibus Index	Parameter ID	Data Type & Read/ Write
No Display	<i>Control Loop (1 to 2)</i> Loop Output Power View the loop output power.	-100.0 to 100.0	----	Instance 1 <i>Map 1</i> 1908 <i>Map 2</i> 2388 Instance 2 <i>Map 1</i> 1978 <i>Map 2</i> 2458	0x97 (151) 1 to 2 0x0F (15)	----	8033	float R
RLP oPEr Alarm Menu								
RLo [A.Lo]	<i>Alarm (1 to 4)</i> Alarm Low Set Point If Alarm Type (Setup Page, Alarm Menu) is set to: process - set the process value that will trigger a low alarm. deviation - set the span of units from the closed loop set point that will trigger a low alarm. A negative set point represents a value below closed loop set point. A positive set point represents a value above closed loop set point.	-1,999.000 to 9,999.000°F or units -1,128.000 to 5,537.000°C	32.0°F or units 0.0°C	Instance 1 <i>Map 1</i> 1482 <i>Map 2</i> 1882 Offset to next instance (<i>Map 1</i>) equals +50 Offset to next instance (<i>Map 2</i>) equals +60	0x6D (109) 1 to 4 2	18	9002	float RWES
Rh [A.hi]	<i>Alarm (1 to 4)</i> Alarm High Set Point If Alarm Type (Setup Page, Alarm Menu) is set to: process - set the process value that will trigger a high alarm. deviation - set the span of units from the closed loop set point that will trigger a high alarm.	-1,999.000 to 9,999.000°F or units -1,128.000 to 5,537.000°C	300.0°F or units 150.0°C	Instance 1 <i>Map 1</i> 1480 <i>Map 2</i> 1880 Offset to next instance (<i>Map 1</i>) equals +50 Offset to next instance (<i>Map 2</i>) equals +60	0x6D (109) 1 to 4 1	19	9001	float RWES
RCLR [A.Clr]	<i>Alarm (1 to 4)</i> Alarm Clear Request Write to this register to clear an alarm Note: If an alarm is setup to latch when active RCLR will appear on the display.	CLR Clear (0) IGNR Ignore (204)	----	Instance 1 <i>Map 1</i> 1504 <i>Map 2</i> 1904 Offset to next instance (<i>Map 1</i>) equals +50, <i>Map 2</i> equals +60)	0x6D (109) 1 to 4 0xD (13)	----	9013	uint W
Note: Some values will be rounded off to fit in the four-character display. Full values can be read with other interfaces.								R: Read W: Write E: EEPROM S: User Set

Operations Page

Display	Parameter name Description	Range	Default	Modbus Relative Address	CIP Class Instance Attribute hex (dec)	Profibus Index	Parameter ID	Data Type & Read/ Write
RSir [A.Sir]	Alarm (1 to 4) Alarm Silence Request Write to this register to silence an alarm Note: If an alarm is setup to silence alarm when active RSir will appear on the display.	Sil Silence Alarm (1010)		Instance 1 <i>Map 1</i> <i>Map 2</i> 1506 1906 Offset to next instance (Map1 1 equals +50, Map 2 equals +60)	0x6D (109) 1 to 4 0xE (14)	----	9014	uint W
RSSt [A.St]	Alarm (1 to 4) Alarm State Current state of alarm	St Startup (88) None None (61) Blk Blocked (12) ALl Alarm low (8) ALh Alarm high (7) Err Error (28)		Instance 1 <i>Map 1</i> <i>Map 2</i> 1496 1896 Offset to next instance [Map1 +50], [Map 2 +60]	0x6D (109) 1 to 4 9	----	9009	uint R
No Display	Alarm (1 to 4) Alarm Clearable Indicates if alarm can be cleared.	no No (59) YES Yes (106)		Instance 1 <i>Map 1</i> <i>Map 2</i> 1502 1902 Offset to next instance (Map1 1 equals +50, Map 2 equals +60)	0x6D (109) 1 to 4 0xC (12)	----	9012	uint R
No Display	Alarm (1 to 4) Alarm Silenced Indicates if alarm is silenced.	YES Yes (106) no No (59)	----	Instance 1 <i>Map 1</i> <i>Map 2</i> 1500 1900 Offset to next instance (Map1 1 equals +50, Map 2 equals +60)	0x6D (109) 1 to 4 0x0B (11)	----	9011	uint R
No Display	Alarm (1 to 4) Alarm Latched Indicates if alarm is latched.	YES Yes (106) no No (59)	----	Instance 1 <i>Map 1</i> <i>Map 2</i> 1498 1898 Offset to next instance (Map1 1 equals +50, Map 2 equals +60)	0x6D (109) 1 to 4 0x0A (10)	----	9010	uint R
OPER Current Menu								
Ch [C.hi]	Current (1) Current High Set Point Set the current value that will trigger a high heater error state.	-1,999.000 to 9,999.000	50.0	Instance 1 <i>Map 1</i> <i>Map 2</i> 1134 1374	0x73 (115) 1 8	----	15008	float RWES
Note: Some values will be rounded off to fit in the four-character display. Full values can be read with other interfaces.								R: Read W: Write E: EEPROM S: User Set

Operations Page

Display	Parameter name Description	Range	Default	Modbus Relative Address	CIP Class Instance Attribute hex (dec)	Profibus Index	Parameter ID	Data Type & Read/ Write
<input type="checkbox"/> C.Lo [C.Lo]	<i>Current (1)</i> Current Low Set Point Set the current value that will trigger a low heater error state.	-1,999.000 to 9,999.000	0.0	Instance 1 <i>Map 1</i> <i>Map 2</i> 1136 1376	0x73 (115) 1 9	----	15009	float RWES
<input type="checkbox"/> CUr [CU.r]	<i>RMS Current (1)</i> Current Read View the RMS current value monitored by the current transformer.	0 to 9,999.00	----	Instance 1 <i>Map 1</i> <i>Map 2</i> 1132 1372	0x73 (115) 1 7	----	15007	float R
<input type="checkbox"/> CEr [C.Er]	<i>Current (1)</i> Current Error View the most recent load status.	<input type="checkbox"/> nonE None (61) <input type="checkbox"/> ShrtE Shorted (127) <input type="checkbox"/> oPEn Open (65)	None	Instance 1 <i>Map 1</i> <i>Map 2</i> 1160 1400	0x73 (115) 1 2	----	15002	uint R
<input type="checkbox"/> hEr [h.Er]	<i>Current (1)</i> Heater Error Determine if load current flow is within the High and Low Set Points.	<input type="checkbox"/> nonE None (61) <input type="checkbox"/> h,gh High (37) <input type="checkbox"/> LoLd Low (53)	None	Instance 1 <i>Map 1</i> <i>Map 2</i> 1124 1364	0x73 (115) 1 3	----	15003	uint R
No Display	<i>Current (1)</i> Error Status View the cause of the most recent load fault	<input type="checkbox"/> nonE None (61) <input type="checkbox"/> FRIL Fail (32)	----	Instance 1 <i>Map 1</i> <i>Map 2</i> 1160 1400	0x73 (115) 1 21	----	15021	uint R
<input type="checkbox"/> MAE <input type="checkbox"/> oPEr Math Menu								
<input type="checkbox"/> SuA [Sv.A]	<i>Math (1)</i> Source Value A View the value of Source A or Linearization 1.	-1,999.000 to 9,999.000°F or units -1,128.000 to 5,537.000°C	0.0	Instance 1 <i>Map 1</i> <i>Map 2</i> ---- 3030	0x7D (125) 1 0x10 (16)	----	25016	float RWES
<input type="checkbox"/> SuB [Sv.b]	<i>Math (1)</i> Source Value B View the value of Source B or Linearization 2.	-1,999.000 to 9,999.000°F or units -1,128.000 to 5,537.000°C	0.0	Instance 1 <i>Map 1</i> <i>Map 2</i> ---- 3032	0x7D (125) 1 0x11 (17)	----	25017	float RWES
<input type="checkbox"/> SuE [Su.E]	<i>Math (1)</i> Source Value E Disables Process/Deviation scale when on.	<input type="checkbox"/> oFF Off (62) <input type="checkbox"/> oN On (63)	0	Instance 1 <i>Map 1</i> <i>Map 2</i> ---- 3038	0x7D (125) 1 0x14 (20)	----	25020	uint RWES
<input type="checkbox"/> oFSt [oFSt]	<i>Math (1)</i> Offset Set an offset to be applied to this function's output.	-1,999.000 to 9,999.000°F or units -1,128.000 to 5,537.000°C	0.0	Instance 1 <i>Map 1</i> <i>Map 2</i> ---- 3044	0x7D (125) 1 0x17 (23)	----	25023	float RWES
<input type="checkbox"/> oV [o.v]	<i>Math (1)</i> Output Value View the value of this function's output.	-1,999.000 to 9,999.000°F or units -1,128.000 to 5,537.000°C	0.0	Instance 1 <i>Map 1</i> <i>Map 2</i> ---- 3042	0x7D (125) 1 0x16 (22)	----	25022	float RWES
Note: Some values will be rounded off to fit in the four-character display. Full values can be read with other interfaces.								R: Read W: Write E: EEPROM S: User Set

Operations Page

Display	Parameter name Description	Range	Default	Modbus Relative Address	CIP Class Instance Attribute hex (dec)	Profibus Index	Parameter ID	Data Type & Read/ Write
No Dis- play	<i>Math (1)</i> Math Output Error View reported cause for math malfunction.	none None (61) open Open (65) short Shorted (127) err Measurement er- ror (140) cal Bad calibration data (139) errA Ambient error (9) errB RTD error (14) fail Fail (32) errM Math error (1423) notSrc Not sourced (246) stale Stale (1617) noPr Can't process (1659)	----	Instance 1 <i>Map 1</i> <i>Map 2</i> ---- 3056	0x7D (125) 1 0x1D (29)	----	25029	uint R
<input type="checkbox"/> SOF <input type="checkbox"/> OPER Special Output Function Menu								
<input type="checkbox"/> SuA [Sv.A]	<i>Special Output Func- tion (1)</i> Source Value 1 View the value of Source A which is connected to Loop Power 1.	-1,999.000 to 9,999.000°F or units -1,128.000 to 5,537.000°C	----	Instance 1 <i>Map 1</i> <i>Map 2</i> ---- 3852	0x87 (135) 1 7	----	35007	float R
<input type="checkbox"/> SuB [Su.b]	<i>Special Output Func- tion (1)</i> Source Value 2 View the value of Source B which is connected to Loop Power 2.	-1,999.000 to 9,999.000°F or units -1,128.000 to 5,537.000°C	----	Instance 1 <i>Map 1</i> <i>Map 2</i> ---- 3854	0x87 (135) 1 8	----	35008	float R
<input type="checkbox"/> ou1 [o.v1]	<i>Special Output Func- tion (1)</i> Output Value 1 View the value of this function's Output 1.	-1,999.000 to 9,999.000°F or units -1,128.000 to 5,537.000°C	----	Instance 1 <i>Map 1</i> <i>Map 2</i> ---- 3858	0x87 (135) 1 0xA (10)	----	35010	float R
<input type="checkbox"/> ou2 [o.v2]	<i>Special Output Func- tion (1)</i> Output Value 2 View the value of this function's Output 2.	-1,999.000 to 9,999.000°F or units -1,128.000 to 5,537.000°C	----	Instance 1 <i>Map 1</i> <i>Map 2</i> ---- 3862	0x87 (135) 1 0xC (12)	----	35012	float R
No Dis- play	<i>Special Output Func- tion (1)</i> Output Error 1 View reported cause for output malfunction.	none None (61) open Open (65) short Shorted (127) err Measurement er- ror (140) cal Bad calibration data (139) errA Ambient error (9) errB RTD error (14) fail Fail (32) errM Math error (1423) notSrc Not sourced (246) stale Stale (1617) noPr Can't process (1659)	----	Instance 1 <i>Map 1</i> <i>Map 2</i> ---- 3860	0x87 (135) 1 0x0B (11)	----	35011	uint R
Note: Some values will be rounded off to fit in the four-character display. Full values can be read with other interfaces.								R: Read W: Write E: EEPROM S: User Set

Operations Page

Display	Parameter name Description	Range	Default	Modbus Relative Address	CIP Class Instance Attribute hex (dec)	Profibus Index	Parameter ID	Data Type & Read/ Write
No Display	<i>Special Output Function (1)</i> Output Error 2 View reported cause for output malfunction.	<u>none</u> None (61) <u>oPEn</u> Open (65) <u>ShrE</u> Shorted (127) <u>ErM</u> Measurement error (140) <u>ECAL</u> Bad calibration data (139) <u>ErAb</u> Ambient error (9) <u>ErEd</u> RTD error (14) <u>FRIL</u> Fail (32) <u>ErM</u> Math error (1423) <u>nSrc</u> Not sourced (246) <u>SEAL</u> Stale (1617) <u>noPr</u> Can't process (1659)	----	Instance 1 <i>Map 1 Map 2</i> ----- 3940	0x87 (135) 1 0x0D (13)	----	35013	uint R
<u>PSEr</u> <u>oPEr</u> Profile Status Menu Profile Menu appears if: (PM _ [R, B*, N, E*] ----)				* Available with PM8/9 only * Some parameters in the Profile Status Menu can be changed for the currently running profile, but should only be changed by knowledgeable personnel and with caution. Changing parameters via the Profile Status Menu will not change the stored profile but will have an immediate impact on the profile that is running. Changes made to profile parameters in the Profiling Pages will be saved and will also have an immediate impact on the running profile.				
<u>PSEr</u> [P.Str]	<i>Profile Status</i> Profile Start Select step to act upon.	1 to 40	1	Instance 1 <i>Map 1 Map 2</i> 2520 4340	0x7A (122) 1 1	204	22001	uint RW
<u>PACr</u> [PACr]	<i>Profile Status</i> Action Request	<u>none</u> None (61) <u>SEEP</u> Step Start (89) <u>End</u> Terminate (148) <u>rESU</u> Resume (147) <u>PAUS</u> Pause (146) <u>ProF</u> Profile (77)	None	Instance 1 <i>Map 1 Map 2</i> 2540 4360	0x7A (122) 1 0xB (11)	205	22011	uint RW
<u>SEp</u> [StP]	<i>Profile Status</i> Step View the currently running step.	1 to 40	0 (none)	Instance 1 <i>Map 1 Map 2</i> 2526 4346	0x7A (122) 1 4	----	22004	uint R
<u>SEYP</u> [S.typ]	<i>Profile Status</i> Active Step Type View the currently running step type.	<u>USEP</u> Unused Step (50) <u>End</u> End (27) <u>JL</u> Jump Loop (116) <u>[LoC]</u> Wait For Time (1543) <u>UdBo</u> Wait For Both (210) <u>UdPr</u> Wait For Process (209) <u>UdE</u> Wait For Event (144) <u>SoRH</u> Soak (87) <u>t</u> Time (143) <u>rRE</u> Rate (81)		Instance 1 <i>Map 1 Map 2</i> 2544 4364	0x7A (122) 1 0xD (13)	----	22013	uint R
<u>ESPI</u> [tg.SP]	<i>Profile Status</i> *Target Set Point Loop 1 View or change the target set point of the current step.	-1,999.000 to 9,999.000°F or units -1,128.000 to 5,537.000°C	0.0°F or units -18.0°C	Instance 1 <i>Map 1 Map 2</i> 2542 4362	0x7A (122) 1 0xC (12)	----	22012	float RW
Note: Some values will be rounded off to fit in the four-character display. Full values can be read with other interfaces.								R: Read W: Write E: EEPROM S: User Set

Operations Page

Display	Parameter name Description	Range	Default	Modbus Relative Ad- dress	CIP Class Instance Attribute hex (dec)	Profibus Index	Param- eter ID	Data Type & Read/ Write
[E,SP2] [tg.SP]	<i>Profile Status</i> *Target Set Point Loop 2 View or change the tar- get set point of the cur- rent step.	-1,999.000 to 9,999.000°F or units -1,128.000 to 5,537.000°C	0.0°F or units -18.0°C	Instance 1 <i>Map 1 Map 2</i> ---- 4434	0x7A (122) 1 0x30 (48)	----	22048	float RW
[R,SP] [AC. SP]	<i>Profile Status</i> Produced Set Point 1 Display the current set point, even if the profile is ramping.	-1,999.000 to 9,999.000°F or units -1,128.000 to 5,537.000°C		Instance 1 <i>Map 1 Map 2</i> 2528 4348	----	----	22005	float R
[P,SP2] [P.SP2]	<i>Profile Status</i> Produced Set Point 2 Display the current set point, even if the profile is ramping.	-1,999.000 to 9,999.000°F or units -1,128.000 to 5,537.000°C		Instance 1 <i>Map 1 Map 2</i> ---- 4440	----	----	22051	float R
[hour] [hoUr]	<i>Profile Status</i> Hours Step time remaining in hours.	0 to 99	0	Instance 1 <i>Map 1 Map 2</i> ---- 4494	0x7A (122) 1 0x4E (78)	----	22078	uint RW
[min] [Min]	<i>Profile Status</i> Minutes Step time remaining in minutes.	0 to 59	0	Instance 1 <i>Map 1 Map 2</i> ---- 4492	0x7A (122) 1 0x4D (77)	----	22077	uint RW
[SEC] [SEC]	<i>Profile Status</i> Seconds Step time remaining in seconds.	0 to 59	0	Instance 1 <i>Map 1 Map 2</i> ---- 4490	0x7A (122) 1 0x4C (76)	----	22076	uint RW
[Ent1] [Ent1]	<i>Profile Status</i> Event 1 View or change the event output states.	[OFF] Off (62) [ON] On (63)	Off	Instance 1 <i>Map 1 Map 2</i> 2546 4366	0x7A (122) 1 0xE (14)	----	22014	uint RW
[Ent2] [Ent2]	<i>Profile Status</i> Event 2 View or change the event output states.	[OFF] Off (62) [ON] On (63)	Off	Instance 1 <i>Map 1 Map 2</i> 2548 4368	0x7A (122) 1 0xF (15)	----	22015	uint RW
[JC] [JC]	<i>Profile Status</i> Jump Count Remain- ing View the jump counts remaining for the cur- rent loop. In a profile with nested loops, this may not indicate the actual jump counts re- maining.	0 to 9,999	0	Instance 1 <i>Map 1 Map 2</i> 2538 4358	0x7A (122) 1 0xA (10)	----	22010	uint R
No Dis- play	<i>Profile Status</i> Profile State Read currentProfile state.	[OFF] Off (62) [PRUN] Running (149) [P,PRU] Pause (146)	----	Instance 1 <i>Map 1 Map 2</i> 2522 4342	0x7A (122) 1 2	----	22002	uint R
No Dis- play	<i>Profile Status</i> Current File Indicates current file be- ing executed.	1 to 4	0	Instance 1 <i>Map 1 Map 2</i> 2524 4344	0x7A (122) 1 3	----	22003	uint R
Note: Some values will be rounded off to fit in the four-character display. Full values can be read with other interfaces.								R: Read W: Write E: EEPROM S: User Set

6

Chapter 6: Setup Page

Navigating the Setup Page

To navigate to the Setup Page, follow the steps below:

1. From the Home Page, press both the Up ▲ and Down ▼ keys for six seconds. [R] will appear in the upper display and [SEE] will appear in the lower display.
2. Press the Up ▲ or Down ▼ key to view available menus.
3. Press the Advance Key ⏩ to enter the menu of choice.
4. If a submenu exists (more than one instance), press the Up ▲ or Down ▼ key to select and then press the Advance Key ⏩ to enter.
5. Press the Up ▲ or Down ▼ key to move through available menu prompts.
6. Press the Infinity Key ∞ to move backwards through the levels: parameter to submenu; submenu to menu; menu to Home Page.
7. Press and hold the Infinity Key ∞ for two seconds to return to the Home Page.

On the following pages, top level menus are identified with a yellow background color.

Note:

Keys must be held continuously until [SEE] is displayed in green. If keys are released when 'OPER' is displayed, press the infinity key or reset key to exit and repeat until [SEE] is displayed.

Note:

Some of these menus and parameters may not appear, depending on the controller's options. See model number information in the Appendix for more information. If there is only one instance of a menu, no sub-menus will appear.

Note:

Some of the listed parameters may not be visible. Parameter visibility is dependent upon controller part number.

[R]
[SEE] Analog Input Menu

[R] Analog Input (1 to 2)

- [SEN] Sensor Type
- [LIN] TC Linearization
- [rEL] RTD Leads
- [UNIT] Units
- [SLA] Scale Low
- [SHI] Scale High
- [rLO] Range Low
- [rHI] Range High
- [PEE] Process Error Enable
- [PEL] Process Error Low Value
- [tC] Thermistor Curve
- [rR] Resistance Range
- [FIL] Filter
- [iER] Input Error Latching
- [dEC] Display Precision
- [SBR] Sensor Backup
- [iCR] Calibration Offset **
- [RIN] Analog Input Value **
- [iER] Input Error Status **

[Lnr]
[SEE] Linearization Menu

[Lnr] Linearization (1 to 2)

- [FN] Function
- [UNIT] Units
- [,P,1] Input Point 1
- [oP,1] Output Point 1
- [,P,2] Input Point 2
- [oP,2] Output Point 2
- [,P,3] Input Point 3
- [oP,3] Output Point 3
- [,P,4] Input Point 4
- [oP,4] Output Point 4
- [,P,5] Input Point 5
- [oP,5] Output Point 5
- [,P,6] Input Point 6
- [oP,6] Output Point 6
- [,P,7] Input Point 7
- [oP,7] Output Point 7
- [,P,8] Input Point 8
- [oP,8] Output Point 8
- [,P,9] Input Point 9
- [oP,9] Output Point 9
- [,P,10] Input Point 10
- [oP,10] Output Point 10

[Pw]
[SEE] Process Value Menu

[Pw] Process Value (1 to 2)

- [FN] Function
- [PUNIT] Pressure Units
- [RUNIT] Altitude Units
- [bPr] Barometric Pressure
- [FIL] Filter

[dIO]
[SEE] Digital Input/Output Menu

[S]

[dIO] Digital I/O (5 to 12)

- [DIR] Direction
- [FN] Output Function
- [FI] Output Function Instance
- [oCT] Output Control
- [oTB] Output Time Base
- [oLP] Output Low Power Scale
- [oHP] Output High Power Scale
- [LEU] Active Level
- [FN] Action Function
- [FI] Function Instance

** These parameters/prompts are available with firmware revisions 11.0 and above.

L.P7
SEE Limit Menu

- L.Sd** Limit Sides
- L.hY** Limit Hysteresis
- SPLH** Set Point High Limit
- SPLL** Set Point Low Limit
- L.hS** Limit High Set Point **
- LL.S** Limit Low Set Point **
- SFnA** Source Function A **
- S.iA** Source Instance A **
- L.Cr** Limit Clear Request **
- L.SE** Limit Status **
- L.iE** Integrate with System

L.o.o.P
SEE Control Loop Menu

i

L.o.o.P Control Loop (1 to 2)

- h.A9** Heat Algorithm
- C.A9** Cool Algorithm
- C.Cr** Cool Output Curve
- h.Pb** Heat Proportional Band
- h.hY** Heat Hysteresis
- C.Pb** Cool Proportional Band
- C.hY** Cool Hysteresis
- t**, Time Integral
- t.d** Time Derivative
- db** Dead Band
- t.t.U.n** TRU-TUNE+ Enable
- t.b.n.d** TRU-TUNE+ Band
- t.g.n** TRU-TUNE+ Gain
- A.E.S.P** Autotune Set Point
- t.A.g.r** Autotune Aggressiveness
- P.d.L** Peltier Delay
- r.E.n** Remote Set Point Enable
- r.t.Y** Remote Set Point Type
- U.F.A** User Failure Action
- F.A.i.L** Input Error Failure
- P7A.n** Fixed Power
- L.d.E** Open Loop Detect Enable
- L.d.t** Open Loop Detect Time
- L.d.d** Open Loop Detect Deviation
- r.P** Ramp Action
- r.S.C** Ramp Scale
- r.r.t** Ramp Rate
- L.S.P** Low Set Point
- h.S.P** High Set Point
- C.S.P** Closed Loop Set Point
- i.d.S** Idle Set Point
- S.P.L.o** Set Point Open Limit Low
- S.P.h.i** Set Point Open Limit High
- o.S.P** Open Loop Set Point
- C.P7** Control Mode

o.t.P.E
SEE Output Menu

i

o.t.P.E Output (1 to 4)

- F.n** Output Function
- F.i** Output Function Instance
- o.C.E** Output Control
- o.t.b** Output Time Base
- o.L.o** Output Low Power Scale
- o.h.i** Output High Power Scale

o.t.P.E Output Process (1, 3)

- o.t.Y** Output Type
- F.n** Output Function
- r.S.r** Retransmit Source
- F.i** Output Function Instance
- S.L.o** Scale Low
- S.h.i** Scale High
- r.L.o** Range Low
- r.h.i** Range High
- o.L.o** Output Low Power Scale

o.h.o Output High Power Scale
o.C.A Calibration Offset

A.L.P7
SEE Alarm Menu

i

A.L.P7 Alarm (1 to 4)

- A.E.Y** Alarm Type
- S.r.A** Alarm Source
- .S.A** Alarm Source Instance
- L.o.o.P** Control Loop
- A.h.Y** Alarm Hysteresis
- A.L.g** Alarm Logic
- A.S.d** Alarm Sides
- A.L.o** Alarm Low Set Point
- A.h.i** Alarm High Set Point
- A.L.A** Alarm Latching
- A.b.L** Alarm Blocking
- A.S**, Alarm Silencing
- A.d.S.P** Alarm Display
- A.d.L** Alarm Delay Time
- A.C.C.R** Alarm Clear Request
- A.S.i.r** Alarm Silence Request
- A.S.t** Alarm State

C.U.r.r
SEE Current Menu

- C.S.d** Current Sides
- C.U.r** Current Read Enable
- C.d.t** Current Detection Threshold
- C.S.C** Input Current Scaling
- C.o.F.S** Heater Current Offset
- C.S.i** Current Output Source Instance

P7A.E
SEE Math Menu

- F.n** Function
- S.F.n.E** Source Function E
- S.i.E** Source Instance E
- S.L.o** Scale Low
- S.h.i** Scale High
- r.L.o** Range Low
- r.h.i** Range High
- F.i.L** Filter

S.o.F
SEE Special Output Function Menu

- F.n** Function
- S.F.n.A** Source Function A
- S.i.A** Source Instance A
- S.F.n.B** Source Function B
- S.i.B** Source Instance B
- P.o.n.A** Power On Level 1
- P.o.f.A** Power Off Level 1
- P.o.n.b** Power On Level 2
- P.o.f.b** Power Off Level 2
- o.n.t** On Time
- o.f.t** Off Time
- t.t** Valve Travel Time
- db** Dead Band
- t.d.L** Time Delay

F.U.n
SEE Function Key Menu

i

F.U.n Function Key (1 to 2)

- L.E.u** Active Level
- F.n** Action Function
- F.i** Function Instance

9.L.b.L
SEE Global Menu

- C.F** Display Units
- A.C.L.F** AC Line Frequency
- r.t.Y.P** Ramping Type
- P.t.Y.P** Profile Type
- 9.S.E** Guaranteed Soak Enable
- 9.S.d.1** Guaranteed Soak Deviation 1
- 9.S.d.2** Guaranteed Soak Deviation 2
- S.i.A** Source Instance A
- S.i.B** Source Instance B
- P.o.t**, Power Off Time
- S.u.t.b** Synchronized Variable Time Base
- C.L.E.d** Communications LED Action
- z.o.n.e** Zone
- C.h.A.n** Channel
- d.P.r.S** Display Pairs
- d.t.i** Display Time
- U.S.r.S** User Settings Save
- U.S.r.r** User Settings Restore

C.O.P7
SEE Communications Menu

i

C.O.P7 Communications (1 to 2)

- P.C.o.L** Protocol
- A.d.S** Standard Bus Address
- b.A.U.d** Baud Rate
- P.A.r** Parity
- P7.h.L** Modbus Word Order
- .P.P7** IP Address Mode
- .P.F.1** IP Fixed Address Part 1
- .P.F.2** IP Fixed Address Part 2
- .P.F.3** IP Fixed Address Part 3
- .P.F.4** IP Fixed Address Part 4
- .P.F.5** IP Fixed Address Part 5
- .P.F.6** IP Fixed Address Part 6
- .P.S.1** IP Fixed Subnet Part 1
- .P.S.2** IP Fixed Subnet Part 2
- .P.S.3** IP Fixed Subnet Part 3
- .P.S.4** IP Fixed Subnet Part 4
- .P.S.5** IP Fixed Subnet Part 5
- .P.S.6** IP Fixed Subnet Part 6
- .P.G.1** IP Fixed Gateway Part 1
- .P.G.2** IP Fixed Gateway Part 2
- .P.G.3** IP Fixed Gateway Part 3
- .P.G.4** IP Fixed Gateway Part 4
- .P.G.5** IP Fixed Gateway Part 5
- .P.G.6** IP Fixed Gateway Part 6
- P7.b.E** Modbus TCP Enable
- E.P.E** EtherNet/IP Enable
- R.o.n.b** CIP Implicit Assembly Output Member Quantity
- R.i.n.b** CIP Implicit Assembly Input Member Quantity
- C.F** Display Units
- P7.A.P** Data Map
- n.v.S** Non-Volatile Save

r.t.C
SEE Real Time Clock

- h.o.U.r** Hours
- P7.m** Minutes
- d.o.W** Day of Week

Setup Page

Display	Parameter Name Description	Range	Default	Modbus Relative Address	CIP Class Instance Attribute hex (dec)	Profibus Index	Parameter ID	Data Type & Read/Write
<div style="border: 1px solid black; padding: 2px;"> <input type="checkbox"/> A <input type="checkbox"/> SEt Analog Input Menu </div>								
<input type="checkbox"/> SEn [SEn]	<p><i>Analog Input (1 to 2)</i></p> <p>Sensor Type Set the analog sensor type to match the device wired to this input.</p> <p>Note: There is no open-sensor detection for process inputs.</p>	<input type="checkbox"/> oFF Off (62) <input type="checkbox"/> tC Thermocouple (95) <input type="checkbox"/> mV Millivolts (56) <input type="checkbox"/> vdc Volts dc (104) <input type="checkbox"/> mA Milliamps dc (112) <input type="checkbox"/> RTD 100 RTD 100 Ω (113) <input type="checkbox"/> RTD 1000 RTD 1,000 Ω (114) <input type="checkbox"/> Pot Potentiometer 1 kΩ (155) <input type="checkbox"/> Therm Thermistor (229)	Off	<p>Instance 1 Map 1 Map 2 368 368</p> <p>Instance 2 Map 1 Map 2 448 458</p>	0x68 (104) 1 to 2 5	3	4005	uint RWES
<input type="checkbox"/> Lin [Lin]	<p><i>Analog Input (1 to 2)</i></p> <p>TC Linearization Set the linearization to match the thermocouple wired to this input.</p>	<input type="checkbox"/> B (11) <input type="checkbox"/> H K (48) <input type="checkbox"/> C (15) <input type="checkbox"/> N (58) <input type="checkbox"/> D (23) <input type="checkbox"/> R (80) <input type="checkbox"/> E (26) <input type="checkbox"/> S (84) <input type="checkbox"/> F (30) <input type="checkbox"/> T (93) <input type="checkbox"/> J (46)	J	<p>Instance 1 Map 1 Map 2 370 370</p> <p>Instance 2 Map 1 Map 2 450 460</p>	0x68 (104) 1 to 2 6	4	4006	uint RWES
<input type="checkbox"/> rtL [rt.L]	<p><i>Analog Input (1 to 2)</i></p> <p>RTD Leads Set to match the number of leads on the RTD wired to this input.</p>	<input type="checkbox"/> 2 2 (1) <input type="checkbox"/> 3 3 (2)	2	<p>Instance 1 Map 1 Map 2 372 372</p> <p>Instance 2 Map 1 Map 2 452 462</p>	0x68 (104) 1 to 2 7	----	4007	uint RWES
<input type="checkbox"/> Unit [Unit]	<p><i>Analog Input (1 to 2)</i></p> <p>Units Set the type of units the sensor will measure.</p>	<input type="checkbox"/> AT Absolute Temperature (1540) <input type="checkbox"/> rh Relative Humidity (1538) <input type="checkbox"/> Proc Process (75) <input type="checkbox"/> Power (73)	Process	<p>Instance 1 Map 1 Map 2 ---- 442</p> <p>Instance 2 Map 1 Map 2 ---- 532</p>	0x68 (104) 1 to 2 0x2A (42)	5	4042	uint RWES
<input type="checkbox"/> SLo [S.Lo]	<p><i>Analog Input (1 to 2)</i></p> <p>Scale Low Set the low scale for process inputs. This value, in millivolts, volts or milliamps, will correspond to the Range Low output of this function block.</p>	-100.0 to 1,000.0	0.0	<p>Instance 1 Map 1 Map 2 388 388</p> <p>Instance 2 Map 1 Map 2 468 478</p>	0x68 (104) 1 to 2 0xF (15)	6	4015	float RWES
<input type="checkbox"/> Shi [S.hi]	<p><i>Analog Input (1 to 2)</i></p> <p>Scale High Set the high scale for process inputs. This value, in millivolts, volts or milliamps, will correspond to the Range High output of this function block.</p>	-100.0 to 1,000.0	20.0	<p>Instance 1 Map 1 Map 2 390 390</p> <p>Instance 2 Map 1 Map 2 470 480</p>	0x68 (104) 1 to 2 0x10 (16)	7	4016	float RWES
<input type="checkbox"/> rLo [r.Lo]	<p><i>Analog Input (1 to 2)</i></p> <p>Range Low Set the low range for this function block's output.</p>	-1,999.000 to 9,999.000	0.0	<p>Instance 1 Map 1 Map 2 392 392</p> <p>Instance 2 Map 1 Map 2 472 482</p>	0x68 (104) 1 to 2 0x11 (17)	8	4017	float RWES
<p>Note: Some values will be rounded off to fit in the four-character display. Full values can be read with other interfaces.</p>								R: Read W: Write E: EEPROM S: User Set

Setup Page

Display	Parameter Name Description	Range	Default	Modbus Relative Address	CIP Class Instance Attribute hex (dec)	Pro-fibus Index	Parameter ID	Data Type & Read/Write
<input type="checkbox"/> r.h.i. [r.hi]	<i>Analog Input (1 to 2)</i> Range High Set the high range for this function block's output.	-1,999.000 to 9,999.000	9,999	Instance 1 Map 1 Map 2 394 394 Instance 2 Map 1 Map 2 474 484	0x68 (104) 1 to 2 0x12 (18)	9	4018	float RWES
<input type="checkbox"/> P.EE [P.EE]	<i>Analog Input (1 to 2)</i> Process Error Enable Turn the Process Error Low feature on or off.	<input type="checkbox"/> OFF Off (62) <input type="checkbox"/> LOUJ Low (53)	Off	Instance 1 Map 1 Map 2 418 418 Instance 2 Map 1 Map 2 498 508	0x68 (104) 1 to 2 0x1E (30)	10	4030	uint RWES
<input type="checkbox"/> P.E.L [P.E.L]	<i>Analog Input (1 to 2)</i> Process Error Low Value If the process value drops below this value, it will trigger an input error.	-100.0 to 1,000.0	0.0	Instance 1 Map 1 Map 2 420 420 Instance 2 Map 1 Map 2 500 510	0x68 (104) 1 to 2 0x1F (31)	11	4031	float RWES
<input type="checkbox"/> t.C [t.C]	<i>Analog Input (1 to 2)</i> Thermistor Curve Select a curve to apply to the thermistor input.	<input type="checkbox"/> A Curve A (1451) <input type="checkbox"/> B Curve B (1452) <input type="checkbox"/> C Curve C (1453) <input type="checkbox"/> USE Custom (180)	Curve A	Instance 1 Map 1 Map 2 434 434 Instance 2 Map 1 Map 2 514 524	0x68 (104) 1 to 2 20x6 (38)	----	4038	uint RWES
<input type="checkbox"/> r.r [r.r]	<i>Analog Input (1 to 2)</i> Resistance Range Set the maximum resistance of the thermistor input.	<input type="checkbox"/> 5 5K (1448) <input type="checkbox"/> 10 10K (1360) <input type="checkbox"/> 20 20K (1361) <input type="checkbox"/> 40 40K (1449)	40K	Instance 1 Map 1 Map 2 432 432 Instance 2 Map 1 Map 2 512 522	0x68 (104) 1 to 2 0x25 (37)	----	4037	uint RWES
<input type="checkbox"/> F.i.L [FiL]	<i>Analog Input (1 to 2)</i> Filter Filtering smooths out the process signal to both the display and the input. Increase the time to increase filtering.	0.0 to 60.0 seconds	0.5	Instance 1 Map 1 Map 2 386 386 Instance 2 Map 1 Map 2 466 476	0x68 (104) 1 to 2 0xE (14)	12	4014	float RWES
<input type="checkbox"/> i.Er [i.Er]	<i>Analog Input (1 to 2)</i> Input Error Latching Turn input error latching on or off. If latching is on, errors must be manually cleared.	<input type="checkbox"/> OFF Off (62) <input type="checkbox"/> ON On (63)	Off	Instance 1 Map 1 Map 2 414 414 Instance 2 Map 1 Map 2 494 504	0x68 (104) 1 to 2 0x1C (28)	----	4028	uint RWES
<input type="checkbox"/> d.EC [d.EC]	<i>Analog Input (1 to 2)</i> Display Precision Set the precision of the displayed value.	<input type="checkbox"/> 0 Whole (105) <input type="checkbox"/> 00 Tenths (94) <input type="checkbox"/> 000 Hundredths (40) <input type="checkbox"/> 0000 Thousandths (96)	Whole	Instance 1 Map 1 Map 2 398 398 Instance 2 Map 1 Map 2 478 488	0x68 (104) 1 to 2 0x14 (20)	----	4020	uint RWES
Note: Some values will be rounded off to fit in the four-character display. Full values can be read with other interfaces.								R: Read W: Write E: EEPROM S: User Set

Setup Page

Display	Parameter Name Description	Range	Default	Modbus Relative Address	CIP Class Instance Attribute hex (dec)	Profibus Index	Parameter ID	Data Type & Read/Write
<input type="checkbox"/> Cal [i.CA]	<i>Analog Input (1 to 2)</i> Calibration Offset Offset the input reading to compensate for lead wire resistance or other factors that cause the input reading to vary from the actual process value.	-1,999.000 to 9,999.000°F or units -1,110.555 to 5,555.000°C	0.0	Instance 1 <i>Map 1</i> <i>Map 2</i> 382 382 Instance 2 <i>Map 1</i> <i>Map 2</i> 462 472	0x68 (104) 1 to 2 0x0C (12)	2	4012	float RWES
<input type="checkbox"/> Ain [Ain]	<i>Analog Input (1 to 2)</i> Analog Input Value View the process value. Note: Ensure that the Input Error Status (below) indicates no error (61) when reading this value using a field bus protocol. If an error exists, the last known value prior to the error occurring will be returned.	-1,999.000 to 9,999.000°F or units -1,128.000 to 5,537.000°C	----	Instance 1 <i>Map 1</i> <i>Map 2</i> 360 360 Instance 2 <i>Map 1</i> <i>Map 2</i> 440 450	0x68 (104) 1 to 2 1	0	4001	float R
<input type="checkbox"/> Er [i.Er]	<i>Analog Input (1 to 2)</i> Input Error Status View the cause of the most recent error. If the REn message is Err1 or Err2 , this parameter will display the cause of the input error.	<input type="checkbox"/> None (61) <input type="checkbox"/> Open (65) <input type="checkbox"/> Shorted (127) <input type="checkbox"/> Measurement Error (149) <input type="checkbox"/> Bad Calibration Data (139) <input type="checkbox"/> Ambient Error (9) <input type="checkbox"/> RTD Error (141) <input type="checkbox"/> Fail (32) <input type="checkbox"/> Not Sourced (246)	None	Instance 1 <i>Map 1</i> <i>Map 2</i> 362 362 Instance 2 <i>Map 1</i> <i>Map 2</i> 442 452	0x68 (104) 1 to 2 2	1	4002	float R
<input type="checkbox"/> Lin <input type="checkbox"/> Set Linearization Menu								
<input type="checkbox"/> Fn [Fn]	<i>Linearization (1 to 2)</i> Function Set how this function will linearize Source A which is Analog Input 1. Source A of Linearization 2 is Analog Input 2.	<input type="checkbox"/> Off (62) <input type="checkbox"/> Interpolated (1482)	Off	Instance 1 <i>Map 1</i> <i>Map 2</i> ---- 3568 Instance 2 <i>Map 1</i> <i>Map 2</i> ---- 3638	0x86 (134) 1 to 2 5	155	34005	uint RWES
<input type="checkbox"/> Unit [Unit]	<i>Linearization (1 to 2)</i> Units Set the units of Source A or Analog Input 1. Source A of Linearization 2 is Analog Input 2.	<input type="checkbox"/> Source (1539) <input type="checkbox"/> Relative Humidity (1538) <input type="checkbox"/> Process (75) <input type="checkbox"/> Power (73) <input type="checkbox"/> Relative Temperature (1541) <input type="checkbox"/> Absolute Temperature (1540) <input type="checkbox"/> None (61)	Source	Instance 1 <i>Map 1</i> <i>Map 2</i> ---- 3616 Instance 2 <i>Map 1</i> <i>Map 2</i> ---- 3686	0x86 (134) 1 to 2 0x29 (41)	156	34029	uint RWES
Note: Some values will be rounded off to fit in the four-character display. Full values can be read with other interfaces.								R: Read W: Write E: EEPROM S: User Set

Setup Page

Display	Parameter Name Description	Range	Default	Modbus Relative Address	CIP Class Instance Attribute hex (dec)	Pro-fibus Index	Parameter ID	Data Type & Read/Write
[P.1] [ip.1]	<i>Linearization (1 to 2)</i> Input Point 1 Set the value that will be mapped to output 1.	-1,999.000 to 9,999.000	0.0	Instance 1 Map 1 Map 2 ---- 3574 Instance 2 Map 1 Map 2 ---- 3644	0x86 (134) 1 to 2 8	157	34008	float RWES
[oP.1] [op.1]	<i>Linearization (1 to 2)</i> Output Point 1 Set the value that will be mapped to input 1.	-1,999.000 to 9,999.000	0.0	Instance 1 Map 1 Map 2 ---- 3594 Instance 2 Map 1 Map 2 ---- 3664	0x86 (134) 1 to 2 0x12 (18)	158	34018	float RWES
[P.2] [ip.2]	<i>Linearization (1 to 2)</i> Input Point 2 Set the value that will be mapped to output 2.	-1,999.000 to 9,999.000	1.0	Instance 1 Map 1 Map 2 ---- 3576 Instance 2 Map 1 Map 2 ---- 3646	0x86 (134) 1 to 2 9	159	34009	float RWES
[oP.2] [op.2]	<i>Linearization (1 to 2)</i> Output Point 2 Set the value that will be mapped to input 2.	-1,999.000 to 9,999.000	1.0	Instance 1 Map 1 Map 2 ---- 3596 Instance 2 Map 1 Map 2 ---- 3666	0x86 (134) 1 to 2 0x13 (19)	160	34019	float RWES
[P.3] [ip.3]	<i>Linearization (1 to 2)</i> Input Point 3 Set the value that will be mapped to output 3.	-1,999.000 to 9,999.000	2.0	Instance 1 Map 1 Map 2 ---- 3578 Instance 2 Map 1 Map 2 ---- 3648	0x86 (134) 1 to 2 0xA (10)	161	34010	float RWES
[oP.3] [op.3]	<i>Linearization (1 to 2)</i> Output Point 3 Set the value that will be mapped to input 3.	-1,999.000 to 9,999.000	2.0	Instance 1 Map 1 Map 2 ---- 3598 Instance 2 Map 1 Map 2 ---- 3668	0x86 (134) 1 to 2 0x14 (20)	162	34020	float RWES
[P.4] [ip.4]	<i>Linearization (1 to 2)</i> Input Point 4 Set the value that will be mapped to output 4.	-1,999.000 to 9,999.000	3.0	Instance 1 Map 1 Map 2 ---- 3580 Instance 2 Map 1 Map 2 ---- 3651	0x86 (134) 1 to 2 0xB (11)	163	34011	float RWES
[oP.4] [op.4]	<i>Linearization (1 to 2)</i> Output Point 4 Set the value that will be mapped to input 4.	-1,999.000 to 9,999.000	3.0	Instance 1 Map 1 Map 2 ---- 3600 Instance 2 Map 1 Map 2 ---- 3670	0x86 (134) 1 to 2 0x15 (21)	164	34021	float RWES
[P.5] [ip.5]	<i>Linearization (1 to 2)</i> Input Point 5 Set the value that will be mapped to output 5.	-1,999.000 to 9,999.000	4.0	Instance 1 Map 1 Map 2 ---- 3582 Instance 2 Map 1 Map 2 ---- 3652	0x86 (134) 1 to 2 0xC (12)	165	34012	float RWES
Note: Some values will be rounded off to fit in the four-character display. Full values can be read with other interfaces.								R: Read W: Write E: EEPROM S: User Set

Setup Page

Display	Parameter Name Description	Range	Default	Modbus Relative Address	CIP Class Instance Attribute hex (dec)	Pro-fibus Index	Parameter ID	Data Type & Read/Write
<input type="checkbox"/> P.5 [op.5]	<i>Linearization (1 to 2)</i> Output Point 5 Set the value that will be mapped to input 5.	-1,999.000 to 9,999.000	4.0	Instance 1 Map 1 Map 2 ---- 3602 Instance 2 Map 1 Map 2 ---- 3672	0x86 (134) 1 to 2 0x16 (22)	166	34022	float RWES
<input type="checkbox"/> P.6 [ip.6]	<i>Linearization (1 to 2)</i> Input Point 6 Set the value that will be mapped to output 6.	-1,999.000 to 9,999.000	5.0	Instance 1 Map 1 Map 2 ---- 3584 Instance 2 Map 1 Map 2 ---- 3654	0x86 (134) 1 to 2 0xD (13)	167	34013	float RWES
<input type="checkbox"/> P.6 [op.6]	<i>Linearization (1 to 2)</i> Output Point 6 Set the value that will be mapped to input 6.	-1,999.000 to 9,999.000	5.0	Instance 1 Map 1 Map 2 ---- 3604 Instance 2 Map 1 Map 2 ---- 3674	0x86 (134) 1 to 2 0x17 (23)	168	34023	float RWES
<input type="checkbox"/> P.7 [ip.7]	<i>Linearization (1 to 2)</i> Input Point 7 Set the value that will be mapped to output 7.	-1,999.000 to 9,999.000	6.0	Instance 1 Map 1 Map 2 ---- 3586 Instance 2 Map 1 Map 2 ---- 3656	0x86 (134) 1 to 2 0xE (14)	169	34014	float RWES
<input type="checkbox"/> P.7 [op.7]	<i>Linearization (1 to 2)</i> Output Point 7 Set the value that will be mapped to input 7.	-1,999.000 to 9,999.000	6.0	Instance 1 Map 1 Map 2 ---- 3606 Instance 2 Map 1 Map 2 ---- 3676	0x86 (134) 1 to 2 0x18 (24)	170	34024	float RWES
<input type="checkbox"/> P.8 [ip.8]	<i>Linearization (1 to 2)</i> Input Point 8 Set the value that will be mapped to output 8.	-1,999.000 to 9,999.000	7.0	Instance 1 Map 1 Map 2 ---- 3588 Instance 2 Map 1 Map 2 ---- 3658	0x86 (134) 1 to 2 0xF (15)	171	34015	float RWES
<input type="checkbox"/> P.8 [op.8]	<i>Linearization (1 to 2)</i> Output Point 8 Set the value that will be mapped to input 8.	-1,999.000 to 9,999.000	7.0	Instance 1 Map 1 Map 2 ---- 3608 Instance 2 Map 1 Map 2 ---- 3678	0x86 (134) 1 to 2 0x19 (25)	172	34025	float RWES
<input type="checkbox"/> P.9 [ip.9]	<i>Linearization (1 to 2)</i> Input Point 9 Set the value that will be mapped to output 9.	-1,999.000 to 9,999.000	8.0	Instance 1 Map 1 Map 2 ---- 3590 Instance 2 Map 1 Map 2 ---- 3660	0x86 (134) 1 to 2 0x10 (16)	173	34016	float RWES
<input type="checkbox"/> P.9 [op.9]	<i>Linearization (1 to 2)</i> Output Point 9 Set the value that will be mapped to input 9.	-1,999.000 to 9,999.000	8.0	Instance 1 Map 1 Map 2 ---- 3610 Instance 2 Map 1 Map 2 ---- 3680	0x86 (134) 1 to 2 0x1A (26)	174	34026	float RWES
Note: Some values will be rounded off to fit in the four-character display. Full values can be read with other interfaces.								R: Read W: Write E: EEPROM S: User Set

Setup Page

Display	Parameter Name Description	Range	Default	Modbus Relative Address	CIP Class Instance Attribute hex (dec)	Pro-fibus Index	Parameter ID	Data Type & Read/Write
[P.10] [ip.10]	<i>Linearization (1 to 2)</i> Input Point 10 Set the value that will be mapped to output 10.	-1,999.000 to 9,999.000	9.0	Instance 1 Map 1 Map 2 ---- 3592 Instance 2 Map 1 Map 2 ---- 3662	0x86 (134) 1 to 2 0x11 (17)	175	34017	float RWES
[oP.10] [op.10]	<i>Linearization (1 to 2)</i> Output Point 10 Set the value that will be mapped to input 10.	-1,999.000 to 9,999.000	9.0	Instance 1 Map 1 Map 2 ---- 3612 Instance 2 Map 1 Map 2 ---- 3682	0x86 (134) 1 to 2 0x1B (27)	176	34027	float RWES
<p>[Pu] [SEt] Process Value Menu</p>								
[Fn] [Fn]	<i>Process Value (1 to 2)</i> Function Set the function that will be applied to the source or sources. Note: Differential and Ratio not available using instance 2.	[oFF] Off (62) [uSLR] Vaisala RH Compensation (1648) [LDb] Wet Bulb/Dry Bulb (1369) [SbR] Sensor Backup (1201) [rRt] Ratio (1374) [dIFF] Differential (1373) [root] Square Root (1380) [ALt] **Pressure to Altitude (1649)	Off	Instance 1 Map 1 Map 2 ---- 3320 Instance 2 Map 1 Map 2 ---- 3390	0x7E (126) 1 to 2 0x15 (21)	123	26021	uint RWES
[P.unt] [P.unt]	<i>Process Value (1 to 2)</i> Pressure Units** Set the units that will be applied to the source.	[PSI] Pounds per Square Inch (1671) [PaSc] Pascal (1674) [Atm] Atmosphere (1675) [mBar] Millibar (1672) [Torr] Torr (1673)	PSI	Instance 1 Map 1 Map 2 ---- 3334 Instance 2 Map 1 Map 2 ---- 3404	0x7E (126) 1 to 2 0x1C (28)	----	26028	uint RWES
[A.unt] [A.unt]	<i>Process Value (1 to 2)</i> Altitude Units** Set the units that will be applied to the source.	[HFt] Kilofeet (1677) [Ft] Feet (1676)	HFt	Instance 1 Map 1 Map 2 ---- 3336 Instance 2 Map 1 Map 2 ---- 3406	0x7E (126) 1 to 2 0x1D (29)	----	26029	uint RWES
[b.Pr] [b.Pr]	<i>Process Value (1 to 2)</i> Barometric Pressure** Set the units that will be applied to the source.	10.0 to 16.0	14.7	Instance 1 Map 1 Map 2 ---- 3338 Instance 2 Map 1 Map 2 ---- 3408	0x7E (126) 1 to 2 0x1E (30)	----	26030	float RWES
[FiL] [FiL]	<i>Process Value (1 to 2)</i> Filter Filtering smooths out the output signal of this function block. Increase the time to increase filtering.	0.0 to 60.0 seconds	0.0	Instance 1 Map 1 Map 2 ---- 3330 Instance 2 Map 1 Map 2 ---- 3400	0x7E (126) 1 to 2 0x1A (26)	----	26026	float RWES
Note: Some values will be rounded off to fit in the four-character display. Full values can be read with other interfaces.								R: Read W: Write E: EEPROM S: User Set

** Pressure Altitude calculation is based on the International Standard Atmosphere 1976

Setup Page

Display	Parameter Name Description	Range	Default	Modbus Relative Address	CIP Class Instance Attribute hex (dec)	Pro-fibus Index	Parameter ID	Data Type & Read/Write
<div style="border: 1px solid black; padding: 2px;"> d.i.o SEt </div> Digital Input / Output Menu								
<div style="border: 1px solid black; padding: 2px;"> d.i.r [dir] </div>	Digital Input/Output (5 to 12) Digital I/O Direction Set this function to operate as an input or output. Note: Modbus Map 1 has instances 5 through 8 only	OPE Output (68) iCon Input Dry Contact (44) .in Input Voltage (193)	Output	Instance 5 Map 1 Map 2 1000 1120 Offset to next instance (Map 1 & Map 2) equals +30	0x6A (106) 5 to C (12) 1	82	6001	uint RWES
<div style="border: 1px solid black; padding: 2px;"> Fn [Fn] </div>	Digital Output (5 to 12) Output Function Select what function will drive this output. Note: Modbus Map 1 has instances 5 through 8 only	OFF Off (62) EntB Profile Event Out B (234) EntA Profile Event Out A (233) Sof2 Special Function Output 2 (1533) Sof1 Special Function Output 1 (1532) Cool Cool (20) HEAT Heat (36) ALRM Alarm (6)	Off	Instance 5 Map 1 Map 2 1008 1128 Offset to next instance (Map 1 & Map 2) equals +30	0x6A (106) 5 to C (12) 5	83	6005	uint RWES
<div style="border: 1px solid black; padding: 2px;"> Fi [Fi] </div>	Digital Output (5 to 12) Output Function Instance Set the instance of the function selected above. Note: Modbus Map 1 has instances 5 through 8 only	1 to 4	1	Instance 5 Map 1 Map 2 1010 1130 Offset to next instance (Map 1 & Map 2) equals +30	0x6A (106) 5 to C (12) 6	84	6006	uint RWES
<div style="border: 1px solid black; padding: 2px;"> o.Ct [o.Ct] </div>	Digital Output (5 to 12) Output Control Set the output control type. This parameter is only used with PID control, but can be set anytime. Note: Modbus Map 1 has instances 5 through 8 only	FTB Fixed Time Base (34) vTB Variable Time Base (103)	Fixed Time Base	Instance 5 Map 1 Map 2 1002 1122 Offset to next instance (Map 1 & Map 2) equals +30	0x6A (106) 5 to C (12) 2	85	6002	uint RWES
<div style="border: 1px solid black; padding: 2px;"> o.tb [o.tb] </div>	Digital Output (5 to 12) Output Time Base Set the time base for fixed-time-base control. Note: Modbus Map 1 has instances 5 through 8 only	[0.1 for Fast and Bi-Directional outputs, 5.0 for Slow outputs] to 60	5.0	Instance 5 Map 1 Map 2 1004 1124 Offset to next instance (Map 1 & Map 2) equals +30	0x6A (106) 5 to C (12) 3	86	6003	float RWES
Note: Some values will be rounded off to fit in the four-character display. Full values can be read with other interfaces.								R: Read W: Write E: EEPROM S: User Set

Setup Page

Display	Parameter Name Description	Range	Default	Modbus Relative Address	CIP Class Instance Attribute hex (dec)	Pro-fibus Index	Parameter ID	Data Type & Read/Write
<u>o.Lo</u> [o.Lo]	<i>Digital Output (5 to 12)</i> Output Low Power Scale The power output will never be less than the value specified and will represent the value at which output scaling begins.	0.0 to 100.0	0.0	Instance 5 <i>Map 1</i> <i>Map 2</i> 1016 1136 Offset to next instance (<i>Map 1</i> & <i>Map 2</i>) equals +30	0x6A (106) 5 to C (12) 9	87	6009	float RWES
<u>o.h</u> [o.hi]	<i>Digital Output (5 to 12)</i> Output High Power Scale The power output will never be greater than the value specified and will represent the value at which output scaling stops.	0.0 to 100.0	100.0	Instance 5 <i>Map 1</i> <i>Map 2</i> 1018 1138 Offset to next instance (<i>Map 1</i> & <i>Map 2</i>) equals +30	0x6A (106) 5 to C (12) 0xA (10)	88	6010	float RWES
<u>LEu</u> [LEv]	<i>Digital Input (5 to 6)</i> Active Level Select which action will be interpreted as a true state.	<u>h,9h</u> High (37) <u>LoLu</u> Low (53)	High	Instance 5 <i>Map 1</i> <i>Map 2</i> 1320 1560 Offset to next instance (<i>Map 1</i> & <i>Map 2</i>) equals +20	0x6E (110) 5 to 6 1	137	10001	uint RW
<u>LEu</u> [LEv]	<i>Digital Input (7 to 12)</i> Active Level Select which action will be interpreted as a true state. Note: Modbus Map 1 has instances 7 and 8 only	<u>h,9h</u> High (37) <u>LoLu</u> Low (53)	High	Instance 7 <i>Map 1</i> <i>Map 2</i> 1400 1640 Offset to next instance <i>Map 2</i> equals +20	0x6E (110) 7 to C (12) 1	137	10001	uint RW
Note: Some values will be rounded off to fit in the four-character display. Full values can be read with other interfaces.								R: Read W: Write E: EEPROM S: User Set

Setup Page

Display	Parameter Name Description	Range	Default	Modbus Relative Address	CIP Class Instance Attribute hex (dec)	Pro- fibus Index	Param- eter ID	Data Type & Read/ Write
<input type="checkbox"/> Fn [Fn]	Digital Input (5 to 6) Action Function Select the function that will be triggered by a true state for Digital Inputs 5 to 6.	<input type="checkbox"/> None None (61) <input type="checkbox"/> Start Step Start Step (1077) <input type="checkbox"/> Profile Start/Stop Profile Start/Stop, level triggered (208) <input type="checkbox"/> Profile Start Start Profile, edge triggered (196) <input type="checkbox"/> Profile Hold/Resume Profile Hold/Resume, level triggered (207) <input type="checkbox"/> Profile Disable Profile Disable, level triggered (206) <input type="checkbox"/> TRU-TUNE+® Disable TRU-TUNE+® Disable, level triggered (219) <input type="checkbox"/> Switch Control Loop Off Switch Control Loop Off, level triggered (90) <input type="checkbox"/> Manual Manual, level triggered (54) <input type="checkbox"/> Tune Tune, edge triggered (98) <input type="checkbox"/> Idle Set Point Idle Set Point, level triggered (107) <input type="checkbox"/> Force Alarm to occur Force Alarm to occur, level triggered (218) <input type="checkbox"/> Control Loops Off and Alarms to Non-alarm State Control Loops Off and Alarms to Non-alarm State, level triggered (220) <input type="checkbox"/> Silence Alarms Silence Alarms, edge triggered (108) <input type="checkbox"/> Alarm Reset Alarm Reset, edge triggered (6) <input type="checkbox"/> Keypad Lockout Keypad Lockout, level triggered (217) <input type="checkbox"/> User Set Restore User Set Restore, edge triggered (227) <input type="checkbox"/> Limit Reset Limit Reset, edge triggered (82) <input type="checkbox"/> Remote Set Point enable Remote Set Point enable (216)	None	Instance 5 <i>Map 1</i> <i>Map 2</i> 1324 1564 Offset to next instance (<i>Map 1 & Map 2</i>) equals +20	0x6E (110) 5 to 6 3	138	10003	uint RWES
Note: Some values will be rounded off to fit in the four-character display. Full values can be read with other interfaces.								R: Read W: Write E: EEPROM S: User Set

Setup Page

Display	Parameter Name Description	Range	Default	Modbus Relative Address	CIP Class Instance Attribute hex (dec)	Pro- fibus Index	Param- eter ID	Data Type & Read/ Write
[Fn] [Fn]	Digital Input (7 to 12) Action Function Select the function that will be triggered by a true state for Digital Inputs 7 through 12. Note: Modbus Map 1 has instances 7 through 10 only	none None (61) START Start Step (1077) START/STOP Profile Start/Stop, level triggered (208) START Start Profile, edge triggered (196) PHOLD Profile Hold/Resume, level triggered (207) DIS Profile Disable, level triggered (206) TRU-TUNE+ TRU-TUNE+® Disable, level triggered (219) OFF Switch Control Loop Off, level triggered (90) MAN Manual, level triggered (54) TUNE Tune, edge triggered (98) IDLE Idle Set Point, level triggered (107) FAL Force Alarm to occur, level triggered (218) ROF Control Loops Off and Alarms to Non-alarm State, level triggered (220) SIL Silence Alarms, edge triggered (108) ALRM Alarm Reset, edge triggered (6) PLCK Keypad Lockout, level triggered (217) USR User Set Restore, edge triggered (227) LRM Limit Reset, edge triggered (82) REN Remote Set Point enable (216)	None	Instance 7 <i>Map 1</i> <i>Map 2</i> 1404 1644 Offset to next instance (<i>Map 1</i> & <i>Map 2</i>) equals +20	0x6E (110) 7 to C (12) 3	138	10003	uint RWES
[Fi] [Fi]	Digital Input (5 to 6) Function Instance Select which Digital Input will be triggered by a true state.	0 to 4	0	Instance 5 <i>Map 1</i> <i>Map 2</i> 1326 1566 Offset to next instance (<i>Map 1</i> & <i>Map 2</i>) equals +20	0x6E (110) 5 to 6 4	139	10004	uint RWES
[Fi] [Fi]	Digital Input (7 to 12) Function Instance Select which Digital Input will be triggered by a true state. Note: Modbus Map 1 has instances 7 through 10 only	0 to 4	0	Instance 7 <i>Map 1</i> <i>Map 2</i> 1406 1646 Offset to next instance (<i>Map 1</i> & <i>Map 2</i>) equals +20	0x6E (110) 7 to C (12) 4	139	10004	uint RWES
Note: Some values will be rounded off to fit in the four-character display. Full values can be read with other interfaces.								R: Read W: Write E: EEPROM S: User Set

** These prompts are only available in this menu with firmware revision 11.0 and above.

Setup Page

Display	Parameter Name Description	Range	Default	Modbus Relative Address	CIP Class Instance Attribute hex (dec)	Pro- fibus Index	Param- eter ID	Data Type & Read/ Write
Limit Menu [L.PP] [SEt]								
[L5d] [L.Sd]	<i>Limit (1)</i> Limit Sides Select which side or sides of the process value will be monitored.	[both] Both (13) [h,9h] High (37) [low] Low (53)	Both	Instance 1 Map 1 Map 2 688 728	0x70 (112) 1 5	40	12005	uint RWES
[LhY] [L.hy]	<i>Limit (1)</i> Limit Hysteresis Set the hysteresis for the limit function. This determines how far into the safe range the process value must move before the limit can be cleared.	0.001 to 9,999.000°F or units 0.001 to 5,555.000°C	3.0°F or units 2.0°C	Instance 1 Map 1 Map 2 682 722	0x70 (112) 1 2	41	12002	float RWES
[SP.Lh] [SP.Lh]	<i>Limit (1)</i> Set Point High Limit Set the high end of the limit set point range.	-1,999.000 to 9,999.000	9,999.000	Instance 1 Map 1 Map 2 696 736	0x70 (112) 1 9	42	12009	float RWES
[SP.LL] [SP.LL]	<i>Limit (1)</i> Set Point Low Limit Set the low end of the limit set point range.	-1,999.000 to 9,999.000	-1,999.000	Instance 1 Map 1 Map 2 698 738	0x70 (112) 1 0x0A (10)	43	12010	float RWES
[LhS] [Lh.S]	<i>Limit (1)</i> Limit High Set Point ** Set the high process value that will trigger the limit.	-1,999.000 to 9,999.000°F or units -1,128.000 to 5,537.000°C	0.0°F or units -18.0°C	Instance 1 Map 1 Map 2 686 726	0x70 (112) 1 4	39	12004	float RWES
[LLS] [LL.S]	<i>Limit (1)</i> Limit Low Set Point ** Set the low process value that will trigger the limit.	-1,999.000 to 9,999.000°F or units -1,128.000 to 5,537.000°C	0.0°F or units -18.0°C	Instance 1 Map 1 Map 2 684 724	0x70 (112) 1 3	38	12003	float RWES
[SFnA] [SFn.A]	<i>Limit (1)</i> Source Function A ** Set the source for the limit reset function.	[none] None (61) [dio] Digital I/O (1142) [FUN] Function Key (1001)	None	Instance 1 Map 1 Map 2 ----- 748	0x70 (112) 1 0x0F (15)	----	12015	uint RWES
[SiA] [Si.A]	<i>Limit (1)</i> Source Instance A ** Set the instance of the function selected above.	1 to 12	1	----	0x70 (112) 1 0x10 (16)	----	12016	uint RWES
[LCr] [LCr]	<i>Limit (1)</i> Limit Clear Request ** Clear limit once limit condition is cleared.	[LCr] Clear (0) [ignr] Ignore (204)	----	Instance 1 Map 1 Map 2 680 720	0x70 (112) 1 1	----	12001	uint W
Note: Some values will be rounded off to fit in the four-character display. Full values can be read with other interfaces.								R: Read W: Write E: EEPROM S: User Set

Setup Page

Display	Parameter Name Description	Range	Default	Modbus Relative Address	CIP Class Instance Attribute hex (dec)	Profibus Index	Parameter ID	Data Type & Read/Write
LSE [L.St]	Limit (1) Limit Status ** Reflects whether or not the limit is in a safe or failed mode.	FAIL Fail (32) SAFE Safe (1667)	----	Instance 1 Map 1 Map 2 ---- 744	0x70 (112) 1 0x0D (13)	----	12013	uint R
LIE [L.it]	Limit Integrate with System In a limit state the controller will turn off the outputs, terminate an active profile and freeze PID and TRU-TUNE+® calculations.	no No (59) YES Yes (106)	No	Instance 1 Map 1 Map 2 694 734	0x70 (112) 1 8	----	12008	uint RWES
No Display	Limit (1) Limit State Clear limit once limit condition is cleared.	OFF Off (62) none None (61) L,h Limit High (51) L,l Limit Low (52) Err Error (28)	----	Instance 1 Map 1 Map 2 690 730	0x70 (112) 1 6	----	12006	uint R
Loop SEt Control Loop Menu								
hAg [h.Ag]	Control Loop (1 to 2) Heat Algorithm Set the heat control method.	OFF Off (62) PID PID (71) On-Off On-Off (64)	PID	Instance 1 Map 1 Map 2 1884 2364 Instance 2 Map 1 Map 2 1954 2434	0x97 (151) 1 to 2 3	72	8003	uint RWES
CAG [C.Ag]	Control Loop (1 to 2) Cool Algorithm Set the cool control method.	OFF Off (62) PID PID (71) On-Off On-Off (64)	Off	Instance 1 Map 1 Map 2 1886 2366 Instance 2 Map 1 Map 2 1956 2436	0x97 (151) 1 to 2 4	73	8004	uint RWES
CCr [C.Cr]	Control Loop (1 to 2) Cool Output Curve Select a cool output curve to change the responsiveness of the system.	OFF Off (62) CrA Non-linear Curve 1 (214) CrB Non-linear Curve 2 (215)	Off	Instance 1 Map 1 Map 2 1888 2368 Instance 2 Map 1 Map 2 1958 2438	0x97 (151) 1 to 2 5	----	8038	uint RWES
hPb [h.Pb]	Control Loop (1 to 2) Heat Proportional Band Set the PID proportional band for the heat outputs.	0.001 to 9,999.000°F or units -1,110.555 to 5,555.000°C	25.0°F or units 14.0°C	Instance 1 Map 1 Map 2 1890 2370 Instance 2 Map 1 Map 2 1960 2440	0x97 (151) 1 to 2 6	65	8009	float RWES
hHy [h.hy]	Control Loop (1 to 2) Heat Hysteresis Set the control switching hysteresis for on-off control. This determines how far into the “on” region the process value needs to move before the output turns on.	0.001 to 9,999.000°F or units 0.001 to 5,555.000°C	3.0°F or units 2.0°C	Instance 1 Map 1 Map 2 1900 2380 Instance 2 Map 1 Map 2 1970 2450	0x97 (151) 1 to 2 0xB (11)	66	8010	float RWES
Note: Some values will be rounded off to fit in the four-character display. Full values can be read with other interfaces.								R: Read W: Write E: EEPROM S: User Set

Setup Page

Display	Parameter Name Description	Range	Default	Modbus Relative Address	CIP Class Instance Attribute hex (dec)	Pro- fibus Index	Param- eter ID	Data Type & Read/ Write
<input type="checkbox"/> Cpb [C.Pb]	<i>Control Loop (1 to 2)</i> Cool Proportional Band Set the PID proportional band for the cool outputs.	0.001 to 9,999.000°F or units 0.001 to 5,555.000°C	25.0°F or units 14.0°C	Instance 1 <i>Map 1 Map 2</i> 1892 2372 Instance 2 <i>Map 1 Map 2</i> 1962 2442	0x97 (151) 1 to 2 7	67	8012	float RWES
<input type="checkbox"/> Chy [C.hy]	<i>Control Loop (1 to 2)</i> Cool Hysteresis Set the control switching hysteresis for on-off control. This determines how far into the “on” region the process value needs to move before the output turns on.	0.001 to 9,999.000°F or units 0.001 to 5,555.000°C	3.0°F or units 2.0°C	Instance 1 <i>Map 1 Map 2</i> 1902 2382 Instance 2 <i>Map 1 Map 2</i> 1972 2522	0x97 (151) 1 to 2 0xC (12)	68	8013	float RWES
<input type="checkbox"/> ti [ti]	<i>Control Loop (1 to 2)</i> Time Integral Set the PID integral for the outputs.	0 to 9,999 seconds per repeat	180 seconds per repeat	Instance 1 <i>Map 1 Map 2</i> 1894 2374 Instance 2 <i>Map 1 Map 2</i> 1964 2444	0x97 (151) 1 to 2 8	69	8006	float RWES
<input type="checkbox"/> td [td]	<i>Control Loop (1 to 2)</i> Time Derivative Set the PID derivative time for the outputs.	0 to 9,999 seconds	0 seconds	Instance 1 <i>Map 1 Map 2</i> 1896 2376 Instance 2 <i>Map 1 Map 2</i> 1966 2446	0x97 (151) 1 to 2 9	70	8007	float RWES
<input type="checkbox"/> db [db]	<i>Control Loop (1 to 2)</i> Dead Band Set the offset to the proportional band. With a negative value, both heating and cooling outputs are active when the process value is near the set point. A positive value keeps heating and cooling outputs from fighting each other.	-1,000.0 to 1,000.0°F or units -556 to 556°C	0	Instance 1 <i>Map 1 Map 2</i> 1898 2378 Instance 2 <i>Map 1 Map 2</i> 1968 2448	0x97 (151) 1 to 2 0xA (10)	71	8008	float RWES
<input type="checkbox"/> ttUn [t.tUn]	<i>Control Loop (1 to 2)</i> TRU-TUNE+™ Enable Enable or disable the TRU-TUNE+™ adaptive tuning feature.	<input type="checkbox"/> no No (59) <input type="checkbox"/> YES Yes (106)	No	Instance 1 <i>Map 1 Map 2</i> 1910 2390 Instance 2 <i>Map 1 Map 2</i> 1980 2460	0x97 (151) 1 to 2 0x10 (16)	- - - -	8022	uint RWES
Note: Some values will be rounded off to fit in the four-character display. Full values can be read with other interfaces.								R: Read W: Write E: EEPROM S: User Set

Setup Page

Display	Parameter Name Description	Range	Default	Modbus Relative Address	CIP Class Instance Attribute hex (dec)	Pro-fibus Index	Parameter ID	Data Type & Read/Write
[t.bnd] [t.bnd]	Control Loop (1 to 2) TRU-TUNE+™ Band Set the range, centered on the set point, within which TRU-TUNE+™ will be in effect. Use this function only if the controller is unable to adaptive tune automatically.	0 to 100	0	Instance 1 Map 1 Map 2 1912 2392 Instance 2 Map 1 Map 2 1982 2462	0x97 (151) 1 to 2 0x11 (17)	----	8034	uint RWES
[t.gn] [t.gn]	Control Loop (1 to 2) TRU-TUNE+™ Gain Select the responsiveness of the TRU-TUNE+™ adaptive tuning calculations. More responsiveness may increase overshoot.	1 to 6	3	Instance 1 Map 1 Map 2 1914 2394 Instance 2 Map 1 Map 2 1984 2464	0x97 (151) 1 to 2 0x12 (18)	----	8035	uint RWES
[A.tSP] [A.tSP]	Control Loop (1 to 2) Autotune Set Point Set the set point that the autotune will use, as a percentage of the current set point.	50.0 to 200.0%	90.0	Instance 1 Map 1 Map 2 1918 2398 Instance 2 Map 1 Map 2 1988 2468	0x97 (151) 1 to 2 0x14 (20)	----	8025	float RWES
[t.Agr] [t.Agr]	Control Loop (1 to 2) Autotune Aggressiveness Select the aggressiveness of the autotuning calculations.	[U ndr] Under damped (99) [C r i t] Critical damped (21) [O v e r] Over damped (69)	Critical	Instance 1 Map 1 Map 2 1916 2396 Instance 2 Map 1 Map 2 1986 2466	0x97 (151) 1 to 2 0x13 (19)	----	8024	uint RWES
[P.dL] [P.dL]	Control Loop (1 to 2) Peltier Delay Set a value that will cause a delay when switching from heat mode to cool mode.	0.0 to 5.0 seconds	0.0	Instance 1 Map 1 Map 2 1934 2414 Instance 2 Map 1 Map 2 2004 2484	0x97 (151) 1 to 2 0x1C (28)	----	8051	float RWES
[r.En] [r.En]	Control Loop (1 to 2) Remote Enable Enable this loop to switch control to the remote set point.	[n o] No (59) [Y E S] Yes (106)	No	Instance 1 Map 1 Map 2 2200 2680 Instance 2 Map 1 Map 2 2280 2760	0x6B (107) 1 to 2 0x15 (21)	48	7021	uint RWES
[r.ty] [r.ty]	Control Loop (1 to 2) Remote Set Point Type Set what type of set point will be used.	[A U T o] Auto (10) [M a n u a l] Manual (54)	Auto	Instance 1 Map 1 Map 2 2202 2682 Instance 2 Map 1 Map 2 2282 2762	0x6B (107) 1 to 2 0x16 (22)	----	7022	uint RWES
Note: Some values will be rounded off to fit in the four-character display. Full values can be read with other interfaces.								R: Read W: Write E: EEPROM S: User Set

Setup Page

Display	Parameter Name Description	Range	Default	Modbus Relative Address	CIP Class Instance Attribute hex (dec)	Pro-fibus Index	Parameter ID	Data Type & Read/Write
<input type="checkbox"/> UFA [UFA]	<i>Control Loop (1 to 2)</i> User Failure Action Select what the controller outputs will do when the user switches control to manual mode.	<input type="checkbox"/> OFF Off, sets output power to 0% (62) <input type="checkbox"/> BPLS Bumpless Transfer, maintains same output power, if it was less than 75% and stable, otherwise 0% (14) <input type="checkbox"/> MAN Fixed Power, sets output power to Manual Power setting (33) <input type="checkbox"/> USER User, sets output power to last open-loop set point the user entered (100)	User	Instance 1 <i>Map 1</i> <i>Map 2</i> 2182 2662 Instance 2 <i>Map 1</i> <i>Map 2</i> 2262 2742	0x6B (107) 1 to 2 0xC (12)	----	7012	uint RWES
<input type="checkbox"/> FAiL [FAiL]	<i>Control Loop (1 to 2)</i> Input Error Failure Select what the controller outputs will do when an input error switches control to manual mode.	<input type="checkbox"/> OFF Off, sets output power to 0% (62) <input type="checkbox"/> BPLS Bumpless Transfer, maintains same output power, if it was less than 75% and stable, otherwise 0% (14) <input type="checkbox"/> MAN Fixed Power, sets output power to Fixed Power setting (33) <input type="checkbox"/> USER User, sets output power to last open-loop set point the user entered (100)	User	Instance 1 <i>Map 1</i> <i>Map 2</i> 2184 2664 Instance 2 <i>Map 1</i> <i>Map 2</i> 2264 2744	0x6B (107) 1 to 2 0xD (13)	----	7013	uint RWES
<input type="checkbox"/> MAN [MAN]	<i>Control Loop (1 to 2)</i> Fixed Power Set the manual output power level that will take effect if an input error failure occurs while User Failure Action is set to Manual Fixed.	Set Point Open Loop Limit Low to Set Point Open Loop Limit High (Setup Page)	0.0	Instance 1 <i>Map 1</i> <i>Map 2</i> 2180 2660 Instance 2 <i>Map 1</i> <i>Map 2</i> 2260 2740	0x6B (107) 1 to 2 0xB (11)	----	7011	float RWES
<input type="checkbox"/> L.dE [L.dE]	<i>Control Loop (1 to 2)</i> Open Loop Detect Enable Turn on the open-loop detect feature to monitor a closed-loop operation for the appropriate response.	<input type="checkbox"/> no No (59) <input type="checkbox"/> YES Yes (106)	No	Instance 1 <i>Map 1</i> <i>Map 2</i> 1922 2402 Instance 2 <i>Map 1</i> <i>Map 2</i> 1992 2472	0x97 (151) 1 to 2 0x16 (22)	74	8039	uint RWES
<input type="checkbox"/> L.dt [L.dt]	<i>Control Loop (1 to 2)</i> Open Loop Detect Time The Open Loop Detect Deviation value must occur for this time period to trigger an open-loop error.	0 to 3,600 seconds	240	Instance 1 <i>Map 1</i> <i>Map 2</i> 1924 2404 Instance 2 <i>Map 1</i> <i>Map 2</i> 1994 2474	0x97 (151) 1 to 2 0x17 (23)	75	8040	uint RWES
<input type="checkbox"/> L.dd [L.dd]	<i>Control Loop (1 to 2)</i> Open Loop Detect Deviation The value entered represents the Process Value deviation that must occur to trigger an open-loop error.	-1,999.000 to 9,999.000°F or units -1,110.555 to 5,555.000°C	10.0°F or units 6.0°C	Instance 1 <i>Map 1</i> <i>Map 2</i> 1926 2406 Instance 2 <i>Map 1</i> <i>Map 2</i> 1996 2476	0x97 (151) 1 to 2 0x18 (24)	76	8041	float RWES
Note: Some values will be rounded off to fit in the four-character display. Full values can be read with other interfaces.								R: Read W: Write E: EEPROM S: User Set

Setup Page

Display	Parameter Name Description	Range	Default	Modbus Relative Address	CIP Class Instance Attribute hex (dec)	Pro- fibus Index	Param- eter ID	Data Type & Read/ Write
rP [rP]	Control Loop (1 to 2) Ramp Action Select when the controller's set point will ramp to the defined end set point.	oFF Off (62) StR Startup (88) StPtE Set Point Change (85) both Both (13)	Off	Instance 1 Map 1 Map 2 2186 2666 Instance 2 Map 1 Map 2 2266 2746	0x6B (107) 1 to 2 0xE (14)	56	7014	uint RWES
rSC [r.SC]	Control Loop (1 to 2) Ramp Scale Select the scale of the ramp rate.	hoUr Hours (39) Min Minutes (57)	Minutes	Instance 1 Map 1 Map 2 2188 2668 Instance 2 Map 1 Map 2 2268 2748	0x6B (107) 1 to 2 0xF (15)	57	7015	uint RWES
rRE [r.rt]	Control Loop (1 to 2) Ramp Rate Set the rate for the set point ramp. Set the time units for the rate with the Ramp Scale parameter.	0.0 to 9,999.000°F or units 0.0 to 5,555.000°C	1.0°F or units 1.0°C	Instance 1 Map 1 Map 2 2192 2672 Instance 2 Map 1 Map 2 2272 2752	0x6B (107) 1 to 2 0x11 (17)	58	7017	float RWES
L.SP [L.SP]	Control Loop (1 to 2) Low Set Point Set the minimum value of the closed loop set point range.	-1,999.000 to 9,999.000°F or units -1,128.000 to 5,537.000°C	-1,999°F or units -1,128°C	Instance 1 Map 1 Map 2 2164 2644 Instance 2 Map 1 Map 2 2244 2724	0x6B (107) 1 to 2 3	52	7003	float RWES
h.SP [h.SP]	Control Loop (1 to 2) High Set Point Set the maximum value of the closed loop set point range.	-1,999.000 to 9,999.000°F or units -1,128.000 to 5,537.000°C	9,999°F or units, 5,537°C	Instance 1 Map 1 Map 2 2166 2646 Instance 2 Map 1 Map 2 2246 2726	0x6B (107) 1 to 2 4	53	7004	float RWES
C.SP [C.SP]	Control Loop (1 to 2) Closed Loop Set Point Set the set point that the controller will automatically control to.	Low Set Point to High Set Point (Setup Page)	75.0°F or units 24.0°C	Instance 1 Map 1 Map 2 2160 2640 Instance 2 Map 1 Map 2 2240 2720	0x6B (107) 1 to 2 1	49	7001	float RWES
idS [id.S]	Control Loop (1 to 2) Idle Set Point Set a closed loop set point that can be triggered by an event state.	Low Set Point to High Set Point (Setup Page)	75.0°F or units 24.0°C	Instance 1 Map 1 Map 2 2176 2656 Instance 2 Map 1 Map 2 2197 2736	0x6B (107) 1 to 2 9	50	7009	float RWES
SP.Lo [SP.Lo]	Control Loop (1 to 2) Set Point Open Limit Low Set the minimum value of the open-loop set point range.	-100 to 100%	-100	Instance 1 Map 1 Map 2 2168 2648 Instance 2 Map 1 Map 2 2248 2728	0x6B (107) 1 to 2 5	54	7005	float RWES
Note: Some values will be rounded off to fit in the four-character display. Full values can be read with other interfaces.								R: Read W: Write E: EEPROM S: User Set

Setup Page

Display	Parameter Name Description	Range	Default	Modbus Relative Address	CIP Class Instance Attribute hex (dec)	Profibus Index	Parameter ID	Data Type & Read/Write
SP.h.i [SP.hi]	<i>Control Loop (1 to 4)</i> Set Point Open Limit High Set the maximum value of the open-loop set point range.	-100 to 100%	100	Instance 1 <i>Map 1 Map 2</i> 2170 2650 Instance 2 <i>Map 1 Map 2</i> 2250 2730	0x6B (107) 1 to 2 6	55	7006	float RWES
o.SP [o.SP]	<i>Control Loop (1 to 2)</i> Open Loop Set Point Set a fixed level of output power when in manual (open-loop) mode.	-100 to 100% (heat and cool) 0 to 100% (heat only) -100 to 0% (cool only)	0.0	Instance 1 <i>Map 1 Map 2</i> 2162 2642 Instance 2 <i>Map 1 Map 2</i> 2242 2722	0x6B (107) 1 to 2 2	51	7002	float RWES
CM [C.M]	<i>Control Loop (1 to 2)</i> Control Mode Select the method that this loop will use to control.	OFF Off (62) AUTO Auto (10) MAN Manual (54)	Auto	Instance 1 <i>Map 1 Map 2</i> 1880 2360 Instance 2 <i>Map 1 Map 2</i> 1950 2430	0x97 (151) 1 to 2 1	63	8001	uint RWES
o.t.P.E S.E.E Output Menu								
Fn [Fn]	<i>Output Digital (1 to 4)</i> Output Function Select what function will drive this output. Note: Output 4 is always a limit when limit is present. Use as primary limit connection.	OFF Off (62) ALARM Alarm (6) HEAT Heat (36) COOL Cool (20) SOF.1 Special Function Output 1 (1532) SOF.2 Special Function Output 2 (1533) ENT.A Profile Event Out A (233) ENT.B Profile Event Out B (234) LIMIT Limit (126)	Output 1 - Heat Output 2 - Alarm Output 3 - Off Output 4 - Off	Instance 1 <i>Map 1 Map 2</i> 888 1008 Offset to next instance (<i>Map 1 & Map 2</i>) equals +30	0x6A (106) 1 to 4 5	83	6005	uint RWES
Fi [Fi]	<i>Output Digital (1 to 4)</i> Output Function Instance Set the instance of the function selected above.	1 to 4	1	Instance 1 <i>Map 1 Map 2</i> 890 1010 Offset to next instance (<i>Map 1 & Map 2</i>) equals +30	0x6A (106) 1 to 4 6	84	6006	uint RWES
Note: Some values will be rounded off to fit in the four-character display. Full values can be read with other interfaces.								R: Read W: Write E: EEPROM S: User Set

Setup Page

Display	Parameter Name Description	Range	Default	Modbus Relative Address	CIP Class Instance Attribute hex (dec)	Pro-fibus Index	Parameter ID	Data Type & Read/Write
<u>o.Ct</u> [o.Ct]	Output Digital (1 to 4) Output Control Set the output control type. This parameter is only used with PID control, but can be set anytime.	<u>FtB</u> Fixed Time Base (34) <u>vtB</u> Variable Time Base (103)	Fixed Time Base	Instance 1 <i>Map 1</i> 882 <i>Map 2</i> 1002 Offset to next instance (<i>Map 1 & Map 2</i>) equals +30	0x6A (106) 1 to 4 2	85	6002	uint RWES
<u>o.tb</u> [o.tb]	Output Digital (1 to 4) Output Time Base Set the time base for fixed-time-base control.	0.1 to 60.0 seconds (solid-state relay or switched dc) 5.0 to 60.0 seconds (mechanical relay or NO-ARC power control)	1.0 sec. for SSR or swdc 5.0 for relay	Instance 1 <i>Map 1</i> 884 <i>Map 2</i> 1004 Offset to next instance (<i>Map 1 & Map 2</i>) equals +30	0x6A (106) 1 to 4 3	86	6003	float RWES
<u>o.Lo</u> [o.Lo]	Output Digital (1 to 4) Output Low Power Scale The power output will never be less than the value specified and will represent the value at which output scaling begins.	0.0 to 100.0%	0.0%	Instance 1 <i>Map 1</i> 896 <i>Map 2</i> 1016 Offset to next instance (<i>Map 1 & Map 2</i>) equals +30	0x6A (106) 1 to 4 9	87	6009	float RWES
<u>o.hi</u> [o.hi]	Output Digital (1 to 4) Output High Power Scale The power output will never be greater than the value specified and will represent the value at which output scaling stops.	0.0 to 100.0%	100.0%	Instance 1 <i>Map 1</i> 898 <i>Map 2</i> 1018 Offset to next instance (<i>Map 1 & Map 2</i>) equals +30	0x6A (106) 1 to 4 0xA (10)	88	6010	float RWES
<u>o.ty</u> [o.ty]	Output Process (1 or 3) Output Type Select whether the process output will operate in volts or milliamps.	<u>volt</u> Volts (104) <u>mamp</u> Milliamps (112)	Volts	Instance 1 <i>Map 1</i> 720 <i>Map 2</i> 840 Instance 3 <i>Map 1</i> 800 <i>Map 2</i> 920	0x76 (118) 1 or 3 1	95	18001	uint RWES
<u>Fn</u> [Fn]	Output Process (1 or 3) Output Function Set the type of function that will drive this output.	<u>off</u> Off (62) <u>heat</u> Heat (36) <u>cool</u> Cool (20) <u>dupl</u> Duplex (212) <u>alrm</u> Alarm (6) <u>entA</u> Profile Event Out A (233) <u>entB</u> Profile Event Out B (234) <u>retr</u> Retransmit (213)	Off	Instance 1 <i>Map 1</i> 722 <i>Map 2</i> 842 Instance 3 <i>Map 1</i> 802 <i>Map 2</i> 922	0x76 (118) 1 or 3 2	96	18002	uint RWES
Note: Some values will be rounded off to fit in the four-character display. Full values can be read with other interfaces.								R: Read W: Write E: EEPROM S: User Set

Setup Page

Display	Parameter Name Description	Range	Default	Modbus Relative Address	CIP Class Instance Attribute hex (dec)	Profibus Index	Parameter ID	Data Type & Read/Write
r.Sr [r.Sr]	<i>Output Process (1 or 3)</i> Retransmit Source Select the value that will be retransmitted.	R , Analog Input (142) SPt , Set Point (85) Cur , Current (22) Pv , Process Value (241)	Analog Input	Instance 1 <i>Map 1 Map 2</i> 724 844 Instance 3 <i>Map 1 Map 2</i> 804 924	0x76 (118) 1 or 3 3	97	18003	uint RWES
F [Fi]	<i>Output Process (1 or 3)</i> Output Function Instance Set the instance of the function selected above.	1 to 4	1	Instance 1 <i>Map 1 Map 2</i> 726 846 Instance 3 <i>Map 1 Map 2</i> 806 926	0x76 (118) 1 or 3 4	98	18004	uint RWES
S.Lo [S.Lo]	<i>Output Process (1 or 3)</i> Scale Low Set the scale low for process output in electrical units. This value; in volts or milliamps, will correspond to 0% PID power output or range low retransmit output.	-100.0 to 100.0	0.00	Instance 1 <i>Map 1 Map 2</i> 736 856 Instance 3 <i>Map 1 Map 2</i> 816 936	0x76 (118) 1 or 3 9	99	18009	float RWES
S.h [S.hi]	<i>Output Process (1 or 3)</i> Scale High Set the scale high for process output in electrical units. This value; in volts or milliamps, will correspond to 100% PID power output or range high retransmit output.	-100.0 to 100.0	10.00	Instance 1 <i>Map 1 Map 2</i> 738 858 Instance 3 <i>Map 1 Map 2</i> 818 938	0x76 (118) 1 or 3 0xA (10)	100	18010	float RWES
r.Lo [r.Lo]	<i>Output Process (1 or 3)</i> Range Low Set the minimum value of the retransmit value range in process units. When the retransmit source is at this value, the retransmit output will be at its Scale Low value.	-1,999.000 to 9,999.000°F or units -1,128.000 to 5,537.000°C	0.0°F or units -18°C	Instance 1 <i>Map 1 Map 2</i> 740 860 Instance 3 <i>Map 1 Map 2</i> 820 940	0x76 (118) 1 or 3 0xB (11)	101	18011	float RWES
r.h [r.hi]	<i>Output Process (1 or 3)</i> Range High Set the maximum value of the retransmit value range in process units. When the retransmit source is at this value, the retransmit output will be at its Scale High value.	-1,999.000 to 9,999.000°F or units -1,128.000 to 5,537.000°C	100.0°F or units 38.0°C	Instance 1 <i>Map 1 Map 2</i> 742 862 Instance 3 <i>Map 1 Map 2</i> 822 942	0x76 (118) 1 or 3 0xC (12)	102	18012	float RWES
Note: Some values will be rounded off to fit in the four-character display. Full values can be read with other interfaces.								R: Read W: Write E: EEPROM S: User Set

Setup Page

Display	Parameter Name Description	Range	Default	Modbus Relative Address	CIP Class Instance Attribute hex (dec)	Pro-fibus Index	Parameter ID	Data Type & Read/Write
<u>oLo</u> [o.Lo]	<i>Output Process (1 or 3)</i> Output Low Power Scale The power output will never be less than the value specified and will represent the value at which power scaling begins.	0.0 to 100%	0.0%	Instance 1 <i>Map 1 Map 2</i> 744 864 Instance 3 <i>Map 1 Map 2</i> 824 944	0x76 (118) 1 or 3 0x0D (13)	103	18013	float RWES
<u>oHi</u> [o.hi]	<i>Output Process (1 or 3)</i> Output High Power Scale The power output will never be greater than the value specified and will represent the value at which power scaling stops.	0.0 to 100%	100%	Instance 1 <i>Map 1 Map 2</i> 746 866 Instance 3 <i>Map 1 Map 2</i> 826 946	0x76 (118) 1 or 3 0x0E (14)	104	18014	float RWES
<u>oCA</u> [o.CA]	<i>Output Process (1 or 3)</i> Calibration Offset Set an offset value for a process output.	-1,999.000 to 9,999.000°F or -1,110.555 to 5,555.000°C	0.0°F or 0.0°C	Instance 1 <i>Map 1 Map 2</i> 732 852 Instance 3 <i>Map 1 Map 2</i> 812 932	0x76 (118) 1 or 3 7	105	18007	float RWES
ALP7								
SEE								
Alarm Menu								
<u>ALY</u> [A.ty]	<i>Alarm (1 to 4)</i> Alarm Type Select whether the alarm trigger is a fixed value or will track the set point.	<u>OFF</u> Off (62) <u>PRAL</u> Process Alarm (76) <u>DEAL</u> Deviation Alarm (24)	Off	Instance 1 <i>Map 1 Map 2</i> 1508 1908 Offset to next instance (<i>Map 1 +50, Map 2 +60</i>)	0x6D (109) 1 to 4 0xF (15)	20	9015	uint RWES
<u>SrA</u> [Sr.A]	<i>Alarm (1 to 4)</i> Alarm Source Select what will trigger this alarm. Note: When using Deviation Alarms with Differential control, the Alarm Source must be set to Process Value.	<u>A</u> Analog Input (142) <u>PuDr</u> Power (73) <u>Pu</u> Process Value (241) <u>Lncr</u> Linearization (238) <u>Ucr</u> Current (22)		Instance 1 <i>Map 1 Map 2</i> 1512 1912 Offset to next instance (<i>Map 1 +50, Map 2 +60</i>)	0x6D (109) 1 to 4 0x11 (17)	21	9017	uint RWES
<u>iSA</u> [i.S.A]	<i>Alarm (1 to 4)</i> Alarm Source Instance Set the instance of the function selected above.	1 or 2	1	Instance 1 <i>Map 1 Map 2</i> 1514 1914 Offset to next instance (<i>Map 1 +50, Map 2 +60</i>)	0x6D (109) 1 to 2 0x12 (18)	22	9018	uint RWES
Note: Some values will be rounded off to fit in the four-character display. Full values can be read with other interfaces.								R: Read W: Write E: EEPROM S: User Set

Setup Page

Display	Parameter Name Description	Range	Default	Modbus Relative Address	CIP Class Instance Attribute hex (dec)	Pro-fibus Index	Parameter ID	Data Type & Read/Write
[Loop] [Loop]	<i>Alarm (1 to 4)</i> Control Loop Set the instance of the Set Point Closed, Control Loop, that will be referenced by the deviation alarm. Note: Not available on single loop models.	1 to 2	1	Instance 1 <i>Map 1</i> <i>Map 2</i> 1524 1924 Offset to next instance (<i>Map 1 +50, Map 2 +60</i>)	0x6D (109) 1 to 2 0x17 (23)	23	9023	uint RWES
[A.hy] [A.hy]	<i>Alarm (1 to 4)</i> Alarm Hysteresis Set the hysteresis for an alarm. This determines how far into the safe region the process value needs to move before the alarm can be cleared.	0.001 to 9,999.000°F or units 0.001 to 5,555.000°C	1.0°F or units 1.0°C	Instance 1 <i>Map 1</i> <i>Map 2</i> 1484 1884 Offset to next instance (<i>Map 1 equals +50, Map 2 +60</i>)	0x6D (109) 1 to 4 3	24	9003	float RWES
[A.Lg] [A.Lg]	<i>Alarm (1 to 4)</i> Alarm Logic Select what the output condition will be during the alarm state.	[ALL] Close On Alarm (17) [ALo] Open On Alarm (66)	Close On Alarm	Instance 1 <i>Map 1</i> <i>Map 2</i> 1488 1888 Offset to next instance (<i>Map 1 +50, Map 2 +60</i>)	0x6D (109) 1 to 4 5	25	9005	uint RWES
[A.Sd] [A.Sd]	<i>Alarm (1 to 4)</i> Alarm Sides Select which side or sides will trigger this alarm.	[both] Both (13) [high] High (37) [low] Low (53)	Both	Instance 1 <i>Map 1</i> <i>Map 2</i> 1486 1886 Offset to next instance (<i>Map 1 +50, Map 2 +60</i>)	0x6D (109) 1 to 4 4	26	9004	uint RWES
[A.Lo] [A.Lo]	<i>Alarm (1 to 4)</i> Alarm Low Set Point If Alarm Type (Setup Page, Alarm Menu) is set to: process - set the process value that will trigger a low alarm. deviation - set the span of units from the closed loop set point that will trigger a low alarm. A negative set point represents a value below closed loop set point. A positive set point represents a value above closed loop set point.	-1,999.000 to 9,999.000°F or units -1,128.000 to 5,537.000°C	32.0°F or units 0.0°C	Instance 1 <i>Map 1</i> <i>Map 2</i> 1482 1882 Offset to next instance (<i>Map 1 +50, Map 2 +60</i>)	0x6D (109) 1 to 4 2	18	9002	float RWES
Note: Some values will be rounded off to fit in the four-character display. Full values can be read with other interfaces.								R: Read W: Write E: EEPROM S: User Set

Setup Page

Display	Parameter Name Description	Range	Default	Modbus Relative Address	CIP Class Instance Attribute hex (dec)	Pro-fibus Index	Parameter ID	Data Type & Read/Write
<input type="checkbox"/> Rh [A.hi]	<i>Alarm (1 to 4)</i> Alarm High Set Point If Alarm Type (Setup Page, Alarm Menu) is set to: process - set the process value that will trigger a high alarm. deviation - set the span of units from the closed loop set point that will trigger a high alarm.	-1,999.000 to 9,999.000°F or units -1,128.000 to 5,537.000°C	300.0°F or units 150.0°C	Instance 1 <i>Map 1</i> <i>Map 2</i> 1480 1880 Offset to next instance (<i>Map 1</i>) equals +50 Offset to next instance (<i>Map 2</i>) equals +60	0x6D (109) 1 to 4 1	19	9001	float RWES
<input type="checkbox"/> RLA [A.LA]	<i>Alarm (1 to 4)</i> Alarm Latching Turn alarm latching on or off. A latched alarm has to be turned off by the user.	<input type="checkbox"/> nLRE Non-Latching (60) <input type="checkbox"/> LRE Latching (49)	Non-Latching	Instance 1 <i>Map 1</i> <i>Map 2</i> 1492 1892 Offset to next instance (<i>Map 1</i> equals +50, for <i>Map 2</i> equals +60)	0x6D (109) 1 to 4 7	27	9007	uint RWES
<input type="checkbox"/> RbL [A.bL]	<i>Alarm (1 to 4)</i> Alarm Blocking Select when an alarm will be blocked. After startup and/or after the set point changes, the alarm will be blocked until the process value enters the normal range.	<input type="checkbox"/> oFF Off (62) <input type="checkbox"/> StR Startup (88) <input type="checkbox"/> SEPe Set Point (85) <input type="checkbox"/> boTh Both (13)	Off	Instance 1 <i>Map 1</i> <i>Map 2</i> 1494 1894 Offset to next instance (<i>Map 1</i> equals +50, for <i>Map 2</i> equals +60)	0x6D (109) 1 to 4 8	28	9008	uint RWES
<input type="checkbox"/> RS [A.Si]	<i>Alarm (1 to 4)</i> Alarm Silencing Turn alarm silencing on to allow the user to disable this alarm.	<input type="checkbox"/> oFF Off (62) <input type="checkbox"/> oN On (63)	Off	Instance 1 <i>Map 1</i> <i>Map 2</i> 1490 1890 Offset to next instance (<i>Map 1</i> equals +50, for <i>Map 2</i> equals +60)	0x6D (109) 1 to 4 6	29	9006	uint RWES
<input type="checkbox"/> RdSP [A.dSP]	<i>Alarm (1 to 4)</i> Alarm Display Display an alarm message when an alarm is active.	<input type="checkbox"/> oFF Off (62) <input type="checkbox"/> oN On (63)	On	Instance 1 <i>Map 1</i> <i>Map 2</i> 1510 1910 Offset to next instance (<i>Map 1</i> equals +50, for <i>Map 2</i> equals +60)	0x6D (109) 1 to 4 0x10 (16)	30	9016	uint RWES
<input type="checkbox"/> RdL [A.dL]	<i>Alarm (1 to 4)</i> Alarm Delay Time Set the span of time that the alarm will be delayed after the process value exceeds the alarm set point.	0 to 9,999 seconds	0	Instance 1 <i>Map 1</i> <i>Map 2</i> 1520 1920 Offset to next instance (<i>Map 1</i> equals +50, for <i>Map 2</i> equals +60)	0x6D (109) 1 to 4 0x15 (21)	31	9021	uint RWES
Note: Some values will be rounded off to fit in the four-character display. Full values can be read with other interfaces.								R: Read W: Write E: EEPROM S: User Set

Setup Page

Display	Parameter Name Description	Range	Default	Modbus Relative Address	CIP Class Instance Attribute hex (dec)	Pro-fibus Index	Parameter ID	Data Type & Read/Write
[RCLR] [A.Clr]	Alarm (1 to 4) Alarm Clear Request Write to this register to clear an alarm Note: If an alarm is setup to latch when active [RCLR] will appear on the display.	[CLR] Clear (0) [IGNR] Ignore (204)	----	Instance 1 <i>Map 1</i> <i>Map 2</i> 1504 1904 Offset to next instance (Map1 1 equals +50, Map 2 equals +60)	0x6D (109) 1 to 4 0xD (13)	----	9013	uint W
[RSIR] [A.Sir]	Alarm (1 to 4) Alarm Silence Request Write to this register to silence an alarm Note: If an alarm is setup to silence alarm when active [RSIR] will appear on the display.	[SIL] Silence (1010)	----	Instance 1 <i>Map 1</i> <i>Map 2</i> 1506 1906 Offset to next instance (Map1 1 equals +50, Map 2 equals +60)	0x6D (109) 1 to 4 0xE (14)	----	9014	uint W
[RSE] [A.St]	Alarm (1 to 4) Alarm State Current state of alarm	[SEr] Startup (88) [nonE] None (61) [bLo] Blocked (12) [RLl] Alarm low (8) [RLh] Alarm high (7) [RLE] Error (28)	----	Instance 1 <i>Map 1</i> <i>Map 2</i> 1496 1896 Offset to next instance (Map1 1 equals +50, Map 2 equals +60)	0x6D (109) 1 to 4 9	----	9009	uint R
[URr] [SEt] Current Menu								
[CSd] [C.Sd]	Current (1) Current Sides Select which side or sides will be monitored.	[oFF] Off (62) [h,9h] High (37) [LoU] Low (53) [boTh] Both (13)	off	Instance 1 <i>Map 1</i> <i>Map 2</i> 1128 1368	0x73 (115) 1 5	145	15005	uint RWES
[CUr] [C.Ur]	Current (1) Current Read Enable Display under/over-range current.	[no] No (59) [yES] Yes (106)	no	Instance 1 <i>Map 1</i> <i>Map 2</i> 1126 1366	0x73 (115) 1 4	146	15004	uint RWES
[Cdt] [C.dt]	Current (1) Input Current Detection Threshold For factory adjustment only.	3 to 59	9	Instance 1 <i>Map 1</i> <i>Map 2</i> 1142 1382	0x73 (115) 1 0xC (12)	147	15012	uint RWES
[CSC] [C.SC]	Current (1) Current Scaling Adjust scaling to match the transformer's high range.	0 to 9,999.000	50.0	Instance 1 <i>Map 1</i> <i>Map 2</i> 1162 1402	0x73 (115) 1 0x16 (22)	148	15022	float RWES
Note: Some values will be rounded off to fit in the four-character display. Full values can be read with other interfaces.								R: Read W: Write E: EEPROM S: User Set

Setup Page

Display	Parameter Name Description	Range	Default	Modbus Relative Address	CIP Class Instance Attribute hex (dec)	Pro-fibus Index	Parameter ID	Data Type & Read/Write
[C.oFS] [C.oFS]	<i>Current (1)</i> Heater Current Offset Calibrate the current reading with an offset value.	-9,999.000 to 9,999.000	0.0	Instance 1 Map 1 Map 2 1140 1380	0x73 (115) 1 0xB (11)	149	15011	float RWES
[C.Si] [C.Si]	<i>Current (1)</i> Current Output Source Instance Select which output instance the current transformer will monitor.	1 to 12	1	Instance 1 Map 1 Map 2 1156 1396	0x73 (115) 1 0x13 (19)	150	15019	uint RWES
PARAMETERS SET Math Menu								
[Fn] [Fn]	<i>Math (1)</i> Function Set the operator that will be applied to the sources.	[OFF] Off (62) [PSC] Process Scale (1371) [dSL] Deviation Scale (1372)	Off	Instance 1 Map 1 Map 2 ---- 3040	0x7D (125) 1 0x15 (21)	128	25021	uint RWES
[SFn.E] [SFn.E]	<i>Math (1)</i> Source Function E Set the type of function that will be used for this source.	[none] None (61) [FUN] Function Key (1001) [dio] Digital I/O (1142)	None	Instance 1 Map 1 Map 2 ---- 3008	0x7D (125) 1 5	----	25005	uint RWES
[Si.E] [Si.E]	<i>Math (1)</i> Source Instance E Set the instance of the function selected above.	1 to 12	1	Instance 1 Map 1 Map 2 ---- 3018	0x7D (125) 1 0xA (10)		25010	float RWES
[S.Lo] [S.Lo]	<i>Math (1)</i> Scale Low This value will correspond to Output Range Low.	-1,999.000 to 9,999.000	0.0	Instance 1 Map 1 Map 2 ---- 3046	0x7D (125) 1 0x18 (24)	129	25024	float RWES
[S.hi] [S.hi]	<i>Math (1)</i> Scale High This value will correspond to Output Range High.	-1,999.000 to 9,999.000	1.0	Instance 1 Map 1 Map 2 ---- 3048	0x7D (125) 1 0x19 (25)	130	25025	float RWES
[r.Lo] [r.Lo]	<i>Math (1)</i> Range Low This value will correspond to Input Scale Low.	-1,999.000 to 9,999.000	0.0	Instance 1 Map 1 Map 2 ---- 3050	0x7D (125) 1 0x1A (26)	131	25026	float RWES
[r.hi] [r.hi]	<i>Math (1)</i> Range High This value will correspond to Input Scale High.	-1,999.000 to 9,999.000	1.0	Instance 1 Map 1 Map 2 ---- 3052	0x7D (125) 1 0x1B (27)	132	25027	float RWES
Note: Some values will be rounded off to fit in the four-character display. Full values can be read with other interfaces.								R: Read W: Write E: EEPROM S: User Set

Setup Page

Display	Parameter Name Description	Range	Default	Modbus Relative Address	CIP Class Instance Attribute hex (dec)	Pro-fibus Index	Parameter ID	Data Type & Read/Write
[FiL] FiL	Math (1) Filter Filtering smooths out the output signal of this function block. Increase the time to increase filtering.	0.0 to 60.0 seconds	0.0	Instance 1 Map 1 Map 2 ---- 3054	0x7D (125) 1 0x1C (28)	----	25028	float RWES
[Sof] [SEt] Special Output Function Menu								
[Fn] Fn	Special Output (1) Function Set the function to match the device it will operate.	[oFF] Off (62) [uVl] Motorized Valve (1508) [CoC] Compressor Control (1506)	Off	Instance 1 Map 1 Map 2 ---- 3856	0x87 (135) 1 9	181	35009	uint RWES
[SFn.A] SFn.A	Special Output (1) Source Function A Set the type of function that will be used for this source.	[nonE] None (61) [PUVr] Power (73) [hPr] Heat Power (160) [CPr] Cool Power (161)	None	Instance 1 Map 1 Map 2 ---- 3840	0x87 (135) 1 1	182	35001	uint RWES
[Si.A] Si.A	Special Output (1) Source Instance A Set the instance of the function selected above.	1 to 2	1	Instance 1 Map 1 Map 2 ---- 3844	0x87 (135) 1 3	183	35003	uint RWES
[SFn.b] SFn.b	Special Output (1) Source Function B Set the type of function that will be used for this source.	[nonE] None (61) [PUVr] Power (73) [hPr] Heat Power (160) [CPr] Cool Power (161)	None	Instance 1 Map 1 Map 2 ---- 3842	0x87 (135) 1 2	184	35002	uint RWES
[Si.b] Si.b	Special Output (1) Source Instance B Set the instance of the function selected above.	1 to 2	1	Instance 1 Map 1 Map 2 ---- 3846	0x87 (135) 1 4	185	35004	uint RWES
[Pon.A] Pon.A	Special Output (1) Power On Level 1 Compressor 1 power on level.	-100.00 to 100.00%	0	Instance 1 Map 1 Map 2 ---- 3874	0x87 (135) 1 0x12 (18)	186	35018	float RWES
[PoF.A] PoF.A	Special Output (1) Power Off Level 1 Compressor 1 power off level.	-100.00 to 100.00%	5	Instance 1 Map 1 Map 2 ---- 3876	0x87 (135) 1 0x13 (19)	187	35019	float RWES
[Pon.b] Pon.b	Special Output (1) Power On Level 2 Compressor 2 power on level.	-100.00 to 100.00%	0	Instance 1 Map 1 Map 2 ---- 3878	0x87 (135) 1 0x14 (20)	188	35020	float RWES
[PoF.b] PoF.b	Special Output (1) Power Off Level 2 Compressor 1 power off level.	-100.00 to 100.00%	5	Instance 1 Map 1 Map 2 ---- 3880	0x87 (135) 1 0x15 (21)	189	35021	float RWES
[on.t] on.t	Special Output (1) On Time At a minimum stay on specified amount of time.	0 to 9,999 seconds	20	Instance 1 Map 1 Map 2 ---- 3882	0x87 (135) 1 0x16 (22)	190	35022	uint RWES
Note: Some values will be rounded off to fit in the four-character display. Full values can be read with other interfaces.								R: Read W: Write E: EEPROM S: User Set

Setup Page

Display	Parameter Name Description	Range	Default	Modbus Relative Address	CIP Class Instance Attribute hex (dec)	Pro- fibus Index	Param- eter ID	Data Type & Read/ Write
<u>oFt</u> [oF.t]	<i>Special Output (1)</i> Off Time At a minimum stay off specified amount of time.	0 to 9,999 seconds	20	Instance 1 <i>Map 1 Map 2</i> ---- 3884	0x87 (135) 1 0x17 (23)	191	35023	uint RWES
<u>t.t</u> [t.t]	<i>Special Output (1)</i> Valve Travel Time The amount of time it takes the valve to fully open and then fully close.	10 to 9,999 seconds	120	Instance 1 <i>Map 1 Map 2</i> ---- 3886	0x87 (135) 1 0x18 (24)	192	35024	uint RWES
<u>db</u> [db]	<i>Special Output (1)</i> Dead Band Output power needs to change by specified level prior to turning on.	1.0 to 100.0%	2	Instance 1 <i>Map 1 Map 2</i> ---- 3888	0x87 (135) 1 0x19 (25)	193	35025	float RWES
<u>t.dL</u> [t.dL]	<i>Special Output (1)</i> Time Delay If requested power is 0.0% for longer than the specified Time Delay, the compressor will shut off.	0 to 9,999 seconds	0	Instance 1 <i>Map 1 Map 2</i> ---- 3890	0x87 (135) 1 0x1A (26)	----	35026	uint RWES
<u>FUn</u> <u>SEt</u> Function Key								
<u>LEu</u> [LEv]	<i>Function Key (3 to 4)</i> Active Level The Function Key will always power up in the low state. Pressing the Function Key will toggle the se- lected action.	<u>h.9h</u> High (37) <u>LoLu</u> Low (53)	High	Instance 3 <i>Map 1 Map 2</i> 1360 1600 Instance 4 <i>Map 1 Map 2</i> 1380 1620	0x6E (110) 3 to 4 1	137	10001	uint RWES
Note: Some values will be rounded off to fit in the four-character display. Full values can be read with other interfaces.								R: Read W: Write E: EEPROM S: User Set

Setup Page

Display	Parameter Name Description	Range	Default	Modbus Relative Address	CIP Class Instance Attribute hex (dec)	Pro- fibus Index	Param- eter ID	Data Type & Read/ Write
<input type="checkbox"/> Fn [Fn]	<i>Function Key (1 to 2)</i> Action Function Program the EZ Key to trigger an action. Functions respond to a level state change or an edge level change. Note: The Limit Reset function is not available in firmware revision 11.0 and above.	<input type="checkbox"/> none None (61) <input type="checkbox"/> r.En Remote Set Point enable (216) <input type="checkbox"/> L.P.P.r Limit Reset, edge triggered (82) <input type="checkbox"/> u.S.r.r User Set Restore, edge triggered (227) <input type="checkbox"/> P.L.o.C Keypad Lockout, level triggered (217) <input type="checkbox"/> R.L.P.P Alarm Reset, edge triggered (6) <input type="checkbox"/> S.i.L Silence Alarms, edge triggered (108) <input type="checkbox"/> R.o.F Control Loops Off and Alarms to Non-alarm State, level triggered (220) <input type="checkbox"/> F.A.L Force Alarm to occur, level triggered (218) <input type="checkbox"/> i.d.L.E Idle Set Point, level triggered (107) <input type="checkbox"/> E.U.n.E Tune, edge triggered (98) <input type="checkbox"/> P.P.P.n Manual, level triggered (54) <input type="checkbox"/> o.F.F Switch Control Loop Off, level triggered (90) <input type="checkbox"/> E.d.R TRU-TUNE+® Disable, level triggered (219) <input type="checkbox"/> P.d.i.S Profile Disable, level triggered (206) <input type="checkbox"/> P.h.o.L Profile Hold/Resume, level triggered (207) <input type="checkbox"/> P.r.o.F Start Profile, edge triggered (196) <input type="checkbox"/> P.S.E.S Profile Start/Stop, level triggered (208) <input type="checkbox"/> S.S.E.P Start Step (1077)	None	Instance 1 <i>Map 1 Map 2</i> 1364 1604 Instance 2 <i>Map 1 Map 2</i> 1384 1624	0x6E (110) 3 to 4 3	138	10003	uint RWES
<input type="checkbox"/> F.i [Fi]	<i>Function Key (1 to 2)</i> Function Instance Select which instance the EZ Key will affect. If only one instance is available, any selection will affect it.	1 to 4	0	Instance 1 <i>Map 1 Map 2</i> 1366 1606 Instance 2 <i>Map 1 Map 2</i> 1386 1626	0x96 (110) 3 to 4 4	139	10004	----
<input type="checkbox"/> GLbL <input type="checkbox"/> SEt Global Menu								
<input type="checkbox"/> C.F [C_F]	<i>Global</i> Display Units Select which scale to use for temperature.	<input type="checkbox"/> F °F (30) <input type="checkbox"/> C °C (15)	°F	Instance 1 <i>Map 1 Map 2</i> 1838 2308	0x67 (103) 1 5	110	3005	uint RWES
Note: Some values will be rounded off to fit in the four-character display. Full values can be read with other interfaces.								R: Read W: Write E: EEPROM S: User Set

Note:

When changing IP address the control power must be cycled for the new address to take effect.

Setup Page

Display	Parameter Name Description	Range	Default	Modbus Relative Address	CIP Class Instance Attribute hex (dec)	Pro-fibus Index	Parameter ID	Data Type & Read/Write
[AC.LF] [AC.LF]	<i>Global</i> AC Line Frequency Set the frequency to the applied ac line power source.	<input type="text" value="50"/> 50 Hz (3) <input type="text" value="60"/> 60 Hz (4)	60 Hz	Instance 1 Map 1 886 Map 2 1006	0x6A (106) 1 4	89	1034	uint RWES
[R.tyP] [R.tyP]	<i>Global</i> Ramping Type	<input type="text" value="RATE"/> Rate (81) <input type="text" value="T"/> Time (143)	Time	Instance 1 Map 1 Map 2 ---- 4414	0x7A (122) 1 26 (38)	----	22038	uint RWE
[P.tyP] [P.tyP]	<i>Global</i> Profile Type Set the profile startup to be based on a set point or a process value.	<input type="text" value="SETP"/> Set Point (85) <input type="text" value="PRO"/> Process (75)	Set Point	Instance 1 Map 1 2534 Map 2 4354	0x7A (122) 1 8	----	22008	uint RWE
[gSE] [gSE]	<i>Global</i> Guaranteed Soak Enable Enables the guaranteed soak deviation function in profiles.	<input type="text" value="OFF"/> Off (62) <input type="text" value="ON"/> On (63)	Off	Instance 1 Map 1 2530 Map 2 4350	0x7A (122) 1 6	----	22006	uint RWE
[gSd1] [gSd1]	<i>Global</i> Guaranteed Soak Deviation 1 Set the value of the deviation band that will be used in all profile step types. The process value must enter the deviation band before the step can proceed.	0.0 to 9,999.000°F or units 0.0 to 5,555.000°C	10.0°F or units 6.0°C	Instance 1 Map 1 2532 Map 2 4352	0x7A (122) 1 7	----	22007	float RWE
[gSd2] [gSd2]	<i>Global</i> Guaranteed Soak Deviation 2 Set the value of the deviation band that will be used in all profile step types. The process value must enter the deviation band before the step can proceed.	0.0 to 9,999.000°F or units 0.0 to 5,555.000°C	10.0°F or units 6.0°C	Instance 1 Map 1 Map 2 ---- 4420	0x7A (122) 1 0x29 (41)	----	22041	float RWE
[Si.a] [Si.a]	<i>Global</i> Source Instance A Set the digital source for Wait for Event 1 in profile.	5 to 12	5	Instance 1 Map 1 Map 2 ---- 4390	0x7A (122) 1 0x1A (26)	----	22060	uint RWES
[Si.b] [Si.b]	<i>Global</i> Source Instance B Set the digital source for Wait for Event 2 in profile.	5 to 12	5	Instance 1 Map 1 Map 2 ---- 4392	7A (122) 1 0x1B (27)	----	22061	uint RWES
Note: Some values will be rounded off to fit in the four-character display. Full values can be read with other interfaces.								R: Read W: Write E: EEPROM S: User Set

Setup Page

Display	Parameter Name Description	Range	Default	Modbus Relative Address	CIP Class Instance Attribute hex (dec)	Pro-fibus Index	Parameter ID	Data Type & Read/Write
[Pot] [Poti]	<i>Global</i> Power Off Time If profile is running and power is lost, profile will resume where it left off provided time set has not expired prior to power restoration.	0 to 9999 seconds	0	Instance 1 Map 1 Map 2 ----- 4484	7A (122) 1 0x49 (73)	----	22073	uint RWE
[Subb] [Subt]	<i>Global</i> Synchronized Variable Time Base Used to acquire tighter accuracy when running a profile. A setting of +0.01 would equate to approximately +9 seconds/day (faster) where a setting of -0.01 would equate to approximately -9 seconds/day (slower).	-2.00 to 2.00 Percent	0.00	----	----	----	----	float RWE
[LEd] [C.LEd]	<i>Global</i> Communications LED Action Turns comms LED on or off for selected comms ports.	[On1] Comm port 1 (1189) [On2] Comm port 2 (1190) [both] Comm port 1 and 2 (13) [off] Off (62)	both	Instance 1 Map 1 Map 2 1856 2326	0x6A (103) 1 0x0E (14)	----	3014	uint RWES
[Zone] [Zone]	<i>Global</i> Zone Turns Zone LED on or off based on selection.	[off] Off (62) [on] On (63)	On	Instance 1 Map 1 Map 2 ----- 2350	0x6A (103) 1 0x1A (26)	----	3026	uint RWES
[Chan] [Chan]	<i>Global</i> Channel Turns Channel LED on or off based on selection.	[off] Off (62) [on] On (63)	On	Instance 1 Map 1 Map 2 ----- 2352	0x6A (103) 1 0x1B (27)	----	3027	uint RWES
[dPrS] [dPrS]	<i>Global</i> Display Pairs Defines the number of Display Pairs.	1 to 10	2	Instance 1 Map 1 Map 2 ----- 2354	0x6A (103) 1 0x1C (28)	----	3028	uint RWES
[d.ti] [d.ti]	<i>Global</i> Display Time Time delay in toggling between Display Pairs.	0 to 60	0	Instance 1 Map 1 Map 2 ----- 2356	0x6A (103) 1 0x1D (29)	----	3029	uint RWES
[USr.S] [USr.S]	<i>Global</i> User Settings Save Save all of this controller's settings to the selected set.	[SEt1] User Set 1 (101) [SEt2] User Set 2 (102) [none] None (61)	None	Instance 1 Map 1 Map 2 26 26	0x(101) 1 0xE (14)	118	1014	uint RWE
[USr.r] [USr.r]	<i>Global</i> User Settings Restore Replace all of this controller's settings with another set.	[Fcty] Factory (31) [none] None (61) [SEt1] User Set 1 (101) [SEt2] User Set 2 (102)	None	Instance 1 Map 1 Map 2 24 24	0x65 (101) 1 0xD (13)	117	1013	uint RWE
Note: Some values will be rounded off to fit in the four-character display. Full values can be read with other interfaces.								R: Read W: Write E: EEPROM S: User Set

Setup Page

Display	Parameter Name Description	Range	Default	Modbus Relative Address	CIP Class Instance Attribute hex (dec)	Profibus Index	Parameter ID	Data Type & Read/Write
CoPn SEt Communications Menu								
PCoL [PCoL]	<i>Communications 1</i> Protocol Set the protocol of this controller to the protocol that this network is using.	Std Standard Bus (1286) RTU Modbus RTU (1057)	Modbus	Instance 1 Map 1 2492 Map 2 2972	0x96 (150) 1 7	----	17009	uint RWE
AdS [Ad.S]	<i>Communications 1</i> Standard Bus Address Set the network address of this controller. Each device on the network must have a unique address. The Zone Display on the front panel will display this number.	1 to 16	1	Instance 1 Map 1 2480 Map 2 2960	0x96 (150) 1 1	----	17001	uint RWE
AdM [Ad.M]	<i>Communications (1 or 2)</i> Modbus Address Set the network address of this controller. Each device on the network must have a unique address.	1 to 247	1	Instance 1 Map 1 2482 Map 2 2962 Instance 2 Map 1 2500 Map 2 2980	0x96 (150) 1 to 2 2	----	17007	uint RWE
bAuD [bAuD]	<i>Communications (1 or 2)</i> Baud Rate Set the speed of this controller's communications to match the speed of the Modbus serial network.	9600 9,600 (188) 192 19,200 (189) 384 38,400 (190)	9,600	Instance 1 Map 1 2484 Map 2 2964 Instance 2 Map 1 2504 Map 2 2984	0x96 (150) 1 to 2 3	----	17002	uint RWE
PAR [PAR]	<i>Communications</i> Parity (1 or 2) Set the parity of this controller to match the parity of the Modbus serial network.	none None (61) Even Even (191) odd Odd (192)	None	Instance 1 Map 1 2486 Map 2 2966 Instance 2 Map 1 2506 Map 2 2986	0x96 (150) 1 to 2 4	----	17003	uint RWE
C_F [C_F]	<i>Communications (1)</i> Display Units Select whether this communications channel will display in Celsius or Fahrenheit. Note: Applies to Modbus only.	F Fahrenheit (30) C Celsius (15)	F	Instance 1 Map 1 2490 Map 2 2970	0x96 (150) 1 6	----	17050	uint RWE
MhL [M.hL]	<i>Communications (1 or 2)</i> Modbus Word Order Select the word order of the two 16-bit words in the floating-point values.	LoHi Low-High (1331) HiLo High-Low (1330)	Low-High	Instance 1 Map 1 2488 Map 2 2968 Instance 2 Map 1 2508 Map 2 2988	0x96 (150) 1 to 2 5	----	17043	uint RWE
Note: Some values will be rounded off to fit in the four-character display. Full values can be read with other interfaces.								R: Read W: Write E: EEPROM S: User Set

Setup Page

Display	Parameter Name Description	Range	Default	Modbus Relative Address	CIP Class Instance Attribute hex (dec)	Profibus Index	Parameter ID	Data Type & Read/Write
[MAP] [Map]	<i>Communications (1)</i> Data Map If set to 1 the control will use PM legacy mapping. If set to 2 the control will use new mapping to accommodate new functions.	1 to 2	1 if 9th digit of part number is a D or 1 otherwise, 2.	----	----	----	17059	uint RWE
[nVS] [nV.S]	<i>Communications (1)</i> Non-Volatile Save If set to Yes all values written to the control will be saved in EEPROM. The EEPROM allows for approximately one million writes.	[YES] Yes (106) [no] No (59)	Yes	Instance 1 <i>Map 1</i> 2494 <i>Map 2</i> 2974	0x96 (150) 1 8	198	17051	uint RWE
[Ad.d] [Ad.d]	<i>Communications (2)</i> DeviceNet™ Node Address Set the DeviceNet™ address for this gateway.	0 to 63	63	----	----	----	17052	----
[bAUd] [bAUd]	<i>Communications (2)</i> Baud Rate DeviceNet™ Set the DeviceNet speed for this gateway's communications to match the speed of the serial network.	[125] 125 kb (1351) [250] 250 kb (1352) [500] 500 kb (1353)	125	----	----	----	17053	----
[FC.E] [FC.E]	<i>Communications (2)</i> DeviceNet™ Quick Connect Enable Allows for immediate communication with the scanner upon power up.	[no] No (59) [YES] Yes (106)	No	----	----	----	17054	----
[PAdd] [P.Add]	<i>Communications (2)</i> Profibus Node Address Set the Profibus address for this control.	0 to 126	126	----	----	----	17060	----
[A.Loc] [A.Loc]	<i>Communications (2)</i> Profibus Address Lock When set to yes will not allow address to be changed using software. Can be changed from front panel.	[no] No (59) [YES] Yes (106)	No	----	----	----	17061	----
[iP.M] [iP.M]	<i>Communications (2)</i> IP Address Mode Select DHCP to let a DHCP server assign an address to this module.	[dHCP] DHCP (1281) [FAdd] Fixed Address (1284)	DHCP	----	----	----	17012	----
[ip.F1] [ip.F1]	<i>Communications (2)</i> IP Fixed Address Part 1 Set the IP address of this module. Each device on the network must have a unique address.	0 to 255	169	----	----	----	17014	----
Note: Some values will be rounded off to fit in the four-character display. Full values can be read with other interfaces.								R: Read W: Write E: EEPROM S: User Set

Setup Page

Display	Parameter Name Description	Range	Default	Modbus Relative Address	CIP Class Instance Attribute hex (dec)	Pro- fibus Index	Param- eter ID	Data Type & Read/ Write
[PF2] [ip.F2]	<i>Communications (2)</i> IP Fixed Address Part 2 Set the IP address of this module. Each device on the network must have a unique address.	0 to 255	254	----	----	----	17015	----
[PF3] [ip.F3]	<i>Communications (2)</i> IP Fixed Address Part 3 Set the IP address of this module. Each device on the network must have a unique address.	0 to 255	1	----	----	----	17016	----
[PF4] [ip.F4]	<i>Communications (2)</i> IP Fixed Address Part 4 Set the IP address of this module. Each device on the network must have a unique address.	0 to 255	1	----	----	----	17017	----
[PF5] [ip.F5]	<i>Communications (2)</i> IP Fixed Address Part 5 Set the IP address of this module. Each device on the network must have a unique address.	0 to 255	0	----	----	----	17018	----
[PF6] [ip.F6]	<i>Communications (2)</i> IP Fixed Address Part 6 Set the IP address of this module. Each device on the network must have a unique address.	0 to 255	0	----	----	----	17019	----
[PS1] [ip.S1]	<i>Communications (2)</i> IP Fixed Subnet Part 1 Set the IP subnet mask for this module.	0 to 255	255	----	----	----	17020	----
[PS2] [ip.S2]	<i>Communications (2)</i> IP Fixed Subnet Part 2 Set the IP subnet mask for this module.	0 to 255	255	----	----	----	17021	----
[PS3] [ip.S3]	<i>Communications (2)</i> IP Fixed Subnet Part 3 Set the IP subnet mask for this module.	0 to 255	0	----	----	----	17022	----
[PS4] [ip.S4]	<i>Communications (2)</i> IP Fixed Subnet Part 4 Set the IP subnet mask for this module.	0 to 255	0	----	----	----	17023	----
[PS5] [ip.S5]	<i>Communications (2)</i> IP Fixed Subnet Part 5 Set the IP subnet mask for this module.	0 to 255	0	----	----	----	17024	----
Note: Some values will be rounded off to fit in the four-character display. Full values can be read with other interfaces.								R: Read W: Write E: EEPROM S: User Set

Setup Page

Display	Parameter Name Description	Range	Default	Modbus Relative Address	CIP Class Instance Attribute hex (dec)	Profibus Index	Parameter ID	Data Type & Read/Write
<input type="checkbox"/> P.56 [ip.S6]	<i>Communications (2)</i> IP Fixed Subnet Part 6 Set the IP subnet mask for this module.	0 to 255	0	----	----	----	17025	----
<input type="checkbox"/> P.91 [ip.g1]	<i>Communications (2)</i> Fixed IP Gateway Part 1 Used for the purpose of sending and receiving messages from another network.	0 to 255	0	----	----	----	17026	----
<input type="checkbox"/> P.92 [ip.g2]	<i>Communications (2)</i> Fixed IP Gateway Part 2 Used for the purpose of sending and receiving messages from another network.	0 to 255	0	----	----	----	17027	----
<input type="checkbox"/> P.93 [ip.g3]	<i>Communications (2)</i> Fixed IP Gateway Part 3 Used for the purpose of sending and receiving messages from another network.	0 to 255	0	----	----	----	17028	----
<input type="checkbox"/> P.94 [ip.g4]	<i>Communications (2)</i> Fixed IP Gateway Part 4 Used for the purpose of sending and receiving messages from another network.	0 to 255	0	----	----	----	17029	----
<input type="checkbox"/> P.95 [ip.g5]	<i>Communications (2)</i> Fixed IP Gateway Part 5 Used for the purpose of sending and receiving messages from another network.	0 to 255	0	----	----	----	17030	----
<input type="checkbox"/> P.96 [ip.g6]	<i>Communications (2)</i> Fixed IP Gateway Part 6 Used for the purpose of sending and receiving messages from another network.	0 to 255	0	----	----	----	17031	----
<input type="checkbox"/> P.75.E [Mb.E]	<i>Communications (2)</i> Modbus TCP Enable Activate Modbus TCP.	<input type="checkbox"/> YES Yes (106) <input type="checkbox"/> NO No (59)	Yes	----	----	----	17041	----
<input type="checkbox"/> E.I.P.E [EiP.E]	<i>Communications (2)</i> EtherNet/IP™ Enable Activate Ethernet/IP™.	<input type="checkbox"/> YES Yes (106) <input type="checkbox"/> NO No (59)	Yes	----	----	----	17042	----
<input type="checkbox"/> Ro.nb [Ao.nb]	<i>Communications (2)</i> CIP Implicit Assembly Output Member Quantity	1 to 20	20	----	----	----	24009	----
Note: Some values will be rounded off to fit in the four-character display. Full values can be read with other interfaces.								R: Read W: Write E: EEPROM S: User Set

Setup Page

Display	Parameter Name Description	Range	Default	Modbus Relative Address	CIP Class Instance Attribute hex (dec)	Pro-fibus Index	Parameter ID	Data Type & Read/Write
Ai.nb [Ai.nb]	<i>Communications (2)</i> CIP Implicit Assembly Input Member Quantity	1 to 20	20	----	----	----	24010	----
C.F [C.F]	<i>Communications (2)</i> Display Units Select which scale to use for temperature passed over communications port 2.	F °F (30) C °C (15)	°F	Instance 2 <i>Map 1</i> <i>Map 2</i> ---- 2990	0x96 (150) 2 6	199	17050	uint RWE
Map [Map]	<i>Communications (2)</i> Data Map If set to 1 the control will use PM legacy mapping. If set to 2 the control will use new mapping to accommodate new functions.	1 to 2	1 if 9 th digit of part number is a D or 1 otherwise, 2.	----	----	----	17059	----
n.US [n.US]	<i>Communications (2)</i> Non-volatile Save If set to Yes all values written to the control will be saved in EEPROM. The EEPROM allows for approximately one million writes.	YES Yes (106) no No (59)	No	Instance 2 <i>Map 1</i> <i>Map 2</i> 2514 2994	96 (150) 2 8	198	17051	uint RWE
RET SEt Real Time Clock Menu								
hoUr [hoUr]	<i>Real Time Clock</i> Hours Set the current time.	0 to 23	0	Instance 1 <i>Map 1</i> <i>Map 2</i> ---- 4004	88 (136) 1 3	----	36003	uint RW
Min [Min]	<i>Real Time Clock</i> Minutes Set the current time.	0 to 59	0	Instance 1 <i>Map 1</i> <i>Map 2</i> ---- 4006	88 (136) 1 4	----	36004	uint RW
doW [doW]	<i>Real Time Clock</i> Day of Week Set the current day of the week.	Sun Sunday (1565) Mon Monday (1559) Tue Tuesday (1560) Wed Wednesday (1561) Thu Thursday (1562) Fri Friday (1563) SAT Saturday (1564)	Sun	Instance 1 <i>Map 1</i> <i>Map 2</i> ---- 4002	88 (136) 1 2	----	36002	uint RW
Note: Some values will be rounded off to fit in the four-character display. Full values can be read with other interfaces.								R: Read W: Write E: EEPROM S: User Set

7

Chapter 7: Profiling Page

Navigating the Profiling Page

Note:

Some of these menus and parameters may not appear, depending on the controller's options. See model number information in the Appendix for more information. If there is only one instance of a menu, no sub-menus will appear.

Profile Setup

First, consider some foundational profile *setup* features that once configured, will apply to all configured profiles. The screen shot below (EZ-ZONE Configurator software) graphically shows the settings (shaded green) that will apply to all profiles; e.g., if Guaranteed Soak is not enabled here this feature will not be available in any individual profile configuration.

Some of those features that apply to all profiles are listed below with a brief description of their function.

- **Ramping Type** (Time or Rate) which changes the profile set point based on a set interval of time or set rate.
- **Profile Type** (Set Point or Process) determines whether a step (any step changing the set point) of a profile will begin by using the process value (Process) or the last closed-loop set point (Set Point).
- **Guaranteed Soak Enable**, when set to on makes this feature available in all profiles. If Guaranteed Soak Enable is on, use Guaranteed Soak Deviation 1 to 2 to set the value for the corresponding loop. Set the deviation or band above or below the working set point where this condition must be met before the profile can proceed.

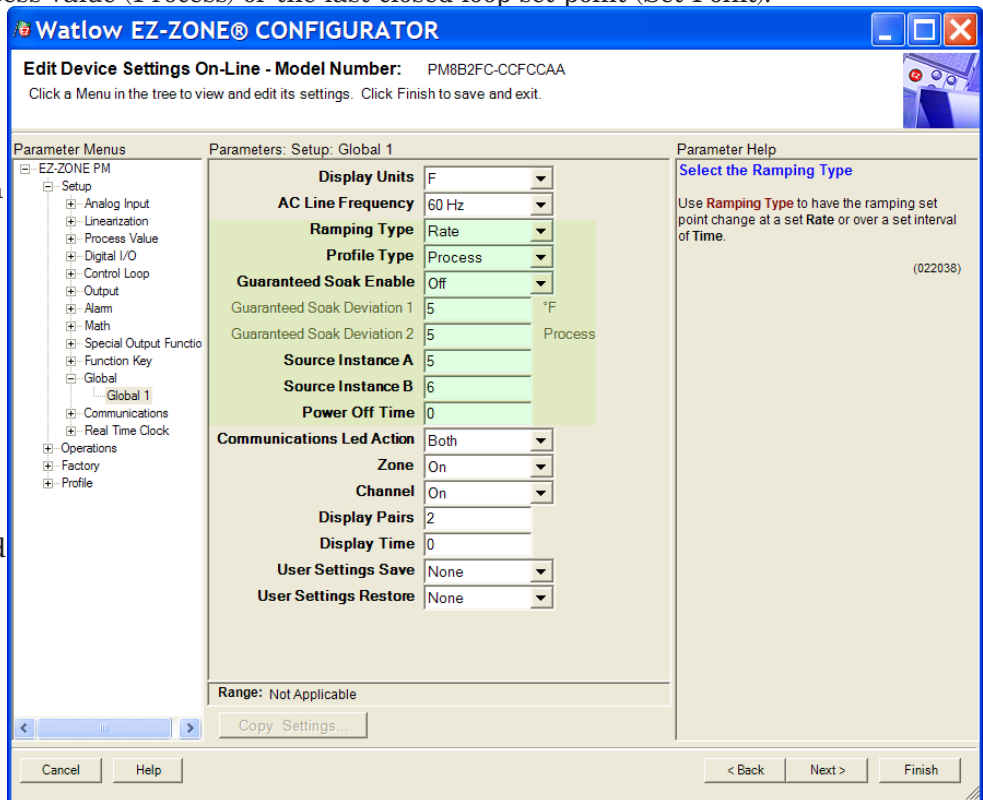

Note:

Changes made to profile parameters in the Profiling Pages will be saved and will also have an immediate impact on the running profile. Some parameters in the Profile Status Menu can be changed for the currently running profile, but should only be changed by knowledgeable personnel and with caution. Changing parameters via the Profile Status Menu will not change the stored profile but will have an immediate impact on the profile that is running.

Once these global profile features are configured, the next step will require navigation to the Profiling Page. Here, each desired ramp and soak profile will be configured.

To navigate to the Profile Page from the front panel, follow the steps below:

1. From the Home Page, press and hold the Advance Key  for approximately five seconds. The profile prompt **PrOf** will appear in the lower display and the profile number (e.g. **P 1**) appears in the upper display.

2. Press the Up ▲ or Down ▼ key to change to another profile (1 to 4).
3. Press the Advance Key ⌂ to move to the selected profiles first step.
4. Press the Up ▲ or Down ▼ keys to move through and select the step type.
5. Press the Advance Key ⌂ to move through the selected step settings.
6. Press the Up ▲ or Down ▼ keys to change the steps settings.
7. Press the Infinity Key ∞ at any time to return to the step number prompt.
8. Press the Infinity Key ∞ again to return to the profile number prompt.
9. From any point press and hold the Infinity Key ∞ for two seconds to return to the Home Page.

If using EZ-ZONE Configurator software, simply click on the plus sign next to Profiles in the left hand column, as shown in the screen shot below.

Notice in the screen shot to the right some fields or parameters are not selectable (grayed out) based on the Step Type that is selected.

Starting a Profile

There are several ways to start a profile. Some of the examples that follow requires that certain optional hardware be available on the control. If you are uncertain as to how your control is equipped, compare the part number of your control to the "Ordering Information" page found in the Appendix of this Users Guide.

Ways to start a profile:

- Function Key
- Digital Input
- Profile Request

Configuring the Function Key to Start and Stop a Profile

1. Navigate to the Setup Page and then the Function menu. From the Home Page, press and hold the ▲ or ▼ key for approximately six seconds where the upper display will show **R**, and the lower display will show **SEE**.
2. Press the Up ▲ or Down ▼ key to navigate to the Function **FUn** menu.
3. Press the Advance Key ⌂ to enter this menu. The upper display will show **h,9h** and the lower display will show **LEu**.
4. Press the Up ▲ or Down ▼ keys to select the level that will start the profile (high or low).

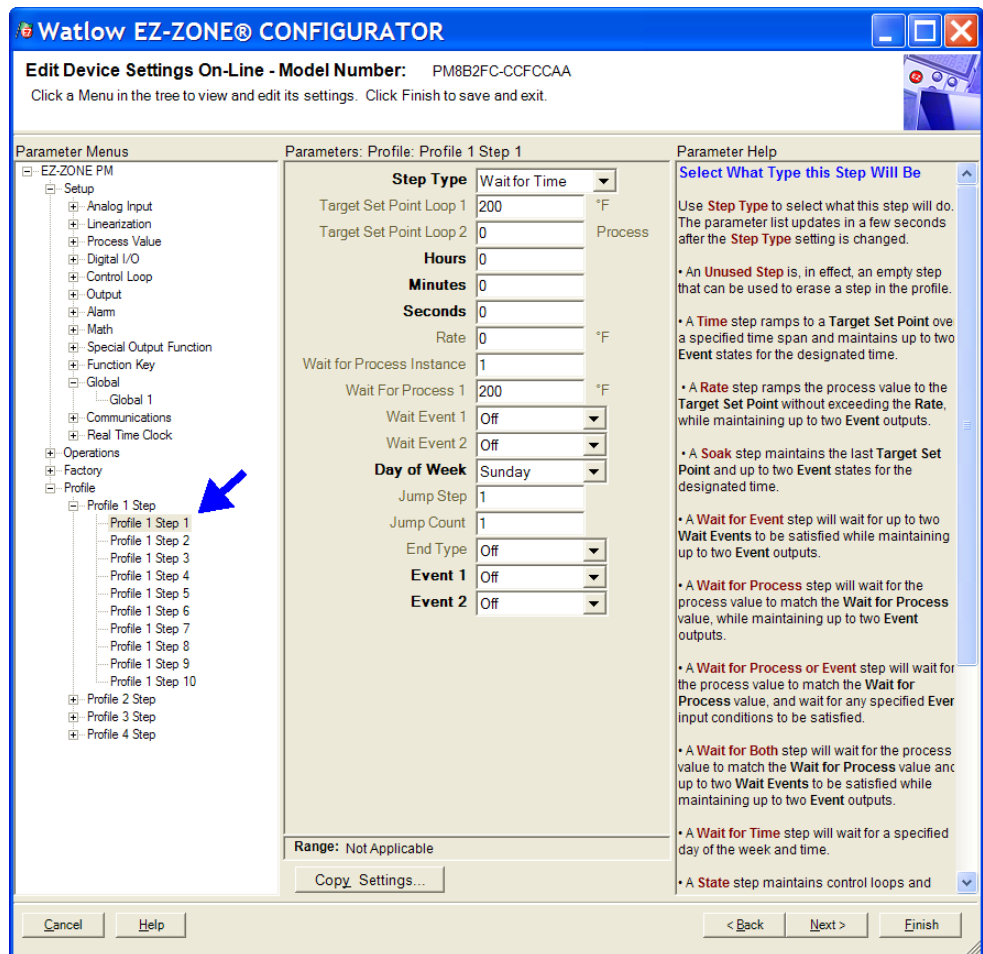

5. Press the Advance Key ⌂ to select the function. In this example, select Profile Start / Stop **P.SES**.
6. Press the Advance Key ⌂ to select the function instance (Profile to start).
7. Return to the Home Page by pressing and holding the Infinity Key ∞ for approximately three seconds.

Note:

The state of the EZ-Function Key (high or low) is maintained with each successive push of the key.

Configuring a Digital Input to Start and Stop a Profile

1. Navigate to the Setup Page and then the Digital I/O menu. From the Home Page, press and hold the **▲** or **▼** key for approximately six seconds where the upper display will show **[R]** and the lower display will show **[SEE]**.
2. Press the Up **▲** or Down **▼** key to navigate to the Digital I/O menu. Upper display will show **[d.i.o]** and the lower display will show **[SEE]**.
3. Press the Advance Key **⊕** where the first available digital instance will be displayed in the upper display.
4. Press the Up **▲** or Down **▼** key to select the input of choice.
5. Press the Advance Key **⊕** to select the direction (input or output). In this example, select Dry Contact **[i.con]**.
6. Select the level (high or low) that will activate the function by pressing the Advance Key **⊕** where the upper display will show **[h,gh]** and the lower display will show **[LEU]**.
7. Press the Up **▲** or Down **▼** keys to select the level that will start the profile (high = closed or low = open).
8. Press the Advance Key **⊕** to select the function. In this example, select Profile Start / Stop **[P.STS]**.
9. Press the Advance Key **⊕** to select the function instance (Profile to start).
10. Return to the Home Page by pressing and holding the Infinity Key **∞** for approximately three seconds.

Starting a Profile from the Operations Page

1. Navigate to the Operations Page and then the Profile Status menu. From the Home Page, press and hold the **▲** or **▼** key for approximately three seconds where the upper display will show **[R]** and the lower display will show **[oPER]**.
2. Press the Up **▲** or Down **▼** key to navigate to the Profile Status **[P.STA]** menu.
3. Press the Advance Key **⊕** to enter this menu. The upper display will show **[]** and the lower display will show **[P.STA]**.
4. Press the Up **▲** or Down **▼** keys to select the Profile or Step to start. In this example select 1.
5. Press the Advance Key **⊕** to select the Profile Action Request. The upper display will show **[nonE]** and the lower display will show **[P.ACR]**.
6. Press the Up **▲** or Down **▼** keys to select the Profile start. The upper display will show **[PROF]** and the lower display will show **[P.ACR]**.

Note:

As soon as the Green Advance key is pressed (step 7 below) the designated Profile or Step (as determined in step 4 above) will start.

7. Press the Advance Key **⊕** to select whether Event 1 will be on or off. The upper display will show **[OFF]** and the lower display will show **[ENT1]**.

Note:

This setting will temporarily override the profile configuration.

8. Press the Up **▲** or Down **▼** keys to select whether Event 1 will be on or off. This will immediately drive the Event to the specified state regardless of the Profile configuration.
9. Press the Advance Key **⊕** to select whether Event 2 will be on or off. The upper display will show **[OFF]** and the lower display will show **[ENT2]**.
10. Press the Up **▲** or Down **▼** keys to select whether Event 2 will be on or off. This will immediately drive the Event to the specified state regardless of the Profile configuration.
11. Press the Advance Key **⊕** to see the current Jump Count. The upper display will show **[0]** and the lower display will show **[JC]**.
11. Return to the Home Page by pressing and holding the Infinity Key **∞** for approximately three seconds.

Ending a Profile from the Operations Page

1. Navigate to the Operations Page and then the Profile Status menu. From the Home Page, press and hold the **▲** or Down **▼** key for approximately three seconds where the upper display will show **[P]** and the lower display will show **[oPEr]**.
2. Press the Up **▲** or Down **▼** key to navigate to the Profile Status **[P,StR]** menu.
3. Press the Advance Key **⊕** to enter this menu. The upper display will show **[]** and the lower display will show **[P,StR]**.
4. Press the Advance Key **⊕** to select the Profile Action Request. The upper display will show **[none]** and the lower display will show **[P,RCr]**.
6. Press the Up **▲** or Down **▼** keys to select the End. The upper display will show **[End]** and the lower display will show **[P,RCr]**.
7. Press the Advance Key **⊕** to end the Profile.
8. Return to the Home Page by pressing and holding the Infinity Key **∞** for approximately three seconds.

Starting a Profile from the Home Page

1. When at the Home Page, press the Advance Key **⊕** to locate Profile Start and select the file or step number to start. The upper display will show **[]** and the lower display will show **[P,StI]**.
2. Press the Up **▲** or Down **▼** key to choose the file or step number.
3. Press the Advance Key **⊕** to select the Profile Action Request. The upper display will show **[none]** and the lower display will show **[P,RCI]**.
4. Press the Up **▲** or Down **▼** keys to select the Profile Start. The upper display will show **[PrOf]** and the lower display will show **[P,RCI]**.
5. Press the Infinity Key to return Home. The Profile will Start

Ending a Profile from the Home Page

1. Press the Advance Key **⊕** to select the Profile Action Request. The upper display will show **[none]** and the lower display will show **[P,RCI]**.
2. Press the Up **▲** or Down **▼** keys to select the End. The upper display will show **[End]** and the lower display will show **[P,RCI]**.
3. Press the Infinity Key to return Home. The Profile will End.

Profiling Parameters

[P]
[PrOf] Profile (1 to 4)
[]
[P] Profile [1 to 4] Step (1 to 40)
[StYP] Step Type
[tSP1] Target Set Point Loop 1
[tSP2] Target Set Point Loop 2
[hOUr] Hours
[MIn] Minutes
[SEC] Seconds
[rRtE] Rate
[WJP1] Wait For Process Instance
[WJP1] Wait For Process 1
[WJE1] Wait For Event 1
[WJE2] Wait for Event 2
[dOLd] Day of Week
[JS] Jump Step
[JC] Jump Count
[End] End Type
[Ent1] Event 1
[Ent2] Event 2

Profiling Page

Display	Parameter Name Description	Range	Default	Modbus Relative Address	CIP Class Instance Attribute hex (dec)	Parameter ID	Data Type & Read/Write
<div style="border: 1px solid black; padding: 2px;"> P1 Pr o F Profiling Menu </div>							
<div style="border: 1px solid black; padding: 2px;"> P1 [P1] to P4 [P4] </div>	Profile [1 to 4] Step Select a step to edit or view.	1 to 10 [profile 1] 11 to 20 [profile 2] 21 to 30 [profile 3] 31 to 40 [profile 4]		----	----	----	----
<div style="border: 1px solid black; padding: 2px;"> SEYP [S.tyP] </div>	Step Type Select a step type. Note: Prior to selecting the Step Type consider whether or not profiles will be based on time or rate of change. By default, profiles are configured for Time E . Therefore, Rate will not be available here. If it is desired to base profiles on rate of change, navigate to the Setup Page and then the Global Menu where Ramping Type can be changed from Time to Rate.	<div style="border: 1px solid black; padding: 2px;"> USEP Unused Step (50) End End (27) JL Jump Loop (116) CLoT Wait For Time (1543) LJbO Wait For Both (210) LJPr Wait For Process (209) LJE Wait For Event (144) SoRH Soak (87) E Time (143) rRE Rate (81) </div>	Unused	Instance 1 Map 1 Map 2 2570 4500 Offset to next instance (Map 1 equals +50, Map 2 equals +100)	0x79 (121) 1 to 40 1	21001	uint RWE
<div style="border: 1px solid black; padding: 2px;"> ESP1 [t.SP1] </div>	<i>Step Type Parameters</i> Target Set Point Loop 1 When Step Type is Time or Rate, enter the closed loop set point for loop 1 to ramp to for this step.	-1,999.000 to 9,999.000°F or units -1,128 to 5,537.000°C	0.0°F or units -18°C	Instance 1 Map 1 Map 2 2572 4502 Offset to next instance (Map 1 equals +50, Map 2 equals +100)	0x79 (121) 1 to 40 2	21002	float RWE
<div style="border: 1px solid black; padding: 2px;"> ESP2 [t.SP2] </div>	<i>Step Type Parameters</i> Target Set Point Loop 2 When Step Type is Time or Rate, enter the closed loop set point for loop 2 to ramp to for this step.	-1,999.000 to 9,999.000°F or units -1,128 to 5,537.000°C	0.0°F or units -18°C	Instance 1 Map 1 Map 2 ---- 4554 Offset to next instance Map 2 equals +100	0x79 (121) 1 to 40 0x1C (28)	21028	float RWE
<div style="border: 1px solid black; padding: 2px;"> hoUr [hoUr] </div>	<i>Step Type Parameters</i> Hours Select the hours (plus Minutes and Seconds) for a timed step.	0 to 99	0	Instance 1 Map 1 Map 2 2574 4504 Offset to next instance (Map 1 equals +50, Map 2 equals +100)	0x79 (121) 1 to 40 3	21003	uint RWE
<div style="border: 1px solid black; padding: 2px;"> Pq.in [Min] </div>	<i>Step Type Parameters</i> Minutes When Step Type is Time, Soak, or Wait For Time enter Minutes (plus Hours and Seconds) for this step.	0 to 59	0	Instance 1 Map 1 Map 2 2576 4506 Offset to next instance (Map 1 equals +50, Map 2 equals +100)	0x79 (121) 1 to 40 4	21004	uint RWE
Note: Some values will be rounded off to fit in the four-character display. Full values can be read with other interfaces.							R: Read W: Write E: EEPROM S: User Set

Profiling Page

Display	Parameter Name Description	Range	Default	Modbus Relative Ad- dress	CIP Class Instance Attribute hex (dec)	Param- eter ID	Data Type & Read/ Write
<input type="checkbox"/> SEC [SEC]	<i>Step Type Parameters</i> Seconds When Step Type is Time, Soak, or Wait For Time enter Seconds (plus Hours and Minutes) for this step.	0 to 59	0	Instance 1 <i>Map 1</i> <i>Map 2</i> 2578 4508 Offset to next instance (<i>Map 1 equals +50, Map 2 equals +100</i>)	0x79 (121) 1 to 40 5	21005	uint RWE
<input type="checkbox"/> REE [rAtE]	<i>Step Type Parameters</i> Rate When Step Type is Rate, enter the rate for ramping in degrees or units per minute.	0 to 9,999.000°F or units per minute 0 to 5,555.000°C per minute	0.0	Instance 1 <i>Map 1</i> <i>Map 2</i> 2580 4510 Offset to next instance (<i>Map 1 equals +50, Map 2 equals +100</i>)	0x79 (121) 1 to 40 6	21006	float RWE
<input type="checkbox"/> W.P.1 [W.Pi]	<i>Step Type Parameters</i> Wait For Process Instance When Step Type is Wait for Process or Wait For Both, enter which analog input specified by Wait For Process 1 must be met before proceeding in profile.	1 or 2	1	Instance 1 <i>Map 1</i> <i>Map 2</i> 2598 4528 Offset to next instance (<i>Map 1 equals +50, Map 2 equals +100</i>)	0x79 (121) 1 to 40 0x0F (15)	21015	uint RWE
<input type="checkbox"/> W.P.1 [W.P1]	<i>Step Type Parameters</i> Wait For Process 1 When Step Type is Wait for Process or Wait For Both, enter wait for process value on analog input specified by Wait For Process Instance before proceeding in profile.	-1,999.000 to 9,999.000°F or units -1,128.000 to 5,537.000°C	0.0°F or units -18.0°C	Instance 1 <i>Map 1</i> <i>Map 2</i> 2590 4520 Offset to next instance (<i>Map 1 equals +50, Map 2 equals +100</i>)	0x79 (121) 1 to 40 0x0B (11)	21011	float RWE
<input type="checkbox"/> WE.1 [WE.1]	<i>Step Type Parameters</i> Wait Event 1 When Step Type is Wait for Event or Wait For Both, select the event state that must be satisfied during this step. Note: Wait Event 1 can be mapped to any available digital input (5 - 12). Navigate to the Setup Page under the Global Menu to find and modify Source Instance A <input type="checkbox"/> 5.a and Source Instance B <input type="checkbox"/> 5.b.	<input type="checkbox"/> OFF Off (62) <input type="checkbox"/> ON On (63) <input type="checkbox"/> NONE None (61)	Off	Instance 1 <i>Map 1</i> <i>Map 2</i> 2586 4516 Offset to next instance (<i>Map 1 equals +50, Map 2 equals +100</i>)	0x79 (121) 1 to 10 9	21009	uint RWE
Note: Some values will be rounded off to fit in the four-character display. Full values can be read with other interfaces.							R: Read W: Write E: EEPROM S: User Set

Profiling Page

Display	Parameter Name Description	Range	Default	Modbus Relative Address	CIP Class Instance Attribute hex (dec)	Parameter ID	Data Type & Read/Write
[LJEE] [WE.2]	<i>Step Type Parameters</i> Wait Event 2 When Step Type is Wait for Event or Wait For Both, select the event state that must be satisfied during this step. Note: Wait Event 2 can be mapped to any available digital input (5 - 12). Navigate to the Setup Page under the Global Menu to find and modify Source Instance A [S,a] and Source Instance B [S,b] .	[OFF] Off (62) [ON] On (63) [NONE] None (61)	Off	Instance 1 <i>Map 1 Map 2</i> 2588 4518 Offset to next instance (<i>Map 1 equals +50, Map 2 equals +100</i>)	0x79 (121) 1 to 40 0xA (10)	21010	uint RWE
[dow] [dow]	<i>Step Type Parameters</i> Day of Week When Step Type is Wait for Time, the profile waits until this Day of Week along with Hours, Minutes and Seconds time of day is met.	[Ed] Every Day (1567) [LJd] Week days (1566) [Sun] Sunday (1565) [Mon] Monday (1559) [Tue] Tuesday (1560) [WEd] Wednesday (1561) [Thu] Thursday (1562) [Fri] Friday (1563) [Sat] Saturday (1564)	Sunday	Instance 1 <i>Map 1 Map 2</i> ---- 4580 Offset to next instance <i>Map 2 equals +100</i>)	0x79 (121) 1 to 40 0x29 (41)	21041	uint RWE
[JS] [JS]	<i>Step Type Parameters</i> Jump Step When Step Type is Jump Loop, this specifies which step to jump back to. Jump Step must be a lower step number than the current step number.	1 to 40	0	Instance 1 <i>Map 1 Map 2</i> 2592 4522 Offset to next instance (<i>Map 1 equals +50, Map 2 equals +100</i>)	0x79 (121) 1 to 40 0xC (12)	21012	uint RWE
[JC] [JC]	<i>Step Type Parameters</i> Jump Count When Step Type is Jump Loop, this specifies the number of jumps to repeat. A value of 0 creates an infinite loop. Loops can be nested four deep.	0 to 9,999	0	Instance 1 <i>Map 1 Map 2</i> 2594 4524 Offset to next instance (<i>Map 1 equals +50, Map 2 equals +100</i>)	0x79 (121) 1 to 40 0xD (13)	21013	uint RWE
[End] [End]	<i>Step Type Parameters</i> End Type When Step Type is End, this specifies what the controller will do when this profile ends.	[OFF] Control Mode set to Off (62) [Hold] Hold last closed-loop set point in the profile (47) [USER] User, reverts to previous set point (100)	Off	Instance 1 <i>Map 1 Map 2</i> 2596 4526 Offset to next instance (<i>Map 1 equals +50, Map 2 equals +100</i>)	0x79 (121) 1 to 40 0xE (14)	21014	uint RWE
Note: Some values will be rounded off to fit in the four-character display. Full values can be read with other interfaces.							R: Read W: Write E: EEPROM S: User Set

Profiling Page

Display	Parameter Name Description	Range	Default	Modbus Relative Address	CIP Class Instance Attribute hex (dec)	Parameter ID	Data Type & Read/Write
Ent1 [Ent1]	<i>Step Type Parameters</i> Event 1 When Step Type is not Unused Step, select whether Event Output 1 or 2 is on or off during this step.	<input type="checkbox"/> oFF Off (62) <input type="checkbox"/> oN On (63)	Off	Instance 1 <i>Map 1 Map 2</i> 2582 4512 Offset to next instance (<i>Map 1 equals +50, Map 2 equals +100</i>)	0x79 (121) 1 to 40 7	21007	uint RWE
Ent2 [Ent2]	<i>Step Type Parameters</i> Event 2 When Step Type is not Unused Step, select whether Event Output 1 or 2 is on or off during this step.	<input type="checkbox"/> oFF Off (62) <input type="checkbox"/> oN On (63)	Off	Instance 1 <i>Map 1 Map 2</i> 2584 4514 Offset to next instance (<i>Map 1 equals +50, Map 2 equals +100</i>)	0x79 (121) 1 to 40 8	21008	uint RWE
Note: Some values will be rounded off to fit in the four-character display. Full values can be read with other interfaces.							R: Read W: Write E: EEPROM S: User Set



Display	Step Type Description	Parameters in Step Type
USEP [UStP]	<i>Step Types</i> Unused Step This is an empty step that can be used to plan for future steps to be inserted or temporarily deactivate a step in a profile. Change step type back when the step should be active again.	----
ET [ti]	<i>Step Types</i> Time If Ramping Type found in the Global Menu of the Setup Page is set for Time, control loop 1 to 2 may be part of the profile and all enabled control loops follow independent set points over the specified time. The state of up to 2 event outputs may be set or maintained.	ET951 Target Set Point Loop 1 ET952 Target Set Point Loop 2 hoUr Hours PT7in Minutes SEC Seconds 95E1 Guaranteed Soak Enable 1 95E2 Guaranteed Soak Enable 2 Ent1 Event 1 Ent2 Event 2
RRE [rAtE]	<i>Step Types</i> Rate If Ramping Type found in the Global Menu of the Setup Page is set for Rate, control loop 1 must be part of the profile and if control loop 2 is enabled it must follow the same set point and rate in degrees or units per minute. Ensure all control loops have the same units of measure. The state of up to 2 event outputs may be set or maintained.	ET951 Target Set Point Loop 1 ET952 Target Set Point Loop 2 95E1 Guaranteed Soak Enable 1 95E2 Guaranteed Soak Enable 2 RRE Rate Ent1 Event 1 Ent2 Event 2
SoRH [SoAk]	<i>Step Types</i> Soak A Soak Step maintains the last Target Set Points for the designated time. The state of up to 2 event outputs may be set or maintained.	hoUr Hours PT7in Minutes SEC Seconds 95E1 Guaranteed Soak Enable 1 95E2 Guaranteed Soak Enable 2 Ent1 Event 1 Ent2 Event 2
CLoC [CLoC]	<i>Step Types</i> Wait For Time A Wait for Time Step is available with the real-time calendar clock feature. This allows the program to wait for a specified day and time before proceeding to the next step. Used to have the profile execute steps everyday or only weekdays. The state of up to 2 event outputs may be set or maintained.	hoUr Hours PT7in Minutes SEC Seconds doWd Day of Week Ent1 Event 1 Ent2 Event 2
WJE [W.E]	<i>Step Types</i> Wait For Event A Wait for Event Step will wait for the two Wait for Event states (1 to 2) to match the specified state. The state of up to 2 event outputs may be set or maintained.	WJE1 Wait Event 1 WJE2 Wait Event 2 Ent1 Event 1 Ent2 Event 2
WJPr [W.Pr]	<i>Step Types</i> Wait For Process A Wait for Process Step will wait for Process Value 1 or 2 to match the Wait for Process Value. The state of up to 2 event outputs may be set or maintained.	WJP1 Wait for Process 1 WJP2 Wait for Process 2 Ent1 Event 1 Ent2 Event 2
WJbo [W.bo]	<i>Step Types</i> Wait For Both A Wait For Process and Event Step will wait for Process Value 1 or 2 to match the Wait for Process 1 value, and/or the two Wait Event states to match the specified state. The state of up to 2 event outputs may be set or maintained.	WJP1 Wait for Process 1 WJP2 Wait for Process 2 WJE1 Wait Event 1 WJE2 Wait Event 2 Ent1 Event 1 Ent2 Event 2
JL [JL]	<i>Step Types</i> Jump Loop A Jump Loop step will repeat previous steps a number of times designated in Jump Count. Jump Loops can be nested up to four deep. The state of up to 2 event outputs may be set or maintained.	J5 Jump Step JC Jump Count Ent1 Event 1 Ent2 Event 2



Display	Step Type Description	Parameters in Step Type
End [End]	<i>Step Types</i> End An End Step will end the profile and set the control modes and set points to match the End Type. The state of up to 2 event outputs may be set or maintained. The event outputs will not be set off unless specifically stated in this step. If a profile does not have an End Step, the profile continues until step 40, then stops and maintains the last set points and control modes.	End End Type Ent 1 Event 1 Ent 2 Event 2

8





Chapter 8: Factory Page

Navigating the Factory Page

To go to the Factory Page from the Home Page, press and hold both the Advance  and Infinity  keys for six seconds.

- Press the Up  or Down  key to view available menus. On the following pages top level menus are identified with a yellow background color.
- Press the Advance Key  to enter the menu of choice.
- If a submenu exists (more than one instance),

press the Up  or Down  key to select and then press the Advance Key  to enter.

- Press the Up  or Down  key to move through available menu prompts.
- Press the Infinity Key  to move backwards through the levels: parameter to submenu; submenu to menu; menu to Home Page.
- Press and hold the Infinity Key  for two seconds to return to the Home Page.

Note:

Some of these menus and parameters may not appear, depending on the controller's options. See model number information in the Appendix for more information. If there is only one instance of a menu, no sub-menus will appear.

Note:

Some of the listed parameters may not be visible. Parameter visibility is dependent upon controller part number.

```

[CUSE]
[FCEY] Custom Setup Menu
  [ ]
  [CUSE] Custom Setup (1 to 20)
    [PRP] Parameter
    [ID] Instance ID

[LoC]
[FCEY] Security Setting Menu
  [LoC] Security Setting
    [LoC.O] Operations Page
    [LoC.P] Profiling Page
    [PASE] Password Enabled
    [rLoC] Read Lock
    [SLoC] Write Security
    [LoC.L] Locked Access Level
    [roLL] Rolling Password
    [PAs,u] User Password
    [PAs,A] Administrator Password

[ULoC]
[FCEY] Security Setting Menu
  [CoDE] Public Key
  [PAsS] Password

[d.iR9]
[FCEY] Diagnostics Menu
  [d.iR9] Diagnostics
    [Pn] Part Number
    [rEv] Software Revision
    [SbLd] Software Build Number
    [Sn] Serial Number
    [dRtE] Date of Manufacture
    [i,PR1] IP Actual Address Mode
    [i,PR1] IP Actual Address Part 1
    [i,PR2] IP Actual Address Part 2
    [i,PR3] IP Actual Address Part 3
  
```

```

[i,PR4] IP Actual Address Part 4
[i,PR5] IP Actual Address Part 5
[i,PR6] IP Actual Address Part 6

[CRl]
[FCEY] Calibration Menu
  [ ]
  [CRl] Calibration (1 to 2)
    [P7u] Electrical Measurement
    [EL.iO] Electrical Input Offset
    [EL.iS] Electrical Input Slope
    [EL.oO] Electrical Output Offset
    [EL.oS] Electrical Output Slope
    [Pn] Part Number
    [CoDE] Code
  
```

Factory Page

Display	Parameter Name Description	Range	Default	Modbus Relative Address	CIP Class Instance Attribute hex (dec)	Pro-fibus Index	Parameter ID	Data Type & Read/Write
Custom [CUSE] [FACTY]								
[PAR] [Par]	<p><i>Custom</i> Parameter 1 to 20 Select the parameters that will appear in the Home Page.</p> <p>The Parameter 1 value will appear in the upper display of the Home Page. It cannot be changed with the Up and Down Keys in the Home Page.</p> <p>The Parameter 2 value will appear in the lower display in the Home Page. It can be changed with the Up and Down Keys, if the parameter is a writable one.</p> <p>Scroll through the other Home Page parameters with the Advance Key .</p> <p>Note: Display Pairs affect the pairing of custom parameters on the Home page. For more information on Display Pairs see the section in this guide entitled "Modifying the Display Pairs".</p>	none [LHY] Limit Hysteresis [LHS] Limit High Set Point [LLS] Limit Low Set Point [CUR] Current Read [PRO] Process [CAL] Calibration Offset [CF] Display Units [USR] User Settings Restore [ALO] Alarm Low Set Point [AHI] Alarm High Set Point [AHY] Alarm Hysteresis [CUSE] Custom Menu [SETP] Set Point [ACPW] Active Process Value [ACSP] Active Set Point [OP] Open Loop Set Point [AUT] Autotune [CPM] Control Mode [HPR] Heat Power [CPR] Cool Power [TI] Time Integral [TD] Time Derivative [DB] Dead Band [HPB] Heat Proportional Band [HHY] Heat Hysteresis [CPB] Cool Proportional Band [CHY] Cool Hysteresis [RR] Ramp Rate [ETUN] TRU-TUNE+® Enable [IDLE] Idle Set Point [PSTR] Profile Start [PARC] Profile Action Request [SSD1] Guaranteed Soak Deviation 1 [SSD2] Guaranteed Soak Deviation 2	See: Home Page	----	----	----	14005	uint RWES
[IID] [iid]	<p><i>Custom (1 to 20)</i> Instance ID Select which instance of the parameter will be selected.</p>	1 to 4		----	----	----	14003	uint RWES
Lock Menu [LoC] [FACTY]								
[LoCo] [LoC.o]	<p><i>Security Setting</i> Operations Page Change the security level of the Operations Page.</p>	1 to 3	2	Instance 1 Map 1 Map 2 1832 2302	0x67 (103) 1 2	----	3002	uint RWE
[LoCP] [LoC.P]	<p><i>Security Setting</i> Profiling Page Change the security level of the Profiling Page.</p>	1 to 3	3	Instance 1 Map 1 Map 2 1844 2314	0x67 (103) 1 8	----	3008	uint RWE
[PASE] [LoC.P]	<p><i>Security Setting</i> Password Enable Set to On to require a password for menu changes.</p>	[OFF] Off [ON] On	Off	----	----	----	3009	uint RWE
<p>Note: Some values will be rounded off to fit in the four-character display. Full values can be read with other interfaces.</p> <p>If there is only one instance of a menu, no submenus will appear.</p>								R: Read W: Write E: EEPROM S: User Set

Factory Page

Display	Parameter Name Description	Range	Default	Modbus Relative Address	CIP Class Instance Attribute hex (dec)	Pro-fibus Index	Parameter ID	Data Type & Read/Write
[rLoC] [rLoC]	<i>Security Setting</i> Read Lock Set the read security clearance level. The user can access the selected level and all lower levels. If the Set Lockout Security level is higher than the Read Lockout Security, the Read Lockout Security level takes priority.	1 to 5	5	Instance 1 <i>Map 1 Map 2</i> 1848 2318	0x67 (103) 1 0x0A (10)	----	3010	uint RWE
[SLoC] [SLoC]	<i>Security Setting</i> Write Security Set the write security clearance level. The user can access the selected level and all lower levels. If the Set Lockout Security level is higher than the Read Lockout Security, the Read Lockout Security level takes priority.	0 to 5	5	Instance 1 <i>Map 1 Map 2</i> 1844 2314	0x67 (103) 1 0x0B (11)	----	3011	uint RWE
[LoC.L] [LoC.L]	<i>Security Setting</i> Locked Access Level Determines user level menu visibility when Password Enable is set to on. See Features section under Password Security.	1 to 5	5	----	----	----	3016	uint RWE
[roLL] [roLL]	<i>Security Setting</i> Rolling Password When power is cycled a new Public Key will be displayed and User Password changes.	<input type="checkbox"/> oFF Off <input type="checkbox"/> oN On	Off	----	----	----	3019	uint RWE
[PAS.u] [PAS.u]	<i>Security Setting</i> User Password Used to acquire access to menus made available through the Locked Access Level setting.	10 to 999	63	----	----	----	3017	uint RWE
[PAS.A] [PAS.A]	<i>Security Setting</i> Administrator Password Used to acquire full access to all menus including disabling or changing passwords.	10 to 999	156	----	----	----	3018	uint RWE
Note: Some values will be rounded off to fit in the four-character display. Full values can be read with other interfaces. If there is only one instance of a menu, no submenus will appear.								R: Read W: Write E: EEPROM S: User Set

Factory Page

Display	Parameter Name Description	Range	Default	Modbus Relative Ad- dress	CIP Class Instance Attribute hex (dec)	Pro- fibus Index	Param- eter ID	Data Type & Read/ Write
<u>U L o C</u> <u>F C t Y</u> Unlock Menu								
<u>C o d e</u> [CodE]	<i>Security Setting</i> Public Key If Rolling Password turned on, generates a random number when power is cycled. If Rolling Password is off fixed number will be displayed. The key can be used to gain access when password is not known.	Customer Specific	0	----	----	----	3020	uint R
<u>P A S S</u> [PASS]	<i>Security Setting</i> Password Enter the User or Administrator password to gain access. After valid password is supplied exit this menu and re-enter the Security Menu via the Factory Page.	-1999 to 9999	0	----	----	----	3022	int RW
<u>d . R 9</u> <u>F C t Y</u> Diagnostics Menu								
<u>P n</u> [Pn]	<i>Diagnostics</i> Part Number Display this controller's part number.	15 characters	----	----	0x65 (101) 1 9	115	1009	string R
<u>r E u</u> [rEu]	<i>Diagnostics</i> Software Revision Display this controller's firmware revision number.	1 to 10	----	Instance 1 <i>Map 1 Map 2</i> 4 4	0x65 (101) 1 3	116	1003	string R
<u>S . b L d</u> [S.bLd]	<i>Diagnostics</i> Software Build Number Display the firmware build number.	0 to 2,147,483,647	----	Instance 1 <i>Map 1 Map 2</i> 8 8	0x65 (101) 1 5	----	1005	dint R
<u>S n</u> [Sn]	<i>Diagnostics</i> Serial Number Display the serial number.	0 to 2,147,483,647	----	Instance 1 <i>Map 1 Map 2</i> 12 12	0x65 (101) 1 0x20 (32)	----	1032	string R
<u>d A t E</u> [dAtE]	<i>Diagnostics</i> Date of Manufacture Display the date code (YYWW). Where YY = year and WW= week..	0 to 2,147,483,647	----	Instance 1 <i>Map 1 Map 2</i> 14 14	0x65 (101) 1 8	----	1008	dint R
No Display	<i>Diagnostics</i> Hardware ID Display the Hardware ID.	0 to 2,147,483,647	----	Instance 1 <i>Map 1 Map 2</i> 0 0	0x65 (101) 1 1	----	1001	dint R
No Display	<i>Diagnostics</i> Firmware ID Display the Firmware ID.	0 to 2,147,483,647	----	Instance 1 <i>Map 1 Map 2</i> 2 2	0x65 (101) 1 2	----	1002	dint R
<u>i P . A C</u> [iP.AC]	<i>Diagnostics</i> IP Address Mode Actual address mode (DHCP or Fixed).	<u>d h c p</u> DHCP (1281) <u>F i x e d</u> Fixed Address (1284)	DHCP	----	----	----	17013	----
Note: Some values will be rounded off to fit in the four-character display. Full values can be read with other interfaces.								R: Read W: Write E: EEPROM S: User Set
If there is only one instance of a menu, no submenus will appear.								

Factory Page

Display	Parameter Name Description	Range	Default	Modbus Relative Ad- dress	CIP Class Instance Attribute hex (dec)	Pro- fibus Index	Param- eter ID	Data Type & Read/ Write
[.PR1] [ip.F1]	<i>Diagnostics</i> IP Actual Address Part 1 Actual IP address of this module. Note: Although it appears as if this can be changed here this is a read only parameter. Go to Setup Page and then the Com Menu to change.	0 to 255	169	----	----	----	17014	R
[.PR2] [ip.F2]	<i>Diagnostics</i> IP Actual Address Part 2 Actual IP address of this module. Note: Although it appears as if this can be changed here this is a read only parameter. Go to Setup Page and then the Com Menu to change.	0 to 255	254	----	----	----	17015	R
[.PR3] [ip.F3]	<i>Diagnostics</i> IP Actual Address Part 3 Actual IP address of this module. Note: Although it appears as if this can be changed here this is a read only parameter. Go to Setup Page and then the Com Menu to change.	0 to 255	1	----	----	----	17016	R
[.PR4] [ip.F4]	<i>Diagnostics</i> IP Actual Address Part 4 Actual IP address of this module. Note: Although it appears as if this can be changed here this is a read only parameter. Go to Setup Page and then the Com Menu to change.	0 to 255	1	----	----	----	17017	R
[.PR5] [ip.F5]	<i>Diagnostics</i> IP Actual Address Part 5 Actual IP address of this module. Note: Although it appears as if this can be changed here this is a read only parameter. Go to Setup Page and then the Com Menu to change.	0 to 255	1	----	----	----	17018	R
Note: Some values will be rounded off to fit in the four-character display. Full values can be read with other interfaces. If there is only one instance of a menu, no submenus will appear.								R: Read W: Write E: EEPROM S: User Set

Factory Page

Display	Parameter Name Description	Range	Default	Modbus Relative Address	CIP Class Instance Attribute hex (dec)	Pro-fibus Index	Parameter ID	Data Type & Read/Write
[PR6] [ip.F6]	Diagnostics IP Actual Address Part 6 Actual IP address of this module. Note: Although it appears as if this can be changed here this is a read only parameter. Go to Setup Page and then the Com Menu to change.	0 to 255	1	----	----	----	17019	R
[CAL] [FCE9] Calibration Menu								
[MV] [Mv]	Calibration (1 to 2) Electrical Measurement Read the raw electrical value for this input in the units corresponding to the Sensor Type (Setup Page, Analog Input Menu) setting.	-3.4e38 to 3.4e38		Instance 1 Map 1 Map 2 400 400 Instance 2 Map 1 Map 2 480 490	0x68 (104) 1 to 2 0x15 (21)	----	4021	float R
[ELi.o] [ELi.o]	Calibration (1 to 2) Electrical Input Offset Change this value to calibrate the low end of the input range.	-1,999.000 to 9,999.000	0.0	Instance 1 Map 1 Map 2 378 378 Instance 2 Map 1 Map 2 458 468	0x68 (104) 1 to 2 0x0A (10)	----	4010	float RWES
[ELi.S] [ELi.S]	Calibration (1 to 2) Electrical Input Slope Adjust this value to calibrate the slope of the input value.	-1,999.000 to 9,999.000	1.0	Instance 1 Map 1 Map 2 380 380 Instance 2 Map 1 Map 2 460 470	0x68 (104) 1 to 2 0xB (11)	----	4011	float RWES
[ELo.o] [ELo.o]	Calibration (1 or 3) Electrical Output Offset Change this value to calibrate the low end of the output range.	-1,999.000 to 9,999.000	0.0	Instance 1 Map 1 Map 2 728 848 Instance 3 Map 1 Map 2 808 928	0x76 (118) 1 or 3 5	----	18005	float RWES
[ELo.S] [ELo.S]	Calibration (1 or 3) Electrical Output Slope Adjust this value to calibrate the slope of the output value.	-1,999.000 to 9,999.000	1.0	Instance 1 Map 1 Map 2 730 850 Instance 3 Map 1 Map 2 810 930	0x76 (118) 1 or 3 6	----	18006	float RWES
[Pn] [Pn]	Calibration (1 to 3) Part Number Displays current setting for control model number.	[FCE9] Factory [USEP] User	Factory	----	----	----	----	uint R
[CodE] [CodE]	Calibration (1 to 3) Public Key Changes the control to a PM Express or back to original model number as shown on the side of the control.	[2501] PM Express [606] Factory model number	4999	----	----	----	----	uint RWES
Note: Some values will be rounded off to fit in the four-character display. Full values can be read with other interfaces. If there is only one instance of a menu, no submenus will appear.								R: Read W: Write E: EEPROM S: User Set

9

Chapter 9: Features

Changing PM Integrated Model Number to PM Express	121
How to Change the Control Model Number to a PM Express	122
How to Restore Original PM Model Number	122
Tuning the PID Parameters	123
Autotuning with TRU-TUNE+®	124
Inputs	125
Calibration Offset	125
Calibration	125
Filter Time Constant	126
Sensor Selection	127
Sensor Backup	127
Scale High and Scale Low	127
Range High and Range Low	127
Receiving a Remote Set Point	128
Ten Point Linearization	128
Outputs	128
Duplex	128
NO-ARC Relay	129
Retransmitting a Process Value or Set Point	129
Cool Output Curve	130
Resetting a Tripped Limit	130
Control Methods	131
Output Configuration	131
Auto (closed loop) and Manual (open loop) Control	131
On-Off Control	132
Proportional and (P) Control	132
Proportional and Integral (PI) Control	133
Proportional, Integral and Derivative (PID) Control	133
Dead Band	133
Variable Time Base	134
Single Set Point Ramping	135
Cascade Control	135
Compressor Control	135
Differential Control	136
Ratio Control	136
Duplex Control	136
Motorized Valve Control	136
Alarms	136
Process and Deviation Alarms	136
Alarm Set Points	136
Alarm Hysteresis	137
Alarm Latching	137
Alarm Silencing	137
Alarm Blocking	137
Current Sensing	138
Open Loop Detection	138
Programming the EZ Key/s	138

9

Chapter 9: Features (cont.)

Using Lockout and Password Security	139
Modbus - Using Programmable Memory Blocks	142
CIP - Communications Capabilities	142
Profibus DP - (Decentralized Peripherals)	144
Software Configuration	144

Changing PM Integrated Model Number to PM Express

EZ-ZONE PM firmware revisions of 13 and above allow the user to switch between a PM Integrated control to a PM Express. Switching to a PM Express eliminates the complexity of the advanced PM Integrated control by allowing the user to operate with a simplified menu structure.

Note:

When switching from an integrated control to an Express version, optional PM hardware (even though installed) and firmware features not available in a PM Express will no longer work. To see exactly what is impacted by this change, compare the chart below to the ordering information page in this document.

Controller

EZ-ZONE® Integrated Controller **Changes to PM Express**

Red-green 7-segment displays

Package Size

No Change

Primary Function

C PID Controller with Universal Input

R **Changes to C**

B

J PID Controller with Universal Input

N **Changes to J**

E

S Custom Firmware

Power Supply

1 100 to 240V~ (ac)

2 **Changes to 1**

3 15 to 36V= (dc) and 24V~ (ac)

4 **Changes to 3**

Output 1 and 2 Hardware Options

	Output 1	Output 2
CA	Switched dc/open collector	None
CH	Switched dc/open collector	NO-ARC 15 A power control
CC	Switched dc/open collector	Switched dc
CJ	Switched dc/open collector	Mechanical relay 5 A, form A
CK	Switched dc/open collector	Solid-state relay 0.5 A, form A
EA	Mechanical relay 5 A, form C	None
EH	Mechanical relay 5 A, form C	NO-ARC 15 A power control
EC	Mechanical relay 5 A, form C	Switched dc
EJ	Mechanical relay 5 A, form C	Mechanical relay 5 A, form A
EK	Mechanical relay 5 A, form C	Solid-state relay 0.5 A, form A
FA	Universal process	None
FC	Universal process	Switched dc (cannot use variable time base)
FJ	Universal process	Mechanical relay 5 A, form A (cannot use variable time base)
FK	Universal process	Solid-state relay 0.5 A, form A (cannot use variable time base)
AK	None	Solid-state relay 0.5 A, form A
KH	Solid-state relay 0.5 A, form A	NO-ARC 15 A power control
KK	Solid-state relay 0.5 A, form A	Solid-state relay 0.5 A, form A

Communications Options or Additional Digital I/O

None

- Standard Bus EIA-485 always included - all models

Auxillary Control Functions

None

Output 3 and 4 Hardware Options

None

Additional Options

B **Changes to Express**

Custom Options

AA Standard EZ-ZONE face plate

AB EZ-ZONE logo and no Watlow name

AC No logo and no Watlow name

12 Class 1, Div. 2 (Not available with Integrated Limit Controller or mechanical relay outputs)

PM - A A A B A A

How to Change the Control Model Number to a PM Express

1. Enter Factory Page (**FCEY**), Calibration Menu (**CAL**) via front panel or using EZ-ZONE Configurator Software.
2. Once there, using the green advance button navigate to the Part Number (**Pn**) prompt (lower display). The upper display will show factory (**FCEY**) indicating the factory model number as shown on the side of the control is currently in effect.
3. Push the green advance button one more time where the Public Key (**Code**) prompt will be displayed in the lower display and the number (**4999**) in the upper display.
4. Using the up or down arrow keys enter 2501 and push the green advance button to execute the change.

Note:

As noted above, when switching from an integrated control to an Express version, optional hardware (even though installed) may no longer work. Also, all settings will be defaulted to that of a PM Express when switched. If switching from a PM Express back to the PM Standard, all settings will be defaulted as shown in this document for the model as shipped.

Note:

After switching the model number to a PM Express this document will no longer apply to the control. Click on the link that follows to acquire the latest version of the PM PID Express User's Guide.

<http://www.watlow.com/literature/manuals.cfm>

Once there, simply enter express in the "Keyword" field to find the appropriate document.

How to Restore Original PM Model Number

1. Enter Factory Page (**FCEY**), Calibration Menu (**CAL**) via front panel or using EZ-ZONE Configurator Software.
2. Once there, using the green advance button navigate to the Part Number (**Pn**) prompt (lower display). The upper display will show User (**USER**) indicating the control is currently a PM Express.
3. Push the green advance button one more time where the Public Key (**Code**) prompt will be displayed in the lower display and the number (**4999**) in the upper display.
4. Using the up or down arrow keys enter 606 and push the green advance button to execute the change.

Note:

When switching from a PM Express back to the original model number all original optional hardware will again be enabled for use (assuming all original hardware is still installed). Also, when executing this step the control will be factory defaulted back to the original model number (as shown on the side of the control) at zone address 1. This User's Guide would once again apply to this control.

Saving and Restoring User Settings

Recording setup and operations parameter settings for future reference is very important. If you unintentionally change these, you will need to program the correct settings back into the controller to return the equipment to operational condition.

After you program the controller and verify proper operation, select User Settings Save (**USR.S**) (Setup Page, Global Menu) to save the settings into either of two files ((**SEET1**) or (**SEET2**)) in the control memory.

Note:

Saving the settings overwrites any previously saved collection of settings. Be sure to document all the controller settings.

If the settings in the controller are altered a user can return the controller to one of three settings. If previously saved, (**SEET1**) or (**SEET2**) can be restored as well as the factory (**FCEY**) settings. Navigate to the Setup Page, Global Menu to find the Restore (**USR.R**) prompt. A digital input or the Function Key can also be configured to restore parameters.

Note:

When restoring factory defaults, I/O assemblies for Modbus, DeviceNet, Profibus and Ethernet along with the zone address will be overwritten when restoring factory defaults.

Tuning the PID Parameters

Autotuning

When an autotune is performed on the EZ-ZONE[®] PM, the set point is used to calculate the tuning set point.

For example, if the active set point is 200° and Autotune Set Point (**RES_P**) (Operations Page, Loop Menu) is set to 90 percent, the autotune function utilizes 180° for tuning. This is also how autotuning works in previous Watlow Winona controllers. In addition, changing the active set point in previous controllers causes the autotune function to restart; where with the EZ-ZONE[®] PM changing the set point after an autotune has been started has no affect.

A new feature in EZ-ZONE[®] PM products will allow set point changes while the control is autotuning, this includes while running a profile or ramping. When the auto tune is initially started it will use the current set point and will disregard all set point changes until the tuning process is complete. Once complete, the controller will then use the new set point.

This is why it is a good idea to enter the active set point before initiating an autotune.

Autotuning calculates the optimum heating and/or cooling PID parameter settings based on the system's response. Autotuning can be enabled whether or not TUNE-TUNE+[™] is enabled. The PID settings generated by the autotune will be used until the autotune feature is rerun, the PID values are manually adjusted or TRU-TUNE+[®] is enabled.

To initiate an autotune, set Autotune Request (**ARE**) (Operations Page, Loop Menu) to **YES**. You should not autotune while a profile is running. If the autotune cannot be completed in 60 minutes, the autotune will time-out and the original settings will take effect.

Depending on which loops are being tuned the lower display may flash **EU_{n1}** or **EU_{n2}** and the set point while the autotuning is underway. The temperature must cross the Autotune Set Point five times to complete the autotuning process. Once complete, the controller controls at the normal set point, using the new parameters.

Select a set point for the tune with Autotune Set Point. The Autotune Set Point is expressed as a percent of the Closed Loop Set Point.

If you need to adjust the tuning procedure's aggressiveness, use Autotune Aggressiveness (**AG_r**) (Setup Page, Loop Menu). Select Under Damped (**Undr**) to bring the process value to the set point quickly. Select over damped (**ovEr**) to bring the process value to the set point with minimal overshoot. Select critical damped (**CrIt**) to balance a rapid response with minimal overshoot.

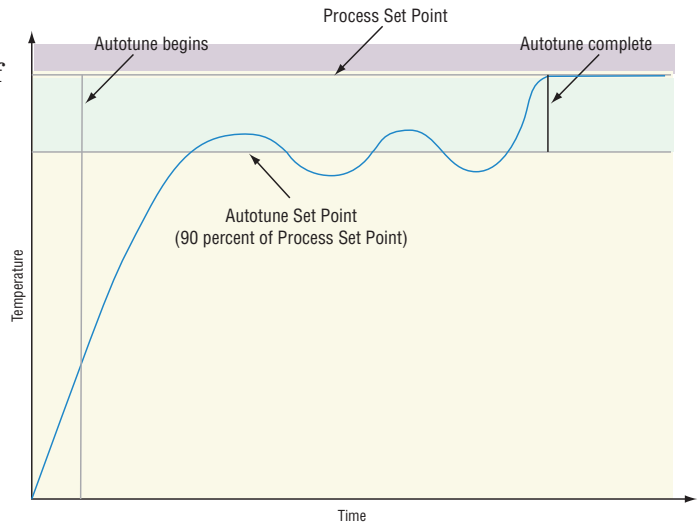

Manual Tuning

In some applications, the autotune process may not provide PID parameters for the process characteristics you desire. If that is the case, you may want to tune the controller manually.

1. Apply power to the controller and establish a set point typically used in your process.
2. Go to the Operations Page, Loop Menu, and set Heat Proportional Band (**hP_b**) and/or Cool Proportional Band (**C_{Pb}**) to 5. Set Time Integral (**t_i**) to 0. Set Time Derivative (**t_d**) to 0.
3. When the system stabilizes, watch the process value. If it fluctuates, increase the Heat Proportional Band or Cool Proportional Band value in 3 to 5° increments until it stabilizes, allowing time for the system to settle between adjustments.
4. When the process has stabilized, watch Heat Power (**hP_r**) or Cool Power (**C_{Pr}**) (Operations Page, Monitor Menu). It should be stable $\pm 2\%$. At this point, the process temperature should also be stable, but it will have stabilized before reaching the set point. The difference between the set point and actual process value can be eliminated with Integral.

Manual Tuning (cont.)

5. Start with an Integral value of 6,000 and allow 10 minutes for the process temperature to reach the set point. If it has not, reduce the setting by half and wait another 10 minutes. Continue reducing the setting by half every 10 minutes until the process value equals the set point. If the process becomes unstable, the Integral value is too small. Increase the value until the process stabilizes.
6. Increase Derivative to 0.1. Then increase the set point by 11° to 17°C. Monitor the system's approach to the set point. If the process value overshoots the set point, increase Derivative to 0.2. Increase the set point by 11° to 17°C and watch the approach to the new set point. If you increase Derivative too much, the approach to the set point will be very sluggish. Repeat as necessary until the system rises to the new set point without overshoot or sluggishness.

For additional information about autotune and PID control, see related features in this chapter.

Autotuning with TRU-TUNE+®

The TRU-TUNE+® adaptive algorithm will optimize the controller's PID values to improve control of dynamic processes. TRU-TUNE+® monitors the Process Value and adjusts the control parameters automatically to keep your process at set point during set point and load changes. When the controller is in the adaptive control mode, it determines the appropriate output signal and, over time, adjusts control parameters to optimize responsiveness and stability. The TRU-TUNE+® feature does not function for on-off control.

The preferred and quickest method for tuning a loop is to establish initial control settings and continue with the adaptive mode to fine tune the settings.

Setting a controller's control mode to tune starts this two-step tuning process. (See Autotuning in this chapter.) This predictive tune determines initial, rough settings for the PID parameters. Then the loop automatically switches to the adaptive mode which fine tunes the PID parameters.

Once the Process Value has been at set point for a suitable period (about 30 minutes for a fast process to roughly two hours for a slower process) and if no further tuning of the PID parameters is desired or needed, TRU-TUNE+™ may be turned off. However, keeping the controller in the adaptive mode allows it to automatically adjust to load changes and compensate for differing control characteristics at various set points for processes that are not entirely linear.

Once the PID parameters have been set by the TRU-TUNE+™ adaptive algorithm, the process, if shut down for any reason, can be restarted in the adaptive control mode.

Turn TRU-TUNE+™ on or off with TRU-TUNE+™ Enable **EEUn** (Setup Page, Loop Menu).

Use TRU-TUNE+™ Band **EBnd** (Setup Page, Loop Menu) to set the range above and below the set point in which adaptive tuning will be active. Adjust this parameter only in the unlikely event that the controller is unable to stabilize at the set point with TRU-TUNE+™ Band set to auto (0). This may occur with very fast processes. In that case, set TRU-TUNE+™ Band to a large value, such as 100.

Use TRU-TUNE+™ Gain **EGn** (Setup Page, Loop Menu) to adjust the responsiveness of the adaptive tuning calculations. Six settings range from 1, with the most aggressive response and most potential overshoot (highest gain), to 6, with the least aggressive response and least potential for overshoot (lowest gain). The default setting, 3, is recommended for loops with thermocouple feedback and moderate response and overshoot potential.

Before Tuning

Before autotuning, the controller hardware must be installed correctly, and these basic configuration parameters must be set:

- Sensor Type **SEn** (Setup Page, Analog Input Menu), and scaling, if required;
- Function **Fn** (Setup Page, Output Menu) and scaling, if required.

How to Autotune a Loop

1. Enter the desired set point or one that is in the middle of the expected range of set points that you want to tune for.
2. Enable TRU-TUNE+.
3. Initiate an autotune. (See Autotuning in this chapter.)

When autotuning is complete, the PID parameters should provide good control. As long as the loop is in the adaptive control mode, TRU-TUNE+® continuously tunes to provide the best possible PID control for the process.



WARNING! During autotuning, the controller sets the output to 100 percent and attempts to drive the Process Value toward the set point. Enter a set point and heat and cool power limits that are within the safe operating limits of your system.

Inputs

Calibration Offset

Calibration offset allows a device to compensate for an inaccurate sensor, lead resistance or other factors that affect the input value. A positive offset increases the input value, and a negative offset decreases the input value.

The input offset value can be viewed or changed with Calibration Offset (Operations Page, Analog Input Menu).

Calibration

Before performing any calibration procedure, verify that the displayed readings are not within published specifications by inputting a known value from a precision source to the analog input. Next, subtract the displayed value with the known value and compare this difference to the published accuracy range specification for that type of input.

Use of the Calibration Offset parameter found in the Operations Page , Analog Input Menu , shifts the readings across the entire displayed range by the offset value.

Use this parameter to compensate for sensor error or sensor placement error. Typically this value is set to zero.

Equipment required while performing calibration:

Obtain a precision source for millivolts, volts, milliamperes or resistance depending on the sensor type to be calibrated. Use copper wire only to connect the precision source to the controller's input. Keep leads between the precision source and controller as short as possible to minimize error. In addition, a precision volt/ohm meter capable of reading values to 4 decimal places or better is recommended. Prior to calibration, connect this volt/ohm meter to the precision source to verify accuracy.

Actual input values do NOT have to be exactly the recommended values, but it IS critical that the actual value of the signal connected to the controller be accurately known to at least four digits.

Calibration of Analog Inputs:

To calibrate an analog input, you will need to provide a source of two electrical signals or resistance values near the extremes of the range that the application is likely to utilize. See recommended values below:

Sensor Type	Precision Source Low	Precision Source High
thermocouple	0.000 mV	50.000 mV
millivolts	0.000 mV	50.000 mV
volts	0.000V	10.000V
milliamps	0.000 mA	20.000 mA
100 Ω RTD	50.00 Ω	350.0 Ω
1,000 Ω RTD	500.0 Ω	3,500 Ω
thermistor 5 kΩ	50.00	5,000
thermistor 10 kΩ	150.0	10,000
thermistor 20 kΩ	1,800	20,000
thermistor 40 kΩ	1,700	40,000
potentiometer	0.000	1,200

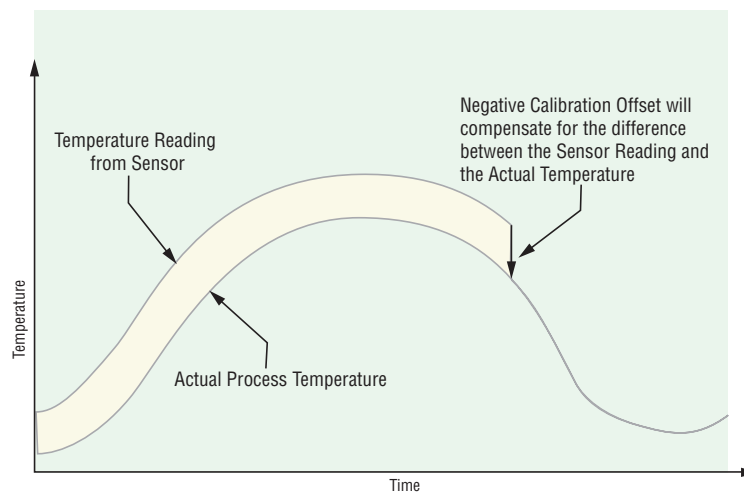

Note:

The user may only calibrate one sensor type. If the calibrator interferences with open thermocouple detection, set Sensor Type **[SEN]** in Setup Page **[SEE]**, Analog Input Menu **[A1]** to millivolt **[MV]** instead of Thermocouple **[TC]** to avoid interference between the calibrator and open thermocouple detect circuit for the duration of the calibration process. Be sure to set sensor type back to the thermocouple type utilized.

1. Disconnect the sensor from the controller.
2. Record the Calibration Offset **[CAL]** parameter value in the Operations Page **[OPER]**, Analog Input Menu **[A1]**, then set value to zero.
3. Wire the precision source to the appropriate controller input terminals to be calibrated. Do not have any other wires connected to the input terminals. Please refer to the Install and Wiring section of this manual for the appropriate connections.
4. Ensure the controller sensor type is programmed to the appropriate Sensor Type **[SEN]** to be utilized in the Setup Page **[SEE]**, Analog Input Menu **[A1]**.
5. Enter Factory Page **[FEY]**, Calibration Menu **[CAL]** via front panel or EZ-ZONE Configurator Software.
6. Select the Calibration **[CAL]** input instance to be calibrated. This corresponds to the analog input to be calibrated.
7. Set Electrical Input Slope **[EL1S]** to 1.000 and Electrical Input Offset **[EL1O]** to 0.000 (this will cancel any prior user calibration values)
8. Input a Precision Source Low value. Read Electrical Measurement value **[MV]** of controller via EZ-Configurator or RUI. This will be referred to as Electrical Measured Low. Record low value _____
9. Input a Precision Source High value.
10. Read Electrical Measurement value **[MV]** of controller via EZ-Configurator or RUI. This will be referred to as Electrical Measured High. Record high value _____
11. Calculated Electrical Input Slope = (Precision High – Precision Low) / (Electrical Measured High - Electrical Measured Low) Calculated Slope value _____
12. Calculated Electrical Input Offset = Precision Low - (Electrical Input Slope * Measured Low) Calculated Offset value _____
13. Enter the calculated Electrical Input Slope **[EL1S]** and Electrical Input Offset **[EL1O]** into the controller.
14. Exit calibration menu.
15. Validate calibration process by utilizing a calibrator to the analog input.
16. Enter calibration offset as recorded in step 2 if required to compensate for sensor error.

Setting Electrical Input Slope **[EL1S]** to 1.000 and Electrical Input Offset **[EL1O]** to 0.000, restores factory calibration as shipped from factory.

Filter Time Constant

Filtering smoothes an input signal by applying a first-order filter time constant to the signal. Filtering the displayed value makes it easier to monitor. Filtering the signal may improve the performance of PID control in a noisy or very dynamic system.

Adjust the filter time interval with Filter Time **[FIL]** (Setup Page, Analog Input Menu). Example: With a filter value of 0.5 seconds, if the process input value instantly changes from 0 to 100 and remained at 100, the display will indicate 100 after five time constants of the filter value or 2.5 seconds.

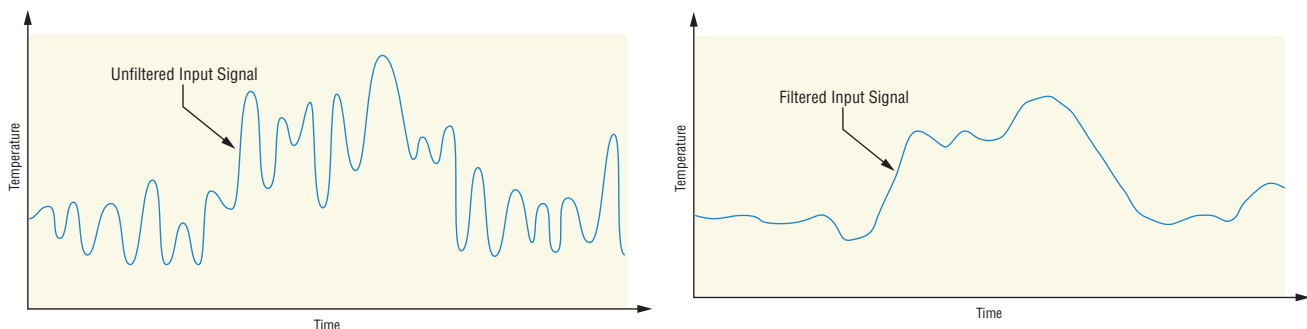

Filter Time Constant

Sensor Selection

You need to configure the controller to match the input device, which is normally a thermocouple, RTD or process transmitter.

Select the sensor type with Sensor Type (Setup Page, Analog Input Menu).

Sensor Backup

Sensor backup maintains closed-loop control after an input failure by switching control to input 2. The sensor backup feature is only available in an EZ-ZONE PM Integrated Limit or Remote Set Point controller. Turn sensor backup on or off with Sensor Backup Enable (Setup Page, Analog Input 1).

Note:

When Sensor Backup is enabled the Process Value function will automatically set itself to Sensor Backup.

Set Point Low Limit and High Limit

The controller constrains the set point to a value between a set point low limit and a set point high limit.

Set the set point limits with Low Set Point and High Set Point (Setup Page, Loop Menu).

There are two sets of set point low and high limits: one for a closed-loop set point, another for an open-loop set point.

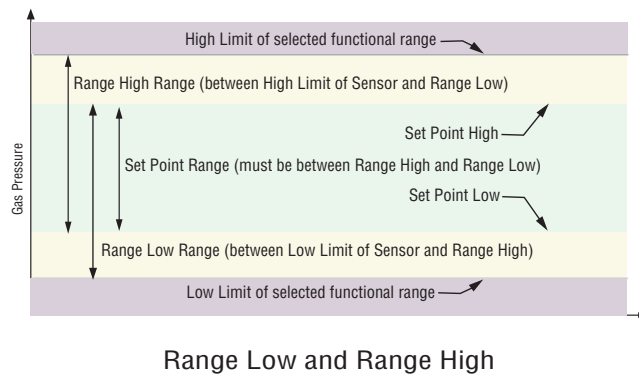

Scale High and Scale Low

When an analog input is selected as process voltage or process current input, you must choose the value of voltage or current to be the low and high ends. For example, when using a 4 to 20 mA input, the scale low value would be 4.00 mA and the scale high value would be 20.00 mA. Commonly used scale ranges are: 0 to 20 mA, 4 to 20 mA, 0 to 5V, 1 to 5V and 0 to 10V.

You can create a scale range representing other units for special applications. You can reverse scales from high values to low values for analog input signals that have a reversed action. For example, if 50 psi causes a 4 mA signal and 10 psi causes a 20 mA signal.

Scale low and high values do not have to match the bounds of the measurement range. These along with range low and high provide for process scaling and can include values not measurable by the controller. Regardless of scaling values, the measured value will be constrained by the electrical measurements of the hardware.

Select the low and high values with Scale Low and Scale High . Select the displayed range with Range Low and Range High (Setup Page, Analog Input Menu).

Range High and Range Low

With a process input, you must choose a value to represent the low and high ends of the current or voltage range. Choosing these values allows the controller's display to be scaled into the actual working units of measurement. For example, the analog input from a humidity transmitter could represent 0 to 100 percent relative humidity as a process signal of 4 to 20 mA. Low scale would be set to 0 to represent 4 mA and high scale set to 100 to represent 20 mA. The indication on the display would then represent percent humidity and range from 0 to 100 percent with an input of 4 to 20 mA.

Select the low and high values with Range Low and Range High (Setup Page, Analog Input Menu).

Receiving a Remote Set Point

The remote set point feature allows the controller to use a thermocouple, RTD, 1 k potentiometer or process signal at input 2 to establish the set point, which allows its set point to be manipulated by an external source. A common application would use one ramping controller with a set-point retransmit output to ramp multiple controllers using the remote set point. Or you could use an analog output from a PLC to send set point values to an EZ-ZONE PM.

The controller must have two process inputs to use the remote set point feature.

You may select between local and remote set points at the front panel, with an event input, from a remote computer using the communications feature or from an external switch using an event input. Make sure all input and output impedances are compatible.

1. Switch to the remote set point with Remote Enable **rEn** (Operations Page, Loop Menu). Select whether the remote set point controls an open- or closed-loop set point with Remote Set Point Type **rty**.
2. Assign the function of switching to a remote set point to a digital input with Digital Input Function **Fn** (Setup Page, Digital Input Menu).
3. Assign the function of switching to a remote set point to the EZ Key with Digital Input Function **Fn** (Setup Page, Function Key Menu).

Ten Point Linearization

The linearization function allows a user to re-linearize a value read from an analog input. There are 10 data points used to compensate for differences between the sensor value read (input point) and the desired value (output point). Multiple data points enable compensation for non-linear differences between the sensor readings and target process values over the thermal or process system operating range. Sensor reading differences can be caused by sensor placement, tolerances, an inaccurate sensor or lead resistance.

The user specifies the unit of measurement and then each data point by entering an input point value and a corresponding output point value. Each data point must be incrementally higher than the previous point. The linearization function will interpolate data points linearly in between specified data points.

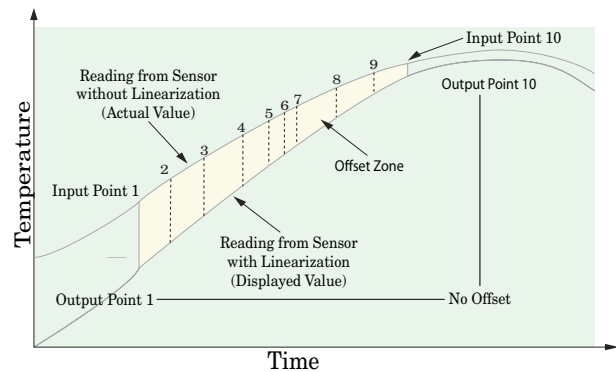

Note:

Output Point 1 will be the minimum value that can be displayed, and Output Point 10 will be the maximum value that can be displayed. Consider setting Output Point 1 to the minimum operating range, and Output Point 10 to the maximum operating range; for that sensor type.

Outputs

Duplex

Certain systems require that a single process output control both heating and cooling outputs. An EZ-ZONE® PM controller with a process output can function as two separate outputs.

With a 4 to 20mA output the heating output will operate from 12 to 20mA (0 to +100 percent) and the cooling output will operate from 12 to 4mA (0 to -100 percent).

In some cases this type of output is required by the device that the EZ-ZONE PM controls, such as a three-way valve that opens one way with a 12 to 20mA signal and opens the other way with a 4 to 12mA signal. This feature reduces the overall system cost by using a single output to act as two outputs.

Outputs 1 and 3 can be ordered as process outputs. Select duplex **DUPL** as the Output Function **Fn** (Setup Page, Output Menu). Set the output to volts **volt** or milliamps **mA** with Output Type **oty**. Set the range of the process output with Scale Low **SLo** and Scale High **Shi**.

NO-ARC Relay

A NO-ARC relay provides a significant improvement in the life of the output relay over conventional relays.

Conventional mechanical relays have an expected life of 100,000 cycles at the rated full-load current. The shorter life for conventional relays is due to the fact that when contacts open while current is flowing metal degradation occurs. This action produces unavoidable electrical arcing causing metal to transfer from one contact to the other. The arcing conditions continue on each subsequent contact opening until over time the resistance through the contacts increases causing the contacts to increase in temperature. Eventually, the contacts will weld together and the relay remains in the on state.

The Watlow NO-ARC relay is a hybrid relay. It uses a mechanical relay for the current load and a triac (solid-state switch) to carry the turn-on and turn-off currents. NO-ARC relays extend the life of the relay more than two million cycles at the rated full-load current.

Although a NO-ARC relay has significant life advantages, a few precautions must be followed for acceptable usage:

Do not use:

- hybrid relays for limit contactors. A limit or safety device must provide a positive mechanical break on all hot legs simultaneously;
- dc loads with hybrid relays. The triacs used for arc suppression will turn off only with ac line voltage;
- hybrid switches to drive any inductive loads, such as relay coils, transformers or solenoids;
- cycle times less than five seconds on hybrid switches;
- on loads that exceed 264V ac through relay;
- on loads that exceed 15 amperes load;
- on loads less than 100 mA;
- NO-ARC relays in series with other NO-ARC relays.

Retransmitting a Process Value or Set Point

The retransmit feature allows a process output to provide an analog signal that represents the set point or process value. The signal may serve as a remote set point for another controller or as an input for a chart recorder documenting system performance over time.

In choosing the type of retransmit signal the operator must take into account the input impedance of the device to be retransmitted to and the required signal type, either voltage or milliamps.

Typically applications might use the retransmit option to record one of the variables with a chart recorder or to generate a set point for other controls in a multi-zone application.

Outputs 1 and 3 can be ordered as process outputs. Select retransmit **RT** as the Output Function **Fn** (Setup Page, Output Menu). Set the output to volts **volt** or milliamps **mA** with Output Type **out**. Select the signal to retransmit with Retransmit Source **rs**.

Set the range of the process output with Scale Low **sl** and Scale High **sh**. Scale the retransmit source to the process output with Range Low **rl** and Range High **rh**.

When the retransmit source is at the Range Low value, the retransmit output will be at its Scale Low value. When the retransmit source is at the Range High value, the retransmit output will be at its Scale High value.

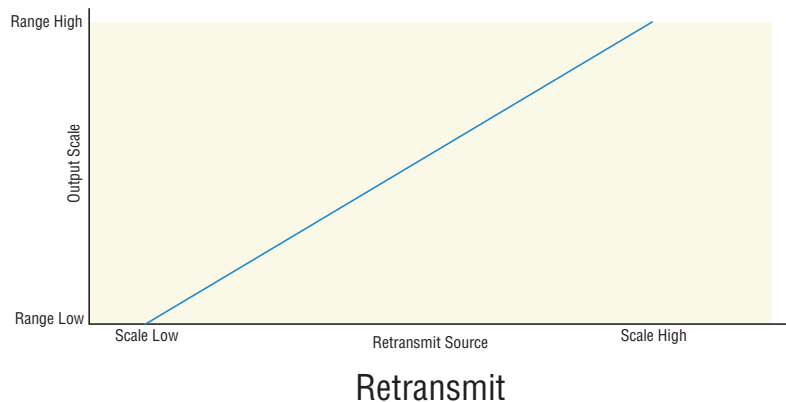

Cool Output Curve

A nonlinear output curve may improve performance when the response of the output device is nonlinear. If a cool output uses one of the nonlinear curves a PID calculation yields a lower actual output level than a linear output would provide.

These output curves are used in plastics extruder applications: curve A for oil-cooled extruders and curve B for water-cooled extruders. Select a nonlinear cool output curve with Cool Output Curve (Setup Menu, Loop Menu).

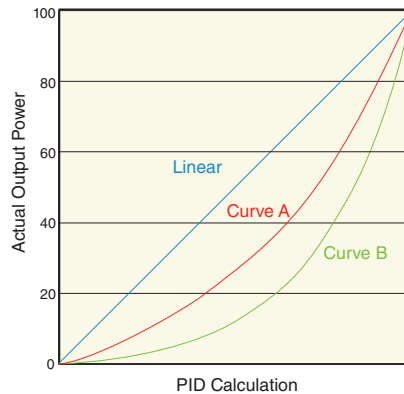

Resetting a Tripped Limit

When a limit controller is ordered (PM _____ - [L,M] _____) output 4 will always be a Form A (normally open) Mechanical Relay and it will always be internally tied to the limit function. When the limit is in a safe state the internal coil for this relay will be energized, therefore the relay will be closed. When a condition occurs that causes the limit to trip, the internal coil will deenergize causing the relay to latch open. When the condition that caused the limit to trip has been resolved, the relay will remain latched open until manually reset. The process to reset a latched limit can be different from control to control and is dependent upon the controller firmware version.

To check the firmware revision of your control do one of the following:

1. Cycle power to the control while observing the number in the top display (this momentary numerical display reflects the current installed firmware version).
2. Navigate to the Factory Page by simultaneously pushing and holding the Advance Key and the Reset Key for approximately 8 seconds and then use the up or down arrow key to navigate to the Diagnostic Menu. Once there, push the Advance Key twice where the revision will be shown in the lower display and the upper display will indicate the current firmware revision.

Execute One of the Following Steps to Reset a Tripped Limit Prior to Firmware Release 11.0:

1. Push the Reset Key .
2. Configure a digital input with the Action Function set to Limit Reset (navigate to the Setup Page under the Digital I/O Menu).
3. Use a field bus protocol, i.e., Modbus, EtherNet/IP, etc...where a value of zero would be written to the associated address (navigate to the Operations Page and look for Limit Clear Request under the Limit Menu to find appropriate address).
4. Cycle the power to the controller.

Execute One of the Following Steps to Reset a Tripped Limit with Firmware Release 11.0 and above:

1. Push the Reset Key .
2. Follow the steps below:
 - 2a. Navigate to the Setup Page and then the Limit Menu
 - 2b. Set Source Function A to the desired device that will reset the limit (Digital I/O or Function Key)
 - 2c. Define the Source Instance
3. Use a field bus protocol, i.e., Modbus, EtherNet/IP, etc...where a value of zero would be written to the associated address (navigate to the Operations Page and look for Limit Clear Request under the Limit Menu to find appropriate address).
4. Cycle the power to the controller.

Control Methods

Output Configuration

Each controller output can be configured as a heat output, a cool output, an alarm output or deactivated. No dependency limitations have been placed on the available combinations. The outputs can be configured in any combination. For instance, all three could be set to cool.

Heat and cool outputs use the set point and Operations parameters to determine the output value. All heat and cool outputs use the same set point value. Heat and cool each have their own set of control parameters. All heat outputs use the same set of heat control parameters and all cool outputs use the same set of cool output parameters.

Each alarm output has its own set of configuration parameters and set points, allowing independent operation.

Auto (closed loop) and Manual (open loop) Control

The controller has two basic modes of operation, auto mode and manual mode. Auto mode allows the controller to decide whether to perform closed-loop control or to follow the settings of Input Error Failure (FAIL) (Setup Page, Loop Menu). The manual mode only allows open-loop control. The EZ-ZONE® PM controller is normally used in the auto mode. The manual mode is usually only used for specialty applications or for troubleshooting.

Manual mode is open-loop control that allows the user to directly set the power level to the controller's output load. No adjustments of the output power level occur based on temperature or set point in this mode.

In auto mode, the controller monitors the input to determine if closed-loop control is possible. The controller checks to make certain a functioning sensor is providing a valid input signal. If a valid input signal is present, the controller will perform closed-loop control. Closed-loop control uses a process sensor to determine the difference between the process value and the set point. Then the controller applies power to a control output load to reduce that difference.

If a valid input signal is not present, the controller will indicate an input error message in the upper display and (ALERT) in the lower display and respond to the failure according to the setting of Input Error Failure (FAIL). You can configure the controller to perform a bumpless transfer (BPLS), switch power to output a preset fixed level (PFRN), or turn the output power off.

Bumpless transfer will allow the controller to transfer to the manual mode using the last power value calculated in the auto mode if the process had stabilized at a ± 5 percent output power level for the time interval of Time Integral (Operations Page, Loop) prior to sensor failure, and that power level is less than 75 percent.

Reverse Bumpless functionality will take effect when the control is changed from Manual to Auto mode. The control will preload the Open Loop Set Point value into the Integral Term, which will allow for a bumpless transition. The normal PID action will then take over to control the output to the Closed Loop Set Point value.

Note:

Reverse bumpless ignores the transition from Off to Auto.

Input Error Latching (IER) (Setup Page, Analog Input Menu) determines the controller's response once a valid input signal returns to the controller. If latching is on, then the controller will continue to indicate an input error until the error is cleared. To clear a latched alarm, press the Advance Key (ⓘ) then the Up Key (↑).

If latching is off, the controller will automatically clear the input error and return to reading the temperature. If the controller was in the auto mode when the input error occurred, it will resume closed-loop control. If the controller was in manual mode when the error occurred, the controller will remain in open-loop control.

The Manual Control Indicator Light % is on when the controller is operating in manual mode.

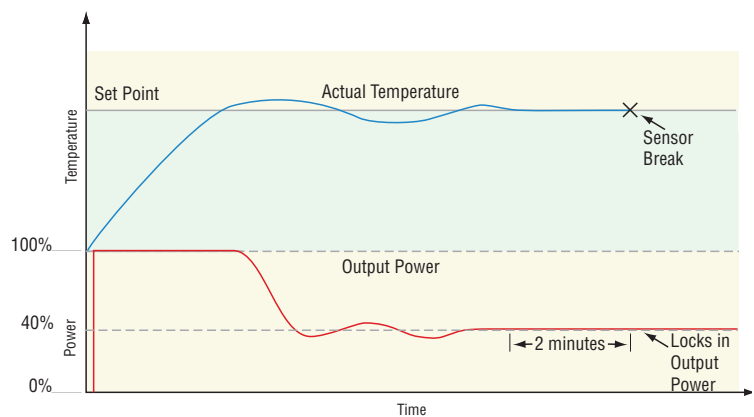

Auto (closed loop) and Manual (open loop) Control (cont.)

You can easily switch between modes if the Control Mode $\boxed{C.P.P}$ parameter is selected to appear in the Home Page.

To transfer to manual mode from auto mode, press the Advance Key \odot until $\boxed{C.P.P}$ appears in the lower display. The upper display will display $\boxed{R.U.E.O}$ for auto mode. Use the Up \blacktriangle or Down \blacktriangledown keys to select $\boxed{P.P.R.n}$. The manual set point value will be recalled from the last manual operation.

To transfer to auto mode from manual mode, press the Advance Key \odot until $\boxed{C.P.P}$ appears in the lower display. The upper display will display $\boxed{P.P.R.n}$ for manual mode. Use the Up \blacktriangle or Down \blacktriangledown keys to select $\boxed{R.U.E.O}$. The automatic set point value will be recalled from the last automatic operation.

Changes take effect after three seconds or immediately upon pressing either the Advance Key \odot or the Infinity Key ∞ .

On-Off Control

On-off control switches the output either full on or full off, depending on the input, set point and hysteresis values. The hysteresis value indicates the amount the process value must deviate from the set point to turn on the output. Increasing the value decreases the number of times the output will cycle. Decreasing hysteresis improves controllability. With hysteresis set to 0, the process value would stay closer to the set point, but the output would switch on and off more frequently, and may result in the output “chattering.” On-off control can be selected with Heat Algorithm $\boxed{H.H.G}$ or Cool Algorithm $\boxed{C.C.G}$ (Setup Page, Loop Menu). On-off hysteresis can be set with Heat Hysteresis $\boxed{H.H.Y}$ or Cool Hysteresis $\boxed{C.C.Y}$ (Operations Page, Loop Menu).

Note:

Input Error Failure Mode $\boxed{F.R.I.L}$ does not function in on-off control mode. The output goes off.

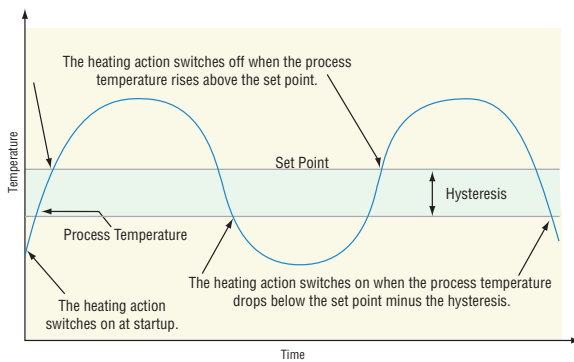

On/Off System Cycles

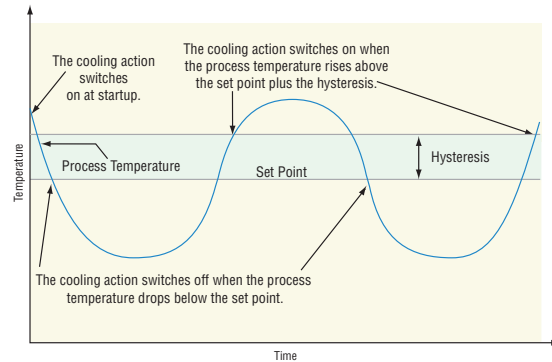

On/Off System Cycles

Proportional and (P) Control

Some processes need to maintain a temperature or process value closer to the set point than on-off control can provide. Proportional control provides closer control by adjusting the output when the temperature or process value is within a proportional band. When the value is in the band, the controller adjusts the output based on how close the process value is to the set point.

The closer the process value is to the set point, the lower the output power. This is similar to backing off on the gas pedal of a car as you approach a stop sign. It keeps the temperature or process value from swinging as widely as it would with simple on-off control. However, when the system settles down, the temperature or process value tends to “droop” short of the set point.

With proportional control the output power level equals (set point minus process value) divided by the proportional band value.

In an application with one output assigned to heating and another assigned to cooling, each will have a separate proportional parameter. The heating parameter takes effect when the process temperature is lower

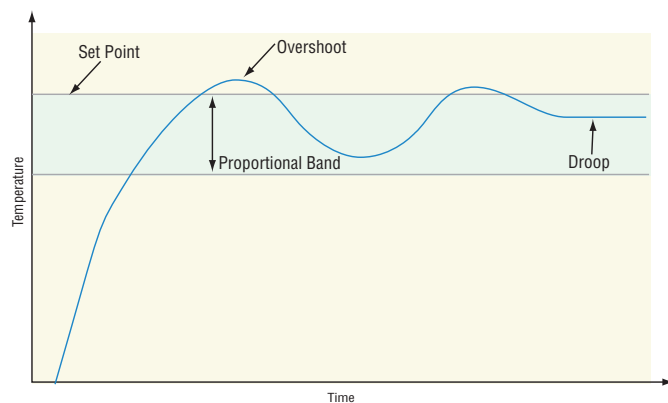

Proportional Control

Proportional and (P) Control (cont.)

than the set point, and the cooling parameter takes effect when the process temperature is higher than the set point.

Adjust the proportional band with Heat Proportional Band or Cool Proportional Band (Operations Page, Loop Menu).

Proportional and Integral (PI) Control

The droop caused by proportional control can be corrected by adding integral (reset) control. When the system settles down, the integral value is tuned to bring the temperature or process value closer to the set point. Integral determines the speed of the correction, but this may increase the overshoot at startup or when the set point is changed. Too much integral action will make the system unstable. Integral is cleared when the process value is outside of the proportional band.

Adjust the integral with Time Integral (Operations Page, Loop Menu).

Proportional, Integral and Derivative (PID) Control

Use derivative (rate) control to minimize the overshoot in a PI-controlled system. Derivative (rate) adjusts the output based on the rate of change in the temperature or process value. Too much derivative (rate) will make the system sluggish.

Derivative action is active only when the process value is within twice the proportional value from the set point.

Adjust the derivative with Time Derivative (Operations Page, Loop Menu).

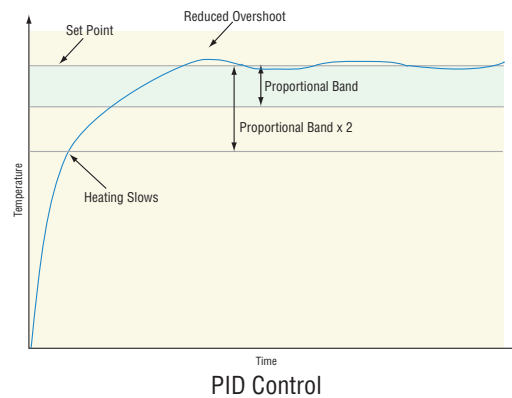

Dead Band

In a PID application the dead bands above and below the set point can save an application's energy and wear by maintaining process temperature within acceptable ranges.

Proportional action ceases when the process value is within the dead band. Integral action continues to bring the process temperature to the set point.

Using a **positive dead band value** keeps the two systems from fighting each other.

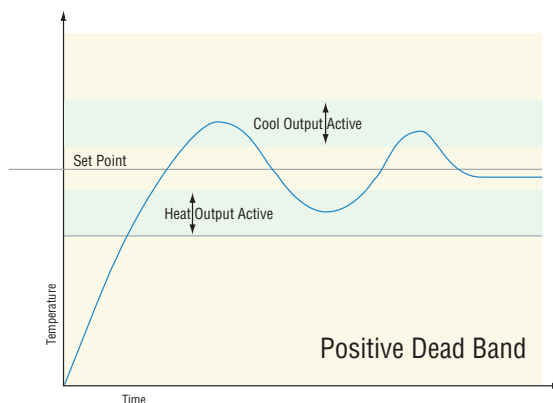

Dead Band (cont.)

When the **dead band value is zero**, the heating output activates when the temperature drops below the set point, and the cooling output switches on when the temperature exceeds the set point.

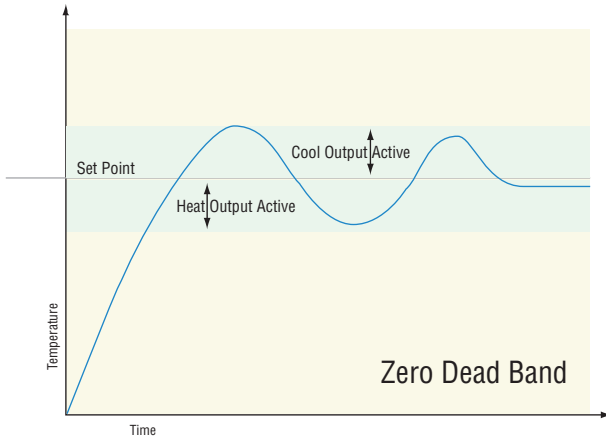

When the **dead band value is a negative value**, both heating and cooling outputs are active when the temperature is near the set point. Adjust the dead band with Dead Band (Operations Page, Loop Menu).

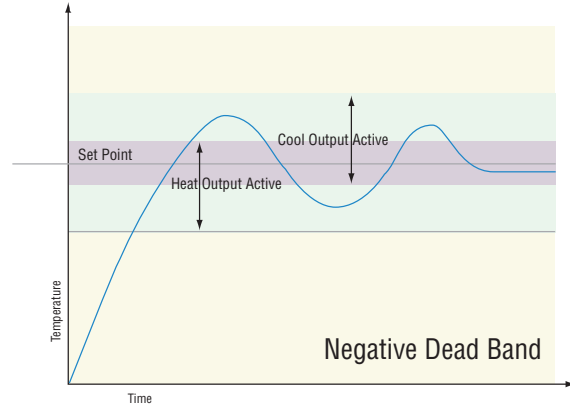

Variable Time Base

Variable time base is the preferred method for controlling a resistive load, providing a very short time base for longer heater life. Unlike phase-angle firing, variable-time-base switching does not limit the current and voltage applied to the heater.

With variable time base outputs, the PID algorithm calculates an output between 0 and 100%, but the output is distributed in groupings of three ac line cycles. For each group of three ac line cycles, the controller decides whether the power should be on or off. There is no fixed cycle time since the decision is made for each group of cycles. When used in conjunction with a zero cross (burst fire) device, such as a solid-state power controller, switching is done only at the zero cross of the ac line, which helps reduce electrical noise (RFI).

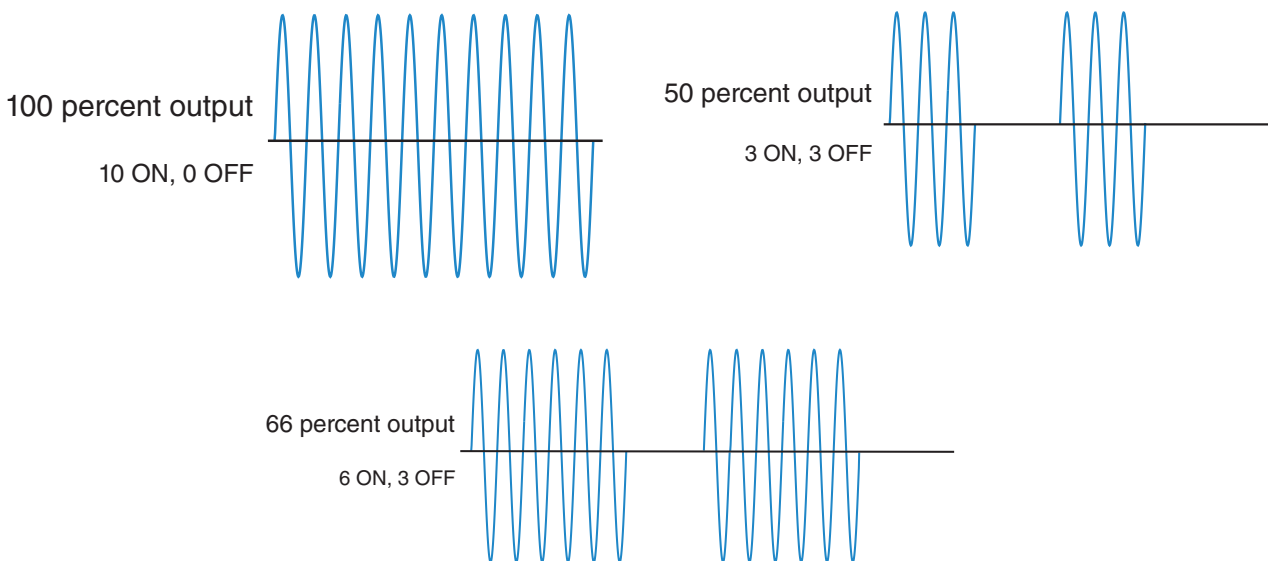

Variable Time Base (cont.)

Variable time base should be used with solid-state power controllers, such as a solid-state relay (SSR) or silicon controlled rectifier (SCR) power controller. Do not use a variable time base output for controlling electromechanical relays, mercury displacement relays, inductive loads or heaters with unusual resistance characteristics.

The combination of variable time base output and a solid-state relay can inexpensively approach the effect of analog, phase-angle fired control.

Select the AC Line Frequency **[ACLF]** (Setup Page, Global Menu), 50 or 60 Hz.

Note:

When output 1 is a universal process output, output 2 cannot use variable time base, fixed time base only.

When output 3 is configured as a universal process, output 4 cannot use variable time base, fixed time base only.

Single Set Point Ramping

Ramping protects materials and systems that cannot tolerate rapid temperature changes. The value of the ramp rate is the maximum degrees per minute or hour that the system temperature can change.

Select Ramp Action **[rP]** (Setup Page, Loop Menu):

[OFF] ramping not active.

[SEr] ramp at startup.

[SEPE] ramp at a set point change.

[both] ramp at startup or when the set point changes.

Select whether the rate is in degrees per minute or degrees per hour with Ramp Scale **[rSC]**. Set the ramping rate with Ramp Rate **[rRE]** (Setup Page, Loop Menu).

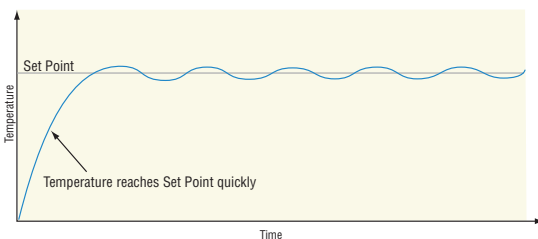

Heating System without Ramping

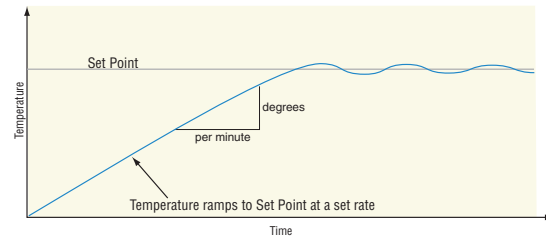

Heating System with Ramping

Cascade Control

The PM (PM4/8/9) can be configured for Cascade control with enhanced firmware. Cascade is used to optimize the performance of thermal systems with long lag times. It utilizes a control strategy in which one control loop provides the set point for another loop. See [Chapter 10](#) for application examples.

Compressor Control

The PM control can be configured for Compressor control with enhanced firmware. The compressor control can save wear on a compressor and prevent it from locking up from short cycling. A bypass valve operated by a control output regulates how the process is cooled, while another output switches the compressor on and off. The compressor will not turn on until the output power exceeds the Power On Level % for a time longer than the specified On Time. The compressor will not turn off until the output power is equal to or less than the Power Off Level % for a time longer than the specified Off Time.

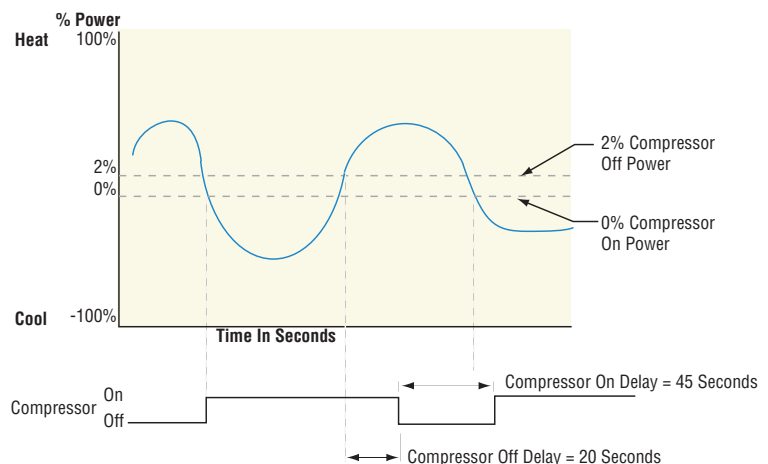

Differential Control

The PM can be configured for Differential Control with enhanced firmware. After configuring the appropriate inputs and their associated internal functions Differential Control allows the PM to drive an output based on the difference between those analog inputs. See [Chapter 10](#) for application examples.

Ratio Control

The PM control can be configured for Ratio control with enhanced firmware, especially useful in applications that mix materials. Ratio control is commonly used to ensure that two or more flows are kept at the same ratio even if the flows are changing. See [Chapter 10](#) for application examples.

Duplex Control

Certain systems require that a single process output control both heating and cooling outputs. A PM control with a process output can function as two separate outputs. With a 4 to 20mA output the heating output, for instance, will operate from 12 to 20mA (0 to +100%) and the cooling outputs will operate from 12 to 4mA (0 to -100%). In some cases this type of output is required by the device, such as a three-way valve that opens one way with a 12 to 20mA signal and opens the other way with a 4 to 12mA signal. This feature reduces the overall system cost by using a single output to act as two outputs.

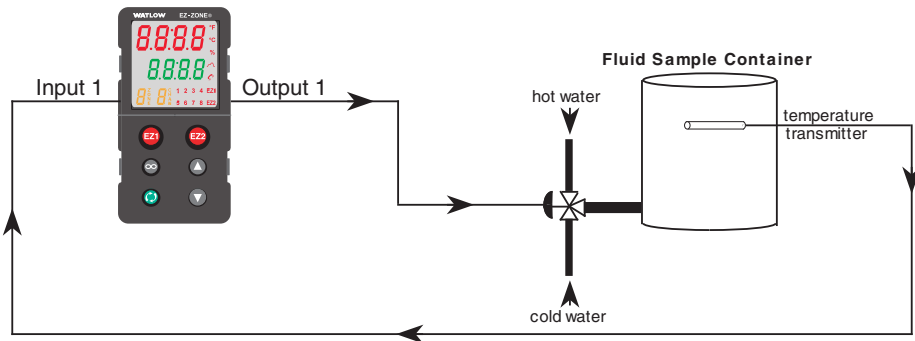

Motorized Valve Control

A motorized valve is used to regulate the flow of fluid which in turn impacts the loop process value. A valve is opened or closed by closing contacts to drive the valve in the intended direction. See [Chapter 10](#) for application examples.

Alarms

Alarms are activated when the output level, process value or temperature leaves a defined range. A user can configure how and when an alarm is triggered, what action it takes and whether it turns off automatically when the alarm condition is over.

Configure alarm outputs in the Setup Page before setting alarm set points.

Alarms do not have to be assigned to an output. Alarms can be monitored and controlled through the front panel or by using software.

Process and Deviation Alarms

A process alarm uses one or two absolute set points to define an alarm condition.

A deviation alarm uses one or two set points that are defined relative to the control set point. High and low alarm set points are calculated by adding or subtracting offset values from the control set point. If the set point changes, the window defined by the alarm set points automatically moves with it.

Select the alarm type with Type **RLY** (Setup Page, Alarm Menu).

Alarm Set Points

The alarm high set point defines the process value or temperature that will trigger a high side alarm. The alarm low set point defines the temperature that will trigger a low side alarm. For deviation alarms, a negative set point represents a value below closed loop set point. A positive set point represents a value above closed loop set point. View or change alarm set points with Low Set Point **RLo** and High Set Point **Rh** (Operations Page, Alarm Menu).

Alarm Hysteresis

An alarm state is triggered when the process value reaches the alarm high or alarm low set point. Alarm hysteresis defines how far the process must return into the normal operating range before the alarm can be cleared.

Alarm hysteresis is a zone inside each alarm set point. This zone is defined by adding the hysteresis value to the alarm low set point or subtracting the hysteresis value from the alarm high set point. View or change alarm hysteresis with Hysteresis **[RHY]** (Setup Page, Alarm Menu).

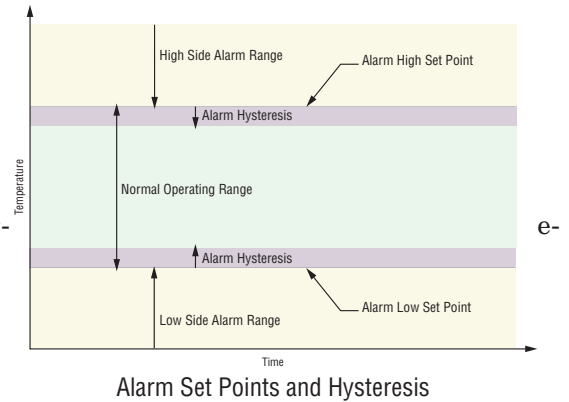

Alarm Latching

A latched alarm will remain active after the alarm condition has passed. It can only be deactivated by the user.

An active message, such as an alarm message, will cause the display to toggle between the normal settings and the active message in the upper display and **[ALARM]** in the lower display.

Push the Advance Key **[A]** to display **[,9nr]** in the upper display and the message source in the lower display.

Use the Up **[U]** or Down **[D]** keys to scroll through possible responses, such as Clear **[CLR]** or Silence **[SIL]**. Then push the Advance **[A]** or Infinity **[∞]** key to execute the action.

See the Keys and Displays chapter and the Home Page chapter for more details.

An alarm that is not latched (self-clearing) will deactivate automatically when the alarm condition has passed.

Turn alarm latching on or off with Latching **[RLA]** (Setup Page, Alarm Menu).

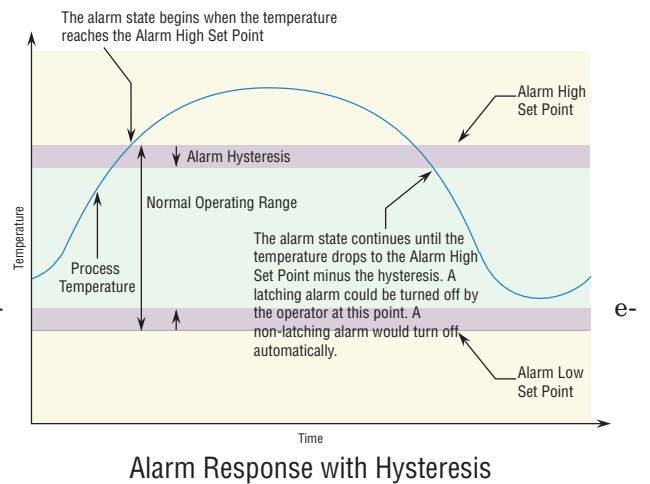

Alarm Silencing

If alarm silencing is on the operator can disable the alarm output while the controller is in an alarm state. The process value or temperature has to enter the normal operating range beyond the hysteresis zone to activate the alarm output function again.

An active message, such as an alarm message, will cause the display to toggle between the normal settings and the active message in the upper display and **[ALARM]** in the lower display.

1. Push the Advance Key **[A]** to display **[,9nr]** in the upper display and the message source in the lower display.
2. Use the Up **[U]** and Down **[D]** keys to scroll through possible responses, such as Clear **[CLR]** or Silence **[SIL]**. Then push the Advance **[A]** or Infinity **[∞]** key to execute the action.

See the Keys and Displays chapter and the Home Page chapter for more details. Turn alarm silencing on or off with Silencing **[RSI]** (Setup Page, Alarm Menu).

Alarm Blocking

Alarm blocking allows a system to warm up after it has been started up. With alarm blocking on, an alarm is not triggered when the process temperature is initially lower than the alarm low set point or higher than the alarm high set point. The process temperature has to enter the normal operating range beyond the hysteresis zone to activate the alarm function.

If the EZ-ZONE PM has an output that is functioning as a deviation alarm, the alarm is blocked when the set point is changed, until the process value re-enters the normal operating range. Turn alarm blocking on or off with Blocking **[RBL]** (Setup Page, Alarm Menu).

Current Sensing

When utilizing the Current Sensing capabilities of this control it is important to know that the measurements taken utilize the AC Line Frequency (**ACLF**) setting found in the Global Menu of the Setup Page. If this setting does not represent the incoming line frequency of this control the readings will be in error and may appear to be frozen. Generally speaking, the RMS value is displayed when viewing the Current (**CUr**) prompt. The display will appear frozen with no current flow and will be erroneous below 2 mA.

Note:

If an alarm is configured to monitor current as its source, the low alarm will be effective only when the current level is equal to or greater than 2 mA. If there is no current present, the low alarm will not be activated.

Open and Shorted Load Circuit Detection

A Current Error (**CEr**) (Operations Page, Current Menu) can detect either an open or shorted load condition. A shorted condition would be present if the control is calling for 0% power while current is detected as flowing through the current transformer. Conversely, an open condition would be present when the control is calling for power with no current flow detected through the transformer.

A Heater Error (**hEr**) (Operations Page, Current Menu) is used to determine if the load current flow is within the specified limits as set by the user through the Current Set Points (Current High Set Point (**Ch**) and Current Low Set Point (**CLo**)); navigate to the Operations Page and then the Current Menu to modify.

Read and monitor the real-time current level through the Current Read (**CUr**) prompt while the most recent faults can be read via the Current Error (**CEr**) and Heater Error (**hEr**) prompts. All of these prompts can be found in the Operations Page under the Current Menu.

Open Loop Detection

When Open Loop Detection is enabled (**LdE**), the controller will look for the power output to be at 100%. Once there, the control will then begin to monitor the Open Loop Detect Deviation (**Ldd**) as it relates to the value entered for the Open Loop Detect Time (**LdE**). If the specified time period expires and the deviation does not occur, an Open Loop Error will be triggered. Once the Open Loop Error condition exists the control mode will go off and an Open Loop message will be display. If the process value goes in the opposite direction, a Reversed Loop message is display. The sensor is likely wired in reverse polarity.

Note:

All prompts identified in this section can be found in the Loop Menu of the Setup Page.

Programming the EZ Key/s

You can program the EZ Key either in the Setup Menu or with configuration software, such as EZ-ZONE Configurator, using a personal computer.

The following examples show how to program the EZ Key to start and stop a profile.

1. To go to the Setup Page from the Home Page, press both the Up **▲** and Down **▼** keys for six seconds. (**RI**) will appear in the upper display and (**SEE**) will appear in the lower display.
2. Press the Up Key **▲** until (**Fun**) appears in the upper display and (**SEE**) will appear in the lower display.
3. Press the Advance Key **⊕** until Digital Input Level (**LEu**) appears in the lower display. Use an arrow key to specify the state of the key (high or low) when the controller is powered up. Functions will toggle with each press of the EZ Key, such as Profile Start/Stop.

Note:

If the level is set to low, the profile will execute automatically on power up.

4. Press the Advance Key **⊕**. The lower display will show Digital Function (**Fn**). Press the Up **▲** or Down **▼** key to scroll through the functions that can be assigned to the EZ Key
When Profile Start/Stop (**PSES**) appears in the upper display and (**Fn**) appears in the lower display, press the Advance Key **⊕** once to select that function and move to the Function Instance (**Fi**) parameter.
5. Press the Up **▲** or Down **▼** key to scroll to the profile that you want the EZ Key to control.
6. The instance tells the controller which of the numbered functions should be acted upon. For profiles, there are 4 instances. Press the Infinity Key **∞** once to return to the submenu, twice to return to the main menu or three times to return to the Home Page.

Using Lockout and Password Security

If unintentional changes to parameter settings might raise safety concerns or lead to downtime, you can use the lockout feature to make them more secure. There are two methods of lockout that can be deployed, both of which are accessible from the Factory Page.

Method 1- Change the value of the Read Lock (**rLoc**) (1 to 5) and Set Lock (**SLoc**) (0 to 5) prompts where the higher the value or setting for each translates to a higher security clearance (greater access).

Method 2- Enable Password Security (**PRSE**) and then modify the Lock Level (**LoLL**) value which ranges from 1 to 5. See the section entitled [Using Lockout Method 2](#) for more detail.

Using Lockout Method 1 (Read and Set Lock)

All Pages have security levels assigned where two of those cannot be changed (Home and Setup). Defaults (factory settings) for each are shown below:



- Home Page = 1
- Operations Page = 2 (changeable to 1, 2 or 3)
- Setup Page = 4
- Profiling Page = 3 (changeable to 1, 2 or 3)
- Factory Page = 5*

*The Factory Page is always visible where all menus within it may or may not be visible/writable. For further detail see table "[Factory Page Menus](#)".

The table below represents the various levels of lockout for the Set Lockout Security prompt (**SLoc**) and the Read Lockout Security prompt (**rLoc**). Looking at the table, "Y" equates to yes (can write/read) where "N" equates to no (cannot write/read). The colored cells simply differentiate one level from the next while also showing the level where read/write is enabled. As stated previously, the Set Lockout has 6 levels (0 to 5) of security where the Read Lockout has 5 (1 to 5). Therefore, level "0" applies to Set Lockout only.

Lockout Security SLoc & rLoc						
Pages	Security Level					
	0	1	2	3	4	5
Home Page (cannot be changed)	N	Y	Y	Y	Y	Y
Operations Page	N	N	Y	Y	Y	Y
Setup Page (cannot be changed)	N	N	N	N	Y	Y
Profile Page	N	N	N	Y	Y	Y
Factory Page	Y	Y	Y	Y	Y	Y

Being able to change the page security level for the Operations and Profile pages allows a user to give access to the Profile Page while locking out the Operations Page. The following example shows how the Lockout feature may be used to accomplish this:

1. Press and hold the Advance  and Infinity  keys for approximately 6 seconds to enter the Factory Page
2. Navigate to the **LoL** Menu using the Up or Down arrow keys
3. Using the green Advance key navigate to the Lock Operations prompt (**LoLo**) and change it (push the Up arrow) from the default value of 2 to 3
4. Push the Advance key again and change the Lock Profiling prompt (**LoLP**) from the default of 3 to 2
5. Change Read Lockout Security (**rLoc**) to 2 and the Set Lockout (**SLoc**) to 2 or higher

With the above settings, the Home Page and the Profiling Page can be accessed, and all writable parameters can be written to. Due to the Read lock setting of 2 all pages with security levels greater than 2 will be locked out (inaccessible).

Another example of Method 1 lockout usage could be that an operator wants read access to all pages while allowing read/write access to the Home Page and the Lockout Menu only.

1. Press and hold the Advance and Infinity keys for approximately 6 seconds to enter the Factory Page
2. Navigate to the **LoL** Menu using the Up or Down arrow keys
3. Using the green Advance key navigate to the Read Lockout Security (**rLoc**) and change it to 5
4. Push the green Advance key and navigate to the and Set Lockout Security (**SLoc**) changing it to 1

Although the Factory Page is always visible, some menus within it can be restricted.

Lockout Security SLoC & rLoC						
Factory Page Menus						
Menus	Security Level					
	0	1	2	3	4	5
Custom Menu	N	N	N	N	N	Y
Lockout Menu*	Y	Y	Y	Y	Y	Y
Diagnostic Menu**	N	Y	Y	Y	Y	Y
Calibration Menu	N	N	N	N	N	Y

* Using lockout Method 1 with **SLoC** set to 0, all writable parameters within the control will be inhibited (not writable) with two exceptions, **SLoC** and **rLoC**. As shown below, both of these parameters can always be seen and modified.

** Diagnostic Menu and all associated prompts are always visible and never writable

Lockout Security SLoC & rLoC						
Factory Page Menu Parameters						
Parameters	Security Level					
	0	1	2	3	4	5
LoC.D	N	Y	Y	Y	Y	Y
LoC.P	N	Y	Y	Y	Y	Y
PRSE	N	Y	Y	Y	Y	Y
rLoC	Y	Y	Y	Y	Y	Y
SLoC	Y	Y	Y	Y	Y	Y

Note:

Using Method 1 Lockout all settings can be modified by anyone who knows how to find their way to the **SLoC** and **rLoC** parameters

Using Lockout Method 2 (Password Enable)

It is sometimes desirable to apply a higher level of security to the control where a password would be required to access the control. If Password Enabled (**PRSE**) in the Factory Page under the **LoC** Menu is set to on, an overriding Password Security will be in effect. Without the appropriate password, specified menus will remain inaccessible. Page and Menu access is defined in the Locked Access Level (**LoC.L**) prompt. On the other hand, a User with a password would have visibility restricted by the Read Lockout Security (**rLoC**). As an example, with Password Enabled and the Locked Access Level (**LoC.L**) set to 1 and **rLoC** is set to 3, the available Pages for a User without a password would be limited to the Home and Factory Pages (locked level 1). If the User password is entered all pages would be accessible with the exception of the Setup Page as defined by level 3 access.

How to Enable Password Security

Follow the steps below:

1. Go to the Factory Page by holding down the Infinity **∞** key and the Advance **⦿** key for approximately six seconds.
2. Push the Down **▼** key one time to get to the **LoC** menu. Again push the Advance **⦿** key until the Password Enabled (**PRSE**) prompt is visible.
3. Push either the up or down key to turn it on. Once on, 4 new prompts will appear:
 1. **LoC.L**, Locked Access Level (1 to 5) corresponding to the lockout table above.
 2. **roll**, Rolling Password will change the Customer Code every time power is cycled.
 3. **PRSE.U**, User Password which is needed for a User to acquire access to the control.
 4. **PRSE.A**, Administrator Password which is needed to acquire administrative access to the control.

The Administrator can either change the User and or the Administrator password or leave them in the default state. Once Password Security is enabled they will no longer be visible to anyone other than the Administrator. In other words the Lock Menu \boxed{LoC} is not available to a User. As can be seen in the formula that follows either the User or Administrator will need to know what those passwords are to acquire a higher level of access to the control. Back out of this menu by pushing the Infinity ∞ key. Once out of the menu, the Password Security will be enabled.

How to Acquire Access to the Control

To acquire access to any inaccessible Pages or Menus, go to the Factory Page and enter the \boxed{ULoC} menu. Once there follow the steps below:

Note:

If Password Security (Password Enabled \boxed{PASE} is On) is enabled the two prompts mentioned below in the first step will not be visible. If the password is unknown, call the individual or company that originally setup the control.

1. Acquire either the User Password $\boxed{PAS,U}$ or the Administrator Password $\boxed{PAS,A}$.
2. Push the Advance \odot key one time where the Code \boxed{CoDE} prompt will be visible.

Note:

a. If the the Rolling Password is off push the Advance key one more time where the Password \boxed{PASS} prompt will be displayed. Proceed to either step 7a or 8a. Pushing the Up \blacktriangle or Down \blacktriangledown arrow keys enter either the User or Administrator Password. Once entered, push and hold the Infinity ∞ key for two seconds to return to the Home Page.

b. If the Rolling Password \boxed{roLL} was turned on proceed on through steps 3 - 9.

3. Assuming the Code \boxed{CoDE} prompt (Public Key) is still visible on the face of the control simply push the Advance key \odot to proceed to the Password \boxed{PASS} prompt. If not find your way back to the Factory Page as described above.
4. Execute the calculation defined below (7b or 8b) for either the User or Administrator.
5. Enter the result of the calculation in the upper display play by using the Up \blacktriangle and Down \blacktriangledown arrow keys or use EZ-ZONE Configurator Software.
6. Exit the Factory Page by pushing and holding the Infinity ∞ key for two seconds.

Formulas used by the User and the Administrator to calculate the Password follows:

Passwords equal:

7. User

- a. If Rolling Password \boxed{roLL} is Off, Password \boxed{PASS} equals User Password $\boxed{PAS,U}$.
- b. If Rolling Password \boxed{roLL} is On, Password \boxed{PASS} equals: $((\boxed{PAS,U} \times \text{code}) \text{ Mod } 929 + 70)$

8. Administrator

- a. If Rolling Password \boxed{roLL} is Off, Password \boxed{PASS} equals User Password $\boxed{PAS,A}$.
- b. If Rolling Password \boxed{roLL} is On, Password \boxed{PASS} equals: $((\boxed{PAS,A} \times \text{code}) \text{ Mod } 997 + 1000)$

Differences Between a User Without Password, User With Password and Administrator

- User **without** a password is restricted by the Locked Access Level \boxed{LoCL} .
- A User **with** a password is restricted by the Read Lockout Security \boxed{rLoC} never having access to the Lock Menu \boxed{LoC} .
- An Administrator is restricted according to the Read Lockout Security \boxed{rLoC} however, the Administrator has access to the Lock Menu where the Read Lockout can be changed.

Modbus - Using Programmable Memory Blocks

When using the Modbus RTU or Modbus TCP protocols, the PM control features a block of addresses that can be configured by the user to provide direct access to a list of 40 user configured parameters. This allows the user easy access to this customized list by reading from or writing to a contiguous block of registers.

To acquire a better understanding of the tables found in the back of this manual (See Appendix: ([Modbus Programmable Memory Blocks](#))) please read through the text below which defines the column headers used.

Assembly Definition Addresses

- Fixed addresses used to define the parameter that will be stored in the "Working Addresses", which may also be referred to as a pointer. The value stored in these addresses will reflect (point to) the Modbus address of a parameter within the ST control.

Assembly Working Addresses

- Fixed addresses directly related to their associated "Assembly Definition Addresses" (i.e., Assembly Working Addresses 200 & 201 will assume the parameter pointed to by Assembly Definition Addresses 40 & 41).

When the Modbus address of a target parameter is stored in an "Assembly Definition Address" its corresponding working address will return that parameter's actual value. If it's a writable parameter, writing to its working register will change the parameter's actual value. As an example, Modbus register 360 represents the Analog Input 1 Process Value (See Operations Page, Analog Input Menu). If the value 360 is loaded into Assembly Definition Address 90 and value 361 is loaded into Assembly Definition Address 91, the process value sensed by analog input 1 will also be stored in Modbus registers 250 and 251. Notice that by default this parameter is also stored in working registers 240 and 241 as well.

Note:

When modifying the Modbus Assembly registers, single register writes (function 06) are not allowed. Multiple register writes (function 16) must be used to modify the assembly.

The table identified as "Assembly Definition Addresses and Assembly Working Addresses" (see Appendix: [Modbus Programmable Memory Blocks](#)) reflects the assemblies and their associated addresses.

CIP - Communications Capabilities

With the introduction of CIP a user can now collect data, configure a device and control industrial devices. CIP is an open protocol at the application layer fully managed by the Open DeviceNet Vendors Association (ODVA, <http://www.odva.org>). Being that this is an open protocol there are many independent vendors offering a wide array of devices to the end user. CIP provides the ability to communicate utilizing both implicit messaging (real-time I/O messaging), and explicit messaging (information/configuration messaging). For implicit communications using a PLC, simply configure the PM assembly size into the I/O structure of the PLC (See: [CIP Implicit Assembly Structures](#)). The assembly structures can also be changed by the user. Explicit communications requires the use of specific addressing information. DeviceNet requires that the node address be specified where EtherNet/IP requires just the Class, Instance and Attribute.

- Node address or MAC ID (0 - 63, DeviceNet only)
- Class ID (1 to 255)
- Instance ID (0 to 255)
- Attribute ID (1 to 255)

EtherNet/IP and DeviceNet are both based on CIP and use the same addressing scheme. In the following menu pages notice the column header identified as CIP. There you will find the Class, Instance and Attribute in hexadecimal, (decimal in parenthesis) which makes up the addressing for both protocols. The Watlow implementation of CIP does not support connected explicit messages but fully supports unconnected explicit messaging.

Rockwell Automation (RA) developed the DF1 serial protocol within the framework of the PCCC application protocol. With the introduction of CIP, the PCCC protocol was encapsulated within it to enable continued communication over Ethernet to the legacy RA programmable controllers, e.g., SLC, Micrologix and PLC-5 controllers equipped with Ethernet capabilities. The Watlow implementation of CIP also supports the PCCC protocol.

EtherNet/IP (Industrial Protocol) is a network communication standard capable of handling large amounts of data at speeds of 10 Mbps or 100 Mbps, and at up to 1,500 bytes per packet. It makes use of standard off-the-shelf Ethernet chip sets and the currently installed physical media (hardware connections). DeviceNet was the first field bus offering of the ODVA group and has been around for many years. DeviceNet can communicate at 125, 250 and 500 kilobytes per second with a maximum limitation of 64 nodes (0 to 63) on the network.

Note:

If the control is brought back to the factory defaults the user configured assemblies will be overwritten.

Note:

The maximum number of implicit input/output members using *DeviceNet* is 200. When using *EtherNet/IP* the maximum is 100.

CIP Implicit Assemblies

Communications using CIP (*EtherNet/IP* and *DeviceNet*) can be accomplished with any PM Integrated control equipped with either *DeviceNet* or *EtherNet/IP* communications cards. As was already mentioned, reading or writing when using CIP can be accomplished via explicit and or implicit communications. Explicit communications are usually executed via a message instruction within the PLC but there are other ways to do this as well outside of the focus of this document.

Implicit communications is also commonly referred to as polled communications. When using implicit communications there is an I/O assembly that would be read or written to. The default assemblies and the assembly size is embedded into the firmware of the PM control. Watlow refers to these assemblies as the T to O (Target to Originator) and the O to T (Originator to Target) assemblies where the Target is always the EZ-ZONE PM controller and the Originator is the PLC or master on the network. The size of the O to T assembly is initially set to 20 (32-bit) members where the T to O assembly consists of 21 (32-bit) members. All assembly members are user configurable with the exception of the first T to O member. The first member of the T to O assembly is called the Device Status, it is unique and cannot be changed. If the module has been properly configured when viewing this 32-bit member in binary format bits 12 and 16 should always be set to 1 where all of the other bits should be 0. The 20 members that follow Device Status are user configurable. The Appendix of this User's Guide contains the PM implicit assemblies (See Appendix: [CIP Implicit Assembly Structures](#)).

Compact Assembly Class

Along with the standard implicit assembly where each module parameter (member) occupies one 32-bit assembly location there is also a Compact Class assembly. The need for the Compact Class assembly members became apparent as the number of member instances grew with the EZ-ZONE family of controls. Because there is a limited number of implicit assembly members (20 input, 20 output), the Compact Class enables the user to modify the standard assembly offering to their liking while also achieving much better utilization of each bit within the 32-bit member. As an example, if a standard Implicit Assembly member were configured to monitor Alarm State 1 the entire 32-bit member would be consumed where just 7 bits out of the 32 will be used to reflect: Startup (88), None (61), Blocked (12), Alarm Low (8), Alarm High (7) or Error (28) for Alarm 1 only. With Compact Class assembly member 12 (identified in this document as "[12 A Alarm Read](#)") in use, the alarm states of all 4 alarms can be placed in one 32-bit assembly member using just 2 bits for each state. Bits 0 and 1 would represent Alarm State 1, bits 2 and 3 Alarm State 2, etc... Each pair of 2 bits can represent the following states: 00 = None, 01 = Alarm Low, 10 = Alarm High and 11 = Other. There is a variety of predefined Compact Class members that can be used (See Appendix: [Compact Class Assembly Structure](#)) to modify the default implicit assemblies.

Note:

As is the case with any available parameter within the PM control the Compact Class members can also be read or written to individually via an explicit message as well.

Modifying Implicit Assembly Members

To change any given member of either assembly (T to O or O to T) simply write the new class, instance and attribute (CIA) to the member location of choice. As an example, if it were desired to change the 14th member of the T to O assembly from the default parameter (Cool Power) to the Compact Class 12th member (See Appendix: [Compact Class Assembly Structure](#)) write the value of 0x71, 0x01 and 0x0C (Class, Instance and Attribute respectively) to 0x77, 0x02 and 0x0D. Once the change is executed, reading this member location (as was discussed above) will return the Alarm States (1-4) to paired bits 0 through 7 where 00 = None, 01 = Alarm Low, 10 = Alarm High and 11 = Other.

The CIP communications instance will always be instance 2.

Profibus DP - (Decentralized Peripherals)

This protocol is typically used to operate sensors and actuators via a centralized controller within industrialized production topologies. Data rates up to 12 Mbit/s on twisted pair cables and/or fiber optics are possible. This protocol is available in three functionally graded version; DP-V0, DP-V1 and DP-V2. It should be noted that Watlow products utilizing this protocol support DP-V0 and DP-V1 only.

DP-V0 - provides the basic functionality of DP, including cyclic data exchange, station, module and channel specific diagnostics and four different interrupt types for diagnostics and process interrupts.

Cyclic Data refers to input/output data that is pre-configured to pass from the Profibus-DP Class 1 Master and the Slave at a known rate. Cyclic data is expected on both the sender and the receiver end of the message.

Note:

To use DP-V0 (cyclic data transfer) first configure and then register the General Station Description (GSD) file. Watlow provides a software tool allowing for total customization of the data to be read and or written to. Acquire this software tool (Profibus GSD Editor) via the CD that shipped with the product or, as an alternative, point your browser to: <http://www.watlow.com/products/controllers/software.cfm> and navigate to the bottom of the page and click on "Software and Demos" to download the software.

Using the GSD Editor a user can configure up to a maximum of 135 different parameters that can be read or written to from Zone 1 through 16. DP-V1 - contains enhancements geared towards process automation, in particular acyclic data communication for parameter assignment, operation, visualization and interrupt control of intelligent field devices, in conjunction with cyclic user data communication.

Acyclic Data is a message that can be sent and or received at any time where they typically have a lower priority than cyclic messages. This type of messaging is typically used for the purpose of configuration or performing some sort of a diagnostic function.

Software Configuration

Using EZ-ZONE® Configurator Software

To enable a user to configure the PM control using a personal computer (PC), Watlow has provided free software for your use. If you have not yet obtained a copy of this software insert the CD (Controller Support Tools) into your CD drive and install the software. Alternatively, if you are viewing this document electronically and have a connection to the internet simply click on the link below and download the software from the Watlow web site free of charge.

http://www.watlow.com/products/software/zone_config.cfm

Once the software is installed double click on the EZ-ZONE Configurator icon placed on your desktop during the installation process. If you cannot find the icon follow the steps below to run the software:

1. Move your mouse to the "Start" button
2. Place the mouse over "All Programs"
3. Navigate to the "Watlow" folder and then the sub-folder "EZ-ZONE Configurator"
4. Click on EZ-ZONE Configurator to run.

The first screen that will appear is shown below.

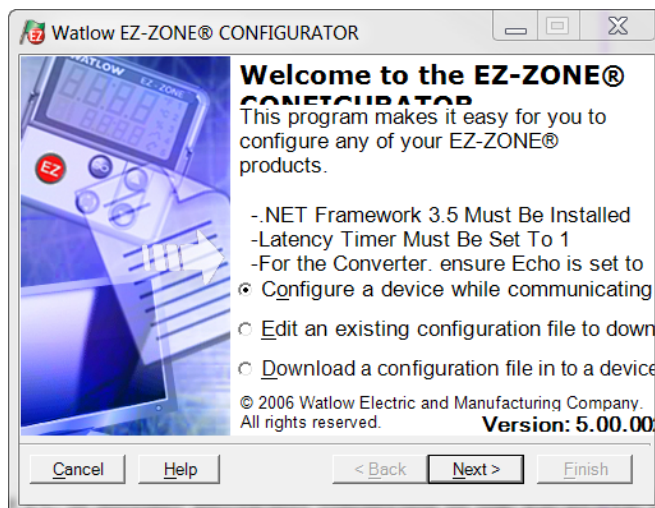

If the PC is already physically connected to the EZ-ZONE PM control click the next button to go on-line.

Note:

When establishing communications from PC to the EZ-ZONE PM control an interface converter will be required. The Standard Bus network uses EIA-485 as the interface. Most PCs today would require a USB to EIA-485 converter. However, some PCs may still be equipped with EIA-232 ports, therefore an EIA-232 to EIA-485 converter would be required.

As can be seen in the above screen shot the software provides the user with the option of downloading a previously saved configuration as well as the ability to create a configuration off-line to download later. The screen shots that follow will take the user on-line.

After clicking the next button above it is necessary to define the communications port that will be used on the PC as shown below. Clicking on the drop down will allow the user to select the appropriate communications port. This will be the port assigned to the EIA-485 to USB converter when it was connected to the PC. The "Advanced" button allows the user to determine how many devices to look for on the network (1 to 17).

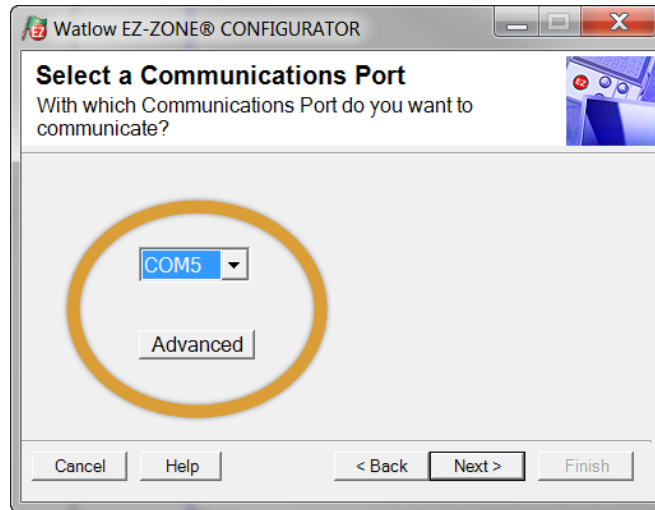

After clicking on the "Next" button, the software will scan the network for the zone addresses specified while showing the progress made (as shown in the graphic below. When complete the software will display all of the available devices found on the network as shown below.

Searching Network for Devices

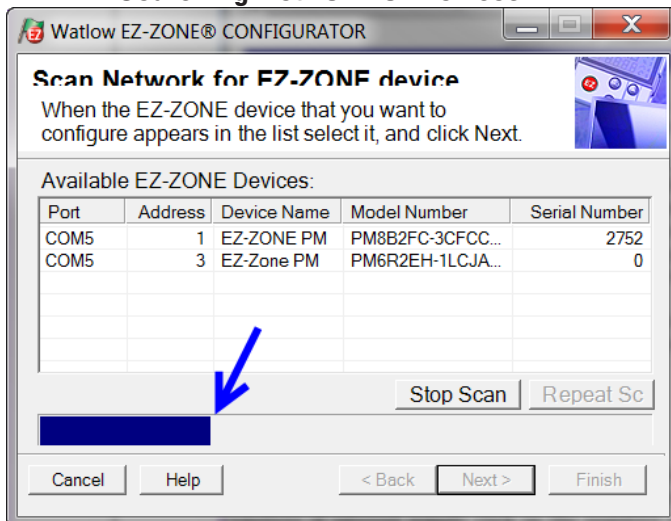

Available Network Devices Displayed

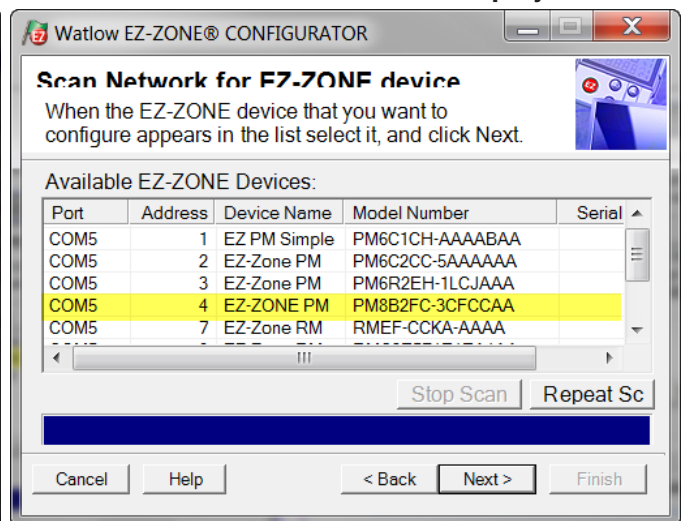

The PM8 is shown highlighted to bring greater clarity to the control in focus. Any EZ-ZONE device on the network will appear in this window and would be available for the purpose of configuration or monitoring; simply click on the control of choice. After doing so, the screen below will appear. In the screen shot below notice that the device part number is clearly displayed at the top of the page (yellow highlight added for emphasis). When multiple EZ-ZONE devices are on the network it is important that the part number be noted prior to configuring so as to avoid making unwanted configuration changes to another control. Looking closely at

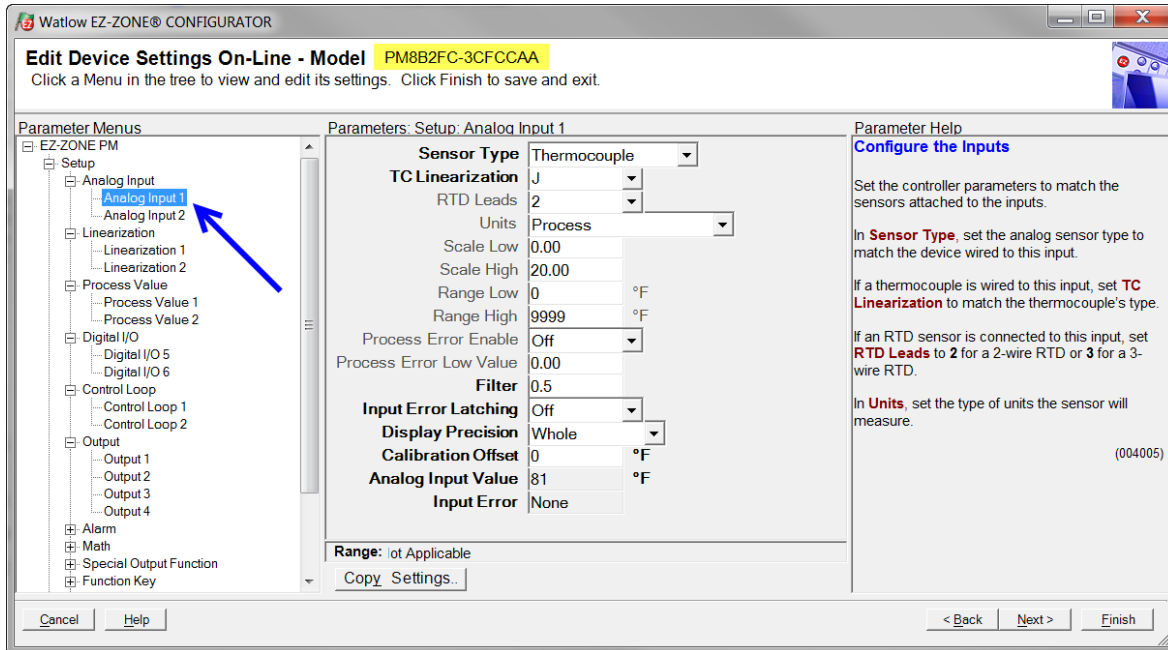

the left hand column (Parameter Menus) notice that it displays all of the available menus and associated parameters within the control. The menu structure as laid out within this software follows:

- Setup - Operations - Factory - Profile

Navigating from one menu to the next is easy and clearly visible. Simply slide the scroll bar up or down to display the menu and parameter of choice. If there is a need to bring greater focus and clarity to the parameters of interest simply click on the negative symbol next to any of the Menu items. As an example if it is desired to work within the Operations page click the negative sign next to Setup where the Setup Page will then collapse. Now click the plus sign next to Operations to find the menu items of choice without viewing unwanted menus and parameters. Once the focus is brought to an individual parameter (single click of mouse) as is the case for Analog Input 1 in the left column; all that can be setup related to that parameter will appear in the center column. The grayed out fields in the center column simply mean that this does not apply for the type of sensor selected. As an example, notice that when a thermocouple is selected, RTD Leads does not apply and is therefore grayed out. To speed up the process of configuration notice that at the bottom of the center column there is an option to copy settings. If Analog Input 1 and 2 are the same type of sensor click on "Copy Settings" where a copy dialog box will appear allowing for quick duplication of all settings. Notice too, that by clicking on any of those items in the center column that context sensitive help will appear for that particular item in the right hand column.

Lastly, when the configuration is complete click the "Finish" button at the bottom right of the previous screen shot. The screen that follows this action can be seen below.

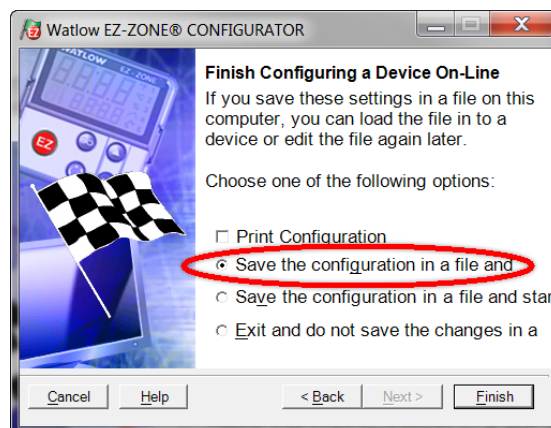

Although the PM control now contains the configuration (because the previous discussion focused on doing the configuration on-line) it is suggested that after the configuration process is completed that the user save this file on the PC for future use. If for some reason someone inadvertently changed a setting without understanding the impact, it would be easy and perhaps faster to download a saved configuration back to the control versus trying to figure out what was changed. Of course, there is an option to exit without saving a copy to the local hard drive. After selecting Save above, click the "Finish" button once again. The screen below will then appear. When saving the configuration, note the location where the file will be placed (saved in) and enter the file name (File name) as well. The default path for saved files follows: Users\Username\My Documents\Watlow\EZ-Zone Configurator\Saved Configurations

The user can save the file to any folder of choice.

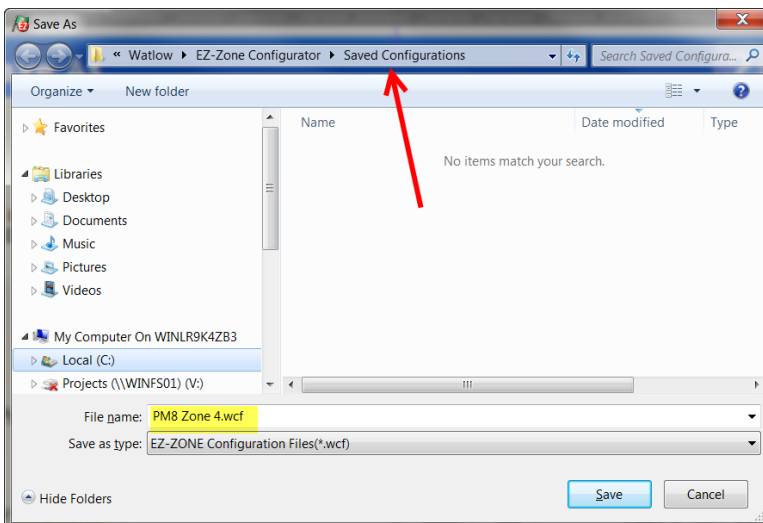

Chapter 10: Applications

Example 1: Single Loop Control

Requirements:

One input is required and at least one output adjusts the controlled part of the process.

Overview:

Controls one process value to a user entered Closed Loop Set Point based on an control algorithm.

Control loop 1 will control Analog Input 1 to Closed Loop Set Point 1.

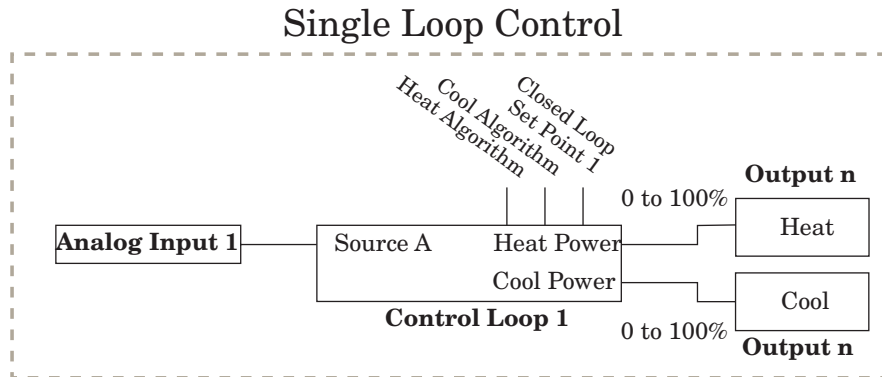

Example 2: Sensor Backup

Requirements:

Two analog inputs and the enhanced software option are required and at least one output adjusts the controlled part of the process.

Overview:

The Sensor Backup feature controls a process based on a primary sensor on Analog Input 1. If this sensor fails, then the process is controlled based on the secondary sensor on Analog Input 2.

When function is set for Sensor Backup, the PV Function output equals Source A if sensor of Analog Input 1 reading is valid or Source B if sensor reading is invalid. Control loop 1 will control the valid Analog Input sensor to Closed Loop Set Point 1.

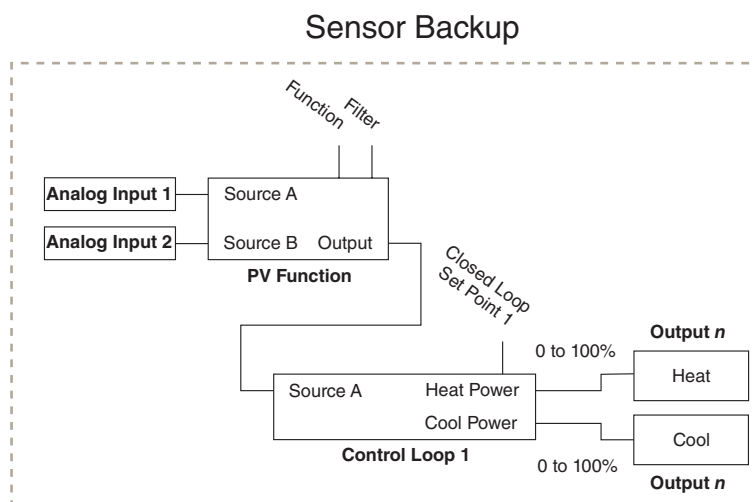

Example 3: Square Root

Requirements:

One analog input and the enhanced software option are required and at least one output adjusts the controlled part of the process.

Overview:

Calculates the square root value of the sensor connected to Analog Input 1.

When function is set for Square Root, the PV Function output equals square root value of Source A. Control loop 1 will control Analog Input 1 to Closed Loop Set Point 1.

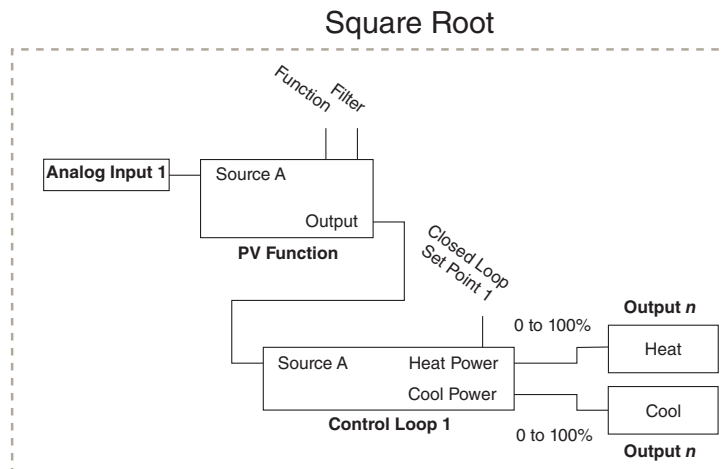

Example 4: Ratio

Requirements:

Two analog inputs and the enhanced software option are required and at least one output adjusts the controlled part of the process.

Overview:

The Ratio feature allows control of one process as a ratio of another process. This is especially useful in applications that mix two materials, whether steam, paint or food ingredients. Analog Input 1 monitors the controlled part of the process. Analog Input 2 of the controller measures the part of the process that is either uncontrolled or controlled by another device. The part of the process controlled will be maintained at a level equal to the quantity measured at input 2 multiplied by the ratio term set by the user as Closed Set Point 1. When function is set for Ratio, the PV Function output equals Source A as a ratio to Source B. Control loop 1 will control Analog Input 1 to Closed Loop Set Point 1.

Applications of ratio control:

- Blending two or more flows to produce a mixture with specified composition.
- Blending two or more flows to produce a mixture with specified physical properties.
- Maintaining correct air and fuel mixture to combustion.

Ratio

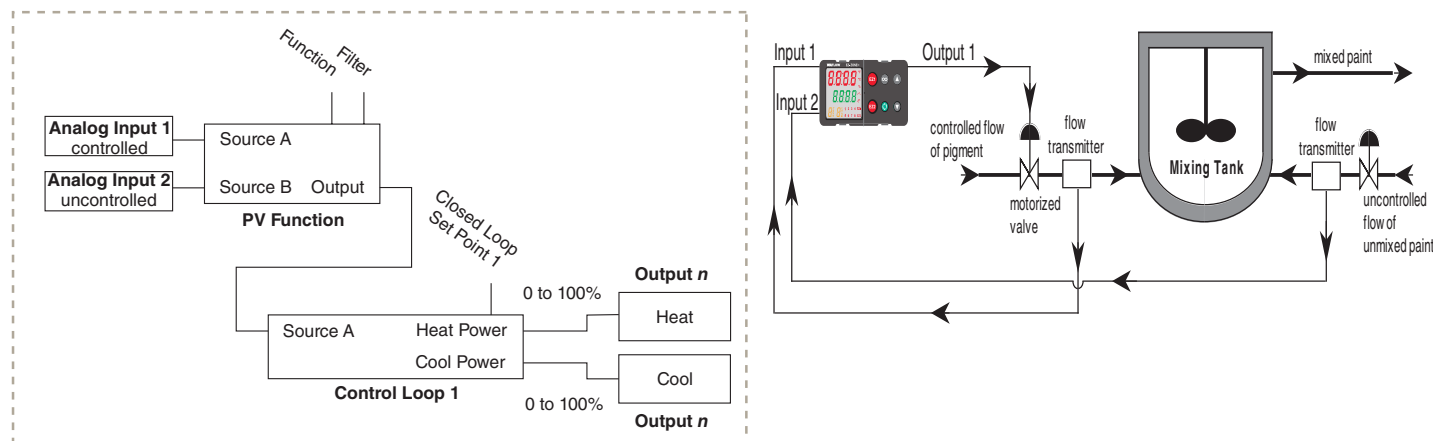

Example 5: Differential

Requirements:

Two analog inputs and the enhanced software option are required and at least one output adjusts the controlled part of the process.

Overview:

Differential control maintains one process at a difference to another process. When function is set for Differential, the PV Function output equals Source A minus Source B. Control loop 1 will control Analog Input 1 difference to Analog Input 2 based on Closed Loop Set Point 1.

Differential

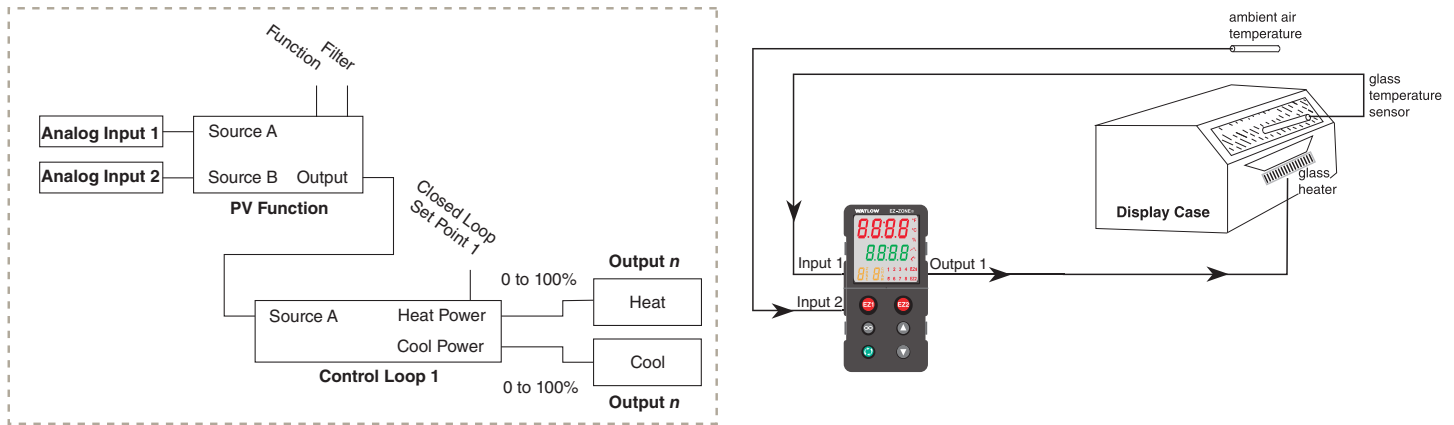

Example 6: Cascade

Requirements:

Two loops of control, two inputs and at least 1 output and the enhanced software option.

Overview:

Cascade control can handle a difficult process with minimal overshoot, while reaching the set point quickly. This minimizes damage to system components and allows for over sizing heaters for optimal heat-up rates. Heater life is also extended by reducing thermal cycling of the heater. Systems with long lag times between the energy source (heater, steam, etc.) and the measured process value cannot be controlled accurately or efficiently with a single control loop, because a lot of energy can build up before a response is detected. This can cause the system to overshoot the set point, which could damage the heater, product or heat transfer medium, such as a heat transfer fluid.

The majority of the user configuration is done via the Math function. There are two user selectable settings that will enable Cascade control, Deviation Scale or process Scale. When Process Scale is selected the remote set point will be within the defined Range low/high and Scale low/high settings. As an example, the graph below shows a heat/cool application where the temperature range is between 32° to 1200°. With the scaling set as shown 100% cool will equate to 32°, likewise when the control is calling for 100% heat the temperature equates to 1200°.

When Deviation Scale is selected the Closed Loop Set Point (CLSP) will not deviate beyond the specified settings. With the settings as shown in the graph below the CLSP (500°) will not deviate beyond $\pm 25^\circ$.

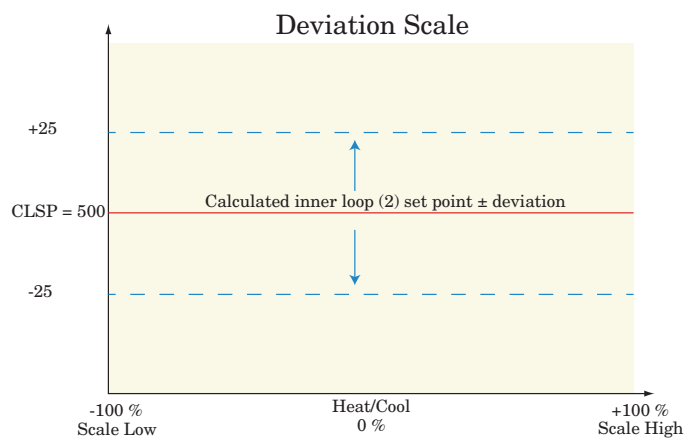
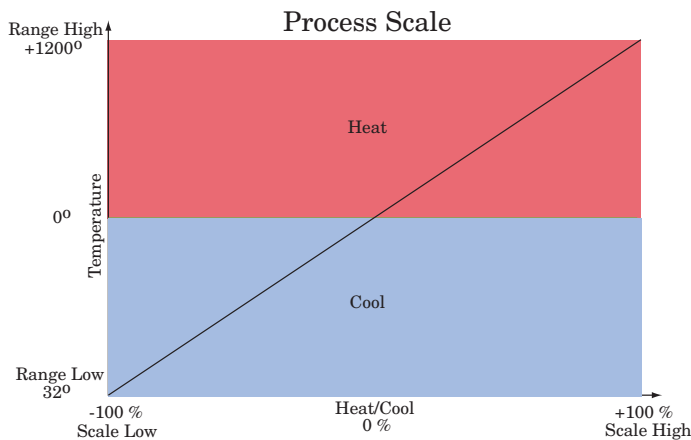

The graph below illustrates a system with a long lag time and the advantages in using cascade control. Curve A represents a single-control system with PID parameters that allow a maximum heat-up rate. Too much energy is introduced and the set point is overshoot. In most long-lag-time systems the process value may never settle out to an acceptable error. Curve C represents a single-control system tuned to minimize overshoot. This results in unacceptable heat-up rates, with the final value taking hours to reach. Curve B shows a cascade system that limits the energy introduced into the system allowing an optimal heat-up rate with minimal overshoot.

Note:
When using cascade control, two loops of control are required. Changing the control mode in either loop will affect both loops of control. In other words, if loop one is changed to manual mode, loop two will also be changed to manual mode automatically.

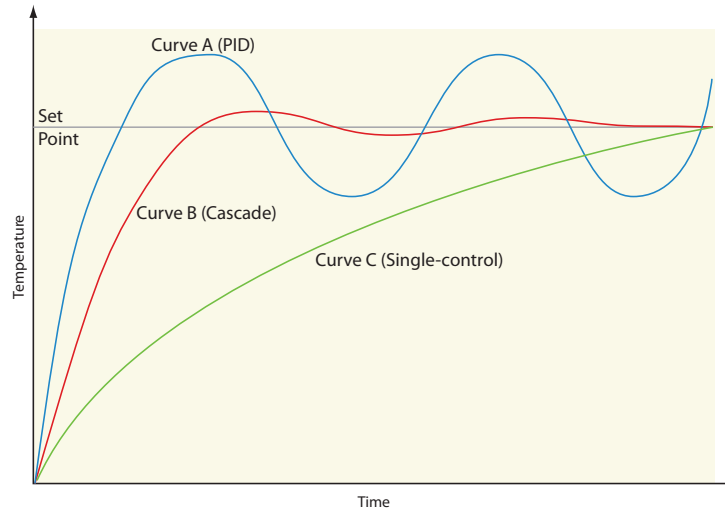

Cascade

When the Math function is set for Process or Deviation Scale and Source E is not connected or false, cascade control is enabled.

Note:
When the Math function is set for Process or Deviation Scale the PM automatically makes the connections for each Control Loop as shown in the graphic below. Each loop, 1 (process) and 2 (energy) outer and inner respectively, cannot be changed. If it is desired to display the inner loop process variable and set point, the home page must be changed via the Factory Page, Custom Menu.

Cascade control uses two control loops (outer - loop 1 and inner - loop 2) to control the process. The outer loop (Analog Input 1) monitors the process or part temperature, which is then compared to the Closed Loop Set Point. The result of the comparison, the error signal, acted on by the PID settings and the Range and Scale high/low settings. Ultimately, the outer loop produces a remote set point for the inner loop. The inner loop input (Analog input 2) monitors the energy source (heating and cooling), which is compared to the remote set point generated by the outer loop. The result of the comparison, the error signal, is acted on by the PID settings in the cascade inner loop (2), which generates an output power level between -100% to +100%. If the power level is positive the heat will be on; if the power level is negative the cool will come on. Power from the energy sources are supplied by the outputs of choice always referenced to Control loop 2. When cascade control is disabled (Source E is true), the Math function output will equal Control Loop 1, Closed Loop Set Point.

Note:
If an input sensor on the outer loop fails when using deviation cascade the inner loop will continue to drive the output.

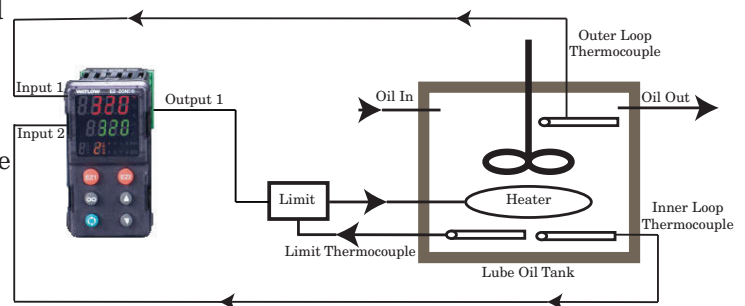
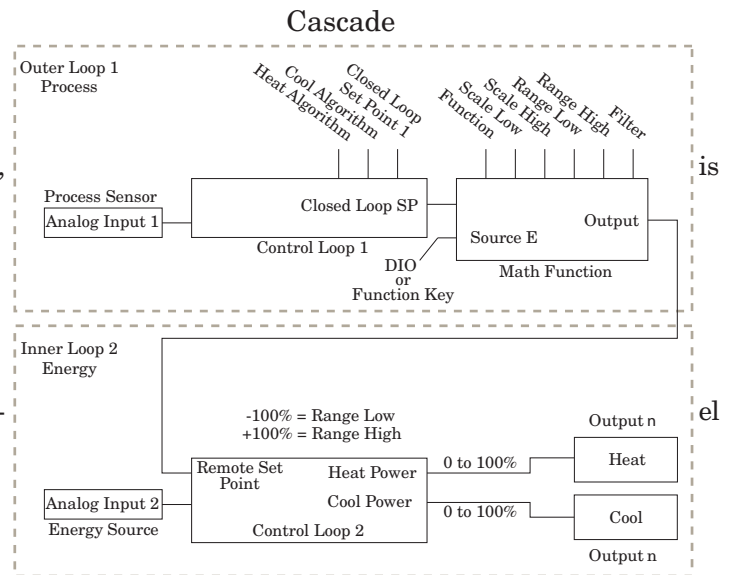

Example 7: Wet Bulb / Dry Bulb

Requirements:

Two analog inputs and at least one output are required to adjust the controlled part of the processes.

Overview:

Wet Bulb/Dry Bulb is a configuration where a dry bulb connected to Analog Input 1 measures temperature on Analog Input 1. A wet bulb sensor that is maintained with moisture has air moved over the sensor. As moisture evaporates from the wet bulb, the temperature drops. A wet bulb input on Analog Input 2, in combination with the dry bulb temperature, senses relative humidity. The controller calculates the temperature difference between the two sensors to determine percent relative humidity. The humidify and dehumidify outputs are disabled when Analog Input 1 temperature falls below 32 F/0 C, or goes above 212 F/100 C. When function is set for Wet Bulb/Dry Bulb, the PV Function output equals calculated humidity. Control loop 1 will control Analog Input 1 to Closed Loop Set Point 1. Control loop 2 will control Analog Input 2 to Closed Loop Set Point 2.

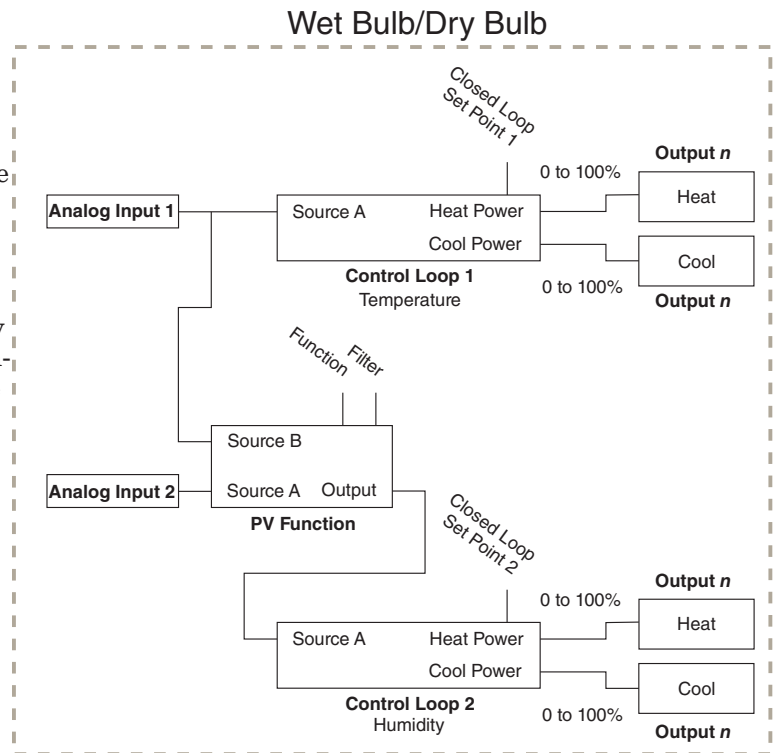

Example 8: Vaisala

Requirements:

Two analog inputs and the enhanced software option are required and at least two outputs adjust the controlled temperature and humidity processes.

Overview:

Vaisala Model HMM-30C Solid-state Relative Humidity Sensor is supported with the Vaisala configuration. Analog Input 1 is used to measure temperature and Analog Input 2 must be a process input connected to a Vaisala sensor. The controller provides temperature compensation for the Vaisala sensor. The humidify and dehumidify outputs are disabled when Analog Input 1 temperature falls below -40 F/- 40 C, or goes above 320 F/160 C. When function is set for Vaisala, the PV Function output equals the calculated relative humidity compensated by the sensor on Analog Input 1.

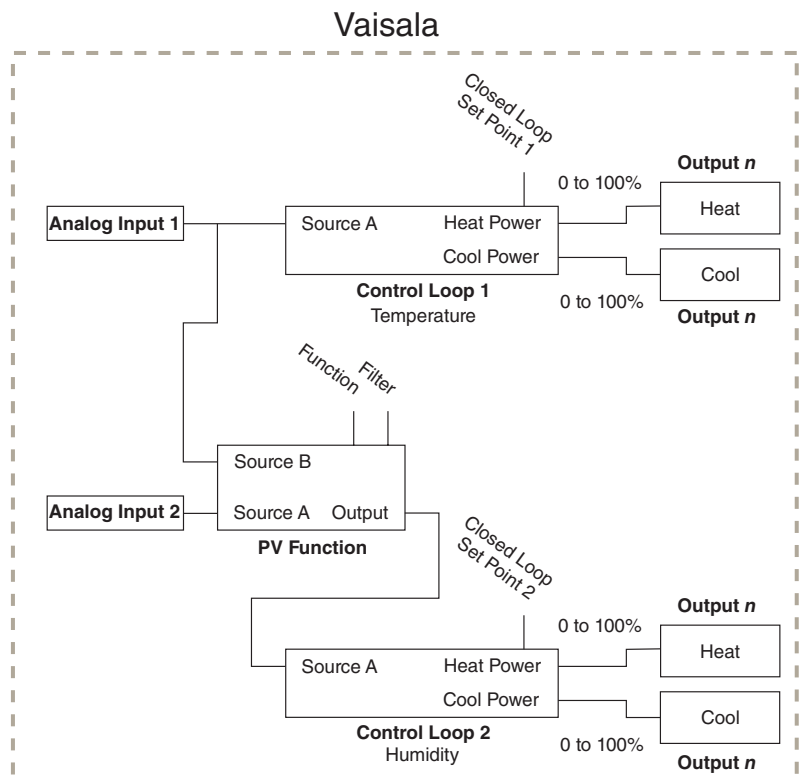

Example 9: Motorized Valve Control

A typical scenario where a motorized valve is used is to regulate the flow of fluid which in turn impacts the loop process value. A valve is opened or closed by closing contacts to drive the valve in the intended direction. Motorized Valves come in a number of configurations. Some valves have a position feedback mechanism that allows the control to measure the valve's position via an internal potentiometer called slide-wire. The controller can measure the potentiometer resistance to determine the initial valve position on power up.

This method may not be desirable for three reasons:

- 1) It requires a second input on the controller to measure valve position.
- 2) The controller and the valve are more expensive.
- 3) Additional wiring is required for the slide-wire feedback.

Other valves take an analog signal and have a localized control mechanism that regulates the valve position. These are typically more expensive valves because of the control mechanism built-in plus it requires an analog signal which is not always available. The actual valve position is not critical because it is a part of a closed loop control.

The Motorized Valve control algorithm is also designed to work with a type of valve that provides two discrete signals: one to open the valve and another to close the valve. The algorithm turns on/off the appropriate signal for an appropriate amount of time to approximate the valve position. This works when the valve is inside a closed control loop because when the valve is not in the correct position, the PID algorithm will adjust the valve further open or close as needed. These valves have travel limit switches which deactivates the motor once the valve is fully open or fully closed so the controller can not cause the valve to over travel and burn out the motor, or the motor is built so it can not overheat at max locked rotor amperes.

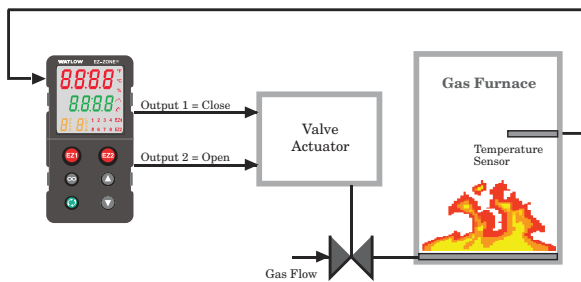

To use the motorized feature, the user programs the Special Output Function to Motorized Valve. Then the Source Function A is selected to either Heat or Cool Power and Source Instance A is set to match the control loop, typically 1.

Next the user enters the amount of time in seconds that the valve requires power to go from a closed state to an open state. The user enters the dead band in percent PID power to prevent the valve from excessive cycling. Larger numbers reduce activity on the valve and smaller numbers improve controllability. Select a value that compromises on these two competing goals.

Lastly, assign an output to Special Output Function 1 that is wired to close the valve. Assign an output to Special Output Function 2 that is wired to open the valve. Typically, these two outputs are normally open mechanical relays but solid state relays or switch DC outputs may be programmed in the same manner.

Definitions:

- *Current Position* is an approximation of the valve's position as it relates to a power level (0 - 100%) where 0% is fully closed and 100% is fully open.
- *Dead Time* is the minimum on time that the valve will travel once it is turned on in either the closed or open direction. $Dead\ Time = Valve\ Dead\ Band / 100 * Valve\ Travel\ Time$.
- *On Time* is the amount of time the valve needs to be turned on (either open or close) to eliminate the error between the estimated valve position and the desired power level. A positive On Time value indicates the need to open the valve while a negative value indicates the need to close the valve. $On\ Time = (Input\ 1\ Value - Current\ Position) / 100 * Valve\ Travel\ Time$

When power is applied to the controller, the valve is closed and time is set to 0.

- *Special Output Function 1* is the close signal to the valve.
- *Special Output Function 2* is the open signal to the valve

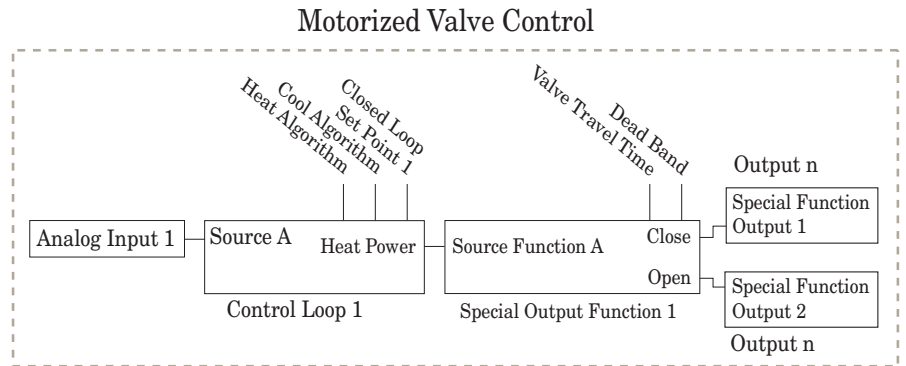

Chapter 11: Appendix

Troubleshooting Alarms, Errors and Control Issues

Indication	Description	Possible Cause(s)	Corrective Action
Alarm won't clear or reset	Alarm will not clear or reset with keypad or digital input	<ul style="list-style-type: none"> Alarm latching is active Alarm set to incorrect output Alarm is set to incorrect source Sensor input is out of alarm set point range Alarm set point is incorrect Alarm is set to incorrect type Digital input function is incorrect 	<ul style="list-style-type: none"> Reset alarm when process is within range or disable latching Set output to correct alarm source instance Set alarm source to correct input instance Correct cause of sensor input out of alarm range Set alarm set point to correct trip point Set alarm to correct type: process, deviation or power Set digital input function and source instance
Alarm won't occur	Alarm will not activate output	<ul style="list-style-type: none"> Alarm silencing is active Alarm blocking is active Alarm is set to incorrect output Alarm is set to incorrect source Alarm set point is incorrect Alarm is set to incorrect type 	<ul style="list-style-type: none"> Disable alarm silencing, if required Disable alarm blocking, if required Set output to correct alarm source instance Set alarm source to correct input instance Set alarm set point to correct trip point Set alarm to correct type: process, deviation or power
AL.E1 Alarm Error AL.E2 AL.E3 AL.E4	Alarm state cannot be determined due to lack of sensor input	<ul style="list-style-type: none"> Sensor improperly wired or open Incorrect setting of sensor type Calibration corrupt 	<ul style="list-style-type: none"> Correct wiring or replace sensor Match setting to sensor used Check calibration of controller
AL.L1 Alarm Low AL.L2 AL.L3 AL.L4	Sensor input below low alarm set point	<ul style="list-style-type: none"> Temperature is less than alarm set point Alarm is set to latching and an alarm occurred in the past Incorrect alarm set point Incorrect alarm source 	<ul style="list-style-type: none"> Check cause of under temperature Clear latched alarm Establish correct alarm set point Set alarm source to proper setting
AL.h1 Alarm High AL.h2 AL.h3 AL.h4	Sensor input above high alarm set point	<ul style="list-style-type: none"> Temperature is greater than alarm set point Alarm is set to latching and an alarm occurred in the past Incorrect alarm set point Incorrect alarm source 	<ul style="list-style-type: none"> Check cause of over temperature Clear latched alarm Establish correct alarm set point Set alarm source to proper setting
Er.1 Error Input Er.2	Sensor does not provide a valid signal to controller	<ul style="list-style-type: none"> Sensor improperly wired or open Incorrect setting of sensor type Calibration corrupt 	<ul style="list-style-type: none"> Correct wiring or replace sensor Match setting to sensor used Check calibration of controller
Limit won't clear or reset	Limit will not clear or reset with keypad or digital input	<ul style="list-style-type: none"> Sensor input is out of limit set point range Limit set point is incorrect Digital input function is incorrect 	<ul style="list-style-type: none"> Correct cause of sensor input out of limit range Set limit set point to correct trip point Set digital input function and source instance
L.E1 Limit Error	Limit state cannot be determined due to lack of sensor input, limit will trip	<ul style="list-style-type: none"> Sensor improperly wired or open Incorrect setting of sensor type Calibration corrupt 	<ul style="list-style-type: none"> Correct wiring or replace sensor Match setting to sensor used Check calibration of controller
L.L1 Limit Low	Sensor input below low limit set point	<ul style="list-style-type: none"> Temperature is less than limit set point Limit outputs latch and require reset Incorrect alarm set point 	<ul style="list-style-type: none"> Check cause of under temperature Clear limit Establish correct limit set point
L.h1 Limit High	Sensor input above high limit set point	<ul style="list-style-type: none"> Temperature is greater than limit set point Limit outputs latch and require reset Incorrect alarm set point 	<ul style="list-style-type: none"> Check cause of over temperature Clear limit Establish correct limit set point

Indication	Description	Possible Cause(s)	Corrective Action
<u>L P o 1</u> <u>L P o 2</u> Loop Open Error	Open Loop Detect is active and the process value did not deviate by a user-selected value in a user specified period with PID power at 100%.	<ul style="list-style-type: none"> Setting of Open Loop Detect Time incorrect Setting of Open Loop Detect Deviation incorrect Thermal loop is open Open Loop Detect function not required but activated 	<ul style="list-style-type: none"> Set correct Open Loop Detect Time for application Set correct Open Loop Deviation value for application Determine cause of open thermal loop: misplaced sensors, load failure, loss of power to load, etc. Deactivate Open Loop Detect feature
<u>L P r 1</u> <u>L P r 2</u> Loop Reversed Error	Open Loop Detect is active and the process value is headed in the wrong direction when the output is activated based on deviation value and user-selected value.	<ul style="list-style-type: none"> Setting of Open Loop Detect Time incorrect Setting of Open Loop Detect Deviation incorrect Output programmed for incorrect function Thermocouple sensor wired in reverse polarity 	<ul style="list-style-type: none"> Set correct Open Loop Detect Time for application Set correct Open Loop Deviation value for application Set output function correctly Wire thermocouple correctly, (red wire is negative)
<u>r P 1</u> Ramping 1 <u>r P 2</u> Ramping 2	Controller is ramping to new set point	<ul style="list-style-type: none"> Ramping feature is activated 	<ul style="list-style-type: none"> Disable ramping feature if not required
<u>E U n 1</u> Autotuning 1 <u>E U n 2</u> Autotuning 2	Controller is autotuning the control loop	<ul style="list-style-type: none"> User started the autotune function Digital input is set to start autotune 	<ul style="list-style-type: none"> Wait until autotune completes or disable autotune feature Set digital input to function other than autotune, if desired
No heat/cool action	Output does not activate load	<ul style="list-style-type: none"> Output function is incorrectly set Control mode is incorrectly set Output is incorrectly wired Load, power or fuse is open Control set point is incorrect Incorrect controller model for application 	<ul style="list-style-type: none"> Set output function correctly Set control mode appropriately (Open vs Closed Loop) Correct output wiring Correct fault in system Set control set point in appropriate control mode and check source of set point: remote, idle, profile, closed loop, open loop Obtain correct controller model for application
No Display	No display indication or LED illumination	<ul style="list-style-type: none"> Power to controller is off Fuse open Breaker tripped Safety interlock switch open Separate system limit control activated Wiring error Incorrect voltage to controller 	<ul style="list-style-type: none"> Turn on power Replace fuse Reset breaker Close interlock switch Reset limit Correct wiring issue Apply correct voltage, check part number
No Serial Communication	Cannot establish serial communications with the controller	<ul style="list-style-type: none"> Address parameter incorrect Incorrect protocol selected Baud rate incorrect Parity incorrect Wiring error EIA-485 converter issue Incorrect computer or PLC communications port Incorrect software setup Wires routed with power cables Termination resistor may be required 	<ul style="list-style-type: none"> Set unique addresses on network Match protocol between devices Match baud rate between devices Match parity between devices Correct wiring issue Check settings or replace converter Set correct communication port Correct software setup to match controller Route communications wires away from power wires Place 120 Ω resistor across EIA-485 on last controller
Process doesn't control to set point	Process is unstable or never reaches set point	<ul style="list-style-type: none"> Controller not tuned correctly Control mode is incorrectly set Control set point is incorrect 	<ul style="list-style-type: none"> Perform autotune or manually tune system Set control mode appropriately (Open vs Closed Loop) Set control set point in appropriate control mode and check source of set point: remote, idle, profile, closed loop, open loop

Indication	Description	Possible Cause(s)	Corrective Action
Temperature runaway	Process value continues to increase or decrease past set point.	<ul style="list-style-type: none"> • Controller output incorrectly programmed • Thermocouple reverse wired • Controller output wired incorrectly • Short in heater • Power controller connection to controller defective • Controller output defective 	<ul style="list-style-type: none"> • Verify output function is correct (heat or cool) • Correct sensor wiring (red wire negative) • Verify and correct wiring • Replace heater • Replace or repair power controller • Replace or repair controller
100 rErr Device Error	Controller displays internal malfunction message at power up.	<ul style="list-style-type: none"> • Controller defective • Sensor input over driven 	<ul style="list-style-type: none"> • Replace or repair controller • Check sensors for ground loops, reverse wiring or out of range values.
hEr Heater Error	Heater Error	<ul style="list-style-type: none"> • Current through load is above current trip set point • Current through load is below current trip set point 	<ul style="list-style-type: none"> • Check that the load current is proper. Correct cause of overcurrent and/or ensure current trip set point is correct. • Check that the load current is proper. Correct cause of undercurrent and/or ensure current trip set point is correct.
CEr Current Error	Load current incorrect.	<ul style="list-style-type: none"> • Shorted solid-state or mechanical relay • Open solid-state or mechanical relay • Current transformer load wire associated to wrong output • Defective current transformer or controller • Noisy electrical lines 	<ul style="list-style-type: none"> • Replace relay • Replace relay • Route load wire through current transformer from correct output, and go to the CS Source Output Instance parameter (Setup Page, Current Menu) to select the output that is driving the load. • Replace or repair sensor or controller • Route wires appropriately, check for loose connections, add line filters
Menus inaccessible	Unable to access SEE , OPER , FCTy or PrOF menus or particular prompts in Home Page	<ul style="list-style-type: none"> • Security set to incorrect level • Digital input set to lockout keypad • Custom parameters incorrect 	<ul style="list-style-type: none"> • Check LoC settings in Factory Page • Enter appropriate password in ULoC setting in Factory Page • Change state of digital input • Change custom parameters in Factory Page
EZ-Key/s don't work	EZ-Key/s does not activate required function	<ul style="list-style-type: none"> • EZ-Key function incorrect • EZ-Key function instance not incorrect • Keypad malfunction 	<ul style="list-style-type: none"> • Verify EZ-Key function in Setup Menu • Check that the function instance is correct • Replace or repair controller
uRLl Value to low	Value to low to be displayed in 4 digit LED display <-1999	<ul style="list-style-type: none"> • Incorrect setup 	<ul style="list-style-type: none"> • Check scaling of source data
uRLh Value to high	Value to high to be displayed in 4 digit LED display >9999	<ul style="list-style-type: none"> • Incorrect setup 	<ul style="list-style-type: none"> • Check scaling of source data

Detection of and Rules Around Abnormal Sensor Conditions	
Inputs	Detection of Abnormal Conditions
Thermocouple	
Shorted	No direct detection, Open loop firmware detection.
Open	Yes, Parasitic pull-up
Reversed	Yes, firmware detection
Current Source	
Shorted	Range limiting only
Open	Range limiting only
Reversed	Range limiting only
Voltage Source	
Open	Range limiting only
Shorted	Range limiting only
Reversed	Range limiting only
RTD	
S1 open	Yes, pulled up.
S2 open	Not implemented.
S3 open	Yes, pulled up.
S1 short to S2	Yes, pulled up
S1 short to S3	Yes, pulled down to under range.
S2 shorted to S3	Not implemented, Possible, monitor S2 voltage.
S1 and S2 open	Yes, pulled down to under range.
S1 and S3 open	Yes, S1 pulled up.
S2 and S3 open	Yes pulled up.
Thermistor	
S1 open	Yes, pulled up to sensor over range.
S3 open	Yes, pulled up to sensor over range.
S1 short to S3	Yes, pulled down to sensor under range.
S1 and S3 open	Yes, S1 pulled up to sensor over range.

Modbus - Programmable Memory Blocks

Assembly Definition Addresses and Assembly Working Addresses

Assembly Definition Addresses	Assembly Working Addresses	Assembly Definition Addresses	Assembly Working Addresses
40 & 41	200 & 201	80 & 81	240 & 241
42 & 43	202 & 203	82 & 83	242 & 243
44 & 45	204 & 205	84 & 85	244 & 245
46 & 47	206 & 207	86 & 87	246 & 247
48 & 49	208 & 209	88 & 89	248 & 249
50 & 51	210 & 211	90 & 91	250 & 251
52 & 53	212 & 213	92 & 93	252 & 253
54 & 55	214 & 215	94 & 95	254 & 255
56 & 57	216 & 217	96 & 97	256 & 257
58 & 59	218 & 219	98 & 99	256 & 259
60 & 61	220 & 221	100 & 101	260 & 261
62 & 63	222 & 223	102 & 103	262 & 263
64 & 65	224 & 225	104 & 105	264 & 265
66 & 67	226 & 227	106 & 107	266 & 267
68 & 69	228 & 229	108 & 109	268 & 269
70 & 71	230 & 231	110 & 111	270 & 271
72 & 73	232 & 233	112 & 113	272 & 273
74 & 75	234 & 235	114 & 115	274 & 275
76 & 77	236 & 237	116 & 117	276 & 277
78 & 79	238 & 239	118 & 119	278 & 279

Assembly Definition Addresses Default Pointers

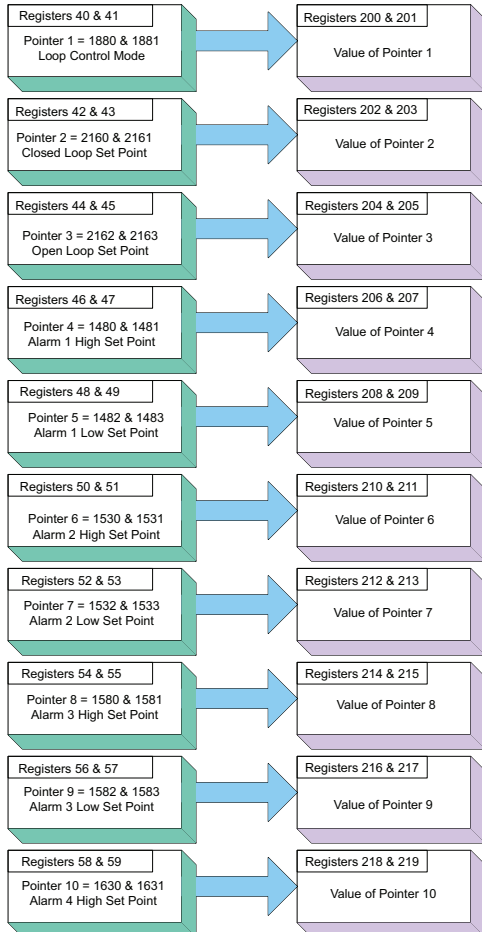

Assembly Definition Addresses Default Pointers

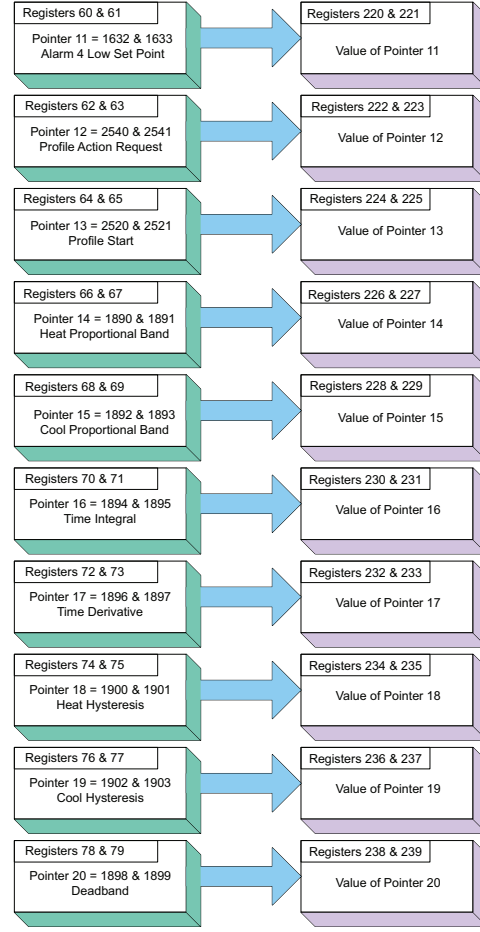

Modbus Default Assembly Structure 80-119

Assembly Definition Addresses Default Pointers

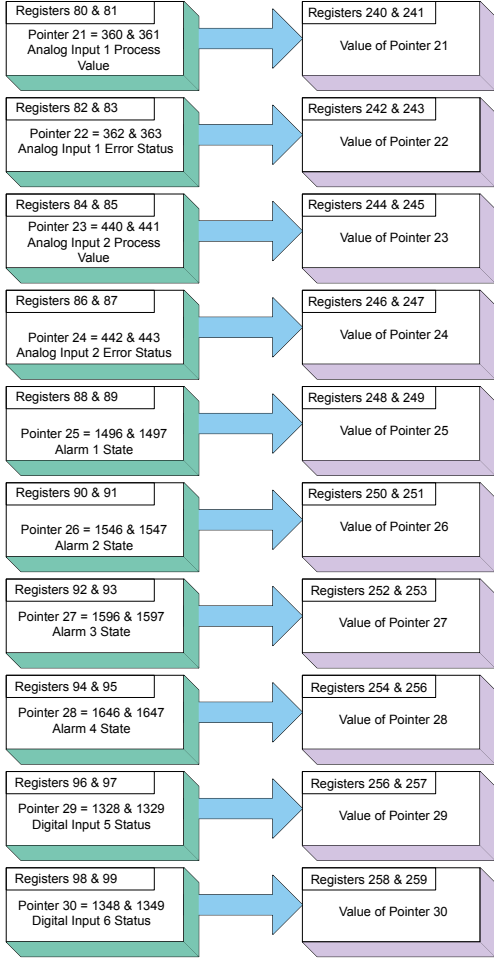

Assembly Definition Registers Default Pointers

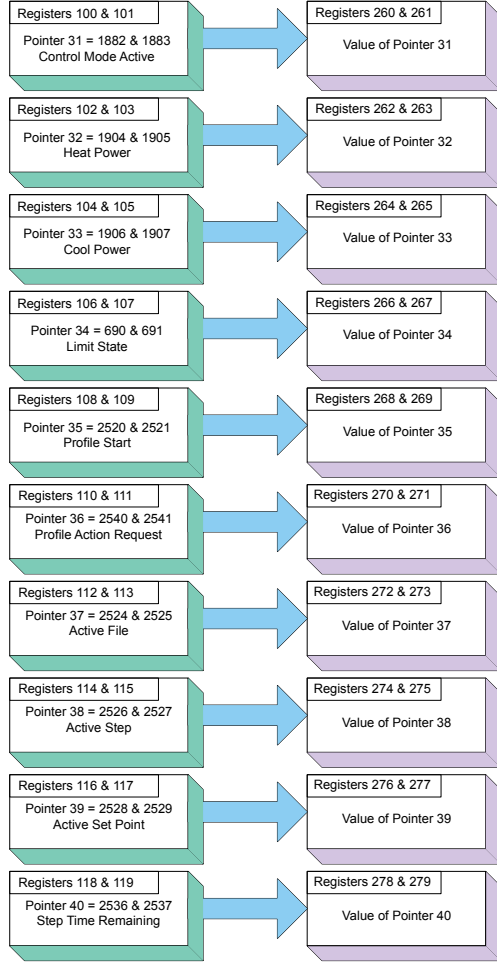

CIP Implicit Assembly Structures

CIP Implicit O to T (Originator to Target) Assembly Structure

CIP Implicit Assembly Originator (Master) to Target (PM)					
Assembly Members	PM Assembly Class, Instance, Attribute	PM Data Type	Parameter	Parameter Class, Instance, Attribute	PLC Data Type
1	0x77, 0x01, 0x01	DINT	Loop Control Mode	0x97, 0x01, 0x01	DINT
2	0x77, 0x01, 0x02	DINT	Closed Loop Set Point	0x6B, 0x01, 0x01	REAL
3	0x77, 0x01, 0x03	DINT	Open Loop Set Point	0x6B, 0x01, 0x02	REAL
4	0x77, 0x01, 0x04	DINT	Alarm 1 - Alarm High Set Point	0x6D, 0x01, 0x01	REAL
5	0x77, 0x01, 0x05	DINT	Alarm 1 - Alarm Low Set Point	0x6D, 0x01, 0x02	REAL
6	0x77, 0x01, 0x06	DINT	Alarm 2 - Alarm High Set Point	0x6D, 0x02, 0x01	REAL
7	0x77, 0x01, 0x07	DINT	Alarm 2 - Alarm Low Set Point	0x6D, 0x02, 0x02	REAL
8	0x77, 0x01, 0x08	DINT	Alarm 3 - Alarm High Set Point	0x6D, 0x03, 0x01	REAL
9	0x77, 0x01, 0x09	DINT	Alarm 3 - Alarm Low Set Point	0x6D, 0x03, 0x02	REAL
10	0x77, 0x01, 0x0A	DINT	Alarm 4 - Alarm High Set Point	0x6D, 0x04, 0x01	REAL
11	0x77, 0x01, 0x0B	DINT	Alarm 4 - Alarm Low Set Point	0x6D, 0x04, 0x02	REAL
12	0x77, 0x01, 0x0C	DINT	Profile Action Request	0x7A, 0x01, 0x0B	DINT
13	0x77, 0x01, 0x0D	DINT	Profile Start	0x7A, 0x01, 0x01	DINT
14	0x77, 0x01, 0x0E	DINT	Heat Proportional Band	0x97, 0x01, 0x06	REAL
15	0x77, 0x01, 0x0F	DINT	Cool Proportional Band	0x97, 0x01, 0x07	REAL
16	0x77, 0x01, 0x10	DINT	Time Integral	0x97, 0x01, 0x08	REAL
17	0x77, 0x01, 0x11	DINT	Time Derivative	0x97, 0x01, 0x09	REAL
18	0x77, 0x01, 0x12	DINT	Heat Hysteresis	0x97, 0x01, 0x0B	REAL
19	0x77, 0x01, 0x13	DINT	Cool Hysteresis	0x97, 0x01, 0x0C	REAL
20	0x77, 0x01, 0x14	DINT	Dead Band	0x97, 0x01, 0x0A	REAL

CIP Implicit T to O (Target to Originator) Assembly Structure

CIP Implicit Assembly Target (PM) to Originator (Master)					
Assembly Members	PM Assembly Class, Instance, Attribute	PM Data Type	Parameter	Parameter Class, Instance, Attribute	PLC Data Type
1	Cannot be changed	Binary	Device Status	none	DINT
2	0x77, 0x02, 0x01	DINT	Analog Input 1, Analog Input Value	0x68, 0x01, 0x01	REAL
3	0x77, 0x02, 0x02	DINT	Analog Input 1, Input Error	0x68, 0x01, 0x02	REAL
4	0x77, 0x02, 0x03	DINT	Analog Input 2, Analog Input Value	0x68, 0x02, 0x01	REAL
5	0x77, 0x02, 0x04	DINT	Analog Input 2, Input Error	0x68, 0x02, 0x02	REAL
6	0x77, 0x02, 0x05	DINT	Alarm 1, Alarm State	0x6D, 0x01, 0x09	DINT
7	0x77, 0x02, 0x06	DINT	Alarm 2, Alarm State	0x6D, 0x02, 0x09	DINT
8	0x77, 0x02, 0x07	DINT	Alarm 3, Alarm State	0x6D, 0x03, 0x09	DINT
9	0x77, 0x02, 0x08	DINT	Alarm 4, Alarm State	0x09, 0x04, 0x09	DINT
10	0x77, 0x02, 0x09	DINT	Event Status	0x6E, 0x01, 0x05	DINT
11	0x77, 0x02, 0x0A	DINT	Event Status	0x6E, 0x02, 0x05	DINT
12	0x77, 0x02, 0x0B	DINT	Control Mode Active	0x97, 0x01, 0x02	DINT
13	0x77, 0x02, 0x0C	DINT	Heat Power	0x97, 0x01, 0x0D	REAL
14	0x77, 0x02, 0x0D	DINT	Cool Power	0x97, 0x01, 0x0E	REAL
15	0x77, 0x02, 0x0E	DINT	Limit State	0x70, 0x01, 0x06	DINT
16	0x77, 0x02, 0x0F	DINT	Profile Start	0x74, 0x01, 0x01	DINT
17	0x77, 0x02, 0x10	DINT	Profile Action Request	0x74, 0x01, 0x0B	DINT
18	0x77, 0x02, 0x11	DINT	Current Profile	0x74, 0x01, 0x03	DINT
19	0x77, 0x02, 0x12	DINT	Current Step	0x74, 0x01, 0x04	DINT
20	0x77, 0x02, 0x13	DINT	Active Set Point	0x74, 0x01, 0x05	REAL
21	0x77, 0x02, 0x14	DINT	Step Time Remaining	0x74, 0x01, 0x09	DINT

As can be seen on the previous page the PM Implicit Assembly defaults (factory settings) to a populated assembly structure. If it is desired to modify any of the given assembly members there are many software tools available to do so. It is outside of the scope of this document to describe how to use those. What can be found in this document is the *process* to build the assembly structure. If viewing this document electronically simply click on the link below to read the section entitled "[Modifying Implicit Assembly Members](#)". Otherwise, turn back to the table of contents to find the above named section.

Compact Class Assembly Structure

On the next four pages, the 17 available members of the Compact Class are displayed. As an orientation to the format as displayed in this document, notice that each member begins with header identified as "Assembly" and below the header you will see the member number along with parameter information contained within. While looking at these illustrations keep in mind that each member is actually 32-bits in length. To better illustrate this information in this document, the following 6 pages present these members divided in half where the letter "A" in the page header and assembly number represents the most significant 16-bits where the letter "B" in the title and assembly number represents the least significant 16-bits of each member. In the event that these pages are printed out and then mixed up, simply match up the page headers placing them side by side. As an example, Compact Class 1 A through 7 A should be paired with Class 1 B through 7 B, left to right.

Assembly	Class, Instance, Attribute
1 A Analog Input Read	C = 0x71 (113) I = 1 to 4 A = 1

For further explanation as to what the Compact Class assembly is, navigate to the section entitled "[Compact Assembly Class](#)"

Compact Class 1 A through 7 A

		Instance i															
Assembly	Class, Instance, Attribute	31	30	29	28	27	26	25	24	23	22	21	20	19	18	17	16
1 A Analog Input Read	C = 0x71 (113) I = 1 to 4 A = 1	Filtered Analog Input Value															

Bits 16 to 31, Signed 16 bits with implied tenths precision (-32768.8 to 3276.7)

		Instance i															
Assembly	Class, Instance, Attribute	31	30	29	28	27	26	25	24	23	22	21	20	19	18	17	16
2 A Control Read/Write	C = 0x71 (113) I = 1 to 4 A = 2	Closed Loop Set Point															

Bits 16 to 31, Signed 16 bits with implied tenths precision (-32768.8 to 3276.7)

		Instance i + 1															
Assembly	Class, Instance, Attribute	31	30	29	28	27	26	25	24	23	22	21	20	19	18	17	16
3 A Control Read/Write	C = 0x71 (113) I = 1 to 4 A = 3	Closed Loop Set Point															

Bits 16 to 31, Signed 16 bits with implied tenths precision (-32768.8 to 3276.7)

		Instance i															
Assembly	Class, Instance, Attribute	31	30	29	28	27	26	25	24	23	22	21	20	19	18	17	16
4 A Control Read/Write	C = 0x71 (113) I = 1 to 4 A = 4	Heat Proportional Band															

Bits 16 to 31, Unsigned 16 bits with implied tenths precision (0 to 6553.5)

		Instance i															
Assembly	Class, Instance, Attribute	31	30	29	28	27	26	25	24	23	22	21	20	19	18	17	16
5 A Control Read/Write	C = 0x71 (113) I = 1 to 4 A = 5	Cool Proportional Band (instance i)															

Bits 16 to 31, Unsigned 16 bits with implied tenths precision (0 to 6553.5)

		Instance i + 1															
Assembly	Class, Instance, Attribute	31	30	29	28	27	26	25	24	23	22	21	20	19	18	17	16
6 A Limit Read	C = 0x71 (113) I = 1 to 4 A = 6	Limit State	Input Error Status	Analog Input Value													

Bits 16 to 28, Signed 16 bits whole (-4096 to 4095)
 Bit 29, Analog Input Error Status (0 = None, 1 = Error)
 Bits 30 and 31, Limit State (00 = None, 01 = Low Limit, 10 = Limit High, 11 = Other)

		Instance i + 1															
Assembly	Class, Instance, Attribute	31	30	29	28	27	26	25	24	23	22	21	20	19	18	17	16
7 A Limit Read/Write	C = 0x71 (113) I = 1 to 4 A = 7	Spare	Limit Clear	Clear Latched Error	Analog Input Value												

Bits 16 to 28, Signed 13 bits whole (-4096 to 4095)
 Bit 29, Clear Latched Input Error (0 = Ignore, 1 = Clear)
 Bits 30, Limit Clear (0 = Ignore, 1 = Clear)

Compact Class 1 B through 7 B

Instance i																
Assembly	15	14	13	12	11	10	9	8	7	6	5	4	3	2	1	0
1 B	Input Error Status	Loop Error Status	Actual Control Mode	Tune Status	Control Loop Output Power											
Bits 0 to 10, Signed 10 bits with implied tenths precision (-100.0 to 100.0) Bit 11, Loop Tuning Status (0 = Off, 1 = Anything Else) Bits 12 and 13, Actual Control Mode (00 = Off, 01 = Manual, 10 = Auto) Bit 14, Loop Error Status (0 = None, 1 = Error) Bit 15, Analog Input Error (0 = None, 1 = Error)																

Instance i																
Assembly	15	14	13	12	11	10	9	8	7	6	5	4	3	2	1	0
2 B	Spare	Open Loop Clear	Control Mode	Initiate Tune	Open Loop Set Point											
Bits 0 to 10, Signed 10 bits with implied tenths precision (-100.0 to 100.0) Bit 11, Initiate Tune (0 = No, 1 = Yes) Bits 12 and 13, Actual Control Mode (00 = Off, 01 = Manual, 10 = Auto) Bit 14, Open Loop Clear (0 = Ignore, 1 = Clear)																

Instance i																
Assembly	15	14	13	12	11	10	9	8	7	6	5	4	3	2	1	0
3 B	Closed Loop Set Point															
Bits 0 to 15, Signed 16 bits with implied tenths precision (-3276.8 to 3276.8)																

Instance i																
Assembly	15	14	13	12	11	10	9	8	7	6	5	4	3	2	1	0
4 B	Integral Time															
Bits 0 to 15, Unsigned 16 bits whole (0 to 65535)																

Instance i																
Assembly	15	14	13	12	11	10	9	8	7	6	5	4	3	2	1	0
5 B	Derivative Time															
Bits 0 to 15, Unsigned 16 bits whole (0 to 65535)																

Instance i																
Assembly	15	14	13	12	11	10	9	8	7	6	5	4	3	2	1	0
6 B	Limit State	Input Error Status	Analog Input Value													
Bits 0 to 12, Signed 13 bits whole (-4096 to 4095) Bits 13, Analog Input Error Status (0 = None, 1 = Error) Bit 14 and 15, Limit State (00 = None, 01 = Limit low, 10 = Limit high, 11 = Other)																

Instance i																
Assembly	15	14	13	12	11	10	9	8	7	6	5	4	3	2	1	0
7 B	Spare	Limit Clear	Clear Latched Error	Limit Set Point High												
Bits 0 to 12, Signed 13 bits whole (-4096 to 4095) Bit 13, Clear Latched Input Error (0 = Ignore, 1 = Clear) Bit 14, Limit Clear (0 = Ignore, 1 = Clear)																

Compact Class 8 A through 13 A

		Instance i + 15		Instance i + 14		Instance i + 13		Instance i + 12		Instance i + 11		Instance i + 10		Instance i + 9		Instance i + 8	
Assembly	Class, Instance, Attribute	31	30	29	28	27	26	25	24	23	22	21	20	19	18	17	16
8 A Limit Read	C = 0x71 (113) I = 1 to 4 A = 8	Limit State		Limit State		Limit State		Limit State		Limit State		Limit State		Limit State		Limit State	

Bits 16 to 31, Paired bits representing the state of up to 16 limits (00 = None, 01 = Limit low,, 10 = Limit High)

		Instance i + 15		Instance i + 14		Instance i + 13		Instance i + 12		Instance i + 11		Instance i + 10		Instance i + 9		Instance i + 8	
Assembly	Class, Instance, Attribute	31	30	29	28	27	26	25	24	23	22	21	20	19	18	17	16
9 A Limit Read/Write	C = 0x71 (113) I = 1 to 4 A = 9	Spare	Limit Clear	Spare	Limit Clear	Spare	Limit Clear	Spare	Limit Clear	Spare	Limit Clear	Spare	Limit Clear	Spare	Limit Clear	Spare	Limit Clear

Bits 16 to 31, Paired bits representing the state of up to 16 limits (00 = None, 01 = Limit low,, 10 = Limit High)

		Instance i															
Assembly	Class, Instance, Attribute	31	30	29	28	27	26	25	24	23	22	21	20	19	18	17	16
10 A Limit Read/Write	C = 0x71 (113) I = 1 to 4 A = 0x0A (10)	Spare	Limit Clear	Clear Latched Error	Limit Set Point High												

Bits 16 to 28, Signed 13 bits whole (-4096 to 4095) - Bit 29, Clear Latched Input Error (0 = Ignore, 1 = Clear)

Bits 30, Limit Clear (0 = Ignore, 1 = Clear)

		Instance i + 1															
Assembly	Class, Instance, Attribute	31	30	29	28	27	26	25	24	23	22	21	20	19	18	17	16
11 A CT Read	C = 0x71 (113) I = 1 to 4 A = 0x0B (11)	Spare	Heater Error	Current Error	Current RMS												

Bits 16 to 28, Unsigned 11 bits (0 to 2047)

Bit 29, Current Error (00 = None, 01 = Low, 10 = High)

Bit 30, Heater Error (00 = None, 01 = Open, 10 = Shorted)

		Instance i + 15		Instance i + 14		Instance i + 13		Instance i + 12		Instance i + 11		Instance i + 10		Instance i + 9		Instance i + 8	
Assembly	Class, Instance, Attribute	31	30	29	28	27	26	25	24	23	22	21	20	19	18	17	16
12 A Alarm Read	C = 0x71 (113) I = 1 to 4 A = 0x0C (12)	Alarm State		Alarm State		Alarm State		Alarm State		Alarm State		Alarm State		Alarm State		Alarm State	

Bits 16 to 31, Paired bits reflecting the state of up to 16 alarms (00 = None, 01 = Alarm Low, 10 = Alarm High, 11 = Other)

		Instance i + 15		Instance i + 14		Instance i + 13		Instance i + 12		Instance i + 11		Instance i + 10		Instance i + 9		Instance i + 8	
Assembly	Class, Instance, Attribute	31	30	29	28	27	26	25	24	23	22	21	20	19	18	17	16
13 A Alarm Read/Write	C = 0x71 (113) I = 1 to 4 A = 0x0D (13)	Alarm Clear		Alarm Silence		Alarm Clear		Alarm Silence		Alarm Clear		Alarm Silence		Alarm Clear		Alarm Silence	

Bits 16 to 31, Paired bits reflecting the state of up to 16 alarms (0 = Ignore, 1 = Clear)

Compact Class 8 B through 13 B

	Instance i + 7		Instance i + 6		Instance i + 5		Instance i + 4		Instance i + 3		Instance i + 2		Instance i + 1		Instance i	
Assembly	15	14	13	12	11	10	9	8	7	6	5	4	3	2	1	0
8 B	Limit State		Limit State		Limit State		Limit State		Limit State		Limit State		Limit State		Limit State	

Bits 0 to 15, Paired bits representing the state of up to 16 limits (00 = None, 01 = Limit low,, 10 = Limit High)

	Instance i + 7		Instance i + 6		Instance i + 5		Instance i + 4		Instance i + 3		Instance i + 2		Instance i + 1		Instance i	
Assembly	15	14	13	12	11	10	9	8	7	6	5	4	3	2	1	0
9 B	Spare	Limit Clear	Spare	Limit Clear	Spare	Limit Clear	Spare	Limit Clear	Spare	Limit Clear	Spare	Limit Clear	Spare	Limit Clear	Spare	Limit Clear

Bits 0, 2, 4, 6, 8, 10, 12 and 14, Limit Clear for instance i to instance i (0 = Ignore, 1 = Clear)

	Instance i															
Assembly	15	14	13	12	11	10	9	8	7	6	5	4	3	2	1	0
10 B	Spare				Limit Set Point Low											

Bits 0 to 12, Signed 13 bits whole (-4096 to 4095)

	Instance i															
Assembly	15	14	13	12	11	10	9	8	7	6	5	4	3	2	1	0
11 B	Spare	Heater Error	Current Error	Current RMS												

Bits 16 to 28, Unsigned 11 bits (0 to 2047)
 Bit 29, Current Error (00 = None, 01 = Low, 10 = High)
 Bit 30, Heater Error (00 = None, 01 = Open, 10 = Shorted)

	Instance i + 7		Instance i + 6		Instance i + 5		Instance i + 4		Instance i + 3		Instance i + 2		Instance i + 1		Instance i	
Assembly	15	14	13	12	11	10	9	8	7	6	5	4	3	2	1	0
12 B	Alarm State		Alarm State		Alarm State		Alarm State		Alarm State		Alarm State		Alarm State		Alarm State	

Bits 0 to 15, Paired bits reflecting the state of up to 16 alarms (00 = None, 01 = Alarm Low, 10 = Alarm High, 11 = Other)

	Instance i + 7		Instance i + 6		Instance i + 5		Instance i + 4		Instance i + 3		Instance i + 2		Instance i + 1		Instance i	
Assembly	15	14	13	12	11	10	9	8	7	6	5	4	3	2	1	0
13 B	Alarm Clear		Alarm Silence		Alarm Clear		Alarm Silence		Alarm Clear		Alarm Silence		Alarm Clear		Alarm Silence	

Bits 0 to 15, Paired bits reflecting the state of up to 16 alarms (0 = Ignore, 1 = Clear)

Compact Class 14 A through 19 A

		Instance i															
Assembly	Class, Instance, Attribute	31	30	29	28	27	26	25	24	23	22	21	20	19	18	17	16
14 A Alarm Read/Write	C = 0x71 (113) I = 1 to 4 A = 0x0E (14)	Alarm Clear	Alarm Set Point High														
		Bits 16 to 30, Signed 15 bits with implied tenths precision (-1638.4 to 1638.3)															
		Bit 31, Alarm Clear (0 = Ignore, 1 = Clear)															

		Instance i + 1															
Assembly	Class, Instance, Attribute	31	30	29	28	27	26	25	24	23	22	21	20	19	18	17	16
15 A Analog Input Read	C = 0x71 (113) I = 1 to 4 A = 0x0F (15)	Input Error Status	Filtered Analog Input Value														
		Bits 16 to 30, Signed 15 bits with implied tenths precision (-1638.4 to 1638.3)															
		Bit 31, Analog Input Error (0 = None, 1 = Error)															

		Instance i + 1															
Assembly	Class, Instance, Attribute	31	30	29	28	27	26	25	24	23	22	21	20	19	18	17	16
16 A Analog Input Read	C = 0x71 (113) I = 1 to 4 A = 0x10 (16)	Filtered Analog Input Value															
		Bits 16 to 31, Signed 16 bits with implied tenths precision (-3276.8 to 3276.8)															

		Instance i + 15		Instance i + 14		Instance i + 13		Instance i + 12		Instance i + 11		Instance i + 10		Instance i + 9		Instance i + 8	
Assembly	Class, Instance, Attribute	31	30	29	28	27	26	25	24	23	22	21	20	19	18	17	16
17 A Analog Input Read	C = 0x71 (113) I = 1 to 4 A = 0x11 (17)	Spare	Input Error Status	Spare	Input Error Status	Spare	Input Error Status	Spare	Input Error Status	Spare	Input Error Status	Spare	Input Error Status	Spare	Input Error Status	Spare	Input Error Status
		Bits 16, 18, 20, 22, 24, 26, 28, 30, Analog Input Error Status (0 = None, 1 = Error)															

Compact Class 14 B through 17 B

		Instance i															
Assembly		15	14	13	12	11	10	9	8	7	6	5	4	3	2	1	0
14 B	Alarm Silence	Alarm Set Point Low															
		Bits 0 to 14, Signed 15 bits with implied tenths precision (-1638.4 to 1638.3) Bit 15, Alarm Silence (0 = Ignore, 1 = Silence)															

		Instance i															
Assembly		15	14	13	12	11	10	9	8	7	6	5	4	3	2	1	0
15 B	Input Error Status	Filtered Analog Input Value															
		Bits 0 to 14, Signed 15 bits with implied tenths precision (-1638.4 to 1638.3) Bit 15, Analog Input Error (0 = None, 1 = Error)															

		Instance i															
Assembly		15	14	13	12	11	10	9	8	7	6	5	4	3	2	1	0
16 B		Filtered Analog Input Value															
		Bits 0 to 15, Signed 16 bits with implied tenths precision (-3276.8 to 3276.8)															

		Instance i + 7		Instance i + 6		Instance i + 5		Instance i + 4		Instance i + 3		Instance i + 2		Instance i + 1		Instance i	
Assembly		15	14	13	12	11	10	9	8	7	6	5	4	3	2	1	0
17 B	Spare	Input Error Status	Spare	Input Error Status	Spare	Input Error Status	Spare	Input Error Status	Spare	Input Error Status	Spare	Input Error Status	Spare	Input Error Status	Spare	Input Error Status	Input Error Status
		Bits 0, 2, 4, 6, 8, 10, 12, 14, Analog Input Error Status(0 = None, 1 = Error)															

Specifications

Line Voltage/Power (Minimum/Maximum Ratings)

- 85 to 264V~ (ac), 47 to 63Hz
- 20 to 28V~ (ac), 47 to 63Hz
- 12 to 40V= (dc)
- 14VA maximum power consumption (PM4, 8 & 9)
- 10VAm maximum power consumption (PM6)
- Data retention upon power failure via non-volatile memory
- Compliant with SEMIF47-0200, Figure R1-1 voltage sag requirements @24V ~ (ac) or higher

Environment

- 0 to 149°F (-18 to 65°C) operating temperature
- -40 to 185°F (-40 to 85°C) storage temperature
- 0 to 90%RH, non-condensing

Accuracy

- Calibration accuracy and sensor conformity: ±0.1% of span, ±1°C @ the calibrated ambient temperature and rated line voltage
- Types R, S, B; 0.2%
- Type T below -50°C; 0.2%
- Calibration ambient temperature @ 77 ±5°F (25±3°C)
- Accuracy span :1000 °F (540°C) min.
- Temperature stability: ±0.1 °F/°F (±0.1°C/°C) rise in ambient max.

Agency Approvals

- UL® Listed to UL 61010-1 File E185611
- UL® Reviewed to CSA C22.2 No.61010-1-04
- UL® 50 Type 4X, NEMA 4X indoor locations, IP66 front panel seal (indoor use only)
- FM Class 3545 File 3029084 temperature limit switches
- CE-See Declaration of Conformity RoHS and W.E.E.E.complaint
- ODVA-EtherNet/IP™ and DeviceNet Compliance
- UL Listed to ANSI/ISA 12.12.01-2007 File E184390
- This equipment is suitable for use in Class 1, Div.2, Groups A, B, C and D or non-hazardous locations only. Temperature Code T4A
- UL reviewed to Standard No. CSA C22.2 No.213-M1987, Canadian Hazardous locations
- All models, CSA C22.2 No. 24 File 158031 Class 4813-02, CSA Approved

Controller

- User selectable heat/cool, on-off, P, PI, PD, PID or alarm action, not valid for limit controllers
- Auto-tune with TRU-TUNE®+ adaptive control algorithm
- Control sampling rates: input = 10Hz, outputs = 10Hz

Profile Ramp/Soak - Real Time Clock and Battery Back-up

- Accuracy (typical): ±30PPM at 77°F (25°C)
- +30/-100 PPM at -4 to 149°F (-20 to 65°C)
- Battery type: lithium (recycle properly)
- Battery typical life: three cumulative years of unpowered life at 77°F (25°C)

Isolated Serial Communications

- EIA232/485, Modbus® RTU
- EtherNet/IP™, DeviceNet™ (ODVA certified)
- Modbus® TCP
- Profibus DP

Wiring Termination—Touch-Safe Terminals

- Input, power and controller output terminals are touch safe removable 12 to 22 AWG

Universal Input

- Thermocouple, grounded or ungrounded sensors
- >20MΩ input impedance
- 3μA open sensor detection
- Max. of 2KΩ source resistance
- RTD 2 or 3 wire, platinum, 100Ω and 1000Ω @ 0°C calibration to

DIN curve (0.00385Ω/Ω/°C)

- Process, 0-20mA @ 100Ω ,or 0-10V = (dc) @ 20kΩ input impedance

Voltage Input Ranges

- Accuracy ±10mV ±1 LSD at standard conditions
- Temperature stability ±100 PPM/°C maximum

Milliamp Input Ranges

- Accuracy ±20μA ±1 LSD at standard conditions
- Temperature stability ±100 PPM/°C maximum

Resolution Input Ranges

- 0 to 10V: 200 μV nominal
- 0 to 20 mA: 0.5 mA nominal

- Potentiometer: 0 to 1,200Ω

- Inverse scaling

Input Type	Max Error @ 25 Deg C	Accuracy Range Low	Accuracy Range High	Units
J	±1.75	0	750	Deg C
K	±2.45	-200	1250	Deg C
T (-200 to 350)	±1.55	-200	350	Deg C
N	±2.25	0	1250	Deg C
E	±2.10	-200	900	Deg C
R	±3.9	0	1450	Deg C
S	±3.9	0	1450	Deg C
B	±2.66	870	1700	Deg C
C	±3.32	0	2315	Deg C
D	±3.32	0	2315	Deg C
F (PTII)	±2.34	0	1343	Deg C
RTD, 100 ohm	±2.00	-200	800	Deg C
RTD, 1000 ohm	±2.00	-200	800	Deg C
mV	±0.05	0	50	mV
Volts	±0.01	0	10	Volts
mAdc	±0.02	2	20	mAmps DC
mAac	±5	-50	50	mAmps AC
Potentiometer, 1K range	±1	0	1000	Ohms

Operating Range		
Input Type	Range Low	Range High
J	-210 °C	1200 °C
K	-270 °C	1371 °C
T	-270 °C	400 °C
N	-270 °C	1300 °C
E	-270 °C	1000 °C
R	-50 °C	1767 °C
S	-50 °C	1767 °C
B	-50 °C	1816 °C
C	0 °C	2315 °C
D	0 °C	2315 °C
F (PTII)	0 °C	1343 °C
RTD (100 ohm)	-200 °C	800 °C
RTD (1000 ohm)	-200 °C	800 °C

Operating Range (cont.)		
mV	-50	50
Volts	0	10
mAdc	0	20
mAac	-50	50
Potentiometer, 1K range	0	1200
Resistance, 5K range	0	5000
Resistance, 10K range	0	10000
Resistance, 20K range	0	20000
Resistance, 40K range	0	40000

Thermistor Input				
Input Type	Max Error @ 25 Deg C	Accuracy Range Low	Accuracy Range High	Units
Thermistor, 5K range	±5	0	5000	Ohms
Thermistor, 10K range	±10	0	10000	Ohms
Thermistor, 20K range	±20	0	20000	Ohms
Thermistor, 40K range	±40	0	40000	Ohms

- 0 to 40KΩ, 0 to 20KΩ, 0 to 10KΩ, 0 to 5KΩ
- 2.252KΩ and 10KΩ base at 77°F (25°C)
- Linearization curves built in
- Third party Thermistor compatibility requirements

Base R @ 25C	Alpha Techniques	Beta THERM	YSI	Prompt 
2.252K	Curve A	2.2K3A	004	A
10K	Curve A	10K3A	016	B
10K	Curve C	10K4A	006	C

Current Measurement

- Accepts 0-50mA signal (user programmable range)
- Displayed operating range and resolution can be scaled and are user programmable
- Requires optional current transformer

2 Digital Input/Output Option - 2 DIO

- Digital input update rate 10Hz
 - DC voltage
 - Max. input 36V @ 3mA
 - Min. high state 3V at 0.25mA
 - Max. low state 2V
 - Dry contact
 - Min. open resistance 10KΩ
 - Max. closed resistance 50Ω
 - Max. short circuit 20mA
- Digital output update rate 10Hz
 - Output voltage 24V, current limit, Output 6 = 10mA max., Output 5 = 3 pole DIN-A-MITE[®] or 24mA max.

6 Digital Input/Output Option - 6 DIO

- Digital input or output
- Update rate 10Hz

- Switched DC
 - Switched DC 24-32 V, 80 mA max, SELV, Limited Energy
 - Max. supply current source 40mA at 20V[≠] (dc) and 80mA @12V[≠] (dc)
 - Max. low state 2V
- Open Collector
 - Max. switched voltage is 32V[≠] (dc)
 - Max. switched current per output is 1.5A
 - Max. switched current for all 6 outputs is 8A

Output Hardware

- Switched dc = 22 to 32V[≠] (dc) @30mA output 1 and 3, 10mA for output 2 and 4
 - Switched dc/open collector = 30V[≠] (dc) max. @ 100mA max. current sink
 - Solid State Relay (SSR), FormA, 0.5A @ 24V~ (ac) min., 240V~ (ac) max., 1A at 50°F linear derating to 0.5A at 149°F resistive, opto-isolated, without contact suppression, 120/240V~ (ac) 20 VA pilot duty
 - Electromechanical relay, Form C, 5A, 24 to 240V~ (ac) or 30V[≠] (dc) max., resistive load, 100,000 cycles at rated load, 125 VA pilot duty at 120/240V~ (ac), 25 VA at 24V~ (ac)
 - Electromechanical relay, FormA, 5A, 24 to 240V~ (ac) or 30V[≠] (dc) max., resistive load, 100,000 cycles at rated load, 125 VA pilot duty at 120/240V~ (ac), 25 VA at 24V~ (ac)
 - NO-ARC relay, FormA, 15A, 24 to 240V~ (ac), 0V[≠] (dc), resistive load, 2 million cycles at rated load
 - Universal process/retransmit, Output range selectable:
 - 0 to 10V[≠](dc) into a min. 1,000Ω load
 - 0 to 20mA into max. 800Ω load
- Resolution*
- dc ranges: 2.5mV nominal
 - mA ranges: 5 μA nominal
- Calibration Accuracy*
- dc ranges: ±15 mV
 - mA ranges: ±30 μA
- Temperature Stability*
- 100 ppm/°C

Operator Interface

- Dual 4 digit, 7 segment LED displays
- Advance, infinity, up and down keys, plus optional programmable EZ-KEY(s) depending on model size
- Typical display update rate 1Hz
- RESET key substituted for infinity on all models including the limit control

Dimensions				
Size	Behind Panel (max.)	Width	Height	Display Character Height
1/4	100.8 mm (3.97 in)	100.3 mm (3.95 in)	100.3 mm (3.95 in)	up: 11.43 mm (0.450 in) middle: 9.53 mm (0.375 in) low: 7.62 mm (0.300 in)
1/16	101.6 mm (4.00 in)	53.3 mm (2.10 in)	53.3 mm (2.10 in)	up: 10.80 mm (0.425 in) low: 6.98 mm (0.275 in)
1/8 (H)	101.6 mm (4.00 in)	100.3 mm (3.95 in)	54.8 mm (2.16 in)	top: 11.4 mm (0.450 in) middle: 9.53 mm (0.375 in) bottom: 7.62 mm (0.300 in)

Dimensions				
Size	Behind Panel (max.)	Width	Height	Display Character Height
1/8 (V)	101.6 mm (4.00 in)	54.8 mm (2.16 in)	100.3 mm (3.95 in)	top: 11.4 mm (0.450 in) middle: 9.53 mm (0.375 in) bottom: 7.62 mm (0.300 in)

Weight	
1/4 DIN (PM4) <ul style="list-style-type: none"> Controller: 331 g (11.7 oz.) 	1/8 DIN (PM8&9) <ul style="list-style-type: none"> Controller: 284 g (10 oz.)
1/16 DIN (PM6) <ul style="list-style-type: none"> Controller: 186 g (6.6 oz.) 	User's Guide <ul style="list-style-type: none"> User's Guide: 284.86 g (10.1 oz)

Modbus® is a trademark of AEG Schneider Automation Inc.

EtherNet/IP™ is a trademark of ControlNet International Ltd. used under license by Open DeviceNet Vendor Association, Inc. (ODVA).

UL® is a registered trademark of Underwriters Laboratories Inc.

DeviceNet™ is a trademark of Open DeviceNet Vendors Association.

Note:

These specifications are subject to change without prior notice.

Ordering Information for PM Integrated Controller Models

Controller

EZ-ZONE® Integrated Controller Models
 TRU-TUNE+® Adaptive Tune, red-green 7-segment displays

PM

Package Size

- 4 Panel Mount 1/4 DIN
- 6 Panel Mount 1/16 DIN
- 8 Panel Mount 1/8 DIN Vertical
- 9 Panel Mount 1/8 DIN Horizontal

Primary Function

- C PID Controller with Universal Input
- R PID Controller with Universal Input and Profiling Ramp and Soak
- B PID Controller with Universal Input and Profiling Ramp and Soak and Battery Backup with Real Time Clock
- J PID Controller with Thermistor Input
- N PID Controller with Thermistor Input and Profiling Ramp and Soak
- E PID Controller with Thermistor Input and Profiling Ramp and Soak and Battery Backup with Real Time Clock
- S Custom Firmware

- Options B and E are not available with PM6

Power Supply, Digital Input/Output

- 1 100 to 240V~ (ac)
- 2 100 to 240V~ (ac) plus 2 Digital I/O points
- 3 15 to 36V= (dc) and 24V~ (ac)
- 4 15 to 36V= (dc) and 24V~ (ac), plus 2 Digital I/O points

Output 1 and 2 Hardware Options

	Output 1	Output 2
CA	Switched dc/open collector	None
CH	Switched dc/open collector	NO-ARC 15 A power control
CC	Switched dc/open collector	Switched dc
CJ	Switched dc/open collector	Mechanical relay 5 A, form A
CK	Switched dc/open collector	Solid-state relay 0.5 A, form A
EA	Mechanical relay 5 A, form C	None
EH	Mechanical relay 5 A, form C	NO-ARC 15 A power control
EC	Mechanical relay 5 A, form C	Switched dc
EJ	Mechanical relay 5 A, form C	Mechanical relay 5 A, form A
EK	Mechanical relay 5 A, form C	Solid-state relay 0.5 A, form A
FA	Universal process	None
FC	Universal process	Switched dc (cannot use variable time base)
FJ	Universal process	Mechanical relay 5 A, form A (cannot use variable time base)
FK	Universal process	Solid-state relay 0.5 A, form A (cannot use variable time base)
AK	None	Solid-state relay 0.5 A, form A
KH	Solid-state relay 0.5 A, form A	NO-ARC 15 A power control
KK	Solid-state relay 0.5 A, form A	Solid-state relay 0.5 A, form A

Communications Options or Additional Digital I/O

- A None
- C 6 Digital I/O - Not available with PM6
- D 6 Digital I/O and EIA-485 Modbus RTU - Not available with PM6
- 1 EIA 485 Modbus RTU®
- 2 Modbus RTU 232/485
- 3 EtherNet/IP™, Modbus TCP
- 5 DeviceNet
- 6 Profibus DP

- Standard Bus EIA-485 always included - all models

Auxiliary Control Functions

- A None
- C 2nd PID Channel with Universal Input - Not available on PM6
- J 2nd PID Channel with Thermistor Input - Not available on PM6
- R Auxillary 2nd input (Universal Input)
- P Auxillary 2nd input (Thermistor Input)
- T Current Transformer Input (The following options are Not Valid for outputs 3 & 4: FA, FC, FJ and FK)
- L Integrated Limit Controller with Universal Input (Valid options for outputs 3 & 4: CJ, EJ, or AJ only)
- M Integrated Limit Controller with Thermistor Input (Valid options for outputs 3 & 4: CJ, EJ, or AJ only)

- PM6 When ordering Communications Options 2 - 6, option A must be ordered above
 Auxillary input can be configured for remote set point, back-up sensor, ratio, differential or wet-bulb / dry-bulb input

Output 3 and 4 Hardware Options

	Output 3	Output 4
AA	None	None
AJ	None	Mechanical relay 5 A, form A
AK	None	Solid-state relay 0.5 A, form A
CA	Switched dc/open collector	None
CC	Switched dc/open collector	Switched dc
CH	Switched dc/open collector	NO-ARC 15 A power control
CJ	Switched dc/open collector	Mechanical relay 5 A, form A
CK	Switched dc/open collector	Solid-state relay 0.5 A, form A
EA	Mechanical relay 5 A, form C	None
EC	Mechanical relay 5 A, form C	Switched dc
EH	Mechanical relay 5 A, form C	NO-ARC 15 A power control
EJ	Mechanical relay 5 A, form C	Mechanical relay 5 A, form A
EK	Mechanical relay 5 A, form C	Solid-state relay 0.5 A, form A
FA	Universal Process	None
FC	Universal Process	Switched dc (cannot use variable time base)
FJ	Universal Process	Mechanical relay 5 A, form A (cannot use variable time base)
FK	Universal Process	Solid-state relay 0.5 A, form A (cannot use variable time base)
KH	Solid-state relay 0.5 A, form A	NO-ARC 15 A power control
KK	Solid-state relay 0.5 A, form A	Solid-state relay 0.5 A, form A

- With Communications Options 2 - 6, option AA must be ordered with PM6 above

- Output options CH, EH and KH not available with PM6

Additional Options

- A Standard
- C Enhanced firmware including: Compressor Control, Cascade, Ratio, Differential, Square-root, Motorized Valve Control without feedback
- D Standard with isolated input 1, input 2 always isolated
- F Enhanced firmware with isolated input 1, input 2 always isolated

Note: Auxiliary Control Function C or J required for cascade control.

Custom Options

- AA Standard EZ-ZONE face plate
- AB EZ-ZONE logo and no Watlow name
- AC No logo and no Watlow name
- 12 Class 1, Div. 2 (Not available with Integrated Limit Controller or mechanical relay outputs)

Index

- AbL** Alarm Blocking 90, 137
- ACLF** AC Line Frequency 96
- AdL** Alarm Delay 90
- AdSP** Alarm Display 90
- Ah,1** Alarm High Set Point 61, 90, 136
- AhY** Alarm Hysteresis 89, 137
- A,1** Analog Input Menu 54, 69
- A,Inb** Implicit Input Assembly 102
- A,IS** Alarm Source Instance 88
- ALA** Alarm Latching 90, 137
- ALe1** **ALe2** **ALe3** **ALe4** Alarm Error 1 to 4 43
- AL9** Alarm Logic 89
- ALh1** **ALh2** **ALh3** **ALh4** Alarm High 1 to 4 43
- ALL1** **ALL2** **ALL3** **ALL4** Alarm Low 1 to 4 43
- ALM** Alarm Menu 61, 88
- ALo** Alarm Low Set Point 61, 89, 136
- ALoc** Profibus Address Lock 99
- Aonb** Implicit Output Assembly 101
- ASd** Alarm Sides 89
- AS,1** Alarm Silencing 90, 137
- ASE** Alarm State 62
- AutSP** Autotune Set Point 59, 82, 123
- AttEn** Attention 43, 45, 137
- AtY** Alarm Type 88, 136
- A,UnE** Altitude Units 74
- AUE** Autotune 59, 123
- b,Pr** Barometric Pressure 74
- CA9** Cool Algorithm 80, 132
- CAL** Calibration Menu 118
- CCr** Cool Output Curve 80, 130
- CEr** Current Error 43, 63, 138
- CEr,1** Current Error 43
- C,F** Display Units 95, 102
- ChAn** Channel 97
- Ch,1** Current High Set Point 62, 138
- ChY** Cool Hysteresis 60, 81, 132
- CLED** Communications LED Activity 97
- CLo** Current Low Set Point 63, 138
- CLoC** Wait for Time 107
- CP** Control Mode 58, 85
- CPA** Control Mode Active 57
- code** Public Key 118
- Code** Public Key 116
- CoP** Communications Menu 98, 102, 107, 114
- CPb** Cool Proportional Band 59, 81, 123, 133
- CPr** Cool Power 57, 123
- CSP** Closed Loop Set Point 59, 84
- CSP** Closed Loop Working Set Point 57
- Cur** Current Read 63
- Cur** Current Menu 62, 91
- CUSE** Custom Menu 47
- dAEE** Date of Manufacture 116
- db** Dead Band 60, 81, 134
- dEC** Decimal 70
- d,io** Digital Input/Output Menu 56, 75
- d,ir** Direction 75
- doS** Digital Output State 56
- doWJ** Day of Week 102
- dPrS** Display Pairs 68, 97
- dt,1** Display Time 97
- E,PE** Ethernet/IP™ Enable 101
- E,IS** Event Input Status 56
- EL,io** Electrical Input Offset 118
- EL,IS** Electrical Input Slope 118
- ELoo** Electrical Output Offset 118
- End** End 112
- Ent,1** Active Event Output 1 66
- Ent,2** Event Output 2 110
- Er,1** **Er,2** Error Input 1 or 2 43
- FR,IL** Input Error Failure 83, 131
- F,1** Digital Output Function Instance 75, 78
- F,1** Output Function Instance 85, 87
- F,IL** Filter 70
- Fn** Function 74
- Fn** Output Function 85, 86
- FUn** Function Key Menu 94
- GLbL** Global Menu 95
- 95d** Guaranteed Soak Deviation 96
- 95d,1** Guaranteed Soak Deviation 1 96
- 95d,2** Guaranteed Soak Deviation 2 96
- 95E** Guaranteed Soak Enable 96
- 95E** Guaranteed Soak Enable 96
- hA9** Heat Algorithm 80, 132
- hEr** Heater Error 43, 63, 138
- hEr,1** Heater Error 43
- hhY** Heat Hysteresis 59, 80, 132
- hoUr** Hours 102
- hPb** Heat Proportional Band 59, 80, 123, 133
- hPr** Heat Power 57, 123
- ,i,CA** Calibration Offset 54, 71, 125–126
- ,idS** Idle Set Point 59, 84
- ,IEr** Input Error Latching 70
- ,IEr** Input Error Status 54, 71
- ,IP,1** Input Point 1 72
- ,IP,2** Input Point 2
- ,IP,3** Input Point 3
- ,IP,4** Input Point 4 72
- ,IP,2** Input Point 2 72
- ,IP,3** Input Point 3 72
- ,IP,4** Input Point 4 72
- ,IP,5** Input Point 5 72
- ,IP,6** Input Point 6 73
- ,IP,7** Input Point 7 73
- ,IP,8** Input Point 8 73
- ,IP,9** Input Point 9 73
- ,IP,10** Input Point 10 74
- ,IPF,1** IP Fixed Address Part 1 99, 117
- ,IPF,2** IP Fixed Address Part 2 100, 117
- ,IPF,3** IP Fixed Address Part 3 100, 117
- ,IPF,4** IP Fixed Address Part 4 97, 100, 117, 118
- ,IPP** IP Address Mode 99, 116
- ,IPS,1** IP Fixed Subnet Part 1 100
- ,IPS,2** IP Fixed Subnet Part 2 100, 101
- ,IPS,3** IP Fixed Subnet Part 3 100
- ,IPS,3** IP Fixed Subnet Part 3 100
- ,IPS,4** IP Fixed Subnet Part 4 100
- JC** Jump Count Remaining 66
- JL** Jump Loop 111
- L,dd** Open Loop Detect Deviation 83
- L,dE** Open Loop Detect Enable 83
- L,dT** Open Loop Detect Time 83
- L,hY** Limit Hysteresis 79
- L,IE,1** Limit Error 1 43
- L,h,1** Limit High 1 43
- L,IP** Limit Menu 57, 79
- L,In** Linearization 69
- LLS** Limit Low Set Point 57, 79
- Lnr** Linearization Menu 54, 71
- LoC** Security Setting Menu 114, 116
- LoCL** Locked Access Level 115
- LoCo** Lock Operations Page 114
- LoCP** Lock Profiling Page 114, 115, 116
- LoopP** Control Loop Menu 80
- LoopP** Loop Menu 58
- LP,o,1** Loop Open Error 43
- LP,o,1** **LP,o,2** Loop Open Error 1 or 2 43
- LP,r,1** Loop Reversed Error 43
- LP,r,1** **LP,r,2** Loop Reversed Error 1 or 2 43

L5d Limit Sides 79	rLoC Read Lockout Security 115	t.tUn TRU-TUNE+™ Enable 81, 124
P7An Manual Power 83	roLL Rolling Password 115	tt Valve Travel Time 94
P7At Math Menu 63, 92	rP Ramp Action 84, 135	tUn1 Tuning 43
P7bE Modbus TCP Enable 101	rP1 Ramping 43	tUn1 tUn2 Tuning 1 or 2 43
P7in Minutes 66	rP1 rP2 Ramping 1 or 2 43	uALh Value to high 43
P7in Minutes 102	rr Thermistor Resistance Range 70	UFA User Failure Action 83
P7on Monitor Menu 57	r.r.t Ramp Rate 84, 135	USrr User Restore Set 97, 122
P7u Electrical Measurement 118	r.SC Ramp Scale 84, 135	USr.S User Save Set 97, 122
nUS Non-volatile Save 98, 99	r.tL RTD Leads 69	US.tP Unused Step 111
o.CA Calibration Offset 88	r.tYP Ramping Type 96	uALL Value to low 43
o.Ct Output Control 75, 86	S.bA Sensor Backup Enable 127	uJbo Wait For Both 111
o.Fn Output Function 124	S.bLd Software Build 116	uJEt Wait Event 2 109
o.FSt PV Offset 55	SEC Seconds 66	Zone Zone 97
o.Ft Minimum Off Time 94	SEn Sensor Type 69, 124, 127	
o.h Output High Power Scale 76, 86	SFn.A Source Function A 88	A
o.Lo Output Low Power Scale 76, 86	SFn.A Source Function A 93	AC Line Frequency 96, 135
o.on.t Minimum On Time 93	SFn.b Source Function B 93	Active Event Output (1 or 2) 66
o.P Open Loop Set Point 60, 85	SFn.E Source Function E 92	Active Step 65
o.P.2 Output Point 2 72	S.h Scale High 69, 87, 127	Active Step Type 65
o.P.3 Output Point 3 72	S.i.A Event Input Source Instance A 96	adaptive tuning 124
o.P.4 Output Point 4 72	S.i.A Source Instance A 93	Address Modbus 98
o.P.5 Output Point 5 73	S.i.b Event Input Source Instance B 96, 97	Address Standard Bus 98, 99, 102
o.P.6 Output Point 6 73	S.i.b Source Instance B 93	Administrator Password 115
o.P.7 Output Point 7 73	S.i.E Source Instance 92	Advance Key 42
o.P.8 Output Point 8 73	S.Lo Scale Low 69, 87, 127	agency approvals 4, 5
o.P.9 Output Point 9 73	S.LoC Set Lockout Security 115, 139, 140	alarm blocking 137
o.P.10 Output Point 10 74	Sn Serial Number 116	Alarm Menu 61, 88
o.tb Output Time Base 75, 86	SoAh Soak 111	alarms 135
o.tPt Output Menu 85	SoF Special Output Function Menu 64	Blocking 90, 137
o.tY Output Type 86	Profile Start Step 77, 78	deviation 136
o.v1 Output Value 1 64	SStP Profile Start Step 77, 78	Display 90
o.v2 Output Value 2 64	StP Active Step 65	Hysteresis 89, 137
o.v Output Value 63	S.tYP Active Step Type 65	Latching 90, 137
PAAdd Profibus Node Address 99	S.u.A Source Value 1 64	Logic 89
PAS.A Administrator Password 115	S.u.A Source Value A 55	process 136
PAS.E Password Enable 114	S.u.b Source Value 2 64	set points 136
PAS.S Password 116	S.u.b Source Value B 55	Sides 89
PAS.u User Password 115	S.u.E Source Value E 63	Silencing 90, 137
P.dL Peltier Delay 82	S.u.tb Synchronized Variable Time Base 97	Source 88
P.EE Process Error Enable 70	t.Agr User Tune Aggressiveness 82	Type 88
P.EL Process Error Low 70	t.Agr User Tune Aggressiveness 123	Altitude Units 67
Pn Part Number 116	t.band TRU-TUNE+™ Band 82	Analog Input Menu 54, 69
P.o.F.A Power Off Level A 93	t.band TRU-TUNE+™ Band 124	Assembly Definition Addresses 158
P.o.F.b Power Off level B 93	t.C Thermistor Curve 70	Assembly Definition Addresses and Assembly Working Addresses 158
P.on.A Power On Level A 93	t.d Time Derivative 60, 81, 123, 133	Assembly Working Addresses 142, 158
P.on.b Power On Level B 93	t.gn TRU-TUNE+™ Gain 82, 124	Attention Codes 43, 45
P.o.t Power Out Time 68	t Time 111	auto (closed loop) control 131, 132
P.StA Profile Status Menu 65	t Time Integral 60, 81, 123, 133	Autotune 123
P.tYP Profile Type 96		Autotune Aggressiveness 82
P.un.t Pressure Units 74		Autotune Set Point 59, 82, 123
P.u Process Value Menu 74		autotuning 123–124
P.u.A Process Value Active 58		autotuning with TRU-TUNE+™ 124
r.AtE Rate 111		
r.En Remote Enable 58, 82, 128		
r.Eu Software Revision 116		
r.h Range High 70, 87, 88, 127		
r.Lo Range Low 69, 87, 127		

- B**
 Barometric Pressure 67
 Baud Rate 98
 Blocking 90, 137
 bumpless transfer 131
- C**
 Calibration Menu 118
 Calibration Offset 54, 71, 88, 125–126
 Cascade Control 135
 changing the set point 45
 Channel 97
 chattering output 132
 chemical compatibility 21
 CIP - Communications Capabilities 142
 CIP Implicit Assemblies 143
 CIP Implicit Assembly Structures 160
 CIP Implicit O to T (Originator to Target) Assembly Structure 160
 CIP Implicit T to O (Target to Originator) Assembly Structure 160
 Closed Loop Set Point 59, 84
 Closed Loop Working Set Point 57
 Common Industrial Protocol 50
 CIP Implicit Assemblies 143
 Compact Implicit Assembly Class 143, 161
 Introduction to CIP 50
 Modifying Implicit Assembly Members 143
 Common Industrial Protocol (CIP) 50
 communications activity light 42
 Communications Menu 98, 102, 107, 114
 Setup Page 52, 67
 Compact Assembly Class 143
 Compact Class Assembly Structure 161
 Compressor Control 151
 Control 75, 86
 Control Loop Menu 80
 control methods 131
 Control Mode 58, 85, 132
 Control Mode Active 57
 Control Module Menus
 Factory Page
 Calibration Menu 118
 Security Setting Menu 114, 116
 Operations Page
 Alarm Menu 61
 Analog Input Menu 54
 Current Menu 62
 Digital Input/Output Menu 56
 Limit Menu 57
 Linearization Menu 54
 Loop Menu 58
 Math Menu 63
 Monitor Menu 57
 Process Value Menu 55
 Profile Status Menu 65
 Special Output Function Menu 64
 Setup Page
 Alarm Menu 88
 Analog Input Menu 69
 Communications Menu 98, 102, 107, 114
 Control Loop Menu 80
 Current Menu 91
 Digital Input/Output Menu 75
 Global Menu 95
 Limit Menu 79
 Linearization Menu 71
 Math Menu 92
 Output Menu 85
 Process Value 74
 Cool Algorithm 80, 132
 Cool Hysteresis 60, 81, 132
 cool output curve 130
 Cool Output Curve 80, 130
 Cool Power 57, 123
 Cool Proportional Band 59, 81, 123, 133
 Current Error 63, 138
 Current Menu 62, 91
 current sensing 138
 Current Sensing 138
- D**
 Data Map 99
 Date of Manufacture 116
 Dead Band 60, 81, 133, 134
 Decimal 70
 default Home Page parameters 42, 45
 deviation alarms 136
 Differential Control 136
 Digital Input Function 95
 Digital Input/Output Menu 56, 75
 dimensions 16, 17, 18, 19
 Direction 75
 Display 90
 Display Pairs 68, 97
 displays 42
 Display Time 97
 Display Units 95, 102
 Down Key 42
 duplex 128
- E**
 Electrical Input Offset 118
 Electrical Input Slope 118
 Electrical Measurement 118
 Electrical Output Offset 118
 Electrical Output Slope 118
 End 112
 End Set Point Value 109
 EtherNet/IP™ 35
 Ethernet/IP™ Enable 101
 Event Output (1 and 2) 110, 111, 112
 Example: Using a Current Transformer 28
 EZ Key 138
- F**
 Factory Page 113
 Filter Time 70, 126
 filter time constant 126
 Function 67, 124
 Function Instance 75, 78
 Function Key Menu 138
- G**
 Global Menu 95
 Setup Page 52, 67
 Guaranteed Soak Deviation 68
 Guaranteed Soak Deviation 96
 Guaranteed Soak Enable 68, 96
- H**
 Heat Algorithm 80, 132
 Heater Error 63, 138
 Heat Hysteresis 59, 80, 132
 Heat Power 57, 123
 Heat Proportional Band 59, 80, 123, 133
 High Power Scale 76, 86
 high range 127
 high scale 127
 High Set Point
 Alarm 61, 62, 90, 91, 136
 Current 62, 63, 138
 Loop 84, 127
 Home Page 45
 Hours 107
 Hysteresis 79, 89, 137
- I**
 Idle Set Point 59, 84
 Input Error Failure 83, 131
 Input Error Latching 70, 131
 Input Error Status 54, 71
 input events 6
 Input Point 1 67
 Input Point 2 67
 Input Point 3 67
 Input Point 4 67
 Input Point 5 67
 Input Point 6 67
 Input Point 7 67
 Input Point 8 67
 Input Point 9 67
 Input Point 10 67

- inputs 6
 - Input Sensor Type 124
 - installation 20
 - Instance 95
 - Integrate 80
 - IP Address Mode 99, 116
 - IP Fixed Address Part 1 99, 117
 - IP Fixed Address Part 2 100, 117
 - IP Fixed Address Part 3 100, 117
 - IP Fixed Address Part 4 97, 100, 117, 118
 - IP Fixed Address Part 5 100
 - IP Fixed Address Part 6 100
 - IP Fixed Subnet Part 1 100
 - IP Fixed Subnet Part 2 100, 101
 - IP Fixed Subnet Part 3 100
 - IP Fixed Subnet Part 4 100
- J**
- Jump Count 109
 - Jump Count Remaining 66
 - Jump Loop 111
 - Jump Step 109
- K**
- keys 42
- L**
- Latching 90, 137
 - Level 94
 - Limit Menu 57, 79
 - Linearization 67, 69
 - Linearization Menu 54, 71
 - Locked Access Level 115
 - Lockout Menu 139
 - Logic 89
 - Loop Menu 58
 - Low Power Scale 76, 86
 - low range 127
 - low scale 127
 - Low Set Point
 - Alarm 61, 89, 136
 - Current 63, 138
 - Limit 57, 79
 - Loop 84, 127
- M**
- Manual Control Indicator Light 131
 - manual (open loop) control 131, 132
 - manual tuning 123
 - Math 68
 - Math Menu 63, 92
 - Message Action 43
 - message, display 43
 - Minimum Off Time 68
 - Minimum On Time 68
 - Minutes 107, 108
 - Modbus Default Assembly Structure 80-119 159
 - Modbus - Programmable Memory
 - Blocks 50, 158
 - Modbus Register Mapping 68
 - Modbus TCP 35
 - Modbus TCP Enable 101
 - Modbus - Using Programmable Memory Blocks 142
 - Modbus Word Order 98
 - Modifying Implicit Assembly Members 143
 - Monitor Menu 57
 - Motorized Valve Control 136, 153
- N**
- navigating
 - Factory Page 113
 - pages and menus 43
 - Profiling Page 103
 - Setup Page 52, 67
 - No-arc Relay 129
 - Non-volatile Save 68
- O**
- ommon Industrial Protocol (CIP)
 - Introduction to CIP 50
 - on-off control 132
 - Open Loop Detect Deviation 83
 - Open Loop Detect Enable 83
 - Open Loop Detection 138
 - Open Loop Detect Time 83
 - Open Loop Set Point 60, 85
 - Operations Page 52
 - ordering information
 - integrated controller models 171
 - output activity lights 42
 - output configuration 131
 - Output Function 86
 - Output Menu 85
 - Output Point 1 67
 - Output Point 2 67
 - Output Point 3 67
 - Output Point 4 67
 - Output Point 5 67
 - Output Point 6 67
 - Output Point 7 67
 - Output Point 8 67
 - Output Point 9 67
 - Output Point 10 67
 - output power scaling 130
 - outputs 6
 - Output State 56
 - Output Type 86
- P**
- P3T armor sealing system 4, 5
 - Parameter 1 to 20 114
 - Parity 98
 - Part Number 116
 - Password 116
 - Peltier Delay 68, 82
 - percent units indicator light 42
 - Power Off Level A 68
 - Power On Level A 68
 - Power Out Time 68, 97
 - Pressure Units 67
 - process alarms 136
 - Process Error Enable 70
 - Process Error Low 70
 - Process Value 54, 67, 71, 74
 - Process Value Active 58
 - Process Value Menu 55
 - Profibus Address Lock 99
 - Profibus DP 39, 51
 - Profibus Node Address 99
 - profile activity light 42
 - Profile Setup 103
 - Profile Status Menu 65
 - Profile Type 96
 - Profiling Page 103
 - profiling parameters 106
 - proportional control
 - plus integral (PI) control 132, 133
 - plus integral plus derivative (PID) control 133
 - Protocol 98
 - Public Key 116, 118
- Q**
- R**
- Ramp Action 84
 - Ramp Rate 84, 135
 - Ramp Scale 84, 135
 - Range High 70, 87, 88, 127
 - Range Low 69, 87, 127
 - Rate 111
 - Ratio Control 136
 - Read 63
 - Real Time Clock 68
 - receiving a remote set point 128
 - Remote Enable 58, 82, 128
 - restoring user settings 122
 - retransmit 129
 - Retransmit Source 87
 - Reverse Bumpless 131
 - Rolling Password 115
 - RTD Leads 69
- S**
- saving user settings 121, 122
 - Scale High 69, 87, 127
 - Scale Low 69, 87, 127
 - Seconds 108
 - Security Setting 114, 116
 - sensor backup 127
 - Sensor Backup Enable 127
 - sensor selection 127
 - Sensor Type 69, 124, 127
 - Serial Number 116
 - set point high limit 127
 - Set Point High Limit Open Loop 85

set point low limit 127
 Set Point Low Limit Open Loop 84
 Setup Page 67
 Sides
 Alarm 89
 Limit 79
 Silencing 90, 137
 single set point ramping 135
 Soak 111
 Software Build 116
 Software Configuration 144
 Software Revision 116
 Source 88
 Source Function A 68
 Source Function E 68
 Source Instance A 68
 Source Instance E 68
 Special Output Function Menu 64
 Starting a Profile 104
 Synchronized Variable Time Base 97
T
 Target Set Point 107
 temperature units indicator lights 42
 Ten Point Linearization 128
 Thermistor 69
 Time 111
 Time Base 75, 76, 86
 Time Derivative 60, 81, 123, 133
 Time Integral 60, 81, 123, 133
 TRU-TUNE+™ Band 82, 124
 TRU-TUNE+™ Enable 81, 124
 TRU-TUNE+™ Gain 82, 124
 tuning the PID parameters 123
 Type 88, 136
U
 Unused Step 111
 Up Key 42
 upper display 42
 User Failure Action 83
 User Password 115
 User Restore Set 97
 User Save Set 97, 122
 User Tune Aggressiveness 123
 Using EZ-ZONE® Configurator Software 144
 using the software 139
V
 Valve Travel Time 68
 variable time base 134
W
 Wait Event (1 and 2) 108, 109
 Wait For Both 111
 Wait For Process Instance 108
 Wait For Time 107
 weight 170
 wiring
 digital input or output 5 25, 26
 digital input or output 6 26
 EIA-232/485 Modbus RTU communications 35
 high power 25
 input 1 process 27
 input 1 RTD 26
 input 1 thermocouple 26
 input 2 current transformer 27
 input 2 thermocouple 27
 low power 25
 Modbus RTU or standard bus EIA-485 communications 34
 output 1 mechanical relay, form C 31
 output 1 switched dc/open collector 28, 29
 output 1 universal process 31
 output 2 mechanical relay, form A 33
 output 2 no-arc relay, form A 33
 output 2 solid-state relay, form A 33
 output 2 switched DC/open collector 32
 standard bus EIA-485 communications 34
X
Y
Z
 zone display 42

Declaration of Conformity

Series EZ-ZONE[®] PM



WATLOW
1241 Bundy Blvd.
Winona, MN 55987 USA

an ISO 9001 approved facility since 1996.

Declares that the following product:

Designation: **Series EZ-ZONE[®] PM (Panel Mount)**
Model Numbers: PM (3, 6, 8, 9 or 4)(Any Letter or number) – (1, 2, 3 or 4)(A, C, E, F or K) (A, C, H, J or K)(Any letter or number) – (Any letter or number)(A, C, E, F or K)(A, C, H, J or K) (Any three letters or numbers)
Classification: Temperature control, Installation Category II, Pollution degree 2, IP66
Rated Voltage and Frequency: 100 to 240 V~ (ac 50/60 Hz) or 15 to 36 V= dc/ 24 V~ac 50/60 Hz
Rated Power Consumption: 10 VA maximum PM3, PM6 Models.
14 VA maximum PM8, PM9, PM4 Models

Meets the essential requirements of the following European Union Directives by using the relevant standards show below to indicate compliance.

2004/108/EC Electromagnetic Compatibility Directive		
EN 61326-1	2006	Electrical equipment for measurement, control and laboratory use – EMC requirements (Industrial Immunity, Class B Emissions).
EN 61000-4-2	1996 +A1,A2	Electrostatic Discharge Immunity
EN 61000-4-3	2006	Radiated Field Immunity 10V/M 80–1000 MHz, 3 V/M 1.4–2.7 GHz
EN 61000-4-4	2004	Electrical Fast-Transient / Burst Immunity
EN 61000-4-5	2006	Surge Immunity
EN 61000-4-6	1996 +A1,A2,A3	Conducted Immunity
EN 61000-4-11	2004	Voltage Dips, Short Interruptions and Voltage Variations Immunity
EN 61000-3-2	2006	Harmonic Current Emissions
EN 61000-3-3 ¹	2005	Voltage Fluctuations and Flicker
SEMI F47	2000	Specification for Semiconductor Sag Immunity Figure R1-1

¹For mechanical relay loads, cycle time may need to be extended up to 160 seconds to meet flicker requirements depending on load switched and source impedance.

2006/95/EC Low-Voltage Directive		
EN 61010-1	2001	Safety Requirements of electrical equipment for measurement, control and laboratory use. Part 1: General requirements

Compliant with 2002/95/EC RoHS Directive

Per 2002/96/EC W.E.E Directive  Please Recycle Properly.

Raymond D. Feller III
Name of Authorized Representative

Winona, Minnesota, USA
Place of Issue

General Manager
Title of Authorized Representative

June 2009
Date of Issue

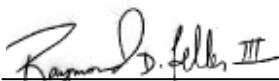
Signature of Authorized Representative

CE DOC EZ-ZONE PM-06-09

How to Reach Us

Corporate Headquarters

Watlow Electric Manufacturing Company
12001 Lackland Road
St. Louis, MO 63146
Sales: 1-800-WATLOW2
Manufacturing Support: 1-800-4WATLOW
Email: info@watlow.com
Website: www.watlow.com
From outside the USA and Canada:
Tel: +1 (314) 878-4600
Fax: +1 (314) 878-6814

Latin America

Watlow de México S.A. de C.V.
Av. Fundación No. 5
Col. Parques Industriales
Querétaro, Qro. CP-76130
Mexico
Tel: +52 442 217-6235
Fax: +52 442 217-6403

Europe

Watlow France
Tour d'Asnières.
4 Avenue Laurent Cély
92600 Asnières sur Seine
France
Tél: + 33 (0)1 41 32 79 70
Télécopie: + 33(0)1 47 33 36 57
Email: info@watlow.fr
Website: www.watlow.fr

Watlow GmbH
Postfach 11 65, Lauchwasenstr. 1
D-76709 Kronau
Germany
Tel: +49 (0) 7253 9400-0
Fax: +49 (0) 7253 9400-900
Email: info@watlow.de
Website: www.watlow.de

Watlow Italy S.r.l.
Viale Italia 52/54
20094 Corsico MI
Italy
Tel: +39 024588841
Fax: +39 0245869954
Email: italyinfo@watlow.com
Website: www.watlow.it

Watlow Ibérica, S.L.U.
C/Marte 12, Posterior, Local 9
E-28850 Torrejón de Ardoz
Madrid - Spain
T. +34 91 675 12 92
F. +34 91 648 73 80
Email: info@watlow.es
Website: www.watlow.es

Watlow UK Ltd.
Linby Industrial Estate
Linby, Nottingham, NG15 8AA
United Kingdom
Telephone: (0) 115 964 0777
Fax: (0) 115 964 0071
Email: info@watlow.co.uk
Website: www.watlow.co.uk
From outside The United Kingdom:
Tel: +44 115 964 0777
Fax: +44 115 964 0071

Asia and Pacific

Watlow Singapore Pte Ltd.
16 Ayer Rajah Crescent,
#06-03/04,
Singapore 139965
Tel: +65 6773 9488 Fax: +65 6778 0323
Email: info@watlow.com.sg Website: www.watlow.com.sg

Watlow Australia Pty., Ltd.
4/57 Sharps Road
Tullamarine, VIC 3043
Australia
Tel: +61 3 9335 6449
Fax: +61 3 9330 3566
Website: www.watlow.com

Watlow Electric Manufacturing Company (Shanghai) Co. Ltd.
Room 501, Building 10, KIC Plaza
290 Songhu Road, Yangpu District
Shanghai, China 200433
China
Phone:
Local: 4006 Watlow (4006 928569)
International: +86 21 3381 0188
Fax: +86 21 6106 1423
Email: vlee@watlow.cn
Website: www.watlow.cn

ワトロー・ジャパン株式会社
〒101-0047 東京都千代田区内神田1-14-4
四国ビル別館9階
Tel: 03-3518-6630 Fax: 03-3518-6632
Email: infoj@watlow.com Website: www.watlow.co.jp

Watlow Japan Ltd.
1-14-4 Uchikanda, Chiyoda-Ku
Tokyo 101-0047
Japan
Tel: +81-3-3518-6630 Fax: +81-3-3518-6632
Email: infoj@watlow.com Website: www.watlow.co.jp

Watlow Korea Co., Ltd.
#1406, E&C Dream Tower, 46, Yangpyeongdong-3ga
Yeongdeungpo-gu, Seoul 150-103
Republic of Korea
Tel: +82 (2) 2628-5770 Fax: +82 (2) 2628-5771
Website: www.watlow.co.kr

Watlow Malaysia Sdn Bhd
1F-17, IOI Business Park
No.1, Persiaran Puchong Jaya Selatan
Bandar Puchong Jaya
47100 Puchong, Selangor D.E.
Malaysia
Tel: +60 3 8076 8745 Fax: +60 3 8076 7186
Email: vlee@watlow.com
Website: www.watlow.com

瓦特龍電機股份有限公司
80143 高雄市前金區七賢二路189號 10樓之一
電話: 07-2885168 傳真: 07-2885568

Watlow Electric Taiwan Corporation
10F-1 No.189 Chi-Shen 2nd Road Kaohsiung 80143
Taiwan
Tel: +886-7-2885168 Fax: +886-7-2885568

Your Authorized Watlow Distributor

