



ResMed

AirSense™ 11

AUTOSET

CPAP

ELITE



Clinical guide
English

Contents

Welcome	1
Indications for use	1
Contraindications	1
Adverse effects	1
Software functionality and device data	2
At a glance	3
About your device	4
Therapy Information	5
AutoSet mode	5
Normal airway	5
Flow limitation	5
Snore	6
Apnea	6
AutoSet for Her mode	7
CPAP mode	7
Reporting	7
Central sleep apnea detection	7
Cheyne-Stokes respiration detection	8
Respiratory effort related arousals reporting	9
Comfort features	9
Ramp	9
Expiratory Pressure Relief	9
AutoSet Response	10
About the heated tubing	10
Climate Control	10
Setting up your device	12
Navigating the touch screen	14
Accessing the Clinical menu	15
Adjusting Clinical settings	17
Connecting your AirSense 11 device and smart device	17
Settings Menu	18
Therapy Settings	18
Comfort Settings	18
Options	19
Configuration	19
Setting the time zone	20
Restoring settings and erasing data	20
Starting/stopping therapy	21
Viewing sleep data and option controls	22
Supplemental oxygen	23
Cleaning and caring for the device	24
Disassembling	25
Cleaning	25
Checking	26
Replacing the air filter	26
Reassembling	26
Preparing the device for use between patients	27
Disassembling	28
Device enclosure	29
Air tubing, outlet connector and HumidAir 11 tub	29

Disinfection	30
Reassembling.....	30
Packing and storing.....	31
Data management and therapy compliance.....	32
Remote monitoring	32
Data storage.....	33
Troubleshooting	34
General Warnings.....	36
Technical specifications	37
Symbols.....	41
Limited warranty	42
Further information	43

Welcome

The AirSense 11 AutoSet™ (including AutoSet for Her) device is ResMed's premium auto-adjusting pressure device. The AirSense 11 Elite and the AirSense 11 CPAP are ResMed's Continuous Positive Airway Pressure (CPAP) devices.

WARNING

Read this entire guide before using the device.

CAUTION

In the US, Federal law restricts this device to sale by or on the order of a physician.

Indications for use

AirSense 11 AutoSet (including AutoSet for Her)

The AirSense 11 self-adjusting system is indicated for the treatment of obstructive sleep apnea (OSA) in patients weighing more than 66 lb (30 kg), including female patients with mild to moderate OSA in AutoSet for Her mode. The AirSense 11 self-adjusting system is intended for home and hospital use.

AirSense 11 CPAP (including Elite)

The AirSense 11 CPAP system is indicated for the treatment of obstructive sleep apnea (OSA) in patients weighing more than 66 lb (30 kg). The AirSense 11 CPAP system is intended for home and hospital use.

Contraindications

Positive airway pressure therapy may be contraindicated in some patients with the following pre-existing conditions:

- severe bullous lung disease
- pneumothorax or pneumomediastinum
- pathologically low blood pressure, particularly if associated with intravascular volume depletion
- dehydration
- cerebrospinal fluid leak, recent cranial surgery, or trauma.

Adverse effects

Patients should report unusual chest pain, severe headache, or increased breathlessness to their prescribing physician. An acute upper respiratory tract infection may require temporary discontinuation of treatment.

The following side effects may arise during the course of therapy with the device:

- drying of the nose, mouth, or throat
- nosebleed
- bloating
- ear or sinus discomfort
- eye irritation
- skin rashes.

Software functionality and device data

This ResMed device is a smart device and includes software functionalities which allow it to be connected to the cloud so that users and their care providers can access data about therapy remotely, receive regular upgrades to the device and much more. Check out <https://myair.resmed.com/> to learn about ResMed's patient coaching application, myAir™.

Software License

License Grant. Subject to the terms and conditions below, ResMed grants you, the owner and/or user of this device, a perpetual, non-exclusive, non-sublicensable, personal, limited license to use the ResMed Software solely in connection with the use of this device. All other rights are reserved by ResMed. You will be deemed to have transferred and assigned this license to any person that acquires the owner's or the user's rights in this device.

License Restrictions. Software included on or with this device is owned by or licensed to ResMed (the "ResMed Software"). Neither the ResMed Software nor any intellectual property rights in the ResMed Software are sold or assigned by ResMed. No person or entity is licensed or authorized to (a) reproduce, distribute, create derivative works, modify, display, perform, decompile or attempt to discover the source code for the ResMed Software, (b) remove or attempt to remove the ResMed Software from the ResMed product, or (c) reverse engineer or disassemble the ResMed product or the ResMed Software. For avoidance of doubt, the foregoing restrictions are not intended to limit any licensee's rights to software code incorporated into or distributed with the ResMed Software and licensed under the terms of any open source, free or community software license (collectively, "Open Source Software").

Over-the-Air Download of Software Updates. If the device is connected to the cloud, then the ResMed Software on the device will automatically and periodically download updates and upgrades to the ResMed Software on the device. Such downloads may be done by various means including, but not limited to, using Bluetooth® wireless technology, WiFi and/or cellular networks and combinations of various wireless technologies and services. Such updates to the ResMed Software might include, without limitation, bug fixes, error corrections, security patches, and new versions and releases of the ResMed Software that may include changes to existing features or functions and/or the addition of new features and functions.

Use of Device Data

When you use this device it gathers and records data about your use and, if your device connectivity is enabled, the device sends certain data to ResMed via the cloud to enable ResMed to deliver various benefits to you and your care provider(s). Additionally, some of that data may be used by ResMed (1) to comply with its legal obligations; these legal obligations include collection and analysis of device data for medical device post market surveillance and vigilance, and compliance with these legal obligations includes assessing if ResMed is required to implement actions to improve device safety, usability and performance, and (2) to perform health-related research, study and/or evaluation for specific scientific and medico-economic purposes. ResMed will only use your device data in compliance with applicable laws and regulations in your country or region (for example the GDPR (Regulation (EU) 2016/679 of the European Parliament and of the Council of 27 April 2016 on the protection of natural persons with regard to the processing of personal data and on the free movement of such data), the MDR (Regulation (EU) 2017/745 of the European Parliament and of the Council of 5 April 2017 on Medical Devices)) in the European Union, and, as applicable, HIPAA (the Health Insurance Portability and Accountability Act of 1996) in the USA). Depending on the data protection or privacy laws of your country or region your device data may constitute your personal data. If so, ResMed has the obligation to inform you about your rights and freedoms for our use of your personal data. You can find more details related to our use of your data, your rights to access, rectify, erase, restrict or object at <https://www.resmed.com/myprivacy/>.

At a glance

WARNING

Use only recommended ResMed masks and accessories or other vented masks as recommended by the prescribing doctor with this device. Using these components allows normal breathing and prevents potential asphyxiation.

The AirSense 11 system includes the following:

- Device
- HumidAir™11 Standard tub
- HumidAir 11 Cleanable tub
- ClimateLineAir™11 heated tubing or SlimLine™ tubing
- 65W AC adaptor
- Travel bag
- SD card (not available in all devices).

A range of accessories is available for use with this device including:

- Air tubing (ClimateLineAir 11, SlimLine and Standard)
- HumidAir 11 Standard tub (Single patient re-use - cannot be reprocessed)
- HumidAir 11 Cleanable tub (Multi patient re-use - can be reprocessed)
- Endcap which allows use without the humidifier
- Air11™ Filter - standard
- Air11 Filter - hypoallergenic
- DC-DC Converter
- SD card
- SD card cover

Notes:

- The AirSense 11 device is compatible with ResMed masks. For a complete list, see the Mask/Device compatibility list on [ResMed.com/downloads/devices](https://www.resmed.com/downloads/devices).
- It is the responsibility of the equipment provider or clinician to ensure that parts and accessories are compatible with this device prior to use by the patient.
- The HumidAir 11 Standard tub and the HumidAir 11 Cleanable tub are the only water tubs used with the AirSense 11 device.
- The ClimateLineAir 11 is the only heated tubing that is compatible with the AirSense 11 device.
- Ensure the patient has an approved ResMed power supply for the region they are using the device.

About your device

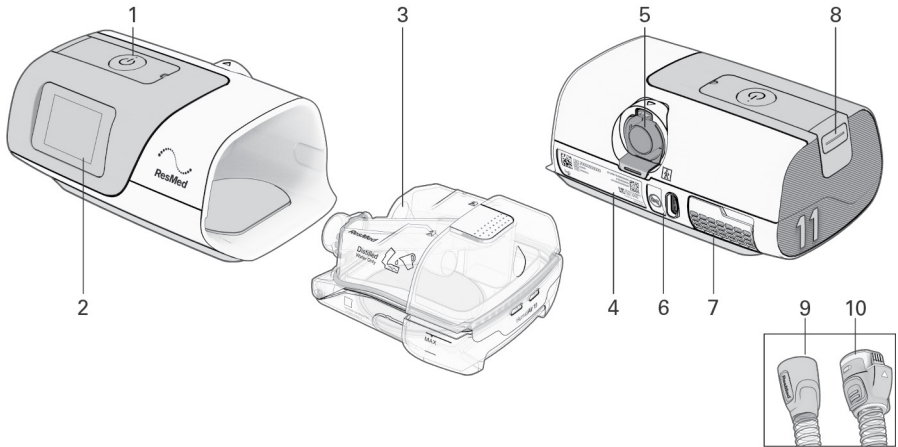

Description	Purpose
1 Start Therapy/ Standby button	Press to start/stop therapy. The LED indicator is green during standby mode, and white during therapy, Test Drive , and Mask Fit functions.
2 Display touch screen	Navigates between functions and displays information on the operating status of the device.
3 HumidAir 11 tub	Water tub that provides heated humidification.
4 Device label	Contains information relevant to the device.
5 Outlet connector	Connects the air tubing
6 Power inlet	Connects the power cord
7 Air inlet filter cover	Contains the air filter
8 SD card cover	Removable cover that protects the SD card slot. The LED indicator is blue when data is written to the SD card.
9 SlimLine tubing	Non-heated air tubing
10 ClimateLineAir 11 tubing	Heated air tubing

Notes:

- If the Start therapy/ Standby button has a flashing white light, a system error has occurred. Refer to the Troubleshooting section for more information.
- Use this device only as directed by your physician or healthcare provider.

Therapy Information

The following modes are available on the AirSense 11 device:

Device	AutoSet	Modes available AutoSet for Her	CPAP
AirSense 11 AutoSet	✓	✓	✓
AirSense 11 CPAP			✓
AirSense 11 Elite			✓

AutoSet mode

The treatment pressure required by the patient may vary due to changes in sleep state, body position and airway resistance. In AutoSet mode, the device provides only that amount of pressure required to maintain upper airway patency.

The device analyzes the state of the patient’s upper airway on a breath-by-breath basis and delivers pressure within the allowed range according to the degree of obstruction. The AutoSet algorithm adjusts treatment pressure as a function of three parameters: inspiratory flow limitation, snore, and apnea.

Normal airway

When the patient is breathing normally, the inspiratory flow measured by the device as a function of time shows a typically rounded curve for each breath.

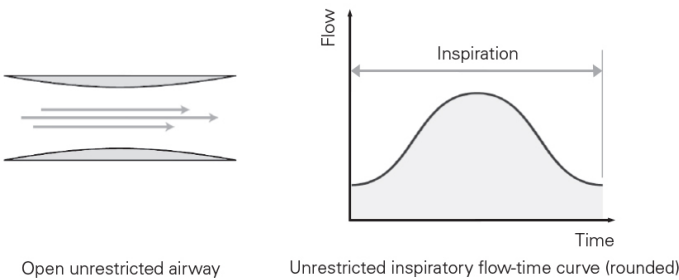

Flow limitation

As the upper airway begins to collapse, the shape of the inspiratory flow-time curve changes. The AirSense 11 recognizes and treats traditional as well as less common flow-limited breath wave forms.

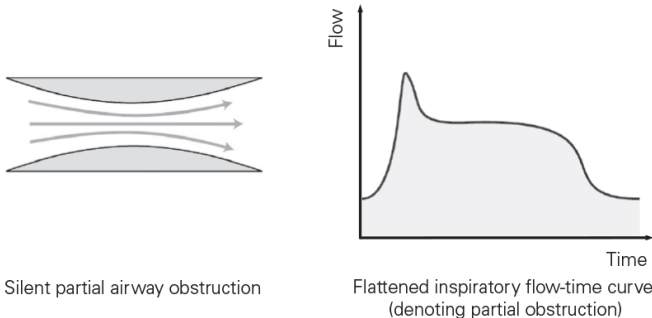

Snore

Snoring is sound generated by vibrations of the walls of the upper airway. It is often preceded by flow limitation or a partial obstruction of the airway.

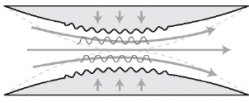

Noisy partial airway obstruction

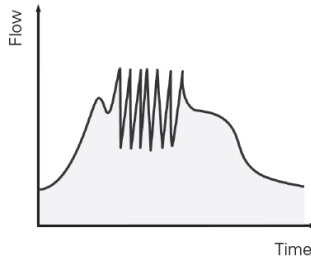

Snore superimposed on inspiratory flow-time curve

Apnea

The enhanced AutoSet algorithm detects both obstructive and central apneas. If an apnea occurs, the device responds appropriately.

Obstructive apnea

An obstructive apnea is when the upper airway becomes severely limited or completely obstructed. AutoSet generally prevents obstructive apneas from occurring by responding to flow limitation and snoring. If an obstructive apnea occurs, the device will respond by increasing pressure.

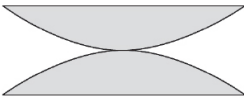

Complete airway obstruction

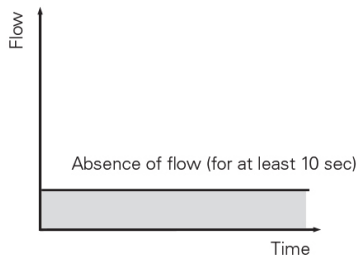

Inspiratory flow-time curve

Central apnea

During a central apnea, the airway will remain open, but there is no flow. When a central apnea is detected, the device responds appropriately by not increasing pressure.

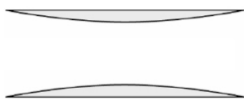

Open unrestricted airway

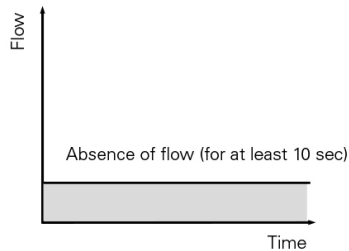

Inspiratory flow-time curve

AutoSet for Her mode

AutoSet for Her mode is based on key aspects of ResMed's AutoSet algorithm and delivers therapeutic responses tailored to the characteristics of female OSA patients.

The AutoSet for Her is similar to ResMed's AutoSet algorithm with the following modifications:

- Reduced rate of pressure increments designed to help prevent arousals.
- Slower pressure decays.
- Treats apneas up to 12 cm H₂O (12 hPa) and continues to respond to flow limitation and snore up to 20 cm H₂O (20 hPa).
- Minimum pressure (Min. Pressure) that adjusts according to the frequency of apneas: If two apneas occur within a minute, the pressure reached in response to the second apnea will become the new minimum treatment pressure until the next treatment session.

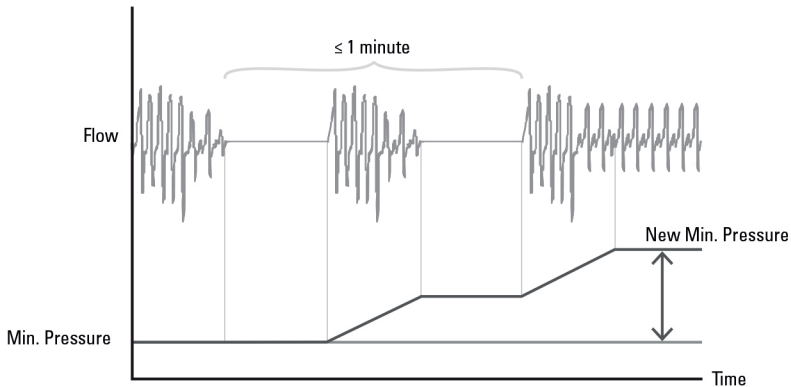

Patients who use AutoSet for Her will still get the benefits of ResMed's AutoSet technology including improved sensitivity to flow-limitation and Central Sleep Apnoea Detection with Forced Oscillation Technique.

CPAP mode

In CPAP mode, a fixed pressure is delivered—with optional Expiratory Pressure Relief (EPR™).

Reporting

The AirSense 11 reports Respiratory Effort Related Arousals (RERA), and detects Central Sleep Apnea (CSA) and Cheyne-Stokes Respiration (CSR). The summary and detailed data of these parameters are available to view on ResMed's patient compliance software (data availability depends on device mode and parameter measured).

Central sleep apnea detection

Available in all modes on the AirSense 11 AutoSet and the AirSense 11 Elite.

The device detects both obstructive and central sleep apneas (CSA). CSA detection uses the Forced Oscillation Technique (FOT) to determine the state of the patient's airway during an apnea. When an apnea has been detected, small oscillations in pressure [1 cm H₂O (1 hPa) peak-to-peak at 4 Hz] are added to the current device pressure. The CSA detection algorithm uses the resulting flow and pressure (determined at the mask) to measure the airway patency.

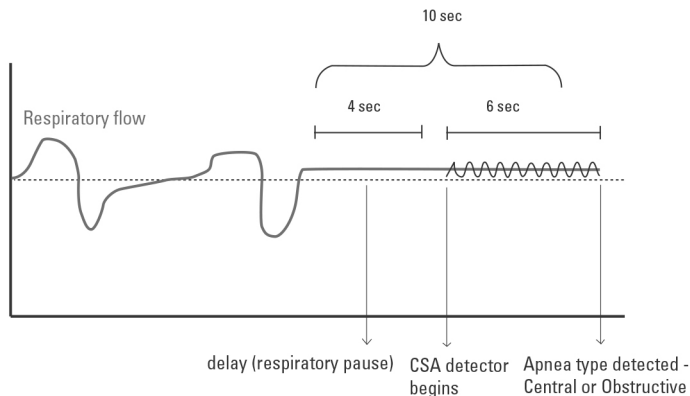

Cheyne-Stokes respiration detection

Available in all modes on the AirSense 11 AutoSet and the AirSense 11 Elite.

Cheyne-Stokes respiration (CSR) is a form of sleep-disordered breathing characterized by a periodic waxing and waning of respiration. The waxing periods (hyperpneas, typically 40 seconds in length) can include large gasping breaths that tend to arouse the patient while the waning periods (hypopneas or apneas, typically 20 seconds in length) cause blood oxygen desaturations.

The following example shows a typical CSR period.

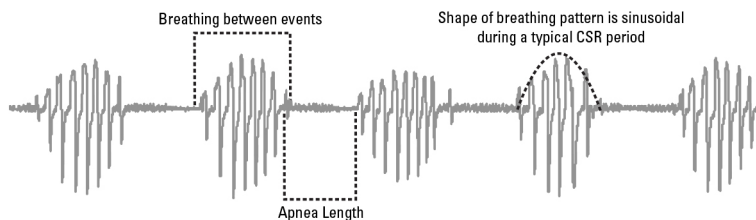

The following example suggests periodic breathing due to the frequently occurring apneas. However, when looking closely at the shape of the hyperpneas it can be seen that it is a typical OSA period.

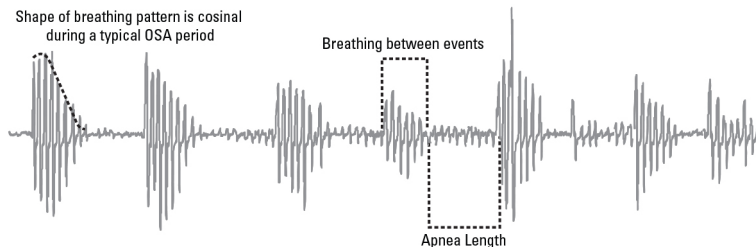

The AirSense 11 device reports the time during therapy in which it detected breathing patterns indicative of CSR. It analyzes the patient's respiratory flow for apnea/hypopnea events, calculates the time between these events, and characterizes the shape of breathing between them.

Respiratory effort related arousals reporting

Respiratory Effort Related Arousals (RERA) reporting is available on the AirSense 11 AutoSet and AirSense 11 Elite in all modes.

RERAs are periods of increasing respiratory effort which are terminated by an arousal. Increasing respiratory effort will be seen as airflow limitation. These flow-based RERA events are logged and stored as summary and/or detailed data and can then be viewed in one of ResMed's patient management systems.

Comfort features

Ramp

Designed to make the beginning of treatment more comfortable, ramp is available in all modes.

In AutoSet and AutoSet for Her mode, ramp time defines the period during which the pressure gradually increases from a lower more comfortable start pressure to the minimum treatment pressure before the auto-adjusting algorithm commences.

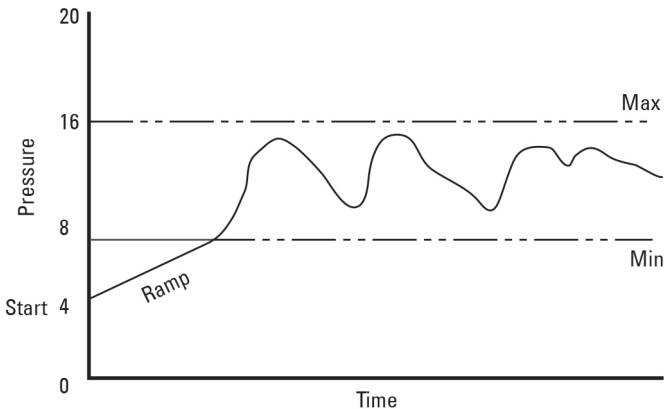

In CPAP mode, the pressure increases from a low pressure (Start Pressure) to the prescribed treatment pressure.

Ramp Time can be set to Off, 5 to 45 minutes or Auto. When Ramp Time is set to Auto, the device will detect sleep onset and then gradually increase from the start pressure to the minimum treatment pressure at a rate of 1 cm H₂O (1 hPa) per minute. However, if sleep onset is not detected, the device will reach the target pressure within 30 minutes.

Expiratory Pressure Relief

Designed to make therapy more comfortable, Expiratory Pressure Relief (EPR) maintains optimal treatment for the patient during inhalation and reduces the delivered mask pressure during exhalation.

EPR On—EPR is enabled.
 Off—EPR is disabled.

The following settings are only available if EPR is On:

EPR Type Full Time—If set to Full Time, EPR is enabled for the whole therapy session.
 Ramp Only—If set to Ramp Only, EPR is only enabled during ramp time.

EPR Level 1, 2, 3 cm H₂O (1, 2, 3 hPa)

When EPR is enabled, the delivered pressure will not drop below a minimum pressure of 4 cm H₂O (4 hPa), regardless of the settings.

AutoSet Response

AutoSet mode (AirSense 11 AutoSet device only).

For patients who are sensitive to faster changes in pressure during therapy, AutoSet Response can be set to either Standard or Soft. If set to soft, patients will receive gentler pressure rises during therapy.

Patients who use the AutoSet Response feature will still get the benefits of ResMed's AutoSet technology including improved sensitivity to flow-limitation and CSA Detection with Forced Oscillation Technique.

About the heated tubing

The ClimateLineAir 11 is a heated breathing tube that delivers air to a compatible mask. When used with the device humidifier tub, ClimateLineAir 11 heated air tubing allows you to use the Climate Control feature.

Note: Not all types of air tubing are available in all regions.

Climate Control

Climate Control is an intelligent system that controls the humidifier and the ClimateLineAir heated air tubing. This feature:

- delivers comfortable humidity level and temperature during therapy
- maintains the set temperature and relative humidity during sleep to prevent dryness in the nose and mouth
- can be set to either **Auto** or **Manual**
- is only available when both the ClimateLineAir 11 and HumidAir 11 tub are attached.

Climate Control - Auto setting

Auto is the recommended and default setting. It is designed to make therapy as easy as possible so there is no need to change the temperature or humidity settings.

- Sets the tube temperature to Auto (80°F/27°C). If the air in the mask is too warm or too cold, you can adjust the tube temperature to anywhere from 60 to 86°F (16 to 30°C) or turn it off completely
- Adjusts the humidifier output to maintain a constant, comfortable humidity level of 85% relative humidity
- Protects against rainout (water droplets in the heated air tubing and mask).

Climate Control - Manual setting

Manual is designed to offer more flexibility and control over settings and offers the following:

- Temperature and humidity can be adjusted to find the most comfortable setting
- Temperature and humidity level can be set independently
- Rainout protection is not guaranteed. If rainout does occur, first try increasing the tube temperature
- If the air temperature becomes too warm and rainout continues, try decreasing the humidity.

Notes:

- If Climate Control is set to **Manual**, the **Auto** Tube Temperature setting is not available.
- The temperature and humidity settings are not measured values.

Tube Temperature

The temperature sensor located at the mask end of the ClimateLineAir 11 heated air tubing enables the system to automatically control the temperature of the air delivered to the patient. This ensures the temperature of the air delivered to the patient does not fall below the set minimum temperature, therefore maximizing breathing comfort for the patient.

Humidity Level

The humidifier moistens the air and is designed to make therapy more comfortable.

- If the patient is getting a dry nose or mouth, turn up the humidity
- If the patient is getting any moisture in the mask turn down the humidity.

- The **Humidity Level** can be set to: Off or between 1 and 8, where 1 is the lowest humidity setting and 8 is the highest humidity setting.

For each humidifier setting, the Climate Control system delivers a constant amount of water vapor, or absolute humidity (AH), to the patient's upper airway.

Automatic Adjustment

The humidifier and ClimateLineAir 11 heated air tubing are controlled by the Climate Control algorithm to deliver constant humidity and temperature outputs. The system adjusts automatically to changes in:

- ambient room temperature and humidity values
- flow due to pressure changes
- flow due to mask or mouth leak.

Setting up your device

WARNING

Do not use any additives in the humidifier tub (eg, scented oils or perfumes). These may reduce humidification output and/or cause deterioration of the tub materials.

CAUTION

Use only ResMed parts (eg, air inlet filter, power supplies), masks and accessories with the machine. Non ResMed parts may reduce the effectiveness of the treatment, may result in excess carbon dioxide rebreathing and/or damage the machine. For compatibility information, refer to ResMed.com for more information.

When using the humidifier tub:

- Always place the device on a level surface, lower than your head, to prevent the mask and air tubing from filling with water.
- Do not overfill the humidifier tub as water may enter the device and air tubing.
- Do not fill the humidifier tub with hot water as this could lead to excessive air temperature at the mask. Ensure the water is cooled to room temperature before filling the humidifier tub.
- Do not place the device on its side while the humidifier is attached as water might get into the device and reduce motor life.

When setting up the AirSense 11 system:

- Do not place the power supply where it can be bumped, stepped on, or where someone is likely to trip over the power cord
- Do not block the air tubing and/or air inlet of the device while in operation as this could lead to overheating of the device
- Keep the area around the device dry, clean and clear of anything (eg, clothes or bedding) that could block the air inlet or cover the power supply unit
- Ensure the system is correctly set up. Incorrect system setup may result in incorrect mask pressure reading.

When using a mask:

- Use only vented masks recommended by ResMed or by the prescribing doctor with this device
- Fitting the mask without the device blowing air can result in rebreathing of exhaled air
- Make sure that the mask vent holes are kept clear and unblocked to maintain the flow of fresh air into the mask.

To set up the device:

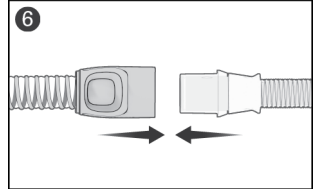
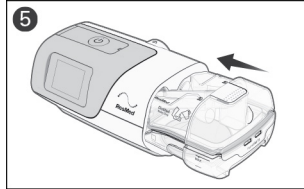
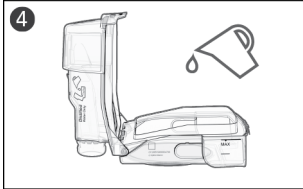
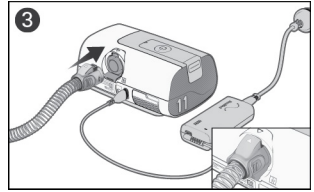
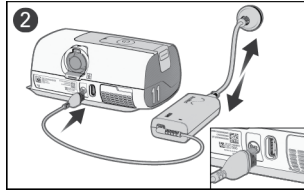
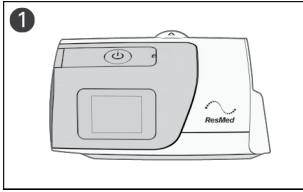

1. Place the device on a stable level surface.
 2. Connect the power cord into the power inlet at the rear of the device. Connect one end of the power cord into the AC adaptor and the other end into the power outlet. Ensure the device is set up and connected to power to enable settings to be applied wirelessly to the device if required.
 3. Connect the air tubing firmly to the outlet connector at the rear of the device.
 4. Open the humidifier tub and fill it with distilled water up to the maximum water level mark. The humidifier tub must be removed from the device before adding water. The humidifier tub has a maximum capacity of 380 mL.
 5. Close the humidifier tub and insert it into the side of the device.
 6. Connect the free end of the air tubing firmly onto the assembled mask.
- See the mask user guide for detailed information.

Recommended masks for use with this device are listed on ResMed.com.









Notes:

- Do not insert any USB cable into the AirSense 11 device or attempt to plug the AC adaptor into a USB device. This may cause damage to the AirSense 11 device or USB device.
- The electrical connector end of the heated air tubing is only compatible with the air outlet at the device end and should not be fitted to the mask.
- Do not use electrically conductive or anti-static air tubing.

Navigating the touch screen

The AirSense 11 device operates via a display touch screen. This allows you to access, view and change therapy and device settings and to track the sleep health progress of your patient.

The status bar at the top of the screen may display icons at different times and may include:

Icon	Description	Purpose
	Home Screen	Return to the Clinical Home screen at any time.
	Humidifier fault	Detects fault in the humidifier. Therapy will run without heating.
	Humidifier warming	Water in the humidifier tub is pre-heating.
	Humidifier cooling	Water in the humidifier tub is cooling.
	Bluetooth connected	Device is successfully connected via Bluetooth wireless technology.
	Cellular signal strength	Indicates the strength of cellular connectivity.
	No cellular connection	Cellular coverage is not available.
	Airplane mode	Device is in airplane mode.

Accessing the Clinical menu

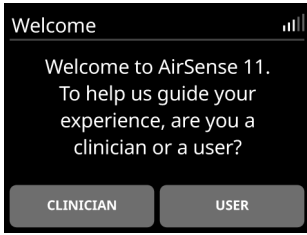

From the Welcome screen, tap **CLINICIAN**

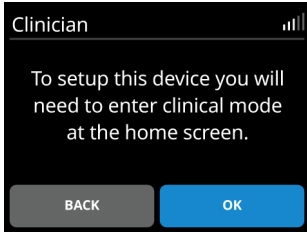

The **Clinician** handover screen will appear.
Tap **OK** to continue or **BACK** to return to previous screen.

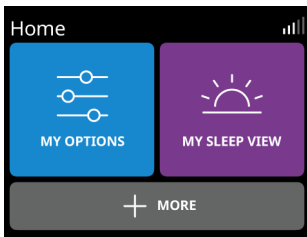

The **Home** screen will appear. This is also the Patient **Home** screen. The menu options are:
MY OPTIONS: for the patient to view and adjust therapy settings (eg, Adjust Ramp time)
MY SLEEP VIEW: for the patient to track their sleep health (eg, check the number of hours used last night or mask status)
MORE: Additional features such as **Mask Fit** or switch to **Airplane Mode**.

To access Clinical mode:

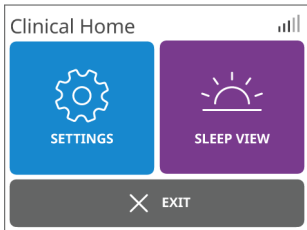

From the **Home** screen, press two fingers anywhere on the screen for 3 seconds to access the **Clinical Home** screen.

From this screen, you can access:

- SETTINGS**: Set up or adjust therapy settings for the patient.
- SLEEP VIEW**: Track the patients sleep health
- EXIT**: Return to the **Home** screen (Patient View)

Notes:

- Patient screens have a black background. Clinical screens have a white background.
- Menu options will also vary by treatment mode. Refer to the Settings menu to view the settings for each therapy mode.

Using the touch screen:

There are two actions to navigate through the touch screen:

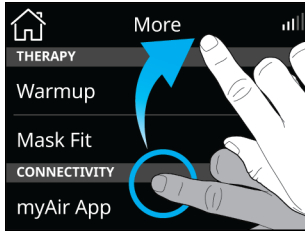

Swipe: Swipe up or down the screen to view menu options..



Tap: Select a parameter setting to update. For other parameters (eg Pressure Relief, Airplane mode), tap the parameter to turn it on

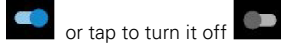

or tap to turn it off

To update settings:

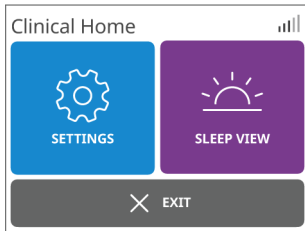

Tap **SETTINGS**. The **Settings** list will display.

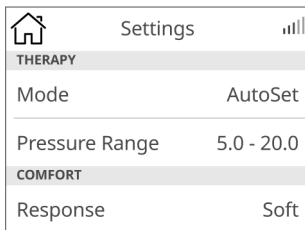

1. Tap the preferred setting (eg, **Response**)
2. Tap on the desired value.
3. Tap **OK** to confirm the change or **CANCEL** to go back to the previous screen.

To exit the Clinical menu:

1. Tap  at any time to return to the **Clinical Home** screen.
2. Tap **EXIT** to leave the Clinical menu.

Adjusting Clinical settings

The AirSense 11 settings and equipment (including accessories) must be configured for each patient. The settings and equipment used should be periodically reassessed to ensure optimal therapy.

All parameters relating to a patient's therapy and device configuration are managed through the **Settings** menu.

Connecting your AirSense 11 device and smart device

myAir™ is a smartphone app that guides the patient through the setup process. This includes device setup videos, mask fitting videos, trying therapy using the Test Drive feature, and tracking their sleep health progress.

The app is not required to operate the AirSense 11 device.

Before pairing the AirSense 11 device to a smartphone, ensure the app's latest version is installed on the smartphone. If not, download the app from the App Store® or on Google Play®. Pair the AirSense 11 device to your phone. To set up the app, go to the **MORE** menu.

1. Ensure the AirSense 11 device is set up correctly and plugged into a power source.
2. Launch the myAir app. Tap **Continue**.
3. Follow the prompts on the myAir app to complete the Bluetooth connection. AirSense 11 is now connected to the app. The Bluetooth connection symbol appears on the status bar to confirm the connection between the AirSense 11 device and the smartphone.
4. Tap **Done**.

Settings Menu

Therapy Settings

Parameter	Description	Mode			Range
		AutoSet	AutoSet for Her	CPAP	
Mode	Sets the therapy mode available on the device.	✓	✓	✓	
Pressure Range	Sets the pressure range for treatment.	✓	✓		Select Min Pres.: 4-20 cm H ₂ O (hPa), 0.2cm H ₂ O (hPa) increments. Select Max Pres.: 4-20 cm H ₂ O (min-20 hPa) 0.2 cm H ₂ O (0.2 hPa) increments.
Set Pressure	Sets the fixed treatment pressure.			✓	4-20 cm H ₂ O (4-20 hPa), 0.2 cm H ₂ O (0.2 hPa) increments.

Comfort Settings

Parameter	Description	Mode			Range
		AutoSet	AutoSet for Her	CPAP	
AutoSet response	Set to Standard or Soft. If Soft is selected, patients will receive gentler pressure rises during therapy.	✓			Standard/Soft
Ramp Time	If Auto is selected, the device will detect sleep onset and automatically rise to the prescribed treatment pressure.	✓	✓	✓	Off/ 5-45 Mins / Auto
Start Pressure	Set the pressure at the start of ramp, up to treatment pressure.	✓	✓	✓	4-Set pressure level, 0.2 cm H ₂ O (0.2 hPa) increments
EPR	Enable/ disable EPR.	✓	✓	✓	On/ Off
EPR Type	Available when EPR is enabled	✓	✓	✓	Full time/ Ramp Only
EPR Level	Set the EPR value.	✓	✓	✓	1 / 2 / 3 cm H ₂ O (1 / 2 / 3 hPa)
Climate Control	Available when the HumidAir 11 tub is used and ClimateLineAir 11 heated air tubing is connected.	✓	✓	✓	Manual/Auto
Tube Temp	Set the minimum temperature of air delivered by heated air tubing such as ClimateLineAir 11 .	✓	✓	✓	Off/60-86°F (16-30°C), increments of 2°F (1°C)
Humidity Level	Set the humidity level.	✓	✓	✓	Off / 1-8

Options

Parameter	Description	Range
Patient View	Set the level of access available to the patient.	Simple/ Advanced
SmartStart™*	Enable/disable the SmartStart feature. If you enable the SmartStart feature, the device will start automatically when the patient breathes into the mask.	On/ Off
SmartStop*	Enable/disable the SmartStop feature. If you enable the SmartStop feature, the device will stop automatically when the patient removes the mask.	On/ Off
Care Check-In*	Enable Care Check-in. A series of simple questions presented to the patient to gain insight on their progress with sleep therapy and enables them to enroll in the myAir application.	On/ Off
Reminders		
Mask	Set a recurring reminder to the patient to replace the mask.	Off/ 1/ 3/ 6/ 9/ Yearly
Tube	Set a recurring reminder to the patient to replace the air tubing	Off/ 1/ 3/ 6/ 9/ Yearly
Filter	Set a recurring reminder to the patient to replace the air filter	Off/ 1/ 3/ 6/ 9/ Yearly
Humidifier	Set a recurring reminder to the patient to replace the water tub	Off/ 1/ 3/ 6/ 9/ Yearly

*Settings are enabled via a Tap on  or tap off .

Configuration

Parameter	Description	Range
Language	Set the display language	English
Temperature Units	Set the temperature units	°F / °C
Restore Defaults	Reset to default settings	OK to restore defaults. Cancel to return to previous menu.
Erase data	Erase all data stored on the device and SD card.	OK to erase data Cancel to return to previous menu.
About	View SN, CG details, Run hours and modem provider	
TimeZone	Set up the correct time zone for the patient	GMT time zone

Note: Not all functions are available in all regions. Functions vary based on therapy mode.

Setting the time zone

Before the patient is set up, ensure the correct time zone has been set. The time zone cannot be changed once patient data has been stored on the device. The patient data will need to be erased before changing the time zone.

The AirSense 11 device is set up with GMT (Greenwich Mean Time) time zone settings.

To change Time Zone:

1. From the **Clinical Home** screen, tap **SETTINGS**
2. Move down the menu to find **CONFIGURATION** options
3. Tap **Time Zone**
4. Select the relevant GMT setting and tap **OK**.

Restoring settings and erasing data

When using the device in a multi-patient environment, the device settings should be reset between patient use.

To restore default settings:

1. From the **Clinical Home** screen, tap **SETTINGS**
2. Move down the menu to find **CONFIGURATION** options
3. Tap **Restore Defaults**
4. Tap **OK** to confirm or **CANCEL** to return to the previous screen.

To erase data from the device:

1. From the **Clinical Home** screen, tap **SETTINGS**
2. Move down the menu to find **CONFIGURATION** options
3. Tap **Erase data**
4. Tap **OK** to confirm or **CANCEL** to return to the previous screen.

Starting/stopping therapy

WARNING

The machine is not intended to be operated by persons (including children) with reduced physical, sensory or mental capabilities without adequate supervision by a person responsible for the patient's safety.

To start therapy:



1. Direct the patient to fit their mask.
2. Direct the patient to press the Start therapy/ Standby button or if the SmartStart feature is enabled, direct them to breathe into their mask. Therapy will begin and the Treatment screen is displayed. A dynamic pulse wave will appear during therapy

Notes:

- The screen will fade and then go black automatically after a short period of time. Tap the screen to turn it back on.
- If power is interrupted during therapy, the device will automatically restart therapy when power is restored.
- The device has a light sensor that adjusts the screen brightness based on the light in the room.

To stop therapy

1. Direct the patient to remove the mask.
2. Direct the patient to press the Start therapy/ Standby button or if SmartStop is enabled, therapy will stop automatically after a few seconds.

Viewing sleep data and option controls

The Sleep View screen shows sleep quality and mask seal status for the most recent therapy session. The parameters displayed will depend on the therapy mode.

In the **Patient view**, there are two types of access levels: Simple and Advanced.

The **Simple** view is designed to:

- Make the device interaction and menu navigation easier for patients
- Provide access to the most important comfort features such as **Ramp Time**, **Mask Fit**, **Humidity level and Warmup** (if humidifier is available)

The **Advanced** view provides highly engaged patients access to additional features to monitor their sleep health. These include:

- **EPR** (if available)
- **SmartStart** and/or **SmartStop**

The Advanced view can be enabled via the **Settings** screen. For more information on the Patient view, see the User Guide.

Sleep View Parameters:

Parameter	Description
Used Hrs	Number of hours the device has been used since last session
Pressure	Average Pressure during the selected period (95th percentile for each day, average of the 95th percentile values for periods >1 day)
Leak	Average of the 95th percentile values of leak during the selected period.
AHI	Apnea-Hypopnea Index - average AHI during the selected period.
Total AI	Apnea Index - average total AI during the selected period
Central AI	Central Apnea Index - average CAI of the Days Used in the selected period.

Supplemental oxygen

Before adding oxygen, familiarize yourself and your patient with the following warnings relating to the use of supplemental oxygen.

WARNING

- Supplemental oxygen must not be used while smoking or in the presence of an open flame.
- When using the device with an oxygen supply, check the following:
 - Starting therapy – ensure the device is on and blowing air before the oxygen supply is turned on.
 - Stopping therapy – ensure the oxygen supply is turned off first, then the device.

This will ensure oxygen does not accumulate within the device and create a risk of fire.

The device is designed to be compatible with up to 15 L/min of supplemental oxygen in all modes.

At a fixed rate of supplemental oxygen flow, the inhaled oxygen concentration will vary depending on the pressure settings, patient breathing pattern, mask selection and the leak rate.

An oxygen connector port is required to connect supplemental oxygen to the device. Oxygen concentration should be measured at the point of delivery to the patient.

Notes:

- Adding oxygen may affect the delivered pressure and the accuracy of the displayed and reported values
- Oxygen concentration can be affected by a partial obstruction downstream of the AirSense 11 system.

Fitting an oxygen port

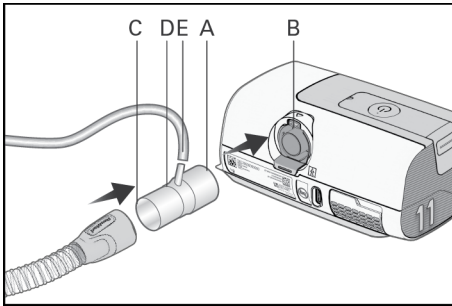

1. Firmly connect the Oxygen Connector Port (A) directly to the air outlet (B) of the flow generator.
2. Connect the non-heated air tubing to the end of the Oxygen Connector Port (C) as shown. Ensure that the non-heated tube is connected up to the indicated line (D).
3. Connect the oxygen supply tubing to the oxygen inlet port (E) as shown.

Cleaning and caring for the device

WARNING

- Beware of electrocution:
 - Do not immerse the device, AC Adaptor or power cord in water.
 - Do not connect to power while the device is wet. Make sure that all parts are dry before plugging it in.
 - If liquids are spilled into or onto the device, unplug the device and let the parts dry.
- Always unplug the device before cleaning and ensure that all parts are dry before plugging it back in.
- Do not perform any maintenance tasks (eg, cleaning, changing the air filter) while the device is in operation.
- Clean the device and its components according to the schedules shown in this guide, to maintain the quality of the device and to prevent the growth of germs that can adversely affect your health.
- Regularly inspect power cords, cables, and power supply for damage or signs of wear. Discontinue use and replace if damaged.
- Do not open or modify the device. There are no user serviceable parts inside. Repairs and servicing should only be performed by an authorized ResMed service agent.

CAUTION

- Do not use bleach, chlorine, or aromatic-based solutions, moisturizing or antibacterial soaps or scented oils to clean the device, the humidifier tub or air tubing. These solutions may cause damage or affect the humidifier performance and reduce the life of the products. Exposure to smoke, including cigarette, cigar or pipe smoke, as well as ozone or other gases, may damage the device. Damage caused by any of the foregoing, will not be covered by ResMed's limited warranty.
- Leave the humidifier tub to cool for ten minutes before handling to allow the water to cool and to make sure that the humidifier tub is not too hot to touch.
- Only clean, maintain and/or reprocess the device and components according to the instructions shown in this guide.

The following sections will help you with:

- Disassembling
- Cleaning
- Checking
- Reassembling.

Disassembling

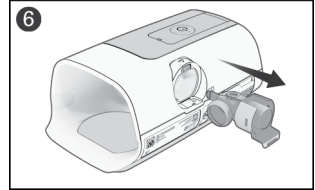
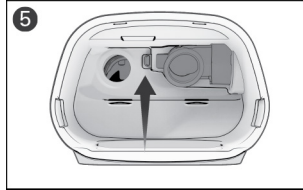
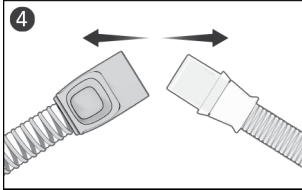
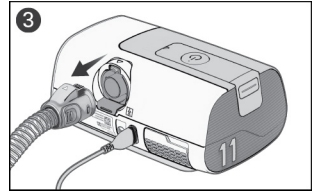
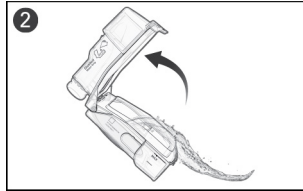
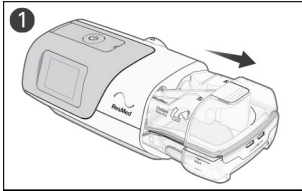

1. Hold the humidifier tub at the top and bottom, press it gently and pull it away from the device.
Note: take care when handling the humidifier tub as the humidifier tub may be hot. Allow 10 minutes for the heater plate and any excess water to cool.
2. Open the humidifier tub and discard any remaining water.
3. Pinch the cuff of the air tubing, and gently pull it away from the device.
4. Hold both the cuff of the air tubing and the swivel of the mask, then gently pull apart.
5. Locate the outlet connector on the inside of the device and release it by pressing the clip firmly.
6. Remove the outlet connector by pulling it out through the outlet connector socket at the rear of the device.

Cleaning

The following instructions are for home cleaning.

You should clean the device, humidifier tub, air tubing, and outlet connector as described. For cleaning your mask, refer to the mask user guide for detailed instructions.

Daily:

1. Empty the humidifier tub and wipe it thoroughly with a clean disposable cloth. Allow it to dry out of direct sunlight.
2. Refill the humidifier tub with distilled water.

Weekly:

1. Wash the components using one of the following options:
 - Wash the humidifier tub, air tubing and outlet connector in warm water using a household dishwashing liquid. Components should not be washed in temperatures higher than 149°F (65°C)OR
 - Wash the humidifier tub and outlet connector in a solution of 1 part vinegar and 9 parts water. Wash the air tubing in warm water using a household dishwashing liquid. The air tubing should not be washed in temperatures higher than 149°F (65°C).
2. Rinse each component thoroughly in water.
3. Allow to dry out of direct sunlight or heat
4. Wipe the exterior of the device with a dry cloth.

Notes:

- The humidifier tub may be washed in a dishwasher on the delicate cycle (top shelf only).
- Do not wash the heated air tubing in a dishwasher or washing machine.
- The air filter is not washable or reusable.

Checking

WARNING

- Discontinue use and contact your care provider or ResMed Service Center if any of the following occur:
 - device does not perform as usual
 - device is making unusual sounds
 - device is damaged
- If using a bacterial/viral filter, regularly check it for signs of moisture or other contaminants, particularly during nebulization or humidification. Failure to do so could result in increased breathing resistance.

CAUTION

If any visible deterioration of a system component is apparent (cracking, discoloration, tears etc.), the component should be discarded and replaced.

Regularly check the humidifier tub, air tubing, and air filter for any damage.

1. Check the humidifier tub:
 - Replace it if it is leaking or has become cracked, cloudy, or pitted.
 - Replace it if the seal is cracked or torn.
 - Remove any white powder deposits using a solution of one-part household vinegar to 10 parts water. Rinse with clean water.
2. Check the air tubing and replace it if there are any holes, tears, or cracks.
3. Check the air filter and replace it every six months. Replace it more often if there are any holes or blockages by dirt or dust.

Replacing the air filter

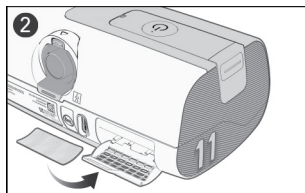
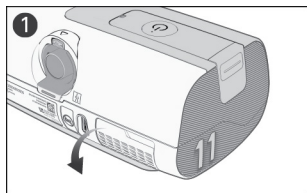

1. Open the air filter cover and remove the old air filter.
2. Place a new air filter onto the air filter cover and then close the cover. Make sure the air filter and air filter cover is fitted at all times to prevent water and dust from entering the device.

Note: The air filter is not washable or reusable.

Reassembling

When the humidifier tub and air tubing are dry, you can reassemble the parts.

To reassemble the AirSense 11 system:

1. Hold the outlet connector with the seal pointing to the left and the clip pointing forward.
2. Make sure the outlet connector is correctly aligned and insert the outlet connector into the socket.
3. Check the outlet connector is inserted correctly.
4. Connect the air tubing firmly to the air outlet located on the rear of the device.
5. Open the humidifier tub and fill it with distilled water under room temperature up to the maximum water level mark.
6. Close the humidifier tub and insert it into the side of the device.
7. Connect the free end of the air tubing firmly onto the assembled mask.

Preparing the device for use between patients

When the device is used for multiple patients, for example, in a sleep lab, clinic, hospital or at a health care provider, the outlet connector, air tubing, cleanable humidifier tub and device enclosure should be reprocessed between each patient.

Described here are ResMed's recommended and validated procedures for cleaning and disinfecting the outlet connector, air tubing, cleanable humidifier tub and device enclosure. The person executing reprocessing activities is responsible for ensuring that reprocessing is completed in line with ResMed's validated procedures. Components not identified in the reprocessing instructions do not require reprocessing or are intended for single patient use.

Note: The standard HumidAir 11 tub cannot be reprocessed.

WARNING

- Always follow cleaning and disinfection instructions. Some cleaning products may damage the components and their function or leave harmful residual vapors.
- Any deviations from the procedures or claimed maximum number of cycles in this guide can have an adverse effect on the components and consequently the safety or the quality of therapy.
- When using detergents, disinfectants or equipment, always follow the instructions provided by the manufacturer of those products. In the event of conflict, this guide takes precedence.
- Always follow safe operating practices, including the use of appropriate Personal Protective Equipment (PPE), as required. Refer to the instructions provided by the manufacturer of those products for more details.
- Beware of electrocution:
 - Do not immerse the device, AC Adaptor or power cord in water.
 - Do not connect to power while the device is wet. Make sure that all parts are dry before plugging it in.

General summary

ResMed has validated the following number of cycles for cleaning and disinfection using a manual cleaning method.

Components

System component	Cleaning - Mild alkaline, anionic detergent (eg, Alconox)	
	Chemical high level disinfection eg, CIDEX-OPA	Thermal high level disinfection 167°F (75°C) for 30 minutes
Outlet connector	120	80
HumidAir 11 Cleanable tub	120	80
ClimateLineAir 11	30	30
Standard tubing	30	30
SlimLine	30	30

Device

	Cleaning and low level disinfection
Device Enclosure	CaviWipes1™

Disassembling

Before disassembly, turn off the device and ensure the AC adapter has been removed.

Cleanable Humidifier tub

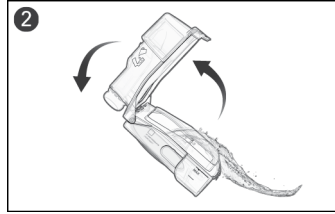
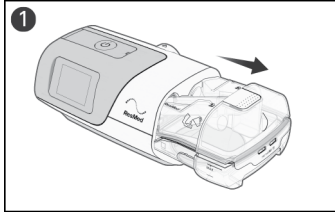

1. Hold the humidifier tub at the top and bottom, press it gently and pull it away from the device.
Note: take care when handling the humidifier tub as the humidifier tub may be hot. Allow 10 minutes for the heater plate and any excess water to cool.
2. Hold the base of the humidifier tub and fully open the humidifier tub lid and pull it away so that it easily detaches from the base.

Air tubing

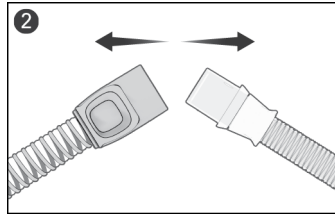
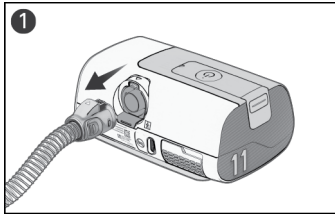

1. Pinch the cuff of the air tubing, and gently pull it away from the device.
2. Hold both the cuff of the air tubing and the swivel of the mask, then gently pull apart.

Outlet connector

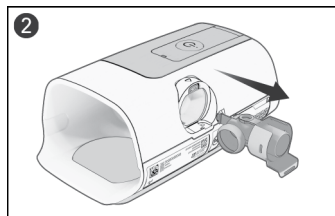
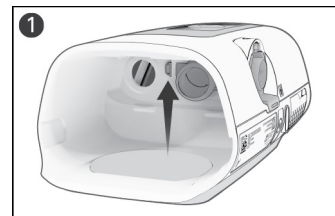

1. Locate the outlet connector on the inside of the device and release it by pressing the clip firmly.
2. Remove the outlet connector by pulling it out through the outlet connector socket at the rear of the device.

Device enclosure

Cleaning

Clean the device enclosure using an alcohol based cleaning and disinfection wipe. ResMed has validated CaviWipes¹.

1. Wipe the exterior of the device using a wipe until visually clean following the manufacturer's instruction for cleaning. Use a minimum of two wipes.

If visual debris is still present, perform the following:

2. Clean the exterior of the device with a dry, soft bristle brush and wipe the exterior of the device using a new cleaning and disinfection wipe following the manufacturer's instruction for cleaning.

Disinfection

Repeat the first step with a new wipe and follow the manufacturer's instructions for low level disinfection.

Note: Failure to clean the component as indicated may result in inadequate disinfection.

Drying

Allow sufficient time for the device to air dry completely.

Note: Drying is not required after cleaning if disinfection is continued immediately.

Inspection

Perform a visual inspection of the device casing. If any visible deterioration is apparent (cracking, crazing etc) discontinue use and contact your care provider or your ResMed Service Centre.

Air tubing, outlet connector and HumidAir 11 tub

Cleaning

1. Make a solution of a mild alkaline anionic detergent and water¹ as directed by the manufacturer's instructions. ResMed has validated :
 - Alconox™ at 1% (10 g/L) in water¹ at 69.8°F to 131°F (21°C to 55°C)
2. Soak all components for 5-10 minutes. Agitate the component in the cleaning solution to ensure there are no air bubbles.
3. Clean the inside and outside of all components with a soft bristle brush while soaking in a detergent solution. Pay particular attention to all crevices and cavities.

- Tubing (Standard, SlimLine and ClimateLineAir 11): 3 minutes of brushing

Note: A soft bristle tube/bottle brush is required to clean the inside of the tubing. Remove tubes from the detergent solution to assist brushing.

- Outlet connector: 1 minute of brushing
- HumidAir 11 Cleanable tub: 2 minutes of brushing

4. Thoroughly rinse each component as follows: in 5 liters of water¹ at ≤ 140°F (≤ 60°C) for each component by immersing it. Rinse tubing for 30-60 seconds. Agitate the component in the rinsing water to ensure there are no air bubbles.

5. Repeat the rinse procedure two additional times using fresh water¹ for a total of three rinses.

Note: Failure to clean the component as indicated may result in inadequate disinfection.

Inspection

Inspect and if required, repeat the cleaning steps until visually clean. Shake air tubing to remove excess water.

Drying

Allow the components to dry out of direct sunlight.

Note: Drying is not required after cleaning if thermal disinfection is continued immediately.

¹ For all cleaning, rinsing and disinfection steps use drinking quality water.

Disinfection

High Level disinfection

In the following procedures, only one disinfection process needs to be performed: Thermal disinfection OR Chemical disinfection.

High level thermal disinfection

1. Immerse the components in a water² bath. Agitate the components in the water bath to ensure no air bubbles are trapped.
2. Soak the components in a hot water bath. ResMed has validated:
 - Water bath: at 167°F (75°C) for 30 minutes

Note: Higher temperatures may damage the components.
3. Allow the components to dry out of direct sunlight.

OR

High level chemical disinfection

1. Make a solution of Ortho-phthalaldehyde 0.55% as directed by the disinfectant manufacturer. ResMed has validated:
 - CIDEX® OPA Ortho-phthalaldehyde
2. Soak the components in the solution at room temperature (approximately 69.8°F to 77°F (21°C to 25°C) for 12 minutes. Agitate the components in the disinfection solution to ensure there are no air bubbles.
3. Rinse and agitate the components in water² 5 liters per component at ≤ 140°F (≤60°C) for 1 minute. Shake air tubing to remove excess water.

Repeat the rinse procedure two additional times using fresh water² for a total of three rinses.

1. Allow the components to dry out of direct sunlight.

Inspection

Perform a visual inspection of each component. If any visible deterioration is apparent (holes, tears or cracks etc) replace the component.

Reassembling

Once the components are dry, reassemble the device.

Outlet connector

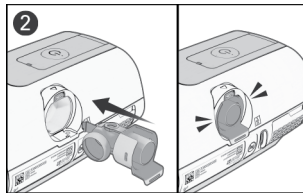
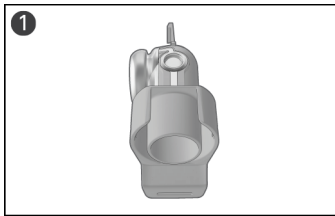

1. Hold the outlet connector with the seal pointing to the left and the clip pointing forward.
2. Make sure the outlet connector is correctly aligned and insert the outlet connector into the socket. It will click in place.

² For all cleaning, rinsing and disinfection steps use drinking quality water.

Cleanable HumidAir 11 tub

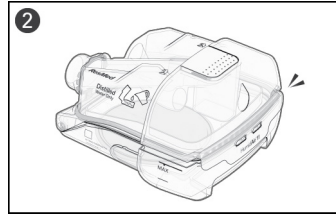

1. Insert one side of the lid into the pivot hole of the base. Insert the other side of the lid into the pivot hole.
2. Push the lid down until it clicks in place.

Air tubing

1. Connect the air tubing firmly to the air outlet located on the rear of the device.
2. Connect the free end of the air tubing firmly onto the assembled mask.

Packing and storing

Store in a dry dust-free environment away from direct sunlight.

Storage and transport temperature: -13°F to +158°F (-25°C to +70°C)

Storage and transport humidity: 5 to 95% relative humidity, non-condensing

Data management and therapy compliance

For therapy management, the AirSense 11 device stores patient therapy data on the device and may have the ability to transfer it remotely to the care provider if wireless network is available. Data can then be accessed via ResMed's AirView™ therapy management solution.

The AirSense 11 device also stores data on the SD card. This data can be transferred via an SD Card Reader to ResMed's ResScan™ therapy management system. The SD card should not be used for any other purpose as it may corrupt therapy data stored on the card. Do not remove the SD card from the device when the SD light is flashing, because data is being written to the card.

For more information on therapy management with AirView or ResScan, refer to the manuals supplied with the software.

Remote monitoring

The AirSense 11 device has cellular communication which has the ability to automatically transmit summary and detailed data on a regular basis. It also allows you to change settings remotely.

The Wireless signal strength icon  displayed at the top right of the screen indicates the signal strength. Advise the patient to check the signal strength on their device.

Therapy data might not be transmitted if used outside of the country or region of purchase.

For AirSense 11 devices that are bundled with an SD card, they will already be inserted and ready to use. Once the data is loaded into ResScan or AirView via the SD Card Reader, you can review and analyze data, as well as update therapy settings and transfer them to the patient's device via the SD card.

To remove the SD card cover and insert SD card:

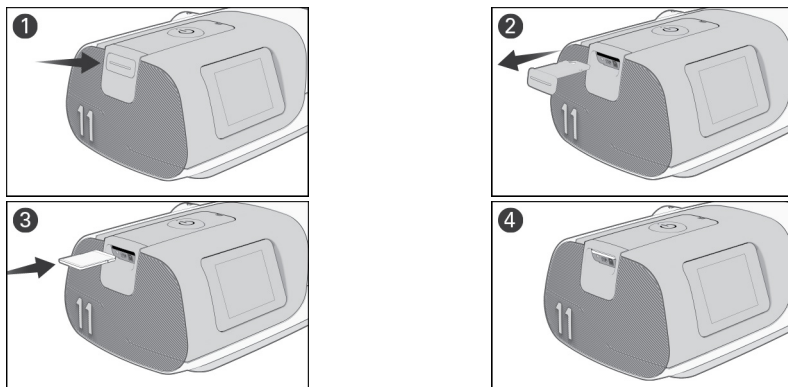

1. Push the SD card cover.
2. Remove the SD card cover and keep the SD card cover in a safe place.
3. Insert the SD card.
4. Push in the SD card until it clicks in place.

To remove the SD card:

1. Push in the SD card to release it.
2. Place the SD card in the protective folder and follow your care provider's instructions.

Data storage

The AirSense 11 device stores summary data such as AHI, Total Hours Used and Leak. Detailed data such as snore is stored on the SD card and can be viewed with AirView and ResScan. High resolution flow and pressure data are stored on the SD card.

Data can be transmitted to therapy management software either remotely via cellular communication, or via SD card. The different ways of transmitting data are detailed in the table below.

For more information on therapy management with AirView or ResScan, refer to the manuals supplied with the software.

Type of data	Transmission method			Sessions stored
	Cellular communication to AirView	SD card to ResScan	SD Card to AirView (card-to-cloud)	
Summary data (compliance data)	✓	✓	✓	365
Detailed data	✓	✓	✓	Limited by usage and SD card storage capacity
High resolution flow (25 Hz - every 40 ms)		✓		

Detailed data is stored on the SD card and can be viewed via ResScan or AirView. Examples of detailed data available is shown below.

Detailed data

Parameter	Sampling rate	
	ResScan	AirView
Apnea or hypopnea events	aperiodic	aperiodic
CSR	aperiodic	aperiodic
RERA (AirSense 11 Elite only)	aperiodic	aperiodic
Flow limitation (flat to round)	1/2 Hz (2 sec)	1 min
Leak (L/sec)	1/2 Hz (2 sec)	1 min
Minute ventilation (L/min)	1/2 Hz (2 sec)	1 min
Pressure (cm H ₂ O)/hPa)	1/2 Hz (2 sec)	1 min
Snore (quiet to loud)	1/2 Hz (2 sec)	1 min

Troubleshooting



If there is a problem, try the following suggestions. If you are not able to fix the problem, contact your local ResMed dealer or ResMed office. Do not open the device.

General troubleshooting

Problem/possible cause	Solution
Air is leaking from around the mask	
Mask may be fitted incorrectly.	Make sure the mask is fitted correctly. See the mask user guide for fitting instructions or run the Mask Fit function.
The patient is getting a dry or blocked nose	
Humidity level may be set too low.	Increase the Humidity Level .
There are droplets of water in the mask and air tubing	
Humidity level may be set too high.	Decrease the Humidity Level .
Tube temperature may be too low	Increase the Tube temp
The patient is getting a very dry mouth	
Air may be escaping through the patient's mouth.	Increase the Humidity Level . The patient may need a chin strap to keep the mouth closed or a full face mask.
The patient feels that too much air is being delivered from the device	
Ramp may be turned off	Use the Ramp Time option.
The patient feels that not enough air is being delivered from the device	
Ramp may be in progress	Wait for air pressure to build up or turn Ramp Time off
Ramp start pressure may be too low	Increase Ramp start pressure.
No display	
Backlight on the screen may have turned off. It turns off automatically after a short period of time	Press the Start therapy /standby button located at the top of the device or touch the screen.
Power may not be connected.	Connect the AC adaptor and make sure the plug is fully inserted.
Therapy has stopped but the device is still blowing air	
Device is cooling down	Device blows a small amount of air in order to avoid condensation in the air tubing. it will stop automatically after 30 minutes.
Humidifier tub is leaking	
Humidifier tub may not be assembled correctly.	Check for damage and reassemble the humidifier tub correctly.
Humidifier tub may be damaged or cracked.	Replace the humidifier tub.
The patient is not getting enough air/oxygen flow is disrupted	
Tubing or humidifier tub may be blocked	Check for blockages. Reconnect the tubing and reassemble the humidifier tub correctly.
The patient's therapy data has not been transmitted	
Wireless coverage may be poor.	Advise the patient to place the device where there is coverage (ie, on their bedside table, not in a drawer or on the floor). The wireless signal strength icon  indicates good coverage when all bars are displayed, and poor coverage when fewer bars are displayed.

Problem/possible cause	Solution
The No wireless connection icon is displayed on the top right of the screen. No wireless network available. Device may be in Airplane Mode.	Advise the patient that therapy data can be sent via SD Card. Turn off Airplane Mode . For instructions see the User Guide.
SmartStart is enabled, but the device does not automatically start when the patient breathes into their mask	
Breath is not deep enough to trigger SmartStart	To start therapy, take a deep breath in and out through the mask, before breathing normally. Press the Start therapy/Standby button located on the top of the device
There is excessive leak	Adjust the mask and headgear Air Tubing may not be connected properly. Connect firmly at both ends.
SmartStop is enabled but does not automatically stop when the patient removes their mask	
Incompatible mask being used	Only use equipment recommended by ResMed. Contact ResMed or see ResMed.com for more information If the patient is using a nasal pillows mask with set pressure less than 7cm H ₂ O (7 hPa), SmartStop will not work and should be disabled. If the patient is using a conduit mask, SmartStop will not work and should be disabled.

Device error messages

Device message/possible cause	Solution
High leak detected, check your humidifier or side cover	
Humidifier tub may not be inserted properly.	Make sure the humidifier tub is correctly inserted.
High leak detected, connect your tubing	
Air tubing may not be connected properly. Mask may be fitted incorrectly.	Make sure the air tubing is firmly connected at both ends. Make sure the mask is fitted correctly. See the mask user guide for fitting instructions or use the Mask Fit function to check the mask fit and seal.
Tubing blocked, check your tubing	
Air tubing may be blocked.	Check the air tubing and remove any blockages. Press the dial to clear the message and then press Start therapy/ Standby button to restart the device.
Read only card, please remove, unlock and re-insert SD card	
SD card switch may be in the lock (read-only) position.	Move the switch on the SD card from the lock position  to the unlock position  and then re-insert it.
System fault, refer to user guide, Error 4	
Device may have been left in a hot environment. Air filter may be blocked.	Allow to cool before re-use. Disconnect the AC adaptor and then reconnect it to restart the device. Check the air filter and replace it if there are any blockages. Disconnect the AC adaptor and then reconnect it to restart the device.

Device message/possible cause	Solution
Air tubing may be blocked.	Check the air tubing and remove any blockages. Press the dial to clear the message and then press Start therapy/Standby button to restart the device.
There may be water in the air tubing.	Empty the water from the air tubing. Disconnect the AC adaptor and then reconnect it to restart the device.
All other error messages, for example, System fault, refer to user guide, Error XX	
An unrecoverable error has occurred on the device.	Contact your local ResMed dealer or ResMed office. Do not open the device.

General Warnings

WARNING

- Any change or modification to the product is not expressly approved by ResMed and could void the user's authority to operate the device.
- The device has not been tested or certified for use in the vicinity of X-ray, CT or MRI equipment. Do not bring the device within 13 ft (4 m) of X-ray or CT equipment. Never bring the device into an MR (Magnetic Resonance) environment.
- This medical device uses a small bore connector design that is different to those specified in ISO80369-2. It may be possible to connect this device with other medical devices (eg, devices that deliver fluid or medicine) which may result in a hazardous situation and cause harm to the patient. Extra care should be taken by the user to mitigate any risks that may result.
- The use of accessories other than those specified for the device is not recommended. These may increase radio frequency energy or be influenced by the interference and result in improper operation.
- The device should not be used adjacent to or stacked with other equipment. If adjacent or stacked use is necessary, the device should be observed to verify normal operation in the configuration in which it will be used.
- Do not use the device with water in the humidifier tub while in transit (eg, on a plane or vehicle) due to the risk of:
 - water spilling into the device
 - the inhalation of water during turbulence.
- Make sure that the humidifier tub is empty before transporting the device.

For any serious incidents that occur in relation to this device, these should be reported to ResMed and the competent authority in your country.

Technical specifications

Operating pressure range

4 to 20 cm H₂O (4 to 20 hPa)

Maximum single fault steady state pressure

Device will shut down in the presence of a single fault if the steady state pressure exceeds:
40 cm H₂O (40 hPa) for more than 1 second.

Pressure measurement tolerance

± 0.5 cm H₂O (0.5 hPa) ±4% of measured reading

Flow measurement tolerance

± 6 L/min or 10% of reading, whichever is greater, at 0 to 150 L/min positive flow

Mode pressure ranges

CPAP: 4-20 cm H₂O (4-20 hPa) (measured at the mask)

CPAP with EPR mode: 4-20 cm H₂O (4-20 hPa) CPAP with EPR settings: EPR off, Level 1 = 1.0 cm H₂O (1 hPa), Level 2 = 2.0 cm H₂O (2 hPa), Level 3 = 3.0 cm H₂O (3 hPa).

AutoSet, AutoSet for Her mode: 4-20 cm H₂O (4-20 hPa)

AutoSet, AutoSet for Her mode with EPR: 4-20 cm H₂O (4-20 hPa) APAP with EPR settings: EPR off, Level 1 = 1.0 cm H₂O (1 hPa), Level 2 = 2.0 cm H₂O (2 hPa), Level 3 = 3.0 cm H₂O (3 hPa).

EPR reduces the pressure during expiration by the amount dependent on the level set above, but the pressure delivered will not drop below 4.0 cm H₂O (4 hPa).

Flow (maximum) at set pressures

The following are measured according to ISO 80601-2-70 201.12.1.103:

Pressure cm H ₂ O (hPa)	AirSense 11, humidifier tub and Standard air tubing L/min	AirSense 11, humidifier tub and SlimLine L/min	AirSense 11, humidifier tub and ClimateLineAir 11 L/min
4	150	145	144
8	147	142	141
12	143	138	138
16	140	135	134
20	136	131	129

Note: Refer to the relevant measurement uncertainty from the Measurement system uncertainties table.

Sound

Declared dual-number noise emission values in accordance with ISO 4871:1996

Sound pressure level measured according to ISO 80601-2-70:2015 (CPAP mode):

Device with SlimLine and humidification 27 dBA with uncertainty of 2 dBA

Sound power level measured according to ISO 80601-2-70:2015 (CPAP mode):

Device with SlimLine and humidification 35 dBA with uncertainty of 2 dBA

Device and humidifier tub

Dimensions (H x W x D):

3.72" x 10.21" x 5.45"
(94.5 mm x 259.4 mm x 138.5 mm)

Air outlet:

The 22 mm conical outlet connector complies with EN ISO 5356-1:2015

Weight (device and standard humidifier tub):

40 oz (1130 g)

Housing construction:

Flame retardant engineering thermoplastic

Hot plate - Material:

Stainless steel

Water capacity:

380 mL

Time between each refill of the humidifier tub:

> 8 hours ±0.5 hours (tested at 23 ±2°C / 73.4 ± 3.6 °F)

Recommended water type to use in the humidifier tub
(Standard tub):

Distilled water (Americas only)

Humidifier tub - Material:	Injection molded plastic, stainless steel and silicone seal
----------------------------	---

65W power supply unit

AC input range	100-240v, 50-60Hz, 2.0A 115V, 400Hz, 1.5A (for aircraft use)
DC output	24 VDC \pm 1 VDC, 2.71A
Typical power consumption	56.1W (111.5VA)
Peak power consumption	73.2W (137.6VA)
Class of equipment	Class II

Environmental conditions

Operating temperature	+41°F to +95°F (+5°C to +35°C) Note: The airflow for breathing produced by this therapy device can be higher than the room temperature. Under extreme ambient temperature conditions (104°F/40°C) the device remains safe.
Operating humidity	10 to 95% relative humidity, non-condensing
Operating altitude	Sea level to 9,870' (3,010 m); air pressure range 1060 hPa to 700 hPa
Storage pressure/Storage altitude	1060 to 700 hPa relative humidity, non-condensing
Storage and transport temperature	-13°F to +158°F (-25°C to +70°C)
Storage and transport humidity	5 to 95% relative humidity, non-condensing

Air Filter

Standard:	Material: Polyester non woven fiber Average arrestance: >75%, when tested to EN779.
Hypoallergenic:	Material: Blended synthetic fibers in a polypropylene carrier Efficiency: >80% (average) when tested to EN13274-7. Note: The use of a ResMed approved hypoallergenic filter will result in a small reduction in the accuracy of the delivered pressure at high leaks.

Electromagnetic compatibility

The AirSense 11 complies with all applicable electromagnetic compatibility requirements (EMC) according to IEC 60601-1-2:2014, for residential, commercial and light industry environments.

Portable and mobile RF communications equipment should be used no closer to any part of the machine, including cables, than the recommended 3.94" (10 cm) separation distance.

The AirSense 11 has been designed to meet EMC standards. However, should you suspect that the device performance (eg. pressure or flow) is affected by other equipment, move the device away from the possible cause of interference.

Information regarding the electromagnetic emissions and immunity of this ResMed device can be found in [ResMed.com/downloads/devices](https://www.resmed.com/downloads/devices).

IEC 60601-1 (Edition 3.1) classification

Class II (double insulation), Type BF, Ingress protection IP22.

Supplemental oxygen maximum flow

15 L/min

Aircraft use

ResMed confirms that the machine meets the Federal Aviation Administration (FAA) requirements (RTCA/DO-160, section 21, category M; RTCA-DO-160, section 20, category T) for all phases of air travel.

Design life

Device, power supply unit:	5 years
Standard humidifier tub:	6 months
Air tubing:	6 months

General

The patient is an intended operator.

Pneumatic flow path

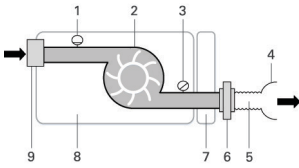

1. Flow sensor
2. Blower
3. Pressure sensor
4. Mask
5. Air tubing
6. Bacterial/viral filter
7. Humidifier
8. Device
9. Inlet filter

Displayed values

Value	Range	Accuracy	Display resolution
Pressure at mask:			
Displayed mask pressure ¹	4-20 cm H ₂ O (4-20 hPa)	±0.5 cm H ₂ O (0.5 hPa) ±4% of measured reading	0.1 cm H ₂ O (0.1 hPa)
Flow derived values:			
Leak ¹	0-120 L/min	± 12 L/min or 20% of reading whichever is greater, 0 to 60 L/min	1 L/min

¹ Results may be inaccurate in the presence of leaks or supplemental oxygen

Pressure accuracy

Maximum static pressure variation at 10 cm H₂O (10 hPa) according to ISO 80601-2-70:2015

Device with humidifier tub and air tubing: ±0.5 cm H₂O (±0.5 hPa)

Note: Refer to the relevant measurement uncertainty from the Measurement system uncertainties table.

Maximum dynamic pressure variation according to ISO 80601-2-70:2015

AirSense 11 with humidifier tub and air tubing

Breath rate	10 BPM	15 BPM	20 BPM
Dynamic pressure variation (cmH ₂ O [hPa])	0.5	0.5	0.8

Measurement system uncertainties

In accordance with ISO 80601-2-70:2015 the measurement uncertainty of the manufacturer's test equipment is:

For measures of flow:	± 3.9 L/min
For measures of static pressure:	± 0.15 cm H ₂ O (± 0.15hPa)
For measures of dynamic pressure:	± 0.04 cm H ₂ O (± 0.04hPa)

Note: ISO 80601-2-70:2015 stated accuracies and test results provided in this manual for these items already include the relevant measurement uncertainty from the table above.

In accordance with ISO 80601-2-74:2017 the measurement uncertainty of the manufacturer's test equipment is

For measures of humidification output	± 0.5 mg/L BTPS
---------------------------------------	-----------------

Bluetooth

Technology used:	Bluetooth Low Energy (BLE)
Connection types:	GATT
Frequency:	2400 to 2483.5 MHz
Max RF power output:	+4 dBm
Operation range:	10 m (Class 2)

Wireless module

Bluetooth

Technology used:	Bluetooth Low Energy (BLE)
Connection types:	GATT

Frequency:	2400 to 2483.5 MHz
Max RF power output:	+4 dBm
Operation range:	10 m (Class 2)

Cellular module

Technology used:	Frequencies (MHz)	Max RF power output (dBm)
2G	900/ 1800 *	33.0
3G	850/ 900/ 1700/ 1900/ 2100*	23.5
4G LTE Cat 1	700/ 850/ 1700/ 1900*	23.0

*Bands may not be available in all regions.

FCC ID: 2ACHL-AIR114G
IC: 9103A-AIR114G

The AirSense 11 device complies with FCC Rules and Industry Canada rules. Operation is subject to the following two conditions:

1. This device may not cause harmful interference; and
2. This device must accept any interference received, including interference that may cause undesired operation.

The AirSense 11 device should be installed and operated with minimum distance of 0.59" (15 mm) between the equipment and the user's body.

Additional information regarding the FCC Rules and IC compliance for this device can be found on ResMed.com/downloads/devices. In Canada, the device has been designed to comply with safety standards to radio waves (SAR) in accordance to RSS-102.

Humidifier

Maximum heater plate temperature:	154°F (68°C)
Temperature cut-out (heater):	165°F (74°C)
Maximum gas temperature (at mask) ¹ :	≤ 106°F (41°C)

¹ The air flow for breathing produced by this therapy device can be higher than the temperature of the room. Under extreme ambient temperature conditions (104°F/40°C) the device remains safe.

Humidifier performance
SlimLine/Standard tubing

Mask Pressure cm H ₂ O (hPa)	Nominal RH output % at 72°F (22°C) ambient temperature		Nominal system output mg/L AH ¹ , BTPS ²	
	Setting 4 (default setting)	Setting 8 (maximum setting)	Setting 4 (default setting)	Setting 8 ³ (maximum setting)
4	80%	100%	≥6	>12
10	80%	100%	≥6	>12
20	80%	100%	≥6	>12

Climate Control Auto - ClimateLineAir 11

Mask Pressure cm H ₂ O (hPa)	Nominal RH output % at 72°F (22°C) ambient temperature		Nominal system output mg/L AH ¹ , BTPS ²	
	4	85%		≥ 12
10	85%		≥ 12	
20	85%		≥ 12	

¹ AH - Absolute Humidity in mg/L

² BTPS - Body Temperature Pressure Saturated

³ Humidifier performance meets ISO 80601-2-74:2017 performance > 12 mg/L BTPS tested at 59°F to 95°F (15°C to 35°C)

Air tubing

	ClimateLineAir 11	SlimLine/ Standard
ClimateLineAir 11 temperature range	60 to 86°F (16 to 30°C)	-
ClimateLineAir 11 temperature cut out	≤106°F (≤41°C)	-
Maximum recommended pressure	30 cm H ₂ O (30 hPa)	30 cm H ₂ O (30 hPa)
Maximum working temperature, when used with a humidifier	-	≤106°F (≤41°C)
Material	Flexible plastic and electrical components	Flexible plastic
Inner diameter	0.6" (15 mm)	SlimLine: 0.6" (15 mm) Standard: 0.74" (19 mm)
Length	6'6" (2.0 m)	SlimLine: 6' (1.8 m) Standard: 6'6" (2.0 m)

Note: The manufacturer reserves the right to change these specifications without notice.

Air tubing resistance to flow and compliance information

Refer to the Air tubing compliance guide in ResMed.com.

Characteristics of compatible Bacterial/ Viral (B/V) filters







Resistance over the flow range:	Recommend a B/V filter with resistance of < 2.5cm H ₂ O at 60 L/min
Dead space (volume):	< 90 mL
Connectors:	ISO 5356-1:2015 compliant connectors
Bacterial Filtration Efficiency (ie BFE):	>99.9%
Viral Filtration Efficiency (ie VFE):	>99.7%
Maximum duration of use:	Refer to manufacturer's datasheet
Replacing B/V filter:	Refer to manufacturer's datasheet
Compliance:	< 0.103mL/ cm H ₂ O (<0.103mL/hPa)



















Note: B/V filters are high in impedance and show variability in their pneumatic characteristics that may affect delivered pressure and the accuracy of displayed and reported values

Applied parts

Patient interface (mask) and air tubing

Symbols

 Follow instructions before use.
  Indicates a warning or caution.
  Temperature limitation.
  Humidity limitation.
  Operating altitude.
  Atmospheric pressure limitation.
  Manufacturer.

 Direct current.
  Class II equipment.
  IP22 Protected against finger sized objects and against dripping water when tilted up to 15 degrees from specified orientation.
  Non-ionising radiation.
  MRI unsafe (do not use in the vicinity of an MRI device).
  RTCA/DO-160 Section 21, Category M Compliant & FAA Compliant.
  Type BF applied part.
  Date of Manufacture.
  Medical device.
  Catalog number.
  Device number.
  Serial number.
  Batch code.
  European Authorized Representative.
  Bluetooth.
  Start therapy/Standby.
  Rx Only Prescription only (In the US, Federal law restricts these devices to sale by or on the order of a physician).
  Distilled Water Only Use distilled water only.

MAX Maximum water level.
  Open tub to fill.

See symbols glossary at ResMed.com/symbols.



Environmental information

This device should be disposed of separately, not as unsorted municipal waste. To dispose of your device, you should use appropriate collection, reuse and recycling systems available in your region. The use of these collection, reuse and recycling systems is designed to reduce pressure on natural resources and prevent hazardous substances from damaging the environment.

If you need information on these disposal systems, please contact your local waste administration. The crossed-bin symbol invites you to use these disposal systems. If you require information on collection and disposal of your ResMed device please contact your ResMed office, local distributor or go to ResMed.com/environment.

California Perchlorate Information:

The coin-cell battery within this device may contain Perchlorate Material - special handling may apply.

See: www.dtsc.ca.gov/hazardouswaste/perchlorate

Limited warranty

ResMed Pty Ltd (hereafter 'ResMed') warrants that your ResMed product shall be free from defects in material and workmanship from the date of purchase for the period specified below.

Product	Warranty period
<ul style="list-style-type: none"> Mask systems (including mask frame, cushion, headgear and tubing)—excluding single-use devices Accessories—excluding single-use devices Flex-type finger pulse sensors Humidifier water tubs 	90 days
<ul style="list-style-type: none"> Batteries for use in ResMed internal and external battery systems 	6 months
<ul style="list-style-type: none"> Clip-type finger pulse sensors CPAP and bilevel device data modules Oximeters and CPAP and bilevel device oximeter adapters Humidifiers and humidifier cleanable water tubs Titration control devices 	1 year
<ul style="list-style-type: none"> CPAP, bilevel and ventilation devices (including external power supply units) Battery accessories Portable diagnostic/screening devices 	2 years

This warranty is only available to the initial consumer. It is not transferable.

During the warranty period, if the product fails under conditions of normal use, ResMed will repair or replace, at its option, the defective product or any of its components.

This limited warranty does not cover: a) any damage caused as a result of improper use, abuse, modification or alteration of the product; b) repairs carried out by any service organization that has not been expressly authorized by ResMed to perform such repairs; c) any damage or contamination due to cigarette, pipe, cigar or other smoke; and d) any damage caused by exposure to ozone, activated oxygen or other gasses.

Warranty is void on product sold, or resold, outside the region of original purchase.

Warranty claims on defective product must be made by the initial consumer at the point of purchase.

This warranty replaces all other expressed or implied warranties, including any implied warranty of merchantability or fitness for a particular purpose. Some regions or states do not allow limitations on how long an implied warranty lasts, so the above limitation may not apply to you.

ResMed shall not be responsible for any incidental or consequential damages claimed to have resulted from the sale, installation or use of any ResMed product. Some regions or states do not allow the exclusion or limitation of incidental or consequential damages, so the above limitation may not apply to you.

This warranty gives you specific legal rights, and you may also have other rights which vary from region to region. For further information on your warranty rights, contact your local ResMed dealer or ResMed office.

Visit [ResMed.com](https://www.resmed.com) for the latest information on ResMed's Limited Warranty.

Further information

If you require additional information on how to setup, use or maintain the Air11™ system (including ClimateLineAir 11 heated tubing), or to report unexpected operation or events, please contact the ResMed Service Centre or your care provider.



myAir™



ResMed Pty Ltd

MANUFACTURER 1 Elizabeth Macarthur Drive Bella Vista NSW 2153 Australia

See ResMed.com for other ResMed locations worldwide. Air11, AirSense, AirView, AutoSet, ClimateLineAir, HumidAir, myAir, SlimLine, EPR, ResScan and SmartStart are trademarks and/or registered trademarks of the ResMed family of companies. For patent and other intellectual property information, see ResMed.com/ip. SD Logo is a trademark of SD-3C, LLC. Google Play and the Google Play logo are trademarks of Google LLC. Apple and the Apple logo are trademarks of Apple Inc., registered in the U.S and other countries. App Store is a service mark of Apple Inc., registered in the U.S and other countries. CaviWipes1 is a registered trademark of Metrex Research, LLC. Alconox is a trademark of Alconox INC. CIDEX OPA is a trademark of ASP Global Manufacturing GmbH. The Bluetooth® word mark and logos are registered trademarks owned by Bluetooth SIG, Inc. and any use of such marks by ResMed is under license. © 2021 ResMed. 398230/2 2021-06

ResMed.com