

Pact Series

MasterPact MTZ - MicroLogic X Control Unit

User Guide

Pact Series offers world-class breakers and switches

DOCA0102EN-07
03/2021



Legal Information

The Schneider Electric brand and any trademarks of Schneider Electric SE and its subsidiaries referred to in this guide are the property of Schneider Electric SE or its subsidiaries. All other brands may be trademarks of their respective owners.

This guide and its content are protected under applicable copyright laws and furnished for informational use only. No part of this guide may be reproduced or transmitted in any form or by any means (electronic, mechanical, photocopying, recording, or otherwise), for any purpose, without the prior written permission of Schneider Electric.

Schneider Electric does not grant any right or license for commercial use of the guide or its content, except for a non-exclusive and personal license to consult it on an "as is" basis. Schneider Electric products and equipment should be installed, operated, serviced, and maintained only by qualified personnel.

As standards, specifications, and designs change from time to time, information contained in this guide may be subject to change without notice.

To the extent permitted by applicable law, no responsibility or liability is assumed by Schneider Electric and its subsidiaries for any errors or omissions in the informational content of this material or consequences arising out of or resulting from the use of the information contained herein.

Table of Contents

Safety Information.....	7
About the Book.....	9
Introduction to the MicroLogic X Control Unit	12
Pact Series Master Range.....	13
MicroLogic X Control Unit: Presentation	14
EcoStruxure Power Commission Software	22
EcoStruxure Power Device App.....	23
Password Management	26
MicroLogic X Control Unit: Optional Digital Modules	29
Go2SE Landing Page	32
MicroLogic X Control Unit: Purchasing and Installing a Digital Module	34
MicroLogic X Control Unit: Date and Time	38
MicroLogic X Control Unit: Power Supply.....	40
MicroLogic X Control Unit: Firmware Update.....	46
Using the MicroLogic X Human Machine Interface.....	48
MicroLogic X HMI Description.....	49
HMI Display Modes.....	52
Quick View Mode.....	53
Tree Navigation Mode.....	57
Protection Setting Procedure.....	64
Measures Menu	67
Alarms & History Menu	72
Maintenance Menu	74
Configuration Menu	76
Protection Menu	79
Pop-up Event Messages	85
Protection Functions.....	89
Introduction	90
Electrical Distribution Protection.....	91
Setting Protection in Accordance With UL489SE Standard.....	96
Standard Protection Functions.....	99
Long-Time Overcurrent Protection (L or ANSI 49RMS/51).....	100
Short-Time Overcurrent Protection (S or ANSI 50TD/51).....	104
Instantaneous Overcurrent Protection (I or ANSI 50)	107
Ground-Fault Protection (G or ANSI 50N-TD/51N).....	111
Earth-Leakage Protection (ANSI 50G-TD)	115
Neutral Protection	118
Dual Settings.....	120
Fallback Settings Mode	123
Zone Selective Interlocking (ZSI).....	125
Optional Protection Functions.....	129
Undervoltage Protection (ANSI 27).....	130
Overvoltage Protection (ANSI 59)	135
Under/Overfrequency Protection (ANSI 81).....	139
Reverse Active Power Protection (ANSI 32P).....	144
Ground-Fault Alarm (ANSI 51N/51G)	148

Energy Reduction Maintenance Settings (ERMS).....	151
IDMTL Overcurrent Protection (ANSI 51).....	158
Directional Overcurrent Protection (ANSI 67).....	164
Setting Guidelines	168
Protection Setting Guidelines	169
Setting the Long-Time Overcurrent Protection (L or ANSI 49RMS/ 51).....	171
Setting the Short-Time Overcurrent Protection (S or ANSI 50TD/ 51).....	174
Setting the Instantaneous Overcurrent Protection (I or ANSI 50).....	176
Setting the IDMTL Overcurrent Protection.....	177
Setting the Directional Overcurrent Protection (ANSI67)	181
Selectivity.....	184
Metering Functions	186
Standard Metering Functions.....	187
Measurement Accuracy in Accordance with IEC61557-12.....	188
Measurement Characteristics	193
Measurement Availability.....	199
Network Settings	207
Real-Time Measurements	208
Calculating Demand Values	212
Power Metering	214
Power Calculation Algorithm.....	216
Energy Metering	218
Total Harmonic Distortion.....	220
Power Factor PF and $\cos \varphi$ Measurement	223
Optional Metering Functions.....	228
Energy per Phase	229
Individual Harmonics Analysis	231
Maintenance and Diagnostic Functions	234
Standard Maintenance and Diagnostic Functions.....	235
Maintenance Tools.....	236
Assistance	237
Maintenance Schedule.....	238
Health State	242
Monitoring the Circuit Breaker	243
Monitoring the Tripping Circuit.....	244
Monitoring the Internal Functioning of the MicroLogic X Control Unit.....	247
Monitoring the Circuit Breaker Service Life.....	252
Monitoring the MicroLogic X Control Unit Service Life.....	253
Monitoring the Opening/Closing Function	254
Monitoring the Contact Wear	257
Monitoring the Load Profile	259
Monitoring the Operating Time	260
Circuit Breaker Overview	261
Optional Maintenance and Diagnostic Functions.....	262
Power Restoration Assistant Digital Module	263
MasterPact Operation Assistant Digital Module	265
Waveform Capture on Trip Event Digital Module.....	267

IEC 61850 for MasterPact MTZ	270
Modbus Legacy Dataset Digital Module	272
Operation Functions	273
Control Modes.....	274
Opening Function	279
Closing Function.....	283
Communication Functions	289
Bluetooth® Low Energy Communication	290
NFC Communication	293
USB On-The-Go (OTG) Connection	295
USB Connection.....	296
Cybersecurity Recommendations	298
Event Management	301
Event Definition	302
Event Type.....	304
Event Notifications.....	309
Event Display	311
Event History.....	312
Event List.....	314
Appendices	325
Appendix A	326
Licensing Information	326
Appendix B	328
MicroLogic Xi Control Unit: Description	328

Safety Information

Important Information

Read these instructions carefully, and look at the equipment to become familiar with the device before trying to install, operate, service, or maintain it. The following special messages may appear throughout this documentation or on the equipment to warn of potential hazards or to call attention to information that clarifies or simplifies a procedure.



The addition of this symbol to a “Danger” or “Warning” safety label indicates that an electrical hazard exists which will result in personal injury if the instructions are not followed.



This is the safety alert symbol. It is used to alert you to potential personal injury hazards. Obey all safety messages that follow this symbol to avoid possible injury or death.

DANGER

DANGER indicates a hazardous situation which, if not avoided, **will result in** death or serious injury.

WARNING

WARNING indicates a hazardous situation which, if not avoided, **could result in** death or serious injury.

CAUTION

CAUTION indicates a hazardous situation which, if not avoided, **could result in** minor or moderate injury.

NOTICE

NOTICE is used to address practices not related to physical injury.

Please Note

Electrical equipment should be installed, operated, serviced, and maintained only by qualified personnel. No responsibility is assumed by Schneider Electric for any consequences arising out of the use of this material.

A qualified person is one who has skills and knowledge related to the construction and operation of electrical equipment and its installation, and has received safety training to recognize and avoid the hazards involved.

CYBERSECURITY SAFETY NOTICE

▲ WARNING

POTENTIAL COMPROMISE OF SYSTEM AVAILABILITY, INTEGRITY, AND CONFIDENTIALITY

- Change default passwords at first use to help prevent unauthorized access to device settings, controls, and information.
- Disable unused ports/services and default accounts to help minimize pathways for malicious attackers.
- Place networked devices behind multiple layers of cyber defenses (such as firewalls, network segmentation, and network intrusion detection and protection).
- Use cybersecurity best practices (for example, least privilege, separation of duties) to help prevent unauthorized exposure, loss, modification of data and logs, or interruption of services.

Failure to follow these instructions can result in death, serious injury, or equipment damage.

About the Book

Document Scope

The aim of this guide is to provide users, installers, and maintenance personnel with the technical information needed to operate MicroLogic™ X control units in MasterPact™ MTZ circuit breakers.

MicroLogic X control units exist in two ranges:

- Control units for IEC standard: MicroLogic 2.0 X, 5.0 X, 6.0 X, 7.0 X
- Control units for UL standard: MicroLogic 3.0 X, 5.0 X, 6.0 X

This guide applies to the following MicroLogic X control units.

Standard	Control units	Commercial reference
IEC	MicroLogic 2.0 X	LV847600
	MicroLogic 5.0 X	LV847602
	MicroLogic 6.0 X	LV847603
	MicroLogic 7.0 X	LV847604
UL	MicroLogic 3.0 X	LV848815
	MicroLogic 5.0 X	LV847609
	MicroLogic 6.0 X	LV847608
<p>NOTE: The commercial reference is printed on the front face of the MicroLogic X control unit. It also identifies the standard, IEC or UL.</p>		

NOTE: This guide also applies to MicroLogic™ Xi control units. A MicroLogic Xi control unit is a MicroLogic X control unit without Bluetooth® Low Energy communication.

All the information related to the MicroLogic X control units presented in this guide applies to MicroLogic Xi control units except information about Bluetooth Low Energy communication.

The specific features of the MicroLogic Xi control units are described in the appendix, page 328.

Validity Note

This guide applies to MicroLogic X control units:

- With firmware version 004.000.000 or greater
- With hardware version 001.000.000 or greater

For a MicroLogic X control unit with a lower firmware version, refer to DOCA0144EN *MasterPact MTZ - MicroLogic X Control Unit - Firmware Release Note* for a description of the new features and bugs fixed in subsequent firmware versions.

If required, contact your Customer Care Centre to obtain the version of this guide that corresponds to the firmware version of your MicroLogic X control unit.

Online Information

The information contained in this guide is likely to be updated at any time. Schneider Electric strongly recommends that you have the most recent and up-to-date version available on www.se.com/ww/en/download.

The technical characteristics of the devices described in this guide also appear online. To access the information online, go to the Schneider Electric home page at www.se.com.

Related Documents for IEC Devices

Title of documentation	Reference number
<i>MasterPact MTZ Catalogue</i>	LVPED216026EN
<i>MasterPact MTZ1 - IEC Circuit Breakers and Switch-Disconnectors - User Guide</i>	DOCA0100EN
<i>MasterPact MTZ2/MTZ3 - IEC Circuit Breakers and Switch-Disconnectors - User Guide</i>	DOCA0101EN
<i>MasterPact MTZ - IEC Circuit Breakers and Switch-Disconnectors - Maintenance Guide</i>	DOCA0099EN
<i>MasterPact MTZ - Modbus Communication Guide</i>	DOCA0105EN
<i>MasterPact MTZ - IEC 61850 Communication Guide</i>	DOCA0162EN
<i>MasterPact, ComPact, PowerPact - Cybersecurity Guide</i>	DOCA0122EN
<i>ULP System for MasterPact and ComPact (IEC Standard) - User Guide</i>	DOCA0093EN
<i>Enerlin'X IO - Input/Output Application Module for One IEC Circuit Breaker - User Guide</i>	DOCA0055EN
<i>Enerlin'X EIFE - Embedded Ethernet Interface for One MasterPact MTZ Drawout Circuit Breaker - User Guide</i>	DOCA0106EN
<i>Enerlin'X IFE - Ethernet Switchboard Server - User Guide</i>	DOCA0084EN
<i>Enerlin'X IFE - Ethernet Interface for One IEC Circuit Breaker - User Guide</i>	DOCA0142EN
<i>Enerlin'X FDM128 - Ethernet Display for Eight Devices - User Guide</i>	DOCA0037EN
<i>Complementary Technical Information</i>	LVPED318033EN
<i>MasterPact MTZ - MicroLogic X Control Unit - Firmware Release Note</i>	DOCA0144EN
<i>MicroLogic Trip Units and Control Units - Firmware History</i>	DOCA0155EN
<i>How Can I Reduce Vulnerability to Cyber Attacks?</i>	Cybersecurity System Technical Note

You can download these technical publications and other technical information from our website at www.se.com/www/en/download.

Related Documents for UL/ANSI Devices

Title of documentation	Reference number
<i>MasterPact MTZ - Circuit Breakers and Switches - Catalog</i>	0614CT1701EN
<i>MasterPact MTZ1 - UL Rated/ANSI Certified 800 to 1600 A Circuit Breakers and Switches - User Guide</i>	0614IB1702EN
<i>MasterPact MTZ2/MTZ3 - UL Rated/ANSI Certified 800 to 6000 A Circuit Breakers and Switches - User Guide</i>	0614IB1701EN
<i>MasterPact MTZ - Modbus Communication Guide</i>	DOCA0105EN
<i>MasterPact MTZ - IEC 61850 Communication Guide</i>	DOCA0162EN
<i>MasterPact, ComPact, PowerPact - Cybersecurity Guide</i>	DOCA0122EN
<i>ULP System (UL Standard) - User Guide</i>	0602IB1503 (EN)
<i>Enerlin'X IO - Input/Output Application Module for One UL Circuit Breaker - User Guide</i>	0613IB1317 (EN)
<i>Enerlin'X EIFE - Embedded Ethernet Interface for One MasterPact MTZ Drawout Circuit Breaker - User Guide</i>	DOCA0106EN
<i>Enerlin'X IFE - Ethernet Switchboard Server - User Guide</i>	1040IB1401 (EN)
<i>Enerlin'X IFE - Ethernet Interface for One UL Circuit Breaker - User Guide</i>	0602IB1801EN
<i>Enerlin'X FDM128 - Ethernet Display for Eight Devices - User Guide</i>	DOCA0037EN
<i>MasterPact MTZ - MicroLogic X Control Unit - Firmware Release Note</i>	DOCA0144EN

Title of documentation	Reference number
<i>MicroLogic Trip Units and Control Units - Firmware History</i>	DOCA0155EN
<i>How Can I Reduce Vulnerability to Cyber Attacks?</i>	Cybersecurity System Technical Note

You can download these technical publications and other technical information from our website at www.se.com/ww/en/download.

Introduction to the MicroLogic X Control Unit

What's in This Part

Pact Series Master Range	13
MicroLogic X Control Unit: Presentation	14
EcoStruxure Power Commission Software	22
EcoStruxure Power Device App.....	23
Password Management	26
MicroLogic X Control Unit: Optional Digital Modules	29
Go2SE Landing Page	32
MicroLogic X Control Unit: Purchasing and Installing a Digital Module	34
MicroLogic X Control Unit: Date and Time	38
MicroLogic X Control Unit: Power Supply	40
MicroLogic X Control Unit: Firmware Update	46

Pact Series Master Range

Future-proof your installation with Schneider Electric's low-voltage and medium-voltage Pact Series. Built on legendary Schneider Electric innovation, the Pact Series comprises world-class circuit breakers, switches, residual current devices and fuses, for all standard and specific applications. Experience robust performance with Pact Series within the EcoStruxure-ready switchgear, from 16 to 6300 A in low-voltage and up to 40.5 kV in medium-voltage.

MicroLogic X Control Unit: Presentation

MicroLogic X Control Units for IEC and UL Standards - Overview

MasterPact MTZ circuit breakers with MicroLogic X control units provide functions of protection, metering, diagnostics, communication, and remote operation. The control unit can be customized with optional Digital Modules, page 29.

MicroLogic X control units allow operation and monitoring of MasterPact MTZ circuit breakers locally or remotely.

The MicroLogic X control units for IEC standard are:

- MicroLogic 2.0 X
- MicroLogic 5.0 X
- MicroLogic 6.0 X
- MicroLogic 7.0 X

The MicroLogic X control units for UL standard are:

- MicroLogic 3.0 X
- MicroLogic 5.0 X
- MicroLogic 6.0 X

Convention

Unless specifically indicated as follows, the information in this guide is valid for both IEC and UL standards:

- Information indicated for *MicroLogic 5.0 X IEC* and *MicroLogic 6.0 X IEC* is valid only for the IEC standard.
- Information indicated for *MicroLogic 5.0 X UL* and *MicroLogic 6.0 X UL* is valid only for the UL standard.

For this guide, electrical phases described as *phase 1*, *phase 2*, *phase 3* cover both IEC standard and UL standard, with the following equivalence:

IEC standard	UL standard
Phase 1	Phase a
Phase 2	Phase b
Phase 3	Phase c

Range of MicroLogic X Control Units for IEC Standard

The following table indicates the standard functions available on MasterPact MTZ circuit breakers with MicroLogic X control units for IEC standard:

	MicroLogic 2.0 X	MicroLogic 5.0 X	MicroLogic 6.0 X	MicroLogic 7.0 X
Commercial reference	LV847600	LV847602	LV847603	LV847604
Long-time overcurrent protection (L)	✓	✓	✓	✓
Short-time overcurrent protection (S)	–	✓	✓	✓
Instantaneous overcurrent protection (I)	✓	✓	✓	✓
Ground-fault protection (G)	–	–	✓	–

	MicroLogic 2.0 X	MicroLogic 5.0 X	MicroLogic 6.0 X	MicroLogic 7.0 X
Earth-leakage protection (V)	–	–	–	✓
Neutral protection	✓	✓	✓	✓
Dual settings	✓	✓	✓	✓
Overcurrent and trip cause indicators	✓	✓	✓	✓
Zone selective interlocking	–	✓	✓	✓
Trip history	✓	✓	✓	✓
Setting change traceability	✓	✓	✓	✓
Embedded power meter class 1	✓	✓	✓	✓
Embedded diagnostics	✓	✓	✓	✓

NOTE: The commercial reference is printed on the front face of the MicroLogic X control unit and also identifies the standard, IEC or UL.

Range of MicroLogic X Control Units for UL Standard

The following table indicates the standard functions available on MasterPact MTZ circuit breakers with MicroLogic X control units for UL standard:

	MicroLogic 3.0 X	MicroLogic 5.0 X	MicroLogic 6.0 X
Commercial reference	LV848815	LV847609	LV847608
Long-time overcurrent protection (L)	✓	✓	✓
Short-time overcurrent protection (S)	–	✓	✓
Instantaneous overcurrent protection (I)	✓	✓	✓
Ground-fault protection (G)	–	–	✓
Earth-leakage protection (V)	–	–	–
Neutral protection	✓	✓	✓
Dual settings	✓	✓	✓
Overcurrent and trip cause indicators	✓	✓	✓
Zone selective interlocking	–	✓	✓
Trip history	✓	✓	✓
Setting change traceability	✓	✓	✓
Embedded power meter class 1	✓	✓	✓
Embedded diagnostics	✓	✓	✓

NOTE: The commercial reference is printed on the front face of the MicroLogic X control unit and also identifies the standard, IEC or UL.

Communication

MicroLogic X control units support wireless and wired communication and enable local and network communication.

Local communication includes:

- Wireless connection to a smartphone running the EcoStruxure Power Device app, page 23 through:

- Bluetooth Low Energy
- NFC
- Wired connection via the mini USB port to:
 - A smartphone running the EcoStruxure Power Device app, page 23 through USB OTG connection
 - A PC running EcoStruxure Power Commission software

Network communication includes:

- Wired connection via the ULP port module (optional) to
 - Ethernet communication network with Modbus TCP/IP and/or IEC 61850 protocols
 - Serial Line communication network with Modbus-SL protocol

MicroLogic X Control Units in Smart Panels

MasterPact circuit breakers with MicroLogic X control units, in conjunction with Enerlin'X, provide simple and reliable access to data from a smartphone or PC.

MicroLogic X control units communicate using:

- Modbus TCP/IP protocol on Ethernet through an IFE server, or an IFE or EIFE interface
- Modbus TCP/IP and IEC 61850 protocols on Ethernet through an IFE or EIFE interface
- Modbus-SL protocol through an IFM interface with reference LV434000 (IFM interface with reference TRV00210 is not compatible with MasterPact MTZ circuit breakers).
- Bluetooth Low Energy or NFC for a wireless connection to the EcoStruxure Power Device app
- The mini USB port to connect to:
 - A PC running EcoStruxure Power Commission software
 - A smartphone running the EcoStruxure Power Device app (USB OTG connection)
- A Com'X energy server and Ethernet to connect to the Internet

The following diagram shows how MicroLogic X control units communicate within a digital system:

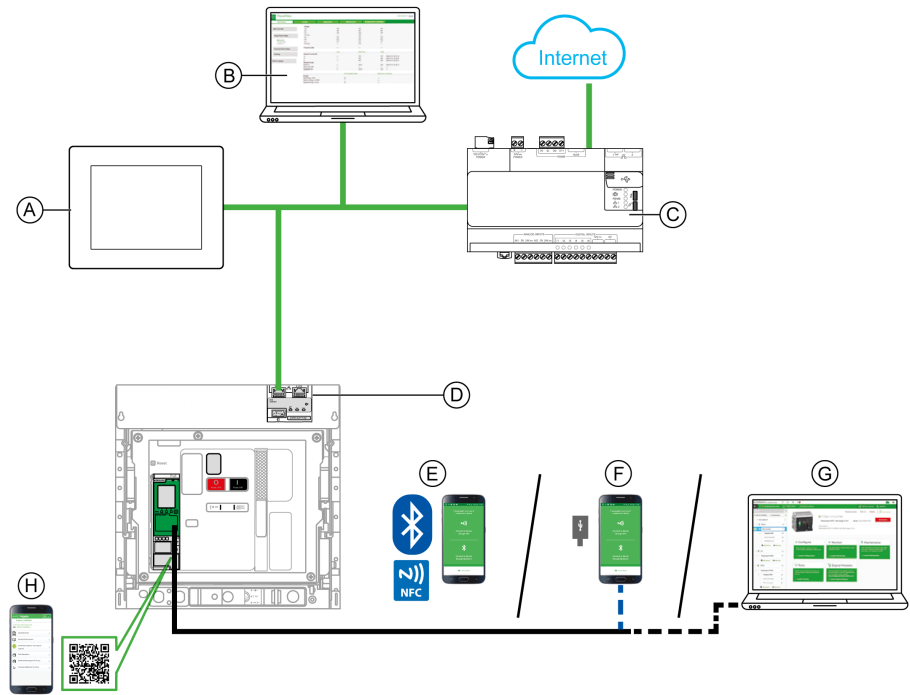

- Ethernet
- USB
- - USB OTG connection

- A** FDM128 Ethernet display for eight devices
- B** IFE/EIFE webpages
- C** Com'X energy server
- D** EIFE interface
- E** EcoStruxure Power Device app through Bluetooth Low Energy or NFC wireless communication
- F** EcoStruxure Power Device app through USB OTG connection
- G** EcoStruxure Power Commission software
- H** Go2SE landing page

MicroLogic X Control Unit: Description

Introduction

The MicroLogic X control unit includes:

- LEDs to monitor the status of the circuit breaker
- A local Human Machine Interface comprising a graphic display with colored backlight, contextual buttons, and dedicated buttons
- LEDs to monitor the cause of trips and alarms

Control Unit Description

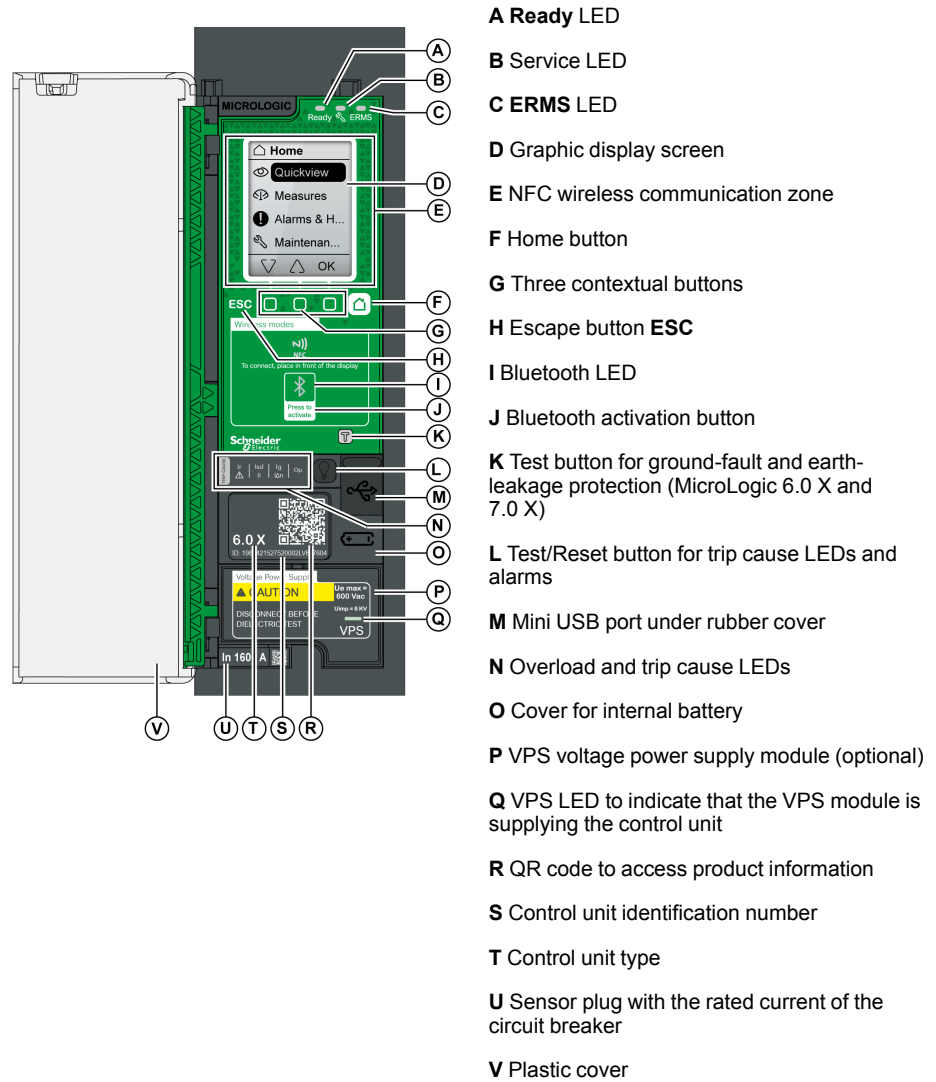

Status LEDs

LED	Description
Ready	The Ready LED blinks slowly when the standard protection functions of the control unit are operational.
	The service LED alerts the user to the health state of the circuit breaker. <ul style="list-style-type: none"> Orange LED: medium severity detected alarm that requires non-urgent maintenance action. Red LED: high severity detected alarm that requires immediate maintenance action.
ERMS	The ERMS (Energy Reduction Maintenance Setting) LED has the following statuses: <ul style="list-style-type: none"> Blue LED: ERMS engaged Off LED: ERMS disengaged

Display Screen with Contextual Buttons and Dedicated Buttons

The local HMI screen and buttons, page 49 are used to:

- Navigate the menu structure.
- Display monitored values.
- Access and edit configuration settings.

NFC Communication Zone

The NFC communication zone is used to establish an NFC connection, page 293 between a smartphone running the EcoStruxure Power Device app and the MicroLogic X control unit. When the connection is established, the circuit breaker operating data is automatically uploaded to the smartphone.

Bluetooth Activation Button and LED

The Bluetooth activation button is used to establish a Bluetooth Low Energy connection, page 291 between a smartphone running the EcoStruxure Power Device app and the MicroLogic X control unit. When the connection is established, the circuit breaker can be monitored and controlled from the smartphone.



When the Bluetooth LED is blinking, it indicates that the MicroLogic X control unit is in communication with a Bluetooth device.



Test Button

The test button is used to test the ground-fault protection for MicroLogic 6.0 X, page 113 and the earth-leakage protection for MicroLogic 7.0 X, page 116.

Overload and Trip Cause LEDs

The indications of the four trip cause LEDs depend on the type of MicroLogic X control unit.

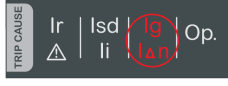
LEDs	Description
	• MicroLogic 2.0 X, 3.0 X, 5.0 X, 6.0 X, 7.0 X: Overload pre-alarm, the load exceeds 90% and is lower than 105% of the Ir setting of the long-time protection.
	• MicroLogic 2.0 X, 3.0 X, 5.0 X, 6.0 X, 7.0 X: Overload alarm, the load exceeds 105% of the Ir setting of the long-time protection.
	• MicroLogic 2.0 X, 3.0 X, 5.0 X, 6.0 X, 7.0 X: Trip due to long-time protection.

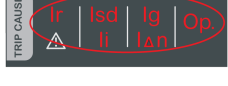
LEDs	Description
	<ul style="list-style-type: none"> MicroLogic 2.0 X, 3.0 X: Trip due to instantaneous protection. MicroLogic 5.0 X, 6.0 X, 7.0 X: Trip due to short-time protection or instantaneous protection.
	<ul style="list-style-type: none"> MicroLogic 2.0 X, 3.0 X, 5.0 X: Not applicable. MicroLogic 6.0 X: Trip due to ground-fault protection. MicroLogic 7.0 X: Trip due to earth-leakage protection.
	<ul style="list-style-type: none"> MicroLogic 2.0 X, 3.0 X, 5.0 X, 6.0 X, 7.0 X: Trip due to optional protections.
	<ul style="list-style-type: none"> MicroLogic 2.0 X, 3.0 X, 5.0 X, 6.0 X, 7.0 X: Invalid control unit self test.

NOTE: If the MicroLogic X control unit is not powered, the trip cause LEDs go off after 4 hours. After this period, press the Test/Reset button to light them again.

Test/Reset Button

The Test/Reset button performs the following functions:

- Test of the internal battery or check LED functionality: press and hold the Test/Reset button for less than 3 seconds, the four trip cause LEDs switch off for one second. One of the following results:
 - The four trip cause LEDs switch on for two seconds: the battery is OK.
 - The four trip cause LEDs flash sequentially for two seconds: the battery is near the end of its life. Replace the battery.
 - The four trip cause LEDs do not light: replace the battery.

NOTE: This test must be carried out immediately after the replacement of the internal battery to check the correct functioning of the new battery. It can then be carried out at any time in the life of the internal battery.
- Reset of the latched events: press and hold the Test/Reset button for more than 3 seconds to reset the latched events. The trip cause LEDs and the service LED switch off.

Mini USB Port

Remove the rubber cover of the mini USB port to connect the following devices:

- A Mobile Power Pack to supply power to the MicroLogic X control unit, page 44.
- A smartphone running the EcoStruxure Power Device app through USB OTG connection, page 295.
- A PC running EcoStruxure Power Commission software, page 296.

NOTE: The MicroLogic X control unit does not support USB keys. Even if a USB key is connected using an adapter, data is not transferred.

QR Code

When the QR code on the front face of a MicroLogic X control unit is scanned with a smartphone running a QR code reader and connected to the Internet, the Go2SE landing page is displayed, page 32. The landing page displays some information about the device and a list of menus.

Control Unit Identification Number

The identification number is made up as follows:

- The serial number of the MicroLogic X control unit in the format FFFFFFFYWWDLXXXX
- The commercial reference of the control unit in the format LV8•••••

Use the identification number to register your MicroLogic X control unit through mySchneider app, the customer care mobile application.

Registering your MicroLogic X control unit enables you to keep your records up to date and enables traceability.

Control Unit Type

This code indicates the type of MicroLogic control unit, page 14:

- The number (for example, 6.0) defines the types of protection provided by the control unit.
- The letter (X) identifies the range of the control unit.

Internal Battery

The internal battery, page 44 powers the trip cause LEDs and the main diagnostic functions in the absence of any other power supply.

VPS Voltage Power Supply Module

The VPS module, page 41 provides an internal voltage supply to the MicroLogic X control unit.

The VPS module is optional for MicroLogic 2.0 X, 3.0 X, 5.0 X, and 6.0 X. It is installed as standard on MicroLogic 7.0 X.

Sensor Plug

The protection ranges depend on the rated current I_n , defined by the sensor plug, page 91 present below the MicroLogic X control unit.

EcoStruxure Power Commission Software

Overview

EcoStruxure Power Commission software helps you to manage a project as part of testing, commissioning, and maintenance phases of the project life cycle. The innovative features in it provide simple ways to configure, test, and commission the smart electrical devices.

EcoStruxure Power Commission software automatically discovers the smart devices and allows you to add the devices for an easy configuration. You can generate comprehensive reports as part of Factory Acceptance Test and Site Acceptance Test to replace your heavy manual work. Additionally, when the panels are under operation, any change of settings made can be easily identified by a yellow highlighter. This indicates the difference between the project and device values, and hence provides a system consistency during the operation and maintenance phase.

The EcoStruxure Power Commission software enables the configuration of the MasterPact MTZ devices with:

- MicroLogic X control unit
- Communication interface modules: IFE, EIFE, and IFM interfaces
- IO application modules
- M2C output module

For more information, refer to the *EcoStruxure Power Commission Online Help*.

The EcoStruxure Power Commission software is available at www.se.com.

Key Features

EcoStruxure Power Commission software performs the following actions for the supported devices and modules:

- Create projects by device discovery
- Save the project in the EcoStruxure Power Commission cloud for reference
- Upload settings to the device and download settings from the device
- Compare the settings between the project and the device
- Perform control actions in a secured way
- Generate and print the device settings report
- Perform a communication wiring test on the entire project and generate and print test report
- View the communication architecture between the devices in a graphical representation
- View the measurements, logs, and maintenance information
- Export Waveform Capture on Trip Event (WFC)
- View the status of device and IO module
- View the alarm details
- Buy, install, uninstall, or retrieve the Digital Modules
- Check the system firmware compatibility status
- Update to the latest device firmware
- Perform force trip test, and automatic trip curve tests with preconfigured or custom test points
- Perform arc energy reduction tests in compliance with NEC 240.87(C)
- Declare MasterPact MTZ accessories

EcoStruxure Power Device App

Presentation

EcoStruxure™ Power Device app is a single mobile application with the necessary information and capabilities to operate and efficiently maintain devices in the EcoStruxure architecture.

The application enables you to connect to devices, including the following:

- MasterPact MTZ circuit breakers
- TeSys GV4 motor circuit breakers
- Easergy P3 protection relays

The application can be installed on a smartphone by downloading the application from:

- Google Play Store for Android smartphones
- App Store for iOS smartphones

MasterPact MTZ Devices in EcoStruxure Power Device App

With the EcoStruxure Power Device app, a smartphone can be used with MasterPact MTZ devices as the primary interface for day-to-day and critical case maintenance. The MicroLogic X control unit is identified on the application by scanning the QR code on the device.

When the EcoStruxure Power Device app is used in conjunction with a Digital Module, additional functions are available:





- With the Power Restoration Assistant Digital Module, tutorials are available, providing information about restoring power and identifying the causes of trips.
- With the MasterPact Operation Assistant Digital Module, remote control of the circuit breaker is available.

Wireless communication is available by Bluetooth and NFC communication. A USB OTG connection is also available.

Using a Bluetooth Low Energy Connection

The MicroLogic X control unit must be powered to establish a Bluetooth Low Energy connection.

Using EcoStruxure Power Device app with a Bluetooth Low Energy connection gives access to and allows sharing of the information types organized in the following tabs:

-  **Quick View:** gives an overview of current values per phase, the health state of the circuit breaker, and recent event history.
-  **Metering:** displays values of RMS current, RMS voltages, network, and energy in real time.
-  **Protection Setting:** displays settings currently selected and allows modification of settings.
-  **Maintenance and Diagnostic:**
 - Displays maintenance reminder, service life, actuator wear, contact wear, and diagnostic counters.

- Interprets contact wear to estimate the circuit breaker ability to isolate, withstand rated duty, operate, and trip.
-  **Status and Control:**
 - Displays status of the circuit breaker.
 - Allows opening and closing operations to be carried out when the MasterPact Operation Assistant Digital Module is installed.





When Digital Modules, page 29 are installed on the MicroLogic X control unit, additional information is available.

For more information, refer to the Bluetooth Low Energy connection procedure, page 291.

Using a USB OTG (On-The-Go) Connection

The MicroLogic X control unit can be powered by a smartphone using the USB OTG connection, if necessary.

Using EcoStruxure Power Device app with a USB OTG connection gives access to and allows sharing of the following information types organized in the following tabs:

-  **Quick View:** gives an overview of current values per phase, the health state of the circuit breaker, and recent event history.
-  **Metering:** displays values of current, RMS voltages, network, and energy in real time.
-  **Protection Setting:** displays settings currently selected and allows modification of settings.
-  **Maintenance and Diagnostic:**
 - Displays maintenance reminder, service life, actuator wear, contact wear, and diagnostic counters.
 - Interprets contact wear to estimate the circuit breaker ability to isolate, withstand rated duty, operate, and trip.
-  **Status and Control:**
 - Displays status of the circuit breaker.
 - Allows opening and closing operations to be carried out when the MasterPact Operation Assistant Digital Module is installed.

When Digital Modules, page 29 are installed on the MicroLogic X control unit, additional information is available.

For more information, refer to the USB OTG (On-The-Go) connection procedure, page 295.

Using an NFC Connection

Connecting to EcoStruxure Power Device app with an NFC connection is always possible, even when the MicroLogic X control unit is not powered. It gives access to the following information:

- Information about the MicroLogic X control unit
- Last trip context: trip type; date and time of last trip; current values before trip
- Protection settings (display only)

- Access to Power Restoration Assistant or MasterPact Operation Assistant Digital Modules, page 30

For more information, refer to the NFC connection procedure, page 293.

Password Management

General Description

Remote access to data on MicroLogic control units and the ULP modules of the IMU is protected by password. Remote access includes:

- EcoStruxure Power Device app
- EcoStruxure Power Commission software
- FDM128 display
- The communication network
- IFE/EIFE webpages

The following four profiles are defined for remote access. An IMU has a different password for each user profile:

- Administrator
- Services
- Engineer
- Operator

The following table shows the functions allowed for each user profile:

User profile	Monitoring	Com. and IP	Settings	Operation	Reset counters	Test	Recovery function
Administrator	✓	✓	✓	✓	✓	✓	✓
Services	✓	✓	✓	✓	✓	✓	–
Engineer	✓	✓	✓	✓	–	✓	–
Operator	✓	✓	–	✓	✓	–	–
No password	✓	–	–	–	–	–	–

The following table describes the functions:

Function	Description
Monitoring	Read all settings, measurements, and data
Com. and IP	Change communication settings and IP address
Settings	Change all MicroLogic X control unit settings (except communication settings)
Operation	<ul style="list-style-type: none"> • Open, close and reset circuit breaker • Engage and disengage ERMS function • Select active curve • Inhibit circuit breaker closing
Reset counters	<ul style="list-style-type: none"> • Reset minimum and maximum values • Reset energy and operation counters
Test	Send test commands
Recovery function	<ul style="list-style-type: none"> • Reset Administrator password • Force ERMS unlock

The following table indicates which functions can be performed through the different remote access paths:

Function	Remote access path				
	EcoStruxure Power Device app	EcoStruxure Power Commission software	FDM128 display	Communication network	IFE/EIFE webpages
Monitoring	✓	✓	✓	✓	✓
Com. and IP	–	✓	–	–	✓
Settings	✓	✓	✓	✓	✓
Operation	✓	✓	✓	✓	✓
Reset counters	✓	✓	–	✓	✓
Test	–	✓	–	–	–
Recovery function	✓	✓	–	–	–

Default Passwords

<p>▲ WARNING</p> <p>POTENTIAL COMPROMISE OF SYSTEM AVAILABILITY, INTEGRITY, AND CONFIDENTIALITY</p> <p>Change default passwords at first use to help prevent unauthorized access to device settings, controls, and information.</p> <p>Failure to follow these instructions can result in death, serious injury, or equipment damage.</p>
--

The default password for each user profile is as follows:

User profile	Default password
Administrator	'0000' = 0x30303030
Services	'1111' = 0x31313131
Engineer	'2222' = 0x32323232
Operator	'3333' = 0x33333333

Changing a Password

A password can be changed with EcoStruxure Power Commission software, page 22.

Entering the current password for a given user profile is required to change the password of this user profile. Entering the Administrator password enables you to change the password of any user profile.

A password is composed of exactly 4 ASCII characters. It is case-sensitive and the allowed characters are:

- Digits from 0 to 9
- Letters from a to z
- Letters from A to Z

IMU Passwords

The MicroLogic X control unit and the ULP modules of the IMU must be protected by the same passwords.

When using EcoStruxure Power Commission software to change a password, the password is changed in the MicroLogic X control unit and the ULP modules of the IMU.

It is compulsory to assign the current IMU passwords to a new module in the IMU in the following cases:

- Addition of a new ULP module in the IMU.
- Replacement of the MicroLogic X control unit or of one of the ULP modules in the IMU.

Use EcoStruxure Power Commission software to change the passwords of a new module to the current IMU passwords.

Example:

An IO module is added to an IMU consisting of a MicroLogic X control unit and an IFE interface. The IO module has the default passwords, for example, Administrator = 0000.

The current IMU Administrator password = 4321.

Use EcoStruxure Power Commission software to change the default Administrator password of the IO module (0000) to the IMU Administrator password (4321).

Modify the other default passwords of the IO module in the same way, changing them to the passwords of the current IMU.

Password Reset

In the case that the Administrator password of the IMU is lost or forgotten, the password can be reset to the default password with EcoStruxure Power Commission software, page 22 and the support of the Schneider Electric Customer Care Center.

MicroLogic X Control Unit: Optional Digital Modules

Presentation

Digital Modules are optional modules that extend the features available across the range of MicroLogic X control units.

Digital Modules can be purchased and installed on the MicroLogic X control unit without changing the hardware or disrupting operations:

- When the MasterPact MTZ circuit breaker is initially ordered. They are pre-installed and functional when the MasterPact MTZ circuit breaker is delivered.
- At any time after the initial order by accessing the GoDigital marketplace, page 34.

Check the compatibility of the MicroLogic X control unit firmware with Digital Modules in the following tables. Update the firmware version of the MicroLogic X control unit if it is not compatible with the Digital Module required, page 46.

Check the compatibility of communication interfaces (IFE/EIFE interfaces, IFM interface) with Digital Modules in the tables, page 31. Update the firmware version of the communication interface if it is not compatible with the Digital Module required.

NOTE: The standard protection functions of a MicroLogic X control unit cannot be upgraded by purchasing a Digital Module. For example, it is not possible to convert a MicroLogic 5.0 X control unit to a MicroLogic 6.0 X control unit. This type of upgrade requires replacing the MicroLogic X control unit.

Digital Modules for Protection Functions

The following table presents the Digital Modules for protection functions, with the minimum MicroLogic X firmware version needed for the Digital Module to function:

Digital Module	Commercial reference	Description	MicroLogic X firmware version
ANSI 27/59 - Under/Over voltage protection	LV850012	Provides protection for generators, monitors phase-to-phase or phase-to-neutral voltages, and trips as follows: <ul style="list-style-type: none"> • When voltages are below setting range: undervoltage protection, page 130 • When voltages are above setting range: overvoltage protection, page 135 	≥ 002.000.000
ANSI 81 - Under/Over frequency protection , page 139	LV850013	Provides protection for generators, monitors frequency, and trips as follows: <ul style="list-style-type: none"> • When frequency is below setting range: underfrequency protection • When frequency is above setting range: overfrequency protection 	≥ 003.012.000
ANSI 32P - Reverse active power protection, page 144	LV850011	Provides protection for synchronous power generator, and trips when active power is negative and exceeds the threshold.	≥ 002.000.000
ANSI 51N/51G - Ground-fault alarm, page 148	LV850007	<ul style="list-style-type: none"> • Provides ground-fault alarm or earth-leakage alarm, independently from the ground-fault and earth-leakage protections and with independent settings • Enables early detection of resistive ground faults with fault currents increasing gradually up to the settings of the ground-fault or earth-leakage protection functions 	≥ 002.000.000
Energy Reduction Maintenance Settings (ERMS), page 151	LV850009	Reduces tripping time when internal arc flash occurs. Used during periods of maintenance or presence of personnel close to energized electrical equipment.	≥ 002.000.000

Digital Module	Commercial reference	Description	MicroLogic X firmware version
ANSI 51 - IDMTL overcurrent protection, page 158	LV850037	Provides overcurrent protection based on the selected IDMTL (Inverse Definite Minimum Time Lag) tripping curve.	≥ 004.000.000
ANSI 67 - Directional short-time overcurrent protection, page 164	LV850015	Provides overcurrent protection based on the direction of the short-circuit current.	≥ 004.000.000

Digital Modules for Metering Functions

The following table presents the Digital Modules for metering functions, with the minimum MicroLogic X firmware version needed for the Digital Module to function:

Digital Module	Commercial reference	Description	MicroLogic X firmware version
Energy per phase, page 229	LV850002	Calculates and displays: <ul style="list-style-type: none"> Imported and exported energy on each phase of the network, at the point of measurement Active, reactive, and apparent energy per phase 	≥ 001.000.000
Individual harmonics analysis, page 231	LV850006	<ul style="list-style-type: none"> Calculates and displays harmonics of voltages and currents up to rank 40 (calculated every 200 ms according to IEC 61000-4-30) Provides average values of harmonics calculated on a time period of 3 seconds 	≥ 002.000.000

Digital Modules for Maintenance and Diagnostic Functions

The following table presents the Digital Modules for maintenance and diagnostic functions, with the minimum MicroLogic X firmware version needed for the Digital Module to function:

Digital Module	Commercial reference	Description	MicroLogic X firmware version
Power Restoration Assistant, page 263	LV850004	Provides assistance and guidance for: <ul style="list-style-type: none"> Power restoration procedure Helping to determine potential causes of events Potential solutions for restoring power 	≥ 001.000.000
MasterPact Operation Assistant, page 265	LV850005	<ul style="list-style-type: none"> Provides assistance to the maintenance operator in reclosing and opening the circuit breaker Displays circuit breaker status Full benefits available when used with communicating diagnostic voltage releases (MX, MN, XF).	≥ 001.000.000
Waveform capture on trip event, page 267	LV850003	<ul style="list-style-type: none"> Automatically logs five cycles of phase and neutral currents in the case of a trip Records the status of the circuit breaker (open/closed/tripped) and ZSI signals 	≥ 001.000.000
Modbus legacy dataset, page 272	LV850045	Provides dataset compliant with the legacy format, which can be used by existing Modbus drivers in supervision software.	≥ 002.000.000
IEC 61850 for MasterPact MTZ, page 270	LV850046	Provides data according to IEC 61850 (Ethernet-based protocol).	≥ 004.000.000

Compatibility of Digital Modules with Communication Interfaces

The following tables present the compatibility of Digital Modules with communication interfaces.

For the following Digital Modules, the table indicates the minimum communication interface firmware version needed for the Digital Module to function.

Digital Module	Commercial reference	IFE/EIFE interface firmware version	IFE server firmware version	IFM interface firmware version
Modbus legacy dataset	LV850045	≥ 003.007.000	≥ 003.007.000	≥ 003.001.000
IEC 61850 for MasterPact MTZ	LV850046	≥ 004.000.000	–	–

For the following Digital Modules, the table indicates the minimum communication interface firmware version needed to access all data from the Digital Module through a remote connection. With earlier communication interface firmware versions, the Digital Module functions correctly. The data is not available via the communication interfaces.

Digital Module	Commercial reference	IFE/EIFE interface firmware version	IFE server firmware version	IFM interface firmware version
ANSI 27/59 - Under/Over voltage protection	LV850012	≥ 003.007.000	≥ 003.007.000	≥ 003.001.000
ANSI 81 - Under/Over frequency protection	LV850013	≥ 003.009.000	≥ 003.009.000	≥ 003.002.000
ANSI 32P - Reverse active power protection	LV850011	≥ 003.007.000	≥ 003.007.000	≥ 003.001.000
ANSI 51N/51G - Ground-fault alarm	LV850007	≥ 003.007.000	≥ 003.007.000	≥ 003.001.000
Energy Reduction Maintenance Settings (ERMS)	LV850009	≥ 003.007.000	≥ 003.007.000	≥ 003.001.000
ANSI 51 - IDMTL	LV850037	≥ 003.010.000	≥ 003.010.000	≥ 003.002.000
ANSI 67 - Directional short-time overcurrent	LV850015	≥ 003.010.000	≥ 003.010.000	≥ 003.002.000
Energy per phase	LV850002	≥ 003.006.000	≥ 003.006.000	≥ 003.000.000
Individual harmonics analysis	LV850006	≥ 003.007.000	≥ 003.007.000	≥ 003.001.000
Power Restoration Assistant	LV850004	≥ 003.006.000	≥ 003.006.000	≥ 003.000.000
MasterPact Operation Assistant	LV850005	≥ 003.006.000	≥ 003.006.000	≥ 003.000.000
Waveform capture on trip event	LV850003	≥ 003.006.000	≥ 003.006.000	≥ 003.000.000

Go2SE Landing Page

Presentation

When the QR code on the front face of a MasterPact MTZ device is scanned with a smartphone running a QR code reader and connected to the Internet, the Go2SE landing page is displayed.

The landing page displays information about the device and a list of menus.

Landing Page Description

The landing page is accessible from Android and iOS smartphones. It displays the same list of menus with slight differences in presentation.

The following example shows the landing page displayed on an Android smartphone:

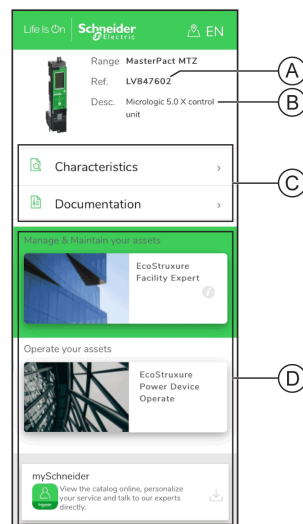

A Commercial reference of MicroLogic X control unit

B Type of MicroLogic X control unit

C Landing page menus. See the following menu descriptions for details.

D Downloadable applications

Characteristics

Selecting this menu gives access to a product datasheet with detailed information about the MicroLogic X control unit.

Documentation

Selecting this menu gives access to a sub-menu with the following options:

- **Asset Life Cycle Documents:** gives access to Safe Repository.
Safe Repository is a web service allowing documentation linked to assets to be consulted, stored, and shared in a Schneider Electric environment. Access to Safe Repository is restricted to authorized users.
Safe Repository gives access to the bill of materials of the MasterPact MTZ circuit breaker.
- **Technical Guidance at Glance:** gives access to the MasterPact MTZ technical publications, including:
 - *MasterPact MTZ - MicroLogic X Control Unit - User Guide*
 - *MasterPact MTZ1 - Circuit Breakers and Switch-Disconnectors - User Guide*

- *MasterPact MTZ2/MTZ3 - Circuit Breakers and Switch-Disconnectors - User Guide*
- All the instruction sheets for MasterPact MTZ devices and MicroLogic X control units
- **Product Documentation:** gives access to the MicroLogic X technical publications

EcoStruxure Facility Expert App

Selecting this application gives access to the EcoStruxure Facility Expert mobile application that can be downloaded on Android and iOS smartphones. For smartphone compatibility, check on your application store.

EcoStruxure Facility Expert optimizes operations and maintenance, helping to ensure business continuity, and provides insights to service providers or facility managers.

EcoStruxure Facility Expert is a real-time collaborative technology available on mobile devices and PCs that enables managers and maintenance personnel to be connected with facilities and equipment. Information exchange between users is simple and fast.

The QR code on MasterPact MTZ devices enables managers and maintenance personnel to access the following automatic downloads:

- MasterPact MTZ device identifier.
- Technical documentation.
- The maintenance plan for the MasterPact MTZ device.

EcoStruxure Facility Expert enables managers and maintenance personnel to access the maintenance plan for MasterPact MTZ devices.

EcoStruxure Facility Expert helps maintenance personnel to diagnose issues remotely and manage maintenance efficiently by:

- Providing relevant information on critical assets.
- Sending immediate state of the equipment and detailed information helping for diagnostics.

EcoStruxure Power Device App

Selecting this application gives access to the EcoStruxure Power Device app that can be downloaded and installed on Android and iOS smartphones. For smartphone compatibility, check on your application store.

mySchneider App

Selecting this application gives access to the Schneider Electric customer care mobile application **mySchneider** app that can be downloaded on Android and iOS smartphones. For smartphone compatibility, check on your application store. The customer care application offers self-service instructions and easy access to expert support and information.

MicroLogic X Control Unit: Purchasing and Installing a Digital Module

Presentation

A Digital Module can be purchased on GoDigital, which is the Schneider Electric marketplace.

The following list indicates the prerequisites for purchasing an optional Digital Module:

- Creation of a Schneider Electric user account with unique user name and password by user
- Creation of a GoDigital customer account
- Setting up of a GoDigital user account by the user. The user must set up the following predefined roles. Roles are cumulative.
 - Admin: enables you to create user profiles and attribute roles.
 - Buyer: enables you to select Digital Modules, add them to a cart, and submit the cart for validation by the payer.
 - Payer: enables you to validate or reject a cart, and check out the cart.
 - Entitlement: enables you to access assets (control units) already added and add a new control unit as an asset.
 - Finance: enables you to manage invoices and payment details.

NOTE: The following role combinations are required to buy Digital Modules:

- Buyer + Payer (for control units already added to GoDigital)
- Buyer + Payer + Entitlement (for new control units)

Proceed as follows to purchase and install optional Digital Modules:

- Get the control unit identification number and access GoDigital, page 34.
- Select and purchase Digital Modules, page 35.
- Download and install the Digital Modules, page 36.

Getting Control Unit Identification Number and Accessing GoDigital

You can get the control unit identification number and/or access GoDigital on site or off site using one of the following means:

- On site, by scanning the QR code on the front face of the MicroLogic X control unit from a smartphone. The QR code identifies the MicroLogic X control unit. Use the **Share** button to share the control unit information with the person qualified to select and purchase Digital Modules.
- On site, from EcoStruxure Power Commission software with a PC connected to the mini USB port of the MicroLogic X control unit. EcoStruxure Power Commission software gets the control unit identification number and, from the **Buy** button on the **Digital Modules** page, gives direct access to the GoDigital webpage for PC.
- Off site, from EcoStruxure Power Commission software. This access can only be used for a MicroLogic X control unit previously registered in the relevant project. EcoStruxure Power Commission software gets the control unit identification number and, from the **Buy** button on the **Digital Modules** page, gives direct access to the GoDigital webpage for PC.
- Off site, and without identifying the MicroLogic X control unit, by pointing a web browser at <https://godigital.schneider-electric.com/> to display the GoDigital webpage for PC. This access can only be used to purchase Digital Modules for a second order for a previously identified MicroLogic X control

unit. The identification numbers of previously identified control units are listed in the **My Assets** tab.

NOTE: When using the EcoStruxure Power Device app, if the functionality required for a task is not present, a **Get this functionality** button provides a link to the GoDigital webpage for PC offering the possibility to purchase the relevant Digital Module. Share this link with the person qualified to select and purchase Digital Modules.

Selecting and Purchasing a Digital Module in GoDigital

After accessing the GoDigital webpage for PC through one of the access points described in the previous paragraph, the following list is displayed:

- **See my assets.** Click to buy a Digital Module for a MicroLogic X control unit already registered. Refer to Buying a Digital Module for a Previously Registered MicroLogic X Control Unit (see following table).
- **Buy for one asset.** Click to buy a Digital Module for one MicroLogic X control unit. Refer to Buying a Digital Module for One MicroLogic X Control Unit, page 35.
- **Buy for multiple assets.** Click to buy a Digital Module for more than one MicroLogic X control unit or more than one Digital Module for one MicroLogic X. Refer to Buying a Digital Module for Multiple MicroLogic X Control Units, page 36.

NOTE: The cart can be saved for future validation and purchase.

Buying a Digital Module for a Previously Registered MicroLogic X Control Unit.

Step	Action
1	Click the See my assets button to purchase a Digital Module for a MicroLogic X control unit which is already registered in GoDigital for a previous purchase. Result: A list of MicroLogic X control units is displayed, identified by the control unit ID number and commercial reference.
2	Select the MicroLogic X control unit for which you want to buy a Digital Module by clicking Buy for this asset next to the MicroLogic X control unit selected.
3	Select the Digital Modules to purchase for your MicroLogic X control unit.
4	Submit the cart. The purchase is validated and the invoice, order confirmation, and a link to the delivery package are sent by email. NOTE: The validation of the purchase is possible only if the GoDigital customer account has been created, page 34.
5	Click the link to download the delivery package and save it onto the PC to be used for the installation of the Digital Module.

Buying a Digital Module for One MicroLogic X Control Unit

Step	Action
1	Click the Buy for one asset button to purchase a Digital Module for a MicroLogic X control unit which is not already registered in GoDigital for a previous purchase.
2	Fill in the serial number and commercial reference of your MicroLogic X control unit.
3	Click Submit . Result: The screen displays a list of Digital Modules available for your MicroLogic X control unit.
4	Select the Digital Modules to purchase for your MicroLogic X control unit.

Step	Action
5	Submit the cart. The purchase is validated and the invoice, order confirmation, and a link to the delivery package are sent by email. NOTE: The validation of the purchase is possible only if the GoDigital customer account has been created, page 34.
6	Click the link to download the delivery package and save it onto the PC to be used for the installation of the Digital Module.

Buying a Digital Module for Multiple MicroLogic X Control Units

Step	Action
1	Click the Buy for multiple assets button to purchase one Digital Module for multiple MicroLogic X control units or multiple Digital Modules for one MicroLogic X control unit.
2	Click Download an example .xls or .xlsx file template .
3	Fill in the .xls file with the following information for the control units that you are buying for: <ul style="list-style-type: none"> Control unit serial numbers Control unit commercial references Digital Module commercial references NOTE: The .xls file supports a maximum of 20 lines.
4	Upload the .xls file to GoDigital by clicking the Browse button. Result: GoDigital checks the order to avoid duplicating purchases for the same MicroLogic X control unit. If a duplication is detected, a message is displayed.
5	Submit the cart. The purchase is validated and the invoice, order confirmation, and a link to the delivery package are sent by email. NOTE: The validation of the purchase is possible only if the GoDigital customer account has been created, page 34.
6	Click the link to download the delivery package and save it onto the PC to be used for the installation of the Digital Module.

Downloading and Installing a Digital Module

Follow this procedure to install a purchased Digital Module on a MicroLogic X control unit:

Step	Action
1	Connect a PC running EcoStruxure Power Commission software directly to the mini USB port on the front of the MicroLogic X control unit.
2	Click the Connect device button to establish a connection between EcoStruxure Power Commission software and the MicroLogic X control unit. EcoStruxure Power Commission software displays the MicroLogic X control unit identification number on the screen.
3	Open the Digital Module page by clicking Digital Modules .
4	Check that the delivery package for the Digital Module to be installed is present on the PC being used. If the delivery package is not installed on the PC, click Retrieve package to download the delivery package.
5	Select the Digital Module to be installed by clicking Install . The standard protection functions of the MicroLogic X control unit remain active during installation of the Digital Module. NOTE: Only modules previously purchased can be installed directly by clicking Install .
6	EcoStruxure Power Commission asks you to confirm the installation. Enter the Administrator password and click Continue .
7	When installation is complete and before unplugging the PC, disconnect EcoStruxure Power Commission software from the device by clicking the Disconnect button.

For more information, refer to *EcoStruxure Power Commission Online Help*.

NOTE: To uninstall a Digital Module, use EcoStruxure Power Commission software.

Predefined Events

The following events are generated when a Digital Module is installed or uninstalled:

Code	Event	History	Severity
0x1130 (4400)	Digital module License installed	Configuration	Low
0x1131 (4401)	Digital module License uninstalled	Configuration	Low

MicroLogic X Control Unit: Date and Time

Presentation

MicroLogic X date and time are used for time stamping events to provide a chronological order.

The date and time of the MicroLogic X control unit and the other ULP modules (IFE, EIFE or IFM interface, IO module) of the intelligent modular unit (IMU) are synchronized. Setting the date and time of one module sets the date and time of all the modules of the IMU.

NOTE: The date and time of MicroLogic X and other ULP modules are automatically reset to default value for the date (Jan 01 2000) when the internal battery of the MicroLogic X control unit is removed and the control unit has no other power supply.

Setting the Date and Time Manually

MicroLogic X date and time can be set manually:

- On MicroLogic X display screen, at **Home > Configuration > General > Date & Time**. The first component of the date is day (dd) and the second component is month (mm).
- With EcoStruxure Power Commission software:
 - By manual setting
 - By user-initiated synchronization with date and time of the PC running EcoStruxure Power Commission software
- With EcoStruxure Power Device app:
 - By manual setting
 - By user-initiated synchronization with date and time of the smartphone running the application
- With a web browser connected to the IFE or EIFE webpage.
- By sending a setting command using the communication network (password-protected).

Synchronizing the Date and Time

MicroLogic X date and time can be automatically updated:

- With the IFE or EIFE Ethernet interface with the following conditions:
 - Ethernet interface is configured in SNTP mode
 - Ethernet interface receives an update date and time request from the SNTP server

NOTE: If the MicroLogic X control unit is connected to an Ethernet interface configured in SNTP mode, manual update of the MicroLogic X date and time is possible but is immediately replaced by the date and time of the Ethernet interface.
- With the IFM Modbus-SL interface receiving an update date and time request from the SNTP server

Predefined Events

The following event is generated when date and time are set manually:

Code	Event	History	Severity
0x1107 (4359)	Date and time set	Configuration	Low

Recommended Actions

Code	Event	Recommended actions
0x1107 (4359)	Date and time set	Check the date and time displayed on the control unit display screen.

MicroLogic X Control Unit: Power Supply

Internal and External Power Supplies

The MicroLogic X control unit is powered by the current through the internal current transformers (CT).

- The standard protection functions of MicroLogic X control units operate with the internal current supply.

NOTE: The earth-leakage protection is powered by the system voltage through the VPS voltage power supply module, installed as standard on MicroLogic 7.0 X.

- If the load current is higher than 20% of the rated current I_n , the internal current supply provides the power supply for the full functioning of the MicroLogic X control unit. This includes:
 - The MicroLogic X HMI, display screen and LEDs
 - The metering functions with accuracies in accordance with IEC 61557-12
 - The maintenance and diagnostic functions
 - Communication through ULP modules
 - Communication through Bluetooth Low Energy wireless technology

To provide a power supply to the MicroLogic X control unit when the load is below 20% of the rated current I_n , and maintain the full functioning of the MicroLogic X control unit, optional power supplies can be used. Optional power supplies include the following:

- Permanent power supplies:
 - Internal voltage power supply (VPS) module, up to 600 Vac.
 - External 24 Vdc power supply.
- Temporary power supplies connected to the mini USB port of the MicroLogic X control unit:
 - External Mobile Power Pack through USB connection.
 - Android smartphone through USB OTG connection (smartphone should be compatible with USB OTG - see list of compatible smartphones available on the Schneider Electric website).
 - PC through USB connection.

Each optional MicroLogic X power supply is described further.

VPS Voltage Power Supply Module

⚠ ⚠ DANGER

HAZARD OF ELECTRIC SHOCK, EXPLOSION OR ARC FLASH

- Do not install a VPS module on a network with a voltage above 600 Vac.
- Turn off all power supplies upstream and downstream of this equipment before installation and removal.

Failure to follow these instructions will result in death or serious injury.

⚠ CAUTION

DETERIORATION OF VPS MODULE

Disconnect the VPS module by pulling it out to the disconnected position before running a dielectric test on the equipment.

Failure to follow these instructions can result in injury or equipment damage.

The VPS module is optional for MicroLogic 2.0 X, 3.0 X, 5.0 X, and 6.0 X. It is installed as standard on MicroLogic 7.0 X.

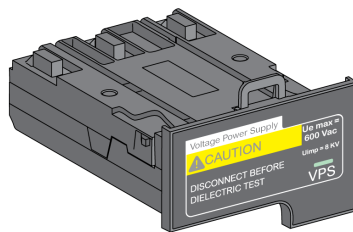

The VPS module is installed in the lower part of the MicroLogic X control unit and can be replaced.

A green LED on the front face indicates that the VPS module is powered and a 24 Vdc output is supplied.

For information about spare part replacement and installation, consult the instruction sheet on the Schneider Electric website: [NVE40741](http://www.se.com/nve40741)

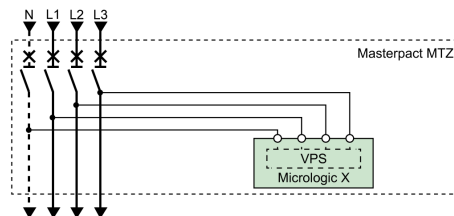

The input voltage of the VPS module is limited to 600 Vac. The module is directly connected to the internal pickup voltage (PTI) on the downstream side of the circuit breaker.

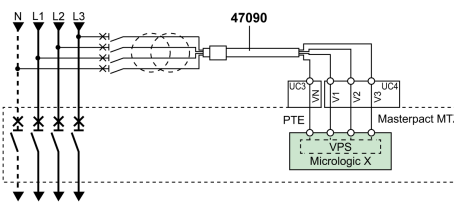

The VPS module can be supplied from an external voltage by means of the optional PTE voltage measurement inputs and voltage transformers (mandatory for voltages above 600 Vac).

The external voltage can be picked up either from the top or the bottom side of the circuit breaker.

When the power source and the PTE option are connected on the same side of the circuit breaker (for example, power source and PTE connected on top side), the MicroLogic X control unit is energized as soon as the power source is live, whatever the position of the circuit breaker (open or closed).

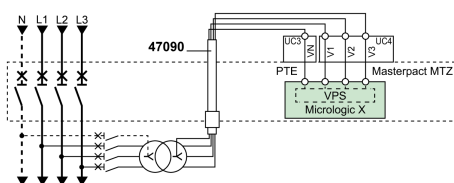

When the power source and the PTE option are connected on different sides of the circuit breaker (for example, power source connected on top side and PTE on bottom side), the MicroLogic X control unit is energized only when the circuit breaker is closed.

External 24 Vdc Power Supply

The 24 Vdc power supply maintains the operation of all functions of the MicroLogic X control unit in all circumstances, even when the circuit breaker is open and not energized.

The 24 Vdc power supply maintains the functions of the MicroLogic X control unit in low load conditions (load below 20%).

NOTICE

LOSS OF DOUBLE INSULATION

- Supply the MicroLogic X control unit with a 24 Vdc SELV (Safety Extra Low Voltage) power supply only, connected through the ULP port module or through the terminal block for external power supply (F1- F2+). Pay attention to the polarity.
- Do not connect devices which do not have double insulation to the 24 Vdc SELV power supply which is being used to supply the MicroLogic X control unit. For example, do not use the same 24 Vdc SELV power supply to supply a MicroLogic X control unit for MasterPact MTZ circuit breakers and a MicroLogic A/E/P/H trip unit for MasterPact NT/NW circuit breakers.

Failure to follow these instructions will result in a basic/single insulated system.

The design of MasterPact MTZ devices with MicroLogic X control units provides double insulation at the front face and for circuit communication lines exiting the device. Double or reinforced insulation is one of the protective measures against electric shock which conforms to IEC and CENELEC HD 60364-4-41 (Low voltage installations - Protection against electric shock).

NOTICE

HAZARD OF EQUIPMENT DAMAGE

Use the same 24 Vdc SELV power supply to supply the MicroLogic X control unit and the other ULP modules connected to the ULP port module.



Failure to follow these instructions can result in equipment damage.

Recommendations for use of external 24 Vdc SELV power supplies:

- The same 24 Vdc SELV power supply can be used to supply several MicroLogic X control units, depending on the overall power requirements of the system.
- Use a separate 24 Vdc power supply to supply the MN/MX/XF voltage releases or the MCH gear motor.
- Use the same 24 Vdc power supply to supply power to the MicroLogic X control unit and the ULP modules.
- The 24 Vdc power supply can be used to supply power to the ESM ERMS switch module.

Recommended 24 Vdc Power Supplies

Available 24 Vdc power supplies include the range of Phaseo ABL8 power supplies and the AD power supplies. For more information, refer to the *MasterPact MTZ Catalogue*.

Characteristic	Phaseo ABL8 power supply	AD power supply
Illustration		
Overvoltage category defined by IEC 60947-1	Category II	<ul style="list-style-type: none"> • Category IV per IEC 62477-1 (Vac model) • Category III per IEC 62477-1 (Vdc model) • Category III per UL 61010-1
Input supply voltage AC	<ul style="list-style-type: none"> • 110–120 Vac • 200–500 Vac 	<ul style="list-style-type: none"> • 110–130 Vac • 200–240 Vac
Input supply voltage DC	–	<ul style="list-style-type: none"> • 24–30 Vdc • 48–60 Vdc • 100–125 Vdc
Dielectric withstand	<ul style="list-style-type: none"> • Input/output: 4 kV RMS for 1 minute • Input/ground: 3 kV RMS for 1 minute • Output/ground: 0.5 kV RMS for 1 minute 	Input/output: <ul style="list-style-type: none"> • 3 kV RMS for 1 minute (110–130 Vac and 200–240 Vac model) • 3 kV RMS for 1 minute (110–125 Vdc model) • 2 kV RMS for 1 minute (24–30 Vdc and 48–60 Vdc model)
Temperature	<ul style="list-style-type: none"> • 50 °C (122 °F) • 60 °C (140 °F) with 80% nominal load maximum 	70 °C (158 °F)
Output current	3 A, 5 A, or 10 A	1 A
Ripple	200 mV peak-peak	200 mV peak-peak
Output voltage setting for line loss compensation	24–28.8 Vdc	22.8–25.2 Vdc

NOTE: For applications requiring an overvoltage category higher than II, install a surge arrester when using a 24 Vdc ABL8 power supply.

24 Vdc Backup Battery

If the 24 Vdc power supply is interrupted, a 24 Vdc backup battery can be used to maintain the operation of the MicroLogic X control unit, including wireless communication. It is installed in series between the MicroLogic X control unit and the 24 Vdc power supply module.

The 24 Vdc backup battery must have the following characteristics (compatible with the MicroLogic X control unit):

- Output voltage 17 V–28.8 Vdc
 - Cut-off voltage 17 Vdc (24 Vdc backup battery must have a shutdown output voltage in case of low voltage level)

- Hysteresis > 3 Vdc (to avoid power-on before the voltage is up to 21 Vdc)
- 24 Vdc backup battery should be able to power an Inrush current of 10 A

NOTE: Refer to the table of power consumption to calculate the necessary battery capacity for your installation.

Mobile Power Pack



The Mobile Power Pack is an external battery that enables power to be supplied temporarily to the MicroLogic X control unit.

The Mobile Power Pack enables use of the MicroLogic X display screen and keypad for setting and displaying when the power supply to the MicroLogic X control unit is interrupted.

The external Mobile Power Pack can be connected by using a USB cable connected to the mini USB port on the MicroLogic X control unit.

Check the charge level of the Mobile Power Pack by pressing the test button for one second. The indicator on the Mobile Power Pack lights up to indicate the remaining charge.

NOTE: During periods of setting, commissioning, testing, and maintenance, a smartphone (with USB OTG connection) or a PC connected through mini USB port also provide a temporary power supply.

Internal Battery

When no other power supply is supplying the MicroLogic X control unit, the internal battery powers:

- The trip cause LEDs
- The service LED
- The internal clock (date and time)
- The maintenance schedule function

ULP Module Consumption

The following table lists the ULP module consumption:

Module		Typical consumption (24 Vdc at 20 °C/68 °F)	Maximum consumption (19.2 Vdc at 60 °C/140 °F)
MicroLogic X control unit for MasterPact MTZ circuit breaker	with external 24 Vdc power supply	200 mA	300 mA
	supplied through mini USB port	400 mA	500 mA
	supplied through ULP port module	200 mA	335 mA
M2C programmable contacts		25 mA	45 mA
ESM ERMS switch module		25 mA	45 mA
IFE Ethernet interface for one circuit breaker		100 mA	140 mA
IFE Ethernet switchboard server		100 mA	140 mA
EIFE embedded Ethernet interface for one MasterPact MTZ drawout circuit breaker		115 mA	180 mA
IFM Modbus-SL interface or one circuit breaker		21 mA	30 mA

Module	Typical consumption (24 Vdc at 20 °C/68 °F)	Maximum consumption (19.2 Vdc at 60 °C/140 °F)
IO input/output application module for one circuit breaker	100 mA	130 mA
ULP port module for MasterPact MTZ circuit breaker	0 mA	0 mA

MicroLogic X Control Unit: Firmware Update

Introduction

The primary reason for updating the firmware of a MicroLogic X control unit is to obtain the latest MicroLogic features. If the latest MicroLogic features are not required, it is not mandatory to update the firmware of the MicroLogic X control unit and the Enerlin X devices of the IMU.

You may need to perform firmware updates to enable compatibility between MicroLogic X control units and Digital Modules installed on the control unit, page 29.

The standard protection functions of the MicroLogic X control unit remain active during a firmware update.

Use the latest version of EcoStruxure Power Commission software, page 22 for all firmware updates.

For more information about firmware updates refer to the following documents:

- DOCA0144EN *MasterPact MTZ - MicroLogic X Control Unit - Firmware Release Note*
- DOCA0155EN *MicroLogic Trip Units and Control Units - Firmware History*

After updating the firmware version of the MicroLogic X control unit, use the latest version of EcoStruxure Power Commission software to check the firmware compatibility between the IMU devices. The **Firmware Update** table helps you to diagnose and identify all discrepancy issues between the IMU devices. This table also provides the recommended actions relevant to the detected discrepancies.

Checking the Firmware Version

Check the firmware version:

- On the MicroLogic X display screen at **Home > Maintenance > Assistance > Firmware version**
- With EcoStruxure Power Commission software
- With EcoStruxure Power Device app

Updating Firmware With EcoStruxure Power Commission Software

NOTICE

INTERRUPTION OF POWER SUPPLY

The MicroLogic X control unit must be continuously powered during the firmware update.

Failure to follow these instructions will result in deterioration of the control unit.

The prerequisites for updating the firmware with EcoStruxure Power Commission software are the following:

- The latest version of EcoStruxure Power Commission software must be downloaded and installed on the PC.
- The PC must be connected to a power supply. Standby mode must be deactivated to avoid the possibility of interruption during the update.
- The PC must be connected to the mini USB port on the MicroLogic X control unit.

- The MicroLogic X control unit must be powered.
 - When the control unit is not connected to other ULP modules, it is powered by the PC through the mini USB port.
 - When the control unit is connected to other ULP modules, it must be powered by an external 24 Vdc power supply

The Administrator password of the MicroLogic X control unit is required to launch the firmware update.

For more information, refer to *EcoStruxure Power Commission Online Help*.

EcoStruxure Power Commission software is available at www.se.com

NOTE: For MicroLogic X control units with firmware version greater than or equal to 002.000.000, the update of the firmware of the associated Enerlin'X devices is also possible with EcoStruxure Power Commission software while the PC is connected to the mini USB port of the MicroLogic X control unit.

Predefined Events

The following events can be generated when a firmware update is performed:

Code	Event	History	Severity
0x0D01 (3329)	Critical firmware modules discrepancy	Diagnostic	Medium
0x0D03 (3331)	Non-critical firmware modules discrepancy	Diagnostic	Medium
0x0D09 (3337)	Firmware discrepancy within control unit	Diagnostic	Medium
0x1434 (5172)	Self diagnostic test - firmware	Diagnostic	Medium
0x112B (4395)	Control unit firmware upgrade mode	Configuration	Low
0x112C (4396)	Control unit firmware upgrade unsuccessful	Configuration	Medium

Recommended Actions

Code	Event	Recommended actions
0x0D01 (3329)	Critical firmware modules discrepancy	Check which module is in critical firmware discrepancy with the EcoStruxure Power Commission software. Update the module.
0x0D03 (3331)	Non-critical firmware modules discrepancy	Check which module is in non-critical firmware discrepancy with the EcoStruxure Power Commission software. Plan to update the module.
0x0D09 (3337)	Firmware discrepancy within control unit	Check the firmware version of the MicroLogic X control unit with EcoStruxure Power Commission software. If not latest, update the firmware of the MicroLogic X control unit.
0x1434 (5172)	Self diagnostic test - firmware	Update the firmware of the MicroLogic X control unit with EcoStruxure Power Commission software.
0x112B (4395)	Control unit firmware upgrade mode	Wait until the update of the MicroLogic X control unit firmware is completed.
0x112C (4396)	Control unit firmware upgrade unsuccessful	Restart the MicroLogic X control unit firmware update procedure. If the message is displayed again, plan to replace the MicroLogic X control unit.

Contact your field service representative for more information about who can carry out the recommended actions.

Using the MicroLogic X Human Machine Interface

What's in This Part

MicroLogic X HMI Description	49
HMI Display Modes	52
Quick View Mode	53
Tree Navigation Mode	57
Protection Setting Procedure.....	64
Measures Menu	67
Alarms & History Menu	72
Maintenance Menu.....	74
Configuration Menu	76
Protection Menu	79
Pop-up Event Messages.....	85

MicroLogic X HMI Description

Introduction

The human machine interface (HMI) of the MicroLogic X control unit includes:

- A graphic display screen with colored backlight
- Buttons to navigate through the menu structure, and access monitored parameters and configuration settings

Display Screen and Buttons

The MicroLogic X control unit includes the following display screen with contextual and dedicated buttons:

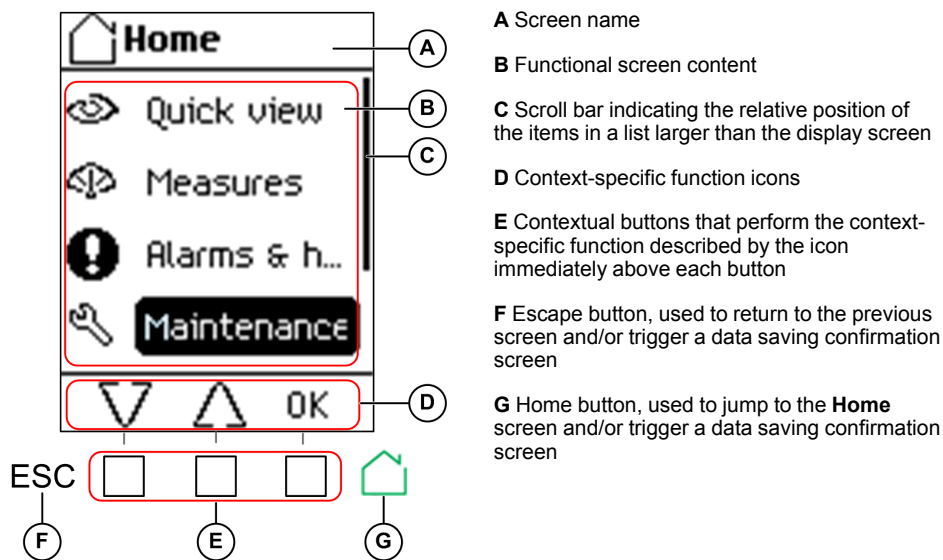

Button Functional Types

Use the buttons beneath the display screen to:

- Navigate the menu structure
- Display monitored values
- Access and edit configuration settings

The control unit provides the following types of buttons:

- Contextual buttons: each screen can have up to three contextual buttons. The function of each button is determined by an icon located on the display screen directly above it.
- Dedicated buttons that perform the escape and home functions.

Contextual Buttons

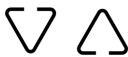
Icon displayed	Description
	<p>Use the up and down buttons to move between:</p> <ul style="list-style-type: none"> • Screen names within the same level of menu hierarchy • List items <p>The up and down arrows do not support looping back. At a terminus of a menu structure or item list, either the up or down arrow is no longer displayed (depending on whether the terminus is the beginning or end of the list). The up and down navigation behavior is the same for all menus and lists.</p>
OK	<p>Use the OK button:</p> <ul style="list-style-type: none"> • To validate a selection • To navigate from the level currently displayed in the hierarchy to the selected sublevel immediately below it. In this way, navigation is possible from: <ul style="list-style-type: none"> ◦ The active menu to the immediate submenu ◦ A submenu to a monitored item or configuration parameter ◦ A monitored item to its monitored value ◦ A configuration parameter to its configuration setting • To view details and acknowledge an event pop-up screen or error message
Y N	<p>Use the Y (Yes) and N (No) buttons to acknowledge actions, for example, when a confirmation screen is displayed.</p>
+ -	<p>Use the + and - buttons to increment or decrement a configuration setting, either numerical values or predefined list items.</p>

Dedicated Buttons

Icon displayed	Description
ESC	<p>Use the ESC (escape) button to:</p> <ul style="list-style-type: none"> • Navigate from the level currently displayed in the hierarchy to the level immediately above • Save a change to a configuration setting. A confirmation screen pops up and must be acknowledged before returning to the menu on the level above.
	<p>Use the home button to:</p> <ul style="list-style-type: none"> • Return to the Home screen • Save a change to a configuration setting. A confirmation screen pops up and must be acknowledged before returning to the Home screen.

Display Screen Backlight

The backlight color and intensity depends on the operating state of the control unit, as follows:

Backlight color	Control unit operating state
White ⁽¹⁾	<ul style="list-style-type: none"> Quick View scrolling is enabled and running Tree navigation mode is enabled for navigating among menus in display screens Bluetooth Low Energy wireless communication is enabled and the Bluetooth pairing message is displayed.
Red	A trip or a high severity event message is displayed.
Orange	A medium severity event message is displayed, and no trip or high severity event is active.
Blue	ERMS engaged.
(1) The backlight of the Health screen in Quick View and in Maintenance is: <ul style="list-style-type: none"> Red if a high severity event is active. Orange if a medium severity event is active. 	

NOTE: When Quick View scrolling is off, the backlight changes from high intensity to low intensity when in standby. High intensity resumes when a button is pressed.

Display Screen Language

To change the display screen language, go to:

Home > Configuration > General > Language

Selections include:

- Deutsch
- English (US)
- Español
- Français
- Italiano
- Русский
- 中文
- English (UK)
- Português

The default language is as follows:

- IEC standard MicroLogic X control unit: English (UK)
- UL standard MicroLogic X control unit: English (US)

Start-up Screen



The start-up screen is displayed every time the MicroLogic X control unit is energized. None of the buttons on the control unit are functional while this screen is displayed. The screen is displayed for the period of the control unit start-up time. At the end of this period, the **Home** screen or any active pop-up screen is displayed.

NOTE: Standard protection functions are operational during start-up screen.

HMI Display Modes

Presentation

The MicroLogic X control unit HMI supports the following display modes:

- Quick View mode to display a selection of data
- Tree Navigation mode to access all data through a menu structure

NOTE: Both Quick View and Tree Navigation display modes are overridden by event messages, page 86.

Quick View Mode

Quick View is the default HMI display mode. It displays a selection of data screens.

When Quick View scrolling is enabled, the screens are displayed automatically one after the other with a configurable time delay.

When Quick View scrolling is disabled, the Quick View screens are available at **Home > Quick View**.

Tree Navigation Mode

In Tree Navigation display mode, use the contextual buttons to navigate in the menu structure. Tree Navigation display mode presents a single network of menus, with monitoring values and editable configuration settings.

Tree navigation is always accessible from Quick View screens by pressing the home button.

Refer to the *MicroLogic X local HMI description*, page 50 for information about how to use the HMI buttons to:

- Navigate the menu structure
- Access and edit settings

Quick View Mode

Quick View

Quick view presents a sequence of screens, depending on the type of MicroLogic X control unit. Each screen displays a snapshot of operating values for the control unit. The values shown on the protection screens are the active protection settings currently used by the protection functions.

With automatic scrolling enabled, the screens are displayed in sequence with a configurable time delay. With automatic scrolling disabled, the screens can be navigated manually.

Quick View scrolling is enabled as the factory setting.

When the MicroLogic X control unit is switched on, Quick View scrolling begins after the configured timeout if there are no active event messages.

Configure the Quick View display by setting:

- The display time for each screen in the Quick View scrolling sequence.
- The time delay for automatically resuming scrolling after scrolling has been interrupted.

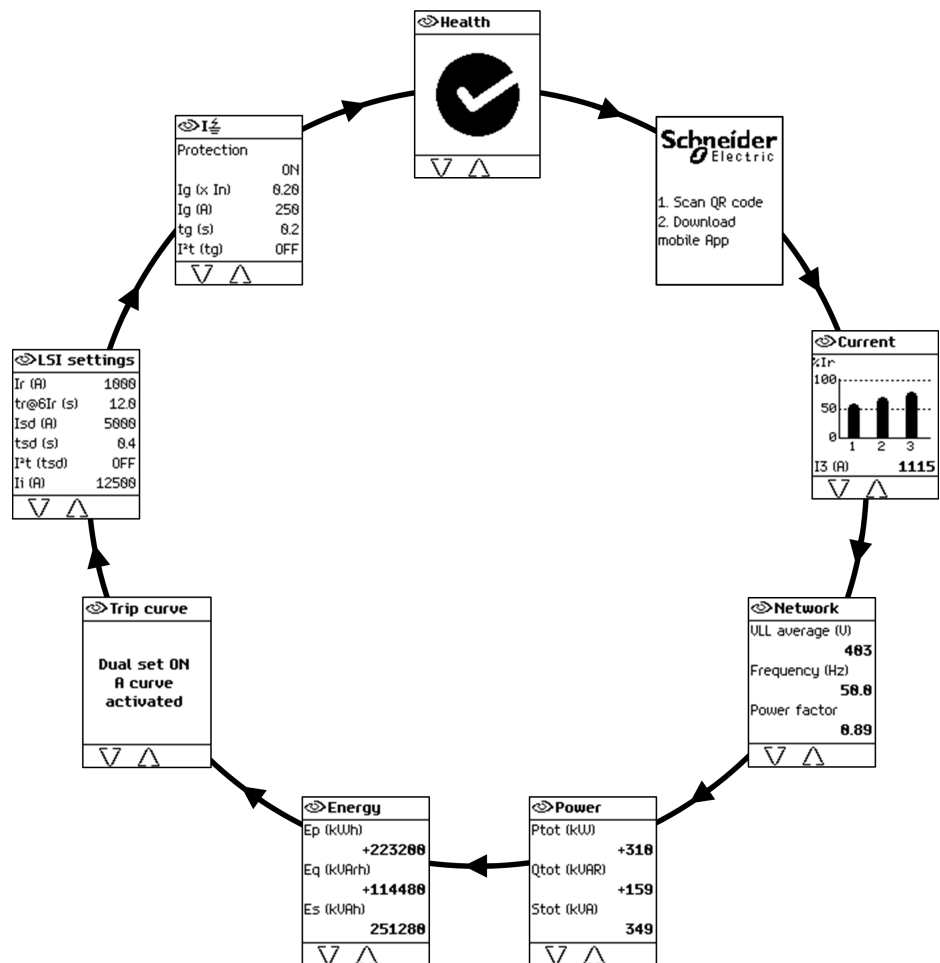

If scrolling is off, the Quick View **Current** screen is displayed after this time delay.

The following is an example of the Quick View screens for the MicroLogic 6.0 X control unit.



List of Quick View Screens

Depending on the type of the MicroLogic X control unit, Quick View displays the following screens:

Screen	Description	MicroLogic X type
Health⁽¹⁾	Displays the health state of the circuit breaker: <ul style="list-style-type: none"> •  OK (white) •  Medium - severity detected alarm that requires non - urgent action (orange) •  High - severity detected alarm that requires immediate action (red) 	MicroLogic 2.0 X, 3.0 X, 5.0 X, 6.0 X, 7.0 X
Start-up screen	Reminds the user to download the EcoStruxure Power Device app mobile application to manage the MicroLogic X control unit.	MicroLogic 2.0 X, 3.0 X, 5.0 X, 6.0 X, 7.0 X
Current⁽¹⁾	Displays I1, I2, I3 RMS current on phase 1, 2, 3 values as bar graphs expressed in % of Ir. The highest phase current value is displayed in Amps under the bar graph.	MicroLogic 2.0 X, 3.0 X, 5.0 X, 6.0 X, 7.0 X
Network⁽¹⁾	Displays real-time values for: <ul style="list-style-type: none"> • Average of 3 RMS phase-to-phase voltage • Frequency • Power factor 	MicroLogic 2.0 X, 3.0 X, 5.0 X, 6.0 X, 7.0 X
Power⁽¹⁾	Displays real-time values for: <ul style="list-style-type: none"> • P tot: total active power • Q tot: total reactive power • S tot: total apparent power 	MicroLogic 2.0 X, 3.0 X, 5.0 X, 6.0 X, 7.0 X
Energy⁽¹⁾	Displays real-time values for: <ul style="list-style-type: none"> • Ep: total active energy • Eq: total reactive energy • Es: total apparent energy 	MicroLogic 2.0 X, 3.0 X, 5.0 X, 6.0 X, 7.0 X
Trip curve	<ul style="list-style-type: none"> • When in fallback settings mode, displays message Fallback settings mode. • When ERMS is engaged, displays message ERMS engaged • When ERMS is disengaged and dual setting is on, displays: <ul style="list-style-type: none"> ◦ Dual set ON A curve activated or ◦ Dual set ON B curve activated • When ERMS is disengaged and dual setting is off, no screen is displayed 	MicroLogic 2.0 X, 3.0 X, 5.0 X, 6.0 X, 7.0 X
LI settings	Displays a selection of active protection settings: <ul style="list-style-type: none"> • Long time overcurrent protection threshold Ir • Long time overcurrent protection time delay tr • Instantaneous overcurrent protection threshold Isd 	MicroLogic 2.0 X
LI settings	Displays a selection of active protection settings: <ul style="list-style-type: none"> • Long time overcurrent protection threshold Ir • Long time overcurrent protection time delay tr • Instantaneous overcurrent protection threshold li 	MicroLogic 3.0 X
LSI settings	Displays a selection of active protection settings: <ul style="list-style-type: none"> • Long time overcurrent protection threshold Ir • Long time overcurrent protection time delay tr • Short time overcurrent protection threshold Isd • Short time overcurrent protection time delay tsd • Instantaneous overcurrent protection threshold li 	MicroLogic 5.0 X, 6.0 X, 7.0 X
I_{Δn}	Displays a selection of active protection settings: <ul style="list-style-type: none"> • Ground fault protection threshold Ig • Ground fault protection time delay tg 	MicroLogic 6.0 X
I earth leakage	Displays a selection of active protection settings: <ul style="list-style-type: none"> • Earth-leakage protection threshold IΔn • Earth-leakage protection time delay Δt 	MicroLogic 7.0 X

(1) Screen data is refreshed every second.

NOTE: The value of the settings displayed on the Quick View screens are the active settings used by the protection functions. They may differ from the settings displayed in the **Protection** menu when **Fallback settings mode**, page 123 is displayed on the **Trip curve** screen.

Configuring Quick View Mode

To configure Quick View settings, go to **Home > Configuration > General > Quick view**. The following settings are available:

- **Scrolling:** Set this to **ON** to enable automatic scrolling in Quick View. (When **OFF** is selected, the Quick View **Current** screen is displayed after the configured timeout.)

When Quick View scrolling is enabled, the following settings are available:

- **Pageflow:** The length of time each Quick View screen is displayed while scrolling.
- **Auto start:** The time delay before Quick View scrolling resumes after an interruption. This time delay is also the event timeout, which is the time delay before an event message is displayed again if the event cause is not acknowledged by pressing **OK**.

When Quick View scrolling is disabled, the following setting is available:

Time out: The time delay before the Quick View **Current** screen is displayed. This time delay is also the event timeout, which is the time delay before an event message is displayed again if the event cause is not acknowledged by pressing **OK**.

The configurable settings are shown in the following table.

Setting	Unit	Range	Step	Factory Setting
Scrolling	–	ON/OFF	–	ON
Pageflow	seconds	3–60	1	3
Auto start	minutes	1–60	1	15
Time out	minutes	1–60	1	15

Starting Quick View Scrolling

When Quick View scrolling is enabled, the scrolling can be restarted:

- Automatically
- Manually

To begin Quick View scrolling automatically, wait for the **Auto start** timeout to elapse.

To begin Quick View scrolling manually:

Step	Action
1	In the Home menu, select Quick view .
2	Press OK to restart scrolling of the Quick View screens.

Stopping Quick View Scrolling

Stop Quick View scrolling as follows:

- Press the **ESC** or home button. The display screen displays the **Home** menu. From here, use the up and down buttons to navigate through the menu structure.

NOTE: If no button is pressed before the **Auto start** timeout expires, Quick View scrolling resumes.

- Press one of the three contextual buttons. Quick View scrolling stops. Use the up and down buttons to scroll manually through the Quick View screens.

When the MicroLogic X control unit detects any of the following events, Quick View scrolling is interrupted and a pop-up message is displayed, page 85:

- Bluetooth pairing
- Trip
- High severity alarm
- Medium severity alarm
- ERMS engaged

Disabling Quick View Automatic Scrolling

To disable Quick View scrolling:

Step	Action
1	Press the home button.
2	Go to Home > Configuration > General > Quick view .
3	Press OK .
4	Use the + or - contextual buttons to set the Scrolling setting to: <ul style="list-style-type: none"> • ON to select Quick View automatic scrolling. • OFF to disable Quick View automatic scrolling.
5	Press OK to save the selection.
6	Press ESC or the home button. A confirmation screen is displayed.
7	In the confirmation screen press one of the following: <ul style="list-style-type: none"> • Y to confirm the change of settings. • N to undo the edit.

Tree Navigation Mode

Tree Structure Screen Display

Use Tree Navigation mode to navigate manually through the MicroLogic X control unit menu structure. Tree Navigation mode enables the following actions:

- Display measurement values for the control unit
- View active alarms, and event history
- View maintenance items, and a history of service records
- Display and edit control unit configuration settings
- Display and edit protection settings

All Tree Navigation menu selections begin at the home button:

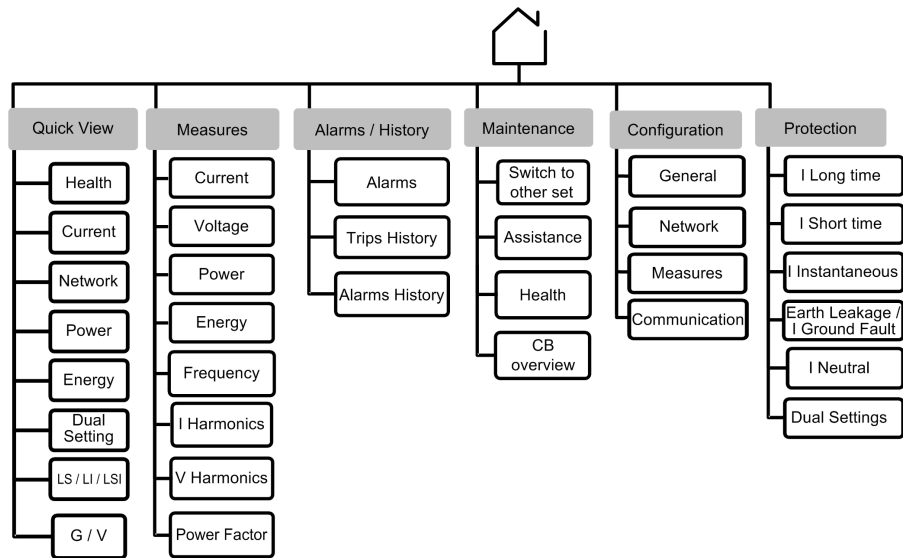

Click the link on one of the following level 2 menus to see its content:

Level 1	Level 2
Home	Quick View , page 53
	Measures , page 67
	Alarms & history , page 72
	Maintenance , page 74
	Configuration , page 76
	Protection , page 79

Navigating in the Menu Structure

Use the contextual and dedicated buttons on the face of the MicroLogic X control unit to navigate in the menu structure, and to access displayed values and configurable settings.

The possible operations are listed below, and are illustrated with an example:

- Display data, for example, energy values
- Reset values or counters, for example, reset the maximum RMS current
- Select options in a list, for example, language
- Edit a value, for example, nominal voltage
- Set protection settings, for example, long-time overcurrent protection

- Validate a pop-up message, for example, a pop-up trip message

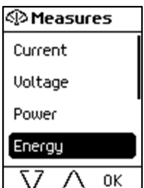
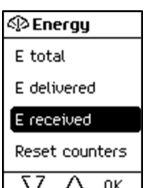
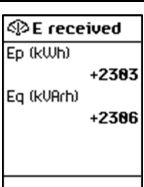

Displaying Data

The following example shows how to display energy values:

Step	Action	Screen
1	Press the home button. The Home menu opens. Press the down arrow to select Measures .	
2	Press OK . The Measures menu opens. Press the down arrow to select Energy .	
3	Press OK . The Energy menu opens. Press the down arrow to select E received .	
4	Press OK . The E received screen is displayed.	
5	To exit the E received screen, press one of the following: <ul style="list-style-type: none"> • The ESC button to return to the Energy menu. • The home button to return to the Home menu. 	



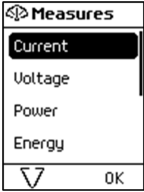

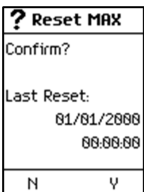
Resetting Values

Some menus present values or counters that can be reset. The following example shows how to navigate to and reset the maximum RMS current:

Step	Action	Screen
1	Press the home button. The Home menu opens. Press the down arrow to select Measures .	
2	Press OK . The Measures menu opens. Select Current .	
3	Press OK . The Current menu opens. Press the down arrow to select Reset Max .	
4	Press OK . The Reset Max confirmation screen opens.	
5	In the confirmation screen, press one of the following: <ul style="list-style-type: none"> • Y to reset the maximum RMS current and return to the Current screen. • N to return to the Current screen without resetting the value. 	–

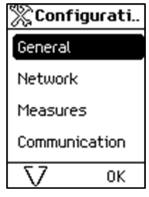

Selecting Options in a List

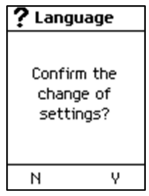
Some menus present options in a list. The following example shows how to navigate to and select language options:

Step	Action	Screen
1	Press the home button. The Home menu opens. Press the down arrow to select Configuration .	
2	Press OK . The Configuration menu opens. Select General .	
3	Press OK . The General menu opens. Select Language .	
4	Press OK . The Language menu opens.	
5	Press the up and down arrow buttons to select a language and press OK . A confirmation check appears next to the selected language.	
6	To save the selection, press one of the following: <ul style="list-style-type: none"> The ESC button to return to the General menu. The home button to return to the Home menu. 	–
7	In the confirmation screen press one of the following: <ul style="list-style-type: none"> Y to confirm the change of settings. N to undo the edit. 	

Restoring the Language Settings

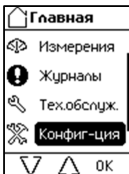
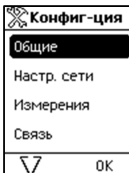
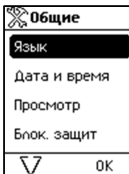
If the language selected for the display screen is unfamiliar to you, the following example shows how the language settings can be restored to a familiar language:

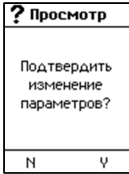
Step	Action	Screen
1	<p>Press the home button. The Home menu opens.</p> <p>Press the down arrow three times to reach the third line in the menu. This is the Configuration menu.</p>	
2	<p>Press OK. The Configuration menu opens.</p> <p>Select the first line. This is the General menu.</p>	
3	<p>Press OK. The General menu opens.</p> <p>Select the first line. This is the Language menu.</p>	
4	<p>Press OK. The Language menu opens.</p> <p>Press the up and down arrow buttons to select the language you want to change to and press OK.</p>	
5	<p>To save the selection, press one of the following:</p> <ul style="list-style-type: none"> The ESC button to return to the General menu. The home button to return to the Home menu. 	
6	<p>In the confirmation screen press one of the following:</p> <ul style="list-style-type: none"> Y to confirm the change of settings. N to undo the edit. 	

Editing and Saving Parameter Settings

When editing a parameter setting, use the + or – buttons to increment or decrement the setting by a single-step amount. Hold down the button to accelerate the process.

This function applies to both numeric values and list selections.

The following example shows how to edit the nominal voltage:

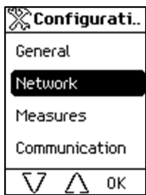
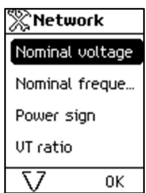
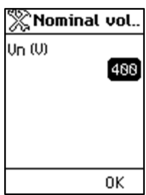
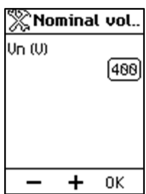
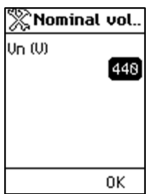
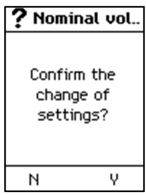
Step	Action	Screen
1	Press the home button. The Home menu opens. Press the down arrow to select Configuration .	
2	Press OK . The Configuration menu opens. Press the down arrow to select Network .	
3	Press OK . The Network menu opens. Select Nominal voltage .	
4	Press OK . The Nominal voltage menu opens.	
5	In the Nominal voltage menu, select Vn (V) and press OK to enable editing of the Vn (V) parameter. The parameter is displayed in black on a white background to indicate that editing is enabled. In this example, 400 , the factory setting value, is displayed.	
6	Press the + and – buttons to scroll through available settings. Possible values are 208, 220, 230, 240, 380, 400, 415, 440, 480, 500, 525, 550, 575, 600, 660, 690, and 1,000. Press OK to select a setting. The background changes to black.	
7	To save the change of settings, press one of the following: <ul style="list-style-type: none"> The ESC button to return to the Nominal voltage screen The home button to return to the Home menu 	–
8	In the confirmation screen, press one of the following: <ul style="list-style-type: none"> Y to confirm and save the change of settings. N to undo the edit. 	

If the edit did not succeed, a detected error message appears. Press **OK** to confirm the message, and then the previous menu is displayed.

Setting Protection Settings

The procedure for setting protection settings conforms to UL489SE. New settings are submitted and applied in separate steps, page 64.

Validating a Pop-Up Message

A trip or alarm event displays a pop-up message on the display screen. The message overrides the screen currently displayed.

The following example shows how to handle a pop-up trip message.

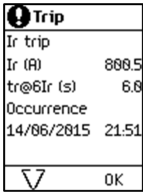
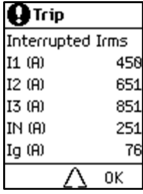
Step	Action	Screen
1	A pop-up trip message appears on the screen.	
2	Press OK to view details of the trip.	
3	If a down arrow appears at the bottom of the screen, press the down arrow to view more details about the trip event.	
4	After taking steps to resolve the cause of the trip, press OK to acknowledge the trip context. The Alarms & history screen is displayed.	–
5	To exit the Alarms & history screen, press one of the following: <ul style="list-style-type: none"> • The ESC button to return to the screen displayed before the pop-up message appeared • The home button to return to the Home menu 	–

Protection Setting Procedure



Protection Setting Session

The procedure for setting a protection setting conforms to UL489SE, with an exclusive editing session and a two-step procedure for submitting and applying protection setting changes.

To set a protection setting, access to protection settings must be enabled by using the MicroLogic X HMI, page 96.

Setting Protection Settings

The following example shows how to set the long-time overcurrent protection:

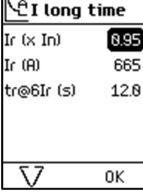
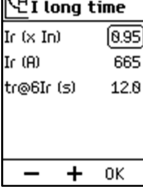
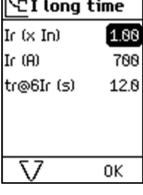
Step	Action	Screen
1	Press the home button. The Home menu opens. Press the down arrow to select Protection .	
2	Press OK . The Protection menu opens. Select I long time .	
3	Press OK . The editing session opens and the I long time menu is displayed. In the I long time menu, select the Ir (x In) parameter.	
4	Press OK to enable editing of the Ir (x In) parameter. The parameter is displayed in black on a white background to indicate that editing is enabled.	
5	Press the + and - buttons to scroll through available settings. Press OK to confirm the new setting. The parameter is displayed in white on a black background.	
6	Use the down arrow and OK to select the next parameter to be set and repeat step 5.	–
7	To submit the new settings, press one of the following: <ul style="list-style-type: none"> The ESC button The home button 	–

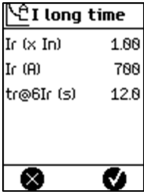
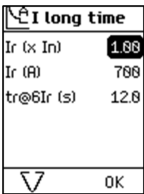
Step	Action	Screen
8	<p>In the submit settings screen, press one of the following:</p> <ul style="list-style-type: none"> • Y to submit the new settings. • N to cancel the change of settings. The screen displays the Home menu if the home button was pressed in the previous step, or the Protection menu if ESC was pressed in the previous step. <p>If you do not press Y to submit the new settings within five minutes of opening the editing session, the changes are rejected and a pop-up notice is displayed (see following table).</p>	
9	<p>The screen displays the new settings. The values on the screen are for display only. They cannot be edited. Press one of the following:</p> <ul style="list-style-type: none"> • ✓ to apply the change of settings. • X to cancel the change of settings and return to the Protection menu. <p>If you do not press ✓ to apply the new settings within five minutes, the changes are rejected and a pop-up notice is displayed (see following table).</p> <p>NOTE: The ESC and home buttons are deactivated when this screen is displayed. Pressing these buttons has no effect.</p>	
10	<p>After applying the settings, the screen displays the new settings on an editable screen.</p> <p>Close the editing session by pressing one of the following:</p> <ul style="list-style-type: none"> • The ESC button, to return to the Protection menu • The home button, to return to the Home page 	

Pop-up Notices

The following table indicates the necessary action to take if a pop-up notice is displayed while editing a protection setting:

Message	Description	Action
Protection locked.To unlock go to Configuration menu.	Access to protection settings is disabled.	<p>Press OK to acknowledge the message and display the Protection menu. The protection parameters are accessible for display only.</p> <p>Go to Home > Configuration > General > Lock protection on the MicroLogic X display screen to enable access to protection settings, page 96.</p>
Access denied. Another session already opened	You cannot open an editing session to set protection settings because a session is open on another interface (EcoStruxure Power Commission software, EcoStruxure Power Device app, communication network), page 97.	<p>Press OK to acknowledge the message and return to the Protection menu. Protection settings are for display only, and can be consulted on the Quick View screens. It is not possible to set settings as long as a session is open on another interface. Try again later.</p>

Message	Description	Action
Session expired	No key pressed for five minutes. The editing session expired on time-out, page 97. The new settings are rejected and the existing protection settings are maintained.	Press OK to acknowledge the message and return to the Protection menu. Open a new editing session by selecting a protection function in the menu.
Access denied due to sensor plug missing. Check sensor plug.	The sensor plug is missing or incorrectly connected.	Press OK to acknowledge the message and return to the Home menu. It is not possible to display or set protection settings. Contact your field service representative to check, and replace or reconnect the sensor plug.

Measures Menu

Presentation

In this guide, electrical phases are described as *phase 1*, *phase 2*, *phase 3* and cover both IEC standard and UL standard. The MicroLogic X control unit displays the phases as follows:

MicroLogic X control unit for IEC standard	MicroLogic X control unit for UL standard
Phase 1	Phase a
Phase 2	Phase b
Phase 3	Phase c

Description

The **Measures** menu contains the following submenus:

Level 1	Level 2	Level 3	Function description
Home	Measures	Current	Current real-time measurements
		Voltage	Voltage real-time measurements
		Power	Power real-time measurements
		Energy	Energy real-time measurements
		Frequency	Frequency real-time measurements
		I harmonics	Current harmonics real-time measurements
		V harmonics	Voltage harmonics real-time measurements
		Power factor	Power factor real-time measurements

Measures Screens with Quality Gauge

A quality gauge is displayed on the following screens to give a graphical representation of the measurement compared to the expected range:

- Real-time maximum of 3 phase current unbalances, **Iunb**
- Average of 3 RMS phase-to-phase voltages **Vavg VLL(V)**
- Real-time maximum of 3 phase-to-phase voltage unbalances **Vunb VLL(%)**
- Frequency **F(Hz)**

For example, for the frequency screen, the following icons indicate the measurement compared to the expected range:

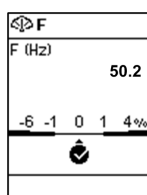

 Measurement OK: the difference between the measured and expected frequencies is less than 1%

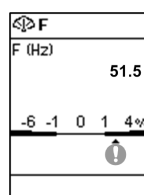

 Measurement out of range: the difference between the measured and expected frequencies is +1-4% or -1-6%

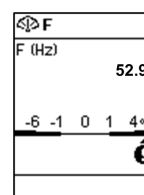

 Measurement significantly out of range: the difference between the measured and expected frequencies is greater than +4% or less than -6%

Current

The **Current** menu presents the following measurements:

Level 3	Level 4	Level 5	Parameter name
Current	I	I1 (A)	RMS current on phase 1
		I2 (A)	RMS current on phase 2
		I3 (A)	RMS current on phase 3
		IN (A)⁽¹⁾	RMS current on neutral
		Ig (A)⁽²⁾	RMS current on ground
		IΔn (A)⁽³⁾	RMS current on earth leakage
	I MAX	I1 (A)	Maximum RMS current on phase 1
		I2 (A)	Maximum RMS current on phase 2
		I3 (A)	Maximum RMS current on phase 3
		IN (A)⁽¹⁾	Maximum RMS current on neutral
		Ig (A)⁽²⁾	Maximum of RMS current on ground
		IΔn (A)⁽³⁾	Maximum of RMS current on earth leakage
	I avg	I (1,2,3) (A)	Average of 3 phase RMS currents
	I unb	I (1,2,3) (%)	Real-time maximum of 3 phase current unbalances, with quality gauge
	I unb MAX	I (1,2,3) (%)	Maximum of maximum of 3 phase current unbalances
	Reset MAX		
(1) Applies to 4-pole circuit breakers or 3-pole circuit breakers with ENCT wired and configured			
(2) Applies to MicroLogic 2.0 X, 3.0 X, 5.0 X, 6.0 X			
(3) Applies to MicroLogic 7.0 X			

Voltage

The **Voltage** menu presents the following measurements:

Level 3	Level 4	Level 5	Parameter name	
Voltage	V	V12 (V)	RMS phase-to-phase voltage 1-2	
		V23 (V)	RMS phase-to-phase voltage 2-3	
		V31 (V)	RMS phase-to-phase voltage 3-1	
		V1N (V)⁽¹⁾	RMS phase-to-neutral voltage 1-N	
		V2N (V)⁽¹⁾	RMS phase-to-neutral voltage 2-N	
		V3N (V)⁽¹⁾	RMS phase-to-neutral voltage 3-N	
		V MAX	V12 (V)	Maximum RMS phase-to-phase voltage 1-2
			V23 (V)	Maximum RMS phase-to-phase voltage 2-3
			V31 (V)	Maximum RMS phase-to-phase voltage 3-1
	V1N (V)⁽¹⁾		Maximum RMS phase-to-neutral voltage 1-N	
	V2N (V)⁽¹⁾		Maximum RMS phase-to-neutral voltage 2-N	
	V3N (V)⁽¹⁾		Maximum RMS phase-to-neutral voltage 3-N	
	V MIN	V12 (V)	Minimum RMS phase-to-phase voltage 1-2	

Level 3	Level 4	Level 5	Parameter name	
		V23 (V)	Minimum RMS phase-to-phase voltage 2-3	
		V31 (V)	Minimum RMS phase-to-phase voltage 3-1	
		V1N (V)⁽¹⁾	Minimum RMS phase-to-neutral voltage 1-N	
		V2N (V)⁽¹⁾	Minimum RMS phase-to-neutral voltage 2-N	
		V3N (V)⁽¹⁾	Minimum RMS phase-to-neutral voltage 3-N	
	V avg	VLL (V)	Average of 3 RMS phase-to-phase voltages (V12+V23+V31)/3, with quality gauge	
		VLN (V)⁽¹⁾	Average of 3 RMS phase-to-neutral voltages (V1N+V2N+V3N)/3	
	V unb	VLL (%)	Real-time maximum of 3 phase-to-phase voltage unbalances, with quality gauge	
		VLN (%)⁽¹⁾	Real-time maximum of 3 phase-to-neutral voltage unbalances	
	V unb MAX	VLL (%)	Maximum of maximum of 3 phase-to-phase voltage unbalances	
		VLN (%)⁽¹⁾	Maximum of maximum of 3 phase-to-neutral voltage unbalances	
	Reset MIN/MAX		Reset of minimum and maximum RMS voltage, with date and time of last reset	
	(1) Applies to 4-pole circuit breakers or 3-pole circuit breakers with ENVT wired and configured.			

Power

The **Power** menu presents the following measurements:

Level 3	Level 4	Level 5	Parameter name	
Power	P	P1 (kW)	Active power on phase 1	
		P2 (kW)	Active power on phase 2	
		P3 (kW)	Active power on phase 3	
		Ptot (kW)	Total active power	
	P MAX	Ptot (kW)	Maximum total active power	
	Q	Q1 (kVAR)⁽¹⁾	Reactive power on phase 1	
		Q2 (kVAR)⁽¹⁾	Reactive power on phase 2	
		Q3 (kVAR)⁽¹⁾	Reactive power on phase 3	
		Qtot (kVAR)	Total reactive power	
	Q MAX	Qtot (kVAR)	Maximum total reactive power	
	S	S1 (kVA)⁽¹⁾	Apparent power on phase 1	
		S2 (kVA)⁽¹⁾	Apparent power on phase 2	
		S3 (kVA)⁽¹⁾	Apparent power on phase 3	
		Stot (kVA)	Total apparent power	
	S MAX	Stot (kVA)	Maximum total apparent power	
	Reset MAX		Reset of maximum power, with date and time of last reset	
	(1) Applies to 4-pole circuit breakers or 3-pole circuit breakers with ENVT wired and configured.			

Energy

The **Energy** menu presents the following measurements:

Level 3	Level 4	Level 5	Parameter name	
Energy	E total	Ep (kWh)	Total active energy	
		Eq (kVArh)	Total reactive energy	
		Es (kVAh)	Total apparent energy	
	E delivered	Ep (kWh)	Total active energy delivered into the load (counted positively)	
		Eq (kVArh)	Total reactive energy delivered into the load (counted positively)	
	E received	Ep (kWh)	Total active energy received out of the load (counted negatively)	
		Eq (kVArh)	Total reactive energy received out of the load (counted negatively)	
	Reset counters		Reset of accumulated energy, with date and time of last reset	

Frequency

The **Frequency** menu presents the following measurements:

Level 3	Level 4	Level 5	Parameter name
Frequency	F	F (Hz)	Frequency with quality gauge
	F MAX	F (Hz)	Maximum frequency
	F MIN	F (Hz)	Minimum frequency
	Reset MIN/MAX		Reset of minimum and maximum frequency, with date and time of last reset

I Harmonics

The **I harmonics** menu presents the following measurements:

Level 3	Level 4	Level 5	Parameter name	
I harmonics	I THD	I1 (%)	Total Harmonic Distortion (THD) of current on phase 1 compared to the fundamental	
		I2 (%)	Total Harmonic Distortion (THD) of current on phase 2 compared to the fundamental	
		I3 (%)	Total Harmonic Distortion (THD) of current on phase 3 compared to the fundamental	
		IN (%) ⁽¹⁾	Total Harmonic Distortion (THD) of current on neutral compared to the fundamental	
	I THD IN MAX ⁽¹⁾	IN (%)	Maximum of Total Harmonic Distortion (THD) of current on neutral compared to the fundamental	
	I THD avg	I (1, 2, 3) (%)	Average of 3 phase current Total Harmonic Distortions (THD) compared to the fundamental	
	I THD avg MAX	I (1, 2, 3) (%)	Maximum average of 3 phase current Total Harmonic Distortions (THD) compared to the fundamental, with date and time of occurrence	
	Reset MAX		Reset of minimum and maximum THD, with date and time of last reset	
	(1) Applies to 4-pole circuit breakers or 3-pole circuit breakers with ENVT wired and configured.			

V Harmonics

The **V harmonics** menu presents the following measurements:

Level 3	Level 4	Level 5	Parameter name
Voltage	V THD	V12 (%)	Total harmonic distortion (THD) of phase-to-phase voltage 1-2 compared to the fundamental
		V23 (%)	Total harmonic distortion (THD) of phase-to-phase voltage 2-3 compared to the fundamental
		V31 (%)	Total harmonic distortion (THD) of phase-to-phase voltage 3-1 compared to the fundamental
		V1N (%) ⁽¹⁾	Total harmonic distortion (THD) phase-to-neutral voltage 1-N compared to the fundamental
		V2N (%) ⁽¹⁾	Total harmonic distortion (THD) phase-to-neutral voltage 2-N compared to the fundamental
		V3N (%) ⁽¹⁾	Total harmonic distortion (THD) phase-to-neutral voltage 3-N compared to the fundamental
	V THD avg	VLL (%)	Average of 3 phase-to-phase voltage Total Harmonic Distortions (THD) compared to the fundamental
		VLN (%) ⁽¹⁾	Average of 3 phase-to-neutral voltage Total Harmonic Distortions (THD) compared to the fundamental
	V THD avg MAX	VLL (%)	Maximum value since last reset of average of 3 phase-to-phase voltage Total Harmonic Distortions (THD) compared to the fundamental
		VLN (%) ⁽¹⁾	Maximum value since last reset of average of 3 phase-to-neutral voltage Total Harmonic Distortions (THD) compared to the fundamental
	Reset MAX		Reset all maximum and minimum voltages

(1) Applies to 4-pole circuit breakers or 3-pole circuit breakers with ENVT wired and configured.

Power Factor Menu

The **Power factor** menu presents the following data:

Level 3	Level 4	Parameter name
Power Factor	PF	Total power factor
	Cos φ	Total fundamental power factor
	Network	<p>The parameters displayed depend on the sign convention for power factor and cos phi selected.</p> <ul style="list-style-type: none"> • If IEEE is selected (factory setting), the displayed parameter is: <ul style="list-style-type: none"> ◦ Leading in the case of lead ◦ Lagging in the case of lag • If IEC is selected, the displayed parameter is: <ul style="list-style-type: none"> ◦ Capacitive in the case of lead ◦ Inductive in the case of lag

Alarms & History Menu

Description

The **Alarms & History** menu contains the following menus:

Level 1	Level 2	Level 3	Function description
Home	Alarms & History	Alarms n	Displays events of medium and high severity of Entry/Exit type, after the occurrence of the alarm and before the completion. The number n indicates the number of active or held alarms. Trips are not displayed.
		Trips history	Displays the history of trips, with the date and time that the trip occurred.
		Alarms history	Displays the history of events of medium and high severity, with the date and time for the following type of events: <ul style="list-style-type: none"> • Pulse-type events with the date and time of occurrence • Entry/exit-type events with the date and time of completion Trips are not displayed in this history.

NOTE: Trip history and alarm history events are listed in chronological order, with the most recent event first.

Alarms Screen

An alarm screen for an active alarm contains the following information:

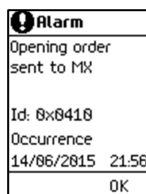

Screen title: Alarm

Description: up to three lines of text describing the nature of the alarm (medium or high severity event).

Event code

Event status: Occurrence

The date and time that the alarm occurred.

Use the up and down arrows at the bottom of the screen to navigate between active alarm screens.

Trips History Screens

A trips history screen contains the following information:

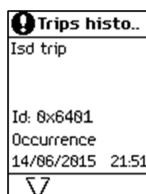

Screen title: Trips history

Description: up to three lines of text describing the nature of the trip (high severity event).

Event code

Event status: Occurrence

The date and time that the event occurred.

Use the up and down arrows at the bottom of the screen to navigate between trips history screens.

Alarms History Screens

An alarms history screen contains the following information:

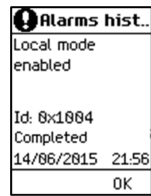

Screen title: Alarms history

Description: up to three lines of text describing the nature of the alarm (medium or high severity event).

Event code

Event status:

- Completed: for Entry/Exit type events.
- Occurrence: for Pulse type events.

The date and time that the event completed or occurred.

Use the up and down arrows at the bottom of the screen to navigate between alarms history screens.

Maintenance Menu

Description

The **Maintenance** menu contains the following submenus:

Level 1	Level 2	Level 3	Function description
Home	Maintenance	Switch to other set ⁽¹⁾	Dual setting configuration, page 120
		Assistance	Presents information about the maintenance schedule and the firmware version of the MicroLogic X control unit., page 237
		Health	Describes the health state of the circuit breaker., page 242
		CB overview	Presents information about the circuit breaker, page 261.
(1) Displayed only when the parameter Dual settings is set to Enabled and the parameter Switch Mode is set to Local HMI .			

Switch to Other Set

The **Switch to other set** menu is displayed only when the parameter **Dual settings** is set to **Enabled** and the parameter **Switch Mode** is set to **Local HMI**. It presents the following data:

Level 3	Level 4	Parameter name
Switch to other set	Switch to set B	Selection of the setting group A or B when the dual settings function is enabled.

Assistance

The **Assistance** menu presents the following data:

Level 3	Level 4	Level 5	Parameter name
Assistance	Maint. schedule	Next Maint.	Displays: <ul style="list-style-type: none"> Next maintenance program to be performed Number of months before program is due, or number of months program is overdue
		Last Maint.	Displays: <ul style="list-style-type: none"> Last maintenance program performed and date Name of maintenance provider Name of maintenance personnel who carried out the program
	Firmware Version	µLogic version	Displays the MicroLogic X firmware version in the format xxx.xxx.xxx.
		M&P version	Displays: <ul style="list-style-type: none"> M&P firmware version and TCI firmware version, used to check compliance with UL 489SE CRC32 code of the firmware versions
		TCI version	
		ASIC version	Displays the ASIC firmware version.

Level 3	Level 4	Level 5	Parameter name
		Measure version	Displays: <ul style="list-style-type: none"> Firmware version of the measurement algorithm, used to check compliance with IEC 61557-12 CRC32 code of the firmware version

Health

The **Health** menu presents the following data:

Level 3	Level 4	Parameter name
Health	Circuit breaker	Displays remaining service life of the breaking block as a percentage
	MicroLogic	Displays remaining service life of the MicroLogic X control unit as a percentage
	Actuator wear	Displays as a percentage the wear of the following auxiliaries: <ul style="list-style-type: none"> MCH gear motor XF closing voltage release MN undervoltage release MX1 opening voltage release MX2 opening voltage release
	Contact wear	Displays wear of the contacts as a percentage

CB Overview

The **CB overview** menu presents the following data:

Level 3	Level 4	Parameter name
CB overview	CB block	Circuit breaker range: MasterPact Device size: MTZ1, MTZ2, or MTZ3 Rated current x 100 A (Example: 08 corresponds to a rated current In of 800 A) Performance level: N1, H1, H2, H3, or L1 Power system: 3P or 4P Standard: IEC, UL, or ANSI

Configuration Menu

Description

The **Configuration** menu contains the following submenus:

Level 1	Level 2	Level 3	Function description
Home	Configura-tion	General	Settings of the HMI display and control of access to protection settings.
		Network	Settings of nominal voltage and frequency, power sign, and VT ratio, page 77.
		Measures	Settings of measurement calculation, page 77.
		Communication	Settings enabling wireless access and the control mode, page 78.

General

The **General** menu presents the following data:

Level 3	Level 4	Level 5	Parameter name
General	Language , page 51		List of display screen languages.
	Date & time , page 38	dd/mm/yyyy	Set the date.
		hh:mm:ss	Set the time.
	Quick view , page 55	Scrolling	Enable/disable Quick View scrolling.
		Auto start (min)	The time delay before Quick View scrolling resumes after an interruption if no button is pressed. NOTE: Only available when Quick View scrolling is enabled.
		Pageflow (s)	The length of time (in seconds) for which each Quick View screen is displayed. NOTE: Only available when Quick View scrolling is enabled.
		Time out (min)	The time delay before the Quick View Current screen is displayed if no button is pressed. NOTE: Only available when Quick View scrolling is not enabled.
	Lock protection , page 96	Keypad	Enable locking of local access to the Protection menu through the MicroLogic X keypad. This helps to prevent unauthorized users from editing protection settings. <ul style="list-style-type: none"> Protection change > Allowed means that the Protection menu can be accessed from the MicroLogic X keypad. Protection change > Not allowed means that the Protection menu cannot be accessed from the MicroLogic X keypad.
		External access	Enable locking of external access to the Protection menu. This helps to prevent unauthorized users from editing protection settings. <ul style="list-style-type: none"> Protection change > Allowed means that the Protection menu can be externally accessed. Protection change > Not allowed means that the Protection menu cannot be externally accessed.

Level 3	Level 4	Level 5	Parameter name
	Pop-up messages , page 87	Auto Acknowledge	Auto-acknowledgment mode for predefined medium severity events displayed in an orange pop-up screen: <ul style="list-style-type: none"> • ON • OFF (factory setting)
		Pop-up delay (s)	Time delay before pop-up is acknowledged automatically when auto-acknowledgment mode is ON . <ul style="list-style-type: none"> • Setting range: 1–250 s • Factory setting = 15 s

Network

The **Network** menu presents the following data:

Level 3	Level 4	Level 5	Parameter name
Network	Nominal voltage	Vn (V)	Rated voltage. Setting values include: 208 / 220 / 230 / 240 / 380 / 400 / 415 / 440 / 480 / 500 / 525 / 550 / 575 / 600 / 660 / 690 / 1000 V. Factory setting = 400.
	Nominal frequency	Hz	Rated frequency <ul style="list-style-type: none"> • 50 Hz (factory setting) • 60 Hz
	Power sign , page 215	–	Power flow sign setting: <ul style="list-style-type: none"> • P+ = the active power flows from upstream (top) to downstream (bottom) (factory setting). • P- = the active power flows from downstream (bottom) to upstream (top).
	VT ratio	VT in	VT primary voltage. Values from 100 to 1,250, in increments of 1.
VT out		VT secondary voltage. Values from 100 to 690, in increments of 1.	

Measures

The **Measures** menu presents the following data:

Level 3	Level 4	Level 5	Parameter name
Measures	PF/Var , page 227		Sign convention for cos φ, PF power factor, and reactive power: <ul style="list-style-type: none"> • IEC • IEEE (factory setting)
		System type , page 208	Nb poles
			ENVT
		ENCT	External neutral current transformer. Setting values include: <ul style="list-style-type: none"> • If 4P: NO (for display only) • If 3P: NO (factory setting) or YES

Level 3	Level 4	Level 5	Parameter name
	Tot. P calcul , page 214		Total power calculation method: <ul style="list-style-type: none"> • Vector • Arithmetic (factory setting)
	E calcul , page 219		Energy Accumulation mode. Energy values to be used in energy calculations: <ul style="list-style-type: none"> • Absolute (factory setting) • Signed

Communication

The **Communication** menu presents the following data:

Level 3	Level 4	Level 5	Parameter name
Communication	Bluetooth ⁽¹⁾ , page 290	ON	Enables Bluetooth control
		OFF (factory setting)	Disables Bluetooth control
		Timer (min)	Time delay before Bluetooth is automatically deactivated: <ul style="list-style-type: none"> • If no connection is established • If no activity is detected From 5 to 60 minutes. Factory setting = 15 minutes
	Control mode , page 274	Mode	Defines the means to control the opening and closing functions: <ul style="list-style-type: none"> • Manual: (BP command only) pushbutton commands only are accepted • Automatic: <ul style="list-style-type: none"> ◦ (Local control) ◦ (Remote control) (factory setting)
(1) The Bluetooth menu cannot be selected on MicroLogic Xi control units, page 329.			

Protection Menu

Description

The **Protection** menu contains the following submenus:

Level 1	Level 2	Level 3	Function description
Home	Protection	I long time	Long-time overcurrent protection, page 100, L or ANSI 49RMS/51
		I short time ⁽¹⁾	Short-time overcurrent protection, page 104, S or ANSI 50TD/51
		I instantaneous	Instantaneous overcurrent protection, page 107, I or ANSI 50
		I ground fault ⁽²⁾	Ground-fault protection, page 111, G or ANSI 50N-TD/51N
		I earth leakage ⁽³⁾	Earth-leakage protection, page 115, ANSI 50G-TD
		I neutral	Neutral protection, page 118
		Dual settings	Dual settings, page 120
(1) Applies to MicroLogic 5.0 X, 6.0 X for IEC and UL standards, and MicroLogic 7.0 X IEC standard			
(2) Applies to MicroLogic 6.0 X IEC and UL standards			
(3) Applies to MicroLogic 7.0 X IEC standard			

Active Settings

The active settings used by the protection functions are displayed in the Quick View, page 54.

The settings in the **Protection** menu are the settings defined by the user. They may differ from the settings used by the protection functions when **Fallback settings mode** is active (see detailed topic, page 123).

I Long Time

The **I long time** menu presents the following data and settings:

Level 3	Level 4	Parameter name
I long time	I _r (x I _n)	I _r long-time overcurrent protection threshold expressed according to the control unit rated current I _n . Used for quick settings: 0.4, 0.5, 0.6, 0.7, 0.8, 0.9, 0.95, 0.98, 1 x I _n .
	I _r (A)	I _r long-time overcurrent protection threshold expressed in Amps. Used for settings with 1 A resolution.
	tr@6I _r (s)	tr long-time overcurrent protection time delay.

I Short Time

The **I short time** menu for MicroLogic 5.0 X, 6.0 X for IEC and UL standards, and MicroLogic 7.0 X IEC standard presents the following data and settings:

Level 3	Level 4	Parameter name
I short time	I_r (A)	I _r long-time overcurrent protection threshold expressed according to the control unit rated current I _n , for display only.
	I_{sd} (x I_r)	I _{sd} short-time overcurrent protection threshold expressed according to the I _r long-time overcurrent protection threshold. Step = 0.5 x I _r . Range = 0.5–10 x I _r
	I_{sd} (A)	I _{sd} short-time overcurrent protection threshold expressed in Amps, for display only.
	t_{sd} (s)	t _{sd} short-time overcurrent protection time delay.
	I²t (t_{sd})	Enable inverse time curve function: ON or OFF

I Instantaneous

The **I instantaneous** menu for MicroLogic 2.0 X IEC standard presents the following data and settings:

Level 3	Level 4	Parameter name
I instantaneous	I_r (A)	I _r long-time overcurrent protection threshold expressed in Amps, for display only.
	I_{sd} (x I_r)	I _{sd} instantaneous overcurrent protection threshold expressed according to the I _r long-time overcurrent protection threshold. Step = 0.5 x I _r . Range = 0.5–10 x I _r
	I_{sd} (A)	I _{sd} instantaneous overcurrent protection threshold expressed in Amps, for display only.

The **I instantaneous** menu for MicroLogic 3.0 X UL standard presents the following data and settings:

Level 3	Level 4	Parameter name
I instantaneous	I_i (x I_n)	I _i instantaneous overcurrent protection threshold expressed according to the control unit rated current I _n .
	I_i (A)	I _i instantaneous overcurrent protection threshold expressed in Amps, for display only.
	I_i tripping mode	Instantaneous overcurrent protection time delay mode: Standard or Fast

The **I instantaneous** menu for MicroLogic 5.0 X, 6.0 X for IEC and UL standards, and MicroLogic 7.0 X IEC standard, presents the following data and settings:

Level 3	Level 4	Parameter name
I instantaneous	Protection	Enable instantaneous overcurrent protection mode: <ul style="list-style-type: none"> OFF: the following menus are not displayed ON: the following menus are displayed
	I_i (x I_n)	I _i instantaneous overcurrent protection threshold expressed according to the control unit rated current I _n . Step = 0.5 x I _n . Range = 0.2–15 x I _n

Level 3	Level 4	Parameter name
	li (A)	li instantaneous overcurrent protection threshold expressed in Amps, for display only.
	li tripping mode	Instantaneous overcurrent protection time delay mode: Standard or Fast

I Ground Fault for IEC Standard

⚠ WARNING	
HAZARD OF EQUIPMENT DAMAGE	
With MicroLogic X control unit for IEC standard, when using source ground return (SGR) with MDGF module:	
<ul style="list-style-type: none"> • Ig mode setting in OFF position is forbidden. • Ig threshold setting must be ≤1,200 A. 	
Failure to follow these instructions can result in death, serious injury, or equipment damage.	

NOTE: Ground-fault protection is also called earth-fault protection.

The **I ground fault** menu for MicroLogic 6.0 X IEC standard presents the following data and settings:

Level 3	Level 4	Level 5	Parameter name
I ground fault		Protection	Enable ground fault overcurrent protection mode: <ul style="list-style-type: none"> • OFF: the following menus are not displayed • ON: the following menus are displayed
		Ig (x In)	Ig ground fault protection threshold expressed according to the control unit rated current In. Used for quick settings: 0.2, 0.3, 0.4, 0.5, 0.6, 0.7, 0.8, 0.9, 1 x In.
		Ig (A)	Ig ground fault protection threshold expressed in Amps. Used for settings with: <ul style="list-style-type: none"> • 1 A resolution for In ≤1000 A • 10 A resolution for In > 1000 A
		tg (s)	tg ground fault protection time delay. Settings: 0, 0.1, 0.2, 0.3, 0.4 s
		I²t (tg)	Enable ground fault protection curve function: ON or OFF

I Ground Fault for UL Standard

The **I ground fault** menu for MicroLogic 6.0 X UL standard presents the following data and settings:

Level 3	Level 4	Level 5	Parameter name
I ground fault		Ig (x In)	Ig ground fault protection threshold expressed according to the control unit rated current In. Used for quick settings: 0.2, 0.3, 0.4, 0.5, 0.6, 0.7, 0.8, 0.9, 1 x In.

Level 3	Level 4	Level 5	Parameter name
		Ig (A)	Ig ground fault protection threshold expressed in Amps. Used for settings with: <ul style="list-style-type: none"> • 1 A resolution for In ≤1000 A • 10 A resolution for In > 1000 A
		tg (s)	tg ground fault protection time delay. Settings: 0, 0.1, 0.2, 0.3, 0.4 s
		I²t (tg)	Enable ground fault protection curve function: ON or OFF

I Earth Leakage

The **I earth leakage** menu for MicroLogic 7.0 X IEC standard presents the following data and settings:

Level 3	Level 4	Parameter name
I earth leakage	IΔn (A)	Earth-leakage protection threshold expressed in Amps. Step = 0.1 A Range = 0.5–30 A
	Δt (s)	Earth-leakage protection time delay. Settings: 0.06, 0.15, 0.23, 0.35, 0.80 s

I Neutral

The **I neutral** menu presents the following data and settings:

Level 3	Level 4	Parameter name
I neutral⁽¹⁾	Nb poles	Number of poles 3P or 4P , for display only.
	Ir (A)	Ir long-time overcurrent protection threshold expressed in Amps, for display only.
	Protection	Set neutral protection: <ul style="list-style-type: none"> • OFF • N/2 (factory setting) • N • Oversized N
	IN (A)	RMS current on neutral, for display only.

(1) Applies to 4-pole circuit breakers and 3-pole circuit breakers with ENCT option.

Dual Settings

The **Dual settings** menu presents the following data and settings:

Level 3	Level 4	Parameter name
Dual settings	Dual settings	Enables dual settings: <ul style="list-style-type: none"> • NO (factory setting): dual settings is disabled • YES: dual settings is enabled
	Settings	Displays the active configuration A or B when Dual settings is enabled.

Level 3	Level 4	Parameter name
	Switch mode (1)	Displays the configured mode for switching between setting group A and setting group B: <ul style="list-style-type: none"> • Local HMI • Remote • IO - 1 Wire • IO - 2 Wires
(1) Displayed if Dual settings is enabled. Configurable through EcoStruxure Power Commission software.		

If the **Dual settings** menu is enabled the menu **Settings B** with the following data and settings is shown and can be configured:

Level 5	Level 6	Parameter name
I long time (1)	Ir (x In)	Ir long-time overcurrent protection threshold expressed according to the control unit rated current In. Used for quick settings: 0.4, 0.5, 0.6, 0.7, 0.8, 0.9, 0.95, 0.98, 1 x In
	Ir (A)	Ir long-time overcurrent protection threshold expressed in Amps. Used for settings with 1 A resolution.
	tr@6Ir (s)	tr long-time overcurrent protection time delay.
I short time (1)	Ir (A)	Ir long-time overcurrent protection threshold expressed according to the control unit rated current In, for display only.
	Isd (x Ir)	Isd short-time overcurrent protection threshold expressed according to the Ir long-time overcurrent protection threshold. Step = 0.5 x Ir; Range = 0.5–10 x Ir.
	Isd (A)	Isd short-time overcurrent protection threshold expressed in Amps, for display only.
	tsd (s)	tsd short-time overcurrent protection time delay.
	I²t	Enable inverse time curve function: ON or OFF
I instantaneous (1)	Ir (A) (2)	Ir long-time overcurrent protection threshold expressed in Amps, for display only.
	Isd (x Ir) (2)	Isd instantaneous overcurrent protection threshold expressed according to the Ir long-time overcurrent protection threshold. Step = 0.5 x Ir. Range = 0.5–10 x Ir
	Isd (A) (2)	Isd instantaneous overcurrent protection threshold expressed in Amps, for display only.
I instantaneous (1)	Protection (3)	Enable instantaneous overcurrent protection mode: <ul style="list-style-type: none"> • OFF: the following menus are not displayed. • ON: the following menus are displayed.
	Ii (x In) (4)	Ii instantaneous overcurrent protection threshold expressed according to the control unit rated current In. Step = 0.5 x In; Range = 0.2–15 x In.
	Ii (A) (4)	Ii instantaneous overcurrent protection threshold expressed in Amps, for display only.
	Ii tripping mode (4)	Instantaneous overcurrent protection time delay mode: Standard or Fast
I  (1)	Protection	Enable ground fault overcurrent protection mode: <ul style="list-style-type: none"> • OFF: the following menus are not displayed. • ON: the following menus are displayed.
	Ig (x In)	Ig ground fault protection threshold expressed according to the control unit rated current In. Used for quick settings: 0.2, 0.3, 0.4, 0.5, 0.6, 0.7, 0.8, 0.9, 1 x In.

Level 5	Level 6	Parameter name
	Ig (A)	Ig ground fault protection threshold expressed in Amps Used for settings with: <ul style="list-style-type: none"> • 1 A resolution for $I_n \leq 1000$ A • 10 A resolution for $I_n > 1000$ A
	tg (s)	tg ground fault protection time delay.
	I²t (tg)	Enable ground fault protection curve function: ON or OFF
<p>(1) If Dual Settings is enabled, B is displayed on the upper left side of these screens.</p> <p>(2) Applies to MicroLogic 2.0 X IEC standard</p> <p>(3) Applies to MicroLogic 5.0 X, 6.0 X, 7.0 X IEC standard and MicroLogic 5.0 X, 6.0 X UL standard</p> <p>(4) Applies to MicroLogic 5.0 X, 6.0 X, 7.0 X IEC standard and MicroLogic 3.0 X, 5.0 X, 6.0 X UL standard</p>		

Pop-up Event Messages

Event Message Types and Priority

When the MicroLogic X control unit detects any of the following events, a pop-up message is displayed, in this order of priority:

- Bluetooth pairing
- Trip
- High severity alarm
- Medium severity alarm
- ERMS engaged
- Error

An event message overrides another event message with lower priority.

An event message overrides both **Quick view** scrolling and tree navigation operating mode displays.

Bluetooth Pairing Display



The Bluetooth pairing message is displayed during the Bluetooth pairing procedure, page 290.

The Bluetooth pairing message has the highest priority and overrides all other messages.

The Bluetooth pairing screen is closed when:

- The pairing is confirmed on the smartphone
- The Bluetooth button on the MicroLogic X control unit is pressed
- The **Cancel** button at the bottom of the MicroLogic X display screen is pressed
- The Bluetooth pairing timeout expires

If an event message was displayed before or occurs during the Bluetooth pairing, it is displayed after the Bluetooth pairing message closes. Otherwise the **Home** screen is displayed.

Pop-up Trip and Alarm Message Displays

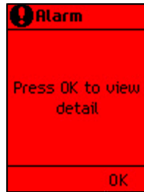
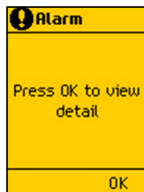
Message type	Description	Example
Trip	When a trip occurs, the trip message is displayed with a red backlight.	
High severity alarm	When a high severity alarm occurs, the high severity alarm message is displayed with a red backlight.	
Medium severity alarm	When a medium severity alarm occurs, the medium severity alarm message is displayed with an orange backlight.	

Handling Pop-up Trip and Alarm Messages

A trip or alarm message indicates that a potentially serious operating event has occurred. To address the event, take the following steps:

Step	Action
1	When the trip or alarm event message displays, press OK . The display screen displays a message explaining the context of the trip or details of the alarm event. The backlight color turns white.
2	After reading the explanatory message, take the remedial steps necessary to resolve the underlying condition that caused the trip or alarm.
3	After resolving the cause of the event, press OK to acknowledge the message. The explanatory message closes, and the display screen shows the Alarms & history menu screen. NOTE: Return to the Home screen by pressing ESC or the home button while a pop-up screen or trip/alarm context screen is displayed.
4	If the event is latched, press the Test/Reset button for three seconds to reset the latched event and switch off the service LED.

NOTE: The display screen displays the trip or alarm message again, with the appropriate backlight color, when the message is not acknowledged by pressing **OK** before the event timeout expires.

For information about recommended action on events, refer to the description in this guide of the function generating the event, and the relevant document, page 10:

- *MasterPact MTZ1- Circuit Breakers and Switch-Disconnectors - User Guide*
- *MasterPact MTZ2/3 - Circuit Breakers and Switch-Disconnectors - User Guide*

For information about how MicroLogic X control units handle events, refer to *Event Management*, page 302.

Auto-acknowledgement of Pop-up Messages

The following medium severity events, displayed in an orange pop-up screen, can be acknowledged automatically by the MicroLogic X control unit, when the auto-acknowledgment mode is **ON**.

Code	Event
0x03F5 (1013)	Ir prealarm (I > 90% Ir)
0x6200 (25088)	Ir start (I > 105% Ir)
0x050C (1292)	Ig alarm
0x050D (1293)	IAn alarm
0x6321 (25377)	IDMTL long time operate
0x6310 (25360)	Undervoltage on 1 phase operate
0x632A (25386)	Undervoltage on all 3 phases operate
0x6311 (25361)	Overvoltage on 1 phase operate
0x632B (25387)	Overvoltage on all 3 phases operate
0x6315 (25365)	Underfrequency operate
0x6316 (25366)	Overfrequency operate
0x6214 (25108)	Reverse power start
0x6314 (25364)	Reverse power operate
0x6323 (25379)	FW directional overcurrent operate
0x6324 (25380)	RV directional overcurrent operate

The auto-acknowledgment mode and pop-up delay parameter can be set only on the MicroLogic X display screen at **General > Pop-up messages**.

Auto-acknowledgment process is as follows:

1. The pop-up delay starts when the orange pop-up screen related to the event is displayed.
2. If the event is in exit mode when the pop-up delay expires, the MicroLogic X control unit automatically acknowledges the orange pop-up screen.

The user does not need to acknowledge the pop-up message locally on the MicroLogic X display screen.

Example: For motor application, the user can set the pop-up delay as the maximum motor start time. Upon completion of the motor start, the MicroLogic X control unit automatically acknowledges the orange pop-up screen related to the event **Ir start (I > 105% Ir)**. Therefore, the user does not need to acknowledge the pop-up message locally on the MicroLogic X display screen at each motor start.

Event Timeout

The event timeout can be configured in **Configuration > General > Quick view**.

If Quick View scrolling is on, the event timeout is the same as the **Auto start** for Quick View.

If Quick View scrolling is off, the event timeout is displayed as **Time out**.

For more information about event timeout configuration, refer to *Configuring Quick View Mode*, page 55.

ERMS Engaged Display

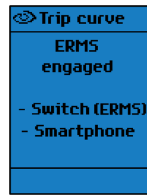

When the ERMS function is engaged by the external selector switch or with EcoStruxure Power Device app, the **ERMS engaged** message is displayed with a blue backlight.

The screen indicates the means used to engage the ERMS function. The screen displays one or both of the following:

- **Switch (ERMS)**
- **Smartphone**

All screens, except pop-up messages, are displayed with a blue backlight while the ERMS function is engaged.

Tree navigation is possible by pressing **ESC** or the home button with the ERMS function engaged.

For more information, refer to the ERMS function description, page 151.

Error Messages

An error message is displayed when the MicroLogic X control unit detects an internal error.

For more information, refer to the following guides, page 10:

- *MasterPact MTZ1 - Circuit Breakers and Switch-Disconnectors - User Guide*
- *MasterPact MTZ2/3 - Circuit Breakers and Switch-Disconnectors - User Guide*

Protection Functions

What's in This Part

Introduction.....	90
Standard Protection Functions	99
Optional Protection Functions	129
Setting Guidelines	168

Introduction

What's in This Chapter

Electrical Distribution Protection	91
Setting Protection in Accordance With UL489SE Standard	96

Electrical Distribution Protection

Presentation

MicroLogic X control units are designed to provide protection against overcurrents and ground-fault currents.

Description

When choosing protection characteristics, take into account:

- Overcurrents (overloads and short-circuits) and potential ground-fault currents
- Conductors that need protection
- Coordination and selectivity between the devices
- The presence of harmonic currents

Protection characteristics can be represented on a trip curve that shows the circuit breaker trip time as a function of the measured current and protection settings. Protection settings are indexed on the rated current I_n of the MicroLogic X control unit.

Rated Current I_n

The protection setting ranges depend on the rated current I_n , defined by the sensor plug inserted in the MicroLogic X control unit.

The sensor plug can be replaced or modified. Mechanical mismatch protection prevents the installation of a sensor plug that is not compatible with the circuit breaker frame.

For IEC standard circuit breakers, the range of sensor plugs available is shown in the following table.

In	Commercial reference	Frame rated current															
		MTZ1					MTZ2								MTZ3		
		06	08	10	12	16	08	10	12	16	20	25	32	40	40	50	63
400 A	LV847053	✓	✓	✓	–	–	✓	✓	–	–	–	–	–	–	–	–	–
630 A	LV833091	✓	✓	✓	✓	–	✓	✓	✓	–	–	–	–	–	–	–	–
800 A	LV833092	–	✓	✓	✓	✓	✓	✓	✓	–	–	–	–	–	–	–	–
1,000 A	LV833093	–	–	✓	✓	✓	–	✓	✓	✓	✓	–	–	–	–	–	–
1,250 A	LV833094	–	–	–	✓	✓	–	–	✓	✓	✓	✓	–	–	–	–	–
1,600 A	LV833095	–	–	–	–	✓	–	–	–	✓	✓	✓	✓	–	–	–	–
2,000 A	LV833982	–	–	–	–	–	–	–	–	–	✓	✓	✓	✓	–	–	–
2,500 A	LV833983	–	–	–	–	–	–	–	–	–	–	✓	✓	✓	–	–	–
3,200 A	LV833984	–	–	–	–	–	–	–	–	–	–	–	✓	✓	–	–	–
3,600 A	LV836390	–	–	–	–	–	–	–	–	–	–	–	–	✓	–	–	–
4,000 A	LV847820	–	–	–	–	–	–	–	–	–	–	–	–	✓	–	–	–
2,000 A	LV847821	–	–	–	–	–	–	–	–	–	–	–	–	–	✓	–	–
2,500 A	LV847822	–	–	–	–	–	–	–	–	–	–	–	–	–	✓	✓	–
3,200 A	LV847823	–	–	–	–	–	–	–	–	–	–	–	–	–	✓	✓	✓
3,600 A	LV836391	–	–	–	–	–	–	–	–	–	–	–	–	–	✓	✓	✓
4,000 A	LV847824	–	–	–	–	–	–	–	–	–	–	–	–	–	✓	✓	✓
5,000 A	LV847825	–	–	–	–	–	–	–	–	–	–	–	–	–	–	✓	✓
6,300 A	LV847826	–	–	–	–	–	–	–	–	–	–	–	–	–	–	–	✓

For UL standard circuit breakers, the range of sensor plugs available is shown in the following table.

In	Commercial reference	Frame rated current												
		MTZ1				MTZ2						MTZ3		
		06	08	12	16	08	12	16	20	25	30	40	50	60
400 A	LV847053	✓	✓	-	-	✓	-	-	-	-	-	-	-	-
600 A	LV848823	✓	✓	✓	-	✓	✓	-	-	-	-	-	-	-
800 A	LV833092	-	✓	✓	✓	✓	✓	✓	-	-	-	-	-	-
1,000 A	LV833093	-	-	✓	✓	-	✓	✓	✓	-	-	-	-	-
1,200 A	LV848824	-	-	✓	✓	-	✓	✓	✓	✓	-	-	-	-
1,600 A	LV833095	-	-	-	✓	-	-	✓	✓	✓	✓	-	-	-
2,000 A	LV833982	-	-	-	-	-	-	-	✓	✓	✓	-	-	-
2,500 A	LV833983	-	-	-	-	-	-	-	-	✓	✓	-	-	-
3,000 A	LV848825	-	-	-	-	-	-	-	-	-	✓	-	-	-
2,000 A	LV847821	-	-	-	-	-	-	-	-	-	-	✓	-	-
2,500 A	LV847822	-	-	-	-	-	-	-	-	-	-	✓	✓	-
3,000 A	LV848826	-	-	-	-	-	-	-	-	-	-	✓	✓	✓
3,200 A	LV847823	-	-	-	-	-	-	-	-	-	-	✓	✓	✓
3,600 A	LV836391	-	-	-	-	-	-	-	-	-	-	✓	✓	✓
4,000 A	LV847824	-	-	-	-	-	-	-	-	-	-	✓	✓	✓
5,000 A	LV847825	-	-	-	-	-	-	-	-	-	-	-	✓	✓
6,000 A	LV848827	-	-	-	-	-	-	-	-	-	-	-	-	✓

For ANSI standard circuit breakers, the range of sensor plugs available is shown in the following table.

In	Commercial reference	Frame rated current												
		MTZ1	MTZ2					MTZ3						
		08	08	16	20	32	40	32	40	50	60			
400 A	LV847053	✓	✓	-	-	-	-	-	-	-	-	-	-	-
600 A	LV848823	✓	✓	-	-	-	-	-	-	-	-	-	-	-
800 A	LV833092	✓	✓	✓	-	-	-	-	-	-	-	-	-	-
1,000 A	LV833093	-	-	✓	✓	-	-	-	-	-	-	-	-	-
1,200 A	LV848824	-	-	✓	✓	-	-	-	-	-	-	-	-	-
1,250 A	LV833094	-	-	✓	✓	-	-	-	-	-	-	-	-	-
1,600 A	LV833095	-	-	✓	✓	✓	-	-	-	-	-	-	-	-
2,000 A	LV833982	-	-	-	✓	✓	✓	-	-	-	-	-	-	-
2,500 A	LV833983	-	-	-	-	✓	✓	-	-	-	-	-	-	-
3,000 A	LV848825	-	-	-	-	✓	✓	-	-	-	-	-	-	-
3,200 A	LV833984	-	-	-	-	✓	✓	-	-	-	-	-	-	-
3,600 A	LV836390	-	-	-	-	-	✓	-	-	-	-	-	-	-
4,000 A	LV847820	-	-	-	-	-	✓	-	-	-	-	-	-	-
2,000 A	LV847821	-	-	-	-	-	-	✓	✓	-	-	-	-	-
2,500 A	LV847822	-	-	-	-	-	-	✓	✓	✓	✓	-	-	-
3,000 A	LV848826	-	-	-	-	-	-	✓	✓	✓	✓	✓	✓	✓
3,200 A	LV847823	-	-	-	-	-	-	✓	✓	✓	✓	✓	✓	✓
3,600 A	LV836391	-	-	-	-	-	-	-	✓	✓	✓	✓	✓	✓

In	Commercial reference	Frame rated current									
		MTZ1		MTZ2				MTZ3			
		08	08	16	20	32	40	32	40	50	60
4,000 A	LV847824	-	-	-	-	-	-	-	✓	✓	✓
5,000 A	LV847825	-	-	-	-	-	-	-	-	✓	✓
6,000 A	LV848827	-	-	-	-	-	-	-	-	-	✓

MicroLogic 2.0 X Control Unit

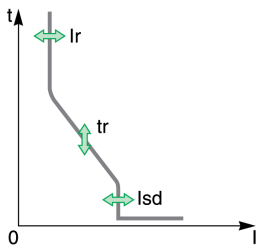

MicroLogic 2.0 X control units for IEC standard provide:

- Long-time overcurrent protection (I_r)
- Instantaneous overcurrent protection (I_{sd})

The protection functions of MicroLogic 2.0 X control units operate without an auxiliary power supply. The control unit is powered by the current flowing through the circuit breaker.

MicroLogic 3.0 X Control Unit

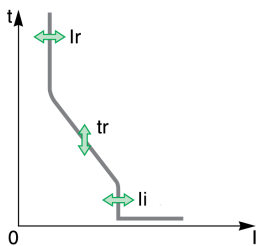

MicroLogic 3.0 X control units for UL standard provide:

- Long-time overcurrent protection (I_r)
- Instantaneous overcurrent protection (I_i)

The protection functions of MicroLogic 3.0 X control units operate without an auxiliary power supply. The control unit is powered by the current flowing through the circuit breaker.

MicroLogic 5.0 X Control Unit

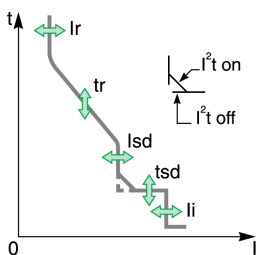

MicroLogic 5.0 X control units for IEC and UL standards provide:

- Long-time overcurrent protection (I_r)
- Short-time overcurrent protection (I_{sd})
- Instantaneous overcurrent protection (I_i)

The protection functions of MicroLogic 5.0 X control units operate without an auxiliary power supply. The control unit is powered by the current flowing through the circuit breaker.

MicroLogic 6.0 X Control Unit

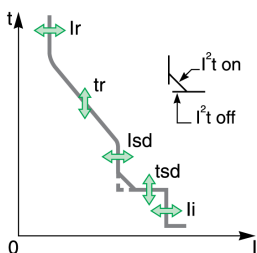

MicroLogic 6.0 X control units for IEC and UL standards provide:

- Long-time overcurrent protection (I_r)
- Short-time overcurrent protection (I_{sd})
- Instantaneous overcurrent protection (I_i)
- Ground-fault protection (I_g)

The protection functions of MicroLogic 6.0 X control units operate without an auxiliary power supply. The control unit is powered by the current flowing through the circuit breaker.

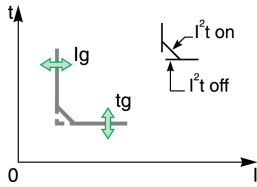

MicroLogic 7.0 X Control Unit

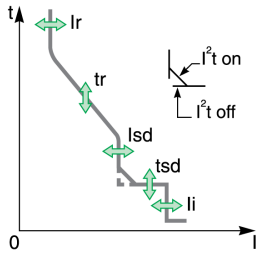

MicroLogic 7.0 X control units for IEC standard provide:

- Long-time overcurrent protection (Ir)
- Short-time overcurrent protection (Isd)
- Instantaneous overcurrent protection (li)
- Earth-leakage protection (IΔn)

The protection functions of MicroLogic 7.0 X control units operate without an external auxiliary power supply.

The MicroLogic X control unit is powered by the current flowing through the circuit breaker. In addition a VPS voltage power supply module is necessary to ensure the operation of the earth-leakage protection in the case of a fault with very low current.

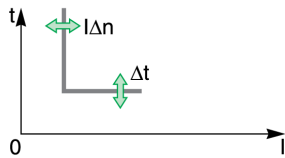

DIN / DINF and SELLIM Instantaneous Protections

DIN / DINF and SELLIM instantaneous protections are internal protections used when the short-circuit current reaches the withstand limit of the circuit breaker. These protections are not adjustable and are unlikely to be triggered in normal operating conditions.

The following predefined events can be generated by the DIN / DINF and SELLIM instantaneous protections.

Code	Event	History	Severity
0x6406 (25606)	Ultimate self-protection trip (SELLIM)	Trip	High
0x641D (25629)	Ultimate self-protection trip (DIN / DINF)	Trip	High
0x6306 (25350)	Ultimate self-protection (SELLIM) operate	Protection	Medium
0x631D (25373)	Ultimate self-protection (DIN / DINF) operate	Protection	Medium

Predefined events cannot be modified by the user. For general information about events, refer to [Event management](#), page 301.

Recommended Actions

Code	Event	Recommended actions
0x6406 (25606)	Ultimate self-protection trip (SELLIM)	Reset the device or use the Power restoration assistant within the EcoStruxure Power Device app.
0x641D (25629)	Ultimate self-protection trip (DIN / DINF)	Reset the device or use the Power restoration assistant within the EcoStruxure Power Device app.

Resetting a Trip Event

For information about resetting the circuit breaker after a trip due to an electrical fault, refer to the relevant document, page 10:

- *MasterPact MTZ1 - Circuit Breakers and Switch-Disconnectors - User Guide*
- *MasterPact MTZ2/MTZ3 - Circuit Breakers and Switch-Disconnectors - User Guide*

Setting Protection in Accordance With UL489SE Standard

Presentation

NOTICE

RISK OF UNINTENDED OPERATION

- The device must only be configured and set by qualified personnel, using the results of the installation protection system study.
- During commissioning of the installation and following any modification, check that the MicroLogic X configuration and protection function settings are consistent with the results of this study.
- MicroLogic X protection functions are set by default to the minimum value, except for the long time protection function which is set to the maximum value, by default.

Failure to follow these instructions can result in equipment damage.

The procedure for setting a protection setting conforms to UL489SE standard. It is safeguarded by an exclusive editing session and by a two-step procedure for submitting and applying setting changes.

The exclusive editing session means that only one interface at a time can access and set protection settings. Access from other interfaces is blocked when an editing session is open.

During the editing session there is no impact on the active protection provided by the MicroLogic X control unit until the new settings are applied. If the new settings are canceled, or the editing session times out before the new settings are applied, the active settings are maintained.

Settings for standard protection functions can be set from the following interfaces:

- On the MicroLogic X display screen, at **Home > Protection**
- With EcoStruxure Power Commission software (password-protected)
- With EcoStruxure Power Device app (password-protected)
- By sending setting commands using the communication network (password-protected)

Settings for optional protection functions, including the ERMS function, can be set from the following interfaces:

- With EcoStruxure Power Commission software (password-protected)
- With EcoStruxure Power Device app (password-protected)

For more information about password management, refer to the [password description](#), page 26.

The protection settings displayed in Quick View are the active protection settings applied on the installation.

To set a protection setting, access to protection settings must be enabled on the MicroLogic X HMI.

Enabling and Disabling Access to Protection Settings

You can enable or disable access to the protection settings by using the MicroLogic X display screen at **Home > Configuration > General > Lock protection**, page 64.

From the **Lock protection** screen of the MicroLogic X control unit, you can allow changes to the protection settings from the following interfaces:

- **Keypad:** MicroLogic X display screen keypad itself
- **External access:** EcoStruxure Power Commission software, EcoStruxure Power Device app, and communication network

For each interface:

- Set as **Allowed** (factory setting) to enable changes to be made.
- Set as **Not Allowed** to disable changes.

Enabling access to protection settings generates two events:

Code	Events	History	Severity
0x1309 (4873)	Protection settings change by display enabled	Protection	Low
0x130A (4874)	Remote protection settings change enabled	Protection	Low

Editing Session for Selecting and Changing Protection Settings

An editing session has the following characteristics:

- Only one editing session at a time can be open. Access to protection settings from other interfaces is blocked when you open an editing session. A pop-up notice is displayed if a session is already open, page 65.
- There is a five-minute timeout for submitting and for applying new settings. The session times out as follows:
 - Five minutes after the session opens, if you do not submit the new settings
 - Five minutes after submitting the new settings, if you do not apply the new settings

NOTE: When setting protection on the MicroLogic X display screen keypad, if the Quick View timeout is set up as less than five minutes, the editing session times out at the end of the time set for Quick View timeout.
- After applying new settings, close the editing session.
- When changing protection settings on the MicroLogic X display screen keypad, only one protection function can be set per editing session. Open a new editing session to make changes to a second protection function.
- When changing protection settings on EcoStruxure Power Device app or through communication, several protection functions can be set in one editing session, with a submit step after making changes to each function and one apply step to apply all the new settings of a given setting group (A, B, or ERMS). Active settings are maintained until the apply step is executed.

Two-Step Procedure for Submitting and Applying Protection Settings

The procedure for changing protection settings requires you to submit and apply the new settings in two consecutive steps:

Step	Action	
1	Submit new settings	Select new settings required and submit. The new settings are displayed so that you can check that the settings are correct before they are applied. Read the new settings to confirm that they are correct.
2	Apply new settings	Apply the new settings. The existing active protection settings are replaced by the new settings.

For more information about the procedure for changing protection settings on the MicroLogic X display screen, refer to *Protection Setting Procedure*, page 64.

Setting Change Traceability

Changing the protection settings generates one of the following events, depending on the interface used to change settings:

Code	Events	History	Severity
0x1100 (4352)	Protection settings changed by display	Protection	Low
0x1108 (4360)	Protection settings changed by Bluetooth/USB/IFE	Protection	Medium

The following data is available with EcoStruxure Power Device app through Bluetooth or USB OTG connection, in addition to the events generated:

- Date and time of the setting change
- Previous settings

Standard Protection Functions

What's in This Chapter

Long-Time Overcurrent Protection (L or ANSI 49RMS/51)	100
Short-Time Overcurrent Protection (S or ANSI 50TD/51)	104
Instantaneous Overcurrent Protection (I or ANSI 50)	107
Ground-Fault Protection (G or ANSI 50N-TD/51N)	111
Earth-Leakage Protection (ANSI 50G-TD)	115
Neutral Protection	118
Dual Settings	120
Fallback Settings Mode	123
Zone Selective Interlocking (ZSI)	125

Long-Time Overcurrent Protection (L or ANSI 49RMS/51)

Presentation

Long-time overcurrent protection helps to protect cables, busbars, and busbar trunking against overloads, based on the true RMS current. It is implemented independently for each phase and for the neutral.

This protection function is an overcurrent time-dependent protection with thermal memory. It operates as a thermal image, using the heating and cooling model of a conductor. After tripping, the protection continues to integrate the cooling of the conductor.

This protection function can be used also for transformer or generator protection thanks to the wide range of settings offered.

Availability

Long-time overcurrent protection is available on:

- MicroLogic 2.0 X, 5.0 X, 6.0 X, and 7.0 X control units for IEC standard
- MicroLogic 3.0 X, 5.0 X, and 6.0 X control units for UL standard
- 3-pole and 4-pole circuit breakers

Long-time overcurrent protection is powered by the current flowing through the internal current transformers of the circuit breaker and it does not require additional external power supply.

Operating Principle

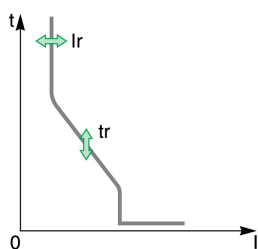

Long-time overcurrent protection is based on the true RMS current of phases and neutral, up to harmonic 15.

Long-time overcurrent protection is implemented independently for each phase and for neutral when present, page 118.

Thermal Image

The control unit uses the calculation of a thermal image to evaluate the conductor heat rise and precisely monitor the thermal state of the conductors.

Example:

Comparison of the heat rise calculation without thermal image (diagram **A**) and with thermal image (diagram **B**):

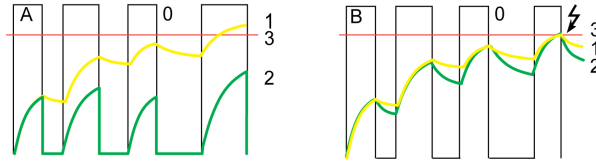

0 Instantaneous current (cyclical) in the load

1 Conductor temperature

2 Thermal state calculated without thermal image (diagram **A**), with thermal image (diagram **B**)

3 Long-time overcurrent protection threshold

- Control unit without thermal image: On each current pulse, the control unit only considers the thermal effect on the pulse under consideration. No tripping occurs despite the build-up in conductor heat rise.
- Control unit with thermal image: The control unit adds the thermal effect of successive current pulses. Tripping occurs based on the actual thermal state of the conductor.

The thermal image function helps to protect cables and busbars from overheating in case of low-amplitude repetitive faults. Such faults can be due to repetitive motor starts, fluctuating load, intermittent ground faults, or subsequent closing after an electrical fault.

Traditional electronic protection does not protect against repetitive faults because the duration of each overload detected above the threshold setting is too short to trigger effective tripping. However, each overload involves a temperature rise in the installation. The cumulative effect of successive overloads can overheat the system.

Thanks to its thermal memory, the thermal image function remembers and integrates thermal heating caused by each overload detected above the threshold setting:

- Before tripping, the integrated heating value reduces the associated time delay. The reaction of the control unit is closer to the real heating of the power network system.
- After tripping, the thermal function reduces the time delay when closing the circuit breaker on an overload.

The thermal memory works whatever the current value. It offers an accurate image of the cable or busbar thermal status. The time constant is the same for heating and cooling.

In the case of a control unit that is not supplied, the thermal memory is performed by a capacitor, which implies a fixed cooling time constant. The time constant is equivalent to a t_r setting of 12 seconds.

Setting the Protection

The long-time overcurrent protection settings are:

- I_r : long-time overcurrent protection threshold
- t_r : long-time overcurrent protection time delay

They can be set as follows:

- On the MicroLogic X display screen, at **Home > Protection > I Long time**

- With EcoStruxure Power Commission software (password-protected)
- With EcoStruxure Power Device app (password-protected)
- By sending a setting command using the communication network (password-protected).

Long-time overcurrent protection can be duplicated when dual settings are activated, page 120.

NOTE: To achieve the equivalent of the long-time rating plug OFF setting (available on MicroLogic trip units for MasterPact NT/NW devices), set the long-time protection settings as follows: $I_r = 1$; $t_r = 24$ s.

Protection Settings

Setting	Unit	Range	Step	Factory setting
I_r	A	0.4–1 x I_n	1 A	1 x I_n
t_r	s	0.5–24	0.5	0.5

The t_r long-time overcurrent protection time delay is given in cold-state conditions, and for a phase or neutral current equal to 6 x I_r .

When the current is higher than I_{sd} or I_i , only short-time overcurrent protection and instantaneous protection are operational.

For more information, refer to the setting guidelines, page 171.

Tripping Time According to t_r Time Delay

The tripping time according to t_r time delay is given in cold-state conditions.

t_r setting (tripping time at 6 x I_r)	0.5 s	1 s	2 s	4 s	8 s	12 s	16 s	20 s	24 s
Resulting tripping time at 1.5 x I_r	12.5 s	25 s	50 s	100 s	200 s	300 s	400 s	500 s	600 s
Resulting tripping time at 7.2 x I_r	0.34 s	0.69 s	1.38 s	2.7 s	5.5 s	8.3 s	11 s	13.8 s	16.6 s

Protection Characteristics

The accuracy on the t_r time delay is:

- -20% to 0% when $t_r > 2$ s
- -25% to 0% when $t_r = 2$ s
- -30% to 0% when $t_r < 2$ s

I_r characteristics:

- $I < 1.05$ x I_r : no trip
- $I > 1.2$ x I_r : trip

Predefined Events

The function generates the following predefined events:

Code	Event	History	Severity
0x6400 (25600)	I_r trip	Trip	High
0x6300 (25344)	I_r operate	Protection	Medium
0x03F5 (1013)	I_r prealarm ($I > 90\%$ I_r)	Protection	Medium
0x6200 (25088)	I_r start ($I > 105\%$ I_r)	Protection	Medium
0x0F11 (3857)	Thermal memory reset order	Protection	Low

Predefined events cannot be modified by the user. For general information about events, refer to [Event management](#), page 301.

Protection events are generated as follows:

- The start event is generated when the protection picks up.
- The operate event is generated when the protection time delay elapses.
- The trip event is generated when the circuit breaker tripping voltage release (MITOP) activates.

Recommended Actions

Code	Event	Recommended actions
0x6400 (25600)	Ir trip	Reset the device or use the Power restoration assistant within the EcoStruxure Power Device app.
0x03F5 (1013)	Ir prealarm (I > 90% Ir)	Check the load.
0x0F11 (3857)	Thermal memory reset order	Make sure someone has performed a tripping test.

Resetting a Trip Event

For information about resetting the circuit breaker after a trip due to an electrical fault, refer to the relevant document, page 10:

- *MasterPact MTZ1 - Circuit Breakers and Switch-Disconnectors - User Guide*
- *MasterPact MTZ2/MTZ3 - Circuit Breakers and Switch-Disconnectors - User Guide*

Short-Time Overcurrent Protection (S or ANSI 50TD/51)

Presentation

Short-time overcurrent protection helps to protect equipment against phase-to-phase, phase-to-neutral and phase-to-ground short circuits with total selectivity. It includes two characteristics, definite time and inverse time, which depend on the status of the I^2t setting.

Availability

Short-time overcurrent protection is available on:

- MicroLogic 5.0 X, 6.0 X, and 7.0 X control units for IEC standard
- MicroLogic 5.0 X and 6.0 X control units for UL standard
- 3-pole and 4-pole circuit breakers

Short-time overcurrent protection is powered by the current flowing through the internal current transformers of the circuit breaker and it does not require an additional external power supply.

Operating Principle

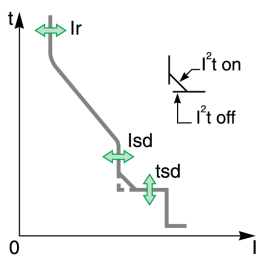

The short-time overcurrent threshold I_{sd} sets the level of short-circuit current at which the circuit breaker trips when reaching the short-time overcurrent time delay.

The short-time overcurrent time delay t_{sd} sets the length of time during which the circuit breaker carries a short circuit within the short-time overcurrent threshold range.

The short-time overcurrent time delay can be adjusted to:

- Four setting values with I^2t ON.
 - Up to $10 I_r$, the tripping curve is an inverse time curve. The time delay decreases as the current increases.
 - Above $10 I_r$, the tripping curve is a definite time curve with a constant tripping time.
- Five setting values with I^2t OFF. The tripping curve is a definite time curve with a constant tripping time.

Short-time overcurrent protection is based on the true RMS current of phases and neutral, up to harmonic 15.

In order to trip on an intermittent fault, the control unit accumulates the intermittent currents in the short-time tripping range that do not last long enough to trigger a trip. This accumulation may lead to shorter tripping times than those set.

Setting the Protection

The short-time overcurrent protection settings are:

- I_{sd} : short-time overcurrent protection threshold
- t_{sd} : short-time overcurrent protection time delay
- I^2t (t_{sd}): short-time overcurrent protection curve (I^2t ON or I^2t OFF)

They can be set as follows:

- On the MicroLogic X display screen, at **Home > Protection > I Short time**
- With EcoStruxure Power Commission software (password-protected)
- With EcoStruxure Power Device app (password-protected)
- By sending a setting command using the communication network (password-protected).

Short-time overcurrent protection can be duplicated when dual settings are activated, page 120.

Protection Settings

Setting	Unit	Range	Step	Factory setting	Accuracy
Isd	A	1.5–10 x Ir	0.5 x Ir ⁽¹⁾	1.5 x Ir	+/- 10%
tsd with I ² t ON	s	0.1–0.4	0.1	–	–
tsd with I ² t OFF	s	0–0.4	0.1	0	–

(1) Finer resolution settings are possible with EcoStruxure Power Commission software and EcoStruxure Power Device app

For more information, refer to the [setting guidelines](#), page 174.

Operating Times at 10 x Ir

The operating times of short-time protection depend on the tsd time delay. They are valid for I²t ON or OFF.

tsd time delay	0 s	0.1 s	0.2 s	0.3 s	0.4 s
Non-tripping time	> 0.02 s	> 0.08 s	> 0.14 s	> 0.23 s	> 0.35 s
Maximum breaking time	< 0.08 s	< 0.14 s	< 0.20 s	< 0.32 s	< 0.50 s

Zone Selective Interlocking (ZSI)

The ZSI characteristics and external wiring of the zone selective interlocking function, are described specifically, [page 125](#).

If ZSI IN is not set to 1 (open circuit between Z3 and Z4 terminals), the maximum breaking time is 0.08 s regardless of the tsd setting value.

When ZSI IN is set to 1 and connected to the ZSI OUT of a downstream device (or when the ZSI function is not used and there is a jumper between the Z3 and Z4 terminals), the tsd time delay is used.

The Isd threshold activates ZSI OUT (Z1 and Z2 terminals).

NOTE: MasterPact MTZ circuit breakers are delivered with a jumper installed between Z3 and Z4.

Predefined Events

The function generates the following predefined events:

Code	Event	History	Severity
0x6401 (25601)	Isd trip	Trip	High
0x6301 (25345)	Isd operate	Protection	Medium
0x6201 (25089)	Isd start (I > Isd)	Protection	Medium

Predefined events cannot be modified by the user. For general information about events, refer to [Event management](#), page 301.

Protection events are generated as follows:

- The start event is generated when the protection picks up.
- The operate event is generated when the protection time delay elapses.
- The trip event is generated when the circuit breaker tripping voltage release (MITOP) activates.

Recommended Actions

Code	Event	Recommended actions
0x6401 (25601)	Isd trip	Reset the device or use the Power restoration assistant within the EcoStruxure Power Device app.

Resetting a Trip Event

For information about resetting the circuit breaker after a trip due to an electrical fault, refer to the relevant document, page 10:

- *MasterPact MTZ1 - Circuit Breakers and Switch-Disconnectors - User Guide*
- *MasterPact MTZ2/MTZ3 - Circuit Breakers and Switch-Disconnectors - User Guide*

Instantaneous Overcurrent Protection (I or ANSI 50)

Presentation

Instantaneous protection helps to protect equipment against phase-to-phase, phase-to-neutral and phase-to-ground short circuits. The protection operates with a definite time characteristic. It trips without additional time delay as soon as the setting current is exceeded.

The protection offers two tripping modes, with different breaking times:

- Standard: breaking time of 50 ms, used for applications requiring selectivity. Full selectivity can be provided with any Compact NSX or PowerPact H-, J-, L-frame circuit breaker installed downstream of a MasterPact MTZ circuit breaker (Refer to selectivity tables for details for $U_e \leq 440$ Vac).
- Fast: breaking time of 30 ms, typically used for applications where the thermal constraints of the equipment need to be limited and when selectivity is not required. For more information, refer to LVPED318033EN *Complementary Technical Information*.

NOTE: On MicroLogic 2.0 X, instantaneous protection is based on short-time protection without time setting with standard breaking time of 80 ms.

Availability

Instantaneous overcurrent protection is available on:

- MicroLogic 2.0 X, 5.0 X, 6.0 X, and 7.0 X control units for IEC standard
- MicroLogic 3.0 X, 5.0 X, and 6.0 X control units for UL standard
- 3-pole and 4-pole circuit breakers

It is powered by the current flowing through the internal current transformers of the circuit breaker and it does not require an additional external power supply.

Operating Principle

The instantaneous overcurrent protection threshold sets the level of short-circuit current at which the circuit breaker trips with no intentional time delay.

For MicroLogic 5.0 X, 6.0 X, 7.0 X control units for IEC and UL standards, instantaneous overcurrent protection can be disabled.

For MicroLogic 2.0 X control units for IEC standard and MicroLogic 3.0 X control units for UL standard, instantaneous overcurrent protection cannot be disabled.

Instantaneous overcurrent protection overrides short-time overcurrent protection when the instantaneous overcurrent threshold is adjusted to the same or a lower setting than the short-time overcurrent threshold.

Setting the Protection for MicroLogic 2.0 X

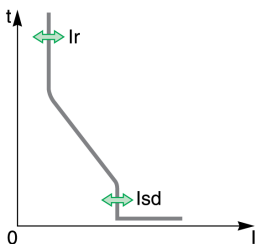

The instantaneous overcurrent protection setting for MicroLogic 2.0 X is:

- Isd: instantaneous overcurrent protection threshold (corresponds to a short-time overcurrent protection threshold without time setting)

It can be set as follows:

- On the MicroLogic X display screen, at **Home > Protection > I Instantaneous**
- With EcoStruxure Power Commission software (password-protected)
- With EcoStruxure Power Device app (password-protected)
- By sending a setting command using the communication network (password-protected).

Instantaneous overcurrent protection can be duplicated when dual settings are activated, page 120.

Protection Settings for MicroLogic 2.0 X

Setting	Unit	Range	Step	Factory setting
Isd	A	1.5–10 x Ir	0.5 x Ir ⁽¹⁾	1.5 x Ir
(1) Finer resolution settings are possible with EcoStruxure Power Commission software and EcoStruxure Power Device app.				

For more information, refer to the setting guidelines, page 176.

Protection Characteristics for MicroLogic 2.0 X

Characteristic	Unit	Value
Breaktime at 2 x Isd threshold	ms	≤ 80
Non-tripping time	ms	> 20
Accuracy on threshold	%	+/- 10

Setting the Protection for MicroLogic 3.0 X

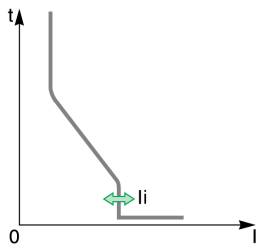

The instantaneous overcurrent protection setting for MicroLogic 3.0 X is:

- Ii: instantaneous overcurrent protection threshold

It can be set as follows:

- On the MicroLogic X display screen, at **Home > Protection > I Instantaneous**
- With EcoStruxure Power Commission software (password-protected)
- With EcoStruxure Power Device app (password-protected)
- By sending a setting command using the communication network (password-protected).

Instantaneous overcurrent protection can be duplicated when dual settings are activated, page 120.

Protection Settings for MicroLogic 3.0 X

Setting	Unit	Range	Step	Factory setting
Ii tripping mode	–	Standard/Fast	–	Standard
Ii	A	1.5–12 x In	0.5 x In ⁽¹⁾	1.5 x In
(1) Finer resolution settings are possible with EcoStruxure Power Commission software and EcoStruxure Power Device app.				

For more information, refer to the setting guidelines, page 176.

Protection Characteristics for MicroLogic 3.0 X

Characteristic	Unit	Ii tripping mode is set to Standard	Ii tripping mode is set to Fast
Breaktime at 2 x threshold	ms	≤ 50	≤ 30
Non-tripping time	ms	> 20	0
Accuracy on threshold	%	+/- 10	+/- 10

Setting the Protection for MicroLogic 5.0 X, 6.0 X, 7.0 X

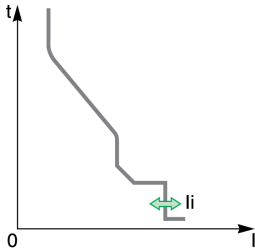

The instantaneous overcurrent protection settings are:

- li mode: enables (ON) or disables (OFF) instantaneous overcurrent protection
- li tripping mode: sets tripping time to standard or fast
- li: instantaneous overcurrent protection threshold

They can be set as follows:

- On the MicroLogic X display screen, at **Home > Protection > I Instantaneous**
- With EcoStruxure Power Commission software (password-protected)
- With EcoStruxure Power Device app (password-protected)
- By sending a setting command using the communication network (password-protected).

Instantaneous overcurrent protection can be duplicated when dual settings are activated, page 120.

Protection Settings for MicroLogic 5.0 X, 6.0 X, 7.0 X

Setting	Unit	Range	Step	Factory setting
li mode	–	ON/OFF	–	ON
li tripping mode	–	Standard/Fast	–	Standard
li	A	2.0–15 x I _n	0.5 x I _n ⁽¹⁾	2.0 x I _n

For more information, refer to the [setting guidelines](#), page 176.

Protection Characteristics for MicroLogic 5.0 X, 6.0 X, 7.0 X

Characteristic	Unit	li tripping mode is set to Standard	li tripping mode is set to Fast
Breaktime at 2 x threshold	ms	≤ 50	≤ 30
Non-tripping time	ms	> 20	0
Accuracy on threshold	%	+/- 10	+/- 10

Predefined Events for MicroLogic 2.0 X

The function generates the following predefined events:

Code	Event	History	Severity
0x6401 (25601)	Isd trip	Trip	High
0x6301 (25345)	Isd operate	Protection	Medium
0x6201 (25089)	Isd start	Protection	Low

Predefined events cannot be modified by the user. For general information about events, refer to [Event management](#), page 301.

Protection events are generated as follows:

- The start event is generated when the protection picks up.
- The operate event is generated when the protection time delay elapses.
- The trip event is generated when the circuit breaker tripping voltage release (MITOP) activates.

Recommended Actions

Code	Event	Recommended actions
0x6401 (25601)	Isd trip	Reset the device or use the Power restoration assistant within the EcoStruxure Power Device app.

Predefined Events for MicroLogic 3.0 X, 5.0 X, 6.0 X, 7.0 X

The function generates the following predefined events:

Code	Event	History	Severity
0x6402 (25602)	li trip	Trip	High
0x6302 (25346)	li operate	Protection	Medium

Predefined events cannot be modified by the user. For general information about events, refer to *Event management*, page 301.

Protection events are generated as follows:

- The operate event is generated when the protection time delay elapses.
- The trip event is generated when the circuit breaker tripping voltage release (MITOP) activates.

Recommended Actions

Code	Event	Recommended actions
0x6402 (25602)	li trip	Reset the device or use the Power restoration assistant within the EcoStruxure Power Device app.

Resetting a Trip Event

For information about resetting the circuit breaker after a trip due to an electrical fault, refer to the relevant document, page 10:

- *MasterPact MTZ1 - Circuit Breakers and Switch-Disconnectors - User Guide*
- *MasterPact MTZ2/MTZ3 - Circuit Breakers and Switch-Disconnectors - User Guide*

Ground-Fault Protection (G or ANSI 50N-TD/51N)

Presentation

Ground-fault protection provides protection against phase-to-ground fault, which is more sensitive than protection based on phase current only. It is generally used in TN-S systems but could also be used in other earthing systems.

NOTE: Ground-fault protection is also called earth-fault protection.

Ground-fault protection is based either on the summation of the phases and neutral current or on the signal delivered by an external sensor, source ground return (SGR) current transformer through the MDGF module.

⚠ WARNING
<p>HAZARD OF EQUIPMENT DAMAGE</p> <p>With MicroLogic X control unit for IEC standard, when using source ground return (SGR) with MDGF module:</p> <ul style="list-style-type: none"> • I_g mode setting in OFF position is forbidden. • I_g threshold setting must be ≤1,200 A. <p>Failure to follow these instructions can result in death, serious injury, or equipment damage.</p>

Availability

Ground-fault protection is available on:

- MicroLogic 6.0 X control units for IEC standard
- MicroLogic 6.0 X control units for UL standard
- 3-pole and 4-pole circuit breakers

External sensors can be used:

- External Neutral Current Transformer (ENCT): measurement of the current on neutral. For information about the installation of ENCT, consult the instruction sheet on the Schneider Electric website: NHA14388.
- Source ground return protection: including ground-fault protection and an SGR sensor installed around the connection of the transformer neutral point to ground.

Ground-fault protection is powered by the current flowing through the internal current transformers of the circuit breaker and it does not require an additional external power supply.

Operating Principle

The ground-fault current is calculated or measured according to the circuit breaker configuration, as shown in the following table.

Circuit breaker configuration	I _g ground-fault current
3P	$I_g = I_1 + I_2 + I_3$
4P	$I_g = I_1 + I_2 + I_3 + I_N$
3P + ENCT	$I_g = I_1 + I_2 + I_3 + I_N$ (ENCT)
3P or 4P + SGR	$I_g = I_{SGR}$

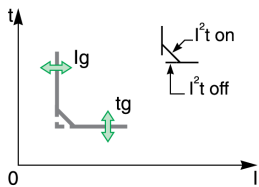

The ground-fault protection threshold I_g sets the level of ground-fault current at which the circuit breaker trips when reaching the ground-fault protection time delay t_g .

The time delay t_g sets the length of time during which the circuit breaker carries a ground-fault within the ground-fault protection threshold I_g range.

The time delay t_g can be adjusted to:

- Four setting values with I^2t ON. In this case, the tripping curve is an inverse time curve up to $2 \times I_r$, meaning that the time delay decreases as the current increases. Above $2 \times I_r$, the tripping curve is a definite time curve with a constant tripping time.
- Five setting values with I^2t OFF. In this case, the tripping curve is a definite time curve with a constant tripping time.

Ground-fault protection is based on the true RMS current of phases and neutral, up to harmonic 15.

In order to trip on an intermittent electrical fault, the control unit accumulates the intermittent currents in the ground-fault tripping range that do not last long enough to trigger a trip. This accumulation leads to shorter tripping times than those set.

Setting the Protection

Ground-fault protection can be enabled or disabled.

The ground-fault protection settings are:

- I_g mode: enables (ON) or disables (OFF) ground fault protection
- I_g : ground-fault protection threshold
- t_g : ground-fault protection time delay
- I^2t (t_g): ground-fault protection curve (I^2t ON or I^2t OFF)

They can be set as follows:

- On the MicroLogic X display screen, at **Home > Protection > I Ground Fault**
- With EcoStruxure Power Commission software (password-protected)
- With EcoStruxure Power Device app (password-protected)
- By sending a setting command using the communication network (password-protected).

The ground-fault protection can be duplicated when dual settings are activated, page 120.

Protection Settings

I_g setting for MicroLogic 6.0 X IEC standard

Setting	Unit	Range	Step	Factory setting	Accuracy
I_g mode	–	ON/OFF	–	ON	–
$I_g^{(1)}$	A	$0.2-1 \times I_n$	10 A	$0.2 \times I_n$	+/- 10%
(1) For $I_n \leq 400$ A, the I_g setting range is $0.3-1 \times I_n$ (factory setting: $0.3 \times I_n$)					

I_g setting for MicroLogic 6.0 X UL standard

Setting	Unit	Range	Step	Factory setting	Accuracy
I_g mode	–	ON (always enabled)	–	ON	–
I_g for $I_n \leq 400$ A	A	$0.3-1 \times I_n$	$0.1 \times I_n$	$0.3 \times I_n$	+/- 10%
I_g for $400 \text{ A} < I_n \leq 1200$ A	A	$0.2-1 \times I_n$	$0.1 \times I_n$	$0.2 \times I_n$	+/- 10%
I_g for $I_n > 1200$ A	A	500–1200 A	–	500 A	+/- 10%

tg setting for MicroLogic 6.0 X IEC and UL standard

Setting	Unit	Setting Value				
tg with I ² t OFF	s	0	0.1	0.2	0.3	0.4
tg with I ² t ON	s	–	0.1	0.2	0.3	0.4
Non-tripping time	s	> 0.02	> 0.08	> 0.14	> 0.23	> 0.36
Maximum breaking time	s	< 0.08	< 0.14	< 0.20	< 0.32	< 0.50

The default tg time delay setting value is 0 s with I²t OFF.

NOTE: When tg is set to 0 s and I²t is changed to ON, the tg time delay is automatically set to 0.1.

Testing the Protection

Test the operation of ground-fault protection as follows:

Step	Action
1	Check that the circuit breaker is closed and the control unit is supplied with power (ready LED is flashing).
2	Use a thin screwdriver to briefly push in (< 1 s) the test button (T) on the front face of the MicroLogic X control unit. This action is recorded as an event.
3	The circuit breaker trips. An event is generated.
4	If the circuit breaker does not trip, an event is generated. Contact your field service representative.

Zone Selective Interlocking (ZSI)

The ZSI characteristics and external wiring of the zone selective interlocking function, are described specifically, page 125.

If ZSI IN is not set to 1 (open circuit between Z3 and Z4 terminals), the maximum breaking time is 0.08 s regardless of the tg setting value.

When ZSI IN is set to 1 and connected to the ZSI OUT of a downstream device (or when ZSI is not used, there is a jumper between the Z3 and Z4 terminals), the tg time delay is used.

The Ig threshold activates ZSI OUT (Z1 and Z2 terminals).

NOTE: MasterPact MTZ circuit breakers are delivered with a jumper installed between Z3 and Z4.

Predefined Events

The function generates the following predefined events:

Code	Event	History	Severity
0x6403 (25603)	Ig trip	Trip	High
0x641E (25630)	IΔn/Ig test trip	Trip	High
0x6203 (25091)	Ig start	Protection	Low
0x6303 (25347)	Ig operate	Protection	Medium
0x142A (5162)	IΔn/Ig test button pressed	Diagnostic	Low
0x1413 (5139)	IΔn/Ig test - no trip	Diagnostic	High
0x142C (5164)	Ig protection configured in OFF mode	Diagnostic	Medium
0x142D (5165)	Ig function inhibited for test purpose	Diagnostic	Low

Predefined events cannot be modified by the user. For general information about events, refer to *Event management*, page 301.

Protection events are generated as follows:

- The start event is generated when the protection picks up.
- The operate event is generated when the protection time delay elapses.
- The trip event is generated when the circuit breaker tripping voltage release (MITOP) activates.

Recommended Actions

Code	Event	Recommended actions
0x6403 (25603)	Ig trip	Reset the device or use the Power restoration assistant within the EcoStruxure Power Device app.
0x641E (25630)	IΔn/Ig test trip	Reset the device or use the Power restoration assistant within the EcoStruxure Power Device app.
0x1413 (5139)	IΔn/Ig test - no trip	Restart the test. If it fails again, replace the control unit.
0x142D (5165)	Ig function inhibited for test purpose	Exit the inhibition status after test.

Resetting a Trip Event

For information about resetting the circuit breaker after a trip due to an electrical fault, refer to the relevant document, page 10:

- *MasterPact MTZ1 - Circuit Breakers and Switch-Disconnectors - User Guide*
- *MasterPact MTZ2/MTZ3 - Circuit Breakers and Switch-Disconnectors - User Guide*

Earth-Leakage Protection (ANSI 50G-TD)

Presentation

Earth-leakage protection is a protection against earth fault with a very high sensitivity. It is generally used in TT or IT earthing systems but could also be used in TN earthing systems in some circumstances. Earth-leakage protection is a residual current protection based on current measured by a rectangular sensor encompassing the three phases or the three phases and neutral. MicroLogic 7.0 X earth-leakage protection including VPS module complies with IEC 60947-2 Annex B. It is a type A residual-current device (RCD).

Availability

⚠ WARNING

HAZARD OF EARTH-LEAKAGE PROTECTION LOSS

- Do not use MasterPact MTZ with embedded MicroLogic 7.0 X control unit without connected rectangular sensor for earth-leakage protection.
- Only ever use Schneider Electric LV833573SP or LV833574SP earth-leakage protection sensors with MasterPact MTZ with embedded MicroLogic 7.0 X control unit.

Failure to follow these instructions can result in death, serious injury, or equipment damage.

Earth-leakage protection is available on:

- MicroLogic 7.0 X control units for IEC standard connected to an external rectangular sensor
- 3-pole and 4-pole circuit breakers

The external rectangular sensor is required to measure the residual current.

For information about installation of the rectangular sensor, consult the instruction sheet on the Schneider Electric website: [NVE35468](#)

The VPS voltage power supply module is delivered with MicroLogic 7.0 X control units to supply power to the control unit in case of a low-level electrical fault and no load, where the power supply based on current flowing through the circuit breaker is not high enough.

The VPS is mandatory to comply with IEC 60947-2 Annex B.

Operating Principle

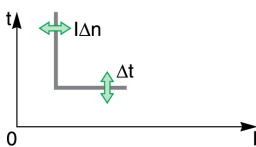

Earth-leakage protection is definite time.

The earth-leakage protection threshold $I\Delta n$ sets the level of earth-leakage at which the circuit breaker trips when reaching the earth-leakage protection time delay Δt .

Setting the Protection

The earth-leakage protection settings are:

- $I\Delta n$: earth-leakage protection threshold
- Δt : earth-leakage protection time delay

They can be set as follows:

- On the MicroLogic X display screen, at **Home > Protection > I Earth Leakage**

- With EcoStruxure Power Commission software (password-protected)
- With EcoStruxure Power Device app (password-protected)
- By sending a setting command using the communication network (password-protected).

Protection Settings

Setting	Unit	Range	Step	Factory setting	Accuracy
I Δ n	A	0.5–30	0.1	0.5	Complies with IEC 60947-2 Annex B

Setting	Unit	Setting Value				
Δ t	s	0.06	0.15	0.23	0.35	0.80
Non-tripping time	s	> 0.06	> 0.15	> 0.23	> 0.35	> 0.80
Maximum breaking time	s	< 0.14	< 0.23	< 0.35	< 0.80	< 1.00

Testing the Protection

Test the operation of earth-leakage protection as follows:

Step	Action
1	Check that the circuit breaker is closed and the control unit is supplied with power (ready LED is flashing).
2	Use a thin screwdriver to briefly push in (< 1 s) the test button (T) on the front face of the MicroLogic X control unit. This action is recorded as an event.
3	The circuit breaker trips. An event is generated.
4	If the circuit breaker does not trip, an event is generated. Contact your field service representative.

Predefined Events

The function generates the following predefined events:

Code	Event	History	Severity
0x6404 (25604)	I Δ n trip	Trip	High
0x641E (25630)	I Δ n/Ig test trip	Trip	High
0x6204 (25092)	I Δ n start	Protection	Low
0x6304 (25348)	I Δ n operate	Protection	Medium
0x142A (5162)	I Δ n/Ig test button pressed	Diagnostic	Low
0x1413 (5139)	I Δ n/Ig test - no trip	Diagnostic	High

Predefined events cannot be modified by the user. For general information about events, refer to [Event management](#), page 301.

Protection events are generated as follows:

- The start event is generated when the protection picks up.
- The operate event is generated when the protection time delay elapses.
- The trip event is generated when the circuit breaker tripping voltage release (MITOP) activates.

Recommended Actions

Code	Event	Recommended actions
0x6404 (25604)	IΔn trip	Reset the device or use the Power restoration assistant within the EcoStruxure Power Device app.
0x641E (25630)	IΔn/lg test trip	Reset the device or use the Power restoration assistant within the EcoStruxure Power Device app.
0x1413 (5139)	IΔn/lg test - no trip	Restart the test. If it fails again, replace the control unit.

Resetting a Trip Event

For information about resetting the circuit breaker after a trip due to an electrical fault, refer to the relevant document, page 10:

- *MasterPact MTZ1 - Circuit Breakers and Switch-Disconnectors - User Guide*
- *MasterPact MTZ2/MTZ3 - Circuit Breakers and Switch-Disconnectors - User Guide*

Neutral Protection

Presentation

A long time overcurrent protection function is dedicated to the neutral protection.

Availability

Neutral protection is available on:

- MicroLogic 2.0 X, 5.0 X, 6.0 X, and 7.0 X control units for IEC standard
- MicroLogic 3.0 X, 5.0 X, and 6.0 X control units for UL standard
- 3-pole circuit breakers with the ENCT option (External Neutral Current Transformer) to measure the neutral current
- 4-pole circuit breakers

Description

Where the cross-sectional area of the neutral conductor is at least equivalent to that of the phase conductor, and the current in the neutral is expected not to exceed the value in the phase conductor, it is not necessary to provide overcurrent protection for the neutral conductor.

The neutral conductor must have protection against overcurrent if:

- The cross-sectional area of the neutral conductor is less than the cross-sectional area of the phase conductors
- Non-linear loads generating third order harmonics (or multiples thereof) are installed

It may be necessary to switch off the neutral for operational reasons (multiple source diagram) or safety reasons (working with power off).

To summarize, the neutral conductor can be:

- Non-distributed (3-pole circuit breaker)
- Distributed, not switched off and not protected (3-pole circuit breaker)
- Distributed, not switched off but protected (3-pole circuit breaker with ENCT option)
- Distributed, switched off and protected (4-pole circuit breaker)

MicroLogic X control units are suitable for all protection types. They incorporate the oversized neutral (OSN) function, which manages protection of the neutral conductor when third-order harmonic currents (and multiples thereof) are present.

Circuit Breaker	Possible Types	Neutral Protection
3-pole circuit breaker	3P, 3D	Off
3-pole circuit breaker with ENCT option	3P, 3D	Off
	3P, 3D + N/2	Half neutral
	3P, 3D + N	Full neutral
	3P, 3D + OSN	Oversized neutral
4-pole circuit breaker	4P, 3D	Off
	4P, 3D + N/2	Half neutral
	4P, 4D	Full neutral
	4P, 4D + OSN	Oversized neutral
P: Pole, D: Control unit, N: Neutral protection		

Operating Principle

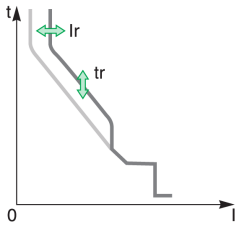

Neutral protection has the same characteristics as phase protection:

- Its threshold is proportional to the long-time protection threshold I_r .
- It has the same t_r time delay values as long-time protection.
- Its short-time and instantaneous protections are identical.

Declaring the External Neutral Current Transformer (ENCT) on 3-Pole Circuit Breakers

On 3P circuit breakers the ENCT option must be declared in one of the following ways:

- On the MicroLogic X display screen, at **Home > Configuration > Measures > System Type > ENCT**
- With EcoStruxure Power Commission software
- By sending a setting command using the communication network (password-protected).

Setting the Neutral Protection for 3-Pole and 4-Pole Circuit Breakers

Set the type of neutral protection in one of the following ways:

- On the MicroLogic X display screen, at **Home > Protection > Neutral**
- With EcoStruxure Power Commission software (password-protected)
- By sending a setting command using the communication network (password-protected).

The following table shows the setting values of the neutral long-time protection and threshold for the type of neutral protection selected:

Neutral protection type		Neutral long-time threshold value
OFF		No long-time protection for neutral
N/2 (factory setting)		$I_r/2$
N		I_r
Oversized N	3-pole (ENCT)	$1.6 \times I_r$
	4-pole	$1.6 \times I_r$ limited to I_n

Dual Settings

Presentation

The dual settings function consists of two sets of parameters for the following protection functions, according to the type of MicroLogic X control unit:

- Long-time overcurrent protection
- Short-time overcurrent protection
- Instantaneous overcurrent protection
- Ground-fault protection

You can switch from one set to the other under certain operating conditions.

A typical application is to adjust short-circuit protection when the circuit breaker can be supplied by two sources with very different short-circuit currents. For example, the circuit breaker is supplied by either the grid or a generator.

Availability

The dual settings function is available on:

- MicroLogic 2.0 X, 5.0 X, 6.0 X, and 7.0 X control units for IEC standard
- MicroLogic 3.0 X, 5.0 X and 6.0 X control units for UL standard

Operating Principle

By default, the dual settings function is disabled.

The dual settings function is enabled and disabled in one of the following ways:

- With EcoStruxure Power Commission software
- On the MicroLogic X display screen at **Home > Protection > Dual settings > Dual settings**

When the dual settings function is enabled, use EcoStruxure Power Commission software to configure the switch mode used to switch between setting group A and setting group B. The following switch modes are available:

- **Local HMI:** MicroLogic X display screen
- **Remote:** communication network
- **IO module - 1 wire:** only available if a selector switch is wired on a digital input of an IO module
- **IO module - 2 wires:** only available if a selector switch is wired on digital inputs of an IO module

The configured switch mode is displayed on the MicroLogic X display screen at **Home > Protection > Dual settings > Switch mode**.

When the dual settings function is enabled, two sets of protection parameters are available:

- Set A corresponds to the settings currently selected.
- Set B is a second set of protection parameters, which can be set as described in *Setting the Protection*, page 121.

Switching between Set A and Set B depends on the switch mode defined in EcoStruxure Power Commission software. Switch between sets as follows:

- IO module -1 wire or 2 wires: by using the selector switch wired on digital inputs of the IO module
- Local: On the MicroLogic X display screen at **Home > Maintenance > Switch to other set > Switch to set B**.
- Remote: by sending a setting command using the communication network (password-protected)

Without an external command, Ir, tr, lsd, tsd, li, lg, and tg settings are those of Set A.

When the **Activate Set B** external command is sent, the Ir, tr, lsd, tsd, li, lg, and tg settings switch to those of Set B.

When the dual settings function is enabled, the settings on the display screen are marked **_A** or **_B**.

Setting the Protection Parameters

The Set A protection parameters are set as follows:

- On the MicroLogic X display screen, at **Home > Protection**
- With EcoStruxure Power Commission software
- By sending a setting command using the communication network (password-protected).

The Set B protection parameters are set as follows:

- On the MicroLogic X display screen, at **Home > Protection > Dual settings > Settings**
- With EcoStruxure Power Commission software
- By sending a setting command using the communication network (password-protected).

Function Settings

Function	Settings	Factory settings	Setting range	MicroLogic X type
Dual settings	Enable	NO	YES/NO	MicroLogic 2.0 X, 3.0 X, 5.0 X, 6.0 X, 7.0 X
	Switch mode	Local HMI	<ul style="list-style-type: none"> • Local HMI • Remote • IO - 1 Wire • IO - 2 Wires 	MicroLogic 2.0 X, 3.0 X, 5.0 X, 6.0 X, 7.0 X
Long-time Set B	Ir	1 x In	Same as set A	MicroLogic 2.0 X, 3.0 X, 5.0 X, 6.0 X, 7.0 X
	tr	0.5 s	Same as set A	
Short-time Set B	lsd	1.5 x Ir	Same as set A	MicroLogic 5.0 X, 6.0 X, 7.0 X
	tsd	0	Same as set A	
Instantaneous Set B	lsd	1.5 x Ir	Same as set A	MicroLogic 2.0 X
Instantaneous Set B	li	1.5 x In	Same as set A	MicroLogic 3.0 X
Instantaneous Set B	li mode	ON	Same as set A	MicroLogic 5.0 X, 6.0 X, 7.0 X
	li tripping mode	Standard	Same as set A	
	li	2.0 x In	Same as set A	
Ground-fault Set B	lg mode	ON	Same as set A	MicroLogic 6.0 X IEC standard
	lg	0.2 x In ⁽¹⁾	Same as set A	
	tg	0	Same as set A	
Ground-fault Set B	lg for In ≤ 1200 A	0.2 x In ⁽¹⁾	Same as set A	MicroLogic 6.0 X UL standard
	lg for In > 1200 A	500 A	Same as set A	
	tg	0	Same as set A	

(1) For In ≤ 400 A, the lg factory setting is 0.3 x In.

Predefined Events

The function generates the following predefined events:

Code	Event	History	Severity
0x1300 (4864)	B curve active	Protection	Low
0x0D06 (3334)	Config error IO/CU: dual settings or inhibit cls.	Configuration	Medium

Recommended Actions

Code	Event	Recommended actions
0x0D06 (3334)	Config error IO/CU: dual settings or inhibit cls.	<p>Correct the configuration error with EcoStruxure Power Commission software:</p> <ul style="list-style-type: none"> • Dual settings configuration error: <ul style="list-style-type: none"> ◦ Set Switch mode to IO-1 Wire or IO-2 Wire. ◦ Set IO module with dual setting assignment. • Inhibit close order configuration error: <ul style="list-style-type: none"> ◦ Set Allow control by digital input under breaker close as enabled. ◦ Set IO module with Enable/Inhibit close order assignment.

Fallback Settings Mode

Presentation

The fallback settings mode is a protection mode. It allows the standard protection functions of the circuit breaker to be maintained with fallback settings values in case of detection of one of the following events:

- **Unable to read sensor plug** (code 0x1409), page 244
- **Internal Current Power Supply (CPS) sensors malfunction. Tsd forced to 0.** (code 0x1510), page 247

Availability

The fallback settings mode is available on:

- MicroLogic 2.0 X, 5.0 X, 6.0 X, and 7.0 X control units for IEC standard
- MicroLogic 3.0 X, 5.0 X and 6.0 X control units for UL standard

Operating Principle

The fallback setting mode is activated automatically after detection of the following events:

Code	Event	Fallback settings
0x1409 (5129)	Unable to read sensor plug	The settings of the standard protection functions of active trip curve are replaced by fallback settings. Follow the recommended actions related to the event to come back to normal mode with application of the original active settings.
0x1510 (5392)	Internal Current Power Supply (CPS) sensors malfunction. Tsd forced to 0.	Only the short-time protection parameters of active trip curve are replaced by fallback settings: Tsd is forced to 0 and I_{pt} to OFF . The other protection settings set by the user remain unchanged. Contact your field service representative to replace the circuit breaker.

When the fallback settings mode is active, only the active trip curve is replaced by fallback settings to maintain the protection efficiency. The fallback settings are fixed and cannot be modified.

NOTE: If the settings of active trip curve are the same as the fallback settings, the settings of active trip curve remain unchanged and the fallback settings mode is not active.

NOTICE
<p>HAZARD OF UNINTENDED OPERATION</p> <p>When the fallback setting mode is active:</p> <ul style="list-style-type: none"> • Do not change the protection settings. • Do not engage/disengage ERMS. • Do not switch the set of protection settings Set A and Set B. <p>Failure to follow these instructions can result in unintended operation.</p>

When the fallback settings mode is active, the event 0x142F (5167) **Last modification of protection settings has not been completely applied** is generated.

Fallback Settings Mode Indication

When the fallback setting mode is active:

- **Fallback settings mode** is displayed on the **Trip curve** screen of the Quick View.
- EcoStruxure Power Commission software and EcoStruxure Power Device App display **Fallback settings mode** on the active trip curve screen.

Zone Selective Interlocking (ZSI)

Presentation

Zone-selective interlocking (ZSI), also called zone restraint, is a system designed to reduce the stress on electrical distribution equipment during short-circuit or ground-fault conditions.

ZSI works with a previously coordinated distribution system to limit stress on the system by reducing the time it takes to clear the electrical fault while maintaining system coordination between overcurrent and ground-fault protective devices.

ZSI allows MicroLogic X control units to communicate with each other so that a short-circuit or ground-fault can be isolated and cleared by the nearest upstream circuit breaker with no intentional time delay. Devices in all other areas of the system (including upstream) remain closed to maintain service to unaffected loads.

Without ZSI, a coordinated system results in the circuit breaker closest to the electrical fault clearing it, usually with an intentional delay. With ZSI, the device closest to the electrical fault ignores its preset short-time and ground-fault delays and clears the electrical fault with no intentional delay.

Zone-selective interlocking eliminates intentional delay without sacrificing coordination and it results in faster tripping times. This limits stress on the system by reducing the amount of let-through energy the system is subjected to during an overcurrent.

The coordination of the system must be correctly set up for zone-selective interlocking to work.

Availability

Zone-selective interlocking is available on:

- MicroLogic 5.0 X, 6.0 X, and 7.0 X control units for IEC standard
- MicroLogic 5.0 X and 6.0 X control units for UL standard

For zone-selective interlocking compatibility with other ranges of circuit breakers, consult the ZSI Interface Module instruction sheet on the Schneider Electric website: [NHA12883](#)

MasterPact MTZ circuit breakers with ZSI capability are shipped with self-restraint jumpers installed. Self-restraint jumpers must be in place unless zone selective interlocking is activated. If jumpers are removed and zone selective interlocking is not activated, the circuit breaker ignores its programmed delay and trips with no intentional delay.

Operating Principle

A pilot wire interconnects a number of circuit breakers equipped with MicroLogic X control units, as illustrated in the following diagram.

The control unit detecting an electrical fault sends a signal upstream and checks for a signal arriving from downstream. If there is a signal from downstream, the circuit breaker remains closed for the full duration of its tripping delay. If there is no signal from downstream, the circuit breaker opens immediately, regardless of the tripping-delay setting.

Electrical Fault in A: Only circuit breaker 1 detects the electrical fault. Because it receives no signal from downstream, it opens immediately, regardless of its tripping delay set to 0.3 s.

Electrical Fault in B: Circuit breakers 1 and 2 detect the electrical fault. Circuit breaker 1 receives a signal from circuit breaker 2 and remains closed for the full duration of its tripping delay, set to 0.3 s. Circuit breaker 2 does not receive a signal from downstream and opens immediately, in spite of its tripping delay set to 0.2 s.

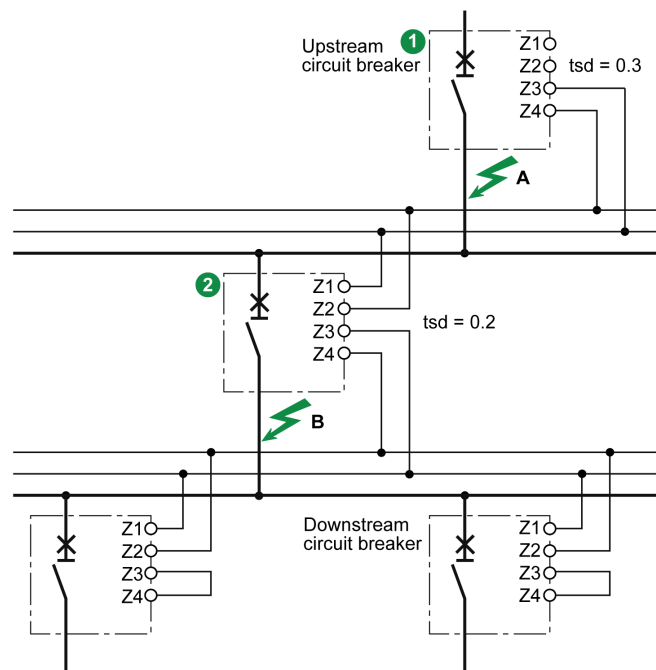

NOTE: On circuit breaker 1, the tsd and tg tripping delays must not be set to zero because this would make selectivity impossible.

Setting the Function

The following settings can be assigned to the ZSI input:

- Short-time overcurrent protection
- Ground-fault protection (MicroLogic 6.0 X)
- Both protections (MicroLogic 6.0 X)

Setting changes can be made as follows:

- With EcoStruxure Power Commission software
- By sending a setting command using the communication network (password-protected).

Connection Principles

The following figure explains how the signal wire is connected to the MicroLogic X control unit:

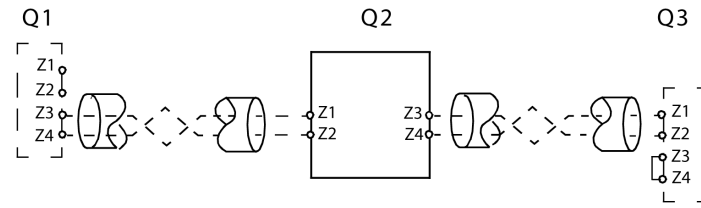

Q1 Upstream circuit breaker

Q2 Circuit breaker to be wired

Q3 Downstream circuit breaker

Z1 ZSI-OUT source

Z2 ZSI-OUT

Z3 ZSI-IN source

Z4 ZSI-IN

NOTE: When ZSI is not used downstream, short circuit inputs Z3 and Z4. The setting of the short-time and ground-fault protection time delays can be inhibited if this principle is not applied.

Multi-Source Distribution

If a number of circuit breakers are installed upstream (multi-source distribution), the same principles apply.

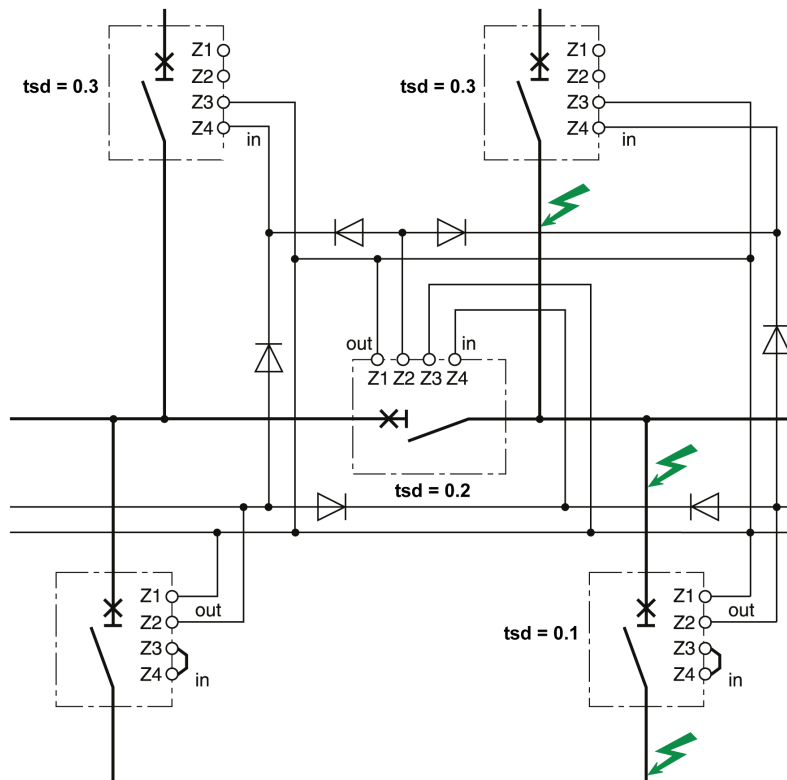

NOTE: Management of this configuration does not require any additional relays for ZSI to be controlled for the sources used.

Connection Wire Characteristics

The following table indicates the characteristics of the inter-device signal wire:

Characteristics	Values
Impedance	2.7 Ω per 300 m (1000 ft)
Maximum length	300 m (1000 ft)
Type of cable	Twisted pair
Permissible conductor cross-section	0.4–2.5 mm ² (20–14 AWG)
Interconnection limit on inputs Z3 and Z4 (to downstream devices)	15 devices
Interconnection limit on outputs Z1 and Z2 (to upstream devices)	5 or 15 devices, depending on the upstream device

Predefined Events

The function generates the following predefined event:

Code	Event	History	Severity
0x1305 (4869)	ZSI test	Diagnostic	Low

Recommended Actions

Code	Event	Recommended actions
0x1305 (4869)	ZSI test	Wait until the test is completed.

Optional Protection Functions

What's in This Chapter

Undervoltage Protection (ANSI 27)	130
Overvoltage Protection (ANSI 59)	135
Under/Overfrequency Protection (ANSI 81)	139
Reverse Active Power Protection (ANSI 32P)	144
Ground-Fault Alarm (ANSI 51N/51G)	148
Energy Reduction Maintenance Settings (ERMS)	151
IDMTL Overcurrent Protection (ANSI 51)	158
Directional Overcurrent Protection (ANSI 67)	164

Undervoltage Protection (ANSI 27)

Presentation

Undervoltage protection (ANSI 27) constantly monitors the system voltage. If the voltage level of an installation goes out of its acceptable limits, the information provided by undervoltage protection can be used to initiate appropriate action to restore good operating conditions in the installation.

The information provided by undervoltage protection is used to generate alarms and circuit breaker tripping when required. In addition, the constant monitoring of phase-to-phase or phase-to-neutral voltages enables appropriate action to be initiated to safeguard the operation of the installation during abnormal or critical situations, for example, load shedding, source change-over, and emergency generator starting.

Prerequisites

Undervoltage protection is available when the ANSI 27/59 - Under/Over voltage protection Digital Module is purchased and installed on a MicroLogic X control unit, page 34.

Undervoltage protection requires an external 24 Vdc power supply.

Undervoltage protection is compatible with:

- MicroLogic 2.0 X, 5.0 X, 6.0 X, and 7.0 X control units for IEC standard
- MicroLogic 3.0 X, 5.0 X, and 6.0 X control units for UL standard
- MicroLogic X control units with firmware version greater than or equal to 002.000.002. Earlier firmware versions need to be updated, page 46.

Data from the Digital Module is available remotely through IFE/EIFE or IFM communication interfaces, if the IFE/EIFE or IFM firmware version is compatible with the Digital Module. For more information, refer to firmware compatibility of the communication interfaces, page 31.

Operating Principle

ANSI 27-1

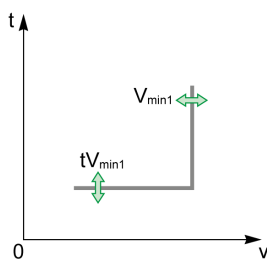

Undervoltage protection monitors either three phase-to-phase voltages (V_{12} , V_{23} , V_{31}), or three phase-to-neutral voltages (V_{1N} , V_{2N} , V_{3N}).

Undervoltage protection is of two types:

- ANSI 27-1: each voltage is monitored independently. The protection picks up when one of three monitored voltages reaches the threshold V_{min1} .
- ANSI 27-2: the three voltages are monitored together. The protection picks up when all three monitored voltages reach the threshold V_{min2} .

Each type of undervoltage protection, ANSI 27-1 and ANSI 27-2 can be disabled.

Both types of undervoltage protection operate according to a settable time delay:

- ANSI 27-1: the time delay tV_{min1} starts as soon as the protection picks up.
- ANSI 27-2: the time delay tV_{min2} starts as soon as the protection picks up.

ANSI 27-2

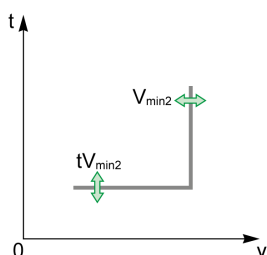

Undervoltage protection operates with a definite time characteristic.

NOTE: The selection of voltages to be monitored (phase-to-phase or phase-to-neutral) applies to both undervoltage and overvoltage protections. It is not possible to select different settings for each type of protection. The selection is made for all four types of protection: ANSI 27-1, ANSI 27-2, ANSI 59-1, and ANSI 59-2.

Inhibiting Protection

To inhibit the undervoltage protection (ANSI 27-1 or ANSI 27-2), both the following conditions must be met:

- Inhibition is enabled on a specific protection (ANSI 27-1 or ANSI 27-2) by setting the Inhibition parameter to ON.
- Inhibition of optional protections is activated by an input of the IO module. The function **Inhibit optional protection** must be assigned to an input of the IO module.

For more information about inhibiting optional protections, refer to *Enerlin X IO - Input/Output Application Module for One Circuit Breaker - User Guide*, page 10.

NOTE: The undervoltage protections (ANSI 27-1 or ANSI 27-2) can be inhibited separately, or together.

Voltage Measurement

For undervoltage protection set in tripping mode, the voltage must be measured on the power source side to allow closing of the circuit breaker. As standard, the MicroLogic X voltage input is directly connected to the internal pickup voltage (PTI) on the bottom side of the circuit breaker. So:

- If the circuit breaker is bottom fed, the internal pickup voltage (PTI) is suitable for undervoltage protection and circuit breaker closing.
- If the circuit breaker is top fed, an external voltage input is required. The external voltage tap (PTE) option must be used to measure the voltage on the power source side or use the **Force to Off when CB is open** option.

Setting for All Under/Overvoltage Protections

Select the type of voltages to monitor before making other settings:

- VLL phase-to-phase voltage selection (factory setting)
- VLN phase-to-neutral voltage selection (this setting should be selected only with 4-pole circuit breakers or 3-pole circuit breakers with ENVV wired and configured)

It can be set as follows:

- With EcoStruxure Power Commission software (password-protected)
- With EcoStruxure Power Device app (password-protected)

Setting ANSI 27-1 and ANSI 27-2 Undervoltage Behavior Parameter

For a top fed circuit breaker without the PTE option, if the undervoltage protection trips the circuit breaker, it can be difficult to close the circuit breaker again. This is due to the protection detecting the absence of voltage and tripping immediately. To enable closing of the circuit breaker, the undervoltage behavior parameter can be set to **Force to Off when CB is open**.

The undervoltage behavior parameter, Vmin behavior, has two settings:

- **Normal:** the protection functions as normal
- **Force to Off when CB is open:** undervoltage protection is disabled when the threshold is reached and the circuit breaker is in the open position

Setting ANSI 27-1 Protection

The settings for undervoltage protection on one phase (ANSI 27-1) are:

- Vmin1 mode: enables (ON) or disables (OFF) undervoltage protection on one phase
- Vmin1 action: sets the result of undervoltage protection activation as trip or alarm

- Trip: the circuit breaker trips and three events are generated (start, operate, and trip)
- Alarm: two events are generated (start and operate)
- Vmin1 inhib: enables (ON) the protection to be inhibited by IO module
- Vmin1: threshold of undervoltage protection on one phase
- tVmin1: time delay of undervoltage protection on one phase

They can be set as follows:

- With EcoStruxure Power Commission software (password-protected)
- With EcoStruxure Power Device app (password-protected)

The dual settings function does not apply to undervoltage protection on one phase. When the dual settings function is enabled, undervoltage protection settings are the same whether set A or set B settings are activated.

Setting ANSI 27-2 Protection

The settings for undervoltage protection on all phases (ANSI 27-2) are:

- Vmin2 mode: enables (ON) or disables (OFF) undervoltage protection on all phases
- Vmin2 action: sets the result of undervoltage protection activation as trip or alarm
 - Trip: the circuit breaker trips and three events are generated (start, operate, and trip)
 - Alarm: two events are generated (start and operate)
- Vmin2 inhib: enables (ON) the protection to be inhibited by IO module
- Vmin2: threshold of undervoltage protection on all phases
- tVmin2: time delay of undervoltage protection on all phases

They can be set as follows:

- With EcoStruxure Power Commission software (password-protected)
- With EcoStruxure Power Device app (password-protected)

The dual settings function does not apply to undervoltage protection on all phases. When the dual settings function is enabled, undervoltage protection settings are the same whether set A or set B settings are activated.

Protection Settings

The following are the settings for ANSI 27-1 and ANSI 27-2:

Type	Settings	Unit	Setting range	Step	Factory setting	Accuracy
ANSI 27 ANSI 59	Voltage selection	–	VLL phase-to-phase/ VLN phase-to-neutral	–	VLL phase-to-phase	–
ANSI 27-1 ANSI 27-2	Vmin behavior	–	Normal/ Force to Off when CB open	–	Normal	–
ANSI 27-1	Vmin1 mode	–	ON/OFF	–	OFF	–
	Vmin1 action	–	Alarm/Trip	–	Alarm	–
	Vmin1 inhib	–	ON/OFF	–	OFF	–
	Vmin1	V	20–1200	1	20	± 2%
	tVmin1	s	0–300	0.01	10.00	± 2%, ± 20 ms
ANSI 27-2	Vmin2 mode	–	ON/OFF	–	OFF	–
	Vmin2 action	–	Alarm/Trip	–	Alarm	–
	Vmin2 inhib	–	ON/OFF	–	OFF	–
	Vmin2	V	20–1200	1	20	± 2%
	tVmin2	s	0–300	0.01	10.00	± 2%, ± 20 ms

Protection Characteristics

Characteristics of undervoltage protection:

- Definite time delay
- Instantaneous reset time
- Hysteresis: fixed 98%
- Minimum breaking time 50 ms
- Maximum breaking time 140 ms with time delay set to 0 s

Predefined Events

The function generates the following predefined events:

Code	Event	History	Severity
0x6410 (25616)	Undervoltage on 1 phase trip	Trip	High
0x6210 (25104)	Undervoltage on 1 phase start	Protection	Low
0x6310 (25360)	Undervoltage on 1 phase operate	Protection	Medium
0x642A (25642)	Undervoltage on all 3 phases trip	Trip	High
0x622A (25130)	Undervoltage on all 3 phases start	Protection	Low
0x632A (25386)	Undervoltage on all 3 phases operate	Protection	Medium
0x0EF8 (3832)	Optional protections inhibited by IO	Protection	Low
0x0D0C (3340)	Config error IO/CU: optional protection Inhibit	Configuration	Medium

Predefined events cannot be modified by the user. For general information about events, refer to [Event management](#), page 301.

Protection events are generated as follows:

- The start event is generated when the protection picks up.
- The operate event is generated when the protection time delay elapses.
The operate event is not generated when the optional protection is inhibited.
- The trip event is generated when the circuit breaker tripping voltage release (MITOP) activates.

The trip event is not generated when:

- The optional protection is set in alarm mode
- The optional protection is inhibited

Recommended Actions

Code	Event	Recommended actions
0x6410 (25616)	Undervoltage on 1 phase trip	Reset the device or use the Power restoration assistant within the EcoStruxure Power Device app.
0x642A (25642)	Undervoltage on all 3 phases trip	Reset the device or use the Power restoration assistant within the EcoStruxure Power Device app.

Code	Event	Recommended actions
0x0EF8 (3832)	Optional protections inhibited by IO	Check inhibition selector switch wired with IO module.
0x0D0C (3340)	Config error IO/CU: optional protection Inhibit	<p>Correct the configuration error with EcoStruxure Power Commission software:</p> <ul style="list-style-type: none"> • If you want optional protection inhibition to be controlled by IO module, connect an IO module with inhibit optional protection assignment. • If you do not want optional protection inhibition to be controlled by IO module, connect an IO module without inhibit optional protection assignment.

Resetting a Trip Event

For information about resetting the circuit breaker after a trip due to an electrical fault, refer to the relevant document, page 10:

- *MasterPact MTZ1 - Circuit Breakers and Switch-Disconnectors - User Guide*
- *MasterPact MTZ2/MTZ3 - Circuit Breakers and Switch-Disconnectors - User Guide*

Overvoltage Protection (ANSI 59)

Presentation

Overvoltage protection (ANSI 59) constantly monitors the voltage level of power supplies. If the voltage level of an installation goes out of its acceptable limits, the information provided by overvoltage protection can be used to initiate appropriate action to restore good operating conditions in the installation.

The information provided by overvoltage protection is used to generate alarms and circuit breaker tripping when required. In addition, the constant monitoring of phase-to-phase or phase-to-neutral voltages enables appropriate action to be initiated to safeguard the operation of the installation during abnormal or critical situations, for example, load shedding, source change-over, and emergency generator starting.

Prerequisites

Overvoltage protection is available when the ANSI 27/59 - Under/Over voltage Digital Module is purchased and installed on a MicroLogic X control unit, page 34.

Overvoltage protection requires an external 24 Vdc power supply.

Overvoltage protection is compatible with:

- MicroLogic 2.0 X, 5.0 X, 6.0 X, and 7.0 X control units for IEC standard
- MicroLogic 3.0 X, 5.0 X, and 6.0 X control units for UL standard
- MicroLogic X control units with firmware version greater than or equal to 002.000.002. Earlier firmware versions need to be updated, page 46.

Data from the Digital Module is available remotely through IFE/EIFE or IFM communication interfaces, if the IFE/EIFE or IFM firmware version is compatible with the Digital Module. For more information, refer to firmware compatibility of the communication interfaces, page 31.

Operating Principle

ANSI 59-1

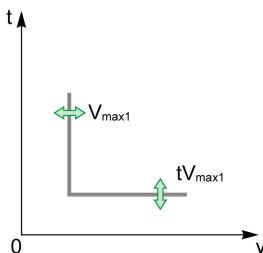

ANSI 59-2

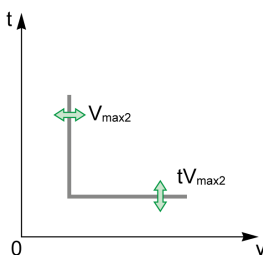

Overvoltage protection monitors either three phase-to-phase voltages (V_{12} , V_{23} , V_{31}), or three phase-to-neutral voltages (V_{1N} , V_{2N} , V_{3N}).

Overvoltage protection is of two types:

- ANSI 59-1: each phase is monitored independently. The protection picks up when one of three monitored voltages reaches the threshold V_{max1} .
- ANSI 59-2: the three phases are monitored together. The protection picks up when all three monitored voltages reach the threshold V_{max2} .

Each type of overvoltage protection, ANSI 59-1 and ANSI 59-2 can be disabled.

Both types of overvoltage protection operate according to a configurable time delay:

- ANSI 59-1: the time delay tV_{max1} starts as soon as the protection threshold is reached.
- ANSI 59-2: the time delay tV_{max2} starts as soon as the protection threshold is reached.

Overvoltage protection operates with a definite time characteristic.

NOTE: The selection of voltages to be monitored (phase-to-phase or phase-to-neutral) applies to both undervoltage and overvoltage protections. It is not possible to select different settings for each type of protection. The selection is made for all four types of protection: ANSI 27-1, ANSI 27-2, ANSI 59-1, and ANSI 59-2.

Inhibiting Protection

To inhibit the overvoltage protection (ANSI 59-1 or ANSI 59-2), both the following conditions must be met:

- Inhibition is enabled on a specific protection (ANSI 59-1 or ANSI 59-2) by setting the Inhibition parameter to ON.
- Inhibition of optional protections is activated by an input of the IO module. The function **Inhibit Optional Protection** must be assigned to an input of the IO module.

For more information about inhibiting optional protections, refer to *Enerlin'X IO - Input/Output Application Module for One Circuit Breaker - User Guide*, page 10.

NOTE: The overvoltage protections (ANSI 59-1 or ANSI 59-2) can be inhibited separately, or together.

Setting for All Under/Overvoltage Protections

Select the type of voltages to monitor before making other settings:

- VLL phase-to-phase voltage selection (factory setting)
- VLN phase-to-neutral voltage selection (this setting should only be selected with 4-pole circuit breakers or 3-pole circuit breakers with ENVT wired and configured)

It can be set as follows:

- With EcoStruxure Power Commission software (password-protected)
- With EcoStruxure Power Device app (password-protected)

Setting ANSI 59-1 Protection

The settings for overvoltage protection on one phase (ANSI 59-1) are:

- Vmax1 mode: enables (ON) or disables (OFF) the protection
- Vmax1 action: sets the result of overvoltage protection action as trip or alarm
 - Trip: the circuit breaker trips and three events are generated (start, operate, and trip)
 - Alarm: two events are generated (start and operate)
- Vmax1 inhib: enables (ON) the protection to be inhibited by IO module
- Vmax1: threshold of overvoltage protection on one phase
- tVmax1: time delay of overvoltage protection on one phase

They can be set as follows:

- With EcoStruxure Power Commission software (password-protected)
- With EcoStruxure Power Device app (password-protected)

The dual settings function does not apply to overvoltage protection on one phase. When the dual settings function is enabled, overvoltage protection settings are the same whether set A or set B settings are activated.

Setting ANSI 59-2 Protection

The settings for overvoltage protection on all phases (ANSI 59-2) are:

- Vmax2 mode: enables (ON) or disables (OFF) the protection
- Vmax2 action: sets the result of overvoltage protection action as trip or alarm
 - Trip: the circuit breaker trips and three events are generated (start, operate, and trip)
 - Alarm: two events are generated (start and operate)
- Vmax2 inhib: enables (ON) the protection to be inhibited by IO module
- Vmax2: threshold of overvoltage protection on all phases (ANSI 59-2)

- tVmax2: time delay of overvoltage protection on all phases (ANSI 59-2)

They can be set as follows:

- With EcoStruxure Power Commission software (password-protected)
- With EcoStruxure Power Device app (password-protected)

The dual settings function does not apply to overvoltage protection on all phases. When the dual settings function is enabled, overvoltage protection settings are the same whether set A or set B settings are activated.

Protection Settings

The following are the settings for ANSI 59-1 and ANSI 59-2:

Type	Settings	Unit	Setting range	Step	Factory setting	Accuracy
ANSI 27 ANSI 59	Voltage selection	–	VLL phase-to-phase/ VLN phase-to-neutral	–	VLL phase-to-phase	–
ANSI 59-1	Vmax1 mode	–	ON/OFF	–	OFF	–
	Vmax1 action	–	Alarm/Trip	–	Alarm	–
	Vmax1 inhib	–	ON/OFF	–	OFF	–
	Vmax1	V	20–1200	1	20	± 2%
	tVmax1	s	0 ⁽¹⁾ –300	0.01	10.00	± 2%, ± 20 ms
ANSI 59-2	Vmax2 mode	–	ON/OFF	–	OFF	–
	Vmax2 action	–	Alarm/Trip	–	Alarm	–
	Vmax2 inhib	–	ON/OFF	–	OFF	–
	Vmax2	V	20–1200	1	20	± 2%
	tVmax2	s	0 ⁽¹⁾ –300	0.01	10.00	± 2%, ± 20 ms

(1) When the time delay is set below 50 ms, overvoltage protection can trip on transient phenomena, such as overvoltages caused by atmospheric disturbance.

Protection Characteristics

Characteristics of overvoltage protection:

- Definite time delay
- Instantaneous reset time
- Hysteresis: fixed 98%
- Minimum breaking time 50 ms
- Maximum breaking time 140 ms with time delay set to 0 s

Predefined Events

The function generates the following predefined events:

Code	Event	History	Severity
0x6411 (25617)	Overvoltage on 1 phase trip	Trip	High
0x6211 (25105)	Overvoltage on 1 phase start	Protection	Low
0x6311 (25361)	Overvoltage on 1 phase operate	Protection	Medium
0x642B (25643)	Overvoltage on all 3 phases trip	Trip	High
0x622B (25131)	Overvoltage on all 3 phases start	Protection	Low
0x632B (25387)	Overvoltage on all 3 phases operate	Protection	Medium

Code	Event	History	Severity
0x0EF8 (3832)	Optional protection inhibited by IO module	Protection	Low
0x0D0C (3340)	Config error IO/CU: optional protection Inhibit	Configuration	Medium

Predefined events cannot be modified by the user. For general information about events, refer to [Event management](#), page 301.

Protection events are generated as follows:

- The start event is generated when the protection picks up.
- The operate event is generated when the protection time delay elapses.
The operate event is not generated when the optional protection is inhibited.
- The trip event is generated when the circuit breaker tripping voltage release (MITOP) activates.

The trip event is not generated when:

- The optional protection is set in alarm mode
- The optional protection is inhibited

Recommended Actions

Code	Event	Recommended actions
0x6411 (25617)	Overvoltage on 1 phase trip	Reset the device or use the Power restoration assistant within the EcoStruxure Power Device app.
0x642B (25643)	Overvoltage on all 3 phases trip	Reset the device or use the Power restoration assistant within the EcoStruxure Power Device app.
0x0D0C (3340)	Config error IO/CU: optional protection Inhibit	Correct the configuration error with EcoStruxure Power Commission software: <ul style="list-style-type: none"> • If you want optional protection inhibition to be controlled by IO module, connect an IO module with inhibit optional protection assignment. • If you do not want optional protection inhibition to be controlled by IO module, connect an IO module without inhibit optional protection assignment.

Resetting a Trip Event

For information about resetting the circuit breaker after a trip due to an electrical fault, refer to the relevant document, page 10:

- *MasterPact MTZ1 - Circuit Breakers and Switch-Disconnectors - User Guide*
- *MasterPact MTZ2/MTZ3 - Circuit Breakers and Switch-Disconnectors - User Guide*

Under/Overfrequency Protection (ANSI 81)

Presentation

The frequency in electrical installations must be maintained within accepted operating levels to minimize the risk of damage to motor loads, sensitive electronics, and to ensure the proper operation and performance of all loads.

There are two independent protections:

- Underfrequency (ANSI 81U)
- Overfrequency (ANSI 81O)

Under/overfrequency protection constantly monitors the frequency. If the frequency of an installation exceeds its acceptable limits, the information delivered by the under/overfrequency protection can be used to initiate appropriate action to restore good operating conditions in the installation. The under/overfrequency protection is used to generate either an alarm or a trip, when required.

Under/overfrequency protection is suitable for generator use. The continuous monitoring of frequency enables appropriate action to be initiated to safeguard the operation of the installation during abnormal or critical situations, for example, load shedding, source change-over, and emergency generator starting.

Prerequisites

Under/overfrequency protection is available when the ANSI 81 - Under/Overfrequency Digital Module is purchased and installed on a MicroLogic X control unit, page 34.

Under/overfrequency protection requires an external 24 Vdc power supply.

Under/overfrequency protection is compatible with:

- MicroLogic 2.0 X, 5.0 X, 6.0 X, and 7.0 X control units for IEC standard
- MicroLogic 3.0 X, 5.0 X, and 6.0 X control units for UL standard
- MicroLogic X control units with firmware version greater than or equal to 003.012.000. Earlier firmware versions need to be updated, page 46.

Data from the Digital Module is available remotely through IFE/EIFE or IFM communication interfaces, if the IFE/EIFE or IFM firmware version is compatible with the Digital Module. For more information, refer to firmware compatibility of the communication interfaces, page 31.

Operating Principle of Underfrequency Protection (ANSI 81U)

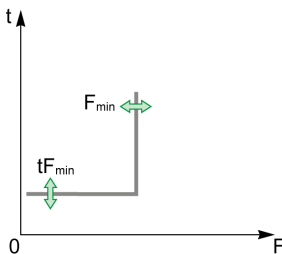

Underfrequency protection monitors the frequency. When the system frequency reaches the threshold F_{min} , the protection picks up and the time delay tF_{min} starts.

The frequency is calculated from V12 phase-to-phase voltage.

Underfrequency protection has the following characteristics:

- Is inhibited when V12 is lower than 20 Vac.
- Operates with a definite time characteristic.
- Can be disabled.

The protection trips if both the following conditions are met:

- The frequency is lower than F_{min} .
- The time delay tF_{min} is elapsed.

Operating Principle of Overfrequency Protection (ANSI 81O)

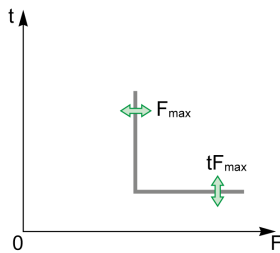

Overfrequency protection monitors the frequency. When the system frequency reaches the threshold F_{max} , the protection picks up and the time delay tF_{max} starts.

The frequency is calculated from V12 phase-to-phase voltage.

Overfrequency protection has the following characteristics:

- Is inhibited when V12 is lower than 20 Vac.
- Operates with a definite time characteristic.
- Can be disabled.

The protection trips if both the following conditions are met:

- The frequency is greater than F_{max} .
- The time delay tF_{max} is elapsed.

Inhibiting Protection

To inhibit the underfrequency (ANSI 81U) or overfrequency (ANSI 81O) protections, both the following conditions must be met:

- Inhibition is enabled by setting the Inhibition parameter to ON. Inhibition is enabled independently on each protection (ANSI 81U or ANSI 81O).
- Inhibition of optional protections is activated by an input of the IO module. The function **Inhibit Optional Protection** must be assigned to an input of the IO module.

For more information about inhibiting optional protections, refer to *Enerlin'X IO - Input/Output Application Module for One Circuit Breaker - User Guide*, page 10.

NOTE: The underfrequency (ANSI 81U) and overfrequency protections (ANSI 81O) can be inhibited separately, or together.

Setting Underfrequency Protection

The settings for underfrequency protection are:

- F_{min} mode: enables (ON) or disables (OFF) underfrequency protection
- F_{min} action: sets the result of underfrequency protection activation as trip or alarm
 - Trip: the circuit breaker trips and three events are generated (start, operate, and trip)
 - Alarm: two events are generated (start and operate)
- F_{min} inhib: enables (ON) the protection to be inhibited by IO module
- F_{min} : underfrequency protection threshold
- tF_{min} : underfrequency protection time delay

They can be set as follows:

- With EcoStruxure Power Commission software (password-protected)
- With EcoStruxure Power Device app (password-protected)

The dual settings function does not apply to underfrequency protection. When the dual settings function is enabled, underfrequency protection settings are the same whether set A or set B settings are activated.

Underfrequency Protection Settings

Settings	Unit	Setting range	Step	Factory settings	Accuracy
Fmin mode	–	ON/OFF	–	OFF	–
Fmin action	–	Alarm/Trip	–	Alarm	–
Fmin inhib	–	ON/OFF	–	OFF	–
Fmin	Hz	40–65	0.1	48	<ul style="list-style-type: none"> ±0.01 Hz for V12 > 100 V ±0.05 Hz for 20 V < V12 < 100 V⁽¹⁾
tFmin	s	0–300	0.05	1	±2%, ±20 ms

(1) Stability on sudden voltage change (phase and magnitude shift) according to IEC 60255-181
Stability on voltage with harmonics (with disturbed zero crossing) according to IEC 60255-181

NOTE: Frequency protections are inhibited when V12 is lower than 20 Vac.

Underfrequency Protection Characteristics

- Definite time delay
- Instantaneous reset time
- Hysteresis: fixed 1.0002
- Minimum breaking time: 50 ms
- Maximum breaking time (with time delay set to 0 s):
 - 140 ms for frequency ramps from 0.5 Hz/s to 5 Hz/s according to IEC 60255-181
 - 140 ms in case of sudden frequency change according to IEC 60255-181 for settings between 48 and 52 for 50 Hz application and 58 to 62 for 60 Hz application
 - 200 ms in case of sudden frequency change according to IEC 60255-181 for settings between 45 and 55 for 50 Hz application and 55 to 65 for 60 Hz application

Setting Overfrequency Protection

The settings for overfrequency protection are:

- Fmax mode: enables (ON) or disables (OFF) overfrequency protection on one phase
- Fmax action: sets the result of overfrequency protection activation as trip or alarm
 - Trip: the circuit breaker trips and three events are generated (start, operate, and trip)
 - Alarm: two events are generated (start and operate)
- Fmax inhib: enables (ON) the protection to be inhibited by IO module
- Fmax: overfrequency protection threshold
- tFmax: overfrequency protection time delay

They can be set as follows:

- With EcoStruxure Power Commission software (password-protected)
- With EcoStruxure Power Device app (password-protected)

The dual settings function does not apply to overfrequency protection. When the dual settings function is enabled, overfrequency protection settings are the same whether set A or set B settings are activated.

Overfrequency Protection Settings

Settings	Unit	Setting range	Step	Factory settings	Accuracy
Fmax mode	–	ON/OFF	–	OFF	–
Fmax action	–	Alarm/Trip	–	Alarm	–
Fmax inhib	–	ON/OFF	–	OFF	–
Fmax	Hz	45–70	0.1	62	<ul style="list-style-type: none"> ±0.01 Hz for V12 >100 V ±0.05 Hz for 20 V < V12 < 100 V⁽¹⁾
tFmax	s	0–300	0.05	1	±2%, ±20 ms

(1) Stability on sudden voltage change (phase and magnitude shift) according to IEC 60255-181
Stability on voltage with harmonics (with disturbed zero crossing) according to IEC 60255-181

NOTE: Frequency protections are inhibited when VLL is lower than 20 Vac.

Overfrequency Protection Characteristics

- Definite time delay
- Instantaneous reset time
- Hysteresis: fixed 0.9998
- Minimum breaking time: 50 ms
- Maximum breaking time (with time delay set to 0 s):
 - 140 ms for frequency ramps from 0.5 Hz/s to 5 Hz/s according to IEC 60255-181
 - 140 ms in case of sudden frequency change according to IEC 60255-181 for settings between 48 and 52 for 50 Hz application and 58 to 62 for 60 Hz application
 - 200 ms in case of sudden frequency change according to IEC 60255-181 for settings between 45 and 55 for 50 Hz application and 55 to 65 for 60 Hz application

Predefined Events

The function generates the following predefined events:

Code	Event	History	Severity
0x6415 (25621)	Underfrequency trip	Trip	High
0x6416 (25622)	Overfrequency trip	Trip	High
0x6215 (25109)	Underfrequency start	Protection	Low
0x6216 (25110)	Overfrequency start	Protection	Low
0x6315 (25365)	Underfrequency operate	Protection	Medium
0x6316 (25366)	Overfrequency operate	Protection	Medium
0x0EF8 (3832)	Optional protection inhibited by IO module	Protection	Low
0x0D0C (3340)	Config error IO/CU: optional protection Inhibit	Configuration	Medium

Predefined events cannot be modified by the user. For general information about events, refer to [Event management](#), page 301.

Protection events are generated as follows:

- The start event is generated when the protection picks up.
- The operate event is generated when the protection time delay elapses.
The operate event is not generated when the optional protection is inhibited.

- The trip event is generated when the circuit breaker tripping voltage release (MITOP) activates.

The trip event is not generated when:

- The optional protection is set in alarm mode
- The optional protection is inhibited

Recommended Actions

Code	Event	Recommended actions
0x6415 (25621)	Underfrequency trip	Reset the device or use the Power restoration assistant within the EcoStruxure Power Device app.
0x6416 (25622)	Overfrequency trip	Reset the device or use the Power restoration assistant within the EcoStruxure Power Device app.
0x0EF8 (3832)	Optional protection inhibited by IO module	Check inhibition selector switch wired with IO module.
0x0D0C (3340)	Config error IO/CU: optional protection Inhibit	Correct the configuration error with EcoStruxure Power Commission software: <ul style="list-style-type: none"> • If you want optional protection inhibition to be controlled by IO module, connect an IO module with inhibit optional protection assignment. • If you do not want optional protection inhibition to be controlled by IO module, connect an IO module without inhibit optional protection assignment.

Resetting a Trip Event

For information about resetting the circuit breaker after a trip due to an electrical fault, refer to the relevant document, page 10:

- *MasterPact MTZ1 - Circuit Breakers and Switch-Disconnectors - User Guide*
- *MasterPact MTZ2/MTZ3 - Circuit Breakers and Switch-Disconnectors - User Guide*

Reverse Active Power Protection (ANSI 32P)

Presentation

Reverse active power protection (ANSI 32P) detects, and trips the circuit breaker, when a synchronous power generator connected to an external network, or running in parallel with other generators, operates as a synchronous motor. It can also be used to monitor the amount of active power exchanged between two parts of an electrical network, with associated alarms, load shedding or tripping as soon as the flow of active power in the selected direction exceeds the set value.

Prerequisites

Reverse active power protection is available when the ANSI 32P - Reverse Active Power Protection Digital Module is purchased and installed on a MicroLogic X control unit, page 34.

Reverse active power protection requires an external 24 Vdc power supply.

Reverse active power protection is compatible with:

- MicroLogic 2.0 X, 5.0 X, 6.0 X, and 7.0 X control units for IEC standard
- MicroLogic 3.0 X, 5.0 X, and 6.0 X control units for UL standard
- MicroLogic X control units with firmware version greater than or equal to 002.000.002. Earlier firmware versions need to be updated, page 46.

Data from the Digital Module is available remotely through IFE/EIFE or IFM communication interfaces, if the IFE/EIFE or IFM firmware version is compatible with the Digital Module. For more information, refer to *firmware compatibility* of the communication interfaces, page 31.

Operating Principle

Reverse active power protection calculates the active power with the RMS values of the voltages and currents. A time delay is associated with the protection. The positive sign of active power is defined by the *power sign setting*, page 215. The same sign is used for active power measurement.

By default, the MicroLogic X control unit assigns the sign + to the active power when the transit of the active power flows from upstream (top) to downstream (bottom) of the circuit breaker. The sign - is assigned when the transit circulates from downstream (bottom) to upstream (top) of the circuit breaker. This assumes that the power source feeding the installation is connected on the top side of the circuit breaker (top-fed circuit breaker).

NOTE: When the power source is connected on the bottom side of the circuit breaker (bottom-fed circuit breaker), the *power sign setting* assigned by default must be changed, page 215.

The protection trips when all of the following conditions are met:

- The active power is negative
- The value of the active power exceeds the setting
- The time delay is elapsed

Tripping Curve Characteristic

To avoid nuisance tripping, the protection does not trip in the case of very low power factor, corresponding to $|Q/P| > 32$ ($87.2^\circ < \varphi < 92.8^\circ$ or $267.2^\circ < \varphi < 272.8^\circ$)

The figure below shows three examples with $R_p = 100$ kW, $R_p = 500$ kW, and $R_p = 1000$ kW.

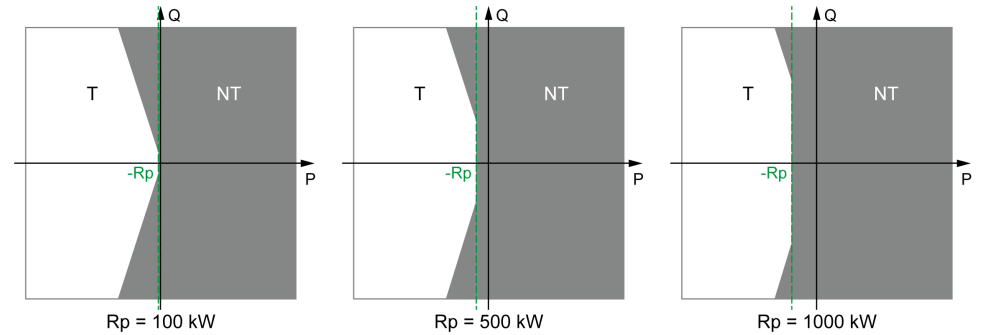

T Trip

NT No trip

Inhibiting Protection

To inhibit the reverse active power protection both the following conditions must be met:

- Inhibition is enabled on the reverse active power protection by setting the Inhibition parameter to ON.
- Inhibition of optional protections is activated by an input of the IO module. The function **Inhibit Optional Protection** must be assigned to an input of the IO module.

For more information about inhibiting optional protections, refer to *Enerlin X IO - Input/Output Application Module for One Circuit Breaker - User Guide*, page 10.

Setting the Protection

The reverse active power protection settings are:

- R_p mode: enables (ON) or disables (OFF) the protection
- R_p action: sets the result of reverse active power protection as trip or alarm
- R_p inhib: enables (ON) the protection to be inhibited by IO module
- R_p : total active power threshold
- tR_p : time delay

They can be set as follows:

- With EcoStruxure Power Commission software (password-protected)
- With EcoStruxure Power Device app (password-protected)

The dual settings function does not apply to reverse active power protection. When the dual settings function is enabled, reverse active power protection settings are the same whether set A or set B settings are activated.

Protection Settings

Setting	Unit	Setting range	Step	Factory setting	Accuracy
R_p mode	–	ON/OFF	–	OFF	–
R_p action	–	Alarm/Trip	–	Alarm	–
R_p inhib	–	ON/OFF	–	OFF	–

Setting	Unit	Setting range	Step	Factory setting	Accuracy
Rp	kW	50–5000	10	500	10%
tRp	s	0–300	0.05	10	± 2%

The following reverse active power protection settings are recommended for the protection of networks powered by turbines or diesel engines:

Function	Recommended setting for Rp
Turbines	2–6% nominal power (Pn)
Diesel engines	8–15% nominal power (Pn)

Protection Characteristics

Characteristics of reverse active power protection:

- Definite time delay
- Instantaneous reset time
- Hysteresis: fixed 98%
- Minimum breaking time 50 ms
- Maximum breaking time 140 ms with time delay set to 0 s

Predefined Events

The function generates the following predefined events:

Code	Event	History	Severity
0x6414 (25620)	Reverse power trip	Trip	High
0x6214 (25108)	Reverse power start	Protection	Medium
0x6314 (25364)	Reverse power operate	Protection	Medium
0x0EF8 (3832)	Optional protection inhibited by IO module	Protection	Low
0x0D0C (3340)	Config error IO/CU: optional protection Inhibit	Configuration	Medium

Predefined events cannot be modified by the user. For general information about events, refer to [Event management](#), page 301.

Protection events are generated as follows:

- The start event is generated when the protection picks up.
- The operate event is generated when the protection time delay elapses.
The operate event is not generated when the optional protection is inhibited.
- The trip event is generated when the circuit breaker tripping voltage release (MITOP) activates.
The trip event is not generated when:
 - The optional protection is set in alarm mode
 - The optional protection is inhibited

Recommended Actions

Code	Event	Recommended actions
0x6414 (25620)	Reverse power trip	Reset the device or use the Power restoration assistant within the EcoStruxure Power Device app.
0x0EF8 (3832)	Optional protection inhibited by IO module	Check inhibition selector switch wired with IO module.
0x0D0C (3340)	Config error IO/CU: optional protection Inhibit	Correct the configuration error with EcoStruxure Power Commission software: <ul style="list-style-type: none"> • If you want optional protection inhibition to be controlled by IO module, connect an IO module with inhibit optional protection assignment. • If you do not want optional protection inhibition to be controlled by IO module, connect an IO module without inhibit optional protection assignment.

Resetting a Trip Event

For information about resetting the circuit breaker after a trip due to an electrical fault, refer to the relevant document, page 10:

- *MasterPact MTZ1 - Circuit Breakers and Switch-Disconnectors - User Guide*
- *MasterPact MTZ2/MTZ3 - Circuit Breakers and Switch-Disconnectors - User Guide*

Ground-Fault Alarm (ANSI 51N/51G)

Presentation

The ground-fault alarm and earth-leakage alarm functions operate as ground-fault and earth-leakage protections, using the same sensors. They are independent from these protections and have their own settings.

The ground-fault alarm is based either on the summation of the phases and neutral current or on the signal delivered by an external sensor, source ground return (SGR) current transformer through the MDGF module.

The earth-leakage alarm function is a residual current alarm based on the current measured by a rectangular sensor encompassing the three phases or the three phases and the neutral.

Prerequisites

The ground-fault alarm function is available when the ANSI 51N/51G Ground-fault alarm Digital Module is purchased and installed on the MicroLogic control unit, page 34.

The ground-fault alarm function is powered by the current flowing through the internal current transformers of the circuit breaker and it does not require an additional external power supply.

The ground-fault alarm function is compatible with:

- 3-pole and 4-pole circuit breakers
- MicroLogic 2.0 X, 5.0 X, 6.0 X, and 7.0 X control units for IEC standard
- MicroLogic 3.0 X, 5.0 X, and 6.0 X control units for UL standard
- MicroLogic X control units with firmware version greater than or equal to 002.000.002. Earlier firmware versions need to be updated, page 46.

Data from the Digital Module is available remotely through IFE/EIFE or IFM communication interfaces, if the IFE/EIFE or IFM firmware version is compatible with the Digital Module. For more information, refer to firmware compatibility of the communication interfaces, page 31.

NOTE: When installed on a MicroLogic 7.0 X control unit, the ANSI 51N/51G Ground-fault Alarm Digital Module activates the earth-leakage alarm.

External sensors can be used:

- External Neutral Current Transformer (ENCT): measurement of the current on neutral. For information about the installation of ENCT, consult the instruction sheet on the Schneider Electric website: NHA14388.
- Source ground return protection: including ground-fault protection and an SGR sensor installed around the connection of the transformer neutral point to ground. For information about the installation of the SGR sensor, consult the instruction sheet on the Schneider Electric website: NHA92405.
- External rectangular sensor: measurement of the residual current. For information about the installation of the external rectangular sensor, consult the instruction sheet on the Schneider Electric website: NVE35468.

Operating Principle

Ground-fault alarm operates in the same way as ground-fault protection, except that an alarm is generated instead of a trip, page 111.

Setting the Function

The ground-fault alarm settings for MicroLogic 2.0 X, 3.0 X, 5.0 X, and 6.0 X are:

- Ig alarm mode: enables or disables ground-fault alarm
- Ig alarm: ground-fault alarm threshold
- tg alarm: ground-fault alarm time delay

The earth-leakage alarm settings for MicroLogic 7.0 X for IEC Standard are:

- IΔn alarm mode: enables or disables earth-leakage alarm
- IΔn alarm: earth-leakage alarm threshold
- Δt alarm: earth-leakage alarm time delay

They can be set as follows:

- With EcoStruxure Power Commission software (password-protected)
- With EcoStruxure Power Device app (password-protected)

The dual settings function does not apply to the ground-fault alarm function. When the dual settings function is enabled, ground-fault alarm settings are the same whether set A or set B settings are activated.

Function Settings

Ground-fault alarm settings on MicroLogic 2.0 X, 5.0 X, and 6.0 X IEC standard:

Setting	Unit	Range	Step	Factory setting	Accuracy
Ig alarm mode	–	ON/OFF	–	OFF	–
Ig alarm	A	0.2–1 x In	1	0.2 x In	±10%
tg alarm	s	1–10	0.1	1	±500 ms

Ground-fault alarm settings on MicroLogic 3.0 X, 5.0 X, and 6.0 X UL standard:

Setting	Unit	Range	Step	Factory setting	Accuracy
Ig alarm mode	–	ON/OFF	–	OFF	–
Ig alarm	A	120–1200	1	120	±10%
tg alarm	s	1–10	0.1	1	±500 ms

Earth-leakage alarm settings on MicroLogic 7.0 X IEC standard

Setting	Unit	Range	Step	Factory setting	Accuracy
IΔn alarm mode	–	ON/OFF	–	OFF	–
IΔn alarm	A	0.5–22	0.1	0.5	Complies with IEC 60947-2 Annex B
Δt alarm	s	1–10	0.1	1	±2%

NOTE: In order to differentiate between earth-leakage alarm and earth-leakage fault, it is recommended to set the earth-leakage alarm threshold below 75% of the earth-leakage fault threshold.

Predefined Events

The function generates the following predefined event for MicroLogic 2.0 X, 3.0 X, 5.0 X, and 6.0 X control units:

Code	Event	History	Severity
0x050C (1292)	Ig alarm	Protection	Medium

The Ig alarm event is not generated when the Ig alarm mode is OFF.

The function generates the following predefined event for MicroLogic 7.0 X control units:

Code	Event	History	Severity
0x050D (1293)	IΔn alarm	Protection	Medium

The IΔn alarm event is not generated when the IΔn alarm mode is OFF.

Predefined events cannot be modified by the user. For general information about events, refer to [Event management](#), page 301.

Recommended Actions

Code	Event	Recommended actions
0x050C (1292)	Ig alarm	Check insulation between phase/neutral and ground (earth).
0x050D (1293)	IΔn alarm	Check insulation between phase/neutral and ground (earth).

Energy Reduction Maintenance Settings (ERMS)

Presentation

The ERMS function is used to reduce protection settings so that the circuit breaker trips as soon as possible when an arc fault occurs. Minimizing the time between fault and trip helps to reduce the risk of injury when qualified electrical personnel are near energized equipment.

The ERMS function defines a separate set of parameters for the following protection functions:

- Long-time overcurrent protection
- Short-time overcurrent protection
- Instantaneous overcurrent protection
- Ground-fault protection

When the ERMS function is engaged, the ERMS set of parameters replaces:

- The currently selected settings if dual settings is not enabled
- Set A or set B if dual settings is enabled. In this case, when the ERMS function is disengaged, the parameter set (A or B) selected at the time of the disengagement is activated.

Prerequisites

The ERMS function is available when the Energy Reduction Maintenance Settings Digital Module is purchased and installed on a MicroLogic X control unit, page 34.

To use the ERMS function with an external selector switch:

- The ESM ERMS switch module must be installed and connected to the MicroLogic X control unit.
- The MicroLogic X control unit must be connected to an external 24 Vdc power supply.

The ERMS function is compatible with:

- MicroLogic 2.0 X, 5.0 X, 6.0 X, and 7.0 X control units for IEC standard
- MicroLogic 3.0 X, 5.0 X, and 6.0 X control units for UL standard
- MicroLogic X control units with firmware version greater than or equal to 002.000.002. Earlier firmware versions need to be updated, page 46.

Data from the Digital Module is available remotely through IFE/EIFE or IFM communication interfaces, if the IFE/EIFE or IFM firmware version is compatible with the Digital Module. For more information, refer to firmware compatibility of the communication interfaces, page 31.

Operating Principle

The following graph shows examples of the tripping curves of the standard protection functions with and without ERMS engaged:

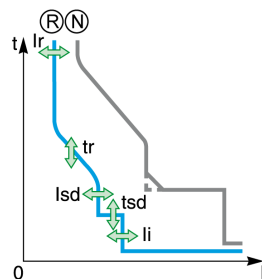

N Normal: Tripping curve for standard protection functions with ERMS disengaged (set A or set B if dual settings is enabled)

R Reduced: Tripping curve for standard protection functions with ERMS engaged

The ERMS function can be engaged using the EcoStruxure Power Device app (password-protected) and/or an external selector switch.

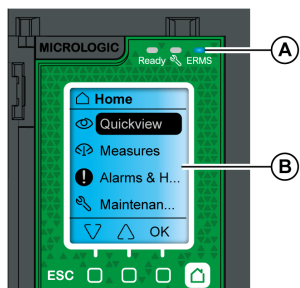

While the ERMS function is engaged:

- A blue ERMS LED (A) is lit on the front face of the MicroLogic X control unit
- Quick View scrolling is interrupted and the **ERMS engaged** message is displayed with a blue backlight
- All screens, except alarm and trip pop-up messages, page 85, are displayed with a blue backlight

Use-case Examples

The conditions of operation of electrical installations are specified by national regulations (for example, NPFA70E for USA, EN 50110 for Europe). These regulations require an assessment of electrical risk before carrying out any operation. The assessment must specify when the ERMS function should be implemented and engaged.

Whenever possible the electrical installation should be de-energized. When working in the vicinity of live parts without all doors or panels of the switchboard closed and secured, the ERMS function can be engaged to reduce the consequences of an arc fault. A risk assessment specific to each situation must be carried out, even when the ERMS function is used.

The following table gives examples of use-cases inside or close to a switchboard, where engaging the ERMS function is recommended. The recommendations are based on the assumptions that:

- The ERMS function is embedded in the upstream device on the supply side of the switchboard in question
- The switchboard has only one supply.

Operation	Location
Addition of device in spare slot in the switchboard	Inside switchboard
Thermal inspection	Inside switchboard
Measurement reading inside switchboard, requiring opening of door or panels	Inside switchboard
Measurement with portable equipment (for example, voltage presence, phase rotation, power quality)	Inside switchboard
First energization or re-energization of the equipment	In electrical room, less than 0.3 m (12 in) from switchboard
Device unlocking with padlock or key	In electrical room, less than 0.3 m (12 in) from switchboard
Device closing	In electrical room, less than 0.3 m (12 in) from switchboard

Engaging the ERMS Function

NOTICE
<p>HAZARD OF LOSS OF POWER</p> <p>Ensure that the ERMS protection settings are properly configured prior to engagement.</p> <p>Failure to follow these instructions can result in loss of service due to power loss.</p>

The ERMS function can be engaged as follows:

- With the EcoStruxure Power Device app (password-protected).
There is a digital lock, page 154 between a smartphone running the EcoStruxure Power Device app and the MicroLogic X control unit.
- By using an external selector switch connected to the optional ESM ERMS switch module.

The ESM module is installed in the circuit breaker and is connected to an external selector switch, which can be padlocked. The ERMS function is engaged by turning the external selector switch.

Disengaging the ERMS Function

⚠ ⚠ DANGER
<p>HAZARD OF ELECTRIC SHOCK, EXPLOSION, OR ARC FLASH</p> <p>Prior to disengaging ERMS:</p> <ul style="list-style-type: none"> • Carefully inspect your work area, and remove any tools and objects left inside the equipment. • Ensure that all personnel are away from the equipment, and devices, doors, and covers are in place. <p>Failure to follow these instructions will result in death or serious injury.</p>

The ERMS function must be disengaged by the interface that engaged it:

- If it is engaged on a smartphone, it must be disengaged by the same smartphone.
- If it is engaged by the external ERMS selector switch connected to the ESM module, it must be disengaged by the ERMS selector switch.
- If it is engaged by both smartphone and ERMS selector switch, it must be disengaged by both smartphone and ERMS selector switch.

ESM ERMS Switch Module

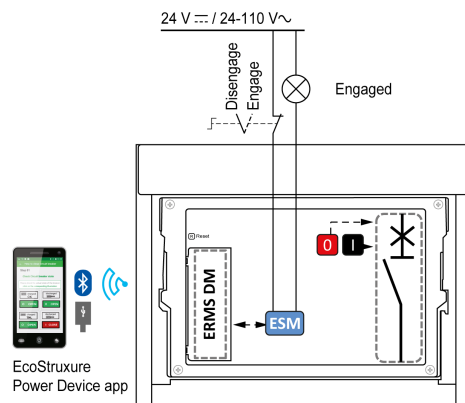

The ESM ERMS switch module is an optional hardware module. It is used with an external lockable selector switch to engage or disengage the ERMS function. It is equipped with:

- An input dedicated to the ERMS selector switch, with the following characteristics:
 - When the input is energized, the ERMS function is disengaged.
 - When the input is not energized, the ERMS function is engaged.
- An output to activate an external pilot light when the ERMS function is engaged.

Digital Lock Function for ERMS

The digital lock function establishes a digital lock between a smartphone running the EcoStruxure Power Device app and the MicroLogic X control unit when the ERMS function is engaged by the smartphone. The digital lock function ensures that when the ERMS function is engaged by a smartphone, it must be disengaged by the same smartphone and cannot be disengaged by another smartphone.

Force Unlock ERMS Function

If the smartphone that was used to engage the ERMS function is unavailable or not functioning, it is possible to send a force unlock command to disengage the ERMS function engaged by smartphone.

⚠️ ⚠️ DANGER

HAZARD OF ELECTRIC SHOCK, EXPLOSION, OR ARC FLASH

Prior to forcing ERMS unlock:

- Carefully inspect your work area, and remove any tools and objects left inside the equipment.
- Ensure that all personnel are away from the equipment, and devices, doors, and covers are in place.

Failure to follow these instructions will result in death or serious injury.

To force the digital lock, smartphone running the EcoStruxure Power Device app and access to the MicroLogic X control unit are required.

If the ERMS function is engaged by an external selector switch, the ERMS function stays engaged after sending the force unlock command. Unlocking the digital lock only disengages the ERMS function engaged by smartphone.

To force the unlocking of the digital lock between smartphone and MicroLogic X control unit, follow this procedure.

Step	Action
1	On a smartphone running the EcoStruxure Power Device app, access the Protection menu to proceed with the force unlock command.
2	Select ERMS - Force Unlock .
3	Select Yes to confirm that you want to force unlock ERMS engage.
4	Enter the Administrator device password and press OK to proceed with the command.
5	Fill in the reason for the force unlock and press Submit .
6	Read the information message on the smartphone explaining the potential risk in disengaging the ERMS function by forcing the unlocking of the digital lock.
7	Accept by pressing I understand
8	Make an L-shaped swipe on the screen displayed on the smartphone to send the force unlock command. Result: The MicroLogic X control unit checks the Administrator password and stores the information provided. A message is displayed requesting you to confirm the action on the display screen of the MicroLogic X control unit.
9	Within two minutes, on the MicroLogic X control unit, press Y to confirm the force unlock command displayed on the screen. NOTE: If you do not press Y within two minutes, or you press N , the force unlock command is aborted, the message on the display screen is canceled, and the information provided is not stored.
10	The control unit launches a 15 second countdown, which is displayed on the display screen of the control unit. At the end of the countdown, the control unit unlocks the digital lock. If the ERMS function is not engaged by external selector switch, ERMS is disengaged. The event Request to unlock ERMS by smartphone is generated when the forcing command is successful. The event is logged in the Protection history with the associated information provided.
11	A message is displayed on the smartphone informing the user that the ERMS function is disengaged. NOTE: If the ERMS function is also engaged by using the selector switch, the digital lock is unlocked but the function stays engaged.

Configuring the ERMS Settings

The ERMS settings can be configured as follows:

- With EcoStruxure Power Commission software through a USB connection (password-protected)
- With the EcoStruxure Power Device app (password-protected)

The dual settings function does not apply to ERMS settings. The ERMS settings are independent of dual settings set A or set B and replace set A or set B when the ERMS function is engaged.

The following ERMS settings are available:

Setting	Unit	Setting range	Factory setting	MicroLogic X type
Ir	A	0.4–1 x In	1 x In	MicroLogic 2.0 X, 3.0 X, 5.0 X, 6.0 X, 7.0 X
tr	s	0.5–24	0.5 s	
Isd	A	1.5–10 x Ir	1.5 x Ir	MicroLogic 5.0 X, 6.0 X, 7.0 X
tsd	s	0–0.4	0	
Isd	A	1.5–10 x Ir	1.5 x Ir	MicroLogic 2.0 X
li	A	1.5–12 x In	1.5 x In	MicroLogic 3.0 X
li tripping mode	–	Standard/Fast	Fast	
li mode	–	ON/OFF	ON	MicroLogic 5.0 X, 6.0 X, 7.0 X
li tripping mode	–	Standard/Fast	Fast	
li	A	2.0–15 x In	2.0 x In	
Ig mode	–	ON/OFF	ON	MicroLogic 6.0 X IEC standard
Ig ⁽¹⁾	A	0.2–1 x In	0.2 x In	
tg	s	0–0.4	0	
Ig for In ≤ 1200 A	A	0.2–1 x In	0.2 x In	MicroLogic 6.0 X UL standard
Ig for In > 1200 A	A	500–1200	500	
tg	s	0–0.4	0	

(1) For In ≤ 400 A, the Ig setting range is 0.3–1 x In (factory setting: 0.3 x In)

Predefined Events

The function generates the following predefined events:

Code	Event	History	Severity
0x0C03 (3075)	ERMS engaged	Protection	Low
0x0C02 (3074)	ERMS engaged for more than 24 hours	Protection	Low
0x0C04 (3076)	ESM (ERMS switch module) self diagnostic alarm	Protection	Medium
0x0C05 (3077)	Communication lost with ESM (ERMS switch module)	Protection	Medium
0x0C06 (3078)	Request to unlock ERMS by Smartphone	Protection	Low

Predefined events cannot be modified by the user. For general information about events, refer to [Event management](#), page 301.

Recommended Actions

Code	Event	Recommended actions
0x0C04 (3076)	ESM (ERMS switch module) self diagnostic alarm	Plan to replace the ESM (ERMS switch module).
0x0C05 (3077)	Communication lost with ESM (ERMS switch module)	Plan to replace the ESM (ERMS switch module).
0x0C02 (3074)	ERMS engaged for more than 24 hours	Disengage ERMS by maintenance switch or/and EcoStruxure Power Device "ERMS."
0x0C06 (3078)	Request to unlock ERMS by Smartphone	Follow the ERMS force unlock procedure in order to disengage ERMS function if the smartphone used to engage ERMS function is unavailable.

ERMS Engaged For More Than 24 Hours

A maintenance operation requiring protection settings to be in ERMS mode normally lasts for no more than a few hours. If the ERMS function is engaged for more than 24 hours without being disengaged, an event is generated to remind the user to disengage the function.

IDMTL Overcurrent Protection (ANSI 51)

Presentation

The ANSI 51 – IDMTL overcurrent protection Digital Module provides overcurrent protection based on one of the following IDMTL (Inverse Definite Minimum Time Lag) tripping curves:

- DT: Definite Time curve (constant tripping time)
- SIT: Standard Inverse Time curve ($I^{0.02t}$)
- VIT: Very Inverse Time curve (I^t)
- EIT: Extremely Inverse Time curve (I^2t)
- HVF: High Voltage Fuse curve (I^4t)

The addition of one of the IDMTL tripping curves to the existing long-time overcurrent protection helps to facilitate selectivity with an upstream protection device.

The ANSI 51 – IDMTL overcurrent protection Digital Module can be used to generate either a trip or an alarm.

Prerequisites

IDMTL overcurrent protection is available when the ANSI 51 – IDMTL overcurrent protection Digital Module is purchased and installed on a MicroLogic X control unit, page 29.

IDMTL overcurrent protection requires an external 24 Vdc power supply or a VPS voltage power supply module.

IDMTL overcurrent protection is compatible with:

- MicroLogic 2.0 X, 5.0 X, 6.0 X, and 7.0 X control units for IEC standard
- MicroLogic 3.0 X, 5.0 X, and 6.0 X control units for UL standard
- MicroLogic X control units with firmware version greater than or equal to 004.000.000. Earlier firmware versions need to be updated, page 46.

Data from the Digital Module is available remotely through IFE/EIFE or IFM communication interfaces, if the IFE/EIFE or IFM firmware version is compatible with the Digital Module. For more information, refer to [firmware compatibility of the communication interfaces](#), page 31.

NOTE: If the external voltage tap (PTE) option is used with no voltage connected, it is recommended to check that the rated frequency network setting corresponds to the nominal frequency of your electrical network (50 Hz or 60 Hz). For more information, refer to [Network Settings](#), page 207.

Operating Principle

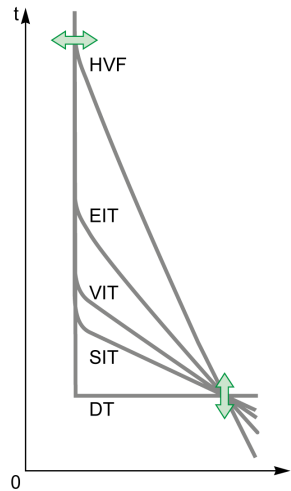

IDMTL overcurrent protection:

- Is based on the true RMS current of phases and neutral, up to the 40th harmonic.
- Has an adjustable reset time.
- Is implemented independently for each phase and the neutral, when neutral is present.
- Is an overcurrent time-dependent protection (except when DT (Definite Time) has been selected).
- Trips if both the following conditions are met:
 - The value of the current exceeds 1.05 x IDMTL I_r setting.
 - The calculated tripping time is elapsed.

NOTE: When the current is higher than I_{sd} or I_{li}, only short-time overcurrent protection and instantaneous protection are operational.

Tripping Time Calculation

For a time-dependent curve (SIT, VIT, EIT, HVF), the tripping time depends on the current I compared to the IDMTL I_r threshold and the IDMTL t_r time delay.

The tripping time (T_{trip}) is calculated using the following equation, according to IEC 60255-151 Annex A:

$$T_{trip} = \left(\frac{IDMTL\ t_r}{\left(\frac{6}{1.125} \right)^{\alpha} - 1} + c \right) \cdot \left(\frac{k}{\left(\frac{I}{1.125 \times IDMTL\ I_r} \right)^{\alpha} - 1} + c \right)$$

The value of parameters k, c, and α for each tripping curve (SIT, VIT, EIT, HVF) are given in the table below:

Tripping curve	Name	k	c	α
SIT	IEC curve type A (inverse)	0.14	0	0.02
VIT	IEC curve type B (very inverse)	13.5	0	1
EIT	IEC curve type C (extremely inverse)	80	0	2
HVF	High voltage fuse	80	0	4

NOTE: The IDMTL tripping time is always greater than or equal to the short-time overcurrent protection time delay t_{sd}.

If the calculated tripping time according to the equation is lower than t_{sd}, the IDMTL tripping time is forced to the short-time tripping time. In this case, and with I > I_{sd}, the circuit breaker tripping cause can be either IDMTL overcurrent protection or short-time overcurrent protection.

Tripping Time According to IDMTL t_r Time Delay

The IDMTL t_r overcurrent protection time delay is the tripping time for a phase or neutral current equal to $6 \times \text{IDMTL } I_r$.

The following table indicates the tripping time for the different types of tripping curve, according to the IDMTL t_r time delay.

IDMTL t_r (s)		0.5	1	2	4	8	12	16	20	24
Tripping curve	Current I	Tripping time (s)								
DT	1.5 x IDMTL I_r	0.5	1	2	4	8	12	16	20	24
	6 x IDMTL I_r	0.5	1	2	4	8	12	16	20	24
	7.2 x IDMTL I_r	0.5	1	2	4	8	12	16	20	24
	10 x IDMTL I_r	0.5	1	2	4	8	12	16	20	24
SIT	1.5 x IDMTL I_r	3	5.9	11.8	23.6	47.2	70.8	94.4	118	142
	6 x IDMTL I_r	0.5	1	2	4	8	12	16	20	24
	7.2 x IDMTL I_r	0.5	0.9	1.8	3.6	7.2	10.8	14.4	18	21.6
	10 x IDMTL I_r	0.4	0.8	1.5	3	6.1	9.1	12.2	15.2	18.3
VIT	1.5 x IDMTL I_r	6.5	13	26	52	104	156	208	260	312
	6 x IDMTL I_r	0.5	1.0	2	4	8	12	16	20	24
	7.2 x IDMTL I_r	0.4	0.8	1.6	3.2	6.4	9.6	12.8	16	19.3
	10 x IDMTL I_r	0.3 ⁽¹⁾	0.5	1.1	2.2	4.4	6.6	8.8	11	13.2
EIT	1.5 x IDMTL I_r	17.6	35.3	70.6	141	282	423	565	706	847
	6 x IDMTL I_r	0.5	1	2	4	8	12	16	20	24
	7.2 x IDMTL I_r	0.3 ⁽¹⁾	0.7	1.4	2.7	5.5	8.2	11	13.7	16.5
	10 x IDMTL I_r	0.2 ⁽¹⁾	0.4	0.7	1.4	2.8	4.2	5.6	7	8.4
HVF	1.5 x IDMTL I_r	187	374	748	1496	2992	4488	5984	7481	8977
	6 x IDMTL I_r	0.5	1	2	4	8	12	16	20	24
	7.2 x IDMTL I_r	0.2 ⁽¹⁾	0.5	1	1.9	3.9	5.8	7.7	9.6	11.6
	10 x IDMTL I_r	0.1 ⁽¹⁾	0.1 ⁽¹⁾	0.3 ⁽¹⁾	0.5	1	1.6	2.1	2.6	3.1

(1) When the calculated tripping time is lower than t_{sd} , the IDMTL tripping time is forced to the short-time tripping time.

Reset Time

An adjustable reset time helps to improve protection in the case of intermittent overcurrents. The reset time of a protection function is the time between the end of the overcurrent detection and the reset of the protection time delay.

The reset time of IDMTL overcurrent protection starts when $I \leq 1.125 \times \text{IDMTL } I_r$.

The following graphic illustrates the operation of definite reset time for different types of overcurrent:

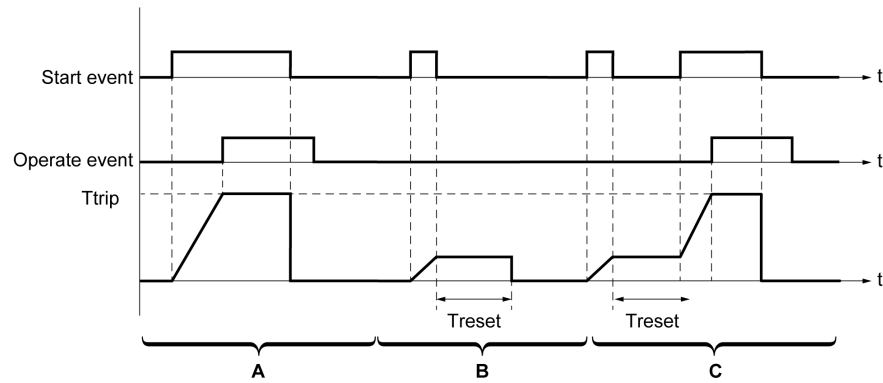

A Permanent overcurrent

B Transient overcurrent

C Intermittent overcurrent

The reset time of IDMTL overcurrent protection is adjustable and has the following types:

- Reset time with definite time curve.

This can be used in the case of intermittent overcurrents. The time to reset is fixed: $T_{reset} = \text{IDMTL reset time}$.

- Reset time with inverse time curve.

This can be used in the case of intermittent overcurrents and functions in a similar way to the thermal memory of long-time overcurrent protection. The time to reset (T_{reset}) is calculated according to the following equation:

$$T_{reset} = \left(\frac{\text{IDMTL reset time}}{1 - \left(\frac{I}{I_r}\right)^2} \right)$$

Inhibiting Protection

To inhibit the IDMTL overcurrent protection, both the following conditions must be met:

- Inhibition is enabled by setting the Inhibition parameter to ON.
- Inhibition of optional protections is activated by an input of the IO module. The function to **Inhibit Optional Protection** must be assigned to an input of the IO module.

For more information about inhibiting optional protections, refer to *Enerlin'X IO - Input/Output Application Module for One Circuit Breaker - User Guide*, page 10.

Setting the Protection

The IDMTL overcurrent protection settings are:

- IDMTL mode: enables (ON) or disables (OFF) the protection
- IDMTL action: sets the result of the protection as trip or alarm
- IDMTL inhib: enables (ON) the protection to be inhibited by IO module
- IDMTL Ir: IDMTL overcurrent protection threshold
- IDMTL tr: IDMTL overcurrent protection time delay
- IDMTL curve: selects the type of IDMTL tripping curve (DT, SIT, VIT, EIT, HVF)

- IDMTL reset time type: selects the reset time type as definite time or inverse time
- IDMTL reset time

They can be set as follows:

- With EcoStruxure Power Commission software (password-protected)
- With EcoStruxure Power Device app (password-protected)

The dual settings function does not apply to IDMTL overcurrent protection. When the dual settings function is enabled, IDMTL overcurrent protection settings are the same whether set A or set B settings are activated.

NOTE: Long-time overcurrent protection (ANSI 49RMS/51) remains active when IDMTL overcurrent protection (ANSI 51) is configured. For recommendations on how to maintain consistency between settings, refer to the setting guidelines, page 177.

Protection Settings

Setting	Unit	Setting range	Step	Factory setting
IDMTL mode	–	ON/OFF	–	OFF
IDMTL action	–	Alarm/Trip	–	Alarm
IDMTL inhibit	–	ON/OFF	–	OFF
IDMTL Ir	A	0.4 –1.5 x In	1	In
IDMTL tr	s	0.1–24	0.1	1
IDMTL curve	–	DT/SIT/MIT/EIT/HVF	–	EIT
IDMTL reset time type	–	Definite time/Inverse time	–	Definite time
IDMTL reset time	s	0–10	0.1	0.5

For more information, refer to the setting guidelines, page 177.

Protection Characteristics

The accuracy of IDMTL Ir is ± 5%.

Characteristics of IDMTL overcurrent protection:

- Time-dependent delay (except when DT selected)
- Reset time: adjustable

IDMTL Ir characteristics:

- $I < 1.05 \times \text{IDMTL Ir}$: no trip
- $I > 1.2 \times \text{IDMTL Ir}$: trip

Predefined Events

The function generates the following predefined events:

Code	Event	History	Severity
0x6421 (25633)	IDMTL long time trip	Trip	High
0x6221 (25121)	IDMTL long time start	Protection	Medium
0x6321 (25377)	IDMTL long time operate	Protection	Medium
0x0EF8 (3832)	Optional protection inhibited by IO module	Protection	Low
0x0D0C (3340)	Config error IO/CU: optional protection Inhibit	Configuration	Medium

Predefined events cannot be modified by the user. For general information about events, refer to [Event management](#), page 301.

Protection events are generated as follows:

- The start event is generated when the protection picks up.
- The operate event is generated when the protection time delay elapses.
The operate event is not generated when the optional protection is inhibited.
- The trip event is generated when the circuit breaker tripping voltage release (MITOP) activates.

The trip event is not generated when:

- The optional protection is set in alarm mode
- The optional protection is inhibited

Recommended Actions

Code	Event	Recommended actions
0x6421 (25633)	IDMTL long time trip	Reset the device or use the Power restoration assistant within the EcoStruxure Power Device app.
0x0EF8 (3832)	Optional protection inhibited by IO module	Check inhibition selector switch wired with IO module.
0x0D0C (3340)	Config error IO/CU: optional protection Inhibit	Correct the configuration error with EcoStruxure Power Commission software: <ul style="list-style-type: none"> • If you want optional protection inhibition to be controlled by IO module, connect an IO module with inhibit optional protection assignment. • If you do not want optional protection inhibition to be controlled by IO module, connect an IO module without inhibit optional protection assignment.

Resetting a Trip Event

For information about resetting the circuit breaker after a trip due to an electrical fault, refer to the relevant document, page 10:

- *MasterPact MTZ1 - Circuit Breakers and Switch-Disconnectors - User Guide*
- *MasterPact MTZ2/MTZ3 - Circuit Breakers and Switch-Disconnectors - User Guide*

Directional Overcurrent Protection (ANSI 67)

Presentation

Due to its ability to detect the direction of a short-circuit current, directional overcurrent protection helps to protect an installation against short-circuit currents that could circulate in both directions through the circuit breaker.

There are two independent protections:

- Forward directional overcurrent
- Reverse directional overcurrent

Directional overcurrent protection helps to protect the installation against phase-to-phase, phase-to-neutral, and phase-to-earth short circuits with total selectivity.

The ANSI 67 - Directional overcurrent protection Digital Module is used to generate either an alarm or a trip.

Prerequisites

Directional overcurrent protection is available when the ANSI 67 - Directional overcurrent protection Digital Module is purchased and installed on the MicroLogic control unit, page 29.

Directional overcurrent protection requires an external 24 Vdc power supply.

Directional overcurrent protection is compatible with the following control units:

- MicroLogic 2.0 X, 5.0 X, 6.0 X, and 7.0 X control units for IEC standard
- MicroLogic 3.0 X, 5.0 X, and 6.0 X control units for UL standard
- MicroLogic X control units with firmware version greater than or equal to 004.000.000. Earlier firmware versions need to be updated, page 46.

NOTE: On MicroLogic 2.0 X and 3.0 X control units, directional overcurrent protection has limited advantages due to the fact that the instantaneous protection cannot be set to OFF. For more information, refer to the [setting guidelines](#), page 181.

Data from the Digital Module is available remotely through IFE/EIFE or IFM communication interfaces, if the IFE/EIFE or IFM firmware version is compatible with the Digital Module. For more information, refer to [firmware compatibility of the communication interfaces](#), page 31.

Operating Principle

Directional overcurrent protection is based on the true RMS current of phases and neutral, up to harmonic 40.

Directional overcurrent protection is implemented independently for each phase and for neutral when neutral is present, page 118.

Directional overcurrent protection:

- Is an overcurrent time-independent protection.
- Detects the direction of the short-circuit current.

Directional overcurrent protection trips if the following conditions are met:

- The value of the current exceeds the setting (Ifw or Irv).
- The associated time delay (tfw or trv) is elapsed.
- The direction of the short-circuit current is detected:
 - From the top connection to the bottom connection of the circuit breaker: forward directional overcurrent protection trips
 - From the bottom connection to the top connection of the circuit breaker: reverse directional overcurrent protection trips

Inhibiting Protection

To inhibit the forward or reverse directional overcurrent protections, both the following conditions must be met:

- Inhibition is enabled by setting the Inhibition parameter to ON. Inhibition is enabled independently on each protection (forward and reverse).
- Inhibition of optional protections is activated by an input of the IO module. The function **Inhibit Optional Protection** must be assigned to an input of the IO module.

For more information about inhibiting optional protections, refer to *Enerlin X IO - Input/Output Application Module for One Circuit Breaker - User Guide*, page 10.

Setting the Protection

The forward directional overcurrent protection settings are:

- Ifw mode: enables (ON) or disables (OFF) the forward directional overcurrent
- Ifw action: sets the result of forward directional overcurrent protection as trip or alarm
 - Trip: the circuit breaker trips and three events are generated (start, operate, and trip)
 - Alarm: two events are generated (start and operate)
- Ifw inhib: enables (ON) the forward directional overcurrent to be inhibited by IO module
- Ifw: forward directional overcurrent protection threshold
- tfw: forward directional overcurrent protection time delay

The reverse directional overcurrent protection settings are:

- Irv mode: enables (ON) or disables (OFF) the reverse directional overcurrent
- Irv action: sets the result of reverse directional overcurrent protection as trip or alarm
 - Trip: the circuit breaker trips and three events are generated (start, operate, and trip)
 - Alarm: two events are generated (start and operate)
- Irv inhib: enables (ON) the reverse directional overcurrent to be inhibited by IO module
- Irv: reverse directional overcurrent protection threshold
- trv: reverse directional overcurrent protection time delay

They can be set as follows:

- With EcoStruxure Power Commission software (password-protected)
- With EcoStruxure Power Device app (password-protected)

The dual settings function does not apply to directional overcurrent protection. When the dual settings function is enabled, directional overcurrent protection settings are the same whether set A or set B settings are activated.

Protection Settings

Direction	Setting	Unit	Range	Step	Factory setting
Forward	Ifw mode	–	ON/OFF	–	OFF
	Ifw action	–	Alarm/Trip	–	Alarm
	Ifw inhib	–	ON/OFF	–	OFF
	Ifw	A	0.5–10 x In	1	1.5 x In
	tfw	s	0.1–0.4	0.1	0.1
Reverse	Irv mode	–	ON/OFF	–	OFF

Direction	Setting	Unit	Range	Step	Factory setting
	Irv action	–	Alarm/Trip	–	Alarm
	Irv inhib	–	ON/OFF	–	OFF
	Irv	A	0.5–10 x In	1	1.5 x In
	trv	s	0.1–0.4	0.1	0.1

For more information, refer to the setting guidelines, page 181.

Operating Times at 10 x Ifw or 10 x Irv

The operating times of directional overcurrent protection depend on the tfw or trv time delay.

tfw or trv time delay (s)	0	0.1	0.2	0.3	0.4
Non-tripping time (s)	0	> 0.02	> 0.14	> 0.27	> 0.40
Maximum breaking time (s)	< 0.10	< 0.14	< 0.23	< 0.32	< 0.50

Protection Characteristics

The accuracy of Ifw and Irv is $\pm 10\%$.

Characteristics of directional overcurrent protection:

- Time-independent
- Hysteresis: fixed 98%

Predefined Events

The function generates the following predefined events:

Code	Event	History	Severity
0x6423 (25635)	Forward directional overcurrent trip	Trip	High
0x6424 (25636)	Reverse directional overcurrent trip	Trip	High
0x6223 (25123)	Forward directional overcurrent start	Protection	Low
0x6224 (25124)	Reverse directional overcurrent start	Protection	Low
0x6323 (25379)	Forward directional overcurrent operate	Protection	Medium
0x6324 (25380)	Reverse directional overcurrent operate	Protection	Medium
0x0EF8 (3832)	Optional protections inhibited by IO	Protection	Low
0x0D0C (3340)	Config error IO/CU: optional protection Inhibit	Configuration	Medium

Predefined events cannot be modified by the user. For general information about events, refer to *Event management*, page 301.

Protection events are generated as follows:

- The start event is generated when the protection picks up.
- The operate event is generated when the protection time delay elapses.
The operate event is not generated when the optional protection is inhibited.
- The trip event is generated when the circuit breaker tripping voltage release (MITOP) activates.

The trip event is not generated when:

- The optional protection is set in alarm mode
- The optional protection is inhibited

Recommended Actions

Code	Event	Recommended actions
0x6423 (25635)	Forward directional overcurrent trip	Reset the device or use the Power restoration assistant within the EcoStruxure Power Device app.
0x6424 (25636)	Reverse directional overcurrent trip	Reset the device or use the Power restoration assistant within the EcoStruxure Power Device app.
0x0EF8 (3832)	Optional protection inhibited by IO module	Check inhibition selector switch wired with IO module.
0x0D0C (3340)	Config error IO/CU: optional protection Inhibit	Correct the configuration error with EcoStruxure Power Commission software: <ul style="list-style-type: none"> • If you want optional protection inhibition to be controlled by IO module, connect an IO module with inhibit optional protection assignment. • If you do not want optional protection inhibition to be controlled by IO module, connect an IO module without inhibit optional protection assignment.

Resetting a Trip Event

For information about resetting the circuit breaker after a trip due to an electrical fault, refer to the relevant document, page 10:

- *MasterPact MTZ1 - Circuit Breakers and Switch-Disconnectors - User Guide*
- *MasterPact MTZ2/MTZ3 - Circuit Breakers and Switch-Disconnectors - User Guide*

Setting Guidelines

What's in This Chapter

Protection Setting Guidelines	169
Setting the Long-Time Overcurrent Protection (L or ANSI 49RMS/51)	171
Setting the Short-Time Overcurrent Protection (S or ANSI 50TD/51)	174
Setting the Instantaneous Overcurrent Protection (I or ANSI 50)	176
Setting the IDMTL Overcurrent Protection	177
Setting the Directional Overcurrent Protection (ANSI67).....	181
Selectivity	184

Protection Setting Guidelines

Presentation

The setting of overcurrent protection relies on installation short-circuit and electrical fault calculations. The setting guidelines cannot replace these calculations.

MasterPact MTZ circuit breakers with MicroLogic X control units offer flexibility to set the required overcurrent protection while maintaining selectivity and stability on transient phenomena, for example, inrush current of transformers or motors, when necessary.

For each circuit, the installation designer needs to provide the following:

- I_z : continuous current capacity of the circuit according to IEC 60364-5-52 or national wiring rules. Current carrying capacity is called ampacity in the US National Electrical Code (NFPA 70).
- $I_{fault\ min}$: minimum electrical fault current at the end of the circuit depending on earthing system
- $T_{max\ short-circuit}$: maximum time for maximum short-circuit current

Guidelines are given for setting the following protections:

- Long-time overcurrent protection
- Short-time overcurrent protection
- Instantaneous overcurrent protection
- IDMTL overcurrent protection
- Directional overcurrent protection

Overcurrent Protection Setting Guidelines by Application

The following table gives the guidelines for overcurrent protection setting by application:

Application	MicroLogic 2.0 X	MicroLogic 3.0 X	MicroLogic 5.0 X, 6.0 X, 7.0 X ⁽¹⁾
Secondary side of MV/LV transformer (switchboard main incomer) with other MasterPact, Compact NS, or PowerPact P- and R-frame circuit breaker downstream as feeder	$I_r = I_z$ $t_r \leq 24\ s$ $I_{sd} \leq I_{fault\ min}$ Selectivity possible with Compact NSXm and Compact NSX feeders only.	$I_r = I_z$ $t_r \leq 24\ s$ $I_i \leq I_{fault\ min}$ I_i tripping mode: Standard Selectivity possible with PowerPact B-, H-, J-, and L-frame feeders only.	$I_r = I_z$ $t_r \leq 24\ s$ $I_{sd} \leq I_{fault\ min}$ $t_{sd} < T_{max\ short-circuit}$ $t_{sd} > t_{sd}$ of downstream MasterPact, Compact NS, or PowerPact P- and R-frame circuit breaker ⁽²⁾ I_i mode: OFF
Secondary side of MV/LV transformer (switchboard main incomer) without other MasterPact, Compact NS, or PowerPact P- and R-frame circuit breaker downstream as feeder	$I_r = I_z$ $t_r \leq 24\ s$ $I_{sd} \leq I_{fault\ min}$	$I_r = I_z$ $t_r \leq 24\ s$ $I_i \leq I_{fault\ min}$ I_i tripping mode: Standard	$I_r = I_z$ $t_r \leq 24\ s$ $I_{sd} \leq I_{fault\ min}$ $t_{sd} = 0$ I_i mode: ON I_i tripping mode: Standard $I_i = I_{sd}$
Generator output with other MasterPact, Compact NS, or PowerPact P- and R-frame circuit breaker downstream as feeder	$I_r = I_z$ $t_r \leq 1\ s$ $I_{sd} \leq I_{fault\ min}$ Selectivity possible with Compact NSXm and Compact NSX feeders only.	$I_r = I_z$ $t_r \leq 1\ s$ $I_i \leq I_{fault\ min}$ I_i tripping mode: Standard	$I_r = I_z$ $t_r \leq 1\ s$ $I_{sd} \leq I_{fault\ min}$ $t_{sd} > t_{sd}$ of downstream MasterPact, Compact NS, or

Application	MicroLogic 2.0 X	MicroLogic 3.0 X	MicroLogic 5.0 X, 6.0 X, 7.0 X ⁽¹⁾
		Selectivity possible with PowerPact B-, H-, J-, and L-frame feeders only.	PowerPact P- and R-frame circuit breaker ⁽²⁾ li mode: OFF
Generator output without other MasterPact, Compact NS, or PowerPact P- and R-frame circuit breaker downstream as feeder	Ir = Iz tr ≤ 1 s I _{sd} ≤ I _{fault min}	Ir = Iz tr ≤ 1 s li ≤ I _{fault min} li tripping mode: Standard	Ir = Iz tr ≤ 1 s I _{sd} ≤ I _{fault min} tsd = 0 li mode: ON li tripping mode: Standard li = I _{sd}
Feeder with other MasterPact, Compact NS, or PowerPact P- and R-frame circuit breaker downstream	Ir = Iz tr ≤ 16 s I _{sd} ≤ I _{fault min} Selectivity possible with Compact NSXm and Compact NSX feeders only.	Ir = Iz tr ≤ 16 s li ≤ I _{fault min} li tripping mode: Standard Selectivity possible with PowerPact B-, H-, J-, and L-frame feeders only.	Ir = Iz tr ≤ 16 s I _{sd} ≤ I _{fault min} tsd > t _{sd} of downstream circuit breaker ⁽²⁾ li mode: OFF
Feeder without other MasterPact, Compact NS, or PowerPact P- and R-frame circuit breaker downstream as feeder	Ir = Iz tr ≤ 16 s I _{sd} ≤ I _{fault min}	Ir = Iz tr ≤ 16 s li ≤ I _{fault min} li tripping mode: Standard	Ir = Iz tr ≤ 16 s I _{sd} ≤ I _{fault min} tsd = 0 li mode: ON li tripping mode: Standard li = I _{sd}
Power electronic (for example, uninterruptible power supplies, variable speed drives, photovoltaic inverters) with no other circuit breaker downstream	Ir = Iz tr ≤ 8 s I _{sd} = 1.5-2 x I _n ≤ I _{fault min}	Ir = Iz tr ≤ 8 s li = 2-3 x I _n ≤ I _{fault min} li tripping mode: Fast	Ir = Iz tr ≤ 16 s I _{sd} = 1.5-2 x I _n ≤ I _{fault min} tsd = 0 li mode: ON li tripping mode: Fast li = 2-3 x I _n
ERMS settings with ERMS Digital Module only	Ir_ERMS = Iz tr_ERMS ≤ 1 s I _{sd_ERMS} = 1.5 x Ir	Ir_ERMS = Iz tr_ERMS ≤ 1 s li_ERMS = 1.5 x I _n li_ERMS tripping mode: Fast	Ir_ERMS = Iz tr_ERMS ≤ 1 s I _{sd_ERMS} = 1.5 x Ir tsd_ERMS = 0 li_ERMS = 2 x I _n li_ERMS tripping mode: Fast

(1) Ground-fault protection and earth-leakage protection depend on the earthing system and local regulations. As a rule ground-fault and earth-leakage sensitivity should be as low as possible without being disturbed by permanent or transient leakage current. The ground-fault and earth-leakage time delay enables selectivity with downstream devices.

(2) When t_{sd} > 0, a fault clearance time reduction system, such as ZSI or ERMS, is required in the USA by National Electricity Code NFPA 70 (240.87) (2011 edition). Refer to the guidelines for ERMS settings.

Setting the Long-Time Overcurrent Protection (L or ANSI 49RMS/51)

Setting Guidelines for Ir

The Ir setting depends on the maximum expected current flow through the breaker and the maximum current that can be withstood by the protected equipment (for example, cables, busbars, generators, and transformers).

The installation rules, such as IEC 60364 Chapter 4.43 or similar national standards, require overload protection for conductors as follows:

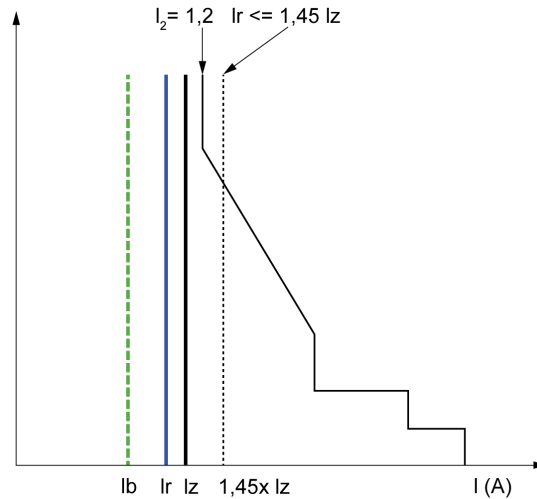

Ib Maximal load current

Ir Long time protection setting

Iz Continuous current-carrying capacity of the circuit

I₂ Conventional operating current of the circuit breaker = 1.2 x Ir for Schneider Electric electronic control unit

I(A) Current through circuit breaker (phase(s) or neutral)

Setting Guidelines for tr

The tr setting depends on the maximum duration at maximum current and the maximum current that can be withstood by the protected equipment (for example, cables, busbars, generators, and transformers).

Thermal memory: As described in long-time overcurrent protection, page 101, this protection function is an overcurrent time-dependent protection with thermal memory. It operates as a thermal image, using the heating and cooling model of a conductor. It can be considered as a first order thermal model with one heating time constant.

The following table shows the relationship between the tr setting and the thermal time constant of the first order thermal model:

tr setting (s)	Unit	0.5	1	2	4	8	12	16	20	24
Equivalent time constant for heating and cooling when control unit is energized	seconds	14	28	56	112	224	335	447	559	671
	minutes	–	–	–	–	3.5	5.6	7.5	9.3	11.2
Time constant for cooling when control unit is not energized	minutes	5								

Summary of tr Setting Guidelines by Application

The following table gives the tr setting guidelines by application:

Application	Principle	Usual value
Secondary side of MV/LV transformer (switchboard main incomer) Tie circuit breaker between two switchboards	Tripping time according to circuit thermal withstand for busbars, busbar trunking, cable > 240 mm ² (500 MCM): <ul style="list-style-type: none"> • Time constant > 11 min • tr = 24 s When smaller cables are used in parallel, a lower setting should be used.	tr ≤ 24 s
Generators	tr ≤ 1 s in order to achieve tripping time < 30 s for 1.5 x Ir (IEC 60034-1 Clause 9.3.2).	tr ≤ 1 s
Feeder (cable or busbar trunking protection)	Tripping time according to circuit thermal withstand for busbars, busbar trunking, cable > 240 mm ² (500 MCM): <ul style="list-style-type: none"> • Time constant > 11 min • tr = 24 s To achieve selectivity with incomer, it can be useful to reduce tr.	<ul style="list-style-type: none"> • tr ≤ 24 s for busbar trunking or cable ≥ 240 mm² (500 MCM) • tr ≤ 16 s for lower cross section cables
Primary side of LV/LV transformer	According to cable or busbar trunking withstand (transformer withstand is generally higher). To achieve selectivity with incomer, it can be useful to reduce tr.	<ul style="list-style-type: none"> • tr ≤ 24 s for busbar trunking or cable ≥ 240 mm² (500 MCM) • tr ≤ 16 s for lower cross section cables
Power electronic (for example, uninterruptible power supplies, variable speed drives, photovoltaic inverters)	According to cable or busbar trunking supplying power electronic equipment.	<ul style="list-style-type: none"> • tr ≤ 24 s for busbar trunking or cable ≥ 240 mm² (500 MCM) • tr ≤ 16 s for lower cross section cables
Motors	If motor is protected against overload by a separate relay, long time setting is done according to circuit thermal withstand. If the MicroLogic control unit is also used for motor thermal overload, motor class must be taken in consideration.	<ul style="list-style-type: none"> • tr = 12 s for a feeder • tr ≥ 8 s for a class 10 motor • tr ≥ 12 s for a class 20 motor • tr ≥ 16 s for a class 30 motor

Example of tr setting according to the application:

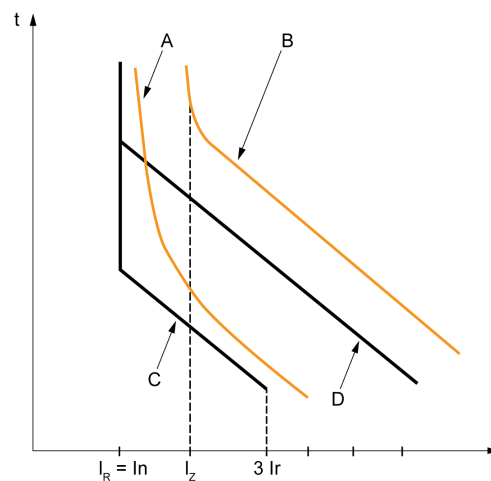

- A** Generator thermal limit
- B** Cable thermal limit
- C** Protection setting generator t_{LT} (minimum notch)
- D** Protection setting cable t_{LT} (maximum notch)

Neutral Protection Setting Guidelines

Some indications for setting neutral protection are given here. For more information, refer to the neutral protection section, page 118.

The following table indicates the long-time protection settings according to the neutral cable cross section:

Cross-sectional area of neutral conductor	Harmonics expected	Neutral protection setting	Long-time protection
Less than cross-sectional area of phase conductors	No	N/2	I_r is set according to I_z of cable, I_r applied to neutral is divided by 2
Equal to cross-sectional area of phase conductors	No	OFF	No harmonics expected: the protection of neutral is not necessary
	Yes	N	Harmonics expected: the neutral must be protected by the long-time protection, set as for the phase protection
Greater than cross-sectional area of phase conductors	No	OFF	No harmonics expected: the protection of neutral is not necessary
	Yes	Oversized N	Harmonics expected: the neutral must be protected by the long-time protection, set as for the phase protection multiplied by 1.6 (Oversized neutral)

NOTE: On 3-pole circuit breakers the ENCT option must be declared.

NOTE: In IT systems, a distributed neutral conductor must be protected. Set the neutral protection to N/2, N or Oversized N.

Setting the Short-Time Overcurrent Protection (S or ANSI 50TD/51)

Setting Guidelines

The I_{sd} and t_{sd} settings help to ensure that the short-time withstand current of protected equipment is not exceeded.

When short-time overcurrent protection automatically disconnects the power supply in accordance with IEC 60364-4-41, the I_{sd} setting must take into consideration the fault loop impedance of the protected circuit. For more information, refer to IEC 60364-4-41 2017 clause 411.4.4 or national low-voltage installation rules.

Alternatively this function can be performed by earth-leakage or ground-fault protection.

Setting Guidelines for I_{sd}

Application	Principle	I_{sd} usual value
Secondary side of MV/LV transformer (switchboard main incomer or tie circuit breaker between two switchboards)	Lower than minimum short-circuit or ground-fault current at the end of the protected circuit. Selectivity with downstream circuit breakers	$10 \times I_r$
Generators	Lower than minimum short-circuit or ground-fault current supplied by the generator. Selectivity with downstream circuit breakers	$2-3 \times I_r$
Feeder with other MasterPact or Compact NS or PowerPact P- and R-frame circuit breaker downstream	Lower than minimum short-circuit or ground-fault current at the end of the protected circuit. Selectivity with downstream circuit breakers	$10 \times I_r$
Feeder without other MasterPact or Compact NS or PowerPact P- and R-frame circuit breaker downstream	Lower than minimum short-circuit or ground-fault current at the end of the protected circuit. Selectivity with downstream circuit breakers	$10 \times I_r$
Primary side of LV/LV transformer	Lower than minimum secondary short-circuit current.	$10 \times I_r$
Power electronic (for example, uninterruptible power supplies, variable speed drives, photovoltaic inverters)	Lower than minimum short-circuit or ground-fault current at the end of the protected circuit. Lower setting possible as no selectivity or transient current is expected.	$1.5-2 \times I_r$
Motors	Lower than minimum short-circuit or ground-fault current at the end of the protected circuit. Lower setting possible above starting current.	$10 \times I_r$

When LV/LV transformers are switched on, very high inrush currents are produced which must be taken into account when choosing overcurrent protection devices. The peak value of the first current wave often reaches 10 to 15 times the rated rms current of the transformer and may reach values of 20 to 25 times the rated current even for transformers rated less than 50 kVA.

Example of inrush current: when transformer is switched on:

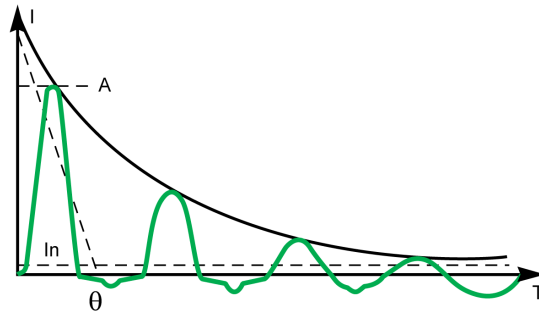

A 1st peak 10 to 25 x I_n

Example of inrush current of direct on line motor when started:

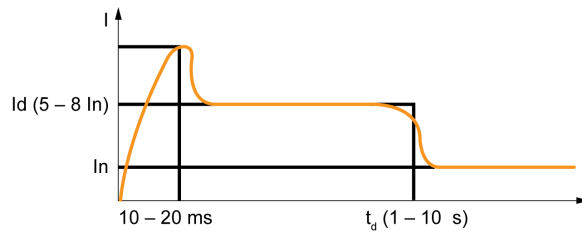

Setting Guidelines for tsd

tsd is set according to selectivity.

Time-based selectivity is provided between two circuit breakers when the supply side circuit breaker short-time delay is at least one step higher than the load side short-time delay.

When downstream circuit breakers are Compact NSX or PowerPact H-, J-, or L-frame circuit breakers, selectivity is always provided with MasterPact MTZ circuit breakers with MicroLogic X control units, for all values of tsd.

Short-time tripping time can be definite time type (tripping time is independent of current level) or time dependent with $I^2t = \text{constant}$ curve. This function allows the curve to be smoothed for low-level overcurrent, providing fast trip at high current. This is recommended for selectivity with fuses.

Application	Principle	tsd usual value
Secondary side of MV/LV transformer (switchboard main incomer or tie circuit breaker between two switchboards)	Selectivity with downstream circuit breakers	tsd > tsd of downstream power circuit breaker (tsd = 0.2 s if installation includes three levels of power circuit breaker)
Feeder with selectivity with other MasterPact MTZ, Compact NS or PowerPact P- and R-frame circuit breaker downstream	Selectivity with downstream circuit breakers	tsd > tsd of downstream power circuit breaker (tsd = 0.1 s if installation includes three levels of power circuit breaker)
Feeder without selectivity with other MasterPact MTZ, Compact NS or PowerPact P- and R-frame circuit breaker downstream	No need for delayed short-time protection	tsd = 0 s
Primary side of LV/LV transformer	Stability during inrush. Selectivity with downstream circuit breakers	tsd = 0.1 s or tsd > tsd of downstream power circuit breaker, if any
Power electronic (Uninterrupted power supplies, variable speed drives, photovoltaic inverters, etc.)	No need for delayed short-time protection	tsd = 0 s
Motors	Stability during inrush	tsd = 0 s or 0.1 s

Setting the Instantaneous Overcurrent Protection (I or ANSI 50)

Settings Guideline

Rules for I_{sd} also apply to the I_i threshold.

Application	Principle	Usual value
Secondary side of MV/LV transformer (switchboard main incomer)	Selectivity with downstream circuit breakers	I _i mode: OFF if other MasterPact circuit breaker downstream I _i = 15 x I _n if Compact NSXm, Compact NSX, or PowerPact B-, H-, J-, L-frame circuit breaker only downstream
Feeder with selectivity with other MasterPact, Compact NS or PowerPact P- or R-frame circuit breaker downstream	Same rule as for I _{sd}	I _i mode: OFF
Feeder without selectivity with other MasterPact, Compact NS or PowerPact P- or R-frame circuit breaker downstream	–	I _i mode: ON I _i tripping mode: Standard I _i = 10-15 x I _n
Primary side of LV/LV transformer	–	I _i mode: OFF
Generators	–	I _i mode: OFF
Power electronic (for example, uninterruptible power supplies, variable speed drives, photovoltaic inverters)	Lower than minimum short-circuit or ground-fault at the end of the protected circuit. Lower setting possible as no selectivity or transient current is expected.	I _i mode: ON I _i tripping mode: Fast I _i = 2 x I _n
Motor	Lower than minimum short-circuit or ground-fault at the end of the cable. Lower setting possible above starting current.	I _i mode: ON I _i tripping mode: Fast I _i ≥ 13 x Full load current of motor

I_i setting allows normal transient overcurrent inrush current for transformers:

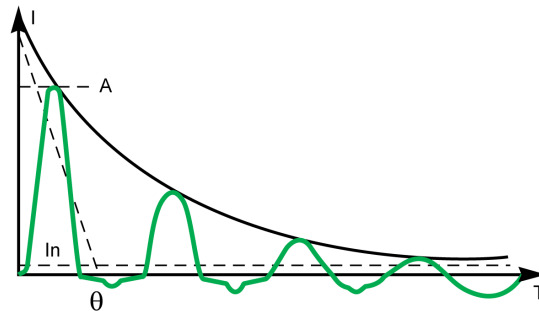

A 1st peak 10 to 25 x I_n

Motor direct on line starting current:

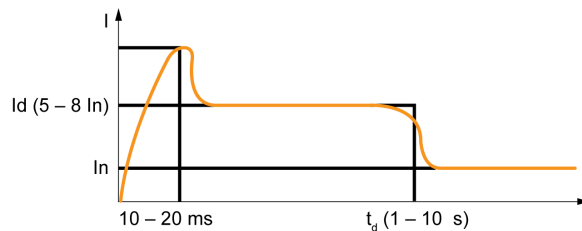

NOTE: MasterPact MTZ1 L1 type circuit breakers are equipped with an additional fast instantaneous trip set at 10 x I_n.

- If used for the protection of the supply side of a transformer, the risk of trip during energization must be considered.
- For motor application, select according to motor starter coordination tables.

Setting the IDMTL Overcurrent Protection

Setting Guidelines

The IDMTL overcurrent protection Digital Module can be used to improve selectivity with upstream overcurrent protection provided by a fuse or standalone relay, for example, a medium voltage relay, without affecting selectivity with downstream low voltage devices.

Fuses and standalone relays often provide tripping curves which are different from the standard tripping curve offered by MicroLogic X long-time overcurrent protection. The setting guidelines give an indication of how the IDMTL tripping curves can be used to maintain improved selectivity with upstream devices.

Selectivity with Upstream Fuse Using HVF Tripping Curve

The following graph shows how the IDMTL HVF curve can be used to curtail the standard long-time overcurrent protection tripping curve to help improve selectivity with an upstream fuse.

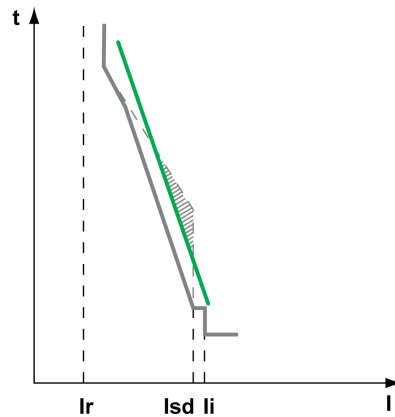

- Upstream fuse tripping curve
- Compromised selectivity with standard long-time overcurrent protection tripping curve
- Tripping curve with IDMTL HVF tripping curve

The following settings are recommended for the IDMTL overcurrent protection:

Setting	Value
IDMTL mode	ON
IDMTL action	Trip
IDMTL inhibit	OFF
IDMTL Ir	1.0 x In ⁽¹⁾
IDMTL tr	1 s ⁽¹⁾
IDMTL curve	HVF
IDMTL reset time type	Definite time
IDMTL reset time	0 s

(1) The setting proposed is consistent with commonly used high voltage fuses. The setting should be checked on a case-by-case basis.

The following settings are recommended for long-time overcurrent protection:

- $I_r \leq I_z$ cable
- $t_r = 24$ s

NOTE: I²t OFF is recommended for short-time overcurrent protection. With I²t ON the long-time protection could trip faster than the short-time protection.

Selectivity with Upstream Relay Using DT Tripping Curve

Without IDMTL overcurrent protection, when the MasterPact MTZ circuit breaker is downstream from a relay using a DT tripping curve, it would be necessary to drastically reduce the long-time overcurrent protection time delay, t_r , or the short-time overcurrent protection time delay, t_{sd} , to improve selectivity between the devices. The reduction would significantly reduce the setting options for downstream feeders and in some cases, would make downstream selectivity impossible.

The following graph shows how the IDMTL DT curve can be used to curtail the standard long-time overcurrent protection tripping curve to help improve selectivity with an upstream relay.

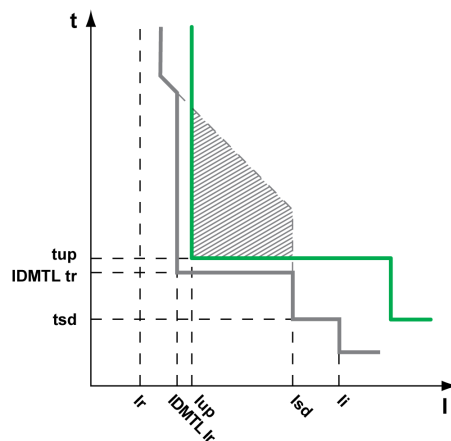

- Upstream relay tripping curve
- Compromised selectivity with standard long-time overcurrent protection tripping curve
- Tripping curve with IDMTL DT tripping curve

The following settings are recommended for the IDMTL overcurrent protection:

Setting	Value
IDMTL mode	ON
IDMTL action	Alarm
IDMTL inhibit	OFF
IDMTL I _r	≤ 1.3 I _{up}
IDMTL t _r	t _{sd} < IDMTL t _r ≤ t _{up} - 0.2 s
IDMTL curve	DT
IDMTL reset time type	Same as reset type of upstream relay
IDMTL reset time	Lower than reset time of upstream relay

Selectivity with Upstream Relay Using SIT or VIT Tripping Curve

As in the previous example, without IDMTL overcurrent protection, when the MasterPact MTZ circuit breaker is downstream from a relay using an SIT or VIT tripping curve, it would be necessary to drastically reduce the long-time overcurrent protection time delay, t_r , or the short-time overcurrent protection time delay, t_{sd} , to improve selectivity between the devices. The reduction would significantly reduce the setting options for downstream feeders and in some cases, would make downstream selectivity impossible.

The following graph shows how the IDMTL SIT or VIT tripping curve can be used to curtail the standard long-time overcurrent protection tripping curve to help improve selectivity with an upstream relay.

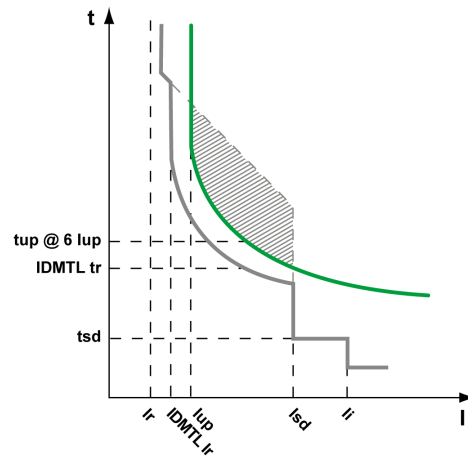

- Upstream relay tripping curve
- Compromised selectivity with standard long-time overcurrent protection tripping curve
- Tripping curve with IDMTL SIT or VIT tripping curve

The following settings are recommended for the IDMTL overcurrent protection:

Setting	Value
IDMTL mode	ON
IDMTL action	Trip
IDMTL inhibit	OFF
IDMTL I_r	$\leq 1.3 I_{lup}$
IDMTL t_r	$t_{sd} < IDMTL t_r \leq t_{up} @ 6 \times I_{lup}$
IDMTL curve	SIT or VIT, same as tripping curve of upstream relay
IDMTL reset time type	Same as reset type of upstream relay
IDMTL reset time	Lower than reset time of upstream relay

NOTE: When the calculated tripping time is lower than t_{sd} , the IDMTL overcurrent protection tripping time is forced to the short-time overcurrent protection tripping time. Setting $IDMTL t_r > t_{sd}$ is recommended to avoid a race between short-time overcurrent protection and IDMTL overcurrent protection for currents higher than I_{sd} .

EIT Tripping Curve Application: Pre-alarm for Load-shedding

An example for the application of this tripping curve is as an adjustable pre-alarm for load shedding.

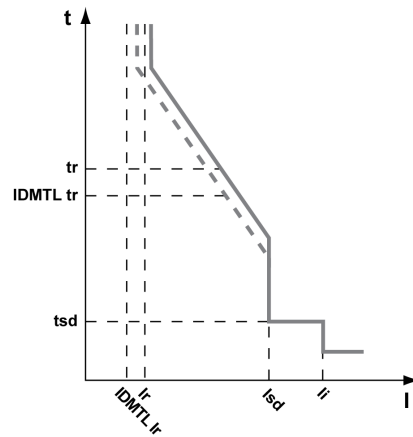

— Tripping curve

- - - IDMTL EIT pre-alarm curve

The following settings are recommended for the IDMTL overcurrent protection:

Setting	Value
IDMTL mode	ON
IDMTL action	Alarm
IDMTL inhibit	OFF
IDMTL I_r	$0.9 I_r$
IDMTL t_r	$t_{sd} < IDMTL t_r \leq t_r$
IDMTL curve	EIT
IDMTL reset time type	Inverse time
IDMTL reset time	10 s

Setting the Directional Overcurrent Protection (ANSI 67)

Setting Guidelines

Directional overcurrent protection is used in conjunction with short-time overcurrent protection. The choice of forward or reverse directional overcurrent protection and time delays (tfw and trv), and the time delay settings of short-time overcurrent protection (tsd) help to protect a power system against short-circuit currents that could circulate in forward and reverse directions.

When directional overcurrent protection is used to trip, instantaneous overcurrent protection (ANSI 50) is usually disabled by setting li mode to OFF.

Application on Power System with Multiple Sources in Parallel

Directional overcurrent protection can be applied on a power system with two or more sources running in parallel to increase power availability. The sources can be transformers or generators.

Examples of two power systems are presented, with and without directional overcurrent protection:

- Two sources running in parallel with no tie circuit breaker.
- Two sources running in parallel with one tie circuit breaker, with tie circuit breaker normally closed.

Hardware configuration	Protection scheme	Power availability	Example applications
2 sources No tie	2 circuit breakers without directional overcurrent protection	–	Commercial and industrial buildings
	2 circuit breakers with directional overcurrent protection	**	Commercial and industrial buildings
2 sources 1 tie, normally closed	2 circuit breakers without directional overcurrent protection	*	Oil and gas applications
	1 tie circuit breaker without directional overcurrent protection		Marine applications
	2 circuit breakers with directional overcurrent protection	***	Data centers
	1 tie circuit breaker without directional overcurrent protection		Oil and gas applications
			Marine applications
			Data centers

Setting Guidelines for Two Sources with No Tie

Q1		
ANSI 50	li1	OFF
	lsd1	10 x Ir A
ANSI 51	tsd1	0.2 s
ANSI 67	lfw1 mode	OFF
	lfw1 action	Alarm
	lfw1 inhib	NO
	lfw1	1.5 x In A
	tfw1	0.4 s
	lrv1 mode	ON
	lrv1 action	Trip
	lrv1 inhib	NO
	lrv1	1.5 x In A
	trv1	0.1 s

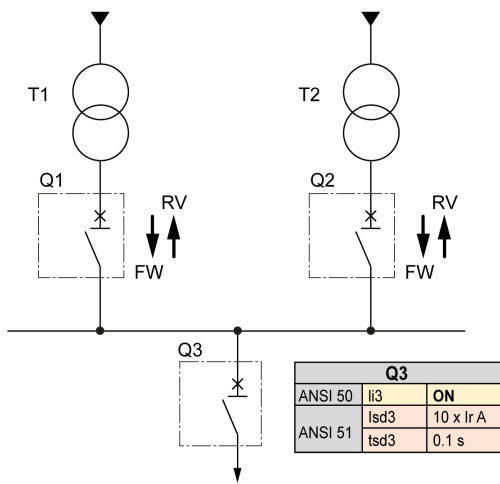

Q2		
ANSI 50	li2	OFF
	lsd2	10 x Ir A
ANSI 51	tsd2	0.2 s
ANSI 67	lfw2 mode	OFF
	lfw2 action	Alarm
	lfw2 inhib	NO
	lfw2	1.5 x In A
	tfw2	0.4 s
	lrv2 mode	ON
	lrv2 action	Trip
	lrv2 inhib	NO
	lrv2	1.5 x In A
	trv2	0.1 s

Q3		
ANSI 50	li3	ON
	lsd3	10 x Ir A
ANSI 51	tsd3	0.1 s

The following table indicates the settings of the overcurrent protections of the circuit breakers:

Circuit breaker	ANSI 50	ANSI 51	ANSI 67 forward	ANSI 67 reverse
Q1 and Q2 without ANSI 67	OFF	tsd = 0.2 s	N/A	N/A
Q1 and Q2 with ANSI 67	OFF	tsd = 0.2 s	OFF	trv = 0.1 s
Q3	ON	tsd = 0.1 s	N/A	N/A

The following table indicates the behavior of the overcurrent protections depending on the location of the short-circuit current:

Case	Q1 and Q2 without ANSI 67	Q1 and Q2 with ANSI 67
Short-circuit in A1 	<ul style="list-style-type: none"> Q1 trips on ANSI 51 Q2 trips on ANSI 51 The busbar is OFF.	<ul style="list-style-type: none"> Q1 trips on ANSI 67 (lrv1 < lsd2, trv1 < tsd2) Q2 is ON The busbar is ON.
Short-circuit in B1 	<ul style="list-style-type: none"> Q1 trips on ANSI 51 Q2 trips on ANSI 51 The busbar is OFF. The addition of a tie circuit breaker can keep half of the busbar ON.	<ul style="list-style-type: none"> Q1 trips on ANSI 51 Q2 trips on ANSI 51 The busbar is OFF. The addition of a tie circuit breaker can keep half of the busbar ON.

Setting Guidelines for Two Sources with One Tie

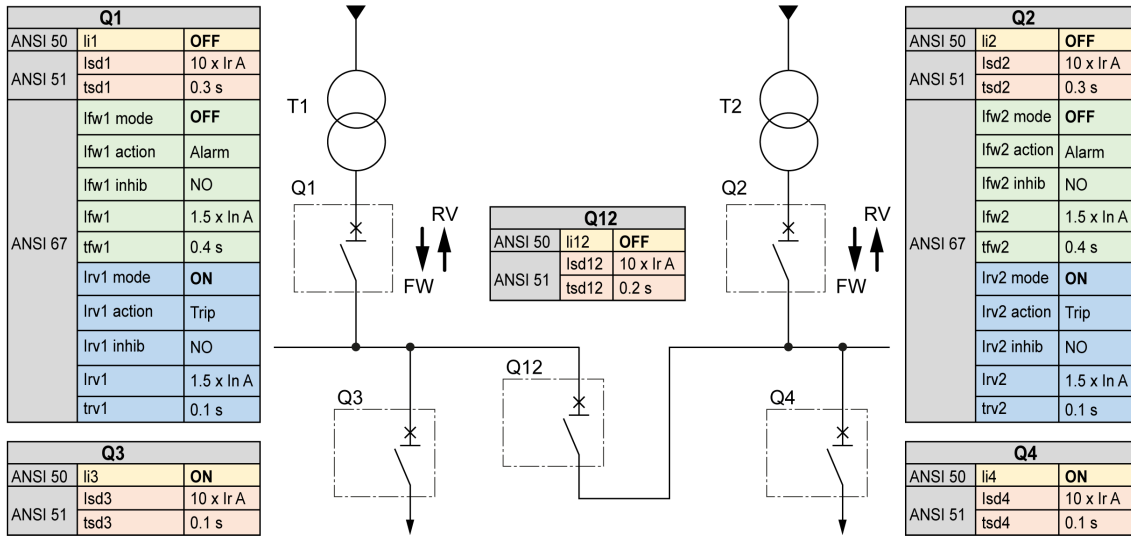

The following table indicates the settings of the overcurrent protections of the circuit breakers:

Circuit breaker	ANSI 50	ANSI 51	ANSI 67 forward	ANSI 67 reverse
Q1 and Q2 without ANSI 67	ON	tsd = 0.3 s	N/A	N/A
Q1 and Q2 with ANSI 67	OFF	tsd = 0.3 s	OFF	trv = 0.1 s
Q12 without ANSI 67	ON	tsd = 0.2 s	N/A	N/A
Q3, Q4	ON	tsd = 0.1 s	N/A	N/A

The following table indicates the behavior of the overcurrent protections depending on the location of the short-circuit current:

Case	Q1, Q2 without ANSI 67	Q1, Q2 with ANSI 67
<p>Short-circuit in A1</p>	<ul style="list-style-type: none"> Q12 trips on ANSI 51 Q1 trips on ANSI 51 Q2 is ON <p>Half of the busbar (1) is OFF.</p> <p>Half of the busbar (2) is ON.</p>	<ul style="list-style-type: none"> Q1 trips on ANSI 67 (lrv1 < lsd2 and lsd12, trv1 < tsd2 and tsd12) Q12 is ON Q2 is ON <p>The busbar is ON.</p>
<p>Short-circuit in B1</p>	<ul style="list-style-type: none"> Q12 trips on ANSI 51 Q1 trips on ANSI 51 Q2 is ON <p>Half of the busbar (1) is OFF.</p> <p>Half of the busbar (2) is ON.</p>	<ul style="list-style-type: none"> Q1 trips on ANSI 51 Q2 trips on ANSI 51 <p>Half of the busbar (1) is OFF.</p> <p>Half of the busbar (2) is ON.</p>

Selectivity

Coordination Between Devices

Coordination between the upstream and downstream devices, especially selectivity, is essential to optimize continuity of service. The large number of options for setting the protection functions on MicroLogic X control units improves the natural coordination between circuit breakers.

Three selectivity techniques can be used:

- Current selectivity, which corresponds to staging of the long-time overcurrent protection threshold.
- Time selectivity, which corresponds to staging of the short-time overcurrent protection threshold.
- Energy selectivity, which corresponds to staging of the circuit breaker energy levels: this applies for high intensity short-circuit currents.

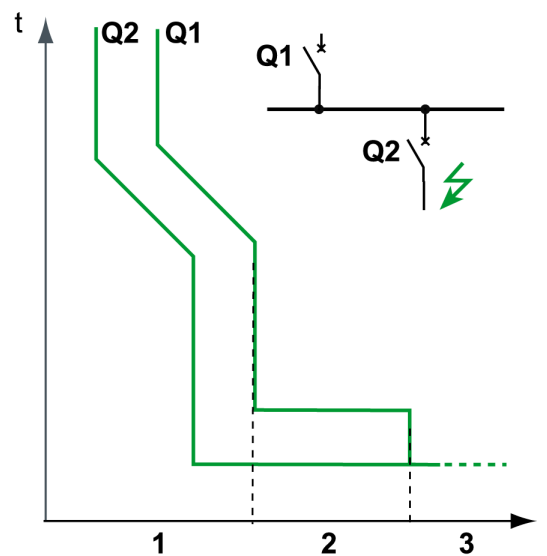

Selectivity Rules

The selectivity rules depend on:

- The type of control unit on the circuit breakers installed upstream and downstream: electronic or thermal-magnetic.
- The accuracy of the settings.

Selectivity of Overcurrent Protection

For overcurrent protection, the selectivity rules between electronic control units are as follows:

- Current and time selectivity:
 - A ratio of $I_r Q1 / I_r Q2$ greater than or equal to 1.3 is sufficient between the I_r threshold for long-time protection of the control unit on the upstream circuit breaker **Q1** and that of the control unit on the downstream circuit breaker **Q2**.
 - The t_r time delay for long-time protection of the control unit on the upstream circuit breaker **Q1** is identical or greater than that of the control unit on the downstream circuit breaker **Q2**.
 - A ratio of 1.5 is sufficient between the I_{sd} threshold for short-time protection of the control unit on the upstream circuit breaker **Q1** and that of the control unit on the downstream circuit breaker **Q2**.

- The t_{sd} time delay for short-time protection of the control unit on the upstream circuit breaker **Q1** is greater than that of the control unit on the downstream circuit breaker **Q2**.
- If the upstream circuit breaker is in the I^2t off position, the downstream circuit breakers must not be in the I^2t on position.
- Energy selectivity is provided by the circuit breaker design and build characteristics. The selectivity limit can only be specified by the manufacturer.

Ground-Fault Protection Selectivity

For ground-fault protection, only the rules for time selectivity should be applied to the I_g protection threshold and t_g time delay:

- A ratio of 1.3 is sufficient between the I_g threshold for ground-fault protection of the control unit on the upstream circuit breaker **Q1** and that of the control unit on the downstream circuit breaker **Q2**.
- The t_g time delay for ground-fault protection of the control unit on the upstream circuit breaker **Q1** is greater than that of the control unit on the downstream circuit breaker **Q2**.
- If the upstream circuit breaker is in the I^2t off position, the downstream circuit breakers must not be in the I^2t on position.

Selectivity Limit

Depending on the staging of circuit breaker ratings and protection parameter settings, selectivity can be:

- Limited (partial selectivity) up to a value lower than the maximum expected short-circuit current.
- Total (total selectivity), performed irrespective of the value of the short-circuit current.

Selectivity Table

Schneider Electric provides selectivity tables showing the type of selectivity (partial or total) between each circuit breaker for its entire range of circuit breakers. For more information, refer to LVPED318033EN *Complementary Technical Information*.

I^2t ON/OFF Function

Use the I^2t inverse time curve function to improve circuit breaker coordination. Use it when a protection device using inverse time only is installed upstream or downstream, for example a fuse protection device.

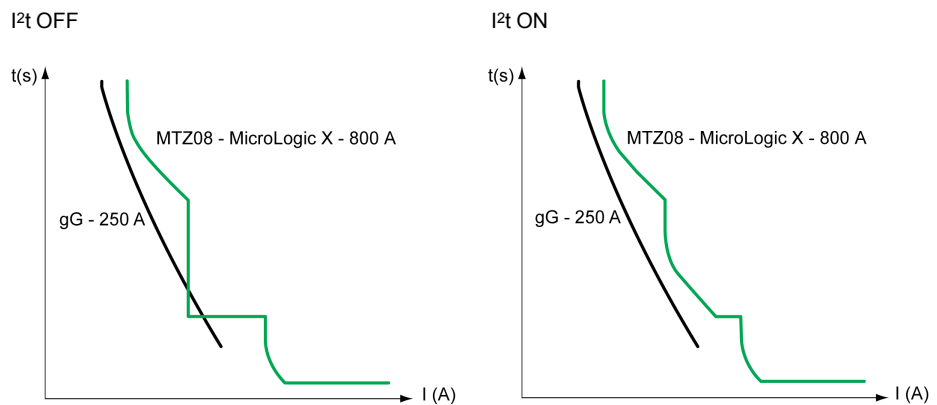

Metering Functions

What's in This Part

Standard Metering Functions	187
Optional Metering Functions	228

Standard Metering Functions

What's in This Chapter

Measurement Accuracy in Accordance with IEC61557-12	188
Measurement Characteristics	193
Measurement Availability	199
Network Settings	207
Real-Time Measurements	208
Calculating Demand Values	212
Power Metering	214
Power Calculation Algorithm	216
Energy Metering	218
Total Harmonic Distortion	220
Power Factor PF and $\cos \varphi$ Measurement	223

Measurement Accuracy in Accordance with IEC 61557-12

Measurements and Electrical Parameters Available on the MicroLogic X Control Unit

Based on the measurement of line currents, neutral current, phase-to-phase voltages, and phase-to-neutral voltages, the MicroLogic X control unit displays the following parameters:

- RMS values of currents and voltages
- Active, reactive, and apparent powers
- Active, reactive, and apparent energies
- Power factor
- Frequency
- Unbalance, THD, and THD-R of voltages and currents

Average values are calculated for the main basic electrical parameters.

The maximum and minimum values are time stamped and logged in the MicroLogic X non-volatile memory. They can be reset as follows:

- On the MicroLogic X display screen
- With EcoStruxure Power Commission software
- On the FDM128 display
- By a remote controller using the communication network
- On the IFE/EIFE webpages

Electrical parameters are refreshed once a second. They can be displayed as follows:

- On the MicroLogic X display screen, at **Home > Measures** , page 67
- With the EcoStruxure Power Device app
- With EcoStruxure Power Commission software
- On the FDM128 display
- By a remote controller using the communication network
- On the IFE/EIFE webpages

The availability of parameters depends on the type of interface used to display data. All parameters are not displayed on all interfaces, page 199.

An optional external 24 Vdc supply or VPS module is mandatory to measure and display parameters, including energy counters, for currents below 20% of the rated current I_n .

The start-up time is the time between when the control unit is energized and the availability of the first measurement. The start-up time is less than or equal to 45 seconds.

Measurement Accuracy

Power and energy metering accuracy in MasterPact MTZ circuit breakers with MicroLogic X control unit is classified as Class 1, according to IEC 61557-12. This standard specifies performance requirements of measuring and monitoring devices that measure and monitor the electrical parameters within electrical distribution systems. It covers both performance measuring devices with external sensors (PMD-S), such as current and/or voltage transformers, for example, stand-alone power meters, and performance measuring devices with embedded sensors (PMD-D), for example, circuit breakers.

A MasterPact MTZ circuit breaker, with MicroLogic X control unit and embedded sensors, is a PMD-DD device with Class 1 accuracy, according to IEC 61557-12 for power and energy metering. It complies with the requirements of K70 temperature class and 'Standard' humidity and altitude operating conditions, according to table 6 and 7 of IEC 61557-12.

The IEC 61557-12 standard defines the following three levels of uncertainty that need to be checked to establish accuracy class:

- Intrinsic uncertainty, page 190
- Operating uncertainty, page 191
- Overall system uncertainty, page 192

A PMD-DD device avoids overall system uncertainty and variation, thanks to its embedded sensors and wiring.

Measured Electrical Parameter Uncertainty

Uncertainty is the estimated percentage by which a measured electrical parameter may differ from the true electrical parameter. In the context of this standard, the total uncertainty of a measured electrical parameter depends on the instrument, the environment, and other elements to be considered.

The following graphic shows the total uncertainty of a measured electrical parameter made by:

- A PMD-D device, with embedded sensors
- A PMD-S device, with external sensors

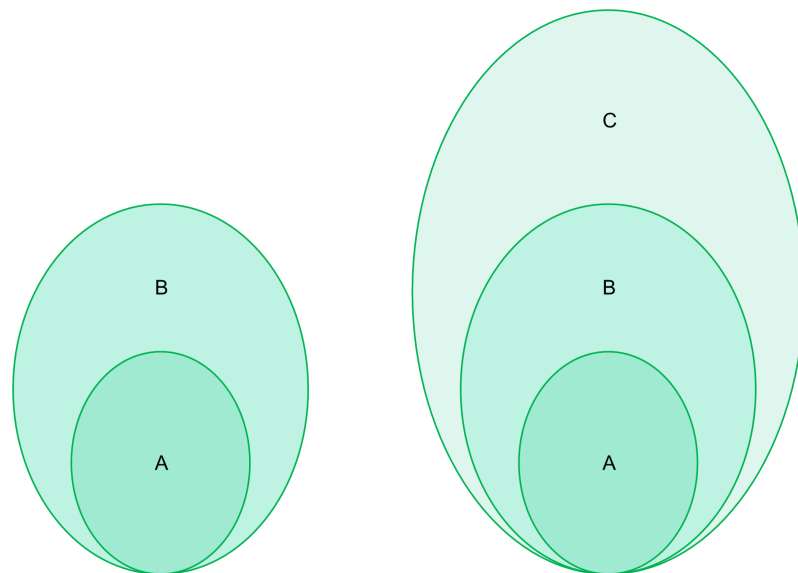

PMD-D device, with embedded sensors

PMD-S device, with external sensors

A Uncertainty under reference conditions: Intrinsic uncertainty according to IEC 61557-12

B Variations due to influence quantity: Operating Uncertainty according to IEC 61557-1; Measurement uncertainty according to IEC 61000-4-30

C Overall system uncertainty according to IEC 61557-12

Intrinsic Uncertainty: IEC 61557-12 Definition

Intrinsic uncertainty is the uncertainty of a measuring instrument when used under reference conditions. In the context of this standard, it is a percentage of the measured electrical parameter defined within the rated range of the measuring instrument.

For MasterPact MTZ circuit breakers with a MicroLogic X control unit, the main values are current and power factor.

The following table indicates, for different MasterPact MTZ circuit breakers, the current values for an intrinsic uncertainty less than or equal to 1%:

Current values for active power with 1% uncertainty (in A)		MasterPact		
Description of current value	Current value	MTZ1	MTZ2	MTZ3
Lowest value of the current at which the circuit breaker starts and continues to register	I _{st} = 0.04% I _b	1.6 A	1.6 A	3.2 A
Lowest value of the current for accuracy less than or equal to 1.5% for active power and energy	5% I _b	20 A	20 A	40 A
Lowest value of the current for accuracy less than or equal to 1% for active power and energy with PF = 1	10% I _b	40 A	40 A	80 A
Lowest value of the current for accuracy less than or equal to 1% for active power and energy with PF = 0.5 Inductive to 0.8 Capacitive	20% I _b	80 A	80 A	160 A
Value of current in accordance with which the relevant performance of a direct connected PMD (PMD Dx) is fixed	I _b	400 A	400 A	800 A
Highest value of current at which the MasterPact MTZ circuit breaker meets the uncertainty requirements of this standard	I _{max}	1,600 A x 1.2	4,000 A x 1.2	6,300 A x 1.2

The following graph gives an example of the intrinsic uncertainty for active power and energy versus current for the MasterPact MTZ2 circuit breaker. It shows that the performance of the MasterPact MTZ2 circuit breaker is equal to or better than the IEC 61557-12 standard.

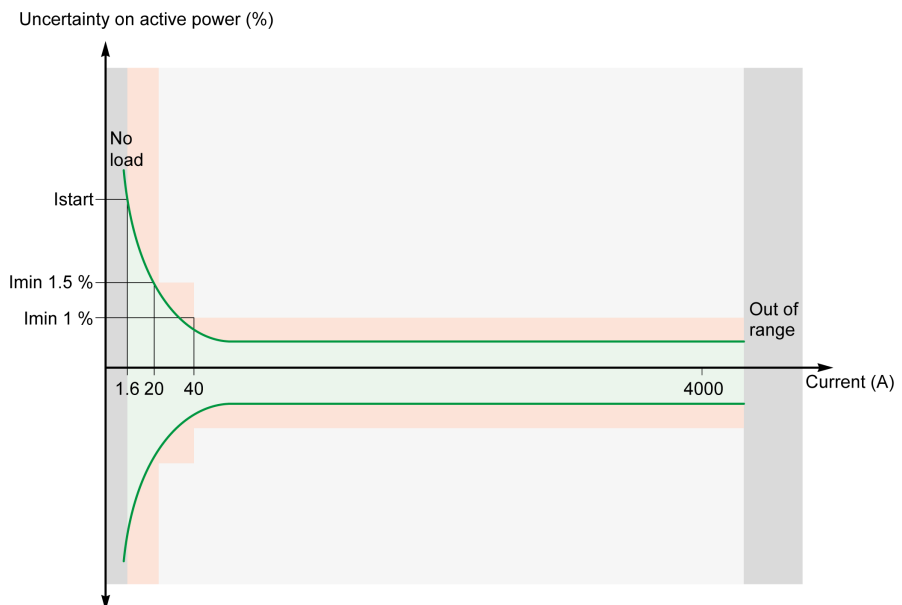

- MasterPact MTZ2 circuit breaker
- IEC 61557-12 standard
- Out of IEC 61557-12 standard

Operating Uncertainty

IEC 61557-12 defines operating uncertainty as uncertainty under the rated operating conditions.

IEC 61557-12 specifies tests and maximum variation of uncertainty according to the following influence quantities:

- Ambient temperature (T°)
- Frequency, unbalance, harmonics, EMC

For MasterPact MTZ circuit breakers with MicroLogic X control unit, the main influence quantity is temperature. MasterPact MTZ circuit breakers are designed to carry high currents, which induce self-heating. The measurement has been designed to offer high stability in a wide range of temperatures.

Effect of Temperature on MasterPact MTZ Measurement System

The temperature variation around the internal current transformer and the MicroLogic X control unit, between minimum current and nominal current load can be up to 90 K. The effect of temperature on measurement accuracy has been carefully managed over an operating ambient temperature range of -25 °C (-13 ° F) to 70 °C (158 °F).

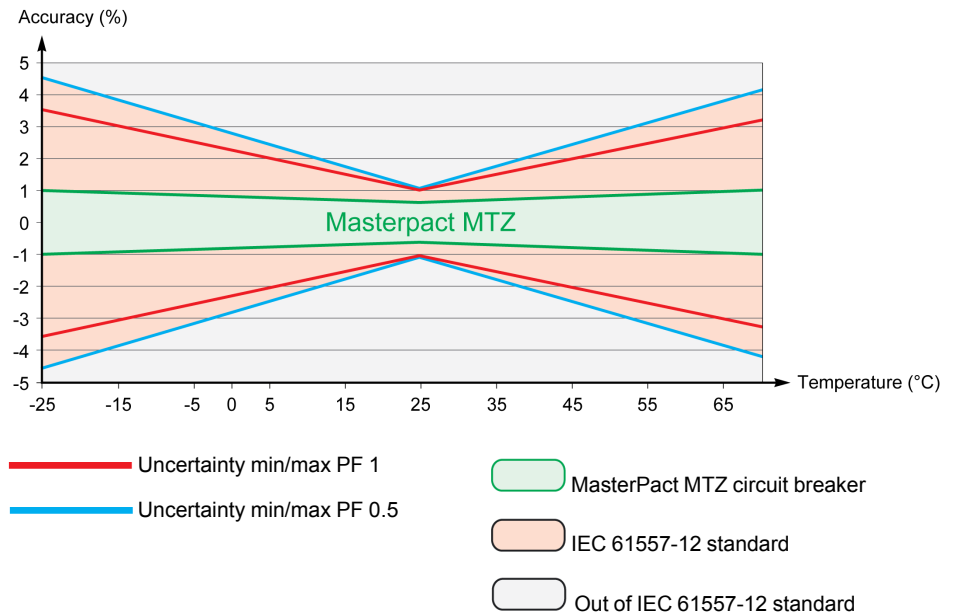

Effect of Electromagnetic Compatibility (EMC) and Other Influence Quantities on MasterPact MTZ Measurement Performance

MasterPact MTZ circuit breakers with MicroLogic X control unit offer a high immunity to influence quantities, with a low operating uncertainty for active power, as specified by Class 1, for a wide range of operating conditions.

The following table summarizes standard requirements and MasterPact MTZ performance regarding influence quantities for active power:

Influence quantity	Table 9 IEC 61557-12 PMD DD CI 1 additional uncertainty variation tolerance		MasterPact MTZ additional uncertainty
Ambient temperature	PF 1	0.05% / K	< 0.01% / K
	PF 0.5 Ind	0.07% / K	< 0.01% / K
Auxiliary power supply	24 Vdc \pm 15%	0.1%	0%
Voltage	PF 1: 80%/120% Vn	0.7%	0%
	PF 0.5 Ind: 80%/120% Vn	1%	0%
Frequency	PF 1: 49–51 Hz/59–61 Hz	0.5%	0%
	PF 0.5: 49–51 Hz/59–61 Hz	0.7%	0%
Reversed phase sequence		1.5%	0%
Voltage unbalance	0 to 10%	2%	0%
Phase missing	1 or 2 phase missing	2%	0%
Harmonics in current and voltage	10% Vn 5th	0.8%	< 0.1%
	20% I _{max} 5th		
	Odd harmonic in current	3%	< 0.1%
	Sub harmonic in current	3%	< 0.1%
Common mode voltage rejection	0–690 Vac/ground	0.5%	0%
Permanent ac magnetic induction	IEC 61326	2%	0%
Electromagnetic RF fields	IEC 61326	2%	< 1%
Conducted disturbances induced by RF fields	IEC 61326	2%	< 1%

Overall System Uncertainty

IEC 61557-12 defines overall system uncertainty as uncertainty including the instrumental uncertainty of several separated instruments (for example, sensors, wires, measuring instruments) under the rated operating conditions.

For MasterPact MTZ circuit breakers, the sensors are embedded in the device for applications up to 690 Vac phase-to-phase and the overall uncertainty is equal to the operating uncertainty.

Measurement Characteristics

Presentation

The following tables indicate the measurements available and specify the following information for each measurement:

- Unit
- Measurement range
- Accuracy
- Accuracy range

Current

Measurement	Unit	Range	Accuracy	Accuracy range
<ul style="list-style-type: none"> • Real-time phase current values I1, I2, I3 • Maximum phase current values I1 MAX, I2 MAX, I3 MAX • Real-time maximum of RMS current of phases I1, I2, I3, IN • Maximum of maximum phase current values • Minimum phase current values I1 MIN, I2 MIN, I3 MIN • Minimum of minimum phase current values 	A	0 ⁽¹⁾ –20 In	+/-0.5%	MTZ1: 40–(1,600 x 1.2) MTZ2: 40–(4,000 x 1.2) MTZ3: 80–(6,300 x 1.2)
<ul style="list-style-type: none"> • Real-time neutral current value IN⁽²⁾ • Maximum neutral current value IN MAX⁽²⁾ • Minimum neutral current value IN MIN⁽²⁾ 	A	0 ⁽¹⁾ –20 In	+/-1%	MTZ1: 40–(1,600 x 1.2) MTZ2: 40–(4,000 x 1.2) MTZ3: 80–(6,300 x 1.2)
<ul style="list-style-type: none"> • Real-time average current value Iavg • Maximum average current value Iavg MAX • Minimum average current value Iavg MIN 	A	0 ⁽¹⁾ –20 In	+/-0.5%	MTZ1: 40–(1,600 x 1.2) MTZ2: 40–(4,000 x 1.2) MTZ3: 80–(6,300 x 1.2)
<ul style="list-style-type: none"> • Real-time ground-fault current value • Maximum value of the ground-fault current • Minimum value of the ground-fault current 	A	0–20 In	5%	MTZ1: 40–(1,600 x 1.2) MTZ2: 40–(4,000 x 1.2) MTZ3: 80–(6,300 x 1.2)
<ul style="list-style-type: none"> • Real-time earth-leakage current value⁽³⁾ • Maximum value of the earth-leakage current⁽³⁾ 	A	0–30 A	10%	0.1–30 A

(1) Below the lowest measurable current (4 A for MTZ1, 10 A for MTZ2/3), the value is 0 A.
 (2) Applies to 4-pole circuit breakers or 3-pole circuit breakers with ENCT wired and configured.
 (3) Applies to MicroLogic 7.0 X control unit.

Current Unbalance

Measurement	Unit	Range	Accuracy	Accuracy range
<ul style="list-style-type: none"> • Real-time phase current unbalance values I1 unbal, I2 unbal, I3 unbal • Maximum values of the 3 phase current unbalances I1 unbal MAX, I2 unbal MAX, I3 unbal MAX • Real-time maximum of 3 phase current unbalances • Maximum of maximum of 3 phase current unbalances 	%	0–100%	+/-5	0–100%

NOTE: The accuracy range is for the current range: 0.2–1.2 In.

Voltage

Measurement	Unit	Range	Accuracy	Accuracy range
<ul style="list-style-type: none"> Real-time phase-to-phase voltage values V12, V23, V31 Maximum values of phase-to-phase voltages V12 MAX, V23 MAX, V31 MAX Minimum values of phase-to-phase voltages V12 MIN, V23 MIN, V31 MIN 	V	0 ⁽¹⁾ –1,150 V	+/-0.5%	208–690 x 1.2 V
<ul style="list-style-type: none"> Real-time phase-to-neutral voltages V1N, V2N, V3N⁽²⁾ Maximum values of phase-to-neutral voltages V1N MAX, V2N MAX, V3N MAX⁽²⁾ Minimum values of phase-to-neutral voltages V1N MIN, V2N MIN, V3N MIN⁽²⁾ 	V	0 ⁽¹⁾ –660 V	+/-0.5%	120–400 x 1.2 V
<ul style="list-style-type: none"> Real-time average phase-to-phase voltage Vavg LL Maximum average phase-to-phase voltage Vavg LL MAX Minimum average phase-to-phase voltage Vavg LL MIN 	V	0 ⁽¹⁾ –1,150 V	+/-0.5%	208–690 x 1.2 V
<ul style="list-style-type: none"> Real-time average phase-to-neutral voltage Vavg LN⁽²⁾ Maximum average phase-to-neutral voltage Vavg LN MAX⁽²⁾ Minimum average phase-to-neutral voltage Vavg LN MIN⁽²⁾ 	V	0 ⁽¹⁾ –600 V	+/-0.5%	120–400 x 1.2 V

(1) Below the lowest measurable voltage (10 V) the value is 0 V.
 (2) Applies to 4-pole circuit breakers or 3-pole circuit breakers with ENVT wired and configured.

Voltage Unbalance

Measurement	Unit	Range	Accuracy	Accuracy range
<ul style="list-style-type: none"> Real-time phase-to-phase voltage unbalances V12unbal, V23unbal, V31unbal Maximum values of the 3 phase-to-phase voltage unbalances V12unbal MAX, V23unbal MAX, V31unbal MAX Real-time maximum of 3 phase-to-phase voltage unbalances Maximum of maximum of 3 phase-to-phase voltage unbalances 	%	0–100%	+/-0.5	0–10%
<ul style="list-style-type: none"> Real-time phase-to-neutral voltage unbalances V1Nunbal, V2Nunbal, V3Nunbal⁽¹⁾ Maximum values of the 3 phase-to-neutral voltage unbalances V1Nunbal MAX, V2Nunbal MAX, V3Nunbal MAX⁽¹⁾ Real-time maximum of 3 phase-to-neutral voltage unbalances⁽¹⁾ Maximum of maximum of 3 phase-to-neutral voltage unbalances⁽¹⁾ 	%	0–100%	+/-0.5	0–10%

(1) Applies to 4-pole circuit breakers or 3-pole circuit breakers with ENVT wired and configured.

NOTE: The accuracy range is for the voltage range: 208–690 x 1.2 Vac.

Power

Measurement	Unit	Range	Accuracy	Accuracy range
<ul style="list-style-type: none"> Real-time active power for each phase P1, P2, P3⁽¹⁾ Maximum values of active power for each phase P1 MAX, P2 MAX, P3 MAX⁽¹⁾ Minimum values of active power for each phase P1 MIN, P2 MIN, P3 MIN⁽¹⁾ 	kW	-16,000–+16,000 kW	+/-1%	See NOTE below
<ul style="list-style-type: none"> Real-time total active power Ptot Maximum value of total active power Ptot MAX Minimum value of total active power Ptot MIN 	kW	-16,000–+16,000 kW	+/-1%	See NOTE below

Measurement	Unit	Range	Accuracy	Accuracy range
<ul style="list-style-type: none"> Real-time reactive power for each phase Q1, Q2, Q3⁽¹⁾ Maximum values of reactive power for each phase Q1 MAX, Q2 MAX, Q3 MAX⁽¹⁾ Minimum values of reactive power for each phase Q1 MIN, Q2 MIN, Q3 MIN⁽¹⁾ 	kVAR	-16,000– +16,000 kW	+/-2%	See NOTE below
<ul style="list-style-type: none"> Real-time total reactive power Qtot Maximum value of total reactive power Qtot MAX Minimum value of total reactive power Qtot MIN 	kVAR	-16,000– +16,000 kW	+/-1%	See NOTE below
<ul style="list-style-type: none"> Real-time apparent power for each phase S1, S2, S3⁽¹⁾ Maximum values of apparent powers for each phase S1 MAX, S2 MAX, S3 MAX⁽¹⁾ Minimum values of apparent powers for each phase S1 MIN, S2 MIN, S3 MIN⁽¹⁾ 	kVA	-16,000– +16,000 kW	+/-1%	See NOTE below
<ul style="list-style-type: none"> Real-time total apparent power Stot Maximum value of total apparent power Stot MAX Minimum value of total apparent power Stot MIN 	kVA	-16,000– +16,000 kW	+/-1%	See NOTE below
(1) Applies to 4-pole circuit breakers or 3-pole circuit breakers with ENVT wired and configured.				

NOTE: The accuracy for the power measurement range according to IEC 61557-12 is defined by current range, voltage, and power factor values.

Operating Indicators

Measurement	Unit	Range	Accuracy	Accuracy range
Operating quadrant	–	1,2, 3, 4	–	–
Phase rotation	–	123 or 132	–	–
Type of load	–	leading or lagging	–	–

Power Factor PF and cos φ

Measurement	Unit	Range	Accuracy	Accuracy range
<ul style="list-style-type: none"> Real-time total power factor PF Maximum value of the total power factor PF MAX Minimum value of the total power factor PF MIN 	–	-1.00–+1.00	+/-0.02	0.5 ind - 0.8 cap
<ul style="list-style-type: none"> Real-time power factors for each phase PF1, PF2, PF3⁽¹⁾ Maximum power factor for each phase PF1 MAX, PF2 MAX, PF3 MAX⁽¹⁾ Minimum power factor for each phase PF1 MIN, PF2 MIN, PF3 MIN⁽¹⁾ 	–	-1.00–+1.00	+/-0.02	0.5 ind - 0.8 cap
<ul style="list-style-type: none"> Real-time total cos φ Maximum cos φ MAX Minimum cos φ MIN 	–	-1.00–+1.00	+/-0.02	0.5 ind - 0.8 cap
<ul style="list-style-type: none"> Real-time cos φ for each phase cos φ 1, cos φ 2, cos φ 3⁽¹⁾ Maximum cos φ for each phase cos φ 1 MAX, cos φ 2 MAX, cos φ 3 MAX⁽¹⁾ Minimum cos φ for each phase cos φ 1 MIN, cos φ 2 MIN, cos φ 3 MIN⁽¹⁾ 	–	-1.00–+1.00	+/-0.02	0.5 ind - 0.8 cap
(1) Applies to 4-pole circuit breakers or 3-pole circuit breakers with ENVT wired and configured.				

NOTE: The accuracy for the power factor measurement range according to IEC 61557-12 is defined by current range and voltage values.

Total Harmonic Distortion Compared to the Fundamental (THD) of Currents and Voltages

Total harmonic distortions are calculated with harmonics up to rank 15.

Measurement	Unit	Range	Accuracy	Accuracy range
<ul style="list-style-type: none"> Real-time total harmonic distortion (THD) of current for each phase THD(I1), THD(I2), THD(I3) 	%	0–1,000%	+/-1.5	0–100% when I > 80 A
<ul style="list-style-type: none"> Real-time total harmonic distortion (THD) of neutral current THD (IN)⁽¹⁾ Maximum value of total harmonic distortion (THD) of neutral current THD(IN) MAX⁽¹⁾ Minimum value of total harmonic distortion (THD) of neutral current THD(IN) MIN⁽¹⁾ 	%	0–1,000%	+/-1.5 x THD/100	100–200%
<ul style="list-style-type: none"> Real-time total harmonic distortion (THD) of phase-to-phase voltage THD(V12), THD(V23), THD(V31) 	%	0–1,000%	+/-0.6	0–20% when V > 208 V
<ul style="list-style-type: none"> Real-time total harmonic distortion (THD) of phase-to-neutral voltage THD(V1N), THD(V2N), THD(V3N)⁽¹⁾ 	%	0–1,000%	+/-0.6	0–20% when V > 120 V
<ul style="list-style-type: none"> Real-time average total harmonic distortion (THD) of the 3 phase currents Maximum value of the average total harmonic distortion (THD) of the 3 phase currents Minimum value of the average total harmonic distortion (THD) of the 3 phase currents 	%	0–1,000%	+/-1.5	0–100% when I > 80 A
<ul style="list-style-type: none"> Real-time average total harmonic distortion (THD) of the 3 phase-to-phase voltages Maximum value of the average total harmonic distortion (THD) of the 3 phase-to-phase voltages Minimum value of the average total harmonic distortion (THD) of the 3 phase-to-phase voltages 	%	0–1,000%	+/-0.6	0–20% when V > 208 V
<ul style="list-style-type: none"> Real-time average total harmonic distortion (THD) of the 3 phase-to-neutral voltages⁽¹⁾ Maximum value of the average total harmonic distortion (THD) of the 3 phase-to-neutral voltages⁽¹⁾ Minimum value of the average total harmonic distortion (THD) of the 3 phase-to-neutral voltages⁽¹⁾ 	%	0–1,000%	+/-0.6	0–20% when V > 120 V

(1) Applies to 4-pole circuit breakers or 3-pole circuit breakers with ENVT wired and configured.

Total Harmonic Distortion Compared to the RMS Value (THD-R) of Currents and Voltages

Measurement	Unit	Range	Accuracy	Accuracy range
<ul style="list-style-type: none"> Real-time total harmonic distortion (THD-R) of current for each phase THD-R(I1), THD-R(I2), THD-R(I3) Real-time total harmonic distortion (THD-R) of neutral current THD-R(IN)⁽¹⁾ Maximum value of total harmonic distortion (THD-R) of neutral current THD-R(IN) MAX⁽¹⁾ Minimum value of total harmonic distortion (THD-R) of neutral current THD-R(IN) MIN⁽¹⁾ 	%	0–100%	+/-1.5 x THD/100	0–100%
<ul style="list-style-type: none"> Real-time total harmonic distortion (THD-R) of the phase-to-phase voltage THD-R(V12), THD-R(V23), THD-R(V31) 	%	0–100%	+/-0.6	0–20% when V > 208 V

Measurement	Unit	Range	Accuracy	Accuracy range
<ul style="list-style-type: none"> Real-time total harmonic distortion (THD-R) of the phase-to-neutral voltage THD-R(V1N), THD-R(V2N), THD-R(V3N)⁽¹⁾ 	%	0–100%	+/-0.6	0–20% when V > 120 V
<ul style="list-style-type: none"> Real-time average total harmonic distortion (THD-R) of the 3 phase currents Maximum value of the average total harmonic distortion (THD-R) of the 3 phase currents Minimum value of the average total harmonic distortion (THD-R) of the 3 phase currents 	%	0–100%	+/-1.5 x THD/100	0–100%
<ul style="list-style-type: none"> Real-time average total harmonic distortion (THD-R) of the 3 phase-to-phase voltages Maximum value of the average total harmonic distortion (THD-R) of the 3 phase-to-phase voltages Minimum value of the average total harmonic distortion (THD-R) of the 3 phase-to-phase voltages 	%	0–100%	+/-0.6	0–20% when V > 208 V
<ul style="list-style-type: none"> Real-time average total harmonic distortion (THD-R) of the 3 phase-to-neutral voltages⁽¹⁾ Maximum value of the average total harmonic distortion (THD-R) of the 3 phase-to-neutral voltages⁽¹⁾ Minimum value of the average total harmonic distortion (THD-R) of the 3 phase-to-neutral voltages⁽¹⁾ 	%	0–100%	+/-0.6	0–20% when V > 120 V

(1) Applies to 4-pole circuit breakers or 3-pole circuit breakers with ENVT wired and configured.

Frequency

Measurement	Unit	Range	Accuracy	Accuracy range
<ul style="list-style-type: none"> Frequency Maximum frequency Minimum frequency 	Hz	40–70 Hz	+/-0.2%	45–65 Hz

Current Demand and Peak Values

Measurement	Unit	Range	Accuracy	Accuracy range
<ul style="list-style-type: none"> Phase (I1, I2, I3, Iavg) current demand values Phase (I1, I2, I3, Iavg) peak current demand values 	A	0–20 In	+/-1%	0.2–1.2 In
<ul style="list-style-type: none"> Neutral (IN) current demand value⁽¹⁾ Neutral (IN) peak current demand value⁽¹⁾ 	A	0–20 In	+/-1%	0.2–1.2 In

(1) Applies to 4-pole circuit breakers or 3-pole circuit breakers with ENCT wired and configured.

Power Demand and Peak Values

Measurement	Unit	Range	Accuracy	Accuracy range
<ul style="list-style-type: none"> Demand value (P dmd) of the total active power (Ptot) Peak demand value (P dmd max) of the total active power (Ptot) 	kW	-16,000– +16,000 kW	+/-1%	-10,000 to -2 kW, 2 to 10,000 kW
<ul style="list-style-type: none"> Demand value (Q dmd) of the total reactive power (Qtot) Peak demand value (Q dmd max) of the total reactive power (Qtot) 	kVAR	-16,000– +16,000 kVAR	+/-1%	-10,000 to -2 kVAR, 2 to 10,000 kVAR
<ul style="list-style-type: none"> Demand value (S dmd) of the total apparent power (Stot) Peak demand value (S dmd max) of the total apparent power (Stot) 	kVA	0–16,000 kVA	+/-1%	2–10,000 kVA

NOTE: The accuracy is for:

- current range: 0.1–1.2 In
- voltage range: 165–830 Vac
- cos ϕ range: -1 to -0.5 and 0.5 to 1

Resettable Energy Meters

Measurement	Unit	Range	Accuracy	Accuracy range
Total active energy value Ep	kWh	-10,000,000 to +10,000,000 kWh	+/-1%	See NOTE below
Total active energy values Epdelivered and Epreceived	kWh	-10,000,000 to +10,000,000 kWh	+/-1%	See NOTE below
Total reactive energy value Eq	kVARh	-10,000,000 to +10,000,000 kVARh	+/-2%	See NOTE below
Total reactive energy values Eqdelivered and Eqreceived	kVARh	-10,000,000 to +10,000,000 kVARh	+/-2%	See NOTE below
Apparent energy Es	kVAh	-10,000,000 to +10,000,000 kVAh	+/-1%	See NOTE below

NOTE: The accuracy for the energy measurement range according to IEC 61557-12 is defined by current range, voltage, and power factor values.

Non-Resettable Energy Meters

Measurement	Unit	Range	Accuracy	Accuracy range
Total active energy value Ep	kWh	-10,000,000 to +10,000,000 kWh	+/-1%	See NOTE below
Total active energy values Epdelivered and Epreceived	kWh	-10,000,000 to +10,000,000 kWh	+/-1%	See NOTE below
Total reactive energy value Eq	kVARh	-10,000,000 to +10,000,000 kVARh	+/-2%	See NOTE below
Total reactive energy values Eqdelivered and Eqreceived	kVARh	-10,000,000 to +10,000,000 kVARh	+/-2%	See NOTE below
Apparent energy Es	kVAh	-10,000,000 to +10,000,000 kVAh	+/-1%	See NOTE below

NOTE: The accuracy for the energy measurement range according to IEC 61557-12 is defined by current range, voltage, and power factor values.

Measurement Availability

Presentation

Measurements can be displayed through the following interfaces:

- On the MicroLogic X display screen
- With the EcoStruxure Power Device app through Bluetooth or USB OTG connection.
- With EcoStruxure Power Commission software
- On the FDM128 display
- By a remote controller using the communication network
- On the IFE/EIFE webpages

The following tables indicate which measurements are displayed on each interface.

Current

The availability of parameters depends on the type of interface used to display data. All parameters are not displayed on all interfaces.

Measurement	MicroLogic X HMI	EcoStruxure Power Device app	EcoStruxure Power Commission software	FDM128	Communication	IFE/EIFE webpages
Real-time phase current values I1, I2, I3	✓	✓	✓	✓	✓	✓
Maximum phase current values I1 MAX, I2 MAX, I3 MAX	✓	✓	✓	✓	✓	✓
Real-time maximum of RMS current of phases I1, I2, I3, IN	–	–	–	✓	✓	–
Maximum of maximum phase current values	–	–	–	–	✓	–
Minimum phase current values I1 MIN, I2 MIN, I3 MIN	–	✓	✓	✓	✓	✓
Minimum of minimum phase current values	–	–	–	–	✓	–
Real-time neutral current value IN ⁽¹⁾	✓	✓	✓	✓	✓	✓
Maximum neutral current value IN MAX ⁽¹⁾	✓	✓	✓	✓	✓	✓
Minimum neutral current value IN MIN ⁽¹⁾	–	✓	✓	✓	✓	✓
Real-time average current value Iavg	✓	✓	✓	✓	✓	✓
Maximum average current value Iavg MAX	–	✓	✓	✓	✓	✓
Minimum average current value Iavg MIN	–	✓	✓	✓	✓	✓
Real-time ground-fault current value	✓	✓	✓	✓	✓	✓
Maximum value of the ground-fault current	✓	✓	✓	✓	✓	✓
Minimum value of the ground-fault current	–	✓	✓	✓	✓	✓
Real-time earth-leakage current value ⁽²⁾	✓	✓	✓	✓	✓	✓
Maximum value of the earth-leakage current ⁽²⁾	✓	✓	✓	✓	✓	✓

(1) Applies to 4-pole circuit breakers or 3-pole circuit breakers with ENCT wired and configured.

(2) Applies to MicroLogic 7.0 X control unit. Values for current related to ground-fault current I_g are not available.

Current Unbalance

Measurement	MicroLogic X HMI	EcoStruxure Power Device app	EcoStruxure Power Commission software	FDM128	Communication	IFE/EIFE webpages
Real-time phase current unbalance values I1 unbal, I2 unbal, I3 unbal	–	–	✓	–	✓	–
Maximum values of the 3 phase current unbalances I1 unbal MAX, I2 unbal MAX, I3 unbal MAX	–	–	✓	–	✓	–
Real-time maximum of 3 phase current unbalances	✓	✓	✓	✓	✓	–
Maximum of maximum of 3 phase current unbalances	✓	✓	✓	✓	✓	–

Voltage

Measurement	MicroLogic X HMI	EcoStruxure Power Device app	EcoStruxure Power Commission software	FDM128	Communication	IFE/EIFE webpages
Real-time phase-to-phase voltage values V12, V23, V31	✓	✓	✓	✓	✓	✓
Maximum values of phase-to-phase voltages V12 MAX, V23 MAX, V31 MAX	✓	✓	✓	✓	✓	✓
Minimum values of phase-to-phase voltages V12 MIN, V23 MIN, V31 MIN	✓	✓	✓	✓	✓	✓
Real-time phase-to-neutral voltages V1N, V2N, V3N ⁽¹⁾	✓	✓	✓	✓	✓	✓
Maximum values of phase-to-neutral voltages V1N MAX, V2N MAX, V3N MAX ⁽¹⁾	✓	✓	✓	✓	✓	✓
Minimum values of phase-to-neutral voltages V1N MIN, V2N MIN, V3N MIN ⁽¹⁾	✓	✓	✓	✓	✓	✓
Real-time average phase-to-phase voltage Vavg LL	✓	✓	✓	✓	✓	✓
Maximum average phase-to-phase voltage Vavg LL MAX	–	✓	✓	✓	✓	✓
Minimum average phase-to-phase voltage Vavg LL MIN	–	✓	✓	✓	✓	✓
Real-time average phase-to-neutral voltage Vavg LN ⁽¹⁾	✓	–	✓	✓	✓	✓
Maximum average phase-to-neutral voltage Vavg LN MAX ⁽¹⁾	–	–	✓	✓	✓	✓
Minimum average phase-to-neutral voltage Vavg LN MIN ⁽¹⁾	–	–	✓	✓	✓	✓

(1) Applies to 4-pole circuit breakers or 3-pole circuit breakers with ENVT wired and configured.

Voltage Unbalance

Measurement	MicroLogic X HMI	EcoStruxure Power Device app	EcoStruxure Power Commission software	FDM128	Communication	IFE/EIFE webpages
Real-time phase-to-phase voltage unbalances V12unbal, V23unbal, V31unbal	–	–	✓	–	✓	–
Maximum values of the 3 phase-to-phase voltage unbalances	–	–	✓	–	✓	–

Measurement	MicroLogic X HMI	EcoStruxure Power Device app	EcoStruxure Power Commission software	FDM128	Communication	IFE/EIFE webpages
V12unbal MAX, V23unbal MAX, V31unbal MAX						
Real-time maximum of 3 phase-to-phase voltage unbalances	✓	✓	✓	✓	✓	–
Maximum of maximum of 3 phase-to-phase voltage unbalances	✓	✓	✓	✓	✓	–
Real-time phase-to-neutral voltage unbalances V1Nunbal, V2Nunbal, V3Nunbal ⁽¹⁾	–	–	✓	–	✓	–
Maximum values of the 3 phase-to-neutral voltage unbalances V1Nunbal MAX, V2Nunbal MAX, V3Nunbal MAX ⁽¹⁾	–	–	✓	–	✓	–
Real-time maximum of 3 phase-to-neutral voltage unbalances ⁽¹⁾	✓	✓	✓	✓	✓	–
Maximum of maximum of 3 phase-to-neutral voltage unbalances ⁽¹⁾	✓	✓	✓	✓	✓	–

(1) Applies to 4-pole circuit breakers or 3-pole circuit breakers with ENVT wired and configured.

Power

Measurement	MicroLogic X HMI	EcoStruxure Power Device app	EcoStruxure Power Commission software	FDM128	Communication	IFE/EIFE webpages
Real-time active power for each phase P1, P2, P3 ⁽¹⁾	✓	–	✓	✓	✓	–
Maximum values of active power for each phase P1 MAX, P2 MAX, P3 MAX ⁽¹⁾	–	–	✓	✓	✓	–
Minimum values of active power for each phase P1 MIN, P2 MIN, P3 MIN ⁽¹⁾	–	–	✓	✓	✓	–
Real-time total active power Ptot	✓	✓	✓	✓	✓	✓
Maximum value of total active power Ptot MAX	✓	✓	✓	✓	✓	✓
Minimum value of total active power Ptot MIN	–	✓	✓	✓	✓	✓
Real-time reactive power for each phase Q1, Q2, Q3 ⁽¹⁾	✓	–	✓	✓	✓	–
Maximum values of reactive powers for each phase Q1 MAX, Q2 MAX, Q3 MAX ⁽¹⁾	–	–	✓	✓	✓	–
Minimum values of reactive powers for each phase Q1 MIN, Q2 MIN, Q3 MIN ⁽¹⁾	–	–	✓	✓	✓	–
Real-time total reactive power Qtot	✓	✓	✓	✓	✓	✓
Maximum value of total reactive power Qtot MAX	✓	✓	✓	✓	✓	✓
Minimum value of total reactive power Qtot MIN	–	✓	✓	✓	✓	✓
Real-time apparent power for each phase S1, S2, S3 ⁽¹⁾	✓	–	✓	✓	✓	–
Maximum values of apparent powers for each phase S1 MAX, S2 MAX, S3 MAX ⁽¹⁾	–	–	✓	✓	✓	–
Minimum values of apparent powers for each phase S1 MIN, S2 MIN, S3 MIN ⁽¹⁾	–	–	✓	✓	✓	–

Measurement	MicroLogic X HMI	EcoStruxure Power Device app	EcoStruxure Power Commission software	FDM128	Communication	IFE/EIFE webpages
Real-time total apparent power Stot	✓	✓	✓	✓	✓	✓
Maximum value of total apparent power Stot MAX	✓	✓	✓	✓	✓	✓
Minimum value of total apparent power Stot MIN	–	✓	✓	✓	✓	✓

(1) Applies to 4-pole circuit breakers or 3-pole circuit breakers with ENVT wired and configured.

Operating Indicators

Measurement	MicroLogic X HMI	EcoStruxure Power Device app	EcoStruxure Power Commission software	FDM128	Communication	IFE/EIFE webpages
Operating quadrant	–	–	–	–	✓	–
Phase rotation	–	✓	–	✓	✓	–
Type of load	✓	–	✓	✓	✓	–

Power Factor PF and cos φ

Measurement	MicroLogic X HMI	EcoStruxure Power Device app	EcoStruxure Power Commission software	FDM128	Communication	IFE/EIFE webpages
Real-time total power factor PF	✓	✓	✓	✓	✓	✓
Maximum value of the total power factor PF MAX	–	✓	✓	✓	✓	✓
Minimum value of the total power factor PF MIN	–	✓	✓	✓	✓	✓
Real-time power factors for each phase PF1, PF2, PF3 ⁽¹⁾	–	–	✓	✓	✓	–
Maximum power factor for each phase PF1 MAX, PF2 MAX, PF3 MAX ⁽¹⁾	–	–	✓	✓	✓	–
Minimum power factor for each phase PF1 MIN, PF2 MIN, PF3 MIN ⁽¹⁾	–	–	✓	✓	✓	–
Real-time total cos φ	✓	✓	✓	✓	✓	–
Maximum value cos φ MAX	–	✓	✓	✓	✓	–
Minimum value cos φ MIN	–	✓	✓	✓	✓	–
Real-time cos φ for each phase cos φ 1, cos φ 2, cos φ 3 ⁽¹⁾	–	–	✓	✓	✓	–
Maximum cos φ for each phase cos φ 1 MAX, cos φ 2 MAX, cos φ 3 MAX ⁽¹⁾	–	–	✓	✓	✓	–
Minimum cos φ for each phase cos φ 1 MIN, cos φ 2 MIN, cos φ 3 MIN ⁽¹⁾	–	–	✓	✓	✓	–

(1) Applies to 4-pole circuit breakers or 3-pole circuit breakers with ENVT wired and configured.

Total Harmonic Distortion Compared to the Fundamental (THD) of Currents

Measurement	MicroLogic X HMI	EcoStruxure Power Device app	EcoStruxure Power Commission software	FDM128	Communication	IFE/EIFE webpages
Real-time total harmonic distortion (THD) of current for each phase THD(I1), THD(I2), THD(I3)	✓	✓	✓	✓	✓	–
Real-time total harmonic distortion (THD) of neutral current THD(IN) ⁽¹⁾	✓	✓	✓	✓	✓	–
Maximum value of total harmonic distortion (THD) of neutral current THD(IN) MAX ⁽¹⁾	✓	✓	✓	✓	✓	–
Minimum value of total harmonic distortion (THD) of neutral current THD(IN) MIN ⁽¹⁾	–	✓	✓	✓	✓	–
Real-time average total harmonic distortion (THD) of the 3 phase currents	✓	✓	✓	–	✓	–
Maximum value of the average total harmonic distortion (THD) of the 3 phase currents	✓	✓	✓	–	✓	–
Minimum value of the average total harmonic distortion (THD) of the 3 phase currents	–	✓	✓	–	✓	–

(1) Applies to 4-pole circuit breakers or 3-pole circuit breakers with ENVT wired and configured.

Total Harmonic Distortion Compared to the Fundamental (THD) of Voltages

Measurement	MicroLogic X HMI	EcoStruxure Power Device app	EcoStruxure Power Commission software	FDM128	Communication	IFE/EIFE webpages
Real-time total harmonic distortion (THD) of phase-to-phase voltage THD(V12), THD(V23), THD(V31)	✓	✓	✓	✓	✓	–
Real-time total harmonic distortion (THD) of phase-to-neutral voltage THD(V1N), THD(V2N), THD(V3N) ⁽¹⁾	✓	✓	✓	✓	✓	–
Real-time average total harmonic distortion (THD) of the 3 phase-to-phase voltages	✓	✓	✓	–	✓	–
Maximum value of the average total harmonic distortion (THD) of the 3 phase-to-phase voltages	✓	✓	✓	–	✓	–
Minimum value of the average total harmonic distortion (THD) of the 3 phase-to-phase voltages	–	✓	✓	–	✓	–
Real-time average total harmonic distortion (THD) of the 3 phase-to-neutral voltages ⁽¹⁾	✓	✓	✓	–	✓	–
Maximum value of the average total harmonic distortion (THD) of the 3 phase-to-neutral voltages ⁽¹⁾	✓	✓	✓	–	✓	–
Minimum value of the average total harmonic distortion (THD) of the 3 phase-to-neutral voltages ⁽¹⁾	–	✓	✓	–	✓	–

(1) Applies to 4-pole circuit breakers or 3-pole circuit breakers with ENVT wired and configured.

Total Harmonic Distortion Compared to the RMS Value (THD-R) of Currents

Measurement	MicroLogic X HMI	EcoStruxure Power Device app	EcoStruxure Power Commission software	FDM128	Communication	IFE/EIFE webpages
Real-time total harmonic distortion (THD-R) of current for each phase THD-R(I1), THD-R(I2), THD-R(I3)	–	✓	✓	–	✓	–
Real-time total harmonic distortion (THD-R) of neutral current THD-R (IN) ⁽¹⁾	–	✓	✓	–	✓	–
Maximum value of total harmonic distortion (THD-R) of neutral current THD-R(IN) MAX ⁽¹⁾	–	✓	✓	–	✓	–
Minimum value of total harmonic distortion (THD-R) of neutral current THD-R(IN) MIN ⁽¹⁾	–	✓	✓	–	✓	–
Real-time average total harmonic distortion (THD-R) of the 3 phase currents	–	✓	✓	–	✓	–
Maximum value of the average total harmonic distortion (THD-R) of the 3 phase currents	–	✓	✓	–	✓	–
Minimum value of the average total harmonic distortion (THD-R) of the 3 phase currents	–	✓	✓	–	✓	–

(1) Applies to 4-pole circuit breakers or 3-pole circuit breakers with ENVT wired and configured.

Total Harmonic Distortion Compared to the RMS Value (THD-R) of Voltages

Measurement	MicroLogic X HMI	EcoStruxure Power Device app	EcoStruxure Power Commission software	FDM128	Communication	IFE/EIFE webpages
Real-time total harmonic distortion (THD-R) of the phase-to-phase voltage THD-R(V12), THD-R(V23), THD-R(V31)	–	✓	✓	–	✓	–
Real-time total harmonic distortion (THD-R) of the phase-to-neutral voltage THD-R(V1N), THD-R(V2N), THD-R(V3N) ⁽¹⁾	–	✓	✓	–	✓	–
Real-time average total harmonic distortion (THD-R) of the 3 phase-to-phase voltages	–	✓	✓	–	✓	–
Maximum value of the average total harmonic distortion (THD-R) of the 3 phase-to-phase voltages	–	✓	✓	–	✓	–
Minimum value of the average total harmonic distortion (THD-R) of the 3 phase-to-phase voltages	–	✓	✓	–	✓	–
Real-time average total harmonic distortion (THD-R) of the 3 phase-to-neutral voltages ⁽¹⁾	–	✓	✓	–	✓	–
Maximum value of the average total harmonic distortion (THD-R) of the 3 phase-to-neutral voltages ⁽¹⁾	–	✓	✓	–	✓	–
Minimum value of the average total harmonic distortion (THD-R) of the 3 phase-to-neutral voltages ⁽¹⁾	–	✓	✓	–	✓	–

(1) Applies to 4-pole circuit breakers or 3-pole circuit breakers with ENVT wired and configured.

Frequency

Measurement	MicroLogic X HMI	EcoStruxure Power Device app	EcoStruxure Power Commission software	FDM128	Communication	IFE/EIFE webpages
Frequency	✓	✓	✓	✓	✓	✓
Maximum frequency	✓	✓	✓	✓	✓	✓
Minimum frequency	✓	✓	✓	✓	✓	✓

Current Demand and Peak Values

Measurement	MicroLogic X HMI	EcoStruxure Power Device app	EcoStruxure Power Commission software	FDM128	Communication	IFE/EIFE webpages
Phase (I1, I2, I3) current demand values	–	✓	✓	✓	✓	✓
Phase (I1, I2, I3) peak current demand values	–	✓	✓	✓	✓	–
Neutral (IN) current demand value ⁽¹⁾	–	✓	✓	✓	✓	✓
Neutral (IN) peak current demand value ⁽¹⁾	–	✓	✓	✓	✓	–
Average (Iavg) current demand value	–	✓	✓	✓	✓	–
Average (Iavg) peak current demand value	–	✓	✓	✓	✓	–

(1) Applies to 4-pole circuit breakers or 3-pole circuit breakers with ENVT wired and configured.

Power Demand and Peak Values

Measurement	MicroLogic X HMI	EcoStruxure Power Device app	EcoStruxure Power Commission software	FDM128	Communication	IFE/EIFE webpages
Demand value (P dmd) of the total active power (Ptot)	–	✓	✓	✓	✓	✓
Peak demand value (P dmd max) of the total active power (Ptot)	–	✓	✓	✓	✓	✓
Demand value (Q dmd) of the total reactive power (Qtot)	–	✓	✓	✓	✓	✓
Peak demand value (Q dmd max) of the total reactive power (Qtot)	–	✓	✓	✓	✓	–
Demand value (S dmd) of the total apparent power (Stot)	–	✓	✓	✓	✓	✓
Peak demand value (S dmd max) of the total apparent power (Stot)	–	✓	✓	✓	✓	–

Resettable Energy Meters

Measurement	MicroLogic X HMI	EcoStruxure Power Device app	EcoStruxure Power Commission software	FDM128	Communication	IFE/EIFE webpages
Total active energy value Ep	✓	✓	✓	✓	✓	✓
Total active energy values: Epdelivered, and Epreceived	✓	✓	✓	✓	✓	–
Total reactive energy value Eq	✓	✓	✓	✓	✓	✓

Measurement	MicroLogic X HMI	EcoStruxure Power Device app	EcoStruxure Power Commission software	FDM128	Communication	IFE/EIFE webpages
Total reactive energy values: $E_{q\text{delivered}}$, and $E_{q\text{received}}$	✓	✓	✓	✓	✓	–
Total apparent energy value E_s	✓	✓	✓	✓	✓	✓

Non-Resettable Energy Meters

Measurement	MicroLogic X HMI	EcoStruxure Power Device app	EcoStruxure Power Commission software	FDM128	Communication	IFE/EIFE webpages
Total active energy value E_p	–	–	✓	–	✓	–
Total active energy values: $E_{p\text{delivered}}$, and $E_{p\text{received}}$	–	–	✓	✓	✓	–
Total reactive energy value E_q	–	–	✓	–	✓	–
Total reactive energy values: $E_{q\text{delivered}}$, and $E_{q\text{received}}$	–	–	✓	–	✓	–
Total apparent energy value E_s	–	–	✓	–	✓	–

Network Settings

Presentation

The following settings are related to the characteristics of the local network. They are used by the measurement functions of the MicroLogic X control unit. These settings have no effect on protections.

Rated Phase-to-Phase Voltage

Available settings include: 208 V / 220 V / 230 V / 240 V / 380 V / 400 V / 415 V / 440 V / 480 V / 500 V / 525 V / 550 V / 575 V / 600 V / 660 V / 690 V / 1,000 V.

Default = 400 V.

The rated voltage can be set as follows:

- On the MicroLogic X display screen, at **Home > Configuration > Network > Nominal Voltage**
- With EcoStruxure Power Commissionsoftware

Rated Frequency

Available settings are:

- 50 Hz
- 60 Hz

The rated frequency can be set as follows:

- On the MicroLogic X display screen, at **Home > Configuration > Network > Nominal Frequency**
- With EcoStruxure Power Commissionsoftware

After changing the rated frequency setting, the MicroLogic X control unit must be restarted for the new setting to be taken into account.

Restart the MicroLogic X control unit in one of the following ways:

- Switch off the power supply to the MicroLogic X control unit, and switch it back on.
- Click the **Restart Module** button on the **Launch Firmware Upgrade** page of EcoStruxure Power Commission software.

VT Ratio

The VT ratio is the ratio between the primary and the secondary rated voltages as measured by a voltage transformer (VT).

The value range for the primary voltage (VT in) is from 100–1,250 in increments of 1 (factory setting: 690).

The value range for the secondary voltage (VT out) is from 100–690 in increments of 1 (factory setting: 690).

The primary and secondary voltages can be set as follows:

- On the MicroLogic X display screen, at **Home > Configuration > Network > VT Ratio**
- With EcoStruxure Power Commission software

Real-Time Measurements

Presentation

MicroLogic X control units perform the following real-time tasks:

- Measure the following currents in real time and as an RMS value:
 - Current for each phase and the neutral (if present)
 - Ground-fault current
 - Earth-leakage current (MicroLogic 7.0 X)
- Calculate the average current in real time
- Determine the maximum and minimum values for these electrical quantities
- Measure the phase-to-phase and phase-to-neutral voltage (if present), in real time and as an RMS value
- Calculate the associated electrical quantities from the RMS values of the currents and voltages:
 - Average phase-to-phase voltage and phase-to-neutral voltage (if present)
 - Current unbalances
 - Phase-to-phase voltage unbalances and phase-to-neutral voltage unbalances (if present)
- Calculate the associated electrical quantities from the current and voltage samples:
 - Powers, page 214
 - Quality indicators: frequency, THD(I), THD(V), THD-R(I), and THD-R(V), page 220, and power factor PF and $\cos \varphi$ measurement, page 223
- Display operating indicators: quadrants, and type of load
- Determine the maximum and minimum values for these electrical quantities
- Increment in real time three energy meters (active, reactive, apparent) using the total power real-time values, page 214

The sampling method uses the values of the harmonic currents and voltages up to the fifteenth order. The sampling process tracks the fundamental frequency and provides 40 samples per fundamental cycle.

The values of the electrical quantities, whether measured or calculated in real time, update once a second at rated frequency.

System Type Setting

On 3-pole circuit breakers, the system type setting allows the activation of:

- The ENCT (external neutral current transformer)
- The ENVT (external neutral voltage tap)

The system type can be set as follows:

- On the MicroLogic X display screen, at **Home > Configuration > Measures > System Type**.
- With EcoStruxure Power Commission software (password-protected)
- By sending a setting command using the communication network (password-protected)

Measuring the Neutral Current

4-pole circuit breakers or 3-pole circuit breakers with the ENCT wired and configured measure the neutral current:

- For a 3-pole circuit breaker, the neutral current is measured by adding a current transformer on the neutral conductor for the transformer information. For more information, refer to *MasterPact MTZ Catalogue*.
- For a 4-pole circuit breaker, the neutral current is measured systematically.

The neutral current is measured in the same way as the phase currents.

Measuring the Ground-Fault Current

The ground-fault current is calculated or measured in the same way as the phase currents, according to the circuit breaker configuration, as shown in the following table.

Circuit breaker configuration	I _g ground-fault current
3P	$I_g = I_1 + I_2 + I_3$
4P	$I_g = I_1 + I_2 + I_3 + I_N$
3P + ENCT	$I_g = I_1 + I_2 + I_3 + I_N$ (ENCT)
3P or 4P + SGR	$I_g = ISGR$

Measuring the Earth-Leakage Current (MicroLogic 7.0 X)

The earth-leakage current is measured by a rectangular sensor encompassing the three phases or the three phases and neutral.

Measuring the Phase-to-Neutral Voltages

4-pole circuit breakers, or 3-pole circuit breakers with the ENVT wired and configured, measure the phase-to-neutral (or line-to-neutral) voltages V_{1N}, V_{2N}, and V_{3N}:

- For a 3-pole circuit breaker, it is necessary to:
 - Connect the wire from the ENVT to the neutral conductor
 - Declare the ENVT in the system type setting
- For 4-pole circuit breakers, the phase-to-neutral voltages are measured systematically.

The phase-to-neutral voltages are measured in the same way as the phase-to-phase voltages.

Calculating the Average Current and Average Voltage

MicroLogic X control units calculate the:

- Average current I_{avg} , the arithmetic mean of the 3 phase currents:

$$I_{avg} = (I_1 + I_2 + I_3) / 3$$

- Average voltages:

- Phase-to-phase V_{avg} , the arithmetic mean of the 3 phase-to-phase voltages:

$$V_{avg} = (V_{12} + V_{23} + V_{31}) / 3$$

- Phase-to-neutral V_{avg} , the arithmetic mean of the 3 phase-to-neutral voltages (4-pole circuit breakers or 3-pole circuit breakers wired and configured with the ENVT):

$$V_{avg} = (V_{1N} + V_{2N} + V_{3N}) / 3$$

Measuring the Current and Voltage Phase Unbalances

MicroLogic X control units calculate the current unbalance for each phase (3 values) and the maximum current unbalance.

The current unbalance is a percentage of the average current:

$$I_k \text{ unbalance (\%)} = \frac{|I_k - I_{avg}|}{I_{avg}} \times 100 \quad \text{where } k = 1, 2, 3$$

MicroLogic X control units calculate:

- The phase-to-phase voltage unbalance for each phase (3 values) and the maximum of 3 phase-to-phase voltage unbalances.
- The phase-to-neutral (if present) voltage unbalance for each phase (3 values) and the maximum of 3 phase-to-neutral voltage unbalances.

The voltage unbalance is expressed as a percentage compared to the average value of the electrical quantity (V_{avg}):

$$V_{jk} \text{ unbalance (\%)} = \frac{|V_{jk} - V_{avg}|}{V_{avg}} \times 100 \quad \text{where } jk = 12, 23, 31 \text{ or } 1N, 2N, 3N$$

Maximum/Minimum Values

The MicroLogic X control unit determines the maximum (MAX) and minimum (MIN) value reached by the following electrical quantities for the period from the last reset to the present time:

- Current: phase and neutral currents, average currents, and current unbalances
- Voltage: phase-to-phase and phase-to-neutral voltages, average voltages, and voltage unbalances
- Power: total power and phase power (active, reactive, and apparent)
- Total harmonic distortion: the total harmonic distortion THD and THD-R for both current and voltage
- Frequency
- The maximum of the maximum value of all phase currents
- The minimum of the minimum value of all phase currents
- The maximum of the maximum value of 3 phase current unbalances
- Maximum of maximum of 3 phase-to-phase voltage unbalances
- Maximum of maximum of 3 phase-to-neutral voltage unbalances

Resetting Maximum/Minimum Values

The maximum and minimum values can be reset as follows:

- On the MicroLogic X display screen, at:
 - **Home > Measures > Current**
 - **Home > Measures > Voltage**
 - **Home > Measures > Power**
 - **Home > Measures > Frequency**
 - **Home > Measures > I Harmonics**
 - **Home > Measures > V Harmonics**
- With EcoStruxure Power Commission software

- With the EcoStruxure Power Device app
- By sending a command using the communication network (password-protected).
- On the IFE/EIFE webpages

NOTE: The maximum and minimum power factors and $\cos \varphi$ can be reset only:

- With EcoStruxure Power Commission software
- By sending a command using the communication network (password-protected).
- On the IFE/EIFE webpages

All maximum and minimum values for the group of electrical quantity selected are reset.

Resetting maximum and minimum values generates the following events:

Code	User message	History	Severity
0x0F12 (3858)	Reset Min/Max currents	Metering	Low
0x0F13 (3859)	Reset Min/Max voltages	Metering	Low
0x0F14 (3860)	Reset Min/Max power	Metering	Low
0x0F15 (3861)	Reset Min/Max frequency	Metering	Low
0x0F16 (3862)	Reset Min/Max harmonics	Metering	Low
0x0F17 (3863)	Reset Min/Max power factor	Metering	Low

Calculating Demand Values

Presentation

The control unit calculates:

- The demand values of phase, neutral, and average currents
- The demand values of the total (active, reactive, and apparent) powers

Each maximum demand value (peak) is stored in memory.

Definition

The demand value is the average value of a quantity over a specified period of time (interval).

Current Demand Value Calculation

The current demand is calculated using the thermal method. The thermal current demand calculates the demand based on a thermal response which mimics the analog thermal demand meters, as shown in the following illustration:

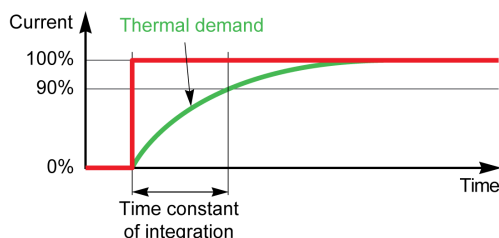

The time constant of integration (current demand calculation interval) settings are as follows:

Setting	Unit	Range	Step	Factory setting
Current demand calculation interval	minute	1–60	1	15

The interval can be set as follows:

- With EcoStruxure Power Commission software (password-protected)
- With EcoStruxure Power Device app (password-protected)
- By sending a setting command using the communication network (password-protected)

Power Demand Value Calculation

The power demand value is calculated using arithmetical integration of power RMS values over a period of time, divided by the length of the period. The result is equivalent to the energy accumulated during the period of time divided by the length of the period. In the MicroLogic X control unit the power demand is calculated according to the sliding block method.

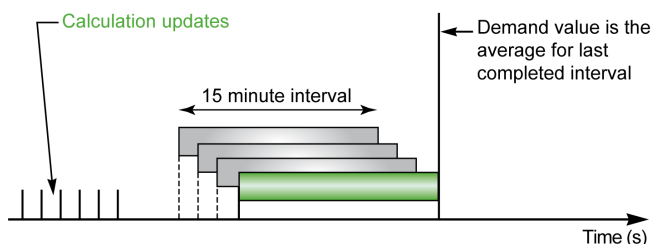

The power demand calculation interval settings are as follows:

Setting	Unit	Range	Step	Factory setting
Power demand calculation interval	minute	1–60	1	15

At the end of the power demand calculation interval and then every one tenth of the interval, for example, for an interval of 15 minutes, every 1 minute 30 seconds:

- The demand value over the interval is calculated and updated.
- Calculation of a new demand value is initialized on a new interval:
 - By eliminating the contribution of the first tenth of the previous interval
 - By adding the contribution of the latest tenth

The power demand calculation interval can be set as follows:

- With EcoStruxure Power Commission software (password-protected)
- With EcoStruxure Power Device app (password-protected)
- By sending a setting command using the communication network (password-protected)

Peak Demand Values

The MicroLogic X control unit determines the following maximum peak demand values for the period from the last reset to the present time:

- Peak current demand
- Peak power demand

Resetting Peak Demand Values

The peak current demand values are reset with the maximum and minimum current values.

The peak power demand values are reset with the maximum and minimum power values.

The peak demand values can be reset:

- On the MicroLogic X display screen, at:
 - **Home > Measures > Current**
 - **Home > Measures > Power**
- With EcoStruxure Power Commission software (password-protected)
- With EcoStruxure Power Device app (password-protected)
- By writing a reset command using the communication network (password-protected)

Resetting the peak demand values generates the following events:

Code	User message	History	Severity
0x0F19 (3865)	Reset Min/Max current demand	Metering	Low
0x0F1A (3866)	Reset Min/Max power demand	Metering	Low

Power Metering

Presentation

The control unit calculates the electrical quantities required for power management:

- The real-time values of the:
 - Active powers (total P_{tot} and per phase) in kW
 - Reactive powers (total Q_{tot} and per phase) in kVAR
 - Apparent powers (total S_{tot} and per phase) in kVA
- The maximum and minimum values for each of these powers
- The $\cos \varphi$ and power factor (PF) indicators (total and per phase)
- The operating quadrant and type of load (leading or lagging)

All these electrical quantities are continuously calculated and their value is updated once a second at rated frequency.

Principle of Power Metering

The control unit calculates the power values from the current and voltage samples.

The calculation principle is based on:

- Definition of the powers
- Algorithms for the 3-wattmeter calculation method, page 216
- Set value of the power sign (circuit breaker powered from upstream (top) or downstream (bottom))

Calculations use harmonics up to the fifteenth.

Total Power Calculation Method

The total reactive and apparent power can be calculated by one of the two following methods:

- Vector
- Arithmetic (factory setting)

The calculation method can be set as follows:

- On the MicroLogic X display screen, at **Home > Configuration > Measures > Total P calcul**
- With EcoStruxure Power Commission software

3-Pole Circuit Breaker, 4-Pole Circuit Breaker

The calculation algorithm is based on the 3-wattmeter method:

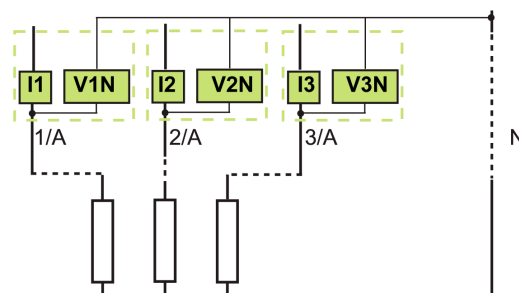

When there is voltage measurement on the neutral (4-pole or 3-pole circuit breaker with ENVT wired and configured), the control unit measures the power by using 3 single-phase loads downstream.

When there is no voltage measurement on the neutral (3-pole circuit breaker on power system without neutral) an internal voltage floating reference is used to measure power.

3-Pole Circuit Breaker, Distributed Neutral

Declare the ENVT in the system type setting, page 208.

NOTE: Declaration of the ENVT alone does not result in correct calculation of the powers. It is essential to connect the wire from the ENVT to the neutral conductor.

Power Sign and Operating Quadrant

By definition, the active powers are:

- Signed + when they are received by the user, that is, when the device is acting as a receiver.
- Signed - when they are delivered by the user, that is, when the device is acting as a generator.

By definition, the reactive powers have:

- The same sign as the active energies and powers when the current lags behind the voltage, that is, when the device is inductive (lagging).
- The opposite sign to the active energies and powers when the current is ahead of the voltage, that is, when the device is capacitive (leading).

These definitions therefore determine 4 operating quadrants (Q1, Q2, Q3, and Q4):

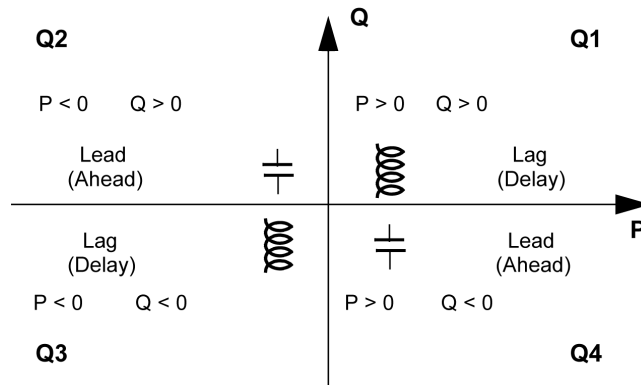

Power Sign Convention

The sign for the power running through the circuit breaker depends on the type of connection:

- Circuit breakers with the active power flowing from upstream (top) to downstream (bottom) should be set with the power sign P+
- Circuit breakers with the active power flowing from downstream (bottom) to upstream (top) should be set with the power sign P-

Set the power sign convention as follows:

- On the MicroLogic X display screen, on the screens **Home > Configuration > Network > Power sign**.
- With EcoStruxure Power Commission software
- By sending a setting command using the communication network (password-protected)

Power Calculation Algorithm

Presentation

The algorithms are given for the 3-wattmeter calculation method. The power definitions and calculation are given for a network with harmonics.

Calculated quantities are displayed:

- On the MicroLogic X display screen, at **Home > Measures > Power** (total power only)
- With EcoStruxure Power Commission software
- With the EcoStruxure Power Device app (total power only)
- On a remote controller using the communication network

Active Powers

The active power for each phase is calculated as follows:

$$P_p = \frac{1}{T} \int_V V_p(t) I_p(t) dt \quad \text{where } p=1, 2, 3 \text{ (phase)}$$

The total active power is calculated as follows:

$$P_{tot} = P_1 + P_2 + P_3$$

Reactive Power

The reactive power with harmonics for each phase is calculated as follows:

$$Q_p = \pm \sqrt{S_p^2 - P_p^2} \quad \text{where } p=1, 2, 3 \text{ (phase)}$$

The total reactive power is calculated as follows:

- With vector method:

$$Q_{tot_V} = Q_1 + Q_2 + Q_3$$

- With arithmetic method:

$$Q_{tot_A} = \pm \sqrt{S_{tot_A}^2 - P_{tot}^2}$$

Apparent Power

The apparent power for each phase and total apparent power is calculated as follows:

$$S_p = (V_p \times I_p) \quad \text{where } p = 1, 2, 3 \text{ (phase)}$$

The apparent power for each phase and total apparent power is calculated as follows:

- With vector method:

$$S_{tot_V} = \sqrt{P_{tot}^2 + Q_{tot_V}^2}$$

- With arithmetic method:

$$S_{tot_A} = S_1 + S_2 + S_3$$

ENVT Wiring and Configuration on 3-Pole Circuit Breaker

When installed on a system with distributed neutral, correct ENVT wiring and configuration are necessary to calculate and display correct values per phase, page 208.

When installed on a system without distributed neutral, if ENVT is configured to Yes, power values per phase are not relevant.

The following table indicates the displayed and calculated values for each configuration:

Power system	MTZ	ENVT wired	ENVT configured	Ptot	Pp	Qtot	Qp	Stot	PFtot	PFp	VLL	Vavg LL	VLN	Vavg LN
3-phase + neutral	4P	NA	NA	✓	✓	✓	✓	✓	✓	✓	✓	✓	✓	✓
	3P	Yes	Yes	✓	✓	✓	✓	✓	✓	✓	✓	✓	✓	✓
	3P	Yes	No	✓	NR	✓	NR	✓	✓	NR	✓	✓	NR	NR
	3P	No	Yes	✓	ND	✓	ND	✓	✓	ND	✓	✓	ND	ND
	3P	No	No	✓	ND	✓	ND	✓	✓	ND	✓	✓	ND	ND
3-phase	3P	Yes	NA	✓	NR	✓	NR	✓	✓	NR	✓	✓	NR	NR
	3P	No	NA	✓	ND	✓	ND	✓	✓	ND	✓	✓	ND	ND

✓ Value is calculated and displayed

NA Not applicable

NR Value displayed is not relevant

ND Value is not displayed

Energy Metering

Presentation

The control unit calculates the different types of energy using energy meters and provides the values of:

- The total active energy E_p , the active energy delivered (into the load) $E_{p\text{delivered}}$, and the active energy received (out of the load) $E_{p\text{received}}$
- The total reactive energy E_q , the reactive energy delivered (into the load) $E_{q\text{delivered}}$, and the reactive energy received (out of the load) $E_{q\text{received}}$
- The total apparent energy E_s

The energy values are calculated every second, and shown as an hourly consumption. Values are stored in non-volatile memory every second.

For each energy meter two types of counter are available: one which can be reset and one which cannot be reset.

NOTE: To perform reliable energy measurement across the current range the control unit must be powered with an external 24 Vdc power supply or VPS module, page 40.

NOTE: The energies per phase are available as an option, page 229. They are calculated using the same principles as total energies.

Principle of Energy Calculation

By definition energy is the integration of the real-time power over a period T. The integration period T lasts for a number of cycles equal to the rated frequency.

$$E = \int_T G \delta(t) \quad \text{where } G = P, Q \text{ or } S$$

Partial Energy Meters

For each type of energy, active or reactive, a partial received energy meter and a partial delivered energy meter calculate the accumulated energy by incrementing once a second:

- $E_{\text{delivered}}(t) = E_{\text{delivered}}(t - 1) + (G_{\text{delivered}}(t))/3600$ where $G_{\text{delivered}} = P_{\text{tot}}$ or $Q_{\text{tot}} > 0$
- Received power is always counted negatively.
 $E_{\text{received}}(t) = E_{\text{received}}(t - 1) + (|G_{\text{received}}(t)|)/3600$ where $G_{\text{received}} = P_{\text{tot}}$ or $Q_{\text{tot}} < 0$

For each total and partial energy meter two types of counter are available: one which can be reset and one which cannot be reset.

Energy Meters

From the partial energy meters and for each type of energy, active or reactive, an energy meter provides either of the following measurements once a second:

- The absolute energy, by adding the received and delivered energies together. The energy accumulation mode is absolute.

$$E(t)_{\text{absolute}} = E_{\text{delivered}}(t) + E_{\text{received}}(t)$$

- The signed energy, by differentiating between received and delivered energies. The energy accumulation mode is signed.

$$E(t)_{\text{signed}} = E_{\text{delivered}}(t) - E_{\text{received}}(t)$$

The apparent energy E_s is always counted positively.

Selecting Energy Calculation

The information sought determines calculation selection:

- The absolute value of the energy that has crossed the poles of a circuit breaker or the cables of an item of electrical equipment is relevant for maintenance of an installation.
- The signed values of the energy delivered and the energy received are required to calculate the economic cost of an item of equipment.

By default, absolute energy accumulation mode is configured.

Select the energy calculation mode using any of the following methods:

- On the MicroLogic X display screen, on the screens **Home > Configuration > Measures > E calcul**
- With EcoStruxure Power Commission software
- By sending a setting command using the communication network (password-protected).

Resetting Energy Meters

The energy meters can be reset as follows:

- On the MicroLogic X display screen, on the screens **Home > Measures > Energy > Reset Counter**
- With EcoStruxure Power Commission software
- With the EcoStruxure Power Device app
- By writing a reset command using the communication network (password-protected).
- On the IFE/EIFE webpages

All resettable energy meters are reset.

Resetting the energy meters generates the following event:

Code	User message	History	Severity
0x0F18 (3864)	Reset energy counters	Metering	Low

Presetting Energy Meters

All resettable energy meters can be preset separately, using EcoStruxure Power Commission software (password-protected).

Total Harmonic Distortion

Presentation

The control unit calculates total harmonic distortion related to the fundamental value THD, and total harmonic distortion related to RMS values THD-R for voltages and currents.

Displaying the Total Harmonic Distortion

The total harmonic distortion related to the fundamental value THD can be displayed as follows:

- On the MicroLogic X display screen:
 - THD(I) at **Home > Measures > I Harmonics**
 - THD(V) at **Home > Measures > V Harmonics**
- With EcoStruxure Power Commission software
- With the EcoStruxure Power Device app
- On the FDM128 display
- Through the communication network

The total harmonic distortion related to RMS values THD-R can be displayed as follows:

- With EcoStruxure Power Commission software
- Through the communication network

Current THD

The current THD is a percentage of the RMS value of harmonic currents of ranks greater than 1, in relation to the RMS value of the fundamental current (first order). The control unit calculates the total harmonic current distortion THD up to the fifteenth harmonic:

$$\text{THD(I)} = 100 \frac{\sqrt{\sum_{n=2}^{15} I_{n\text{rms}}^2}}{I_{1\text{rms}}}$$

The current THD can be higher than 100%.

Use the total harmonic distortion THD(I) to assess the distortion of the current wave with a single number. The following table shows the THD limit values.

THD(I) Value	Comments
THD(I) < 10%	Low harmonic currents: little risk of disturbance.
10% < THD(I) < 50%	Significant harmonic currents: risk of heat rise, oversizing of supplies.
50% < THD(I)	High harmonic currents: the risks of disturbance, degradation, and heat rise are almost certain unless the installation is calculated and sized with this restriction in mind.

Distortion of the current wave created by a nonlinear device with a high THD(I) can lead to distortion of the voltage wave, depending on the level of distortion and the source impedance. This distortion of the voltage wave affects all of the devices powered by the supply. Sensitive devices on the system can therefore be affected. A device with a high THD(I) may not be affected itself but could cause disturbance on other, more sensitive devices on the system.

NOTE: THD(I) measurement is an effective way of determining the potential for problems from the devices on electrical networks.

Voltage THD

The voltage THD is the percentage of the RMS value of harmonic voltages of ranks greater than 1, in relation to the RMS value of the fundamental voltage (first order). The control unit calculates the voltage THD up to the fifteenth harmonic:

$$THD(V) = \frac{\sqrt{\sum_{n=2}^{15} V_{nrms}^2}}{V_{1rms}}$$

This factor can in theory be higher than 100% but is in practice rarely higher than 15%.

Use the total harmonic distortion THD(V) to assess the distortion of the voltage wave with a single number. The limit values below are commonly evaluated by energy distribution companies:

THD(V) Value	Comments
THD(V) < 5%	Insignificant distortion of the voltage wave: little risk of disturbance.
5% < THD(V) < 8%	Significant distortion of the voltage wave: risk of heat rise and disturbance.
8% < THD(V)	Significant distortion of the voltage wave: there is a high risk of disturbance unless the installation is calculated and sized based on this distortion.

Distortion of the voltage wave affects all devices powered by the supply.

NOTE: Use the THD(V) indication to assess the risks of disturbance of sensitive devices supplied with power.

Current THD-R

The current THD-R is a percentage of the RMS value of harmonic currents of ranks greater than 1 in relation to the RMS value of the fundamental plus harmonic currents. The control unit calculates the total harmonic current distortion THD-R up to the fifteenth harmonic using the following equation:

$$THD(I) = 100 \frac{\sqrt{\sum_{n=2}^{15} I_{nrms}^2}}{I_{rms}}$$

The current THD-R cannot be higher than 100%.

Use the total harmonic distortion THD-R(I) to assess the distortion of the current wave with a single number. The following table shows the THD-R limit values.

THD-R(I) Value	Comments
THD-R(I) < 10%	Low harmonic currents: little risk of disturbance.
10% < THD-R(I) < 50%	Significant harmonic currents: risk of heat rise, oversizing of supplies.
50% < THD-R(I)	High harmonic currents: the risks of disturbance, degradation, and heat rise are almost certain unless the installation is calculated and sized with this restriction in mind.

Distortion of the current wave created by a nonlinear device with a high THD-R(I) can lead to distortion of the voltage wave, depending on the level of distortion and the source impedance. This distortion of the voltage wave affects all of the devices powered by the supply. Sensitive devices on the system can therefore be affected. A device with a high THD-R(I) may not be affected itself but could cause disturbance on other, more sensitive devices on the system.

NOTE: THD-R(I) measurement is an effective way of determining the potential for problems from the devices on electrical networks.

Voltage THD-R

The voltage THD-R is the percentage the RMS value of harmonic voltages greater than 1 in relation to the RMS value of the fundamental plus harmonic voltages. The control unit calculates the total harmonic voltage distortion THD-R up to the fifteenth harmonic using the following equation:

$$\text{THD}(V) = \frac{\sqrt{\sum_{n=2}^{15} V_{n\text{rms}}^2}}{V_{\text{rms}}}$$

Use the total harmonic distortion THD-R(V) to assess the distortion of the voltage wave with a single number. The limit values below are commonly evaluated by energy distribution companies:

THD-R(V) Value	Comments
THD-R(V) < 5%	Insignificant distortion of the voltage wave: little risk of disturbance.
5% < THD-R(V) < 8%	Significant distortion of the voltage wave: risk of heat rise and disturbance.
8% < THD-R(V)	Significant distortion of the voltage wave: there is a high risk of disturbance unless the installation is calculated and sized based on this distortion.

Distortion of the voltage wave affects all devices powered by the supply.

NOTE: Use the THD-R(V) indication to assess the risks of disturbance of sensitive devices supplied with power.

Power Factor PF and $\cos \varphi$ Measurement

Power Factor PF

The control unit calculates:

- The power factor per phase PF1, PF2, PF3, from the phase active and apparent powers.
- The total power factor PF from the total active power P_{tot} and the total apparent power S_{tot} :

$$PF = \frac{P_{tot}}{S_{tot}}$$

NOTE: S_{tot} is the vector or arithmetic total apparent power, depending on the setting, page 216.

This indicator qualifies:

- The oversizing necessary for the installation power supply when harmonic currents are present.
- The presence of harmonic currents by comparison with the value of the $\cos \varphi$ (see below).

$\cos \varphi$

The control unit calculates:

- The $\cos \varphi$ per phase from the phase active and apparent fundamental powers.
- The $\cos \varphi$ from the total fundamental active power $P_{fundtot}$ and the total fundamental apparent power $S_{fundtot}$:

$$\cos \varphi = \frac{P_{fundtot}}{S_{fundtot}}$$

This indicator qualifies the usage of the fundamental energy and defines the quadrant of operation. The $\cos \varphi$ is also called the Displacement Power Factor (DPF).

Power Factor PF and $\cos \varphi$ when Harmonic Currents are Present

If the supply voltage is not too distorted, the power factor PF is expressed as a function of the $\cos \varphi$ and the THD(I) by:

$$PF \approx \frac{\cos \varphi}{\sqrt{1 + \text{THD}(I)^2}}$$

The following graph specifies the value of PF/ $\cos \varphi$ as a function of the THD(I):

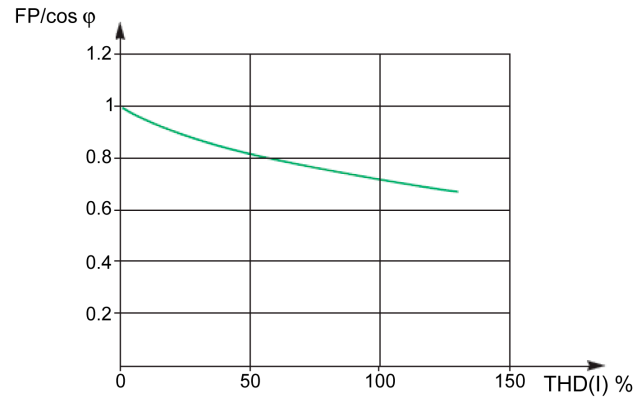

By comparing the 2 values, it is possible to estimate the level of harmonic deformation on the supply.

Sign for the Power Factor PF and $\cos \varphi$

Two sign conventions can be applied for these indicators:

- IEC convention: The sign for these indicators complies strictly with the signed calculations of the powers (that is, P_{tot} , S_{tot} , $P_{fundtot}$, and $S_{fundtot}$).
- IEEE convention: The indicators are calculated in accordance with the following formula:

$$PF = \frac{P_{tot}}{S_{tot}} \times (-\text{sign}(Q)) \quad \text{and} \quad \cos \varphi = \frac{P_{fundtot}}{S_{fundtot}} \times (-\text{sign}(Q))$$

The following figures define the sign for the power factor PF and $\cos \varphi$ by quadrant (Q1, Q2, Q3 and Q4) for both conventions:

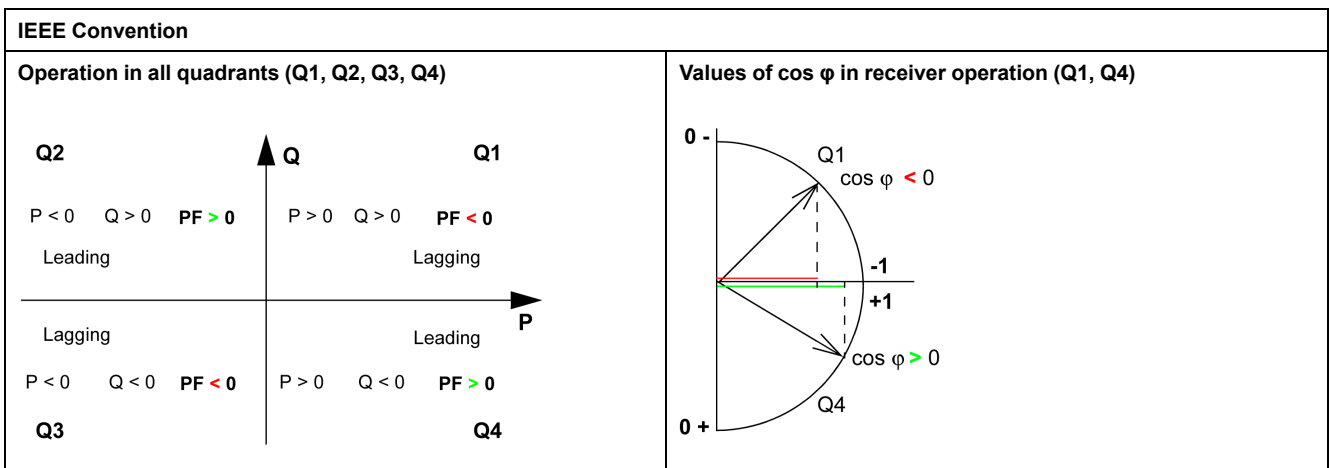
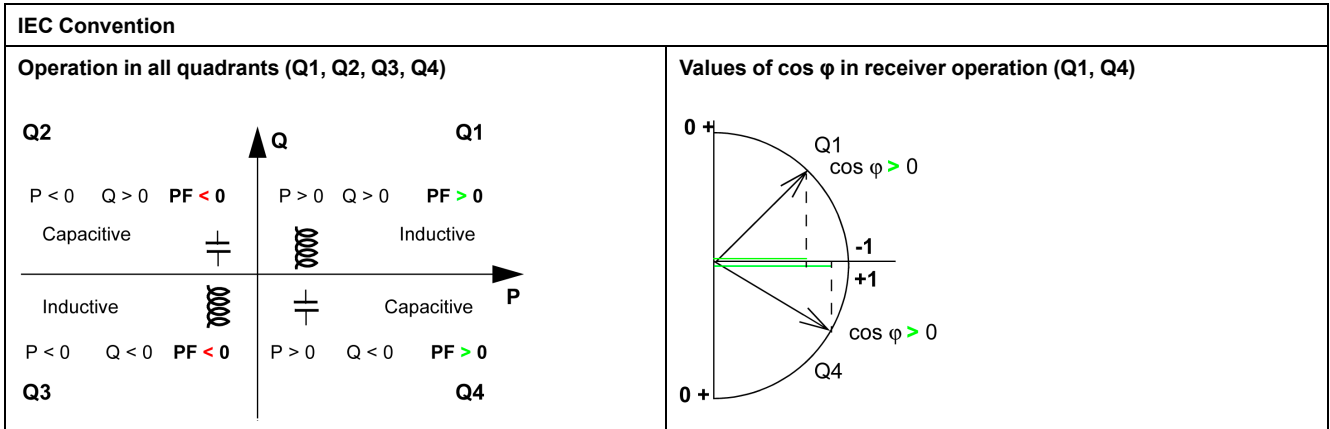

NOTE: For a device, a part of an installation which is only a receiver (or generator), the advantage of the IEEE convention is that it adds the type of reactive component to the PF and $\cos \varphi$ indicators:

- Lead: positive sign for the PF and $\cos \varphi$ indicators.
- Lag: negative sign for the PF and $\cos \varphi$ indicators.

Managing the Power Factor PF and $\cos \varphi$: Minimum and Maximum Values

Managing the PF and $\cos \varphi$ indicators consists of:

- Defining critical situations.
- Implementing monitoring of the indicators in accordance with the definition of critical situations.

Situations are considered critical when the values of the indicators are around 0. The minimum and maximum values of the indicators are defined for these situations.

The following figure illustrates the variations of the $\cos \varphi$ indicator (with the definition of the $\cos \varphi$ MIN/MAX) and its value according to IEEE convention for a receiver application:

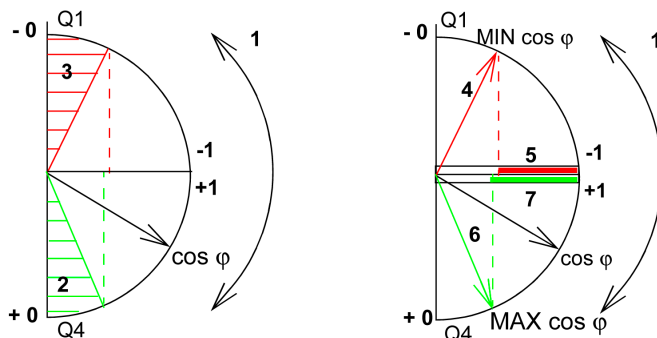

- 1 Arrows indicating the $\cos \varphi$ variation range for the load in operation
- 2 Critical zone + 0 for highly capacitive devices (shaded green)
- 3 Critical zone - 0 for highly inductive devices (shaded red)
- 4 Minimum position of the load $\cos \varphi$ (lagging): red arrow
- 5 Variation range of the value of the load $\cos \varphi$ (lagging): red
- 6 Maximum position of the load $\cos \varphi$ (leading): green arrow
- 7 Variation range of the value of the load $\cos \varphi$ (leading): green

PF MAX (or $\cos \varphi$ MAX) is obtained for the smallest positive value of the PF (or $\cos \varphi$) indicator.

PF MIN (or $\cos \varphi$ MIN) is obtained for the largest negative value of the PF (or $\cos \varphi$) indicator.

NOTE: The minimum and maximum values of the PF and $\cos \varphi$ indicators are not physically significant: they are markers which determine the ideal operating zone for the load.

Monitoring the $\cos \varphi$ and Power Factor PF Indicators

According to the IEEE convention, critical situations in receiver mode on a capacitive or inductive load are detected and differentiated (two values).



The following table indicates the direction in which the indicators vary and their value in receiver mode:

IEEE Convention		
Operating quadrant	Q1	Q4
Direction in which the $\cos \varphi$ (or PFs) vary over the operating range		
Value of the $\cos \varphi$ (or PFs) over the operating range	0...-0.3...-0.8...-1	+1...+0.8...+0.4...0

The quality indicator MAX and MIN indicate both critical situations.

According to the IEC convention, critical situations in receiver mode on a capacitive or inductive load are detected but not differentiated (one value).

The following table indicates the direction in which the indicators vary and their value in receiver mode:

IEC Convention		
Operating quadrant	Q1	Q4
Direction in which the $\cos \varphi$ (or PFs) vary over the operating range		
Value of the $\cos \varphi$ (or PFs) over the operating range	0...+0.3...+0.8...+1	+1...+0.8...+0.4...0

The quality indicator MAX indicates both critical situations.

Selecting the Sign Convention for the $\cos \varphi$ and Power Factor PF

Set the sign convention for the $\cos \varphi$ and PF indicators as follows:

- On the MicroLogic X display screen, at **Home > Configuration > Measures > PF/VAR Conv.**
- With EcoStruxure Power Commission software.
- By sending a setting command using the communication network (password-protected).

The factory setting of the sign convention is IEEE.

Optional Metering Functions

What's in This Chapter

Energy per Phase.....	229
Individual Harmonics Analysis	231

Energy per Phase

Presentation

The Energy per Phase Digital Module enables the analysis of energy consumption per phase. It is especially recommended for low voltage installations having a large amount of unbalanced loads. At the point of measurement, it allows the calculation of and displays the received and delivered energy on each phase of the network. It calculates and displays active, reactive and apparent energy per phase.

The energy per phase is calculated using the method described for calculating energy, page 218.

The Energy per Phase Digital Module can be installed:

- On a 4-pole MasterPact MTZ circuit breaker.
- On a 3-pole MasterPact MTZ circuit breaker with neutral connected to the VN terminal and with ENVT wired and configured.

Prerequisites

Energy per phase is available when the Energy per Phase Digital Module is purchased and installed on a MicroLogic X control unit, page 34.

The Energy per Phase Digital Module is compatible with:

- MicroLogic 2.0 X, 5.0 X, 6.0 X, and 7.0 X control units for IEC standard
- MicroLogic 3.0 X, 5.0 X, and 6.0 X control units for UL standard
- MicroLogic X control units with firmware version greater than or equal to 001.000.000

Data from the Digital Module is available remotely through IFE/EIFE or IFM communication interfaces, if the IFE/EIFE or IFM firmware version is compatible with the Digital Module. For more information, refer to firmware compatibility of the communication interfaces, page 31.

Energy Meter Characteristics

Measurement	Unit	Range	Accuracy	Accuracy range
Total active energy per phase E _{pdelivered} (1,2,3)	kWh	-10,000,000 to 10,000,000 kWh	+/-1%	See NOTE below
Total active energy per phase E _{preceived} (1,2,3)	kWh	-10,000,000 to 10,000,000 kWh	+/-1%	See NOTE below
Total reactive energy per phase E _{qdelivered} (1,2,3)	kVARh	-10,000,000 to 10,000,000 kVARh	+/-1%	See NOTE below
Total reactive energy per phase E _{qreceived} (1,2,3)	kVARh	-10,000,000 to 10,000,000 kVARh	+/-1%	See NOTE below
Total apparent energy per phase E _s (1,2,3)	kVARh	0 to 10,000,000 kVARh	+/-1%	See NOTE below

NOTE: The accuracy for the energy measurement range according to IEC 61557-12 is defined by current range, voltage, and power factor values.

Availability of Resettable Energy Meters

Measurement	MicroLogic X HMI	EcoStruxure Power Device app	EcoStruxure Power Commission software	FDM128	Communication	IFE/EIFE webpages
Total active energy per phase: E _p delivered(1,2,3), and E _p received (1,2,3)	–	✓	✓	✓	✓	–
Total reactive energy per phase: E _q delivered(1,2,3), and E _q received (1,2,3)	–	✓	✓	✓	✓	–
Total apparent energy per phase: E _s (1,2,3)	–	✓	✓	✓	✓	–

Availability of Non-Resettable Energy Meters

Measurement	MicroLogic X HMI	EcoStruxure Power Device app	EcoStruxure Power Commission software	FDM128	Communication TCP/IP	IFE/EIFE webpages
Total active energy value E _p	–	–	✓	–	✓	–
Total active energy values: E _p delivered, and E _p received	–	–	✓	✓	✓	–
Total reactive energy value E _q	–	–	✓	–	✓	–
Total reactive energy values: E _q delivered, and E _q received	–	–	✓	–	✓	–
Total apparent energy value E _s	–	–	✓	–	✓	–

Resetting Energy Per Phase

Energy per phase resettable meters can be reset as other energy measurements, page 219.

Individual Harmonics Analysis

Presentation

The Individual Harmonics Analysis Digital Module provides real-time monitoring of individual harmonics of voltages and currents up to rank 40. If harmonic pollution reaches unacceptable levels, it helps you to select appropriate corrective action.

Total harmonic distortions THD(I), THD(V), THD-R(I), and THD-R(V) are calculated as standard by the MicroLogic X control unit, page 220.

Individual harmonics are calculated by the MicroLogic X control unit according to the measurement methods specified in IEC 61000-4-30 (Testing and measurement techniques - Power quality measurement methods). The calculation of individual harmonics is performed every 200 ms. The MicroLogic X control unit provides the aggregated values of individual harmonics calculated on a time period of 3 s.

Prerequisites

Individual harmonics analysis is available when the Individual Harmonics Analysis Digital Module is purchased and installed on a MicroLogic X control unit, page 34.

The Individual Harmonics Analysis Digital Module is compatible with:

- MicroLogic 2.0 X, 5.0 X, 6.0 X, and 7.0 X control units for IEC standard
- MicroLogic 3.0 X, 5.0 X, and 6.0 X control units for UL standard
- MicroLogic X control units with firmware version greater than or equal to 002.000.000. Earlier firmware versions need to be updated, page 46.

Data from the Digital Module is available remotely through IFE/EIFE or IFM communication interfaces, if the IFE/EIFE or IFM firmware version is compatible with the Digital Module. For more information, refer to firmware compatibility of the communication interfaces, page 31.

Characteristics

Measurement	Unit	Range	Accuracy	Accuracy range
<ul style="list-style-type: none"> • Harmonics of currents on phase 1 from rank 1 to 40 (40 values) • Harmonics of currents on phase 2 from rank 1 to 40 (40 values) • Harmonics of currents on phase 3 from rank 1 to 40 (40 values) • Harmonics of currents on neutral from rank 1 to 40 (40 values) 	A	0–20 x I _n	5%	MTZ1: 40–(1,600 x 1.2) MTZ2: 40–(4,000 x 1.2) MTZ3: 80–(6,300 x 1.2)
<ul style="list-style-type: none"> • Harmonics of phase-to-phase voltage V₁₂ from rank 1 to 40 (40 values) • Harmonics of phase-to-phase voltage V₂₃ from rank 1 to 40 (40 values) • Harmonics of phase-to-phase voltage V₃₁ from rank 1 to 40 (40 values) 	V	0–1,150	5%	208–690 x 1.2
<ul style="list-style-type: none"> • Harmonics of phase-to-neutral voltage V_{1N} from rank 1 to 40 (40 values) • Harmonics of phase-to-neutral voltage V_{2N} from rank 1 to 40 (40 values) • Harmonics of phase-to-neutral voltage V_{3N} from rank 1 to 40 (40 values) 	V	0–660	5%	120–400 x 1.2

Data Availability

Measurement	MicroLogic X HMI	EcoStruxure Power Device app	EcoStruxure Power Commission software	FDM128	Communication TCP/IP	IFE/EIFE webpages
Magnitude of harmonic n of current phase x (fundamental)	–	✓	–	–	✓	–
Magnitude of harmonic n of neutral current (fundamental)	–	✓	–	–	✓	–
Magnitude of harmonic n of phase-to-phase voltage Vxy (fundamental)	–	✓	–	–	✓	–
Magnitude of harmonic n of phase-to-neutral voltage VxN (fundamental)	–	✓	–	–	✓	–

The harmonic spectrum is displayed on the EcoStruxure Power Device app through a Bluetooth or USB OTG connection.

The harmonic spectrum can be exported as a file in JSON format by using the EcoStruxure Power Device app.

Origin and Effects of Harmonics

The presence of multiple nonlinear loads on an electrical network creates harmonic currents in the electrical network.

Harmonic currents distort the current and voltage waves, and degrade the quality of the distributed energy.

If they are significant, distortions can result in:

- Disturbance or degraded operation in the powered devices.
- Unwanted heat rise in the devices and conductors.
- Excessive power consumption.

These various effects increase the system installation and operating costs. It is therefore necessary to monitor energy quality.

Definition of a Harmonic

A periodic signal is a superimposition of:

- The original sinusoidal signal at the fundamental frequency (for example, 50 Hz or 60 Hz).
- Sinusoidal signals whose frequencies are multiples of the fundamental frequency called harmonics.
- Any DC component.

This periodic signal is broken down into a sum of terms:

$$y(t) = y_0 + \sum_1^{\infty} y_n (\sqrt{2} \times \sin(n\omega t - \varphi_n))$$

where:

- y_0 : value of the DC component
- y_n : RMS value of the nth harmonic
- ω : pulsation of the fundamental frequency
- φ_n : phase displacement of harmonic component n

NOTE: The first harmonic is called the fundamental.

Example of a current wave distorted by a harmonic component:

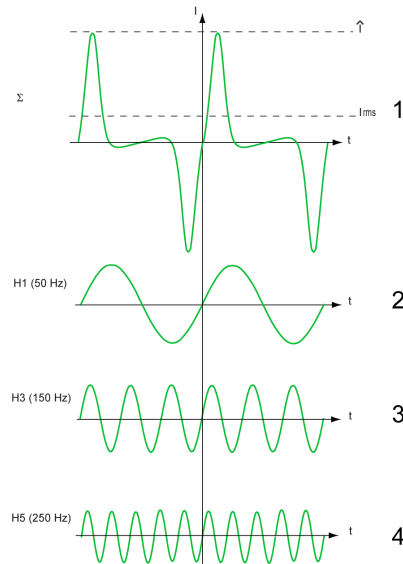

- 1 I_{rms} : RMS value of the harmonic waveform
- 2 I_1 : fundamental current
- 3 I_3 : third order harmonic current
- 4 I_5 : fifth order harmonic current

Example of Screen

The following screen gives an example of the information available on the EcoStruxure Power Device app.

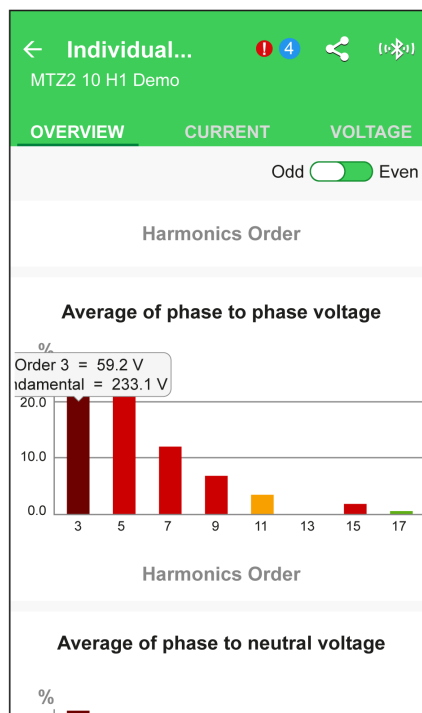

Maintenance and Diagnostic Functions

What's in This Part

Standard Maintenance and Diagnostic Functions	235
Optional Maintenance and Diagnostic Functions.....	262

Standard Maintenance and Diagnostic Functions

What's in This Chapter

Maintenance Tools	236
Assistance	237
Maintenance Schedule	238
Health State	242
Monitoring the Circuit Breaker	243
Monitoring the Tripping Circuit	244
Monitoring the Internal Functioning of the MicroLogic X Control Unit.....	247
Monitoring the Circuit Breaker Service Life	252
Monitoring the MicroLogic X Control Unit Service Life	253
Monitoring the Opening/Closing Function	254
Monitoring the Contact Wear	257
Monitoring the Load Profile	259
Monitoring the Operating Time	260
Circuit Breaker Overview	261

Maintenance Tools

Presentation

The following tools are available to support maintenance and diagnostic functions:

- MySchneider app, page 33
- EcoStruxure Power Device app, page 23
- EcoStruxure Facility Expert app, page 33
- EcoStruxure Asset Advisor software

EcoStruxure Asset Advisor for Electrical Distribution Services

EcoStruxure Asset Advisor for Electrical Distribution enhances asset performance management, combining Internet of Things (IoT) and cloud-based technologies with Schneider Electric expertise to improve business continuity. Data is available on mobile phones, tablets, and desktop computers.

EcoStruxure Asset Advisor for Electrical Distribution offers both Predictive and Preventive maintenance services. Customers can make data-driven decisions, enabling them to address potential maintenance issues early, and move from reactive to predictive maintenance.

The following features complement MasterPact MTZ embedded capabilities:

- Remote condition monitoring: a cloud-based platform to:
 - Evaluate live data from connected equipment and environmental sensors
 - Apply asset-specific analytics (equivalent to health indicators produced by MicroLogic X control units while correlated to other devices), to identify potential issues
 - Trigger smart alarms and notifications to end users and experts
- Experts to manage end-to-end process: Service experts orchestrate platform insights, recommended field actions and follow up optional on-site support for your electrical distribution system, including connectivity from gateway.

More information about EcoStruxure Asset Advisor is available on the Schneider Electric website.

Assistance

Presentation

The assistance menu on the MicroLogic X display screen gives information on the following:

- Maintenance Schedule, page 238
- Firmware version: The display screen gives information about the firmware version of the microprocessors installed in the MicroLogic X control unit. Firmware updates are managed with EcoStruxure Power Commission software.

Data Availability

The firmware version is available as follows:

- On the MicroLogic X display screen, at: **Home > Maintenance > Assistance > Firmware version**
- With EcoStruxure Power Commission software
- With EcoStruxure Power Device app
- On a remote controller using the communication network

Maintenance Schedule

Presentation

The MicroLogic X control unit provides information to help with scheduling preventive maintenance operations.

It monitors maintenance programs performed and generates events to indicate that maintenance is due.

For more information about maintenance programs and maintenance frequency, refer to [DOCA0099EN MasterPact MTZ - Circuit Breakers and Switch-Disconnectors - Maintenance Guide](#).

Operating Principle

The MicroLogic X control unit generates events to inform the user that maintenance needs to be planned.

A maintenance schedule event is completed when the date of the maintenance program performed is declared by using EcoStruxure Power Commission.

The schedule for maintenance operations depends on:

- The operating and environmental conditions of the MasterPact MTZ circuit breaker.
- The criticality of the user application.
- The date of the last maintenance program performed, and declared by using EcoStruxure Power Commission software.

Basic and standard end-user maintenance schedule events and Manufacturer maintenance schedule events are calculated:

- For the first event:
 - From the commissioning date of the circuit breaker, if this date is declared by using EcoStruxure Power Commission software.
 - Otherwise from the assembly date of the circuit breaker.
- For subsequent events, from the date of the previous maintenance program (Basic, Standard, or Manufacturer) performed, if the date is declared by using EcoStruxure Power Commission software.

NOTE: Subsequent Manufacturer maintenance schedule events are calculated from the previous Manufacturer maintenance program performed and declared by using EcoStruxure Power Commission software.

If the date of the maintenance program performed is not declared by using EcoStruxure Power Commission software, the MicroLogic X control unit continues to use the commissioning date or assembly date to calculate the maintenance schedule events.

Maintenance Programs

The following table summarizes maintenance operations for the three preventive maintenance programs:

Maintenance program	Maintenance description	Performed by
Basic end-user maintenance	Visual inspection and functional testing, replacement of inoperative accessories.	<ul style="list-style-type: none"> Trained and qualified end-user personnel Trained and qualified maintenance services provider personnel Schneider Electric field service representative
Standard end-user maintenance	Basic end-user maintenance, plus operational servicing and subassembly tests.	<ul style="list-style-type: none"> Trained and qualified maintenance services provider personnel Schneider Electric field service representative
Manufacturer maintenance	Standard end-user maintenance, plus diagnostics and part replacements by Schneider Electric Services.	Schneider Electric field service representative

Maintenance Frequency

The maintenance frequency is determined from the following recorded parameters and declared settings.

The following parameters for environmental conditions are recorded by the MicroLogic X control unit:

- Temperature
- Percent load
- Harmonics
- Relative humidity
- Vibration

The following settings for environmental conditions and user application criticality are declared by using EcoStruxure Power Commission software (password-protected).

Setting		Value	Factory setting
Environmental conditions	Corrosive atmosphere	<ul style="list-style-type: none"> 3C1 (Rural area) 3C2 (Urban area) 3C3 (Immediate vicinity of industrial pollution) 3C4 (Inside polluting industrial premises) 	3C2
	Salt environment	<ul style="list-style-type: none"> None (No salt mist) Moderate (Salt mist < 10 km (6.5 mi) from seaside) Significant (Salt mist < 1 km (0.65 mi) from seaside) 	None
	Dust	<ul style="list-style-type: none"> Low level Moderate level High level 	Low level
User application criticality		<ul style="list-style-type: none"> Low Moderate High 	Low

Recording Data of Maintenance Programs Performed

<i>NOTICE</i>
INCORRECT MAINTENANCE SCHEDULE
The date of the maintenance program performed must be declared by using EcoStruxure Power Commission software.
Failure to follow these instructions will result in invalid maintenance schedule.

After performing a preventive maintenance program, maintenance personnel must declare the following data by using EcoStruxure Power Commission software:

- Maintenance program performed: Basic, Standard, Manufacturer
- Date of maintenance operation
- Name of service provider
- Name of maintenance personnel

Data Availability

Maintenance schedule data is as follows:

- Data of the last maintenance program performed, if the data is declared by using EcoStruxure Power Commission software:
 - Program performed: Basic, Standard, or Manufacturer
 - Date of maintenance operation
 - Name of service provider
 - Name of maintenance personnel
- Data of the next maintenance program to be performed:
 - Program to be performed: Basic, Standard, or Manufacturer
 - Either the number of months before the program is due or the number of months it is overdue

Maintenance schedule data is available as follows:

- On the MicroLogic X display screen at: **Home > Maintenance > Assistance > Maint.schedule**
- With EcoStruxure Power Commission software
- With EcoStruxure Power Device app through Bluetooth or USB OTG connection
- On a remote controller using the communication network

Predefined Events

The maintenance schedule function generates the following events:

Code	Event	History	Severity
0x1480 (5248)	Schedule basic maintenance within one month	Diagnostic	Medium ⁽¹⁾
0x1481 (5249)	Schedule standard maintenance within one month	Diagnostic	Medium ⁽²⁾
0x1482 (5250)	Schedule manufacturer maintenance within three months	Diagnostic	Medium ⁽²⁾
(1) Disabled by default. Customizable with EcoStruxure Power Commission software.			
(2) Enabled by default, with pop-up messages.			

Recommended Actions

Code	Event	Recommended actions
0x1480 (5248)	Schedule basic maintenance within one month	Plan to schedule the basic preventive maintenance program within one month. To plan, edit, report, and track maintenance intervention, you may use EcoStruxure Facility Expert app.
0x1481 (5249)	Schedule standard maintenance within one month	Plan to schedule the standard preventive maintenance program within one month. To plan, edit, report, and track maintenance intervention, you may use EcoStruxure Facility Expert app.
0x1482 (5250)	Schedule manufacturer maintenance within three months	Plan to schedule the manufacturer preventive maintenance program within three months. To plan, edit, report, and track maintenance intervention, you may use EcoStruxure Facility Expert app.

For information about the preventive maintenance programs, refer to [DOCA0099EN MasterPact MTZ - Circuit Breakers and Switch-Disconnectors - Maintenance Guide](#).

Contact your field service representative for more information about who can carry out the recommended actions.



Health State

Presentation

The health state of the circuit breaker is determined from the following functions:

- Maintenance schedule, page 238
- Circuit breaker monitoring, page 243
- Circuit breaker service life monitoring, page 252
- MicroLogic X control unit service life monitoring, page 253
- Actuator wear monitoring, page 254
- Contact wear monitoring, page 257

The health state of the circuit breaker is represented with one of the following icons:

-  OK (white).
-  Medium severity detected alarm that requires non-urgent action (orange).
-  High severity detected alarm that requires immediate corrective action (red).

For more information, refer to the list of events, page 314.

Service LED

The service LED alerts the user to the health state of the circuit breaker:

- Orange LED: medium severity detected alarm that requires non-urgent maintenance action
- Red LED: high severity detected alarm that requires immediate maintenance action

Data Availability

The health state indicator with additional details about the health state of the circuit breaker is available as follows:

- On the MicroLogic X display screen, at: **Home > Quick View > Health**
- With EcoStruxure Power Commission software
- With EcoStruxure Power Device app through Bluetooth or USB OTG connection
- On a remote controller using the communication network

NOTE: Quick View on the MicroLogic X display screen displays the health state with the OK icon  when no high or medium severity event is detected.

When a high or medium severity event is detected a pop-up screen is displayed, page 85. If the pop-up is acknowledged by pressing OK, the orange or red icon is displayed again in Quick View scrolling and is available at **Home > Quick View > Health** if scrolling is disabled.

Monitoring the Circuit Breaker

Presentation

The monitoring of the circuit breaker consists in monitoring its ability to establish or interrupt a circuit and to provide protection against electrical faults. The MicroLogic X control unit therefore monitors:

- The tripping circuit, page 244
- Actuator wear, page 254
- The internal functioning of the MicroLogic X control unit, page 247

When the MicroLogic X control unit detects an incident in one of the monitored functions listed, an event is generated with an orange or red pop-up screen and corresponding event message.

Data Availability

Circuit breaker monitoring state data is available as follows:

- With EcoStruxure Power Commission software
- With the EcoStruxure Power Device app through Bluetooth or USB OTG connection
- On a remote controller using the communication network

Monitoring the Tripping Circuit

Presentation

When the MicroLogic X control unit is energized, it provides constant monitoring of the following:

- The internal tripping circuit
- The connection of the internal sensors (internal current transformers, sensor plug, performer plug)
- The connection of the circuit breaker tripping voltage release (MITOP) to the MicroLogic X control unit
- The connection of the ENCT (External Neutral Current Transformer)
- The connection of the earth-leakage (Vigi) sensor

NOTE: The mechanism is not monitored. It is recommended to perform preventive maintenance as proposed by Schneider Electric. For more information, refer to DOCA0099EN *MasterPact MTZ - Circuit Breakers and Switch-Disconnectors - Maintenance Guide*.

Operating Principle: Ready LED



A Ready LED

The result of the monitoring is indicated by the ready LED on the front face of the MicroLogic X control unit, as follows:

- The ready LED is flashing green: the internal tripping circuit of the circuit breaker is functioning correctly
- The ready LED is off:
 - Either the MicroLogic X control unit is not energized. Provide power to the control unit with a Mobile Power Pack. If the ready LED is still off, consult the log of active events at **Home > Alarms & History > Alarms** to diagnose the situation.
 - Or there is a detected incident in the tripping circuit. Consult the log of active events at **Home > Alarms & History > Alarms** to diagnose the situation.

Circuit Breaker Status

Following the detection of an incident in the tripping circuit the circuit breaker may be tripped or not, depending on the type of incident detected.

Tripping Data and Availability

The following data about the tripping function is logged by the MicroLogic X control unit:

- Total number of trips
- The name and date of the most recent trip

The tripping data is available as follows:

- With EcoStruxure Power Commission software
- On a remote controller using the communication network

Predefined Events

The monitoring of the tripping circuit generates the following events:

Code	Event	History	Severity
0x6407 (25607)	Self diagnostic trip	Trip	High with trip
0x641F (25631)	Circuit breaker self diagnostic trip	Trip	High with trip ⁽¹⁾
0x1400 (5120)	Control unit self test major malfunction 1	Diagnostic	High, with trip depending on the malfunction detected
0x1404 (5124)	Control unit self test major malfunction 2	Diagnostic	High, with trip depending on the malfunction detected
0x1405 (5125)	Control unit self test major malfunction 3	Diagnostic	High, with trip depending on the malfunction detected
0x1406 (5126)	Control unit self test major malfunction 4	Diagnostic	High, with trip depending on the malfunction detected
0x1416 (5142)	Control unit self test major malfunction 5	Diagnostic	High, with trip depending on the malfunction detected
0x1402 (5122)	Internal current sensor disconnected	Diagnostic	High with trip
0x1403 (5123)	External neutral current sensor disconnected	Diagnostic	High with trip
0x1430 (5168)	Protection settings reset to factory values	Diagnostic	High
0x1409 (5129)	Unable to read sensor plug	Diagnostic	High
0x1408 (5128)	Earth leakage (Vigi) sensor disconnected	Diagnostic	High

(1) The event is used to trip the circuit breaker in case of internal current sensor major malfunction. The user can configure this trip event as an alarm event by using EcoStruxure Power Commission software.

Recommended Actions

Code	Event	Recommended actions
0x6407 (25607)	Self diagnostic trip	Plan to replace the MicroLogic X control unit.
0x641F (25631)	Circuit breaker self diagnostic trip	Replace the circuit breaker.
0x1400 (5120)	Control unit self test major malfunction 1	Plan to replace the MicroLogic X control unit.
0x1404 (5124)	Control unit self test major malfunction 2	Plan to replace the MicroLogic X control unit.
0x1405 (5125)	Control unit self test major malfunction 3	Plan to replace the MicroLogic X control unit.
0x1406 (5126)	Control unit self test major malfunction 4	Plan to replace the MicroLogic X control unit.
0x1416 (5142)	Control unit self test major malfunction 5	Plan to replace the MicroLogic X control unit.
0x1402 (5122)	Internal current sensor disconnected	Plan to replace the MicroLogic X control unit.
0x1403 (5123)	External neutral current sensor disconnected	Check connection of the External Neutral Current Sensor (ENCT).
0x1430 (5168)	Protection settings reset to factory values	Update the MicroLogic X control unit firmware with EcoStruxure Power Commission software. Otherwise, plan to replace the MicroLogic X control unit.

Code	Event	Recommended actions
0x1409 (5129)	Unable to read sensor plug	Check connection of the sensor plug and performer plugs. If the connection is good but it fails again, replace the sensor plug or the control unit.
0x1408 (5128)	Earth leakage (Vigi) sensor disconnected	Check the connection of the external earth leakage (Vigi) sensor.

Contact your field service representative for more information about who can carry out the recommended actions.

Resetting a Trip Event

For information about resetting the circuit breaker after a trip due to an incident detected by the MicroLogic X self-tests, refer to the relevant document, page 10:

- *MasterPact MTZ1 - Circuit Breakers and Switch-Disconnectors - User Guide*
- *MasterPact MTZ2/MTZ3 - Circuit Breakers and Switch-Disconnectors - User Guide*

Monitoring the Internal Functioning of the MicroLogic X Control Unit

Presentation

The MicroLogic X control unit carries out a series of self tests to monitor:

- Correct internal functioning
- Wireless communication
- The ULP modules:
 - IO modules
 - IFE Ethernet interface
- The presence and state of the internal battery
- The presence of the 24 Vdc power supply
- The presence of the internal current power supply sensors

Operating Principle

The ready LED, service LED, and trip cause LEDs provide visual information about the health state of the MicroLogic X control unit. The detection of an invalid result in the self tests generates an event (logged in the Diagnostic history) which can be classified as high, medium, or low severity:

- Low severity event indicates the detection of an invalid result which has no operational impact. The standard (LSI G/V) protection functions are unaffected.
- Medium severity event indicates the detection of an invalid result which has a minor operational impact. The standard (LSI G/V) protection functions are unaffected. A check must be performed at next maintenance.
 - The ready LED is flashing
 - The service LED is lit in orange if the event requires non-urgent maintenance
 - All trip cause LEDs are off
 - An orange pop-up screen is displayed
- High severity event indicates the detection of an invalid result which can have a major operational impact. The standard (LSI G/V) protection functions can be affected. The control unit must be replaced without delay.
 - The ready LED is off
 - The service LED is lit in red if the event requires immediate maintenance
 - All trip cause LEDs are lit
 - A red pop-up screen is displayed

When monitoring of the internal functioning of MicroLogic X control unit detects an invalid result with medium or high severity, an event is generated with an orange or red pop-up screen and corresponding event message.

Data Availability

Monitoring data is available as follows:

- With EcoStruxure Power Commission software for all severities
- With the EcoStruxure Power Device app through Bluetooth or USB OTG connection for medium and high severities.

Restarting MicroLogic X Control Unit

If the display screen of the MicroLogic X control unit no longer displays menus for protection, alarms, or measures screens, it is recommended to restart the

MicroLogic X control unit. The restart is performed through EcoStruxure Power Commission software. It is not necessary to interrupt the power supply to the MicroLogic X control unit during the restart. The settings of the MicroLogic X control unit are not affected by the restart. **The standard protection functions remain active during the restart.**

Predefined Events

The function generates the following events:

Code	Event	History	Severity
0x142F (5167)	Last modification of protection settings has not been completely applied	Diagnostic	Medium
0x140F (5135)	Protection settings no accessible #1	Diagnostic	Medium
0x1474 (5236)	Protection settings no accessible #2	Diagnostic	Medium
0x1475 (5237)	Protection settings no accessible #3	Diagnostic	Medium
0x1476 (5238)	Protection settings no accessible #4	Diagnostic	Medium
0x1477 (5239)	Protection settings no accessible #5	Diagnostic	Medium
0x1407 (5127)	Control unit self test #1	Diagnostic	Low
0x1470 (5232)	Control unit self test #2	Diagnostic	Low
0x1471 (5233)	Control unit self test #3	Diagnostic	Medium
0x1472 (5234)	Control unit self test #4	Diagnostic	Medium
0x1473 (5235)	Control unit self test #5	Diagnostic	Low
0x1411 (5137)	Invalid measurement and optional protection #1	Diagnostic	Medium
0x1478 (5240)	Invalid measurement and optional protection #2	Diagnostic	Low
0x1479 (5241)	Invalid measurement and optional protection #3	Diagnostic	Medium
0x147C (5244)	Invalid optional protection self test	Diagnostic	Medium
0x140A (5138)	Invalid display screen or wireless communication #1	Diagnostic	Low
0x147A (5242)	Invalid display screen or wireless communication #2	Diagnostic	Medium
0x147B (5243)	Invalid display screen or wireless communication #3	Diagnostic	Medium
0x1436 (5174)	Control unit alarm reset	Diagnostic	Medium
0x0D00 (3328)	Critical hardware modules discrepancy	Diagnostic	Medium
0x0D01 (3329)	Critical firmware modules discrepancy	Diagnostic	Medium
0x0D02 (3330)	Non-critical hardware modules discrepancy	Diagnostic	Medium
0x0D03 (3331)	Non-critical firmware modules discrepancy	Diagnostic	Medium
0x0D08 (3336)	Address conflict between modules	Diagnostic	Medium
0x0D09 (3337)	Firmware discrepancy within control unit	Diagnostic	Medium
0x1412 (5138)	NFC invalid communication #1	Diagnostic	Medium
0x1414 (5140)	NFC invalid communication #2	Diagnostic	Medium
0x1415 (5141)	NFC invalid communication #3	Diagnostic	Medium
0x1422 (5154)	Invalid Bluetooth communication	Diagnostic	Medium
0x1433 (5171)	Replace internal battery	Diagnostic	Medium
0x1437 (5175)	Internal battery not detected	Diagnostic	Low
0x0D0A (3338)	Invalid Control Unit factory config #1	Diagnostic	High
0x0D0B (3339)	Invalid Control Unit factory config #2	Diagnostic	High
0x0D0E (3342)	Discrepancy between display and MicroLogic	Diagnostic	Medium
0x1306 (4870)	Presence of external 24V power supply	Diagnostic	Low

Code	Event	History	Severity
0x150F (5391)	Internal Current Power Supply (CPS) sensors malfunction.	Diagnostic	High
0x1510 (5392)	Internal Current Power Supply (CPS) sensors malfunction. Tsd forced to 0.	Diagnostic	High
0x1511 (5393)	Partial Internal Current Power Supply (CPS) sensors malfunction.	Diagnostic	Medium
0x1512 (5394)	Partial Internal Current Power Supply (CPS) sensors major malfunction.	Diagnostic	High
0x1120 (4384)	Communication lost with IO#1 module	Diagnostic	Medium
0x1121 (4385)	Communication lost with IO#2 module	Diagnostic	Medium
0x1122 (4386)	Communication lost with EIFE or IFE module	Diagnostic	Medium
0x1123 (4387)	Communication lost with IFM module	Diagnostic	Medium

Recommended Actions

Code	Event	Recommended actions
0x142F (5167)	Last modification of protection settings has not been completely applied	Apply again the protection settings.
0x140F (5135)	Protection settings no accessible #1	Plan to replace the MicroLogic X control unit.
0x1474 (5236)	Protection settings no accessible #2	Plan to replace the MicroLogic X control unit.
0x1475 (5237)	Protection settings no accessible #3	Plan to replace the MicroLogic X control unit.
0x1476 (5238)	Protection settings no accessible #4	Plan to replace the MicroLogic X control unit.
0x1477 (5239)	Protection settings no accessible #5	Plan to replace the MicroLogic X control unit.
0x1407 (5127)	Control unit self test #1	Plan to replace the MicroLogic X control unit.
0x1470 (5232)	Control unit self test #2	Plan to replace the MicroLogic X control unit.
0x1471 (5233)	Control unit self test #3	Plan to replace the MicroLogic X control unit.
0x1472 (5234)	Control unit self test #4	Plan to replace the MicroLogic X control unit.
0x1473 (5235)	Control unit self test #5	Plan to replace the MicroLogic X control unit.
0x1411 (5137)	Invalid measurement and optional protection #1	Plan to replace the MicroLogic X control unit.
0x1478 (5240)	Invalid measurement and optional protection #2	Plan to replace the MicroLogic X control unit.
0x1479 (5241)	Invalid measurement and optional protection #3	Plan to replace the MicroLogic X control unit.
0x147C (5244)	Invalid optional protection self test	Plan to replace the MicroLogic X control unit.
0x140A (5138)	Invalid display screen or wireless communication #1	Plan to replace the embedded display screen, as it contains the wireless antenna.
0x147A (5242)	Invalid display screen or wireless communication #2	Plan to replace the embedded display screen, as it contains the wireless antenna.
0x147B (5243)	Invalid display screen or wireless communication #3	Plan to replace the embedded display screen, as it contains the wireless antenna.
0x1436 (5174)	Control unit alarm reset	Plan to replace the MicroLogic X control unit.
0x0D00 (3328)	Critical hardware modules discrepancy	Check which module is in critical hardware discrepancy with the Firmware menu of EcoStruxure Power Commission software. Replace the module.
0x0D01 (3329)	Critical firmware modules discrepancy	Check which module is in critical hardware discrepancy with the EcoStruxure Power Commission software. Update the module.
0x0D02 (3330)	Non-critical hardware modules discrepancy	Check which module is in non-critical hardware discrepancy with the Firmware menu of EcoStruxure Power Commission software. Plan to replace the module.

Code	Event	Recommended actions
0x0D03 (3331)	Non-critical firmware modules discrepancy	Check which module is in non-critical firmware discrepancy with the EcoStruxure Power Commission software. Plan to replace the module.
0x0D08 (3336)	Address conflict between modules	Check If two IO modules are installed in the system, make sure one is configured as IO#1, the other as IO#2.
0x0D09 (3337)	Firmware discrepancy within control unit	Check the firmware version of the MicroLogic X control unit with EcoStruxure Power Commission software. If not latest, update the firmware of the MicroLogic X control unit.
0x1412 (5138)	NFC invalid communication #1	Plan to replace the embedded display screen, as it contains the wireless antenna.
0x1414 (5140)	NFC invalid communication #2	Plan to replace the embedded display screen, as it contains the wireless antenna.
0x1415 (5141)	NFC invalid communication #3	Plan to replace the embedded display screen, as it contains the wireless antenna.
0x1422 (5154)	Invalid Bluetooth communication	Plan to replace the embedded display screen.
0x1433 (5171)	Replace internal battery	Replace the internal battery.
0x1437 (5175)	Internal battery not detected	Install the internal battery.
0x0D0A (3338)	Invalid Control Unit factory config #1	Check and reload protection parameters to the MicroLogic X control unit with EcoStruxure Power Commission software.
0x0D0B (3339)	Invalid Control Unit factory config #2	Check and reload protection parameters to the MicroLogic X control unit with EcoStruxure Power Commission software.
0x0D0E (3342)	Discrepancy between display and MicroLogic	Replace MicroLogic display.
0x1306 (4870)	Presence of external 24V power supply	Check the connection of 24V power supply.
0x150F (5391)	Internal Current Power Supply (CPS) sensors malfunction.	Replace the circuit breaker.
0x1510 (5392)	Internal Current Power Supply (CPS) sensors malfunction. Tsd forced to 0.	Replace the circuit breaker.
0x1511 (5393)	Partial Internal Current Power Supply (CPS) sensors malfunction.	Plan to replace the circuit breaker.
0x1512 (5394)	Partial Internal Current Power Supply (CPS) sensors major malfunction.	Replace the circuit breaker.
0x1120 (4384)	Communication lost with IO#1 module	Check the power supply of the IO1 module. Check the ULP cable connection.
0x1121 (4385)	Communication lost with IO#2 module	Check the power supply of the IO2 module. Check the ULP cable connection.
0x1122 (4386)	Communication lost with EIFE or IFE module	Check the power supply of the EIFE or IFE module. Check the ULP cable connection.
0x1123 (4387)	Communication lost with IFM module	Check the power supply of the IFM module. Check the ULP cable connection.

Contact your field service representative for more information about who can carry out the recommended actions.

Display Screen Replacement

The display screen can be replaced. Always replace the display screen with one that corresponds to the control unit type (MicroLogic X with wireless communication or MicroLogic Xi without wireless communication).

For information about display screen replacement, consult the instruction sheets on the Schneider Electric website:

- **NHA49910**: replacement of the MicroLogic X display screen (commercial reference LV850054SP)
- **GDE66729**: replacement of the MicroLogic Xi display screen (commercial reference LV850054WWSP)

Replacing the display screen of a MicroLogic X control unit with a MicroLogic Xi display screen (and vice versa) generates the event **Discrepancy between display and MicroLogic**. This discrepancy has no impact on the protections provided by the control unit. The control unit is operational.

Nonetheless, the control unit operation is limited as follows:

- The Quick View screens are displayed in English.
- Only the standard protection functions of the control unit, page 99 in the **Protection** menu can be read and set. They are available only in English.

The other menus cannot be accessed and control unit firmware update is not possible.

NOTE: For more information about MicroLogic Xi control unit, refer to the appendix, page 328.

Internal Battery Replacement

The internal battery of the MicroLogic X control unit can be replaced on site when discharged. The replacement can be made with the circuit breaker in the open or closed position, and the control unit supplied with power. A test of the internal battery, page 21 must be carried out immediately after the replacement of the internal battery to check the correct functioning of the new battery.

For information about internal battery replacement and installation, consult the instruction sheet on the Schneider Electric website: NHA57283

Monitoring the Circuit Breaker Service Life

Presentation

The service life indicator helps anticipate the replacement of the breaking block before mechanical or electrical breakdown. Circuit breaker service life depends on the daily number of operating cycles with or without current. For more information about the service life and the maximum number of operating cycles, refer to *MasterPact MTZ Catalogue*.

Operating Principle

Each time the circuit breaker operates (performs an open and close cycle with or without current), the corresponding mechanical and electrical operating counters are incremented. Based on these counters, the MicroLogic X control unit calculates two service life ratios as a percentage of the maximum number of mechanical and electrical operations. The highest ratio is taken into account to indicate the percentage of lifetime remaining for the circuit breaker.

When the MicroLogic X control unit service life algorithm calculates a value which is below one of the predefined thresholds (20% and 0%), an event is generated with an orange or red pop-up screen and corresponding event message.

Data Availability

Service life monitoring data is available as follows:

- On the MicroLogic X display screen at **Home > Maintenance > Health > Circuit breaker**
- With EcoStruxure Power Commission software
- With the EcoStruxure Power Device app through Bluetooth or USB OTG connection
- On the FDM128 display
- On a remote controller using the communication network

Predefined Events

Service life monitoring generates the following events:

Code	Event	History	Severity
0x1443 (5187)	Remaining service life of circuit breaker is below alarm threshold	Diagnostic	Medium
0x1444 (5188)	Circuit breaker has reached the max number of operations	Diagnostic	High

Recommended Actions

Code	Event	Recommended actions
0x1443 (5187)	Remaining service life of circuit breaker is below alarm threshold	Plan to replace the circuit breaker. To refine the service life calculation by taking into account environmental parameters, you can ask for aging diagnostics. If the device is cloud connected, use EcoStruxure Asset Advisor for remote aging diagnostics, page 236. Otherwise, contact Schneider Electric services for local aging diagnostics.
0x1444 (5188)	Circuit breaker has reached the max number of operations	Replace the circuit breaker.

Contact your field service representative for more information about who can carry out the recommended actions.

Monitoring the MicroLogic X Control Unit Service Life

Presentation

The MicroLogic X control unit service life indicator helps anticipate the replacement of the control unit before breakdown. The service life of the control unit is measured from the date of manufacture of the control unit. This date is stored in the memory of the MicroLogic X control unit.

For more information about the service life of the MicroLogic X control unit, refer to DOCA0099EN *MasterPact MTZ - IEC Circuit Breakers and Switch-Disconnectors - Maintenance Guide*.

Operating Principle

The MicroLogic X control unit measures time passed since the date of manufacture of the control unit. When the MicroLogic X control unit service life algorithm calculates a value which is below one of the predefined thresholds (20% and 0%), an event is generated with an orange or red pop-up screen and corresponding event message.

Data Availability

Control unit service life monitoring data is available in the following ways:

- On the MicroLogic X display screen at **Home > Maintenance > Health > MicroLogic**
- With EcoStruxure Power Commission software
- With the EcoStruxure Power Device app through Bluetooth or USB OTG connection
- On a remote controller using the communication network

Predefined Events

The MicroLogic X control unit service life monitoring generates the following events:

Code	Event	History	Severity
0x1445 (5189)	Remaining service life of MicroLogic is below alarm threshold	Diagnostic	Medium
0x1446 (5190)	MicroLogic control unit has reached the max service life	Diagnostic	High

Recommended Actions

Code	Event	Recommended actions
0x1445 (5189)	Remaining service life of MicroLogic is below alarm threshold	Plan to replace the MicroLogic X control unit. To refine this theoretical alarm by taking in account environmental parameters, you may ask for aging diagnostic. If the device is cloud connected, use EcoStruxure Asset Advisor for remote aging diagnostic, page 236. Otherwise, contact Schneider Electric services for a local aging diagnostic.
0x1446 (5190)	MicroLogic control unit has reached the max service life	Replace the MicroLogic X control unit.

Contact your field service representative for more information about who can carry out the recommended actions.

Monitoring the Opening/Closing Function

Presentation

Monitoring of the opening/closing function by the MicroLogic X control unit consists in:

- Monitoring the communicating voltage releases:
 - The diagnostic MN undervoltage release (MN diag).
 - The diagnostic and communicating MX opening voltage release (MX diag&com).
 - The diagnostic and communicating XF closing voltage release (XF diag&com).
- Monitoring the MCH gear motor.

NOTE: Standard voltage releases are not monitored by the MicroLogic X control unit.

Monitoring the Communicating Voltage Releases

The MicroLogic X control unit:

- Checks the presence of voltage release
- Counts the number of operations performed by the voltage release
- Generates an event when:
 - The voltage release reaches 80% of recommended maximum number of operations
 - The voltage release reaches 100% of recommended maximum number of operations
- Monitors the state of the internal circuit of the voltage release

For more information about the recommended number of operations, refer to DOCA0099EN *MasterPact MTZ - Circuit Breakers and Switch-Disconnectors - Maintenance Guide*.

Monitoring the MCH Gear Motor

The MicroLogic X control unit:

- Counts the number of charging sequences performed to rearm the closing mechanism after each circuit breaker closure.
- Measures and records the last charging time of the MCH gear motor to rearm the closing mechanism.
- Generates an event when:
 - MCH gear motor reaches 80% of recommended maximum number of charging operations
 - MCH gear motor reaches 100% of recommended maximum number of charging operations

For more information about the recommended number of operations, refer to DOCA0099EN *MasterPact MTZ - Circuit Breakers and Switch-Disconnectors - Maintenance Guide*.

Data Availability

The MCH gear motor data is available as follows:

- On the MicroLogic X display screen, at: **Home > Maintenance > Health > Actuator wear**
- On a remote controller using the communication network

Predefined Events

The monitoring of the opening/closing function generates the following events:

Code	Event	History	Severity
0x1460 (5216)	Invalid self test - MX1 voltage release	Diagnostic	Medium
0x1461 (5217)	MX1 voltage release not detected	Diagnostic	Medium
0x1452 (5202)	MX1 voltage release operation counter is above alarm threshold	Diagnostic	Medium
0x1453 (5203)	MX1 voltage release has reached the max number of operations	Diagnostic	High
0x1468 (5224)	Invalid self test - MX2 voltage release	Diagnostic	Medium
0x1469 (5225)	MX2 voltage release not detected	Diagnostic	Medium
0x1458 (5208)	MX2 voltage release operation counter is above alarm threshold	Diagnostic	Medium
0x1459 (5209)	MX2 voltage release has reached the max number of operations	Diagnostic	High
0x1464 (5220)	Invalid self test - MN undervoltage release	Diagnostic	Medium
0x1465 (5221)	MN undervoltage release not detected	Diagnostic	Medium
0x1456 (5206)	MN undervoltage release operation counter is above alarm threshold	Diagnostic	Medium
0x1457 (5207)	MN undervoltage release has reached the max number of operations	Diagnostic	High
0x1466 (5222)	Voltage loss on MN undervoltage release	Diagnostic	Medium
0x1467 (5223)	Communication loss on MN undervoltage release	Diagnostic	Medium
0x1462 (5218)	Invalid self test - XF voltage release	Diagnostic	Medium
0x1463 (5219)	XF voltage release not detected	Diagnostic	Medium
0x1454 (5203)	XF voltage release operation counter is above alarm threshold	Diagnostic	Medium
0x1455 (5205)	XF voltage release has reached the max number of operations	Diagnostic	High
0x1450 (5200)	MCH charging operations above threshold	Diagnostic	Medium
0x1451 (5201)	MCH has reached the max number of operations	Diagnostic	High
0x1438 (5176)	Main voltage loss and circuit breaker closed	Diagnostic	Medium

Recommended Actions

Code	Event	Recommended actions
0x1460 (5216)	Invalid self test - MX1 voltage release	Plan to replace the MX1 voltage release.
0x1461 (5217)	MX1 voltage release not detected	Check the connection of the MX1 voltage release.
0x1452 (5202)	MX1 voltage release operation counter is above alarm threshold	Plan to replace the MX1 voltage release. Consult the predicted date of replacement on EcoStruxure Power Device app.
0x1453 (5203)	MX1 voltage release has reached the max number of operations	Replace the MX1 voltage release.
0x1468 (5224)	Invalid self test - MX2 voltage release	Replace the MX2 voltage release.
0x1469 (5225)	MX2 voltage release not detected	Check the connection of the MX2 voltage release.
0x1458 (5208)	MX2 voltage release operation counter is above alarm threshold	Plan to replace the MX2 voltage release. Consult the predicted date of replacement on EcoStruxure Power Device app.
0x1459 (5209)	MX2 voltage release has reached the max number of operations	Replace the MX2 voltage release.
0x1464 (5220)	Invalid self test - MN undervoltage release	Plan to replace the MN undervoltage release.
0x1465 (5221)	MN undervoltage release not detected	Check the connection of the MN undervoltage release.

Code	Event	Recommended actions
0x1456 (5206)	MN undervoltage release operation counter is above alarm threshold	Plan to replace the MN undervoltage release. Consult the predicted date of replacement on EcoStruxure Power Device app.
0x1457 (5207)	MN undervoltage release has reached the max number of operations	Replace the MN undervoltage release.
0x1466 (5222)	Voltage loss on MN undervoltage release	Check the control voltage.
0x1467 (5223)	Communication loss on MN undervoltage release	Check the internal connection of MN undervoltage release.
0x1462 (5218)	Invalid self test - XF voltage release	Plan to replace the XF voltage release.
0x1463 (5219)	XF voltage release not detected	Check the connection of the XF voltage release.
0x1454 (5204)	XF voltage release operation counter is above alarm threshold	Plan to replace the XF voltage release. Consult the predicted date of replacement on EcoStruxure Power Device app..
0x1455 (5205)	XF voltage release has reached the max number of operations	Replace the XF voltage release.
0x1450 (5200)	MCH charging operations above threshold	Plan to replace the MCH. Consult the predicted date of replacement on EcoStruxure Power Device app.
0x1451 (5201)	MCH has reached the max number of operations	Replace the MCH.
0x1438 (5176)	Main voltage loss and circuit breaker closed	Check main voltage on the bus bar.

Contact your field service representative for more information about who can carry out the recommended actions.

Monitoring the Contact Wear

Presentation

The pole contacts undergo wear due to the number of operating cycles with current and interrupted current during short circuits. It is recommended to check them at periodic intervals to decide whether the contacts must be changed or not. To avoid regular inspection of the contacts and the arc chute, the contact wear estimate helps with the planning of visual inspections based on the estimated wear (from 0% - new contact - to 100% - totally worn contact).

Operating Principle

The contact wear increases every time the circuit breaker interrupts the circuit with or without current.

When the MicroLogic X control unit contact wear algorithm calculates a value which is above one of the predefined thresholds (60%, 95%, and 100%) an event is generated with an orange or red pop-up screen and corresponding event message.

Contact Wear Interpretation

Consult contact wear interpretation on EcoStruxure Power Device app in order to estimate the ability of the circuit breaker to isolate, carry rated current, operate, and trip:

- **Isolate:** Capability of the circuit breaker, once opened or tripped, to separate and isolate the circuit or a device from the rest of the electrical installation during maintenance or repair.
- **Carry rated current:** Capability of a circuit breaker to continuously carry its rated current without thermal runaway. It is recommended to limit the current load to 80% of its rated current to avoid accelerated aging of the circuit breaker.
- **Operate and trip on overload:** Capability of the circuit breaker to operate in normal or overload conditions. In overload conditions, the higher the overload current, the lower the number of remaining operations. Overloads occur on a healthy electrical circuit (for example, motor starting, or too many devices operating at the same time on a circuit).
- **Trip on short circuit:** Capability of the circuit breaker to operate in milliseconds to limit the consequences and/or the damage that may occur on the installation due to the thermal and electrodynamic effects of a short circuit between live conductors or between live conductors and earth.

Data Availability

Contact wear monitoring data is available as follows:

- On the MicroLogic X display screen at **Home > Maintenance > Health > Contact wear**
- With EcoStruxure Power Commission software
- With the EcoStruxure Power Device app through Bluetooth or USB OTG connection
- On the FDM128 display
- On a remote controller using the communication network

Predefined Events

The function generates the following events:

Code	Event	History	Severity
0x1440 (5184)	Contact wear is above 60%. Check contacts	Diagnostic	Medium
0x1441 (5185)	Contact wear is above 95%. Plan for replacement	Diagnostic	Medium
0x1442 (5186)	Contacts 100% worn out. CB needs to be replaced	Diagnostic	High

Recommended Actions

Code	Event	Recommended actions
0x1440 (5184)	Contact wear is above 60%. Check contacts	Inspect visually the arc chute and main contacts at the next scheduled maintenance.
0x1441 (5185)	Contact wear is above 95%. Plan for replacement	Plan to replace the circuit breaker. Consult contact wear interpretation on EcoStruxure Power Device app in order to estimate the circuit breaker ability to isolate, withstand rated duty, operate, trip.
0x1442 (5186)	Contacts 100% worn out. CB needs to be replaced	Replace the circuit breaker. Consult contact wear interpretation on EcoStruxure Power Device app in order to estimate the circuit breaker ability to isolate, withstand rated duty, operate, trip.

Contact your field service representative for more information about who can carry out the recommended actions.

Monitoring the Load Profile

Presentation

Four load profile counters report the number of hours during which the MicroLogic X control unit has measured current flowing through the circuit breaker, in the following I_n ratio ranges:

- Number of hours with current measured between 0 and 49% of the rated current I_n
- Number of hours with current measured between 50 and 79% of the rated current I_n
- Number of hours with current measured between 80 and 89% of the rated current I_n
- Number of hours with current measured at 90% of the rated current I_n or above

Data Availability

Load profile monitoring data is available as follows:

- With EcoStruxure Power Commission software
- With the EcoStruxure Power Device app through Bluetooth or USB OTG connection
- On the FDM128 display
- On a remote controller using the communication network.

Monitoring the Operating Time

Presentation

Two operating times are measured by the MicroLogic X control unit:

- Operating time with load: total time since energization of the control unit with current flowing through the circuit breaker.
- Operating time: total time when control unit is powered on by:
 - Current flowing through the circuit breaker
 - External 24 Vdc power supply
 - External power source connected through mini USB port on the front face of the MicroLogic X control unit

Data Availability

Data is available on a remote controller using the communication network.

Circuit Breaker Overview

Presentation

The circuit breaker overview function displays a description of the circuit breaker block, including:

- Circuit breaker range
- Device size
- Rated current
- Performance level
- Power system
- Standard

Data Availability

The circuit breaker overview data is available as follows:

- On the MicroLogic X display screen at **Home > Maintenance > CB overview**
- WithEcoStruxure Power Commission software
- On a remote controller using the communication network

Optional Maintenance and Diagnostic Functions

What's in This Chapter

Power Restoration Assistant Digital Module	263
MasterPact Operation Assistant Digital Module	265
Waveform Capture on Trip Event Digital Module	267
IEC 61850 for MasterPact MTZ	270
Modbus Legacy Dataset Digital Module	272

Power Restoration Assistant Digital Module

Presentation

The Power Restoration Assistant Digital Module extends and enhances the functions of the EcoStruxure Power Device app.

The Power Restoration Assistant Digital Module provides the maintenance operator with the following assistance on the power restoration procedure:

- Displays information about events and circuit breaker status.
- Assists in determining the cause of events such as an opening, a trip, or a loss of power supply.
- Provides guidance for potential solutions to restore the power supply.

The Power Restoration Assistant Digital Module helps to reduce the downtime of the power supply at critical load (mean time to repair (MTTR) after a trip, an opening, or a loss of upstream power supply).

DANGER

HAZARD OF ELECTRIC SHOCK, EXPLOSION, OR ARC FLASH

- Do not operate the circuit breaker without confirming that doing so will not create a hazardous situation.
- Do not allow any person to work on the electrical network without physically validating the successful execution of the local or remote software actions for opening the circuit breaker or switching off the electrical circuit.
- Do not allow any person to work on the electrical network without physically validating the successful execution of the local or remote software actions for closing the circuit breaker or switching on the electrical circuit.

Failure to follow these instructions will result in death or serious injury.

WARNING

HAZARD OF CLOSING ON ELECTRICAL FAULT

Do not close the circuit breaker again without first inspecting and, if necessary, repairing the downstream electrical equipment.

Failure to follow these instructions can result in death, serious injury, or equipment damage.

Prerequisites

The Power Restoration Assistant Digital Module is an optional Digital Module, which can be purchased and installed on a MicroLogic X control unit, page 34.

The prerequisites are:

- The EcoStruxure Power Device app must be installed on a smartphone
- The smartphone must be connected to the MicroLogic X control unit through:
 - Bluetooth: the control unit must be powered
 - NFC: the control unit does not need to be powered
 - USB OTG: the control unit does not need to be powered
- The MicroLogic X date and time must be up to date

The Power Restoration Assistant Digital Module is compatible with:

- MicroLogic 2.0 X, 5.0 X, 6.0 X, and 7.0 X control units for IEC standard
- MicroLogic 3.0 X, 5.0 X, and 6.0 X control units for UL standard
- MicroLogic X control units with firmware version greater than or equal to 001.000.000.

- IFE/EIFE interface with firmware version greater than or equal to 003.006.000
- IFM interface with firmware version greater than or equal to 003.000.000

Availability of Assistance

Availability of features differs depending on the type of connection to the Digital Module:

- Through Bluetooth or USB OTG connection: all features are available
- Through NFC (connection can be made when control unit is not powered): basic circuit breaker information is provided. It also provides step by step assistance by asking the user to provide circuit breaker status and giving guidance for power restoration.

Examples of Screens

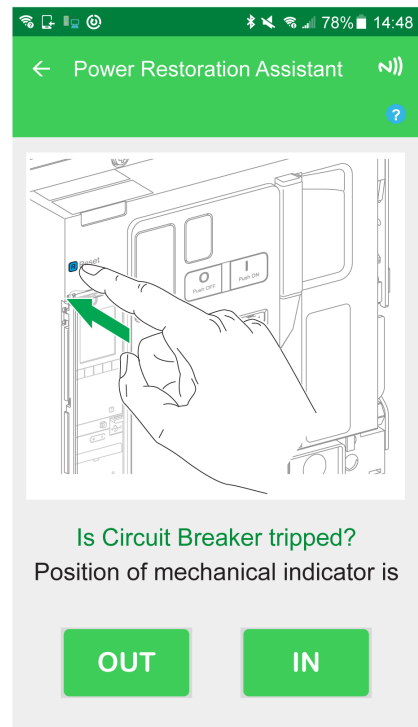
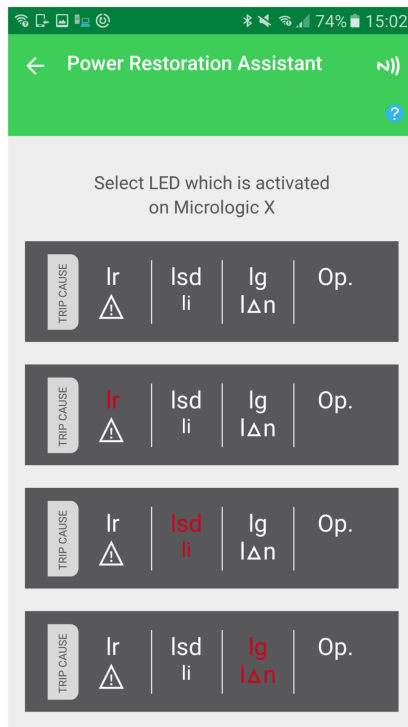

MasterPact Operation Assistant Digital Module

Presentation

The MasterPact Operation Assistant Digital Module extends and enhances the functions of the EcoStruxure Power Device app.

The MasterPact Operation Assistant Digital Module assists the operator in operating the circuit breaker by delivering instructions to carry out actions.

It displays circuit breaker status, such as:

- Ready-to-close status
- Spring status
- Voltage release status (with communicating and diagnostic voltage releases)

By using the communicating and diagnostic voltage releases, it allows the circuit breaker to be opened or closed from a distance of a few meters.

DANGER

HAZARD OF ELECTRIC SHOCK, EXPLOSION, OR ARC FLASH

- Do not operate the circuit breaker without confirming that doing so will not create a hazardous situation.
- Do not allow any person to work on the electrical network without physically validating the successful execution of the local or remote software actions for opening the circuit breaker or switching off the electrical circuit.
- Do not allow any person to work on the electrical network without physically validating the successful execution of the local or remote software actions for closing the circuit breaker or switching on the electrical circuit.

Failure to follow these instructions will result in death or serious injury.

WARNING

HAZARD OF CLOSING ON ELECTRICAL FAULT

Do not close the circuit breaker again without first inspecting and, if necessary, repairing the downstream electrical equipment.

Failure to follow these instructions can result in death, serious injury, or equipment damage.

Prerequisites

The MasterPact Operation Assistant Digital Module is an optional Digital Module, which can be purchased and installed on a MicroLogic X control unit, page 34.

The prerequisites are:

- The EcoStruxure Power Device app must be installed on a smartphone.
- The smartphone must be connected to the MicroLogic X control unit through:
 - Bluetooth: the control unit must be powered.
 - NFC: the control unit does not need to be powered.
 - USB OTG: the control unit can be powered by the smartphone.
- The MicroLogic X date and time must be up to date.
- Diagnostic and communicating voltage releases (MX, MN, XF) must be installed in the MasterPact MTZ circuit breaker.

The MasterPact Operation Assistant Digital Module is compatible with:

- MicroLogic 2.0 X, 5.0 X, 6.0 X, and 7.0 X control units for IEC standard
- MicroLogic 3.0 X, 5.0 X, and 6.0 X control units for UL standard
- MicroLogic X control units with firmware version greater than or equal to 001.000.000.
- IFE/EIFE interface with firmware version greater than or equal to 003.006.000
- IFM interface with firmware version greater than or equal to 003.000.000

Availability of Assistance

Availability of features differs depending on the type of connection to the Digital Module:

- Through Bluetooth, USB OTG, and the diagnostic and communicating voltage releases: all features are available.
- Through NFC (connection can be made when control unit is not powered): basic circuit breaker information and the context of the last trip are provided. It also provides step by step assistance by asking the user to provide circuit breaker status and giving guidance for manual operation of the circuit breaker.

Examples of Screens

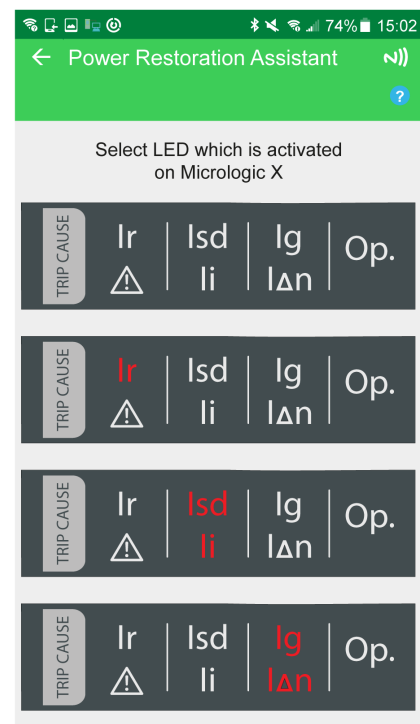
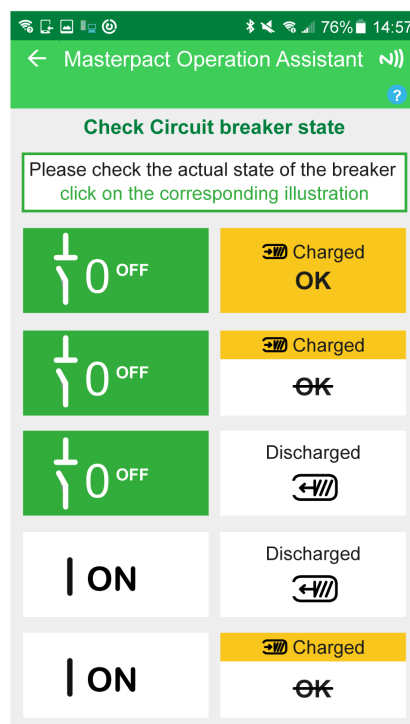

Waveform Capture on Trip Event Digital Module

Presentation

The Waveform capture on trip event Digital Module provides both short waveform capture and long waveform capture.

Short Waveform Capture

The short waveform capture function records five cycles of phase currents and neutral currents after a trip on all standard protection functions and optional protection functions. The sampling period is 512 μ s. The short waveform capture function records four cycles before and one after the trip event.

The short waveform capture function records the digital status of the following:

- TRIP event: activation of the circuit breaker tripping voltage release (MITOP)
- SDE: fault-trip indication contact
- OPEN: open position of circuit breaker
- ZSI-out and ZSI-in: ZSI signals

Only one short waveform capture on trip event is available at a time. Generating a new short waveform capture replaces the previous one.

At delivery, no short waveform capture is available. A short waveform capture on trip event is available after the circuit breaker has tripped due to any standard or optional protection function. Trips due to tests that are run with EcoStruxure Power Commission software are not recorded.

The short waveform capture is stored in non-volatile memory without requiring an external 24 Vdc power supply.

The short waveform capture is a COMTRADE (Common Format for Transient Data Exchange) file. Refer to the IEEE C37.111 or IEC 60255-24 standard for more information about the COMTRADE file format.

Long Waveform Capture

The long waveform capture function records 50 cycles of phase currents, neutral currents, and phase-to-neutral voltage after a trip due to any standard protection function or optional protection function. The sampling period is 625 μ s. The long waveform capture function records 35 cycles before and 15 cycles after the trip event.

The long waveform capture function records the digital status of the OPERATE event when the associated time delay elapses.

Three long waveform captures on trip events are available at a time. Generating a new long waveform capture replaces the oldest one.

At delivery, no long waveform capture is available. A long waveform capture on trip event is available after the circuit breaker has tripped due to any standard or optional protection function. Trips due to tests that are run with EcoStruxure Power Commission software are not recorded.

The long waveform capture function requires an external 24 Vdc power supply to store the waveform capture in non-volatile memory.

The long waveform capture is a COMTRADE (Common Format for Transient Data Exchange) file. Refer to the IEEE C37.111 or IEC 60255-24 standard for more information about the COMTRADE file format.

Prerequisites

The Waveform capture on trip event Digital Module is an optional Digital Module, which can be purchased and installed on a MicroLogic X control unit, page 34.

The prerequisites are:

- The EcoStruxure Power Device app must be installed on a smartphone.
- The smartphone must be connected to the MicroLogic X control unit through Bluetooth, or USB OTG.
- The MicroLogic X date and time must be up to date.

The Waveform capture on trip event Digital Module is compatible with:

- MicroLogic 2.0 X, 5.0 X, 6.0 X, and 7.0 X control units for IEC standard
- MicroLogic 3.0 X, 5.0 X, and 6.0 X control units for UL standard
- Short waveform capture is available with MicroLogic X control units with firmware version greater than or equal to 001.000.000.
- Long waveform capture is available with MicroLogic X control units with firmware version greater than or equal to 002.000.000.

Data from the Digital Module is available remotely through IFE/EIFE or IFM communication interfaces, if the IFE/EIFE or IFM firmware version is compatible with the Digital Module. For more information, refer to *firmware compatibility* of the communication interfaces, page 31.

Data Availability

The waveform capture is displayed in the following ways:

- On the EcoStruxure Power Device app through Bluetooth, or USB OTG
- In EcoStruxure Power Commission software

The waveform capture can be exported as a file in COMTRADE format through the EcoStruxure Power Device app or the EcoStruxure Power Commission software, for use with Schneider Electric Wavewin-SE software.

The file names for waveform captures have the following formats:

- Short waveform capture: wfctxxx_MM_DD_YYYY_HH_MM_SS
- Long waveform capture: long_wfctxxx_MM_DD_YYYY_HH_MM_SS

Examples of Screens

The following screens give examples of the type of information available on the EcoStruxure Power Device app thanks to the Waveform capture on trip event Digital Module:

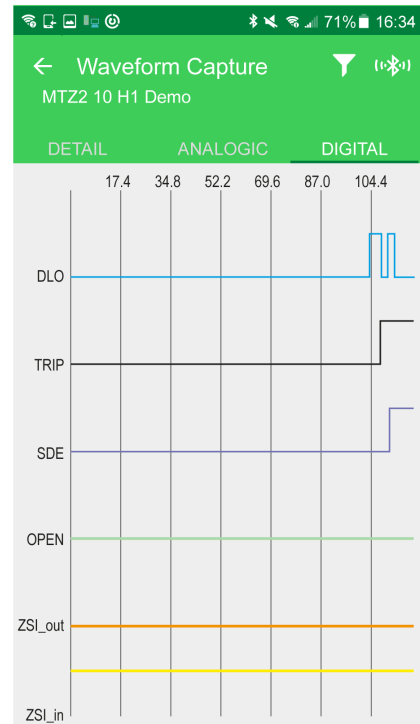
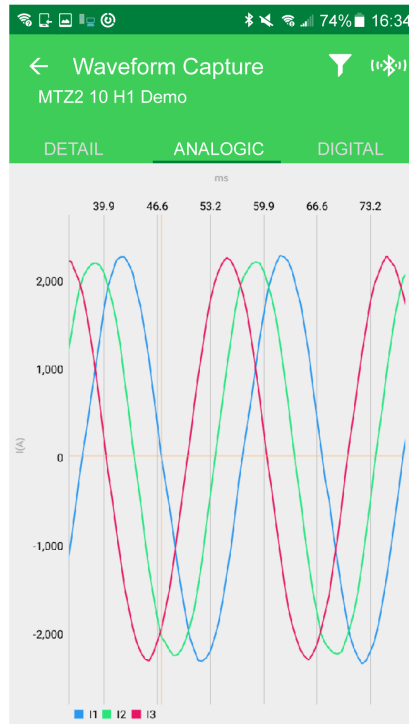

IEC 61850 for MasterPact MTZ

Presentation

IEC 61850 is a standard for communication networks and systems in substations. Based on Ethernet protocol, it is a standardized method of communication, developed to support integrated systems composed of multi-vendor, self-describing IEDs (Intelligent Electronic Devices) that are networked together to perform real-time protection, control, measurement, and monitoring functions. IEC 61850 is widely used in critical applications, for example, oil and gas, or data centers.

The IEC 61850 for MasterPact MTZ Digital Module provides the following MasterPact MTZ circuit breaker data over an Ethernet network in conformance with IEC 61850 MMS (Manufacturing Message Specification) communication protocol:

- Class 1 energy metering
- Electrical measurements
- Status
- Control

The IEC 61850 MMS communication protocol helps to integrate low voltage circuit breakers in medium voltage installations without the need for an additional gateway.

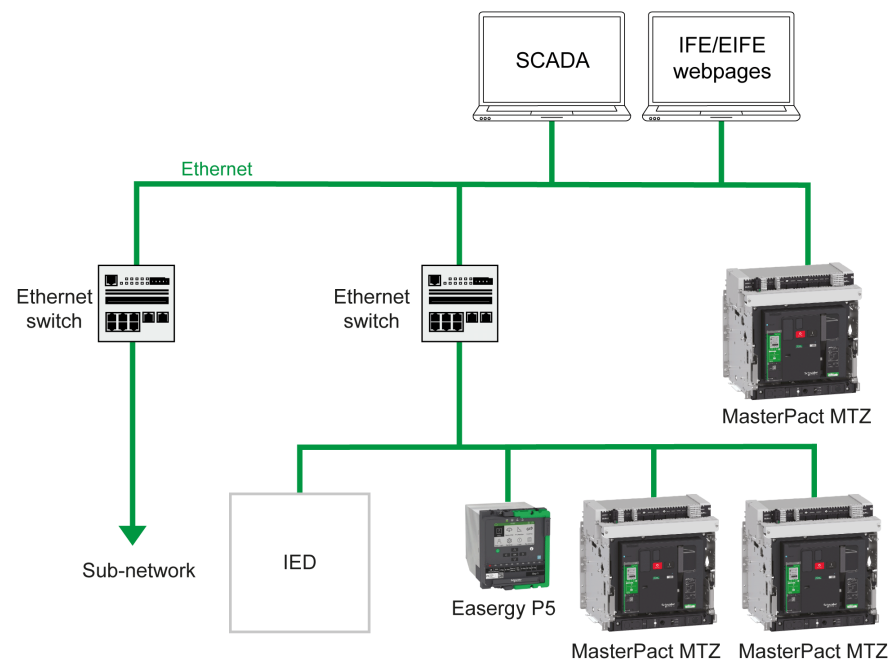

For more information, refer to DOCA0162EN *MasterPact MTZ - IEC 61850 Communication Guide*.

Prerequisites

The IEC 61850 for MasterPact MTZ Digital Module is an optional Digital Module, which can be purchased and installed on a MicroLogic X control unit, page 34.

The IEC 61850 for MasterPact MTZ Digital Module is compatible with:

- MicroLogic 2.0 X, 5.0 X, 6.0 X, and 7.0 X control units for IEC standard
- MicroLogic 3.0 X, 5.0 X, and 6.0 X control units for UL standard
- MicroLogic X control units with firmware version greater than or equal to 004.000.000. Earlier firmware versions need to be updated, page 46.

MasterPact MTZ IED Definition

The MasterPact MTZ IED (Intelligent Electronic Device) is composed of:

- One MasterPact MTZ1, MTZ2, or MTZ3 circuit breaker
- One MicroLogic X control unit with IEC 61850 for MasterPact MTZ Digital Module installed
- One IFE or EIFE Ethernet interface
- One or two IO modules (optional)

Data Availability

Data through IEC 61850 communication is available on a remote controller through the following communication interfaces:

- IFE Ethernet interface
- EIFE Ethernet interface

The following table indicates the minimum version of the communication interface firmware required for the Digital Module to function:

Communication Interface	Part number	Minimum firmware version required
IFE Ethernet interface	LV434001	004.000.000
EIFE Ethernet interface	–	004.000.000

Characteristics

The IEC 61850 for MasterPact MTZ Digital Module supports IEC 61850 Edition 2 standard and provides the following logical nodes:

Logical node	Description
CSWI	Switch controller. Used to control circuit breakers.
GGIO	Generic process IO module. For information on how to configure the inputs and outputs of the IO module, refer to <i>DOCA0055EN Enerlin'X IO - Input/Output Application Module for One Circuit Breaker - User Guide</i> .
LLNO	Logical node zero. Contains the data related to the associated IED (Intelligent Electronic Device).
LPHD	Physical device. Contains information related to the physical device.
MHAI	Harmonics. Consists of harmonic values such as THD.
MMTR	Metering. Consists of the integrated values (energy), primarily for billing purposes.
MMXU	Measurements. Contains per-phase and total current, voltage, and power flow for operational purposes.
PTOC	Time overcurrent protection.
PIOC	Instantaneous overcurrent protection.
PTOV	Overvoltage protection.
PTUV	Undervoltage protection.
PDOP	Reverse power protection.
PTRC	Protection trip conditioning.
XCBR	Circuit Breaker. Indicates the status of the circuit breaker.

Modbus Legacy Dataset Digital Module

Presentation

The Modbus legacy dataset Digital Module provides a dataset for MasterPact MTZ circuit breakers compliant with legacy formats.

The Modbus legacy dataset Digital Module converts data from the standard format registers starting at 32000 to the legacy format registers starting at 12000.

NOTE: The standard dataset remains available after the conversion.

The Modbus legacy dataset Digital Module collects the following information:

- Circuit breaker status
- Tripping causes
- Real time values for currents, voltages, power and energy.

For more information, refer to DOCA0105EN *MasterPact MTZ - Modbus Communication Guide*.

Prerequisites

The Modbus legacy dataset Digital Module is an optional Digital Module, which can be purchased and installed on a MicroLogic X control unit, page 34.

The Modbus legacy dataset is compatible with:

- MicroLogic 2.0 X, 5.0 X, 6.0 X, and 7.0 X control units for IEC standard
- MicroLogic 3.0 X, 5.0 X, and 6.0 X control units for UL standard
- MicroLogic X control units with firmware version greater than or equal to 002.000.000. Earlier firmware versions need to be updated, page 46.

Data Availability

The Modbus legacy dataset is available on a remote controller using the communication network through the following communication interfaces:

- IFE Ethernet interface
- EIFE Ethernet interface
- IFE server
- IFM Modbus-SL interface

The following table indicates the minimum firmware version of the communication interfaces required for the Digital Module to function:

Communication Interface	Part number	Minimum firmware version required
IFE Ethernet interface	LV434010	003.007.000
	LV434001	003.007.000
EIFE Ethernet interface	–	003.007.000
IFE server	LV434002	003.007.000
	LV434011	003.007.000
IFM Modbus-SL interface	LV434000	003.001.000

Operation Functions

What's in This Part

Control Modes 274
Opening Function 279
Closing Function 283

Control Modes

Presentation

The circuit breaker control mode is a MicroLogic X setting which defines the means to control the opening and closing functions of the circuit breaker.

Two control modes are available: Manual and Auto.

Manual control mode only accepts orders made using one of the following:

- The mechanical buttons on the front of the circuit breaker.
- The external pushbutton connected to the MN/MX/XF voltage releases.
- The BPF E electrical closing pushbutton.

Auto control mode has two settings: Local or Remote. All orders accepted in Manual control mode are accepted in Auto control mode, as well as orders from local or remote communication as follows:

- Auto Local: the operator needs to be close to the circuit breaker to establish communication and only orders sent from a local source through communication are accepted:
 - EcoStruxure Power Commission software through USB connection
 - EcoStruxure Power Device app with MasterPact Operation Assistant Digital Module through Bluetooth or USB OTG connection
- Auto Remote: the operator does not need to be next to the circuit breaker to establish communication and orders are accepted only when sent from a remote source through the communication network.

NOTE: EcoStruxure Power Commission software connected through the communication network can be used to send control orders to the circuit breaker.

The control mode factory setting is Auto Remote.

NOTE: The switch-disconnector control mode corresponds to the Manual control mode of circuit breakers. To operate a switch-disconnector through communication, it is possible to use an IO module. Refer to DOCA0055EN *Enerlin X IO - Input/Output Application Module for One IEC Circuit Breaker - User Guide*.

Operation According to Control Mode Configured

The following table summarizes the opening and closing operations available, depending on the control mode configured:

Control mode	Type of order and delivery method							
	Mechanical	Electrical		Through communication				
	Pushbutton	BPF E	Point to point (voltage release)	IO module	EcoStruxure Power Commission software ⁽¹⁾	EcoStruxure Power Device app + MasterPact Operation Assistant Digital Module ⁽²⁾	Communi-cation network	IFE/EIFE Webpages
Manual	✓	✓	✓	–	–	–	–	–
Auto: Local	✓	✓	✓	✓ ⁽³⁾	✓	✓	–	–
Auto: Remote	✓	✓	✓	✓ ⁽³⁾	–	–	✓	✓

(1) Through USB
 (2) Through Bluetooth or USB OTG
 (3) According to IO input mode setting

Operation in Manual Control Mode

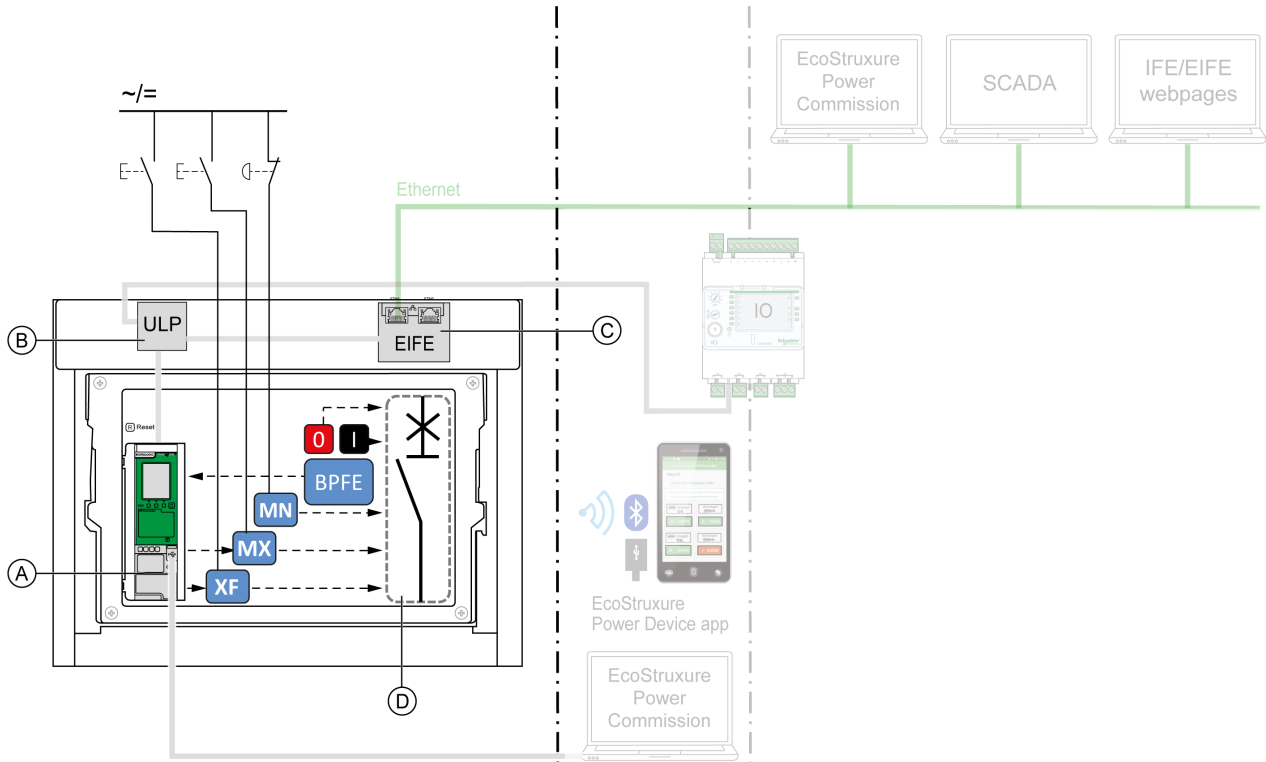

- A** MicroLogic X control unit
- B** ULP port module
- C** EIFE embedded Ethernet interface
- D** Circuit breaker mechanism

Opening and closing operations available in Manual control mode:

- 0: mechanical opening pushbutton
- 1: mechanical closing pushbutton
- BPFE: electrical closing pushbutton
- External pushbuttons wired by customer, and connected to:
 - XF: standard or communicating and diagnostic closing voltage release
 - MX: standard or communicating and diagnostic opening voltage release
 - MN: standard or diagnostic undervoltage release

Operation in Auto: Local Mode

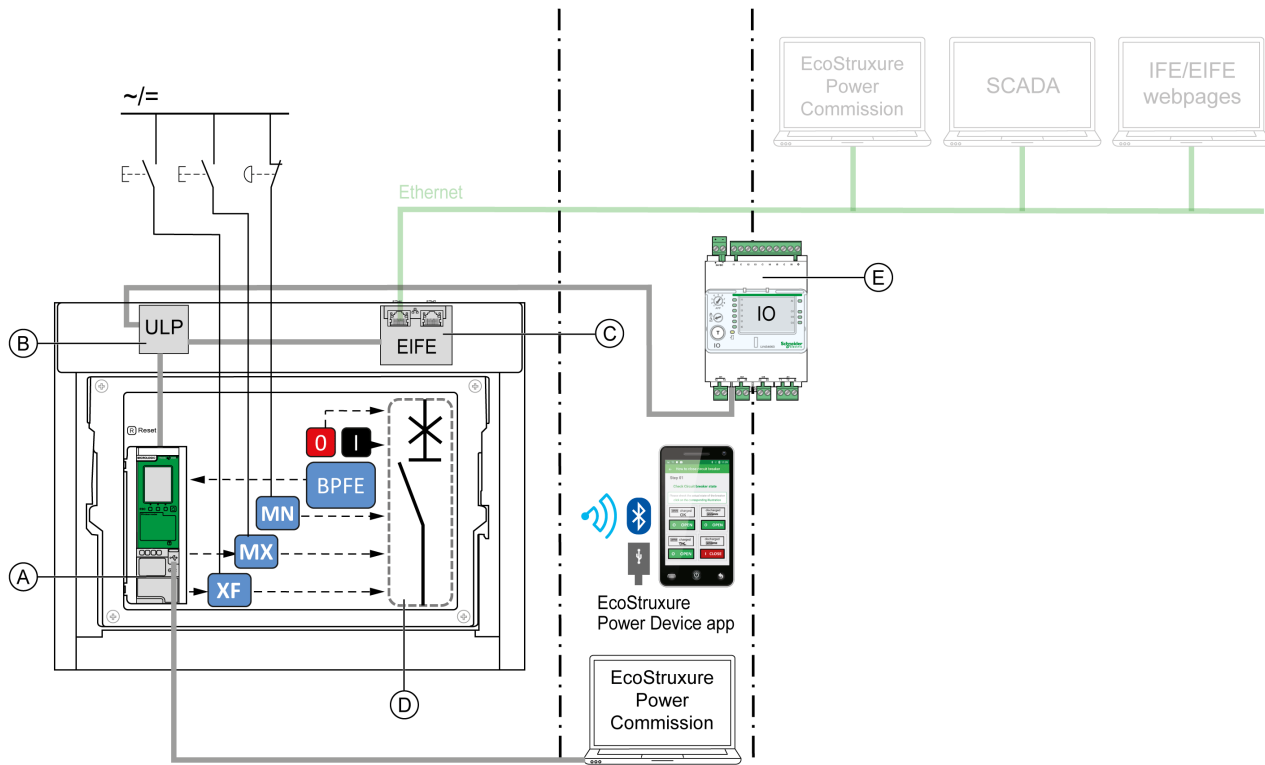

- A** MicroLogic X control unit
- B** ULP port module
- C** EIFE embedded Ethernet interface
- D** Circuit breaker mechanism
- E** IO input/output application module

Opening and closing operations available in Auto: Local mode:

- 0: mechanical opening pushbutton
- 1: mechanical closing pushbutton
- BPF: electrical closing pushbutton
- External pushbuttons wired by customer, and connected to:
 - XF: communicating and diagnostic closing voltage release
 - MX: communicating and diagnostic opening voltage release
 - MN: standard or diagnostic undervoltage release
- IO: with the Breaker Operation predefined application of the IO module set to local control mode
- EcoStruxure Power Commission software: command sent through USB connection
- EcoStruxure Power Device app with MasterPact Operation Assistant Digital Module:
 - Through Bluetooth low energy wireless communication
 - Through USB OTG connection

Operation in Auto: Remote Mode

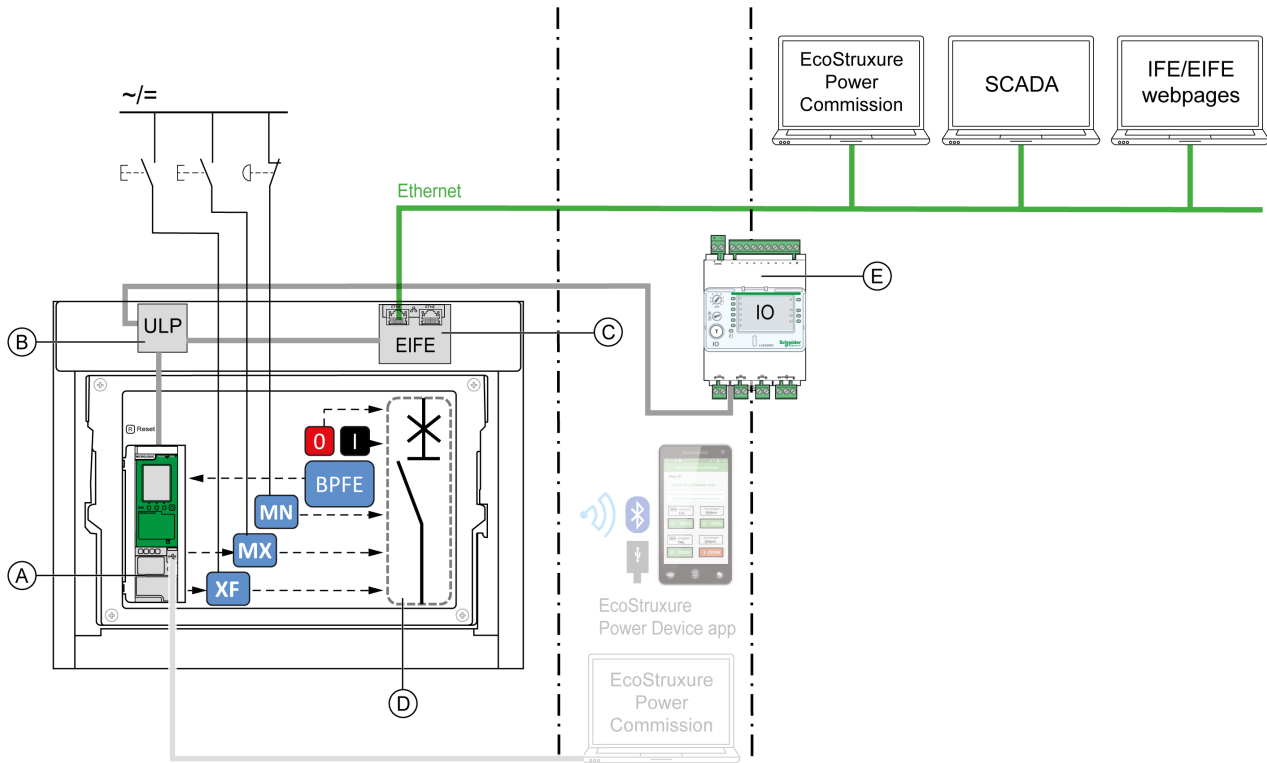

- A** MicroLogic X control unit
- B** ULP port module
- C** EIFE embedded Ethernet interface
- D** Circuit breaker mechanism
- E** IO input/output application module

Opening and closing operations available in Auto: Remote mode:

- 0: mechanical opening pushbutton
- 1: mechanical closing pushbutton
- BPFE: electrical closing pushbutton
- External pushbuttons wired by customer, and connected to:
 - XF: communicating and diagnostic closing voltage release
 - MX: communicating and diagnostic opening voltage release
 - MN: standard or diagnostic undervoltage release
- IO: with the Breaker Operation predefined application of the IO module set to remote control mode
- Communication: remote command through IFE, EIFE, or IFM interface.

Setting the Control Mode

The Auto or Manual control mode can be set as follows:

- On the MicroLogic X display screen, at **Home > Configuration > Communication > Control Mode > Mode**.
- With the EcoStruxure Power Device app through Bluetooth or USB OTG connection.

The Local or Remote mode can be set as follows:

- When the IO module is used with the Breaker Operation predefined application, the local or remote mode is defined only by the control mode selector switch wired on the digital input I1 of the IO module.
- When the IO module is not used with the Breaker Operation predefined application, the local or remote mode can be set as follows:
 - With EcoStruxure Power Commission software through USB connection
 - With the EcoStruxure Power Device app through Bluetooth or USB OTG connection.

NOTE:

- The Local or Remote mode cannot be set on the MicroLogic X display screen.
- When Auto control mode is set, the control mode is Auto Local or Auto Remote, depending on the last setting.

Displaying the Control Mode

The control mode (Manual, Auto Local, or Auto Remote) is displayed as follows:

- On the MicroLogic X display screen, at **Home > Configuration > Communication > Control Mode > Mode**
- With EcoStruxure Power Commission software through USB connection
- With the EcoStruxure Power Device app through Bluetooth or USB OTG connection
- On the IFE/EIFE webpages
- By a remote controller using the communication network.

Predefined Events

Changing the control mode settings generates the following events:

Code	Event	History	Severity
0x1002 (4098)	Manual mode enabled	Operation	Low
0x1004 (4100)	Local mode enabled	Operation	Low
0x0D0D (3341)	Config. error IO and CU - Local/Remote mode	Configuration	Medium

Recommended Actions

Code	Event	Recommended actions
0x0D0D (3341)	Config. error IO and CU - Local/Remote mode	Correct the configuration error with EcoStruxure Power Commission: <ul style="list-style-type: none"> • If you want the L/R mode to be controlled by the IO module, connect an IO module with L/R mode assignment. • If you do not want the L/R mode to be controlled by the IO module, connect an IO module without L/R mode assignment.

Opening Function

Presentation

MicroLogic X control units receive and process electrical opening orders. An event is generated on opening.

Operating Principle

Opening orders can be sent as follows:

- Directly through a mechanical opening pushbutton.
- Locally through an external opening pushbutton.
- Remotely through a remote order which is managed by the MicroLogic X control unit.

Opening orders have priority over closing orders. No closing orders are taken into account as long as an open order is active.

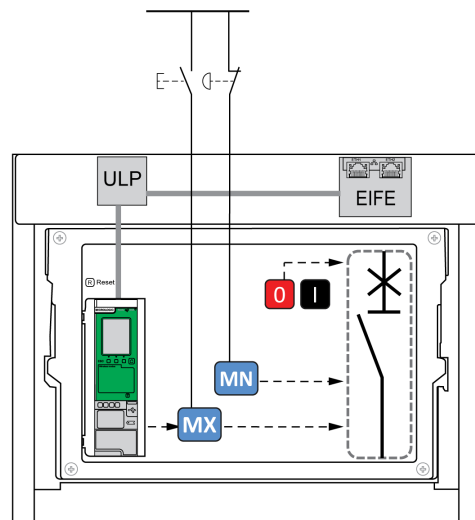

The open orders on MN or MX voltage releases by external pushbutton can be maintained to force the circuit breaker in open position and reject any close order. The MicroLogic X open orders are not maintained.

Management of Opening Function

DANGER

HAZARD OF ELECTRIC SHOCK, EXPLOSION, OR ARC FLASH

- Do not operate the circuit breaker without confirming that doing so will not create a hazardous situation.
- Do not allow any person to work on the electrical network without physically validating the successful execution of the local or remote software actions for opening the circuit breaker or switching off the electrical circuit.

Failure to follow these instructions will result in death or serious injury.

The MicroLogic X control unit manages opening orders issued by the following means:

- IO module with the Breaker Operation predefined application. Refer to *Enerlin'X IO - Input/Output Application Module for One Circuit Breaker - User Guide*, page 10.
- EcoStruxure Power Commission software.
- EcoStruxure Power Device app through Bluetooth or USB OTG with MasterPact Operation Assistant Digital Module installed and activated.
- Remote controller connected to the communication network:
 - For communication through Modbus protocol, refer to DOCA0105EN *MasterPact MTZ - Modbus Communication Guide*
 - For communication through IEC 61850 communication standard, refer to DOCA0162EN *MasterPact MTZ - IEC 61850 Communication Guide*
- IFE/EIFE webpages. Refer to the relevant document, page 10:
 - *Enerlin'X EIFE - Embedded Ethernet Interface for One MasterPact MTZ Drawout Circuit Breaker - User Guide*
 - *Enerlin'X IFE - Ethernet Interface for One IEC Circuit Breaker - User Guide*
 - *Enerlin'X IFE - Ethernet Switchboard Server - User Guide*
- FDM128 display through IFE or EIFE interface. Refer to DOCA0037EN *Enerlin'X FDM128 - Ethernet Display for Eight Devices - User Guide*.

The opening function is monitored by the MicroLogic X control unit, page 254.

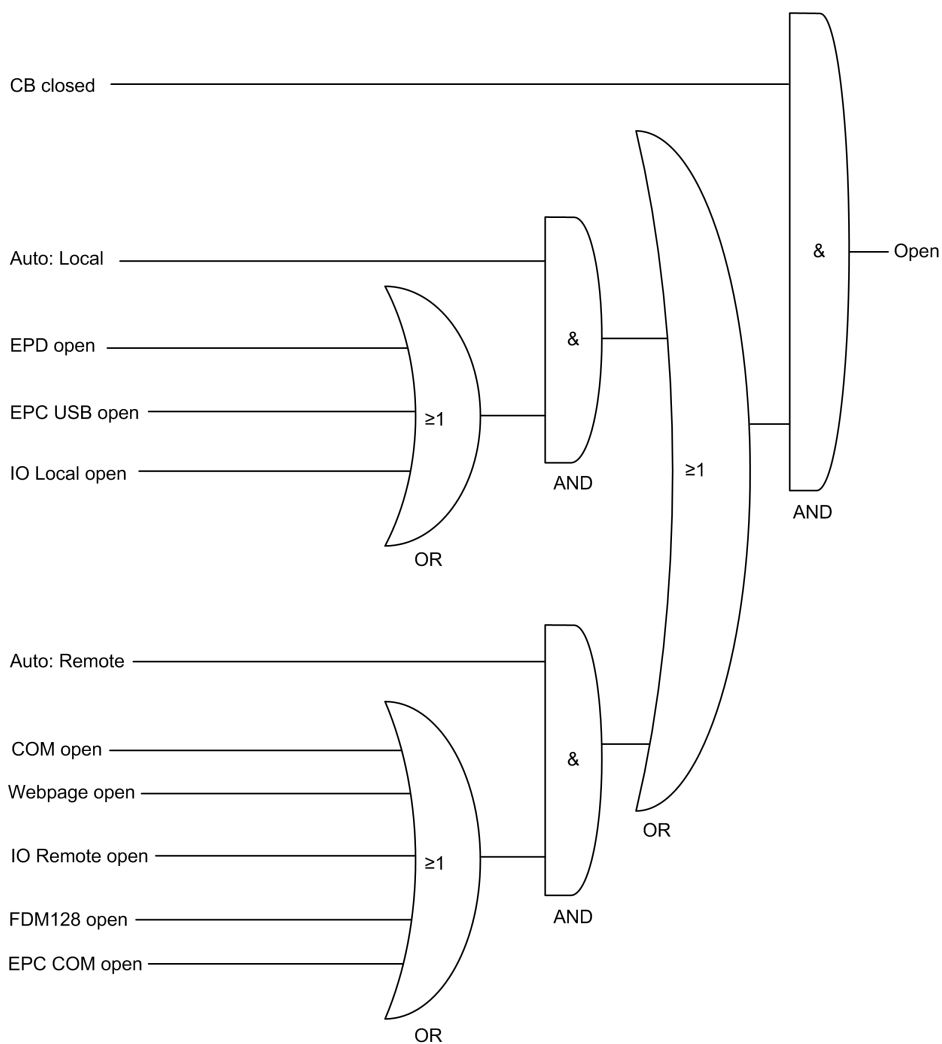

CB closed	Circuit breaker is closed
Auto: Local	Control mode is Auto Local
EPD open	Open order from EcoStruxure Power Device app with MasterPact Operation Assistant Digital Module
EPC USB open	Open order from EcoStruxure Power Commission software connected to the mini USB port on control unit
IO local open	Local open order from IO module with the Breaker Operation predefined application (I5)
Auto: Remote	Control mode is Auto Remote
COM open	Open order from a remote controller
Webpage open	Open order from IFE/EIFE webpage
IO remote open	Remote open order from IO module with the Breaker Operation predefined application (I2)
FDM128 open	Open order from FDM128 display
EPC COM open	Open order from EcoStruxure Power Commission software through the communication network
Open	MicroLogic X open order to the MX communicating opening voltage release

Predefined Events

The function generates the following predefined events:

Code	Event	History	Severity
0x1000 (4096)	Circuit breaker opened	Operation	Low
0x0410 (1040)	Opening order sent to MX voltage release	Operation	Low
0x111F (4383)	Allow control by digital input is disabled	Operation	Low

Closing Function

Presentation

MicroLogic X control units receive and process electrical closing orders. An event is generated on closure.

Operating Principle

Closing orders can be sent as follows:

- Directly through a mechanical closing pushbutton.
- Locally through an external closing pushbutton.
- Remotely through a remote order which is managed by the MicroLogic X control unit.

Opening orders have priority over closing orders. No closing orders are taken into account as long as an open order is active.

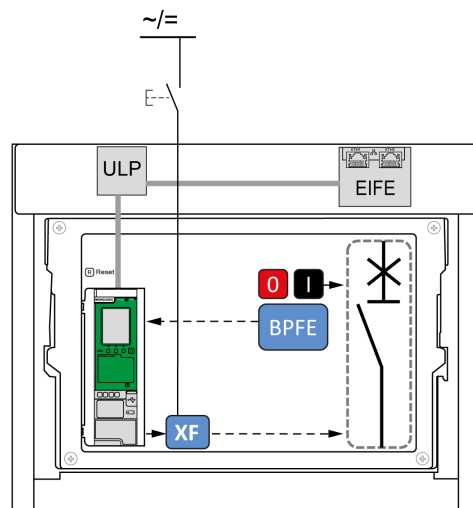

NOTE: The BPFE electrical closing pushbutton can be connected to MicroLogic X control unit, as shown in the preceding diagram. In this case the control unit manages the closing function and the closing orders from the BPFE. The BPFE closing order is available in both Manual and Auto control modes.

Alternatively, the BPFE electrical closing pushbutton can be connected to the XF communicating closing voltage release, as shown in the following diagram. In this case the MicroLogic X control unit does not manage the closing function and only closing orders in Manual mode are valid.

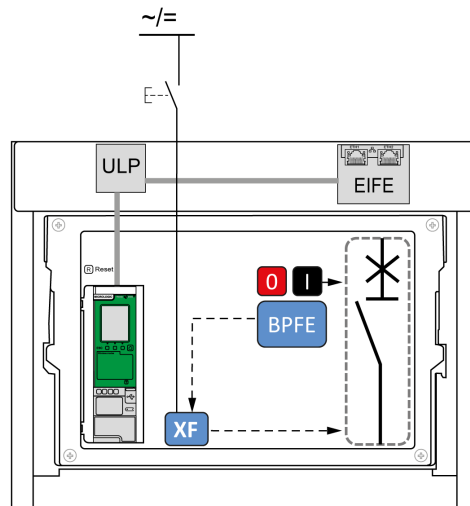

Management of Closing Function

⚠️ DANGER

HAZARD OF ELECTRIC SHOCK, EXPLOSION, OR ARC FLASH

- Do not operate the circuit breaker without confirming that doing so will not create a hazardous situation.
- Do not allow any person to work on the electrical network without physically validating the successful execution of the local or remote software actions for closing the circuit breaker or switching on the electrical circuit.

Failure to follow these instructions will result in death or serious injury.

⚠️ WARNING

HAZARD OF CLOSING ON ELECTRICAL FAULT

Do not close the circuit breaker again without first inspecting and, if necessary, repairing the downstream electrical equipment.

Failure to follow these instructions can result in death, serious injury, or equipment damage.

The MicroLogic X control unit manages closing orders issued by the following means:

- BPFE connected to MicroLogic X control unit.
- IO module with the Breaker Operation predefined application. Refer to *Enerlin'X IO - Input/Output Application Module for One Circuit Breaker - User Guide*, page 10.
- EcoStruxure Power Commission software.
- EcoStruxure Power Device app through Bluetooth or USB OTG with MasterPact Operation Assistant Digital Module installed and activated.
- Remote controller connected to the communication network:
 - For communication through Modbus protocol, refer to DOCA0105EN *MasterPact MTZ - Modbus Communication Guide*
 - For communication through IEC 61850 communication standard, refer to DOCA0162EN *MasterPact MTZ - IEC 61850 Communication Guide*
- IFE/EIFE webpages. Refer to the relevant document, page 10:
 - *Enerlin'X EIFE - Embedded Ethernet Interface for One MasterPact MTZ Drawout Circuit Breaker - User Guide*
 - *Enerlin'X IFE - Ethernet Interface for One IEC Circuit Breaker - User Guide*
 - *Enerlin'X IFE - Ethernet Switchboard Server - User Guide*
- FDM128 display through IFE or EIFE interface. Refer to DOCA0037EN *Enerlin'X FDM128 - Ethernet Display for Eight Devices - User Guide*.

The closing function is monitored by the MicroLogic X control unit, page 254.

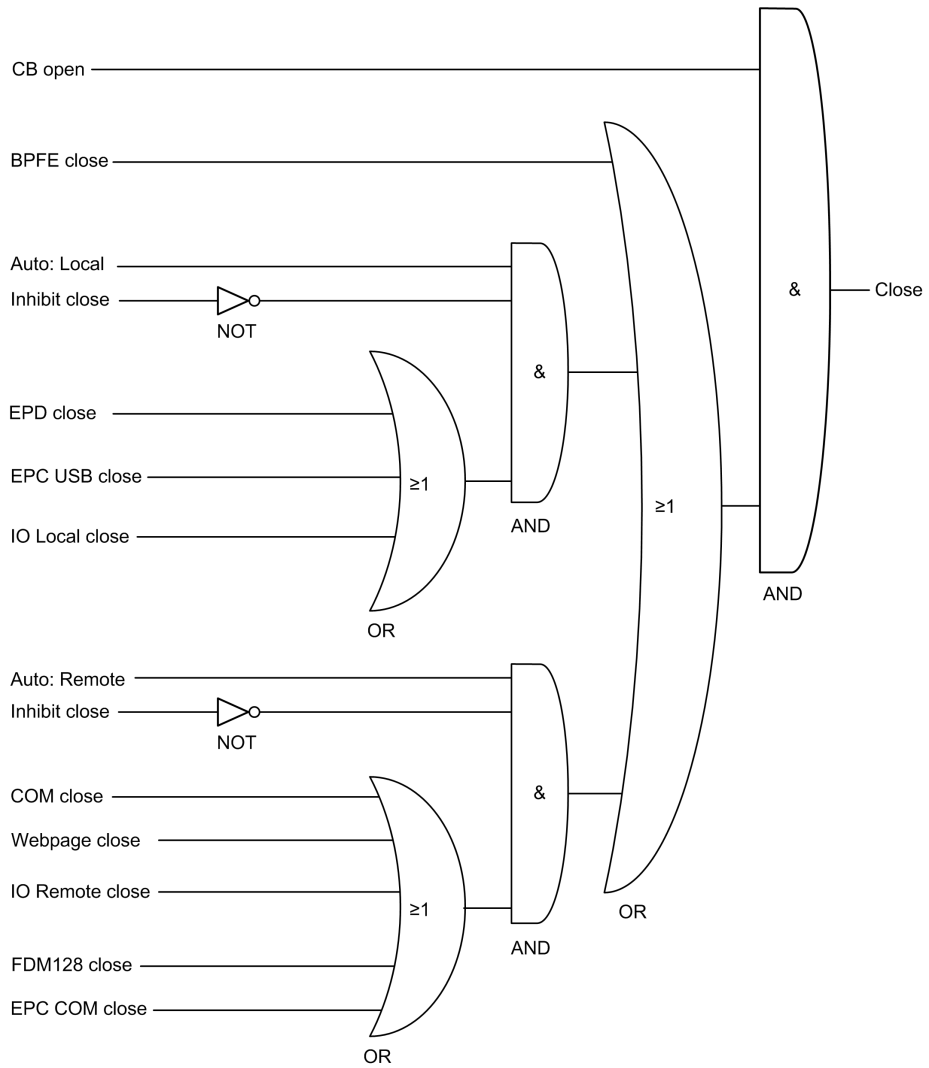

CB open	Circuit breaker is open
BPFE close	Close order from BPFE (when BPFE connected to MicroLogic X control unit)
Auto: Local	Control mode is Auto Local
Inhibit close	Close orders allowed in Auto control mode are inhibited
EPD close	Close order from EcoStruxure Power Device app with MasterPact Operation Assistant Digital Module
EPC USB close	Close order from EcoStruxure Power Commission software connected to mini USB port on control unit
IO local close	Local close order from IO module with the Breaker Operation predefined application (I6)
Auto: Remote	Control mode is Auto Remote
COM close	Close order from a remote controller
Webpage close	Close order from IFE/EIFE webpage
IO remote close	Remote close order from IO module with the Breaker Operation predefined application (I3)
FDM128 close	Close order from FDM128 display
EPC COM close	Close order from EcoStruxure Power Commission software through the communication network
Close	MicroLogic X close order to the XF communicating closing voltage release

Inhibiting the Closing Function

The closing function can be inhibited by sending a command through:

- The communication network or EcoStruxure Power Commission software
- The IO module

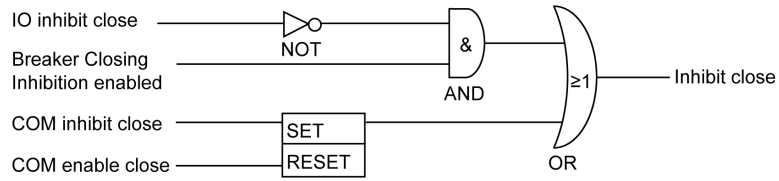

NOTE: Using EcoStruxure Power Commission software, page 22, you can determine whether the closing inhibition can be controlled by using the IO module, or not.

IO Inhibit close	Inhibit close order from IO module with the Breaker Operation predefined application (I4)
Breaker Closing Inhibition enabled	A setting of the MicroLogic X control unit, set by using EcoStruxure Power Commission software, enabling control of closing inhibition through IO module.
COM inhibit close	Inhibit close order from a remote controller using the communication network or from EcoStruxure Power Commission software
COM enable close	Enable close order from a remote controller using the communication network or from EcoStruxure Power Commission software
Inhibit close	Close orders allowed in Auto control mode are inhibited (1) or enabled (0)

⚠ WARNING

RESTRICTED CLOSING INHIBITION

Do not use the inhibit closing order to lock the device in open position.

Failure to follow these instructions can result in death, serious injury, or equipment damage.

The inhibit close order inhibits only the closing orders allowed in Auto control mode. The closing orders issued from the mechanical closing pushbutton or BPF, or from the pushbutton directly connected to the XF voltage release are not inhibited.

Predefined Events

The function generates the following predefined events:

Code	Event	History	Severity
0x1001 (4097)	Circuit breaker closed	Operation	Low
0x100A (4106)	Closing inhibited by communication	Operation	Low
0x1009 (4105)	Closing inhibited through IO module	Operation	Low
0x0411 (1041)	Closing order sent to XF voltage release	Operation	Low
0x111F (4383)	Allow control by digital input is disabled	Operation	Low
0x0D06 (3334)	Config error IO/CU:dual settings or inhibit cls.	Configura-tion	Medium

Recommended Actions

Code	Event	Recommended actions
0x0D06 (3334)	Config error IO/CU:dual settings or inhibit cls.	<p>Correct the configuration error with EcoStruxure Power Commission software:</p> <ul style="list-style-type: none">• Dual settings configuration error:<ul style="list-style-type: none">◦ Set Switch mode to IO-1 Wire or IO-2 Wire.◦ Set IO module with dual setting assignment.• Inhibit close order configuration error:<ul style="list-style-type: none">◦ Set Allow control by digital input under breaker close as enabled.◦ Set IO module with Enable/Inhibit close order assignment.

Communication Functions

What's in This Part

Bluetooth® Low Energy Communication 290
NFC Communication 293
USB On-The-Go (OTG) Connection 295
USB Connection 296
Cybersecurity Recommendations 298

Bluetooth® Low Energy Communication

Description

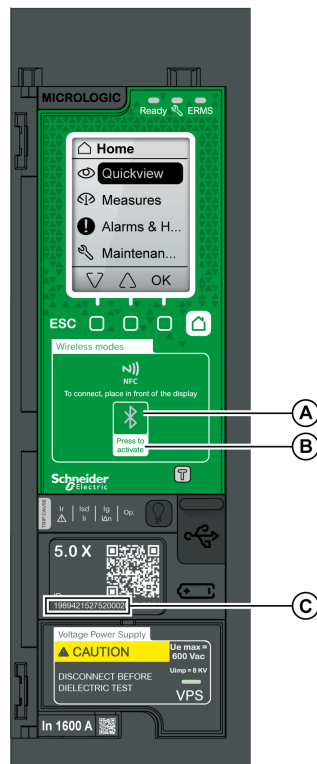

- A Bluetooth LED
- B Bluetooth activation button
- C Serial number of MicroLogic X control unit

Using Bluetooth® Low Energy communications, you can access the MicroLogic X control unit from a smartphone running the EcoStruxure Power Device app, page 23. This application offers a task-oriented interface with the control unit.

You can establish a Bluetooth Low Energy connection with only one MicroLogic X control unit at the same time. Only one smartphone at a time can connect to a control unit.

During the connection, the control unit is identified by the last digits of its serial number. The format of the identifier is **MTZ** <ProtectionType> <EndOfSerialNumber>, for example, MTZ 5 012345, where 5 indicates MicroLogic 5.0 X control unit and 012345 are the last 6 digits of the serial number.

Bluetooth Low Energy communications are encrypted using Advanced Encryption Standard (AES) 128-bit encryption.

Prerequisites for Using Bluetooth Low Energy Connection

The prerequisites for establishing a Bluetooth Low Energy connection are:

- The MicroLogic X control unit must be powered, page 40.
- Bluetooth Low Energy communication must be enabled on the control unit.
- You must have a smartphone running the EcoStruxure Power Device app.
- The smartphone must support Android 4.4 or iOS 9 or above, and be compatible with Bluetooth Low Energy wireless technology.
- You must have access to the MicroLogic X control unit, and be physically within an open field range of 20 to 30 meters (22 to 32 yards) (within 10 meters (11 yards) for optimized connection) for the duration of the connection.

Enabling and Disabling Bluetooth Low Energy Communication

By default, Bluetooth Low Energy communication is disabled.

Bluetooth Low Energy communication can be enabled or disabled as follows:

- On the MicroLogic X display screen, at **Home > Configuration > Communication > Bluetooth**, set **Bluetooth** to **ON** or **OFF**.

- With EcoStruxure Power Commission software, at **Home > Configuration > Communication > Bluetooth**, set **Bluetooth activation** to **ON** or **OFF**.

The Bluetooth Low Energy communication status (enabled or disabled) can be displayed as follows:

- On the MicroLogic X display screen, at **Home > Communication > Bluetooth**
- With EcoStruxure Power Commission software
- On a remote controller using the communication network

Predefined Events

Enabling Bluetooth communication generates the following event:

Code	Event	History	Severity
0x1429 (5161)	Bluetooth communication enabled	Communication	Low
0x1427 (5159)	Connection on Bluetooth port	Communication	Low

Setting the Bluetooth Disconnection Timer

When Bluetooth communication is activated using the activation pushbutton on the MicroLogic X control unit, there is a timer on the connection with a smartphone that ends the communication after a period of idle time. By default, this automatic disconnection timer is set to 15 minutes.

The setting for the Bluetooth disconnection timer can be changed as follows:

- On the MicroLogic X display screen, at **Home > Configuration > Communication > Bluetooth**, set **Bluetooth** to **ON**, and then set the **BLE timer (min)** value.
- With EcoStruxure Power Commission software, at **Home > Configuration > Communication > Bluetooth**, set **Bluetooth time out delay (min)** to the appropriate value.

You can set the value from 5 to 60 minutes (default = 15 minutes) in increments of 1.

Establishing a Bluetooth Low Energy Connection

Follow the steps below to establish a Bluetooth Low Energy connection from your smartphone to the MicroLogic X control unit.

Step	Action
1	Start EcoStruxure Power Device app on your smartphone.
2	Select Connect to device through Bluetooth .
3	On the MicroLogic X control unit, press the Bluetooth activation pushbutton. The Bluetooth LED lights up. If it does not, you must enable the Bluetooth communication feature first. On your smartphone, the EcoStruxure Power Device app starts scanning and displays a list of Bluetooth devices in the neighborhood. MicroLogic X control units are identified by their ID number.
4	Select the MicroLogic X control unit to which you want to connect. A 6-digit pairing code is displayed on the MicroLogic X display screen.

Step	Action
5	Enter the pairing code in EcoStruxure Power Device app within 30 seconds. <ul style="list-style-type: none"> If the pairing code is incorrect, or if more than 30 seconds have elapsed, Bluetooth communication is deactivated (the LED turns off), and you must start the connection procedure again at Step 3. If the connection is established, the Bluetooth LED starts blinking.
6	To end the connection, you can either: <ul style="list-style-type: none"> Press the Bluetooth pushbutton on the MicroLogic X control unit. Disconnect from EcoStruxure Power Device app.

While your smartphone remains within the communication range (an open field range of 20 to 30 meters (22 to 32 yards) from the MicroLogic X control unit), the Bluetooth Low Energy connection remains active and the information displayed is refreshed.

NOTE: Each connection is unique, you cannot save the connection parameters for your next Bluetooth Low Energy connection.

Bluetooth LED

The Bluetooth LED on the front face of the MicroLogic X control unit can be:

- ON:** A Bluetooth connection procedure is in progress.
- OFF:** Bluetooth is not activated or disabled.
- Blinking:** A Bluetooth connection is established and active.

NOTE: The Bluetooth LED does not indicate whether the Bluetooth Low Energy communication feature is enabled or disabled in the MicroLogic X control unit. When this feature is disabled, the LED does not light up when you press the Bluetooth activation button.

Troubleshooting Bluetooth Low Energy Communication Issues

The following table lists common problems when establishing a Bluetooth connection to the MicroLogic X control unit.

Problem description	Probable causes	Solutions
The Bluetooth LED does not light up when you press the Bluetooth activation pushbutton on the MicroLogic X control unit.	The Bluetooth function is not enabled in the MicroLogic X control unit.	Enable Bluetooth communication in the MicroLogic X control unit.
	The MicroLogic X control unit is not powered.	Check the power supply of the MicroLogic X control unit.
The Bluetooth connection was established but the signal is lost.	The smartphone has been moved out of range.	Place the smartphone within the range for Bluetooth and establish a new connection.
The Bluetooth LED is blinking on the control unit but you cannot see its ID number in the list of devices available.	A smartphone is already connected to the MicroLogic X control unit.	Check whether another smartphone within range is also connected to the control unit.

NFC Communication

Description



A NFC wireless communication zone

Using Near Field Communication (NFC), you can access the MicroLogic X control unit from a smartphone running the EcoStruxure Power Device app, page 23. With NFC, you can access the control unit and download data to your smartphone, even when the control unit is not powered.

NFC communication is always enabled and cannot be disabled.

You can establish an NFC connection with only one MicroLogic X control unit at the same time and only one smartphone at a time can connect to a control unit.

MicroLogic X control units use a passive NFC tag, which does not have a power source. It draws power from the smartphone that reads it, and therefore does not emit any electromagnetic waves when NFC communication is not in use.

NOTE: NFC communication is only accessible from the Android version of the EcoStruxure Power Device app.

Prerequisites for Using NFC

The prerequisites for establishing an NFC connection are:

- You must have a smartphone running the EcoStruxure Power Device app.
- The smartphone must support NFC.
- You must have physical access to the MicroLogic X control unit. The smartphone must be held within 20 mm (0.8 in) of the display screen of the control unit.

Establishing an NFC Connection

Follow the steps below to establish an NFC connection from your smartphone to the MicroLogic X control unit.

Step	Action
1	Start EcoStruxure Power Device app on your smartphone.
2	Select Connect to device through NFC .

Step	Action
3	<p>Place your smartphone against the MicroLogic X display screen at a maximum distance of 20 mm (0.8 in), in the wireless NFC communication zone.</p> <p>NOTE: The NFC antenna of the control unit is located around the MicroLogic X display screen. The position of the NFC antenna on the smartphone depends on the model used. If communication is not established, check where the NFC antenna is located on your smartphone and repeat the procedure.</p> <p>The first beep indicates that the communication is established. The EcoStruxure Power Device app then starts downloading data. The second beep indicates that the data download is complete.</p> <p>If the operation fails, a message is displayed on the smartphone. Start the procedure again.</p> <p>NOTE: You must not remove your smartphone from the MicroLogic X display screen while the data download is in progress. If you do, the download is incomplete (you lose the NFC connection).</p>
4	Remove your smartphone from the MicroLogic X display screen.

NFC data downloaded from the MicroLogic X control unit is not automatically refreshed. To get updates, you must establish a new NFC connection. Be aware that each new set of data downloaded overwrites the previous data. You can use the EcoStruxure Power Device app to consult downloaded data.

Troubleshooting NFC Communication Issues

The following table lists common problems when establishing an NFC connection to the MicroLogic X control unit.

Problem description	Probable causes	Solutions
The NFC connection is not established. (No beep)	The smartphone is out of the NFC wireless communication zone.	Move your smartphone so that its antenna is in the NFC wireless communication zone and repeat the connection procedure.
	Your smartphone has a reinforced case (for example, metallic) which is blocking the signal.	Remove the case of your smartphone and repeat the connection procedure.
	Your smartphone does not have NFC capability.	–
	NFC communication is not activated on your smartphone.	Make sure NFC communication is activated on your smartphone.
The NFC connection was established but the signal is lost. (No second beep)	The smartphone was moved out of NFC wireless communication zone before the data transmission finished.	Move your smartphone into the NFC wireless communication zone and repeat the connection procedure. Keep the smartphone in the zone until you hear the second beep.
The data is not transmitted. The message Memory fail. Please try again. is displayed on the smartphone.		
Information not available, or limited.	The internal battery charge is too low to record the information.	Replace the internal battery for information to be recorded in future.

USB On-The-Go (OTG) Connection

Description

Using a USB OTG connection, you can access the MicroLogic X control unit from a smartphone running the *EcoStruxure Power Device* app, page 23. This application offers a task-oriented interface with the control unit.

Prerequisites for Using a USB OTG Connection

The prerequisites for establishing a USB OTG connection are:

- You must have a smartphone running the *EcoStruxure Power Device* app.
- The smartphone must support Android 4.4 or iOS 9 or above.
- You must have physical access to the MicroLogic X control unit to connect the cable directly to the mini USB port of the control unit.
- You must have a USB OTG adaptor (not supplied) and a USB Type A cable to connect the USB port of the smartphone to the mini USB port of the MicroLogic X control unit.

The USB Type A cable must correspond to one of the following conditions:

- L ≤ 1 m, minimum diameter AWG 26/28
- L ≤ 2 m, minimum diameter AWG 24 (example: Molex Ref 88732-8902)

Connecting a Smartphone with EcoStruxure Power Device App to Mini USB Port

Follow the steps below to connect to the MicroLogic X control unit using the mini USB port.

Step	Action
1	Connect your smartphone to the mini USB port of the MicroLogic X control unit using a USB OTG adaptor and a USB Type A cable. The smartphone provides power to the MicroLogic X control unit if necessary.
2	Start <i>EcoStruxure Power Device</i> app on your smartphone.

Predefined Events

The function generates the following events:

Code	Event	History	Severity
0x1301 (4865)	Connection on USB port	Communication	Low

USB Connection

Description

From a PC running EcoStruxure Power Commission software, you can access all of the monitoring and control functions of the MicroLogic X control unit by connecting a PC directly to the mini USB port of the control unit.

Prerequisites for Using a USB Connection

The prerequisites for establishing a USB connection are:

- You must have the USB driver installed on the PC.
- You must have physical access to the MicroLogic X control unit to connect the cable directly to the mini USB port of the control unit.
- You must have a USB cable (reference LV850067SP) to connect the USB port of the PC to the mini USB port of the MicroLogic X control unit.

Connecting a PC Running EcoStruxure Power Commission Software to Mini USB Port

Follow the steps below to connect to the MicroLogic X control unit using the mini USB port.

Step	Action
1	Connect your PC to the mini USB port of the MicroLogic X control unit using a cable with reference LV850067SP. The PC provides power to the MicroLogic X control unit if necessary.
2	Start EcoStruxure Power Commission software on the PC and log in.
3	On the EcoStruxure Power Commission home page, connect to the MicroLogic X control unit. There are different ways to connect EcoStruxure Power Commission software to the MicroLogic X control unit, depending on whether it is the first connection and how the device was discovered. For more information, refer to <i>EcoStruxure Power Commission Online Help</i> .
4	With EcoStruxure Power Commission software connected to the MicroLogic X control unit you have access to all functions of the software.

Control Unit Test Mode

The test mode is activated when EcoStruxure Power Commission software is connected to the device through a PC connected to the mini USB port on the MicroLogic X control unit and the **Force trip** button is clicked. For more information, refer to *EcoStruxure Power Commission Online Help*.

Predefined Events

The function generates the following events:

Code	Event	History	Severity
0x1301 (4865)	Connection on USB port	Communication	Low
0x1302 (4866)	Control unit in test mode	Diagnostic	Low

Code	Event	History	Severity
0x1303 (4867)	Injection test in progress	Diagnostic	Low
0x1304 (4868)	Test aborted by user	Diagnostic	Low

Recommended Actions

Code	Event	Recommended actions
0x1301 (4865)	Connection on USB port	Do not unplug USB port before closing EcoStruxure Power Commission software.
0x1302 (4866)	Control unit in test mode	Exit the test mode after test.
0x1303 (4867)	Injection test in progress	Wait until the test is completed.

Cybersecurity Recommendations

Overview

The MasterPact MTZ circuit breaker with its MicroLogic X control unit is a key component of your installation. It offers multiple communication features that bring greater efficiency and flexibility in managing your installation. However the features also make it potentially vulnerable to cyber attacks.

This section lists some of the elementary precautions that you must take to protect the communications paths that give access to information about your installation, and control over it.

The communication paths to protect include:

- Local access communication paths
 - Wireless Bluetooth Low Energy communication
 - Wireless NFC communication
 - The mini USB port
- Remote access communication paths
 - The Ethernet network when the IFE or EIFE interface is present
 - The Modbus-SL network when the IFM interface is present

For more detailed information about cybersecurity for the MasterPact MTZ circuit breakers, refer to DOCA0122EN *MasterPact, ComPact, PowerPact - Cybersecurity Guide*.

General Cybersecurity Recommendations

▲ WARNING

POTENTIAL COMPROMISE OF SYSTEM AVAILABILITY, INTEGRITY, AND CONFIDENTIALITY

- Change default passwords at first use to help prevent unauthorized access to device settings, controls, and information.
- Disable unused ports/services and default accounts to help minimize pathways for malicious attackers.
- Place networked devices behind multiple layers of cyber defenses (such as firewalls, network segmentation, and network intrusion detection and protection).
- Use cybersecurity best practices (for example, least privilege, separation of duties) to help prevent unauthorized exposure, loss, modification of data and logs, or interruption of services.

Failure to follow these instructions can result in death, serious injury, or equipment damage.

For a general introduction to cybersecurity threats and how to address them, refer to *How Can I Reduce Vulnerability to Cyber Attacks?*.

Cybersecurity Recommendations for Local Access Communication Paths

To help protect local access communication paths, it is recommended to:

- Keep locked the enclosure where the MasterPact MTZ circuit breaker is located so that no unauthorized person can access the MicroLogic X control unit.

Specific Cybersecurity Recommendations for Wireless Bluetooth Low Energy Communication

Data transfers using Bluetooth Low Energy wireless communication are encrypted, therefore the risk of an unauthorized person gaining access to confidential information during transmission is limited.

To protect access to functions accessible through Bluetooth, it is recommended to:

- Disable Bluetooth communications, page 290 if you do not want to use Bluetooth.
- Set the Bluetooth automatic disconnection timer to the minimum time (5 minutes).
- Make sure that the smartphones running the EcoStruxure Power Device app are password-protected and for professional use only.
- Do not give away information about the smartphone (telephone number, MAC address) if it is not necessary.
- Disconnect the smartphone from the Internet during a Bluetooth connection with the MicroLogic X control unit.
- Do not store confidential or sensitive information on smartphones.

Specific Cybersecurity Recommendations for Wireless NFC Communication

To protect access to data accessible through NFC, it is recommended to make sure that the smartphones running the EcoStruxure Power Device app are password-protected and for professional use only.

Specific Cybersecurity Recommendations for USB Connection

To protect access to functions accessible through a USB connection on the MicroLogic X control unit, it is recommended that:

- The PCs running the monitoring software are hardened following the guidelines provided in *MasterPact, ComPact, PowerPact - Cybersecurity Guide*
- The most up-to-date hardening methods for the operating system are running on your PCs.

Specific Cybersecurity Recommendations for USB OTG Connection

To protect access to functions accessible through a USB OTG connection on the MicroLogic X control unit, it is recommended that:

- The smartphones running the EcoStruxure Power Device app are hardened following the guidelines provided in *MasterPact, ComPact, PowerPact - Cybersecurity Guide*
- The most up-to-date hardening methods for the operating system are running on your smartphones.

Cybersecurity Recommendations for Remote Access Communication Paths Through a Communication Network

When the MasterPact MTZ circuit breaker is connected to a communication network through the IFE, EIFE or IFM interface, it is recommended to:

- Follow general security rules to protect your network.
- Make sure that the PCs running the monitoring software are hardened following the guidelines provided in *MasterPact, ComPact, PowerPact - Cybersecurity Guide*, and with the most up-to-date hardening methods for the operating system running on your PCs.

Event Management

What's in This Part

- Event Definition..... 302
- Event Type 304
- Event Notifications 309
- Event Display..... 311
- Event History 312
- Event List 314

Event Definition

Definition

An event is a change in state of digital data, or any incident detected by the MicroLogic X control unit, EIFE Ethernet interface, or IO modules.

Events are time stamped and logged in the event history of each module.

Events are categorized according to a level of severity:

- High: urgent corrective action is required.
- Medium: corrective action needs to be scheduled.
- Low: for information only.

All high and medium severity events generate an alarm and a pop-up notification screen, page 309 on the MicroLogic X control unit display screen.

Low severity events are information-type events. They can be consulted as follows:

- With EcoStruxure Power Commission software.
- With EcoStruxure Power Device app

Alarms and trips are events that require specific attention from the user:

- A trip is a high severity event generated when the circuit breaker trips.
- An alarm is an event with medium or high severity.

The information in this chapter is valid for events detected by the MicroLogic X control unit. Refer to the following documents for events detected by the EIFE Ethernet interface, or by IO modules:

- For information about EIFE events, refer to *DOCA0106EN Enerlin'X EIFE - Embedded Ethernet Interface for One MasterPact MTZ Drawout Circuit Breaker - User Guide*.
- For information about IO events, refer to *Enerlin'X IO - Input/Output Application Module for One Circuit Breaker - User Guide*, page 10.

Maintenance Events

Maintenance events are events that have an impact on the health state of the circuit breaker. They are notified by the service LED in addition to generating a medium or high severity event.

- Orange service LED: medium severity detected alarm that requires non-urgent maintenance action.
- Red service LED: high severity detected alarm that requires immediate maintenance action.

Management of Events by MicroLogic X Control Unit

The following diagram gives an overview of how events are managed by the MicroLogic X control unit.

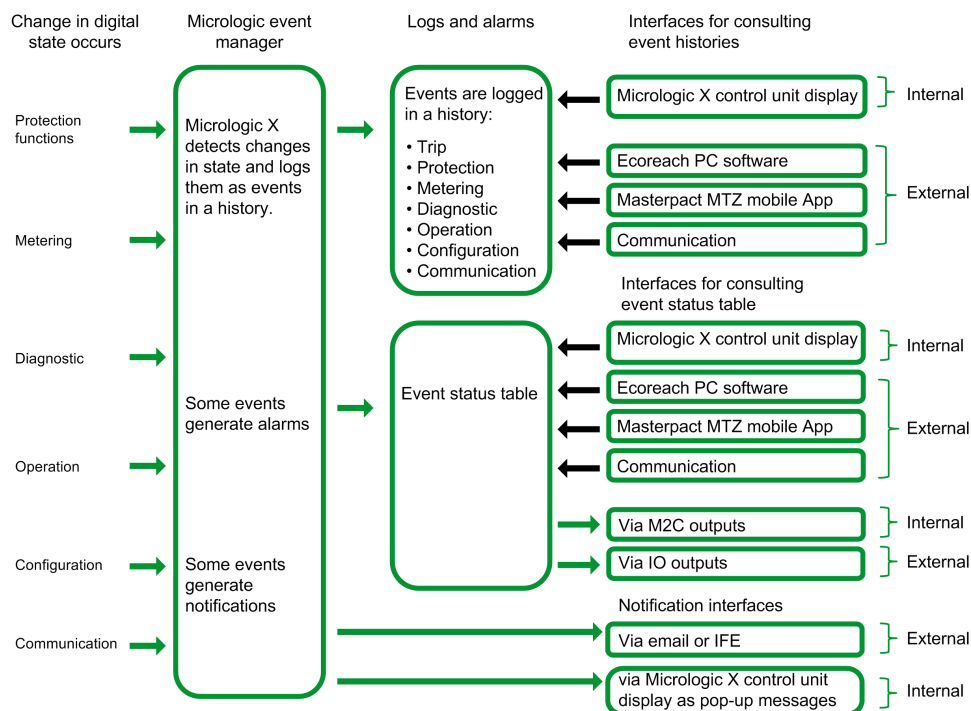

Event Time Stamping

Each event is time stamped with the date and time of the MicroLogic X internal clock, page 38.

Event Type

Overview

Events can be the following types:

- **Occurrence/completion** (Entry/Exit): Events which have a defined beginning and end, representing the beginning or end of a system state. The occurrence and completion are both time-stamped and logged in a history. For example, **Manual mode enabled** is an occurrence/completion event.
- **Instantaneous** (Pulse): Events with no duration. Only the occurrence of the event is time-stamped and logged in a history. For example, the reception of an opening order, a change to settings, or a circuit breaker trip are instantaneous events.

The event type cannot be customized.

Event Status Definition

The status of an event is active, inactive, or held. It depends on the event type and latch mode. The status of all events can be consulted at any time, page 311.

Latch Mode

An event can be unlatched or latched:

- **Unlatched**: The event status is active while the cause of the event is present. It automatically returns to inactive when the cause of the event disappears or is resolved.
- **Latched**: The event status does not automatically return to inactive when the cause of the event disappears or is resolved. It stays in the held state until it is reset by the user.

The latch mode of certain events, page 314 can be customized through EcoStruxure Power Commission software.

Activity

Certain events can be disabled so that the event is not taken into consideration by the MicroLogic X control unit. In this case, the event is not logged in a history and does not generate an alarm.

Events can be disabled through EcoStruxure Power Commission software. For more information about which events can be disabled, refer to the event list, page 314. Events can be enabled again after being disabled.

Unlatched Occurrence/Completion Events

The following graph shows the event status for an unlatched occurrence/completion event:

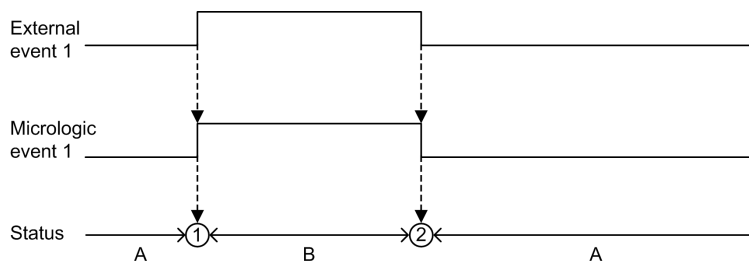

A Event inactive

B Event active

1 Event occurrence: event is time stamped, logged in a history and notified, depending on severity

2 Event completion: event is time stamped and logged in a history

Latched Occurrence/Completion Events

The following graph shows the event status for a latched occurrence/completion event:

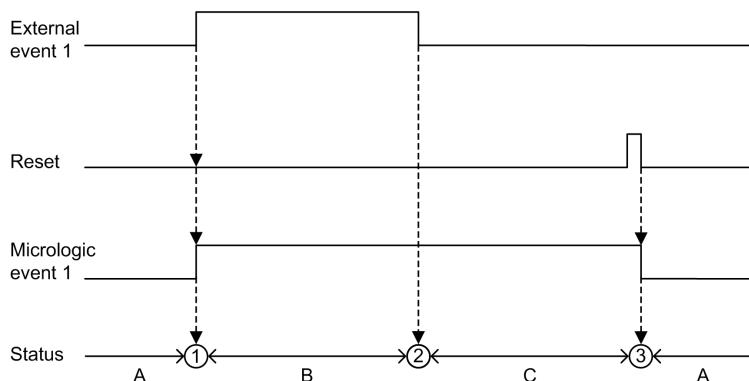

A Event inactive

B Event active

C Event held

1 Event occurrence: event is time stamped, logged in a history and notified, depending on severity

2 Event completion: event is time stamped and logged in a history

3 Event reset: reset command is time stamped and logged in operation history. All held events are reset.

The following graph shows the event status for a latched event where a reset is attempted before completion of the event:

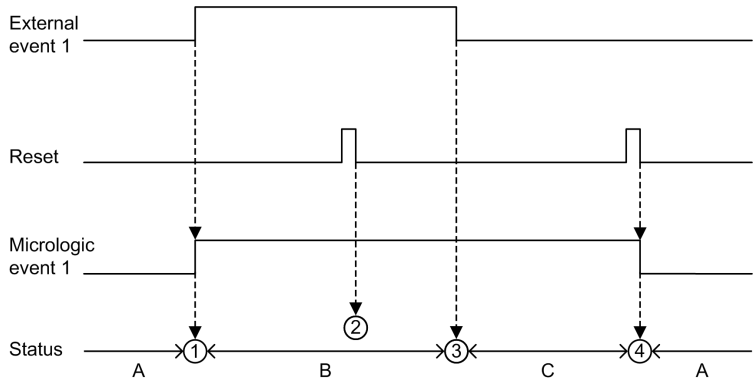

A Event inactive

B Event active

C Event held

1 Event occurrence: event is time stamped, logged in a history and notified, depending on severity

2 Event reset: reset command is time-stamped and logged in the operation history but has no effect on MicroLogic event 1 as external event is not completed

3 Event completion: event is time stamped and logged in a history

4 Event reset: reset command is time stamped and logged in the operation history. All held events are reset.

The following graph shows the event status for a latched, recurring occurrence/ completion event:

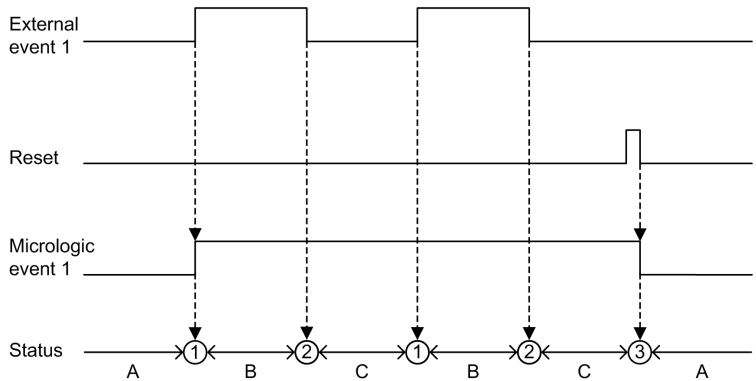

A Event inactive

B Event active

C Event held

1 Event occurrence: event is time stamped, logged in a history and notified, depending on severity

2 Event completion: event is time stamped and logged in a history

3 Event reset: reset command is time stamped and logged in the operation history. All held events are reset.

Unlatched Instantaneous Events

The following graph shows the event status for an unlatched instantaneous event:

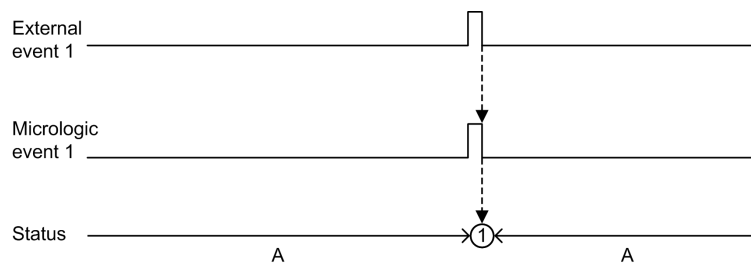

A Event inactive

1 Event occurrence: event is time stamped, logged in a history and notified, depending on severity

Latched Instantaneous Events

The following graph shows the event status for a latched instantaneous event:

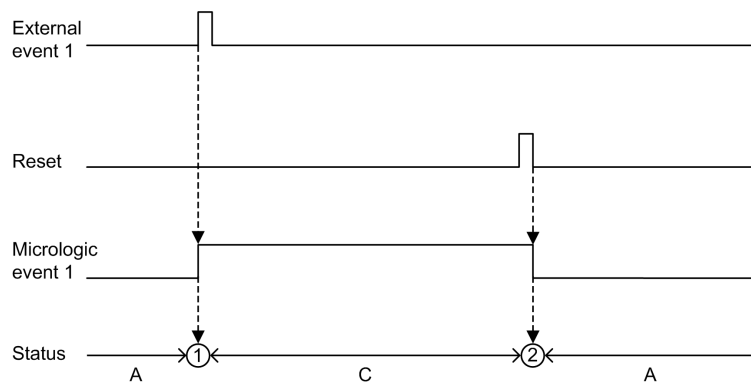

A Event inactive

C Event held

1 Event occurrence: event is time stamped, logged in a history and notified, depending on severity

2 Event reset: reset command is time stamped and logged in the operation history. All held events are reset.

The following graph shows the event status for a latched, recurring instantaneous event:

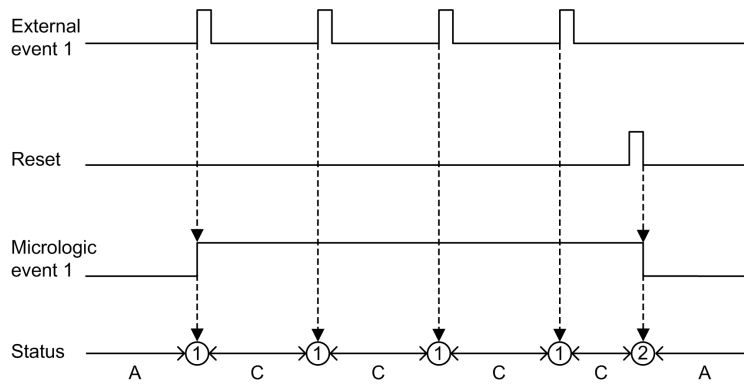

A Event inactive

C Event held

1 Event occurrence: event is time stamped, logged in a history and notified, depending on severity

2 Event reset: reset command is time stamped and logged in the operation history. All held events are reset.

Resetting Latched Events

Latched events can be reset as follows:

- By pressing the Test/Reset button on the front of the MicroLogic X control unit for 3–15 seconds.
- By sending a setting command using the communication network (password-protected).

Reset commands do not target specific events. All held event states managed by the MicroLogic X control unit are reset, and all trip cause LEDs are cleared.

Reset commands target a specific module. For example, pressing the Test/Reset button for 3–15 seconds resets the events of the MicroLogic X control unit but does not reset the events of the IO module.

The reset command generates the following event:

Code	Event	History	Severity
0x1307 (4871)	Alarm reset	Operation	Low

Event Notifications

Presentation

High severity events (including trips) and medium severity events are notified by a pop-up screen on the MicroLogic X control unit.

Trip events are notified by SDE1 standard fault-trip indication contact and SDE2 optional fault-trip indication contact.

In addition, events can be configured to be notified in the following ways:

- By optional M2C module.
- By optional IO module.
- By email from IFE or EIFE Ethernet interface.

Pop-up Screen

All high and medium severity events generate a pop-up screen on the MicroLogic X display screen, page 85:

- A red pop-up screen indicates a trip or high severity event, needing immediate attention.
- An orange pop-up screen indicates a medium severity event, recommending action.

The following table presents the medium severity events, displayed in an orange pop-up screen, which have auto-acknowledgment mode. For more information, see auto-acknowledgement mode, page 87.

Code	Event
0x03F5 (1013)	Ir prealarm (I > 90% Ir)
0x6200 (25088)	Ir start (I > 105% Ir)
0x050C (1292)	Ig alarm
0x050D (1293)	IAn alarm
0x6321 (25377)	IDMTL long time operate
0x6310 (25360)	Undervoltage on 1 phase operate
0x632A (25386)	Undervoltage on all 3 phases operate
0x6311 (25361)	Overvoltage on 1 phase operate
0x632B (25387)	Overvoltage on all 3 phases operate
0x6315 (25365)	Underfrequency operate
0x6316 (25366)	Overfrequency operate
0x6214 (25108)	Reverse power start
0x6314 (25364)	Reverse power operate
0x6323 (25379)	FW directional overcurrent operate
0x6324 (25380)	RV directional overcurrent operate

M2C Notifications

EcoStruxure Power Commission software can be used to assign the notification of a group of up to eight events or alarms to either of the two M2C outputs.

The M2C output remains on as long as one of the events assigned to it is active or held.

EcoStruxure Power Commission software also enables the status of the M2C outputs to be forced.

Forcing an M2C output generates the following events:

Code	Event	History	Severity
0x130B (4875)	M2C output 1 is forced	Operation	Low
0x130C (4876)	M2C output 2 is forced	Operation	Low

Recommended Actions

Forcing an M2C output generates the following events:

Code	Event	Recommended actions
0x130B (4875)	M2C output 1 is forced	Unforce output with EcoStruxure Power Commission software.
0x130C (4876)	M2C output 2 is forced	Unforce output with EcoStruxure Power Commission software.

IO Module Notifications

When an output of the IO module is not assigned to a pre-defined application, EcoStruxure Power Commission can be used to assign the notification of:

- A single event.
- A group of up to eight events or alarms.

For more information, refer to *EcoStruxure Power Commission Online Help*.

When the IO module output is assigned to a group of alarms, the output remains on as long as one of the events assigned to it is active or held. The operating mode of the IO module output must be set as non-latching.

EcoStruxure Power Commission software also enables the status of IO module outputs to be forced.

Refer to *Enerlin'X IO - Input/Output Application Module for One Circuit Breaker - User Guide*, page 10.

Email Notification

IFE or EIFE webpages allow events to be selected for notification by email. The notification by email is not configured by default.

For more information, refer to the relevant document, page 10:

- *Enerlin'X EIFE - Embedded Ethernet Interface for One MasterPact MTZ Drawout Circuit Breaker - User Guide*
- *Enerlin'X IFE - Ethernet Interface for One IEC Circuit Breaker - User Guide*
- *Enerlin'X IFE - Ethernet Switchboard Server - User Guide*

Event Display

Introduction

The event status table contains the status of all events at the time of consultation. The status can be inactive, active, or held.

Events which are in the active and held state are displayed on the following interfaces:

- MicroLogic X display screen.
- EcoStruxure Power Commission software.
- EcoStruxure Power Device app.

The status of an event can be checked using the communication network.

Displaying Events on the MicroLogic X Display Screen

Display the active and held events on the MicroLogic X display screen at **Home > Alarms & History > Alarms**.

High and medium severity active and held events are displayed.

The events are displayed in no specific order, with the description of the event and the time it occurred.

If the event is completed while the screen is open, the message **Completed** is displayed on the screen.

Displaying Events on EcoStruxure Power Commission Software

High and medium severity, active and held events are displayed.

Events can be sorted by:

- Date
- Severity:
 - High severity events
 - Medium severity events
- History
- Type

Displaying Events on EcoStruxure Power Device App

By default, events are sorted chronologically. They can be sorted by other parameters such as date, severity, type or history.

Event History

Overview

All events are logged in one of the histories of the MicroLogic X control unit:

- Trip
- Protection
- Diagnostic
- Metering
- Configuration
- Operation
- Communication

All severities of events are logged, including low-severity events.

Events logged in histories are displayed as follows:

- On the MicroLogic X display screen
- With EcoStruxure Power Commission software
- With the EcoStruxure Power Device app

The event histories can be downloaded using the communication network.

The following information is logged in a history for each event:

- Event ID: event code
- Event type: Entry/Exit or Pulse
- Time stamp: date and time of occurrence and completion
- Context data (only for certain events)

Maximum Number of Events in Each History

Each history has a predefined maximum size. When a history is full, each new event overwrites the oldest event in the relevant history.

Event history	Maximum number of events stored in history
Trip	50
Protection	100
Diagnostic	300
Metering	300
Configuration	100
Operation	300
Communication	100

Displaying Event History on MicroLogic X Display Screen

For more information about how events are displayed on MicroLogic X display screen, refer to *Alarm and History menu*, page 72.

Displaying Event History on EcoStruxure Power Commission Software

All events logged in histories can be consulted using EcoStruxure Power Commission software. The events can be exported as an Excel file.

Events in histories are displayed in chronological order, starting with the most recent event.

Displaying Event History on EcoStruxure Power Device App

All events logged in histories are displayed on the EcoStruxure Power Device app.

Events in histories are displayed in chronological order, starting with the most recent event.

Events can be sorted by date and time, or by sequence number, and filtered by using the following criteria:

- Type
- Severity
- History

Clicking on a specific event in the list displays a list of all occurrences of the same event, in chronological order.

Event List

Event Characteristics

The events are listed according to the history in which they are logged, page 312.

Each event is defined by the following characteristics:

- Code: event code
- Event: user message
- History, page 312
- Type, page 304: not customizable
 - Entry/Exit: occurrence/completion event.
 - Pulse: instantaneous event.
- Latched, page 304:
 - Yes: the event is latched and the user must reset the event status.
 - No: the event is unlatched.

NOTE: The latch mode of events marked ⁽¹⁾ in the following tables can be customized with EcoStruxure Power Commission software.
- Activity, page 304:
 - Enabled
 - Disabled

NOTE: The activity of events marked ⁽¹⁾ in the following tables can be customized with EcoStruxure Power Commission software.
- Severity, page 302:
 - High severity events.
 - Medium severity events.
 - Low severity events.
- Service LED, page 242:
 - Yes: the service LED is lit in either orange or red, depending on the severity of the event. Maintenance action is required
 - No: the service LED is not lit. No maintenance action is required.

Trip Events

Code	Event	History	Type	Latched	Activity	Severity	Service LED
0x6400 (25600)	lr trip , page 100	Trip	Pulse	Yes	Enabled	High	No
0x6401 (25601)	lsd trip , page 104	Trip	Pulse	Yes	Enabled	High	No
0x6402 (25602)	li trip , page 107	Trip	Pulse	Yes	Enabled	High	No
0x6403 (25603)	lg trip , page 111	Trip	Pulse	Yes	Enabled	High	No
0x6404 (25604)	lΔn trip , page 115	Trip	Pulse	Yes	Enabled	High	No
0x6406 (25606)	Ultimate self-protection trip (SELLIM) , page 94	Trip	Pulse	Yes	Enabled	High	No

Code	Event	History	Type	Latched	Activity	Severity	Service LED
0x6407 (25607)	Self diagnostic trip , page 244	Trip	Pulse	Yes	Enabled	High	No
0x641F (25631)	Circuit breaker self diagnostic trip , page 244	Trip	Pulse	Yes	Enabled	High	No
0x641D (25629)	Ultimate self-protection trip (DIN/DINF) , page 94	Trip	Pulse	Yes	Enabled	High	No
0x641E (25630)	IΔn/Ig test trip , page 113	Trip	Pulse	Yes	Enabled	High	No
0x6414 (25620)	Reverse power trip , page 144	Trip	Pulse	Yes	Enabled	High	No
0x6410 (25616)	Undervoltage on 1 phase trip , page 130	Trip	Pulse	Yes	Enabled	High	No
0x642A (25642)	Undervoltage on all 3 phases trip , page 130	Trip	Pulse	Yes	Enabled	High	No
0x6411 (25617)	Overvoltage on 1 phase trip , page 135	Trip	Pulse	Yes	Enabled	High	No
0x642B (25643)	Overvoltage on all 3 phases trip , page 135	Trip	Pulse	Yes	Enabled	High	No
0x6415 (25621)	Underfrequency trip , page 139	Trip	Pulse	Yes	Enabled	High	No
0x6416 (25622)	Overfrequency trip , page 139	Trip	Pulse	Yes	Enabled	High	No
0x6421 (25633)	IDMTL long-time trip , page 158	Trip	Pulse	Yes	Enabled	High	No
0x6423 (25635)	Forward directional overcurrent trip , page 164	Trip	Pulse	Yes	Enabled	High	No
0x6424 (25636)	Reverse directional overcurrent trip , page 164	Trip	Pulse	Yes	Enabled	High	No

Protection Events

Code	Event	History	Type	Latch	Activity	Severity	Service LED
0x631D (25373)	Ultimate self-protection (DIN/DINF) operate , page 94	Protection	Entry/Exit	No	Enabled	Medium	No
0x6306 (25350)	Ultimate self-protection (SELLIM) operate , page 94	Protection	Entry/Exit	No	Enabled	Medium	No
0x0F11 (3857)	Thermal memory reset order , page 101	Protection	Pulse	No ⁽¹⁾	Enabled	Low	No
0x03F5 (1013)	Ir prealarm (I > 90% Ir) , page 102	Protection	Entry/Exit	No	Enabled ⁽¹⁾	Medium	No
0x6200 (25088)	Ir start (I > 105% Ir) , page 102	Protection	Entry/Exit	No ⁽¹⁾	Enabled	Medium	No

Code	Event	History	Type	Latch	Activity	Severity	Service LED
0x6300 (25344)	Ir operate , page 102	Protection	Entry/Exit	No	Enabled	Medium	No
0x6201 (25089)	Isd start , page 105	Protection	Entry/Exit	No ⁽¹⁾	Enabled	Low	No
0x6301 (25345)	Isd operate , page 105	Protection	Entry/Exit	No	Enabled	Medium	No
0x6302 (25346)	Ii operate , page 107	Protection	Entry/Exit	No	Enabled	Medium	No
0x050C (1292)	Ig alarm , page 148	Protection	Entry/Exit	No ⁽¹⁾	Enabled	Medium	No
0x6203 (25091)	Ig start , page 111	Protection	Entry/Exit	No ⁽¹⁾	Enabled	Low	No
0x6303 (25347)	Ig operate , page 111	Protection	Entry/Exit	No	Enabled	Medium	No
0x050D (1293)	IΔn alarm , page 148	Protection	Entry/Exit	No ⁽¹⁾	Enabled ⁽¹⁾	Medium	No
0x6204 (25092)	IΔn start , page 115	Protection	Entry/Exit	No ⁽¹⁾	Enabled	Low	No
0x6304 (25348)	IΔn operate , page 115	Protection	Entry/Exit	No	Enabled	Medium	No
0x6210 (25104)	Undervoltage on 1 phase start , page 130	Protection	Entry/Exit	No ⁽¹⁾	Enabled	Low	No
0x6310 (25360)	Undervoltage on 1 phase operate , page 130	Protection	Entry/Exit	No	Enabled	Medium	No
0x622A (25130)	Undervoltage on all 3 phases start , page 130	Protection	Entry/Exit	No ⁽¹⁾	Enabled	Low	No
0x632A (25386)	Undervoltage on all 3 phases operate , page 130	Protection	Entry/Exit	No	Enabled	Medium	No
0x6211 (25105)	Overvoltage on 1 phase start , page 135	Protection	Entry/Exit	No ⁽¹⁾	Enabled	Low	No
0x6311 (25361)	Overvoltage on 1 phase operate , page 135	Protection	Entry/Exit	No	Enabled	Medium	No
0x622B (25131)	Overvoltage on all 3 phases start , page 135	Protection	Entry/Exit	No ⁽¹⁾	Enabled	Low	No
0x632B (25387)	Overvoltage on all 3 phases operate , page 135	Protection	Entry/Exit	No	Enabled	Medium	No
0x6216 (25110)	Overfrequency start , page 139	Protection	Entry/Exit	No	Enabled ⁽¹⁾	Low	No
0x6316 (25366)	Overfrequency operate , page 139	Protection	Entry/Exit	No	Enabled	Medium	No
0x6215 (25109)	Underfrequency start , page 139	Protection	Entry/Exit	No	Enabled ⁽¹⁾	Low	No

Code	Event	History	Type	Latch	Activity	Severity	Service LED
0x6315 (25365)	Underfrequency operate , page 139	Protection	Entry/Exit	No	Enabled	Medium	No
0x6214 (25108)	Reverse power start , page 144	Protection	Entry/Exit	No ⁽¹⁾	Enabled	Medium	No
0x6314 (25364)	Reverse power operate , page 144	Protection	Entry/Exit	No	Enabled	Medium	No
0x6221 (25121)	IDMTL long-time start , page 158	Protection	Entry/Exit	No	Enabled	Low	No
0x6321 (25377)	IDMTL long-time operate , page 158	Protection	Entry/Exit	No	Enabled	Medium	No
0x6223 (25123)	Forward directional overcurrent start , page 164	Protection	Entry/Exit	No ⁽¹⁾	Enabled	Low	No
0x6224 (25124)	Reverse directional overcurrent start , page 164	Protection	Entry/Exit	No ⁽¹⁾	Enabled	Low	No
0x6323 (25379)	Forward directional overcurrent operate , page 164	Protection	Entry/Exit	No	Enabled	Medium	No
0x6324 (25380)	Reverse directional overcurrent operate , page 164	Protection	Entry/Exit	No	Enabled	Medium	No
0x0C03 (3075)	ERMS engaged , page 151	Protection	Entry/Exit	No	Enabled	Low	No
0x0C04 (3076)	ESM (ERMS switch module) self diagnostic alarm , page 151	Protection	Entry/Exit	No	Enabled	Medium	No
0x0C05 (3077)	Communication lost with ESM (ERMS switch module) , page 151	Protection	Entry/Exit	No	Enabled	Medium	No
0x0C06 (3078)	Request to unlock ERMS by smartphone , page 151	Protection	Pulse	No	Enabled	Low	No
0x1300 (4864)	B curve active , page 120	Protection	Entry/Exit	No	Enabled	Low	No
0x1309 (4873)	Protection settings change by display enabled , page 96	Protection	Entry/Exit	No ⁽¹⁾	Enabled	Low	No
0x130A (4874)	Remote protection settings change enabled , page 96	Protection	Entry/Exit	No ⁽¹⁾	Enabled	Low	No
0x1100 (4352)	Protection settings changed by display , page 97	Protection	Pulse	No ⁽¹⁾	Enabled	Low	No
0x1108 (4360)	Protection settings changed by Bluetooth/USB/IFE , page 97	Protection	Pulse	No ⁽¹⁾	Enabled	Medium	No
0x0EF8 (3832)	Optional protections inhibited by IO , page 129	Protection	Entry/Exit	No	Enabled	Low	No

(1) Customizable with EcoStruxure Power Commission software

Diagnostic Events

Code	Event	History	Type	Latch	Activity	Severity	Service LED
0x1120 (4384)	Communication lost with IO#1 module , page 247	Diagnostic	Pulse	Yes	Enabled ⁽¹⁾	Medium	No
0x1121 (4385)	Communication lost with IO#2 module , page 247	Diagnostic	Pulse	Yes	Enabled ⁽¹⁾	Medium	No
0x1122 (4386)	Communication lost with EIFE or IFE module , page 247	Diagnostic	Pulse	Yes	Enabled ⁽¹⁾	Medium	No
0x1123 (4387)	Communication lost with IFM module , page 247	Diagnostic	Pulse	Yes	Enabled ⁽¹⁾	Medium	No
0x1302 (4866)	Control unit in test mode , page 296	Diagnostic	Entry/Exit	No	Enabled	Low	No
0x1303 (4867)	Injection test in progress , page 296	Diagnostic	Entry/Exit	No	Enabled	Low	No
0x1304 (4868)	Test aborted by user , page 296	Diagnostic	Pulse	No	Enabled	Low	No
0x142C (5164)	Ig protection configured in OFF mode , page 111	Diagnostic	Pulse	No	Enabled	Medium	No
0x142D (5165)	Ig function inhibited for test purpose , page 111	Diagnostic	Entry/Exit	No	Enabled	Low	No
0x1400 (5120)	Control unit self test major malfunction 1 , page 244	Diagnostic	Entry/Exit	No	Enabled	High	Yes
0x1404 (5124)	Control unit self test major malfunction 2 , page 244	Diagnostic	Entry/Exit	No	Enabled	High	Yes
0x1405 (5125)	Control unit self test major malfunction 3 , page 244	Diagnostic	Entry/Exit	No	Enabled	High	Yes
0x1406 (5126)	Control unit self test major malfunction 4 , page 244	Diagnostic	Entry/Exit	No	Enabled	High	Yes
0x1416 (5142)	Control unit self test major malfunction 5 , page 244	Diagnostic	Entry/Exit	No	Enabled	High	Yes
0x1402 (5122)	Internal current sensor disconnected , page 244	Diagnostic	Entry/Exit	No	Enabled	High	Yes
0x1403 (5123)	External neutral current sensor disconnected , page 244	Diagnostic	Entry/Exit	No	Enabled	High	Yes
0x1408 (5128)	Earth leakage (Vigi) sensor disconnected , page 244	Diagnostic	Entry/Exit	No	Enabled	High	Yes
0x1430 (5168)	Protection settings reset to factory values , page 244	Diagnostic	Entry/Exit	No	Enabled	High	Yes
0x142F (5167)	Last modification of protection settings has not been completely applied , page 247	Diagnostic	Entry/Exit	No	Enabled	Medium	No
0x140F (5135)	Protection settings no accessible #1 , page 247	Diagnostic	Entry/Exit	No	Enabled	Medium	Yes

Code	Event	History	Type	Latch	Activity	Severity	Service LED
0x1474 (5236)	Protection settings no accessible #2 , page 247	Diagnostic	Entry/Exit	No	Enabled	Medium	Yes
0x1475 (5237)	Protection settings no accessible #3 , page 247	Diagnostic	Entry/Exit	No	Enabled	Medium	Yes
0x1476 (5238)	Protection settings no accessible #4 , page 247	Diagnostic	Entry/Exit	No	Enabled	Medium	Yes
0x1477 (5239)	Protection settings no accessible #5 , page 247	Diagnostic	Entry/Exit	No	Enabled	Medium	Yes
0x1407 (5127)	Control unit self test #1 , page 247	Diagnostic	Entry/Exit	No	Enabled	Low	No
0x1470 (5232)	Control unit self test #2 , page 247	Diagnostic	Entry/Exit	No	Enabled	Low	No
0x1471 (5233)	Control unit self test #3 , page 247	Diagnostic	Entry/Exit	No	Enabled	Medium	Yes
0x1472 (5234)	Control unit self test #4 , page 247	Diagnostic	Entry/Exit	No	Enabled	Medium	Yes
0x1473 (5235)	Control unit self test #5 , page 247	Diagnostic	Entry/Exit	No	Enabled	Low	No
0x1411 (5137)	Invalid measurement and optional protection #1 , page 247	Diagnostic	Entry/Exit	No	Enabled	Medium	No
0x1478 (5240)	Invalid measurement and optional protection #2 , page 247	Diagnostic	Entry/Exit	No	Enabled	Low	No
0x1479 (5241)	Invalid measurement and optional protection #3 , page 247	Diagnostic	Entry/Exit	No	Enabled	Medium	Yes
0x147C (5244)	Invalid optional protection self test , page 247	Diagnostic	Entry/Exit	No	Enabled	Medium	Yes
0x1412 (5138)	NFC invalid communication #1 , page 247	Diagnostic	Entry/Exit	No	Enabled ⁽¹⁾	Low	Yes
0x1414 (5140)	NFC invalid communication #2 , page 247	Diagnostic	Entry/Exit	No	Enabled ⁽¹⁾	Medium	Yes
0x1415 (5141)	NFC invalid communication #3 , page 247	Diagnostic	Entry/Exit	No	Enabled ⁽¹⁾	Medium	Yes
0x140A (5130)	Invalid display screen or wireless communication #1 , page 247	Diagnostic	Entry/Exit	No	Enabled	Low	No
0x147A (5242)	Invalid display screen or wireless communication #2 , page 247	Diagnostic	Entry/Exit	No	Enabled	Medium	Yes
0x147B (5243)	Invalid display screen or wireless communication #3 , page 247	Diagnostic	Entry/Exit	No	Enabled	Medium	Yes
0x1422 (5154)	Invalid Bluetooth communication , page 247	Diagnostic	Entry/Exit	No	Enabled ⁽¹⁾	Medium	Yes
0x1433 (5171)	Replace internal battery , page 247	Diagnostic	Entry/Exit	No	Enabled ⁽¹⁾	Medium	Yes

Code	Event	History	Type	Latch	Activity	Severity	Service LED
0x1437 (5175)	Internal battery not detected , page 247	Diagnostic	Entry/Exit	No	Enabled ⁽¹⁾	Low	No
0x1436 (5174)	Control Unit alarm reset , page 247	Diagnostic	Pulse	No	Enabled	Low	No
0x1434 (5172)	Self diagnostic test - firmware , page 46	Diagnostic	Entry/Exit	No	Disabled	Medium	No
0x1409 (5129)	Unable to read sensor plug , page 244	Diagnostic	Entry/Exit	No	Enabled	High	Yes
0x0D0A (3338)	Invalid Control Unit factory config #1 , page 247	Diagnostic	Entry/Exit	No	Enabled	Medium	No
0x0D0B (3339)	Invalid Control Unit factory config #2 , page 247	Diagnostic	Entry/Exit	No	Enabled	High	No
0x0D0E (3342)	Discrepancy between display and MicroLogic , page 247	Diagnostic	Entry/Exit	No	Enabled	Medium	Yes
0x0D00 (3328)	Critical hardware modules discrepancy , page 247	Diagnostic	Entry/Exit	No	Enabled	Medium	No
0x0D01 (3329)	Critical firmware modules discrepancy , page 46	Diagnostic	Entry/Exit	No	Enabled	Medium	No
0x0D02 (3330)	Non critical hardware modules discrepancy , page 247	Diagnostic	Entry/Exit	No	Enabled	Medium	No
0x0D03 (3331)	Non critical firmware modules discrepancy , page 46	Diagnostic	Entry/Exit	No	Enabled	Medium	No
0x0D08 (3336)	Address conflict between modules , page 247	Diagnostic	Entry/Exit	No	Enabled	Medium	No
0x0D09 (3337)	Firmware discrepancy within control unit , page 46	Diagnostic	Entry/Exit	No	Enabled	Medium	Yes
0x1413 (5139)	IΔn/Ig test - no trip IΔn, page 116 Ig, page 113	Diagnostic	Pulse	No	Enabled	High	No
0x142A (5162)	IΔn/Ig test button pressed IΔn, page 116 Ig, page 113	Diagnostic	Pulse	No	Enabled	Low	No
0x1305 (4869)	ZSI test in progress , page 128	Diagnostic	Pulse	No	Enabled	Low	No
0x1440 (5184)	Contact wear is above 60%. Check contacts , page 257	Diagnostic	Entry/Exit	No	Enabled ⁽¹⁾	Medium	Yes
0x1441 (5185)	Contact wear os above 95%. Plan for replacement , page 257	Diagnostic	Entry/Exit	No	Enabled ⁽¹⁾	Medium	Yes
0x1442 (5186)	Contacts 100% worn out. CB needs to be replaced , page 257	Diagnostic	Entry/Exit	No	Enabled	High	Yes
0x1443 (5187)	Remaining service life of circuit breaker is below alarm threshold , page 252	Diagnostic	Entry/Exit	No	Enabled ⁽¹⁾	Medium	Yes

Code	Event	History	Type	Latch	Activity	Severity	Service LED
0x1444 (5188)	Circuit breaker has reached the max number of operations , page 252	Diagnostic	Entry/Exit	No	Enabled ⁽¹⁾	High	Yes
0x1460 (5216)	Invalid self test - MX1 voltage release , page 254	Diagnostic	Entry/Exit	No	Enabled	Medium	Yes
0x1461 (5217)	MX1 voltage release not detected , page 254	Diagnostic	Entry/Exit	No	Disabled ⁽¹⁾	Medium	Yes
0x1450 (5200)	MCH charging operations above threshold , page 254	Diagnostic	Entry/Exit	No	Enabled ⁽¹⁾	Medium	Yes
0x1451 (5201)	MCH has reached the max number of operations , page 254	Diagnostic	Entry/Exit	No	Enabled ⁽¹⁾	High	Yes
0x1462 (5218)	Invalid self test - XF voltage release , page 254	Diagnostic	Entry/Exit	No	Enabled	Medium	Yes
0x1463 (5219)	XF voltage release not detected , page 254	Diagnostic	Entry/Exit	No	Disabled ⁽¹⁾	Medium	Yes
0x1464 (5220)	Invalid self test - MN undervoltage release , page 254	Diagnostic	Entry/Exit	No	Enabled	Medium	Yes
0x1465 (5221)	MN undervoltage release not detected , page 254	Diagnostic	Entry/Exit	No	Disabled ⁽¹⁾	Medium	Yes
0x1466 (5222)	Voltage loss on MN undervoltage release , page 254	Diagnostic	Entry/Exit	No	Disabled ⁽¹⁾	Medium	Yes
0x1467 (5223)	Communication loss on MN undervoltage release , page 254	Diagnostic	Entry/Exit	No	Disabled ⁽¹⁾	Medium	Yes
0x1468 (5224)	Invalid self test - MX2 voltage release , page 254	Diagnostic	Entry/Exit	No	Enabled	Medium	Yes
0x1469 (5225)	MX2 voltage release not detected , page 254	Diagnostic	Entry/Exit	No	Disabled ⁽¹⁾	Medium	Yes
0x1306 (4870)	Presence of external 24V power supply , page 247	Diagnostic	Entry/Exit	No	Enabled ⁽¹⁾	Low	No
0x150F (5391)	Internal Current Power Supply (CPS) sensors malfunction. , page 247	Diagnostic	Entry/Exit	No	Enabled	High	No
0x1510 (5392)	Internal Current Power Supply (CPS) sensors malfunction. Tsd forced to 0. , page 247	Diagnostic	Entry/Exit	No	Enabled	High	No
0x1511 (5393)	Partial Internal Current Power Supply (CPS) sensors malfunction. , page 247	Diagnostic	Entry/Exit	No	Enabled	Medium	No
0x1512 (5394)	Partial Internal Current Power Supply (CPS) sensors major malfunction. , page 247	Diagnostic	Entry/Exit	No	Enabled	High	No
0x1438 (5176)	Main voltage loss and CB is closed , page 254	Diagnostic	Entry/Exit	No	Enabled ⁽¹⁾	Medium	No
0x1445 (5189)	Remaining service life of MicroLogic is below alarm threshold , page 253	Diagnostic	Entry/Exit	No	Enabled ⁽¹⁾	Medium	Yes
0x1446 (5190)	MicroLogic control unit has reached the max service life , page 253	Diagnostic	Entry/Exit	No	Enabled ⁽¹⁾	High	Yes

Code	Event	History	Type	Latch	Activity	Severity	Service LED
0x1452 (5202)	MX1 voltage release operation counter is above alarm threshold , page 238	Diagnostic	Entry/Exit	No	Enabled ⁽¹⁾	Medium	Yes
0x1453 (5203)	MX1 voltage release has reached the max number of operations , page 238	Diagnostic	Entry/Exit	No	Enabled ⁽¹⁾	High	Yes
0x1454 (5204)	XF voltage release operation counter is above alarm threshold , page 238	Diagnostic	Entry/Exit	No	Enabled ⁽¹⁾	Medium	Yes
0x1455 (5205)	XF voltage release has reached the max number of operations , page 238	Diagnostic	Entry/Exit	No	Enabled ⁽¹⁾	High	Yes
0x1456 (5206)	MN undervoltage release operation counter is above alarm threshold , page 238	Diagnostic	Entry/Exit	No	Enabled ⁽¹⁾	Medium	Yes
0x1457 (5207)	MN undervoltage release has reached the max number of operations , page 238	Diagnostic	Entry/Exit	No	Enabled ⁽¹⁾	High	Yes
0x1458 (5208)	MX2 voltage release operation counter is above alarm threshold , page 238	Diagnostic	Entry/Exit	No	Enabled ⁽¹⁾	Medium	Yes
0x1459 (5209)	MX2 voltage release has reached the max number of operations , page 238	Diagnostic	Entry/Exit	No	Enabled ⁽¹⁾	High	Yes
0x1480 (5248)	Schedule basic maintenance within one month , page 238	Diagnostic	Entry/Exit	No	Disabled ⁽¹⁾	Medium	Yes
0x1481 (5249)	Schedule standard maintenance within one month , page 238	Diagnostic	Entry/Exit	No	Enabled ⁽¹⁾	Medium	Yes
0x1482 (5250)	Schedule manufacturer maintenance within three months , page 238	Diagnostic	Entry/Exit	No	Enabled ⁽¹⁾	Medium	Yes
(1) Customizable with EcoStruxure Power Commission software							

Metering Events

Code	Event	History	Type	Latch	Activity	Severity	Service LED
0x0F12 (3858)	Reset Min/Max currents , page 210	Metering	Pulse	No ⁽¹⁾	Enabled	Low	No
0x0F13 (3859)	Reset Min/Max voltages , page 210	Metering	Pulse	No ⁽¹⁾	Enabled	Low	No
0x0F14 (3860)	Reset Min/Max power , page 210	Metering	Pulse	No ⁽¹⁾	Enabled	Low	No
0x0F15 (3861)	Reset Min/Max frequency , page 210	Metering	Pulse	No ⁽¹⁾	Enabled	Low	No
0x0F16 (3862)	Reset Min/Max harmonics , page 210	Metering	Pulse	No ⁽¹⁾	Enabled	Low	No
0x0F17 (3863)	Reset Min/Max power factor , page 210	Metering	Pulse	No ⁽¹⁾	Enabled	Low	No
0x0F19 (3865)	Reset Min/Max current demand , page 213	Metering	Pulse	No ⁽¹⁾	Enabled	Low	No

Code	Event	History	Type	Latch	Activity	Severity	Service LED
0x0F1A (3866)	Reset Min/Max power demand , page 213	Metering	Pulse	No ⁽¹⁾	Enabled	Low	No
0x0F18 (3864)	Reset energy counters , page 219	Metering	Pulse	No ⁽¹⁾	Enabled	Low	No

(1) Customizable with EcoStruxure Power Commission software

Operation Events

Code	Event	History	Type	Latch	Activity	Severity	Service LED
0x0C02 (3074)	ERMS engaged for more than 24 hours , page 151	Operation	Entry/Exit	No	Enabled	Low	No
0x1000 (4096)	Circuit breaker opened , page 279	Operation	Pulse	No ⁽¹⁾	Enabled ⁽¹⁾	Low	No
0x1001 (4097)	Circuit breaker closed , page 283	Operation	Pulse	No ⁽¹⁾	Enabled ⁽¹⁾	Low	No
0x0411 (1041)	Closing order sent to XF voltage release , page 283	Operation	Pulse	No	Enabled ⁽¹⁾	Low	No
0x0410 (1040)	Opening order sent to MX voltage release , page 279	Operation	Pulse	No	Enabled ⁽¹⁾	Low	No
0x1002 (4098)	Manual mode enabled , page 278	Operation	Entry/Exit	No	Enabled	Low	No
0x1004 (4100)	Local mode enabled , page 278	Operation	Entry/Exit	No	Enabled	Low	No
0x111F (4383)	Allow control by digital input is disabled , page 279	Operation	Pulse	No	Enabled	Low	No
0x100A (4106)	Closing inhibited by communication , page 283	Operation	Entry/Exit	No	Enabled	Low	No
0x1009 (4105)	Closing inhibited through IO module , page 283	Operation	Entry/Exit	No	Enabled	Low	No
0x1307 (4871)	Alarm reset , page 308	Operation	Pulse	No	Enabled	Low	No
0x130B (4875)	M2C output 1 is forced , page 309	Operation	Entry/Exit	No	Enabled	Low	No
0x130C (4876)	M2C output 2 is forced , page 309	Operation	Entry/Exit	No	Enabled	Low	No

(1) Customizable with EcoStruxure Power Commission software

Configuration Events

Code	Event	History	Type	Latch	Activity	Severity	Service LED
0x0D06 (3334)	Config error IO/CU:dual settings or inhibit cls. Dual settings, page 120 Inhibit close order, page 283	Configuration	Entry/Exit	No	Enabled	Medium	No
0x0D0C (3340)	Config error IO/CU: optional protection inhibit , page 129	Configuration	Entry/Exit	No	Enabled	Medium	No
0x0D0D (3341)	Config. error IO and CU - Local/ Remote mode , page 129	Configuration	Entry/Exit	No	Enabled	Medium	No
0x112B (4395)	Control unit firmware update mode , page 46	Configuration	Entry/Exit	No	Enabled	Low	No
0x112C (4396)	Control unit firmware update unsuccessful , page 46	Configuration	Pulse	No	Enabled	Medium	No
0x1107 (4359)	Date and time set , page 38	Configuration	Pulse	No ⁽¹⁾	Enabled	Low	No
0x1130 (4400)	Digital Module license installed , page 36	Configuration	Pulse	No	Enabled	Low	No
0x1131 (4401)	Digital Module license uninstalled , page 36	Configuration	Pulse	No	Enabled	Low	No
(1) Customizable with EcoStruxure Power Commission software							

Communication Events

Code	Event	History	Type	Latch	Activity	Severity	Service LED
0x1301 (4865)	Connection on USB port , page 296	Communication	Entry/Exit	No	Enabled	Low	No
0x1429 (5161)	Bluetooth communication enabled , page 290	Communication	Entry/Exit	No	Enabled ⁽¹⁾	Low	No
0x1427 (5159)	Connection on Bluetooth port , page 290	Communication	Entry/Exit	No	Enabled	Low	No
(1) Customizable with EcoStruxure Power Commission software							

Appendices

What's in This Part

Appendix A 326
Appendix B 328

Appendix A

What's in This Chapter

Licensing Information	326
-----------------------------	-----

Licensing Information

Licensing Information for Cryptographic Software

Copyright © 1995-1997 Eric Young (eay@cryptsoft.com).

Copyright © 1998-2006 The OpenSSL Project. All rights reserved.

Copyright © 2002 Sun Microsystems, Inc. All rights reserved.

This product includes cryptographic software written by Eric Young (eay@cryptsoft.com).

THIS SOFTWARE IS PROVIDED BY ERIC YOUNG "AS IS" AND ANY EXPRESS OR IMPLIED WARRANTIES, INCLUDING, BUT NOT LIMITED TO, THE IMPLIED WARRANTIES OF MERCHANTABILITY AND FITNESS FOR A PARTICULAR PURPOSE ARE DISCLAIMED. IN NO EVENT SHALL THE AUTHOR OR CONTRIBUTORS BE LIABLE FOR ANY DIRECT, INDIRECT, INCIDENTAL, SPECIAL, EXEMPLARY, OR CONSEQUENTIAL DAMAGES (INCLUDING, BUT NOT LIMITED TO, PROCUREMENT OF SUBSTITUTE GOODS OR SERVICES; LOSS OF USE, DATA, OR PROFITS; OR BUSINESS INTERRUPTION) HOWEVER CAUSED AND ON ANY THEORY OF LIABILITY, WHETHER IN CONTRACT, STRICT LIABILITY, OR TORT (INCLUDING NEGLIGENCE OR OTHERWISE) ARISING IN ANY WAY OUT OF THE USE OF THIS SOFTWARE, EVEN IF ADVISED OF THE POSSIBILITY OF SUCH DAMAGE.

This product includes software developed by the OpenSSL Project for use in the OpenSSL Toolkit (<http://www.openssl.org/>).

THIS SOFTWARE IS PROVIDED BY THE OpenSSL PROJECT "AS IS" AND ANY EXPRESSED OR IMPLIED WARRANTIES, INCLUDING, BUT NOT LIMITED TO, THE IMPLIED WARRANTIES OF MERCHANTABILITY AND FITNESS FOR A PARTICULAR PURPOSE ARE DISCLAIMED. IN NO EVENT SHALL THE OpenSSL PROJECT OR ITS CONTRIBUTORS BE LIABLE FOR ANY DIRECT, INDIRECT, INCIDENTAL, SPECIAL, EXEMPLARY, OR CONSEQUENTIAL DAMAGES (INCLUDING, BUT NOT LIMITED TO, PROCUREMENT OF SUBSTITUTE GOODS OR SERVICES; LOSS OF USE, DATA, OR PROFITS; OR BUSINESS INTERRUPTION) HOWEVER CAUSED AND ON ANY THEORY OF LIABILITY, WHETHER IN CONTRACT, STRICT LIABILITY, OR TORT (INCLUDING NEGLIGENCE OR OTHERWISE) ARISING IN ANY WAY OUT OF THE USE OF THIS SOFTWARE, EVEN IF ADVISED OF THE POSSIBILITY OF SUCH DAMAGE.

Licensing Information for USB Communication

Copyright © 2010 Texas Instruments Incorporated (<http://www.ti.com/>).

This product includes software developed by Texas Instruments Incorporated (<http://www.ti.com/>).

THIS SOFTWARE IS PROVIDED BY THE COPYRIGHT HOLDERS AND CONTRIBUTORS "AS IS" AND ANY EXPRESS OR IMPLIED WARRANTIES, INCLUDING, BUT NOT LIMITED TO, THE IMPLIED WARRANTIES OF MERCHANTABILITY AND FITNESS FOR A PARTICULAR PURPOSE ARE DISCLAIMED. IN NO EVENT SHALL THE COPYRIGHT OWNER OR CONTRIBUTORS BE LIABLE FOR ANY DIRECT, INDIRECT, INCIDENTAL, SPECIAL, EXEMPLARY, OR CONSEQUENTIAL DAMAGES (INCLUDING, BUT NOT LIMITED TO, PROCUREMENT OF SUBSTITUTE GOODS OR SERVICES; LOSS OF USE, DATA, OR PROFITS; OR BUSINESS INTERRUPTION)

HOWEVER CAUSED AND ON ANY THEORY OF LIABILITY, WHETHER IN CONTRACT, STRICT LIABILITY, OR TORT (INCLUDING NEGLIGENCE OR OTHERWISE) ARISING IN ANY WAY OUT OF THE USE OF THIS SOFTWARE, EVEN IF ADVISED OF THE POSSIBILITY OF SUCH DAMAGE.

Appendix B

What's in This Chapter

MicroLogic Xi Control Unit: Description 328

MicroLogic Xi Control Unit: Description

Presentation

The MicroLogic Xi control units are MicroLogic X control units without Bluetooth Low Energy communication.

All the information related to the MicroLogic X control unit presented in this guide applies to MicroLogic Xi control units except information about Bluetooth Low Energy communication.

The differences between the MicroLogic X and MicroLogic Xi control units include:

- Commercial references
- MicroLogic Xi front face
- **Communication** menu

These differences are described further in this appendix.

Commercial References of MicroLogic Xi Control Unit

Standard	Control units	Commercial reference
IEC	MicroLogic 2.0 Xi	LV857600
	MicroLogic 5.0 Xi	LV857602
	MicroLogic 6.0 Xi	LV857603
	MicroLogic 7.0 Xi	LV857604
UL	MicroLogic 3.0 Xi	LV857610
	MicroLogic 5.0 Xi	LV857609
	MicroLogic 6.0 Xi	LV857608
<p>NOTE: The commercial reference is printed on the front face of the MicroLogic Xi control unit. It also identifies the standard, IEC or UL.</p>		

MicroLogic Xi Control Unit Description

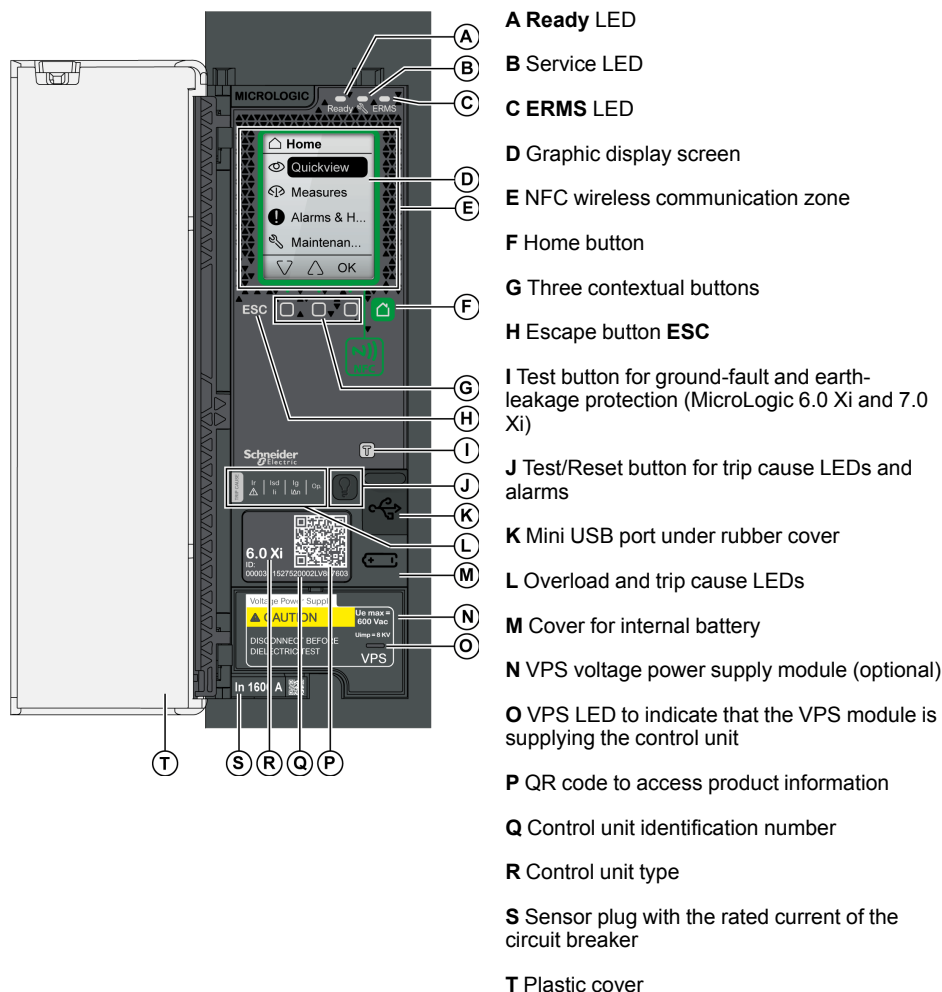

The MicroLogic Xi control units have no Bluetooth Low Energy communication.

The other features of MicroLogic Xi control units are identical to the features of MicroLogic X control units, page 18.

NFC Communication Zone

The MicroLogic Xi control units have the Near Field Communication (NFC) function.

The NFC communication zone is used to establish an NFC connection, page 293 between a smartphone running the EcoStruxure Power Device app and the MicroLogic Xi control unit. When the connection is established, the circuit breaker operating data is automatically uploaded to the smartphone.

Communication Menu

The **Home > Configuration > Communication** menu presents the following data:

Level 3	Level 4	Level 5	Parameter name
Communication	Bluetooth		Not supported by MicroLogic Xi control unit. Bluetooth is displayed in gray but cannot be selected.

Level 3	Level 4	Level 5	Parameter name
	Control mode, page 274	Mode	Defines the means to control the opening and closing functions: <ul style="list-style-type: none"> • Manual: (BP command only) pushbutton commands only are accepted • Automatic: <ul style="list-style-type: none"> ◦ (Local control) ◦ (Remote control) (factory setting)

Display Screen Replacement

The display screen can be replaced. Always replace the display screen with one that corresponds to the control unit type (MicroLogic X with wireless communication or MicroLogic Xi without wireless communication).

For information about replacement of the MicroLogic Xi display screen (commercial reference LV850054WWSP), consult the instruction sheet on the Schneider Electric website: [GDE66729](#)

Replacing the display screen of a MicroLogic X control unit with a MicroLogic Xi display screen (and vice versa) generates the hardware discrepancy event **Discrepancy between display and MicroLogic**. This discrepancy has no impact on the protections provided by the control unit. The control unit is operational.

Nonetheless, the control unit operation is limited as follows:

- The Quick View screens are displayed in English.
- Only the standard protection functions of the control unit, page 99 in the **Protection** menu can be read and set. They are available only in English.

The other menus cannot be accessed and control unit firmware update is not possible.

NOTE: Bluetooth Low Energy communication is not available if a display screen with Bluetooth Low Energy communication is installed on a MicroLogic Xi control unit.

Schneider Electric
35 rue Joseph Monier
92500 Rueil Malmaison
France

+ 33 (0) 1 41 29 70 00

www.se.com

As standards, specifications, and design change from time to time,
please ask for confirmation of the information given in this publication.

© 2021 – Schneider Electric. All rights reserved.

DOCA0102EN-07