

THE DreamMachine 2

Operation Manual Addendum

Embroidery and Sewing Machine

Product Code: 882-W20/W22 Model: XV8550D



Be sure to read this document before using the machine.
We recommend that you keep this document nearby for future reference.

ABOUT THIS MANUAL

This manual provides details on the new functions added from My Dream Machine (✨ Note: This symbol next to the title denotes a new or enhanced features, within the My Dream Machine II). Please refer to this manual for the functions of My Design Center.

CONTENTS



ABOUT THIS MANUAL	1
ABOUT MY DESIGN CENTER	3
Basics: Creating a Pattern	3
PATTERN DRAWING SCREEN	6
■ Key functions	7
Before Creating Designs	8
Drawing Lines	8
■ Setting the line types, stitch types and colors	9
Drawing Regions	10
■ Setting the brush types and fill colors	10
Using the stamp key	11
Using the erase key	12
Using the select key	13
STITCH SETTINGS SCREEN	14
Specifying individual stitch settings	14
■ Line settings	14
■ Region settings	15
Specifying global stitch settings	16
After specifying the settings generate embroidery pattern	16
EMBROIDERY IMAGE PREVIEW SCREEN	17
MY DESIGN CENTER WITH SCAN	18
Using the Scanning Frame	18
■ Scanning with an Embroidery Frame	19
Scanning to Trace Background Image	19
■ Importing the Background image	21
LINE SCAN	22
Using the Scanning Frame to Create a Pattern with Line Scan	22
ILLUSTRATION SCAN	25
Using the Scanning Frame to Create a Pattern with Illustration Scan	25
STIPLING	28
Basic Stippling with My Design Center	28
Scanning Drawing to Create Stippling Pattern	31
Scanning Fabric and Stippling	35
Decorative stitching around a pattern in embroidery (a quilting function)	38
Stippling Without Using My Design Center	42
Other Useful Functions	43
Additional built-in patterns	43
Addition of 24 cm × 24 cm frame	43
Specifying individual appliqués	43
Combining bobbin work patterns	44
Thread color sorting	44
Adding line feeds and inserting new embroidery character patterns	45
■ Line feeding	45
■ Inserting	45
Character alignment	46
Selecting multiple patterns at the same time	46
Grouping multiple selected patterns	47
Saving/deleting multiple patterns	48

ABOUT MY DESIGN CENTER

With My Design Center, you can use the functions listed below:

- Hand-drawn functions - creating embroidery patterns by drawing on the LCD screen
- Scanning functions - creating embroidery patterns by not only scanning object with built-in camera, but also imported data from USB media, SD card or computer.

You can also combine patterns that you have created with the machine's built-in patterns.

Start My Design Center by pressing  in the home page screen or pressing  in the embroidery pattern selection screen.

⚠ CAUTION

- Only touch the screen with your finger or the pen (stylus) included with the sewing machine. Do not use a mechanical pencil, screwdriver or any other hard or sharp object. In addition, do not press the screen with extreme pressure. Otherwise the screen may be damaged.
- All or part of the screen may sometimes become darker or lighter due to changes in the surrounding temperature or other changes in the environment. This is not a sign of a malfunction. If the screen is difficult to read, adjust its brightness.

Basics: Creating a Pattern

1. Draw a line drawing in the pattern drawing screen. (page 8)

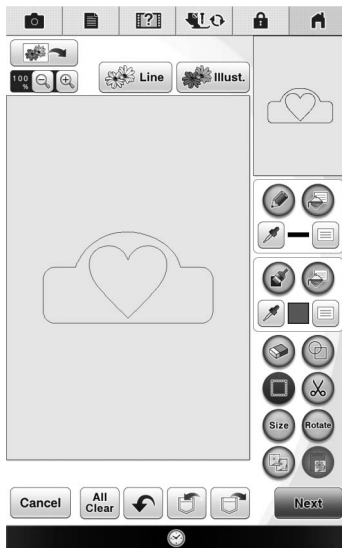

2. Add color to the pattern.



3. Select colors, fill stitches and desired patterns to complete your design.



4. Specify stitch settings. (page 14)

- * Further customize your pattern by specifying embroidery stitch settings, such as satin stitch width and density.

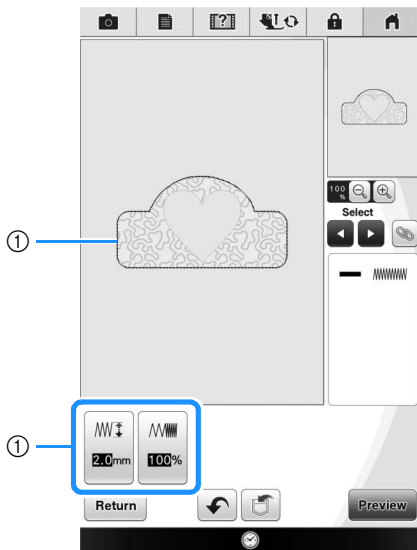

① Shows the stitch settings for the selected line.

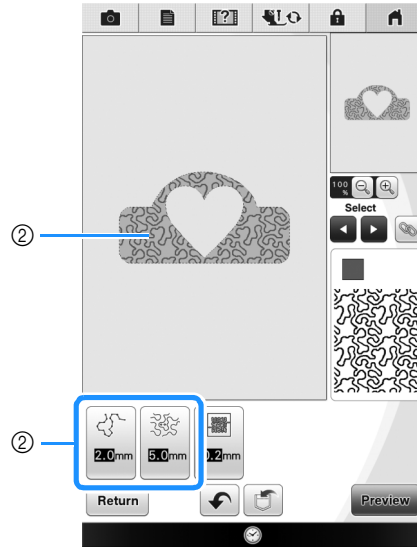

② Shows the stitch settings for the selected region.

5. Convert image data to embroidery data.

- The embroidery image preview screen appears. (page 17)

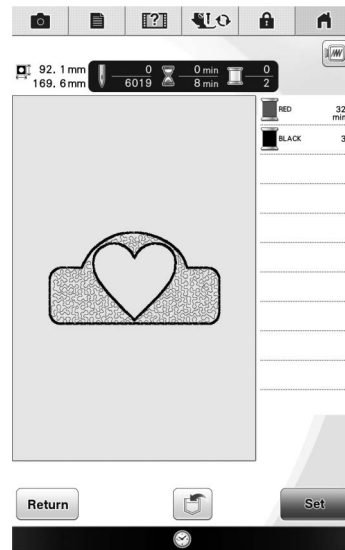

6. Edit the pattern in the embroidery edit screen, for example, by combining it with the machine's built-in patterns.

- * For details on how to edit the pattern, refer to "EDITING PATTERNS" in the Operation Manual.

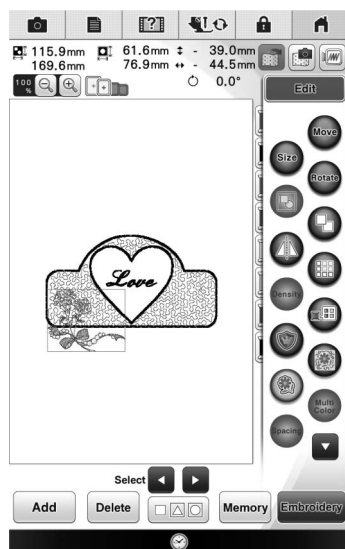

→ Embroidering begins.

PATTERN DRAWING SCREEN

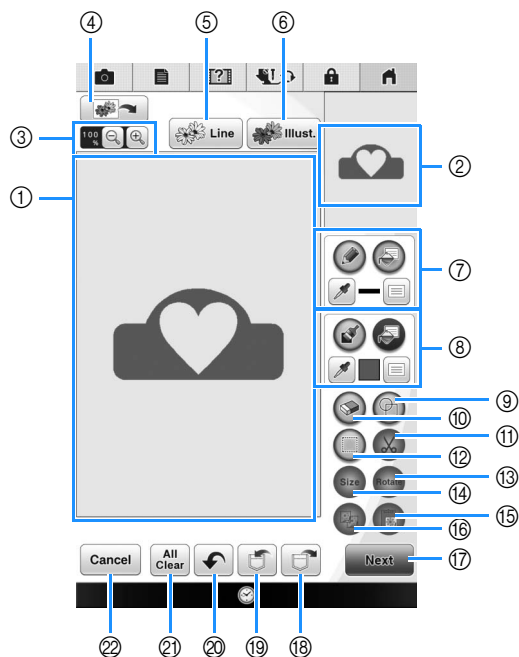























- ① Pattern drawing area
- ② Pattern preview area

Memo

- The actual dimension of the pattern area is the size of the embroidery frame, which is 36 cm × 24 cm (approx. 14 inches × 9-1/2 inches). The pattern you drew may be bigger than you expected. Please resize the pattern after converting the design to the embroidery pattern.
- When the pattern is enlarged so that only a part of it appears in the pattern drawing area, the entire pattern is displayed in the pattern preview area. The red frame in the pattern preview area indicates the part of the pattern displayed in the pattern drawing area. Move the red frame in the pattern preview area with the touch pen or your finger to display the corresponding area in the pattern drawing area.

■ Key functions

No.	Display	Key Name	Explanation	Page
③		Magnify key	Press this key to magnify the pattern.	10
④		Image scan key	Press this key to scan the attached frame and display on the screen as the background while using the My Design Center. You can scan the fabric as the background or scan the picture as the reference when creating the pattern.	—
⑤		Line design key	Press this key to scan the line drawing to edit and convert to the embroidery data using the built-in camera. You can also import the line drawing image from USB media, computer or SD card and create the embroidery design.	22
⑥		Illustration design key	Press this key to scan the illustration to edit and convert to the embroidery data using the built-in camera. You can also import the illustration from USB media, computer or SD card and create the embroidery design.	25
⑦		Line tool key	Draw lines and set the color. You can select the line type, stitch type and color as you need. Press  to pick up the color from a line in the pattern within the pattern drawing area. The picked up color is shown as the currently selected line color beside the button and as the selected color in the Line Property screen.	8
⑧		Brush tool key	Paint with brush and set the color. You can select the brush type, fill type and color as you need. Painted lines and areas will be converted to the pattern embroidered with fill stitch. Press  to pick up the color from a region in the pattern within the pattern drawing area. The picked up color is shown as the currently selected region color beside the button and as the selected color in the Region Property screen.	10
⑨		Stamp key	Press this key to select the stamp shape for pattern drawing.	11
⑩		Erase key	Press this key to erase lines and shapes that have been drawn. You can select the size/shape of the eraser.	12
⑪		Cut key	Press this key to cut out the selected section.	13
⑫		Select key	Press this key to select a section for moving by finger or pen, copying, deleting, changing size and rotating lines and shapes that have been drawn.	13
⑬		Rotate key	Press this key to rotate the selected section.	13
⑭		Size key	Press this key to change the size of the selected section.	13
⑮		Paste key	Press this key to paste in the selected section duplicated with the duplicate key or a selected section using the cut key.	—
⑯		Duplicate key	Press this key to duplicate the selected section. The temporarily positioned section can immediately be rotated, enlarged, reduced or moved.	—
⑰		Next key	Press this key to continue to the stitch settings screen.	—
⑱		Recall key	Press this key to recall image data created with My Design Center from the machine's memory, USB media, SD card or the computer.	—
⑲		Store key	Press this key to store the pattern being created.	—
⑳		Undo key	Press this key to undo the last operation that was performed and return to the previous state. Each press of this key will undo one operation.	—
㉑		All Clear key	Press this key to clear all the lines and shapes and start from the beginning. The background image is also cleared.	—
㉒		Cancel key	Press this key to exit from the My Design Center. All lines and shapes are erased when you press this key.	—

Before Creating Designs ✨

The pattern preview displays the design smaller than the actual size. You can view the actual pattern size by setting the “Embroidery Frame Display”.

With “Embroidery Frame Display” in the settings screen, the embroidery frame and grid can be specified separately. For details on the types of embroidery frames and grids available, refer to “Changing the Embroidery Frame Display” in the Operation Manual included with the machine.

1 Press .

2 Select the grid line of the “Embroidery Frame Display”.

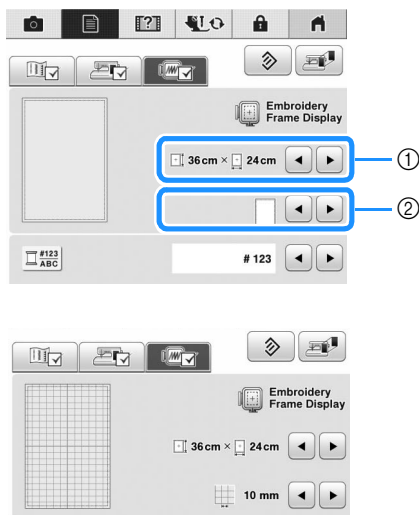

① Embroidery frame types

② Grid types

* Select the grid size 10 mm (3/8 inch) or 25 mm (1 inch).

Drawing Lines ✨

1 Press  and draw lines.

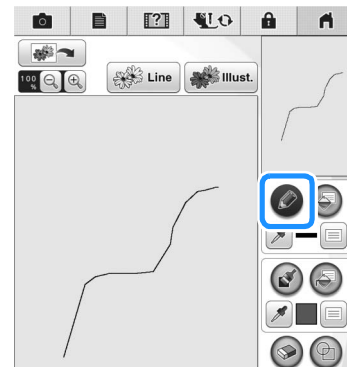

Memo

- When  is pressed, all regions will be displayed in the background to clarify the drawing lines on the screen.

■ Setting the line types, stitch types and colors

You can set or change the line types, stitch types and colors anytime. You can also specify the line types, stitch types and colors before drawing lines.

- 1 Press  to set the line types, stitch types and colors.

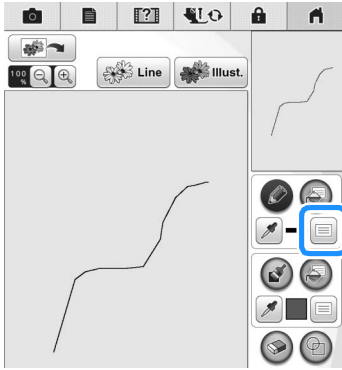



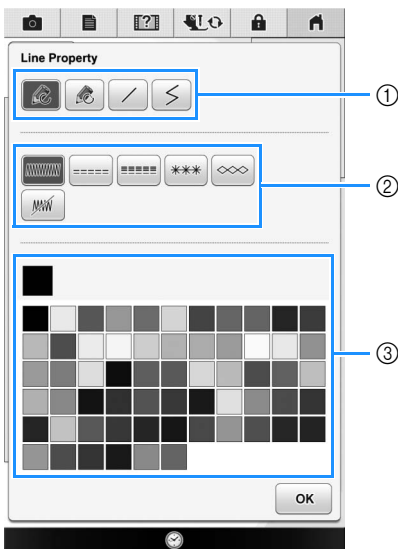

→ The settings screen appears.









- ① Line types
- ② Stitch types
- ③ Line color selection: touch the color palette to activate the drawing pen color.

Line types

	Freehand line with the end open.
	Freehand line closing the end automatically.
	Straight line with one stroke
	Straight line changing directions to the point you select. If the end point is created near the start point, a closed object will be created.

Stitch types

	Zigzag stitch
	Running stitch
	Triple stitch
	Candlewicking stitch
	Chain stitch
	Line without stitch for creating a region. Created region will be defined by the gray line.

- 2 Press  to return to the pattern drawing screen.

- The color bar on the line tool key is changed to the selected color.
- * The appearance of the line does not change even if the line type was changed. The specified line type can be checked in the stitch settings screen.

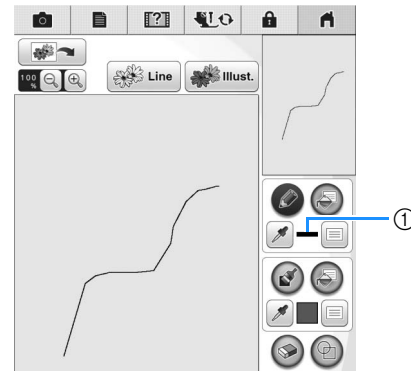



- ① Color bar

3 Press  then press on the line to change its color.

→ The connected line will be changed to the selected color.

Memo

- Press  to magnify the image when you cannot press on the line correctly. For details on magnify the image, refer to “Displaying Patterns in the Screen Magnified” in the Operation Manual included with the machine.
- Press , and then select a color within the pattern drawing area to apply the same color to other lines or parts of the pattern.



① Use  to select the line color.

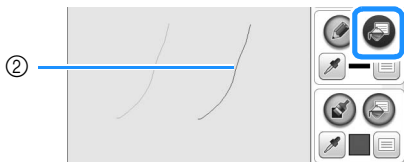

② Press  for changing the line color, and then select the pattern to be changed.

Drawing Regions

1 Press  and draw with brush.

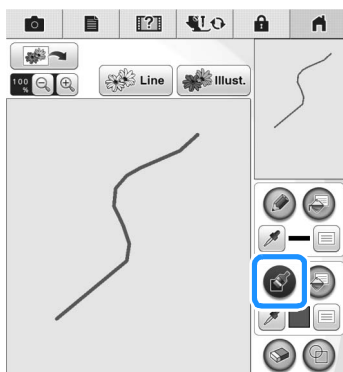



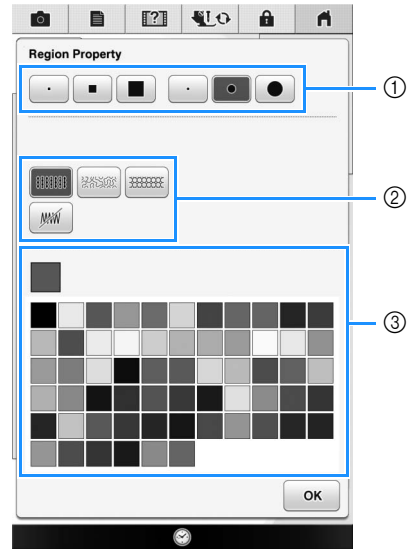

Setting the brush types and fill colors







1 Press  to set the brush types and fill colors.







- ① Brush types
- ② Fill stitch types
- ③ Fill color selection: touch the color palette to activate the paint brush color.

Brush shapes/sizes

	Square brush	
	Round brush	

	Small brush	
	Medium brush	
	Large brush	

Fill stitch types

	Fill stitch pattern
	Stippling pattern
	Select decorative fill patterns Displays a fill pattern selection screen, where  can be pressed to select a pattern.

Select  when you don't want fill stitch.

2 Press **OK** to return to the pattern drawing screen.

→ The color bar on the brush tool key is changed to the selected color.

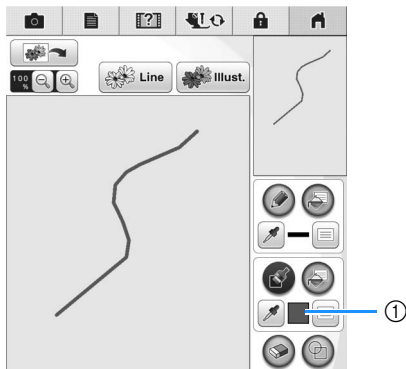

- ① Color bar
- * If a stippling pattern or decorative fill pattern has been specified, the settings are displayed.

3 Press **Stamp** and press on the brush line to change color and fill stitch types. You can also set the fill color, stitch type and fill pattern of a closed area made of the lines and brush lines.

Memo

- Press **Magnify** to magnify the image when you cannot press on the fill correctly.
- Press **Brush**, and then select a pattern color in the pattern drawing area to apply that fill color to other patterns.

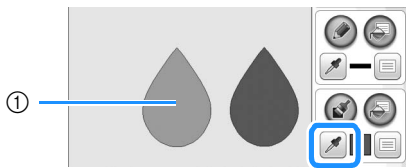

① Use **Brush** to select the fill color.

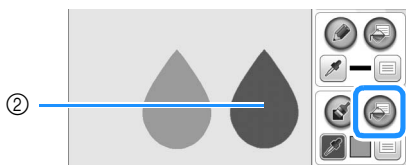

② Press **Stamp** for changing the fill color, and then select the pattern to be changed.

Using the stamp key

1 Press **Stamp**.

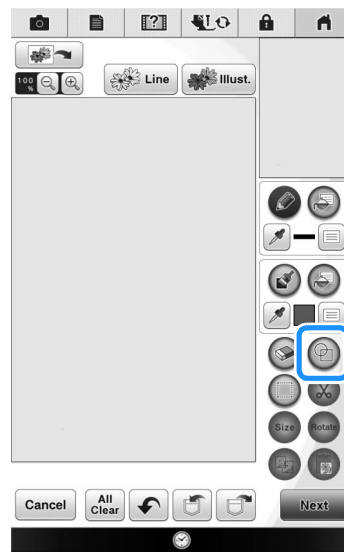

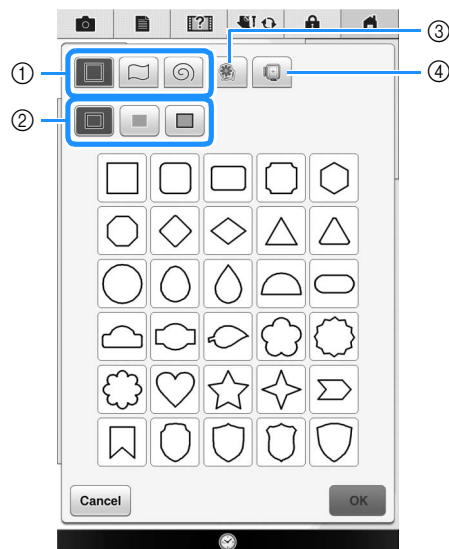

2 Select a stamp type and stamp shape.









- ① Stamp shapes
- ② Stamp types
- ③ Saved outlines
- ④ Frame embroidering areas

Stamp shapes

	Basic shapes
	Closed shapes
	Open shapes

Stamp types (Only for Basic shapes)

	Outline
	Fill stitch
	Outline and fill stitch

* Select the outline () , fill stitch () , or outline and fill stitch () of a basic shape.

Saved outlines

	Embroidery pattern outlines can be registered as stamp shapes. When registering stamp shapes, select from the last six embroidery patterns used. If more than six shapes are registered, the oldest one is automatically erased. For details on registering a stamp shape, refer to “Decorative stitching around a pattern in embroidery (a quilting function)” on page 38.
---	---

Frame embroidering areas

	Select an embroidering area in order to arrange the pattern to fit an embroidery frame.
---	---

* Press **Cancel** to return to the pattern drawing screen.

3 Press **OK** to set the selected stamp.

- The pattern drawing screen is displayed.
- * You can change size of, rotate or move the shape right after you create it by pressing **Size** or **Rotate**.

Using the erase key

1 Press .

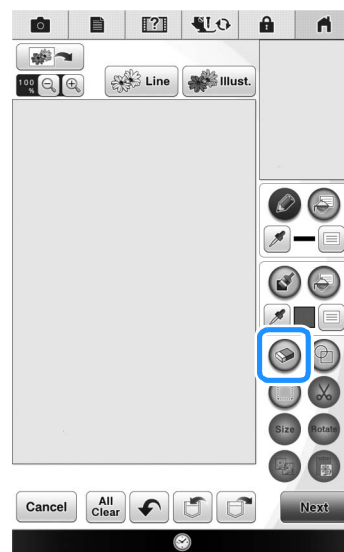

2 Select the size and shape of the eraser.

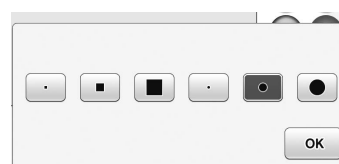

- * If the selected key will be used, press **OK**.
- The pattern drawing screen is displayed.

3 Drag along the area or line that you want to erase while the key appears as .

Using the select key

You can select the part of the design to move and/or edit. Some keys are available only after you select the part.

1 Press .

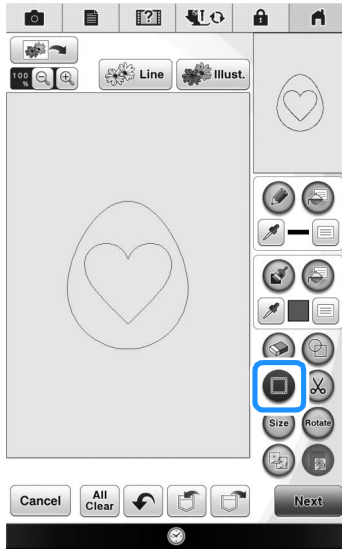

2 Select the area you want to edit.

* To select an area you want to edit, hold the stylus at a point on the screen and drag the stylus to create the red box around your selected area to be edited.

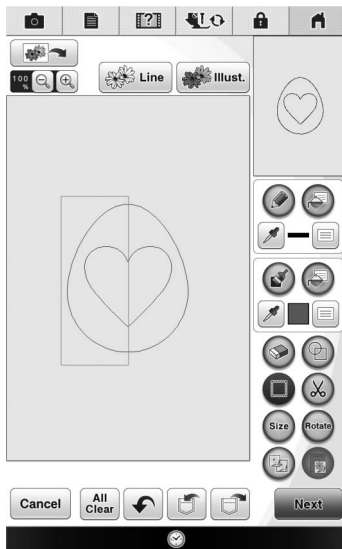

3 When  is pressed, the pattern size is displayed in the screen.

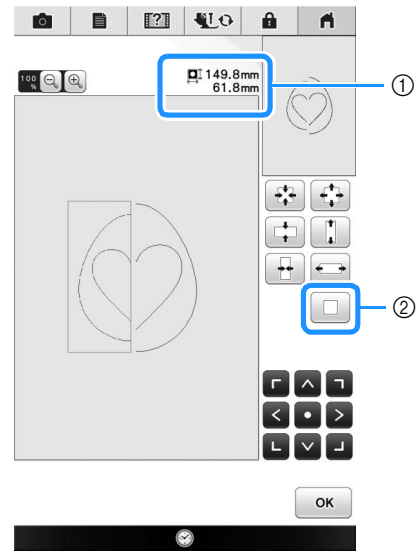

- ① Shows the size for the selected the part.
- ② Reverts to the original size.

4 When  is pressed, the pattern rotation angle is displayed in the screen.

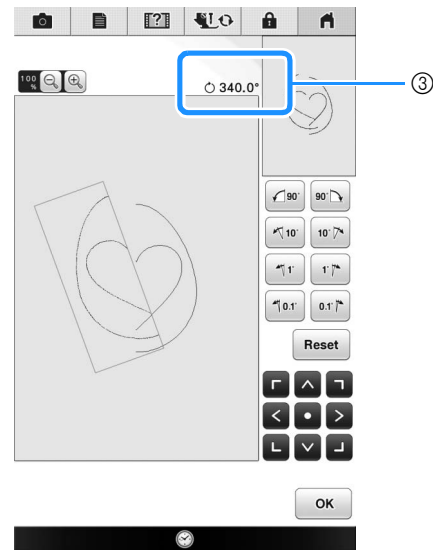

- ③ Shows the angle for the selected part.

5 Edit the design with available keys. (See "Key functions" on page 7 for the details of each key function.)



6 Press , and then specify the stitch setting.

STITCH SETTINGS SCREEN

Before creating the embroidery pattern, specify the stitch settings. Lines of the design are sewn with various stitches and areas are sewn with fill stitches or stippling stitches. Stitching of the areas was already selected in “Drawing Regions” on page 10, so specify values of detailed settings.

After specifying the settings, press **OK** to create the embroidery pattern.

If the design data is saved, the settings can be changed after a trial embroidering.

Specifying individual stitch settings



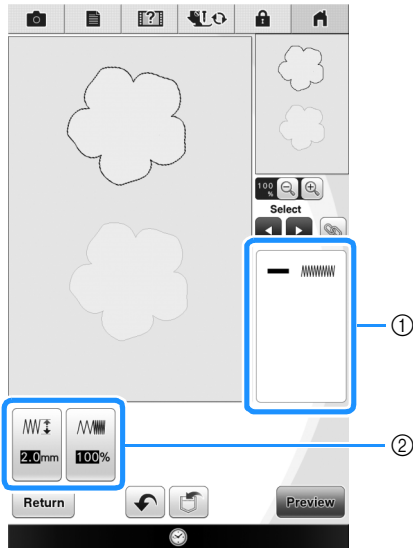

Select a pattern in the stitch settings screen to specify its line and region stitch settings. If multiple patterns are selected, the settings are applied to those patterns.

Line settings





- ① Shows the stitch type and color for the selected line.
- ② Shows the stitch settings for the selected line.

Line sew stitch settings

Select the type of stitching you want applied to your line art, from zigzag stitch (), running stitch (), triple stitch (), candlewicking stitch () or chain stitch ().

Zigzag stitch 



 Zigzag width	Specifies the width of the zigzag stitches used to sew the lines of the design.
 Density	Specifies the density of the zigzag stitches used to sew the lines of the design.

Running stitch  /Triple stitch 



* Both includes an under sewing.

 Run pitch	Specifies the length of the straight stitch of the design.
---	--

Candlewicking Stitch 

 Size	Increases/reduces the size of the pattern.
 Spacing	Specifies the spacing of the candlewicking stitch.

Chain stitch 



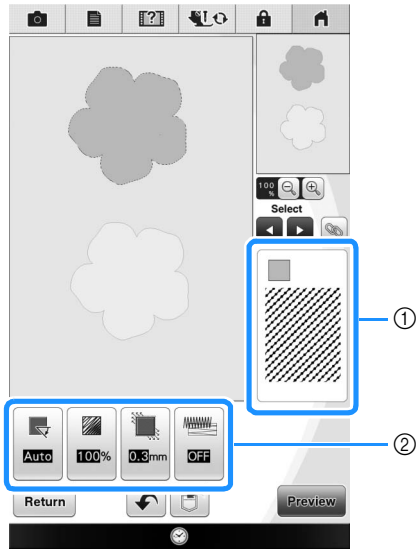

 Size	Increases/reduces the size of the pattern.
 Repetition	Sets repeated sewing at the same part.

Region settings





- ① Shows the stitch type and color for the selected region.
- ② Shows the stitch settings for the selected region.



Fill stitch settings



 Direction	Specifies the sewing direction. Select "Manual" to change to the desired direction of fill stitch.
 Density	Specifies the stitch density of fill stitch.
 Pull compensation	Specifies to correct the shrinkage of the pattern by slightly shortening or lengthening the stitching. Change the setting after you embroider the pattern and can check the shrinkage.
 Under sewing	Select if you need or do not need the under sewing for the stabilized fabric.



Stippling stitch settings

 Run pitch	Specifies the length of a stitch of the stippling stitch.
 Spacing	Specifies the spacing between the stitches when embroidering the stippling stitch.
 Distance	Specifies the offset from the pattern outline.

Decorative fill

 Size	Increases/reduces the size of the pattern.
 Direction	Specifies the rotation angle of the pattern.
 Outline	Select whether (ON) or (OFF) the outline is also converted to embroidery data. If "ON" is selected, the number of thread jumps can be reduced.

1 Use   to select the line or region to be changed.



→ Each press of   moves the highlighting of the selected pattern in order.

2 Select the setting to be changed, and then change the setting in the screen that appears. (In this example, the sewing direction will be changed.)



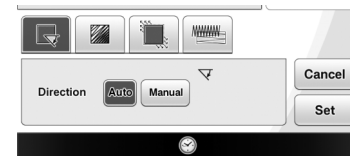

→ The setting screen appears.



3 Press , and then use   to change the direction.



4 Press  to apply the setting.

- *  appears on the tab for settings that were changed.
- * Change other settings in the same way.

Specifying global stitch settings ✨

The same stitch settings can be changed at the same time for multiple patterns of the same type.

- 1 Use **◀ ▶** to select the stitch whose settings are to be changed, and then press **⌘**.

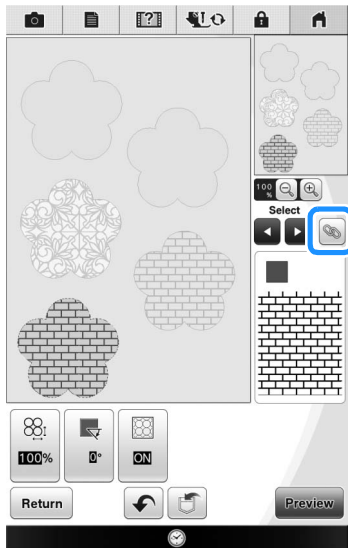

→ The same stitch type areas will be selected at the same time.

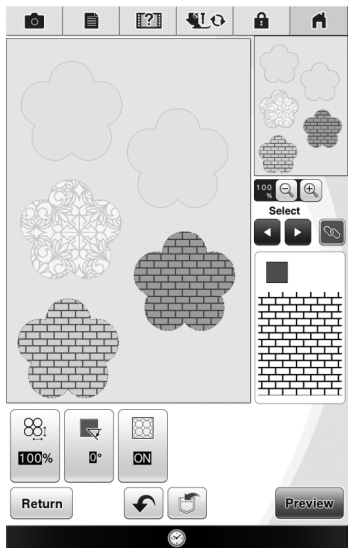



- 2 Follow steps **2** through **4** in “Specifying individual stitch settings” on page 15 to change the settings.

After specifying the settings generate embroidery pattern

Press **Preview** to create the embroidery pattern.

EMBROIDERY IMAGE PREVIEW SCREEN

You can check the total stitch number, embroidery time and spool thread color number to embroider the pattern. Press  to check the pattern image within the embroidery frame.

Press  to proceed to the embroidery edit screen.



Note

- Once you proceed to the embroidery edit screen, you cannot return to the My Design Center.

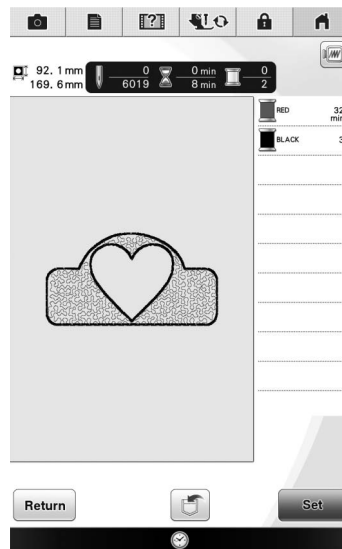

Press  to save the pattern as the embroidering data.

Press  to return to the stitch settings screen.

MY DESIGN CENTER WITH SCAN

Using the Scanning Frame

1 Prepare the desired drawing/illustration.

⚠ CAUTION

- To avoid having the embroidery foot strike the frame during the scanning process and possibly causing injury, check the following: the thickness of the fabric or paper, creases or folds in the fabric or paper that may be rolled up too close to the frame.

📖 Memo

- Only one sheet of paper can be placed in the scanning frame per scan.

2 Place the paper to be scanned in the scanning frame, and then secure the paper in place with the magnets.

- * Place the magnets at six locations around the paper to secure it, making sure that the line drawing is not covered.

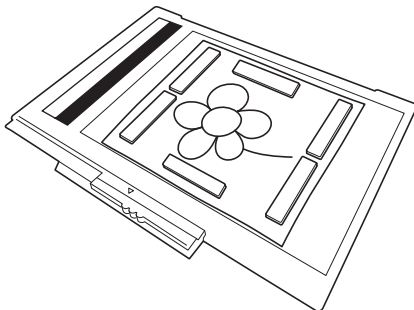

💡 Note

- When placing the paper in the scanning frame, make sure that the white balance area is not hidden; otherwise, the drawing cannot be scanned correctly. At the same time, be sure to place the scan image within the scan area. The image out of the scan area will not be scanned.

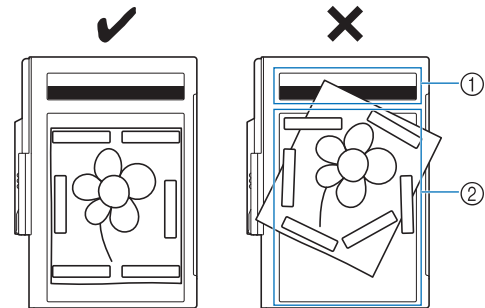

- ① White balance area
- ② Scan area

- Make sure that the white balance area or the scan area is not dirty or scratched; otherwise, the image cannot be scanned correctly.
- Be sure to use the magnets which are included with the scanning frame. If any other magnets are used, they may become attached to the machine during scanning, or other problems, such as a misaligned scan image, may occur.
- Be sure to place the magnets so that they secure the paper firmly. If the paper is placed unevenly, the image cannot be scanned correctly.
- If the scanning frame is dirty, wipe it with a cloth dampened with a diluted neutral detergent solution.

📖 Memo

- If you want to scan an image from a small piece of paper that can't be held with the magnets, copy that image onto a larger piece of paper, to then be placed on the scanning frame.

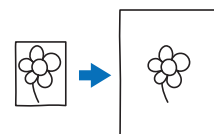

3 Attach the embroidery unit to the machine, and then turn on the machine.

* Refer to "Attaching the Embroidery Unit" in the Operation Manual included with the machine.

Note

- Unthread the machine to avoid having the thread slipping out of the needle or getting caught on the embroidery frame.

4 Press the "Presser Foot Lifter" button to raise the presser foot, and then press the "Needle Position" button to raise the needle.

* The presser foot is not raised high enough when raised with the presser foot lever.

CAUTION

- Make sure that presser foot and needle are fully raised. If scanning is started with the presser foot and needle lowered, the scanning frame may hit the machine, causing damage.

5 After attaching the scanning frame to the embroidery unit, swing the frame-securing lever toward you to secure the frame.

* Refer to "ATTACHING THE EMBROIDERY FRAME" in the Operation Manual included with the machine.

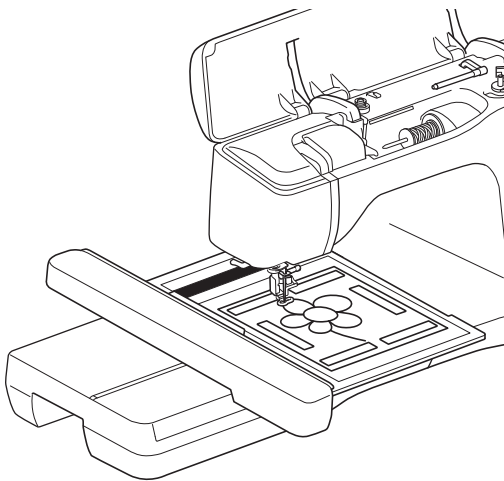

Note

- Be sure not to attach any presser foot other than the embroidery foot "W+" or "W", otherwise the presser foot will be scanned.

Scanning with an Embroidery Frame

Drawings and illustrations can also be scanned using an embroidery frame. Hoop the embroidery frame with fabric larger than the frame. Place the

paper to be scanned on the fabric, and then secure it, with tape.

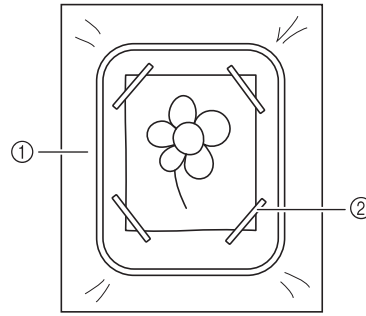

- ① Fabric
- ② Tape

Scanning to Trace Background Image

If you have a favorite picture or drawing, it can easily be traced on the scanned background image and you can create your own pattern.

1 Press  **.**



→ The image display screen appears.

2 Using the magnets, affix a picture to the scanning frame and attach the frame to the machine. Refer to “Using the Scanning Frame” on page 18.

3 Press **Scan**.

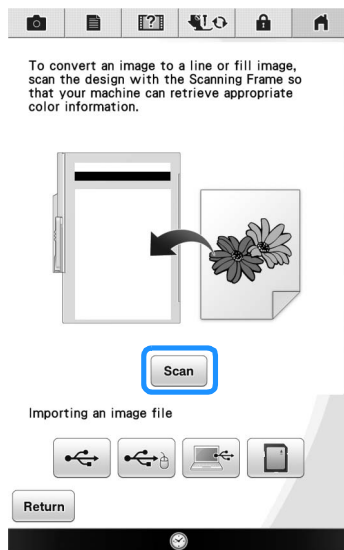

Note

- When scanning starts, some of the machine lights will turn off in certain circumstances, in order to increase the scan quality. The machine lights will return to their original brightness when scanning ends.
- You can import an image of 2 MB or smaller from USB media, computer or SD card.

→ When the following message appears, press **OK**.

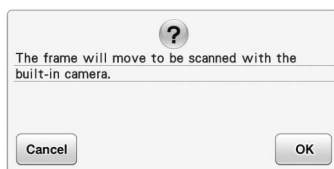

→ Scanning begins.
* To stop scanning and return to the screen in step **3**, press **Cancel**.

4 When scanning is finished, scanned image is displayed transparently in the pattern drawing area.

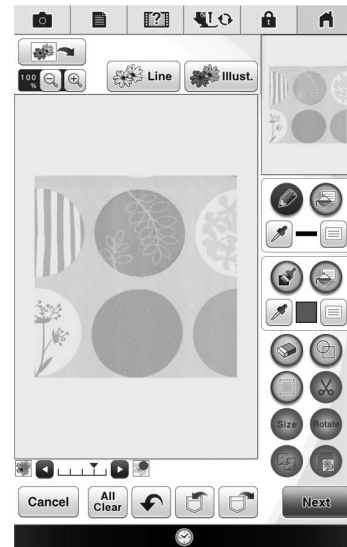



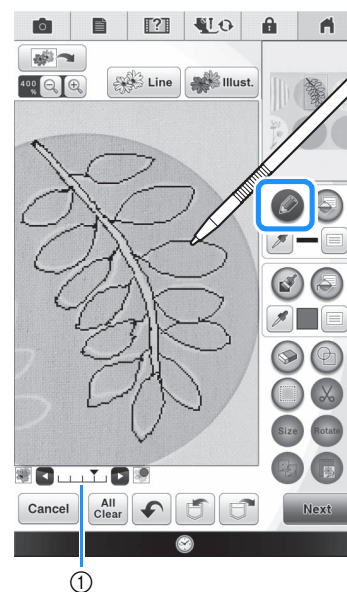

5 Using the included touch pen, press , and then draw lines to trace the image.

* For details on drawing lines, refer to “Drawing Lines” on page 8.



① Transparency adjustment

* Press  or  to adjust the transparency of the background.
Each press of  lightens the background, making the line pattern darker. Each press of  darkens the background, making the line pattern lighter.

6 After editing the pattern, press **Next** to specify the settings for pattern.

7 Press **Preview** to create the embroidery pattern.

■ Importing the Background image

Prepare the data file of your favorite picture so that you can create an embroidery pattern. Save data as a .jpg file type in your computer, on a USB media stick or SD card.

1 Press .



→ The image display screen appears.

2 Select the device you saved the data to.

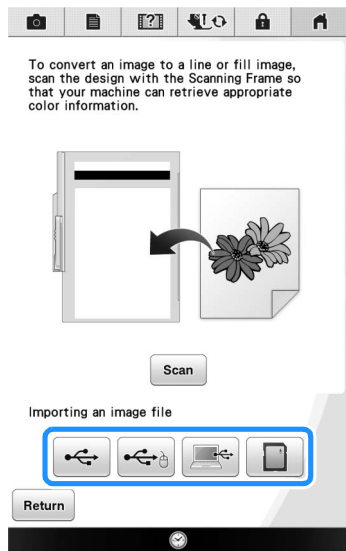

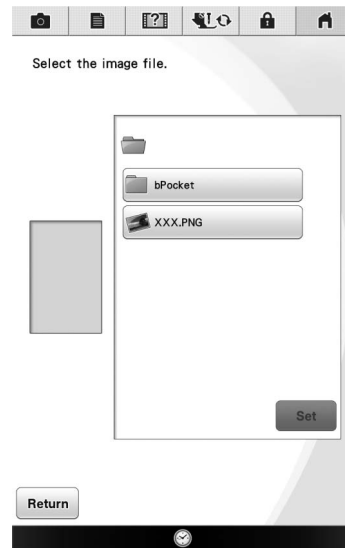

3 Select the data, and then press .

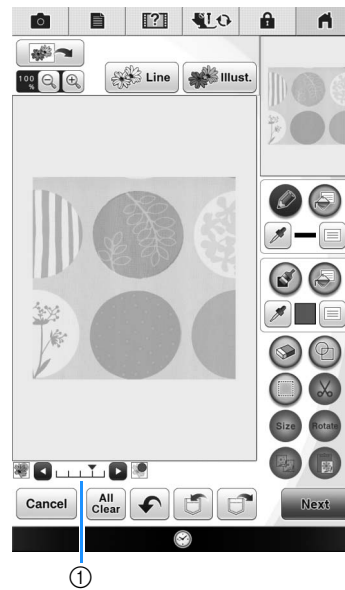

4 The selected image is displayed transparently in the pattern drawing area.



* After the scanned image is converted to stitching, it appears as a background in the pattern drawing screen. Use gauge ① to adjust the transparency of the background. Each press of  lightens the background, making the line pattern darker. Each press of  darkens the background, making the line pattern lighter.

LINE SCAN

Custom patterns can be created from drawings. You can create patterns by scanning your drawings using the included scanning frame or importing an image from USB media, computer or SD card.

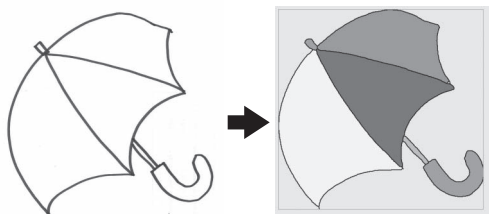

Recommended line drawings for Line Scan

- Line drawings must be drawn clearly using lines with approximately 1 mm thickness.
- Line drawings should be drawn in a strong contrast.
- If the lines are too short or gathered too densely, they will not be scanned correctly.



Note

- For details on creating patterns using color illustrations, refer to “ILLUSTRATION SCAN” on page 25.
- If you cannot scan the drawings as expected, you can edit the design in the My Design Center. Refer to “PATTERN DRAWING SCREEN” on page 6.
- Line drawings are scanned without recognizing the thickness of lines. If you want to change the thickness of lines, specify in the Settings screen. Refer to “STITCH SETTINGS SCREEN” on page 14.
- Line drawings are scanned as black lines. If you want to change the colors, specify in the My Design Center. Refer to “Drawing Regions” on page 10.



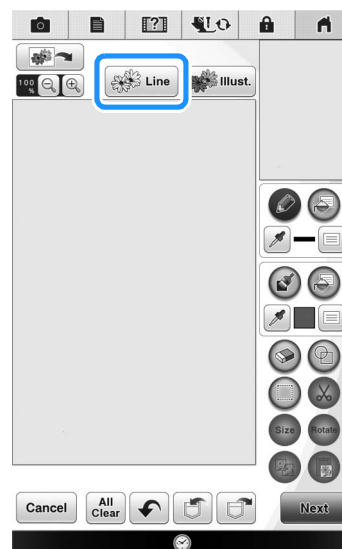

Using the Scanning Frame to Create a Pattern with Line Scan

1 Press .



→ The image display screen appears.

2 Press .

- * To import an image from USB media, computer or SD card, press , ,  or .
- * If you scan the image, make sure that the scanning frame is attached to the machine. Refer to “Using the Scanning Frame” on page 18.

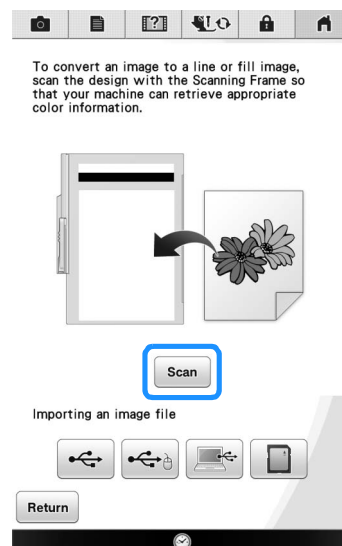



Note

- When scanning starts, some of the machine lights will turn off in certain circumstances, in order to increase the scan quality. The machine lights will return to their original brightness when scanning ends.
- You can import an image of 2 MB or smaller from USB media, computer or SD card.

→ When the following message appears, press **OK**.

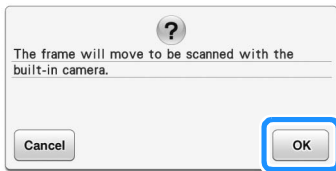

→ Scanning begins.

- * To stop scanning and return to the screen in step 2, press **Cancel**.

3 When scanning is finished, specify the **“Gray-Scale Detection level”** on the screen if necessary.

The “Gray-Scale Detection level” can change the black and white threshold for the image.

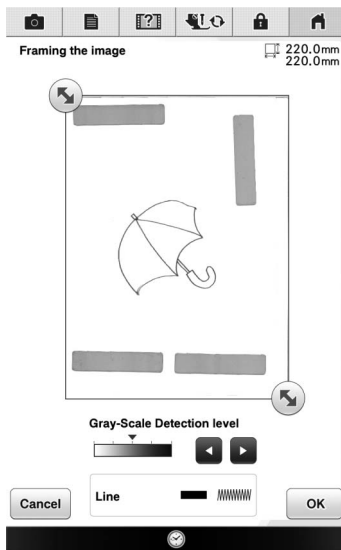

- * If you do not know how the settings should be changed, first continue the operation without specifying settings and check the results.
- * To stop scanning and return to the screen in step 2, press **Cancel**. The scanned image will be deleted when you return to the previous screen.

4 Move to frame the image for the pattern.

5 Press **OK**.

→ The screen for confirming the converted image appears.

6 In the screen for confirming the converted image, you can adjust the **“Gray-Scale Detection level”** again, if necessary.

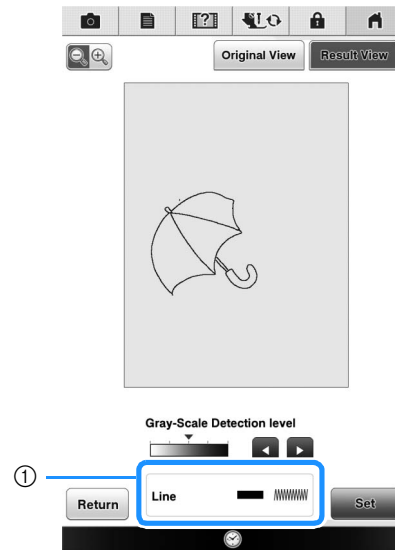

① The settings for the lines to be sewn appear.

- * If you do not know how the settings should be changed, first continue the operation without specifying settings and check the results.
- * To enlarge the image, press .
- * To display the image before being converted, press **Original View**. Compare the images before and after being converted, and then change the settings if necessary.
- * To return to the previous screen, press **Return**.

→ After changes to the settings for “Detection level” is applied, **Set** changes to **Retry**. Press **Retry** to check that the image is as desired.



7 Press **Set**.

→ The pattern drawing screen is displayed.

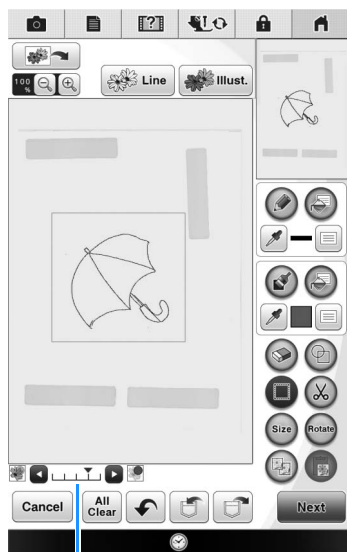
8 If necessary, edit the scanned image.



①

- * After the scanned image is converted to stitching, it appears as a background in the pattern drawing screen. Use gauge ① to adjust the transparency of the background. Each press of  lightens the background, making the line pattern darker. Each press of  darkens the background, making the line pattern lighter.



Note

- During scanning, the small dots that appear and unnecessary lines can be erased.

ILLUSTRATION SCAN

Custom patterns can be created from color illustrations. You can create patterns by scanning an illustration using the included scanning frame or importing an image from USB media, computer or SD card.

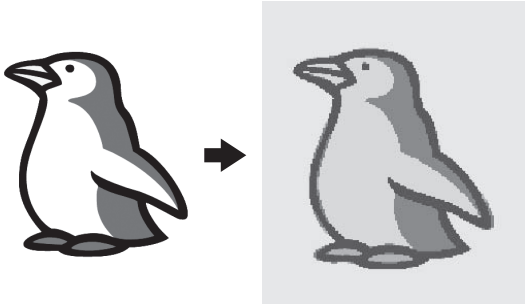

Recommended illustrations for Illustration Scan

- Patterns that are clearly drawn, with no gradation, fading or blurriness.
- Patterns that are at least a 5 mm square
- Patterns that are extremely simple images



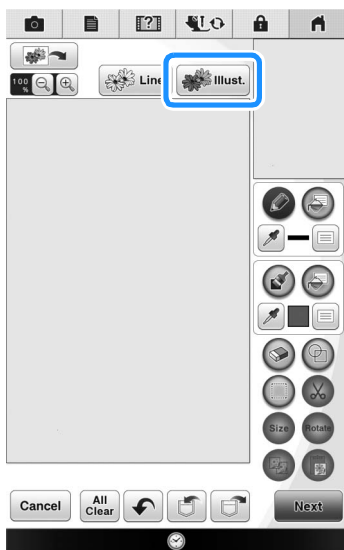

Using the Scanning Frame to Create a Pattern with Illustration Scan

1 Press  .





→ The image display screen appears.

2 Press  .

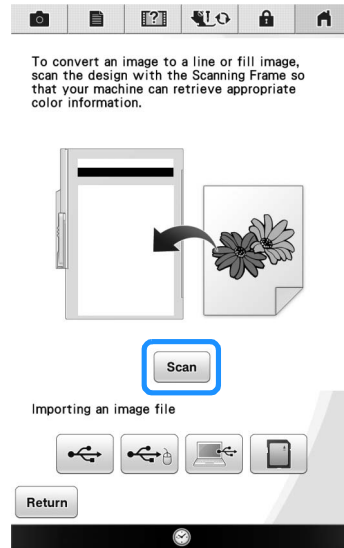
* To import an image from USB media, computer or SD card, press , ,  or  .



Note  • When scanning starts, some of the machine lights will turn off in order to increase the scan quality. The machine lights will return to their original brightness when scanning ends.

→ When the following message appears, press  .

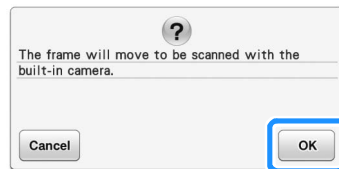

→ Scanning begins.
* To stop scanning and return to the screen in step **2**, press  .

3 When scanning is finished, specify the necessary settings in the scan image confirmation screen.

Change the settings to adjust the image so it can easily be converted to the desired pattern.

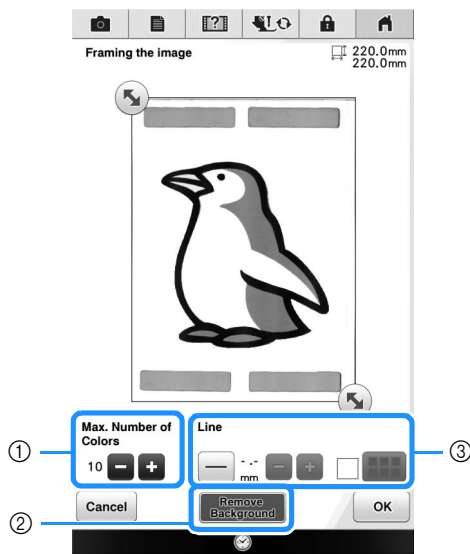



①	Max. Number of Colors	The number of colors in an image will be reduced less than the number specified here, and then the outline will be extracted.
②	Remove Background	Select whether or not the background color will be included as one of the colors.
③	Line	Select whether or not the outline will be detected as a line. A thick outline can also be detected as a region. When detected as a line, the line thickness and color can be specified.

* To stop scanning and return to the screen in step 2, press **Cancel**.

Memo

- Press **—** to detect the outline. Line thickness can be specified from 1.0 mm (1/16 inch) to 5.0 mm (3/16 inch).



- Press  to select the outline color. Select by touching the color, or moving  icon

using  in the color selection screen.

4 Move to frame the image for the pattern.

5 Press **OK**.

→ The screen for confirming the converted image appears.

6 In the screen for confirming the converted image, adjust the image as necessary in step 3.

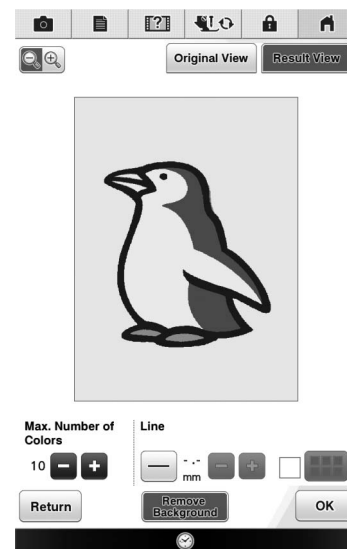

- * To enlarge the image, press .
- * To display the image before being converted, press **Original View**. Compare the images before and after being converted, and then change the settings if necessary.

- * To return to the previous screen, press **Return**.

→ After changes to the settings described above have been applied, **OK** changes to **Retry**. Press **Retry** to check that the image is as desired.



7 Press **OK**.

→ The pattern drawing screen is displayed.

8 If necessary, edit the scanned image.



①

- * After the scanned image is converted to stitching, it appears as a background in the pattern drawing screen. Use gauge ① to adjust the transparency of the background. Each press of  lightens the background, making the illustration pattern darker. Each press of  darkens the background, making the illustration pattern lighter.



Note

- During scanning, the small dots that appear and unnecessary lines can be erased.

STIPLING

Basic Stippling with My Design Center

Create a stippling design with the basic procedure.
Example:

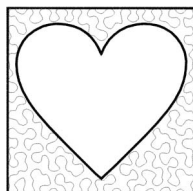

1 Press .

* You can also start the function by pressing

 in "Embroidery" mode.

2 Press .



3 Select the square shape, and then press .

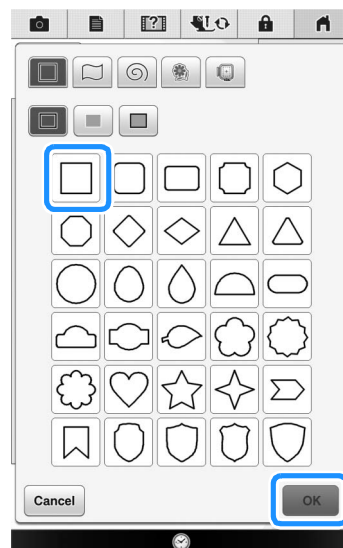

4 Press .

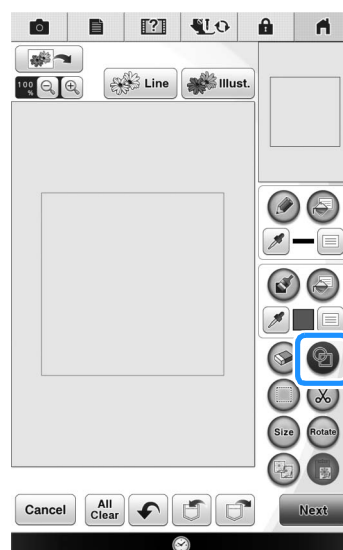

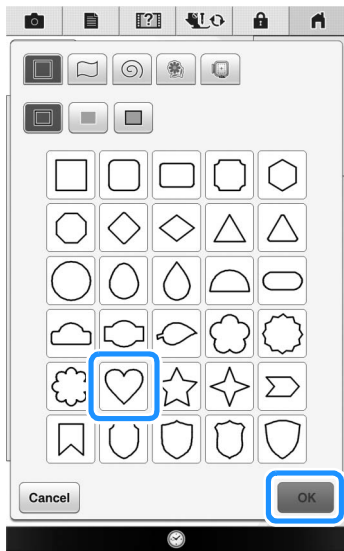

- 5 Select the heart shape, and then press **OK**.



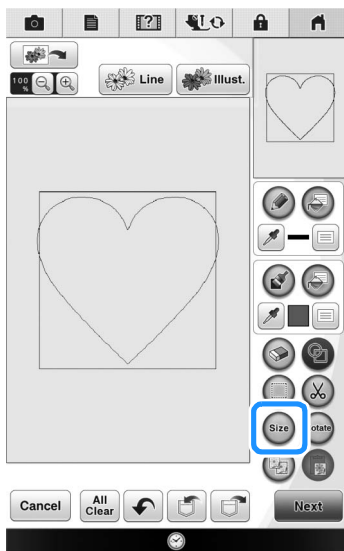

- 6 Press **Size**.

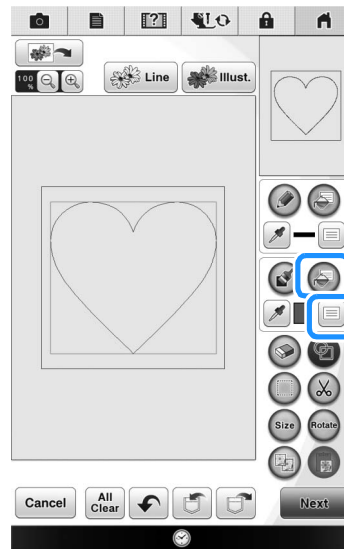

- 7 Press  until the heart shape fits in the square shape, and then press **OK**.

- 8 Press , and then press .



- 9 Press , and then select the stitch color. Press **OK** after setting the color.

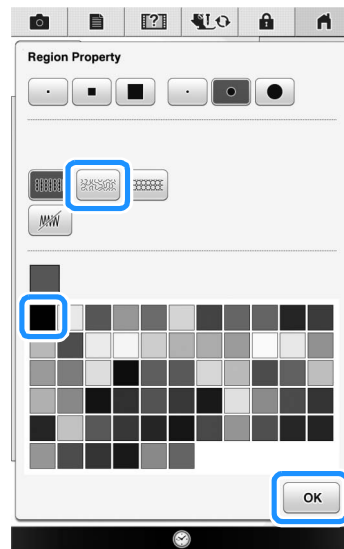

10 Select the area you want to set stippling effect.

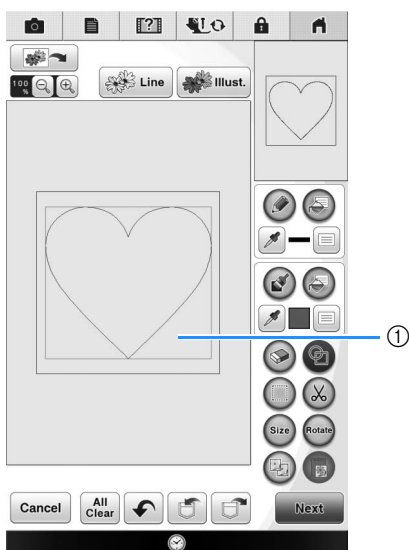

① Select this area.

11 Press **Next**.

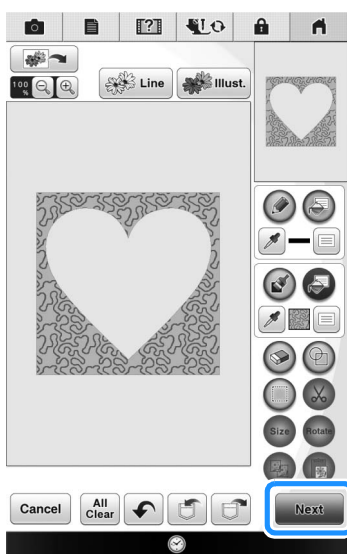

12 Adjust the stippling settings to create the desired effect, and then press **Preview**.

* For details, refer to “Specifying individual stitch settings” on page 14.

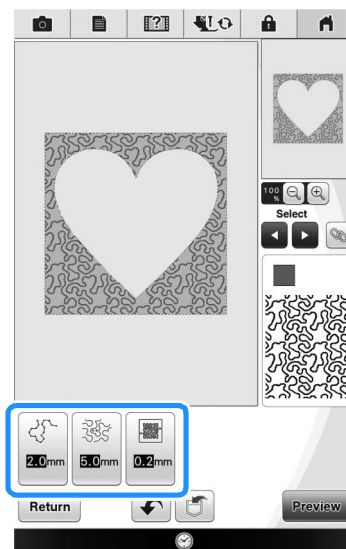

13 When the following message appears, press

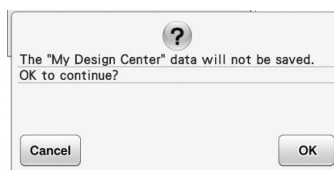

14 Press **Set** to convert into embroidery.

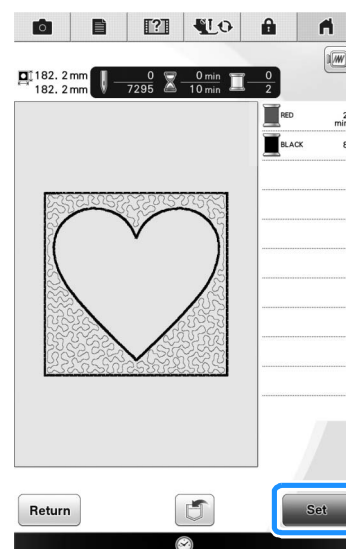

→ When the following message appears, press **OK**.

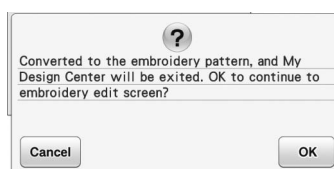





- 15 Follow the procedure described on “EDITING PATTERNS” in the Operation Manual included with the machine to edit the pattern as desired.

Scanning Drawing to Create Stippling Pattern

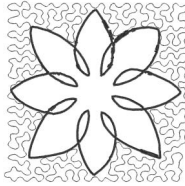
Create a custom pattern with stippling design.

Example:



- 1 Place a drawing of your design on the scanning frame.
- 2 Press  .
 - * You can also start the function by pressing  in “Embroidery” mode.
- 3 Press  .

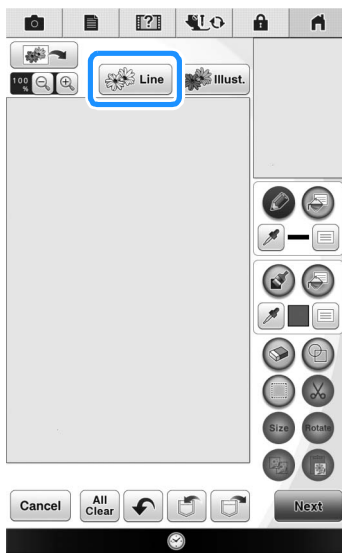

→ The image display screen appears.

- 4 Position the scanning frame on the machine, and then press  .

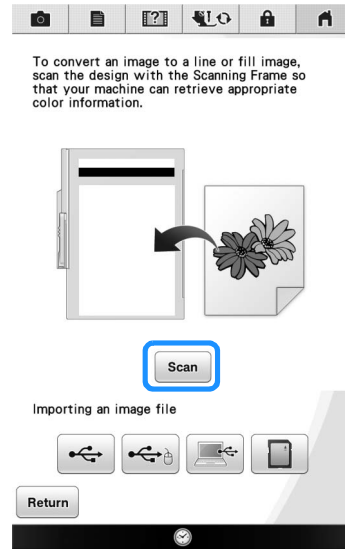

Note

- When scanning starts, some of the machine lights will turn off in certain circumstances, in order to increase the scan quality. The machine lights will return to their original brightness when scanning ends.
- You can import an image of 2 MB or smaller from USB media, computer or SD card.

→ When the following message appears, press **OK**.

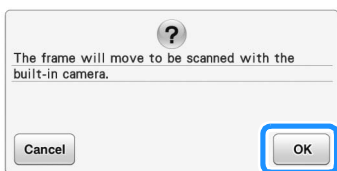

→ Scanning begins.

* To stop scanning and return to the screen in step 4, press **Cancel**.

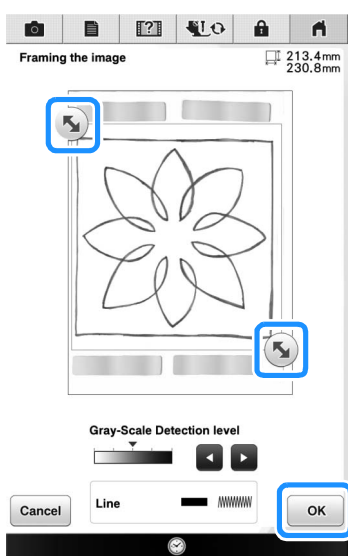

5 When scanning is finished, move  to frame the image for the pattern, and then press **OK**.



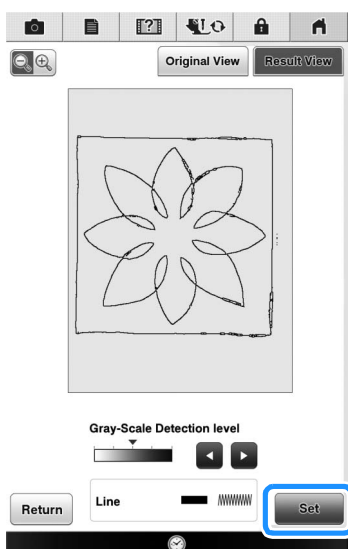

6 The screen for confirming the converted image appears, adjust the image if necessary and then press **Set**.

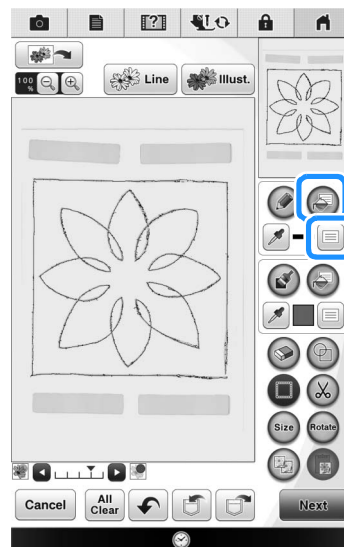

→ The pattern drawing screen is displayed.

7 To set the outline of the pattern, press , and then .



8 Press  and then **OK**. This will set the outline without a stitch.

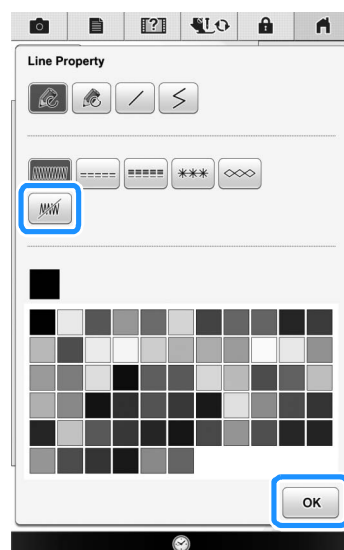

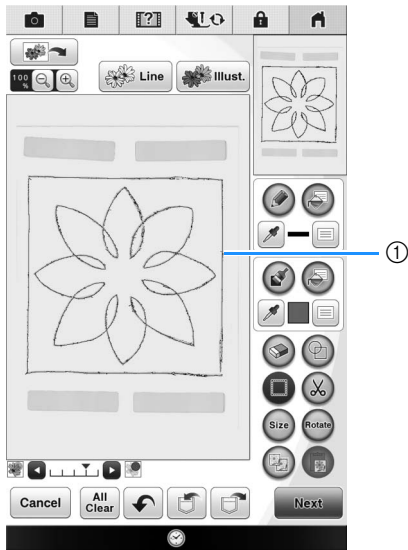

9 Select the outline of the pattern.

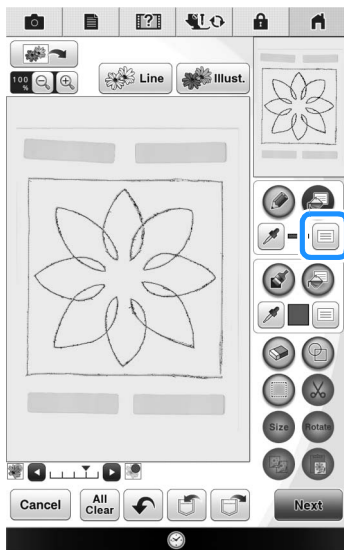

① Outline of the pattern

10 Press  to select the color of the stitch around the stippling effect.



11 Press  and select the stitch color, and then press .

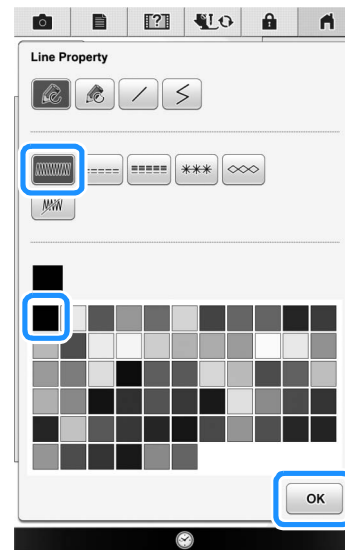

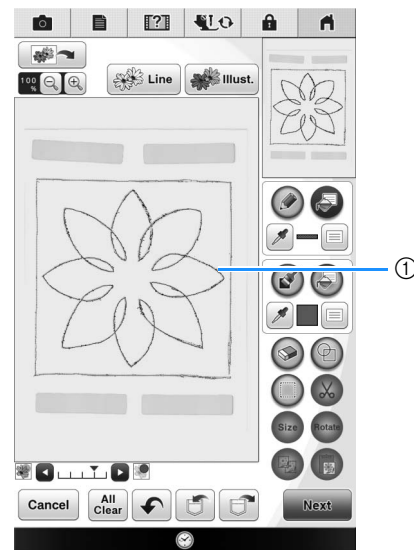

12 Select the stitch line around the stippling effect.

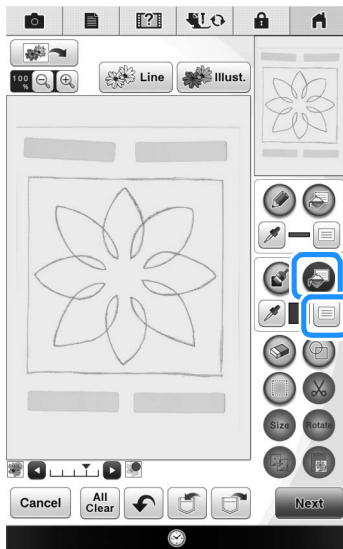

① Stitch line

- 13** To set the stitch color and fill stitch type, press , and then .



- 14** Press , and then select the stitch color. Press  after setting the color.

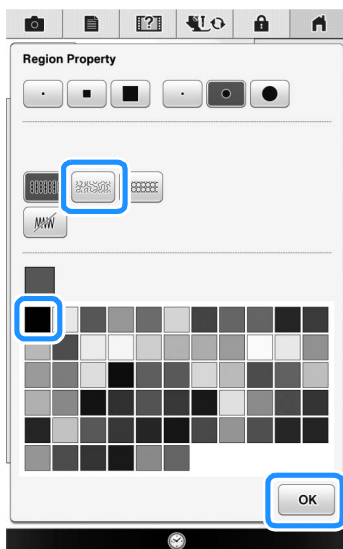

- 15** Select the area you want to set stippling effect.

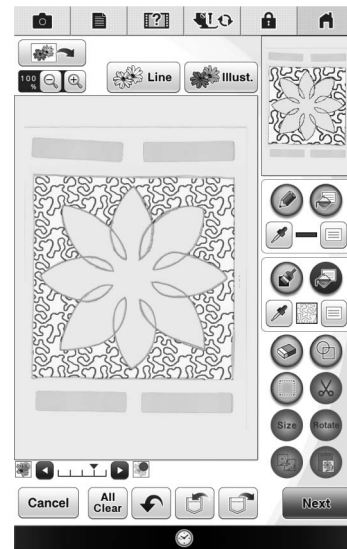

- 16** Follow the procedure from step **11** on page 28 of “Basic Stippling with My Design Center”.

Scanning Fabric and Stippling

Use the fabric pattern to coordinate with the stippling pattern.

1 Set the fabric to the embroidery frame.

2 Press .

* You can also start the function by pressing

 in "Embroidery" mode.

3 Press .



→ The image display screen appears.

4 Position the embroidery frame on the machine, and then press .

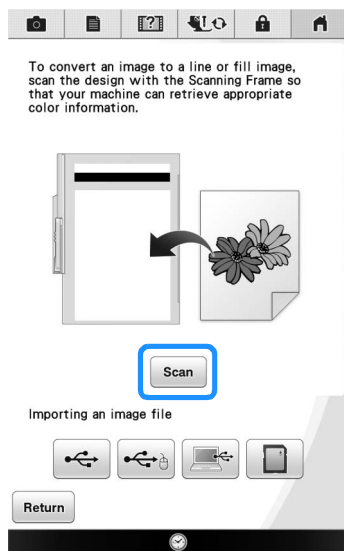

Memo

- Although the instructions in the LCD screen refer to the scanning frame, this example uses an embroidery frame for scanning.

Note

- When scanning starts, some of the machine lights will turn off in certain circumstances, in order to increase the scan quality. The machine lights will return to their original brightness when scanning ends.
- You can import an image of 2 MB or smaller from USB media, computer or SD card.

→ When the following message appears, press .

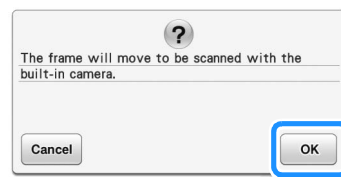

→ Scanning begins.

* To stop scanning and return to the screen in step **4**, press .

5 Press .

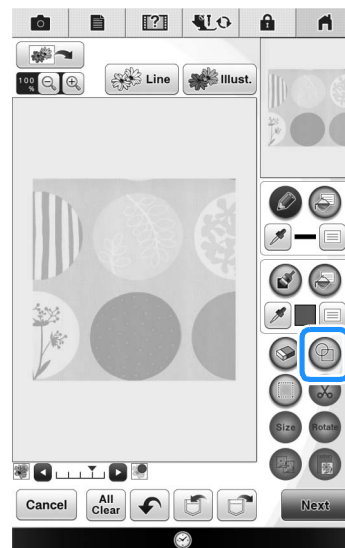



6 Select the circle shape, and then press

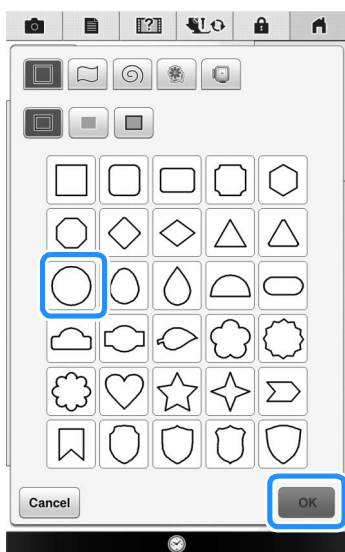

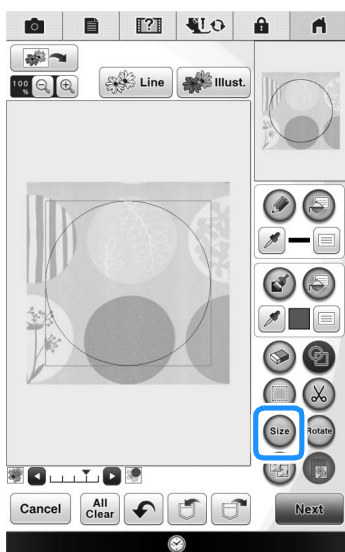

OK .





7 Press **Size** to increase or decrease the size of the circle.



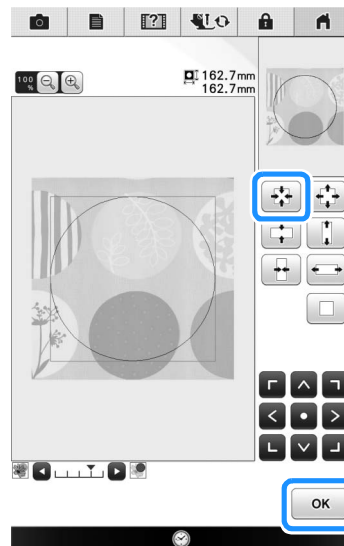

8 Press  until the size of circle fits the pattern on the fabric, and then press **OK** .

* Use    to align the position of the circle to the pattern on the fabric.
 

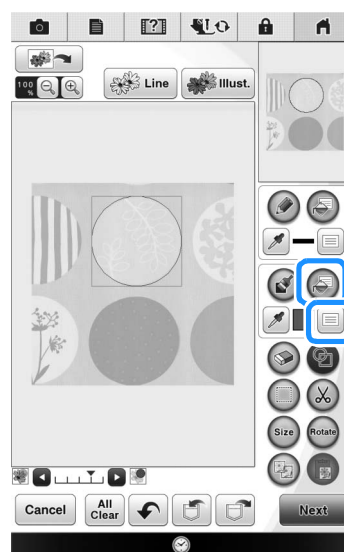

9 To set the stitch color and fill stitch type, press , and then .



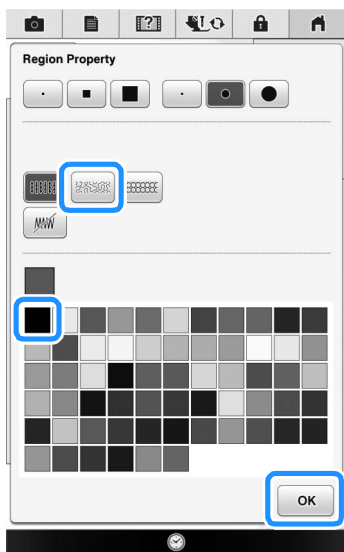

- 10 Press , and then select the stitch color. Press  after setting the color.

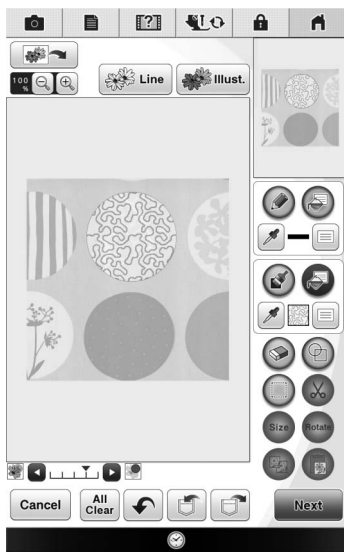

- 11 Select the area you want to set stippling effect.



- 12 To set the outline of the pattern, press , and then .

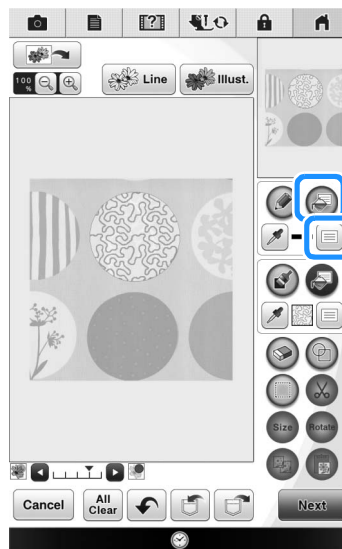

- 13 Press  and then . This will set the outline without a stitch.

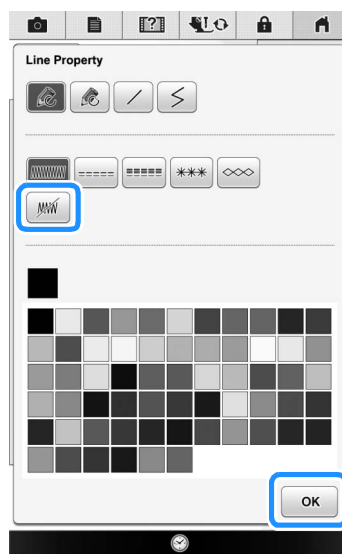

14 Select the outline of the pattern.

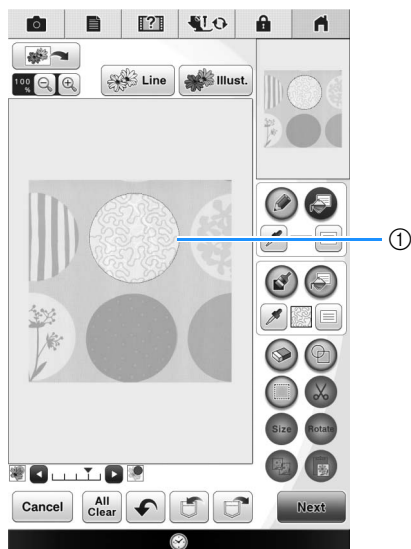

① Outline of the pattern

15 Follow the procedure from step 11 on page 28 of “Basic Stipling with My Design Center”.

→ Start embroidering on the fabric that you scanned at first.



Decorative stitching around a pattern in embroidery (a quilting function) ✨



Memo

- For best results, reduce the sewing speed.

A quilt can be created with stippling around an embroidery pattern.

- 1 Hoop the embroidery frame with batting sandwiched between two layers of fabric, and then attach the frame to the machine.
- 2 Press  and select the pattern that decorative stitching will be added around, and then press  in the embroidery edit screen.

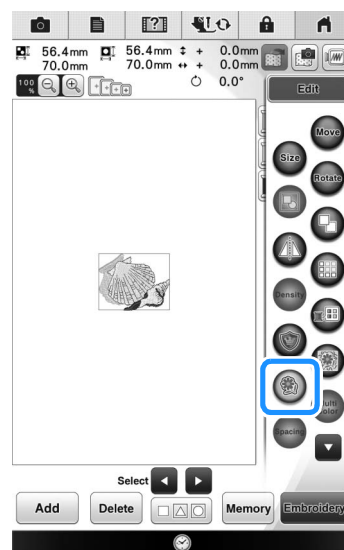

→ The outline of the pattern is displayed.

3 Press  .

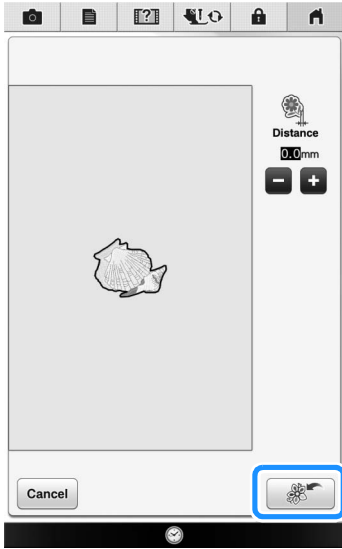

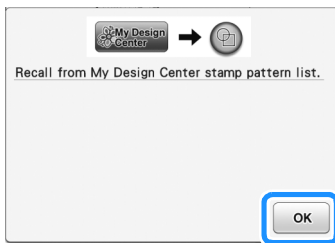

→ A message appears, and the pattern outline is registered as a stamp shape in My Design Center.

Press  .



4 Press  to continue to the embroidery screen, and then embroider the pattern.

5 Press  in the home page screen to start the My Design Center.

6 Press  to scan the embroidered fabric.

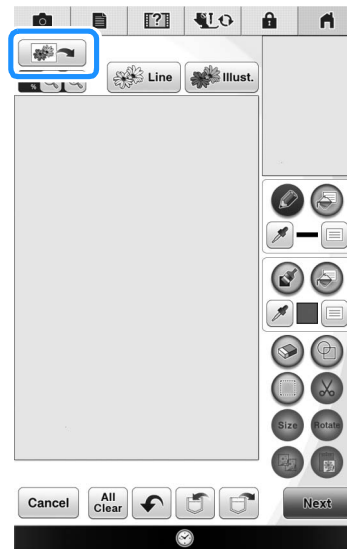

7 Press , press  to recall the stamp shape registered in step 3, and then arrange it over the scanned pattern.

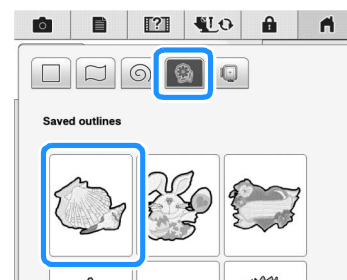
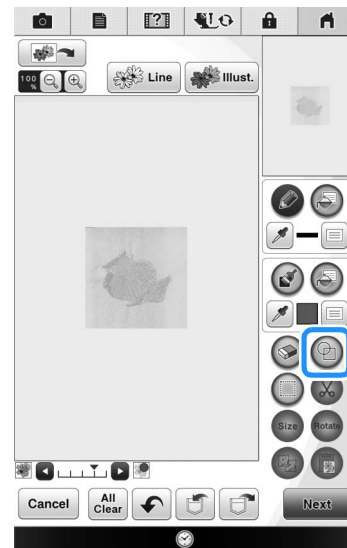

8 Use a stamp or rectangular frame to determine the area to be stitched.



Note

- If the area is to be drawn by hand, be sure to draw a completely closed shape. If the area is not closed, it cannot be correctly filled with the decorating.

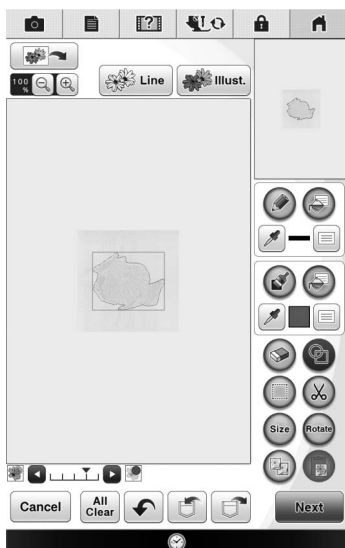

9 Use the brush tool keys to select the pattern and color of the decorative stitching.

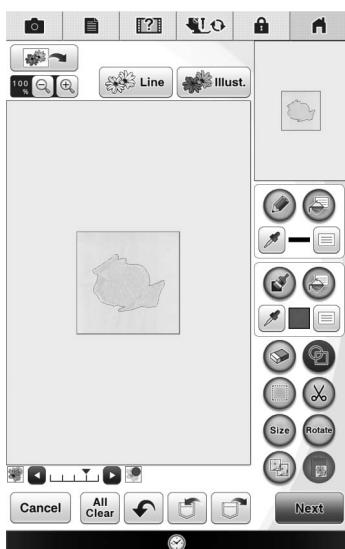

10 Fill the area to be stitched outside of the stamp shape outline.

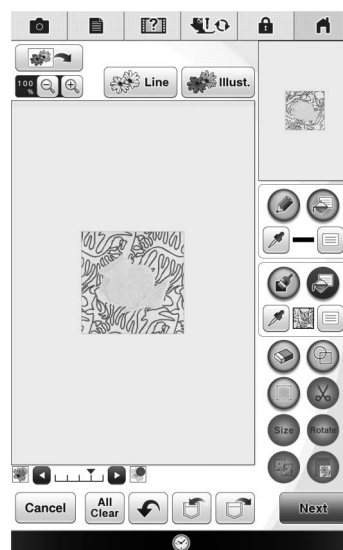

11 Set the line type for the frame and pattern to , and then press **Next**.

* Stitch settings can be adjusted in the stitch settings screen. For details, refer to "STITCH SETTINGS SCREEN" on page 14.

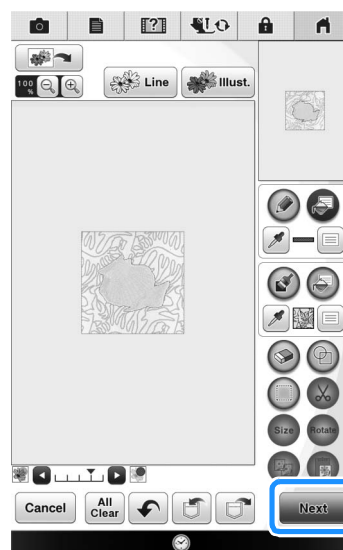

12 Specify the stitch spacing and length in the stitch settings screen, and then press

Preview.



→ Check the pattern, and then press **Set**.

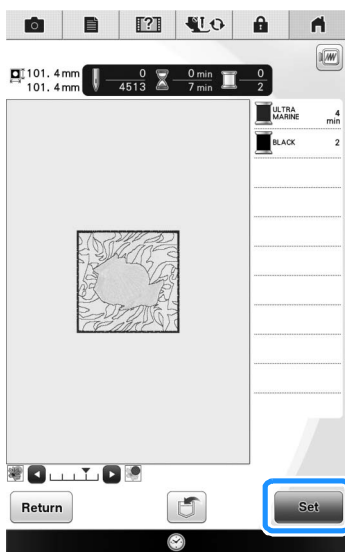

13 Embroider the stippling around the embroidery pattern.

Stippling Without Using My Design Center ✨

Stippling can easily be sewn around an embroidery pattern.

Memo

- If this simple stippling operation is used with batting sandwiched between two layers of fabric, the embroidery pattern and stippling may become misaligned. For quilting, refer to “Decorative stitching around a pattern in embroidery (a quilting function)” on page 38.

1 Select the pattern that stippling will be added around.

2 Press  in the embroidery edit screen.

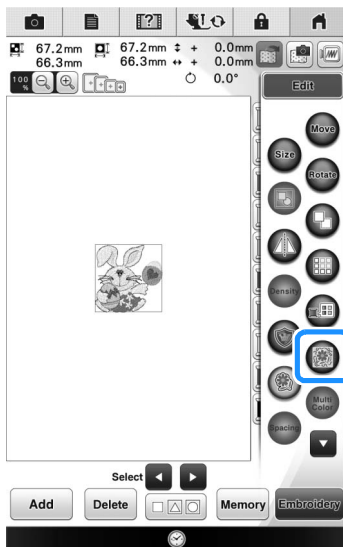

→ Stippling is automatically applied around the selected pattern.
To select multiple patterns, refer to “Selecting multiple patterns at the same time” on page 46.

3 After specifying the stitch settings for the stippling, press .

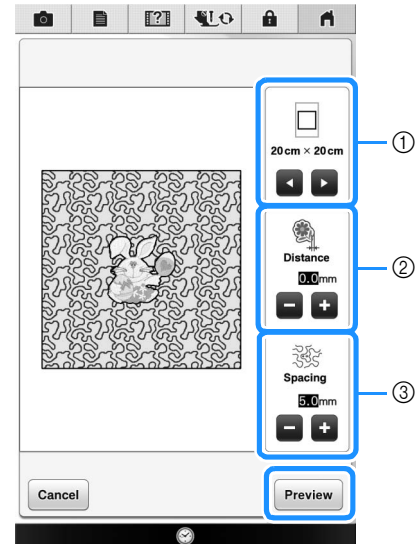

- ① If an embroidery frame size is selected, the stippling is added within the area of the selected frame size. If the pattern is larger than the selected frame size, the area indicating the frame size will appear in gray.
- ② Specify the distance from the outline of the pattern to the stippling.
- ③ Specify the spacing for the stippling.

4 Press .

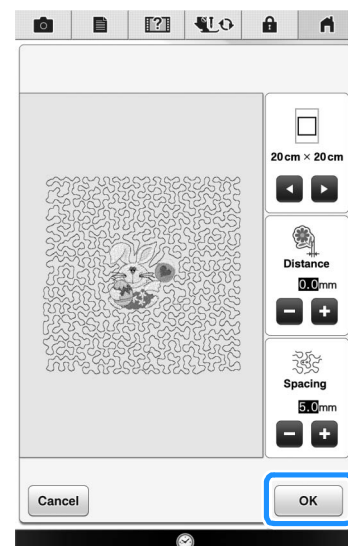

Other Useful Functions ✨

Various pattern editing functions have been improved for easier use.

Additional built-in patterns

20 Exclusive and 30 "Vine" Alphabet built-in patterns have been added. For details, refer to the Embroidery Design Guide.

Addition of 24 cm × 24 cm frame

The machine has been upgraded to be compatible with the embroidery frame (quilt) H 24 cm × W 24 cm (H 9-1/2 inches × W 9-1/2 inches).

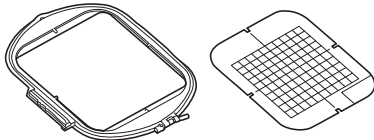

For details on how to insert the fabric into the embroidery frame, refer to "PREPARING THE FABRIC" in the Operation Manual included with the machine.

Specifying individual appliqué

When multiple patterns are arranged in the embroidery edit screen, you can select the pattern that will be used to create the appliqué.

- 1 Select the pattern to be used for the appliqué, and then press .

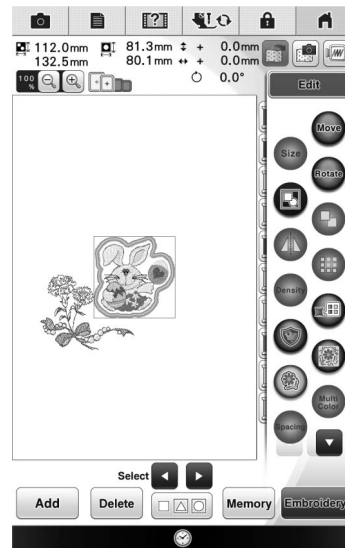
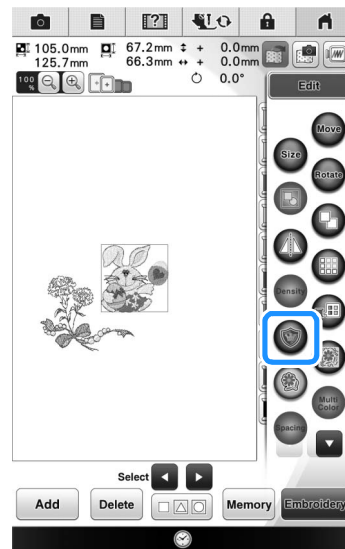

- The appliqué setting is applied only to the selected pattern.
To select multiple patterns, refer to "Selecting multiple patterns at the same time" on page 46.



Note

- At this time, the pattern and outline will be grouped.

Combining bobbin work patterns

Bobbin work patterns can be combined and sewn together. For details on creating bobbin work, refer to "How to Create Bobbin Work" in the Operation Manual included with the machine.

- 1 After the first bobbin work pattern has been selected, press **Add**, and then add the second bobbin work pattern.

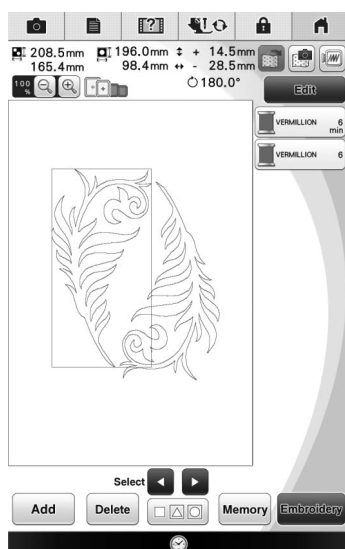

Memo

- Bobbin work patterns cannot be combined with a different category of pattern.

- 2 Press **Embroidery**.

→ A message appears after sewing is finished for each pattern. Complete the operation according to the instructions in the message.

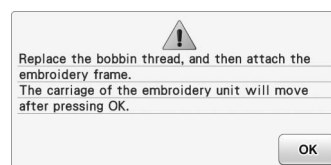
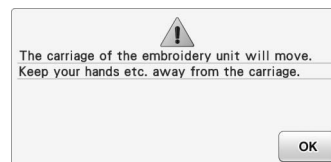
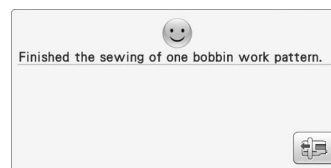

Thread color sorting

This function allows you to embroider while replacing the thread spool a minimal number of times.

Before starting to embroider, press **Embroidery** in the embroidery screen to rearrange the embroidery order and sort it by thread colors.

- 1 Press **Edit** in the embroidery screen.

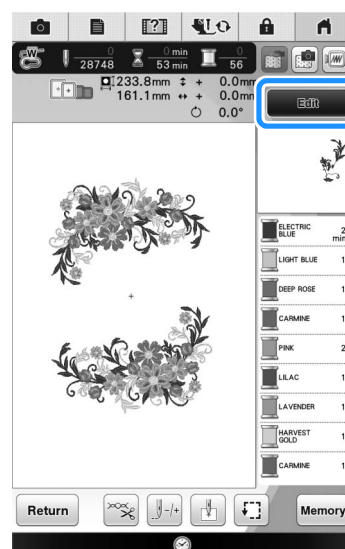

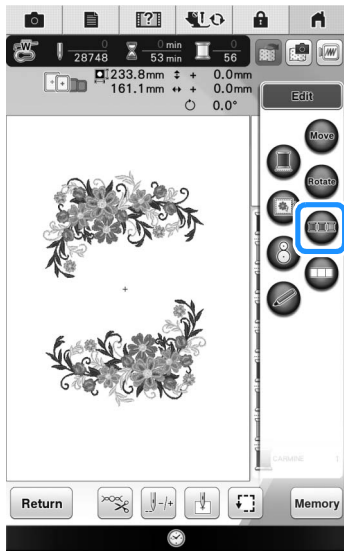

2 Press .

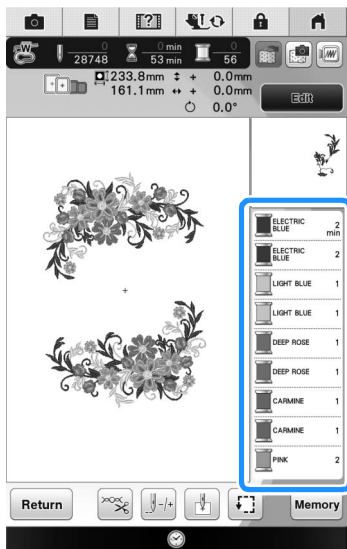

* Press  again to check the sorted thread colors.



The embroidery color order is rearranged and sorted by thread colors.

Press , then  to cancel color sorting and embroider with the original embroidery color order.



Note

- This function does not work on overlapping designs.

Adding line feeds and inserting new embroidery character patterns

Line feeding

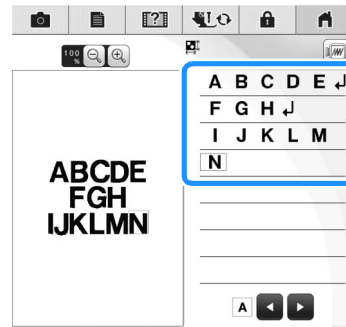

When a line feed is added, the line feed code appears in the text box on the right side of the screen.

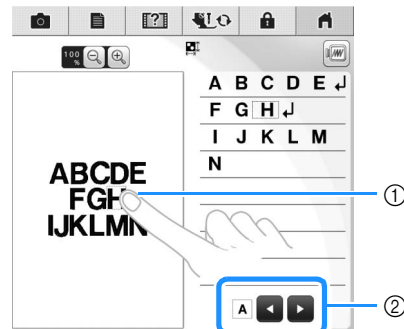

Inserting

Even after text has been entered, characters can be selected and edited (resized, etc.).



- ① Directly select a character.
- ② Press  and  to move the cursor and select a character.

Character alignment

Each press of  switches between right alignment, left alignment and center alignment, in that order.



 Right alignment

ABCDE
FGH
IJKLMN

 Left alignment

ABCDE
FGH
IJKLMN

 Center alignment

ABCDE
FGH
IJKLMN

Selecting multiple patterns at the same time

Multiple patterns can easily be edited, for example, when moving patterns that are combined, if they are all selected together.

1 Press .

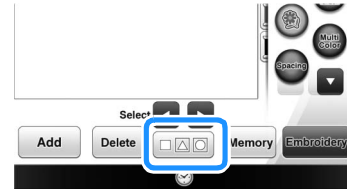

→ The Multiple Selection screen appears.

2 Touch each pattern to select multiple patterns.

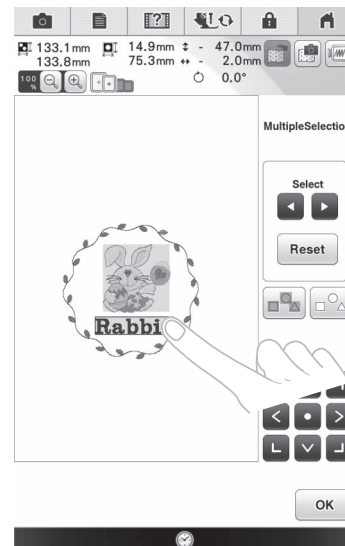

Memo

- Multiple patterns can also be selected by dragging your finger in the screen.
- Multiple patterns can be selected or deselected from the Multiple Selection screen. Press ◀ or ▶ to check the patterns to be selected, and then press



The selected patterns are surrounded with a red box.

- Press to select all patterns in the pattern display area.
- Press to deselect all selected patterns.
- The patterns can also be selected by touching them directly in the screen.
- While the Multiple Selection screen is displayed, patterns can be moved with



- The following functions cannot be used while multiple patterns are selected.
 - Resizing
 - Rotating
 - Appliqué
 - Border
 - Thread color changing

3 Press to return to the embroidery edit screen.

* Each selected pattern is surrounded with a red box.

Grouping multiple selected patterns

If the multiple patterns selected in “Selecting multiple patterns at the same time” on page 46 are grouped, they can be edited as a single pattern.

1 Press so that it changes to .

→ The selected patterns are grouped.

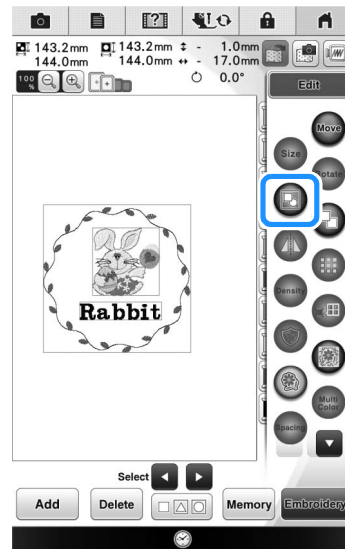

* Press to ungroup the patterns. If there are multiple grouped patterns, the selected pattern group is ungrouped.

Memo

- When patterns are grouped, the following functions are applied to all patterns in the pattern group.
 - Moving
 - Rotating
 - Appliqué
 - Border
 - Extracting pattern outlines
 - Simple stippling
 - Thread color changing

Saving/deleting multiple patterns

It may be useful to save all or multiple data from USB media, for example, to the machine. The data can only be saved to the machine's memory (pocket).

- 1 Press , and then either select the thumbnails of the patterns or press .

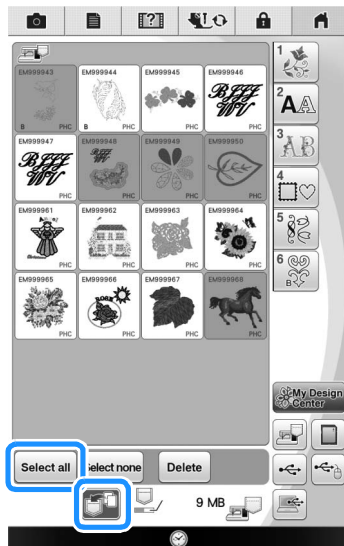

→ The thumbnails of selected patterns appear in blue. To deselect the pattern, either press the thumbnail again or press .

Memo

- When selecting USB media or SD card, is displayed. When is selected, all the selected files are saved to the machine's memory.



Please visit us at <http://support.brother.com/> where you can get product support and answers to frequently asked questions (FAQs).

English
882-W20/W22
Printed in Taiwan



XG6969-001