

Service Manual

Inverter Pair Wall Mounted Type D-Series



[Applied Models]

●Inverter Pair : Heat Pump

Inverter Pair D-Series

●Heat Pump

Indoor Unit

FTXS09DVJU
FTXS12DVJU
FTXS15DVJU
FTXS18DVJU
FTXS24DVJU

FDXS09DVJU
FDXS12DVJU

Outdoor Unit

RXS09DVJU
RXS12DVJU
RXS15DVJU
RXS18DVJU
RXS24DVJU

1. Introduction	vi
1.1 Safety Cautions	vi
Part 1 List of Functions	1
1. List of Functions	2
Part 2 Specifications	5
1. Specifications	6
Part 3 Printed Circuit Board Connector Wiring Diagram	11
1. Printed Circuit Board Connector Wiring Diagram.....	12
1.1 FTXS09/12DVJU.....	12
1.2 FTXS15/18/24DVJU.....	14
1.3 FDXS09/12DVJU	16
1.4 RXS09/12DVJU.....	18
1.5 RXS15/18/24DVJU.....	20
Part 4 Function and Control.....	23
1. Main Functions.....	25
1.1 Frequency Principle.....	25
1.2 Power-Airflow Dual Flaps, Wide-Angle Louvres and Auto-Swing (Only for the Single Split Duct-Free System)	27
1.3 Fan Speed Control for Indoor Units.....	28
1.4 Program Dry Function	29
1.5 Automatic Operation.....	30
1.6 Thermostat Control.....	31
1.7 NIGHT SET Mode	32
1.8 INTELLIGENT EYE	33
1.9 HOME LEAVE Operation	35
1.10 Inverter Powerful Operation	36
1.11 Other Functions.....	37
2. Function of Thermistor	39
2.1 Heat Pump Model.....	39
3. Control Specification (09/12 Class).....	40
3.1 Mode Hierarchy	40
3.2 Frequency Control.....	41
3.3 Controls at Mode Changing / Start-up.....	43
3.4 Discharge Pipe Control	44
3.5 Input Current Control.....	45
3.6 Freeze-up Protection Control	45
3.7 Heating Peak-cut Control	46
3.8 Fan Control.....	46
3.9 Liquid Compression Protection Function 2.....	46
3.10 Defrost Control	47
3.11 Electronic Expansion Valve Control	48
3.12 Malfunctions	51

3.13	Forced Operation Mode	52
3.14	Additional Function.....	52
4.	Control Specification (15/18/24 Class).....	53
4.1	Mode Hierarchy	53
4.2	Frequency Control.....	54
4.3	Controls at Mode Changing / Start-up.....	56
4.4	Discharge Pipe Temperature Control.....	57
4.5	Input Current Control.....	58
4.6	Freeze-up Protection Control	59
4.7	Heating Peak-cut Control	59
4.8	Fan Control.....	60
4.9	Liquid Compression Protection Function 2.....	60
4.10	Low Hz High Pressure Limit	61
4.11	Defrost Control	61
4.12	Electronic Expansion Valve Control	62
4.13	Malfunctions	65
4.14	Forced Operation Mode	66
4.15	Additional Function.....	66
Part 5	System Configuration.....	67
1.	System Configuration.....	68
2.	Instruction.....	69
2.1	Safety Precautions	69
2.2	The Single Split Duct-Free System FTXS09/12DVJU.....	71
2.3	The Single Split Duct-Free System FTXS15/18/24DVJU.....	96
2.4	The Slim Duct Built-in System FDXS09/12DVJU.....	121
Part 6	Service Diagnosis.....	141
1.	Caution for Diagnosis.....	142
2.	Problem Symptoms and Measures	144
3.	Service Check Function	145
4.	Troubleshooting	148
4.1	Error Codes and Description	148
4.2	Indoor Unit PCB Abnormality	149
4.3	Freeze-up Protection Control or High Pressure Control.....	150
4.4	Fan Motor or Related Abnormality	152
4.5	Thermistor or Related Abnormality (Indoor Unit).....	155
4.6	Signal Transmission Error (between Indoor and Outdoor Unit)	156
4.7	OL Activation (Compressor Overload)	157
4.8	Compressor Lock	158
4.9	DC Fan Lock	160
4.10	Input Over Current Detection	161
4.11	Four Way Valve Abnormality.....	164
4.12	Discharge Pipe Temperature Control.....	168
4.13	High Pressure Control in Cooling	170
4.14	Position Sensor Abnormality	174
4.15	DC Voltage / Current Sensor Abnormality.....	176

4.16 CT or Related Abnormality	177
4.17 Thermistor or Related Abnormality (Outdoor Unit)	179
4.18 Electrical Box Temperature Rise	181
4.19 Radiation Fin Temperature Rise	183
4.20 Output Over Current Detection.....	185
4.21 Insufficient Gas.....	189
4.22 Over-voltage Detection.....	193
4.23 Low-voltage Detection.....	194
5. Check	195
5.1 How to Check	195
Part 7 Removal Procedure	205
1. FTXS09/12DVJU.....	206
1.1 Removal of Air Filter.....	206
1.2 Removal of Front Grille	209
1.3 Removal of Horizontal Blade and Vertical Blade.....	212
1.4 Removal of Electrical Box, PCB and Swing Motor	214
1.5 Removal of Heat Exchanger	220
1.6 Install of Drain Plug	223
1.7 Removal of Fan Rotor and Fan Motor.....	225
2. FTXS15/18/24DVJU.....	229
2.1 Removal of the Air Filter / Front Panel	229
2.2 Removal of the Front Grille	233
2.3 Removal of the Horizontal Blades / Vertical Blades	236
2.4 Removal of the Electrical Box / PCB / Swing Motor	239
2.5 Removal of the Heat Exchanger	247
2.6 Removal of the Fan Rotor / Fan Motor.....	250
3. RXS09/12DVJU	253
3.1 Removal of Panels and Fan Motor.....	253
3.2 Removal of Electrical Box	261
3.3 Removal of Reactor and Partition Plate	263
3.4 Removal of Sound Blanket.....	265
3.5 Removal of Four Way Valve.....	268
3.6 Removal of Compressor.....	270
3.7 Removal of PCB.....	273
4. RXS15/18/24DVJU	276
4.1 Removal of the Panels and Plates	276
4.2 Removal of the Fan Motor / Propeller Fan	281
4.3 Removal of the PCB / Electrical Box	285
4.4 Removal of the Reactor.....	294
4.5 Removal of the Sound Blanket.....	296
4.6 Removal of the Four Way Valve.....	299
4.7 Removal of the Electronic Expansion Valve.....	300
4.8 Removal of the Compressor.....	301

Part 8 Others303

- 1. Others 304
 - 1.1 Test Run from the Remote Controller 304
 - 1.2 Jumper Settings 305

Part 9 Appendix.....307

- 1. Piping Diagrams..... 308
 - 1.1 Indoor Units 308
 - 1.2 Outdoor Units 309
- 2. Wiring Diagrams..... 311
 - 2.1 Indoor Units 311
 - 2.2 Outdoor Units 313





Index i

Drawings & Flow Charts v





1. Introduction









1.1 Safety Cautions

Cautions and Warnings

- Be sure to read the following safety cautions before conducting repair work.
- The caution items are classified into “ **Warning**” and “ **Caution**”. The “ **Warning**” items are especially important since they can lead to death or serious injury if they are not followed closely. The “ **Caution**” items can also lead to serious accidents under some conditions if they are not followed. Therefore, be sure to observe all the safety caution items described below.
- About the pictograms
 - △ This symbol indicates an item for which caution must be exercised.
The pictogram shows the item to which attention must be paid.
 - This symbol indicates a prohibited action.
The prohibited item or action is shown inside or near the symbol.
 - This symbol indicates an action that must be taken, or an instruction.
The instruction is shown inside or near the symbol.
- After the repair work is complete, be sure to conduct a test operation to ensure that the equipment operates normally, and explain the cautions for operating the product to the customer.



1.1.1 Caution in Repair



 Warning	
<p>Be sure to disconnect the power cable plug from the plug socket before disassembling the equipment for a repair. Working on the equipment that is connected to a power supply can cause an electrical shock. If it is necessary to supply power to the equipment to conduct the repair or inspecting the circuits, do not touch any electrically charged sections of the equipment.</p>	
<p>If the refrigerant gas discharges during the repair work, do not touch the discharging refrigerant gas. The refrigerant gas can cause frostbite.</p>	
<p>When disconnecting the suction or discharge pipe of the compressor at the welded section, release the refrigerant gas completely at a well-ventilated place first. If there is a gas remaining inside the compressor, the refrigerant gas or refrigerating machine oil discharges when the pipe is disconnected, and it can cause injury.</p>	
<p>If the refrigerant gas leaks during the repair work, ventilate the area. The refrigerant gas can generate toxic gases when it contacts flames.</p>	
<p>The step-up capacitor supplies high-voltage electricity to the electrical components of the outdoor unit. Be sure to discharge the capacitor completely before conducting repair work. A charged capacitor can cause an electrical shock.</p>	

 Warning	
Do not start or stop the air conditioner operation by plugging or unplugging the power cable plug. Plugging or unplugging the power cable plug to operate the equipment can cause an electrical shock or fire.	
Do not repair the electrical components with wet hands. Working on the equipment with wet hands can cause an electrical shock.	
Do not clean the air conditioner by splashing water. Washing the unit with water can cause an electrical shock.	
Be sure to provide the grounding when repairing the equipment in a humid or wet place, to avoid electrical shocks.	
Be sure to turn off the power switch and unplug the power cable when cleaning the equipment. The internal fan rotates at a high speed, and cause injury.	
Do not tilt the unit when removing it. The water inside the unit can spill and wet the furniture and floor.	
Be sure to check that the refrigerating cycle section has cooled down sufficiently before conducting repair work. Working on the unit when the refrigerating cycle section is hot can cause burns.	
Use the welder in a well-ventilated place. Using the welder in an enclosed room can cause oxygen deficiency.	





1.1.2 Cautions Regarding Products after Repair



 Warning	
Be sure to use parts listed in the service parts list of the applicable model and appropriate tools to conduct repair work. Never attempt to modify the equipment. The use of inappropriate parts or tools can cause an electrical shock, excessive heat generation or fire.	
When relocating the equipment, make sure that the new installation site has sufficient strength to withstand the weight of the equipment. If the installation site does not have sufficient strength and if the installation work is not conducted securely, the equipment can fall and cause injury.	

 Warning	
Be sure to install the product correctly by using the provided standard installation frame. Incorrect use of the installation frame and improper installation can cause the equipment to fall, resulting in injury.	For integral units only
Be sure to install the product securely in the installation frame mounted on a window frame. If the unit is not securely mounted, it can fall and cause injury.	For integral units only
Be sure to use an exclusive power circuit for the equipment, and follow the technical standards related to the electrical equipment, the internal wiring regulations and the instruction manual for installation when conducting electrical work. Insufficient power circuit capacity and improper electrical work can cause an electrical shock or fire.	
Be sure to use the specified cable to connect between the indoor and outdoor units. Make the connections securely and route the cable properly so that there is no force pulling the cable at the connection terminals. Improper connections can cause excessive heat generation or fire.	
When connecting the cable between the indoor and outdoor units, make sure that the terminal cover does not lift off or dismount because of the cable. If the cover is not mounted properly, the terminal connection section can cause an electrical shock, excessive heat generation or fire.	
Do not damage or modify the power cable. Damaged or modified power cable can cause an electrical shock or fire. Placing heavy items on the power cable, and heating or pulling the power cable can damage the cable.	
Do not mix air or gas other than the specified refrigerant (R-410A / R22) in the refrigerant system. If air enters the refrigerating system, an excessively high pressure results, causing equipment damage and injury.	
If the refrigerant gas leaks, be sure to locate the leak and repair it before charging the refrigerant. After charging refrigerant, make sure that there is no refrigerant leak. If the leak cannot be located and the repair work must be stopped, be sure to perform pump-down and close the service valve, to prevent the refrigerant gas from leaking into the room. The refrigerant gas itself is harmless, but it can generate toxic gases when it contacts flames, such as fan and other heaters, stoves and ranges.	
When replacing the coin battery in the remote controller, be sure to disposed of the old battery to prevent children from swallowing it. If a child swallows the coin battery, see a doctor immediately.	

 Caution	
Installation of a leakage breaker is necessary in some cases depending on the conditions of the installation site, to prevent electrical shocks.	
Do not install the equipment in a place where there is a possibility of combustible gas leaks. If a combustible gas leaks and remains around the unit, it can cause a fire.	
Be sure to install the packing and seal on the installation frame properly. If the packing and seal are not installed properly, water can enter the room and wet the furniture and floor.	For integral units only

1.1.3 Inspection after Repair



 Warning	
Check to make sure that the power cable plug is not dirty or loose, then insert the plug into a power outlet all the way. If the plug has dust or loose connection, it can cause an electrical shock or fire.	
If the power cable and lead wires have scratches or deteriorated, be sure to replace them. Damaged cable and wires can cause an electrical shock, excessive heat generation or fire.	
Do not use a joined power cable or extension cable, or share the same power outlet with other electrical appliances, since it can cause an electrical shock, excessive heat generation or fire.	



 Caution	
Check to see if the parts and wires are mounted and connected properly, and if the connections at the soldered or crimped terminals are secure. Improper installation and connections can cause excessive heat generation, fire or an electrical shock.	
If the installation platform or frame has corroded, replace it. Corroded installation platform or frame can cause the unit to fall, resulting in injury.	
Check the grounding, and repair it if the equipment is not properly grounded. Improper grounding can cause an electrical shock.	
Be sure to measure the insulation resistance after the repair, and make sure that the resistance is 1 Mohm or higher. Faulty insulation can cause an electrical shock.	
Be sure to check the drainage of the indoor unit after the repair. Faulty drainage can cause the water to enter the room and wet the furniture and floor.	

1.1.4 Using Icons

Icons are used to attract the attention of the reader to specific information. The meaning of each icon is described in the table below:

1.1.5 Using Icons List

Icon	Type of Information	Description
 Note:	Note	A “note” provides information that is not indispensable, but may nevertheless be valuable to the reader, such as tips and tricks.
 Caution	Caution	A “caution” is used when there is danger that the reader, through incorrect manipulation, may damage equipment, lose data, get an unexpected result or has to restart (part of) a procedure.

Icon	Type of Information	Description
 Warning	Warning	A “warning” is used when there is danger of personal injury.
	Reference	A “reference” guides the reader to other places in this binder or in this manual, where he/she will find additional information on a specific topic.

Part 1

List of Functions

1. List of Functions2

1. List of Functions

Category	Functions	FTXS09-12DVJU RXS09-12DVJU	FTXS15-18-24DVJU RXS15-18-24DVJU	Category	Functions	FTXS09-12DVJU RXS09-12DVJU	FTXS15-18-24DVJU RXS15-18-24DVJU	
Basic Function	Inverter (with Inverter Power Control)	○	○	Health & Clean	Air Purifying Filter with Bacteriostatic, Virustatic Functions	—	—	
	Operation Limit for Cooling (°FDB)	14~115	14~115		Photocatalytic Deodorizing Filter	—	—	
	Operation Limit for Heating (°FWB)	5~64	5~64		Air Purifying Filter with Photocatalytic Deodorizing Function	○	○	
	PAM Control	○	○		Titanium Apatite Photocatalytic Air-Purifying Filter	—	—	
Compressor	Oval Scroll Compressor	—	—		Mold Proof Air Filter	○	○	
	Swing Compressor	○	○		Wipe-clean Flat Panel	○	○	
	Rotary Compressor	—	—		Washable Grille	—	—	
	Reluctance DC Motor	○	○		Filter Cleaning Indicator	—	—	
Comfortable Airflow	Power-Airflow Flap	—	—		Good-Sleep Cooling Operation	—	—	
	Power-Airflow Dual Flaps	○	○		24-Hour On/Off Timer	○	○	
	Power-Airflow Diffuser	—	—		Night Set Mode	○	○	
	Wide-Angle Louvers	○	○		Auto-Restart (after Power Failure)	○	○	
	Vertical Auto-Swing (Up and Down)	○	○	Self-Diagnosis (Digital, LED) Display	○★	○★		
	Horizontal Auto-Swing (Right and Left)	—	○	Wiring Error Check	—	—		
	3-D Airflow	—	○	Anticorrosion Treatment of Outdoor Heat Exchanger	○	○		
	Comfort Airflow Mode	—	—	Flexibility	Multi-Split / Split Type Compatible Indoor Unit	—	—	
3-Step Airflow (H/P Only)	—	—	Flexible Voltage Correspondence		—	—		
Comfort Control	Auto Fan Speed	○	○		High Ceiling Application	—	—	
	Indoor Unit Silent Operation	○	○		Chargeless	33ft	33ft	
	Night Quiet Mode (Automatic)	—	—		Either Side Drain (Right or Left)	○	○	
	Outdoor Unit Silent Operation (Manual)	○	○		Power Selection	—	—	
	Intelligent Eye	○	○		Remote Control	5-Rooms Centralized Controller (Option)	○	○
	Quick Warming Function	○	○			Remote Control Adapter (Normal Open-Pulse Contact) (Option)	○	○
	Hot-Start Function	○	○	Remote Control Adapter (Normal Open Contact) (Option)		○	○	
	Automatic Defrosting	○	○	Remote Controller	DIII-NET Compatible (Adapter) (Option)	○	○	
Operation	Automatic Operation	○	○		Wireless	○	○	
	Program Dry Function	○	○		Wired	—	—	
	Fan Only	○	○					
Lifestyle Convenience	New Powerful Operation (Non-Inverter)	—	—					
	Inverter Powerful Operation	○	○					
	Priority-Room Setting	—	—					
	Cooling / Heating Mode Lock	—	—					
	Home Leave Operation	○	○					
	Indoor Unit On/Off Switch	○	○					
	Signal Reception Indicator	○	○					
	Temperature Display	—	—					
Another Room Operation	—	—						

Note: ○ : Holding Functions
— : No Functions

★ : Digital Only

Category	Functions	FDXS09-12DVJU RXS09-12DVJU	Category	Functions	FDXS09-12DVJU RXS09-12DVJU	
Basic Function	Inverter (with Inverter Power Control)	○	Health & Clean	Air Purifying Filter with Bacteriostatic, Virustatic Functions	—	
	Operation Limit for Cooling (°FDB)	14~ 115		Photocatalytic Deodorizing Filter	—	
	Operation Limit for Heating (°FWB)	5~ 64		Air Purifying Filter with Photocatalytic Deodorizing Function	—	
	PAM Control	○		Titanium Apatite Photocatalytic Air-Purifying Filter	—	
Compressor	Oval Scroll Compressor	—		Mold Proof Air Filter	—	
	Swing Compressor	○		Wipe-clean Flat Panel	—	
	Rotary Compressor	—		Washable Grille	—	
	Reluctance DC Motor	○		Filter Cleaning Indicator	—	
Comfortable Airflow	Power-Airflow Flap	—		Timer	Good-Sleep Cooling Operation	—
	Power-Airflow Dual Flaps	—			24-Hour On/Off Timer	○
	Power-Airflow Diffuser	—			Night Set Mode	○
	Wide-Angle Louvers	—			Auto-Restart (after Power Failure)	○
	Vertical Auto-Swing (Up and Down)	—	Worry Free "Reliability & Durability"	Self-Diagnosis (Digital, LED) Display	○ ★	
	Horizontal Auto-Swing (Right and Left)	—		Wiring Error Check	—	
	3-D Airflow	—		Anticorrosion Treatment of Outdoor Heat Exchanger	○	
	Comfort Airflow Mode	—		Multi-Split / Split Type Compatible Indoor Unit	—	
3-Step Airflow (H/P Only)	—	Flexibility	Flexible Voltage Correspondence	—		
Comfort Control	Auto Fan Speed		○	High Ceiling Application	—	
	Indoor Unit Silent Operation		○	Chargeless	33ft	
	Night Quiet Mode (Automatic)		—	Either Side Drain (Right or Left)	—	
	Outdoor Unit Silent Operation (Manual)		○	Power Selection	—	
	Intelligent Eye		—	Remote Control	5-Rooms Centralized Controller (Option)	○
	Quick Warming Function		○		Remote Control Adapter (Normal Open-Pulse Contact) (Option)	○
	Hot-Start Function		○		Remote Control Adapter (Normal Open Contact) (Option)	○
	Automatic Defrosting	○	DIII-NET Compatible (Adapter) (Option)		○	
Operation	Automatic Operation	○	Remote Controller	Wireless	○	
	Program Dry Function	○		Wired	—	
	Fan Only	○				
Lifestyle Convenience	New Powerful Operation (Non-Inverter)	—				
	Inverter Powerful Operation	○				
	Priority-Room Setting	—				
	Cooling / Heating Mode Lock	—				
	Home Leave Operation	○				
	Indoor Unit On/Off Switch	○				
	Signal Reception Indicator	○				
	Temperature Display	—				
Another Room Operation	—					

Note: ○ : Holding Functions
— : No Functions

★ : Digital Only

Part 2 Specifications

1. Specifications6

1. Specifications

The Single Split Duct-Free System

60Hz 208-230V

Models	Indoor Units		FTXS09DVJU		FTXS12DVJU	
	Outdoor Units		RXS09DVJU		RXS12DVJU	
			Cooling	Heating	Cooling	Heating
Capacity Rated (Min.-Max.)	Btu/h		8,500 (4,400~8,500)	10,000 (4,400~10,000)	11,500 (4,800~11,500)	11,500 (4,800~11,500)
Moisture Removal	Pt/h		2.3	—	3.2	—
Running Current (Rated)	A		4.13	4.98	5.51	4.73
Power Consumption Rated (Min.-Max.)	W		770(300~770)	1,070(290~1,220)	1,290(300~1,290)	1,000(310~1,190)
Power Factor	%		76.9	89.9	93.9	88.2
EER (Rated)	Btu/h·W		11.0	—	9.3	—
COP (Rated)	W/W		—	2.74	—	3.37
Energy Efficiency	SEER		16.0	—	16.0	—
	HSPF		—	8.8	—	8.8
Piping Connections	Liquid	inch	ϕ 1/4		ϕ 1/4	
	Gas	inch	ϕ 3/8		ϕ 3/8	
	Drain	inch	ϕ 11/16		ϕ 11/16	
Heat Insulation			Both Liquid and Gas Pipes		Both Liquid and Gas Pipes	
Max. Interunit Piping Length	feet		65		65	
Max. Interunit Height Difference	feet		49		49	
Chargeless	feet		33		33	
Amount of Additional Charge of Refrigerant	oz/ft		0.22		0.22	
Indoor Units			FTXS09DVJU		FTXS12DVJU	
Front Panel Color			White		White	
Air Flow Rate	cfm (m ³ /min)	H	246(7.0)	253(7.2)	242(6.8)	286(8.1)
		M	197(5.6)	220(6.2)	195(5.5)	237(6.7)
		L	148(4.2)	187(5.3)	148(4.2)	187(5.3)
Fan	Type	Cross Flow Fan		Cross Flow Fan		
	Motor Output	W	18		18	
	Speed	Steps	5 Steps, Silent and Auto		5 Steps, Silent and Auto	
Air Direction Control			Right, Left, Horizontal and Downward		Right, Left, Horizontal and Downward	
Air Filter			Removable / Washable / Mildew Proof		Removable / Washable / Mildew Proof	
Running Current (Rated)	A		0.18		0.18	
Power Consumption (Rated)	W		40		40	
Power Factor	%		96.6		96.6	
Temperature Control			Microcomputer Control		Microcomputer Control	
Dimensions (HxWxD)	inch		10-3/4x30-7/8x7-11/16		10-3/4x30-7/8x7-11/16	
Packaged Dimensions (HxWxD)	inch		10-3/16x32-13/16x12-13/16		10-3/16x32-13/16x12-13/16	
Weight	Lbs		16.6		16.6	
Gross Weight	Lbs		25.0		25.0	
Operation Sound	H/M/L	dBA	38 / 32 / 25	38 / 33 / 28	40 / 33 / 26	39 / 34 / 29
Outdoor Units			RXS09DVJU		RXS12DVJU	
Casing Color			Ivory White		Ivory White	
Compressor	Type	Hermetically Sealed Swing Type		Hermetically Sealed Swing Type		
	Model	1YC23NXD#EA		1YC23NXD#EA		
	Motor Output	W	600		600	
Refrigerant Oil	Type	FVC50K		FVC50K		
	Charge	oz	12.6		12.6	
Refrigerant	Type	R-410A		R-410A		
	Charge	Lbs	1.76		2.2	
Air Flow Rate	cfm (m ³ /min)	H	1,120(31.7)	1,008(28.5)	1,031(29.2)	927(26.3)
		L	816(23.1)	813(23.0)	737(20.9)	737(20.9)
Fan	Type	Propeller		Propeller		
	Motor Output	W	31		31	
Running Current (Rated)	A	3.93	4.8	5.33	4.6	
Power Consumption (Rated)	W	730	1,030	1,190	960	
Power Factor	%	80.4	93.3	97.1	91.7	
Starting Current	A	5.0		6.4		
Dimensions (HxWxD)	inch	21-5/8x30-1/8x11-1/4		21-5/8x30-1/8x11-1/4		
Packaged Dimensions (HxWxD)	inch	25x34-5/8x14-3/16		25x34-5/8x14-3/16		
Weight	Lbs	74.0		79.0		
Gross Weight	Lbs	84.0		91.0		
Operation Sound	H / L	dBA	48 / —	49 / —	49 / —	51 / —
Drawing No.			C: 3D047919		C: 3D047920	

Note: ■ The data are based on the conditions shown in the table below.

Cooling	Heating	Piping Length
Indoor ; 80°FDB/67°FWB Outdoor ; 95°FDB/75°FWB	Indoor ; 70°FDB/60°FWB Outdoor ; 47°FDB/43°FWB	25ft

Conversion Formulae
kcal/h=kWx860 Btu/h=kWx3414 cfm=m ³ /minx35.3

60Hz 208-230V

Model	Indoor Units		FTXS15DVJU		FTXS18DVJU	
	Outdoor Units		RXS15DVJU		RXS18DVJU	
			Cooling	Heating	Cooling	Heating
Capacity Rated (Min.-Max.)	Btu/h		15,000 (3,200~15,000)	18,000 (3,200~21,200)	18,000 (3,200~18,000)	21,600 (3,200~24,000)
Moisture Removal	Pt/h		3.4	—	4.3	—
Running Current (Rated)	A		5.44	6.88	6.97	8.71
Power Consumption Rated (Min.-Max.)	W		1,230(450~1,230)	1,570(450~2,540)	1,590(450~1,590)	2,000(450~2,620)
Power Factor	%		95.1	96.7	96.7	97.8
EER (Rated)	Btu/h·W		12.2	—	11.3	—
COP (Rated)	W/W		—	3.36	—	3.17
Energy Efficiency	SEER		17.0	—	16.3	—
	HSPF		—	10.1	—	9.1
Piping Connections	Liquid	inch	φ 1/4		φ 1/4	
	Gas	inch	φ 1/2		φ 1/2	
	Drain	inch	φ 11/16		φ 11/16	
Heat Insulation			Both Liquid and Gas Pipes		Both Liquid and Gas Pipes	
Max. Interunit Piping Length	feet		98.4		98.4	
Min. Interunit Piping Length	feet		4.9		4.9	
Max. Interunit Height Difference	feet		65.6		65.6	
Chargeless	feet		33		33	
Amount of Additional Charge of Refrigerant	oz/ft		0.22		0.22	
Indoor Unit			FTXS15DVJU		FTXS18DVJU	
Front Panel Color			White		White	
Air Flow Rate	cfm (m³/min)	H	519(14.7)	515(14.6)	549(15.5)	609(17.2)
		M	436(12.3)	459(13.0)	476(13.5)	529(15.0)
		L	353(10.0)	402(11.4)	402(11.4)	448(12.7)
Fan	Type		Cross Flow Fan		Cross Flow Fan	
	Motor Output	W	43		43	
	Speed	Steps	5 Steps, Silent and Auto		5 Steps, Silent and Auto	
Air Direction Control			Right, Left, Horizontal and Downward		Right, Left, Horizontal and Downward	
Air Filter			Removable / Washable / Mildew Proof		Removable / Washable / Mildew Proof	
Running Current (Rated)	A		0.18		0.18	
Power Consumption (Rated)	W		40		40	
Power Factor	%		96.6		96.6	
Temperature Control			Microcomputer Control		Microcomputer Control	
Dimensions (HxWxD)	inch		11-7/16x41-5/16x9-3/8		11-7/16x41-5/16x9-3/8	
Packaged Dimensions (HxWxD)	inch		13-1/4x45-3/16x14-7/16		13-1/4x45-3/16x14-7/16	
Weight	Lbs		26.5		26.5	
Gross Weight	Lbs		38.0		38.0	
Operation Sound	H/M/L	dBA	45 / 41 / 36	44 / 40 / 35	45 / 41 / 36	44 / 40 / 35
Outdoor Unit			RXS15DVJU		RXS18DVJU	
Casing Color			Ivory White		Ivory White	
Compressor	Type		Hermetically Sealed Swing Type		Hermetically Sealed Swing Type	
	Model		2YC32JXD#E		2YC32JXD#E	
Refrigerant Oil	Motor Output	W	1,500		1,500	
	Model		FVC50K		FVC50K	
Refrigerant	Charge	oz	21.8		21.8	
	Model		R-410A		R-410A	
Air Flow Rate	cfm (m³/min)	H	1,603(45.4)	1,367(38.7)	1,603(45.4)	1,367(38.7)
		L	1,451(41.1)	1,367(38.7)	1,451(41.1)	1,367(38.7)
Fan	Type		Propeller		Propeller	
	Motor Output	W	53		53	
Running Current (Rated)	A		5.3	6.7	6.79	8.5
Power Consumption (Rated)	W		1,190	1,530	1,550	1,960
Power Factor	%		98.4	99.3	99.3	99.9
Starting Current	A		10.0		11.4	
Dimensions (HxWxD)	inch		28-15/16x32-1/2x11-13/16		28-15/16x32-1/2x11-13/16	
Packaged Dimensions (HxWxD)	inch		31-7/16x37-15/16x15-3/8		31-7/16x37-15/16x15-3/8	
Weight	Lbs		117.0		117.0	
Gross Weight	Lbs		133.0		133.0	
Operation Sound	H / L	dBA	51 / —	51 / —	51 / —	51 / —
Drawing No.			3D047921		3D047922	

Note: ■ The data are based on the conditions shown in the table below.

Cooling	Heating	Piping Length
Indoor ; 80°FDB/67°FWB Outdoor ; 95°FDB/75°FWB	Indoor ; 70°FDB/60°FWB Outdoor ; 47°FDB/43°FWB	25ft

Conversion Formulae
kcal/h=kWx860 Btu/h=kWx3414 cfm=m³/minx35.3

60Hz 208-230V

Model	Indoor Units		FTXS24DVJU	
	Outdoor Units		RXS24DVJU	
			Cooling	Heating
Capacity Rated (Min.-Max.)	Btu/h	22,000 (3,200~22,000)		24,000 (3,200~25,400)
Moisture Removal	Pt/h	6.3		—
Running Current (Rated)	A	10.3		11.3
Power Consumption Rated (Min.-Max.)	W	2,360(450~2,360)		2,590(450~3,320)
Power Factor	%	97.7		97.9
EER (Rated)	Btu/h-W	9.3		—
COP (Rated)	W/W	—		2.72
Energy Efficiency	SEER	15.0		—
	HSPF	—		9.2
Piping Connections	Liquid	φ 1/4		
	Gas	φ 5/8		
	Drain	φ 11/16		
Heat Insulation		Both Liquid and Gas Pipes		
Max. Interunit Piping Length	feet	98.4		
Min. Interunit Piping Length	feet	4.9		
Max. Interunit Height Difference	feet	65.6		
Chargeless	feet	33		
Amount of Additional Charge of Refrigerant	oz/ft	0.22		
Indoor Unit		FTXS24DVJU		
Front Panel Color		White		
Air Flow Rate	cfm (m³/min)	H	536(15.2)	586(16.6)
		M	473(13.4)	532(15.1)
		L	409(11.6)	477(13.5)
Fan	Type	Cross Flow Fan		
	Motor Output	W		
	Speed	Steps		
Air Direction Control		Right, Left, Horizontal and Downward		
Air Filter		Removable / Washable / Mildew Proof		
Running Current (Rated)	A	0.20		
Power Consumption (Rated)	W	45		
Power Factor	%	97.8		
Temperature Control		Microcomputer Control		
Dimensions (HxWxD)	inch	11-7/16x41-5/16x9-3/8		
Packaged Dimensions (HxWxD)	inch	13-1/4x45-3/16x14-7/16		
Weight	Lbs	26.5		
Gross Weight	Lbs	38.0		
Operation Sound	H/M/L	dBA	46 / 42 / 37	46 / 42 / 37
Outdoor Unit		RXS24DVJU		
Casing Color		Ivory White		
Compressor	Type	Hermetically Sealed Swing Type		
	Model	2YC45EXD#E		
	Motor Output	W		
Refrigerant Oil	Model	FVC50K		
	Charge	oz		
	Model	R-410A		
Refrigerant	Charge	Lbs		
	Model	R-410A		
Air Flow Rate	cfm (m³/min)	H	1,752(49.6)	1,465(41.5)
		L	1,529(43.3)	1,398(39.6)
Fan	Type	Propeller		
	Motor Output	W		
Running Current (Rated)	A	10.1	11.1	
Power Consumption (Rated)	W	2,315	2,545	
Power Factor	%	99.7	99.7	
Starting Current	A	11.8		
Dimensions (HxWxD)	inch	28-15/16x32-1/2x11-13/16		
Packaged Dimensions (HxWxD)	inch	31-7/16x37-15/16x15-3/8		
Weight	Lbs	121.0		
Gross Weight	Lbs	137.0		
Operation Sound	H / L	dBA	54 / —	54 / —
Drawing No.		3D047923		

Note: ■ The data are based on the conditions shown in the table below.

Cooling	Heating	Piping Length
Indoor ; 80°FDB/67°FWB Outdoor ; 95°FDB/75°FWB	Indoor ; 70°FDB/60°FWB Outdoor ; 47°FDB/43°FWB	25ft

Conversion Formulae
kcal/h=kWx860 Btu/h=kWx3414 cfm=m³/minx35.3

The Slim Duct Built-in System

60Hz 208-230V

Models	Indoor Units		FDXS09DVJU		FDXS12DVJU	
	Outdoor Units		RXS09DVJU		RXS12DVJU	
			Cooling	Heating	Cooling	Heating
Capacity Rated (Min.-Max.)	Btu/h		8,500 (4,400~8,500)	10,000 (4,400~10,000)	11,500 (4,800~11,500)	11,500 (4,800~11,500)
Moisture Removal	Pt/h		2.5	—	4.0	—
Running Current (Rated)	A		4.2	4.5	5.9	4.6
Power Consumption Rated (Min.-Max.)	W		770(300~770)	950(290~1,220)	1,290(300~1,290)	960(290~1,190)
Power Factor	%		79.7	91.8	95.1	90.7
EER (Rated)	Btu/h·W		10.9	—	8.85	—
COP (Rated)	W/W		—	3.0	—	3.5
Energy Efficiency	SEER		13.0	—	13.0	—
	HSPF		—	7.7	—	7.7
Piping Connections	Liquid	inch	φ 1/4		φ 1/4	
	Gas	inch	φ 3/8		φ 3/8	
	Drain	inch	VP20 (O.D. φ 1-1/32, I.D. φ 25/32)		VP20 (O.D. φ 1-1/32, I.D. φ 25/32)	
Heat Insulation			Both Liquid and Gas Pipes		Both Liquid and Gas Pipes	
Max. Interunit Piping Length	feet		65		65	
Max. Interunit Height Difference	feet		49		49	
Chargeless	feet		33		33	
Amount of Additional Charge of Refrigerant	oz/ft		0.22		0.22	
Indoor Units			FDXS09DVJU		FDXS12DVJU	
External Static Pressure	Pa		30		30	
Air Flow Rate	cfm	H	305	305	305	305
		M	280	280	280	280
		L	260	260	260	260
Fan	Type		Sirocco Fan		Sirocco Fan	
	Motor Output	W	62		62	
	Speed	Steps	5 Steps, Silent, Auto		5 Steps, Silent, Auto	
Air Filter			Removable / Washable / Mildew Proof		Removable / Washable / Mildew Proof	
Running Current (Rated)	A		0.52		0.52	
Power Consumption (Rated)	W		72		72	
Power Factor	%		60.2		60.2	
Temperature Control			Microcomputer Control		Microcomputer Control	
Dimensions (HxWxD)	inch		7-7/8x27-9/16x24-7/16		7-7/8x27-9/16x24-7/16	
Packaged Dimensions (HxWxD)	inch		10-13/16x30-1/4x36-5/16		10-13/16x30-1/4x36-5/16	
Weight	Lbs		47		47	
Gross Weight	Lbs		64		64	
Operation Sound	H/M/L	dBA	35 / 33 / 31	35 / 33 / 31	35 / 33 / 31	35 / 33 / 31
Outdoor Units			RXS09DVJU		RXS12DVJU	
Casing Color			Ivory White		Ivory White	
Compressor	Type		Hermetically Sealed Swing Type		Hermetically Sealed Swing Type	
	Model		1YC23NXD#EA		1YC23NXD#EA	
	Motor Output	W	600		600	
Refrigerant Oil	Type		FVC50K		FVC50K	
	Charge	oz	12.6		12.6	
Refrigerant	Type		R-410A		R-410A	
	Charge	Lbs	1.76		2.2	
Air Flow Rate	cfm (m³/min)	H	1,120(31.7)	1,008(28.5)	1,031(29.2)	927(26.3)
		L	816(23.1)	813(23.0)	737(20.9)	737(20.9)
Fan	Type		Propeller		Propeller	
	Motor Output	W	31		31	
Running Current (Rated)	A		3.7	4.1	5.4	4.1
Power Consumption (Rated)	W		698	888	1,218	888
Power Factor	%		82.0	94.2	98.1	94.2
Dimensions (HxWxD)	inch		21-5/8x30-1/8x11-1/4		21-5/8x30-1/8x11-1/4	
Packaged Dimensions (HxWxD)	inch		25x34-5/8x14-3/16		25x34-5/8x14-3/16	
Weight	Lbs		74.0		79.0	
Gross Weight	Lbs		84.0		91.0	
Operation Sound	H / L	dBA	48 / —	49 / —	49 / —	51 / —
Drawing No.			3D051781A		3D051782A	

Note: ■ The data are based on the conditions shown in the table below.

Cooling	Heating	Piping Length
Indoor ; 80°FDB/67°F WB Outdoor ; 95°FDB/75°F WB	Indoor ; 70°FDB/60°F WB Outdoor ; 47°FDB/43°F WB	25ft

Conversion Formulae
kcal/h=kW×860 Btu/h=kW×3414 cfm=m³/min×35.3

Part 3

Printed Circuit Board

Connector Wiring Diagram

1. Printed Circuit Board Connector Wiring Diagram.....	12
1.1 FTXS09/12DVJU.....	12
1.2 FTXS15/18/24DVJU.....	14
1.3 FDXS09/12DVJU	16
1.4 RXS09/12DVJU.....	18
1.5 RXS15/18/24DVJU.....	20

1. Printed Circuit Board Connector Wiring Diagram

1.1 FTXS09/12DVJU

Connectors

- | | |
|-------------|--|
| 1) S1 | Connector for fan motor |
| 2) S6 | Connector for swing motor (horizontal blades) |
| 3) S7 | Connector for fan motor (Hall IC) |
| 4) S21 | Connector for centralized control (HA) |
| 5) S26 | Connector for signal receiver PCB |
| 6) S27, S36 | Connector for control PCB |
| 7) S32 | Connector for heat exchanger thermistor |
| 8) S35 | Connector for INTELLIGENT EYE sensor PCB |



Note: Other designations

- | | |
|----------|---|
| 1) V1 | Varistor |
| 2) JA | Address setting jumper |
| JB | Fan speed setting when compressor is OFF on thermostat |
| JC | Power failure recovery function (auto-restart)
* Refer to page 305 for detail. |
| 3) SW7 | Forced operation ON / OFF switch |
| 4) LED1 | LED for operation (green) |
| 5) LED2 | LED for timer (yellow) |
| 6) LED3 | LED for HOME LEAVE operation (red) |
| 7) FU1 | Fuse (3.15A) |
| 8) RTH1 | Room temperature thermistor |
| 9) LED A | LED for service monitor (green) |

PCB Detail

PCB(1): Control PCB
PCB(2): Signal Receiver PCB

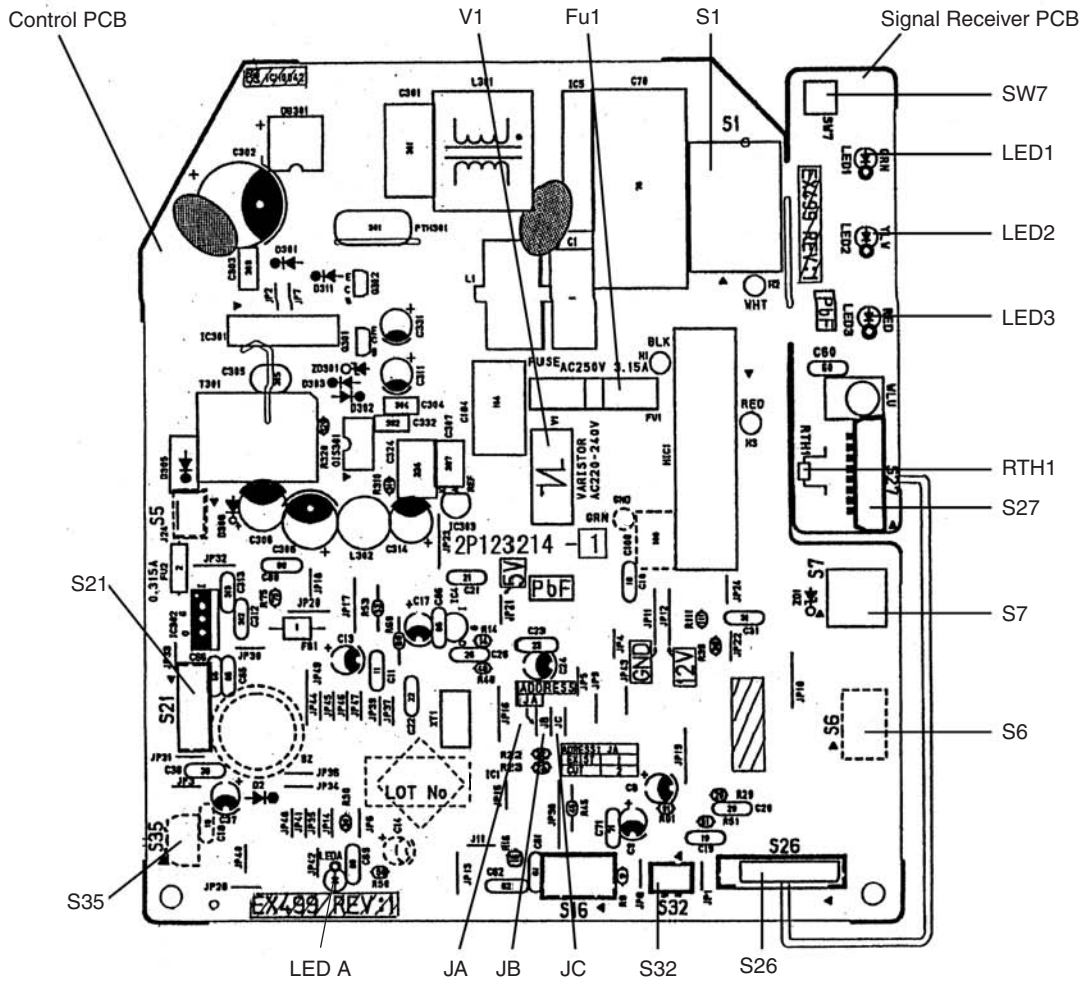

(R4011)

PCB(3): INTELLIGENT EYE sensor PCB

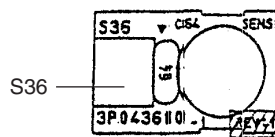

(R3321)

1.2 FTXS15/18/24DVJU

Connectors

- | | |
|------------------|--|
| 1) S1 | Connector for fan motor |
| 2) S6 | Connector for swing motor (horizontal blades) |
| 3) S8 | Connector for swing motor (vertical blades) |
| 4) S21 | Connector for centralized control (HA) |
| 5) S26, S37 | Connector for buzzer PCB |
| 6) S27, S29, S36 | Connector for control PCB |
| 7) S28 | Connector for signal receiver PCB |
| 8) S32 | Connector for heat exchanger thermistor |
| 9) S35 | Connector for Intelligent Eye sensor PCB |
| 10) S38 | Connector for display PCB |



Note: Other designations

- | | |
|----------|--|
| 1) V1 | Varistor |
| 2) JA | Address setting jumper |
| JB | Fan speed setting when compressor is OFF on thermostat |
| JC | Power failure recovery function
* Refer to page 305 for detail. |
| 3) SW1 | Forced operation ON / OFF switch |
| 4) LED1 | LED for operation (green) |
| 5) LED2 | LED for timer (yellow) |
| 6) LED3 | LED for Home Leave operation (red) |
| 7) FU1 | Fuse (3.15A) |
| 8) RTH1 | Room temperature thermistor |
| 9) LED A | LED for service monitor (green) |

PCB Detail

PCB(1): Control PCB (indoor unit)

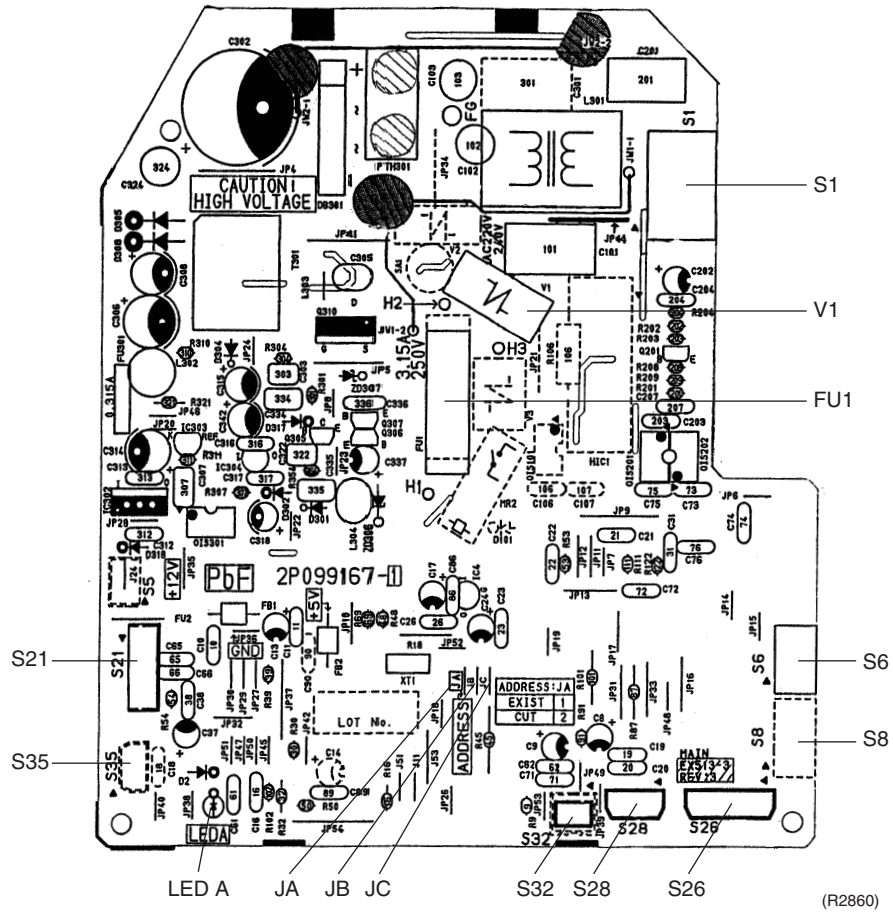

PCB(2): Signal Receiver PCB

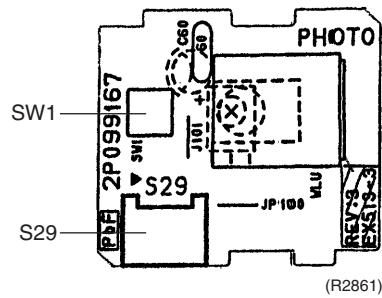

PCB(3): Buzzer PCB

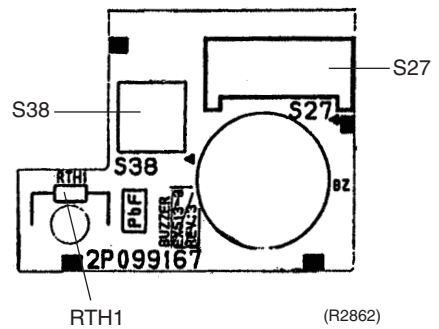

PCB(4): Display PCB

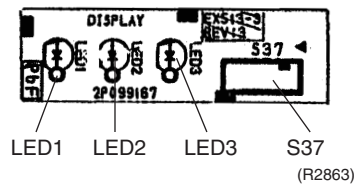

PCB(5): Intelligent Eye sensor PCB

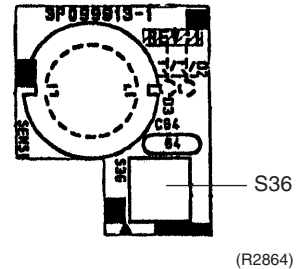

1.3 FDXS09/12DVJU

Connectors

PCB (1) (Control PCB)

- 1) **S1** Connector for fan motor
- 2) **S7** Connector for fan motor
- 3) **S21** Connector for centralized control
- 4) **S26** Connector for display PCB
- 5) **S32** Connector for room temp/heat exchanger thermistor

PCB (2) (Display PCB)

- 1) **S1** Connector for control PCB



Note: Other designations

PCB (1) (Control PCB)

- 1) **V1** Varistor
- 2) **JA** Address setting jumper
- JB** Fan speed setting when compressor is OFF on thermostat.
- JC** Power failure recovery function.
- * Refer to page 305 for more detail.
- 3) **LED A** LED for service monitor (green)
- 4) **FU1** Fuse (3.15A)

PCB (2) (Display PCB)

- 1) **SW1** Forced operation ON/OFF switch
- 2) **LED1** LED for operation (Green)
- 3) **LED2** LED for timer (Yellow)
- 4) **LED3** LED for HOME LEAVE Operations (Red)
- 5) **RTH1** Room temperature thermistor

PCB Detail

PCB (1): Control PCB

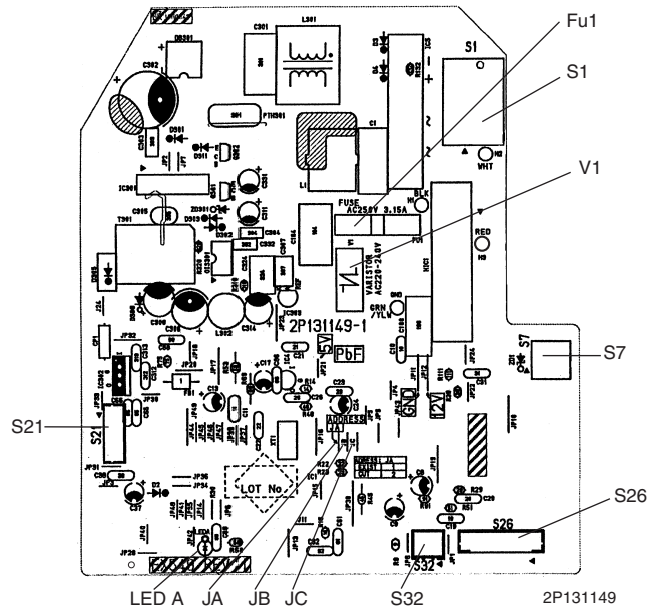

PCB Detail

PCB (2): Display PCB

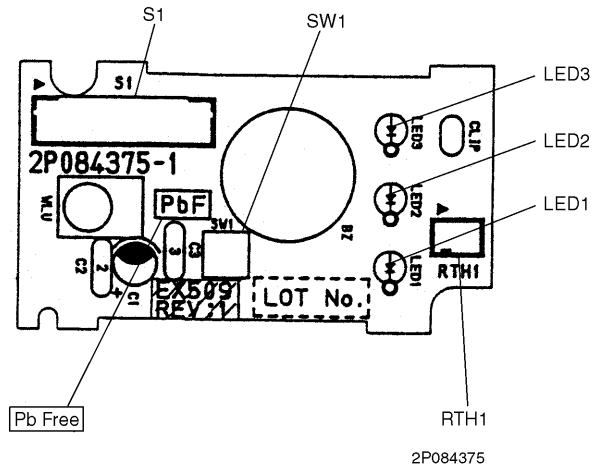

1.4 RXS09/12DVJU

Connectors

PCB(1)(Filter PCB)

- 1) **S11** Connector for control PCB

PCB(2)(Control PCB)

- 1) **S10** Connector for filter PCB
 2) **S20** Connector for electronic expansion valve coil
 3) **S30** Connector for compressor motor
 4) **S40** Connector for overload protector
 5) **S70** Connector for fan motor
 6) **S80** Connector for four way valve coil
 7) **S90** Connector for thermistors
 (outdoor air, heat exchanger, discharge pipe)
 8) **HC3, HC4, HL3, HN3** Connector for filter PCB



Note:

Other designations

PCB(1)(Filter PCB)

- 1) **FU3** Fuse (20A)
 2) **V2, V3** Varistor

PCB(2)(Control PCB)

- 1) **FU1, FU2** Fuse (3.15A)
 2) **LED A** Service monitor LED
 3) **V1** Varistor

1.5 RXS15/18/24DVJU

Connectors

PCB(1)(Control PCB)

- | | |
|--------------|--|
| 1) S10, AC2 | Connector for terminal strip |
| 2) S20 | Connector for electronic expansion valve coil |
| 3) S31, S32 | Connector for SPM |
| 4) S33, S71 | Connector for MID |
| 5) S40 | Connector for overload protector |
| 6) S51, S101 | Connector for service monitor PCB |
| 7) S80 | Connector for four way valve coil |
| 8) S90 | Connector for thermistors
(outdoor air, heat exchanger, and discharge pipe) |
| 9) S91 | Connector for fin thermistor |
| 10) AC1, E | Connector for power supply PCB |
| 11) H1, H2 | Connector for diode bridge |

PCB(2)(Power Supply PCB)

- | | |
|--------------|------------------------------|
| 1) HL | Connector for terminal strip |
| 2) HAC1, HE1 | Connector for control PCB |
| 3) HE2 | Connector for earth |

PCB(3)(Service Monitor PCB)

- | | |
|--------------|---------------------------|
| 1) S52, S102 | Connector for control PCB |
|--------------|---------------------------|

MID

- | | |
|-------------|---------------------------|
| 1) S34, S72 | Connector for control PCB |
| 2) S70 | Connector for fan motor |

SPM

- | | |
|---------------|---------------------------|
| 1) CN11, CN14 | Connector for control PCB |
| 2) L1, L2 | Connector for reactor |



Note:

Other Designations

PCB(1)(Control PCB)

- | | |
|--------|--------------|
| 1) FU2 | Fuse (3.15A) |
|--------|--------------|

PCB(2)(Power Supply PCB)

- | | |
|--------|------------|
| 1) FU1 | Fuse (30A) |
| 2) V3 | Varistor |

PCB(3)(Service Monitor PCB)

- | | |
|----------|--------------------------------|
| 1) LED A | Service monitor LED |
| 2) SW1 | Forced operation ON/OFF switch |

MID

- | | |
|----------|--------------|
| 1) FU201 | Fuse (3.15A) |
|----------|--------------|

PCB Detail

PCB(1): Control PCB (outdoor unit)

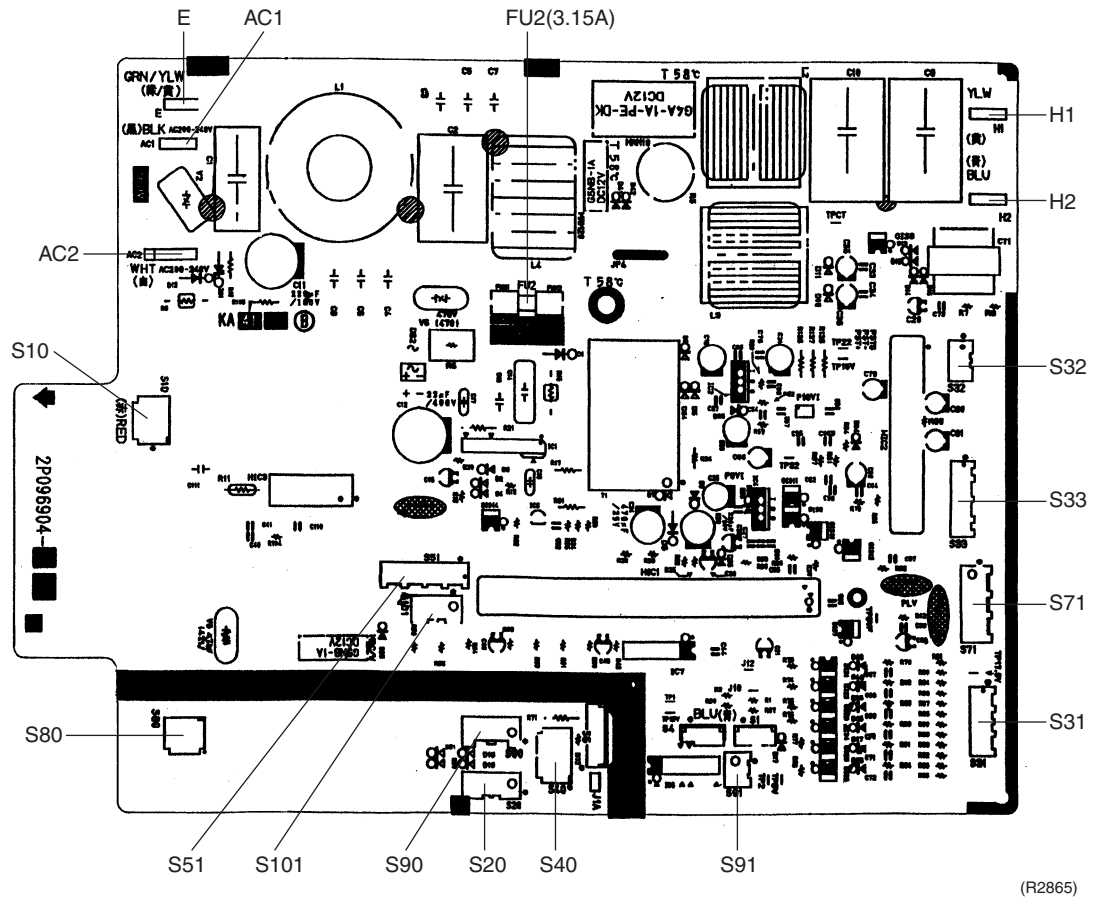

PCB(2): Power Supply PCB

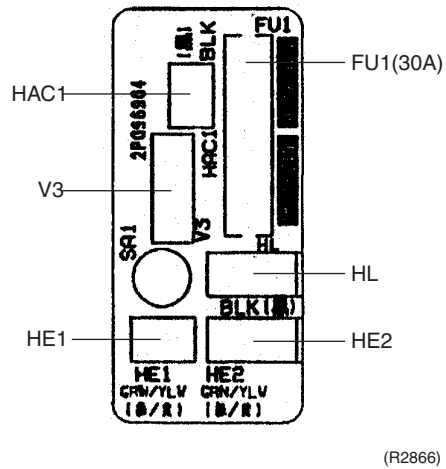

Service Monitor PCB

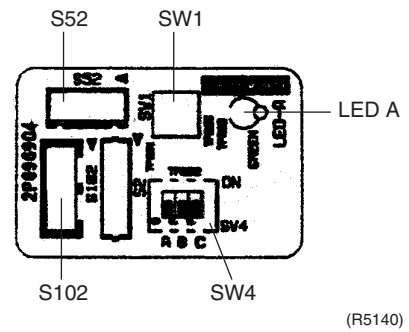

MID

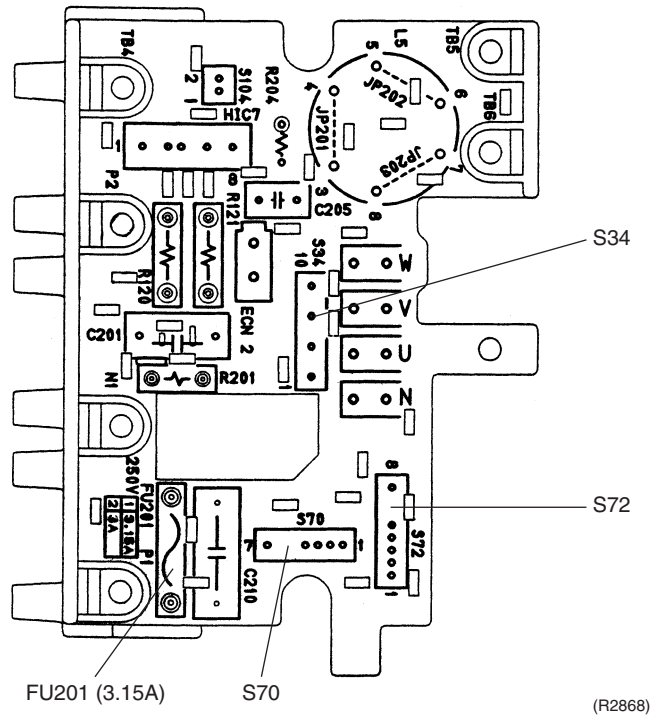

SPM

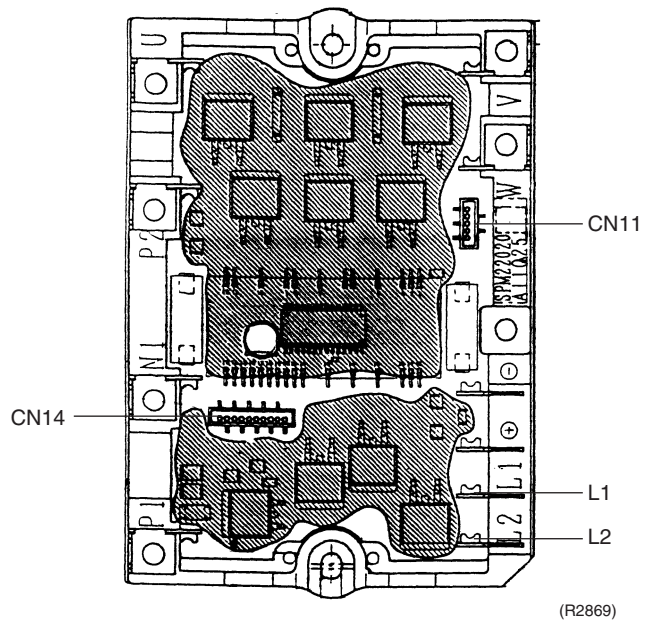

Part 4

Function and Control

1. Main Functions	25
1.1 Frequency Principle.....	25
1.2 Power-Airflow Dual Flaps, Wide-Angle Louvres and Auto-Swing (Only for the Single Split Duct-Free System)	27
1.3 Fan Speed Control for Indoor Units.....	28
1.4 Program Dry Function	29
1.5 Automatic Operation.....	30
1.6 Thermostat Control.....	31
1.7 NIGHT SET Mode	32
1.8 INTELLIGENT EYE	33
1.9 HOME LEAVE Operation	35
1.10 Inverter Powerful Operation	36
1.11 Other Functions.....	37
2. Function of Thermistor	39
2.1 Heat Pump Model.....	39
3. Control Specification (09/12 Class).....	40
3.1 Mode Hierarchy	40
3.2 Frequency Control.....	41
3.3 Controls at Mode Changing / Start-up.....	43
3.4 Discharge Pipe Control	44
3.5 Input Current Control.....	45
3.6 Freeze-up Protection Control	45
3.7 Heating Peak-cut Control	46
3.8 Fan Control.....	46
3.9 Liquid Compression Protection Function 2.....	46
3.10 Defrost Control	47
3.11 Electronic Expansion Valve Control	48
3.12 Malfunctions	51
3.13 Forced Operation Mode	52
3.14 Additional Function.....	52
4. Control Specification (15/18/24 Class).....	53
4.1 Mode Hierarchy	53
4.2 Frequency Control.....	54
4.3 Controls at Mode Changing / Start-up.....	56
4.4 Discharge Pipe Temperature Control.....	57
4.5 Input Current Control.....	58
4.6 Freeze-up Protection Control	59
4.7 Heating Peak-cut Control	59
4.8 Fan Control.....	60
4.9 Liquid Compression Protection Function 2.....	60
4.10 Low Hz High Pressure Limit.....	61

4.11 Defrost Control	61
4.12 Electronic Expansion Valve Control	62
4.13 Malfunctions	65
4.14 Forced Operation Mode	66
4.15 Additional Function.....	66

1. Main Functions

i Note: See the list of functions for the functions applicable to different models.

1.1 Frequency Principle

Main Control Parameters

The compressor is frequency-controlled during normal operation. The target frequency is set by the following 2 parameters coming from the operating indoor unit:

- The load condition of the operating indoor unit
- The difference between the room temperature and the set temperature

Additional Control Parameters

The target frequency is adapted by additional parameters in the following cases:

- Frequency restrictions
- Initial settings
- Forced cooling operation

Inverter Principle

To regulate the capacity, a frequency control is needed. The inverter makes it possible to vary the rotation speed of the compressor. The following table explains the conversion principle:

Phase	Description
1	The supplied AC power source is converted into the DC power source for the present.
2	The DC power source is reconverted into the three phase AC power source with variable frequency. <ul style="list-style-type: none"> ■ When the frequency increases, the rotation speed of the compressor increases resulting in an increased refrigerant circulation. This leads to a higher amount of the heat exchange per unit. ■ When the frequency decreases, the rotation speed of the compressor decreases resulting in a decreased refrigerant circulation. This leads to a lower amount of the heat exchange per unit.

Drawing of Inverter

The following drawing shows a schematic view of the inverter principle:

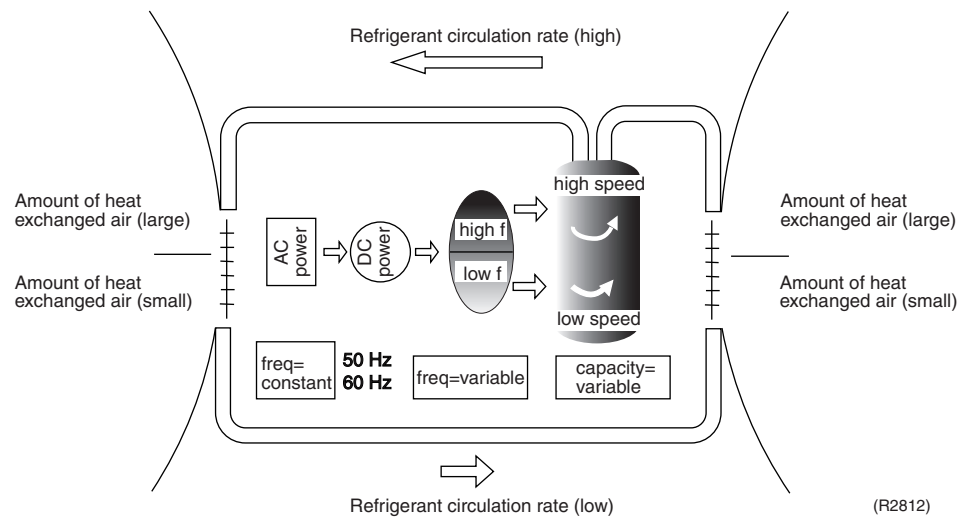

Inverter Features

The inverter provides the following features:

- The regulating capacity can be changed according to the changes in the outdoor air temperature and cooling / heating load.
- Quick heating and quick cooling
The compressor rotational speed is increased when starting the heating (or cooling). This enables a quick set temperature.

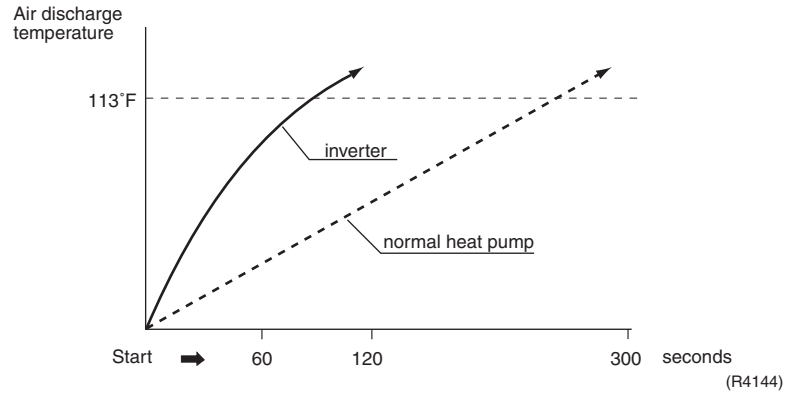

- Even during extreme cold weather, the high capacity is achieved. It is maintained even when the outdoor air temperature is 36°F.
- Comfortable air conditioning
A detailed adjustment is integrated to ensure a fixed room temperature. It is possible to air condition with a small room temperature variation.
- Energy saving heating and cooling
Once the set temperature is reached, the energy saving operation enables to maintain the room temperature at low power.

Frequency Limits

The following table shows the functions that define the minimum and maximum frequency:

Frequency limits	Limited during the activation of following functions
Low	<ul style="list-style-type: none"> ■ Four way valve operation compensation. Refer to page 43.
High	<ul style="list-style-type: none"> ■ Input current control. Refer to page 45. ■ Compressor protection function. Refer to page 44. ■ Heating peak-cut control. Refer to page 46. ■ Freeze-up protection control. Refer to page 45. ■ Defrost control. Refer to page 47.

Forced Cooling Operation

For more information, refer to “Forced operation mode” on page 52.

1.2 Power-Airflow Dual Flaps, Wide-Angle Louvres and Auto-Swing (Only for the Single Split Duct-Free System)

Power-Airflow Dual Flaps

The large flaps send a large volume of air downwards to the floor. The flap provides an optimum control area in cooling, heating and dry mode.

Heating Mode

During heating mode, the large flap enables direct warm air straight downwards. The flap presses the warm air above the floor to reach the entire room.

Cooling Mode

During cooling mode, the flap retracts into the indoor unit. Then, cool air can be blown far and pervaded all over the room.

Wide-Angle Louvres

The louvres, made of elastic synthetic resin, provide a wide range of airflow that guarantees a comfortable air distribution.

Auto-Swing

The following table explains the auto swing process for heating, cooling, dry and fan :

■ 09/12 Class

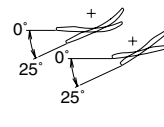
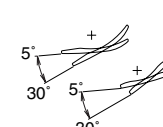
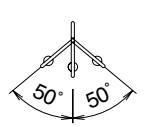
Vertical Swing (up and down)		Horizontal Swing (right and left: manual)
Cooling / Dry / Fan	Heating	Heating, Cooling
 <p>(R2946)</p>	 <p>(R4013)</p>	 <p>(R2817)</p>

■ 15/18/24 Class

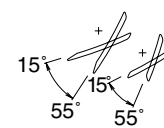
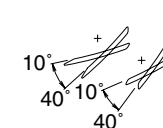
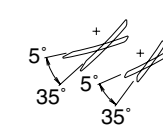
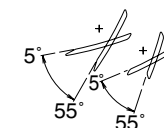
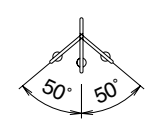
Vertical Swing (up and down)				Horizontal Swing (right and left)
Heating	Cooling	Dry	Fan	Heating, Cooling
 <p>(R2813)</p>	 <p>(R2814)</p>	 <p>(R2815)</p>	 <p>(R2816)</p>	 <p>(R2817)</p>

Outline of 3-D Airflow

Alternative repetition of vertical and horizontal swing motions enables uniform air-conditioning of the entire room. This function is effective for starting the air conditioner.

Detail of the Action

When the horizontal swing and vertical swing are both set to auto mode, the airflow become 3-D airflow and the horizontal swing and vertical swing motions are alternated. The order of swing motion is such that it turns counterclockwise, starting from the right upper point as viewed to the front side of the indoor unit.

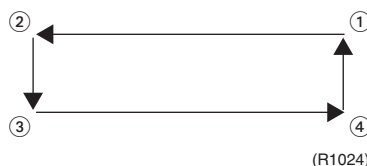

1.3 Fan Speed Control for Indoor Units

Control Mode

The airflow rate can be automatically controlled depending on the difference between the set temperature and the room temperature. This is done through phase control and Hall IC control.



For more information about Hall IC, refer to trouble shooting for fan motor on page 152.

Phase Steps

Phase control and fan speed control contains 9 steps: LLL, LL, SL, L, ML, M, MH, H and HH.

Step	Cooling	Heating	Dry mode
LLL (Heating thermostat OFF)	 (R4085)	 (R4085)	09/12 class : 500 - 860 rpm (During powerful operation : 850 - 910 rpm) 15/18/24 class : 750 - 1000 rpm (During powerful operation : 1050 rpm)
LL (Cooling thermostat OFF)			
SL (Silent)			
L			
ML			
M			
MH			
H			
HH (Powerful)			

= Within this range the airflow rate is automatically controlled when the FAN setting button is set to automatic.



Note:

1. During powerful operation, fan operate H tap + 50 - 90 rpm.
2. Fan stops during defrost operation.

Automatic Air Flow Control for Heating

The following drawing explains the principle for fan speed control for heating:

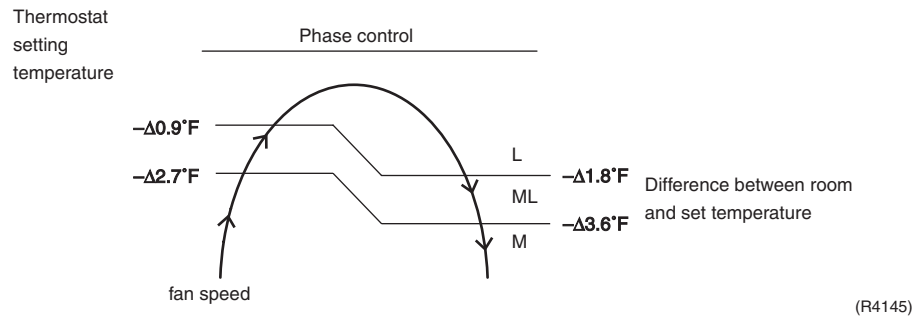

Automatic Air Flow Control for Cooling

The following drawing explains the principle of fan speed control for cooling:

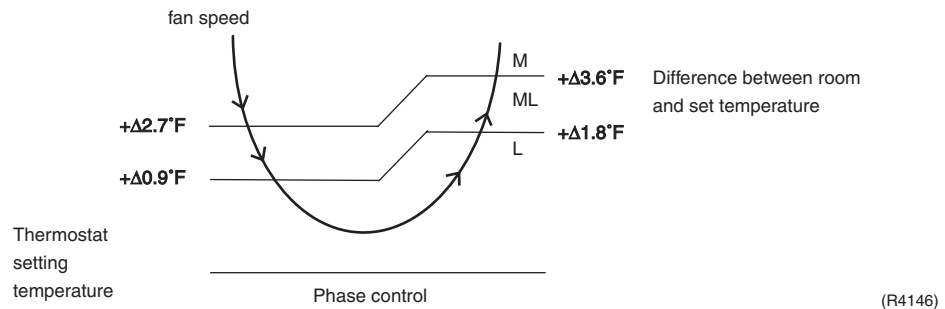

1.4 Program Dry Function

Program dry function removes humidity while preventing the room temperature from lowering. Since the microcomputer controls both the temperature and air flow volume, the temperature adjustment and fan adjustment buttons are inoperable in this mode.

In Case of Inverter Units

The microcomputer automatically sets the temperature and fan settings. The difference between the room temperature at startup and the temperature set by the microcomputer is divided into two zones. Then, the unit operates in the dry mode with an appropriate capacity for each zone to maintain the temperature and humidity at a comfortable level.

Room temperature at startup	Temperature (ON point) at which operation starts	Frequency switching point	Temperature difference for operation stop
75°F	Room temperature at startup	$\Delta 0.9^\circ\text{F}$	$\Delta 2.7^\circ\text{F}$
64°F	64°F		$\Delta 1.8^\circ\text{F}$
63°F		—	

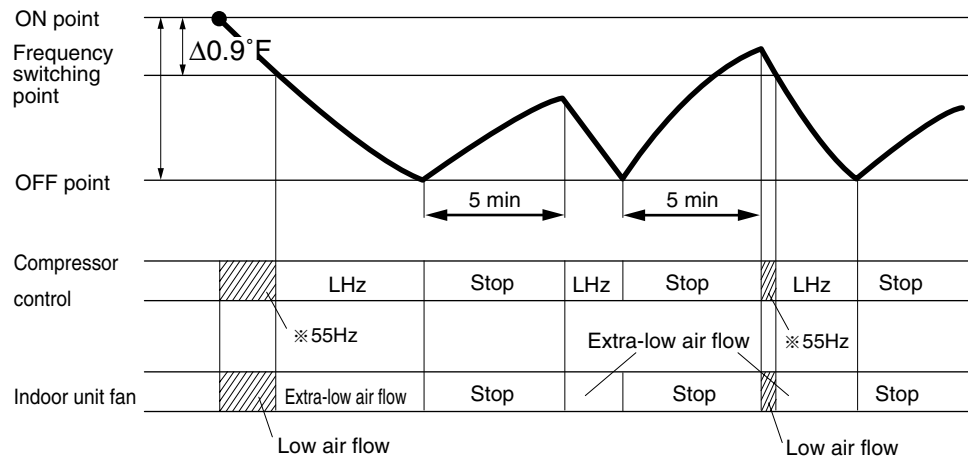

LHz indicates low frequency. Item marked with * varies depending on models.

(R4147)

1.5 Automatic Operation

Automatic Cooling / Heating Function (Heat Pump Only)

When the AUTO mode is selected with the remote controller, the microcomputer automatically determines the operation mode from cooling and heating according to the room temperature and setting temperature at the time of the operation startup, and automatically operates in that mode. The unit automatically switches the operation mode to cooling or heating to maintain the room temperature at the main unit setting temperature.

Detailed Explanation of the Function

1. Remote controller setting temperature is set as automatic cooling / heating setting temperature (64 to 86°F).
2. Main unit setting temperature equals remote controller setting temperature plus correction value (correction value / cooling: $\Delta 0^\circ\text{F}$, heating: $\Delta 3.6^\circ\text{F}$).
3. Operation ON / OFF point and mode switching point are as follows.
 - ① Heating → Cooling switching point:
Room temperature \geq Main unit setting temperature $+\Delta 4.5^\circ\text{F}$
 - ② Cooling → Heating switching point:
Room temperature $<$ Main unit setting temperature $-\Delta 4.5^\circ\text{F}$
 - ③ Thermostat ON / OFF point is the same as the ON / OFF point of cooling or heating operation.
4. During initial operation
Room temperature \geq Remote controller setting temperature: Cooling operation
Room temperature $<$ Remote controller setting temperature: Heating operation

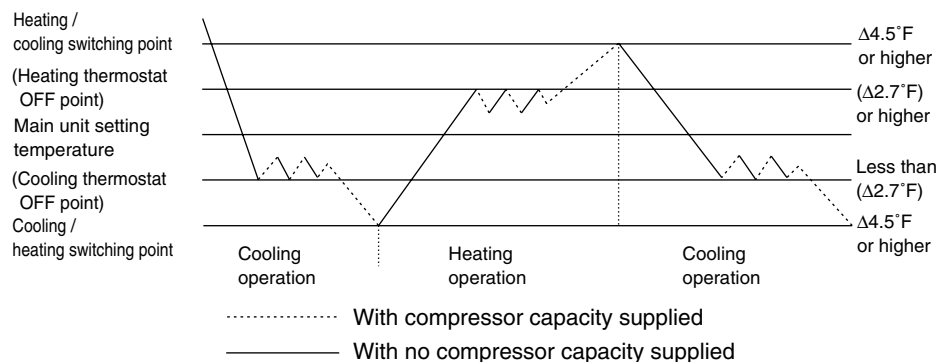

(R4148)

1.6 Thermostat Control

Thermostat control is based on the difference between the room temperature and the setpoint.

Thermostat OFF Condition

- ◆ The temperature difference is in the zone A.

Thermostat ON Condition

- ◆ The temperature difference is above the zone C after being in the zone A.
- ◆ The system resumes from defrost control in any zones except A.
- ◆ The operation turns on in any zones except A.
- ◆ The monitoring time has passed while the temperature difference is in the zone B.
(Cooling / Dry : 10 minutes, Heating : 10 seconds)

Cooling / Dry

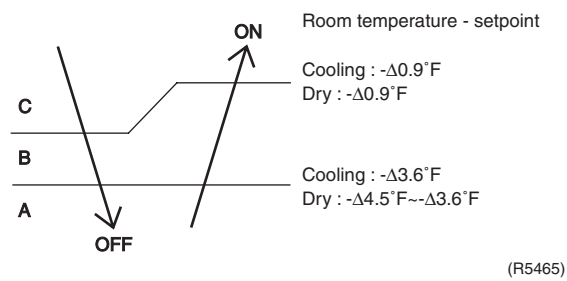

Heating

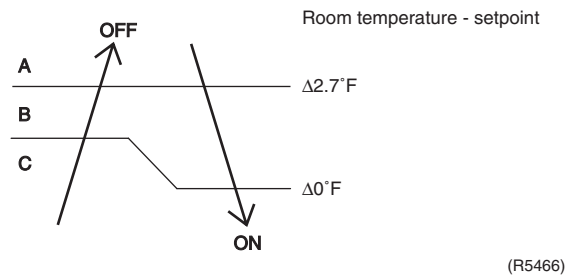

1.7 NIGHT SET Mode

When the OFF timer is set, the NIGHT SET circuit automatically activates. The NIGHT SET circuit maintains the airflow setting made by users.

The NIGHT SET Circuit

The NIGHT SET circuit continues heating or cooling the room at the set temperature for the first one hour, then automatically raises the temperature setting slightly in the case of cooling, or lowers it slightly in the case of heating, for economical operations. This prevents excessive heating in winter and excessive cooling in summer to ensure comfortable sleeping conditions, and also conserves electricity.

Cooling Operation

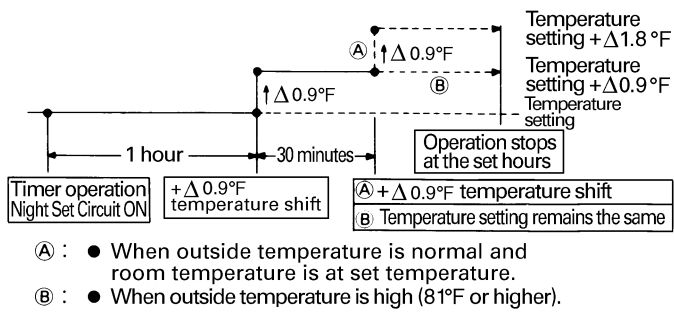

Heating Operation

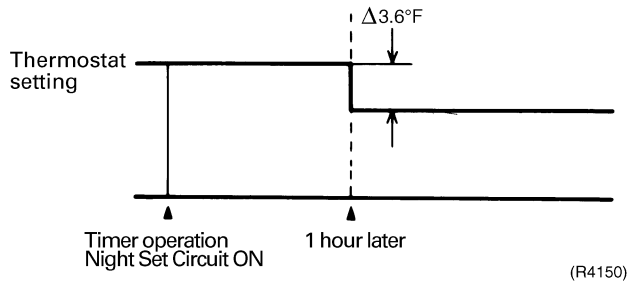

1.8 INTELLIGENT EYE

This is the function that detects existence of humans in the room by a human motion sensor (INTELLIGENT EYE) and reduces the capacity when there is no human in the room in order to save electricity.

Processing

1. Detection method by INTELLIGENT EYE

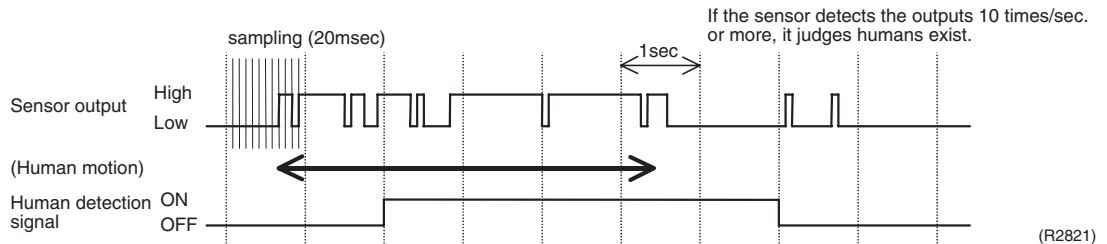

- This sensor detects human motion by receiving infrared rays and displays the pulse wave output.
- A microcomputer in an indoor unit carries out a sampling every 20 msec. and if it detects 10 cycles of the wave in one second in total (corresponding to $20\text{msec.} \times 10 = 100\text{msec.}$), it judges human is in the room as the motion signal is ON.

2. The motions (for example: in cooling)

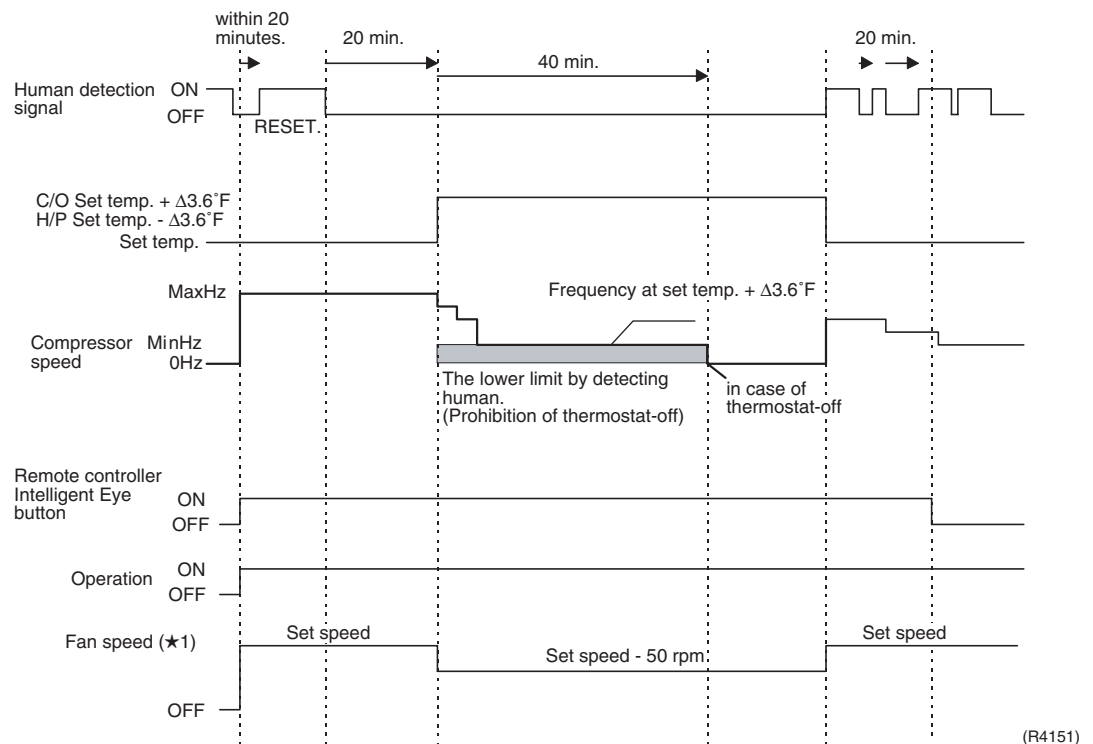

- When a microcomputer doesn't have a signal from the sensor in 20 minutes, it judges that nobody is in the room and operates the unit in temperature sifted $\Delta 3.6^\circ\text{F}$ from the set temperature. (COOL : $\Delta 3.6^\circ\text{F}$ higher, DRY : $\Delta 1.8^\circ\text{F}$ higher, AUTO : according to the operation mode at that time.)

★1 In case of FAN mode, the fan speed reduces by 50 rpm.

- Since the set temperature is shifted by $\Delta 3.6^{\circ}\text{F}$ higher for 40 minutes, compressor speed becomes low and can realize energy saving operation. But as thermostat is prone to be off by the fact that the set temperature has been shifted, the thermostat-off action is prohibited in 40 minutes so as to prevent this phenomena.
After this 40 minutes, the prohibition of the thermostat-off is cancelled and it can realize the conditions to conduct thermostat-off depending on the room temperature. In or after this forty minutes, if the sensor detects human motion detection signal, it let the set temperature and the fan speed return to the original set point, keeping a normal operation.

Others

- The dry operation can't command the setting temperature with a remote controller, but internally the set temperature is shifted by $\Delta 1.8^{\circ}\text{F}$.

1.9 HOME LEAVE Operation

Outline

In order to respond to the customer's need for immediate heating and cooling of the room after returning home or for house care, a measure to switch the temperature and air volume from that for normal time over to outing time by one touch is provided. (This function responds also to the need for keeping up with weak cooling or heating.)

This time, we seek for simplicity of operation by providing the special temperature and air volume control for outing to be set by the exclusive button.

Detail of the Control

1. Start of Function

The function starts when the [HOME LEAVE] button is pressed in cooling mode or heating mode (including stopping and powerful operation). If this button is pressed while the operation is stopped, the function becomes effective when the operation is started. If this button is pressed in powerful operation, the powerful operation is reset and this function becomes effective.

- The [HOME LEAVE] button is ineffective in dry mode and fan mode.

2. Details of Function

A mark representing [HOME LEAVE] is indicated on the liquid crystal display of the remote controller. The indoor unit is operated according to the set temperature and air volume for HOME LEAVE which were pre-set in the memory of the remote controller.

The LED (Red) of indoor unit representing [HOME LEAVE] lights up. (It goes out when the operation is stopped.)

3. End of Function

The function ends when the [HOME LEAVE] button is pressed again during [HOME LEAVE] operation or when the powerful operation button is pressed.

Scene <cooling>



Scene <Heating>



Others

The set temperature and set air volume are memorized in the remote controller. When the remote controller is reset due to replacement of battery, it is necessary to set the temperature and air volume again for [HOME LEAVE].

1.10 Inverter Powerful Operation

Outline

In order to exploit the cooling and heating capacity to full extent, operate the air conditioner by increasing the indoor fan rotating speed and the compressor frequency.

Details of the Control

When POWERFUL button is pushed in each operation mode, the fan speed / setting temperature will be converted to the following states in a period of twenty minutes.

Operation mode	Fan speed	Target set temperature
COOL	H tap + 90 rpm	64°F
DRY	Dry rotating speed + 50 rpm	Normally targeted temperature in dry operation; Approx. $-\Delta 3.6^{\circ}\text{F}$
HEAT	H tap + 90 rpm	86°F
FAN	H tap + 90 rpm	—
AUTO	Same as cooling / heating in Powerful operation	The target is kept unchanged

Ex.) : Powerful operation in cooling mode.

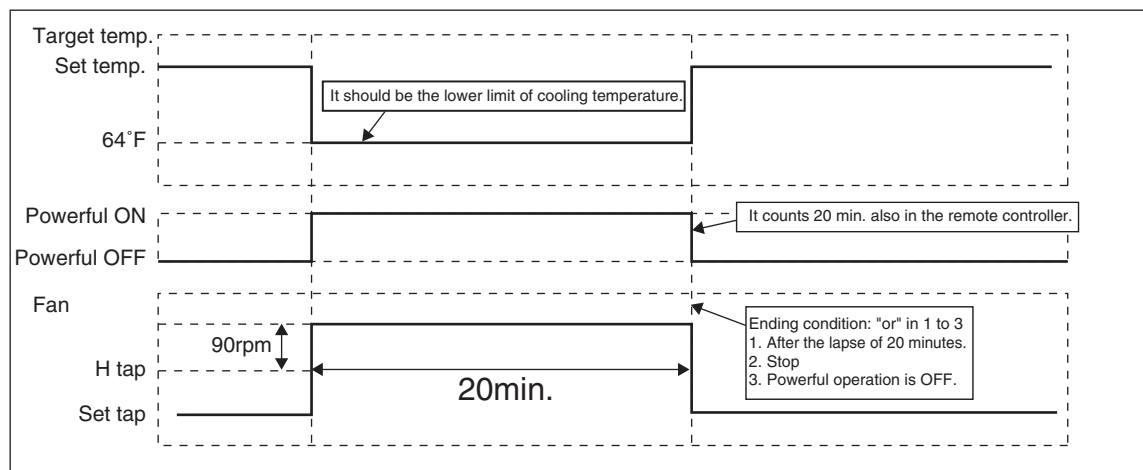

(R5488)

1.11 Other Functions

1.11.1 Hot Start Function

Heat Pump Only

In order to prevent the cold air blast that normally comes when heating is started, the temperature of the heat exchanger of the indoor unit is detected, and either the air flow is stopped or is made very weak thereby carrying out comfortable heating of the room.

*The cold air blast is also prevented using a similar control when the defrosting operation is started or when the thermostat gets turned ON.

1.11.2 Signal Receiving Sign

When the indoor unit receives a signal from the remote controller, the unit emits a signal receiving sound.

1.11.3 ON/OFF Button on Indoor Unit

An ON/OFF switch is provided on the front panel of the unit. Use this switch when the remote controller is missing or if its battery has run out.

Every press of the switch changes from Operation to Stop or from Stop to Operation

In case of the Single Split Duct-Free System

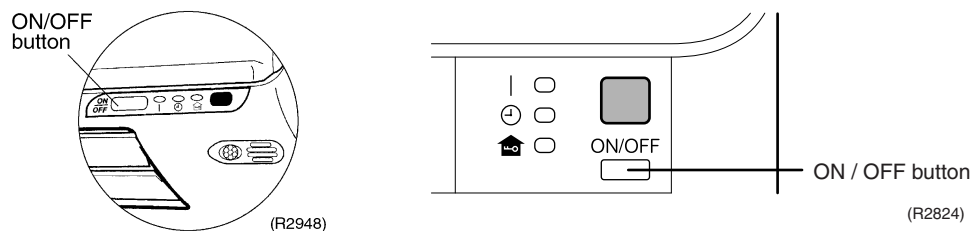

In case of the Slim Duct Built-in System

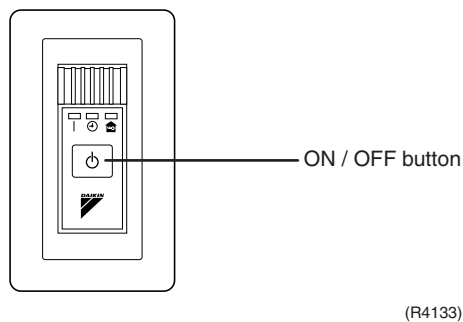

- Push this button once to start operation. Push once again to stop it.
- This button is useful when the remote controller is missing.
- The operation mode refers to the following table.

	Mode	Temperature setting	Air flow rate
Heat Pump	AUTO	77°F	AUTO

- In the case of multi system operation, there are times when the unit does not activate with this button.

1.11.4 Air Purifying Filter with Photocatalytic Deodorizing Function

The Single Split Duct-Free System Only

This filter incorporates the benefits the Air Purifying Filter and Photocatalytic Deodorizing Filter in a single unit. Combining the two filters in this way increases the active surface area of the new filter. This larger surface area allows the filter to effectively trap microscopic particles, decompose odours and deactivate bacteria and viruses even for the high volume of air required to air-condition large living rooms. The filter can be used for approximately 3 years if periodic maintenance is performed.

1.11.5 Mold Proof Air Filter

The Single Split Duct-Free System Only

The air filter net is impregnated with a safe, odourless mould preventative to make the filter virtually immune to mould.

1.11.6 Self-Diagnosis Digital Display

The microcomputer continuously monitors main operating conditions of the indoor unit, outdoor unit and the entire system. When an abnormality occur, the LCD remote controller displays error code. These indications allow prompt maintenance operations.

1.11.7 Auto-restart Function

Even if a power failure (including one for just a moment) occurs during the operation, the operation restarts in the condition before power failure automatically when power is restored.

(Note) It takes 3 minutes to restart the operation because the 3-minutes standby function is activated.

2. Function of Thermistor

2.1 Heat Pump Model

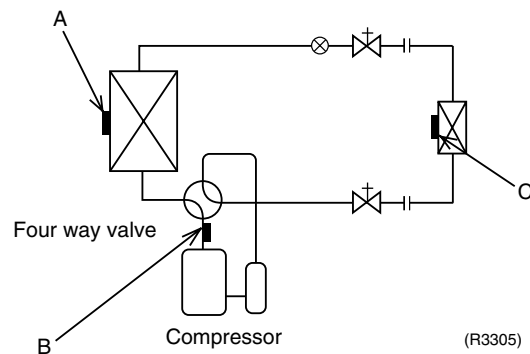

A Outdoor Heat Exchanger Thermistor (DCB)

1. The outdoor heat exchanger thermistor is used for controlling target discharge temperature. Set a target discharge temperature depending on the outdoor and indoor heat exchanger temperature. Control the electronic expansion valve opening so that the target discharge temperature can be obtained.
2. The outdoor heat exchanger thermistor is used for detecting the discharge thermistor disconnected when cooling. When the temperature of the discharge piping is lower than the temperature of outdoor heat exchanger, a disconnected discharge thermistor can be detected.
3. The outdoor heat exchanger thermistor is used for high pressure protection during cooling operation.

B Discharge Pipe Thermistor (DOT)

1. The discharge pipe thermistor is used to control the discharge pipe. If the temperature of discharge pipe (used in place of the inner temperature of the compressor) rises abnormally, the operating frequency drops or the operation must be halted.
2. The discharge pipe thermistor is used for detecting the discharge thermistor disconnected.

C Indoor Heat Exchanger Thermistor (DCN)

1. The indoor heat exchanger thermistor is used for controlling target discharge pipe temperature. Set a target discharge pipe temperature according to the outdoor and indoor heat exchanger temperature. Control the electronic expansion valve so that the target discharge pipe temperature can be obtained.
2. The indoor heat exchanger thermistor is used to prevent freezing. During the cooling operation, if the temperature drops abnormally, the operating frequency becomes lower, then the operation must be halted.
3. The indoor heat exchanger thermistor is used for anti-icing control. During the cooling operation, if the heat exchanger temperature in the room where operation is halted becomes 30°F, or if the room temperature - heat exchanger temperature in the room where operation is halted becomes $\geq 18^\circ\text{F}$, it is assumed as icing.
4. During heating: the indoor heat exchanger thermistor is used for detecting the discharge pipe thermistor disconnected. When the discharge pipe temperature become lower than an indoor heat exchanger temperature, a disconnected discharge pipe thermistor can be detected.

3. Control Specification (09/12 Class)

3.1 Mode Hierarchy

Outline

There are two modes; the mode selected in user's place (normal air conditioning mode) and forced operation mode for installation and providing service.

Detail

For heat pump model

There are following modes; stop, cooling (includes drying), heating (include defrosting)

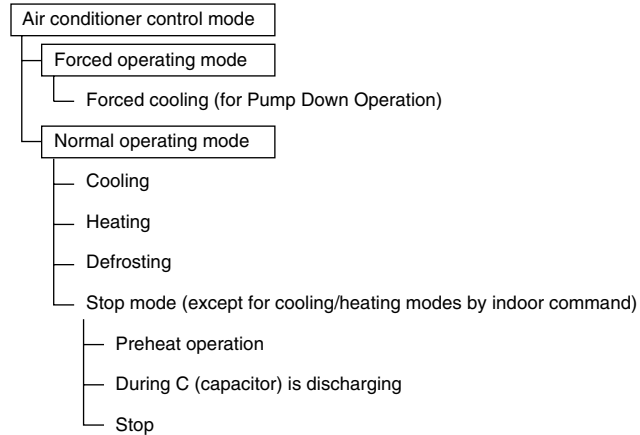

(R2829)



Note: Unless specified otherwise, an indoor dry operation command must be regarded as cooling operation.

3.2 Frequency Control

Outline

Frequency will be determined according to the difference between room and set temperature. The function is explained as follows.

1. How to determine frequency.
2. Frequency command from an indoor unit. (The difference between a room temperature and the temperature set by the remote controller.)
3. Frequency command from an indoor unit.
4. Frequency initial setting.
5. PI control.

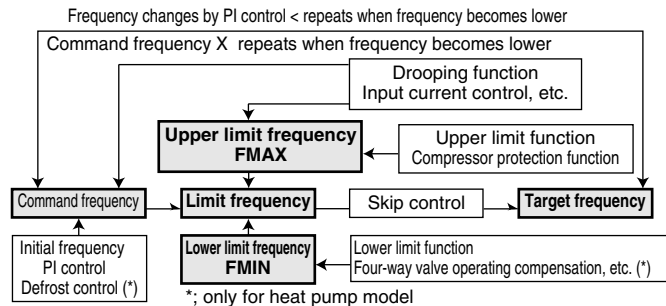

(R2831)

Detail

How to Determine Frequency

The compressor's frequency will finally be determined by taking the following steps.

For Heat Pump Model

1. Determine command frequency

- ◆ Command frequency will be determined in the following order of priority.
 - 1.1 Limiting frequency by drooping function
 - ◆ Input current, discharge pipes, peak cutting, freeze-up protection, dew prevention, fin thermistor temperature.
 - 1.2 Limiting defrost control time
 - 1.3 Forced cooling
 - 1.4 Indoor frequency command

2. Determine upper limit frequency

- ◆ Set a minimum value as an upper limit frequency among the frequency upper limits of the following functions:
Compressor protection, input current, discharge pipes, peak cutting, freeze-up protection, defrost.

3. Determine lower limit frequency

- ◆ Set a maximum value as a lower limit frequency among the frequency lower limits of the following functions:
Four way valve operating compensation, draft prevention, pressure difference upkeep.

4. Determine prohibited frequency

- ◆ There is a certain prohibited frequency such as a power supply frequency.

Indoor Frequency Command (ΔD signal)

The difference between a room temperature and the temperature set by the remote controller will be taken as the " ΔD signal" and is used for frequency command.

Temperature difference	ΔD signal	Temperature difference	ΔD signal	Temperature difference	ΔD signal	Temperature difference	ΔD signal
0	*Th OFF	2.0	4	4.0	8	6.0	C
0.5	1	2.5	5	4.5	9	6.5	D
1.0	2	3.0	6	5.0	A	7.0	E
1.5	3	3.5	7	5.5	B	7.5	F

*Th OFF = Thermostat OFF

Frequency Initial Setting**<Outline>**

When starting the compressor, or when conditions are varied due to the change of the room, the frequency must be initialized according to the ΔD value of the indoor unit and the Q value of the indoor unit.

Q value: Indoor unit output determined from indoor unit volume, air flow rate and other factors.

PI Control (Determine Frequency Up / Down by ΔD Signal)**1. P control**

Calculate ΔD value in each sampling time (20 seconds), and adjust the frequency according to its difference from the frequency previously calculated.

2. I control

If the operating frequency is not change more than a certain fixed time, adjust the frequency up and down according to the ΔD value, obtaining the fixed ΔD value.

When the ΔD value is small...lower the frequency.

When the ΔD value is large...increase the frequency.

3. Frequency management when other controls are functioning

- ◆ When frequency is drooping;
Frequency management is carried out only when the frequency droops.
- ◆ For limiting lower limit
Frequency management is carried out only when the frequency rises.

4. Upper and lower limit of frequency by PI control

The frequency upper and lower limits are set depending on indoor unit.

When low noise commands come from the indoor unit or when outdoor unit low noise or quiet commands come from indoor unit, the upper limit frequency must be lowered than the usual setting.

3.3 Controls at Mode Changing / Start-up

3.3.1 Preheating Operation

Outline Operate the inverter in the open phase operation with the conditions including the preheating command from the discharge pipe temperature.

Detail

Preheating ON Condition

- When the discharge pipe temperature is below 50°F, inverter in open phase operation starts.

OFF Condition

- When the discharge pipe temperature is higher than 54°F, inverter in open phase operation stops.

3.3.2 Four Way Valve Switching

Outline of Heating Operation

Heat Pump Only

During the heating operation current must be conducted and during cooling and defrosting current must not be conducted. In order to eliminate the switching sound (as the four way valve coil switches from ON to OFF) when the heating is stopped, the delay switch of the four way valve must be carried out after the operation stopped.

Detail

The OFF delay of four way valve
Energize the coil for 160 sec after unit operation is stopped.

3.3.3 Four Way Valve Operation Compensation

Outline

Heat Pump Only

At the beginning of the operation as the four way valve is switched, acquire the differential pressure required for activating the four way valve by having output the operating frequency, which is more than a certain fixed frequency, for a certain fixed time.

Detail

Starting Conditions

1. When starting compressor for heating.
2. When the operating mode changes to cooling from heating.
3. When starting compressor for rushing defrosting or resetting.
4. When starting compressor for the first time after the reset with the power is ON.
5. When starting compressor for heating next to the suspension of defrosting.
6. When starting compressor next to the fault of switching over cooling / heating.

Set the lower limit frequency to 68 (model by model) Hz for 45 seconds with any conditions 1 through 4 above.

3.3.4 3-minutes Standby

Prohibit to turn ON the compressor for 3 minutes after turning it off.
(except when defrosting)

3.3.5 Compressor Protection Function

When turning the compressor from OFF to ON, the upper limit of frequency must be set as follows.
(The function must not be used when defrosting.)

FCG 3	88
FCG 2	64
FCG 1	48
TCG1	240
TCG2	360
TCG3	180

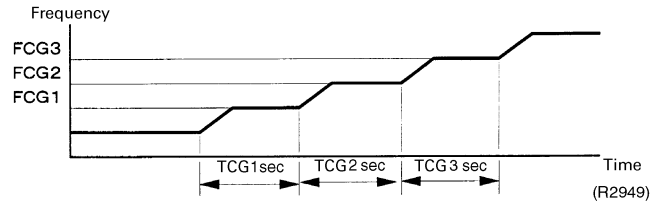

3.4 Discharge Pipe Control

Outline

The discharge pipe temperature is used as the compressor's internal temperature. If the discharge pipe temperature rises above a certain level, the operating frequency upper limit is set to keep this temperature from going up further.

Detail

Divide the Zone

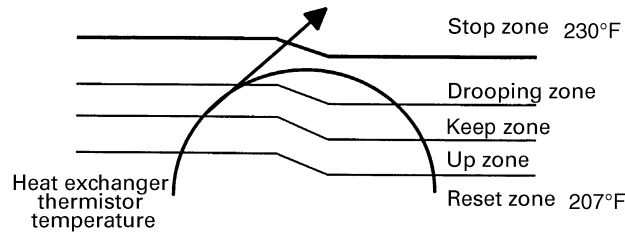

(R5467)

Management within the Zones

Zone	Control contents
Stop zone	When the temperature reaches the stop zone, stop the compressor and correct abnormality.
Drooping zone	Start the timer, and the frequency will be drooping.
Keep zone	Keep the upper limit of frequency.
Return / Reset zone	Cancel the upper limit of frequency.

3.5 Input Current Control

Outline

Detect an input current by the CT during the compressor is running, and set the frequency upper limit from such input current.
 In case of heat pump model, this control is the upper limit control function of the frequency which takes priority of the lower limit of four way valve activating compensation.

Detail

The frequency control will be made within the following zones.

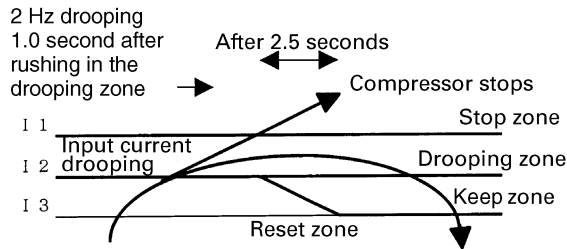

(R4598)

When a “stop current” continues for 2.5 seconds after rushing on the stop zone, the compressor operation stops.

If a “drooping current” is continues for 1.0 second after rushing on the drooping zone, the frequency will be 2 Hz drooping.

Repeating the above drooping continues until the current rushes on the drooping zone without change.

In the keep zone, the frequency limit will remain.

In the return / reset zone, the frequency limit will be cancelled.

Limitation of current drooping and stop value according to the outdoor air temperature

1. In case the operation mode is cooling
 - ♦ The current droops when outdoor air temperature becomes higher than a certain level (model by model).
2. In case the operation mode is heating
 - ♦ The current droops when outdoor air temperature becomes higher than a certain level (model by model).

3.6 Freeze-up Protection Control

Outline

During cooling operation, the signals being sent from the indoor unit allow the operating frequency limitation and then prevent freezing of the indoor heat exchanger. (The signal from the indoor unit must be divided into the zones as the followings.)

Detail

Conditions for Start Controlling

Judge the controlling start with the indoor heat exchanger temperature after 2 sec from operation start.

Control in Each Zone

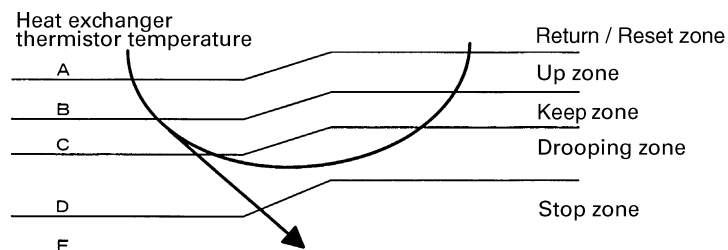

(R5469)

3.7 Heating Peak-cut Control

Outline **Heat Pump Only**
During heating operation, the signals being sent from the indoor unit allow the operating frequency limitation and prevent abnormal high pressure. (The signal from the indoor unit must be divided as follows.)

Detail **Conditions for Start Controlling**
Judge the controlling start with the indoor heat exchanger temperature after 2 sec. from operation start.

Control in Each Zone

The heat exchange intermediate temperature of indoor unit controls the following.

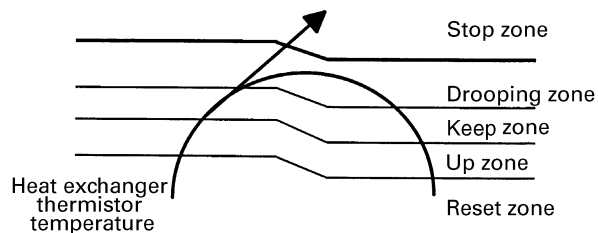

(R4599)

3.8 Fan Control

Outline Fan control is carried out according to the following priority.

1. Fan control when defrosting
2. Fan OFF delay when stopped
3. ON/OFF control when cooling operation
4. Tap control when drooping function is working
5. Fan control when forced operation
6. Fan control in low noise mode
7. Fan control during heating operation
8. Fan control in the quiet mode
9. Fan control in the powerful mode
10. Fan control for pressure difference upkeep

Detail **Fan OFF Control when Stopped**
 ■ Fan OFF delay for 60 seconds must be made when the compressor is stopped.

3.9 Liquid Compression Protection Function 2

Outline In order to obtain the dependability of the compressor, the compressor must be stopped according to the conditions of the temperature of the outdoor air and outdoor heat exchanger.

Detail ■ Operation stop depending on the outdoor air temperature
Compressor operation turns OFF under the conditions that the system is in cooling operation and outdoor air temperature is below 14°F.

3.10 Defrost Control

Outline

Heat Pump Only

Defrosting is carried out by the cooling cycle (reverse cycle). The defrosting time or outdoor heat exchanger temperature must be more than its fixed value when finishing.

Detail

Conditions for Starting Defrost

The starting conditions must be made with the outdoor air temperature and heat exchanger temperature. Under the conditions that the system is in heating operation, 6 minutes after the compressor is started and more than 44 minutes of accumulated time pass since the start of the operation or ending the defrosting.

Conditions for Canceling Defrost

The judgment must be made with heat exchanger temperature. (39°F~72°F)

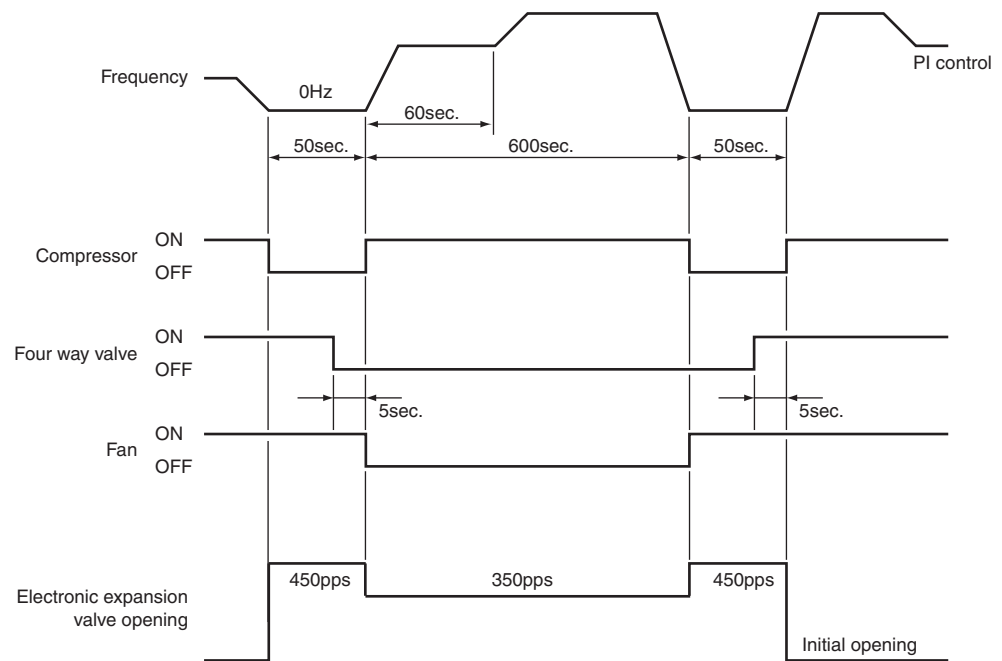

(R4014)

3.11 Electronic Expansion Valve Control

Outline

The following items are included in the electronic expansion valve control.

Electronic expansion valve is fully closed

1. Electronic expansion valve is fully closed when turning on the power.
2. Pressure equalizing control

Open Control

1. Electronic expansion valve control when starting operation
2. Control when frequency changed
3. Control for defrosting (only for heat pump model)
4. Control when a discharge pipe temperature is abnormally high
5. Control when the discharge pipe thermistor is disconnected

Feedback Control

1. Discharge pipe temperature control

Detail

The followings are the examples of control which function in each mode by the electronic expansion valve control.

Operation pattern		Control when frequency changed	Control for abnormally high discharge pipe temperature
When power is turned ON	○ : function × : not function		
↓	Fully closed when power is turned ON	×	×
↓	Cooling operation	×	○
↓	(Control of target discharge pipe temperature)	○	○
↓	Stop		
↓	Pressure equalizing control	×	×
↓	Heating operation	×	○
↓ (only for heat pump model)	(Control of target discharge pipe temperature)	○	○
↓	(Defrost control FD=1) (only for heat pump model)	×	×
↓	Stop		
↓	Pressure equalizing control	×	×
↓	Heating operation	×	○
↓ (only for heat pump model)	Open control when starting	×	○
↓	Control of discharge pipe thermistor disconnection	×	×
↓	Continue	×	×
↓	Stop		
↓	Pressure equalizing control	×	×

(R2833)

3.11.1 Fully Closing with Power ON

Initialize the electronic expansion valve when turning on the power, set the opening position and develop pressure equalizing.

3.11.2 Pressure Equalization Control

When the compressor is stopped, open and close the electronic expansion valve and develop pressure equalization.

3.11.3 Opening Limit

Outline

Limit a maximum and minimum opening of the electronic expansion valve.

Detail

- ◆ A maximum electronic expansion valve opening : 450 pulses
 - ◆ A minimum electronic expansion valve opening : 52 pulses
- The electronic expansion valve is fully closed in the room where cooling is stopped and is opened with fixed opening during defrosting.

3.11.4 Starting Operation Control

Control the electronic expansion valve opening when the system is starting, and prevent the system to be super heated or moistened.

3.11.5 High Temperature of the Discharge Pipe

When the compressor is operating, if the discharge pipe temperature exceeds a certain value, open the electronic expansion valve and remove the refrigerant to the low pressure side and lower discharge temperature.

3.11.6 Disconnection of the Discharge Pipe Thermistor

Outline

Detect a disconnected discharge pipe thermistor by comparing the discharge pipe temperature with the condensation temperature. If any is disconnected, open the electronic expansion valve according to the outdoor air temperature and the operating frequency and operate for a specified time, and then stop.

After 3 minutes of waiting, restart the unit and check if any is disconnected. If any is disconnected stop the system after operating for a specified time. If the disconnection is detected 4 times in succession, then the system will be down.

Detail

Detect Disconnection

If the timer for open control (cooling : 12min., heating : 15min.) becomes over, and the 9-minute timer for the compressor operation continuation is not counting time, the following adjustment must be made.

1. When the operation mode is cooling
When the discharge pipe temperature is lower than the outdoor heat exchanger temperature, the discharge pipe thermistor disconnection must be ascertained.
2. When the operation mode is heating
When the discharge pipe temperature is lower than the max temperature of indoor unit heat exchanger, the discharge pipe thermistor disconnection must be ascertained.

Adjustment when the thermistor is disconnected

When compressor stop repeats specified time, the system should be down.

3.11.7 Control when frequency is changed

When the target discharge pipe temperature control is active, if the target frequency is changed for a specified value in a certain time period, cancel the target discharge pipe temperature control and change the target opening of the electronic expansion valve according to the shift.

3.11.8 Target Discharge Pipe Temperature Control

Obtain the target discharge pipe temperature from the indoor and outdoor heat exchanger temperature, and adjust the electronic expansion valve opening so that the actual discharge pipe temperature become close to that temperature. (Indirect SH control using the discharge pipe temperature)

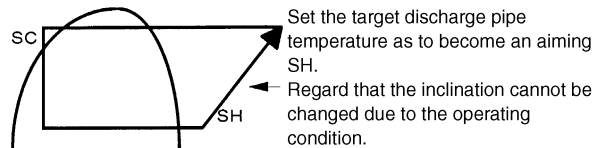

(R1389)

Determine a correction value of the electronic expansion valve compensation and drive it according to the deflection of the target discharge temperature and actual discharge temperature, and the discharge temperature variation by the 20 sec.

3.12 Malfunctions

3.12.1 Sensor Malfunction Detection

Sensor malfunction may occur in the thermistor.

Relating to Thermistor Malfunction

1. Outdoor heat exchanger thermistor
2. Discharge pipe thermistor
3. Fin thermistor
4. Outdoor air thermistor

3.12.2 Detection of Overload and Over Current

Outline

In order to protect the inverter, detect an excessive output current, and for protecting compressor, monitor the OL operation.

Detail

- If the OL (compressor head) temperature exceeds 248°F (depending on the model), the compressor gets interrupted.
- If the inverter current exceeds 22 A, the compressor gets interrupted too.

3.12.3 Insufficient Gas Control

Outline

There are three ways of control to detect insufficient gas.

I Detecting by power consumption

If the power consumption is below the specified value and the frequency is higher than the specified frequency, it is regarded as insufficient gas.

The power consumption is weak comparing with that in the normal operation when gas is insufficient, and gas insufficiency is detected by checking a power consumption.

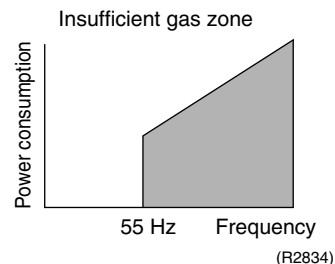

II Detecting by discharge pipe temperature

If the discharge temperature is higher than the target discharge pipe temperature, and the electronic expansion valve is fully open (450 pulses) more than the specified time, it is regarded as insufficient gas.

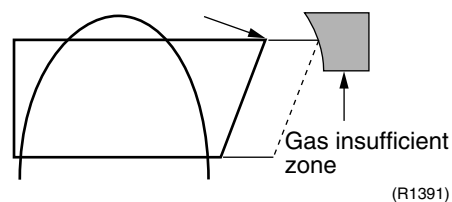

III Detecting by the difference of temperature

If the difference between inhale and exhale temperature is smaller than the specified value, it is regarded as insufficient gas.

Detail**I Judgment by power consumption**

When an output frequency is exceeds 55 Hz and the input current is less than specified value, the adjustment is made for insufficient gas.

II Judgment by discharge pipe temperature

When discharge pipe temperature is $\Delta 36^{\circ}\text{F}$ higher than target value and the electronic expansion valve opening is 450 pulses (max.), the adjustment is made for insufficient gas.

III Judgment by the difference of temperature

When the difference of the temperature is smaller than Δ , it is regarded as insufficient gas.

		Δ
Cooling	room temperature – indoor heat exchanger temperature	$\Delta 7.2^{\circ}\text{F}$
	outdoor heat exchanger temperature – outdoor temperature	$\Delta 7.2^{\circ}\text{F}$
Heating	indoor heat exchanger temperature – room temperature	$\Delta 7.2^{\circ}\text{F}$
	outdoor temperature – outdoor heat exchanger temperature	$\Delta 5.4^{\circ}\text{F}$

3.13 Forced Operation Mode

Outline

Forced operating mode includes only forced cooling.

Detail**Forced Cooling**

Item	Forced Cooling
Forced operation allowing conditions	1) The outdoor unit is not abnormal and not in the 3-minute stand-by mode.
	2) The operating mode of the outdoor unit is the stop mode.
	3) The forced operation is ON. The forced operation is allowed when the above "and" conditions are met.
Starting/adjustment	If the forced operation switch is pressed as the above conditions are met.
1) Command frequency	68 Hz
2) Electronic expansion valve opening	It depends on the capacity of the indoor unit.
3) Outdoor unit adjustment	Compressor is in operation
4) Indoor unit adjustment	The command of forced operation is transmitted to the indoor unit.
End	1) When the forced operation switch is pressed again.
	2) The operation is to end automatically after 15 min.
Others	The protect functions are prior to all others in the forced operation.

3.14 Additional Function

3.14.1 Powerful Operation Mode

Compressor operating frequency is increased to PI Max. (Max. Hz of operating room) and outdoor unit airflow rate is increased.

3.14.2 Voltage Detection Function

Power supply voltage is detected each time equipment operation starts.

4. Control Specification (15/18/24 Class)

4.1 Mode Hierarchy

Outline

There are two modes; the mode selected in user's place (normal air conditioning mode) and forced operation mode for installation and providing service.

Detail

For heat pump model

There are following modes; stop, cooling (includes drying), heating (include defrosting)

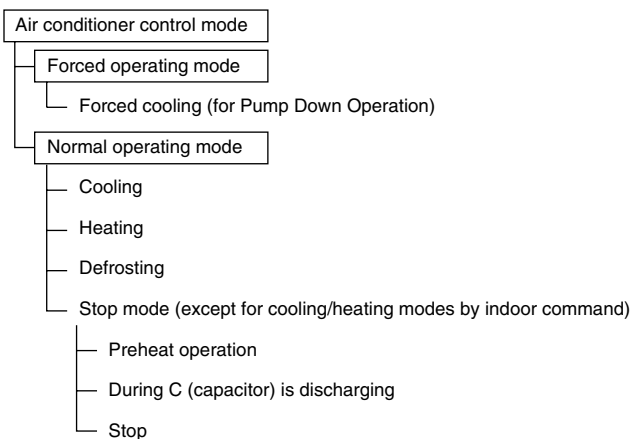

(R2829)



Note: Unless specified otherwise, an indoor dry operation command must be regarded as cooling operation.

4.2 Frequency Control

Outline

Frequency will be determined according to the difference between room and set temperature. The function is explained as follows.

1. How to determine frequency.
2. Frequency command from an indoor unit. (The difference between a room temperature and the temperature set by the remote controller.)
3. Frequency command from an indoor unit.
4. Frequency initial setting.
5. PI control.

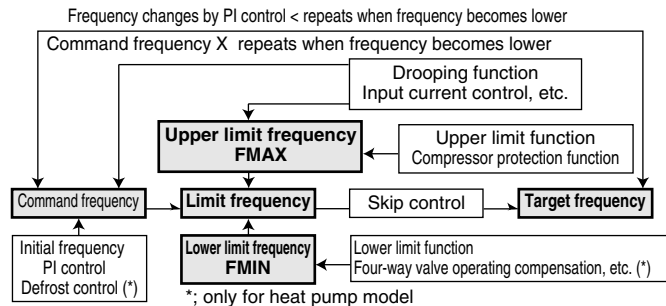

(R2831)

Detail

How to Determine Frequency

The compressor's frequency will finally be determined by taking the following steps.

For Heat Pump Model

1. Determine command frequency

- ◆ Command frequency will be determined in the following order of priority.
 - 1.1 Limiting frequency by drooping function
 - ◆ Input current, discharge pipes, low Hz high pressure limit, peak cutting, freeze prevention, dew prevention, fin thermistor temperature.
 - 1.2 Limiting defrost control time
 - 1.3 Forced cooling
 - 1.4 Indoor frequency command

2. Determine upper limit frequency

- ◆ Set a minimum value as an upper limit frequency among the frequency upper limits of the following functions:
Compressor protection, input current, discharge pipes, Low Hz high pressure, peak cutting, freeze prevention, defrost.

3. Determine lower limit frequency

- ◆ Set a maximum value as a lower limit frequency among the frequency lower limits of the following functions:
Four way valve operating compensation, draft prevention, pressure difference upkeep.

4. Determine prohibited frequency

- ◆ There is a certain prohibited frequency such as a power supply frequency.

Indoor Frequency Command (ΔD signal)

The difference between a room temperature and the temperature set by the remote controller will be taken as the " ΔD signal" and is used for frequency command.

Temperature difference	ΔD signal	Temperature difference	ΔD signal	Temperature difference	ΔD signal	Temperature difference	ΔD signal
0	*Th OFF	2.0	4	4.0	8	6.0	C
0.5	1	2.5	5	4.5	9	6.5	D
1.0	2	3.0	6	5.0	A	7.0	E
1.5	3	3.5	7	5.5	B	7.5	F

*Th OFF = Thermostat OFF

Frequency Initial Setting

<Outline>

When starting the compressor, or when conditions are varied due to the change of the room, the frequency must be initialized according to the total of a maximum ΔD value of the indoor unit and the Q value of the indoor unit.

Q value: Indoor unit output determined from indoor unit volume, air flow rate and other factors.

PI Control (Determine Frequency Up/Down by ΔD Signal)

1. P control

Calculate ΔD value in each sampling time (20 seconds), and adjust the frequency according to its difference from the frequency previously calculated.

2. I control

If the operating frequency is not change more than a certain fixed time, adjust the frequency up and down according to the ΔD value, obtaining the fixed ΔD value.

When the ΔD value is small...lower the frequency.

When the ΔD value is large...increase the frequency.

3. Limit of frequency variation width

When the difference between input current and input current drooping value is less than 1.5 A, the frequency increase width must be limited.

4. Frequency management when other controls are functioning

- ◆ When frequency is drooping;
Frequency management is carried out only when the frequency droops.
- ◆ For limiting lower limit
Frequency management is carried out only when the frequency rises.

5. Upper and lower limit of frequency by PI control

The frequency upper and lower limits are set depending on indoor unit.

When low noise commands come from the indoor unit or when outdoor unit low noise or quiet commands come from indoor unit, the upper limit frequency must be lowered than the usual setting.

4.3 Controls at Mode Changing / Start-up

4.3.1 Preheating Operation

Outline Operate the inverter in the open phase operation with the conditions including the preheating command from the indoor, the outdoor air temperature and discharge pipe temperature.

Detail

Preheating ON Condition

- When outdoor air temperature and discharge pipe temperature are below 51°F, inverter in open phase operation starts.

OFF Condition

- When outdoor air temperature or discharge pipe temperature is higher than 54°F, inverter in open phase operation stops.

4.3.2 Four Way Valve Switching

Outline of heating operation **Heat Pump Only**

During the heating operation current must be conducted and during cooling and defrosting current must not be conducted. In order to eliminate the switching sound (as the four way valve coil switches from ON to OFF) when the heating is stopped, the delay switch of the four way valve must be carried out after the operation stopped.

Detail The OFF delay of four way valve
Energize the coil for 150 sec after unit operation is stopped.

4.3.3 Four Way Valve Operation Compensation

Outline **Heat Pump Only**

At the beginning of the operation as the four way valve is switched, acquire the differential pressure required for activating the four way valve by having output the operating frequency, which is more than a certain fixed frequency, for a certain fixed time.

Detail **Starting Conditions**

1. When starting compressor for heating.
2. When the operating mode changes from the previous time.
3. When starting compressor for starting defrosting or resetting.
4. When starting compressor for the first time after the reset with the power is ON.
Set the lower limit frequency to 55 (model by model) Hz for 70 seconds with any conditions 1 through 4 above.

4.3.4 3 Minutes Stand-by

Prohibit to turn ON the compressor for 3 minutes after turning it off.
(except when defrosting)

4.3.5 Compressor Protection Function

When turning the compressor from OFF to ON, the upper limit of frequency must be set as follows. (The function must not be used when defrosting.)

FCG 3	85
FCG 2	70
FCG 1	55

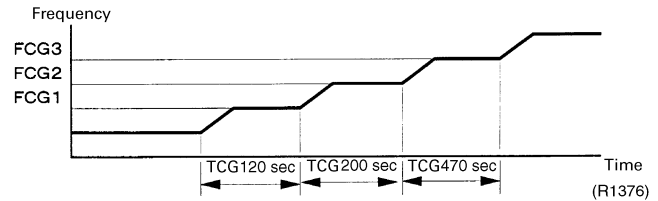

4.4 Discharge Pipe Temperature Control

Outline

The discharge pipe temperature is used as the compressor's internal temperature. If the discharge pipe temperature rises above a certain level, the operating frequency upper limit is set to keep this temperature from going up further.

Detail

Divide the Zone

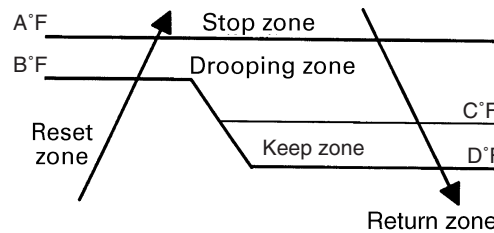

A	230
B	217.4
C	215.6
D	213.8

(R5470)

Management within the Zones

Zone	Control contents
Stop zone	When the temperature reaches the stop zone, stop the compressor and correct abnormality.
Drooping zone	Start the timer, and the frequency will be drooping.
Keep zone	Keep the upper limit of frequency.
Return / Reset zone	Cancel the upper limit of frequency.

4.5 Input Current Control

Outline

Detect an input current by the CT during the compressor is running, and set the frequency upper limit from such input current.

In case of heat pump model, this control is the upper limit control function of the frequency which takes priority of the lower limit of four way valve activating compensation.

Detail

The frequency control will be made within the following zones.

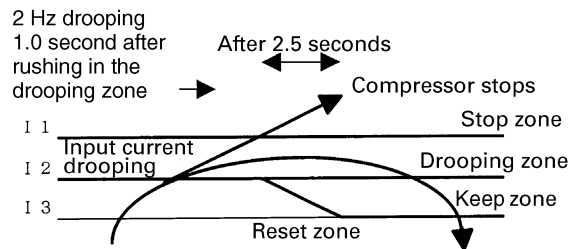

(R4598)

When a “stop current” continues for 2.5 seconds after rushing on the stop zone, the compressor operation stops.

If a “drooping current” is continues for 1.0 second after rushing on the drooping zone, the frequency will be 2 Hz drooping.

Repeating the above drooping continues until the current rushes on the drooping zone without change.

In the keep zone, the frequency limit will remain.

In the return / reset zone, the frequency limit will be cancelled.

Limitation of current drooping and stop value according to the outdoor air temperature

1. In case the operation mode is cooling
 - ♦ The current droops when outdoor air temperature becomes higher than a certain level (model by model).
2. In case the operation mode is heating
 - ♦ The current droops when outdoor air temperature becomes higher than a certain level (model by model).

4.6 Freeze-up Protection Control

Outline During cooling operation, the signals being sent from the indoor unit allow the operating frequency limitation and then prevent freezing of the indoor heat exchanger. (The signal from the indoor unit must be divided into the zones as the followings.)

Detail **Conditions for Start Controlling**
 Judge the controlling start with the indoor heat exchanger temperature after 2 sec from operation start.

Control in Each Zone

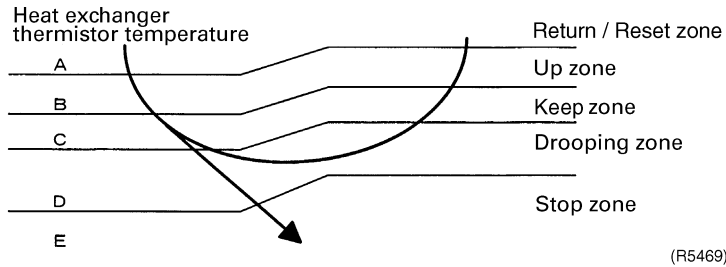

(R5469)

4.7 Heating Peak-cut Control

Outline **Heat Pump Only**
 During heating operation, the signals being sent from the indoor unit allow the operating frequency limitation and prevent abnormal high pressure. (The signal from the indoor unit must be divided as follows.)

Detail **Conditions for Start Controlling**
 Judge the controlling start with the indoor heat exchanger temperature after 2 min from operation start.

Control in Each Zone

The heat exchange intermediate temperature of indoor unit controls the following.

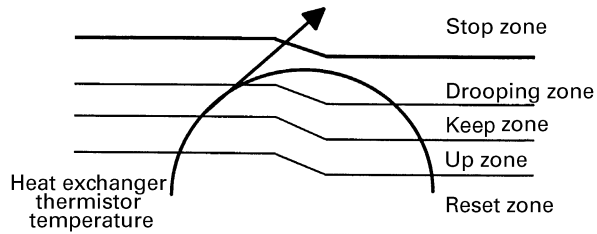

(R4599)

4.8 Fan Control

Outline

Fan control is carried out according to the following priority.

1. Fan ON control for electric component cooling fan
 2. Fan control when defrosting
 3. Fan OFF delay when stopped
 4. ON/OFF control in cooling operation
 5. Tap control when drooping function is working
 6. Fan control in forced operation
 7. Fan control in indoor/outdoor unit silent operation
 8. Fan control in powerful mode
 9. Fan control in normal operation
-

Detail

Fan OFF Control when Stopped

- Fan OFF delay for 60 seconds must be made when the compressor is stopped.

Tap Control in indoor/outdoor unit silent operation

1. When Cooling Operation
When the outdoor air temperature is lower than 99°F, the fan tap must be set to L.
2. When Heating Operation
When the outdoor air temperature is higher than 39°F, the fan tap must be turned to L (only for heat pump model).

4.9 Liquid Compression Protection Function 2

Outline

In order to obtain the dependability of the compressor, the compressor must be stopped according to the conditions of the temperature of the outdoor air and outdoor heat exchanger.

Detail

Heat Pump Model

- Operation stop depending on the outdoor air temperature
Compressor operation turns OFF under the conditions that the system is in cooling operation and outdoor air temperature is below 14°F.

4.10 Low Hz High Pressure Limit

Outline

Heat Pump Only

Set the upper limit of high pressure in a low Hz zone. Set the upper limit of the indoor heat exchanger temperature by its operating frequency of Hz. Separate into three zones, reset zone, unchanged zone and drooping zone and the frequency control must be carried out in such zones.

Detail

Separate into Zones

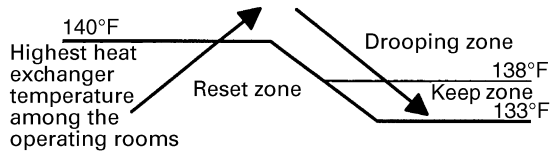

(R5471)



Note: Drooping: The system stops 2 minutes after staying in the drooping zone.

4.11 Defrost Control

Outline

Heat Pump Only

Defrosting is carried out by the cooling cycle (reverse cycle). The defrosting time or outdoor heat exchanger temperature must be more than its fixed value when finishing.

Detail

Conditions for Starting Defrost

The starting conditions must be made with the outdoor air temperature and heat exchanger temperature. Under the conditions that the system is in heating operation, 6 minutes after the compressor is started and more than 44 minutes of accumulated time pass since the start of the operation or ending the defrosting.

Conditions for Canceling Defrost

The judgment must be made with heat exchanger temperature. (39°F~54°F)

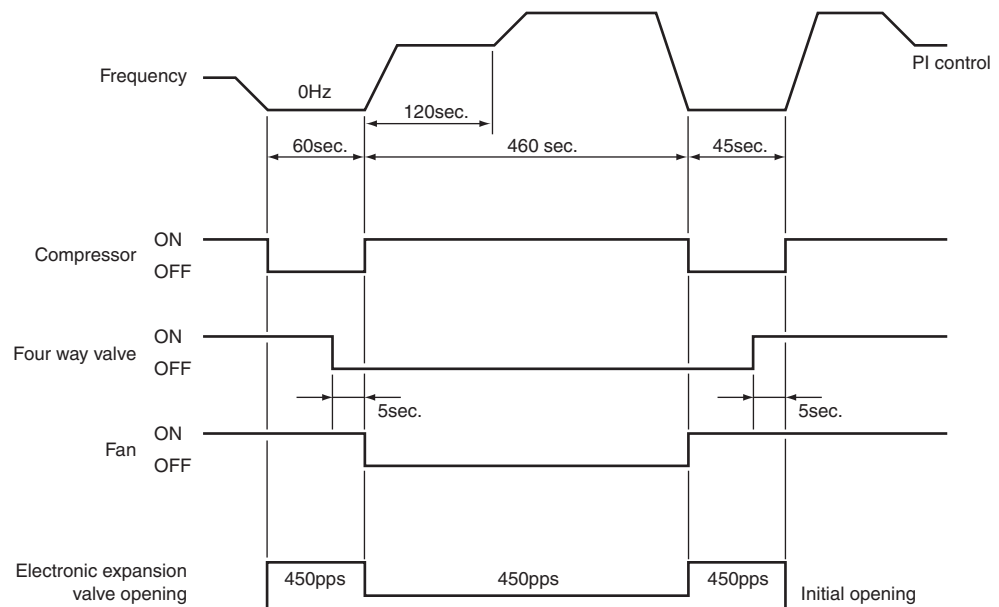

(R4082)

4.12 Electronic Expansion Valve Control

Outline

The following items are included in the electronic expansion valve control.

Electronic expansion valve is fully closed

1. Electronic expansion valve is fully closed when turning on the power.
2. Pressure equalizing control

Open Control

1. Electronic expansion valve control when starting operation
2. Control when frequency changed
3. Control for defrosting (only for heat pump model)
4. Control when a discharge pipe temperature is abnormally high
5. Control when the discharge pipe thermistor is disconnected

Feedback Control

1. Discharge pipe temperature control

Detail

The followings are the examples of control which function in each mode by the electronic expansion valve control.

Operation pattern		Control when frequency changed	Control for abnormally high discharge pipe temperature
	○ : function × : not function		
When power is turned ON	Fully closed when power is turned ON	×	×
Cooling operation	Open control when starting	×	○
	(Control of target discharge pipe temperature)	○	○
Stop	Pressure equalizing control	×	×
Heating operation (only for heat pump model)	Open control when starting	×	○
	(Control of target discharge pipe temperature)	○	○
	(Defrost control FD=1) (only for heat pump model)	×	×
Stop	Pressure equalizing control	×	×
Heating operation (only for heat pump model)	Open control when starting	×	○
Control of discharge pipe thermistor disconnection	Continue	×	×
Stop	Pressure equalizing control	×	×

(R2833)

4.12.1 Fully Closing with Power ON

Initialize the electronic expansion valve when turning on the power, set the opening position and develop pressure equalizing.

4.12.2 Pressure Equalization Control

When the compressor is stopped, open and close the electronic expansion valve and develop pressure equalization.

4.12.3 Opening Limit

Outline

Limit a maximum and minimum opening of the electronic expansion valve.

Detail

- ◆ A maximum electronic expansion valve opening : 450 pulses
 - ◆ A minimum electronic expansion valve opening : 54 pulses
- The electronic expansion valve is fully closed in the room where cooling is stopped and is opened with fixed opening during defrosting.

4.12.4 Starting Operation Control

Control the electronic expansion valve opening when the system is starting, and prevent the system to be super heated or moistened.

4.12.5 High Temperature of the Discharge Pipe

When the compressor is operating, if the discharge pipe temperature exceeds a certain value, open the electronic expansion valve and remove the refrigerant to the low pressure side and lower discharge temperature.

4.12.6 Disconnection of the Discharge Pipe Thermistor

Outline

Detect a disconnected discharge pipe thermistor by comparing the discharge pipe temperature with the condensation temperature. If any is disconnected, open the electronic expansion valve according to the outdoor air temperature and the operating frequency, and operate for a specified time, and then stop.

After 3 minutes of waiting, restart the unit and check if any is disconnected. If any is disconnected stop the system after operating for a specified time. If the disconnection is detected 4 times in succession, then the system will be down.

Detail

Detect Disconnection

If a 630-second timer for open control becomes over, and a 9-minute timer for the compressor operation continuation is not counting time, the following adjustment must be made.

1. When the operation mode is cooling
 - When the discharge pipe temperature is lower than the outdoor heat exchanger temperature, the discharge pipe thermistor disconnection must be ascertained.
2. When the operation mode is heating
 - When the discharge pipe temperature is lower than the max temperature of operating room heat exchanger, the discharge pipe thermistor disconnection must be ascertained.

Adjustment when the thermistor is disconnected

When compressor stop repeats specified time, the system should be down.

4.12.7 Control when frequency is changed

When the target discharge pipe temperature control is active, if the target frequency is changed for a specified value in a certain time period, cancel the target discharge pipe temperature control and change the target opening of the electronic expansion valve according to the shift.

4.12.8 Target Discharge Pipe Temperature Control

Obtain the target discharge pipe temperature from the indoor and outdoor heat exchanger temperature, and adjust the electronic expansion valve opening so that the actual discharge pipe temperature become close to that temperature. (Indirect SH control using the discharge pipe temperature)

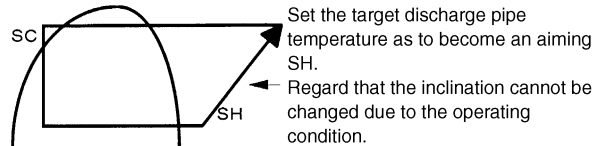

(R1389)

Determine a correction value of the electronic expansion valve compensation and drive it according to the deflection of the target discharge temperature and actual discharge temperature, and the discharge temperature variation by the 20 sec.

4.13 Malfunctions

4.13.1 Sensor Malfunction Detection

Sensor malfunction may occur either in the thermistor or current transformer (CT) system.

Relating to Thermistor Malfunction

1. Outdoor heat exchanger thermistor
2. Discharge pipe thermistor
3. Fin thermistor
4. Outside air thermistor

Relating to CT Malfunction

When the output frequency is more than 55 Hz and the input current is less than 1.25A, carry out abnormal adjustment.

4.13.2 Detection of Overload and Over Current

Outline

In order to protect the inverter, detect an excessive output current, and for protecting compressor, monitor the OL operation.

Detail

- If the OL (compressor head) temperature exceeds 248~266°F (depending on the model), the compressor gets interrupted.
- If the inverter current exceeds 30 A, the compressor gets interrupted too.

4.13.3 Insufficient Gas Control

Outline

If a power consumption is below the specified value in which the frequency is higher than the specified frequency, it must be regarded as gas insufficient.

In addition to such conventional function, if the discharge temperature is higher than the target discharge pipe temperature, and the electronic expansion valve is fully open (450 pulses) more than the specified time, it is considered as an insufficient gas.

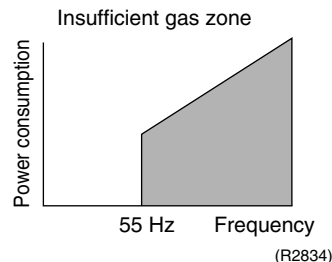

With the conventional function, a power consumption is weak comparing with that in the normal operation when gas is insufficient, and gas insufficiency is detected by checking a power consumption.

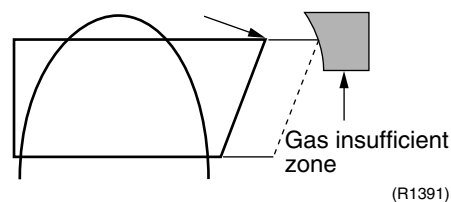

When operating with insufficient gas, although the rise of discharge pipe temperature is great and the electronic expansion valve is open, it is presumed as an insufficient gas if the discharge pipe temperature is higher than the target discharge pipe temperature.

Detail

Judgment by Input Current

When an output frequency is exceeds 55 Hz and the input current is less than specified value, the adjustment is made for insufficient gas.

Judgment by Discharge Pipe Temperature

When discharge pipe temperature is $\Delta 36^{\circ}\text{F}$ higher than target value and the electronic expansion value opening is 450 plus (max.), the adjustment is made for insufficient gas.

4.14 Forced Operation Mode

Outline Forced operating mode includes only forced cooling.

Detail

Forced Cooling

Item	Forced Cooling
Forced operation allowing conditions	1) The outdoor unit is not abnormal and not in the 3-minute stand-by mode.
	2) The operating mode of the outdoor unit is the stop mode.
	3) The forced operation is ON. The forced operation is allowed when the above "and" conditions are met.
Starting/adjustment	If the forced operation switch is pressed as the above conditions are met.
1) Command frequency	66 Hz
2) Electronic expansion valve opening	It depends on the capacity of the indoor unit.
3) Outdoor unit adjustment	Compressor is in operation
4) Indoor unit adjustment	The command of forced operation is transmitted to the indoor unit.
End	1) When the forced operation switch is pressed again.
	2) The operation is to end automatically after 15 min.
Others	The protect functions are prior to all others in the forced operation.

4.15 Additional Function

4.15.1 Powerful Operation Mode

Compressor operating frequency is increased to PI Max. (Max. Hz of operating room) and outdoor unit airflow rate is increased.

4.15.2 Voltage Detection Function

Power supply voltage is detected each time equipment operation starts.

Part 5

System Configuration

1. System Configuration.....	68
2. Instruction.....	69
2.1 Safety Precautions	69
2.2 The Single Split Duct-Free System FTXS09/12DVJU.....	71
2.3 The Single Split Duct-Free System FTXS15/18/24DVJU.....	96
2.4 The Slim Duct Built-in System FDXS09/12DVJU.....	121

1. System Configuration

After the installation and test operation of the room air conditioner have been completed, it should be operated and handled as described below. Every user would like to know the correct method of operation of the room air conditioner, to check if it is capable of cooling (or heating) well, and to know a clever method of using it.

In order to meet this expectation of the users, giving sufficient explanations taking enough time can be said to reduce about 80% of the requests for servicing. However good the installation work is and however good the functions are, the customer may blame either the room air conditioner or its installation work because of improper handling. The installation work and handing over of the unit can only be considered to have been completed when its handling has been explained to the user without using technical terms but giving full knowledge of the equipment.

2. Instruction

2.1 Safety Precautions

Safety precautions

- Keep this manual where the operator can easily find it.
- Read this manual carefully before starting the unit.
- For safety reason, the operator must read the following cautions carefully.
- This manual classifies precautions into DANGER, WARNING and CAUTION. Be sure to follow all precautions below: they are all important for ensuring safety.

 DANGER	 WARNING	 CAUTION
Indicates an imminently hazardous situation which, if not avoided, will result in death or serious injury.	If you do not follow these instructions exactly, the unit may cause property damage, personal injury or loss of life.	If you do not follow these instructions exactly, the unit may cause minor or moderate property damage or personal injury.

 Never do.

 Be sure to ground the air conditioner.

 Never touch the air conditioner (including the remote controller) with a wet hand.



 Be sure to follow the instructions.

 Never cause the air conditioner (including the remote controller) to get wet.

DANGER

- For refrigerant leakage, consult your dealer.
Refrigerant gas is heavier than air and replaces oxygen. A massive leak could lead to oxygen depletion, especially in basements, and an asphyxiation hazard could occur leading to serious injury or death.
- Refrigerant gas may produce a toxic gas if it comes in contact with fire such as from a fan heater, stove or cooking device. Exposure to this gas could cause severe injury or death.
- Any abnormalities in the operation of the air conditioner such as smoke or fire could result in severe injury or death. Turn off the power and contact your dealer immediately for instructions.
- Do not install the unit in an area where flammable materials are present due to risk of explosion resulting in serious injury or death.
- If equipment utilizing a burner is used in the same room as the air conditioner, there is the danger of oxygen deficiency which could lead to an asphyxiation hazard resulting in serious injury or death.
Be sure to ventilate the room sufficiently to avoid this hazard.
- Safely dispose of the packing materials.
Packing materials, such as nails and other metal or wooden parts, may cause stabs or other injuries. Tear apart and throw away plastic packaging bags so that children will not play with them. Children playing with plastic bags face the danger of death by suffocation.

WARNING

- It is not good for health to expose your body to the air flow for a long time.
- Do not put your finger, a rod or other objects into the air outlet or inlet. As the fan is rotating at a high speed and could, cause injury. Always keep small children away from the unit during operation. 
- Do not attempt to repair, relocate, modify or reinstall the air conditioner by yourself. Incorrect work or modifications could cause electric shocks, fire or other damage.
For repairs and reinstallation, consult your Daikin dealer for advice and information.
- If the air conditioner is not cooling (heating) properly, the refrigerant may be leaking, contact your authorized dealer or qualified service repairman. 
- When making repairs which requires adding refrigerant, consult with your authorized dealer or qualified service repairman.
- Do not attempt to install the air conditioner by yourself. Improper installation could result in water leakage, electric shocks or fire. For installation, consult your authorized dealer or a qualified technician.

⚠ CAUTION

- The air conditioner must be grounded to the earth. Improper grounding may result in electric shocks. Do not connect the earth grounding wire to a gas pipe, water pipe, lightning rod, or a telephone ground line. Follow all local and state electrical codes. 

- Do not use this unit for cooling precision instruments, food, plants, animals or works of art. 
- Never expose little children, plants or animals directly to the air flow.
- Do not block air inlets nor outlets. Impaired air flow may result in poor performance or equipment problems.
- Do not stand, sit, or place objects on the outdoor unit. To avoid injury, do not remove the fan guard.
- Do not place anything under the indoor or outdoor unit that must be kept away from moisture, such as electrical or electronic equipment. In certain conditions, moisture in the air may condense and drip.
- Check the unit stand and fittings for damage annually.
- Do not touch the air inlet and aluminum fins of outdoor unit. It may cause injury and/or damage the heat transfer surface.
- This appliance is NOT intended for use by young children or impaired persons without proper supervision.
- Young children should be supervised to ensure that they DO NOT play with or near the air flow of this appliance.
- Do not pull at the conduit or hang anything on it. Otherwise it will cause fire or electric shock.
- Do not touch the heat exchanger fins. Improper handling may result in injury.
- Do not turn off the power immediately after stopping operation. Always wait at least five minutes before turning off the power. Otherwise, water leakage and trouble may occur.

- To avoid personal injury or equipment damage be sure to stop the operation, turn the breaker off or pull out the supply cord before cleaning or servicing the unit. NOTE: More than one disconnect may be required to shut off all power. 
- Do not connect the air conditioner to a power supply different from the one specified. It may cause improper operation or fire.
- Depending on the environment, state and local electrical codes, a ground fault circuit interrupter may be required. Improper grounding or lack of a ground fault circuit interrupter may result in electrical shock, injuries, or death.
- Arrange the drain hose to ensure smooth drainage. Improper drainage may cause water damage to the building, or it's furnishing.
- Depending on the usage environment, water may leak from the air conditioner. If this happens, contact your Daikin Dealer.
- Safely dispose of the packing materials. Packing materials, such as nails and other metal or wooden parts, may cause stabs or other injuries. Tear apart and throw away plastic packaging bags so that children will not play with them. If children play with a plastic bag which was not torn apart, they face the risk of suffocation.
- The remote controller should be installed in such way that children cannot play with it.
- Do not place objects in direct proximity of the outdoor unit and do not let leaves and other debris accumulate around the unit. Leaves are a hotbed for small animals which can enter the unit. Once in the unit, such animals can cause malfunctions, smoke or fire when making contact with electrical parts.

- Do not operate the air conditioner with wet hands. 

- Do not wash the indoor unit with excessive water, only use a slightly wet cloth. 
- Do not place things such as vessels containing water or anything else on top of the unit. Water may penetrate into the unit and degrade electrical insulations, resulting in an electric shock.

Installation site.

- To install the air conditioner in the following types of environments, consult your authorized dealer.
 - Places with an oily ambient or where steam or soot occurs.
 - Salty environment such as coastal areas.
 - Places where sulfide gas occurs such as hot springs.
 - Places where snow may block the outdoor unit.

The drain from the outdoor unit must be discharged to a place of good drainage.

Consider nuisance to your neighbors from noises.

- For installation, choose a place as described below.
 - A place solid enough to bear the weight of the unit which does not amplify the operation noise or vibration.
 - A place from where the air discharged from the outdoor unit or the operation noise will not annoy your neighbors.

Electrical work.

- For power supply, be sure to use a separate power circuit dedicated to the air conditioner. Follow all local and state electrical codes.

System relocation.

- Relocating the air conditioner requires specialized knowledge and skills. Please consult your authorized dealer if relocation is necessary for moving or remodeling.

2.2 The Single Split Duct-Free System FTXS09/12DVJU

2.2.1 Names of Parts

Names of parts

■ Indoor Unit

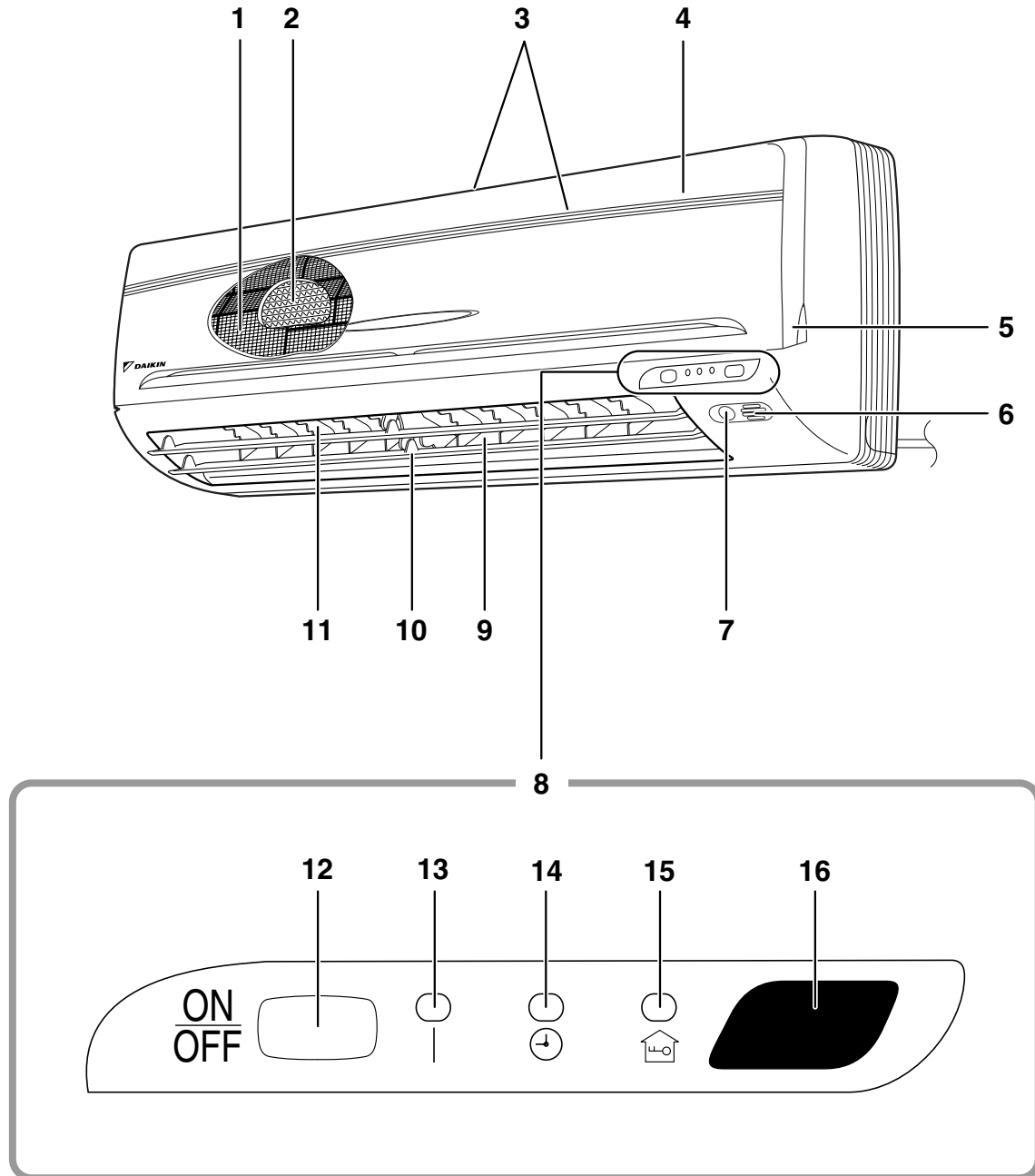

■ Outdoor Unit

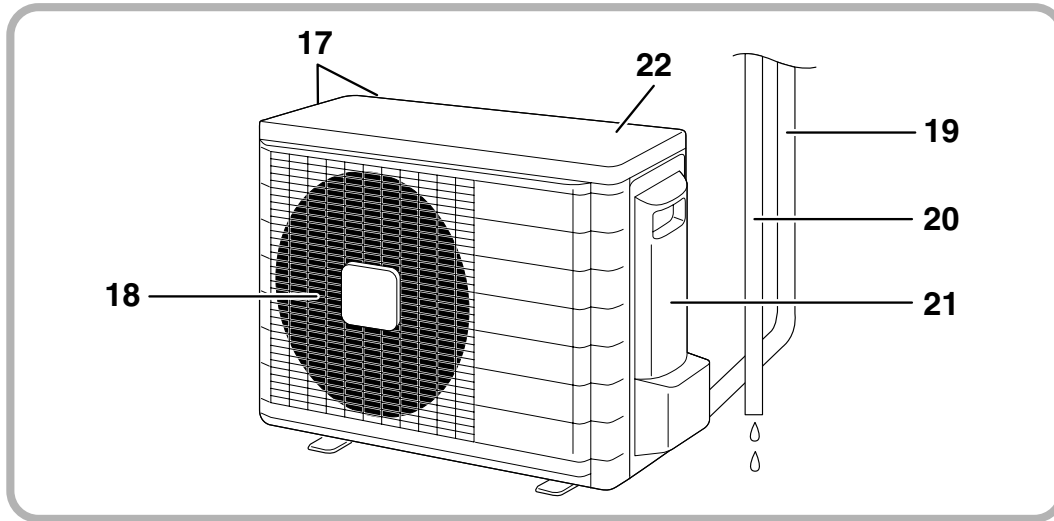

■ Indoor Unit

- 1. Air filter
- 2. Air-purifying filter with photocatalytic deodorizing function:
 - These filters are attached to the inside of the air filters.
- 3. Air inlet
- 4. Front panel
- 5. Panel tab
- 6. Room temperature sensor:
 - It senses the air temperature around the unit.
- 7. INTELLIGENT EYE sensor:
 - It detects the movements of people and automatically switches between normal operation and energy saving operation. (page 18.)
- 8. Display
- 9. Air outlet
- 10. Flaps (horizontal blades): (page 12.)
- 11. Louvers (vertical blades):
 - The louvers are inside of the air outlet. (page 13.)

- 12. Indoor Unit ON/OFF switch: (page 10.)
 - Push this switch once to start operation. Push once again to stop it.
 - The operation mode refers to the following table.

Mode	Temperature setting	Airflow rate
AUTO	77°F	AUTO

- This switch is useful when the remote controller is missing.
- 13. Operation lamp (green)
- 14. TIMER lamp (yellow): (page 20.)
- 15. HOME LEAVE lamp (red): (page 16.)
- 16. Signal receiver:
 - It receives signals from the remote controller.
 - When the unit receives a signal, you will hear a short beep.
 - Operation startbeep-beep
 - Settings changedbeep
 - Operation stopbeeeeeeep

■ Outdoor Unit

- 17. Air inlet: (Back and side)
- 18. Air outlet
- 19. Refrigerant piping and inter-unit cable
- 20. Drain hose
- 21. Earth grounding terminal:
 - It is inside of this cover.
- 22. Outside air temperature sensor:
 - It senses the ambient temperature around the unit.

Appearance of the outdoor unit may differ from some models.

■ Remote Controller

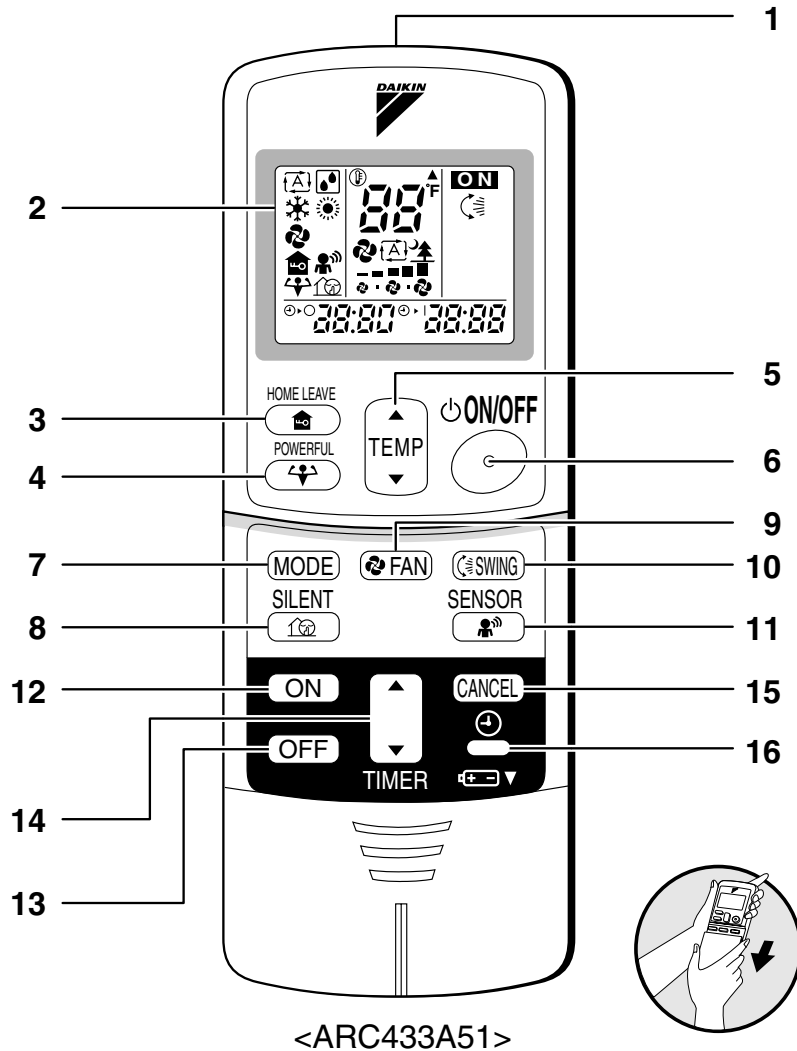

1. Signal transmitter:

- It sends signals to the indoor unit.

2. Display:

- It displays the current settings.
(In this illustration, each section is shown with all its displays ON for the purpose of explanation.)

3. HOME LEAVE button:

HOME LEAVE operation (page 16.)

4. POWERFUL button: (Maximum operation)

POWERFUL operation (page 14.)

5. TEMPERATURE adjustment buttons:

- It changes the temperature setting.

6. ON/OFF button:

- Press this button once to start operation.
Press once again to stop it.

7. MODE selector button:

- It selects the operation mode.
(AUTO/DRY/COOL/HEAT/FAN) (page 10.)

8. SILENT button: OUTDOOR UNIT SILENT operation (page 15.)

9. FAN setting button:

- It selects the airflow rate setting.

10. SWING button: (page 12.)

11. SENSOR button: INTELLIGENT EYE operation (page 18.)

12. ON TIMER button: (page 21.)

13. OFF TIMER button: (page 20.)

14. TIMER Setting button:

- It changes the time setting.

15. TIMER CANCEL button:

- It cancels the timer setting.

16. CLOCK button: (page 9.)

2.2.2 Preparation before Operation

Preparation Before Operation

■ To set the batteries

1. Slide the front cover to take it off.
2. Set two dry batteries (AAA).
3. Set the front cover as before.

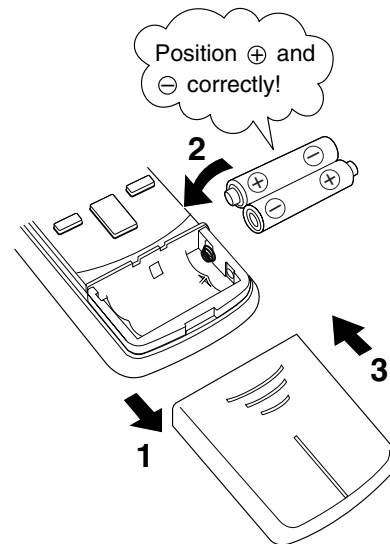

ATTENTION

■ About batteries

- When replacing the batteries, use batteries of the same type, and replace the two old batteries together.
- When the system is not used for a long time, take the batteries out. In case the remote controller is not used for a long time remove all batteries in order to prevent liquid leak of the battery.
- We recommend replacing once a year, although if the remote controller display begins to fade or if reception deteriorates, please replace with new alkali batteries. Using manganese batteries reduces the lifespan.
- The attached batteries are provided for the initial use of the system.
The usable period of the batteries may be short depending on the manufactured date of the air conditioner.
- Pressing two or more buttons simultaneously may cause the strange display of the remote controller.
The remote controller is not malfunction. In this case take the batteries out and reset them.

■ Replacing the Batteries

- When replacing the battery, remove the old battery, wait one minute, and then insert the new battery.

Preparation Before Operation

■ To operate the remote controller

- To use the remote controller, aim the transmitter at the indoor unit. If there is anything to block signals between the unit and the remote controller, such as a curtain, the unit will not operate.
- Do not drop the remote controller. Do not get it wet.
- The maximum distance for communication is about 23 Ft..

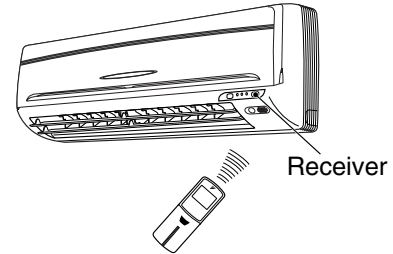

■ To fix the remote controller holder on the wall

1. Choose a place from where the signals reach the unit.
2. Fix the holder to a wall, a pillar, etc. with the screws supplied with the holder.
3. Place the remote controller in the remote controller holder.

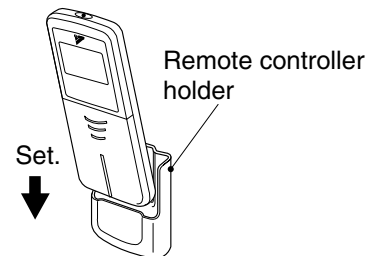

- To remove, pull it upwards.

ATTENTION

■ About remote controller

- Do not put the remote controller in the following places.
 - In direct sunlight.
 - In vicinity of a heater.
- Dust on the signal transmitter or receiver will reduce the sensitivity. Wipe off dust with soft cloth.
- Signal communication may be disabled if an electronic-starter-type fluorescent lamp (such as inverter-type lamps) is in the room. Consult your authorized dealer if that is the case.
- If the remote controller signals happen to operate another appliance, move that appliance to somewhere else, or consult your authorized dealer.

■ To set the clock

1. Press “CLOCK button”.

0:00 is displayed.

⌚ blinks.

2. Press “TIMER setting button” to set the clock to the present time.

Holding down “▲” or “▼” button rapidly increases or decreases the time display.

3. Press “CLOCK button”.

⌚ blinks.

■ Turn the breaker ON

- Turning ON the breaker opens the flap, then closes it again. (This is a normal procedure.)

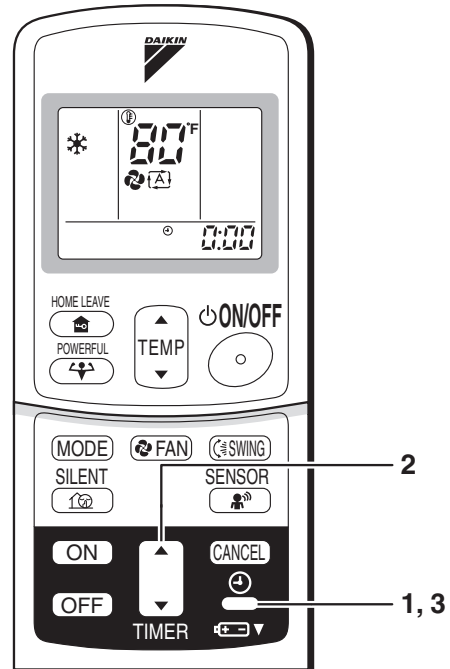

NOTE

■ Tips for saving energy

- Be careful not to cool (heat) the room too much. Keeping the temperature setting at a moderate level helps save energy.
- Cover windows with a blind or a curtain. Blocking sunlight and air from outdoors increases the cooling (heating) effect.
- Clogged air filters cause inefficient operation and waste energy. Clean them once every two weeks.

Recommended temperature setting	
For cooling:	78°F – 82°F
For heating:	68°F – 75°F

■ Please note

- When the main power switch is turned on, some watts of electricity are being used even when the system is not operating.
- If you are not going to use the air conditioner for a long period, for example in spring or autumn, turn the breaker OFF to save energy.
- Use the air conditioner in the following conditions.

Mode	Operating conditions	If operation is continued out of this range
COOL	Outdoor temperature: 14 to 115 °F Indoor temperature: 64 to 90 °F Indoor humidity: 80% max.	<ul style="list-style-type: none"> • A safety device may work to stop the operation under 0 °F and over 115 °F outdoor temperature. • See Note 2 for 0 °F to 14 °F operation. • Condensation may occur on the indoor unit and drip.
HEAT	Outdoor temperature: 5 to 64 °F Indoor temperature: 50 to 86 °F	<ul style="list-style-type: none"> • A safety device may work to stop the operation under 0 °F or over 64 °F outdoor temperature. See the Note 3 for 0 °F to 5 °F.
DRY	Outdoor temperature: 14 to 115 °F Indoor temperature: 64 to 90 °F Indoor humidity: 80% max.	<ul style="list-style-type: none"> • A safety device may work to stop the operation. • Condensation may occur on the indoor unit and drip.

- Operation outside this humidity or temperature range may cause a safety device to disable the system.

<Note 1> A Breaker must be turned on for 24 hours before the operation start if the ambient is below 14 °F, otherwise the unit will not start operation smoothly.

<Note 2> 1. Use low outdoor ambient cooling operation for equipment cooling applications only. This operation is not intended for human comfort cooling.

2. Intermittent noises may be produced by the indoor unit due to the outdoor fan rotation speed change.

3. Do not place humidifiers or other items which might raise the humidity in rooms at 0 to 14 °F outdoor temperature. A humidifier may cause condensation to drip from the indoor unit outlet vent.

4. Set the indoor unit at the highest air flow rate.

<Note 3> When the outdoor temperature is 0 to 5 degrees F, the system may not have sufficient cooling capacity.

2.2.3 AUTO • DRY • COOL • HEAT • FAN Operation

AUTO • DRY • COOL • HEAT • FAN Operation

The air conditioner operates with the operation mode of your choice.
 From the next time on, the air conditioner will operate with the same operation mode.

■ To start operation

1. Press “MODE selector button” and select a operation mode.

- Each pressing of the button advances the mode setting in sequence.

- Ⓐ: AUTO
- Ⓑ: DRY
- ❄: COOL
- ☀: HEAT
- 🌀: FAN



2. Press “ON/OFF button” .

- The OPERATION lamp lights up.



■ To stop operation

3. Press “ON/OFF button” again.

- Then OPERATION lamp goes off.

■ To change the temperature setting



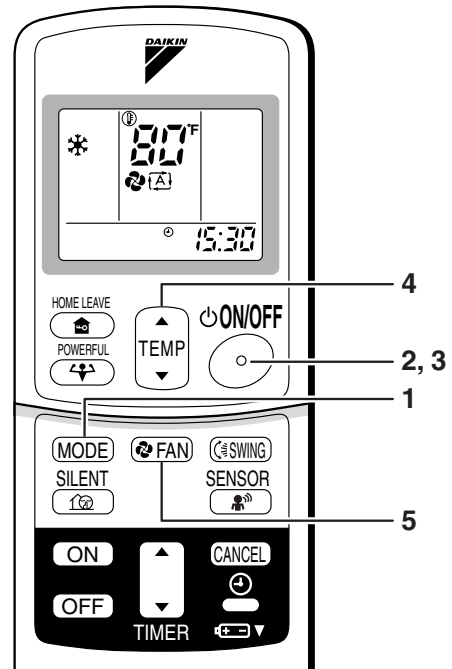

4. Press “TEMPERATURE adjustment button”.



DRY or FAN mode	AUTO or COOL or HEAT mode
The temperature setting is not variable.	Press “▲” to raise the temperature and press “▼” to lower the temperature.
	Set to the temperature you like. 

■ To change the airflow rate setting

5. Press “FAN setting button”.

DRY mode	AUTO or COOL or HEAT or FAN mode
The airflow rate setting is not variable.	Five levels of airflow rate setting from “  ” to “  ” plus “  ” “  ” are available. 

- Indoor unit quiet operation
When the airflow is set to “”, the noise from the indoor unit will become quieter. Use this when making the indoor unit quieter.
The unit might lose capacity when the airflow rate is set to a low level.

NOTE

■ Note on HEAT operation

- Since this air conditioner heats the room by taking heat from outdoor air to indoors, the heating capacity becomes smaller in lower outdoor temperatures. If the heating effect is insufficient, it is recommended to use another heating appliance in combination with the air conditioner.
- The heat pump system heats the room by circulating hot air around all parts of the room. After the start of heating operation, it takes some time before the room gets warmer.
- In heating operation, frost may occur on the outdoor unit and lower the heating capacity. In that case, the system switches into defrosting operation to take away the frost.
- During defrosting operation, hot air does not flow out of indoor unit.

■ Note on COOL operation

- This air conditioner cools the room by blowing the hot air in the room outside, so if the outside temperature is high, performance drops.

■ Note on DRY operation

- The computer chip works to rid the room of humidity while maintaining the temperature as much as possible. It automatically controls temperature and fan strength, so manual adjustment of these functions is unavailable.

■ Note on AUTO operation

- In AUTO operation, the system selects an appropriate operation mode (COOL or HEAT) based on the room temperature at the start of the operation.
- The system automatically reselects setting at a regular interval to bring the room temperature to user-setting level.
- If you do not like AUTO operation, you can manually select the operation mode and setting you like.

■ Note on airflow rate setting

- At smaller airflow rates, the cooling (heating) effect is also less.

2.2.4 Adjusting the Airflow Direction

Adjusting the Airflow Direction

You can adjust the airflow direction to increase your comfort.

■ To adjust the horizontal blades (flaps)

1. Press “SWING button”.

 The display will light up and the flaps will begin to swing.

2. When the flaps have reached the desired position, press “SWING button” once more.

The display will go blank.
The flaps will stop moving.

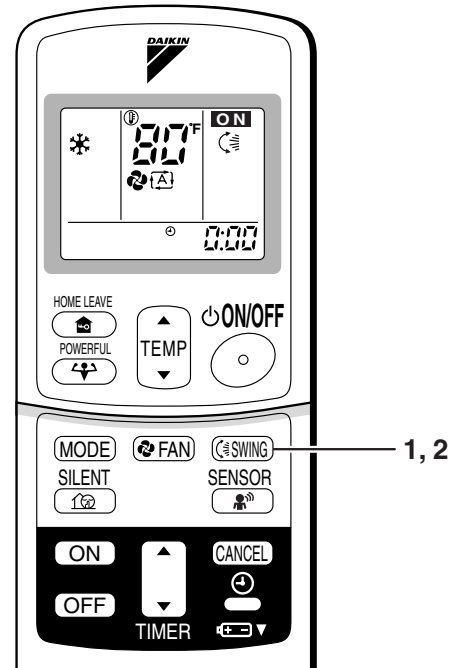

■ **To adjust the vertical blades (louvers)**

Hold the knob and move the louvers.

(You will find a knob on the left-side and the right-side blades.)

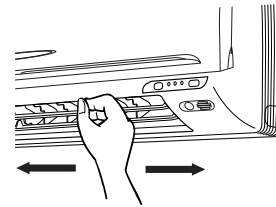

Notes on flaps and louvers angles

- When “ **SWING button** ” is selected, the flaps swinging range depends on the operation mode. (See the figure.)

■ **ATTENTION**

- Always use a remote controller to adjust the flaps angle. If you attempt to move it forcibly with hand when it is swinging, the mechanism may be broken.
- Be careful when adjusting the louvers. Inside the air outlet, a fan is rotating at a high speed and may cause bodily injury if fan comes in contact with fingers.

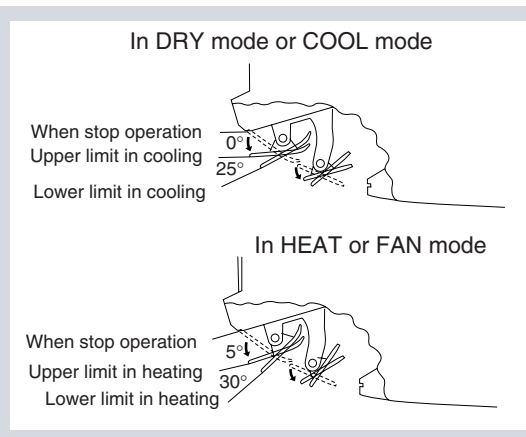

2.2.5 POWERFUL Operation

POWERFUL Operation

POWERFUL operation quickly maximizes the cooling (heating) effect in any operation mode. You can get the maximum capacity.

■ To start POWERFUL operation

1. Press “POWERFUL button”.
 - POWERFUL operation ends in 20 minutes. Then the system automatically operates again with the settings which were used before POWERFUL operation.
 - When using POWERFUL operation, there are some functions which are not available.
 - “” is displayed on the LCD.

■ To cancel POWERFUL operation

2. Press “POWERFUL button” again.
 - “” disappears from the LCD.

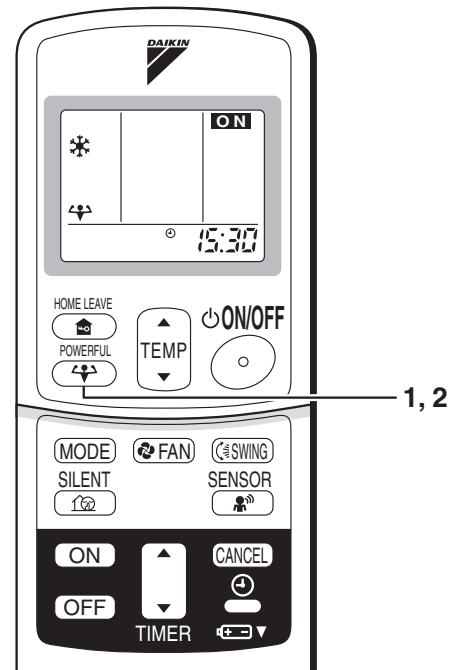

NOTE

■ Notes on POWERFUL operation

- POWERFUL Operation cannot be used together with SILENT Operation. Priority is given to the function of whichever button is pressed last.
- POWERFUL Operation can only be set when the unit is running. Pressing the operation stop button causes the settings to be canceled, and the “” disappears from the LCD.
- **In COOL and HEAT mode**
To maximize the cooling (heating) effect, the capacity of outdoor unit must be increased and the airflow rate be fixed to the maximum setting.
The temperature and airflow settings are not variable.
- **In DRY mode**
The temperature setting is lowered by 4.5° F and the airflow rate is slightly increased.
- **In FAN mode**
The airflow rate is fixed to the maximum setting.

2.2.6 OUTDOOR UNIT SILENT Operation

OUTDOOR UNIT SILENT Operation

OUTDOOR UNIT SILENT operation lowers the noise level of the outdoor unit by changing the fan speed on the outdoor unit. This function is convenient during night.

■ To start OUTDOOR UNIT SILENT operation

1. Press "SILENT button".
 - "🔇" is displayed on the LCD.

■ To cancel OUTDOOR UNIT SILENT operation

2. Press "SILENT button" again.
 - "🔇" disappears from the LCD.

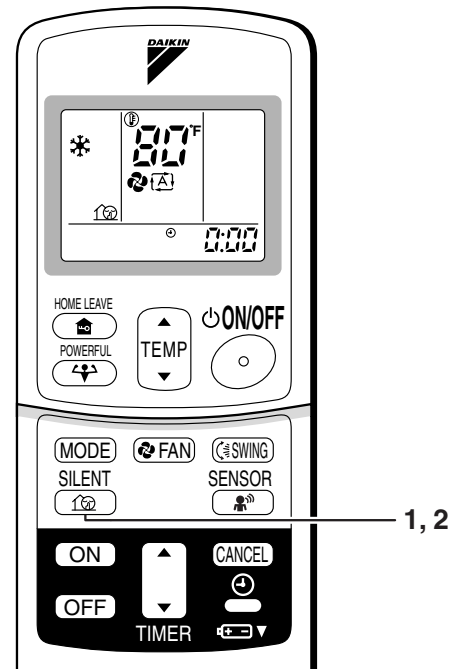

NOTE

■ Note on OUTDOOR UNIT SILENT operation

- This function is available in COOL, HEAT, and AUTO modes. (This is not available in FAN and DRY modes.)
- POWERFUL operation and OUTDOOR UNIT SILENT operation cannot be used at the same time. Priority is given to the function of whichever button is pressed last.
- If operation is stopped using the remote controller or the main unit ON/OFF switch when using OUTDOOR UNIT SILENT operation, "🔇" will remain on the remote controller display.

2.2.7 HOME LEAVE Operation

HOME LEAVE Operation

HOME LEAVE operation is a function which allows you to record your preferred temperature and airflow rate settings.

■ To start HOME LEAVE operation

1. Press “HOME LEAVE button” .

- “” is displayed on the LCD.
- The HOME LEAVE lamp lights up.



■ To cancel HOME LEAVE operation

2. Press “HOME LEAVE button” again.

- “” disappears from the LCD.
- The HOME LEAVE lamp goes off.

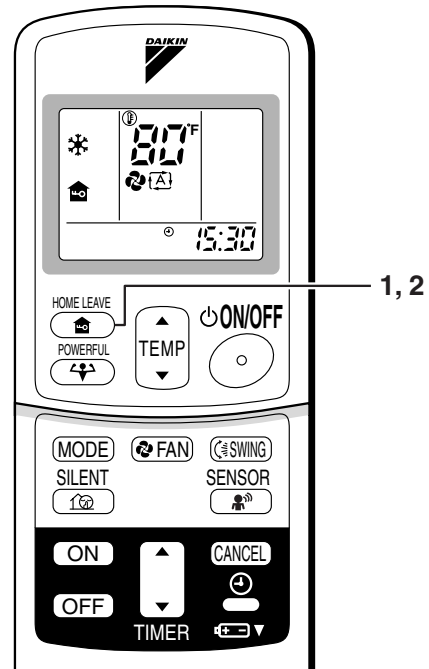

Before using HOME LEAVE operation.

■ To set the temperature and airflow rate for HOME LEAVE operation

When using HOME LEAVE operation for the first time, please set the temperature and airflow rate for HOME LEAVE operation. Record your preferred temperature and airflow rate.

	Initial setting		Selectable range	
	Temperature	Airflow rate	Temperature	Airflow rate
Cooling	77°F	AUTO	64-90°F	5 step, AUTO and SILENT
Heating	77°F	AUTO	50-86°F	5 step, AUTO and SILENT

1. Press “HOME LEAVE button”. Make sure “” is displayed in the remote controller display.
2. Adjust the set temperature with “▲” or “▼” as you like.
3. Adjust the airflow rate with “FAN” setting button as you like.

Home leave operation will run with these settings the next time you use the unit. To change the recorded information, repeat steps 1 – 3.

■ What's the HOME LEAVE operation?

Is there a set temperature and airflow rate which is most comfortable, a set temperature and airflow rate which you use the most? HOME LEAVE operation is a function that allows you to record your favorite set temperature and airflow rate. You can start your favorite operation mode simply by pressing the HOME LEAVE button on the remote controller. This function is convenient in the following situations.

■ Useful in these cases

1. Use as an energy-saving mode.

Set the temperature 3-5°F higher (cooling) or lower (heating) than normal. Setting the fan speed to the lowest setting allows the unit to be used in energy-saving mode. Also convenient for use while you are out or sleeping.

• Every day before you leave the house...

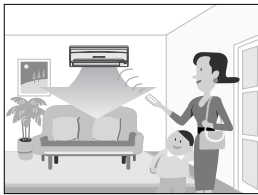

When you go out, push the "HOME LEAVE Operation" button, and the air conditioner will adjust capacity to reach the preset temperature for HOME LEAVE Operation.



When you return, you will be welcomed by a comfortably air conditioned room.

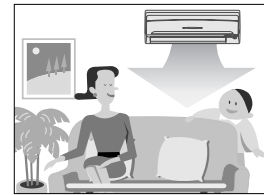

Push the "HOME LEAVE Operation" button again, and the air conditioner will adjust capacity to the set temperature for normal operation.

• Before bed...

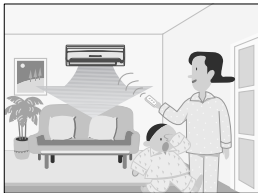

Set the unit to HOME LEAVE Operation before leaving the living room when going to bed.



The unit will maintain the temperature in the room at a comfortable level while you sleep.



When you enter the living room in the morning, the temperature will be just right. Disengaging HOME LEAVE Operation will return the temperature to that set for normal operation. Even the coldest winters will pose no problem!

2. Use as a favorite mode

Once you record the temperature and airflow rate settings you most often use, you can retrieve them by pressing HOME LEAVE button. You do not have to go through troublesome remote controller operations.

NOTE

- Once the temperature and airflow rate for HOME LEAVE operation are set, those settings will be used whenever HOME LEAVE operation is used in the future. To change these settings, please refer to the "Before using HOME LEAVE operation" section above.
- HOME LEAVE operation is only available in COOL and HEAT mode. It cannot be used in AUTO, DRY, and FAN mode.
- HOME LEAVE operation runs in accordance with the previous operation mode (COOL or HEAT) before using HOME LEAVE operation.
- HOME LEAVE operation and POWERFUL operation cannot be used at the same time. Last button that was pressed has priority.
- The operation mode cannot be changed while HOME LEAVE operation is being used.
- When operation is shut off during HOME LEAVE operation, using the remote controller or the indoor unit ON/OFF switch, "🏠" will remain on the remote controller display.

2.2.8 INTELLIGENT EYE Operation

INTELLIGENT EYE Operation

“INTELLIGENT EYE” is the infrared sensor which detects the human movement.

■ To start INTELLIGENT EYE operation

1. Press “SENSOR button”.
 - “” is displayed on the LCD.

■ To cancel the INTELLIGENT EYE operation

2. Press “SENSOR button” again.
 - “” disappears from the LCD.

[EX.]

When somebody is in the room

- Normal operation.



When nobody is in the room

- 20 min. after, start energy saving operation.



When somebody is back in the room

- Back to normal operation.

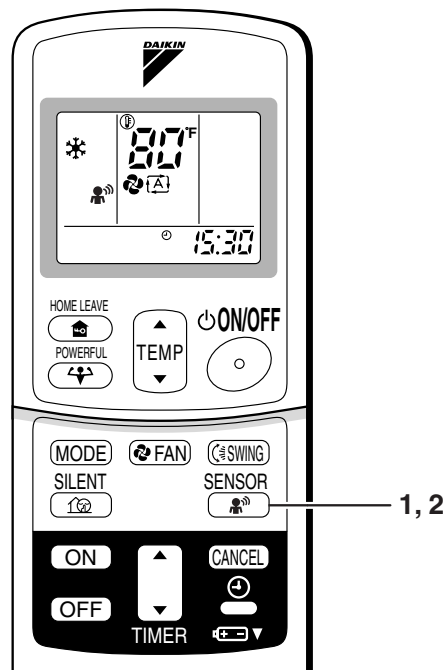

■ To adjust the angle of the INTELLIGENT EYE sensor

- You can adjust the angle of the INTELLIGENT EYE sensor to increase the detection area.
(Adjustable angle: 15° to right and left of centre)

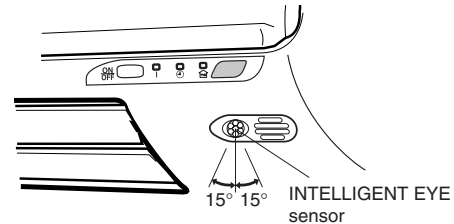

- Gently push and slide the sensor to adjust the angle.
- After adjusting the angle, wipe the sensor gently with a clean cloth, being careful not to scratch the sensor.

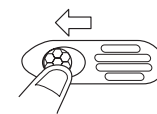

Moving the sensor to the left

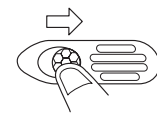

Moving the sensor to the right

“INTELLIGENT EYE” is useful for Energy Saving.

■ Energy saving operation

- Change the temperature -3.6°F in heating / $+3.6^{\circ}\text{F}$ in cooling / $+1.8^{\circ}\text{F}$ in dry mode from set temperature.
- Decrease the airflow rate slightly in fan operation. (In FAN mode only)

Notes on “INTELLIGENT EYE”

- Application range is as follows.

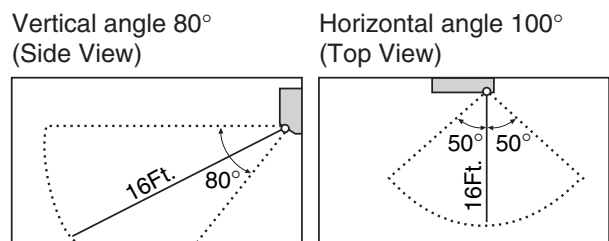

- Sensor may not detect moving objects further than 16Ft. away. (Check the application range)
- Sensor detection sensitivity changes according to indoor unit location, the speed of passersby, temperature range, etc.
- The sensor also mistakenly detects pets, sunlight, fluttering curtains and light reflected off of mirrors as passersby.
- INTELLIGENT EYE operation will not go on during powerful operation.
- Night set mode (page 20.) will not go on during your use of INTELLIGENT EYE operation.

⚠ CAUTION

- Do not place large objects near the sensor. Also keep heating units or humidifiers outside the sensor’s detection area. This sensor can detect objects it shouldn’t as well as not detect objects it should.
- Do not hit or violently push the INTELLIGENT EYE sensor. This can lead to damage and malfunction.

2.2.9 TIMER Operation

TIMER Operation

Timer functions are useful for automatically switching the air conditioner on or off at night or in the morning. You can also use OFF TIMER and ON TIMER in combination.

■ To use OFF TIMER operation

- Check that the clock is correct. If not, set the clock to the present time. (page 9.)

1. Press “OFF TIMER button”.

0:00 is displayed.

⊕-⊖ blinks.

2. Press “TIMER Setting button” until the time setting reaches the point you like.

- Every pressing of either button increases or decreases the time setting by 10 minutes. Holding down either button changes the setting rapidly.

3. Press “OFF TIMER button” again.

- The TIMER lamp lights up.

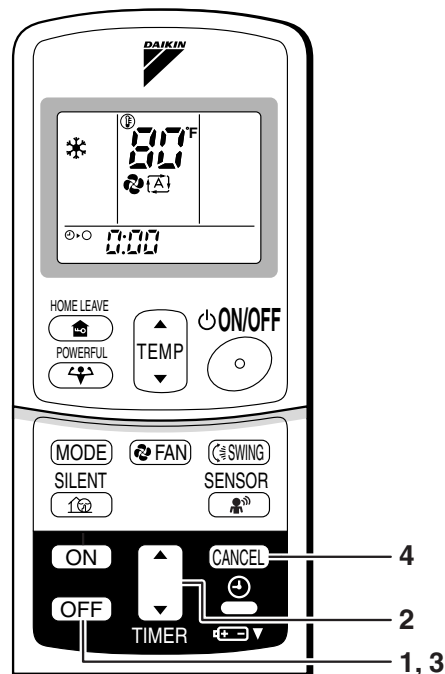

■ To cancel the OFF TIMER operation

4. Press “CANCEL button”.

- The TIMER lamp goes off.

NOTE

- When TIMER is set, the present time is not displayed.
- Once you set ON, OFF TIMER, the time setting is kept in the memory. (The memory is lost when remote controller batteries are replaced.)
- When operating the unit via the ON/OFF Timer, the actual length of operation may vary from the time entered by the user.

■ NIGHT SET MODE

When the OFF TIMER is set, the air conditioner automatically adjusts the temperature setting (1°F up in COOL, 3.6°F down in HEAT) to prevent excessive cooling (heating) for your pleasant sleep.

■ To use ON TIMER operation

- Check that the clock is correct. If not, set the clock to the present time. (page 9.)

1. Press “ON TIMER button”.

6:00 is displayed.

⊕·| blinks.

2. Press “TIMER Setting button” until the time setting reaches the point you like.

- Every pressing of either button increases or decreases the time setting by 10 minutes. Holding down either button changes the setting rapidly.

3. Press “ON TIMER button” again.

- The TIMER lamp lights up.



■ To cancel ON TIMER operation

4. Press “CANCEL button”.

- The TIMER lamp goes off.

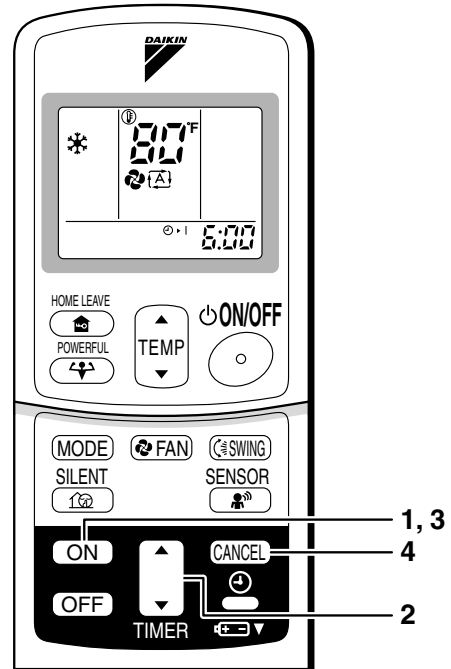

■ To combine ON TIMER and OFF TIMER

- A sample setting for combining the two timers is shown below.

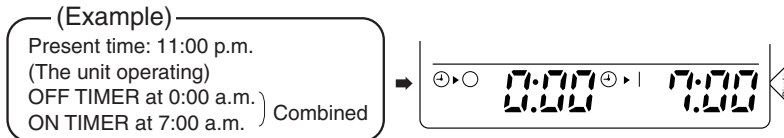

ATTENTION

■ In the following cases, set the timer again.

- After a breaker has turned OFF.
- After a power failure.
- After replacing batteries in the remote controller.

2.2.10 Care and Cleaning

Care and Cleaning



CAUTION Before cleaning, be sure to stop the operation and turn the breaker OFF.

Units

To avoid possible bodily injury, units should be shutoff or disconnected before any cleaning or servicing is attempted.

■ Indoor unit, Outdoor unit and Remote controller

1. Wipe them with dry soft cloth.

■ Front panel

1. Open the front panel.

- Hold the panel by the tabs on the two sides and lift it until it stops with a click.

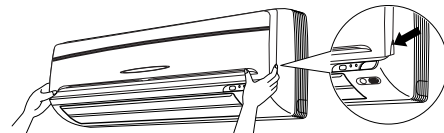

2. Remove the front panel.

- Supporting the front panel with one hand, release the lock by sliding down the knob with the other hand.
- To remove the front panel, pull it toward yourself with both hands.

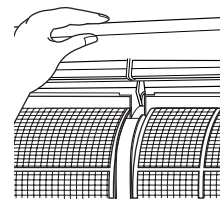

3. Clean the front panel.

- Wipe it with a soft cloth soaked in water.
- Only neutral detergent may be used.
- In case of washing the panel with water, dry it with cloth, dry it up in the shade after washing.

4. Attach the front panel.

- Set the 3 keys of the front panel into the slots and push them in all the way.
- Close the front panel slowly and push the panel at the 3 points.
(1 on each side and 1 in the middle.)
- Check to see if the rotating axis in the upper center section is moving.

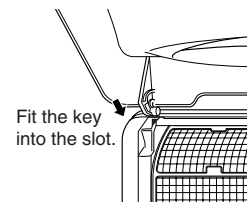

CAUTION

- Don't touch the metal parts of the indoor unit. If you touch those parts, this may cause an injury.
- When removing or attaching the front panel, use a robust and stable stool and watch your steps carefully.
- When removing or attaching the front panel, support the panel securely with hand to prevent it from falling.
- For cleaning, do not use hot water above 104°F, benzene, gasoline, thinner, nor other volatile oils, polishing compound, scrubbing brushes, nor other hand stuff.
- After cleaning, make sure that the front panel is securely fixed.

Filters

1. **Open the front panel. (page 22.)**
2. **Pull out the air filters.**
 - Push a little upwards the tab at the center of each air filter, then pull it down.
3. **Take off the air-purifying filter with photocatalytic deodorizing function.**
 - Hold the recessed parts of the frame and unhook the four claws.
4. **Clean or replace each filter.**
See figure.

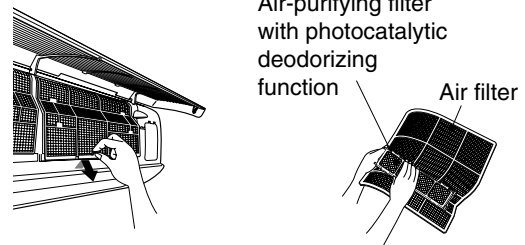
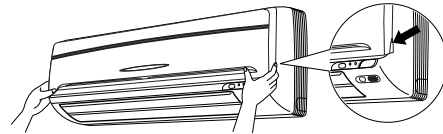

5. **Set the air filter and the air-purifying filter with photocatalytic deodorizing function as they were and close the front panel.**
 - Insert claws of the filters into slots of the front panel. Close the front panel slowly and push the panel at the 3 points. (1 on each side and 1 in the middle.)

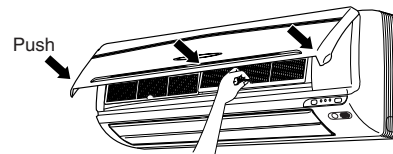

■ **Air Filter**

1. **Wash the air filters with water or clean them with vacuum cleaner.**
 - If the dust does not come off easily, wash them with neutral detergent thinned with lukewarm water, then dry them up in the shade.
 - It is recommended to clean the air filters every two weeks.

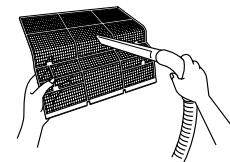

■ **Air-purifying filter with photocatalytic deodorizing function (gray)**

The Air-purifying filter with photocatalytic deodorizing function can be renewed by washing it with water once every 6 months. We recommend replacing it once every 3 years.

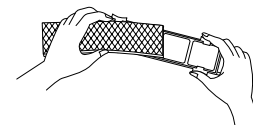

[**Maintenance**]

1. **Remove dust with a vacuum cleaner and wash lightly with water.**
2. **If it is very dirty, soak it for 10 to 15 minutes in water mixed with a neutral cleaning agent.**
3. **Do not remove filter from frame when washing with water.**
4. **After washing, shake off remaining water and dry in the shade.**
5. **Since the material is made out of paper, do not wring out the filter when removing water from it.**

[**Replacement**]

1. **Remove the tabs on the filter frame and replace with a new filter.**
 - Dispose of the old filter as flammable waste.

Check

Check that the base, stand and other fittings of the outdoor unit are not decayed or corroded. Check the units to ensure they are level and secure.

Check that nothing blocks the air inlets and the outlets of the indoor unit and the outdoor unit.

Check that the water drains smoothly out of the drain hose during COOL or DRY operation.

- If no drain water is seen, water may be leaking from the indoor unit. Stop operation and consult your authorized dealer.

■ Before a long idle period

1. Operate the “FAN only” for several hours on a warm day to dry out the inside.
 - Press “MODE selector button” and select “FAN” operation.
 - Press “ON/OFF button” and start operation.
2. After operation stops, turn off the electrical circuit breaker for the room air conditioner.
3. Remove and clean the air filters. Reinstall filters after cleaning.
4. Take out batteries from the remote controller.

NOTE

- Operation with dirty filters:
 - (1) cannot deodorize the air. (2) cannot clean the air.
 - (3) results in poor heating or cooling. (4) may cause odor.
- To order air-purifying filter with photocatalytic deodorizing function, contact your authorized dealer where you bought the air conditioner.
- Dispose of old filters as required by local codes.

Item	Part No.
Air-purifying filter with photocatalytic deodorizing function. (with frame) 1 set	KAF918A43
Air-purifying filter with photocatalytic deodorizing function. (without frame) 1 set	KAF918A44

2.2.11 Troubleshooting

Trouble Shooting

Conditions that appear to be abnormal but are not operational problems.

The following cases are not abnormal problems and you may just continue using it.

Case	Explanation
Operation does not start quickly. <ul style="list-style-type: none"> • When ON/OFF button was pressed soon after operation was stopped. • When the mode was reselected. 	<ul style="list-style-type: none"> • This is to protect the air conditioner. You should wait for about 3 minutes.
Hot air does not flow out soon after the start of heating operation.	<ul style="list-style-type: none"> • The air conditioner is warming up. You should wait for 1 to 4 minutes. (The system is designed to start discharging air only after it has reached a certain temperature.)
The heating operation stops suddenly and a flowing sound is heard.	<ul style="list-style-type: none"> • The system is taking away the frost on the outdoor unit. You should wait for about 3 to 8 minutes.
The outdoor unit emits water or steam.	<ul style="list-style-type: none"> ■ In HEAT mode <ul style="list-style-type: none"> • The frost on the outdoor unit melts into water or steam when the air conditioner is in defrost operation. ■ In COOL or DRY mode <ul style="list-style-type: none"> • Moisture in the air condenses into water on the cool surface of outdoor unit piping and drips.
Mists come out of the indoor unit.	<ul style="list-style-type: none"> ■ This happens when the air in the room is cooled into mist by the cold airflow during cooling operation.
The indoor unit gives out odor.	<ul style="list-style-type: none"> ■ This happens when smells of the room, furniture, or cigarettes are absorbed into the unit and discharged with the airflow. (If this happens, we recommend you to have the indoor unit washed by a technician. Consult your authorized dealer where you bought the air conditioner.)
The outdoor fan rotates while the air conditioner is not in operation.	<ul style="list-style-type: none"> ■ After operation is stopped: <ul style="list-style-type: none"> • The outdoor fan continues rotating for another 60 seconds for system protection. ■ While the air conditioner is not in operation: <ul style="list-style-type: none"> • When the outdoor temperature is very high, the outdoor fan starts rotating for system protection.
The operation stopped suddenly. (OPERATION lamp is on.)	<ul style="list-style-type: none"> ■ For system protection, the air conditioner may stop operating on a sudden large voltage fluctuation. It automatically resumes operation in about 3 minutes.

Check again.

Please check again before calling a repair person.

Case	Check
The air conditioner does not operate. (OPERATION lamp is off.)	<ul style="list-style-type: none"> • Has a breaker been turned OFF or a fuse blown? • Is there a power failure? • Are fresh batteries installed in the remote controller? • Is the timer setting correct?
Cooling (Heating) effect is poor.	<ul style="list-style-type: none"> • Are the air filters clean? • Is anything blocking the air inlet or the outlet of the indoor and the outdoor units? • Is the temperature setting appropriate? • Are the windows and doors closed? • Are the airflow rate and the air direction set appropriately? • Is the unit set to the INTELLIGENT EYE mode? (page 18.)
Operation stops suddenly. (OPERATION lamp flashes.)	<ul style="list-style-type: none"> • Are the air filters clean? • Is there anything blocking the air inlet or the outlet of the indoor and the outdoor units? Turn the electrical breaker off, clean the air filters or take all obstacles away from inlet and outlet. Then turn the breaker ON again and try operating the air conditioner with the remote controller. If the lamp still flashes, call your authorized dealer where you bought the air conditioner.
An abnormal functioning happens during operation.	<ul style="list-style-type: none"> • The air conditioner may malfunction with lightning or radio waves. Turn the circuit breaker OFF, to reset. Then turn it ON again and try operating the air conditioner with the remote controller.

Call your authorized dealer immediately.

 **WARNING**

- When an abnormality (such as a burning smell) occurs, stop operation and turn the circuit breaker OFF. Continued operation in an abnormal condition may result in troubles, electric shocks or fire. Consult your authorized dealer where you bought the air conditioner.
- Do not attempt to repair or modify the air conditioner by yourself. Work performed by untrained persons could result in electric shocks, personal injury, fire, or additional damage to equipment. Consult the service shop where you bought the air conditioner.

If one of the following symptoms takes place, call your authorized dealer immediately.

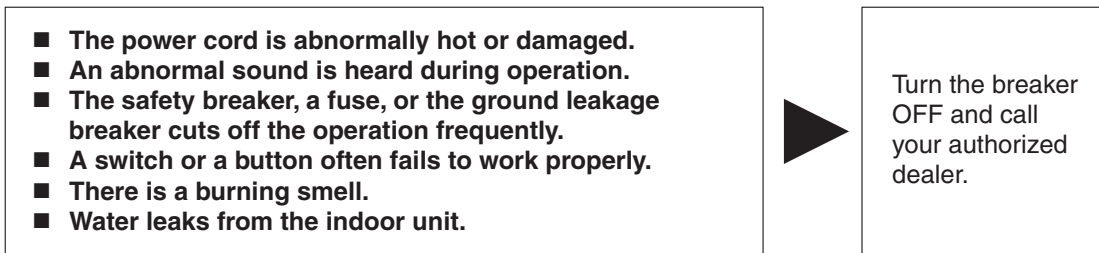

<ul style="list-style-type: none"> ■ After a power failure The air conditioner automatically resumes operation in about 3 minutes. You should just wait for a while. 	<ul style="list-style-type: none"> ■ Lightning If lightning may strike the neighboring area, stop operation and turn the breaker OFF for system protection.
--	---

Disposal requirements

Dismantling of the unit, treatment of the refrigerant, oil and eventual other parts, should be done in accordance with the relevant local and national regulations. Contact your authorized dealer for assistance.

We recommend periodical maintenance.

In certain operating conditions, the inside of the air conditioner may get foul after several seasons of use, resulting in poor performance. It is recommended to have periodical maintenance by a specialist aside from regular cleaning by the user. For specialist maintenance, contact your authorized dealer where you bought the air conditioner.

The maintenance cost must be born by the user.

Fault diagnosis.**FAULT DIAGNOSIS BY REMOTE CONTROLLER**

In the ARC433A series, the temperature display sections on the main unit indicate corresponding codes.

1. When the **TIMER CANCEL** button is held down for 5 seconds, a "00" indication flashes on the temperature display section.

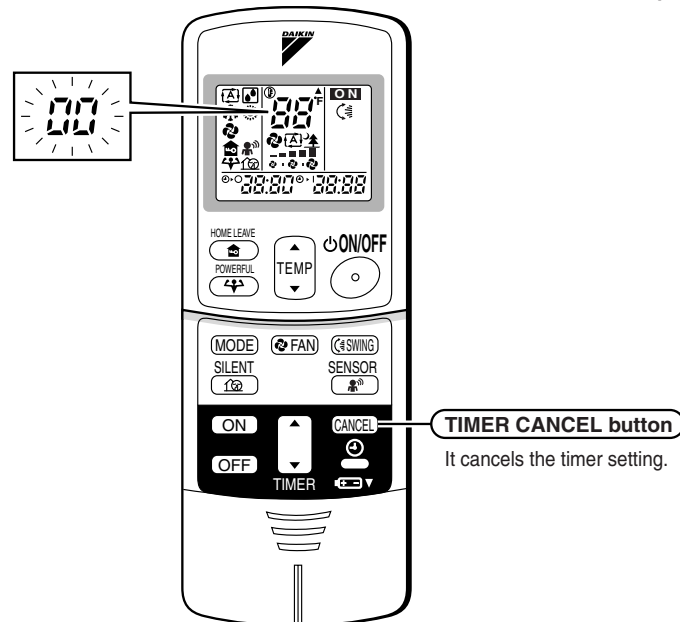

2. Press the **TIMER CANCEL** button repeatedly until a continuous beep is produced.

- The code indication changes as shown below, and notifies with a long beep.

	CODE	MEANING
SYSTEM	00	NORMAL
	U0	REFRIGERANT SHORTAGE
	U2	DROP VOLTAGE OR MAIN CIRCUIT OVERVOLTAGE
	U4	FAILURE OF TRANSMISSION (BETWEEN INDOOR UNIT AND OUTDOOR UNIT)
INDOOR UNIT	A1	INDOOR PCB DEFECTIVENESS
	A5	HIGH PRESSURE CONTROL OR FREEZE-UP PROTECTOR
	A6	FAN MOTOR FAULT
	C4	FAULTY HEAT EXCHANGER TEMPERATURE SENSOR
OUTDOOR UNIT	C9	FAULTY SUCTION AIR TEMPERATURE SENSOR
	EA	COOLING-HEATING SWITCHING ERROR
	E5	OL STARTED
	E6	FAULTY COMPRESSOR START UP
	E7	DC FAN MOTOR FAULT
	E8	OPERATION HALT DUE TO DETECTION OF INPUT OVER CURRENT
	F3	HIGH TEMPERATURE DISCHARGE PIPE CONTROL
	F6	HIGH PRESSURE CONTROL (IN COOLING)
	H6	OPERATION HALT DUE TO FAULTY POSITION DETECTION SENSOR
	H8	CT ABNORMALITY
	H9	FAULTY SUCTION AIR TEMPERATURE SENSOR
	J3	FAULTY DISCHARGE PIPE TEMPERATURE SENSOR
	J6	FAULTY HEAT EXCHANGER TEMPERATURE SENSOR
	L4	HIGH TEMPERATURE AT INVERTER CIRCUIT HEATSINK
	L5	OUTPUT OVERCURRENT
P4	FAULTY INVERTER CIRCUIT HEATSINK TEMPERATURE SENSOR	

NOTE

1. A short beep and two consecutive beeps indicate non-corresponding codes.
2. To cancel the code display, hold the **TIMER CANCEL** button down for 5 seconds. The code display also cancel itself if the button is not pressed for 1 minute.

2.3 The Single Split Duct-Free System FTXS15/18/24DVJU

2.3.1 Names of Parts

Names of parts

■ Indoor Unit

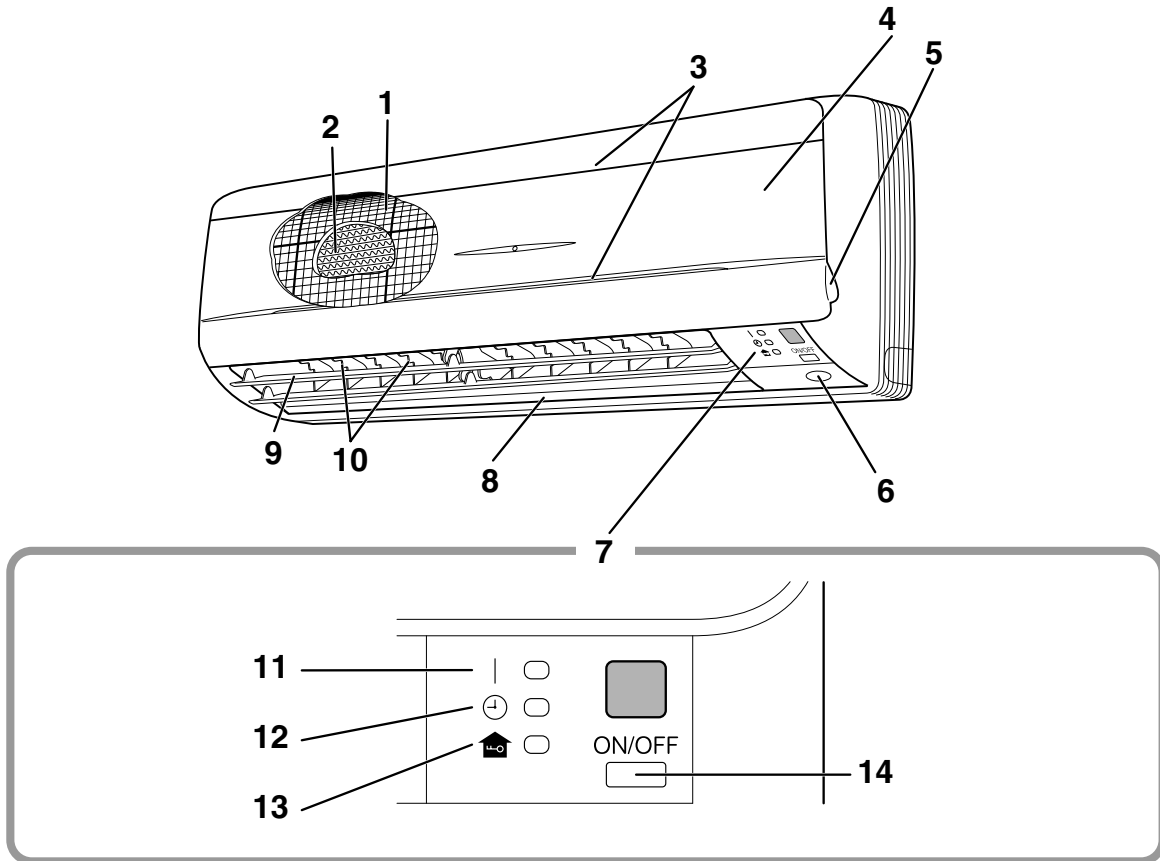

■ Main unit control panel

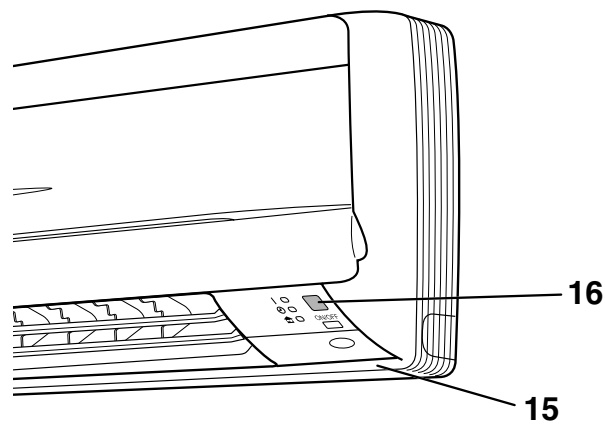

■ Outdoor Unit

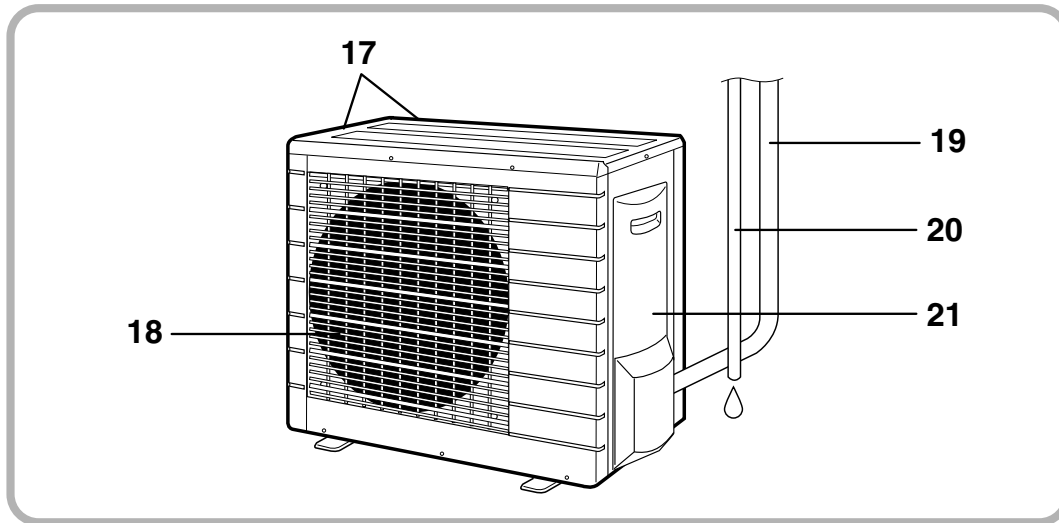

■ Indoor Unit

1. Air filter
2. Air-purifying filter with photocatalytic deodorizing function:
 - These filters are attached to the inside of the air filters.
3. Air inlet
4. Front panel
5. Panel tab
6. INTELLIGENT EYE sensor:
 - It detects the movements of people and automatically switches between normal operation and energy saving operation. (page 18.)
7. Display
8. Air outlet
9. Flaps (horizontal blades): (page 12.)
10. Louvers (vertical blades):
 - The louvers are inside of the air outlet. (page 13.)
11. Operation lamp (green)
12. TIMER lamp (yellow): (page 20.)
13. HOME LEAVE lamp (red):
 - Lights up when you use HOME LEAVE Operation. (page 16.)

14. Indoor Unit ON/OFF switch:

- Push this switch once to start operation. Push once again to stop it.
- The operation mode refers to the following table.

Mode	Temperature setting	Airflow rate
AUTO	77°F	AUTO

- This switch is useful when the remote controller is missing.

15. Room temperature sensor:

- It senses the air temperature around the unit.

16. Signal receiver:

- It receives signals from the remote controller.
- When the unit receives a signal, you will hear a short beep.
 - Operation startbeep-beep
 - Settings changedbeep
 - Operation stopbeeeeeeep

■ Outdoor Unit

17. Air inlet: (Back and side)
18. Air outlet
19. Refrigerant piping and inter-unit cable
20. Drain hose
21. Earth grounding terminal:
 - It is inside of this cover.

Appearance of the outdoor unit may differ from some models.

■ Remote Controller

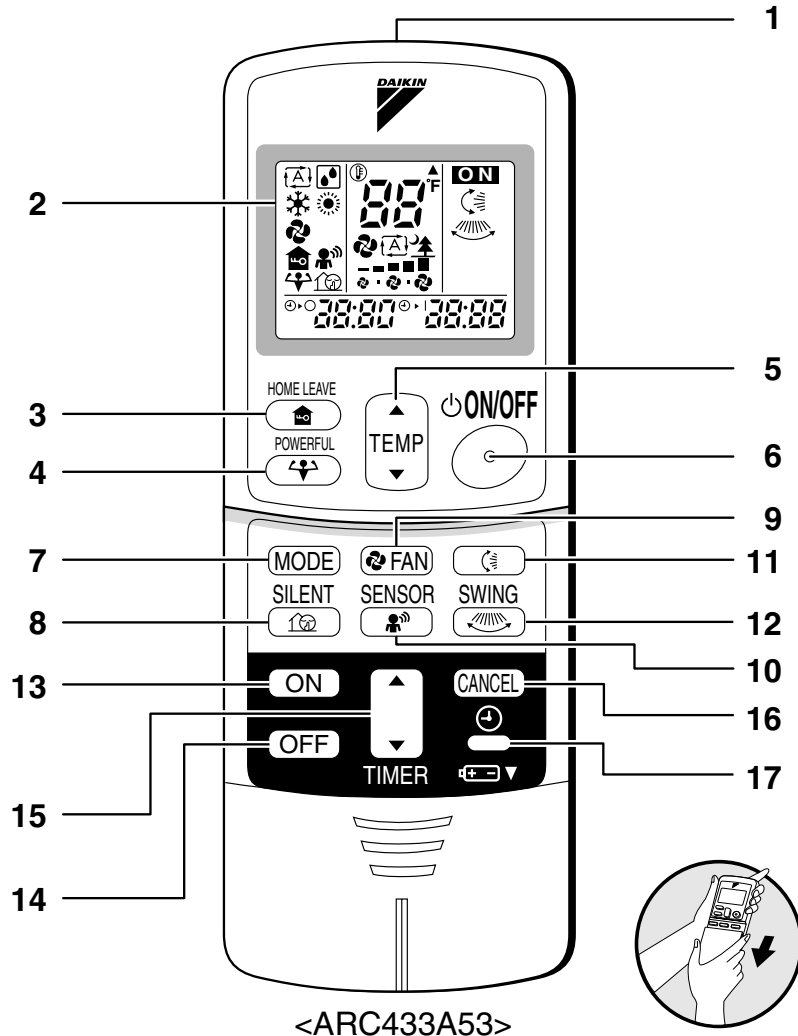

<ARC433A53>

- | | |
|---|--|
| <p>1. Signal transmitter:</p> <ul style="list-style-type: none"> • It sends signals to the indoor unit. <p>2. Display:</p> <ul style="list-style-type: none"> • It displays the current settings.
(In this illustration, each section is shown with all its displays ON for the purpose of explanation.) <p>3. HOME LEAVE button:
HOME LEAVE operation (page 16.)</p> <p>4. POWERFUL button: (Maximum operation)
POWERFUL operation (page 14.)</p> <p>5. TEMPERATURE adjustment buttons:</p> <ul style="list-style-type: none"> • It changes the temperature setting. <p>6. ON/OFF button:</p> <ul style="list-style-type: none"> • Press this button once to start operation.
Press once again to stop it. <p>7. MODE selector button:</p> <ul style="list-style-type: none"> • It selects the operation mode.
(AUTO/DRY/COOL/HEAT/FAN) (page 10.) | <p>8. SILENT button: OUTDOOR UNIT SILENT operation (page 15.)</p> <p>9. FAN setting button:</p> <ul style="list-style-type: none"> • It selects the airflow rate setting. <p>10. SENSOR button: INTELLIGENT EYE operation (page 18.)</p> <p>11. SWING button: (page 12.)</p> <ul style="list-style-type: none"> • Flap (Horizontal blade) <p>12. SWING button: (page 12.)</p> <ul style="list-style-type: none"> • Louver (Vertical blades) <p>13. ON TIMER button: (page 21.)</p> <p>14. OFF TIMER button: (page 20.)</p> <p>15. TIMER Setting button:</p> <ul style="list-style-type: none"> • It changes the time setting. <p>16. TIMER CANCEL button:</p> <ul style="list-style-type: none"> • It cancels the timer setting. <p>17. CLOCK button: (page 9.)</p> |
|---|--|

2.3.2 Preparation before Operation

Preparation Before Operation

■ To set the batteries

1. Slide the front cover to take it off.
2. Set two dry batteries (AAA).
3. Set the front cover as before.

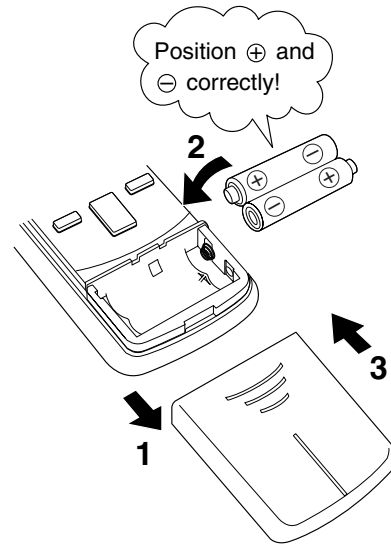

ATTENTION

■ About batteries

- When replacing the batteries, use batteries of the same type, and replace the two old batteries together.
- When the system is not used for a long time, take the batteries out. In case the remote controller is not used for a long time remove all batteries in order to prevent liquid leak of the battery.
- We recommend replacing once a year, although if the remote controller display begins to fade or if reception deteriorates, please replace with new alkali batteries. Using manganese batteries reduces the lifespan.
- The attached batteries are provided for the initial use of the system.
The usable period of the batteries may be short depending on the manufactured date of the air conditioner.
- Pressing two or more buttons simultaneously may cause the strange display of the remote controller.
The remote controller is not malfunction. In this case take the batteries out and reset them.

■ Replacing the Batteries

- When replacing the battery, remove the old battery, wait one minute, and then insert the new battery.

Preparation Before Operation

■ To operate the remote controller

- To use the remote controller, aim the transmitter at the indoor unit.
If there is anything to block signals between the unit and the remote controller, such as a curtain, the unit will not operate.
- Do not drop the remote controller. Do not get it wet.
- The maximum distance for communication is about 23 Ft..

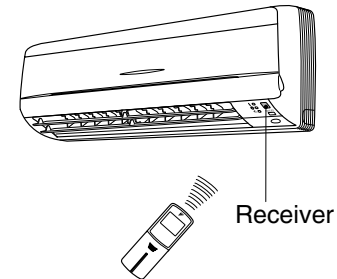

■ To fix the remote controller holder on the wall

1. Choose a place from where the signals reach the unit.
2. Fix the holder to a wall, a pillar, etc. with the screws supplied with the holder.
3. Place the remote controller in the remote controller holder.

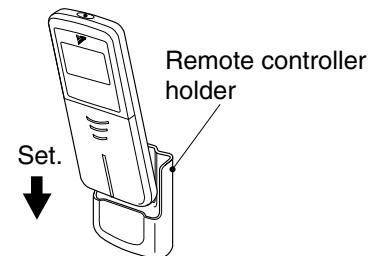

- To remove, pull it upwards.

ATTENTION

■ About remote controller

- Do not put the remote controller in the following places.
 - In direct sunlight.
 - In vicinity of a heater.
- Dust on the signal transmitter or receiver will reduce the sensitivity. Wipe off dust with soft cloth.
- Signal communication may be disabled if an electronic-starter-type fluorescent lamp (such as inverter-type lamps) is in the room. Consult your authorized dealer if that is the case.
- If the remote controller signals happen to operate another appliance, move that appliance to somewhere else, or consult your authorized dealer.

■ **To set the clock**

1. Press “CLOCK button”.

0:00 is displayed.

⌚ blinks.

2. Press “TIMER setting button” to set the clock to the present time.

Holding down “▲” or “▼” button rapidly increases or decreases the time display.

3. Press “CLOCK button”.

⌚ blinks.

■ **Turn the breaker ON**

- Turning ON the breaker opens the flap, then closes it again. (This is a normal procedure.)

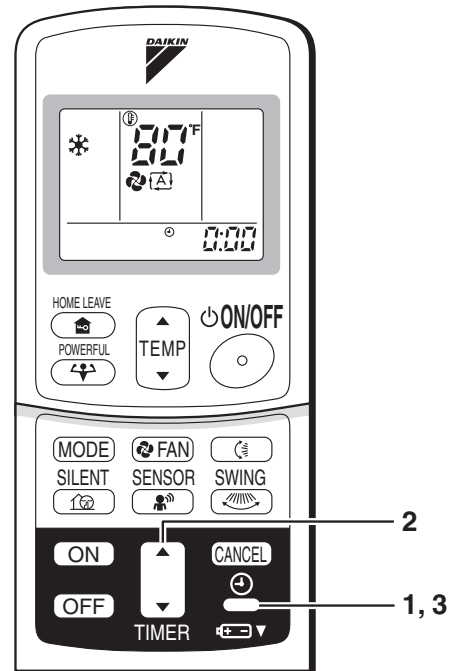

NOTE

■ **Tips for saving energy**

- Be careful not to cool (heat) the room too much. Keeping the temperature setting at a moderate level helps save energy.
- Cover windows with a blind or a curtain. Blocking sunlight and air from outdoors increases the cooling (heating) effect.
- Clogged air filters cause inefficient operation and waste energy. Clean them once every two weeks.

Recommended temperature setting

For cooling: 78°F – 82°F
For heating: 68°F – 75°F

■ **Please note**

- When the main power switch is turned on, some watts of electricity are being used even when the system is not operating.
- If you are not going to use the air conditioner for a long period, for example in spring or autumn, turn the breaker OFF to save energy.
- Use the air conditioner in the following conditions.

Mode	Operating conditions	If operation is continued out of this range
COOL	Outdoor temperature: 14 to 115 °F Indoor temperature: 64 to 90 °F Indoor humidity: 80% max.	<ul style="list-style-type: none"> • A safety device may work to stop the operation under 0 °F and over 115 °F outdoor temperature. • See Note 2 for 0 °F to 14 °F operation. • Condensation may occur on the indoor unit and drip.
HEAT	Outdoor temperature: 5 to 64 °F Indoor temperature: 50 to 86 °F	<ul style="list-style-type: none"> • A safety device may work to stop the operation under 0 °F or over 64 °F outdoor temperature. See the Note 3 for 0 °F to 5 °F.
DRY	Outdoor temperature: 14 to 115 °F Indoor temperature: 64 to 90 °F Indoor humidity: 80% max.	<ul style="list-style-type: none"> • A safety device may work to stop the operation. • Condensation may occur on the indoor unit and drip.

- Operation outside this humidity or temperature range may cause a safety device to disable the system.
- <Note 1> A Breaker must be turned on for 24 hours before the operation start if the ambient is below 14 °F, otherwise the unit will not start operation smoothly.
- <Note 2> 1. Use low outdoor ambient cooling operation for equipment cooling applications only. This operation is not intended for human comfort cooling.
2. Intermittent noises may be produced by the indoor unit due to the outdoor fan rotation speed change.
3. Do not place humidifiers or other items which might raise the humidity in rooms at 0 to 14 °F outdoor temperature. A humidifier may cause condensation to drip from the indoor unit outlet vent.
4. Set the indoor unit at the highest air flow rate.
- <Note 3> When the outdoor temperature is 0 to 5 degrees F, the system may not have sufficient cooling capacity.

2.3.3 AUTO • DRY • COOL • HEAT • FAN Operation

AUTO • DRY • COOL • HEAT • FAN Operation

The air conditioner operates with the operation mode of your choice.
 From the next time on, the air conditioner will operate with the same operation mode.

■ To start operation

1. Press “MODE selector button” and select a operation mode.
 - Each pressing of the button advances the mode setting in sequence.
 - A: AUTO
 - D: DRY
 - ☼: COOL
 - ☀: HEAT
 - F: FAN



2. Press “ON/OFF button” .
 - The OPERATION lamp lights up.

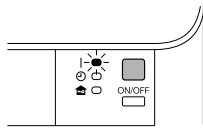



■ To stop operation

3. Press “ON/OFF button” again.
 - Then OPERATION lamp goes off.

■ To change the temperature setting

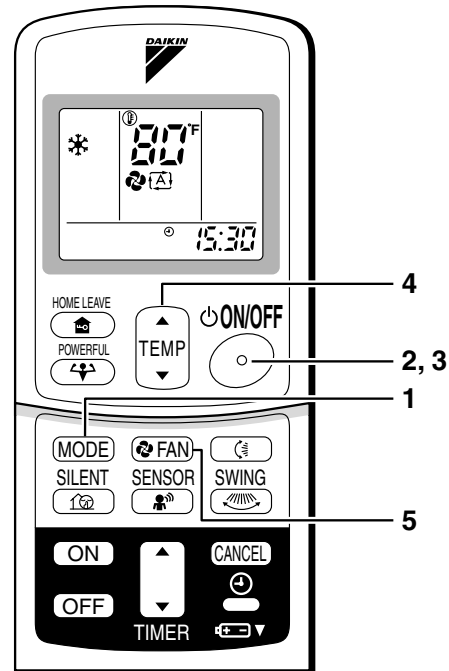



4. Press “TEMPERATURE adjustment button”.



DRY or FAN mode	AUTO or COOL or HEAT mode
The temperature setting is not variable.	Press “▲” to raise the temperature and press “▼” to lower the temperature.
	Set to the temperature you like. 

■ To change the airflow rate setting

5. Press “FAN setting button”.

DRY mode	AUTO or COOL or HEAT or FAN mode
The airflow rate setting is not variable.	Five levels of airflow rate setting from “  ” to “  ” plus “  ” “  ” are available. 

- Indoor unit quiet operation

When the airflow is set to “”, the noise from the indoor unit will become quieter.
Use this when making the indoor unit quieter.

The unit might lose capacity when the airflow rate is set to a low level.

NOTE

■ Note on HEAT operation

- Since this air conditioner heats the room by taking heat from outdoor air to indoors, the heating capacity becomes smaller in lower outdoor temperatures. If the heating effect is insufficient, it is recommended to use another heating appliance in combination with the air conditioner.
- The heat pump system heats the room by circulating hot air around all parts of the room. After the start of heating operation, it takes some time before the room gets warmer.
- In heating operation, frost may occur on the outdoor unit and lower the heating capacity. In that case, the system switches into defrosting operation to take away the frost.
- During defrosting operation, hot air does not flow out of indoor unit.

■ Note on COOL operation

- This air conditioner cools the room by blowing the hot air in the room outside, so if the outside temperature is high, performance drops.

■ Note on DRY operation

- The computer chip works to rid the room of humidity while maintaining the temperature as much as possible. It automatically controls temperature and fan strength, so manual adjustment of these functions is unavailable.

■ Note on AUTO operation

- In AUTO operation, the system selects an appropriate operation mode (COOL or HEAT) based on the room temperature at the start of the operation.
- The system automatically reselects setting at a regular interval to bring the room temperature to user-setting level.
- If you do not like AUTO operation, you can manually select the operation mode and setting you like.

■ Note on airflow rate setting



- At smaller airflow rates, the cooling (heating) effect is also less.

2.3.4 Adjusting the Airflow Direction

Adjusting the Airflow Direction



You can adjust the airflow direction to increase your comfort.

■ To adjust the horizontal blade (flap)

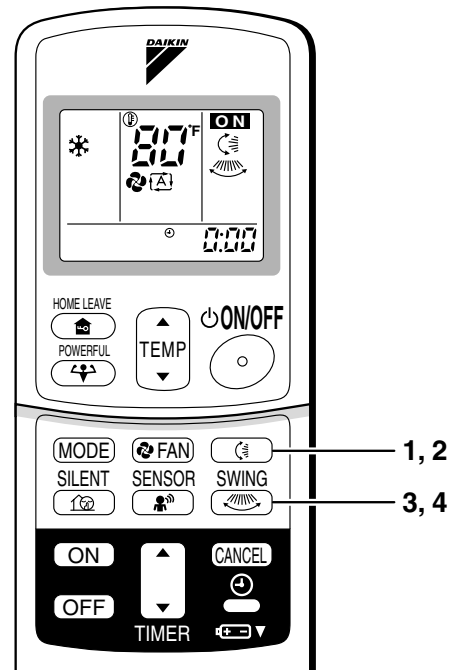
1. Press “SWING button ”.
 - “” is displayed on the LCD.
2. When the flap has reached the desired position, press “SWING button ” once more.
 - The flap will stop moving.



■ To adjust the vertical blades (louvers)

3. Press “SWING button ”.
 - “” is displayed on the LCD.
4. When the louvers have reached the desired position, press the “SWING button ” once more.
 - The louvers will stop moving.

■ To 3-D Airflow

Press the “SWING button 

■ To cancel 3-D Airflow

Press either the “SWING button 

Notes on louvers angles

■ ATTENTION

- Always use a remote controller to adjust the louvers angles. Inside the air outlet, a fan is rotating at a high speed and may cause bodily injury if fan comes in contact with fingers.

Notes on flaps angles

- When “**SWING button**” is selected, the flaps swinging range depends on the operation mode. (See the figure.)

Three-Dimensional (3-D) Airflow

- Using three-dimensional airflow circulates cold air, which tends to be collected at the bottom of the room, and hot air, which tends to collect near the ceiling, throughout the room, preventing areas of cold and hot developing.

■ ATTENTION

- Always use a remote controller to adjust the flaps angle. If you attempt to move it forcibly with hand when it is swinging, the mechanism may be broken.
- Be careful when adjusting the louvers. Inside the air outlet, fan is rotating at a high speed and may cause bodily injury if fan comes in contact with fingers.

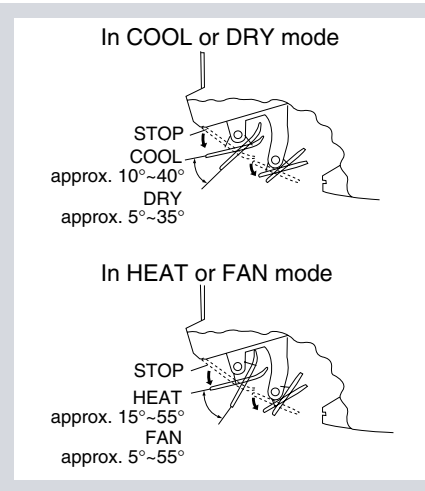

2.3.5 POWERFUL Operation

POWERFUL Operation

POWERFUL operation quickly maximizes the cooling (heating) effect in any operation mode. You can get the maximum capacity.

■ To start POWERFUL operation

1. Press “POWERFUL button”.
 - POWERFUL operation ends in 20 minutes. Then the system automatically operates again with the settings which were used before POWERFUL operation.
 - When using POWERFUL operation, there are some functions which are not available.
 - “” is displayed on the LCD.

■ To cancel POWERFUL operation

2. Press “POWERFUL button” again.
 - “” disappears from the LCD.

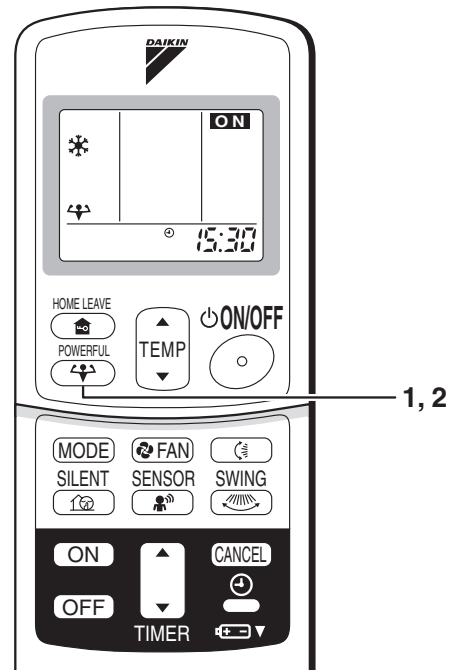

NOTE

■ Notes on POWERFUL operation

- POWERFUL Operation cannot be used together with SILENT Operation. Priority is given to the function of whichever button is pressed last.
- POWERFUL Operation can only be set when the unit is running. Pressing the operation stop button causes the settings to be canceled, and the “” disappears from the LCD.
- **In COOL and HEAT mode**
To maximize the cooling (heating) effect, the capacity of outdoor unit must be increased and the airflow rate be fixed to the maximum setting.
The temperature and airflow settings are not variable.
- **In DRY mode**
The temperature setting is lowered by 4.5°F and the airflow rate is slightly increased.
- **In FAN mode**
The airflow rate is fixed to the maximum setting.

2.3.6 OUTDOOR UNIT SILENT Operation

OUTDOOR UNIT SILENT Operation

OUTDOOR UNIT SILENT operation lowers the noise level of the outdoor unit by changing the fan speed on the outdoor unit. This function is convenient during night.

■ To start OUTDOOR UNIT SILENT operation

1. Press “SILENT button”.

- “” is displayed on the LCD.

■ To cancel OUTDOOR UNIT SILENT operation

2. Press “SILENT button” again.

- “” disappears from the LCD.

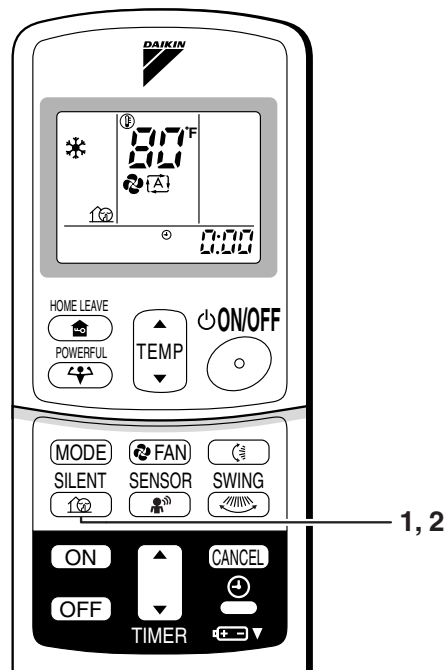

NOTE

■ Note on OUTDOOR UNIT SILENT operation

- This function is available in COOL, HEAT, and AUTO modes. (This is not available in FAN and DRY modes.)
- POWERFUL operation and OUTDOOR UNIT SILENT operation cannot be used at the same time. Priority is given to the function of whichever button is pressed last.
- If operation is stopped using the remote controller or the main unit ON/OFF switch when using OUTDOOR UNIT SILENT operation, “” will remain on the remote controller display.

2.3.7 HOME LEAVE Operation

HOME LEAVE Operation

HOME LEAVE operation is a function which allows you to record your preferred temperature and airflow rate settings.

■ To start HOME LEAVE operation

1. Press “HOME LEAVE button” .
 - “” is displayed on the LCD.
 - The HOME LEAVE lamp lights up.

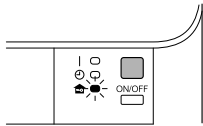

■ To cancel HOME LEAVE operation

2. Press “HOME LEAVE button” again.
 - “” disappears from the LCD.
 - The HOME LEAVE lamp goes off.

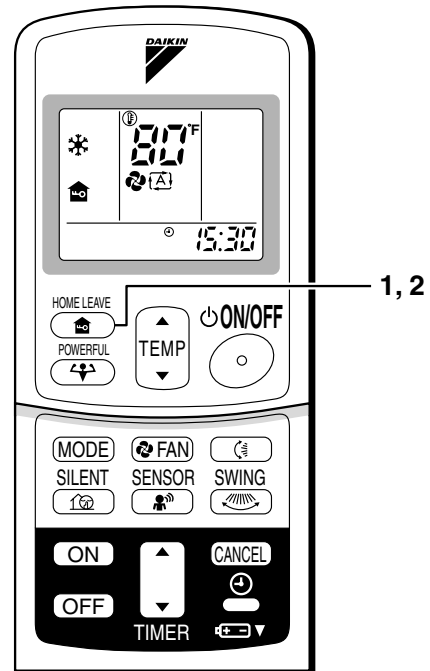

Before using HOME LEAVE operation.

■ To set the temperature and airflow rate for HOME LEAVE operation

When using HOME LEAVE operation for the first time, please set the temperature and airflow rate for HOME LEAVE operation. Record your preferred temperature and airflow rate.

	Initial setting		Selectable range	
	Temperature	Airflow rate	Temperature	Airflow rate
Cooling	77°F	AUTO	64-90°F	5 step, AUTO and SILENT
Heating	77°F	AUTO	50-86°F	5 step, AUTO and SILENT

1. Press “HOME LEAVE button”. Make sure “” is displayed in the remote controller display.
2. Adjust the set temperature with “▲” or “▼” as you like.
3. Adjust the airflow rate with “FAN” setting button as you like.

Home leave operation will run with these settings the next time you use the unit. To change the recorded information, repeat steps 1 – 3.

■ What's the HOME LEAVE operation?

Is there a set temperature and airflow rate which is most comfortable, a set temperature and airflow rate which you use the most? HOME LEAVE operation is a function that allows you to record your favorite set temperature and airflow rate. You can start your favorite operation mode simply by pressing the HOME LEAVE button on the remote controller. This function is convenient in the following situations.

■ Useful in these cases

1. Use as an energy-saving mode.

Set the temperature 3-5°F higher (cooling) or lower (heating) than normal. Setting the fan speed to the lowest setting allows the unit to be used in energy-saving mode. Also convenient for use while you are out or sleeping.

• Every day before you leave the house...

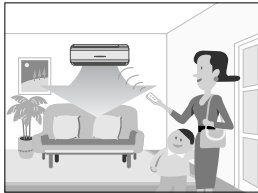

When you go out, push the "HOME LEAVE Operation" button, and the air conditioner will adjust capacity to reach the preset temperature for HOME LEAVE Operation.

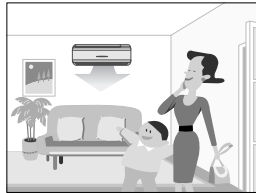

When you return, you will be welcomed by a comfortably air conditioned room.

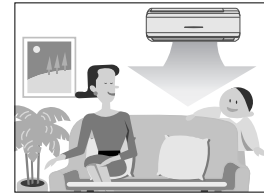

Push the "HOME LEAVE Operation" button again, and the air conditioner will adjust capacity to the set temperature for normal operation.

• Before bed...

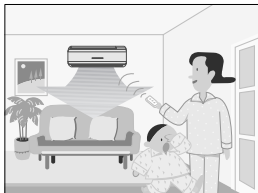

Set the unit to HOME LEAVE Operation before leaving the living room when going to bed.



The unit will maintain the temperature in the room at a comfortable level while you sleep.

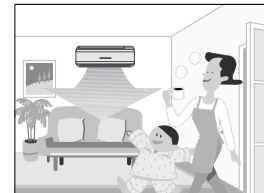

When you enter the living room in the morning, the temperature will be just right. Disengaging HOME LEAVE Operation will return the temperature to that set for normal operation. Even the coldest winters will pose no problem!

2. Use as a favorite mode

Once you record the temperature and airflow rate settings you most often use, you can retrieve them by pressing HOME LEAVE button. You do not have to go through troublesome remote controller operations.

NOTE

- Once the temperature and airflow rate for HOME LEAVE operation are set, those settings will be used whenever HOME LEAVE operation is used in the future. To change these settings, please refer to the "Before using HOME LEAVE operation" section above.
- HOME LEAVE operation is only available in COOL and HEAT mode. It cannot be used in AUTO, DRY, and FAN mode.
- HOME LEAVE operation runs in accordance with the previous operation mode (COOL or HEAT) before using HOME LEAVE operation.
- HOME LEAVE operation and POWERFUL operation cannot be used at the same time. Last button that was pressed has priority.
- The operation mode cannot be changed while HOME LEAVE operation is being used.
- When operation is shut off during HOME LEAVE operation, using the remote controller or the indoor unit ON/OFF switch, "🏠" will remain on the remote controller display.

2.3.8 INTELLIGENT EYE Operation

INTELLIGENT EYE Operation

“INTELLIGENT EYE” is the infrared sensor which detects the human movement.

■ To start INTELLIGENT EYE operation

1. Press “SENSOR button”.
 - “” is displayed on the LCD.

■ To cancel the INTELLIGENT EYE operation

2. Press “SENSOR button” again.
 - “” disappears from the LCD.

[EX.]

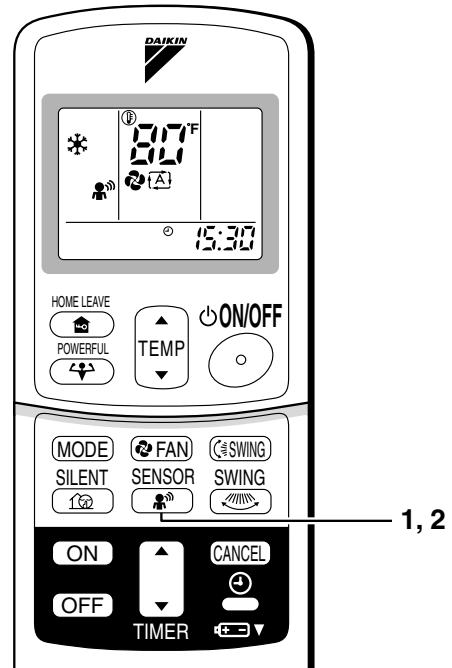
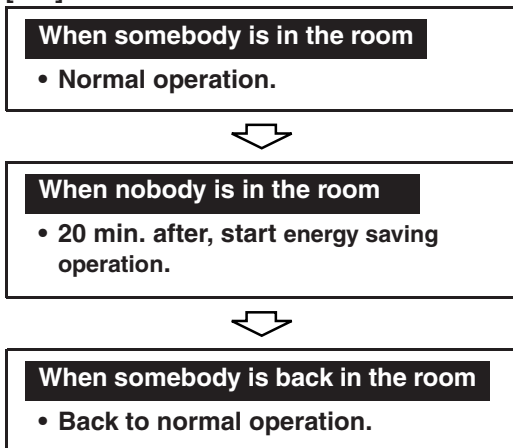

“INTELLIGENT EYE” is useful for Energy Saving

■ Energy saving operation

- Change the temperature -3.6°F in heating / $+3.6^{\circ}\text{F}$ in cooling / $+1.8^{\circ}\text{F}$ in dry mode from set temperature.
- Decrease the airflow rate slightly in fan operation. (In FAN mode only)

Notes on “INTELLIGENT EYE”

- Application range is as follows.

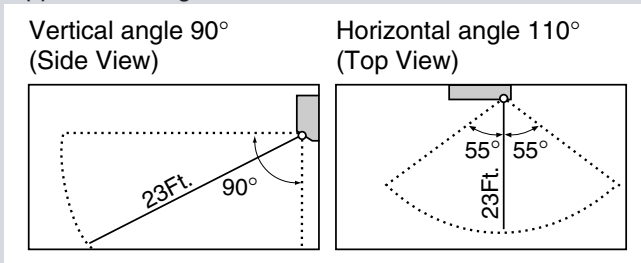

- Sensor may not detect moving objects further than 23Ft. away. (Check the application range)
- Sensor detection sensitivity changes according to indoor unit location, the speed of passersby, temperature range, etc.
- The sensor also mistakenly detects pets, sunlight, fluttering curtains and light reflected off of mirrors as passersby.
- INTELLIGENT EYE operation will not go on during powerful operation.
- Night set mode (page 20.) will not go on during your use of INTELLIGENT EYE operation.

! CAUTION

- Do not place large objects near the sensor.
Also keep heating units or humidifiers outside the sensor's detection area. This sensor can detect objects it shouldn't as well as not detect objects it should.
- Do not hit or violently push the INTELLIGENT EYE sensor. This can lead to damage and malfunction.

2.3.9 TIMER Operation

TIMER Operation

Timer functions are useful for automatically switching the air conditioner on or off at night or in the morning. You can also use OFF TIMER and ON TIMER in combination.

■ To use OFF TIMER operation

- Check that the clock is correct. If not, set the clock to the present time. (page 9.)

1. Press “OFF TIMER button”.

0:00 is displayed.

⊕-⊖ blinks.

2. Press “TIMER Setting button” until the time setting reaches the point you like.

- Every pressing of either button increases or decreases the time setting by 10 minutes. Holding down either button changes the setting rapidly.

3. Press “OFF TIMER button” again.

- The TIMER lamp lights up.

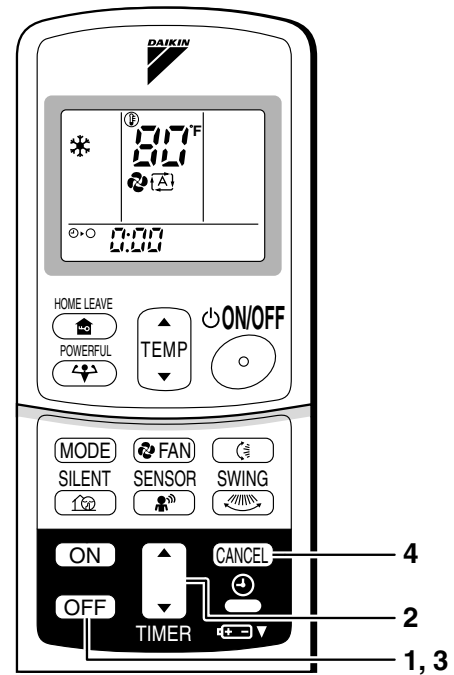
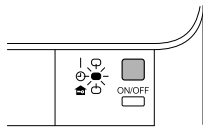

■ To cancel the OFF TIMER operation

4. Press “CANCEL button”.

- The TIMER lamp goes off.

NOTE

- When TIMER is set, the present time is not displayed.
- Once you set ON, OFF TIMER, the time setting is kept in the memory. (The memory is lost when remote controller batteries are replaced.)
- When operating the unit via the ON/OFF Timer, the actual length of operation may vary from the time entered by the user.

■ NIGHT SET MODE

When the OFF TIMER is set, the air conditioner automatically adjusts the temperature setting (1°F up in COOL, 3.6°F down in HEAT) to prevent excessive cooling (heating) for your pleasant sleep.

■ To use ON TIMER operation

- Check that the clock is correct. If not, set the clock to the present time. (page 9.)

1. Press “ON TIMER button”.

6:00 is displayed.

- $\odot \triangleright$ blinks.

2. Press “TIMER Setting button” until the time setting reaches the point you like.

- Every pressing of either button increases or decreases the time setting by 10 minutes. Holding down either button changes the setting rapidly.

3. Press “ON TIMER button” again.

- The TIMER lamp lights up.

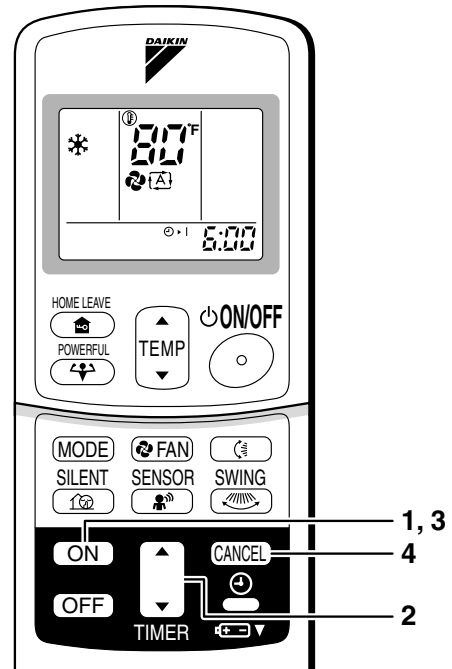
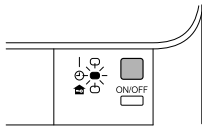

■ To cancel ON TIMER operation

4. Press “CANCEL button”.

- The TIMER lamp goes off.

■ To combine ON TIMER and OFF TIMER

- A sample setting for combining the two timers is shown below.

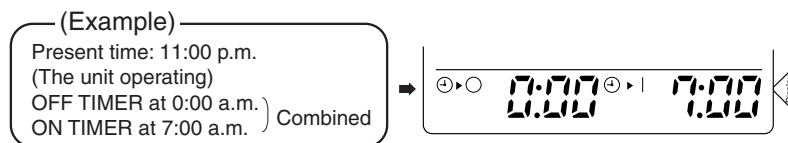

ATTENTION

■ In the following cases, set the timer again.

- After a breaker has turned OFF.
- After a power failure.
- After replacing batteries in the remote controller.

2.3.10 Care and Cleaning

Care and Cleaning

⚠ CAUTION Before cleaning, be sure to stop the operation and turn the breaker OFF.

Units

To avoid possible bodily injury, units should be shutoff or disconnected before any cleaning or servicing is attempted.

■ Indoor unit, Outdoor unit and Remote controller

1. Wipe them with dry soft cloth.

■ Front panel

1. Open the front panel.

- Hold the panel by the tabs on the two sides and lift it until it stops with a click.

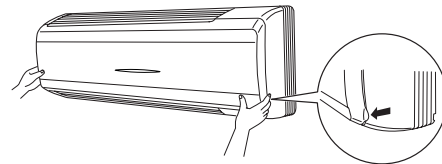

2. Remove the front panel.

- Open the front panel further while sliding it to either the left or right and pulling it toward you. This will disconnect the rotation dowel on one side. Then disconnect the rotation dowel on the other side in the same manner.

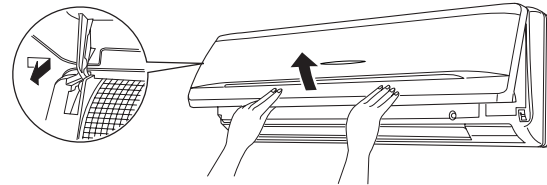

3. Clean the front panel.

- Wipe it with a soft cloth soaked in water.
- Only neutral detergent may be used.
- In case of washing the panel with water, dry it with cloth, dry it up in the shade after washing.

4. Attach the front panel.

- Align the rotation dowels on the left and right of the front panel with the slots, then push them all the way in.
- Close the front panel slowly. (Press the panel at both sides and the center.)

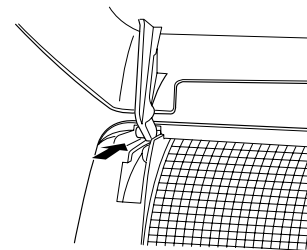

⚠ CAUTION

- Don't touch the metal parts of the indoor unit. If you touch those parts, this may cause an injury.
- When removing or attaching the front panel, use a robust and stable stool and watch your steps carefully.
- When removing or attaching the front panel, support the panel securely with hand to prevent it from falling.
- For cleaning, do not use hot water above 104°F, benzene, gasoline, thinner, nor other volatile oils, polishing compound, scrubbing brushes, nor other hand stuff.
- After cleaning, make sure that the front panel is securely fixed.

Filters

1. Open the front panel. (page 22.)

2. Pull out the air filters.

- Push a little upwards the tab at the center of each air filter, then pull it down.

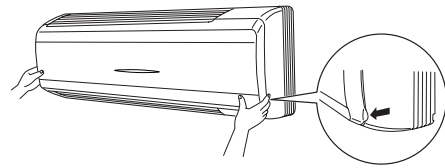

3. Take off the air-purifying filter with photocatalytic deodorizing function.

- Press the top of the air-cleaning filter onto the tabs (3 at top). Then press the bottom of the filter up slightly, and press it onto the tabs (3 at bottom).

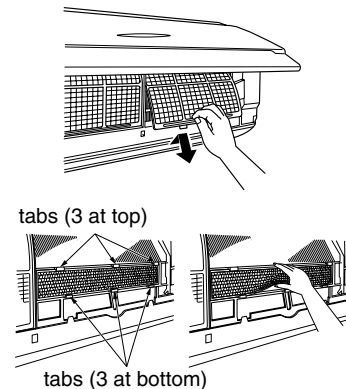

4. Clean or replace each filter.

See figure.

5. Set the air filter and the air-purifying filter with photocatalytic deodorizing function as they were and close the front panel.

- Press the front panel at both sides and the center.

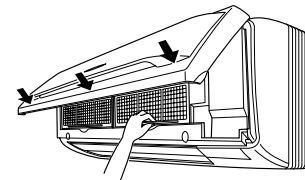

■ Air Filter

1. Wash the air filters with water or clean them with vacuum cleaner.

- If the dust does not come off easily, wash them with neutral detergent thinned with lukewarm water, then dry them up in the shade.
- It is recommended to clean the air filters every two weeks.

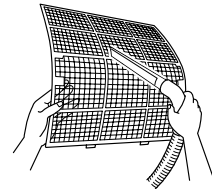

■ Air-purifying filter with photocatalytic deodorizing function (gray)

The Air-purifying filter with photocatalytic deodorizing function can be renewed by washing it with water once every 6 months. We recommend replacing it once every 3 years.

[Maintenance]

1. Remove dust with a vacuum cleaner and wash lightly with water.
2. If it is very dirty, soak it for 10 to 15 minutes in water mixed with a neutral cleaning agent.
3. After washing, shake off remaining water and dry in the shade.
4. Since the material is made out of paper, do not wring out the filter when removing water from it.

[Replacement]

1. Remove the tabs on the filter frame and replace with a new filter.
 - Dispose of the old filter as flammable waste.

Check

Check that the base, stand and other fittings of the outdoor unit are not decayed or corroded. Check the units to ensure they are level and secure.
Check that nothing blocks the air inlets and the outlets of the indoor unit and the outdoor unit.
Check that the water drains smoothly out of the drain hose during COOL or DRY operation. <ul style="list-style-type: none"> • If no drain water is seen, water may be leaking from the indoor unit. Stop operation and consult your authorized dealer.

■ Before a long idle period

- 1. Operate the “FAN only” for several hours on a warm day to dry out the inside.**
 - Press “MODE selector button” and select “FAN” operation.
 - Press “ON/OFF button” and start operation.
- 2. After operation stops, turn off the electrical circuit breaker for the room air conditioner.**
- 3. Remove and clean the air filters. Reinstall filters after cleaning.**
- 4. Take out batteries from the remote controller.**

NOTE

- Operation with dirty filters:
 - (1) cannot deodorize the air.
 - (2) cannot clean the air.
 - (3) results in poor heating or cooling.
 - (4) may cause odor.
- To order air-purifying filter with photocatalytic deodorizing function, contact your authorized dealer where you bought the air conditioner.
- Dispose of old filters as required by local codes.

Item	Part No.
Air-purifying filter with photocatalytic deodorizing function. (without frame) 1 set	KAF952A42

2.3.11 Troubleshooting

Trouble Shooting

Conditions that appear to be abnormal but are not operational problems.

The following cases are not abnormal problems and you may just continue using it.

Case	Explanation
Operation does not start quickly. <ul style="list-style-type: none"> • When ON/OFF button was pressed soon after operation was stopped. • When the mode was reselected. 	<ul style="list-style-type: none"> • This is to protect the air conditioner. You should wait for about 3 minutes.
Hot air does not flow out soon after the start of heating operation.	<ul style="list-style-type: none"> • The air conditioner is warming up. You should wait for 1 to 4 minutes. (The system is designed to start discharging air only after it has reached a certain temperature.)
The heating operation stops suddenly and a flowing sound is heard.	<ul style="list-style-type: none"> • The system is taking away the frost on the outdoor unit. You should wait for about 3 to 8 minutes.
The outdoor unit emits water or steam.	<ul style="list-style-type: none"> ■ In HEAT mode <ul style="list-style-type: none"> • The frost on the outdoor unit melts into water or steam when the air conditioner is in defrost operation. ■ In COOL or DRY mode <ul style="list-style-type: none"> • Moisture in the air condenses into water on the cool surface of outdoor unit piping and drips.
Mists come out of the indoor unit.	<ul style="list-style-type: none"> ■ This happens when the air in the room is cooled into mist by the cold airflow during cooling operation.
The indoor unit gives out odor.	<ul style="list-style-type: none"> ■ This happens when smells of the room, furniture, or cigarettes are absorbed into the unit and discharged with the airflow. (If this happens, we recommend you to have the indoor unit washed by a technician. Consult your authorized dealer where you bought the air conditioner.)
The outdoor fan rotates while the air conditioner is not in operation.	<ul style="list-style-type: none"> ■ After operation is stopped: <ul style="list-style-type: none"> • The outdoor fan continues rotating for another 60 seconds for system protection. ■ While the air conditioner is not in operation: <ul style="list-style-type: none"> • When the outdoor temperature is very high, the outdoor fan starts rotating for system protection.
The operation stopped suddenly. (OPERATION lamp is on.)	<ul style="list-style-type: none"> ■ For system protection, the air conditioner may stop operating on a sudden large voltage fluctuation. It automatically resumes operation in about 3 minutes.

Check again.

Please check again before calling a repair person.

Case	Check
The air conditioner does not operate. (OPERATION lamp is off.)	<ul style="list-style-type: none"> • Has a breaker been turned OFF or a fuse blown? • Is there a power failure? • Are fresh batteries installed in the remote controller? • Is the timer setting correct?
Cooling (Heating) effect is poor.	<ul style="list-style-type: none"> • Are the air filters clean? • Is anything blocking the air inlet or the outlet of the indoor and the outdoor units? • Is the temperature setting appropriate? • Are the windows and doors closed? • Are the airflow rate and the air direction set appropriately?
Operation stops suddenly. (OPERATION lamp flashes.)	<ul style="list-style-type: none"> • Are the air filters clean? • Is there anything blocking the air inlet or the outlet of the indoor and the outdoor units? <p>Turn the electrical breaker off, clean the air filters or remove obstacles away from inlet and outlet. Then turn the breaker ON again and try operating the air conditioner with the remote controller. If the lamp still blinks, call your authorized dealer where you bought the air conditioner.</p>
An abnormal functioning happens during operation.	<ul style="list-style-type: none"> • The air conditioner may malfunction with lightning or radio waves. Turn the circuit breaker OFF, to reset unit. Then turn it ON again and try operating the air conditioner with the remote controller.

Call your authorized dealer immediately.

 **WARNING**

- When an abnormality (such as a burning smell) occurs, stop operation and turn the circuit breaker OFF. Continued operation in an abnormal condition may result in troubles, electric shocks or fire. Consult your authorized dealer where you bought the air conditioner.
- Do not attempt to repair or modify the air conditioner by yourself. Work performed by untrained persons could result in electric shocks, personal injury, fire, or additional damage to equipment. Consult your authorized dealer where you bought the air conditioner.

If one of the following symptoms takes place, call your authorized dealer immediately.

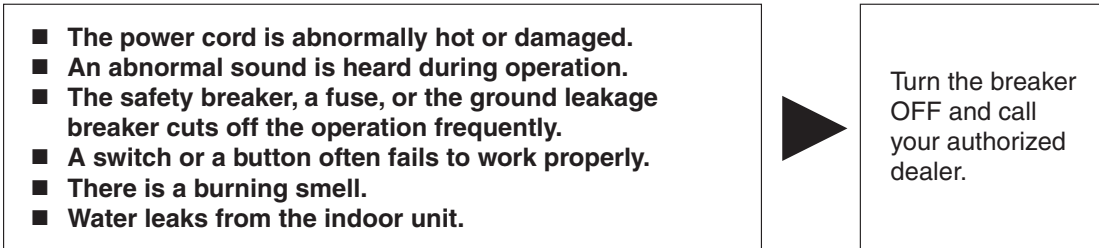

<ul style="list-style-type: none"> ■ After a power failure The air conditioner automatically resumes operation in about 3 minutes. You should just wait for a while. 	<ul style="list-style-type: none"> ■ Lightning If lightning may strike the neighboring area, stop operation and turn the breaker OFF for system protection.
--	---

Disposal requirements

Dismantling of the unit, treatment of the refrigerant, oil and eventual other parts, should be done in accordance with the relevant local and national regulations. Contact your authorized dealer for assistance.

We recommend periodical maintenance.

In certain operating conditions, the inside of the air conditioner may get foul after several seasons of use, resulting in poor performance. It is recommended to have periodical maintenance by a specialist aside from regular cleaning by the user. For specialist maintenance, contact your authorized dealer where you bought the air conditioner.

The maintenance cost must be born by the user.

Fault diagnosis.

FAULT DIAGNOSIS BY REMOTE CONTROLLER

In the ARC433A series, the temperature display sections on the main unit indicate corresponding codes.

1. When the **TIMER CANCEL** button is held down for 5 seconds, a “00” indication flashes on the temperature display section.

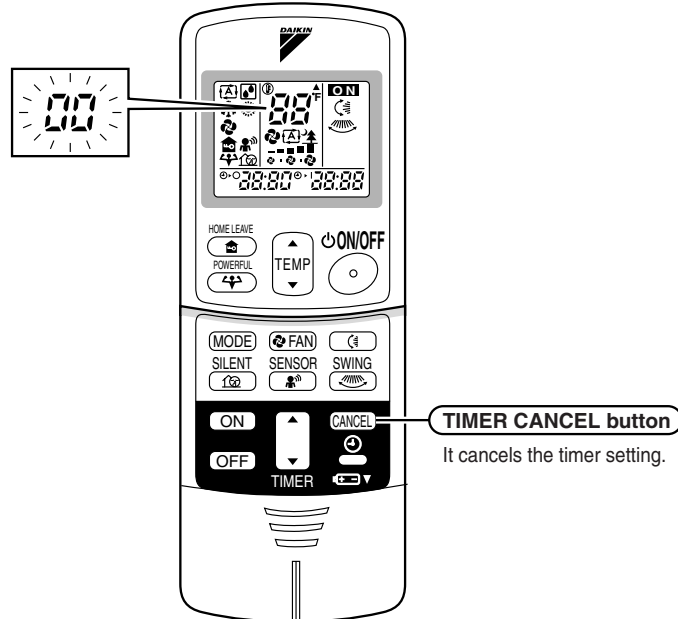

2. Press the **TIMER CANCEL** button repeatedly until a continuous beep is produced.

- The code indication changes as shown below, and notifies with a long beep.

	CODE	MEANING
SYSTEM	00	NORMAL
	U0	REFRIGERANT SHORTAGE
	U2	DROP VOLTAGE OR MAIN CIRCUIT OVERVOLTAGE
	U4	FAILURE OF TRANSMISSION (BETWEEN INDOOR UNIT AND OUTDOOR UNIT)
INDOOR UNIT	A1	INDOOR PCB DEFECTIVENESS
	A5	HIGH PRESSURE CONTROL OR FREEZE-UP PROTECTOR
	A6	FAN MOTOR FAULT
	C4	FAULTY HEAT EXCHANGER TEMPERATURE SENSOR
	C9	FAULTY SUCTION AIR TEMPERATURE SENSOR
OUTDOOR UNIT	EA	COOLING-HEATING SWITCHING ERROR
	E5	OL STARTED
	E6	FAULTY COMPRESSOR START UP
	E7	DC FAN MOTOR FAULT
	E8	OPERATION HALT DUE TO DETECTION OF INPUT OVER CURRENT
	F3	HIGH TEMPERATURE DISCHARGE PIPE CONTROL
	H6	OPERATION HALT DUE TO FAULTY POSITION DETECTION SENSOR
	H8	CT ABNORMALITY
	H9	FAULTY SUCTION AIR TEMPERATURE SENSOR
	J3	FAULTY DISCHARGE PIPE TEMPERATURE SENSOR
	J6	FAULTY HEAT EXCHANGER TEMPERATURE SENSOR
	L4	HIGH TEMPERATURE AT INVERTER CIRCUIT HEATSINK
	L5	OUTPUT OVERCURRENT
P4	FAULTY INVERTER CIRCUIT HEATSINK TEMPERATURE SENSOR	

NOTE

1. A short beep and two consecutive beeps indicate non-corresponding codes.
2. To cancel the code display, hold the **TIMER CANCEL** button down for 5 seconds. The code display also cancel itself if the button is not pressed for 1 minute.

2.4 The Slim Duct Built-in System FDXS09/12DVJU

2.4.1 Names of Parts

Names of parts

■ Indoor Unit

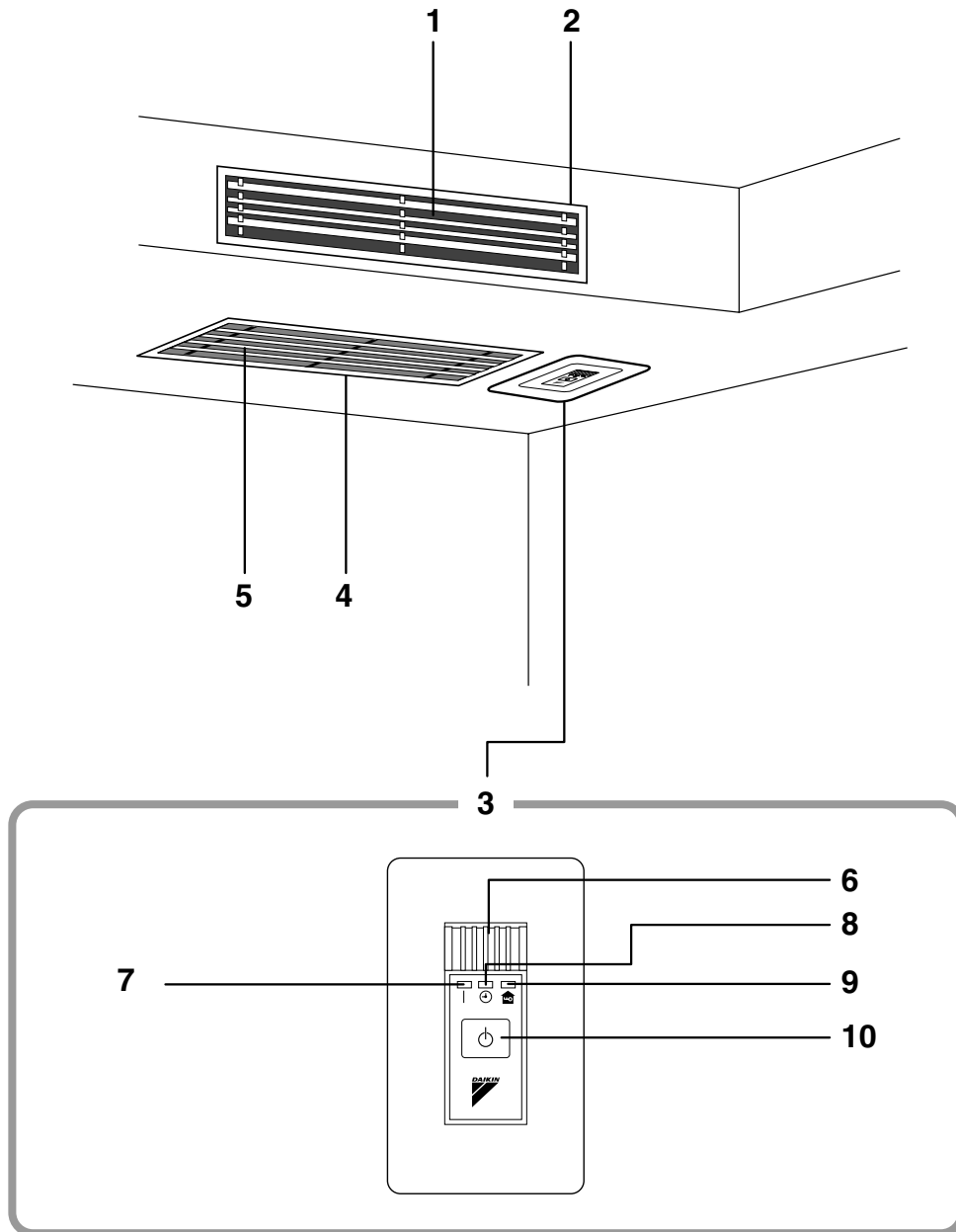

■ Outdoor Unit

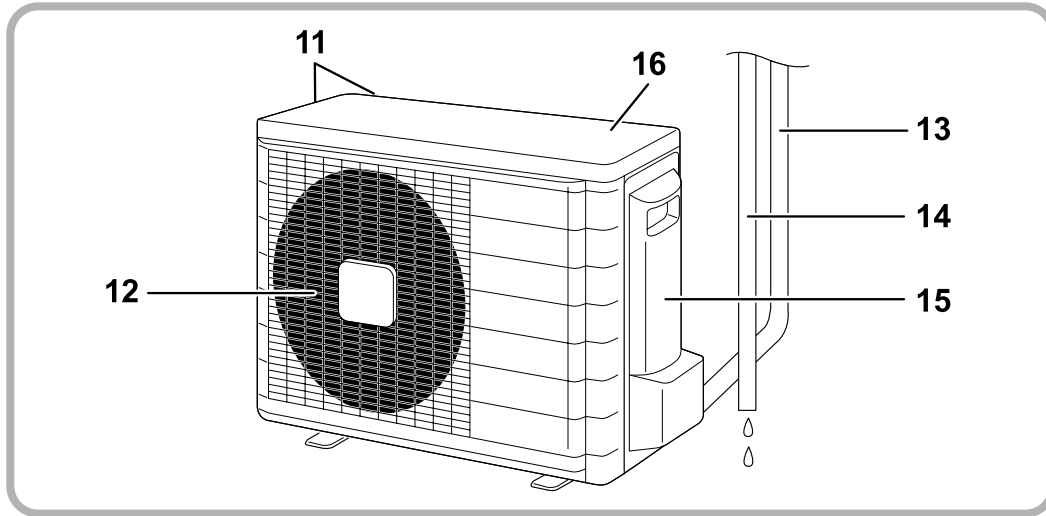

■ Indoor Unit

- 1. Air outlet
- 2. Air outlet grille: (Field supply)
 - Appearance of the Air outlet grille and Air inlet grille may differ with some models.
- 3. Receiver
- 4. Suction grille: (Option)
 - Appearance of the suction grille and Air inlet grille may differ with some models.
- 5. Air inlet
- 6. Room temperature sensor:
 - It senses the air temperature around the unit.
- 7. Operation lamp (green)

- 8. **TIMER lamp (yellow):** (page 16.)
- 9. **HOME LEAVE lamp (red):**
 - Lights up when you use HOME LEAVE operation. (page 14.)
- 10. **Indoor Unit ON/OFF switch:**
 - Push this switch once to start operation. Push once again to stop it.
 - This switch is useful when the remote controller is missing.
 - **The operation mode refers to the following table.**

Mode	Temperature setting	Air flow rate
AUTO	77°F	AUTO

■ Outdoor Unit

- 11. Air inlet: (Back and side)
- 12. Air outlet
- 13. Refrigerant piping and inter-unit cable
- 14. Drain hose
- 15. **Earth grounding terminal:**
 - It is inside of this cover.
- 16. **Outside air temperature sensor:**
 - It senses the ambient temperature around the unit.

Appearance of the outdoor unit may differ from some models.

■ Remote Controller

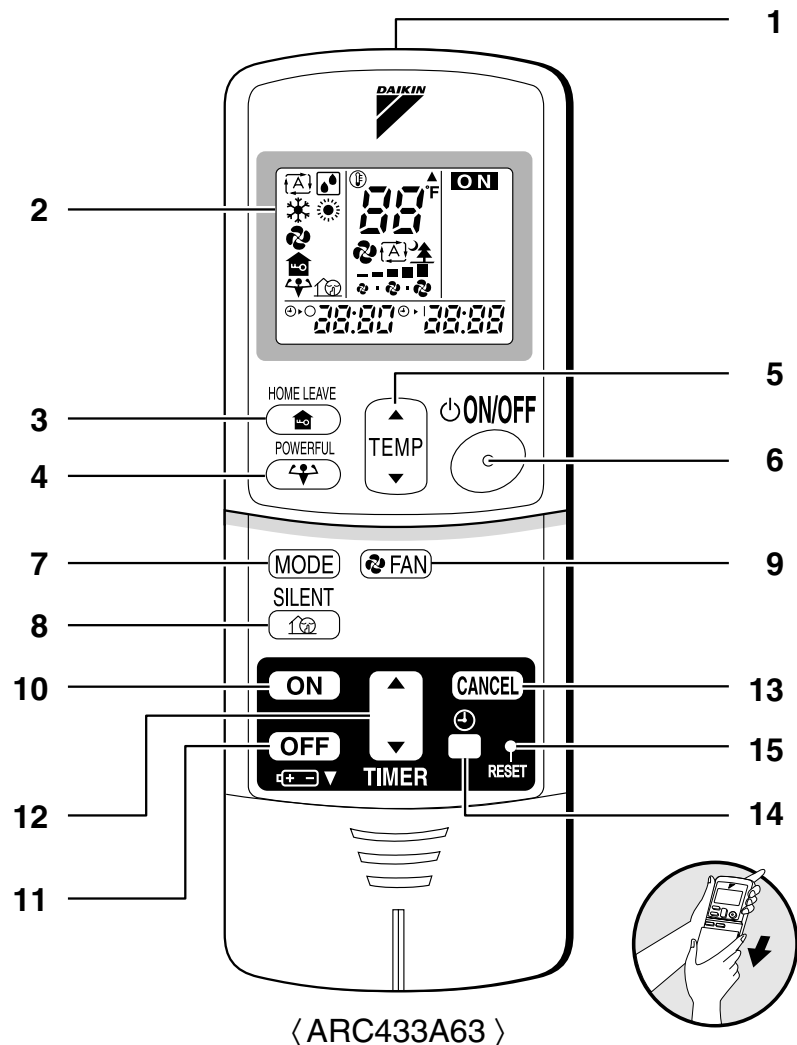

1. Signal transmitter:

- It sends signals to the indoor unit.

2. Display:

- It displays the current settings.
(In this illustration, each section is shown with all its displays ON for the purpose of explanation.)

3. HOME LEAVE button:

- HOME LEAVE operation (page 14.)

4. POWERFUL button:

- POWERFUL operation (page 12.)

5. TEMPERATURE adjustment buttons:

- It changes the temperature setting.

6. ON/OFF button:

- Press this button once to start operation.
Press once again to stop it.

7. MODE selector button:

- It selects the operation mode.
(AUTO/DRY/COOL/HEAT/FAN) (page 10.)

8. SILENT button: OUTDOOR UNIT SILENT operation (page 13.)

9. FAN setting button:

- It selects the air flow rate setting.

10. ON TIMER button: (page 17.)

11. OFF TIMER button: (page 16.)

12. TIMER Setting button:

- It changes the time setting.

13. TIMER CANCEL button:

- It cancels the timer setting.

14. CLOCK button: (page 9.)

15. RESET button:

- Restart the unit if it freezes.
• Use a thin object to push.

2.4.2 Preparation before Operation

Preparation Before Operation

■ To set the batteries

1. Slide the front cover to take it off.
2. Set two dry batteries (AAA).
3. Set the front cover as before.

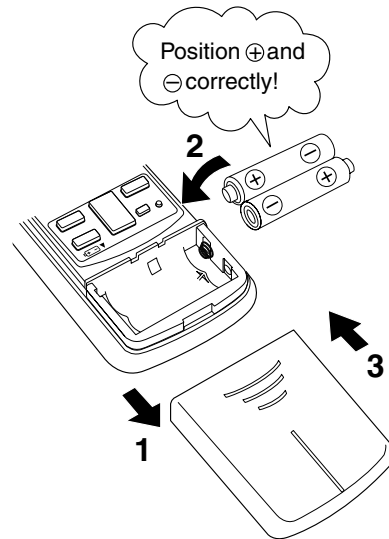

ATTENTION

■ About batteries

- When replacing the batteries, use batteries of the same type, and replace the two old batteries together.
- When the system is not used for a long time, take the batteries out.
- We recommend replacing once a year, although if the remote controller display begins to fade or if reception deteriorates, please replace with new alkali batteries. Do not use manganese batteries.
- The attached batteries are provided for the initial use of the system. The usable period of the batteries may be short depending on the manufactured date of the air conditioner.

Preparation Before Operation

■ To operate the remote controller

- To use the remote controller, aim the transmitter at the indoor unit. If there is anything to block signals between the unit and the remote controller, such as a curtain, the unit will not operate.
- Do not drop the remote controller. Do not get it wet.
- The maximum distance for communication is about 13ft.

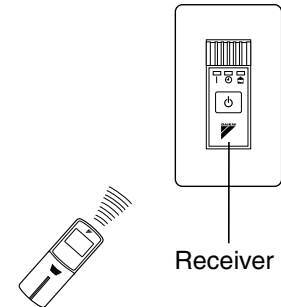

■ To fix the remote controller holder on the wall

1. Choose a place from where the signals reach the unit.
2. Fix the holder to a wall, a pillar, etc. with the screws supplied with the holder.
3. Place the remote controller in the remote controller holder.

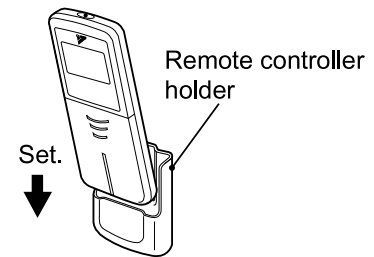

- To remove, pull it upwards.

ATTENTION

■ About remote controller

- Never expose the remote controller to direct sunlight.
- Dust on the signal transmitter or receiver will reduce the sensitivity. Wipe off dust with soft cloth.
- Signal communication may be disabled if an electronic-starter-type fluorescent lamp (such as inverter-type lamps) is in the room. Consult the shop if that is the case.
- If the remote controller signals happen to operate another appliance, move that appliance to somewhere else, or consult the shop.

■ To set the clock

1. Press “CLOCK button”.

0:00 is displayed.

⌚ blinks.

2. Press “TIMER setting button” to set the clock to the present time.

Holding down “▲” or “▼” button rapidly increases or decreases the time display.

3. Press “CLOCK button”.

⌚ blinks.

■ Turn the breaker ON

- Turning ON the breaker opens the flap, then closes it again. (This is a normal procedure.)

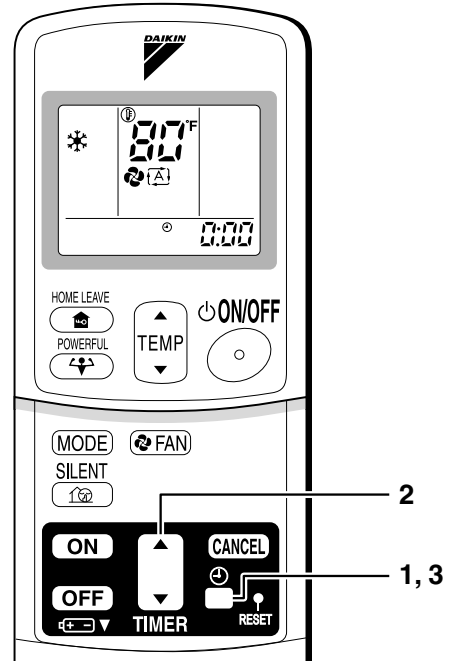

NOTE

■ Tips for saving energy

- Be careful not to cool (heat) the room too much. Keeping the temperature setting at a moderate level helps save energy.
- Cover windows with a blind or a curtain. Blocking sunlight and air from outdoors increases the cooling (heating) effect.
- Clogged air filters cause inefficient operation and waste energy. Clean them once every two weeks.

Recommended temperature setting
For cooling: 78°F – 82°F
For heating: 68°F – 75°F

■ Please note

- The air conditioner always consumes 15-35 watts of electricity even while it is not operating.
- If you are not going to use the air conditioner for a long period, for example in spring or autumn, turn the breaker OFF.
- Use the air conditioner in the following conditions.

Mode	Operating conditions	If operation is continued out of this range
COOL	Outdoor temperature: 14 to 115°F Indoor temperature: 64 to 90°F Indoor humidity: 80% max.	<ul style="list-style-type: none"> • A safety device may work to stop the operation. • Condensation may occur on the indoor unit and drip.
HEAT	Outdoor temperature: 5 to 64°F Indoor temperature: 50 to 86°F	<ul style="list-style-type: none"> • A safety device may work to stop the operation.
DRY	Outdoor temperature: 14 to 115°F Indoor temperature: 64 to 90°F Indoor humidity: 80% max.	<ul style="list-style-type: none"> • A safety device may work to stop the operation. • Condensation may occur on the indoor unit and drip.

- Operation outside this humidity or temperature range may cause a safety device to disable the system.

2.4.3 AUTO • DRY • COOL • HEAT • FAN Operation

AUTO • DRY • COOL • HEAT • FAN Operation

The air conditioner operates with the operation mode of your choice.
 From the next time on, the air conditioner will operate with the same operation mode.

■ To start operation

1. Press “MODE selector button” and select a operation mode.

- Each pressing of the button advances the mode setting in sequence.

- ☐A: AUTO
- ☐B: DRY
- ☐C: COOL
- ☐D: HEAT
- ☐E: FAN

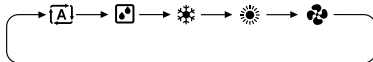

2. Press “ON/OFF button”.

- The OPERATION lamp lights up.

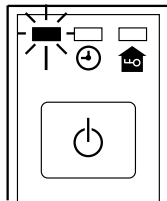

■ To stop operation

3. Press “ON/OFF button” again.

- Then OPERATION lamp goes off.

■ To change the temperature setting



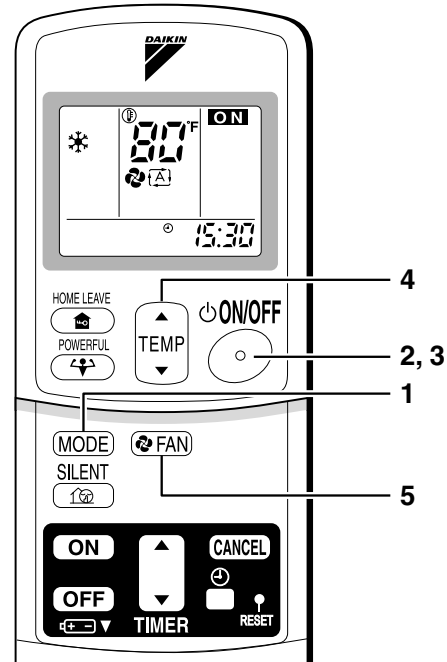

4. Press “TEMPERATURE adjustment button”.

DRY or FAN mode	AUTO or COOL or HEAT mode
The temperature setting is not variable.	Press “▲” to raise the temperature and press “▼” to lower the temperature.
	Set to the temperature you like.



■ To change the air flow rate setting

5. Press “FAN setting button”.

DRY mode	AUTO or COOL or HEAT or FAN mode
The air flow rate setting is not variable.	Five levels of air flow rate setting from “  ” to “  ” plus “  ” “  ” are available. 

- Indoor unit quiet operation
When the air flow is set to “”, the noise from the indoor unit will become quieter. Use this when making the indoor unit quieter.
The unit might lose capacity when the fan strength is set to a weak level.

NOTE

■ Note on HEAT operation

- Since this air conditioner heats the room by taking heat from outdoor air to indoors, the heating capacity becomes smaller in lower outdoor temperatures. If the heating effect is insufficient, it is recommended to use another heating appliance in combination with the air conditioner.
- The heat pump system heats the room by circulating hot air around all parts of the room. After the start of heating operation, it takes some time before the room gets warmer.
- In heating operation, frost may occur on the outdoor unit and lower the heating capacity. In that case, the system switches into defrosting operation to take away the frost.
- During defrosting operation, hot air does not flow out of indoor unit.

■ Note on COOL operation

- This air conditioner cools the room by blowing the hot air in the room outside, so if the outside temperature is high, performance drops.

■ Note on DRY operation

- The computer chip works to rid the room of humidity while maintaining the temperature as much as possible. It automatically controls temperature and fan strength, so manual adjustment of these functions is unavailable.

■ Note on AUTO operation

- In AUTO operation, the system selects a temperature setting and an appropriate operation mode (COOL or HEAT) based on the room temperature at the start of the operation.
- The system automatically reselects setting at a regular interval to bring the room temperature to user-setting level.
- If you do not like AUTO operation, you can manually select the operation mode and setting you like.

■ Note on air flow rate setting

- At smaller air flow rates, the cooling (heating) effect is also smaller.

2.4.4 POWERFUL Operation

POWERFUL Operation

POWERFUL operation quickly maximizes the cooling (heating) effect in any operation mode. You can get the maximum capacity.

■ To start POWERFUL operation

1. Press “POWERFUL button”.

- POWERFUL operation ends in 20 minutes. Then the system automatically operates again with the settings which were used before POWERFUL operation.
- When using POWERFUL operation, there are some functions which are not available.
- “” is displayed on the LCD.

■ To cancel POWERFUL operation

2. Press “POWERFUL button” again.

- “” disappears from the LCD.

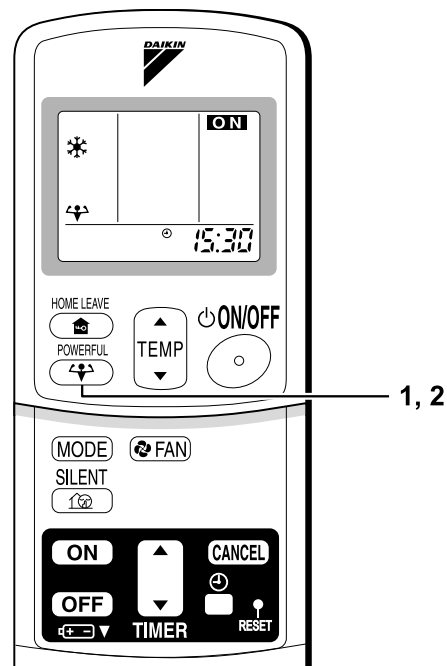

NOTE

■ Notes on POWERFUL operation

- POWERFUL Operation cannot be used together with SILENT Operation. Priority is given to the function of whichever button is pressed last.
- POWERFUL Operation can only be set when the unit is running. Pressing the operation stop button causes the settings to be canceled, and the “” disappears from the LCD.
- **In COOL and HEAT mode**
To maximize the cooling (heating) effect, the capacity of outdoor unit must be increased and the air flow rate be fixed to the maximum setting.
The temperature and air flow settings are not variable.
- **In DRY mode**
The temperature setting is lowered by 4.5°F and the air flow rate is slightly increased.
- **In FAN mode**
The air flow rate is fixed to the maximum setting.

2.4.5 OUTDOOR UNIT SILENT Operation

OUTDOOR UNIT SILENT Operation

OUTDOOR UNIT SILENT operation lowers the noise level of the outdoor unit by changing the frequency and fan speed on the outdoor unit. This function is convenient during night.

■ To start OUTDOOR UNIT SILENT operation

1. Press "SILENT button".
 - "🔇" is displayed on the LCD.

■ To cancel OUTDOOR UNIT SILENT operation

2. Press "SILENT button" again.
 - "🔇" disappears from the LCD.

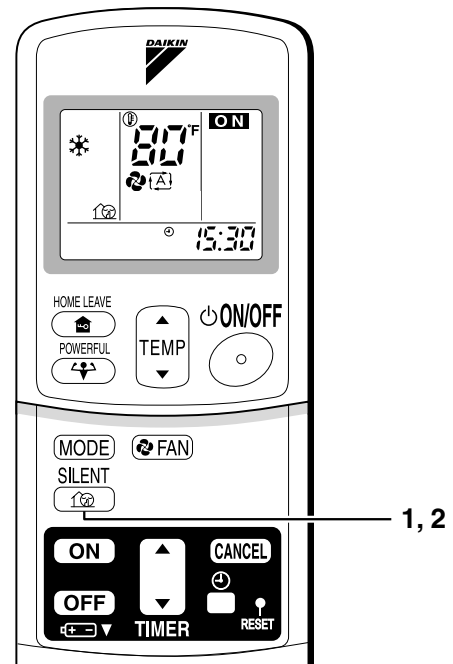

NOTE

■ Note on OUTDOOR UNIT SILENT operation

- This function is available in COOL, HEAT, and AUTO modes. (This is not available in FAN and DRY modes.)
- POWERFUL operation and OUTDOOR UNIT SILENT operation cannot be used at the same time. Priority is given to the function of whichever button is pressed last.
- If operation is stopped using the remote controller or the main unit ON/OFF switch when using OUTDOOR UNIT SILENT operation, "🔇" will remain on the remote controller display.

2.4.6 HOME LEAVE Operation

HOME LEAVE Operation

HOME LEAVE operation is a function which allows you to record your preferred temperature and air flow rate settings.

■ To start HOME LEAVE operation

1. Press “HOME LEAVE button”.

- “” is displayed on the LCD.
- The HOME LEAVE lamp lights up.

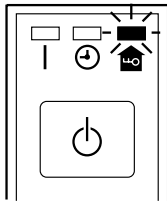

■ To cancel HOME LEAVE operation

2. Press “HOME LEAVE button” again.

- “” disappears from the LCD.
- The HOME LEAVE lamp goes off.

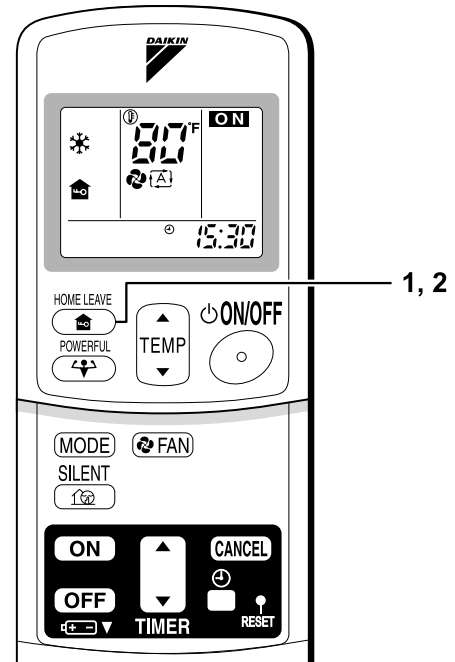

Before using HOME LEAVE operation.

■ To set the temperature and air flow rate for HOME LEAVE operation

When using HOME LEAVE operation for the first time, please set the temperature and air flow rate for HOME LEAVE operation. Record your preferred temperature and air flow rate.

	Initial setting		Selectable range	
	Temperature	Air flow rate	Temperature	Air flow rate
Cooling	77°F	AUTO	64-90°F	5 step, AUTO and SILENT
Heating	77°F	AUTO	50-86°F	5 step, AUTO and SILENT

1. Press “HOME LEAVE button”. Make sure “” is displayed in the remote controller display.
2. Adjust the set temperature with “▲” or “▼” as you like.
3. Adjust the air flow rate with “FAN” setting button as you like.

Home leave operation will run with these settings the next time you use the unit. To change the recorded information, repeat steps 1 – 3.

■ What's the HOME LEAVE operation?

Is there a set temperature and air flow rate which is most comfortable, a set temperature and air flow rate which you use the most? HOME LEAVE operation is a function that allows you to record your favorite set temperature and air flow rate. You can start your favorite operation mode simply by pressing the HOME LEAVE button on the remote controller. This function is convenient in the following situations.

■ Useful in these cases

1. Use as an energy-saving mode.

Set the temperature 4-5°F higher (cooling) or lower (heating) than normal. Setting the fan strength to the lowest setting allows the unit to be used in energy-saving mode. Also convenient for use while you are out or sleeping.

• Every day before you leave the house...

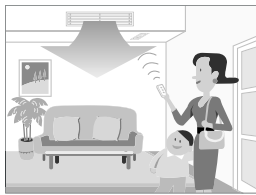

When you go out, push the "HOME LEAVE Operation" button, and the air conditioner will adjust capacity to reach the preset temperature for HOME LEAVE Operation.

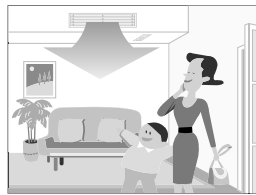

When you return, you will be welcomed by a comfortably air conditioned room.

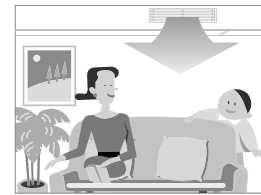

Push the "HOME LEAVE Operation" button again, and the air conditioner will adjust capacity to the set temperature for normal operation.

• Before bed...

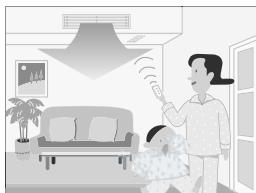

Set the unit to HOME LEAVE Operation before leaving the living room when going to bed.



The unit will maintain the temperature in the room at a comfortable level while you sleep.



When you enter the living room in the morning, the temperature will be just right. Disengaging HOME LEAVE Operation will return the temperature to that set for normal operation. Even the coldest winters will pose no problem!

2. Use as a favorite mode.

Once you record the temperature and air flow rate settings you most often use, you can retrieve them by pressing HOME LEAVE button. You do not have to go through troublesome remote controller operations.

NOTE

- Once the temperature and air flow rate for HOME LEAVE operation are set, those settings will be used whenever HOME LEAVE operation is used in the future. To change these settings, please refer to the "Before using HOME LEAVE operation" section above.
- HOME LEAVE operation is only available in COOL and HEAT mode. Cannot be used in AUTO, DRY, and FAN mode.
- HOME LEAVE operation runs in accordance with the previous operation mode (COOL or HEAT) before using HOME LEAVE operation.
- HOME LEAVE operation and POWERFUL operation cannot be used at the same time. Last button that was pressed has priority.
- The operation mode cannot be changed while HOME LEAVE operation is being used.
- When operation is shut off during HOME LEAVE operation, using the remote controller or the indoor unit ON/OFF switch, "HOME LEAVE" will remain on the remote controller display.

2.4.7 TIMER Operation

TIMER Operation

Timer functions are useful for automatically switching the air conditioner on or off at night or in the morning. You can also use OFF TIMER and ON TIMER in combination.

■ To use OFF TIMER operation

- Check that the clock is correct. If not, set the clock to the present time. (page 9.)

1. Press “OFF TIMER button”.

0:00 is displayed.

⊖-○ blinks.

2. Press “TIMER Setting button” until the time setting reaches the point you like.

- Every pressing of either button increases or decreases the time setting by 10 minutes. Holding down either button changes the setting rapidly.

3. Press “OFF TIMER button” again.

- The TIMER lamp lights up.

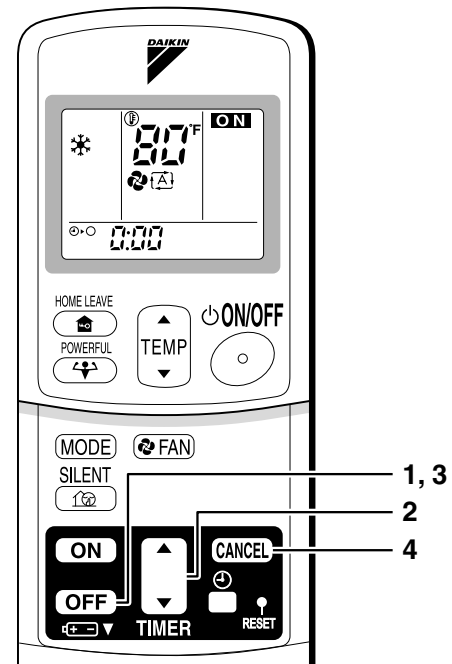
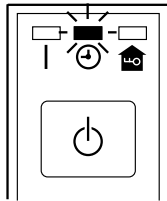

■ To cancel the OFF TIMER operation

4. Press “CANCEL button”.

- The TIMER lamp goes off.

NOTE

- When TIMER is set, the present time is not displayed.
- Once you set ON, OFF TIMER, the time setting is kept in the memory. (The memory is canceled when remote controller batteries are replaced.)
- When operating the unit via the ON/OFF Timer, the actual length of operation may vary from the time entered by the user. (Maximum approx. 10 minutes)

■ NIGHT SET MODE

When the OFF TIMER is set, the air conditioner automatically adjusts the temperature setting (1°F up in COOL, 4°F down in HEAT) to prevent excessive cooling (heating) for your pleasant sleep.

■ **To use ON TIMER operation**

- Check that the clock is correct. If not, set the clock to the present time. (page 9.)

1. Press “ON TIMER button”.

5:00 is displayed.

⊙·| blinks.

2. Press “TIMER Setting button” until the time setting reaches the point you like.

- Every pressing of either button increases or decreases the time setting by 10 minutes. Holding down either button changes the setting rapidly.

3. Press “ON TIMER button” again.

- The TIMER lamp lights up.

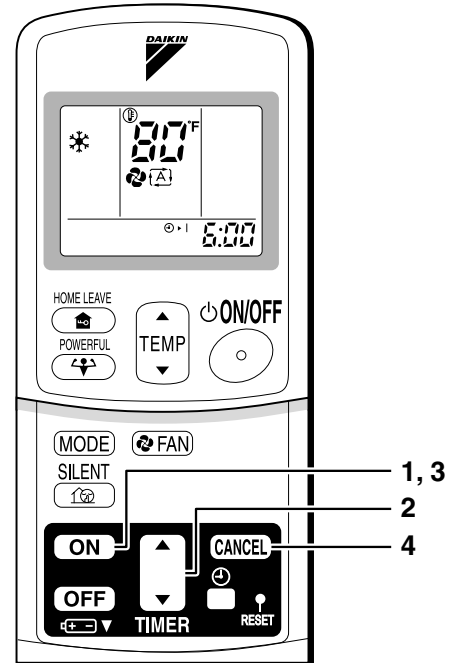
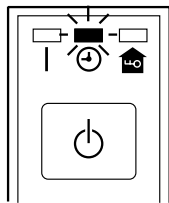

■ **To cancel ON TIMER operation**

4. Press “CANCEL button”.

- The TIMER lamp goes off.

■ **To combine ON TIMER and OFF TIMER**

- A sample setting for combining the two timers is shown below.

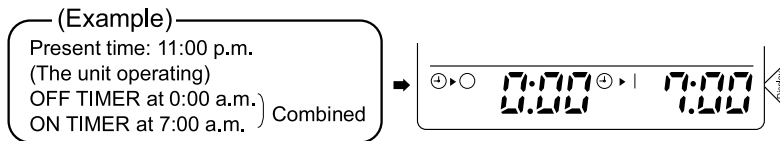

ATTENTION

■ **In the following cases, set the timer again.**

- After a breaker has turned OFF.
- After a power failure.
- After replacing batteries in the remote controller.

2.4.8 Care and Cleaning

Care and Cleaning

- ⚠ CAUTION**
- Only a qualified service person is allowed to perform maintenance.
 - Before cleaning, be sure to stop the operation and turn the breaker OFF.

■ Cleaning the air filter

1. Removing the air filter.

- Rear suction
Pull the bottom side of the air filter backwards, over the 2 bends.
- Bottom suction
Pull the filter over the 2 bends situated at the backside of the unit.

2. Cleaning the air filter.

Remove dust from the air filter using a vacuum cleaner and gently rinse them in cool water. Do not use detergent or hot water to avoid filter shrinking or deformation. After cleaning dry them in the shade.

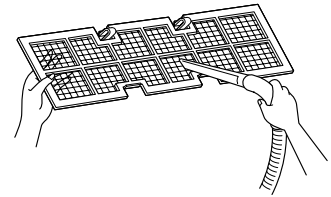

3. Replacing the air filter.

- Rear suction
Hook the filter behind the flap situated at the top of the unit and push the other side gently over the 2 bends.
- Bottom suction
Hook the filter behind the flap situated at the middle of the unit and push the other side gently over the 2 bends.

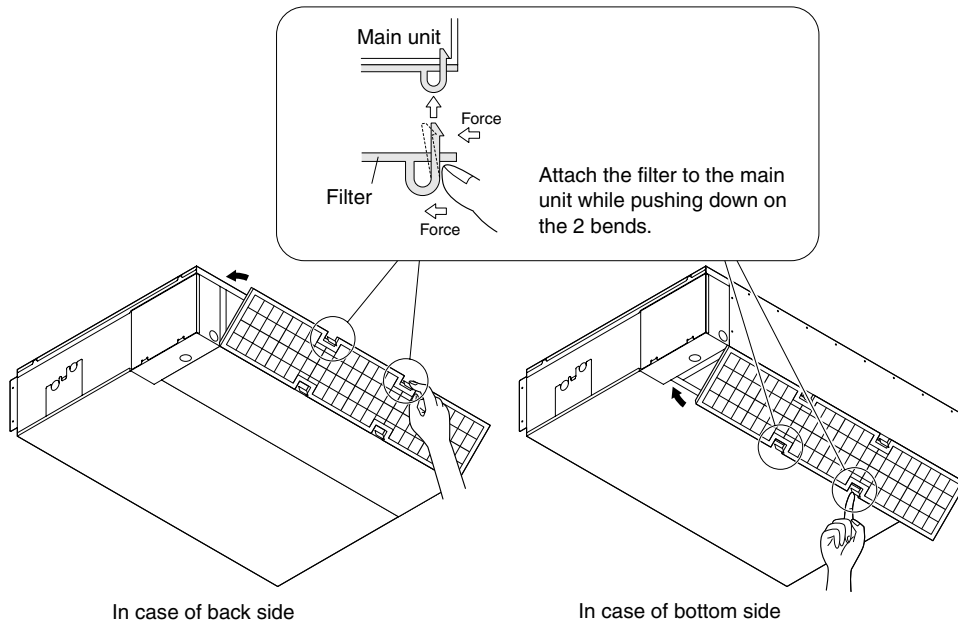

■ Cleaning the drain pan

- Clean the drain pan periodically, or drain piping may be clogged with dust and may result in water leakage. Ask your DAIKIN dealer to clean them.
- Prepare a cover locally to prevent any dust in the air around the indoor unit from getting in the drain pan, if there is a great deal of dust present.

CAUTION

- Do not operate the air conditioner without filters, this to avoid dust accumulation inside the unit.
- Do not remove the air filter except when cleaning. Unnecessary handling may damage the filter.
- Do not use gasoline, benzene, thinner, polishing powder, liquid insecticide. It may cause discoloring or warping.
- Do not let the indoor unit get wet. It may cause an electric shock or a fire.
- Operation with dusty air filters lowers the cooling and heating capacity and wastes energy.
- The suction grille is option.
- Do not use water or air of 122°F or higher for cleaning air filters and outside panels.
- Ask your DAIKIN dealer how to clean it.

Check

Check that the base, stand and other fittings of the outdoor unit are not decayed or corroded.
Check that nothing blocks the air inlets and the outlets of the indoor unit and the outdoor unit.
Check that the drain comes smoothly out of the drain hose during COOL or DRY operation.
<ul style="list-style-type: none"> • If no drain water is seen, water may be leaking from the indoor unit. Stop operation and consult the service shop if this is the case.

■ Before a long idle period

- 1. Operate the “FAN only” for several hours on a fine day to dry out the inside.**
 - Press “MODE selector button” and select “FAN” operation.
 - Press “ON/OFF button” and start operation.
- 2. Clean the air filters and set them again.**
- 3. Take out batteries from the remote controller.**
- 4. Turn OFF the breaker for the room air conditioner.**

2.4.9 Troubleshooting

Trouble Shooting

These cases are not troubles.

The following cases are not air conditioner troubles but have some reasons. You may just continue using it.

Case	Explanation
Operation does not start soon. <ul style="list-style-type: none"> When ON/OFF button was pressed soon after operation was stopped. When the mode was reselected. 	<ul style="list-style-type: none"> This is to protect the air conditioner. You should wait for about 3 minutes.
Hot air does not flow out soon after the start of heating operation.	<ul style="list-style-type: none"> The air conditioner is warming up. You should wait for 1 to 4 minutes. (The system is designed to start discharging air only after it has reached a certain temperature.)
The heating operation stops suddenly and a flowing sound is heard.	<ul style="list-style-type: none"> The system is taking away the frost on the outdoor unit. You should wait for about 3 to 8 minutes.
The outdoor unit emits water or steam.	<ul style="list-style-type: none"> In HEAT mode <ul style="list-style-type: none"> The frost on the outdoor unit melts into water or steam when the air conditioner is in defrost operation. In COOL or DRY mode <ul style="list-style-type: none"> Moisture in the air condenses into water on the cool surface of outdoor unit piping and drips.
Mist comes out of the indoor unit.	<ul style="list-style-type: none"> This happens when the air in the room is cooled into mist by the cold air flow during cooling operation.
The indoor unit gives out odour.	<ul style="list-style-type: none"> This happens when smells of the room, furniture, or cigarettes are absorbed into the unit and discharged with the air flow. (If this happens, we recommend you to have the indoor unit washed by a technician. Consult the service shop where you bought the air conditioner.)
The outdoor fan rotates while the air conditioner is not in operation.	<ul style="list-style-type: none"> After operation is stopped: <ul style="list-style-type: none"> The outdoor fan continues rotating for another 30 seconds for system protection. While the air conditioner is not in operation: <ul style="list-style-type: none"> When the outdoor temperature is very high, the outdoor fan starts rotating for system protection.
The operation stopped suddenly. (OPERATION lamp is on.)	<ul style="list-style-type: none"> For system protection, the air conditioner may stop operating on a sudden large voltage fluctuation. It automatically resumes operation in about 3 minutes.

Check again.

Please check again before calling a repair person.

Case	Check
The air conditioner does not operate. (OPERATION lamp is off.)	<ul style="list-style-type: none"> • Hasn't a breaker turned OFF or a fuse blown? • Isn't it a power failure? • Are batteries set in the remote controller? • Is the timer setting correct?
Cooling (Heating) effect is poor.	<ul style="list-style-type: none"> • Are the air filters clean? • Is there anything to block the air inlet or the outlet of the indoor and the outdoor units? • Is the temperature setting appropriate? • Are the windows and doors closed? • Are the air flow rate and the air direction set appropriately?
Operation stops suddenly. (OPERATION lamp blinks.)	<ul style="list-style-type: none"> • Are the air filters clean? <p>Is there anything to block the air inlet or the outlet of the indoor and the outdoor units?</p> <p>Clean the air filters or take all obstacles away and turn the breaker OFF. Then turn it ON again and try operating the air conditioner with the remote controller. If the lamp still blinks, call the service shop where you bought the air conditioner.</p>
An abnormal functioning happens during operation.	<ul style="list-style-type: none"> • The air conditioner may malfunction with lightning or radio waves. Turn the breaker OFF, turn it ON again and try operating the air conditioner with the remote controller.

Call the service shop immediately.**⚠ WARNING**

- When an abnormality (such as a burning smell) occurs, stop operation and turn the breaker OFF.
Continued operation in an abnormal condition may result in troubles, electric shocks or fire.
Consult the service shop where you bought the air conditioner.
- Do not attempt to repair or modify the air conditioner by yourself.
Incorrect work may result in electric shocks or fire.
Consult the service shop where you bought the air conditioner.

If one of the following symptoms takes place, call the service shop immediately.

- **The power cord is abnormally hot or damaged.**
- **An abnormal sound is heard during operation.**
- **The safety breaker, a fuse, or the earth leakage breaker cuts off the operation frequently.**
- **A switch or a button often fails to work properly.**
- **There is a burning smell.**
- **Water leaks from the indoor unit.**



Turn the breaker OFF and call the service shop.

<ul style="list-style-type: none"> ■ After a power failure 	<ul style="list-style-type: none"> ■ Lightning
<p>The air conditioner automatically resumes operation in about 3 minutes. You should just wait for a while.</p>	<p>If lightning may strike the neighbouring area, stop operation and turn the breaker OFF for system protection.</p>

Disposal requirements

Dismantling of the unit, treatment of the refrigerant, oil and eventual other parts, should be done in accordance with the relevant local and national regulations. Contact your authorized dealer for assistance.

We recommend periodical maintenance.

In certain operating conditions, the inside of the air conditioner may get foul after several seasons of use, resulting in poor performance. It is recommended to have periodical maintenance by a specialist aside from regular cleaning by the user. For specialist maintenance, contact the service shop where you bought the air conditioner.

The maintenance cost must be born by the user.

Fault diagnosis.

FAULT DIAGNOSIS BY REMOTE CONTROLLER

In the ARC433A series, the temperature display sections on the main unit indicate corresponding codes.

1. When the **TIMER CANCEL** button is held down for 5 seconds, a "00" indication flashes on the temperature display section.

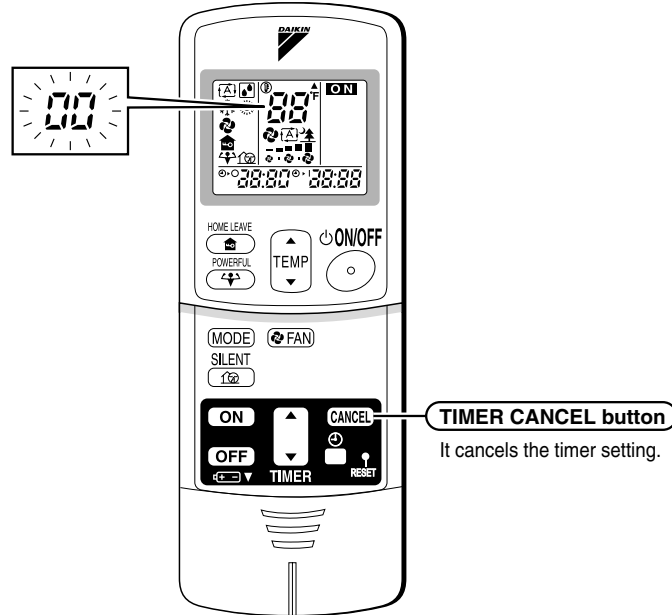

2. Press the **TIMER CANCEL** button repeatedly until a continuous beep is produced.

- The code indication changes in the sequence shown below, and notifies with along beep.

	CODE	MEANING
SYSTEM	00	NORMAL
	U0	REFRIGERANT SHORTAGE
	U2	DROP VOLTAGE OR MAIN CIRCUIT OVERVOLTAGE
	U4	FAILURE OF TRANSMISSION (BETWEEN INDOOR UNIT AND OUTDOOR UNIT)
INDOOR UNIT	A1	INDOOR PCB DEFECTIVENESS
	A5	HIGH PRESSURE CONTROL OR FREEZE-UP PROTECTOR
	A6	FAN MOTOR FAULT
	C4	FAULTY HEAT EXCHANGER TEMPERATURE SENSOR
OUTDOOR UNIT	C9	FAULTY SUCTION AIR TEMPERATURE SENSOR
	EA	COOLING-HEATING SWITCHING ERROR
	E5	OL STARTED
	E6	FAULTY COMPRESSOR START UP
	E7	DC FAN MOTOR FAULT
	E8	OPERATION HALT DUE TO DETECTION OF INPUT OVER CURRENT
	F3	HIGH TEMPERATURE DISCHARGE PIPE CONTROL
	F6	HIGH PRESSURE CONTROL (IN COOLING)
	H6	OPERATION HALT DUE TO FAULTY POSITION DETECTION SENSOR
	H8	CT ABNORMALITY
	H9	FAULTY SUCTION AIR TEMPERATURE SENSOR
	J3	FAULTY DISCHARGE PIPE TEMPERATURE SENSOR
	J6	FAULTY HEAT EXCHANGER TEMPERATURE SENSOR
	L4	HIGH TEMPERATURE AT INVERTER CIRCUIT HEATSINK
L5	OUTPUT OVERCURRENT	
P4	FAULTY INVERTER CIRCUIT HEATSINK TEMPERATURE SENSOR	

NOTE

1. A short beep and two consecutive beeps indicate non-corresponding codes.
2. To cancel the code display, hold the **TIMER CANCEL** button down for 5 seconds. The code display also cancel itself if the button is not pressed for 1 minute.

Part 6

Service Diagnosis

1. Caution for Diagnosis	142
2. Problem Symptoms and Measures	144
3. Service Check Function	145
4. Troubleshooting	148
4.1 Error Codes and Description	148
4.2 Indoor Unit PCB Abnormality	149
4.3 Freeze-up Protection Control or High Pressure Control.....	150
4.4 Fan Motor or Related Abnormality	152
4.5 Thermistor or Related Abnormality (Indoor Unit).....	155
4.6 Signal Transmission Error (between Indoor and Outdoor Unit)	156
4.7 OL Activation (Compressor Overload)	157
4.8 Compressor Lock	158
4.9 DC Fan Lock	160
4.10 Input Over Current Detection	161
4.11 Four Way Valve Abnormality.....	164
4.12 Discharge Pipe Temperature Control.....	168
4.13 High Pressure Control in Cooling	170
4.14 Position Sensor Abnormality	174
4.15 DC Voltage / Current Sensor Abnormality.....	176
4.16 CT or Related Abnormality	177
4.17 Thermistor or Related Abnormality (Outdoor Unit).....	179
4.18 Electrical Box Temperature Rise	181
4.19 Radiation Fin Temperature Rise	183
4.20 Output Over Current Detection.....	185
4.21 Insufficient Gas.....	189
4.22 Over-voltage Detection.....	193
4.23 Low-voltage Detection.....	194
5. Check	195
5.1 How to Check	195

1. Caution for Diagnosis

The operation lamp flashes when any of the following errors is detected.

1. When a protection device of the indoor or outdoor unit is activated or when the thermistor malfunctions, disabling equipment operation.
 2. When a signal transmission error occurs between the indoor and outdoor units.
- In either case, conduct the diagnostic procedure described in the following pages.

Location of Operation Lamp

■ The Single Split Duct-Free System 09/12 Class

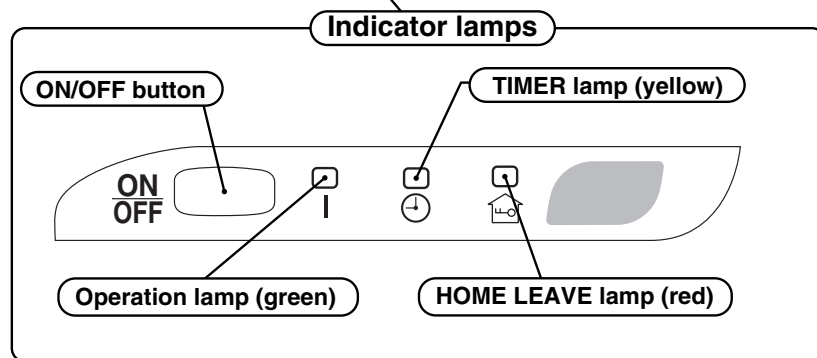
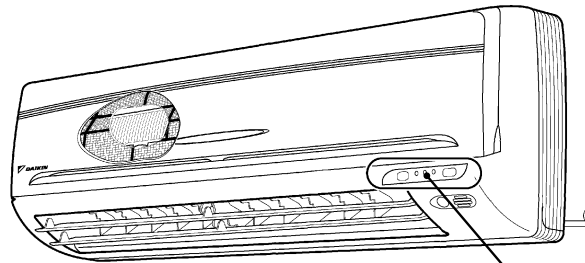

(R2950)

■ The Single Split Duct-Free System 15/18/24 Class

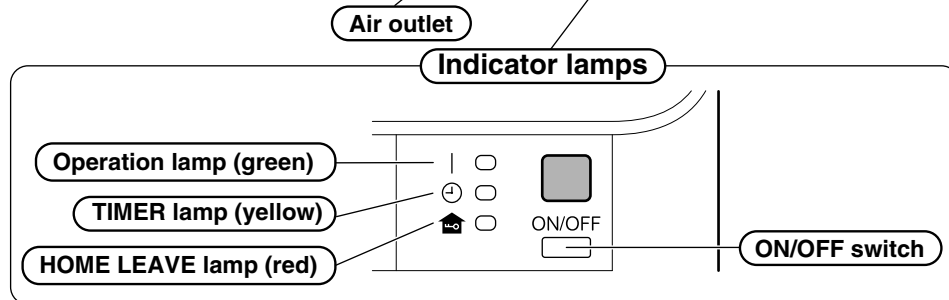
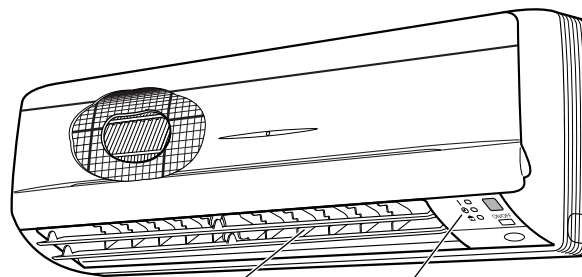

(R2837)

■ The Slim Duct Built-in System 09/12 Class

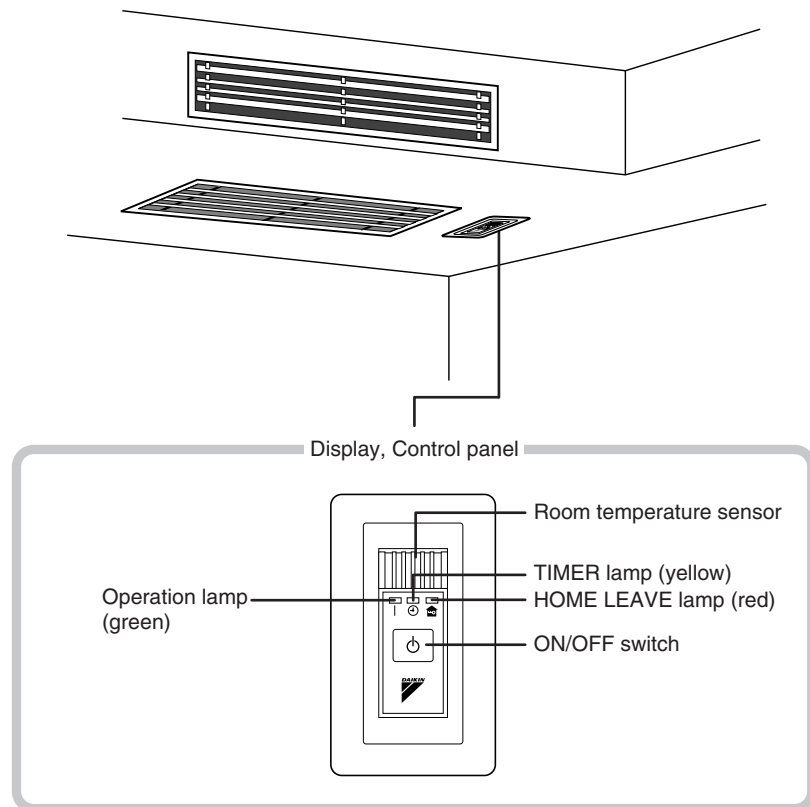

(R4134)

Troubleshooting with LED Indication

The outdoor unit has one green LED (LED A) on the PCB. The flashing green LED indicates normal condition of microcomputer operation.

■ 15/18/24 Class

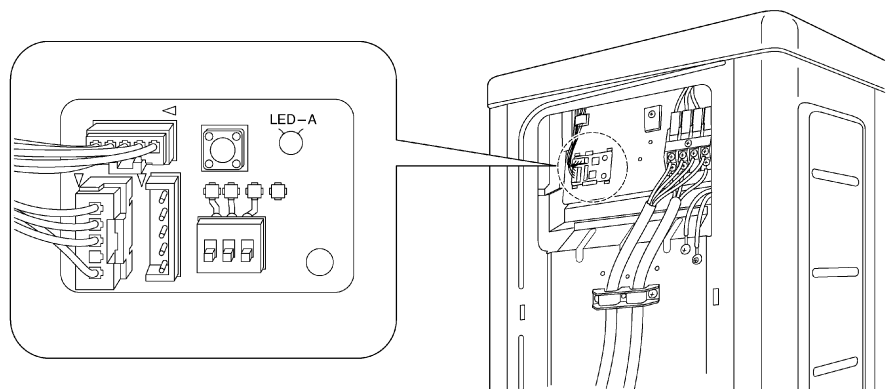

(R2838)

2. Problem Symptoms and Measures

Symptom	Check Item	Details of Measure	Reference Page
None of the units operates.	Check the power supply.	Check to make sure that the rated voltage is supplied.	—
	Check the type of the indoor units.	Check to make sure that the indoor unit type is compatible with the outdoor unit.	—
	Check the outdoor air temperature.	Heating operation cannot be used when the outdoor air temperature is 64.4°F or higher (only for heat pump model), and cooling operation cannot be used when the outdoor air temperature is below 14°F.	—
	Diagnosis with remote controller indication	—	148
	Check the remote controller addresses.	Check to make sure that address settings for the remote controller and indoor unit are correct.	—
Operation sometimes stops.	Check the power supply.	A power failure of 2 to 10 cycles can stop air conditioner operation. (Operation lamp OFF)	—
	Check the outdoor air temperature.	Heating operation cannot be used when the outdoor air temperature is 64.4°F or higher (only for heat pump model), and cooling operation cannot be used when the outdoor air temperature is below 14°F.	—
	Diagnosis with remote controller indication	—	148
Equipment operates but does not cool, or does not heat (only for heat pump model).	Check for wiring and piping errors in the indoor and outdoor units connection wires and pipes.	Conduct the wiring/piping error check described on the product diagnosis nameplate.	—
	Check for thermistor detection errors.	Check to make sure that the main unit's thermistor has not dismantled from the pipe holder.	—
	Check for faulty operation of the electronic expansion valve.	Set the units to cooling operation, and compare the temperatures of the liquid side connection pipes of the connection section among rooms to check the opening and closing operation of the electronic expansion valves of the individual units.	—
	Diagnosis with remote controller indication	—	148
	Diagnosis by service port pressure and operating current	Check for insufficient gas.	201
Large operating noise and vibrations	Check the output voltage of the power transistor.	—	202
	Check the power transistor.	—	—
	Check the installation condition.	Check to make sure that the required spaces for installation (specified in the Engineering Data book Guide, etc.) are provided.	—

3. Service Check Function

In the **ARC433A** series remote controller, the temperature display sections on the main unit indicate corresponding codes.

Check Method 1

1. When the timer cancel button is held down for 5 seconds, a “00” indication flashes on the temperature display section.

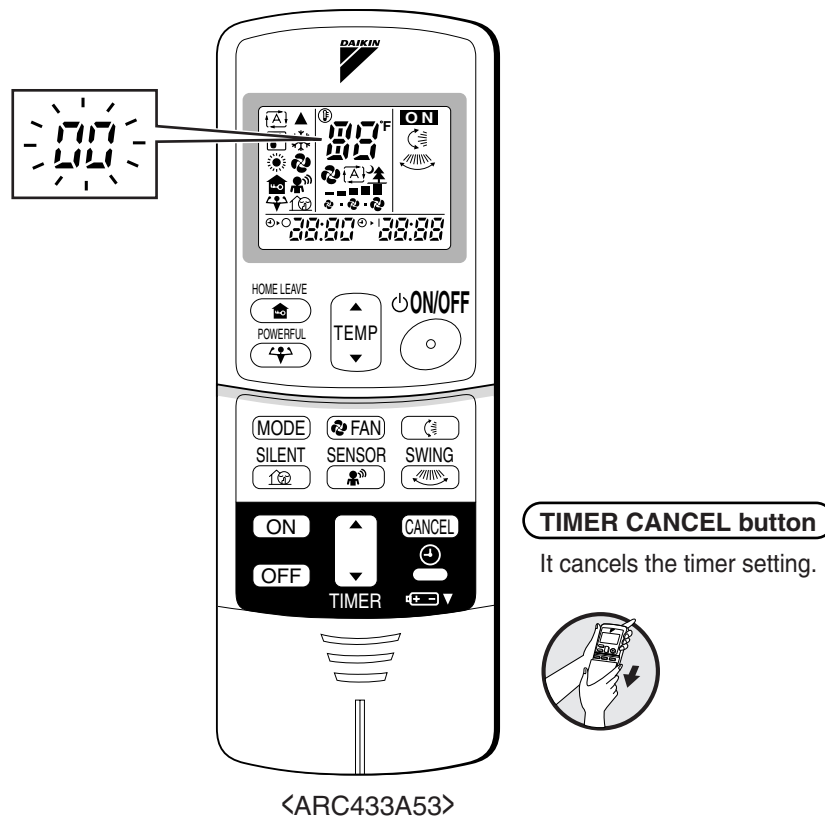

(R4156)

2. Press the timer cancel button repeatedly until a continuous beep is produced.
 - The code indication changes in the sequence shown below, and notifies with a long beep.

No.	Code	No.	Code	No.	Code
1	00	12	C7	23	H0
2	U4	13	H8	24	E1
3	F3	14	J3	25	P4
4	E6	15	A3	26	L3
5	L5	16	A1	27	L4
6	A6	17	C4	28	H6
7	E5	18	C5	29	H7
8	F6	19	H9	30	U2
9	C9	20	J6	31	UH
10	U0	21	UA	32	EA
11	E7	22	A5	33	AH



Note:

1. A short beep and two consecutive beeps indicate non-corresponding codes.
2. To cancel the code display, hold the timer cancel button down for 5 seconds. The code display also cancels itself if the button is not pressed for 1 minute.

Check Method 2

1. Enter the diagnosis mode.
Press the 3 buttons (TEMP▲,TEMP▼, MODE) simultaneously.

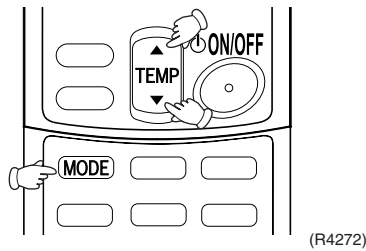

- The digit of the number of tens blinks.
★Try again from the start when the digit does not blink.

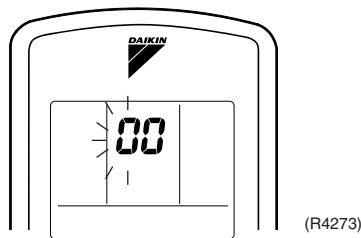

2. Press the TEMP button.
Press TEMP▲ or TEMP▼ and change the digit until you hear the sound of “beep” or “pi pi”.

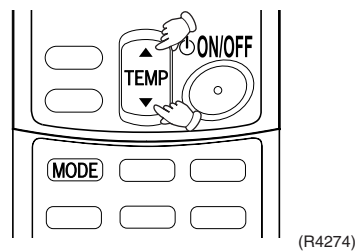

3. Diagnose by the sound.
 - ★“pi” : The number of tens does not accord with the error code.
 - ★“pi pi” : The number of tens accords with the error code.
 - ★“beep” : The both numbers of tens and units accord with the error code. (→See 7.)

4. Enter the diagnosis mode again.
Press the MODE button.

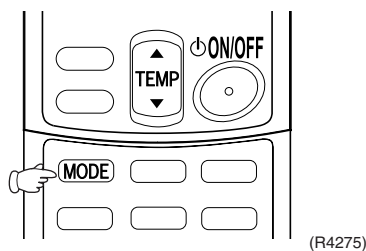

The digit of the number of units blinks.

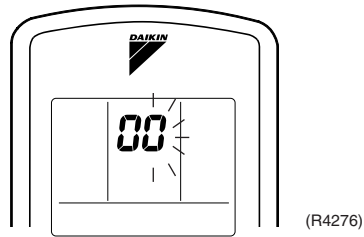

5. Press the TEMP button.
Press TEMP▲ or TEMP▼ and change the digit until you hear the sound of “beep”.

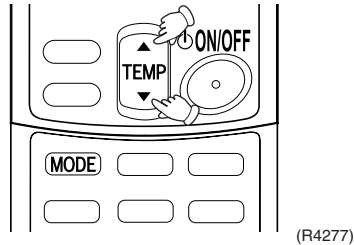

6. Diagnose by the sound.
- ★“pi” : The both numbers of tens and units do not accord with the error code.
 - ★“pi pi” : The number of tens accords with the error code.
 - ★“beep” : The both numbers of tens and units accord with the error code.

7. Determine the error code.
The digits indicated when you hear the “beep” sound are error code.
(Error codes and description → Refer to page 148.)

8. Exit from the diagnosis mode.
Press the MODE button.

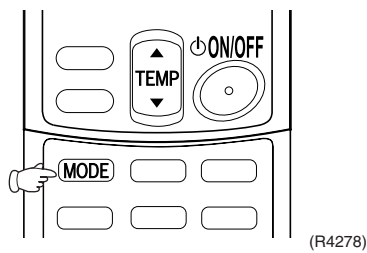

4. Troubleshooting

4.1 Error Codes and Description

	Code Indication	Description	Reference Page		
			09/12 Class	15/18/24 Class	
System	00	Normal	—	—	
	U0★	Insufficient gas	189	191	
	U2	Over-voltage detection	193	—	
		Low-voltage detection	—	194	
U4	Signal transmission error (between indoor and outdoor unit)	156	156		
Indoor Unit	A1	Indoor unit PCB abnormality	149	149	
	A5	Freeze-up protection control or high pressure control	150	150	
	A6	Fan motor or related abnormality	AC Motor	152	—
			DC Motor	—	153
	C4	Heat exchanger temperature thermistor abnormality	155	155	
C9	Room temperature thermistor abnormality	155	155		
Outdoor Unit	E5★	OL activation (compressor overload)	157	157	
	E6★	Compressor lock	158	159	
	E7	DC fan lock	160	160	
	E8	Input over current detection	161	162	
	EA	Four way valve abnormality	164	166	
	F3	Discharge pipe temperature control	168	169	
	F6	High pressure control in cooling	170	172	
	H6	Position sensor abnormality	174	175	
	H8	DC voltage/current sensor abnormality	CT or related abnormality	176	—
				—	177
	H9	Outdoor air thermistor or related abnormality	179	179	
	J3	Discharge pipe temperature thermistor or related abnormality	179	179	
	J6	Heat exchanger temperature thermistor or related abnormality	179	179	
	L3	Electrical box temperature rise	181	181	
	L4	Radiation fin temperature rise	183	183	
	L5	Output over current detection	185	187	
P4	Heat radiation fin thermistor or related abnormality	179	179		

★: Displayed only when system-down occurs.

4.2 Indoor Unit PCB Abnormality

Remote
Controller
Display

A1

Method of
Malfunction
Detection

Evaluation of zero-cross detection of power supply by indoor unit.

Malfunction
Decision
Conditions

When there is no zero-cross detection in approximately 10 continuous seconds.

Supposed
Causes

- Faulty indoor unit PCB
- Faulty connector connection

Troubleshooting

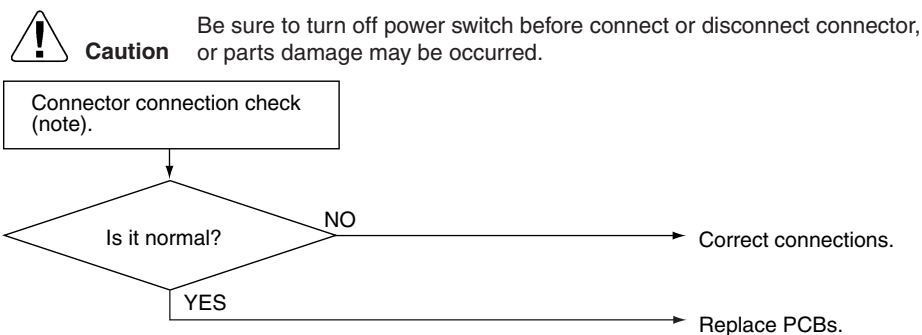

(R1400)



Note: Connector Nos. vary depending on models.

Model Type	Connector No.
Wall Mounted Type	Terminal strip~Control PCB

4.3 Freeze-up Protection Control or High Pressure Control

<p>Remote Controller Display</p>	<p>A5</p>
<p>Method of Malfunction Detection</p>	<ul style="list-style-type: none"> ■ High pressure control (heat pump model only) During heating operations, the temperature detected by the indoor heat exchanger thermistor is used for the high pressure control (stop, outdoor fan stop, etc.) ■ Freeze-up protection control (operation halt) is activated during cooling operation according to the temperature detected by the indoor unit heat exchanger thermistor.
<p>Malfunction Decision Conditions</p>	<ul style="list-style-type: none"> ■ High pressure control During heating operations, the temperature detected by the indoor heat exchanger thermistor is above 149°F ■ Freeze-up protection When the indoor unit heat exchanger temperature is below 32°F during cooling operation.
<p>Supposed Causes</p>	<ul style="list-style-type: none"> ■ Operation halt due to clogged air filter of the indoor unit. ■ Operation halt due to dust accumulation on the indoor unit heat exchanger. ■ Operation halt due to short-circuit. ■ Detection error due to faulty indoor unit heat exchanger thermistor. ■ Detection error due to faulty indoor unit PCB.

Troubleshooting



Check No.06
Refer to P.198

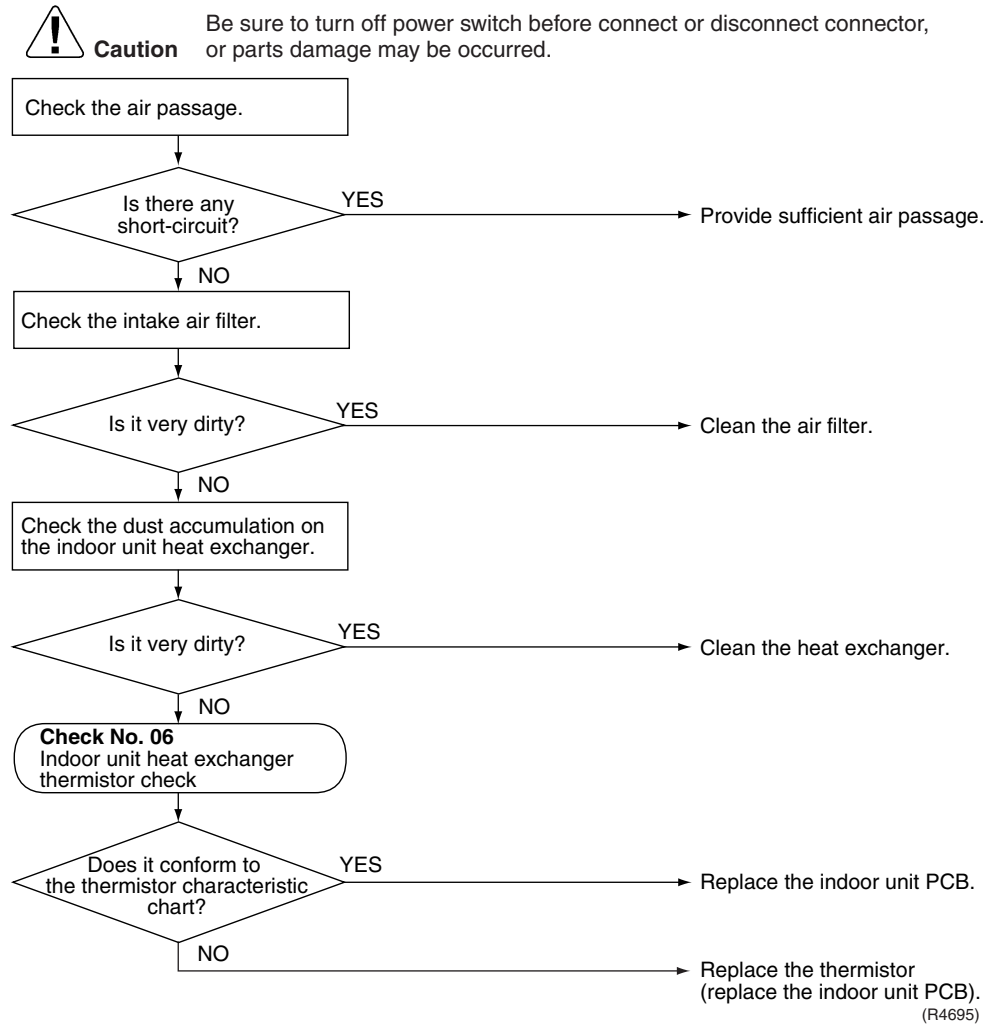

4.4 Fan Motor or Related Abnormality

4.4.1 AC Motor

Remote
Controller
Display

A6

Method of
Malfunction
Detection

The rotation speed detected by the Hall IC during fan motor operation is used to determine abnormal fan motor operation.

Malfunction
Decision
Conditions

When the detected rotation speed does not reach the demanded rotation speed of the target tap, and is less than 50% of the maximum fan motor rotation speed.

Supposed
Causes

- Operation halt due to short circuit inside the fan motor winding.
- Operation halt due to breaking of wire inside the fan motor.
- Operation halt due to breaking of the fan motor lead wires.
- Operation halt due to faulty capacitor of the fan motor.
- Detection error due to faulty indoor unit PCB.

Troubleshooting



Check No.16
Refer to P.204



Caution

Be sure to turn off power switch before connect or disconnect connector, or parts damage may be occurred.

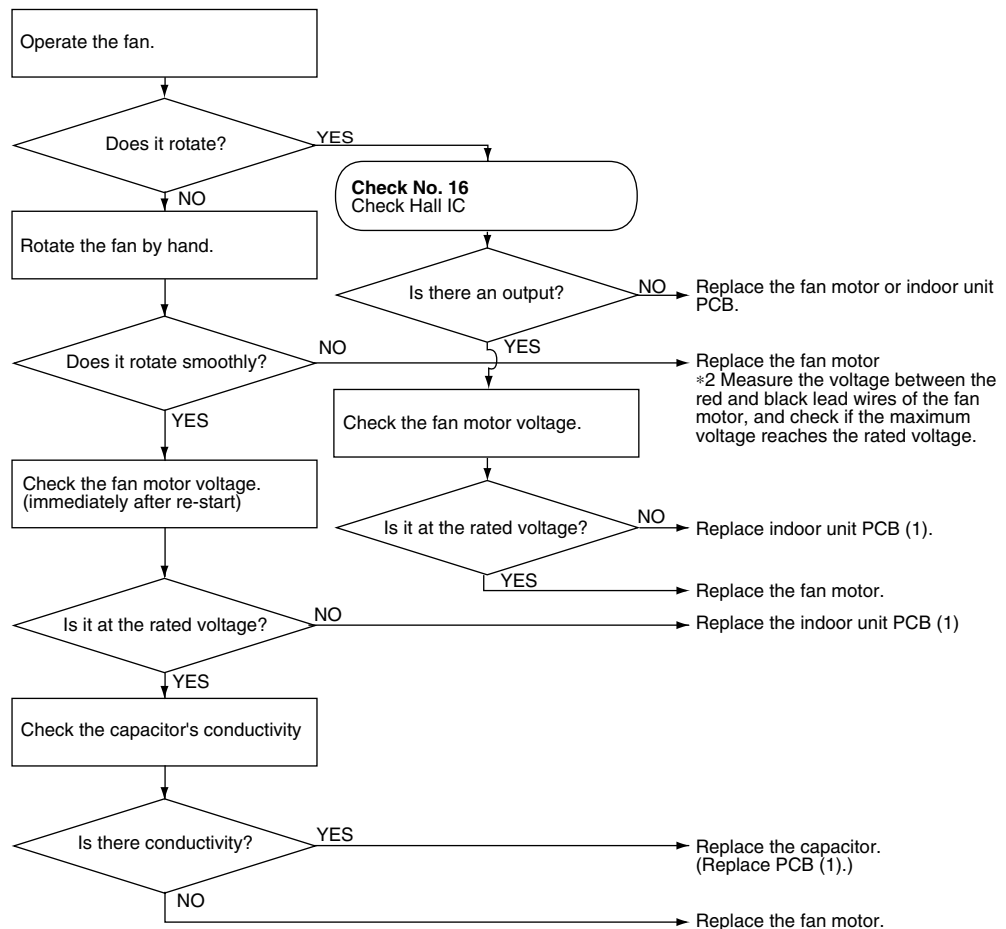

(R4096)

4.4.2 DC Motor

Remote
Controller
Display

A6

Method of
Malfunction
Detection

The rotation speed detected by the [Hall IC](#) during fan motor operation is used to determine abnormal fan motor operation.

Malfunction
Decision
Conditions

When the detected rotation speed does not reach the demanded rotation speed of the target tap, and is less than 50% of the maximum fan motor rotation speed.

Supposed
Causes

- Operation halt due to short circuit inside the fan motor winding.
- Operation halt due to breaking of wire inside the fan motor.
- Operation halt due to breaking of the fan motor lead wires.
- Operation halt due to faulty capacitor of the fan motor.
- Detection error due to faulty indoor unit PCB.

Troubleshooting



Check No.01
Refer to P.195



Caution

Be sure to turn off power switch before connect or disconnect connector, or parts damage may be occurred.

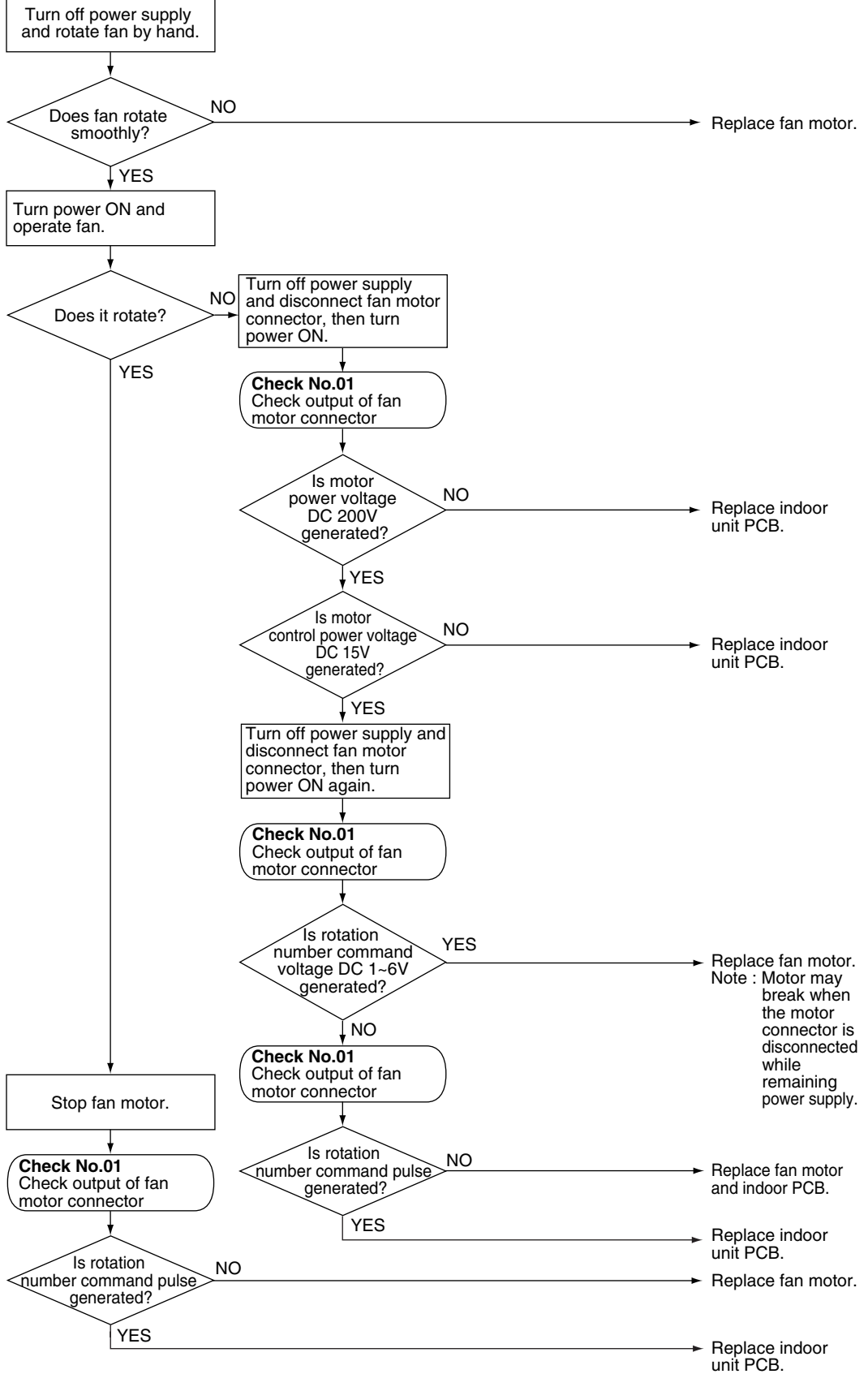

(R3098)

4.5 Thermistor or Related Abnormality (Indoor Unit)

Remote
Controller
Display

C4, C9

Method of
Malfunction
Detection

The temperatures detected by the thermistors are used to determine thermistor errors.

Malfunction
Decision
Conditions

When the thermistor input is more than 4.96 V or less than 0.04 V during compressor operation*.
* (reference)
When above about 414°F (less than 120 Ω) or below about -58°F (more than 1,860 kΩ).



Note: The values vary slightly in some models.

Supposed
Causes

- Faulty connector connection
- Faulty thermistor
- Faulty PCB

Troubleshooting



Check No.06
Refer to P.198



Caution

Be sure to turn off power switch before connect or disconnect connector, or parts damage may be occurred.

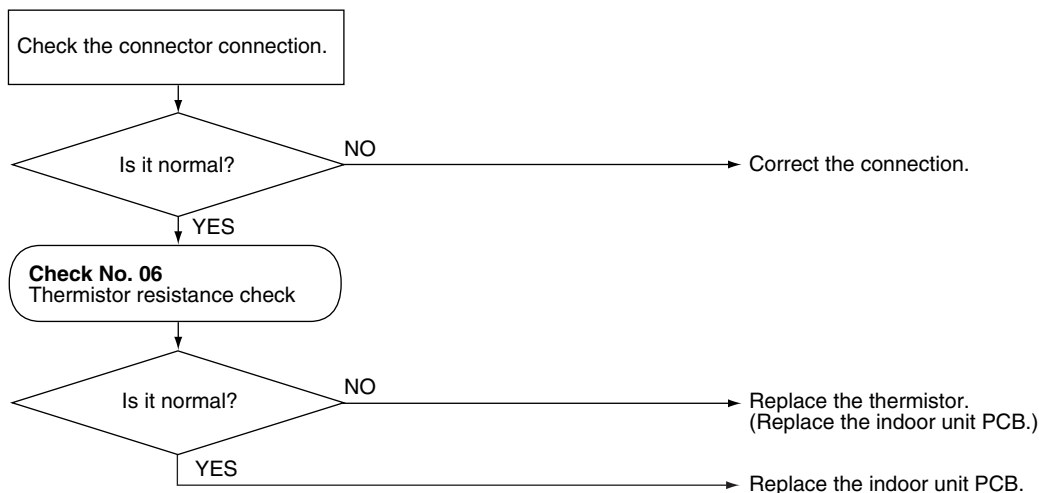

(R4696)

C4 : [Heat exchanger thermistor](#)
C9 : [Room temperature thermistor](#)

4.6 Signal Transmission Error (between Indoor and Outdoor Unit)

Remote Controller Display

U4

Method of Malfunction Detection

The data received from the outdoor unit in indoor unit-outdoor unit signal transmission is checked whether it is normal.

Malfunction Decision Conditions

When the data sent from the outdoor unit cannot be received normally, or when the content of the data is abnormal.

Supposed Causes

- Faulty outdoor unit PCB.
- Faulty indoor unit PCB.
- Indoor unit-outdoor unit signal transmission error due to wiring error.
- Indoor unit-outdoor unit signal transmission error due to disturbed power supply waveform.
- Indoor unit-outdoor unit signal transmission error due to breaking of wire in the connection wires between the indoor and outdoor units (wire No. 2).

Troubleshooting



Check No.10
Refer to P.201



Caution

Be sure to turn off power switch before connect or disconnect connector, or parts damage may be occurred.

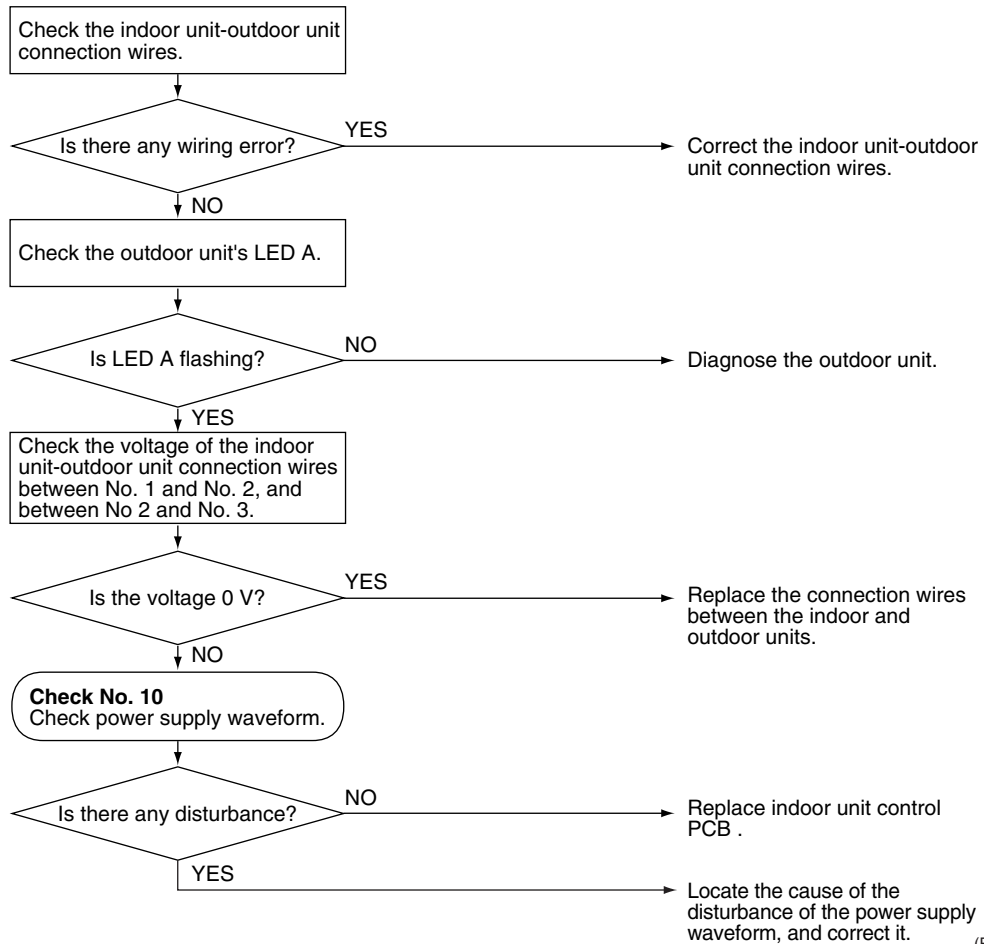

(R2840)

4.7 OL Activation (Compressor Overload)

Remote
Controller
Display

E5

Method of
Malfunction
Detection

A compressor overload is detected through compressor OL.

Malfunction
Decision
Conditions

- If the compressor OL is activated twice, the system will be shut down.
 - The error counter will reset itself if this or any other error does not occur during the following 60-minute compressor running time (total time).
- * The operating temperature condition is not specified.

Supposed
Causes

- Refrigerant shortage
- Four way valve malfunctioning
- Outdoor unit PCB defective
- Water mixed in the local piping
- Electronic expansion valve defective
- Stop valve defective

Troubleshooting

Check No.04
Refer to P.195

Check No.05
Refer to P.196

Check No.06
Refer to P.198

Check No.11
Refer to P.201

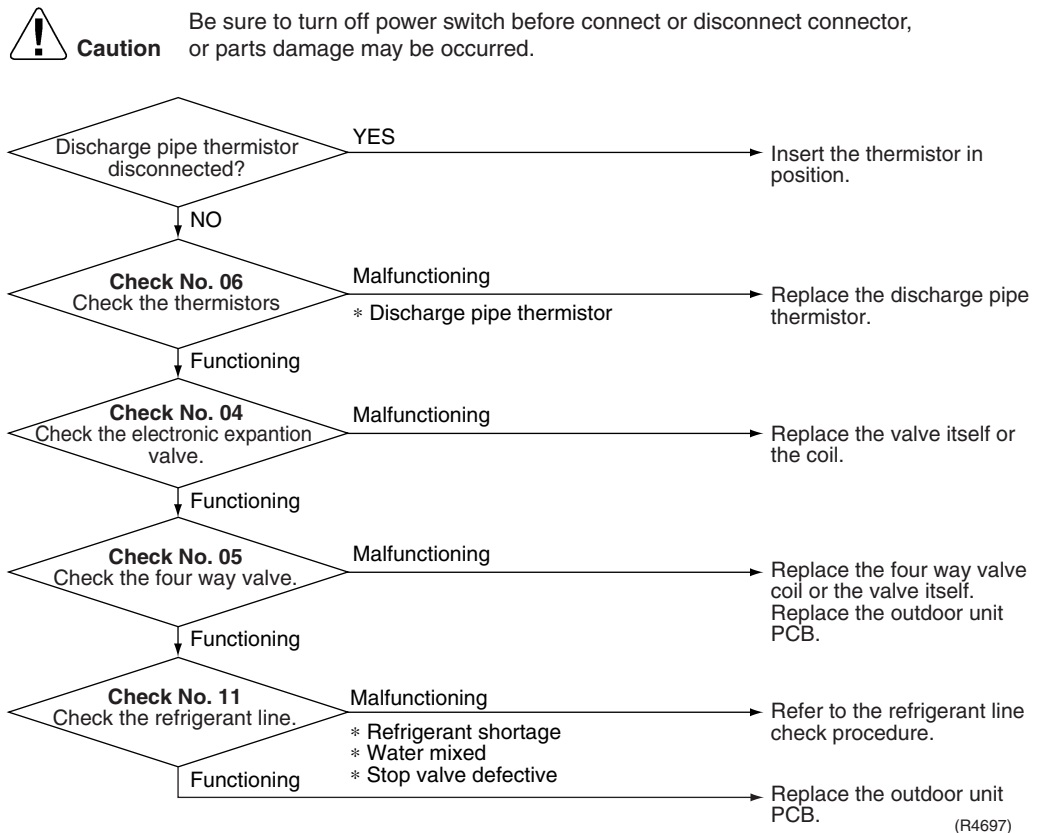

4.8 Compressor Lock

4.8.1 09/12 Class

Remote
Controller
Display

E6

Method of
Malfunction
Detection

A compressor lock is detected by checking the compressor running condition through the position detection circuit.

Malfunction
Decision
Conditions

- The system judges the compressor lock, and stops due to over current.
- The system judges the compressor lock, and cannot operation with position detection within 15 seconds after start up.
- The system will be shut down if the error occurs 16 times.
- Clearing condition: Continuous run for about 10 minutes (normal)

Supposed
Causes

- Compressor locked
- Compressor harness disconnected

Troubleshooting

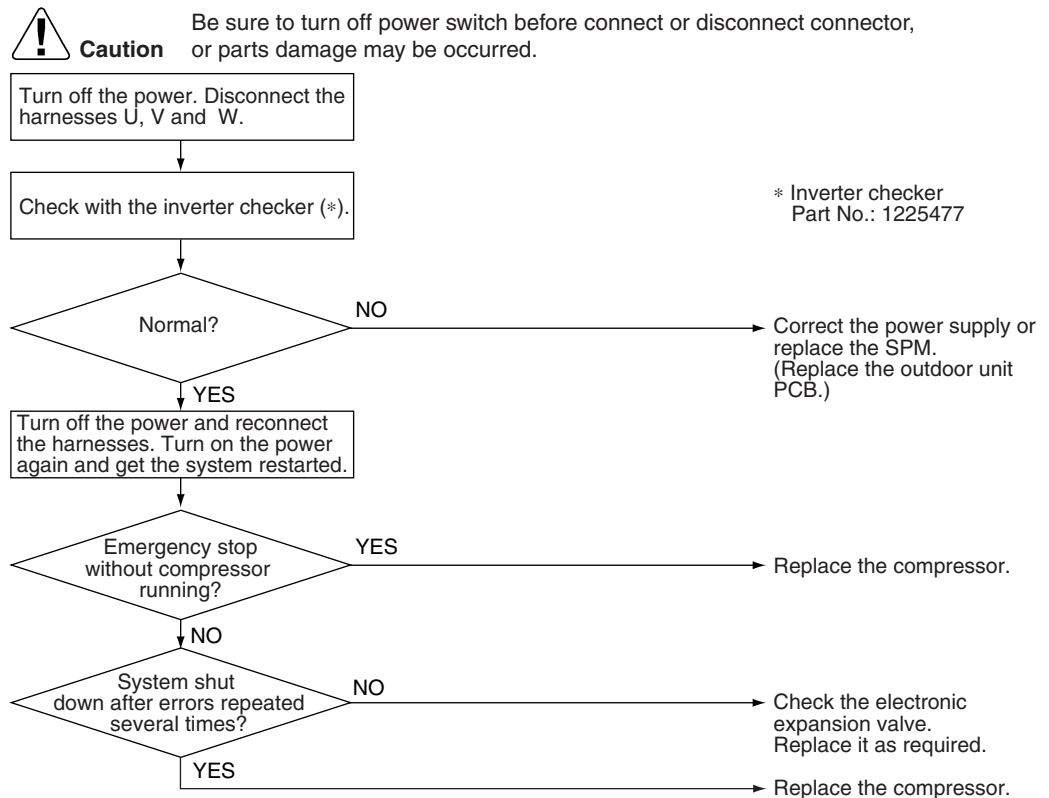

Note: If the model doesn't have SPM, replace the outdoor unit PCB.

4.8.2 15/18/24 Class

Remote
Controller
Display

E6

Method of
Malfunction
Detection

A compressor lock is detected by checking the compressor running condition through the position detection circuit.

Malfunction
Decision
Conditions

- The position detection circuit detects a compressor frequency of below 10 Hz for 20 seconds or a frequency of above 160 Hz.
- 40 seconds after the compressor has started, the position detection circuit detects a compressor frequency of above 180 Hz.
- The system will be shut down if the error occurs 16 times.
- Clearing condition: Continuous run for about 5 minutes (normal)

Supposed
Causes

- Compressor locked

Troubleshooting

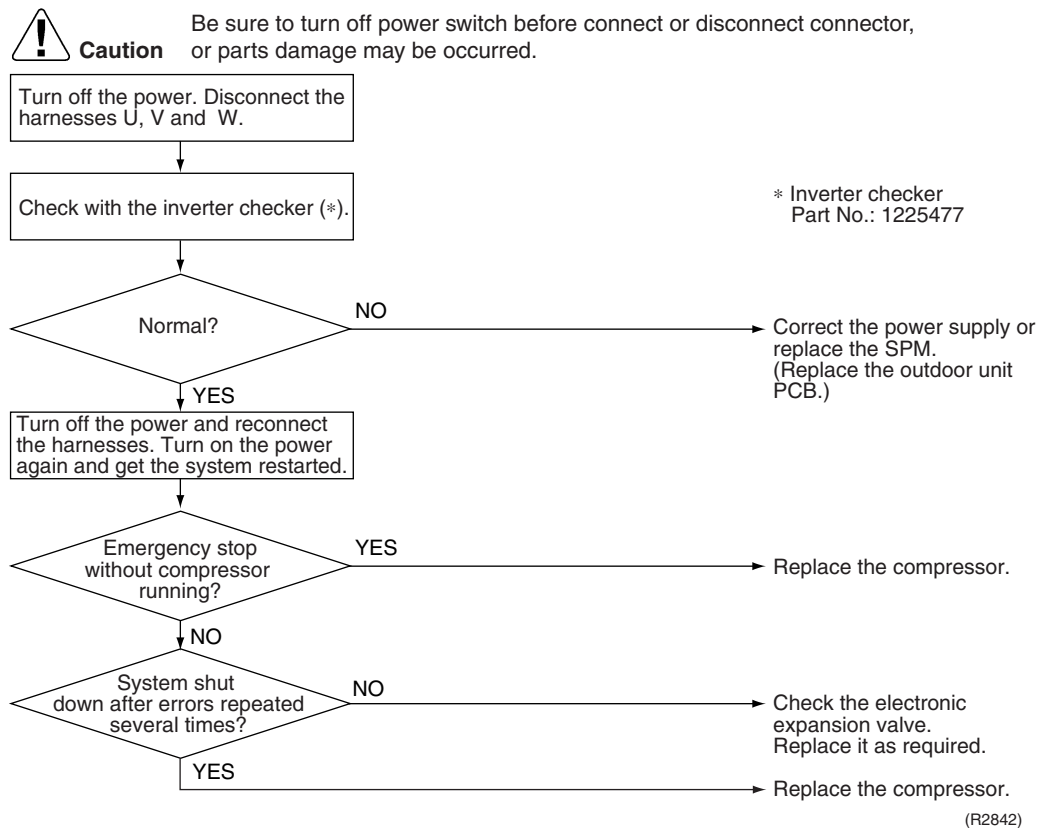

4.9 DC Fan Lock

Remote
Controller
Display

E7

Method of
Malfunction
Detection

A fan motor or related error is detected by checking the high-voltage fan motor rpm being detected by the Hall IC.

Malfunction
Decision
Conditions

- The fan does not start in 30 seconds even when the fan motor is running.
- The system will be shut down if the error occurs 16 times.
- Clearing condition: Continuous run for about 5 minutes (normal)

Supposed
Causes

- Fan motor breakdown
- Harness or connector disconnected between fan motor and PCB or in poor contact
- Foreign matters stuck in the fan

Troubleshooting



Check No.15
Refer to P.203

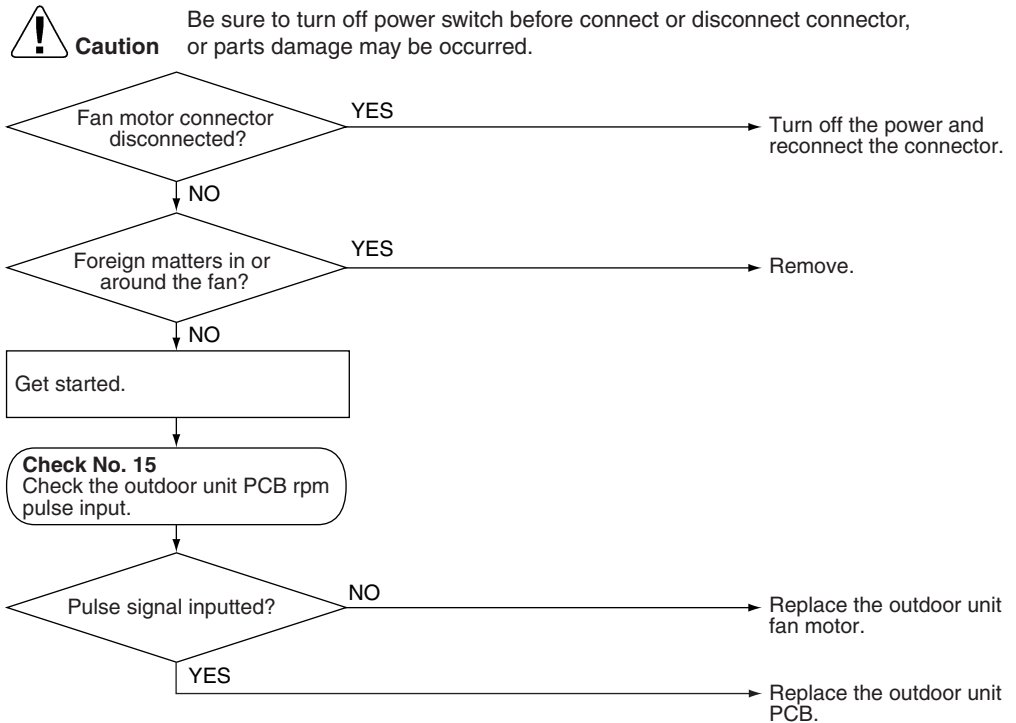

4.10 Input Over Current Detection

4.10.1 09/12 Class

Remote
Controller
Display

E8

Method of
Malfunction
Detection

An input over-current is detected by checking the input current value with the compressor running.

Malfunction
Decision
Conditions

- The following current with the compressor running continues for 2.5 seconds.
Cooling · Heating: Above 12A

Supposed
Causes

- Over-current due to compressor failure
- Over-current due to defective power transistor
- Over-current due to defective outdoor unit PCB
- Error detection due to outdoor unit PCB
- Over-current due to short-circuit

Troubleshooting



Check No.07
Refer to P.199



Check No.08
Refer to P.199



Caution

Be sure to turn off power switch before connect or disconnect connector, or parts damage may be occurred.

* An input over-current may result from wrong internal wiring. If the wires have been disconnected and reconnected for part replacement, for example, and the system is interrupted by an input over-current, take the following procedure.

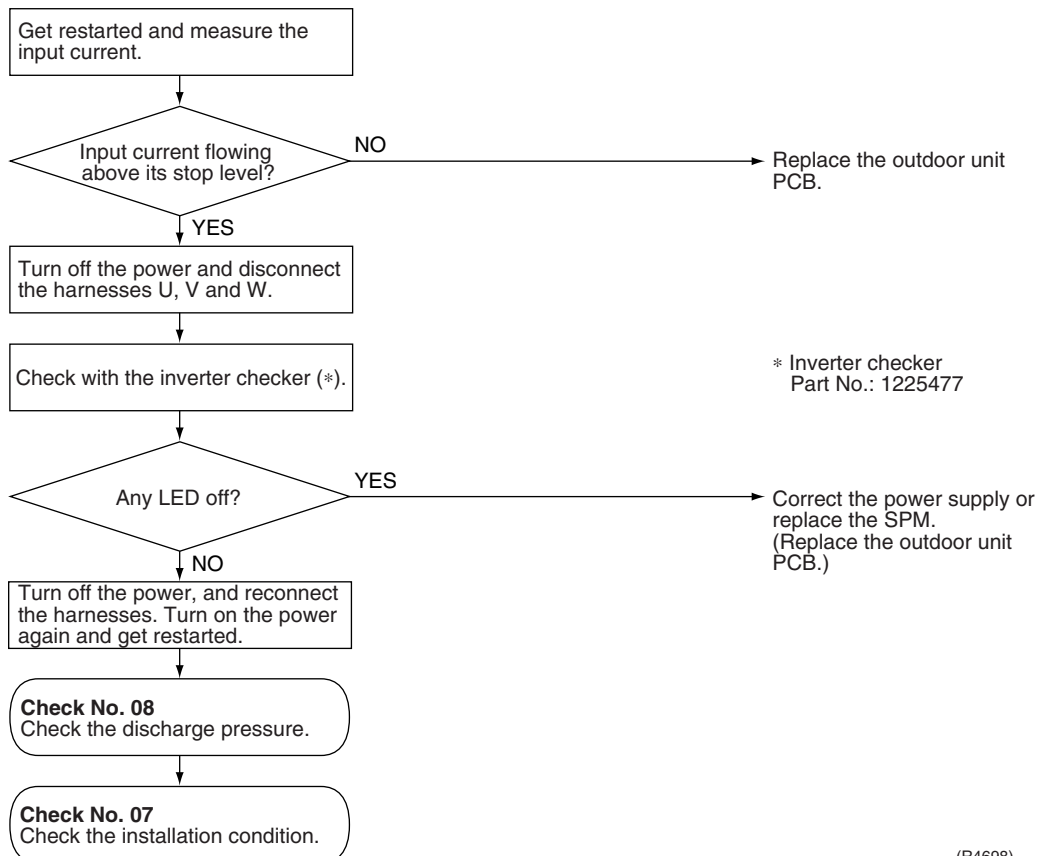

* Inverter checker
Part No.: 1225477

(R4698)



Note: If the model doesn't have SPM, replace the outdoor unit PCB.

4.10.2 15/18/24 Class

<p>Remote Controller Display</p>	<p style="color: blue; font-size: 2em; font-weight: bold;">E8</p>
<p>Method of Malfunction Detection</p>	<p>An input over-current is detected by checking the input current value being detected by CT with the compressor running.</p>
<p>Malfunction Decision Conditions</p>	<ul style="list-style-type: none"> ■ The following CT input with the compressor running continues for 2.5 seconds. CT input : Above 20 A ■ The system will be shut down if the error occurs 16 times. ■ Clearing condition : Continuous run for about 5 minutes (normal)
<p>Supposed Causes</p>	<ul style="list-style-type: none"> ■ Over-current due to compressor failure ■ Over-current due to defective power transistor ■ Over-current due to defective inverter main circuit electrolytic capacitor ■ Over-current due to defective outdoor unit PCB ■ Error detection due to outdoor unit PCB ■ Over-current due to short-circuit

Troubleshooting



Check No.07
Refer to P.199



Check No.08
Refer to P.199



Check No.14
Refer to P.203

**Caution**

Be sure to turn off power switch before connect or disconnect connector, or parts damage may be occurred.

* An input over-current may result from wrong internal wiring. If the wires have been disconnected and reconnected for part replacement, for example, and the system is interrupted by an input over-current, take the following procedure.

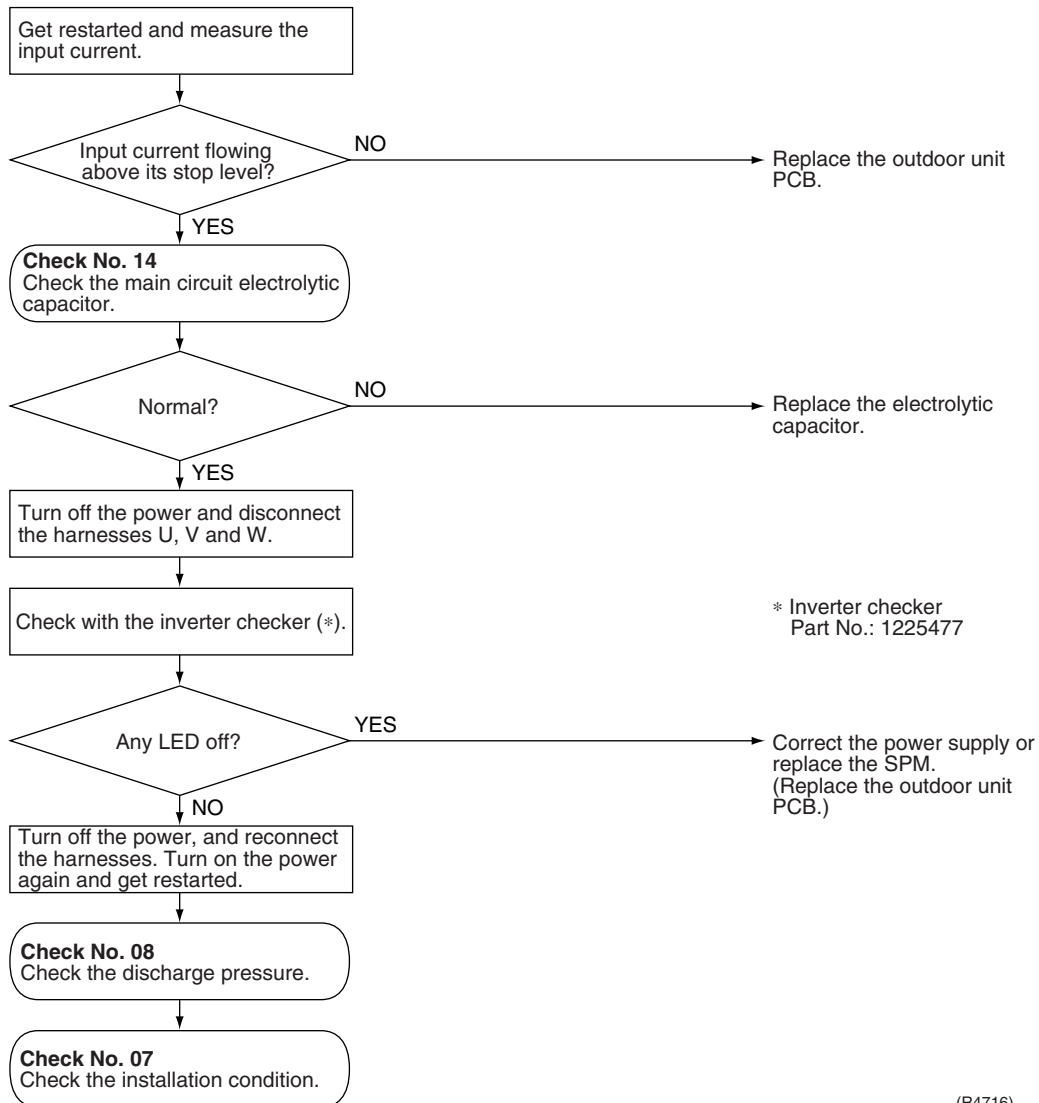

(R4716)

4.11 Four Way Valve Abnormality

4.11.1 09/12 Class

Remote
Controller
Display

EA

Method of
Malfunction
Detection

The indoor air temperature thermistor, the indoor unit heat exchanger thermistor, the outdoor temperature thermistor and the outdoor unit heat exchanger thermistor are checked to see if they function within their normal ranges in the operating mode.

Malfunction
Decision
Conditions

A following condition continues over 10 minute after operating 5 minutes.

- Cooling / dry operation
(room temp. – indoor heat exchanger temp.) < $-\Delta 9^{\circ}\text{F}$
- Heating
(indoor unit heat exchanger temp. – room temp.) < $-\Delta 9^{\circ}\text{F}$

Supposed
Causes

- Connector in poor contact
- Thermistor defective
- Outdoor unit PCB defective
- Four way valve coil or harness defective
- Four way valve defective
- Foreign substance mixed in refrigerant
- Insufficient gas

Troubleshooting



Check No.05
Refer to P.196



Check No.06
Refer to P.198



Check No.11
Refer to P.201



Caution Be sure to turn off power switch before connect or disconnect connector, or parts damage may be occurred.

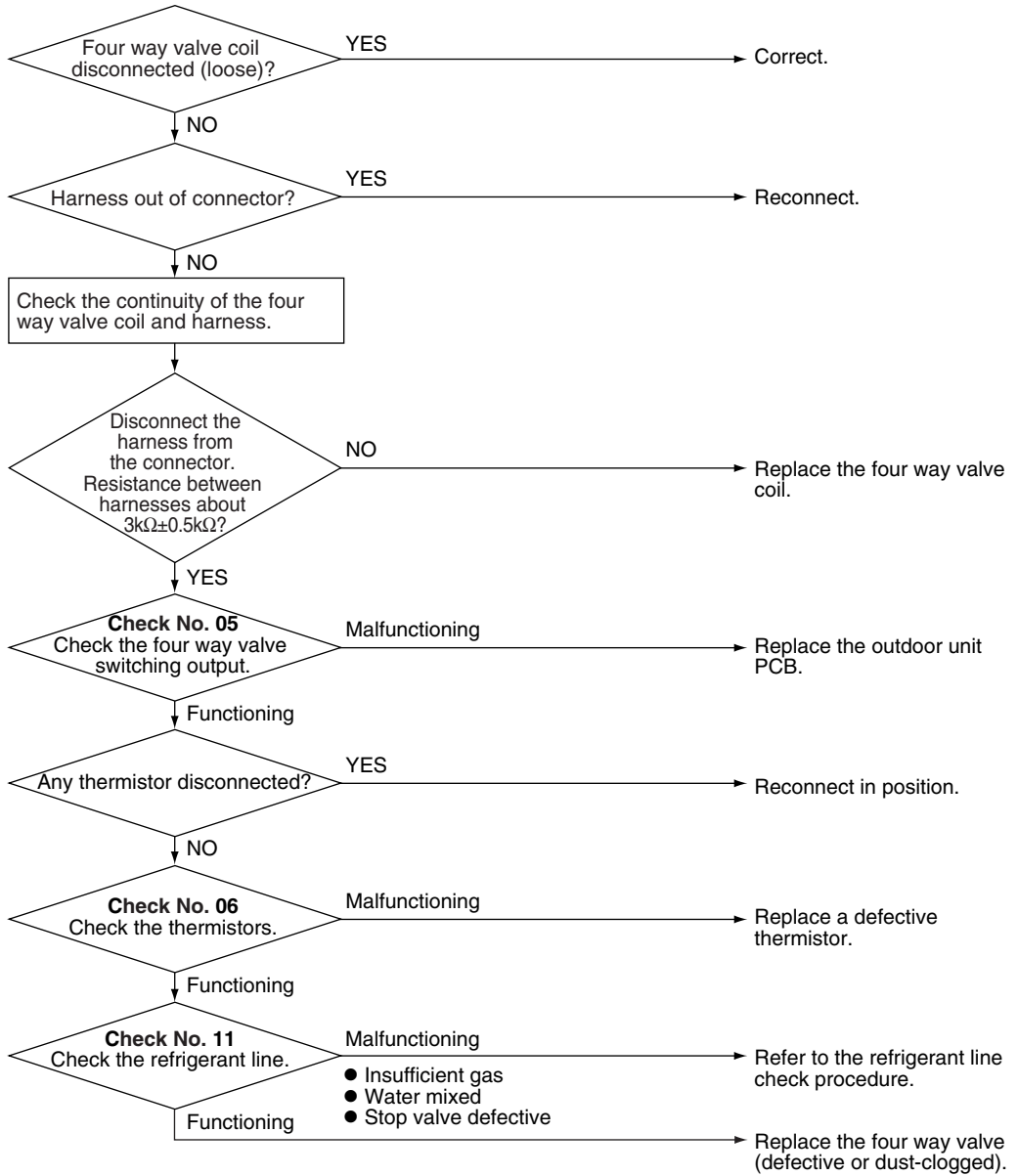

(R4699)

4.11.2 15/18/24 Class

**Remote
Controller
Display**

EA

**Method of
Malfunction
Detection**

The room temperature thermistor, the indoor unit heat exchanger thermistor, the outdoor temperature thermistor and the outdoor unit heat exchanger thermistor are checked to see if they function within their normal ranges in the operating mode.

**Malfunction
Decision
Conditions**

A following condition continues over 1 minute after operating 10 minutes.

- Cooling / dry operation
(room temp. – indoor heat exchanger temp.) < $-\Delta 18^{\circ}\text{F}$
- Heating
(indoor unit heat exchanger temp. – room temp.) < $-\Delta 18^{\circ}\text{F}$

**Supposed
Causes**

- Connector in poor contact
- Thermistor defective
- Outdoor unit PCB defective
- Four way valve coil or harness defective
- Four way valve defective
- Foreign substance mixed in refrigerant
- Insufficient gas

Troubleshooting



Check No.05
Refer to P.196



Check No.06
Refer to P.198



Check No.11
Refer to P.201



Caution Be sure to turn off power switch before connect or disconnect connector, or parts damage may be occurred.

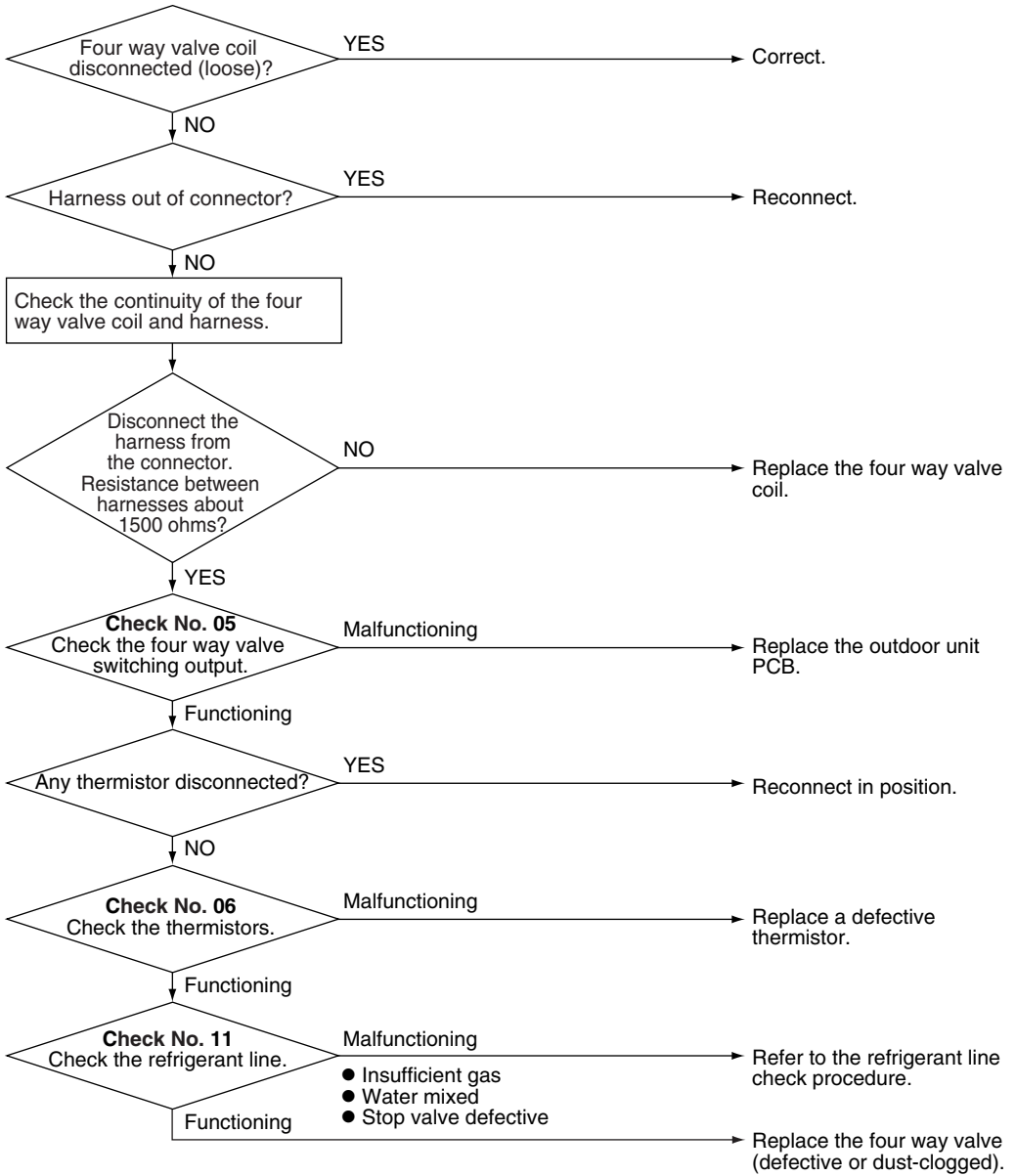

(R4710)

4.12 Discharge Pipe Temperature Control

4.12.1 09/12 Class

Remote
Controller
Display

F3

Method of
Malfunction
Detection

The discharge pipe temperature control (stop, frequency drooping, etc.) is checked with the temperature being detected by the discharge pipe thermistor.

Malfunction
Decision
Conditions

- If a stop takes place 4 times successively due to abnormal discharge pipe temperature, the system will be shut down.
- If the temperature being detected by the discharge pipe thermistor rises above $\text{A } ^\circ\text{F}$, the compressor will stop. (The error is cleared when the temperature has dropped below $\text{B } ^\circ\text{F}$.)

Stop temperatures	A	B
(1) above 45Hz (rising), above 40Hz (dropping)	230	207
(2) 30~45Hz (rising), 25~40Hz (dropping)	221	198
(3) below 30Hz (rising), below 25Hz (dropping)	210	187

- The error counter will reset itself if this or any other error does not occur during the following 60-minute compressor running time (total time).

Supposed
Causes

- Refrigerant shortage
- Four way valve malfunctioning
- Discharge pipe thermistor defective (heat exchanger or outdoor air temperature thermistor defective)
- Outdoor unit PCB defective
- Water mixed in the local piping
- Electronic expansion valve defective
- Stop valve defective

Troubleshooting

Check No.04
Refer to P.195

Check No.06
Refer to P.198

Check No.11
Refer to P.201

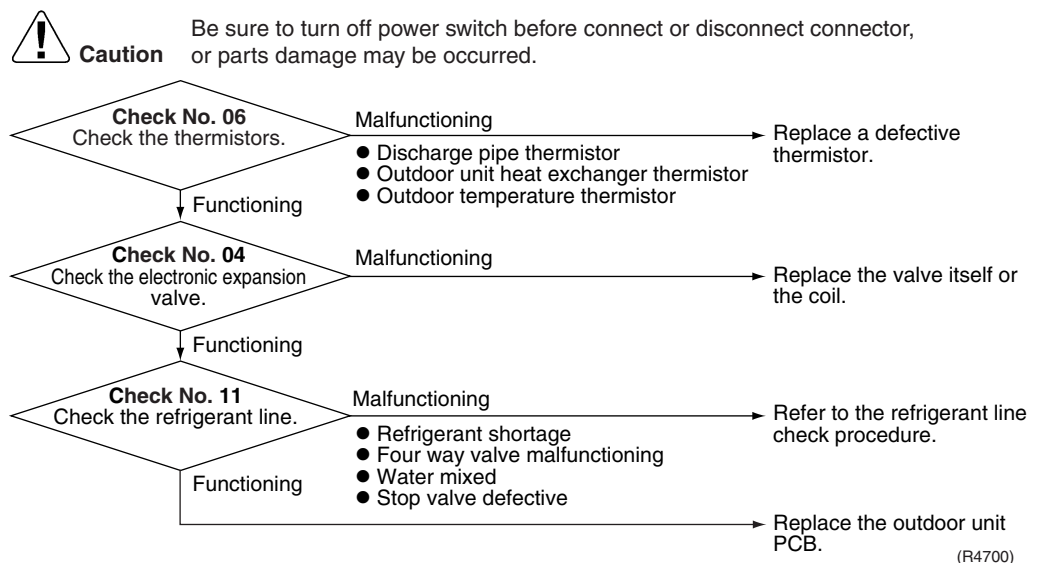

4.12.2 15/18/24 Class

Remote
Controller
Display

F3

Method of
Malfunction
Detection

The discharge pipe temperature control (stop, frequency drooping, etc.) is checked with the temperature being detected by the discharge pipe thermistor.

Malfunction
Decision
Conditions

- If a stop takes place 6 times successively due to abnormal discharge pipe temperature, the system will be shut down.
- If the temperature being detected by the discharge pipe thermistor rises above 248°F, the compressor will stop. (The error is cleared when the temperature has dropped below 225°F.)

Stop temperatures (variable by models)

(1) 230°F : above 45Hz (rising), above 40Hz (dropping)

(2) 216°F : 30~45Hz (rising), 25~40Hz (dropping)

(3) 208°F : below 30Hz (rising), below 25Hz (dropping)

- The error counter will reset itself if this or any other error does not occur during the following 60-minute compressor running time (total time).

Supposed
Causes

- Refrigerant shortage
- Four way valve malfunctioning
- Discharge pipe thermistor defective
(heat exchanger or outdoor temperature thermistor defective)
- Outdoor unit PCB defective
- Water mixed in the local piping
- Electronic expansion valve defective
- Stop valve defective

Troubleshooting



Check No.04
Refer to P.195



Check No.06
Refer to P.198



Check No.11
Refer to P.201



Caution

Be sure to turn off power switch before connect or disconnect connector, or parts damage may be occurred.

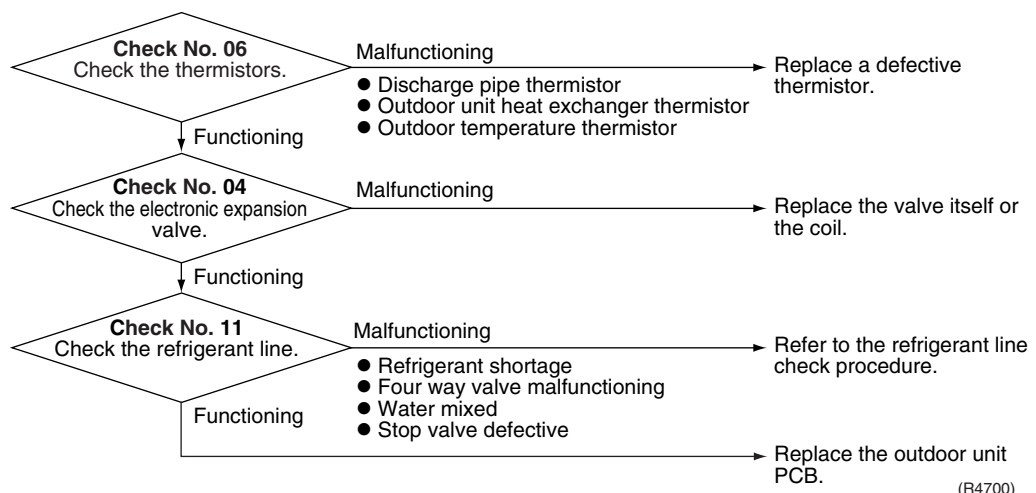

4.13 High Pressure Control in Cooling

4.13.1 09/12 Class

Remote
Controller
Display

F6

Method of
Malfunction
Detection

High-pressure control (stop, frequency drop, etc.) is activated in the cooling mode if the temperature being sensed by the heat exchanger thermistor exceeds the limit.

Malfunction
Decision
Conditions

Activated when the temperature being sensed by the heat exchanger thermistor rises above 149°F. (The error is cleared when the temperature drops below 129°F.)

Supposed
Causes

- The installation space is not large enough.
- Faulty outdoor unit fan
- Faulty electronic expansion valve
- Faulty defrost thermistor
- Faulty outdoor unit PCB
- Faulty stop valve
- Dirty heat exchanger

Troubleshooting



Check No.04
Refer to P.195



Check No.06
Refer to P.198



Check No.07
Refer to P.199



Check No.09
Refer to P.200



Caution Be sure to turn off power switch before connect or disconnect connector, or parts damage may be occurred.

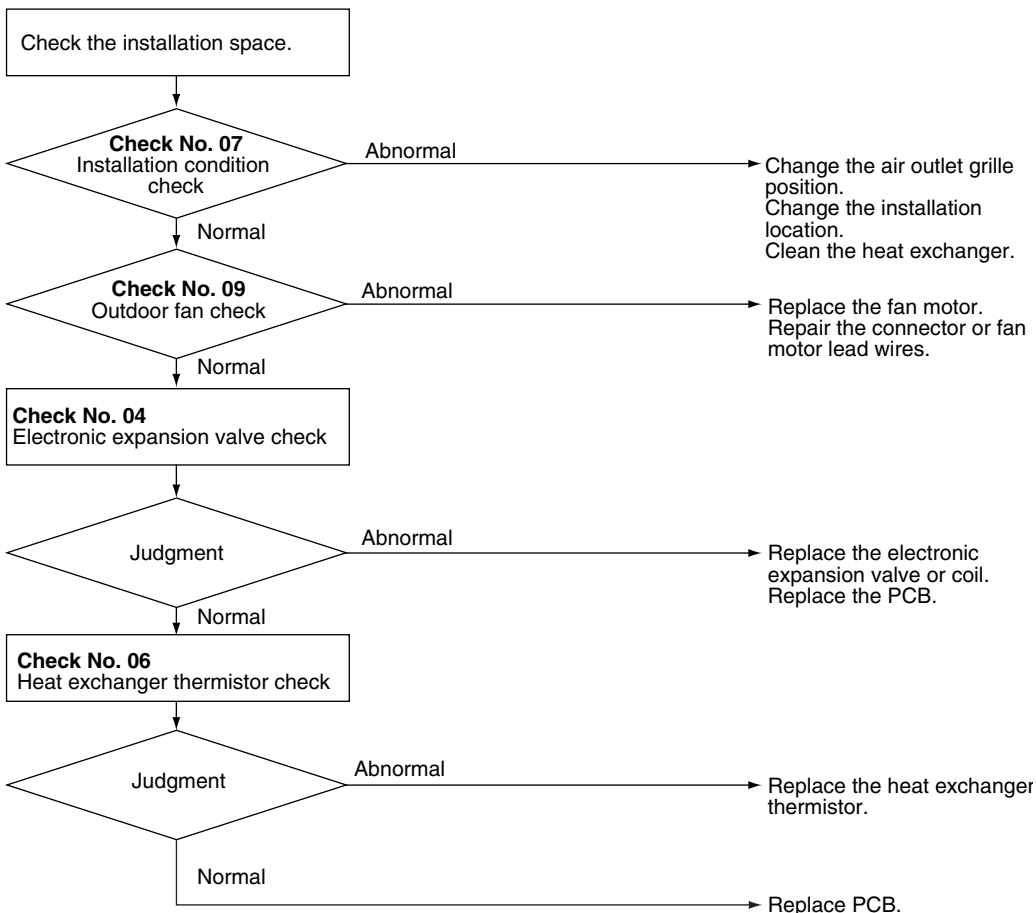

(R4701)

4.13.2 15/18/24 Class

**Remote
Controller
Display**

F6

**Method of
Malfunction
Detection**

High-pressure control (stop, frequency drop, etc.) is activated in the cooling mode if the temperature being sensed by the heat exchanger thermistor exceeds the limit.

**Malfunction
Decision
Conditions**

Activated when the temperature being sensed by the heat exchanger thermistor rises above 140°F. (Deactivated when the said temperature drops below 122°F.)

**Supposed
Causes**

- The installation space is not large enough.
- Faulty outdoor unit fan
- Faulty electronic expansion valve
- Faulty defrost thermistor
- Faulty outdoor unit PCB
- Faulty stop valve
- Dirty heat exchanger

Troubleshooting



Check No.04
Refer to P.195



Check No.06
Refer to P.198



Check No.07
Refer to P.199



Check No.09
Refer to P.200



Caution Be sure to turn off power switch before connect or disconnect connector, or parts damage may be occurred.

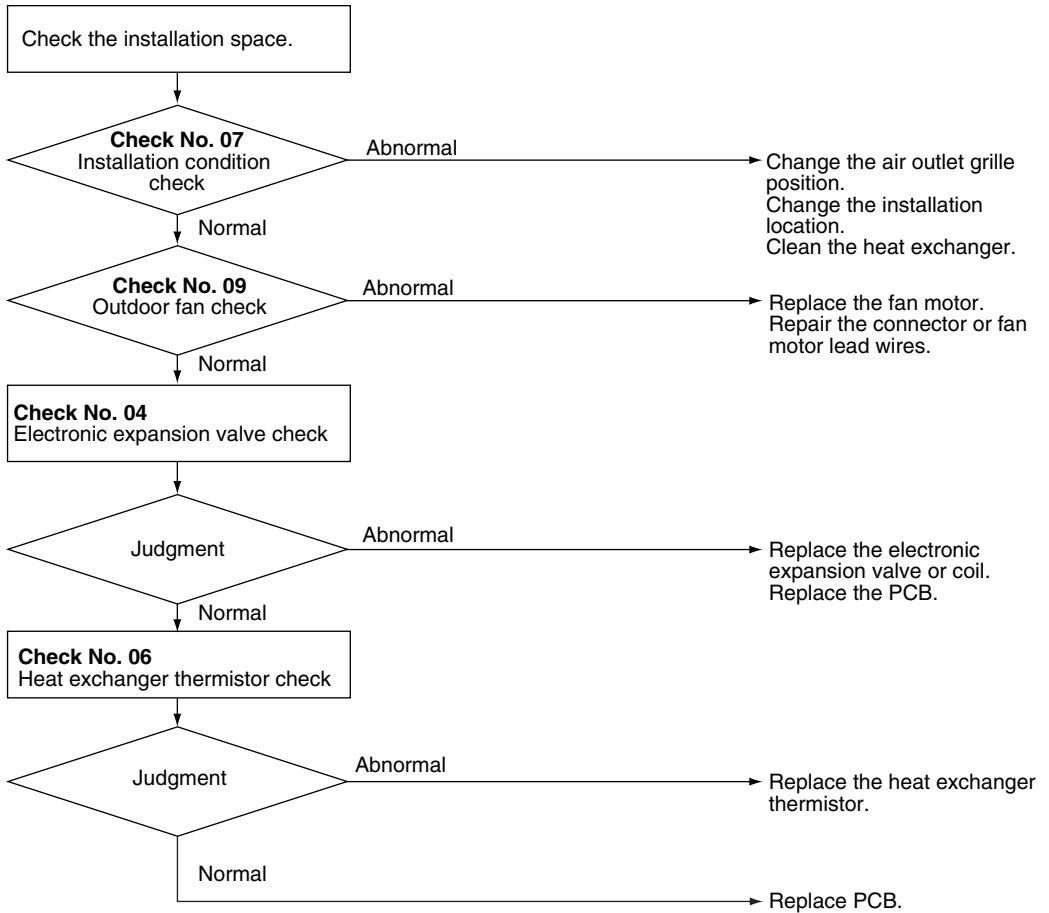

(R4701)

4.14 Position Sensor Abnormality

4.14.1 09/12 Class

Remote
Controller
Display

H6

Method of
Malfunction
Detection

A compressor startup failure is detected by checking the compressor running condition through the position detection circuit.

Malfunction
Decision
Conditions

- The compressor fails to start in about 15 seconds after the compressor run command signal is sent.
- Clearing condition: Continuous run for about 10 minutes (normal)
- The system will be shut down if the error occurs 16 times.

Supposed
Causes

- Compressor relay cable disconnected
- Compressor itself defective
- Outdoor unit PCB defective
- Stop valve closed
- Input voltage out of specification

Troubleshooting



Check No.13
Refer to P.202



Caution Be sure to turn off power switch before connect or disconnect connector, or parts damage may be occurred.

Check No. 13
Check for short-circuit.

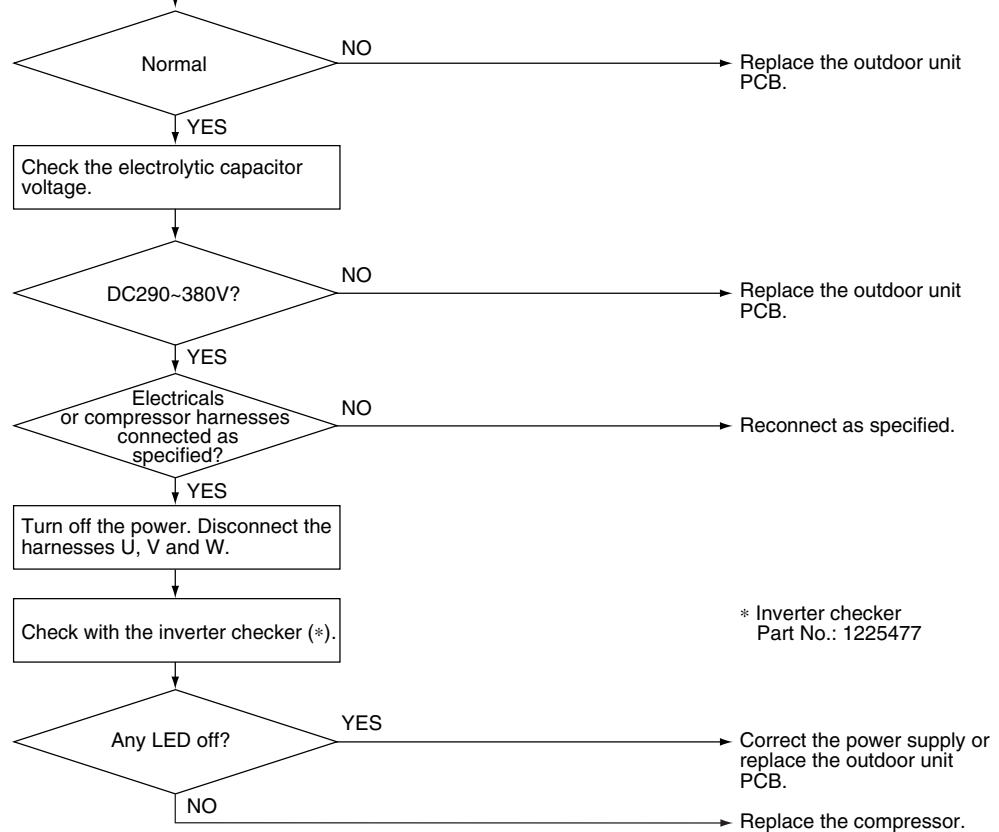

(R3041)

4.14.2 15/18/24 Class

Remote
Controller
Display

H6

Method of
Malfunction
Detection

A compressor startup failure is detected by checking the compressor running condition through the position detection circuit.

Malfunction
Decision
Conditions

- The compressor fails to start in about 15 seconds after the compressor run command signal is sent.
- Clearing condition: Continuous run for about 5 minutes (normal)
- The system will be shut down if the error occurs 16 times.

Supposed
Causes

- Compressor relay cable disconnected
- Compressor itself defective
- Outdoor unit PCB defective
- Stop valve closed
- Input voltage out of specification

Troubleshooting



Check No.13
Refer to P.202



Caution

Be sure to turn off power switch before connect or disconnect connector, or parts damage may be occurred.

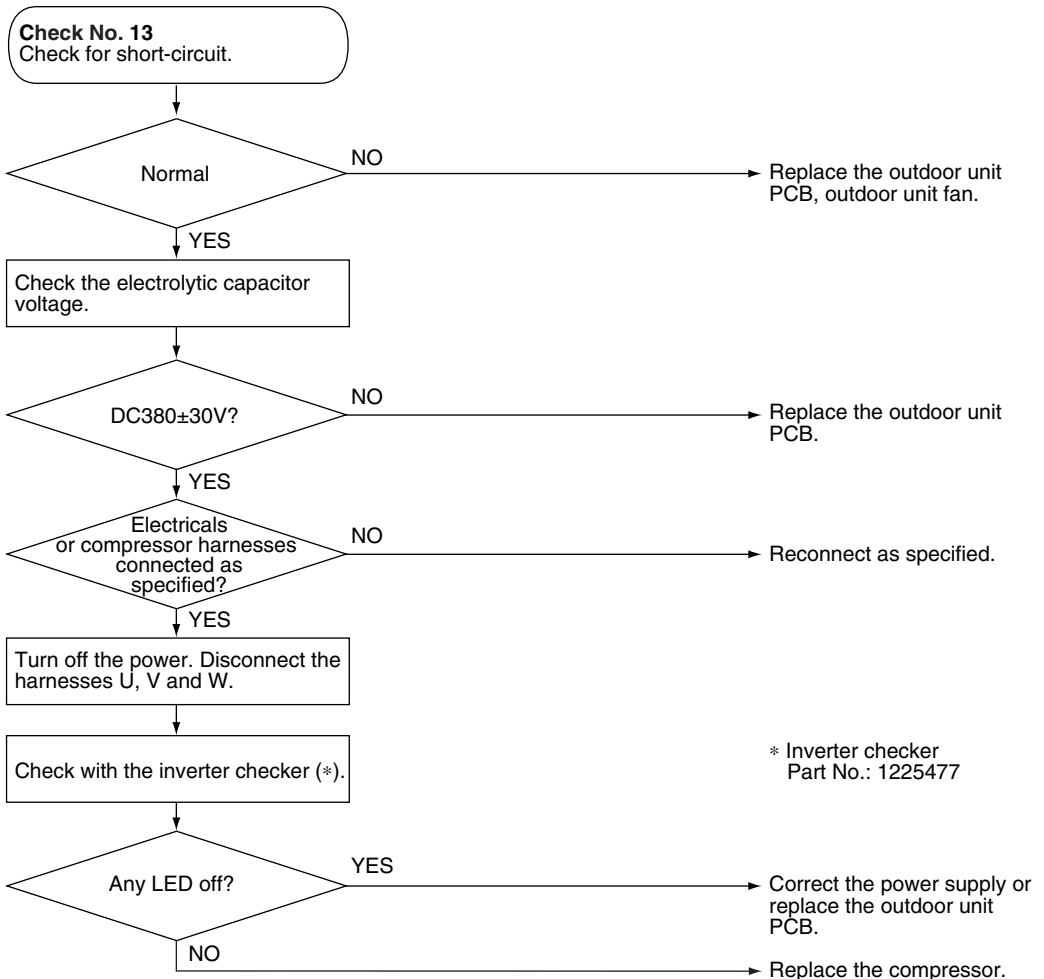

(R2847)

4.15 DC Voltage / Current Sensor Abnormality

Remote Controller Display	H8
Method of Malfunction Detection	Detecting abnormality of the DC sensor by the running frequency of compressor and by the input current multiplied DC voltage and current.
Malfunction Decision Conditions	<p>The compressor running frequency is below 52 Hz. (The input current is also below 0.5 A.)</p> <ul style="list-style-type: none"> ■ If this error repeats 4 times, the system will be shut down. ■ The error counter will reset itself if this or any other error does not occur during the following 60-minute compressor running time (total time).
Supposed Causes	<ul style="list-style-type: none"> ■ Outdoor unit PCB defective
Troubleshooting	<div style="margin-bottom: 10px;">  <p>Caution Be sure to turn off power switch before connect or disconnect connector, or parts damage may be occurred.</p> </div> <p>Replace the outdoor unit PCB.</p>

4.16 CT or Related Abnormality

**Remote
Controller
Display**

H8

**Method of
Malfunction
Detection**

A CT or related error is detected by checking the compressor running frequency and CT-detected input current.

**Malfunction
Decision
Conditions**

The compressor running frequency is below 55 Hz and the CT input is below 0.1 V.
(The input current is also below 1.25 A.)

- If this error repeats 4 times, the system will be shut down.
 - The error counter will reset itself if this or any other error does not occur during the following 60-minute compressor running time (total time).
-

**Supposed
Causes**

- Power transistor defective
- Internal wiring broken or in poor contact
- Reactor defective
- Outdoor unit PCB defective

Troubleshooting



Check No.12
Refer to P.202



Caution

Be sure to turn off power switch before connect or disconnect connector, or parts damage may be occurred.

Turn off the power and turn it on again.

Get the system started.

* Running current as shown at right with relay cable 1 or 2?

YES

Replace the outdoor unit PCB.

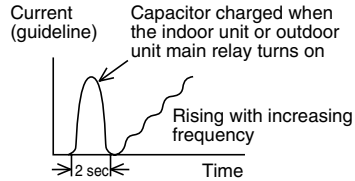

NO

Check No. 12
Check the capacitor voltage.

DC380±30V?

YES

Turn off the power. Disconnect the harnesses U, V and W.

Check with the inverter checker (*).

* Inverter checker
Part No.: 1225477

NO

Measure the rectifier input voltage.

Any LED off?

YES

Correct the power supply or replace the SPM. (Replace the outdoor unit PCB.)

Turn off the power and reconnect the above harnesses. Then turn on the power again and get the system restarted.

Compressor running?

YES

Replace the outdoor unit PCB.

NO

Replace the compressor.

Voltage within the allowable range (Supply voltage±15%)?

YES

Replace the outdoor unit PCB.

NO

Check the supply voltage.

(R2848)

4.17 Thermistor or Related Abnormality (Outdoor Unit)

Remote
Controller
Display

P4, J3, J6, H9

Method of
Malfunction
Detection

This type of error is detected by checking the thermistor input voltage to the microcomputer.
[A thermistor error is detected by checking the temperature.]

Malfunction
Decision
Conditions

The thermistor input is above 4.96 V or below 0.04 V with the power on.
Error *J3* is judged if the discharge pipe thermistor temperature is smaller than the condenser thermistor temperature.

Supposed
Causes

- Connector in poor contact
- Thermistor defective
- Outdoor unit PCB defective
- Indoor unit PCB defective
- Condenser thermistor defective in the case of *J3* error (outdoor unit heat exchanger thermistor in the cooling mode, or indoor unit heat exchanger thermistor in the heating mode)

Troubleshooting



Check No.06
Refer to P.198



Caution

Be sure to turn off power switch before connect or disconnect connector, or parts damage may be occurred.

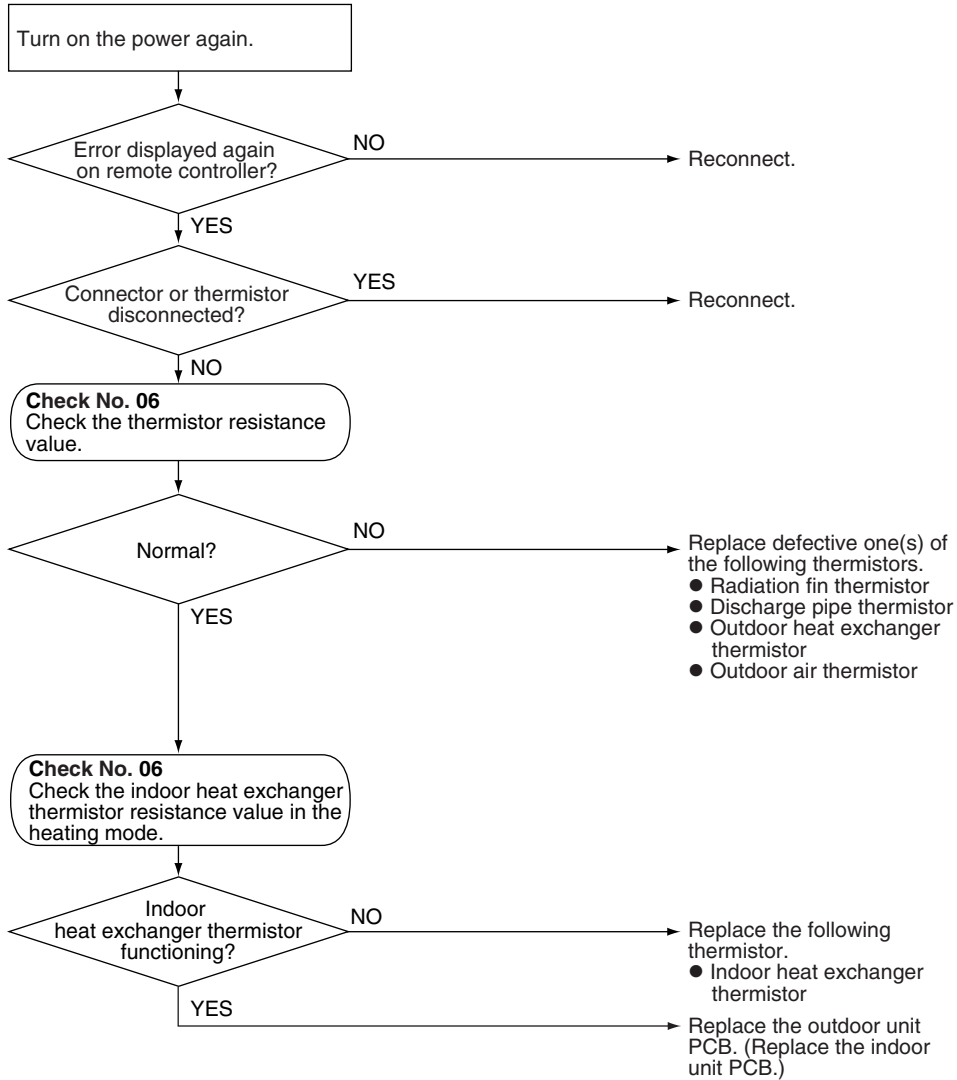

(R4702)

- P4 : Radiation fin thermistor
- J3 : Discharge pipe thermistor
- J6 : Outdoor heat exchanger thermistor
- H9 : Outdoor air temperature thermistor

4.18 Electrical Box Temperature Rise

**Remote
Controller
Display**

L3

**Method of
Malfunction
Detection**

An electrical box temperature rise is detected by checking the radiation fin thermistor with the compressor off.

**Malfunction
Decision
Conditions**

With the compressor off, the radiation fin temperature is above 176°F. Reset is made when the temperature drops below 158°F.

**Supposed
Causes**

- Fin temperature rise due to defective outdoor unit fan
- Fin temperature rise due to short-circuit
- Fin thermistor defective
- Connector in poor contact
- Outdoor unit PCB defective

Troubleshooting



Check No.06
Refer to P.198



Check No.07
Refer to P.199



Check No.09
Refer to P.200



Caution Be sure to turn off power switch before connect or disconnect connector, or parts damage may be occurred.

Turn off the power and turn it on again.



WARNING

To cool down the electricals, the outdoor unit fan gets started when the radiation fin temperature rises above 176°F and stops itself when it drops below 158°F.

Error again or outdoor unit fan activated?

YES

NO

Check No. 06
Check the thermistor resistance value.

● Fin thermistor

Check the radiation fin temperature.

Thermistor as specified in its characteristic chart?

NO

Replace the fin thermistor.

YES

Above 176°F?

NO

Replace the outdoor unit PCB.

YES

Check No. 09
Check the outdoor unit fan or related.

Malfunctioning

Replace the fan motor. Correct the connectors and fan motor leads. Replace the outdoor unit PCB.

Functioning

Radiation fin dirty?

Too dirty

Clean up the radiation fin.

Slightly dirty

Check No. 07
Check the installation condition.

(R5474)

4.19 Radiation Fin Temperature Rise

Remote
Controller
Display

L4

Method of
Malfunction
Detection

A radiation fin temperature rise is detected by checking the radiation fin thermistor with the compressor on.

Malfunction
Decision
Conditions

If the radiation fin temperature with the compressor on is above 194°F.

- If a radiation fin temperature rise takes place 4 times successively, the system will be shut down.
- The error counter will reset itself if this or any other error does not occur during the following 60-minute compressor running time (total time).

Supposed
Causes

- Fin temperature rise due to defective outdoor unit fan
- Fin temperature rise due to short-circuit
- Fin thermistor defective
- Connector in poor contact
- Outdoor unit PCB defective

Troubleshooting



Check No.06
Refer to P.198



Check No.07
Refer to P.199



Check No.09
Refer to P.200



Caution Be sure to turn off power switch before connect or disconnect connector, or parts damage may be occurred.

Turn off the power and turn it on again to get the system started.

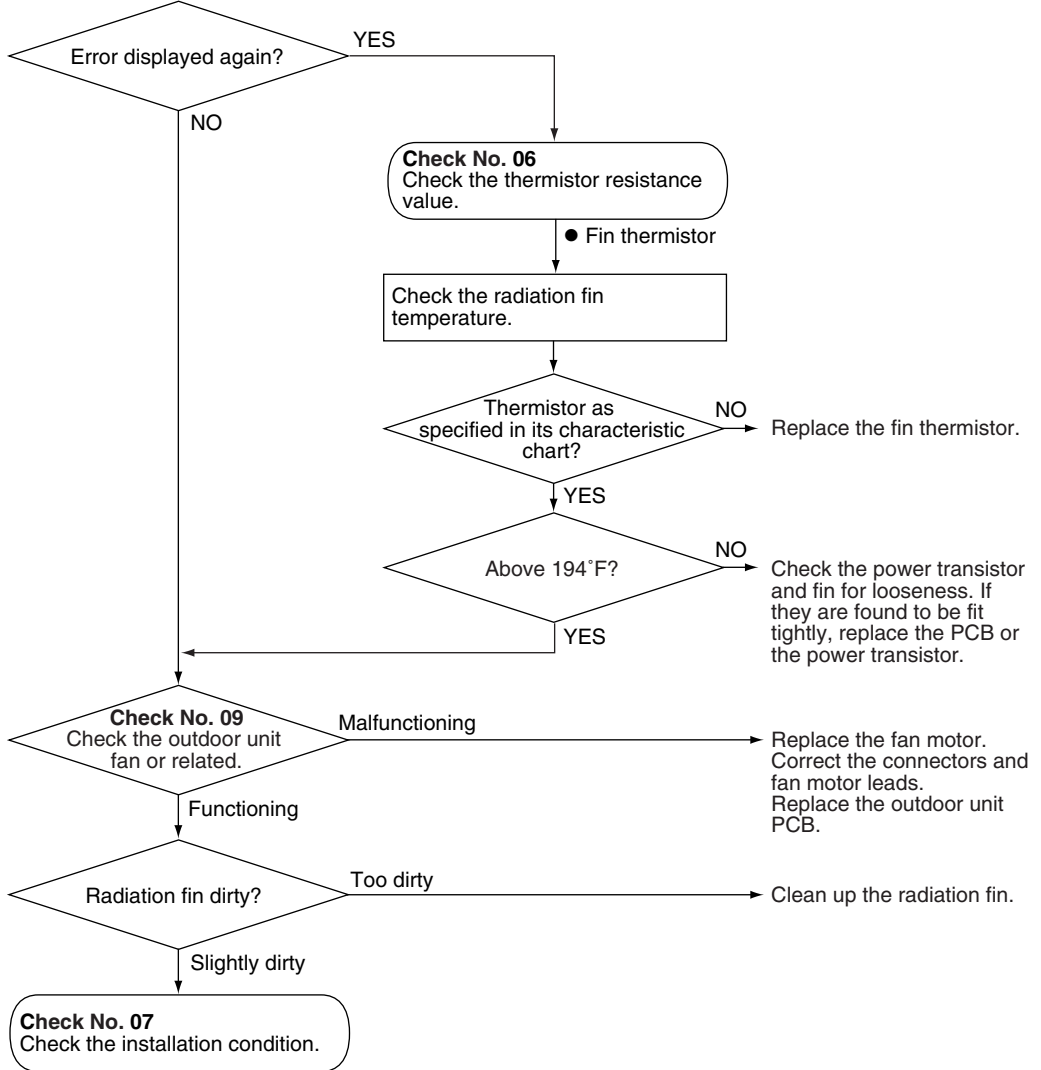

(R5475)

4.20 Output Over Current Detection

4.20.1 09/12 Class

Remote
Controller
Display

L5

Method of
Malfunction
Detection

An output over-current is detected by checking the current that flows in the inverter DC section.

Malfunction
Decision
Conditions

- A position signal error occurs while the compressor is running.
- A speed error occurs while the compressor is running.
- An output over-current input is fed from the output over-current detection circuit to the microcomputer.
- The system will be shut down if the error occurs 255 times.
- Clearing condition: Continuous run for about 10 minutes (normal)

Supposed
Causes

- Over-current due to defective power transistor
- Over-current due to wrong internal wiring
- Over-current due to abnormal supply voltage
- Over-current due to defective PCB
- Error detection due to defective PCB
- Over-current due to closed stop valve
- Over-current due to compressor failure
- Over-current due to poor installation condition

Troubleshooting



Check No.07
Refer to P.199



Check No.08
Refer to P.199



Check No.13
Refer to P.202



Caution Be sure to turn off power switch before connect or disconnect connector, or parts damage may be occurred.

* An output over-current may result from wrong internal wiring. If the wires have been disconnected and reconnected for part replacement, for example, and the system is interrupted by an output over-current, take the following procedure.

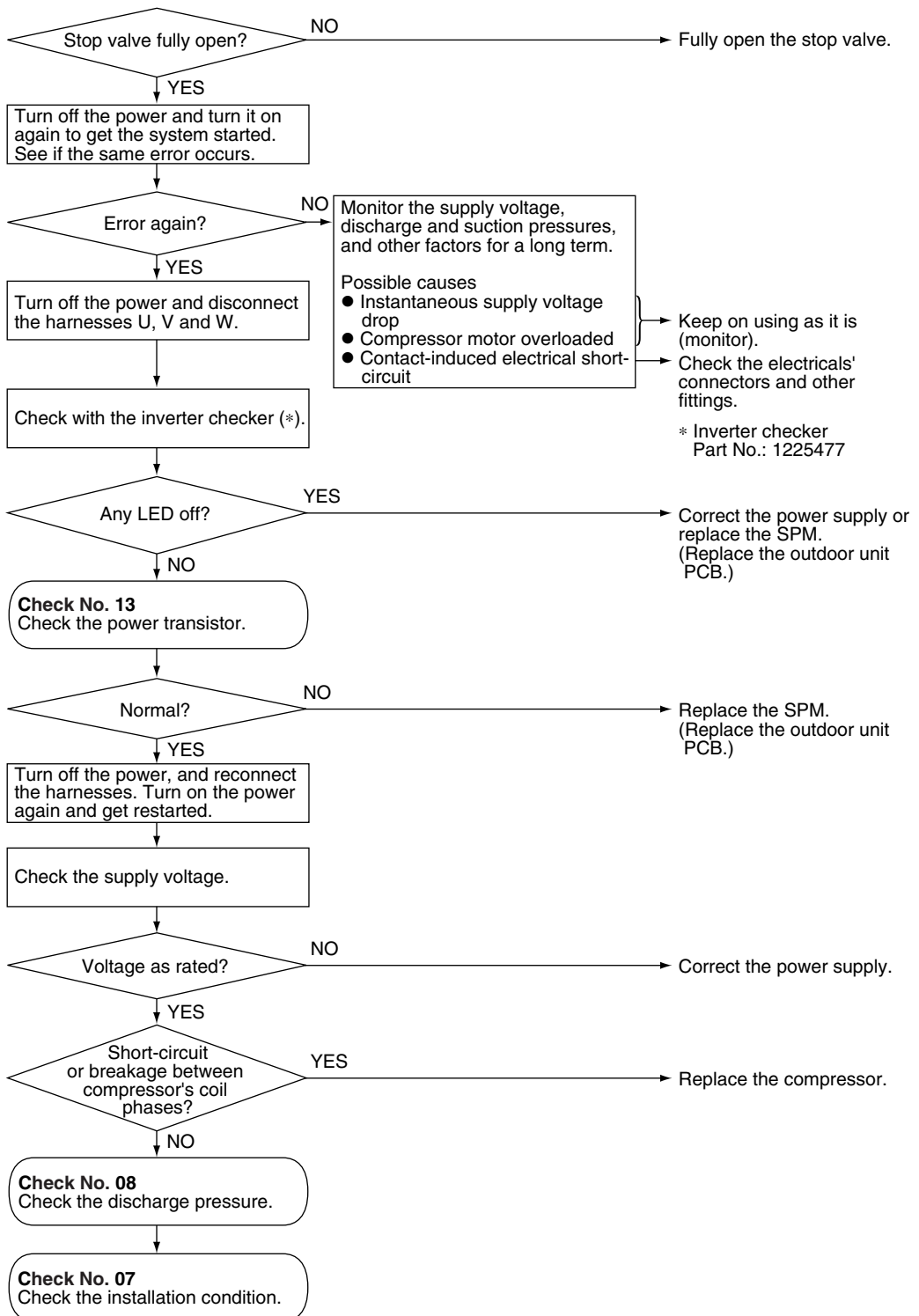

(R4705)



Note: If the model doesn't have SPM, replace the outdoor unit PCB.

4.20.2 15/18/24 Class

**Remote
Controller
Display**

L5

**Method of
Malfunction
Detection**

An output over-current is detected by checking the current that flows in the inverter DC section.

**Malfunction
Decision
Conditions**

- A position signal error occurs while the compressor is running.
 - A speed error occurs while the compressor is running.
 - An output over-current input is fed from the output over-current detection circuit to the microcomputer.
 - The system will be shut down if the error occurs 16 times.
 - Clearing condition: Continuous run for about 5 minutes (normal)
-

**Supposed
Causes**

- Over-current due to defective power transistor
- Over-current due to wrong internal wiring
- Over-current due to abnormal supply voltage
- Over-current due to defective PCB
- Error detection due to defective PCB
- Over-current due to closed stop valve
- Over-current due to compressor failure
- Over-current due to poor installation condition

Troubleshooting



Check No.07
Refer to P.199



Check No.08
Refer to P.199



Check No.13
Refer to P.202



Caution Be sure to turn off power switch before connect or disconnect connector, or parts damage may be occurred.

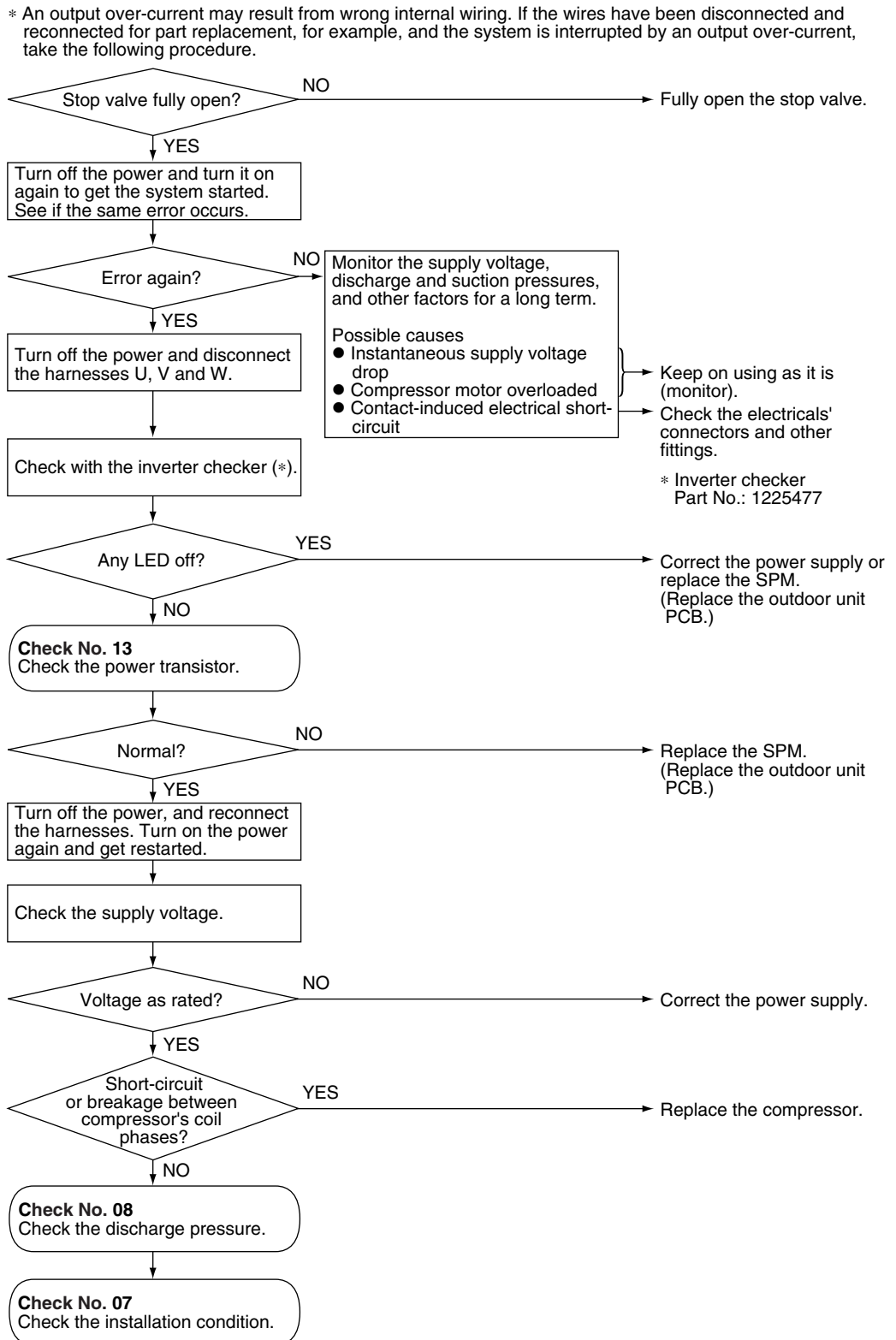

(R4705)

4.21 Insufficient Gas

4.21.1 09/12 Class

Remote
Controller
Display

U0

Method of
Malfunction
Detection

Gas shortage detection I : A gas shortage is detected by checking the compressor running frequency.

Gas shortage detection II : A gas shortage is detected by checking the difference between indoor unit heat exchanger temperature and room temperature as well as the difference between outdoor unit heat exchanger temperature and room temperature.

Gas shortage detection III : A gas shortage is detected by checking the difference between inhale and exhale temperature.

Malfunction
Decision
Conditions

Gas shortage detection I :

Input current < Δ (A/Hz) x Compressor running frequency x Voltage + Δ

However, when the status of running frequency > Δ (Hz) is kept on for a certain time.

Note : The values are different from model to model.

Δ	Δ	Δ
640 / 256	0	55

Gas shortage detection II :

If a gas shortage error takes place 4 times successively, the system will be shut down. The error counter will reset itself if this or any other error does not occur during the following 60-minute compressor running time (total time).

Gas shortage detection III :

When the difference of the temperature is smaller than Δ , it is regarded as insufficient gas.

		Δ
Cooling	room temperature – indoor heat exchanger temperature	$\Delta 7.2^{\circ}\text{F}$
	outdoor heat exchanger temperature – outdoor temperature	$\Delta 7.2^{\circ}\text{F}$
Heating	indoor heat exchanger temperature – room temperature	$\Delta 7.2^{\circ}\text{F}$
	outdoor temperature – outdoor heat exchanger temperature	$\Delta 5.4^{\circ}\text{F}$

Supposed
Causes

- Refrigerant shortage (refrigerant leakage)
- Poor compression performance of compressor
- Discharge pipe thermistor disconnected, or indoor unit or outdoor unit heat exchanger thermistor disconnected, room or outdoor air temperature thermistor disconnected
- Stop valve closed
- Electronic expansion valve defective

Troubleshooting



Check No.04
Refer to P.195



Check No.06
Refer to P.198



Caution Be sure to turn off power switch before connect or disconnect connector, or parts damage may be occurred.

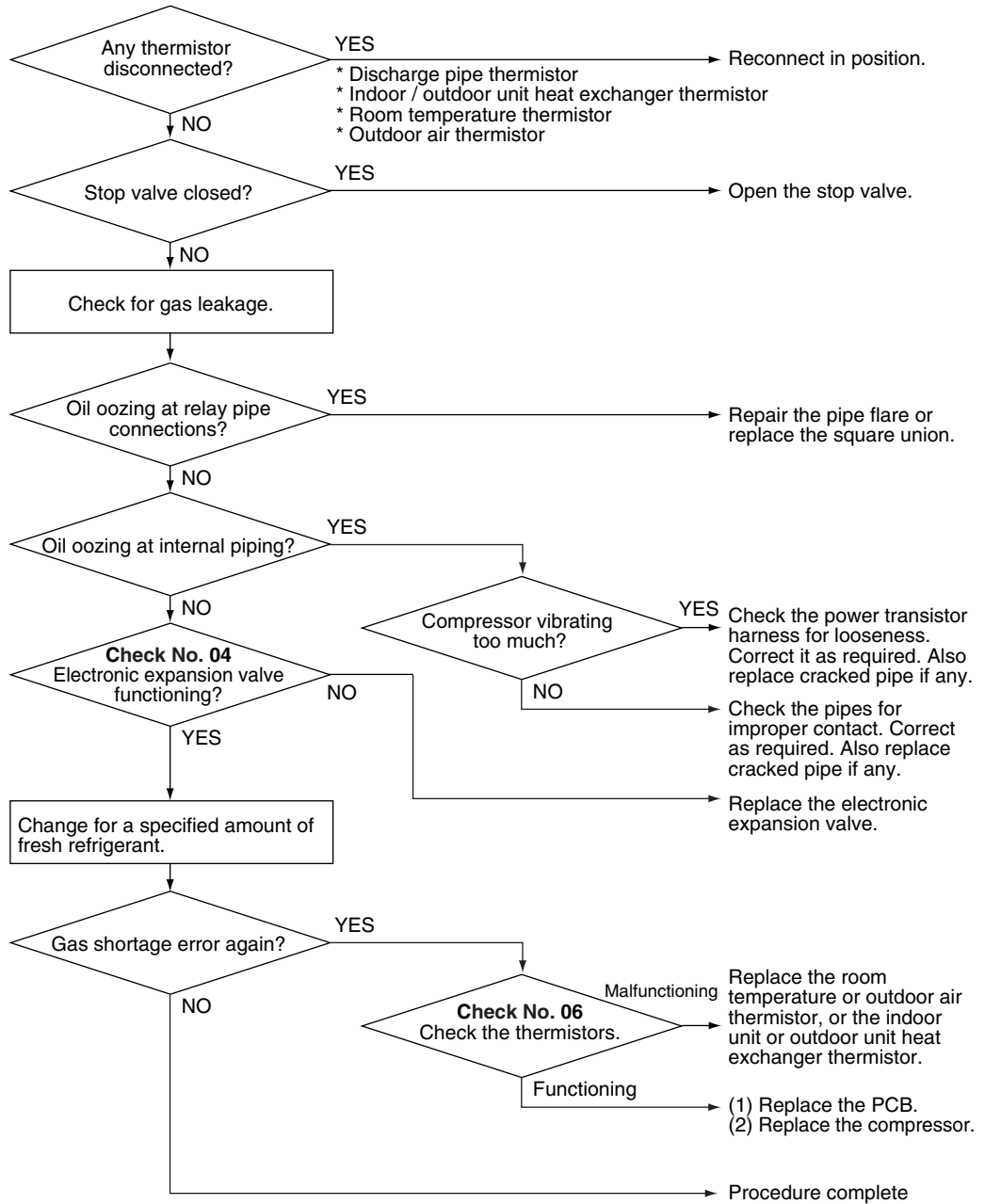

(R4706)

4.21.2 15/18/24 Class

Remote
Controller
Display

U0

Method of
Malfunction
Detection

Gas shortage detection I : A gas shortage is detected by checking the CT-detected input current value and the compressor running frequency.

Gas shortage detection II : A gas shortage is detected by checking the difference between indoor unit heat exchanger temperature and room temperature as well as the difference between outdoor unit heat exchanger temperature and room temperature.

Malfunction
Decision
Conditions

Gas shortage detection I :

Input current < A (A/Hz) x Compressor running frequency x Voltage + B

However, when the status of running frequency > 55 (Hz) is kept on for a certain time.

Note : The values are different from model to model.

A	B
1756 / 256	-50

Gas shortage detection II :

If a gas shortage error takes place 4 times successively, the system will be shut down. The error counter will reset itself if this or any other error does not occur during the following 60-minute compressor running time (total time).

Supposed
Causes

- Refrigerant shortage (refrigerant leakage)
- Poor compression performance of compressor
- Discharge pipe thermistor disconnected, or indoor unit or outdoor unit heat exchanger thermistor disconnected, room or outside air temperature thermistor disconnected
- Stop valve closed
- Electronic expansion valve defective

Troubleshooting



Check No.04
Refer to P.195



Check No.06
Refer to P.198



Caution Be sure to turn off power switch before connect or disconnect connector, or parts damage may be occurred.

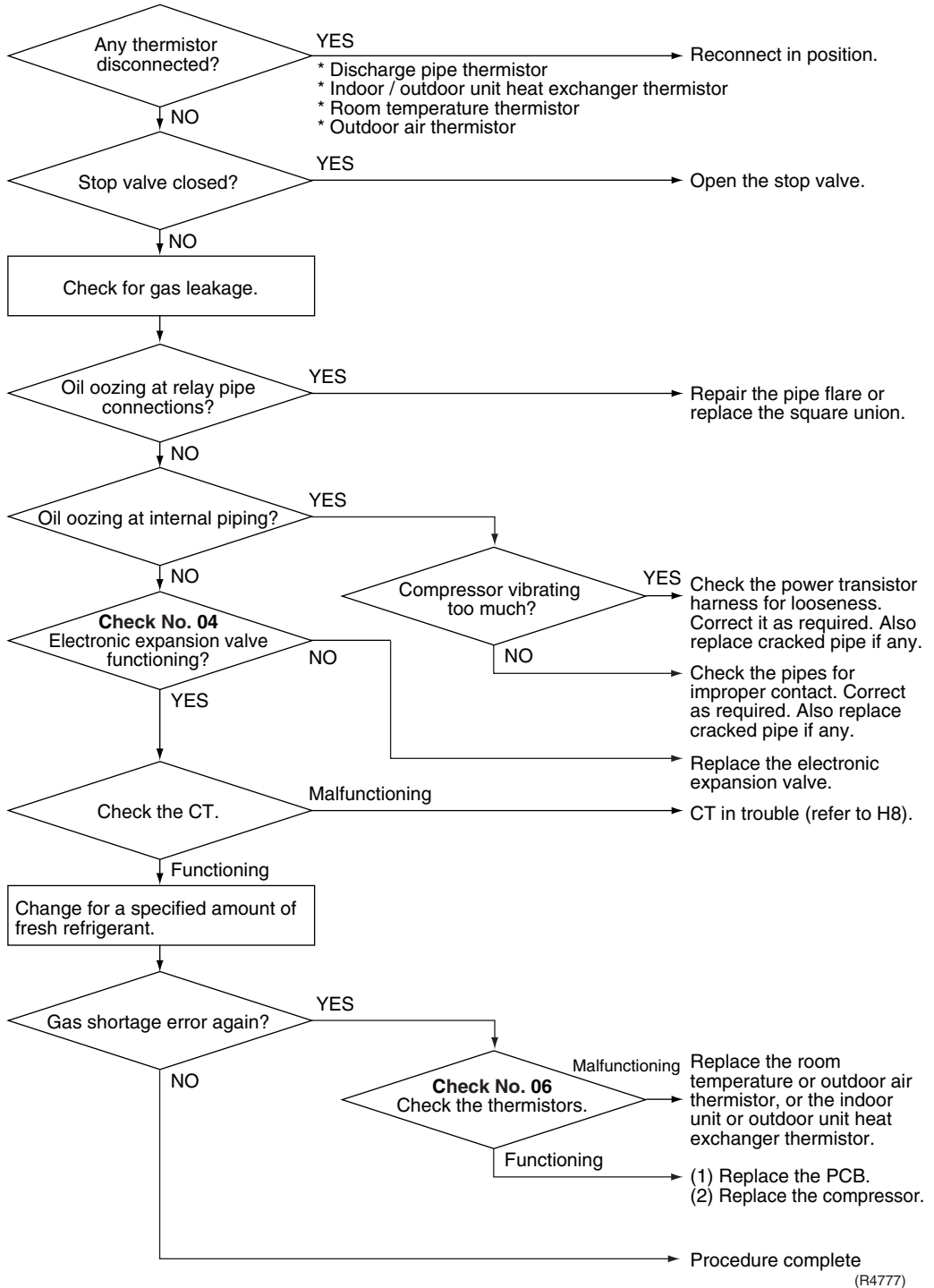

4.22 Over-voltage Detection

Remote
Controller
Display

U2

Method of
Malfunction
Detection

An abnormal voltage rise is detected by checking the specified over-voltage detection circuit.

Malfunction
Decision
Conditions

- An over-voltage signal is fed from the over-voltage detection circuit to the microcomputer (The voltage is over 400V).
- The system will be shut down if the error occurs 255 times.
- Clearing condition: Continuous run for about 10 minutes (normal)

Supposed
Causes

- Supply voltage not as specified
- Over-voltage detection circuit defective
- PAM control part(s) defective

Troubleshooting

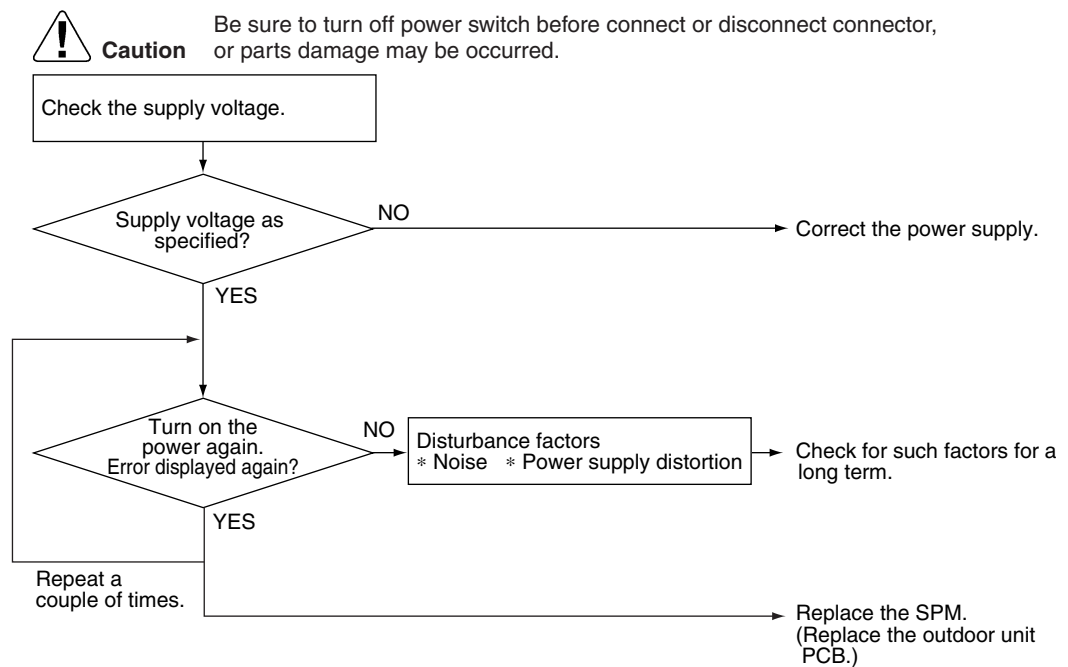

(R2957)



Note: If the model doesn't have SPM, replace the outdoor unit PCB.

4.23 Low-voltage Detection

Remote
Controller
Display

U2

Method of
Malfunction
Detection

An abnormal voltage rise or drop is detected by checking the detection circuit or DC voltage detection circuit.

Malfunction
Decision
Conditions

- An over-voltage signal is fed from the over-voltage detection circuit to the microcomputer, or the voltage being detected by the DC voltage detection circuit is judged to be below 150 V for 0.1 second.
- The system will be shut down if the error occurs 16 times.
- Clearing condition: Continuous run for about 60 minutes (normal)

Supposed
Causes

- Supply voltage not as specified
- Over-voltage detector or DC voltage detection circuit defective
- PAM control part(s) defective

Troubleshooting

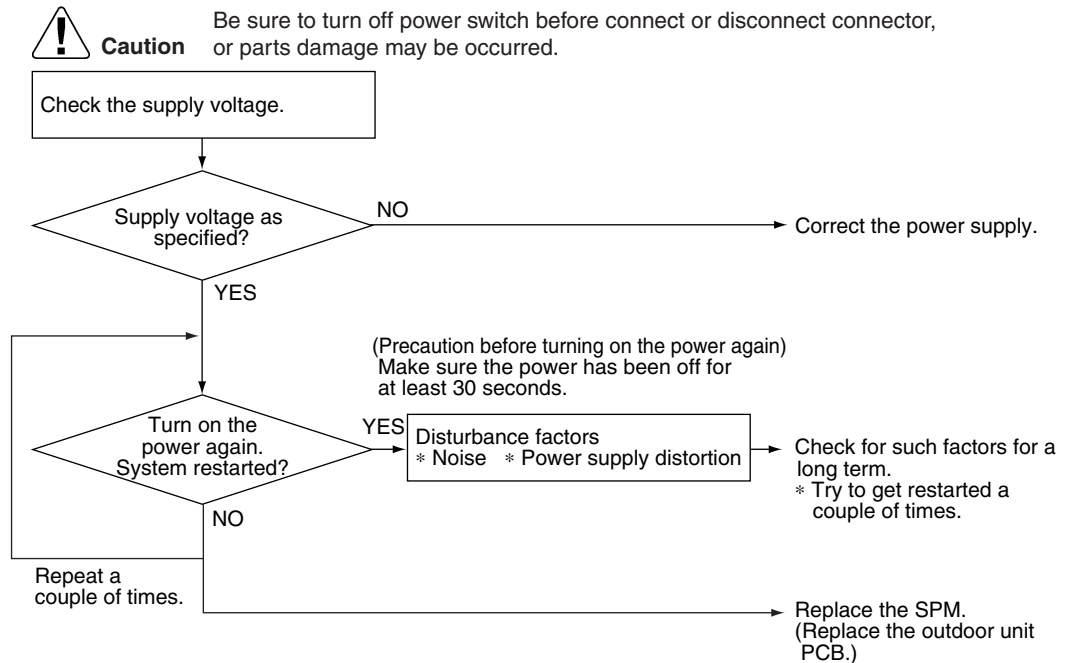

(R2854)

5. Check

5.1 How to Check

5.1.1 Fan Motor Connector Output Check

Check No.01

1. Check connector connection.
2. Check motor power supply voltage output (pins 4-7).
3. Check motor control voltage (pins 4-3).
4. Check rotation command voltage output (pins 4-2).
5. Check rotation pulse input (pins 4-1).

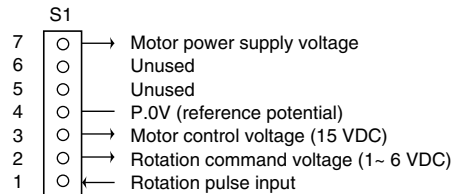

5.1.2 Electronic Expansion Valve Check

Check No.04

Conduct the followings to check the electronic expansion valve (EV).

1. Check to see if the EV connector is correctly inserted in the PCB. Compare the EV unit and the connector number.
2. Turn the power off and back on again, and check to see if all the EVs generate latching sound.
3. If any of the EVs does not generate latching noise in the above step 2, disconnect that connector and check the conductivity using a tester.

Check the conductivity between pins 1, 3 and 6, and between pins 2, 4 and 5. If there is no conductivity between the pins, the EV coil is faulty.

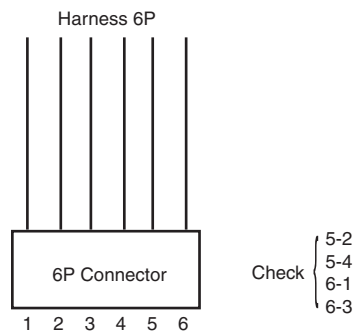

4. If no EV generates latching sound in the above step 2, the outdoor unit PCB is faulty.
5. If the conductivity is confirmed in the above step 2, mount a good coil (which generated latching sound) in the EV unit that did not generate latching sound, and check to see if that EV generates latching sound.
 - *If latching sound is generated, the outdoor unit PCB is faulty.
 - *If latching sound is not generated, the EV unit is faulty.



Note: Please note that the latching sound varies depending on the valve type.

5.1.3 Four Way Valve Performance Check

Check No.05

■ 09/12 Class

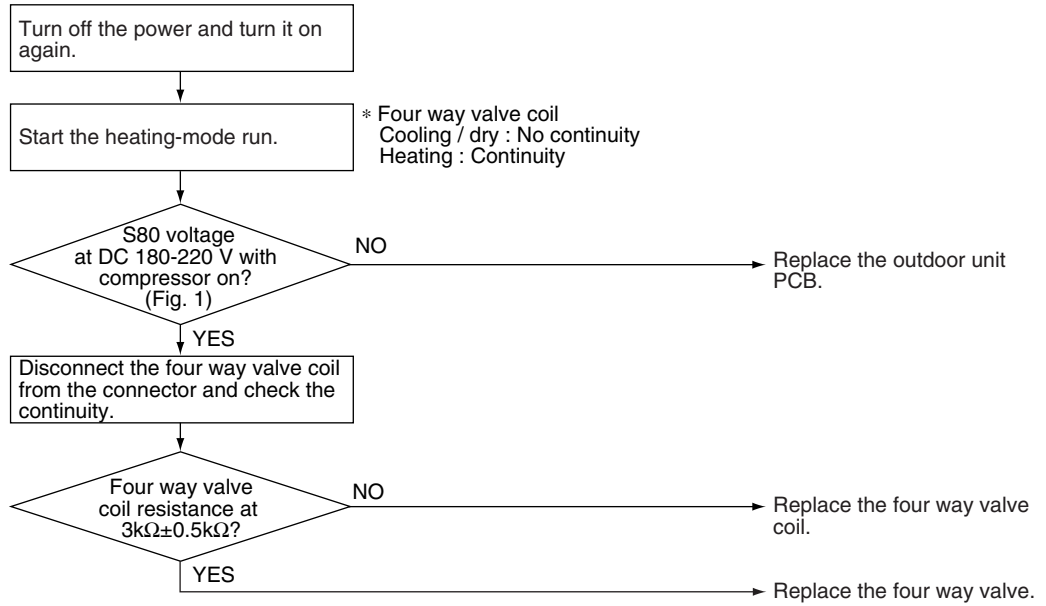

(Fig. 1)

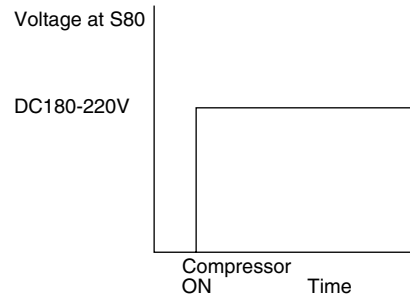

(R3047)

■ 15/18/24 Class

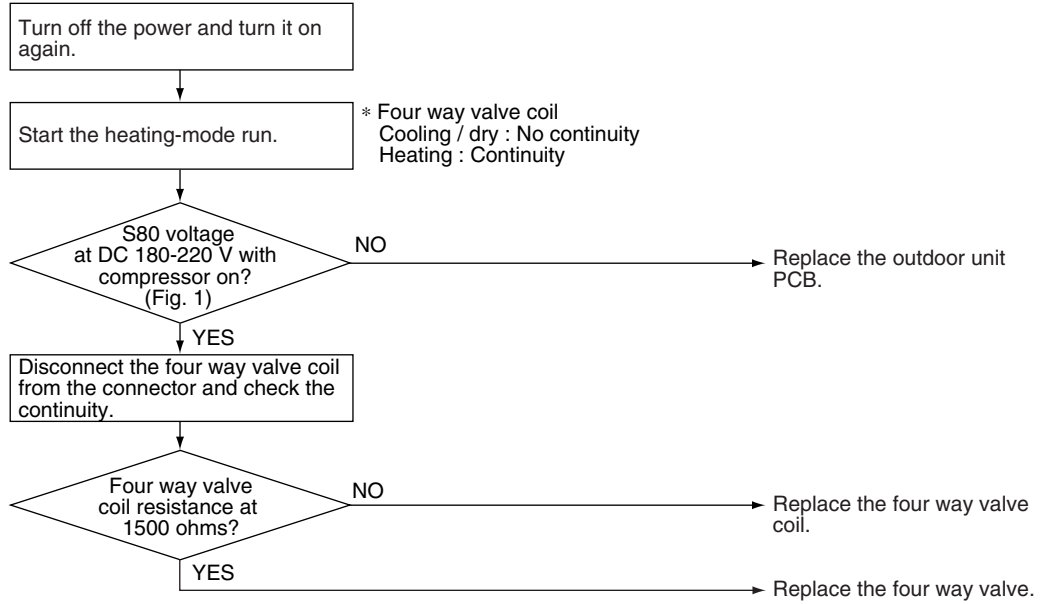

(Fig. 1)

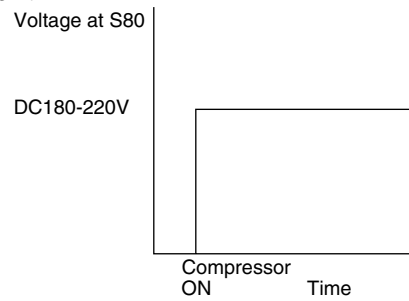

(R2856)

5.1.4 Thermistor Resistance Check

Check No.06

Remove the connectors of the thermistors on the PCB, and measure the resistance of each thermistor using tester.

The relationship between normal temperature and resistance is shown in the graph and the table below.

Temperature (°F)	Thermistor R77°F=20kΩ B=3950
4	211.0 (kΩ)
5	150
14	116.5
23	88
32	67.2
41	51.9
50	40
59	31.8
68	25
77	20
86	16
95	13
104	10.6
113	8.7
122	7.2

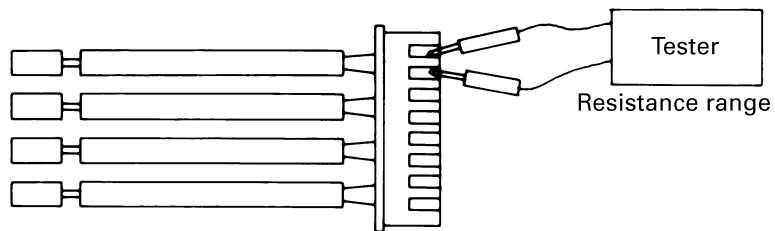

(R77°F = 20k Ω 、 B = 3950)

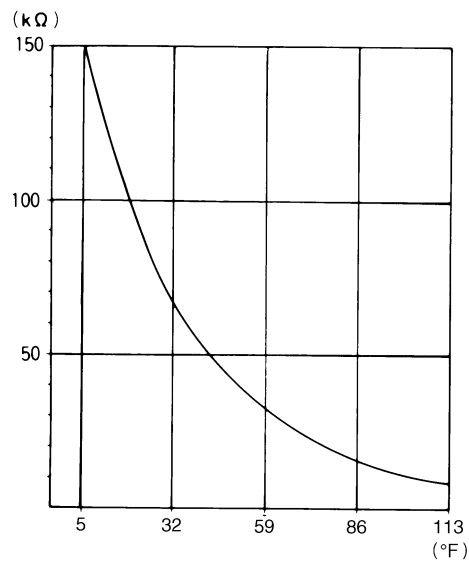

(R4159)

5.1.5 Installation Condition Check

Check No.07

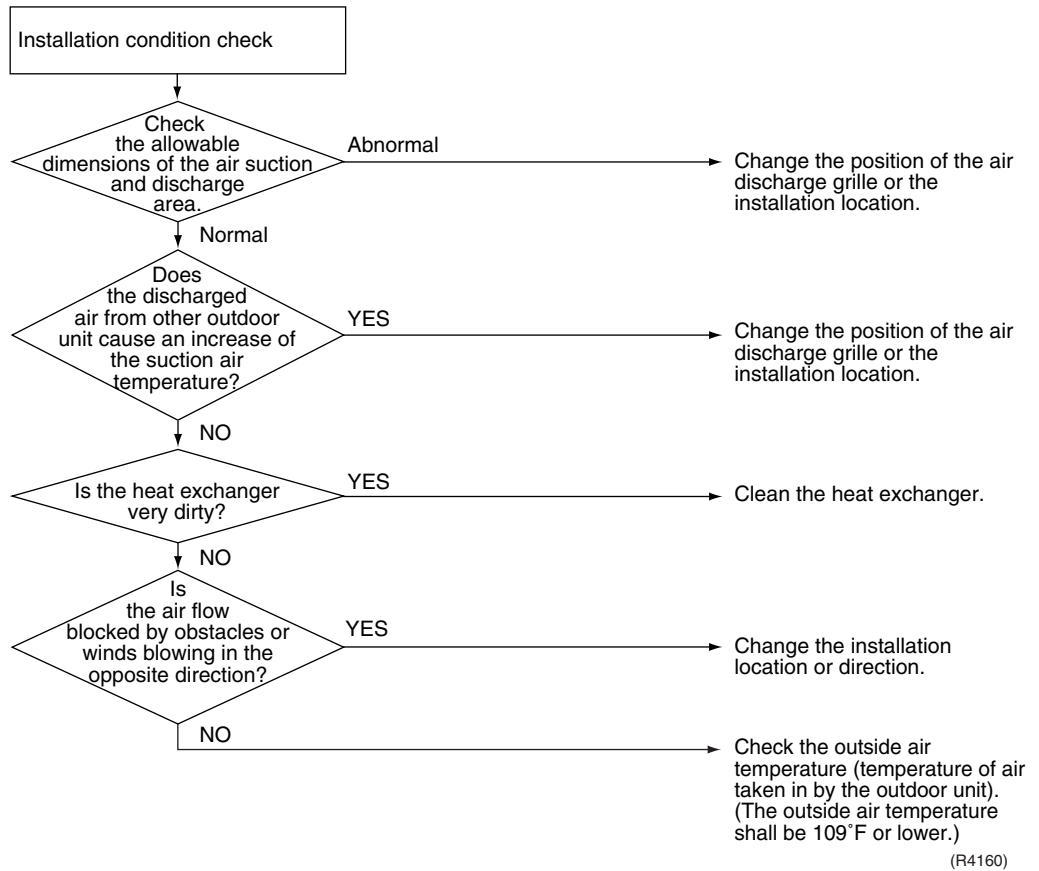

5.1.6 Discharge Pressure Check

Check No.08

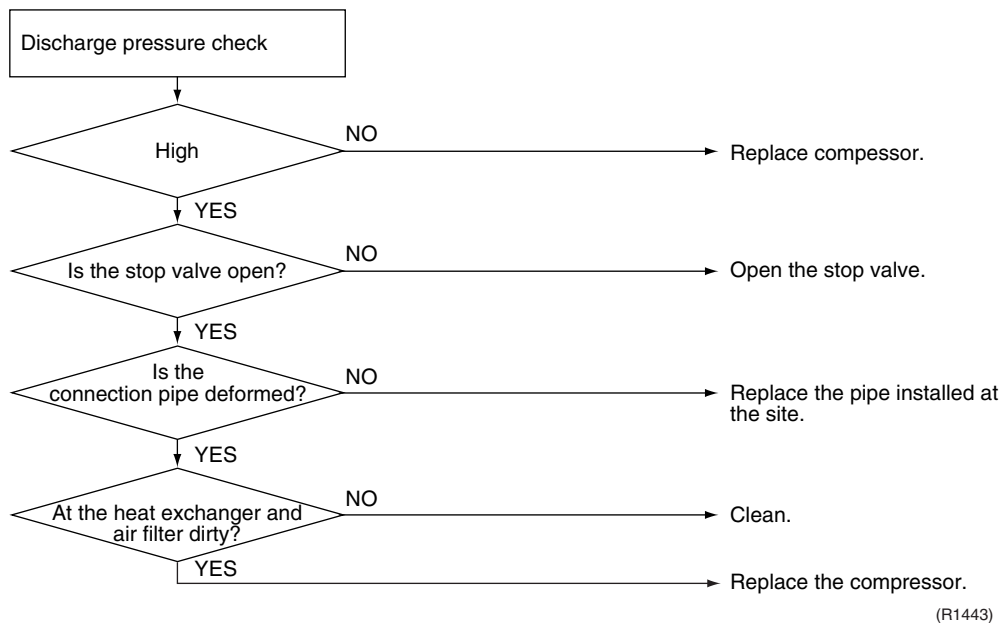

5.1.7 Outdoor Unit Fan System Check

Check No.09

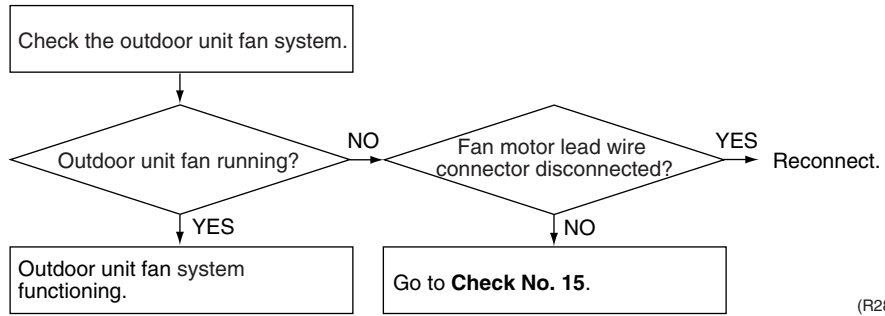

(R2857)

5.1.8 Power Supply Waveforms Check

Check No.10

Measure the power supply waveform between pins 1 and 3 on the terminal board, and check the waveform disturbance.

- Check to see if the power supply waveform is a sine wave (Fig.1).
- Check to see if there is waveform disturbance near the zero cross (sections circled in Fig.2)

[Fig.1]

[Fig.2]

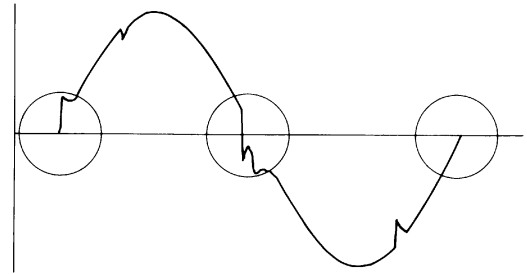
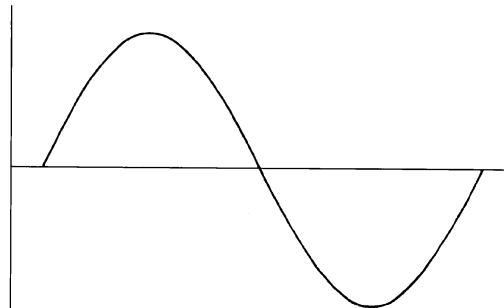

(R1736)

(R1444)

5.1.9 Inverter Units Refrigerant System Check

Check No.11

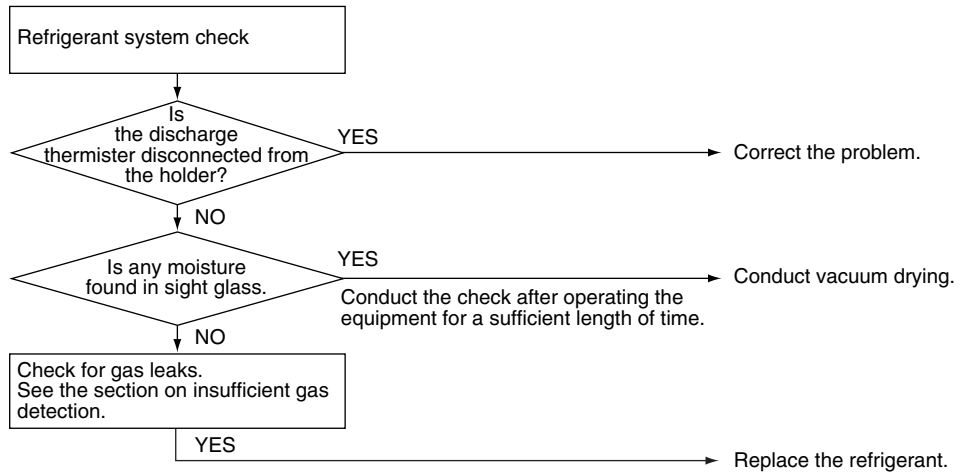

(R1445)

5.1.10 Capacitor Voltage Check

Check No.12

Before this checking, be sure to check the main circuit for short-circuit.

- Checking the capacitor voltage
- With the circuit breaker still on, measure the voltage according to the drawing of the model in question. Be careful never to touch any live parts.

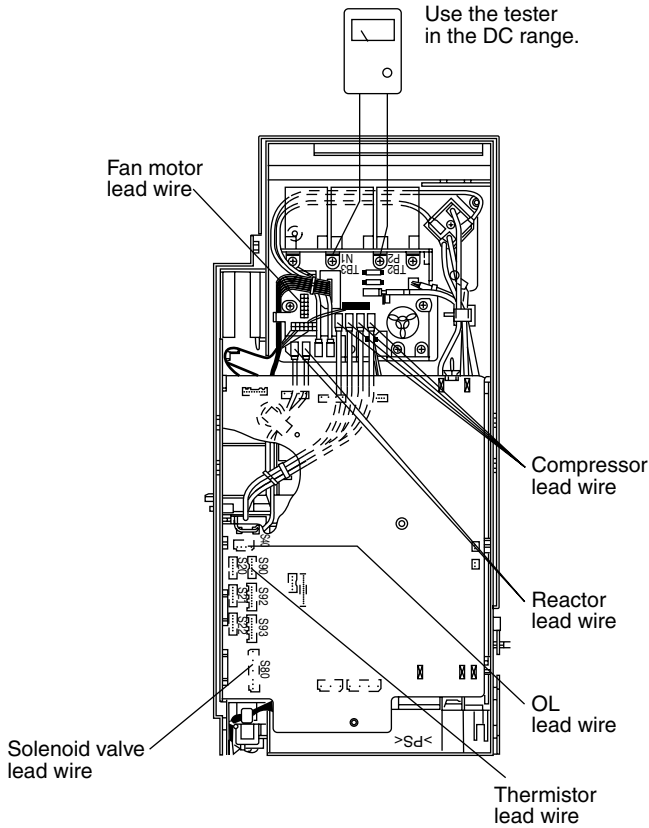

(R5473)

5.1.11 Power Transistor Check

Check No.13

- Checking the power transistor
- Never touch any live parts for at least 10 minutes after turning off the circuit breaker.
- If you cannot avoid to touch a live part, make sure that the power transistor's supply voltage is below 50 V using the tester.
- For the UVW, make measurements at the Faston terminal on the board or the relay connector.

Tester's negative terminal	Power transistor (+)	UVW	Power transistor (-)	UVW
Tester's positive terminal	UVW	Power transistor (+)	UVW	Power transistor (-)
Normal resistance	Several kΩ to several MΩ			
Abnormal resistance	0 or ∞			

5.1.12 Main Circuit Electrolytic Capacitor Check

Check No.14

- Checking the main circuit electrolytic capacitor
- Never touch any live parts for at least 10 minutes after turning off the circuit breaker.
- If you cannot avoid to touch a live part, make sure that there is no DC voltage using the tester.
- Check the continuity with the tester. Reverse the pins and make sure there is continuity.

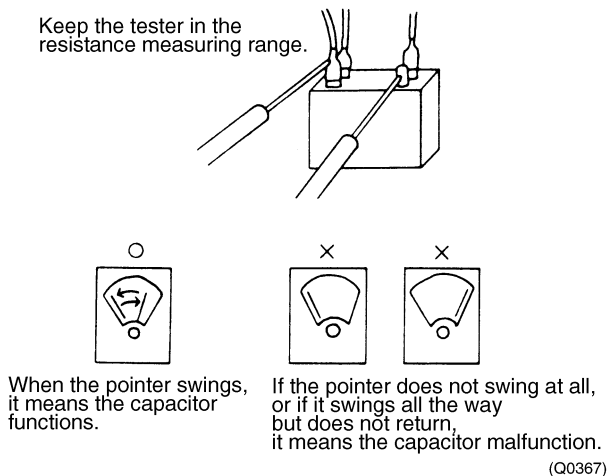

5.1.13 Turning Speed Pulse Input on the Outdoor Unit PCB Check

Check No.15

<Propeller fan motor>

Make sure the voltage of $270\pm 30V$ is being applied.

- (1) Stop the operation first and then the power off, and disconnect the connector S70.
- (2) Make sure there is about DC 270 V between pins 4 and 7.
- (3) With the system and the power still off, reconnect the connector S70.
- (4) Make a turn of the fan motor with a hand, and make sure the pulse (0-15 V) appears twice at pins 1 and 4.

If the fuse is blown out, the outdoor-unit fan may also be in trouble. Check the fan too.

If the voltage in Step (2) is not applied, it means the PCB is defective. Replace the PCB.

If the pulse in Step (4) is not available, it means the Hall IC is defective. Replace the DC fan motor. If there are both the voltage (2) and the pulse (4), replace the PCB.

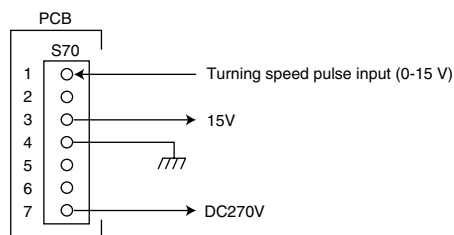

* Propeller fan motor : S70

5.1.14 Hall IC Check

Check No.16

1. Check the connector connection.
2. With the power ON, operation OFF, and the connector connected, check the following.
 - *Output voltage of about 5 V between pins 1 and 3.
 - *Generation of 3 pulses between pins 2 and 3 when the fan motor is operating.

Failure of (1) → faulty PCB → Replace the PCB.

Failure of (2) → faulty Hall IC → Replace the fan motor.

Both (1) and (2) result → Replace the PCB.

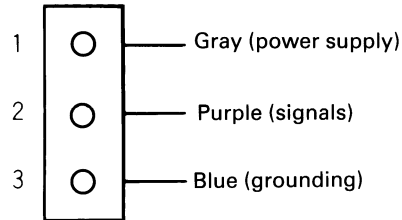

(R1968)

Part 7

Removal Procedure

1. FTXS09/12DVJU.....	206
1.1 Removal of Air Filter.....	206
1.2 Removal of Front Grille	209
1.3 Removal of Horizontal Blade and Vertical Blade.....	212
1.4 Removal of Electrical Box, PCB and Swing Motor	214
1.5 Removal of Heat Exchanger	220
1.6 Install of Drain Plug	223
1.7 Removal of Fan Rotor and Fan Motor	225
2. FTXS15/18/24DVJU.....	229
2.1 Removal of the Air Filter / Front Panel	229
2.2 Removal of the Front Grille	233
2.3 Removal of the Horizontal Blades / Vertical Blades	236
2.4 Removal of the Electrical Box / PCB / Swing Motor	239
2.5 Removal of the Heat Exchanger	247
2.6 Removal of the Fan Rotor / Fan Motor	250
3. RXS09/12DVJU	253
3.1 Removal of Panels and Fan Motor	253
3.2 Removal of Electrical Box	261
3.3 Removal of Reactor and Partition Plate	263
3.4 Removal of Sound Blanket.....	265
3.5 Removal of Four Way Valve.....	268
3.6 Removal of Compressor.....	270
3.7 Removal of PCB.....	273
4. RXS15/18/24DVJU	276
4.1 Removal of the Panels and Plates	276
4.2 Removal of the Fan Motor / Propeller Fan	281
4.3 Removal of the PCB / Electrical Box	285
4.4 Removal of the Reactor.....	294
4.5 Removal of the Sound Blanket.....	296
4.6 Removal of the Four Way Valve.....	299
4.7 Removal of the Electronic Expansion Valve.....	300
4.8 Removal of the Compressor.....	301

Note:

The removal procedures for FDXS09/12DVJU is not described.

1. FTXS09/12DVJU

1.1 Removal of Air Filter

Procedure



Warning Be sure to wait 10 minutes or more after turning off all power supplies before disassembling work.

Step	Procedure	Points
<p>1. External features</p>		<ul style="list-style-type: none"> ■ If ON/OFF button is kept pushing for 5 seconds, a forced cooling operation will be carried out for approx. 15 minutes.
<p>2. Removing air filters</p> <p>1 Pull protrusions on left and right sides of panel with fingers and open front grille all the way.</p>		

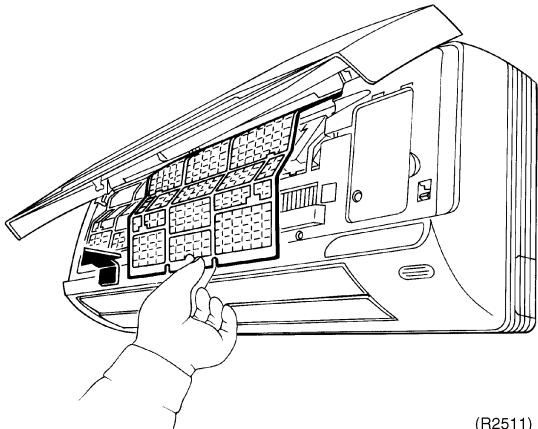
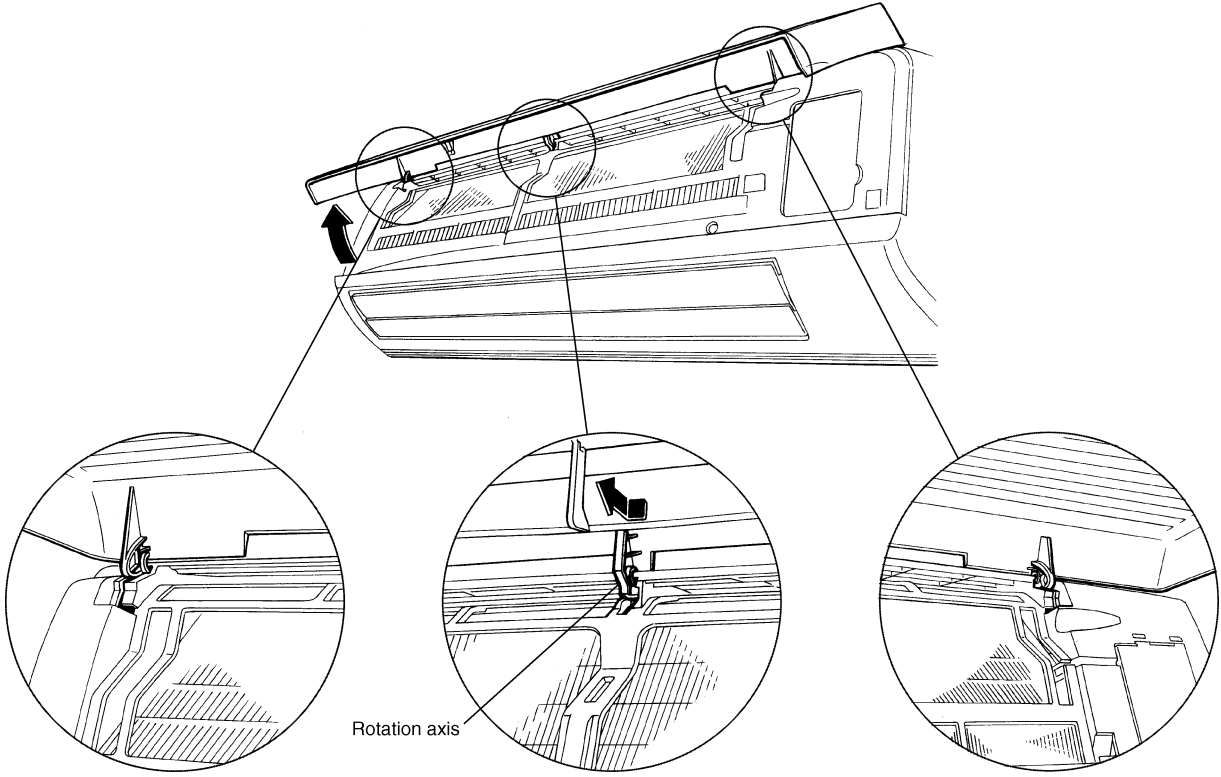
Step	Procedure	Points
2	<p>Lift center section of air filter and disengage hooks. Remove air filter by pulling forward.</p>  <p style="text-align: right;">(R2511)</p>	<ul style="list-style-type: none"> ■ Left and right filters are interchangeable. ■ To re-install, insert air filter along the guide.
3. Opening and shutting front panel	<p>1 Hook a finger onto the projection part provided on the both sides of the unit's panel and open up the panel to the position higher than it will stop.</p>	<p>Support the front panel by one hand, while remove the rotation axis at the upper center by the other hand.</p> <ul style="list-style-type: none"> ■ And pull out the front panel forward to remove.
 <p style="text-align: center;">Slide the center rotary axis the left and remove it out.</p> <p style="text-align: right;">(R2512)</p>		

Step	Procedure	Points
2	Remove front panel from the unit.	
3	When restoring the air filter, make sure that the projection parts on the panel are in the guide groove, and then shut the panel.	

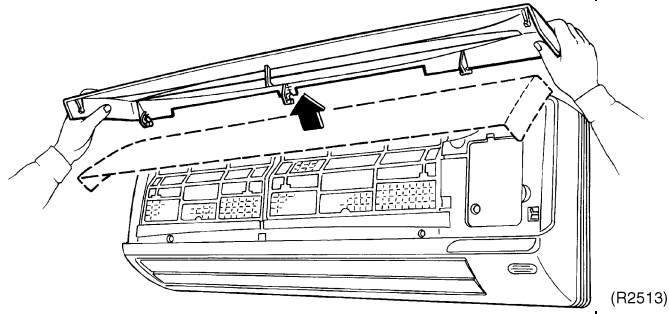

(R2513)

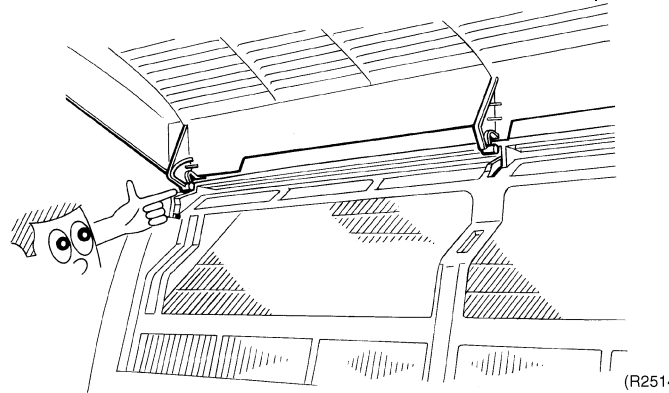

(R2514)

1.2 Removal of Front Grille

Procedure

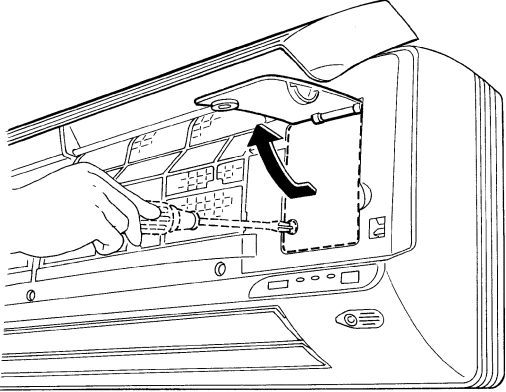
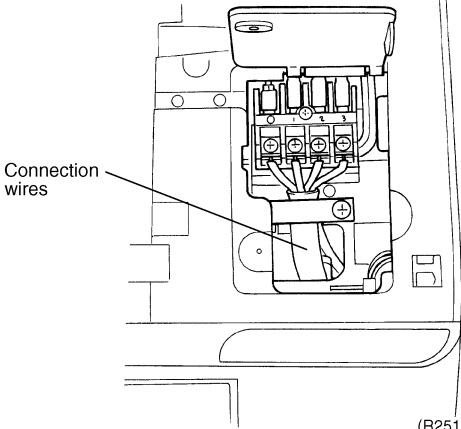

Warning Be sure to wait 10 minutes or more after turning off all power supplies before disassembling work.

Step	Procedure	Points
1. Opening and closing of service cover		
1	<p>Remove a service cover mounting screw. Open service cover upward</p>  <p style="text-align: right;">(R2515)</p>  <p style="text-align: right;">(R2516)</p>	<ul style="list-style-type: none"> ■ A switch for field setting is not provided in particular.

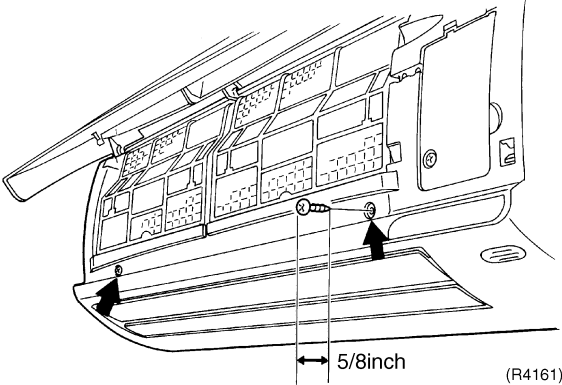
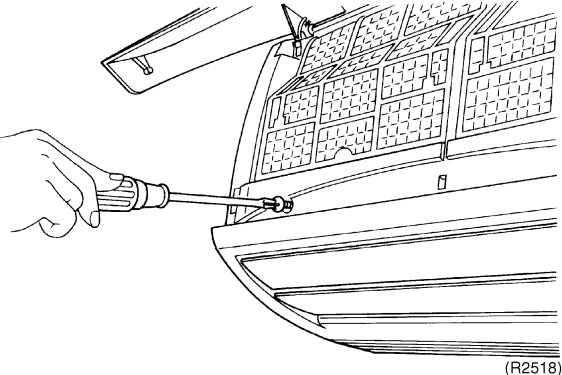
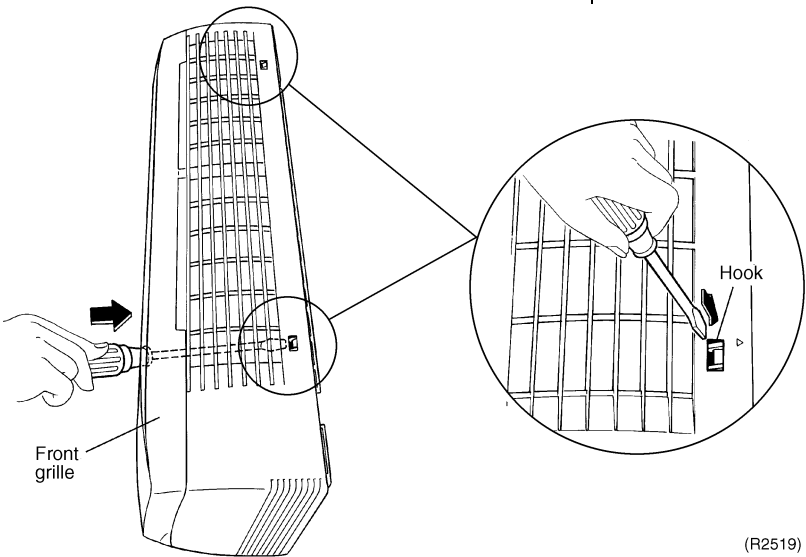
Step	Procedure	Points
2. Removal of front grille assembly		
1	<p>Remove the 2 screws, in the right and the left, which fix the main body with the front grille.</p>  	<ul style="list-style-type: none"> ■ Screw stoppers inside the flap which were equipped in the existing models are not provided.
2	<p>Disengage the 2 hooks on the upper part. In case that the hooks are not pressed from above, remove the front panel and then remove the grille while pushing the hook through a clearance between the front grille and the heat exchanger.</p> 	<ul style="list-style-type: none"> ■ At the upper part there are 2 hooks in the left and the right. ■ Disengage the hooks by pressing knobs with a screwdriver.

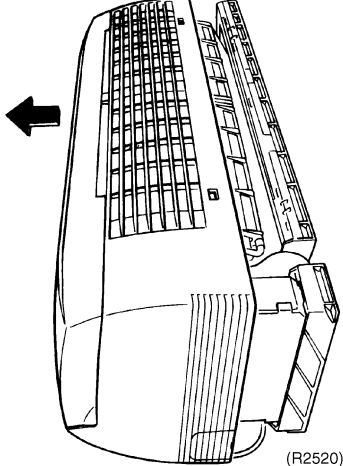
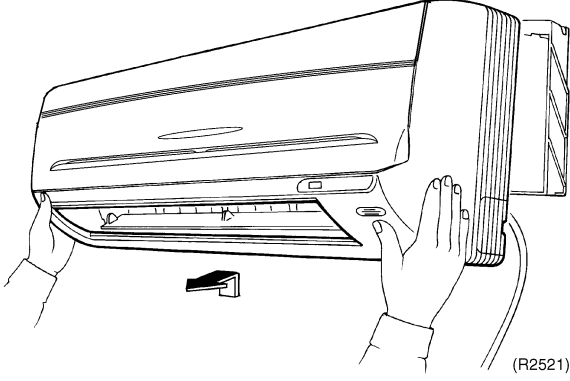
Step	Procedure	Points
3	<p data-bbox="220 216 488 373">The front grille can be removed in a manner to pull out the upper part forward and lift up the lower part.</p>  <p data-bbox="914 716 971 737">(R2520)</p>  <p data-bbox="1027 1129 1084 1150">(R2521)</p>	<ul data-bbox="1109 216 1433 310" style="list-style-type: none">■ When restoring the grille, Make sure whether each hook is set as it was.

1.3 Removal of Horizontal Blade and Vertical Blade

Procedure

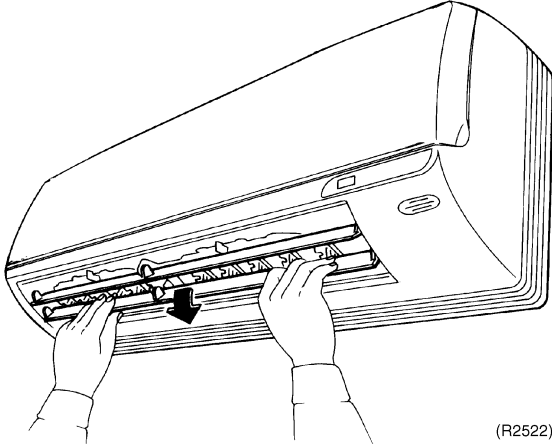
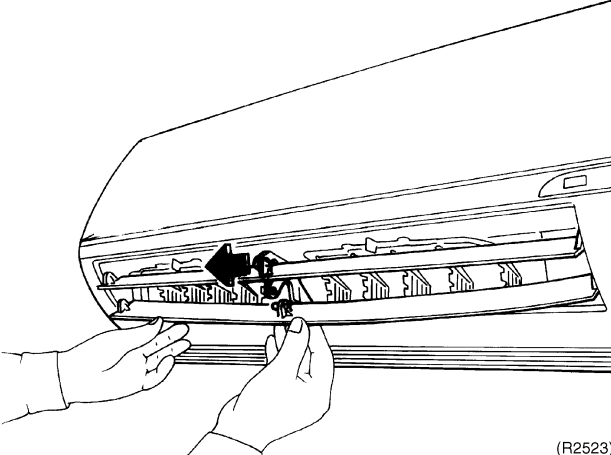
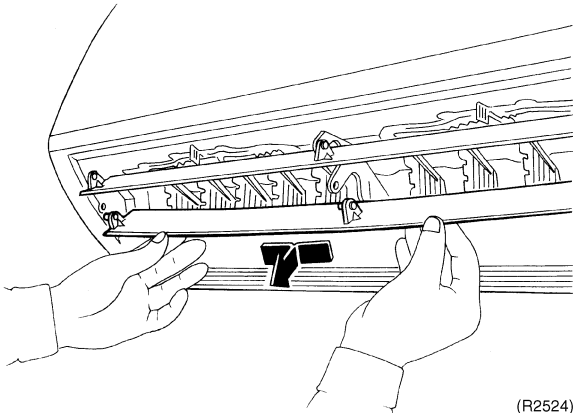

Warning Be sure to wait 10 minutes or more after turning off all power supplies before disassembling work.

Step	Procedure	Points
1. Remove horizontal blade	<p data-bbox="172 401 472 457">1 Lift horizontal blade to open position.</p>  <p data-bbox="1016 835 1076 856">(R2522)</p>	<ul style="list-style-type: none"> <li data-bbox="1109 401 1466 527">■ Screw stoppers inside the flap which were equipped in the existing models are not provided.
2 Disengage horizontal blade from blade retaining section.	 <p data-bbox="1073 1371 1133 1392">(R2523)</p>	
3 Bend blade slightly and remove it from the unit.	 <p data-bbox="1024 1881 1084 1902">(R2524)</p>	

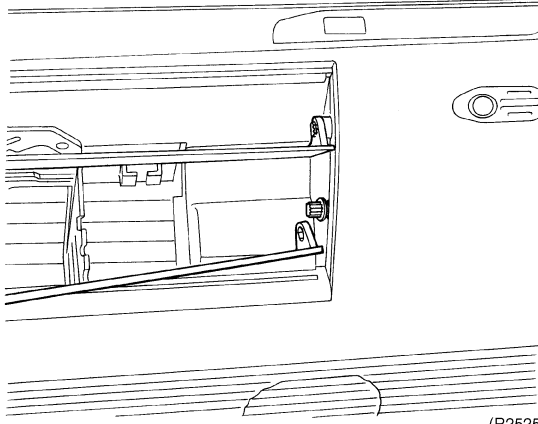
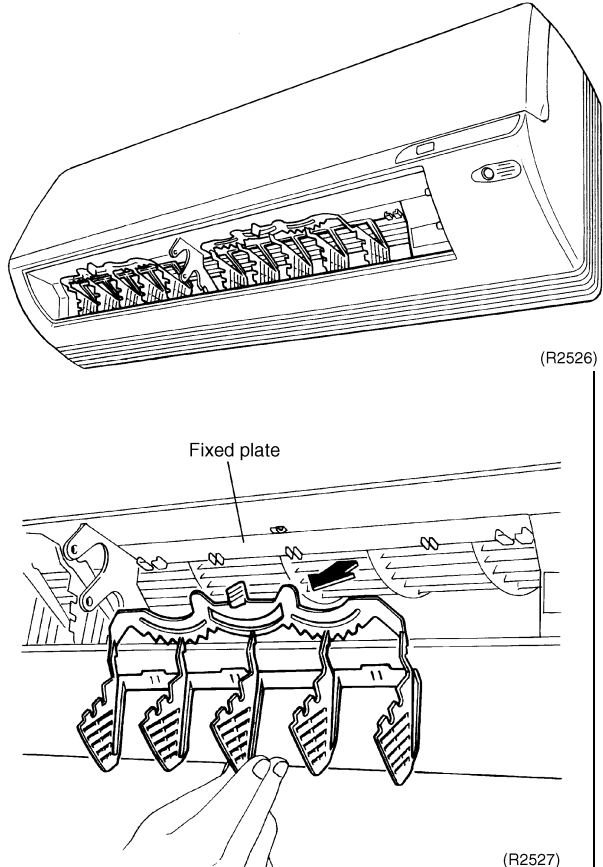
Step	Procedure	Points
	 <p>(R2525)</p>	<ul style="list-style-type: none"> ■ For restoring. 1. Since the key pattern hook is provided on the left side, insert the edge of the blade to the tip while rotating it. 2. Restore the 2 fixed parts of the horizontal blade onto the hook.
<p>2. Removal of vertical blade</p> <p>1</p> <p>2</p>	<p>Disengage the vertical blade's joint from the fixed plate.</p> <p>Remove the blade forward.</p>  <p>Fixed plate</p> <p>(R2526)</p> <p>(R2527)</p>	<ul style="list-style-type: none"> ■ Five vertical blades are integrated with the joint rod. (so, only one blade can't be exchanged.)

1.4 Removal of Electrical Box, PCB and Swing Motor

Procedure



Warning Be sure to wait 10 minutes or more after turning off all power supplies before disassembling work.

Step	Procedure	Points
<p>■ Remove front grill.</p>		
<p>1. Remove electrical box</p> <p>1 Disconnect the connection wires.</p> <p>2 Disconnect connectors (S1 and S7) of fan motor.</p> <p>3 Disconnect one connector (S6) of swing motor.</p> <p>4 Remove heat exchanger thermistor.</p>	<p>(R2529)</p> <p>(R2530)</p>	<p>■ Pay attention to the direction of the retainer of the thermistor so that the retainer will not touch the harness (same as the existing models.)</p>

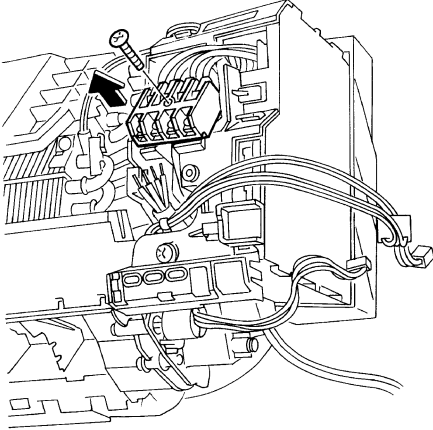
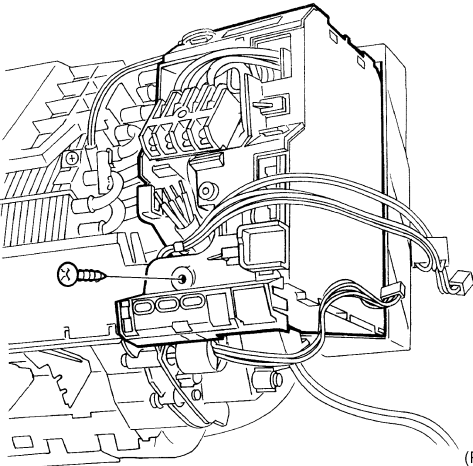
Step	Procedure	Procedure	Points
5	Remove a screw on the terminal board.	 <p>(R2531)</p>	<ul style="list-style-type: none">■ The electrical box can be removed instead of disengaging the terminal board.
6	Remove a screw on the electrical box.	 <p>(R2532)</p>	

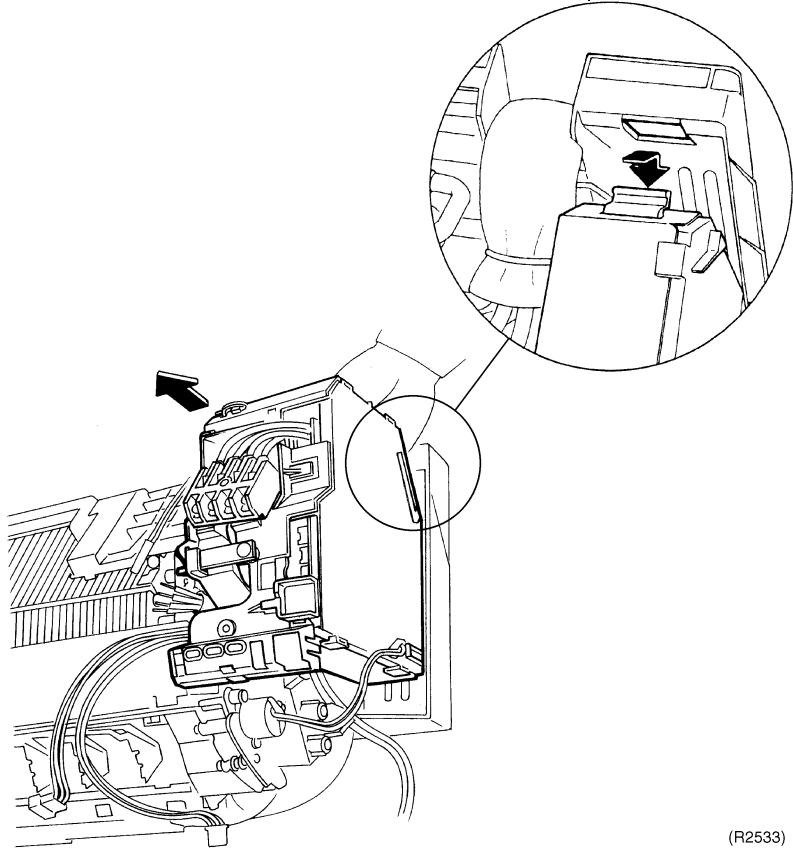
Step	Procedure	Points
7	<p>Pull up the electrical box forward to remove.</p> 	<ul style="list-style-type: none"> ■ A hook is provided on the behind. <p>(R2533)</p>

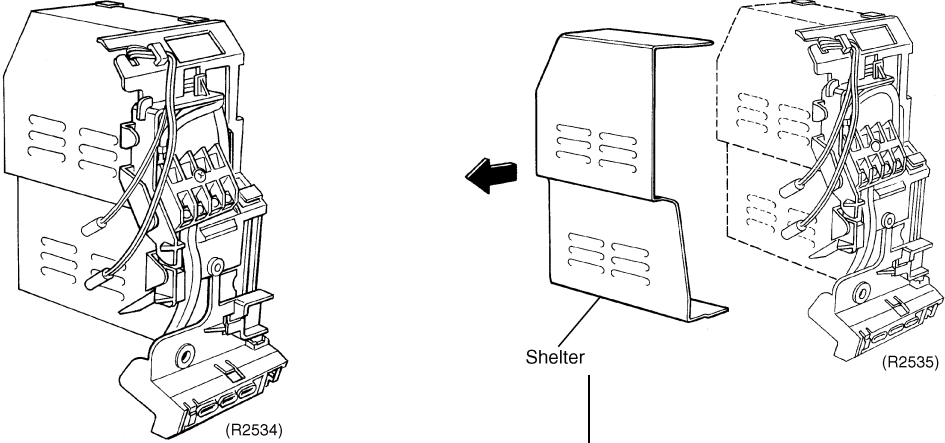
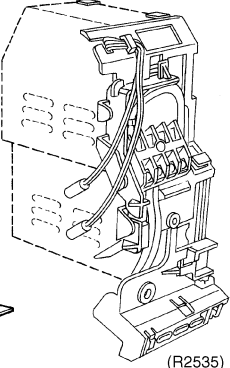
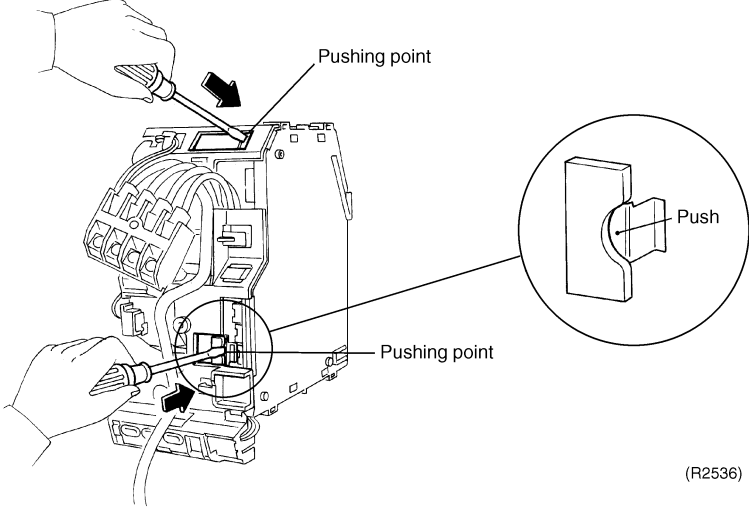
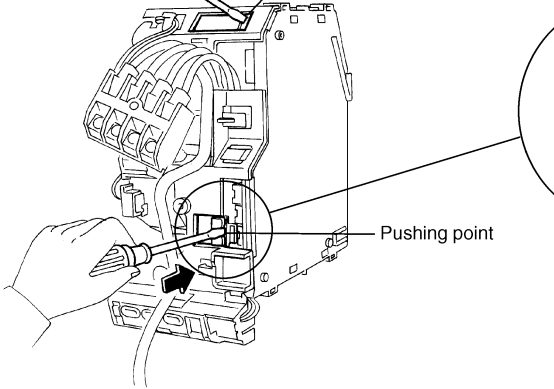
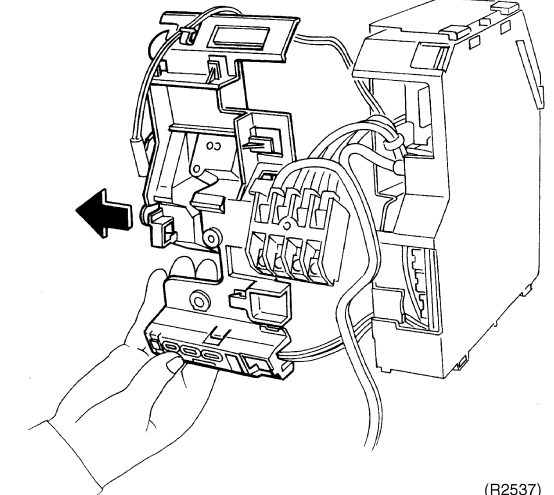
Step	Procedure	Points
2. Removal of PCB		
1	<p>Remove the shelter.</p> 	
2	<p>Disengage the front plate of the electrical box. Disengage the knobs by pushing the 2 hooks at the top and the bottom.</p> 	
3	<p>Sliding to the left, the front part of the electrical box can be removed.</p> 	

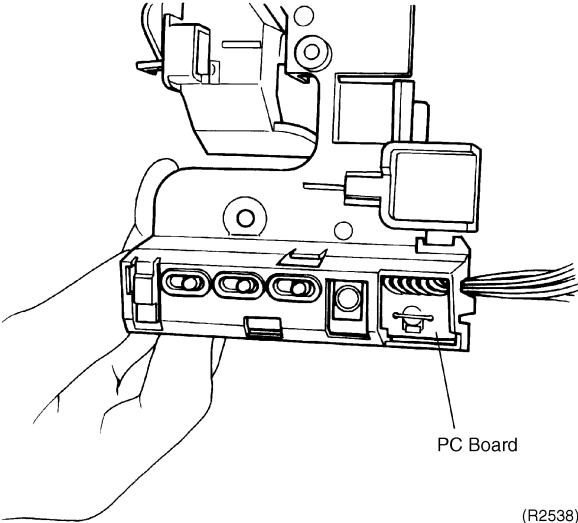
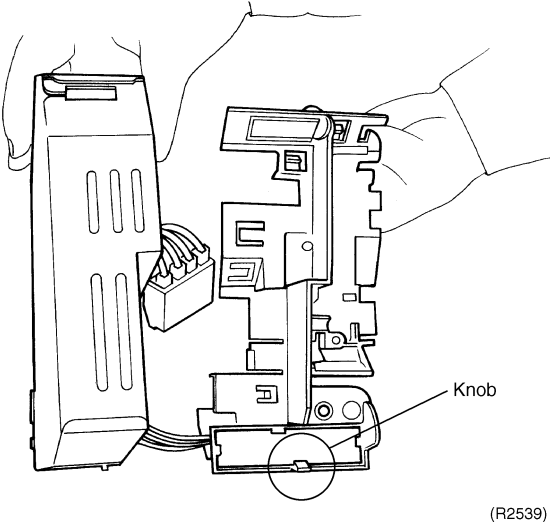
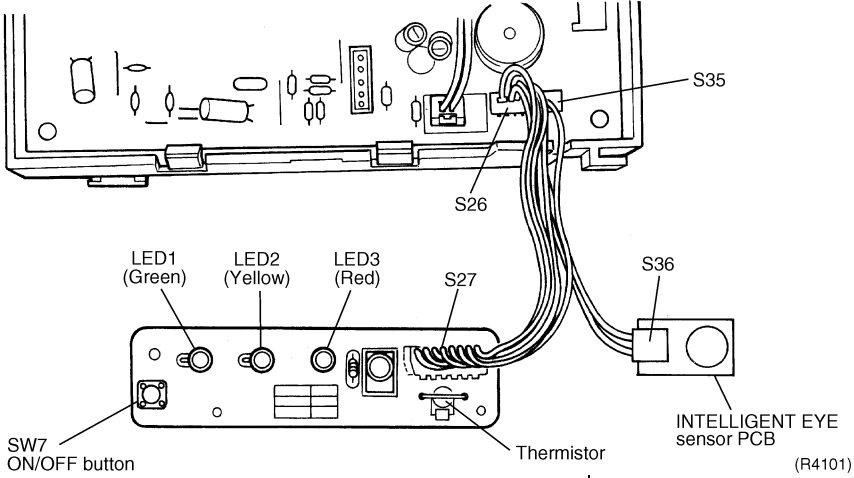
Step	Procedure	Points
4	<p>Disengage the four knobs on the back of the signal receiver PCB.</p>  <p>PC Board</p> <p>(R2538)</p>	
5	<p>Signal receiver PCB</p>  <p>Knob</p> <p>(R2539)</p>  <p>LED1 (Green)</p> <p>LED2 (Yellow)</p> <p>LED3 (Red)</p> <p>SW7 ON/OFF button</p> <p>Thermistor</p> <p>S26</p> <p>S27</p> <p>S35</p> <p>S36</p> <p>INTELLIGENT EYE sensor PCB</p> <p>(R4101)</p>	

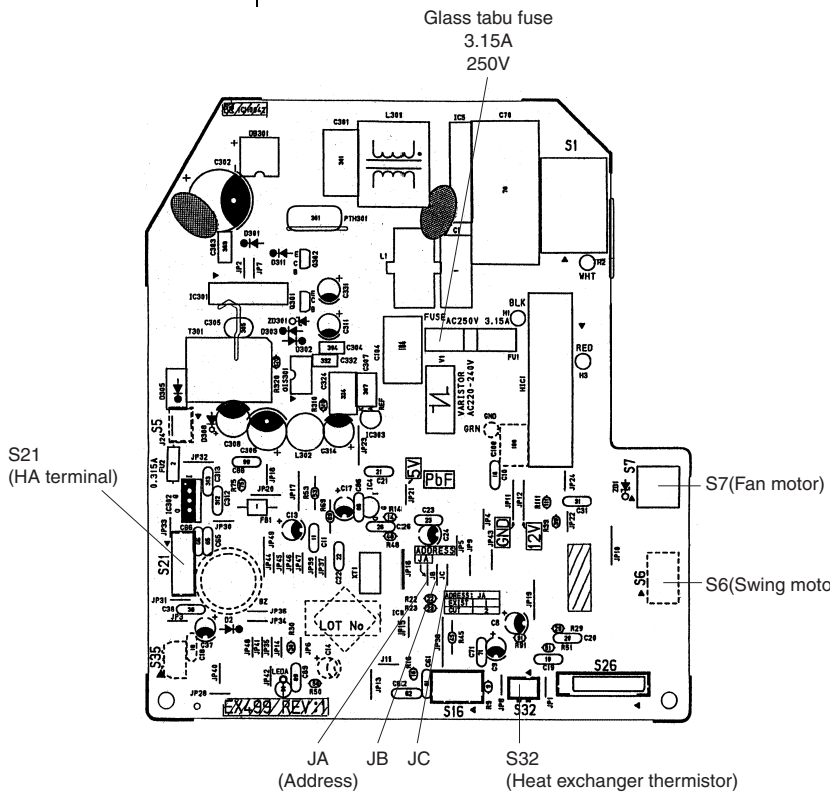
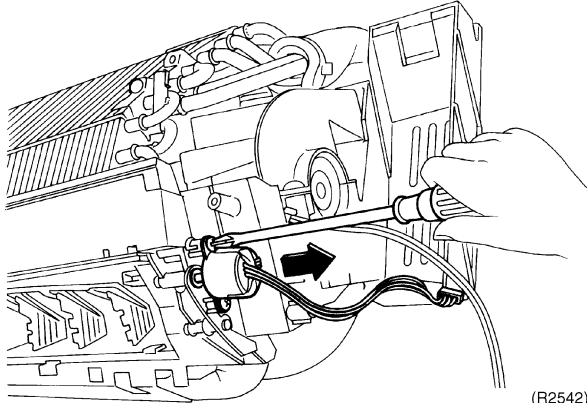
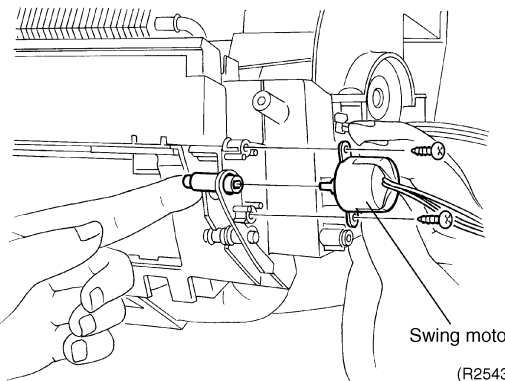
Step	Procedure	Points
6	<p>Control PCB.</p>  <p>(R2541)</p>	<ul style="list-style-type: none"> The control PCB is integrated with the power supply PCB.
3.	<p>Remove swing motor assembly.</p> <p>1 To remove swing motor assembly, remove 2 screws. (Manual adjusting for the vertical blades.)</p>  <p>(R2542)</p>  <p>Swing motor (R2543)</p>	<ul style="list-style-type: none"> Provide a supporter so that the joint link will not drop off, in case the horizontal blade assembly is removed.

1.5 Removal of Heat Exchanger

Procedure

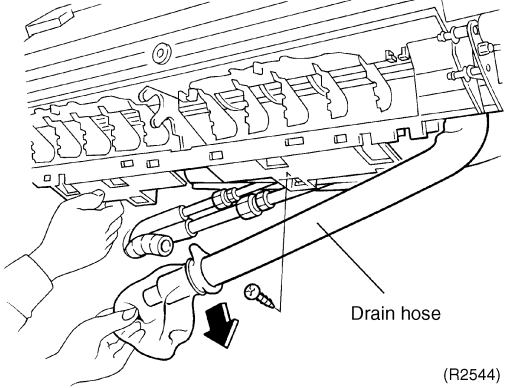
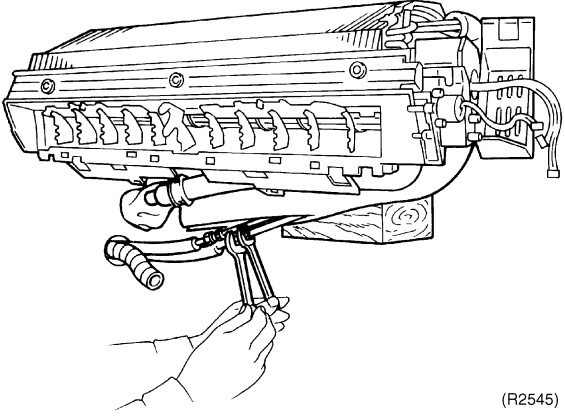

Warning Be sure to wait 10 minutes or more after turning off all power supplies before disassembling work.

Step	Procedure	Points
<ul style="list-style-type: none"> ■ Conduct pump-down operation. ■ Remove the installation frame from the mounting plate. 		
<p>1 Remove the drain hose. Make curing so that the residual drain water will not leak out.</p>	 <p style="text-align: right;">(R2544)</p>	<p>Warning If gas leaks, repair the leak location, then connect all refrigerant from the unit. Conduct vacuum drying, and charge proper amount of refrigerant.</p> <p>Warning Do not mix any gas (including air) other than the specified refrigerant (R-410A) into refrigerating cycle. (Mixing of air or other gas causes abnormal temperature rise in refrigerating cycle, and this results in pipe rupture or personal injuries.)</p> <ul style="list-style-type: none"> ■ Pay attention so that the residual drain will not make a floor dirty. ■ In case that a drain hose is buried inside a wall, remove it after the drain hose in the wall is pulled out.
<p>2 Disengage the insulation tube and disconnect the flare nuts for the gas line and the liquid line.</p> <p>3 Disengage the indoor unit from the installation plate.</p>	 <p style="text-align: right;">(R2545)</p>	<ul style="list-style-type: none"> ■ Use two wrenches to disconnect pipe. ■ After pipes are disconnected, close all pipe openings with caps to prevent dust and moisture from entering pipes.

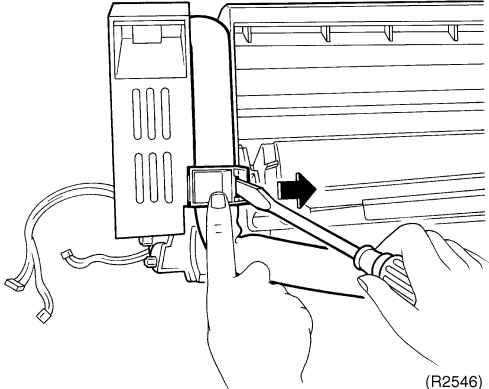
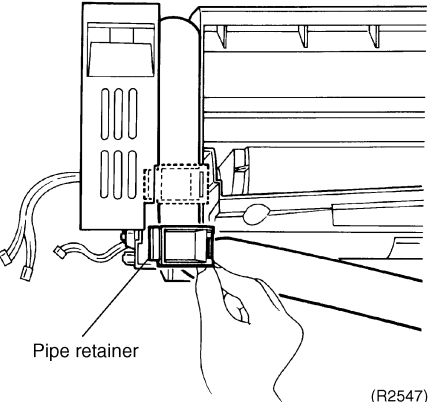
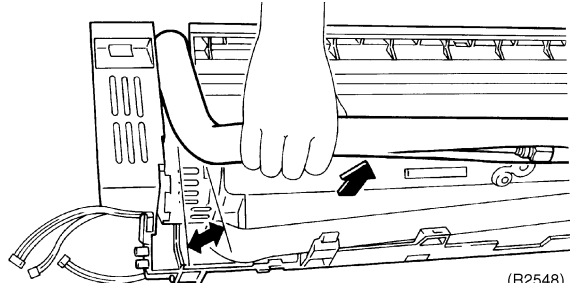
Step		Procedure	Points
4	Disengage the hooks of the pipe retainer on the back.	 <p>(R2546)</p>	 <p>Pipe retainer</p> <p>(R2547)</p>
5	Pull auxiliary pipe forward to an angle of 10 to 20 degrees.	 <p>(R2548)</p>	<ul style="list-style-type: none"> ■ Be careful to prevent pipe deformation.

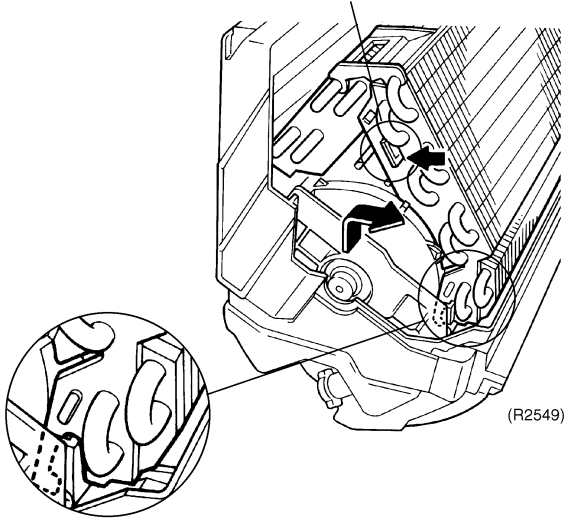
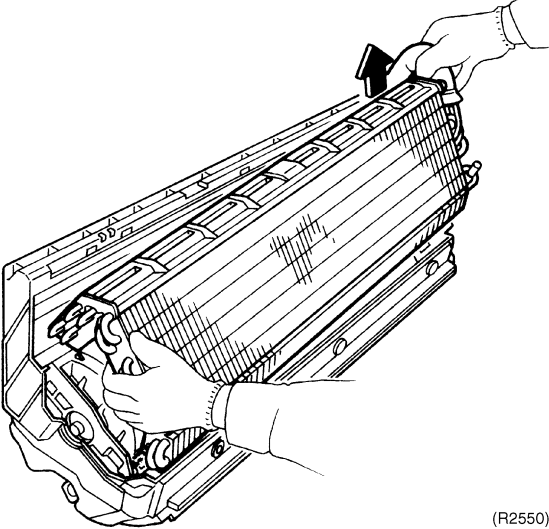
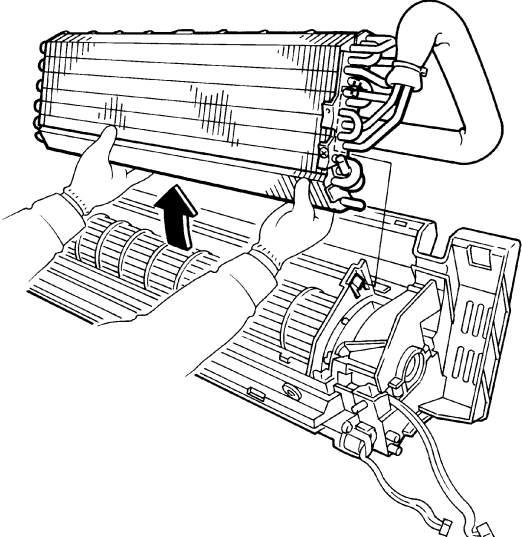
Step	Procedure	Points
<p>6</p> <p>Disengage hooks located right and left side, and pull heat exchanger forward. The hooks are symmetrically placed in the right and the left.</p>	<p>This hook is located both side of heat exchanger. Press this hook to remove heat exchanger easily.</p>  <p>(R2549)</p>	<ul style="list-style-type: none"> ■ Lifting the heat-exchanger slightly upward to the right, the left hook comes to be disengaged easily.  <p>(R2550)</p>
<p>7</p> <p>Lift and remove heat exchanger.</p>	 <p>(R2551)</p>	<p>⚠ Caution When removing or re-installing heat exchanger, be sure to wear protective gloves or wrap heat exchanger with cloths. (Fins can cut fingers.)</p>

1.6 Install of Drain Plug

Procedure

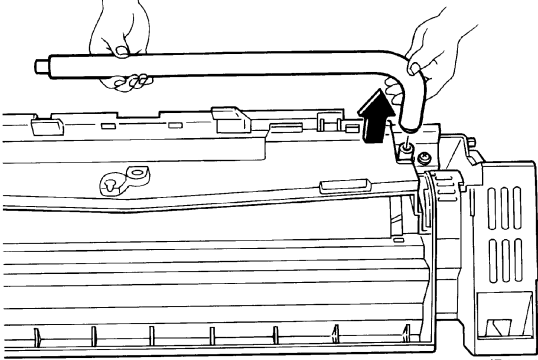
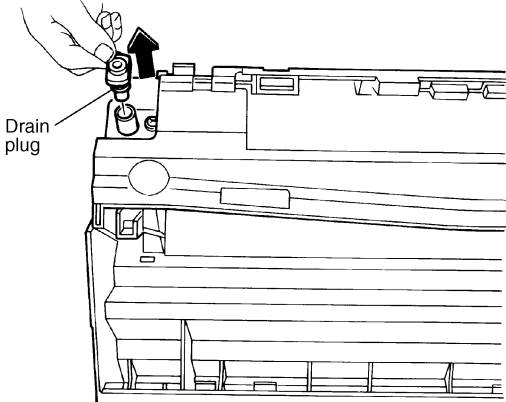
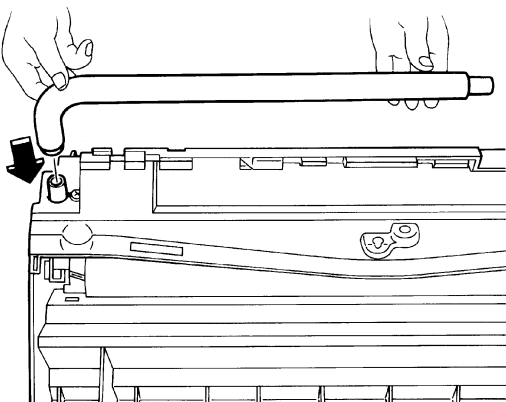

Warning Be sure to wait 10 minutes or more after turning off all power supplies before disassembling work.

Step	Procedure	Procedure	Points
1	Disconnect drain hose .	 <p>(R2552)</p>	<ul style="list-style-type: none"> ■ The drain pan is integrated with the bottom plate.
2	Pull out the drain plug in the left on the drain pan by hand.	 <p>(R2553)</p>	
3	Insert the drain hose,	 <p>(R2554)</p>	<ul style="list-style-type: none"> ■ Push it into the inner part firmly.

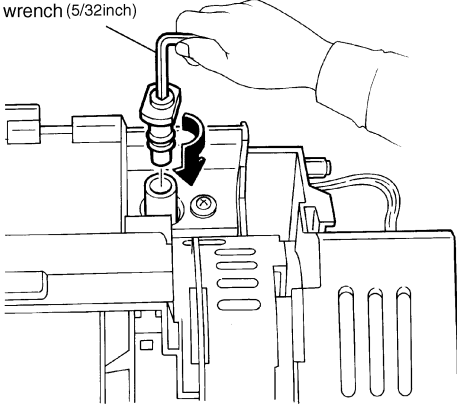
Step	Procedure	Points
4	<p data-bbox="220 216 488 300">Push the drain plug into the right by Allen wrench.</p> <p data-bbox="548 233 732 254">Allen wrench (5/32inch)</p>  <p data-bbox="997 636 1057 653">(R4162)</p>	<ul data-bbox="1109 216 1433 275" style="list-style-type: none">■ Push it into the inner part firmly.

1.7 Removal of Fan Rotor and Fan Motor

Procedure



Warning Be sure to wait 10 minutes or more after turning off all power supplies before disassembling work.

Step	Procedure	Points
<p>■ Remove heat exchanger.</p>	<p>(R2556)</p>	
<p>1 To remove right side plate, remove three screws.</p>	<p>Right side plate</p> <p>(R2557)</p>	

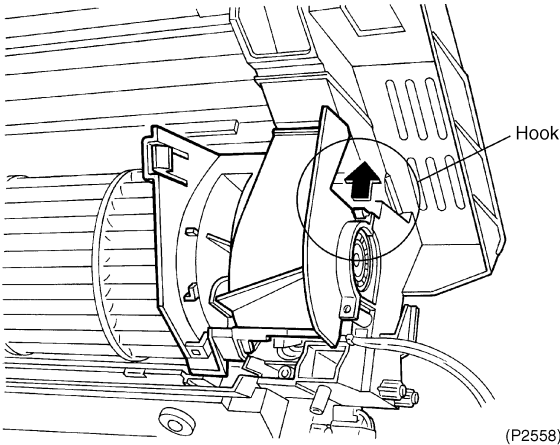
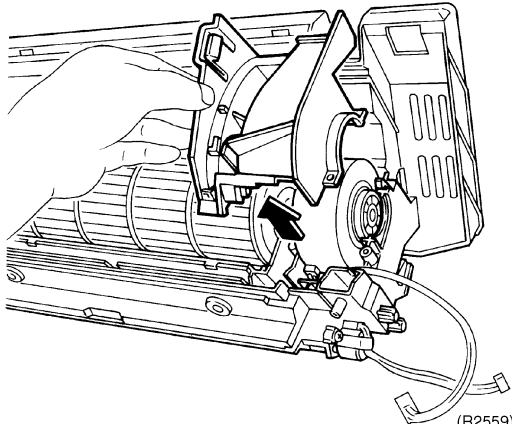
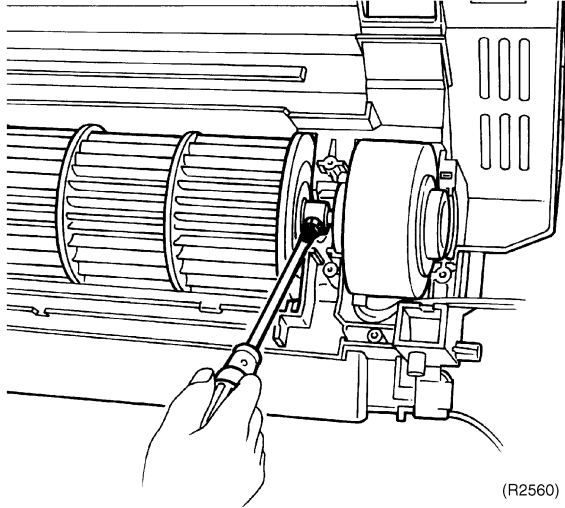
Step		Procedure	Points
2	Disengage hook.	 <p>(P2558)</p>  <p>(R2559)</p>	
3	Loosen the hexagon head set screw on the fan rotor.	 <p>(R2560)</p>	

Step	Procedure	Points
4	Remove the motor and fan rotor.	
5	Remove a screw on the left side plate.	

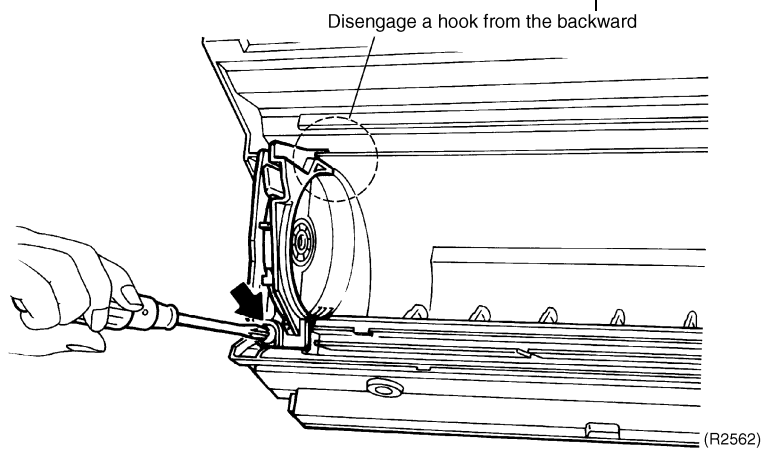
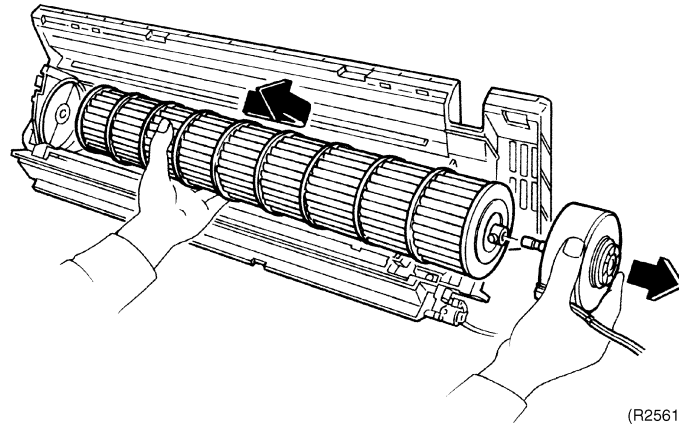

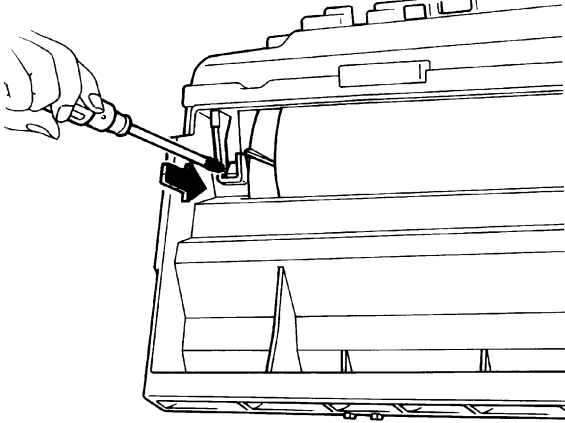
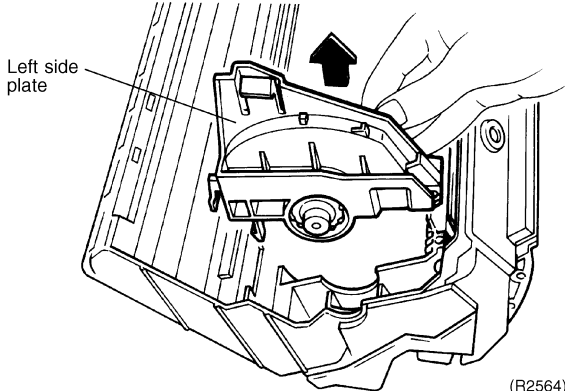
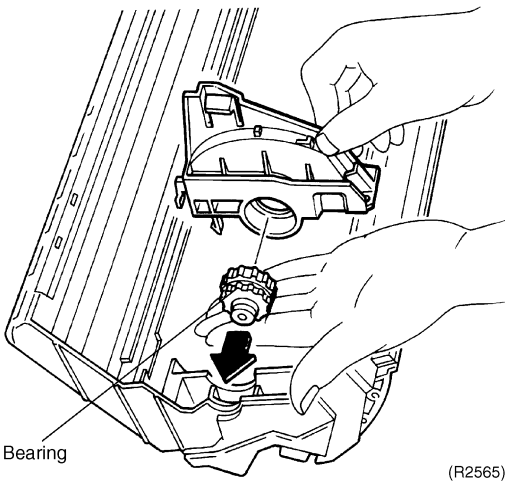
Step	Procedure	Points
<p>6</p>	<p>Disengage a hook from the backward.</p>  <p>(R2563)</p>  <p>Left side plate</p> <p>(R2564)</p>	
<p>7</p>	<p>Since the fan bearing is made of rubber, push it strongly off from the inside. The bearing can be removed just as the left side plate is attached with.</p>  <p>Bearing</p> <p>(R2565)</p>	

2. FTXS15/18/24DVJU

2.1 Removal of the Air Filter / Front Panel

Procedure



Warning

Be sure to wait 10 minutes or more after turning off all power supplies before disassembling work.

Step	Procedure	Points
1. Features		<ul style="list-style-type: none"> When the signal receiver catches a signal from the remote controller, it produces beep sound and the operation lamp blinks.
2. Remove the air filters.	<p>1 Hold the front panel by the tabs on the both sides and lift it until it stops with a click.</p>	

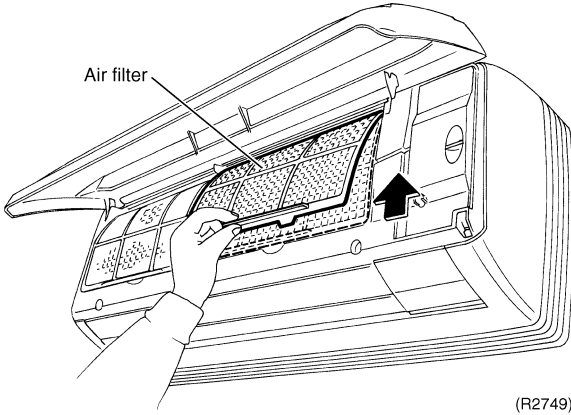
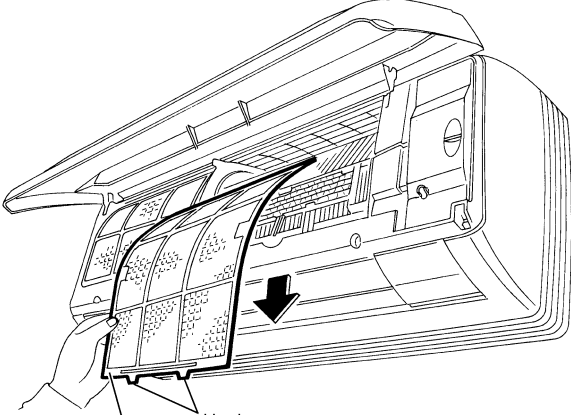
Step	Procedure	Points
<p>2</p>	<p>Lift an air filter upwards slightly by the center knob, and then pull it out downwards.</p>  <p>(R2749)</p>  <p>"FRONT" Hooks</p> <p>(R5476)</p>	<ul style="list-style-type: none"> ■ The right and left filters are interchangeable. ■ Insert the air filters along grooves when installing. ■ Set the air filters with displaying "FRONT" on the front side. ■ Insert 2 hooks of the air filter completely.

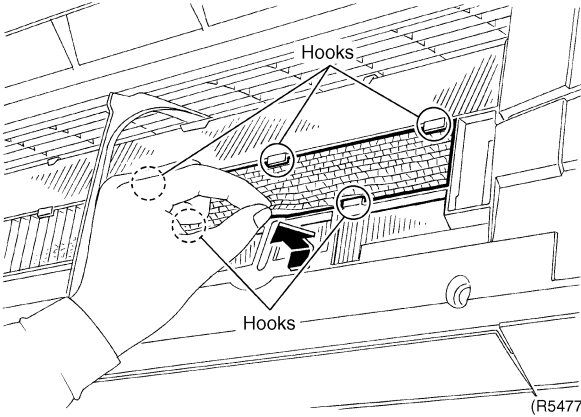
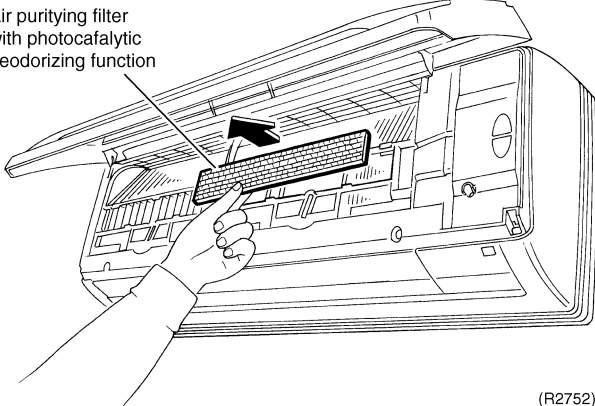
Step	Procedure	Points
3. Remove an “air purifying filter with photocatalytic deodorizing function”.	<p data-bbox="212 310 475 478">1 Push up the bottom of an air purifying filter to undo the hooks (2 on lower, 3 on upper) and take the filter out.</p>  <p data-bbox="524 808 695 877">Air purifying filter with photocatalytic deodorizing function</p>  <p data-bbox="1031 745 1089 766">(R5477)</p> <p data-bbox="1073 1192 1131 1213">(R2752)</p>	<ul style="list-style-type: none"> <li data-bbox="1105 310 1446 373">■ The right and left filters are interchangeable.

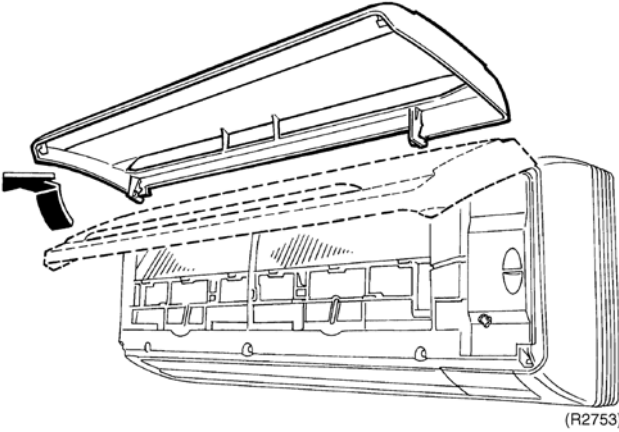
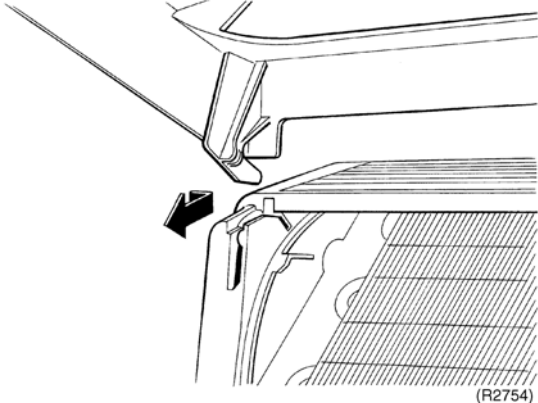
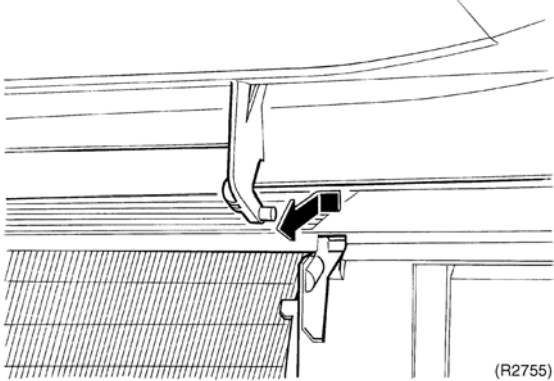
Step	Procedure	Points
<p>4. Remove the front panel.</p> <p>1</p>	<p>While opening the front panel further than it stops, release both axes and remove the front panel.</p>   	<ul style="list-style-type: none"> ■ Slide the front panel side to side to release each axis. ■ Align the right and left axes with grooves in turn and insert them to the end when installing.

2.2 Removal of the Front Grille

Procedure



Warning

Be sure to wait 10 minutes or more after turning off all power supplies before disassembling work.

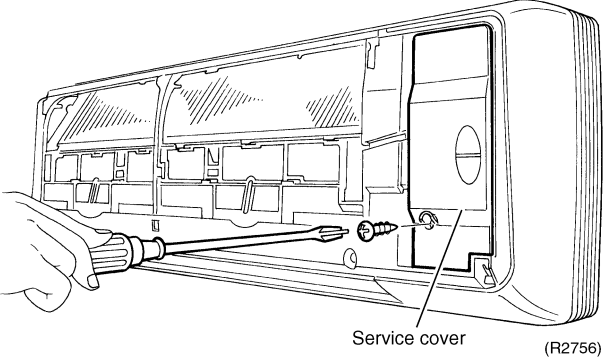
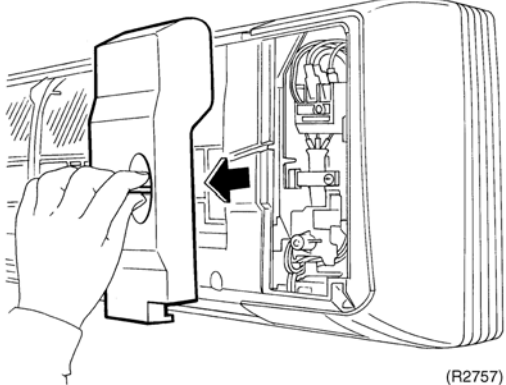
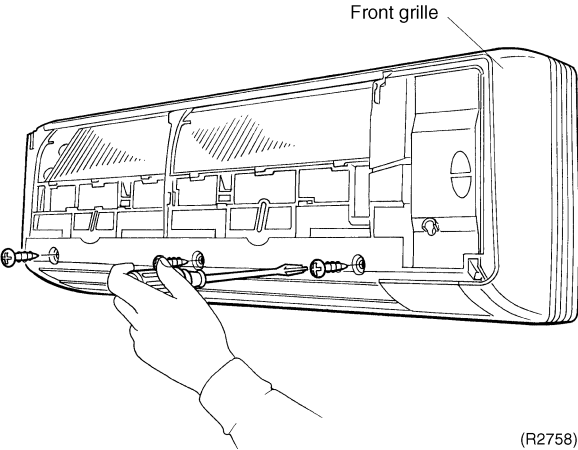
Step	Procedure	Points
1. Remove the service cover .	 <p>Service cover (R2756)</p>  <p>(R2757)</p>	<ul style="list-style-type: none"> ■ No field setting switch is inside it. ■ You can remove the front grille without detaching the service cover.
2. Remove the front grille .	 <p>Front grille (R2758)</p>	<ul style="list-style-type: none"> ■ It has no fixing screws inside blades, though previous models had.

Step	Procedure	Points
<p>2</p>	<p>Undo the three hooks on the top of the front grille.</p>	<ul style="list-style-type: none"> ■ The front grille has three hooks on the center and the both sides of the upper part. ■ Refer to the removal procedure in a reverse way when reassembling.

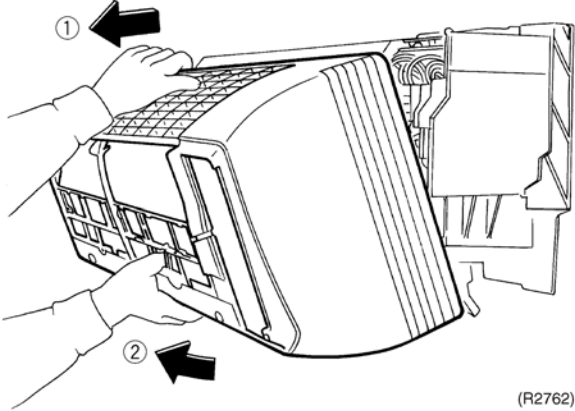
Step	Procedure	Points
3	<p data-bbox="215 214 464 369">Pull the upper part of the front grille out and lift the lower part up, and then remove the front grille.</p>  <p data-bbox="1024 655 1084 676">(R2762)</p>	<ul data-bbox="1105 214 1463 306" style="list-style-type: none">■ Make sure that all the hooks are placed securely when reassembling.

2.3 Removal of the Horizontal Blades / Vertical Blades

Procedure



Warning

Be sure to wait 10 minutes or more after turning off all power supplies before disassembling work.

Step	Procedure	Points
1. Remove the horizontal blades.	<p style="text-align: right;">(R2763)</p>	<ul style="list-style-type: none"> ■ It has no fixing screws inside blades, though previous models had.
1 Open the horizontal blades.	<p style="text-align: right;">(R2764)</p>	
2 Undo the left pivot of the horizontal blades.	<p style="text-align: right;">(R2765)</p>	
1	2	3
1	2	3
1	2	3
1	2	3
1	2	3
1	2	3
1	2	3
1	2	3
1	2	3
1	2	3
1	2	3
1	2	3
1	2	3
1	2	3
1	2	3
1	2	3

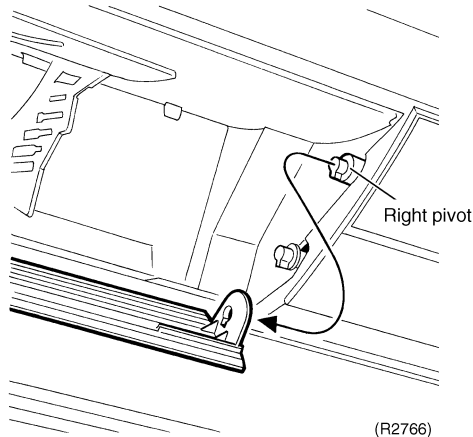
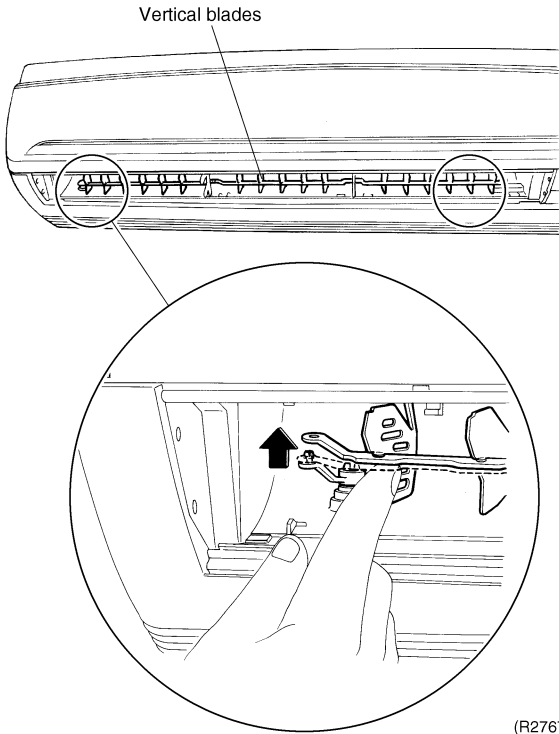
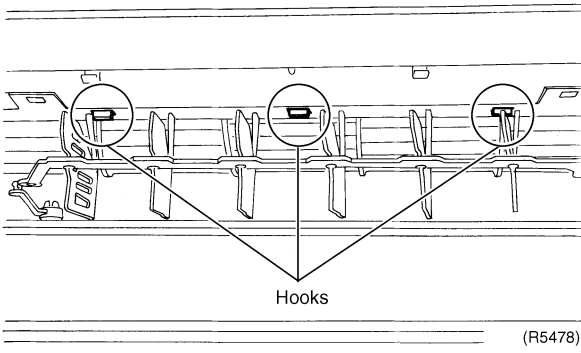
Step	Procedure	Points
		<p>■ Installation procedure</p> <ol style="list-style-type: none"> 1. Since key pattern hook is provided, rotate the blades and fit it to the right pivot first. 2. Fit the blades to the center and left pivots.
<p>2. Remove the vertical blades.</p>		
<p>1 Undo the right and left pivots.</p>		
<p>2 Undo the three hooks.</p>		

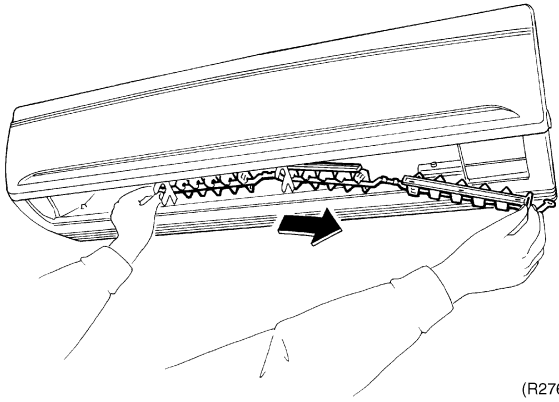
Step	Procedure	Procedure	Points
3	Pull the vertical blades rightwards and remove it.	 <p>(R2769)</p>	

2.4 Removal of the Electrical Box / PCB / Swing Motor

Procedure



Warning

Be sure to wait 10 minutes or more after turning off all power supplies before disassembling work.

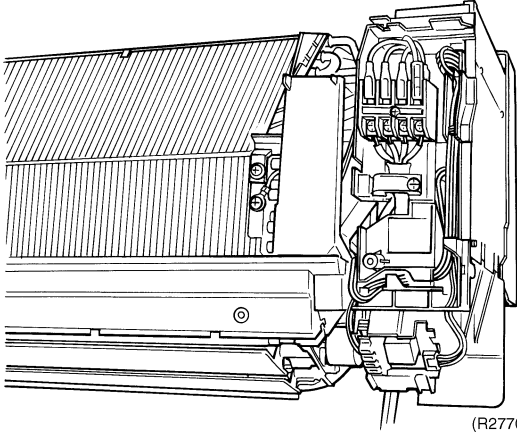
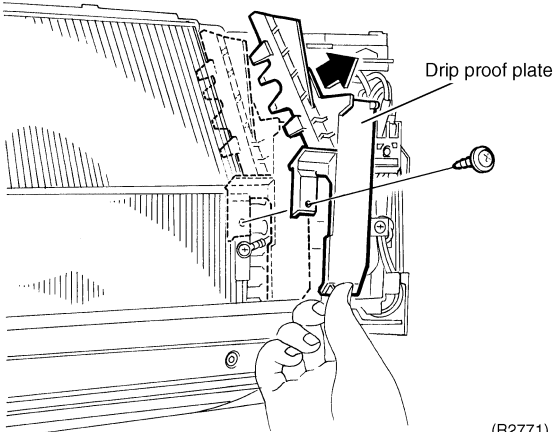
Step	Procedure	Points
1. Remove the front grille.	 <p style="text-align: right;">(R2770)</p>	<ul style="list-style-type: none"> ■ Parts layout
2. Remove the drip proof plate.	<p>1 Loosen the screw.</p>  <p style="text-align: right;">(R2771)</p>	

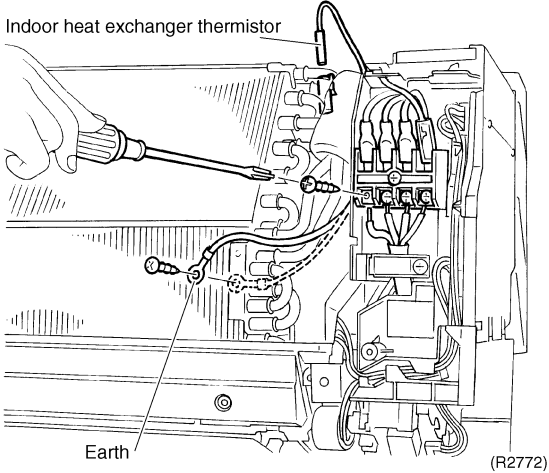
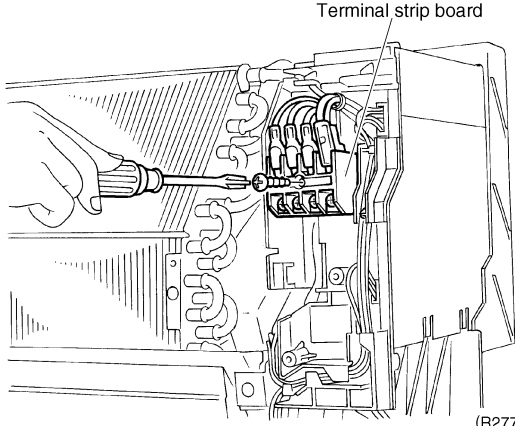
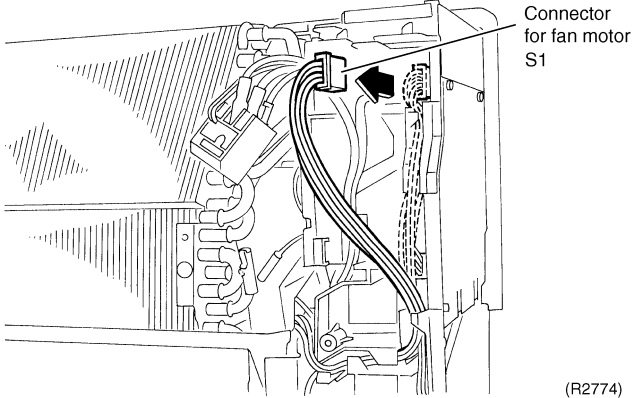
Step	Procedure	Points
<p>3. Disconnect the indoor heat exchanger thermistor and the earth</p>	 <p>Indoor heat exchanger thermistor</p> <p>Earth</p> <p>(R2772)</p>	<ul style="list-style-type: none"> ■ Mind that not to lose the clip for the thermistor.
<p>4. Remove the electrical box</p>	<p>1 Disconnect the 4 connection wirings. Loosen the screw and remove the terminal strip board.</p>  <p>Terminal strip board</p> <p>(R2773)</p> <p>2 Disconnect the connectors for fan motor (S1).</p>  <p>Connector for fan motor S1</p> <p>(R2774)</p>	<ul style="list-style-type: none"> ■ You can remove the electrical box without detaching the terminal strip board. ■ Screw: M4x25

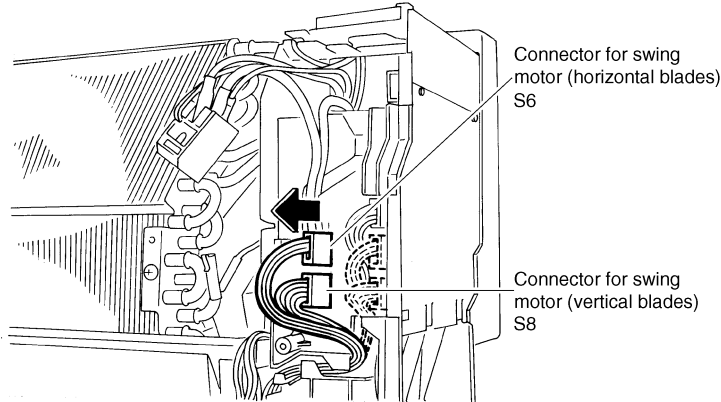
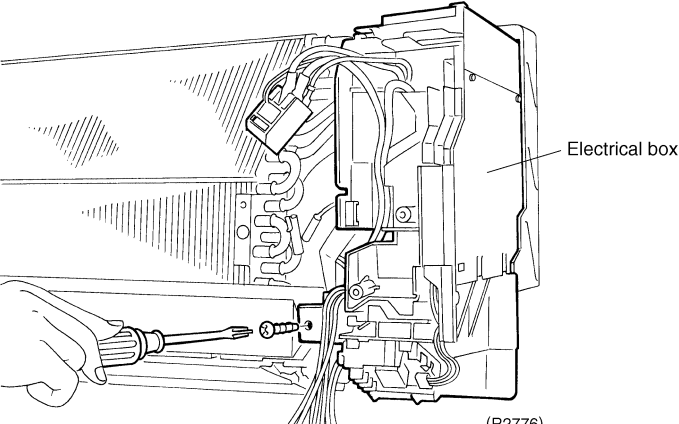
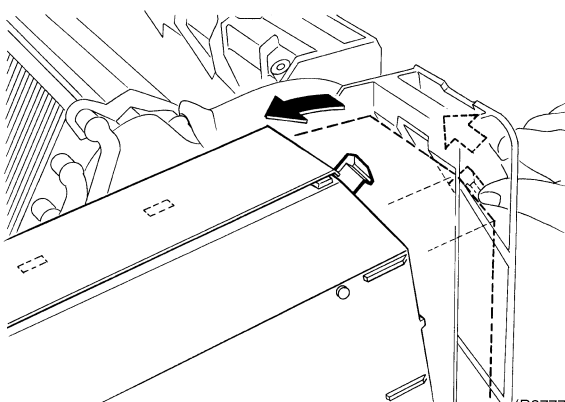
Step	Procedure	Points
3	Disconnect the connectors for swing motor (S6, S8).	 <p>Connector for swing motor (horizontal blades) S6</p> <p>Connector for swing motor (vertical blades) S8</p> <p>(R2775)</p>
4	Loosen the fixing screw of the electrical box.	 <p>Electrical box</p> <p>(R2776)</p>
5	Dislocate the electrical box to the left and undo the back hook.	 <p>(R2777)</p> <ul style="list-style-type: none"> ■ The electrical box has a hook on its back.

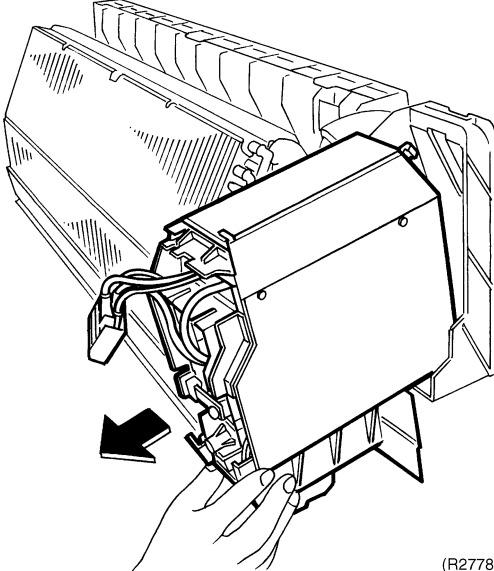
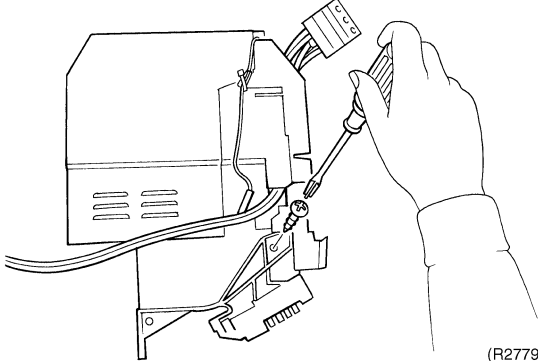
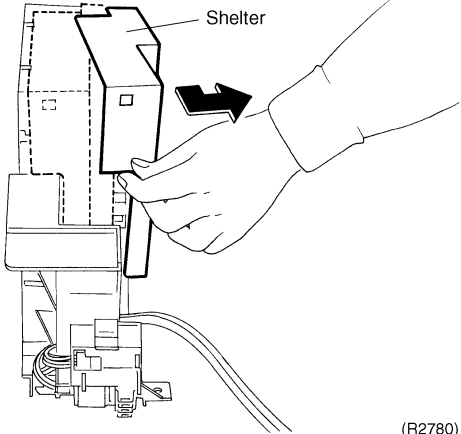
Step	Procedure	Points
6	Pull the electrical box out towards you.	 <p>(R2778)</p>
7	Loosen the screw on the electrical box.	 <p>(R2779)</p>
8	Push the shelter up and undo the hook.	 <p>(R2780)</p>

- Hook the back hook of the electrical box when reassembling.

- Screw: M4×16

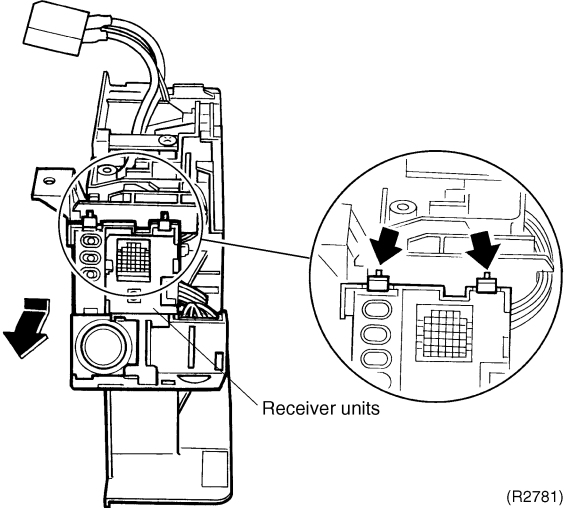
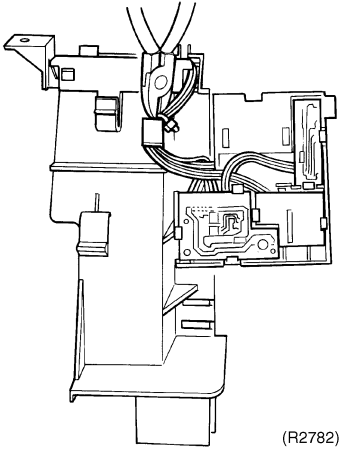
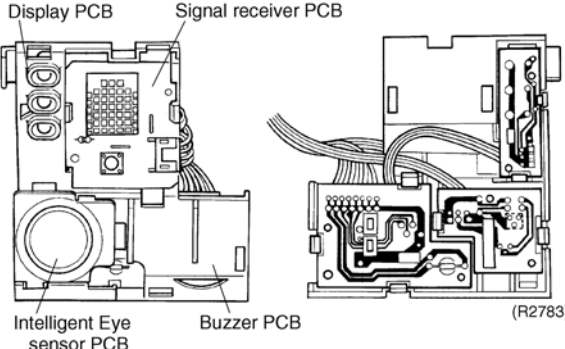
Step	Procedure	Points
9	<p>Press the receiver units down and release the hooks on the upper side, and then undo the hooks on the lower side.</p>  <p style="text-align: right;">(R2781)</p>	<ul style="list-style-type: none"> ■ Release the hooks on the upper side.
10	<p>Cut the clamp.</p>  <p style="text-align: right;">(R2782)</p>	
11	<p>The receiver units contain four PCBs. Remove each PCB with releasing hooks. Disconnect every connector from each PCB.</p>  <p style="text-align: right;">(R2783)</p>	<ul style="list-style-type: none"> ■ Remove the receiver units while pushing the hooks of connectors.

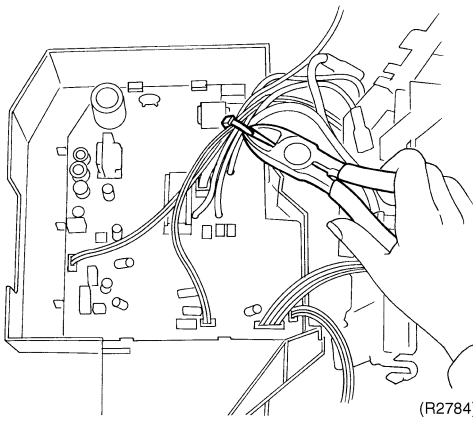
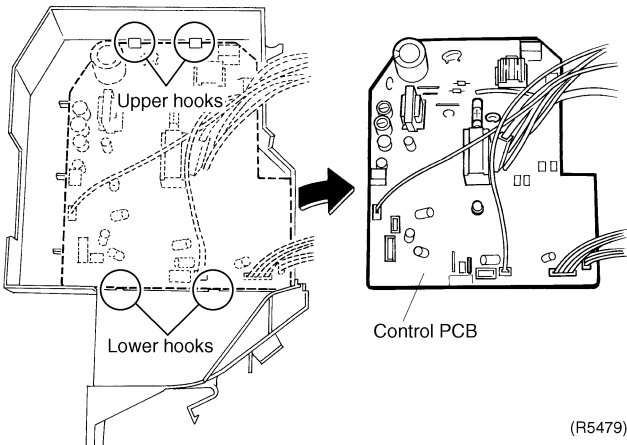
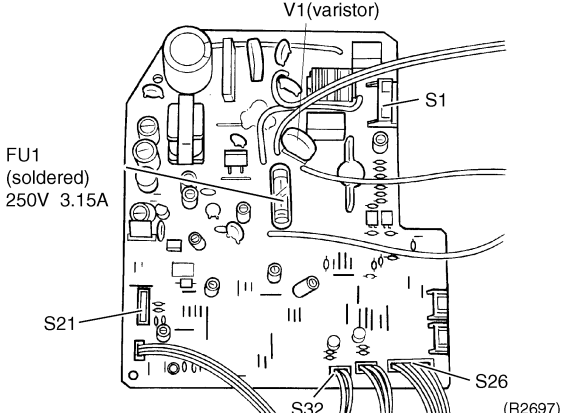
Step	Procedure	Points
12	Cut the clamp.	 <p>(R2784)</p>
5. Remove the control PCB.		
1	<p>Undo the 2 hooks on the lower side, and then the 2 hooks on the upper side. Remove the control PCB.</p>	 <p>Upper hooks</p> <p>Lower hooks</p> <p>Control PCB</p> <p>(R5479)</p>
2	<p>Control PCB (indoor unit) S1: connector for the fan motor S21: HA S26: connector for the room temperature thermistor S32: connector for the heat exchanger thermistor</p>	 <p>V1 (varistor)</p> <p>S1</p> <p>S21</p> <p>S26</p> <p>S32</p> <p>FU1 (soldered) 250V 3.15A</p> <p>(R2697)</p>

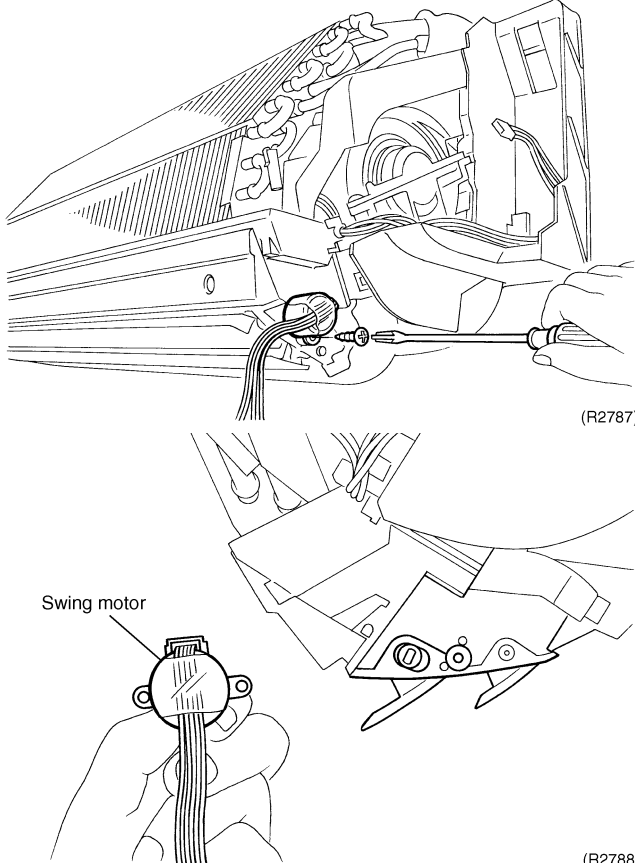
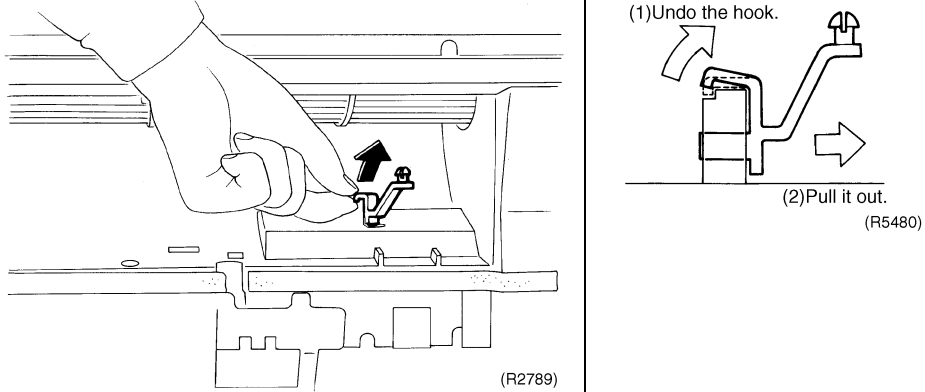
Step	Procedure	Points
6. Remove the swing motor for horizontal blades.	<p data-bbox="215 279 480 342">1 Remove the screw of the swing motor.</p>  <p data-bbox="1092 705 1149 726">(R2787)</p> <p data-bbox="1092 1146 1149 1167">(R2788)</p>	
7. Remove the swing motor for vertical blades.	<p data-bbox="215 1245 480 1308">1 Release the swing axis on the right side.</p>  <p data-bbox="1011 1665 1068 1686">(R2789)</p> <p data-bbox="1373 1507 1430 1528">(R5480)</p>	<p data-bbox="1105 1245 1422 1276">■ Releasing the swing axis</p> <p data-bbox="1141 1297 1295 1318">(1)Undo the hook.</p> <p data-bbox="1295 1486 1401 1507">(2)Pull it out.</p>

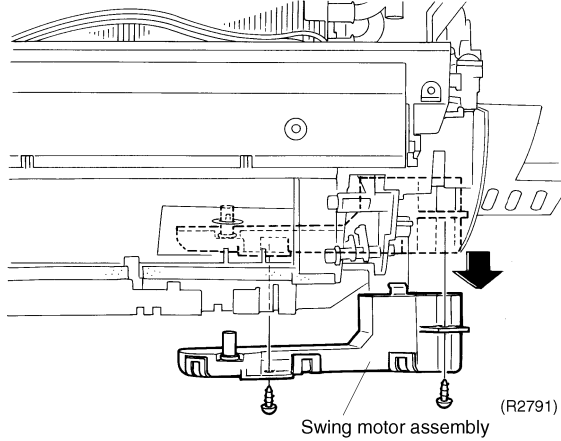
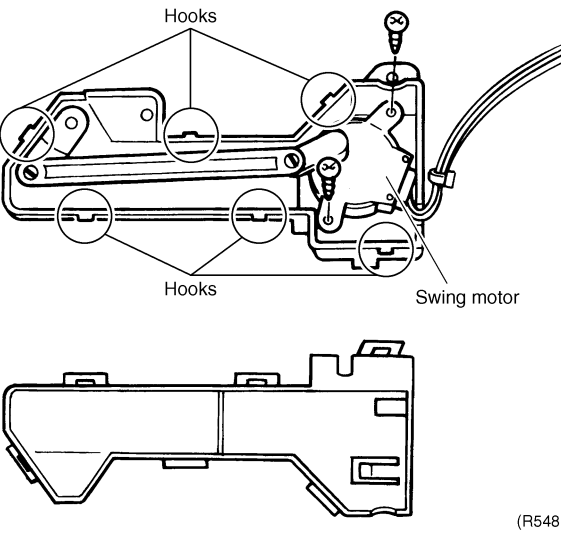
Step	Procedure	Points
2	Loosen the 2 screws and detach the swing motor assembly.	
3	Loosen the 2 screws and remove the swing motor.	 <ul style="list-style-type: none"> ■ Six hooks hold the assembly.

2.5 Removal of the Heat Exchanger

Procedure



Warning

Be sure to wait 10 minutes or more after turning off all power supplies before disassembling work.

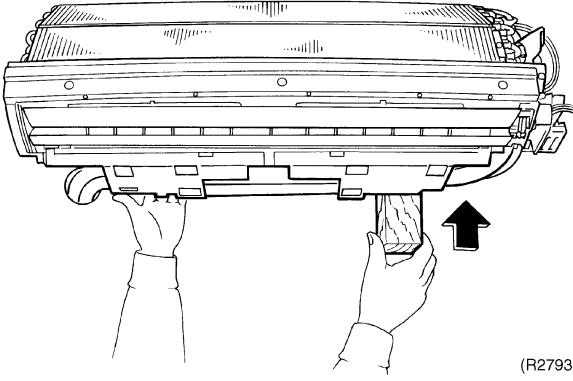
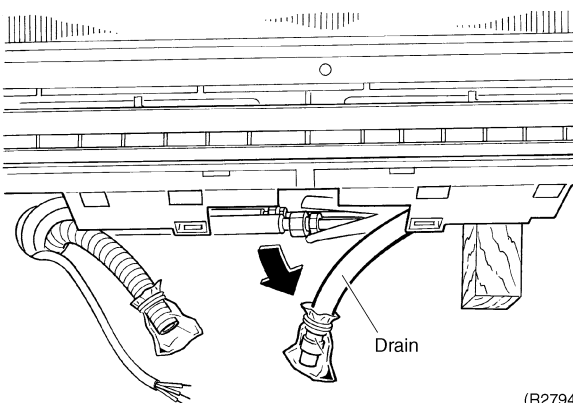
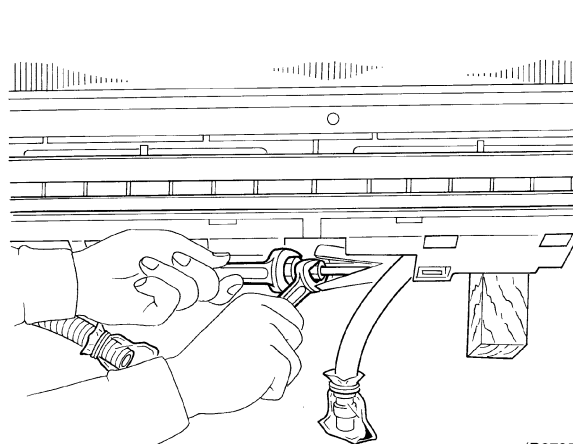
Step	Procedure	Points
<ul style="list-style-type: none"> ■ Remove the electrical box. 		
<ul style="list-style-type: none"> 1. Disconnect the refrigerant piping. 		
<ul style="list-style-type: none"> 1 Hold the indoor unit up by a piece of wood etc.. 	 <p style="text-align: right;">(R2793)</p>	<ul style="list-style-type: none"> ⚠ Caution If gas leaks, repair the spot of leaking, then collect all refrigerant from the unit. After conducting vacuum drying, recharge proper amount of refrigerant. ⚠ Caution Do not contaminate any gas (including air) other than the specified refrigerant (R-410A) into refrigerant cycle. (Contaminating of air or other gas causes abnormal high pressure in refrigerating cycle, and this results in pipe breakage or personal injuries.)
<ul style="list-style-type: none"> 2 Unscrew the flare nut for gas piping by 2 wrenches. 	 <p style="text-align: right;">(R2794)</p>  <p style="text-align: right;">(R2795)</p>	<ul style="list-style-type: none"> ■ Pay attention so that the residual water in the drain will not make the floor wet. ■ In case that a drain hose is buried inside a wall, remove it after the drain hose in the wall is pulled out. ■ Use two wrenches to disconnected pipes. ■ When disconnecting pipes, cover every nozzle with caps so as not to let dust and moisture in.

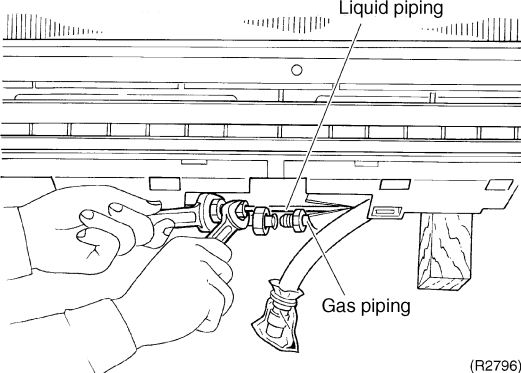
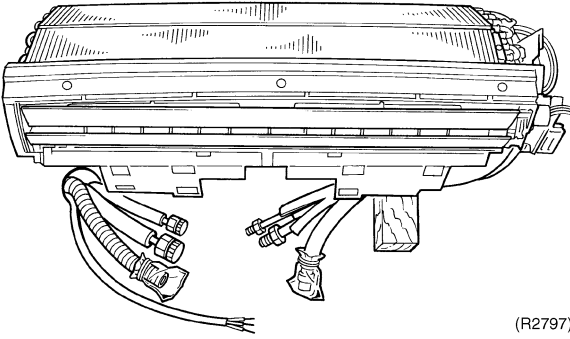
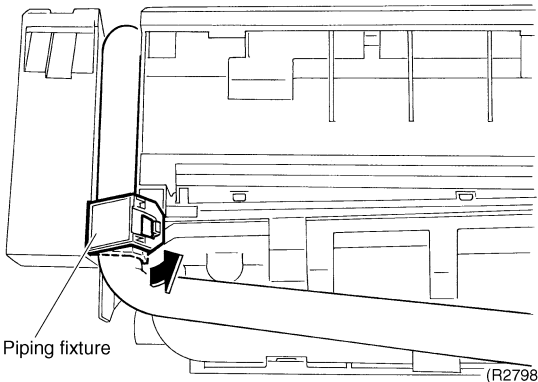
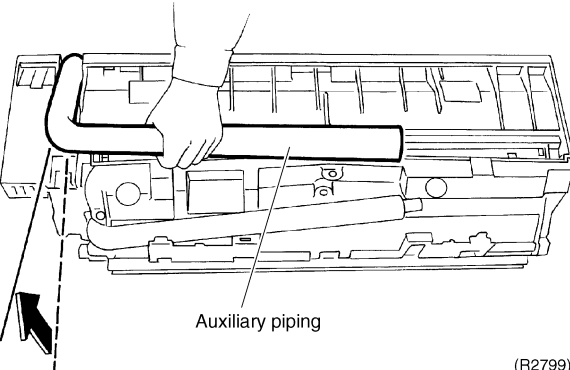
Step	Procedure	Points
3	<p>Unscrew the flare nut for liquid piping by 2 wrenches.</p>  <p>(R2796)</p>	
2. Remove the indoor unit.		
1	<p>Detach the indoor unit from the installation plate.</p>  <p>(R2797)</p>	
3. Remove the piping fixture.		
1	<p>Release the hook on the upper side of the piping fixture on the back of the unit.</p>  <p>(R2798)</p>	
4. Remove the heat exchanger.		
1	<p>Widen the auxiliary piping to the extent of 10°~20°.</p>  <p>(R2799)</p>	<p>■ At an angle of 10°~20°</p>

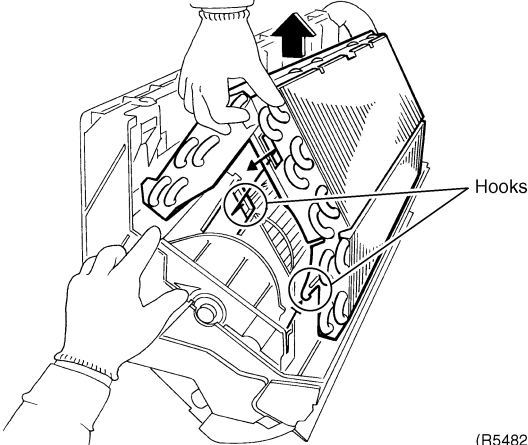
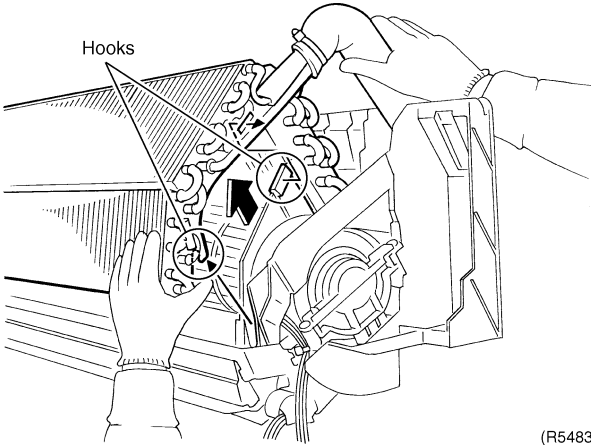
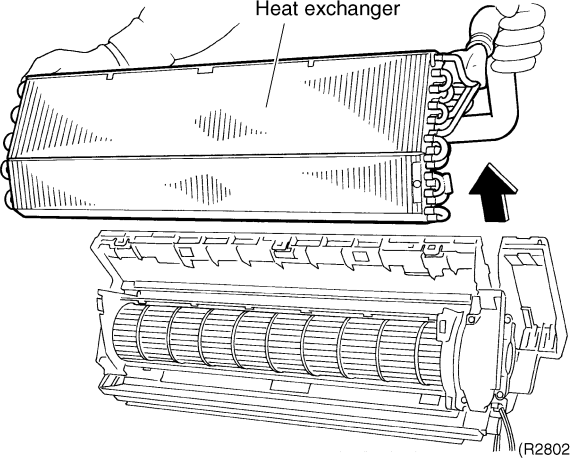
Step	Procedure	Procedure	Points
2	Release the hooks on the left side.	 <p>(R5482)</p>	
3	Push the fixing hooks on the right side and release.	 <p>(R5483)</p>	
4	Pull the heat exchanger to the front side and undo the hooks completely, and then lift it.	 <p>(R2802)</p>	<p>! Caution When removing or reinstalling heat exchanger, be sure to wear protective gloves or wrap the heat exchanger with cloths. (Fins can cut fingers.)</p>

2.6 Removal of the Fan Rotor / Fan Motor

Procedure



Warning

Be sure to wait 10 minutes or more after turning off all power supplies before disassembling work.

Step	Procedure	Points
1. Remove the right side panel.	<div data-bbox="516 415 1076 821" data-label="Image"> <p>Right side panel (R2803)</p> </div> <div data-bbox="537 846 1053 1291" data-label="Image"> <p>(R2804)</p> </div>	<ul style="list-style-type: none"> ■ You can remove the fan rotor without detaching the right side panel.
2. Remove the fan rotor.	<div data-bbox="534 1356 1058 1791" data-label="Image"> <p>Fan motor fixture (R2805)</p> </div>	

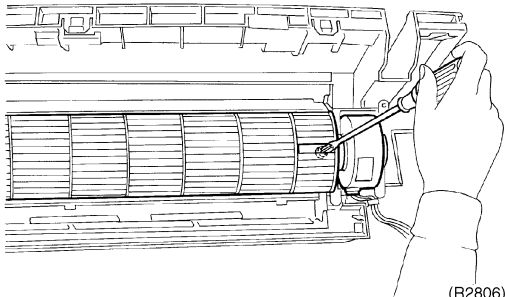
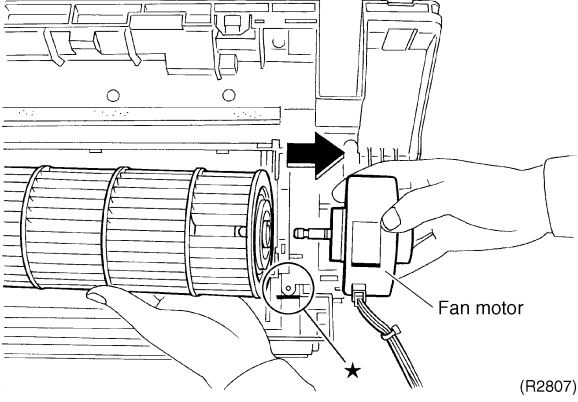
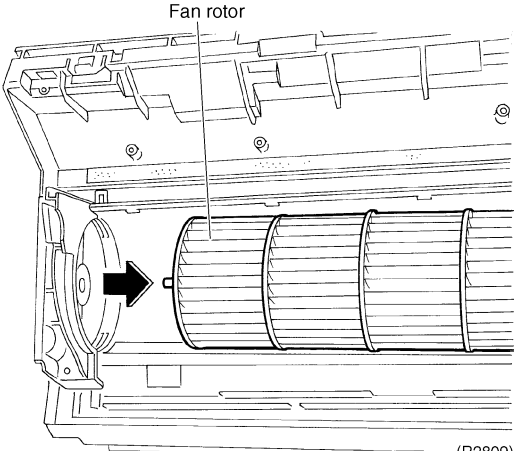
Step	Procedure	Points
2	Loosen the fixing screw of the fan rotor.	 <p>(R2806)</p>
3.	Remove the fan motor. 1 Remove the fan motor.	 <p>(R2807)</p> <p>■ Reassembling the fan motor (1) When reassembling the fan rotor, provide as much as 3/16inch of play between the side face of the rotor and the bottom frame.</p> <p>Side face of rotor Side face of bottom frame 3/16inch (R4163)</p>
4.	Remove the bearing. 1 Remove the fan rotor. The bearing is on the left side.	 <p>(R2809)</p> <p>(2) When reassembling the fan motor, align the end of the connector with the height of ★ for play.</p>

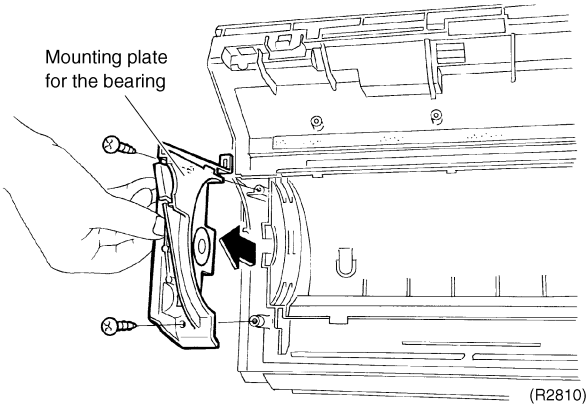
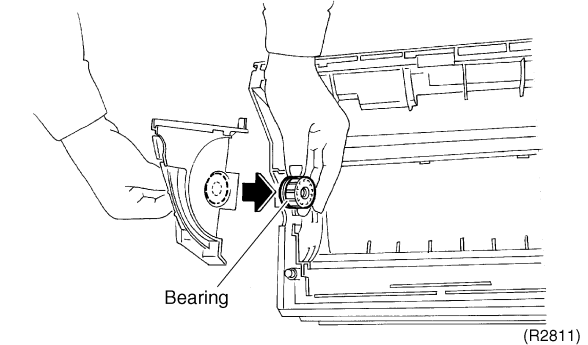
Step		Procedure	Points
2	Loosen the 2 screws and remove the mounting plate for the bearing.	 <p>(R2810)</p>	
3	The bearing is made of rubber. Push it inwards firmly and remove it.	 <p>(R2811)</p>	

3. RXS09/12DVJU

3.1 Removal of Panels and Fan Motor

Procedure



Warning Be sure to wait 10 minutes or more after turning off all power supplies before disassembling work.

Step	Procedure	Points
1. Features		<ul style="list-style-type: none"> Take care not to cut your finger by the fins of the heat exchanger.
1	<p>Loosen the screw of the stop valve cover. Pull down the stop valve cover and remove it.</p>	

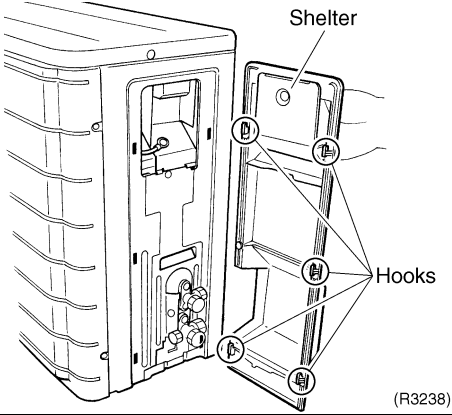
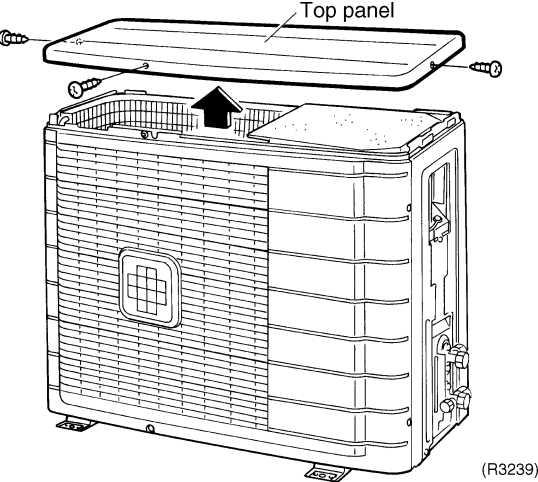
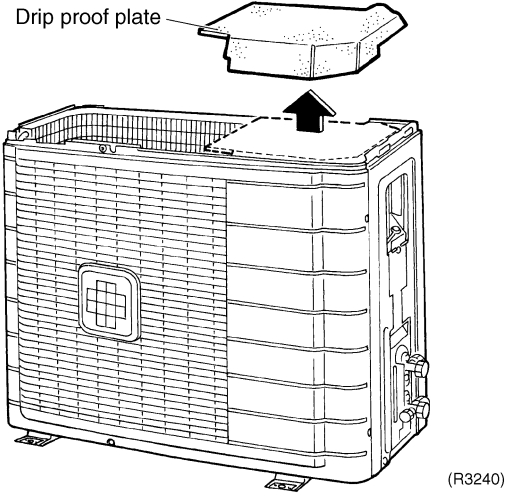
Step	Procedure	Points
	 <p style="text-align: right;">(R3238)</p>	<ul style="list-style-type: none"> ■ The stop valve cover is united with the shelter. ■ When reassembling, make sure to fit the 5 hooks.
<p>2. Remove the panels</p> <p>1</p>	<p>Loosen the 3 screws (front, right, left) and lift the top panel.</p>  <p style="text-align: right;">(R3239)</p> <p>2</p> <p>Remove the drip proof plate.</p>  <p style="text-align: right;">(R3240)</p>	

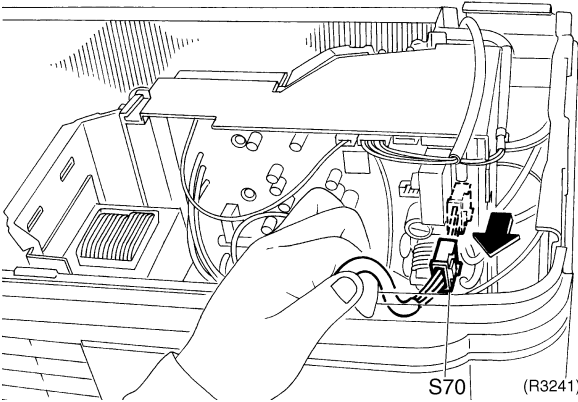
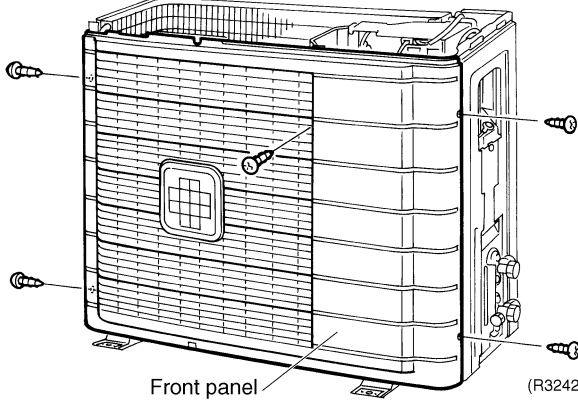
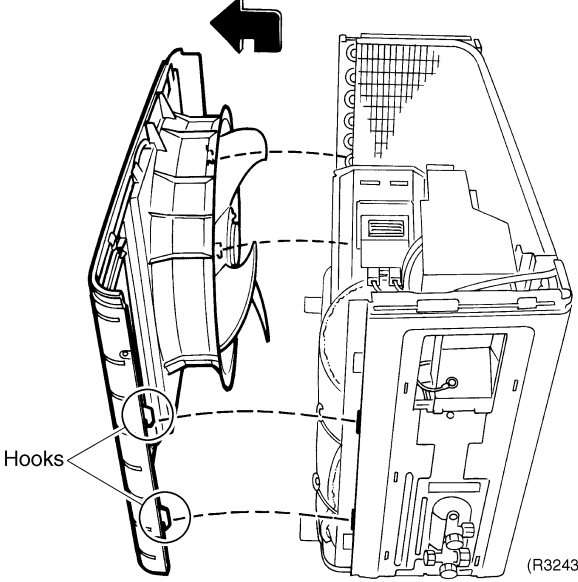
Step	Procedure	Points
3	<p>Disconnect the connector for fan motor (S70).</p> 	<ul style="list-style-type: none"> ■ The fan motor is united with the front panel.
4	<p>Loosen the 5 screws of the front panel.</p> 	
5	<p>Undo the hooks. Pull and remove the front panel.</p> 	<ul style="list-style-type: none"> ■ The front panel has 4 hooks. ■ The fan motor is united with the front panel.

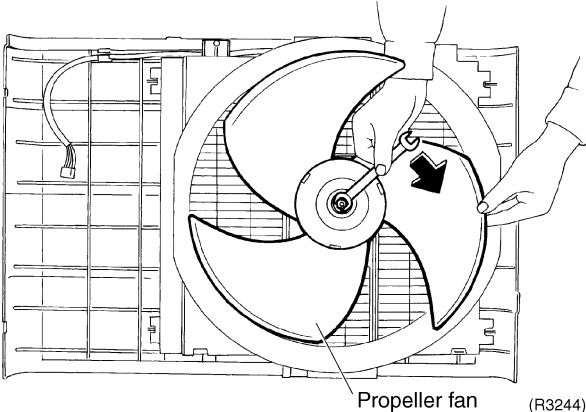
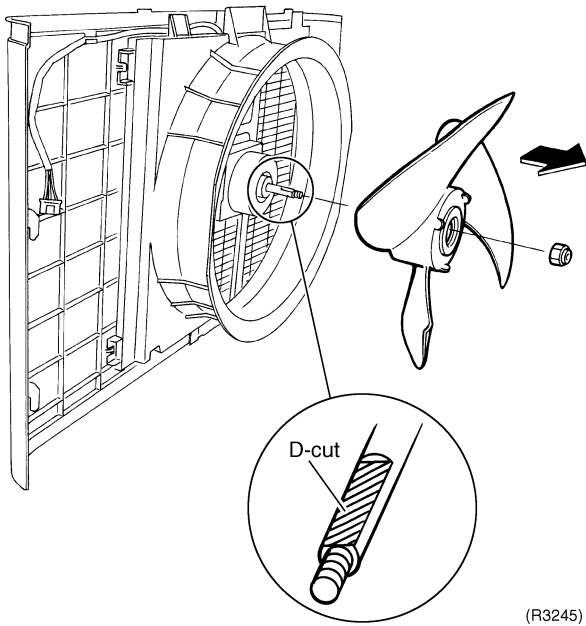
Step	Procedure	Points
<p>3. Remove the fan motor</p> <p>1</p>	<p>Unscrew the washer-fitted nut (M10) of the propeller fan with a spanner.</p>  <p>Propeller fan (R3244)</p> <p>2</p> <p>Remove the propeller fan.</p>  <p>D-cut (R3245)</p>	<ul style="list-style-type: none"> ■ The screw has reverse winding. ■ Align ▼ mark of the propeller fan with D-cut section of the motor shaft when reassembling.

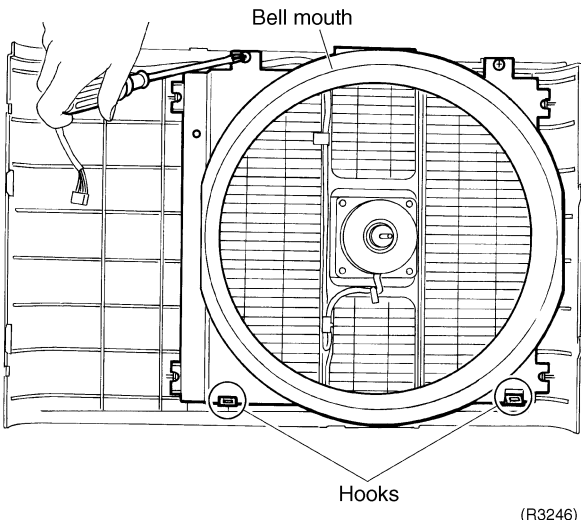
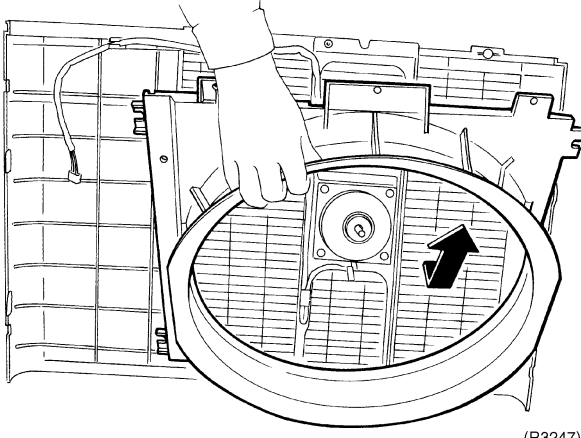
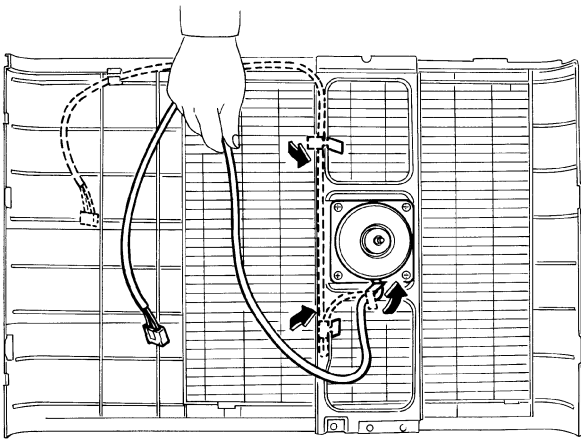
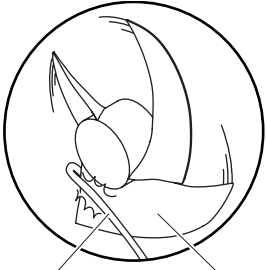
Step	Procedure	Points
<p>3</p>	<p>Loosen the 2 screws and lift the bell mouth to undo the hooks. Remove the bell mouth.</p>  	
<p>4</p>	<p>Loosen the fixing hooks and release the lead wire.</p> 	<ul style="list-style-type: none"> Put the lead wire through the back of the motor when reassembling. (so as not to be entangled with the propeller fan) 

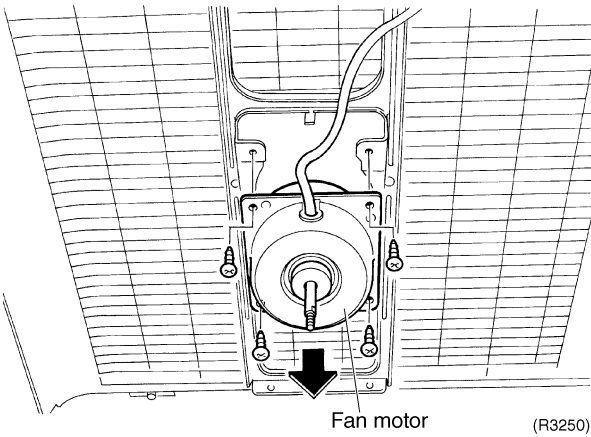
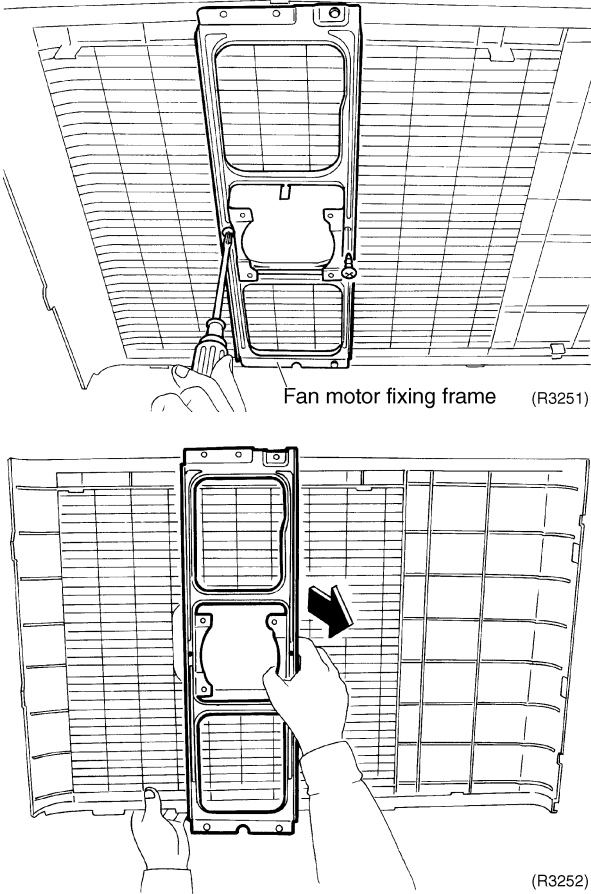
Step	Procedure	Points
5	<p>Loosen the 4 screws to remove the fan motor.</p> 	<ul style="list-style-type: none"> ■ M4x16 ■ DC fan motor
6	<p>Loosen the 2 screws to remove the fan motor fixing frame.</p> 	

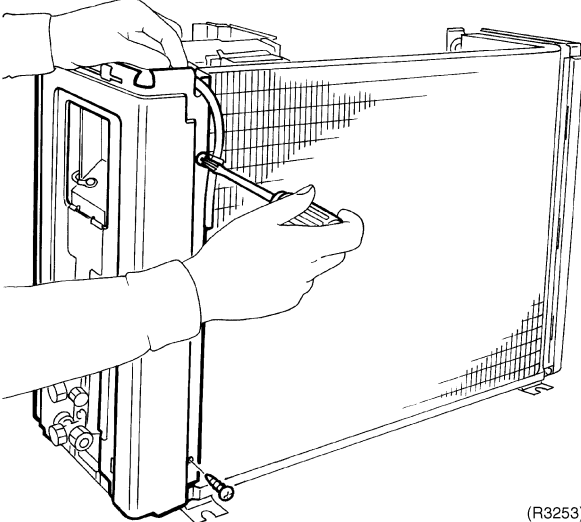
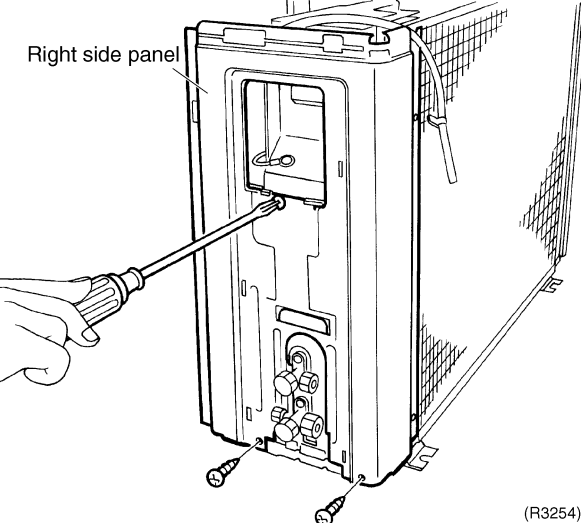
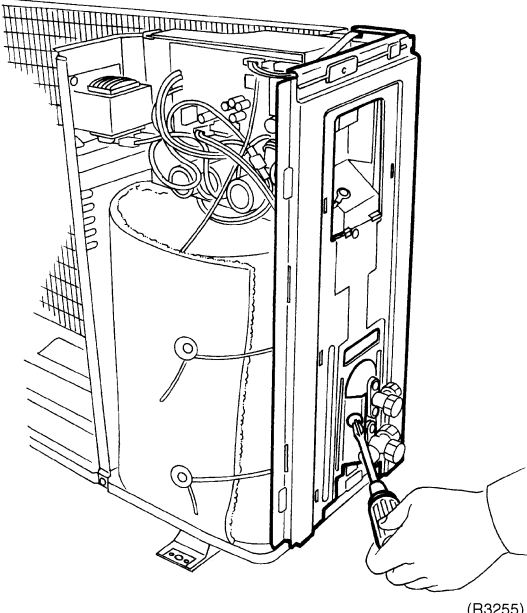
Step	Procedure	Points
4. Remove the right side panel.	 <p>(R3253)</p>	
1 Loosen the 2 screws on the rear side.	 <p>Right side panel</p> <p>(R3254)</p>	
2 Loosen the 3 screws on the right side.	 <p>(R3255)</p>	
3 Loosen the screw and lift the connection port to remove.		

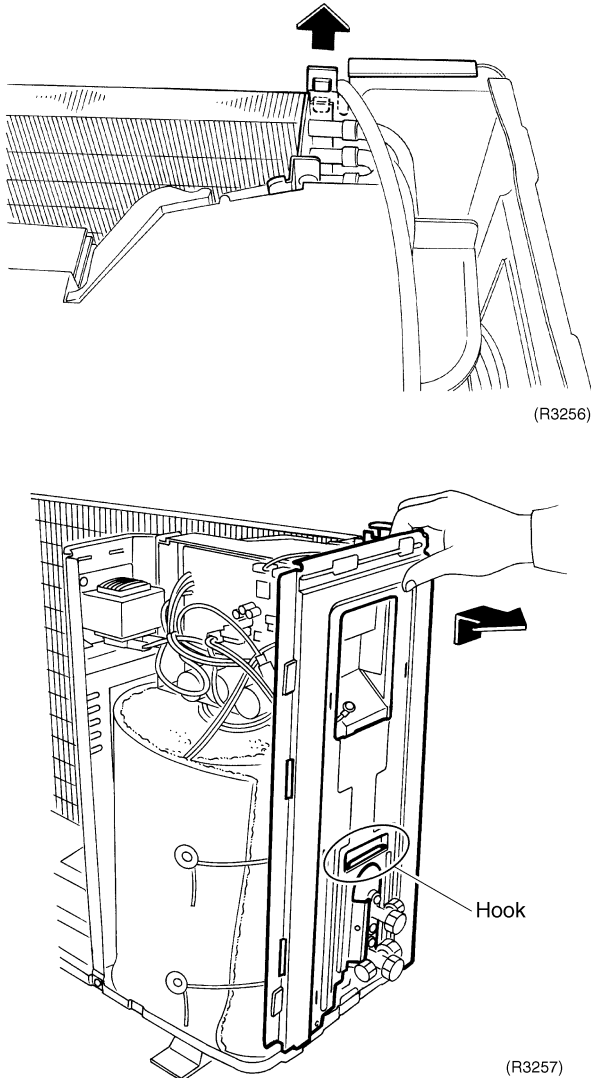
Step	Procedure	Points
	 <p>(R3256)</p> <p>(R3257)</p>	<ul style="list-style-type: none">■ When reassembling, make sure to fit the hook.

3.2 Removal of Electrical Box

Procedure

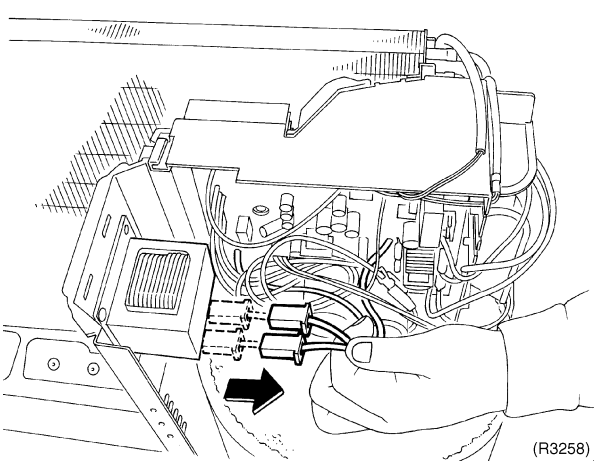
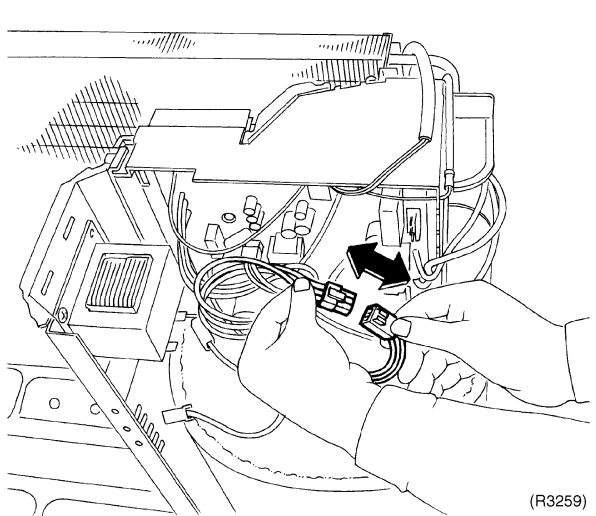
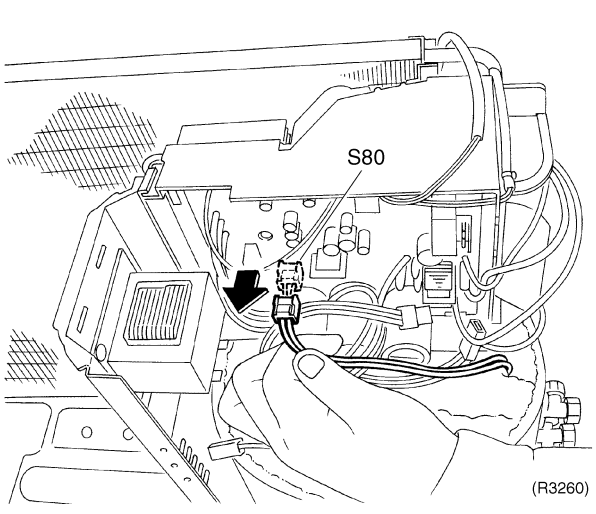

Warning Be sure to wait 10 minutes or more after turning off all power supplies before disassembling work.

Step	Procedure	Points
<ul style="list-style-type: none"> ■ Remove the top panel. ■ Disconnect the connector for fan motor. 	 <p style="text-align: right;">(R3258)</p>	
1. Remove the electrical box.		
1 Disconnect the 2 reactor harnesses.		
2 Disconnect the relay connector for compressor lead wire.	 <p style="text-align: right;">(R3259)</p>	
3 Disconnect the connector for four way valve (S80).	 <p style="text-align: right;">(R3260)</p>	<ul style="list-style-type: none"> ■ When reassembling, coil the excessive lead wire and hang the loop on the hook.

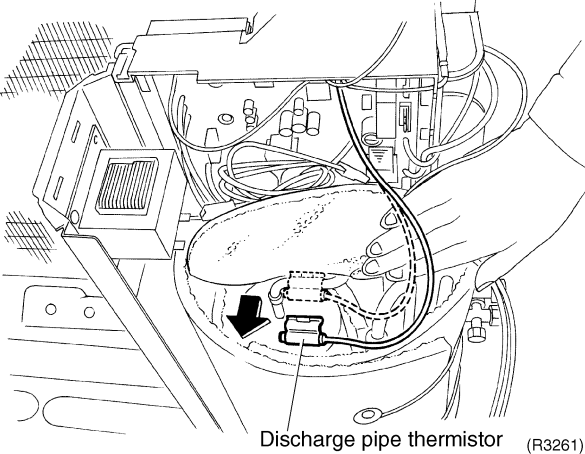
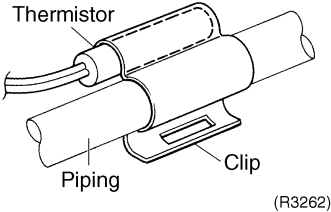
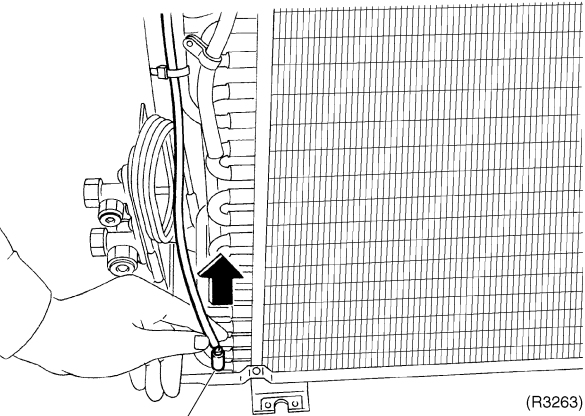
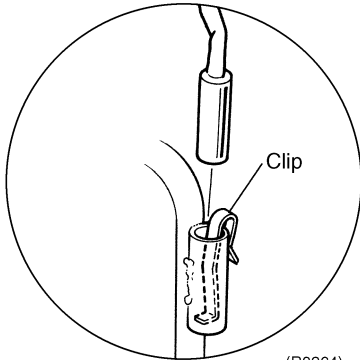
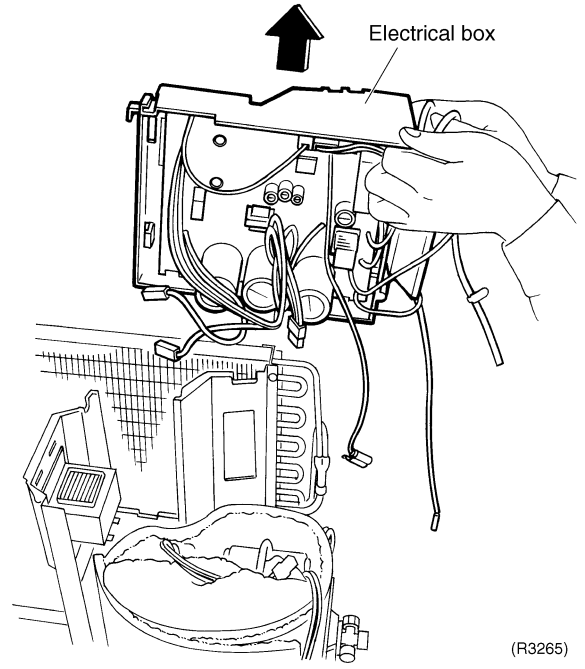
Step	Procedure	Points	
4	Release the discharge pipe thermistor.	 <p style="text-align: center;">Discharge pipe thermistor (R3261)</p>	<p>■ Pay attention so as not to lose the clip for thermistor.</p>  <p style="text-align: right;">(R3262)</p>
5	Release the heat exchanger thermistor.	 <p style="text-align: center;">Heat exchanger thermistor (R3263)</p>	<p>■ Pay attention so as not to lose the clip.</p>  <p style="text-align: right;">(R3264)</p>
6	Lift and remove the electrical box.	 <p style="text-align: center;">Electrical box (R3265)</p>	

3.3 Removal of Reactor and Partition Plate

Procedure

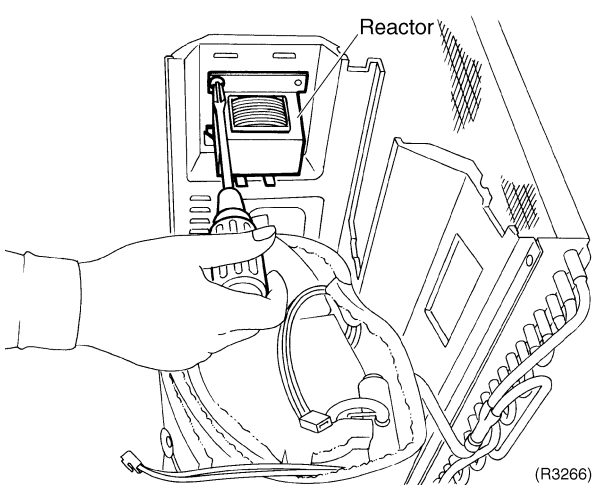
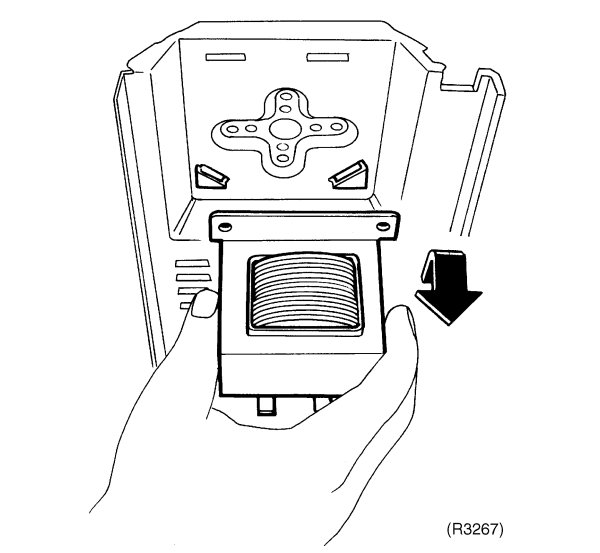

Warning Be sure to wait 10 minutes or more after turning off all power supplies before disassembling work.

Step	Procedure	Points
<ul style="list-style-type: none"> ■ Remove the outer panels. ■ Remove the electrical box. 	 <p style="text-align: right;">(R3266)</p>  <p style="text-align: right;">(R3267)</p>	
<p>1. Remove the reactor.</p>		<p>1 Loosen the screw. Lift and remove the reactor.</p>

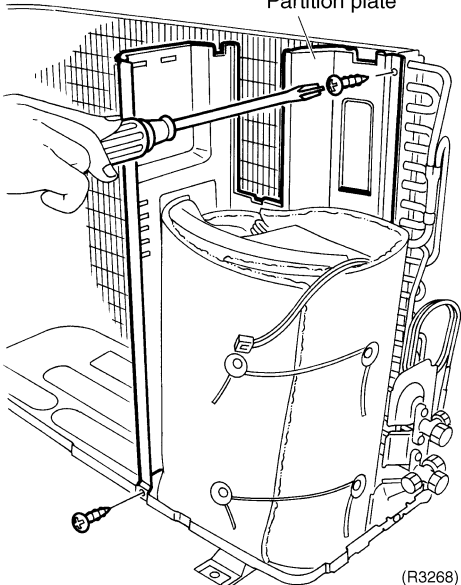
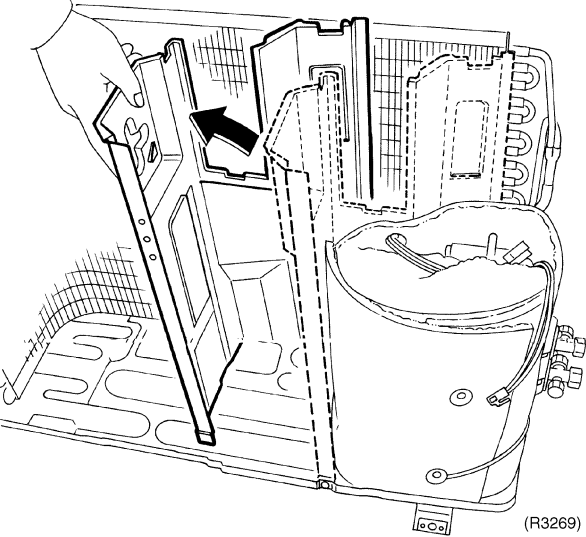
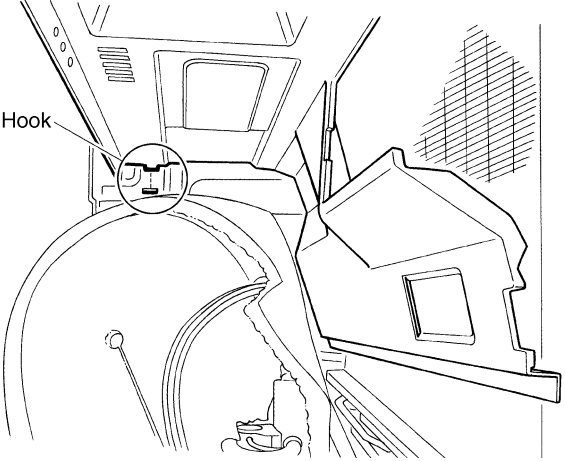
Step	Procedure	Points
2. Remove the partition plate.	<p data-bbox="168 281 456 308">1 Loosen the 2 screws.</p>  <p data-bbox="964 800 1024 821">(R3268)</p> <p data-bbox="168 831 469 989">2 The partition plate has a hook on the lower side. Lift and pull the partition plate to remove.</p>  <p data-bbox="1024 1360 1084 1381">(R3269)</p>  <p data-bbox="505 1528 553 1549">Hook</p> <p data-bbox="1032 1881 1092 1902">(R3270)</p> <p data-bbox="1105 1409 1446 1499">■ When reassembling, fit the lower hook into the bottom frame.</p>	

3.4 Removal of Sound Blanket

Procedure



Warning Be sure to wait 10 minutes or more after turning off all power supplies before disassembling work.

Step	Procedure	Points
<ul style="list-style-type: none"> ■ Remove the outer panels. ■ Remove the electrical box. 		
<p>1. Remove the sound blanket.</p>		
<p>1 Untie the strings and open the sound blanket.</p>		
<p>2 Lift and remove the sound blanket (body) as it is opened.</p>		<ul style="list-style-type: none"> ■ Since the piping ports on the sound blanket are torn easily, remove the blanket carefully.

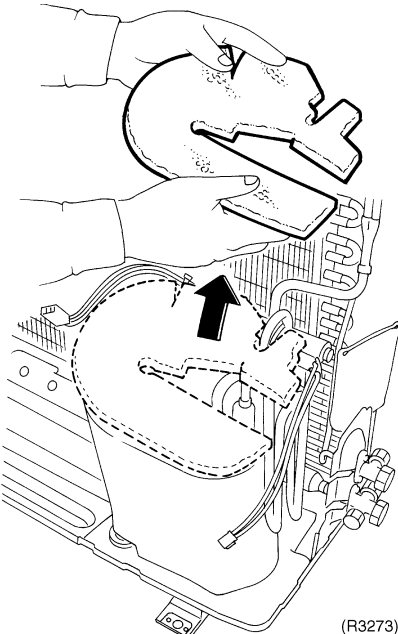
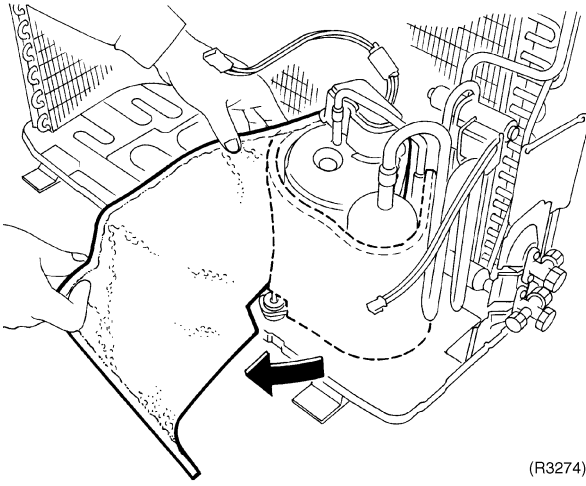
Step	Procedure	Points
3	Lift and remove the sound blanket (top).	 <p>(R3273)</p>
4	Pull the sound blanket (inner) out.	 <p>(R3274)</p>

- Since the piping ports on the sound blanket are torn easily, remove the blanket carefully.

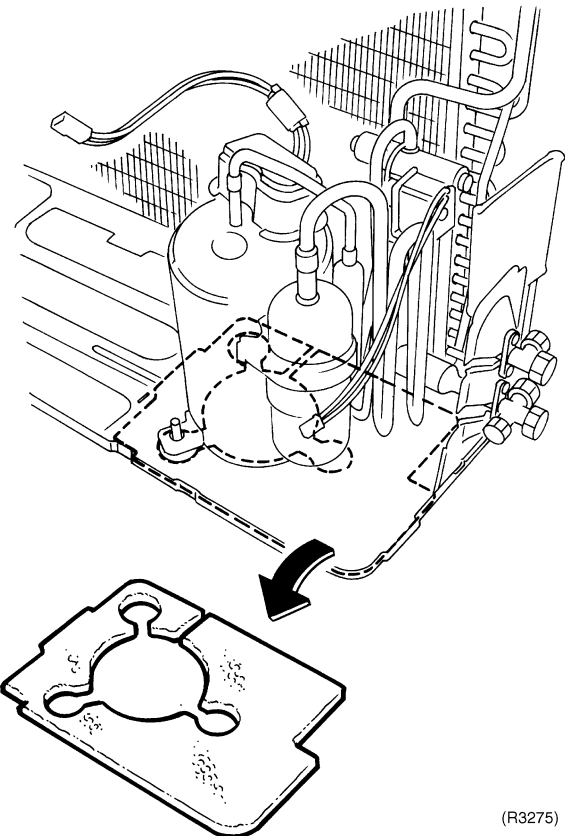
Step		Procedure	Points
5	Pull the sound blanket (bottom) out.	 <p>(R3275)</p>	

3.5 Removal of Four Way Valve

Procedure



Warning Be sure to wait 10 minutes or more after turning off all power supplies before disassembling work.

Step	Procedure	Points
1. Remove the peripheries.	<div data-bbox="516 373 1076 898"> <p>Terminal cover</p> <p>(R3276)</p> </div> <div data-bbox="500 930 1089 1346"> <p>Red (U)</p> <p>Yellow (V)</p> <p>Blue (W)</p> <p>(R3277)</p> </div>	<ul style="list-style-type: none"> ■ Be careful so as not to burn the compressor terminals or the name plate. <p>Make a note.</p>
2. Loosen the screw of the four way valve coil.	<div data-bbox="500 1381 1089 1858"> <p>(R3278)</p> </div>	

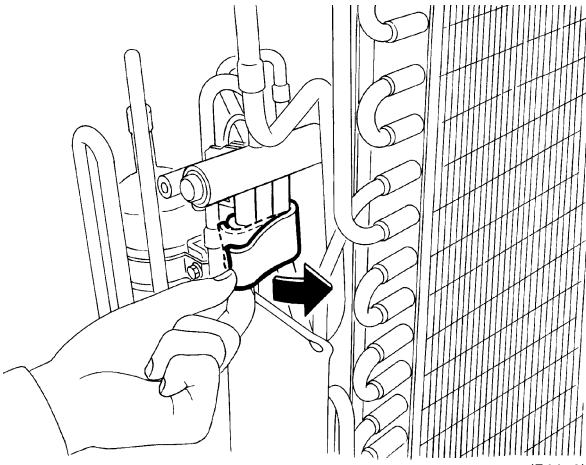
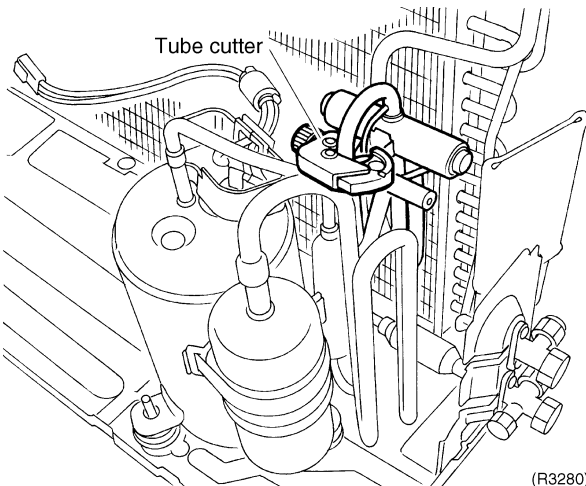
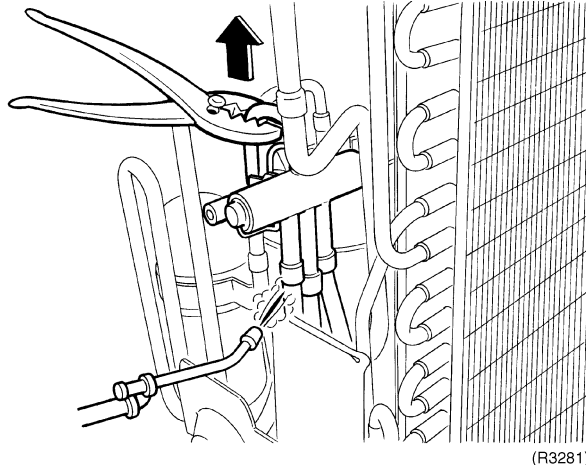
Step	Procedure	Points
3	<p>Remove the sheets of putty. Cut the pipe with a tube cutter.</p>  <p>(R3279)</p>  <p>Tube cutter</p> <p>(R3280)</p>	
4	<p>Heat up the brazed part and withdraw the piping with pliers.</p>  <p>(R3281)</p>	<ul style="list-style-type: none"> ■ Provide a protective sheet or a steel plate so that the brazing flame cannot influence peripheries. ■ Be careful so as not to break the pipes by pressing it excessively by pliers when withdrawing it.

3.6 Removal of Compressor

Procedure

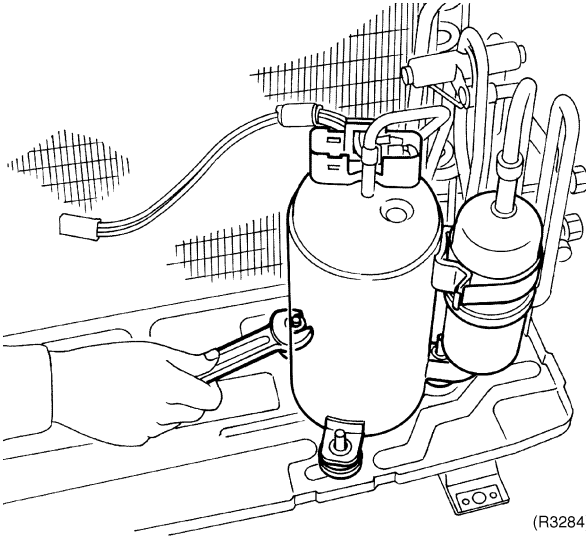

Warning Be sure to wait 10 minutes or more after turning off all power supplies before disassembling work.

Step	Procedure	Points
1. Remove the compressor.		<p>Warning Ventilate when refrigerant leaks during the work. (If refrigerant contacts fire, it will cause to arise toxic gas.)</p> <ul style="list-style-type: none"> ■ Provide a protective sheet or a steel plate so that the brazing flame cannot influence peripheries. ■ Be careful so as not to burn the compressor terminals or the name plate. ■ Be careful so as not to burn the heat exchanger fin. <p>Warning Since it may happen that refrigeration oil in the compressor will catch fire, prepare wet cloth so as to extinguish fire immediately.</p>
<p>1</p> <p>Unscrew the nut of the compressor.</p> <ul style="list-style-type: none"> ■ Before working, make sure that the refrigerant is empty in the circuit. ■ Be sure to apply nitrogen replacement when heating up the brazed part. 		

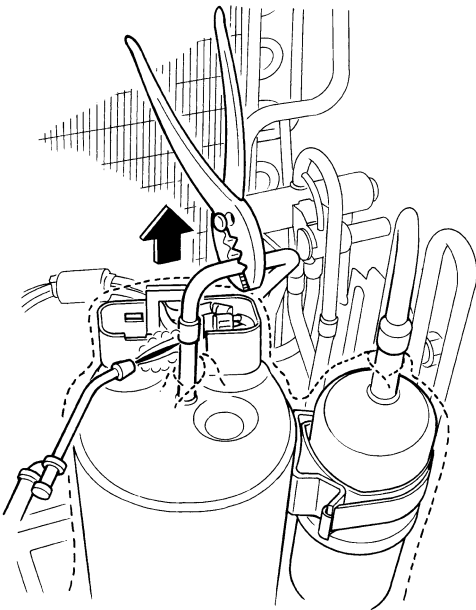
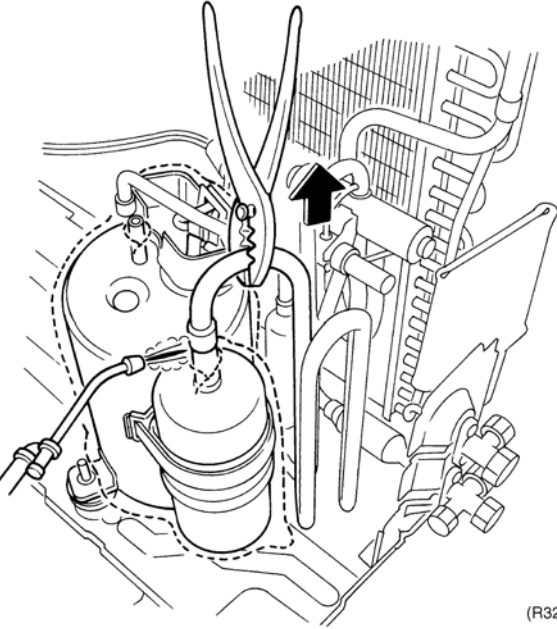
Step	Procedure	Procedure	Points
2	Heat up the brazed part of the discharge side and disconnect.	 <p>(R3285)</p>	<p>In case of the difficulty with gas brazing machine</p> <ol style="list-style-type: none"> 1. Disconnect the brazed part where is easy to disconnect and restore. 2. Cut pipes on the main unit by a miniature copper tube cutter in order to make it easy to disconnect. <p>Cautions for restoration</p> <ol style="list-style-type: none"> 1. Restore the piping by non-oxidation brazing. 2. It is required to prevent the carbonization of the oil inside the four way valve and the deterioration of the gaskets affected by heat. For the sake of this, wrap the four way valve with wet cloth and provide water so that the cloth will not be dried and avoid excessive heating. (Keep below 248°F) <p>i Note: Do not use a metal saw for cutting pipes by all means because the sawdust come into the circuit.</p>
3	Heat up the brazed part of the suction side and disconnect.	 <p>(R3282)</p>	

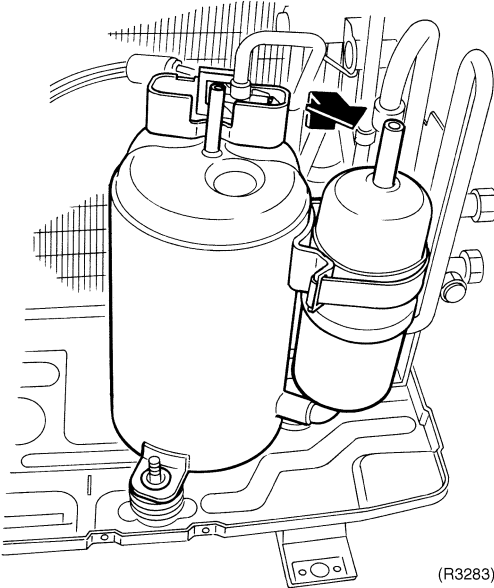
Step	Procedure	Points
4	<p>Lift the compressor up and remove it.</p>  <p>(R3283)</p>	

3.7 Removal of PCB

Procedure

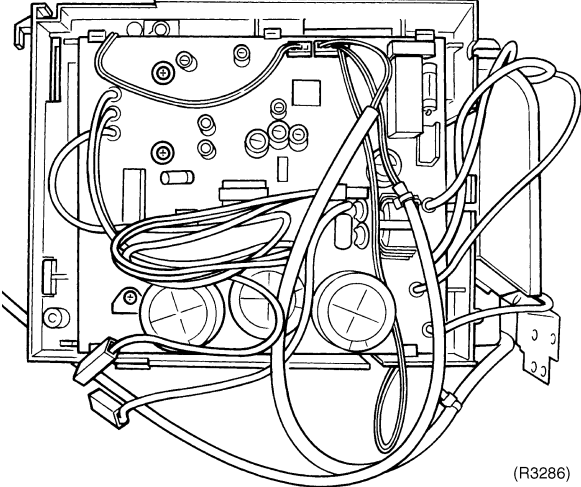
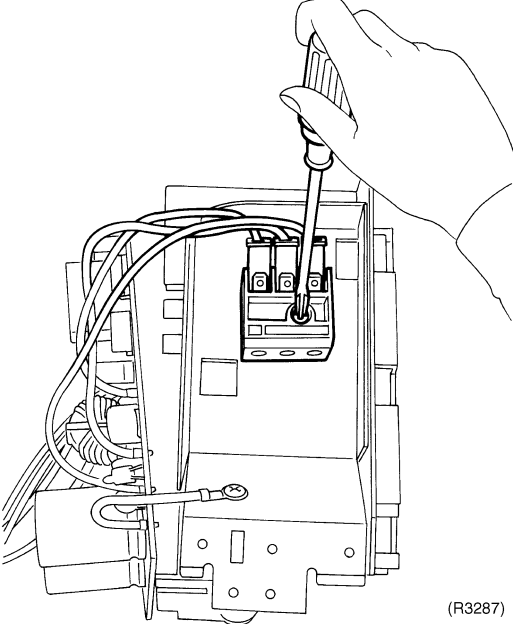

Warning Be sure to wait 10 minutes or more after turning off all power supplies before disassembling work.

Step	Procedure	Points
1. Remove the PCB. 1 Feature of the PCB 2 Loosen the screw on the terminal board.	 <p style="text-align: right;">(R3286)</p>  <p style="text-align: right;">(R3287)</p>	<ul style="list-style-type: none"> ■ You can remove the PCB when you disconnect the read wires on the terminal board without removing the electrical box. ■ PbF (Pb free brazing) is adopted.

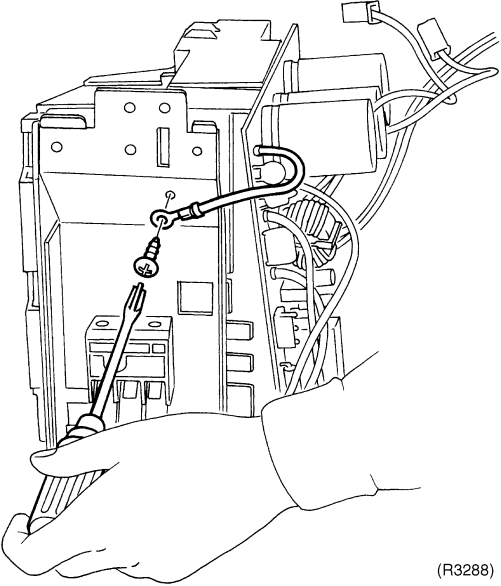
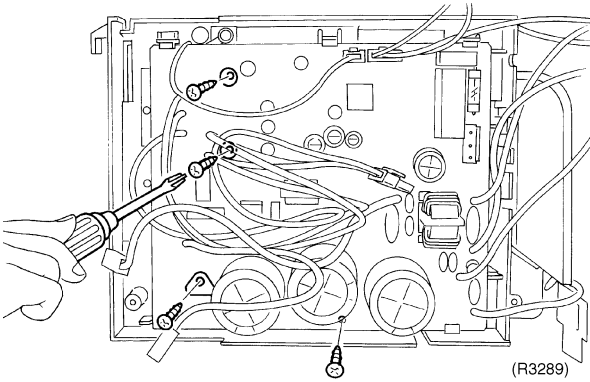
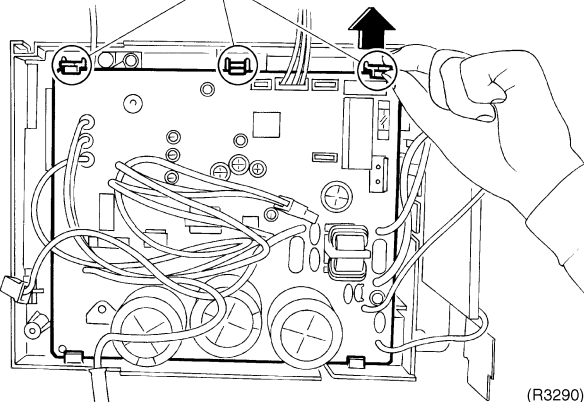
Step	Procedure	Points	Points
3	Release the earth terminal.	 <p>(R3288)</p>	
4	Loosen the 4 screws.	 <p>(R3289)</p>	
5	Undo the 3 hooks on the upper side.	<p>Hooks</p>  <p>(R3290)</p>	

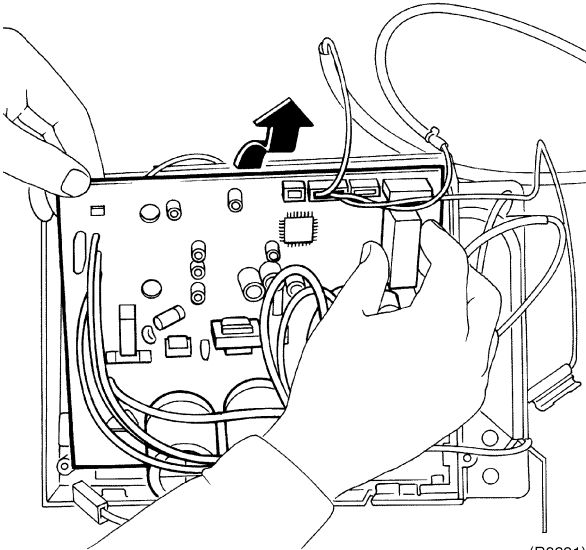
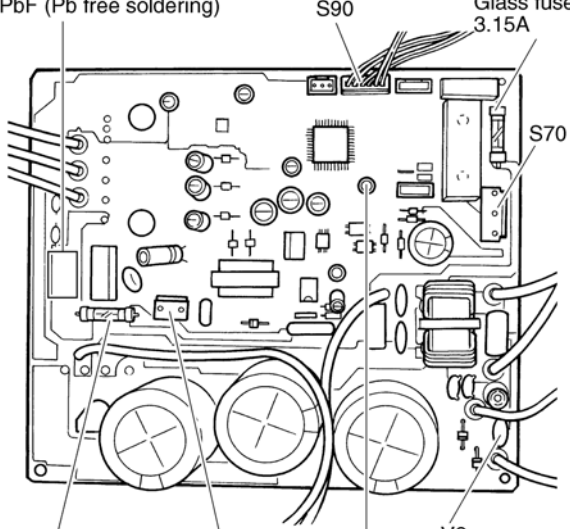
Step	Procedure	Points
6	<p>Lift and pull out the PCB.</p>  <p>(R3291)</p>	
7	<p>Feature of the PCB S70: fan motor S80: four way valve S90: thermistor (outdoor air, heat exchanger, discharge pipe)</p>  <p>(R3292)</p>	

4. RXS15/18/24DVJU

4.1 Removal of the Panels and Plates

Procedure



Warning

Be sure to wait 10 minutes or more after turning off all power supplies before disassembling work.

Step	Procedure	Points
1. Remove the panels and plates.	<p style="text-align: right;">(R2676)</p> <p style="text-align: right;">(R2677)</p>	<ul style="list-style-type: none"> ■ Take care not to cut your finger by the fins of the heat exchanger.

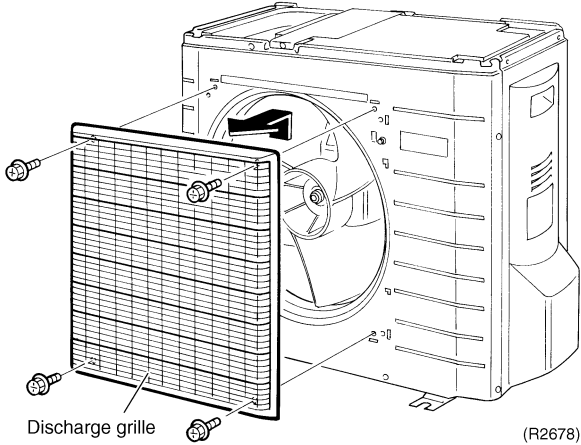
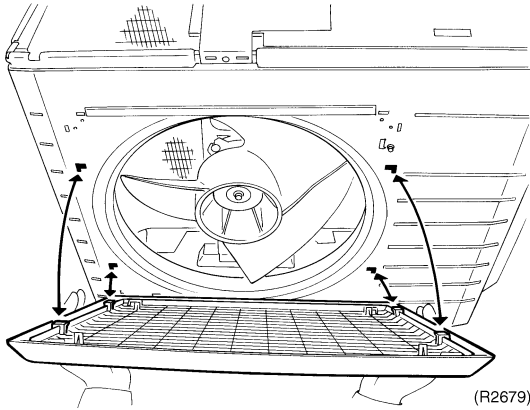
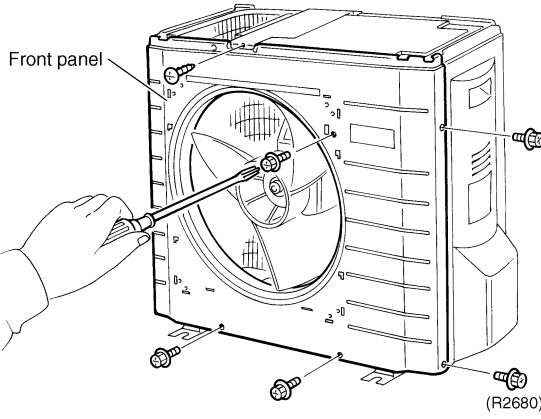
Step	Procedure	Procedure	Points
2	Loosen the 4 screws and remove the discharge grille.	 <p>Discharge grille (R2678)</p>  <p>(R2679)</p>	<ul style="list-style-type: none"> ■ The front grille has 4 hooks. Slide the discharge grille upwards and remove it.
3	Loosen the 6 screws of the front panel.	 <p>Front panel (R2680)</p>	

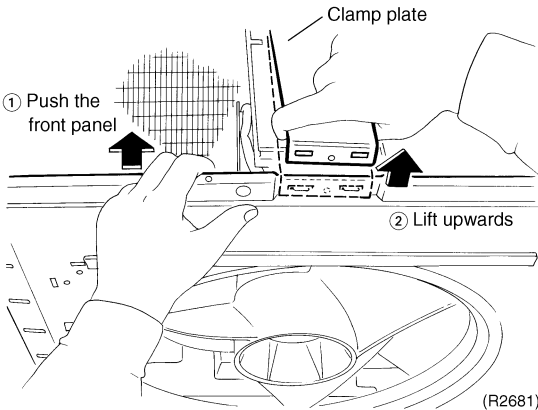
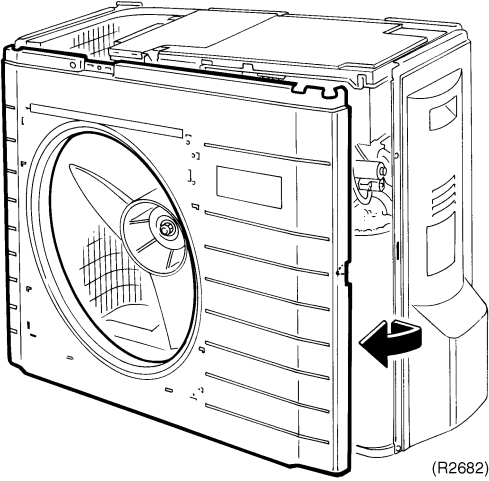
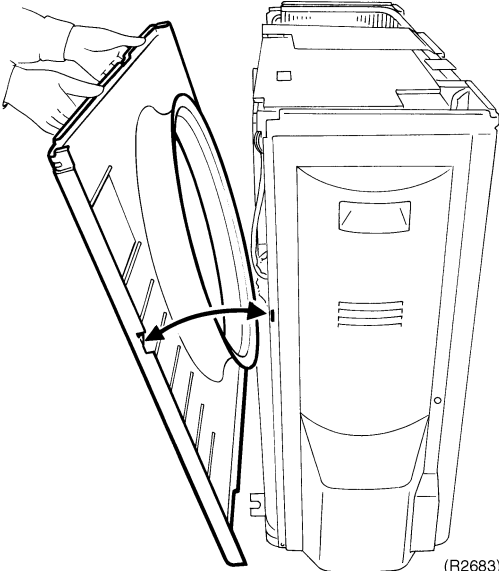
Step	Procedure	Points
<p>4</p>	<p>Push the front panel and undo the hook. Lift the clamp plate and remove it.</p>  <p>(R2681)</p>	
<p>5</p>	<p>Undo the right side hook, and then the left side hooks. Remove the front panel.</p>  <p>(R2682)</p>  <p>(R2683)</p>	<p>■ Lift the front panel and remove it while pushing the right side panel inwards.</p>

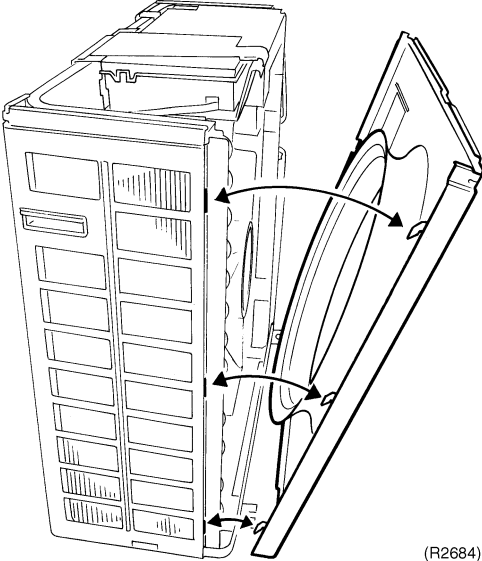
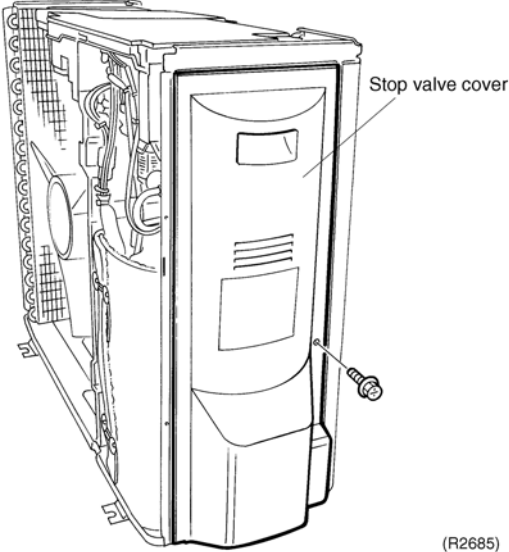
Step	Procedure	Points
	 <p style="text-align: right;">(R2684)</p>	<ul style="list-style-type: none"> ■ Lift the front panel and undo the left side hooks. ■ Fit the left side of the front panel first when installing.
2.	Remove the stop valve cover .	
1	Loosen the screw of the stop valve cover.  <p style="text-align: right;">(R2685)</p>	

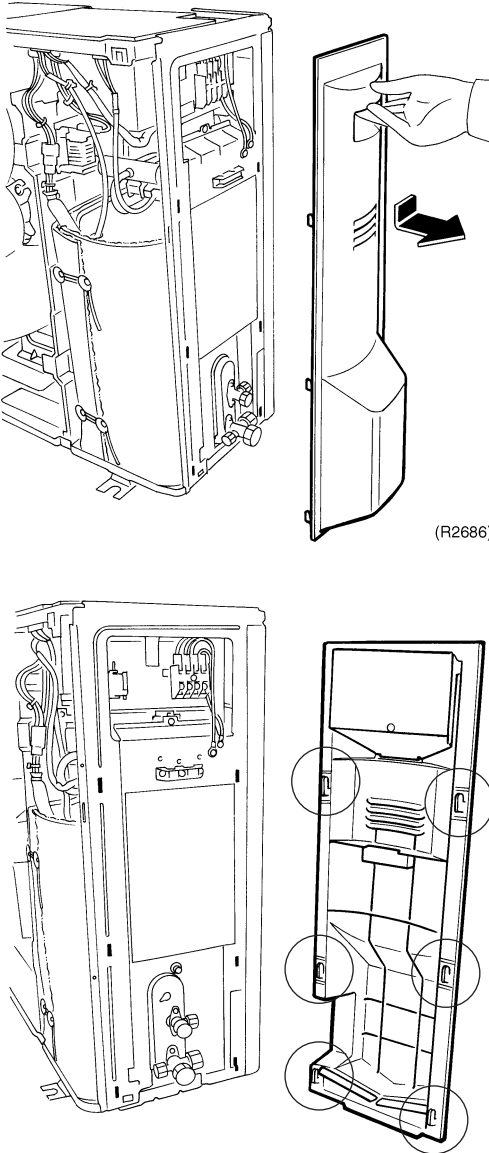
Step		Procedure	Points
2	Pull down the stop valve cover to undo the hooks and remove it.	 <p>(R2686)</p> <p>(R2687)</p>	<ul style="list-style-type: none"> ■ The stop valve cover has 6 hooks.

4.2 Removal of the Fan Motor / Propeller Fan

Procedure



Warning

Be sure to wait 10 minutes or more after turning off all power supplies before disassembling work.

Step	Procedure	Points
<ul style="list-style-type: none"> ■ Remove the top panel and the front panel. 		<ul style="list-style-type: none"> ■ This procedure is not necessary to remove the propeller fan only.
<ul style="list-style-type: none"> 1. Remove the electrical box cover. 		<ul style="list-style-type: none"> ■ The hooks have been released since the front panel was removed.
<ul style="list-style-type: none"> 1 Loosen the screw on the back of the shelter. 		
<ul style="list-style-type: none"> 2 Undo the 2 hooks and remove it. 		
<ul style="list-style-type: none"> 3 Release the 4 hooks of the electrical box cover and remove it. 		

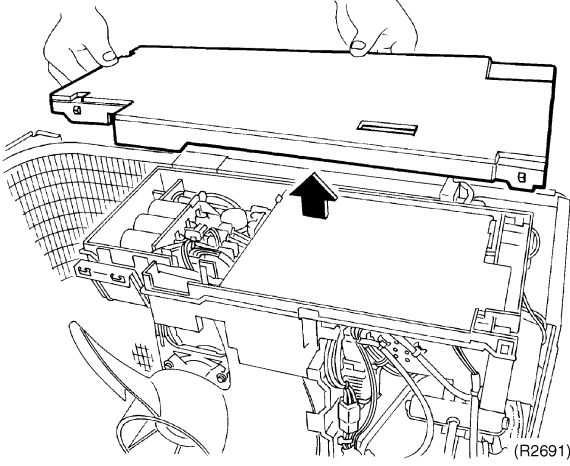
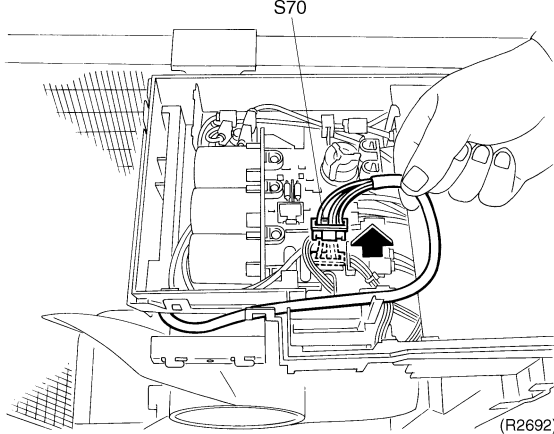
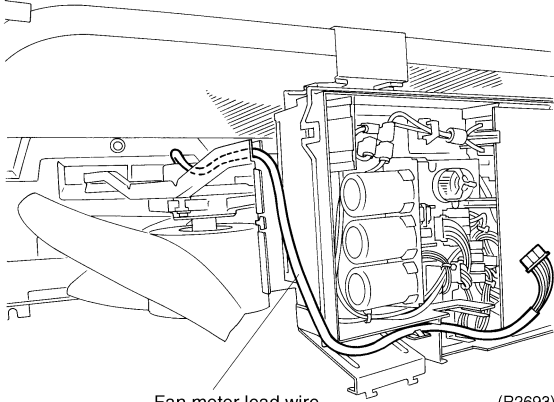
Step	Procedure	Points
	 <p>(R2691)</p>	
<p>2. Remove the fan motor.</p> <p>1</p>	<p>Disconnect the connector for fan motor (S70).</p>  <p>(R2692)</p> <p>2 The illustration shows arrangement of the fan motor lead wire.</p>  <p>Fan motor lead wire (R2693)</p>	

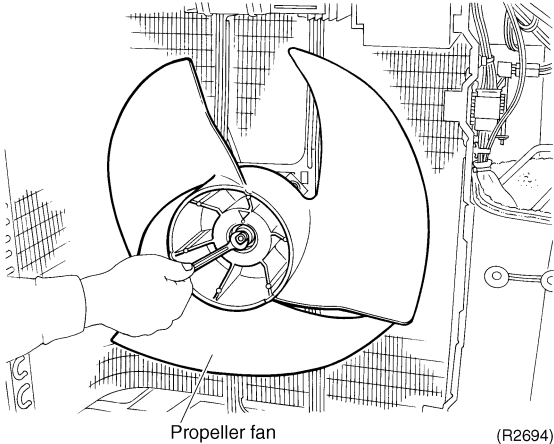
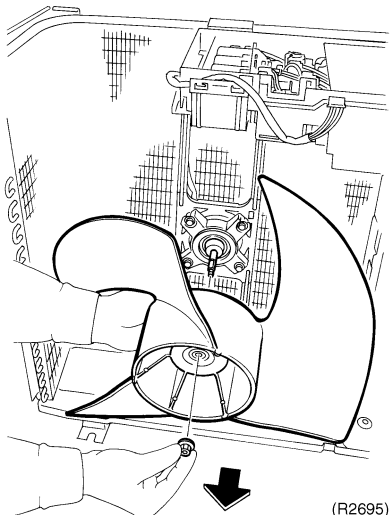
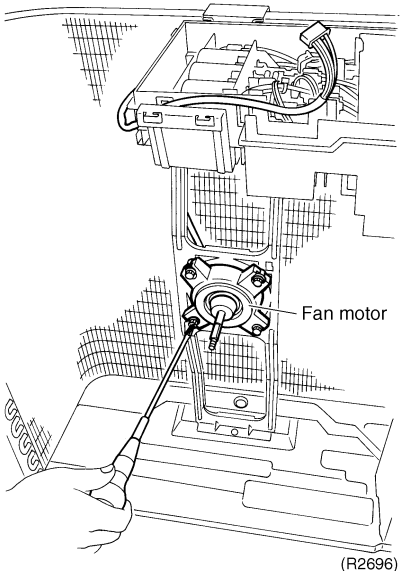
Step	Procedure	Procedure	Points
3	Unscrew the washer-fitted nut (M10) of the propeller fan with a spanner.	 	<ul style="list-style-type: none"> ■ Align ▼ mark of the propeller fan with D-cut section of the motor shaft when reassembling.
4	Remove the 4 screws from the fan motor .		

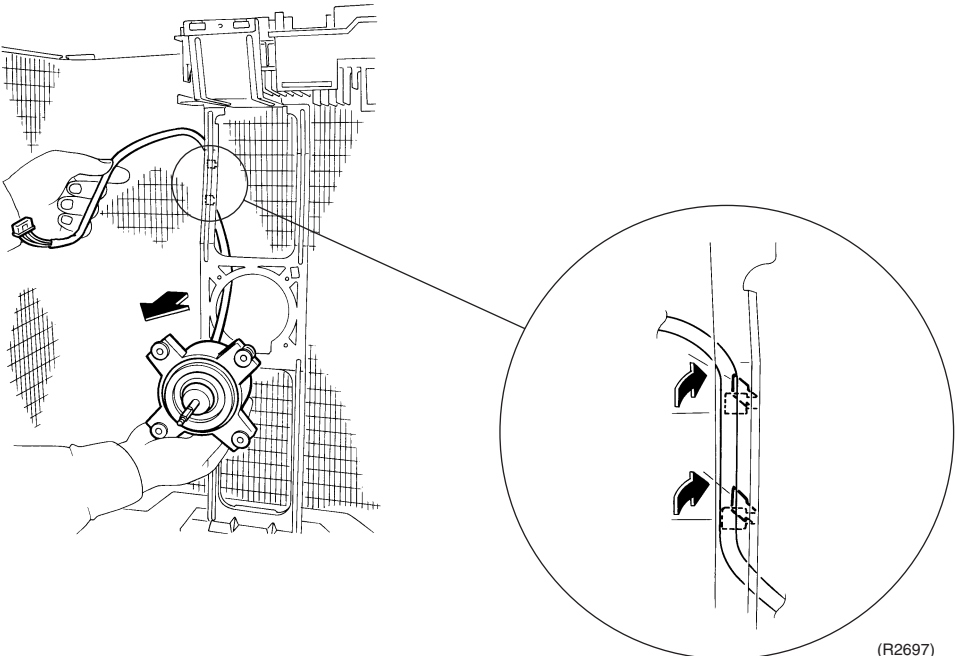
Step	Procedure	Points
5	<p data-bbox="219 212 467 237">Pull the fan motor out.</p>  <p data-bbox="1390 1073 1450 1094">(R2697)</p>	<ul style="list-style-type: none"> <li data-bbox="1109 212 1464 373">■ Put the lead wire through the back of the motor when reassembling. (so as not to be entangled with the propeller fan)

4.3 Removal of the PCB / Electrical Box

Procedure



Warning

Be sure to wait 10 minutes or more after turning off all power supplies before disassembling work.

Step	Procedure	Points
<ul style="list-style-type: none"> ■ Remove the top panel and the front panel. 		
<ul style="list-style-type: none"> 1. Remove the right side panel. 		
<ul style="list-style-type: none"> 1 	<p>Disconnect the 3 connection wirings and the 2 earth wires.</p>	<p>Terminal strip number black (1) ----- power supply white (2) ----- power supply red (3) ----- transmission yellow / green (\perp) ----- earth</p>
<ul style="list-style-type: none"> 2 	<p>Loosen the 3 screws of the right side panel.</p>	

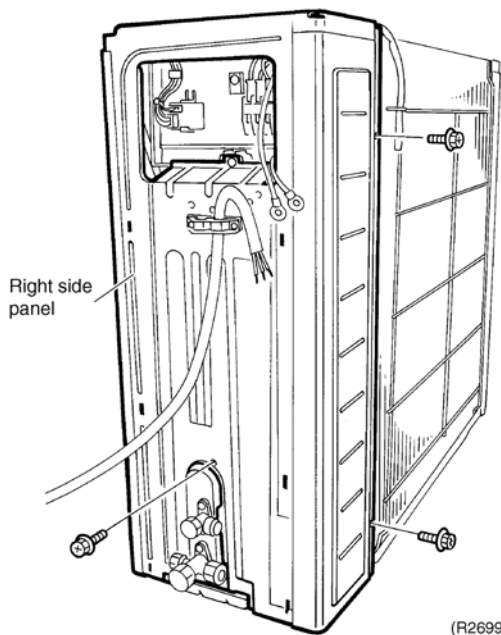
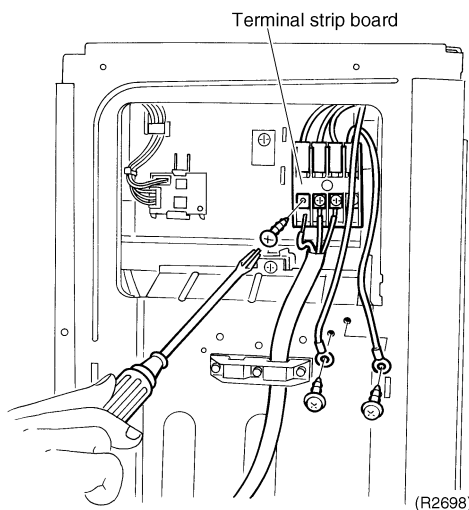

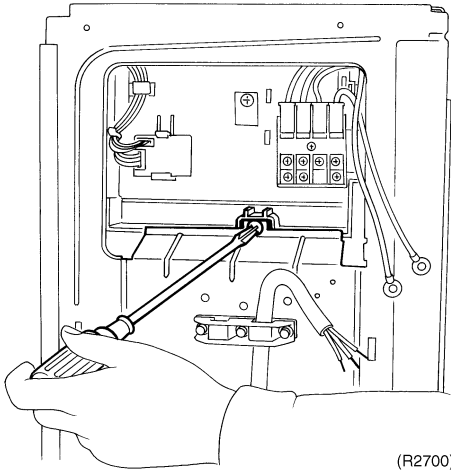
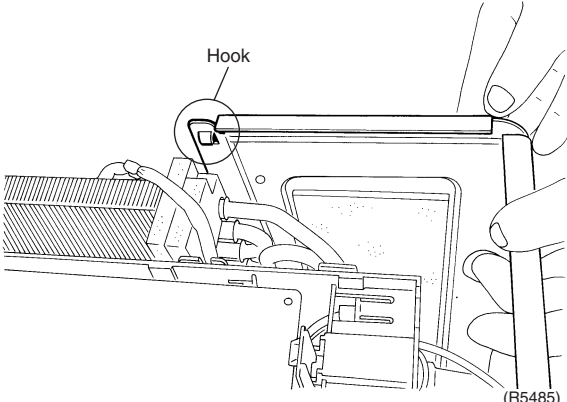
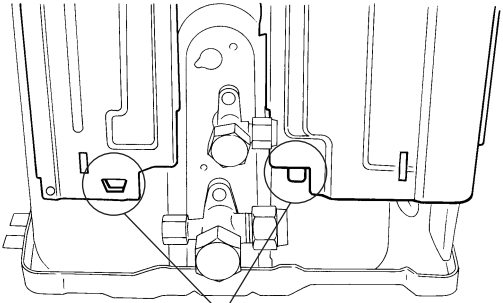
Step	Procedure	Points
3	<p data-bbox="215 212 483 275">Loosen the fixing screw of the electrical box.</p>  <p data-bbox="963 674 1024 695">(R2700)</p>  <p data-bbox="716 800 768 821">Hook</p> <p data-bbox="1016 1146 1078 1167">(R5485)</p>  <p data-bbox="740 1493 802 1514">Hooks</p> <p data-bbox="976 1493 1037 1514">(R5486)</p>	<ul style="list-style-type: none"> <li data-bbox="1105 705 1464 835">■ Insert the two hooks of the lower part and the one hook of the upper back when reassembling.

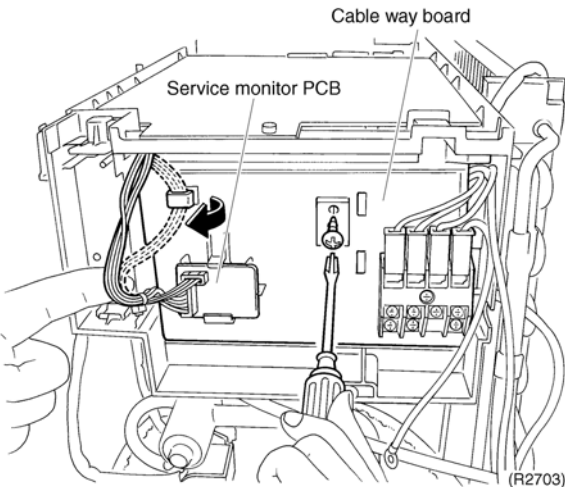
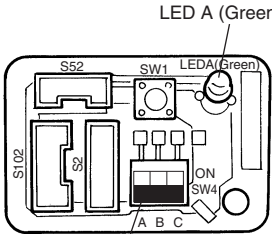
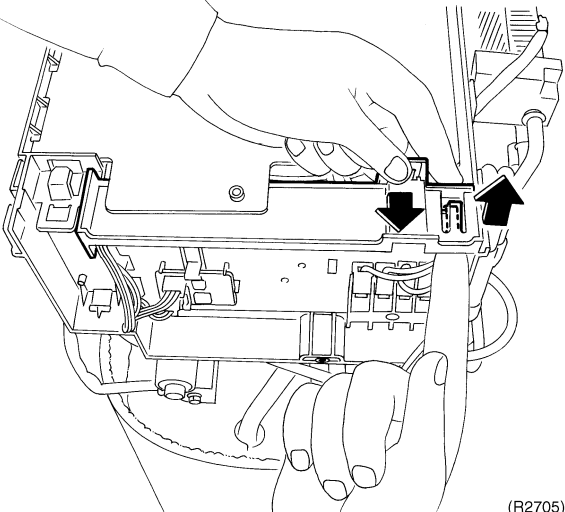
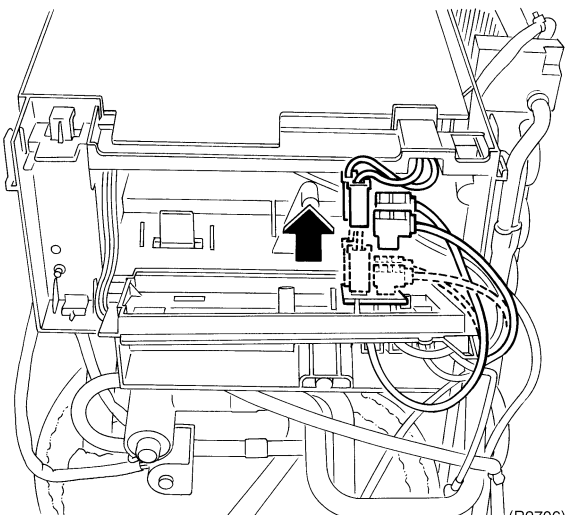
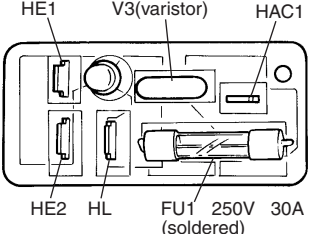
Step	Procedure	Points
2. Disconnect harnesses.		
1	<p>Loosen the fixing screw of the cable way board.</p>  <p>(R2703)</p>	<p>■ Service monitor PCB</p>  <p>LED A (Green)</p> <p>SW4 (Initial setting: OFF) (R2704)</p>
2	<p>Push the hook up to release the cable way board. Open the cable way board.</p>  <p>(R2705)</p>	
3	<p>Disconnect the harnesses from the power supply PCB. HL (black) to the terminal strip HE2 (yellow / green) to the terminal strip (earth) HAC1 (black) from the control PCB (AC1) HE1 (yellow / green) from the control PCB (E)</p>  <p>(R2706)</p>	<p>■ Power supply PCB</p>  <p>HE1 V3 (varistor) HAC1</p> <p>HE2 HL FU1 250V 30A (soldered) (R2707)</p>

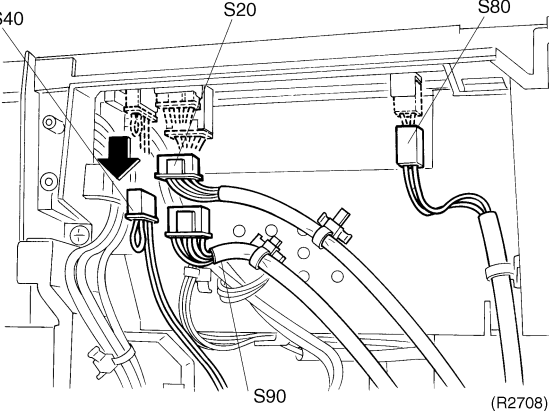
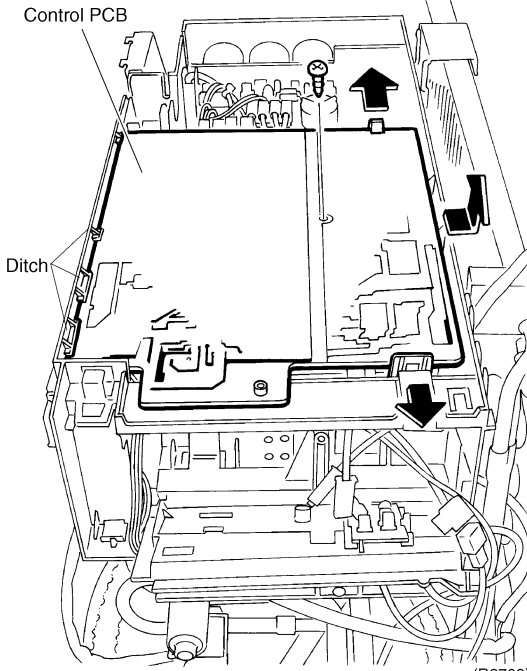
Step	Procedure	Points
4	<p>Disconnect the connectors of the front side.</p> <p>S20: electronic expansion valve S40: overload protector S80: four way valve S90: thermistors (discharge pipe, outdoor air, heat exchanger)</p> 	
5	<p>Loosen the screw of the control PCB.</p>	
6	<p>Undo the 2 hooks and release the control PCB from the ditch of the front side.</p> 	

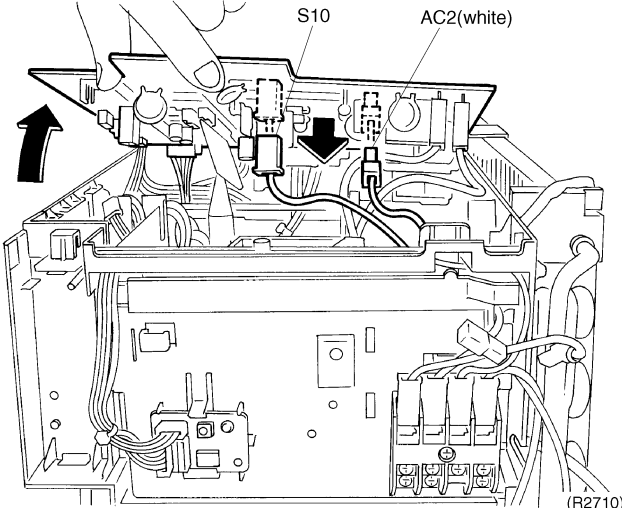
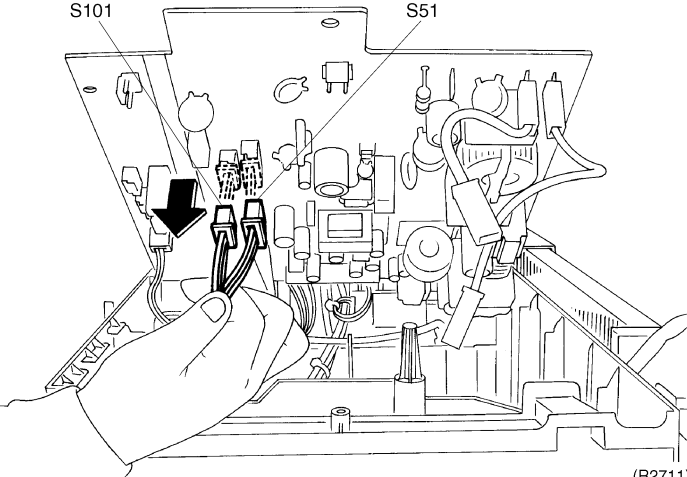
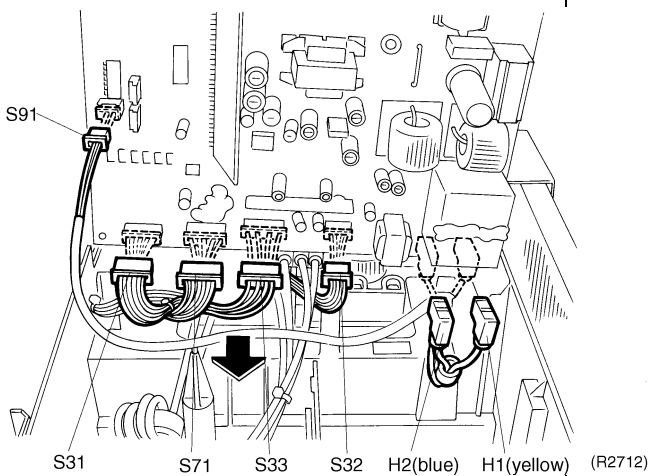
Step	Procedure	Points
7	<p>Disconnect the harnesses while opening the control PCB.</p> <p>S10: to the terminal strip</p> <p>AC2: to the terminal strip</p>	
8	<p>Disconnect the connectors.</p> <p>S51: to the service monitor PCB</p> <p>S101: to the service monitor PCB</p>	
9	<p>Disconnect the connectors.</p> <p>S31: to the SPM</p> <p>S32: to the SPM</p> <p>S33: to the MID</p> <p>S71: to the MID</p> <p>S91: fin thermistor</p>	

Step	Procedure	Points
<p>10</p>	<p>Control PCB (outdoor unit) S10: to the terminal strip S20: electronic expansion valve S31: to CN14 of the SPM S32: to CN11 of the SPM S33: to S34 of the MID S40: overload protector S51: to S52 of the service monitor PCB S71: to S72 of the MID S80: four way valve S90: thermistors (discharge pipe, outdoor air, heat exchanger) S91: fin thermistor S101: to S102 of the service monitor PCB</p>	
<p>11</p>	<p>Disconnect the relaying wire connector for the compressor.</p>	

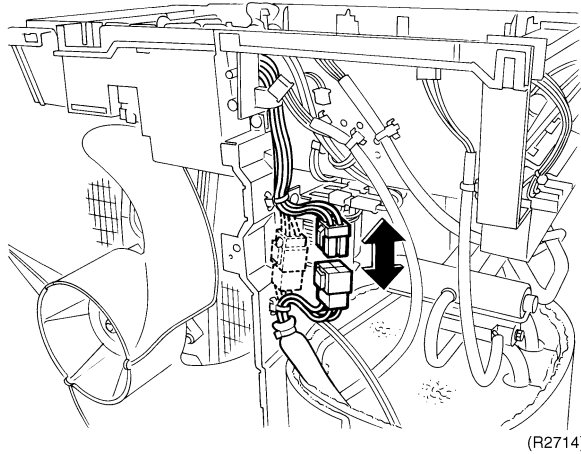
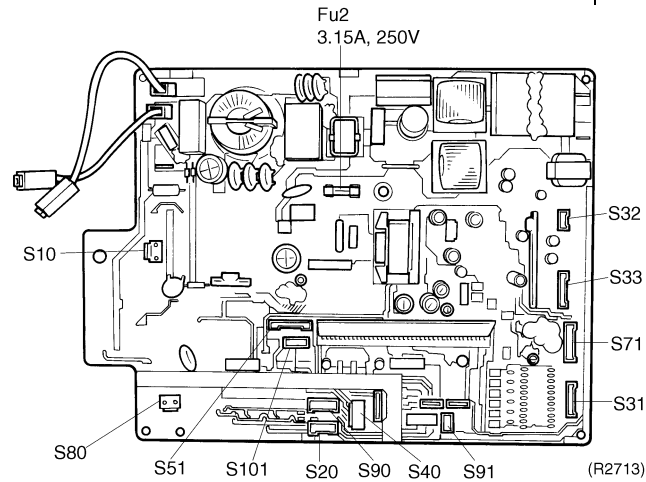

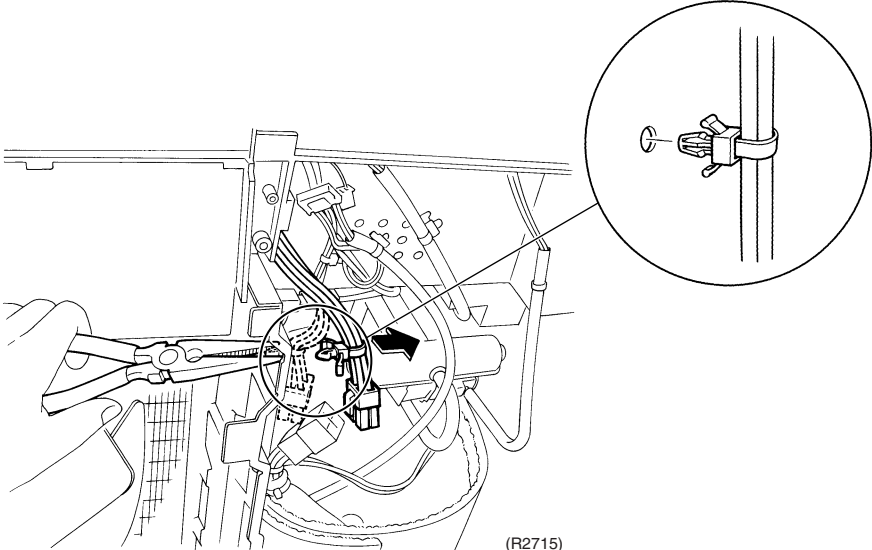
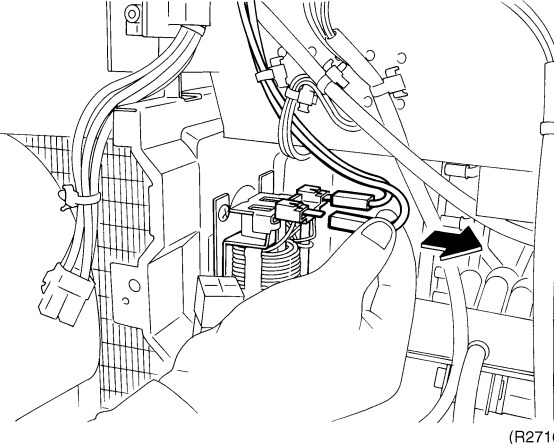
Step	Procedure	Procedure	Points
12	Release the clamp by pliers.	 <p>(R2715)</p>	
13	Disconnect the reactor harness.	 <p>(R2716)</p>	

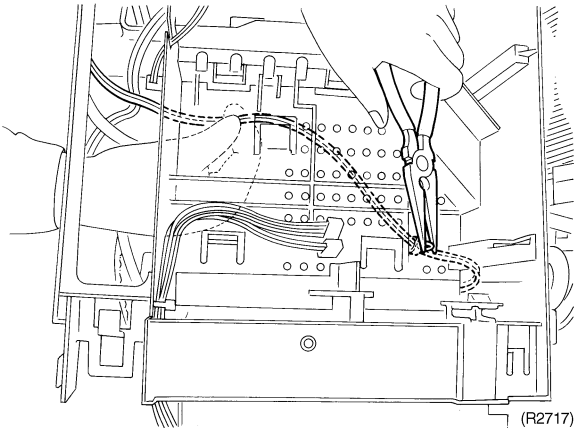
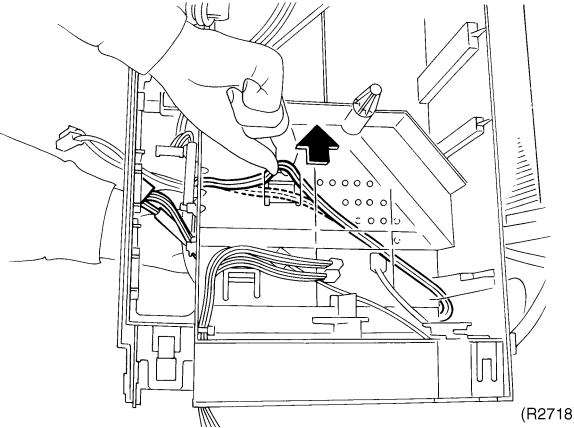
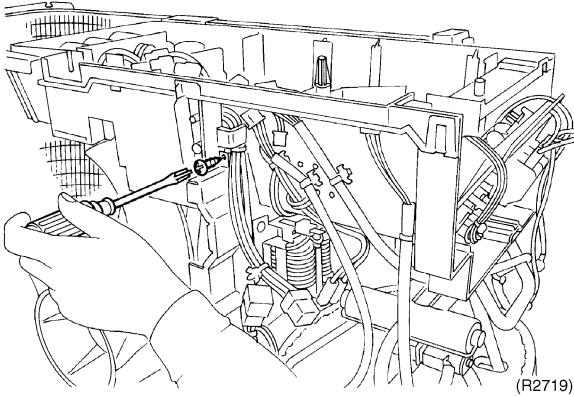
Step	Procedure	Points
<p>14</p>	<p>Pull the clamp and draw the thermistor harness out from the back of the electrical box.</p>  <p>(R2717)</p>  <p>(R2718)</p>	
<p>15</p>	<p>Loosen the screw of the electrical box.</p>  <p>(R2719)</p>	

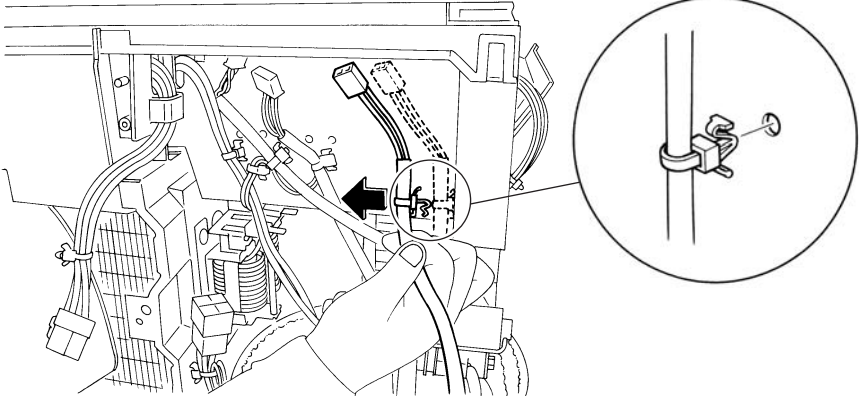
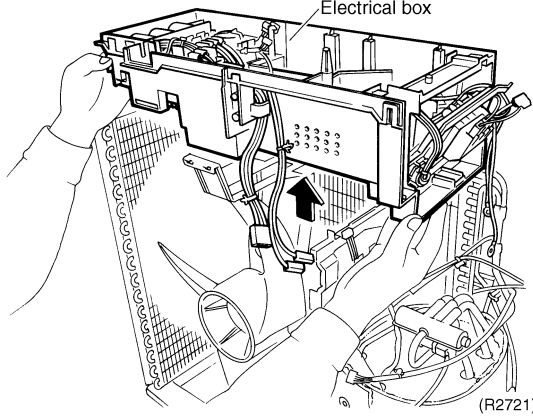
Step	Procedure	Procedure	Points
16	Release the clamp of the four way valve harness.	 <p>(R2720)</p>	
17	Lift the electrical box and remove it.	 <p>(R2721)</p>	

4.4 Removal of the Reactor

Procedure



Warning

Be sure to wait 10 minutes or more after turning off all power supplies before disassembling work.

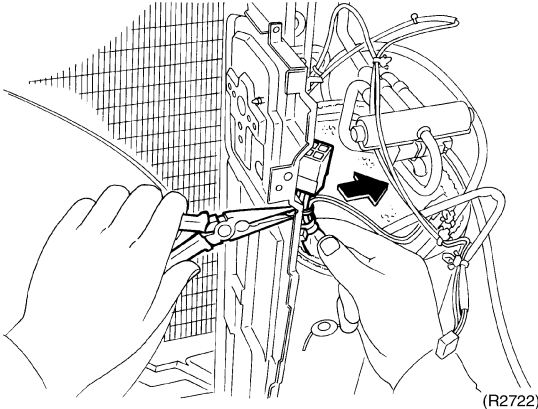
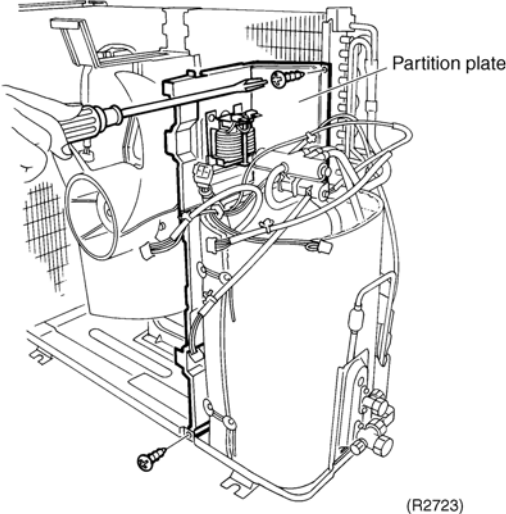
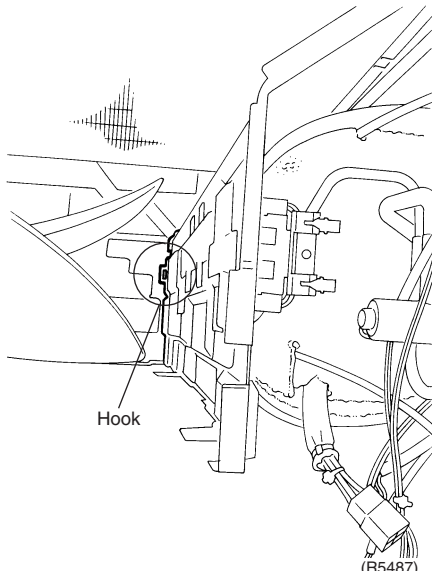
Step	Procedure	Points	
<p>■ Remove the electrical box.</p>			
<p>1. Remove the partition plate.</p>			
<p>1</p>	<p>Release the clamp by pliers.</p>	 <p>(R2722)</p>	
<p>2</p>	<p>Loosen the 2 screws of the partition plate.</p>	 <p>Partition plate</p> <p>(R2723)</p>	
		 <p>Hook</p> <p>(R5487)</p>	<p>■ The partition plate is fixed to the bottom frame with a hook.</p>

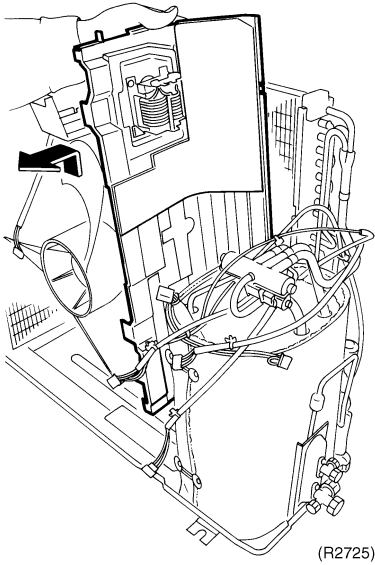
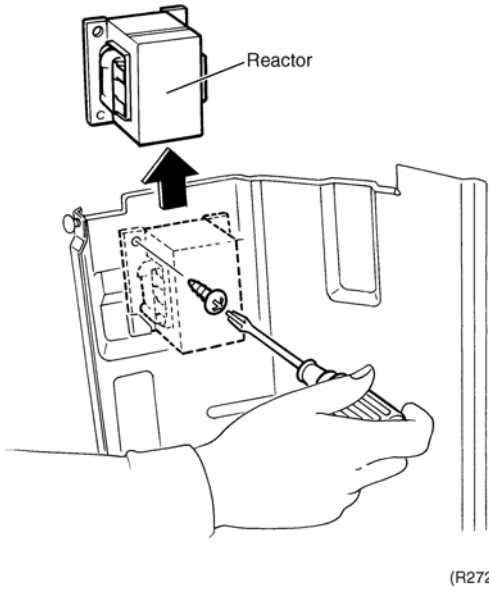
Step	Procedure	Procedure	Points
3	Lift the partition plate and remove it.	 <p>(R2725)</p>	
4	Loosen the screw. Slide the reactor and remove it from the partition plate.	 <p>(R2726)</p>	

4.5 Removal of the Sound Blanket

Procedure



Warning

Be sure to wait 10 minutes or more after turning off all power supplies before disassembling work.

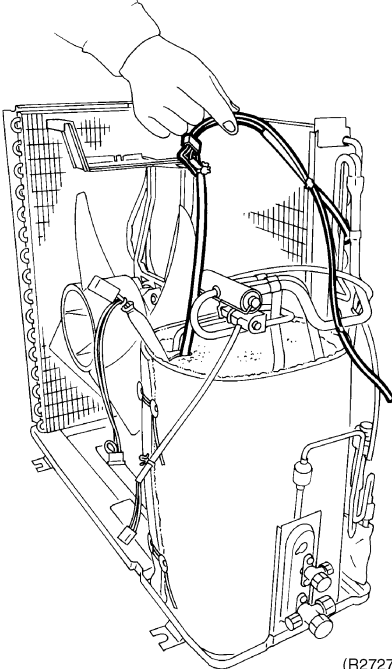
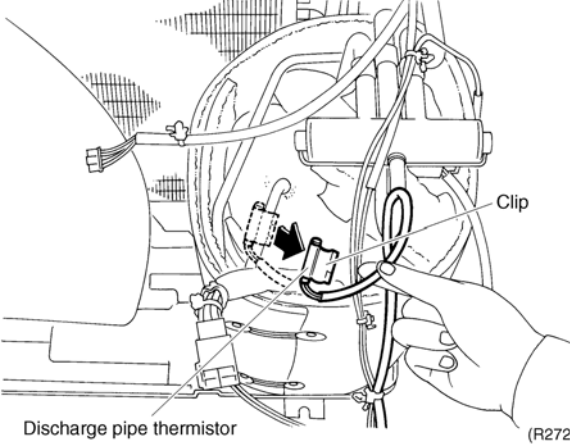
Step	Procedure	Procedure	Points
1	Disconnect the harness of each thermistor.	 <p>(R2727)</p>	
2	Release the discharge pipe thermistor.	 <p>Discharge pipe thermistor</p> <p>Clip</p> <p>(R2728)</p>	<ul style="list-style-type: none"> ■ Pay attention to the direction of the clip so as not to touch the lead wire of the thermistor when reassembling.

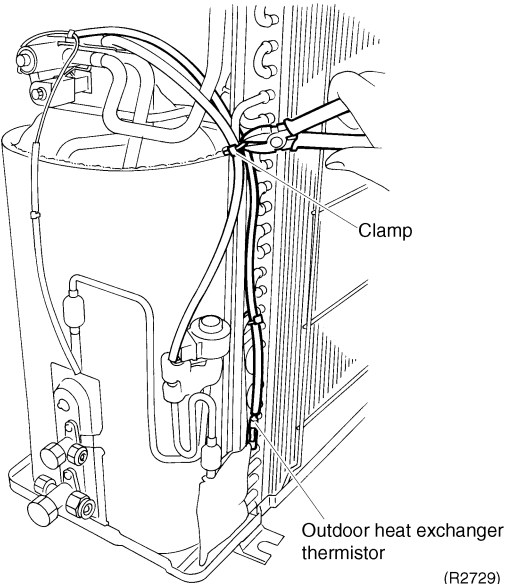
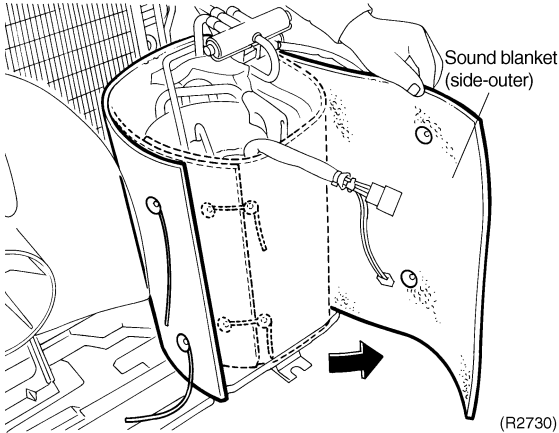
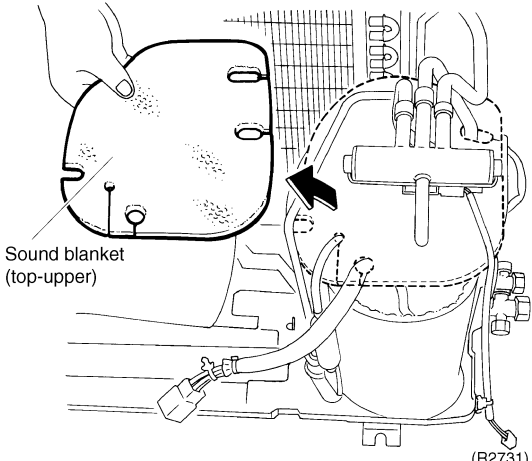
Step	Procedure	Points
3	<p>Cut the clamp by nippers. Disconnect the outdoor heat exchanger thermistor.</p>  <p style="text-align: right;">(R2729)</p>	<ul style="list-style-type: none"> Clamps should be always available. Fix it as it was before.
4	<p>Remove the sound blanket (side-outer).</p>  <p style="text-align: right;">(R2730)</p>	<ul style="list-style-type: none"> Since the piping ports on the sound blanket (side-outer) are torn easily, remove the blanket carefully.
5	<p>Remove the sound blanket (top-upper).</p>  <p style="text-align: right;">(R2731)</p>	

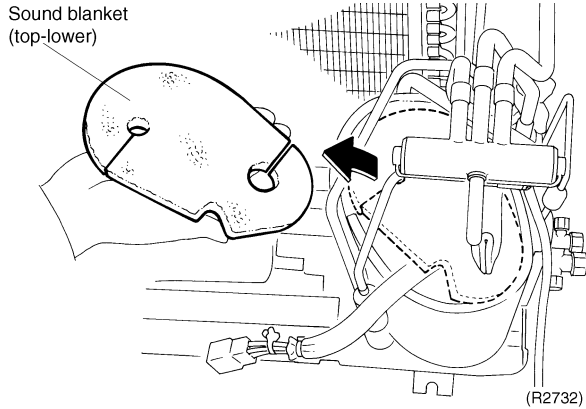
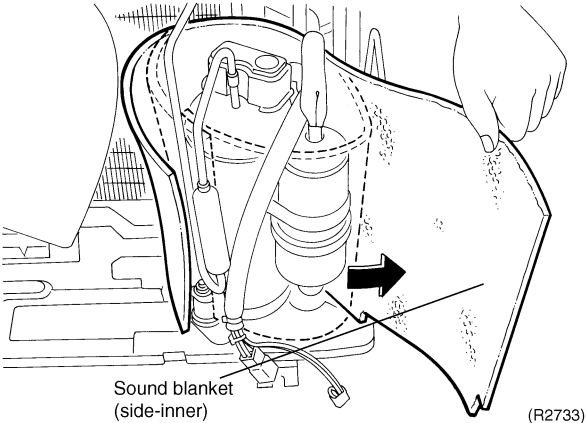
Step	Procedure	Points
6	<p>Remove the sound blanket (top-lower).</p> 	
7	<p>Remove the sound blanket (side-inner).</p> 	<ul style="list-style-type: none"> ■ Since the piping ports on the sound blanket (side-inner) are torn easily, remove the blanket carefully.

4.6 Removal of the Four Way Valve

Procedure

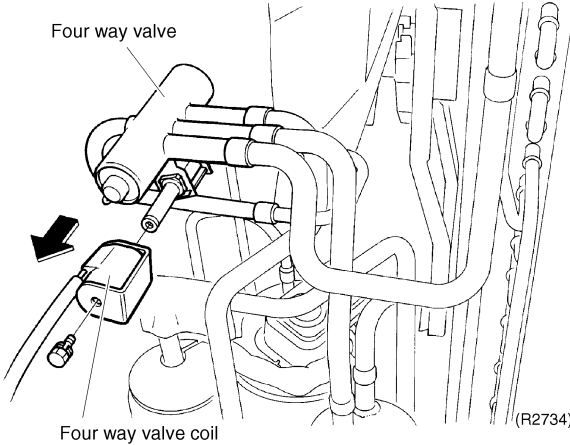
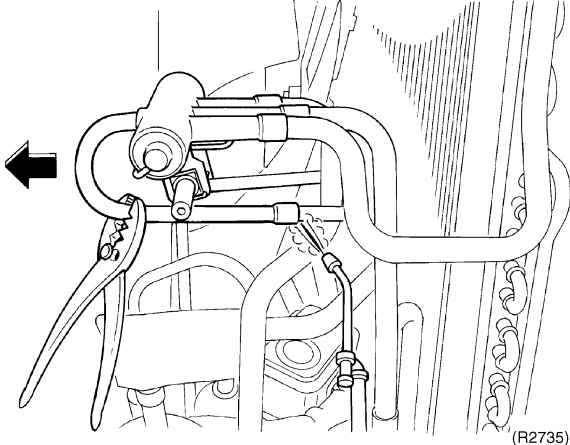
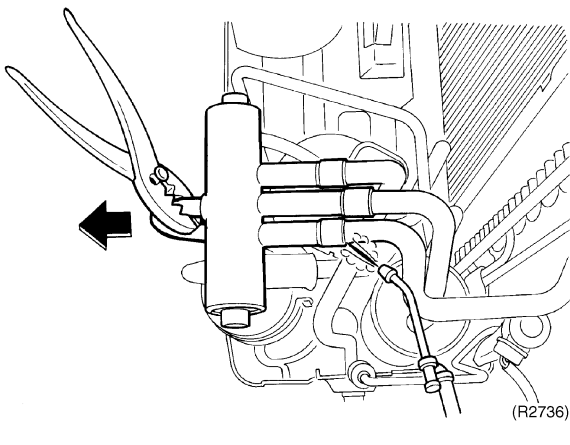

Warning Be sure to wait 10 minutes or more after turning off all power supplies before disassembling work.

Step	Procedure	Procedure	Points
1	Loosen the screw of the four way valve coil .		<ul style="list-style-type: none"> ■ Provide a protective sheet or a steel plate so that the brazing flame cannot influence peripheries. ■ Be careful so as not to break the pipes by pressing it excessively by pliers when withdrawing it. <p>Caution Be careful about the four way valve, pipes and so on, which were heated up by a gas brazing machine, so as not to get burnt your hands.</p>
2	Heat up the brazed part of the four way valve and disconnect. <ul style="list-style-type: none"> ■ Be sure to apply nitrogen replacement when heating up the brazed part. 		<p>Cautions for restoration</p> <ol style="list-style-type: none"> 1. Restore the piping by non-oxidation brazing. Braze it quickly when no nitrogen gas can be used. 2. It is required to prevent the carbonization of the oil inside the four way valve and the deterioration of the gaskets affected by heat. For the sake of this, wrap the four way valve with wet cloth and provide water so that the cloth will not be dried and avoid excessive heating. (Keep below 248°F)
3	Heat up every brazed part in turn and disconnect.		<p>In case of the difficulty with gas brazing machine</p> <ol style="list-style-type: none"> 1. Disconnect the brazed part where is easy to disconnect and restore. 2. Cut pipes on the main unit by a miniature copper tube cutter in order to make it easy to disconnect. <p>Note: Do not use a metal saw for cutting pipes by all means because the sawdust come into the circuit.</p>

4.7 Removal of the Electronic Expansion Valve

Procedure

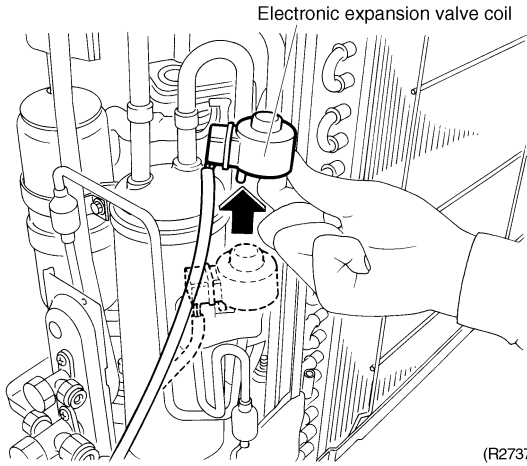
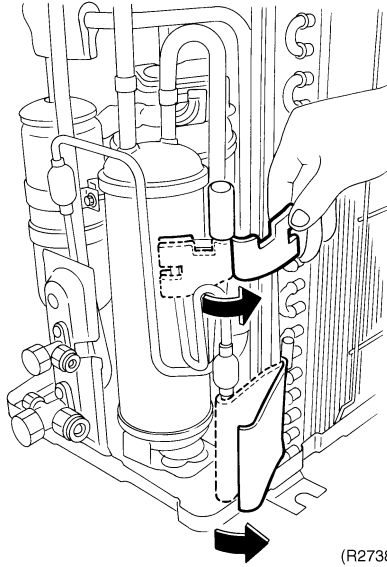
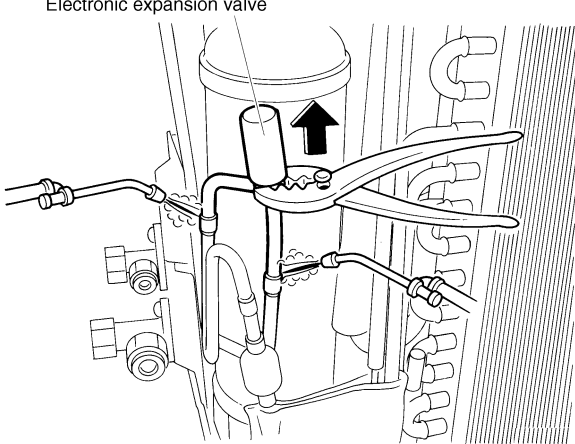

Warning Be sure to wait 10 minutes or more after turning off all power supplies before disassembling work.

Step	Procedure	Procedure	Points
1	Remove the electronic expansion valve coil .	 <p style="text-align: right;">(R2737)</p>	
2	Remove the sheets of putty.	 <p style="text-align: right;">(R2738)</p>	
3	Heat up the two brazed parts of the electronic expansion valve and disconnect.	 <p style="text-align: right;">(R2739)</p>	<p>Caution Be careful about the electronic expansion valve, pipes and so on, which were heated up by a gas brazing machine, so as not to get burnt your hands.</p> <p>Warning Ventilate when refrigerant leaks during the work. (If refrigerant contacts fire, it will cause to arise toxic gas.)</p>

■ Before working, make sure that the refrigerant is empty in the circuit.

■ Be sure to apply nitrogen replacement when heating up the brazed part.

4.8 Removal of the Compressor

Procedure



Warning

Be sure to wait 10 minutes or more after turning off all power supplies before disassembling work.

Step	Procedure	Procedure	Points
1	Remove the terminal cover.	<p>(R2740)</p>	
2	Disconnect the lead wires of the compressor.	<p>(R2741)</p> <p>(R2742)</p>	<p>■ Be careful so as not to burn the compressor terminals or the name plate.</p> <p>Make a note.</p> <div style="border: 1px solid black; padding: 5px; width: fit-content; margin: 10px auto;"> <p style="text-align: center;">U V N W</p> </div> <p>U : red V : yellow W : blue N : brown</p>

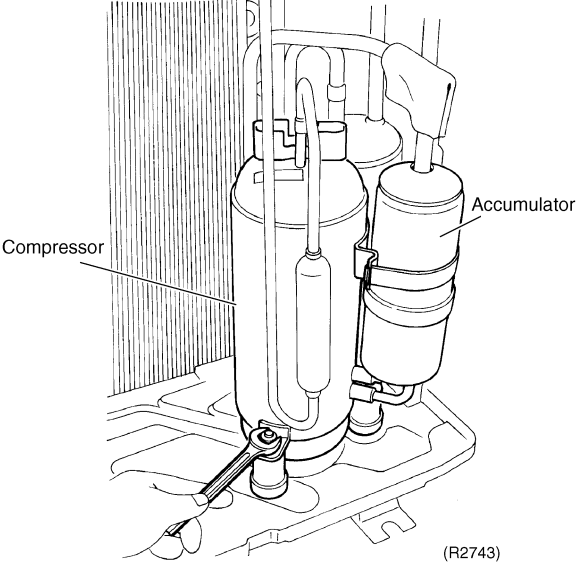
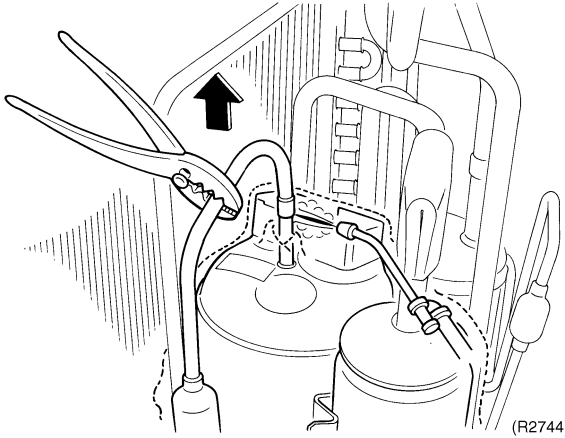
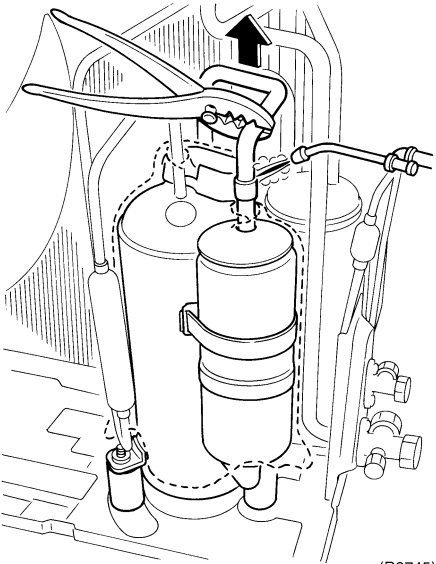
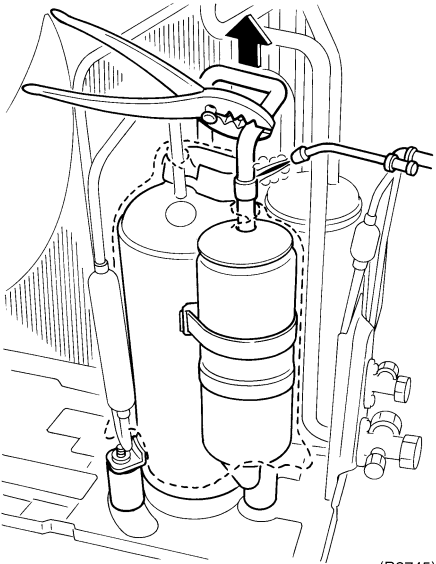
Step	Procedure	Points
3	Unscrew the nut of the compressor .	
4	Remove the putty of the accumulator .	
5	Heat up the brazed part of the discharge side and disconnect.	
7	Lift the compressor up and remove it.	

- Before working, make sure that the refrigerant is empty in the circuit.
- Be sure to apply nitrogen replacement when heating up the brazed part.

Warning
 Ventilate when refrigerant leaks during the work.
 (If refrigerant contacts fire, it will cause to arise toxic gas.)

- Provide a protective sheet or a steel plate so that the brazing flame cannot influence peripheries.
- Be careful so as not to burn the compressor terminals or the name plate.

- Be careful so as not to burn the heat exchanger fin.

Warning
 Since it may happen that refrigeration oil in the compressor will catch fire, prepare wet cloth so as to extinguish fire immediately.

Part 8 Others

1. Others	304
1.1 Test Run from the Remote Controller	304
1.2 Jumper Settings	305

1. Others

1.1 Test Run from the Remote Controller

For Heat pump

In cooling mode, select the lowest programmable temperature; in heating mode, select the highest programmable temperature.

- Trial operation may be disabled in either mode depending on the room temperature.
- After trial operation is complete, set the temperature to a normal level.
(78°F to 82°F in cooling mode, 68°F to 75°F in heating mode)
- For protection, the system disables restart operation for 3 minutes after it is turned off.

Trial Operation and Testing

1. Measure the supply voltage and make sure that it falls in the specified range.
 2. Trial operation should be carried out in either cooling or heating mode.
 3. Carry out the test operation in accordance with the Operation Manual to ensure that all functions and parts, such as louver movement, are working properly.
- The air conditioner requires a small amount of power in its standby mode. If the system is not to be used for some time after installation, shut off the circuit breaker to eliminate unnecessary power consumption.
 - If the circuit breaker trips to shut off the power to the air conditioner, the system will restore the original operation mode when the circuit breaker is opened again.

Trial operation from Remote Controller

- (1) Press ON/OFF button to turn on the system.
- (2) Simultaneously press center of TEMP button and MODE buttons.
- (3) Press MODE button twice.
(“T” will appear on the display to indicate that Trial Operation mode is selected.)
- (4) Trial run mode terminates in approx. 30 minutes and switches into normal mode. To quit a trial operation, press ON/OFF button.

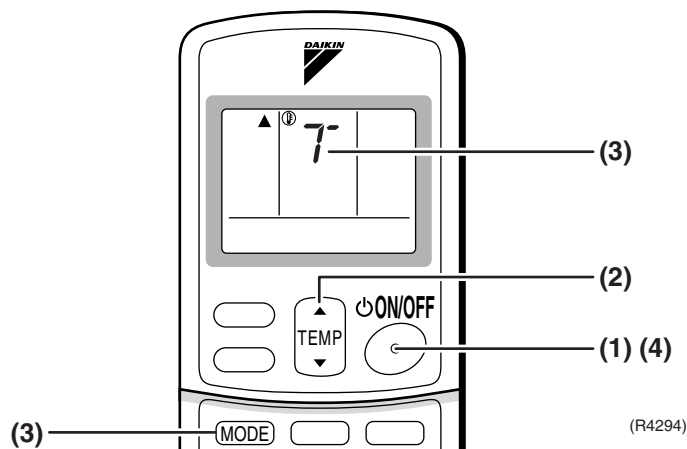

1.2 Jumper Settings

1.2.1 When Two Units are Installed in One Room

When two indoor units are installed in one room, the two wireless remote controllers can be set for different addresses.

How to set the different addresses

- Control PCB of the indoor unit
 - (1) Remove the front grille. (3 screws)
 - (2) Remove the electrical box (1-screw).
 - (3) Remove the drip proof plate. (4 tabs)
 - (4) Cut the address jumper **JA** on the control PCB.

- Wireless remote controller
 - (1) Slide the front cover and take it off.
 - (2) Cut the address jumper **J4**.

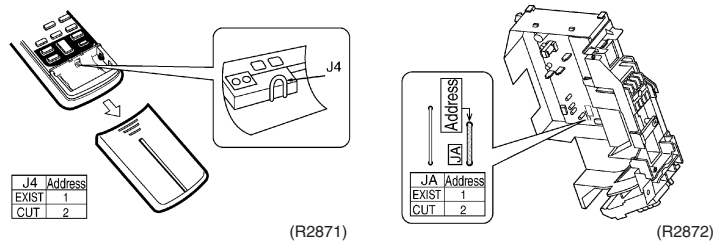

1.2.2 Jumper Setting

Jumper (On indoor control PCB)	Function	When connected (factory set)	When cut
JC	Power failure recovery function	Auto-restart	Unit does not resume operation after recovering from a power failure. Timer ON-OFF settings are cleared.
JB	Fan speed setting when compressor is OFF on thermostat. (effective only at cooling operation)	Fan speed setting ; Remote controller setting	Fan rpm is set to "0" <Fan stop>

Part 9 Appendix

1. Piping Diagrams.....	308
1.1 Indoor Units.....	308
1.2 Outdoor Units.....	309
2. Wiring Diagrams.....	311
2.1 Indoor Units.....	311
2.2 Outdoor Units.....	313

1. Piping Diagrams

1.1 Indoor Units

1.1.1 The Single Split Duct-Free System

FTXS09/12DVJU

FTXS15/18/24DVJU

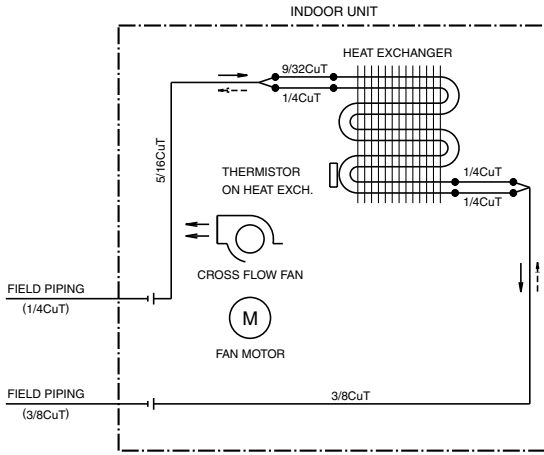

REFRIGERANT FLOW
 → COOLING
 - - -> HEATING

4D047158

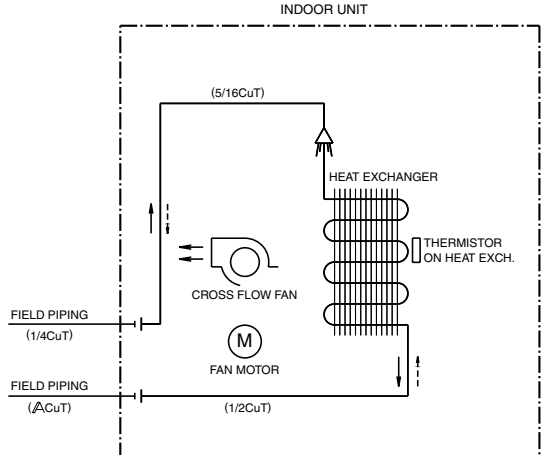

REFRIGERANT FLOW
 → COOLING
 - - -> HEATING

	A
FTXS15	1/2
FTXS18	1/2
FTXS24	5/8

4D047162

1.1.2 The Slim Duct Built-in System

FDXS09/12DVJU

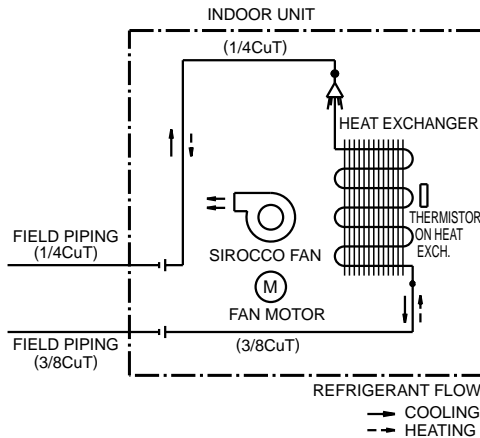

REFRIGERANT FLOW
 → COOLING
 - - -> HEATING

4D051787

1.2 Outdoor Units

RXS09DVJU

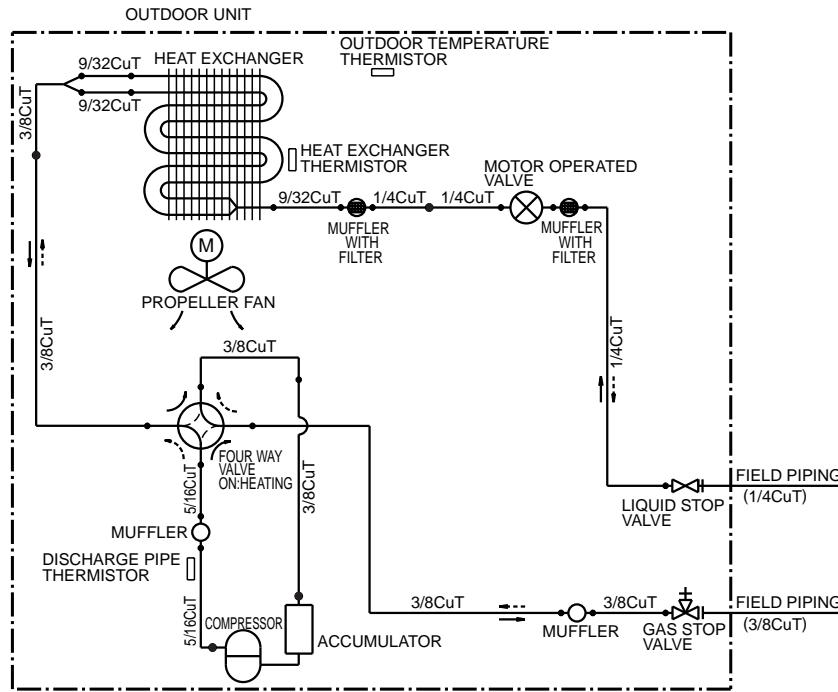

3D047143A

RXS12DVJU

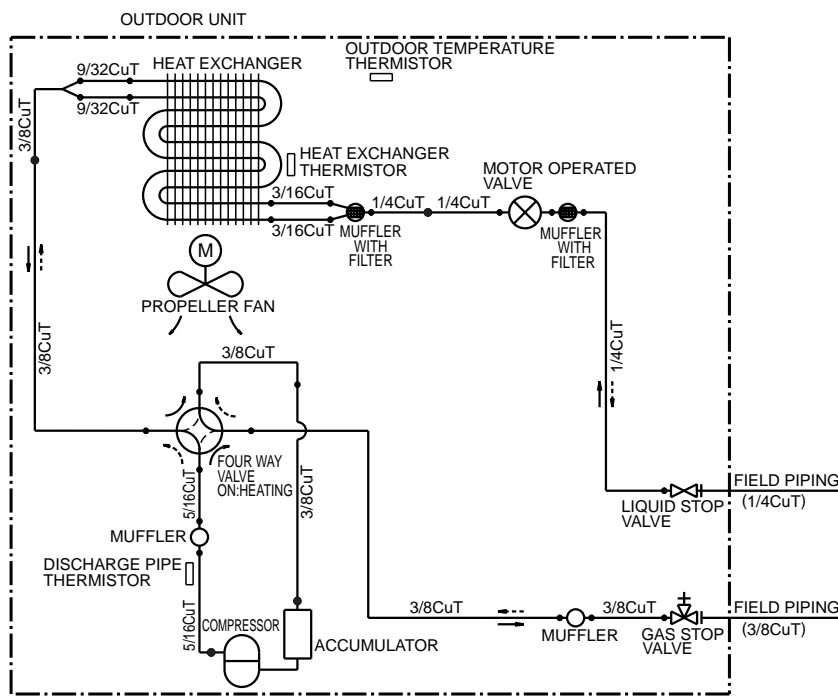

3D047142A

RXS15/18DVJU

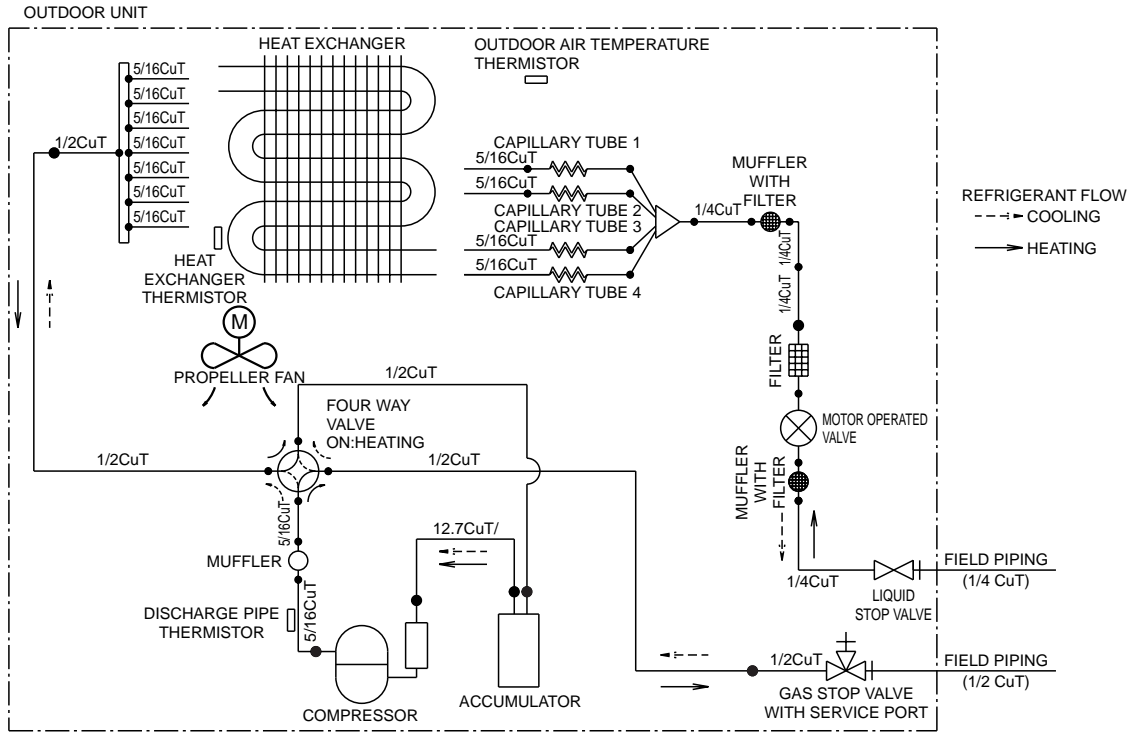

RXS24DVJU

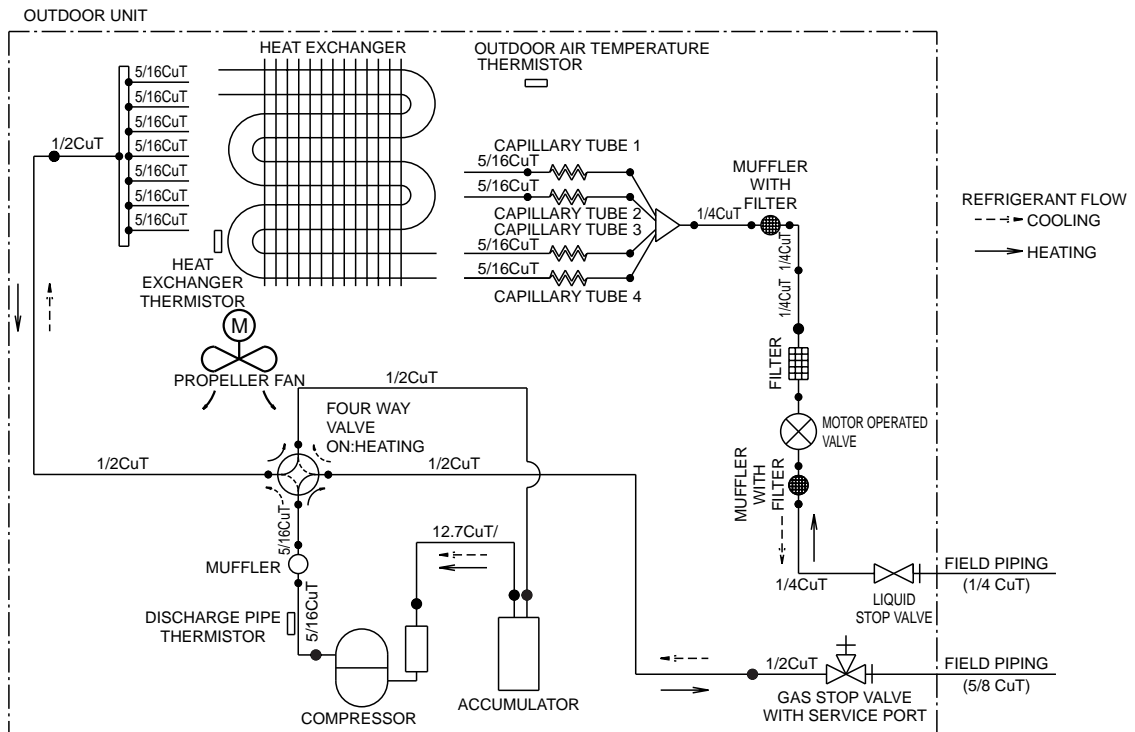

2. Wiring Diagrams

2.1 Indoor Units

2.1.1 The Single Split Duct-Free System

FTXS09/12DVJU

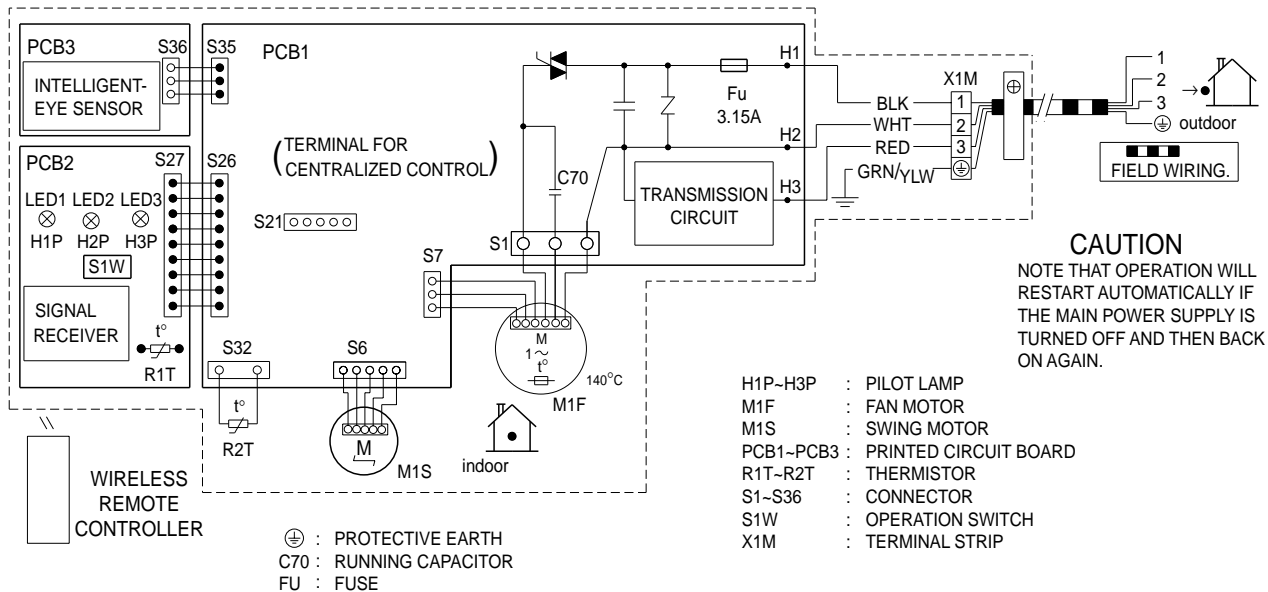

3D033599G

FTXS15/18/24DVJU

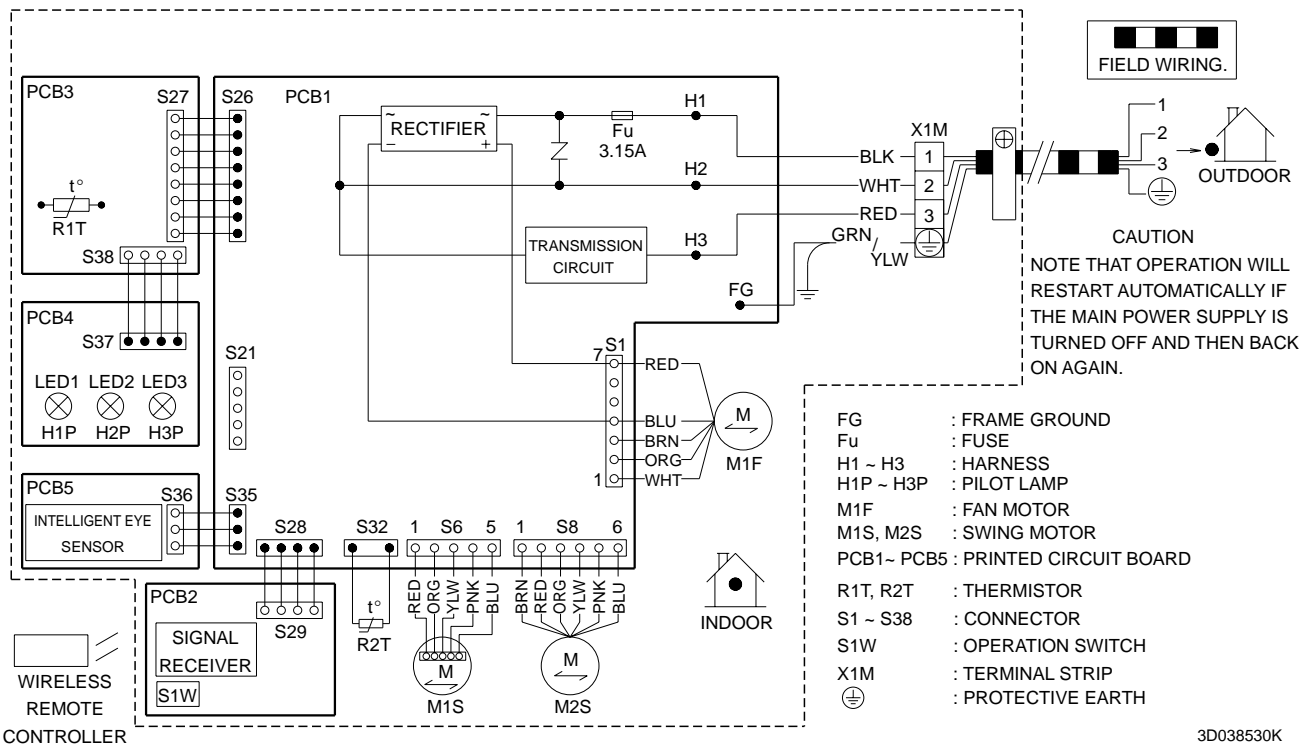

3D038530K

2.1.2 The Slim Duct Built-in System

FDXS09/12DVJU

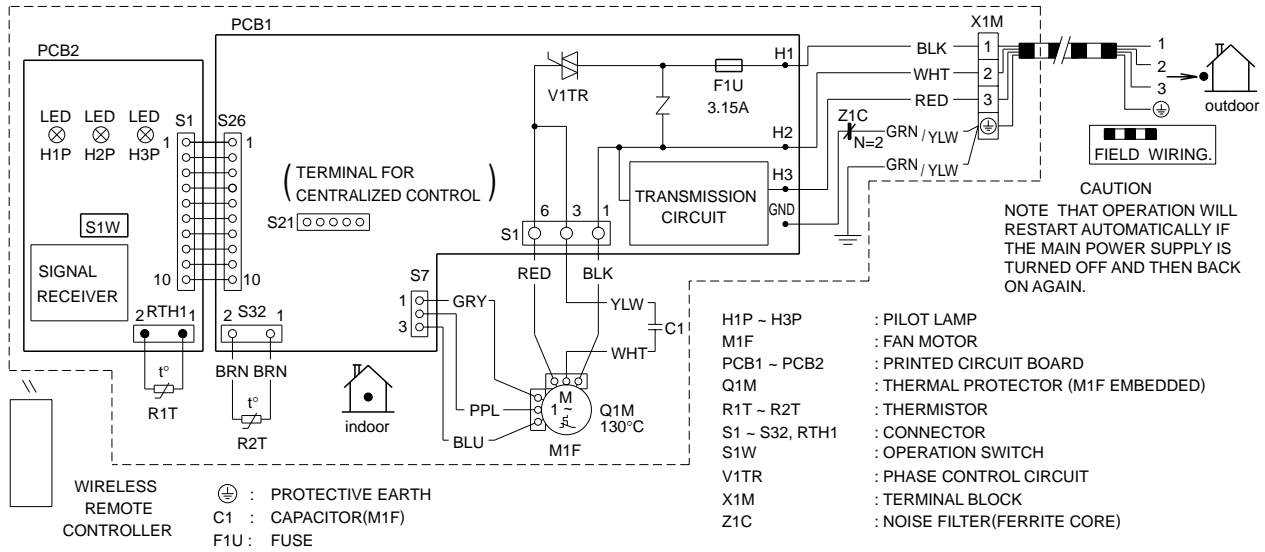

3D045012J

2.2 Outdoor Units

RXS09/12DVJU

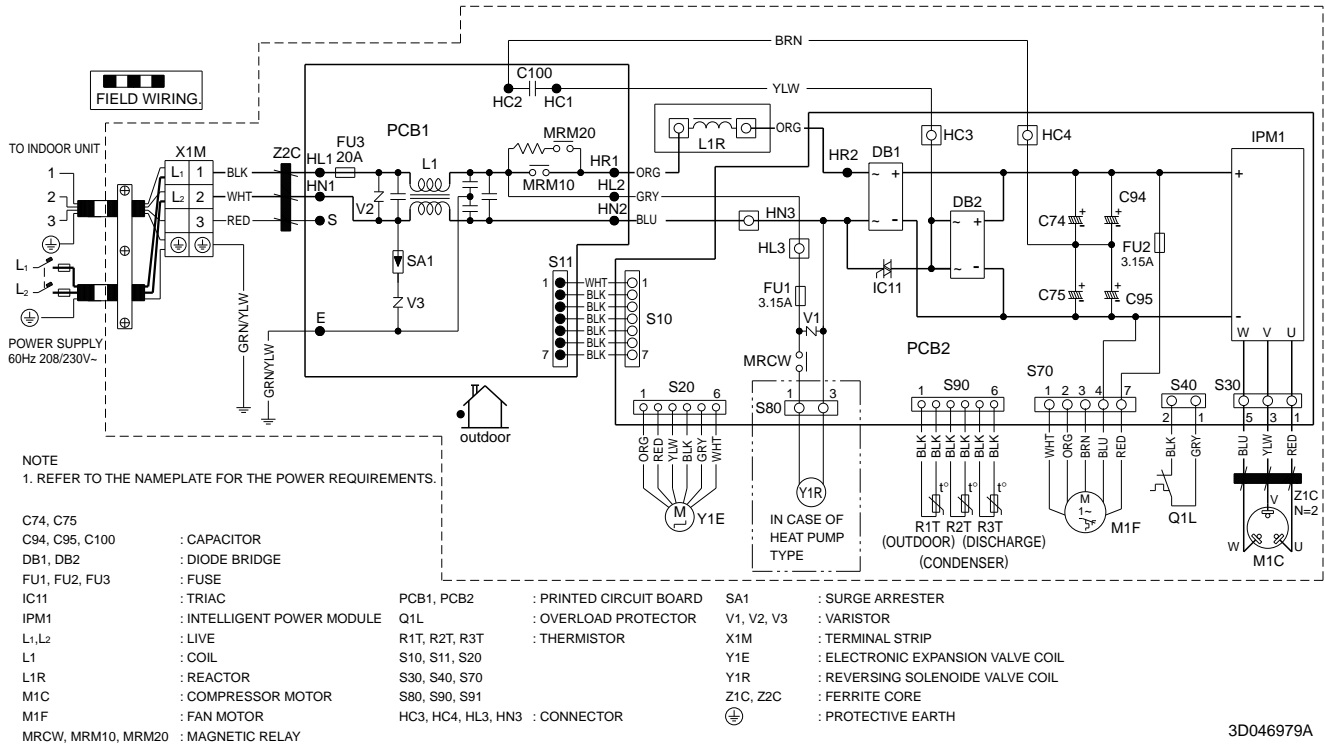

RXS15/18/24DVJU

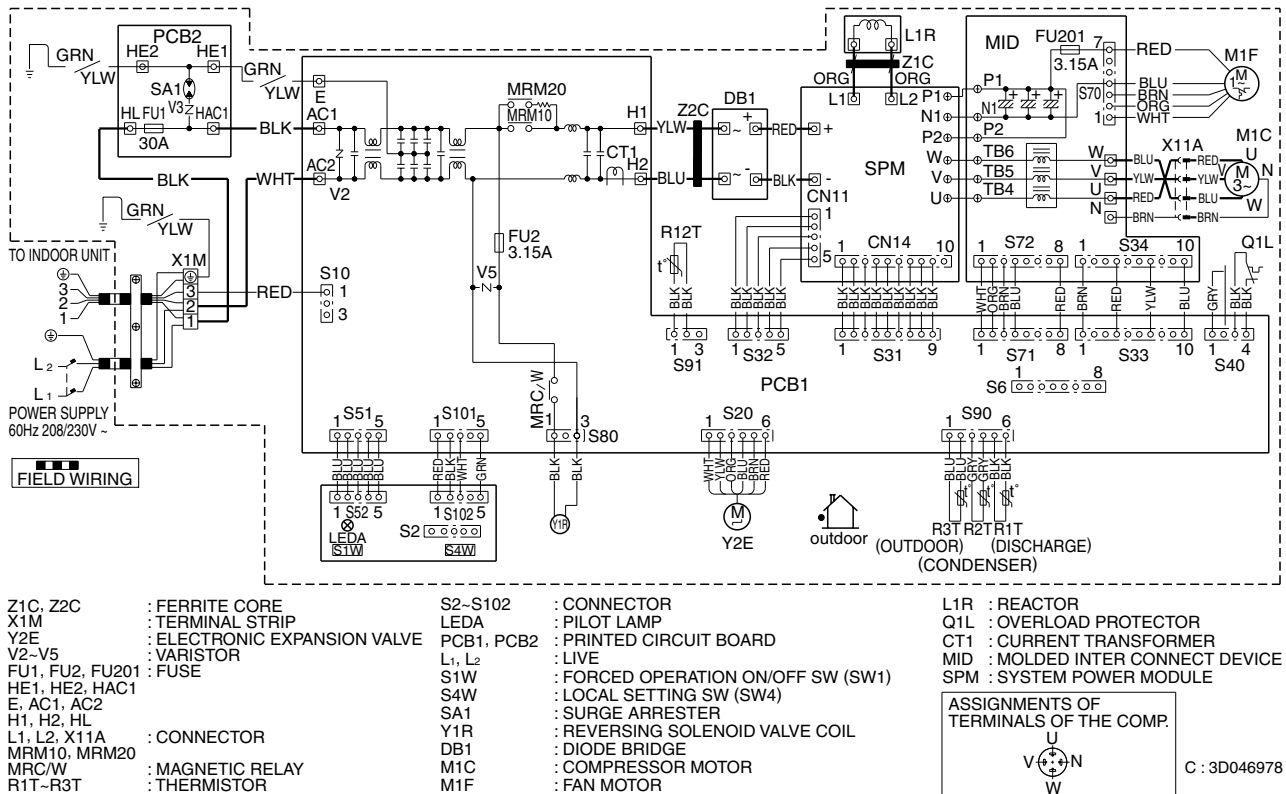

Index

Numerics

00	148
3 minutes stand-by	38, 44, 56
3-D airflow	27

A

A1	149
A5	150
A6	152, 153
AC1	20, 287
AC2	20, 289
accumulator	302
address setting jumper	12, 14
air filter	38, 206, 230
air flow control	28
air purifying filter with photocatalytic deodorizing function	38, 231
ARC433A	145
automatic operation	30
auto-restart	12, 305
auto-restart function	38
auto-swing	27
auxiliary pipe	221
auxiliary piping	248

B

bearing	251
bell mouth	257
blades	236
buzzer PCB	15

C

C4	155
C9	155
cable way board	287
capacitor voltage check	202
centralized control	12, 14
check	
capacitor voltage check	202
discharge pressure check	199
electronic expansion valve check	195
fan motor connector output check	195
four way valve performance check	196
Hall IC check	204
installation condition check	199
inverter units refrigerant system check	201
main circuit electrolytic capacitor check	203
outdoor unit fan system check	200
power supply waveforms check	201
power transistor check	202
thermistor resistance check	198

turning speed pulse input on the outdoor unit

PCB check	203
check No.01	195
check No.04	195
check No.05	196
check No.06	198
check No.07	199
check No.08	199
check No.09	200
check No.10	201
check No.11	201
check No.12	202
check No.13	202
check No.14	203
check No.15	203
check No.16	204
clamp plate	278
CN11	20, 290
CN14	20, 290
compressor	270, 302
compressor lock	158
compressor overload	157
compressor protection function	44, 57
connectors	12, 14, 16, 18, 20
connectors	
fan motor	214, 255
four way valve	261
swing motor	214
control PCB	16
control PCB (indoor unit)	13, 15, 219, 244
control PCB (outdoor unit)	19, 21, 273, 290
cover	
service cover	209
stop valve cover	253
terminal cover	268
CT or related abnormality	177

D

DC fan lock	160
DC voltage / current sensor abnormality	176
defrost control	47, 61
diagnosis mode	146
diode bridge	20
discharge grille	277
discharge pipe	49, 63
discharge pipe control	44
discharge pipe temperature control	50, 57, 64, 168
discharge pipe thermistor	39, 49, 63, 180, 262, 296
discharge pressure check	199
display PCB	15, 17
drain	247

drain hose	220, 223	fan rotor	225, 251
drain plug	223	fan speed control	28
drip proof plate	239, 254	fan speed setting	12, 14, 305
E		filter	
E	20, 287	air filter	38, 206
E5	157	air purifying filter with photocatalytic	
E6	158, 159	deodorizing function	38
E7	160	filter PCB	19
E8	161, 162	forced cooling operation	26
EA	164, 166	forced operation mode	52, 66
earth	240, 285	forced operation ON/OFF switch	14, 20
electrical box	214, 241, 261, 293	four way valve	268, 299
electrical box cover	281	four way valve abnormality	164
electrical box temperature rise	181	four way valve coil	299
electronic expansion valve	300	four way valve operation compensation	43, 56
electronic expansion valve check	195	four way valve performance check	196
electronic expansion valve coil	300	four way valve switching	43, 56
electronic expansion valve control	48, 62	four way valve, connector	261
error codes		freeze-up protection control	45, 59, 150
00	148	frequency control	25, 41, 54
A1	149	frequency principle	25
A5	150	front grille	209, 233
A6	152, 153	front panel	207, 229, 255, 277
C4	155	FU1	12, 14, 16, 18, 20
C9	155	FU2	18, 20
E5	157	FU201	20
E6	158, 159	FU3	18
E7	160	functions, list	2
E8	161, 162	fuse	12, 14, 18
EA	164, 166	G	
F3	168, 169	gas piping	247
F6	170, 172	H	
H6	174, 175	H1	20
H8	176, 177	H2	20
H9	179	H6	174, 175
J3	179	H8	176, 177
J6	179	H9	179
L3	181	HA	12, 14, 244
L4	183	HAC1	20, 287
L5	185, 187	Hall IC	28, 152, 153
P4	179	Hall IC check	204
U0	189, 191	HC3	18
U2	193, 194	HC4	18
U4	156	HE1	20, 287
error codes and description	148	HE2	20, 287
F		heat exchanger	220, 249, 276
F3	168, 169	heat exchanger thermistor	
F6	170, 172	39, 155, 180, 214, 240, 262, 297
fan control	46, 60	heating peak-cut control	46, 59
fan motor	225, 251, 258, 283	high pressure control	150
fan motor connector output check	195	high pressure control in cooling	170
fan motor fixing frame	258	HL	20, 287
fan motor fixture	250	HL3	18
fan motor or related abnormality	152	HN3	18
fan motor, connector	214, 255	HOME LEAVE operation	35

- horizontal blade 212, 236
hot start function 37
- I
- indoor unit PCB abnormality 149
input current control 45, 58
input over current detection 161
installation condition check 199
insufficient gas 189
insufficient gas control 51, 65
INTELLIGENT EYE 33
INTELLIGENT EYE sensor PCB 13, 15
inverter POWERFUL operation 36
inverter principle 25
inverter units refrigerant system check 201
- J
- J3 179
J4 305
J6 179
JA 12, 14, 16, 305
JB 12, 14, 16, 305
JC 12, 14, 16, 305
jumper settings 305
- L
- L1 20
L2 20
L3 181
L4 183
L5 185, 187
LED A 12, 14, 16, 18, 20
LED1 12, 14, 16
LED2 12, 14, 16
LED3 12, 14, 16
left side plate 227
liquid compression protection function 2 46, 60
liquid piping 248
low Hz high pressure limit 61
low-voltage detection 194
- M
- main circuit electrolytic capacitor check 203
MID 22
mode changing control 43
mode hierarchy 40, 53
mold proof air filter 38
motor
 fan motor 225, 258
 swing motor 219
mounting plate for the bearing 252
- N
- night set mode 32
- O
- OL activation 157
- ON/OFF button on indoor unit 37
operation lamp 142
outdoor air temperature thermistor 180
outdoor unit fan system check 200
output over current detection 185
over current 51, 65, 161, 185
overload 51, 65, 157
overload protector 18
over-voltage detection 193
- P
- P4 179
panel
 front panel 207, 255
 right side panel 259
 top panel 254
partition plate 263, 294
PI control 42, 55
piping diagrams 308
piping fixture 248
plate
 drip proof plate 254
 left side plate 227
 partition plate 263
 right side plate 225
 shelter 217, 254
position sensor abnormality 174
power failure recovery function 12, 14, 305
power supply PCB 21, 287
power supply waveforms check 201
power transistor check 202
power-airflow dual flaps 27
POWERFUL operation 36, 66
POWERFUL operation mode 52
preheating operation 43, 56
printed circuit board (PCB)
 buzzer PCB 15
 control PCB 16
 control PCB (indoor unit) 13, 15, 219, 244
 control PCB (outdoor unit) 19, 21, 273, 290
 display PCB 15, 17
 filter PCB 19
 INTELLIGENT EYE sensor PCB 13, 15
 MID 22
 power supply PCB 21, 287
 service monitor PCB 21, 287
 signal receiver PCB 13, 15, 218
 SPM 22
problem symptoms and measures 144
programme dry function 29
propeller fan 256, 283
- R
- radiation fin temperature rise 183
radiation fin thermistor 180
reactor 263, 295
reactor harnesses 261

receiver units	243	swing motor	219
remote controller	145	swing motor assembly	246
right side panel	250, 259, 285	swing motor for horizontal blades	245
right side plate	225	swing motor for vertical blades	245
room temperature thermistor	155	swing motor, connector	214
RTH1	12, 14, 16		
S			
S1	12, 14, 16, 214, 240, 244	T	
S10	18, 20, 289, 290	terminal board	215, 273
S101	20, 289, 290	terminal cover	268, 301
S102	20, 290	terminal strip	240, 285
S11	18	test run	304
S20	18, 20, 288, 290	thermistor	
S21	12, 14, 16, 244	discharge pipe thermistor	
S26	12, 14, 16, 244	39, 49, 63, 180, 262, 296
S27	12, 14	indoor heat exchanger thermistor	
S28	14	39, 155, 214, 240
S29	14	outdoor air temperature thermistor	180
S30	18	outdoor heat exchanger thermistor	
S31	20, 290	39, 180, 262, 297
S32	12, 14, 16, 20, 244, 290	radiation fin thermistor	180
S33	20, 290	room temperature thermistor	155
S34	20, 290	thermistor or related abnormality (indoor unit)	155
S35	12, 14	thermistor or related abnormality (outdoor unit)	179
S36	12, 14	thermistor resistance check	198
S37	14	thermostat control	31
S38	14	top panel	254, 276
S40	18, 20, 288, 290	troubleshooting	148
S51	20, 289, 290	troubleshooting with LED indication	143
S52	20, 290	turning speed pulse input on the outdoor unit PCB	
S6	12, 14, 214, 241	check	203
S7	12, 16, 214		
S70	18, 20, 255, 282	U	
S71	20, 290	U0	189, 191
S72	20, 290	U2	193, 194
S8	14, 241	U4	156
S80	18, 20, 261, 288, 290		
S90	18, 20, 288, 290	V	
S91	20, 290	V1	12, 14, 16, 18
self-diagnosis digital display	38	V2	18
sensor malfunction detection	51, 65	V3	18, 20
service check function	145	varistor	12, 14, 18, 20
service cover	209, 233	vertical blade	213
service monitor PCB	21, 287	vertical blades	237
shelter	217, 242, 254, 281	voltage detection function	52, 66
signal receiver	229		
signal receiver PCB	13, 15, 218	W	
signal receiving sign	37	wide-angle louvres	27
signal transmission error	156	wiring diagrams	311
sound blanket	265, 297		
specifications	6		
SPM	22		
starting control	43		
stop valve cover	253, 279		
SW1	14, 16, 20		
SW7	12		

Drawings & Flow Charts

A			
ARC433A	145		
automatic air flow control	28		
automatic operation	30		
auto-swing	27		
B			
buzzer PCB	15		
C			
capacitor voltage check	202		
compressor lock	158		
compressor protection function	44, 57		
control PCB	16		
control PCB (indoor unit)	13, 15		
control PCB (outdoor unit)	19, 21		
CT or related abnormality	177		
D			
DC fan lock	160		
DC voltage / current sensor abnormality	176		
defrost control	47, 61		
diagnosis mode	146		
discharge pipe control	44		
discharge pipe temperature control	57, 168		
discharge pressure check	199		
display PCB	15, 17		
E			
electrical box temperature rise	181		
electronic expansion valve check	195		
electronic expansion valve control	48, 62		
F			
fan motor connector output check	195		
fan motor or related abnormality	152		
filter PCB	19		
four way valve abnormality	164		
four way valve performance check	196		
freeze-up protection control	45, 59		
freeze-up protection control or high pressure control	150		
frequency control	41, 54		
frequency principle	25		
function of thermistor			
heat pump model	39		
H			
Hall IC check	204		
heating peak-cut control	46, 59		
high pressure control in cooling	170		
HOME LEAVE operation	35		
I			
indoor unit PCB abnormality	149		
input current control	45, 58		
input over current detection	161		
installation condition check	199		
insufficient gas	189		
insufficient gas control	51, 65		
INTELLIGENT EYE	33		
INTELLIGENT EYE sensor PCB	13, 15		
inverter features	26		
inverter POWERFUL operation	36		
inverter units refrigerant system check	201		
J			
jumper settings	305		
L			
low Hz high pressure limit	61		
low-voltage detection	194		
M			
main circuit electrolytic capacitor check	203		
MID	22		
mode hierarchy	40, 53		
N			
night set mode	32		
O			
OL activation (compressor overload)	157		
ON/OFF button on indoor unit	37		
operation lamp	142		
outdoor unit fan system check	200		
output over current detection	185		
over-voltage detection	193		
P			
piping diagrams			
FDXS09/12DVJU	308		
FTXS09/12DVJU	308		
FTXS15/18/24DVJU	308		
RXS09DVJU	309		
RXS12DVJU	309		
RXS15/18DVJU	310		
RXS24DVJU	310		
position sensor abnormality	174		
power supply PCB	21		
power supply waveforms check	201		
power transistor check	202		

POWERFUL operation	36
programme dry function	29
R	
radiation fin temperature rise	183
remote controller	145
S	
service check function	145
service monitor PCB	21
signal receiver PCB	13, 15
signal transmission error (between indoor and outdoor units)	156
SPM	22
T	
target discharge pipe temperature control	50, 64
thermistor or related abnormality (indoor unit)	155
thermistor or related abnormality (outdoor unit)	179
thermistor resistance check	198
thermostat control	31
trial operation from remote controller	304
turning speed pulse input on the outdoor unit PCB check	203
W	
wiring diagrams	
FDXS09/12DVJU	312
FTXS09/12DVJU	311
FTXS15/18/24DVJU	311
RXS09/12DVJU	313
RXS15/18/24DVJU	313

Warnings



- Always use a licensed installer or contractor to install this product. Do not try to install the product yourself. Improper installation can result in water or refrigerant leakage, electrical shock, fire or explosion.
- Use only those parts and accessories supplied or specified by Daikin. Ask a licensed contractor to install those parts and accessories. Use of unauthorized parts and accessories or improper installation of parts and accessories can result in water or refrigerant leakage, electrical shock, fire or explosion.
- Read the User's Manual carefully before using this product. The User's Manual provides important safety instructions and warnings. Be sure to follow these instructions and warnings.

For any inquiries, contact your local Daikin sales office.



© 2004 Daikin Industries, Limited.



The air conditioners manufactured by Daikin Industries have received **ISO 9001** certification for quality assurance.

Certificate Number.
(ISO9001) JMI-0107
JQA-0495
JQA-1452



All Daikin Industries locations and subsidiaries in Japan have received environmental management system standard **ISO 14001** certification.

Daikin Industries, Ltd.
Domestic Group
Certificate Number. EC99J2044

About ISO 14001

ISO 14001 is the standard defined by the International Organization for Standardization (ISO) relating to environmental management systems. Our group has been acknowledged by an internationally accredited compliance organisation as having an appropriate programme of environmental protection procedures and activities to meet the requirements of ISO 14001.

Dealer

DAIKIN AC (AMERICAS), INC.

1645 Wallace Drive, Suite 110
Carrollton, TX 75006

info@daikinac.com
www.daikinac.com

©All rights reserved

•The specifications, designs, and information in this brochure are subject to change without notice.