



Liebert®

Remote Monitoring Panel

User Manual

The information contained in this document is subject to change without notice and may not be suitable for all applications. While every precaution has been taken to ensure the accuracy and completeness of this document, Vertiv assumes no responsibility and disclaims all liability for damages resulting from use of this information or for any errors or omissions. Refer to other local practices or building codes as applicable for the correct methods, tools, and materials to be used in performing procedures not specifically described in this document.

The products covered by this instruction manual are manufactured and/or sold by Vertiv. This document is the property of Vertiv and contains confidential and proprietary information owned by Vertiv. Any copying, use or disclosure of it without the written permission of Vertiv is strictly prohibited.

Names of companies and products are trademarks or registered trademarks of the respective companies. Any questions regarding usage of trademark names should be directed to the original manufacturer.

Technical Support Site

If you encounter any installation or operational issues with your product, check the pertinent section of this manual to see if the issue can be resolved by following outlined procedures. Visit <https://www.VertivCo.com/en-us/support/> for additional assistance.

TABLE OF CONTENTS

IMPORTANT SAFETY INSTRUCTIONS	1
1.0 INTRODUCTION	2
2.0 INSTALLATION	4
2.1 Preliminary Checks	4
2.2 Location	4
2.3 Power Supply	4
2.4 Cable Specifications	4
2.5 Mounting the RMP on Drywall	5
2.6 Electrical Connections.....	6
3.0 OPERATION	8
3.1 Startup and Reset.....	8
3.2 LED Mimic Power Flow.....	11
3.3 Audible Alarms—Buzzer.....	11
3.4 Direct Access Push Buttons—Keys.....	12
3.5 LCD Monitor and Menu Keys	12
3.6 Detailed Description of Menu Items	14
3.7 Status and Event Messages	16
3.8 Prompt (Popup) Windows	19
3.9 Dynamic Energy Flow Chart and UPS Help Screen	20
3.10 Default Screen Saver	21
4.0 TECHNICAL SPECIFICATIONS	22
4.1 Agency and Certifications	22

FIGURES

Figure 1 Remote Monitoring Panel components and functions	2
Figure 2 Remote Monitoring Panel layout constraints.....	3
Figure 3 RMP electrical input plug	4
Figure 4 Communication cable connection.....	5
Figure 5 Mounting hole dimensions	5
Figure 6 Power and communication cable routing.....	6
Figure 7 RS-485 cable connection to Liebert NX.....	7
Figure 8 Opening screen	8
Figure 9 Data loading progress screen	8
Figure 10 UPS and RMP firmware are compatible screen.....	9
Figure 11 Silence On/Off screens	9
Figure 12 Communication with UPS failed.....	10
Figure 13 Firmware not compatible with UPS screen.....	10
Figure 14 Graphic LCD monitor windows and keypad	12
Figure 15 Menu tree	13
Figure 16 Help screen	20
Figure 17 Default screen.....	21

TABLES

Table 1	RMP component location in Figure 1	2
Table 2	Communication cable specifications	4
Table 3	Rectifier indicator	11
Table 4	Battery indicator	11
Table 5	Bypass indicator	11
Table 6	Inverter indicator	11
Table 7	Load indicator	11
Table 8	Status (Alarm) indicator	11
Table 9	Audible alarm key	11
Table 10	Menu key Icons and their meaning	12
Table 11	UPS system window	14
Table 12	Descriptions of RMP menus and data window items	14
Table 13	RMP messages	16
Table 14	Prompt windows, meanings, controlled at UPS only	19
Table 15	Prompt windows, meanings, controlled at RMP	20
Table 16	Mechanical specifications	22
Table 17	Environmental specifications	22
Table 18	Electrical specifications	22
Table 19	Cable specifications	22
Table 20	Electromagnetic interference (EMI) Emission limits	22
Table 21	Electromagnetic susceptibility (EMS)—Immunity levels	23

IMPORTANT SAFETY INSTRUCTIONS

SAVE THESE INSTRUCTIONS

This manual contains important safety and operating instructions concerning the installation and operation of the Liebert NX Remote Monitoring Panel (RMP). Read all safety, installation and operating instructions before beginning installation. Adhere to all warnings on the unit and in this manual. Follow all operating and user instructions.

The Liebert NX Remote Monitoring Panel must be commissioned and serviced by an engineer approved by Liebert. Failure to do so may result in personnel safety risk, equipment malfunction and invalidation of warranty.

The Remote Monitoring Panel is designed and intended for commercial and industrial use. It is not recommended for use in life-support applications.

ELECTROMAGNETIC COMPATIBILITY—This is a low-emission, Class A product. Operating this device in a residential area is likely to cause harmful interference that users must correct at their own expense. Pursuant to FCC regulations, operation is subject to the following two conditions:

- This device may not cause harmful interference; and
- This device must accept any interference received, including interference that may cause undesired operation.

Conformity and Standards

This equipment complies with CE directives 73/23 & 93/68 (LV Safety) and 89/336 (EMC), with Australia and New Zealand EMC Framework (C-Tick) and with the following product standards for Uninterruptible Power System (UPS).

- EN / IEC / AS 62040-1-1-General and safety requirements for use in operator access area
- EN / IEC / AS 62040-2-EMC requirements; Class A compliant
- EN / IEC / AS 62040-3-Performance requirements and test methods

This equipment complies with UL 60950-1:2003, First Edition CSA C22.2 No. 60950-1-03 1st Ed. April 1, 2003.

For details, see **4.0 - Technical Specifications**. Continued compliance requires installation in accordance with these instructions and the use of manufacturer-approved accessories only.

General

The unit must be grounded in accordance with applicable current local electrical regulations. As with other types of power equipment, dangerous voltages are present within the RMP enclosure. The risk of contact with these voltages is minimized as the live component parts are housed behind a hinged, lockable door. No risk exists to any personnel when operating the equipment in the normal manner, following the recommended operating procedures. All equipment maintenance and servicing procedures involve internal access and should be carried out only by trained personnel.

User-Serviceable Parts

There are no user-serviceable parts behind covers requiring a tool for removal. All equipment maintenance and servicing procedures involving internal access requires the use of a tool and should be carried out only by trained personnel.

INFORMATION FOR THE PROTECTION OF THE ENVIRONMENT

Unit Servicing

This unit makes use of components dangerous for the environment, including electronic cards and other electronic components. Any of these components that are removed from the unit must be taken to specialized collection and disposal centers.

Unit Dismantling

If this unit must be dismantled, this operation must be carried out only by properly trained and qualified specialized personnel. The unit must be taken to a center that specializes in collection and disposal of dangerous substances.

1.0 INTRODUCTION

The Liebert NX Remote Monitoring Panel (RMP) is designed as a remote user interface to monitor Liebert NX Uninterruptible Power Systems. The RMP monochrome liquid crystal display measures 122 x 92mm (4.8 x 3.6 inches). It reports the same data and status and alarm messages that are shown by the LCD on the UPS door. The RMP does not offer control of the UPS.

The RMP should be installed in a room where it is readily and easily observed by personnel, such as facility and maintenance staff. This type location enhances the unit's capacity to provide notice if a status change or alarm requires an electrician or a UPS technician's intervention. The RMP can monitor only one Liebert NX UPS. If there are multiple Liebert NX UPS's, an RMP will need to be installed for each unit. For parallel systems, the system load information may be viewed via the system screen from any RMP that is connected to a UPS in that system (see **3.6 - Detailed Description of Menu Items.**)

Figure 1 Remote Monitoring Panel components and functions

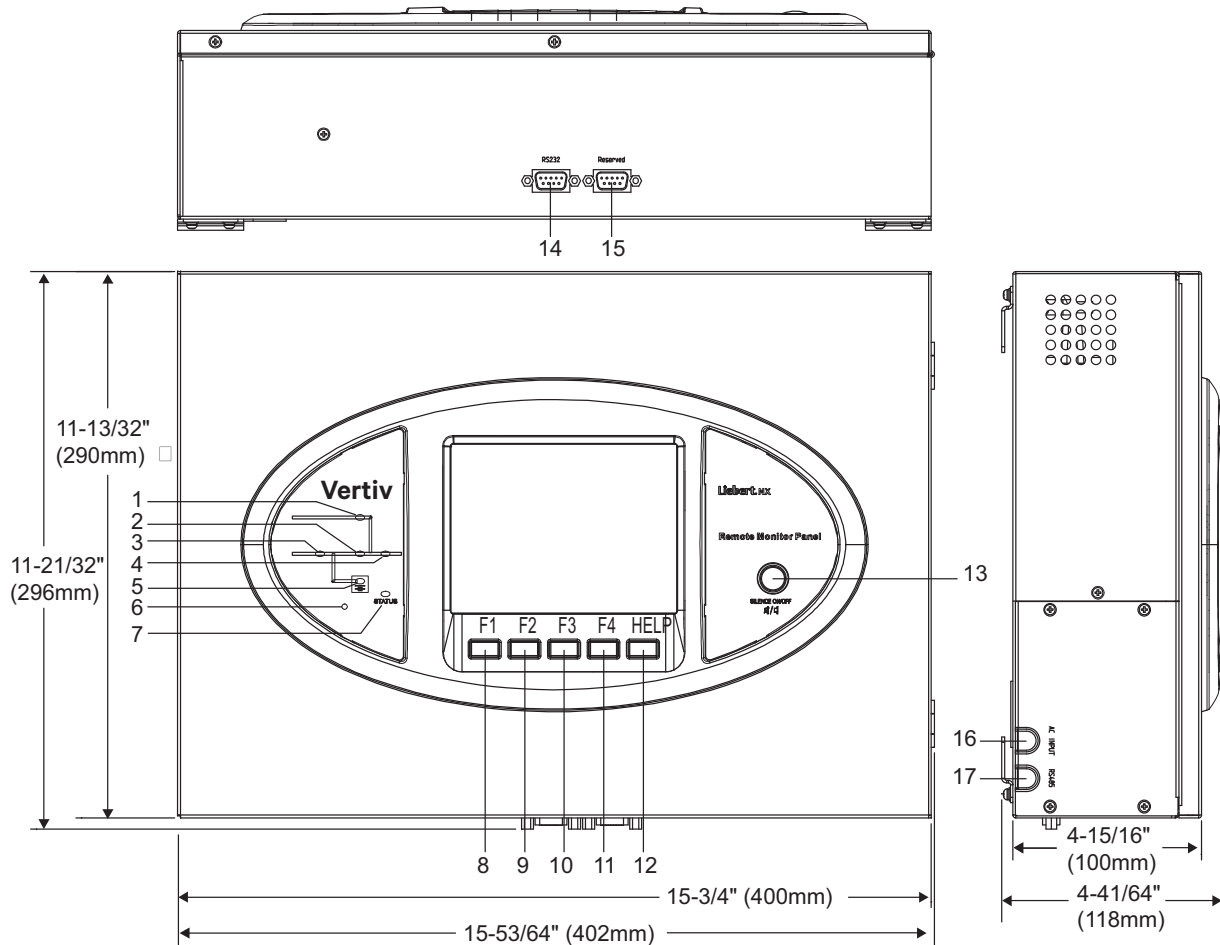
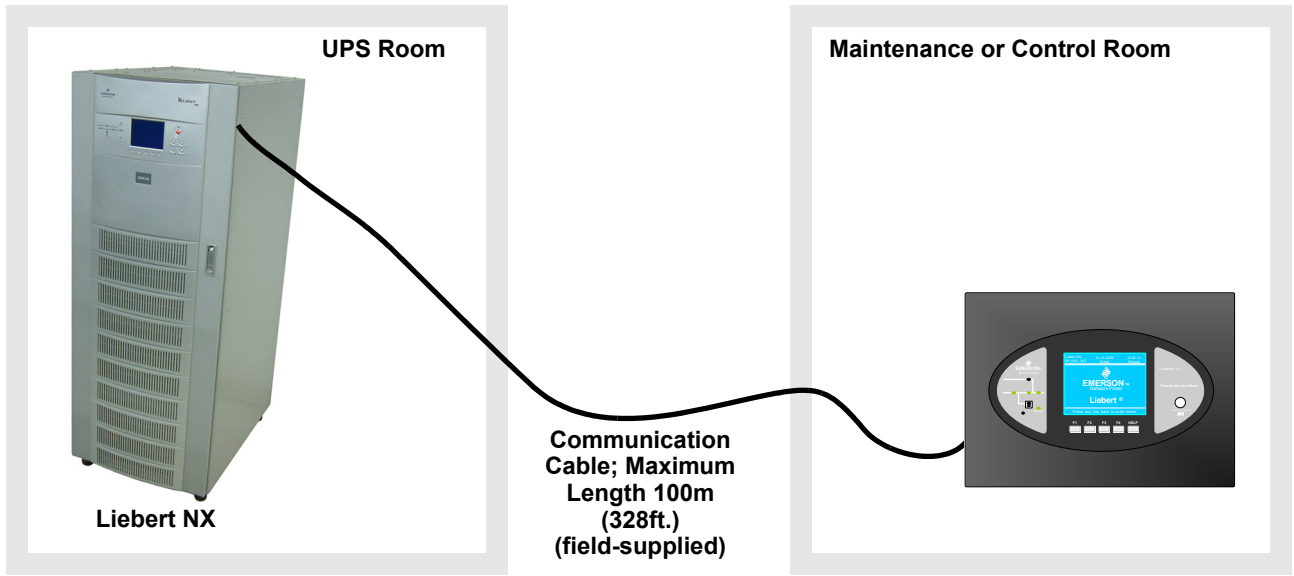

Table 1 RMP component location in Figure 1

1	Bypass Input	10	F3 Function Key
2	Inverter—DC to AC	11	F4 Function Key
3	Rectifier—Input AC to DC	12	Help Key
4	Load—AC Output	13	Silence On/Off Audible—Alarm Mute
5	Battery—DC Backup	14	RS-232—for firmware update
6	Audible Alarm—Buzzer	15	RS-232—Reserved, not used
7	UPS Status and Alarm indicator	16	AC power input cable entry
8	F1 Function Key	17	RS-485 communication cable entry
9	F2 Function Key		

Figure 2 Remote Monitoring Panel layout constraints



2.0 INSTALLATION

2.1 PRELIMINARY CHECKS

Before beginning to install the RMP, verify that the equipment has reached site in its own packaging and in good general condition. Please notify immediately the shipper, Vertiv and your local Liebert representative of any damage. These items should be included in the package:

- RMP box with LCD screen
- 4 mounting screws
- 4 plastic wall anchors (6mm-by-26mm)
- 2 Phoenix connectors for connection with the UPS
- User manual

2.2 LOCATION

The RMP is designed for indoor use and should be installed in an environment with clean air and adequate ventilation to keep the temperature within the specified operating range (see **Table 17**). If the RMP is to be installed on a wall or other vertical surface, ensure that the surface can bear the weight (see **Table 16**) and there is no water leakage.

2.3 POWER SUPPLY

The RMP requires a 120V/230V AC input (for detailed electrical specifications, see **Table 18**).

Figure 3 RMP electrical input plug

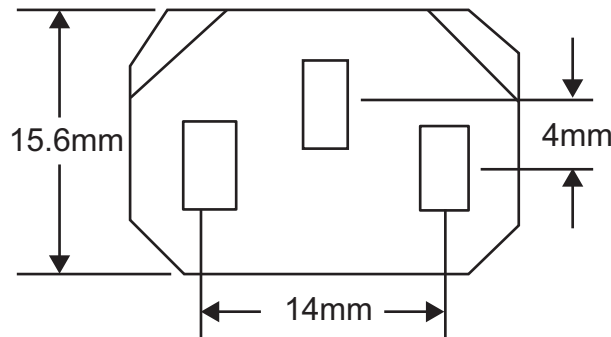

2.4 CABLE SPECIFICATIONS

Connect the RMP to the Liebert NX with a field-supplied communication cable meeting the specifications in **Table 2**.

Table 2 Communication cable specifications

No	Item	Specification
1	Connector type	Both terminals are all 4-pin Phoenix terminal (supplied with RMP)
2	Cable Length	<100m (328ft.)
3	Cable type	a shielded and twisted pair of 0.5 to 1 mm ² (16-20AWG) wires
4	Connection mode	See Figure 4

Figure 4 Communication cable connection

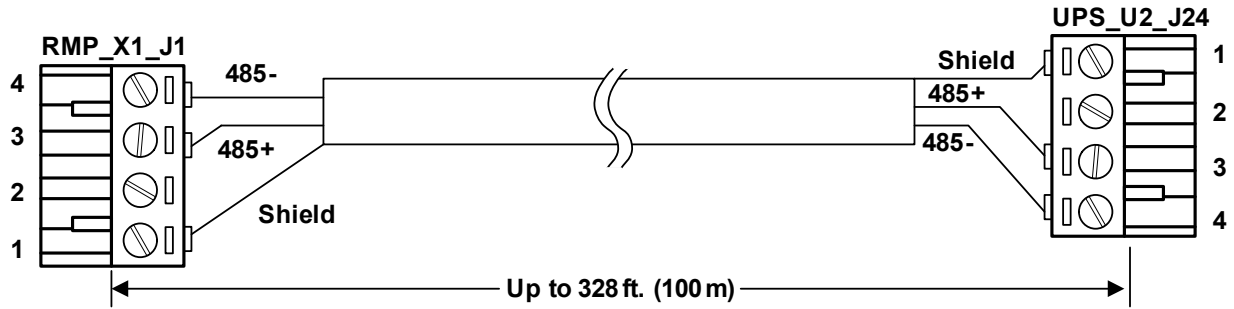

2.5 MOUNTING THE RMP ON DRYWALL

To hang the RMP on drywall or similar surface:

1. Drill four holes (6mm-by-26mm) in the wall, spacing them as shown in **Figure 5**.
2. Insert the four factory-supplied, plastic anchors into the holes.
3. Insert one screw into each anchor and tighten firmly.
4. Remove the four hooks from the RMP, reverse them, then reattach them to the RMP.
5. Hang the RMP on the wall by slipping the hooks over the heads of the screws and lowering the RMP slowly until the screws are seated in the slotted portion of the hooks.

Figure 5 Mounting hole dimensions

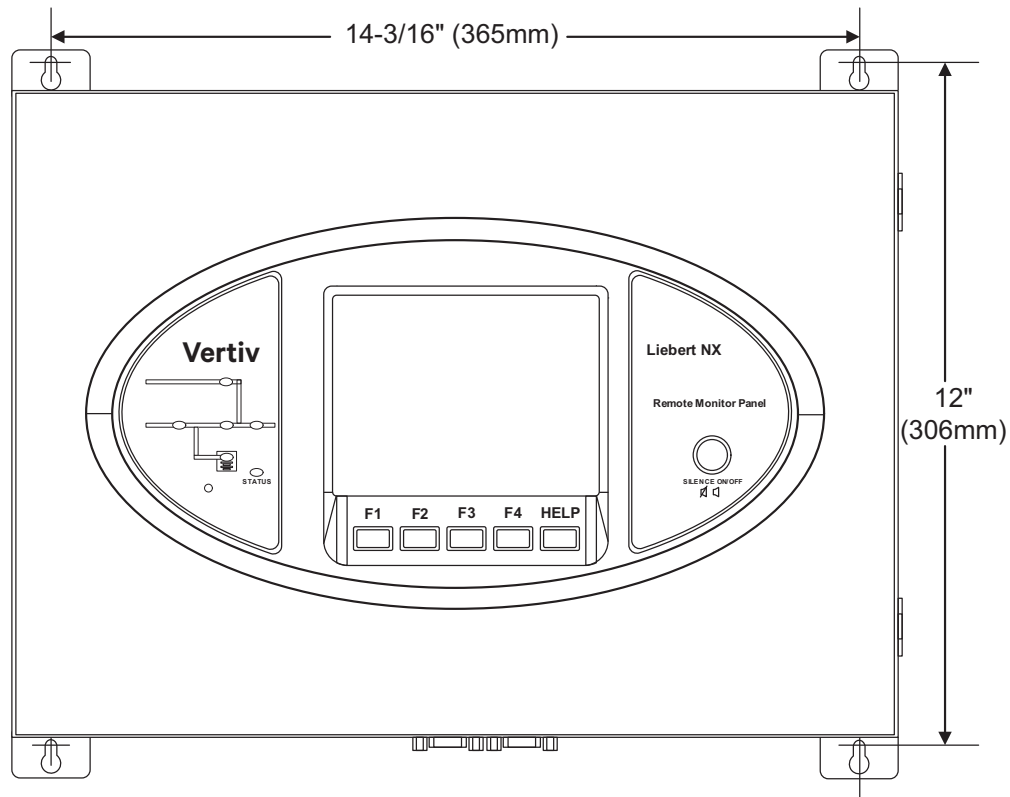

2.6 ELECTRICAL CONNECTIONS

Connect the power and communication cables to the RMP as shown in **Figure 6**.

Figure 6 Power and communication cable routing

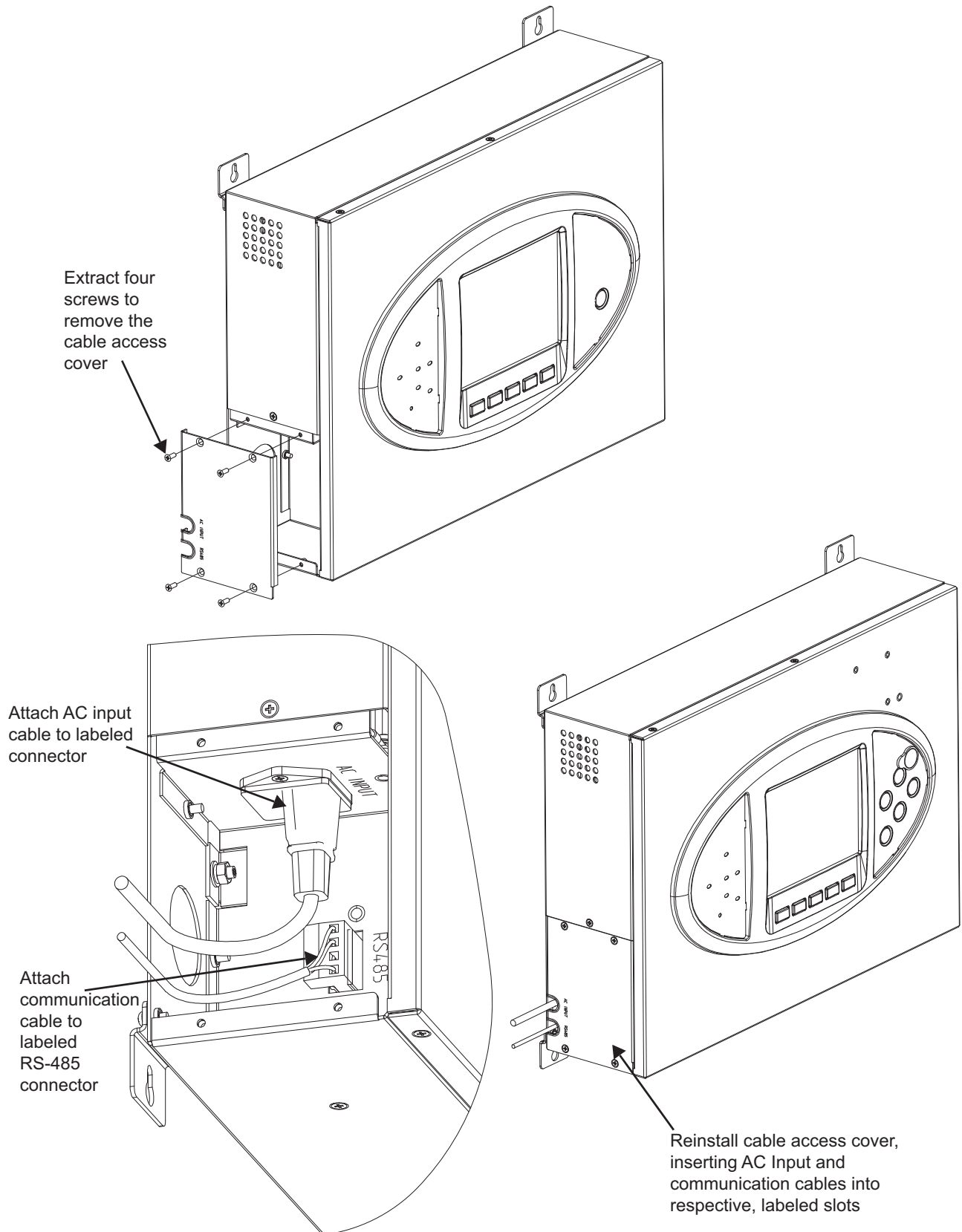

Connect the RS-485 communication cable to the Liebert NX as shown in **Figure 7**.

Figure 7 RS-485 cable connection to Liebert NX

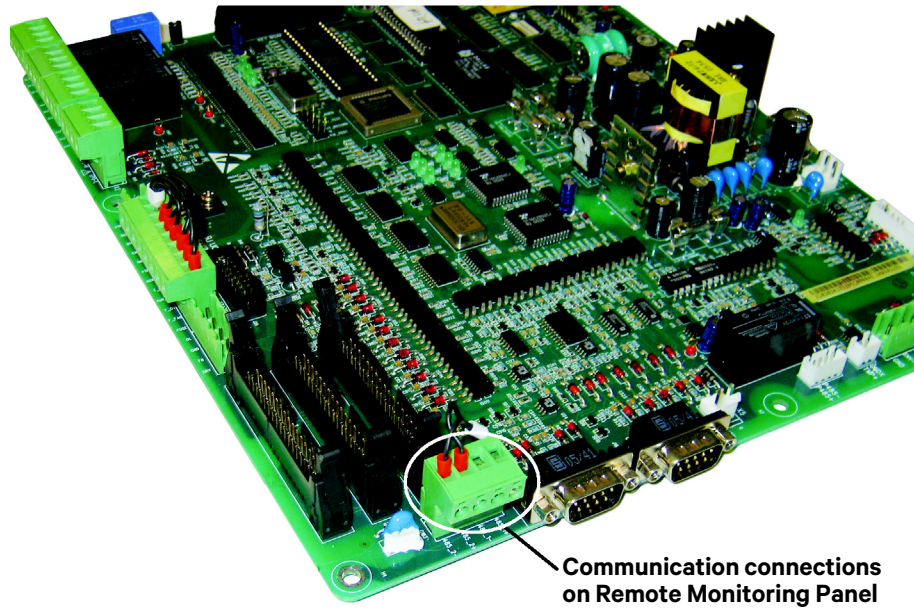

Connect the other end of the RS-485 signal cable to the X4 slot on the monitor board. The monitor board is inside the UPS front door.

3.0 OPERATION

3.1 STARTUP AND RESET

The RMP will start as soon as the power supply is connected. The LCD will illuminate without any data displayed; the LEDs will light up yellow. After 20 seconds, all LED's will turn Off and the LCD will show the opening screen, shown in **Figure 8**, for 10 seconds.

Figure 8 Opening screen



If all conditions above are met, the RMP will start to get all messages from the UPS. The screen in **Figure 9** will be displayed while the data is loading. The loading time is about 30 seconds.

Figure 9 Data loading progress screen

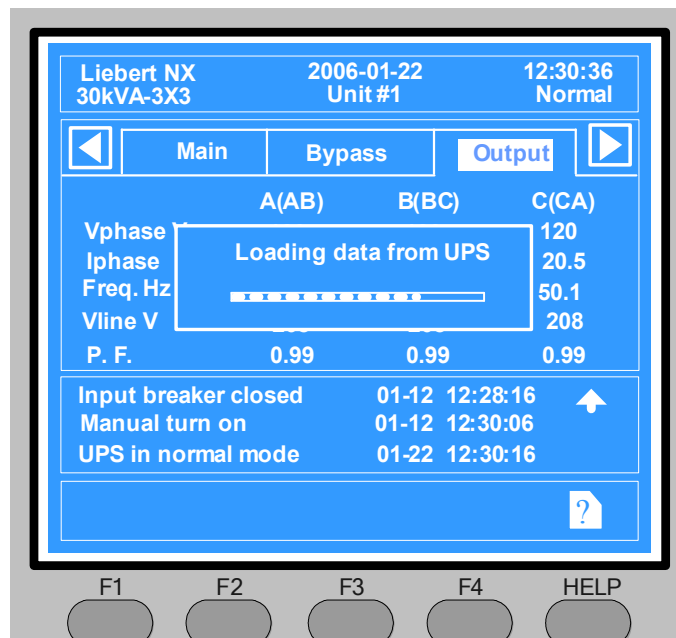

If the firmware in the UPS and the RMP are compatible, the RMP will display the screen shown in **Figure 10**. The Liebert NX screen will display the same screen.

Figure 10 UPS and RMP firmware are compatible screen

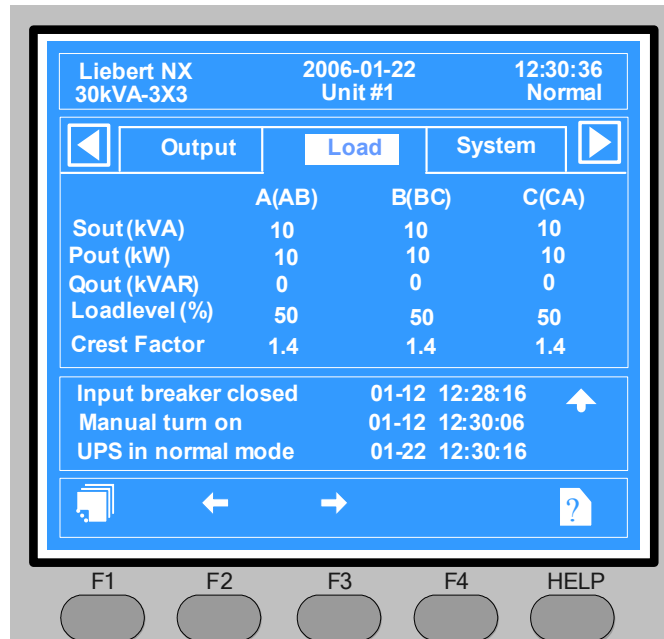

When the Silence On/Off button is pushed, the relevant screen in **Figure 11** will be displayed for 5 seconds.



NOTE

The Silence On/Off button will control only the audible alarm in the Remote Monitoring Panel. It will not silence the audible alarm in the UPS.

Figure 11 Silence On/Off screens

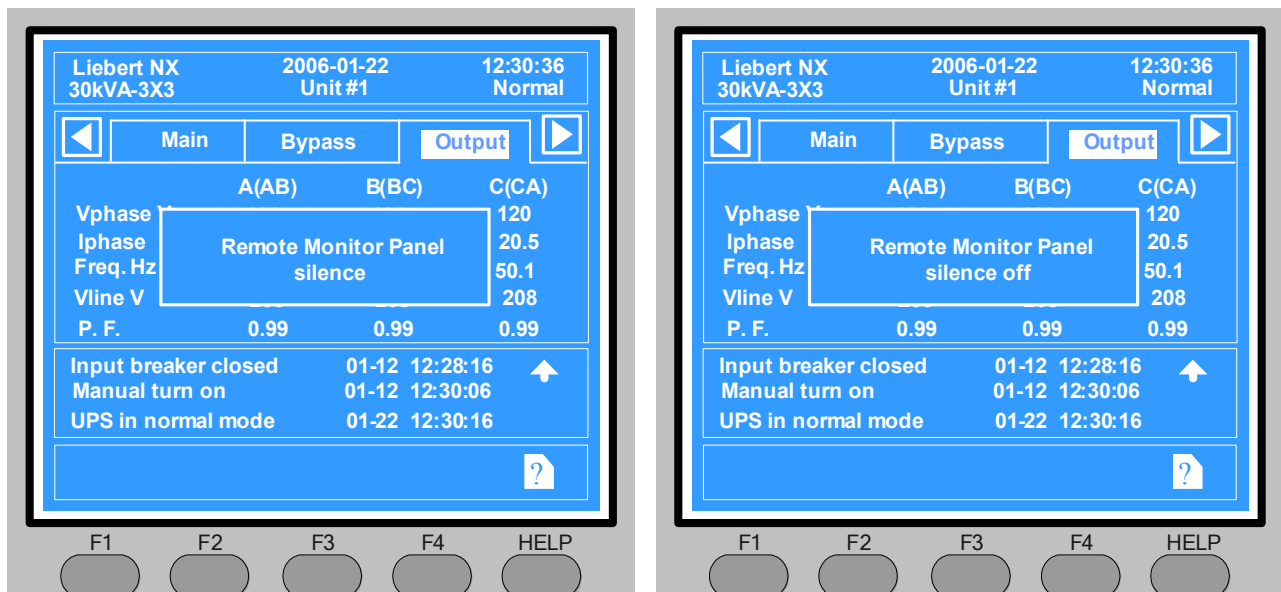

If the RMP is abnormal or the connection with the UPS is incorrect, the RMP will show the screen in **Figure 12** to report communication with UPS failed.

Figure 12 Communication with UPS failed

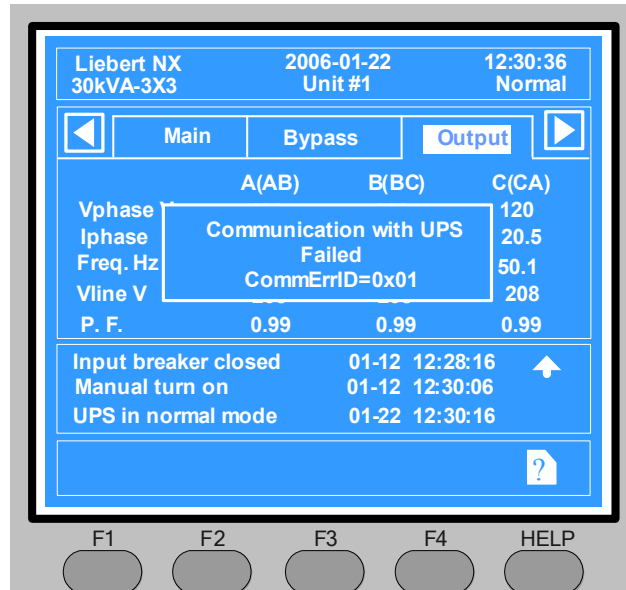

If the RMP is functioning properly and the connection with UPS is correct, but the UPS does not support the communication function with RMP, then the RMP will display a the screen shown in **Figure 13** to report *Firmware is not Compatible with UPS*.

Figure 13 Firmware not compatible with UPS screen

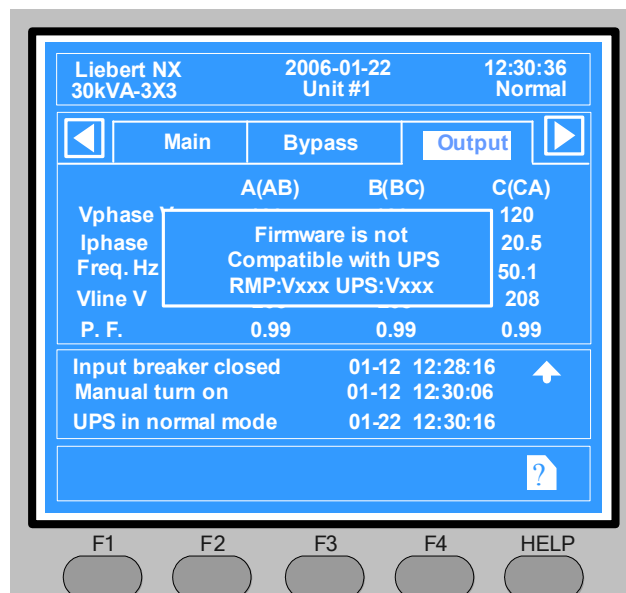

If the RMP determines that the UPS firmware is not compatible, after loading all messages available from the UPS, the RMP will display the screen shown in **Figure 13**.

3.2 LED MIMIC POWER FLOW

The LEDs mounted on the mimic flow chart represent the various power paths and current UPS operational status.

Table 3 Rectifier indicator

Green	Rectifier in normal operation
Flashing Green	Input AC Normal, but rectifier not operating
Red	Rectifier failed
Off	Rectifier not operating, input AC not available or out of normal range

Table 4 Battery indicator

Green	Battery Normal, but discharging and powering the load
Flashing Green	Battery end of discharge pre-warning
Red	Battery abnormal (failed, absent or polarity reversed) or battery converter abnormal (failed, overcurrent, overtemperature)
Off	Battery and Converter Normal, Battery charging

Table 5 Bypass indicator

Green	Load on bypass power
Red	Bypass not available, out of normal range or static bypass switch fault
Off	Bypass normal, load not on bypass

Table 6 Inverter indicator

Green	Inverter normal and powering the load
Flashing Green	Inverter On, starting up, synchronizing, or standing by (ECO Mode)
Red	Inverter failed
Off	Inverter not operating

Table 7 Load indicator

Green	UPS output On and normal
Red	UPS output On and overloaded
Off	UPS output Off.

Table 8 Status (Alarm) indicator

Green	Normal operation
Yellow	UPS Warning, e.g. AC Input Failure
Red	UPS fault (eg., fuse or hardware failure)

3.3 AUDIBLE ALARMS—BUZZER

UPS activity is accompanied by the following sounds:

Table 9 Audible alarm key

Single beep	Direct Access key acknowledgment
One beep per second	UPS Warning, (ex. AC Input Failure)
Continuous beep	Fault, (ex. Fuse or Hardware Failure)

3.4 DIRECT ACCESS PUSH BUTTONS—KEYS

The NX Remote Monitoring Panel has one direct access push button: Silence On/Off. The Silence On/Off button is a toggle type buzzer mute; any new fault re-enables the buzzer.

3.5 LCD MONITOR AND MENU KEYS

The menu-driven, 320 x 240 dot graphic LCD monitor displays real time data and, at the same time, stores 512 historical records that can be retrieved for reference and diagnosis.

The user can perform commands or browse through the input, output, load and battery parameters. For quick reference, the UPS status and any warnings are always highlighted without the need of navigating through the menu. The versions of converter firmware, inverter firmware and internal monitor firmware can also be displayed on the LCD. Menu keys F1 to F4 are used to navigate within the graphic LCD monitor windows.

Table 10 Menu key icons and their meaning



Key	F1	F2	F3	F4	Help
Window Type 1	 Next Data Window	 LEFT	 RIGHT	 ENTER	 HELP
Window Type 2	ESC Escape	 UP	 DOWN		

Figure 14 Graphic LCD monitor windows and keypad

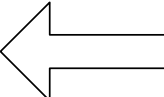
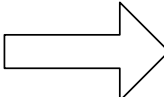
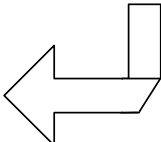

The function of keys F1 to F4 is shown by a self-explanatory icon as appropriate for the particular window. As shown in **Figure 14** above, pressing F1 moves the cursor (resting in *OUTPUT*) from the UPS Menu Window (2) to current record window (4) where it would first rest in *input breaker closed*. In a similar manner, pressing F2 would move the cursor from the Output data window to the Bypass data window.

The summary menu tree is shown in **Figure 15**. Refer to **Table 12** for a detailed description of each menu item.

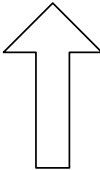
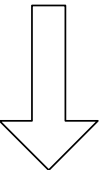
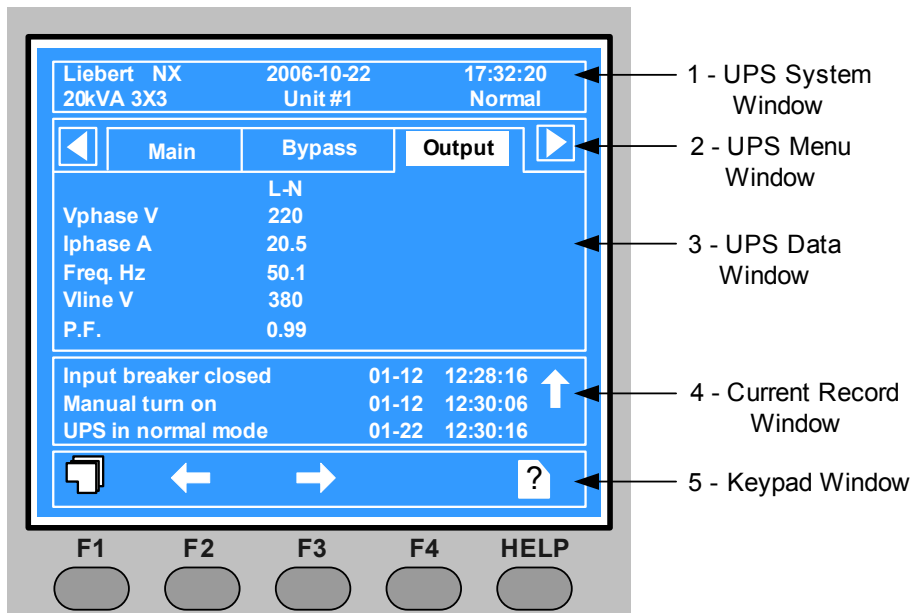
Figure 15 Menu tree

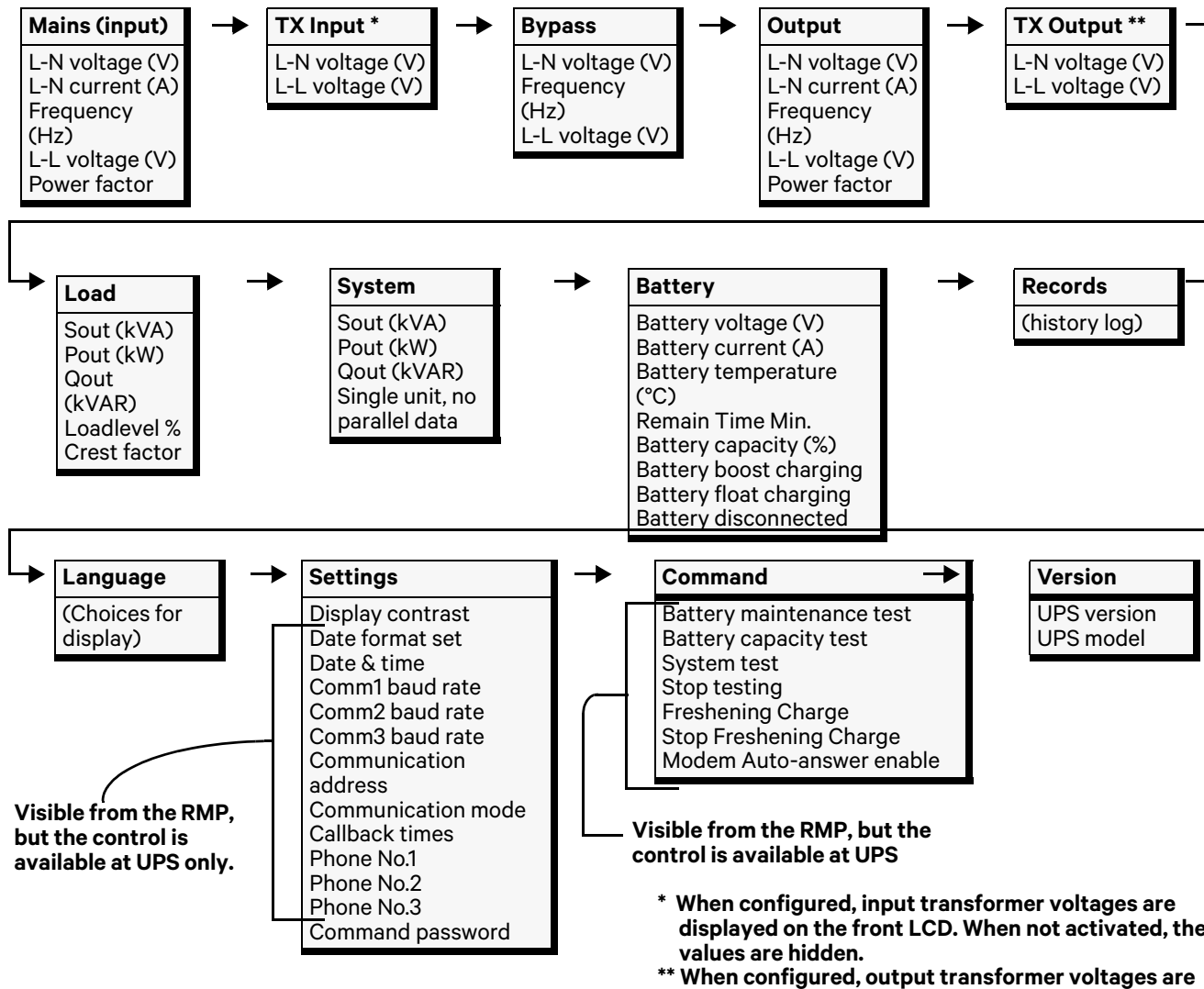

3.6 DETAILED DESCRIPTION OF MENU ITEMS

The description that follows refers to the graphic LCD monitor window shown in **Figure 14**. UPS System Window. This fixed-pane window displays current time and date and identifies the UPS, its configuration and its status.

Table 11 UPS system window

Description	Explanation
Liebert NX	UPS family name
2005-10-22	YYYY-MM-DD (see Settings menu for other date formats)
12:30:36	Current Time (24 hr HH:MM:SS format)
30kVA-3x3	30kVA = UPS rated output, 3 x 3 = 3-phase input and output
(Configuration) Single, ECO, Master, Slave or Unit # 1	Single = single double-conversion unit ECO = single stand-by unit with double-conversion fall-back Master = master in a 1+1 Hot Stand-By system Slave = slave in a 1+1 Hot Stand-By system Unit # 1 = of max 6 double-conversion units in a parallel system
(Status) Normal, Warning or Fault	Normal = UPS operating Normal Warning = System attention required, e.g., AC Input Failure Fault = UPS Fuse or Hardware Failure

Menu and Data Window

Use the horizontal arrow keys to navigate between any of the selectable menu and data windows.

Table 12 Descriptions of RMP menus and data window items

Menu Type	Item	Type Explanation
Mains (input)	L-N voltage (V)	Phase voltage
	L-N current (A)	Phase current
	Frequency (Hz)	Input frequency
	L-L voltage (V)	Line-line voltage
	Power factor	Power factor
TX Input	L-N voltage (V)	Phase voltage
	L-L voltage (V) Line-line voltage	
Bypass	L-N voltage (V)	Phase voltage
	Frequency (Hz)	Bypass frequency
	L-L voltage (A)	Line-line voltage
Output	L-N voltage (V)	Phase voltage
	L-N current (A)	Phase current
	Frequency (Hz)	Output frequency
	L-L voltage (V)	Line-line voltage
	Power factor	Power factor
TX Output	L-N voltage (V)	Phase voltage
	L-L voltage (V)	Line-line voltage

Table 12 Descriptions of RMP menus and data window items (continued)

Menu Type	Item	Type Explanation
Load	Sout (kVA)	Sout: Apparent power
	Pout (kW)	Pout: Active power
	Qout (kVAR)	Qout: Reactive power
	Load level %	The percent of the UPS rating load
	Crest factor	Output current Crest Factor
System	Sout (kVA)	Sout: Apparent power
	Pout (kW)	Pout: Active power
	Qout (kVAR)	Qout: Reactive power
	Single unit, no parallel data	When configured as a single unit, UPS has only native load, no system load.
Battery	Battery voltage (V)	Battery bus voltage
	Battery current (A)	Battery bus current
	Battery temperature (°C)	Battery temperature °C
	Remain Time Min.	Battery run time remaining
	Battery boost charging	Battery is boost charging
	Battery float charging	Battery is float charging
	Battery disconnected	Battery is not connected
Records	(history log)	Displays all records in the history log
Language	(choices for text displayed)	User may select any of 12 languages for LCD text.
Settings	Display contrast	Adjust the LCD display contrast
	Date format set *	Choose the format for date display: M/D/Y, D/M/Y, M/D/Y, Y/M/D
	Date & time *	Set the date and time
	Comm1 baud rate *	Communication baud rate setting for IntelliSlot 1
	Comm2 baud rate *	Communication baud rate setting for IntelliSlot 2
	Comm3 baud rate *	Communication baud rate setting for IntelliSlot 3
	Communication address *	This setting is applicable to RS-485 communication mode
	Communication mode *	Communication Mode Setting
	Callback times *	When IntelliSlot 1 Communication Mode is <i>Modem</i> , this parameter sets the number of times a number is redialed to send an alarm notification.
	Phone No.1 *	When IntelliSlot 1 Communication Mode is <i>Modem</i> , this is the first phone number to be dialed (to send an alarm notification).
	Phone No.2 *	When IntelliSlot 1 Communication Mode is <i>Modem</i> , this is the second phone number to be dialed (to send an alarm notification).
	Phone No.3 *	When IntelliSlot 1 Communication Mode is <i>Modem</i> , this is the third phone number to be dialed (to send an alarm notification).
	Command password *	User can modify the command password.

Table 12 Descriptions of RMP menus and data window items (continued)

Menu Type	Item	Type Explanation
Command (start/stop battery and system tests)	Battery maintenance test *	This test performs a partial discharge of the battery to obtain a rough estimate of the battery capacity. Load must be between 20% and 100%.
	Battery capacity test *	This test performs a full discharge of the battery to obtain a precise measure of the battery capacity. Load must be between 20% and 100%.
	System test *	This is a self-test of the UPS. When the user activates this function, a popup window appears about 5 seconds later to show the results.
	Stop testing *	Manually stops a battery maintenance test, battery capacity test or system test.
	Freshening Charge *	This command will allow a temporary equalize charge for the batteries. This charge is configurable for 1 to 36 hours
	Stop Freshening Charge *	Manually stop a freshening charge
	Modem Auto-answer enable *	Manually enable the auto-answer function of modem.
Version	UPS version	Provides UPS firmware version numbers for the inverter, rectifier and software display board.
	UPS model	Provides UPS model information—For example, 400V-50Hz.

* Visible from the RMP, but the control is available at UPS only.

Current Record Window

Keeps a log the events that resulted in the current mode of operation. Ignores transient conditions that have been resolved. Use “page” (F1) and Up / Down arrow to read the events. For a complete history log, refer to the Records tab of the Menu and Data Window. Refer to **Table 13** for a complete list of supported status messages.

3.7 STATUS AND EVENT MESSAGES

Refer to **Table 13** for descriptions of events and alarms.

Table 13 RMP messages

Message	Description / Suggested Action (if any)
Inverter Comm. Fail	Internal RS485 communication failure between monitor and inverter
Rectifier Comm. Fail	Internal RS485 communication failure between monitor and rectifier
Parallel Comm. Fail	The CAN communication between different UPS's within a parallel system fails. 1. Check whether there are some UPS's not powered On in the parallel system. If so, power On these UPS's and check whether the alarm disappears. 2. Press <i>Fault Clear</i> push button.
Battery Overtemp.	The battery temperature is over limit. Check the battery temperature and ventilation.
Ambient Overtemp.	The ambient temperature is over limit. Check the ventilation of UPS room.
Battery Fault	Battery detected faulty (Reserved)
Replace Battery	Battery test failed; battery should be replaced.
Battery Low Pre-warning	Before the end of discharge, a battery undervoltage pre-warning should occur. After this pre-warning, the battery should have the capacity for 3 minutes discharging with full load. The time is user-configured from 3 to 60 minutes. Shut down the load in time.
Battery End of Discharge	Inverter turned Off due to low battery voltage. Check the utility failure and try to recover it.
Mains Volt. Abnormal	Mains voltage exceeds the upper or lower limit and results in rectifier shutdown. Check the input line-to-neutral voltage amplitude of rectifier.
Mains Undervoltage	Mains voltage is undervoltage with derated load. Check the input line-to-line voltage amplitude of rectifier
Mains Freq. Abnormal	Mains frequency is out of limit range and results in rectifier shutdown. Check the rectifier's input voltage frequency.

Table 13 RMP messages (continued)

Message	Description / Suggested Action (if any)
Rectifier Fault	Rectifier detected faulty. Rectifier shuts down. Battery discharges.
Rectifier Overtemp.	The temperature of heat sink is too high to keep the rectifier running. The UPS can recover automatically. Check the environment and ventilation.
Batt. Contactor Fail	Battery contactor or circuit breaker not responding to control signals.
Batt. Charger Fault	The voltage of the battery charger is too high.
Control Power 1 Fail	UPS operates but redundant control power is not available.
Mains Phase Reversed	AC Input phase sequence is reversed.
Rectifier Overcurrent	Rectifier is overloaded.
Soft Start Fail	Rectifier could not start due to low DC bus voltage.
Bypass Unable to Trace	<p>This alarm is triggered by an inverter software routine when the amplitude or frequency of bypass voltage is beyond the normal range. The amplitude threshold is fixed for positive and negative 10% rating. This alarm automatically resets once the bypass voltage goes normal.</p> <ol style="list-style-type: none"> 1. First, verify that the bypass voltage and frequency displayed on the panel is within the selected range. Note here the rated voltage and frequency are specified by <i>Output voltage level</i> and <i>Output frequency level</i> respectively. 2. If the displayed voltage is believed to be abnormal, then verify the bypass voltage and frequency presented to the UPS. Check the external supply if it is found to be faulty.
Bypass Abnormal	<p>This alarm is triggered by an inverter software routine when the amplitude or frequency of bypass voltage exceeds the limit. This alarm automatically resets once the bypass voltage goes normal. First check if there are some relevant alarms such as <i>Bypass disconnect open</i>, <i>Bypass phase reverse</i> and <i>Mains neutral lost</i>. If they appear, solve them first.</p> <ol style="list-style-type: none"> 1. Then verify that the bypass voltage and frequency displayed on the panel is within the bypass limit. Note here the rated voltage and frequency are specified by <i>Output voltage level</i> and <i>Output frequency level</i> respectively. 2. If the displayed voltage is believed to be abnormal, then verify the bypass voltage and frequency presented to the UPS. Check the external bypass supply if it is found to be faulty. If the utility is likely to trigger this alarm frequently, the bypass limit can be changed a little larger through the configuration software according to the customer's agreement.
Inverter Asynchronous	<p>This alarm is triggered by an inverter software routine when the inverter and bypass waveforms are misaligned by more than 6 degrees in phase. This alarm resets automatically once the condition is no longer true.</p> <ol style="list-style-type: none"> 1. First, check whether the alarm <i>Bypass Unable to Trace</i> or <i>Bypass Abnormal</i> occurs. If so, solve it first. 2. Verify the waveform of the bypass voltage. If it is too distorted, ask the customer to verify and seek any possible measurements.
Inverter Fault	Inverter output voltage beyond limits. Load transfers to bypass.
Inverter Overtemp.	<p>The temperature of the inverter heat sink is too high to keep inverter running. This alarm is triggered by the signal from a temperature monitoring thermostat on the inverter bridge heat sink. The UPS will recover automatically after a 5 minute delay from the disappearance of the overtemperature signal. If the overtemperature condition is true, then check for and verify:</p> <ul style="list-style-type: none"> • high ambient air temperature • blocked cooling airway • any fan failure • prolonged inverter overload
Fan Fault	At least one of the cooling fans has failed.
Inverter STS Fail	At least one of the static switches of inverter side is open or short circuited. This fault is locked until power Off.
Bypass STS Fail	At least one of the static switches of bypass side is open or short circuit. This fault is locked until power Off
Operation Invalid	This record is registered following an incorrect operation
Output Fuse Fail	At least one of the inverter output fuses is blown. Inverter shuts down. Load transfers to bypass.
Control Power 2 Fail	UPS operates but redundant control power is not available.

Table 13 RMP messages (continued)

Message	Description / Suggested Action (if any)
Unit Overload	<p>The UPS is confirmed to be overload when the load arises above 105% nominal rating. The alarm automatically resets once the overload condition is removed.</p> <ol style="list-style-type: none"> 1. Confirm that the alarm is true by checking the load percent indicated on the LCD panel to determine which phase is being overloaded. 2. If the alarm is true, measure the actual output current to verify that the indications are valid. Disconnect unnecessary load and ensure the safety. In a parallel system, a severe load sharing error can also lead to the alarm.
System Overload	<p>The UPS parallel system is confirmed to overload when the total load arises above 105% nominal rating for the set basic number of UPSs. The alarm automatically resets once the overload condition is removed.</p> <ol style="list-style-type: none"> 1. Confirm that the alarm is true by checking the system load percent indicated on the LCD panel to determine which phase is being overloaded. 2. If the alarm is true, measure the actual output current to verify that the indications are valid. Disconnect unnecessary load and ensure the safety. In a parallel system, a severe load sharing error can also lead to the alarm. Unit Overload Timeout The UPS is confirmed to overload and the overload times out. <p>Note 1: The highest loaded phase will indicate overload timing-out first. Note 2: When the timer is active, the alarm <i>Unit overload</i> should also be active as the load is above nominal. Note 3: When the timer has expired, the inverter static switch is opened and the load transferred to bypass. The inverter shutdown and will restart after 10 seconds. Note 4: If the load decreases lower than 95% after 5 minutes, the system will transfer back to inverter mode. Confirm that the alarm is genuine by checking the load percent indicated on the LCD. If an overload is indicated, then check the load and investigate any additional load connected prior to the alarm (if applicable).</p>
Byp. Abnormal Shutdown	Both bypass and inverter voltages unavailable. Load interruption
Inverter Over Current	Inverter pulse width modulation module overloaded.
Bypass Phase Reversed	The phase sequence direction of bypass voltage is reversed. Normally, the phase of Phase B lags 120 degrees behind Phase A, and the phase of Phase C lags 120 degrees behind Phase B. Verify that the phase rotation of the bypass supply presented to the UPS is correct, and rectify it if it is found to be in error.
Load Impact Transfer	A transfer to bypass occurred due to a large step load. The UPS should recover automatically. Turn on connected equipment in sequential order to reduce the step loading of the inverter.
Transfer Time-out	The load is on bypass power due to excessive number of transfers that occurred within the last hour. The UPS will recover automatically and will transfer the load back to inverter power within an hour.
Load Sharing Fault	UPS modules within a parallel system are not sharing the load current equally.
DC Bus Abnormal	DC input voltage to inverter beyond limits. Inverter shuts down. Load transfers to bypass.
System Transfer	The whole paralleled UPS system transferred to bypass at the same time. This message will appear on the UPS which passive transfer to bypass.
Parallel Board Fault	Malfunction of the paralleling control circuits of this UPS module. Can cause System Transfer to bypass.
DC Bus Over Voltage	Rectifier, inverter and battery converter were shutdown because DC bus voltage is too high. Check whether there is a fault in rectifier side. If no, then check whether overload occurs. Restart the inverter after resetting the fault.
Parallel Connect Fault	The parallel cables are not connected correctly in a parallel system. Reset the fault by pressing the Fault clear button, then restart the inverter by pressing the inverter on button.
Bypass Over Current	Bypass current is over limit above 135% rating. The UPS just alarms and does nothing.
LBS Active	Load Bus Synchronization is active. The UPS is acting as an LBS master or slave in a dual bus configuration.
Setting Save Error	History records not saved. (Reserved)
Mains Neutral Lost	AC Input mains reference neutral not detected.
Protocol version clash	Firmware incompatibility between Monitor Board and Digital Signal Processor Board.
Battery ground fault	Battery leakage to ground detected (option)
Inv. Turned On Manually	Manual Turn On via front panel

Table 13 RMP messages (continued)

Message	Description / Suggested Action (if any)
Inv. Turned Off Manually	Manual Turn Off via front panel
EPO	Emergency Power Off direct access key pressed or external command received
Transfer Confirm	Prompt to press <i>Enter</i> key to acknowledge that an interrupted load transfer to bypass will happen.
Transfer Cancel	Prompt to press <i>ESC</i> key to avoid an interrupted load transfer to bypass will happen.
Unit Off Confirm	Prompt to press <i>Enter</i> key to acknowledge that the UPS will be disconnected from other paralleled UPS modules.
System Off Confirm	Prompt to press <i>Enter</i> key to acknowledge that the all paralleled UPS will be disconnected from the load.
Fault Reset	Fault clear direct access key pressed
Alarm Silence	Silence On/Off direct access key pressed
Turn On Fail	Inverter failed to turn on when Inverter On direct access key was pressed. This may be as a result of Invalid Operation (Maintenance bypass on) or DC bus or rectifier not ready.
Alarm Reset	Fault clear or Silence On/Off direct access key pressed
Bypass Mode	Load supplied from AC input bypass supply.
Normal Mode	Load supplied from inverter output through double conversion of the AC mains input supply.
Battery Mode	Load supplied from inverter output through double conversion of the battery supply.
Source Share Mode	Load supplied from Inverter output through shared double conversion of the AC mains input supply and of the battery supply.
UPS Shutdown	UPS Shutdown, output power-down
Check UPS Output	Inverter Off during normal startup (diagnostics information only)
Generator Connected	Generator active signal received. Source share mode may be activated pending UPS settings.
BCB open	Battery Circuit Breaker status (open)
BCB closed	Battery Circuit Breaker status (closed)
Battery Float Charging	Battery status (Float Charge Mode)
Battery Boost Charging	Battery status (Boost Charge Mode)
Battery Discharging	Battery status (Discharge Mode)
Battery Period Testing	Automatic periodic battery maintenance discharge test (20% capacity discharge)
Batt. Capacity Testing	User-initiated battery capacity discharge test (100% capacity discharge)
Batt. Maint. Testing	User-initiated maintenance discharge test (20% capacity discharge)
UPS System Testing	User-initiated UPS self test
Inverter in Setting	Inverter starting up and synchronizing
Rectifier in Setting	Rectifier starting up and synchronizing
MBP-T Cabinet Fan Fault	Maintenance bypass cabinet fans fault.
Ext Input TX Overtemp	External input isolation transformer overtemperature
Ext Output TX Overtemp	External output isolation transformer overtemperature
Battery Room Alarm	Environment in battery room needs attention
Rotary Sw. Test Pos.	Rotary switch is in test position.
Rotary Sw. Normal Pos.	Rotary switch is in normal position.

Table 13 RMP messages (continued)

Message	Description / Suggested Action (if any)
Rotary Sw. Bypass Pos.	Rotary switch is in bypass position.
Rotary Sw. Maint. Pos.	Rotary switch is in maintenance position.
Battery Contactor Open	Battery contactor open
Battery Contactor Close	Battery contactor closed
Battery Reverse	Connect the battery again and check the wiring of batteries
No Battery	Check the battery and the wiring of batteries
Auto start	After UPS was shutdown at EOD, inverter auto starts when utility restore
Rec. Flash Update	Rectifier firmware is being updated
Inv. Flash Update	Inverter firmware is being updated
Monitor Flash Update	Monitor firmware is being updated
Input contactor fault	Input contactor is in fault
Contactor P.S. 1 fault	Contactor power supply board 1 fault
Contactor P.S. 2 fault	Contactor power supply board 2 fault
LBS abnormal	LBS is abnormal
DSP firmware error	The inverter firmware does not match with the rectifier firmware.

3.8 PROMPT (POPUP) WINDOWS

A prompt window is displayed during the operation of the system to alert the user to certain conditions and / or to require user confirmation of a command.



NOTE

*The items in **Table 14** are visible from the RMP, but the controls for them are available only at the UPS.*

Table 14 Prompt windows, meanings, controlled at UPS only

Prompt	Meaning
Transfer with interrupt, please Confirm or Cancel	Inverter and bypass supplies are not synchronized and any load transfer between the supplies will cause a brief load interruption.
The load is too high to be transferred with interrupt	The total load must be less than the capacity of one unit to allow a parallel system to perform an interrupted transfer from bypass to inverter.
This Operation Leads to Output Shutdown, Confirm or Cancel	No alternative supply is available and any Inverter Off operation will cause the load to be de-energized.
This operation leads to inverter overload, Confirm or Cancel	The turn-off this inverter will lead to the overload of remaining inverter(s) in a parallel system.
Turn on more UPS to carry current load	The number of paralleled inverters already turned on is insufficient to carry the existing load.
Battery will be depleted, confirm	Battery capacity test discharges the battery 100%

Table 14 Prompt windows, meanings, controlled at UPS only

Prompt	Meaning
System self test finished - Everything is OK	No action required
System self test finished - Please check the current warnings.	Check <i>Current Records</i> window
Enter control password	Required for battery or UPS test (default = 12345)
Battery Self Test aborted, condition not met	Battery self-test condition is not enough. User should check whether battery state is boost charging and whether load level is greater than 20 percent.
Battery Refresh Charge aborted, condition not met	Boost charging condition is not enough, such as (No battery, charger has failed, etc.).

Table 15 Prompt windows, meanings, controlled at RMP

Prompt	Meaning
Communication with UPS failed	The communication between RMP and UPS failed.
Loading data from UPS	The RMP are loading data from UPS
Remote Monitoring Panel silence	The RMP unit has been muted.
Remote Monitoring Panel silence off	The RMP silence is off
Remote Monitoring Panel firmware updating	The RMP is updating firmware from ParameSet tool.
Firmware is not compatible with UPS	The RMP firmware is not compatible with UPS

3.9 DYNAMIC ENERGY FLOW CHART AND UPS HELP SCREEN

This screen displays a mimic diagram of the UPS that includes energy flow and status of isolation and transfer switches. Press the *Help* key to activate this screen. Press *Help* again to toggle between this screen and the main screen.

Figure 16 Help screen

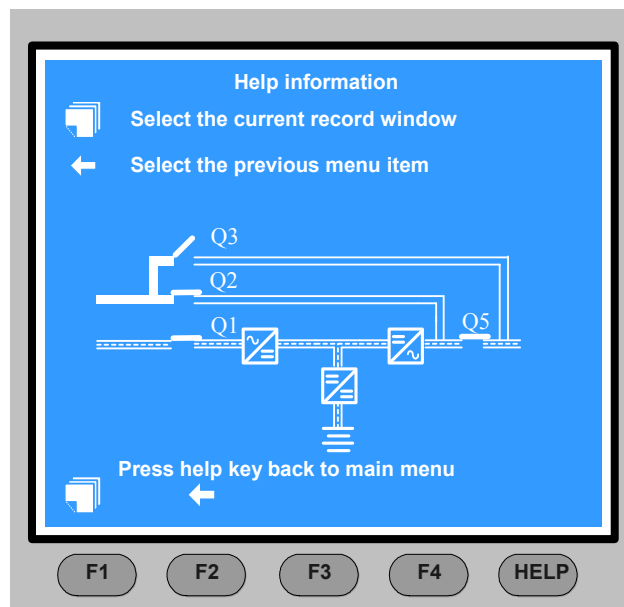

3.10 DEFAULT SCREEN SAVER

This default screen is displayed following 2 minutes of operation with no new alarm or activity. After another 2 minutes of inactivity, the back light turns Off. Press any key (F1-F4 or Help) to reactivate the screen.

Figure 17 Default screen

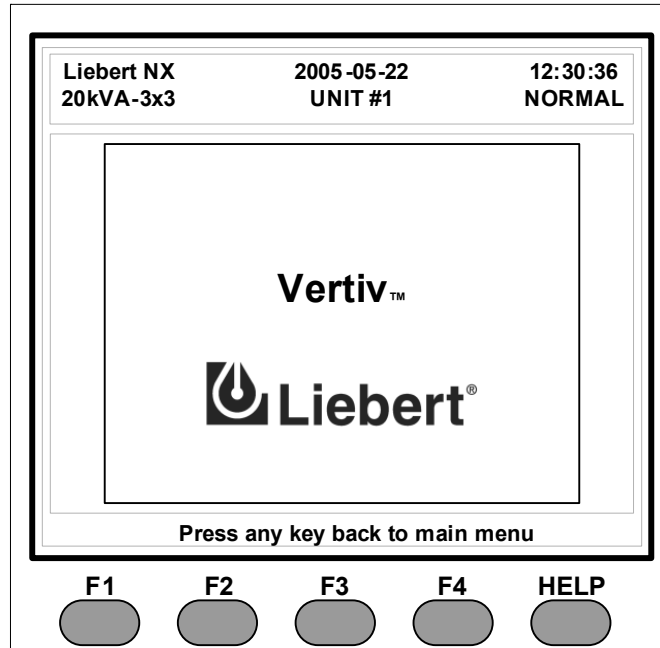

4.0 TECHNICAL SPECIFICATIONS

Table 16 Mechanical specifications

Mechanical Characteristics	Units	Value
Height	mm	100
Width	mm	400
Depth	mm	290
Weight	kg	5.28
Ventilation	—	Air cooling
Cable entry	—	Left side
Color	—	Black
Protection Grade	—	IP 20

Table 17 Environmental specifications

Environmental Characteristics	Units	Value
Operating Temperature	°C	0~40
Relative humidity	—	90% or less at 20°C
Acoustical noise	dBA	<32
Altitude of operation	m	<2000
Storage-transport temperature	°C	-25 ~70

Table 18 Electrical specifications

Electrical Characteristics	Units	Value
Rated input voltage	VAC	100, 120, 220, 230, 240
Input voltage range	VAC	90-254
Input Frequency	Hz	50/60
Input frequency tolerance	Hz	47-67
Input Current	A	0.7A Max.

Table 19 Cable specifications

Item	Specification
Input power cable *	3-pin plug containing L+N+E
RS-485 signal cable *	a shielded and twisted pair of 0.5 to 1 mm ² wires (16-20 AWG)

* These cables must be field-supplied.

4.1 AGENCY AND CERTIFICATIONS

Safety Standard: IEC/EN/AS 62040-1-1 incorporating applicable portions of IEC/EN/UL/AS 60950-1

Certification: CE and UL 60950-1:2003, First Edition CSA C22.2 No. 60950-1-03 1st Ed.

Electromagnetic Compatibility Standard: IEC/EN/AS 62040-2 incorporating applicable portions of emission and immunity standards as detailed in **Tables 20** and **21** below.

Table 20 Electromagnetic interference (EMI) Emission limits

Standard	IEC/EN/AS	Class
Harmonic Current	61000-3-2	—
Voltage Fluctuations & Flicker	61000-3-3	—
Conducted RF	CISPR 22	A
Radiated RFI	CISPR 22	A

Table 21 Electromagnetic susceptibility (EMS)—Immunity levels

Standard	IEC/EN/AS	Requirement	Level	Criterion
Electrostatic Discharge	61000-4-2	6 kV contact, 8 kV air	3	B
Radiated Electric Fields	61000-4-3	10 V/m	3	A
Fast Electrical Transients	61000-4-4	2 kV / 5 kHz (Power and Signal ports)	3	B
Surges	61000-4-5	Power port 2kV (common mode) 1kV (differential mode) Signal port 1kV	3	B
Continuous Conducted Interfer.	61000-4-6	10V	3	A
Magnetic Field at Power Freq	61000-4-8	30A/m	—	B
Voltage Dips and Short Interruptions	61000-4-11	70%Ut:		
		1ms, 3ms, 10ms	—	A
		30ms, 100ms, 300ms, 1000ms	—	B
		40%Ut:		
		1ms, 3ms	—	A
		10ms, 30ms, 100ms, 300ms, 1000ms	—	B
		0%Ut		
		1ms	—	A
3ms, 10ms, 30ms, 100ms, 300ms, 1000ms	—	B		
Low Frequency Signals	61000-2-2	10V 140Hz-250Hz-360Hz	—	A

NOTES



